



HAL
open science

Towards a Bernstein presentation of the affine Hecke category

Leonardo Maltoni

► **To cite this version:**

Leonardo Maltoni. Towards a Bernstein presentation of the affine Hecke category. Representation Theory [math.RT]. Sorbonne Université; Institut de Mathématiques de Jussieu - Paris Rive Gauche; University of Sydney, 2022. English. NNT: . tel-04117735v1

HAL Id: tel-04117735

<https://theses.hal.science/tel-04117735v1>

Submitted on 27 Nov 2022 (v1), last revised 5 Jun 2023 (v3)

HAL is a multi-disciplinary open access archive for the deposit and dissemination of scientific research documents, whether they are published or not. The documents may come from teaching and research institutions in France or abroad, or from public or private research centers.

L'archive ouverte pluridisciplinaire **HAL**, est destinée au dépôt et à la diffusion de documents scientifiques de niveau recherche, publiés ou non, émanant des établissements d'enseignement et de recherche français ou étrangers, des laboratoires publics ou privés.



Distributed under a Creative Commons Attribution 4.0 International License

Towards a Bersntein presentation of the affine Hecke category

The Wakimoto sheaves in type \tilde{A}_1

Leonardo Maltoni

Supervised by Prof. Daniel Juteau
and Prof. Geordie Williamson

A thesis presented for the degree of
Doctor of Philosophy

Institut de Mathématiques de Jussieu-Paris Rive Gauche
ED386-Mathématiques
Sorbonne Université
Paris, France
10/06/2022

Abstract

The affine Hecke algebra has a remarkable commutative subalgebra corresponding to the coroot lattice inside the affine Weyl group. Its nature is encoded in the *Bernstein presentation* and reveals some fundamental representation theoretic properties of the Hecke algebra.

We consider *categorifications* of this algebra, namely the diagrammatic category or the category of equivariant parity sheaves on the affine flag variety. Then this subalgebra corresponds to a class of complexes (in the homotopy category) called *Wakimoto sheaves*. In this thesis we study these objects in type A_1 . Firstly we determine completely the extension groups between them over characteristic zero fields. Secondly we describe a dg model which allows us to compute these groups in the antispherical category for arbitrary coefficients.

To do so, we interpret these objects as Rouquier complexes. Over characteristic zero fields one can compute their minimal complexes and use them to determine the extension groups. In general, we consider a dg version of the category of Rouquier complexes, where the extension groups are encoded in the cohomology of the dg modules of morphisms. To study the latter, we extend the diagrammatic presentation of the Hecke category to one for this dg category.

A key result is a general reduction of Rouquier complexes. Namely, over an arbitrary coefficient ring, they admit representatives in the homotopy category which are considerably simpler than the naive ones.

...tòtt e bèl, savéiv, l'è te zarchè

Tonino Guerra

Contents

Introduction	1
0.1 Hecke algebras and Hecke categories	2
0.1.1 Hecke algebras	2
0.1.2 Functional specializations	2
0.1.3 Bernstein presentation	3
0.1.4 Kazhdan-Lusztig conjectures	3
0.1.5 Categorifications from the dictionary	3
0.1.6 Mixed version	4
0.2 Modular setting	4
0.2.1 Parity sheaves	4
0.2.2 Modular mixed perverse sheaves	5
0.2.3 Diagrammatic category	5
0.2.4 Character formulas and Hecke actions	5
0.3 Rouquier complexes	6
0.3.1 The 2-braid group	6
0.3.2 Link invariants	7
0.4 Results	7
0.4.1 Soergel calculus with patches	7
0.4.2 A general reduction for Rouquier complexes	7
0.4.3 Wakimoto sheaves in type \tilde{A}_1	9
0.4.4 Extension in the antispherical category	10
0.5 Perspectives	11
0.5.1 DG model for the affine Hecke category	11
0.5.2 The coherent realization	11
0.5.3 Generalizations and the case of type A	12
1 Coxeter systems and Hecke algebras	15
1.1 Coxeter systems and braid groups	15
1.1.1 Coxeter systems	15
1.1.2 Basic properties of Coxeter systems	17
1.1.3 Root data and Weyl groups	18
1.1.4 The Affine Weyl group	20
1.1.5 Braid groups	21
1.2 Hecke algebras	22
1.2.1 The Hecke algebra	22
1.2.2 Basic properties of the Hecke algebra	22
1.2.3 The affine Hecke algebra	23
1.2.4 The Bernstein presentation	24

2	The Hecke category and Wakimoto sheaves	25
2.1	The diagrammatic Hecke category	25
2.1.1	Motivation	25
2.1.2	Two-colored quantum numbers	26
2.1.3	Realizations of Coxeter systems	26
2.1.4	Further assumptions on realizations	28
2.1.5	Definition of the category	29
2.1.6	Categorification of the Hecke algebra	33
2.1.7	Relation with the geometric version	35
2.1.8	Light leaves and double leaves	36
2.2	Rouquier complexes and Wakimoto sheaves	38
2.2.1	Rouquier complexes	38
2.2.2	Basic properties of Rouquier complexes	38
2.2.3	Wakimoto sheaves	39
2.2.4	The mixed derived category	39
3	Working with Rouquier complexes	41
3.1	Soergel calculus with patches	41
3.1.1	Notation for graded objects and complexes	41
3.1.2	A dg monoidal category of Rouquier complexes	42
3.1.3	Diagrammatics	42
3.1.4	Inverse relation	46
3.1.5	Braid relation	47
3.1.6	Explicit homotopy equivalences	50
3.1.7	Rouquier formula	50
3.2	A general reduction for Rouquier complexes	51
3.2.1	Large scale Gaussian elimination for complexes	53
3.2.2	Exact structure for complexes	56
3.2.3	Reduced complexes	57
3.2.4	Multiword decomposition	59
3.2.5	Colored polytopal complexes	62
3.2.6	Proof of the theorem	63
3.2.7	Negative case	64
3.2.8	Reduced diagrammatics	65
4	Extensions in type \tilde{A}_1	71
4.1	Type \tilde{A}_1 setting	71
4.1.1	Reduced words	71
4.1.2	Realizations	71
4.1.3	Hecke category and Wakimoto sheaves in type \tilde{A}_1	72
4.2	The characteristic zero case	73
4.2.1	More on two-colored quantum numbers	73
4.2.2	Minimal subcomplexes of the Wakimoto sheaves	74
4.2.3	Consequences of Soergel's conjecture	75
4.2.4	Extension groups	76
4.3	The two color garden	81
4.3.1	DG diagrams for Wakimoto sheaves	81
4.3.2	Shrubberies	82
4.3.3	Gardening principles	86
4.3.4	Weeding the garden	88

<i>CONTENTS</i>	vii
4.4 The antispherical category	92
4.4.1 Generalities	92
4.4.2 Double leaves bases	93
4.4.3 Categories of complexes	94
4.4.4 Antispherical Wakimoto sheaves	94
4.4.5 Even more on two-color quantum numbers	96
4.4.6 Extension groups	97
Bibliography	105

Introduction

Modular representation theory studies linear representations of groups in positive characteristic. In the case of reductive algebraic groups, a very important object in the study of such representations is the affine Hecke algebra.

Recall that, given a reductive algebraic group G over an algebraically closed field, with a Borel subgroup B and a maximal torus T , the affine Hecke algebra \mathbf{H} is a deformation of the group algebra of the affine Weyl group W attached to this data. The latter contains the coroot lattice acting by translations t_λ and one can find, also in \mathbf{H} , elements θ_λ with the property that $\theta_{\lambda_1}\theta_{\lambda_2} = \theta_{\lambda_1+\lambda_2}$. In other words we have a commutative subalgebra of \mathbf{H} corresponding to the lattice in W . Bernstein gave a presentation of the affine Hecke algebra which highlights the properties of this lattice, and is very useful when trying to address representation theoretic questions about \mathbf{H} .

The affine Hecke algebra can be seen as the Grothendieck ring of some graded monoidal additive category \mathcal{H} which is called *Hecke category*. There are actually several versions of the latter, which are equivalent under certain assumptions. In the modular setting two versions are of particular interest: the category of equivariant parity sheaves over the affine flag variety, and its diagrammatic presentation. It is then natural to ask what the higher level counterpart of the θ_λ 's is. To find an appropriate answer one should consider the *mixed* setting, which in this case consists of the bounded homotopy category of \mathcal{H} . Here we find complexes Θ_λ which correspond to the θ_λ 's, called *Wakimoto sheaves*. Hence, in order to somehow “lift” the Bernstein presentation to a categorical level, one should understand the subcategory that these objects form, and, to begin with, study the morphisms between them.

The homotopy category of \mathcal{H} was already considered by Rouquier, and the Wakimoto sheaves above are special cases of *Rouquier complexes*. The latter form an interesting subcategory of $\mathcal{K}^b(\mathcal{H})$ which is known to categorify (the actions of) a quotient of the braid group associated with W . Hence, studying morphisms between Wakimoto sheaves also acquires a topological meaning for the categorified affine braid group.

In this thesis we study these morphism spaces in type \tilde{A}_1 with arbitrary coefficients. We use the diagrammatic description of the Hecke category by Elias and Williamson and we extend it to a dg version of the category of Rouquier complexes. A crucial step is a reduction of Rouquier complexes that can be performed in general via Gaussian elimination.

We will describe our results in more detail at the end of the introduction, but let us first take a step back and describe how the various objects that we mentioned emerged and what role they play in representation theory.

0.1 Hecke algebras and Hecke categories

Hecke algebras arise naturally in Lie theory, not only in the representation theory of reductive algebraic groups over algebraically closed fields, but also of finite groups of Lie type and p -adic groups. It soon became clear, also, that a deeper understanding would come from the study of the “categorifications” of the Hecke algebra.

0.1.1. Hecke algebras. Recall that one can define, for an arbitrary Coxeter system (W, S) , the corresponding Hecke algebra $\mathbf{H}_{(W,S)}$. For the precise definition see § 1.2.1 below: it can be seen as a quotient of the group algebra over $\mathbb{Z}[v, v^{-1}]$ of the braid group corresponding to W by a certain deformed involution relation. One has then a *standard* basis $\{\delta_w\}_{w \in W}$ labeled by elements in the group W . We will refer to this description as the *Iwahori-Matsumoto presentation*. Let now G , B and T be as above. Then these define: a (finite) Weyl group $W_f := N_G(T)/T$, where $N_G(T)$ is the normalizer of the torus, with a distinguished set of *simple reflections* $S_f \subset W_f$ making (W_f, S_f) a Coxeter system; and an *affine* Weyl group $W := W_f \ltimes \mathbb{Z}\Phi^\vee$, where $\mathbb{Z}\Phi^\vee$ is the coroot lattice (contained in the cocharacter lattice X^\vee), which is again a Coxeter system with respect to the set S of simple *affine* reflections.

In the rest of this introduction, we will write \mathbf{H}_f for the *finite* Hecke algebra $\mathbf{H}_{(W_f, S_f)}$, and \mathbf{H} for the *affine* Hecke algebra $\mathbf{H}_{(W, S)}$.

0.1.2. Functional specializations. Let now q be a power of a prime p and suppose G is split over \mathbb{F}_q . Let also \mathbb{K} be a field admitting a square root of q (for instance \mathbb{C} or $\overline{\mathbb{Q}}_\ell$, with $\ell \nmid q$). Then, via the map $v \mapsto q^{-1/2}$, the finite Hecke algebra \mathbf{H}_f specializes to the algebra of bi- $B(\mathbb{F}_q)$ -invariant functions on $G(\mathbb{F}_q)$:

$$\mathbf{H}_f \otimes_{\mathbb{Z}[v, v^{-1}]} \mathbb{K} \cong \mathbb{K}[B(\mathbb{F}_q) \backslash G(\mathbb{F}_q) / B(\mathbb{F}_q)]. \quad (1)$$

The affine Hecke algebra \mathbf{H} specializes to that of compactly supported bi- I -equivariant functions on $G(\mathbb{F}_q((t)))$, where I is the Iwahori subgroup corresponding to B (namely, the inverse image of $B(\mathbb{F}_q)$ via the evaluation map $G(\mathbb{F}_q[[t]]) \rightarrow G(\mathbb{F}_q)$ sending t to 0):

$$\mathbf{H} \otimes_{\mathbb{Z}[v, v^{-1}]} \mathbb{K} \cong \mathbb{K}_c[I \backslash G(\mathbb{F}_q((t))) / I].$$

Taking $q = p$, one also has¹

$$\mathbf{H} \otimes_{\mathbb{Z}[v, v^{-1}]} \mathbb{K} \cong \mathbb{K}_c[I \backslash G(\mathbb{Q}_p) / I],$$

for an analogous definition of $I \subset G(\mathbb{Z}_p)$.

From this description one can see that part of the representation theory of the groups $G(\mathbb{F}_q)$ or $G(\mathbb{F}_q((t)))$ and $G(\mathbb{Q}_p)$ is controlled by that of the corresponding Hecke algebras.

¹This isomorphism was first established by Iwahori and Matsumoto [39], whereas (1) was found by Iwahori [40].

0.1.3. Bernstein presentation. Determining the center of \mathbf{H} is fundamental for its representation theory.

As we mentioned, one can find a large commutative subalgebra which corresponds to the lattice $\mathbb{Z}\Phi^\vee$ in W . This is somewhat hidden in terms of the Iwahori-Matsumoto presentation: the elements δ_{t_λ} , for t_λ a translation in W , do not commute in general. Instead, following Bernstein, we should write $\lambda \in \mathbb{Z}\Phi^\vee$ as a difference $\lambda = \mu - \nu$ with μ and ν dominant, and consider the elements $\theta_\lambda = \delta_{t_\mu} \delta_{t_\nu}^{-1} \in \mathbf{H}$. One can show that these are well defined and have the property that $\theta_{\lambda_1} \theta_{\lambda_2} = \theta_{\lambda_1 + \lambda_2}$. One can then show that the commutative subalgebra that they span contains the center of \mathbf{H} as the $\mathbb{Z}[v, v^{-1}]$ -span of those linear combinations of the θ_λ which are invariant under the action of $W_{\mathfrak{f}}$ (see [24, Ch. 7]).

Then, in the *Bernstein presentation* of \mathbf{H} , instead of the generators δ_{s_0} , corresponding to affine simple reflections, one takes the elements θ_{α^\vee} (for simple coroots α^\vee), and imposes commutativity relations between them and relations intertwining the θ_{α^\vee} 's with the other δ_s 's.

This presentation is also more natural, for example, for establishing the well known isomorphism between the (extended²) affine Hecke algebra and the $G^\vee \times \mathbb{G}_m$ -equivariant K -theory of the Steinberg variety associated with the Langlands dual group G^\vee of G . This result, first proven by Kazhdan and Lusztig [45], plays a fundamental role in the classification of the representations of \mathbf{H} .

0.1.4. Kazhdan-Lusztig conjectures. One of the most celebrated results showing the applications of the Hecke algebra in Lie theory was conjectured by Kazhdan and Lusztig [46].

They showed that any Hecke algebra $\mathbf{H}_{(W,S)}$ admits a *canonical* basis $\{b_w\}$, which is self-dual with respect to a natural involution, and satisfying a certain uni-triangularity property with respect to the standard basis. Then they conjectured that the canonical basis of $\mathbf{H}_{\mathfrak{f}}$ encodes the multiplicities of the simple modules inside the Verma modules in the Bernstein-Gel'fand-Gel'fand category \mathcal{O} associated with a complex semisimple Lie algebra \mathfrak{g} with Weyl group $W_{\mathfrak{f}}$. This was soon proved, independently, by Beilinson and Bernstein [13] and Brylinski and Kashiwara [22], using the freshly developed theory of perverse sheaves from [11], D -modules and the Riemann-Hilbert correspondence.

Partly motivated by this result, Lusztig [56] conjectured that the canonical basis of \mathbf{H} should govern in a similar way the characters of the simple representations of G over an algebraically closed field of characteristic $p > 0$.

0.1.5. Categorifications from the dictionary. Already from the well known relation between the canonical basis and the intersection cohomology of Schubert varieties [47], one can guess that the Hecke algebra is the shadow of some higher level geometric object.

If we consider the functional specialization of the Hecke algebra, then, according to the Grothendieck philosophy of the *function-sheaf dictionary*, a natural candidate should be some category \mathcal{P} of equivariant ℓ -adic perverse sheaves over the (affine) flag variety G/B (or $G((t))/I$), defined over the algebraic closure $\overline{\mathbb{F}_q}$ (recall that this space admits a nice stratification by affine spaces, labeled by

²This means that one should replace $\mathbb{Z}\Phi^\vee$ with X^\vee

the corresponding finite or affine Weyl group). Then the specialized Hecke algebra can be seen as a *deategorification* of this category (more precisely one gets back functions as alternate sums of traces of the Frobenius endomorphism over stalks at \mathbb{F}_q -points). Here the standard basis elements δ_w are “categorified” by *standard perverse sheaves* Δ_w , and their inverses by *costandard* perverse sheaves ∇_w , whereas the product becomes the convolution operation.

Then, mimicking the construction of Bernstein, Mirković introduced, for $\lambda = \mu - \nu$ as before, the objects $\Theta_\lambda := \Delta_\mu * \nabla_\nu$, called *Wakimoto sheaves*, as as a categorification of the θ_λ ’s (see for example [9]).

The canonical basis elements b_w are categorified by the *intersection cohomology sheaves* \mathcal{IC}_w . Furthermore, as the field of coefficients has characteristic zero, the Decomposition Theorem from [11] guarantees good properties of these objects under the push-forward functor: this implies that the subcategory of direct sums of shifted \mathcal{IC} ’s (usually called “*semisimple*” complexes) is closed under convolution. If we now take the split Grothendieck ring of this additive category we obtain the non-specialized Hecke algebra, where the multiplication by v is categorified by the shift. This is a first version of the *Hecke category*.

0.1.6. Mixed version. As was pointed out by Beilinson, Ginzburg and Soergel [12], it is actually more convenient, for applications in representation theory, to consider the category \mathcal{P}^{mix} of *mixed* perverse sheaves. This category is equipped with a *Tate twist* and can be thought as a graded version of \mathcal{P} with nice properties: for instance, it exhibits *Koszul duality*.

The standard, costandard and Wakimoto sheaves from above lift to \mathcal{P}^{mix} , and it is then natural to investigate their properties inside this category. In particular, understanding the subcategory of Wakimoto sheaves, which categorify the lattice part of the Hecke algebra, is a first step for a higher level version of the Bernstein presentation. A basic information in this direction is given, for instance, by morphism spaces and extension groups between them.

To understand similar homological properties of this category, it is useful to consider an appropriate derived setting. Achar and Riche [2] introduced a t-category \mathcal{D}^{mix} , whose heart identifies with \mathcal{P}^{mix} , in term of the homotopy category of complexes of *pure* sheaves. Furthermore they proved that the realization functor $\mathcal{D}^b(\mathcal{P}^{\text{mix}}) \rightarrow \mathcal{D}^{\text{mix}}$ is an equivalence in this case.

0.2 Modular setting

One can also construct the Hecke category, in an analogous way, with varieties defined over the complex numbers. This allows us to treat any characteristic, or even to take integral coefficients. Hence this is the preferred version in the modular setting. Nevertheless several issues occur. On the one hand, because of the failure of the Decomposition Theorem in positive characteristic the above category of semisimple complexes is not well-behaved anymore and, on the other hand, because of the absence of the Frobenius endomorphism, it is not clear how to replace notions like *mixed* and *pure*.

0.2.1. Parity sheaves. After observing that the techniques of de Cataldo and Migliorini [26] can be used to measure the failure of the Decomposition

Theorem in positive characteristic, Juteau, Mautner and Williamson [43] introduced the category of *parity sheaves*, which restores the compatibility with push-forward and convolution as before, and hence provides a suitable replacement for semisimple complexes. For characteristic zero coefficients these two categories coincide. Hence the category of equivariant parity sheaves over the (affine) flag variety is called the *geometric Hecke category*.

0.2.2. Modular mixed perverse sheaves. The question of finding appropriate replacements for the mixed categories in the modular setting is one of the topics of a trilogy of papers by Achar and Riche [5, 6, 7]. They define the modular version of the mixed derived category as the homotopy category of complexes of parity sheaves (instead of pure sheaves). They also define a t -structure in this category whose heart is the modular version for mixed perverse sheaves, with an analogue of the Tate twist, which again can be seen as a graded version of the category of perverse sheaves.

In this category we have standard and costandard objects and we can consider as before the Wakimoto sheaves. Furthermore in this setting the realization functor is an equivalence, and for flag varieties this is true also in the equivariant setting. Hence, extension groups between (modular) mixed perverse sheaves can be computed as shifted morphism spaces in the (modular) mixed derived category, which means: between the corresponding complexes of parity sheaves.

0.2.3. Diagrammatic category. The geometric Hecke category admits a presentation by generators and relations, introduced by Elias and Williamson [34]. This was initially a presentation for the category of *Soergel bimodules*, introduced in [65] as an algebraic model of the Hecke category, obtained via equivariant cohomology from the semisimple geometric version in characteristic 0. See § 2.1.1 below for a brief account on this construction.

One first observes that the Hecke category is obtained by Karoubian completion from (the additive hull of) a certain *Bott-Samelson* category, that can be thought of as its monoidal skeleton. Hence one can give a presentation to this smaller category and then recover the whole Hecke category formally. The generating objects, denoted B_s , correspond to simple reflections, and are represented as colored points (one color for each $s \in S$). The morphisms between tensor products of the B_s 's are described by certain *diagrams* inside the strip $\mathbb{R} \times [0, 1]$. Namely, these are planar graphs obtained from some generating vertices, that connect the sequences of colored points corresponding to the source and the targets, identified by some relations. For more detail see § 2.1 below.

This *diagrammatic Hecke category*, denoted by \mathcal{H} , only depends on the Weyl group and its action on the character lattice, so it is actually available for any Coxeter system, equipped with a *realization* \mathfrak{h} (i.e. a finite rank representation over the coefficient ring satisfying certain properties).

Furthermore we have explicit bases for the morphism spaces, given in terms of *light leaves* maps. These were first introduced by Libedinsky [53], and then described diagrammatically in [34].

0.2.4. Character formulas and Hecke actions. As a side remark, to further illustrate the importance of this category in modular representation theory, let us mention the following. If \mathbb{k} is a complete local ring (with residue field of

characteristic p), then (either version of) the Hecke category is Krull-Schmidt and the basis of indecomposables in the split Grothendieck group, which is the Hecke algebra, is called the *p-canonical basis*. This coincides with the canonical basis only for very large values of p and, in the affine case, it turned out to be a much better replacement in character formulas along the lines of Lusztig's conjecture.

Furthermore, one can establish an action of the affine Hecke category on the principal block of the category of representations of G . This was conjectured by Riche and Williamson [60], and proved by Ciappara [25] via Smith-Treumann theory, and independently by Bezrukavnikov and Riche [15], using Harish-Chandra bimodules and the revisited version of Soergel bimodules described by Abe [1].

0.3 Rouquier complexes

Let us now go back to our problem and rephrase it in terms of the homotopy category $\mathcal{K}^b(\mathcal{H})$ of the (diagrammatic) Hecke category. For a simple reflection s the standard and costandard sheaves correspond to certain complexes denoted by F_s and F_s^{-1} , and the Wakimoto sheaves will then correspond to certain tensor products between these. For a general Coxeter group W , the objects obtained as products between the $F_s^{\pm 1}$ in all possible ways are called *Rouquier complexes*, and they form a very interesting subcategory of $\mathcal{K}^b(\mathcal{H})$.

Our first result is a general reduction which can be performed on these objects, so let us introduce them more precisely.

0.3.1. The 2-braid group. Rouquier complexes were introduced in [63] in order to define a categorification of the braid group B_W associated with a Coxeter system (W, S) .

Actions of braid groups on categories appeared in representation theory already in the works of Carlin [23] or Rickard [61], and a precise definition was made by Deligne [27]. They describe higher symmetries of the categories acted upon and usually give rich information about them. A classical example is the braid action on $\mathcal{D}^b(\mathcal{O})$, the bounded derived category of the aforementioned category \mathcal{O} , or, as a geometric counterpart, on $\mathcal{D}^b(G/B)$.

Rouquier pointed out the interest of studying the category of self-equivalences induced by these actions and understand transformations between them. He introduced the *2-braid group* \mathcal{B}_W , that upgrades the braid group to a category which serves as a model to understand this kind of transformations. This is the subcategory of $\mathcal{K}^b(\mathcal{H})$ mentioned above: one can associate any braid ω to a Rouquier complex F_ω and obtain a functor

$$\begin{aligned} B_W &\longrightarrow \mathcal{B}_W \\ \omega &\longmapsto F_\omega \end{aligned}$$

where B_W is considered as a category with only the identity maps. Rouquier conjectured this to be faithful. This was shown in type A by Khovanov and Seidel [52], in simply laced finite type by Brav and Thomas [21], and in all finite types by Jensen [41].

0.3.2. Link invariants. This category also plays an important role in algebraic topology. Khovanov and Rozansky [51] began the construction of link invariants from Rouquier complexes, that was made precise by Khovanov [50] as a triply graded link homology. The idea is that the homology of the complex obtained computing Hochschild (co)homology of the Rouquier complex F_ω associated to a braid ω , is an invariant, up to an overall shift, of the link $\bar{\omega}$ obtained by closing ω (Rouquier complexes come with a cohomological and a polynomial degree, and Hochschild homology provides a third grading).

0.4 Results

Let us now describe the results of this thesis in more detail.

0.4.1. Soergel calculus with patches. First we consider the dg category of complexes $\mathcal{C}_{\text{dg}}^b(\mathcal{H})$ with objects in the Hecke category. We extend the diagrammatic description of \mathcal{H} to one for the subcategory of $\mathcal{C}_{\text{dg}}^b(\mathcal{H})$ generated by Rouquier complexes. We consider the complexes of the form:

$$F_{s_1}^{\pm 1} F_{s_2}^{\pm 1} \dots F_{s_n}^{\pm 1}. \quad (2)$$

The associated graded objects splits into Bott-Samelson objects (one for each subexpression of $s_1 s_2 \dots s_n$), each of which lies in a certain cohomological degree. Roughly speaking, morphisms between two such complexes are again linear combinations of diagrams, but in each diagram one has to specify the starting and ending summand. To do this one covers some of the boundary points by *patches*, thus picking a certain subexpression of the starting (and ending) word. Then we describe the rules to compute the image via the differential of a certain morphism.

With this language we recover some classical results about Rouquier complexes. Namely, in Theorem 2.9 we establish the categorification of the relations in the braid group:

$$\begin{cases} F_s F_s^{-1} \simeq F_s^{-1} F_s \simeq \mathbb{1} & \text{for } s \in S, \\ F_s F_t F_s \dots \simeq F_t F_s F_t \dots & \text{for } s, t \in S. \end{cases}$$

Then, in §3.1.7, we prove the so-called Rouquier formula. Given an element $w \in W$, its *positive lift* is obtained by replacing each simple reflection in any reduced word for w by the corresponding positive generator of the braid group. One can show that this is a well defined element of the braid group. Similarly one defines the *negative lift*. Let then ω is the positive lift of an element w of W , and ν is the negative lift of another element v , then

$$\text{Hom}_{\mathcal{K}^b(\mathcal{H})}(F_\omega, F_\nu) = \begin{cases} R & \text{if } w = v, \\ 0 & \text{otherwise.} \end{cases}$$

0.4.2. A general reduction for Rouquier complexes. Our main result about Rouquier complexes is however a general homotopy reduction on the complexes (2). We consider a *positive* Rouquier complex, of the form:

$$F_w^\bullet = F_{s_1} F_{s_2} \dots F_{s_n}$$

for $s_i \in S$. As we said, as a graded object, this is the direct sum of Bott-Samelson objects indexed by the 2^n subexpressions of $\underline{w} = s_1 s_2 \dots s_n$. We find a summand $F_{\underline{w}}$ which, as a grade object, is a direct sum indexed over *subwords* (each of which can correspond to several subexpressions). Then we show the following.

Theorem. *The inclusion of the complex $F_{\underline{w}}$ in $F_{\underline{w}}^\bullet$ is a homotopy equivalence.*

When the category \mathcal{H} is Krull-Schmidt (see Theorem 2.4), any complex admits a *minimal subcomplex*: a homotopy equivalent summand with no contractible direct summand. Furthermore, one can show that this is unique up to isomorphism. The minimal subcomplex is very hard to find in general, but one can see our result as a first step of such a reduction, available with no restriction on the coefficients. Let us see an example of our simplification.

Example 0.1. Let $\underline{w} = ssttss$. The original complex $F_{\underline{w}}^\bullet$ is drawn in Figure 1. It is a cube of dimension 6, whose vertices are labeled by the $2^6 = 64$ subexpressions of $ssttss$. The arrows (the edges of the cube) describe the differential map: each subexpression has a map towards those subexpressions that can be obtained by canceling a symbol from it. The complex $F_{\underline{w}}$ instead is showed in

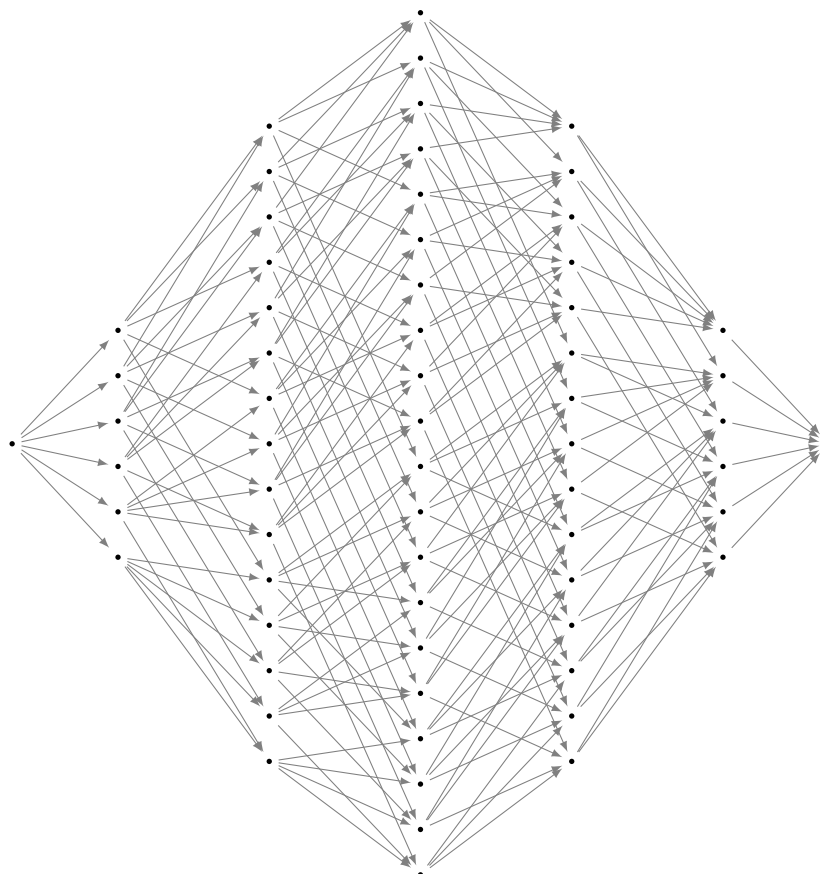

Figure 1: A picture of the complex $F_{\underline{ssttss}}^\bullet$.

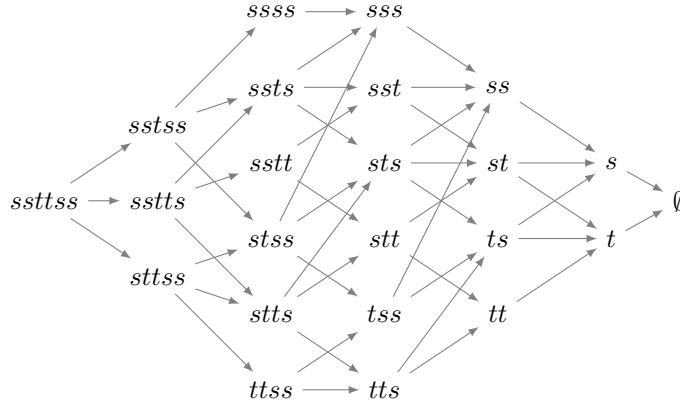

Figure 2: The complex F_{ssttss} .

Figure 2. The vertices this time are labeled by the 23 subwords and the arrows (representing the new differential) connect a certain word with all its subwords (the symbol \emptyset denotes the empty word).

This reduction is obtained via a strong use of *Gaussian elimination for complexes*. This is a tool from homological algebra which allows to reduce a given complex when some component of the differential is an isomorphism. In § 3.2.1, we develop a “large scale” version of this technique.

We then adapt the diagrammatic description of the morphisms for the complexes $F_{\underline{w}}$. Roughly speaking, this allows us to get rid of patches. Nevertheless, the first version of the category keeps a certain interest: for instance it is a dg monoidal subcategory of $\mathcal{C}_{\text{dg}}^b(\mathcal{H})$.

0.4.3. Wakimoto sheaves in type \tilde{A}_1 . Then we pass to the main problem of this thesis: describe morphisms between Wakimoto sheaves. We address this problem in type \tilde{A}_1 . Here the Wakimoto sheaves are indexed by the integers.

First we assume that \mathbb{k} is a characteristic zero field. In this case one can actually compute the minimal subcomplexes of the Wakimoto sheaves. In § 4.2.4, we use this to compute the extension groups. The result is described in Table 1, where the cell (n, j) shows the space $\text{Hom}(\Theta_{-n}, \mathbb{1}[j])$ (for positive values of the index, one gets zero by the Rouquier formula).

$n \backslash j$	0	1	2	3	4	5	6	7	8	9	...
0	R										
1			$\mathbb{k}(2)$								
2			$\mathbb{k}(0)$		$\mathbb{k}(4)$						
3			$\mathbb{k}(-2)$		$\mathbb{k}(2)$		$\mathbb{k}(6)$				
4			$\mathbb{k}(-4)$		$\mathbb{k}(0)$		$\mathbb{k}(4)$		$\mathbb{k}(8)$		
...

Table 1: The morphism space $\text{Hom}(\Theta_{-n}, \mathbb{1}[j])$.

For a more general coefficient ring it is much harder to find the minimal subcomplex, and, if the category is not Krull-Schmidt, this is not even well defined. Nevertheless we can use our general reduction to describe morphism spaces in the dg category of complexes. We consider the dg module of morphisms

$$\mathrm{Hom}^\bullet(\Theta_{-n}, \mathbb{1}). \quad (3)$$

The problem of finding the extension groups is equivalent to computing the cohomology of this complex. The dg module (3) is free as a left dg R -module with a basis given by a certain version of the light leaves maps. The differential is now described by matrices with entries in R . A crucial observation is that many of these entries are just ± 1 so we can use Gaussian elimination to simplify the complex of morphisms. In this way, in § 4.3.4, we find a much simpler model for (3), homotopy equivalent to it. It is still hard to compute its cohomology but the complexity is remarkably decreased. Furthermore this allows us to compute the cohomology in the *antispherical category*, considered in [60] or [55].

0.4.4. Extension in the antispherical category. We are then able to describe the extension groups between the images ${}^I\Theta_n$ of the Wakimoto sheaves in the antispherical category, with arbitrary coefficients.

The result is expressed in terms of *two-color cyclotomic polynomials* ϕ_n , a certain data depending on the realization of the Coxeter system. For the standard Cartan matrix, ϕ_n is the exponential of the Von Mangoldt function:

$$\phi_n = \begin{cases} p & \text{if } n = p^r \text{ for a prime } p, \\ 1 & \text{otherwise.} \end{cases}$$

Let $\hat{P}(k)$ denote the set of partitions of a positive integer k such that each part divides the next. For $\lambda = (\lambda_1, \dots, \lambda_i) \in \hat{P}(k)$, consider the cube of the following form (the picture is for $i = 3$).

$$\begin{array}{ccccc} & & \mathbb{k} & \xrightarrow{-\phi_{\lambda_2}} & \mathbb{k} & & \\ & \nearrow \phi_{\lambda_1} & & \searrow -\phi_{\lambda_2} & & \searrow \phi_{\lambda_3} & \\ & & \mathbb{k} \oplus \mathbb{k} & & \mathbb{k} \oplus \mathbb{k} & & \\ & \searrow \phi_{\lambda_2} & & \nearrow \phi_{\lambda_1} & & \searrow -\phi_{\lambda_3} & \\ \mathbb{k} & \xrightarrow{\phi_{\lambda_2}} & \mathbb{k} & & \mathbb{k} & \xrightarrow{-\phi_{\lambda_3}} & \mathbb{k} \\ & \searrow \phi_{\lambda_3} & & \nearrow -\phi_{\lambda_3} & & \nearrow \phi_{\lambda_1} & \\ & & \mathbb{k} \oplus \mathbb{k} & & \mathbb{k} \oplus \mathbb{k} & & \\ & \nearrow \phi_{\lambda_3} & & \searrow \phi_{\lambda_1} & & \nearrow \phi_{\lambda_1} & \\ & & \mathbb{k} & \xrightarrow{\phi_{\lambda_1}} & \mathbb{k} & & \\ & & & \xrightarrow{\phi_{\lambda_2}} & & & \end{array}$$

One can show that the complex $\mathrm{Hom}^\bullet({}^I\Theta_{-n}, \mathbb{1})$ reduces to many small cubes as above, each with a certain shift. So we can compute the cohomology of each of them and then patch the contributions together.

For $\lambda \in \hat{P}(k)$, let I_λ be the ideal of \mathbb{k} generated by the corresponding cyclotomic polynomials:

$$I_\lambda = (\phi_{\lambda_1}, \phi_{\lambda_2}, \dots, \phi_{\lambda_{k-1}}, \phi_{\lambda_k}).$$

Then it is easy to see that the cohomology of a cube as above is \mathbb{k}/I_λ in the top degree and zero elsewhere.

One finally obtains the following pattern. For a given partition λ with k parts and with d distinct numbers appearing, the *weight* $|\lambda|$ is defined as $2k - d$. Then we define the graded \mathbb{k} modules H_k as follows:

$$H_1 = \mathbb{k}, \quad H_k := \bigoplus_{\lambda \in \hat{P}(k)} \mathbb{k}/I_\lambda[1 - |\lambda|], \quad \text{for } k > 2.$$

Then we have (see Theorem 4.33 below):

Theorem. *The cohomology of $\text{Hom}^\bullet(I\Theta_{-n}, \mathbb{1})$ is*

$$\bigoplus_{i=2}^{2n} H_{\lfloor i/2 \rfloor}[i - 2 - 2n],$$

where $\lfloor \cdot \rfloor$ denotes the floor function.

We display the cohomology for the first values of n in Table 2 at page 13. The entry i stands for $\mathbb{k}/(\phi_i)$, and (i, j) for $\mathbb{k}/(\phi_i, \phi_j)$. Stacked entries represent direct sums. So, for example the entry

$$\begin{array}{c} 6 \\ 2,4 \\ 2 \end{array}$$

means $\mathbb{k}/(\phi_6) \oplus \mathbb{k}/(\phi_2, \phi_4) \oplus \mathbb{k}/(\phi_2)$. Notice that, in characteristic zero, the only part that would survive is the upper “stair” of \mathbb{k} 's.

0.5 Perspectives

0.5.1. DG model for the affine Hecke category. In order to really obtain a Bernstein presentation of the affine Hecke category, one could try to use the information about the morphism spaces to find a dg model for it. For example, by constructing a dg monoidal category \mathcal{B} , by generators and relations, that admits a quasi-equivalence from the dg category $\langle F_s^{\pm 1} \rangle$ generated by the Rouquier complexes. This means a dg functor $\langle F_s^{\pm 1} \rangle \rightarrow \mathcal{B}$ such that the induced maps between morphism complexes give isomorphisms in cohomology. This would be a dg model for the triangulated category generated by standard and costandard objects in $\mathcal{K}^b(\mathcal{H})$. In fact one could take the *triangulated envelope* (in the sense of [17]: see also [49] or [18]) and the above functor would induce a triangulated monoidal equivalence. An example is the category of patches mentioned above, but it is somehow “tautological” because the corresponding dg functor is an isomorphism. One could hope to find a more insightful model which captures more closely the structure of the morphism spaces at the triangulated level.

0.5.2. The coherent realization. The affine Hecke category also admits another geometric realization. In fact, as it was shown by Bezrukavnikov in [14], realizing a project started with Arkhipov in [8], one can categorify the classical isomorphism between the affine Hecke algebra and the equivariant K-theory of the Steinberg variety associated with the Langlands dual group. One should actually consider the derived category of G^\vee -equivariant coherent sheaves on the dg scheme $\tilde{\mathcal{N}}^\vee \times_{\mathfrak{g}^\vee}^L \tilde{\mathcal{N}}^\vee$, where \mathfrak{g}^\vee is the Lie algebra of the Langlands dual group G^\vee and $\tilde{\mathcal{N}}^\vee$ is the Springer resolution of the associated nilpotent cone.

This category is then equivalent to the I -equivariant derived category of sheaves on the affine flag variety. Hence it would also be extremely interesting to understand the meaning of our calculations on the constructible side in terms of this coherent realization. The equivalence is shown via Koszul duality from another equivalence between the I^0 -equivariant derived category of sheaves on the *extended* affine flag variety $G((t))/I^0$, where I^0 is the pro- p radical of I , and the derived category of G^\vee -equivariant coherent sheaves on $\tilde{\mathfrak{g}}^\vee \times_{\mathfrak{g}^\vee} \tilde{\mathfrak{g}}^\vee$, where $\tilde{\mathfrak{g}}^\vee$ is the Grothendieck-Spinger resolution. Hence a first possibility to proceed would be to follow these steps in the SL_2 case. In this simple case one could actually also try to describe the above dg scheme more directly.

0.5.3. Generalizations and the case of type A . Of course another natural direction to proceed is to try to generalize the study of Wakimoto sheaves to other types, starting from A_2 . In parallel, one could try to go further in the reduction of Rouquier complexes, for example extending our results to all words and not only positive or negative.

Finally, we also mention that Gorsky, Neguț and Rasmussen proposed in [36] the construction of a monoidal functor from the derived category of coherent sheaves on the flag Hilbert scheme to the homotopy category of the Hecke category, which categorifies the maximal commutative subalgebra of the Hecke algebra in type A . It would also be very interesting to find some relations between our computations on Rouquier complexes and this geometric interpretation.

$n \backslash j$	0	1	2	3	4	5	6	7	8	9	10	11	12	13	14	15	16	17	18	19	20	21	22	23	24	...	
0	\mathbb{k}																									...	
1		\mathbb{k}																									...
2			\mathbb{k}																								...
3				\mathbb{k}																							...
4					\mathbb{k}																						...
5						\mathbb{k}																					...
6							\mathbb{k}																				...
7								\mathbb{k}																			...
8									\mathbb{k}																		...
9										\mathbb{k}																	...
10											\mathbb{k}																...
11												\mathbb{k}															...
12													\mathbb{k}														...
...																											...

Table 2: The cohomology of $\text{Hom}^*(I\Theta_{-n}, \mathbb{1})$.

Chapter 1

Coxeter systems and Hecke algebras

In order to introduce our main problem, we need to recall some basic notions and establish notation. In this first chapter, we give the definitions of Coxeter groups, braid groups and Hecke algebras, with particular attention to those corresponding to finite and affine Weyl groups attached to reductive algebraic groups. We will omit the proofs and refer the reader to [16, 20, 38].

1.1 Coxeter systems and braid groups

1.1.1. Coxeter systems. The following fundamental notion gives a general framework to study finite and affine Weyl groups.

Definition 1.1. A *Coxeter system* is a pair (W, S) with W a group (where 1 denotes the neutral element) and $S \subset W$ a subset such that:

- (i) each $s \in S$ is an involution, so $s^2 = 1$;
- (ii) if, for $s, t \in S$, the order of st in W is $m_{st} \in \mathbb{N} \cup \{\infty\}$ (so in particular $m_{ss} = 1$ for each $s \in S$), then the natural morphism

$$\langle s \in S \mid (st)^{m_{st}} = 1, \text{ if } m_{st} < \infty \rangle \rightarrow W$$

is an isomorphism.

Then W is called *Coxeter group*, the elements of S are called *simple reflections*, and their conjugates are called *reflections*. The relations $(st)^{m_{st}} = 1$ can also be written

$$\underbrace{stst \dots}_{m_{st}} = \underbrace{tsts \dots}_{m_{st}}$$

and are called *braid relations*.

In this thesis we will only consider the case of *finitely generated* Coxeter systems, when $|S| < \infty$. A particular case is when $|W| < \infty$. It is well known that finite irreducible Coxeter groups can be classified into the families

$$A, B = C, D, E, F, G, H \text{ or } I.$$

For more details, see [38, Ch. 2] or [20, Ch. VI, § 4].

Example 1.2. (i) The most basic example of Coxeter system is the symmetric group on n symbols with the subset of consecutive transpositions:

$$W = \mathfrak{S}_n = \{\text{permutations of the numbers } 1, \dots, n\}$$

$$S = \{s_i = (i, i + 1) \mid i = 1, \dots, n - 1\}$$

where $(i, i + 1)$ denotes the transposition exchanging i and $i + 1$. Then it is easy to see that

$$s_i^2 = 1$$

$$s_i s_{i+1} s_i = s_{i+1} s_i s_{i+1} \quad \text{for } i = 1, \dots, n - 1$$

$$s_i s_j = s_j s_i \quad \text{for } |i - j| > 1$$

and that these relations give a presentation of \mathfrak{S}_n . The reflections in this case are the transpositions.

A Coxeter system of this form is said of *type* A_{n-1} and it can be seen as the symmetry group of the $(n - 1)$ -simplex $[v_1, \dots, v_n]$: the generator s_i corresponds to the reflection exchanging v_i and v_{i+1} and leaving all the other vertices fixed.

For example, the group \mathfrak{S}_4 is the group of symmetries of the tetrahedron.

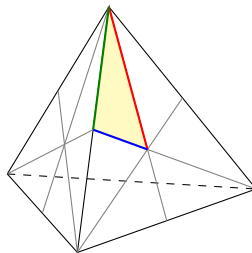

Each reflection plane contains an edge and the mid point of the opposite edge. They cut the surface of the tetrahedron along the gray lines in the picture. The group is generated, for example, by the reflections across the three planes corresponding to the colored segment in the picture. The triangle they form is a fundamental domain for the action of the group on the surface of the tetrahedron.

(ii) The subgroup of symmetries of a regular polygon of m sides in the Euclidean plane is a Coxeter system with respect to the reflections s and t across two consecutive axes, as in the picture.

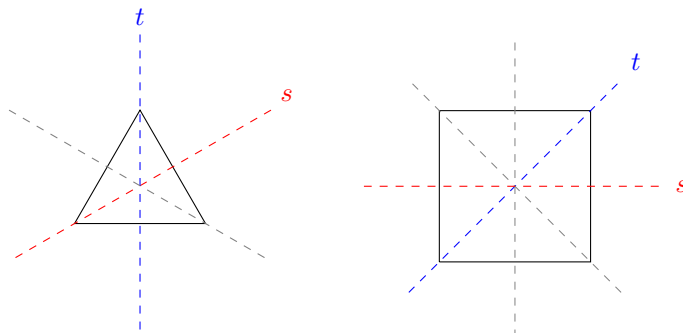

In this case the presentation is

$$\langle s, t \mid s^2 = t^2 = (st)^m = 1 \rangle.$$

This is the *dihedral* group, of type $I_2(m)$.

- (iii) One can take $m = \infty$ in the last example and get the *infinite dihedral* group which can be seen as the subgroup of transformations of the real line generated by the reflections across 0 and a positive number ρ .

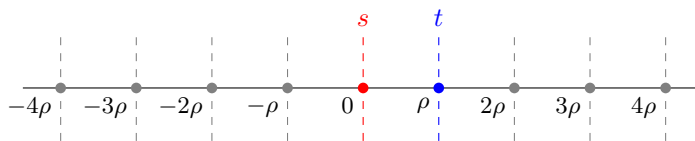

This is the Coxeter group of type \tilde{A}_1 : as we will see later, it is the affine Weyl group associated to that of type A_1 . Reflections in this case are just odd-length elements. The other elements are translations by even multiples of ρ . The group is then the semidirect product of the translation lattice and the group generated by the reflection across the origin s :

$$W = \langle s \rangle \ltimes \mathbb{Z}.$$

Let \mathfrak{W}_S be the free monoid generated by S . Its elements are called *Coxeter words* and will be denoted by underlined letters. We say that a word is *one color* if it contains only (repetitions of) one letter. If \underline{w} is a Coxeter word, we say that it *expresses* the element $w \in W$ if w is its image via the natural morphism $\mathfrak{W}_S \rightarrow W$ (this morphism is surjective because each s is an involution). Let $\ell(\underline{w})$ denote the length of \underline{w} , i.e. the number of its letters. The word \underline{w} is said to be *reduced* if there is no shorter word expressing w . This defines a *length function* $\ell : W \rightarrow \mathbb{N}$, where $\ell(w)$ is the length of any reduced word for w .

For $\underline{w}, \underline{x} \in \mathfrak{W}_S$, we say that \underline{x} is a *subword* of \underline{w} , and we write $\underline{x} \preceq \underline{w}$, if \underline{x} is obtained from \underline{w} by erasing some letters. In other words, if $\underline{w} = s_{i_1} s_{i_2} \cdots s_{i_n}$ with $s_i \in S$, then \underline{x} is of the form $s_{i_1} s_{i_2} \cdots s_{i_r}$, with $1 \leq i_1 \leq i_2 \leq \cdots \leq i_r \leq n$. A *subexpression* is instead the datum of a subword together with the information of the precise positions of the letters in the original word. This can be encoded in a *01-sequence* $\mathbf{e} \in \{0, 1\}^n$ where the ones correspond to the letters that we pick and the zeros to those we do not pick.

Example 1.3. Let $w = s_4 s_2 s_5 s_1 s_1 s_3$. Then $x = s_4 s_2 s_1$ is a subword, obtained by erasing s_5 , s_3 and one of the two s_1 's. It corresponds to both subexpressions 110010, which picks the first occurrence of s_1 , and 110100, which picks the second one.

The *Bruhat graph* is the directed graph whose vertices are the elements $w \in W$ and there is a directed edge from w to all elements of the form wt with t a reflection such that $\ell(wt) > \ell(w)$. Then we define the *Bruhat order* as the transitive closure of the relation defined by the Bruhat graph.

1.1.2. Basic properties of Coxeter systems. Here are some important properties of Coxeter systems that we will use in the sequel.

Exchange Property. Let $s \in S$ and $\underline{w} = s_1 \dots s_k$ be a reduced Coxeter word for $w \in W$. If $\ell(sw) \leq \ell(w)$ then there exists a j with $1 \leq j \leq k$ such that

$$ss_1 \dots s_{j-1} = s_1 \dots s_{j-1}s_j.$$

Then one can deduce that for each $s \in S$ and $w \in W$ we have either $\ell(ws) < \ell(w)$ or $\ell(ws) > \ell(w)$. In the first case we say that s is in the *right descent* of w (and one can define the *left descent* analogously). The Exchange Property also implies that if s is in the right descent of w then w admits a reduced word ending with s (and similarly for the left descent). See [16, Theorem 1.4.3], [20, IV, § 1.4, Lemma 3], [38, § 1.7].

Word property (or Matsumoto Theorem). Two reduced words \underline{w}_1 and \underline{w}_2 for the same element $w \in W$ can be transformed one into the other only via applications of the braid relation.

Consider, for a given $w \in W$, the graph whose vertices are the reduced words for w and the edges are given by single applications of the braid relations. Then the Word Property implies that this graph is connected. A path in this graph, which is nothing but a sequence of applications of braid relations, is called *braid move*. See [16, Theorem 3.3.1].

Longest element. If W is finite, there exist a unique element w_0 of maximal length (which is also maximal in the Bruhat order). See [16, Theorem 2.3.1], [20, IV, § 1, Ex. 22], [38, § 1.8].

1.1.3. Root data and Weyl groups. Let now G be a reductive algebraic group over an algebraically closed field. The unfamiliar reader can find details for the following material in [19, Ch. IV], [37, Ch. VIII-X] or [67, Ch. 6-8].

Fix a Borel subgroup B and a maximal torus T . Then recall that, if $N_G(T)$ is the normalizer of the torus, then the quotient $W_f := N_G(T)/T$ is a finite group called the *Weyl group*. Recall also that T defines a *root datum* $(X, \mathbb{Z}\Phi, X^\vee, \mathbb{Z}\Phi^\vee)$, where $X = \text{Hom}(T, \mathbb{G}_m)$ and $X^\vee = \text{Hom}(\mathbb{G}_m, T)$ are respectively the character and cocharacter lattices containing the sets Φ of *roots* and Φ^\vee of *coroots*. The spans $\mathbb{Z}\Phi$ and $\mathbb{Z}\Phi^\vee$ are called *root lattice* and *coroot lattice* respectively. By definition, the Weyl group acts naturally on these lattices, and, furthermore, each root α is associated with a *reflection* $s_\alpha \in W_f$ which acts via

$$\begin{aligned} s_\alpha(\lambda) &= \lambda - \langle \lambda, \alpha^\vee \rangle \alpha & \forall \lambda \in X \\ s_\alpha(\lambda^\vee) &= \lambda^\vee - \langle \alpha, \lambda^\vee \rangle \alpha^\vee & \forall \lambda^\vee \in X^\vee \end{aligned}$$

where $\langle \cdot, \cdot \rangle$ denote the natural pairing $X \times X^\vee \rightarrow \mathbb{Z}$. The Borel subgroup B determines \mathbb{Z} -bases of *simple* roots and coroots Δ and Δ^\vee of $\mathbb{Z}\Phi$ and $\mathbb{Z}\Phi^\vee$ respectively, such that, if $\Phi^+ = \mathbb{N}\Delta \cap \Phi$ and $\Phi^- = -\Phi^+$, then Φ decomposes as $\Phi^+ \sqcup \Phi^-$ (and similarly for coroots). Here $\mathbb{N}\Delta$ (and $\mathbb{N}\Delta^\vee$) denotes the set of linear combinations of simple (co)roots with non-negative integer coefficients. If we consider the vector spaces $V = \mathbb{R} \otimes \mathbb{Z}\Phi$ and $V^\vee = \mathbb{R} \otimes \mathbb{Z}\Phi^\vee$, then Φ and Φ^\vee define a *root system*, in the sense of [20, VI, § 1.1]. The matrix $(\langle \alpha, \alpha^\vee \rangle)_{\alpha \in \Delta}$ is called *Cartan matrix* and it determines W_f and its action on the (co)root lattice completely. If we set $S_f = \{s_\alpha \mid \alpha \in \Delta\}$, the pair (W_f, S_f) is a Coxeter system. The groups of this form are all *crystallographic*: the orders m_{st} all

belong to $\{1, 2, 3, 4, 6\}$. Vice versa, all finite crystallographic Coxeter groups are Weyl groups, and the irreducible root systems are classified by the families A, B, C, D, E, F, G . The corresponding Weyl groups are then the Coxeter systems of the first seven families from above.

Example 1.4. (i) For $G = \text{SL}_2$, identifying both X and X^\vee with \mathbb{Z} (the pairing is just multiplication), we have $\Phi = \{\pm 2\}$, and $\Phi^\vee = \{\pm 1\}$.

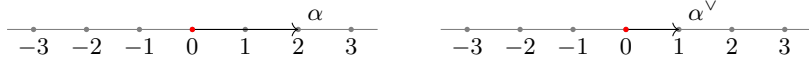

The Weyl group is $W = \{1, s\}$ where s is the reflection across 0.

(ii) If $G = \text{SL}_3$, then X and X^\vee are free \mathbb{Z} -modules of rank 2 that we can picture as follows:

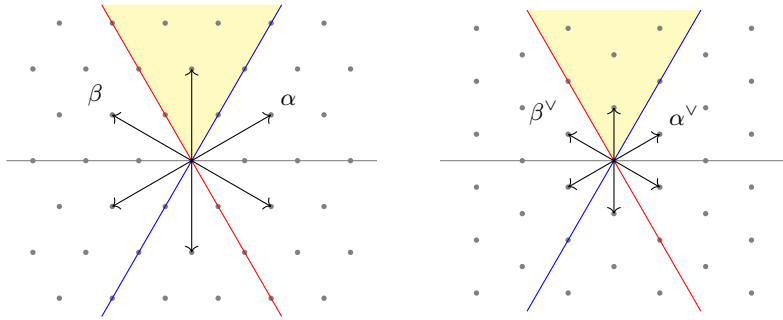

The gray points are the (co)characters and the arrows are the (co)roots. The lines are the hyperplanes for the reflections in W_f : the red and blue ones are a choice of simple reflections corresponding to $\Delta = \{\alpha, \beta\}$.

(iii) If $G = \text{Sp}_4$, again X and X^\vee are free \mathbb{Z} -modules of rank 2 of the form:

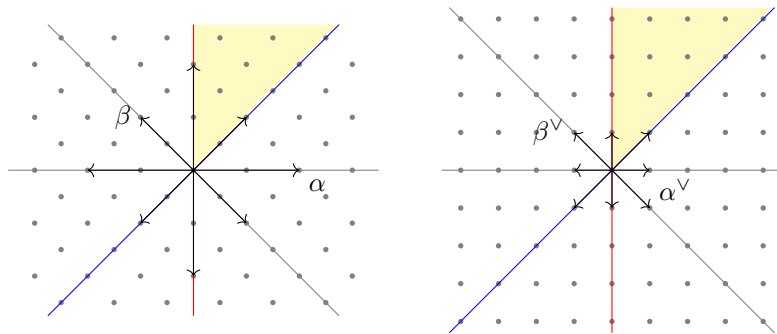

Recall that $\lambda \in X$ is called *dominant* if $\langle \lambda, \alpha^\vee \rangle \geq 0$, for all α^\vee in Δ^\vee . Dominant cocharacters are defined similarly. The closure of

$$\{x \in V \mid \langle x, \alpha^\vee \rangle > 0\}$$

is called *dominant chamber* (yellow in the pictures) and it is a fundamental domain for the action of W_f on V (and similarly for V^\vee).

1.1.4. The Affine Weyl group. One defines the *affine* Weyl group as

$$W := W_f \ltimes \mathbb{Z}\Phi^\vee.$$

The elements corresponding to $\lambda \in \mathbb{Z}\Phi^\vee$ are denoted by t_λ : one can consider an induced action of W on $\mathbb{Z}\Phi^\vee$ where the t_λ 's act by translation.

The group W is generated by *affine* reflections of the form

$$s_{\alpha,k} = t_{k\alpha^\vee} s_\alpha \quad (\alpha \in \Phi, k \in \mathbb{Z}).$$

One can show that W again forms a Coxeter system with the set $S = S_f \cup S_0$ where we added some additional *affine* simple reflections. If W is irreducible, then S_0 contains only one affine simple reflection which is $s_{\tilde{\alpha},1}$, where $\tilde{\alpha}$ is the highest root. Then one uses the letters $\tilde{A}, \tilde{B}, \tilde{C}, \dots$ to identify the families of irreducible affine Weyl groups associated to the corresponding root systems. Notice, for instance, that, even if the Weyl groups of type B and C are isomorphic as Coxeter systems, the affine Weyl groups of type \tilde{B} and \tilde{C} are not. For more details see [20, VI, § 2].

Example 1.5. We have already seen in Example 1.2 (iii) the affine Weyl group of type \tilde{A}_1 : if the only positive coroot α^\vee is identified with 1 then, in the notation of that example, we have $\rho = \frac{1}{2}$.

Here are the pictures of the affine Weyl groups of type \tilde{A}_2 and \tilde{B}_2 .

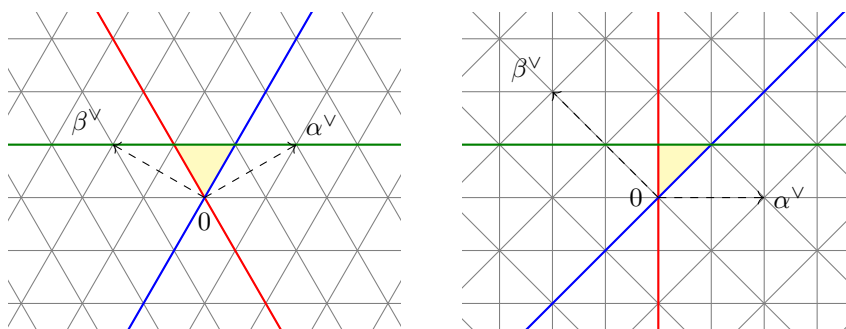

The affine reflection lines are drawn in grey. The dashed arrows are the simple coroots: the highest root is $\tilde{\alpha} = \alpha + \beta$ for A_2 and $\tilde{\alpha} = \alpha + 2\beta$ for B_2 , then $\tilde{\alpha}^\vee$ is $\alpha^\vee + \beta^\vee$ in both cases. The reflection s_0 is then $t_{\alpha^\vee + \beta^\vee} s_{\alpha + \beta}$ for \tilde{A}_2 and $t_{\alpha^\vee + \beta^\vee} s_{\alpha + 2\beta}$ for \tilde{B}_2 . In the pictures the simple reflections in S_f are red and blue and the simple affine reflection s_0 is green.

The closure in V of any connected component of the complement of the reflecting hyperplanes is called *alcove*. The only one containing 0 and contained in the dominant chamber is called *fundamental alcove* A_0 , yellow in the pictures above. Then we have the two following properties.

(i) The action of W on V gives a bijection

$$\begin{aligned} W &\longleftrightarrow \{\text{alcoves}\} \\ w &\longmapsto w(A_0) \end{aligned}$$

(ii) One can compute the length of an element $w \in W$ as the number of hyperplanes separating the fundamental alcove A_0 from $w(A_0)$ (a hyperplane is said to *separate* two alcoves, if they lie in different sides with respect to it).

1.1.5. Braid groups. Let (W, S) be a Coxeter system. We associate to it the corresponding *Artin-Tits group* (or *generalized braid group*) B_W . One takes the free group generated by the set S and quotients it by only braid relations:

$$B_W = \langle \sigma_s, s \in S \mid \underbrace{\sigma_s \sigma_t \dots}_{m_{st}} = \underbrace{\sigma_t \sigma_s \dots}_{m_{st}} \rangle$$

Hence we have a natural surjection $B_W \rightarrow W$ sending both σ_s and σ_s^{-1} to s . Let $\Sigma^+ = \{\sigma_s\}_{s \in S}$, $\Sigma^- = \{\sigma_s^{-1}\}_{s \in S}$ and $\Sigma = \Sigma^+ \sqcup \Sigma^-$.

Example 1.6. For W of type A_n we recover the classical braid group on $n + 1$ strands. For example, for $n = 2$, the group B_W is

$$\langle \sigma_s, \sigma_t \mid \sigma_s \sigma_t \sigma_s = \sigma_t \sigma_s \sigma_t \rangle.$$

The isomorphism with the classical braid group on 3 strands is given by:



Recall that the composition $\omega_1 \omega_2$ in the braid group is obtained by stacking ω_1 on top of ω_2 . Then, for example, we have:

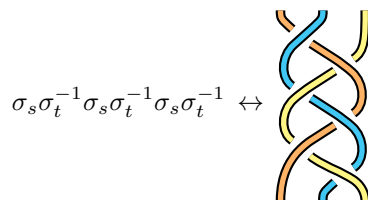

The surjection $B_W \rightarrow W$ is in this case the map sending a braid to the corresponding permutation (for the above braid this is just the identity).

Let \mathfrak{W}_Σ be the free monoid generated by Σ . Its elements are called *braid words*. Then \mathfrak{W}_S is naturally a submonoid of \mathfrak{W}_Σ . We call the elements of Σ^+ (and Σ^-) *positive letters* (respectively *negative letters*). A braid word is called *positive* (or *negative*) if all its letters are. The notion of subword is defined in \mathfrak{W}_Σ in the same way as in \mathfrak{W}_S .

We call *Coxeter projection* the map $\mathfrak{W}_\Sigma \rightarrow \mathfrak{W}_S$, sending both σ_s and σ_s^{-1} to s . This has two distinguished sections: any Coxeter word $\underline{w} = s_1 s_2 \dots s_k$ has a *positive word lift* $\sigma_{s_1} \sigma_{s_2} \dots \sigma_{s_k}$ and a *negative word lift* $\sigma_{s_1}^{-1} \sigma_{s_2}^{-1} \dots \sigma_{s_k}^{-1}$. By the Word Property above, these also descend to sections $W \rightarrow B_W$ sending w to the braid expressed by the positive (or negative) word lift of any reduced word for w . This is called *positive* (*negative*) *lift*.

Given a non-empty $\underline{w} \in \mathfrak{W}_\Sigma$, we can write it as

$$\underline{\omega}_1 \underline{\omega}_2 \dots \underline{\omega}_k \tag{1.1}$$

where $\underline{\omega}_i$ are non-empty words such that:

- (i) each $\underline{\omega}_i$ is either positive or negative;
- (ii) $\underline{\omega}_i$ is positive if and only if $\underline{\omega}_{i+1}$ is negative.

We call (1.1) the *alternating* decomposition of $\underline{\omega}$.

Finally we call *degree* the morphism of monoids

$$\delta : \mathfrak{M}_\Sigma \rightarrow (\mathbb{Z}, +)$$

with $\delta(\sigma_s) = 1$ and $\delta(\sigma_s^{-1}) = -1$. Hence, if $\underline{\omega} = \sigma_1 \cdots \sigma_n$, then

$$\delta(\underline{\omega}) = \sum_{i=1}^n \delta(\sigma_i) = |\{i \mid \sigma_i \in \Sigma^+\}| - |\{i \mid \sigma_i \in \Sigma^-\}|$$

Notice that the restriction of δ to \mathfrak{M}_S is just the function counting the number of letters of a Coxeter word.

1.2 Hecke algebras

1.2.1. The Hecke algebra. Let (W, S) be a Coxeter system and consider the ring $\mathbb{Z}[v, v^{-1}]$ of integral Laurent polynomial in one variable.

Definition 1.7. The *Hecke algebra* $\mathbf{H}_{(W,S)}$ is the $\mathbb{Z}[v, v^{-1}]$ -algebra generated by $\{\delta_s\}_{s \in S}$ with relations

$$\begin{cases} (\delta_s + v)(\delta_s - v^{-1}) = 0 & \text{for all } s \in S \\ \underbrace{\delta_s \delta_t \cdots}_{m_{st}} = \underbrace{\delta_t \delta_s \cdots}_{m_{st}} & \text{if } m_{st} < \infty \end{cases}$$

Notice that $\mathbf{H}_{(W,S)}$ can be seen as the quotient of the group algebra of the braid group B_W over $\mathbb{Z}[v, v^{-1}]$, by the above v -deformed version of the involution relation in W .

By the first relation, the elements δ_s are invertible: namely

$$\delta_s^{-1} = \delta_s + v - v^{-1}.$$

One endows $\mathbf{H}_{(W,S)}$ with the \mathbb{Z} -linear ring involution $\overline{(\cdot)}$, called *duality*, determined by $\overline{v} = v^{-1}$ and $\overline{\delta_s} = \delta_s^{-1}$.

1.2.2. Basic properties of the Hecke algebra. Here we recall some well-known properties of $\mathbf{H}_{(W,S)}$. See [16, Ch. 5-6], [20, IV, § 2 Ex. 23], or [38, Ch. 7]:

- (i) The Hecke algebra is a free $\mathbb{Z}[v, v^{-1}]$ -module with a *standard* basis $\{\delta_w\}_{w \in W}$, where $\delta_w := \delta_{s_1} \delta_{s_2} \cdots \delta_{s_k}$ for any reduced expression $\underline{w} = s_1 s_2 \cdots s_k$ for w . Then all the basis elements are invertible.
- (ii) The dual of the basis element δ_w is δ_w^{-1} .

- (iii) The Hecke algebra also admits a *canonical* basis $\{b_w\}_{w \in W}$, introduced by Kazhdan and Lusztig [46], which is self-dual, $\overline{b_w} = b_w$, and uni-triangular with respect to the standard basis in the Bruhat order:

$$b_w = \sum_{x \leq w} h_{x,w} \delta_x,$$

with $h_{w,w} = 1$. The elements $h_{x,w}$, belong to $\mathbb{Z}[v]$ and are called *Kazhdan-Lusztig polynomials*.

Remark 1.8. These polynomials actually belong to $\mathbb{N}[v]$. This was shown by Kazhdan and Lusztig [47] for the Weyl group case and by Elias and Williamson [35] in general, as a consequence of Soergel's conjecture (see Remark 2.5 (ii) below).

Then we can define (see [34, § 2.4]) a *standard trace* $\epsilon : \mathbf{H}_{(W,S)} \rightarrow \mathbb{Z}[v, v^{-1}]$ by

$$\epsilon\left(\sum_{w \in W} a_w \delta_w\right) := a_1.$$

Notice that it satisfies $\epsilon(hh') = \epsilon(h'h)$ for all h, h' in $\mathbf{H}_{(W,S)}$.

Let then ω be the ring anti-involution

$$\omega : \mathbf{H}_{(W,S)}^{\text{op}} \rightarrow \mathbf{H}_{(W,S)}$$

such that $\omega(b_s) = b_s$, for all $s \in S$ and $\omega(v) = v^{-1}$. This allows to define a *standard pairing*

$$(\cdot, \cdot) : \mathbf{H}_{(W,S)} \times \mathbf{H}_{(W,S)} \rightarrow \mathbb{Z}[v, v^{-1}],$$

by $(h, h') := \epsilon(h'\omega(h))$. This is semi-linear over $\mathbb{Z}[v, v^{-1}]$: we have $(v^{-1}h, h') = (h, vh')$. One can easily check that the element b_s is self-biadjoint with respect to this pairing, which means:

$$(b_s h, h') = (h, b_s h'), \quad (h b_s, h') = (h, h' b_s).$$

1.2.3. The affine Hecke algebra. When we take (W, S) to be the Coxeter system corresponding to the affine Weyl group, we obtain the associated *affine Hecke algebra* \mathbf{H} . This is the case that will concern us more, so we now explore some of its special features.

Let us start by some observations about W and the affine braid group B_W .

- (i) Let $\mu, \nu \in \mathbb{Z}\Phi^\vee$ be dominant. Then $\ell(t_{\mu+\nu}) = \ell(t_\mu) + \ell(t_\nu)$. One can easily see this using the characterization of the length of $w \in W$ as the number of affine hyperplanes separating the fundamental alcove A_0 from $w(A_0)$.
- (ii) Consider positive lifts τ_μ and τ_ν in B_W of t_μ and t_ν respectively. Then $\tau_\mu \tau_\nu = \tau_\nu \tau_\mu$. In fact, by (i), they are both equal to the positive lift $\tau_{\mu+\nu}$ of $t_{\mu+\nu}$.
- (iii) Then we also have $\tau_\nu^{-1} \tau_\mu = \tau_\mu \tau_\nu^{-1}$.
- (iv) Consider $\lambda \in \mathbb{Z}\Phi^\vee$ and write $\lambda = \mu - \nu$ with μ and ν dominant. Then we can define $\tau_\lambda := \tau_\mu \tau_\nu^{-1}$. By the preceding points this does not depend on the choice of μ and ν .

(v) These τ_λ 's have the property that $\tau_{\lambda_1}\tau_{\lambda_2} = \tau_{\lambda_1+\lambda_2}$.

In other words, the lattice $\mathbb{Z}\Phi^\vee$ embeds not only inside W but also inside B_W .

If we now pass to the Hecke algebra, we get, for $\lambda \in \mathbb{Z}\Phi^\vee$, the elements

$$\theta_\lambda := \delta_{t_\mu} \delta_{t_\nu}^{-1}$$

which give a commutative subalgebra of \mathbf{H} . This is the lattice subalgebra mentioned in the introduction. In the next chapter we will describe a category whose Grothendieck group is isomorphic to \mathbf{H} and we will introduce the objects corresponding to these θ_λ 's.

To conclude this chapter, we mention now an alternative presentation of the affine Hecke algebra, in terms of this subalgebra and the finite Hecke algebra, reflecting the definition of W as the semidirect product of W_f and $\mathbb{Z}\Phi^\vee$.

1.2.4. The Bernstein presentation. Consider the the $\mathbb{Z}[v, v^{-1}]$ -algebra \mathbf{H}_B given by the following presentation. We take generators corresponding to the finite Hecke algebra and the translation lattice, namely δ_{s_α} and $\theta_{\alpha^\vee}^{\pm 1}$ for $\alpha \in \Delta$. Then we impose the usual relations between the δ_s 's, and the additional relations

$$\begin{cases} \theta_{\alpha^\vee} \theta_{\alpha^\vee}^{-1} = \theta_{\alpha^\vee}^{-1} \theta_{\alpha^\vee} = 1 & \alpha \in \Delta, \\ \theta_{\alpha^\vee} \theta_{\beta^\vee} = \theta_{\beta^\vee} \theta_{\alpha^\vee}, & \alpha, \beta \in \Delta, \\ \delta_{s_\alpha} \theta_{s_\alpha(\beta^\vee)} - \theta_{\beta^\vee} \delta_{s_\alpha} = (v - v^{-1}) \frac{\theta_{\beta^\vee} - \theta_{s_\alpha(\beta^\vee)}}{1 - \theta_{\alpha^\vee}} & \alpha, \beta \in \Delta. \end{cases}$$

The fraction in the second relation is well defined, because, if $n = \langle \alpha, \beta^\vee \rangle$, then

$$\begin{aligned} \theta_{\beta^\vee} - \theta_{s_\alpha(\beta^\vee)} &= \theta_{\beta^\vee} (1 - \theta_{s_\alpha(\beta^\vee) - \beta^\vee}) = \theta_{\beta^\vee} (1 - \theta_{n\alpha^\vee}) \\ &= \theta_{\beta^\vee} (1 - \theta_{\alpha^\vee}) (1 + \theta_{\alpha^\vee} + \cdots + \theta_{(n-1)\alpha^\vee}). \end{aligned}$$

Then, for $\lambda \in \mathbb{Z}\Phi^\vee$ we can define θ_λ in the natural way: if $\lambda = \sum_{\alpha \in \Delta} n_\alpha \alpha^\vee$, then $\theta_\lambda := \prod_{\alpha \in \Delta} \theta_{\alpha^\vee}^{n_\alpha}$. This is well defined by the commutativity relation, and we obviously have $\theta_{\lambda_1} \theta_{\lambda_2} = \theta_{\lambda_1 + \lambda_2}$. The second relation then generalizes as

$$\delta_{s_\alpha} \theta_{s_\alpha(\lambda)} - \theta_\lambda \delta_{s_\alpha} = (v - v^{-1}) \frac{\theta_\lambda - \theta_{s_\alpha(\lambda)}}{1 - \theta_{\alpha^\vee}}.$$

Then one can prove that this is a presentation for the same algebra (see [39]).

Theorem. *The obvious map from \mathbf{H}_B to \mathbf{H} is an isomorphism of algebras.*

Remark. The first published version of this presentation appeared in a paper by Lusztig [57], based on previous, unpublished, work by Bernstein, partly in collaboration with Zelevinsky.

Chapter 2

The Hecke category and Wakimoto sheaves

In this chapter we give a precise definition of Wakimoto sheaves. First we introduce the (diagrammatic) Hecke category for a general realization of a Coxeter system, then we introduce Rouquier complexes and the modular version of the mixed derived category. Finally we give a precise formulation of the main problem of this thesis: studying the extension groups between Wakimoto sheaves.

2.1 The diagrammatic Hecke category

In this section we recall the construction, by Elias and Williamson [34], of the *diagrammatic Hecke category* associated with (a realization of) an arbitrary Coxeter system. First we give some motivation concerning the origin and the role of this category.

2.1.1. Motivation. Our goal is to give a categorification of the Hecke algebra associated to a Coxeter system, as defined in §1.2.1. Consider first the case of the Weyl group of a reductive algebraic group. As mentioned in the introduction, in this case, a natural candidate is the category of equivariant parity sheaves over the corresponding flag variety.

Let us restrict for a moment to the case of characteristic zero coefficients, when this category is equivalent to that of equivariant semisimple complexes. Soergel [65] gave a purely algebraic description of this category, via the equivariant cohomology functor. Let \mathfrak{h} be the Lie algebra of the torus T , so that $R = S(\mathfrak{h}^*)$ is the T -equivariant cohomology of a point: then the equivariant cohomology of any sheaf can be shown to be a module over $R \otimes R$, so, as R is commutative, an R -bimodule. Soergel showed that this functor is fully faithful and characterized the essential image as a certain full subcategory of the category of graded R -bimodules, that only depends on the action of W on \mathfrak{h} . This category of *Soergel bimodules* can be obtained via Karoubi completion from the subcategory of Bott-Samelson bimodules (each of which corresponds to the direct image of the constant sheaf along the Bott-Samelson resolution of a Schubert variety). Then the indecomposable objects of the category correspond to

(shifts of) equivariant \mathcal{IC} sheaves.

The diagrammatic category, that we are going to describe, gives, under some assumptions, a presentation by generators and relations of this category. However, these assumptions typically fail in the modular setting, and the diagrammatic category turns out to be better behaved in this case. Furthermore, Riche and Williamson [60] proved that whenever the geometric Hecke category of parity sheaves is defined (i.e. when the Coxeter system is crystallographic), the two categories are equivalent (with an appropriate choice of realization). Hence, with some abuse, one can also simply speak about *the* Hecke category.

In this work we will use the diagrammatic language, so we will now describe this version of the category in more detail.

First we need some preliminary notions.

2.1.2. Two-colored quantum numbers. Consider the ring $\mathbb{Z}[x, y]$ and define $[1]_x := [1]_y := 1$ and $[2]_x := x$ and $[2]_y := y$. Then, recursively

$$\begin{aligned} [n+1]_x &:= [2]_x[n]_y - [n-1]_x, \\ [n+1]_y &:= [2]_y[n]_x - [n-1]_y. \end{aligned}$$

These are the *two-colored quantum numbers*. It is easy to see that if n is odd then $[n]_x = [n]_y$, so we will sometimes omit the index in this case.

Remark 2.1. If we consider the morphism $\mathbb{Z}[x, y] \rightarrow \mathbb{Z}[v, v^{-1}]$ sending both x and y to $v + v^{-1}$, the images of the two-colored quantum numbers are (the symmetrized version of) the usual quantum numbers:

$$[n]_x, [n]_y \mapsto \frac{v^n - v^{-n}}{v - v^{-1}} = v^{-n+1} + v^{-n+3} + \dots + v^{n-3} + v^{n-1}.$$

The two-colored version, as we will see, shares many properties with the usual one.

2.1.3. Realizations of Coxeter systems. Let (W, S) be a Coxeter system and \mathbb{k} a commutative ring. We consider a *realization* of W in the sense of [34, §3.1]. This consists in a free, finite rank, \mathbb{k} -module \mathfrak{h} , with distinguished elements $\{\alpha_s^\vee\}_{s \in S} \subset \mathfrak{h}$ and $\{\alpha_s\}_{s \in S} \subset \mathfrak{h}^* = \text{Hom}(\mathfrak{h}, \mathbb{k})$, that we call respectively *simple coroots* and *simple roots*, satisfying the following conditions.

- (i) If $\langle \cdot, \cdot \rangle : \mathfrak{h}^* \times \mathfrak{h} \rightarrow \mathbb{k}$ is the natural pairing, then $\langle \alpha_s, \alpha_s^\vee \rangle = 2$, for each $s \in S$.
- (ii) The \mathbb{k} -module \mathfrak{h} is a representation of W via

$$s(v) = v - \langle \alpha_s, v \rangle \alpha_s^\vee, \quad \forall v \in \mathfrak{h}, \forall s \in S. \quad (2.1)$$

Then W acts on \mathfrak{h}^* by the contragredient representation, described by similar formulas:

$$s(\lambda) = \lambda - \langle \lambda, \alpha_s^\vee \rangle \alpha_s, \quad \forall \lambda \in \mathfrak{h}^*, \forall s \in S. \quad (2.2)$$

There is also a third condition that needs some more notation to be phrased properly.

The action over simple roots and coroots is encoded in the coefficients¹ $a_{st} := \langle \alpha_s, \alpha_t^\vee \rangle$, that we store in the *Cartan matrix* $(a_{st})_{s,t \in S}$.

Let $R = S(\mathfrak{h}^*)$, with \mathfrak{h}^* in degree 2. The action of W on \mathfrak{h}^* defined by (2.2) extends naturally to R . We define, for each $s \in S$, the *Demazure operator* $\partial_s : R \rightarrow R$, via:

$$f \mapsto \frac{f - s(f)}{\alpha_s}.$$

Then, in particular, we have² $\partial_s(\alpha_t) = \langle \alpha_t, \alpha_s^\vee \rangle$.

Consider the morphism:

$$\phi_{st} : \mathbb{Z}[x, y] \rightarrow \mathbb{k},$$

sending x to $-\partial_s(\alpha_t)$ and y to $-\partial_t(\alpha_s)$. Then define:

$$[n]_s := \phi_{st}([n]_x), \quad [n]_t := \phi_{st}([n]_y).$$

Sometimes we will still refer to these elements in \mathbb{k} , which depend on the realization, as two-colored quantum numbers. Now we can state the third condition defining a realization.

(iii) for $s, t \in S$, if $m_{st} < \infty$, we assume that

$$[m_{st}]_s = [m_{st}]_t = 0$$

From condition (ii), by imposing that $(st)^{m_{st}}$ acts as the identity on simple roots, one obtains certain equations in terms of quantum numbers which make the above assumption quite natural. The two conditions are actually independent but we require the latter to ensure the *rotation invariance* of *Jones-Wenzl morphisms* which will be mentioned later. For more details, see [34, § 3.1].

Example 2.2. Here are some interesting examples of realizations (cf. [34, Ex. 3.3] and [60]).

(i) For any Coxeter group (W, S) one can consider the *geometric representation* $\mathfrak{h} := \bigoplus_{s \in S} \mathbb{R}\alpha_s^\vee$ with $\alpha_s \in \mathfrak{h}^*$ defined via $\langle \alpha_s, \alpha_t^\vee \rangle = -2 \cos(\pi/m_{st})$, with $m_{ss} := 1$ as usual, and $\pi/\infty := 0$. Then the simple roots are linearly independent if and only if W is finite. For example, if W is the Weyl group of type A_1 ,

$$W = \langle s, t \mid s^2 = t^2 = 1 \rangle,$$

then the only two off-diagonal entries in the Cartan matrix are -2 and $\alpha_t = -\alpha_s$. Notice that in this case the realization is defined over any ring \mathbb{k} .

(ii) If W_f is a Weyl group as in § 1.1.3, then one has a natural realization coming from the root datum. One takes $\mathfrak{h}^* = \mathbb{k} \otimes X$ (so $\mathfrak{h} = \mathbb{k} \otimes X^\vee$), and $\{\alpha_s\}$ and $\{\alpha_s^\vee\}$ to be the sets of simple roots and coroots respectively. One can also take \mathfrak{h} to be $\mathbb{k} \otimes \mathbb{Z}\Phi^\vee$ (then a natural assumption to make is that $\mathbb{k} \otimes \mathbb{Z}\Phi \times \mathbb{k} \otimes \mathbb{Z}\Phi^\vee \rightarrow \mathbb{k}$ is a perfect pairing so as to identify \mathfrak{h}^* with the base-changed root lattice).

¹For the notation, we follow Bourbaki [20]: notice that the pairing considered here is the transposed of that of [34], and [44].

²Notice that $\partial_s(\alpha_t)$ is the same as in [34], so this notation avoids transposition issues.

- (iii) For the affine case $W = W_{\mathfrak{f}} \ltimes \mathbb{Z}\Phi^\vee$, if $s \in S \setminus S_{\mathfrak{f}}$ is an affine simple reflection, consider the image of s under the projection $W \rightarrow W_{\mathfrak{f}}$. This will be a reflection associated to some positive coroot $\tilde{\alpha}^\vee$. Then we put $\alpha_s^\vee := -\tilde{\alpha}^\vee$ and $\alpha_s := -\tilde{\alpha}$. In this case neither $\{\alpha_s\}$, nor $\{\alpha_s^\vee\}$ are linearly independent. This is the realization considered in [60], up to a different choice of notation (exchanging roots and coroots). Notice that the action of W here factors through that of $W_{\mathfrak{f}}$.
- (iv) One can start with a *generalized Cartan matrix* $(a_{st})_{s,t \in S}$ (i.e. a matrix satisfying $a_{ss} = 2$, $a_{st} \in \mathbb{Z}_{\leq 0}$ and $a_{st} = 0 \Leftrightarrow a_{ts} = 0$) and build a realization as described in [44]. One considers the Kac-Moody Lie algebra \mathfrak{g} , defined by (a_{st}) , and takes \mathfrak{h} to be any \mathbb{Z} -lattice of the Cartan subalgebra of \mathfrak{g} , containing the coroot lattice and such that the dual lattice \mathfrak{h}^* contains the root lattice. In this way one obtains the *Kac-Moody* realization of the Weyl group W associated with \mathfrak{g} . Here both the simple roots and the simple coroots are linearly independent.
- (v) More generally, one can consider any *Kac-Moody root datum* associated to a generalized Cartan matrix as above. This is a free \mathbb{Z} -module of finite rank Λ with distinguished elements $\{\alpha_s\} \subset \Lambda$ and $\{\alpha_s^\vee\} \subset \text{Hom}(\Lambda, \mathbb{Z})$, such that $\alpha_s^\vee(\alpha_t) = a_{ts}$. Then one can take $\mathfrak{h}^* = \mathbb{k} \otimes \Lambda$ and $\mathfrak{h} = \mathbb{k} \otimes \text{Hom}(\Lambda, \mathbb{Z})$. From the same data one can construct a Kac-Moody ind-group scheme \mathcal{G} over \mathbb{Z} , with canonical Borel subgroup and a maximal torus, such that the character group of the latter identifies with Λ . Then \mathfrak{h} is a realization of the Weyl group associated to \mathcal{G} . Hence this example is a generalization of (ii).

2.1.4. Further assumptions on realizations. In this thesis we will only consider realizations that satisfy two additional conditions.

A realization is said *balanced* when, in addition to condition (iii), one also has:

$$[m_{st} - 1]_s = [m_{st} - 1]_t = 1.$$

This assumption, which makes the description of the diagrammatic category easier³, is actually very natural and satisfied, for instance, by all the realizations in Example 2.2.

We will also assume *Demazure surjectivity* (see [34, Ass. 3.9]), namely we suppose that, for each $s \in S$, the maps:

$$\langle \alpha_s, \cdot \rangle : \mathfrak{h} \rightarrow \mathbb{k} \quad \text{and} \quad \langle \cdot, \alpha_s^\vee \rangle : \mathfrak{h}^* \rightarrow \mathbb{k}$$

are surjective. In this case we can (and do) choose some $\delta_s \in \mathfrak{h}^*$ such that $\langle \delta_s, \alpha_s^\vee \rangle = 1$. Notice that if 2 is invertible in \mathbb{k} then this assumption always holds (take for instance $\delta_s = \alpha_s/2$). In the special case of the affine Weyl group of type \tilde{A}_1 , the invertibility of 2 is actually necessary to have Demazure surjectivity for the geometric and the natural realizations (Ex. 2.2 (i) and (iii), respectively).

³Namely, it makes the aforementioned Jones-Wenzl morphisms invariant not only by $2\pi/m_{st}$ rotations but also by π/m_{st} rotations. We will make this slightly more precise below.

2.1.5. Definition of the category. Given a realization \mathfrak{h} over \mathbb{k} of a Coxeter system (W, S) , one constructs the corresponding diagrammatic Hecke category $\mathcal{H} = \mathcal{H}(\mathfrak{h}, \mathbb{k})$. This is a \mathbb{k} -linear monoidal category enriched in graded R -bimodules. First one defines the Bott-Samelson category \mathcal{H}_{BS} by generators and relations, then one gets \mathcal{H} as the Karoubi envelope of the closure of \mathcal{H}_{BS} by direct sums and shifts.

- (i) The objects of \mathcal{H}_{BS} are generated by tensor product from objects B_s for $s \in S$. So a general object corresponds to a Coxeter word: if $\underline{w} = s_1 \dots s_n$, let $B_{\underline{w}}$ denote the object $B_{s_1} \otimes \dots \otimes B_{s_n}$. Let also $\mathbb{1}$ denote the monoidal unit, corresponding to the empty word.
- (ii) Morphisms in $\text{Hom}_{\mathcal{H}_{\text{BS}}}(B_{\underline{w}_1}, B_{\underline{w}_2})$ are \mathbb{k} -linear combinations of *Soergel graphs*, which are defined as follows.

- We associate a color to each simple reflection.
- A Soergel graph is then a colored, *decorated* planar graph contained in the planar strip $\mathbb{R} \times [0, 1]$, with boundary in $\mathbb{R} \times \{0, 1\}$.
- The bottom (and top) boundary is the arrangement of boundary points colored according to the letters of the source word \underline{w}_1 (and target word \underline{w}_2 , respectively).
- The edges of the graph are colored in such a way that those connected with the boundary have colors consistent with the boundary points.
- The other vertices of the graph are either:
 - (a) univalent (called *dots*), which are declared of degree 1, or;
 - (b) trivalent with three edges of the same color, of degree -1 , or;
 - (c) $2m_{st}$ -valent with edges of alternating colors corresponding to s and t , if $m_{st} < \infty$, of degree 0. By poetic licence, we also call them (s, t) -ars.

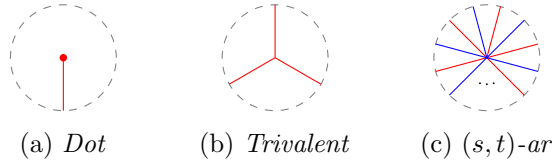

- Decorations are boxes labeled by homogeneous elements in R that can appear in any region (i.e. connected component of the complement of the graph): we will usually omit the boxes and just write the polynomials.

Then, composition of morphism is given by gluing diagrams vertically, whereas tensor product is given by gluing them horizontally. The identity morphism of the object $B_{\underline{w}}$ is the diagram with parallel vertical strands colored according to the word \underline{w} .

Notice that (s, t) -ars can be used to associate morphisms to applications of the braid relation. More precisely, consider a Coxeter word \underline{x} and let \underline{x}' be obtained via one application of a braid relation. Then we have a morphism $\beta : B_{\underline{x}} \rightarrow B_{\underline{x}'}$ obtained by tensoring the $2m$ -valent vertex, corresponding

to the braid relation used, with the appropriate identity morphisms on both sides, as in the following picture:

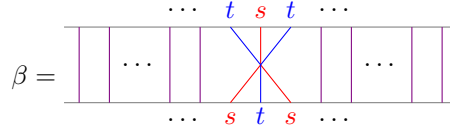

More generally, let \underline{x}' be obtained from \underline{x} via the braid move Φ . Recall that this is a sequence of applications of braid relations. Then we can consider the composition of the corresponding morphisms β as above. We call this composition $\beta(\Phi)$.

(iii) These diagrams are identified via some relations:

Polynomial relations. The first such relation says that whenever two polynomials are in the same region, they multiply. This gives morphism spaces the structure of R -bimodules, by acting on the leftmost or the rightmost region.

The other polynomial relations are:

Barbell relation: (2.3)

Sliding relation: (2.4)

One color relations. These are the following:

Frobenius associativity: (2.5)

Frobenius unit: (2.6)

Needle relation: (2.7)

Remark 2.3. Relations (2.5) and (2.6) could be phrased by saying that B_s is a *Frobenius algebra object* in the category \mathcal{H}_{BS} , which explains the terminology. This was pointed out in [31], see [33, Ch. 8] for a thorough discussion. In particular the object B_s is self-biadjoint. This means that we have natural isomorphisms

$$\begin{aligned} \text{Hom}_{\mathcal{H}}(B_s -, -) &\cong \text{Hom}_{\mathcal{H}}(-, B_s -) \\ \text{Hom}_{\mathcal{H}}(-B_s, -) &\cong \text{Hom}_{\mathcal{H}}(-, -B_s). \end{aligned}$$

These are given by the following units and counits (for both adjunctions):



and the zig-zag relations hold trivially by isotopy. Of course one should think that it is thanks to this property (on the level of Soergel bimodules, for example) that we can identify morphisms up to isotopy.

Two color relations. These allow to move dots, or trivalent vertices, across (s, t) -ars. We give the two versions, according to the parity of m_{st} :

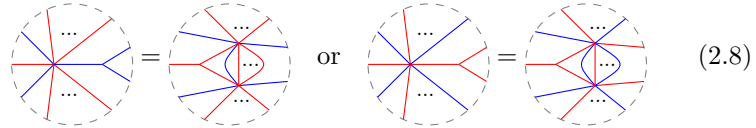

and

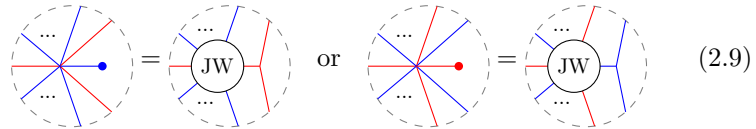

where the circles labeled JW are the *Jones-Wenzel morphisms*. These are certain \mathbb{k} -linear combinations of diagrams (with circular boundary and $2m_{st} - 2$ boundary points around it) that can be described in terms of the 2-colored Temperley-Lieb category⁴. One can show that the technical condition (iii) from § 2.1.3 ensures here that they are $2\pi/m_{st}$ -rotation invariant, and that the further assumption that \mathfrak{h} is balanced guarantees that the morphisms obtained by exchanging s and t and rotating by π/m_{st} are again the same. This is the π/m_{st} -rotation invariance that we mentioned above and makes the above relations unambiguous.

⁴More precisely, one can obtain them by deformation retract from a colored version of certain idempotents in the Temperley-Lieb algebra, which correspond to the highest weight irreducible summands inside tensor powers of the standard representation of $U_q(\mathfrak{sl}_2)$.

Here are the examples for the first few values of m_{st} :

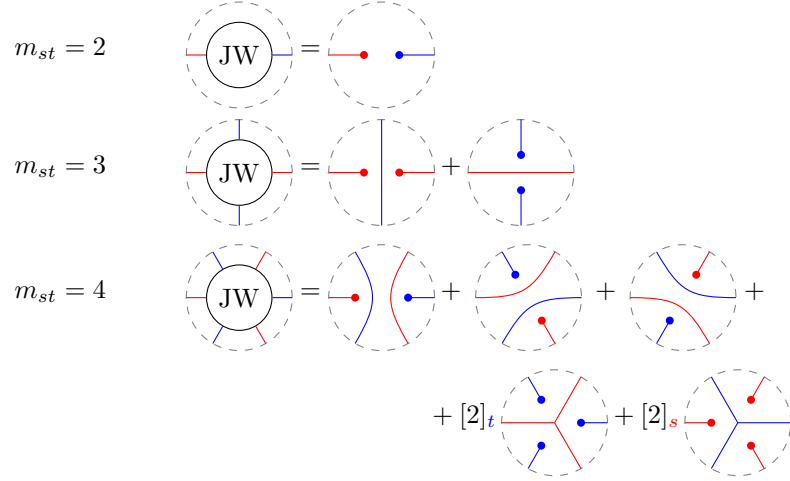

Notice that these are all the Jones-Wenzl morphisms that we need to handle with Coxeter groups of types A, B, D, E, F . In these cases, Relation (2.9) becomes:

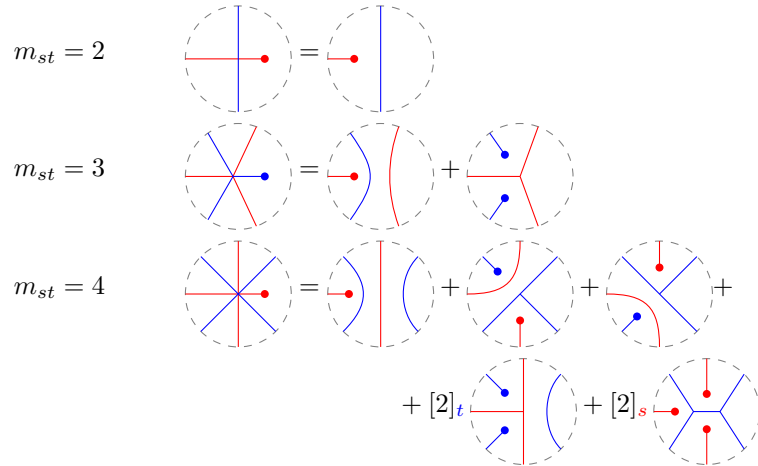

Later, according to need, we will recall some other properties of these morphisms. For further detail, we refer the reader to [34, § 5.2], [30] or [33, Ch. 8].

Three color relations. For each finite parabolic subgroup W_I of rank 3, there is a relation ensuring compatibility between the three corresponding $2m$ -valent vertices. More precisely, one considers the graph of reduced words for the longest element of W_I , where arrows correspond to applications of the braid relation. Then a path in this graph is a braid move connecting reduced words for the longest element. The corresponding three color relation imposes that, for a certain pair of paths Φ_1 and Φ_2 with the same starting and ending points, the two corresponding morphisms $\beta(\Phi_1)$ and $\beta(\Phi_2)$ are equal or equal modulo certain *lower terms*⁵.

⁵These are morphisms that factor through a shorter word. In all types but H_3 , one can

Actually, all loops in the graphs of reduced words for any element of W are generated, in a suitable sense, by the rank-3 ones (see [62]), so it is natural to expect that no relations with more than three colors are needed.

Notice that all the relations are homogeneous, so the morphism spaces are *graded* R -bimodules.

This completes the definition of \mathcal{H}_{BS} .

Example. Let $s, t, u \in S$ with $m_{st} = m_{su} = 2$ and $m_{tu} = 3$. Then the following diagram represents a morphism from $B_{stutust}$ to B_{utsu}

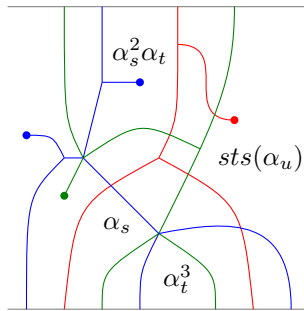

The interested reader can play around with the relations, for example trying to “move” all the polynomials towards the leftmost region (which will produce a combination of diagrams by Relation (2.4)). In the sequel we will sometimes omit the bottom and top lines.

Now we can finally give the main definition of this section.

Definition. The *diagrammatic Hecke category* \mathcal{H} is the Karoubi envelope of the closure of \mathcal{H}_{BS} by shifts and direct sums.

2.1.6. Categorification of the Hecke algebra. Let (\cdot) denote the shift in the polynomial grading and let $[\cdot]_{\oplus}$ denote the operation of taking the split Grothendieck group of an additive category. Notice that $[\mathcal{H}]_{\oplus}$ is naturally a $\mathbb{Z}[v, v^{-1}]$ -algebra: the ring structure is induced by the tensor product and the action of v corresponds to the shift (more precisely $v[B] := [B(1)]$). Hence we can state the following *categorification* result (see [34, § 6.6]).

Theorem 2.4. *If \mathbb{k} is a complete local ring, then*

(i) *there is a unique isomorphism of $\mathbb{Z}[v, v^{-1}]$ -algebras, called character,*

$$\text{ch} : [\mathcal{H}] \xrightarrow{\sim} \mathbf{H}_{(W,S)} \tag{2.10}$$

sending the class of B_s to b_s ;

actually make a choice of paths that gives an exact equality in terms of morphisms between Soergel bimodules, so that one can impose the corresponding relation without lower terms. For type H_3 , however, no such choice exists and, moreover, for no choice of paths, the exact lower terms that should be taken are currently known. This makes the relation not explicit, and then the definition of the category slightly incomplete, in this case. See [34, § 5].

- (ii) the category \mathcal{H} is Krull-Schmidt [34, Lemma 6.25], and the indecomposable objects are parametrized by elements of W . More precisely if \underline{w} is a reduced word for w , then there is a unique summand B_w in $B_{\underline{w}}$ that is not a summand of any $B_{\underline{x}}$ with $x \leq w$. Furthermore all indecomposable objects of \mathcal{H} , up to shift, appear in this way;
- (iii) if B and B' are objects in \mathcal{H} then $\text{Hom}(B, B')$ is free as a left (or right) graded R -module and its graded rank is

$$\text{grk Hom}(B, B') = (\text{ch}(B), \text{ch}(B')) \tag{2.11}$$

where (\cdot, \cdot) is the standard pairing from § 1.2.2.

Remark 2.5. (i) Via the isomorphism of the theorem, the indecomposable correspond to a basis of $\mathbf{H}_{(W,S)}$ over $\mathbb{Z}[v, v^{-1}]$. Consider realizations as in Example 2.2 (ii) and (iii). Then one can show (see for example [42]) that this basis only depends on the type of the root datum and on the characteristic p of the residue field of \mathbb{k} . This is the p -canonical basis of $\mathbf{H}_{(W,S)}$ that we mentioned in the introduction. This appeared in new⁶ character formulas for tilting and simple modules: see the work of Achar, Makisumi, Riche and Williamson [4] and the already mentioned [60].

- (ii) Soergel [66] conjectured that, if \mathbb{k} is a characteristic zero field, then

$$\text{ch}(B_w) = b_w.$$

In other words that the 0-canonical basis coincides with the Kazhdan-Lusztig basis. For realizations over \mathbb{R} , this was proved by Elias and Williamson [35]. As we mentioned, this shows the positivity of the coefficients of Kazhdan-Lusztig polynomials: in fact the character can be defined in terms of graded ranks of certain morphism spaces in (quotients of) the Hecke category.

- (iii) Suppose that $\text{char}(\mathbb{k}) \neq 2$ and that the realization \mathfrak{h} is *reflection faithful*. This means that it is a faithful representation of W such that there is a bijection between the reflections of W and the codimension one subspaces of \mathfrak{h} fixed by some $w \in W$. Then \mathcal{H} is equivalent to the category of Soergel bimodules, see [34, Theorem 6.30]. Reflection faithfulness is the assumption mentioned in § 2.1.1 and it is, for instance, rarely satisfied by realizations of affine Weyl groups in positive characteristic.

Example 2.6. The basic example of a diagrammatic computation in \mathcal{H} is the following (see [34, § 5]). If $s \in S$, then

$$B_s \otimes B_s \cong B_s(-1) \oplus B_s(1)$$

In fact consider the maps:

$$\iota_1 = \begin{array}{c} \delta_s \\ \diagdown \quad \diagup \\ \text{---} \end{array}, \quad \pi_1 = \begin{array}{c} \text{---} \\ \diagup \quad \diagdown \\ \text{---} \end{array}, \quad \iota_2 = \begin{array}{c} \text{---} \\ \diagup \quad \diagdown \\ \text{---} \end{array}, \quad \pi_2 = - \begin{array}{c} \text{---} \\ \diagdown \quad \diagup \\ \text{---} \\ s(\delta_s) \end{array}.$$

⁶The Lusztig conjecture was proved to hold for p very large, but Williamson [69] showed that the values of p for which the statement does not hold grow exponentially.

Then one can check that:

$$\begin{aligned} p_1 i_1 &= \text{id}_{B_s(-1)}, & p_1 i_2 &= 0, \\ p_2 i_2 &= \text{id}_{B_s(1)}, & p_2 i_1 &= 0, \end{aligned}$$

and $i_1 p_1 + i_2 p_2 = \text{id}_{B_s B_s}$.

This decomposition lifts the following equality, easy to check, in the Hecke algebra:

$$b_s b_s = (v + v^{-1})b_s.$$

2.1.7. Relation with the geometric version. We conclude by saying a word about the *geometric Hecke category*. We will not introduce it precisely but simply describe its relation with the diagrammatic one.

Consider the setting (and the notation) of § 1.1.3, with G defined over the complex numbers. The flag variety G/B has a well known stratification by *Bruhat cells*

$$G/B = \bigsqcup_{w \in W_f} BwB/B$$

where each stratum BwB/B is an affine space $\mathbb{A}^{\ell(w)}$.

One can then construct the category \mathcal{H}^g of B -equivariant parity sheaves, in the sense of [43], over G/B with coefficients in \mathbb{k} . This is endowed with a convolution operation which makes it a monoidal category.

One can define a subcategory \mathcal{H}_{BS}^g of *Bott-Samelson objects*, generated, by convolution, by the shifted constant sheaves $\mathcal{E}_s := \mathbb{k}_{P_s/B}[1]$ over the closures $\overline{BsB/B}$, for $s \in S$, which are the subvarieties $P_s/B \cong \mathbb{P}^1$ corresponding to minimal parabolic subgroups P_s .

The split Grothendieck ring of this category (the multiplication by v corresponds in this version to the cohomological shift) is isomorphic to \mathbf{H}_f , with $[\mathcal{E}_s] = b_s$, for $s \in S$.

If $\text{char}(\mathbb{k}) = 0$, then, thanks to the Decomposition Theorem, this category is equivalent to that of semisimple complexes (they actually are the same subcategory of $\mathcal{D}_B^b(G/B, \mathbb{k})$).

Riche and Williamson [60] showed that, for general \mathbb{k} (with 2 invertible in some cases), the category \mathcal{H}_{BS}^g is equivalent to \mathcal{H}_{BS} with the realization of W_f from Example 2.2 (ii). If furthermore \mathbb{k} is a complete local ring then the entire categories \mathcal{H} and \mathcal{H}^g are also equivalent.

In a similar way, let I be the Iwahori subgroup of $G((t))$ corresponding to B . One can consider the affine flag variety $G((t))/I$. This is an ind-variety which has an analogous (infinite) stratification, called *Cartan decomposition*,

$$G((t))/I = \bigsqcup_{w \in W} IwI/I,$$

where again each stratum IwI/I is an affine space $\mathbb{A}^{\ell(w)}$.

For simplicity, let us assume that G is simply connected. The diagrammatic category corresponding to the realization of W from Example 2.2 (iii) is equivalent to the category of I -equivariant parity sheaves on the connected component of $G((t))/I$ containing the base point I/I (see [60, Theorem 10.16]).

In this case then, with the same assumption on \mathbb{k} as before, either version categorifies \mathbf{H} and is called *affine Hecke category*.

More generally, one can consider the setting of Example 2.2 (v) and construct the corresponding Kac-Moody flag variety over the complex numbers⁷. Then again the corresponding category of parity sheaves agrees with the diagrammatic one (see [60, Theorem 10.5]).

We conclude this section by describing a fundamental tool for the sequel: some special maps forming bases of morphism spaces in the Hecke category.

2.1.8. Light leaves and double leaves. Let \underline{w} be a Coxeter word and \underline{x} a subword which is reduced. One can construct, in the space $\mathrm{Hom}_{\mathcal{H}}(B_{\underline{w}}, B_{\underline{x}})$, some special morphisms called the *light leaves maps*, that were introduced by Libedinsky in [53], and described diagrammatically in [34]. Then, one can use these maps to construct an explicit basis of the general morphism space $\mathrm{Hom}_{\mathcal{H}}(B_{\underline{w}_1}, B_{\underline{w}_2})$ as a left R -module. Let us recall this construction more precisely.

For a Coxeter word $\underline{w} = s_1 \cdots s_k$, and a subexpression (or 01-sequence) $\mathbf{e} = (e_1, \dots, e_k) \in \{0, 1\}^k$, we say that \mathbf{e} *expresses* the element $x \in W$ if $x = s_1^{e_1} \cdots s_k^{e_k}$ (where $s_i^0 := 1$): in this case we write $x = \underline{w}^{\mathbf{e}}$.

Let \underline{x} be a reduced subword of \underline{w} , corresponding to the element x in W . The light leaves maps in $\mathrm{Hom}(B_{\underline{w}}, B_{\underline{x}})$ are labeled by 01-sequences expressing x in the following way.

A 01-sequence determines the elements $x_i := \underline{w}_{\leq i}^{\mathbf{e}_{\leq i}} \in W$, where $\underline{w}_{\leq i}$ is the word consisting of the first i letters of \underline{w} and $\mathbf{e}_{\leq i}$ is the 01-sequence consisting of the first i symbols of \mathbf{e} . This describes a path along the Bruhat graph, called *Bruhat stroll*, which allows us to *decorate* \mathbf{e} . The idea is that, at each step i , we consider the position where the next simple reflection *would* bring us, regardless of the fact that this reflection will actually be taken or not, and we decorate the corresponding symbol in \mathbf{e} in the following way.

- if $x_i s_{i+1} > x_i$ then we decorate e_{i+1} with a U (for “up”: taking the reflection s_{i+1} *would* bring us up in the Bruhat graph);
- if $x_i s_{i+1} < x_i$ then we decorate it with a D (for “down”).

We can then construct a morphism $L_{\underline{w}, \mathbf{e}} : B_{\underline{w}} \rightarrow B_{\underline{x}}$ from this data. This will actually depend on some choices.

Definition. First, choose, for each i , a reduced expression \underline{x}_i for x_i . We define $L_{\underline{w}, \mathbf{e}}$ by induction. Let λ_0 to be $\mathrm{id}_{\mathbb{1}}$. Then, suppose we have constructed a morphism $\lambda_i : B_{\underline{w}_{\leq i}} \rightarrow B_{\underline{x}_i}$, and consider the decorated value of e_{i+1} .

- (i) If $e_{i+1} = U0$, then $x_i = x_{i+1}$ and we choose a braid move Φ from \underline{x}_i to \underline{x}_{i+1} .
- (ii) If $e_{i+1} = U1$, then $x_{i+1} = x_i s_{i+1}$ and we choose a braid move Φ from the reduced word $\underline{x}_i s_{i+1}$ to \underline{x}_{i+1} .
- (iii) If $e_{i+1} = D0$, then s_{i+1} belongs to the right descent of x_i and we choose a braid move Ψ from \underline{x}_i to a word of the form $\underline{z} s_{i+1}$ (that exists by the

⁷One can also take varieties defined over any algebraically closed field K and work with étale sheaves. In this case one takes \mathbb{k} to be the algebraic closure, or a finite extension, of \mathbb{Q}_ℓ , or its ring of integer, or its residue field (of characteristic ℓ), with ℓ prime to the characteristic of K .

Exchange property from § 1.1.2). Furthermore, we choose another braid move Φ from the latter to \underline{x}_{i+1} .

- (iv) Finally, if $e_{i+1} = D1$, then we choose, as in the previous case, a braid move Ψ from \underline{x}_i to $\underline{z}s_{i+1}$. This time \underline{z} is a reduced expression for x_{i+1} and we choose another braid move Φ from \underline{z} to \underline{x}_{i+1} .

Then λ_{i+1} is defined by one of the following diagrams, according to the decorated value of e_{i+1} :

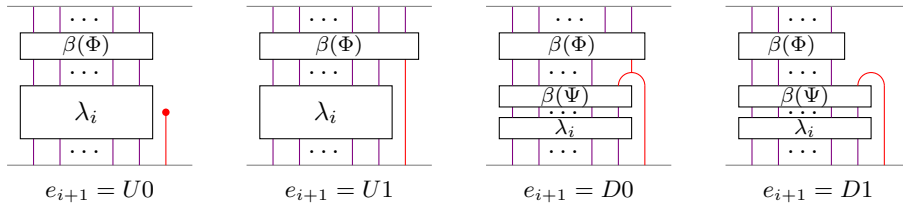

Then one can check that the ending word of λ_{i+1} is the reduced word \underline{x}_{i+1} and the induction can continue.

Finally we define $L_{w,e}$ to be $\lambda_k \in \text{Hom}_{\mathcal{H}}(B_w, B_x)$.

Example 2.7. Let $w = stsuts$, with $m_{st} = 3$, and $x = st$. Consider the subexpression $e = 111001$ expressing x . One can check that the corresponding decoration of e is:

$$U1U1U1U0D0D1.$$

Hence this is the construction of $L_{w,e}$.

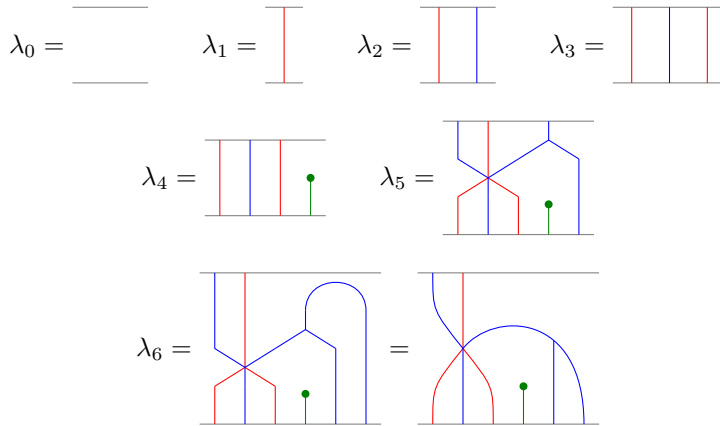

Now consider two braid words w_1 and w_2 . We want to construct an R -basis for $\text{Hom}(B_{w_1}, B_{w_2})$. Consider the *flip operation* (\cdot) on diagrams, consisting of flipping diagrams upside down. Now, for each pair of 01-sequences e_1 of w_1 and e_2 of w_2 such that $w_1^{e_1} = w_2^{e_2}$ we pick a *choice of* morphism L_{w_1, e_1} and a *choice of* morphism L_{w_2, e_2} as defined above. This means that we make a choice for all the needed reduced words and braid moves and consider the corresponding light leaves maps. Let then $\mathbb{L}_{w_1, w_2} \subset \text{Hom}(B_{w_1}, B_{w_2})$ be the set of the compositions $\overline{L_{w_2, e_2}} \circ L_{w_1, e_1}$. Then we have the following (see [34, Theorem 6.12]).

Theorem 2.8. *The set \mathbb{L}_{w_1, w_2} is a basis of $\text{Hom}_{\mathcal{H}}(B_{w_1}, B_{w_2})$.*

Morphisms as those in \mathbb{L}_{w_1, w_2} are called *double leaves maps*.

2.2 Rouquier complexes and Wakimoto sheaves

In this section we introduce the Rouquier complexes in the homotopy category of the Hecke category and define the Wakimoto sheaves. This category can be seen as a modular version of the mixed derived category, following [6].

2.2.1. Rouquier complexes. Consider the homotopy category $\mathcal{K}^b(\mathcal{H})$. The monoidal structure of \mathcal{H} extends to $\mathcal{K}^b(\mathcal{H})$ via the usual definition of tensor product of complexes. Recall that this is as follows. Let $A^\bullet, B^\bullet \in \mathcal{K}^b(\mathcal{H})$, then:

$$(A^\bullet \otimes B^\bullet)^i = \bigoplus_{p+q=i} A^p \otimes B^q,$$

and the differential map, restricted to $A^p \otimes B^q$ is:

$$d \otimes \text{id} + (-1)^p \text{id} \otimes d. \quad (2.12)$$

Notice that the unit of \mathcal{H} , seen as a complex concentrated in degree 0, is the unit of $\mathcal{K}^b(\mathcal{H})$, and it will still be denoted by $\mathbb{1}$.

Consider the following *standard* and *costandard* complexes

$$\begin{array}{ccccccccccc} F_s = \cdots & \longrightarrow & 0 & \longrightarrow & 0 & \longrightarrow & B_s & \xrightarrow{\quad \color{red}{\uparrow} \quad} & \mathbb{1}(1) & \longrightarrow & 0 & \longrightarrow & \cdots \\ & & \color{green}{-2} & & \color{green}{-1} & & \color{green}{0} & & \color{green}{1} & & \color{green}{2} & & \\ F_s^{-1} = \cdots & \longrightarrow & 0 & \longrightarrow & \mathbb{1}(-1) & \xrightarrow{\quad \color{red}{\downarrow} \quad} & B_s & \longrightarrow & 0 & \longrightarrow & 0 & \longrightarrow & \cdots \end{array}$$

where the numbers in the middle row denote the cohomological degree in $\mathcal{K}^b(\mathcal{H})$. If $\sigma = \sigma_s^{\pm 1} \in \Sigma$, then let F_σ denote $F_s^{\pm 1}$. Then, for any braid word $\underline{\omega} = \sigma_1 \sigma_2 \dots \sigma_n$, with $\sigma_i \in \Sigma$, we put

$$F_{\underline{\omega}}^\bullet := F_{\sigma_1} \otimes F_{\sigma_2} \otimes \cdots \otimes F_{\sigma_n}.$$

In the sequel we will often omit tensor products. The objects of this form are called *Rouquier complexes*. They were introduced in [63] in terms of Soergel bimodules to categorify braid group actions on categories and study natural transformations between the induced endofunctors.

2.2.2. Basic properties of Rouquier complexes. These properties were first proved by Rouquier [63] in the language of Soergel bimodules.

Proposition 2.9. *One has the following.*

(i) *Let $s \in S$, then $F_s F_s^{-1} \cong F_s^{-1} F_s \cong \mathbb{1}$.*

(ii) *Let $s, t \in S$ with $m_{st} < \infty$, then*

$$\underbrace{F_s F_t F_s F_t \cdots}_{m_{st} \text{ times}} \cong \underbrace{F_t F_s F_t F_s \cdots}_{m_{st} \text{ times}}$$

Hence, for each pair of braid words $\underline{\omega}_1, \underline{\omega}_2$ expressing the same element $\omega \in B_W$, there is an isomorphism $F_{\underline{\omega}_1}^\bullet \cong F_{\underline{\omega}_2}^\bullet$. Furthermore:

(iii) (Rouquier Canonicity) for each $\underline{\omega}_1$ and $\underline{\omega}_2$ as above, we have

$$\mathrm{Hom}(F_{\underline{\omega}_1}^\bullet, F_{\underline{\omega}_2}^\bullet) \cong R,$$

and one can chose $\gamma_{\underline{\omega}_1}^{\underline{\omega}_2}$ such that the system $\{\gamma_{\underline{\omega}_1}^{\underline{\omega}_2}\}_{\underline{\omega}_1, \underline{\omega}_2}$ is transitive.

Let us skip the proof for the moment. The next chapter is devoted to Rouquier complexes and we will discuss these properties in more detail there. Let us just observe that, thanks to these properties, the Rouquier complex F_ω associated to $\omega \in B_W$ is well defined up to a canonical isomorphism.

2.2.3. Wakimoto sheaves. Let now W be an affine Weyl group of the form $W_f \ltimes \mathbb{Z}\Phi^\vee$ as in § 1.1.4. We refer to the notation therein.

Consider $\lambda \in \mathbb{Z}\Phi^\vee$ and write, as in § 1.2.3, $\lambda = \mu - \nu$ with μ and ν dominant. Then, with τ_μ and τ_ν positive lifts of t_μ and t_ν , we define the (modular) *Wakimoto sheaf* associated to λ as

$$\Theta_\lambda := F_{\tau_\mu} F_{\tau_\nu}^{-1}$$

By the observations in § 1.2.3 and Proposition 2.9, this definition does not depend on the choice of μ and ν . Furthermore, in the same way we have

$$\Theta_{\lambda_1} \Theta_{\lambda_2} \cong \Theta_{\lambda_1 + \lambda_2} \quad (2.13)$$

These are the objects categorifying the lattice part of the Hecke algebra, and our goal is to study the subcategory they form. More precisely we want to understand the morphism spaces:

$$\mathrm{Hom}_{\mathcal{K}^b(\mathcal{H})}(\Theta_{\lambda_1}, \Theta_{\lambda_2}[i]), \quad i \in \mathbb{Z}. \quad (2.14)$$

Then notice that (2.13) implies that $\Theta_{-\lambda}$ is dual to Θ_λ , hence one can reduce to the case $\lambda_2 = 0$, which means $\Theta_{\lambda_2} = \mathbb{1}$.

Let us conclude this chapter by considering the geometric setting and mentioning how one can interpret these objects there.

2.2.4. The mixed derived category. Let \mathcal{H}^g be the geometric affine Hecke category as introduced in § 2.1.7. Its homotopy category $\mathcal{K}^b(\mathcal{H}^g)$ was considered by Achar and Riche [6, § 3.5] as a modular version of the equivariant mixed derived category on the affine flag variety. For each stratum IwI/I , with $w \in W$, one can define *standard* and *costandard* sheaves $\Delta_w^{\mathrm{mix}}, \nabla_w^{\mathrm{mix}}$, which are the (modular) mixed versions of the classical standard and costandard sheaves in the equivariant derived category $\mathcal{D}_I^b(G((t))/I, \mathbb{k})$.

If $\lambda = \mu - \nu$, with μ and ν dominant as above, one can then define the (modular) Wakimoto sheaves

$$\Theta_\lambda := \Delta_{t_\mu}^{\mathrm{mix}} * \nabla_{t_\nu}^{\mathrm{mix}},$$

which are analogues of the classical Wakimoto sheaves considered by Mirković.

When s is a simple reflection, the standard and costandard sheaves look as follows:

$$\begin{array}{cccccccc}
 \Delta_s^{\text{mix}} = \dots & \longrightarrow & 0 & \longrightarrow & 0 & \longrightarrow & \mathcal{E}_s & \longrightarrow & \mathcal{E}_e\{1\} & \longrightarrow & 0 & \longrightarrow & \dots \\
 & & & & -2 & & -1 & & 0 & & 1 & & 2 \\
 \nabla_s^{\text{mix}} = \dots & \longrightarrow & 0 & \longrightarrow & \mathcal{E}_e\{-1\} & \longrightarrow & \mathcal{E}_s & \longrightarrow & 0 & \longrightarrow & 0 & \longrightarrow & \dots
 \end{array}$$

where $\{\cdot\}$ denotes the (cohomological) shift in the category of parity sheaves, which corresponds to the polynomial shift (\cdot) in the diagrammatic category and should not be confused with the cohomological shift $[\cdot]$ of the homotopy category $\mathcal{K}^b(\mathcal{H})$. The morphisms in the above complexes are given respectively by the unit $\text{id} \rightarrow i^*i_*$ and the counit $i^!i_! \rightarrow \text{id}$, where $i : \{I/I\} \hookrightarrow P_s/I \hookrightarrow G((t))/I$. Via the equivalences described in §2.1.7, these correspond precisely to the objects F_s and F_s^{-1} introduced above.

If $\underline{w} = s_1 s_2 \dots s_k$ is a reduced expression for $w \in W$, one has

$$\Delta_w^{\text{mix}} = \Delta_{s_1}^{\text{mix}} * \Delta_{s_2}^{\text{mix}} * \dots * \Delta_{s_k}^{\text{mix}}$$

and a similar equality holds for the costandard. Hence, if ω is a positive lift of w , then Δ_w^{mix} corresponds to F_ω and ∇_w^{mix} to $F_{\omega^{-1}}$, so this justifies the above definition of Wakimoto sheaves in the setting of Rouquier complexes.

Suppose \mathbb{k} is either a finite extension of \mathbb{Q}_ℓ or its ring of integers, or the residue field of the latter. Then, one can define a t-structure in $\mathcal{K}^b(\mathcal{H}^{\text{g}})$ whose heart \mathcal{P}^{mix} contains the standard and costandard sheaves above, and also the Wakimoto sheaves. This is the modular version of the category of mixed perverse sheaves. This category is stable under the composition of shifts $\{-1\}[1]$ which is called *Tate twist* and corresponds to the original one in terms of the Tate sheaf.

In this case, the realization functor $\mathcal{D}^{\text{mix}}(\mathcal{P}^{\text{mix}}) \rightarrow \mathcal{K}^b(\mathcal{H}^{\text{g}})$ is an equivalence. Hence the extension groups between objects in the heart can be computed as shifted morphism spaces in the ambient triangulated category. In particular, the extension groups between (modular) Wakimoto sheaves correspond to the spaces (2.14) above.

Chapter 3

Working with Rouquier complexes

As we want to compute morphisms between certain Rouquier complexes, it will be useful to introduce some tools to work with them.

In the first section of this chapter, we adapt the diagrammatic description of the Hecke category to a differential graded version of the category of Rouquier complexes. This will allow us to express morphisms easily. We use this description to recover in a purely combinatorial way the braid categorification results as well as the Rouquier formula.

The main result of this section is however that the objects $F_{\underline{\omega}}^{\bullet}$ introduced in §2.2.1 admit simpler, homotopy equivalent, versions $\bar{F}_{\underline{\omega}}$ obtained via Gaussian elimination. In the second section we will describe these objects and simplify the description of morphisms accordingly.

3.1 Soergel calculus with patches

We will consider the objects $F_{\underline{\omega}}^{\bullet}$ in the dg category of complexes $\mathcal{C}_{\text{dg}}(\mathcal{H})$ and describe morphism spaces between them using Soergel diagrams. Then the morphisms in the homotopy category are obtained as the cohomology at zero of the morphism complexes in $\mathcal{C}_{\text{dg}}(\mathcal{H})$. In this setting we will recover the fundamental properties of Rouquier complexes, namely those stated in Proposition 2.9. This approach will give an algorithm to determine explicitly the homotopy equivalence categorifying the braid relation. Furthermore we will give a diagrammatic proof of the Rouquier formula.

3.1.1. Notation for graded objects and complexes. Given a \mathbb{k} -linear additive category \mathcal{C} , a *graded object* is a family $\{A^q\}_{q \in \mathbb{Z}}$, where A^q is an object of \mathcal{C} for all $q \in \mathbb{Z}$. If A is an object of \mathcal{C} , then $A[-q]$ denotes the graded object whose only nonzero entry is A in degree q . The direct sum of graded objects is defined in a natural way, so that we can also write

$$\{A^q\}_{q \in \mathbb{Z}} = \bigoplus_{q \in \mathbb{Z}} A^q[-q].$$

A (degree 0) morphism of graded objects $A^\bullet = \{A^q\}$ and $B^\bullet = \{B^q\}$ is a family of morphisms

$$\{f^q : A^q \rightarrow B^q\}_{q \in \mathbb{Z}}.$$

This defines a category $\mathcal{G}_0(\mathcal{C})$ of graded objects. The *shift* functor [1] sends the graded object $\{A^q\}_{q \in \mathbb{Z}}$ to $\{A^{q+1}\}_{q \in \mathbb{Z}}$. Then one can define the *graded category* $\mathcal{G}(\mathcal{C})$ with the same objects and morphism spaces

$$\mathrm{Hom}_{\mathcal{G}(\mathcal{C})}(A^\bullet, B^\bullet) := \bigoplus_{p \in \mathbb{Z}} \mathrm{Hom}_{\mathcal{G}_0(\mathcal{C})}(A^\bullet, B^\bullet[p]).$$

The p -th graded piece is denoted by $\mathrm{Hom}^p(A^\bullet, B^\bullet)$ and its elements are said *homogeneous* of degree p . A complex in $\mathcal{C}(\mathcal{C})$ is then determined by a graded object A^\bullet endowed with an endomorphism $d : A^\bullet \rightarrow A^\bullet$ of degree 1, such that $d^2 = 0$. Viceversa, let $(\cdot)^{\mathrm{gr}} : \mathcal{C}(\mathcal{C}) \rightarrow \mathcal{G}(\mathcal{C})$ denote the forgetful functor sending (A^\bullet, d) to A^\bullet .

The *dg category* of complexes $\mathcal{C}_{\mathrm{dg}}(\mathcal{C})$ has the same objects as $\mathcal{C}(\mathcal{C})$ but the morphism space between the complexes A^\bullet and B^\bullet , is the dg \mathbb{k} -module whose underlying graded module is $\mathrm{Hom}_{\mathcal{G}(\mathcal{C})}(A^\bullet, B^\bullet)$, and the differential map is

$$\begin{aligned} \mathrm{Hom}^p(A^\bullet, B^\bullet) &\longrightarrow \mathrm{Hom}^{p+1}(A^\bullet, B^\bullet) \\ (f^q)_{q \in \mathbb{Z}} &\longmapsto (d_B^{q+p} \circ f^q - (-1)^p f^{q+1} \circ d_A^q). \end{aligned} \quad (3.1)$$

A homogeneous map f is said *closed* if it lies in the kernel of (3.1) and *exact* if it lies in the image. It is easy to see that closed degree zero maps are precisely morphisms in $\mathcal{C}(\mathcal{C})$, and exact degree zero maps are null-homotopic morphisms of complexes. Hence, the cohomology at zero of the dg module $\mathrm{Hom}^\bullet(A^\bullet, B^\bullet)$ is the space of morphisms in the category $\mathcal{K}(\mathcal{H})$.

Finally, let $\mathcal{G}^{\mathrm{b}}(\mathcal{C})$, $\mathcal{C}^{\mathrm{b}}(\mathcal{C})$, $\mathcal{C}_{\mathrm{dg}}^{\mathrm{b}}(\mathcal{C})$ and $\mathcal{K}^{\mathrm{b}}(\mathcal{C})$ denote the *bounded* subcategories, in the obvious sense.

3.1.2. A dg monoidal category of Rouquier complexes. Consider the Hecke category \mathcal{H} defined in §2.1.5 and take $\mathcal{C}_{\mathrm{dg}}(\mathcal{H})$. By the definition of \mathcal{H} , this is a dg monoidal category and the space $\mathrm{Hom}^\bullet(A^\bullet, B^\bullet)$ has the structure of dg R -bimodule, with an additional grading, inherited from the polynomial grading of \mathcal{H} . The shift in the polynomial grading is still denoted by (1) and the shift in the cohomological degree by [1], as in the homotopy category.

Hence one can consider the dg monoidal subcategory generated by the standard and costandard complexes

$$\mathcal{B}_W^{\mathrm{dg}} = \langle F_\sigma \mid \sigma \in \Sigma \rangle_{\oplus, \otimes, [\cdot]} \subset \mathcal{C}_{\mathrm{dg}}(\mathcal{H}).$$

Its objects will be direct sums of shifts of the $F_{\underline{\omega}}$'s. In this section we will extend the Elias-Williamson presentation to $\mathcal{B}_W^{\mathrm{dg}}$.

3.1.3. Diagrammatics. For a given subexpression \mathbf{i} of a braid word $\underline{\omega}$, let $\omega_{\mathbf{i}}$ denote the subword corresponding to it. Then let $B_{\mathbf{i}}$ be the Bott-Samelson object corresponding to the Coxeter projection of $\omega_{\mathbf{i}}$. For example, given

$$\underline{\omega} = \sigma_s \sigma_t \sigma_t \sigma_u^{-1},$$

and $\mathbf{i} = 0101$, we have $\underline{\omega}_{\mathbf{i}} = \sigma_t \sigma_u^{-1}$ and then $B_{\mathbf{i}} = B_{\underline{tu}} = B_t B_u$.

By definition of tensor product of complexes, we have

$$(F_{\underline{\omega}}^{\bullet})^{\text{gr}} = \bigoplus_{\mathbf{i} \in \{0,1\}^{\ell(\underline{\omega})}} B_{\mathbf{i}} \langle q_{\mathbf{i}} \rangle,$$

where $q_{\mathbf{i}} = \delta(\underline{\omega}) - \delta(\underline{\omega}_{\mathbf{i}})$ and $\langle 1 \rangle$ denotes the Tate twist $(1)[-1]$ (cf § 2.2.4). One can then compute the components of the differential map, according to (2.12). The only nonzero components $B_{\mathbf{i}} \rightarrow B_{\mathbf{i}'}$ are those for which \mathbf{i}' is obtained from \mathbf{i} by changing one symbol in such a way that $q_{\mathbf{i}'} = q_{\mathbf{i}} + 1$. In this case the component is either

$$(-1)^k \left[\begin{array}{|c|c|c|c|} \hline \dots & \bullet & \dots & \\ \hline \end{array} \right] \quad \text{or} \quad (-1)^k \left[\begin{array}{|c|c|c|c|} \hline \dots & \bullet & \dots & \\ \hline \end{array} \right]. \quad (3.2)$$

where k is the number of 0's in \mathbf{i} preceding the changed symbol.

Example 3.1. Let $s, t \in S$ and $\underline{\omega} = \sigma_s \sigma_s \sigma_t^{-1}$. Then the complex $F_{\underline{\omega}}^{\bullet} = F_s F_s F_t^{-1}$ is the following:

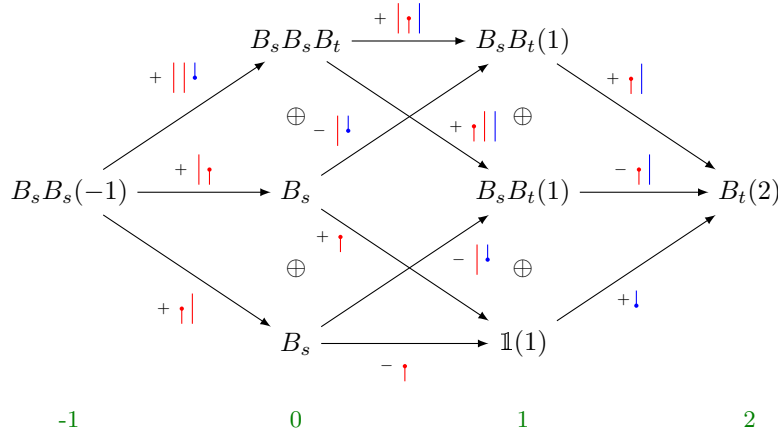

Let now $\underline{\omega}, \underline{\omega}' \in \mathfrak{W}_{\Sigma}$ and consider $\text{Hom}^{\bullet}(F_{\underline{\omega}}, F_{\underline{\omega}'})$. This decomposes as

$$\bigoplus_{\mathbf{i}, \mathbf{i}'} \text{Hom}_{\mathcal{H}}(B_{\mathbf{i}}, B_{\mathbf{i}'}) \langle q_{\mathbf{i}'} - q_{\mathbf{i}} \rangle \quad (3.3)$$

for an analogous definition of $B_{\mathbf{i}'}$ and $q_{\mathbf{i}'}$. Each of the summands of (3.3) is a morphism space in the diagrammatic Hecke category \mathcal{H} , so its elements are linear combinations of Soergel diagrams as described in § 2. Hence an element of $\text{Hom}^{\bullet}(F_{\underline{\omega}}, F_{\underline{\omega}'})$ is also a \mathbb{k} -linear combination of diagrams each of which lives in one of the summands above. To keep track of this information we write it as a linear combination of *dg diagrams*. A dg diagram is defined as follows.

(i) On the boundaries we always arrange all the letters for the source and target braid words and we use different styles for the boundary line according to the sign of the letters:

- the black line is for positive letters on the bottom boundary or negative letters on the top boundary;

- the white line is for all the other ones.

The reason for which we invert the colors on the top boundary will be clear very soon. For the empty word we only draw a normal line.

- (ii) The starting and ending words correspond to the 1's in the subexpressions \mathbf{i} and \mathbf{i}' , hence we cover with a *patch* \otimes every letter corresponding to a 0.
- (iii) A dg diagram is then a usual Soergel diagram whose boundary points are those which are not covered by patches.

Example 3.2. If $\omega = \sigma_s^3 \sigma_t^{-1} \sigma_u^{-1} \sigma_t$, and $\omega' = \sigma_s \sigma_t^{-2} \sigma_u^2$, then the following diagram represents a morphism in the summand $\text{Hom}_{\mathcal{H}}(B_{011111}, B'_{10101})$.

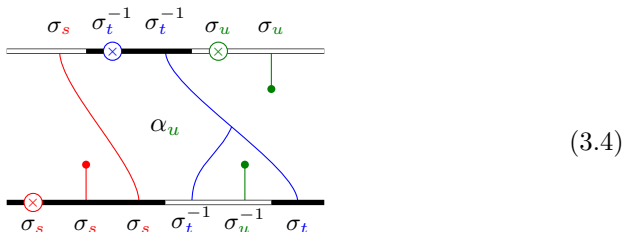

Remark 3.3. (i) We recover the cohomological degree p of a morphism from the patches: each patch counts $+1$ on the black line and -1 on the white line.

(ii) The polynomial degree of a diagram is $d - p$, if d is its degree as a Soergel diagram (as described in § 2.1.5) and p is its cohomological degree. This is due to the Tate twists in (3.3).

(iii) We can compute the differential map on the diagram according to (3.1) and (3.2), as follows. Consider the following operations:

Dot-sprouting:



Strand-uprooting:



Notice that we only allow the dot-sprouting operation on the black boundary, and the strand-uprooting on the white boundary. The image of a diagram via the differential map is the linear combination of all diagrams obtained by one of the above operations, with coefficients ± 1 according to (3.2). More precisely, when acting on the top boundary, if k is the number of patches on the left of the sprouted dot/uprooted strand, the sign is $(-1)^k$. The same rule applies to the bottom boundary but we also need to multiply by an additional $(-1)^{p+1}$ where p is the cohomological degree of the initial morphism. For example, the image via the differential

map of the above diagram is the combination below.

$$d \left(\begin{array}{c} \text{---} \circ \text{---} \circ \text{---} \\ \text{---} \circ \text{---} \end{array} \right) = \begin{array}{c} \begin{array}{c} \text{---} \circ \text{---} \circ \text{---} \\ \text{---} \circ \text{---} \end{array} \\ + \\ \begin{array}{c} \text{---} \circ \text{---} \circ \text{---} \\ \text{---} \circ \text{---} \end{array} \\ + \\ \begin{array}{c} \text{---} \circ \text{---} \circ \text{---} \\ \text{---} \circ \text{---} \end{array} \\ + \\ \begin{array}{c} \text{---} \circ \text{---} \circ \text{---} \\ \text{---} \circ \text{---} \end{array} \\ + \\ \begin{array}{c} \text{---} \circ \text{---} \circ \text{---} \\ \text{---} \circ \text{---} \end{array} \\ - \\ \begin{array}{c} \text{---} \circ \text{---} \circ \text{---} \\ \text{---} \circ \text{---} \end{array} \\ - \\ \begin{array}{c} \text{---} \circ \text{---} \circ \text{---} \\ \text{---} \circ \text{---} \end{array} \end{array}$$

In fact, we have three possibilities on top (uprooting the first or the last strand, or sprouting a dot over the blue patch) and three for the bottom (sprouting a dot on the red patch, or uprooting the middle blue strand or the green strand). Here the initial morphism has degree 1, hence the additional sign term for the bottom boundary is just +1.

- (iv) One can compose diagrams by gluing them vertically as before, but because the summands have to match, the composition is zero unless one has the same arrangement of patches on the gluing boundary line (notice also that, by our convention, we will glue two diagrams along boundary lines with complementary styles).
- (v) Recall that the monoidal structure of $\mathcal{C}_{\text{dg}}(\mathcal{H})$ respects the Koszul rule, hence the tensor product of two dg diagrams D_1 and D_2 is obtained by gluing them horizontally and multiplying by the sign $(-1)^{pq}$ where p is the cohomological degree of D_2 and q is the number of bottom patches of D_1 .
- (vi) The identity morphism of any $F_{\underline{\omega}}^{\bullet}$ is

$$\sum_{\mathbf{i}} \text{id}_{B_{\mathbf{i}}},$$

hence it is represented by the sum of all diagrams with the same arrangements of patches on top and on bottom and consisting in parallel vertical lines. For example, if $\underline{\omega} = \sigma_s^2 \sigma_t^{-1}$, then

$$\text{id}_{F_{\underline{\omega}}^{\bullet}} = \begin{array}{c} \text{---} \circ \text{---} \circ \text{---} \\ \text{---} \circ \text{---} \end{array} + \begin{array}{c} \text{---} \circ \text{---} \circ \text{---} \\ \text{---} \circ \text{---} \end{array} + \begin{array}{c} \text{---} \circ \text{---} \circ \text{---} \\ \text{---} \circ \text{---} \end{array} + \begin{array}{c} \text{---} \circ \text{---} \circ \text{---} \\ \text{---} \circ \text{---} \end{array} + \begin{array}{c} \text{---} \circ \text{---} \circ \text{---} \\ \text{---} \circ \text{---} \end{array} + \begin{array}{c} \text{---} \circ \text{---} \circ \text{---} \\ \text{---} \circ \text{---} \end{array} + \begin{array}{c} \text{---} \circ \text{---} \circ \text{---} \\ \text{---} \circ \text{---} \end{array} + \begin{array}{c} \text{---} \circ \text{---} \circ \text{---} \\ \text{---} \circ \text{---} \end{array}$$

and one can check for example that this is a closed degree zero morphism which is the neutral element of composition.

- (vii) By Theorem 2.8, each summand of (3.3) is a free R -module with a basis given by (a choice of) double leaves maps. Hence, if we collect all these bases together we have a basis for the whole morphism space. Recall that the elements of the basis of each $\text{Hom}(B_{\mathbf{i}}, B_{\mathbf{i}'})$ are labeled by subexpressions \mathbf{e} and \mathbf{e}' of the starting and ending words, which are in

turn determined by \mathbf{i} and \mathbf{i}' . It will be convenient to extend these subexpressions \mathbf{e} and \mathbf{e}' to the whole words $\underline{\omega}$ and $\underline{\omega}'$, by simply adding zeros where already \mathbf{i} or \mathbf{i}' have zeros. For example, the morphism (3.4), if we forget the α_u , is actually a double leaves map in $\text{Hom}(B_{\underline{sstut}}, B_{\underline{stu}})$, corresponding to the subexpressions 01100 of \underline{sstut} and 110 of \underline{stu} . The extended subexpressions that we want to consider are then **00**1100 and **10**100, where the additional zeros are boldface. Then notice that we can also decorate the new zeros and the decorations of the other symbols do not depend on whether we look at them in the original subexpression or in the extended one. Hence a basis for the whole space is labeled by quadruples $(\mathbf{i}, \mathbf{i}', \mathbf{e}, \mathbf{e}')$, with \mathbf{i} and \mathbf{e} subexpressions of $\underline{\omega}$ such that $\mathbf{i}_k \geq \mathbf{e}_k$, and \mathbf{i}' and \mathbf{e}' subexpressions of $\underline{\omega}'$ with the same property. The first two entries determine the source and target summands and the last two determine the double leaves map.

Before we pass to the properties of Rouquier complexes we introduce a notation that will turn out to be useful. Let $\underline{\omega}$ and $\underline{\omega}'$ be braid words and construct a (dg) double leaves basis of $\text{Hom}^\bullet(F_{\underline{\omega}}, F_{\underline{\omega}'})$ as in Remark 3.3 (vii). For L and L' double leaves maps of this set, we write

$$L \succ^d L'$$

if L' appears with a nonzero coefficient in the linear combination for $d(L)$.

3.1.4. Inverse relation. We now prove Proposition 2.9 in a completely combinatorial way.

The first property, namely $F_s F_s^{-1} \cong \mathbb{1}$, can be easily proven via Gaussian elimination (see § 3.2.1 below). Here we give an explicit description of the inverse isomorphisms.

Proof of Proposition 2.9 (i). For any $s \in S$, the following morphisms give mutually inverse homotopy equivalences:

$$F_s F_s^{-1} \begin{array}{c} \xrightarrow{\eta^-} \\ \xleftarrow{\epsilon^+} \end{array} \mathbb{1}, \quad F_s^{-1} F_s \begin{array}{c} \xrightarrow{\eta^+} \\ \xleftarrow{\epsilon^-} \end{array} \mathbb{1}. \quad (3.5)$$

Here

$$\begin{array}{l} \epsilon^+ = \begin{array}{c} \text{---} \circ \text{---} \circ \text{---} \\ \text{---} \end{array} + \begin{array}{c} \text{---} \\ \text{---} \end{array} \\ \epsilon^- = \begin{array}{c} \text{---} \circ \text{---} \circ \text{---} \\ \text{---} \end{array} - \begin{array}{c} \text{---} \\ \text{---} \end{array} \\ \eta^+ = \begin{array}{c} \text{---} \\ \text{---} \circ \text{---} \circ \text{---} \end{array} + \begin{array}{c} \text{---} \\ \text{---} \end{array} \\ \eta^- = \begin{array}{c} \text{---} \\ \text{---} \circ \text{---} \circ \text{---} \end{array} - \begin{array}{c} \text{---} \\ \text{---} \end{array} \end{array}$$

We treat the first one, the second being similar. One can easily obtain

$$\eta^- \epsilon^+ = \text{id}_1$$

from the rules of composition of dg diagrams. On the other hand we have:

$$\text{id}_{F_s F_s^{-1}} - \epsilon^+ \eta^- = \begin{array}{c} \text{---} \\ \text{---} \end{array} + \begin{array}{c} \text{---} \circ \text{---} \\ \text{---} \circ \text{---} \end{array} + \begin{array}{c} \text{---} \circ \text{---} \\ \text{---} \end{array} - \begin{array}{c} \text{---} \\ \text{---} \end{array} + \begin{array}{c} \text{---} \circ \text{---} \\ \text{---} \end{array} + \begin{array}{c} \text{---} \\ \text{---} \end{array}.$$

We want to show that this is exact, hence null-homotopic. Notice that, by (2.4), (2.5) and (2.6), we have

$$\begin{aligned}
 \begin{array}{c} \text{---} \\ | \\ \text{---} \end{array} &= \begin{array}{c} \text{---} \\ \delta_s \\ | \\ \text{---} \end{array} - \begin{array}{c} \text{---} \\ | \\ \text{---} \\ s(\delta_s) \\ | \\ \text{---} \end{array} = \begin{array}{c} \text{---} \\ \diagdown \\ \text{---} \\ \text{---} \\ \diagup \\ \text{---} \end{array} + \begin{array}{c} \text{---} \\ | \\ \text{---} \\ s(\delta_s) \\ | \\ \text{---} \end{array} + \begin{array}{c} \text{---} \\ \diagup \\ \text{---} \\ \text{---} \\ \diagdown \\ \text{---} \end{array} - \begin{array}{c} \text{---} \\ | \\ \text{---} \\ \delta_s \\ | \\ \text{---} \end{array} \\
 \begin{array}{c} \text{---} \\ \diagdown \\ \text{---} \\ \text{---} \\ \diagup \\ \text{---} \end{array} &= - \begin{array}{c} \text{---} \\ \diagup \\ \text{---} \\ s(\delta_s) \\ | \\ \text{---} \end{array} + \begin{array}{c} \text{---} \\ \diagdown \\ \text{---} \\ \delta_s \\ | \\ \text{---} \end{array} = - \begin{array}{c} \text{---} \\ | \\ \text{---} \\ s(\delta_s) \\ | \\ \text{---} \end{array} + \begin{array}{c} \text{---} \\ | \\ \text{---} \\ \delta_s \\ | \\ \text{---} \end{array}
 \end{aligned}$$

Hence the difference $\text{id}_{F_s F_s^{-1}} - \epsilon^+ \eta^-$ above becomes

$$\begin{array}{c} \text{---} \\ \diagdown \\ \text{---} \\ \text{---} \\ \diagup \\ \text{---} \end{array} + \begin{array}{c} \text{---} \\ \diagup \\ \text{---} \\ \text{---} \\ \diagdown \\ \text{---} \end{array} + \begin{array}{c} \text{---} \\ | \\ \text{---} \\ \otimes \\ | \\ \text{---} \end{array} + \begin{array}{c} \text{---} \\ | \\ \text{---} \\ \otimes \\ | \\ \text{---} \end{array} + \begin{array}{c} \text{---} \\ | \\ \text{---} \\ \otimes \\ | \\ \text{---} \end{array} - \begin{array}{c} \text{---} \\ \diagdown \\ \text{---} \\ \otimes \\ \diagup \\ \text{---} \end{array} + \begin{array}{c} \text{---} \\ \diagup \\ \text{---} \\ \otimes \\ \diagdown \\ \text{---} \end{array}$$

and one can check that this is

$$d \left(\begin{array}{c} \text{---} \\ \diagdown \\ \text{---} \\ \otimes \\ \diagup \\ \text{---} \end{array} + \begin{array}{c} \text{---} \\ \diagup \\ \text{---} \\ \otimes \\ \diagdown \\ \text{---} \end{array} \right)$$

□

3.1.5. Braid relation. We now pass to the braid relation. We will reduce the dg morphism space $\text{Hom}^\bullet(F_s F_t \dots, F_t F_s \dots)$ by describing a large null-homotopic dg submodule, and we will see that the quotient is just a copy of R in degree 0. This will give a canonical homotopy equivalence $F_s F_t \dots \rightarrow F_t F_s \dots$.

Definition 3.4. Let $s, t \in S$ such that st has order $m < \infty$ in W and let

$$\underline{\omega}_{s,t} = \underbrace{\sigma_s \sigma_t \sigma_s \dots}_{m \text{ times}} \quad \underline{\omega}_{t,s} = \underbrace{\sigma_t \sigma_s \sigma_t \dots}_{m \text{ times}}$$

Then we define $N_{s,t} \subset \text{Hom}^\bullet(F_{\underline{\omega}_{s,t}}^\bullet, F_{\underline{\omega}_{t,s}}^\bullet)$ to be the span of all homogeneous morphisms factoring through words with less than m symbols. This in particular contains all morphisms with staring or ending subexpressions different from $11\dots 1$.

Proposition 3.5. *We have:*

- (i) the space $N_{s,t}$ is a dg submodule of $\text{Hom}^\bullet(F_{\underline{\omega}_{s,t}}, F_{\underline{\omega}_{t,s}})$;
- (ii) the quotient is $R[0]$, i.e. we have a short exact sequence

$$0 \longrightarrow N_{s,t} \longrightarrow \text{Hom}^\bullet(F_{\underline{\omega}_{s,t}}, F_{\underline{\omega}_{t,s}}) \longrightarrow R[0] \longrightarrow 0; \quad (3.6)$$

- (iii) the dg-module $N_{s,t}$ is null-homotopic, hence the quotient map above is a homotopy equivalence.

Proof. (i) This is easy by the definition of the differential map: if a morphism factors through a shorter word then any morphism obtained after the sprouting of a dot or the uprooting of a strand will still factor through that shorter word.

- (ii) One can write a basis of double leaves maps for the whole morphism space such that the only one which does not factor through shorter words is the (s, t) -ar.
- (iii) By (ii) all the double leaves maps different from the (s, t) -ar are a basis of $N_{s,t}$. Observe that any subexpression different from $11\dots 1$ of a reduced word (such as $\underline{sts\dots}$) has to contain at least one $U0$. In fact it is sufficient to take the first 0 from the left: this has to be decorated with a U by reducedness. Then we can conclude by Lemma 3.6 below. □

Lemma 3.6. *Consider a morphism space $\text{Hom}^\bullet(F_{\underline{\omega}}, F_{\underline{\omega}'})$ and let N be a dg submodule spanned by double leaves that all contain some black $U0$. Then N is null-homotopic.*

Proof. Consider the double leaves basis of N and denote each double leaves map by a quadruple $(\mathbf{i}, \mathbf{i}', \mathbf{e}, \mathbf{e}')$ as before. Then define the following equivalence relation. We say that

$$(\mathbf{i}, \mathbf{i}', \mathbf{e}, \mathbf{e}') \sim (\mathbf{j}, \mathbf{j}', \mathbf{f}, \mathbf{f}')$$

if the following hold

- (i) the (decorated) subexpressions defining the double leaves agree: $(\mathbf{e}, \mathbf{e}') = (\mathbf{f}, \mathbf{f}')$;
- (ii) the subexpression defining the arrangement of the patches can only differ over black $U0$'s: the pair $(\mathbf{i}, \mathbf{i}')$ differs from $(\mathbf{j}, \mathbf{j}')$ only at black boundary points where the corresponding value of $\mathbf{e} = \mathbf{f}$ (or $\mathbf{e}' = \mathbf{f}'$) is $U0$.

Roughly speaking, two double leaves maps are equivalent when they only differ by the presence of patches (or boundary dots) in correspondence of black $U0$'s.

Now consider the following partial order on the set of equivalence classes determined by \sim . First we say that $C \succ C'$ if there are $L \in C$ and $L' \in C'$ such that $L \stackrel{d}{\succ} L'$. Then consider the transitive closure of this relation. By looking at the arrangements of patches one sees that this defines a (strict) partial order on the set of equivalence classes. Consider a total refinement of this partial order:

$$C_1 \leq C_2 \leq \dots \leq C_k.$$

Then define N_i as the span of the double leaves maps in C_1, \dots, C_i . By definition this gives a filtration by dg submodules

$$N_1 \subset N_2 \subset \dots \subset N_k.$$

The subquotients N_{i+1}/N_i are spanned by the double leaves maps from a single class and the differential acts only on the black $U0$'s. Then this dg module is isomorphic to $(R \xrightarrow{\text{id}} R)^{\otimes n_i}$ for some n_i . Hence it is null-homotopic. But then the whole N is null-homotopic. □

Example 3.7. Here is an example of a subquotient as above:

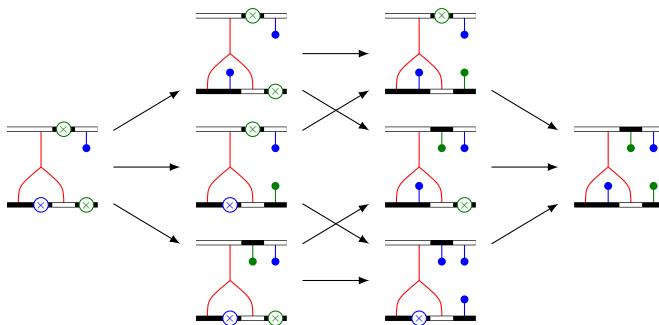

In this case it is isomorphic to $(R \xrightarrow{\text{id}} R)^{\otimes 3}$.

Now, taking cohomology at zero in the short exact sequence (3.6) gives a unique morphism in $\mathcal{K}^b(\mathcal{H})$ up to a polynomial. Furthermore the latter is the coefficient of the $2m$ -valent vertex in any representative in $\mathcal{C}_{\text{dg}}(\mathcal{H})$. Take $\gamma_{s,t}$ to be the morphism where this coefficient is 1. The following proves Proposition 2.9 (ii).

Proposition 3.8. *The morphisms $\gamma_{s,t}$ and $\gamma_{t,s}$ are inverse homotopy equivalences.*

Proof. Notice that combining relations (2.8) and (2.9), we obtain the following equality (the picture is for $m_{s,t}$ even):

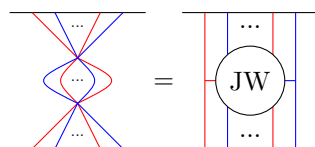

One can show that this is the identity (i.e. the morphism given by parallel vertical strands), modulo morphisms that factor through shorter Coxeter words: see [34, Claim 7.1]. Now we can repeat the argument of Proposition 3.5 for $\text{Hom}^\bullet(F_{\underline{\omega}_{s,t}}, F_{\underline{\omega}_{s,t}})$ and obtain that, up to a polynomial, the only nonzero morphism in $\mathcal{K}^b(\mathcal{H})$ is the identity. Then the composition above has to be homotopy equivalent to the identity. \square

Let us now consider two braid words ω_1 and ω_2 , such that ω_2 is obtained from ω_1 by applying one of the relations of B_W . By appropriately tensoring with identity to the left and to the right the morphisms (3.5) or those in Proposition 3.8, we get a homotopy equivalence $\gamma_{\omega_1}^{\omega_2}$ corresponding to the relation used.

If more generally ω_2 is obtained from ω_1 via a sequence of relations then one gets a homotopy equivalence $\gamma_{\omega_1}^{\omega_2}$ given by the corresponding composition of morphisms as above, which, a priori, depends on the choice of relations used.

Remark 3.9. The morphisms $\gamma_{\omega_1}^{\omega_2}$ above are, up to sign, the canonical isomorphisms defined by Rouquier [63, § 9.3]. In fact consider a braid word ω . We have a homotopy equivalence $\text{Hom}^\bullet(F_\omega, F_\omega) \simeq R[0]$ compatible with the ring structure (because null-homotopic morphisms form a two-sided ideal). Hence any loop of relations transforming ω into itself gives a homotopy equivalence that corresponds to an invertible element of R . Now taking $\mathbb{k} = \mathbb{Z}$ we deduce that this element is ± 1 .

Remark 3.10. Another argument for canonicity is given in [29] for characteristic zero fields.

3.1.6. Explicit homotopy equivalences. The above gives a recipe for an explicit diagrammatic description of $\gamma_{s,t}$. In type A such a description can be found in a paper by Elias and Krasner [32].

Let $\mathbb{L}_{s,t}$ be a basis of double leaves for the space $N_{s,t}$ and take $\mathbb{L}_{s,t}^0$ to be the subset of maps of cohomological degree 0 (this means: with the same number of patches on bottom and on top). One can also restrict further to those maps of polynomial degree 0. Let β be the morphism consisting in the (s,t) -ar. Then, by § 3.1.5, we know that

$$\gamma_{s,t} = \beta + \sum_{L \in \mathbb{L}_{s,t}^0} a_L L$$

and that it is the unique morphism of complexes up to homotopy satisfying these properties. Then it is sufficient to find any choice of coefficients a_L such that

$$d(\beta + \sum_{L \in \mathbb{L}_{s,t}^0} a_L L) = 0.$$

So this reduces to a linear algebra problem. Here are the cases $m = 2, 3$.

Example 3.11. For $m_{s,t} = 2$ we obtain

$$\gamma_{s,t} = \begin{array}{c} \text{---} \\ \diagup \quad \diagdown \\ \text{---} \\ \text{---} \end{array} + \begin{array}{c} \text{---} \\ \text{---} \\ \text{---} \\ \text{---} \end{array} + \begin{array}{c} \text{---} \\ \text{---} \\ \text{---} \\ \text{---} \end{array} + \begin{array}{c} \text{---} \\ \text{---} \\ \text{---} \\ \text{---} \end{array}$$

For $m_{s,t} = 3$, we get

$$\begin{array}{c} \gamma_{s,t} = \begin{array}{c} \text{---} \\ \diagup \quad \diagdown \\ \text{---} \\ \text{---} \end{array} + \begin{array}{c} \text{---} \\ \text{---} \\ \text{---} \\ \text{---} \end{array} + \begin{array}{c} \text{---} \\ \text{---} \\ \text{---} \\ \text{---} \end{array} + \begin{array}{c} \text{---} \\ \text{---} \\ \text{---} \\ \text{---} \end{array} + \begin{array}{c} \text{---} \\ \text{---} \\ \text{---} \\ \text{---} \end{array} + \\ + a \begin{array}{c} \text{---} \\ \text{---} \\ \text{---} \\ \text{---} \end{array} + (1-a) \begin{array}{c} \text{---} \\ \text{---} \\ \text{---} \\ \text{---} \end{array} + \begin{array}{c} \text{---} \\ \text{---} \\ \text{---} \\ \text{---} \end{array} - \begin{array}{c} \text{---} \\ \text{---} \\ \text{---} \\ \text{---} \end{array} - \begin{array}{c} \text{---} \\ \text{---} \\ \text{---} \\ \text{---} \end{array} + \\ - a \begin{array}{c} \text{---} \\ \text{---} \\ \text{---} \\ \text{---} \end{array} - (1-a) \begin{array}{c} \text{---} \\ \text{---} \\ \text{---} \\ \text{---} \end{array} + \begin{array}{c} \text{---} \\ \text{---} \\ \text{---} \\ \text{---} \end{array} \end{array}$$

where a can be any value in \mathbb{k} . Notice that

$$d\left(a \begin{array}{c} \text{---} \\ \text{---} \\ \text{---} \\ \text{---} \end{array}\right) = a \begin{array}{c} \text{---} \\ \text{---} \\ \text{---} \\ \text{---} \end{array} - a \begin{array}{c} \text{---} \\ \text{---} \\ \text{---} \\ \text{---} \end{array} - a \begin{array}{c} \text{---} \\ \text{---} \\ \text{---} \\ \text{---} \end{array} + a \begin{array}{c} \text{---} \\ \text{---} \\ \text{---} \\ \text{---} \end{array}$$

so the morphism above is actually unique up to homotopy.

3.1.7. Rouquier formula. As a byproduct of Lemma 3.6, we can now prove the so-called Rouquier formula (conjectured in [64], and proved in [54], and in [58])

Corollary 3.12. *Let $w, v \in W$ and let \underline{w} and \underline{v} be reduced words expressing them. Let $\underline{\omega}$ be the positive word lift of \underline{w} and $\underline{\nu}$ be the negative word lift for \underline{v} . Then*

$$\text{Hom}^\bullet(F_{\underline{\omega}}, F_{\underline{\nu}}) \simeq \begin{cases} R[0] & \text{if } w = v, \\ 0 & \text{otherwise.} \end{cases}$$

Proof. Suppose that $w \neq v$ and suppose that $\ell(w) > \ell(v)$ (the other case being analogous). Any subexpression of \underline{w} for a shorter word has to contain at least one 0 and then at least one $U0$ by reducedness. Then Lemma 3.6 implies the claim.

Suppose instead that $w = v$. Then the only dg light leaves not factoring through shorter words is that with subexpressions $U1 \dots U1$ for both w and v (which gives a morphism corresponding to a certain braid move from w to v). Now notice that the span N of all the other dg double leaves maps is a dg submodule and then we again conclude by Lemma 3.6. \square

3.2 A general reduction for Rouquier complexes

The complex $F_{\underline{\omega}}^\bullet$ has the form of a cube of dimension equal the number of letters in $\underline{\omega}$: the vertices correspond to the Bott-Samelson objects obtained from all possible subexpressions of $\underline{\omega}$ (see Example 3.1).

When the category \mathcal{H} is Krull-Schmidt, one can get rid of a maximal null-homotopic summand of each $F_{\underline{\omega}}^\bullet$ and obtain the *minimal subcomplex* $F_{\underline{\omega}}$. This is a summand which does not admit null-homotopic factor. One can then show that this is unique up to isomorphism (and not just homotopy equivalence): see [35, § 6.1].

For general coefficients, this notion is not well defined, but for $\underline{\omega}$ positive (or negative) we can find a much simpler summand inside $F_{\underline{\omega}}^\bullet$ which is homotopy equivalent to it, by getting rid of a large null-homotopic summand. Roughly speaking, the new complex has objects labeled by subwords, instead of subexpressions.

Let us start with a simple example to illustrate our result.

Example 3.13. Let $\underline{\omega} = \sigma_s \sigma_s \sigma_s$. Then $F_{\underline{\omega}}^\bullet$ is

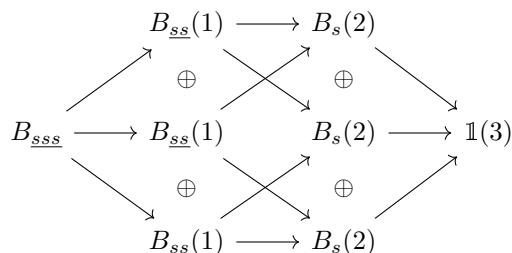

According to Example 2.6, the Bott-Samelson objects appearing above decompose as

$$B_{\underline{ss}}(1) = B_s \oplus B_s(2), \quad B_{\underline{sss}} = B_s(-2) \oplus B_s^{\oplus 2} \oplus B_s(2).$$

Hence the complex can be written

$$\begin{array}{ccccccc}
 & & & B_s \oplus B_s(2) & \longrightarrow & B_s(2) & \\
 & & & \oplus & & \oplus & \\
 & & & \searrow & & \swarrow & \\
 B_s(-2) \oplus B_s^{\oplus 2} \oplus B_s(2) & \longrightarrow & B_s \oplus B_s(2) & & B_s(2) & \longrightarrow & \mathbb{1}(3) \\
 & & \oplus & & \oplus & & \\
 & & \swarrow & & \searrow & & \\
 & & B_s \oplus B_s(2) & \longrightarrow & B_s(2) & &
 \end{array} \tag{3.7}$$

and can be filtered by the subquotients:

$$G_3, \quad G_2, \quad G_1, \quad G_0,$$

corresponding to the colors in the above picture (for a precise definition of subquotient in this setting, see below). One can now check that the components of the differential map in each G_i are just identities. For instance, the blue and the green pieces are

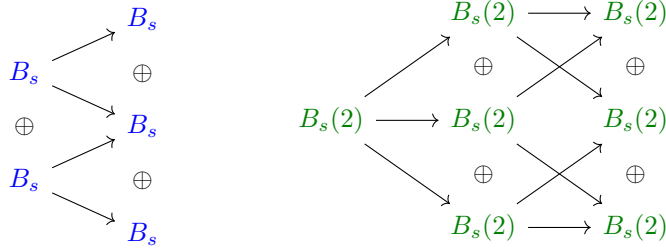

Notice that we can describe these complexes by simplicial sets whose faces correspond to some $B_s(i)$, and where face relationship corresponds to the arrows. More precisely, consider the following simplicial sets.



Namely, in the blue picture, the edges correspond to the two B_s 's in lower cohomological degree and the three vertices to the others, and similarly in the green picture.

One can then use Gaussian elimination (see below) to reduce these complexes: roughly speaking, one can eliminate arrows which are isomorphisms and obtain a summand of the original complex which is homotopy equivalent to it. This corresponds, in the simplicial sets, to “collapsing” a simplex with one of its faces. For example, for the green part, we can perform three of these eliminations (the triangular face with one of the edges, and two edges with two vertices) and obtain a complex concentrated in the maximal cohomological degree $B_s(2)[-2]$. One can then show that all these eliminations can be performed together: each simplicial set can be collapsed to a point. and the original complex can be reduced to

$$B_s(-2) \longrightarrow B_s \longrightarrow B_s(2) \longrightarrow \mathbb{1}(3)$$

Furthermore the procedure gives formulas for the projection corresponding to this summand and allows to compute the new differential map. In this case this is given by the following three morphisms:

$$\delta_s \left| - \right| s(\delta_s) \qquad \delta_s \left| - \right| \delta_s \qquad \bullet$$

Finally, notice that each of the colored part that we defined above corresponds to a subword of sss , and reduces to a single object in the final complex.

We would now like to generalize this procedure to any positive Rouquier complex. First we need to introduce the homological algebra techniques that we mentioned.

3.2.1. Large scale Gaussian elimination for complexes. Our main tool is Gaussian elimination for complexes. Let \mathcal{C} be an additive category. A summand of a complex in the category $\mathcal{C}^b(\mathcal{C})$ will be called *Gaussian* if the projection and the inclusion morphisms are mutually inverse homotopy equivalences.

The following was first pointed out by Bar-Natan [10].

Lemma 3.14. *Consider the following complex in $\mathcal{C}^b(\mathcal{C})$*

$$A \xrightarrow{\begin{pmatrix} \epsilon \\ \xi \end{pmatrix}} B \oplus E \xrightarrow{\begin{pmatrix} \alpha & \beta \\ \gamma & \phi \end{pmatrix}} C \oplus E' \xrightarrow{(\eta \ \theta)} D$$

and suppose that $\phi : E \rightarrow E'$ is an isomorphism in \mathcal{C} . Then the following

$$A \xrightarrow{\epsilon} B \xrightarrow{\alpha - \beta\phi^{-1}\gamma} C \xrightarrow{\eta} D$$

is a Gaussian summand.

Proof. Consider the projection morphism π given by:

$$\begin{array}{ccccccc} A & \xrightarrow{\begin{pmatrix} \epsilon \\ \xi \end{pmatrix}} & B \oplus E & \xrightarrow{\begin{pmatrix} \alpha & \beta \\ \gamma & \phi \end{pmatrix}} & C \oplus E' & \xrightarrow{(\eta \ \theta)} & D \\ \parallel & & \downarrow (\text{id}_B \ 0) & & \downarrow (\text{id}_C \ -\beta\phi^{-1}) & & \parallel \\ A & \xrightarrow{\epsilon} & B & \xrightarrow{\alpha - \beta\phi^{-1}\gamma} & C & \xrightarrow{\eta} & D \end{array} \quad (3.8)$$

and the inclusion morphism ι described by:

$$\begin{array}{ccccccc} A & \xrightarrow{\begin{pmatrix} \epsilon \\ \xi \end{pmatrix}} & B \oplus E & \xrightarrow{\begin{pmatrix} \alpha & \beta \\ \gamma & \phi \end{pmatrix}} & C \oplus E' & \xrightarrow{(\eta \ \theta)} & D \\ \parallel & & \left(\begin{array}{c} \text{id}_B \\ -\phi^{-1}\gamma \end{array} \right) \uparrow & & \left(\begin{array}{c} \text{id}_C \\ 0 \end{array} \right) \uparrow & & \parallel \\ A & \xrightarrow{\epsilon} & B & \xrightarrow{\alpha - \beta\phi^{-1}\gamma} & C & \xrightarrow{\eta} & D \end{array}$$

It is easy to check that $\pi\iota = \text{id}$. The idempotent $\iota\pi$ is homotopy equivalent to the identity because

$$\begin{array}{ccccccc} A & \longrightarrow & B \oplus E & \longrightarrow & C \oplus E' & \longrightarrow & D \\ & \searrow 0 & & \searrow \left(\begin{array}{c} 0 & 0 \\ 0 & \phi^{-1} \end{array} \right) & & \searrow 0 & \\ A & \longrightarrow & B \oplus E & \longrightarrow & C \oplus E' & \longrightarrow & D \end{array}$$

is a homotopy from the complementary idempotent to the zero morphism. \square

We want now to describe a way to perform many Gaussian eliminations on complexes containing many isomorphisms that fit together in a nice way. In particular we consider the case when they can be described by a polytopal set, as in Example 3.13.

Recall that a *polytopal set*¹ of dimension n is a finite collection Π of convex polytopes in \mathbb{R}^d of dimensions up to n such that:

- (i) a face of a polytope $\sigma \in \Pi$ belongs to Π ;
- (ii) if $\sigma, \sigma' \in \Pi$ then the intersection $\sigma \cap \sigma'$ is either empty or a common face of σ and σ' (so in particular it belongs to Π).

Let Π^i denote the subset of i -dimensional polytopes of Π . Here 0-dimensional polytopes are just points. This generalizes the notion of simplicial complex.

We can now make our notion precise.

Definition 3.15. Let Π be a polytopal set of dimension n , and let A be a complex in $\mathcal{C}^b(\mathcal{C})$. We say that A is *left-described* by Π if:

- (i) as a graded object, the complex A decomposes as

$$\bigoplus_{\sigma \in \Pi} A_{\sigma}[\dim \sigma]$$

with A_{σ} in \mathcal{C} . So lower dimensional polytopes correspond to objects in higher cohomological degrees.

- (ii) the component $\phi_{\tau, \sigma} : A_{\sigma} \rightarrow A_{\tau}$ of the differential map is non-zero if and only if τ is a face of σ .
- (iii) all non-zero components of the differential map are isomorphisms.

One can think of the objects A_{σ} as “living over” the polytopes of Π . The dual notion of *right-description* can be obtained by reversing all the arrows. The face relationship is also reversed: in a right-description higher dimensional polytopes correspond to objects in higher cohomological degrees.

Consider the 1-skeleton $\Pi^0 \cup \Pi^1$ of a polytopal set Π which left-describes a complex A . If e is an oriented edge from the vertex p to the vertex q , then we have isomorphisms $\phi_{p,e}$ and $\phi_{q,e}$. We define the *isomorphism associated to the oriented edge e* to be

$$\Phi(e) = -\phi_{q,e}(\phi_{p,e})^{-1}.$$

We put a minus sign for a technical reason that will become clear later. Notice that if $-e$ is the same edge with opposite orientation, then $\Phi(-e) = \Phi(e)^{-1}$. Given an oriented path P through the oriented edges e_1, \dots, e_r along the 1-skeleton of Π , the *isomorphism associated to P* is the composition

$$\Phi(P) := \Phi(e_r) \cdots \Phi(e_1).$$

Clearly, if P' is another path starting from the endpoint of P , and P'' is the concatenation of P and P' , then

$$\Phi(P'') = \Phi(P')\Phi(P).$$

¹The standard terminology (see for example [70, §8.1]) is *polytopal complex* but in our context the word “complex” would be overdetermined.

Lemma 3.16. *If two paths P and P' connecting the point q to p are homotopic in the Π then $\Phi(P) = \Phi(P')$.*

Proof. It is sufficient to prove that the isomorphism associated to a contractible loop P is the identity. Such a loop is the boundary of the union of a finite number of polygons. By splitting the isomorphism as shown below,

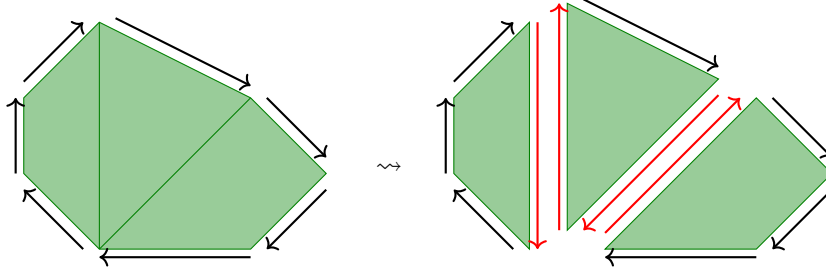

we can restrict to the case where P is the boundary of a single polygon σ . Let e_1, \dots, e_r be the consecutive oriented edges forming P , and let $q_0, \dots, q_{r-1}, q_r = q_0$ be its vertices, so that e_i goes from q_{i-1} to q_i . Then

$$\Phi(P) = \Phi(e_r) \dots \Phi(e_1) = (-1)^r \phi_{q_r, e_r} \phi_{q_{r-1}, e_r}^{-1} \dots \phi_{q_1, e_1} \phi_{q_0, e_1}^{-1}. \quad (3.9)$$

The square of the differential map vanishes, so, computing the component $A_\sigma \rightarrow A_{q_i}$ of d^2 , we have

$$\phi_{q_i, e_{i+1}} \phi_{e_{i+1}, \sigma} + \phi_{q_i, e_i} \phi_{e_i, \sigma} = 0.$$

This implies

$$\phi_{q_i, e_{i+1}}^{-1} \phi_{q_i, e_i} = -\phi_{e_{i+1}, \sigma} \phi_{e_i, \sigma}^{-1} \quad (3.10)$$

and, applying (3.10) to (3.9), we get the identity. \square

A face of a polytope of Π is called *free* if it is not the face of any other polytope of Π . An *collapse* is the operation of removing from Π a polytope σ of maximal dimension together with a free face τ and all the faces of σ containing τ . A collapse is called *elementary* if the face τ has codimension 1 (so we are only removing σ and τ). One can show that any collapse can be obtained by a sequence of elementary collapses. Then Π is called *collapsible* if there is a sequence of (elementary) collapses that reduces it to a single point.

We can now give the key lemma for large scale Gaussian elimination.

Lemma 3.17. *Let A be a complex left-described by a polytopal set Π . If Π is collapsible to the point p , then $A_p[0]$ is a Gaussian summand of A . Furthermore, if one chooses a path P_q from each point q to p , then the projection morphism π is given componentwise by*

$$\begin{cases} \pi_q = \Phi(P_q) & \text{if } q \in \Pi^0, \\ \pi_\sigma = 0 & \text{if } \sigma \notin \Pi^0. \end{cases}$$

Proof. Notice that the elementary collapse of a face σ with a free face τ in Π corresponds to the elimination of the isomorphism $\phi_{\tau, \sigma}$ in A . The condition on

τ to be free corresponds to the condition $\phi_{\sigma',\tau} = 0$ for any $\sigma' \neq \sigma$. In other words, the complex is of the form

$$\dots \longrightarrow \left(\bigoplus_{\sigma' \in \Pi^i \setminus \{\sigma\}} A_{\sigma'} \right) \oplus A_{\sigma} \xrightarrow{\begin{pmatrix} * & \phi_{\tau,\sigma}^* \\ 0 & \phi_{\tau,\sigma} \end{pmatrix}} \left(\bigoplus_{\tau' \in \Pi^{i-1} \setminus \{\tau\}} A_{\tau'} \right) \oplus A_{\tau} \longrightarrow \dots$$

Hence, by Lemma 3.14, we can eliminate A_{σ} and A_{τ} and the projection, according to (3.8), behaves as follows:

- it is the identity on all $A_{\sigma'}$ for $\sigma' \neq \sigma, \tau$;
- it is zero on A_{σ} ;
- it sends A_{τ} on each $A_{\tau'}$ via $-\phi_{\tau',\sigma} \phi_{\tau,\sigma}^{-1}$.

The Gaussian summand is now the complex left-described by $\Pi \setminus \{\sigma, \tau\}$. Then we can proceed by induction.

If we compose all the projections thus obtained, we see that all A_{σ} with $\sigma \notin \Pi^0$ are eventually sent to zero, whereas the A_q for $q \in \Pi^0$ are sent to A_p by a composition of $-\phi_{q',e} \phi_{q,e}^{-1}$ which gives precisely a path from q to p .

Any two paths connecting q to p are homotopic by contractibility (collapsible polytopal sets are clearly contractible). Hence the morphism $\Phi(P_q)$ does not depend on the choice of the path, by Lemma 3.16. \square

Of course one can reverse all the arrows in the lemma, and consider inclusion morphism instead of projection, and obtain an analogous statement for right-described complexes.

3.2.2. Exact structure for complexes. We want to give a precise meaning to filtrations in the category $\mathcal{C}^b(\mathcal{C})$.

Definition 3.18. We say that a sequence

$$A \rightarrow B \rightarrow C$$

is *exact* in $\mathcal{C}^b(\mathcal{C})$ if it is split exact in the additive category $\mathcal{G}^b(\mathcal{C})$. In this case we say that A is a *subcomplex* of B and C is a *quotient*

This defines an exact structure on $\mathcal{C}^b(\mathcal{C})$ in the sense of [59]. Notice that when we pass to the homotopy category, exact sequences become distinguished triangles. See [68, § 2-4].

We say that complexes A_i ($i = 0, \dots, n$) *filter* A by subcomplexes when A_i is a subcomplex of A_{i+1} , $A_0 = 0$ and $A_n = A$. Then the quotients of A_{i+1} by A_i are called *subquotients* of the filtration.

We will use the following fact.

Lemma 3.19. *If A and B are complexes filtered by A_i and B_i respectively, and $f : A \rightarrow B$ a morphism compatible with the filtrations. Then f is the projection to (inclusion of) a Gaussian summand if and only if it is so on all subquotients.*

Proof. It suffices to prove that, given a commutative diagram

$$\begin{array}{ccccc} X & \longrightarrow & Y & \longrightarrow & Z \\ \downarrow & & \downarrow & & \downarrow \\ X' & \longrightarrow & Y' & \longrightarrow & Z' \end{array}$$

where the rows are exact, if two of the vertical arrows are projections to a Gaussian summand, then the third is too. Complete the diagram to a square

$$\begin{array}{ccccc}
 X'' & \longrightarrow & Y'' & \longrightarrow & Z'' \\
 \downarrow & & \downarrow & & \downarrow \\
 X & \longrightarrow & Y & \longrightarrow & Z \\
 \downarrow & & \downarrow & & \downarrow \\
 X' & \longrightarrow & Y' & \longrightarrow & Z'
 \end{array}$$

where all rows and columns are exact (this is possible by the exact category versions of the 3×3 lemma and the snake lemma). Now the first and last columns are split by hypothesis and X'' and Z'' are null-homotopic, because X' and Z' are Gaussian. Then also Y'' is null-homotopic (it suffices to see the top row as a distinguished triangle in the homotopy category). But then the middle column has to be split too (contractible complexes are injective/projective for the Frobenius structure on $\mathcal{C}^b(\mathcal{C})$: see for example [48]). The case of inclusions is symmetric. \square

3.2.3. Reduced complexes. Let us now describe the reduced version for positive Rouquier complexes more generally. If \underline{w} is a Coxeter word, we write $F_{\underline{w}}^\bullet$ for the corresponding positive Rouquier complex (we should replace \underline{w} with its positive word lift). We now describe a new complex $F_{\underline{w}}$ that we will obtain after Gaussian elimination.

If $s \in S$ and \underline{x} is the word consisting of n repetitions of the letter s , we set

$$C_{\underline{x}} := B_s(-n + 1).$$

If \underline{x} is any Coxeter word, first write it as

$$\underline{x}_1 \underline{x}_2 \cdots \underline{x}_k$$

where each \underline{x}_i is one-color and of a different color than \underline{x}_{i+1} . Then set

$$C_{\underline{x}} := C_{\underline{x}_1} C_{\underline{x}_2} \cdots C_{\underline{x}_k} \subset_{\oplus} B_{\underline{x}}.$$

We also set $C_{\emptyset} := \mathbb{1}$.

Example 3.20. Let $\underline{x} = sssttusuu$, then

$$\underline{x}_1 = sss, \quad \underline{x}_2 = tt, \quad \underline{x}_3 = u, \quad \underline{x}_4 = s, \quad \underline{x}_5 = uu.$$

Hence $C_{\underline{x}} = B_s(-2) \otimes B_t(-1) \otimes B_u \otimes B_s \otimes B_u(-1) = B_{stusuu}(-4)$.

Let now \underline{w} be a Coxeter word: the graded object corresponding to $F_{\underline{w}}$ is

$$(F_{\underline{w}})^{\text{gr}} = \bigoplus_{\underline{x} \preceq \underline{w}} C_{\underline{x}} \langle q_{\underline{w}, \underline{x}} \rangle, \quad (3.11)$$

where $q_{\underline{w}, \underline{x}} = \ell(\underline{w}) - \ell(\underline{x})$ and $\langle 1 \rangle$ denotes the *Tate twist* $(1)[-1]$ (cf § 2.2.4). We have to describe the differential map d . We will specify the components

$$d_{\underline{x}', \underline{x}} : C_{\underline{x}} \langle q_{\underline{w}, \underline{x}} \rangle \rightarrow C_{\underline{x}'} \langle q_{\underline{w}', \underline{x}'} \rangle,$$

for $\underline{x}, \underline{x}' \preceq \underline{w}$ and $\ell(\underline{x}) = \ell(\underline{x}') + 1$. This map is nonzero only if $\underline{x}' \preceq \underline{x}$, which means that \underline{x}' is obtained from \underline{x} by eliminating one letter. The simplest such situation is when \underline{x} and \underline{x}' are one-color of color s , of lengths $k + 1$ and k respectively. Then we set

$$d_{\underline{x}', \underline{x}} = d_{s,k} := \begin{cases} \uparrow & \text{if } k = 0, \\ \delta_s \mid - \mid \delta_s = \alpha_s \mid - \mid \uparrow & \text{if } k > 0 \text{ is odd,} \\ \delta_s \mid - \mid s(\delta_s) = \uparrow & \text{if } k > 0 \text{ is even.} \end{cases} \quad (3.12)$$

In general, one can write \underline{x} and \underline{x}' in the form

$$\underline{x} = \underline{z}_1 \underbrace{sss \dots s}_{k+1} \underline{z}_2, \quad \underline{x}' = \underline{z}_1 \underbrace{ss \dots s}_k \underline{z}_2,$$

where \underline{z}_1 and \underline{z}_2 are (possibly empty) Coxeter words such that \underline{z}_1 does not end with s and \underline{z}_2 does not start with s . Hence we set

$$d_{\underline{x}', \underline{x}} := (-1)^{\ell(\underline{z}_1)} \text{id}_{C_{\underline{z}_1}} \otimes d_{s,k} \otimes \text{id}_{C_{\underline{z}_2}}.$$

If $k = 0$ and \underline{z}_1 ends with same letter as \underline{z}_2 starts, then we also compose on top with the corresponding trivalent:



Example 3.21. Let $\underline{w} = tsst$, then $F_{\underline{w}}$ is

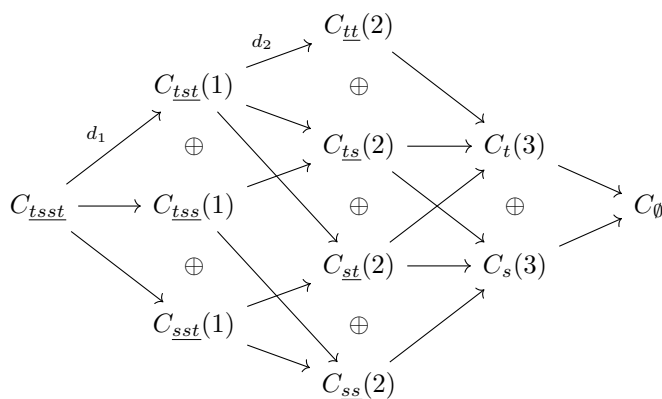

We describe the arrows d_1 and d_2 , as an example, and we leave the others to the reader. We have $C_{tsst} = B_t B_s B_t(-1)$ and $C_{tst}(1) = B_t B_s B_t(1)$. We are canceling the letter s and passing from two occurrences to one. Furthermore the length of the word preceding the group of s 's is one, hence the morphism d_1 is:

$$- \left[\begin{array}{|c|} \hline \delta_s \\ \hline \end{array} \right] + \left[\begin{array}{|c|} \hline \delta_s \\ \hline \end{array} \right]$$

Next, we have $C_{\underline{tt}}(2) = B_t(1)$ and the morphism d_2 is eliminating the only s from $C_{\underline{tst}}$. Notice that the two adjacent letters are both t 's, hence d_2 is

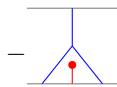

Proposition 3.22. *The differential map d defined above satisfies $d^2 = 0$.*

One can prove this directly but it will follow from Claim 1 below (which is proven independently of this statement).

Here is the statement of the main result of this section.

Theorem 3.23. *Let \underline{w} be a Coxeter word. Then the complex $F_{\underline{w}}^\bullet$ admits $F_{\underline{w}}$ as a Gaussian summand. In particular $F_{\underline{w}}^\bullet \simeq F_{\underline{w}}$.*

The rest of this section is devoted to the proof of this result. We will explicitly construct a projection from $F_{\underline{w}}^\bullet$ to $F_{\underline{w}}$ and then show that it is a homotopy equivalence.

3.2.4. Multiword decomposition. The first step is a convenient decomposition of the original complex, generalizing that of Example 3.13. We will need the following notion.

We call *multiword* an expression of the form

$$\mu = s_1^{n_1} \dots s_k^{n_k}$$

with $s_i \in S$ and $k_i \in \mathbb{Z}_{>0}$. Notice that s_i need not be different from s_{i+1} . If all the s_i are equal we say that μ is *one-color*. Equivalently, a multiword is an element of the free monoid generated by $S \times \mathbb{Z}_{>0}$. Let \mathfrak{M} denote the set of multiwords. To each multiword we can associate a Coxeter word in two natural ways: one can either expand the exponents, or forget them. This gives two maps

$$\mathfrak{M} \begin{array}{c} \xrightarrow{e} \\ \xrightarrow{f} \end{array} \mathfrak{W}_S,$$

where

$$e(\mu) = \underbrace{s_1 \dots s_1}_{n_1} \dots \underbrace{s_k \dots s_k}_{n_k},$$

$$f(\mu) = s_1 \dots s_k.$$

We say that a multiword is *simple* if all multiplicities are 1's, or equivalently $e(\mu) = f(\mu)$.

Recall now the decomposition of Example 2.6. Iterating, we get

$$B_s^{\otimes 3} = B_s(-2) \oplus B_s^{\oplus 2} \oplus B_s(2),$$

$$B_s^{\otimes 4} = B_s(-3) \oplus B_s(-1)^{\oplus 3} \oplus B_s(1)^{\oplus 3} \oplus B_s(3),$$

$$\dots,$$

and in general

$$B_s^{\otimes(n+1)} = \bigoplus_{k=0}^n B_s(n-2k)^{\oplus \binom{n}{k}}. \tag{3.14}$$

The inclusion morphisms of the $\binom{n}{k}$ summands of the form $B_s(n - 2k)$ are all possible combinations of inclusions ι_1 and ι_2 from Example 2.6. Hence they are of the form

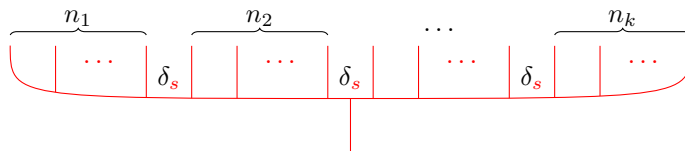

where $n_1 + n_2 + \dots + n_k = n + 1$, and there is no decoration in between each group of n_i strands. We label these summands by one-color multiwords: the summand corresponding to the inclusion above will be denoted by C_μ with $\mu = s^{n_1} s^{n_2} \dots s^{n_k}$. The corresponding projection is obtained by appropriately combining projections π_1 and π_2 from Example 2.6: one reflects the diagram vertically, and replaces empty decorations with $-s(\delta_s)$ and δ_s with empty decorations.

Example 3.24. There are $\binom{3}{2} = 3$ copies of $B_s(-1)$ inside $B_s^{\otimes 4}$. Their inclusion morphisms are:

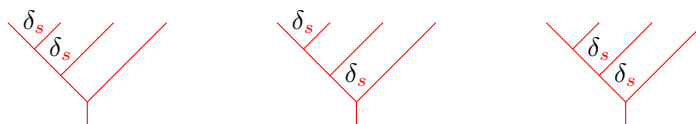

and the corresponding projection morphisms are respectively:

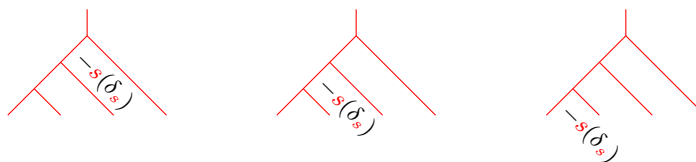

With the multiwords notation the three summands are, respectively,

$$C_{ss^2s^2} \qquad C_{ss^2s} \qquad C_{s^2ss}.$$

Let us now pass to the general case. For an arbitrary multiword μ , first we decompose it into one-color multiwords $\mu_1 \dots \mu_k$ with μ_i and μ_{i+1} of different colors, then we set

$$C_\mu := C_{\mu_1} \dots C_{\mu_k}.$$

Notice that when the multiword μ is simple and $e(\mu) = f(\mu) = \underline{x}$ then $C_\mu = C_{\underline{x}}$, so our notation is consistent.

Let \underline{x} be an arbitrary Coxeter word. We can apply the one color case to each sequence of repeated letters and decompose the Bott-Samelson object $B_{\underline{x}}$ accordingly. Hence we get

Proposition 3.25. *Let \underline{x} be a Coxeter word, then:*

$$B_{\underline{x}} = \bigoplus_{e(\mu)=\underline{x}} C_\mu.$$

Let us apply this to the graded object $(F_{\underline{w}}^\bullet)^{\text{gr}}$. For a subexpression \mathbf{i} of \underline{w} , let $\underline{w}_{\mathbf{i}}$ be the subword of \underline{w} corresponding to it. For a given subword \underline{x} , let $M_{\underline{x}}$ denote the following set:

$$M_{\underline{x}} := \{(\mathbf{i}, \mu) \in \{0, 1\}^{\ell(\underline{w})} \times \mathfrak{M} \mid f(\mu) = \underline{x}, e(\mu) = \underline{w}_{\mathbf{i}}\}.$$

Then, using Proposition 3.25, we have:

$$(F_{\underline{w}}^\bullet)^{\text{gr}} = \bigoplus_{\mathbf{i} \in \{0, 1\}^{\ell(\underline{w})}} B_{\mathbf{i}} \langle q_{\mathbf{i}} \rangle = \bigoplus_{\mathbf{i}} \bigoplus_{e(\mu) = \underline{w}_{\mathbf{i}}} C_{\mu} \langle q_{\mathbf{i}} \rangle = \bigoplus_{\underline{x} \preceq \underline{w}} \underbrace{\bigoplus_{(\mathbf{i}, \mu) \in M_{\underline{x}}} C_{\mu} \langle q_{\mathbf{i}} \rangle}_{:= G_{\underline{x}}}.$$

We will use the notation $C_{\mathbf{i}, \mu} := C_{\mu} \langle q_{\mathbf{i}} \rangle$.

In Example 3.13, the subwords of $\underline{w} = sss$ are

$$\underline{sss}, \underline{ss}, \underline{s}, \emptyset.$$

So the corresponding sets are the following:

$$M_{\underline{sss}} = \{(111, sss)\},$$

$$M_{\underline{ss}} = \{(110, ss), (101, ss), (011, ss), (111, s^2s), (111, ss^2)\},$$

$$M_{\underline{s}} = \{(100, s), (010, s), (001, s), (110, s^2), (101, s^2), (011, s^2), (111, s^3)\},$$

$$M_{\emptyset} = \{(000, \emptyset)\}.$$

Then $G_{\underline{sss}}, G_{\underline{ss}}, G_{\underline{s}}$ and G_{\emptyset} are respectively the violet, blue, green and black parts in (3.7).

These $G_{\underline{x}}$ allow us to define a filtration of the complex as in the example.

Lemma 3.26. *Choose an total ordering $\underline{x}_0, \underline{x}_1, \dots, \underline{x}_N$ of the subwords of \underline{w} , refining \preceq . Then the objects*

$$G_{\leq n} := \bigoplus_{i=0}^n F_{\underline{x}_i}$$

define a filtration of $F_{\underline{w}}^\bullet$ by subcomplexes.

Proof. It is sufficient to prove that the component $G_{\underline{x}} \rightarrow G_{\underline{z}}$ of the differential map can be nonzero only if $\underline{z} = \underline{x}$ or $\underline{z} \preceq \underline{x}$. Consider the composition:

$$C_{\mathbf{i}, \mu} \hookrightarrow B_{\mathbf{i}} \xrightarrow{d} B_{\mathbf{i}'} \twoheadrightarrow C_{\mathbf{i}', \mu'}. \quad (3.15)$$

This is nonzero only if \mathbf{i}' is obtained from \mathbf{i} by turning a 1 to a 0, by definition of the differential. Then $e(\mu') \preceq e(\mu)$ and $\ell(e(\mu)) = \ell(e(\mu')) + 1$. Then one can easily see that either $f(\mu') = f(\mu)$ or $f(\mu') \preceq f(\mu)$. \square

As in Example 3.13, each of the subquotients $G_{\underline{x}}$ will shrink to a single object $C_{\underline{x}}$, via large scale Gaussian elimination, and we will assemble these reductions together to a reduction of the entire complex.

3.2.5. Colored polytopal complexes. To reduce the subquotients we will use large scale Gaussian elimination. More precisely, the subquotient $G_{\underline{x}}$ is left-described by a collapsible polytopal set $\Pi(\underline{w}, \underline{x})$ that we now describe.

Let Δ^i denote the i -simplex. The polytopes of $\Pi(\underline{w}, \underline{x})$ are labeled by the set $M_{\underline{x}}$. The polytope labeled (\mathbf{i}, μ) is a multisimplex $\Delta^{n_1-1} \times \dots \times \Delta^{n_k-1}$, where $\mu = s_1^{n_1} \dots s_k^{n_k}$. The faces of this multisimplex are those corresponding to pairs (\mathbf{i}', μ') , where $\mathbf{i}' \leq \mathbf{i}$ (componentwise) and μ' is of the form $s_1^{m_1} \dots s_k^{m_k}$ with $1 \leq m_i \leq n_i$. For instance, the vertices are labeled by all the subexpressions for \underline{x} (and the only simple multiwords for them).

Example 3.27. Here are two examples of these polytopal sets.

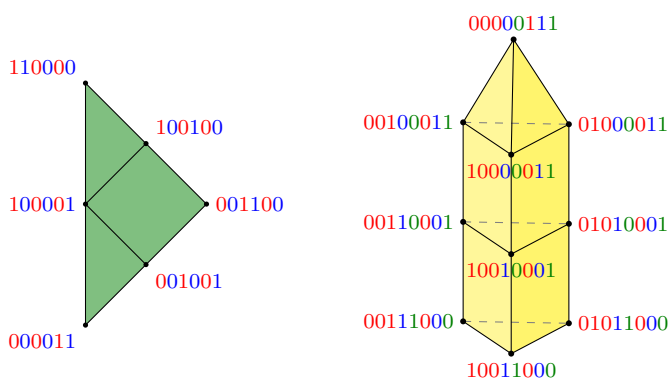

The first is $\Pi(\underline{ststst}, \underline{st})$, the second is $\Pi(\underline{ssstustu}, \underline{stu})$. The vertices are labeled by colored subexpressions: we color the symbols of the 01-sequences according to the corresponding simple reflections.

Proposition 3.28. *The polytopal set $\Pi(\underline{w}, \underline{x})$ left-describes the subquotient $G_{\underline{x}}$.*

Proof. Of course, we associate $C_{\mathbf{i}, \mu}$ to the polytope labeled (\mathbf{i}, μ) . We need to check that the nonzero morphisms correspond to the face relationship and that they are isomorphisms.

Recall the proof of Lemma 3.26 and the composition (3.15). When $f(\mu') = f(\mu)$, the only possibility is that

$$\mu = \dots s_{i-1}^{n_{i-1}} s_i^{n_i} s_{i+1}^{n_{i+1}} \dots, \quad \mu' = \dots s_{i-1}^{n_{i-1}} s_i^{n_i-1} s_{i+1}^{n_{i+1}} \dots$$

and one can check that the composition is just the identity, up to sign. \square

Proposition 3.29. *The polytopal set $\Pi(\underline{w}, \underline{x})$ is collapsible.*

Proof. Consider the lexicographic order on 01-sequences and take the smallest. This corresponds to a point and it is easy to see that there is only one maximal polytope containing it. Then we can collapse them. Then we can proceed by induction. \square

To finally prove Theorem 3.23, we have to glue all the reductions of the subquotients together

3.2.6. Proof of the theorem. We now define the homotopy equivalence from F_w^\bullet to F_w . Given an element of $\{0,1\}^n$, we call a *flip* the replacement of a subsequence “01” with “10” or viceversa. For each subexpression \mathbf{i} let $|\mathbf{i}|$ be the minimal number of flips that are necessary to turn \mathbf{i} into the sequence $11\dots 100\dots 0$. Consider the maps

$$\begin{cases} C_{\mathbf{i},\mu} \xrightarrow{(-1)^{|\mathbf{i}|}} C_{\underline{x}} & \text{if } e(\mu) = f(\mu) = \underline{x} \\ C_{\mathbf{i},\mu} \rightarrow 0 & \text{otherwise} \end{cases}$$

One can glue them together to form a morphism $\pi : (F_w^\bullet)^{\text{gr}} \rightarrow (F_w)^{\text{gr}}$.

Claim 1. *The morphism π is compatible with the differential maps.*

Remark. As π is surjective, this also implies Proposition 3.22.

Proof of Claim 1. We will check this over each $C_{\mathbf{i},\mu}$. Let first μ be simple and $e(\mu) = f(\mu) = \underline{x}$. Let \underline{x}' be a word obtained by \underline{x} by removing a letter. Then the component $C_{\mathbf{i},\mu} \rightarrow C_{\underline{x}'}$ of the composition $d\pi$ is

$$(-1)^{|\mathbf{i}|} d_{\underline{x}',\underline{x}}$$

as defined in § 3.2.3. The same component of the composition πd is the sum of the compositions

$$C_{\mathbf{i},\mu} \xrightarrow{\quad} B_{\mathbf{i}} \xrightarrow{d} B_{\mathbf{i}'} \xrightarrow{\quad} C_{\mathbf{i}',\mu'} \xrightarrow{\quad} C_{\underline{x}'}, \quad (3.16)$$

for all possible \mathbf{i}' obtained from \mathbf{i} by turning a 1 to a 0. Let $\underline{x} = \underline{z}_1 s s s \dots s \underline{z}_2$ and $\underline{x}' = \underline{z}_1 s s \dots s \underline{z}_2$, then the only nonzero such composition are those where the new 0 corresponds to one of the s 's, and we get

$$\sum_{\mathbf{i}'} (-1)^{|\mathbf{i}'|} \dots \left(\begin{array}{c} \delta_s \quad \delta_s \quad \dots \quad \delta_s \quad \delta_s \quad \dots \quad \delta_s \\ \text{---} \end{array} \right) \dots$$

and one can check that this gives the same.

If μ is not simple, we have to check that the composition πd is zero. Consider again the component $C_{\mathbf{i},\mu} \rightarrow C_{\underline{x}'}$, with \underline{x}' as above. The only non trivial case for the compositions (3.16) is

$$\mu = s_1 \dots s_{i-1} s_i^2 s_{i+1} \dots s_k, \quad \mu = s_1 \dots s_{i-1} s_i s_{i+1} \dots s_k,$$

and there are only two possibilities for \mathbf{i}' . These give

$$\pm \dots \left(\begin{array}{c} \text{---} \\ \text{---} \end{array} \right) \dots \mp \dots \left(\begin{array}{c} \text{---} \\ \text{---} \end{array} \right) \dots = 0$$

□

Now, consider a total ordering $\underline{x}_1, \dots, \underline{x}_N$ on the subwords of w . This gives a filtration on F_w^\bullet as in Lemma 3.26 and also naturally on F_w : the filtered pieces are just the $C_{\underline{x}_i}$.

Claim 2. *The map π is compatible with the filtrations. Furthermore, on subquotients, it coincides, up to a sign with the projection coming from Proposition 3.29.*

Proof. The compatibility with the filtrations is obvious by the definition of π . Notice that the edges of $\Pi(\underline{w}, \underline{x})$ connect vertices that can be obtained from one another by a *colored flip*: this is a replacement of a subsequence “10...00” with “00...01” where the symbols in the middle are all zeros (that can have any color). For example the following is a colored flip:

$$\underline{00000}\underline{111} \rightsquigarrow \underline{10000}\underline{011}.$$

Then one can check that the isomorphism associated to an edge is $(-1)^n$ where n is the number of zeros involved in the flip. In the example above $n = 5$. Then one sees that up to a global sign, the isomorphisms associated with the paths to a given point agree with π . \square

This concludes the proof of Theorem 3.23.

3.2.7. Negative case. Of course everything works symmetrically for the negative case. Let \underline{w} be a Coxeter word and $\underline{\omega}$ its negative word lift. Then one can describe a complex $F_{\underline{w}}^-$ homotopy equivalent to $F_{\underline{\omega}}^\bullet$ as follows.

First we define, for \underline{x} a word consisting of n repetition of the letter s ,

$$C_{\underline{x}}^- := B_s(n-1).$$

Then, as before, with $\underline{x} = x_1 x_2 \dots x_k$ as before, set

$$C_{\underline{x}} := C_{x_1}^- C_{x_2}^- \cdots C_{x_k}^- \subset B_{\underline{x}}.$$

The graded object corresponding to $F_{\underline{w}}^-$ is

$$(F_{\underline{w}}^-)^{\text{gr}} = \bigoplus_{\underline{x} \preceq \underline{w}} C_{\underline{x}}^- \langle -q_{\underline{w}, \underline{x}} \rangle.$$

The differential is given, again, via its components $d_{\underline{x}', \underline{x}}^-$. These are nonzero only if $\underline{x}' \succeq \underline{x}$ which implies that \underline{x}' is obtained from \underline{x} by inserting a single occurrence of a letter s . Again, we first consider \underline{x} and \underline{x}' consisting of respectively k and $k+1$ occurrences of the same letter s . In this case

$$d_{\underline{x}', \underline{x}}^- = d_{s, k}^- := \begin{cases} \downarrow & \text{if } k = 0 \\ \delta_s \mid - \mid \delta_s = \alpha_s \mid - \downarrow & \text{if } k > 0 \text{ is odd} \\ \delta_s \mid - \mid s(\delta_s) = \downarrow & \text{if } k > 0 \text{ is even} \end{cases}$$

In general, one can write \underline{x} and \underline{x}' in the form

$$\underline{x} = z_1 \underbrace{ss \dots s}_k z_2, \quad \underline{x}' = z_1 \underbrace{ss \dots s}_{k+1} z_2,$$

where \underline{z}_1 and \underline{z}_2 are as in the previous case. Then we set

$$d_{\underline{x}', \underline{x}} := (-1)^{|\underline{z}_1|} \text{id}_{C_{\underline{z}_1}^-} \otimes d_{s,k}^- \otimes \text{id}_{C_{\underline{z}_2}}.$$

Again we need to treat the case when $k = 0$ and \underline{z}_1 ends with same letter as \underline{z}_2 starts. In this case we compose on bottom with a trivalent:

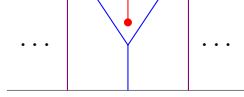

This concludes the definition of $F_{\underline{w}}^-$ and we have the analogue of Theorem 3.23:

Theorem. *Let \underline{w} be a Coxeter word and $\underline{\omega}$ its negative word lift. Then the complex $F_{\underline{\omega}}^\bullet$ admits $F_{\underline{w}}^-$ as a Gaussian summand. In particular $F_{\underline{\omega}}^\bullet \simeq F_{\underline{w}}^-$.*

For an arbitrary braid word $\underline{\omega}$ we can first write its alternating decomposition

$$\underline{\omega} = \underline{\omega}_1 \underline{\omega}_2 \dots \underline{\omega}_k$$

and consider the corresponding $F_{\underline{w}_i}$ and $F_{\underline{w}_j}^-$. Then define $F_{\underline{\omega}}$ to be their tensor product. Then we have $F_{\underline{\omega}}^\bullet \simeq F_{\underline{\omega}}$.

3.2.8. Reduced diagrammatics. We want now to give a diagrammatic description of morphisms between the $F_{\underline{w}}$'s. Roughly speaking, the reduction from subexpression to subwords allows us to forget about patches.

It will be convenient to see the morphisms between the $C_{\underline{x}}$'s (or the $C_{\underline{x}}^-$'s) on the level of the corresponding $B_{\underline{x}}$'s. More precisely, consider the following.

- (i) Let $\Lambda_{\underline{x}} \subset \bigoplus_{\underline{z}} \text{Hom}(B_{\underline{x}}, B_{\underline{z}})$ be the left ideal generated by decorated bottom trivalent vertices of the form

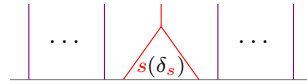

- (ii) Let $V_{\underline{x}} \subset \bigoplus_{\underline{z}} \text{Hom}(B_{\underline{z}}, B_{\underline{x}})$ be the right ideal generated by top trivalent vertices of the form

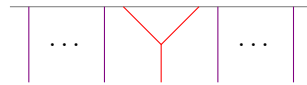

- (iii) Let $\Lambda_{\underline{x}}^-$ be the left ideal generated by bottom trivalent vertices of the form



- (iv) Let $V_{\underline{x}}^-$ be the right ideal generated by top decorated trivalent vertices of the form

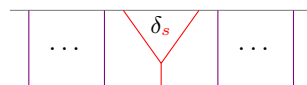

Then we have

Proposition 3.30. *Let \underline{x} and \underline{x}' be Coxeter words, then*

$$\begin{aligned}\mathrm{Hom}(C_{\underline{x}}, C_{\underline{x}'}) &= V_{\underline{x}'} \setminus \mathrm{Hom}(B_{\underline{x}}, B_{\underline{x}'}) / \Lambda_{\underline{x}}, \\ \mathrm{Hom}(C_{\underline{x}}, C_{\underline{x}'}^-) &= V_{\underline{x}'^-} \setminus \mathrm{Hom}(B_{\underline{x}}, B_{\underline{x}'}) / \Lambda_{\underline{x}}, \\ \mathrm{Hom}(C_{\underline{x}}^-, C_{\underline{x}'}) &= V_{\underline{x}'} \setminus \mathrm{Hom}(B_{\underline{x}}, B_{\underline{x}'}) / \Lambda_{\underline{x}}^-, \\ \mathrm{Hom}(C_{\underline{x}}^-, C_{\underline{x}'^-}) &= V_{\underline{x}'^-} \setminus \mathrm{Hom}(B_{\underline{x}}, B_{\underline{x}'}) / \Lambda_{\underline{x}}^-.\end{aligned}$$

Proof. In any additive category, if A is a summand of B with inclusion ι , we have, for any other object C a surjective morphism

$$\begin{aligned}\mathrm{Hom}(B, C) &\rightarrow \mathrm{Hom}(A, C) \\ \phi &\mapsto \phi \circ \iota,\end{aligned}$$

whose kernel is given by morphisms annihilating ι . The inclusion morphism of $C_{\underline{x}}$ in $B_{\underline{x}}$ was described in § 3.2.4 (it is the case with all possible decorations), hence it is clear that it is annihilated by all morphisms in $\Lambda_{\underline{x}}$. By considering the complementary summands (given by all other multiwords and inclusions) one sees that this is actually the whole annihilator. One argues similarly, with projections instead of inclusions, for the quotient by $V_{\underline{x}}$ on the other side. This proves the first equality, the others are proven similarly. \square

Consider now two Coxeter words \underline{w} and \underline{w}' . We have

$$\mathrm{Hom}^\bullet(F_{\underline{w}}, F_{\underline{w}'}) = \bigoplus_{\substack{\underline{x} \preceq \underline{w} \\ \underline{x}' \preceq \underline{w}'}} \mathrm{Hom}(C_{\underline{x}}, C_{\underline{x}'} \langle q_{\underline{w}', \underline{x}'} - q_{\underline{w}, \underline{x}} \rangle).$$

By Proposition 3.30, this is

$$\bigoplus_{\substack{\underline{x} \preceq \underline{w} \\ \underline{x}' \preceq \underline{w}'}} V_{\underline{x}'} \setminus \mathrm{Hom}(B_{\underline{x}}, B_{\underline{x}'}) / \Lambda_{\underline{x}} \langle q_{\underline{w}', \underline{x}'} - q_{\underline{w}, \underline{x}} \rangle.$$

Similarly we can describe the other morphism spaces $\mathrm{Hom}^\bullet(F_{\underline{w}}^\pm, F_{\underline{w}'}^\pm)$. This justifies the following description of morphisms between $F_{\underline{w}}$ and $F_{\underline{w}'}$, for braid words \underline{w} and \underline{w}' . They are linear combinations of diagrams obtained as follows.

- Consider the usual planar strip $\mathbb{R} \times [0, 1]$ and divide the boundary in white and black pieces according to the alternating decomposition of \underline{w} and \underline{w}' .
- For each piece of the boundary choose a subword of the corresponding positive or negative piece of \underline{w} or \underline{w}' . Then draw the starting and ending points corresponding to these subwords.
- Draw an ordinary Soergel diagram with the chosen boundary points.

Notice that here a general morphism could be a combination of diagrams with different starting or ending words. Furthermore, as this time we do not represent the canceled letters it is important to keep track of the entire words \underline{w} and \underline{w}' . A diagram alone does not identify a morphism.

Example 3.31. Let $\underline{\omega} = \sigma_s^3 \sigma_t^{-1} \sigma_u^{-1} \sigma_t$ and $\underline{\omega}' = \sigma_s \sigma_t^{-2} \sigma_u^2$. Then the diagram

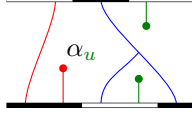

should be interpreted as the element of

$$\text{Hom}(C_{\underline{s}\underline{s}} C_{\underline{t}\underline{u}}^- C_{\underline{t}}, C_{\underline{s}} C_{\underline{t}}^- C_{\underline{u}}) = \text{Hom}(B_s(-1) B_{\underline{t}\underline{u}} B_t, B_s B_t B_u) = \text{Hom}(B_{\underline{st}\underline{ut}}, B_{\underline{stu}}),$$

corresponding to the diagram:

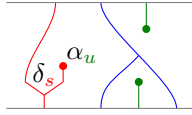

We have to point out some features of this description of the morphisms.

Remark 3.32. (i) The diagrams also undergo the following relations:

$$\begin{array}{cc} \begin{array}{c} \text{---} \\ \delta_s \\ \text{---} \end{array} = 0, & \begin{array}{c} \text{---} \\ \text{---} \end{array} = 0, \\ \begin{array}{c} \text{---} \\ \delta_s \\ \text{---} \end{array} = 0, & \begin{array}{c} \text{---} \\ \text{---} \end{array} = 0. \end{array}$$

These represent the double quotient by the annihilators Λ and V from above.

- (ii) The cohomological degree of a diagram is $p = q' - q$, with $q = \delta(\underline{\omega}) - \delta(\underline{\xi})$ and $q' = \delta(\underline{\omega}') - \delta(\underline{\xi}')$, where $\underline{\xi}$ and $\underline{\xi}'$ are the subwords of $\underline{\omega}$ and $\underline{\omega}'$ respectively that one can read on the boundaries of the diagram. Hence the degree can still be recovered from the diagram, provided we specify the words $\underline{\omega}$ and $\underline{\omega}'$.
- (iii) The polynomial degree of a diagram is still $d - p$, if d is the degree as a Soergel diagram (as described in § 2.1.5) and p is its cohomological degree.
- (iv) We want to describe the differential map. First observe that, by the same computations used in the proof of Claim 1, we have

$$d_{s,k} = \sum_{i=0}^k (-1)^i \begin{array}{c} \text{---} \\ \delta_s \quad \delta_s \quad \dots \quad \delta_s \quad \delta_s \quad \dots \quad \delta_s \\ \text{---} \end{array}$$

which is equal to

$$\pi \circ \left(\sum_{i=0}^k (-1)^i \begin{array}{c} \text{---} \\ \text{---} \end{array} \right) \circ \iota,$$

where ι and π are respectively the inclusion and the projection corresponding to the summand $C_{ss\dots s}$ inside $B_{ss\dots s}$ (as described in § 3.2.4). A similar formula holds for $d_{s,k}^-$. This means that, on the level of the B_x 's, the differential map acts as an alternating sum of dots. This justifies the following description. Consider the operations:

- adding a positive boundary dot on the bottom boundary or a negative boundary dot on the top boundary (*dot-sprouting*);
- removing a negative starting point or a positive ending point and adding a dot at the end of the corresponding strand (*strand-uprooting*);

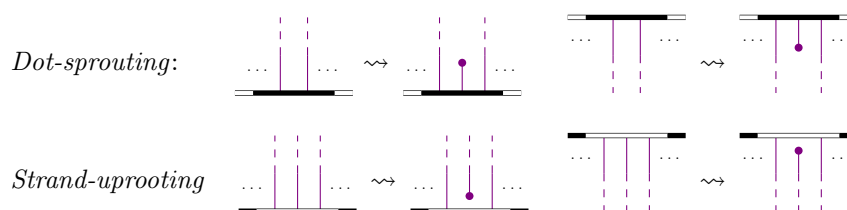

Each operation changes one of the subwords in a (white or black) piece of the boundary. We say that it is *admissible* when this gives again a subword of the word corresponding to that piece.

Then, the image via the differential map of a single diagram is the sum, with appropriate signs, of all the diagrams obtained by one of the above operations, when they are admissible.

The sign is given by the following rule. When operating on the top boundary, let r be the number of starting points to the left of the sprouting dot or the uprooted strand, then the sign is $(-1)^r$. The same rule applies to the bottom boundary but we also need to multiply by an additional $(-1)^{p+1}$ where p is the cohomological degree of the initial morphism.

For example, here is the image via the differential map of the above diagram:

$$\begin{aligned}
 d \left(\begin{array}{c} \text{---} \\ \alpha_u \\ \text{---} \end{array} \right) &= \begin{array}{c} \text{---} \\ \alpha_u \\ \text{---} \end{array} - \begin{array}{c} \text{---} \\ \alpha_u \\ \text{---} \end{array} + \begin{array}{c} \text{---} \\ \alpha_u \\ \text{---} \end{array} + \\
 &+ \begin{array}{c} \text{---} \\ \alpha_u \\ \text{---} \end{array} + \begin{array}{c} \text{---} \\ \alpha_u \\ \text{---} \end{array} - \begin{array}{c} \text{---} \\ \alpha_u \\ \text{---} \end{array} + \\
 &+ \begin{array}{c} \text{---} \\ \alpha_u \\ \text{---} \end{array} - \begin{array}{c} \text{---} \\ \alpha_u \\ \text{---} \end{array} + \begin{array}{c} \text{---} \\ \alpha_u \\ \text{---} \end{array}
 \end{aligned}$$

Here the initial morphism has degree 1, hence the additional sign term for the bottom boundary is just +1.

- (v) Composition of morphisms is always given by gluing diagrams vertically, but we have to take into account the inclusions and projections of the summands. If not all subwords match then the composition is zero, otherwise the middle line is then replaced by the corresponding idempotents. For example:

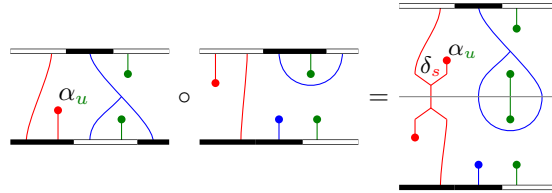

- (vi) Tensor product of morphisms is given by gluing diagrams horizontally, with the usual sign from Koszul rule.
- (vii) Finally, we can adapt the double leaves bases to this new description. For each choice of subwords one considers the usual double leaves basis but excluding some elements. More precisely, one should avoid the following configurations:
- the pairs of consecutive symbols of the same color with decorations $U1D1$, $U1D0$, $D0D1$ or $D0D0$ on a white piece;
 - the pairs of consecutive symbols of the same color with decorations $D1U1$, $D1U0$, $U0U1$ or $U0U0$ on a black piece.

A set of double leaves maps which does not contain these configurations is a basis for the morphism space. In fact one can show that the double leaves with the above configurations form a basis for the annihilators.

Chapter 4

Extensions in type \tilde{A}_1

Let us now go back to our main problem. We will study the type \tilde{A}_1 case. First we will determine completely the extension groups between Wakimoto sheaves in characteristic 0, then we will use the results from last chapter to produce a much simpler dg model for the morphism space $\text{Hom}(\Theta_\lambda, \mathbb{1})$ in general. Finally we will apply this to the antispherical category and determine completely the extension groups between the corresponding objects with arbitrary coefficients.

4.1 Type \tilde{A}_1 setting

We start with some observations and introduce some special notation for type \tilde{A}_1 .

4.1.1. Reduced words. Let W be the affine Weyl group of type \tilde{A}_1 . There are two simple reflections $S = \{s, t\}$, where $S_f = \{s\}$ is the finite reflection and $\{t\} = S \setminus S_f$ is the affine reflection (see Example 1.2 (iii)). Notice that, for $n > 0$, there are exactly two elements in W with length n , and each of them has a unique reduced word. Let

$$\underline{s}_n := \underbrace{stst\dots}_{n \text{ letters}} \qquad \underline{t}_n := \underbrace{tsts\dots}_{n \text{ letters}}$$

and let \mathbf{s}_n and \mathbf{t}_n denote the corresponding elements in W . Recall that in W the reflections are precisely the elements of odd length. and that $W = \langle s \rangle \times \mathbb{Z}$ with translation lattice generated by ts .

4.1.2. Realizations. In type \tilde{A}_1 the Cartan matrix is a 2×2 matrix of the form

$$\begin{pmatrix} 2 & \langle \alpha_s, \alpha_t^\vee \rangle \\ \langle \alpha_t, \alpha_s^\vee \rangle & 2 \end{pmatrix} = \begin{pmatrix} 2 & \partial_t(\alpha_s) \\ \partial_s(\alpha_t) & 2 \end{pmatrix} = \begin{pmatrix} 2 & -[2]_t \\ -[2]_s & 2 \end{pmatrix}$$

and it is determined by the two values $[2]_s = -\partial_s(\alpha_t)$ and $[2]_t = -\partial_t(\alpha_s)$ (see §2.1.3). The *standard* Cartan matrix for A_1 is that with $[2]_s = [2]_t = 2$.

Remark 4.1. Notice that, in order to satisfy Demazure surjectivity, we may have to assume that 2 is invertible in \mathbb{k} . Recall Example 2.2: we definitely need this assumption for the geometric realization (i) and the natural realization (iii) whereas we could avoid it for the Kac-Moody realizations (iv) and (v).

For the standard Cartan matrix, here is a picture of the action of the Kac-Moody realization over the root lattice (one has a similar picture for the coroot lattice).

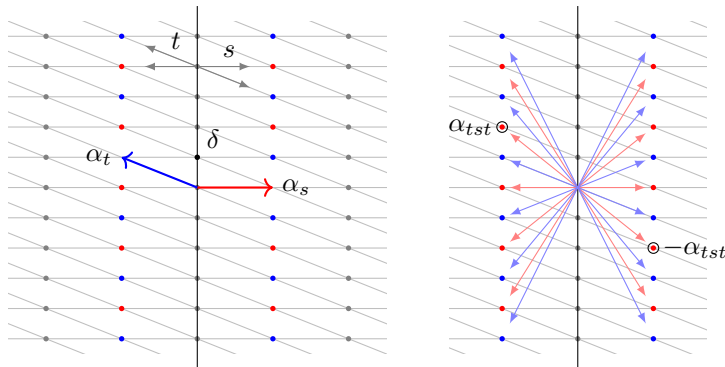

In the picture on the left, the actions of s and t are indicated by the gray arrows, and the red (and blue) points are the orbit of α_s (and α_t) via W . The points in the vertical black line are fixed by W .

In the picture on the right, one can see the action of (not only simple) reflections: the conjugates of s are drawn in red and the conjugates of t in blue. Each reflection x is associated with a unique pair of roots $\pm\alpha_x \in \mathfrak{h}^*$ and of coroots $\pm\alpha_x^\vee \in \mathfrak{h}$, such that

$$x(v) = v - \langle \alpha_x, v \rangle \alpha_x^\vee, \quad \forall v \in \mathfrak{h}.$$

If $x = wsw^{-1}$ one sees that $\alpha_x^\vee = \pm w(\alpha_s^\vee)$ and $\alpha_x = \pm w(\alpha_s)$. We put $\alpha_x := w(\alpha_s)$ where w is of minimal length (and similarly with t instead of s). In the picture, we have indicated for example $\alpha_{tst} = t(\alpha_s)$. In the context of [44], these correspond to the positive roots and coroots of the corresponding Kac-Moody algebra, but we extend the definition to all realizations of \tilde{A}_1 .

Remark 4.2. One has the following formulas (easily proved by induction) for the roots associated to arbitrary reflections:

$$\begin{aligned} \alpha_{\mathbf{s}_{2r+1}} &= [r+1]_s \alpha_s + [r]_t \alpha_t, \\ \alpha_{\mathbf{t}_{2r+1}} &= [r]_s \alpha_s + [r+1]_t \alpha_t. \end{aligned}$$

One has analogous formulas for the coroots.

4.1.3. Hecke category and Wakimoto sheaves in type \tilde{A}_1 . Let \mathcal{H} be the diagrammatic Hecke category for a given realization of the Coxeter system of type \tilde{A}_1 . From now on, we will use red for the simple reflection s and blue for t . Notice that we do not have any (s, t) -ar in the diagrams because there is no braid relation in the group.

Then we can consider the homotopy category $\mathcal{K}^b(\mathcal{H})$ and Rouquier complexes $F_{\underline{\omega}}^\bullet$ for all braid words $\underline{\omega}$ in the braid group. In this case the lift of the translation lattice in the braid group is given by

$$\{(\sigma_t \sigma_s)^n \mid n \in \mathbb{Z}\}.$$

Hence the Wakimoto sheaves in type \tilde{A}_1 are:

$$\begin{cases} \Theta_n^\bullet = (F_t F_s)^n & \text{if } n > 0 \\ \Theta_n^\bullet = (F_s^{-1} F_t^{-1})^{-n} & \text{if } n \leq 0. \end{cases}$$

By the general properties from §2.2.3, to compute morphisms between these objects, we can restrict to $\text{Hom}(\Theta_n^\bullet, \mathbb{1}[i])$. Furthermore, by the Rouquier formula, we already know that this is zero if $n > 0$.

The object of study of this chapter is then the dg-module

$$\text{Hom}^\bullet(\Theta_{-n}^\bullet, \mathbb{1}) \tag{4.1}$$

for $n \in \mathbb{N}$.

4.2 The characteristic zero case

Under the assumption that \mathbb{k} is of characteristic zero, the category \mathcal{H} has nice decomposition properties: for instance, in type \tilde{A}_1 , one can compute the minimal subcomplexes of the Wakimoto sheaves quite easily.

More precisely, in this section we assume

$$\text{char}(\mathbb{k}) = 0, \quad [n]_s, [n]_t \in \mathbb{k}^\times, \quad \forall n \in \mathbb{Z}_{>0}. \tag{4.2}$$

Notice that for the standard Cartan matrix, the two-colored quantum numbers are just the integers:

$$[n]_s = [n]_t = n.$$

So, in this case, the second assumption in (4.2) is automatic from the first.

4.2.1. More on two-colored quantum numbers. We will use the following properties, which can be easily proved by induction: if n is odd and $m \geq n$, then

$$[n][m]_x = \sum_{k=1}^n [m - n + 2k - 1]_x, \quad [n][m]_y = \sum_{k=1}^n [m - n + 2k - 1]_y.$$

If instead n is even then

$$[n]_y[m]_x = \sum_{k=1}^n [m - n + 2k - 1]_y, \quad [n]_x[m]_y = \sum_{k=1}^n [m - n + 2k - 1]_x.$$

In words, for an appropriate choice of colors, the product of the two-colored quantum numbers corresponding to n and m can be written as a sum of an increasing sequence of n two-colored quantum numbers, centered at m . Note that the recursive definition is the particular case $n = 2$.

We also define (two-colored quantum) factorials,

$$[n]_x! = [n]_x [n-1]_x \cdots [1]_x,$$

and binomial coefficients,

$$\begin{bmatrix} n \\ k \end{bmatrix}_x = \frac{[n]_x!}{[k]_x! [n-k]_x!},$$

and similarly for y . One can show that these are still elements of $\mathbb{Z}[x, y]$.

4.2.2. Minimal subcomplexes of the Wakimoto sheaves. As we mentioned above, under assumptions (4.2), one can actually compute the minimal subcomplex Θ_n (see §3.2) of the Wakimoto sheaves in type \tilde{A}_1 . Recall that this is a homotopy equivalent summand with no contractible summands: for complexes in \mathcal{H} , when \mathbb{k} is a field, or, more generally, a complete local ring, this property identifies a unique complex up to isomorphism. The minimal subcomplexes $F_{\mathfrak{t}_n}$ (and $F_{\mathfrak{s}_n}$) of $F_{\mathfrak{t}_n}$ (and $F_{\mathfrak{s}_n}$ respectively) were computed in [3] for the (infinite) dihedral group, so we will refer to this result. The case of $F_{\mathfrak{t}_{-1}}$ (and $F_{\mathfrak{s}_{-1}}$) is symmetric, but for convenience of application of this result, we prefer to use the positive complexes. So we compute the cohomology of

$$\mathrm{Hom}^\bullet(\mathbb{1}, \Theta_n) \tag{4.3}$$

with $n \geq 0$, which, by the remarks in the previous sections, is the same as (4.1).

The assumptions (4.2) allow to define, for all m , the Jones-Wenzl morphism from §2.1.5:

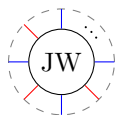

with $2m - 2$ strands around the circle. We emphasize that, in §2.1.5, the general assumptions on the realization allowed to define some of these morphisms (namely one for each braid relation), whereas now we can define them all at once. These morphisms can be described inductively: later, in the proof of a technical lemma, we will give one of the known recursive formulas for them. For other such formulas, see [30] or [33].

From each Jones-Wenzl morphism, one can build an idempotent as follows

$$\begin{aligned} \mathrm{JW}_{\mathfrak{s}_n} &= \boxed{\mathrm{JW}_{\mathfrak{s}_n}} = \text{circle with JW and } 2n \text{ strands} \\ \mathrm{JW}_{\mathfrak{t}_n} &= \boxed{\mathrm{JW}_{\mathfrak{t}_n}} = \text{circle with JW and } 2n \text{ strands} \end{aligned}$$

Here and below we will use violet to represent a non-specified color among red and blue: in this case the actual color depends on the parity of n .

These idempotents give the maximal indecomposable summands mentioned in Remark (i) in §2.1.6. More precisely, let $w \in W$ and let \underline{w} be the (unique) reduced word corresponding to it. Then the idempotent $JW_{\underline{w}}$ defined above identifies the summand B_w of $B_{\underline{w}}$.

Let us define the complex $F_{\underline{t}_n}$ to be

$$\begin{array}{ccccccc}
 & B_{\underline{t}_{n-1}}(1) & \rightarrow & B_{\underline{t}_{n-2}}(2) & \rightarrow & \dots & \rightarrow & B_{\underline{t}}(n-1) \\
 & \nearrow & & \nearrow & & \nearrow & & \nearrow \\
 B_{\underline{t}_n} & & \oplus & & \oplus & & \dots & \oplus & & R(n) \\
 & \searrow & & \searrow & & \searrow & & \searrow & & \searrow \\
 & B_{\underline{s}_{n-1}}(1) & \rightarrow & B_{\underline{s}_{n-2}}(2) & \rightarrow & \dots & \rightarrow & B_{\underline{s}}(n-1)
 \end{array} \quad (4.4)$$

where each arrow $\phi_{w,u} = B_w(n - \ell(w)) \rightarrow B_u(n - \ell(u))$ is given, in terms of the corresponding Bott-Samelson objects (via the Jones-Wenzl idempotents), as follows:

$$\begin{array}{cc}
 \phi_{\underline{t}_k, \underline{t}_{k-1}} = (-1)^{k+1} \begin{array}{c} \text{---} \\ | \\ \boxed{JW_{\underline{t}_{k-1}}} \\ | \\ \dots \\ | \\ \boxed{JW_{\underline{t}_k}} \\ | \\ \text{---} \end{array} & \phi_{\underline{t}_k, \underline{s}_{k-1}} = \begin{array}{c} \text{---} \\ | \\ \boxed{JW_{\underline{s}_{k-1}}} \\ | \\ \dots \\ | \\ \boxed{JW_{\underline{t}_k}} \\ | \\ \text{---} \end{array} \\
 \phi_{\underline{s}_k, \underline{s}_{k-1}} = (-1)^{k+1} \begin{array}{c} \text{---} \\ | \\ \boxed{JW_{\underline{s}_{k-1}}} \\ | \\ \dots \\ | \\ \boxed{JW_{\underline{s}_k}} \\ | \\ \text{---} \end{array} & \phi_{\underline{s}_k, \underline{t}_{k-1}} = \begin{array}{c} \text{---} \\ | \\ \boxed{JW_{\underline{t}_{k-1}}} \\ | \\ \dots \\ | \\ \boxed{JW_{\underline{s}_k}} \\ | \\ \text{---} \end{array}
 \end{array} \quad (4.5)$$

The fact that this is indeed a complex follows from the properties of the Jones-Wenzl idempotents (see for example [3] or [34]), which imply in particular that a smaller Jones-Wenzl idempotent is *swallowed* by a bigger one¹. One can define $F_{\underline{s}_n}$ similarly (the formulas for the ϕ 's being the same).

Then we have (see [3, §9]):

Theorem. *For $w \in W$ and \underline{w} its unique reduced word, the minimal subcomplex of $F_{\underline{w}}$ is F_w .*

Hence, in particular, the minimal subcomplex of a dominant Wakimoto sheaf are $\Theta_n = F_{\underline{t}_{2n}}$.

4.2.3. Consequences of Soergel's conjecture. Our next ingredient is the nice decomposition behavior of the Hecke category in this case, which is encoded in Soergel's conjecture (see Remark 2.5 (ii)).

Remark 4.3. (i) For the \tilde{A}_1 case, any realization satisfying assumption (4.2) will have this property.

¹Notice that this implies that we could simplify the diagrams for the ϕ 's in (4.5). We displayed them in this way to highlight the considered summands inside the Bott-Samelson object.

(ii) Now, observe that in type \tilde{A}_1 , Kazhdan-Lusztig polynomials are all trivial, which means that the Kazhdan-Lusztig basis is of the form

$$b_w = \sum_{x \leq w} v^{\ell(w) - \ell(x)} \delta_x.$$

(iii) Finally, by formula (2.11), this implies that

$$\text{Hom}(\mathbb{1}, B_w) = R(-\ell(w)). \tag{4.6}$$

Furthermore, a basis for $\text{Hom}(\mathbb{1}, B_w)$ is given, on the Bott-Samelson level, by the morphism

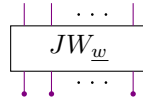

which has degree $\ell(w)$. In particular the basis of $\text{Hom}(\mathbb{1}, \mathbb{1})$ is the identity.

4.2.4. Extension groups. We can now compute the extension groups under our assumptions. The complex $\text{Hom}^\bullet(\mathbb{1}, F_{\mathbf{t}_n})$ is, by (4.4), the following:

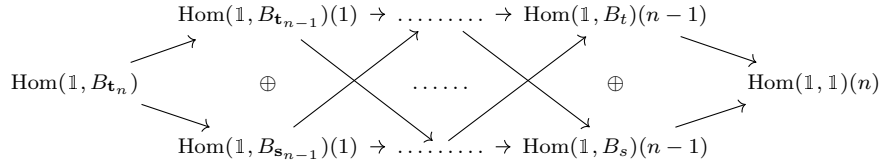

Hence, by (4.6), this becomes

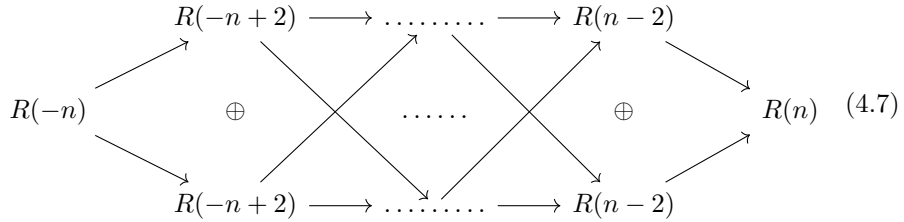

Here, each arrow is the multiplication by a certain polynomial that we now want to determine.

We have the following recursive formula, which we shall prove later, for the elements of R obtained by putting dots everywhere above and under a Jones-Wenzl morphism.

Lemma 4.4. *Let $u < w$ be elements of W with $\ell(w) = \ell(u) + 1$. Then*

$$\text{Diagram of } JW_w = q_{w,u} \text{ Diagram of } JW_u \tag{4.8}$$

where the coefficient $q_{w,u} \in R$ is as follows:

(i) if $\ell(u) = 2r$ is even, then

$$q_{w,u} = \begin{cases} \frac{[r]_s}{[2r]_s} \alpha_{\mathbf{s}_n} & \text{if } w = \mathbf{s}_n, \\ \frac{[r]_t}{[2r]_t} \alpha_{\mathbf{t}_n} & \text{if } w = \mathbf{t}_n; \end{cases}$$

(ii) if $\ell(u) = 2r + 1$ is odd, then

$$q_{w,u} = \begin{cases} \frac{[r+1]_t}{[2r+1]_t} \alpha_{\mathbf{s}_n} & \text{if } u = \mathbf{t}_n, \\ \frac{[r+1]_s}{[2r+1]_s} \alpha_{\mathbf{t}_n} & \text{if } u = \mathbf{s}_n. \end{cases}$$

In other words, up to a scalar, the coefficient is the root corresponding to the only reflection which is a subword of \underline{w} but not of \underline{u} .

Let us assume this lemma and go back to the complex (4.7). The arrow $\text{Hom}(\mathbb{1}, B_w) \rightarrow \text{Hom}(\mathbb{1}, B_u)$ is given by a polynomial $p_{w,u}$ such that

Now it suffices to add dots on all top strands, use the expressions of $\phi_{w,u}$ in (4.5), and then compare the result with the formula of the lemma to get

$$\begin{aligned} (-1)^{k+1} p_{\mathbf{t}_k, \mathbf{t}_{k-1}} &= q_{\mathbf{t}_k, \mathbf{t}_{k-1}} & p_{\mathbf{t}_k, \mathbf{s}_{k-1}} &= q_{\mathbf{t}_k, \mathbf{s}_{k-1}} \\ (-1)^{k+1} p_{\mathbf{s}_k, \mathbf{s}_{k-1}} &= q_{\mathbf{s}_k, \mathbf{s}_{k-1}} & p_{\mathbf{s}_k, \mathbf{t}_{k-1}} &= q_{\mathbf{s}_k, \mathbf{t}_{k-1}} \end{aligned}$$

We can now compute the cohomology of the complex (4.7): suppose first that n is even (which is the case of Wakimoto sheaves). Now, take $1 < k < n - 1$. If k is even and $n - k = 2r$, the complex at degree k looks as follows:

$$R(-n + 2k - 2)^{\oplus 2} \xrightarrow{f} R(-n + 2k)^{\oplus 2} \xrightarrow{g} R(-n + 2k + 2)^{\oplus 2},$$

where

$$\begin{aligned} f &= \begin{pmatrix} \frac{[r]_t}{[2r]_t} \alpha_{\mathbf{t}_{n-k+1}} & \frac{[r]_s}{[2r]_s} \alpha_{\mathbf{s}_{n-k+1}} \\ \frac{[r]_t}{[2r]_t} \alpha_{\mathbf{t}_{n-k+1}} & \frac{[r]_s}{[2r]_s} \alpha_{\mathbf{s}_{n-k+1}} \end{pmatrix}, \\ g &= \begin{pmatrix} -\frac{[r]_t}{[2r-1]_t} \alpha_{\mathbf{s}_{n-k-1}} & \frac{[r]_t}{[2r-1]_t} \alpha_{\mathbf{s}_{n-k-1}} \\ \frac{[r]_s}{[2r-1]_s} \alpha_{\mathbf{t}_{n-k-1}} & -\frac{[r]_s}{[2r-1]_s} \alpha_{\mathbf{t}_{n-k-1}} \end{pmatrix}. \end{aligned}$$

The cohomology at degree k is then

$$\begin{aligned} \frac{R}{\left(\frac{[r]_s}{[2r]_s} \alpha_{\mathbf{s}_{n-k+1}}, \frac{[r]_t}{[2r]_t} \alpha_{\mathbf{t}_{n-k+1}} \right)}(-n + 2k) &= \frac{R}{(\alpha_{\mathbf{s}_{n-k+1}}, \alpha_{\mathbf{t}_{n-k+1}})}(-n + 2k) \\ &= \frac{R}{(\alpha_s, \alpha_t)}(-n + 2k). \end{aligned}$$

If α_s and α_t generate \mathfrak{h}^* then this is $\mathbb{k}(-n+2k)$.

If instead k is odd and $n-k=2r+1$, the complex at degree k has the form

$$R(-n+2k-2)^{\oplus 2} \xrightarrow{f} R(-n+2k)^{\oplus 2} \xrightarrow{g} R(-n+2k+2)^{\oplus 2}$$

where

$$f = \begin{pmatrix} -\frac{[r+1]_t}{[2r+1]_t} \alpha_{\mathbf{s}_{n-k}} & \frac{[r+1]_t}{[2r+1]_t} \alpha_{\mathbf{s}_{n-k}} \\ \frac{[r+1]_s}{[2r+1]_s} \alpha_{\mathbf{t}_{n-k}} & -\frac{[r+1]_s}{[2r+1]_s} \alpha_{\mathbf{t}_{n-k}} \end{pmatrix}$$

$$g = \begin{pmatrix} \frac{[r]_t}{[2r]_t} \alpha_{\mathbf{t}_{n-k}} & \frac{[r]_s}{[2r]_s} \alpha_{\mathbf{s}_{n-k}} \\ \frac{[r]_t}{[2r]_t} \alpha_{\mathbf{t}_{n-k}} & \frac{[r]_s}{[2r]_s} \alpha_{\mathbf{s}_{n-k}} \end{pmatrix}$$

and hence the cohomology at degree k is 0. It is easy to adapt the above computation to the cases $k=0, 1$ and $k=n-1, n$. The results are summarized in the following table (where empty cells are zeroes).

$n \backslash j$	0	1	2	3	4	5	6	7	8	9	...
0	R										
2			$\mathbb{k}(2)$								
4			$\mathbb{k}(0)$		$\mathbb{k}(4)$						
6			$\mathbb{k}(-2)$		$\mathbb{k}(2)$		$\mathbb{k}(6)$				
8			$\mathbb{k}(-4)$		$\mathbb{k}(0)$		$\mathbb{k}(4)$		$\mathbb{k}(8)$		
...

(for simplicity, the table corresponds to the case $R/(\alpha_s, \alpha_t) = \mathbb{k}$).

When n is odd we can proceed similarly and obtain an analogous parity vanishing of the cohomology (in this case in even degrees), but we get something different for $k=1$. In fact, if $n=2r+1$ is odd, the beginning of the complex has the form

$$R(-n) \begin{pmatrix} \frac{[r]_t}{[2r]_t} \alpha_{\mathbf{t}_n} \\ \frac{[r]_s}{[2r]_s} \alpha_{\mathbf{t}_n} \end{pmatrix} \rightarrow R(-n+2)^{\oplus 2} \begin{pmatrix} -\frac{[r]_t}{[2r-1]_t} \alpha_{\mathbf{s}_{n-2}} & \frac{[r]_t}{[2r-1]_t} \alpha_{\mathbf{s}_{n-2}} \\ \frac{[r]_s}{[2r-1]_s} \alpha_{\mathbf{t}_{n-2}} & -\frac{[r]_s}{[2r-1]_s} \alpha_{\mathbf{t}_{n-2}} \end{pmatrix} \rightarrow R(-n+4)^{\oplus 2}$$

which gives zero cohomology in degree 0 and $R/(\alpha_{\mathbf{t}_n})(-n+2)$ in degree 1. Hence the table one gets is the following.

$n \backslash j$	0	1	2	3	4	5	6	7	8	9	...
1		$\frac{R}{(\alpha_t)}(1)$									
3		$\frac{R}{(\alpha_{\mathbf{t}_3})}(-1)$		$\mathbb{k}(3)$							
5		$\frac{R}{(\alpha_{\mathbf{t}_5})}(-3)$		$\mathbb{k}(1)$		$\mathbb{k}(5)$					
7		$\frac{R}{(\alpha_{\mathbf{t}_7})}(-5)$		$\mathbb{k}(-1)$		$\mathbb{k}(3)$		$\mathbb{k}(7)$			
9		$\frac{R}{(\alpha_{\mathbf{t}_9})}(-7)$		$\mathbb{k}(-3)$		$\mathbb{k}(1)$		$\mathbb{k}(5)$		$\mathbb{k}(9)$	
...

One has, of course, similar tables for $\text{Hom}^\bullet(1, F_{\mathbf{s}_n})$. We now turn to the proof of the recursive formula.

Proof of Lemma 4.4. We will suppose $w = \mathfrak{s}_{n+1}$ and $u = \mathfrak{s}_n$. The other cases can then be obtained by swapping s and t and/or applying horizontal reflection.

For convenience, let ω_n denote the polynomial obtained by putting dots everywhere above and under $JW_{\mathfrak{s}_n}$:

$$\omega_n := \begin{array}{c} \cdot \quad \cdot \quad \cdots \quad \cdot \\ \boxed{JW_{\mathfrak{s}_n}} \\ \cdot \quad \cdot \quad \cdots \quad \cdot \end{array}$$

So we want to show that

$$\omega_{n+1} = q_{\mathfrak{s}_{n+1}, \mathfrak{s}_n} \omega_n$$

We shall use the symbol

$$z(k) := \begin{cases} s & \text{if } k \text{ is odd} \\ t & \text{otherwise} \end{cases}$$

The lemma is a direct consequence of a recursive formula for Jones-Wenzl morphisms, which can be found in [3, §8.2] (for clarity we put a numbering over the strands):

$$\begin{array}{c} \begin{array}{c} \curvearrowright \quad \curvearrowright \quad \cdots \quad \curvearrowright \quad \curvearrowright \\ \boxed{JW_{\mathfrak{s}_{n+1}}} \\ \curvearrowleft \quad \curvearrowleft \quad \cdots \quad \curvearrowleft \quad \curvearrowleft \end{array} = \begin{array}{c} \curvearrowright \quad \curvearrowright \quad \cdots \quad \curvearrowright \quad \curvearrowright \\ \boxed{JW_{\mathfrak{s}_n}} \\ \curvearrowleft \quad \curvearrowleft \quad \cdots \quad \curvearrowleft \quad \curvearrowleft \end{array} + \frac{[1]_t}{[n]_{z(n+1)}} \begin{array}{c} \curvearrowright \quad \curvearrowright \quad \cdots \quad \curvearrowright \quad \curvearrowright \\ \boxed{JW_{\mathfrak{s}_n}} \\ \curvearrowleft \quad \curvearrowleft \quad \cdots \quad \curvearrowleft \quad \curvearrowleft \end{array} + \\ + \sum_{a=2}^{n-2} \frac{[a]_{z(a+1)}}{[n]_{z(n+1)}} \begin{array}{c} \curvearrowright \quad \curvearrowright \quad \cdots \quad \curvearrowright \quad \curvearrowright \\ \boxed{JW_{\mathfrak{s}_n}} \\ \curvearrowleft \quad \curvearrowleft \quad \cdots \quad \curvearrowleft \quad \curvearrowleft \end{array} + \frac{[n-1]_{z(n)}}{[n]_{z(n+1)}} \begin{array}{c} \curvearrowright \quad \curvearrowright \quad \cdots \quad \curvearrowright \quad \curvearrowright \\ \boxed{JW_{\mathfrak{s}_n}} \\ \curvearrowleft \quad \curvearrowleft \quad \cdots \quad \curvearrowleft \quad \curvearrowleft \end{array} \end{array} \quad (4.9)$$

If we put dots everywhere in (4.9), we obtain

$$\begin{array}{c} \begin{array}{c} \cdot \quad \cdot \quad \cdots \quad \cdot \quad \cdot \\ \boxed{JW_{\mathfrak{s}_{n+1}}} \\ \cdot \quad \cdot \quad \cdots \quad \cdot \quad \cdot \end{array} = \begin{array}{c} \cdot \quad \cdot \quad \cdots \quad \cdot \quad \cdot \\ \boxed{JW_{\mathfrak{s}_n}} \\ \cdot \quad \cdot \quad \cdots \quad \cdot \quad \cdot \end{array} + \frac{[1]_t}{[n]_{z(n+1)}} \begin{array}{c} \cdot \quad \cdot \quad \cdots \quad \cdot \quad \cdot \\ \boxed{JW_{\mathfrak{s}_n}} \\ \cdot \quad \cdot \quad \cdots \quad \cdot \quad \cdot \end{array} + \\ + \sum_{a=2}^{n-2} \frac{[a]_{z(a+1)}}{[n]_{z(n+1)}} \begin{array}{c} \cdot \quad \cdot \quad \cdots \quad \cdot \quad \cdot \\ \boxed{JW_{\mathfrak{s}_n}} \\ \cdot \quad \cdot \quad \cdots \quad \cdot \quad \cdot \end{array} + \frac{[n-1]_{z(n)}}{[n]_{z(n+1)}} \begin{array}{c} \cdot \quad \cdot \quad \cdots \quad \cdot \quad \cdot \\ \boxed{JW_{\mathfrak{s}_n}} \\ \cdot \quad \cdot \quad \cdots \quad \cdot \quad \cdot \end{array} \end{array}$$

After applying relations (2.3) and (2.6), we see that all the terms on the right are multiples of ω_n and we get

$$\begin{aligned}\omega_{n+1} &= \left(\alpha_{z(n+1)} + \frac{[1]_t}{[n]_{z(n+1)}} \alpha_t + \sum_{a=2}^{n-2} \frac{[a]_{z(a+1)}}{[n]_{z(n+1)}} \alpha_{z(a+1)} + \frac{[n-1]_{z(n)}}{[n]_{z(n+1)}} \alpha_{z(n)} \right) \omega_n \\ &= \left(\frac{[1]_t \alpha_t + [2]_s \alpha_s + \cdots + [n-1]_{z(n)} \alpha_{z(n)} + [n]_{z(n+1)} \alpha_{z(n+1)}}{[n]_{z(n+1)}} \right) \omega_n\end{aligned}$$

Now suppose that $n = 2r$ is even: if we split the sum according to the color and we use the properties of the two-colored quantum numbers, the coefficient becomes

$$\begin{aligned}\left(\frac{[2]_s + [4]_s + \cdots + [2r]_s}{[2r]_s} \right) \alpha_s + \left(\frac{[1]_t + [3]_t + \cdots + [2r-1]_t}{[2r]_s} \right) \alpha_t \\ = \left(\frac{[r]_s [r+1]_s}{[2r]_s} \right) \alpha_s + \left(\frac{[r]_s [r]_t}{[2r]_s} \right) \alpha_t \\ = \frac{[r]_s}{[2r]_s} ([r+1]_s \alpha_s + [r]_t \alpha_t) = \frac{[r]_s}{[2r]_s} \alpha_{s_{n+1}}\end{aligned}$$

If instead $n = 2r + 1$ is odd then it is

$$\begin{aligned}\left(\frac{[2]_s + [4]_s + \cdots + [2r]_s}{[2r+1]_t} \right) \alpha_s + \left(\frac{[1]_t + [3]_t + \cdots + [2r+1]_t}{[2r+1]_t} \right) \alpha_t \\ = \left(\frac{[r]_s [r+1]_s}{[2r+1]_t} \right) \alpha_s + \left(\frac{[r+1]_s [r+1]_t}{[2r+1]_t} \right) \alpha_t \\ = \frac{[r+1]_s}{[2r+1]_s} ([r]_s \alpha_s + [r+1]_t \alpha_t) = \frac{[r+1]_s}{[2r+1]_s} \alpha_{t_n}\end{aligned}$$

This concludes the proof. \square

Let us observe that

$$\frac{[1]_s [2]_s [3]_s [4]_s \cdots [2r]_s}{[1]_s [1]_s [2]_s [2]_s \cdots [r]_s} = [2r]_s$$

and that

$$\frac{[1]_s [2]_s [3]_s [4]_s \cdots [2r+1]_s}{[1]_s [1]_s [2]_s [2]_s \cdots [r+1]_s} = [2r+1]_s$$

and similarly for t . Hence, by induction from the lemma, one obtains the following formulas for the everywhere-dotted Jones-Wenzl morphisms.

Corollary 4.5. *Let T be the set of reflections in W . Then, for $n \geq 0$, one has:*

$$\left[\begin{array}{c} n-1 \\ \lceil \frac{n-1}{2} \rceil \end{array} \right]_s \begin{array}{c} \color{red}\uparrow \color{blue}\uparrow \cdots \color{purple}\uparrow \\ \boxed{JW_{\mathbf{s}_n}} \\ \color{red}\downarrow \color{blue}\downarrow \cdots \color{purple}\downarrow \end{array} = \prod_{\substack{v \in T \\ x \leq \mathbf{s}_n}} \alpha_x \quad \left[\begin{array}{c} n-1 \\ \lceil \frac{n-1}{2} \rceil \end{array} \right]_t \begin{array}{c} \color{blue}\uparrow \color{red}\uparrow \cdots \color{purple}\uparrow \\ \boxed{JW_{\mathbf{t}_n}} \\ \color{blue}\downarrow \color{red}\downarrow \cdots \color{purple}\downarrow \end{array} = \prod_{\substack{x \in T \\ x \leq \mathbf{t}_n}} \alpha_x$$

where $\lceil \cdot \rceil : \mathbb{R} \rightarrow \mathbb{Z}$ is the ceiling function.

Remark. Dhillon and Makam [28] compute extensions between Verma modules for the dihedral groups in a graded version of category \mathcal{O} . They consider the category of *Soergel modules* which is obtained from the Hecke category by killing on the right the maximal ideal generated by positive degree monomials. Then one can see the dihedral groups as quotients of the infinite dihedral group \hat{A}_1 . This defines a functor under which the Wakimoto sheaves are sent to the Verma modules and if one repeats our computations in that category one can actually deduce the same result.

4.3 The two color garden

We now drop assumption (4.2) and we consider an arbitrary realization \mathfrak{h} .

In the last chapter we described a reduced summand $F_{\underline{\omega}}$ inside $F_{\underline{\omega}}^\bullet$, for any braid word $\underline{\omega}$, which is homotopy equivalent to it. Let Θ_n denote this summand inside Θ_n^\bullet , for $n \in \mathbb{Z}$.

It is very hard to reduce further the complex Θ_n in this generality. In characteristic zero we could take advantage of the simplicity of decomposing Bott-Samelson objects (essentially encoded in the fact that Kazhdan-Lusztig polynomials are all 1 in this case).

Nevertheless, from last chapter we have a description of the dg-module of morphisms

$$C_n := \text{Hom}^\bullet(\Theta_{-n}, \mathbb{1})$$

in the category $\mathcal{C}_{\text{dg}}(\mathcal{H})$. We will reduce this dg-module with some homological algebra, strongly using the basis of light leaves maps.

4.3.1. DG diagrams for Wakimoto sheaves. Recall from § 3.2.8 that the space C_n can be written, as a graded module, as

$$C_n = \bigoplus_{\underline{x} \in \underline{\mathfrak{s}}_{2n}} \text{Hom}_{\mathcal{H}}(B_{\underline{x}}, \mathbb{1}) / \Lambda_{\underline{x}} \langle q_{\underline{x}} \rangle$$

where the sum is over all subwords of $\underline{\mathfrak{s}}_{2n}$ (which is the Coxeter projection of $(\sigma_t \sigma_s)^{-n}$), and $q_{\underline{x}} = 2n - \ell(\underline{x})$. The symbol Λ denotes the bottom-ideal generated by boundary trivalent vertices, of the following form.



Recall that the differential map of C_n acts by successively *uprooting* strands, as in the following picture

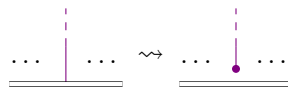

The image of a diagram via the differential map is then a linear combination, with some signs, of all the diagrams obtained by uprooting a single strand connected to the bottom boundary. The sign is determined by the subword \underline{u} and the position of the strand being uprooted, as follows. Let r be the number of missing colors on the right of the uprooted strand, with respect to the sequence $\dots ststst$, then the sign is given by $(-1)^{r+1}$.

Example 4.6. When applying the differential map to

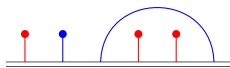

we obtain

$$\begin{aligned}
 & - \text{[Diagram 1]} - \text{[Diagram 2]} + \text{[Diagram 3]} + \\
 & \quad + \text{[Diagram 4]} - \text{[Diagram 5]} + \text{[Diagram 6]}.
 \end{aligned}$$

Here, for instance, the sign of the second term, obtained by uprooting the blue dot, is -1 : in fact there are two colors missing on its right (a red on the right of the blue dot, and a blue between the two red dots under the arch), so $r = 2$ in this case.

It is convenient to consider the (unbounded) dg-module

$$\Gamma = \bigoplus_{\underline{x}} \text{Hom}_{\mathcal{H}}(B_{\underline{x}}, \mathbb{1}) / \Lambda_{\underline{x}} \langle -\ell(\underline{x}) \rangle$$

where \underline{x} runs through all Coxeter words, and the differential map is the same as before. Then notice that the dg tensor product of morphisms, as defined in §3.1.3 (with signs according to the Koszul rule), makes Γ a dg-algebra. We see the space C_n as a dg submodule of $\Gamma[-2n]$.

Remark 4.7. Notice that if $k \leq n$ all Coxeter words of length k appear as subwords of \underline{s}_{2n} . This means that, if $\tilde{\tau}^{\geq i}$ is the naive truncation in $\mathcal{K}^b(\mathcal{H})$ (or even in $\mathcal{C}_{\text{dg}}(\mathcal{H})$) we have

$$\tilde{\tau}^{\geq n}(C_n) = \tilde{\tau}^{\geq n}(\Gamma[-2n])$$

In other words, for high cohomological degree the “tails” of C_n and Γ are the same (up to a shift). So the properties of Γ will correspond to *asymptotic* properties of C_n .

A crucial property of C_n and Γ for our purpose is that they are free as left R -modules. Bases are obtained from the light leaves bases of the spaces $\text{Hom}(B_{\underline{x}}, \mathbb{1})$, as explained in Remark 3.32 (vii). Let us now give a precise description of these basis for C_n .

4.3.2. Shrubberies. First let us look more closely to the light leaves maps in type \tilde{A}_1 .

We are interested in morphism spaces of the form $\text{Hom}(B_{\underline{w}}, \mathbb{1})$. In the sequel the *length* of an element γ of such a space, denoted by $\ell(\gamma)$, will just mean the length of \underline{w} as a Coxeter word.

We introduce an operation on morphisms of this form. For a given positive integer k , consider the morphism

$$\psi_k^s := \underbrace{\text{[Diagram with arch and dots]}_{k+1} \in \text{Hom}_{\mathcal{H}}(B_{\underline{s} \dots \underline{s}}, \mathbb{1})$$

For $i = 1, \dots, k$, let \underline{w}_i be a Coxeter word and $\gamma_i \in \text{Hom}_{\mathcal{H}}(B_{\underline{w}_i}, \mathbb{1})$. Then we define

$$(\gamma_1 | \dots | \gamma_k) := \psi_k^s \circ (\text{id}_{B_s} \otimes \gamma_1 \otimes \text{id}_{B_s} \otimes \dots \otimes \text{id}_{B_s} \otimes \gamma_k \otimes \text{id}_{B_s})$$

This is a morphism from $B_{\underline{w}'}$ to $\mathbb{1}$ where

$$\underline{w}' = s\underline{w}_1 s \dots s\underline{w}_k s.$$

In other words, this is the morphism obtained by covering the original ones with an s -arch and separating them by vertical strands.

Example 4.8. Let

$$\begin{aligned} \gamma_1 &= \text{diagram} \in \text{Hom}(B_{tst}, \mathbb{1}) \\ \gamma_2 &= \text{diagram} \in \text{Hom}(B_{ststss}, \mathbb{1}) \\ \gamma_3 &= \text{diagram} \in \text{Hom}(B_{ts}, \mathbb{1}) \end{aligned}$$

Then

$$(\gamma_1 | \gamma_2 | \gamma_3) = \text{diagram} \in \text{Hom}(B_{ststssststssstss}, \mathbb{1})$$

In a similar way one defines ψ_k^t and $(\cdot | \dots | \cdot)$.

Now, recall the construction of light leaves maps from §2.1.8. Notice that, as we only have one reduced expression for all elements of W and there is no braid relation, the light leaves basis does not depend on any choice. Furthermore we can easily write its elements.

Example 4.9. The following diagram is a light leaves map in \tilde{A}_1 towards the unit.

$$\text{diagram} \tag{4.10}$$

On bottom we have indicated the decorated 01-sequence (expressing the identity element) corresponding to it.

Remark 4.10. Let $\underline{w} = s_1 \dots s_k$ and $x = 1$. If the Bruhat stroll defined by a subexpression \mathbf{e} of \underline{w} passes through the identity at the step i , namely $\underline{w}_{<i}^{\mathbf{e}} = 1$, then the corresponding light leaves map $L_{\underline{w}, \mathbf{e}}$ can be split as the tensor product $L_{\underline{w}_{<i}, \mathbf{e}_{<i}} \otimes L_{\underline{w}_{>i}, \mathbf{e}_{>i}}$. For example the above map can be written as the tensor product of four pieces.

Here is some terminology to describe these morphisms.

- (i) The empty basis element, whose starting word is the empty word, is called *trivial*;

- (ii) A non-trivial basis element that cannot be written as the tensor product of smaller non-trivial basis elements is called *shrub* (this corresponds to the fact that the Bruhat stroll determined by the 01-sequence \mathbf{e} does not return to the identity element until the end). The trivial basis element will also be referred to as a *trivial shrub* in the sequel;
- (iii) A (non-trivial) shrub is said to be *red* (or *blue*) if its first starting point is red (or blue, respectively). This means that its outer strand, the one adjacent to the topmost region of the strip, is red (or blue). We declare that the trivial shrub is both red and blue;
- (iv) Any basis element is then written uniquely as the tensor product of shrubs, and we will refer to it as a *shrubby*. Clearly we have a separation between different shrubs whenever the Bruhat stroll gets to the identity element. For example, the shrubby (4.10) has four shrubs, two of them are red and the other two blue;
- (v) A shrubby is *red* (or *blue*) if all its shrubs are red (or blue respectively).

We can now give a recursive description of shrubbies:

- We denote by \bullet and \circ the red and blue dots respectively;
- A blue shrub can be uniquely written in the form $(L_1 | \dots | L_k)$ for a sequence of (possibly trivial) red shrubbies L_1, \dots, L_k (we see the blue dot as the case $k = 0$). Formally, if $(\underline{u}_1, \mathbf{e}_1), \dots, (\underline{u}_k, \mathbf{e}_k)$ are the starting words and subexpressions defining L_1, \dots, L_k , this corresponds to take $(\underline{u}, \mathbf{e})$ as follows

$$\begin{aligned} \underline{u} &= t \underline{u}_1 t \underline{u}_2 \dots t \underline{u}_k t \\ \mathbf{e} &= 1 \mathbf{e}_1 0 \mathbf{e}_2 \dots 0 \mathbf{e}_k 1 \end{aligned}$$

(the decorations of the new symbols will be necessarily U for the first and D for all the others). Vice versa, one gets a red shrub starting by a sequence of blue shrubbies.

- Finally, a shrubby is denoted by the concatenation of its shrubs. Hence, for example, the shrubby (4.10) would be

$$((\bullet | (|)))(| \bullet) \bullet$$

Remark 4.11. Notice that one can easily pass from the above notation to the pair $(\underline{w}, \mathbf{e})$ and vice versa. The word \underline{w} corresponds to the sequence of colors and for \mathbf{e} we use the dictionary:

$$(\leftrightarrow U1 \quad \bullet \leftrightarrow U0 \quad) \leftrightarrow D1 \quad | \leftrightarrow D0$$

Remark 4.12. Let L be a shrubby with starting word \underline{w} , and consider the morphism (L) . If L is red then this is a blue shrub. Otherwise, if L contains at least one blue shrub, then it can be written as

$$K_1(L_1 | \dots | L_k)K_2$$

where K_1 and K_2 are (any) shrubberies and L_1, \dots, L_k are red shrubberies (recall that $k = 0$ correspond to a blue dot). Notice then that we can protract a blue dot from the blue shrub and factor (L) as

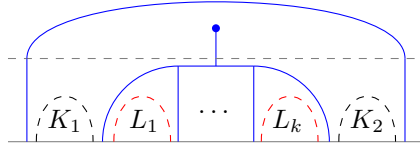

Then notice that

$$\begin{aligned} \text{Diagram} &= \text{Diagram} = \text{Diagram} - \text{Diagram} \\ &= t(\delta_t) + \partial_t(\delta_t) - \text{Diagram} - \partial_t(t(\delta_t)) \\ &= -\alpha_t \text{Diagram} + \text{Diagram} + \text{Diagram} \end{aligned}$$

(in fact $t(\delta_t) = \delta_t - \langle \delta_t, \alpha_t^\vee \rangle \alpha_t = \delta_t - \alpha_t$).

Hence

$$(L) = -\alpha_t(K_1|L_1| \dots |L_k|K_2) + \bullet K_1(L_1| \dots |L_k|K_2) + (K_1|L_1| \dots |L_k)K_2 \bullet$$

and, iterating the process if necessary, one gets the linear combination of shrubberies expressing (L) .

One can then see that for any $\gamma_1, \dots, \gamma_k$, the morphism $(\gamma_1| \dots | \gamma_k)$ can be written as a linear combination of shrubberies which are either products of smaller shrubs, or shrubs in which the sequence of the sizes of the arches is a refinement of the starting one. This means shrubs of the form

$$(L_1^{(1)}| \dots |L_{r_1}^{(1)}|L_1^{(2)}| \dots |L_{r_2}^{(2)}| \dots | \dots |L_1^{(k)}| \dots |L_{r_k}^{(k)})$$

where $\ell(L_1^{(j)}) + \dots + \ell(L_{r_j}^{(j)}) = \ell(\gamma_j)$.

Finally, to find bases for C_n we have to quotient by the morphisms in $\Lambda_{\underline{x}}$. More precisely, as we have seen in Remark 3.32 (vii), the spaces $\text{Hom}_{\mathcal{H}}(B_{\underline{x}}, \mathbb{1})/\Lambda_{\underline{x}}$ are still free with bases given by light leaves maps that do not belong to $\Lambda_{\underline{x}}$. Then the collection of all such light leaves maps when \underline{x} runs through the subwords of \underline{s}_{2n} give a basis for C_n . Similarly, one gets a basis for Γ by considering all Coxeter words.

The shrubberies that are not in the annihilator are precisely those that do not have *empty arches*, namely subsequences of one of the forms

$$(|, \quad (, \quad ||, \quad |).$$

In fact, these correspond precisely to the forbidden sequences.

Example 4.13. Here is a shrubbery with this property,

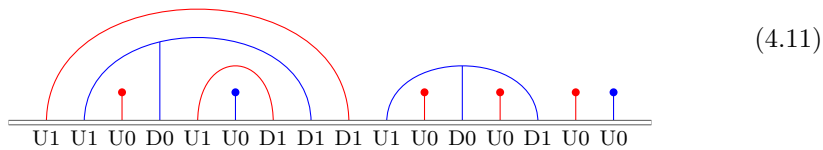

which corresponds to the expression

$$((\bullet|\bullet))(\bullet|\bullet)\bullet$$

Let \mathcal{L} denote the set of all such shrubberies, so that \mathcal{L} is a basis for Γ . Let also \mathcal{L}_s and \mathcal{L}_t denote the subsets of red and blue shrubberies respectively.

Remark 4.14. As every shrubbery is the tensor product of shrubs, we see that Γ is generated by shrubs, as a dg- R -algebra.

4.3.3. Gardening principles. We will now investigate the properties of the differential map with respect to this basis.

We introduce a little more terminology. Again, if L is a shrubbery its *length* $\ell(L)$ is that of its starting word. We say that a shrub is *complete* when its starting word is of the form \mathbf{t}_{2h+1} or \mathbf{s}_{2h+1} (i.e. the colors of its starting points are alternating). A shrubbery is said *complete* when all of its shrubs are (notice that the whole starting word need not be alternating). We call *stem* a vertical strand connecting the boundary with a trivalent vertex (so stems correspond precisely to $D0$'s in \mathbf{e}). A shrubbery is *well-tended* if it is complete and without stems. Hence notice that well-tended *shrubs* have to be of the form

$$((\dots((\bullet))\dots)) = \text{diagram of nested arches}$$

In particular, dots are well-tended shrubs. Also the empty diagram is declared to be well-tended. Notice that a well-tended shrub is determined by the number of its strands and by its outer color: we will denote ρ_k and β_k respectively the red and blue well-tended shrubs with k strands (which has length $2k - 1$).

We want to define a partial order \leq on shrubberies of a given length ℓ . We proceed by induction on ℓ .

Definition 4.15. (i) If $\ell = 0, 1$ (i.e. when the only shrubberies are, respectively, the empty one, or the red dot and the blue dot) we declare that $L \leq L'$ if and only if $L = L'$;

(ii) If $\ell > 1$, suppose that we have defined a partial order on all sets of shrubberies of length smaller than ℓ . Take first two *shrubs* L and L' of length ℓ . We declare that $L \leq L'$ if they are of the same color, say blue, and, when written as

$$\begin{aligned} L &= (L_1 | \dots | L_k) \\ L' &= (L'_1 | \dots | L'_{k'}) \end{aligned}$$

we have either:

- $\ell(L_1) < \ell(L'_1)$ (we also call these the *sizes of the first arches*), or;
- $\ell(L_1) = \ell(L'_1)$ and $L_1 < L'_1$ in the order of shrubberies of length $\ell(L_1)$, or;
- $L_1 = L'_1$, and $(L_2 | \dots | L_k) \leq (L_2 | \dots | L'_{k'})$ in the order of shrubs of length $\ell - \ell(L_1)$ (notice that if $k = 1$, we already have $L = L'$).

(iii) Finally take two shrubberies L and L' , which are not just shrubs, and decompose them into shrubs

$$\begin{aligned} L &= K_1 \otimes \cdots \otimes K_m \\ L' &= K'_1 \otimes \cdots \otimes K'_{m'}. \end{aligned}$$

Then we declare that $L \leq L'$ if, either:

- $\ell(K_1) < \ell(K'_1)$ or;
- $\ell(K_1) = \ell(K'_1)$ and $K_1 < K'_1$ in the order on shrubs of length $\ell(K_1)$, or;
- $K_1 = K'_1$, and $K_2 \otimes \cdots \otimes K_m \leq K'_2 \otimes \cdots \otimes K'_{m'}$ in the order of shrubberies of length $\ell - \ell(K_1)$.

Remark 4.16. By definition, the order is lexicographic with respect to the monoidal structure, which means that, given the shrubberies L, L', M, M' and N , we have

$$L < L' \Rightarrow N \otimes L \otimes M < N \otimes L' \otimes M'$$

We now want to prove that the differential map has an upper-triangularity property with respect to this order.

Remark 4.17. Uprooting a stem from a shrubbery always gives another shrubbery. Given L a shrubbery with at least one stem, let $u(L)$ be the shrubbery obtained by uprooting the leftmost outer stem. More precisely, if L is a single, say, red shrub $(L_1|L_2|\dots|L_k)$ with $k > 1$, then $u(L) := (L_1L_2|\dots|L_k)$ (and same for blue); if $k = 1$ then set $u(L) = (u(L_1))$ recursively. If L is a product of shrubs $K_1 \otimes \cdots \otimes K_m$ and K_i has a stem whereas K_1, \dots, K_{i-1} have not, then $u(L) := K_1 \otimes \cdots \otimes u(K_i) \otimes \cdots \otimes K_m$.

Lemma 4.18. *Let L be a shrubbery with at least one stem. Then*

$$d(L) \in \pm u(L) + \bigoplus_{L' < u(L)} RL'$$

Proof. By Remark 4.16, it is sufficient to deal with the case where L is a single, say, red shrub. We can write L in the form

$$L = (L_1|\dots|L_k)$$

where the L_j 's are blue shrubberies.

We proceed by induction. The smallest such L is the following of length 5

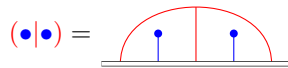

and one can easily work out that

$$d((\bullet|\bullet)) = \bullet(\bullet) - [2]_t \bullet(\bullet) + (\bullet\bullet) - [2]_s (\bullet)\bullet + (\bullet)\bullet \tag{4.12}$$

and $(\bullet\bullet) = u(L)$ is bigger than all the other shrubberies appearing.

For a general shrub L , the image $d(L)$ is the following linear combination of diagrams obtained by uprooting strands

$$d(L) = \sigma_0 L_1(L_2 | \dots | L_k) + \sum_j \sigma_j (L_1 | \dots | L_j L_{j+1} | \dots | L_k) + \\ - (L_1 | \dots | L_{k-1}) L_k + \sum_j \sigma'_j (L_1 | \dots | d(L_j) | \dots | L_k)$$

for some signs σ_j and σ'_j . The first and third terms, obtained by uprooting the first and last stems, are product of smaller shrubs, so they are clearly lower than $u(L)$.

Now, if $k > 1$, then $u(L)$ is the term with $j = 1$ in the first sum and its first arch has size $\ell(L_1) + \ell(L_2)$, hence it is bigger than that of all the other terms of that sum.

For the second sum one can use the remark 4.12 to see that, each term can be developed as a linear combination of shrubberies that are either products of smaller shrubberies or that have first arch with size $\leq \ell(L_1)$.

If $k = 1$ then the shrubbery L_1 has to have at least one stem. The above sum reduces to

$$d(L) = \sigma_0 L_1 \bullet - \bullet L_1 + \sigma'(d(L_1))$$

and the first two terms are again clearly smaller than $u(L)$. Then we can apply the induction hypothesis on L_1 and we conclude. \square

4.3.4. Weeding the garden. In this section we will describe a simpler dg-module \tilde{C}_n homotopy equivalent to C_n , which is much more handy and will allow us to compute cohomology in the antispherical category. In fact the direct computation on C_n would still be prohibitive, so we use Gaussian elimination to reduce it.

Let $\tilde{\Gamma}$ be the free associative dg- R -algebra generated by elements $\tilde{\rho}_k$ and $\tilde{\beta}_k$ for $k \in \mathbb{Z}_{>0}$. Both $\tilde{\rho}_0$ and $\tilde{\beta}_0$ will denote the unit and $\tilde{\rho}_k$ and $\tilde{\beta}_k$ are in degree $-2k + 1$. The differential map is defined as follows

$$d(\tilde{\rho}_k) = \begin{cases} \alpha_s \tilde{\rho}_0 & \text{if } k = 1 \\ -\sum_{i=1}^{k-1} \begin{bmatrix} k \\ i \end{bmatrix}_s \tilde{\rho}_{k-i} \tilde{\rho}_i + \sum_{i=1}^{k-1} \begin{bmatrix} k-1 \\ i-1 \end{bmatrix}_t (\tilde{\rho}_i \tilde{\beta}_{k-i} + \tilde{\beta}_{k-1} \tilde{\rho}_i) & \text{if } k > 1 \end{cases}$$

$$d(\tilde{\beta}_k) = \begin{cases} -\alpha_t \tilde{\beta}_0 & \text{if } k = 1 \\ \sum_{i=1}^{k-1} \begin{bmatrix} k \\ i \end{bmatrix}_t \tilde{\beta}_{k-i} \tilde{\beta}_i - \sum_{i=1}^{k-1} \begin{bmatrix} k-1 \\ i-1 \end{bmatrix}_s (\tilde{\beta}_i \tilde{\rho}_{k-i} + \tilde{\rho}_{k-1} \tilde{\beta}_i) & \text{if } k > 1 \end{cases}$$

and then extended R -linearly and according to *right* Leibniz rule, which means, for monomials x and y :

$$d(xy) = xd(y) + (-1)^{|y|} d(x)y,$$

where $|y|$ is the number of generators appearing in y .

We define the *word associated* to a monomial in $\tilde{\Gamma}$ as

$$\tilde{\rho}_k \mapsto \underline{\mathfrak{s}}_{2k-1} \qquad \tilde{\beta}_k \mapsto \underline{\mathfrak{t}}_{2k-1}$$

and then extended multiplicatively to a map of monoids $\langle \tilde{\rho}_k, \tilde{\beta}_k \rangle_{k \in \mathbb{N}} \rightarrow \mathfrak{W}_S$. Then the span of the monomials whose associated word is a subword of $\underline{\mathfrak{s}}_{2n}$ is a dg submodule of $\tilde{\Gamma}$, that will be denoted by \tilde{C}_n .

We can now state the main result of this section

Theorem 4.19. *The dg-module C_n is homotopy equivalent to $\tilde{C}_n[-2n]$*

Remark 4.20. Consider a complete shrubbery L , which is not well-tended. There will be a nonempty set of stems. The shrubberies obtained by uprooting some of these stems are still not well-tended, and we can divide them into two classes. The class \mathcal{E}_L will contain those in which the leftmost outer stem has not been uprooted, and \mathcal{F}_L the others. Then the function u gives a bijection from \mathcal{E}_L to \mathcal{F}_L .

The following is an example where L has 3 stems.

Example 4.21. Take

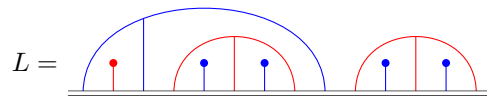

then the two classes and the bijection are described by the following picture

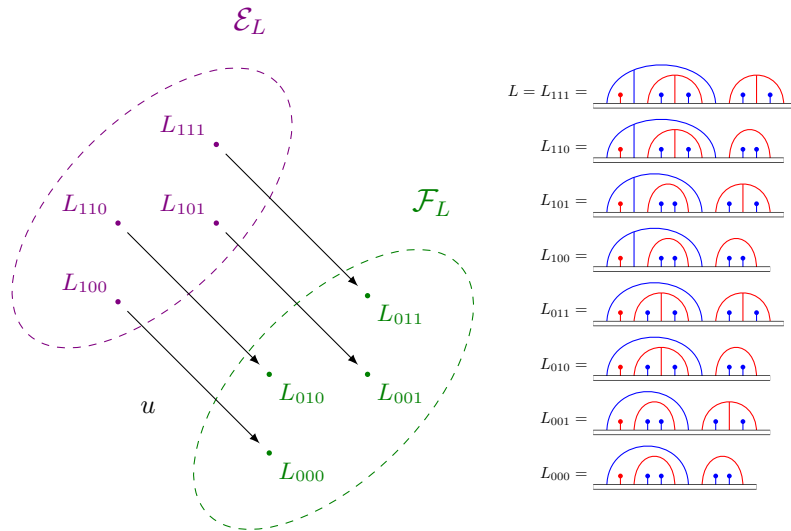

Here the sequences of 0's and 1's that label the shrubberies indicate which stems have been uprooted.

Let us then prove the theorem.

Proof. If one makes the subdivision of Remark 4.20 for all complete non well-tended shrubberies L , one gets two classes of shrubberies, \mathcal{E} and \mathcal{F} , which span graded submodules

$$E = \bigoplus_{L \in \mathcal{E}} R \cdot L \quad \text{and} \quad F = \bigoplus_{L \in \mathcal{F}} R \cdot L.$$

Let now $A = \bigoplus_p A^p$ be the span of the well-tended shrubberies. The dg-module

C_n will then look as follows

$$\begin{array}{ccccccc}
 \dots & \longrightarrow & A^{p-1} & \xrightarrow[\quad g^{p-1}]{\quad a^{p-1}} & A^p & \xrightarrow[\quad g^p]{\quad a^p} & A^{p+1} & \longrightarrow & \dots \\
 & & \oplus & & \oplus & & \oplus & & \\
 \dots & \longrightarrow & E^{p-1} & \xrightarrow[\quad f^{p-1}]{\quad} & E^p & \xrightarrow[\quad f^p]{\quad} & E^{p+1} & \longrightarrow & \dots \\
 & & \oplus & & \oplus & & \oplus & & \\
 \dots & \longrightarrow & F^{p-1} & \xrightarrow[\quad \phi^{p-1}]{\quad} & F^p & \xrightarrow[\quad \phi^p]{\quad} & F^{p+1} & \longrightarrow & \dots
 \end{array}$$

We claim that all the morphisms $\phi^p : E^p \rightarrow F^{p+1}$ (green in the picture) are isomorphisms. In fact, by the remark 4.20, the morphism ϕ^p is expressed by a square matrix with respect to the bases of E^p and F^{p+1} , and by lemma 4.18, this matrix is upper triangular with ± 1 on the diagonal. Hence, by Gaussian elimination, the dg-module C_n is homotopy equivalent to

$$\dots \longrightarrow A^{p-1} \xrightarrow{\tilde{d}^{p-1}} A^p \xrightarrow{\tilde{d}^p} A^{p+1} \longrightarrow \dots \quad (4.13)$$

where $\tilde{d}^p = a^p - g^p(\phi^p)^{-1}f^p$.

Recall now that A is spanned by well-tended shrubberies which are tensor products of well-tended shrubs of the form ρ_k and β_k , such that the starting word is a subword of σ_{2n} . Hence the map sending

$$\begin{aligned}
 \tilde{\rho}_k &\mapsto \rho_k \\
 \tilde{\beta}_k &\mapsto \beta_k
 \end{aligned}$$

and extended multiplicatively, defines an isomorphism of graded modules between $\tilde{C}_n[-2n]$ and (4.13). We have to show that also the differential maps agree.

Observe that, as d is compatible with the monoidal structure, and tensoring with elements in A stabilizes A , E and F , then also the new differential d is compatible with the monoidal structure. Hence it is sufficient to deal with the case of a single (well-tended) shrub. The case $k = 1$ is immediate. For $k > 1$, we have to prove that

$$\tilde{d}(\rho_k) = - \sum_{i=1}^{k-1} \left[\begin{matrix} k \\ i \end{matrix} \right]_s \rho_{k-i} \rho_i + \sum_{i=1}^{k-1} \left[\begin{matrix} k-1 \\ i-1 \end{matrix} \right]_t (\rho_i \beta_{k-i} + \beta_{k-i} \rho_i),$$

and the analogous equality (with signs reversed) for $\tilde{d}(\beta_k)$.

When $k = 2$ we have directly

$$\rho_2 = (\bullet) \xrightarrow{d} \bullet \bullet - [2]_s \bullet \bullet + \bullet \bullet = \beta_1 \rho_1 - [2]_s \rho_1 \rho_1 + \rho_1 \beta_1.$$

When $k = 3$, we have

$$\begin{aligned}
 \rho_3 &= ((\bullet)) \xrightarrow{d} (\bullet) \bullet + \bullet (\bullet) - [2]_t (\bullet \bullet) + (\bullet) \bullet + \bullet (\bullet) = \\
 &= \beta_2 \rho_1 + \rho_1 \rho_2 - [2]_t (\bullet \bullet) + \rho_2 \rho_1 + \rho_1 \beta_2.
 \end{aligned}$$

This can be written, using the notation from the above diagram,

$$a(\rho_3) = \beta_2\rho_1 + \rho_1\rho_2 + \rho_2\rho_1 + \rho_1\beta_2, \quad f(\rho_3) = -[2]_t(\bullet\bullet).$$

On the other hand, equation (4.12) implies

$$g((\bullet|\bullet)) = \beta_1\rho_2 - [2]_s\rho_1\rho_2 - [2]_s\rho_2\rho_1 + \rho_2\beta_1, \quad \phi((\bullet|\bullet)) = (\bullet\bullet).$$

Hence

$$\begin{aligned} \tilde{d}(\rho_3) &= \beta_2\rho_1 + \rho_1\rho_2 + \rho_2\rho_1 + \rho_1\beta_2 + [2]_t(\beta_1\rho_2 - [2]_s\rho_1\rho_2 - [2]_s\rho_2\rho_1 + \rho_2\beta_1) \\ &= (\rho_1\beta_2 + \beta_2\rho_1) + [2]_t(\rho_2\beta_1 + \beta_1\rho_2) - ([2]_t[2]_s - 1)\rho_1\rho_2 + \\ &\quad - ([2]_t[2]_s - 1)\rho_2\rho_1 \\ &= (\rho_1\beta_2 + \beta_2\rho_1) + [2]_t(\rho_2\beta_1 + \beta_1\rho_2) - [3]_s\rho_1\rho_2 - [3]_s\rho_2\rho_1 \\ &= (\rho_1\beta_2 + \beta_2\rho_1) + [2]_t(\rho_2\beta_1 + \beta_1\rho_2) - [3]_s\rho_1\rho_2 - [3]_s\rho_2\rho_1 \end{aligned}$$

Now we want to proceed by induction. One can see, along the lines of Remark 4.12, that the image via the differential map of any shrub is a sum of shrubberies with at most two shrubs. In particular $d(\rho_k)$ is such a sum, and looking at the starting word one can see that the only terms contained in F have one shrub. This implies that also $\tilde{d}(\rho_k)$ is a sum of (well-tended) shrubberies with at most two shrubs. But from the form of well-tended shrubberies we deduce that that all these terms have exactly two shrubs which are not both blue. Hence we can write

$$\tilde{d}(\rho_k) = \sum_{i=1}^{k-1} \lambda_{k,i}^{ss} \rho_i \rho_{k-i} + \sum_{i=1}^{k-1} \lambda_{k,i}^{st} \rho_i \beta_{k-i} + \sum_{i=1}^{k-1} \lambda_{k,i}^{ts} \beta_i \rho_{k-i},$$

In the same way, we argue that $\tilde{d}(\beta_k)$ is a sum of shrubberies with at most two shrubs that are not both red, hence:

$$\tilde{d}(\beta_k) = \sum_{i=1}^{k-1} \mu_{k,i}^{ss} \beta_i \beta_{k-i} + \sum_{i=1}^{k-1} \mu_{k,i}^{st} \rho_i \beta_{k-i} + \sum_{i=1}^{k-1} \mu_{k,i}^{ts} \beta_i \rho_{k-i}.$$

We want to show that

$$\begin{aligned} \lambda_{k,i}^{ss} &= -\left[\begin{matrix} k \\ i \end{matrix} \right]_s, & \lambda_{k,i}^{st} &= \left[\begin{matrix} k-1 \\ i-1 \end{matrix} \right]_t, & \lambda_{k,i}^{ts} &= \left[\begin{matrix} k-1 \\ k-i-1 \end{matrix} \right]_t, \\ \mu_{k,i}^{tt} &= \left[\begin{matrix} k \\ i \end{matrix} \right]_t, & \mu_{k,i}^{st} &= -\left[\begin{matrix} k-1 \\ k-i-1 \end{matrix} \right]_s, & \mu_{k,i}^{ts} &= -\left[\begin{matrix} k-1 \\ i-1 \end{matrix} \right]_s. \end{aligned}$$

The differential preserves the horizontal symmetry of the well-tended shrubberies, hence $\lambda_{k,i}^{st} = \lambda_{k,k-i}^{ts}$ and $\mu_{k,i}^{st} = \mu_{k,k-i}^{ts}$. So it is sufficient to determine only one version for the mixed coefficients. Notice also that we can easily get, for all k

$$\lambda_{k,1}^{st} = 1 \tag{4.14}$$

because this is the coefficient of $\rho_1\beta_k$ in the expansion of $a(\rho_k)$ and this shrubbery cannot appear in the expansion of any image via g of a shrub in E .

Now we use that $\tilde{d}^2 = 0$ to deduce all the other coefficients. The coefficient of $\rho_1\beta_j\beta_{k-j-1}$ in $\tilde{d}^2(\rho_k)$ is

$$0 = \lambda_{k,1}^{st} \mu_{k-1,j}^{tt} - \lambda_{k,j+1}^{st} \lambda_{j+1,1}^{st} = \left[\begin{matrix} k-1 \\ j \end{matrix} \right]_t - \lambda_{k,j+1}^{st},$$

where for the second equality we used induction and (4.14). We deduce that

$$\lambda_{k,j+1}^{st} = \left[\begin{matrix} k-1 \\ j \end{matrix} \right]_t.$$

Similarly we get $\mu_{k,j+1}^{ts} = -\left[\begin{matrix} k-1 \\ j \end{matrix} \right]_s$.

Secondly, the coefficient of $\rho_1 \rho_1 \beta_{k-2}$ is

$$0 = \lambda_{k,1}^{ss} \lambda_{k-1,1}^{st} - \lambda_{k,2}^{st} \lambda_{2,1}^{ss} + \lambda_{k,1}^{st} \mu_{k-1,k-2}^{st} = \lambda_{k,1}^{ss} + [k-1]_t [2]_s - [k-2]_s,$$

where we used again (4.14) and the values of the coefficients known by induction.

We deduce $\lambda_{k,1}^{ss} = -[k-1]_t [2]_s + [k-2]_s = -[k]_s$.

Finally, the coefficient of $\rho_1 \rho_{i-1} \rho_{k-i}$ is

$$0 = \lambda_{k,1}^{ss} \lambda_{k-1,i-1}^{ss} - \lambda_{k,i}^{ss} \lambda_{i,1}^{ss}$$

and we get

$$\lambda_{k,i}^{ss} = -\frac{[k]_s \left[\begin{matrix} k-1 \\ i-1 \end{matrix} \right]_s}{[i]_s} = -[k]_s.$$

In a similar way we get $\mu_{k,i}^{tt} = \left[\begin{matrix} k \\ i \end{matrix} \right]_t$. This concludes the proof. \square

Passing to the limit, one obtains

Corollary 4.22. *The dg-algebra Γ is homotopy equivalent to $\tilde{\Gamma}$.*

4.4 The antispherical category

The above reduction allows to determine morphism spaces between Wakimoto sheaves in the *anti-spherical category*. Let us first recall the definition of the latter.

4.4.1. Generalities. In [60], Riche and Williamson describe a diagrammatic categorification of the anti-spherical module of the affine Hecke algebra with respect to the finite Weyl group. Their construction actually extends (see remark [60, Rmk 4.10]) to any Coxeter system with respect to a parabolic subgroup W_I determined by a subset $I \subset S$. Libedinsky and Williamson also define, in [55], a similar category using the geometric representation of the group W .

Let ${}^I W$ be the set of minimal length representatives of the left cosets of W_I in W . Let us call *I-words* those words starting with an element of I (called *I-sequences* in [55]).

Definition 4.23. The *Bott-Samelson anti-spherical category* ${}^I \mathcal{H}_{\text{BS}}$ is the quotient of the Bott-Samelson diagrammatic Hecke category by those morphisms which are of the form $\gamma \cdot \phi$ with $\gamma \in \mathfrak{h}^*$ and those which factor through *I-words*.

This is naturally a graded \mathbb{k} -linear² category.

To clarify which category we are considering, the objects in ${}^I \mathcal{H}_{\text{BS}}$ will be denoted by ${}^I B_{\bar{w}}$. Then one takes ${}^I \mathcal{H}$ to be the Karoubi envelope of ${}^I \mathcal{H}_{\text{BS}}$. Over a complete local ring, one can also define ${}^I \mathcal{H}$ to be the quotient of \mathcal{H} by the

²Here we follow [60]. One could also quotient only by the roots α_s , with $s \in I$ as done in [55].

ideal generated by the indecomposable objects $B_x(k)$ for all $x \notin {}^I W$. Then one can see that the two definitions agree (see [55, Proposition 3.2]³).

One has a natural full, essentially surjective functor

$${}^I(-) : \mathcal{H}_{(\text{BS})} \rightarrow {}^I\mathcal{H}_{(\text{BS})} \quad (4.15)$$

sending the object $B_{\underline{w}}$ to ${}^I B_{\underline{w}}$. The category ${}^I\mathcal{H}$ (and already ${}^I\mathcal{H}_{\text{BS}}$) is endowed with a natural right action of the Hecke category given by ${}^I B_{\underline{w}} \cdot B_s = {}^I B_{\underline{w}s}$.

Notice that in the \tilde{A}_1 case the only interesting choices for I are $\{s\}$ or $\{t\}$.

4.4.2. Double leaves bases. Both [60, Lemma 4.7, Remark 4.10] and [55, Theorem 3.7] prove that a certain subset of the light leaves maps (or rather, the double leaves maps obtained from them) are spanning sets for the morphism spaces in the categorified anti-spherical module.

Namely, given a Coxeter word $\underline{w} = s_1 \cdots s_k$, we say that a 01-sequence \mathbf{e} avoids $K \subset W$, when, for all $i = 0, 1, \dots, k-1$, we have $\underline{w}_{\leq i}^{\mathbf{e}} s_{i+1} \notin K$. This means that in the corresponding Bruhat stroll we never even consider to pass through K . Then the considered light leaves maps are the $L_{\underline{w}, \mathbf{e}}$ such that \mathbf{e} avoids $W \setminus {}^I W$.

Remark 4.24. Consider the spaces $\text{Hom}(B_{\underline{w}}, \mathbb{1})$ in \tilde{A}_1 . One can rather easily see that 01-sequences avoiding $W \setminus {}^I W$ correspond precisely to blue (red) shrubberies if $I = \{s\}$ (respectively $I = \{t\}$). So they span, over \mathbb{k} , the dg-modules ${}^I C_n$ and ${}^I \Gamma$.

Furthermore, both [60] and [55] show that these sets form bases for the realizations considered in those works. It is actually not difficult to show directly that they form a basis of $\text{Hom}(B_{\underline{w}}, \mathbb{1})$, for all realizations of \tilde{A}_1 .

Lemma 4.25. *Blue (respectively red) shrubberies form an \mathbb{k} -basis for $\text{Hom}(B_{\underline{w}}, \mathbb{1})$, when $I = S_{\mathfrak{f}} = \{s\}$ (or $I = \{t\}$ respectively).*

Proof. Take $I = \{s\}$. It is sufficient to prove that the morphisms factoring through I -words are precisely those which can be written in the form

$$\alpha_s \sum_{K \in \mathcal{L}_t} f_K K + \sum_{K \notin \mathcal{L}_t} f_K K.$$

In fact then it is easy to see that blue shrubberies span (just consider surjectivity of the map ${}^I a$) and if a \mathbb{k} -linear combination

$$\sum_{K \in \mathcal{L}_t} f'_K K$$

is zero in ${}^I \Gamma$, then, in Γ , it can be written in the above form. But this implies $f'_K = \alpha_s f_K$, so it is zero in \mathbb{k} .

Let us then prove the claim. Take a morphism ϕ in $\text{Hom}(B_{\underline{w}}, \mathbb{1})$ factoring through $B_{\underline{x}}$ with \underline{x} a word starting with s . Then, using relation (2.6), we can

³The proof there is made over \mathbb{R} but the only property of the Kazhdan-Lusztig basis which is used is also shared by the p -canonical basis.

factor it as

$$\phi = \begin{array}{c} \text{---} \\ \boxed{*} \\ \vdots \\ \boxed{*} \\ \vdots \\ \text{---} \end{array} = \begin{array}{c} \text{---} \\ \boxed{*} \\ \vdots \\ \boxed{*} \\ \vdots \\ \text{---} \end{array} = \phi_1 \circ \left(\begin{array}{c} \text{---} \\ \bullet \\ \text{---} \end{array} \otimes \text{id}_{B_{\underline{w}}} \right)$$

Where $\phi_1 \in \text{Hom}(B_{s\underline{w}}, \mathbb{1})$. Write ϕ_1 as a linear combination of shrubberies

$$\phi_1 = \sum_K f_K K$$

and notice that by the form of the starting word, all K 's must start with a red shrub. Consider the compositions

$$K \circ \left(\begin{array}{c} \text{---} \\ \bullet \\ \text{---} \end{array} \otimes \text{id}_{B_{\underline{w}}} \right).$$

If the first shrub of K is a red dot then we get a factor α_s . Otherwise the above composition will give a shrubbery which still has at least one red shrub, which concludes the proof of the claim. \square

4.4.3. Categories of complexes. The functor (4.15) induces a functor on the level of homotopy categories, as well as on the level of dg categories of complexes, that will still be denoted by ${}^I(-)$. The above right action induces a right (dg) action of $\mathcal{K}^b(\mathcal{H})$, and $\mathcal{C}_{\text{dg}}(\mathcal{H})$, on $\mathcal{K}^b({}^I\mathcal{H})$, and $\mathcal{C}_{\text{dg}}({}^I\mathcal{H})$, respectively. For a braid word ω and a letter $\sigma \in \Sigma$, we have ${}^IF_\omega \cdot F_\sigma = {}^IF_{\omega\sigma}$. Hence $-\cdot F_\sigma$ and $-\cdot F_{\sigma^{-1}}$ define mutually inverse self-equivalences of $\mathcal{K}^b({}^I\mathcal{H})$.

4.4.4. Antispherical Wakimoto sheaves. We want to describe morphism spaces between the images ${}^I\Theta_k$ of the Wakimoto sheaves (the homotopy equivalence $\Theta_k^* \simeq \Theta_k$ carries over to the anti-spherical category), and we see them as the cohomology groups of the dg morphism spaces

$$\text{Hom}^\bullet({}^I\Theta_{k_1}, {}^I\Theta_{k_2}). \quad (4.16)$$

Using the right action, one can reduce (4.16) to the case $k_2 = 0$ as before.

Furthermore, by (the anti-spherical version of) the Rouquier formula (see §3.1.7) this gives zero when k_1 is positive. So we are again reduced to study

$${}^IC_n := \text{Hom}^\bullet(\Theta_{-n}, \mathbb{1})$$

for $n > 0$. We will denote Id the differential map of IC_n . As a graded module we can still write it as

$${}^IC_n = \bigoplus_{\underline{x} \preceq \mathfrak{s}_{2n}} \text{Hom}_{{}^I\mathcal{H}}({}^IB_{\underline{x}}, \mathbb{1}) / \Lambda_{\underline{x}}.$$

Notice that the terms for \underline{x} an I -word are zero. As before, we can consider

$${}^I\Gamma = \bigoplus_{\underline{x}} \text{Hom}_{{}^I\mathcal{H}}({}^IB_{\underline{x}}, \mathbb{1}) / \Lambda_{\underline{x}}.$$

The functor (4.15) induces a surjective morphism of dg-modules $I_a : \Gamma \rightarrow {}^I\Gamma$, which endows ${}^I\Gamma$ with a structure of dg-algebra: the product is $I_a(\gamma_1)I_a(\gamma_2) := I_a(\gamma_1\gamma_2)$ and it is well defined because if δ_1 and δ_2 are morphisms in Γ factoring through I -words, then

$$I_a((\gamma_1 + \delta_1)(\gamma_2 + \delta_2)) = I_a(\gamma_1\gamma_2 + \gamma_1\delta_2 + \delta_1\gamma_2 + \delta_1\delta_2) = I_a(\gamma_1\gamma_2).$$

In fact the three morphisms $\gamma_1\delta_2$, $\delta_1\gamma_2$ and $\delta_1\delta_2$ all factor through I -words, their target being the unit.

By Lemma 4.25, a basis of ${}^I C_n$ (or ${}^I\Gamma$) is given by the collection of blue (or red) shrubberies without empty arches, whose starting word is a subword of \underline{s}_{2n} (respectively, any Coxeter word).

The reduction of last section is compatible with the passage to the antisppherical category. In particular, consider the quotient ${}^I\tilde{\Gamma}$ of $\tilde{\Gamma}$ obtained by imposing $\rho_k = 0$ for all $k > 0$. One can define ${}^I\tilde{C}_n$ in a similar way.

Proposition 4.26. *The complex ${}^I\Gamma$ is homotopy equivalent to ${}^I\tilde{\Gamma}$ and ${}^I C_n$ is homotopy equivalent to ${}^I\tilde{C}_n$, in such a way that the following diagrams commute:*

$$\begin{array}{ccc} \Gamma & \xrightarrow{\sim} & \tilde{\Gamma} \\ \downarrow & & \downarrow \\ {}^I\Gamma & \xrightarrow{\sim} & {}^I\tilde{\Gamma} \end{array} \quad \begin{array}{ccc} C_n & \xrightarrow{\sim} & \tilde{C}_n[-2n] \\ \downarrow & & \downarrow \\ {}^I C_n & \xrightarrow{\sim} & {}^I\tilde{C}_n[-2n] \end{array}$$

Notice that, by the form of the differential, the complex ${}^I\tilde{C}_n$ splits into smaller complexes:

$${}^I\tilde{C}_n = \bigoplus_{m \leq n} B_m, \quad (4.17)$$

where B_m is the span of the monomials $\tilde{\beta}_{k_1}\tilde{\beta}_{k_2}\dots\tilde{\beta}_{k_r}$ with $k_1+k_2+\dots+k_r = m$.

Example 4.27. The complex ${}^I\tilde{C}_4$ decomposes into four pieces. The first is:

$$\begin{array}{ccccccc} & & \mathbb{k} \cdot \tilde{\beta}_1\tilde{\beta}_3 & \xrightarrow{-c_1^3} & \mathbb{k} \cdot \tilde{\beta}_1\tilde{\beta}_1\tilde{\beta}_2 & & \\ & \nearrow^{c_1^4} & \oplus & \begin{array}{c} \xrightarrow{-c_2^3} \\ \searrow^{c_1^2} \end{array} & \oplus & \searrow^{c_1^2} & \\ \mathbb{k} \cdot \tilde{\beta}_4 & \xrightarrow{c_2^4} & \mathbb{k} \cdot \tilde{\beta}_2\tilde{\beta}_2 & & \mathbb{k} \cdot \tilde{\beta}_1\tilde{\beta}_2\tilde{\beta}_1 & \xrightarrow{-c_1^2} & \mathbb{k} \cdot \tilde{\beta}_1\tilde{\beta}_1\tilde{\beta}_1\tilde{\beta}_1 \\ & \searrow^{c_3^4} & \oplus & \begin{array}{c} \xrightarrow{-c_1^2} \\ \searrow^{c_1} \end{array} & \oplus & \nearrow^{c_1^2} & \\ & & \mathbb{k} \cdot \tilde{\beta}_3\tilde{\beta}_1 & \xrightarrow{c_2^3} & \mathbb{k} \cdot \tilde{\beta}_2\tilde{\beta}_1\tilde{\beta}_1 & & \end{array}$$

where c_j^i is a shortcut for $[\begin{smallmatrix} i \\ j \end{smallmatrix}]_t$. The other three pieces are:

$$\begin{array}{ccccccc} & & \mathbb{k} \cdot \tilde{\beta}_1\tilde{\beta}_2 & & \mathbb{k} \cdot \tilde{\beta}_1\tilde{\beta}_1\tilde{\beta}_1 & , & \mathbb{k} \cdot \tilde{\beta}_2 & \xrightarrow{c_1^2} & \mathbb{k} \cdot \tilde{\beta}_1\tilde{\beta}_1 & , & \mathbb{k} \cdot \tilde{\beta}_1, & \mathbb{k} \cdot \tilde{\beta}_0 \\ & \nearrow^{c_1^3} & \oplus & \searrow^{c_1^2} & & & & & & & & \\ \mathbb{k} \cdot \tilde{\beta}_3 & & & & \mathbb{k} \cdot \tilde{\beta}_1\tilde{\beta}_1\tilde{\beta}_1 & & & & & & & \\ & \searrow^{c_2^3} & \mathbb{k} \cdot \tilde{\beta}_2\tilde{\beta}_1 & \xrightarrow{-c_1^2} & & & & & & & & \end{array}$$

We want to compute the cohomology of this dg module. First we need some more properties of two-color quantum binomial coefficients.

4.4.5. Even more on two-color quantum numbers. The two-color quantum numbers, as the standard ones, can be factorized in $\mathbb{Z}[x, y]$ into *two color cyclotomic polynomials*.

Proposition 4.28. *Consider the decomposition of the polynomials $[n]_x$ and $[n]_y$ into irreducible factors. Then we have:*

- (i) *each $[n]_x$ has a factor $\phi_{n,x} \in \mathbb{Z}[x, y]$ not appearing in the decomposition of $\phi_{k,x}$ for $k < n$, and similarly for y ;*
- (ii) *one has*

$$[n]_x = \prod_{d|n} \phi_{d,x}$$

and similarly for y ;

- (iii) *for $n > 2$, we have $\phi_{n,x} = \phi_{n,y}$.*

Proof. If n is odd, then $[n]_x = [n]_y$ is a polynomial in xy . If n is even, then $[n]_x/x$ is a polynomial in xy , and similarly for y . For $n \geq 3$ let $p_n \in \mathbb{Z}[t]$ be the minimal polynomial of $4 \cos^2(\pi/n)$. Then let $\phi_n := p_n(xy)$. Now notice that the n -th symmetric quantum numbers in $\mathbb{Z}[v, v^{-1}]$ vanishes at $e^{\frac{\pi i}{n}}$. Using the specialization from Remark 2.1, we deduce that $[n]_x$ and $[n]_y$ are divisible by ϕ_n . One then proves that under this specialization, the ϕ_d give (the symmetric version of) the usual cyclotomic polynomials. The other properties are proved as those of the standard cyclotomic polynomials. \square

Definition 4.29. Let $n \geq 2$. The polynomials $\phi_{n,x}$ and $\phi_{n,y}$ from the proposition are called *two-color cyclotomic polynomials*. For $n > 2$ we will simply write ϕ_n .

The following two results will be useful in the computation of the cohomology.

Lemma 4.30. *Let $d, n \geq 2$ with $d | n$. Then $\phi_d | \begin{bmatrix} n \\ k \end{bmatrix}_y$ if and only if $d \nmid k$.*

Proof. One can argue just as in the standard case. \square

In fact, as in the standard case, two-color cyclotomic polynomials show the nice factorization pattern in the *two-color quantum Pascal triangle* (i.e. the triangle of two-color quantum binomial coefficients), shown in Figure 4.1.

Lemma 4.31. *If $k < n$ are natural numbers with $k \nmid n$, then the ideal generated by $\phi_{k,x}$ and $\phi_{n,x}$ is the whole ring $\mathbb{Z}[x, y]$:*

$$(\phi_{k,x}, \phi_{n,x}) = (1)$$

Proof. Again one can deduce the result from the analogous property of usual cyclotomic polynomials, via the specialization map. \square

Remark 4.32. With the standard Cartan matrix the cyclotomic polynomials give:

$$\phi_{n,x}(2, 2) = \phi_{n,y}(2, 2) = e^{\Lambda(n)},$$

where Λ denotes the Von Mangoldt function

$$\Lambda(n) = \begin{cases} \log(p) & \text{if } n = p^r \text{ with } p \text{ prime,} \\ 0 & \text{otherwise.} \end{cases}$$

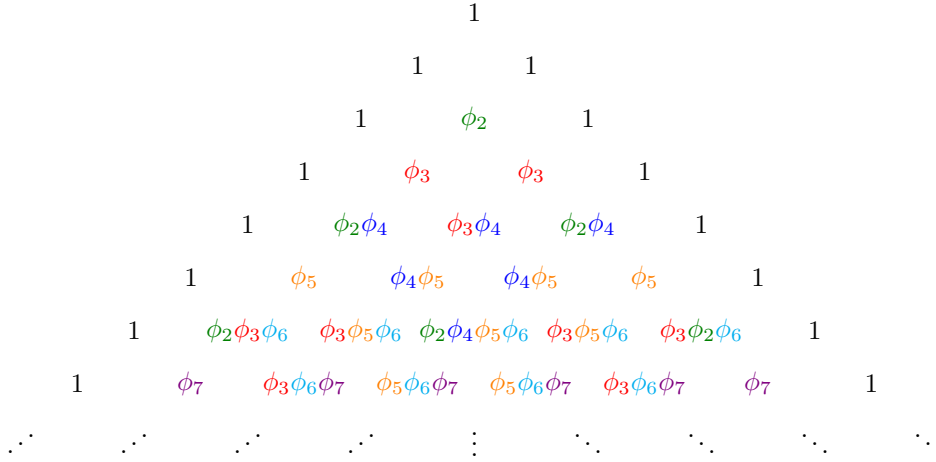

Figure 4.1: The two-color quantum Pascal triangle

4.4.6. Extension groups. We now use our reduction to compute the cohomology of the complex $I\tilde{C}_n$. We will work over $\mathbb{k} = \mathbb{Z}[x, y]$ so that one can specialize to any realization. For convenience, let $[n] := [n]_y$ and $\begin{bmatrix} n \\ k \end{bmatrix} = \begin{bmatrix} n \\ k \end{bmatrix}_y$. Let also $\phi_2 := \phi_{2,y}$.

We first describe the result. We call a partition $\lambda = (\lambda_1 \geq \lambda_2 \geq \dots \geq \lambda_{k-1} \geq \lambda_k)$ of n *distinguished* if the parts divide each other:

$$\lambda_k \mid \lambda_{k-1} \mid \dots \mid \lambda_2 \mid \lambda_1.$$

Let $\hat{P}(n)$ denote the set of distinguished partitions. For such a partition, let I_λ be the ideal of \mathbb{k} generated by the corresponding cyclotomic polynomials (of color y):

$$I_\lambda = (\phi_{\lambda_1}, \phi_{\lambda_2}, \dots, \phi_{\lambda_{k-1}}, \phi_{\lambda_k}).$$

For a given partition λ with k parts and with d distinct numbers appearing, the *weight* $|\lambda|$ is defined as $2k - d$. In other words, it is the sum between the number of parts and the number of repetitions. For example the partition $(5, 4, 4, 2, 1)$ of 16 has weight 6.

Now, define the graded \mathbb{k} -modules H_k as follows. We set $H_1 = \mathbb{k}[0]$, and for $k \geq 2$,

$$H_k := \bigoplus_{\lambda \in \hat{P}(k)} \mathbb{k}/I_\lambda[1 - |\lambda|].$$

Then we have

Theorem 4.33. *The cohomology of $I\tilde{C}_n$ is*

$$H^\bullet(I\tilde{C}_n) = \bigoplus_{i=2}^{2n} H_{\lfloor i/2 \rfloor}[i - 2],$$

where $\lfloor \cdot \rfloor$ denotes the floor function.

Example 4.34. Let $n = 6$. We first compute the H_k for k up to 6. Of course, for k prime H_k is simply $\mathbb{k}/(\phi_k)$. Hence it remains to compute H_4 and H_6 . We have

$$\begin{aligned}\hat{P}(4) &= \{(4), (2, 2)\}, \\ \hat{P}(6) &= \{(6), (4, 2), (3, 3), (2, 2, 2)\}.\end{aligned}$$

Then

$$\begin{aligned}H_4 &= \mathbb{k}/(\phi_4) \oplus \mathbb{k}/(\phi_2)[-2], \\ H_6 &= \mathbb{k}/(\phi_6) \oplus \mathbb{k}/(\phi_4, \phi_2)[-1] \oplus \mathbb{k}/(\phi_3)[-2] \oplus \mathbb{k}/(\phi_2)[-4].\end{aligned}$$

So we can patch them together according to Theorem 4.33 and get Table 4.1 where the entry i represents $\mathbb{k}/(\phi_i)$ and i, j represents $\mathbb{k}/(\phi_i, \phi_j)$. In the different rows one can see the contributions of the different H_i . In each column one

	-10	-9	-8	-7	-6	-5	-4	-3	-2	-1	0
H_1											\mathbb{k}
$H_1[1]$										\mathbb{k}	
$H_2[2]$									2		
$H_2[3]$								2			
$H_3[4]$							3				
$H_3[5]$						3					
$H_4[6]$					4		2				
$H_4[7]$				4		2					
$H_5[8]$			5								
$H_5[9]$		5									
$H_6[10]$	6	2, 4	3		2						

Table 4.1: The cohomology of ${}^I\tilde{C}_8$.

can read off the cohomology at the corresponding degree. For example, the cohomology at degree -9 is

$$\mathbb{k}/(\phi_5) \oplus \mathbb{k}/(\phi_2, \phi_4) \oplus \mathbb{k}/(\phi_3).$$

Before we pass to the proof of the theorem, let us show how this pattern emerges with an example.

Example 4.35. Let again $n = 6$. By (4.17), we can restrict to the B_m 's, so let us consider the complex B_6 , illustrated in Figure 4.2. Each node is labeled by the composition of 6 representing a basis element. For instance, 213 represents $\tilde{\beta}_2\tilde{\beta}_1\tilde{\beta}_3$.

We want to find a convenient change of basis in order to split the complex into smaller pieces. The basis of B_6 is given in terms of the variables $\tilde{\beta}_k$ and the differential is defined multiplicatively from its values over the $\tilde{\beta}_k$. Hence the idea is to define new variables such that the formula for the differential gets simpler. In fact one can find variables γ_1 , and γ_k^\pm , for $k = 2, \dots, 6$ such that

$$d(\gamma_1) = 0, \quad d(\gamma_k^+) = [k]\gamma_k^-, \quad d(\gamma_k^-) = 0. \quad (4.18)$$

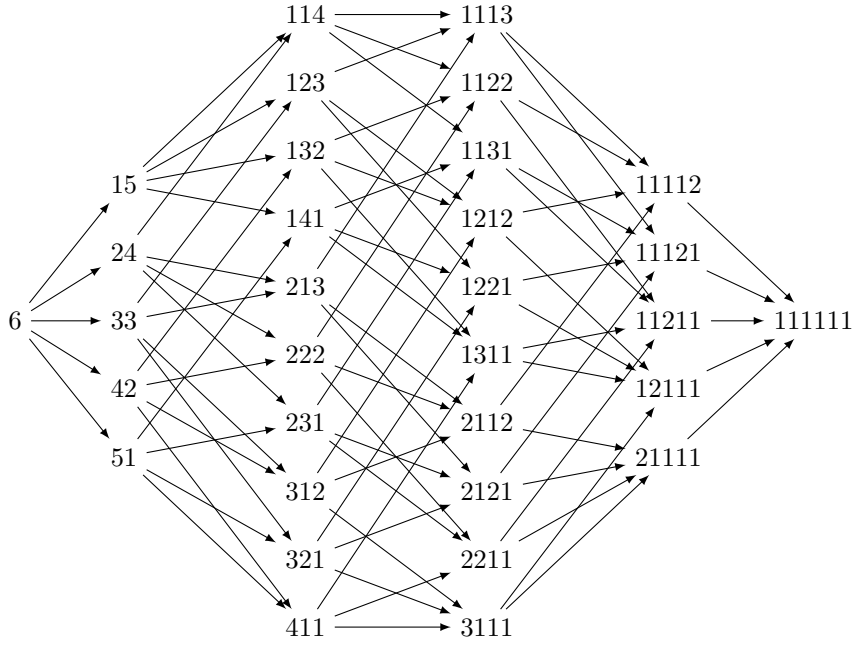

Figure 4.2: The complex B_6 .

This can be done as follows. Let $\gamma_1 := \tilde{\beta}_1$ and $\gamma_k^+ := \tilde{\beta}_k$ for all $k = 2, 3, 4, 5, 6$. Then let

$$\begin{aligned} \gamma_2^- &= \tilde{\beta}_1 \tilde{\beta}_1, \\ \gamma_3^- &= \tilde{\beta}_1 \tilde{\beta}_2 + \tilde{\beta}_2 \tilde{\beta}_1, \\ \gamma_4^- &= \tilde{\beta}_1 \tilde{\beta}_3 + \frac{[4]}{[6]} \tilde{\beta}_2 \tilde{\beta}_2 + \tilde{\beta}_3 \tilde{\beta}_1, \\ \gamma_5^- &= \tilde{\beta}_1 \tilde{\beta}_4 + \frac{[5]}{[5]} \tilde{\beta}_2 \tilde{\beta}_3 + \frac{[5]}{[5]} \tilde{\beta}_3 \tilde{\beta}_2 + \tilde{\beta}_4 \tilde{\beta}_1, \\ \gamma_6^- &= \tilde{\beta}_1 \tilde{\beta}_5 + \frac{[6]}{[6]} \tilde{\beta}_2 \tilde{\beta}_4 + \frac{[6]}{[6]} \tilde{\beta}_3 \tilde{\beta}_3 + \frac{[6]}{[6]} \tilde{\beta}_4 \tilde{\beta}_2 + \tilde{\beta}_1 \tilde{\beta}_5. \end{aligned}$$

By the values of the differential on the $\tilde{\beta}_k$'s, one sees that we actually get (4.18). Now we want to find a basis of B_6 in terms of the new variables. Consider the

set:

$$\begin{aligned}
\gamma_6^\pm, & & (2 \text{ elements}) \\
\gamma_4^\pm \gamma_2^\pm, & & (4 \text{ elements}) \\
\gamma_3^\pm \gamma_3^\pm, & & (4 \text{ elements}) \\
\gamma_2^\pm \gamma_4^\pm, & & (4 \text{ elements}) \\
\gamma_2^\pm \gamma_2^\pm \gamma_2^\pm, & & (8 \text{ elements}) \\
\gamma_1 \gamma_5^\pm, & & (2 \text{ elements}) \\
\gamma_1 \gamma_3^\pm \gamma_2^\pm, & & (4 \text{ elements}) \\
\gamma_1 \gamma_2^\pm \gamma_3^\pm. & & (4 \text{ elements})
\end{aligned}$$

By the formulas for the new variables one sees that, choosing an appropriate order, the new basis is uni-triangular with respect to the old one.

With respect to this basis, the complex becomes the one illustrated in Figure 4.3. However the change of basis that we defined is defined over $\mathbb{Q}(x, y)$ but not over $\mathbb{Z}[x, y]$. This can be restored by rescaling the new basis elements with appropriate factors. More precisely, one could define a change of basis over $\mathbb{Z}[x, y]$ which has the same overall effect on the complex as our change of basis, after rescaling. In this case, we will make the following replacements.

$$\begin{aligned}
\gamma_6^- &\rightsquigarrow \gamma_6^- \cdot \phi_2 \phi_3, & \gamma_4^- \gamma_2^+ &\rightsquigarrow \gamma_4^- \gamma_2^+ \cdot \phi_2, & \gamma_4^- \gamma_2^- &\rightsquigarrow \gamma_4^- \gamma_2^- \cdot \phi_2, \\
\gamma_3^+ \gamma_3^+ &\rightsquigarrow \frac{\gamma_3^+ \gamma_3^+}{\phi_3}, & \gamma_2^+ \gamma_2^+ \gamma_2^+ &\rightsquigarrow \frac{\gamma_2^+ \gamma_2^+ \gamma_2^+}{\phi_2}, & \gamma_2^- \gamma_4^- &\rightsquigarrow \gamma_2^- \gamma_4^- \cdot \phi_2, \\
\gamma_2^+ \gamma_4^+ &\rightsquigarrow \frac{\gamma_2^+ \gamma_4^+}{\phi_2}, & & & \gamma_2^+ \gamma_2^+ \gamma_2^- &\rightsquigarrow \frac{\gamma_2^+ \gamma_2^+ \gamma_2^-}{\phi_2}, \\
& & & & \gamma_2^- \gamma_2^+ \gamma_2^+ &\rightsquigarrow \frac{\gamma_2^- \gamma_2^+ \gamma_2^+}{\phi_2}.
\end{aligned}$$

This has the effect of changing the morphisms in the complex (the new ones are written in red in Figure 4.3). One can now see that, by Lemma 4.31, the only pieces giving non trivial cohomology are the circled ones. Those circled in violet give $H_6[10]$ and the one in orange give $H_5[9]$. These are precisely the last two rows of Table 4.1.

By applying the same argument to the other pieces B_i for $i = 0, \dots, 5$, one finds that each B_i with $i \geq 3$ contributes with $H_i[2i-2] \oplus H_{i-1}[2i-3]$, whereas B_2 gives $H_2[2]$, B_1 gives $H_1[1]$ and B_0 gives H_1 .

Let us now prove the theorem in general.

Proof of Theorem 4.33. By (4.17), we can restrict to B_n . Let us consider the following variables

$$\gamma_1 := \tilde{\beta}_1, \quad \gamma_k^+ := \tilde{\beta}_k, \quad \gamma_k^- := \sum_{i=1}^{k-1} \frac{\binom{k}{i}_y}{\binom{k}{k-i}_y} \tilde{\beta}_i \tilde{\beta}_{k-i}.$$

Then the differential map satisfies (4.18). Now consider the set

$$\{\gamma_{k_1}^\pm \dots \gamma_{k_r}^\pm \mid k_1 + \dots + k_r = n\} \cup \{\gamma_{k_1}^\pm \dots \gamma_{k_r}^\pm \gamma_1 \mid k_1 + \dots + k_r = n-1\}.$$

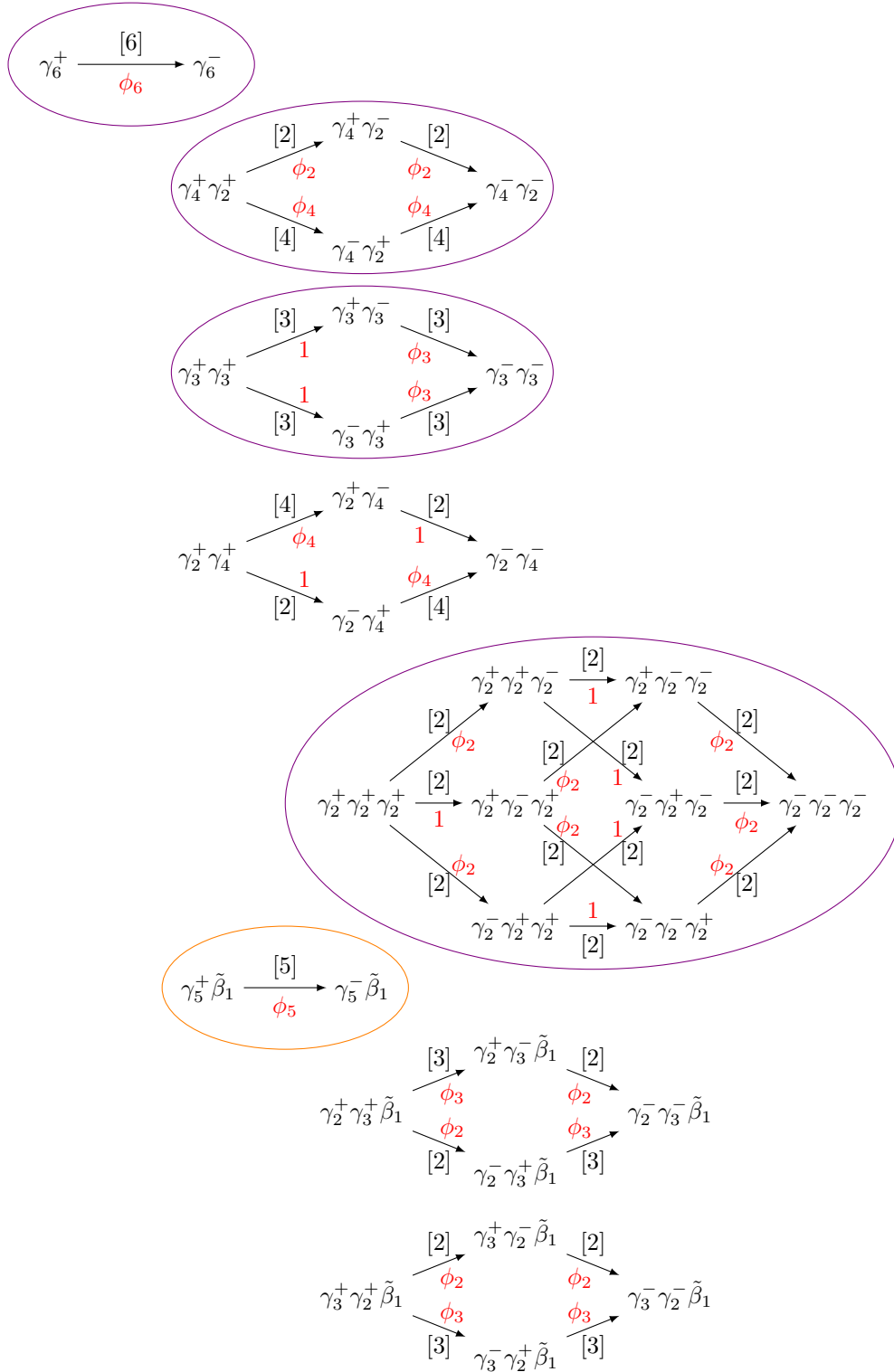

Figure 4.3: The complex B_6 after change(s) of basis.

As in the example, with an appropriate ordering, this set is uni-triangular with respect to the original basis, then it defines a new basis.

By (4.18), fixed a composition (k_1, \dots, k_r) of n with each $k_i \geq 2$, the span $B'_{(k_1, \dots, k_r)}$ of all the basis elements

$$\gamma_{k_1}^\pm \cdots \gamma_{k_r}^\pm \quad (4.19)$$

is a summand of B_n . In the same way, if (k_1, \dots, k_r) is a composition of $n - 1$ the span $B''_{(k_1, \dots, k_r)}$ of all the basis elements

$$\gamma_{k_1}^\pm \cdots \gamma_{k_r}^\pm \gamma_1$$

is another summand of B_n . The complex B_n is the direct sum of all the summand obtained in this way.

We now have to rescale our basis. Consider a monomial of the form (4.19). The d -weight is the maximal number of disjoint submonomials of the form $\gamma_d^+ \gamma_{kd}^\pm$. For example $\gamma_2^+ \gamma_2^+ \gamma_2^+ \gamma_4^-$ has 2-weight equal 2 (it contains $\gamma_2^+ \gamma_2^+$ and $\gamma_2^+ \gamma_4^-$ and they do not intersect), as well as $\gamma_2^+ \gamma_2^+ \gamma_2^+ \gamma_2^+ \gamma_4^-$. Instead $\gamma_2^- \gamma_4^+ \gamma_2^+$ has 2-weight zero. Given a basis element of the form (4.19). For each d , let w_d be its d -weight and let r_d be the number of occurrences of γ_d^- . Then we rescale it by the factor

$$\frac{\prod_d [d]^{r_d}}{\prod_d \phi_d^{w_d + r_d}}.$$

At this point, consider $B'_{(k_1, \dots, k_r)}$ with the new basis. The following facts are a bit technical but not difficult to prove and are left to the reader:

- if (k_1, \dots, k_r) is not decreasing, then $B'_{(k_1, \dots, k_r)}$ is contractible.
- if it is decreasing, but not strictly, say $k_i = k_{i+1}$, then $B'_{(k_1, \dots, k_r)}$ is homotopy equivalent to $B'_{(k_1, \dots, \hat{k}_i, \dots, k_r)}$.
- finally, if it is strictly decreasing, then $B'_{(k_1, \dots, k_r)}$ is isomorphic to

$$(\mathbb{k} \xrightarrow{\phi_{k_1}} \mathbb{k}) \otimes \cdots \otimes (\mathbb{k} \xrightarrow{\phi_{k_r}} \mathbb{k})$$

which gives cohomology $\mathbb{k}/(\phi_{k_1}, \dots, \phi_{k_r})$.

The same holds for the summands B'' .

It remains to prove that it is possible to obtain the same complex with a change of basis defined over $\mathbb{Z}[x, y]$.

For simplicity we treat the lowest cohomological degree. The argument for the higher ones is essentially the same. Here the complex B_n looks as follows:

$$\tilde{\beta}_n \xrightarrow{\alpha} \langle \tilde{\beta}_1 \tilde{\beta}_{n-1}, \tilde{\beta}_2 \tilde{\beta}_{n-2}, \dots, \tilde{\beta}_{n-1} \tilde{\beta}_1 \rangle \longrightarrow \dots$$

where

$$\alpha = \begin{pmatrix} [n] \\ [1] \\ [n] \\ [2] \\ \vdots \\ [n] \\ [n-1] \end{pmatrix}.$$

Let $d_1 < d_2 < \dots < d_k$ be the non trivial divisors of n (i.e. different from 1 and n). By Lemma 4.30, the binomial coefficient $\begin{bmatrix} n \\ d_i \end{bmatrix}$ is not divisible by ϕ_{d_i} . Consider

$$\begin{aligned} a_1 &= [n], & b_1 &= \begin{bmatrix} n \\ d_1 \end{bmatrix}, & z_1 &= \frac{[n]}{\phi_{d_1}}, \\ a_2 &= \frac{[n]}{\phi_{d_1}}, & b_2 &= \begin{bmatrix} n \\ d_2 \end{bmatrix}, & z_2 &= \frac{[n]}{\phi_{d_1}\phi_{d_2}}, \\ \dots, & & \dots, & & \dots, & \\ a_k &= \frac{[n]}{\phi_{d_1}\phi_{d_2}\dots\phi_{d_{k-1}}}, & b_k &= \begin{bmatrix} n \\ d_k \end{bmatrix}, & z_k &= \frac{[n]}{\phi_{d_1}\phi_{d_2}\dots\phi_{d_k}} = \phi_n. \end{aligned}$$

By Lemma 4.31 we can find, for $i = 1, \dots, k$, elements $x_i, y_i \in \mathbb{k}$ such that

$$a_i x_i + b_i y_i = z_i, \quad \forall i = 1, \dots, k.$$

Now consider the matrices, with coefficients in \mathbb{k} ,

$$\begin{pmatrix} x_i & & & & & & & y_i \\ & 1 & & & & & & \\ & & \ddots & & & & & \\ & & & 1 & & & & \\ -\frac{b_i}{z_i} & & & & \frac{a_i}{z_i} & & & \\ & & & & & 1 & & \\ & & & & & & \ddots & \\ & & & & & & & 1 \end{pmatrix}.$$

Each of them decomposes, in $\mathbb{Q}(x, y)$, as

$$\underbrace{\begin{pmatrix} 1 & & & & & \\ & \ddots & & & & \\ & & 1 & & & \\ & & & \ddots & & \\ & & & & \frac{y_i z_i}{a_i} & \\ & & & & & 1 \end{pmatrix}}_{A_i} \underbrace{\begin{pmatrix} \frac{z_i}{a_i} & & & & & \\ & \ddots & & & & \\ & & \frac{a_i}{z_i} & & & \\ & & & \ddots & & \\ & & & & \dots & \end{pmatrix}}_{B_i} \underbrace{\begin{pmatrix} 1 & & & & & \\ & \ddots & & & & \\ & & -\frac{b_i}{a_i} & & & \\ & & & 1 & & \\ & & & & \ddots & \\ & & & & & 1 \end{pmatrix}}_{C_i}.$$

Now, composing all these matrices we obtain

$$M = A_k B_k C_k \dots A_2 B_2 C_2 A_1 B_1 C_1.$$

One can check that

$$M\alpha = \begin{pmatrix} \phi_n \\ * \\ \vdots \\ * \end{pmatrix}$$

with zeros in the d_i -th rows. Now, by Lemma 4.30, we can eliminate all the remaining terms via a matrix C with coefficients in \mathbb{k} . Now, the matrices A_i can be “shifted” to the left, up to some changes that do not involve the first column. More precisely, the product $C_{k+1}M$ becomes

$$A' C_{k+1} B_k C_k \dots B_1 C_1,$$

where A' is an invertible matrix of the form

$$A' = \begin{pmatrix} 1 & * & \dots & * \\ & \vdots & \ddots & \vdots \\ & * & \dots & * \end{pmatrix}.$$

On the other hand, if we shift the C_i 's to the right we get

$$B_k \dots B_1 C'_{k+1} \dots C'_1.$$

Now, the product $B_k \dots B_1$ gives precisely our rescaling, whereas the product $C'_{k+1} \dots C'_1$ gives the first change of basis. In particular,

$$C_{k+1} B_k C_k \dots B_1 C_k \alpha = \begin{pmatrix} \phi_n \\ 0 \\ \vdots \\ 0 \end{pmatrix}.$$

Hence the additional matrix A' has no effect on the above vector. \square

Bibliography

- [1] N. Abe. On Soergel bimodules, 2019.
- [2] P. N. Achar and S. Riche. Koszul duality and semisimplicity of Frobenius. In *Annales de l'Institut Fourier*, volume 63 of number 4, pages 1511–1612, 2013.
- [3] P. N. Achar, S. Makisumi, S. Riche, and G. Williamson. Free-monodromic mixed tilting sheaves on flag varieties, 2017. arXiv: 1703.05843 [math.RT].
- [4] P. N. Achar, S. Makisumi, S. Riche, and G. Williamson. Koszul duality for Kac-Moody groups and characters of tilting modules. *J. Amer. Math. Soc.*, 32(1):261–310, 2019.
- [5] P. N. Achar and S. Riche. Modular perverse sheaves on flag varieties I: tilting and parity sheaves. *Ann. Sci. Éc. Norm. Supér. (4)*, 49(2):325–370, 2016. With a joint appendix with Geordie Williamson.
- [6] P. N. Achar and S. Riche. Modular perverse sheaves on flag varieties II: Koszul duality and formality. *Duke Math. J.*, 165(1):161–215, 2016.
- [7] P. N. Achar and S. Riche. Modular perverse sheaves on flag varieties III: positivity conditions. *Trans. Amer. Math. Soc.*, 370(1):447–485, 2018.
- [8] S. Arkhipov and R. Bezrukavnikov. Perverse sheaves on affine flags and Langlands dual group. *Israel Journal of Mathematics*, 170(1):135–183, 2009.
- [9] S. Arkhipov, R. Bezrukavnikov, and V. Ginzburg. Quantum groups, the loop Grassmannian, and the Springer resolution. *J. Amer. Math. Soc.*, 17(3):595–678, 2004.
- [10] D. Bar-Natan. Fast Khovanov homology computations. *J. Knot Theory Ramifications*, 16(3):243–255, 2007.
- [11] A. Beilinson, J. Bernstein, P. Deligne, and O. Gabber. *Faisceaux pervers*. Société mathématique de France, 2018.
- [12] A. Beilinson, V. Ginzburg, and W. Soergel. Koszul duality patterns in representation theory. *J. Amer. Math. Soc.*, 9(2):473–527, 1996.
- [13] J. Bernstein and A. Beilinson. Localisation de g -modules. *CR Acad. Sci. Paris*, 292:15–18, 1981.
- [14] R. Bezrukavnikov. On two geometric realizations of an affine Hecke algebra. *Publications mathématiques de l'IHÉS*, 123(1):1–67, 2016.
- [15] R. Bezrukavnikov and S. Riche. Hecke action on the principal block, 2020.

- [16] A. Björner and F. Brenti. *Combinatorics of Coxeter groups*, volume 231 of *Graduate Texts in Mathematics*. Springer, New York, 2005, pages xiv+363.
- [17] A. I. Bondal and M. M. Kapranov. Framed triangulated categories. *Mat. Sb.*, 181(5):669–683, 1990.
- [18] A. I. Bondal, M. Larsen, and V. A. Lunts. Grothendieck ring of pretriangulated categories. *Int. Math. Res. Not.*, (29):1461–1495, 2004.
- [19] A. Borel. *Linear algebraic groups*, volume 126 of *Graduate Texts in Mathematics*. Springer-Verlag, New York, second edition, 1991, pages xii+288.
- [20] N. Bourbaki. *Éléments de mathématique. Fasc. XXXIV. Groupes et algèbres de Lie. Chapitre IV: Groupes de Coxeter et systèmes de Tits. Chapitre V: Groupes engendrés par des réflexions. Chapitre VI: systèmes de racines*. Actuelles Scientifiques et Industrielles [Current Scientific and Industrial Topics], No. 1337. Hermann, Paris, 1968, 288 pp. (loose errata).
- [21] C. Brav and H. Thomas. Braid groups and Kleinian singularities. *Math. Ann.*, 351(4):1005–1017, 2011.
- [22] J.-L. Brylinski and M. Kashiwara. Kazhdan-Lusztig conjecture and holonomic systems. *Inventiones mathematicae*, 64(3):387–410, 1981.
- [23] K. J. Carlin. Extensions of Verma modules. *Trans. Amer. Math. Soc.*, 294(1):29–43, 1986.
- [24] N. Chriss and V. Ginzburg. *Representation Theory and Complex Geometry*. Modern Birkhäuser Classics. Birkhäuser Boston, 2009.
- [25] J. Ciappara. Hecke category actions via Smith-Treumann theory. *arXiv preprint arXiv:2103.07091*, 2021.
- [26] M. de Cataldo and L. Migliorini. The decomposition theorem, perverse sheaves and the topology of algebraic maps. *Bulletin of the American Mathematical Society*, 46(4):535–633, 2009.
- [27] P. Deligne. Action du groupe des tresses sur une catégorie. *Invent. Math.*, 128(1):159–175, 1997.
- [28] G. Dhillon and V. Makam. Extensions between Verma modules for dihedral groups, 2017.
- [29] B. Elias. Gaiitgory’s central sheaves via the diagrammatic Hecke category, 2018. arXiv: 1811.06188 [math.RT].
- [30] B. Elias. The two-color Soergel calculus. *Compos. Math.*, 152(2):327–398, 2016.
- [31] B. Elias and M. Khovanov. Diagrammatics for Soergel categories. *Int. J. Math. Math. Sci.*:Art. ID 978635, 58, 2010.
- [32] B. Elias and D. Krasner. Rouquier complexes are functorial over braid cobordisms. *Homology Homotopy Appl.*, 12(2):109–146, 2010.
- [33] B. Elias, S. Makisumi, U. Thiel, and G. Williamson. *Introduction to Soergel bimodules*, volume 5 of *RSME Springer Series*. Springer, Cham, [2020] ©2020, pages xxv+588.
- [34] B. Elias and G. Williamson. Soergel calculus. *Represent. Theory*, 20:295–374, 2016.

- [35] B. Elias and G. Williamson. The Hodge theory of Soergel bimodules. *Ann. of Math. (2)*, 180(3):1089–1136, 2014.
- [36] E. Gorsky, A. Neguț, and J. Rasmussen. Flag Hilbert schemes, colored projectors and Khovanov-Rozansky homology. *arXiv preprint arXiv:1608.07308*, 2016.
- [37] J. E. Humphreys. *Linear algebraic groups*. Graduate Texts in Mathematics, No. 21. Springer-Verlag, New York-Heidelberg, 1975, pages xiv+247.
- [38] J. E. Humphreys. *Reflection groups and Coxeter groups*, volume 29 of *Cambridge Studies in Advanced Mathematics*. Cambridge University Press, Cambridge, 1990, pages xii+204.
- [39] N. Iwahori and H. Matsumoto. On some Bruhat decomposition and the structure of the Hecke rings of p -adic Chevalley groups. *Inst. Hautes Études Sci. Publ. Math.*, (25):5–48, 1965.
- [40] N. Iwahori. On the structure of a Hecke ring of a Chevalley group over a finite field. *J. Fac. Sci. Univ. Tokyo Sect. I*, 10:215–236 (1964), 1964.
- [41] L. T. Jensen. The 2-braid group and Garside normal form. *Math. Z.*, 286(1-2):491–520, 2017.
- [42] L. T. Jensen and G. Williamson. The p -canonical basis for Hecke algebras. In *Categorification and higher representation theory*. Volume 683, Contemp. Math. Pages 333–361. Amer. Math. Soc., Providence, RI, 2017.
- [43] D. Juteau, C. Mautner, and G. Williamson. Parity sheaves. *J. Amer. Math. Soc.*, 27(4):1169–1212, 2014.
- [44] V. G. Kac. *Infinite-dimensional Lie algebras*. Cambridge University Press, Cambridge, third edition, 1990, pages xxii+400.
- [45] D. Kazhdan and G. Lusztig. Equivariant K -theory and representations of Hecke algebras. II. *Invent. Math.*, 80(2):209–231, 1985.
- [46] D. Kazhdan and G. Lusztig. Representations of Coxeter groups and Hecke algebras. en. *Inventiones Mathematicae*, 53(2):165–184, June 1979.
- [47] D. Kazhdan and G. Lusztig. Schubert varieties and Poincaré duality. In *Geometry of the Laplace operator (Proc. Sympos. Pure Math., Univ. Hawaii, Honolulu, Hawaii, 1979)*, Proc. Sympos. Pure Math., XXXVI, pages 185–203. Amer. Math. Soc., Providence, R.I., 1980.
- [48] B. Keller. Deriving DG categories. en. *Annales scientifiques de l'École Normale Supérieure*, Ser. 4, 27(1):63–102, 1994.
- [49] B. Keller. On differential graded categories. *International Congress of Mathematicians, ICM 2006*, 2, Feb. 2006.
- [50] M. Khovanov. Triply-graded link homology and Hochschild homology of Soergel bimodules. *Internat. J. Math.*, 18(8):869–885, 2007.
- [51] M. Khovanov and L. Rozansky. Matrix factorizations and link homology. *Fund. Math.*, 199(1):1–91, 2008.
- [52] M. Khovanov and P. Seidel. Quivers, Floer cohomology, and braid group actions. *J. Amer. Math. Soc.*, 15(1):203–271, 2002.
- [53] N. Libedinsky. Sur la catégorie des bimodules de Soergel. *J. Algebra*, 320(7):2675–2694, 2008.

- [54] N. Libedinsky and G. Williamson. Standard objects in 2-braid groups. *Proceedings of the London Mathematical Society*, 109(5):1264–1280, June 2014.
- [55] N. Libedinsky and G. Williamson. The anti-spherical category, 2017. arXiv: 1702.00459 [math.RT].
- [56] G. Lusztig. Some problems in the representation theory of finite Chevalley groups. *Proc. Symp. in Pure Math.*, 37:313–317, 1980.
- [57] G. Lusztig. Affine Hecke algebras and their graded version. *J. Amer. Math. Soc.*, 2(3):599–635, 1989.
- [58] S. Makisumi. Mixed modular perverse sheaves on moment graphs, 2017. arXiv: 1703.01571 [math.RT].
- [59] D. Quillen. Higher algebraic k-theory: i. In H. Bass, editor, *Higher K-Theories*, pages 85–147, Berlin, Heidelberg. Springer Berlin Heidelberg, 1973.
- [60] S. Riche and G. Williamson. Tilting modules and the p -canonical basis. *Astérisque*, 397, 2018.
- [61] J. Rickard. Translation functors and equivalences of derived categories for blocks of algebraic groups. In *Finite-dimensional algebras and related topics (Ottawa, ON, 1992)*. Volume 424, NATO Adv. Sci. Inst. Ser. C: Math. Phys. Sci. Pages 255–264. Kluwer Acad. Publ., Dordrecht, 1994.
- [62] M. Ronan. *Lectures on buildings*. University of Chicago Press, IL, 2009.
- [63] R. Rouquier. Categorification of \mathfrak{sl}_2 and braid groups. In *Trends in representation theory of algebras and related topics*. Volume 406, Contemp. Math. Pages 137–167. Amer. Math. Soc., Providence, RI, 2006.
- [64] R. Rouquier. Derived equivalences and finite dimensional algebras. In *International Congress of Mathematicians. Vol. II*, pages 191–221. Eur. Math. Soc., Zürich, 2006.
- [65] W. Soergel. Kazhdan-Lusztig-Polynome und unzerlegbare Bimoduln über Polynomringen. en. *Journal of the Institute of Mathematics of Jussieu*, 6(03):501, July 2007.
- [66] W. Soergel. The combinatorics of Harish-Chandra bimodules. 1992.
- [67] T. A. Springer. *Linear algebraic groups*. Modern Birkhäuser Classics. Birkhäuser Boston, Inc., Boston, MA, second edition, 2009, pages xvi+334.
- [68] J.-L. Verdier. Catégories Derivées, Quelques résultats (Etat 0). In *Cohomologie Etale*, pages 262–311, Berlin, Heidelberg. Springer Berlin Heidelberg, 1977.
- [69] G. Williamson. Schubert calculus and torsion explosion. *J. Amer. Math. Soc.*, 30(4):1023–1046, 2017. With a joint appendix with Alex Kontorovich and Peter J. McNamara.
- [70] G. M. Ziegler. *Lectures on Polytopes: Updated Seventh Printing of the First Edition*, volume 152. Springer New York, New York, NY, 1995.