



**HAL**  
open science

## The role of hydrogen in the energy transition

Sai Bravo Melgarejo

► **To cite this version:**

Sai Bravo Melgarejo. The role of hydrogen in the energy transition. Economics and Finance. Université de Pau et des Pays de l'Adour, 2021. English. NNT : 2021PAUU2106 . tel-04121814

**HAL Id: tel-04121814**

**<https://theses.hal.science/tel-04121814v1>**

Submitted on 8 Jun 2023

**HAL** is a multi-disciplinary open access archive for the deposit and dissemination of scientific research documents, whether they are published or not. The documents may come from teaching and research institutions in France or abroad, or from public or private research centers.

L'archive ouverte pluridisciplinaire **HAL**, est destinée au dépôt et à la diffusion de documents scientifiques de niveau recherche, publiés ou non, émanant des établissements d'enseignement et de recherche français ou étrangers, des laboratoires publics ou privés.

# THÈSE

UNIVERSITE DE PAU ET DES PAYS DE L'ADOUR  
École doctorale Sciences Sociales et Humanités (481)

Présentée et soutenue le 17 décembre 2021  
par **Sai BRAVO MELGAREJO**

pour obtenir le grade de docteur  
de l'Université de Pau et des Pays de l'Adour  
**Spécialité : Sciences Économiques**

## Le rôle de l'hydrogène dans la transition énergétique

### MEMBRES DU JURY

#### RAPPORTEURS

- Anna CRETI
- Thibaud VERGÉ

Professeur Université Paris Dauphine PSL  
Professeur ENSAE Paris-CREST

#### EXAMINATEURS

- Fabien CANDAU
- Aude POMMERET

Professeur Université de Pau et des Pays de l'Adour  
Professeur Université de Savoie Mont Blanc

#### DIRECTRICE

- Carole HARITCHABALET

Professeur Université de Pau et des Pays de l'Adour



# Acknowledgements

This thesis would not have been possible without the support and help from many people.

I would first like to express my sincere gratitude to my advisor Carole Haritchabalet for all her kindness, invaluable feedback, academic guidance, and encouragement. For giving me the freedom to work on different topics and models connected to Hydrogen Economics. I have really enjoyed working with her for the past three years.

Great gratitude to all the members of the jury, Anna Creti and Thibaud Vergé who have agreed to evaluate my thesis despite the time constraints, as well as Fabian Caudau and Aude Pommeret how have agreed to be part of the jury.

I would like to thank the Chair The Economics of Natural Gas and its sponsors for the financial support, as well as its member for all the fructuous discussions: François Lévêque, Olivier Massol, Carole Haritchabalet, and Anna Creti.

Furthermore, my sincere thanks go to Alexandre Volle who provided useful comments to improve my second chapter, and to Steve Lawford who proofread my thesis. I take this opportunity to express my gratitude to Estelle Malavolti, who believed in me and helped me find funding for my PhD.

I am deeply grateful to all the members of TREE for the great environment during these past few years, I wish you the best in your future carriers.

Thanks to all my friends who have followed from afar my progress. For those of you are working on a thesis, I wish you the best.

Immense gratitude to my loving family. Especially to my mom, who always believed in me and made many sacrifices so that I could follow my dreams. I could never thank you enough. To my grandmother who always been there for me, and my grandfather who left too soon but encouraged me to follow a carrier on Economics.

Least but not last, to Thomas with whom I share my life, I cannot thank you enough for all your support during this PhD journey.

As Cerati said “Gracias Totales”.

Sai

---

# Contents

<b>Acknowledgements</b>	<b>i</b>
<b>Introduction</b>	<b>1</b>
<b>1 Certification of low-carbon hydrogen in the transport market</b>	<b>9</b>
1 Introduction . . . . .	10
2 Theoretical Framework . . . . .	13
2.1 Supply-side . . . . .	13
2.2 Demand-side . . . . .	13
2.3 Timing . . . . .	14
3 No information about quality . . . . .	15
3.1 No entry threat . . . . .	15
3.2 Entry threat . . . . .	16
4 Solutions to the information problem . . . . .	17
4.1 No government intervention: Vertical restraints . . . . .	17
4.2 Label . . . . .	21
4.3 Should we use a label for high-quality hydrogen? . . . . .	24
5 Conclusion . . . . .	25
A Appendix . . . . .	26
A.1 Proof of Lemma 1.1 . . . . .	26
A.2 Proof of Lemma 1.2 . . . . .	26
A.3 Proof of Lemma 1.3 . . . . .	27
A.4 Proof of Proposition 1.1 . . . . .	29
A.5 Proof of Proposition 1.2 . . . . .	29
A.6 Proof of Proposition 1.3 . . . . .	30
A.7 Proof of Lemma 1.4 . . . . .	30
A.8 Proof of Proposition 1.4 . . . . .	32
A.9 Proof of Proposition 1.5 . . . . .	32

---

<b>2</b>	<b>Greening public fleets: Evidence from California</b>	<b>35</b>
1	Introduction . . . . .	36
2	Context and Data . . . . .	39
	2.1 Public Green Fleets . . . . .	39
	2.2 Data . . . . .	42
3	Empirical Strategy . . . . .	47
	3.1 Market structure on technology adoption . . . . .	48
	3.2 Institutional environment on technology adoption . . . . .	50
4	Results and discussion . . . . .	51
	4.1 Market structure on technology adoption . . . . .	51
	4.2 Institutional environment on technology adoption . . . . .	54
5	Conclusion . . . . .	61
<b>3</b>	<b>Prosumers: Grid Storage vs Small Fuel-Cell</b>	<b>67</b>
1	Introduction . . . . .	68
2	The model . . . . .	71
3	Quantity regulation . . . . .	72
4	Price regulation . . . . .	74
	4.1 Feed-in-tariff smaller than the energy price . . . . .	74
	4.2 Feed-in-tariff valued at the energy price . . . . .	76
5	Quantity vs Price regulation . . . . .	77
	5.1 Parametrization: Case Study Canada . . . . .	77
	5.2 Results . . . . .	80
6	Conclusion . . . . .	93
A	Appendix . . . . .	95
	A.1 Quantity regulation . . . . .	95
	A.2 Price regulation . . . . .	97
B	Price regulation with a feed-in-tariff larger than the energy retail price . . .	100

# List of Tables

1	CVRP Rebates. . . . .	41
2	Summary Statistics. . . . .	42
3	Regression Results Market Structure. . . . .	52
4	Regression Results Institutional Environment. . . . .	55
5	Regression Results Sensitivity Analysis. . . . .	59
1	Calibration . . . . .	78
2	Benchmark equilibrium quantities. . . . .	80
3	Equilibrium quantities with $\alpha > 0$ , and $\lambda^G = 100\%$ . . . . .	82
4	Equilibrium quantities with $\alpha > 0$ , and $\lambda^G = 95\%$ . . . . .	83
5	Equilibrium quantities with $\alpha > 0$ , and $\lambda^G = 66.5\%$ . . . . .	83
6	Equilibrium quantities with price regulation. . . . .	85
7	Equilibrium quantities with quantity regulation. . . . .	86
8	Equilibrium quantities with price regulation. . . . .	87
9	Equilibrium quantities with price regulation ( $\lambda^S = 95\%$ ). . . . .	90
10	Equilibrium quantities with price regulation ( $\lambda^S = 100\%$ ). . . . .	90



---

# List of Figures

1	Organisation of the value chain: vertical restraints. . . . .	18
2	Organisation of the value chain: label. . . . .	21
1	Vehicles purchases per technology 1988–2020. . . . .	40
2	CalEnviroScreen Score construction. . . . .	41
3	Vehicle count by technology. . . . .	44
4	Number of fleets and vehicles. . . . .	47
5	Vehicle count by manufacturer. . . . .	49
6	Purchased Vehicles vs Number of Rebates. . . . .	56
1	Benchmark quantity regulation. . . . .	81
2	Quantity regulation with $\alpha > 0$ , and $\lambda^G = 100\%$ . . . . .	82
3	Quantity regulation with $\alpha > 0$ , and $\lambda^G = 95\%$ . . . . .	83
4	Quantity regulation with $\alpha > 0$ , and $\lambda^G = 66.5\%$ . . . . .	84
5	Price regulation. . . . .	85
6	Equilibrium quantities under smaller capacity costs . . . . .	87
7	Profits, Consumer Surplus and Welfare under smaller capacity costs. . . . .	88
8	Equilibrium quantities under a larger round-trip efficiency. . . . .	90
9	Grid profits under a larger round-trip efficiency. . . . .	91
10	Consumer surplus and Welfare under a larger round-trip efficiency. . . . .	92
11	Grid profits with $c_C = c_D$ . . . . .	92
12	Welfare with $c_C = c_D$ . . . . .	93



# Introduction

The Paris Agreement is an international legally binding climate change treaty in which 195 countries committed to limit global warming below 2°C, and pursue efforts to limit it to 1.5°C. To meet these goals, signatories need to achieve carbon neutrality by 2050 according to the [Intergovernmental Panel on Climate Change \(2018\)](#). Despite the Paris Agreement, the global temperature has already increased by 1°C above pre-industrial levels. In this context the [European Commission \(2020\)](#) launched a set of policy initiatives, the *European Green Deal*, to reach carbon neutrality in a fair, cost-effective and competitive way by 2050. Among these initiatives, a significant share consider hydrogen-based technologies to decarbonise different sectors.

This thesis investigates, through three self-contained chapters, the role of hydrogen in the energy transition to help overcome challenges related to carbon neutrality. It provides economic intuitions and policy implications regarding different environmental regulations to support the energy transition. The two first chapters each address a challenge related to hydrogen's deployment in the transport sector, while the third one investigates the use of hydrogen-based storage in the electricity sector.

According to the [International Energy Agency \(2019\)](#), the transport sector accounts for about 27% of global greenhouse gases (GHG) emissions. This sector is often considered to have hard-to-abate emissions, since electricity-based solutions are not cost-efficient, and present technical challenges. For instance, battery-electric vehicles (BEV) have a limited driving range of about 241 km, and refuelling time can go up to 12h; whereas fuel-cell electric vehicles (FCEV) offer a larger driving range of 579 km and a refuelling time of around 3 minutes ([International Energy Agency \(2019\)](#)). Thus, the latter are a low-carbon alternative to fossil fuels such as oil and gas, with a similar driving range and refuelling time. Nevertheless, this last statement is only true if hydrogen comes from a low carbon production pathway. There exist different production paths for hydrogen, they differ in terms of cost-efficiency and carbon emissions. Hydrogen production has traditionally relied

---

on carbon-intensive fossil-fuels-based technologies, with a unit cost of 1.5€/kg. According to the [International Renewable Energy Agency \(2018\)](#), about 95% of global hydrogen production in 2018 came from fossil fuels. Fossil-fuel based technologies can be combined with Carbon Capture and Storage techniques (CCS) to reduce emissions, but at a higher unit production cost of 2€/kg. Production from renewable energy sources is also possible, but is more costly (about 2.5–5.5€/kg).

In EU legislation, there is no distinction between these different production pathways. One might wonder whether this lack of legislation would limit the deployment of low-carbon hydrogen, since consumers cannot identify hydrogen’s origin. In this limited information context, the first chapter of this thesis, “*Certification of low-carbon hydrogen in the transport market*”, develops a theoretical framework to investigate the conditions that favour the transition to a low-carbon hydrogen-based road transport sector. The road transport sector value chain considers hydrogen producers upstream, and fuel stations downstream; with production technologies differing in cost efficiency and carbon emissions. This chapter builds on two strands of the economic literature: vertical mergers with differentiated products ([Bacchiaga et al. \(2018\)](#); [Nocke and Rey \(2018\)](#)), and labels in vertically related markets ([Fulton and Giannakas \(2004\)](#); [Lapan and Moschini \(2007\)](#); [Bonroy and Lemarié \(2012\)](#)). It compares how government intervention in the form of a certification scheme performs compared to a *laissez faire* approach. The certification scheme builds on *Certifhy*, a guarantee of origin label proposed by [HyLaw \(2019\)](#). Findings suggest that society is better-off without government intervention, when producers use vertical restraints to inform about the hydrogen’s production pathway. The value chain optimal organisation depends on the cost difference between production technologies. Currently, low-carbon hydrogen is not cost-competitive, but its cost is expected to decrease in the near future. As the cost difference between technologies decreases, we experience a mismatch between private incentives and social welfare. At the equilibrium, a label policy never leads to a larger welfare compared to a *laissez faire* approach. Thus, instruments such as a carbon tax, or a subsidy for environmentally friendly technologies would be better suited for promoting low-carbon hydrogen. Indeed, the latter could help to reduce the cost difference between production technologies. These results can be extended to other low-carbon technologies, such as electricity or biofuels.

FCEV suffer from indirect network effects, or the *chicken-egg-dilemma*: their deployment requires simultaneous ramp-up of retail fuel stations. To overcome this problem, the [International Renewable Energy Agency \(2018\)](#) has proposed deployment of local captive fleets. In the literature, a new technology’s uptake depends on the market structure, and

---

the institutional environment (Hall (2004); Stoneman and Battisti (2010)). The second chapter of this thesis, “*Greening public fleets: Evidence from California*”, builds an empirical strategy based on a Poisson regression model with robust standard errors and two-way fixed effects, to investigate market diffusion of green (FCEV and BEV) vehicles fleets. It exploits the context created by two environmental policies in California between 2012 and 2019. During that period, the state launched an executive order (B-16-12) defining fleet replacement targets at the 2015, 2020 and 2030 horizons. The latter also have access to rebates from the Clean Vehicle Rebate Project; since 2016 they might ask for increased ones, when located in a disadvantaged community (DAcs). DAcs are determined by the screening tool CalEnviroScreen (CES) score, which aims to identify the communities that are more vulnerable to climate change using pollution and demographic indicators. The first part of the chapter investigates the relationship between market structure and market diffusion of green public fleets. It should be noted that the public market is characterised by barriers to entry. Indeed, the acquisition of a fleet follows a highly hierarchical year long process. Moreover, the market is easily saturated since fleet purchases are infrequent, and include multiple vehicles at once (Shriver (2015)). Findings suggest that green fleets follow a diffusion equilibrium of innovation (Reinganum (1981); Fudenberg and Tirole (1985); Aghion et al. (2005)), but the effect is not strong. This could be related to the existence of command-and-control regulations defining fleet replacement targets. The second part of this chapter studies the effect of the CES score on the number of green fleets, and fleet size. More broadly, it aims to assess whether policies that are relevant for consumers can also be used in the case of public purchases. Findings suggest that instruments such as rebates do not provide good incentives for green fleets. Conversely, the literature (Diamond (2009); Chandra et al. (2010); Gallagher and Muehlegger (2011); Sierzchula et al. (2014); Li et al. (2017); Münzel et al. (2019)) finds that rebates have a positive effect. This could be related to a lack of information about the available monetary incentives. Moreover, there is an inverse U shaped relationship between air pollution, and green fleet purchases. Overall the results suggest that command-and-control regulations are better suited for public purchases than market based instruments.

The electricity sector accounts for about 38% of the world’s greenhouse gas emissions (International Renewable Energy Agency (2018)). Renewable energy sources contribute to reducing emissions, but their intermittent production calls for flexibility options, such as energy storage. Hydrogen is a storable gas; thus, it can be used as a back-up for renewable energy sources. In this context, one might wonder about the optimal organisation of the storage branch, such that it provides incentives to invest in power-to-gas technology. For

---

instance, who should store energy either a traditional producer or a consumer, i.e. whether storage should be centralised or decentralised.

The third chapter, “*Prosumers: Grid Storage vs Small Fuel-Cell*”, considers a stylised microeconomic model of the electricity market to study investments on solar and storage capacity by consumers connected to the grid. It builds on the literature on consumers’ incentives to invest in decentralised production and storage (Durmaz et al. (2017); Andreolli et al. (2020); Boampong and Brown (2020); Dato et al. (2020, 2021)), and makes the link with the literature on incentives to invest in storage from a producer’s point of view (Durmaz (2016); Helm and Mier (2018); Ambec and Crampes (2019); Andrés-Cerezo and Fabra (2020)). The government may choose between a quantity or a price-based energy regulation. The first one is compatible with centralised storage, and the second with decentralised storage. The regulations differ in two economic dimensions. First, consumers can sell energy to the grid only under a price regulation. Second, the policy instruments available to the government are not the same. The same three consumer profiles emerge under both regulations: consumers, prosumers and storers. Consumers invest in solar capacity under the same threshold value of the solar capacity cost with both regulations. The model is calibrated using data from Quebec to evaluate the conditions under which power-to-gas storage is feasible. Under the current capacity costs, and round-trip efficiency, power-to-gas storage is never possible. Capacity costs are expected to decrease in the future, while round-trip efficiency is expected to increase (the latter should be between 77%–90% at the 2030 horizon, according to the [International Energy Agency \(2019\)](#)). Under a price regulation, without a cost reduction of the grid’s operating costs, the latter operates at a loss; whereas with a cost reduction, a feed-in-tariff such that consumers invest in decentralised storage, guarantees positive profits. Nevertheless, consumer surplus and welfare are always larger with a quantity regulation. Moreover, a grid tariff, such that there is centralised storage, always guarantees positive profits.

---

## Bibliography

- Aghion, P., Bloom, N., Blundell, R., Griffith, R., and Howitt, P. (2005). Competition and innovation: An inverted-U relationship. *The Quarterly Journal of Economics*, 120(2):701–728.
- Ambec, S. and Crampes, C. (2019). Decarbonizing Electricity Generation with Intermittent Sources of Energy. *Journal of the Association of Environmental and Resource Economists*, 6(6):1105–1134.
- Andreolli, F., D’Alpaos, C., and Moretto, M. (2020). Valuing investments in domestic PV-battery systems under uncertainty. Technical report.
- Andrés-Cerezo, D. and Fabra, N. (2020). Storing Power: Market Structure Matters. Cambridge Working Papers in Economics 20122, Faculty of Economics, University of Cambridge.
- Bacchiega, E., Bonroy, O., and Petrakis, E. (2018). Contract contingency in vertically related markets. *Journal of Economics & Management Strategy*, 27(4):772–791.
- Boampong, R. and Brown, D. P. (2020). On the benefits of behind-the-meter rooftop solar and energy storage: The importance of retail rate design. *Energy Economics*, 86:104682.
- Bonroy, O. and Lemarié, S. (2012). Downstream labeling and upstream price competition. *European Economic Review*, 56(3):347–360.
- Chandra, A., Gulati, S., and Kandlikar, M. (2010). Green drivers or free riders? An analysis of tax rebates for hybrid vehicles. *Journal of Environmental Economics and Management*, 60(2):78–93.
- Dato, P., Durmaz, T., and Pommeret, A. (2020). Smart grids and renewable electricity generation by households. *Energy Economics*, 86(C).
- Dato, P., Durmaz, T., and Pommeret, A. (2021). Feed-in tariff policy in Hong Kong: Is it efficient? *City and Environment Interactions*, 10:100056.
- Diamond, D. (2009). The impact of government incentives for hybrid-electric vehicles: Evidence from US states. *Energy Policy*, 37(3):972–983.
- Durmaz, T. (2016). Precautionary Storage in Electricity Markets. Working Papers 2016.07, FAERE - French Association of Environmental and Resource Economists.



- 
- Durmaz, T., Pommeret, A., and Ridley, I. (2017). Willingness to Pay for Solar Panels and Smart Grids. MITP: Mitigation, Innovation and Transformation Pathways 257879.
- European Commission (2020). A hydrogen strategy for a climate-neutral Europe. Technical report.
- Fudenberg, D. and Tirole, J. (1985). Preemption and rent equalization in the adoption of new technology. *The Review of Economic Studies*, 52(3):383–401.
- Fulton, M. and Giannakas, K. (2004). Inserting GM products into the food chain: The market and welfare effects of different labeling and regulatory regimes. *American Journal of Agricultural Economics*, 86(1):42–60.
- Gallagher, K. S. and Muehlegger, E. (2011). Giving green to get green? Incentives and consumer adoption of hybrid vehicle technology. *Journal of Environmental Economics and Management*, 61(1):1–15.
- Hall, B. H. (2004). Innovation and diffusion. Working Paper 10212, National Bureau of Economic Research.
- Helm, C. and Mier, M. (2018). Subsidising Renewables but Taxing Storage? Second-Best Policies with Imperfect Pricing. Working Papers V-413-18, University of Oldenburg, Department of Economics.
- HyLaw (2019). Deliverable 4.5 EU Policy Paper. Technical report.
- Intergovernmental Panel on Climate Change (2018). Global warming of 1.5°C. Technical report.
- International Energy Agency (2019). The Future of Hydrogen: Seizing today’s opportunities. Technical report.
- International Renewable Energy Agency (2018). Hydrogen from renewable power technology outlook for the energy transition. Technical report.
- Lapan, H. and Moschini, G. (2007). Grading, minimum quality standards, and the labeling of genetically modified products. *American Journal of Agricultural Economics*, 89(3):769–783.
- Li, S., Tong, L., Xing, J., and Zhou, Y. (2017). The market for electric vehicles: Indirect network effects and policy design. *Journal of the Association of Environmental and Resource Economists*, 4(1):89–133.

- 
- Münzel, C., Plötz, P., Sprei, F., and Gnann, T. (2019). How large is the effect of financial incentives on electric vehicle sales? A global review and european analysis. *Energy Economics*, 84:104493.
- Nocke, V. and Rey, P. (2018). Exclusive dealing and vertical integration in interlocking relationships. *Journal of Economic Theory*, 177(C):183–221.
- Reinganum, J. F. (1981). Market structure and the diffusion of new technology. *The Bell Journal of Economics*, 12(2):618–624.
- Shriver, S. K. (2015). Network effects in alternative fuel adoption: Empirical analysis of the market for ethanol. *Marketing Science*, 34(1):78–97.
- Sierzchula, W., Bakker, S., Maat, K., and van Wee, B. (2014). The influence of financial incentives and other socio-economic factors on electric vehicle adoption. *Energy Policy*, 68:183–194.
- Stoneman, P. and Battisti, G. (2010). *The Diffusion of New Technology*, volume 2 of *Handbook of the Economics of Innovation*. Elsevier.

---

# Chapter 1

## Certification of low-carbon hydrogen in the transport market

### **Abstract**

This paper develops a theoretical framework to study the deployment of free-of-emissions green hydrogen in the transport sector. We consider a vertically related market, with hydrogen producers upstream and fuel stations downstream. Production technologies differ in cost efficiency and carbon emissions. We show that when consumers have limited information about the hydrogen origin, no new green producers are able to enter the market. A label for green hydrogen allows multiple production technologies to co-exist, but society is better-off when producers use vertical restraints to increase consumers' information.

*Keywords:* Label, Vertical Restraints, Innovation, Hydrogen

*JEL:* L13, L15, L42, Q42

---

# 1 Introduction

Meeting the European Green Deal and the Paris Agreement implies achieving carbon neutrality by 2050. The [European Commission \(2020\)](#) states that reaching such a goal requires reducing the transport sector emissions by 90%. Renewable energy and biofuels are expected to decarbonise a large share of this sector, but there are still hard to abate parts of the transport system. Fuel-Cell Electric Vehicles (FCEV) could help to reduce carbon emissions (CO<sub>2</sub>), but this is only true if the hydrogen used to power FCEV comes from a low-carbon source. Otherwise, the level of emissions will not be any lower than with current fuels (oil and gas).

Different production pathways are possible for hydrogen, which differ in costs and carbon emissions. Traditionally, production has relied on carbon-intensive fossil-fuels-based technologies with a unit cost of 1.5€/kg. The latter can be upgraded with Carbon Capture and Storage techniques (CCS) to reduce emissions but at a higher unit production cost of 2€/kg. Production from renewable energy sources is also possible but more costly (about 2.5–5.5€/kg). The [International Energy Agency \(2019\)](#) considers that some countries might try to exploit near-term opportunities based on fossil fuels and later on shift to more environmentally friendly processes. In the current EU legislation, there is no a distinction between these different production pathways: could this lack of legislation limit the deployment of decarbonised hydrogen?

The [European Commission \(2020\)](#) is working to develop a policy framework to support the transition to a decarbonised hydrogen market while informing consumers. It has stated its intention to provide a definition of decarbonised hydrogen building on the certification system *Certifhy* proposed by [HyLaw \(2019\)](#). This certification, developed as an industry initiative, proposes to build on green energy’s guarantees of origin (GoO)<sup>1</sup>. This type of certification scheme is relevant in the hydrogen market, since transportation and distribution optimisation requires unbundling production and consumption. *Certifhy* differentiates between three types of hydrogen: Grey hydrogen produced using fossil-fuel-based technologies, Green and Blue hydrogen with 60% fewer emissions compared to Grey hydrogen, respectively produced with renewable, and non-renewable energy. The second part of this paper aims to study whether this policy framework performs better than a *laissez faire* approach by which producers take actions to inform consumers, in terms of conveying information and social welfare. For simplicity, we consider only two types of hydrogen, low (grey) and high-quality (blue or green) hydrogen.

---

<sup>1</sup>A GoO certifies that for each demanded kilogram of decarbonised hydrogen, the equivalent will be produced using the relevant technology.

To answer the question of the deployment of decarbonised hydrogen, we develop a model of a hydrogen-based road transport sector, where consumers have no direct information about the production pathway.

Traditionally, infrastructure-intensive markets (such as telecoms, energy, water, transportation, etc) have first relied on a state-owned monopoly, but in the case of hydrogen, this is unlikely. Indeed, hydrogen is already widely used in industrial processes (e.g. refining), with well-established players along the supply chain. We consider a vertically related market, with hydrogen producers upstream and fuel stations downstream (retailers). We consider an incumbent producer with fossil-fuel-based technology and a potential renewable entrant producer. When fuel stations, that sell hydrogen to FCEV owners, are not able to communicate on the hydrogen origin, we show that decarbonised hydrogen deployment can only be done by the incumbent. We then explore alternative solutions to solve the information problem: vertical restrictions and labels.

This paper contributes to two strands of the economic literature. First, it contributes to the literature of vertical mergers with differentiated products ([Bacchiega et al. \(2018\)](#); [Nocke and Rey \(2018\)](#)). In particular, we consider a merger between a fuel station and a high-quality producer. Our main assumption is that integrated retailers do not support other producers' quality. In a similar setup, [Nocke and Rey \(2018\)](#) find that a merger between the low-quality producer and retailer increases their joint profits. This paper departs from their model, introducing an information problem downstream and considering price competition. The [Nocke and Rey \(2018\)](#) result holds when the cost difference between qualities is small. Otherwise, the merger does not increase their joint profits. Second, the paper contributes to the literature of labels in vertically related markets ([Fulton and Giannakas \(2004\)](#); [Lapan and Moschini \(2007\)](#); [Bonroy and Lemarié \(2012\)](#)). In a similar setup, [Bonroy and Lemarié \(2012\)](#) show that the introduction of a label in a vertically related market increases the high-quality quantity in the market. Retailer's heterogeneity compared to consumer's determines who bears the burden of the label. We depart from their paper considering retailers with identical distribution costs, as a result the high-quality producer always bears the cost of the label.

We first characterise the equilibrium outcome under the *laissez faire* approach. We find that depending on the cost difference between qualities, we either observe pairwise vertical integration (when the cost difference is small) or single vertical integration with exclusive dealing (when the cost difference is large). Furthermore, we show that the merger between the incumbent and the independent station is profitable earlier than it becomes socially desirable. Also, we consider a label policy, and show that producers and stations prefer to specialise, which is always detrimental to society. As a consequence, society will be better-off

---

without government intervention.

The remainder of this paper is organised as follows. Section 2 describes the hydrogen market value chain. Section 3 presents the equilibrium outcome when quality information is not passed to consumers. Section 4 presents the equilibrium outcome when producers use vertical restraints and when a label is introduced. Section 5 concludes.

## 2 Theoretical Framework

In this section, we describe the organisation of the road transport sector value chain based on FCEV.

### 2.1 Supply-side

We consider a vertically related market with hydrogen producers upstream and hydrogen fuel stations downstream. It is possible to produce hydrogen using several technologies that differ in terms of costs and negative externalities (carbon emissions). We consider two types of hydrogen  $j = f, g$ . A low quality one  $f$  with positive CO<sub>2</sub> emissions, and a high quality one  $g$  with zero-emissions.

Producers sell hydrogen to fuel stations at a wholesale linear price  $w$ . Fuel stations distribute hydrogen to FCEV owners at retail price  $p$ .

**Upstream market (Hydrogen Producers).** We consider that there is an incumbent (*i*) monopoly producer offering a low environmental quality  $f$  produced at marginal cost  $c_f$ . The incumbent can upgrade its technology to a high environmental quality  $g$  at fixed investment fee  $E_\gamma > 0$ , increasing its unit cost to  $\gamma + c_f > c_f$ , where  $\gamma \in [0; 1]$ ; the unit cost of capturing carbon emissions.

There is a potential entrant (*e*) with a high environmental quality  $g$ . The latter must incur a fixed investment fee  $E_g$  to enter the market and produces hydrogen at a cost  $c_g$ .

The incumbent has an absolute cost advantage with its low quality hydrogen ( $c_g > c_f$ ).

**Downstream market (Fuel Stations).** For matters of simplicity, we consider that there are only two fuel stations 1 and 2 distributing hydrogen to consumers at a unit cost  $d + w$ , with  $d$  the distribution cost, and  $w$  the hydrogen wholesale price. We assume that distribution costs do not differ between the incumbent and new firms. This might be the case with an hydrogen pipeline network operated by a third party that does not differentiate by production technologies nor market structure.

We assume that stations perfectly observe quality, but this information cannot be conveyed to consumers.

### 2.2 Demand-side

The demand side of the market consists of a continuum of consumers with hydrogen valuation  $v$ , large enough to have a covered market. This is coherent with our framework



---

since consumers here are FCEV owners, such that there is no outside option. We also assume that consumers have a willingness to pay for high environmental quality ( $\theta$ ), where the taste parameter for high environmental quality  $\theta$  is uniformly distributed on the unit interval. Consumers may have limited information about quality at the level of fuel stations. We assume that they perfectly anticipate the market share  $\alpha \in [0; 1]$  of high-quality producers and thus expect an average quality weighted by the market share of each quality. For instance, according to the [International Renewable Energy Agency \(2018\)](#) about 95% of today's hydrogen production relies on fossil fuel based technologies. The utility of a non-informed  $\theta$ -type consumer buying hydrogen at price  $p$  is then:

$$U = v + \theta\alpha - p$$

Otherwise, when consumers can perfectly observe the product quality at the level of fuel stations, then, denoting respectively  $p_f$  and  $p_g$  the price of the low and high quality, the indirect utility of a  $\theta$ -type consumer is:

$$U = \begin{cases} v + \theta - p_g & \text{if } j = g \\ v - p_f & \text{if } j = f \end{cases}$$

## 2.3 Timing

Firms interactions are non-cooperative and take place in two stages. The timing of the game is as follows. In stage 1, producers make investment/entry decisions and compete in prices to sell to fuel stations. In stage 2, fuel stations compete in prices to supply consumers.

Hydrogen has many applications across sectors (e.g. transports, energy, industrial, etc) such that producers always have an outside option. We consider that producers only enter the transport market when they make positive profits. An hydrogen pipeline network allows fuel stations to have a constant flow of hydrogen, then, we consider a short-run price competition game. Our equilibrium concept is sub-game perfect equilibrium.

### 3 No information about quality

This section characterises our benchmark case where no information about hydrogen quality is provided to consumers at the level of fuel stations. Then, if both firms operate, only hydrogen of expected average quality  $v + \theta\alpha$  is available in the market. Demand for the product with average quality  $\alpha$  writes:

$$D_\alpha(p) = 1 + \theta\alpha - p$$

In stage 2, fuel stations compete à la Bertrand and buy from the lowest price producer at retail price  $w_\alpha$ . At the equilibrium, the stations' retail price equals marginal cost:

$$p_\alpha = p_1 = p_2 = d + w_\alpha$$

each fuel station serves half of the market and makes zero-profits.

In stage 1, the incumbent might or not face an entry threat. We have four different sub-games, where the incumbent decides whether to invest (or not), while facing (or not) an entry threat.

#### 3.1 No entry threat

When the incumbent does not face an entry threat, it might upgrade its technology at an investment fee  $E_\gamma > 0$  unknown to consumers. Its product quality improves and increases consumers demand from  $D_0$  to  $D_1$ , but it leads to larger production costs  $c_f + \gamma > c_f$ . The incumbent invests if and only if:

$$D_1(w_i^1)(w_i^1 - c_f - \gamma) - E_\gamma \geq D_0(w_i^0)(w_i^0 - c_f)$$

where  $w_i^k = \operatorname{argmax}_{w_i} D_k(w_i)(w_i - c_f - \gamma \mathbb{1}_1) - E_\gamma \mathbb{1}_1$  and  $k \in [0, 1]$

**Lemma 1.1.** *When there is no entry threat, the incumbent invests in high-quality technology if and only if  $E_\gamma \leq \hat{E}_\gamma$ .*

*Proof.* See Appendix A.1. □

The threshold value  $\hat{E}_\gamma$  is defined in Appendix A.1. Incentives to invest decrease with the cost of capturing  $CO_2$  emissions  $\left(\frac{\partial \hat{E}_\gamma}{\partial \gamma} = -\frac{1+\theta-\gamma-c_g-d}{2} < 0\right)$ .

---

## 3.2 Entry threat

When the incumbent faces an entry threat, it might upgrade its technology (or not). First, we study the equilibrium outcome when the incumbent does not invest. In such a case, both qualities might co-exist in the market  $0 \leq \alpha \leq 1$ . Second, we determine the conditions under which the incumbent invests such that  $\alpha = 1$ .

**Lemma 1.2.** *When there is an entry threat, there exist a unique equilibrium where entry is always deterred.*

- *When  $E_\gamma \geq E_g$  the incumbent does not upgrade quality.*
- *When  $E_\gamma \leq E_g$  the incumbent upgrades quality if  $E_\gamma \leq \bar{E}_\gamma < E_g$ .*

*Proof.* See Appendix A.2. □

When two producers compete with asymmetric fixed costs and there is only one product variety, only the cost-efficient firm serves the market. These results are in line with the literature on price competition with asymmetric costs (Chaudhuri (1996); Marquez (1997); Chowdhury (2002); Sheldon and Roe (2007); Coloma and Saporiti (2009)). In our model, only the incumbent can introduce high-quality hydrogen in the market. The information problem limits the transition to a low-carbon road transport sector since the incumbent only invests in high quality when it is profitable. This is the case for low-values of the fixed investment cost: when  $E_\gamma < \bar{E}_\gamma$  the incumbent will invest in high-quality when it faces an entry threat. Otherwise when alone in the market, it is more likely to invest in high-quality technology, i.e. for larger values of  $E_\gamma (< \hat{E}_\gamma)$ . It follows that here  $\bar{E}_\gamma < \hat{E}_\gamma$ .

## 4 Solutions to the information problem

We have an information problem at the level of fuel stations that limits the deployment of high-quality hydrogen in the market. This section proposes two solutions to this information problem. First, we study what may happen under a *laissez faire* approach. Second, we consider government intervention in the form of a label at the level of fuel stations.

### 4.1 No government intervention: Vertical restraints

Without government intervention, the entrant may consider directly entering the downstream market. We consider that there is a vertical merger between the entrant and fuel station 1. We also assume that when part of a vertical structure, stations deliver only one quality (single-fuel stations). An independent station may or may not buy from a vertical structure.

The entrant is a high-quality producer, then, consumers are aware that its station sells high-quality hydrogen, whereas the hydrogen quality is uncertain when buying from the independent station. Producers' market shares are anticipated but consumers do not observe how the former interacts with the independent station. This context creates two different qualities on the market: a high quality from the entrant's fuel station, and a lower "uncertain" quality from the independent station. If we denote  $p_1$  (resp.  $p_2$ ) the price at the entrant's (independent) station, the demand for each station is:

$$D_{\alpha}^1(p_1, p_2) = \frac{1 - \alpha - p_1 + p_2}{1 - \alpha} \quad \text{and} \quad D_{\alpha}^2(p_1, p_2) = \frac{p_1 - p_2}{1 - \alpha}$$

We first consider the case of single vertical integration between the entrant and fuel station 1 and analyse the integrated structure's incentives to supply the independent fuel station. Then, we study the incumbent's incentives to merge with the independent station, such that we only have integrated stations in the market. Finally, we compare these different regimes (Figure 1) in terms of private incentives and welfare implications.

#### Single Vertical Integration with Exclusive Dealing (ED)

First, we consider the case in which the entrant sells exclusively through its own station. The independent station can only buy from the incumbent ( $0 < \alpha < 1$ ) but this is not observed by consumers. In stage 2, the independent station competes with the entrant's. The latter chooses a retail price  $p_1$ , while facing unit cost  $d + c_g$ , and an investment fee  $E_g$ . The independent station chooses a retail price  $p_2$ , and has unit cost  $d + w_i$ , where  $w_i$  is the incumbent's wholesale price. The stations' programs are:

Figure 1: Organisation of the value chain: vertical restraints.

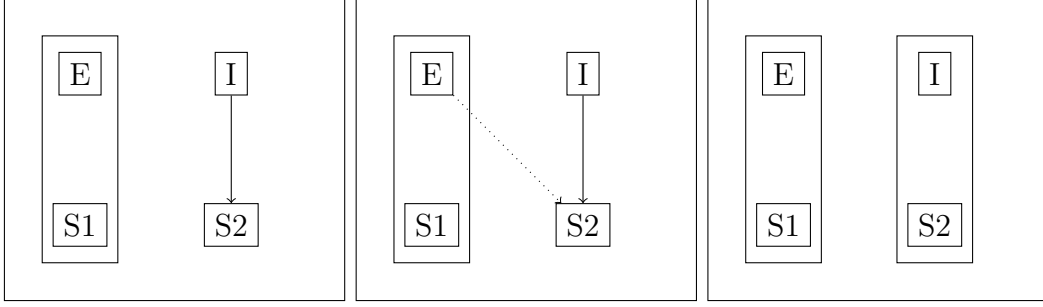

*Note:* We study three possible organisations of the value chain: exclusive dealing, non-exclusive dealing, and pairwise vertical integration.

$$\begin{aligned} \max_{p_1} \quad \pi_1(p_1, p_2) &= D_\alpha^1(p_1, p_2)(p_1 - c_g - d) - E_g \\ \max_{p_2} \quad \pi_2(p_1, p_2) &= D_\alpha^2(p_1, p_2)(p_2 - w_i - d) \end{aligned}$$

which gives the following retail prices:

$$\begin{aligned} p_1(w_i) &= \frac{2(1 - \alpha + c_g) + 3d + w_i}{3} \\ p_2(w_i) &= \frac{1 - \alpha + c_g + 3d + 2w_i}{3} \end{aligned}$$

Retail prices are increasing in the incumbent's wholesale price. In terms of quantities, the high-quality is increasing in the wholesale price  $\frac{\partial D_\alpha^1(p_1(w_i), p_2(w_i))}{\partial w_i} = \frac{1}{3} > 0$ , while the low-quality is decreasing  $\frac{\partial D_\alpha^2(p_1(w_i), p_2(w_i))}{\partial w_i} = -\frac{1}{3} < 0$ . In stage 1, the incumbent chooses its wholesale price  $w_i$ :

$$\max_{w_i} \quad \pi_i(w_i) = D_\alpha^2(p_1(w_i), p_2(w_i))(w_i - c_f)$$

which gives the equilibrium wholesale price:

$$w_i^* = \frac{1 - \alpha + c_g + c_f}{2}$$

We plug  $w_i^*$  into the equilibrium retail prices, and determine the equilibrium demanded quantities of the entrant's and incumbent's respective qualities:

$$\begin{aligned} D_e(p_1^*, p_2^*) &= \frac{5(1 - \alpha) + c_f - c_g}{6(1 - \alpha)} \\ D_i(p_1^*, p_2^*) &= \frac{1 - \alpha + c_g - c_f}{6(1 - \alpha)} \end{aligned}$$

Finally, we determine the equilibrium market share of the high-quality producer:

$$\alpha^* = \frac{11 - \sqrt{1 + 24(c_g - c_f)}}{12}$$

The market share of the high-quality producer is decreasing on the cost difference between qualities, i.e. when the cost difference between high and low-quality hydrogen decreases, we have more high-quality in the market.

### Single Vertical Integration with Non-Exclusive Dealing (NED)

Second, we consider that the entrant does not distribute exclusively through its own retailer. In stage 1, producers compete to serve the independent station.

**Lemma 1.3.** *There exists a unique Nash Equilibrium where the incumbent serves the independent station with  $w_i^*$ .*

*Proof.* See Appendix A.3. □

The entrant is never able to offer a wholesale price that guarantees positive profits to the independent station. At the equilibrium, the incumbent serves the independent station at its profit maximising wholesale price ( $w_i^*$ ) regardless of the entrant's strategy. Consumers buying from the independent station get a lower quality than anticipated.

This is in line with [Nocke and Rey \(2018\)](#), who show that when there is a vertical merger between a producer and a retailer, an equilibrium where the vertically integrated firm “forecloses” the downstream rival exists. In our model, this equilibrium arises because of informational reasons.

### Pairwise Vertical Integration (PVI)

[Nocke and Rey \(2018\)](#) show that when facing an integrated structure, an independent producer and a retailer can increase their joint profits by merging. We study whether this result holds when there is an information problem at the level of fuel stations. We consider that the incumbent merges with station 2, such that we have two competing vertically integrated supply chains. Consumers perfectly observe quality at the level of fuel stations, the entrant's and incumbent's station demands writes:

$$D^1(p_1, p_2) = 1 - p_1 + p_2 \quad \text{and} \quad D^2(p_1, p_2) = p_1 - p_2$$

The entrant's and incumbent's stations programs are:

---

$$\max_{p_1} \pi_1 = D^1(p_1, p_2)(p_1 - c_g - d) - E_g$$

$$\max_{p_2} \pi_2 = D^2(p_1, p_2)(p_2 - c_f - d)$$

which gives the following equilibrium retail prices:

$$p_1^* = \frac{2 + c_f + 2c_g + 3d}{3}$$

$$p_2^* = \frac{1 + 2c_f + c_g + 3d}{3}$$

In a vertically related market with differentiated products, at the equilibrium, whether the incumbent and the independent station have an incentive to merge depends on the cost difference between qualities.

**Proposition 1.1.** *The equilibrium outcome depends on the cost difference between qualities  $\hat{c} = c_g - c_f$ :*

- *If  $\hat{c} \geq c^p$  the incumbent and independent station do not merge.*
- *If  $\hat{c} < c^p$  the incumbent and independent station merge.*

*Proof.* See Appendix A.4. □

When the cost difference between qualities is large the incumbent prefers not to merge with the independent station and exploit the informational problem. There is a trade-off between the intensity of competition (driven by the perceived qualities) and cost-efficiency. When the cost difference between qualities is large, the incumbent prefers to exploit the double marginalisation. Otherwise, it prefers to differentiate from the entrant's quality to reduce the intensity of competition.

**Proposition 1.2.** *Private incentives and society are aligned if the cost difference between qualities is either  $\hat{c} \leq c^w$  or  $\hat{c} \geq c^p$ .*

*Proof.* See Appendix A.5. □

When  $c^w < \hat{c} < c^p$  a merger between the incumbent and the independent station increases their joint profits but is detrimental to society.

## 4.2 Label

The [European Commission \(2020\)](#) is working on a certification scheme for low-carbon hydrogen based on green energy GoO. This is relevant in the case of the transport sector since it would help avoid duplication of infrastructure (a pipeline) while making quality differentiation possible. We have seen that without government intervention when the entrant decides to enter directly the downstream market, the equilibrium outcome is not always socially desirable.

We study the equilibrium outcome when a label for high-quality hydrogen is introduced at the level of fuel stations. A label is a policy instrument imposed by the government or a third-party regulating the presentation of a product's specific information to consumers [Bonroy and Constantatos \(2014\)](#).

We have shown that when consumers have no information about quality there is one equilibrium where entry is always deterred. Only for low values of the fixed investment fee on technology ( $E_\gamma$ ) does the incumbent upgrade its technology. A label policy might allow both low and high-quality hydrogen to co-exist in the upstream market.

Denoting  $p_e$  (resp.  $p_i$ ) the retail price of the entrant (incumbent) hydrogen quality, demand for each quality is:

$$D^e(p_e, p_i) = 1 - p_e + p_i \quad \text{and} \quad D^i(p_e, p_i) = p_e - p_i$$

We consider two types of stations (Figure 2), non-specialised and specialised, and compare their performance in terms of private incentives and social welfare.

Figure 2: Organisation of the value chain: label.

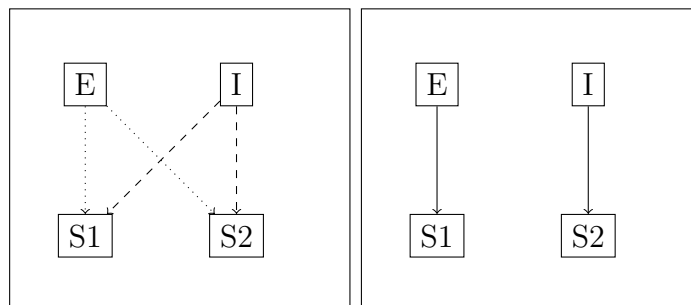

*Note:* We study two types of stations: non-specialised, and specialised.



---

## Non specialised stations (NS)

Non-specialised stations simultaneously support both hydrogen qualities. This configuration has interlocking relationships (Rey and Vergé (2008)): the upstream competing firms deal with the same downstream competing retailers. The high-quality unit cost increases to  $d + w_e + l$ , where  $l$  is the unit certification cost. Costs for the low-quality remain unchanged. In stage 2, fuel stations compete à la Bertrand within each quality market. At the equilibrium, low and high-quality prices equal their respective marginal costs:

$$p_e(w_e) = p_1^e = p_2^e = w_e + d + l$$

$$p_i(w_i) = p_1^i = p_2^i = w_i + d$$

Stations serve half of each quality market, and make zero profits. In stage 1, producers compete in prices:

$$\begin{aligned} \max_{w_i} \quad \pi_i &= D^i(p_i(w_i), p_e(w_e))(w_i - c_f) \\ \max_{w_e} \quad \pi_e &= D^e(p_i(w_i), p_e(w_e))(w_e - c_g) - E_g \end{aligned}$$

which gives the following equilibrium wholesale prices:

$$\begin{aligned} w_i^* &= \frac{1 + c_g + l + 2c_f}{3} \\ w_e^* &= \frac{2(1 + c_g) - l + c_f}{3} \end{aligned}$$

**Proposition 1.3.** *With non specialised stations we retrieve the same profits as with pairwise vertical integration if the certification cost is set to 0. As the certification cost increases, the entrant's profits and social welfare decrease.*

*Proof.* See Appendix A.6. □

## Specialised Stations (S)

Specialised stations only support one quality, i.e. only buy from one producer. We consider station 1 only buys from the entrant and station 2 from the incumbent. Consumers choose which station to visit based on their preferences for high-quality hydrogen. In stage 2, stations compete in prices with differentiated products. The programs of the specialised stations are:

$$\max_{p_1} \pi_1(p_1, p_2) = D^e(p_1, p_2)(p_1 - w_e - d)$$

$$\max_{p_2} \pi_2(p_1, p_2) = D^i(p_1, p_2)(p_2 - w_i - d)$$

which gives the following retail prices:

$$p_1(w_e, w_i) = \frac{2 + w_i + 2w_e + 3d + 2l}{3}$$

$$p_2(w_e, w_i) = \frac{1 + 2w_i + w_e + 3d + l}{3}$$

In stage 1, producers choose the wholesale price for their respective qualities:

$$\max_{w_e} \pi_e(p_1(w_e, w_i), p_2(w_e, w_i)) = D^e(p_1(w_e, w_i), p_2(w_e, w_i))(w_e - c_g) - E_g$$

$$\max_{w_i} \pi_i(p_1(w_e, w_i), p_2(w_e, w_i)) = D^i(p_1(w_e, w_i), p_2(w_e, w_i))(w_i - c_f)$$

which yields the following equilibrium wholesale prices:

$$w_e^* = \frac{5 + c_f + 2c_g - l}{3}$$

$$w_i^* = \frac{4 + 2c_f + c_g + l}{3}$$

The following lemma describes the difference between having non-specialised or specialised stations:

**Lemma 1.4.** *When stations do not specialise, the label puts an economic burden on the entrant. Otherwise, if they specialise both the entrant and its specialised station share the economic burden of the label.*

*Proof.* See Appendix A.7. □

In terms of welfare, society is always better off with non-specialised stations, but producers and stations prefer specialised ones.

Moreover, producers retrieve the same joint profits with non-specialised stations as with two vertically integrated chains. Then, a vertical merger is never profitable for producers when the government introduces a label. Social welfare decreases with the certification cost regardless of the type of station.

---

**Proposition 1.4.** *Private incentives are never aligned with society, producers and stations prefer to specialise which is detrimental to social welfare.*

*Proof.* See Appendix A.8. □

If the government wants to introduce a label at the level of fuel stations, then, it might want to label only non-specialised stations. In the next section, we compare how the *laissez faire* equilibrium performs in terms of welfare versus the label.

### 4.3 Should we use a label for high-quality hydrogen?

As shown in the previous section, government intervention in the form of a label reveals information about quality but at the equilibrium private incentives are never aligned with society. Indeed, producers and stations specialise but society will be better-off if they did not. In the *laissez faire* scenario, vertical integration acts as an information mechanism such that both hydrogen qualities co-exist in the downstream market. In particular, under pairwise vertical integration consumers have perfect information about quality.

**Proposition 1.5.** *Social welfare is always higher with the *laissez faire* approach.*

*Proof.* See Appendix A.9. □

Proposition 1.2 shows that a socially desirable outcome is achieved when  $\hat{c} \geq c^p$  or  $\hat{c} \leq c^w$ . When  $c^w < \hat{c} < c^p$  the first best is not achieved at the equilibrium but the *laissez faire* approach leads to a higher social welfare than a label.

## 5 Conclusion

This paper studies the conditions that favour the decarbonisation of a hydrogen-based road transport sector. The results can be also extended to other low-carbon technologies, such as electricity or biofuels. Building on the certification scheme *Certifhy* proposed by [HyLaw \(2019\)](#) we studied why industrial players might propose a labelling initiative, and whether without government intervention, firms could achieve an outcome on their own that maximises social welfare.

We have seen that the lack of a proper definition of low-carbon hydrogen results in quite a strong information problem: new low-carbon hydrogen producers are excluded from the market.

A label like *Certifhy*'s allows high-quality producers to enter the market. Nevertheless, society will be better off without government intervention.

Currently, low-carbon hydrogen is not cost-competitive, but in the future we expect its cost to decrease, such that the cost difference between qualities becomes small. During such transition, without government intervention, we would experience a mismatch between private incentives and society. Instruments such as a carbon tax or subsidies to environmentally friendly technologies could help low-carbon hydrogen to become cost-competitive.

---

## A Appendix

### A.1 Proof of Lemma 1.1

The analysis of the equilibrium builds on [Chowdhury \(2002\)](#). There is one producer with an absolute cost advantage: marginal and fixed cost advantage. Costs functions have increasing returns to scale. Let  $W = \{w_0, \dots, w_n\}$ , with  $n \in N$ , denote the set of permissible wholesale prices with  $w_0 = 0$  and  $w_n = 1 - d$ . Let  $\pi_j(w) = (1 - w - d)(w - c_j)$  be the variable profit of a firm of quality  $j$ , with  $c_j > c_{-j}$ . Let us assume that firm  $j$  has undercut its rival with wholesale price  $w$ . Let  $\bar{w}(E_j)$  be the minimum wholesale price such that  $\pi_j(\bar{w}(E_j)) = E_j$ , and  $w_j(\epsilon) \in W$  the minimum wholesale price such that  $\pi_j(w_j(\epsilon)) - E_j \geq 0$ , with  $\epsilon$  very small.

There are two Nash equilibria with grid price variation ([Chaudhuri \(1996\)](#); [Chowdhury \(2002\)](#)). In the first one, firm  $-j$  charges  $w_j(\epsilon) - \epsilon$  and firm  $j$  charges  $w_j(\epsilon)$ ; and in the second one firm  $-j$  charges  $w_j(\epsilon)$  while firm  $j$  charges  $w_j(\epsilon) + \epsilon$ . As  $\epsilon$  tends to zero there is only one Nash equilibrium: the limit-pricing outcome  $\bar{w}_j(E_j)$ . Thus, there is only one Nash equilibrium where the firm with the cost advantage ( $-j$ ) deters entry by setting its wholesale price equal to the other firm's limit price  $w_{-j} = \bar{w}_j(E_j)$ .  $\square$

Before investing the incumbent always has an absolute cost advantage  $c_g > c_f$  (and  $E_f = 0$ ), then, entry is deterred with:

$$w_i^0 = \bar{w}_e(E_g)^0 = \frac{1 - d + c_g - \sqrt{(1 - d - c_g)^2 - 4E_g}}{2}$$

$\square$

### A.2 Proof of Lemma 1.2

After investment, the incumbent needs to cover an investment fee  $E_\gamma > 0$ , thus losing its absolute cost advantage when  $E_\gamma \geq E_g$ . In such case, a strictly dominant strategy for the incumbent is to not upgrade its technology.

Otherwise, if it keeps an absolute cost advantage after investment, i.e.  $E_g > E_\gamma$ , entry can be deterred using limit-pricing:

$$w_i^1 = \bar{w}_e(E_g)^1 = \frac{1 + \theta - d + c_g - \sqrt{(1 + \theta - d + c_g)^2 - 4(E_g + c_g(1 + \theta - d))}}{2}$$

and the incumbent invests if and only if:

$$D_1(\bar{w}_e(E_g)^1)(\bar{w}_e(E_g)^1 - c_f - \gamma) - E_\gamma \geq D_0(\bar{w}_e(E_g)^0)(\bar{w}_e(E_g)^0 - c_f)$$

We have:

$$\begin{aligned} \hat{E}_\gamma &= \frac{1}{4}((1 + \theta - c_g - d + \sqrt{(1 + \theta - d + c_g)^2 - 4(E_g + c_g(1 + \theta - d))}) \\ &\quad (1 + \theta + c_g - d - 2(c_f + \gamma) - \sqrt{(1 + \theta - d + c_g)^2 - 4(E_g + c_g(1 + \theta - d))}) \\ &\quad - (1 - c_g - d + \sqrt{(1 - d - c_g)^2 - 4E_g})(1 + c_g - d - 2c_f - \sqrt{(1 - d - c_g)^2 - 4E_g})) \end{aligned}$$

When  $E_g > E_\gamma$ , if  $\hat{E}_\gamma \geq E_\gamma$  the incumbent invests in high-quality technology ( $\alpha = 1$ ). Otherwise if  $\hat{E}_\gamma < E_\gamma$ , it remains a low-quality one ( $\alpha = 0$ ).  $\square$

### A.3 Proof of Lemma 1.3

We study equilibrium candidates for the low-quality wholesale price when the entrant does not deal exclusively.

First, we assume that the two stations buy from the entrant such that  $\alpha = 1$ . There is only high-quality hydrogen in the market and demand is:

$$D_1(p) = 1 + \theta - p$$

In stage 2, the entrant's and the independent station compete to serve consumers. Station 1 (resp. 2) has marginal cost  $c_g + d$  ( $w_e + d$ ), since we have price competition there are three possibilities:

1. If  $w_e < c_g$ , then station 2 serves all market with  $p = c_g + d - \epsilon$ , and makes  $\pi_2 > 0$ . However, this implies that the entrant makes negative profits since  $w_e - c_g < 0$ .
2. If  $w_e = c_g$ , then each station serves half the market with  $p = c_g + d$ , and makes  $\pi_1 = \pi_2 = 0$ . However, this implies that the entrant makes negative profits since  $\pi_e = \frac{D_1(p)}{2}(c_g - c_g) + \frac{D_1(p)}{2}(c_g + d - c_g - d) - E_g < 0$ .
3. If  $w_e > c_g$ , then station 1 serves all market with  $p = w_e + d - \epsilon$  and makes  $\pi_1 > 0$ . In such case the entrant makes positive profits since  $\pi_e = (w_e - c_g - d)D_1(p) - E_g \geq 0$ .

---

If the entrant is the only upstream producer, then station 2 never makes positive profits. Indeed, the only strategy that guarantees the entrant a non-negative profit is  $w_e > c_g$  implying that station 1 serves all the market.

Second, we consider the strategy of the incumbent. If it wants to sell to the independent station, it must guarantee the latter a profit such that:

$$\pi_2(w_i) \geq \pi_2(w_e)$$

If the incumbent serves the independent station, then we have both qualities in the market  $0 < \alpha < 1$  the demand addressed to the independent station is:

$$D_\alpha^2(p_1, p_2) = \frac{p_1 - p_2}{1 - \alpha}$$

If the incumbent serves the independent station, stations programs are:

$$\begin{aligned} \max_{p_1} \quad \pi_1(p_1, p_2) &= D_\alpha^1(p_1, p_2)(p_1 - c_g - d) - E_g \\ \max_{p_2} \quad \pi_2(p_1, p_2) &= D_\alpha^2(p_1, p_2)(p_2 - w_i - d) \end{aligned}$$

which gives the following retail prices:

$$\begin{aligned} p_1(w_i) &= \frac{2(1 - \alpha + c_g) + 3d + w_i}{3} \\ p_2(w_i) &= \frac{1 - \alpha + c_g + 3d + 2w_i}{3} \end{aligned}$$

The independent station profit is thus:

$$\pi_2(w_i) = \frac{(1 - \alpha + c_g - w_i)^2}{9(1 - \alpha)}$$

As mentioned above the entrant sets its wholesale price equal to  $w_e > c_g$ , which implies non positive profits for the independent station. If it is the incumbent who serves the independent station, a wholesale price  $w_i \in ]1 - \alpha + c_g; c_f[$  guarantees positive profits  $\pi_i = (w_i - c_f)\left(\frac{1 - \alpha + c_g - w_i}{1 - \alpha}\right) \geq 0$ .

If  $\pi_2(w_i) \geq 0$  the independent station will buy from the incumbent; this is the case for any  $1 - \alpha + c_g \geq w_i$ .

Let us now study the incumbent's equilibrium strategy, the wholesale price that maximises its profits is such that:

$$\max_{w_i} \quad \pi_i(w_i) = (w_i - c_f)\left(\frac{1 - \alpha + c_g - w_i}{1 - \alpha}\right)$$

$$\iff w_i^* = \frac{1 - \alpha + c_g + c_f}{2}$$

Given that  $0 < \alpha < 1$  and  $c_g > c_f$ , it follows that  $1 - \alpha + c_g > w_i^*$ . Then, at the equilibrium the incumbent serves the independent station at  $w_i^*$ .  $\square$

#### A.4 Proof of Proposition 1.1

We determine the strategy played by producers at the equilibrium. In Appendix A.3 we have shown that regardless of the entrant's strategy, i.e. whether it deals exclusively or not, the incumbent always serves the independent station with its profit-maximising wholesale fee from when the entrant deals exclusively  $w_i^*$ .

Then, to determine the equilibrium strategy when there is a vertical merger between the entrant and station 1, we study whether a vertical merger between the incumbent and the independent station 2 is a strictly dominant strategy. We have:

$$\begin{aligned} \pi_i^{PVI} - (\pi_i^{ED} + \pi_2^{ED}) &= \frac{(1 + c_g - c_f)^2}{9} - \frac{(1 - \alpha + c_g - c_f)^2}{9(1 - \alpha)} \\ &= \frac{11 + 12(c_g - c_f)^2 - \sqrt{1 + 24(c_g - c_f)} + 6(c_g - c_f)(1 - \sqrt{1 + 24(c_g - c_f)})}{108} \end{aligned}$$

Merging with the independent station is a strictly dominant strategy for the incumbent if and only if  $\pi_i^{PVI} - (\pi_i^{ED} + \pi_2^{ED}) > 0$ . If  $\hat{c} = c_g - c_f \leq 0.65 = c^p$  a vertical merger increases joint profits. Otherwise, if  $\hat{c} > c^p$  the merger does not guarantee larger profits.  $\square$

#### A.5 Proof of Proposition 1.2

We now determine the outcome that provides the largest social welfare which writes:

$$SW = v + \int_{1-D^1(p_1^*, p_2^*)}^1 \theta d\theta - D^1(p_1^*, p_2^*)(c_g + d) - D^2(p_1^*, p_2^*)(c_f + d) - E_g$$

We compare the social welfare when the incumbent and the independent station merge against the alternative:

$$\begin{aligned} &SW^{ED} - SW^{PVI} \\ &= \frac{1}{144} [7 - 40(c_g - c_f)^2 - \sqrt{1 + 24(c_g - c_f)} + 4(c_g - c_f)(3\sqrt{1 + 24(c_g - c_f)} - 8)] \end{aligned}$$



Whether a merger between the incumbent and the independent station is desirable for society depends on the cost differences between qualities. If  $\hat{c} \geq \frac{1}{50}[14 + \sqrt{46}] = c^w$  a vertical merger is not desirable for society since  $SW^{ED} \geq SW^{PVI}$ . Otherwise, if  $\hat{c} \leq c^w$  a vertical merger is welfare enhancing.

When  $c^w < \hat{c} < c^p$  at the equilibrium the incumbent and independent station merge which is detrimental to society; whereas when either  $\hat{c} \leq c^w$  or  $c^p \leq \hat{c}$  the equilibrium outcome is socially desirable.  $\square$

## A.6 Proof of Proposition 1.3

First, recall that when we have two vertically integrated chains competing in the downstream market producers profits are:

$$\pi_i^{PVI} = \frac{(1 + c_g - c_f)^2}{9} \quad \text{and} \quad \pi_e^{PVI} = \frac{(2 + c_f - c_g)^2}{9} - E_g$$

and social welfare is  $SW^{PVI} = \frac{18(v-d)+5(c_g-c_f)^2+2(4-7c_g-2c_f)}{18} - E_g$ . When a costly label is introduced at the level of non-specialised stations, producers profits are:

$$\pi_i^{NS} = \frac{(1 + c_g - c_f + l)^2}{9} \quad \text{and} \quad \pi_e^{NS} = \frac{(2 + c_f - c_g - l)^2}{9} - E_g$$

Stations make zero profits  $\pi_1 = \pi_2 = 0$ . Social welfare is:

$$\begin{aligned} SW^{NS} &= v + \int_{1-D^e(p_e^*, p_i^*)}^1 \theta d\theta - D^e(p_e^*, p_i^*)(c_g + d + l) - D^i(p_e^*, p_i^*)(c_f + d) - E_g \\ &= \frac{18(v-d) + 5(c_g - c_f)^2 + 2(4 - 7c_g - 2c_f) - 2l[c_g - c_f + 4l(1+l)]}{18} - E_g \end{aligned}$$

If we set  $l=0$  we have  $\pi_i^{NS} = \pi_i^{PVI}$ ,  $\pi_e^{NS} = \pi_e^{PVI}$  and  $SW^{NS} = SW^{PVI}$ .  $\square$

## A.7 Proof of Lemma 1.4

The effect of a costly label on producers profits when stations do not specialise is:

$$\frac{\partial \pi_i^{NS}}{\partial l} = \frac{2}{9}(1 + c_g - c_f + l) > 0 \quad \text{and} \quad \frac{\partial \pi_e^{NS}}{\partial l} = -\frac{2}{9}(2 + c_f - c_g - l), < 0$$

The effect on social welfare is:

$$\frac{\partial SW^{NS}}{\partial l} = -\frac{\partial D^i(p_e^*, p_i^*)}{\partial l} [1 + D^i(p_e^*, p_i^*)] - l \frac{\partial D^e(p_e^*, p_i^*)}{\partial l} - D^e(p_e^*, p_i^*)$$

$$\frac{\partial SW^{NS}}{\partial l} = -\frac{1}{9}(7 - 5(c_g - c_f + l)) < 0$$

A costly label puts a burden on the high-quality producer, and reduces social welfare.

When stations specialise, producers profits are:

$$\pi_i^S = \frac{(4 + c_g - c_f + l)^2}{27} \quad \text{and} \quad \pi_e^S = \frac{(5 + c_f - c_g - l)^2}{27} - E_g$$

and stations profits are:

$$\pi_2^S = \frac{(4 + c_g - c_f + l)^2}{81} \quad \text{and} \quad \pi_1^S = \frac{(5 + c_f - c_g - l)^2}{81}$$

The effect of a costly label on producers and stations profits, when stations specialise in one quality is:

$$\frac{\partial \pi_i^S}{\partial l} = \frac{2}{27}(4 - c_f + c_g + l) > 0$$

$$\frac{\partial \pi_e^S}{\partial l} = -\frac{2}{27}(5 + c_f - c_g - l) < 0$$

$$\frac{\partial \pi_1^S}{\partial l} = -\frac{2}{81}(5 + c_f - c_g - l) < 0$$

$$\frac{\partial \pi_2^S}{\partial l} = \frac{2}{81}(4 - c_f + c_g + l) > 0$$

The entrant's and its specialised station profits decrease with the label, whereas the incumbent's and its specialised station profits increase. Social Welfare when stations specialise is:

$$\begin{aligned} SW^S &= v + \int_{1-D^e(p_1^*, p_2^*)}^1 \theta d\theta - D^e(p_1^*, p_2^*)(c_g + d + l) - D^i(p_1^*, p_2^*)(c_f + d) - E_g \\ &= \frac{162(v - d) + 17(c_g - c_f)^2 + 65 - 2(32c_f + 49c_g) + l[17l - 2(17(c_f + c_g) - 49)]}{162} - E_g \end{aligned}$$

The effect of the label on social welfare is:

$$\frac{\partial SW^S}{\partial l} = -\frac{\partial D^i(p_1^*, p_2^*)}{\partial l}[1 + D^i(p_1^*, p_2^*)] - l\frac{\partial D^e(p_1^*, p_2^*)}{\partial l} - D^e(p_1^*, p_2^*)$$

$$\frac{\partial SW^S}{\partial l} = -\frac{1}{81}(49 - 17(c_g - c_f + l)) < 0$$

Thus, social welfare decreases with the label.  $\square$

---

## A.8 Proof of Proposition 1.4

First, we determine the strategy played by producers when a label is introduced at the level of stations:

$$\Pi_e^S - \Pi_e^{NS} = \frac{1}{27}[13 + 2(c_g - c_f)(1 - c_g + c_f - 4l) + 2l(1 + l)] > 0$$

$$\Pi_i^S - \Pi_i^{NS} = \frac{1}{27}[13 + 2(c_g - c_f)(1 - c_g + c_f - 4l) + 2l(1 + l)] > 0$$

Regardless of the cost difference between qualities and the label cost producers always prefer specialised stations. Stations prefer also to specialise:

$$\Pi_1^S - \Pi_1^{NS} = \frac{(5 + c_f - c_g - l)^2}{81} > 0$$

$$\Pi_2^S - \Pi_2^{NS} = \frac{(4 + c_g - c_f + l)^2}{81} > 0$$

Second, we determine the socially desirable outcome:

$$SW^S - SW^{NS} = -\frac{7}{162}[1 - 2(c_g - c_f + l)]^2 < 0$$

Thus, society will be better-off with non-specialised stations but this outcome is never played at the equilibrium.  $\square$

## A.9 Proof of Proposition 1.5

We compare whether a label would be welfare enhancing when the cost difference between qualities is  $c^w < \hat{c} < c^p$ :

$$SW^{PVI} - SW^S = \frac{l}{162}[14 - 10(c_g - c_f) - 5l] > 0$$

Thus, society is always better-off without government intervention. What about if the government only allowed non-specialised stations to use the label:

$$SW^{PVI} - SW^{NS} = \frac{1}{162}[7 + (1 - 2(c_g - c_f))^2 + 2l(49 - 17(c_g - c_f)) - 17l^2] > 0$$

Thus, a label never performs better than vertical restraints in terms of social welfare.  $\square$

## Bibliography

- Bacchiega, E., Bonroy, O., and Petrakis, E. (2018). Contract contingency in vertically related markets. *Journal of Economics & Management Strategy*, 27(4):772–791.
- Bonroy, O. and Constantatos, C. (2014). On the Economics of Labels: How Their Introduction Affects the Functioning of Markets and the Welfare of All Participants. *American Journal of Agricultural Economics*, 97(1):239–259.
- Bonroy, O. and Lemarié, S. (2012). Downstream labeling and upstream price competition. *European Economic Review*, 56(3):347–360.
- Chaudhuri, P. R. (1996). The contestable outcome as a Bertrand equilibrium. *Economics Letters*, 50(2):237 – 242.
- Chowdhury, P. R. (2002). Limit-pricing as Bertrand equilibrium. *Economic Theory*, 19(4):811–822.
- Coloma, G. and Saporiti, A. (2009). Bertrand’s price competition in markets with fixed costs. RCER Working Papers 549, University of Rochester - Center for Economic Research (RCER).
- European Commission (2020). A hydrogen strategy for a climate-neutral Europe. Technical report.
- Fulton, M. and Giannakas, K. (2004). Inserting GM products into the food chain: The market and welfare effects of different labeling and regulatory regimes. *American Journal of Agricultural Economics*, 86(1):42–60.
- HyLaw (2019). Deliverable 4.5 EU Policy Paper. Technical report.
- International Energy Agency (2019). The Future of Hydrogen: Seizing today’s opportunities. Technical report.
- International Renewable Energy Agency (2018). Hydrogen from renewable power technology outlook for the energy transition. Technical report.
- Lapan, H. and Moschini, G. (2007). Grading, minimum quality standards, and the labeling of genetically modified products. *American Journal of Agricultural Economics*, 89(3):769–783.

- 
- Marquez, R. (1997). A note on Bertrand competition with asymmetric fixed costs. *Economics Letters*, 57(1):87–96.
- Nocke, V. and Rey, P. (2018). Exclusive dealing and vertical integration in interlocking relationships. *Journal of Economic Theory*, 177(C):183–221.
- Rey, P. and Vergé, T. (2008). Economics of vertical restraints. In Buccirosi, P., editor, *Handbook of Antitrust Economics*, pages 353–390. The MIT Press.
- Sheldon, I. and Roe, B. (2007). Credence good labeling: The efficiency and distributional implications of several policy approaches. *American Journal of Agricultural Economics*, 89(4):1020–1033.

## Chapter 2

# Greening public fleets: Evidence from California

### **Abstract**

This paper investigates the drivers of green (battery and fuel cell electric) vehicles adoption in California for the period 2012–2019. It focuses on a market that has received little attention in the literature: public fleets. Green fleets follow a diffusion equilibrium of innovation; but this effect seems to be limited by regulation instruments such as fleet replacement targets. In addition, this study investigates the relationship between the CalEnviroScreen score, and green fleets market diffusion. Findings suggest that instruments such as rebates performs poorly as a means of providing incentives for green fleets. Moreover, there is an inverse U-shaped relationship between air pollution, and green fleets purchases. Thus, command-and-control regulations are better suited for public purchases compared to market based instruments.

*Keywords:* Public Fleets, Rebates, Innovation, Air Pollution

*JEL:* L62, L91, O33, Q48, Q53, Q55

---

# 1 Introduction

In the context of the energy transition, one can observe the deployment of new environmentally friendly technologies to reduce greenhouse gas emissions. For example, in the transport sector *green vehicles* such as battery (BEV) and fuel cell electric vehicles (FCEV) contribute to this goal. In the economic literature, a new technology's uptake depends on different parameters such as the market structure, and the institutional environment (Hall (2004); Stoneman and Battisti (2010)). In addition, green vehicles suffer from indirect network effects (Corts (2010)): fuel demand needs to be sufficiently large to support investments on retail fuel stations. Then, the availability of retail stations might also drive or limit green vehicles market diffusion.

This paper investigates the drivers of green vehicles' adoption in a very particular setting: public fleets. Throughout the paper, a fleet is defined as a group of vehicles from the same manufacturer, and technology. This study uses data from California, where there are two policies in place to promote green fleets adoption. The first one is a mandate (executive order B-16-12) with fleet replacement targets for the 2015, 2020, and 2035 horizons. The second one is a rebate program for green vehicles.

This paper contributes to two strands of the literature. First, it contributes to the literature on the relationship between market structure and innovation, where results are not unambiguous. Early theoretical contributions (Reinganum (1981); Fudenberg and Tirole (1985)) found evidence of a *diffusion equilibrium* of innovation. The idea is that competition initially increases the rate of innovation, since early adopters escape competition. As the number of adopters increases, the profits from innovating decrease; thus, discouraging laggard firms from investing in the new technology. Conversely, early empirical contributions (Karshenas and Stoneman (1993); Hannan and McDowell (1984); Levin et al. (1987)) found evidence of an *epidemic equilibrium* of innovation, where all firms simultaneously adopt the new technology. A more recent empirical contribution by Aghion et al. (2005) supports the idea of an inverse U-shaped diffusion equilibrium of innovation; while contributions by Argenziano and Schmidt-Dengler (2012, 2014) provide a theoretical interpretation of the epidemic equilibrium of innovation. Simultaneous investments are the result of an intense preemption race among laggard firms when expected profits are extremely close. Determining who are the potential adopters of a technology is empirically challenging; one can only observe who adopts a technology once they enter the market. Some contributions use survival analysis to assess the effect of competition on innovation (Karshenas and Stoneman (1993); Hannan and McDowell (1984); Levin et al. (1987); Pavan et al. (2020)), while others rely on highly computational structural dynamic entry games (Igami and Yang (2016);

Igami (2017)). This paper exploits executive order B-16-12 to investigate the relationship between market structure and innovation. To my knowledge, this paper is the first one to study such a relationship in the context of public fleets. It should be noted that the public market is characterised by barriers to entry. Indeed, the acquisition of a fleet follows a highly hierarchical year long process. Moreover, the market is easily saturated since fleet purchases are infrequent, and include multiple vehicles at the time (Shriver (2015)). Before executive order B-16-12, there were not any green fleets in the market. This context is similar to Pavan et al. (2020); thus, I use information on previous purchases to construct different measures of market concentration, and investigate their effect on the number of purchased green fleets. The latter is zero-inflated, since there is a large share of markets which have not adopted any green fleet (about 64%). Then, I rely on a Poisson regression model with robust standard errors (Santos Silva and Tenreyro (2011)). I find that there is a *diffusion equilibrium* of green public fleets; however, this strategy seems to be limited by regulation instruments such as fleet replacement targets and a ban on non-green vehicles. Indeed, manufacturers in this market are forced to switch to new technologies since state agencies are no longer allowed to buy non-green vehicles.

Second, it contributes to the literature on the effect of state's policies on alternative vehicles<sup>1</sup> market diffusion. Policies to support market diffusion of alternative fuel vehicles can be divided into two categories: monetary and non-monetary. Several contributions (Diamond (2009); Chandra et al. (2010); Gallagher and Muehlegger (2011); Sierchula et al. (2014); Li et al. (2017b); Münzel et al. (2019)) retrieve a positive effect of monetary incentives, such as rebates, on alternative vehicles market diffusion. This is also the case for non-monetary incentives such as retail fuel stations (Sierchula et al. (2014); Vergis and Chen (2015); Mersky et al. (2016); Li et al. (2017b); Wang et al. (2017); Münzel et al. (2019)). Most of the empirical literature (see Münzel et al. (2019) for a literature review) has focused on retail vehicles purchases, but little attention has been given to public fleets. State agencies demand is not as large as retail, but its size in the market is not insignificant: in 2016 fleet purchases accounted for about 15% of the United States market. A first contribution to the literature by Leard et al. (2019) studied how different types of consumers responded to an increase in the fuel price. They found that public buyers are unresponsive to such a variation, suggesting that policies that drive retail purchases might not be relevant for public fleets. Indeed, the latter might be subject to a budget, or require specific vehicles without a less emitting alternative. The objective of this paper is to study the relationship between the CalEnviroScreen (CES) score and green public fleets market diffusion. This

---

<sup>1</sup>Battery electric vehicles, Plug-in hybrid vehicles, Flex-fuel vehicles, and Fuel-cell electric vehicles.



---

score aggregates different measures of pollution and socioeconomic characteristics to assign a climate change vulnerability score to each census tract in California. Even though state agencies are not directly concerned by the socioeconomic characteristics, they are exposed to pollution, which could result in a higher willingness to purchase green fleets. Moreover, it is possible that fleet managers are more willing to submit non-essential green fleets requests to the Office of Fleet Management. Instead, this study retrieves a negative effect of the CES score on new green fleets. This relationship is persistent over time, since different policies changes around 2016 did not inverse the trend. Nevertheless, the effect is relatively small; the CES score leads to a 3.7% decrease in the number of green fleets. These findings could be related to a lack of information about the available monetary incentives. [Diamond \(2009\)](#) points out that a delay between the rebate payment and the purchase decision leads to a poor performance of rebates. Another possibility is that fleet managers favour larger fleets, rather than different ones. Nevertheless, the results of this chapter suggest that this score has no effect on the fleet size. Thus, policies that are relevant for consumers, are not transferable to public purchases.

As mentioned above, this score builds on measures of pollution and socioeconomic characteristics. Some contributions ([MacInnis and de Mello \(2005\)](#); [Li et al. \(2017a\)](#)) have found evidence of a non-linear relationship between air pollution and pro-environmental behaviours. I investigate whether this relationship holds in the context of green fleets. The results suggest that there is an inverse U-shaped relationship between air pollution and market diffusion of green fleets. However, this effect is small: pollution leads to a 1.7% increase in the number of new green fleets; but as its concentration increases, then, beyond a certain threshold, it leads to a 0.001% decrease. Thus, it is possible that some state agencies in areas with high concentrations of pollution do not make efforts to reduce pollution. Then, perhaps the weights of the pollution measures included in the CES score might need to be reevaluated for policies aimed at state agencies. Another possibility would be to introduce increased rebates non-based on income but on pollution.

Following [Clinton and Steinberg \(2019\)](#), I control for possible network effects between retail stations and green fleets. Captive fleets are often used to motivate investments in retail stations, and might be simultaneously deployed with their own station. This paper finds that the location of retail stations has an important effect on green fleets purchases. In particular, because investing in a station represents a significant burden on an agency's budget. The interaction between retail stations and budget requires further investigation.

The remainder of this paper is organised as follows. Section 2 describes the context and presents the data used for the study. Section 3 presents the empirical strategy. Section 4 presents and discuss the results. Section 5 concludes the paper.

## 2 Context and Data

This paper exploits data on public fleets purchases and demographic characteristics in California. During the past decades, petrol and diesel vehicles have dominated the market; whereas green fleets purchases only took off from 2012 onwards.

### 2.1 Public Green Fleets

This section briefly describes the purchasing process of a public fleet, and presents the different environmental policies for green public fleets in California.

#### Public fleet purchasing process

Since 2012, all state agencies have been subject to the purchasing guidelines established by the Department of General Services (DGS). The acquisition of a fleet follows a highly hierarchical year long process.

Let us consider a representative public employee whose daily work activities justify the acquisition of a work vehicle. To acquire a vehicle, the employee must refer to the state's state-wide contract which provides a comprehensive list of all the models, the price, and the contractors (manufacturers) from whom state agencies can purchase fleets ([Department of General Services \(2021\)](#)). This list is updated every two years upon which manufacturers need to re-negotiate terms (submit new models, and update prices). Thus, if a new manufacturer wishes to enter this market, the latter must wait for the state-wide contract renewal period. The state agency's employee needs to submit its chosen vehicle to its state department's fleet manager. The latter gathers all the requests from different states agencies within its state department and submits an annual fleet acquisition plan to the state's Office of Fleet Management (OFAM). The fleet manager job is to analyse all purchases requests within a state department and optimise purchases based on the current fleet and costs.

Notice that since 2011, the state fleet size is limited by executive order B-2-11. Thus, for any new purchase, a fleet manager must submit a comprehensive description of how the asset would contribute to the agency.

The OFAM gathers fleets requests from all state departments across the state, and analyses the documents provided by fleet managers. If the OFAM approves the request, then the public employee can contact a manufacturer. Otherwise, without the OFAM's approval it is not possible to purchase a vehicle.

---

## Policies for public fleets

During the last decade, California has invested in and implemented several policies to reduce emissions from the transport sector. The latter accounts for about 50% of air pollution, according to the [United States Environmental Protection Agency \(2020\)](#). In particular, there are two policies directly supporting green public fleets deployment: a mandate, and a rebate program.

**Mandates for green public fleets.** In 2012, a regulation instrument in the form of an executive order (B-16-12) established that state agencies should increase the number of zero-emission passengers light-vehicles<sup>2</sup> through the normal course of fleet replacement by at least 10% by 2015, 25% by 2020, and 50% by 2030. In 2019, executive order N-19-19 established that state agencies could no longer purchase non-zero-emission vehicles.

Figure 1: Vehicles purchases per technology 1988–2020.

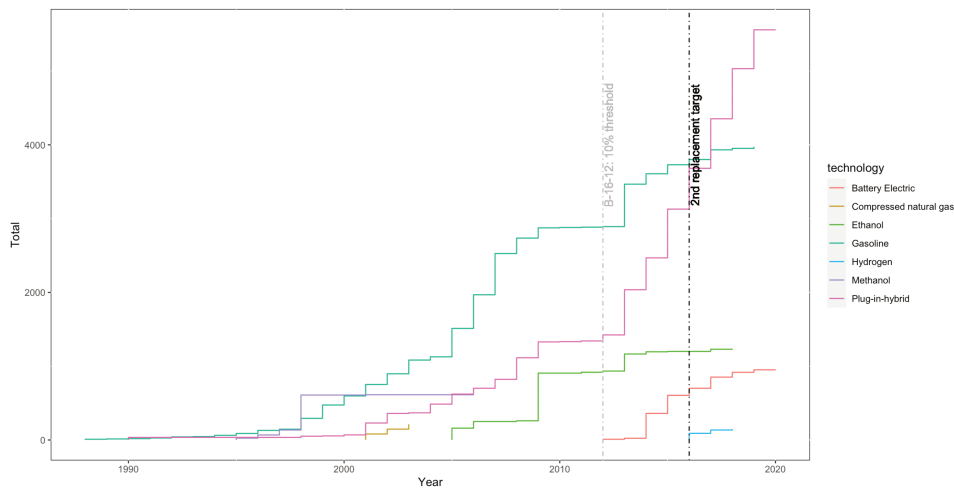

Author’s figure based on data from ([Office of Fleet and Asset Management, 2019](#)).

In the data, it is possible to observe that plug-in-hybrid vehicles were incorporated into the state fleet as early as 2008, but vehicles without tailpipe emissions (i.e. battery and fuel-cell electric vehicles) entered this market only after executive order B-16-12 (Figure 1).

**Rebates for green public fleets.** The Clean Vehicle Rebate Project (CVRP) is sponsored by the California Air Resources Board since 2010 it offers subsidies for the purchase of new light passenger green vehicles as well as plug-in hybrid vehicles. State agencies are eligible for these rebates, but they must apply to the program between 18 months before and up to

---

<sup>2</sup>This directive does not apply to special performances vehicles.

3 months after the vehicle purchase. In addition, since 2016 they have access to increased rebates (Table 1), if located in a census tract identified as a disadvantaged community (DACs) by the screening tool CalEnviroScreen (CES) score.

Table 1: CVRP Rebates.

Type of Vehicles	Standard Rebate (USD)	Increased Rebate (USD)
Plug-in-hybrid	1000	3500
Battery	2000	4500
Fuel-Cell	4500	7000

Source: CVRP (2021).

This screening tool identifies the communities that are more vulnerable to climate change using pollution and demographic indicators.

Figure 2: CalEnviroScreen Score construction.

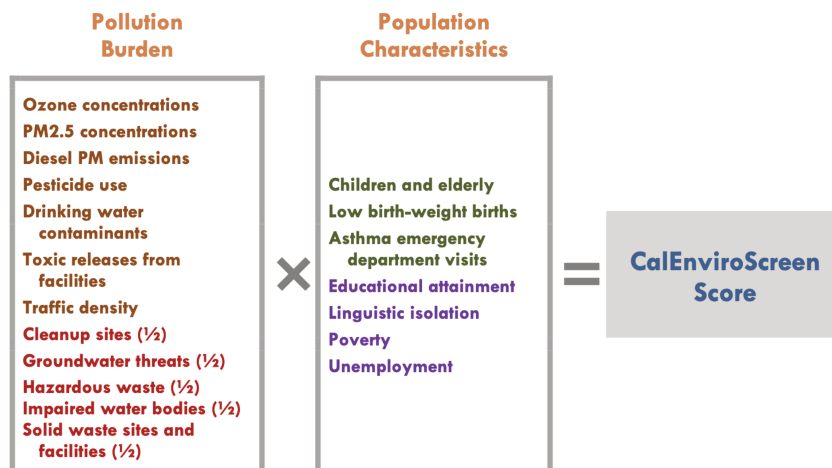

Source: OEHHA (2014).

In particular it builds on two scores: a pollution burden one, and another which considers population characteristics (Figure 2). The first one considers measures of exposure (such as concentration levels of Ozone, PM2.5, Diesel PM, Pesticides, etc) and environmental effects (essentially near by waste and toxic sites) from different pollution sources. The second one considers measures of biological traits (infants or elderly population, asthmatic residents, low-weight at birth) and socioeconomic factors (such as low-level of education, unemployment, linguistic isolation) that might increase the sensitivity to pollution.

More generally, the aim of the CES score is to identify DACs, such that state resources are directed towards reducing environmental damages in such communities. Thus, it is possible that an employee of a state agency located in a DACs, while not directly concerned by the socioeconomic characteristics of this indicator, is exposed to pollution which could result in a higher willingness to purchase a green vehicle. Moreover, it is possible that fleet managers are more willing to submit green fleets requests to the OFAM, even if the latter are not essential for the state agency. It is also likely that the OFAM approves more likely requests for green fleets in DACs.

## 2.2 Data

This paper uses a data-set on public fleets purchases in California, constructed using information from the California Open Data Portal<sup>3</sup>. Table 2 presents the summary statistics for the variables considered in the study.

Table 2: Summary Statistics.

	Mean	SD	Pctl(25)	Pctl(75)	Min	Max
<i>Dependent Variables</i>						
CNfleets	0.36	1.13	0	0	0	13
Nfleets	0.10	0.36	0	0	0	5
Nvehicles	0.65	3.71	0	0	0	85
fleet size	0.58	3.49	0	0	0	85
<i>Market Characteristics</i>						
comp	2.13	1.66	1	2	1	8
stations	1.23	2	0	2	0	17
tech	1.61	0.86	1.00	2.00	1.00	5.00
hhi	0.7	0.3	0.3	1	0.1	1
<i>Demographic Characteristics</i>						
returns	15885.19	9011.50	9568	21915	94	47617
percagi (\$)	69421	51610	43090	76240	2763	539895
<i>Public Characteristics</i>						
agencies	1.62	1.98	1	2	1	24
budget (\$)	45843453	78786504	8646823	50275836	65516	822683621
<i>Environmental Indicators</i>						
PM25 ( $\mu\text{g}/\text{m}^3$ )	10.40	3.07	8.36	12.51	3.79	20.51
DieselPM ( $\mu\text{g}/\text{m}^3$ )	19.00	16.69	6.82	26.14	0.09	106.39
CES	29.67	13.98	18.66	38.66	1.75	73.42
Pollution Score	36.19	21.29	8.92	52.75	2.35	88.10
Population Score	40.70	24.89	8.97	61.30	1.38	95.70

Notes: All values are in US Dollars 2019.

<sup>3</sup>data.ca.gov

## California State Vehicle Fleet

The Fleet Asset Management System ([Office of Fleet and Asset Management, 2019](#)) collects information about all non-confidential assets of the California State Vehicle Fleet. To my knowledge, this paper is the first one to exploit this data set. The available information was extracted from the system between 2015–2019, but it incorporates information about previous purchases. In particular, the data includes any asset purchased before 2015 that has not been disposed of, and all assets disposed of from 2013 onwards. The present study only focuses on light passenger vehicles, since state agencies only need to follow environmental guidelines for vehicles that do not have special performances. For each purchased vehicle I have information about the postcode, the manufacturer, the model, the state department, the technology, the year of purchase, and the disposition year (if disposed). A few observations have missing data; then, I keep only the observations for which at least the following information is available: postcode, purchase year, manufacturer, and technology. There is a total of 12701 passenger vehicles between 1988 and 2019.

The present study aims to assess the factors contributing to green fleets market diffusion. The main dependent variable considers the number of new green fleets by postcode in a year ( $Nfleets$ ). I also construct a variable for the aggregated number of purchased green fleets ( $CNfleets$ ), the number of new green vehicles ( $Nvehicles$ ), and for the average green fleet size ( $fleet\ size$ ) per year in a postcode. It should be noted that green fleets are fairly new in the public market; as of 2019, only about 36% of the postcodes had purchased at least one green fleet. Thus, the dependent variable is zero-inflated. One might notice that states agencies tends to purchase large fleets, since both the number of new green vehicles and the average green fleet size are between 0 and 85.

To study the relationship between market concentration, and green fleets uptake, I use the available information on purchases before executive order B-16-12. I construct three indicators of market concentration. One that considers the number of non-green manufacturers ( $comp$ ), another that accounts for the number of technologies ( $tech$ ), and the Herfindahl-Hirschman Index ( $hhi$ ) per postcode. It should be noted that other alternative vehicles (Figure 3) were already present in this market before 2012. The  $hhi$  index considers markets shares per manufacturer-technology pair.

Market concentration is quite important in this market, since for some postcodes the  $hhi$  is as large as 1. To account for a possible non-linear relationship between market structure and innovation, I construct the squared version of the above market concentration indicators. The objective is to identify whether there is a diffusion or an epidemic equilibrium of innovation. In the former, we expect a positive relationship between market concentration,

Figure 3: Vehicle count by technology.

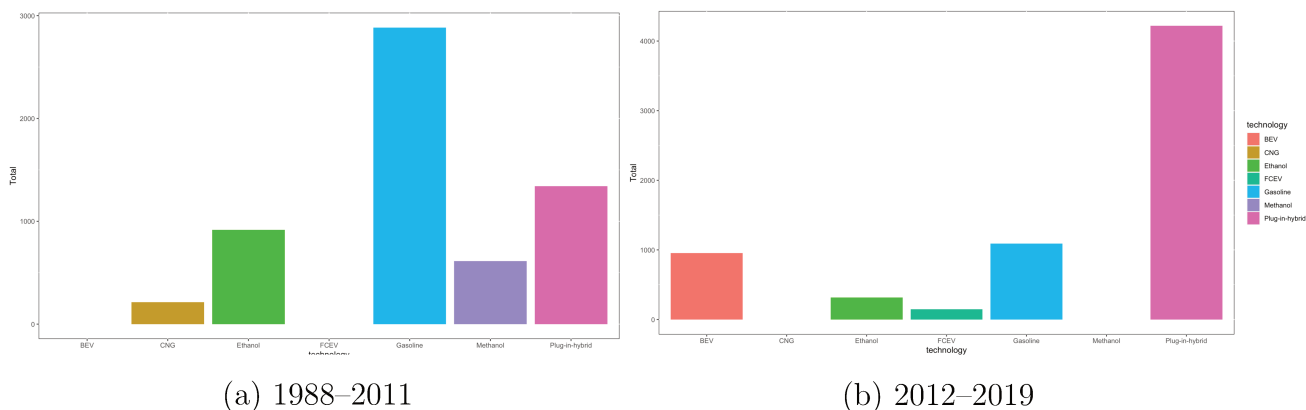

Source: Author’s figure based on data from (Office of Fleet and Asset Management, 2019).

and the number of green fleets, which becomes negative as market concentration decreases. In the latter, market concentration always has a positive impact on green fleets purchases.

It is customary in the entry literature (Berry and Reiss (2007)) to control for market size using a market’s population. Nevertheless, this study focuses on public purchases; thus, instead I construct a variable accounting for all the state agencies (*agencies*) present in the data per postcode. On average, there are 1.62 agencies per postcode, but there is significant variation in this indicator since it is between 1 and 24.

## Fuel Stations

The [Alternative Fuels Data Center \(2021\)](#) collects and updates information about all the nationwide alternative retail fuel stations (i.e. biodiesel, natural gas, electricity, and hydrogen). The information includes the exact address of each fuel station, which allows me to construct a variable that considers all the stations that might serve green fleets (*stations*) within a postcode in a given year. It includes the new stations deployed during the year. There is a strong evidence of a positive relationship between retail stations and market diffusion of alternative fuel vehicles (Sierchula et al. (2014); Vergis and Chen (2015); Mersky et al. (2016); Li et al. (2017b); Wang et al. (2017); Münzel et al. (2019)). However, this result might not hold in the context of public fleets, since they can be deployed with its own station.

Green vehicles suffer from indirect networks effects, or the *chicken-egg-dilemma*: their deployment requires simultaneous ramp-up of fuel stations. On the one side, vehicle manufacturers will not engage in mass production of green vehicles unless the density of retail

distribution stations is sufficiently large. On the other side, retail stations might be limited by small fuel demand. Among the solutions to overcome this problem, building captive fleets can help reduce uncertainty about future fuel demand ([International Energy Agency \(2019\)](#)). This creates concerns about potential endogeneity of the number of retail stations. Thus, following [Clinton and Steinberg \(2019\)](#), I construct a variable for the lagged number of total stations per year in a postcode (*lstations*).

### Demographic Characteristics

In the entry literature ([Berry and Reiss \(2007\)](#)), it is common to control for the level of income in a market. The latter has a positive effect on the decision to enter a market, since wealthier consumers are more likely to purchase a new product. The US Census Bureau only publicly releases five-years estimates of demographic characteristics; then instead this paper uses information on the individual income tax returns filed with the [IRS \(2020\)](#). Moreover, I focus on state agencies instead of retail consumers; thus, fiscal information might be more relevant for the analysis of public purchases. In particular, a large share of state agencies' budget comes from income taxes.

The aggregated information per postcode considers, for each year, the total number of individuals filling a tax return (*returns*), the total adjusted gross income (AGI), and the total tax liability (Taxes). The AGI and Taxes, respectively, correspond to the total yearly income after accounting for all applicable tax deductions, and the total collected income tax in a postcode per year. I construct a measure for the average budget per state agency within a postcode in a given year (*budget*). This measure exhibits significant variation between 65516\$ and 822683621\$, it is quite intuitive to expect that agencies with larger budgets tend to purchase more green fleets. Nevertheless, one cannot rule out the possibility of instead finding a negative impact, since wealthy markets do not have access to increased rebates. Moreover, it is likely that there exists some level of budget redistribution across state agencies. I also construct an indicator for the average adjusted gross income per tax payer (*percagi*), the latter is between 2763 \$ and 539895\$. This data is not representative of the full population since it only considers individuals that are required to fill out an income tax return, and negative adjusted gross incomes are not included.

### Environmental Indicators

The CalEnviroScreen screening tool assigns a climate change vulnerability score to each census tract in California. There is a significant variation of this indicator in the sample, between 1.75 and 73.42. This indicators build on two scores: a pollution burden (*Pollution*



---

*Score*) and a population characteristics (*Population Score*) one. Although employees of a state agency are not necessarily concerned by the socioeconomic characteristics of this indicator, they are exposed to pollution, which could result in a higher willingness to adopt green fleets. Thus, I expect the CES score to have a positive effect on green fleet adoption.

I use data from the 1.1 (2011), 2.0 (2014) and 3.0 (2018) versions and construct a measure by postcode for the CES, pollution, and population scores using the information of all census tracts within a postcode weighted by the concerned population. The average population score is larger than the pollution burden one: 40.7 versus 36.19.

I also construct two postcode-level measures of pollution related to vehicles emissions. One for all particulate matter emissions (*PM25*) excluding the ones from diesel vehicles, and one for particulate matter emissions only related to diesel vehicles (*DieselPM*). DieselPM concentrations exhibit significant variation between  $0.09\mu\text{g}/\text{m}^3$  and  $106.39\mu\text{g}/\text{m}^3$ . The variation is less important for PM25 between  $3.79\mu\text{g}/\text{m}^3$  and  $20.511\mu\text{g}/\text{m}^3$ . Overall, concentration levels of Diesel PM are larger than PM25. [Guo et al. \(2020\)](#)'s findings suggest that there is a positive relationship between high particulate matter concentrations and alternative vehicles market diffusion adoption; thus, PM25 and DieselPM are expected to have a positive effect.

### 3 Empirical Strategy

This paper combines the data on public fleet purchases, and market characteristics presented in section 2.2 at the postcode level. Although census tracts are the most disaggregated statistical area in the US, data on public purchases is only available at the postcode-level. This paper studies how market structure and environmental policy influences green fleet purchases. The empirical approach uses a reduced-form model to express the number of purchased fleets in a postcode for a given year as a function of different groups of variables. Throughout the paper, a market is defined as a postcode  $i$  in a given year  $t$ .

One of the characteristics of the data is that before executive order B-16-12, there were no green fleets in the market; thus, a significant share of zero-valued observations are present in early years. In addition, for some postcodes, zero-valued observations cover the whole sample period (Figure 4). Indeed, for the observed years, there is a large share of markets which have not adopted any green fleet (about 64%). One could interpret this as the data being left censored, then, the traditional modeling approach would be to use a Tobit model (Corts (2010)). Nevertheless, in this context a non null number of purchased fleets is observed if and only if the utility to buy a green fleet is strictly positive. Thus, the zero-valued observations in the data represent the decision of not buying a green fleet even though the latter are available in the market.

Figure 4: Number of fleets and vehicles.

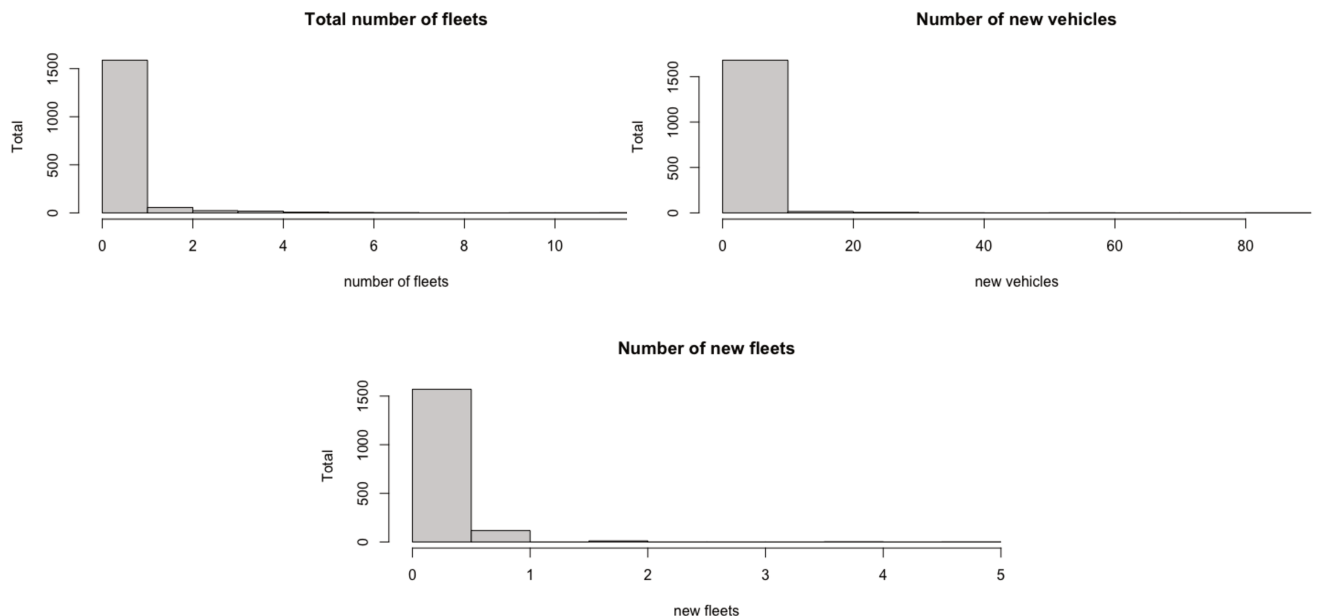

Source: Author's figure based on data from (Office of Fleet and Asset Management, 2019).

---

The total number of purchased green fleets in a market is right-skewed (3.23) and has a large kurtosis (8.46). This is also the case for the number of new fleets, and the number of new vehicles in a market; their respective skewness is 5.51 and 12.40 and the kurtosis is 45.8 and 220.58. Following a traditional ordinary least squares (OLS) estimation with a large presence of zeros in the dependent variables might lead to biased estimates. Moreover, the error term would be heteroskedastic.

Most of the empirical literature on adoption of alternative vehicles uses a log transformation of the dependent variable to obtain a normal distribution. Nevertheless, such a strategy would considerably reduce the number of observations in this paper because of the large number of zero-valued observations. To analyse count data with numerous zeros, there are two relevant methodologies: a Poisson regression model with robust standard errors, and a zero-inflated negative binomial (zib) model. Santos Silva and Tenreyro (2011)'s findings suggest that the estimates obtained with a Poisson model with robust standards errors are consistent even when we observe a large number of zero observations in the dependent variable. Moreover, when fitting a zib model, estimates might be biased since they are not robust to distributional misspecifications. Indeed, the zib model requires stronger distributional assumptions than a Poisson model with robust standard errors (Cameron et al. (1998)). Thus, I chose to fit a Poisson model with robust standard errors to analyse my zero-inflated data.

### 3.1 Market structure on technology adoption

This paper exploits a command-and-control regulation (executive order B-16-12) to investigate the relationship between market structure and innovation in the context of public purchases. The aim of this regulation is to induce public agencies to buy a more environmentally friendly technology: green vehicles. Determining who are the potential adopters of a technology is empirically challenging; one can only observe who adopts a technology once they enter the market. In the data, it is possible to observe that state agencies purchase non-green and green vehicles from the same manufacturers as illustrated in Figure 5.

Thus, the number of manufacturers procuring state agencies before 2012 seems as a reasonable candidate for a measure of potential competition<sup>4</sup>. This paper exploits the postcode level data to study whether the level of potential competition induces an *epidemic* or a *diffusion* equilibrium of innovation.

A reduced form model expresses the relationship between potential competition and the total number of purchased green fleets:

---

<sup>4</sup>Pavan et al. (2020) use a similar measure of potential competition.

Figure 5: Vehicle count by manufacturer.

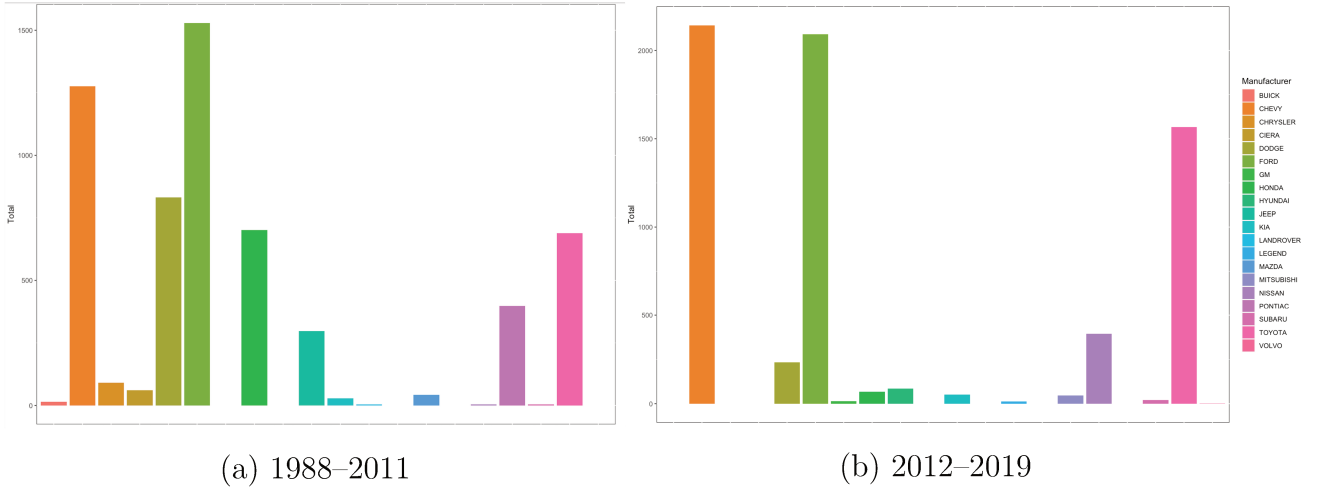

Source: Author's figure based on data from (Office of Fleet and Asset Management, 2019).

$$Pr[\sum Fleets|x_i] = \exp(\eta comp_i + \psi comp_i^2 + \beta x_i + \zeta_c)$$

Let  $Y_i$  denote the total number of purchased green fleets in a postcode  $i$  as of 2019, and  $comp_i$  be the number of potential competitors. A first specification can be written as follows:

$$Y_i = \alpha + \eta comp_i + \psi comp_i^2 + \beta x_i + \zeta_c + \epsilon_i \quad (2.1)$$

where  $\alpha$  is a constant term,  $comp_i^2$  controls for a possible non-linear relationship between competition and innovation. If  $\eta > 0$  and  $\psi > 0$ , then, potential competition induces an *epidemic* equilibrium. Otherwise, if  $\eta > 0$  and  $\psi < 0$  there is a *diffusion equilibrium*.  $x_i$  is a vector of market characteristics at the postcode level and  $\beta_x$  measures the effect of the covariates in vector  $x_i$ . I include *percagi* which acts as a proxy for income, and *returns* acts as proxy a for market size. Nevertheless, since I focus on state agencies instead of retail consumers, I also consider the average budget per agency *budget* as a control for income, and *agencies* as a proxy for market size. I include in the regression two measures of air pollution, *PM25* and *DieselPM*. I also control for unobserved, time-invariant, city level  $\zeta_c$  fixed effects. Finally, I control for the total number of available retail stations *Cstations*. The error term  $\epsilon_i$  represents the net effect of all other unobservable factors that might influence green fleet adoption. Regression results are presented in Table 3.

---

### 3.2 Institutional environment on technology adoption

In this section, I study the relationship between the CES score and green public fleet purchases. One might be concerned about a possible reverse causality bias between the dependent variable and the CES score. On the one hand, a high score gives state agencies access to increased incentives for green fleets. On the other, the presence of a large fleet of green vehicles reduces pollution which results in a smaller score (since an air pollution measure is included in this score as seen in Figure 2). I use a one-year lag between the explanatory and dependent variable to reduce potential endogeneity<sup>5</sup>. I exploit the panel data nature of the postcode-level data to investigate the relationship between public fleets and the CalEnviroScreen score:

$$Pr[NewFleets|x_{i,t}] = \exp\left(\gamma CES_{i,t-1} + \kappa lstations_{i,t} + \beta x_{i,t} + \mu_i + \phi_t\right)$$

Let  $y_{it}$  denote the number of new fleets in a market. This relationship is expressed using a reduced form model:

$$y_{i,t} = \gamma CES_{i,t-1} + \kappa lstations_{i,t} + \beta x_{i,t} + \mu_i + \phi_t + \epsilon_{i,t} \quad (2.2)$$

*CES* is the CalEnviroScreen score, *lstations* the lagged number of available retail stations, and  $x_{it}$  a vector of market characteristics that might affect public buyers' behaviour. I include the lagged value of budget as an explanatory variable. In general, taxes collected in a fiscal year are redistributed the following year. This model incorporates two-ways fixed effects. I control for unobserved, time-invariant, postcode  $\mu_i$  fixed effects, and for state-wide trends that vary over time, I use year  $\phi_t$  fixed effects. During the period covered by the data, the CES score has only been updated three times<sup>6</sup>. This reduces the number of observations due to a lack of variation in the main explanatory variable.  $\epsilon_{it}$  is the error term representing the net effect of all other unobservable factors that might influence fleet adoption.

Notice that one cannot incorporate measures of pollution since they are already accounted for in the CES score. Moreover, I cannot include the number of agencies and measures of market concentration in the regression since they are time-invariant; thus, their effects are captured through regional fixed effects when applied. Regression results are presented in Table 4.

---

<sup>5</sup>A combination of two-way fixed effects with a time-varying instrument (Lin and Wooldridge (2019)) would allow also me to simultaneously account for omitted variables and reverse causality bias. Unfortunately, I have not been able to retrieve such an instrument, but a good example would be wind speed per year in a postcode

<sup>6</sup>2011, 2014 and 2018

## 4 Results and discussion

This section presents results of my two empirical strategies to analyse green public fleet purchase data.

### 4.1 Market structure on technology adoption

This section investigates the relationship between market structure and green fleet adoption by state agencies using different specifications of equation (1). The reported standard errors are robust and clustered at the city level.

Columns (1) to (4) consider the number of potential competitors in a market as a measure of market concentration, and progressively incorporate control variables. Columns (5) and (6), respectively, consider the number of technologies and the Herfindahl-Hirschman Index as measures of market competition. The specification in column (7) incorporates measures of market size and income that are used in the literature on retail purchases. Their signs are in line with the predictions, but are not statistically significant. This is consistent with the initial hypothesis that such measures are not relevant for public purchases.

Across specifications, a high level of market concentration has a positive significant effect on the total number of green public fleets; while a low level of market concentration has a negative effect. Thus, there is evidence of a diffusion equilibrium of innovation. It should be noted that in the specifications on columns (3) and (4) the coefficient estimates associated to the market concentration squared (i.e. a low level of market concentration) are no longer statistically significant. This could be a result of fleet replacement targets limiting manufacturers' diffusion strategy, since they need to comply with the new technologies. However, the preferred specification based on the Akaike Information Criteria (AIC) and Schwartz Criterion (BIC) is the one on column (6), where both coefficients associated to the level of market concentration are highly significant at the 0.1% level. Nevertheless, the coefficients estimates are very small. This specification considers the HHI index as a measure of market concentration, and as explained in section 2.2 it considers market shares per manufacturer-technology pairs. Thus, it is more relevant for this study since it incorporates in one indicator both the dimensions related to the number of manufacturers and the available technologies.

In line with the initial predictions, market size and income, i.e. the log of *agencies* and the log of *budget* both have a positive effect on the total number of purchased green public fleets. Nevertheless, only the number of agencies in a postcode has a statistically significant effect. When the number of potential competitors, technologies and the HHI are respectively used as measures of market concentration, this effect is significant at the 5%, 0.1% and 0.1%

Table 3: Regression Results Market Structure.

	(1)	(2)	(3)	(4)	(5)	(6)	(7)
comp	0.815*** (3.92)	0.893*** (3.90)	0.753*** (2.96)	0.560+ (1.74)			0.619*** (3.63)
comp2	-0.0488* (-2.20)	-0.0618* (-2.28)	-0.0411 (-1.28)	-0.0178 (-0.43)			-0.0133 (-0.68)
log(agencies)	0.660*** (2.74)	0.658+ (1.83)	1.015* (2.42)	1.137* (2.55)	1.483*** (2.76)	1.339*** (2.63)	
log(budget)	0.177 (0.95)	0.140 (0.53)	0.269 (1.09)	0.162 (0.66)	0.242 (0.79)	0.0539 (0.23)	
DieselPM		0.0276+ (1.69)	0.0313*** (2.83)	0.0252+ (1.86)	0.0449*** (2.87)	0.0241* (2.36)	
PM25		-0.716 (-1.11)	-0.229 (-0.43)	0.112 (0.18)	-0.322 (-0.41)	0.216 (0.35)	
stations			-0.123*** (-3.03)	-0.777 (-1.51)	-0.963*** (-2.60)	-1.358*** (-2.89)	
log(budget)*stations				0.0396 (1.32)	0.0526* (2.42)	0.0759*** (2.86)	
tech					1.113*** (2.75)		
tech2					-0.0977 (-1.59)		
hhi						-0.00134*** (-3.20)	
hhi2						8.83e-08*** (2.68)	
log_ret							0.0847 (0.32)
log_percagi							-0.00670 (-0.02)
<i>N</i>	189	189	189	189	189	189	189

*Notes:* The dependent variable is the total number purchased fleets in a postcode as of 2019.

Robust standard errors clustered by city in parentheses.

P-values of levels +  $p < 0.10$ , \*  $p < 0.05$ , \*\*  $p < 0.01$ , \*\*\*  $p < 0.001$ .

level. This could be related to an important level of budget redistribution between state agencies across postcodes. Moreover, state agencies have other sources of funding besides income taxes, like state grants. Thus, although the collected taxes in a postcode account for a large share of the budget, other unobserved mechanisms captured by the fixed effects might be in place.

On what concerns the air pollution measures based on particulate matter emissions concentrations, I have mixed results.

On the one hand, the level of *DieselPM*, as expected, has a positive and statistically significant effect across specifications. When the number of potential competitors, technologies and the HHI are respectively used as measures of market concentration, a 1% increase in *DieselPM* concentrations increases by 2.5%, 4.5% and 2.4% the total number of purchased green fleets, *ceteris paribus*. This effect is respectively statistically significant at the 10%, 0.1% and 5% levels.

On the other hand, the *PM25* measure coefficient estimate sign changes across specifications. Nevertheless, it is not statistically significant. Diesel vehicles were introduced into the market as a cleaner alternative to petrol. Thus, it is possible that state agencies in markets with high concentrations of diesel particulate matter are more willing to switch to environmentally friendly technologies than markets with high concentrations of *PM25*. In particular, it is implicit that *PM25* includes all particulate matter emissions from other pollution sources. Thus, these mixed results could be related to *PM25* emissions being beyond the scope of state agencies. Some might not even be aware of the high concentration of this pollution measure.

Finally, across specifications, and unlike what was expected, I retrieve a negative effect of the number of available retail stations on the total number of purchased green fleets. This effect is more important when the HHI is used as a measure of market concentration.

Two mechanisms can explain this counter-intuitive result. First, as mentioned above, public fleets can be simultaneously deployed with a fuel station. Nevertheless, this represents a considerable burden on an agencies' budget<sup>7</sup>; thus, it is possible that when there are many retail stations in a market, agencies do not invest in distribution infrastructure. Depending on the location of retail stations, it could represent a burden in terms of deviation time for employees. This is in line with Kelley and Kuby (2017)'s findings of fleet drivers without their own station choosing retail ones based on the smallest deviation time. Thus, employees perhaps favour other vehicles with retail stations at shorter deviation time. Second, as pointed out by Münzel et al. (2019), the effect of retail station's availability on alternative

---

<sup>7</sup>To reduce this burden, since 2020 the DGS now provides grants for green fuel stations.



---

vehicles purchases varies over time. The dependent variable considers all the purchased fleets as of 2019, thus, perhaps in early years, there was a positive network effect that became less prominent over time. To account for the first mechanism, I include an interaction term between the level of budget and the number of retail stations. The latter has a positive, significant impact on the total number of purchased green public fleets. Thus, when the number of retail stations increases, if an agency's budget is large, the latter no longer has a negative impact on green fleet purchases. Indeed, the agency can invest in a station of its own. This confirms that the negative effect of retail stations on green public fleets purchases is related to the deviation time burden. The second mechanism will be explored in section 4.2.

In conclusion, green fleets seem to follow a *diffusion* equilibrium of innovation, but the effect is not strong. This could be related to the existence of command-and-control regulations defining targets for fleet replacement and bans on non-green fleets starting in 2019. Market size does play a significant role in the total number of purchased green fleets, and so do particle matter emissions from diesel vehicles. Thus, it suggests that when state agencies care about pollution, they are more willing to switch to new green fleets. Also, it seems that retail stations do not have the same effect on public fleets as they do on retail purchases. Nevertheless, the sample size is relatively small, which might explain the lack of significance of some coefficients of the control variables.

## 4.2 Institutional environment on technology adoption

In this section, I first investigate the relationship between the CES score and green fleets adoption by state agencies. Second, I consider three types of sensitivity analysis. Across specifications, I use a log-linear model; thus, the non-log transformed dependent variables can be interpreted as semi-elasticities.

### CalEnviroScreen score effect on green fleet purchases

This section presents and discusses regression results of different specifications of equation (2). All specifications consider the number of new green fleets in a market as the dependent variable. I use two-ways fixed effects to control for possible unobserved, time-invariant, postcode-level trends, and for time-varying state-wide trends. Standard errors are robust and clustered at the postcode-level.

The specifications in columns (1) to (4) model the relationship between the CES score and the number of new green fleets. Across specifications, I find a consistent negative effect of the CES score on new green fleets purchases unlike what was expected. Nevertheless,

Table 4: Regression Results Institutional Environment.

	(1)	(2)	(3)	(4)	(5)
CES	-0.0372 <sup>+</sup> (-1.93)				
LCES		-0.0385* (-2.00)	-0.0381 <sup>+</sup> (-1.84)	-0.0444* (-2.14)	
lstations			-0.0778 (-1.33)	0.853 (1.23)	0.592 (0.78)
log(lbudget)			0.259 (1.44)	0.374 (1.46)	0.413 <sup>+</sup> (1.90)
lstations*log(lbudget)				-0.0550 (-1.35)	-0.0402 (-0.91)
LPollutionScore					0.132 <sup>+</sup> (1.90)
LPollutionScore2					-0.00140 <sup>+</sup> (-1.93)
LPopulationScore					0.0171 (0.73)
Year FE	Yes	Yes	Yes	Yes	Yes
Regional FE	Yes	Yes	Yes	Yes	Yes
<i>N</i>	496	496	496	496	496

*Notes:* The dependent variable is the number of new fleets in a market.

Robust standard errors clustered by postcode in parentheses.

P-values of levels <sup>+</sup>  $p < 0.10$ , \*  $p < 0.05$ , \*\*  $p < 0.01$ , \*\*\*  $p < 0.001$ .

this effect is not strong. In the first specification, a 1% increase in the CES score reduces by 3.6% the number of new green fleets in a market, ceteris paribus. The specification in column (2) considers a one-year lag of the CES score to account for potential reverse causality between the score and the dependent variable. The lagged version of the CES score decreases by 3.7% the number of new green fleets. This counter-intuitive result can be explained by different mechanisms.

First, it should be noted that compared to other vehicles, green ones are more expensive. They represent a burden in terms of budget compared to other technologies. Rebates for public fleets are available state-wide, but initially only consumers could benefit from rebates. Thus, public employees might not be aware of such monetary incentives. Moreover, as pointed out by [Diamond \(2009\)](#), a significant delay between the rebate payment and the purchase decision results in a poor uptake of such a monetary incentive. This is illustrated in Figure 6; one might notice that compared to the number of purchased green public vehicles, in absolute, only a small number have actually benefited from a rebate.

Figure 6: Purchased Vehicles vs Number of Rebates.

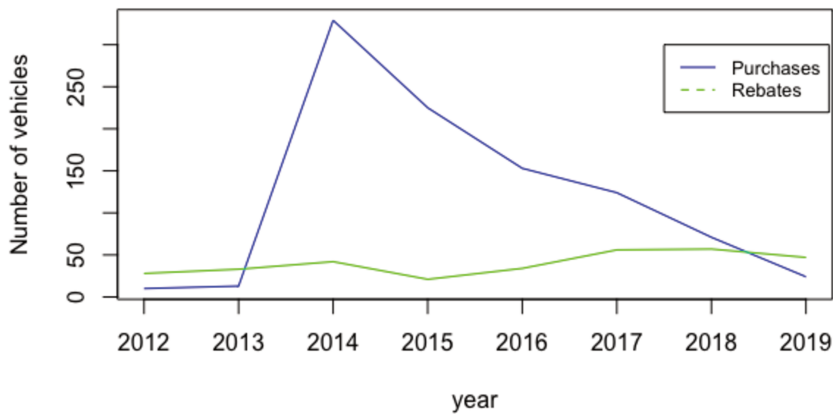

Source: Author’s figure based on data from ([Office of Fleet and Asset Management, 2019](#)) and ([Center for Sustainable Energy, 2021](#)).

Second, a larger number of fleets also implies a larger number of technologies. Not all green vehicles share the same type of charging infrastructure, and it is unlikely that a state agency would invest in many types of stations. Thus, diversifying technologies also increases the burden in terms of deviation time from relying on retail stations. As a result, in a market with a large CES score, fleet managers and the OFAM would tend to favour larger fleets instead of different fleets. In such a case, one should expect to observe a positive relationship between the number of new green vehicles and the CES score.

I control for the level of budget and the number of retail stations in the specification in column (3). The coefficients are consistent in sign with those in section 4.1, but they are not statistically significant. The effect of other time-invariant variables is captured by the fixed effects.

In the specification in column (4), I include an interaction term between the level of budget and the number of retail stations. One can observe that now the number of retail stations has a positive impact, opposite to the relationship retrieved in the previous section. The panel nature of the data allows me to capture the effect of retail fuel stations over time per postcode. [Münzel et al. \(2019\)](#) find that the effect of a retail station's availability on alternative vehicles purchases varies over time. Thus, it seems that retail stations have a positive effect on the number of new fleets in line with the literature ([Sierzchula et al. \(2014\)](#); [Vergis and Chen \(2015\)](#); [Mersky et al. \(2016\)](#); [Li et al. \(2017b\)](#); [Wang et al. \(2017\)](#); [Münzel et al. \(2019\)](#)). The coefficient estimate of the interaction between the log of budget and the number of retail stations indicates a negative effect on the number of new fleets. On the one hand, if the number of retail stations is large, a state agency is less sensitive to budget, since it no longer needs to invest in a fuel station. On the other hand, if the budget is large then, regardless of the number of retail stations, an agency can invest on its own. Nevertheless, none of the control variables have a statically significant effect.

Finally, another mechanism which can explain the negative relationship between the number of new fleets and the CES score is related to air pollution. One of the advantages of the CES score is that it takes into account multiple dimensions of pollution, as well as socioeconomic characteristics. Nevertheless, the different measures included in the CES score might have unequal effects on the number of new green fleets in a market. [MacInnis and de Mello \(2005\)](#) find that when environmental conditions worsen above a certain threshold, consumers tend to give up their pro-environmental behaviours. This finding is supported by [Li et al. \(2017a\)](#) who find a U-shaped relationship between air pollution and non-green vehicles purchases. This paper instead considers green vehicles; thus, it is possible that there exists an inverse U-shape relationship between air pollution and green fleet purchases.

To test the hypothesis of different measures of the CES score having unequal effects on green fleets purchases, the specification in column (5) includes the pollution burden and the population characteristics measures from the CES score. I allow for a non-linear relationship between pollution and the number of new green fleets in a market. The control variables are the same as in column (4). The results confirm the existence of an inverse U-shaped relationship between pollution and the number of new green fleets. The estimator has a log-linear nature; thus, for low levels of pollution an increase of 1% in the pollution burden score leads to a 1.7% increase in the number of new green fleets, *ceteris paribus*. Conversely, when pollution increases beyond a certain threshold, a 1% increase in the pollution burden score leads to a 0.001% decrease in the number of new green fleets, *ceteris paribus*. Notice that the sizes of these effects are relatively small, and they are significant at the 10% level. The pollution burden score aggregates many measures, and so it is possible that some have

---

unequal or no effect on the number of new green fleets, which could explain the size of the coefficients. The population score has a positive but insignificant effect on the number of green purchased fleets. This is in line with the initial hypothesis that state agencies' employees are not necessarily concerned by the socioeconomic characteristics of the area. The control variables have the same signs as in the previous specification. One can observe that the log of budget is now statistically significant at the 10% level, with an elasticity of 0.413.

Overall, the results suggest a persistent negative effect of the CES score on the number of new green fleets purchases in a market. Three mechanisms can explain this relationship. First, it seems that there is a lack of information about the available monetary incentives. Second, fuel stations represent a significant burden on an agency's budget. Finally, the measures included in the CES score have unequal effects. Thus, to provide incentives for state agencies to switch to greener technologies, the weights of the measures included in the CES score might need to be reevaluated. It could be relevant to also introduce increased rebates based not on income but on pollution.

### **Sensitivity analysis**

This section presents the results of three different types of sensitivity analysis of the model specified in equation (2). The first one splits the sample into two, to account for different policy changes around 2016. The second one, considers other dependent variables. Finally, the third one exploits different levels of regional aggregation. The reported standard errors are robust and are clustered at the postcode-level for the first four columns of Table 5.

In Figure 1, one can observe that after the first fleet replacement target of executive order B-16-12, fuel-cell fleets took off. Moreover, since 2016 public fleets have access to increased rebates when located in a DAcS. It is possible that these policy changes could have changed the trends observed in the previous section. Thus, to investigate the effect of these policy changes, the data is split into two periods: 2012–2015, and 2016–2019. The specification in column (1) present estimates for the period 2012–2015, and the one in column (2) for the period 2016–2019. Notice that, in both sub-samples, the CES score has a negative effect on the number of new green fleets, but the effect is no longer statistically significant. Thus, this trend seems to be consistent over time. On what concerns the other control variables, we observe that their signs change from one period to another, but the estimates are not statistically significant. In early years of this study, the number of retail stations had a positive effect, which became negative after 2015. This is in line with [Münzel et al. \(2019\)](#)

Table 5: Regression Results Sensitivity Analysis.

	Nfleets		Nvehicles	fleet size	Nfleets	
	(1)	(2)	(3)	(4)	(5)	(6)
	2012–2015	2016–2019			City	County
LCES	-0.0408 (-1.33)	-0.0470 (-1.03)	0.0269 (0.74)	0.0320 (0.90)	-0.0490 <sup>+</sup> (-1.75)	-0.0706 <sup>+</sup> (-1.76)
lstations	4.200 (0.82)	-0.676 (-0.62)	1.235 <sup>+</sup> (1.80)	1.162 (1.62)	0.0388 (0.20)	-0.225 (-0.65)
log(lbudget)	-0.838 (-1.07)	0.316 (1.01)	0.101 (0.26)	0.124 (0.35)	0.591 (1.41)	1.365* (2.10)
lstations*log(lbudget)	-0.240 (-0.76)	0.0342 (0.53)	-0.0786 <sup>+</sup> (-1.96)	-0.0726 <sup>+</sup> (-1.73)	-0.00395 (-0.39)	0.0127 (0.67)
Year FE	Yes	Yes	Yes	Yes	Yes	Yes
Regional FE	Yes	Yes	Yes	Yes	Yes	Yes
<i>N</i>	128	212	496	496	352	200

*Notes:* Different dependent variables are considered.

Robust standard errors clustered by postcode in parentheses.

P-values of levels <sup>+</sup>  $p < 0.10$ , \*  $p < 0.05$ , \*\*  $p < 0.01$ , \*\*\*  $p < 0.001$ .

findings of the effect of stations changing over time. Surprisingly, in early years of this study, the log of budget has a negative impact. One would have instead expected a positive effect that decreased with the introduction of increased rebates. This is also the case for the interaction term between stations and the budget. There are other mechanisms accounting for this sign change. For example, an early important redistribution of taxes across state agencies, or even grants received between the two periods. These trends changes require further investigation, and data collection.

Second, I study whether the CES score has a positive effect on the number of new green vehicles. The specification in column (3) considers the number of new green vehicles in a market as the dependent variable; while the one in column (4) the average fleet size. In both cases, the CES score has a positive effect; this is in line with the hypothesis that fleet managers prefer larger fleets than different ones. Nevertheless, the effect is not statistically significant. In both specifications, the number of stations has a positive effect. Indeed,

---

even if an agency owns a fuel station, with a large fleet, public employees would still rely on retail stations. As a result, if a market has numerous stations, this would favour larger fleets. In particular, this effect is statistically significant at the 10% level when the number of new vehicles is considered as the dependent variable. One extra fuel station increases the number of new green vehicles by a factor of 3.4. The log of budget is in line with the initial predictions but is not statistically significant. Finally, the interaction term between the number of stations and the log of budget has a negative statistically significant effect on both cases. One might notice that, across specifications, when the interaction estimate coefficient has a positive sign, then, the estimate coefficient of the number of stations is negative. With many retail stations, green vehicle purchases are less sensitive to budget and, with a large number of retail stations, vehicle purchases are less sensitive to an agency's budget.

Finally, I exploit different levels of regional aggregation, from the most disaggregated one that is available up to the county level. The aim of this regional aggregation is to observe the stability of the explanatory variables coefficients. In column (5) I present the regression results when considering a regional aggregation at the city level, while in column (7) the results when considering a regional aggregation at the county level. In the two specifications, the CES score has a negative and significant impact (at the 10%) on the number of new green fleets in a market. A 1% increase in the CES score leads to a 4.8% decrease in the number of new green fleets when aggregating at the city level; while it leads to a 6.8% decrease when aggregating at the county level, *ceteris paribus*. The log of budget shows stability in sign. Notice that the effect of budget becomes statistically significant at the 5% level when aggregating at the county level. Perhaps budget re-distribution happens within a county and not within the state. As for the number of retail stations and its interaction term with the log of budget, we observe a change between the two levels of regional aggregation. When aggregating at the city level, the number of stations has a positive and insignificant impact, while the interaction term has a negative effect, as when aggregating at the postcode-level. One might notice that the size of the coefficient becomes smaller with the aggregation. When aggregating at the county level, the number of stations has a negative impact while the interaction term a positive one, but neither is statistically significant. This change in the coefficients sign could be related to retail stations being more sparse when considering the all-county, than when considering more disaggregated areas.

These results confirm the negative effect of the CES score on green fleet purchases. The policy changes around 2016 had no effect on this relationship. It seems that fleet managers favour larger fleets, rather than different ones. The spatial dimension of retail stations' location seem to be quite important for fleet purchases. The sparser they are, the larger the

deviation time burden.

## 5 Conclusion

This paper studies the drivers of green public fleets in California. During the past decades, petrol and diesel vehicles have dominated the market; whereas green fleet purchases only took off from 2012 onwards.

This paper shows a diffusion equilibrium of green public fleets, but this strategy seems to be limited by regulation instruments such as fleet replacement targets and a ban on non-green vehicles. The results indicate a persistent negative effect of the CalEnviroScreen score on the number of new green fleets, and its effect is insignificant on the number of green vehicles. It seems that there is a lack of information about the available monetary incentives. There is a non-linear relationship between air pollution, and green fleet purchases. Retail stations presence highly impacts an agency's budget. Thus, command-and-control regulations seem to be a better fit to drive green fleet purchases, compared to market based instruments.

This paper has policy implications. First, considering the non-linear nature of the relationship between air pollution and green fleets, it could be interesting to introduce increased rebates based not on income but on pollution. Second, given the poor performance of the CES score, the state needs to inform state agencies about the available monetary incentives.

This paper leaves scope for future work. First, an agency's budget seems to be affected by unobserved mechanisms that this paper did not account for. For instance, whether the state agency has benefited from a grant resulting in a larger budget. Second, this paper aggregates the CES score by postcode, whereas it is available at the census tract level. This aggregation might lead to some noise in the results, since the CES score might be under or overestimated.



---

## Bibliography

- Aghion, P., Bloom, N., Blundell, R., Griffith, R., and Howitt, P. (2005). Competition and innovation: An inverted-U relationship. *The Quarterly Journal of Economics*, 120(2):701–728.
- Alternative Fuels Data Center (2021). Alternative fueling station locator.
- Argenziano, R. and Schmidt-Dengler, P. (2012). Inefficient entry order in preemption games. *Journal of Mathematical Economics*, 48(6):445–460.
- Argenziano, R. and Schmidt-Dengler, P. (2014). Clustering In  $N$ -Player Preemption Games. *Journal of the European Economic Association*, 12(2):368–396.
- Berry, S. and Reiss, P. (2007). Empirical models of entry and market structure. In Armstrong, M. and Porter, R., editors, *Handbook of Industrial Organization*, volume 3, chapter 29, pages 1845–1886. Elsevier.
- Cameron, A. C., Hammond, P., Holly, A., and Trivedi, P. K. (1998). *Regression Analysis of Count Data*. Cambridge University Press, Cambridge.
- Center for Sustainable Energy (2021). California air resources board clean vehicle rebate project, rebate statistics.
- Chandra, A., Gulati, S., and Kandlikar, M. (2010). Green drivers or free riders? An analysis of tax rebates for hybrid vehicles. *Journal of Environmental Economics and Management*, 60(2):78–93.
- Clinton, B. C. and Steinberg, D. C. (2019). Providing the spark: Impact of financial incentives on battery electric vehicle adoption. *Journal of Environmental Economics and Management*, 98:102255.
- Corts, K. (2010). Building out alternative fuel retail infrastructure: Government fleet spillovers in E85. *Journal of Environmental Economics and Management*, 59(3):219–234.
- Department of General Services (2021). Statewide contract fleet vehicles.
- Diamond, D. (2009). The impact of government incentives for hybrid-electric vehicles: Evidence from US states. *Energy Policy*, 37(3):972–983.
- Fudenberg, D. and Tirole, J. (1985). Preemption and rent equalization in the adoption of new technology. *The Review of Economic Studies*, 52(3):383–401.

- Gallagher, K. S. and Muehlegger, E. (2011). Giving green to get green? Incentives and consumer adoption of hybrid vehicle technology. *Journal of Environmental Economics and Management*, 61(1):1–15.
- Guo, J., Zhang, X., Gu, F., Zhang, H., and Fan, Y. (2020). Does air pollution stimulate electric vehicle sales? Empirical evidence from twenty major cities in China. *Journal of Cleaner Production*, 249.
- Hall, B. H. (2004). Innovation and diffusion. Working Paper 10212, National Bureau of Economic Research.
- Hannan, T. and McDowell, J. (1984). The determinants of technology adoption: The case of the banking firm. *RAND Journal of Economics*, 15(3):328–335.
- Igami, M. (2017). Estimating the innovators dilemma: Structural analysis of creative destruction in the hard disk drive industry, 1981–1998. *Journal of Political Economy*, 125(3):798–847.
- Igami, M. and Yang, N. (2016). Unobserved heterogeneity in dynamic games: Cannibalization and preemptive entry of hamburger chains in Canada. *Quantitative Economics*, 7(2):483–521.
- International Energy Agency (2019). The Future of Hydrogen: Seizing today’s opportunities. Technical report.
- IRS (2020). Individual income tax zip code data.
- Karshenas, M. and Stoneman, P. L. (1993). Rank, stock, order, and epidemic effects in the diffusion of new process technologies: An empirical model. *RAND Journal of Economics*, 24(4):503–528.
- Kelley, S. and Kuby, M. (2017). Decentralized refueling of compressed natural gas (CNG) fleet vehicles in Southern California. *Energy Policy*, 109(C):350–359.
- Leard, B., McConnell, V., and Zhou, Y. C. (2019). The effect of fuel price changes on fleet demand for new vehicle fuel economy. *The Journal of Industrial Economics*, 67(1):127–159.
- Levin, S., Levin, S. L., and Meisel, J. B. (1987). A dynamic analysis of the adoption of a new technology: The case of optical scanners. *The Review of Economics and Statistics*, 69(1):12–17.

- 
- Li, J., Moul, C. C., and Zhang, W. (2017a). Hoping grey goes green: air pollution's impact on consumer automobile choices. *Marketing Letters*, 28(2):267–279.
- Li, S., Tong, L., Xing, J., and Zhou, Y. (2017b). The market for electric vehicles: Indirect network effects and policy design. *Journal of the Association of Environmental and Resource Economists*, 4(1):89–133.
- Lin, W. and Wooldridge, J. M. (2019). Testing and correcting for endogeneity in nonlinear unobserved effects models. In Tsionas, M., editor, *Panel Data Econometrics*, chapter 2, pages 21–43. Academic Press.
- MacInnis, D. J. and de Mello, G. E. (2005). The concept of hope and its relevance to product evaluation and choice. *Journal of Marketing*, 69(1):1–14.
- Mersky, A. C., Sprei, F., Samaras, C., and Qian, Z. S. (2016). Effectiveness of incentives on electric vehicle adoption in Norway. *Transportation Research Part D: Transport and Environment*, 46:56–68.
- Münzel, C., Plötz, P., Sprei, F., and Gnann, T. (2019). How large is the effect of financial incentives on electric vehicle sales? A global review and european analysis. *Energy Economics*, 84:104493.
- Office of Fleet and Asset Management (2019). Fleet asset management system data extract 2015–2018.
- Pavan, G., Pozzi, A., and Rovigatti, G. (2020). Strategic entry and potential competition: Evidence from compressed gas fuel retail. *International Journal of Industrial Organization*, 69(C).
- Reinganum, J. F. (1981). Market structure and the diffusion of new technology. *The Bell Journal of Economics*, 12(2):618–624.
- Santos Silva, J. and Tenreyro, S. (2011). Further simulation evidence on the performance of the Poisson pseudo-maximum likelihood estimator. *Economics Letters*, 112(2):220–222.
- Shriver, S. K. (2015). Network effects in alternative fuel adoption: Empirical analysis of the market for ethanol. *Marketing Science*, 34(1):78–97.
- Sierchula, W., Bakker, S., Maat, K., and van Wee, B. (2014). The influence of financial incentives and other socio-economic factors on electric vehicle adoption. *Energy Policy*, 68:183–194.

- Stoneman, P. and Battisti, G. (2010). *The Diffusion of New Technology*, volume 2 of *Handbook of the Economics of Innovation*. Elsevier.
- United States Environmental Protection Agency (2020). Fast facts on transportation greenhouse gas emissions. Technical report.
- Vergis, S. and Chen, B. (2015). Comparison of plug-in electric vehicle adoption in the United States: A state by state approach. *Research in Transportation Economics*, 52:56–64.
- Wang, N., Pan, H., and Zheng, W. (2017). Assessment of the incentives on electric vehicle promotion in China. *Transportation Research Part A: Policy and Practice*, 101:177–189.

---

## Chapter 3

# Prosumers: Grid Storage vs Small Fuel-Cell

### **Abstract:**

We consider a stylised microeconomic model of the energy market to study investments on solar and storage capacity by consumers connected to the grid. The government may choose between a quantity or a price-based energy regulation. The first is compatible with centralised storage, and the second with decentralised storage. The regulations differ in two economic dimensions. First, consumers can sell energy to the grid only under a price regulation. Second, the policy instruments available to the government are not the same. Nevertheless, we retrieve the same consumer profiles under both regulations. Our model is calibrated, using data from Quebec, to evaluate the conditions under which power-to-gas storage is feasible. We find that the latter is not possible with the current technology. Cost reductions, combined with a larger round-trip efficiency, would allow investments in decentralised storage, but the grid operates at a loss. Only a cost reduction of the grid's operating costs would simultaneously allow investments in decentralised storage, while guaranteeing positive profits. Nevertheless, consumer surplus and welfare are always larger with a quantity regulation.

*Keywords:* Renewable Energy, Storage, Decentralised Production, Hydrogen

*JEL:* D15, D24, Q41, Q42, L94

---

# 1 Introduction

The electricity sector accounts for about 38% of the world’s greenhouse gases emissions ([International Renewable Energy Agency \(2018\)](#)). To meet the Paris Agreement’s temperature goals, this sector needs to achieve carbon neutrality by 2050. Renewable energy sources contribute to the reduction of emissions, but their integration into the energy-mix calls for flexibility options, such as energy storage. Hydrogen is a storable gas; thus, it can help smooth intermittent renewable production. In that context, one might wonder about the optimal organisation of the storage branch, to provide incentives for investments in power-to-gas technology. For instance, who should store energy either a traditional producer or a consumer, i.e. whether storage should be centralised or decentralised. In particular, during the last few years consumers have become more active in the energy market, with a massive deployment of decentralised solar capacity resulting of technology costs reductions (about 80% between 2008–2016 according to [Schopfer et al. \(2018\)](#)), environmental concerns and support policies.

Depending on the country’s legislation, consumers equipped with solar capacity might inject surplus production into the grid. The energy injected into the grid can be compensated in the form of an energy credit. In parts of Europe, North America and Asia, where there is a price-based energy regulation, this energy credit is associated to a monetary compensation. In Canada (Quebec), Brazil and Argentina (Chubut), there is a quantity-based energy regulation, which instead allows consumers to store surplus production in the grid, and retrieve it at a latter period

We consider a stylised microeconomic model of the energy market to study investments on solar and storage capacity by consumers connected to the grid. First, we consider that the government sets a quantity regulation, such that consumers can store energy in the grid. This setting is compatible with centralised storage. Second, we consider that the government sets a price regulation, such that consumers can sell surplus production to the grid. In addition, they can invest in decentralised storage.

Our objective is two-fold. First, we study how consumers behave in terms of energy consumption, injection and production under a quantity, and price regulation. We aim to assess the conditions under which consumers store energy. Second, we perform a numerical evaluation of the model, using data from Quebec, to determine the preferred energy regulation, quantity or price, by the grid and by consumers. To our knowledge, our paper is the first to compare a quantity versus a price based energy regulation when storage is available to consumers.

Our paper contributes to the literature on energy storage. A first strand of the literature studied the incentives to invest in storage from a producer's point of view, in perfectly competitive markets (Durmaz (2016); Helm and Mier (2018); Ambec and Crampes (2019)), and under alternative market configurations (Ambec and Crampes (2019); Andrés-Cerezo and Fabra (2020)). In a competitive market, storage increases investments in renewable energy, and reduces carbon emissions (Helm and Mier (2018); Ambec and Crampes (2019)). Moreover, investments in storage capacity might reduce price volatility (Durmaz (2016)). Market power creates important distortions, it reduces investments in storage capacity (Andrés-Cerezo and Fabra (2020)), and might increase carbon emissions unless properly accounting for the social cost of carbon (Ambec and Crampes (2019)). Closer to this paper, a second strand of the literature has focused on consumer's incentives to invest in decentralised storage. Some contributions (Andreolli et al. (2020); Boampong and Brown (2020)) consider a setting where surplus production cannot be sold to the grid. Other contributions analyse investments in decentralised storage, when consumers inject energy into the grid at a feed-in-tariff (FiT) valued at the energy retail price. Their findings suggest that dynamic pricing drives investments in storage capacity (Durmaz et al. (2017); Dato et al. (2020)). Moreover, consumers only invest in decentralised storage when capacity costs are small (Durmaz et al. (2017); Dato et al. (2020, 2021)). Our paper provides a link between these two strands of literature, focusing on the consumer side.

We compare two possible energy regulations, a quantity one compatible with centralised storage, and a price one compatible with decentralised storage. They differ in two main economic dimensions. First, consumers can sell energy to the grid only under a price regulation. Second, the policy instruments available to the government are not the same. Under a quantity regulation the government has two policy instruments, a grid tariff, and the share of stored energy that can be retrieved by consumers; whereas under a price regulation the government has only one instrument, the FiT. Interestingly, our results imply that the same profiles emerge under these two regulations. Our numerical evaluation of the model suggests that under the current technology costs, consumers with a small consumption level (less than 40kW) do not invest in solar capacity. Moreover, when the solar capacity cost meets grid parity (0.04 EU/kW), consumers no longer buy from the grid, when solar production is possible. As for energy storage, a FiT strictly smaller than the energy retail price accounted for energy losses drives investments in decentralised storage. Conversely, a FiT at the energy retail price does not provide incentives to invest in storage. Nevertheless, solar and storage capacity costs need to be small. Similarly, under a quantity regulation, consumers store energy only when the solar capacity cost and the grid tariff associated to centralised storage are small. Thus, under the current technological conditions, power-to-gas storage is not possible



---

with a quantity nor a price regulation. Finally, we find that neither a price nor a quantity regulation allow consumers to exit the grid. Indeed, despite investments in solar and storage technologies, consumers continue to buy from the grid when solar production is not possible.

The results from our Quebec case study suggest that the grid is always better-off with a price regulation, provided that the FiT is small. In such a case, with the current technology, consumers prefer to sell energy to the grid than invest in decentralised storage. With a larger FiT, the grid operates at a loss. A reduction of the grid's variable cost can increase the grid's profit, but it is implicit that a price regulation is only possible if enough consumers do not invest in solar capacity. Conversely, consumer surplus and welfare are larger always under a quantity regulation, and provided that round trip efficiency of power-to-gas storage increases, then there is centralised storage. The latter allows the grid to always retrieve positive profits.

The remainder of this paper is organised as follows. Section 2 presents the general theoretical framework. Section 3 studies the decision to invest in solar capacity and store energy with a quantity regulation. Section 4 considers a price regulation. Section 5 compares the two regulations using a case study. Section 6 concludes.

## 2 The model

We consider a consumer that can install solar capacity  $K$  at unit cost  $r$  up to  $\bar{K}$  which is determined by exogenous factors (roof size, garden size, etc). Intermittent solar production depends on exogenous climatic conditions. We consider two states of nature  $i \in \{f, u\}$  with respective probabilities  $\rho_f$  and  $1 - \rho_f$ . We can interpret  $\rho_f$  as the capacity factor of solar energy in a given location. If  $i = f$ , climatic conditions are favourable and solar technology produces energy up to its installed capacity  $K$ . Otherwise, when  $i = u$  conditions are unfavourable and solar production is zero.

We consider a two-period economy with  $t \in [1, 2]$ . At  $t = 1$ , climatic conditions are favourable, we have  $K_1 = K$ . Production at  $t = 2$  is determined by climatic conditions:

$$K_2 = \begin{cases} K & \text{if } i = f \\ 0 & \text{if } i = u \end{cases}$$

The government has the choice between two energy policies: a quantity and a price based one. We consider a fixed retail energy price  $p$ .

Under a quantity regulation, consumers might adopt grid storage ( $G$ ); in this case, surplus solar production is stored in the grid at  $t = 1$  in the form of an energy credit  $R$  at unit cost  $\alpha$ . At  $t = 2$ , consumers can retrieve  $\lambda^G$  energy from the grid, with  $\lambda^G$  fixed by the government.

Under a price regulation, consumers instead have the possibility to sell surplus solar production to the grid at a feed-in-tariff  $\tau$ , chosen by the government. In this case, energy exchanges with the grid  $g_t^i$  can be negative or positive. In addition, consumers might deploy a small fuel-cell ( $S$ ) at unit capacity cost  $r_s$  up to an exogenous capacity  $\bar{S}$  (the largest commercially available fuel-cell). This technology suffers from an energy loss of  $1 - \lambda^S$  when a consumer stores  $S$  energy.

We define

$$\phi_t^i = \begin{cases} p & \text{if the consumer buys energy from the grid} \\ \tau & \text{if the consumer sells energy to the grid} \end{cases}$$

Consumers derive utility  $U(q_t^i)$  from consuming  $q_t^i$  units of energy. We consider  $U(\cdot)$  to be a standard concave, twice differentiable, continuous function.

### 3 Quantity regulation

In this section we consider that the government introduces a quantity-based energy regulation. Consumers might buy from the grid but cannot sell energy to it, i.e.  $\phi_1 = \phi_2^f = \phi_2^u = p$  and  $g_1 \geq 0$ ,  $g_2^u \geq 0$  and  $g_2^f \geq 0$ . When equipped with solar capacity, they can store surplus solar production in the grid at  $t = 1$  at a unit cost  $\alpha$ . The grid tariff  $\alpha$ , as well as the share of energy grid stored that can be retrieved from the grid  $\lambda^G$  at  $t = 2$ , are set by the government. The representative consumer problem is then:

$$\begin{aligned} & \max_{K, R, g_1, g_2^f, g_2^u} U(K - R + g_1) - pg_1 \\ & + \beta \left( \rho_f [U(K + \lambda^G R + g_2^f) - pg_2^f] + (1 - \rho_f) [U(\lambda^G R + g_2^u) - pg_2^u] \right) - \alpha R - rK \end{aligned}$$

subject to:  $\bar{K} \geq K$ ,  $K \geq 0$ ,  $R \geq 0$ ,  $g_1 \geq 0$ ,  $g_2^f \geq 0$ , and  $g_2^u \geq 0$ .

The discount rate is normalized to  $\beta = 1$ . We solve the above problem and characterise the consumer's choices under a quantity regulation. The following proposition summarises the possible profiles:

**Proposition 3.1.** *The profiles under a quantity regulation are:*

Consumers: *Do not invest in solar capacity nor store energy.*

- If  $U'(\bar{K}) > p$  and  $r > \bar{r}^q$  :  $K^* = R^* = 0$ .

Prosumers: *Invest in solar capacity but do not store energy. We have two types:*

1. *Solar capacity does not fully cover energy demand.*

- If  $U'(\bar{K}) > p$  and  $r = \bar{r}^q$  :  $K^* = U'^{-1}(p) - g_1$  and  $R^* = 0$ .
- If  $U'(\bar{K}) > p$  and  $r < \bar{r}^q$  :  $K^* = \bar{K}$  and  $R^* = 0$ .

2. *Solar capacity fully covers energy demand when  $i = f$ .*

- If  $U'(\bar{K}) \leq p$ ,  $r = \tilde{r}^q$  and  $\alpha > \alpha^q$  :  $K^* = U'^{-1}(\frac{r}{1+\rho_f})$  and  $R^* = 0$ .
- If  $U'(\bar{K}) \leq p$ ,  $r < \tilde{r}^q$  and  $\alpha > \alpha^q$  :  $K^* = \bar{K}$  and  $R^* = 0$ .

Storers: *Invest in solar capacity, and store energy.*

- If  $U'(\bar{K}) \leq p$ ,  $r < \underline{r}^q$  and  $\alpha \leq \alpha^q$ :  $K^* = \bar{K}$  and  $R^*$  verifies  $\{\alpha = \lambda^G[\rho_f U'(\bar{K} + \lambda^G R) + (1 - \rho_f)p] - U'(\bar{K} - R)\}$

The values of  $\bar{r}^q$ ,  $\tilde{r}^q$ ,  $\underline{r}^q$  and  $\alpha^q$  are defined in Appendix A. We have several takeaways from the above results. Notice that consumers do not engage in *precautionary storage* (buy energy to store it). In a setup with responsive consumers, i.e. exposed to dynamic pricing, [Durmaz \(2016\)](#) finds that consumers do engage in precautionary storage. This result is related to *prudence* ( $U'''(\cdot) > 0$ ) since it decreases the cost of uncertain price spikes. This result does not hold in our setup because consumers are exposed to a fixed energy price; then there is no consumption risk. There is one exception in our paper, when the government sets  $\lambda^G = 1$ , and the grid tariff is zero ( $\alpha = 0$ ); then we might observe that some consumers buy energy to store<sup>1</sup>. Also, we observe that buying from the grid at the first period only happens when the marginal utility from the maximal possible solar capacity is larger than the energy price ( $U'(\bar{K}) > p$ ). In this case, consumers might install solar capacity only if its unit cost is small enough ( $r \leq \bar{r}^q$ ). Otherwise, they prefer to remain traditional consumers.

When the energy price is smaller than the marginal utility from the maximal solar capacity ( $U'(\bar{K}) \leq p$ ), the storage decision is driven by the unit cost of solar capacity and the grid tariff. If the government sets a high grid tariff  $\alpha > \alpha^q$ , even if the solar capacity cost is very small (we have  $\underline{r}^q > \tilde{r}^q$ ), consumers do not store energy. Otherwise, if the grid tariff is small ( $\alpha \leq \alpha^q$ ), consumers store energy; but never become fully independent from the grid. Nevertheless, solar production fully covers demand when climatic conditions are favourable.

---

<sup>1</sup>This is the case in Quebec, as illustrated in section 5.

---

## 4 Price regulation

In this section we consider that the government adopts a price-based energy regulation. As in the previous section, consumers can buy energy from the grid at the retail energy price  $p$ . When equipped with solar capacity, consumers can also sell surplus solar production to the grid at the established FiT  $\tau$ . In addition, they can invest in a small fuel-cell of capacity  $S$  at unit cost  $r_s$ . The representative consumer problem is then:

$$\begin{aligned} & \max_{K, S, g_1, g_2^f, g_2^u} U(K - S + g_1) - \phi_1 g_1 \\ & + \beta \left( \rho_f [U(K + \lambda^S S + g_2^f) - \phi_2^f g_2^f] + (1 - \rho_f) [U(\lambda^S S + g_2^u) - \phi_2^u g_2^u] \right) - r_s S - rK \end{aligned}$$

subject to:  $\bar{K} \geq K$ ,  $K \geq 0$ ,  $\bar{S} \geq S$ , and  $S \geq 0$ .

The discount rate is normalized to  $\beta = 1$ . Our problem is similar to [Durmaz et al. \(2017\)](#) and [Dato et al. \(2020\)](#) who consider, respectively, a two-period and a four-period model in which consumers can install solar and small-scale storage capacities. In addition, consumers are equipped with smart-meters such that they are exposed to dynamic pricing, and surplus solar production is rewarded at the energy price.

In our model, the retail energy price is fixed, and we study different values of the FiT. Across the globe, energy exchanges with the grid are not valued at the same amount depending on whether energy is sold or bought to/from the grid. We characterise the solution under a price regulation under different valuations of the FiT. First, we consider a FiT smaller than the energy retail price. Second, a FiT valued at the energy price. In Appendix B, we extend our model to the case where the FiT is larger than the energy retail price.

### 4.1 Feed-in-tariff smaller than the energy price

In this section, we solve the consumers' program under a price regulation, and characterise the solution when the retail energy price is larger than the FiT<sup>2</sup>. The following proposition summarises the possible profiles:

**Proposition 3.2.** *The profiles under a price regulation when  $p > \tau$  are:*

*Consumers: Do not invest in solar capacity nor storage.*

---

<sup>2</sup>This is the case in most European countries.

- If  $U'(\bar{K}) > p$  and  $r > \bar{r}^p$ :  $K^* = S^* = 0$ .

*Prosumers: Invest in solar capacity but not in storage. We have two types:*

1. *Solar capacity does not fully cover energy demand.*

- If  $U'(\bar{K}) > p$  and  $r = \bar{r}^p$ :  $K^* = U'^{-1}(p) - g_1$  and  $S^* = 0$ .
- If  $U'(\bar{K}) > p$  and  $r < \bar{r}^p$ :  $K^* = \bar{K}$  and  $S^* = 0$ .

2. *Solar capacity fully covers energy demand when  $i = f$ .*

- If  $U'(\bar{K}) \leq p$ ,  $r = \bar{r}^p$  and  $\lambda^S p < \tau$ :  $K^* = U'^{-1}(\tau) + g_1$  and  $S^* = 0$ .
- If  $U'(\bar{K}) \leq p$ ,  $r < \bar{r}^p$ ,  $\lambda^S p \geq \tau$  and  $r_s > \bar{r}_s^p$ :  $K^* = \bar{K}$  and  $S^* = 0$ .

*Storers: Invest in solar and storage capacity.*

- If  $U'(\bar{K}) \leq p$ ,  $r = \bar{r}^p$ ,  $\lambda^S p \geq \tau$  and  $r_s = \bar{r}_s^p$ :  $K^* = U'^{-1}(\tau) - U'^{-1}(p) + g_2^f + g_2^u$  and  $S^* = \lambda^{S-1}[U'^{-1}(p) - g_2^u]$ .
- If  $U'(\bar{K}) \leq p$ ,  $r < \bar{r}^p$ ,  $\lambda^S p \geq \tau$  and  $r_s = \bar{r}_s^p$ :  $K^* = \bar{K}$  and  $S^* = \lambda^{S-1}[U'^{-1}(p) - g_2^u]$ .
- If  $U'(\bar{K}) \leq p$ ,  $r = \bar{r}^p$ ,  $\lambda^S p \geq \tau$  and  $r_s < \bar{r}_s^p$ :  $K^* = U'^{-1}(\tau) + g_1 + \bar{S}$  and  $S^* = \bar{S}$ .
- If  $U'(\bar{K}) \leq p$ ,  $r < \bar{r}^p$ ,  $\lambda^S p \geq \tau$  and  $r_s < \bar{r}_s^p$ :  $K^* = \bar{K}$  and  $S^* = \bar{S}$ .

The values of  $\bar{r}^p$ ,  $\tilde{r}^p$ , and  $\bar{r}_s^q$  are defined in Appendix B.1. From our results above, we find that, as with a quantity regulation, when the marginal utility from the maximum solar capacity is larger than the energy price ( $U'(\bar{K}) > p$ ), consumers install solar capacity only if its unit cost is small enough ( $r \leq \bar{r}^p$ ). Otherwise, they prefer to remain traditional consumers.

When the energy price is smaller than the marginal utility from the maximal solar capacity ( $U'(\bar{K}) > p$ ), the storage adoption decision is driven by the solar ( $r \leq \bar{r}^p$ ) and storage ( $r_s \leq \bar{r}_s^p$ ) capacity costs, as well as the FiT size compared to the retail energy price, when accounting for energy losses from storage ( $\lambda^S p \geq \tau$ ).

When solar production covers energy consumption in favourable states of nature, consumers prefer to sell energy to the grid rather than store it, if the FiT is larger than the energy price accounted for energy losses ( $\lambda^H p < \tau$ ). Otherwise, when it is smaller ( $\lambda^H p \geq \tau$ ), provided that the storage unit capacity cost is small ( $r_s \leq \bar{r}_s^p$ ), consumers invest in storage capacity ( $S > 0$ ). Thus, when the energy loss from storage is large, even if the storage capacity cost is small, consumers prefer to sell energy to the grid than store it.

---

## 4.2 Feed-in-tariff valued at the energy price

In this section, we solve the consumer's problem under a price regulation, and characterise the solution when the FiT is valued at the retail energy price<sup>3</sup>. The following proposition summarises the possible profiles:

**Proposition 3.3.** *The profiles under a price regulation when  $p = \tau$  are:*

Consumers: *Do not invest in solar capacity nor storage.*

- If  $r > \bar{r}^{p2}$ :  $K^* = S^* = 0$ .

Prosumers: *Invest in solar capacity but not in storage.*

- If  $\bar{r}^{p2} = r$ :  $K^* = U'^{-1}(p) - g_1$  and  $S^* = 0$ .
- If  $\bar{r}^{p2} > r$ :  $K^* = \bar{K}$  and  $S^* = 0$ .

The threshold value  $\bar{r}^{p2}$  is defined in Appendix B.2. We observe that when the FiT is valued at the energy price, solar production complements energy from the grid. Thus, consumers always rely on the grid to serve demand.

**Lemma 3.1.** *Under a price regulation, if the feed-in-tariff is equal to the energy retail price  $p = \tau$ , consumers never invest in fuel-cell storage.*

These findings depart from [Dato et al. \(2020\)](#) who also considered a FiT valued at the energy retail price. In their model, deployment of storage technology is driven by the price difference between periods<sup>4</sup>. Indeed, consumers are equipped with smart-meters, which is not the case in our paper.

---

<sup>3</sup>This is the case in the UK and in the US.

<sup>4</sup>The difference between on-peak and off-peak energy prices makes it optimal to install storage technology.

## 5 Quantity vs Price regulation

In this section, we determine the preferred energy regulation, quantity or price, by the grid and by consumers. Our objective is to evaluate how energy consumption, production and storage impacts the grid's profit, consumer surplus, and welfare. We compare the conditions under which the grid and consumers prefer either centralised or decentralised storage.

The two possible energy regulations differ in two main dimensions. First, consumers are only allowed to sell energy to the grid under a price regulation. Second, under a quantity regulation the government has two policy instruments, the grid tariff  $\alpha$ , and the share of stored energy that can be retrieved by consumers  $\lambda^G$ ; whereas under a price regulation the government only has one instrument, the FiT  $\tau$ .

In the previous sections, we studied the profiles that emerged under a quantity and a price regulation.

**Proposition 3.4.** *Consumers install solar capacity when the capacity cost is such that:*

$$r \leq \bar{r}^q = \bar{r}^p = \bar{r}^{p2} = (1 + \rho_f)p$$

*regardless of the energy regulation*

The threshold value of the solar capacity cost under which consumers install solar capacity, represents the cost of buying energy from the grid in favourable states of nature over two periods. Thus, provided that the solar capacity cost is sufficiently small, consumers install solar capacity regardless of the energy regulation. Consumers invest in decentralised production under both regulations, but this does not extend to storage. With a price regulation, when the FiT is equal to the energy retail price  $p = \tau$ , consumers do not adopt fuel-cell storage. Hereafter, we focus only on a price regulation with a FiT strictly smaller than the energy retail price.

It should be noted that in our model quantities are endogenously determined by consumers. It cannot be solved analytically. We therefore rely on a numerical evaluation of the model which requires assigning values to its structural parameters.

### 5.1 Parametrization: Case Study Canada

We calibrate our model in Matlab for the Quebec region in Canada using data from [Hydro Quebec \(2021a,b\)](#).



---

Table 1: Calibration

Parameters	Mnemonic	Value	Unit
<i>Preferences</i>			
Subsistence Consumption Level	$\bar{q}$	5	kWh
Relative Risk Aversion	$\gamma$	0.9	
Discount factor	$\beta$	1	
<i>Technology</i>			
Solar Capacity Cost	r	0.069	EU/kW
Fuel-Cell Storage Capacity Cost	$r_s$	0.05	EU/kW
Round-trip efficiency Fuel-Cell Storage	$\lambda^S$	66.5	%
<i>Market Characteristics Quebec</i>			
Energy Retail Price	p	0.04	EU/kW
Maximal Solar Capacity	$\bar{K}$	40	kW
Capacity Factor Solar Energy	$\rho_f$	13	%
Share of the retail energy retrieve by the Grid	$\psi$	40	%
<i>Quantity regulation</i>			
Grid Tariff	$\alpha$	0	EU/kW
Round-trip efficiency Grid Storage	$\lambda^G$	100	%
<i>Price regulation</i>			
Feed-in-tariff	$\tau$	0.03	EU/kW
<i>Grid costs</i>			
Variable cost injected energy	$c_D$	0.0005	EU/kW
Variable cost retrieved energy	$c_C$	0.0001	EU/kW
Fixed cost consumer-grid	$F_C$	0.28	EU
Fixed cost prosumer-consumer	$F_D$	0.3	EU

*Note:* Initial values used in the calibration.

In Quebec, the state-owned company HydroQuebec manages energy generation, transmission, and distribution. Residential consumers are eligible for *self-generation without compensation*, which allows them to install solar capacity at unit cost  $r = 0,0995$  CAD/kW<sup>5</sup> (0.069 EU/kW). There is a quantity-based energy regulation in place: surplus energy production can be stored at zero-cost  $\alpha = 0$ , and consumers recover all the stored energy  $\lambda^G = 1$ . Every two years the amount of stored energy is reset to zero.

Residential consumers pay a fixed retail price equal to 0.06159 CAD/kWh (0.04 EU) for a daily consumption up to 40kW<sup>6</sup>. The capacity factor of solar energy in the Quebec region is between 9 – 17 % (Canada Energy Regulator, 2021); we set  $\rho_f = 0.13$ .

We consider a representative consumer with a daily consumption up to 40kW. Following Durmaz et al. (2017), we consider that the consumer has CRRA preferences:

$$U_t^i(q_t^i) = \frac{(q_t^i - \bar{q})^{1-\gamma}}{1-\gamma}$$

with  $\bar{q}$ , the minimum energy consumption level that can be interpreted as a subsistence consumption level (Durmaz et al. (2017)) which is set to 5kW. We use a sensitivity analysis and fix  $\gamma = 0.9$ .

Grid operators cover their costs through an uniform energy tariff known as the distribution tariff, which accounts for about 20–40% of the final energy retail price. With decentralised production, this dynamic has changed, since prosumers inject energy into the grid. Depending on the energy regulation, the latter might receive a FiT for the injected energy. This FiT is indirectly financed by traditional consumers, who are fed the energy injected by prosumers. When the energy comes from decentralised production, per kW prosumers receive the FiT, and the rest is retrieved by the grid.

Grid operators are characterised as natural monopolies with convex costs. We distinguish the costs of centralised ( $j = C$ ) and decentralised ( $j = D$ ) production. Let  $C_t(Q_t) = c_j Q_t^2$  be the variable cost per kWh, with  $Q_t$  the energy quantity that transits through the grid at period  $t$ . The cost of energy transmission for consumers in Quebec is not public information. Initially we set  $c_C = 0.0001$  EU/kW and  $c_D = 0.0005$  EU/kW. Following Gautier et al. (2018), we consider that the grid also incurs a fixed cost  $F_j$  to connect a consumer to the grid, or to other consumers. In Quebec the daily fixed grid access fee for consumers is equal to 0.4 CAD (0.28 EU). The cost of connecting a consumer to the grid is smaller than the cost

---

<sup>5</sup>Levelised cost of solar capacity in Quebec according to Sunmetrix (2021).

<sup>6</sup>Above that threshold value, the energy price is equal to 0.09502 CAD/kWh (0.069 EU). Energy contracts including dynamic pricing are also available for consumers but this is beyond the scope of this study.

of connecting a prosumer to a consumer (Gautier et al. (2018)). Thus, we set  $F_C = 0.28$ , and  $F_D = 0.3$ . The grid's profit under a quantity regulation is:

$$\pi(R^*, g_2^{u*}) = \alpha R^* - c_C R^{*2} - \beta c_C (\lambda^G R^*)^2 + \beta(1 - \rho_f)(\psi p g_2^{u*} - c_C (g_2^{u*})^2) - F_C$$

with  $\psi$  the share of the energy retail price retrieved by the grid.

Under a quantity regulation, prosumers are not connected to other consumers, but rather the energy is stored in a centralised facility. Thus, the costs of the energy injected and retrieved from the grid are the same.

The grid's profit under a price regulation is:

$$\begin{aligned} \pi(g_1^*, g_2^{f*}, g_2^{u*}) &= (p - \tau)g_1^* - c_D (g_1^*)^2 + \beta[\rho_f((p - \tau)g_2^{f*} - c_D (g_2^{f*})^2) \\ &\quad + (1 - \rho_f)(\psi p g_2^{u*} - c_C (g_2^{u*})^2)] - F_C - F_D \end{aligned}$$

Under a price regulation prosumers are connected to other consumers, and so the costs of the energy injected and retrieved from the grid are not the same.

## 5.2 Results

### Benchmark

We first consider the benchmark situation under Quebec's current technology costs and regulation. From our theoretical results, we know that a necessary condition for storage adoption under both regulations is  $U'(\bar{K}) \leq p$ . In our calibrated scenario, this condition is met when the maximal solar capacity is such that  $\bar{K} \geq 35.75\text{kW}$ . The threshold value of solar capacity cost, such that consumers install solar capacity, is  $\bar{r}^q = \bar{r}^p = 0.0452 \text{ EU/kW}$ .

Table 2: Benchmark equilibrium quantities.

$r$	$K$	$R$	$g_1$	$g_2^f$	$g_2^u$
0.069	0	0	35.75	35.75	35.75
0.045	14.23	7.35	28.87	14.17	28.4
0.04	40	3.41	0	0	32.34
0.02	40	3.41	0	0	32.34
0.01	40	3.41	0	0	32.34
0	40	3.41	0	0	32.34

Figure 1: Benchmark quantity regulation.

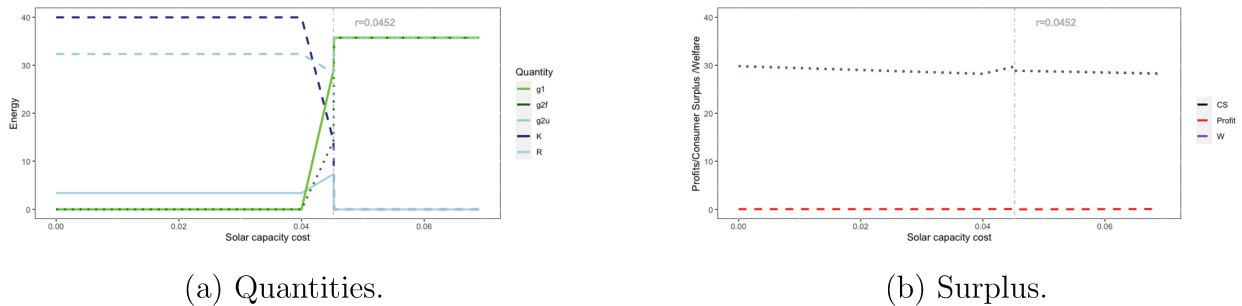

Figure 1.a presents the energy consumed, produced and stored; while Figure 1.b presents the grid's profit, consumer surplus and welfare as functions of the solar capacity cost. We study how the representative consumer energy consumption, production and storage evolve when the solar capacity cost decreases.

We find that under the current prices, our representative consumer does not invest on solar capacity; and buys  $35.75\text{kW}^7$  from the grid, regardless of climatic conditions.

Consumers invest in solar capacity when  $r \leq \bar{r}^q = \bar{r}^p = 0.0452$  EU/kW, in line with our theoretical results. It should be noted that when the solar capacity cost is  $0.04 \text{ EU/kW} < r \leq 0.0452 \text{ EU/kW}$ , consumers engage in precautionary storage ( $R > 0$  and  $g_1 > 0$ ). Moreover, we observe that consumer surplus is larger with precautionary storage.

When the solar capacity cost is  $r \leq 0.04$  EU/kW, the amount of energy bought from the grid decreases. Consumers no longer buy from the grid in favourable states of nature, but they continue to buy in unfavourable states of nature. The quantity of energy bought increases, whereas the quantity of stored energy decreases. Solar production reaches the maximal solar capacity  $\bar{K} = 40$ .

We conclude that under the current conditions, consumers do not install solar capacity. If the solar capacity cost decreased, then, consumers would invest in solar capacity. Notice that when the solar capacity cost meets grid parity  $r = p = 0.04$  EU/kW, then, consumers no longer rely on the grid at favourable states of nature. Moreover, the grid's profit, consumer surplus and welfare stay fairly constant regardless of the solar capacity cost.

## Policy Analysis

Our objective is now to analyse the effect of different policies on the grid's profits, consumer surplus and welfare. Also, we study the conditions under which consumers store energy.

<sup>7</sup>This is the solution to  $p = 0.04 = U'(q_t^i)$ .

**Quantity regulation.** We consider that the government chooses a positive grid tariff  $\alpha > 0$ . The share of stored energy that can be retrieved from the grid  $\lambda^G$  is set at three different levels: 100%, 95 % and 66.5%. It should be noted that the current round-trip efficiency of an alkaline electrolyzer is 66.5% ([International Energy Agency \(2019\)](#)). Our goal is to assess consumer's behaviour, in terms of energy consumption, if centralised storage used a power-to-gas storage technology. The calibration considers grid parity for the solar capacity cost:  $r = 0.04$  EU/kW.

Table 3: Equilibrium quantities with  $\alpha > 0$ , and  $\lambda^G = 100\%$ .

$\alpha$	$K$	$R$	$g_1$	$g_2^f$	$g_2^u$
0.03	40	0	0	0	35.75
0.02	40	0	0	0	35.75
0.003	40	0.38	0	0	35.38
0.001	40	2.44	0	0	33.31
0	40	3.41	0	0	32.34

Figure 2: Quantity regulation with  $\alpha > 0$ , and  $\lambda^G = 100\%$ .

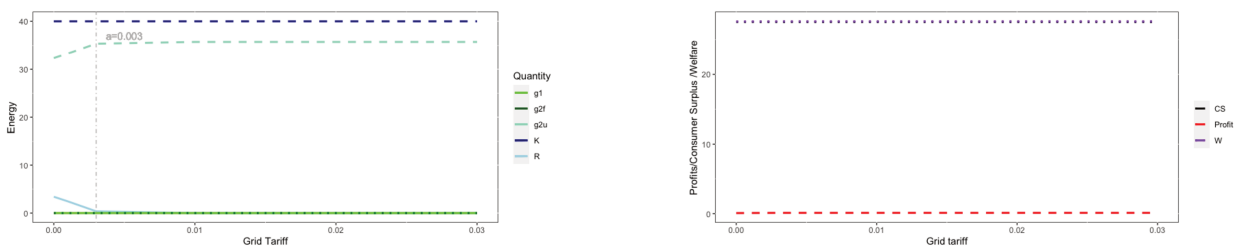

(a) Quantities.

(b) Surplus.

First, we consider that consumers can recover all the stored energy at  $t = 2$ . Figure 2.a presents the energy consumed, produced and stored, while Figure 2.b presents the grid's profit, consumer surplus and welfare as functions of the grid tariff. We observe that the grid's profit, consumer surplus and welfare stay fairly constant regardless of the solar capacity cost. We find that consumers only store energy when the grid tariff is such that  $\alpha \leq 0.003$  EU/kW.

Table 4: Equilibrium quantities with  $\alpha > 0$ , and  $\lambda^G = 95\%$ .

$\alpha$	$K$	$R$	$g_1$	$g_2^f$	$g_2^u$
0.03	40	0	0	0	35.75
0.02	40	0	0	0	35.75
0.003	40	0	0	0	35.75
0.001	40	0.41	0	0	35.36
0	40	1.47	0	0	34.36

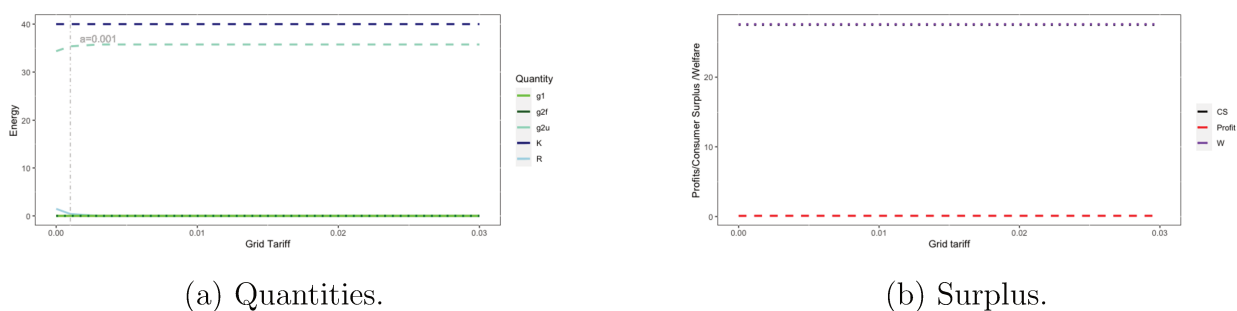
 Figure 3: Quantity regulation with  $\alpha > 0$ , and  $\lambda^G = 95\%$ .

Second, we consider that consumers can recover only 95% of the initial stored energy at  $t = 2$ . Figure 3.a presents the energy consumed, produced and stored, while Figure 3.b presents the grid's profit, consumer surplus and welfare as functions of the grid tariff. We observe that the grid's profit, consumer surplus and welfare stay fairly constant regardless of the grid tariff. We find that under a round-trip efficiency of 95%, consumers store energy only when the grid tariff is such that  $\alpha \leq 0.001$  EU/kW.

 Table 5: Equilibrium quantities with  $\alpha > 0$ , and  $\lambda^G = 66.5\%$ .

$\alpha$	$K$	$R$	$g_1$	$g_2^f$	$g_2^u$
0.03	40	0	0	0	35.75
0.02	40	0	0	0	35.75
0.003	40	0	0	0	35.75
0.001	40	0	0	0	35.75
0	40	0	0	0	35.75

Finally, we consider that consumers can only recover 66.5% of the initial stored energy,

Figure 4: Quantity regulation with  $\alpha > 0$ , and  $\lambda^G = 66.5\%$ .

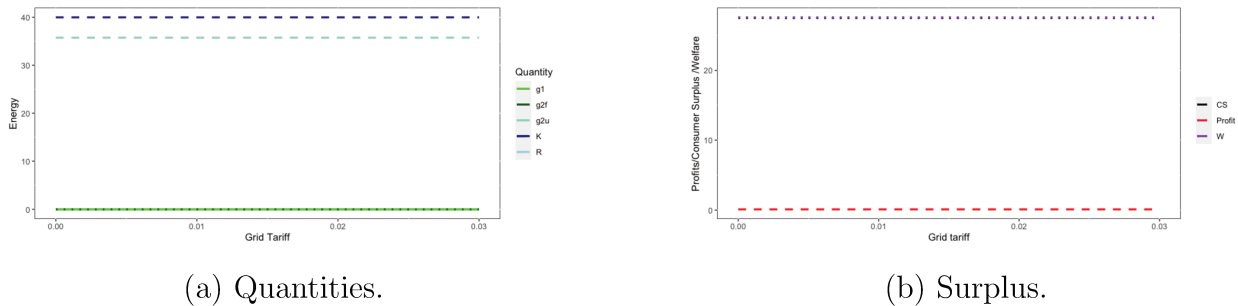

(a) Quantities.

(b) Surplus.

as would be the case with centralised storage based on power-to-gas. Figure 4.a presents the energy consumed, produced and stored, while Figure 4.b presents the grid's profit, consumer surplus and welfare as functions of the grid tariff. We observe that the grid's profit, consumer surplus, and welfare stay fairly constant regardless of the grid tariff. We find that under a round-trip efficiency of 66.5%, consumers never store energy. Thus, under such conditions, centralised storage based on power-to-gas is not optimal if the government wants consumers to store energy.

To summarise, consumers only store energy when they can retrieve a significant share of the stored energy, 95% or more, and the grid tariff is small. Thus, if the government's objective is for consumers to store energy, then, it must set a relatively small grid tariff while allowing consumers to retrieve as much stored energy as possible.

In line with our theoretical results, regardless of the grid tariff and the round-trip efficiency, solar production is always equal to the maximal solar capacity, and consumers never buy from the grid when climatic conditions are favourable. When climatic conditions are unfavourable, if consumers do not store energy, the latter buy 35.75kW from the grid. Otherwise, if consumers store energy, then the amount of energy bought from the grid slowly decreases with as the grid tariff decreases.

**Price regulation.** Now, we consider that instead, the government chooses a price regulation. Consumers can no longer store energy in the grid, but they can sell it at a FiT  $\tau$ . In addition, they can invest in a small fuel-cell with a round trip efficiency at  $\lambda^S = 66.5\%$ . From our theoretical results, it should be noted that consumers invest in fuel-cell storage only when the FiT is such that  $\tau \leq \lambda^S p$ .

The calibration considers grid parity for the solar capacity cost:  $r = 0.04$  EU/kW. As

for fuel-cell storage, the technology is still under development. Thus, we consider that the storage capacity cost is strictly larger than the solar capacity cost  $r_s = 0.05$  EU/kW.

Table 6: Equilibrium quantities with price regulation.

$\tau$	$K$	$S$	$g_1$	$g_2^f$	$g_2^u$
0.03	24.86	0	-19.86	-19.86	35.75
0.02	29.39	0	-24.39	-24.39	35.75
0.01	36.05	0	-31.05	-31.05	35.75
0	40	0	-35	-35	35.75

Figure 5: Price regulation.

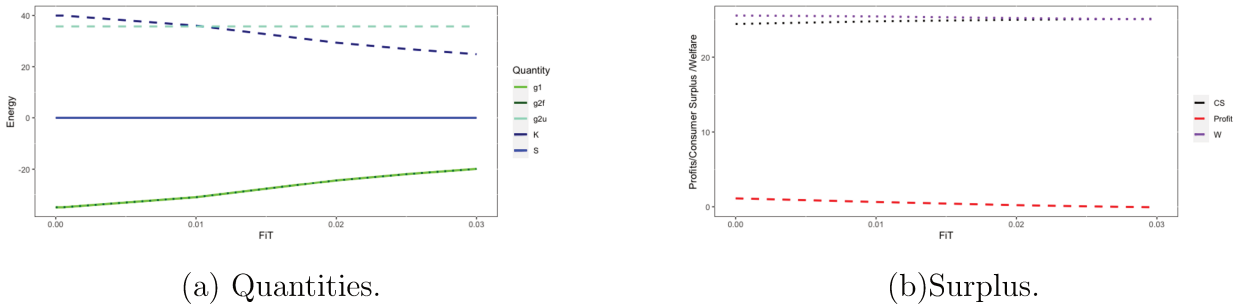

Figure 5.a presents the energy consumed, produced and stored, while Figure 5.b presents the grid's profit, consumer surplus and welfare as functions of the FiT. We observe that the grid's profit, and social welfare decrease with the FiT, while the consumer surplus increases. We find that, under the conditions mentioned above, consumers never invest in fuel-cell storage. As a result, consumers always buy 35.75kW from the grid in unfavourable states of nature. Solar production, and the amount of energy injected into the grid in favourable states of nature, decrease with the FiT. This is in line with our theoretical results; consumers only invest in small-scale storage when the capacity costs are such that:

$$r \leq \tilde{r}^p = (1 + \rho_f)\tau$$

and

$$r_s \leq \tilde{r}_s^p = \lambda^S(1 - \rho_f)p - (1 - \lambda^S\rho_f)\tau$$

Thus, the threshold value of the solar and the storage capacity cost, such that consumers invest in both technologies, varies with the FiT set by the government. It should be noted



---

that under the current pricing scheme, the FiT must be such that  $0.026 \text{ EU/kWh} \geq \tau$ , for a positive storage capacity cost  $\bar{r}_s^P > 0$ . Otherwise, consumers never install storage capacity.

We conclude that, under the current conditions, power-to-gas storage is not possible under a price regulation.

### Technological Progress

In the previous section, we found that under a price regulation, consumers only store energy when capacity costs are small; while under a quantity regulation, consumers store energy only when the share of stored energy that can be retrieved is large.

We consider three possible dimensions of technological progress, and study how the energy consumed, produced, and injected into the grid impacts profits, consumer surplus and welfare. First, we consider that solar and fuel-cell storage capacity costs decrease. Second, we consider that, in addition, the round-trip efficiency of fuel-cell storage improves. Finally, we consider that the variable costs of managing injected energy decrease.

**Capacity costs.** First, we consider that the solar and the storage capacity costs decrease, we calibrate the model under very optimistic capacity costs:  $r = 0.0009 \text{ EU/kW}$ , and  $r_s = 0.001 \text{ EU/kW}$ . We consider that the government sets  $\lambda^G = 100\%$  under a quantity regulation such that consumers store energy<sup>8</sup>.

Table 7: Equilibrium quantities with quantity regulation.

$\alpha$	$K$	$R$	$g_1$	$g_2^f$	$g_2^u$
0.03	40	0	0	0	35.75
0.02	40	0	0	0	35.75
0.01	40	0	0	0	35.75
0.003	40	0.37	0	0	35.37
0.001	40	2.44	0	0	33.31
0	40	3.40	0	0	32.34

Figure 6.a, and Figure 6.b, respectively, present the energy consumed, produced, and injected into the grid under a quantity, and a price regulation.

From our theoretical results, we know that under a quantity regulation consumers store energy only when the government sets a grid tariff such that  $\alpha < \alpha^q$ . In our calibrated

---

<sup>8</sup>This implies that centralised storage would not be based on power-to-gas.

Table 8: Equilibrium quantities with price regulation.

$\tau$	$K$	$S$	$g_1$	$g_2^f$	$g_2^u$
0.03	40	0	-9.21	-9.21	35.75
0.02	40	2.65	-32.35	-35.46	33.98
0.01	40	0	-35.00	-35.00	35.75
0.003	40	0	-35.00	-35.00	35.75
0.001	40	0	-35.00	-35.00	35.75
0	40	0	-35.00	-35.00	35.75

Figure 6: Equilibrium quantities under smaller capacity costs

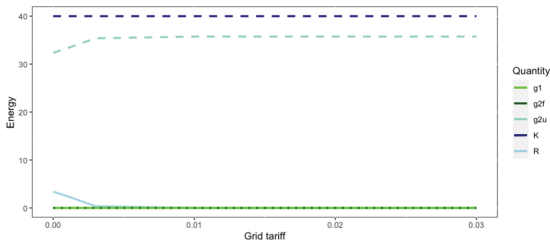

(a) Quantity regulation.

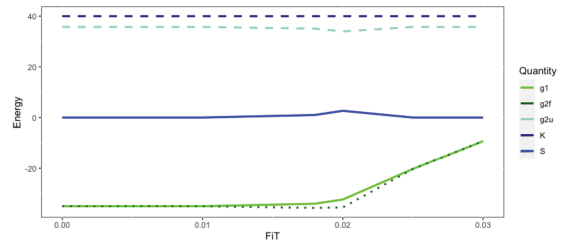

(b) Price regulation.

scenario, we find  $\alpha^q = 0.0003$  EU/kW. Thus, when  $\alpha < 0.0003$  EU/kW, consumers store energy, and at  $t = 2$ , when conditions are unfavourable the amount of energy bought from the grid decreases as the grid tariff decreases.

Under a price regulation, when  $\tau \leq 0.018$  EU/kWh, we observe that the energy consumed, produced, and injected into the grid is always the same regardless of the FiT. Consumers never store energy, and the energy injected into the grid is such that consumers set their consumption to their subsistence level of 5kW. The gains from selling energy to the grid at  $t = 1$  are larger than the potential cost reduction from storing energy instead of buying when conditions are unfavourable. Even though stored energy is transferred to  $t = 2$ , the small round-trip efficiency of fuel-cell storage, significantly reduces consumers potential revenues from injecting energy to the grid at  $t = 2$  instead of  $t = 1$ , when conditions are favourable.

When  $0.018 \text{ EU/kWh} \leq \tau \leq 0.0226 \text{ EU/kWh}$ , consumers store energy, but the amount is modest  $S < 2.66 \text{ kW}$ . As a result, when conditions are favourable, the energy injected into the grid at  $t = 1$  is smaller compared to  $t = 2$ . Moreover, when conditions are unfavourable, consumers rely less on the grid; thus, storage is a substitute for the grid.

Finally, when  $0.0226 \text{ EU/kW} \leq \tau$ , consumers never install storage capacity, and the energy injected into the grid decreases as the FiT increases. From our theoretical results, we know that when  $\tau \geq \lambda^S p$ , the cost of buying from the grid when conditions are unfavourable is smaller than the gains from injecting into the grid when conditions are favourable. Nevertheless, storage capacity costs are too large.

To resume, for a FiT either too large or too small, consumers prefer to sell energy rather than store it. They strategically reduce their energy consumption to their subsistence level, to inject as much energy into the grid as possible. In general, under a price regulation, the grid manages<sup>9</sup> more energy when conditions are favourable, than with a quantity regulation.

Figure 7: Profits, Consumer Surplus and Welfare under smaller capacity costs.

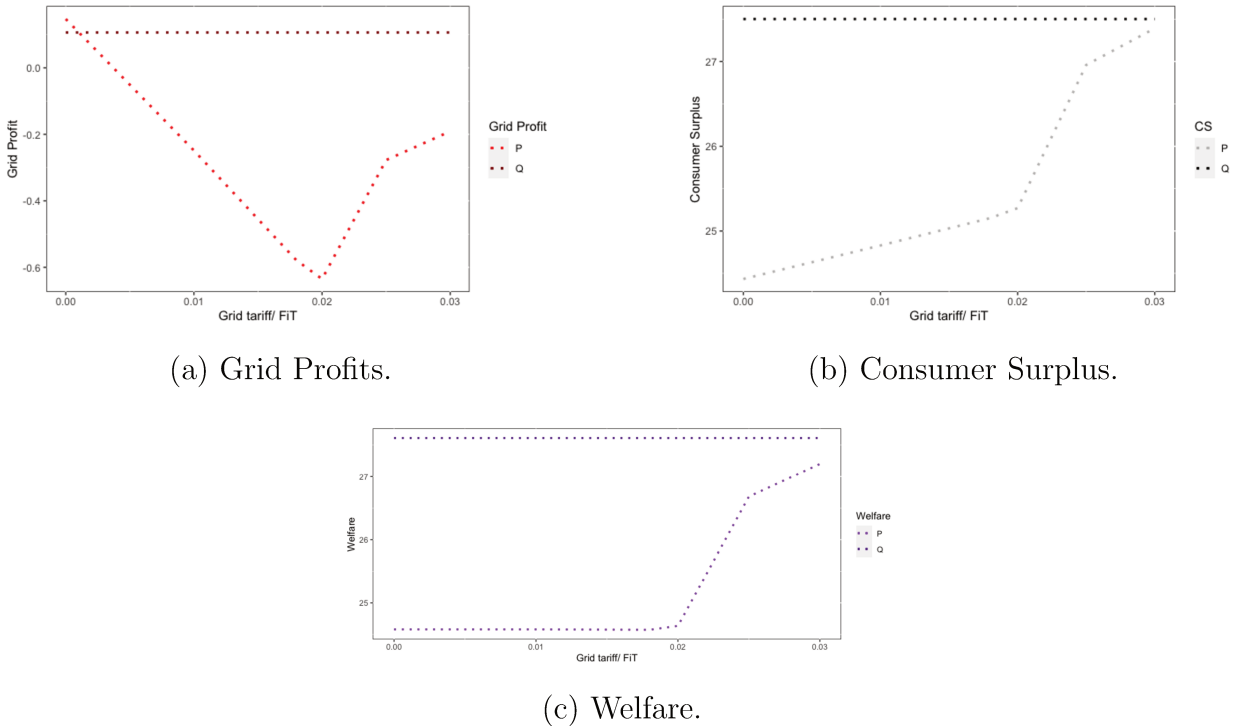

Figure 7.a presents the grid's profits, under a quantity and a price regulation, when solar and storage capacity costs are very small. Profits are larger under a price regulation, provided that the government sets a FiT  $\tau \leq 0.0001 \text{ EU/kW}$ . Otherwise, if such a FiT is not possible, then the grid is better-off under a quantity regulation.

Notice that, under a quantity regulation, profits remain constant as long as there is no energy storage. If the grid tariff is such that consumers store energy, then the grid's profits decrease as the grid tariff decreases. This is the result of two economic mechanisms. First,

<sup>9</sup>This means that, under a price regulation, congestion problems are more likely than with a quantity regulation.

the grid's revenues decrease as the grid tariff decreases. Second, the grid's operating costs increase as the grid tariff decreases, since the latter provides incentives for consumers to inject energy into the grid.

Instead, under a price regulation, the grid operates at a loss as long as  $\tau \geq 0.003$  EU/kW. When  $\tau \geq 0.02$  EU/kW, the grid's profit decrease with the FiT. Two economic mechanisms drive profits down. First, notice that the amount of energy injected into the grid is small, which decreases the latter's revenues. It should be noted that for  $0.02 \text{ EU/kW} < \tau \leq 0.0266 \text{ EU/kW}$ , at  $t = 1$  the amount of energy injected into the grid is even smaller because of energy storage. Second, the grid needs to cover the fixed costs from connecting consumers between each other, which also reduces its revenues.

Otherwise, when  $\tau < 0.02$  EU/kW, the grid's profit increases as the FiT decreases. Consumers inject more energy into the grid at  $t = 2$ , which increases the grid's revenues. Moreover, since the FiT is smaller, the grid retrieves a larger share of the energy retail price. The grid no longer operates at a loss when the FiT becomes small enough, such that the share of the retail energy price retrieved by the grid compensates the fixed costs from connecting consumers to one another.

As for consumers, they are always better-off under a quantity regulation (Figure 7.b). This is also the case for welfare (Figure 7.c).

We conclude that the grid is always better-off under a price regulation, provided that  $\tau \leq 0.001$  EU/kW. Conversely, consumer surplus and welfare are larger under a quantity regulation. Moreover, with a FiT  $\tau \leq 0.001$  EU/kW, consumers never invest in fuel-cell storage, they prefer to inject energy into the grid. As mentioned above, they even reduce their consumption levels to their subsistence one, such that they inject as much energy into the grid as possible.

Thus, if the government wants to promote fuel-cell storage, then it should limit the quantity that consumers can inject into the grid. Consumers store energy under a quantity regulation for a grid tariff  $\alpha \geq 0.003$  EU/kW, provided that they can retrieve all the energy stored, which is not possible with power-to-gas storage.

**Round-trip efficiency.** Second, we consider that fuel-cell storage round-trip efficiency improves to 95%, and at 100%.

Figure 8.a and Figure 8.b, respectively, present the energy consumed, produced, and injected into the grid under a price regulation with a round-trip efficiency at 95% and at 100%. When the FiT increases, so do the consumer's potential revenues from injecting

Table 9: Equilibrium quantities with price regulation ( $\lambda^S = 95\%$ ).

$\tau$	$K$	$S$	$g_1$	$g_2^f$	$g_2^u$
0.03	40	15.28	-19.72	-5.30	21.24
0.02	40	10.14	-24.86	-27.59	26.12
0.01	40	4.02	-30.98	-38.82	31.93
0.003	40	0	-35	-35	35.75
0.001	40	0	-35	-35	35.75
0	40	0	-35	-35	35.75

Table 10: Equilibrium quantities with price regulation ( $\lambda^S = 100\%$ ).

$\tau$	$K$	$S$	$g_1$	$g_2^f$	$g_2^u$
0.03	40	15.98	-19.02	-6.77	19.77
0.025	40	13.79	-21.21	-6.47	21.95
0.02	40	11.14	-23.86	-26.08	24.61
0.018	40	10	-25.08	-36.89	25.83
0.01	40	5	-30	-40	30.75
0.003	40	0.61	-34.39	-35.61	35.14

Figure 8: Equilibrium quantities under a larger round-trip efficiency.

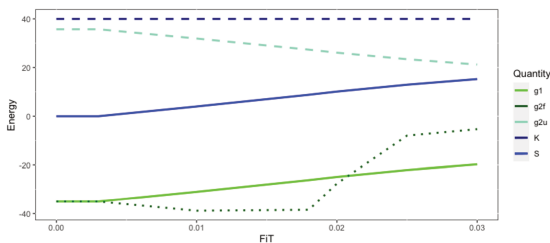

(c) Price regulation with  $\lambda^S = 95\%$ .

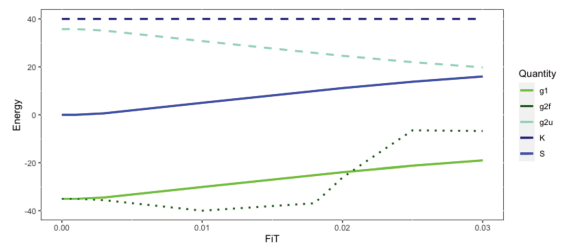

(d) Price regulation with  $\lambda^S = 100\%$ .

energy into the grid. Conversely, we observe that the energy injected into the grid, and the energy bought from the grid decrease with the FiT, while stored energy increases. Two economic mechanisms can explain these counter-intuitive results. First, notice that in our framework storage capacity costs are very small compared to the energy price. Thus, storing energy is always cheaper than buying energy from the grid at  $t = 2$ , when conditions are unfavourable. Second, round-trip efficiency is very large, at  $t = 2$ , consumers recover all (resp. almost all) the stored energy when  $\lambda^S = 100\%$  ( $\lambda^S = 95\%$ ). As a result, if conditions

are unfavourable, then consumers rely less on the grid which reduces their costs. Otherwise, if conditions are favourable, then consumers can inject the extra energy into the grid. Given that energy losses are very limited, they retrieve the same revenues as if they would have if they instead injected energy into the grid at  $t = 1$ .

Thus, there is an arbitrage between potential costs and gains from interacting with the grid, which explains why energy storage increases with the FiT. Notice that this effect is more important, when there are no energy losses.

Figure 9: Grid profits under a larger round-trip efficiency.

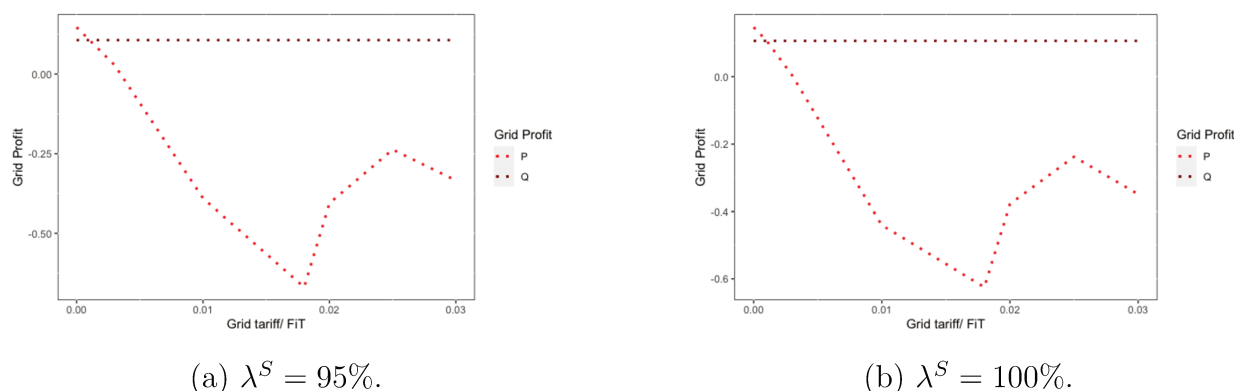

Figure 9.a and Figure 9.b, respectively, present the grid's profits under a quantity and a price regulation, when  $\lambda^S = 95\%$  and  $\lambda^S = 100\%$ . The grid is better-off under a price regulation provided that the FiT is such that  $\tau \leq 0.0001$  EU/kW. Otherwise, if such a FiT is not possible, then the grid is better-off under a quantity regulation.

As for consumers, in Figure 10.a and Figure 10.b we observe that despite of the improvement of fuel-cell storage round-trip efficiency, they are always better-off under a quantity regulation. This is also the case for welfare, as can be observed in Figure 10.c and Figure 10.d.

We conclude that the grid is always better-off under a price regulation, provided that  $\tau \leq 0.001$  EU/kW. Conversely, consumer surplus and welfare are larger under a quantity regulation. Consumers invest in fuel-cell storage for  $\tau \geq 0.0001$  EU/kW; whereas when  $\tau \leq 0.001$  EU/kW they prefer to inject energy into the grid. Under a quantity regulation, consumers store energy for a grid tariff  $\alpha \geq 0.003$  EU/kW, provided that they can retrieve all the energy stored, which would be viable with power-to-gas storage.

**Grid Costs:** We now consider that the variable cost of managing injected energy is equal to the one of retrieved energy. This cost reduction only impacts the grid's profits; then,

Figure 10: Consumer surplus and Welfare under a larger round-trip efficiency.

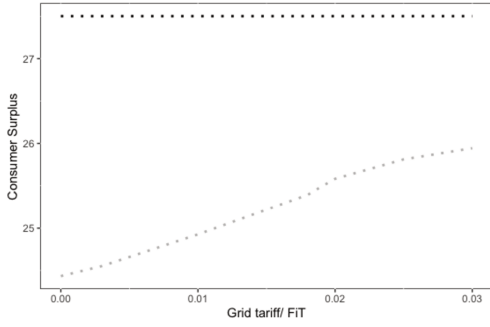

(a) Consumer Surplus with  $\lambda^S = 95\%$ .

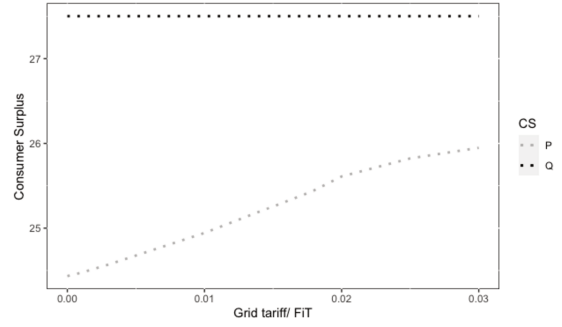

(b) Consumer Surplus with  $\lambda^S = 100\%$ .

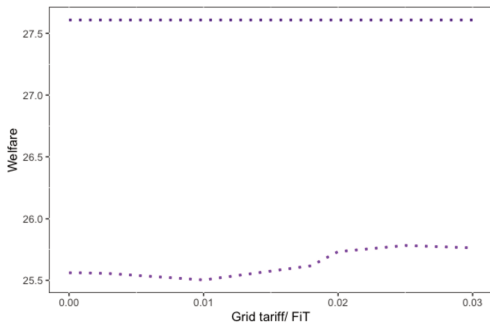

(c) Welfare with  $\lambda^S = 95\%$ .

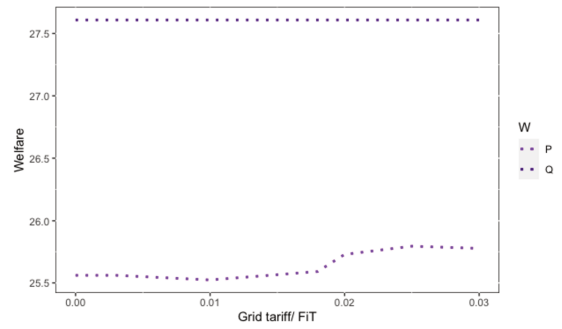

(d) Welfare with  $\lambda^S = 100\%$ .

consumer surplus remains unchanged. Consumers are always better-off under a quantity regulation.

Figure 11: Grid profits with  $c_C = c_D$ .

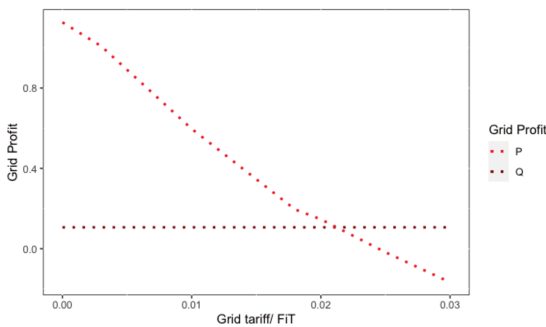

(a)  $\lambda^S = 95\%$ .

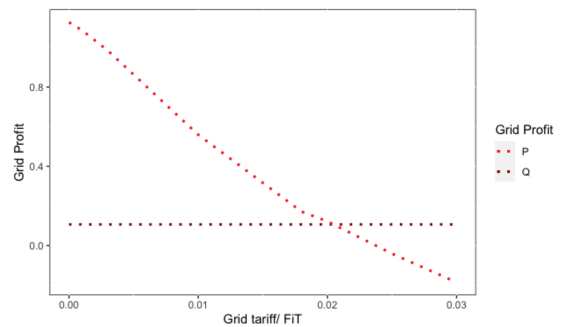

(b)  $\lambda^S = 100\%$ .

Figure 11.a and Figure 11.b, respectively, present the grid's profits under a quantity and a price regulation, when  $\lambda^S = 95\%$  and  $\lambda^S = 100\%$ . We observe that grid is better-off

under a price regulation, provided that  $\tau \leq 0.0205$  EU/kW. Such a FiT is compatible with fuel-cell storage, since consumers invest in storage capacity when  $\tau \geq 0.001$  EU/kW.

Figure 12: Welfare with  $c_C = c_D$ .

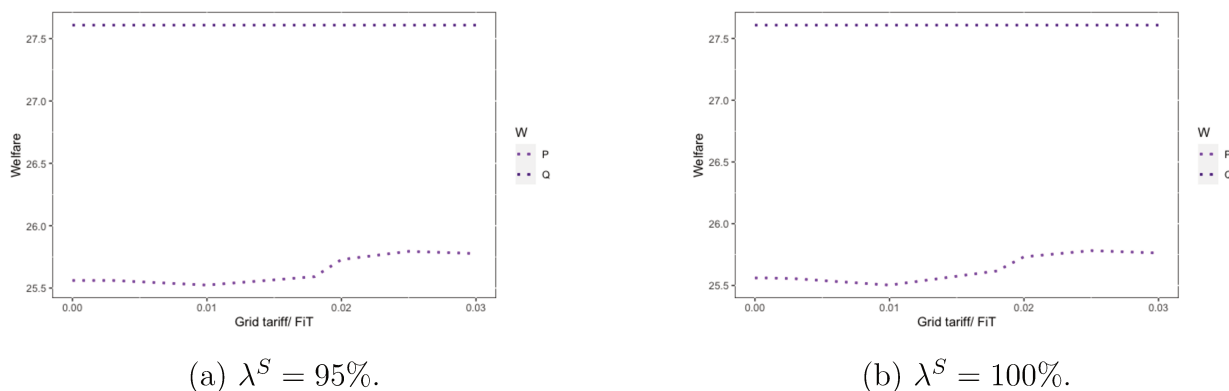

As for welfare, in Figure 11.a and Figure 11.b we observe that despite the technological improvements, society is always better-off under a quantity regulation.

We conclude that the grid is always better-off under a price regulation, provided that  $\tau \leq 0.0205$  EU/kW. Moreover, if  $\tau \geq 0.001$  EU/kW there is fuel-cell storage. Conversely, consumer surplus and welfare are larger under a quantity regulation. Thus, a cost reduction of the grid's variable costs provides incentives to invest in fuel-cell storage while allowing the grid to no longer operate at a loss. It should be noted that a price regulation implies that demand for energy injected to the grid needs to be sufficiently large, i.e. if energy demand is not large enough when conditions are favourable, then the injected energy would be curtailed. Otherwise, the grid would deal with congestion problems at the risk of a black-out. Nevertheless, society is always better-off under a quantity regulation, which is also compatible with power-to-gas storage, while allowing the grid to retrieve positive profits.

## 6 Conclusion

In the context of the energy transition, renewables integration into the energy-mix calls for solutions to smooth production intermittency. Power-to-gas storage can contribute to this goal.

We developed a theoretical framework to study solar capacity and storage adoption by consumers under two possible energy regulations. A quantity one, compatible with



---

centralised storage, and a price one, compatible with decentralised storage. We found that both regulations lead to three types of profiles: consumers, prosumers and storers. Moreover, the threshold value of the solar capacity cost under which consumers invest in solar capacity is the same under both energy regulations.

The results from our numerical evaluation suggest that under the current technology costs, and round-trip efficiency, power-to-gas storage is never possible. Nevertheless, capacity cost are expected to decrease in the future, while round-trip efficiency is expected to increase.

Without a cost reduction of the grid operating costs, with a FiT such that consumers invest in decentralised storage, the grid operates at a loss under a price regulation. Consumer surplus and welfare are larger with a quantity regulation. If the grid tariff is such that there is centralised storage, the grid makes positive profits.

With a cost reduction of the grid operating costs, a FiT such that consumers invest in decentralised storage, guarantees the grid positive profits. Nevertheless, consumer surplus and welfare are always larger with a quantity regulation.

It is implicit that a price regulation needs enough *traditional consumers*, who do not invest in solar capacity, to be possible. Thus, a quantity regulation would be better suited to promote energy storage while limiting the *death spiral*.

## A Appendix

### A.1 Quantity regulation

The Lagrangian of the consumer's problem is:

$$\begin{aligned} \mathcal{L}(\cdot) = & U(K - R + g_1) - pg_1 + \rho_f[U(K + \lambda^G R + g_2^f) - pg_2^f] + (1 - \rho_f)[U(\lambda^G R + g_2^u) - pg_2^u] \\ & - \alpha R - rK + \mu_1(\bar{K} - K) + \mu_2 K + \mu_3 R + \mu_4 g_1 + \mu_5 g_2^f + \mu_6 g_2^u \end{aligned}$$

This yields to the following first order conditions:

$$\frac{\partial \mathcal{L}(\cdot)}{\partial K} = U'(K - R + g_1) + \rho_f U'(K + \lambda^G R + g_2^f) - r - \mu_1 + \mu_2 = 0 \quad (3.1)$$

$$\frac{\partial \mathcal{L}(\cdot)}{\partial R} = -U'(K - R + g_1) + \lambda^G [\rho_f U'(K + \lambda^G R + g_2^f) + (1 - \rho_f) U'(\lambda^G R + g_2^u)] - \alpha + \mu_3 = 0 \quad (3.2)$$

$$\frac{\partial \mathcal{L}(\cdot)}{\partial g_1} = U'(K - R + g_1) - p + \mu_4 = 0 \quad (3.3)$$

$$\frac{\partial \mathcal{L}(\cdot)}{\partial g_2^f} = \rho_f [U'(K + \lambda^G R + g_2^f) - p] + \mu_5 = 0 \quad (3.4)$$

$$\frac{\partial \mathcal{L}(\cdot)}{\partial g_2^u} = (1 - \rho_f) [U'(\lambda^G R + g_2^u) - p] + \mu_6 = 0 \quad (3.5)$$

plus the complementary slackness conditions.

We look for the possible consumer profiles.

1. If  $g_1 > 0$ ,  $g_2^f > 0$  and  $g_2^u > 0$  ( $\mu_4 = \mu_5 = \mu_6 = 0$ ), from (3.3), (3.4) and (3.5) we have:  $p = U'(K - R + g_1) = U'(K + \lambda^G R + g_2^f) = U'(\lambda^G R + g_2^u)$ .

This implies that  $U'(\bar{K}) > p$  since  $U'(\cdot)$  is decreasing. Combining (3.1), (3.3), and (3.4) we obtain:

$$(1 + \rho_f)p - r - \mu_1 + \mu_2 = 0$$

When  $\bar{K} > K > 0$  ( $\mu_1 = \mu_2 = 0$ ) we define  $\bar{r}^q = (1 + \rho_f)p$ . If  $\bar{K} = K > 0$  ( $\mu_1 > 0$ ,  $\mu_2 = 0$ ):  $\bar{r}^q > r = (1 + \rho_f)p - \mu_1$ . If  $\bar{K} > K = 0$  ( $\mu_1 = 0$ ,  $\mu_2 > 0$ ):  $r = (1 + \rho_f)p + \mu_2 > \bar{r}^q$ . Otherwise, if  $\bar{K} = K = 0$  ( $\mu_1 > 0$ ,  $\mu_2 > 0$ ):  $r = (1 + \rho_f)p - \mu_1 + \mu_2 > \bar{r}^q$  or we have a contradiction.

Combining (3.2), (3.3), (3.4) and (3.5) we obtain:

$$\mu_3 = (1 - \lambda^G)p + \alpha$$

which is strictly positive (provided that both  $\lambda^G \neq 1$  and  $\alpha \neq 0$ ), then  $R = 0$ .

**2.** If  $g_1 = g_2^f = 0$  and  $g_2^u > 0$  ( $\mu_4 > 0, \mu_5 > 0, \mu_6 = 0$ ), from (3.3), (3.4) and (3.5) we have:  $p > U'(K - R)$ ,  $p > U'(K + \lambda^G R)$  and  $p = U'(\lambda^G R + g_2^u)$ .

This implies that  $U'(\bar{K}) < p$  since  $U'(\cdot)$  is decreasing. Combining (3.1), (3.3), and (3.4) we obtain:

$$(1 + \rho_f)U'(K) - r - \mu_1 + \mu_2 = 0$$

If  $K = 0$  ( $\mu_2 > 0$ ) we have  $U'(0) = \infty$  at  $t = 1$  and  $t = 2$  when  $i = u$  which is not possible:  $K > 0$ . Combining (3.2), (3.3), (3.4) and (3.5) we obtain:

$$\mu_3 = \alpha + U'(K - R) - \lambda^G[\rho_f U'(K + \lambda^G R) + (1 - \rho_f)p]$$

We have two sub-cases:

**2.a.** If  $R = 0$  ( $\mu_3 > 0$ ), and  $\bar{K} > K$  ( $\mu_1 = 0$ ).

We define  $\tilde{r}^q = (1 + \rho_f)U'(K)$ .

Otherwise, if  $\bar{K} = K$  ( $\mu_3 = 0$ ):  $\tilde{r}^q > r = (1 + \rho_f)U'(K) - \mu_1$ .

**2.b.** If  $R > 0$  ( $\mu_3 = 0$ ), and  $\bar{K} > K$  ( $\mu_1 = 0$ ).

We define  $\alpha^q = \lambda^G[\rho_f U'(K + \lambda^G R) + (1 - \rho_f)p] - U'(K - R)$ ,

and  $\underline{r}^q = U'(K - R) + \rho_f U'(K + \lambda^G R)$ .

Otherwise, if  $\bar{K} = K$  ( $\mu_1 > 0$ ):  $\underline{r}^q > r = U'(K - R) + \rho_f U'(K + \lambda^G R) - \mu_1$ .

Given that  $U'(\cdot)$  is decreasing and since  $R > \lambda^G R$  we have  $\underline{r}^q > \tilde{r}^q$ .

**3.** If  $g_1 = g_2^f = g_2^u = 0$  ( $\mu_4 > 0, \mu_5 > 0, \mu_6 > 0$ ), from (3.3), (3.4) and (3.5) we have:  $p > U'(K - R)$ ,  $p > U'(K + \lambda^G R)$  and  $p > U'(\lambda^G R)$ .

This implies that  $U'(\bar{K}) < p$  since  $U'(\cdot)$  is decreasing. Combining (3.1), (3.3), and (3.4) we obtain:

$$U'(K - R) + \rho_f U'(K + \lambda^G R) - r - \mu_1 + \mu_2 = 0$$

It is the same as in case 2.b. Combining (3.2), (3.3), (3.4) and (3.5) we obtain:

$$\mu_3 = U'(K - R) + \alpha - \lambda^G[\rho_f U'(K + \lambda^G R) + (1 - \rho_f)U'(\lambda^G R)]$$

Notice that  $U'(\lambda^G R) < p$ , then, if  $U'(K - R) + \alpha - \lambda^G[\rho_f U'(K + \lambda^G R) + (1 - \rho_f)U'(\lambda^G R)] = 0$  it would imply  $\mu_3 < 0$ : we have a contradiction.

**4.** If  $g_1 > 0, g_2^f = 0$  and  $g_2^u > 0$  ( $\mu_4 = \mu_6 = 0, \mu_5 > 0$ ), from (3.3), (3.4) and (3.5) we have:  $p = U'(K - R + g_1) = U'(\lambda^G R + g_2^u)$  and  $p > U'(K + \lambda^G R)$ .

Combining (3.2), (3.3), (3.4) and (3.5) we obtain:

$$\mu_3 = \alpha + p(1 - \lambda^G) + \lambda^G \rho_f (p - U'(K + \lambda^G R))$$

if this is strictly positive, then  $R = 0$ . This implies  $K > K + g_1$  given that  $U'(\cdot)$  is decreasing we have a contradiction.

**5.** If  $g_1 > 0$  and  $g_2^f = g_2^u = 0$  ( $\mu_4 = 0, \mu_5 > 0, \mu_6 > 0$ ), from (3.3), (3.4) and (3.5) we have:  $p = U'(K - R + g_1)$ ,  $p > U'(K + \lambda^G R)$  and  $p > U'(\lambda^G R)$ .

Combining (3.2), (3.3), (3.4) and (3.5) we obtain:

$$\mu_3 = \alpha + p - \lambda^{GS} [\rho_f U'(K + \lambda^G R) + (1 - \rho_f) U'(\lambda^G R)]$$

this is strictly positive, so  $R=0$ . At  $t = 2$  when  $i = u$ , we have  $U'(0) = +\infty$  which is not possible.

**6.** If  $g_1 = 0$ ,  $g_2^f > 0$  and  $g_2^u = 0$  ( $\mu_4 > 0, \mu_5 = 0, \mu_6 > 0$ ), from (3.3), (3.4) and (3.5) we have:  $p > U'(K - R)$ ,  $p = U'(K + \lambda^G R + g_2^f)$  and  $p > U'(\lambda^G R)$ .

This implies that  $K - R > K + \lambda^G R + g_2^f$  given that  $U'(\cdot)$  is decreasing we have a contradiction.

**7.** If  $g_1 = 0$ ,  $g_2^f > 0$  and  $g_2^u > 0$  ( $\mu_4 > 0, \mu_5 = \mu_6 = 0$ ), from (3.3), (3.4) and (3.5) we have:  $p > U'(K - R)$  and  $p = U'(K + \lambda^G R + g_2^f) = U'(\lambda^G R + g_2^u)$ .

This implies that  $K - R > K + \lambda^G R + g_2^f$  given that  $U'(\cdot)$  is decreasing we have a contradiction.

**8.** If  $g_1 > 0$ ,  $g_2^f > 0$  and  $g_2^u = 0$  ( $\mu_4 = \mu_5 = 0, \mu_6 > 0$ ), from (3.3), (3.4) and (3.5) we have:  $p = U'(K - R + g_1) = U'(\lambda^G R + g_2^u)$  and  $p > U'(K + \lambda^G R)$ .

This implies that  $\lambda^G R > K + \lambda^G R + g_2^f$  given that  $U'(\cdot)$  is decreasing we have a contradiction.

Thus, cases 1, 2.a and 2.b are solutions.

## A.2 Price regulation

The Lagrangian of the consumer's problem is:

$$\begin{aligned} \mathcal{L}(\cdot) = & U(K - S + g_1) - \phi_1 g_1 + \rho_f [U(K + \lambda^S S + g_2^f) - \phi_2^f g_2^f] + (1 - \rho_f) [U(\lambda^S S + g_2^u) - \phi_2^u g_2^u] \\ & - r_s S - rK + \eta_1 (\bar{K} - K) + \eta_2 K + \eta_3 (\bar{S} - S) + \eta_4 S \end{aligned}$$

This yields to the following first order conditions:

$$\frac{\partial \mathcal{L}(\cdot)}{\partial K} = U'(K - S + g_1) + \rho_f U'(K + \lambda^S S + g_2^f) - r - \eta_1 + \eta_2 = 0 \quad (3.6)$$

---

$$\frac{\partial \mathcal{L}(\cdot)}{\partial S} = -U'(K - S + g_1) + \lambda^S [\rho_f U'(K + \lambda^S S + g_2^f) + (1 - \rho_f) U'(\lambda^S S + g_2^u)] - r_s - \eta_3 + \eta_4 = 0 \quad (3.7)$$

$$\frac{\partial \mathcal{L}(\cdot)}{\partial g_1} = U'(K - S + g_1) - \phi_1 = 0 \quad (3.8)$$

$$\frac{\partial \mathcal{L}(\cdot)}{\partial g_2^f} = (1 - \rho_f) [U'(\lambda^S S + g_2^u) - \phi_2^u] = 0 \quad (3.9)$$

$$\frac{\partial \mathcal{L}(\cdot)}{\partial g_2^u} = \rho_f [U'(K + \lambda^S S + g_2^f) - \phi_2^f] = 0 \quad (3.10)$$

plus the complementary slackness conditions.

### Feed-in-tariff smaller than the energy price

1. If  $\phi_1 = \phi_2^f = \phi_2^u = p$ , from (3.8), (3.9) and (3.10) we have:  $p = U'(K - S + g_1) = U'(K + \lambda^S S + g_2^f) = U'(\lambda^S S + g_2^u)$ .

Combining (3.6), (3.8), and (3.9) we obtain:

$$(1 + \rho_f)p - r - \eta_1 + \eta_2 = 0$$

When  $\bar{K} > K > 0$  ( $\eta_1 = \eta_2 = 0$ ) we define  $\bar{r}^p = (1 + \rho_f)p$ . If  $\bar{K} = K > 0$  ( $\eta_1 > 0, \eta_2 = 0$ ):  $\bar{r}^p > r = (1 + \rho_f)p - \eta_1$ . If  $\bar{K} > K = 0$  ( $\eta_1 = 0, \eta_2 > 0$ ):  $r = (1 + \rho_f)p + \eta_2 > \bar{r}^p$ . Otherwise, if  $\bar{K} = K = 0$  ( $\eta_1 > 0, \eta_2 > 0$ ):  $(1 + \rho_f)p - \eta_1 + \eta_2 > \bar{r}^p$  or we have a contradiction.

Combining (3.7), (3.8), (3.9) and (3.10) we obtain:

$$\eta_4 - \eta_3 - (1 - \lambda^S)p - r_s = 0$$

If  $S > 0$  ( $\eta_4 = 0$ ) we have  $-\eta_3 - (1 - \lambda^S)p - r_s < 0$  which is not possible: thus  $S = 0$ .

2. If  $\phi_1 = \tau$  and  $\phi_2^f = \phi_2^u = p$ , from (3.8), (3.9) and (3.10) we have:  $\tau = U'(K - S - g_1)$  and  $p = U'(K + \lambda^S S + g_2^f) = U'(\lambda^S S + g_2^u)$ .

This implies  $K + \lambda^S S > K - S > K - S - g_1$ , we have  $p > \tau$  and since  $U'(\cdot)$  is decreasing there is a contradiction.

3. If  $\phi_1 = \phi_2^f = \tau$  and  $\phi_2^u = p$ , from (3.8), (3.9) and (3.10) we have:  $\tau = U'(K - g_1 - S) = U'(K + \lambda^S S - g_2^f)$  and  $p = U'(\lambda^S S + g_2^u)$ .

Combining (3.6), (3.8), and (3.9) we obtain:

$$(1 + \rho_f)\tau - r - \eta_1 + \eta_2 = 0$$

When  $\bar{K} > K > 0$  ( $\eta_1 = \eta_2 = 0$ ) we define  $\tilde{r}^p = (1 + \rho_f)\tau$ . If  $\bar{K} = K > 0$  ( $\eta_1 > 0, \eta_2 = 0$ ):  $\tilde{r}^p > r = (1 + \rho_f)\tau - \eta_1$ . Otherwise, if  $\bar{K} \geq K = 0$  ( $\eta_1 \geq 0, \eta_2 > 0$ ) we have  $U'(0) = \infty$  at  $t = 1$  which is not possible.

Combining (3.7), (3.8), (3.9) and (3.10) we obtain:

$$\eta_4 - \eta_3 - (1 - \lambda^S \rho_f)\tau + \lambda^S(1 - \rho_f)p - r_s = 0$$

When  $\bar{S} > S > 0$  ( $\eta_3 = \eta_4 = 0$ ) we define  $\bar{r}_s^p = \lambda^S(1 - \rho_f)p - (1 - \lambda^S \rho_f)\tau$ . If  $\bar{S} = S > 0$  ( $\eta_3 > 0, \eta_4 = 0$ ):  $\bar{r}_s^p \geq r_s = \lambda^S(1 - \rho_f)p - (1 - \lambda^S \rho_f)\tau - \eta_3$ . If  $\bar{S} > S = 0$  ( $\eta_3 = 0, \eta_4 > 0$ ):  $\bar{r}_s^p \geq r_s = \lambda^S(1 - \rho_f)p - (1 - \lambda^S \rho_f)\tau + \eta_4$ . Otherwise, if  $\bar{S} = S = 0$  ( $\eta_3 > 0, \eta_4 > 0$ ):  $r_s = \lambda^S(1 - \rho_f)p - (1 - \lambda^S \rho_f)\tau + \eta_4 - \eta_3 > \bar{r}_s^p$  or we have a contradiction.

Notice that  $S > 0$  only possible if  $-\eta_3 - (1 - \lambda^S \rho_f)\tau + \lambda^S(1 - \rho_f)p - r_s > 0$  which is never true if  $\lambda^S p < \tau$ . In such case, it is only possible to have  $S = 0$ .

**4.** If  $\phi_1 = \phi_2^f = \phi_2^u = \tau$ , from (3.8), (3.9) and (3.10) we have:  $\tau = U'(K - S - g_1) = U'(K + \lambda^S S - g_2^f) = U'(\lambda^S S - g_2^u)$ .

If  $S = 0$  ( $\eta_4 > 0$ ) at  $t = 2$  when  $i = u$  we have  $U'(0) = +\infty$  which is not possible. If  $S > 0$  ( $\eta_4 = 0$ ) we have  $-\eta_3 - (1 - \lambda^S)\tau - r_s < 0$  which is not possible.

**5.** If  $\phi_1 = p$  and  $\phi_2^f = \phi_2^u = \tau$ , from (3.8), (3.9) and (3.10) we have:  $p = U'(K - S + g_1)$  and  $\tau = U'(K + \lambda^S S - g_2^f) = U'(\lambda^S S - g_2^u)$ .

If  $S = 0$  ( $\eta_4 > 0$ ) at  $t = 2$  when  $i = u$  we have  $U'(0) = +\infty$  which is not possible. If  $S > 0$  ( $\eta_4 = 0$ ) we have  $-\eta_3 - p + \lambda^S \tau - r_s < 0$  which is not possible.

**6.** If  $\phi_1 = \phi_2^f = p$  and  $\phi_2^u = \tau$ , from (3.8), (3.9) and (3.10) we have:  $p = U'(K - S + g_1) = U'(K + \lambda^S S + g_2^f)$  and  $\tau = U'(\lambda^S S - g_2^u)$ .

If  $S = 0$  ( $\eta_4 > 0$ ) at  $t = 2$  when  $i = u$  we have  $U'(0) = +\infty$  which is not possible. If  $S > 0$  ( $\eta_4 = 0$ ) it implies that  $K + \lambda^S S + g_2^f > \lambda^S S - g_2^u$  and since  $U'(\cdot)$  is decreasing we have a contradiction.

**7.** If  $\phi_1 = p$ ,  $\phi_2^f = \tau$  and  $\phi_2^u = p$ , from (3.8), (3.9) and (3.10) we have:  $p = U'(K - S + g_1) = U'(\lambda^S S + g_2^u)$  and  $\tau = U'(K + \lambda^S S - g_2^f)$ .

If  $S > 0$  ( $\eta_4 = 0$ ) we have  $-\eta_3 - [1 - \lambda^S(1 - \rho_f)]p + \lambda^S \rho_f \tau - r_s < 0$  which is not possible.

If  $S = 0$  ( $\eta_4 > 0$ ) it implies that  $K - g_2^f > K + g_1$  since  $U'(\cdot)$  is decreasing we have a contradiction.

**8.** If  $\phi_1 = \tau$ ,  $\phi_2^f = p$  and  $\phi_2^u = \tau$ , from (3.8), (3.9) and (3.10) we have:  $\tau = U'(K - S - g_1) = U'(\lambda^S S - g_2^u)$  and  $p = U'(K + \lambda^S S + g_2^f)$ .

This implies  $K + \lambda^S S + g_2^f > K - S - g_1$  since  $U'(\cdot)$  is decreasing we have a contradiction.

Thus, cases 1 and 3 are solution.

---

## Feed-in-tariff valued at the energy price

We have  $\phi_1 = \phi_2^f = \phi_2^u = p = \tau$ . Combining (3.6), (3.8), and (3.9) we obtain:

$$(1 + \rho_f)p - r - \eta_1 + \eta_2 = 0$$

When  $\bar{K} > K > 0$  ( $\eta_1 = \eta_2 = 0$ ) we define  $\bar{r}^{p2} = (1 + \rho_f)p$ . If  $\bar{K} = K > 0$  ( $\eta_1 > 0, \eta_2 = 0$ ):  $\bar{r}^{p2} > r = (1 + \rho_f)p - \eta_1$ . If  $\bar{K} > K = 0$  ( $\eta_1 = 0, \eta_2 > 0$ ):  $r = (1 + \rho_f)p + \eta_2 > \bar{r}^{p2}$ . Otherwise, if  $\bar{K} = K = 0$  ( $\eta_1 > 0, \eta_2 > 0$ ):  $(1 + \rho_f)p - \eta_1 + \eta_2 > \bar{r}^{p2}$  or we have a contradiction.

Combining (3.7), (3.8), (3.9) and (3.10) we obtain:

$$\eta_4 - \eta_3 - (1 - \lambda^S)p - r_s = 0$$

If  $S > 0$  ( $\eta_4 = 0$ ) we have  $\eta_3 - (1 - \lambda^S)p - r_s < 0$  which is impossible, thus,  $\eta_4 > 0$  and  $S = 0$ .

## B Price regulation with a feed-in-tariff larger than the energy retail price

We extend our model and consider that the government chooses a price regulation with a FiT larger than the energy retail price<sup>10</sup>. We look for the possible consumer profiles:

1. If  $\phi_1 = \phi_2^f = \phi_2^u = p$ , combining (3.6), (3.8), and (3.9) we obtain:

$$(1 + \rho_f)p - r - \eta_1 + \eta_2 = 0$$

When  $\bar{K} > K > 0$  ( $\eta_1 = \eta_2 = 0$ ) we define  $\underline{r}^{p3} = (1 + \rho_f)p$ . If  $\bar{K} = K > 0$  ( $\eta_1 > 0, \eta_2 = 0$ ):  $\underline{r}^{p3} > r = (1 + \rho_f)p - \eta_1$ . If  $\bar{K} > K = 0$  ( $\eta_1 = 0, \eta_2 > 0$ ):  $r = (1 + \rho_f)p + \eta_2 > \underline{r}^{p3}$ . Otherwise, if  $\bar{K} = K = 0$  ( $\eta_1 > 0, \eta_2 > 0$ ):  $(1 + \rho_f)p - \eta_1 + \eta_2 > \underline{r}^{p3}$  or we have a contradiction. Combining (3.7), (3.8), (3.9) and (3.10) we obtain:

$$\eta_4 - \eta_3 - (1 - \lambda^S)p - r_s = 0$$

If  $S > 0$  ( $\eta_4 = 0$ ) we have  $-\eta_3 - (1 - \lambda^S)p - r_s < 0$  which is not possible:  $S = 0$ .

2. If  $\phi_1 = \tau$  and  $\phi_2^f = \phi_2^u = p$ , combining (3.6), (3.8), and (3.9) we obtain:

$$\tau + \rho_f p - r - \eta_1 + \eta_2 = 0$$

---

<sup>10</sup>This is the case in Hong-Kong

When  $K = 0$  ( $\eta_2 > 0$ ) at  $t = 1$ , we have  $U'(0) = \infty$  which is not possible:  $K > 0$  ( $\eta_2 = 0$ ). If  $\bar{K} > K > 0$  ( $\eta_1 = \eta_2 = 0$ ) we define  $\tilde{r}^{p3} = \tau + \rho_f p$ . Otherwise, if  $\bar{K} = K > 0$  ( $\eta_1 > 0, \eta_2 = 0$ ):  $\tilde{r}^{p3} > r = \tau + \rho_f p - \eta_1$ . Combining (3.7), (3.8), (3.9) and (3.10) we obtain:

$$\eta_4 - \eta_3 - \tau + \lambda^S p - r_s = 0$$

If  $S > 0$  ( $\eta_4 = 0$ ) we have  $-\eta_3 - \tau + \lambda^S p - r_s < 0$  which is not possible:  $S = 0$ .

**3.** If  $\phi_1 = \phi_2^f = \tau$  and  $\phi_2^u = p$ , combining (3.6), (3.8), and (3.9) we obtain:

$$(1 + \rho_f)\tau - r - \eta_1 + \eta_2 = 0$$

When  $K = 0$  ( $\eta_2 > 0$ ) if  $i = f$ , we have  $U'(0) = \infty$  which is not possible:  $K > 0$  ( $\eta_2 = 0$ ). If  $\bar{K} > K > 0$  ( $\eta_1 = \eta_2 = 0$ ) we define  $\bar{r}^{p3} = (1 + \rho_f)\tau$ . Otherwise, if  $\bar{K} = K > 0$  ( $\eta_1 > 0, \eta_2 = 0$ ):  $\bar{r}^{p3} > r = (1 + \rho_f)\tau - \eta_1$ . Combining (3.7), (3.8), (3.9) and (3.10) we obtain:

$$\eta_4 - \eta_3 + \lambda^S(1 - \rho_f)p - (1 - \lambda^S \rho_f)\tau - r_s = 0$$

If  $S > 0$  ( $\eta_4 = 0$ ) we have  $-\eta_3 - \lambda^S(1 - \rho_f)p - (1 - \lambda^S \rho_f)\tau - r_s < 0$  which is not possible:  $S = 0$ .

**4.** If  $\phi_1 = \phi_2^f = \phi_2^u = \tau$ , combining (3.7), (3.8), (3.9) and (3.10) we obtain:

$$\eta_4 - \eta_3 - (1 - \lambda^S)\tau - r_s = 0$$

If  $S > 0$  ( $\eta_4 = 0$ ) we have  $-\eta_3 - (1 - \lambda^S)\tau - r_s < 0$  which is not possible. Otherwise, if  $S = 0$  ( $\eta_4 > 0$ ) at  $t = 2$  when  $i = u$  we have  $U'(0) = \infty$  which is not possible.

**5.** If  $\phi_1 = p$  and  $\phi_2^f = \phi_2^u = \tau$ , combining (3.6), (3.8), and (3.9) we obtain:

$$p + \rho_f \tau - r - \eta_1 + \eta_2 = 0$$

When  $\bar{K} > K > 0$  ( $\eta_1 = \eta_2 = 0$ ) we define  $\hat{r}^{p3} = p + \rho_f \tau$ . If  $\bar{K} = K > 0$  ( $\eta_1 > 0, \eta_2 = 0$ ):  $\hat{r}^{p3} > r = p + \rho_f \tau - \eta_1$ . If  $\bar{K} > K = 0$  ( $\eta_1 = 0, \eta_2 > 0$ ):  $r = p + \rho_f \tau + \eta_2 > \hat{r}^{p3}$ . Otherwise, if  $\bar{K} = K = 0$  ( $\eta_1 > 0, \eta_2 > 0$ ):  $p + \rho_f \tau \eta_1 + \eta_2 > \hat{r}^{p3}$  or we have a contradiction.

Combining (3.7), (3.8), (3.9) and (3.10) we obtain:

$$\eta_4 - \eta_3 - p + \lambda^S \tau - r_s = 0$$

When  $S = 0$  ( $\eta_4 > 0$ ) at  $t = 2$  we have  $U'(0) = \infty$  which is not possible. If  $\bar{S} > S > 0$  ( $\eta_3 = 0, \eta_4 = 0$ ) we define  $\bar{r}_s^{p3} = \lambda^S \tau - p$ . Otherwise, if  $\bar{S} = S > 0$  ( $\eta_3 > 0, \eta_4 = 0$ ):  $\bar{r}_s^{p3} > r_s = \lambda^S \tau - p - \eta_3$ .

Notice that  $S > 0$  only possible if  $\lambda^S \tau - p - \eta_3 - r_s > 0$  which is never true if  $p > \lambda^S \tau$ . In such case, this case cannot be solution to the consumer problem.



6. If  $\phi_1 = \phi_2^f = p$  and  $\phi_2^u = \tau$ , combining (3.6), (3.8), and (3.9) we obtain:

$$(1 + \rho_f)p - r - \eta_1 + \eta_2 = 0$$

It is the same as in case 1. Combining (3.7), (3.8), (3.9) and (3.10) we obtain:

$$\eta_4 - \eta_3 - (1 - \lambda^S \rho_f)p + \lambda^S(1 - \rho_f)\tau - r_s = 0$$

When  $S = 0$  ( $\eta_4 > 0$ ) at  $t = 2$  when  $i = u$  we have  $U'(0) = \infty$  which is not possible. If  $\bar{S} > S > 0$  ( $\eta_3 = 0, \eta_4 = 0$ ) we define  $\hat{r}_s^{p3} = \lambda^S(1 - \rho_f)\tau - (1 - \lambda^S \rho_f)p$ . Otherwise, if  $\bar{S} = S > 0$  ( $\eta_3 > 0, \eta_4 = 0$ ):  $\hat{r}_s^{p3} > r_s = \lambda^S(1 - \rho_f)\tau - (1 - \lambda^S \rho_f)p - \eta_3$ .

Notice that  $S > 0$  only possible if  $\lambda^S(1 - \rho_f)\tau - (1 - \lambda^S \rho_f)p - \eta_3 - r_s > 0$  which is never true if  $(1 - \lambda^S \rho_f)p > \lambda^S(1 - \rho_f)\tau$ . In such case, this case cannot be a solution to the consumer problem.

7. If  $\phi_1 = p, \phi_2^f = \tau$  and  $\phi_2^u = p$ , combining (3.6), (3.8), and (3.9) we obtain:

$$p + \tau \rho_f - r - \eta_1 + \eta_2 = 0$$

It is the same as in case 5. Combining (3.7), (3.8), (3.9) and (3.10) we obtain:

$$\eta_4 - \eta_3 - [1 - \lambda^S(1 - \rho_f)]p + \lambda^S \rho_f \tau - r_s = 0$$

When  $\bar{S} > S > 0$  ( $\eta_3 = 0, \eta_4 = 0$ ) we define  $\hat{r}_s^{p3} = \lambda^S \rho_f \tau - [1 - \lambda^S(1 - \rho_f)]p$ . If  $\bar{S} = S > 0$  ( $\eta_3 > 0, \eta_4 = 0$ ):  $\hat{r}_s^{p3} > r_s = \lambda^S \rho_f \tau - [1 - \lambda^S(1 - \rho_f)]p - \eta_3$ . If  $\bar{S} > S = 0$  ( $\eta_3 = 0, \eta_4 > 0$ ):  $r_s = \lambda^S \rho_f \tau - [1 - \lambda^S(1 - \rho_f)]p + \eta_4 > \hat{r}_s^{p3}$ . Otherwise, if  $\bar{S} = S = 0$  ( $\eta_3 > 0, \eta_4 > 0$ ):  $r_s = \lambda^S \rho_f \tau - [1 - \lambda^S(1 - \rho_f)]p + \eta_4 - \eta_3 > \hat{r}_s^{p3}$  or we have a contradiction.

Notice that when  $K = 0$  we cannot have  $S = 0$  since at  $t = 2$  when  $i = f$  it implies  $U'(0) = \infty$  which is not possible. Also,  $S > 0$  is only possible if  $-[1 - \lambda^S(1 - \rho_f)]p + \lambda^S \rho_f \tau - r_s > 0$  which is never true if  $(1 - \lambda^S(1 - \rho_f))p > \lambda^S \rho_f \tau$ . Hence, this case can be solution to the consumer problem only if  $K > 0$ .

8. If  $\phi_1 = \tau, \phi_2^f = p$  and  $\phi_2^u = \tau$ , combining (3.7), (3.8), (3.9) and (3.10) we obtain:

$$\eta_4 - \eta_3 - [1 - \lambda^S(1 - \rho_f)]\tau + \lambda^S \rho_f p - r_s = 0$$

When  $S > 0$  ( $\eta_4 = 0$ ) we have  $-\eta_3 - [1 - \lambda^S(1 - \rho_f)]\tau + \lambda^S \rho_f p - r_s < 0$  which is not possible. Otherwise, when  $S = 0$  ( $\eta_4 > 0$ ) at  $t = 2$  when  $i = u$  we have  $U'(0) = \infty$  which is not possible.

Thus, cases 1, 2, 3, 5, 6 and 7 are solutions. We have several takeaways from our results above.

First, we observe that there are profiles under which  $K = 0$  and  $S > 0$  (“storers”). In practice, consumers can only inject energy into the grid when  $K > 0$ . Indeed, around the world only consumers equipped with solar capacity can inject energy into the grid.

Second, notice that we have some profiles where consumers seem to engage in *precautionary storage*. In Durmaz (2016), the latter was driven by uncertain price spikes, whereas in our model the energy retail price is fixed. A FiT larger than the retail price promotes storage, but it corresponds to *strategical storage*: store energy to sell. Then, consumers use the grid to generate energy revenues, thus distorting consumption patterns since storage is no longer seen as a grid substitute.

Third, whether consumers invest in solar capacity depends on the relationship between the marginal utility from the maximal solar capacity, the energy retail price and the FiT.

If  $U'(\bar{K}) > \tau$  (i.e.  $\bar{K}$  is small), and the solar capacity cost is such that  $r > \underline{r}^{p3}$ , then consumers prefer not to invest in solar capacity, and remain *traditional consumers*. For smaller values of the solar capacity cost ( $\underline{r}^{p3} \geq r$ ), consumers invest in solar capacity, but the latter does not cover demand.

If  $p < U'(\bar{K}) < \tau$ , and the solar capacity cost is such that  $\bar{r}^{p3} \geq r$ , then solar energy covers demand when conditions are favourable. Thus, consumers can inject energy into the grid. For smaller values of the solar capacity, it seems that consumers buy more from the grid in favourable states of nature: at  $t = 2$  when  $\bar{r}^{p3} \geq r > \hat{r}^{p3}$ , and at  $t = 1$  when  $\hat{r}^{p3} \geq r > \underline{r}^{p3}$  and  $r_s > \tilde{r}_s^{p3}$ . Then, large solar capacity costs  $\bar{r}^{p3} > r > \tilde{r}^{p3}$ , seems to motivate consumers to have a better control of their consumption.

Otherwise, if  $U'(\bar{K}) < p$  (i.e.  $\bar{K}$  is large), and the solar capacity cost is such that  $\bar{r}^{p3} > r$ , then consumers also seem to manage better their consumption.

Finally, whether consumers invest in storage capacity depends on the relationship between the marginal utility from the maximal retrieved stored energy, the energy price and the FiT.

If  $U'(\lambda^S \bar{S}) > \tau$  (i.e.  $\bar{S}$  is small), and the solar and storage capacity costs are  $\hat{r}^{s3} \geq r$  and  $\hat{r}_s^{s3} \geq r_s$ , then consumers engage in *strategical storage* at  $t = 2$  when  $i = f$ . When  $i = u$ , they rely on the grid to serve demand.

If  $p < U'(\lambda^S \bar{S}) < \tau$ , different profiles arise depending on the solar and storage capacity costs.

When  $\hat{r}^{p3} \geq r > \underline{r}^{p3}$  and  $\bar{r}_s^{p3} \geq r_s > \hat{r}_s^{p3}$  (or  $\bar{r}_s^{p3} \geq r_s > \tilde{r}_s^{p3}$ ) if  $\rho_f \geq \frac{1}{2}$  ( $\rho_f < \frac{1}{2}$ ), then, consumers engage in *strategical storage* regardless of conditions at  $t = 2$  (if  $g_2^f \neq 0$  and/or  $g_2^u \neq 0$ ).

---

For smaller values of the storage capacity cost  $\hat{r}_s^{p3} \geq r_s > \tilde{r}_s^{p3}$  (resp.  $\hat{r}_s^{p3} \geq r_s$ ), if  $\rho_f \geq \frac{1}{2}$  ( $\rho_f < \frac{1}{2}$ ), and the solar capacity cost is  $\hat{r}^{p3} \geq r > \underline{r}^{p3}$ , then storage no longer covers demand at  $t = 2$  when conditions are unfavourable. Nevertheless, consumers still engage in *strategical storage* at  $t = 2$  when  $i = f$ .

If the solar capacity is small  $\underline{r}^{p3} \geq r$ , and the storage capacity cost is  $\tilde{r}_s^{p3} \geq r_s$  (resp.  $\tilde{r}_s^{p3} \geq r_s > \hat{r}_s^{p3}$ ) when  $\rho_f \geq \frac{1}{2}$  ( $\rho_f < \frac{1}{2}$ ), then storage does not cover demand at  $t = 2$  when conditions are favourable. Indeed, consumers seem to over-consume when conditions are favourable at  $t = 2$ ; thus, they rely on the grid to cover demand. Nevertheless, consumers still engage in *strategical storage* at  $t = 2$  when conditions are unfavourable.

Otherwise, if  $U'(\lambda^S \bar{S}) < p$  (i.e.  $\bar{S}$  large), and the solar and storage capacity are  $\hat{r}^{p3} \geq r$  and  $\bar{r}_s^{p3} \geq r_s$ , then stored energy is large enough to cover demand at  $t = 2$ . Consumers might engage in *strategical storage*.

To conclude a FiT larger than the retail price induces strategical storage. As the storage capacity cost decreases at  $t = 2$ , consumers rely more and more on the grid despite stored energy: they over-consume energy.

## Bibliography

- Ambec, S. and Crampes, C. (2019). Decarbonizing Electricity Generation with Intermittent Sources of Energy. *Journal of the Association of Environmental and Resource Economists*, 6(6):1105–1134.
- Andreolli, F., D’Alpaos, C., and Moretto, M. (2020). Valuing investments in domestic PV-battery systems under uncertainty. Technical report.
- Andrés-Cerezo, D. and Fabra, N. (2020). Storing Power: Market Structure Matters. Cambridge Working Papers in Economics 20122, Faculty of Economics, University of Cambridge.
- Boampong, R. and Brown, D. P. (2020). On the benefits of behind-the-meter rooftop solar and energy storage: The importance of retail rate design. *Energy Economics*, 86:104682.
- Canada Energy Regulator (2021). Economics of Solar Power in Canada Results. Technical report.
- Dato, P., Durmaz, T., and Pommeret, A. (2020). Smart grids and renewable electricity generation by households. *Energy Economics*, 86(C).
- Dato, P., Durmaz, T., and Pommeret, A. (2021). Feed-in tariff policy in Hong Kong: Is it efficient? *City and Environment Interactions*, 10:100056.
- Durmaz, T. (2016). Precautionary Storage in Electricity Markets. Working Papers 2016.07, FAERE - French Association of Environmental and Resource Economists.
- Durmaz, T., Pommeret, A., and Ridley, I. (2017). Willingness to Pay for Solar Panels and Smart Grids. MITP: Mitigation, Innovation and Transformation Pathways 257879.
- Gautier, A., Jacqmin, J., and Poudou, J.-C. (2018). The prosumers and the grid. *Journal of Regulatory Economics*, 53(1):100–126.
- Helm, C. and Mier, M. (2018). Subsidising Renewables but Taxing Storage? Second-Best Policies with Imperfect Pricing. Working Papers V-413-18, University of Oldenburg, Department of Economics.
- Hydro Quebec (2021a). Autoproduction sans compensation.
- Hydro Quebec (2021b). Rate D.

---

International Energy Agency (2019). The Future of Hydrogen: Seizing today's opportunities. Technical report.

International Renewable Energy Agency (2018). Hydrogen from renewable power technology outlook for the energy transition. Technical report.

Schopfer, S., Tiefenbeck, V., and Staake, T. (2018). Economic assessment of photovoltaic battery systems based on household load profiles. *Applied Energy*, 223:229–248.

Sunmetrix (2021). Solar Tax Credits, Incentives and Solar Rebates in Quebec.



Résumé :

Le respect du pacte vert européen et des accords de Paris implique de parvenir à la neutralité carbone d'ici 2050. Cette thèse étudie, à travers trois chapitres, le rôle de l'hydrogène dans la transition énergétique. Les deux premiers chapitres abordent chacun un défi lié au déploiement de l'hydrogène dans le secteur des transports, tandis que le troisième aborde le stockage à base d'hydrogène dans le marché de l'électricité. Le premier chapitre développe un modèle théorique étudiant les conditions pour la transition vers un secteur des transports routiers à faible niveau d'émissions carbone. Les résultats suggèrent qu'aucun producteur vert ne peut entrer sur le marché lorsque les consommateurs ont des informations limitées sur l'origine de l'hydrogène. Un label pour l'hydrogène vert permet à plusieurs technologies de production de coexister, alors que l'utilisation de restrictions verticales est préférable pour la société. Le deuxième chapitre s'appuie sur une stratégie empirique pour étudier la diffusion des véhicules verts dans les flottes publiques en Californie entre 2012 et 2019. Ces flottes suivent un équilibre de diffusion de l'innovation qui semble être limité par des instruments de régulation. Les résultats suggèrent que les bonus sont peu efficaces pour promouvoir l'achat public de véhicules verts. Les réglementations d'injonction et de contrôle semblent donc plus adaptées que les instruments de marché pour les achats publics. Le troisième chapitre construit un modèle du marché de l'électricité étudiant l'investissement dans l'énergie solaire et son stockage. Le modèle est calibré avec des données du Québec. Le gouvernement peut choisir entre une régulation par les quantités ou les prix. Compte tenu des coûts et de l'efficacité actuels, le stockage d'hydrogène n'est jamais possible. Pour que les consommateurs investissent dans du stockage décentralisé et que le réseau ait des bénéfices, une réduction des coûts d'exploitation du réseau est nécessaire. Le surplus des consommateurs et le bien-être social sont toujours plus importants avec une régulation par les quantités. Celle-ci est compatible avec du stockage centralisé.

Abstract:

To meet the European Green Deal and the Paris Agreement, carbon neutrality must be achieved by 2050. This thesis investigates, through three chapters, the role of hydrogen in the energy transition. The first two chapters each address a challenge related to hydrogen's deployment in the transport sector, while the third one investigates the use of hydrogen-based storage in the electricity market. The first chapter develops a theoretical framework to investigate the conditions that favour the transition to a low-carbon hydrogen-based road transport sector. Findings suggest that when consumers have limited information about the hydrogen origin, no new green producers enter the market. A label for green hydrogen allows multiple production technologies to co-exist, but society is better-off when producers use vertical restraints to increase consumers' information. The second chapter relies on an empirical strategy to investigate the market diffusion of green vehicles in public fleets in California between 2012 and 2019. Green fleets follow a diffusion equilibrium of innovation; but manufacturer's strategies seems to be limited by regulation instruments such as fleet replacement targets. Findings suggest that rebates perform poorly to provide incentives for green fleets. Thus, command-and-control regulations are better suited for public purchases compared to market based instruments. The third chapter builds a model of the electricity market calibrated with data from Quebec, to study investments on solar and storage capacity. The government chooses between a quantity or a price-based energy regulation. Under the current technology costs, and round-trip efficiency, power-to-gas storage is never possible. Only a cost reduction of the grid's operating costs allows a feed-in-tariff such that consumers invest in decentralised storage, and the grid makes positive profits. Consumer surplus and welfare are always larger with a quantity regulation, which is compatible with centralised storage.