



**HAL**  
open science

# Les emballages alimentaires à base de PHA dans un contexte d'économie circulaire : Etude de l'effet des polyphénols sur la stabilité du PHBV au cours des différentes étapes de son cycle vie.

Chloë Bonnenfant

## ► To cite this version:

Chloë Bonnenfant. Les emballages alimentaires à base de PHA dans un contexte d'économie circulaire : Etude de l'effet des polyphénols sur la stabilité du PHBV au cours des différentes étapes de son cycle vie.. Autre. Université de Montpellier, 2022. Français. NNT : 2022UMONG090 . tel-04135690

**HAL Id: tel-04135690**

**<https://theses.hal.science/tel-04135690>**

Submitted on 21 Jun 2023

**HAL** is a multi-disciplinary open access archive for the deposit and dissemination of scientific research documents, whether they are published or not. The documents may come from teaching and research institutions in France or abroad, or from public or private research centers.

L'archive ouverte pluridisciplinaire **HAL**, est destinée au dépôt et à la diffusion de documents scientifiques de niveau recherche, publiés ou non, émanant des établissements d'enseignement et de recherche français ou étrangers, des laboratoires publics ou privés.

# THÈSE POUR OBTENIR LE GRADE DE DOCTEUR DE L'UNIVERSITÉ DE MONTPELLIER

En Biomatériaux

École doctorale GAIA :  
Agroressources, Procédés, Aliments, Produits

Unité de recherche :  
Ingénierie des Agropolymères et Technologies Émergentes

Les emballages alimentaires à base de PHA dans un  
contexte d'économie circulaire :

Etude de l'effet des polyphénols sur la stabilité du  
PHBV au cours des différentes étapes de son cycle de vie

Présentée par Chloë BONNENFANT  
Le 23 novembre 2022

Sous la direction de Chahinez AOUF  
et Nathalie GONTARD

Devant le jury composé de

Anna MASEK, maître de conférences, Lodz University of Technology, Lodz, Pologne  
Pascal DEGRAEVE, professeur des universités, Université Claude Bernard, Lyon  
Chahinez AOUF, chargée de recherche, INRAe Montpellier  
Nathalie GONTARD, directrice de recherche, INRAe Montpellier

Rapporteure  
Président du jury  
Directrice de thèse  
Co-directrice de thèse



UNIVERSITÉ  
DE MONTPELLIER







*Chacun d'entre nous a un talent.  
Chacun d'entre nous peut faire sa part.  
Il suffit de trouver comment.*

*Cyril Dion*



## Remerciements

Je souhaiterais dans un premier temps remercier les membres de mon jury ; mes rapporteuses ; Anna Masek et Valérie Langlois, mon examinateur et finalement président du jury : Pascal Degraeve, ainsi qu'Hélène Fulcran en tant que membre extérieure pour nos échanges riches et intéressants lors de ma soutenance. Merci infiniment à Anna Masek d'être venue spécialement de Pologne pour juger ce travail.

J'aimerais ensuite remercier mes directrices de thèse Chahinez Aouf et Nathalie Gontard. Merci pour vos conseils précieux qui m'ont permis d'arriver au bout de ces trois ans de thèse de la manière la plus sereine possible.

Nathalie, merci pour ton temps, pour tes conseils d'expertes qui ont été si importants pour prendre du recul sur notre travail. Nos discussions m'ont permis de souvent me remettre en question et de replacer cette thèse dans son contexte global pour ne pas oublier notre objectif à long terme. J'admire ton ouverture, tes collaborations et ton engagement pour transmettre et vulgariser nos découvertes à un public plus large. Tu es une véritable source d'inspiration.

Chahinez, je ne te remercierai jamais assez pour ton soutien quotidien pendant ces trois années. Ta disponibilité nous a permis d'avoir de nombreux échanges et réflexions qui m'ont aidé à aller au bout de ce projet. Tu as toujours su me rappeler l'intérêt de notre recherche, et me rappeler la signification de cette petite pierre que j'apportais à ce grand édifice. Je suis très heureuse et fière d'avoir été au bout de ce beau projet à tes côtés.

Je remercie également l'UMR IATE de m'avoir accueilli dans ses locaux et en particulier l'équipe ePOP dans laquelle j'ai eu la chance de travailler pendant ces trois années. La disponibilité de chacun de ses membres a rendu les interactions fluides et les partages de connaissances aisés. Vous avez tous participé à votre manière à mon intégration et à me faire sentir bien avec vous. Merci en particulier à Lucile pour ton aide précieuse en microbiologie et biodégradation, à Fanny et Hélène pour tous vos conseils qui ont été si importants pour moi et enfin merci à mon papa Seb pour tout ce que tu as fait moi (du dépannage express d'ordi, à S.O.S fourmis en passant par notre amour en commun pour les pâtisseries).



J'ai eu la chance de collaborer et d'obtenir de l'aide d'un bon nombre de personnes durant cette thèse, que je me dois de remercier grandement :

- Cecile Barron pour ton aide en statistiques et tes explications d'XLSTAT.
- Aurélie Putois pour tes nombreuses après-midi passées en ma compagnie au MEB.
- Amine Geneste à l'UM pour ta rapidité dans les mesures d'OIT.
- Genevière Conejero pour ton accueil au CIRAD et ton expertise sur la microscopie fluorescente.
- Nicolas Lemoigne pour ton accueil aux Mines d'Alès et ton temps précieux pour m'accompagner lors de mes mesures de microscopie en lumière polarisée.
- Thiebault Niedelet pour la formation que tu nous as dispensé sur les études statistiques et l'utilisation du logiciel R.
- Lucas Suc pour nos nombreuses heures passées devant cette HPLC de malheurs qui ne marchait qu'avec toi ! Merci pour ta patience.

Je voudrais également remercier mon comité de suivi de thèse : Eric Pollet, Claire Dufour et Céline Pochat-Bohatier. Ces deux comités m'ont permis de me préparer à la soutenance sans même que je ne m'en rende compte. Merci pour vos conseils précieux et vos encouragements.

Un grand merci également à tous les stagiaires avec qui j'ai eu la chance de travailler :

- Hugues Cazette, mon premier stagiaire en tant qu'encadrante. Merci pour tout le travail que tu as fourni qui nous aura valu un joli papier sur les tests d'usage.
- Clara Campos, merci pour toute ton aide en microbio, ainsi qu'au microcompounder.
- Lucas Rodriguez et Alexis Bessière, merci pour votre temps passé à doser mes petits pots de soude et à suivre la biodégradation. Votre aide m'a permis de me libérer énormément de temps si précieux.

Un mot ensuite pour mes collègues et amis du labo qui sont devenus ma deuxième famille. Merci pour tous ces moments partagés ensemble qui m'ont fait me sentir bien et m'ont permis de me surpasser dans les moments plus difficiles. Merci à Grégoire, Anaïs et Khoa d'avoir été là quand je suis arrivée pour bien m'intégrer et pour répondre à mes

50 000 questions. Merci Marouane pour toutes nos discussions si intéressantes, pour tous ces délicieux repas marocains, ces karaokés enflammés, ces crêpes à mille trous, ces pièces de théâtre. Tu as toujours été là quand j'en ai eu besoin et je te remercie pour ça. Merci infiniment au Gossip Brunch : Lulu, Isa, Dine et Camcam. A distance ou près de moi pour ces 3 années vous avez été si importantes. Merci pour l'organisation incroyable de tous les anniversaires, merci pour votre écoute et vos conseils. Merci pour les brunchs dantesques, et les soirées de crise puzzle. Je n'oublierai jamais votre soutien du début à la fin de cette thèse. Merci à ma Colinette, tu as été pour moi un modèle de persévérance et de résilience. Nous nous sommes découvertes de nombreux points communs et cette thèse qui nous aura mis à rude épreuve sera le tremplin vers un avenir plus aligné j'espère, j'y veillerais. Merci à tous ceux qui ont rejoint l'aventure en route Chloé, Alexis, Estelle, Emma, Alli, Paul, Aynura et Heloïse. Vous avez apporté un regard nouveau et de l'air frais sur ces trois années de thèse. Vous avez contribué à me faire sentir bien au labo. Nous nous sommes découvert de nombreuses passions communes que ce soit la politique, la musique ou les dégustations de vin... Et évidemment un grand merci à vous tous pour avoir organisé ma soutenance, je n'aurais pas pu espérer mieux.

Je souhaiterais ensuite remercier tous mes amis en dehors de Montpellier qui ont été si précieux également et qui m'ont permis de m'aérer l'esprit pendant ces trois ans.

Merci à mon amie de toujours, ma Chachou. Tu as toujours été là dans toutes les épreuves et tu m'as montré encore une fois ton amitié indéfectible. Merci pour les bouffées d'oxygène et pour ces voyages en Côte d'Ivoire qui m'ont permis de respirer.

Merci à mes amis du Lycée de Barbezieux, Luc, Clément, Gwen et Max pour nos retrouvailles charentaises et votre soutien depuis de nombreuses années.

Un grand merci également à la teamCG de Poitiers ; Agnès, Julien, Nino, Pierrot et Doudou. Vous savez à quel point vous êtes important pour moi. Je pensais avoir vécu le plus dur avec vous pendant la prépa, finalement peut-être pas ! Mais dans tous les cas, vous avez toujours été là pour me soutenir.

Un petit mot bien sûr pour mes amis de Strasbourg qui ont été très présents pour moi pendant ces trois années :

Merci à la team sudiste Mag et Marion pour nos escapades marseillaises ainsi que nos visios toujours très qualitatives. Merci à ma Laetitia toujours là pour m'écouter me plaindre chaque

semaine dans mes podcasts audio de 20 min. Tu sais à quel point ça a été important pour moi. Merci à Kim, Laz, Antoine et Nina de m'avoir toujours accueilli à Strasbourg comme il se doit. Merci à la Team Pussy : Tiff, Valou et mention particulière aux petites catchouteuses Arthur et Dan avec qui j'ai passé de sacrées soirées parisiennes et autre. Merci à mon Loïc et mon Brice pour vos visites et vos messages, un jour promis on arrivera à se faire ces vacances tous les trois !!

Merci à ma famille ECPM si précieuse : Flo, Jérôme, Lisa et Adrien.

Merci à ma grosse tchoin de Caen, Quentin. Merci d'avoir pris un train de nuit pour venir me rendre visite et passer un moment d'ouf autour de discussions philosophiques existentielles.

Merci aussi à Bérénice et Milane que je n'ai pas pu voir énormément pendant ces trois ans mais que je n'oublie pas.

Un petit mot à mes amis rencontrés en Argentine : Eva merci pour ton soutien et pour nos week-ends à Montpellier qui m'ont toujours fait beaucoup de bien. Tamara, thank you so much for supporting me since the beginning. I had a great time visiting Vienna during this PhD and it helped me a lot to have you by my side even at the opposite of Europe. Thank you for being here!! Y por fin, un gran gracias y abrazo para la guanaca Silvina. Gracias para mostrarme lo que era una tesis sin estrès, jajaja !! Gracias tambien por tu visita en Montpellier. La pase re bien, aunque me estreso un monton la redacion de la tesis. Gracias por todo.

Et enfin, je souhaiterais remercier tous les membres de ma famille qui me soutiennent depuis toujours. Ces trois ans ont été éprouvant parfois mais je savais où aller lorsque je voulais me sentir bien. Merci pour ce cocon que j'aime tant. Merci à Papa et Maman, à Carla qui a pris mon appart pour sa résidence de vacances, à Yoyo et Noémie pour l'air frais de la montagne, à Tata Nicole pour son soutien inconditionnel, à Tonton Patrice pour ces appels, à Annie et Jean pour leurs messages de soutien et à Jimmy pour ces blagues téléphoniques. Et bien sûr un grand merci à tout le reste de la famille, ils sont si nombreux, votre soutien a été essentiel.

## Valorisation des travaux de recherche

### Published articles:

C. Bonnenfant, N. Gontard, C. Aouf (2022). *Extending biopolyesters circularity by using natural stabilizers: A review on the potential of polyphenols to enhance Poly(hydroxyalkanoates) thermal stability while preserving its biodegradability*. *Polymer testing*, 110, 107561. <https://doi.org/10.1016/j.polymertesting.2022.107561>.

C. Bonnenfant, N. Gontard, C. Aouf (2022). *Biobased and biodegradable polymers in a circular economy context: Understanding quercetin and gallic acid impacts on PHBV thermal properties*. *Polymer degradation and Stability* 201, 109975. <https://doi.org/10.1016/j.polymdegradstab.2022.109975>.

C. Bonnenfant, L. Chattelard, N. Gontard, C. Aouf. (2022) *Effect of quercetin and gallic acid on the microbial degradation of PHBV materials*. *Journal of Polymers and the Environment*. <https://doi.org/10.1007/s10924-022-02708-7>

### Articles submitted or waiting for submission:

C. Bonnenfant, N. Gontard, C. Aouf. *Reuse ability of PHBV-based food packaging materials*. (under review in *Polymers*)

I. Dedieu, C. Bonnenfant, S. Peyron, N. Gontard, C. Aouf. *Decontamination of PHBV material intended for food contact applications: relevance of the contaminants panel and the role of quercetin as additive*.

### Posters in national and international congress:

C. Bonnenfant, N. Gontard, C. Aouf, *Active Packaging: Incorporation of polyphenols in polyhydroxyalkanoates (PHA): thermal stabilization and antioxidant properties*.

Presented in:

- VII International Seminar on Biopolymers and sustainable composites. Valencia (Spain) 4-5 March 2020.
- 16ème journées du Groupe Français des Polymères – section Méditerranée. Alès (France) 9-10 March 2020.

**Oral presentation in national congresses:**

C. Bonnenfant, N. Gontard, C. Aouf, Thermal stabilization during processing: impact of blending PHA with polyphenols.

Presented in:

- 48èmes Journée d'Etudes des Polymères. Ile de Porquerolles (France) 3-8 October 2021.
- 17ème journées du Groupe Français des Polymères – section Méditerranée. Marseille (France) 7-8 April 2022.

**Oral presentation in international congress:**

C. Bonnenfant, N. Gontard, C. Aouf. *Biobased and biodegradable polymers in a circular economy context: Understanding quercetin and gallic acid impacts on PHBV thermal properties*. EPF – European Polymer Congress. Prague (Czech Republic) 26 June- 1 July 2022.



# Summary

GENERAL INTRODUCTION	1
CHAPTER 1. STATE OF THE ART	9
<b>I. Plastic waste hierarchy</b>	<b>11</b>
I.1 What is the fate of conventional plastic waste in a linear economy model?	11
I.1.1 Linear economy of plastics: the fact	11
I.1.2 Drawbacks of the linear economy of plastics	12
I.2. Circular economy of plastics: implementation and limitations	13
I.2.1 Create an efficient after-use plastics economy: reuse and recycling	14
I.2.1.1 Reuse	14
I.2.1.2 Recycling	15
I.2.2 Decouple plastics from fossil feedstock: bio-based polymers	17
I.2.3 Drastically reduce the leakage and impact of plastic into natural systems: biodegradable polymer	19
<b>II. Polyphenols in PHA matrix: impact on thermal stability and biodegradability</b>	<b>20</b>
II.1 Polyhydroxyalkanoates	20
II.1.1 Definitions	20
II.1.2 PHA chemical-physical properties	22
II.1.2.1 Mechanical properties	22
II.1.2.2 Barrier properties	23
II.1.2.3 PHAs as food contact material	24
II.1.3 PHA as food packaging: present status	25
II.1.4 End-of-life options of PHAs: present status	25
II.1.4.1 Reuse of PHA-based packaging	25
II.1.4.2 Mechanical recycling of PHA-based packaging	26
II.1.5 PHA thermal degradation	26
II.1.6 Strategies to improve thermal and mechanical properties of PHA	28
II.2. Polyphenols	29
II.2.1 Definition and properties	29
II.2.2 Quercetin and Gallic acid	31
II.2.2.1 Quercetin	31
II.2.2.2 Gallic acid	31
II.3 Polyphenols as additives in PHAs and their effects on thermal stability	32

II.4 Effect of polyphenols on PHAs biodegradation	39
II.4.1 The antimicrobial activity of polyphenols	39
II.4.2 The microbial degradation of PHAs	40
II.4.3 Impact of polyphenols on polymers biodegradation	43
II.5 Conclusion	45
<b>CHAPTER 2. MATERIALS AND METHODS</b>	<b>49</b>
<b>I. Materials</b>	<b>51</b>
I.1 Polymer	51
I.2 Polyphenols	51
I.3 Other chemicals	52
<b>II. Methods</b>	<b>52</b>
II.1 Chemical synthesis	52
II.2 Preparation of PHBV/polyphenols and PET films	53
II.3 Simulation of use and reuse of PHBV-based materials: food contact ability and washing cycles	54
II.3.1 Usage simulation: contact with food simulants	54
II.3.2 Reuse simulation: washing cycles	55
II.3.3 Overall migration measurement (OM)	55
II.3.4 Relative migration (RM)	56
II.4 Simulation of closed-loop mechanical recycling: thermal decontamination	57
II.4.1 Contamination procedure of PHBV and PHBV-Q	57
II.4.2 Decontamination procedure	57
II.4.2.1 Decontamination process	57
II.4.2.2 Decontamination efficiency	58
II.5 Assessment of PHBV-based material biodegradability	58
II.5.1 PHBV-based films degradation in liquid medium, in the presence of <i>Streptomyces exfoliatus</i>	58
II.5.1.1 The preparation of the <i>S. exfoliatus</i> solution	58
II.5.1.2 Degradation of PHBV-based films in pure culture solution of <i>S. exfoliatus</i>	59
II.5.1.3 Evaluation of the microbial growth and cell morphology	59
II.5.1.4 Evaluation of the antibiotic effect of polyphenols	59
II.5.2 Biodegradation of PHBV-based films under home compost conditions	60
II.6 UPLC/MS analysis	62
II.7 Characterization of the physical-chemical properties of PHBV-based materials	62
II.7.1 Size exclusion chromatography (SEC)	62



II.7.2 Differential scanning calorimetry (DSC)	63
II.7.3 Thermogravimetric analysis (TGA)	63
II.7.4 Tensile properties	64
II.8 Structural characterization of PHBV-based materials	64
II.8.1 Fluorescent microscopy	64
II.8.2 Polarized optical microscopy (POM)	64
II.8.3 Scanning electron microscopy (SEM)	65
II.9 Statistical analyses	65
<b>CHAPTER 3. IMPACT OF POLYPHENOLS ON THE STRUCTURAL AND THERMOMECHANICAL PROPERTIES OF PHBV DURING PROCESSING</b>	<b>67</b>
<b>I. Introduction</b>	<b>70</b>
<b>II. Materials and methods</b>	<b>72</b>
II.1 Materials	72
II.2 Synthesis of methyl gallate	72
II.3 Preparation of PHBV/polyphenols films	72
II.4 Extraction of polyphenols from the films and their UPLC quantification	73
II.5 Morphological analyses	73
II.5.1 Fluorescence Microscopy	73
II.5.2 Polarized Optical Microscopy (POM)	74
II.6 Thermal analyses	74
II.6.1 Differential scanning calorimetry (DSC)	74
II.6.2 Thermogravimetric Analysis (TGA)	75
II.7 Size Exclusion Chromatography (SEC)	75
II.8 Mechanical analysis: tensile test	75
II.9 Statistical analyses	76
<b>III. Results and discussion</b>	<b>76</b>
III.1 Polyphenols in the PHBV matrices	76
III.1.1 Stability of polyphenols during the thermoforming process	76
III.1.2 The morphology of the PHBV/polyphenol matrices	76
III.1.2.1 Fluorescence microscopy	77
III.1.2.2 Polarized Optical microscopy	78
III.2 Impact of polyphenols on thermal and mechanical properties of PHBV	80
III.2.1 Impact of polyphenols on thermal properties of PHBV	80
III.2.2 Impact of polyphenols on mechanical properties of PHBV	83

III.3 The role of the polyphenol structure on the degradation mechanism of PHBV: case of gallic acid	85
<b>IV. Conclusion</b>	<b>87</b>
<b>CHAPTER 4. IMPACT OF POLYPHENOLS ON PHBV-BASED FOOD PACKAGING UNDER USE AND REUSE CONDITIONS</b>	<b>89</b>
<b>I. Introduction</b>	<b>92</b>
<b>II. Material and methods</b>	<b>94</b>
II.1 Materials	94
II.2 Preparation of the PHBV/quercetin films	95
II.3 Migration into food simulants	95
II.4 Simulation of polymer washing	96
II.5 The overall migration/release measurement (OM)	96
II.6 The relative migration/release measurement (RM)	97
II.7 Scanning electron microscopy (SEM)	98
II.8 Differential scanning calorimetry (DSC)	98
II.9 Thermogravimetric Analysis (TGA)	98
II.10 Size Exclusion Chromatography (SEC)	99
II.11 Statistical analysis	99
<b>III. Results and Discussion</b>	<b>99</b>
III.1. Stability of PHBV and PHBV-Q films after one cycle of reuse	99
III.1.1 Overall and relative migration	100
III.1.2 Physical-chemical properties of PHBV and PHBV-Q after one cycle of reuse (food contact-detergent washing-food contact)	102
III.2 Stability of PHBV and PHBV-Q films after successive cycles of washing in water and detergent	103
III.2.1 Overall and relative release after successive washing in water and detergent	104
III.2.2 Physical-chemical properties of PHBV and PHBV-Q after successive washing cycles in water and detergent	106
III.3 Stability of PHBV and PHBV-Q films after caustic soda washing	111
III.3.1 PHBV and PHBV-Q films microstructure after caustic soda washing	111
III.3.2 Overall and relative release of PHBV and PHBV-Q films after NaOH washing	114
<b>IV. Conclusion</b>	<b>117</b>
<b>V. Complementary results: The impact of gallic acid on PHBV film under reuse conditions</b>	<b>119</b>
V.1 Stability of PHBV-GA after food contact simulation	119
V.1.1 Overall and relative migration	119
V.1.2 Physical-chemical properties of PHBV-GA after one food contact simulation	120

V.2 Stability of PHBV-GA after successive cycles of washing in water and detergent	121
V.2.1 Overall and relative release of PHBV-GA after successive washing in water and detergent	121
V.2.2 Physical-chemical properties of PHBV-GA after successive washing cycles in water and detergent.	121
V.3 Stability of PHBV-GA after caustic soda washing	123
V.3.1 PHBV-GA films microstructure after caustic soda washing	123
V.3.2 Overall and relative release of PHBV-GA films after NaOH washing	125
<b>CHAPTER 5. EVALUATING/OPTIMIZING THE THERMAL DECONTAMINATION OF PHBV FOOD PACKAGING</b>	<b>127</b>
<b>I. Introduction</b>	<b>130</b>
<b>II. Materials and methods</b>	<b>132</b>
II.1 Materials	132
II.2 Production of neat-PHBV and PHBV-quercetin (PHBV-Q) films	133
II.3 Contamination procedure of PHBV and PHBV-Q flakes	134
II.4 Decontamination procedure of PHBV and PHBV-Q flakes	134
II.4.1 Decontamination process	134
II.4.2 Decontamination efficiencies	135
II.5 Characterization of the physical-chemical properties of PHBV and PHBV-Q flakes after decontamination process	135
II.5.1 Size Exclusion Chromatography (SEC)	135
II.5.2 Differential Scanning Calorimetry (DSC)	136
II.6 Statistical analysis	136
<b>III. Results and discussion</b>	<b>137</b>
III.1 Decontamination of neat PHBV film	137
III.2 Impact of quercetin on the decontamination efficiency and thermal properties of PHBV film	140
<b>IV. Conclusion</b>	<b>143</b>
<b>CHAPTER 6. IMPACT OF POLYPHENOLS ON PHBV BIODEGRADABILITY</b>	<b>145</b>
<b>I. Introduction</b>	<b>148</b>
<b>II. Material and methods</b>	<b>150</b>
II.1 Preparation of PHBV-polyphenols and PET films	150
II.2. PHBV-based films degradation in liquid medium, in the presence of <i>Streptomyces exfoliatus</i>	151
II.2.1 Preparation of the <i>S. exfoliatus</i> solution	151
II.2.2 Degradation of PHBV-based films by in pure culture solution of <i>S. exfoliatus</i>	151

II. 3 Characterizations of the PHBV-residual films and culture media after degradation	152
II.3.1 Evaluation of the microbial growth and cell morphology	152
II.3.2 Polyphenols quantification in the culture supernatant	152
II.3.3 Characterization of PHBV-based films	152
II.3.3.1 Scanning Electron Microscopy (SEM)	152
II.3.3.2 Differential scanning calorimetry (DSC)	153
II.4 Evaluation of the antibiotic effect of polyphenols	153
II.5 Biodegradation of PHBV-based films under home compost conditions	154
II.6 Statistical analysis	155
<b>III. Results and discussion</b>	<b>155</b>
III.1 Microbial degradation of PHBV-based materials by <i>S. exfoliatus</i> in liquid media	155
III.1.1 Development of <i>S. exfoliatus</i> during the polymers degradation	156
III.1.2 The behavior of <i>S. exfoliatus</i> in the presence of quercetin and gallic acid solutions at different concentrations (antimicrobial sensitivity test)	158
III.1.3 The evolution of the surface morphology of PHBV, PHBV-Q and PHBV-GA films throughout <i>S. exfoliatus</i> -assisted degradation	161
III.2 Biodegradability of PHBV-based materials under home composting condition	164
<b>IV. Conclusion</b>	<b>167</b>
CONCLUSION, GENERAL DISCUSSION AND PERSPECTIVES	169
REFERENCES	179
APPENDIX 1	199
APPENDIX 2	207

## Abbreviations

PHA: polyhydroxyalkanoates

PHBV: poly(hydroxybutyrate-co-hydroxyvalerate)

PP: polypropylene

PLA: polylactic acid

PBS: polybutylene succinate

PVA: poly(vinyl alcohol)

PCL: polycaprolactone

PEG: polyethylene glycol

BHA: butyl hydroxyl anisol

BHT: butyl hydroxyl toluene

TGA: thermogravimetric analysis

DSC: differential scanning calorimetry

SEM: scanning electron microscopy

POM: polarized optical microscopy

OM: overall migration

RM: relative migration

FS: food simulant

WL: washing liquid

MIC: minimum inhibitory concentration

ESFA: european food safety authority

ASTM: american society for testing and material

GYM: glucose/yeast/malt

# GENERAL INTRODUCTION

## Introduction

La production mondiale de plastique a atteint 367 Mt en 2020, avec plus de 40 % destinée au secteur de l'emballage. Depuis les années 2000, l'utilisation de plastique pour la production de matériaux à usage unique ou à très courte durée de vie a connu une recrudescence considérable. En conséquence, plus de 75 % du plastique produit à ce jour se présente sous forme de déchets, dont un tiers environ se retrouve dans l'environnement [1]. Cette pollution, n'a malheureusement pas été anticipée, lorsque la production des matières plastiques était considérée comme une véritable révolution. Contrairement au bois, au coton, à la laine et au papier, qui en se dégradant réintègrent assez rapidement le cycle du carbone, les liaisons chimiques qui composent les plastiques sont résistantes aux attaques microbiennes. Le processus de dégradation, qui se fait principalement par érosion, dure plusieurs centaines d'années et conduit à la formation de micro et nano-particules qui se propagent dans l'air, l'eau, le sol, absorbent les contaminants qu'ils rencontrent sur leur chemin et finissent par pénétrer dans les organismes vivants [2]. La quantité de plastiques rejetée dans notre environnement est aujourd'hui astronomique. Le danger qui en résulte est tellement important qu'il est difficile à quantifier car ces particules vont persister au moins plusieurs siècles [3].

Face à cette catastrophe environnementale, une approche systémique du problème doit être envisagée avec des prises de mesures immédiates sur toute la chaîne de valeur du plastique, mais également une responsabilisation de toutes les parties prenantes impliquées. Ainsi, de nombreuses initiatives commencent à voir le jour. A titre d'exemple, en France, le ministère de la transition écologique a mis en place le « Plan gouvernemental économie circulaire » dans lequel s'inscrit la loi « anti-gaspillage pour une économie circulaire » (AGEC). Afin de concrétiser ce plan, des décrets ont été promulgués, dont le plus récent est le décret 3R (avril 2022). Il vise à asseoir les trois piliers suivants : Réduction, Réemploi et Recyclage.

Au niveau européen, des mesures ont également été prises, comme l'incitation des états membres à interdire la commercialisation de certains produits à usage unique (couverts, coton tiges, ...) à partir du premier janvier 2021, en référence à la directive 2019/904 [4].

Outre les gouvernements et les associations, le monde de la recherche s'est également vite saisi de cette question et tente d'apporter des solutions innovantes, économiquement viables et respectueuses de l'environnement. En plus des multiples études portant sur l'amélioration des voies de recyclage (mécanique, chimique, biologique), de plus en plus de chercheurs et chercheuses se penchent aujourd'hui sur l'utilisation des matériaux biosourcés et biodégradables pour la conception de matériaux à usage unique, et notamment dans le domaine des emballages alimentaires. Le caractère biosourcé de ces matériaux permet de s'affranchir de l'utilisation de matière première fossile tandis que leur caractère biodégradable permet de résoudre les problématiques liées à la fin de vie des plastiques [5]. Dans un but de valorisation maximale de la chaîne de valeur du polymère, l'idée est d'aller plus loin en intégrant les matériaux biosourcés et biodégradables dans les circuits d'économie circulaire définis au préalable pour les polymères usuels. Cette combinaison permettrait une valorisation dans sa globalité du matériau en l'intégrant dans des boucles de ré-usage et de recyclage, avec comme fin de vie ultime, la biodégradation, qui permet de garantir que le matériau ne représente aucun risque de propagation de particules, contrairement au plastique traditionnel. De nombreux projets de recherche, notamment des projets européens auxquels notre équipe a participé ou que nous avons coordonnés (EcoBioCAP, NoAW, Glopac, Usable), se sont développés au cours de la dernière décennie afin d'explorer différentes voies d'amélioration de ces matériaux biodégradables pour leur permettre de s'insérer dans le marché des plastiques d'aujourd'hui [6] et de celui de la valorisation de la biomasse non alimentaire dans les domaines de l'énergie et des matériaux. La réduction des coûts de production et l'ajustement des propriétés fonctionnelles aux besoins exprimés ont été les aspects les plus largement étudiés.

Parmi les polymères biosourcés et biodégradables en conditions naturelles, les polyhydroxyalcanoates (PHA) sont des polyesters qui suscitent un intérêt croissant. Ce sont des polymères produits par fermentation bactérienne de sucres et de lipides, provenant notamment de résidus agroalimentaires. Les propriétés des PHAs sont hautement dépendantes des monomères qui les constituent et il en existe une grande variété. Appartenant à la famille des PHAs, le PHBV (poly(hydroxybutyrate-co-hydroxyvalérate)) est un copolymère biocompatible, avec de bonnes propriétés barrières et certaines propriétés mécaniques proches de celles du polypropylène (PP), ce qui fait de lui un bon candidat pour remplacer les polymères pétro-sourcés dans le domaine de l'emballage [7]. Cependant, le



déploiement de ce type de polymères est encore limité, à cause principalement de leur coût élevé et de leur sensibilité thermique (dégradation à des températures proches de leur point de fusion) [8].

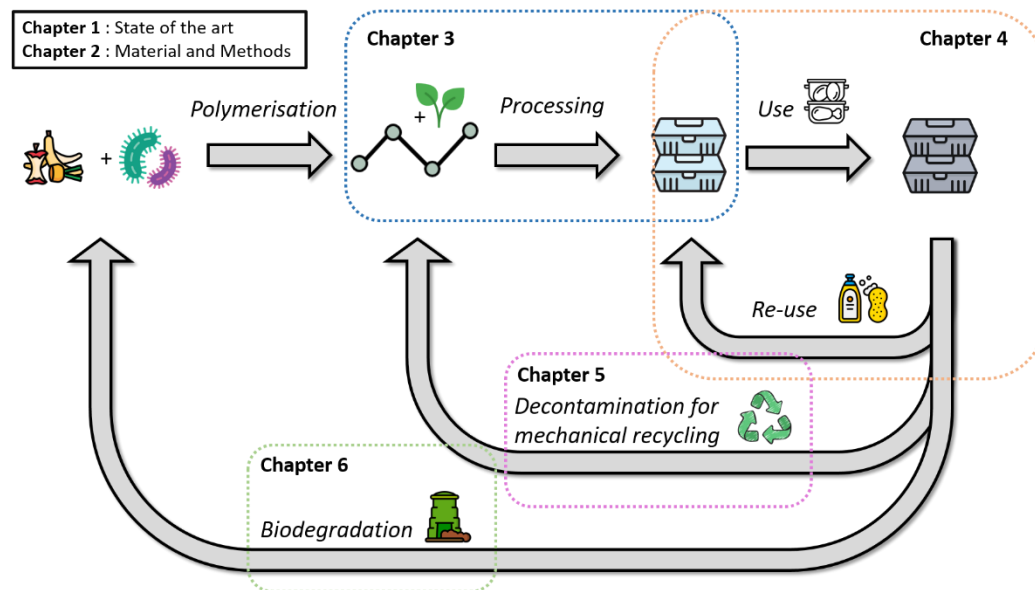
De nombreuses études sont en cours afin de réduire le coût de production de ces polymères telles que l'utilisation de résidus d'agroressources comme matière première, ou l'amélioration des procédés de séparation et de purification [9]. En ce qui concerne l'amélioration des propriétés fonctionnelles, différentes voies ont été envisagées, parmi lesquelles, se trouvent essentiellement les mélanges (blends) des PHAs avec d'autres polymères biodégradables comme le PLA ou le PBS, ou l'ajout d'additifs inorganiques tels que l'oxyde de zinc. Afin de conserver le caractère biosourcé, biocompatible et biodégradable des PHAs, certaines études se sont intéressées à l'utilisation d'additifs issus d'extraits végétaux, comme les terpènes et les composés phénoliques. Les polyphénols sont des métabolites secondaires de plantes, impliqués dans la protection contre les UV et la lutte contre les agressions des agents pathogènes. On les retrouve chez les végétaux supérieurs, dans pratiquement toutes les parties de la plante (racines, feuilles, écorces, fruits). Ils se caractérisent par la présence d'un ou plusieurs groupements phénoliques associés en structures plus ou moins complexes. Les polyphénols ont un caractère antioxydant bien établi, et certains d'entre eux ne se dégradent qu'à des températures dépassant les 200 °C. Afin de substituer les stabilisants phénoliques de synthèse (BHA, BHT), qui sont souvent controversés pour leurs potentiels effets de perturbateurs endocriniens [10], un nombre croissant d'études s'intéressent aux pouvoirs stabilisants (thermique, thermo-oxydatifs, UV...) des polyphénols dans des matrices polymériques.

Si certaines études se sont penchées sur l'addition de polyphénols aux matrices PHAs, très peu de travaux ont été effectués sur les mécanismes d'interaction entre ces derniers durant le processus de formulation, et aucune étude (à notre connaissance) ne s'est intéressée à l'impact des polyphénols sur la stabilité des PHAs, au cours du cycle de vie d'un emballage alimentaire.

Ce travail de thèse a pour but d'apporter de nouvelles connaissances sur l'utilisation d'additifs naturels pour l'amélioration des propriétés d'usage et de réusage des emballages alimentaires biosourcés et biodégradables. Ce travail a été réalisé au sein de l'équipe ePOP

(eco-efficient Polymeric and Organic Packaging) de l'UMR IATE (Ingénierie des Agro-polymères et Technologies Émergentes) à Montpellier.

L'objectif principal est d'étudier l'impact d'additifs polyphénoliques sur une matrice PHA, plus particulièrement le PHBV, au cours des étapes du cycle de vie d'un emballage alimentaire, à savoir, la formulation, l'usage, le ré-usage, le recyclage et la biodégradation (Figure 1).



**Figure 1:** Organisation des différents chapitres de la thèse suivant le cycle de vie d'un emballage alimentaire à base de PHBV.

Ce travail a tenté de répondre à deux questions scientifiques :

- Quelles sont les interactions/relations entre les polyphénols et le PHBV lors des différentes étapes du cycle de vie de l'emballage alimentaire ?
- Quel est l'impact des polyphénols sur la stabilité du PHBV au cours de ces différentes étapes ?

Notre choix s'est porté sur deux composés phénoliques de structure simple : l'acide gallique et la quercétine.

-L'acide gallique fait partie de la famille des acides phénoliques. À l'état naturel, il se retrouve principalement dans les galles de chênes ou les écorces, comme unité monomérique de structure complexe appelées gallotannins. D'un point de vue structurel, il est caractérisé

par la présence d'un seul cycle phénolique portant un groupement carboxylique et trois groupements hydroxyles en position *ortho*. Son effet en tant que stabilisant thermique a été peu étudié. Seul Luzi *et al.* ont montré une stabilisation thermique par ATG, lors de l'ajout de 5% en masse d'acide gallique dans une matrice poly(alcool vinylique) PVA [11].

-La quercétine est un polyphénol de la famille des flavonoïdes, composée de deux cycles aromatiques (séparés par un cycle pyrane), et quatre groupements hydroxyles phénoliques répartis sur les deux cycles aromatiques. Elle est présente dans plusieurs plantes communes comme l'oignon rouge ou le cacaoyer, généralement sous sa forme glycosidée (reliée généralement à un sucre). Elle se caractérise par une stabilité thermique plus importante que les autres flavonoïdes. D'anciennes études réalisées en 1951, *in vitro*, ont attesté de l'effet mutagène de la quercétine. Cependant, des études plus récentes ont prouvé le contraire, en démontrant l'absence de tout effet mutagène, cancérigène ou reproducteur lorsque la quercétine était ingérée pure à des doses de 100-150 mg.kg<sup>-1</sup> de poids corporel.jour<sup>-1</sup> [12].

Deux raisons ont motivé le choix de ces composés phénoliques :

- Leur simplicité structurelle qui va permettre de mieux étudier/comprendre les interactions entre additifs et matrice polymère.
- La différence de structure qui va permettre d'évaluer l'impact des groupements chimiques constituant la molécule phénolique sur la stabilisation du polymère.

Ce manuscrit de thèse est articulé en cinq chapitres.

Le premier chapitre est une synthèse bibliographique en deux parties. La première donne un aperçu sur les différentes réglementations en vigueur concernant le traitement des déchets plastiques dans un schéma d'économie circulaire. La seconde est consacrée à l'utilisation des polyphénols comme additifs dans les matrices PHAs et son impact sur la stabilisation thermique et la biodégradation de ces polymères.

Le matériel et les méthodes utilisés dans cette thèse sont regroupés dans le second chapitre.

Dans le troisième chapitre, nous nous intéressons à l'impact des polyphénols sur la stabilisation thermique du PHBV durant la formulation (extrusion, thermo-pressage). Pour cela, différents pourcentages d'additifs ont été testés et le mécanisme d'interaction entre les polyphénols et le PHBV a été élucidé. A l'issue de ce chapitre le pourcentage de polyphénols qui a présenté le meilleur résultat en matière de stabilisation, a été sélectionné.

Le quatrième chapitre aborde l'usage et le ré-usage du PHBV et l'impact des polyphénols durant ces étapes. Ainsi, les matériaux vierges et additivés ont subi des cycles d'usage au contact de simulants alimentaires, ainsi que des cycles de ré-usages se traduisant par des lavages successifs avec de l'eau, du détergent et de la soude. Le lavage au détergent vise à simuler des cycles de lavage au lave-vaisselle. Le lavage à la soude est quant à lui une simulation des prétraitements subis par les plastiques lors du recyclage mécanique.

La simulation de l'une des étapes clés du recyclage mécanique en boucle fermée des emballages alimentaires est abordée dans le chapitre 5. Dans ce chapitre, le PHBV et les PHBV- polyphénols contaminés avec un certain panel de molécules chimiques, ont subi un traitement thermique sous vide dans le but d'éliminer les contaminants. Le rôle des polyphénols, en particulier de la quercétine, sur l'efficacité de décontamination, ainsi que sur la stabilité thermique du polymère lors de ce processus a été étudié.

Finalement, l'impact de ces polyphénols sur la biodégradation du PHBV est évalué dans le chapitre 6. La première partie de l'étude a porté sur l'effet des polyphénols sur une bactérie connue pour la dégradation du PHBV (*Streptomyces exfoliatus*). Dans la seconde partie, l'effet des polyphénols sur la dégradation du PHBV en condition de compost domestique a été étudié.



# CHAPTER 1

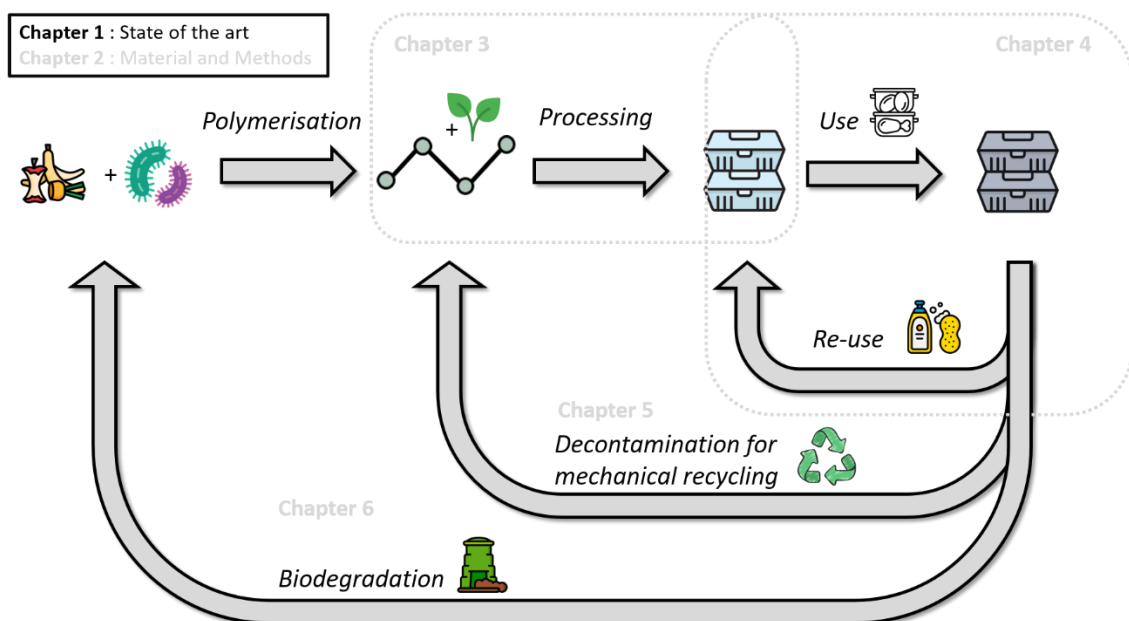
## STATE OF THE ART

## Chapter 1. State of the art

Ce premier chapitre vise à donner une vue d'ensemble du contexte dans lequel s'inscrit la thèse, en plus des travaux réalisés jusqu'à aujourd'hui sur l'impact des polyphénols sur la stabilité thermique des PHAs, et sur leur biodégradabilité.

La première partie présente une comparaison des deux modèles économiques de gestion des déchets plastiques. Le modèle linéaire prédominant, avec ses nombreux inconvénients, et le modèle plus vertueux qu'est l'économie circulaire des plastiques. Les différentes actions entreprises et à mener pour se diriger vers ce modèle sont abordées.

La seconde partie regroupe des généralités concernant les PHAs et les polyphénols, puis aborde l'effet des polyphénols sur les matrices PHAs, en terme de stabilisation thermique et mécanique, ainsi que sur leur biodégradabilité. Cette partie a fait l'objet d'une revue intitulée *"Extending biopolyesters circularity by using natural stabilizers: A review on the potential of polyphenols to enhance poly(hydroxyalkanoates) thermal stability while preserving its biodegradability"* publiée dans Polymer Testing Journal en Juin 2022 (doi.org/10.1016/j.polymertesting.2022.107561).



A major part of this chapter was the subject of a review intituled “*Extending biopolyesters circularity by using natural stabilizers: A review on the potential of polyphenols to enhance poly(hydroxyalkanoates) thermal stability while preserving its biodegradability*”, published in Polymer Testing Journal ([doi.org/10.1016/j.polymertesting.2022.107561](https://doi.org/10.1016/j.polymertesting.2022.107561)). To complete the chapter, additional paragraphs have been included, to define the hierarchy of plastic waste in a circular economy model, and to provide further clarification on the ability of PHAs to be used as food packaging.

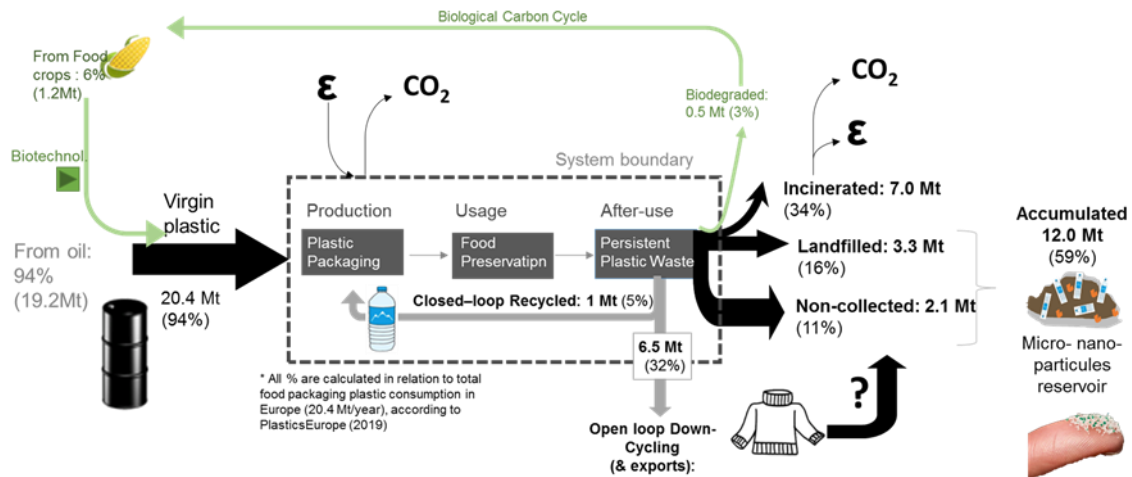
## **I. Plastic waste hierarchy**

### **I.1 What is the fate of conventional plastic waste in a linear economy model?**

#### **I.1.1 Linear economy of plastics: the fact**

Since the invention of synthetic polymers (early 1900’s), most of plastics are integrated in a linear economy model, which means that they are produced, used once and then discarded, the famous “single-use-plastic “. This description corresponds in particular to plastic packaging which represent almost 40 % of the 55 Mt of plastics produced in the Europe in 2020 [13]. The main types of plastic used in packaging are PET (bottles for water, juices...) LDPE and HDPE (milk and shampoo containers, bags, trays...) or PP (microwave dishes...). Today, 95 % of the value of plastic packaging, estimated at USD 80-100 billion annually, is lost to the economy. Based on the estimates of Geyer *et al.*, Figure 2 was constructed to give an overview of plastic packaging in Europe in 2019 [14]. In fact, almost 60 % are accumulated in the environment, between landfill, leakage and down-cycling; and approximately 34 % are transformed into energy. A very small portion (about 5 %) is currently recycled mechanically in a closed loop, with a very mature technology for bottle-to-bottle PET recycling. But even in this case, half of the PET produced is collected, and only 7 % is recycled in a closed loop [15].





**Figure 2:** Global current scenario of European plastic packaging consumption and end-of-life, adapted from Geyer *et al.* [14] and Gontard *et al.* [16].

### I.1.2 Drawbacks of the linear economy of plastics

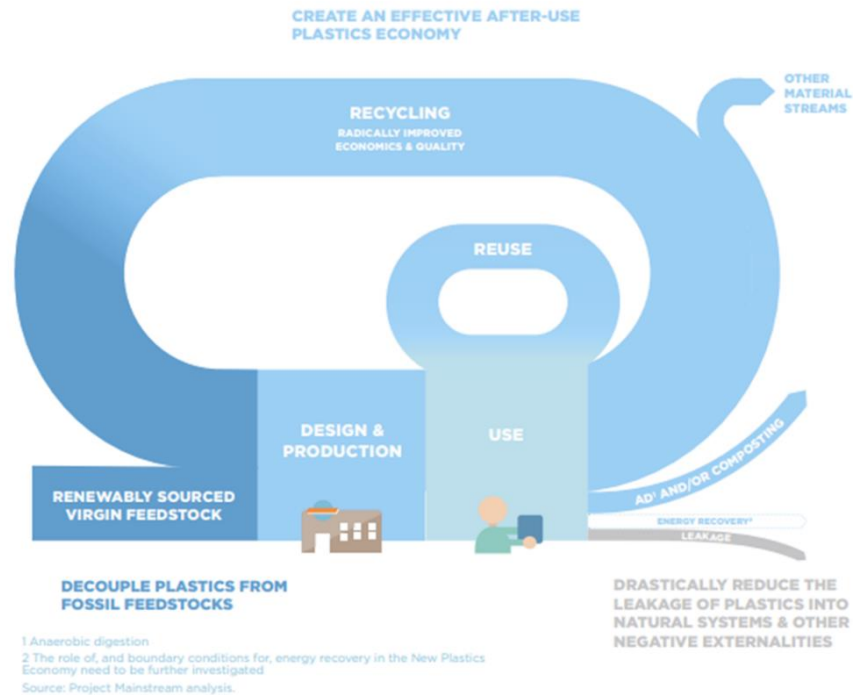
Several drawbacks are generated by this linear model of the plastics life cycle. First, with the increasing usage of plastic, the consumption of fossil resources by the plastic sector is expected to reach 20 % of the total global consumption by 2050 [15, 17]. Therefore, oil depletion could become a major issue in future production. Secondly, the greenhouse gases (GHGs) emitted by the production and incineration of plastics are of great concern, as the plastics industry's GHG emissions would reach 15 % of the total carbon footprint by the same deadline [15]. Plastic leaks into the environment are responsible for 8 million tons of waste in the ocean each year [18]. These materials are generally chemically resistant, which means that they degrade slowly by photodegradation, thermooxidative degradation, hydrolysis or biodegradation by microorganisms [19] which is leading to dissociation into increasingly smaller fragments. This overall process is very slow and can take 50 years for a foam plastic cups to 600 years for a fishing line [20]. When these degradations occur, all the micro and nanoparticles generated release all the additives and pollutants they harbor, including volatile organic species or Bisphenol A for example, with a risk of water and land pollution. In addition, these micro-plastics are ingested by organisms as fish and seabirds and can be found in air, water and ecosystems [21]. Although there is not yet solid evidence of their toxic effect on human health, research is continuing in this area [22].

In view of the consequences of such a linear economy, the transition to another more sustainable and more virtuous model becomes a necessity.

## **I.2 Circular economy of plastics: implementation and limitations**

The circular economy was conceived as an alternative to the current unsustainable linear economy model, which involves circularity of resource flows by preventing the loss of material from the system [23]. It is obviously going beyond the concept of recycling, as it represents a systemic approach combining economic activity, environmental and social sustainability. One of the main objectives behind the circular economy is to develop products that will be maintained at their highest value for as long as possible, eliminating dependence on fossil fuel resources. These products are pre-designed to reduce as much waste as possible and to minimize pollution and toxicity [24]. To integrate plastics in a circular economy model (Figure 3), a radical change in current practices and a complete overhaul of the plastic economy will be required. The Ellen Mac Arthur foundation in its report “The new plastics economy” proposes three main guidelines to move in this direction [15]:

- Create an efficient after-use plastics economy.
- Decouple plastics from fossil feedstock.
- Drastically reduce the leakage and impact of plastic in natural systems.



**Figure 3:** Guidelines for moving from linear to circular economy of plastics [15].

### I.2.1 Create an efficient after-use plastics economy: reuse and recycling

The circular economy of plastics is based on reuse and recycling, which are the main pillars of value retention in the material cycle.

#### I.2.1.1 Reuse

Fifty years ago, the reuse of post-consumer packaging (jars, glass bottles) was common. After the plastic revolution, filling systems gradually disappeared, and the remaining or returning points are now considered local niche activities. However, the most effective way to limit the amount of waste and reduce the quantities of raw materials used in production, is to reuse products [25, 26]. By reusing materials, the carbon footprint of manufacturing and the supply chain is reduced, and waste management actions are limited, resulting in reduced environmental and economic impacts. It is estimated that at least 20 % of plastic packaging could be replaced by reusable products [15]. To be implemented, the reuse strategy requires to design reusable, modular and standardized plastic packaging. But beyond the product itself, it is entire logistics around collection, shipping, storage and remarketing that must be thought out.

### I.2.1.2 Recycling

The second priority in the plastic waste management hierarchy is recycling. The concept of recycling is quite complex because of the different types of recycling/recovery systems that exist. Four categories are defined in ASTM D5033, as shown in Table 1. It should be noted that biological recycling, which involves the degradation of plastics into mineral products using bacteria and fungi, is considered as a type of recycling and is included by some researchers in the tertiary recycling category.

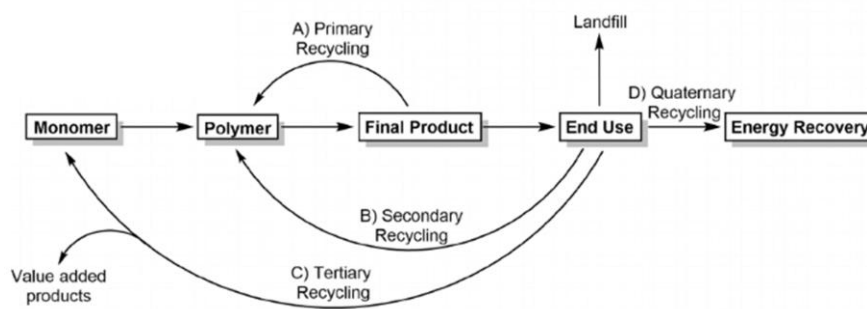
**Table 1:** The different types of plastics recycling defined in ASTM D5033 (adapted from Hopewell *et al.* [27]).

ASTM D5033 definitions	Equivalent ISO 15270 definitions	Other equivalent terms
primary recycling	mechanical recycling	closed-loop recycling
secondary recycling	mechanical recycling	down-cycling / open loop recycling
tertiary recycling	chemical recycling	feedstock recycling
quaternary recycling	energy recovery	valorisation

Figure 4 illustrates the recovery state of the product after each recycling type defined below [24]:

- *The primary recycling* or “closed-loop recycling” is a process in which waste materials are used, collected and mechanically reprocessed to produce the same product, without loss of quality or properties. This type of recycling is practical when the polymer can be (i) effectively and easily decontaminated and (ii) stabilized against degradation during reprocessing and subsequent use. The main existing recycling plants currently focus on the separation of the four main common plastics (LDPE, HDPE, PP and PET). Different separation methods can be used including flotation, electrostatic separation or infrared spectroscopy. Closed loop recycling is poorly implemented on a large scale due to many drawbacks: (i) up to 30 % of plastics cannot be separated or are too contaminated to be recycled. (ii) the recyclate must be pure at 95 %, which is difficult to achieve, in the presence of plastic additives and other polymers. (iii) the recyclability of food and beverage packaging is hindered by strong safety constraints related to human health issues standards that recyclates need to fulfil, to be use in food packaging applications

- The secondary recycling or “open-loop recycling” or “down-cycling” consists of mechanical reprocessing into lower quality products requiring lower properties. As closed-loop recycling cannot continue indefinitely, the degraded material is transformed into a product with lesser properties and intended for other applications. A typical example is the large amount of PET bottles recycled (almost 70 % of the waste collected) to make polyester clothing [28], or other goods such as lubricating grease or building materials [29].
- The tertiary recycling or “chemical recycling” is the process by which polymers are broken down into their constituent monomers or other small organic compounds that can be used as feedstock for re-polymerization to new polymers or exploited in other chemical processes. Several approaches are possible, the most common methods being chemolysis, pyrolysis, fluid catalytic cracking and hydrocracking. Recently, more and more research is exploring enzymatic catalyzed degradation which is carried out under milder conditions than the other chemical recycling methods [30, 31]. As mentioned earlier, biological recycling, involving composting, biodegradation, and anaerobic digestion is included by some researchers in tertiary recycling category [27, 32]. Chemical recycling technologies are not yet widespread and/or economically viable for the most common packaging plastics [19]. However, as they could allow post-consumer plastics to be recycled into virgin quality polymer again, they could become an option for materials for which mechanical recycling is complex (thermal sensitive plastics).
- The quaternary recycling or “recovery of energy” consist of the ultimate valorization of the plastic waste by recovering energy from their combustion. Incineration is not really part of the circular economy concept as it does not support the continued use of plastics or the transformation of waste into inputs. This type of recycling should only be done as a last resort when other recycling processes fail. Nevertheless, it can be considered as a complement to recycling by avoiding the need for landfill [33].



**Figure 4:** Different plastic waste treatment options, adapted from Lamberti *et al.* [34].

Over the past ten years, laws and decrees to support circular economy orientations have multiplied. Thus, the AGEC French law (“no-waste for a circular economy”) voted in 2020 [35], defined the “3R” plan (Reduce, Reuse, Recycle), which sets targets for the period 2021-2025, to move towards the end of single-use plastics by 2040 [36]. For the first 5 years (until 2025), it is recommended to reduce single-use packaging by 20 % and to establish a fully operational recycling stream for each single-use packaging. By 2040, a 100 % reduction of unnecessary single-use plastics (e.g. blisters) should be achieved.

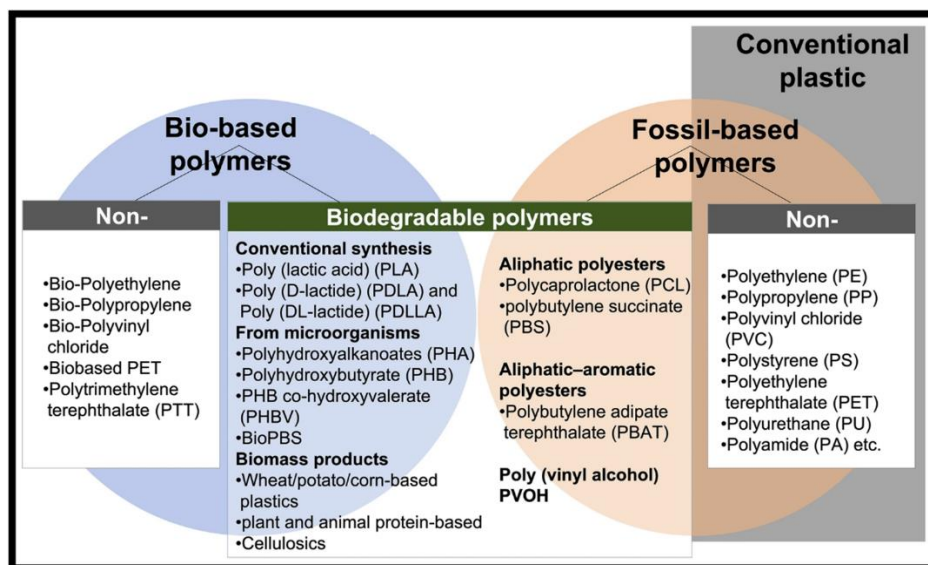
At the European level, in December 2015, the European Commission published an action plan for the transition to a circular economy. It was complemented in January 2018 by the publication of the “European Strategy for Plastics in a Circular Economy” [37]. It calls for all plastic packaging on the EU market to be either reusable or recyclable by 2030. To achieve these goals, the EU calls for a more integrated supply chain, the elimination of substances that hinder recycling, the development of innovative materials and alternative raw materials for plastic production, and an improved collection and sorting of plastic waste.

### **I.2.2 Decouple plastics from fossil feedstock: Bio-based polymers**

Reuse and recycling are essential to decouple the use of plastic packaging from the consumption of fossil-based raw materials. However, they are probably insufficient on their own. The use of virgin raw materials from renewable sources (biomass) could do more to decouple plastics production from finite fossil feedstock, reducing, thereby, the greenhouse gas footprint of plastic.

Bio-based polymers are obtained from renewable resources (plants, bacteria, algae, microorganisms...). They can be produced either directly, or through bio-based monomers that have to be chemically or enzymatically polymerized [38]. The biobased origin of plastics does not guarantee their biodegradability or compostability. On the contrary, some polymers of fossil origin can be biodegradable. Therefore, the end of life of a plastic is not correlated to its origin (Figure 5). Biobased plastics can be produced from different generations of raw materials. The first generation corresponds to edible biomass (e.g. sugarcane, starch), the second to non-edible biomass (lignocellulosic material) and the third to biomass derived from algae. Using second or third generation biomass to synthesize bioplastics would avoid competition with food crops production, and significantly reduce the carbon footprint [39].

Here again, government support is visible, as the French decree n°2016-1170 recommends that all disposable tableware (cups, plates, etc.) be produced from 60 % renewable materials by January 2025 [40].



**Figure 5:** Classification of bio-based, fossil-based and biodegradable polymers. Adapted from






Bhagwat *et al.* [41].

### I.2.3 Drastically reduce the leakage and impact of plastic into natural systems: biodegradable polymers

Globally, an estimated 32 % of plastics escape the collection systems [18], with at least 8 million tons ending up in the ocean every year. In the circular economy model, plastic leaks into the environment have no place, and several actions must be combined to try to drastically reduce this phenomenon. For example, infrastructure for collection, storage and post-use reprocessing needs to be improved, especially in countries where leakage is high [42]; and the use of landfill must be reduced. In the United Kingdom, a landfill tax has been in place since 1996, and it is expected to increase each year to encourage more waste recovery [43]. One of the emerging solutions to reduce plastic leaks, is the production and development of biodegradable plastics (see classification, Figure 5).

Biodegradability is a two-step process that consist of a first fragmentation of polymer chains into oligomers and monomers, and then, their mineralization by microorganisms (bacteria, fungi) into water, carbon dioxide, methane and biomass [44]. The biodegradation process can take place in different media: soil, water, compost... and is dependent on many factors: oxygen, light, pH, microorganisms, temperature, humidity... Several standards and norms exist today to attest the biodegradability of plastics in different environments. While waiting for standardized norms involving "more realistic conditions", and reflecting real environments, we can today refer to some norms and logos to ensure the biodegradability of certain plastics (Table 2).

**Table 2:** Standards and existing labels for the different biodegradation environments [45].

Standard	Description	Biodegradation environment	Existing label	Logo
ISO 23517:2021	Soil biodegradable materials for mulch films for use in agriculture and horticulture	Biodegradation in soil	OK biodegradable Soil	
ISO 14852 : 2018	Determination of the ultimate aerobic biodegradability of plastic materials in an aqueous medium	Biodegradation in aqueous medium	OK biodegradable Water	
ISO 23977-1 : 2020 ISO 23977-2 : 2020	Plastics: determination of the aerobic biodegradation of plastic materials exposed to seawater – part 1 and 2.	Biodegradation in marine environment	OK biodegradable Marine	
ISO17088 : 2021	Specifications for compostable plastics.	Industrial composting	OK compost	
NF T51-800	Specifications for plastics suitable for home composting.	Home composting	OK compost Home	



Of course, the biodegradability of these plastics should not encourage their dispersion in natural environments. Also, biodegradation and reuse/recycling should not be considered as incompatible, but complementary ways to save resources, reduce production costs, while avoiding the generation of persistent plastic waste. The shift towards plastic circular economy will only make sense in the frame of a plastic waste hierarchy where material reuse and polymer recycling are first maximized, before considering the return to the carbon cycle.

Several promising bio-based and biodegradable polymers are emerging today. PLA is one of them, and it is currently the one with the most mature production technology, and it is also commercialized by some companies. However, PLA is not biodegradable under natural conditions, and its degradation is only possible in industrial composting facilities [46, 47].

In this thesis, we have worked exclusively on the life cycle of PHAs, and more particularly of PHBV. There were two main reasons for this choice. First, PHAs are bio-based polymers, produced by bacterial fermentation. They are biocompatible and with good barrier properties, making them good candidates to replace conventional plastics in food packaging applications [8]. Second, PHAs are fully biodegradable in natural environments. Unlike PLA and PBS, they are completely mineralized in soil within a short time, and are the only polymers that have shown degradation in marine environments [48]. Even after cycles of reuse and recycling, their ultimate end-of-life option is to return carbon to the soil or the environment, without any hazardous consequences. Although the diffusion of PHAs is currently limited by their high cost, several initiatives are being taken to overcome this problem, such as the use of agricultural residues as raw material, or the optimization of extraction and purification processes [9]. Today, the Chinese producer Tianan<sup>®</sup> produces good quality PHB and PHBV for researchers.

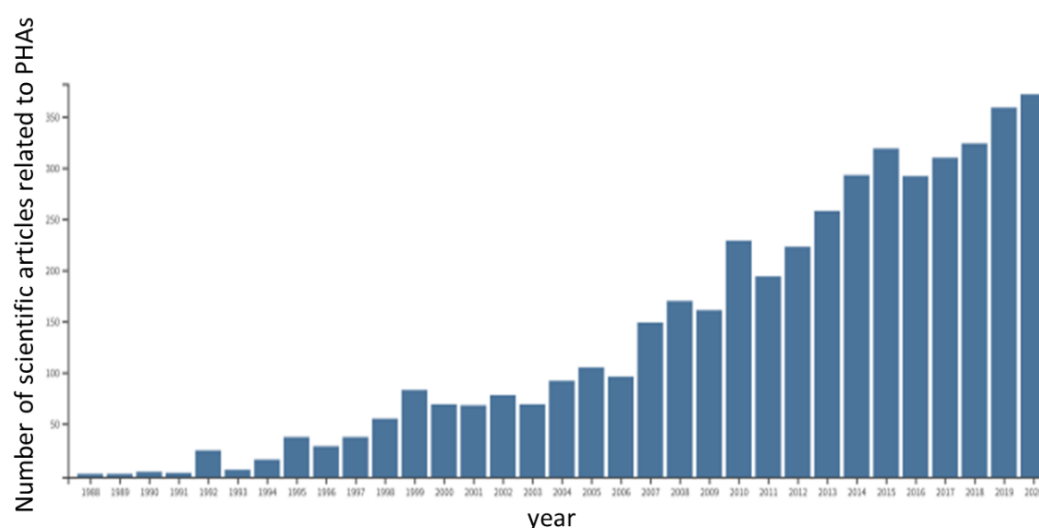
## **II. Polyphenols in PHA matrix: impact on thermal stability and biodegradability**

### **II.1 Polyhydroxyalkanoates**

#### **II.1.1 Definitions**

As described in the first part, biobased and biodegradable polymer are one of the alternative to replace traditional oil-based plastics. In 2020, 1.22 million tons of bio-based biodegradable plastics were produced in the world [49]. It may seem trivial compared to the production of conventional plastic, but the market of these plastics is continuously growing

and diversifying. It is expected to grow with compounded annual growth rate (CAGR) of 11 % from 2019 to 2025 [50]. Among the different groups of biopolymers, poly(hydroxyalkanoates) (PHAs) are naturally occurring polyesters synthesized by various microorganisms as energy and carbon reserves under nutrient stress conditions. They are nontoxic, biocompatible and biodegradable materials. They are highly crystalline, optically active, thermoplastics and hydrophobic. These features make them highly competitive with some petrochemical-derived plastics such as polypropylene [7, 51]. As a result, over the last few decades, PHAs have attracted considerable commercial and research interest, as evidenced by the increasing number of publications on these polymers over the last 30 years (Figure 6). Today, there are several companies involved in the PHAs materials business, namely Metabolix Inc (USA), Shenzhen Ecomann Technology Co. Ltd (China), Meridian Inc. (USA), and Biomer (Germany), with maximum growth and developments for the two first mentioned companies [7]. The biodegradability and biocompatibility of PHAs make them prime candidates for medical and packaging applications. Initially, they were used to make shampoo bottles and packaging materials by Wella (Germany). They are now also developed for use as shopping bags, containers and paper coatings, as well as medical surgical garments, medical implants and drug delivery carriers, among others [52-54].



**Figure 6:** Evolution of scientific literature in the field of PHAs over the last 30 years (Web of Science report. Thomson Reuters, New York, USA. 2021).

Poly(hydroxyalkanoates) are a wide class of linear polyesters belonging to bio-based and biodegradable thermoplastic polymers. They are synthesized by a large number of microorganisms as intracellular carbon and energy stocks. Depending on microorganisms and carbon source used, 3-hydroxyalkanoic acid monomers of different length can be arranged to give rise to multiple congeners of PHAs. To date, about 150 different hydroxyalkanoate polymers have been reported [55], in which the pendant alkyl group of monomers can vary from methyl (C1) to tridecyl (C13) [7]. According to this, PHAs are classified into three classes of short, medium and long chain length (scl, mcl, lcl) polyesters, with different properties [56]. Poly(3-hydroxybutyrate) (PHB), Poly(3-hydroxyvalerate) (PHV) and their co-polymer poly(3-hydroxybutyrate-co-3-hydroxyvalerate) (PHBV) are typical examples of short chain length PHAs. In this class PHB and PHBV are the most common and intensively studied PHAs [57].

## **II.1.2 PHA chemical-physical properties**

### **II.1.2.1 Mechanical properties**

Depending on their monomeric composition, PHAs can range from high crystalline polyesters (PHB) to more elastic materials such as poly(3-hydroxyoctanoate) (PHO) [58, 59]. In the case of PHBV, the mechanical properties are dependent on the molar content of HV [60], where its increasing results in better flexibility, and a progressive decrease of the tensile strength [58]. In Table 3, the mechanical properties of some bio-based and conventional plastics are compared with those of PHB and PHBV [61]. It appears that the lack of flexibility (low strain at break) is the most significant obstacle in the use of PHAs as food packaging but, many studies are working on improving these mechanical properties [62].

**Table 3:** Mechanical properties of PHB and PHBV, compared to some other polymers. Presented value are indicative only. Extracted from Plackett *et al.* (2011) [61].

Polymer*	Tensile strength (MPa)	Young's modulus (MPa)	Strain at break (%)
PHB	40	1700–3500	3–6
PHBV	30–38	700–2900	20
PLA	28–50	1200–2700	7–9
PCL	16	400	120–800
PET	56	2200	70–100
LDPE	10–15	200	300–500
PP	35–40	1700	150
PS	12–50	1600–3100	3–4
PVC	10–60	300–2400	12–32

\* Values for individual films will depend on a number of factors including polymer molecular weight, crystallinity and film orientation as well as the mechanical testing conditions.

### II.1.2.2 Barrier properties

Water vapor permeability of PHAs is similar to that of some conventional thermoplastics such as PVC or PET (see Table 4) [63, 64]. Unlike other bio-polymers such as starch and cellulose, they have a lower hydrophobicity and do not swell in the contact with water. Their oxygen permeability is close to that of PET, and it is high enough to prevent the oxidative degradation of unsaturated fatty acids and the growth of aerobic microorganisms. For PHBV, the higher the molar content of HV, the higher the permeability to water vapor and oxygen [65]. For CO<sub>2</sub>, PHB has been reported to have 5 times lower permeability than PET, which favors its ability to replace PET for carbonated beverage packaging [61].

**Table 4:** Water vapor, oxygen and CO<sub>2</sub> permeabilities of PHB and PHBV compared to those of other polymers. Presented values are indicative only. Extracted from Plackett *et al.* (2011) [61].

Polymer*	O <sub>2</sub> permeability at 23°C, 0–50% RH (ml mm m <sup>-2</sup> day <sup>-1</sup> atm <sup>-1</sup> )	Water vapour permeability at 23°C–38°C, 50–90% RH (g mm m <sup>-2</sup> day <sup>-1</sup> )	CO <sub>2</sub> permeability at 23°C, 0–50% RH (ml mm m <sup>-2</sup> day <sup>-1</sup> atm <sup>-1</sup> )
PHB	2–10	1–5	3
PHBV	5–14	1–3	–
PLA	15–25	5–7	35–70
PCL	20–200	300	–
LDPE	50–200	0.5–2	800–1000
PET	1–5	0.5–2	15–20
PP	50–100	0.2–0.4	200–400
PS	100–150	1–4	250–500
PVC	2–8	1–2	10–15

\* Values for individual films will depend upon a number of factors including polymer molecular weight and crystallinity as well as the permeability testing conditions.

### II.1.2.3 PHAs as food contact material

Many years ago, Europe has established a harmonized legal framework for the safety of food contact materials (FCM) with the regulation (EC) No 1935/2004 [66], whose main purpose is to define the principle of inertness of all materials intended for use in contact with food. Article 3 of this regulation stipulates that these FCMs must not release constituents into the food in quantities that may endanger human health, or alter the composition, taste, odor or texture of the food. In the particular case of plastic packaging, the (EC) No 10/2011 regulation was set up [67]. In its article 5, it is stated that only substances included in the union list for authorized substances may be intentionally used in food contact plastic materials. These substances are submitted to an overall and a specific migration limits. To date, bioplastics (both bio-based and biodegradable) are considered similar to petroleum-based plastics, and are not subject to any specific guidelines or recommendations. Regarding the neo-formed substances, crotonic acid, an organic acid which results from the thermal degradation of PHAs is accepted with a specific migration limit of 0.05 mg.kg<sup>-1</sup> food [68]. In addition, poly((R)-3-hydroxybutyrate-co-(R)-3-hydroxyhexanoate) (PHBH), one of the PHA copolyesters, has been considered safe by the European Food Safety Authority (EFSA), if used alone or in a polymer blend, for more than 6 months at room temperature [68].

Considering the different properties mentioned above, PHAs could be considered as promising alternatives to conventional food packaging, in particular, rigid packaging such as trays or jars (due to their lack of flexibility).

### **II.1.3 PHA as food packaging: present status**

The use of PHA in food packaging sector is still limited. There were few studies on PHAs as coatings, for paper or cardboard, for example, by preparing PHB and PHBV granules as paper-sizing agents [61]. Another field under development in food packaging industry, is the incorporation of nanoparticles in PHA matrix. Nanoparticles have the ability to improve certain properties such as gas permeability and some thermal, mechanical and antimicrobial properties. Thus, copper or silver nanoparticles have been incorporated into PHA, either in the form of coatings or wrappings [69]. From a market point of view, in 2019, Nestlé Waters in partnership with Danimer Scientific, announced a development of biodegradable water bottles made from Nodax® PHA, in order to replace PET. PepsiCo is also in collaboration with Danimer Scientific for the development of next generation compostable flexible packaging (snack bags), using PHA biopolymers mixed with mineral fillers [70].

### **II.1.4 End-of-life options of PHAs: present status**

#### **II.1.4.1 Reuse of PHA-based packaging**

To our knowledge, the reuse of PHA materials as food packaging has never been addressed before. Only one study conducted in our laboratory, investigated the impact of several dishwashing cycles on the properties of PHBV materials. Doineau *et al.* [71] showed that the mechanical properties and inertness of the materials (after contact with food simulants) are retained after 125 wash cycles, proving that the reuse of PHA-based food packaging is not a crazy idea.

#### **II.1.4.2 Mechanical recycling of PHA-based packaging**

Similarly, the mechanical recyclability of PHA has been little studied, and the few studies in this area have focused on the impact of thermal reprocessing by extrusion on the mechanical properties of PHAs. Zembouai *et al.* and Zaverl *et al.* investigated the effect of several extrusion cycles (up to 6) on PHBV with 3 % and 14 % HV, respectively. In both cases, a decrease in polymer molecular weight was observed. However, the PHBV with higher valerate content maintained its mechanical properties until the fourth cycle, in contrast to the PHBV-3%, which became more brittle [72, 73]. A similar study carried out in our laboratory, was interested in the impact of successive extrusion cycles on the production of crotonic acid. It was shown that although crotonic acid is increasingly produced during processing cycles, its migration into food never exceeds the recommended migration limit [74].

Further studies are being conducted in our laboratory to investigate the food contact ability of recycled PHBV. Indeed, after an intentional contamination of PHBV by a panel of surrogates, the efficiency of thermal treatment processes on the elimination of these contaminants is evaluated [75].

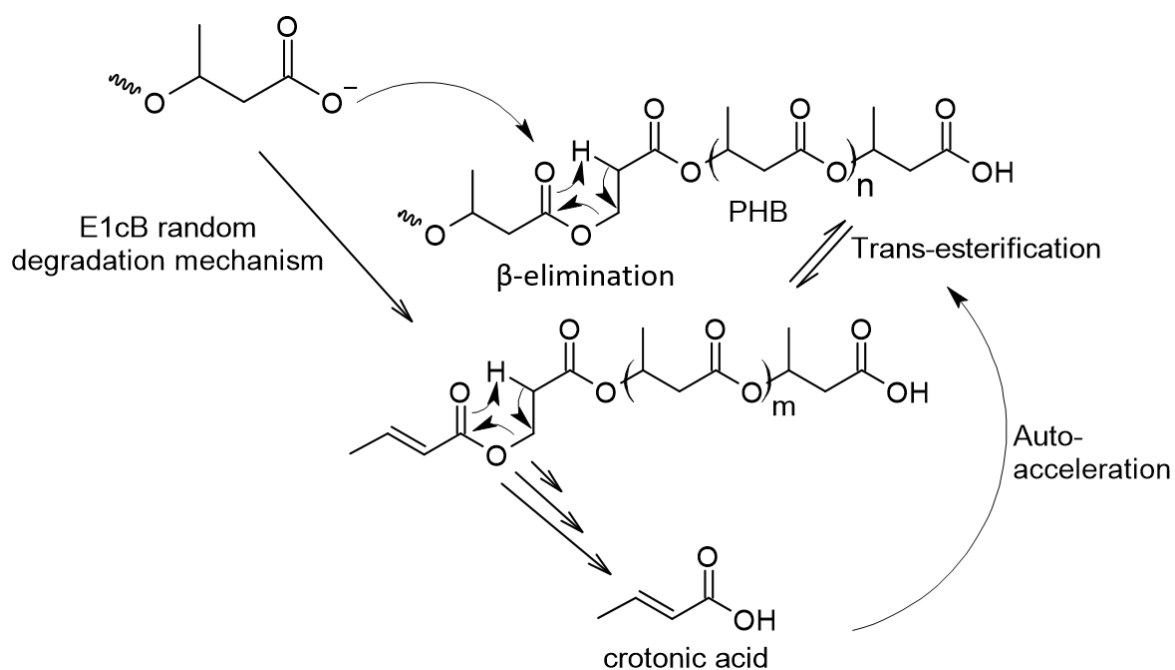
Despite the promising potential of PHAs, their exploitation (use, reuse/recycling) in the food packaging sector is still very limited. Beyond the high cost issues, which are being mitigated, the main drawback is their thermal sensitivity.

The following sections provide a brief description of the degradation mechanisms of PHAs, followed by a discussion of the potential of polyphenols to improve their thermal stability. Finally, the influence of the presence of polyphenols on the biodegradability of PHAs will be presented.

#### **II.1.5 PHA thermal degradation**

PHAs are completely biosynthesized and biodegradable. They are biocompatible with good barrier properties [8] which makes them good alternatives to some traditional fossil plastics. However, the applications of PHAs are limited due to some undesirable physical properties. These polymers suffer from their low glass transition temperature, slow crystallization rate, large spherulite size, and secondary recrystallization behaviors which result in their brittle products [51, 52]. PHB and to a lesser extent PHBV are highly crystalline with ordered crystal structure, which leads not only to brittleness but also to the degradation

at a temperature slightly above the melting point [76, 77]. The thermal degradation mechanism of PHB and PHBV in isothermal and non-isothermal conditions has been widely investigated [78-81]. In their book chapter, Nishida *et al.* [82] summarized the main mechanisms involved in the thermal-induced chain scission of PHB (Scheme 1). It has long been considered that the reduction of polymer molecular weight is essentially generated by random chain scission process, induced by the  $\beta$ -elimination reaction, giving rise to crotonic acid and crotonyl end-group chains as degradation products. Then, Kawalec *et al.* [83] proposed an  $\alpha$ -deprotonation mechanism (E1cB) by a carboxylate anion, resulting in the same products. Oligomers bearing crotonate end-groups undergo subsequently an unzipping- $\beta$ -elimination, accelerating the production of crotonic acid. Nguyen *et al.* [84] have suggested that the crotonic acid thus produced induce the catalysis or the auto-acceleration of the random degradation by initiating transesterification reactions. The influence of oxygen on the thermal degradation of PHB was investigated by Michalak *et al.* [85]. It was observed that the process carried out in pure oxygen (flow of 90 L.h<sup>-1</sup>) at 140 °C led to a scission of the polymer backbone typical of a normal thermal degradation. The exposure of PHB to a mixture of oxygen/ozone was necessary to accelerate its degradation into 3-butyric acid and 3-malic acid units. They concluded that in the presence of oxygen, at temperatures above 100 °C, the PHB degradation does not respond to a thermo-oxidative mechanism.



**Scheme 1:** Expected overall thermal degradation mechanism of PHB reported by Nishida *et al.* [82].



### II.1.6 Strategies to improve thermal and mechanical properties of PHA

To mitigate the brittleness of PHAs and to improve their thermal resistance, several strategies has been implemented such as plasticizing, chemical modification, polymer blending and additivation (Table 5).

**Table 5:** Strategies for thermal stabilization and improvement of mechanical properties of PHAs.

Improvement strategy	Technique/Reagent/Polymer	Reference
<b>Plasticizing (reduce PHAs brittleness)</b>	Glycerol, 4-nonylphenol, acetyl tributyl citrate, salicylic ester, soybean oil, epoxidized soybean oil, epoxidized broccoli oil, fatty alcohols and polyethylene glycol...	[8, 86]
<b>Chemical modification</b>	Grafting reactions, chlorination, cross-linking, epoxidation, hydroxyl and carboxylic acid functionalization...	[87]
<b>Polymer blending</b>	poly(ethylene oxide), poly(methyl acrylate), poly(vinyl acetate), poly(vinylidene fluoride), poly(epichlorohydrine), poly(butylenes adipate), epoxidized natural rubber, or poly(vinyl phenol), poly( $\epsilon$ -caprolactone) (PCL), poly(butylene succinate) (PBS), poly(butylene adipate-co-terephthalate) (PBAT), and poly(3-thiophene ethyl acetate) (PTAcET)	[88, 89]
<b>Additivation</b>	zinc oxide (ZnO), cellulose nanocrystals, graphene nano-sheets, titanium dioxide (TiO <sub>2</sub> ), nanoclay, silane-treated-recycled wood fibers	[89-92]
<b>Synthetic phenolic compound additives</b>	Irganox 1010	[93]

These different strategies often involve the incorporation of non-biobased, non-biodegradable compounds into PHA matrices, which can cause them to lose their biodegradability. Thus, the move towards natural and biodegradable additives should be a priority in a sustainable and ecological approach. In recent years, the use of natural polyphenols as thermal stabilizers for PHAs has begun to emerge and will be discussed in the next section.

## II.2. Polyphenols

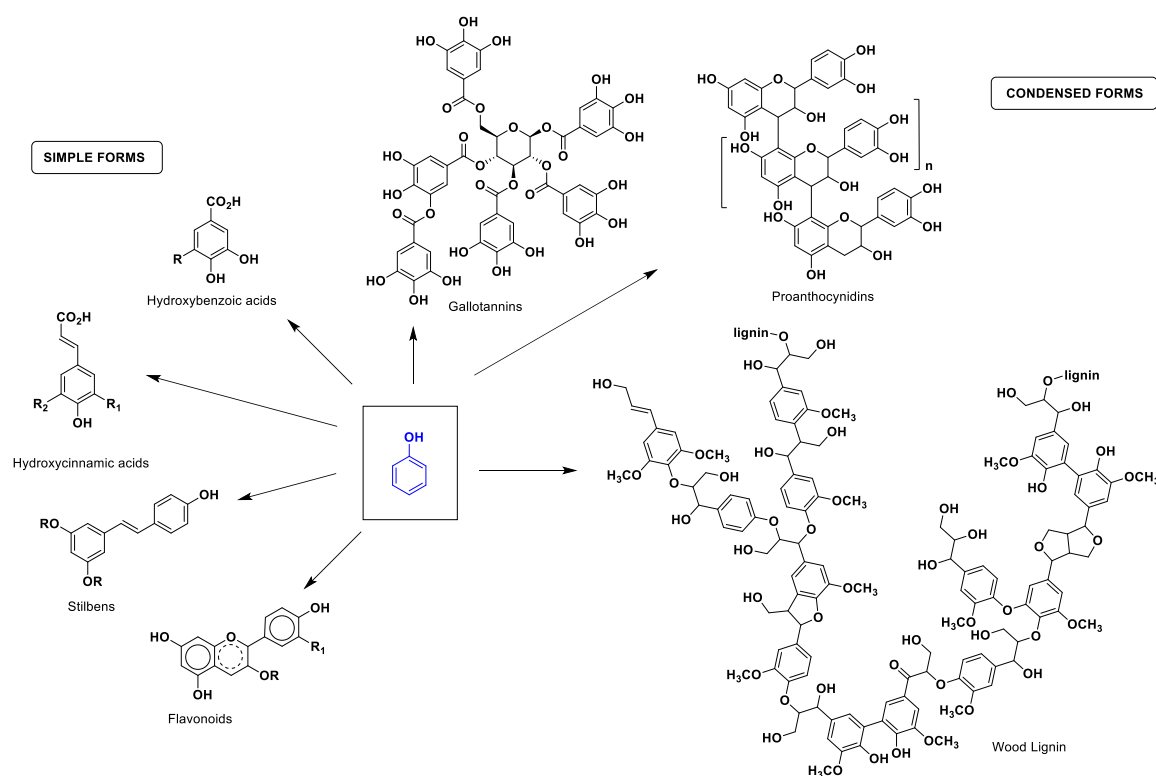
### II.2.1 Definition and properties

Polyphenols are a large family of secondary metabolites produced by higher plants, mainly for their protection from predators. Some academic experts on polyphenols claim that one can only call plant polyphenols the compounds having molecular weight ranging from 500 to 4000 Da and possessing 12 to 16 hydroxyl groups on five to seven aromatic rings per 1000 Da of relative molecular mass (definition of Haslam-Bath-Smith-Swain and White) [94]. Going beyond this very strict definition, the term “polyphenols” is widely attributed to organic compounds with one or more hydroxyl groups attached to a phenyl ring. According to that, polyphenols could be classified into two main categories: polyphenols with simple chemical structures including flavonoids, hydroxybenzoic acids, hydroxycinnamic acids and stilbens; and complex polyphenols with polymeric structures comprising tannins (proanthocyanidins, gallotannins, ellagitannins), and lignin (Scheme 2) [95]. Lignin is a peculiar class of natural phenolic compounds. It is a cross-linked macromolecular material based on phenylpropanoid monomer structure, with molar mass ranging from 1000 to 20000 g.mol<sup>-1</sup>. Lignin isolation from lignocellulose materials is conducted under conditions that reduce progressively the molecular weight, resulting in structural modifications compared to native lignin. The major extraction processes are based on acid or base-catalyzed depolymerizations. The most common are sulfite, soda, kraft and organosolv processes [96, 97].

The antioxidant capacity of polyphenols has been widely demonstrated. *In vitro*, they essentially act as free radical scavengers by donating the proton of their phenolic hydroxyls to free radicals. The aromatic radicals resulting from this proton transfer are then stabilized thanks to the delocalization of the  $\pi$ -electron system [98]. The antioxidant effect of polyphenols has been widely exploited in different domains. In food preservation, polyphenols

mainly act as inhibitors of lipid oxidation [99-101]. In health, they are considered as good agents for the reduction of the oxidative stress by scavenging reactive oxygen species [102]. More recently, polyphenols have been studied for their ability to inhibit polymer degradation, if initiated by free radicals [103-105].

The involvement of polyphenols in polymer formulations requires the study of their capacity to maintain their structural integrity and activity in the different stages of polymer production and use. The thermal stability was mainly investigated for polyphenols with condensed structures such as tannins and lignin. Proanthocyanidins extracted from *Radiata* pine bark can withstand processing temperatures up to 200 °C if the carbohydrate content of the extract is below 5 wt% [106]. Proanthocyanidins from quebracho and hydrolysable tannins extracted from chestnut and tara pods showed similar degradation rates at temperatures ranging from 200 °C to 400 °C [107], which is above the melting temperatures of some biodegradable polyesters. Wheat straw and quersus lignin as well as birch lignin obtained respectively from klason and organosolv processes displayed maximum degradation at temperatures between 320 °C - 380 °C [108]. On the other hand, the thermal stability of structurally simple polyphenols, such as flavonoids and phenolic acids, at elevated temperatures has hardly been studied. The majority of reported treatments were performed at temperatures not exceeding 100 °C [109-111], which does not correspond to the processing conditions of polymers.



**Scheme 2:** Chemical structures of the different polyphenol groups.

## II.2.2 Quercetin and Gallic acid

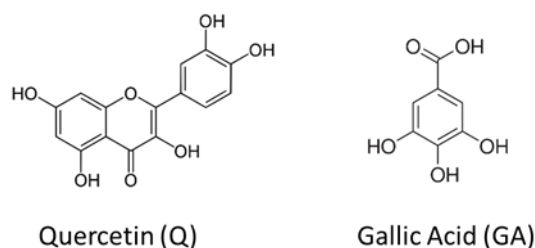
### II.2.2.1 Quercetin

Quercetin (3,3',4',5,7-pentahydroxyflavone) belongs to the large class of flavonoid compounds. It is found in many fruits, vegetables, leaves, seeds, generally, under rutin (quercetin-3-O-rutinoside) form [112]. Structurally, quercetin is composed of two aromatic cycles separated by a pyran cycle and four phenolic hydroxyls over the two aromatic cycles (Scheme 3). Quercetin is considered a good antioxidant compound, due to its ability to scavenge free radicals and chelate metal ions [113]. It is also one of the most thermally stable flavonoids, with a decomposition temperature of about 350 °C. In addition, its antiviral and antibacterial properties have also been demonstrated [114, 115].

### II.2.2.2 Gallic acid

Gallic acid (3,4,5 trihydroxybenzoic acid) is a polyphenol belonging to the phenolic acid family. It is present in most plants (e.g. gallnuts, tea leaves) frequently as monomeric unit of gallotannins [116]. It is constituted of one phenolic cycle with a carboxylic group and three

hydroxyl groups in *ortho* position. Its strong antioxidant activity has been widely reported, and several studies addressed its use as an additive in active food packaging [117]. However, its impact as a thermal stabilizer has been little studied until now.



**Scheme 3:** Chemical structures of quercetin and gallic acid.

### II.3 Polyphenols as additives in PHAs and their effects on thermal stability

Although not yet widely studied, the incorporation of polyphenols into PHB or PHBV matrices to overcome their thermomechanical limitations has been reported in several studies (summary in Table 6). The treatment of PHB film in rheometer at 190 °C during 2700 s led to a massive thermal degradation, corresponding to a drop of  $M_w$  to 20 % of the initial value (200 kDa). On the contrary the  $M_w$  drop was slightly slower when 30 wt% of Klason lignin was added to neat PHB. In addition, polydispersity index of the blend was lower and storage modulus value and complex viscosity were higher, indicating an improvement in melt stability [118]. Loading of PHBV with 1-10 wt% kraft lignin by melt compounding resulted in an increase in  $T_g$ , improvement in E-modulus (from 19 % to 58 % depending on lignin concentration), stabilization of tensile strength value and change in crystallinity. Elongation at break values, stable up to 5 wt% lignin addition, showed a decrease of about 42 % when lignin reached 10 wt% in the polymer [119]. When radical initiator such as dicumyl peroxide was used, kraft lignin was grafted to PHVB through C-C covalent bonds, leading to a better stabilization of the polymer. This resulted in higher modulus and viscosity, along with an increase of the tensile strength by 11% [120]. The same trend was observed when other types of polyphenols were used as additives. Solvent mixture of PHB with tannic acid up to 15 wt% led to the shift of the weight loss curves to higher temperatures, confirming the delay of thermal degradation process to longer times. The presence of tannic acid up to 20 wt% resulted in less ordered crystals [121] and increased the transition state and cold crystallization temperatures by 20 °C and 60 °C respectively. In addition, improvements were

observed for the stress, tensile strength, elongation at break and fracture work. However, when the loading of tannic acid exceeded 20 wt%, all these parameters showed a significant decrease [76]. Flavonoids derivative, namely catechin was added to PHB at 15 to 50 wt% by solvent mixing. In blends with catechin content lower than 30 wt%, the melting temperature of PHB decreased from 179 °C to 164 °C and T<sub>g</sub> shifted to higher temperatures, illustrating a higher viscosity and a better thermal stability of the blends. DSC analysis showed a disappearance of the melting point of catechin, suggesting that the miscibility of catechin in the polymer matrix suppressed its crystallization, but over 30 wt% of catechin loading, the double glass transition state appeared, attesting to the presence of two distinct entities [122]. Hydro-alcoholic extract from Cabernet wine pomace, containing 4 wt% of catechin-derivative compounds was mixed to PHB polymer in solution. Two films containing respectively 5 wt% and 15 wt% of pomace extract were produced by injection molding. The presence of phenolic compounds provoked an increase in both material viscosity and polymer molecular weight. Moreover, the thermal degradation of the blends occurred through a single weight loss at temperatures higher by about 15 °C compared to neat PHB. In this case, the thermal degradation was independent on the additive amount. However, the glass transition temperature (T<sub>g</sub>) decreased when PHB was doped with 15 wt% of pomace extract, indicating the plasticizing effect of this amount of additive. This was reflected by the increase in elongation at break and the decrease of tensile strength, making the material more ductile [123]. Instead of phenolic extract of wine pomace, David *et al.* [124] tested the introduction of wine pomace fillers devoid of polyphenols into PHBV matrix. It was observed that the absence of polyphenols resulted in greater thermal degradation of the composites, confirming the thermal stabilizing role of polyphenols. Another catechin-based extract, namely tea extract was added to PHBV by solvent casting. Increasing the amount of tea polyphenols from 0 to 40 wt% resulted in the increase in both T<sub>g</sub> and cold crystallization temperature by about 56 °C and 66 °C respectively. The melting temperature decreased by about 17 °C, indicating a disruption in crystallization behavior of the blends. Up to 20 wt% loading of tea polyphenols, the elongation at break increased with an increasing ratio of 2430 %. The same trend was observed for the tensile strength and the strain. Beyond this amount of additive, a significantly decrease of these parameters was recorded [125].

PHA materials with polyphenol coating were also studied. Cellulose nanopapers were coated with mcl-PHA mixed with apple pomace extract at 1, 3 and 5 wt% content. The coating

of these nanopapers with mcl-PHA alone provoked an improvement of 650 % and 9700 % in tensile strength and Young's modulus respectively. The incorporation of the phenolic extract resulted in a decrease in modulus as the amount of the extract increased. This was attributed to the plasticizing effect of apple pomace extract [126].

In the light of these different studies, it appears that the addition of polyphenols up to a certain amount to PHA matrices by solvent mixing or melt compounding generally leads to an increase in  $T_g$ , a shift in degradation temperatures towards higher values, an increase in tensile strength as well as a disruption of crystallization, which results in lower temperatures and enthalpies of fusion. These stabilizing effects are largely attributed to the intermolecular hydrogen bonds linking the carbonyl groups of PHA and the hydroxyl groups of polyphenols, revealed by FTIR analyses [76, 118, 120, 121, 123, 125, 127, 128]. It was shown that the band around  $1720\text{ cm}^{-1}$  related to the carbonyl stretching of the ester group in PHA crystalline part shifts into smaller wavenumbers, while the small shoulder around  $1740\text{ cm}^{-1}$  attributed to the carbonyl bond in the amorphous region becomes more intense [76, 120, 121]. Although the characteristic band shifts after the addition of polyphenols remain very small, FTIR remains the preferred method to support the hypothesis of the presence of hydrogen bonds between the polymer matrix and the polyphenols. These hydrogen bonds will contribute to the polymer stabilization by hindering the formation of the six-membered transition structure involved in the random chain scission of the polymer during the thermal degradation (Scheme 1) [78]. Their presence will also modify the crystallization through a significant increase in the number of spherulites in PHA, accompanied by a consequent reduction of their size [76, 120, 125]. In the presence of these uniform spherulites with small radius, the crystalline phase acts as cross-linking point, while amorphous area is in rubbery state, increasing thereby the blend toughness [76]. On the other hand, the opposite effect occurs when polyphenols loading exceeds a certain amount. This was mainly attributed to the heterogeneous distribution of the polyphenols in the polymer matrix [129] and the over reduction of PHA spherulites, leading to the formation of a continuous amorphous phase [76].

Aside from an excess additive, other factors may accelerate the polymer degradation. PHBV mixed with liginosulfonates by mechanical melt processing, showed an increase in its degradation rate even with low amounts of lignin derivatives (10 wt%). The PHBV/liginosulfonate films presented a cracked appearance of the fracture surfaces caused by

the formation of lignosulfonate domains which increased with its concentration. Despite the poor interactions between the two blend components, their degradation processes were not independent. At temperatures ranging from 210 °C to 260 °C, water and acids were released during the thermal decomposition of lignosulfonate, which provoked the hydrolysis of PHBV polymer chains [130]. Therefore, depending on the polyphenol used, its decomposition products may catalyze the degradation reaction of the polymer.

The use of polyphenols as additives to PHAs was not only to improve the thermal stability of these polymers. Some authors have studied the new functionalities that polyphenols could confer to PHAs such as barrier properties and antioxidant and antimicrobial activities.

In term of barrier properties modification, the 1-10 wt% PHBV/Kraft lignin blends exhibited lower O<sub>2</sub> and CO<sub>2</sub> permeability compared to neat PHBV, that decreased with the increasing amount of lignin. At only 1 wt% loading, the permeability of PHBV film to O<sub>2</sub> and CO<sub>2</sub> decreased by about 77 % and 91 % respectively. The gas permeability is a result of both sorption and diffusion processes. As sorption coefficient proved higher solubility of both gases in PHBV/lignin films, it was concluded that lignin inhibited the diffusion in the polymer [119]. Electrospun PHBV showed water vapor and limonene permeability of  $4.05 \times 10^{-14} \text{ kg.m}^{-2} \cdot \text{s}^{-1} \cdot \text{Pa}^{-1}$  and  $3.75 \times 10^{-14} \text{ kg.m}^{-2} \cdot \text{s}^{-1} \cdot \text{Pa}^{-1}$  respectively. These values decreased to  $0.95 \times 10^{-14} \text{ kg.m}^{-2} \cdot \text{s}^{-1} \cdot \text{Pa}^{-1}$  and  $0.81 \times 10^{-14} \text{ kg.m}^{-2} \cdot \text{s}^{-1} \cdot \text{Pa}^{-1}$  respectively, when 15 wt% of eugenol was added. The decrease in water vapor permeability is mainly due to the dispersion of the hydrophobic eugenol in the polymer matrix, which impairs the mobility of water molecules [131]. When eugenol was encapsulated in the pores of mesoporous silica nanoparticles, the water vapor and limonene permeability increased for a loading of 2-7 wt% of nano-particles, before decreasing above 7 wt% encapsulated eugenol. With the lower amount of additive, the plasticizing effect of eugenol reduced the barrier properties, but with the higher loading, the presence of a large amount of particles hindered vapor diffusion [132].

Depending on the polyphenols structure, their antioxidant activity was not always maintained when incorporated into PHA matrices. mcl-PHA with 5 wt% of apple pomace displayed a radical scavenger activity of 80 % in the presence of ABTS radical cation [126]. However, green tea and rosemary extracts introduced in PHBV matrix by electrospinning and annealing lost approximately 50 % of their DPPH scavenging activity. This decline in activity,



which has continued over time, has been attributed to the release of volatile active compounds, although this release was not assessed by the authors [133].

When tested for their antimicrobial activity, some PHAs/polyphenols systems (containing eugenol and curcumin) exhibited strong to moderate activity against *E. Coli*, *Staphylococcus aureus*, *Bacillus subtilis* and *Pseudomonas aeruginosa* strains, among others [131, 132, 134]. The proven antimicrobial activity of polyphenols in these few examples raises the question of their general behavior towards microorganisms, and consequently their impact on the biodegradability of PHAs.

**Table 6:** Main thermomechanical effects induced by the addition of polyphenols to PHAs.

PHA	Polyphenol : amount		Blending process	Thermomechanical characteristics compared to neat PHA	Reference
PHB	Klason lignin: 30 wt%	LIGNIN	Solvent mixture	<ul style="list-style-type: none"> <li>- <math>M_w</math> drop of 60 % compared to 70 % drop for neat PHB</li> <li>- Lower <math>M_w/M_n</math></li> <li>- Higher storage modulus <math>G_o'</math></li> <li>- Higher complex viscosity</li> <li>- Improvement of melt stability</li> </ul>	[118]
PHBV	Kraft lignin: 1-5 wt%		Melt compounding	<ul style="list-style-type: none"> <li>- Increase of <math>T_g</math> (-3.7 to -1.5 °C)</li> <li>- Nucleation of crystals with higher thermal stability</li> <li>- Improvement of E-modulus by 19-58 %</li> <li>- Stable value of elongation at break</li> <li>- <math>T_{onset}</math> and <math>T_{max}</math> : shift to higher temperatures by 0.7- 1.7 °C and 2.9-4.9 °C respectively</li> </ul>	[119]
PHB/PHBV	Tannic acid: 10-20 wt%	GALLOTANNINS	Solvent mixture	<ul style="list-style-type: none"> <li>- Weight loss curves: shift to higher temperatures</li> <li>- <math>T_g</math> increase by 20 °C</li> <li>- Increase of cold crystallization <math>T_c</math> by 60 °C</li> <li>- Decrease of <math>T_m</math> by 17 °C</li> <li>- Hydrogen bonding (polymer/additive)</li> <li>- Improvement of stress, tensile strength, elongation at break and fracture work</li> </ul>	[76, 121]

PHB	Catechin < 30 wt%	PROCYANIDINS	Solvent mixture	<ul style="list-style-type: none"> <li>- Decrease of <math>T_m</math> from 179 to 164 °C</li> <li>- Shift of <math>T_g</math> to higher temperatures</li> <li>- Decrease of crystallization rate <math>X_c</math> about 20 %</li> </ul>	[122]
PHB	Cabernet wine pomace extract: 5-15 wt%		Solvent mixture	<ul style="list-style-type: none"> <li>- <math>M_w</math> drop of 30 % compared to 80 % drop for neat PHB</li> <li>- Decrease of <math>T_g</math> from 1.8 °C to 0.8 °C (plasticizer effect)</li> <li>- Higher thermal degradation temperature by 15 °C</li> <li>- Increase of <math>T_{onset}</math> from 255 °C to 273 °C</li> <li>- Decrease of Young modulus from 2.84 to 1.95 GPa</li> <li>- Increase of elongation at break from 1.3 to 2.4 %</li> <li>- Decrease of strength from 30 to 25 MPa</li> </ul>	[123]
PHBV	Tea extract: 20-40 wt%		Solvent casting	<ul style="list-style-type: none"> <li>- Increase of <math>T_g</math> by 54 °C</li> <li>- Increase of cold crystallization <math>T_c</math> by 66 °C</li> <li>- Decrease of <math>T_m</math> by 17 °C</li> <li>- Increase of elongation at break ratio of 2430 %</li> </ul>	[125]

## II.4 Effect of polyphenols on PHAs biodegradation

### II.4.1 The antimicrobial activity of polyphenols

The antimicrobial activity of polyphenols has been widely reported. However, most articles have focused on pathogenic micro-organisms (bacteria, viruses and fungi) which are not representative of the enormous bacterial variety present in the environment. Table 7 is a brief compilation of the most cited bacteria in the three reviews of M. Daglia *et al.* [135], I. Gorniak *et al.* [136], and MC. Lima *et al.* [137] dealing with the antibacterial activity of polyphenols. It can be seen that all types of polyphenols are able to inhibit different strains of the two gram-positive bacteria *Staphylococcus aureus* and *Listeria monocytogene*; as well as the gram-negative bacterium *Escherichia coli*.

**Table 7:** Bacteria sensitive to the different types of polyphenols.

Polyphenol	Target bacteria/ stains	Reference
Flavonoids	<i>E. coli</i> , <i>S. aureus</i> , <i>B. cereus</i> , <i>F. nucleatum</i> , <i>P. vulgaris</i> , <i>L. monocytogenes</i>	[135, 136, 138, 139]
Phenolic acids (hydroxybenzoic and hydroxycinnamic acids)	<i>E. coli</i> , <i>S. aureus</i> , <i>L. monocytogenes</i> , <i>P. aeruginosa</i> , <i>Salmonella enteritidis</i> , <i>B. cereus</i> , MRSA	[135, 140-142]
Condensed tannins (procyanidins)	<i>S. mutans</i> , <i>E. coli</i> , <i>S. aureus</i> , <i>B. cereus</i> , <i>L. monocytogenes</i>	[135, 141, 143]
Gallotannins	Stains of: <i>Salmonella</i> , <i>Staphylococcus</i> , <i>Helicobacter</i> , <i>E. coli</i> , <i>Bacillus</i> , <i>Colostridium</i> , <i>Campylobacter</i> , <i>Lystria</i>	[135]

Ellagitannins	<i>B. subtilis</i> , <i>E. coli</i> , <i>L. monocytogenes</i> , <i>S. aureus</i> , <i>Salmonella enteritidis</i> , <i>Y. enterocolitica</i> , <i>P. aeruginosa</i> , <i>L. innocua</i> , <i>Enterococcus faecalis</i>	[144-146]
Lignin	<i>L. monocytogenes</i> , <i>S. aureus</i>	[147]

The inhibitory effect of polyphenols on bacteria is not yet well established, but several modes of action have been described, especially for flavonoids. The most common are (i) the membrane disruption: The bacterial plasma membrane is responsible for different functions including osmoregulation, respiration and lipid synthesis. Some polyphenols have the ability to bind to the lipid bilayer and to inactivate or inhibit the synthesis of intracellular and extracellular enzymes; (ii) the inhibition of biofilm formation: thanks to the formation of biofilm, the bacteria become from 10 to 1000 times more resistant to antimicrobial agents compared to their planktonic cells. Polyphenols disrupt the formation of this biofilm by inhibiting the alginate formation or other siderophore proteins, resulting in a declination in bacterial adherence and aggregation; and (iii) the neutralization of bacterial toxins: these toxins interact with host tissues or mask the bacterial surface from host's defense mechanisms. Due to their antioxidant activity, polyphenols are able to neutralize these toxins [135, 136]. For example, condensed tannins and phenolic acids may induce damages at cell membranes by binding with enzymes, and flavonoids such as catechin can neutralize bacterial toxins. Other lesser-known inhibition mechanisms have been reported, including, among others, the inhibition of cell envelop and nucleic acid synthesis, and the inactivation of bacterial-metal enzymes [136].

#### II.4.2 The microbial degradation of PHAs

In the environment, several micro-organisms are able to degrade solid PHAs into water-soluble monomers and oligomers which are then used as nutrients. These microorganisms including bacteria and fungi have been isolated from various ecosystems such as soil, compost, aerobic and anaerobic sewage sludge, fresh and marine water, estuarine sediment, and air [148]. Fungi that were identified as dominant microorganisms colonizing the

polymer's surface polymers, belong mainly to *Comycetes*, *Basidiomycetes*, *Deuteromycetes* (such as *Aspergillus fumigatus* and *Penicillium sp.*), *Zygomycetes*, *Micromycetes* and *Ascomycota* groups [48, 149-153].

In the case of bacterial degradation, Meereboer et al. reported that the dominant PHA degraders in aerobic and anaerobic environments are members of the genera of *Variovorax*, *Stenotrophomonas*, *Acinetobacter*, *Pseudomonas*, *Bacillus*, *Burkholderia*, *Cupriavidus*, *Mycobacterium* and *Streptomyces* [48]. Additional genera such as *Stenotrophomonas*, *Alcaligenes*, *Comamonas*, *Rhodococcus*, *Rhodocyclus*, *Xanthomonas*, *Syntrophomonas*, *Ilyobacter*, and *Ralstonia* have been mentioned by Fernandes et al. [152]. Among these genera, several strains have been isolated from soil or sludge. Luzier et al. [154] and Mergaert et al. [155] isolated different strains of soil bacteria including *Acidovorax facilis*, *Comamonas spp.*, *Pseudomonas lemoignei* and *Variovorax paradoxus*. Shah et al. listed the main bacterial strains found in composts, and marine water, namely *Bacillus sp. AF3*, *Pseudomonas fluorescens*, *Nocardiopsis aegyptia*, *Streptomyces sp. SNG9*, *Streptomyces exfoliatus*, *Streptomyces venezuelae*, and *Actinomadura sp.* [156]. For more information, see the article of Bano et al. gathering the main microorganisms responsible for PHA degradation [157].

These bacteria have the ability to produce extracellular enzymes called hydrolases and depolymerases, which are capable of degrading PHA into small molecules that can penetrate the bacterial membrane and be used as carbon and energy sources. Most of PHA-depolymerases share several characteristics. They are highly stable at a wide range of temperature and ionic strength; they have relatively small  $M_w$  (<70 kDa) with most of depolymerases consisting of only one peptide chain; and they show maximum activity at pH between 7.5 to 9.5 [148, 158, 159]. For example, PHBV-depolymerases from both *Streptomyces sp. AF11* and *Acidovorax sp. HB01* strains showed a 100 % activity at temperatures ranging from 35 °C to 55 °C and pH from 7.0 to 8.0 [149, 160].

The depolymerases adhesion and adsorption on the polymer is largely influenced by the polymer surface properties (surface area, hydrophilicity and hydrophobicity) as well as its crystallinity, and crystal structure [159]. It was observed that the degradation rate decreased with the increasing degree of crystallinity. P(3HB-4HB) which had the lowest degree of crystallinity (50 %) showed the highest degradation rate ( $1.63 \text{ mg}\cdot\text{day}^{-1}$ ), compared to P(3HB) (78 % crystallinity) which degraded at a rate of  $0.61 \text{ mg}\cdot\text{day}^{-1}$ . In the case of PHA copolymers,

the crystallinity decreases as the HV content increases, which accelerates the enzymatic degradation rate [161, 162]. The amorphous region allows permeation of moisture and enzymes, and thus, its degradation would increase the surface area of available crystalline regions. Only enzymes A and B from *Pseudomonas lemoignei* stand out by displaying a similar degradation rate of both amorphous and crystalline regions indiscriminately [163]. To a lesser extent, the stiffness of the material may also affect the bacterial degradation by affecting the biofilm formation. In general, an increasing stiffness is favorable for bacteria attachment [164].

Most of the purified depolymerases are known to be scl-PHA-specific. Volova *et al.* [165] submitted PHA films with different monomeric composition to the extracellular enzymes from different bacteria. It was reported that P(3HB) was degraded by bacteria of the genera *Acidovorax* and *Mitsuaria*, which were not active against P(3HB-3HV) and P(3HB-4HB) films. *Streptomyces gardneri* and *Cupriavidus sp.* were specific degraders for P(3HB-4HB), while P(3HB-3HV) was depolymerized by *Roseomonas massiliae* and *Delftia acidovorans*. Nevertheless, these three PHA types were degraded by *Streptomyces*. Again, *Pseudomonas lemoignei* is the exception, as it is able to degrade the homopolyester PHV while most other PHB-degrading bacteria are unable to. This bacterium is capable of producing at least five extracellular depolymerases, three of which (A, B and D) are specific for PHB and PHBV with a low HV content; and depolymerases C and poly(D-3-hydroxyvalerate)(PHV) depolymerase which degrade both PHB and PHV [158, 166].

The availability of medium chain depolymerases is hardly reported. Only a few species have been described so far, mainly belonging to *Pseudomonas* and *Streptomyces* genera [167, 168].

Research on chemical agents that inhibit scl-PHA-depolymerases is very limited. Currently, reducing agents and serine hydrolase inhibitors such as diisopropyl-fluorophosphate are the most incriminated compounds [148, 158, 159]. Metal ions such as  $Fe^{2+}$  and  $Cu^{2+}$  were designated by Wang *et al.* as inhibitors of *Acidovorax sp. HB01* strain, due to their effect on the active site of the extracellular enzyme [160].

Since polyphenols are reducing agents, it is conceivable that they could contribute to the inhibition of PHA-extracellular depolymerases. Therefore, it is important to review the studies on the impact of polyphenols on the biodegradation of PHAs and bioplastics.

### II.4.3 Impact of polyphenols on polymers biodegradation

Very little research has been done on the impact of polyphenols on polymers biodegradation. The most important findings are summarized in Figure 7.

The delay in biodegradation caused by the presence of polyphenols was observed by Latos-Brozio *et al.* [169] when P(3,4HB) and PLA films containing curcumin and morin were home composted under controlled conditions (30 °C and 60 % moisture), during 6 months. The carbonyl index was used as an indicator of degradation, since its increase is related to the breaking of polymer chains. The degradation of neat P(3, 4HB) was visible after the first month of composting, while the addition of morin retarded the degradation process by one month. The same trend was observed for PLA, with a one-month delay in degradation between pure PLA and PLA/morin sample. At the end of composting, PLA/curcumin sample had a higher weight loss than PHA/curcumin. This was attributed to the difference of miscibility and solubility of the additive in the polymer matrices. Stronger the interactions between the two components, slower the polymer degradation. The same authors studied the impregnation of P(3,4HB) and PLA pellets by the ethanolic extracts of *Cistus linnaeus* (*Cistus* L.) and green husk of walnut *Juglans regia* Linnaeus (*Juglans regia* L.). The chemical composition of the extracts was not accurately determined, but the presence of phenolic acids, flavones and their glycosides, in addition to juglone and carotenoids was detected by FTIR. The microbial degradation of the impregnated polymers was carried out in the presence of mold fungus *Aspergillus niger*, *Paecilomyces varioti*, *Chaetomium globosum*, *Trichoderma viride* and *Penicillium funiculosum*. Unlike the previous study, polymers have preserved their biodegradation rates after the impregnation with phenolic compounds. This behavior was mainly attributed to the fact that during impregnation, small fragments of plant material were able to attach to the polymers, providing a carbon source that favors the growth of microorganisms on the polymer surface [170]. However, as the biodegradation processes are different, it is not obvious to compare these two studies.

Vine shoot fibers, without polyphenols (after the extraction of procyanidins), were biodegraded in soil according to NF EN 17033 standard at 28 °C. Compared to the virgin vine shoot fibers (still containing polyphenols) which degraded at 83 % after 80 days, the exhausted fibers reached a final rate of biodegradation of 97 % for the same period. Since the polyphenols extraction did not modify the fibers morphology and crystallinity, this delay was



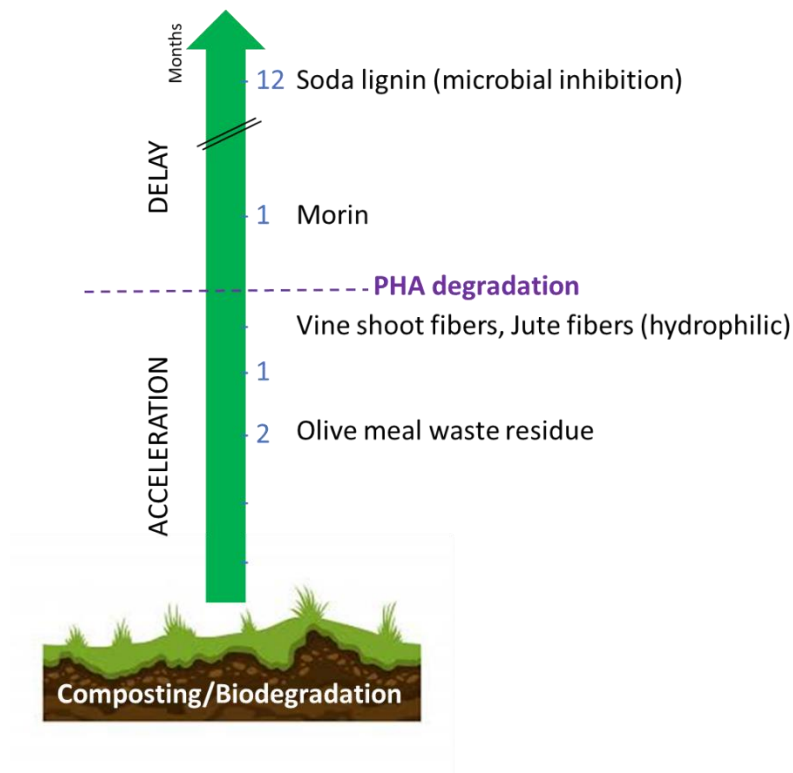
attributed to the removal of the antimicrobial polyphenols. Interestingly, PHBV polymer reinforced with these two types of fibers (virgin and exhausted) at 20 wt% loading, exhibited the same degradation behavior, indicating that the biodegradation process was mainly driven by the behavior of the PHBV matrix [171].

The higher water vapor permeability induced by the introduction of natural fibers seems to favor the biodegradability of PHA-based composites, even if these lignocellulosic fibers contain a portion of lignin, which is recalcitrant to microbial attack. Indeed, PHB polymer reinforced with 30 wt% of jute and hemp fibers were placed in home compost during 12 weeks. PHB/jute fibers composite degraded at 84 % between week 8 and 12, while PHB/hemp fibers composite and neat PHB underwent 68 % and 50 % weight loss respectively within the same period. Jute fibres with the highest lignin content (12-14 %) were better able to promote the biodegradation of PHB thanks to the good dispersion of these hydrophilic fibers which led to a better water absorption and increased surface area for microbial attack [172]. The same finding was made by Carofiglio *et al.* when they assessed the soil degradation of PHB polymer reinforced with lignocellulosic material from olive mill wastewater residue (OMWR) [173]. After 8 weeks of soil burial, PHB/OMWR composite (with 40 wt % of fillers) recorded 20 % of mass loss, while no evidence of biodegradation was observed for neat PHB.

Although lignin is part of lignocellulose composition, its effect on PHA biodegradation was not clearly demonstrated. Only Mousavioun *et al.* investigated the soil degradation of PHB films reinforced with soda lignin [174]. Thus, PHB films containing from 10 to 90 wt% of soda lignin were buried in soil, and their biodegradability was assessed over 52 weeks, according to ASTM D 4972 standard. Once lignin is present in the blend, the polymer degradation is inhibited. Indeed, the lowest amounts of lignin increased the crystallinity of PHB, and the highest amounts (over 30 wt%) reduced or prevented the accumulation of the microorganisms on the films surface, because of its antimicrobial property.

From these few studies, the inhibitory effect of polyphenols on the biodegradation of PHAs has not been clearly established. Despite the antimicrobial property of polyphenols, many other factors come into play, such as the chemical nature of the polyphenols (pure molecules or involved in a plant tissue), their amount, as well as the modification of the polymer structure induced by polyphenols (nucleating agent, plasticizer). In addition, the

degradation conditions (temperature, time and microbial consortium) should not be neglected to make an accurate comparison.



**Figure 7:** Effect of some polyphenols on PHAs biodegradation.

## II.5 Conclusion

Highly promising biobased and biodegradable PHAs are struggling to replace conventional plastics in a wide range of applications, because of their brittleness and thermal instability. Many efforts are being made to address these problems, and one of the solutions to preserve the biodegradability of these polymers is the use of natural polyphenols as additives. It has been shown that regardless of the nature (pure or extract) or structure of the polyphenol, its addition to PHA matrices, up to a certain amount (generally <30 wt%) contributes to an improvement of their thermal and mechanical properties. This, is likely attributed to the hydrogen bonds between the phenolic hydroxyls of polyphenols and the carbonyl groups of PHAs. On the contrary, an excess of polyphenols leads to accelerate the thermomechanical degradation of the blends, due to their immiscibility and/or their plasticizing effect. The biodegradability of PHAs in the presence of polyphenols was then

examined and no inhibitory effect was clearly established. Some studies claim that the presence of polyphenols delays the biodegradation of PHAs due to their antimicrobial effect (lignin), while others show an accelerated degradation of polymers loaded with polyphenols contained in fiber tissues or in extracts with other components. Indeed, the biodegradability is a complex process influenced also by the polymer properties, the environment and the bacterial consortium. To clearly establish the effect of polyphenols, all the biodegradation tests should be performed on similar polymers (in term of structure) and under the same conditions.

## Conclusion

Dans cette étude bibliographique, nous avons donné un aperçu des actions et initiatives actuelles pour la transition du modèle linéaire de gestion des déchets plastiques vers un modèle circulaire.

Bien que les polymères biosourcés et biodégradables soient l'une des solutions envisagées pour réduire la dépendance aux ressources fossiles, ainsi que la propagation des déchets plastiques dans l'environnement, leur intégration dans des boucles de réutilisation et de recyclage est assez limitée, en particulier pour les PHAs.

Au-delà du coût élevé de ces polymères, leur instabilité thermique est un obstacle à leur réutilisation et à leur recyclage. Nous avons donc fait le point sur les études réalisées pour améliorer la stabilité thermomécanique des PHAs, en utilisant des polyphénols comme additifs. La majorité de ces études ont prouvé l'efficacité des polyphénols lorsque certaines quantités ne sont pas dépassées. Mais, là encore, toutes les études réalisées ont considéré l'effet stabilisant des polyphénols lors des étapes de production et de formulation. Très peu d'études se sont penchées sur leur impact au cours d'un cycle de vie complet du plastique.

Enfin, plusieurs études ont attesté de l'effet antimicrobien des polyphénols. Mais malgré cela, aucun consensus n'a été atteint sur leur effet retardateur de biodégradation des PHAs. Ceci est certainement dû au nombre limité d'études sur le sujet, et aux conditions expérimentales très différentes, qui empêchent une comparaison rigoureuse.

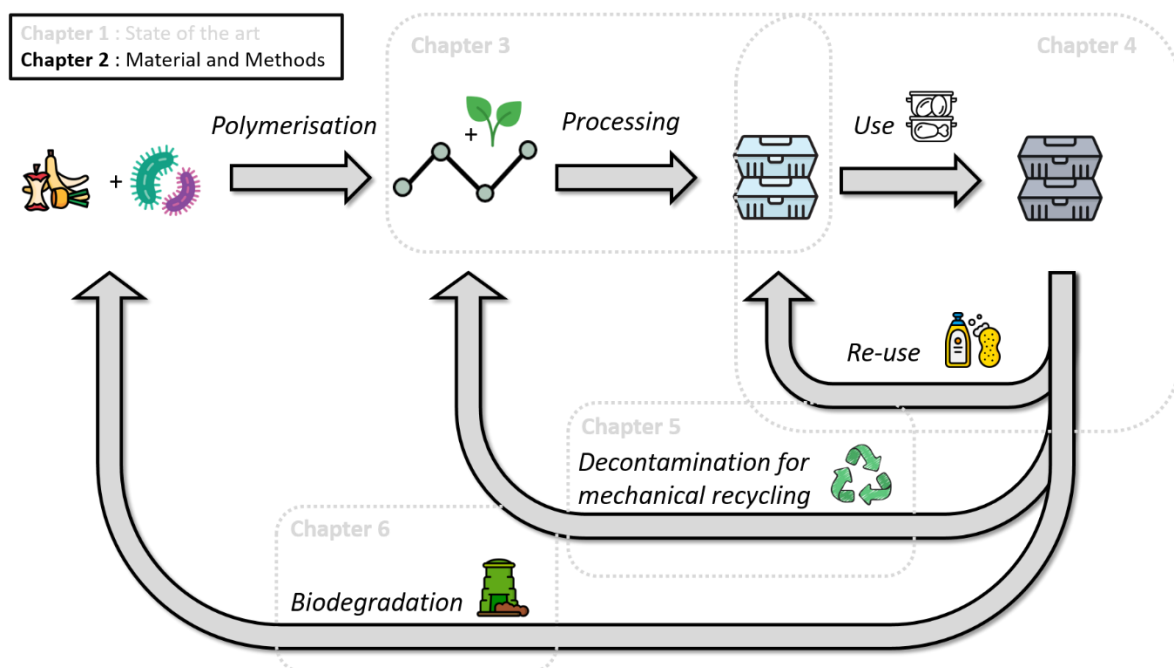


# CHAPTER 2

## MATERIALS AND METHODS

## Chapter 2. Materials and methods

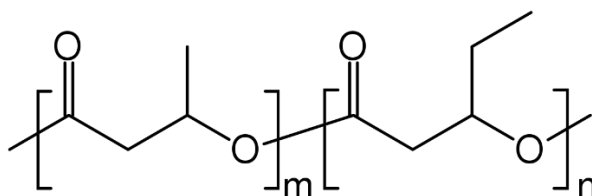
Ce chapitre décrit le matériel et les méthodes utilisés au cours de cette thèse. Sa lecture n'est pas indispensable à la compréhension des chapitres 3, 4, 5 et 6, étant donné que chacun de ces chapitres contient la partie matériel et méthodes qui lui est spécifique. Ce chapitre permet, toutefois, de regrouper toutes les méthodes expérimentales. Tout d'abord, le polymère (PHBV), ainsi que les additifs (quercétine et acide gallique) utilisés sont présentés. Ensuite, le procédé de mise en œuvre des films vierges et additivés, ainsi que les procédés d'usage, de ré-usage, de recyclage et de biodégradation sont décrits. Enfin, une dernière partie est consacrée aux méthodes de caractérisation des matériaux, (structurale, thermique, mécanique), ainsi que des milieux liquides en contact avec eux (simulants alimentaires, liquides de lavage et milieu de culture bactérien).



## I. Materials

### I.1 Polymer

The polymer used was the poly(3-hydroxybutyrate-co-3-hydroxyvalerate) commonly known as PHBV (Figure 8). The polymer powder was purchased from Natureplast (France) under the grade PHI003. As reported by the supplier, it contains 1-3 mol % of valerate. The main properties given by the supplier are presented in Table 8.



**Figure 8:** Formula of PHBV.

**Table 8:** Main characteristics of the PHBV grade (PHI003) given by the supplier NaturePlast.

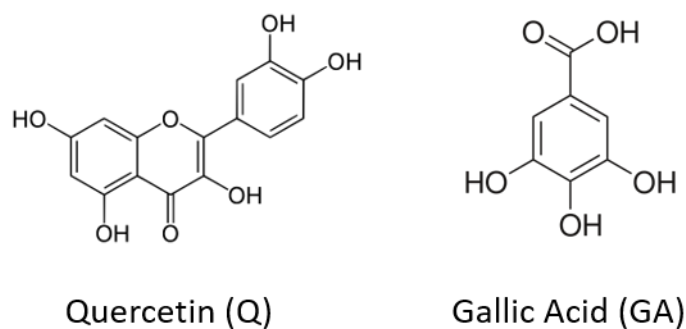
	Method	Unity	Value
Physical properties			
Density	ISO 1183	/	1.24
MFI (190 °C ; 2.16 kg)	ISO 1133	g.10min <sup>-1</sup>	15-30
Mechanical properties			
Elongation at Break	ISO 527	%	4.0
Tensile Modulus	ISO 527	GPa	4.20
Thermal properties			
Melting temperature	DSC	°C	171-177

The polymer powder was stored away from air and light and from any heat source.

### I.2 Polyphenols

Quercetin and Gallic acid were purchased from Sigma Aldrich France. Their chemical structures are shown in Scheme 3.





**Scheme 3:** Chemical structures of quercetin and gallic acid.

### I.3 Other chemicals

All chemicals, Boron Nitride, Sodium Chloride, Sulfuric Acid ( $\text{H}_2\text{SO}_4$ ), Magnesium Sulfate, acetic acid, vanillic acid, PEG 550, PEG 200, catechin, ferulic acid; and solvents (Methanol, ethyl acetate, ethanol, acetonitrile) were purchased from Sigma Aldrich France.

Dishwasher detergent (5-15 % oxygen bleach, < 5 % polycarboxylates, non-ionic surface agent, phosphonates) from SUN<sup>®</sup> was used to prepare a 0.3 wt% solution in water to simulate the food packaging washing conditions.

## II. Methods

### II.1 Chemical synthesis

#### *Synthesis of methyl gallate*

Methyl gallate was synthesized in order to substitute gallic acid during PHBV film formulation. The purpose was to assess the role of the carboxylic group of gallic acid on the thermal degradation mechanism of PHBV.

Gallic acid (1 g, 5.88 mmol) was dissolved in 25 mL of methanol under magnetic stirring. Then,  $\text{H}_2\text{SO}_4$  (47  $\mu\text{L}$ , 0.88 mmol) was added and the solution was heated under reflux at 66 °C during 18 h. After cooling, water (30 mL) was added to the reaction mixture, and the aqueous phase was extracted with 3  $\times$  30 mL of ethyl acetate. The organic phase was washed with 30 mL of brine, then dried over  $\text{MgSO}_4$ , and vacuum concentrated. Methyl gallate was obtained as a white solid powder with a quantitative yield (100%). Mass spectrometry analysis:  $\text{C}_8\text{H}_8\text{O}_5$   $[\text{M}+\text{H}]^+$ : 184.1461 (see section II.6).

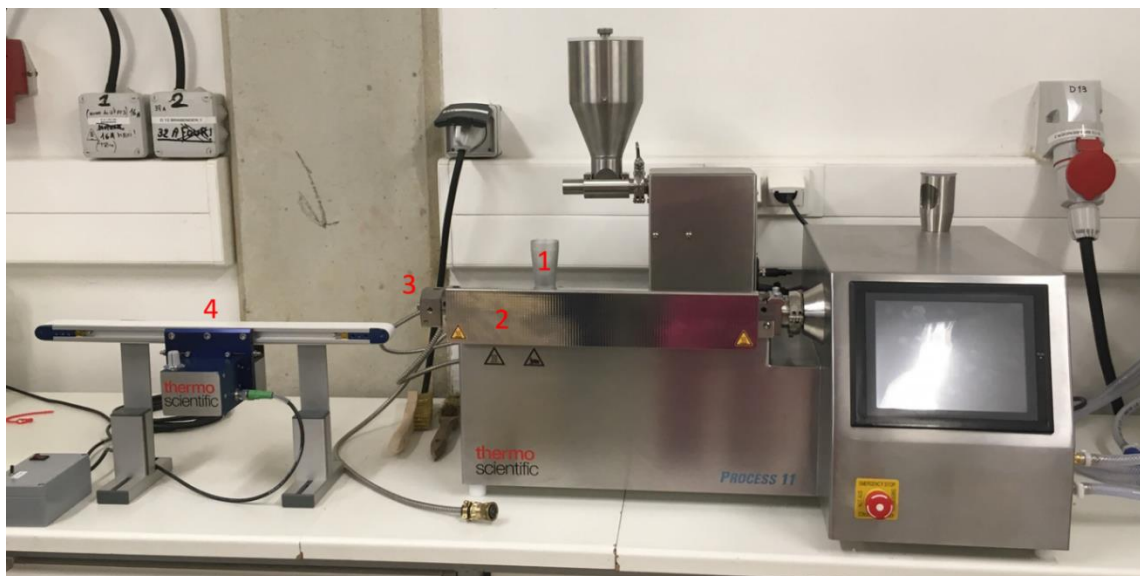
## II.2 Preparation of PHBV/polyphenols and PET films

PHBV and polyphenol (quercetin, gallic acid and methyl gallate) powders were dried at 60 °C for 24 h. Prior to thermal processing, 0.5 wt% boron nitride was added to PHBV as a nucleating agent. The resulting powder was pre-mixed with each polyphenol in different ratio, in a powder blender (Turbula T10B, Laboservices, Montpellier, France). The obtained mixtures were extruded in lab scale twin screw extruder Thermo Scientific Process 11 Twin-Screw Extruder, ThermoScientific, Karlsruhe, Germany (Figure 9), equipped with a L/D ratio of 40, a screw diameter of 11 mm, and a 3 mm rod die. The temperature profile set at 180 °C was uniform from the feeding area to the die and the screw profile was the one described in Vandi *et.al* [175]. The screw speed was set at 200 rpm and the residence time was approximately 2 min. After pelletization, PHBV/polyphenol blends were transformed into thin films of 12 × 12 cm, using heated hydraulic press (20T, Pinette Emidecau Industries, Chalon-sur-Saône, France). Pellets were heated at 180 °C during 5 min and then pressed between Teflon coated plates by regularly increasing the pressure from 5 bar to 150 bar over 7 minutes. Films were cooled down to room temperature for 10 minutes. Then, they were left for stabilization during 14 days at 50 % of humidity. Virgin PHBV films without additives were prepared in the same way.

Films of 300 µm were prepared for the processing and use/reuse studies, while, 200 µm films were used for the biodegradation study.

For the processing study: five weight contents of quercetin and gallic acid were considered, *i.e* 0.5, 1, 5, 10 and 15 wt%. The samples were named Q0.5, Q1, Q5, Q10 and Q15 for quercetin, and GA0.5, GA1, GA5, GA10 and GA15 for gallic acid. Concerning the blends with methyl gallate, two additive content were used namely 1 and 5 wt%, giving rise to samples MG1 and MG5 respectively.

For the use/reuse and biodegradation studies: only the formulations with 1 wt% of quercetin and gallic acid were retained, and named PHBV-Q and PHBV-GA respectively.



**Figure 9:** Melt extrusion set-up with 1: the screw feeder 2: screws 3: filament die  
4: treadmill.

For the biodegradation study, PET films were used as negative control, during the home composting test. Using the hydraulic press, and under the same pressure conditions as for PHBV, PET pellet (TK Chemical, Seoul, Korea) were transformed into 200  $\mu\text{m}$  PET films, at 255 °C.

### **II.3 Simulation of use and reuse of PHBV-based materials: food contact ability and washing cycles**

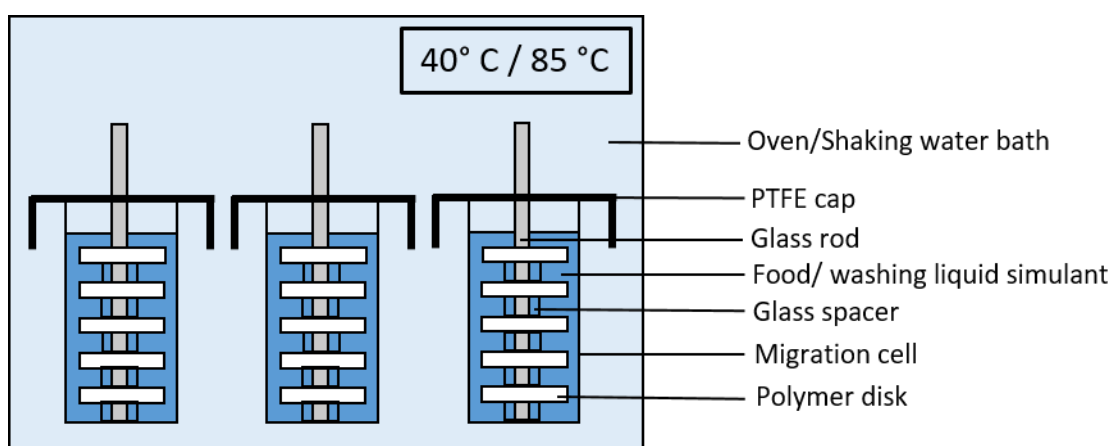
#### **II.3.1 Usage simulation: contact with food simulants**

Three food simulants were selected to study the evolution of the films properties and the migration of additives and/or degradation products : food simulant D2 (95 % (v/v) ethanol) to replace vegetable oil and simulate food containing free fats on the surface; simulant B (3 % (w/v) acetic acid) corresponding to food with hydrophilic character with a pH below 4.5, and food simulant A (10 % (v/v) ethanol), corresponding to food with hydrophilic character (European Standard EN 10/2011) [67]. Migration studies were conducted in triplicate at 40°C, over 10 days (EN 10/2011 regulation for long time storage). As displayed in Scheme 4, five 2.8 cm diameter polymer discs were double-side immersed in 100 mL of food simulant (total area to volume around 6  $\text{dm}^2 \cdot \text{L}^{-1}$ ). Material degradation and migration kinetics were monitored by collecting one disc and 20 mL of food simulant after 1, 2, 3, 5 and 10 days. After

drying, thermal properties of the polymer samples were characterized and food simulant solutions were analysed in UPLC.

### II.3.2 Reuse simulation: washing cycles

Using the device depicted in Scheme 4, washing operations were simulated. To simulate dishwashing, the polymer discs were immersed in water, or detergent solution (0.3 % w/v) for 20 washing cycles of 60 min each, at 85 °C. The simulation of the decontamination step was performed in NaOH solutions (1 % and 2 % w/v) for 5 washing cycles of 60 min each, at the same temperature. Each simulation was conducted in triplicate. Material degradation kinetic was monitored by collecting one disc and 10 mL or 20 mL of washing liquid after each washing cycle. After drying, thermal properties of the polymer samples were characterized and washing liquids were analysed in UPLC when possible.



**Scheme 4:** Scheme of the device used for migration and washing tests.

### II.3.3 Overall migration measurement (OM)

The calculation of the OM was used to know how much materials is migrating into the food simulant or the washing liquids. After each simulation, dry polymer discs were weighed using a microbalance (0.1 mg resolution); and their weight were compared to the initial one. The overall migration/release was calculated in milligrams per square decimetre of the surface of the polymer and was defined by Equation 1:

$$\text{Overall migration} = \frac{m_{discs, \text{ before contact}} - m_{discs, \text{ after contact}}}{A_c} \quad (1)$$

Where :  $m_{discs, \text{ before contact}}$  and  $m_{discs, \text{ after contact}}$  (mg) are respectively the masses of the discs before and after contact with the food simulant or the washing liquid and  $A_c$  (dm<sup>2</sup>) is the contact area between the discs and the liquids.

In food simulants, the overall migration limit (OML) has been set at 10 mg.dm<sup>-2</sup> by the European commission [67].

For the washing steps, overall release was converted to mg.L<sup>-1</sup> for a better representation of the amount of products lost in the washing liquid.

### II.3.4 Relative migration (RM)

The relative migration/release represents the percentage of an additive or a degradation product that migrates from polymer into food simulant or washing liquid. Additive (quercetin and gallic acid) and identified degradation products (crotonic acid) which migrated into food simulants or washing liquids were quantified by UPLC (see section II.6)

In the impossibility of injecting the washing liquid containing the detergent, PHBV-Q films were extracted in order to determine the amount of quercetin remaining in the film. The extraction was carried out in methanol at 40 °C with stirring for 48 h and the solutions were injected in UPLC.

The relative migration of quercetin (%) was calculated according to the Equation 2:

$$\text{Relative migration} = \frac{m_{r,additive}}{m_{i,additive}} \times 100 \quad (2)$$

Where :  $m_{r,additive}$ (mg) is the mass of additive recovered in the food simulant or the washing liquid and  $m_{i,additive}$  (mg) is the initial mass of additive in the film sample.

Since crotonic acid is a degradation product of the washing process, its release is directly measured in mg.L<sup>-1</sup> by means of UPLC-assisted quantification.

## II.4 Simulation of closed-loop mechanical recycling: thermal decontamination

In this part, only PHBV and PHBV-Q were used.

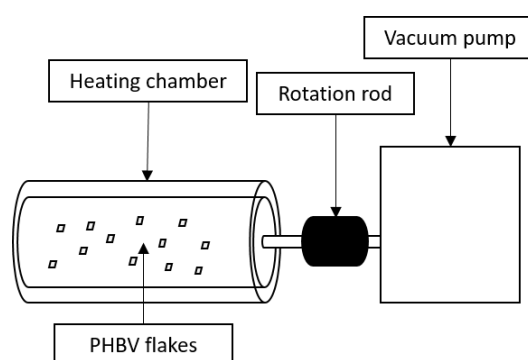
### II.4.1 Contamination procedure of PHBV and PHBV-Q

Surrogates contaminants (gallic acid, catechin, felulic acid, PEG 200) were dissolved in methanol, at a concentration of  $9 \text{ mg}\cdot\text{mL}^{-1}$  and  $23 \text{ mg}\cdot\text{mL}^{-1}$  for phenolic compounds and PEG200 respectively, and stirred until a homogeneous solution was obtained. In sealed containers, this surrogate's mixture was dropped on PHBV and PHBV-Q flakes at a concentration of 500 mg of surrogates per kg of flakes. Containers were stored for 10 days at  $40 \text{ }^\circ\text{C}$  with continuous rotatory agitation until a sorption equilibrium was reached. After 10 days, the contamination level was evaluated by measuring the surrogate concentration in the flakes.

### II.4.2 Decontamination procedure

#### II.4.2.1 Decontamination process

Decontamination of the contaminated flakes was performed at elevated temperature and under vacuum ( $< 20 \text{ mbar}$ ) in a glass oven (Buchi, B-585). The experimental process is schematized in Scheme 5. Polymer flakes were introduced in the heating chamber, under vacuum and rotation, at  $130 \text{ }^\circ\text{C}$ ,  $145 \text{ }^\circ\text{C}$  and  $160 \text{ }^\circ\text{C}$ , during 6, 20 and 48 hours for neat PHBV and at  $160 \text{ }^\circ\text{C}$ , for 6 and 48 hours for PHBV-Q.



**Scheme 5:** Scheme of the PHBV and PHBV-Q flakes decontamination process according to Dedieu *et.al* [75].

The surrogates and quercetin (the additive) concentrations in the polymer flakes after contamination and decontamination were determined using the following extraction method:

5 mL of methanol were added to 0.3 g of both PHBV-based material flakes in a glass vial, and samples were stored at 40 °C for 24 hours under magnetic agitation. All the extracts, obtained in triplicate, were analysed in UPLC (see section II.6)

#### II.4.2.2 Decontamination efficiency

Decontamination efficiencies were determined for each surrogate by comparing the surrogate concentration in the flakes after decontamination with the initial concentration before heat treatment (Equation 3).

$$\text{Decontamination efficiency} = \left(1 - \frac{\text{sample concentration}}{\text{initial concentration}}\right) \times 100 \quad (3)$$

### II.5 Assessment of PHBV-based material biodegradability

#### II.5.1 PHBV-based films degradation in liquid medium, in the presence of *Streptomyces exfoliatus*

##### II.5.1.1 The preparation of the *S. exfoliatus* solution

Dry culture of *S. exfoliatus* (DSM 41693 from the German Collection of Microorganisms and Cell Culture DSMZ) was regenerated in 50 mL of GYM medium (from Sigma Aldrich, France in g.L<sup>-1</sup>: glucose: 4.0; yeast extract: 4.0; malt extract: 10.0), as recommended by the supplier, and then preserved in a 40 % (v/v) aqueous solution of glycerol (Sigma Aldrich, France) at - 80 °C, before use.

Frozen *S. exfoliatus* were regenerated in 50 mL of liquid GYM solution at 28 °C during 48 h in order to obtain a high concentrated bacterial solution. To remove the residual carbon content of GYM medium, 15 mL of this bacterium solution was washed with 25 mL of sterile physiological water in a 50 mL sterile centrifuge tube. After dynamic hand shaking, the tube was centrifuged for 5 min at 4000 rpm. This operation was repeated again, after discarding the supernatant. Finally, 15 mL of sterile physiological water were added before to vortex the carbon-free suspension of *S. exfoliatus*.

### II.5.1.2 Degradation of PHBV-based films in the pure culture solution of *S. exfoliatus*

Pre-sterilized polymer films (2x 1 cm pieces) were introduced in sterile 100 mL flasks, equipped with cotton stoppers. Then, 50 mL of minimal nutrient solution were added (Sigma Aldrich), in g.L<sup>-1</sup>: Na<sub>2</sub>HPO<sub>4</sub>: 12.8; KH<sub>2</sub>PO<sub>4</sub>: 3; NaCl: 0.5; NH<sub>4</sub>Cl: 1; H<sub>3</sub>BO<sub>3</sub>: 0.06; MnSO<sub>4</sub>, H<sub>2</sub>O: 1.017; CoCl<sub>2</sub>,6H<sub>2</sub>O: 0.025; ZnCl<sub>2</sub>: 0.07; NiCl<sub>2</sub>,6H<sub>2</sub>O: 0.025; CuCl<sub>2</sub>,2H<sub>2</sub>O: 0.015; NaMoO<sub>4</sub>,2H<sub>2</sub>O: 0.025; HCl: 1,755) adapted from Chatellard *et al.* [176], followed by 500 µL of the previously prepared bacterium suspension. Flasks without bacterium and without polymer were used as control.

PHBV films microbial degradation was performed for four months at 28 °C in an orbital shaker (120 rpm, IK KS4000, Dutcher France), previously cleaned with a 70 % ethanol solution. Residual film samples, cell biomass and culture supernatants were collected in duplicate at month 1, 2 and 4 for analyses.

### II.5.1.3 Evaluation of the microbial growth and cell morphology

To follow the microbial growth, as well as the presence of contaminants, 100 µL of microbial suspension were collected at each sampling time and incubated 48 h at 28 °C on GYM agar plate (GYM medium with agar, 12 g.L<sup>-1</sup>).

In parallel, microbial cells morphology (size and shape) was observed with an optical microscope equipped with an immersive objective (magnification x100, Ernst Leitz Wetzlar, Germany), after Gram staining. For this, 2 mL of microbial culture were centrifuged for 5 min to concentrate the bacterial suspension (2000 g, centrifuge Eppendorf 5427R, Dutcher, France). After removing 1.5 mL of supernatant, the bacterial pellet was homogenized and fixed on a microscope slide. The slide was finally Gram stained following this method: it was first stained 1 min in crystal violet stain, 1 min in lugol, rinsed with 70 % ethanol solution, and finally stained 3 min with safranin.

### II.5.1.4 Evaluation of the antibiotic effect of polyphenols

In order to test the resistance of *S. exfoliatus* to gallic acid and quercetin, aqueous solutions of these two compounds, with a range of concentrations of 2, 4, 8, 20, 50 mg.L<sup>-1</sup> for quercetin and 3, 6, 12, 50 and 500 mg.L<sup>-1</sup> for gallic acid, were prepared and sterilized. The screening antimicrobial test was carried out by disc diffusion using 100 µL of suspension



containing the bacterium, spread on the surface of GYM nutrient agar in Petri dishes. Sterile Whatman filter paper was used to prepare 5 mm diameter discs soaked into the sterile polyphenol solutions, before to be lay on the inoculated agar. Each plates were done in duplicate. Negative controls were prepared using the same solvent to dissolve polyphenols. Supernatants of PHBV-Q and PHBV-GA culture media sampled at the fourth month, were also tested for the antibiotic tests. The inoculated plates were incubated at 28 °C for 48 h, and pictures were taken after this period.

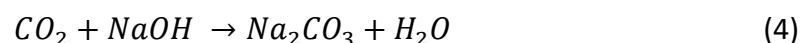
### II.5.2 Biodegradation of PHBV-based films under home compost conditions

The biodegradation of PHBV-based materials under aerobic home composting conditions was measured at lab scale with a method adapted from the methodological standard ISO 14855-1:2012. The study was conducted for 6 months at 28 °C using a respirometric test that is based on the quantification of the CO<sub>2</sub> released during the aerobic degradation of organic matter (e.g. PHBV). Cellulose (Arbocel® BE 600-10 TG, Germany) was used as positive control, PET as negative control, and compost without substrate as reference to measure the endogenous respiration of the inoculum.

Mature compost (pH in H<sub>2</sub>O = 7.4, 30.4 % of organic matter, 53.2 % of dry matter) was collected from an industrial composting platform (Aspiran, France), on September 2021. The compost was first sieved through 2 mm screen in order to obtain a homogeneous medium, and then dried for two months to reach 97 % dry matter.

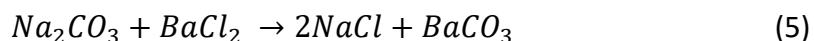
Polymer films were milled with a micro-grinder (IKA A10, Germany) into a powder of 0.5 mm particle size. After determining the carbon content of each polymer, exactly 50 mg of equivalent carbon were put into 6 g of compost. Before mixing, the humidity of the compost was adjusted to 50 %.

As described by David *et al.* [171], respirometric tests (done in triplicate) were performed in 1 L glass reactors (Le parfait, France) containing three 60 mL opened polypropylene flasks . The first flask contained the compost/polymer mixture prepared previously, the second flask was filled with 10 mL of water to maintain a constant relative humidity of 100 %, and the third flask contained 10 mL of NaOH aqueous solution (0.2 M) to trap the CO<sub>2</sub> emitted during the organic matter biodegradation (Equation 4).

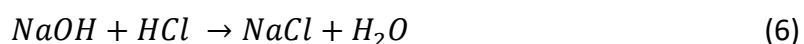


Glass reactors were hermetically closed and incubated at  $28\text{ }^{\circ}\text{C} \pm 2\text{ }^{\circ}\text{C}$  (incubator TS 606/4-I, WTW, Austria). Regularly, they were opened for 5 min to renew the air inside, and to measure the quantity of  $\text{CO}_2$  released via the degradation, and trapped by the NaOH solution.

NaOH flasks were removed from the glass reactors and 5 mL of barium chloride solution (20 % in water) were added to precipitate the carbonate salt resulting from the reaction of NaOH and  $\text{CO}_2$  (Equation 5).



The excess of NaOH was titrated with HCl aqueous solution at 0.2 M, in the presence of thymophtalein (0.10 % in ethanol) as color indicator (Equation 6).



The percentage of biodegradation %B is calculated using Equation 7:

$$\%B = \frac{\text{CO}_2 \text{ material} - \text{CO}_2 \text{ blank}}{\text{CO}_2 \text{ theoretical}} \times 100 \quad (7)$$

Where “ $\text{CO}_2$  material” and “ $\text{CO}_2$  blank” are the quantity of  $\text{CO}_2$  produced by the sample and the blank (compost without polymer) respectively (in mg); “ $\text{CO}_2$  theoretical” is the amount of carbon dioxide that could be release if all the material is biodegraded (in mg).

According to the methodological standard ISO 14855, the experiment is valid if:

- The degradation of the reference material (here cellulose) is higher than 70 % after 90 days.
- The standard deviation between the replicates of the reference material is lower than 20 %.
- The blank has produced between 50 and 150 mg of  $\text{CO}_2$  per g of compost after 10 days.

According to the specification standard NF T 51-800, the material is considered as biodegradable if its degradation reach at least 90 % in 365 days

## II.6 UPLC/MS analysis

The UPLC-analysis was used several times:

- To verify the exact concentration of polyphenols in PHBV films, after processing.
- To determine the amount of polyphenols and degradation products that have migrated into food simulants, washing liquids and culture media.
- To quantify the residual contaminants in PHBV materials after the decontamination process.

The corresponding samples were injected in Aquity UPLC (Waters, Milford, MA) liquid chromatography system, equipped with a photodiode array detector (DAD) and a mass spectrometer. The Waters column was 100 mm x 2.1 mm, HSS T3, particles size was 1.8  $\mu\text{m}$ . The solvent used were A (99.9 %  $\text{H}_2\text{O}$  and 0.1 %  $\text{HCOOH}$  v/v) and B (80 %  $\text{CH}_3\text{CN}$ ; 19 %  $\text{H}_2\text{O}$ ; 1 %  $\text{HCOOH}$ ) with a flow rate of 0.55  $\text{mL}\cdot\text{min}^{-1}$ . The injection volume was 2  $\mu\text{l}$  and DAD was set at 280 nm ( $\lambda_{\text{max}}$  of phenolic compounds) and 208 nm ( $\lambda_{\text{max}}$  for crotonic acid). PEG 200 was detected with a Bruker amazon X electrospray ionization (ESI) ion trap (Bruker Daltonics, Bremen, Germany). The nebulizer pressure was 3.03 bar, the temperature of drying gas was set at 200  $^{\circ}\text{C}$  with a 12  $\text{L}\cdot\text{min}^{-1}$  flow; and the capillary voltage was set at -5.5 kV. The mass spectra were acquired over a mass range of 50-2000 Th in the positive ionization mode. The mass spectrum acquisition speed was set at  $m/z$  8100  $\text{s}^{-1}$ . PEG 200 was quantified by integrating the mass spectrometry peak at 300  $m/z$ . Calibration curves of quercetin, gallic acid, crotonic acid, as well as those of the surrogate contaminants were previously plotted to assist quantification. Vanillic acid and PEG 550 at 30  $\text{mg}\cdot\text{L}^{-1}$  were used as internal standards.

## II.7 Characterization of the physical-chemical properties of PHBV-based materials

### II.7.1 Size exclusion chromatography (SEC)

The number-average molecular weight ( $M_n$ ), average molecular weight ( $M_w$ ), and polydispersity index ( $M_w/M_n$ ) were determined by SEC, performed in Technopolym platform (Toulouse, France).

Samples were placed in sealed tubes and dissolved in chloroform at a concentration of 3–5  $\text{mg}\cdot\text{mL}^{-1}$ , during 1–5 hours at 70  $^{\circ}\text{C}$ . Then, they were filtered through 0.45  $\mu\text{m}$  nylon filters. SEC analyses were carried out in a UHPLC (Ultimate 3000 Thermoscientific Pump) equipped

with Agilent PL gel 5  $\mu\text{m}$  Mixed C column. Injection volume was 50  $\mu\text{L}$  and the flow rate was 1  $\text{mL}\cdot\text{min}^{-1}$ . Detection was performed by means of three detectors, namely differential refractometric detector (Optilab Rex Wyatt,  $T = 35\text{ }^\circ\text{C}$ ), 3 angle-light-static-diffusion detector (TREOS Wyatt,  $\lambda = 658\text{ nm}$ ) and UV detector (Shimadzu SPD-M20A,  $\lambda = 254\text{ nm}$ ).

### II.7.2 Differential scanning calorimetry (DSC)

DSC analyses were carried out using a calorimeter DSC series Q200, TA Instruments, under a nitrogen atmosphere with a heating rate of  $10\text{ }^\circ\text{C}\cdot\text{min}^{-1}$ . Samples of 8-10 mg were used for each analysis and all experiments were done in triplicate. To determine the crystallinity degree and the thermal properties of the films, the following heating/cooling protocol was used [177]. First, the samples cooled down from  $25\text{ }^\circ\text{C}$  to  $-30\text{ }^\circ\text{C}$ , were heated to  $200\text{ }^\circ\text{C}$ , maintained at  $200\text{ }^\circ\text{C}$  for 5 min, and cooled down again to  $-30\text{ }^\circ\text{C}$ . The second heating was then performed from  $-30\text{ }^\circ\text{C}$  to  $200\text{ }^\circ\text{C}$ .

The melting temperature ( $T_m$ ), the crystallisation temperature ( $T_c$ ) and the apparent melting enthalpy ( $\Delta H_m$ ) were determined from the DSC curves from the second cool-heat cycle, using the Universal Analysis 2000 Software by TA Instruments. The crystallinity degree ( $X_c$ ) of neat PHBV and PHBV-Q samples was determined by the Equation 8:

$$X_c(\%) = \frac{\Delta H_m}{\Delta H_m^\circ} \times \frac{100}{w} \quad (8)$$

Where :  $\Delta H_m$  is the melting enthalpy of the polymer matrix,  $w$  is the polymer weight fraction in the sample and  $\Delta H_m^\circ$  is the theoretical melting enthalpy of the polymer assumed to be 100 % crystalline,  $\Delta H_m^\circ = 109\text{ J}\cdot\text{g}^{-1}$  for PHBV [178].

### II.7.3 Thermogravimetric analysis (TGA)

TGA analyses were carried out in triplicate, under nitrogen flow ( $50\text{ mL}\cdot\text{min}^{-1}$ ), using a Mettler TGA2 apparatus (Schwerzebbbach, Switzerland) equipped with XP5U balance (precision of 0.0001 mg). For each measurement, about 10 mg of material were used and the heating rate was  $10\text{ }^\circ\text{C}\cdot\text{min}^{-1}$  from  $25\text{ }^\circ\text{C}$  to  $600\text{ }^\circ\text{C}$ . The maximum degradation temperature ( $T_{deg}$ ) corresponds to the temperature at which the degradation rate was maximum. The onset degradation temperature ( $T_{onset}$ ) was measured when the first derivative of the weight loss became higher than 0.1 %.

### **II.7.4 Tensile properties**

The tensile strength, Young's modulus and elongation at break were measured according to DIN EN ISO 527–1 using a device INSTRON 68 SC-5 with a load cell of 2 kN. Measurements were performed on dog bone shaped film specimens (width of 4 mm and gauge length of 25 mm) which were inserted with an effective length of 40 mm between the clamps at the beginning of the tests. The samples were tested under a monoaxial tension with a cross head speed of 10 mm.min<sup>-1</sup>. Ten replicates were realized for each measurement.

## **II.8 Structural characterization of PHBV-based materials**

### **II.8.1 Fluorescent microscopy**

Fluorescence imaging was performed with a microscope 880 NLO (Zeiss, Jena, Germany) equipped with a Chameleon Ultra II laser (Coherent, Santa Clara, CA, USA) and visible lasers, and fitted with Plan Apo 20 × /1.0 Zeiss objective, (Montpellier Ressources Imagerie platform, [www.mri.cnrs.fr](http://www.mri.cnrs.fr)). The pulsed laser of the multiphoton microscope causes the excitation of phenolic compounds similarly to that of a UV laser. Optimal excitation for quercetin was obtained at a wavelength  $\lambda = 780$  nm with a bandpass emission in the 411–686 nm range (spectral detector). This spectral detector yielded spectral images and emission spectra in different parts of the sample. For gallic acid, the best excitation was obtained with a 405 nm laser and the same bandpass emission. The spectral detector yielded spectral images and emission spectra between 411 and 686 nm. These spectral signatures were used to visualize these molecules in the films. Image acquisition was performed using ZEN2 software (Zeiss, Germany).

### **II.8.2 Polarized optical microscopy (POM)**

POM observations were performed using a Laborlux 11 POL S (Leitz, Germany) microscope in the transmission mode, equipped with a mono-CDD Leica DFC420 camera (resolution 1728 × 1296 pixels) and piloted by the Archimede software (Microvision Instruments, France). Each sample was placed between two glass slides, then heated on a LTS420 hot stage (Linkam, UK) up to 200 °C at 30 °C.min<sup>-1</sup>. After being annealed for 3 min, it was cooled down to 100 °C at 10 °C.min<sup>-1</sup>. Observations were performed after 5 minutes of

stabilisation, the presence of boron nitride in all samples led to an almost instantaneous crystallisation.

### **II.8.3 Scanning electron microscopy (SEM)**

Pieces of films were adhered to a carbon adhesive tape and covered with a thin layer (4 nm) of Au/Pd sputter coating. They were observed using a benchtop Phenom Pro X scanning electron microscope (Phenom World, Eindhoven, The Netherlands) with an acceleration voltage of 10 kV in image mode and a backscattered electron detector.

### **II.9 Statistical analyses**

Analysis of variance (ANOVA) and mean comparison was conducted using the statistical program R version 3.4.4. If significant differences were found, the Tukey's Multiple Comparison Test was used for comparisons ( $p \leq 0.05$ ).



**CHAPTER 3**

**IMPACT OF POLYPHENOLS ON THE**

**STRUCTURAL AND**

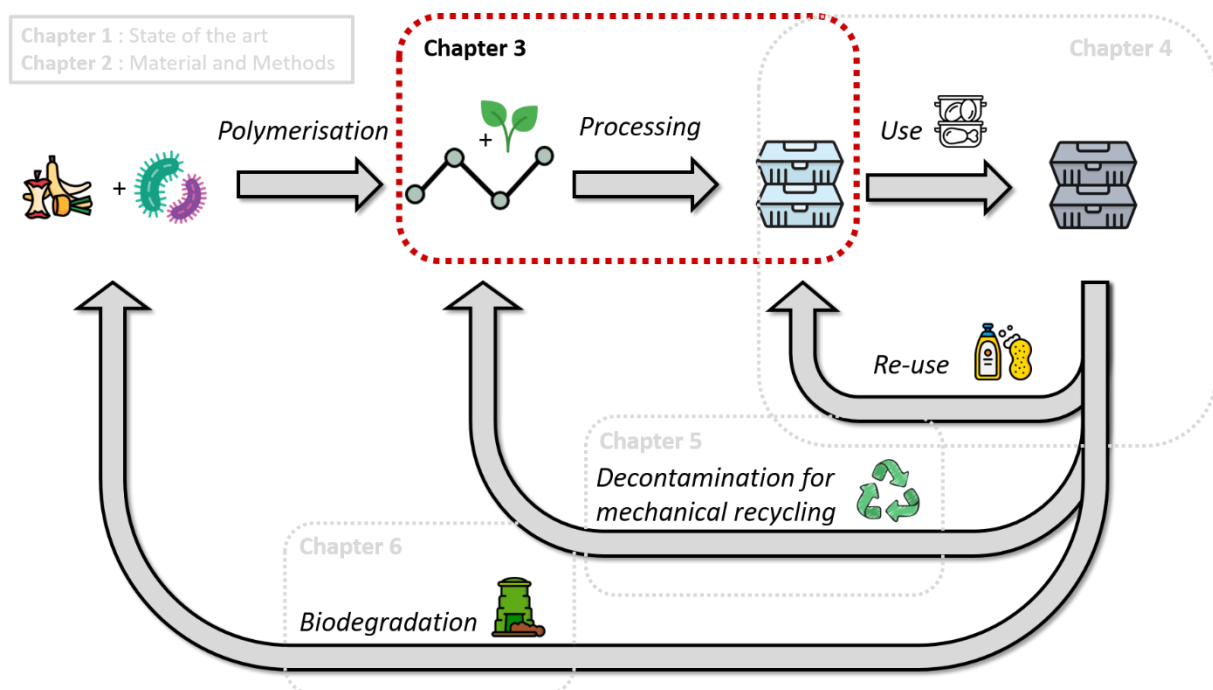
**THERMOMECHANICAL PROPERTIES OF**

**PHBV DURING PROCESSING**



## Chapter 3. Impact of polyphenol on the structural and thermomechanical properties of PHBV during processing

Ce chapitre a pour but d'étudier l'impact des polyphénols sur les propriétés structurales et thermomécaniques du PHBV lors de la phase de formulation (extrusion + thermopressage). Les polyphénols sélectionnés, à savoir la quercétine et l'acide gallique ont été ajoutés à la matrice PHBV, à des pourcentages allant de 0.5 à 15 % en masse. Différentes techniques de caractérisation ont été employées afin d'élucider le rôle des interactions initiées par les polyphénols, dans la modification de la microstructure du polymère. Ainsi, l'évolution de la microstructure du polymère en fonction du type de polyphénol et de son pourcentage a été étudiée, à l'aide, de microscopie fluorescente et en lumière polarisée. La conséquence de cette évolution sur la cristallinité, le poids moléculaire, la température de dégradation, ainsi que de la rigidité du film, a également été déterminée. Cela a permis de sélectionner le pourcentage de polyphénol qui présentait le meilleur effet stabilisant.



## Biobased and biodegradable polymers in a circular economy context: understanding quercetin and gallic acid impacts on PHBV thermal properties

Chloë Bonnenfant<sup>a</sup>, Nathalie Gontard<sup>b</sup> and Chahinez Aouf<sup>b</sup>

<sup>a</sup>UMR 1208 IATE, Univ Montpellier, INRAE, Institut Agro, Montpellier, France.

<sup>b</sup>UMR 1208 IATE, INRAE-2 Place Pierre Viala Montpellier, France

Published in *Polymer Degradation and Stability*. July 2022.

doi: 10.1016/j.polymdegradstab.2022.109975

### Abstract

As they cannot massively accumulate in our eco-system, biodegradable polymers represent one of the solutions to mitigate plastic pollution. Meanwhile their ability to be recirculated before being biodegraded is important to maximize their economic value. Like all other polymers, their ability to be recycled and reused is highly dependent of their thermal stability, which also deserves to be investigated. Here, we clarify the potential impact of two natural phenolic additives, quercetin and gallic acid on the thermal stability of a promising microbial biodegradable polyester, poly(3-hydroxybutyrate-co-3-hydroxyvalerate) (PHBV). The effect of the structure and the percentage of polyphenols (0 to 15 wt%) on the morphological behaviour and thermomechanical stability of PHBV was studied. Up to 5 wt%, homogeneous blends characterized by intermolecular bonding interactions between the phenolic compounds and the polymer matrix were obtained. Above this percentage, a phase separation was observed in the presence of quercetin, while gallic acid crystals were embedded into the PHBV matrix, hindering its crystallization. It was concluded that regardless the additive percentage, the structural evolution of PHBV during the thermal treatment was strongly affected by the polyphenol structure: Quercetin slightly improved the structural integrity and thermo-mechanical stability of PHBV, while the carboxylic group of gallic acid contributed to auto-catalyse the polymer chain scission, accelerating its degradation.

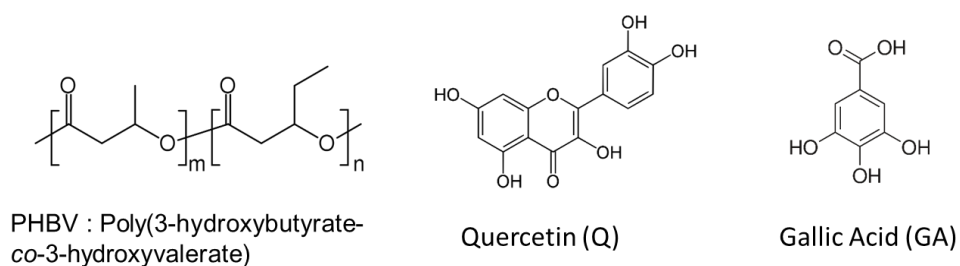
**Keywords:** Biodegradable polyester, polyphenols, PHBV, thermal stability.

## I. Introduction

In the last 20 years, important efforts have been dedicated to tackle plastic pollution by substituting petroleum-based persistent polymers by bio-based biodegradable materials, especially by thermoplastic bio-polymers [179, 180]. Among the 1.22 Mt of biobased and biodegradable plastics produced in the world in 2020 [50], bio-polyesters produced by micro-organisms as energy and carbon reserve, have attracted worldwide interest, especially the polyhydroxyalkanoate (PHA) family. Indeed, with functional properties close to those of polyethylene terephthalate (PET) (*e.g.* in applications such as rigid food trays) [181], their main interest lies in their biodegradability in natural environment [171] preventing their accumulation in our ecosystem as observed for petrochemical persistent plastic. In the PHAs family, Poly(3-hydroxybutyrate-co-3-hydroxyvalerate) (PHBV) is a thermoplastic polyester used in the formulation of a number of products such as food, cosmetic or electronic packaging [182, 183]. While many studies are devoted to the usage performances and biodegradability of PHAs-based materials, there is a very poor understanding of their ability to follow the different end-of-life options recommended in the Circular Economy Action Plan adopted in 2020 by the European commission, and relayed by the recent French AGEC law [184]. These options are, by priority order: (object) re-use, mechanical polymers recycling, chemical monomers recycling, organic recycling and energy recovery as last option [185]. Thermal stability is one of the key properties enabling a material to withstand the two first possible options (reuse and polymers recycling). In closed-loop mechanical recycling, polyesters are decontaminated at high temperature and their thermal stability is crucial to limit their degradation rate per cycle [186]. One of the main strategy to improve the thermal resistance of the polymers is the use of non-biobased additives such as Irganox, triphenyl phosphite (TPP) or hydroxylamines [187, 188]. The antioxidants BHA and BHT have long been used in olefins to reduce their thermo-oxidative degradation, but they are now controversial because of their potential action as endocrine disruptors [10, 189]. Very few studies have addressed the use of such additives to improve the thermomechanical properties of PHAs. The majority of them have focused on the use of nanomaterials such as titanium dioxide, graphene oxide, zinc oxide [89], nanoclay [190] and cellulose nanocrystals [92]. Although nanomaterials have contributed to the reinforcement of PHA polymers by increasing the temperature of maximum degradation and the stress-strain modulus, there are growing

concerns among consumers about the use of nanoparticles, especially in contact with food [191].

In order to prevent controversies and to preserve the biodegradable and bio-based characters of PHAs, several researches have been conducted in the last decades on the use of natural phenolic compounds to improve the thermal stability of PHAs. Polyphenols are a large family of secondary metabolites produced by higher plants. In plant kingdom, they are mainly occurring as complex polymeric structures comprising procyanidins (with flavonoids as monomeric units) and gallotannins (with gallic acid as monomeric unit) [95]. In addition to their known antioxidant activity, their thermal stability has been proven at temperatures up to 200 °C (above the melting temperatures of some biodegradable polyesters) [107]. The addition of these phenolic compounds such as tannic acid, catechin and gallate derivatives, up to a certain amount to PHA matrices, generally led to an increase in  $T_g$ , a shift of degradation temperatures towards higher values as well as a crystallization disruption, resulting in a higher thermal stability [192-194]. Without extensive study on the interaction mechanisms between the polyphenols and the polymer, or the role of the polyphenol chemical structure in these interactions, the stabilization effects were attributed to the intermolecular hydrogen bonds occurring between the carbonyl groups of PHA and the hydroxyl group of polyphenols [125]. This study aims to bring new insights about the impact of the chemical structure of the polyphenol on the evolution of the polymer behavior during the heat treatment. Quercetin and gallic acid (Scheme 6), two phenolic compounds with different chemical structures, were selected to achieve this objective. Quercetin belongs to the group of flavonoids, composed of phenolic rings resorcinol and catechol connected by an unsaturated heterocycle. Gallic acid is a mono-phenolic ring carrying three *ortho*-hydroxyl groups and one carboxylic group. The impact of these chemical moieties on the degradation mechanism of PHBV will be investigated.



**Scheme 6:** Chemical structure of PHBV, Quercetin(Q) and Gallic acid (GA).

## II. Materials and methods

### II.1 Materials

PHBV powder was purchased from Natureplast (Ips, France) under the reference PHI003. As reported by the supplier, it contains 1-3 mol % of valerate and had a true density of  $1.24 \text{ g.cm}^{-3}$ . Extra characterisation was performed and an apparent diameter ( $d_{50}$ ) of  $41 \text{ }\mu\text{m}$  was measured.

All chemicals, Boron Nitride, anhydrous gallic acid (with  $d_{50}$  of  $13.5 \text{ }\mu\text{m}$ ), quercetin (with  $d_{50}$  of  $2.5 \text{ }\mu\text{m}$ ), Sodium Chloride, Sulfuric Acid ( $\text{H}_2\text{SO}_4$ ), magnesium sulfate and solvents (methanol, ethanol, ethyl acetate) were purchased from Sigma Aldrich France.

### II.2 Synthesis of methyl gallate

Gallic acid (1 g, 5.88 mmol) was dissolved in 25 mL of methanol under magnetic stirring. Then,  $\text{H}_2\text{SO}_4$  (47  $\mu\text{L}$ , 0.88 mmol) was added and the solution was heated under reflux at  $66 \text{ }^\circ\text{C}$  during 18 h. After cooling, water (30 mL) was added to the reaction mixture, and the aqueous phase was extracted with 3 x 30 mL of ethyl acetate. The organic phase was washed with 30 mL of brine, then dried over  $\text{MgSO}_4$ , and vacuum concentrated. Methyl gallate was obtained as a white solid powder with a quantitative yield (100 %). Mass spectrometry analysis:  $\text{C}_8\text{H}_8\text{O}_5$   $[\text{M}+\text{H}]^+$ : 184.1461.

### II.3 Preparation of PHBV/polyphenols films

PHBV and polyphenol (quercetin, gallic acid and methyl gallate) powders were dried at  $60 \text{ }^\circ\text{C}$  for 24 h. Prior to thermal processing, 0.5 wt% boron nitride was added to PHBV as a nucleating agent. The resulting powder was pre-mixed with each polyphenol in different ratio, in a powder blender (Turbula T10B, Laboservices, Montpellier, France). The obtained mixtures were extruded in lab scale twin screw extruder Thermo Scientific Process 11 Twin-Screw Extruder, ThermoScientific, Karlsruhe, Germany, equipped with a L/D ratio of 40, a screw diameter of 11 mm, and a 3 mm rod die. The temperature profile set at  $180 \text{ }^\circ\text{C}$  was uniform from the feeding area to the die and the screw profile was the one described in Vandi *et al.* [175]. The screw speed was set at 200 rpm and the residence time was approximately 2 min. After pelletization, PHBV/polyphenol blends were transformed into thin films of  $12 \times 12 \text{ cm}$  and  $300 \text{ }\mu\text{m}$  thickness, using heated hydraulic press (20T, Pinette Emidecau Industries, Chalon-sur-

Saône, France). Pellets were heated at 180 °C during 5 min and then pressed between Teflon coated plates by regularly increasing the pressure from 5 bar to 150 bar over 7 minutes. Films were cooled down to room temperature for 10 minutes. Then, they were left for stabilization during 14 days at 50 % of humidity. Virgin PHBV films without additives were prepared in the same way.

For quercetin and gallic acid, five weight contents were considered, *i.e.* 0.5, 1, 5, 10 and 15 wt%. The samples were named Q0.5, Q1, Q5, Q10 and Q15 for quercetin, and GA0.5, GA1, GA5, GA10 and GA15 for gallic acid. Concerning the blends with methyl gallate, two additive content were used namely 1 and 5 wt%, giving rise to samples MG1 and MG5 respectively.

#### **II.4 Extraction of polyphenols from the films and their UPLC quantification**

After formulation, polyphenols content in the films was determined by UPLC analysis. Polyphenols were first extracted in Methanol during 48 h at 40 °C. These extracted solutions were, then, injected in Acquity UPLC (Waters, Milford, MA) liquid chromatography system, equipped with a photodiode array detector (DAD). The Waters column was 100 mm x 2.1 mm, HSS T3, with particles size of 1.8 µm. The solvent used were A (99.9 % H<sub>2</sub>O and 0.1 % HCOOH v/v) and B (80 % CH<sub>3</sub>CN; 19.9 % H<sub>2</sub>O; 0.1 % HCOOH) with a flow rate of 0.55 mL.min<sup>-1</sup>. The injection volume was 2 µL and DAD was set at 280 nm ( $\lambda_{\text{max}}$  of phenolic compounds).

Calibration curve for quercetin and gallic acid were plotted beforehand to quantify their concentration in the extracted liquid.

#### **II.5 Morphological analyses**

##### **II.5.1 Fluorescence Microscopy**

Fluorescence imaging was performed with a microscope 880 NLO (Zeiss, Jena, Germany) equipped with a Chameleon Ultra II laser (Coherent, Santa Clara, CA, USA) and visible lasers, and fitted with Plan Apo 20×/1.0 Zeiss objective, (Montpellier Ressources Imagerie platform, [www.mri.cnrs.fr](http://www.mri.cnrs.fr)). The pulsed laser of the multiphoton microscope causes the excitation of phenolic compounds similarly to that of a UV laser. Optimal excitation for quercetin was obtained at a wavelength  $\lambda = 780$  nm with a bandpass emission in the 411-686 nm range (spectral detector). This spectral detector yielded spectral images and emission

spectra in different parts of the sample. For gallic acid, the best excitation was obtained with a 405 nm laser and the same bandpass emission. The spectral detector yielded spectral images and emission spectra between 411 and 686 nm. These spectral signatures were used to visualize these molecules in the films. Image acquisition was performed using ZEN2 software (Zeiss, Germany).

### II.5.2 Polarized Optical Microscopy (POM)

POM observations were performed using a Laborlux 11 POL S (Leitz, Germany) microscope in the transmission mode, equipped with a mono-CDD Leica DFC420 camera (resolution 1728 x 1296 pixels) and piloted by the Archimede software (Microvision Instruments, France). Each sample was placed between two glass slides, then heated on a LTS420 hot stage (Linkam, UK) up to 200 °C at 30 °C.min<sup>-1</sup>. After being annealed for 3 min, it was cooled down to 100 °C at 10 °C.min<sup>-1</sup>. Observations were performed after 5 minutes of stabilisation, the presence of boron nitride in all samples led to an almost instantaneous crystallisation.

## II.6 Thermal analyses

### II.6.1 Differential scanning calorimetry (DSC)

DSC analyses were carried out using a calorimeter DSC series Q200, TA Instruments, under nitrogen atmosphere with a heating rate of 10 °C.min<sup>-1</sup>. Samples of 8-10 mg were used for each analysis and all experiments were done in triplicate. To determine the crystallinity degree and the thermal properties of the films, the following heating/cooling protocol was used [177]. First, the samples cooled down from 25 °C to -30 °C, were heated to 200 °C, maintained at 200 °C for 5 min, and cooled down again to -30 °C. The second heating was then performed from -30 °C to 200 °C.

The melting temperature ( $T_m$ ) and the apparent melting enthalpy ( $\Delta H_m$ ) were determined from the DSC curves using the Universal Analysis 2000 Software by TA Instruments. The crystallinity degree ( $X_c$ ) of neat PHBV and PHBV/polyphenols samples was determined by Equation 8:

$$X_c(\%) = \frac{\Delta H_m}{\Delta H_m^\circ} \times \frac{100}{w} \quad (8)$$

Where :  $\Delta H_m$  is the melting enthalpy of the polymer matrix,  $w$  is the polymer weight fraction in the sample and  $\Delta H_m^\circ$  is the theoretical melting enthalpy of the polymer assumed to be 100 % crystalline,  $\Delta H_m^\circ = 109 \text{ J.g}^{-1}$  for PHBV [178].

### II.6.2 Thermogravimetric Analysis (TGA)

TGA analyses were carried out in triplicate, under nitrogen flow ( $50 \text{ mL.min}^{-1}$ ), using a Mettler TGA2 apparatus (Schwerzebbbach, Switzerland) equipped with XP5U balance (precision of  $0.0001 \text{ mg}$ ). For each measurement, about  $10 \text{ mg}$  of material were used and the heating rate was  $10 \text{ }^\circ\text{C.min}^{-1}$  from  $25 \text{ }^\circ\text{C}$  to  $600 \text{ }^\circ\text{C}$ . The maximum degradation temperature ( $T_{deg}$ ) corresponds to the temperature at which the degradation rate is maximum. The onset degradation temperature ( $T_{onset}$ ) was measured when the first derivative of the weight loss became higher than  $0.1\%$ .

### II.7 Size Exclusion Chromatography (SEC)

The number-average molecular weight ( $M_n$ ), average molecular weight ( $M_w$ ), and polydispersity index ( $M_w/M_n$ ) were determined by SEC, performed in Technopolym platform (Toulouse, France).

Samples were placed in sealed tubes and dissolved in chloroform at a concentration of  $3\text{-}5 \text{ mg.mL}^{-1}$ , during  $1\text{-}5$  hours at  $70 \text{ }^\circ\text{C}$ . Then, they were filtered through  $0,45 \text{ }\mu\text{m}$  nylon filters. SEC analyses were carried out in a UHPLC (Ultimate 3000 Thermoscientific Pump) equipped with Agilent PL gel  $5 \text{ }\mu\text{m}$  Mixed C column. Injection volume was  $50 \text{ }\mu\text{L}$  and the flow rate was  $1 \text{ mL.min}^{-1}$ . Detection was performed by means of three detectors, namely differential refractometric detector (Optilab Rex Wyatt,  $T=35^\circ\text{C}$ ), 3 angle-light-static-diffusion detector (TREOS Wyatt,  $\lambda = 658\text{nm}$ ) and UV detector (Shimadzu SPD-M20A,  $\lambda = 254\text{nm}$ ).

### II.8 Mechanical analysis: tensile test

The tensile strength, Young's modulus and elongation at break were measured according to DIN EN ISO 527-1 using a device INSTRON 68 SC-5 with a load cell of  $2 \text{ kN}$ . Measurements were performed on dog bone shaped film specimens (width of  $4 \text{ mm}$  and gauge length of  $25 \text{ mm}$ ) which were inserted with an effective length of  $40 \text{ mm}$  between the



clamps at the beginning of the tests. The samples were tested under a monoaxial tension with a cross head speed of 10 mm.min<sup>-1</sup>. Ten replicates were realized for each measurement.

## **II.9 Statistical analyses**

Analysis of variance (ANOVA) was conducted using the statistical program R version 3.4.4. If significant differences were found, the Tukey's Multiple Comparison Test was used for comparisons ( $p \leq 0.05$ ).

## **III. Results and discussion**

### **III.1 Polyphenols in the PHBV matrices**

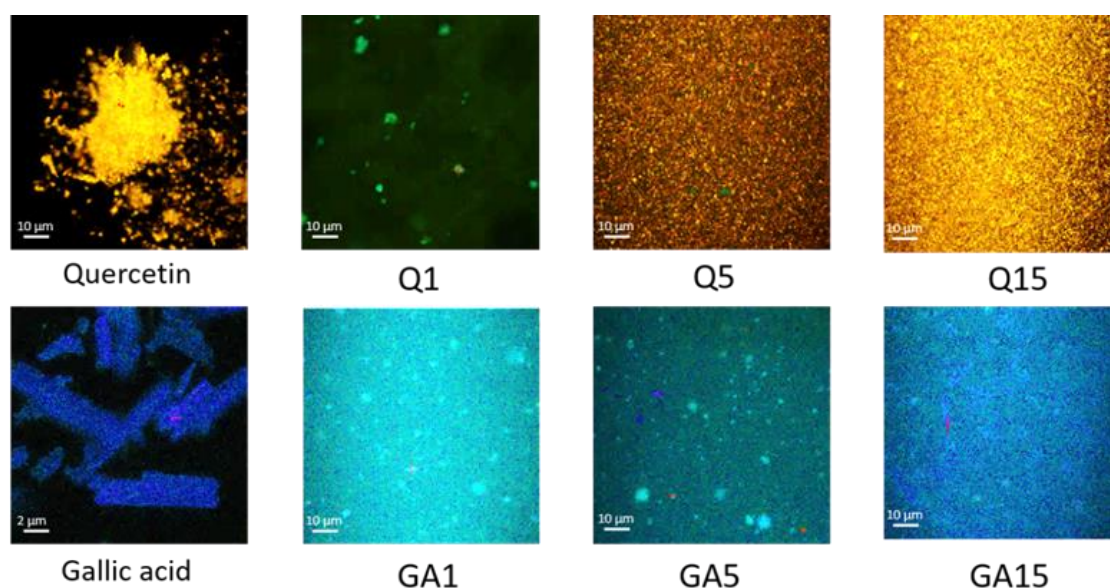
#### **III.1.1 Stability of polyphenols during the thermoforming process**

The mass loss data of pure quercetin (Q) and gallic acid (GA) were obtained from TGA analysis under nitrogen atmosphere. After the first mass loss at 106 °C corresponding to the loss of H<sub>2</sub>O molecules from its hydrate form, the decomposition temperature of quercetin was recorded at 360 °C. Gallic acid exhibited two stages of weight loss at 262 °C and 341 °C corresponding to its molecular decomposition (data not shown). As the degradation temperatures of these two polyphenols are much higher than the temperature applied for the thermoforming of polymer films (180 °C), it seems obvious that they remain stable during this process. To confirm this assumption, PHBV films containing 1 wt% of quercetin or gallic acid were extracted in methanol at 40 °C, and released polyphenols were quantified by UPLC. The totality of quercetin and gallic acid were recovered, confirming that the film processing did not cause structural alteration of the polyphenols.

#### **III.1.2 The morphology of the PHBV/polyphenol matrices**

To investigate the distribution of polyphenols in the polymer matrices as well as their influence on polymer microstructure, both confocal and polarized optical microscopy analyses were carried out.

## III.1.2.1 Fluorescence microscopy



**Figure 10:** Spectral images of pure polyphenols and PHBV/polyphenol films, observed using fluorescence microscopy. Quercetin ( $\lambda_{ex} = 780\text{nm}$ ) was observed in biphoton microscope and gallic acid ( $\lambda_{ex} = 405\text{nm}$ ) was observed in confocal microscope.

The auto-fluorescence of polyphenolic compounds has been widely reported in the literature [195, 196]. When excited by UV/Visible radiation of suitable wavelengths, a fluorescence emission is observed from these fluorophore molecules. As depicted in Figure 10, the biphotonic excitation of pure quercetin at  $\lambda_{ex} = 730\text{ nm}$  resulted in an intense fluorescence emission in orange region ( $\lambda_{em} = 600\text{ nm}$ ). In the case of pure gallic acid, a monophotonic excitation at  $\lambda_{ex} = 405\text{ nm}$ , gave rise to a fluorescence wavelength at  $\lambda_{em} = 490\text{ nm}$ , in the bright indigo region. When quercetin and gallic acid at 0.5 and 1 wt%, were incorporated in PHBV films, a shift in the fluorescence wavelengths was observed. For quercetin,  $\lambda_{em}$  shifted from orange to green domain ( $\lambda_{em} = 520\text{ nm}$ ) and gallic acid emitted at  $\lambda_{em} = 450\text{ nm}$ , with a shift from indigo to cyan domain. The shift in fluorescence emission was previously described in the literature as fluorescence quenching due to the non-covalent bonding of polyphenols with some proteins [197-199]. Thus, the fluorescence of polyphenols is modified when they interact with their environment through Van der Waals or hydrogen bonds. It is established that the hydroxyl groups of phenolic compounds are able to form hydrogen bonds with carbonyl groups of different polymers [200, 201]. Concerning PHB/PHBV, FTIR analyses were mainly employed to justify the hydrogen bonding between the

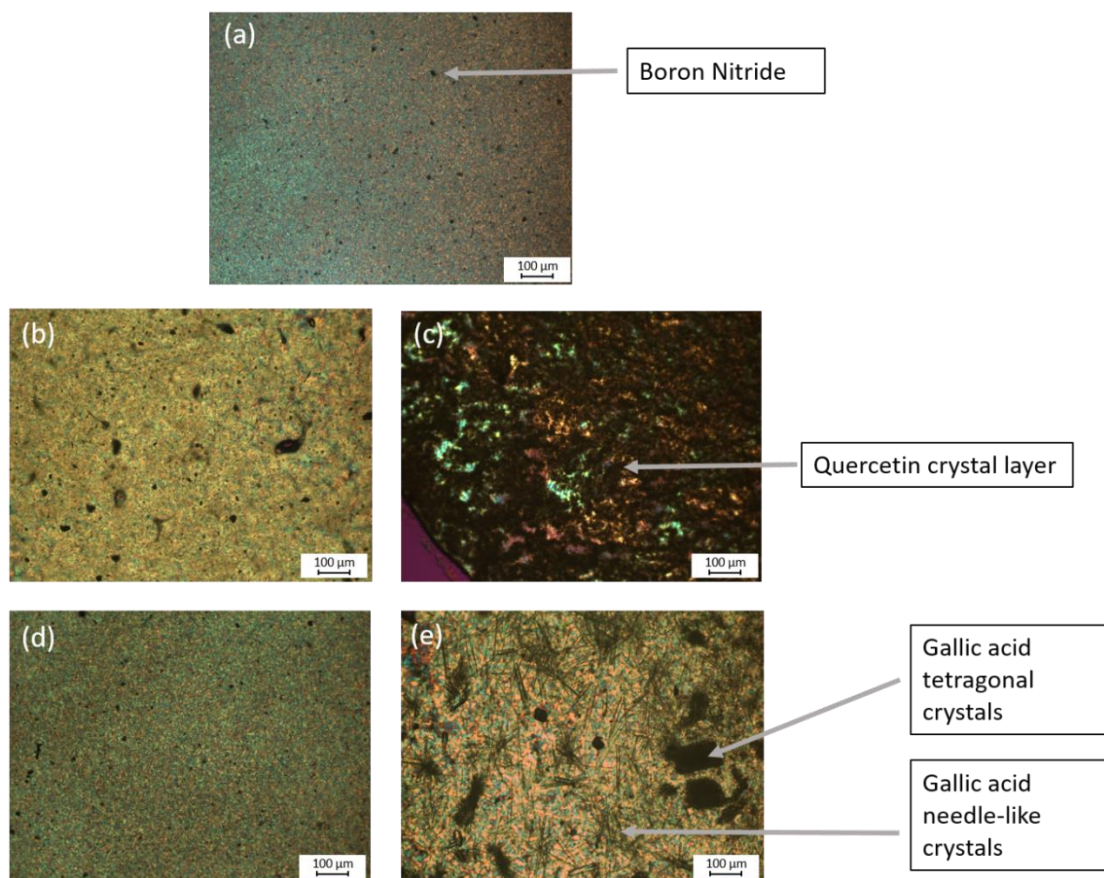
polymer and the polyphenols. Authors generally rely on a slight shift of the absorbance band characteristic of the stretching vibration of hydroxyl and carbonyl groups of polyphenols and PHBV respectively, to confirm the hydrogen interactions between the two components [76, 122]. As is the case of the majority of the studies reviewed, the band absorbance shifts at wavenumbers  $1680\text{-}1780\text{ cm}^{-1}$  (PHBV carbonyl group) and  $3100\text{-}3600\text{ cm}^{-1}$  (polyphenol hydroxyl groups) between PHBV, GA powder and PHBV/GA films were very subtle (see appendix 1, Figure 35). Therefore, the use of the confocal microscopy was more accurate in establishing the hydrogen bonding between polyphenols and PHBV polymer.

Above 1 wt% loading of polyphenols (from 5 to 15 wt%), an overlapping of both fluorescence wavelengths (orange and green for quercetin and cyan and indigo for gallic acid) corresponding to pure and hydrogen bonded molecules was detected, indicating the co-existence of both linked and free phenolic compounds in the polymer matrix when the phenolic content exceeds 5 wt%.

### III.1.2.2 Polarized Optical microscopy

The impact of both polyphenol structure and amount on the microstructure of the polymer and its crystallization behaviour was assessed by means of polarized optical microscopy (POM). POM was used to display the final crystalline structure of PHBV/polyphenols blends after preheating at  $200\text{ }^{\circ}\text{C}$  and cooling to complete recrystallisation. At this temperature, a complete melting of polymer crystals was achieved. Only crystals of quercetin and gallic acid were still present. POM images of Q1, Q10, GA1 and GA10 are shown in Figure 11. For the lowest amounts of quercetin and gallic acid, no significant difference in the size and growth rate of spherulites was observed compared to the non-additivated PHBV. Due to the presence of the 0.5 wt% of the nucleating agent (boron nitride), a homogeneous crystalline structure with small spherulites ( $0.25\text{ }\mu\text{m}$  compared to  $100\text{ }\mu\text{m}$  for spherulites in PHBV without nucleating agent: data not shown) was rapidly detected. This behaviour remained unchanged in PHBV films containing 0.5-1 wt% of quercetin or gallic acid. Because of the low amount of polyphenols, the crystallization behaviour was rather governed by the nucleating agent. However, for PHBV films with higher polyphenols loading, two distinct behaviours were observed depending on the polyphenol structure. By increasing the quercetin amount from 5 to 15 wt%, a separate phase of quercetin crystals was formed

releasing the polymer chains and initiating nucleation. Indeed, a higher amount of quercetin has favoured the intramolecular quercetin-quercetin hydrogen bonds to the detriment of intermolecular quercetin-PHBV hydrogen bonds. Hence, the polymer molecular chains were released and their rearrangement into an ordered structure was facilitated. This phase separation was also observed by Mousavioun *et al.* [202] when the amount of soda lignin in PHB was more than 50 wt%. Instead of phase separation, gallic acid had a different behaviour. As shown in Figure 11, PHBV film containing 10 wt% of GA showed a complete melting of polymer spherulites at 200 °C. Only tetragonal-like crystals of GA remained non-melted. The gradual cooling of the blend gave rise, at the end, to a random distribution of both tetragonal and needle-like crystals of GA in the bulk of the polymer, with an initiation of polymer nucleation around GA crystals. Polymorphism of GA monohydrate leading to different crystal forms is well documented, and anhydrous GA is also polymorphic although only one solvent-free structure has been published [203]. Contrary to quercetin, GA at higher amounts was embedded in the spherulites of PHBV. In spite of its nucleating effect, it may damage these spherulites, as it was the case of alkaline lignin incorporated in PHBV at 5 and 10 wt% [204].



**Figure 11:** POM images of PHBV (a), Q1 (b), Q10 (c), GA1(d) and GA10 (e).

## III.2 Impact of polyphenols on thermal and mechanical properties of PHBV

### III.2.1 Impact of polyphenols on thermal properties of PHBV

Figure 12 reports the values of the average molecular weight  $M_w$  and number average molecular weight  $M_n$  of PHBV and PHBV/polyphenol formulations. The thermal stability of these samples was assessed by TGA, and  $T_{onset}$  is represented in Figure 13 (the evolution of  $T_{deg}$  is reported in appendix 1, Figure 36). TGA curves of PHBV/Q and PHBV/GA blends are depicted in appendix 1, Figure 37.

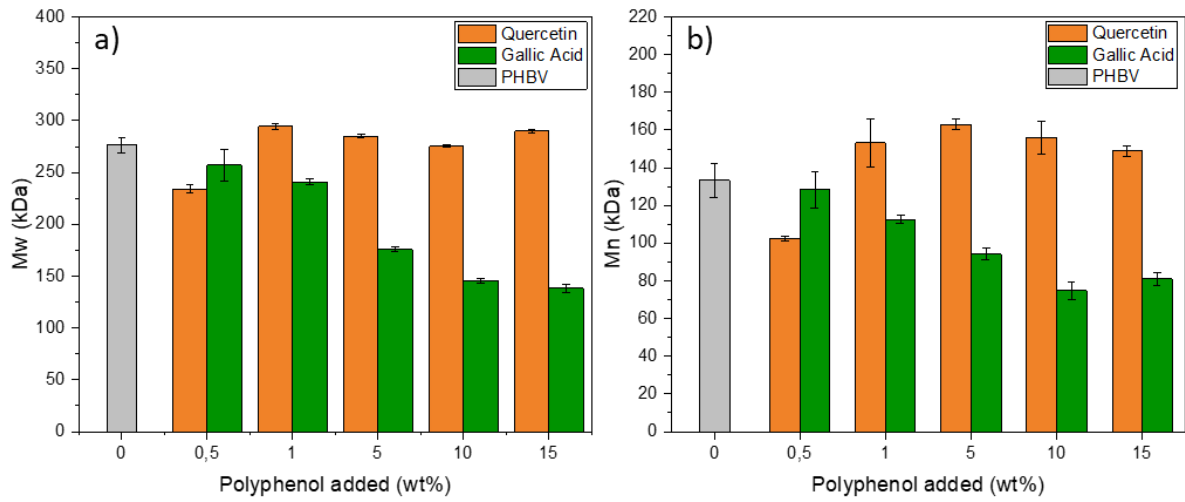
First, it should be noted that a dramatic decrease in  $M_w$  and  $M_n$  occurred after the PHBV film thermoforming from the powder, with a molecular weight ( $M_w$ ) loss of about 60 % (appendix 1, Table 27). Addition of quercetin up to 15 wt% to the PHBV powder prior to processing led to an increase or maintenance of the  $M_w$  of the resulting films compared to neat PHBV film. Quercetin loading of 1wt % prevented polymer chain scission, as  $M_n$  of PHBV/Q was higher by 16-30 kDa than  $M_n$  obtained for pure formulated PHBV. The important decrease in the average molecular weight between PHBV powder and PHBV film did not have a significant impact on thermal stability, as the  $T_{onset}$  and  $T_{deg}$  values of both samples are equivalent (appendix 1, Table 27). The presence of quercetin in any amount maintained the  $T_{onset}$  of PHBV and caused a slight decrease of about 4-5 °C in  $T_{deg}$ , from 10 wt% of quercetin. Compared with neat PHBV, GA loading from 1 wt% caused a significant decrease in  $M_w$  and  $M_n$ , to reach up to 50 % and 40 % loss of  $M_w$  and  $M_n$  respectively in the case of GA15 which was confirmed by MFI measurements (see appendix 1, Table 28). Concerning the thermal stability of GA-based polymers,  $T_{onset}$  was maintained up to 1 wt% loading, followed by a drop to 254 °C for the highest amount of GA ( $T_{onset}$  of neat PHBV = 268°C). The temperature decrease was, however, less pronounced in the case of  $T_{deg}$  (appendix 1, Figure 36).

Therefore, the phase separation (observed in POM) in the case of the highest amounts of quercetin did not influence the polymer chain structure of the blends. On the contrary, the increasing amount of GA contributed to accelerate the depolymerization and degradation of the polymer chains. Melting and crystallization behaviour of neat PHBV and PHBV combined with polyphenols were examined under nitrogen atmosphere by DSC.  $T_m$  (melting temperature) and calculated  $X_c$  (crystallization rate) obtained from the second heating, as well as the crystallization temperature ( $T_c$ ), obtained from the cooling between the first and

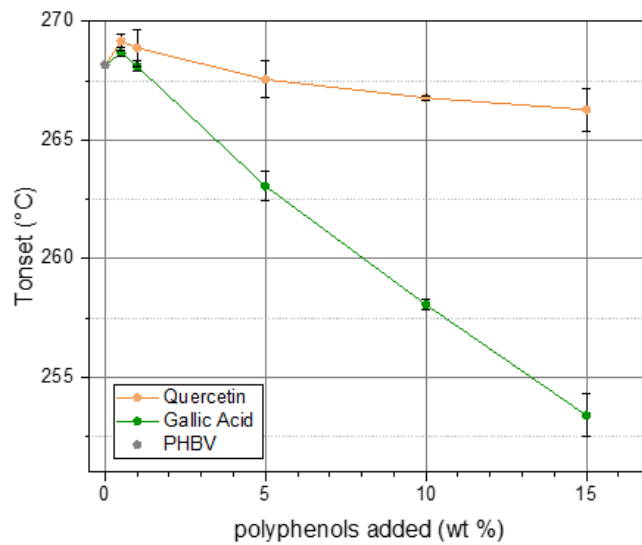
second heating, are summarized in Table 9. All the original DSC curves are reported in appendix 1, Figure 38 and 39.

As boron nitride was added in film formulation,  $T_c$ ,  $T_m$  and  $X_c$  of PHBV film are higher than those of the powder. The addition of quercetin up to 5 wt% caused a decrease in  $T_m$ ,  $T_c$  and  $X_c$  of the blends. At 10-15 wt% of quercetin loading, the three parameters increased again, especially  $T_c$ . The decrease in  $T_c$  from 0.5 to 5 wt% quercetin is indicative of the intermolecular hydrogen bond interaction (see confocal spectroscopy results) which restricts molecular chain motion in PHBV polymer, and breaks coordination effect of lamellae layers of the PHBV spherulites radial growth [125]. For larger amounts of quercetin, phase separation occurred (POM results), releasing the polymer chains and inducing nucleation.

Almost a similar trend was observed for GA-based blends. At 5 wt% GA, a significant decrease in  $T_m$  and  $T_c$  was observed. While the  $T_c$  value increased slightly after the addition of 10-15 wt% GA, the melting temperature continued to fall reaching 165 °C for 15 wt% GA. Compared to quercetin, the increase in  $T_c$  remained less important. This, together with a decrease in the melting temperature and in the crystallization rate, confirms the assumption made from the POM results regarding the embedding of gallic acid crystals into the polymer bulk causing the deterioration of its spherulites [204].



**Figure 12:** a) average molecular weight ( $M_w$ ) and b) number average molecular weight ( $M_n$ ) of PHBV and PHBV/polyphenol films.



**Figure 13:** The evolution of  $T_{onset}$  of PHBV films as a function of the polyphenol amount.

**Table 9:** Results from DSC analyses of PHBV powder, PHBV film and PHBV/polyphenol formulations.

Sample	$T_m$ (°C)	$X_c$ (%)	$T_c$ (°C)
PHBV powder	172,4 ± 0,4	73,1 ± 0,8	85,0 ± 0,6
PHBV	176,6 ± 0,1a	82,0 ± 1,1a	124,4 ± 0,6a
Q0,5	175,5 ± 0,3b	79,5 ± 1,0b	117,5 ± 0,3b
Q1	174,5 ± 0,4c	76,9 ± 0,8cd	110,1 ± 0,3d
Q5	171,9 ± 0,2e	74,9 ± 0,6d	106,3 ± 0,1e
Q10	173,1 ± 0,5d	78,9 ± 0,6bc	116,2 ± 0,6c
Q15	173,9 ± 0,3cd	79,9 ± 0,9ab	117,8 ± 0,1b

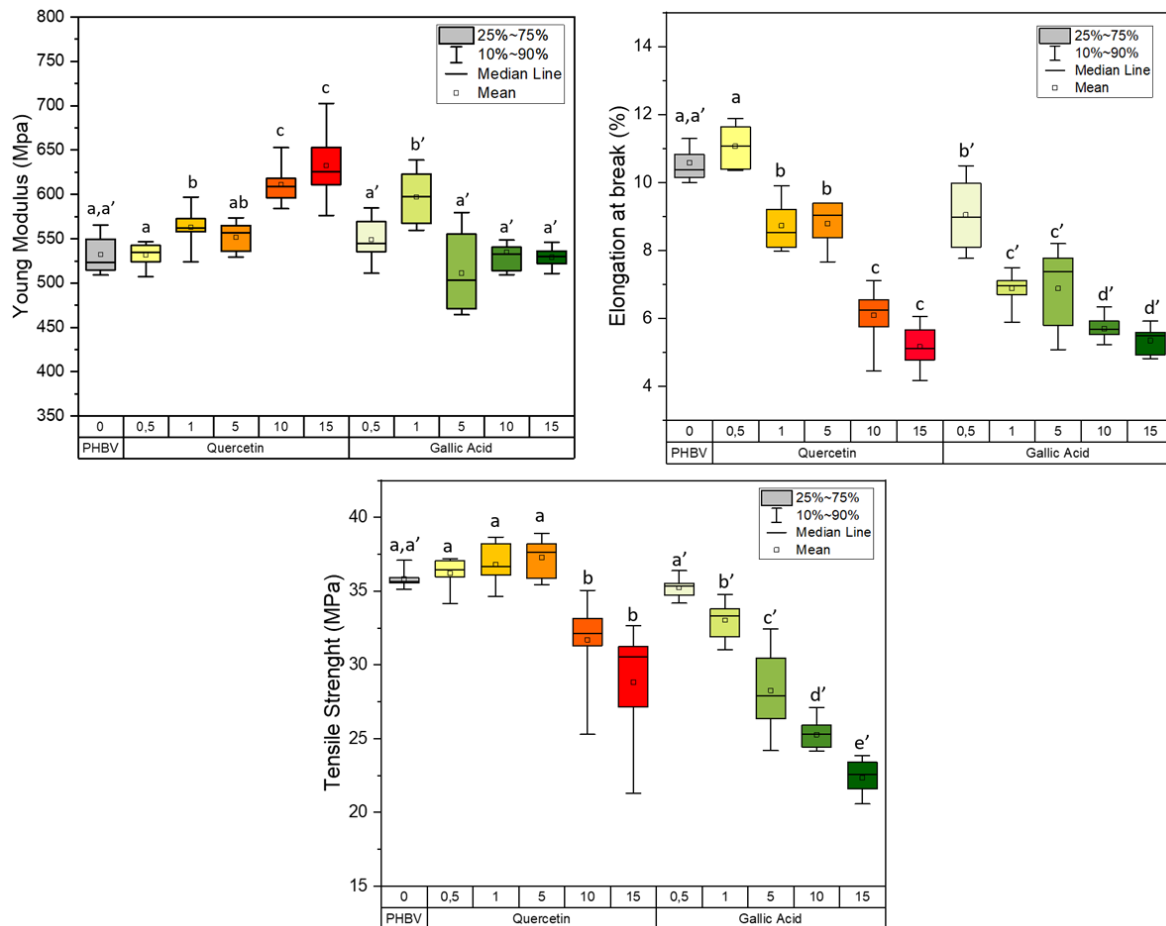
  

Sample	$T_m$ (°C)	$X_c$ (%)	$T_c$ (°C)
PHBV	176,6 ± 0,1a'	82,0 ± 1,1a'	124,4 ± 0,6a'
GA0,5	175,9 ± 0,3a'	83,2 ± 0,6a'	123,0 ± 0,3b'
GA1	174,7 ± 0,1b'	83,2 ± 0,5a'	121,9 ± 0,1c'
GA5	164,6 ± 0,1c'	79,9 ± 0,7b'c'	109,5 ± 0,2f'
GA10	165,5 ± 0,7c'	78,2 ± 0,7d'	111,8 ± 0,5e'
GA15	164,9 ± 0,7c'	77,6 ± 0,5c'd'	113,4 ± 0,5d'
MGA1	174,7 ± 0,7	80,2 ± 3,1	120,9 ± 0,5
MGA5	172,1 ± 0,1	83,7 ± 4,4	109,9 ± 4,9

### III.2.2 Impact of polyphenols on mechanical properties of PHBV

The impact of polyphenols on the tensile properties of PHBV polymer was evaluated and the evolution of both Young's modulus, elongation at break and tensile strength as a function of polyphenol amount is shown in Figure 14. Original stress-strain curves of PHBV and PHBV/polyphenol blends are displayed in appendix 1, Figure 40.





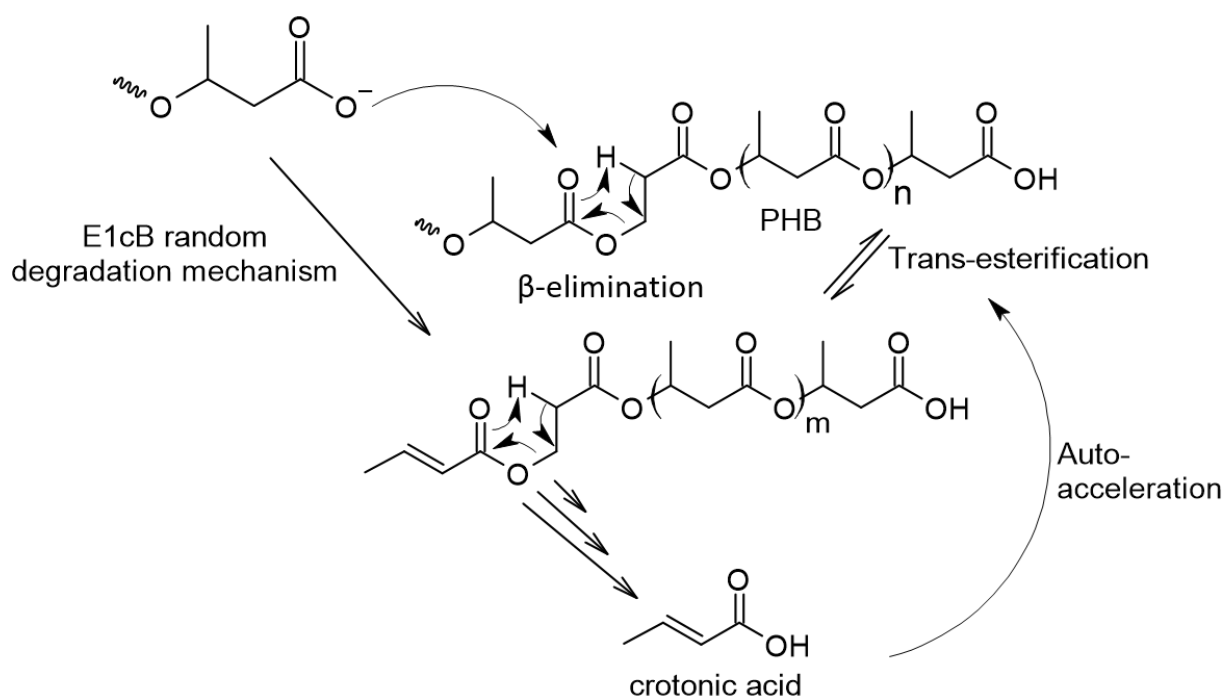
**Figure 14:** The evolution of elongation at break, Young's modulus, and tensile strength of PHBV/polyphenol films as a function of polyphenol amount.

From 5 wt% quercetin loading, a significant increase in Young's modulus compared to neat PHBV is observed, indicating an increasing stiffness of the material. For GA, the Young's modulus is more or less stable regardless of the polyphenol amount. Elongation at break dramatically dropped after adding 1 wt% of both quercetin and gallic acid, with a loss of about 50 % for the higher polyphenol amounts. The same trend was observed for the tensile strength after 5 wt% of polyphenol loading. These results reveal that high amounts of polyphenols in PHBV matrix enhance the stiffness and the brittleness of the material, with an increased risk of its fracture. This is in agreement with the previous results that highlighted the modification of the polymer microstructure caused by the highest amounts of polyphenols.

### III.3 The role of the polyphenol structure on the degradation mechanism of PHBV: case of gallic acid

As previously shown, the difference in behaviour between quercetin and gallic acid is notable. While quercetin contributed to improve/maintain the structural integrity and the stability of the PHBV matrix, gallic acid acted as degradation accelerator of the polymer, especially when it was used above 5 wt%. Apparently, its physical effect reflected by its inclusion in the polymer bulk is not the only reason, and its role in the thermal degradation mechanism of PHBV needs to be clarified.

The thermal degradation of PHA polymers (especially PHB) was widely investigated. In their book chapter, Nishida *et al.* [82] gathered the main mechanisms involved in the rupture of polymer chains (Scheme 1). The random chain scission by  $\beta$ -elimination has long been considered as the only mechanism responsible for the degradation of PHAs, leading to the formation of crotonic acid and oligomers with crotonate end-groups. Then, Kawalec *et al.* proposed an  $\alpha$ -deprotonation mechanism (E1cB) by a carboxylate anion, resulting in the same products [83]. Oligomers bearing crotonate end-groups undergo subsequently an unzipping- $\beta$ -elimination, accelerating the production of crotonic acid. Nguyen *et al.* [84] have suggested that the crotonic acid thus produced, induce the catalysis or the auto-acceleration of the random degradation. By attacking the ester groups of the polymer, it would initiate a transesterification reaction, resulting in the production of other carboxylic groups and a drastic decrease in the polymer molecular weight. The key factor of the auto-accelerated random degradation was designed as the self-proliferation of the carboxylic compounds in the bulk of the polymer [82].



**Scheme 1:** Expected overall thermal degradation mechanism of PHB reported by Nishida *et al.*[82].

As a carboxylic compound, gallic acid could act in the same way as crotonic acid and induce the auto-acceleration of the random degradation, especially since it is included in the polymer bulk at a content of 10-15 wt% (POM). This could explain the accelerated degradation of PHBV under such conditions. To verify this hypothesis, the carboxylic group of gallic acid was protected by esterification reaction with methanol, and the resulting methyl gallate was used as an additive in PHBV at 1 wt% and 5 wt%. As shown in Table 9, the crystallization behaviour of MGA1 and MGA5 was not different from that of the respective polymers GA1 and GA5, indicating similar interactions between the polymer and the additive. However, the molecular weight ( $M_w$ ) of the methyl gallate-based polymers is much higher than that of their counterparts, reaching that observed for quercetin ( $M_w_{MGA1} = 274$  kDa;  $M_w_{GA1} = 240$  kDa, and  $M_w_{MGA5} = 286$  kDa;  $M_w_{GA5} = 175$  kDa). The same trend is observed for the *Tonset* temperature which evolved from 263.1 °C for GA5 to 267.6 °C for MGA5 (appendix 1, Table 27). Therefore, it was confirmed that the carboxyl group of gallic acid is catalysing the PHBV random degradation.

Quercetin, with its structure free of acid groups, tended, instead, to stabilize the polymer. Because of their higher polarity [123, 125], the phenolic group hydrogens of

quercetin bind more easily to the carbonyl of the polymer than the hydrogens of its carbon at the  $\beta$  position. Thus, PHBV-quercetin interactions could interfere with the formation of the pseudo-six-member structure involved in the  $\beta$ -elimination mechanism, affording a better stabilization.

#### **IV. Conclusion**

Quercetin and gallic acid, two natural phenolic compounds with distinct chemical structures, were used as additives to PHBV in different amounts, and their ability to improve the thermal stability of the polymer was investigated. The polymer-additive interactions are dependent on the chemical structure of the phenolic compound. Up to 5 wt% loading, both phenolic compounds showed hydrogen bond interactions with the polymer. Above this amount, quercetin formed a separate phase with the polymer, while gallic acid crystals were embedded into the PHBV matrix, hindering its crystallization. Furthermore, the positive/neutral impact of quercetin (at different amounts of loading) on the thermomechanical properties of PHBV was opposite to that of gallic acid, which instead contributed to accelerate the degradation of the polymer. It was suggested that the carboxylic group of gallic acid was involved in transesterification reactions that auto-catalyse the polymer chain scission reaction.

Although the impact of quercetin and gallic acid on the thermal stabilization of PHBV during thermoforming is not very pronounced, their impact on the stabilization of PHBV throughout its life as a food packaging is relevant to study.

#### **Acknowledgements**

The authors are grateful to Geneviève Conejero (MRI-PHIV) and Nicolas Le Moigne (IMT-Mines Alès) for their help and advices in fluorescence microscopy and polarized optical microscopy, respectively. They thank Thibault Nidelet (UMR SPO) for sharing his expertise in R studio software and statistical analyses.

#### **Funding**

This project was supported by a ministerial grant provided by the University of Montpellier.

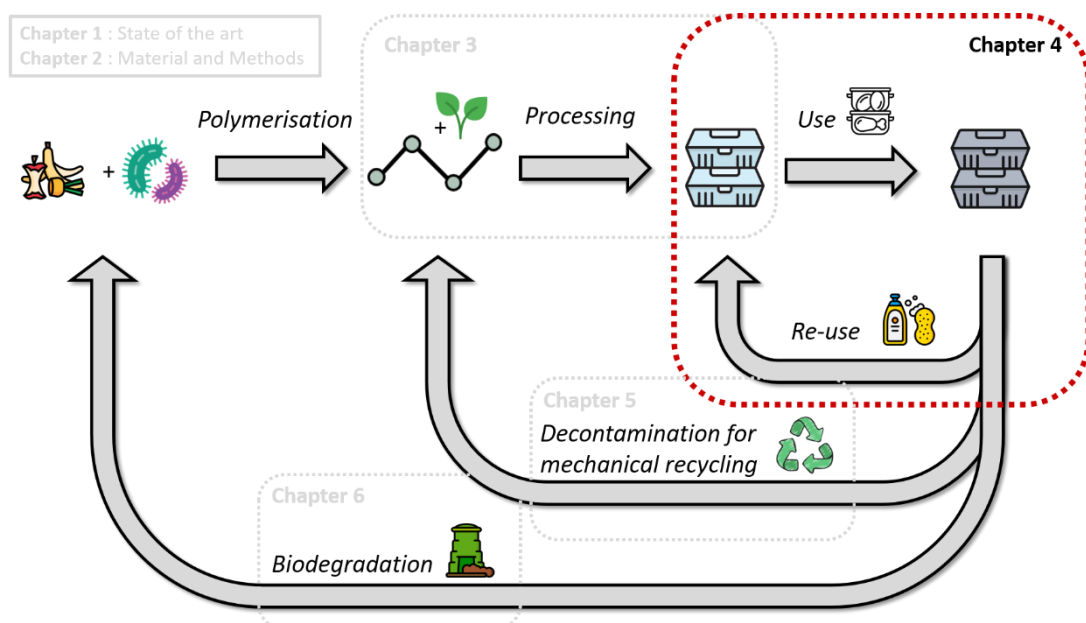


**CHAPTER 4**

**IMPACT OF POLYPHENOLS ON PHBV-  
BASED FOOD PACKAGING UNDER USE  
AND REUSE CONDITIONS**

## Chapter 4. Impact of polyphenol on PHBV-based food packaging under use and reuse conditions

Ce chapitre est consacré à l'étude de l'impact des polyphénols sur la stabilité d'un emballage alimentaire à base de PHBV, pendant la phase d'usage et de réusage. L'usage a été simulé en mettant les matériaux PHBV, PHBV-Q et PHBV-GA au contact de différents simulants alimentaires. La migration des polyphénols, ainsi que des produits de dégradation des polymères dans ces simulants a, ainsi, été quantifiée. Le réusage a été abordé de deux manières différentes. Tout d'abord, les matériaux ont subi un premier contact avec les simulants alimentaires, suivi d'un lavage au détergent, pour finir par un autre contact alimentaire. L'objectif était de mesurer l'impact d'un cycle de lavage sur l'aptitude au contact des matériaux. Dans un deuxième temps, des cycles de lavages successifs avec du détergent pour simuler des lavages en lave-vaisselle, ainsi qu'avec de la soude, pour mimer les prétraitements appliqués à certains plastiques, lors des procédés de recyclage mécanique, ont été appliqués. A l'issue de cette étude, nous avons pu évaluer la capacité de réusage du PHBV, ainsi que l'influence des polyphénols sur ses propriétés.



## PHBV-based polymers as food packaging: Physical-chemical and structural stability under reuse conditions

Chloë Bonnenfant, Nathalie Gontard and Chahinez Aouf

UMR 1208 IATE, Univ Montpellier, INRAE, Institut Agro, Montpellier, France.

Under review in Journal of Cleaner Production. (Submitted in July 2022)

*In this article, only the impact of quercetin on the stability of PHBV food packaging was considered. The influence of gallic acid is presented in complementary result: section V at the end of the chapter.*

### Abstract

Until recently, reuse models for food packaging plastics were generally considered burdensome or a thing of the past. Today, reuse is placed second in the waste management hierarchy of the plastics circular economy. This work addresses, for the first time, the reuse of biobased and biodegradable materials such as PHBV and PHBV-quercetin materials. For this, two scenarios were considered: (i) the safety and the structural integrity of the materials within a full reuse cycle including: food contact/detergent-washing/food contact; and (ii) the impact of successive washing operations in water, detergent and NaOH aqueous solutions, on the structural and physical-chemical properties of these materials. PHBV material that underwent the full reuse cycle using aqueous (10 % ethanol) and acidic (3 % acetic acid) food simulants showed an overall migration close to zero with a maintenance of its physical-chemical properties. It was also able to withstand up to 20 cycles of washing in water and detergent with slight changes in its intrinsic properties. Its washing with a 1 wt% aqueous NaOH solution, for one cycle, led to the removal of its external surface without altering its physical-chemical properties. The use of quercetin as additive had no consequence in the first scenario (the full reuse cycle). Even the migration of a part of it (2 wt% from the initial amount in the polymer) in the first contact with the food was far below the admissible daily intake. However, the release of quercetin during detergent washing steps and the production of acidic oxidation products during NaOH washing contributed to accelerate material degradation, questioning the use of such additives for PHAs.

**Keywords:** Biodegradable packaging, Reuse, PHBV, Polyphenols.



## I. Introduction

Plastics have revolutionized our daily life and are in 2022 one of the most commonly used materials for food packaging. Essential for food safety and security, food packaging, represents the largest market use of plastics and accounts for nearly half (up to 40 %) of the plastic waste generated worldwide [205, 206]. After being used once, most food packaging is landfilled or incinerated, with all the negative effects that has on the environment[207, 208]. It has also been shown to slowly but inexorably turn into persistent and widespread micro- and nanoparticles that have already been found even in food chains within living organisms [209, 210].

A plastics waste hierarchy that places reuse and/or recycling as the first option will maximize the economic value of the polymer, extend its life cycle, and reduce the spreading of these fine particles. This is also an integral part of the European and French strategies, in particular through the 3R (Reduction, Reuse, recycle) decree to move towards a more sustainable plastic economy, by making at least 50 % of plastic packaging reusable by 2030 [211]. Going further by replacing non-biodegradable petroleum-based food packaging with bio-based and biodegradable materials, while ensuring a closed-loop regeneration system, with the biodegradation as the ultimate carbon cycle, is today the only way to overcome the disastrous impact of plastic waste pollution [212].

Of the currently available food contact bio-based plastics, few are biodegradable under natural conditions, such as poly(hydroxyalkanoates) (PHAs) [213]. PHAs are thermoplastic polyesters synthesized by microorganisms under specific growth conditions [214]. In recent years, they have attracted the attention of scientists thanks to their properties close to those of some conventional plastics [215], especially for PHBV poly(3-hydroxybutyrate-co-3-hydroxyvalerate) which has better physical properties (toughness, flexibility and processability) compared to other PHA homo-polyesters [216]. PHBV-based materials are authorized for food contact applications by the European Plastics Regulation (EU) No 10/2011, and their inertness in liquid food simulants, has already been assessed, through overall migration testing [217, 218]. In a previous work, the structural and physical-chemical properties of PHBV films under food contact condition were evaluated. It has been shown that with the exception of 95 % ethanol (v/v), which is not suitable for polar polyesters, the

stability of the PHBV polymer was maintained for 10 days at 40 °C, in all tested food simulant [219].

On the other hand, there is a great interest in the use of polyphenols as natural additives for PHA polymers whether as thermal stabilizers, oxygen/radical scavengers or antimicrobial agents. Indeed, several studies have shown that the use of pure or extracted polyphenols such as catechin, tannic acid and lignin at a certain amount contributes to improve the thermal resistance of PHB and PHBV polymers, without a clear evidence on their negative effect on the polymers biodegradability [122, 192, 220]. Gallic acid incorporated in PHBV matrix at 5 wt% acted as oxygen scavenger and antiradical agent, resulting in an active food packaging [117]. The inhibitory effect of PHB-vanillin films has been demonstrated against bacterial and fungal food contaminants such as *Escherichia coli* and *Aspergillus parasiticus* [221]. In a previous work, enhanced thermomechanical stability of PHBV was observed when quercetin (flavonoid compound) was used as additive at 1 wt% [222]. Thus, the use of natural polyphenols will provide stability and new functional properties to PHAs. Moreover, they will make it possible to avoid the use of certain controversial synthetic additives (BHA, BHT), while guaranteeing the absence of propagation of toxic compounds in the environment during the biodegradation of materials.

Despite an increasing demand for bio-based and biodegradable materials such as PHBV (neat and active) for food packaging, the studies on their reuse and/or recycling are almost non-existent. Only a few studies have addressed the evolution of PHA properties over several heat treatment cycles to simulate mechanical recycling, without any reference to food contact applications [223].

To shed light on the reuse potential of PHBV-based materials, a first study was conducted in our laboratory to evaluate their thermomechanical and structural stability during successive dishwashing cycles, according to the NF EN 12875-1 standard. Up to 125 dishwashing cycles (the number of cycles required to consider the material reusable), PHBV films shown a very slight decrease in rigidity and ductility, with overall properties maintained. In the two food simulants used, ethanol 50 % and 95 % (v/v), the overall migration was below the 10 mg. dm<sup>-2</sup> limit (established by the EU committee), up to 50 washing cycles [71].

To go further, the objective of this work is to investigate the impact of different reuse conditions on the structural and physical-chemical properties and safety of PHVB and PHBV-

quercetin (PHBV-Q) materials. Quercetin is a secondary plant metabolite mainly present as quercetin glycoside (conjugated to a sugar residue) [224]. The free form of quercetin (the aglycone), although showing a mutagenic effect on bacteria *in vitro*, has been shown to be non-mutagenic, carcinogenic or reproductive *in vivo*. This is mainly because absorbed quercetin is rapidly and efficiently metabolized into non-mutagenic derivatives [12]. Used as an additive for LLDPE and PHBV, it helped protect the polymers from oxidative and thermal degradation during processing [222, 225].

The reuse of PHBV and PHBV-Q materials will first be simulated through a full reuse cycle, including food contact/washing/food contact cycle, in the presence of three food simulants, 10 % ethanol, 95 % ethanol (v/v) and 3 wt% acetic acid. Then, successive washing cycles (up to 20) with water and detergent will be applied. The plastic pre-treatment before mechanical recycling process will be carried out by means of a deep cleaning with a NaOH solution that is often used for PET in order to peel the polymer surface in which the contaminants are accumulated [226].

## **II. Material and methods**

### **II.1 Materials**

PHBV powder was purchased from Natureplast (Iffs, France) under the reference PHI003. As reported by the supplier, it contains 1-3 mol% of valerate and has a true density of 1.24 g.cm<sup>-3</sup>. Extra characterisation was performed and an apparent diameter (d50) of 41 µm was measured.

Chemicals, Boron Nitride (98 %), quercetin (95 %), sodium hydroxide (98 %), crotonic acid (98 %) and methanol (99.8 %) were purchased from Sigma Aldrich France.

Acetic acid and ethanol were provided by Sigma Aldrich with a purity > 99 % and were used to prepare the food simulants: aqueous 3 % (w/v) acetic acid, and 10 % (v/v) and 95 % (v/v) ethanol.

Dishwasher detergent (5-15 % oxygen bleach, < 5 % polycarboxylates, non-ionic surface agent, phosphonates) from SUN® was used to prepare a 0.3 wt% solution in water to simulate the food packaging washing conditions.

## II.2 Preparation of the PHBV/querceetin films

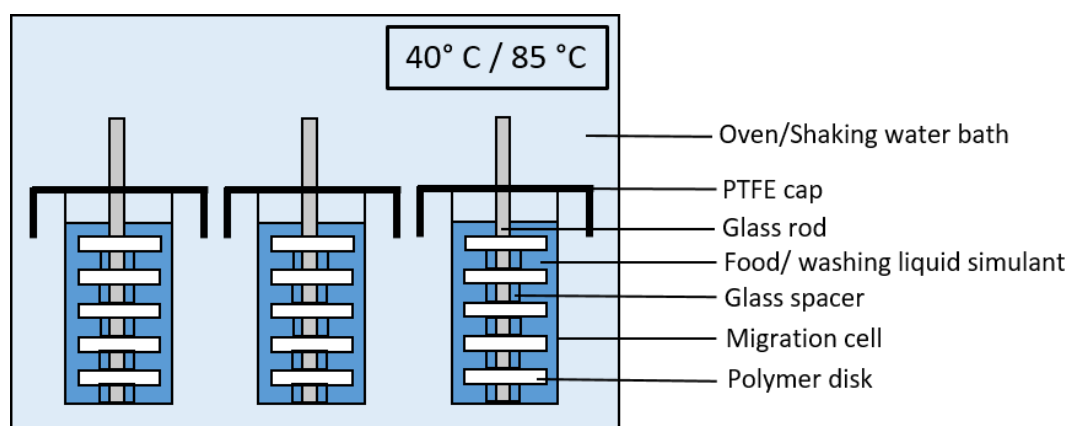
Before thermal processing, PHBV and quercetin powders were dried at 60 °C for 24 h, and boron nitride (0.5 wt%) was added to PHBV as a nucleating agent. Then, the resulting powder was pre-mixed with quercetin at 1 wt%, in a powder blender (Turbula T10B, Laboservices, Montpellier, France). The mixture was extruded in a lab scale Thermo Scientific Process 11 Twin-Screw Extruder (ThermoScientific, Karlsruhe, Germany), equipped with a L/D ratio of 40, a screw diameter of 11 mm, and a 3 mm rod die. The temperature profile set at 180 °C was uniform from the feeding to the die and the screw profile was the one described in Vandi *et al.* [175]. The screw speed was set at 200 rpm, and the resident time was approximately 2 min. After pelletization, PHBV/quercetin blend was transformed into thin films of 12x12 cm and 300 µm thickness, using heated hydraulic press (20T, Pinette Emidecau Industries, Chalon-sur-Saône, France). Pellets were heated at 180 °C during 5 min and then pressed between Teflon coated plates by regularly increasing the pressure from 5 bar to 150 bar, over 7 minutes. Films were cooled down at room temperature during 10 minutes. Then, they were left for stabilization during 14 days at 50 % of humidity. PHBV films with 1 wt% of quercetin were named PHBV-Q. Virgin PHBV films without additives were prepared in the same way. Before each experimentation, polymer films were dried at 60 °C for 24 h.

## II.3 Migration into food simulants

Three food simulants were selected to study the evolution of the films properties and the migration of additives and/or degradation products: food simulant D2 (95 % (v/v) ethanol) to replace vegetable oil and simulate food containing free fats on the surface; simulant B (3 % (w/v) acetic acid) corresponding to food with hydrophilic character with a pH below 4.5, and food simulant A (10 % (v/v) ethanol) corresponding to food with hydrophilic character (European Standard EN 10/2011) [67]. Migration studies were conducted in triplicate at 40 °C, over 10 days (EN 10/2011 regulation for long time storage). As displayed in Scheme 4, five 2.8 cm diameter polymer discs were double-side immersed in 100 mL of food simulant (total area to volume around 6 dm<sup>2</sup>.L<sup>-1</sup>). Material degradation and migration kinetics were monitored by collecting one disc and 20 mL of food simulant after 1, 2, 3, 5 and 10 days. After drying, thermal properties of the polymer samples were characterized and food simulant solutions were analysed in UPLC.

## II.4 Simulation of polymer washing

Using the device depicted in Scheme 4, washing operations were simulated. To simulate dishwashing, the polymer discs were immersed in water, or detergent solution (0.3 %w/v) for 20 washing cycles of 60 min, each at 85 °C. The simulation of the decontamination step was performed in NaOH solutions (1 % and 2 % w/v) for 5 washing cycles of 60 min each, at the same temperature. Each simulation was conducted in triplicate. Material degradation kinetic was monitored by collecting one disc and 10 mL or 20 mL of washing liquid after each washing cycle. After drying, thermal properties of the polymer samples were characterized and washing liquids were analysed in UPLC when possible.



**Scheme 4:** Scheme of the device used for migration and washing tests.

## II.5 The overall migration/release measurement (OM)

After each simulation, dry polymer discs were weighed using a microbalance (0.1 mg resolution); and their weight were compared to the initial one. The overall migration/release was calculated in milligrams per square decimetre of the surface of the polymer and was defined by Equation 1:

$$\text{Overall migration} = \frac{m_{discs, \text{ before contact}} - m_{discs, \text{ after contact}}}{A_c} \quad (1)$$

Where :  $m_{discs, \text{ before contact}}$  and  $m_{discs, \text{ after contact}}$  (mg) are respectively the masses of the discs before and after contact with the food simulant or the washing liquid and  $A_c$  (dm<sup>2</sup>) is the contact area between the discs and the liquids.

In food simulants, the overall migration limit (OML) has been set at 10 mg.dm<sup>-2</sup> by the European commission [67].

For the washing steps, overall release was converted to mg.L<sup>-1</sup> for a better representation of the amount of products lost in the washing liquid.

## II.6 The relative migration/release measurement (RM)

The relative migration/release represents the percentage of an additive or a degradation product that migrates from polymer into food simulant or washing liquid. Additive (quercetin) and identified degradation products (crotonic acid) which migrated into food simulants or washing liquids were quantified by injecting the respective solutions in Acquity UPLC (Waters, Milford, MA) liquid chromatography system, equipped with a photodiode array detector (DAD). The Waters column was 100 mm x 2.1 mm, HSS T3, particles size was 1.8 µm. The solvent used were A (99.9 % H<sub>2</sub>O and 0.1 %HCOOH v/v) and B (80 % CH<sub>3</sub>CN; 19.9 % H<sub>2</sub>O; 0.1 % HCOOH) with a flow rate of 0.55 mL.min<sup>-1</sup>. The injection volume was 2 µL and DAD was set at 280 nm (λ<sub>max</sub> of phenolic compounds) and 208 nm (λ<sub>max</sub> for crotonic acid). Calibration curves for quercetin and crotonic acid were previously plotted to assist quantification.

In the impossibility of injecting the washing liquid containing the detergent, PHBV-Q films were extracted in order to determine the amount of quercetin remaining in the film. The extraction was carried out in methanol at 40 °C with stirring for 48 h and the solutions were injected in UPLC described above.

The relative migration of quercetin (%) was calculated according to Equation 2:

$$\text{Relative migration} = \frac{m_{r,additive}}{m_{i,additive}} \times 100 \quad (2)$$

Where :  $m_{r,additive}$  (mg) is the mass of additive recovered in the food simulant or the washing liquid and  $m_{i,additive}$  (mg) is the initial mass of additive in the film sample.

Since crotonic acid is a degradation product of the washing process, its release is directly measured in mg.L<sup>-1</sup> by means of UPLC-assisted quantification.

## II.7 Scanning electron microscopy (SEM)

Pieces of PHBV and PHBV-Q films were adhered to a carbon adhesive tape and covered with a thin layer (4 nm) of Au/Pd sputter coating. They were observed using a benchtop Phenom Pro X scanning electron microscope (Phenom World, Eindhoven, The Netherlands) with an acceleration voltage of 10 kV in image mode and a backscattered electron detector.

## II.8 Differential scanning calorimetry (DSC)

DSC analyses were carried out using a calorimeter DSC series Q200, TA Instruments, under a nitrogen atmosphere with a heating rate of 10 °C.min<sup>-1</sup>. Samples of 8-10 mg were used for each analysis and all experiments were done in triplicate. To determine the crystallinity degree and the thermal properties of the films, the following heating/cooling protocol was used [177]. First, the samples cooled down from 25 °C to -30 °C, were heated to 200 °C, maintained at 200 °C for 5 min, and cooled down again to -30 °C. The second heating was then performed from -30 °C to 200 °C.

The melting temperature ( $T_m$ ), the crystallisation temperature ( $T_c$ ) and the apparent melting enthalpy ( $\Delta H_m$ ) were determined from the DSC curves from the second cool-heat cycle, using the Universal Analysis 2000 Software by TA Instruments. The crystallinity degree ( $X_c$ ) of neat PHBV and PHBV-Q samples was determined by the Equation 8:

$$X_c(\%) = \frac{\Delta H_m}{\Delta H_m^\circ} \times \frac{100}{w} \quad (8)$$

Where :  $\Delta H_m$  is the melting enthalpy of the polymer matrix,  $w$  is the polymer weight fraction in the sample and  $\Delta H_m^\circ$  is the theoretical melting enthalpy of the polymer assumed to be 100 % crystalline,  $\Delta H_m^\circ = 109 \text{ J.g}^{-1}$  for PHBV [178].

## II.9 Thermogravimetric Analysis (TGA)

TGA analyses were carried out in triplicate, under nitrogen flow (50 mL.min<sup>-1</sup>), using a Mettler TGA2 apparatus (Schwerzebbbach, Switzerland) equipped with XP5U balance (precision of 0.0001 mg). For each measurement, about 10 mg of material were used and the heating rate was 10 °C.min<sup>-1</sup> from 25 °C to 600 °C. The maximum degradation temperature ( $T_{deg}$ ) corresponds to the temperature at which the degradation rate was maximum. The

onset degradation temperature (*T<sub>onset</sub>*) was measured when the first derivative of the weight loss became higher than 0.1 %.

## II.10 Size Exclusion Chromatography (SEC)

The number-average molecular weight (*M<sub>n</sub>*), average molecular weight (*M<sub>w</sub>*), and polydispersity index (*M<sub>w</sub>/M<sub>n</sub>*) were determined by SEC, performed in Technopolym platform (Toulouse, France).

Samples were placed in sealed tubes and dissolved in chloroform at a concentration of 3-5 mg.mL<sup>-1</sup>, for 1-5 hours at 70 °C. Then, they were filtered on 0.45 µm nylon filter. SEC analyses were carried out in a UHPLC (Ultimate 3000 ThermoScientific Pump) equipped with Agilent PL gel 5 µm Mixed C column. Injection volume was 50 µL and flow rate 1 mL.min<sup>-1</sup>. Detection was performed by means of three detectors, namely differential refractometric detector (Optilab Rex Wyatt, T = 35°C), 3 angle-light-static-diffusion detector (TREOS Wyatt, λ = 658nm) and UV detector (Shimadzu SPD-M20A, λ = 254nm).

## II.11 Statistical analysis

Analysis of variance (ANOVA) was conducted using the statistical program R version 3.4.4. If significant differences were found, the Tukey's Multiple Comparison Test was used for comparisons (p ≤ 0.05).

## III. Results and Discussion

### III.1 Stability of PHBV and PHBV-Q films after one cycle of reuse

One cycle of reuse corresponds to: contact with food simulants, washing with detergent, followed by further food contact. Three food simulants were selected to represent hydrophilic, amphiphilic and lipophilic food: simulant A (10 % ethanol) can simulate some aqueous sauces and cheese preserved in aqueous medium like feta or mozzarella; Simulant B (3 % acetic acid) is used to simulate acidic foods like yogurt, buttermilk, vinegar, mustard...; simulant D (95 % ethanol) is used to substitute fatty food such as olive oil. Although 95 % ethanol represents the worst case for PHBV, it was used to evaluate the potential stabilizing role of quercetin.



### III.1.1 Overall and relative migration

Figure 15a shows the overall and quercetin migrations of PHBV and PHBV-Q films in the three food simulants cited above (the first food contact).

According to Article 12 of the European Regulation (EC) 10/2011 [67], food contact material must not transfer any substance likely to present a danger to human health and to alter the flavour and composition of food. Therefore, the overall migration limit, which represents the maximum allowed amount of non-volatile substances released from a material into food or food simulants, was set at 10 mg of substances per 1 dm<sup>2</sup> of surface area of the plastic material, which corresponds to 60 mg.kg<sup>-1</sup> of food. As represented in Figure 15a, the overall migration of PHBV film in the three food simulants do not exceed the limit set in the regulation. This overall migration is almost equivalent in 10 % ethanol and 3 % acetic acid, while it is higher in 95 % ethanol.

In the case of PHBV-Q film, the overall migration is higher, especially due to the release of quercetin in food simulants. The quercetin migration in 10 % ethanol (3 mg.L<sup>-1</sup>) was higher than in 3 % acetic acid (0.8 mg.L<sup>-1</sup>), while it exceeded 150 mg.L<sup>-1</sup> in the case of 95 % ethanol . In this latter case, it represents 99 % of quercetin initially loaded in the polymer and is caused by the swelling of the polymer in ethanol. In the absence of other observable compounds in HPLC, it was assumed that the migration products correspond to volatile components as well as monomers, resulting from the PHBV production process [227].

Quercetin is an antioxidant compound with a GRAS (Generally Recognized As Safe) status in US [228], and in Japan, it is permitted as a food additive under the list of existing food additives [229]. It was calculated that, in the worst-case scenario of estimating intake, a heavy-end consumer of pure quercetin should not be exposed to more than 4.70 mg quercetin.kg<sup>-1</sup> body weight.day<sup>-1</sup>, which corresponds to 329 mg quercetin.person<sup>-1</sup>.day<sup>-1</sup> for a person of 70 kg [12]. On contact with 10 % ethanol, 3 mg of quercetin were released per kg of food simulant, which corresponds to about 2.5 % of the initial quercetin in the film. Considering that a conventional 10 g tray, containing 150 g of food is used, the migration of 2.5 % of the initial quercetin will lead to an ingestion of 2.5 mg of quercetin for an adult per day, which is well below the admissible daily intake of 329 mg.person<sup>-1</sup>.day<sup>-1</sup>. Therefore, we can consider the use of PHBV and PHBV-Q films for packaging aqueous and acidic food to be safe. The overall migration of PHBV-Q film exceeded the regulatory limit in 95 % ethanol, which is

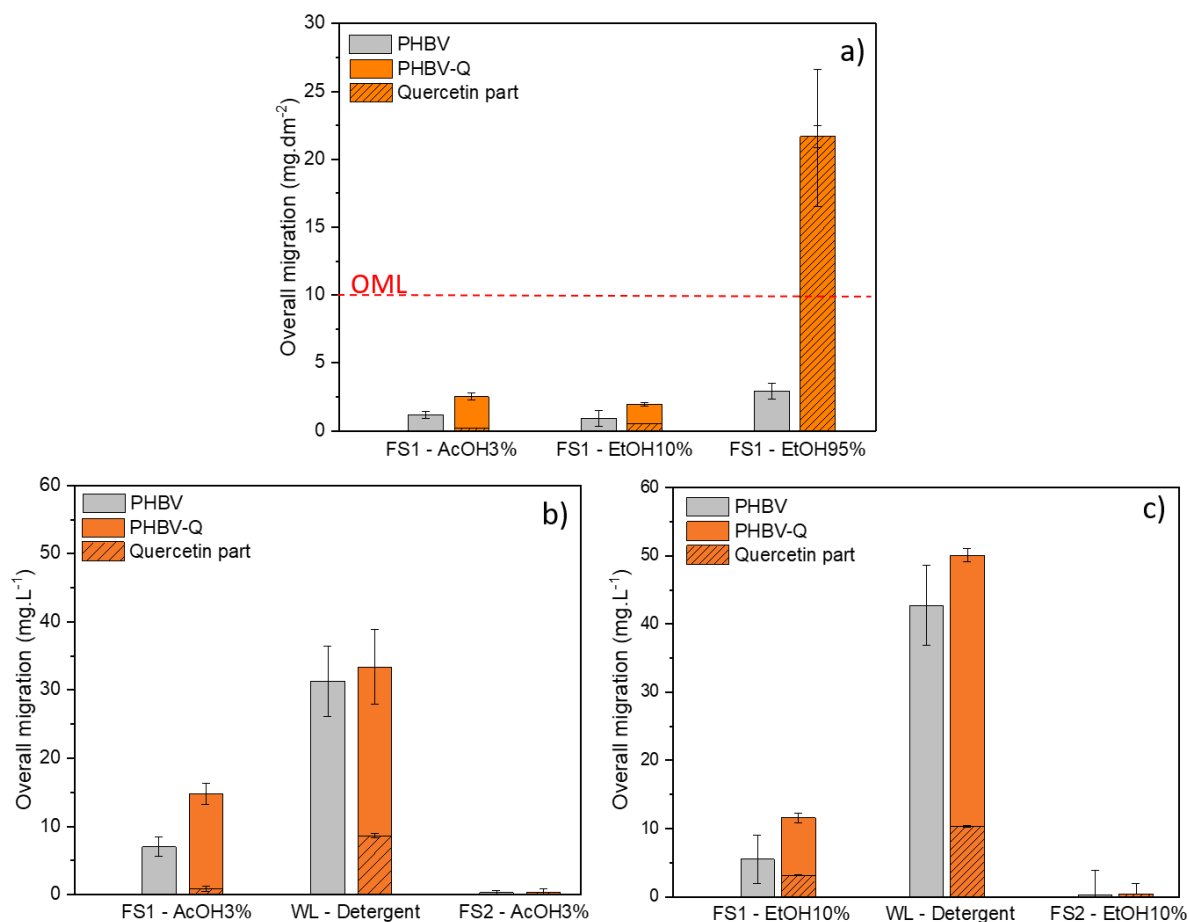
considered by EFSA to be unsuitable food simulant for such polar polymers [230]. Hence, this food simulant was discarded for the rest of the experiments.

Figures 15b and 15c summarize the overall migration and quercetin migration (in  $\text{mg.L}^{-1}$ ) of PHBV and PHBV-Q films that have undergone a complete reuse cycle, *i.e.* food contact, detergent washing at 85 °C, and food contact again.

First, it was observed that the overall release, during washing, is higher when PHBV or PHBV-Q films were previously in contact with 10 % ethanol. Indeed, it is 42 and 50  $\text{mg.L}^{-1}$  for PHBV and PHBV-Q respectively after contact with 10 % ethanol, against about 32  $\text{mg.L}^{-1}$  for both polymers after being in contact with 3 % acetic acid. This is likely due to the ethanol-induced swelling of the polymer that facilitates the release of plastic monomers, oligomers and micro and nanoparticles. The role of the washing step on the overall migration of PHBV-based films will be discussed further in the next section.

Concerning PHBV-Q film, the release of quercetin was more important during the washing step, due to the high temperature (85 °C), associated with the mechanical stirring. After these two first steps (food contact and washing), PHBV film lost 7 % of quercetin in contact with 10 % ethanol and 3.5 % of the polyphenol when 3 % acetic acid was used as food simulant.

Interestingly, after the washing step, the second food contact resulted in an overall migration of PHBV and PHBV-Q films close to zero in both food simulants, 3 % acetic acid and 10 % ethanol. Therefore, even if the overall and relative migration in aqueous and acidic foods is below the regulatory limit (first step), a preliminary washing step may be preferable to provide an increased level of safety.



**Figure 15:** Overall migration of PHBV and PHBV-Q a) for the first food simulant contact with 3 % AcOH, 10 % EtOH and 95 % EtOH (in mg.dm<sup>-2</sup>) b) for the 3 steps of the complete reuse cycle in 3 % AcOH (in mg.L<sup>-1</sup>) c) for the 3 steps of the complete reuse cycle in 10 % EtOH ( in mg.L<sup>-1</sup>). All figures are reported in Table 29 in appendix 2. FS1: first contact with food simulant. WL: washing liquid. FS2: second contact with food simulant.

### III.1.2 Physical-chemical properties of PHBV and PHBV-Q after 1 cycle of reuse (food contact-detergent washing-food contact)

Table 10 summarizes the evolution of the molecular weight and thermal properties of PHBV and PHBV-Q after a full cycle of reuse for the 10 % ethanol and 3 % acetic acid food simulants.

**Table 10:** results from SEC and DSC analyses of PHBV and PHBV-Q films after a full cycle of reuse. C1 represents a full cycle of reuse.

Food simulant	10 % EtOH				
Film properties	$T_m$ (°C)	$X_c$ (%)	$T_c$ (°C)	$T_{onset}$ (°C)	$M_w$ (kDa)
PHBV	176.6±0.1 <sup>a</sup>	82.1±1.0 <sup>a</sup>	124.4±0.6 <sup>a</sup>	268.2±0.1 <sup>a</sup>	276.3±7.6 <sup>a</sup>
PHBV C1	174.2±0.8 <sup>b</sup>	89.7±0.6 <sup>b</sup>	120.1±0.4 <sup>b</sup>	266.7±0.4 <sup>b</sup>	275.0±1.2 <sup>a</sup>
PHBV-Q	174.5±0.4 <sup>a'</sup>	76.9±0.8 <sup>a'</sup>	110.1±0.3 <sup>a'</sup>	268.9±0.8 <sup>a'</sup>	294.6±2.9 <sup>a'</sup>
PHBV-Q C1	171.6±0.4 <sup>b'</sup>	84.4±1.7 <sup>b'</sup>	104.9±0.4 <sup>b'</sup>	266.9±0.1 <sup>b'</sup>	277.7±10.2 <sup>b'</sup>
Food simulant	3 % AcOH				
Film properties	$T_m$ (°C)	$X_c$ (%)	$T_c$ (°C)	$T_{onset}$ (°C)	$M_w$ (kDa)
PHBV	176.6±0.1 <sup>a</sup>	82.1±1.0 <sup>a</sup>	124.4±0.6 <sup>a</sup>	268.2±0.1 <sup>a</sup>	276.3±7.6 <sup>a</sup>
PHBV C1	173.9±0. <sup>b</sup>	89.4±0.3 <sup>b</sup>	120.4±0.4 <sup>b</sup>	265.6±0.2 <sup>b</sup>	221.2±7.3 <sup>b</sup>
PHBV-Q	174.5±0.4 <sup>a'</sup>	76.9±0.8 <sup>a'</sup>	110.1±0.3 <sup>a'</sup>	268.9±0.8 <sup>a'</sup>	294.6±2.9 <sup>a'</sup>
PHBV-Q C1	171.6±0.1 <sup>b'</sup>	83.4±0.5 <sup>b'</sup>	104.9±0.4 <sup>b'</sup>	267.3±0.3 <sup>a'</sup>	259.4±14.8 <sup>b'</sup>

The evolution of the thermal properties of the PHBV and PHBV-Q films after a complete cycle of reuse are quite similar. Indeed, a slight degradation of the materials was observed with a decrease of  $T_m$ ,  $T_c$  and  $T_{onset}$ , accompanied by an increase of the crystallinity. This is due to the decrease of  $M_w$ , which is more pronounced in 3 % acetic acid, leading to materials embrittlement. However, these slight evolutions should not prevent the reuse of the material for other washing and food packaging cycles.

### III.2 Stability of PHBV and PHBV-Q films after successive cycles of washing in water and detergent

This section discusses the possibility of reusing PHBV and PHBV-Q films after several successive washing cycles. Assuming that 20 washing cycles would sufficiently challenge the plastic materials, PHBV-based materials were subjected to one to twenty repeated cycles in both water and detergent media at 85 °C. Then, the evolution of their physical-chemical properties throughout the washing cycles was evaluated.

### III.2.1 Overall and relative release after successive washing in water and detergent

The terms overall and quercetin migration have been used so far to indicate the amount of residue that migrates from the packaging into the food. Here, the term release will be used instead, as residues will be released into the washing media. Overall residue release was calculated as mg residue per L of washing medium.

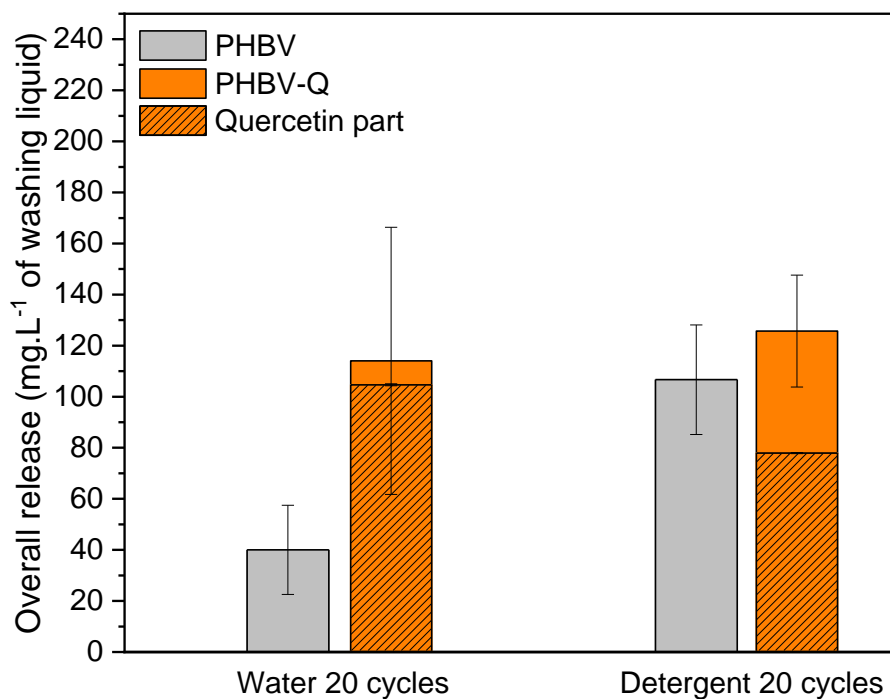
Figure 16 shows that for the neat PHBV film, the overall release after 20 water washing cycles is about 2.7 times lower than that in the detergent. It reached an average of  $107 \text{ mg.L}^{-1}$  in detergent, while it was only  $40 \text{ mg.L}^{-1}$  on average in water.

In the absence of crotonic acid, considered as the main thermal degradation product of PHA, as well as 2-pentenoic acid which is the dehydration monomer form the 3HV fraction [231] (in appendix 2, see the chromatogram, Figure 41 of the water washing media, after 20 cycles), it can be assumed that the released compounds, in both washing media, are mainly volatile substances, dehydration oligomers, as well as plastic micro- and nanoparticles. Indeed, the oligomers resulting from PHA dehydration were identified as hydroxyl- and crotyl-end-groups products with different molecular weights [68]. Some studies have reported the release of micro ( $100\text{-}600 \mu\text{m}$ ) and nanoparticles ( $<50 \mu\text{m}$ ) of PHA into aqueous medium [232, 233]. However, observation of these particles by SEM revealed that a rich microbial community develops on their surface [232], and their rapid degradation compared to other plastic particles such as PLA and PVC was reported by Ma *et al.* [234], who found that after incubation in aerobic sludge for 43 days, the weight loss (reflecting the microbial hydrolysis) of PLA and PVC particles was lower than 1 %, whereas the PHA weight loss reached more than 50 % for the same period.

Through the evaluation of the effect of laundering conditions on the formation and release of polyesters particles, the detergent was identified as an accelerating agent. Compared to home washing of polyester fabrics in water at  $44 \text{ }^\circ\text{C}$ , the use of detergent resulted in an increase in the number and mass of microfibers with  $25\text{-}200 \mu\text{m}$  length [235].

In the case of PHBV-Q film, the overall release in both water and detergent is higher than that of neat PHBV. This is mainly due to the release of quercetin into the washing media (Figure 16). After 20 cycles, the release of quercetin to water was  $104 \text{ mg.L}^{-1}$  on average, which corresponds to a weight loss of approximately 37 % from the initial amount of quercetin in the film. In the detergent, the mass loss was slightly lower with an average loss of 30 %

(with  $77 \text{ mg.L}^{-1}$  released in this media). Although quercetin release started faster in the detergent ( $27 \text{ mg.L}^{-1}$  in the detergent vs  $6 \text{ mg.L}^{-1}$  in the water after one cycle) (Table 11), the trend reversed at the end with a greater amount released into the water, probably due to the greater solubility of quercetin in water. Taking into account the quite high standard deviations (due to the sensitivity of the measurement method), it is noted that the released part corresponding to the PHBV components could reach up to  $60 \text{ mg.L}^{-1}$  in water and  $70 \text{ mg.L}^{-1}$  in detergent. It is almost equivalent to that observed for neat PHBV. However, it is not possible at this stage to establish the role of quercetin in the overall release of PHBV (acceleration or delay).



**Figure 16:** Overall release of PHBV and PHBV-Q films after 20 washing cycles in water and detergent media.

**Table 11:** Quercetin release from PHBV-Q films after 1, 10 and 20 washing cycles in both water and detergent media.

Washing medium	Quercetin release mg.L <sup>-1</sup>		
	Number of washing cycle		
	1	10	20
H <sub>2</sub> O	5.7 ± 0.1	79.2 ± 0.3	104.0 ± 0.4
Detergent	27.1 ± 0.1	49.8 ± 0.2	77.3 ± 0.2

### III.2.2 Physical-chemical properties of PHBV and PHBV-Q after successive washing cycles in water and detergent

Before assessing the microstructure of the materials after the washing cycles, pictures of PHBV and PHBV-Q films were taken after 0, 10 and 20 cycles in order to see any potential visual differences in colour or bleaching (see Figure 42 in appendix 2).

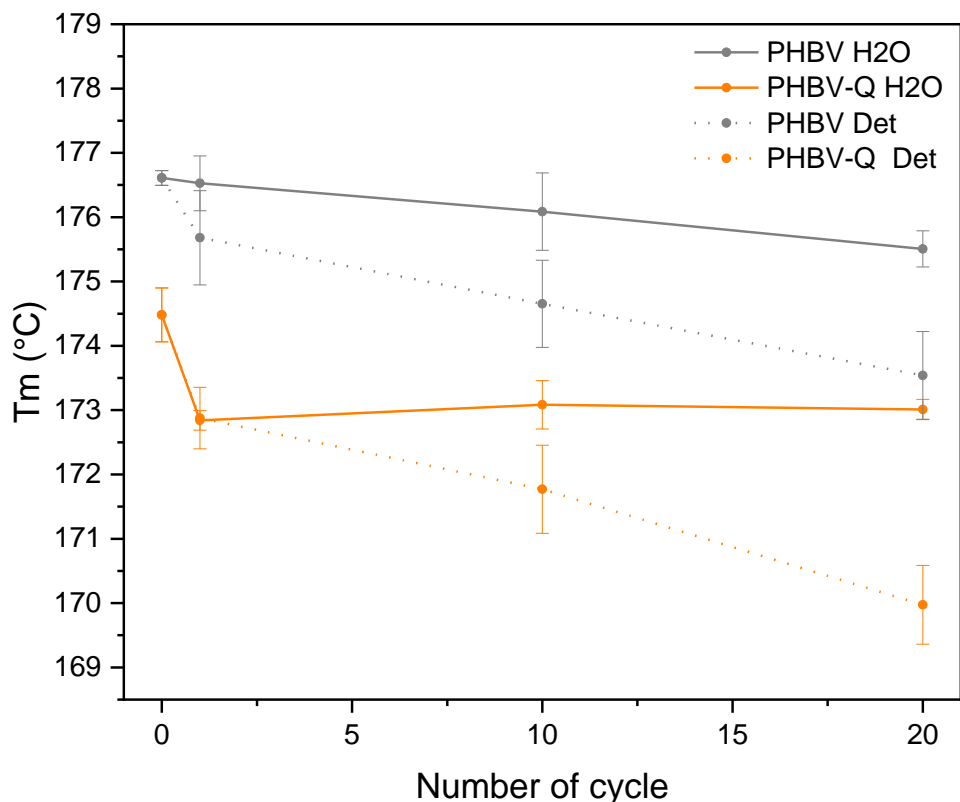
No significant change in the visual appearance of the films is detected, except for a darker colour of PHBV films after 20 washing cycles in both media. The addition of quercetin to PHBV films even at 1 wt% gave a bright yellow color to the film, which underwent gradual bleaching throughout the washing cycles in water and detergent, due to the release of quercetin. In both media, the integrity of the films was not affected because no fragments were detached from them.

To evaluate the impact of washing cycles on the microstructure of the films, DSC analyses were performed and the evolution of the melting temperature ( $T_m$ ), crystallization temperature ( $T_c$ ) and crystallization rate ( $X_c$ ) were reported in Table 30 in appendix 2. The evolution of  $T_m$  and  $M_w$  as a function of the washing cycles number is depicted in Figures 17 and 19 respectively.

First, it is noted that without any washing,  $T_m$ ,  $T_c$  and  $X_c$  of neat PHBV are higher than those of PHBV-Q film, especially for  $T_c$  which is 14 °C higher in the case of neat PHBV. This has been previously reported as the result of the intermolecular hydrogen bonds between PHBV carbonyl group and quercetin hydroxyl groups, which restrict the molecular chain motions of the polymer, and break coordination effect of lamellae layer of PHBV spherulites radial growth [222].

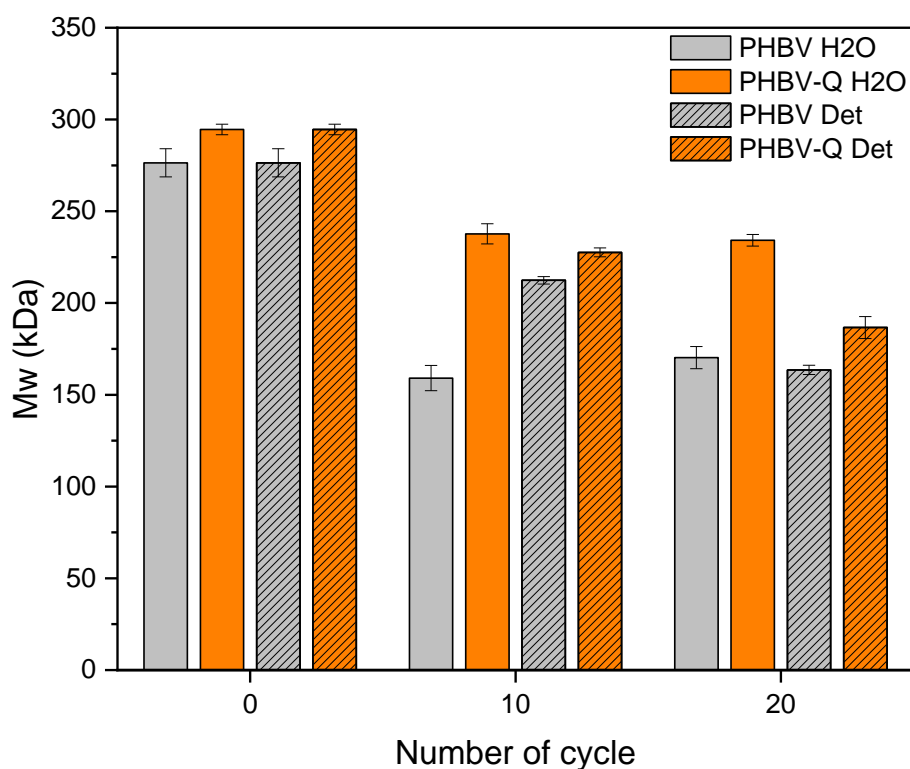
Regarding the effect of washing cycles, a slight difference in the crystallization rate of PHBV and PHBV-Q films in water and detergent was detected after 20 cycles. It was also the case for  $T_c$ , except for PHBV-Q in detergent where, it decreased from 110 °C to 105 °C. This was more significant for  $T_m$  (Figure 17) which showed a drop of almost 5 °C (from 174 to 169 °C) when PHBV-Q film was washed 20 times in detergent. For neat PHBV film the drop was less pronounced with 3 °C drop in the same medium (from 177 to 174 °C). The decrease in  $T_m$  generally attributed to polymer chain scission [236] was confirmed by the decrease in the onset degradation temperature and the molecular weight of PHBV and PHBV-Q films after 20 cycles, particularly pronounced in detergent (Figure 18).

However, after 10 cycles, a very slight evolution of  $T_m$ ,  $T_c$ ,  $X_c$ , and  $T_{onset}$  was observed for PHBV and PHBV-Q polymers in aqueous and detergent media, with a less pronounced decrease in  $M_w$  when quercetin is present (Figures 17 and 18 and Table 30).



**Figure 17:** Evolution of  $T_m$  of PHBV and PHBV-Q films throughout the washing cycles in water and detergent media.





**Figure 18:** Evolution of the average molecular weight ( $M_w$ ) of PHBV and PHBV-Q films after 0, 10 and 20 washing cycles in water and detergent media.

In a recent study conducted in our lab, it was shown that dishwashing neat PHBV films up to 125 cycles at 65-90 °C (90 min per cycle) had a slight impact on their thermal properties (melting and crystallization temperatures). In addition, only a small decrease of rigidity and ductility was observed after 5 washing cycles, then remained stable up to 125 cycles [71]. As our washing conditions are quite similar, we can assume that the same evolution of mechanical properties could occur and that the PHBV material is able to withstand 20 wash cycles in detergent without deterioration.

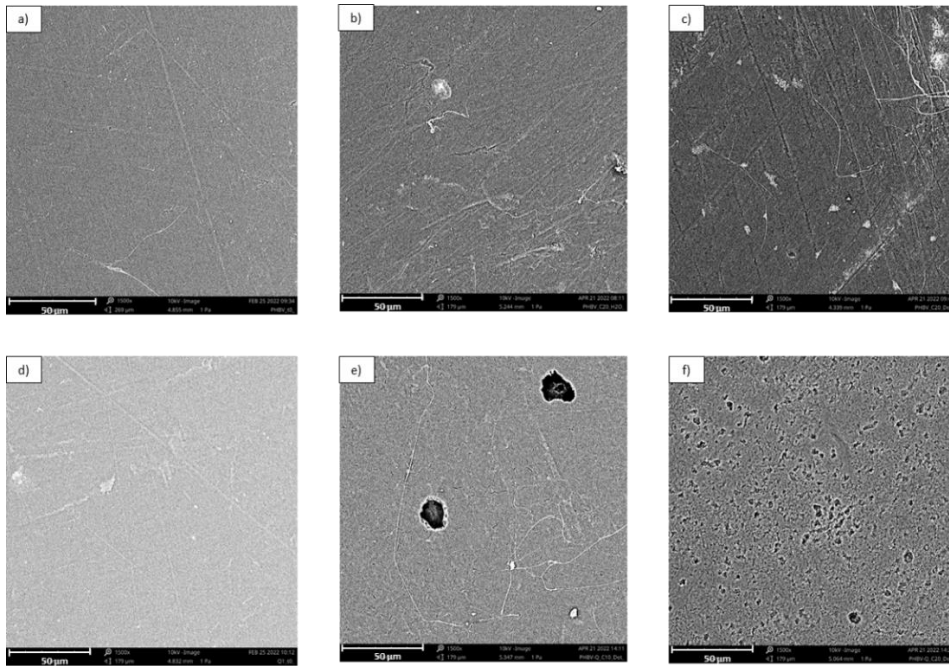
However, the microstructure of PHBV-Q film (DSC analysis) was more affected, especially in detergent, suggesting that this film may be subjected to more severe degradation. To confirm this assumption and complete the microstructure analyses, SEM images were taken on the surface of PHBV and PHBV-Q at cycle 0, 10 and 20 in both water (Figure 43, appendix 2) and detergent media (Figure 19).

In water, the surface structure of both PHBV and PHBV-Q was not really modified, except of some irregularities (thin white trails) that appeared after 20 washing cycles, probably due

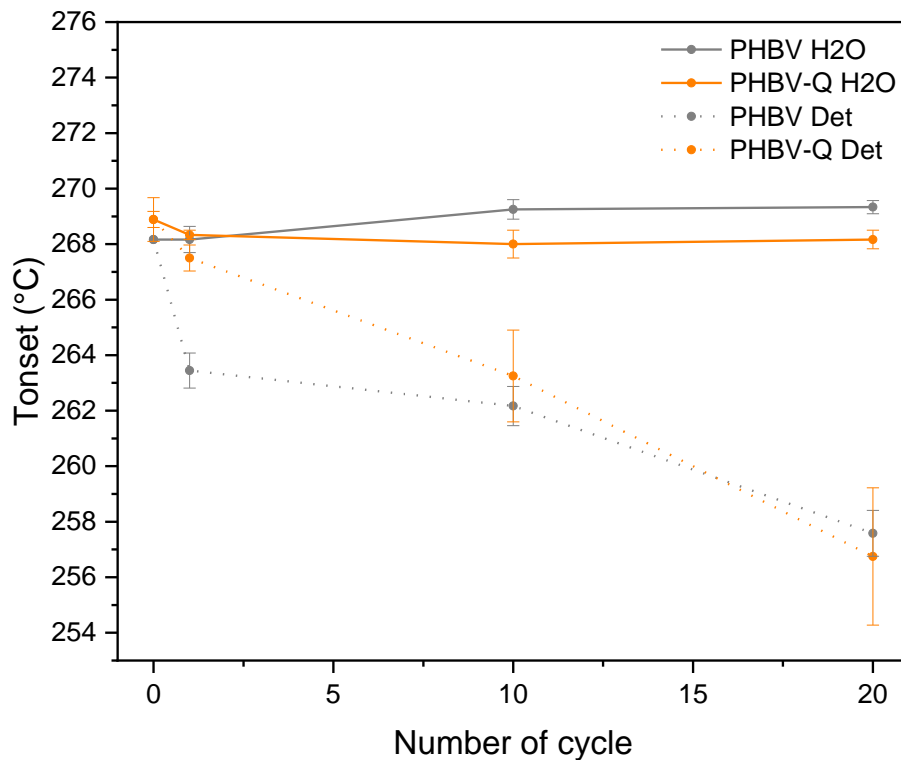
to the infiltration of water into the irregularities created during the processing and accelerated by the high temperature and repeated cycles [237].

In detergent (Figure 19), the irregularities are slightly more pronounced for neat PHBV film, due to the rougher effect of this medium, discussed earlier. However, for PHBV-Q the surface deterioration is clearly visible, with the apparition of holes and a multitude of cracks after just 10 washing cycles. After 20 cycles, the cracks turned into cavities homogeneously distributed over the films surface, creating a porous surface. These cavities were created both by the detergent effect which accelerated the surface erosion and the de-bonding of quercetin (release) which created preferential pathways for the sorption of water, accelerating and promoting the hydrolysis reactions. Accelerated polymer hydrolysis caused by the release of the additives was also observed by Xie *et al.* when water soluble PEG was introduced into PLA matrix. The release of PEG enhanced the water diffusion into the polymer and promoted the reaction of PLA with the medium [238].

Although the release of quercetin in water was higher than in detergent (Table 11), the structural degradation of the polymer was lower, revealing the determining effect of the detergent. This is clearly confirmed by the evolution of the *Tonset* which remained stable in water for both PHBV and PHBV-Q films, with an average of 268-269 °C, throughout the 20 cycles, and registered an average drop of 13 °C, at the last washing cycle in detergent for both materials (Figure 20).



**Figure 19:** SEM images of PHBV and PHBV-Q films having undergone 0, 10 and 20 washing cycles in detergent. a) PHBV C0, b) PHBV C10, c) PHBV C20, d) PHBV-Q C0, e) PHBV-Q C10, f) PHBV-Q C20. (x1500 magnification). C0, C10 and C20 corresponds to 0, 10 and 20 washing cycles



**Figure 20:** The evolution of *Tonset* of PHBV and PHBV-Q films in water and detergent throughout the washing cycles.

### **III.3 Stability of PHBV and PHBV-Q films after caustic soda washing**

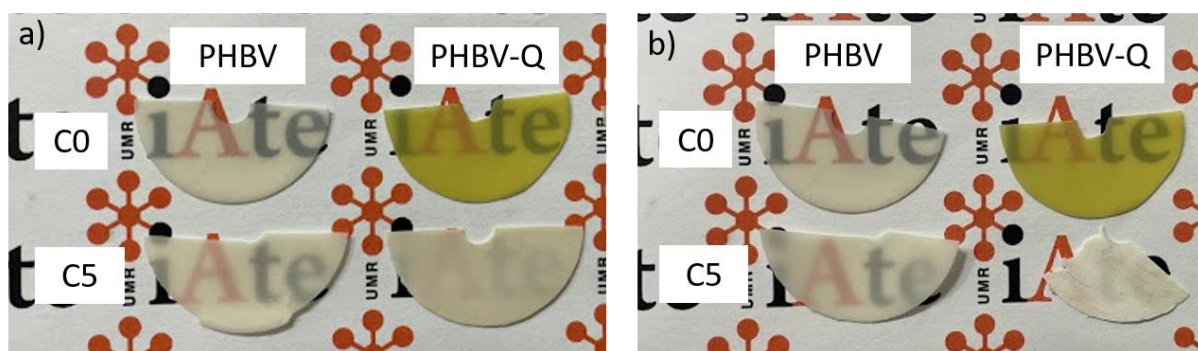
#### **III.3.1 PHBV and PHBV-Q films microstructure after caustic soda washing**

Caustic soda (aqueous solution of NaOH) is often used for the decontamination of PET containers either for direct reuse or as a pre-treatment for the mechanical recycling (thermal re-processing). The objective is to remove the surface layer of the polymer where chemical and biological contaminants accumulate [239-241].

In general, washing PET requires the use of 1 to 2 wt% NaOH solutions at temperatures ranging from 60 to 90 °C for different periods of time [239-241]. Washing of PLA with caustic soda has also been tested at 85 °C with 1 wt% NaOH solution [242] .

In this study, NaOH solution with two concentrations of 1 and 2 wt% was used. The washing cycles were at 85 °C for 60 min, and they were repeated 5 times.

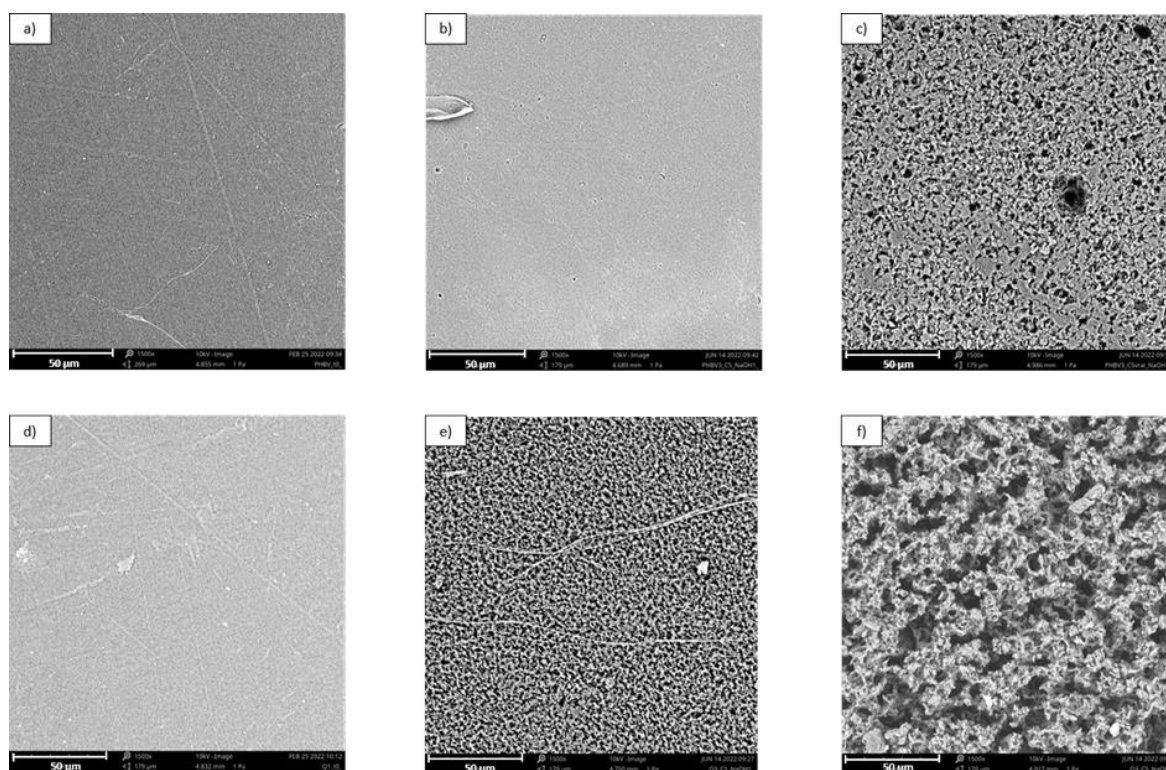
As with water and detergent washing, pictures of PHBV and PHBV-Q after washing with NaOH solutions were taken to see the visual changes caused by the washing cycles. The appearance evolution of PHBV and PHBV-Q films after 5 cycles with 1 wt% NaOH and 2 wt% NaOH solutions is shown in Figure 21 (a and b respectively). The deterioration of the films is noticeable, as PHBV film became more opaque, with high surface roughness, reflecting significant surface erosion. In addition, some edge portions of the film were missed, especially after washing with 2 wt% NaOH. PHBV-Q film showed even more marked deterioration with total bleaching in both cases; and film crumbling, with particles found in the 2 wt% NaOH washing liquid. The significant erosion of the films surface at the latter NaOH concentration, especially in the case of PHBV-Q, was confirmed by measuring the film thickness after each washing cycle. It was found that while the PHBV film thickness decreased from 385 to 338  $\mu\text{m}$  after the 5 washing cycles (47  $\mu\text{m}$  loss), PHBV-Q film lost 149  $\mu\text{m}$  in thickness (Figure 44, appendix 2).



**Figure 21:** Pictures of PHBV and PHBV-Q films after 5 cycles washing in an aqueous solution of: a) 1 wt% NaOH b) 2 wt% NaOH. C0 corresponds to unwashed films. C5 are the films which underwent 5 washing cycles.

The visual deterioration of the films being more pronounced after washing with 2 wt% NaOH, it seems that this concentration is not suitable for PHBV polyester. Therefore, only the structural and physicochemical analyses of the films washed with 1 wt% NaOH will be presented (for the analyses of the films washed with 2 wt% NaOH, see appendix 2, Figures 44 and 45 and Table 31).

The surface erosion caused by the NaOH washing was unambiguously established through the SEM images, taken for PHBV and PHBV-Q films after 1 and 5 washing cycles (Figure 22). It was observed that from the first cycle, holes and cracks started to appear on the surface of PHBV. These cracks turned into holes and cavities homogeneously distributed on the surface of the films creating porous materials in the presence of quercetin. After 5 cycles, it appeared that the deterioration has reached the bulk of the polymer, with greater damage for PHBV-Q.



**Figure 22:** SEM images of PHBV and PHBV-Q films after 1 and 5 washing cycles with an aqueous solution of 1 wt% NaOH. a) PHBV C0, b) PHBV C1 c) PHBV C5, d) PHBV-Q C0 e) PHBV-Q C1 f) PHBV-Q C5. (x1500magnificence). C0, C1 and C5 corresponds to 0,1 and 5 washing cycles.

As mentioned earlier, the purpose of using caustic soda is to remove the polymer surface layer containing the contaminants, without degrading the polymer which can be re-used. Washing neat PHBV film with 1 wt% NaOH for one cycle seems to achieve this goal because, the polymer surface was eroded without a significant modification of the polymer thermal properties. Indeed, Table 12 reveals slight changes in  $T_m$ ,  $T_c$ ,  $X_c$  and  $T_{onset}$  of PHBV film after one cycle washing with 1 wt% NaOH, despite a decrease of  $M_w$  of about 22 %. Similar behaviour was observed for PLA washed with 1 wt% NaOH at 85 °C for 15 min. The decrease of about 20 % of polymer viscosity (induced by a decrease in molecular weight) did not affect the thermal stability, crystallinity or mechanical properties [242]. After 5 cycles, the degradation is too pronounced to consider reusing the material.

On the contrary, the presence of quercetin seems to accelerate the polymer degradation even after one washing cycle with 1 wt% NaOH (Table 12). The decrease in molecular weight

from 294 to 251 kDa has led to a decrease in  $T_m$  (by about 4 °C) and an increase in crystallinity rate ( $X_c$ ). All this was accompanied by a decrease of  $T_{onset}$  by about 20 °C.

**Table 12:** Evolution of  $T_m$ ,  $T_c$ ,  $X_c$ ,  $T_{onset}$  and  $M_w$  of PHBV and PHBV-Q films after 1 and 5 washing cycles in aqueous solutions of 1 wt% NaOH.

1 wt% NaOH						
	Number of washing cycle	$T_m$ (°C)	$X_c$ (%)	$T_c$ (°C)	$T_{onset}$ (°C)	$M_w$ (kDa)
PHBV	0	176.6 ± 0.1 <sup>a</sup>	82.1 ± 1.1 <sup>a</sup>	124.4 ± 0.6 <sup>a</sup>	268.2 ± 0.1 <sup>a</sup>	276.3 ± 7.6 <sup>a</sup>
	1	175.9 ± 0.3 <sup>b</sup>	83.3 ± 0.6 <sup>a</sup>	123.5 ± 0.2 <sup>a</sup>	266.1 ± 2.2 <sup>a</sup>	213.6 ± 0.7 <sup>b</sup>
	5	173.2 ± 0.9 <sup>c</sup>	82.6 ± 1.4 <sup>a</sup>	123.8 ± 0.2 <sup>a</sup>	257.9 ± 5.9 <sup>b</sup>	211.3 ± 1.1 <sup>c</sup>
PHBV-Q	0	174.5 ± 0.4 <sup>a'</sup>	76.9 ± 0.8 <sup>a'</sup>	110.1 ± 0.3 <sup>a'</sup>	268.9 ± 0.8 <sup>a'</sup>	294.6 ± 2.9 <sup>a'</sup>
	1	170.1 ± 0.9 <sup>b'</sup>	77.9 ± 1.4 <sup>a'</sup>	106.0 ± 0.6 <sup>b'</sup>	249.3 ± 4.8 <sup>b'</sup>	250.9 ± 0.9 <sup>b'</sup>
	5	160.1 ± 1.7 <sup>c'</sup>	77.2 ± 0.8 <sup>a'</sup>	104.2 ± 1.9 <sup>b'</sup>	224.4 ± 5.8 <sup>c'</sup>	259.7 ± 3.4 <sup>c'</sup>

Since the release of quercetin was very low in the washing medium (see next section), the accelerated hydrolysis of PHBV-Q films cannot be explained by the quercetin debonding which would promote the water diffusion into the polymer. Thus, the effect could not be attributed to quercetin itself but rather to its degradation products. Indeed, Zenkevich *et al.* studied the behaviour of quercetin in alkaline solution at pH 8-10 at room temperature, without radical initiator or light radiation. At this pH, oxidation of quercetin by the oxygen of air led to the formation of two major oxidation products, namely 3,4-dihydroxybenzoic acid and 2,4,6-trihydroxybenzoic acid at relative contents of 53 % and 33 % respectively [243]. In a previous study, we demonstrated that the presence of carboxylic acids in the bulk of PHBV contributes to auto-catalyse its thermal degradation [222]. This could therefore explain the greater degradation of PHBV-Q film under the washing conditions employed.

### III.3.2 Overall and relative release of PHBV and PHBV-Q films after NaOH washing

The overall release of PHBV and PHBV-Q films in 1 and 2wt% NaOH solutions is displayed in Figure 23.

As expected and due to the polymer surface erosion, the overall release is about 100 times higher in NaOH than in water or detergent. Figure 23 shows that after one cycle, the overall release in 1 wt% and 2 wt% NaOH solutions is almost equivalent for both PHBV and

PHBV-Q films. After 5 cycles, the release increases with increasing NaOH concentration, reaching almost  $7 \text{ g.L}^{-1}$  in the case of PHBV-Q film.

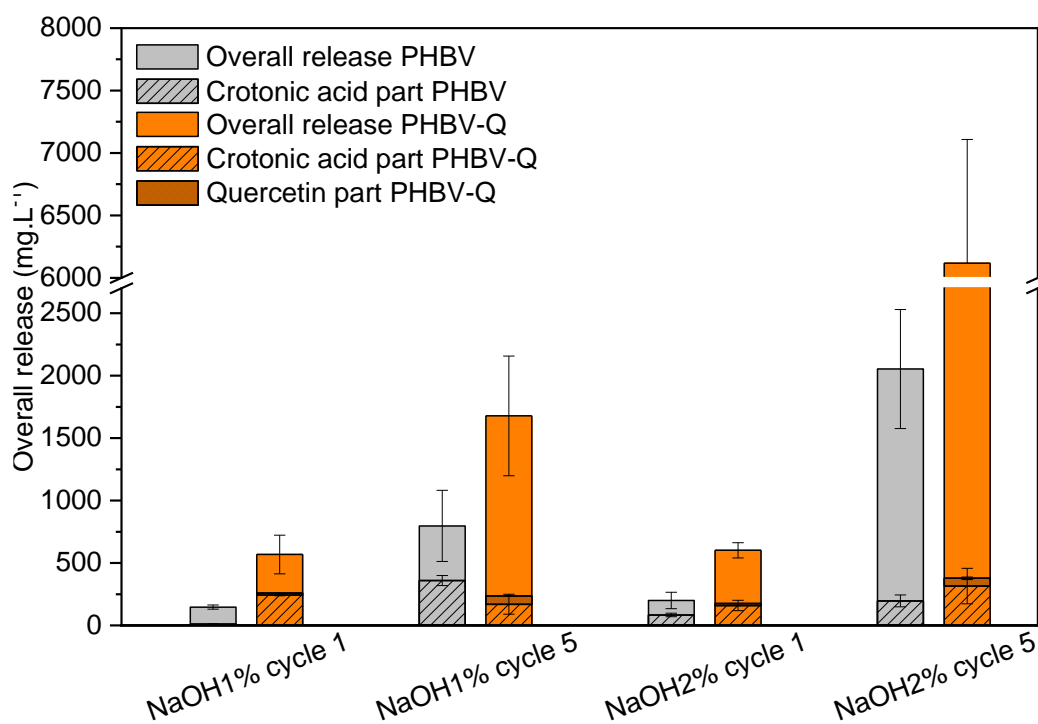
For PHBV-Q film, quercetin represents a very small part of the overall release. It reached only  $66.7 \text{ mg.L}^{-1}$  and  $62.3 \text{ mg.L}^{-1}$ , after 5 cycles washing with 1 wt% and 2 wt% NaOH respectively. Because the quercetin oxidation products were not detectable under the UPLC conditions used, it is not clear whether they remained in the film or were released into the washing medium.

In contrast with water and detergent, the use of NaOH as a washing medium led to the formation of crotonic acid, one of the major products of the thermal degradation of PHAs. It results from the random scission of the polymer chain under high temperatures, and is often produced during processing at temperatures close to the melting temperatures of PHAs [82]. In this case, it was produced even at  $85 \text{ }^\circ\text{C}$ , in the presence of aqueous NaOH, and its amount increased with the number of washing cycles. Crotonic acid was formed in all the formulations, except for PHBV washed one cycle with 1 wt% NaOH, confirming the quite low degradation of the polymer under these conditions.

Apart from crotonic acid and quercetin, most of the release representing up to  $500 \text{ mg.L}^{-1}$  for PHBV washed 5 cycles with 1 wt% NaOH could be polymer hydrolysis products as well as plastic particles.

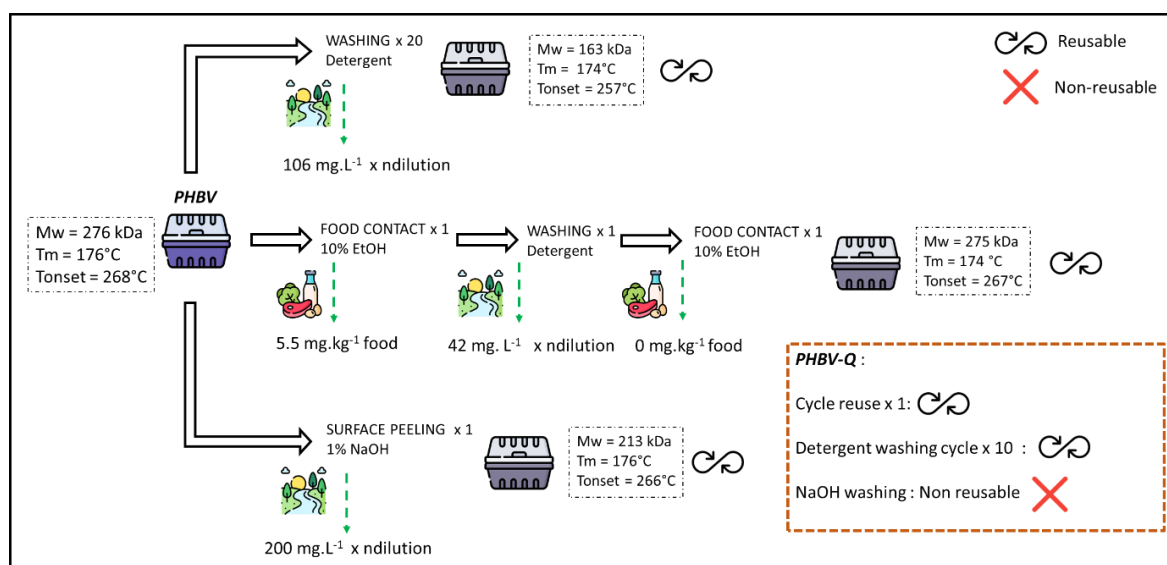
Very few studies address the impact of crotonic acid release into the environment. Only one study suggests that an aqueous solution containing crotonic acid caused 50 % inhibition of root growth in carrot and cress at a concentration of  $0.5 \text{ mg.L}^{-1}$ , while onion and cucumber were more resistant with growth inhibition at concentrations above  $5 \text{ mg.L}^{-1}$  [244]. In our experimental conditions, the release of crotonic acid from PHBV after one cycle washing with 1 wt% NaOH is about  $10 \text{ mg.L}^{-1}$ . However, this does not reflect the real conditions since this compound will be diluted in water treatment plants.





**Figure 23:** Overall release of PHBV and PHBV-Q films after 1 and 5 cycles in aqueous solution of NaOH at 1 and 2 wt%.

All results on overall migration and release have been summarized in Scheme 7, in order to consider the potential re-use of PHBV and PHBV-Q polymers in the field of food contact materials. To approximate real-life conditions, washing of the materials was considered in detergent and with 1 wt% NaOH. As can be seen, the PHBV polymer can withstand several reuse conditions without affecting human health or environment. However, the presence of quercetin which is considered as an effective antioxidant and a thermal stabilizer, has unfortunately contributed to its weakening during its reuse cycles.



**Scheme 7:** The potential reuse of PHBV and PHBV-Q materials as food packaging under different conditions.

#### IV. Conclusion

The objective of this work was to address the possible reuse of PHBV-based materials (neat and loaded with 1 wt% quercetin) as food packaging by studying their structural evolution throughout different cycles. PHBV-based materials were subjected to three use/reuse scenarios. (i) one full use/reuse cycle with simulated food contact. (ii) 20 washing cycles with water and detergent to simulate dishwashing conditions, and (iii) washing with a 1 and 2 wt% NaOH solution to mimic recycling pre-treatment, consisting of removal of the outer polymer surface.

When food simulants 10 % ethanol and 3 % acetic acid were used, the PHBV material showed a very slight change in its structural and physical-chemical properties. Moreover, the overall migration was lower than the 10 mg.dm<sup>-2</sup> set by the European regulation. After a washing cycle, followed by a new contact with these food simulants, the migration level reached zero and the structural properties were maintained. The PHBV material was also able to withstand several washing cycles in water and detergent (up to 20) without severe changes in its structure and properties. Even a washing cycle with 1 wt% NaOH solution, resulting on a removal of the surface layer did not alter the physical chemical properties of the material.

Quercetin is a natural polyphenol used in polymers to replace synthetic and controversial additives. It has proven to be an effective thermal stabilizer, preventing thermal

and thermo-oxidative degradation of polymers such as PHBV during processing. However, its presence in the bulk of the polymer contributed to accelerate its degradation, due to its release in detergent medium, and to its oxidation products in the presence of NaOH. Therefore, the use of additives in polymers intended for reuse/recycling as food packaging must be accompanied by studies throughout the life cycle of the material, not just during processing.

It should be noted that to complete this study and to conclude on the possible reuse of PHBV as a food contact material, it is necessary to carry out alternating steps of use in food contact and washing, and also to couple the thermal analyses with mechanical tests. It would also be interesting to evaluate the amount of contaminants removed by the NaOH-assisted peeling of the polymer surface.

## V. Complementary results: The impact of gallic acid on PHBV film under reuse conditions

The behaviour of PHBV with 1 wt% GA under the same reuse conditions, exposed previously will be developed in the following section.

### V.1 Stability of PHBV-GA after food contact simulation

#### V.1.1 Overall and relative migration

The stability of PHBV-GA under usage conditions has only been studied in food simulants B (3 % acetic acid) and D (95 % ethanol). The result of the overall migrations as well as the gallic acid part release is shown Table 13. As for quercetin loaded films, PHBV-GA films have a higher overall migration than virgin PHBV because of the release of gallic acid into the food simulants, especially in 95 % ethanol where 100 % of the additive migrated into the contact liquid. Consequently, the overall migration in 95 % ethanol was well above the 10 mg.dm<sup>-2</sup> set by the European Regulation (EC) 10/2011, indicating that this type of polymer could not be used for fatty food packaging, although the use of 95 % ethanol as a food simulant is not suitable for PHA polyesters, as explained above. However, the regulatory limit was not exceeded for the 3 % AcOH food simulant. On the other hand, no Admissible Daily Intake (ADI) are defined for gallic acid but only for propyl gallate (a gallic acid ester). Assuming that their ADI are similar (0.2 mg.kg<sup>-1</sup> of body weight), it represents a limit of 14 mg for an adult with an average body weight of 70 kg [245]. With the 2.67 mg.dm<sup>-2</sup> of gallic acid released into the 3 % acetic acid food simulant, corresponding to 2.34 mg of GA for one adult using a tray containing 150 g of food, this release is under the limitation. Then, from a safety point of view, gallic acid could be used as additive in food packaging for acidic food. Nevertheless, global properties of the materials must also be studied.

**Table 13:** Overall migration (mg.dm<sup>-2</sup>) of PHBV-GA and the corresponding gallic acid part in 3 % AcOH and 95 % EtOH food simulants.

Food simulant	Overall migration (mg.dm <sup>-2</sup> )	Gallic acid part (mg.dm <sup>-2</sup> )
3 % AcOH	3.63 ± 0.83	2.67 ± 0.27
95 % EtOH	19.57 ± 2.42	19.37 ± 1.72

### V.1.2 Physical-chemical properties of PHBV-GA after one food contact simulation

Table 14 summarizes the evolution of the molecular weight and thermal properties of PHBV, PHBV-Q and PHBV-GA after contact with 95 % ethanol and 3 % acetic acid food simulant (FS).

**Table 14:** results from SEC and DSC analyses of PHBV, PHBV-Q and PHBV-GA after contact with food simulants (FS) during 10 days, at 40°C.

Food simulant	95 % EtOH				
Film properties	$T_m$ (°C)	$X_c$ (%)	$T_c$ (°C)	$Tonset$ (°C)	$M_w$ (kDa)
PHBV	176.6 ± 0.1 <sup>a</sup>	82.1 ± 1.0 <sup>a</sup>	124.4 ± 0.6 <sup>a</sup>	268.2 ± 0.1 <sup>a</sup>	276.3 ± 7.6 <sup>a</sup>
PHBV + 10 days FS	176.4 ± 0.3 <sup>a</sup>	81.6 ± 0.7 <sup>a</sup>	124.3 ± 0.3 <sup>a</sup>	265.2 ± 0.9 <sup>b</sup>	281.7 ± 6.5 <sup>a</sup>
PHBV-Q	174.5 ± 0.4 <sup>a'</sup>	76.9 ± 0.8 <sup>a'</sup>	110.1 ± 0.3 <sup>a'</sup>	268.9 ± 0.8 <sup>a'</sup>	294.6 ± 2.9 <sup>a'</sup>
PHBV-Q + 10 days FS	175.5 ± 0.5 <sup>a'</sup>	81.9 ± 0.9 <sup>b'</sup>	119.2 ± 1.3 <sup>b'</sup>	267.0 ± 0.5 <sup>b'</sup>	275.6 ± 1.8 <sup>b'</sup>
PHBV-GA	174.7 ± 0.1 <sup>a''</sup>	82.8 ± 0.5 <sup>a''</sup>	121.9 ± 0.1 <sup>a''</sup>	268.1 ± 0.3 <sup>a''</sup>	240.8 ± 2.8 <sup>a''</sup>
PHBV-GA + 10 days FS	176.5 ± 0.1 <sup>b''</sup>	86.7 ± 1.6 <sup>b''</sup>	124.4 ± 0.2 <sup>b''</sup>	266.3 ± 0.3 <sup>b''</sup>	223.7 ± 4.0 <sup>b''</sup>
Food simulant	3 % AcOH				
Film properties	$T_m$ (°C)	$X_c$ (%)	$T_c$ (°C)	$Tonset$ (°C)	$M_w$ (kDa)
PHBV	176.6 ± 0.1 <sup>a</sup>	82.1 ± 1.0 <sup>a</sup>	124.4 ± 0.6 <sup>a</sup>	268.2 ± 0.1 <sup>a</sup>	276.3 ± 7.6 <sup>a</sup>
PHBV + 10 days FS	176.9 ± 0.4 <sup>a</sup>	83.7 ± 0.5 <sup>b</sup>	124.7 ± 0.1 <sup>a</sup>	265.0 ± 1.8 <sup>b</sup>	234.2 ± 2.3 <sup>a</sup>
PHBV-Q	174.5 ± 0.4 <sup>a'</sup>	76.9 ± 0.8 <sup>a'</sup>	110.1 ± 0.3 <sup>a'</sup>	268.9 ± 0.8 <sup>a'</sup>	294.6 ± 2.9 <sup>a'</sup>
PHBV-Q + 10 days FS	173.8 ± 0.3 <sup>a'</sup>	78.2 ± 0.4 <sup>a'</sup>	110.2 ± 0.6 <sup>a'</sup>	266.6 ± 0.9 <sup>b'</sup>	273.0 ± 4.3 <sup>b'</sup>
PHBV-GA	174.7 ± 0.1 <sup>a''</sup>	82.8 ± 0.5 <sup>a''</sup>	121.9 ± 0.1 <sup>a''</sup>	268.1 ± 0.3 <sup>a''</sup>	240.8 ± 2.8 <sup>a''</sup>
PHBV-GA + 10 days FS	174.0 ± 0.8 <sup>a''</sup>	82.3 ± 1.5 <sup>a''</sup>	122.2 ± 0.6 <sup>a''</sup>	266.5 ± 0.9 <sup>b''</sup>	171.9 ± 0.3 <sup>b''</sup>

The microstructural properties of PHBV, PHBV-Q and PHBV-GA are not really affected after one contact with food simulants. As described in the above article, a slight decrease in  $T_m$  and  $Tonset$  with an increase in crystallinity were observed, reflecting a progressive degradation of the polymer. However, in 3 % acetic acid, PHBV-GA lost almost 30 % of its molecular weight (from 240 kDa to 171 kDa). This is likely due to the acidic structure of gallic acid which catalysed the hydrolysis reaction of the polyester in this aqueous medium. These slight changes in polymer properties do not appear to be too significant to prohibit the use of PHBV-GA as food packaging for acidic foods. However, the mechanical properties of these polymers need to be determined to confirm this claim.

## V.2 Stability of PHBV-GA after successive cycles of washing in water and detergent

### V.2.1 Overall and relative release of PHBV-GA after successive washing in water and detergent

**Table 15:** Overall release of PHBV-GA and the corresponding gallic acid part after 20 washing cycles in water and detergent media.

Washing liquid	Overall release ( mg.L <sup>-1</sup> )	Gallic acid part (mg.L <sup>-1</sup> )
Water	200 ± 83	217 ± 1
Detergent	180 ± 31	154 ± 1

After 20 washing cycles, almost all the release is due to the gallic acid part, because of its high solubility in aqueous media (12 g.L<sup>-1</sup> at 25 °C in water against 60 g.L<sup>-1</sup> at 25 °C in water for quercetin) (Table 15). Almost 78 % of the gallic acid loaded in the film was released in water and 58 % in detergent after 20 successive washing cycles. This difference could be attributed to the presence of salts in the detergent solution which can decrease the GA solubility. This phenomenon, called the "salting-out effect", was reported in the Noubigh *et al.* study, where the solubility of GA in water decreased in the presence of electrolytes such as sulphates [246].

### V.2.2 Physical-chemical properties of PHBV-GA after successive washing cycles in water and detergent

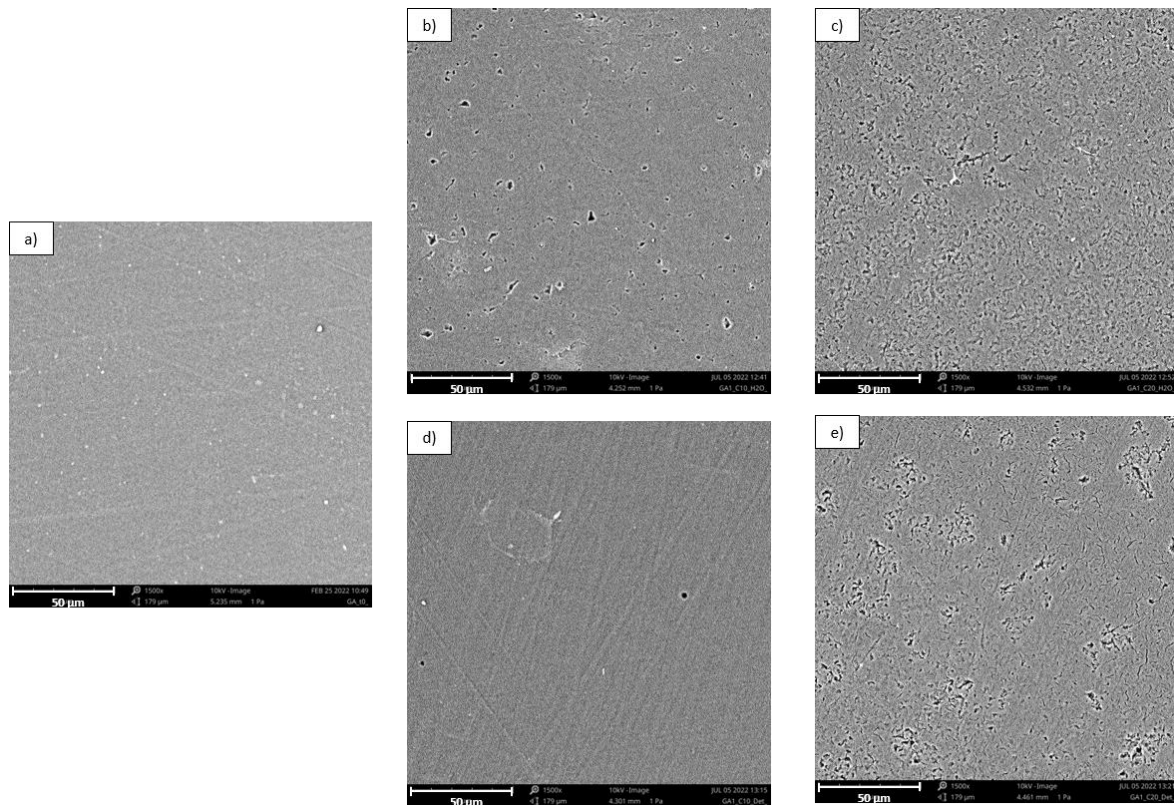
To evaluate the impact of washing cycles on the thermal and structural properties of PHBV-GA films, DSC, SEC and TGA analyses were performed and the evolution of the molecular weight ( $M_w$ ), the melting temperature ( $T_m$ ), the degree of crystallinity ( $X_c$ ), the crystallization temperature ( $T_c$ ) and the onset temperature ( $T_{onset}$ ) were reported in Table 16.

**Table 16:** The evolution of  $M_w$ ,  $T_m$ ,  $X_c$ ,  $T_c$  and  $T_{onset}$  of PHBV-GA throughout the washing cycles in water and detergent media.

Washing medium	Water				
Film properties	$T_m$ ( $^{\circ}C$ )	$X_c$ (%)	$T_c$ ( $^{\circ}C$ )	$T_{onset}$ ( $^{\circ}C$ )	$M_w$ (kDa)
PHBV-GA	$174.7 \pm 0.1^a$	$82.8 \pm 0.2^a$	$121.9 \pm 0.1^a$	$268.1 \pm 0.3^a$	$240.8 \pm 2.8^a$
PHBV-GA 10 cycles	$172.9 \pm 0.1^b$	$83.1 \pm 0.6^a$	$120.8 \pm 0.2^b$	$267.3 \pm 0.1^b$	$146.1 \pm 0.8^b$
PHBV-GA 20 cycles	$172.4 \pm 0.4^b$	$84.5 \pm 0.3^b$	$120.8 \pm 0.5^b$	$267.3 \pm 0.4^b$	$115.3 \pm 1.6^c$
Washing medium	Detergent				
Film properties	$T_m$ ( $^{\circ}C$ )	$X_c$ (%)	$T_c$ ( $^{\circ}C$ )	$T_{onset}$ ( $^{\circ}C$ )	$M_w$ (kDa)
PHBV-GA	$174.7 \pm 0.1^a$	$82.8 \pm 0.2^a$	$121.9 \pm 0.1^a$	$268.1 \pm 0.3^a$	$240.8 \pm 2.8^a$
PHBV-GA 10 cycles	$173.3 \pm 0.2^b$	$83.8 \pm 0.8^a$	$120.8 \pm 0.1^a$	$265.3 \pm 0.7^b$	$133.4 \pm 0.4^b$
PHBV-GA 20 cycles	$170.5 \pm 0.3^c$	$84.0 \pm 0.6^a$	$120.9 \pm 0.6^a$	$252.8 \pm 0.5^c$	$95.7 \pm 2.4^c$

The global degradation of PHBV-GA films after successive washing cycles in water and detergent was more pronounced than that of PHBV and PHBV-Q. In particular, PHBV-GA material lost 60 % of its molecular weight after 20 cycles in detergent (against 40 % for PHBV and 36 % for PHBV-Q), accompanied with a decrease in  $T_{onset}$  (from 268.1  $^{\circ}C$  to 252.8  $^{\circ}C$ ) and  $T_m$  (from 174.7  $^{\circ}C$  to 170.5  $^{\circ}C$ ). This confirms that detergent is a more aggressive medium for PHBV-based food packaging and that PHBV-GA is particularly susceptible to degradation under these conditions.

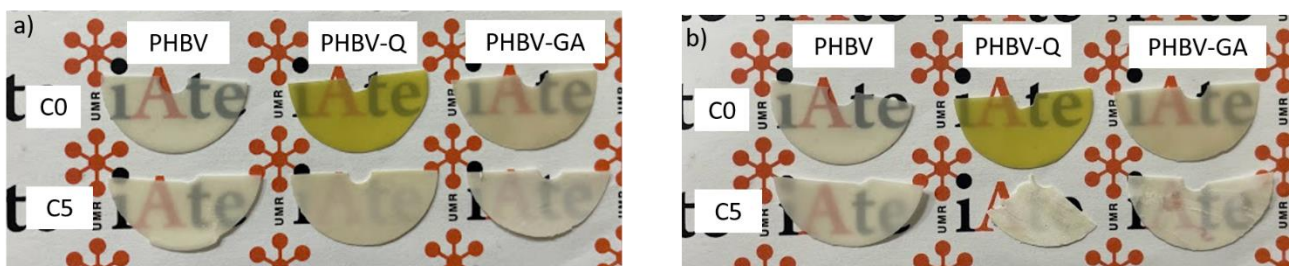
To complete the structural analyses, the microstructure of the film surfaces was observed in SEM and images are shown in Figure 24. After 10 washing cycles, the appearance of porosities and holes on the surface of the material is more pronounced in water than in detergent. After 20 cycles, the degradation appears to be very similar in both washing media, with a slightly more homogeneous surface erosion in water. Compared to PHBV-Q film which underwent a very little surface degradation in water even after 20 washing cycles, PHBV-GA is much more degraded. Once more, the high solubility of gallic acid in water caused its release out of the polymer, creating porosity and preferential paths for water to infiltrate the matrix. Therefore, due to the high solubility of gallic acid in aqueous media, it will be during washing and is not a good candidate for PHBV stabilization in such applications.



**Figure 24:** SEM images of PHBV-GA films having undergone 0,10 and 20 washing cycles in water and detergent a) PHBV-GA C0 b) PHBV-GA C10 H<sub>2</sub>O c) PHBV-GA C20 H<sub>2</sub>O d) PHBV-GA C10 Det e) PHBV-GA C20 Det (x1500 magnification). C0, C10 and C20 corresponds to 0,10 and 20 washing cycles.

### V.3 Stability of PHBV-GA after caustic soda washing

#### V.3.1 PHBV-GA films microstructure after caustic soda washing

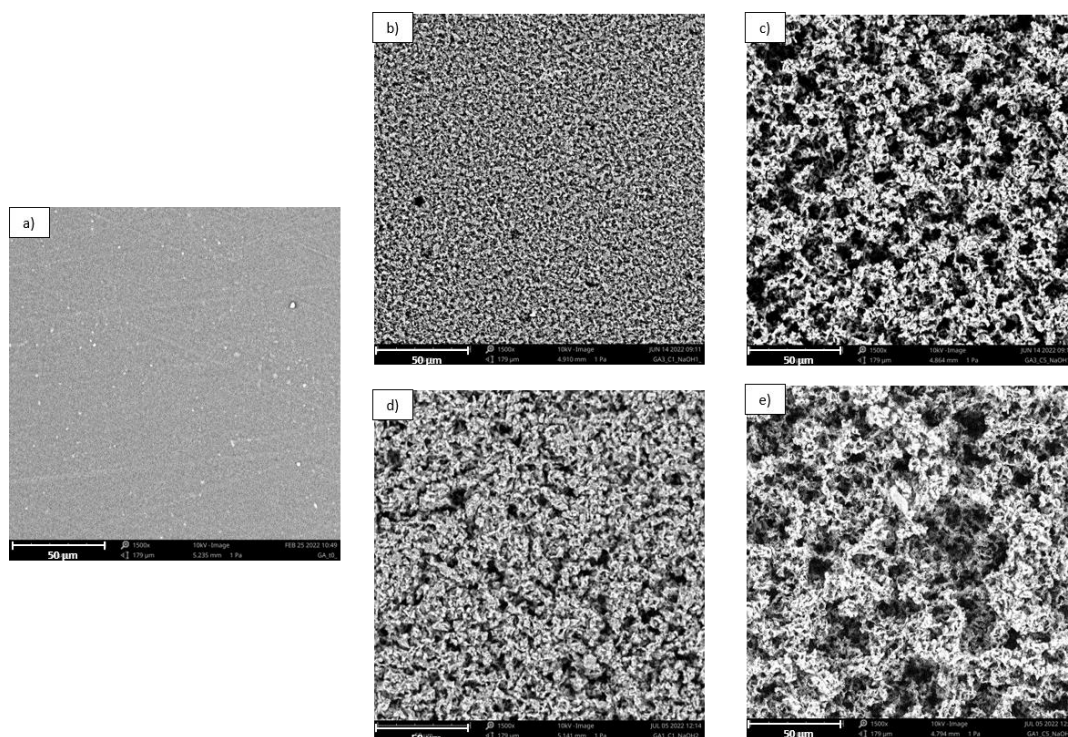


**Figure 25:** Pictures of PHBV, PHBV-Q and PHBV-GA after 5 cycles washing in aqueous solutions of a) 1 wt% NaOH b) 2 wt% NaOH. C0 corresponds to unwashed films. C5 are the films which underwent 5 washing cycles.



As mentioned previously and as shown in Figure 25, washing the PHBV materials with caustic soda solution causes important degradation of the films, especially in the case of 2 wt% NaOH and particularly for the added materials. Furthermore, significant bleaching of the films is observed as well as the missing of film particles that were found in the washing liquids.

The surface erosion was established through SEM analysis after 1 and 5 washing cycles (Figure 26). The degradation of PHBV-GA films was even greater than that of PHBV and PHBV- Q. From the first washing cycle, a homogeneous porosity appeared on the film surface and it developed continuously with increasing number of washing cycles. 2 wt% NaOH solution provoked more damage on the film surface, and as can be seen in Figure 26.e), the erosion reached the polymer bulk, after 5 cycles



**Figure 26:** SEM image of PHBV-GA after 1 and 5 washing cycles in aqueous solution of 1 wt% and 2 wt% NaOH. a) PHBV-GA C0 b) PHBV-GA C1 1 wt% NaOH c) PHBV-GA C5 1wt% NaOH d) PHBV-GA C1 2 wt% NaOH e) PHBV-GA C5 2 wt% NaOH (x1500 magnificence). C0, C1 and C5 corresponds to 0, 1 and 5 washing cycles.

**Table 17:** The evolution of  $T_m$ ,  $T_c$ ,  $X_c$ ,  $T_{onset}$  and  $M_w$  of PHBV-GA film after 1 and 5 washing cycles in aqueous solutions of 1 wt% and 2 wt% NaOH.

1 wt% NaOH						
	Number of washing cycle	$T_m$ (°C)	$X_c$ (%)	$T_c$ (°C)	$T_{onset}$ (°C)	$M_w$ (kDa)
PHBV-GA	0	174.7 ± 0.1 <sup>a</sup>	83.2 ± 0.5 <sup>a</sup>	121.9 ± 0.1 <sup>a</sup>	268.1 ± 0.3 <sup>a</sup>	240.8 ± 2.8 <sup>a</sup>
	1	172.0 ± 0.7 <sup>b</sup>	82.6 ± 0.5 <sup>a</sup>	120.7 ± 0.4 <sup>b</sup>	256.1 ± 8.5 <sup>b</sup>	219.5 ± 4.0 <sup>b</sup>
	5	170.5 ± 0.1 <sup>c</sup>	84.3 ± 0.1 <sup>b</sup>	120.1 ± 1.8 <sup>ab</sup>	239.1 ± 9.7 <sup>c</sup>	177.5 ± 0.7 <sup>c</sup>
2 wt% NaOH						
	Number of washing cycle	$T_m$ (°C)	$X_c$ (%)	$T_c$ (°C)	$T_{onset}$ (°C)	$M_w$ (kDa)
PHBV-GA	0	174.7 ± 0.1 <sup>a</sup>	83.2 ± 0.5 <sup>a</sup>	121.9 ± 0.1 <sup>a</sup>	268.1 ± 0.3 <sup>a</sup>	240.8 ± 2.8 <sup>a</sup>
	1	173.0 ± 1.7 <sup>a</sup>	84.6 ± 0.9 <sup>a</sup>	122.2 ± 0.5 <sup>a</sup>	237.6 ± 10.5 <sup>b</sup>	169.2 ± 1.8 <sup>b</sup>
	5	116.3 ± 11.8 <sup>b</sup>	36.2 ± 12.9 <sup>c</sup>	64.1 ± 21.1 <sup>b</sup>	194.0 ± 3.3 <sup>c</sup>	148.7 ± 2.2 <sup>c</sup>

Measurement of the thermal properties of PHBV-GA films after the washing cycles with NaOH solutions was quite difficult, as the analyses were performed on the remaining parts of the films that were still whole. Therefore, these analyses are not representative of the complete state of the films, since some parts were lost in the liquid. As an example, a sample washed 5 times with a 2 wt% NaOH solution was not able to recrystallize after the first ramp of heating in DSC. Thus, the results summarized in Table 17 should be interpreted with great caution, although they still reflect the degradation of the films.

### V.3.2 Overall and relative release of PHBV-GA films after NaOH washing

The overall release of PHBV-GA in 1wt% and 2wt% NaOH solution is displayed in Table 18.

**Table 18:** Overall release of PHBV-GA after 1 (C1) and 5 (C5) cycles in aqueous solution of 1 wt% and 2 wt%. NaOH.

Washing medium	Overall release (mg.L <sup>-1</sup> )	Gallic acid part (mg.L <sup>-1</sup> )	Crotonic acid part (mg.L <sup>-1</sup> )
1 wt% NaOH C1	606 ± 70	53.5 ± 1.6	81.6 ± 11.9
1 wt% NaOH C5	3265 ± 714	129.7 ± 3.9	352.6 ± 164.2
2 wt% NaOH C1	1 673 ± 1 247	49.1 ± 2.6	425.2 ± 37.7
2 wt% NaOH C5	21 065 ± 997	121.9 ± 3.6	757.8 ± 103.3

Compared to PHBV-Q, the overall release of PHBV-GA after successive washing in NaOH aqueous solution is much more important. Indeed, after one cycle in 1 wt% NaOH solution,

the overall release of the two materials was similar but it increased after 5 cycles for PHBV- GA (2 g.L<sup>-1</sup> for PHBV-Q and 3 g.L<sup>-1</sup> for PHBV-GA). This difference can be ascribed to the more important part of crotonic acid produced during the washing cycles. Gallic acid has been shown to catalyse the random chain scission mechanism, taking place during the thermal degradation of PHBV. This leads to the formation of crotonic acid through transesterification reactions [222]. Under alkaline conditions and in the presence of gallic acid catalysts, the transesterification reactions are favoured [247] and significant amount of crotonic acid is produced. Yet, the amount of crotonic is far from being the only contributor to the high overall release. Small film parts, micro-plastics, and degradation products that cannot be measured by UPLC methods, all combined together, are responsible for the increased release.

Therefore, it can be concluded that gallic acid is not a suitable additive for PHBV food packaging materials intended for washing with caustic solutions.

**CHAPTER 5**

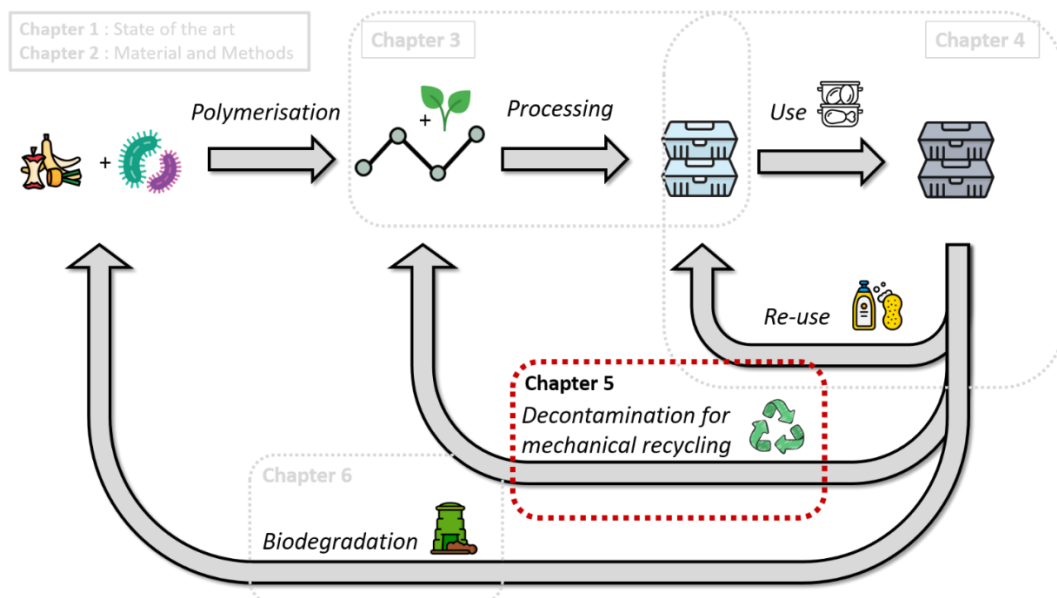
**EVALUATING/OPTIMIZING THE**

**THERMAL DECONTAMINATION OF PHBV**

**BASED FOOD PACKAGING**

## Chapter 5. Evaluating/optimizing the thermal decontamination of PHBV food packaging

Le travail présenté dans ce chapitre repose sur une collaboration avec Isabelle Dedieu, une doctorante de l'équipe qui travaille sur la recyclabilité mécanique, en boucle fermée, des emballages alimentaires à base de PHBV. Les travaux menés par Isabelle ont montré que le panel de contaminants modèles adoptés pour l'EFSA, pour simuler la contamination du PET n'était pas adapté aux PHAs. En effet, ces derniers possèdent des propriétés barrières plus faibles que celles du PET, ce qui les rend capables de sorber des contaminants de poids moléculaires et de polarités plus élevés. L'objectif de ce chapitre est, donc, d'évaluer la capacité de décontamination du PHBV lorsqu'il est mis en contact avec ce type de contaminants. Après contamination par des molécules telles que la catéchine, l'acide gallique, l'acide férulique et le PEG 200, l'efficacité du procédé de décontamination thermique a été évaluée. En parallèle, une stabilisation du PHBV lors du traitement thermique, par l'ajout de quercétine, a été tentée. L'effet de la quercétine sur l'intégrité structurale du PHBV, ainsi que sur l'efficacité de décontamination a été étudié.



## Decontamination of PHBV material intended for food contact applications: relevance of the contaminants panel and the role of quercetin as additive

Isabelle Dedieu<sup>a\*</sup>, Chloë Bonnenfant<sup>b</sup>, Stéphane Peyron<sup>b</sup>, Nathalie Gontard<sup>a</sup>, Chahinez Aouf<sup>a</sup>

<sup>a</sup>UMR IATE, INRAE, Montpellier, France;

<sup>b</sup>UMR IATE, Université de Montpellier, Montpellier, France

To be completed before publication

*In this article, only the effect of quercetin on the decontamination efficiency of PHBV was considered.*

### Abstract

The closed-loop recyclability of PHBV materials for food contact applications was investigated. Going beyond the EFSA contaminant panel (established for bottle-to-bottle PET recycling), PHBV was contaminated with polar contaminants, namely gallic acid, catechin, ferulic acid and PEG 200. Due to the low volatility of these molecules and hydrogen bonding interactions with the polymer, their decontamination efficiencies were well below safety limits. After 48 h at 160 °C, a decontamination of 25.9 % for gallic acid, 68.5 % for catechin, 67 % for ferulic acid and 86.8 % for PEG 200 was reached. To increase the temperature/decontamination time combination, quercetin was used as a thermal stabilizer. The presence of quercetin decreased the contaminant removal (-8.5 % for gallic acid, -57.4 % for catechin, -18.7 % for ferulic acid, and -31.9 % for PEG 200), for shorter decontamination times, by generating hydrogen bonds and  $\pi$ -stacking interactions with the contaminants. With longer decontamination times, a great degradation of the polymer occurred (-83 % *M<sub>w</sub>* and -45 % *X<sub>c</sub>*), accelerated by the presence of quercetin.

**Keywords:** mechanical recycling; polyhydroxybutyrate-co-valerate; decontamination; food packaging; quercetin.

## I. Introduction

The recycling of food packaging plastics, considered as “single-use” plastics, is at the heart of the European and French strategies to reduce plastic waste for the period 2025-2040 [37, 248]. Last April, the French government published the 3Rs strategy (Reduce, Reuse, Recycle), which calls for the extension of recycling to all types of single-use plastics, with a priority on food packaging [36]. In terms of recycling, mechanical recycling is mainly targeted as it is the most implemented and mature technology, with important economic and environmental benefits [249].

However, mechanical recycling is often confused with down-cycling, where the recycled materials are of lower quality and cannot withstand the endless recycling loops, ending up in landfills or incineration facilities. Indeed, only 2 % of plastic packaging is been kept within a closed-loop system [250]. One of the solutions to reduce the pressure on raw materials and prevent the accumulation of plastic waste is to consider closed-loop recycling of plastics that, at the end of their life cycle, do not present any danger to human health or environment. The recycling of biodegradable plastics should therefore be studied. Indeed, recycling is often opposed to biodegradability, although these two end-of-life options are complementary. Combined in an integrated system, recycling creates an after-use economy, while biodegradability eradicates definitively the issues of the environmental spreading of the persistent plastic waste.

To date, almost all closed-loop mechanical recycling technologies have been developed for polyethylene terephthalate (PET) bottle-to-bottle applications [251]. To ensure safety, the European Food Safety Authority (EFSA) evaluates and issues an opinion on any recycling process which aims at decontaminating post-consumer PET, during the recycling process. Until 2021, approximately 180 EFSA opinions have been published [251]. The evaluation is part of a "challenge test" approach which consists in doping the plastic with known contaminants, and analysing their elimination through the recycling process, mainly based on a thermal treatment under vacuum or gas flow [252]. The recycled plastic is considered safe if the residual concentration of contaminants does not exceed the limits corresponding to the toxicity thresholds [253]. For PET, model substances with different chemical structures (such as toluene, chlorobenzene, methyl salicylate, methyl stearate...) have been selected to simulate the real-case contaminants mainly identified in post-consumer food packaging.

These substances are listed in EFSA and FDA (US Food and Drug Administration) regulations [254].

While closed-loop recycling of other plastics such as PE and PP is still challenging [255], no work has been done on biodegradable plastics, and in particular on one of the promising biosourced, biocompatible and biodegradable plastics, poly(hydroxybutyrate-co-valerate). PHBV is a co-polyester produced by microorganisms, with interesting mechanical and barrier properties that make it a good substitute for conventional polypropylene in rigid packaging. In recent decades, it has gained significant attention and its production is constantly increasing [256].

To initiate a study on the closed-loop recyclability of PHBV, two points need to be raised: (i) the compatibility of the EFSA contaminant panel (established for PET) with PHBV, with the possibility of extrapolating the results obtained for PET, (ii) the quality of the recycled PHBV after the decontamination process.

First, the contamination is highly dependent on the polymer intrinsic properties. Unlike PET, polyolefin are rubbery at room temperature, with much lower barrier properties. It results in a greater diffusion of contaminants into their matrix and the possibility of contamination by higher molecular weight substances, as established by Palkopoulou *et al.* [255]. Rubbery PHBV, which is more polar than PET and PE, could be contaminated not only by higher molecular weight substances, but also by more polar molecules. Therefore, the EFSA panel of contaminants should be extended in the case of PHBV.

Second, PHBV is known to be a thermal sensitive polymer which undergoes random chain scission close to its melting temperature [257, 258]. Therefore, the decontamination process should be tailored to maximize contaminant removal, while minimizing degradation of the polymer structure. One option to improve the stability of the polymer is the addition of a thermal stabilizer.

This work will therefore have two objectives. The first will be dedicated to the evaluation of the efficiency of our thermal treatment process on the removal of a larger panel of contaminants, containing molecules of higher polarity and lower volatility (in comparison to those of EFSA panel). The selected molecules are gallic acid, catechin, ferulic acid and PEG 200. This follows a previous study on the decontamination efficiency of the EFSA substances



panel [75]. In parallel, the impact of decontamination conditions on the structural evolution of the polymer will be evaluated. Depending on the structural behaviour of the polymer, the use of quercetin as thermal stabilizer will be studied. Quercetin is a natural and non-toxic polyphenolic compound that has already proven its effectiveness as a thermal stabilizer in the manufacture of PHBV [222] and other polymers [225], preventing chain scission caused by heat and oxidation. To link the two parts, the role of quercetin on the affinity of polymers for contaminants as well as on the efficiency of decontamination will also be studied.

## **II. Materials and methods**

### **II.1 Materials**

PHBV with 3 mol% of 3-hydroxyvalerate units (HV) in the form of pure uncompounded powder was obtained from Nature plast (France) under the commercial name of PHI003. According to the manufacturer, it has a true density of  $1.25 \text{ g.cm}^{-3}$  and a melting temperature of 170-176 °C.

Nucleating agent (boron nitride, 98 %), polyphenolic additive (quercetin, 95 %), chemical contaminants (listed below), solvents (methanol, 99.8 % and ethanol, 99.8 %), vanillic acid 97 % and PEG 550 (as internal measurement standards for HPLC, and mass spectrometry analyses for phenolic contaminants and PEG 200 respectively), were purchased from Sigma Aldrich France. PHBV flakes were spiked with a set of surrogate contaminants, which aim to present a higher polarity than those of FDA and EFSA guidelines. The list of surrogates is: gallic acid, catechin, ferulic acid and polyethylene glycol 200 (PEG 200). Their physical-chemical properties, and those of quercetin additive are reported in Table 19.

**Table 19:** Contaminants and quercetin (additive) physical-chemical properties.

Substance	M <sub>w</sub> (g.mol <sup>-1</sup> )	Log K <sub>aw</sub>	Vapor pressure (mmHg)	Reference
Quercetin	302	1.5	2.8x10 <sup>-14</sup>	[259, 260]
Gallic acid	170	0.7	1.3x10 <sup>-7</sup>	[261, 262]
Catechin	290	1.5	0.3x10 <sup>-5</sup>	[260, 263]
Ferulic acid	194	1.5	2.7x10 <sup>-6</sup>	[264, 265]
PEG 200	190-210	-2.0	0.09	[266, 267]

## II.2 Production of neat-PHBV and PHBV-quercetin (PHBV-Q) films

Before thermal processing, PHBV, quercetin and boron nitride powders were dried at 60 °C during 24 h in order to remove potential water content. Neat PHBV was produced from the extrusion of a mixture of PHBV powder with 0.5 wt% of boron nitride. To produce PHBV-Q material, a mixture of PHBV powder with 0.5 wt% of boron nitride and 1 wt% of quercetin was extruded. Extrusion was carried out in a lab scale Thermo scientific Process 11 parallel twin-screw micro-compounder (Thermoscientific, Karlsruhe, Germany), equipped with a L/D ratio of 40, a screw diameter of 11 mm, and a 3 mm rod die. The temperature profile set at 180 °C was uniform from the feeding to the die, and the screw profile was the one described in [175]. The screw speed was set at 150 rpm, with a residence time of approximately 2 min. After granulation, the pellets were dried at 60 °C for 24 h, then neat PHBV and 12x12 cm PHBV-Q films with an average thickness of 300 µm were produced by thermo-compression using heated hydraulic press (20T, Pinette Emidecau Industries). The pressure was first set at 5 bars for 1 min, for melting the pellets, then progressively increased from 5 to 150 bars in 30 s before stabilization at 150 bars during 30 s. Flakes from PHBV and PHBV-Q films were produced by cutting the films into squares of 1.5X1.5 cm.

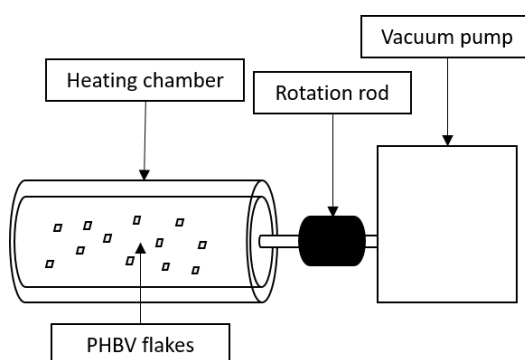
### II.3 Contamination procedure of PHBV and PHBV-Q flakes

Surrogate contaminants were dissolved in methanol, at a concentration of 9 mg. mL<sup>-1</sup> and 23 mg.mL<sup>-1</sup> for phenolic compounds and PEG 200 respectively, and stirred until a homogeneous solution was obtained. In sealed containers, this surrogate's mixture was dropped on PHBV and PHBV-Q flakes at a concentration of 500 mg of surrogates per kg of flakes. Containers were stored for 10 days at 40 °C with continuous rotatory agitation until a sorption equilibrium was reached. After 10 days, the contamination level was evaluated by measuring the surrogate concentration in the flakes.

### II.4 Decontamination procedure of PHBV and PHBV-Q flakes

#### II.4.1 Decontamination process

Decontamination of the contaminated flakes was performed at elevated temperature and under vacuum (< 20 mbar) in a glass oven (Buchi, B-585). The experimental process, already described in a previous study [75] is schematized in Scheme 5. Polymer flakes were introduced in the heating chamber, under vacuum and rotation, at 130 °C, 145 °C and 160 °C, during 6, 20 and 48 hours for neat PHBV and at 160 °C, for 6 and 48 hours for PHBV-Q.



**Scheme 5:** Scheme of the PHBV and PHBV-Q flakes decontamination process according to Dedieu *et al.* [75].

The surrogate and quercetin (the additive) concentrations in the polymer flakes after contamination and decontamination were determined using the following extraction method: 5 mL of methanol were added to 0.3 g of both PHBV material flakes in a glass vial, and samples

were stored at 40 °C for 24 hours under magnetic agitation. All the extracts, obtained in triplicate, were analysed using an Acquity UPLC (Waters, Milford, MA) liquid chromatography system, equipped with a photodiode array detector (DAD) and a mass spectrometer. The Waters column was 100 mm x 2.1 mm, HSS T3, particles size was 1.8 µm. The solvent used were A (99.9 % H<sub>2</sub>O and 0.1 % HCOOH v/v) and B (80 % CH<sub>3</sub>CN; 19 % H<sub>2</sub>O; 1 % HCOOH) with a flow rate of 0.55 mL.min<sup>-1</sup>. The injection volume was 2 µl and DAD was set at 280 nm in order to detect gallic acid, catechin and ferulic acid. PEG 200 was detected with a Bruker amazon X electrospray ionization (ESI) ion trap (Bruker Daltonics, Bremen, Germany). The nebulizer pressure was 3.03 bar, the temperature of drying gas was set at 200 °C with a 12 L.min<sup>-1</sup> flow; and the capillary voltage was set at -5.5 kV. The mass spectra were acquired over a mass range of 50-2000 Th in the positive ionization mode. The mass spectrum acquisition speed was set at m/z 8100 s<sup>-1</sup>. PEG 200 was quantified by integrating the mass spectrometry peak at 300 m/z. The peaks identification and quantification were based on the use of the different surrogates and quercetin as external standards (calibration curves with concentration range of 10 – 45 mg. L<sup>-1</sup>), as well as the use of vanillic acid and PEG 550 at 30 mg.L<sup>-1</sup> as internal standards.

#### II.4.2 Decontamination efficiencies

The decontamination efficiencies were determined for each surrogate by comparing the surrogate concentration in the flakes after decontamination with the initial concentration before heat treatment (Equation 3).

$$\text{Decontamination efficiency} = \left(1 - \frac{\text{sample concentration}}{\text{initial concentration}}\right) \times 100 \quad (3)$$

### II.5 Characterization of the physical-chemical properties of PHBV and PHBV-Q flakes after decontamination process

#### II.5.1 Size Exclusion Chromatography (SEC)

After decontamination, the average molecular weight (*M<sub>w</sub>*) and the number-average molecular weight (*M<sub>n</sub>*) were determined by SEC performed in the University of Bologna (Italy). 5mg of each sample were placed in sealed tubes with 2 mL of Chloroform (CHCl<sub>3</sub>) for 24 hours. Then, 10 drops of hexafluoroisopropanol (HFIP) were added in order to achieve a solvent ratio of 95:5 (v/v), and the mixture was stirred for 2 hours before to be filtered over 45 µm nylon

filter. SEC analyses were carried out in a UHPLC HP 1100 Series with a PL gel 5  $\mu\text{m}$  Minimixed-C column. Injection volume was 20  $\mu\text{L}$  and chloroform flow rate was 0.3  $\text{mL}\cdot\text{min}^{-1}$ . Detection was performed by means of refractive index and UV detectors. Instrument calibration was done with polystyrene standards, and all the sample analyses were performed in triplicates.

### II.5.2 Differential Scanning Calorimetry (DSC)

DSC analyses were carried out using a calorimeter DSC series Q200, TA Instruments, under a nitrogen atmosphere (50  $\text{mL}\cdot\text{min}^{-1}$ ) with a heating rate of 10  $^{\circ}\text{C}\cdot\text{min}^{-1}$ .

Around 8 mg of sample was used for each analysis and all experiments were done in triplicate. To determine the crystallization rate and the thermal properties, the following heating/cooling protocol was used: first heating from -30 to 200  $^{\circ}\text{C}$ , with stabilization for 3 min; then cooling down up to -30  $^{\circ}\text{C}$  with again a stabilization for 3 min; followed by a second heating scan up to 200  $^{\circ}\text{C}$ .

The melting temperature ( $T_m$ ), the crystallisation temperature ( $T_c$ ) and the apparent melting enthalpy ( $\Delta H_m$ ) were determined from the DSC curves from the second cool-heat cycle, using the Universal Analysis 2000 Software by TA Instruments.

The crystallinity rate ( $X_c$ ) was calculated from the melting enthalpy according to Equation 8.

$$X_c(\%) = \frac{\Delta H_m}{\Delta H_m^{\circ}} \times \frac{100}{w} \quad (8)$$

Where :  $\Delta H_m$  is the melting enthalpy of the polymer matrix,  $w$  is the polymer weight fraction in the sample and  $\Delta H_m^{\circ}$  is the theoretical melting enthalpy of the polymer assumed to be 100 % crystalline,  $\Delta H_m^{\circ} = 109 \text{ J}\cdot\text{g}^{-1}$  for PHBV [178].

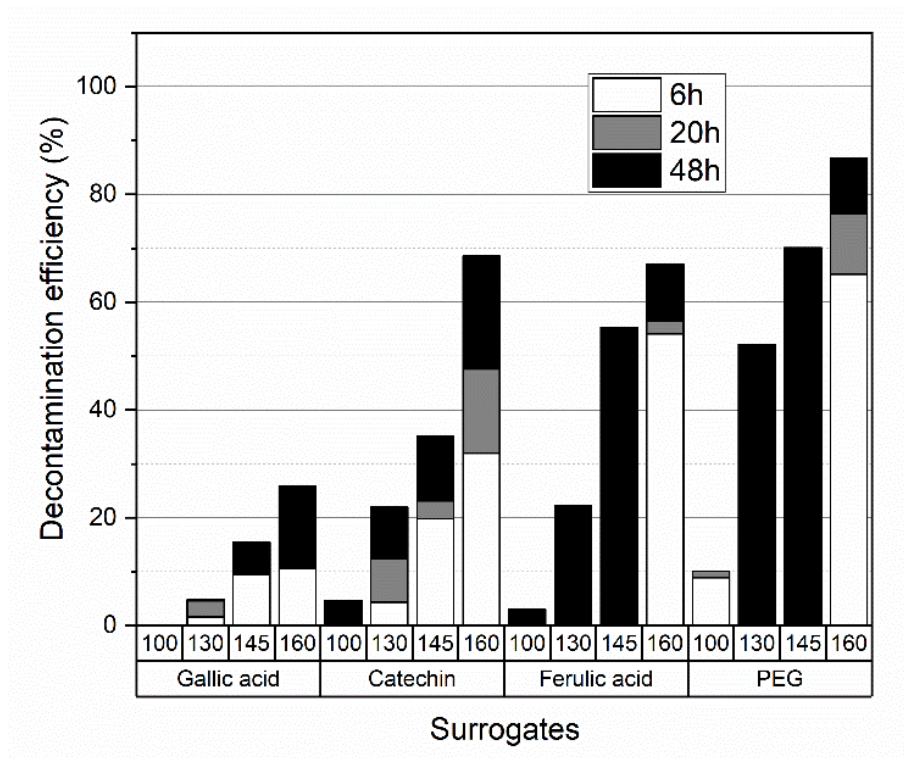
### II.6 Statistical analysis

Statistical analyses and data visualization were performed in R (RStudio, 2021). The variables were checked for normality (Shapiro-Wilk test). The significance of results was examined by one-way analysis of variance (ANOVA) followed by a Tukey test with a confidence interval of 95 %. Then, the significant difference between the data was defined.

### III. Results and discussion

#### III.1 Decontamination of neat PHBV film

Decontamination of PHBV from gallic acid, catechin, ferulic acid and PEG 200 was conducted at different temperature/time combination, in order to determine the optimal decontamination conditions. PHBV flakes were submitted to thermal treatment, under vacuum, at different temperatures (100, 130, 145, 160 °C) for 6, 20 and 48 h. Decontamination efficiency of each contaminant, under the different conditions is represented in Figure 27.



**Figure 27:** Decontamination efficiency of gallic acid, catechin, ferulic acid and PEG 200 as a function of decontamination temperature and duration.

First, it was observed that the decontamination efficiency increased with the treatment time and temperature for each contaminant. This has already been reported in a previous work when the decontamination of PHBV from the EFSA panel (the model surrogates used for the PET challenge test) was studied [75]. It has been shown that increasing temperature leads to an increase in contaminant diffusion and volatility, which are well known to respectively influence the diffusion and desorption of a chemical from a polymer matrix. The most efficient decontaminations were obtained for the highest temperature and duration, with 25.9 %

decontamination for gallic acid, 68.5 % for catechin, 67 % for ferulic acid, and 86.8 % for PEG 200 after 48 h, at 160 °C. Under these conditions, the decontamination of chemical substances from the polymer occurs via two successive steps: (i) the diffusion of the contaminant within the material and (ii) their subsequent desorption and volatilization from the surface. The nature of the polymer, such as polarity, free volume and chain mobility, as well as that of the molecule, such as molecular weight, polarity and shape, play a major role in the diffusion process. The volatility of the molecule is also responsible of its desorption from the polymer surface.

From the decontamination kinetics (data not shown), it is clear that the decontamination of these molecules does not follow a Fickian diffusion behaviour. Thus, this process is not only a combination of diffusion/volatilization phenomena, but seems to be governed by the physical-chemical parameters of the contaminants and their interactions with the polymer. The molecular weight of each contaminant as well as its polarity (expressed as  $\text{Log } K_{aw}$ ) and vapour pressure are shown in Table 19.

In terms of contaminant properties, molecular weight ( $M_w$ ) does not appear to govern the decontamination of molecules, since gallic acid with the lowest  $M_w$  is less decontaminated than catechin with the highest  $M_w$ . Thus, other physicochemical parameters can affect the molecule/polymer affinity, and consequently the decontamination efficiency. Gallic acid is the contaminant with the highest polarity (showing a better affinity for the polar PHBV) and the lowest vapour pressure, which may limit its diffusion and its volatilization respectively, explaining its lowest decontamination compared to the other substances. PEG 200, whose polarity is close to that of catechin and ferulic acid, is by far the most volatile compound in the panel, which showed the most effective decontamination.

In addition to the individual characteristics of the polymer and the contaminants, the chemical interactions between the two can play a crucial role in the decontamination process. Apart from PEG 200, the other contaminants (gallic acid, catechin and ferulic acid) belong to the polyphenols family. These compounds are prone to form intermolecular hydrogen bonds due to their phenolic hydroxyls which are good hydrogen donors. In the presence of hydrogen acceptors like PHBV (with its carbonyl groups), they can form hydrogen bonds [268] with an energy of 6 - 30  $\text{kJ}\cdot\text{mol}^{-1}$  [269]. Moreover, it has been shown that polyphenols with gallate moieties (which is the case of gallic acid) form 40 % more hydrogen bonds than those without

(catechin and ferulic acid) [270]. This is another argument explaining the lower decontamination of these compounds and especially gallic acid. On the other hand, phenolic intermolecular hydrogen bonds could also be formed, since polyphenols can be both hydrogen donors and acceptors [94]. These complex interactions inevitably act as a brake on polymer decontamination.

As a result, the efficiency of PHBV decontamination with these polar molecules, under these conditions is far from satisfactory and the recycled materials pose safety concerns [75]. However, the use of polar aprotic (non-hydrogen donor) molecules should be considered to complete this study.

As a solution, it can be argued that higher temperature and/or decontamination time can increase the diffusion of molecules within the polymer matrix and help break the hydrogen bonds formed, thereby improving decontamination. However, extending the decontamination time or temperatures to 160 °C and above will inevitably result in significant polymer degradation. Indeed, in the previous work dealing with the PHBV decontamination from EFSA molecules panel, it has been shown that exposing the polymer to 160 °C during 48 h resulted in a decrease in  $M_w$  by 57 %, and a decrease in tensile strength and elongation at break by 100 %, making the material too brittle [75].

Therefore, one condition for moving to more drastic decontamination parameters is to stabilize the polymer to prevent or reduce its thermal degradation. One of the methods used is the addition of thermal stabilizers. Quercetin as an additive, was chosen for two reasons: it is a natural biocompatible polyphenol that does not interfere with the biodegradability of PHBV [271], and it has already proven to be an effective thermal stabilizer in the production of PHBV films. Due to the hydrogen bonds formed with the polymer, the formation of the six-membered ring, a precursor of the thermal degradation mechanism, was prevented [222].

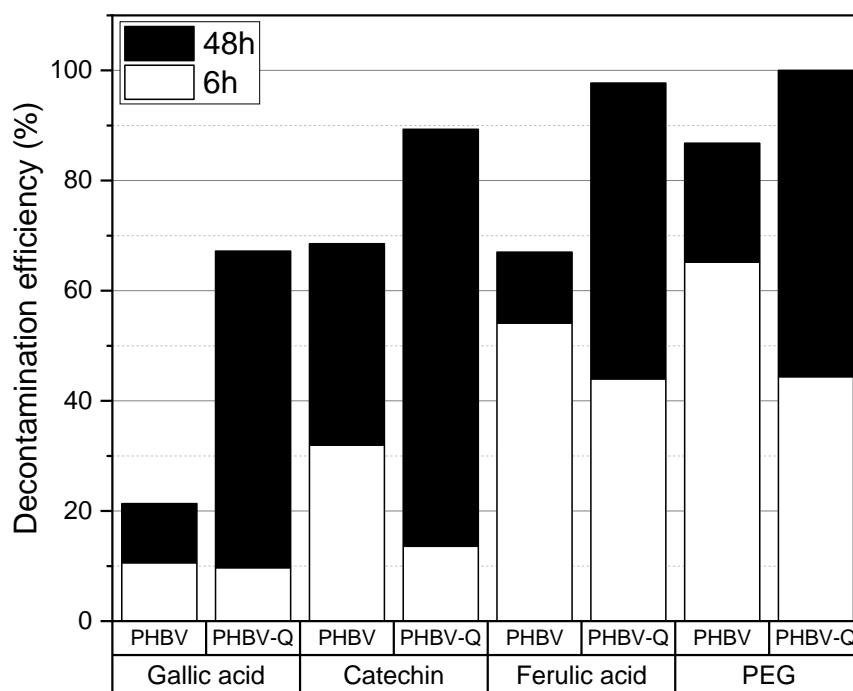
In the next section, the decontamination efficiency as well as the structural evolution of PHBV will be studied, in the presence of quercetin as an additive.



### III.2 Impact of quercetin on the decontamination efficiency and thermal properties of PHBV film

It is important to note that after contamination with a methanolic solution of surrogates, 70% of the quercetin present in the film were lost by extraction. Therefore, in the decontamination process, PHBV films were containing only 0.3% of quercetin.

Before evaluating the effect of quercetin on the thermal stabilization of the PHBV film during the decontamination process, its role on the decontamination efficiency was first studied. Thus, the decontamination of PHBV-Q film from the same surrogates was performed at 160 °C (the highest temperature) for 6 and 48 h. The decontamination efficiency results are shown in Figure 28.



**Figure 28:** Decontamination efficiency of gallic acid, catechin, ferulic acid and PEG 200 of PHBV and PHBV-Q after 6 and 48 h at 160 °C.

First, it is important to remind that quercetin was incorporated into the material during the production process of the film (by extrusion). Thus, the polyphenol crystals were homogeneously distributed in the polymer matrix with strong hydrogen bonds between the two [222]. During all the decontamination process, the initial amount of quercetin remained

unchanged (quercetin concentration:  $3.23 \pm 0.08 \text{ mg.g}^{-1}$  at 0 h,  $3.32 \pm 0.31 \text{ mg.g}^{-1}$  at 6 h and  $3.29 \pm 0.07 \text{ mg.g}^{-1}$  at 48 h). This means that the interactions between quercetin and PHBV were strong enough to remain stable during heat treatment.

Regarding the decontamination efficiency, it was found that the presence of quercetin delayed the removal of contaminants after 6 h at 160 °C, compared to neat PHBV. Indeed, the decontamination percentage decreased by about 8.5 %, for gallic acid, 57.4 % for catechin, 18.7 % for ferulic acid and 31.9 % for PEG 200. Since quercetin is a polyphenolic compound homogeneously distributed in the polymer matrix, it is easy to consider that besides the interactions that could occur between the contaminants and the polymer (discussed above), the phenolic contaminants could also interact with quercetin via hydrogen bonds and  $\pi$ -stacking interactions. These complex interactions require more energy to break down [272], that 160 °C for 6 h would allow.

To confirm this assumption, the affinity of the different contaminants with PHBV and PHBV-Q films was compared. For this, the percentage of sorption of the contaminants on the two films was calculated and the results were summarized in Table 20.

**Table 20:** Evolution of sorption percentage of contaminants on PHBV and PHBV-Q films.

Contaminant	Percentage of sorption (%)			
	Gallic acid	Catechin	Ferulic acid	PEG 200
PHBV	$77.3 \pm 2.4$	$67.4 \pm 1.5$	$84.6 \pm 4.5$	$81.2 \pm 0.6$
PHBV-Q	$96.1 \pm 3.8$	$82.6 \pm 2.4$	$100.0 \pm 4.9$	$80.6 \pm 5.2$
Evolution	+ 18.8 %	+15.2 %	+15.4 %	-0.6 %

As can be seen, the presence of quercetin resulted in approximately 15-18 % higher sorption of phenolic contaminants due to the interactions discussed above. In addition, it has been shown in a previous work that the addition of quercetin at 0.5 wt% decreased the crystallinity rate from 82 % to 79 % [222], which creates more amorphous phase, capable of being contaminated.

Surprisingly, the trend was reversed when the decontamination time was extended to 48 h. In this case, the decontamination efficiencies were higher in the presence of quercetin.

The higher release of contaminants from PHBV-Q film after 48 h could be related to the structural evolution of the polymer. Table 21 shows the change in molecular weight and polymer crystallinity caused by the heat treatment.

**Table 21:** Molecular weight and crystallinity changes of PHBV and PHBV-Q depending on decontamination duration at 160 °C.

Time (h)	Molecular weight change (%)		Crystallinity change (%)	
	PHBV	PHBV-Q	PHBV	PHBV-Q
6	-28.50 ± 1.13	-35.14 ± 1.67	+ 22.82 ± 1.95	+23.01 ± 0.91
48	-56.73 ± 0.33	-83.82 ± 0.12	+ 36.58 ± 1.38	+45.48 ± 3.62

After 48 h of decontamination PHBV-Q have lost 83 % of its molecular weight against 53 % for PHBV. Moreover, the crystallinity rate increased by 45 % for PHBV-Q, compared to 36 % for PHBV. The decrease in molecular weight accompanied by an increase in crystallinity reveals the degradation of the polymer via a random chain scission mechanism [81]. Thus, it appears that contrary to expectations, quercetin accelerated the thermal degradation of PHBV. Hence, the polymer chain scission increased the mobility of the chain, allowing easier release of contaminants. However, the acceleration of polymer degradation by quercetin is not fully understood and requires further investigation.

In summary, this preliminary study reveals that the use of quercetin had an impact on decontamination efficiency and polymer stability, but not in the desired manner. However, considering that quercetin was bound to contaminants by hydrogen bonds, it was shown that a heat treatment at 160 °C for 6h was not able to break these bonds. On the other hand, the suitability of a material for a food contact application depends on its ability to release contaminants into food. Therefore, we can ask whether binding with quercetin would not slow down the migration of contaminants into food. Future studies on the contact of these recycled materials with food simulants should be conducted to answer this question.

#### **IV. Conclusion**

The evaluation of the decontamination of the PHBV material with an extended panel of contaminants was studied in this article. Polar protic contaminants showed high affinity to the polymer through hydrogen bonding interactions, resulting in a low level of decontamination.

The use of quercetin as a thermal stabilizer increased the affinity of the contaminants for the polymer and decreased the decontamination efficiency after 6h of thermal treatment. Extending the decontamination time to 48 h led to extensive degradation of the polymer, making it impossible to reuse.

Further research should be conducted on polar aprotic contaminants and the role of quercetin in slowing the migration of contaminants into foods.



**CHAPTER 6**

**IMPACT OF POLYPHENOLS ON PHBV**

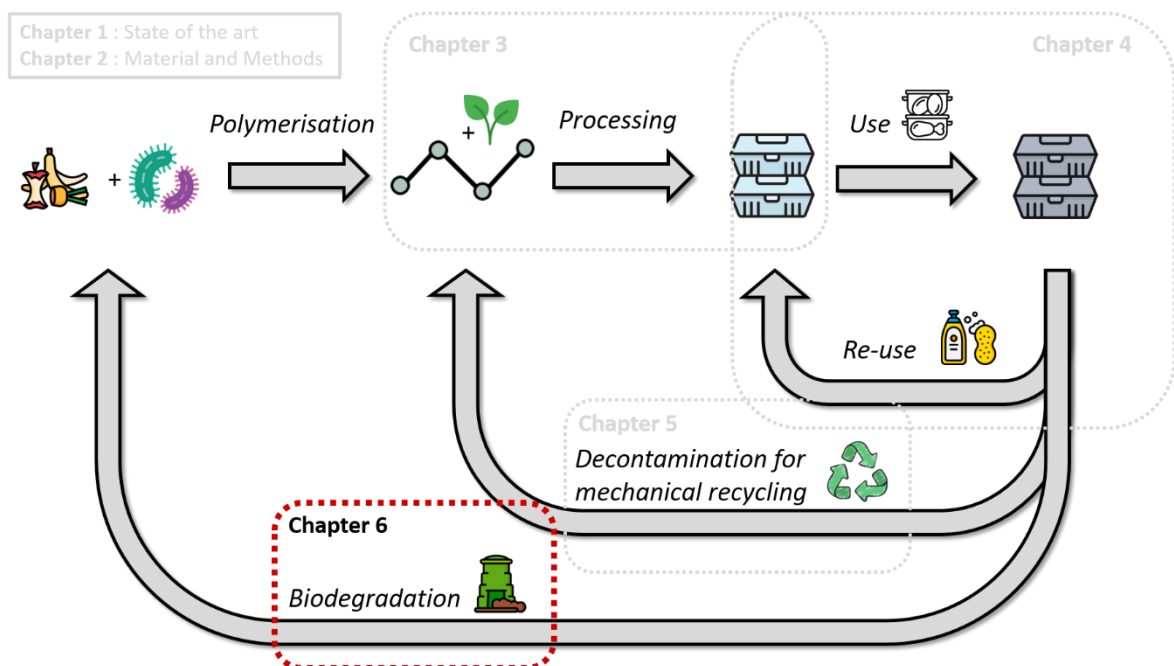
**BIODEGRADABILITY**

## Chapter 6. Impact of polyphenols on PHBV biodegradability

Ce chapitre a pour but d'étudier l'effet engendré par l'ajout des polyphénols sur la biodégradabilité du PHBV. L'intérêt principal de l'utilisation des PHAs en tant que substituts d'emballages alimentaires conventionnels, est leur biodégradation en milieu naturel. Il est donc crucial de s'interroger sur le rôle des additifs dans le maintien de cette biodégradation.

Dans un premier temps, la dégradation des matériaux PHBV, PHBV-Q at PHBV-GA a été étudiée en milieu liquide, en culture pure, en présence d'une bactérie connue pour la dégradation du PHBV, *Streptomyces exfoliatus*. Durant les quatre mois de l'expérimentation, l'évolution structurale de la surface des matériaux, ainsi que l'impact des polyphénols sur la croissance bactérienne, ont été examinés

Dans un second temps, la dégradation de ces matériaux dans des conditions plus proche de la réalité a été évaluée. Ainsi, des simulations de compost domestique ont été réalisées, et les cinétiques de minéralisation ont été suivies par respirométrie. Là encore, le rôle des polyphénols a été étudié, et comparé à celui exercé en culture pure.



## Effect of quercetin and gallic acid on the microbial degradation of PHBV materials

Chloë Bonnenfant<sup>a</sup>, Lucile Chatellard<sup>a</sup>, Nathalie Gontard<sup>b</sup> and Chahinez Aouf<sup>b</sup>

<sup>a</sup>UMR IATE, Université de Montpellier, Montpellier, France

<sup>b</sup>UMR IATE, INRAE, Montpellier, France;

To be submitted in International Biodeterioration and Biodegradation

### Abstract

Compounds of plant origin are used in biodegradable polymers as stabilizers and functional additives. However, these substances often have a biological activity (antimicrobial) that can affect the biodegradability of these polymers. The objective of this work is to study the effect of two polyphenols, quercetin and gallic acid on the biodegradability of the natural polyester poly(3-hydroxybutyrate-co-3-hydroxyvalerate) (PHBV). The biodegradation of the materials was evaluated in pure liquid culture media in the presence of the PHBV-degrading bacterium *Streptomyces exfoliatus*, and also by a respirometric test in compost. The bacterial inhibition was demonstrated from the second and fourth month of incubation in the presence of quercetin and gallic acid, respectively. This was confirmed by microscopic observations of the bacterial cells (showing the disappearance of the bacterial filament network) and SEM analysis (showing no structural change on the surface of the additivated films). However, all the films produced were considered fully biodegradable, according to the specification standard NF T51-800, leading to the conclusion that the use of polyphenolic additives to PHBV materials (instead of synthetic additives) to improve their functionality is not an obstacle to their biodegradation in home compost.

**Keywords:** PHBV, polyphenols, biodegradability, bacterial inhibition, home compost.



## I. Introduction

The world is facing a global plastic crisis, with nearly 75 % of the plastic produced since the 1950s, now accumulating as waste in the environment [1]. With almost half of the total share of plastic [273], packaging is the main generator of waste, which threatens wildlife, alters ecosystems, and causes risks to human life. Among the several initiatives to solve the problem of plastic pollution, the emergence of biodegradable plastics has become almost an evidence [274].

Biodegradable polymers, and in particular, bio-based ones have attracted a great deal of interest in recent decades, especially in the fields of medicine, agriculture and packaging [48]. Among them, polyhydroxyalkanoates (PHAs) is a family of polyesters synthesized by several microorganisms as intracellular carbon and energy stocks. Depending on the carbon source and the microorganism, 3-hydroxyalkanoic monomers of different lengths can be combined to give rise to PHA polymers with great structural diversity [56]. Among the short chain length (scl) PHAs, poly(3-hydroxybutyrate-co-3-hydroxyvalerate) (PHBV) is one of the most studied polyesters because of its mechanical properties close to propylene and polystyrene (strength and elasticity), gas barrier properties close to those of PET, and its compliance with food contact material regulation, which make it a good candidate for food packaging applications [256, 275]. In general, PHAs polymers are biodegradable plastics that - as the name suggests- have the capacity to ensure safe and timely return of carbon to the ecosystem by complete assimilation of the degraded material as a food source for soil or aquatic microorganisms [276]. Recent studies (from 2010 to 2020) gathered, in Meereboer *et al.* review, have indicated that depending on the nature of soil, its moisture, pH, and temperature, scl-PHAs can reach up to 80 % degradation within 80 to 100 days [48]. Like in soil, the home composting of PHAs is dependent on the environmental conditions. According to ASTM D5988 standard, PHAs are the most promising soil biodegradable materials with 100 % degradation in 90 days, while PCL would take up to 270 days. In marine environment, PHAs are the only class of bio-based materials exhibiting efficient degradation, according to ASTM standards [48, 277]. In natural environment, numerous microorganisms, including fungi and bacteria, can degrade solid PHAs into water-soluble monomers and oligomers, which are used as nutrients. In their review, Meereboer *et al.* reported that the

dominant PHA bacteria degraders in aerobic and anaerobic conditions are members of the genera *Variovorax*, *Stenotrophomonas*, *Acinetobacter*, *Pseudomonas*, *Bacillus*, *Burkholderia*, *Cupriavidus*, *Mycobacterium*, and *Streptomyces* [48]. Contrary to different bacteria which are known to be scl-PHA-specific, *Streptomyces* sp. and *Pseudomonas* sp. are able to degrade several homo and copolymers including P(3HB), P(3HB-3HV), P(3HB-4HV), as well as PHV [165]. For the majority of these bacteria, the mode of action is through extracellular enzymes called hydrolases and depolymerases, which are capable of degrading PHA, nearby the bacterium, into small molecules that can penetrate the bacterial membrane and be used as carbon and energy sources [159].

In spite of these promising properties, the production of PHA on 2021 did not exceed 2 % of the global production of bioplastics [278]. In addition to their high production cost, that is mitigated mainly by the use of agricultural residues as a source of biomass, and the optimization of extraction processes [279], the main obstacle to their commercial extension is their thermal instability.

Several approaches have been implemented to improve the thermal stability and mechanical properties of PHAs, especially during their formulation. Among the promising approaches, the use of natural additives, such as polyphenols is in full development. In our recent review, the effect of polyphenols as thermal stabilizers of PHAs has been established. This was mainly reflected by an increase in T<sub>g</sub> (glass transition temperature), a shift of degradation temperatures to higher values, or a disruption of crystallinity [220]. However, the antimicrobial activity of these molecules is widely documented. As reported in various reviews, polyphenols are able to inhibit various strains of gram-positive and gram-negative bacteria including *Staphylococcus aureus*, *Listeria monocytogenes* and *Escherichia coli* [136, 280]. While most studies have focused on pathogenic bacteria, and the role of polyphenols as inhibitors in foods, there is a limited interest in their effect as polymer additives in the biodegradability of plastics, probably due to the recent nature of this research area. The limited research collected in our review revealed a lack of consensus on the role of polyphenols. As an example, the presence of morin (a flavonoid compound) delayed the degradation of P(3, 4 HB) by one month in a domestic compost, while impregnation of the same polymer with Citrus Linnaeus phenolic extracts did not affect its biodegradation rate in liquid medium [220].

In our strategy to produce PHA polymers while respecting a compromise between performance and biodegradability, we used two polyphenols with different chemical structures, quercetin and gallic acid, as additives in PHBV. The stabilizing effect of quercetin and, with a lower efficiency of gallic acid, were demonstrated in a previous work [222]. In this work, the impact of quercetin and gallic acid on the biodegradability of PHBV is studied. For this purpose, two approaches were implemented: (i) the study of PHBV film degradation in liquid medium with the presence of *Streptomyces exfoliatus* (that has the capacity to degrade PHBV [156]). (ii) the study of the biodegradability of these films under home composting conditions.

## II. Material and methods

### II.1 Preparation of PHBV-polyphenols and PET films

Powders of PHBV (PHI003, Natureplast, Iffs, France) and polyphenols (quercetin and gallic acid, both purchased from Sigma Aldrich, France) were dried at 60 °C for 24 h. Prior to thermal processing, 0.5 wt% boron nitride (Sigma Aldrich, France) was added to PHBV as a nucleating agent. The resulting powder was pre-mixed with 1 wt% of each polyphenol, in a powder blender (Turbula T10B, Laboservices, Montpellier, France). The obtained mixtures were extruded in lab scale twin screw extruder Thermo Scientific Process 11 (ThermoScientific, Karlsruhe, Germany), equipped with a L/D ratio of 40, a screw diameter of 11 mm, and a 3 mm rod die. The temperature profile set at 180 °C was uniform from the feeding area to the die. The screw profile was the one described in Vandi *et al.* [175]. The screw speed was set at 200 rpm and the residence time was approximately 2 min. After pelletizing, PHBV-polyphenol blends were transformed into thin films of 12 × 12 cm and 200 µm thickness, using heated hydraulic press (20T, Pinette Emidecau Industries, Chalon-sur-Saône, France). Pellets were, first, heated at 180 °C during 5 min, and then pressed between Teflon coated plates by regularly increasing the pressure from 5 bar to 150 bar, over 7 minutes. Films were cooled down to room temperature for 10 minutes. Then, they were left for stabilization during 14 days at 50 % of humidity. Virgin PHBV films without additives were prepared in the same way.

PHBV containing 1wt % of quercetin and gallic acid were respectively named PHBV-Q and PHBV-GA.

Under the same pressure conditions, control 200  $\mu\text{m}$  PET films were prepared by thermopressing PET pellet (TK Chemical, Seoul, Korea), at 255 °C. PET films were used only for the home compost study.

## **II.2. PHBV-based films degradation in liquid medium, in the presence of *Streptomyces exfoliatus***

### **II.2.1 Preparation of the *S. exfoliatus* solution**

Dry culture of *S. exfoliatus* (DSM 41693 from the German Collection of Microorganisms and Cell Culture DSMZ) was regenerated in 50 mL of GYM medium (from Sigma Aldrich, France in  $\text{g}\cdot\text{L}^{-1}$ : glucose: 4.0; yeast extract: 4.0; malt extract: 10.0), as recommended by the supplier, and then preserved in a 40 % (v/v) aqueous solution of glycerol (Sigma Aldrich, France) at - 80 °C, before use.

Frozen *S. exfoliatus* were regenerated in 50 mL of liquid GYM solution at 28 °C during 48 h in order to obtain a high concentrated bacterial solution. To remove the residual carbon content of GYM medium, 15 mL of this bacterium solution was washed with 25 mL of sterile physiological water in a 50 mL sterile centrifuge tube. After dynamic hand shaking, the tube was centrifuged for 5 min at 4000 rpm. This operation was repeated again, after discarding the supernatant. Finally, 15 mL of sterile physiological water were added before to vortex the carbon-free suspension of *S. exfoliatus*.

### **II.2.2 Degradation of PHBV-based films in pure culture solution of *S. exfoliatus***

Pre-sterilized polymer films (2x 1 cm pieces) were introduced in sterile 100 mL flasks, equipped with cotton stoppers. Then, 50 mL of minimal nutrient solution were added (Sigma Aldrich), in  $\text{g}\cdot\text{L}^{-1}$ :  $\text{Na}_2\text{HPO}_4$ : 12.8;  $\text{KH}_2\text{PO}_4$ : 3; NaCl: 0.5;  $\text{NH}_4\text{Cl}$ : 1;  $\text{H}_3\text{BO}_3$ : 0.06;  $\text{MnSO}_4$ ,  $\text{H}_2\text{O}$ : 1.017;  $\text{CoCl}_2\cdot 6\text{H}_2\text{O}$ : 0.025;  $\text{ZnCl}_2$ : 0.07;  $\text{NiCl}_2\cdot 6\text{H}_2\text{O}$ : 0.025;  $\text{CuCl}_2\cdot 2\text{H}_2\text{O}$ : 0.015;  $\text{NaMoO}_4\cdot 2\text{H}_2\text{O}$ : 0.025; HCl: 1,755) adapted from Chatellard *et al.* [176], followed by 500  $\mu\text{L}$  of the previously prepared bacterium suspension. Flasks without bacterium and without polymer were used as control.

PHBV films microbial degradation was performed for four months at 28 °C in an orbital shaker (120 rpm, IK KS4000, Dutcher France), previously cleaned with a 70 % ethanol solution.

Residual film samples, cell biomass and culture supernatants were collected in duplicate at month 1, 2 and 4 for analyses.

## **II.3 Characterizations of the PHBV-residual films and culture media after degradation**

### **II.3.1 Evaluation of the microbial growth and cell morphology**

To follow the microbial growth, as well as the presence of contaminants, 100  $\mu\text{L}$  of microbial suspension were collected at each sampling time and incubated 48 h at 28 °C on GYM agar plate (GYM medium with agar, 12  $\text{g}\cdot\text{L}^{-1}$ ).

In parallel, microbial cells morphology (size and shape) was observed with an optical microscope equipped with an immersive objective (magnification x100, Ernst Leitz Wetzlar, Germany), after Gram staining. For this, 2 mL of microbial culture were centrifuged for 5 min to concentrate the bacterial suspension (2000 g, centrifuge Eppendorf 5427R, Dutcher, France). After removing 1.5 mL of supernatant, the bacterial pellet was homogenized and fixed on a microscope slide. The slide was finally Gram stained following this method: it was first stained 1 min in crystal violet stain, 1 min in lugol, rinsed with 70 % ethanol solution, and finally stained 3 min with safranin.

### **II.3.2 Polyphenols quantification in the culture supernatant**

To evaluate the amount of polyphenols released from PHBV films into the culture medium, polymer films were extracted with methanol. 50 mg of polymer were immersed in 2 mL of methanol, and magnetically stirred at 40 °C, for 48 h. The resulting solutions, containing residual polyphenols, were injected in Acquity UPLC (Waters, Milford, MA) liquid chromatography system, equipped with a photodiode array detector (DAD). The Waters column was 100 mm x 2.1 mm, HSS T3, particles size was 1.8  $\mu\text{m}$ . The solvents used were A (99.9 %  $\text{H}_2\text{O}$  and 0.1 %  $\text{HCOOH}$  v/v) and B (80 %  $\text{CH}_3\text{CN}$ ; 19.9 %  $\text{H}_2\text{O}$ ; 0.1 %  $\text{HCOOH}$ ) with a flow rate of 0.55  $\text{mL}\cdot\text{min}^{-1}$ . The injection volume was 2  $\mu\text{L}$  and DAD was set at 280 nm ( $\lambda_{\text{max}}$  of phenolic compounds). Calibration curves of quercetin and gallic acid were previously plotted to assist quantification.

### II.3.3 Characterization of PHBV-based films

#### II.3.3.1 Scanning Electron Microscopy (SEM)

Pieces of PHBV, PHBV-Q and PHBV-GA films were fixed to a carbon adhesive tape and covered with a thin layer (4 nm) of Au/Pd sputter coating. They were observed using a benchtop Phenom Pro X scanning electron microscope (Phenom World, Eindhoven, The Netherlands) with an acceleration voltage of 10 kV in image mode and a backscattered electron detector.

#### II.3.3.2 Differential scanning calorimetry (DSC)

DSC analyses were carried out using a calorimeter DSC series Q200, TA Instruments, under a nitrogen atmosphere with a heating rate of 10 °C.min<sup>-1</sup>. Samples of 8–10 mg were used for each analysis and all experiments were done in triplicate. To determine the crystallinity degree and the thermal properties of the films, the following heating/cooling protocol was used. First, the samples cooled down from 25 °C to -30 °C were heated to 200 °C, maintained at 200 °C for 5 min, and cooled down again to -30 °C. The second heating phase was then performed from -30 °C to 200 °C. The melting temperature ( $T_m$ ) and the apparent melting enthalpy ( $\Delta H_m$ ) were determined from the DSC curves using the Universal Analysis 2000 Software by TA Instruments.

The crystallinity degree ( $X_c$ ) of neat PHBV and PHBV-polyphenols samples was determined by the Equation 8:

$$X_c(\%) = \frac{\Delta H_m}{H_m} \times \frac{100}{w} \quad (8)$$

Where:  $\Delta H_m$  is the melting enthalpy of the polymer matrix,  $w$  is the polymer weight fraction in the sample and  $H_m$  is the theoretical melting enthalpy of the polymer assumed to be 100 % crystalline,  $\Delta H_m=109 \text{ J.g}^{-1}$  for PHBV [178].

### II.4 Evaluation of the antibiotic effect of polyphenols

In order to test the resistance of *S. exfoliatus* to gallic acid and quercetin, aqueous solutions of these two compounds, with a range of concentrations of 2, 4, 8, 20, 50 mg.L<sup>-1</sup> for quercetin and 3, 6, 12, 50 and 500 mg.L<sup>-1</sup> for gallic acid, were prepared and sterilized. The screening antimicrobial test was carried out by disc diffusion using 100 µL of suspension

containing the bacterium, spreaded on the surface of GYM nutrient agar in Petri dishes. Sterile Whatman filter paper was used to prepare 5 mm diameter discs soaked into the sterile polyphenol solutions, before to be lay on the inoculated agar. Each plates were done in duplicate. Negative controls were prepared using the same solvent to dissolve polyphenols. Supernatants of PHBV-Q and PHBV-GA culture media sampled at the fourth month, were also tested for the antibiotic tests. The inoculated plates were incubated at 28 °C for 48 h, and pictures were taken after this period.

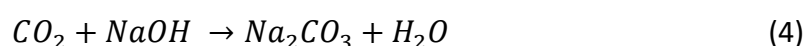
## II.5 Biodegradation of PHBV-based films under home compost conditions

The biodegradation of PHBV-based materials under aerobic home composting conditions was measured at lab scale with a method adapted from the methodological standard ISO 14855-1:2012. The study was conducted for 6 months, at 28 °C, using a respirometric test that is based on the quantification of the CO<sub>2</sub> released during the aerobic degradation of organic matter (*e.g.* PHBV). Cellulose (Arbocel® BE 600-10 TG, Germany) was used as positive control, PET as negative control, and compost without substrate as reference to measure the endogenous respiration of the inoculum.

Mature compost (pH in H<sub>2</sub>O = 7.4, 30.4 % of organic matter, 53.2 % of dry matter) was collected from an industrial composting platform (Aspiran, France), on September 2021. The compost was first sieved through 2 mm screen in order to obtain a homogeneous medium, and then dried for two months to reach 97 % dry matter.

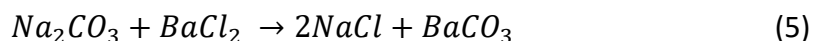
Polymer films were milled with a micro-grinder (IKA A10, Germany) into a powder of 0.5 mm particle size. After determining the carbon content of each polymer, exactly 50 mg of equivalent carbon were put into 6 g of compost. Before mixing, the humidity of the compost was adjusted to 50 %.

As described by David *et al.* [171] , respirometric tests (done in triplicate) were performed in 1 L glass reactors (Le parfait, France) containing three 60 mL opened polypropylene flasks. The first flask contained the compost/polymer mixture prepared previously, the second flask was filled with 10 mL of water to maintain a constant relative humidity of 100 %, and the third flask contained 10 mL of NaOH aqueous solution (0.2 M) to trap the CO<sub>2</sub> emitted during the organic matter biodegradation (Equation 4).

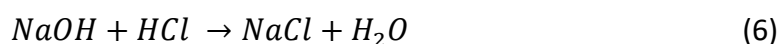


Glass reactors were hermetically closed and incubated at  $28\text{ }^{\circ}\text{C} \pm 2\text{ }^{\circ}\text{C}$  (incubator TS 606/4-I, WTW, Austria). Regularly, they were opened for 5 min to renew the air inside, and to measure the quantity of  $\text{CO}_2$  released via the degradation, and trapped by the NaOH solution.

NaOH flasks were removed from the glass reactors and 5 mL of barium chloride solution (20 % in water) were added to precipitate the carbonate salt resulting from the reaction of NaOH and  $\text{CO}_2$  (Equation 5).



The excess of NaOH was titrated with HCl aqueous solution at 0.2 M, in the presence of thymophtalein (0.10 % in ethanol) as color indicator (Equation 6).



The percentage of biodegradation %B is calculated using Equation 7:

$$\%B = \frac{\text{CO}_2 \text{ material} - \text{CO}_2 \text{ blank}}{\text{CO}_2 \text{ theoretical}} \times 100 \quad (7)$$

Where “ $\text{CO}_2$  material” and “ $\text{CO}_2$  blank” are the quantity of  $\text{CO}_2$  produced by the sample and the blank (compost without polymer) respectively (in mg); “ $\text{CO}_2$  theoretical” is the amount of carbon dioxide that could be release if all the material is biodegraded (in mg).

## II.6 Statistical analysis

Analysis of variance (ANOVA) and mean comparison (Fisher test  $p \leq 0.05$ ) were conducted using the XLSTAT program.

## III. Results and discussion

### III.1 Microbial degradation of PHBV-based materials by *S. exfoliatus* in liquid media

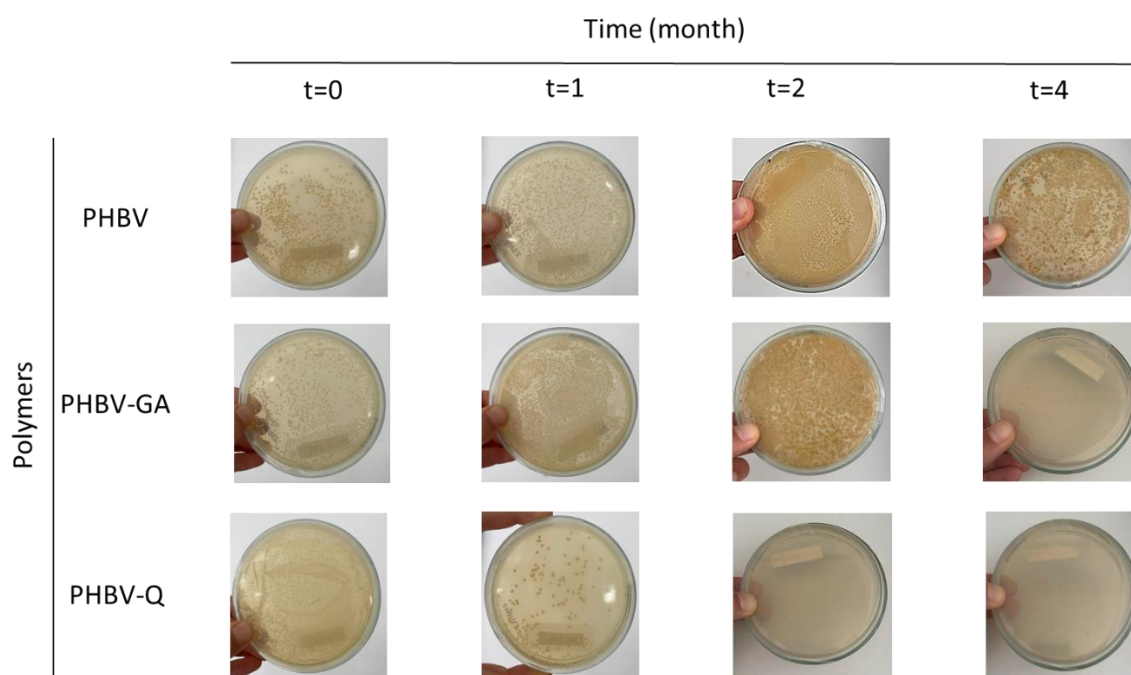
Before testing the degradation of PHBV-polyphenol materials in home compost (in a complex, mixed culture medium), the impact of quercetin and gallic acid on the growth and development of a bacterium known to effectively degrade PHBV, namely *Streptomyces exfoliatus*, was studied. For this, pieces of PHBV, PHBV-Q and PHBV-GA films (2x1 cm) were



immersed in a minimal culture solution, in the presence of the bacterium. Then, the growth of the bacterial cells, as well as the film pieces properties were monitored at 1, 2 and 4 months.

### III.1.1 Development of *S. exfoliatus* during the polymers degradation

In order to examine the bacterial growth over the degradation time, the culture media were collected and inoculated on nutritive GYM agar plates. Pictures were taken after 48 h and are shown in Figure 29.

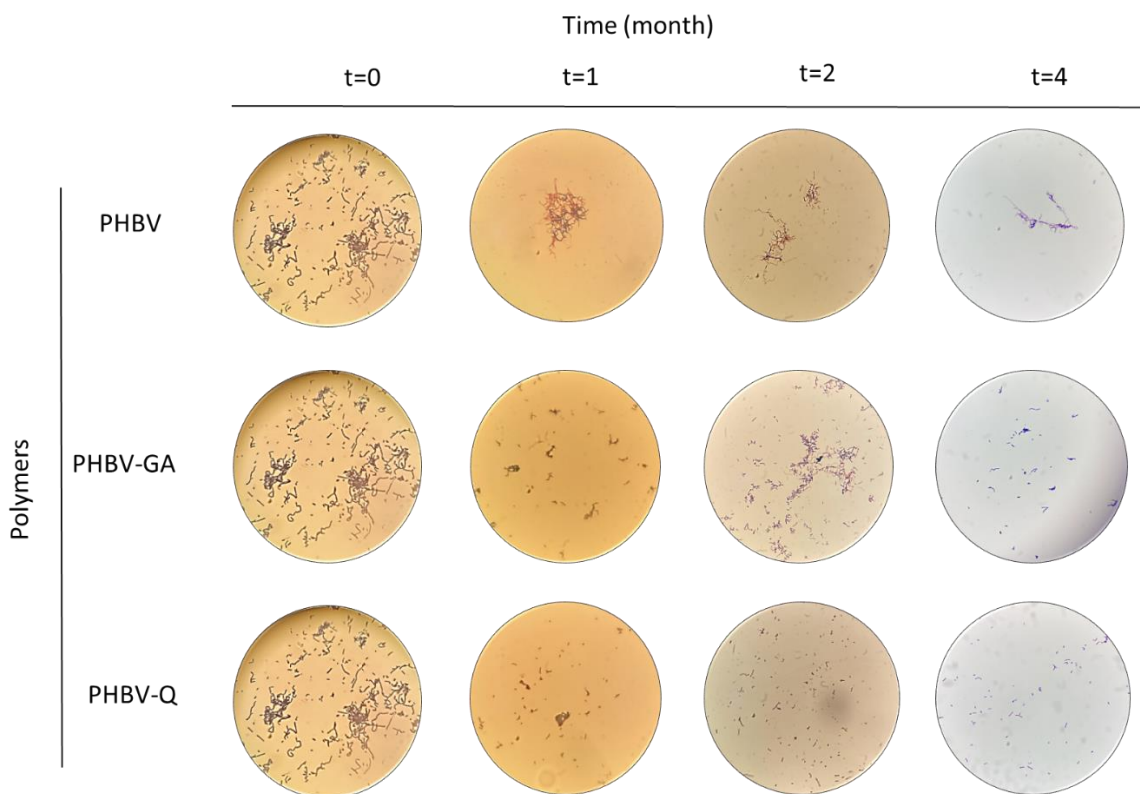


**Figure 29:** Pictures (after 48 h) of *S. exfoliatus* cultured on GYM agar plates. Colonies correspond to bacterial growth at t0 and after sampling at t1, t2 and t4 (months) from the culture media of PHBV, PHBV-Q and PHBV-GA degradation flasks.

After one month in contact with the different polymers, it was noticed that the concentration of *S. exfoliatus* in the culture media of PHBV and PHBV-GA remained similar to that at t0 (approximately the same number of bacterial colonies were observed in the agar plates). On the contrary, the number of *S. exfoliatus* colonies significantly decreased in the presence of PHBV-Q. This was confirmed after two months of degradation, where no bacterial growth from the PHBV-Q culture medium was noticed on GYM agar medium. For the same period of time, bacterial growth in presence of PHBV and PHBV-GA was not affected. Two months later (4 months of total bacterial contact), no bacterial growth was observed in the

PHBV-GA culture medium. It is, therefore, clear that contact with PHBV films containing quercetin and gallic acid contributed to inhibit the development of *S. exfoliatus*, with a faster effect with quercetin (1 to 2 months for quercetin and 3 to 4 months for gallic acid). The bacterium retained its ability to grow only in the presence of PHBV.

To complete these results, the bacterium cells morphology, after each sampling, was observed under microscope after gram staining (Figure 30). As *S. exfoliatus* is a gram-positive bacterium, it is supposed to be colored in violet.



**Figure 30:** Microscope images (magnification x100) of the Gram stained *S. exfoliatus* after sampling from PHBV, PHBV-Q and PHBV-GA culture media, at t0, t1, t2 and t4 (months).

Microscope images at t0 (before contact with PHBV materials) showed aggregation of bacterial colonies forming long violet filaments. As described by Jones *et al.* [281], the life cycle of *Streptomyces* sp. generally initiates with the emergence of germ tubes from dormant spores, followed by the extension of these tubes and the appearance of branching, and finally the formation of a dense network of filaments, called vegetative mycelium. Thus, images at t0 attests of the bacterium “good health” at the beginning of the experiment. After one month of culture, the branching network decreased, especially in contact of PHBV-Q and PHBV-GA

cultures. Even the presence of PHBV failed to maintain the initial density of the network, reflecting nutrient depletion, which forces the bacterium to switch from branching vegetative growth to non-branching aerial growth, which consists of its second growth stage [281]. The filaments and branching network disappeared completely after two months in the presence of PHBV-Q, and after four months in the presence of PHBV-GA, confirming the inhibitory effect, or the hostile environment, induced by the phenolic additives on the normal growth of *S. exfoliatus*. At this stage of the study, it is not possible to differentiate between the death of bacterial cells or the formation of dormant spores.

The inhibitory effect induced by quercetin and gallic acid could have three origins: (i) the release of these phenolic compounds into the culture media, reaching an inhibitory concentration for *S. exfoliatus*, (ii) the production of oxidation/degradation products of the phenolic compounds over time, which contribute to inhibit the bacterium after their release, (iii) the contact of bacterial cells with polyphenols on the film. To explore the first two assumptions, antimicrobial sensitivity tests were conducted in the presence of aqueous solutions of quercetin and gallic acid, at different concentrations, as well as the liquids of the culture medium in contact with PHBV-Q and PHBV-GA, after four months of incubation.

### **III.1.2 The behavior of *S. exfoliatus* in the presence of quercetin and gallic acid solutions at different concentrations (antimicrobial sensitivity test)**

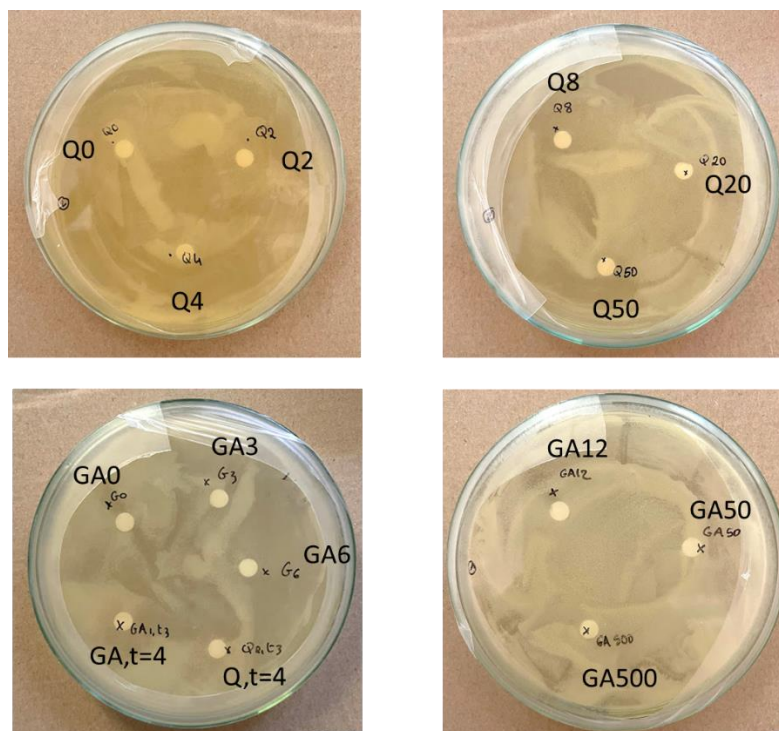
To our knowledge, the minimum inhibitory concentration (MIC) of quercetin and gallic acid for *Streptomyces* sp. has not been determined. However, some MIC values are available in the literature, and they are all bacteria dependent. For example, the antibacterial activity of gallic acid, on four pathogenic bacteria, was studied by Borges *et al.* who found that the MIC ranges from 500 to 2000 mg.L<sup>-1</sup> [282]. In the case of quercetin, the inhibitory effect is achieved with lower concentrations, ranging from 1 to 500 mg.L<sup>-1</sup> [114].

In our case, the polyphenol concentrations in the culture media was determined after each sampling time and the results were gathered in Table 22.

**Table 22:** Polyphenol concentrations in *S. exfoliatus* culture media (Q: quercetin, GA: gallic acid).

Polymer	PHBV-Q		
Time (months)	t = 1	t = 2	t = 4
Quercetin concentration (mg.L <sup>-1</sup> )	0.78 ± 0.19	3.62 ± 0.72	3.40 ± 0.67
Polymer	PHBV-GA		
Time (months)	t = 1	t = 2	t = 4
Gallic acid concentration (mg.L <sup>-1</sup> )	4.40 ± 0.15	5.82 ± 0.49	6.48 ± 1.10

At first glance, the concentration of quercetin in the culture media after two and four months ( $\approx 4 \text{ mg.L}^{-1}$ ) of incubation is within the range of MIC values available in the literature. However, for gallic acid ( $\approx 6 \text{ mg.L}^{-1}$ ), it is 100 to 1000 times lower. To evaluate the effect of polyphenol concentrations on bacterial cell growth, an antimicrobial sensitivity test was performed with a range of quercetin and gallic acid concentrations, including those measured at month 4 (Table 22). Active culture of *S. exfoliatus* was grown on GYM nutrient agar plates in the presence of filter paper circles soaked in these aqueous solutions, and pictures of the agar plates were taken after 48h (Figure 31).



**Figure 31:** Pictures of resistance assay of *S. exfoliatus* to quercetin and gallic acid solutions, realized on nutritive GYM agar plates. Q0, Q2, Q4, Q8, Q20, Q50 quote for aqueous solutions of quercetin at concentrations of 0, 2, 4, 8, 20 and 50 mg.L<sup>-1</sup> respectively. GA0, GA3, GA6, GA12, GA50 and GA500 quote for aqueous solutions of gallic acid at concentrations of 0, 3, 6, 12, 50 and 500 mg.L<sup>-1</sup> respectively. Q,t=4 and GA,t=4 represent the test with culture media liquids of PHBV-Q and PHBV-GA respectively, after 4 months of incubation.

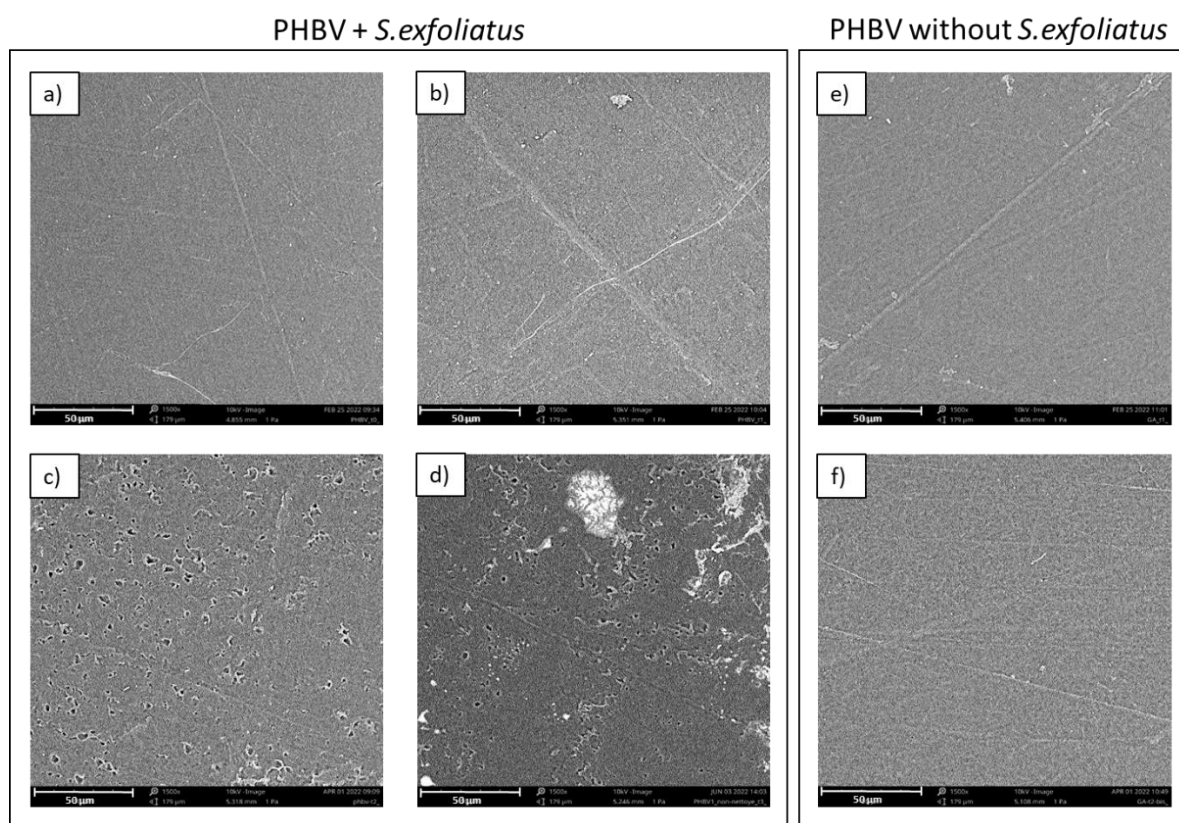
As shown in Figure 31, after 48 h, normal growth of the bacterium was observed in the different agar plates, both far and close to the filter papers. Thus, none of the concentrations of quercetin or gallic acid used (even the highest) inhibited the bacterial growth. It can be concluded that the gradual release of phenolic compounds into the culture media has not reached a critical concentration that induced inhibition of the bacterium cells.

As quercetin and gallic acid, even at high concentrations, are not responsible for the inhibition of the bacteria growth, could their oxidation/degradation products formed during the aerobic incubation time and released into the culture solution, be at the origin of the cellular damage? To answer this question, the same resistance assay was conducted in the presence of filter papers soaked in the culture media of PHBV-Q and PHBV-GA, after 4 months of incubation (Q,t =4 and GA,t =4 in Figure 31). In this case also, no inhibition of *S. exfoliatus*

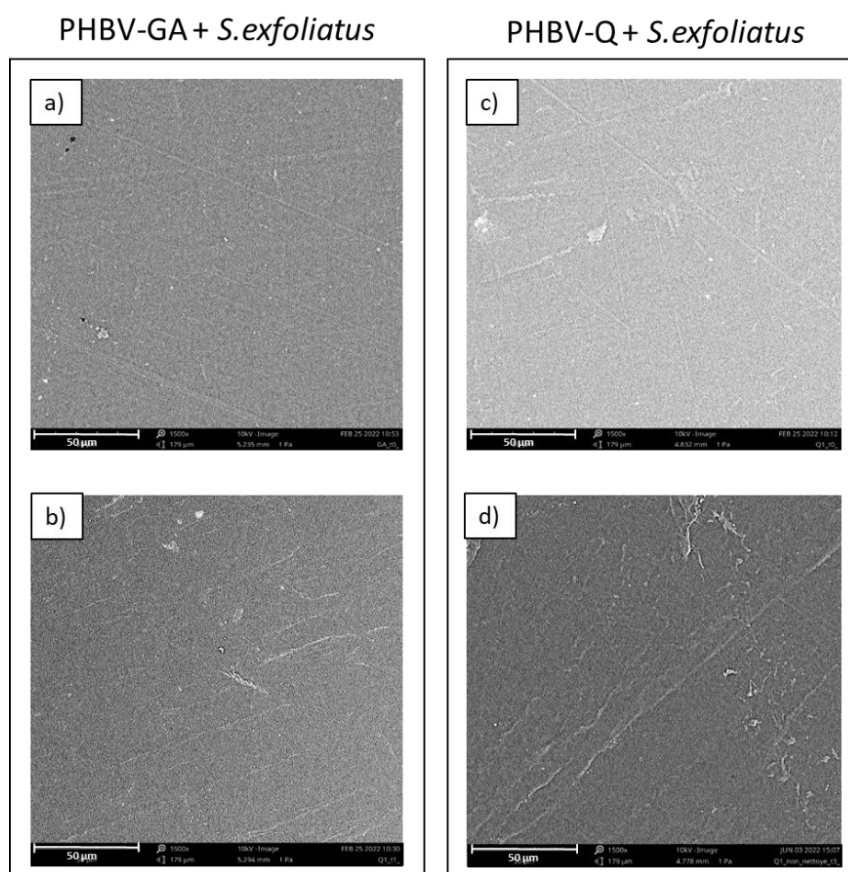
growth was observed, confirming that the oxidation or degradation products of polyphenols did not cause the bacterium inhibition.

### III.1.3 The evolution of the surface morphology of PHBV, PHBV-Q and PHBV-GA films throughout *S. exfoliatus*-assisted degradation.

The surface morphology of the films over the different incubation time was observed using scanning electron microscopy (SEM). SEM images of neat PHBV polymers in both blank (without bacterium) and culture media are shown in Figure 32. PHBV-Q and PHBV-GA film surfaces are shown in Figure 33.



**Figure 32:** SEM pictures (magnification x1500) of PHBV throughout the *S. exfoliatus*-assisted degradation at a) t0 b) t1 c) t2 and d) t4 (months), and PHBV in the absence of *S. exfoliatus* (negative control) at e) t0 and f) t4 (months).



**Figure 33:** SEM pictures (magnification x1500) of PHBV-GA throughout the *S. exfoliatus*- assisted degradation at a) t0 and b) t4 (months); and PHBV-Q at c) t0 and d) t4 (months).

Up to one month of incubation, the PHBV films present a smooth and regular surface, only crossed by few irregularities resulting from the films processing (Figure 32). After two months of incubation with *S. exfoliatus*, the deterioration of the PHBV film surface structure is clearly visible, and is confirmed by the presence of holes and cavities at four months. On the contrary, no surface changes were observed in the blank solution (PHBV without bacterium). The lack of surface modification of the PHBV film in the blank solution reveals the continuous and progressive role of *S. exfoliatus* on the surface degradation of the PHBV film from the second month of incubation. This correlates with the "good health" of the bacteria, even after four months, as shown before.

No surface degradation was observed for PHBV-Q and PHBV-GA films even after four months contact with *S. exfoliatus* (Figure 33). Before concluding about the role of phenolic compounds on the bacterial inhibition, the crystallinity rates of the different polymers were

determined. Indeed, as the increased crystallinity of the polymer contributes to reduce the water penetration and the extracellular enzymes activity, it was important to compare the crystallinity rate of PHBV, PHBV-Q and PHBV-GA. The latter was determined by DSC and the results are gathered in Table 23.

As shown in Table 23, the incorporation of 1wt% polyphenol into the PHBV matrix helped to slightly reduce its crystallinity, and this remained true throughout the incubation process. Hence, the possibility of a lower degradation of PHBV-polyphenols due to higher crystallinity can be excluded.

The inhibition of bacterial growth without any film surface modification in the case of PHBV-polyphenols may indicate an anti-bacterial effect on the film surface, with a higher impact in the case of quercetin. Since the antimicrobial activity is bacteria-dependent, it could be concluded that gallic acid has a weaker inhibitory effect on *Streptomyces* bacteria, especially since it has been reported that gallic acid is highly antimicrobial against gram-negative pathogens [283], which is not the case for *S. exfoliatus*.

**Table 23:** Crystallinity percentage of PHBV-based material obtained by DSC measurement, over incubation time.

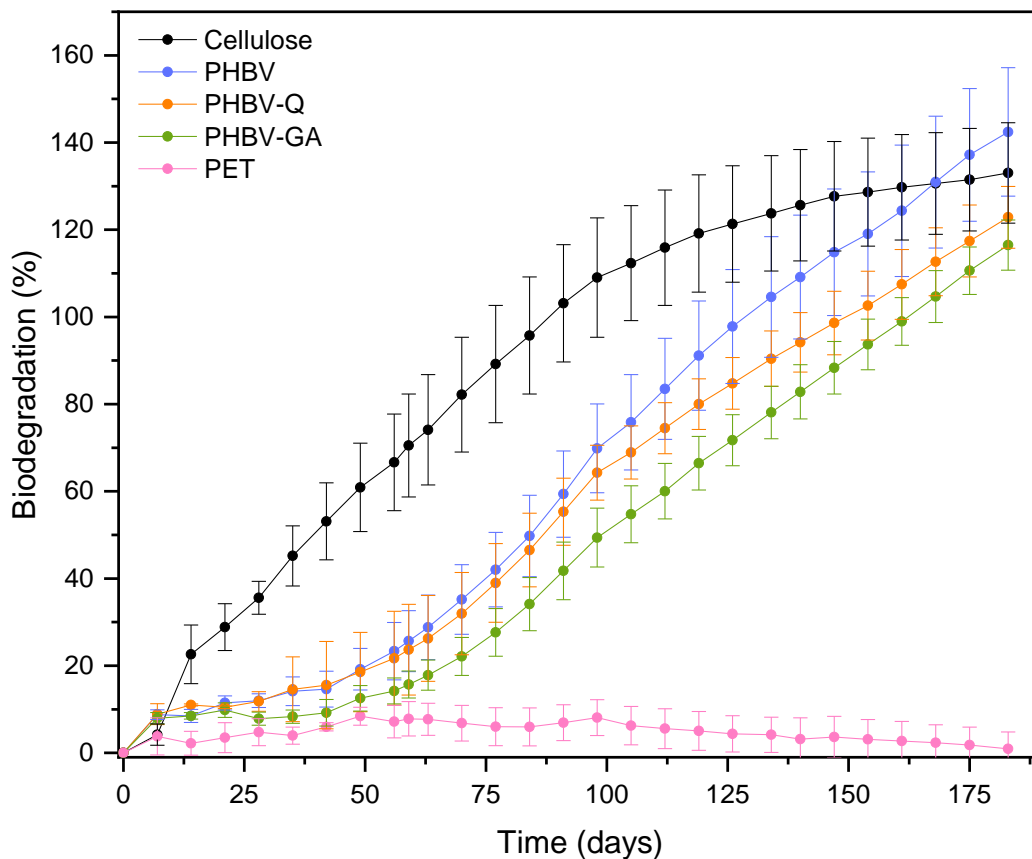
Time (months)	$X_c$ (%)		
	PHBV	PHBV-GA	PHBV-Q
t = 0	$85.2 \pm 0.8^a$	$84.7 \pm 0.5^a$	$80.4 \pm 1.8^a$
t = 1	$91.9 \pm 0.4^b$	$90.9 \pm 0.3^b$	$87.2 \pm 0.1^b$
t = 2	$92.8 \pm 1.3^b$	$89.9 \pm 1.6^b$	$87.7 \pm 0.1^b$
t = 4	$93.2 \pm 0.5^b$	$91.3 \pm 0.4^b$	$88.1 \pm 0.4^b$

Under pure culture conditions, quercetin and gallic acid appear to act as anti-bacterial agents when being in contact with *S. exfoliatus*. However, it is necessary to investigate their effect under real conditions. Thus, the biodegradability of PHBV, PHBV-Q and PHBV-GA films under home composting conditions was studied (next section).



### III.2 Biodegradability of PHBV-based materials under home composting condition

The biodegradability of neat PHBV, PHBV-polyphenol materials, PET (negative control) and cellulose (reference material) were tested under home composting conditions at lab scale, according to ISO 14855-1 methodological standard. The resulting biodegradation curves are shown in Figure 34.



**Figure 34:** Biodegradation kinetic curves of PHBV, PHBV-Q, PHBV-GA, PET and cellulose obtained at lab scale.

According to the methodological standard ISO 14855-1, a biodegradation test is considered as valid if: i) the degradation of the reference material (here cellulose) is greater than 70 % after 90 days; ii) the standard deviation between replicates of the reference material is lower than 20 %; iii) the inoculum produces between 50 and 150 mg of CO<sub>2</sub> per g of compost after 10 days in absence of any substrate. According to the French specification standard NF T51 800, the studied material is considered biodegradable if it degrades at least 90 % in 365 days.

In Figure 34, it can be observed that cellulose (the reference material) reached a 103 % degradation after 90 days, with standard deviations between replicates of 12 %. The blank production of CO<sub>2</sub>, after 10 days was at 64 mg.g<sup>-1</sup> of compost (not presented in the figure), and no degradation was noticed of the negative control, PET. Therefore, the experiment is valid.

Concerning the studied materials, a complete mineralization was achieved at 130, 150, and 170 days for neat PHBV, PHBV-Q and PHBV-GA, respectively, which is much earlier than the 365 days required by the standard. Thus, all these data show that all the tested PHBV-based materials can be considered as home compostable materials.

However, some points need to be discussed regarding the biodegradation kinetic curves, as well as the different behaviors of the PHBV materials, depending on the added polyphenol.

First, the carbon dioxide release plateau was not reached after the six-months of the experiment, suggesting that the experiment should be extended. But since a complete degradation of the materials was reached, the experiment was stopped. Secondly, at the end of the experiment, the degradation rate of the different materials exceeded 100 %. It was 133 % for cellulose, 142 % for neat PHBV, 122 % for PHBV-Q and 116 % for PHBV-GA. This so called “priming effect” has already been described by Kuzyakov *et al.* [284]. It was defined as “an extra decomposition of organic carbon, after addition of easily-decomposable organic substances to the soil”. In other words, the addition of these organic materials (cellulose, PHBV materials) to the soil, stimulated the decomposition of the already existing organic matter, resulting in a greater release of CO<sub>2</sub>. This has already been observed during composting of PLA [285] and for PHBV biodegradation [286, 287].

As mentioned earlier, all PHBV materials were mineralized for a shorter incubation time than required by the standard. However, some differences in their behavior were noticed. During the biodegradation of a biopolymer, three phases can be defined; i) the lag phase where the microbial population take time to adapt to the available carbon substrate; ii) the biodegradation phase during which the adapted microbial population begins to use the carbon substrate for its cellular life processes; and iii) the plateau stage when the substrate is completely used by microorganisms [288]. In our study, after the six months’ experiment, the plateau phase was not reached yet. However, the lag phase was identified and the biodegradation phase appeared to present two different phases, the first one modeled by an

exponential model ( $y=A*\exp(rx)$ ) and the second one by a linear model ( $y= \alpha x+\beta$ ). The two important parameters which have a physical meaning are  $r$  and  $\alpha$ , representing the biodegradation rate for each phase, and allow to compare the polymers with each others.

The duration of the lag period as well as  $r$  and  $\alpha$  parameters are shown in Table 24.

**Table 24:** Characteristic parameters extracted from the modeling of the different biodegradation phases of PHBV-based materials.

Polymer	Lag phase (days)	Exponential phase $y = A * e^{rx}$ ( $r$ )	Linear phase $y = \alpha x + \beta$ ( $\alpha$ )
PHBV	$28 \pm 2^a$	$0.025 \pm 0.001^a$	$0.80 \pm 0.04^a$
PHBV-Q	$28 \pm 2^a$	$0.028 \pm 0.010^a$	$0.67 \pm 0.02^b$
PHBV-GA	$42 \pm 2^b$	$0.030 \pm 0.003^a$	$0.78 \pm 0.04^a$

Regarding the lag phase, it was noticed that the presence of gallic acid induces a delay in the initiation of biodegradation, with 42 days of latency compared to 28 days for PHBV and PHBV-Q. This resulted in a decrease in the degradation rate of PHBV-GA between 25 and 100 days, compared to the other two materials (Figure 34). The determination of the exponential factor  $r$  ( $\approx 0.028$ , Table 24), showed that the three materials followed the same kinetic during the exponential growth phase. Surprisingly, regardless of the length of the lag period, the transition from exponential to linear phase was about 100 days for all three materials. Considering the linear phase, a deceleration of the degradation kinetics of PHBV-Q can be observed from 100 days to 180 days, with a lower  $\alpha$  slope ( $\alpha = 0.67$ ) than that of PHBV and PHBV-GA materials ( $\alpha \approx 0.80$ ).

The delay in the onset of biodegradation caused by gallic acid, and the deceleration of PHBV degradation in the linear phase caused by quercetin are in line with the observations made in pure culture medium, concerning the anti-bacterial effect of these polyphenols on *Streptomyces*. However, PHBV-Q and PHBV-GA polymers are fully biodegradable under home composting conditions, and their inhibitory effect is negligible in a complex and mixed microbial environment. This result is promising and encourages the use of natural polyphenols instead of synthetic additives for the improvement of PHBV-based packaging materials.

#### **IV. Conclusion**

The impact of quercetin and gallic acid on the biodegradation of PHBV materials was studied in both pure liquid culture medium, in the presence of *Streptomyces exfoliatus*, and under home composting conditions.

The presence of polyphenols in PHBV films induced the inhibition of *Streptomyces exfoliatus* growth, probably by an anti-bacterial effect by contact, particularly pronounced in the case of quercetin. This antibacterial effect was also observed during the degradation of the films in home compost, through a longer lag phase for gallic acid and a slower linear phase in the case of quercetin. However, it did not prevent the complete mineralization of PHBV-Q and PHBV-GA within the time recommended by NF T51 800 standard. This study therefore demonstrated that the biodegradation of PHBV materials containing polyphenols such as quercetin and gallic acid is not hindered by the antimicrobial activity of these molecules.



**GENERAL DISCUSSION,  
CONCLUSIONS AND PERSPECTIVES**

### **Rappel des objectifs**

La production de plastique ne fait qu'augmenter d'année en année et ses conséquences nocives sur l'environnement également. Le secteur de l'emballage est l'un des plus polluants de par sa production de plastique à usage unique ou avec une durée de vie très courte. Un vrai besoin d'alternatives se fait ressentir pour lutter contre les catastrophes écologiques engendrées par l'accumulation de ces plastiques conventionnels.

Le développement de matériaux biosourcés et biodégradables est vu comme une véritable innovation permettant de s'affranchir des problèmes liés à la fin de vie des plastiques. Cependant, ces polymères sont encore peu déployés sur le marché de l'emballage, principalement à cause de leur faible stabilité thermique, qui entrave leur mise en forme et leur utilisation sous différentes conditions. Afin d'améliorer les propriétés de ces polymères tout en conservant leurs caractères biosourcés et biodégradables, l'ajout de stabilisants naturels semble être une solution adéquate. Ces dernières années, l'ajout de polyphénols au sein de matrices polymères a été de plus en plus étudié. Dans un premier temps, c'est leur capacité à limiter/réduire les réactions oxydatives qui était visée, pour ensuite se tourner vers leur effet de stabilisation thermique. De nombreuses études ont porté sur l'effet des polyphénols sur la stabilisation thermique des polymères biosourcés et biodégradables. Cependant, très peu de recherches ont été menées sur l'impact qu'ils pourraient avoir sur les propriétés d'un emballage alimentaire au cours de son cycle de vie, qui dans un schéma d'économie circulaire, comprend des étapes de ré-usage et de recyclage. En effet l'ajout des polyphénols dans les emballages alimentaires soulève des questions sur la capacité de ces derniers à rester aptes au contact alimentaire, à se décontaminer de manière efficace, et à conserver leur biodégradabilité.

L'objectif appliqué de cette thèse était de produire des matériaux biodégradables et biosourcés destinés à l'emballage alimentaire, à partir d'un polyester de la famille des PHAs (le PHBV) et d'additifs polyphénoliques (la quercétine et l'acide gallique). L'objectif scientifique était la compréhension de l'influence de ces additifs sur la structure et les propriétés fonctionnelles du matériau pendant toute sa durée de vie. Cette thèse a tenté de répondre à deux questions scientifiques majeures :

- Quelles sont les interactions/rerelations entre le PHBV et les polyphénols lors des différentes étapes du cycle de vie d'un emballage alimentaire ?

- Quel est l'impact des polyphénols sur la stabilité du PHBV au cours de ces différentes étapes ?

### **Discussion et perspectives**

La première étape de ce travail a consisté à incorporer différents pourcentages de quercétine et d'acide gallique dans la matrice PHBV par extrusion et thermopressage. Une étude des propriétés thermiques et mécaniques des films PHBV-polyphénols obtenus, a ensuite été menée, afin de sélectionner la formulation, qui conduirait à la meilleure stabilisation, pour la suite des travaux. Des pourcentages allant de 0.5 % à 15 % en masse de polyphénols dans la matrice ont été testés. Une stabilisation thermique, se traduisant par une température de début de dégradation et une masse moléculaire plus élevée que celles du polymère vierge après mise en forme, n'a été observée que pour les plus faibles pourcentages en quercétine (0.5 et 1 %). Pour le reste des formulations, c'est-à-dire, les pourcentages plus élevés en quercétine (5 % à 15 %) et toute la gamme de formulation d'acide gallique, des propriétés structurales et thermiques moindres ont été obtenues. Par ailleurs, les propriétés mécaniques des blends étudiés, n'ont pas été affectées par l'ajout de polyphénols à faible pourcentage, tandis que des taux plus importants ont rendu le matériau plus rigide et plus fragile qu'au départ. Dans l'ensemble, comparé à la quercétine, l'acide gallique a provoqué une dégradation thermique et une fragilisation du PHBV plus importante. La microscopie fluorescente nous a permis de confirmer la présence de liaisons hydrogène entre le PHBV et la quercétine, lorsque celle-ci est ajoutée à faibles quantités. Ces liaisons hydrogène inhibent le mécanisme de  $\beta$ -scission, et réduisent la rupture aléatoire des chaînes polymériques. Dans le cas de l'acide gallique ou des fortes teneurs en polyphénols, la microscopie en lumière polarisée a mis en évidence les modifications de microstructures du polymère qui ont conduit à l'accélération de sa dégradation.

Ainsi, cette étude nous a permis de comprendre les mécanismes d'action de l'acide gallique et de la quercétine sur le PHBV en fonction du type et de la quantité de polyphénol introduit. Cependant, les résultats obtenus en matière de stabilisation thermique et mécanique, au vu de ce qui avait été montré dans la littérature, ont été un peu décevants. En effet, seules les formulations contenant 0.5 % et 1 % de quercétine ont montré une stabilisation thermique, qui de surcroît, n'est pas très importante. Bien évidemment, l'acide gallique et la quercétine, à eux seuls, sont loin de représenter la très grande famille des



polyphénols, et d'autres études avec d'autres composés phénoliques, seraient intéressantes pour élargir la compréhension de l'impact de la structure chimique sur les mécanismes de stabilisation (positive ou négative). Enfin, il est possible d'aller au-delà des procédés d'extrusion classique qui conduisent généralement à la formation de liaisons hydrogène, entre la matrice et l'additif, et de développer des voies de création de liaisons covalentes entre les deux entités. Le principe d'extrusion réactive avec des agents de greffage s'est fortement développé ces dernières années, et des résultats concluants ont été obtenus quant à l'amélioration des propriétés d'interface entre la lignine ou la cellulose avec des PHAs. Il serait donc intéressant d'appliquer cette technique aux mélanges polyphénols-PHBV afin de voir si de meilleures interactions entre l'additif et le polymère seraient gages d'une meilleure stabilité.

En vue des résultats obtenus, nous avons décidé de ne retenir que deux formulations, le PHBV avec 1 % d'acide gallique et 1 % de quercétine. Bien que nous ayons montré que l'acide gallique engendrait une dégradation plus importante du PHBV nous avons estimé intéressant de le conserver dans l'étude des différentes étapes de vie du polymère, afin de continuer à comparer les comportements des deux structures polyphénoliques.

Le caractère antibactérien des polyphénols a été grandement démontré, en particulier sur les microorganismes pathogènes. Cependant, leur potentiel effet retardateur ou accélérateur de biodégradation des polymères, en milieu naturel, n'a pas été prouvé de manière consensuelle. Nous avons, donc, voulu vérifier leurs effets sur la biodégradation du PHBV. Une première étude a consisté à mettre les formulations retenues (PHBV, PHBV-GA et PHBV-Q) sous forme de film, au contact d'une bactérie connue pour la dégradation des PHBVs, *Streptomyces exfoliatus*, en milieu liquide, sur une période de 4 mois. En l'absence d'autres sources de carbone, la bactérie n'avait d'autre choix, pour proliférer, que de consommer le carbone qui constitue le PHBV. Grâce à un suivi de l'état des cellules bactériennes, sur gélose nutritive, et par microscopie optique, nous avons pu mettre en évidence l'inhibition de *S. exfoliatus*, au bout de deux et quatre mois, en présence de PHBV-Q et PHB-GA, respectivement. L'imagerie MEB est venue confirmer ces résultats en montrant que seul le PHBV avait subi une attaque en surface par *S. exfoliatus*. Ainsi ces observations ont permis de montrer le caractère antibactérien des films contenant de la quercétine et de l'acide gallique vis-à-vis de *S. exfoliatus*. Les antibiogrammes réalisés avec des solutions aqueuses de

quercétine et d'acide gallique à différentes concentrations, et ceux avec le surnageant des incubations de PHBV-Q et PHBV-GA à 4 mois, n'ont montré aucun effet inhibiteur de la bactérie. Il est donc possible d'affirmer que l'inhibition de la bactérie n'est pas causée par la migration des polyphénols dans les solutions de culture, mais est plutôt due au contact direct entre *S. exfoliatus* et les polyphénols contenus dans le film au moment de la colonisation bactérienne de la surface du polymère.

Afin de comparer ces résultats à des données de biodégradation en « conditions réelles », l'étude de l'impact des polyphénols sur le PHBV en condition de compost domestique a été réalisée, grâce à des tests de respirométrie. Les taux de biodégradation obtenus après 6 mois pour les différents polymères (incluant les contrôles positif et négatif) ont été reportés dans le Tableau 25.

**Tableau 25** : Taux de biodégradation obtenu pour les différents matériaux étudiés après 6 mois.

Taux de biodégradation (%)				
Cellulose	PHBV	PHBV-Q	PHBV-GA	PET
133	142	123	116	2

Il faut noter que des valeurs de dégradation supérieures à 100 % ont été obtenues en raison du phénomène de « *priming effect* », qui s'explique par une stimulation de la minéralisation de la matière organique contenue dans le compost, lors de la dégradation des matériaux. Tous les matériaux testés (excepté le PET) sont biodégradables puisque leur taux de biodégradation a dépassé 90 %, avant d'atteindre la limite de 365 jours (NF-T-51-800). L'ajout de polyphénols ne remet donc pas en question le caractère biodégradable du PHBV. Malgré tout, de légères différences de cinétique de biodégradation ont été observées, avec un taux de latence avant biodégradation plus long au départ en présence d'acide gallique, ainsi qu'une cinétique plus lente lors de la phase linéaire de biodégradation en présence de quercétine. Il est également intéressant de voir que finalement, en culture mixte dans un compost naturel (non reconstitué), la présence des polyphénols n'a pas conduit à l'inhibition des microorganismes, contrairement à ce qui avait été observé en culture bactérienne pure précédemment. Un complément intéressant serait de faire le séquençage de l'ADN des bactéries présentes dans le compost, afin d'en faire l'inventaire. Ceci permettra, par la suite,

d'étudier l'impact des polyphénols sur cette communauté bactérienne, et de déterminer la part des bactéries dans cette dégradation. Bien que le compost domestique soit un milieu naturel, il reste contrôlé. Une étude de biodégradabilité en conditions non contrôlées, en sol ou en milieu marin, pourrait apporter plus de rigueur aux résultats.

Nous avons ainsi démontré que l'incorporation des polyphénols dans une matrice PHBV, permettait une certaine amélioration de ses propriétés thermiques (en particulier dans le cas de la quercétine), tout en lui conservant son caractère biodégradable. Mais qu'en est-il de leur effet tout au long du cycle de vie d'un emballage alimentaire, comprenant des étapes d'usage, de ré-usage et de recyclage ?

Dans un premier temps, nous avons étudié l'aptitude au contact alimentaire de nos formulations. Par la suite, nous avons simulé un cycle complet d'usage et de ré-usage, à savoir, le contact avec un simulant alimentaire, lavage au détergent, suivi d'un autre contact avec l'aliment. Nous avons terminé par des lavages successifs au détergent et à la soude, pour mimer les lavages au lave-vaisselle, dans le premier cas, et les prétraitements lors du recyclage mécanique, dans le second. Lorsque les simulants alimentaires éthanol 10 % et acide acétique 3 % ont été employés, les propriétés structurelles et physico-chimiques des films PHBV, PHBV-GA et PHBV-Q ont été peu modifiés. De plus, les migrations globales étant en dessous de la limite des 10 mg.dm<sup>-2</sup> définie par la réglementation européenne (EC 10/2011), ils sont donc aptes au contact alimentaire, dans le cas des aliments correspondant aux simulants alimentaires utilisés. Après un premier contact alimentaire, suivi du lavage au détergent, quasiment aucune migration n'a été observée lors du second contact alimentaire pour le PHBV et PHBV-Q, dans les deux simulants choisis. Nous en avons donc conclu que ces matériaux pouvaient subir un cycle de vie complet en tant qu'emballage alimentaire, sans que cela n'altère leurs propriétés structurelles ou leur inertie.

Concernant l'aptitude des polymères à base de PHBV à subir plusieurs lavages successifs au détergent, nous avons démontré que le PHBV vierge supportait jusqu'à vingt cycles de lavage, sans modification de ses propriétés thermiques. Cependant, les PHBV additivés, présentaient des signes de dégradation dès le dixième lavage. Elles ont été causées par la migration des polyphénols dans la solution de lavage, ce qui a induit la formation de pores et de réseaux d'infiltration, qui ont facilité la pénétration de l'eau dans la matrice polymère.

Enfin, l'étude du lavage de nos matériaux avec des solutions de soude à 1 et 2 % en masse, a révélé la fragilité globale des matériaux à base de PHBV, en milieu alcalin. Après 5 lavages avec une solution de NaOH 1 %, une réduction importante des propriétés des matériaux (*Tonset*, *Mw*, *Tm*) a été observée. Les résultats ont montré une plus grande fragilité des mélanges PHBV-polyphénols. Ceci est principalement dû aux polyphénols ou à leurs produits d'oxydation qui sont des accélérateurs de rupture de chaînes. Les analyses en MEB des films PHBV-Q et PHBV-GA, ont révélé une altération des polymères au-delà de la surface, allant jusqu'au cœur du matériau. Les analyses DSC ont confirmé une dénaturation du matériau avec des propriétés thermiques très éloignées de celle du polymère de départ. Ainsi, seul le PHBV vierge semble pouvoir supporter au moins un cycle de lavage à la soude. Ces résultats n'excluent pas l'utilisation de polyphénols en tant qu'additif pour les PHBVs visant à être recyclés, étant donné que le prétraitement à la soude n'est pas systématique, et que le lavage au détergent est le plus souvent employé (d'après ce qui est décrit pour le recyclage mécanique du PET).

L'utilisation de polyphénols dans une matrice PHBV est donc compatible avec une réutilisation du polymère en tant qu'emballage alimentaire. Cependant, au-delà d'une dizaine de lavages au détergent, l'intégrité physique du film commencera à se détériorer. Afin de compléter cette étude, il serait intéressant de déterminer les propriétés mécaniques des matériaux afin de conclure sur le nombre exact de cycles qu'ils pourraient subir. Il serait également pertinent de tester leur aptitude au contact alimentaire, après les différents cycles de lavage, en prenant en compte le taux des polyphénols qui migrent dans l'aliment. En l'absence de réglementation sur les limites de migration spécifiques des polyphénols, nous devrions adapter les technologies afin de limiter leur migration. Le lavage à la soude avait pour objectif de retirer la couche superficielle du polymère, dans laquelle des contaminants pourraient s'accumuler. Afin de compléter l'étude sur le PHBV, une contamination préalable, suivie d'un lavage à la soude, permettrait de tester l'efficacité et la pertinence de cette méthode.

Dans la continuité des simulations relatives au recyclage mécanique, une dernière étude (en collaboration avec Isabelle Dedieu), s'est intéressée à la décontamination thermique des matériaux PHBV et PHBV-Q. Compte tenu des propriétés de transfert / barrière du PHBV, qui sont plus faibles que celles du PET, un panel de contaminants différents de celui

établit par l'EFSA a été choisi. Il contient des molécules avec des polarités et des poids moléculaires plus élevés.

En raison de la faible volatilité de ces contaminants et des liaisons hydrogène qu'ils ont formées avec le PHBV, l'efficacité du procédé de décontamination a été inférieure à celle précédemment obtenue sur les molécules du panel de l'EFSA (<https://doi.org/10.1080/19440049.2022.2122589> de Dedieu *et.al*). Il en résulte une contamination résiduelle élevée, et un risque sanitaire pour le consommateur, excluant ainsi, ces matériaux recyclés de l'usage en tant qu'emballages alimentaires. Nous avons émis l'hypothèse que l'utilisation de la quercétine comme stabilisant thermique permettrait d'effectuer la décontamination dans des conditions plus drastiques (température plus élevée, temps de séjour plus long), tout en maintenant la stabilité du polymère. Nous avons au contraire mis en évidence une affinité accrue des contaminants pour le polymère, à cause des liaisons hydrogène formées avec la quercétine lors de la sorption (jusqu'à 20 % plus importante pour l'acide gallique, par exemple). Malgré cela, la décontamination du PHBV-Q a été beaucoup plus efficace que celle du PHBV vierge, sur des temps plus longs (48 h), et ce, sur tout le panel de contaminant (Tableau 26). Cependant, la présence de la quercétine n'a malheureusement pas permis d'empêcher/réduire la dégradation du polymère. Au contraire, une baisse de poids moléculaire presque deux fois supérieur en présence de quercétine a été enregistrée, rendant difficile la remise en forme du polymère.

**Tableau 26:** Evolution du pourcentage de décontamination et de la masse moléculaire de PHBV et PHBV-Q, en fonction de la durée de décontamination.

Durée de décontamination	Evolution de la décontamination (%)								Evolution de la masse moléculaire (%)	
	PHBV				PHBV-Q				PHBV	PHBV-Q
	Acide gallique	Catéchine	Acide férulique	PEG	Acide gallique	Catéchine	Acide férulique	PEG		
6h	+10.6	+32.0	+54.1	+65.2	+9.7	+13.6	+44.0	+44.4	-28.5	-35.1
48h	+25.9	+68.5	+67.0	+86.8	+67.2	+89.3	+97.9	+100	-56.7	-83.8

D'autre part, cette affinité de la quercétine pour certains contaminants pourrait être exploitée. En effet, si les interactions sont assez fortes, la quercétine pourrait jouer le rôle de piègeur de contaminants, en les empêchant de migrer vers l'aliment. Des études

complémentaires doivent être menées pour confirmer cette hypothèse. Au vu de ces résultats, nous pouvons conclure que l'ajout de stabilisants thermiques lors de la décontamination du PHBV n'est pas la meilleure solution, et que tout le procédé de recyclage de ce dernier doit être repensé. En effet, le PHBV est un polymère instable thermiquement avec des propriétés barrières inférieures à celles du PET. De ce fait, un procédé de recyclage identique à celui du PET n'est peut-être pas adapté. Ainsi, toute la filière de collecte, de tri, de décontamination et de remise en forme doit être réfléchi, en tenant compte des spécificités des PHAs.

Pour conclure, cette thèse a permis d'apporter des éléments de réponse sur l'effet des polyphénols sur la matrice PHBV, et en particulier sur les interactions/réactions qui ont lieu au cours du cycle de vie d'un emballage. De par leur origine biosourcée et leurs nombreuses propriétés, les polyphénols apparaissent comme des additifs prometteurs à intégrer dans des polymères biodégradables tels que les PHAs, lors de leurs formulations. D'ailleurs de nombreuses études en attestent. Cependant, et à l'opposé des autres études, nous sommes allées plus loin, et nous avons démontré que le caractère stabilisant des polyphénols ne se maintenait pas forcément lorsque le matériau est soumis à d'autres conditions, comme le contact alimentaire, le lavage ou encore le recyclage. Il est donc essentiel d'adapter l'additif à l'application visée, et ne pas se contenter de faire des tests de stabilisation après formulation. Nous avons également mis en évidence l'importance de la structure chimique lors du choix de l'additif. En effet, en fonction du mécanisme de dégradation du polymère et des substances qui peuvent catalyser cette dégradation, l'emploi de certaines molécules est à éviter.

De manière plus globale, les PHAs avec ou sans additifs sont encore loin de concurrencer les plastiques conventionnels et au vu de l'urgence environnementale actuelle, c'est tout le système de l'emballage qui devrait être remis en question. A-t-on réellement besoin d'utiliser autant de plastique ? N'aurait-on pas besoin de moins d'emballage si les produits que nous utilisons venaient de moins loin ? Les acteurs du monde de l'emballage sont dépendants de la demande des consommateurs et c'est là que nous avons notre rôle à jouer. La recherche d'alternatives aux plastiques usuels est évidemment essentielle, mais c'est loin d'être la seule porte d'accès à un monde plus durable et supportable.



## REFERENCES



1. Kaza, S.A.Y., Lisa A Bhada-Tata, Perinaz A Van Woerden, Frank, *What a Waste 2.0: A Global Snapshot of Solid Waste Management to 2050*. What a Waste 2.0: A Global Snapshot of Solid Waste Management to 2050.
2. Hale, R.C., et al., *A Global Perspective on Microplastics*. Journal of Geophysical Research: Oceans, 2020. **125**(1): p. e2018JC014719.
3. Gontard, N., et al., *Recognizing the long-term impacts of plastic particles for preventing distortion in decision-making*. Nature Sustainability, 2022. **5**(6): p. 472-478.
4. European Commission. *Directive 2019/904 on the reduction of the impact of certain plastic products on the environment*. <https://eur-lex.europa.eu/legal-content/EN/TXT/PDF/?uri=CELEX:32019L0904&from=EN>. 2019.
5. Avérus, L., *Les polymères biodégradables et biosourcés: des matériaux pour un futur durable* L'Actualité Chimique 2013. **375-376**.
6. Bossu, J., et al., *GLOPACK Project—New generation of bio-based and fully degradable composite food-trays made of biopolymers and fibres from agrowastes. Materials optimization for upscaled productive solutions*.
7. Mathuriya, A.S., et al., *Polyhydroxyalkanoates: Biodegradable plastics and their applications*. Handbook of ecomaterials, 2017: p. 1-29.
8. Bugnicourt, E., et al., *Polyhydroxyalkanoate (PHA): Review of synthesis, characteristics, processing and potential applications in packaging*. 2014.
9. Zheng, Y., et al., *Engineering biosynthesis of polyhydroxyalkanoates (PHA) for diversity and cost reduction*. Metab Eng, 2020. **58**: p. 82-93.
10. Chen, C., A.M. Pearson, and J.I. Gray, *Effects of synthetic antioxidants (BHA, BHT and PG) on the mutagenicity of IQ-like compounds*. Food chemistry., 1992. **43**(3): p. 177-183.
11. Luzi, et al., *Gallic Acid and Quercetin as Intelligent and Active Ingredients in Poly(vinyl alcohol) Films for Food Packaging*. Polymers, 2019. **11**: p. 1999.
12. Harwood, M., et al., *A critical review of the data related to the safety of quercetin and lack of evidence of in vivo toxicity, including lack of genotoxic/carcinogenic properties*. Food Chem Toxicol, 2007. **45**(11): p. 2179-205.
13. *Plastics Europe, Plastics-The facts 2020* [https://www.plasticseurope.org/application/files/5716/0752/4286/AF\\_Plastics\\_the\\_facts-WEB-2020-ING\\_FINAL.pdf](https://www.plasticseurope.org/application/files/5716/0752/4286/AF_Plastics_the_facts-WEB-2020-ING_FINAL.pdf). 2020.
14. Geyer, R., J.R. Jambeck, and K.L. Law, *Production, use, and fate of all plastics ever made*. Science Advances, 2017. **3**(7): p. e1700782.
15. MacArthur, D.E., D. Waughray, and M.R. Stuchtey. *The new plastics economy, rethinking the future of plastics*. in *World Economic Forum*. 2016. Ellen MacArthur Foundation and McKinsey & Company London, UK.
16. Gontard, N., *Que faire des emballages plastiques ?* 2021, Groupe Pour la science. p. 46-52.

17. Horodytska, O., F.J. Valdés, and A. Fullana, *Plastic flexible films waste management – A state of art review*. Waste Management, 2018. **77**: p. 413-425.
18. Jambeck, J.R., et al., *Plastic waste inputs from land into the ocean*. Science, 2015. **347**(6223): p. 768-771.
19. Andrady, A.L., *Microplastics in the marine environment*. Marine pollution bulletin, 2011. **62**(8): p. 1596-1605.
20. Le Guern, C., *When the mermaids cry: the great plastic tide*. Santa Anguila Foundation, 2018.
21. Rhodes, C.J., *Plastic pollution and potential solutions*. Science progress, 2018. **101**(3): p. 207-260.
22. Wright, S.L. and F.J. Kelly, *Plastic and human health: a micro issue?* Environmental science & technology, 2017. **51**(12): p. 6634-6647.
23. Kovacic, Z., R. Strand, and T. Völker, *The circular economy in Europe: Critical perspectives on policies and imaginaries*. 2019: Routledge.
24. Bucknall, D.G., *Plastics as a materials system in a circular economy*. Philosophical Transactions of the Royal Society A: Mathematical, Physical and Engineering Sciences, 2020. **378**(2176): p. 20190268.
25. Potting, J., et al., *Circular economy: measuring innovation in the product chain*. Planbureau voor de Leefomgeving, 2017(2544).
26. Reike, D., W.J. Vermeulen, and S. Witjes, *The circular economy: new or refurbished as CE 3.0?—exploring controversies in the conceptualization of the circular economy through a focus on history and resource value retention options*. Resources, Conservation and Recycling, 2018. **135**: p. 246-264.
27. Hopewell, J., R. Dvorak, and E. Kosior, *Plastics recycling: challenges and opportunities*. Philosophical Transactions of the Royal Society B: Biological Sciences, 2009. **364**(1526): p. 2115-2126.
28. Shen, L., E. Worrell, and M.K. Patel, *Open-loop recycling: A LCA case study of PET bottle-to-fibre recycling*. Resources, Conservation and Recycling, 2010. **55**(1): p. 34-52.
29. Singh, N., et al., *Recycling of plastic solid waste: A state of art review and future applications*. Composites Part B: Engineering, 2017. **115**: p. 409-422.
30. Banerjee, A., K. Chatterjee, and G. Madras, *Enzymatic degradation of polymers: a brief review*. Materials Science and Technology, 2014. **30**(5): p. 567-573.
31. Pathak, V.M. and Navneet, *Review on the current status of polymer degradation: a microbial approach*. Bioresources and Bioprocessing, 2017. **4**(1): p. 15.
32. Zhuo, C. and Y.A. Levendis, *Upcycling waste plastics into carbon nanomaterials: A review*. Journal of Applied Polymer Science, 2014. **131**(4).
33. Van Caneghem, J., et al., *Waste-to-energy is compatible and complementary with recycling in the circular economy*. Clean Technologies and Environmental Policy, 2019. **21**(5): p. 925-939.

34. Lamberti, F., L. Román-Ramírez, and J. Wood, *Recycling of Bioplastics: Routes and Benefits*. Journal of Polymers and the Environment, 2020. **28**.
35. *La loi anti-gaspillage pour une économie circulaire ( AGEC law)* <https://www.legifrance.gouv.fr/jorf/id/JORFTEXT000041553759>. 2021.
36. *Décret n° 2021-517 du 29 avril 2021 relatif aux objectifs de réduction, de réutilisation et de réemploi, et de recyclage des emballages en plastique à usage unique pour la période 2021-2025* <https://www.legifrance.gouv.fr/jorf/id/JORFTEXT000043458675>. 2021.
37. *A european strategy for plastics in a circular economy* <https://www.europarc.org/wp-content/uploads/2018/01/Eu-plastics-strategy-brochure.pdf>. 2018.
38. Koncar, V., 2 - *Composites and hybrid structures*, in *Smart Textiles for In Situ Monitoring of Composites*, V. Koncar, Editor. 2019, Woodhead Publishing. p. 153-215.
39. Spierling, S., et al., *Bio-based plastics - A review of environmental, social and economic impact assessments*. Journal of Cleaner Production, 2018. **185**: p. 476-491.
40. Helanto, K.E., et al., *Bio-based Polymers for Sustainable Packaging and Biobarriers: A Critical Review*. 2019, 2019. **14**(2): p. 50.
41. Bhagwat, G., et al., *Benchmarking Bioplastics: A Natural Step Towards a Sustainable Future*. Journal of Polymers and the Environment, 2020. **28**(12): p. 3055-3075.
42. *Ocean Conservancy and McKinsey Center for Business and Environment, Stemming the Tide: Land-based strategies for a plastic-free ocean* 2015.
43. UK Parliament website <https://publications.parliament.uk/pa/cm201415/cmselect/cmenvfru/241/24105.htm>. 2014.
44. Agarwal, S., *Biodegradable Polymers: Present Opportunities and Challenges in Providing a Microplastic-Free Environment*. Macromolecular Chemistry and Physics, 2020. **221**(6): p. 2000017.
45. Havstad, M.R., *Chapter 5 - Biodegradable plastics*, in *Plastic Waste and Recycling*, T.M. Letcher, Editor. 2020, Academic Press. p. 97-129.
46. Hermann, B., et al., *To compost or not to compost: Carbon and energy footprints of biodegradable materials' waste treatment*. Polymer Degradation and Stability, 2011. **96**(6): p. 1159-1171.
47. McKeown, P. and M.D. Jones, *The chemical recycling of PLA: a review*. Sustain. Chem, 2020. **1**(1): p. 1-22.
48. Meereboer, K.W., M. Misra, and A.K. Mohanty, *Review of recent advances in the biodegradability of polyhydroxyalkanoate (PHA) bioplastics and their composites*. Green Chemistry, 2020. **22**(17): p. 5519-5558.
49. *European Bioplastics Conference. Bioplastics Market Development Update 2020*.
50. Rai, P., et al., *Recent advances in the sustainable design and applications of biodegradable polymers*. Bioresource technology, 2021: p. 124739.

51. Tan, G.-Y.A., et al., *Start a research on biopolymer polyhydroxyalkanoate (PHA): a review*. *Polymers*, 2014. **6**(3): p. 706-754.
52. Chen, G.-Q., *A microbial polyhydroxyalkanoates (PHA) based bio-and materials industry*. *Chemical Society Reviews*, 2009. **38**(8): p. 2434-2446.
53. Rodriguez-Contreras, A., *Recent advances in the use of polyhydroxyalkanoates in biomedicine*. *Bioengineering*, 2019. **6**(3): p. 82.
54. Weiner, R.M., *Biopolymers from marine prokaryotes*. *Trends in biotechnology*, 1997. **15**(10): p. 390-394.
55. Zhang, B., R. Carlson, and F. Srienc, *Engineering the monomer composition of polyhydroxyalkanoates synthesized in Saccharomyces cerevisiae*. *Applied and environmental microbiology*, 2006. **72**(1): p. 536-543.
56. Raza, Z.A., S. Abid, and I.M. Banat, *Polyhydroxyalkanoates: Characteristics, production, recent developments and applications*. *International Biodeterioration & Biodegradation*, 2018. **126**: p. 45-56.
57. Liu, J., et al., *Poly (3-hydroxybutyrate-co-3-hydroxyvalerate) production by Rhodospirillum rubrum using a two-step culture strategy*. *Journal of Chemistry*, 2019. **2019**.
58. Khanna, S. and A.K. Srivastava, *Recent advances in microbial polyhydroxyalkanoates*. *Process biochemistry*, 2005. **40**(2): p. 607-619.
59. Yun, S.I., et al., *Mechanical properties of biodegradable polyhydroxyalkanoates/single wall carbon nanotube nanocomposite films*. *Polymer Bulletin*, 2008. **61**(2): p. 267-275.
60. Barham, P.J., *Physical Properties of Poly(Hydroxybutyrate) and Poly(Hydroxybutyrate-Co-Hydroxyvalerate)*, in *Novel Biodegradable Microbial Polymers*, E.A. Dawes, Editor. 1990, Springer Netherlands: Dordrecht. p. 81-96.
61. Plackett, D. and I. Siró, *Polyhydroxyalkanoates (PHAs) for food packaging*, in *Multifunctional and Nanoreinforced Polymers for Food Packaging*, J.-M. Lagarón, Editor. 2011, Woodhead Publishing. p. 498-526.
62. Ten, E., et al., *3 - Mechanical performance of polyhydroxyalkanoate (PHA)-based biocomposites*, in *Biocomposites*, M. Misra, J.K. Pandey, and A.K. Mohanty, Editors. 2015, Woodhead Publishing. p. 39-52.
63. Cyras, V.P., et al., *Biodegradable double-layer films based on biological resources: Polyhydroxybutyrate and cellulose*. *Journal of Applied Polymer Science*, 2007. **106**(2): p. 749-756.
64. Miguel, O., M. Fernandez-Berridi, and J. Iruiñ, *Survey on transport properties of liquids, vapors, and gases in biodegradable poly (3-hydroxybutyrate)(PHB)*. *Journal of applied polymer science*, 1997. **64**(9): p. 1849-1859.
65. Shogren, R., *Water vapor permeability of biodegradable polymers*. *Journal of environmental polymer degradation*, 1997. **5**(2): p. 91-95.

66. Regulation (EC) No 1935/2004 on materials and articles intended to come into contact with food <https://eur-lex.europa.eu/legal-content/EN/ALL/?uri=celex%3A32004R1935>. 2004.
67. Commission regulation (EU) No 10/2011. Of 14 January 2011 on plastic materials and articles intended to come into contact with food. *Official Journal of the European Union*. 2011. p. 1–89.
68. EFSA Panel on Food Contact Materials, E., et al., *Safety assessment of the substance poly ((R)-3-hydroxybutyrate-co-(R)-3-hydroxyhexanoate) for use in food contact materials*. *Efsa Journal*, 2019. **17**(1): p. e05551.
69. De Souza, L. and S. Shivakumar, *Polyhydroxyalkanoates (PHAs)-biodegradable polymers for 'green' food packaging materials*. *Recent Advances in Biotechnology*; Delhi Printer & Lamination: New Delhi, India, 2017: p. 149.
70. Koller, M., *The Handbook of Polyhydroxyalkanoates*. *The Handbook of Polyhydroxyalkanoates*. 2020: CRC Press.
71. Doineau, E., et al., *Physical-Chemical and Structural Stability of Poly (3HB-co-3HV)/(ligno-)cellulosic Fibre-Based Biocomposites over Successive Dishwashing Cycles*. *Membranes*, 2022. **12**(2): p. 127.
72. Zembouai, I., et al., *Mechanical recycling of poly (3-hydroxybutyrate-co-3-hydroxyvalerate)/polylactide based blends*. *Journal of Polymers and the Environment*, 2014. **22**(4): p. 449-459.
73. Zaverl, M., et al., *Studies on recyclability of polyhydroxybutyrate-co-valerate bioplastic: Multiple melt processing and performance evaluations*. *Journal of Applied Polymer Science*, 2012. **125**(S2): p. E324-E331.
74. Dedieu, I., et al., *Recycled poly(hydroxybutyrate-co-valerate) as food packaging: effect of multiple melt processing on packaging performance and food contact suitability (accepted)*. *Journal of Polymers and the Environment*, 2022.
75. Dedieu, I., et al., *Mechanical recyclability of biodegradable polymers used for food packaging: case study of PHBV*. *Food Additives & Contaminants*, 2022.
76. Xiang, H., et al., *Natural polyphenol tannic acid reinforced poly (3-hydroxybutyrate-co-3-hydroxyvalerate) composite films with enhanced tensile strength and fracture toughness*. *Polymer Composites*, 2015. **36**(12): p. 2303-2308.
77. Xiang, H.-x., et al., *Synthesis and and Thermostability of Crystalline/Amorphous Triblock Copolymers Consisting of PHBV and PMMA*. *ACTA POLYMERICA SINICA*, 2014(1): p. 40-48.
78. Abe, H., *Thermal degradation of environmentally degradable poly (hydroxyalkanoic acid) s*. *Macromolecular bioscience*, 2006. **6**(7): p. 469-486.
79. Chen, Y., et al., *Thermal degradation of poly (3-hydroxybutyrate) and poly (3-hydroxybutyrate-co-3-hydroxyvalerate) in drying treatment*. *Journal of Applied Polymer Science*, 2013. **130**(5): p. 3659-3667.
80. Daly, P.A., et al., *Thermal degradation kinetics of poly (3-hydroxybutyrate-co-3-hydroxyhexanoate)*. *Journal of applied polymer science*, 2005. **98**(1): p. 66-74.

81. Xiang, H., et al., *Thermal depolymerization mechanisms of poly (3-hydroxybutyrate-co-3-hydroxyvalerate)*. Progress in Natural Science: Materials International, 2016. **26**(1): p. 58-64.
82. Nishida, H., et al., *Precise Depolymerization of Poly(3-hydroxybutyrate) by Pyrolysis*. 2010.
83. Kawalec, M., et al., *Carboxylate-induced degradation of poly (3-hydroxybutyrate) s*. Biomacromolecules, 2007. **8**(4): p. 1053-1058.
84. Nguyen, S., G.-e. Yu, and R.H. Marchessault, *Thermal Degradation of Poly(3-hydroxyalkanoates): Preparation of Well-Defined Oligomers*. Biomacromolecules, 2002. **3**(1): p. 219-224.
85. Michalak, M., et al., *Oxidative degradation of poly (3-hydroxybutyrate). A new method of synthesis for the malic acid copolymers*. RSC advances, 2016. **6**(16): p. 12809-12818.
86. Audic, J.L., L. Lemiègre, and Y.M. Corre, *Thermal and mechanical properties of a polyhydroxyalkanoate plasticized with biobased epoxidized broccoli oil*. Journal of Applied Polymer Science, 2014. **131**(6).
87. Roy, I. and P. Visakh, *Polyhydroxyalkanoate (PHA) based blends, composites and nanocomposites*. Vol. 30. 2014: Royal Society of Chemistry.
88. Arza, C.R., et al., *Effect of additives on the melt rheology and thermal degradation of poly [(R)-3-hydroxybutyric acid]*. Journal of Applied Polymer Science, 2015. **132**(15).
89. Rivera-Briso, A.L. and Á. Serrano-Aroca, *Poly (3-Hydroxybutyrate-co-3-Hydroxyvalerate): Enhancement strategies for advanced applications*. Polymers, 2018. **10**(7): p. 732.
90. Castro-Mayorga, J.L., et al., *The impact of zinc oxide particle morphology as an antimicrobial and when incorporated in poly (3-hydroxybutyrate-co-3-hydroxyvalerate) films for food packaging and food contact surfaces applications*. Food and Bioproducts Processing, 2017. **101**: p. 32-44.
91. Wang, B.-j., et al., *Crystallization behavior, thermal and mechanical properties of PHBV/graphene nanosheet composites*. Chinese Journal of Polymer Science, 2013. **31**(4): p. 670-678.
92. Yu, H.-Y., et al., *Simultaneous improvement of mechanical properties and thermal stability of bacterial polyester by cellulose nanocrystals*. Carbohydrate polymers, 2012. **89**(3): p. 971-978.
93. Wang, L., et al., *Processability modifications of poly (3-hydroxybutyrate) by plasticizing, blending, and stabilizing*. Journal of Applied Polymer Science, 2008. **107**(1): p. 166-173.
94. Quideau, S., D. Deffieux, and C. Douat-Casassus, *Plant polyphenols: Chemical properties. Biological activities and synthesis*. Angewandte Chemie, 2011. **50**: p. 586-621.
95. Sakihama, Y., et al., *Plant phenolic antioxidant and prooxidant activities: phenolics-induced oxidative damage mediated by metals in plants*. Toxicology, 2002. **177**(1): p. 67-80.
96. Doherty, W.O., P. Mousavioun, and C.M. Fellows, *Value-adding to cellulosic ethanol: Lignin polymers*. Industrial crops and products, 2011. **33**(2): p. 259-276.

97. Wang, C., S.S. Kelley, and R.A. Venditti, *Lignin-based thermoplastic materials*. ChemSusChem, 2016. **9**(8): p. 770-783.
98. Ignat, I., et al., *Antioxidant and antibacterial activities of some natural polyphenols*. cytokines, 2013. **4**: p. 5.
99. Beya, M.M., et al., *Plant-based phenolic molecules as natural preservatives in comminuted meats: A review*. Antioxidants, 2021. **10**(2): p. 263.
100. Cao, Q., et al., *The mechanism of chlorogenic acid inhibits lipid oxidation: An investigation using multi-spectroscopic methods and molecular docking*. Food Chemistry, 2020. **333**: p. 127528.
101. López-Fernández, O., et al., *Improving oxidative stability of foods with apple-derived polyphenols*. Comprehensive Reviews in Food Science and Food Safety, 2022. **21**(1): p. 296-320.
102. Hano, C. and D. Tungmunnithum, *Plant Polyphenols, More than Just Simple Natural Antioxidants: Oxidative Stress, Aging and Age-Related Diseases*. 2020, Multidisciplinary Digital Publishing Institute.
103. Contardi, M., et al., *Combining dietary phenolic antioxidants with polyvinylpyrrolidone: transparent biopolymer films based on p-coumaric acid for controlled release*. Journal of Materials Chemistry B, 2019. **7**(9): p. 1384-1396.
104. Nanni, A., et al., *Thermal and UV aging of polypropylene stabilized by wine seeds wastes and their extracts*. Polymer Degradation and Stability, 2019. **165**: p. 49-59.
105. Kirschweng, B., et al., *Natural antioxidants as stabilizers for polymers*. Polymer Degradation and Stability, 2017. **145**: p. 25-40.
106. Gaugler, M. and W.J. Grigsby, *Thermal Degradation of Condensed Tannins from Radiata Pine Bark*. Journal of Wood Chemistry and Technology, 2009. **29**(4): p. 305-321.
107. Sebestyen, Z., et al., *Thermal degradation study of vegetable tannins and vegetable tanned leathers*. Journal of Analytical and Applied Pyrolysis, 2019. **138**: p. 178-187.
108. Brebu, M., T. Tamminen, and I. Spiridon, *Thermal degradation of various lignins by TG-MS/FTIR and Py-GC-MS*. Journal of analytical and applied pyrolysis, 2013. **104**: p. 531-539.
109. Fischer, U.A., R. Carle, and D.R. Kammerer, *Thermal stability of anthocyanins and colourless phenolics in pomegranate (*Punica granatum* L.) juices and model solutions*. Food Chemistry, 2013. **138**(2): p. 1800-1809.
110. Ross, C., C. Hoyer, and V. Fernandez-Plotka, *Influence of Heating on the Polyphenolic Content and Antioxidant Activity of Grape Seed Flour*. Journal of food science, 2011. **76**: p. C884-90.
111. Nikolić, M., et al., *Thermal degradation kinetics of total polyphenols, flavonoids, anthocyanins and individual anthocyanins in two types of wild blackberry jams*. Advanced Technologies, 2018. **7**: p. 20-27.
112. Mack Easton, P., et al., *Synthetic investigations in the field of flavonoids. Total synthesis of quercetin-3-, 9-rutinoside, rutin*. Zh. Obshch. Khim.(USSR), 1962. **32**: p. 390-6.

113. Ozgen, S., O.K. Kilinc, and Z. Selamoğlu, *Antioxidant activity of quercetin: a mechanistic review*. Turkish Journal of Agriculture-Food Science and Technology, 2016. **4**(12): p. 1134-1138.
114. Nguyen, T.L.A. and D. Bhattacharya, *Antimicrobial Activity of Quercetin: An Approach to Its Mechanistic Principle*. Molecules, 2022. **27**(8).
115. Di Petrillo, A., et al., *Quercetin and its derivatives as antiviral potentials: A comprehensive review*. Phytotherapy Research, 2022. **36**(1): p. 266-278.
116. Fernandes, F.H.A. and H.R.N. Salgado, *Gallic Acid: Review of the Methods of Determination and Quantification*. Critical Reviews in Analytical Chemistry, 2016. **46**(3): p. 257-265.
117. Di Giuseppe, F., et al., *Activated gallic acid as radical and oxygen scavenger in biodegradable packaging film*. Food Packaging and Shelf Life, 2022. **31**: p. 100811.
118. Angelini, S., et al., *Acid-insoluble lignin and holocellulose from a lignocellulosic biowaste: Bio-fillers in poly (3-hydroxybutyrate)*. European Polymer Journal, 2016. **76**: p. 63-76.
119. Kovalcik, A., et al., *Designing Packaging Materials with Viscoelastic and Gas Barrier Properties by Optimized Processing of Poly(3-hydroxybutyrate-co-3-hydroxyvalerate) with Lignin*. Reactive and Functional Polymers, 2015. **94**: p. 25-34.
120. Luo, S., J. Cao, and A. McDonald, *Interfacial Improvements in a Green Biopolymer Alloy of Poly(3-hydroxybutyrate-co-3-hydroxyvalerate) and Lignin via in Situ Reactive Extrusion*. ACS Sustainable Chemistry & Engineering, 2016. **4**.
121. Auriemma, M., et al., *Blending poly (3-hydroxybutyrate) with tannic acid: influence of a polyphenolic natural additive on the rheological and thermal behavior*. European Polymer Journal, 2015. **63**: p. 123-131.
122. Li, J., et al., *Thermal and Infrared Spectroscopic Studies on Hydrogen-Bonding Interaction between Poly(3-hydroxybutyrate) and Catechin*. Polymer Journal, 2003. **35**(4): p. 384-392.
123. Persico, P., et al., *Enhancement of poly(3-hydroxybutyrate) thermal and processing stability using a bio-waste derived additive*. International journal of biological macromolecules, 2012. **51**: p. 1151-8.
124. David, G., et al., *Eco-conversion of two winery lignocellulosic wastes into fillers for biocomposites: Vine shoots and wine pomaces*. Polymers, 2020. **12**(7): p. 1530.
125. Xiang, H.X., et al., *Structural characteristics and enhanced mechanical and thermal properties of full biodegradable tea polyphenol/poly(3-hydroxybutyrate-co-3-hydroxyvalerate) composite films*. eXPRESS Polymer Letters, 2013. **7**: p. 778-786.
126. Urbina, L., et al., *Valorization of apple waste for active packaging: Multicomponent polyhydroxyalkanoate coated nanopapers with improved hydrophobicity and antioxidant capacity*. Food Packaging and Shelf Life, 2019. **21**: p. 100356.
127. Mousavioun, P., W.O. Doherty, and G. George, *Thermal stability and miscibility of poly (hydroxybutyrate) and soda lignin blends*. Industrial Crops and Products, 2010. **32**(3): p. 656-661.



128. Li, J., et al., *Thermal and crystallization behavior of hydrogen-bonded miscible blend of poly(3-hydroxybutyrate) and enzymatically polymerized polyphenol*. Journal of Applied Polymer Science, 2005. **97**: p. 2439-2449.
129. Halley, P. and W. Doherty, *Thermophysical properties and rheology of PHB/lignin blends*. Industrial Crops and Products, 2013. **50**: p. 270-275.
130. Lemes, A., et al., *Effect of Lignosulfonate on the Thermal and Morphological Behavior of Poly(3-hydroxybutyrate-co-3-hydroxyvalerate)*. Journal of Polymers and the Environment, 2010. **18**: p. 250-259.
131. Figueroa-Lopez, K.J., et al., *Development of electrospun poly (3-hydroxybutyrate-co-3-hydroxyvalerate) monolayers containing eugenol and their application in multilayer antimicrobial food packaging*. Frontiers in Nutrition, 2020. **7**.
132. Melendez-Rodriguez, B., et al., *Electrospun antimicrobial films of poly (3-hydroxybutyrate-co-3-hydroxyvalerate) containing eugenol essential oil encapsulated in mesoporous silica nanoparticles*. Nanomaterials, 2019. **9**(2): p. 227.
133. Figueroa-Lopez, K.J., et al., *Antimicrobial and antioxidant performance of various essential oils and natural extracts and their incorporation into biowaste derived poly (3-hydroxybutyrate-co-3-hydroxyvalerate) layers made from electrospun ultrathin fibers*. Nanomaterials, 2019. **9**(2): p. 144.
134. De Souza, L. and S. Shivakumar, *Polyhydroxyalkanoates (PHA)–Applications in Wound Treatment and as Precursors for Oral Drugs*, in *Biotechnological Applications of Polyhydroxyalkanoates*. 2019, Springer. p. 227-270.
135. Daglia, M., *Polyphenols as antimicrobial agents*. Current opinion in biotechnology, 2011. **23**: p. 174-81.
136. Górniak, I., R. Bartoszewski, and J. Króliczewski, *Comprehensive review of antimicrobial activities of plant flavonoids*. Phytochemistry Reviews, 2019. **18**(1): p. 241-272.
137. Lima, M., et al., *A review of the current evidence of fruit phenolic compounds as potential antimicrobials against pathogenic bacteria*. Microbial pathogenesis, 2019. **130**: p. 259-270.
138. Basile, A., et al., *Antibacterial and antifungal properties of acetonic extract of Feijoa sellowiana fruits and its effect on Helicobacter pylori growth*. Journal of medicinal food, 2010. **13**(1): p. 189-195.
139. Kuete, V., et al., *Antimicrobial activity of the methanolic extract, fractions and four flavonoids from the twigs of Dorstenia angusticornis Engl.(Moraceae)*. Journal of ethnopharmacology, 2007. **112**(2): p. 271-277.
140. Salaheen, S., et al., *Eradication and sensitization of methicillin resistant Staphylococcus aureus to methicillin with bioactive extracts of berry pomace*. Frontiers in microbiology, 2017. **8**: p. 253.
141. Sanhueza, L., et al., *Synergistic interactions between phenolic compounds identified in grape pomace extract with antibiotics of different classes against Staphylococcus aureus and Escherichia coli*. PloS one, 2017. **12**(2): p. e0172273.

142. Shen, X., et al., *Antimicrobial effect of blueberry (Vaccinium corymbosum L.) extracts against the growth of Listeria monocytogenes and Salmonella Enteritidis*. Food control, 2014. **35**(1): p. 159-165.
143. Coman, M.M., et al., *Polyphenol content and in vitro evaluation of antioxidant, antimicrobial and prebiotic properties of red fruit extracts*. European food research and technology, 2018. **244**(4): p. 735-745.
144. Al-Zoreky, N., *Antimicrobial activity of pomegranate (Punica granatum L.) fruit peels*. International journal of food microbiology, 2009. **134**(3): p. 244-248.
145. Gullon, B., et al., *Assessment of polyphenolic profile and antibacterial activity of pomegranate peel (Punica granatum) flour obtained from co-product of juice extraction*. Food Control, 2016. **59**: p. 94-98.
146. Rosas-Burgos, E.C., et al., *Antimicrobial activity of pomegranate peel extracts as affected by cultivar*. Journal of the Science of Food and Agriculture, 2017. **97**(3): p. 802-810.
147. Dong, X., et al., *Antimicrobial and antioxidant activities of lignin from residue of corn stover to ethanol production*. Industrial Crops and Products, 2011. **34**(3): p. 1629-1634.
148. Jendrossek, D. and R. Handrick, *Microbial degradation of polyhydroxyalkanoates*. Annual Review of Microbiology, 2002. **56**(1): p. 403-432.
149. Akbar, S., et al., *Production and purification of poly (3-hydroxybutyrate-co-3-hydroxyvalerate) degrading enzyme from Streptomyces sp. AF-111*. Journal of Polymers and the Environment, 2013. **21**(4): p. 1109-1116.
150. Alshehrei, F., *Biodegradation of synthetic and natural plastic by microorganisms*. Journal of Applied & Environmental Microbiology, 2017. **5**(1): p. 8-19.
151. Boyandin, A., et al., *Biodegradation of polyhydroxyalkanoates by soil microbial communities of different structures and detection of PHA degrading microorganisms*. Applied Biochemistry and Microbiology, 2012. **48**(1): p. 28-36.
152. Fernandes, M., M. Alves, and A.A. Vicente, *Factors affecting polyhydroxyalkanoates biodegradation in soil*. Polymer Degradation and Stability, 2020: p. 109408.
153. Matavulj, M. and H.-P. Molitoris, *Fungal degradation of polyhydroxyalkanoates and a semiquantitative assay for screening their degradation by terrestrial fungi*. FEMS microbiology reviews, 1992. **9**(2-4): p. 323-331.
154. Luzier, W.D., *Materials derived from biomass/biodegradable materials*. Proceedings of the National Academy of Sciences, 1992. **89**(3): p. 839-842.
155. Mergaert, J., et al., *Microbial degradation of poly (3-hydroxybutyrate) and poly (3-hydroxybutyrate-co-3-hydroxyvalerate) in soils*. Applied and environmental microbiology, 1993. **59**(10): p. 3233-3238.
156. Shah, A.A., et al., *Microbial degradation of aliphatic and aliphatic-aromatic co-polyesters*. Applied Microbiology and Biotechnology, 2014. **98**(8): p. 3437-3447.

157. Bano, K., et al., *Microbial enzymatic degradation of biodegradable plastics*. Current Pharmaceutical Biotechnology, 2017. **18**(5): p. 429-440.
158. Tokiwa, Y. and B.P. Calabia, *Review degradation of microbial polyesters*. Biotechnology letters, 2004. **26**(15): p. 1181-1189.
159. Zaheer, M.R. and M. Kuddus, *PHB (poly- $\beta$ -hydroxybutyrate) and its enzymatic degradation*. Polymers for Advanced Technologies, 2018. **29**(1): p. 30-40.
160. Wang, Z., et al., *Purification and characterization of an extracellular poly (3-hydroxybutyrate-co-3-hydroxyvalerate) depolymerase from Acidovorax sp. HB01*. World Journal of Microbiology and Biotechnology, 2012. **28**(6): p. 2395-2402.
161. Choi, G.G., H.W. Kim, and Y.H. Rhee, *Enzymatic and non-enzymatic degradation of poly (3-hydroxybutyrate-co-3-hydroxyvalerate) copolyesters produced by Alcaligenes sp. MT-16*. The Journal of Microbiology, 2004. **42**(4): p. 346-352.
162. Weng, Y.-X., X.-L. Wang, and Y.-Z. Wang, *Biodegradation behavior of PHAs with different chemical structures under controlled composting conditions*. Polymer Testing, 2011. **30**(4): p. 372-380.
163. Spyros, A., et al., *H NMR Imaging Study of Enzymatic Degradation in Poly (3-hydroxybutyrate) and Poly (3-hydroxybutyrate-co-3-hydroxyvalerate). Evidence for Preferential Degradation of the Amorphous Phase by PHB Depolymerase B from Pseudomonas lemoignei*. Macromolecules, 1997. **30**(26): p. 8218-8225.
164. Song, F., H. Koo, and D. Ren, *Effects of material properties on bacterial adhesion and biofilm formation*. Journal of dental research, 2015. **94**(8): p. 1027-1034.
165. Volova, T.G., et al., *Microbial Degradation of Polyhydroxyalkanoates with Different Chemical Compositions and Their Biodegradability*. Microbial Ecology, 2017. **73**(2): p. 353-367.
166. Chen, G.G.-Q., *Plastics from bacteria: natural functions and applications*. Vol. 14. 2009: Springer Science & Business Media.
167. Martínez, V., et al., *Novel extracellular medium-chain-length polyhydroxyalkanoate depolymerase from Streptomyces exfoliatus K10 DSMZ 41693: a promising biocatalyst for the efficient degradation of natural and functionalized mcl-PHAs*. Applied microbiology and biotechnology, 2015. **99**(22): p. 9605-9615.
168. Ramsay, B.A., et al., *A method for the isolation of microorganisms producing extracellular long-side-chain poly ( $\beta$ -hydroxyalkanoate) depolymerase*. Journal of environmental polymer degradation, 1994. **2**(1): p. 1-7.
169. Latos-Brozio, M. and A. Masek, *The Effect of Natural Additives on the Composting Properties of Aliphatic Polyesters*. Polymers, 2020. **12**(9): p. 1856.
170. Latos, B. and Masek, *Effect of Impregnation of Biodegradable Polyesters with Polyphenols from Cistus Linnaeus and Juglans regia Linnaeus Walnut Green Husk*. Polymers, 2019. **11**: p. 669.
171. David, G., et al., *How Vine Shoots as Fillers Impact the Biodegradation of PHBV-Based Composites*. International Journal of Molecular Sciences, 2020. **21**(1).

172. Gunning, M.A., et al., *Mechanical and biodegradation performance of short natural fibre polyhydroxybutyrate composites*. *Polymer Testing*, 2013. **32**(8): p. 1603-1611.
173. Carofiglio, V.E., et al., *Novel PHB/Olive mill wastewater residue composite based film: Thermal, mechanical and degradation properties*. *Journal of Environmental Chemical Engineering*, 2017. **5**(6): p. 6001-6007.
174. Mousavioun, P., G.A. George, and W.O.S. Doherty, *Environmental degradation of lignin/poly(hydroxybutyrate) blends*. *Polymer Degradation and Stability*, 2012. **97**(7): p. 1114-1122.
175. Vandi, L.-J., et al., *Experimental data for extrusion processing and tensile properties of poly(hydroxybutyrate-co-hydroxyvalerate) (PHBV) polymer and wood fibre reinforced PHBV biocomposites*. *Data in Brief*, 2019. **22**: p. 687-692.
176. Chatellard, L., E. Trably, and H. Carrère, *The type of carbohydrates specifically selects microbial community structures and fermentation patterns*. *Bioresource Technology*, 2016. **221**: p. 541-549.
177. David, G., N. Gontard, and H. Angellier-Coussy, *Mitigating the Impact of Cellulose Particles on the Performance of Biopolyester-Based Composites by Gas-Phase Esterification*. *Polymers*, 2019. **11**(2): p. 200.
178. Srithep, Y., et al., *Melt compounding of poly (3-hydroxybutyrate-co-3-hydroxyvalerate) (PHBV) / nanofibrillated cellulose (NFC) nanocomposites: Properties and solubility of carbon dioxide*. *Annual Technical Conference - ANTEC, Conference Proceedings*, 2013. **1**: p. 866-871.
179. Bank, M.S. and S.V. Hansson, *The Plastic Cycle: A Novel and Holistic Paradigm for the Anthropocene*. *Environmental Science & Technology*, 2019. **53**(13): p. 7177-7179.
180. Rillig, M.C., et al., *The Global Plastic Toxicity Debt*. *Environmental Science & Technology*, 2021. **55**(5): p. 2717-2719.
181. Martinez-Sanz, M., et al., *On the extraction of cellulose nanowhiskers from food by-products and their comparative reinforcing effect on a polyhydroxybutyrate-co-valerate polymer*. *Cellulose*, 2015. **22**(1): p. 535 - 551.
182. Javid, A.M. and B. Monika, *Polyhydroxyalkanoates: An Indispensable Alternative*, in *Handbook of Research on Environmental and Human Health Impacts of Plastic Pollution*, W. Khurshheed Ahmad, A. Lutfah, and S.M. Zuber, Editors. 2020, IGI Global: Hershey, PA, USA. p. 370-387.
183. Kaur, L., et al., *Polyhydroxyalkanoates: biosynthesis to commercial production-A review*. *Journal of Microbiology, Biotechnology and Food Sciences*, 2021. **2021**: p. 1098-1106.
184. *Circular economy action plan : for a cleaner and more competitive Europe - European Commission 2020*: Publications Office.
185. *Circular economy package - Four legislative proposals on waste*, E.P.R. Service, Editor. 2017.
186. Ishii, S., et al., *Safety evaluation of recycling process used to produce recycled pulp for adult paper diapers*. *Regulatory Toxicology and Pharmacology*, 2021. **122**: p. 104909.

187. Gijssman, P., *23 - Polymer Stabilization*, in *Handbook of Environmental Degradation of Materials (Second Edition)*, M. Kutz, Editor. 2012, William Andrew Publishing: Oxford. p. 673-714.
188. Murphy, J., *CHAPTER 8 - Modifying Specific Properties: Resistance to Heat – Heat Stabilizers*, in *Additives for Plastics Handbook (Second Edition)*, J. Murphy, Editor. 2001, Elsevier Science: Amsterdam. p. 93-106.
189. Stokes, J.D. and C.L. Scudder, *The effect of butylated hydroxyanisole and butylated hydroxytoluene on behavioral development of mice*. *Developmental Psychobiology*, 1974. **7**(4): p. 343-350.
190. Zhao, H., et al., *Processing and characterization of solid and microcellular poly(lactic acid)/polyhydroxybutyrate-valerate (PLA/PHBV) blends and PLA/PHBV/Clay nanocomposites*. *Composites Part B: Engineering*, 2013. **51**: p. 79-91.
191. Alfei, S., B. Marengo, and G. Zuccari, *Nanotechnology application in food packaging: A plethora of opportunities versus pending risks assessment and public concerns*. *Food Research International*, 2020. **137**: p. 109664.
192. Auriemma, M., et al., *Blending poly(3-hydroxybutyrate) with tannic acid: Influence of a polyphenolic natural additive on the rheological and thermal behavior*. *European Polymer Journal*, 2015. **63**: p. 123-131.
193. Latos-Brozio, M. and A. Masek, *The Application of (+)-Catechin and Polydatin as Functional Additives for Biodegradable Polyesters*. *International Journal of Molecular Sciences*, 2020. **21**(2): p. 18.
194. Latos-Brozio, M. and A. Masek, *Biodegradable Polyester Materials Containing Gallates*. *Polymers*, 2020. **12**(3): p. 677.
195. Talamond, P., J.-L. Verdeil, and G. Conéjéro, *Secondary metabolite localization by autofluorescence in living plant cells*. *Molecules*, 2015. **20**(3): p. 5024-5037.
196. Zembyla, M., et al., *Stability of water-in-oil emulsions co-stabilized by polyphenol crystal-protein complexes as a function of shear rate and temperature*. *Journal of Food Engineering*, 2020. **281**: p. 109991.
197. El-Messery, T.M., et al., *Spectroscopic studies of the interaction between isolated polyphenols from coffee and the milk proteins*. *Surfaces and Interfaces*, 2020. **20**: p. 100558.
198. Falkovskaia, E., P.K. Sengupta, and M. Kasha, *Photophysical induction of dual fluorescence of quercetin and related hydroxyflavones upon intermolecular H-bonding to solvent matrix*. *Chemical Physics Letters*, 1998. **297**(1): p. 109-114.
199. Rawel, H.M., et al., *Determining the binding affinities of phenolic compounds to proteins by quenching of the intrinsic tryptophan fluorescence*. *Molecular nutrition & food research*, 2006. **50**(8): p. 705-713.
200. Xu, L.Q., K.-G. Neoh, and E.-T. Kang, *Natural polyphenols as versatile platforms for material engineering and surface functionalization*. *Progress in Polymer Science*, 2018. **87**: p. 165-196.
201. Liu, Y., et al., *Electrospun Antimicrobial Polylactic Acid/Tea Polyphenol Nanofibers for Food-Packaging Applications*. *Polymers*, 2018. **10**: p. 561.

202. Mousavioun, P., P.J. Halley, and W.O. Doherty, *Thermophysical properties and rheology of PHB/lignin blends*. Industrial crops and products, 2013. **50**: p. 270-275.
203. Braun, D.E., et al., *Complex Polymorphic System of Gallic Acid • Five Monohydrates, Three Anhydrates, and over 20 Solvates*. Crystal growth & design, 2013. **13**(1): p. 19-23.
204. Shichao, W., et al., *Influence of amorphous alkaline lignin on the crystallization behavior and thermal properties of bacterial polyester*. Journal of Applied Polymer Science, 2015. **132**(4).
205. Defruyt, S., *Towards a new plastics economy*. Field Actions Science Reports. The journal of field actions, 2019(Special Issue 19): p. 78-81.
206. Walther, B.A., et al., *Plastic pollution in East Asia: macroplastics and microplastics in the aquatic environment and mitigation efforts by various actors*. Plastics in the Aquatic Environment-Part I, 2020: p. 353-403.
207. Boucher, J., et al., *(Micro) plastic fluxes and stocks in Lake Geneva basin*. TrAC Trends in Analytical Chemistry, 2019. **112**: p. 66-74.
208. Cartraud, A.E., et al., *Plastic ingestion in seabirds of the western Indian Ocean*. Marine Pollution Bulletin, 2019. **140**: p. 308-314.
209. Laskar, N. and U. Kumar, *Plastics and microplastics: A threat to environment*. Environmental technology & innovation, 2019. **14**: p. 100352.
210. Schymanski, D., et al., *Analysis of microplastics in water by micro-Raman spectroscopy: release of plastic particles from different packaging into mineral water*. Water research, 2018. **129**: p. 154-162.
211. *A European Strategy for Plastics in a Circular Economy*. <https://eur-lex.europa.eu/legal-content/EN/TXT/?qid=1516265440535&uri=COM:2018:28:FIN>. 2018.
212. Guillard, V., et al., *The next generation of sustainable food packaging to preserve our environment in a circular economy context*. Frontiers in nutrition, 2018: p. 121.
213. Volova, T., et al., *Biodegradation of polyhydroxyalkanoates (PHAs) in tropical coastal waters and identification of PHA-degrading bacteria*. Polymer degradation and stability, 2010. **95**(12): p. 2350-2359.
214. Chen, G.-Q., *Plastics completely synthesized by bacteria: polyhydroxyalkanoates*, in *Plastics from bacteria*. 2010, Springer. p. 17-37.
215. Khatami, K., et al., *Waste to bioplastics: How close are we to sustainable polyhydroxyalkanoates production?* Waste Management, 2021. **119**: p. 374-388.
216. Wang, Y., et al., *Biosynthesis and thermal properties of PHBV produced from levulinic acid by *Ralstonia eutropha**. PLoS One, 2013. **8**(4): p. e60318.
217. Díez-Pascual, A.M. and A.L. Díez-Vicente, *Poly (3-hydroxybutyrate)/ZnO bionanocomposites with improved mechanical, barrier and antibacterial properties*. International journal of molecular sciences, 2014. **15**(6): p. 10950-10973.

218. Yu, H., et al., *Reinforcement of biodegradable poly (3-hydroxybutyrate-co-3-hydroxyvalerate) with cellulose nanocrystal/silver nanohybrids as bifunctional nanofillers*. Journal of Materials Chemistry B, 2014. **2**(48): p. 8479-8489.
219. Chea, V., et al., *Poly (3-hydroxybutyrate-co-3-hydroxyvalerate) films for food packaging: Physical–chemical and structural stability under food contact conditions*. Journal of Applied Polymer Science, 2016. **133**(2).
220. Bonnenfant, C., N. Gontard, and C. Aouf, *Extending biopolyesters circularity by using natural stabilizers: A review on the potential of polyphenols to enhance Poly (hydroxyalkanoates) thermal stability while preserving its biodegradability*. Polymer Testing, 2022. **110**: p. 107561.
221. Xavier, J.R., et al., *Material properties and antimicrobial activity of polyhydroxybutyrate (PHB) films incorporated with vanillin*. Applied biochemistry and biotechnology, 2015. **176**(5): p. 1498-1510.
222. Bonnenfant, C., N. Gontard, and C. Aouf, *Biobased and biodegradable polymers in a circular economy context: understanding quercetin and gallic acid impacts on PHBV thermal properties*. Polymer Degradation and Stability, 2022. **Submitted article**.
223. Lamberti, F.M., L.A. Román-Ramírez, and J. Wood, *Recycling of bioplastics: routes and benefits*. Journal of Polymers and the Environment, 2020. **28**(10): p. 2551-2571.
224. Andres, S., et al., *Safety aspects of the use of quercetin as a dietary supplement*. Molecular Nutrition & Food Research, 2018. **62**(1): p. 1700447.
225. Koontz, J.L., et al., *Polymer processing and characterization of LLDPE films loaded with  $\alpha$ -tocopherol, quercetin, and their cyclodextrin inclusion complexes*. Journal of applied polymer science, 2010. **117**(4): p. 2299-2309.
226. Mancini, S.D., et al., *Additional steps in mechanical recycling of PET*. Journal of Cleaner Production, 2010. **18**(1): p. 92-100.
227. Li, C., F. Xue, and E. Ding, *Preparation of polyacrylamide grafted collagen extracted from leather wastes and their application in kaolin flocculation*. Journal of Applied Polymer Science, 2015. **132**(13).
228. Arrieta, M.P., et al., *On the use of PLA-PHB blends for sustainable food packaging applications*. Materials, 2017. **10**(9): p. 1008.
229. Akiyama, H., *Regulation of Food Additives in Japan*, in *Food Additives and Packaging*. 2014, ACS Publications. p. 11-25.
230. Silano, V., et al., *Safety assessment of the substance poly ((R)-3-hydroxybutyrate-co-(R)-3-hydroxyhexanoate) for use in food contact materials*. 2019.
231. Norraahim, M., et al., *Performance evaluation and chemical recyclability of a polyethylene/poly (3-hydroxybutyrate-co-3-hydroxyvalerate) blend for sustainable packaging*. RSC advances, 2013. **3**(46): p. 24378-24388.
232. Shruti, V. and G. Kutralam-Muniasamy, *Bioplastics: Missing link in the era of Microplastics*. Science of the Total Environment, 2019. **697**: p. 134139.

233. Straub, S., P.E. Hirsch, and P. Burkhardt-Holm, *Biodegradable and petroleum-based microplastics do not differ in their ingestion and excretion but in their biological effects in a freshwater invertebrate Gammarus fossarum*. International journal of environmental research and public health, 2017. **14**(7): p. 774.
234. Ma, J., et al., *Elucidating degradation properties, microbial community, and mechanism of microplastics in sewage sludge under different terminal electron acceptors conditions*. Bioresource Technology, 2022. **346**: p. 126624.
235. Zambrano, M.C., et al., *Microfibers generated from the laundering of cotton, rayon and polyester based fabrics and their aquatic biodegradation*. Marine pollution bulletin, 2019. **142**: p. 394-407.
236. Berthet, M.-A., N. Gontard, and H. Angellier-Coussy, *Impact of fibre moisture content on the structure/mechanical properties relationships of PHBV/wheat straw fibres biocomposites*. Composites Science and Technology, 2015. **117**: p. 386-391.
237. Deroiné, M., et al., *Accelerated ageing and lifetime prediction of poly (3-hydroxybutyrate-co-3-hydroxyvalerate) in distilled water*. Polymer testing, 2014. **39**: p. 70-78.
238. Xie, L., et al., *Toward faster degradation for natural fiber reinforced poly (lactic acid) biocomposites by enhancing the hydrolysis-induced surface erosion*. Journal of Polymer Research, 2014. **21**(3): p. 1-15.
239. Jabłońska, B., et al., *Physical and chemical properties of waste from PET bottles washing as a component of solid fuels*. Energies, 2019. **12**(11): p. 2197.
240. Jetten, J. and N.d. Kruijf, *Quality and safety aspects of reusable plastic food packaging materials: influence of reuse on intrinsic properties*. Food Additives & Contaminants, 2002. **19**(1): p. 76-88.
241. Krehula, L.K., et al., *Cleaning efficiency of poly (ethylene terephthalate) washing procedure in recycling process*. Journal of Elastomers & Plastics, 2013. **45**(5): p. 429-444.
242. Beltrán, F., et al., *Effect of simulated mechanical recycling processes on the structure and properties of poly (lactic acid)*. Journal of environmental management, 2018. **216**: p. 25-31.
243. Zenkevich, I.G., et al., *Identification of the products of oxidation of quercetin by air oxygen at ambient temperature*. Molecules, 2007. **12**(3): p. 654-672.
244. Jasicka-Misiak, I., P.P. Wiczorek, and P. Kafarski, *Crotonic acid as a bioactive factor in carrot seeds (Daucus carota L.)*. Phytochemistry, 2005. **66**(12): p. 1485-1491.
245. additives, E.P.o.F. and N.S.a.t. Food, *Scientific Opinion on the re-evaluation of propyl gallate (E 310) as a food additive*. EFSA Journal, 2014. **12**(4): p. 3642.
246. Noubigh, A., et al., *Solubility of Gallic Acid, Vanillin, Syringic Acid, and Protocatechuic Acid in Aqueous Sulfate Solutions from (293.15 to 318.15) K*. Journal of Chemical & Engineering Data, 2008. **53**(7): p. 1675-1678.
247. Abdelaal, M.Y., T.R. Sobahi, and M.S.I. Makki, *Chemical Degradation of Poly(Ethylene Terephthalate)*. International Journal of Polymeric Materials and Polymeric Biomaterials, 2008. **57**(1): p. 73-80.



248. A European green deal striving to be the first climate-neutral continent [https://ec.europa.eu/info/strategy/priorities-2019-2024/european-green-deal\\_en](https://ec.europa.eu/info/strategy/priorities-2019-2024/european-green-deal_en). 2019.
249. Shamsuyeva, M. and H.-J. Endres, *Plastics in the context of the circular economy and sustainable plastics recycling: Comprehensive review on research development, standardization and market*. Composites Part C: Open Access, 2021. **6**: p. 100168.
250. TOMRA, *Only 2% of plastic packaging is recycled in a closed loop. What about the other 98%?* <https://newsroom.tomra.com/only-2-plastic-packaging-closed-loop/>. 2020.
251. Franz, R. and F. Welle, *Recycling of post-consumer packaging materials into new food packaging applications—critical review of the european approach and future perspectives*. Sustainability, 2022. **14**(2): p. 824.
252. Welle, F., *Twenty years of PET bottle to bottle recycling—An overview*. Resources, Conservation and Recycling, 2011. **55**(11): p. 865-875.
253. EFSA Panel on Food Contact Materials, E., Flavourings and P. Aids, *Scientific opinion on the criteria to be used for safety evaluation of a mechanical recycling process to produce recycled PET intended to be used for manufacture of materials and articles in contact with food*. EFSA Journal, 2011. **9**(7): p. 2184.
254. Welle, F., *Decontamination efficiency of a new post-consumer poly (ethylene terephthalate)(PET) recycling concept*. Food additives and contaminants, 2008. **25**(1): p. 123-131.
255. Palkopoulou, S., et al., *Critical review on challenge tests to demonstrate decontamination of polyolefins intended for food contact applications*. Trends in Food Science & Technology, 2016. **49**: p. 110-120.
256. Ragaert, P., et al., *Polyhydroxyalkanoates for food packaging applications*, in *Reference module in food science*. 2019, Elsevier.
257. Liu, Q.-S., et al., *Reducing the formation of six-membered ring ester during thermal degradation of biodegradable PHBV to enhance its thermal stability*. Polymer Degradation and Stability, 2009. **94**(1): p. 18-24.
258. Nguyen, S., G.-e. Yu, and R.H. Marchessault, *Thermal degradation of poly (3-hydroxyalkanoates): preparation of well-defined oligomers*. Biomacromolecules, 2002. **3**(1): p. 219-224.
259. *Quercetin compound summary* <https://pubchem.ncbi.nlm.nih.gov/compound/5280343>.
260. Gao, J., *Using Hansen Solubility Parameters (HSPs) to develop antioxidant-packaging film to achieve controlled release*. 2014: Michigan State University.
261. *Gallic Acid compound summary* <https://pubchem.ncbi.nlm.nih.gov/compound/370>.
262. Dewi, S.R., et al., *Investigating the role of solvent type and microwave selective heating on the extraction of phenolic compounds from cacao (Theobroma cacao L.) pod husk*. Food and Bioproducts Processing, 2022.
263. *Catechin compound summary* <https://pubchem.ncbi.nlm.nih.gov/compound/9064>.

264. *Ferulic Acid compound summary* <https://pubchem.ncbi.nlm.nih.gov/compound/445858>.
265. Zuorro, A., A. Iannone, and R. Lavecchia, *Water–organic solvent extraction of phenolic antioxidants from brewers’ spent grain*. *Processes*, 2019. **7**(3): p. 126.
266. Ruellan, A., *Thesis: "Conception raisonnée à l’aide de la formulation et du procédé d’un film souple biosourcé et biodégradable pour emballage alimentaire"*. 2015.
267. *Tetra Ethylene Glycol compound summary* <https://pubchem.ncbi.nlm.nih.gov/compound/8200>.
268. Zhu, B., et al., *Effect of steric hindrance on hydrogen-bonding interaction between polyesters and natural polyphenol catechin*. *Journal of applied polymer science*, 2004. **91**(6): p. 3565-3573.
269. Milo, R., et al., *BioNumbers—the database of key numbers in molecular and cell biology*. *Nucleic acids research*, 2010. **38**(suppl\_1): p. D750-D753.
270. Phan, H.T., et al., *Structure-dependent interactions of polyphenols with a biomimetic membrane system*. *Biochimica et Biophysica Acta (BBA)-Biomembranes*, 2014. **1838**(10): p. 2670-2677.
271. Bonnenfant, C., et al., *Effect of quercetin and gallic acid on the microbial degradation of PHBV materials ( under submission)* 2022.
272. Torres, F.G., et al., *Sorption of chemical contaminants on degradable and non-degradable microplastics: Recent progress and research trends*. *Science of the Total Environment*, 2021. **757**: p. 143875.
273. *Plastics Europe, Plastics-The facts 2021* <https://plasticseurope.org/knowledge-hub/plastics-the-facts-2021/>. 2021.
274. Moshood, T.D., et al., *Biodegradable plastic applications towards sustainability: A recent innovations in the green product*. *Cleaner Engineering and Technology*, 2022: p. 100404.
275. Jost, V., *Packaging related properties of commercially available biopolymers – An overview of the status quo*. *Express Polymer Letters*, 2018. **12**: p. 429-435.
276. Havstad, M.R., *Biodegradable plastics*, in *Plastic waste and recycling*. 2020, Elsevier. p. 97-129.
277. Weng, Y.-X., et al., *Biodegradation behavior of PHBV films in a pilot-scale composting condition*. *Polymer Testing*, 2010. **29**(5): p. 579-587.
278. *Bioplastics market development update 2021* [https://docs.european-bioplastics.org/publications/market\\_data/2021/Report\\_Bioplastics\\_Market\\_Data\\_2021\\_short\\_version.pdf](https://docs.european-bioplastics.org/publications/market_data/2021/Report_Bioplastics_Market_Data_2021_short_version.pdf). 2021
279. Zheng, Y., et al., *Engineering biosynthesis of polyhydroxyalkanoates (PHA) for diversity and cost reduction*. *Metabolic engineering*, 2020. **58**: p. 82-93.
280. Lima, M.d.C., et al., *A review of the current evidence of fruit phenolic compounds as potential antimicrobials against pathogenic bacteria*. *Microbial pathogenesis*, 2019. **130**: p. 259-270.

281. Jones, S.E. and M.A. Elliot, '*Exploring' the regulation of Streptomyces growth and development*. Current Opinion in Microbiology, 2018. **42**: p. 25-30.
282. Borges, A., et al., *Antibacterial activity and mode of action of ferulic and gallic acids against pathogenic bacteria*. Microb Drug Resist, 2013. **19**(4): p. 256-65.
283. Askun, T., et al., *Characterization of the phenolic composition and antimicrobial activities of Turkish medicinal plants*. Pharmaceutical Biology, 2009. **47**(7): p. 563-571.
284. Kuzyakov, Y., J. Friedel, and K. Stahr, *Review of mechanisms and quantification of priming effects*. Soil Biology and Biochemistry, 2000. **32**(11-12): p. 1485-1498.
285. Balaguer, M.P., et al., *Compostability assessment of nano-reinforced poly (lactic acid) films*. Waste management, 2016. **48**: p. 143-155.
286. Lammi, S., et al., *How olive pomace can be valorized as fillers to tune the biodegradation of PHBV based composites*. Polymer Degradation and Stability, 2019. **166**: p. 325-333.
287. Lajarrige, A.s., *Exploration des risques et des bénéfices liés à l'utilisation de nano-argiles dans des matériaux biodégradables destinés au contact alimentaire*. 2019, Montpellier.
288. Goel, V., et al., *Biodegradable/Bio-plastics: Myths and Realities*. Journal of Polymers and the Environment, 2021. **29**: p. 1-26.

# APPENDIX 1

## Supporting information: Chapter 3

## Biobased and biodegradable polymers in a circular economy context: understanding quercetin and gallic acid impacts on PHBV thermal properties

Polymer films were analyzed using an infrared spectrometer (Vertex 70v, Brüker, Ettlingen, Germany) in Attenuated Total Reflectance (ATR) mode. FTIR-ATR spectra were recorded at room temperature and under vacuum conditions, from 4000 to 800  $\text{cm}^{-1}$ , at a spectral resolution of 4  $\text{cm}^{-1}$  and averaged over 128 scans. Spectra were processed using the OPUS software version 8.2.28.

Figure 35

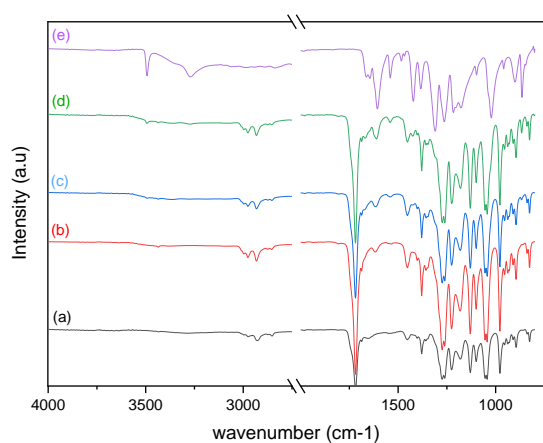


Figure 35.1

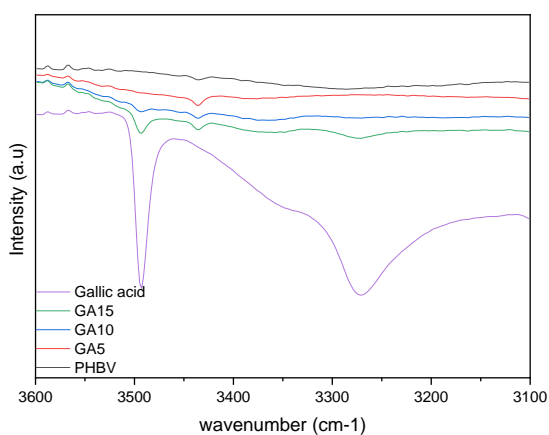
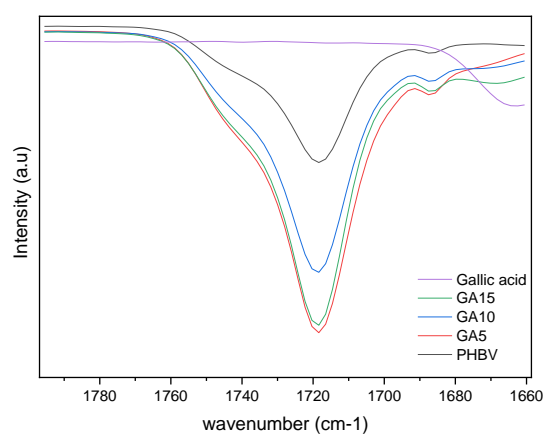
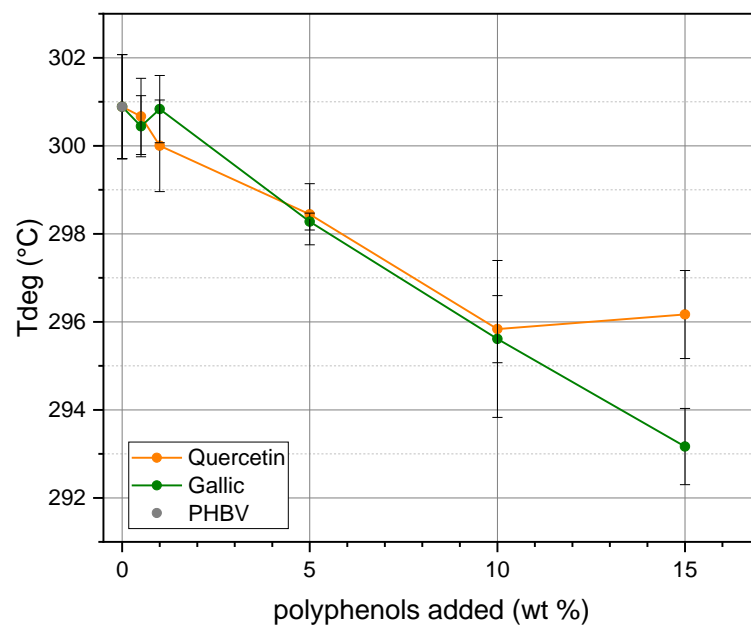
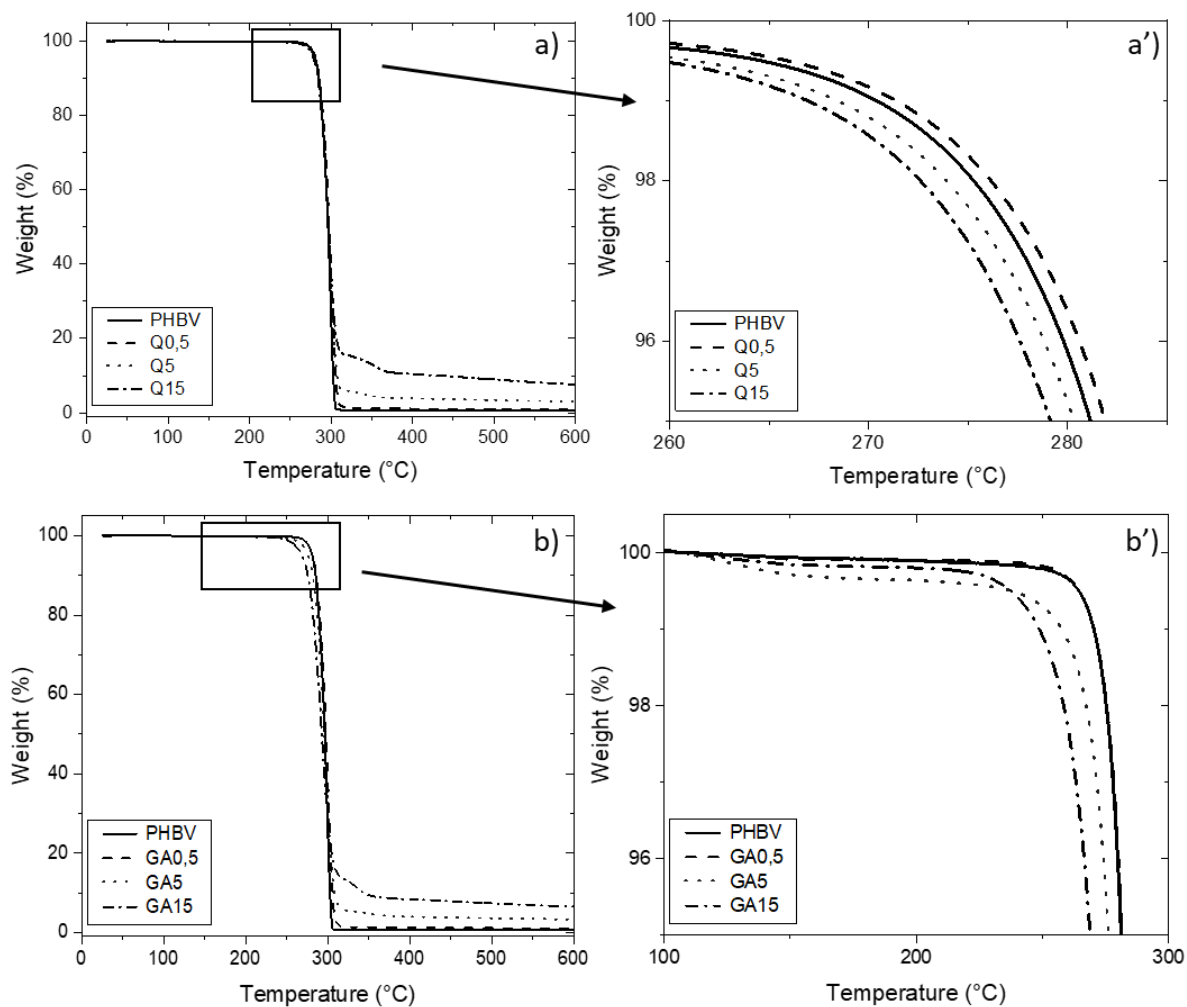


Figure 35.2

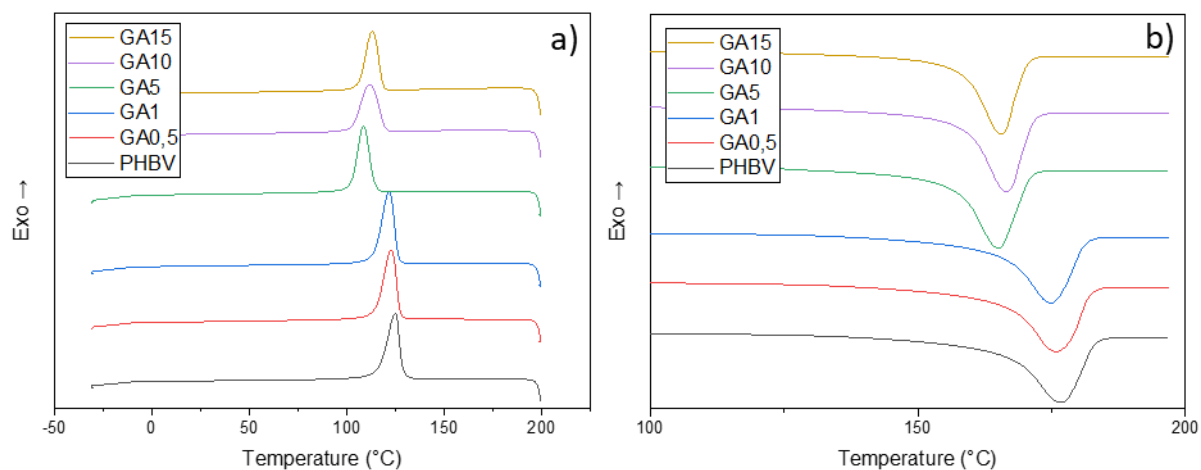
**Figure 35:** FTIR analysis of PHBV/GA blends. a) PHBV film, b) GA5, c) GA10, d) GA15, e) GA powder (as a reference). **Figure 35.1** is a zoom of Figure 35 at wavenumbers 1680-1780  $\text{cm}^{-1}$ . **Figure 35.2** is a zoom of Figure 35 at wavenumbers 3100-3600  $\text{cm}^{-1}$ .



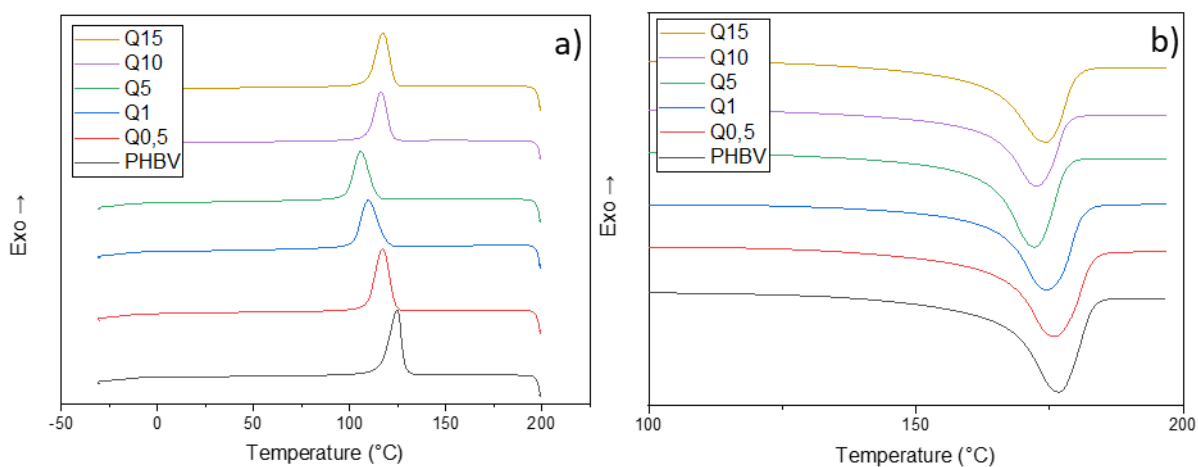
**Figure 36:** The evolution of Tdeg of PHBV film as a function of the amount of polyphenol additive.



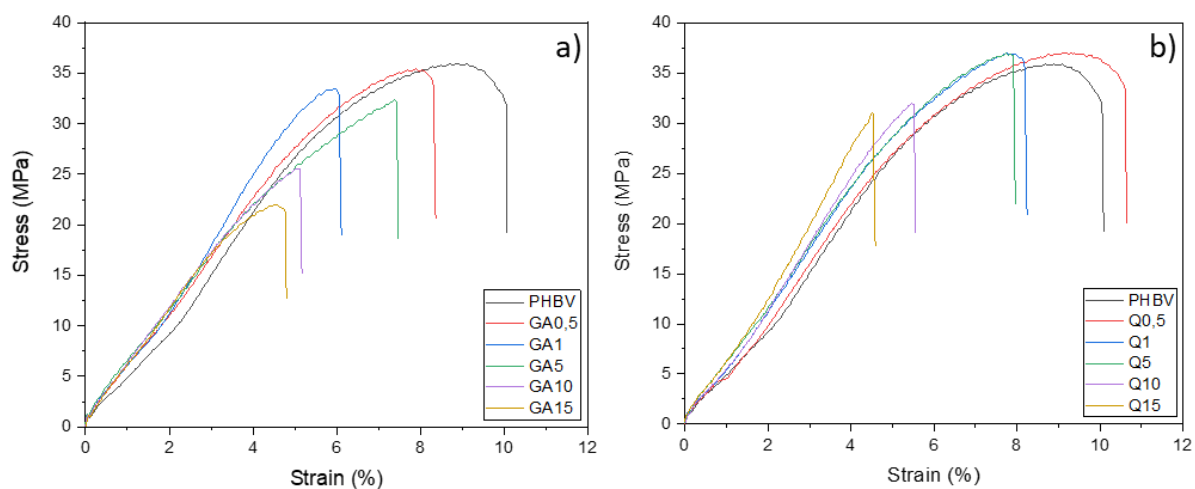
**Figure 37:** TGA curves for a) PHBV-Q films (full curve); a') PHBV-Q films (zoom between 260 and 290 °C); b) PHBV-GA films (full curve); b') PHBV-GA films (zoom between 100 and 300 °C)



**Figure 38:** DSC curves of PHBV-GA films, with a) the cool down from 200 °C to -30 °C  
b) the second heating ramp from -30 °C to 200 °C.



**Figure 39:** DSC curves of PHBV-Q films, with a) the cool down from 200 °C to -30 °C  
b) the second heating ramp from -30 °C to 200 °C.



**Figure 40:** Original stress-strain curves of (a) PHBV-GA films and (b) PHBV-Q films.



**Table 27:** Results from SEC, TGA and DSC analyses of PHBV powder, PHBV film and PHBV/polyphenols formulations.

Sample	Mw(kDa)	Mn (kDa)	Mw/Mn	Tonset (°C)	Tdeg (°C)	Tm (°C)	Xc (%)	Tc (°C)
PHBV powder	697 ± 7	294 ± 13	2.58	265 ± 1.3	298.0 ± 1.8	172.4 ± 0.4	73.1 ± 0.8	85.0 ± 0.6
PHBV	276 ± 7b	133 ± 9bc	2.08a	268.2 ± 0.1ab	300.8 ± 1.1a	176.6 ± 0.1a	82.0 ± 1.1a	124.4 ± 0.6a
Q0.5	279 ± 4ab	122 ± 1c	2.29a	269.2 ± 0.3a	300.6 ± 0.8a	175.5 ± 0.3b	79.5 ± 1.0b	117.5 ± 0.3b
Q1	294 ± 3a	153 ± 12abc	1.93ab	268.9 ± 0.7a	300.0 ± 1.0a	174.5 ± 0.4c	76.9 ± 0.8cd	110.1 ± 0.3d
Q5	285 ± 1ab	163 ± 3a	1.75b	267.6 ± 0.8abc	298.4 ± 0.7ab	171.9 ± 0.2e	74.9 ± 0.6d	106.3 ± 0.1e
Q10	275 ± 1b	156 ± 8ab	1.76b	266.8 ± 0.1bc	295.8 ± 0.8c	173.1 ± 0.5d	78.9 ± 0.6bc	116.2 ± 0.6c
Q15	290 ± 1a	149 ± 2abc	1.94ab	266.7 ± 0.9c	296.2 ± 1.0bc	173.9 ± 0.3cd	79.9 ± 0.9ab	117.8 ± 0.1b
PHBV	276 ± 7a'	133 ± 9a'	2.08a'b'	268.2 ± 0.1a'	300.8 ± 1.1a'	176.6 ± 0.1a'	82.0 ± 1.1a'	124.4 ± 0.6a'
GA0.5	257 ± 10a'b'	128 ± 10a'b'	2.01a'b'	268.7 ± 0.1a'	300.4 ± 0.7a'	175.9 ± 0.3a'	83.2 ± 0.6a'	123.0 ± 0.3b'
GA1	240 ± 3b'	112 ± 2b'	2.14 a'	268.2 ± 0.2a'	300.8 ± 0.8a'	174.7 ± 0.1b'	83.2 ± 0.5a'	121.9 ± 0.1c'
GA5	175 ± 2c'	94 ± 3c'	1.86 b'c'	263.5 ± 0.6b'	298.3 ± 0.2a'b'	164.6 ± 0.1c'	79.9 ± 0.7b'c'	109.5 ± 0.2f'
GA10	145 ± 2d'	75 ± 5d'	1.94 a'b'c'	258.1 ± 0.2c'	295.6 ± 1.7b'c'	165.5 ± 0.7c'	78.2 ± 0.7d'	111.8 ± 0.5e'
GA15	138 ± 4d'	80 ± 4c'd'	1.70 c'	254.3 ± 0.9d'	293.2 ± 0.9c'	164.9 ± 0.7c'	77.6 ± 0.5c'd'	113.4 ± 0.5d'
MGA1	274 ± 5	162 ± 5	1.68	269.3 ± 0.2	300.5 ± 1.0	174.7 ± 0.7	80.2 ± 3.1	120.9 ± 0.5
MGA5	286 ± 4	145 ± 9	1.97	267.6 ± 0.1	298.9 ± 1.1	172.1 ± 0.1	83.7 ± 4.4	109.9 ± 4.9

**Table 28:** Melt flow index measurements of PHBV, Q1, Q15, GA1 and GA15.

MFI measurements were carried out with Dynisco LMFI 55 (Heilbronn, Germany) using a 2.16 kg load at a temperature of 190 °C.

Sample	MFI (g/10min)
PHBV	4.28 ± 0.62
Q1	4.93 ± 0.70
Q15	5.15 ± 0.58
GA1	8.49 ± 1.14
GA15	N.D*

\* The viscosity of the GA15 was too low (liquid polymer at 190°C) to allow the MFI measurement.



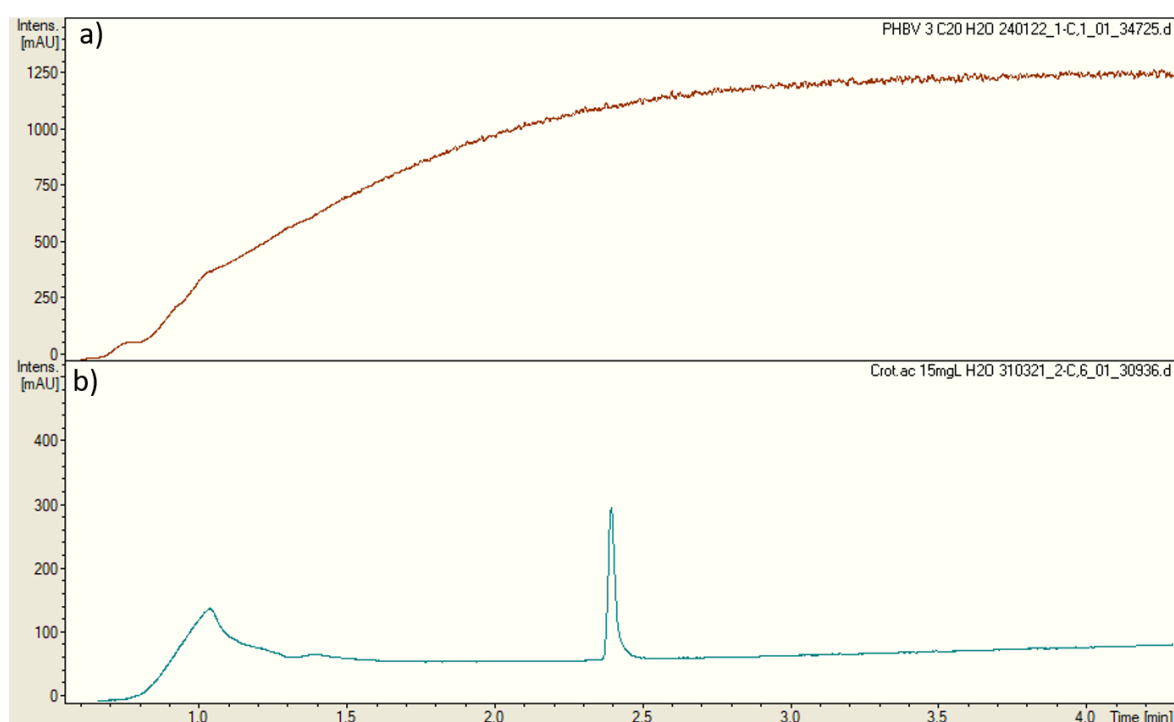
# APPENDIX 2

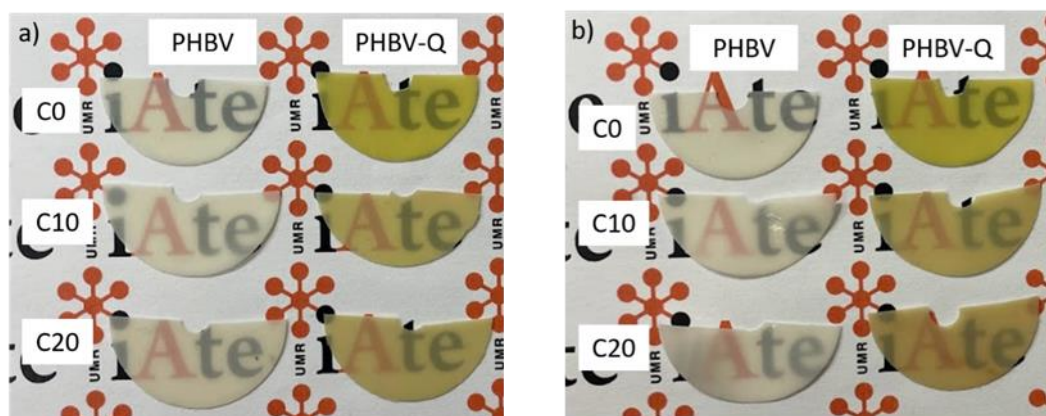
## Supporting information: Chapter 4

## PHBV-based polymers as food packaging: Physical-chemical and structural stability under reuse conditions

**Table 29:** Overall migration ( $\text{mg}\cdot\text{L}^{-1}$ ) of PHBV and PHBV-Q for full reuse cycle in 10 % EtOH and 3 % acetic acid.

Type of cycle	Using steps	PHBV	PHBV-Q	
		Overall migration $OM$ ( $\text{mg}\cdot\text{L}^{-1}$ )	Overall migration $OM$ ( $\text{mg}\cdot\text{L}^{-1}$ )	Quercetin part ( $\text{mg}\cdot\text{L}^{-1}$ )
10 % EtOH Complete reuse cycle	FS 1 – 10 % EtOH	$5.5 \pm 3.5$	$11.5 \pm 0.7$	$3.0 \pm 0.1$
	WL 1 - Detergent	$42.7 \pm 5.9$	$50.0 \pm 1.0$	$10.2 \pm 0.2$
	FS 2 – 10 % EtOH	$0.1 \pm 3.5$	$0.2 \pm 1.5$	$0.2 \pm 0.02$
3 % AcOH Complete reuse cycle	FS 1 – 3 % AcOH	$7.0 \pm 1.4$	$14.7 \pm 1.5$	$0.8 \pm 0.4$
	WL 1 - Detergent	$31.3 \pm 5.2$	$33.3 \pm 5.5$	$8.6 \pm 0.3$
	FS 2 – 3 % AcOH	$0.1 \pm 0.5$	$0.3 \pm 0.4$	$0.4 \pm 0.2$

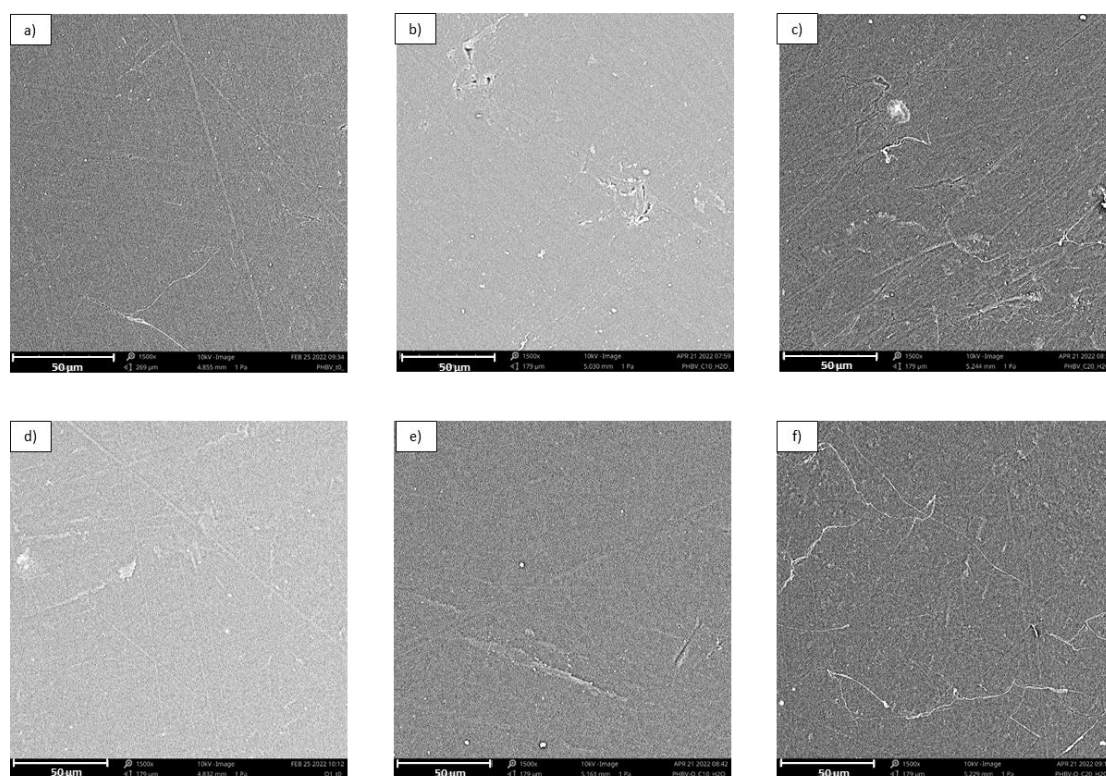
**Figure 41:** UV Chromatogram a) water washing media after 20 cycles at 210 nm b) solution of crotonic acid in water ( $15\text{mg}\cdot\text{L}^{-1}$ ) at 210 nm.



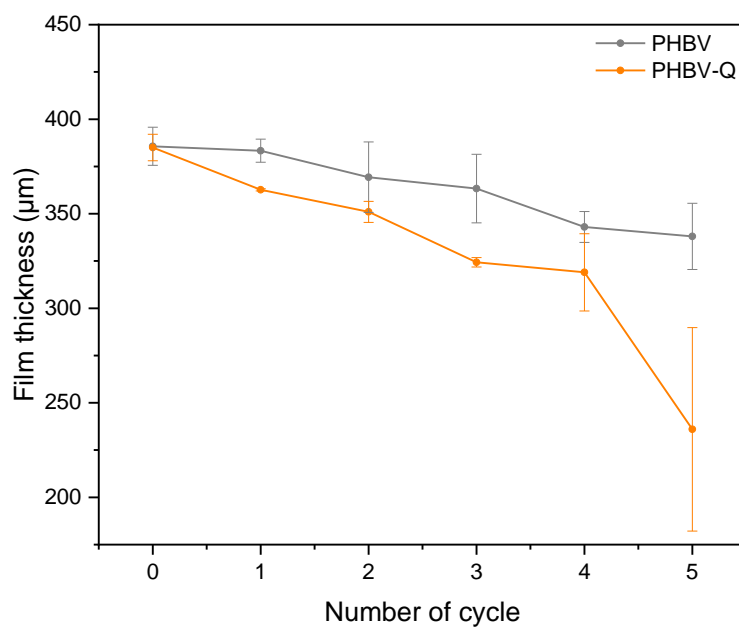
**Figure 42:** Pictures of PHBV and PHBV-Q films having undergone 0, 10 and 20 washing cycles in water (a) and detergent (b) media.

**Table 30:** DSC, ATG and SEC results of PHBV and PHBV-Q in function of the number of washing cycle in water and detergent.

H <sub>2</sub> O washing									
	Number of washing cycle	<i>T<sub>m</sub></i> (°C)	<i>X<sub>c</sub></i> (%)	<i>T<sub>c</sub></i> (°C)	<i>T<sub>onset</sub></i> (°C)	<i>T<sub>deg</sub></i> (°C)	<i>M<sub>n</sub></i> (kDa)	<i>M<sub>w</sub></i> (kDa)	<i>I = M<sub>w</sub>/M<sub>n</sub></i>
PHBV	0	176.6 ± 0.1 <sup>a</sup>	82.1 ± 1.1 <sup>a</sup>	124.4 ± 0.6 <sup>a</sup>	268.2 ± 0.1 <sup>a</sup>	300.9 ± 1.2 <sup>a</sup>	133.4 ± 9.1 <sup>a</sup>	276.4 ± 7.6 <sup>a</sup>	2.0 ± 0.1 <sup>a</sup>
	10	176.1 ± 0.4 <sup>a</sup>	82.9 ± 0.4 <sup>a</sup>	123.3 ± 0.2 <sup>b</sup>	269.2 ± 0.3 <sup>b</sup>	299.7 ± 3.5 <sup>a</sup>	95.8 ± 5.5 <sup>b</sup>	159.1 ± 6.8 <sup>b</sup>	1.6 ± 0.1 <sup>b</sup>
	20	175.5 ± 0.3 <sup>b</sup>	83.9 ± 0.1 <sup>b</sup>	123.2 ± 0.1 <sup>b</sup>	269.3 ± 0.2 <sup>b</sup>	301.8 ± 0.3 <sup>a</sup>	101.8 ± 3.9 <sup>b</sup>	170.3 ± 6.0 <sup>b</sup>	1.7 ± 0.1 <sup>b</sup>
PHBV-Q	0	174.5 ± 0.4 <sup>a'</sup>	76.9 ± 0.8 <sup>a'</sup>	110.1 ± 0.3 <sup>a'</sup>	268.9 ± 0.8 <sup>a'</sup>	300.0 ± 1.0 <sup>a'</sup>	153.2 ± 12.2 <sup>a'</sup>	294.5 ± 2.9 <sup>a'</sup>	1.9 ± 0.1 <sup>a'</sup>
	10	173.1 ± 0.4 <sup>b'</sup>	77.2 ± 0.9 <sup>a'</sup>	108.3 ± 1.2 <sup>b'</sup>	268.0 ± 0.6 <sup>a'</sup>	298.8 ± 0.6 <sup>a'</sup>	115.7 ± 2.0 <sup>b'</sup>	237.7 ± 5.5 <sup>b'</sup>	2.1 ± 0.1 <sup>a'</sup>
	20	173.0 ± 0.2 <sup>b'</sup>	77.5 ± 1.1 <sup>a'</sup>	108.4 ± 0.7 <sup>b'</sup>	268.2 ± 0.3 <sup>a'</sup>	298.8 ± 0.3 <sup>a'</sup>	117.5 ± 1.6 <sup>b'</sup>	234.2 ± 3.2 <sup>b'</sup>	1.9 ± 0.1 <sup>a'</sup>
Detergent washing									
	Number of washing cycle	<i>T<sub>m</sub></i> (°C)	<i>X<sub>c</sub></i> (%)	<i>T<sub>c</sub></i> (°C)	<i>T<sub>onset</sub></i> (°C)	<i>T<sub>deg</sub></i> (°C)	<i>M<sub>n</sub></i> (kDa)	<i>M<sub>w</sub></i> (kDa)	<i>I = M<sub>w</sub>/M<sub>n</sub></i>
PHBV	0	176.6 ± 0.1 <sup>a</sup>	82.1 ± 1.1 <sup>a</sup>	124.4 ± 0.6 <sup>a</sup>	268.2 ± 0.1 <sup>a</sup>	300.9 ± 1.2 <sup>a</sup>	133.4 ± 9.1 <sup>a</sup>	276.4 ± 7.6 <sup>a</sup>	2.0 ± 0.1 <sup>a</sup>
	10	174.6 ± 0.7 <sup>b</sup>	84.1 ± 0.2 <sup>b</sup>	123.9 ± 0.2 <sup>a</sup>	262.2 ± 0.7 <sup>b</sup>	298.3 ± 0.9 <sup>b</sup>	109.2 ± 2.6 <sup>b</sup>	212.4 ± 2.0 <sup>b</sup>	1.9 ± 0.1 <sup>a</sup>
	20	173.5 ± 0.7 <sup>b</sup>	83.6 ± 0.4 <sup>ab</sup>	123.2 ± 0.5 <sup>a</sup>	257.6 ± 0.8 <sup>c</sup>	295.9 ± 2.0 <sup>b</sup>	84.5 ± 3.1 <sup>c</sup>	163.5 ± 2.5 <sup>c</sup>	1.9 ± 0.1 <sup>a</sup>
PHBV-Q	0	174.5 ± 0.4 <sup>a'</sup>	76.9 ± 0.8 <sup>a'</sup>	110.1 ± 0.3 <sup>a'</sup>	268.9 ± 0.8 <sup>a'</sup>	300.0 ± 1.0 <sup>a'</sup>	153.2 ± 12.0 <sup>a'</sup>	294.5 ± 2.9 <sup>a'</sup>	1.9 ± 0.1 <sup>a'</sup>
	10	171.8 ± 0.7 <sup>b'</sup>	77.2 ± 0.5 <sup>a'</sup>	107.8 ± 0.8 <sup>b'</sup>	263.3 ± 3.1 <sup>b'</sup>	296.3 ± 2.6 <sup>b'</sup>	121.1 ± 2.7 <sup>b'</sup>	227.6 ± 2.4 <sup>b'</sup>	1.9 ± 0.1 <sup>a'</sup>
	20	169.9 ± 0.6 <sup>c'</sup>	76.1 ± 0.6 <sup>a'</sup>	105.6 ± 0.3 <sup>c'</sup>	256.8 ± 2.5 <sup>c'</sup>	294.8 ± 1.5 <sup>b'</sup>	94.5 ± 3.7 <sup>c'</sup>	186.6 ± 6.0 <sup>c'</sup>	1.9 ± 0.1 <sup>a'</sup>

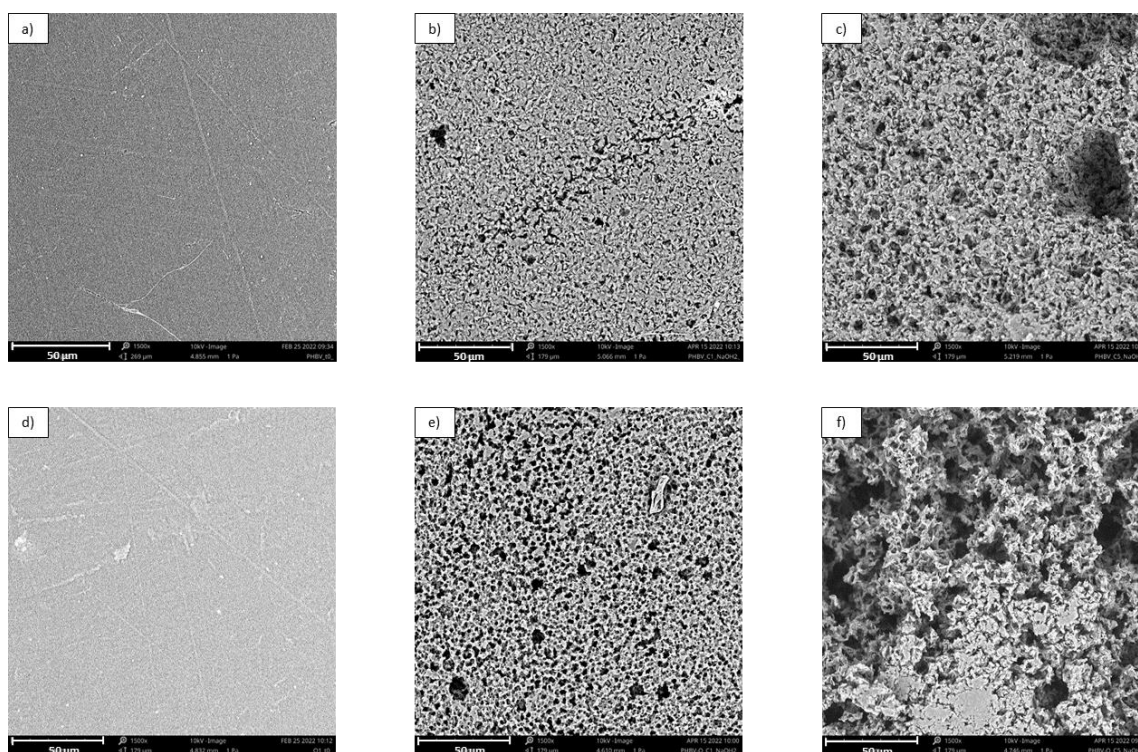


**Figure 43:** SEM images of PHBV and PHBV-Q films having undergone 0, 10 and 20 washing cycles in water, a) PHBV C0, b) PHBV C10, c) PHBV C20, d) PHBV-Q C0, e) PHBV-Q C10, f) PHBV-Q C20 (x1500 magnification).



**Figure 44:** Evolution of the film thickness in function of the number of washing cycle in a 2 wt% NaOH solution.





**Figure 45:** SEM images of PHBV and PHBV-Q films after 1 and 5 washing cycles with an aqueous solution of 2 wt% NaOH a) PHBV C0, b) PHBV C1, c) PHBV C5, d) PHBV-Q C0, e) PHBV-Q C1, f) PHBV-Q C5 (x1500magnificence). C1 corresponds to 1 cycle and C5 to 5 cycles.

**Table 31:** The evolution of  $T_m$ ,  $T_c$ ,  $X_c$ ,  $T_{onset}$  and  $M_w$  of PHBV and PHBV-Q films after 1 and 5 washing cycles in aqueous solutions of 2wt% NaOH.

2 wt% NaOH						
	Number of washing cycle	$T_m$ (°C)	$X_c$ (%)	$T_c$ (°C)	$T_{onset}$ (°C)	$M_w$ (kDa)
PHBV	0	$176.6 \pm 0.1^a$	$82.1 \pm 1.1^a$	$124.4 \pm 0.6^a$	$268.2 \pm 0.1^a$	$276.3 \pm 7.6^a$
	1	$174.6 \pm 0.1^b$	$84.2 \pm 0.5^b$	$124.1 \pm 0.5^a$	$258.1 \pm 1.1^b$	$234.1 \pm 3.3^b$
	5	$174.0 \pm 0.1^c$	$85.5 \pm 0.5^b$	$123.6 \pm 0.5^a$	$256.3 \pm 11.2^b$	$246.3 \pm 14.6^b$
PHBV-Q	0	$174.5 \pm 0.4^{a'}$	$76.9 \pm 0.8^{a'}$	$110.1 \pm 0.3^{a'}$	$268.9 \pm 0.8^{a'}$	$294.5 \pm 2.3^{a'}$
	1	$173.3 \pm 0.1^{b'}$	$81.8 \pm 0.5^{b'}$	$108.6 \pm 0.2^{b'}$	$255.9 \pm 10.1^{b'}$	$302.8 \pm 6.2^{b'}$
	5	$160.6 \pm 5.1^{c'}$	$80.6 \pm 1.7^{b'}$	$106.4 \pm 1.8^{b'}$	$217.1 \pm 24.4^{c'}$	$269.1 \pm 14.6^{c'}$







---

Les emballages alimentaires à base de PHA dans un contexte d'économie circulaire : Etude de l'effet des polyphénols sur la stabilité du PHBV au cours des différentes étapes de son cycle de vie.

---

L'utilisation de plastiques biosourcés et biodégradables comme substituts aux plastiques conventionnels, dans le domaine de l'emballage alimentaire, est une alternative pour réduire significativement la pollution plastique. De plus, l'intégration de ces plastiques biodégradables dans un cycle vertueux de ré-usage et de recyclage, préserverait les ressources en matières premières et permettrait d'exploiter la valeur maximale du produit. Cependant, ces plastiques sont souvent peu compétitifs, en raison de leur instabilité thermique. L'objectif de ces travaux de thèse est d'étudier l'impact de molécules naturelles, les polyphénols, sur la stabilisation potentielle d'un biopolyester issu de synthèses microbiennes, et biodégradable en conditions naturelles, le PHBV (Poly(3-hydroxybutyrate-co-3-hydroxyvalérate)). L'effet stabilisant de la quercétine et de l'acide gallique est étudié au cours des différentes étapes du cycle de vie d'un emballage alimentaire, de la formulation, à la biodégradation, en passant par le ré-usage et le recyclage. Les deux questions scientifiques majeures auxquelles cette thèse tente de répondre sont les suivantes : (i) Quelles sont les interactions/relations entre les polyphénols et le PHBV lors des différentes étapes du cycle de vie de l'emballage alimentaire ? (ii) Quel est l'impact des polyphénols sur la stabilité du PHBV au cours de ces différentes étapes ? La première partie de cette thèse, est consacrée à évaluer la capacité des polyphénols (en termes de quantité et de structure chimique) à apporter une stabilisation à la matrice polymère. La seconde partie traite de l'influence des polyphénols sur l'évolution structurale (macro- et microscopique) du PHBV au cours des étapes d'usage/ré-usage, et de recyclage mécanique. Enfin, le maintien de la biodégradabilité du PHBV, en présence des polyphénols, est évalué, dans une dernière partie.

Mots-clés : polyester biodégradable, polyphénols, PHBV, stabilité, emballage alimentaire, cycle de vie.

---

PHA based food packaging in a circular economy context: Impact of polyphenols on the PHBV stability during the different stages of its life cycle.

---

The use of biosourced and biodegradable plastics as substitutes for conventional plastics in food packaging, is an alternative to significantly reduce plastic pollution. Moreover, the integration of these biodegradable plastics into a virtuous cycle of reuse and recycling would preserve raw material resources, and exploit the maximum value of the product. However, these plastics are often uncompetitive due to their thermal instability. The objective of this thesis is to study the impact of natural molecules; polyphenols, on the potential stabilization of a biopolyester derived from microbial synthesis, and biodegradable under natural conditions, PHBV (Poly(3-hydroxybutyrate-co-3-hydroxyvalérate)). The stabilizing effect of quercetin and gallic acid is studied during the different stages of the life cycle of a food packaging, from formulation to biodegradation, through reuse and recycling. The two major scientific questions that this thesis attempts to answer are: (i) What are the interactions/relationships between polyphenols and PHBV during the different stages of the life cycle of a food packaging? (ii) What is the impact of polyphenols on the stability of PHBV during these different stages? The first part of this thesis is devoted to the evaluation of the capacity of polyphenols (in terms of quantity and chemical structure) to bring stabilization to the polymer matrix. The second part deals with the influence of polyphenols on the structural evolution (macro- and microscopic) of PHBV during the use/reuse and mechanical recycling stages. Finally, the maintenance of the biodegradability of PHBV, in the presence of polyphenols, is evaluated, in a last part.

Keywords: biodegradable polyester, polyphenols, PHBV, stability, food packaging, lifecycle.