



HAL
open science

Ecology and evolution of evasive mimicry in butterflies : insights from the diverse Neotropical genus *Adelpha*

Erika Páez Vargas

► To cite this version:

Erika Páez Vargas. Ecology and evolution of evasive mimicry in butterflies : insights from the diverse Neotropical genus *Adelpha*. Animal biology. Sorbonne Université, 2022. English. NNT : 2022SORUS187 . tel-04140266

HAL Id: tel-04140266

<https://theses.hal.science/tel-04140266v1>

Submitted on 25 Jun 2023

HAL is a multi-disciplinary open access archive for the deposit and dissemination of scientific research documents, whether they are published or not. The documents may come from teaching and research institutions in France or abroad, or from public or private research centers.

L'archive ouverte pluridisciplinaire **HAL**, est destinée au dépôt et à la diffusion de documents scientifiques de niveau recherche, publiés ou non, émanant des établissements d'enseignement et de recherche français ou étrangers, des laboratoires publics ou privés.

Sorbonne Université

École Doctorale Sciences de la Nature et de l'Homme – ED 227

Institut de Systématique, Évolution, Biodiversité UMR7205 – Équipe

Biodiversité : Interactions, Adaptation, Spéciation

Ecology and evolution of evasive mimicry in butterflies: insights from the diverse Neotropical genus *Adelpha*

Par **Erika Estefanía Páez Vargas**

Thèse de doctorat de Biologie évolutive

Dirigée par **Marianne Elias et Keith Willmott**

Présentée et soutenue publiquement le 24 juin 2022

Devant un jury composé de :

Tony ROBILLARD, Professeur au MNHN	Président
Bibiana ROJAS, Assistant Professor at VetMedUni	Rapportrice
Gaël KERGOAT, Directeur de Recherche à INRAE	Rapporteur
André VL FREITAS, Principal investigator at UNICAMP	Examineur
Mónica ARIAS, Cadre de Recherche au CIRAD	Examinatrice
Marianne ELIAS, Directrice de Recherche au CNRS	Co-directrice
Keith R WILLMOTT, Principal investigator at University of Florida	Co-directeur



Dedico este trabajo a Amanda, quien me inspira cada día a ser un agente de transformación

Acknowledgments

I want to express my sincere gratitude to the members of the jury Tony Robillard, Bibiana Rojas, Gaël Kergoat, Mónica Arias and André Freitas for accepting to evaluate this dissertation. I admire your research and I hope you enjoy reading this thesis which has been extremely enriching for me these last 4 years.

I would like to thank to my supervisors Marianne Elias and Keith Willmott, without them this work would not have been possible.

I will switch to spanish, luckily both of my supervisors speak fluently Spanish!

Marianne, muchas gracias por permitirme formar parte de tu equipo. Realmente te admiro como investigadora, has sido una guía super importante en estos 4 años. Estoy agradecida por haberte tenido como directora de tesis, porque a parte de tu gran nivel académico, tu calidez humana ha hecho menos pesado el camino del PhD.

Keith, muchas gracias por el tiempo invertido en mi tesis y darme la confianza desde el primer día que trabajé contigo, hace ya casi 10 años en Yasuní! Tu pasión por las mariposas y el trabajo de campo es inspiradora.

I would like to warmly thank to the members of the lab, I always felt welcome and I really enjoyed being part of the team, despite COVID took us the opportunity to share more moments outside the lab: Violaine, Vincent, Sylvain Raphael, Céline and to my co-doctorants Violaine (it was really nice to share in the field with you), Mäel (many thanks for your help with the analyses in R!), Ludo, Ariane, Pierre and Agathe. To Camille, Lea and Ombeline who were part of the lab as well, when I arrived.

Specially, I would like to thank Charline, for welcoming me in her house during the last months of the thesis. I wish you all the best and you are always welcome to Ecuador!

También quiero agradecer a todas las personas que han compartido conmigo a lo largo del doctorado. A mis amigos, a pesar de la distancia, desde diferentes partes del planeta han sido un gran apoyo en los momentos más duros de la tesis: Andre, Nelly, Daniel, Pablito, Chovi, Cami, Carlita. A las Chicas en Paris, Karen y Lili, gracias por los momentos lindos, por los viernes de “pola” y aportar el calor del sur a mi vida en estas tierras. A los nuevos amigos y amigas por acá, Lenard, Alexandra, Cyril, Mary, Isabel, Iván, Romain, Ana, Sara M, Dani, Patty, Laurence y Mathias Koch, siempre dispuestos a ayudar y de quienes me llevo muchos lindos recuerdos, muchas gracias por su cariño y por los momentos compartidos.

A Carlita, Sofi, Sebas, Kari, Eli, Daniela, por su aporte en el campo y museo (y muchas fotos Sebas!) para esta tesis. Nicolas Chazot, merci pour tout l’aide avec les analyses et dernier minute plots !

Y finalmente, pero no menos importante, quiero agradecer a mi familia, Abuelita Georgia, Mami, Pa, Marita, Fabio, Lili, Paul, quienes siempre me han apoyado de diferentes maneras y en diferentes momentos en este proyecto. Por darme las fuerzas para seguir adelante en los momentos más difíciles y celebrar siempre todos mis logros. Gracias por estar siempre para mí y para la Amandi. A Andrés, gracias por todo el apoyo desde el inicio para hacer realidad este proyecto. A Nancy y María Elena Moscoso gracias por su cariño y de igual manera por el apoyo a lo largo de estos años. A Gaby y Manu, mi familia acá en Francia, quienes siempre nos recibieron con los brazos abiertos.

El cansancio de los últimos días me gana, espero no haberme olvidado de nadie!

Mi gratitud infinita a mi Amandi, por su comprensión, su amor, por soportar mis ausencias y stress de la tesis y por darme siempre luz.

Y gracias al bosque y a las mariposas! quienes despertaron mi interés por la biología.

TABLE OF CONTENTS

TABLE OF CONTENTS.....	1
GENERAL INTRODUCTION.....	3
1 Biodiversity.....	3
1.1 <i>Biodiversity patterns and underlying processes.....</i>	<i>3</i>
1.2 <i>Traits.....</i>	<i>5</i>
1.3 <i>Biodiversity in the Neotropical region.....</i>	<i>6</i>
2 Neotropical butterflies.....	7
2.1 <i>Patterns of diversity of Neotropical butterflies.....</i>	<i>7</i>
2.2 <i>Wing colour patterns.....</i>	<i>8</i>
3 Aposematism and Mimicry.....	12
3.1 <i>Classical aposematism and mimicry.....</i>	<i>13</i>
3.2 <i>An overlooked aposematism, and evasive mimicry.....</i>	<i>16</i>
3.3 <i>Can a conspicuous colour pattern associated with difficulty of capture be considered as an aposematic signal?.....</i>	<i>20</i>
4 The Neotropical genus <i>Adelpha</i> as a case study.....	22
4.1 <i>General description.....</i>	<i>22</i>
4.2 <i>Mimicry in <i>Adelpha</i>.....</i>	<i>24</i>
4.3 <i>Systematics and taxonomic problems.....</i>	<i>28</i>
QUESTIONS AND OBJECTIVES.....	32
<i>References.....</i>	<i>35</i>
CHAPTER I - EMPIRICAL TESTING OF EVASIVE MIMICRY.....	59
<i>Abstract.....</i>	<i>59</i>
<i>Background.....</i>	<i>60</i>
<i>Materials and Methods.....</i>	<i>61</i>
<i>Results.....</i>	<i>67</i>
<i>Discussion.....</i>	<i>71</i>
<i>Conclusion.....</i>	<i>75</i>
<i>References.....</i>	<i>76</i>
<i>Supplementary material.....</i>	<i>83</i>
CHAPTER II - MIMICRY AND SPECIES DIVERSIFICATION.....	94
<i>Introduction.....</i>	<i>95</i>
<i>Materials and Methods.....</i>	<i>97</i>
<i>Results.....</i>	<i>102</i>
<i>Discussion.....</i>	<i>109</i>
<i>Conclusion.....</i>	<i>115</i>
<i>References.....</i>	<i>117</i>
<i>Supplementary material.....</i>	<i>127</i>
CHAPTER III – SPATIAL STRUCTURE OF DIVERSITY.....	155
<i>Introduction.....</i>	<i>156</i>
<i>Materials and methods.....</i>	<i>161</i>
<i>Results.....</i>	<i>167</i>
<i>Discussion.....</i>	<i>176</i>
<i>Conclusion.....</i>	<i>182</i>

2 General Introduction

<i>References</i>	183
<i>Supplementary material</i>	197
GENERAL DISCUSSION AND PERSPECTIVES	204
<i>The existence of evasive mimicry</i>	206
<i>Evasive mimicry versus classical mimicry</i>	212
<i>Mimicry implications for diversification</i>	216
<i>Conclusion</i>	223
<i>References</i>	225



GENERAL INTRODUCTION

1 Biodiversity

Biological diversity, or “biodiversity”, is the variety of organisms considered at all levels, from genetic variants of a single species through arrays of species to arrays of genera, families and higher taxonomic levels as well. It comprises the variety of ecosystems, which includes both the communities of organisms within specific habitats and the physical conditions under which they live (Lincon, Boxshall, and Clarck 1998; E. O. Wilson 1988). Biodiversity also reflects the diversity of interactions, such as those between individuals and species which coexist in space and time, but also interactions between genes. This term was introduced in 1985 by Walter G. Rosen for the “National Forum on BioDiversity” but was popularised by Edgar O. Wilson from a conservation perspective. He drew attention to species loss, and in particular the accelerated loss of species caused by human activities (E. O. Wilson 1988).

Since then, the description of biodiversity patterns and the mechanisms driving these patterns have been of interest for biologists and naturalists. Determining the status of biodiversity also facilitates predictions about the effects of climate change and the implementation of strategic decisions for conserving biodiversity.

1.1 Biodiversity patterns and underlying processes

A multi-level approach to understand contemporary global patterns of biodiversity is necessary because ecological and evolutionary processes take place at local scales, where interactions occur, and generate large scale patterns.

Processes at a local scale can be categorised as follows:

- Based on specific interactions: i) *intra-guild species interactions* such as competition, which may lead to niche partitioning (Macarthur and Levins 1967; Stubbs and Wilson 2004), reproductive interference (Brown and Wilson 1956; Grant and Grant 2006; Gröning and Hochkirch 2008; Hochkirch, Gröning, and Bücken 2007), mutualism such

4 General Introduction

as Müllerian (mutualistic) mimicry (Chazot et al. 2014; Hale, Valdovinos, and Martinez 2020), group foraging, among others. ii) *inter-guild species interactions* such as predation, parasitism (e.g., Batesian [parasitic] mimicry, mutualism (e.g., pollination or facilitation)(Antonelli and Sanmartín 2011; Okuyama and Holland 2008);

- Adaptive (other than specific interactions), such as habitat (environmental) filtering (Ackerly 2003; Woodward and Diament 1991);
- Non-adaptive, such as random dispersal (Hubbell 2001).

Analogously, micro-evolutionary processes include speciation and ongoing adaptive radiation (Davis Rabosky et al. 2016). These processes are generated by a range of mechanisms, such as vicariance (Mayr 1942) and divergent selection (Nosil 2012).

Conversely, macro-ecological (e.g., large-scale statistical studies of emergent ecological patterns across species, such as species distributions in relation to environment and historical mechanisms) (Cadle and Greene 1993; Ricklefs and Latham 1993; J. A. Wiens 1991) and macro-evolutionary processes and patterns (e.g., diversification, functional trait co-evolution, niche evolution) (Clavel and Morlon 2017; Condamine et al. 2012; Jetz et al. 2012; Kunte, Kizhakke, and Nawge 2021; Ortiz-Acevedo et al. 2020; Da Silva, Rylands, and Da Fonseca 2005), are viewed through the perspective of geological time, across higher taxonomic units or lineages and in relation to a variety of factors (e.g. paleo-temperatures, paleo-altitude of mountains, paleo-sea level).

The increasing availability of phylogenetic and trait data for communities has fueled research that integrates ecological and evolutionary processes (Cavender-Bares et al. 2004; Chazot et al. 2014; Graham et al. 2009; Qian, Ricklefs, and Thuiller 2021). Many communities are phylogenetically structured, exhibiting nonrandom patterns of evolutionary relatedness among constituent species (Webb et al. 2002). Several indices have been developed to measure the phylogenetic structure of communities such as the community differentiation coefficients Ist , Pst and $IIst$ of Hardy & Senterre (2007), or the net relatedness index NRI (Webb 2000). Webb *et al.* (2002) proposed a framework for inferring the processes that shape the community structure using the phylogenetic relatedness of species as a proxy for their ecological similarity; in other words, recently diverged taxa tend to be ecologically similar (Darwin 1859; Lord, Westoby, and Leishman 1995; J. J. Wiens and Graham 2005). This framework focuses on two ecological processes: i) habitat filtering, whereby species with specific adaptations occur in a given habitat; and ii) competitive exclusion, the limitation of coexistence of ecologically similar

species. Ecological processes combined with the phylogenetic distribution of traits underlying species interaction or local adaptation, either conserved or convergent, lead to a particular phylogenetic structure of communities, as illustrated in the following table.

	Phylogenetic distribution of traits	
<i>Ecological process</i>	<i>Conserved</i>	<i>Convergent</i>
Habitat filtering	Clustered	Overdispersed
Competition	Overdispersed	Random

However, this framework only applies to certain types of ecological processes, such as intra-guild competition and habitat filtering, overlooking other kinds of intra-guild interactions such as facilitation, multispecies foraging and Müllerian mimicry that can influence species assemblages (DeVries *et al.*, 1999; Elias *et al.*, 2008, 2009; Doré *et al.* submitted). Chazot *et al.* (2014) showed that, despite strong filtering by altitude, communities of Müllerian mimetic butterflies, where multiple defended species converge in their wing colour patterns, are also shaped by those mutualistic interactions.

1.2 Traits

A trait can be defined as “a variable measured on an organism at any scale, from gene to whole organism and which can be scaled up from individuals to genotype, population, species, or community” (Volaire, Gleason, and Delzon 2020). Species traits can be phenological (e.g., timing of breeding, flowering in plants), morphological (e.g., body mass, wing shape, colour), physiological (e.g., thermal tolerance, stoichiometry), reproductive (e.g., age maturity) or behavioural (e.g., migration routes).

Traits underlie most processes that shape biodiversity, such as interactions (e.g., pollination syndrome and fruit type facilitate mutualisms between bellflowers [Campanulaceae] and pollinators [bees and hummingbirds] [Lagomarsino *et al.*, 2016]); adaptation to a given habitat (e.g., Darwin’s finches in the Galapagos Islands exhibit different beak shapes associated with different alimentary regimes [Grant, 1999]); dispersal (e.g., in flying insects, wing length and thorax size are connected with flight ability and dispersal [Chai & Srygley, 1990]); and speciation (e.g., wing patterns as mate recognition signal in Lycaenidae lead to assortative mating [Fordyce *et al.*, 2002]). Therefore, studying trait diversity and evolution is necessary to fully understand the processes that shape biodiversity.

1.3 Biodiversity in the Neotropical region

It is well established that biodiversity on Earth is unevenly distributed. The Neotropical region is the most biologically diverse of the world's major biogeographic regions (Gaston and Hudson 1994; Hawkins et al. 2007; Myers et al. 2000). It extends from Mexico to northern Argentina, including the Amazon basin, the tropical Andean cordillera and the Atlantic forest. Two main explanations are available for understanding the origin and diversification of extant Neotropical biodiversity. A primary hypothesis suggests that diversity is the result of *in situ* speciation (Gentry 1982; Raven and Axelrod 1974; Simpson and Haffer 1978), while an alternative hypothesis suggests that an important part of the extant diversity can be explained by *ex situ* origins and dispersal of the taxa into the Neotropics (Antonelli *et al.* 2009; Erkens, Maas, and Couvreur 2009; Hughes and Eastwood 2006). On the other hand, two hypothetical models are available for the mode of diversification: the “museum model” and the “evolutionary cradles model”. The first model states that diversity in the Neotropics has been shaped by a gradual accumulation and/or preservation of species over time via constant speciation rates and/or low extinction rates (e.g., Wallace, 1878; Stebbins, 2013; Bruun-Lund *et al.*, 2018). The “evolutionary cradles model” postulates that diversity is the result of recent and rapid accumulation of species via high speciation rates (e.g., Richardson *et al.*, 2001; Pennington *et al.*, 2015).

Moreover, even within the Neotropical region, there are marked spatial gradients in species richness, including an increase in species richness from higher latitudes towards the equator, one of the most prevalent patterns in ecology (Brown and Lomolino 1998; Hillebrand 2004; Willig, Kaufman, and Stevens 2003) referred to as the latitudinal diversity gradient (LDG) (figure 1). The great increase in biological diversity towards the equator was noticed by naturalists in the mid-1800s (Darwin 1859; Wallace 1878), and since then similar spatial patterns of species richness have been described in the Neotropics across many taxonomic groups including plants (Antonelli and Sanmartín 2011), fishes (Albert, Petry, and Reis 2011), birds (Hawkins et al. 2007; Weir 2006) and mammals (Patterson and Upham 2014; Villalobos, Rangel, and Diniz-Filho 2013). In the case of butterflies, more than 7000 species are found in the Neotropical region, which represents 40% of the world's species (Lamas, 2004).

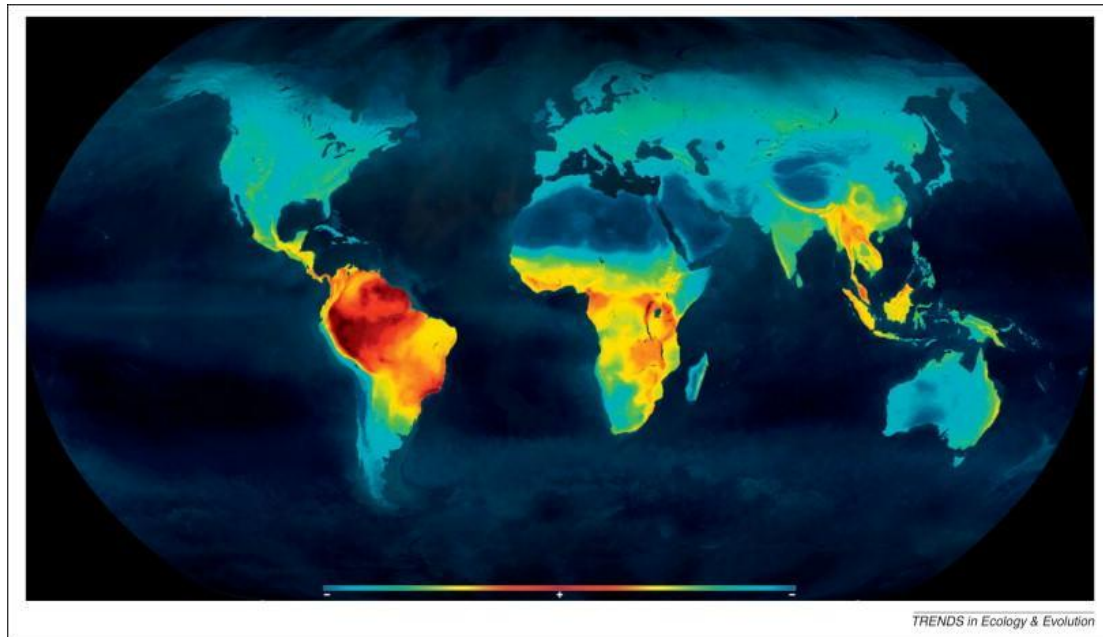

Figure 1. Example of latitudinal biodiversity gradient (extant terrestrial vertebrate) showing that diversity is concentrated in the equatorial regions and declines polewards. Figure from Mannion *et al* 2013.

2 Neotropical butterflies

2.1 Patterns of diversity of Neotropical butterflies

The Neotropics harbours one of the worldwide's biodiversity hotspots, the Tropical Andes (Myers *et al.* 2000) (figure 2). In montane regions, an ecological gradient related to altitude is often expected: species richness should decrease as elevation increases (Brown and Lomolino 1998; Rahbek 1995). In practice, different patterns can be encountered: species richness can increase and sometimes decrease with altitude, but the most common pattern at mesoscales involves a peak of species richness at mid-elevation (e.g., Orme *et al.*, 2005; Grenyer *et al.*, 2006; Grytnes & McCain, 2007; Despland *et al.*, 2012). In the Tropical Andes, the diversity of butterflies' peaks along the eastern slopes on the Andes, at the interface with the Amazonian basin (e.g., Willmott, 2003; Chazot *et al.*, 2016). Several works on diversification of Lepidoptera, and more specifically on butterflies, have focused in this region (Adams 1985; Casner and Pycrz 2010; Descimon 1986; M. Elias *et al.* 2009; Hall 2005; De-Silva *et al.* 2017; Matos-Maraví *et al.* 2013; Pycrz *et al.* 2014; Willmott, Hall, and Lamas 2001), because the Tropical Andes is the world's most biodiverse montane region for these organisms, containing at least 4000 butterfly species (Pycrz *et al.* 2014). A common pattern observed among Neotropical butterflies is that of diverse taxa with a large distribution throughout all Neotropical latitudes that possess their richness-peak in foothill-lower montane regions. For example, butterflies from the genus *Actinote* (Nymphalidae: Heliconiinae:

Acraeini) occur from southern Mexico to northern Argentina (Lamas 2004; Neild 2008; Willmott *et al.* 2009; Willmott, Lamas, and Hall 2017) and the genus reaches its greatest species richness in the montane areas of south-eastern Brazil (Lamas 2004; Paluch, Casagrande, and Mielke 2006; Silva-Brandão *et al.* 2008). Similarly, butterflies from the tribe Ithomiini (Nymphalidae: Danainae) which is distributed from Mexico to Argentina as well (Beccaloni 1995; Chazot, Willmott, *et al.* 2019; Lamas 2004; Willmott and Lamas 2007), present their highest diversity along the eastern slopes of the Tropical Andes (Chazot *et al.* 2016; Doré *et al.* submitted).

A broader study (Pyrzcz *et al.* 2014) that included different montane Lepidoptera taxonomic groups, including Ithomiini, Acraeini, Callicorini, Pronophilina, Aporiina, *Leptophobia*, *Penaincisalia*, and *Erateina* (Geometridae), also reported an uneven distribution of species richness in the tropical Andes across latitudes. Pyrcz *et al.* (2014) suggested that the observed peak in species richness at 3–11°S is the result of multiple factors, such as geological age of the Andes, area, and climatic seasonality; with age explaining patterns in the north and seasonality in the south Andes.

Ecological and phenotypic features of butterflies presumably play a key role in diversification. For example, the interaction between butterflies and plants has been extensively documented and studied among butterflies (Allio *et al.* 2021; Edger *et al.* 2015). Historical host plant shifts have been shown to precede increases in diversification rate in several lineages (Ebel *et al.* 2015; Fordyce 2010; Janz and Nylin 2008), and such increases in diversification may have been caused by adaptive radiations (Dres and Mallet 2002; Ehrlich and Raven 1964; Janz, Nylin, and Wahlberg 2006; Sahoo *et al.* 2017). Additionally, other ecological features such as wing colour patterns have proven to have a crucial role on diversification among lineages, being involved in intra- and inter-specific interactions and speciation (e.g., Lycaenidae [J. A. Fordyce *et al.* 2002; Lukhtanov *et al.* 2005]; *Heliconius* [Chris D. Jiggins *et al.* 2001, 2006]).

2.2 Wing colour patterns

The remarkable diversity of animal colour patterns has been a popular subject of research for centuries (Caro 2017) (figure 2). Darwin's and Wallace's observations (Darwin 1880; Wallace 1877) have encouraged a vast body of research on colour patterns and the role they might play in the evolution of insects (Berthier 2005; Grimaldi and Engel 2005; Jiggins *et al.* 2001; Kemp 2007; Mallet and Gilbert 1995).

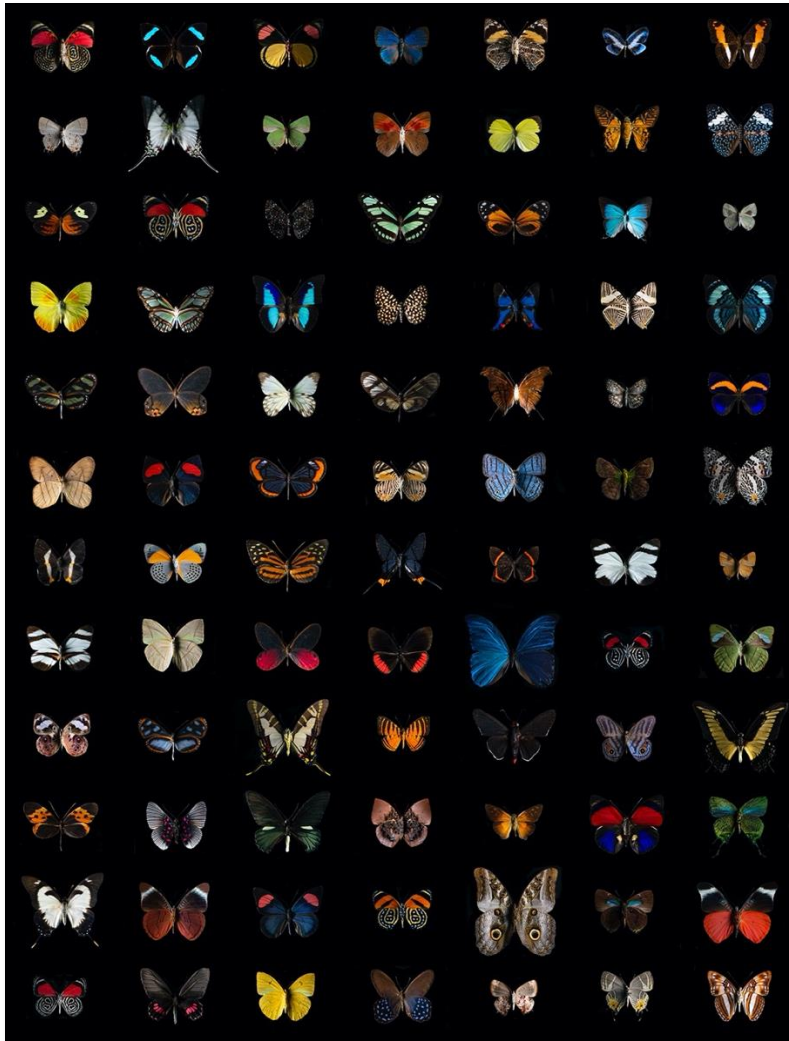

Figure 2. An example of the diversity of wing colour patterns. Butterflies from Amazonia, Ecuador ©Sebastian Mena.

In particular, Neotropical butterflies have been crucial in the understanding of colour pattern diversity and its relation to multiple selection pressures on organisms. Here I give a brief outline of the main functions of colour patterns in butterflies:

- **Thermoregulation** is an important adaptive function of animal coloration to help regulate body temperature (figure3). The thermoregulatory significance of wing melanization has been most clearly demonstrated in *Colias* of the family Pieridae (Kingsolver 1985; Watt 1968), where it affects behavioural strategies such as flight in cooler environments (e.g., Berwaerts *et al.* 1998; Ellers and Boggs 2004; Forister and Shapiro 2003; Pivnick and McNeil 1986), basking for warmth (Douglas and Gula 1978; Ellers and Boggs 2004) (in addition to physical and behavioural adaptations see e.g., Tsai *et al.* (2020), male perching or patrolling (e.g., Van Dyck and Matthysen, 1998).



Figure 3. Example of thermoregulation behaviour of three Lycaenidae species. Butterflies couple behaviour with colour patterns to thermoregulate. From left to right: photos showing lateral basking behaviour. Last image: plot of the summary of basking experiments where butterflies were exposed to same ambient temperature which was controlled by a Xenon lamp. When the lamp was turned on, the butterflies closed their wings and tilted sideways to expose their thoraces and ventral wing surfaces to the illumination. Plot shows that the percentage of time spent basking decreases as the ambient temperature (T_a) increases. Figure modified from Tsai *et al* 2020.

- **Intraspecific communication** is crucial at the initial stages of courtship (Scott 1973; Silberglied 1977) since butterflies have excellent colour discrimination in both the “visible” and UV reflective spectrum (Briscoe and Chittka 2001; Kinoshita, Shimada, and Arikawa 1999) (figure 4). In the Neotropical genus *Heliconius*, bright wing colour patterns serve as a cue in male mate choice, where assortative mating based on colour pattern is observed (Jiggins *et al.* 2001; Kronforst *et al.* 2006). In fact, reproductive isolation in butterflies is often facilitated by differences in wing colour patterns such as ultraviolet reflectance (e.g., nymphalids [Robertson and Monteiro, 2005], pierids [Silberglied and Taylor, 1973; Ficarrota *et al.*, 2022]), visible colours (e.g., lycaenids [Fordyce *et al.*, 2002; Lukhtanov *et al.*, 2005]; *Heliconius* butterflies [McMillan *et al.*, 1997; Jiggins *et al.*, 2001; Kronforst, Kapan, *et al.*, 2006]), or degree of melanization (Ellers and Boggs 2003; Wiernasz 1989; Wiernasz and Kingsolver 1992).



Figure 4 (previous page). Example of intraspecific communication. Left image: two species of Pieridae (*Dismorphia lewy* and *Leptophobia eleone* which resemble on their dorsal wing pattern but differ in the ventral side ©Andrew Neild. Right: UV iridescence differentiates males from two incipient species of Pieridae. Figure modified from Ficarrota *et al* 2022.

- Colour patterns with a role in *anti-predator defences* are varied. Camouflage or crypsis, masquerade and disruptive coloration can reduce the likelihood of butterflies being detected by predators or recognized as a prey (Endler 1991; Merrill *et al.* 2012; Ruxton, Speed, and Sherratt 2004; Stevens and Merilaita 2009)(figure 5).

Cryptic patterns are commonly found in Neotropical butterflies (Chai 1986; Pinheiro and Cintra 2017; Pinheiro and Campos 2019), such as *Hamadryas* butterflies which blend with their background when perching on trunks with their wings open and their heads down (a behaviour that differs from that of most other butterflies)(Pinheiro and Campos 2019).

Masquerade, or the resemblance to an object of no inherent interest to a potential predator such as leaves, thorns, sticks, stones or bird droppings (Ruxton *et al.* 2018; Skelhorn 2015), is also common in the tropics, such as in Neotropical butterflies which disguise themselves as dead, brown leaves e.g., *Anaeni* (Nymphalidae: Charaxinae) and *Marpesia* (Nymphalidae: Cyrestinae).

Disruptive camouflage involves using colour patterns to hinder detection or recognition of an object's outline, or other conspicuous features of its body (Ruxton *et al* 2018). In skipper butterflies of the genus *Hylephila* (Hesperiidae), the disruptive pattern makes them very difficult to detect in the middle of their habitat (grassland).

Colour patterns can also be involved in attack deflection, in which prey influence the position of the initial contact of the predator with their body in a way that benefits the prey (Ruxton *et al* 2018). A striking example includes the false heads of numerous Lycaenidae species, such as *Arawacus* butterflies, where deflection involves the pairing of behaviour (hind wing movement mimicking antennal movement) with pigmentation (false head). Such species stand higher chances to escape from predators' attacks because the attack is drawn to the false head structure (López-Palafox and Cordero 2017; López-Palafox, Luis-Martínez, and Cordero 2015; Sourakov 2013).

Conspicuous eyespots on wings are another example of a colour pattern serving as an antipredator defence, which can either be a deflecting function when small, in groups and placed closer to the periphery of wings (Kodandaramaiah, Lindenfors, and Tullberg 2013), or

a deimatic function when large, inducing a startle response in would-be-predators by mimicking the eyes of their own predators, e.g., the Neotropical genus *Caligo* (Nymphalidae: Brassolini) (Crees, Devries, and Penz 2020). Finally, colour patterns can signal the presence of toxins or other defence, i.e., aposematism, a topic which will be expanded in the following section.

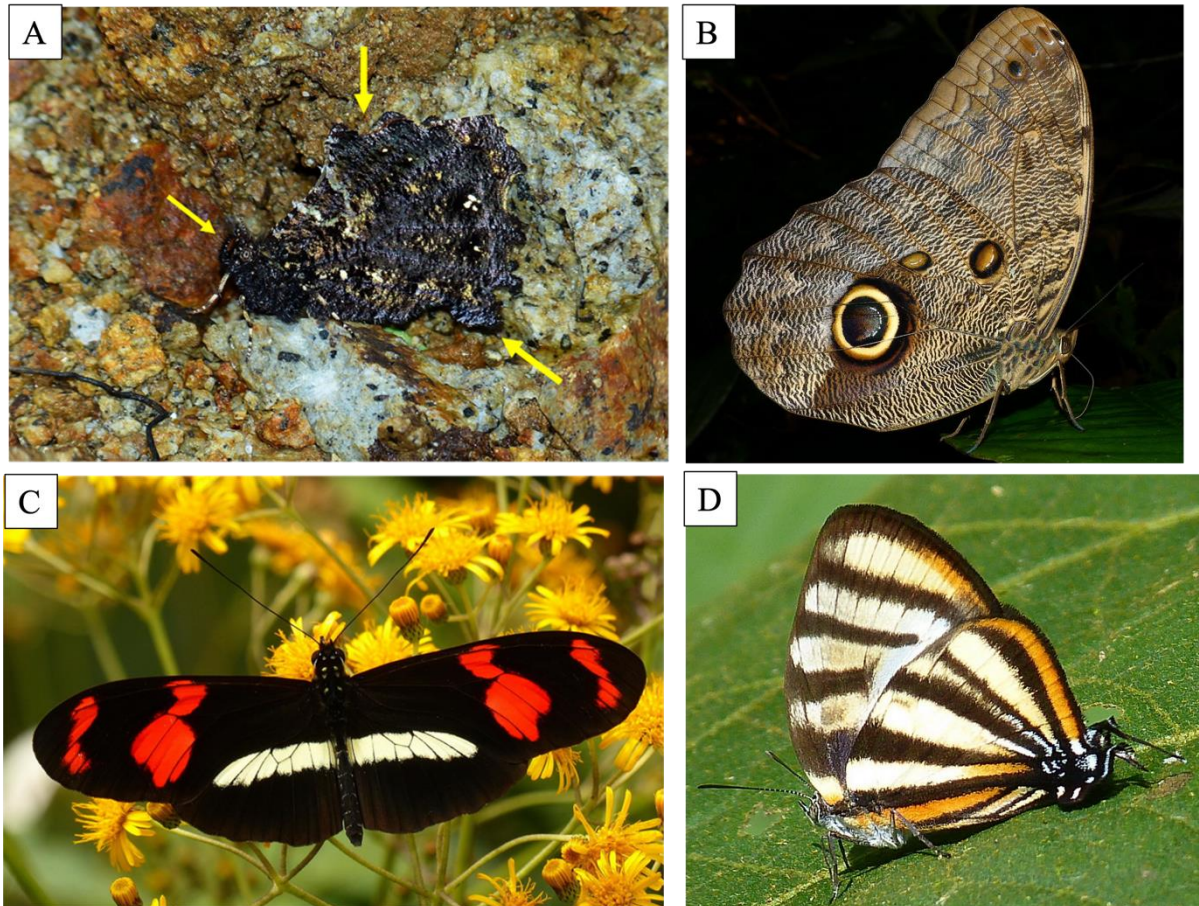

Figure 5. Example of wing colour patterns with a role in antipredator defences. (A) cryptic butterfly *Steroma bega* (Nymphalidae: Satyrinae) (yellow arrows spot the butterfly). (B) *Caligo* butterfly (Nymphalidae: Brassolini) that harbour conspicuous eyespot that have a deimatic or deflective function to predators (C) conspicuous coloured butterfly *Heliconius* (Nymphalidae: Heliconiinae), here the wing pattern signals unpalatability to predators (D) *Arawacus* butterfly (Lycaenidae) harbours a false head which paired with movement deflects predators' attacks. Images from ©Andrew Neild.

3 Aposematism and Mimicry

Defended prey organisms often exhibit bright and contrasting colours that signal something unpleasant or dangerous to predators. The pairing of conspicuous colour patterns with a defensive strategy is known as aposematism (Poulton 1890). Aposematism has evolved many times in multiple taxa across the world (e.g., poisson frogs [Saporito *et al.*, 2007]; catfish [Wright, 2011]; millipedes [Marek and Bond, 2009]; velvet ants [Wilson *et al.*, 2015]; coral snake [Banci *et al.*,

2020], and there has been convergent evolution across major lineages towards certain aposematic signal phenotypes, such as yellow, orange or red bands interspersed with dark colours. Aposematic signals are a defensive mechanism that efficiently educates predators (Cott 1940; Huheey 1976; Joron and Mallet 1998; Kikuchi and Sherratt 2015; Mappes, Marples, and Endler 2005) because they are more easily detected, identified and memorable than are the cryptic patterns typical of more profitable prey items (Mappes, Marples, and Endler 2005; Ruxton *et al.* 2018). Unpleasant or unprofitable traits associated with aposematic signals include chemical, mechanical and behavioural defences (Edmunds 1974; Ruxton *et al.* 2008).

3.1 Classical aposematism and mimicry

Basic theories about the function and evolution of aposematism were developed long ago. When Charles Darwin (1867) was developing his sexual selection hypothesis, he remarked that other selection pressures might explain conspicuous colours in sphinx caterpillars (Sphingidae), which were not under sexual selection. Wallace suggested that conspicuous colours could be adaptive if they acted as a signal that warned predators about their distastefulness. The latter hypothesis was not developed further until Henry Walter Bates' (1862) publication on species resemblance among Amazonian butterflies. He described the phenomenon when palatable species (the mimics) gain a degree of protection from predators by resembling an unpalatable species (the model). Bates' explanation for this phenomenon is the well-known hypothesis of Batesian mimicry: the evolution of similar wing patterns in palatable species to mimic (adaptively resemble) unpalatable (or otherwise defended) species. Mimics are under natural selection because predators will tend to avoid attacking prey when they resemble something harmful.



Figure 6. Extraordinary examples of classical mimicry in the Ecuadorian Amazonia. These two mimicry rings known as the “Orange tip complex” (above) and Small Dark Transparent Complex (below) are composed of different taxa of Nymphalidae (e.g., Danainae (Ithomiini), Nymphalinae, Biblidinae) and less related taxa such as Riodinidae, Pieridae and Arctiidae, or even more distantly related from another order of insects i.e, the Odonata (Zygoptera). Illustration adapted from Beccaloni (1997).

Bates also realised that groups of conspicuous coloured species that were putatively unpalatable and slow moving also resembled each other, and that colour patterns changed consistently from locality to locality, preserving resemblance among species. He speculated that this resemblance was due to the shared environment. Only later, in 1879, did Fritz Muller (1879) propose a simple, yet convincing predation-driven explanation for the resemblance between defended prey (now called Müllerian mimicry). The theory of Müllerian mimicry is based on the idea that naive predators must attack a certain number of individuals of an unpalatable prey species to learn to avoid that species; if multiple species share the same colour pattern, then fewer individuals of each species are lost during the period of predator learning, benefiting all species involved in the mimicry. Convergence in warning colour patterns often results in large groups of different species,

which are known as mimicry rings (Joron and Mallet 1998; Mallet and Gilbert 1995; Papageorgis 1975) (figure 6, 7); an outstanding example of such colour convergence is the “lycid mimicry ring” (orange with black tips), which includes distasteful lycid beetles, arctiid moths, parasitic Hymenoptera, and Diptera (Ruxton *et al.* 2018). Other examples of diverse mimicry rings are observed in taxa such as frogs (Symula, Schulte, and Summers 2001), fish (Alexandrou *et al.* 2011), snakes (Sanders, Malhotra, and Thorpe 2006) and birds (Dumbacher and Fleischer 2001).

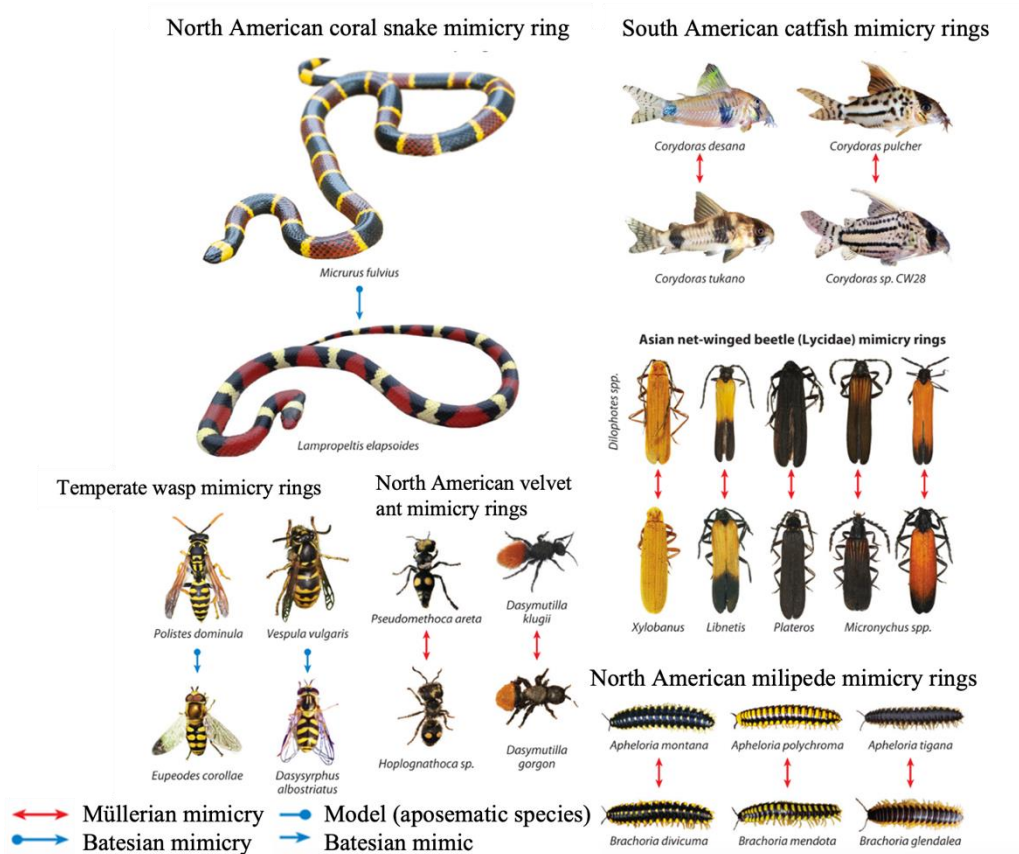

Figure 7. Mimicry rings in other taxa. Kunte's *et al.* (2021) figure illustrates (red and blue arrows) the nature of classical mimicry (Batesian or Müllerian) among different taxa (catfishes, millipedes, velvet ants, wasps and coral snakes).

Mimicry can also entail selection well beyond colour patterns, with implications for evolution of additional mating cues (e.g., chemical cues [Estrada and Jiggins, 2008; Mérot *et al.*, 2013; Llaurens *et al.*, 2014]), genetic architecture of genes underlying colour pattern (Mathieu Joron *et al.* 2006, 2011; Le Poul *et al.* 2014; Supple *et al.* 2013), mating behaviour (Chouteau *et al.* 2017) and ecology (Marianne Elias and Joron 2015).

Ithomiini butterflies have provided evidence for ecological implications of mimicry at different scales. Mimicry rings are segregated along multiple ecological niche axes, such as microhabitat (DeVries, Lande, and Murray 1999; Elias *et al.* 2008); Hill 2010, Willmott *et al.* 2017), host plant

preference (Willmott and Mallet 2004), and flight height or forest strata (Beccaloni 1997; Marianne Elias *et al.* 2008).

Mimicry rings can also be segregated at larger spatial scales such as altitude or climatic niche (Doré *et al.* submitted). For example, the altitudinal niches of co-mimetic species of *Ithomiini* along the Andean slopes are more similar than would be predicted by their phylogenetic relationships (Chazot *et al.* 2014). Moreover, Merrill *et al.* (2013) revealed an ecological and genetic association between shifts in habitat, host plant use and mimetic colour pattern that have likely facilitated speciation and coexistence of two closely related species of *Heliconius* butterflies.

3.2 An overlooked aposematism, and evasive mimicry

Similar to unpalatable, aposematic species, many palatable butterflies possess conspicuous colours on their wings that contrast with the background coloration when they fly or perch with open wings (Pinheiro *et al.* 2016). Several authors have proposed that the conspicuous coloration of these butterflies might signal another unprofitable trait to predators such as difficulty of capture (Pinheiro and Freitas 2014; Pinheiro 1996; Pinheiro and Campos 2019; Pinheiro *et al.* 2016; Van Someren and Jackson 1959; Srygley 1999; Srygley 1994). Predator selection pressure on such evasive prey might select for convergence in their conspicuous colour patterns, mirroring classical mimicry. The idea of evasive aposematism and mimicry was introduced a long time ago by Van Someren and Jackson (1959) in discussions of African butterflies. They proposed that protective resemblance exists in edible butterflies and that it could be explained by factors other than unpalatability, such as difficulty of capture. Lindroth (1971) introduced an example of evasive mimicry between beetles from two different Coleoptera families (Chrysomelidae leaf-beetles and Carabidae ground-beetles), where none of these beetles were unpalatable but one (leaf-beetle) could jump as an effective escape behaviour and the other not. He proposed that escape ability was the unprofitable feature involved in this Batesian mimetic interaction. Müllerian evasive mimicry was described by Hespenheide (1973) in a group of flies and agile beetles in the Neotropics, and Holm and Kirsten (1979) suggested that a complex of scarab beetles from the Namib desert were involved in both Batesian and Müllerian evasive mimicry as well. More recently, (Pinheiro and Freitas 2014) presented some possible cases of evasive mimicry in Neotropical butterflies and suggested several potential mimicry rings, e.g. “bright blue bands” (*Archaeoprepona*, *Prepona* [Preponini] and *Doxocopa* [Apaturinae]) and “creamy bands”

mimicry rings (*Colobura dirce*, *C. annulata* [Nymphalinae] and *Hypna Clytemnestra* [Charaxinae]).

There are many other examples of species potentially using conspicuous coloration to warn predators about difficulty of capture (Dudley and Srygley 1994; Penz and Mohammadi 2013; Pinheiro and Freitas 2014; Pinheiro 1996; Dittrich *et al.* 1993), which suggests that evasive aposematism and mimicry may be more common in nature than supposed (Pinheiro and Freitas 2014). However, due to the complexity of the phenomenon and logistic limitations in simulating natural environments for predators and prey under controlled conditions, evasive mimicry has not been comprehensively demonstrated, and only a few experiments have been performed in the last fifty years (Gibson 1974, 1980; Hancox and Allen 1991; Pinheiro 1996). These studies approached the study of evasive mimicry by using artificial prey and birds as predators. Gibson's (1974, 1980) and Hancox and Allen's (1991) experiments showed that the survival rate of prey was higher when they were brightly coloured and hard-to-catch. All experiments involved presenting to birds coloured seeds or pastry models that suddenly disappeared from the sight of birds (by means of a hinged platform) when attacked (see figure 8).

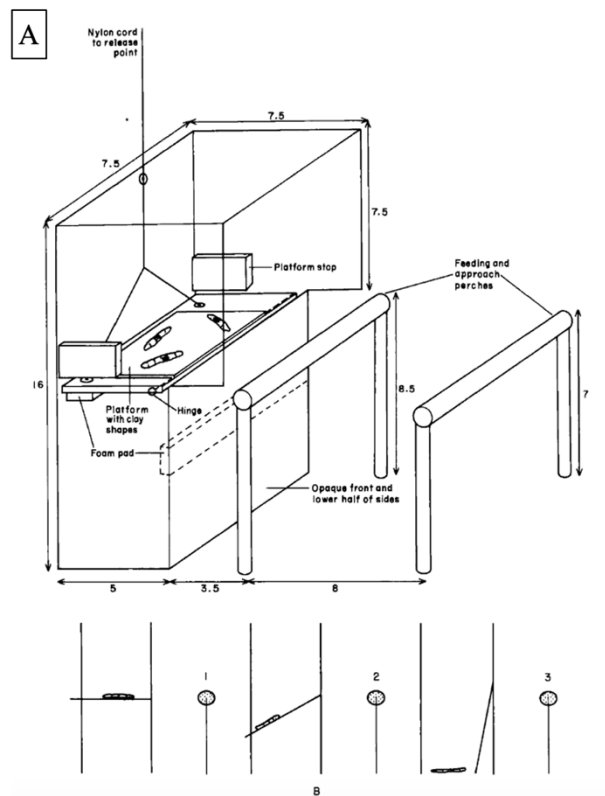

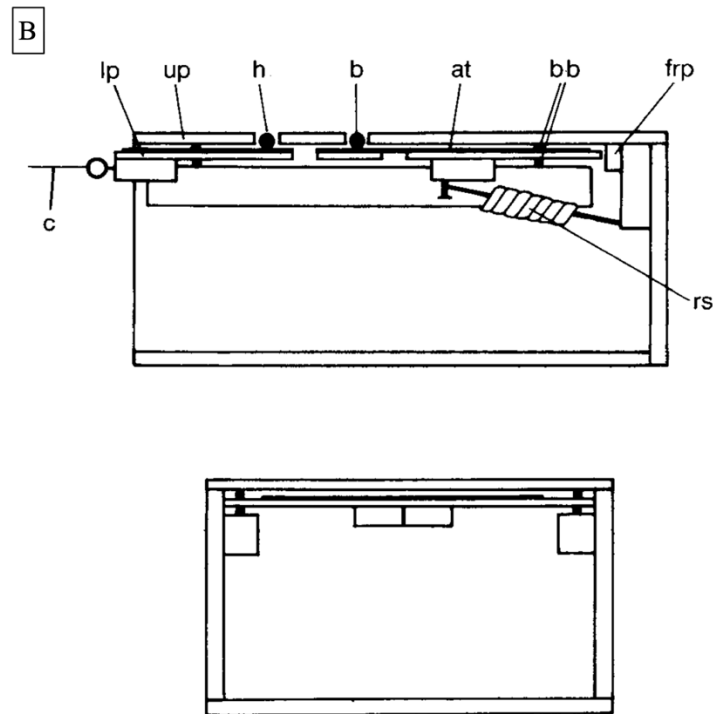

Figure 8. (A) (previous page) Experimental cage showing the apparatus and method of releasing the platform to simulate prey's escape by Gibson (1980) experiment. Lower illustration shows the release mechanism: 1) platform with the prey in position before bird approaches; 2) when bird lands to the perch, the platform is released to make prey slide away from bird; 3) prey completely out of sight of bird with the platform down. (B) Bird platform for simulating the escaping behaviour by Hancox and Allen 1991 experiment. Abbreviations indicate: at = acetate template, b = bait, bb = ball bearings, c = chord, frp = foam rubber pad, h = hole, lp = lower plate, rs = return spring, up = upper plate. When the cord is pulled in (upper illustration) only the left-hand bait will 'escape'. Illustrations modified after Gibson (1980), and Hancox and Allen (1991).

Gibson (1974) suggested that an efficient escape mechanism could be as powerful as distastefulness in influencing a predator's strategy in prey selection. In addition, these studies showed that pattern generalisation can lead to a benefit for other similarly appearing prey. However, Brower (1995) argued that these studies did not provide conclusive evidence for evasive Batesian mimicry, mainly due to the quick loss of aversion for evasive prey, in contrast to the long-term aversion observed with unpalatable prey. In relation to this argument, Ruxton *et al.* (2004) argued that Gibson's (1974, 1984) and Hancox and Allen's (1991) experiments on evasive mimicry presented unrealistic scenarios, representing an ecological situation where the evasive model only appears for a brief period early in the season, whereas mimics are only available later. They argued that in nature, models and mimics might occur simultaneously, and so predators will continue encountering models as well as mimics. Ruxton *et al.* (2004) suggested that experiments

that allow predators to “jog their memory”, through periodic experiences with evasive models, would be more accurate to evaluate whether evasive mimicry can be sustained in more ecologically realistic circumstances. Pinheiro *et al.*, (2016) observed that experienced, wild insectivorous birds avoid attacking (sight-rejected) palatable butterflies that display a strong flight e.g., *Morpho* (Nymphalidae: Morphini) or *Caligo* (Nymphalidae: Brassolini), suggesting that they might remember such prey.

In addition, Ruxton *et al.* (2004) noted other factors that might limit the prevalence of evasive mimicry in the natural world. They developed a theoretical model to elucidate the conditions under which evasive Batesian and Müllerian mimicry might evolve. They found that evasive Batesian mimicry is more likely to evolve when pursuing an evasive prey is costly in terms of time and energy for predators, when mimics are encountered less frequently than models, and when alternative prey is abundant. Evasive Müllerian mimicry might evolve when evasive prey differs in abundance, predators are slow to learn, and when evading capture is costly to prey.

Assessing a butterfly’s ability to escape predator attacks is also crucial to evaluate the escape mimicry hypothesis, although studies are rare. Previous studies (Chai and Srygley 1990; Pinheiro 1996) in which chemically defended and palatable butterflies were presented to wild Neotropical birds showed that palatable butterflies displayed a greater ability to escape than unpalatable species. Pinheiro (1996) showed that unpalatability was negatively correlated with escaping ability and proposed that evasiveness and unpalatability are mutually exclusive features of a prey and that they might evolve alternatively. But, more recently, Pinheiro *et al.* (2016) suggested that signalling difficulty of capture to predators might not be limited to palatable butterflies, unpalatable butterflies may also signal efficient escape abilities to predators depending on the predator involved.

Butterflies without chemical defences use various ways to escape predator attacks (reviewed in Ruxton *et al.* 2018). Therefore, traits that allow prey to escape and are perceived by visually oriented predators might differ between palatable (and evasive) and unpalatable species (e.g., fast and erratic flight in evasive prey [see Jantzen and Eisner, 2008], greater wing toughness in unpalatable relative to palatable butterflies [see De Vries, 2002, 2003, among others]). Differences in terms of predator selective pressures between classical and evasive mimicry might be expected as well. For example, selection for convergence and co-occurrence may not be as strong in evasive mimetic systems based on the idea that evasiveness seems to be a stronger stimulus compared to unpalatability, and surviving attacks by naive predators is higher in evasive systems (Páez *et al.* 2021).

3.3 Can a conspicuous colour pattern associated with difficulty of capture be considered as an aposematic signal?

It is important to consider the potential differences between classical aposematism, where the signal is associated with chemical defence, and aposematism associated with a behavioural defence such as difficulty of capture. Aposematic signals have been defined as those that inform would-be-predators that consuming a prey might be unpleasant because they are defended (Cott 1940; Huheey 1964; Joron and Mallet 1998; Kikuchi and Sherratt 2015; Mappes, Marples, and Endler 2005). On the other hand, Ruxton *et al.* (2018) introduced the term “elusiveness signals”, which are those that inform predators that an attempt to catch the prey is likely to be unsuccessful. These signals are restricted to mobile prey that can display an active response to deter an attack, such as fleeing, which is not necessarily the case with classical aposematic signals. Also, elusiveness signals might not be displayed continuously, and might need to be triggered once the prey detects the predator (e.g., stotting in gazelles which advertises to predators that they have been detected or that the prey individual is particularly fleet [Caro, 1986]); or when the prey is under imminent attack (e.g., singing of skylarks which potentially signals their strong flight and is initiated when they are pursued by predators [Cresswell, 1994]).

For the moment, the concept of a warning signal paired with evasiveness seems to fall partially (at least for butterflies) into one of the two current concepts for aposematic or elusiveness signalling. Unlike elusiveness signals, the warning signal (i.e., conspicuous wing colour pattern of palatable and evasive butterflies) can be displayed only under an imminent attack (e.g., *Hamadryas* butterflies flick their hindwings up showing their conspicuous ventral side of the wings when predators or conspecific approach to them (Young 1974); or not only while signalling or escaping to predators, e.g., gliding flight, some species display their brightly colour patterns when flying, and thus their bright colour patterns are displayed continuously in these situations (e.g., *Morpho* butterflies). On the other hand, the conspicuous colour pattern is not continuously displayed (as expected for an aposematic signal) in butterflies that harbour a cryptic pattern on their ventral side (Pinheiro *et al* 2016), which might have the function of reducing the probability of being targeted by predators in “risky” situations (e.g. puddling, host plant assessment in females) as presumably is also the function of cryptic ventral patterns in non-aposematic butterflies (Stevens, Stubbins, and Hardman 2008; Prudic *et al.* 2015). Contrary to this, conspicuous colour patterns can also be displayed either while under attack, or in circumstances when attack is more likely (e.g., perching in open areas), as observed in *Adelpha* (Nymphalidae: Limenitidinae) butterflies (Willmott 2003a). Certainly, the limits between the

types of signalling as described by Ruxton *et al.* (2018) are difficult to establish. We suggest that “elusiveness signals” (defined in Ruxton *et al.* 2018) are another type of aposematic signal, not a different kind of signal. Similarly, warning signals for evasiveness are another kind of aposematic signal.

Further research on aposematic signals associated with alternative types of defences (e.g., evasiveness), and elusiveness signalling within taxa other than vertebrates, could improve our understanding of these predator-prey interactions.

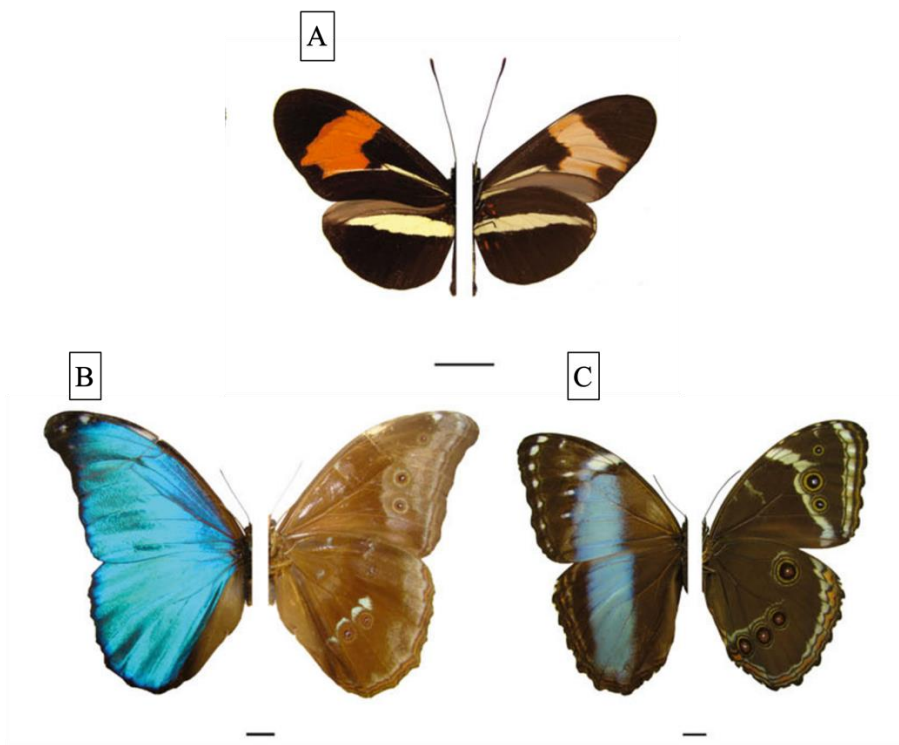

Figure 9. Example of (A) fully aposematic butterfly *Heliconius* (dorsal [left] and ventral [right] conspicuous wing pattern) from the classical mimicry system; and (B-C) aposematic (dorsal side [left]) and cryptic (ventral side [right]) butterflies which are potentially involved in evasive mimicry (*Morpho*). Figure adapted from Pinheiro and Campos 2017.

Aposematic but cryptic?

Palatable butterflies that potentially signal difficulty of capture commonly harbour brightly coloured patterns on the dorsal wing side that appear when they fly or perch with the wings open. However, ventral cryptic patterns are exhibited when their wings are closed (Chai 1986; Pinheiro and Cintra 2017) (see figure 9). What could explain this repeated dual pattern among multiple taxa? Intuitively, a butterfly is more vulnerable to attacks from ambushing predators when it is resting, feeding, puddling or during oviposition. In addition, Pinheiro *et al.* (2016) showed that

experienced bird predators avoid attacking palatable prey with conspicuous coloration when flying, but they use alternative hunting tactics to locate and attack them when they stop flying and perch on a given substrate. In addition, they showed that palatable butterflies harbouring a conspicuous dorsal pattern and cryptic ventral pattern, showed a greater ability to escape while at rest compared to completely cryptic palatable butterflies. It could be possible that initiating evasive actions in response to attacks incurs a significant cost to the prey, thus we should expect that displaying a cryptic coloration in these situations may reduce this cost (Cott 1940). However, this remains speculative since such costs are not yet quantified. More importantly, strong flight in ectothermic organisms is thermally constrained i.e., mainly adequate ambient temperature/sun conditions are needed to initiate flight or maintain strong flight. Thus, butterflies will not be able to escape for a large part of the day when climatic conditions are not optimal.

4 The Neotropical genus *Adelpha* as a case study

4.1 General description

The Neotropical genus *Adelpha* Hübner (1819) (tribe Limenitidini) is one of the largest and most diverse genera in the family Nymphalidae. In the last ten million years it has radiated into more than 200 described species and subspecies. *Adelpha* is the only member of the tribe Limenitidini in tropical America, with a small clade of *Limenitis* species likewise being the tribe's only member in temperate America. *Adelpha* exhibits a marked latitudinal and elevational gradient in species richness throughout its distribution from northwestern United States to Uruguay, with increased species richness at lower latitudes in equatorial regions and a peak in species richness at the base of the eastern Andes (Willmott 2003a) (figure 10).

Many *Adelpha* species are common and are present in a wide range of habitats from sea level to 3000m. Like many sun-loving nymphalids they are most often observed in bright, sunlit areas, such as tree-fall forest openings, river sides, paths and roads. Moreover, most species appear to be confined to the forest canopy, with a few exceptions (KW pers. obs). The greatest species richness occurs in primary forest, with diversity dropping markedly in secondary forest. *Adelpha* caterpillars exhibit one of the widest host plant breadths of any nymphalid genus (Ackery 1988), including 22 plant families, 66 genera and around 116 species (Willmott 2003a).

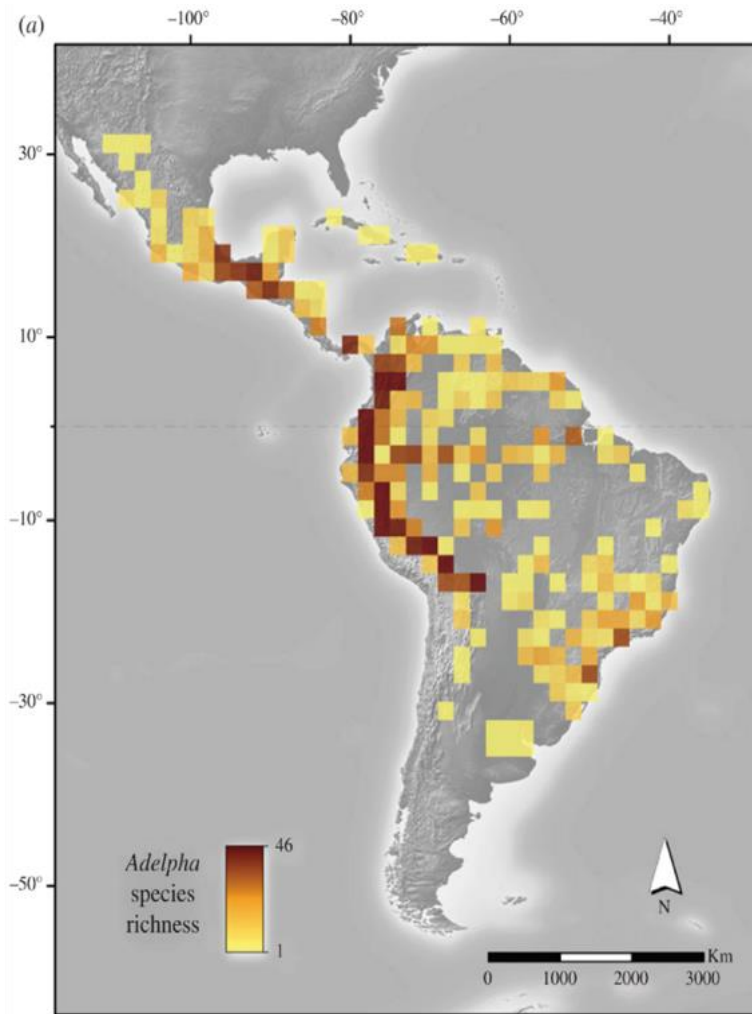

Figure 10. *Adelpha* species richness across the Neotropical region. Figure from Ebel *et al* 2015.

The greater species diversity in *Adelpha* compared to its sister clade *Limenitis* was initially hypothesised to be due to an earlier colonisation of the New World by the former and longer time for speciation (Willmott 2003b). However, Mullen *et al.* (2011) and Ebel *et al.* (2015) refuted this hypothesis and provided support for the idea of rapid diversification due to ecological speciation, especially through early shifts onto novel host plants, which may have triggered diversification in *Adelpha*. Host plant (and morphological) diversity is primarily limited to the large lowland clade (among the two major *Adelpha* clades) (figure 11). A small clade, the montane “*alala* group”, is genetically and ecologically distinct from the diverse lowland clade, and indeed may be more closely related to other limenitidines (Chazot *et al.* 2021; Hui-Yun *et al.* 2022).

Studies of mate recognition in *Adelpha* are non-existent, but it has been suggested that it may be partly mediated by pheromones (Willmott 2003a). Wing pattern might be thought to play only an initial role in mate recognition since there is great variation at the subspecies level and high

similarity between many co-occurring species. In addition, there are potential cases of hybridization between closely related but phenotypically distinct species that might support this hypothesis (Willmott 2003a).

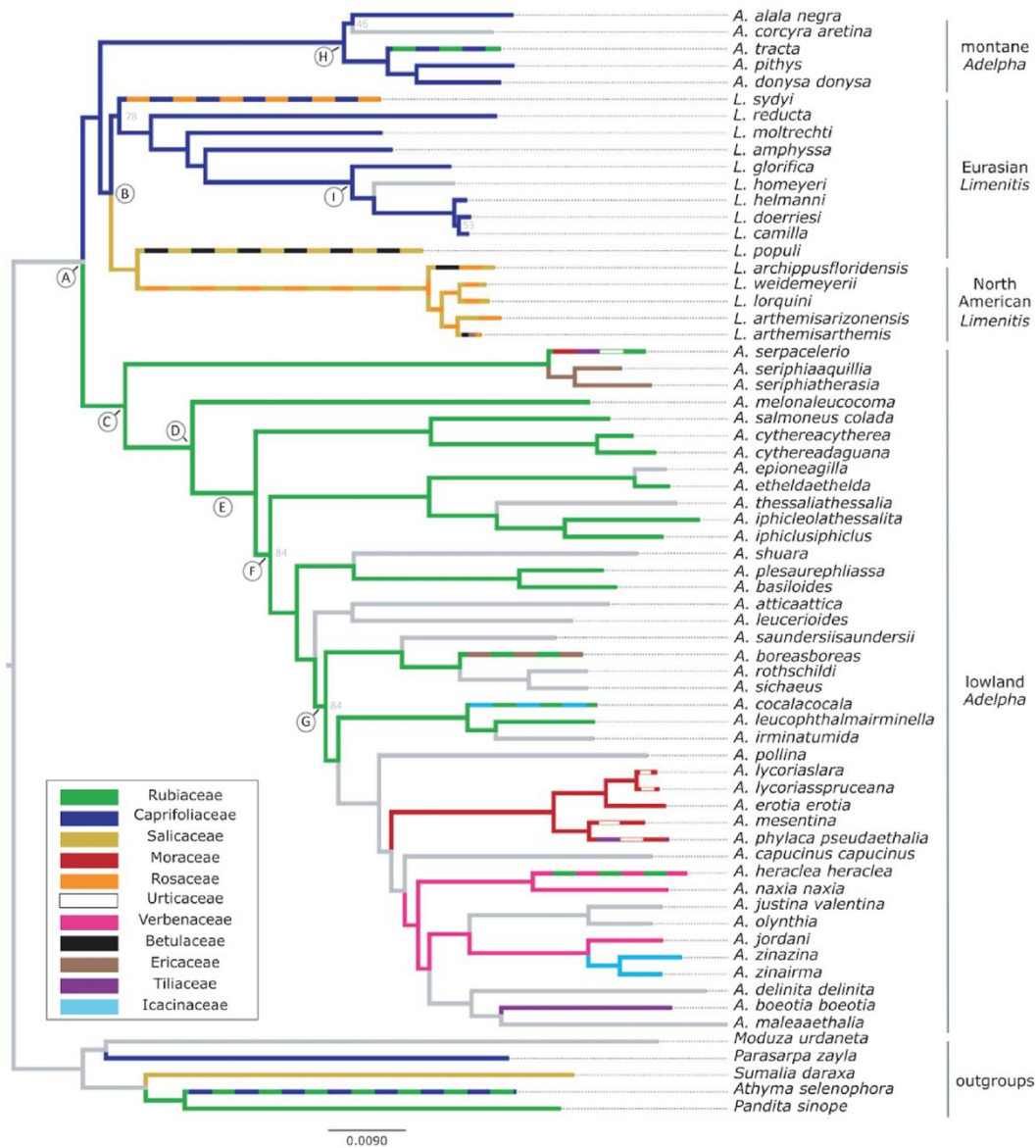

Figure 11. Ancestral state reconstruction of *Adelpha* host plant use. Maximum-likelihood tree is based on RAD-sequences. Branches are coloured by the host plant family. Grey branches indicate an unknown host plant. Figure from Ebel *et al* 2015.

4.2 Mimicry in *Adelpha*

Adelpha butterflies have long been of interest due to the remarkable dorsal wing pattern resemblance among many sympatric species, which has made species identification difficult (Aiello 1984; DeVries 1987; Moss 1933; Willmott 2003a)(figure 12).

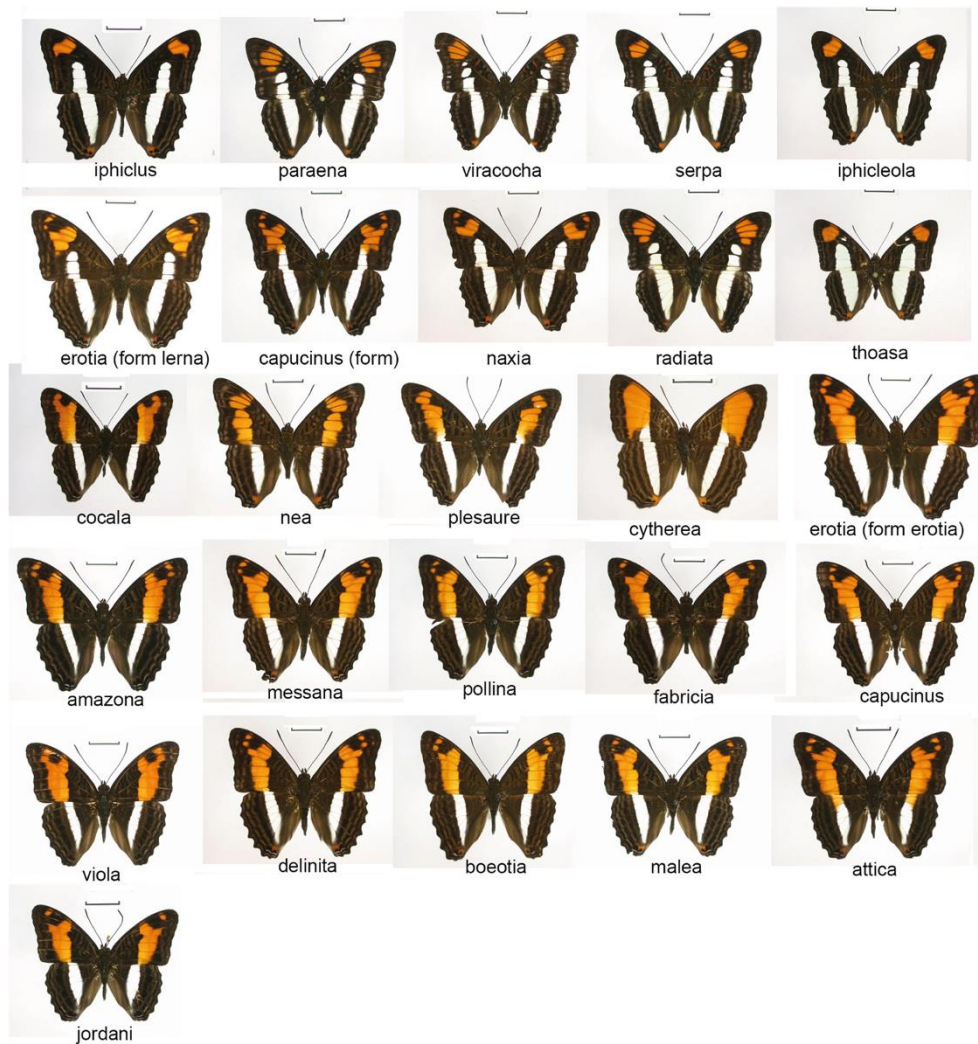

Figure 12. Species from two putative mimicry rings in *Adelpha* from East Ecuador. ©Keith R. Willmott.

Aiello Aiello (1984) argued that species with similar wing patterns might be distantly related, based on differences in the morphology and ecology of their immature stages. She speculated that *Adelpha* comprises multiple mimicry rings, based upon. Cladistic analysis (Willmott 2003b) and molecular based phylogenies (Ebel *et al* 2015, Mullen *et al* 2011) provided support for mimicry in *Adelpha* (figure 13,15). These studies confirmed repeated convergence in wing colour patterns among distantly related species (14 mimicry rings were defined by Willmott [2003a]), along with parallel intraspecific changes in wing pattern across geographic regions in sympatric species.

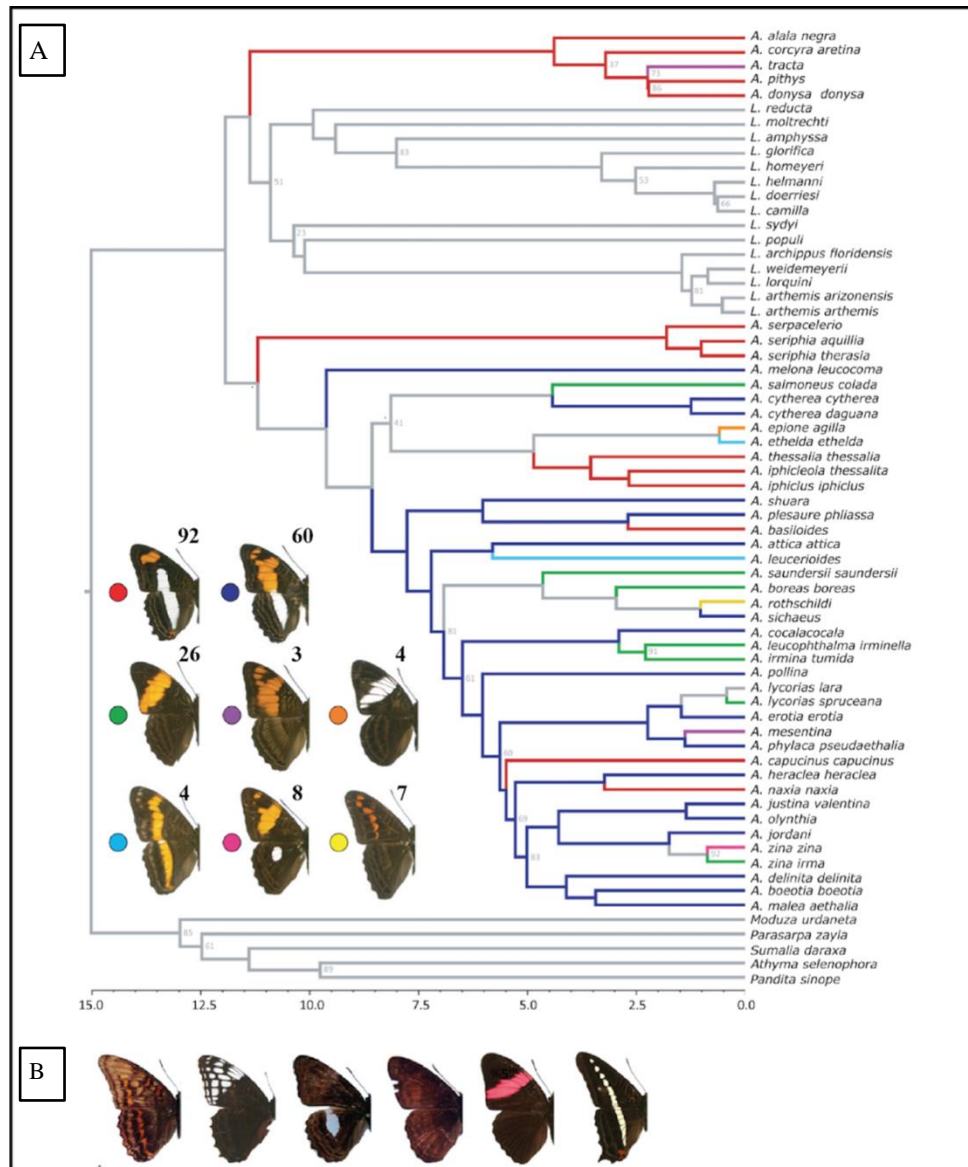

Figure 13. A) Bayesian maximum clade credibility tree based on RAD sequences from Ebel et al 2015. Nodes with posterior probabilities ≥ 95 are unlabelled. Branches are coloured by *Adelpha* putative mimicry rings defined by Ebel et al. (2015) and named here from a prominent species of each mimicry ring (not necessarily the species figured here): IPHICLUS (red), COCALA (blue), SALMONEUS (green), MESENTINA (purple), EPIONE (orange), LEUCERIA (light blue), ZINA (pink), ROTHSCHILDI (yellow). B) Five species have a unique wing pattern. From left: EGREGIA (*A. seriphia egregia*), DEMIALBA (*A. demialba*), INESAE (*A. justina inesae*), PYRCZI (*A. zina pyrczi*), LYCORIAS (*A. lycorias lara*). The last mimicry ring is GELANIA harbouring 3 species, and which was not included in Ebel et al.'s (2015) study. Figure modified from Ebel et al 2015.

In addition, there are numerous examples of close correspondence of subspecies ranges in which dorsal wing patterns change synchronously from one region to another, such as a complex of species that has a narrow white dorsal band in western Ecuador but a broad white band in the north of Venezuela (Willmott 2003a).

Moreover, mimicry in *Adelpha* also extends beyond the genus, and other sympatric butterfly species from less related taxa covary throughout the neotropics (e.g., females of most *Doxocopa* species [subfamily Apaturinae], the riordinid *Synargis phliasus*, which was included in the genus in the original description of *Adelpha* (Hübner 1891) (figure 14).

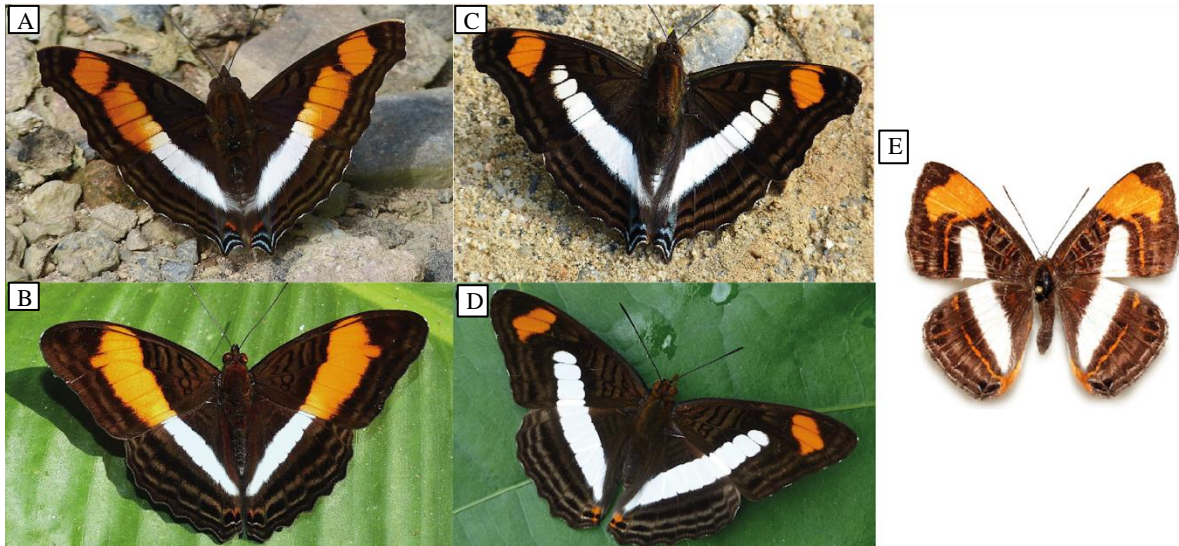

Figure 14. Mimetic butterflies from *Adelpha* and distantly related groups (a) *Doxocopa laure* (Nymphalidae: Apaturinae), (b) *Adelpha cocala*, (c) *Doxocopa linda* (Nymphalidae: Apaturinae), (d) *Adelpha iphicles*, (e) *Synargis phliasus velabrum* (Riodinidae). Images from ©Andrew Neild and <https://www.butterfliesofamerica.com>

Batesian mimicry between unpalatable and palatable limenitidine species often occurs in temperate zones (Brower and Brower 1972; Prudic, Skemp, and Papaj 2007; Prudic, Shapiro, and Clayton 2002; Ritland and Brower 1991). For example, Prudic, Shapiro, and Clayton 2002 provided evidence for unpalatability in a species of *Adelpha* which seems to be a model for *Limenitis lorquini* in temperate zones. Feeding responses of birds (*Aphelocoma californica*) were quantified and it was observed that birds usually demonstrated long handling times, feather ruffling and bill wiping after consuming *A. bredowii* compared to *L. lorquini*. However, evidence for unpalatability in Neotropical *Adelpha* is lacking, with experiments showing that putative unpalatable species in *Adelpha* are consumed by avian predators in the field (Pinheiro 1996; Srygley and Chai 1990).

An alternative hypothesis for colour pattern convergence in the genus is evasive mimicry (Van Someren and Jackson 1959). *Adelpha*, with their fast and erratic flight, might be unprofitable to predators (Mallet and Singer 1987; Willmott 2003b). Therefore, a possible alternative hypothesis for wing pattern convergence in *Adelpha* is unprofitability due to difficulty of capture (i.e., evasive mimicry) (DeVries 1987; Pinheiro and Freitas 2014). It seems plausible that these butterflies are

involved in mimetic interactions through convergence in dorsal wing patterns between less related and sympatric *Adelpha* species. In addition, it is well-known that aposematic species behave more conspicuously by feeding in groups or exposed on leaf tops (Lindström et al. 1999; Poulton 1887; Riipi, Lindström, and Mappes 2001; Tullberg 1988), the latter being characteristic of *Adelpha* (Willmott 2003a)

Although selection pressure from avian predators remains the most likely driver for mimetic colour convergence in *Adelpha*, evasiveness might be under selection from a variety of predators including other invertebrates, lizards, and mammals. Further research on evasive mimicry targeting other types of predators and taxa will help us to better understand this predator-prey interaction, but also whether evasive mimicry has the same implications as classical Müllerian mimicry (e.g., in terms of species assemblages, niche evolution, genomics).

4.3 Systematics and taxonomic problems

Many species of *Adelpha* are superficially so similar in appearance that they challenged taxonomists for decades because of difficulty in defining species limits and misidentifications of type specimens, resulting in confusing nomenclature.

The first *Adelpha* species were described in 1758 by Linnaeus from specimens originating from the Guianas, and they were included under the genus *Papilio*. Hübner (1819) introduced the genus *Adelpha* with 8 species based mainly on wing pattern and shape (erroneously including a likely mimetic species of Riodinidae). However, this generic name was ignored by subsequent authors for decades. In 1836 Boisduval introduced a new generic name, *Heterochroa*, along with a new species *H. serpa*. In 1847, the beginning of the most intensive period of activity for the Neotropical butterfly taxonomy, Hewitson (1847) described 8 species of *Adelpha* under the name *Heterochroa*, and he was the first to appreciate the great importance of ventral wing pattern characters, especially in the forewing discal cell, for distinguishing species.

Westwood (1850) provided a first detailed description of the external morphology, but also named the genus *Heterochroa* with *Adelpha* as synonym. In addition, he stated that the genera *Limenitis* and *Apatura* were closely related to *Adelpha*. *Heterochroa* was broadly used until Kirby (1871) formally restored the name *Adelpha*, placing *Heterochroa* as synonym. Subsequently, Butler (1870) and Godman and Salvin (1884) contributed significantly to *Adelpha* taxa descriptions. Godman & Salvin (1884) were the first authors to describe the male genitalia.

Fruhstorfer's revision of the genus in the *Macrolepidoptera of the World* (Fruhstorfer 1915) became the foundation for subsequent work for many decades. His most important contribution was the recognition and description of a number of superficially similar southeast Brazilian species, and he was the first to recognize that "orange and white banded" *Adelpha* contained many more species than had previously been considered. However, many of the new names he authored resulted in more subsequent taxonomic confusion than clarification, for many years. Hall (1938) tried to assess the validity of many of the names after examination of Fruhstorfer's collection and he synonymized many of the subspecific names. Subsequently, Forbes worked on a review of *Adelpha* which remained unfinished and unpublished at the time of his death in 1968. Forbes's main contribution was the recognition of the importance of establishing wing pattern element homologies to identify species.

The 1970's and 1980's were a period of revival of interest in *Adelpha*, when several species from Mexico, Colombia, and Costa Rica were described. Nevertheless, at that time the understanding of the relationships and diversity of *Adelpha* was still rather incomplete. Finally, the important work of Neild (1996), the revision of the genus by Willmott (2003a,b), and phylogenetic studies based on DNA sequences (Mullen *et al* 2011, Ebel *et al* 2015), have allowed a better understanding of the classification of *Adelpha*.

Nevertheless, even now there remains debate about the monophyly of the genus. Willmott (2003a) found several wing pattern characters that supported monophyly of *Adelpha*, but more recently molecular phylogenetic studies (Mullen *et al* 2011; Ebel *et al* 2015; Dhungel and Wahlberg 2018) have suggested that *Adelpha* is paraphyletic, with the montane "alala clade" sister to Palearctic *Limenitis*.

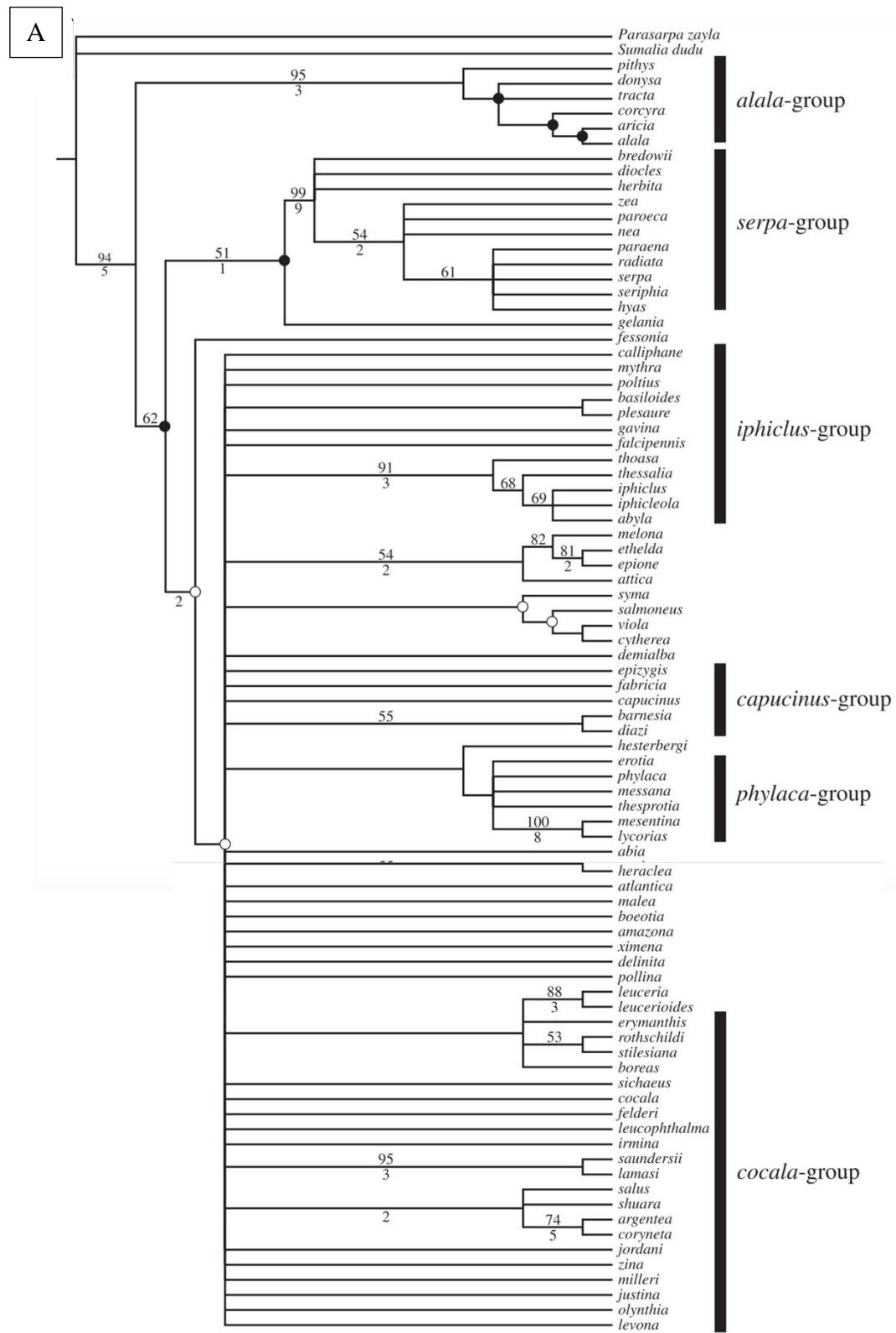

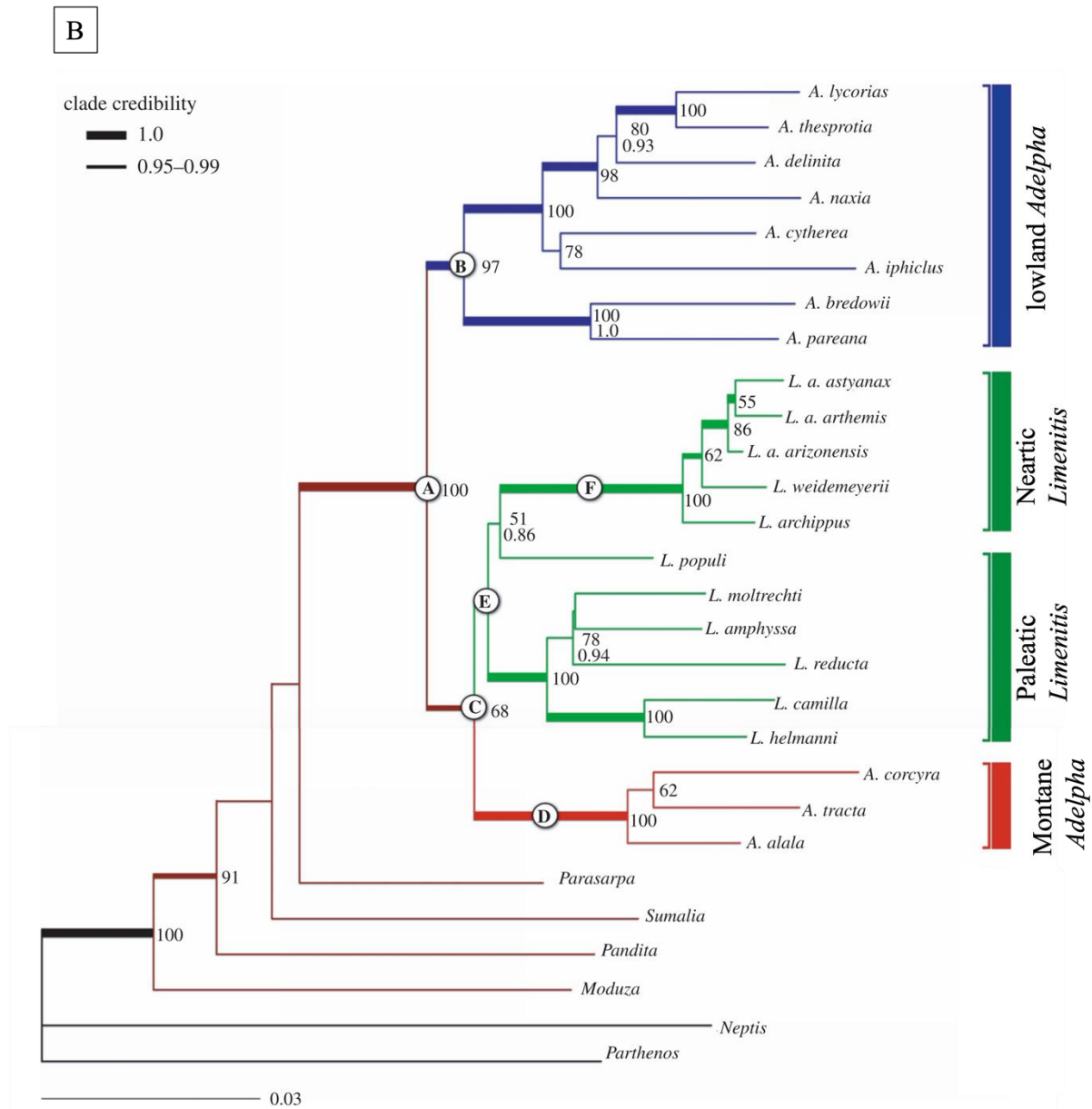

Figure 15. (A) (previous page). Cladogram from Willmott 2003. Bootstrap values are above branches. (B) Bayesian consensus phylogram from Mullen *et al* 2011 based on six genes including 11 *Adelpha* species. Branch weights represent posterior probabilities for clade support. Figure modified from Willmott 2003 and Mullen *et al.* 2011.

Although substantial progress has been made recently regarding systematics and ecology of the genus *Adelpha*, there are still some outstanding questions and further research to be done, notably regarding the question of evasive mimicry. Nowadays, phylogenetic tools are available to infer a more comprehensive phylogeny, which is necessary for several reasons. First, to solve systematic issues such as the taxonomy and monophyly of the genus. Second, to assess multiple aspects of the evolution of the genus, such as spatial and temporal diversification patterns, and understanding key drivers assembling communities and driving the evolution of traits.

In addition, evasive mimicry remains a clear possibility in theory and there are several potential examples in nature including the genus *Adelpha*, but there is still a lot to uncover: can predators learn to avoid realistic patterns when they are associated with evasiveness, and generalise their avoidance to similar patterns? Is resemblance in *Adelpha* mostly due to convergent evolution, or to shared ancestry? If resemblance is driven by evasive mimicry, is this associated with increased co-occurrence of species harbouring similar patterns, as observed in classical mimicry?

Using *Adelpha* as a model, this thesis addresses several of these questions, relating to systematics, to the existence and evolution of evasive mimicry in this genus and its impact on species assemblage, by integrating experimental, phylogenetic, and community ecology approaches.

QUESTIONS AND OBJECTIVES

CHAPTER I – Hard to catch: Experimental evidence supports evasive mimicry

Can predators learn to avoid naturally occurring wing colour patterns when they are associated with evasiveness, and generalise their avoidance to similar patterns?

In the first chapter, I tested empirically the evasive mimicry hypothesis. Experiments were performed at the Konnevesi Research station (Finland) in 2019, and we used wild blue tits () as naïve predators and artificial paper butterflies harbouring *Adelpha* wing colour patterns as prey.

Evasive mimicry is an understudied topic with only a handful of empirical studies in the last 50 years. This is a valuable contribution to the literature on antipredator defences.

Abstract

Most research on aposematism has focused on chemically defended prey but signalling difficulty of capture remains poorly explored. Similar to classical Batesian and Müllerian mimicry related to distastefulness, such “evasive aposematism” may also lead to convergence in warning colours, known as evasive mimicry. A prime candidate group for evasive mimicry are *Adelpha* butterflies, which are agile insects and show remarkable colour pattern convergence. We tested the ability of naïve blue tits to learn to avoid and generalise *Adelpha* wing patterns associated with difficulty of capture and compared their response to that of birds that learned to associate the same wing patterns with distastefulness. Birds learned to avoid all wing patterns tested and generalised their aversion to other prey to some extent, but learning was faster with evasive prey compared to distasteful prey. Our results on generalisation agree with longstanding observations of striking

convergence in wing colour patterns among *Adelpha* species since, in our experiments, perfect mimics of evasive and distasteful models were always protected during generalisation and suffered the lowest attack rate. Moreover, generalisation on evasive prey was broader compared to that on distasteful prey. Our results suggest that being hard to catch may deter predators at least as effectively as distastefulness. This study provides empirical evidence for evasive mimicry, a potentially widespread but poorly understood form of morphological convergence driven by predator selection.

This chapter was published in Proceedings of the Royal Society B:

Páez E, Valkonen JK, Willmott KR, Matos-Maraví P, Elias M, Mappes J. 2021. Hard to catch: experimental evidence supports evasive mimicry. *Proc. R. Soc. B* 288: 20203052. <https://doi.org/10.1098/rspb.2020.3052>

CHAPTER II – Comprehensive phylogeny of *Adelpha*, ancestral state reconstruction of mimetic patterns and their evolution

The second chapter has two components: first, we infer a comprehensive phylogeny of the genus *Adelpha* at a subspecies level to test the current relationships and classification of the genus. Here we address whether the current classification that regards *Adelpha* as monophyletic should be maintained, and to what extent the current species classification is robust with the addition of molecular data to explore relationships among subspecific taxa. Our phylogeny conceived *Adelpha* as monophyletic, but we nevertheless suggest that more molecular data should be included, especially from more outgroup taxa within *Limenitis*.

Secondly, using our phylogeny, we addressed some aspects of *Adelpha* evolution which potentially provide insights into factors affecting spatial gradients in species diversity. More specifically, we inferred ancestral colour patterns and examined whether shifts in wing colour pattern are associated with speciation events; we investigated whether potential abiotic and biotic factors might influence wing colour pattern evolution; and finally, we studied how *Adelpha* mimicry rings are phylogenetically structured.

We found the IPHICLUS mimicry pattern as the ancestral state which is broadly distributed across the phylogeny. Additionally, we did not find evidence that shifts in mimetic wing colour patterns are associated with speciation in *Adelpha*. Finally, rates of evolution of mimicry patterns vary across the phylogeny, with higher rates in the lowland clade, and increasing rates towards the

equator. Both results are consistent with the idea that climatic gradients can influence the evolution of traits that could be associated with diversification.

CHAPTER III – The role of evasive mimicry and altitude in shaping the structure of butterfly communities in Ecuador: the case of *Adelpha*.

In this final chapter, we focus on a smaller, local scale (i.e., the community level) to investigate the processes shaping *Adelpha* communities in Ecuador, which is one of the most diverse regions for butterflies on Earth. We studied patterns of species co-occurrence in relation to mimicry and altitude. At the community level, we detected a random phylogenetic structure meaning that overall, there is no strong phylogenetic turnover between communities. However, a finer analysis revealed that communities at similar altitudes have similar phylogenetic composition, suggesting that filtering by altitude is an important process in species assemblages.

In relation to mimicry, we observed that subspecies hypothesised to be involved in mimetic interactions (i.e., subspecies that share the same wing colour pattern), coexist more often than expected at random, but this was only detected for 2 mimicry rings: COCALA and ROTHSCHILDI. We also found an association between mimicry structure and altitude. Such association could be partly caused by shared ancestry since we found a strong phylogenetic signal for mimicry patterns and altitude. However, phylogenetic comparative analyses showed that the association between mimicry and altitude is stronger than that expected given the phylogeny, strongly suggesting that adaptive convergence for wing patterns and/or altitudinal range is driven by mimicry.

References

- Ackerly, David D. 2003. "Community Assembly , Niche Conservatism , and Adaptive Evolution in Changing Environments." *Evolution* 164 (S3): S164–84.
- Ackery, P.R. 1988. "Host-Plants and Classification: A Review of Nymphalid Butterflies." *Biological Journal of the Linnean Society* 33: 95–203.
- Adams, M.J. 1985. "Speciation in the Pronophilina Butterflies (Satyridae) of the Northern Andes." *Journal of Research on the Lepidoptera* (1): 33–49.
- Aiello, Annette. 1984. "Adelpha (Nymphalidae): Deception on the Wing." *Psyche* 91(1–2): 1–45.
- Albert, James S., Paulo Petry, and Roberto E. Reis. 2011. Historical Biogeography of Neotropical Freshwater Fishes *Major Biogeographic and Phylogenetic Patterns*.
- Alexandrou, Markos A. et al. 2011. "Competition and Phylogeny Determine Community Structure in Müllerian Co-Mimics." *Nature* 469(7328): 84–89.
- Allio, Rémi et al. 2021. "Genome-Wide Macroevolutionary Signatures of Key Innovations in Butterflies Colonizing New Host Plants." *Nature Communications* 12(354). <http://dx.doi.org/10.1038/s41467-020-20507-3>.
- Antonelli, Alexandre, Johan A.A. Nylander, Claes Persson, and Isabel Sanmartín. 2009. "Tracing the Impact of the Andean Uplift on Neotropical Plant Evolution." *Proceedings of the National Academy of Sciences of the United States of America* 106(24): 9749–54.
- Antonelli, Alexandre, and Isabel Sanmartín. 2011. "Why Are There so Many Plant Species in the Neotropics?" *Taxon* 60(2): 403–14.
- Arias, Mónica et al. 2016. "Crossing Fitness Valleys: Empirical Estimation of a Fitness Landscape Associated with Polymorphic Mimicry." *Proceedings of the Royal Society B: Biological Sciences* 283(1829).
- Banci, Karina R.S., André Eterovic, Patrícia S. Marinho, and Otavio A.V. Marques. 2020. "Being a Bright Snake: Testing Aposematism and Mimicry in a Neotropical Forest." *Biotropica* 52(6): 1229–41.
- Barraclough, Timothy G, James E Hogan, and Alfried P Vogler. 1999. "Testing Whether Ecological Factors Promote Cladogenesis in a Group of Tiger Beetles (Coleoptera: Cicindelidae)." *Proc. R. Soc. Lond. B* 266: 1061–67.
- Bates, Henry Walter. 1862. "Contributions to an Insect Fauna of the Amazon Valley. Lepidoptera: Heliconidae." *Transactions of the Linnean Society of London* 23: 495–566.

- Beccaloni, George W. 1995. "Studies on the Ecology and Evolution of Neotropical Ithomiine Butterflies (Nymphalidae: Ithomiinae)." *University of London*.
- Beccaloni, George W. 1997a. "Ecology, Natural History and Behaviour of Ithomiine Butterflies and Their Mimics in Ecuador (Lepidoptera: Nymphalidae: Ithomiinae)." *Tropical Lepidoptera* 8(2): 103–24.
- Beccaloni, George W. 1997b. "Vertical Stratification of Ithomiine Butterfly (Nymphalidae: Ithomiinae) Mimicry Complexes: The Relationship between Adult Flight Height and Larval Host-Plant Height." *Biological Journal of the Linnean Society* 62(3): 313–41.
- Berry, Vincent, François Chevenet, Jean Philippe Doyon, and Emmanuelle Jousset. 2018. "A Geography-Aware Reconciliation Method to Investigate Diversification Patterns in Host/Parasite Interactions." *Molecular Ecology Resources* 18(5): 1173–84.
- Berthier, Serge. 2005. "Thermoregulation and Spectral Selectivity of the Tropical Butterfly *Prepona meander*: A Remarkable Example of Temperature Autoregulation." *Applied Physics A* 80: 1397–1400.
- Berwaerts, K., H. Van Dyck, S. Van Dongen, and E Matthyssen. 1998. "Morphological and Genetic Variation in the Speckled Wood Butterfly (*Pararge aegeria* L.) among Differently Fragmented Landscape." *Neth. J. Zool.* 48: 241–53.
- Boppre, Michael. 1978. "Chemical Communication, Plant Relationships, and Mimicry in the Evolution of Danaid Butterflies." *Entomologia Experimentalis et Applicata* 24(3): 264–77.
- Braby, Michael F, and Trueman, . 2006. "Evolution of Larval Host Plant Associations and Adaptive Radiation in Pierid Butterflies." *J. Evol. Biol* 19: 1677–90.
- Briscoe, Adriana, and Chittka, Lars. 2001. "Insect Color Vision." *Annual Review of Entomology* 46: 471–510.
- Brower, Andrew V.Z. 1995. "Locomotor Mimicry in Butterflies? A Critical Review of the Evidence." *Philosophical Transactions Royal Society of London B: Biological Sciences* 347(1322): 413–25.
- Brower, Lincon P., and J.V.Z. Brower. 1972. *Transactions of the Connecticut Academy of Arts and Sciences Parallelism, Convergence, Divergence and the New Concept of Advergence in the Evolution of Mimicry*. New Haven, Connecticut.
- Brown, James H., and M. V. Lomolino. 1998. *Biogeography*. Second. Massachusetts: Sinauer Associates, Inc. Publishers.
- Brown, Keith S. 1979. "Ecologia Geográfica e Evolução Nas Florestas Neotropicais." Thesis. Universidade Estadual de Campinas.

- Brown, L.W., and E.O. Wilson. 1956. "Character Displacement." *Systematics Zoology* 5(2): 49–64.
- Bruno, John F., John J. Stachowicz, and Mark D. Bertness. 2003. "Inclusion of Facilitation into Ecological Theory." *Trends in Ecology and Evolution* 18(3): 119–25.
- Bruun-Lund, Sam, Brecht Verstraete, Finn Kjellberg, and Nina Rønsted. 2018. "Rush Hour at the Museum – Diversification Patterns Provide New Clues for the Success of Figs (*Ficus* L., Moraceae)." *Acta Oecologica* 90: 4–11.
- Cadle, J. E., and H. W. Greene. 1993. "Phylogenetic Patterns, Biogeography, and the Ecological Structure of Neotropical Snake Assemblages." In *Species Diversity in Ecological Communities: Historical and Geographical Perspectives*, eds. Robert E. Ricklefs and D. Schluter. Chicago: University of Chicago Press, 281–93.
- Caro, Tim. 2017. "Wallace on Coloration: Contemporary Perspective and Unresolved Insights." *Trends in Ecology and Evolution* 32: 23–30.
- Caro, Tim M. 1986. "The Functions of Stotting in Thomson's Gazelles: Some Tests of the Predictions." *Animal Behaviour* 34(3): 663–84.
- Casner, Kayce L., and Tomasz W. Pyrcz. 2010. "Patterns and Timing of Diversification in a Tropical Montane Butterfly Genus, *Lymanopoda* (Nymphalidae, Satyrinae)." *Ecography* 33(2): 251–59.
- Cavender-Bares, J., D. D. Ackerly, D. A. Baum, and F. A. Bazzaz. 2004. "Phylogenetic Overdispersion in Floridian Oak Communities." *American Naturalist* 163(6): 823–43.
- Chai, Peng. 1986. "Field Observations and Feeding Experiments on the Responses of Rufous-Tailed Jacamars (*Galbula ruficauda*) to Free-Flying Butterflies in a Tropical Rain Forest." *Biol J Linn Soc* 29: 161–89.
- Chai, Peng, and Robert B Srygley. 1990. "Predation and the Flight, Morphology, and Temperature of Neotropical Rain-Forest Butterflies." *The American Naturalist* 135(6): 748–65.
- Chamberlain, Nicola L. et al. 2009. "Polymorphic Butterfly Reveals the Missing Link in Ecological Speciation." *Science* 326(5954): 847–50.
- Chazot, Nicolas et al. 2014. "Mutualistic Mimicry and Filtering by Altitude Shape the Structure of Andean Butterfly Communities." *The American Naturalist* 183(1): 26–39. <http://www.journals.uchicago.edu/doi/10.1086/674100>.
- Chazot, Nicolas 2016. "Into the Andes: Multiple Independent Colonizations Drive Montane Diversity in the Neotropical Clearwing Butterflies Godyridina." *Molecular Ecology*

25(22): 5765–84.

- Chazot, Nicolas, Niklas Wahlberg, et al. 2019. “Priors and Posteriors in Bayesian Timing of Divergence Analyses: The Age of Butterflies Revisited.” *Systematic Biology* 68(5): 797–813.
- Chazot, Nicolas, Keith R. Willmott, et al. 2019. “Renewed Diversification Following Miocene Landscape Turnover in a Neotropical Butterfly Radiation.” *Global Ecology and Biogeography* 28(8): 1118–32.
- Chazot, Nicolas et al. 2021. “Conserved Ancestral Tropical Niche but Different Continental Histories Explain the Latitudinal Diversity Gradient in Brush-Footed Butterflies.” *Nature Communications*: 1–10. <http://dx.doi.org/10.1038/s41467-021-25906-8>.
- Chouteau, Mathieu, Violaine Llaurens, Florence Piron-Prunier, and Mathieu Joron. 2017. “Polymorphism at a Mimicry Supergene Maintained by Opposing Frequency-Dependent Selection Pressures.” *Proceedings of the National Academy of Sciences of the United States of America* 114(31): 8325–29.
- Clavel, Julien, and H el ene Morlon. 2017. “Accelerated Body Size Evolution during Cold Climatic Periods in the Cenozoic.” *Proceedings of the National Academy of Sciences of the United States of America* 114(16): 4183–88.
- Coley, P.D, and T.M Aide. 1991. “Comparison of Herbivory and Plant Defenses in Temperate and Tropical Broad- Leaved Forests.” In *Plant-Animal Interactions: Evolutionary Ecology in Tropical and Temperate Regions*, (Eds) PW Price, TM Lewinsohn, GW Fernandes, and WW Benson. New York: John Wiley & Sons, 25–49.
- Condamine, Fabien L. et al. 2012. “What Causes Latitudinal Gradients in Species Diversity? Evolutionary Processes and Ecological Constraints on Swallowtail Biodiversity.” *Ecology Letters* 15(3): 267–77.
- Cott, Hugh B. 1940. *Adaptive Coloration in Animals*. London, UK. eds. Methuen and Co. London: Methuen.
- Crees, Logan D, Phil Devries, and Carla M Penz. 2020. “Do Hind Wing Eyespots of Caligo Butterflies Function in Both Mating Behavior and Antipredator Defense ? (Lepidoptera, Nymphalidae).” *Annals of the Entomological Society of America* XX(X): 1–9.
- Cresswell, W. 1994. “Song as a Pursuit Deterrent Signal, and Its Occurrence Relative to Other Antipredation Behaviors of Skylark (*Alauda Arvensis*) on Attack by Merlins (*Falco Columbarius*).” *Behav. Ecol. Sociobiol* 34: 217–23.
- Darwin, Charles. 1859. *On the Origin of Species by Means of Natural Selection, or Preservation of Favoured Races in the Struggle for Life*. London.

- Darwin, Charles. 1880. "The Sexual Colors of Certain Butterflies." *Nature* 21(237).
- Davis Rabosky, Alison R. et al. 2016. "Coral Snakes Predict the Evolution of Mimicry across New World Snakes." *Nature Communications*. 7:11484. doi:10.1038/ncomms11484
- Descimon, H. 1986. "Origins of Lepidopteran Faunas in the High Tropical Andes." In *High Altitude Tropical Biogeography*, eds. F. Vuilleumier and M. Monasterio. New York: Oxford University Press, 500–532.
- Despland, Emma, Rolando Humire, and Sandra San Martín. 2012. "Species Richness and Phenology of Butterflies along an Altitude Gradient in the Desert of Northern Chile." *Arctic, Antarctic, and Alpine Research* 44(4): 423–31.
- DeVries, P. J., R. Lande, and D. Murray. 1999. "Associations of Co-Mimetic Ithomiine Butterflies on Small Spatial and Temporal Scales in a Neotropical Rainforest." *Biological Journal of the Linnean Society* 67(1): 73–85.
- DeVries, Philip J. 1987. *The Butterflies of Costa Rica and Their Natural History. Vol. I: Papilionidae, Pieridae, Nymphalidae*. United Kingdom: Princeton University Press.
- Dhungel, Bidur, and Niklas Wahlberg. 2018. "Molecular Systematics of the Subfamily Limenitidinae (Lepidoptera : Nymphalidae)." *PeerJ* 6(e4311): 1–17.
- Dittrich, Winand et al. 1993. "Imperfect Mimicry: A Pigeon's Perspective." *Proc. R. Soc. Lond. B* 251: 195–200.
- Dobzhansky, Theodosius. 1950. "Evolution in the Tropics." *American Scientist* 38(2): 208–21. <http://www.jstor.org/stable/27826306>.
- Doorenweerd, Camiel, Erik J. Van Nieukerken, and Steph B.J. Menken. 2015. "A Global Phylogeny of Leafmining Ectoedemia Moths (Lepidoptera: Nepticulidae): Exploring Host Plant Family Shifts and Allopatry as Drivers of Speciation." *PLoS ONE* 10(3): 1–20.
- Doré, Mael et al. 2022. "Mutualistic Interactions Shape Global Spatial Congruence and Climatic Niche Evolution in Neotropical Mimetic Butterflies." *PNAS*.
- Douglas, M.M., and J.W. Grula. 1978. "Thermoregulatory Adaptations Allowing Ecological Range Expansion by the Pierid Butterfly *Nathalis iole* Boisduval." *Evolution* 32: 776–83.
- Dres, M., and J. Mallet. 2002. "Host Races in Plant Feeding Insects and Their Importance in Sympatric Speciation." *Philosophical Transactions Royal Society of London B: Biological Sciences* 357: 471–92.
- Dudley, R, and R Srygley. 1994. "Flight Physiology of Neotropical Butterflies: Allometry of Airspeeds During Natural Free Flight." *The Journal of experimental biology* 191(1): 125–39.
- Dumbacher, J. P., and R. C. Fleischer. 2001. "Phylogenetic Evidence for Colour Pattern

- Convergence in Toxic Pitohuis: Müllerian Mimicry in Birds?" *Proceedings of the Royal Society B: Biological Sciences* 268(1480): 1971–76.
- Van Dyck, H., and E. Matthysen. 1998. "Thermoregulatory Differences between Phenotypes in the Speckled Wood Butterfly: Hot Perchers and Cold Patrollers?" *Oecologia* 114(3): 326–34.
- Ebel, Emily R. et al. 2015. "Rapid Diversification Associated with Ecological Specialization in Neotropical Adelpha Butterflies." *Molecular Ecology* 24(10): 2392–2405.
- Edelman, Nathaniel B et al. 2019. "Genomic Architecture and Introgression Shape a Butterfly Radiation." *Science* 366: 594–99.
- Edger, Patrick P et al. 2015. "The Butterfly Plant Arms-Race Escalated by Gene and Genome Duplications." *PNAS* 112.
- Edmunds, M. 1974. *Defence in Animals: A Survey of Anti-Predator Defences*. Harlow: Longman.
- Ehrlich, Paul R., and Peter H Raven. 1964. "Butterflies and Plants: A Study in Coevolution." *Evolution* 18: 586–608.
- Elias, M. et al. 2009. "Out of the Andes: Patterns of Diversification in Clearwing Butterflies." *Molecular Ecology* 18(8): 1716–29.
- Elias, Marianne, Zachariah Gompert, Chris Jiggins, and Keith Willmott. 2008. "Mutualistic Interactions Drive Ecological Niche Convergence in a Diverse Butterfly Community." *PLoS biology* 6(12).
- Elias, Marianne, Zachariah Gompert, Keith Willmott, and Chris Jiggins. 2009. "Phylogenetic Community Ecology Needs to Take Positive Interactions into Account: Insights from Colorful Butterflies." *Communicative and Integrative Biology* 2(2): 113–16.
- Elias, Marianne, and Mathieu Joron. 2015. "Mimicry in Heliconius and Ithomiini Butterflies: The Profound Consequences of an Adaptation." In *BIO Web of Conferences*, <http://dx.doi.org/10.1051/bioconf/20150400008>.
- Ellers, J., and C.L Boggs. 2004. "Functional Ecological Implications of Intraspecific Differences in Wing Melanization in Colias Butterflies." *Biol J Linn Soc* 82: 79–87.
- Ellers, Jacintha, and Carol L. Boggs. 2003. "The Evolution of Wing Color: Male Mate Choice Opposes Adaptive Wing Color Divergence in Colias Butterflies." *Evolution* 57(5): 1100–1106.
- Endler, John A. 1991. "Interactions between Predators and Prey." In *Behavioural Ecology: An Evolutionary Approach*, eds. JA Krebs and NB Davies. Oxford: Blackwell Scientific, 169–96.

- Erkens, Roy H.J., Jan W. Maas, and Thomas L.P. Couvreur. 2009. "From Africa via Europe to South America: Migrational Route of a Species-Rich Genus of Neotropical Lowland Rain Forest Trees (*Guatteria*, Annonaceae)." *Journal of Biogeography* 36(12): 2338–52.
- Erwin, Douglas H. 2009. "Climate as a Driver of Evolutionary Change." *Current Biology* 19(14): R575–83. <http://dx.doi.org/10.1016/j.cub.2009.05.047>.
- Estrada, C., and C. D. Jiggins. 2008. "Interspecific Sexual Attraction Because of Convergence in Warning Colouration: Is There a Conflict between Natural and Sexual Selection in Mimetic Species?" *Journal of Evolutionary Biology* 21(3): 749–60.
- Ficarrotta, Vincent et al. 2022. "A Genetic Switch for Male UV Iridescence in an Incipient Species Pair of Sulphur Butterflies." *Proceedings of the National Academy of Sciences of the United States of America* 119(3).
- Fordyce, J. A., C. C. Nice, M. L. Forister, and A. M. Shapiro. 2002. "The Significance of Wing Pattern Diversity in the Lycaenidae: Mate Discrimination by Two Recently Diverged Species." *Journal of Evolutionary Biology* 15(5): 871–79.
- Fordyce, James A. 2010. "Host Shifts and Evolutionary Radiations of Butterflies." *Proceedings of the Royal Society B: Biological Sciences* 277(1701): 3735–43.
- Forister, M.L., and A.M. Shapiro. 2003. "Wing Pattern Variation in the Anise Swallowtail, *Papilio zelicaon* (Lepidoptera: Papilionidae)." *Ann. Entomol. Soc. Am* 96: 73–80.
- Fruhstorfer, H. 1915. "49. Gattung *Adelpha* Hbn." In *Die Gross-Schmetterlinge Der Erde*, ed. A. Seitz. Stuttgart: Alfred Kernen, 510–533.
- Gaston, Kevin J., and Elodie Hudson. 1994. "Regional Patterns of Diversity and Estimates of Global Insect Species Richness." *Biodiversity and Conservation* 3(6): 493–500.
- Gentry, A. H. 1982. "Neotropical Floristic Diversity: Phytogeographical Connections between Central and South America, Pleistocene Climatic Fluctuations, or an Accident of the Andean Orogeny?" *Annals - Missouri Botanical Garden* 69(3): 557–93.
- Gibson, Dianne O. 1974. "Batesian Mimicry without Distastefulness?" *Nature* 250: 77–79. <http://www.nature.com/doi/10.1038/250077a0> (October 23, 2018).
- Gibson, Dianne O. 1980. "The Role of Escape in Mimicry and Polymorphism: I. The Response of Captive Birds to Artificial Prey." *Biological Journal of the Linnean Society* 14: 201–14.
- Giraldo, Nathalia et al. 2008. "Two Sisters in the Same Dress: *Heliconius* Cryptic Species." *BMC Evolutionary Biology* 8(1): 1–11.
- Godman, F.D., and O.S. Salvin. 1884. *Biologia Central-Americana. Insecta. Lepidoptera-Rhopalocera*. London: Dulau, Bernard Quaritch.

- Grafen, A. 1989. "The Phylogenetic Regression." *Philosophical Transactions of the Royal Society of London. Series B, Biological Sciences* 326(1233): 119–57.
- Graham, Catherine H., Juan L. Parra, Carsten Rahbek, and Jimmy A. McGuire. 2009. "Phylogenetic Structure in Tropical Hummingbird Communities." *Proceedings of the National Academy of Sciences of the United States of America* 106: 18435–36.
- Grant, Peter R. 1999. *Ecology and Evolution of Darwin's Finches*. Princeton Univ. Press, Princeton, NJ.
- Grant, Peter R., and B. Rosemary Grant. 2006. "Evolution of Character Displacement in Darwin's Finches." *Science* 313(5784): 224–26.
- Grenyer, Richard et al. 2006. "Global Distribution and Conservation of Rare and Threatened Vertebrates." *Nature* 444(7115): 93–96.
- Grimaldi, D., and M.S. Engel. 2005. *Evolution of the Insects*. Cambridge, UK: Cambridge Univ Press.
- Gröning, Julia, and Axel Hochkirch. 2008. "Reproductive Interference between Animal Species." *Quarterly Review of Biology* 83(3): 257–82.
- Gross, Kevin. 2008. "Positive Interactions among Competitors Can Produce Species-Rich Communities." *Ecology Letters* 11(9): 929–36.
- Grytnes, J.A., and C.M. McCain. 2007. "Elevation Patterns in Species Richness." In *Encyclopedia of Biodiversity*, ed. Levin S. Elsevier, 1–8.
- Hale, Kayla R.S., Fernanda S. Valdovinos, and Neo D. Martinez. 2020. "Mutualism Increases Diversity, Stability, and Function of Multiplex Networks That Integrate Pollinators into Food Webs." *Nature Communications* 11(1): 1–14. <http://dx.doi.org/10.1038/s41467-020-15688-w>.
- Hall, A. 1938. 71 *On the Types of Adelpha (Lep., Nymphalidae) in the Collection of the British Museum, Ent. (London)*.
- Hall, Jason P.W. 2005. "Montane Speciation Patterns in Ithomiola Butterflies (Lepidoptera: Riodinidae): Are They Consistently Moving up in the World?" *Proceedings of the Royal Society B: Biological Sciences* 272(1580): 2457–66.
- Hancox, A. P., and J. A. Allen. 1991. "A Simulation of Evasive Mimicry in the Wild." *Journal of Zoology* 223(1): 9–13.
- Hardy, Olivier J., and Bruno Senterre. 2007. "Characterizing the Phylogenetic Structure of Communities by an Additive Partitioning of Phylogenetic Diversity." *Journal of Ecology* 95(3): 493–506.
- Hawkins, Bradford A., José Alexandre Felizola Diniz-Filho, Carlos A. Jaramillo, and Stephen

- A. Soeller. 2007. "Climate, Niche Conservatism, and the Global Bird Diversity Gradient." *American Naturalist*. Vol. 170, pp. S16–S27
- Hespenheide, H. 1973. "A Novel Mimicry Complex: Beetles and Flies." *Journal of Entomology* 48: 49–56.
- Hill, R. I. 2010. "Habitat Segregation among Mimetic Ithomiine Butterflies (Nymphalidae)." *Evolutionary Ecology* 24: 273–85.
- Hill, Ryan I. 2021. "Convergent Flight Morphology among Müllerian Mimic Mutualists." *Evolution* 75(10): 2460–79.
- Hillebrand, Helmut. 2004. "On the Generality of the Latitudinal Diversity Gradient." *American Naturalist* 163(2): 192–211.
- Hoang, Diep Thi et al. 2017. "UFBoot2 : Improving the Ultrafast Bootstrap Approximation." *35(2)*: 518–22.
- Hochkirch, Axel, Julia Gröning, and Amelie Bücken. 2007. "Sympatry with the Devil: Reproductive Interference Could Hamper Species Coexistence." *Journal of Animal Ecology* 76(4): 633–42.
- Holm, E., and J.F. Kirsten. 1979. "Pre-Adaptation and Speed Mimicry among Namib Desert Scarabaeids with Orange Elytra." *Journal of Arid Environments* 2(3): 263–71. [http://dx.doi.org/10.1016/S0140-1963\(18\)31776-2](http://dx.doi.org/10.1016/S0140-1963(18)31776-2).
- Hubbell, Stephen P. 2001. *The Unified Neutral Theory of Biodiversity and Biogeography*. Princeton University Press.
- Hughes, Colin, and Ruth Eastwood. 2006. "Island Radiation on a Continental Scale: Exceptional Rates of Plant Diversification after Uplift of the Andes." *Proceedings of the National Academy of Sciences of the United States of America* 103(27): 10334–39.
- Huheey, J. E. 1964. "Studies in Warning Coloration and Mimi- Cry. IV. A Mathematical Model of Model–Mimic Frequencies." *Ecology* 45: 185–88.
- Huheey, James E . 1976. "Studies in Warning Coloration and Mimicry . VII . Evolutionary Consequences of a Batesian–Müllerian Spectrum : A Model for Müllerian." *Evolution* 30(1): 86–93.
- Hui-Yun, Tseng et al. 2022. "Out of Asia: Intercontinental Dispersals after the Eocene-Oligocene Transition Shaped the Zoogeography of Limenitidinae Butterflies (Lepidoptera: Nymphalidae)." *Molecular Phylogenetics and Evolution* 170(February): 107444. <https://doi.org/10.1016/j.ympev.2022.107444>.
- Jantzen, B., and T. Eisner. 2008. "Hindwings Are Unnecessary for Flight but Essential for Execution of Normal Evasive Flight in Lepidoptera." *Proceedings of the National*

- Academy of Sciences* 105(43): 16636–40.
<http://www.pnas.org/cgi/doi/10.1073/pnas.0807223105>.
- Janz, Niklas, and Sören Nylin. 2008. “Host Plant Range and Speciation: The Oscillation Hypothesis.” In *Specialization, Speciation, and Radiation: The Evolutionary Biology of Herbivorous Insects*, ed. K. J. Tilmon. California: Univ. of California Press, 203–15.
- Janz, Niklas, Sören Nylin, and Niklas Wahlberg. 2006. “Diversity Begets Diversity: Host Expansions and the Diversification of Plant-Feeding Insects.” *BMC Evolutionary Biology* 6(4).
- Janzen, Daniel H. 1970. “Herbivores and the Number of Tree Species in Tropical Forests.” *The American Naturalist* 104(940).
- Jetz, W. et al. 2012. “The Global Diversity of Birds in Space and Time.” *Nature* 491(7424): 444–48.
- Jiggins, C. D., I. Emelianov, and J. Mallet. 2004. “Pleiotropy Promotes Speciation: Examples from Phytophagous Moths and Mimetic Butterflies.” In *Insect Evolutionary Ecology*, eds. M. Fellowes, G. Holloway, and J. Rolff. London: Royal Entomological Society, 451–473.
- Jiggins, C. D., M. Salazar, Linares, and J Mavárez. 2008. “Hybrid Speciation in *Heliconius* Butterflies.” *Philos. Trans. R. Soc. Lond. B* 363: 3047–54.
- Jiggins, Chris D. 2008. “Ecological Speciation in Mimetic Butterflies.” *BioScience* 58(6): 541–48.
- Jiggins, Chris D., Ricardo Mallarino, Keith R. Willmott, and Eldredge Bermingham. 2006. “The Phylogenetic Pattern of Speciation and Wing Pattern Change in Neotropical *Ithomia* Butterflies (Lepidoptera: Nymphalidae).” *Evolution* 60(7): 1454.
- Jiggins, Chris D., Russell E Naisbit, Rebecca L. Coe, and James Mallet. 2001. “Reproductive Isolation Caused by Colour Pattern Mimicry.” *Nature* 411: 302–5. www.nature.com (May 17, 2019).
- de Jong, Rienk. 2017. “Fossil Butterflies, Calibration Points and the Molecular Clock (Lepidoptera: Papilionoidea).” *Zootaxa* 4270(1): 1–63.
- Joron, M, and J L Mallet. 1998. “Diversity in Mimicry: Paradox or Paradigm?” *Trends in ecology & evolution* 13(11): 461–66.
- Joron, Mathieu et al. 2006. “A Conserved Supergene Locus Controls Colour Pattern Diversity in *Heliconius* Butterflies.” *PLoS Biology* 4(10): 1831–40.
- Joron, Mathieu. 2011. “Chromosomal Rearrangements Maintain a Polymorphic Supergene Controlling Butterfly Mimicry.” *Nature* 477(7363): 203–6.
- Jousselin, Emmanuelle et al. 2013. “Is Ecological Speciation a Major Trend in Aphids? Insights

- from a Molecular Phylogeny of the Conifer-Feeding Genus *Cinara*.” *Frontiers in Zoology* 10(1): 1–18.
- Jousselin, Emmanuelle, and Marianne Elias. 2019. “Testing Host-Plant Driven Speciation in Phytophagous Insects : A Phylogenetic Perspective.” Prepr. arXiv:1910.09510
- Kemp, D.J. 2007. “Female Butterflies Prefer Males Bearing Bright Iridescent Ornamentation.” *Proceedings of the Royal Society B: Biological Sciences* 274: 1043–1047.
- Kergoat, Gael J et al. 2018. “Opposite Macroevolutionary Responses to Environmental Changes in Grasses and Insects during the Neogene Grassland Expansion.” *Nature Communications* 9: 5089.
- Kikuchi, David W., and Thomas N. Sherratt. 2015. “Costs of Learning and the Evolution of Mimetic Signals.” *American Naturalist* 186(3): 321–32.
- Kingsolver, Joel G. 1985. “Thermoregulatory Significance of Wing Melanization in Pieris Butterflies (Lepidoptera: Pieridae): Physics, Posture, and Pattern.” *Oecologia* 66(4): 546–53.
- Kinoshita, M., N. Shimada, and K. Arikawa. 1999. “Colour Vision in the Foraging Swallowtail Butterfly *Papilio Xuthus*.” *Journal of Experimental Biology* 202: 95–102.
- Kirby, W. F. 1871. *A Synonymic Catalogue of Diurnal Lepidoptera*. John Van V. London.
- Kodandaramaiah, U., P. Lindenfors, and S.B. Tullberg. 2013. “Deflective and Intimidating Eyespots: A Comparative Study of Eyespot Size and Position in *Junonia* Butterflies.” *Ecology and Evolution* 3: 4518–4524.
- Kozak, Krzysztof M., Mathieu Joron, W. Owen McMillan, and Chris D. Jiggins. 2021. “Rampant Genome-Wide Admixture across the *Heliconius* Radiation.” *Genome Biology and Evolution* 13(7): 1–17.
- Kraft, Nathan J.B., William K. Cornwell, Campbell O. Webb, and David D. Ackerly. 2007. “Trait Evolution, Community Assembly, and the Phylogenetic Structure of Ecological Communities.” *American Naturalist* 170(2): 271–83.
- Kronforst, Marcus R. et al. 2006. “Linkage of Butterfly Mate Preference and Wing Color Preference Cue at the Genomic Location of *Wingless*.” *Proceedings of the National Academy of Sciences of the United States of America* 103(17): 6575–80.
- Kronforst, Marcus R., Durrell D. Kapan, and Lawrence E. Gilbert. 2006. “Parallel Genetic Architecture of Parallel Adaptive Radiations in Mimetic *Heliconius* Butterflies.” *Genetics* 174(1): 535–39.
- Kunte, Krushnamegh, Athulya Girish Kizhakke, and Viraj Nawge. 2021. “Evolution of

- Mimicry Rings as a Window into Community Dynamics.” *Annual Review of Ecology, Evolution, and Systematics* 52(1): 315–41.
- Lagomarsino, Laura P. et al. 2016. “The Abiotic and Biotic Drivers of Rapid Diversification in Andean Bellflowers (Campanulaceae).” *New Phytologist* 210(4): 1430–42.
- Lamas, Gerardo. 2004. “Checklist: Part 4A. Hesperioidea-Papilionoidea.” In *Atlas of Neotropical Lepidoptera, Vol. 5A*, ed. J.B. Heppner. Gainesville: Association for Tropical Lepidoptera/Scientific Publishers, xxxvi + 439.
- Lanfear, Robert, Brett Calcott, Simon Y.W. Ho, and Stephane Guindon. 2012. “PartitionFinder: Combined Selection of Partitioning Schemes and Substitution Models for Phylogenetic Analyses.” *Molecular Biology and Evolution* 29(6): 1695–1701.
- Li, Wenlin et al. 2019. “Genomes of Skipper Butterflies Reveal Extensive Convergence of Wing Patterns.” *Proceedings of the National Academy of Sciences of the United States of America* 116(13): 6232–37.
- Lincon, R, G Boxshall, and P Clarck. 1998. *A Dictionary of Ecology, Evolution and Systematics*. Second. Cambridge: Cambridge University Press.
- Lindroth, Carl H. 1971. “Disappearance as a Protective Factor.” *Ent. scand.* 2: 41–48.
- Lindström, Leena et al. 1999. “Can Aposematic Signals Evolve by Gradual Change?” *Nature* 397(6716): 249–51.
- Lisa De-Silva, Donna et al. 2017. “North Andean Origin and Diversification of the Largest Ithomiine Butterfly Genus.” *Scientific Reports* 7: 1–17.
- Llaurens, V., M. Joron, and M. Théry. 2014. “Cryptic Differences in Colour among Müllerian Mimics: How Can the Visual Capacities of Predators and Prey Shape the Evolution of Wing Colours?” *Journal of Evolutionary Biology* 27(3): 531–40.
- López-Palafox, Tania G., Armando Luis-Martínez, and Carlos C. Cordero. 2015. “The Movement of ‘ False Antennae ’ in Butterflies with ‘ False Head ’ Wing Patterns.” *Current Aology* 61(4): 758–64.
- López-Palafox, Tania G, and Carlos R Cordero. 2017. “Two-Headed Butterfly vs . Mantis : Do False Antennae Matter ?” *PeerJ* 5(e3493): 1–10.
- Lord, Janice, Mark Westoby, and Michelle Leishman. 1995. “Seed Size and Phylogeny in Six Temperate Floras : Constraints , Niche Conservatism , and Adaptation Author (s): Janice Lord , Mark Westoby and Michelle Leishman Published by : University of Chicago Press for American Society of Naturalists Stable URL :” *The American Naturalist* 146(3): 349–64.
- Losos, Jonathan B. et al. 2003. “Niche Lability in the Evolution of a Caribbean Lizard

- Community.” *Nature* 424(6948): 542–45.
- Lovette, Irby J., and Wesley M. Hochachka. 2006. “Simultaneous Effects of Phylogenetic Niche Conservatism and Competition on Avian Community Structure.” *Ecology* 87(7): 14–28.
- Lukhtanov, Vladimir A. et al. 2005. “Reinforcement of Pre-Zygotic Isolation and Karyotype Evolution in *Agrodiaetus* Butterflies.” *Nature* 436(7049): 385–89.
- M. Pagel. 1999. “Inferring the Historical Patterns of Biological Evolution.” *Nature* 401(October 1999): 877–84.
- MacArthur, Robert, and Richard Levins. 1967. “The Limiting Similarity, Convergence, and Divergence of Coexisting Species Author(s): Robert MacArthur and Richard Levins. *The American Naturalist*, 101(921): 377–85.
- Mallet, James, and Nicholas H Barton. 1989. “Strong natural selection in a warning-color hybrid zone.” *Evolution* 43(2): 421–31.
<https://onlinelibrary.wiley.com/doi/pdf/10.1111/j.1558-5646.1989.tb04237.x>
- Mallet, James, and Lawrence Gilbert. 1995. “Why Are There so Many Mimicry Rings? Correlations between Habitat, Behaviour and Mimicry in *Heliconius* Butterflies.” *Biological Journal of the Linnean Society* 55(2): 159–80.
- Mallet, James, W Owen Mcmillan, and Chris D Jiggins. 1998. *Mimicry and Warning Color at the Boundary between Races and Species*. In *Endless Forms: Species and Speciation* (Berlocher, S. and Howard, D., eds), pp. 390–403, Oxford University Press
- Mallet, James, and Michael Singer. 1987. “Individual Selection, Kin Selection, and the Shifting Balance in the Evolution of Warning Colours: The Evidence from Butterflies.” *Biological Journal of the Linnean Society* 32: 337–50.
- Mappes, Johanna, Nicola Marples, and John A Endler. 2005. “The Complex Business of Survival by Aposematism.” *TRENDS in ecology & evolution* 20(11): 598–603.
- Marek, Paul E., and Jason E. Bond. 2009. “A Müllerian Mimicry Ring in Appalachian Millipedes.” *Proceedings of the National Academy of Sciences of the United States of America* 106(24): 9755–60.
- Martins, Emilia, and Thomas Hansen. 1997. “Phylogenies and the Comparative Method: A General Approach to Incorporating Phylogenetic Information into the Analysis of Interspecific Data.” *The American Naturalist* 149(4): 646–67.
- Matos-Maraví, Pável F et al. 2013. “Systematics and Evolutionary History of Butterflies in the ‘Taygetis Clade’ (Nymphalidae: Satyrinae: Euptychiina): Towards a Better Understanding of Neotropical Biogeography.” *Molecular Phylogenetics and Evolution*

- 66(1): 54–68. <http://dx.doi.org/10.1016/j.ympev.2012.09.005>.
- Mavárez, Jesús et al. 2006. “Speciation by Hybridization in Heliconius Butterflies.” *Nature* 441(7095): 868–71.
- Mayr, Ernest. 1942. *Systematics and the Origin of Species, from the Viewpoint of a Zoologist*. New York: Columbia University Press.
- McClure, Melanie et al. 2019. “Does Divergent Selection Predict the Evolution of Mate Preference and Reproductive Isolation in the Tropical Butterfly Genus *Melinaea* (Nymphalidae: Ithomiini)?” *Journal of Animal Ecology* 88(6): 940–52.
- Mcmillan, W. Owen, Chris D. Jiggins, and James Mallet. 1997. “What Initiates Speciation in Passion-Vine Butterflies?” *Proceedings of the National Academy of Sciences of the United States of America* 94(16): 8628–33.
- Meade, Andrew, and Mark Pagel. 2011. “BayesTrees 1.3.” <http://www.evolution.reading.ac.uk/BayesTrees.html>.
- Mérot, Claire et al. 2013. “Genetic Differentiation without Mimicry Shift in a Pair of Hybridizing *Heliconius* Species (Lepidoptera: Nymphalidae).” *Biological Journal of the Linnean Society* 109(4): 830–47.
- Merrill, Richard M. et al. 2012. “Disruptive Ecological Selection on a Mating Cue.” *Proceedings of the Royal Society B: Biological Sciences* 279(1749): 4907–13.
- Merrill, Richard M., Bas Van Schooten, Janet A. Scott, and Chris D. Jiggins. 2011. “Pervasive Genetic Associations between Traits Causing Reproductive Isolation in *Heliconius* Butterflies.” *Proceedings of the Royal Society B: Biological Sciences* 278(1705): 511–18.
- Miller, James S. 1987. “Host-Plant Relationships in the Papilionidae (Lepidoptera): Parallel Cladogenesis or Colonization?” *Cladistics* 3(2): 105–20.
- Miller, Mark A, Wayne Pfeiffer, and Terri Schwartz. 2010. “Creating the CIPRES Science Gateway for Inference of Large Phylogenetic Trees.” http://www.phylo.org/sub_sections/portal/sc2010_paper.pdf.
- Minh, Bui Quang, Minh Anh, Thi Nguyen, and Arndt Von Haeseler. 2013. “Ultrafast Approximation for Phylogenetic Bootstrap.” 30(5): 1188–95.
- Mirarab, Siavash et al. 2015. “PASTA: Ultra-Large Multiple Sequence Alignment for Nucleotide and Amino-Acid Sequences.” *Journal of Computational Biology* 22(5): 377–86.
- Moss, A.M. 1933. “Some Generalizations on *Adelpha*, a Neotropical Genus of Nymphalids Butterflies of the Group *Limenitidi*.” *Novit. Zool.* 39(12).
- Mullen, Sean P. 2006. “Wing Pattern Evolution and the Origins of Mimicry among North

- American Admiral Butterflies (Nymphalidae: Limenitis).” *Molecular Phylogenetics and Evolution* 39(3): 747–58.
- Mullen, Sean P., Wesley K. Savage, Niklas Wahlberg, and Keith R. Willmott. 2011. “Rapid Diversification and Not Clade Age Explains High Diversity in Neotropical Adelpha Butterflies.” *Proceedings of the Royal Society B: Biological Sciences* 278(1713): 1777–85.
- Muller, F. 1879. “Ituna and Thyridia; a Remarkable Case of Mimicry in Butterflies.” *Proc. R. Ent. Soc. Lond.*: xx–xxix.
- Myers, Norman et al. 2000. “A Critically Endangered New Species of Nectophrynoidea (Anura: Bufonidae) from the Kihansi Gorge, Udzungwa Mountains, Tanzania.” *African Journal of Herpetology* 403(Nature): 853–58.
- Neild, A.F.E. 2008. *The Butterflies of Venezuela Part 2: Nymphalidae II (Acraeinae, Libytheinae, Nymphalinae, Ithomiinae, Morphinae)*. Greenwich, London: Meridian Publications.
- Neild, A. 1996. *The Butterflies of Venezuela. Part 1: Nymphalidae I (Limenitidinae, Apaturinae, Charaxinae). A Comprehensive Guide to the Identification of Adult Nymphalidae, Papilionidae, and Pieridae*. London: Meridian Publications.
- Nosil, Patrik. 2012. *Ecological Speciation*. Oxford Univ. Press.
- Novotny, Vojtech et al. 2006. “Why Are There so Many Species of Herbivorous Insects in Tropical Rainforests?” *Science* 313(5790): 1115–18.
- Nylin, Sören, Jessica Slove, and Niklas Janz. 2013. “Host Plant Utilization, Host Range Oscillations and Diversification in Nymphalid Butterflies: A Phylogenetic Investigation.” *Evolution* 68(1): 105–24.
- Okuyama, Toshinori, and J. Nathaniel Holland. 2008. “Network Structural Properties Mediate the Stability of Mutualistic Communities.” *Ecology Letters* 11(3): 208–16.
- Orme, C. David L. et al. 2005. “Global Hotspots of Species Richness Are Not Congruent with Endemism or Threat.” *Nature* 436(7053): 1016–19.
- Orme, D. et al. 2013. “Caper: Comparative Analyses of Phylogenetics and Evolution in R. R Package Version 0.5.2.” <https://cran.r-project.org/web/packages/caper/index.html>.
- Ortiz-Acevedo, Elena et al. 2020. “The Roles of Wing Color Pattern and Geography in the Evolution of Neotropical Preponini Butterflies.” *Ecology and Evolution* 10(23): 12801–16.
- Páez, Erika et al. 2021. “Hard to Catch: Experimental Evidence Supports Evasive Mimicry.” *Proceedings of the Royal Society B: Biological Sciences* 288(1946): 1–10.

- Pagel, Mark, Andrew Meade, and Daniel Barker. 2004. "Bayesian Estimation of Ancestral Character States on Phylogenies." *Systematic Biology* 53(5): 673–84.
- Paluch, M., M.M. Casagrande, and O.H.H. Mielke. 2006. "Três Espécies e Duas Subespécies Novas de Actinote Hübner (Nymphalidae, Heliconiinae, Acraeini)." *Rev. Bras. Zool* 23(3): 764–78.
- Papageorgis, C. 1975. "Mimicry in Neotropical Butterflies." *American Scientist* 63: 522e532.
- Pardo-Diaz Carolina et al. 2012. "Adaptive Introgression across Species Boundaries in Heliconius Butterflies." *Plos Genet* 8(6): e1002752.
- Patterson, Bruce D., and Nathan S. Upham. 2014. "Rodent Phylogeny Revised: Analysis of Six Nuclear Genes from All Major Rodent Clades." *Frontiers in Ecology and the Environment* 2: 1–2.
- Peña, Carlos, and Niklas Wahlberg. 2008. "Prehistorical Climate Change Increased Diversification of a Group of Butterflies." *Biology Letters* 4(3): 274–78.
- Pennington, R. Toby, Mark Hughes, and Peter W. Moonlight. 2015. "The Origins of Tropical Rainforest Hyperdiversity." *Trends in Plant Science* 20(11): 693–95. <http://dx.doi.org/10.1016/j.tplants.2015.10.005>.
- Penz, Carla Maria, and Neda Mohammadi. 2013. "Diversidade de Padrão Das Asas Em Brassolini (Nymphalidae, Satyrinae)." *Biota Neotropica* 13(3): 154–80.
- Pinheiro, C.E.G., and A.V.L. Freitas. 2014. "Some Possible Cases of Escape Mimicry in Neotropical Butterflies." *Neotropical Entomology* 43: 393–98.
- Pinheiro, Carlos E. G., and Renato Cintra. 2017. "Butterfly Predators in the Neotropics: Which Birds Are Involved?" *Journal of the Lepidopterists' Society* 71(2): 109–14. <http://www.bioone.org/doi/10.18473/lepi.71i2.a5>.
- Pinheiro, Carlos E.G. 2003. "Does Mullerian Mimicry Work in Nature? Experiments with Butterflies and Birds (Tyrannidae)1." *Biotropica* 35(3): 356–64. <http://doi.wiley.com/10.1111/j.1744-7429.2003.tb00589.x>.
- Pinheiro, Carlos E.G. 1996. "Palatability and Escaping Ability in Neotropical Butterflies : Tests with Wild Kingbirds (Tyrannus Melancholicus , Tyrannidae)." *Biological Journal of the Linnean Society* 59: 351–65.
- Pinheiro, Carlos E.G. 2003. "Does Müllerian Mimicry Work in Nature? Experiments with Butterflies and Birds (Tyrannidae)." *Biotropica* 35(3): 356–64.
- Pinheiro, Carlos E.G., and Vitor C. Campos. 2019. "The Responses of Wild Jacamars (Galbula Ruficauda, Galbulidae) to Aposematic, Aposematic and Cryptic, and Cryptic Butterflies in Central Brazil." *Ecological Entomology*. DOI: 10.1111/een.12723 N

- Pinheiro, Carlos E.G, André V.L. Freitas, Philip J Devries, and Carla M Penz. 2016. “Both Palatable and Unpalatable Butterflies Use Bright Colors to Signal Difficulty of Capture to Predators.” *Neotropical Entomology* 45: 107–13.
- Pivnick, K.A., and J.N McNeil. 1986. “Sexual Differences in the Thermoregulation of *Thymelicus Lineola* Adults (Lepidoptera: Hesperiiidae).” *Ecology* 67: 1024–1035.
- Le Poul, Yann et al. 2014. “Evolution of Dominance Mechanisms at a Butterfly Mimicry Supergene.” *Nature Communications* 5: 1–8. <http://dx.doi.org/10.1038/ncomms6644>.
- Poulton, E. B. 1887. “The Experimental Proof of the Protective Value of Colour and Markings in Insects in Reference to Their Vertebrate Enemies.” *Proceedings of the Zoological Society of London* 55(2): 191–274.
- Poulton, E.B. 1907. “The Significance of Some Secondary Sexual Characters in Butterflies.” *Trans. R. Entomol. Soc. Lond.*: XI–Xlii.
- Poulton, Sir Edward Bagnall. 1890. *The Colours of Animals: Their Meaning and Use Especially Considered in the Case of Insects*. 2nd ed. eds. Paul Kegan, Trench Trübner, and Co. London, UK: Trübner & Co Ltd.
- Prudic, K. L., A. M. Stoehr, B. R. Wasik, and A. Monteiro. 2015. Eyespots deflect predator attack increasing fitness and promoting the evolution of phenotypic plasticity. *Proc. Biol. Sci.* 282: 20141531
- Prudic, K.L., A.K Skemp, and D.R Papaj. 2007. “Aposematic Coloration, Luminance Contrast, and the Benefits of Conspicuousness.” *Behavioral Ecology* 18: 41–46.
- Prudic, Kathleen L., Arthur M. Shapiro, and Nicola S. Clayton. 2002. “Evaluating a Putative Mimetic Relationship between Two Butterflies, *Adelpha Bredowii* and *Limenitis Lorquini*.” *Ecological Entomology* 27: 68–75.
- Pyrzcz, Tomasz W. et al. 2014. “Latitudinal Gradient and Spatial Covariance in Species Richness of Tropical Lepidoptera in the Andes.” *Insect Conservation and Diversity* 7(4): 355–64.
- Qian, Hong, Robert E. Ricklefs, and Wilfried Thuiller. 2021. “Evolutionary Assembly of Flowering Plants into Sky Islands.” *Nature Ecology and Evolution* 5(5): 640–46. <http://dx.doi.org/10.1038/s41559-021-01423-1>.
- Rahbek, Carsten. 1995. “The Elevation Gradient of Species Richness: A Uniform Pattern?” *Ecography* 18: 200–205.
- Rambaut, Andrew et al. 2018. “Posterior Summarization in Bayesian Phylogenetics Using Tracer 1 . 7.” *Systematic Biology* 67(5): 901–4.
- Raven, Peter H, and Daniel I Axelrod. 1974. “Angiosperm Biogeography and Past Continental

- Movements as Continental Movements.” *Annals of the Missouri Botanical Garden* 61(3): 539–673.
- Richardson, J. E., R. T. Pennington, T. D. Pennington, and P. M. Hollingsworth. 2001. “Rapid Diversification of a Species-Rich Genus of Neotropical Rain Forest Trees.” *Science* 293(5538): 2242–45.
- Ricklefs R.E., and Orourke K. 1975. “Aspect Diversity in Moths: Temperate-Tropical Comparison.” *Evolution* 29: 313–24.
- Ricklefs, Robert E. 2009. “Aspect Diversity in Moths Revisited.” *American Naturalist* 173(3): 411–16.
- Ricklefs, Robert E, and Roger Earl Latham. 1993. “Global Patterns of Tree Species Richness in Moist Forests : Energy- Diversity Theory Does Not Account for Variation in Species Richness.” *Oikos* 67(2): 325–33. <http://www.jstor.org/stable/3545479>.
- Riipi, Marianna, Leena Lindström, and Johanna Mappes. 2001. “Multiple Benefits of Gregariousness Cover Detectability Costs in Aposematic Aggregations.” *Nature* 413: 512–514.
- Ritland, D.B., and L.P. Brower. 1991. “The Viceroy Butterfly Is Not a Batesian Mimic.” *Nature* 350: 497–98.
- Robertson, K. A., and A. Monteiro. 2005. “Female *Bicyclus Any-Nana* Butterflies Choose Males on the Basis of Their Dorsal UV- Reflective Eyespot Pupils.” *Proceedings of the Royal Society B* 272: 1541–1546.
- Ronquist, F., J. Huelsenbeck, and M. Teslenko. 2011. “MrBayes Version 3.2 Manual: Tutorials and Model Summaries.” *Manual MrBayes*: 1–103.
- Ruxton, G. D., M. Speed, and T. N. Sherratt. 2004. “Evasive Mimicry: When (If Ever) Could Mimicry Based on Difficulty of Capture Evolve?” *Proceedings of the Royal Society B: Biological Sciences* 271(1553): 2135–42.
- Ruxton, Graeme D., William L Allen, Tom N. Sherratt, and Michael P. Speed. 2018. *Avoiding Attack: The Evolutionary Ecology of Crypsis, Warning Signals, and Mimicry*. Oxford University Press.
- Ruxton, Graeme D., Dan W. Franks, Alexandra C.V. Balogh, and Olof Leimar. 2008. “Evolutionary Implications of the Form of Predator Generalization for Aposematic Signals and Mimicry in Prey.” *Evolution* 62(11): 2913–21.
- Sahoo, Ranjit Kumar, Andrew D Warren, Steve C Collins, and Ullasa Kodandaramaiah. 2017. “Hostplant Change and Paleoclimatic Events Explain Diversification Shifts in Skipper Butterflies (Family : Hesperiiidae).” 17(1):174. doi: 10.1186/s12862-017-1016-x.

- Sanders, K L, A Malhotra, and R S Thorpe. 2006. "Evidence for a Müllerian Mimetic Radiation in Asian Pitvipers." *Proceedings of the Royal Society B: Biological Sciences* 273(1590): 1135–41.
- Saporito, Ralph A. et al. 2007. "Experimental Evidence for Aposematism in the Dendrobatid Poison Frog *Oophaga Pumilio*." *Copeia*: 1006–11.
- Schemske, Douglas W. 2002. "Ecological and Evolutionary Perspectives on the Origins of Tropical Diversity." In *Foundations of Tropical Forest Biology*, eds. R.L Chazdon and T.C Whitmore. Chicago: Univ. of Chicago Press, 163–73.
- Schemske, Douglas W. 2009. "Biotic Interactions and Speciation." In *Speciation and Patterns of Diversity*, eds. RK Butlin, JR Bridle, and D Schluter. Cambridge, United Kingdom: Cambridge Univ. Press, 219–39.
- Schemske, Douglas W. 2009. "Is There a Latitudinal Gradient in the Importance of Biotic Interactions?" *Annual Review of Ecology, Evolution, and Systematics* 40: 245–69.
- Scott, James A. 1973. "Mating of Butterflies." *The Journal of Research on the Lepidoptera* 11: 99–127.
- Servedio, Maria R. et al. 2011. "Magic Traits in Speciation: 'magic' but Not Rare?" *Trends in Ecology and Evolution* 26(8): 389–97.
- Sherratt, Thomas N. 2008. "The Evolution of Müllerian Mimicry." *Naturwissenschaften* 95(8): 681–95.
- Silberglied, R. E. 1977. "Communication in the Lepidoptera." In *How Animals Communicate*, ed. T. A. Sebeok. Indiana Univ. Press, Bloomington.
- Silberglied, R. E., and O. R. Taylor. 1973. "Ultraviolet Differences between the Sulphur Butterflies, *Colias Eurytheme* and *C. Philodice*, and a Possible Isolating Mechanism [14]." *Nature* 241(5389): 406–8.
- Silva-Brandão, K.L. et al. 2008. "Phylogenetic Relationships of Butterflies of the Tribe Acraeini (Lepidoptera, Nymphalidae, Heliconi- Inae) and the Evolution of Host Plant Use." *Mol. Phylogenet. Evol.* 46: 515–531.
- Da Silva, José Maria Cardoso, Anthony B. Rylands, and Gustavo A.B. Da Fonseca. 2005. "The Fate of the Amazonian Areas of Endemism." *Conservation Biology* 19(3): 689–94.
- Simpson, Beryl B, and Jürgen Haffer. 1978. "Speciation Patterns in Amazonian Rainforest Biota." *Annual Review of Ecology and Systematics* 9(60): 497–518.
- Skelhorn, J. 2015. "Masquerade." *Current Biology* 25: R643–R644.
- Slove, Jessica, and Niklas Janz. 2011. "The Relationship between Diet Breadth and Geographic Range Size in the Butterfly Subfamily Nymphalinae – A Study of Global Scale." *PLoS*

ONE 6(1): 1–5.

- Smith, Stephen A., and Casey W. Dunn. 2008. “Phyutility: A Phyloinformatics Tool for Trees, Alignments and Molecular Data.” *Bioinformatics* 24(5): 715–16.
- Van Someren, V.G.L J, and T.H.E Jackson. 1959. “Some Comments on the Protective Resemblance Amongst African Lepidoptera (Rhopalocera).” *Journal of the Lepidopterists’ Society* 13(3).
- Sourakov, Andrei. 2013. “Two Heads Are Better than One: False Head Allows Calycopis Cecrops (Lycaenidae) to Escape Predation by a Jumping Spider, Phidippus Pulcherrimus (Salticidae).” *Journal of Natural History* 47(15–16): 1047–54.
- Srygley, R. B. 1999. “Incorporating Motion into Investigations of Mimicry.” *Evolutionary Ecology* 13: 691–708.
- Srygley, Robert B., and C. P. Ellington. 1999. “Discrimination of Flying Mimetic, Passion-Vine Butterflies *Heliconius*.” *Proceedings of the Royal Society B: Biological Sciences* 266(1434): 2137–40.
- Srygley, Robert B. 1994. “Locomotor Mimicry in Butterflies? The Associations of Positions of Centres of Mass among Groups of Mimetic, Unprofitable Prey.” *Philosophical Transactions Royal Society of London B: Biological Sciences* 343: 145–55.
- Srygley, Robert B, and Peng Chai. 1990. “Flight Morphology of Neotropical Butterflies : Palatability and Distribution of Mass to the Thorax and Abdomen.” *Oecologia* 84(4): 491–99.
- Stebbins, G Ledyard. 2013. *Flowering Plants: Evolution above the Species Level*. Cambridge, MA: Harvard University Press.
- Stevens, M., and S. Merilaita. 2009. “Animal Camouflage: Current Issues and New Perspectives.” *Philosophical Transactions Royal Society of London B: Biological Sciences* 364: 423–427.
- Stevens, M., C.L. Stubbins, and C. J. Hardman. 2008. “The Anti-Predator Function of ‘Eyespots’ on Camouflaged and Conspicuous Prey.” *Behav. Ecol. Sociobiol* 62: 1787–1793.
- Stubbs, Wendy J., and J. Bastow Wilson. 2004. “Evidence for Limiting Similarity in a Sand Dune Community.” *Journal of Ecology* 92(4): 557–67.
- Supple, Megan A. et al. 2013. “Genomic Architecture of Adaptive Color Pattern Divergence and Convergence in *Heliconius* Butterflies.” *Genome Research* 23(8): 1248–57.
- Symula, R., R. Schulte, and K. Summers. 2001. “Molecular Phylogenetic Evidence for a Mimetic Radiation in Peruvian Poison Frogs Supports a Müllerian Mimicry Hypothesis.”

- Proceedings of the Royal Society B: Biological Sciences* 268(1484): 2415–21.
- Thawornwattana, Yuttapong, Fernando A Seixas, Ziheng Yang, and James Mallet. 2021. “Complex Introgression History of the Erato-Sara Clade of *Heliconius* Butterflies.” *preprint* <https://doi.org/10.1101/2021.02.10.430600>.
- The *Heliconius* Genome Consortium. 2012. “Butterfly Genome Reveals Promiscuous Exchange of Mimicry Adaptations among Species.” *Nature* 487(7405): 94–98.
- Trifinopoulos, Jana, Lam-Tung Nguyen, Arndt von Haeseler, and Bui Quang Minh. 2016. “W-IQ-TREE: A Fast Online Phylogenetic Tool for Maximum Likelihood Analysis.” *Nucleic Acids Research* 44:W232–35.
- Tsai, Cheng-chia et al. 2020. “Physical and Behavioral Adaptations to Prevent Overheating of the Living Wings of Butterflies.” *Nature Communications* 11(151): 1–14. <http://dx.doi.org/10.1038/s41467-020-14408-8>.
- Tullberg, Birgitta Sillén. 1988. “Evolution of Gregariousness in Aposematic Butterfly Larvae: A Phylogenetic Analysis.” *Evolution* 42(2): 293–305.
- Valiente-Banuet, Alfonso, and Miguel Verdú. 2007. “Facilitation Can Increase the Phylogenetic Diversity of Plant Communities.” *Ecology Letters* 10(11): 1029–36.
- Vane-Wright, R. I., and M. Boppre. 1993. “Visual and Chemical Signalling in Butterflies: Functional and Phylogenetic Perspectives.” *Philosophical Transactions - Royal Society of London, B* 340(1292): 197–205.
- Villalobos, Fabricio, Thiago F. Rangel, and José Alexandre F. Diniz-Filho. 2013. “Phylogenetic Fields of Species: Cross-Species Patterns of Phylogenetic Structure and Geographical Coexistence.” *Proceedings of the Royal Society B: Biological Sciences* 280(1756).
- Voltaire, Florence, Sean M Gleason, and Sylvain Delzon. 2020. “What Do You Mean ‘Functional’ in Ecology? Patterns versus Processes.” 10:11875–85.
- De Vries, P. J. 2002. “Differential Wing Toughness in Distasteful and Palatable Butterflies: Direct Evidence Supports Unpalatable Theory.” *Biotropica* 34: 176–81.
- De Vries, P. J. 2003. “Tough African Models and Weak Mimics: New Horizons in the Evolution of Bad Taste.” *Journal of the Lepidopterists’ Society* 57(3): 235–38.
- Wahlberg, Niklas, and André V.L. Freitas. 2007. “Colonization of and Radiation in South America by Butterflies in the Subtribe Phyciodina (Lepidoptera: Nymphalidae).” *Molecular Phylogenetics and Evolution* 44(3): 1257–72.
- Wallace, A. R. 1878. *Tropical Nature, and Other Essays*. London & New York: Macmillan & Co.

- Wallace, A.R. 1877. "The Colours of Animals and Plants." *The American Naturalist* 11: 713–28.
- Watt, Ward B. 1968. "Adaptive Significance of Pigment Polymorphisms in *Colias* Butterflies. I. Variation of Melanin Pigment in Relation to Thermoregulation." *Evolution* 22: 437–58.
- Webb, Campbell O. 2000. "Exploring the Phylogenetic Structure of Ecological Communities: An Example for Rain Forest Trees." *American Naturalist* 156(2): 145–55.
- Webb, Campbell O., David D. Ackerly, Mark A. McPeck, and Michael J. Donoghue. 2002. "Phylogenies and Community Ecology." *Annual Review of Ecology and Systematics* 33: 475–505.
- Weir, J.T. 2006. "Divergent Timing and Patterns of Species Accumulation in Lowland and Highland Neotropical Birds." *Evolution* 60: 842–55.
- Wheat, Christopher W et al. 2007. "The Genetic Basis of a Plant-Insect Coevolutionary Key Innovation." *PNAS* 104(51): 20427–20431.
- Wiens, John A. 1991. "Ecological Society of America." *Ecological Society of America* 72(2): 479–95.
- Wiens, John J., and Catherine H. Graham. 2005. "Niche Conservatism: Integrating Evolution, Ecology, and Conservation Biology." *Annual Review of Ecology, Evolution, and Systematics* 36: 519–39.
- Wiernasz, D. C. 1989. "Female Choice and Sexual Selection of Male Wing Melanin Pattern in *Pieris Occidentalis* (Lepidoptera)." *Evolution* 43(8): 1672–82.
- Wiernasz, Diane C., and Joel G. Kingsolver. 1992. "Wing Melanin Pattern Mediates Species Recognition in *Pieris Occidentalis*." *Animal Behaviour* 43(1): 89–94.
- Willig, M. R., D. M. Kaufman, and R. D. Stevens. 2003. "Latitudinal Gradients of Biodiversity: Pattern, Process, Scale, and Synthesis." *Annual Review of Ecology, Evolution, and Systematics* 34: 273–309.
- Willmott, K.R. et al. 2009. "A New Species of Actinote Hübner from the Eastern Andes of Ecuador (Lepidoptera: Nymphalidae: Heliconiinae)." *Proc. Entomol. Soc. Wash* 111: 47–56.
- Willmott, K.R., and G. Lamas. 2007. "A Revision of *Pachacutia*, a New Genus of Rare Andean Ithomiine Butterflies (Nymphalidae: Ithomiinae), with the Description of Two New Species." *Ann Entomol Soc Am* 100: 449–69.
- Willmott, K.R., G. Lamas, and J.P.W. Hall. 2017. "Notes on the Taxonomy of *Actinote Intensa* Jordan (Lepidoptera: Nymphalidae: Heliconiinae) and the Description of a New Sibling Species from Eastern Ecuador." *Trop. Lepid. Res* 27(1): 6–15.

- Willmott, Keith, Jason P.W. Hall, and Gerardo Lamas. 2001. “Systematics of Hypanartia (Lepidoptera: Nymphalidae: Nymphalinae), with a Test for Geographical Speciation Mechanisms in the Andes.” *Systematic Entomology* 26: 369–99.
- Willmott, Keith R. 2003a. *The Genus Adelpha: Its Systematics, Biology and Biogeography*, (Lepidoptera: Nymphalidae: Limenitidini). Scientific Publishers.
- Willmott, Keith R. 2003b. “Cladistic Analysis of the Neotropical Butterfly Genus *Adelpha* (Lepidoptera: Nymphalidae), with Comments on the Subtribal Classification of Limenitidini.” *Systematic Entomology* 28(3): 279–322.
- Willmott, Keith R., and André V.L. Freitas. 2006. “Higher-Level Phylogeny of the Ithomiinae (Lepidoptera: Nymphalidae): Classification, Patterns of Larval Hostplant Colonization and Diversification.” *Cladistics* 22(4): 297–368.
- Willmott, Keith R., and Jason P.W. Hall. 2013. “A New Species and Two New Subspecies of *Adelpha* Hubner, [1819] from the Tropical Andes (Nymphalidae: Limenitidinae).” *Journal of the Lepidopterists’ Society* 67(4): 241–52.
- Willmott, Keith R., and James Mallet. 2004. “Correlations between Adult Mimicry and Larval Host Plants in Ithomiine Butterflies.” *Proceedings of the Royal Society B: Biological Sciences* 271 Suppl 5(Suppl 5), S266–S269.
<https://doi.org/10.1098/rsbl.2004.0184>
- Willmott, Keith R., Julia C. Robinson Willmott, Marianne Elias, and Chris D. Jiggins. 2017. “Maintaining Mimicry Diversity: Optimal Warning Colour Patterns Differ among Microhabitats in Amazonian Clearwing Butterflies.” *Proceedings of the Royal Society B: Biological Sciences* 284 (20170744).
- Wilson, Edgar O. 1988. *Biodiversity*. ed. National Academy of Sciences Smithsonian Institution. Washington, DC: The National Academic Press.
- Wilson, Joseph S. et al. 2015. “North American Velvet Ants Form One of the World’s Largest Known Müllerian Mimicry Complexes.” *Current Biology* 25(16): R704–6.
- Woodward, F. I., and A. D. Diament. 1991. “Functional Approaches to Predicting the Ecological Effects of Global Change.” *Functional Ecology* 5(2): 202.
- Wright, Jeremy J. 2011. “Conservative Coevolution of Müllerian Mimicry in a Group of Rift Lake Catfish.” *Evolution* 65(2): 395–407.
- Young, Allen M. 1974. “On the Biology of *Hamadryas Februa* (Lepidoptera: Nymphalidae) in Guanacaste, Costa Rica.” *Zeitschrift für Angewandte Entomologie* 76(1–4): 380–93.

Empirical testing of evasive mimicry

This chapter was published in 2021:

Páez E, Valkonen JK, Willmott KR, Matos-Maraví P, Elias M, Mappes J. 2021 Hard to catch: experimental evidence supports evasive mimicry. *Proc. R. Soc. B* 288: 20203052.

<https://doi.org/10.1098/rspb.2020.3052>

Hard to catch: experimental evidence supports evasive mimicry

Erika Páez,[†], Janne K. Valkonen,[†], Keith R. Willmott, Pável Matos-Maraví, Marianne Elias¹ and Johanna Mappes

Abstract

Most research on aposematism has focused on chemically defended prey but signalling difficulty of capture remains poorly explored. Similar to classical Batesian and Müllerian mimicry related to distastefulness, such “evasive aposematism” may also lead to convergence in warning colours, known as evasive mimicry. A prime candidate group for evasive mimicry are *Adelpha* butterflies, which are agile insects and show remarkable colour pattern convergence. We tested the ability of naïve blue tits to learn to avoid and generalise *Adelpha* wing patterns associated with difficulty of capture and compared their response to that of birds that learned to associate the same wing patterns with distastefulness. Birds learned to avoid all wing patterns tested and generalised their aversion to other prey to some extent, but learning was faster with evasive prey compared to distasteful prey. Our results on generalisation agree with longstanding observations of striking convergence in wing colour patterns among *Adelpha* species since, in our experiments, perfect mimics of evasive and distasteful models were always protected during generalisation and suffered the lowest attack rate. Moreover, generalisation on evasive prey was broader compared to that on distasteful prey. Our results suggest that being hard to catch may deter predators at least as effectively as distastefulness. This study provides empirical evidence for evasive mimicry, a

potentially widespread but poorly understood form of morphological convergence driven by predator selection.

Keywords:

Adelpha - evasive aposematism - predator learning - distastefulness – convergence - prey defence

Background

Many organisms with chemical, morphological or behavioural defences often display a conspicuous signal, such as a colour pattern, that warns predators of the potential cost of attacks [1]. Possession of such warning signals is known as aposematism [1,2]. In many cases, the effectiveness of aposematism in terms of prey avoidance depends on the ability of predators to associate the signal with an unpleasant experience (i.e., learning and lasting memory), and to attribute signal properties to different prey individuals (i.e., generalisation, reviewed in [3]; [4–6]). Aposematic prey is under positive frequency-dependent selection, which can result in convergence of warning signals among co-occurring defended species, known as Müllerian mimicry [7]. Aposematism and Müllerian mimicry associated with distastefulness have been extensively studied in many taxa [8–11], and especially so in Lepidoptera [12–16]. However, there is increasing evidence that aposematism may also be associated with an alternative defence, namely evasiveness ([17,18]; reviewed in [19]). Theoretically, predators should avoid attacking evasive prey since unsuccessful attacks likely represent a significant cost in time and energy [19–21], similar to that described for prey that signal long handling times [22]. Selection exerted by predators is thus expected to drive convergence in signals that they associate with the evasiveness of their prey [18,23–27], in a process known as escape mimicry or evasive mimicry (hereafter we use the latter term).

Previous experiments have shown that bird predators can use visual cues to identify evasive prey [28–30], but more empirical work is needed to test whether outstanding potential examples of evasive mimicry could indeed be the result of selection for such signals related to evasiveness. One such example is the diverse Neotropical butterfly genus *Adelpha*, where repeated convergence of their apparently conspicuous and contrasting wing patterns among distantly related sympatric species has been interpreted as evidence for mimicry [31–33]. Putative aposematic displays occur in *Adelpha* butterflies when they are at rest (not perching) with the wings open, and during flight as well, which involves short bursts of wing beats and longer periods of gliding i.e., with the wings open and horizontal).

Mimicry in *Adelpha* has been hypothesised to be at least partly driven by chemical defences in some species [34–36], but there is currently limited, conflicting evidence for distastefulness [25,35,37,38]. In contrast to most classic groups of chemically defended butterflies, *Adelpha* butterflies have short and stout thoraxes which are favourable traits for strong flight [37,39], and exhibit an irregular flight with sharp turns and powered dives when pursued by avian predators (K.W., personal observations, [21]), making the genus a prime candidate for evasive mimicry [40]. Moreover, species resembling *Adelpha* exist in distantly related lineages (e.g., females from the genus *Doxocopa*, belonging to a different subfamily [21,31]), whereas closely related, allopatric *Adelpha* species may harbour different wing colour patterns, suggesting convergence rather than inheritance from a shared ancestor [32,33,41].

In this study, we use artificial prey models based on common *Adelpha* wing patterns and wild blue tits as naïve bird predators to address the following questions: 1. Can birds learn to associate wing colours and patterns with evasiveness of prey? 2. Can such a signal be generalised across putative mimetic species? 3. What type of defence drives faster learning by predators, evasiveness or distastefulness?

Materials and Methods

We used wild blue tits (*Cyanistes caeruleus*) to examine whether birds learn to avoid *Adelpha* colour patterns associated with evasive (escaping) behaviour, and whether birds generalise the learned avoidance across similar, naturally occurring wing patterns. In addition, we conducted parallel experiments with distasteful prey having the same colour pattern but not evasiveness. European blue tits were chosen as predators because: 1) they have no previous experience with wing colour patterns displayed by Neotropical *Adelpha* butterflies, 2) they have been used extensively in learning experiments as naïve (and experienced) predators with various types of prey [4,42–44], 3) they are visual foragers and their visual capabilities are well understood [45,46], and 4) they eagerly catch both stationary prey as well as moving prey (e.g., flying butterflies, JM personal observations). Potential unwanted behaviours of naïve predators (e.g., startling, fleeing prey sooner or no motivation to attack) were controlled first during the pre-training phase in their home aviaries the day before the experiment, and then in the experimental aviaries; an approximate 2–3-hour habituation period was needed until startling, or no motivation to attack disappeared (See electronic supplementary material S1).

Experiments were conducted from January to March 2019 at Konnevesi Research Station in Central Finland, which provided the infrastructure, wildlife research and collection permits, and expertise needed to conduct experiments with wild birds in captivity. Blue tits were captured from feeding sites around the station and were maintained in captivity for a maximum of 10 days. During captivity, they were kept singly in illuminated plywood cages (daily light period of 12 h 30 min) with food and fresh water available *ad libitum*. After experiments, each bird's sex and age were determined, birds were ringed and released into the site of capture. Our sample comprised individuals of both sexes (51 males and 36 females) and was composed mainly by juveniles (65 out of 87), which likely reflects natural variation in the composition of blue tit winter flocks (JM personal observations, see [47]). We performed preliminary generalized linear mixed models (GLMMs) to test the effects of sex and age on learning. We did not find any significant effect of sex on learning ($Z=0.55$; p value= 0.58; CI= 0.82 – 1.42), therefore, we excluded the sex factor from further analyses. Although juveniles tended to learn slightly faster than adults (mean \pm SD number of attacks until learning criterion is achieved: adults 53.1 \pm 21.4; juveniles 49.4 \pm 20.7), the effect of age on learning was not significant either ($Z=1.906$; p value= 0.06; CI 0.99 – 1.93), in agreement with studies that have not detected a strong age effect in blue tits' learning of novel prey (e.g., [48]). We therefore also excluded the age factor from further analyses.

Artificial prey

Artificial defended prey (4.1 x 2.5 cm) were constructed by printing images (HP Color Laserjet CP2025, regular printer paper) of different wing colour patterns displayed by the species *Adelpha salmoneus* (orange forewing band), *A. cocala* (orange and white transverse band), and *A. epione* (white forewing band; figure 1). These species represent three putatively distinct mimicry rings [31,33] and were chosen because they differ in colour and pattern. We used these to test if apparently distinct signals may provide protection from predation in evasive mimicry. An entirely dark brown model of a non-defended prey was constructed as a control. To make prey attractive for birds, a piece of almond (reward) was glued to the underside of prey. For distasteful models (see below), almonds were soaked in chloroquine phosphate solution (7%) to give them a bitter taste (following e.g., [49]).

Experimental procedures

The experiments took place in experimental aviaries of 49 x 48 x 67 cm. To mimic daylight conditions, aviaries were illuminated with a TRUE-LIGHT Daylight 6000 20W (960 lm) fluorescent light bulbs (these lamps do not emit enough amount of UV to be reflected by our paper

models). Each aviary contained a perch and a water bowl. Birds were observed through a one-way glass situated on the front of the aviary. Two plastic prey holders gliding on aluminium profile rails (fixed on both sides of the aviary's floor) allowed simulation of the artificial prey's escaping (see electronic supplementary material, S1-figure 2 and a video is available in S4).

Avoidance learning

We used 87 birds, trained to attack artificial butterflies (see the electronic supplementary material, S1 for details of the training procedure), divided into 3 treatment groups (figure 1). The first two groups were trained to avoid evasive prey and a third group was trained to avoid distasteful prey with the same wing colour pattern as group 2. Before initiating the experiment, birds were habituated to the experimental aviary for at least an hour. In the treatment group where birds were trained to avoid escaping prey, the learning experiments consisted of presenting simultaneously two prey items to the bird, one control and one displaying an *Adelpha* wing colour pattern. Birds had one opportunity of attack per trial. If they approached the control prey, they were allowed to capture and eat the almond of that prey; if they approached the evasive prey, it was rapidly pulled out of reach (i.e., escaping) when the bird was less than 5 cm from the prey and displaying a clear intention to attack (see electronic supplementary material S1 and video S4). In the treatment group where birds were trained to avoid distasteful prey they were allowed to consume the attacked prey (i.e., distasteful prey and control prey). Training presentations continued for at maximum 80 trials or until the bird attacked an evasive or distasteful prey no more than twice over ten consecutive trials. This learning criterion was important for two reasons: 1) it allowed us to test if some treatments were associated with a faster learning than others; and 2) it ensured that all birds, i.e., “quick” and “slow” learners, reached the same level of knowledge despite encountering different numbers of preys (“quick” learners encountered fewer preys than “slow” learners) which is important for generalisation.

Birds that finished the experiment earlier and were able to continue with the generalisation experiment the same day received a break of at least 2 hours with 3 sunflower seeds offered every 30 minutes before starting the next experiment. Otherwise, those birds that finished the experiment late in the afternoon were placed back in their home cages and continued with the generalisation experiment the next day. Birds that finished the experiment but did not achieve the learning criterion were not included in the generalisation test.

Generalisation of learned avoidance to other prey (imperfect mimics)

We used only birds that achieved the learning criterion in the previous phase (group 1 $n=23$ out of 28, group 2 $n=25$ out of 31, group 3 $n=18$ out of 28) to test whether and to what extent the previously learned avoidance of warning colouration associated with evasiveness (group 1 and 2) or distastefulness (group 3) can be remembered and generalised to novel wing colour patterns that shared similar features (i.e., either colour or pattern, figure 1). Those novel colour patterns are referred to as imperfect mimics. This phase consisted of a single trial where birds encountered simultaneously four types of prey: a (i) control prey, (ii) the model they have previously learned (which can be regarded as a perfect mimic) and (iii) two imperfect mimics (figure 1). The experiment was finished after the first choice of attack was registered (see electronic supplementary material, S1 for detailed description).

Before starting the experiment, each bird received, on average, a 15-minute habituation period to the new mechanism for presenting prey (see electronic supplemental material, S1 for details), during which three pre-training prey with one sunflower seed were offered. When the three pre-training prey and the sunflower seeds were consumed, the bird was considered ready to start the test.

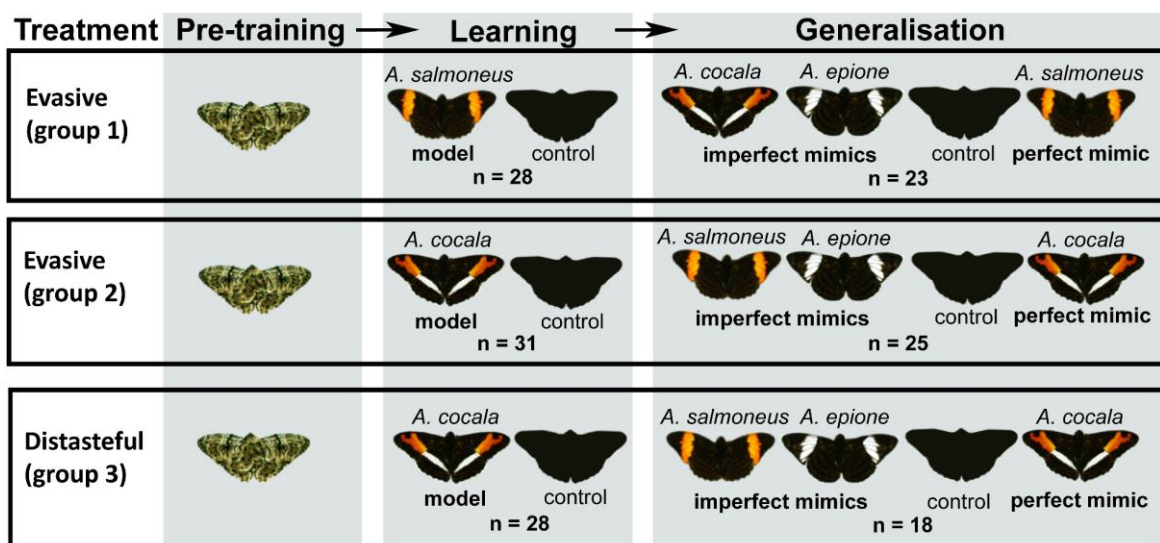

Figure 1. Schematic illustration of the experimental design that consisted of 3 phases: pre-training, learning and generalisation. A forewing orange-banded prey (*A. salmoneus*) was presented as a model and perfect mimic for group 1, and as an imperfect mimic during generalisation for group 2 and 3. A transverse forewing orange/hindwing white-banded prey (*A. cocala*) was the model and perfect mimic for group 2 and 3, and an imperfect mimic during generalisation for group 1. The forewing white-banded prey (*A. epione*) was presented as an imperfect mimic during generalisation for all groups.

Statistical analyses

Avoidance learning

We examined whether wing colour pattern affected learning of birds from group 1 (n=28) and group 2 (n=31) by assessing the probability of prey survival within trials. Learning curves and their confidence intervals (figure 2A) were estimated as a function of the interaction between treatments (i.e., groups) and trial (“*ggeffects*” package version 4.0.3 in RStudio). We performed a generalized linear mixed model (GLMM) (“*lme4*” package v.1.1.23 in RStudio version v.4.0.2) with a logit link function and binomial distribution. Survival probability of prey within trial was explained by the wing colour pattern (explanatory variable). To account for repeated measurements, bird ID nested within trial was added as random factor. Additionally, we calculated the odds ratio (OR) based on GLMM estimates and its confidence interval (CI) to assess the strength of the effect of different wing patterns.

Comparison of avoidance learning between evasive and distasteful prey

To compare avoidance learning among birds facing aposematic prey signalling for evasiveness and birds facing aposematic prey signalling for distastefulness with the same colour pattern (group 2 and 3, respectively; figure 1), we performed another GLMM following the method above. Survival of prey within trial was explained by the type of prey defence (i.e. evasiveness or distastefulness). Bird ID nested within trial was defined as random factor. Odds ratio based on GLMM estimates and confidence intervals were calculated as well to assess the strength of the effect of type of defence.

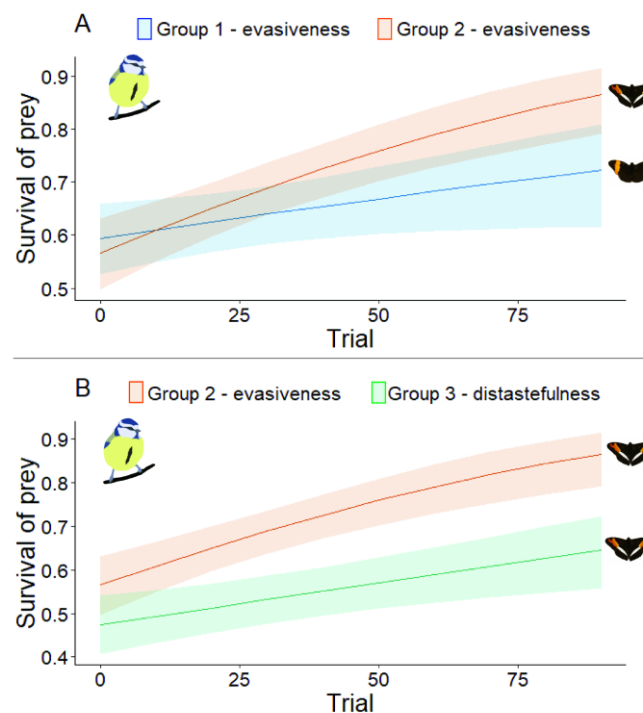

Figure 2. Predicted probability of prey survival among trials. Each curve illustrates predicted values with their 95% confidence intervals (bands) for birds attacks on prey per group and among trials. Each plot shows the comparison between (A) group 1 versus group 2; and (B) group 2 (evasiveness) versus group 3 (distastefulness). The plotted data were derived from the generalised linear mixed models.

Generalisation of learned avoidance to other prey (imperfect mimics)

For each experimental group, to test for differences in attack probabilities between the different types of prey (the control, the model and the two imperfect mimics, figure 1), we calculated the log-likelihood of observing the number of attacks that were recorded on each prey type compared to others in the group as follows (calculation details are in electronic supplementary material, S3.1).

$$\log_{10}(L) = \sum_i [a_i \log_{10}(P_i) + (N - a_i) \log_{10}(1 - P_i)] + K$$

Where i is one of the four prey types; N is the total number of trials; a_i is the number of times a butterfly of type i was attacked; P_i is the attack rate of butterflies of type i and K is a constant term that disappears in model comparisons. This maximum-likelihood method has been used in previous studies to estimate differences in probabilities of attack [16] and to investigate mate preference [50]. We explored several scenarios where attack rates of different types of prey could be equal or not (see figure 3 and electronic supplementary material S3.2 for a list of all those scenarios) and calculated the log-likelihood functions of those scenarios. As an example, a scenario where the attack rate on the control is equal to those on the imperfect mimics and higher than that on the perfect mimic means that birds only generalises the learned avoidance to the perfect mimic, and not to the imperfect mimics; a scenario where the attack rate on the perfect mimic is equal to those on the imperfect mimics and lower than that on the control means that birds have fully generalised the learned avoidance to the perfect and imperfect mimics; and a scenario where the attack rate on the imperfect mimics is lower than that on the control but higher than that on the perfect mimic means that birds have partially generalised the learned avoidance to the imperfect mimics, compared to the perfect mimic.

Models were selected on the basis of their AICc, which accounts for the number of parameters and the sample size. For each group, the model with the lowest AICc was considered the best. We considered that models within a 2-unit AICc interval from the best model could not be rejected.

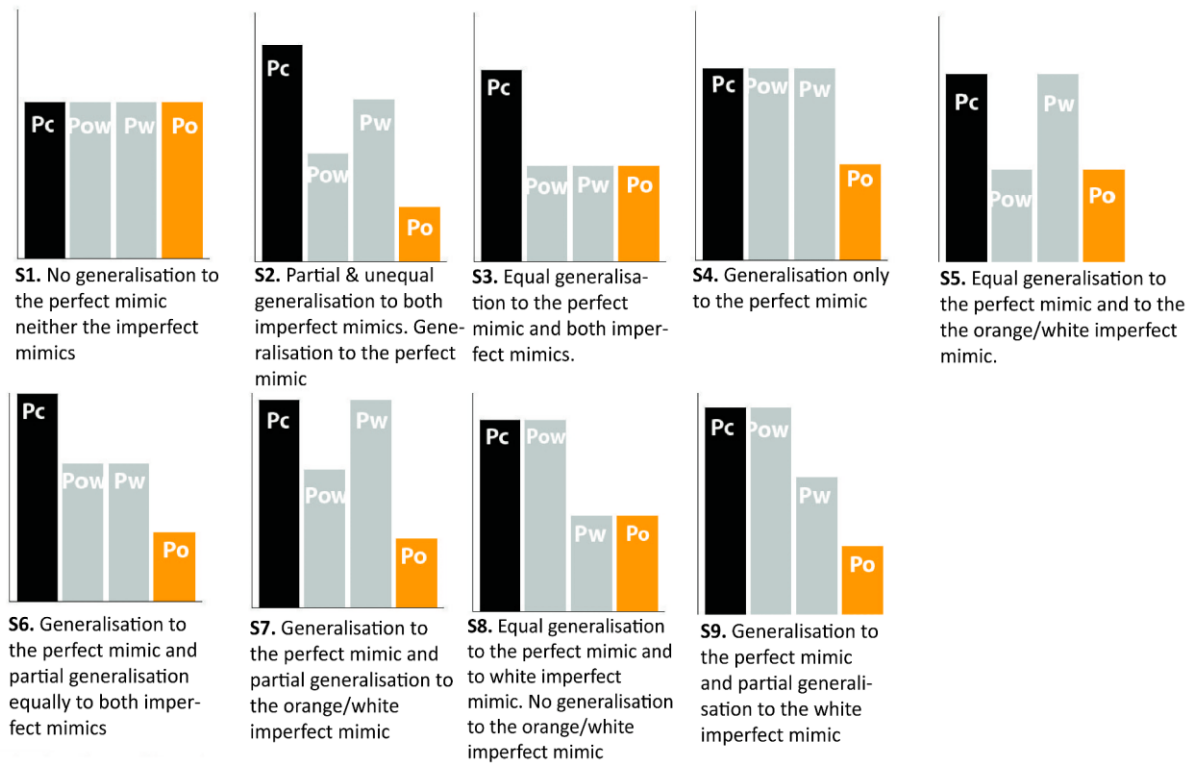

Here we present the case of group 1 where the model learned (and the perfect mimic) in the previous phase was the orange forewing band pattern Po . Bars illustrate the probability of attack of the control prey Pc (black coloured bar), imperfect mimics (grey coloured bars) such as the orange/white transverse band pattern Pow for group 1 or orange forewing band pattern Po for group 2 and group 3; and the white forewing band pattern Pw for all groups. For groups 2 and 3, the model (and the perfect mimic) Pow is the orange/white transverse band pattern.

Figure 3. Scenarios investigated based on attack rates from the generalisation experiment (group 1 is used as an example).

Results

Avoidance learning

According to the learning criterion, most birds learned to avoid their evasive prey model: 23 out of 28 birds from group 1 (i.e., orange forewing band) and 29 out of 31 birds from group 2 (i.e., orange/white transverse band). Additionally, 18 out of 28 birds (group 3) learned to avoid the distasteful prey model.

The generalized linear mixed model detected no significant effect of treatments on predicted survival probabilities within trials ($Z=0.01$; $P=0.992$) (OR=1.002; CI 0.736 – 1.362) for group 1 and group 2, i.e., birds that learned to avoid different wing patterns of evasive prey. For group 2 and 3, (birds that learned to avoid evasive or distasteful prey that harboured the same pattern) a significant effect of treatment on predicted survival probabilities within trials was detected

($Z=3.60$; $P=0.0003$). Birds were 1.6 times more likely to attack distasteful prey than evasive prey (OR=1.640; CI=1.248 – 2.159) (figure 2B).

Generalisation of learned avoidance to other prey (perfect and imperfect mimics)

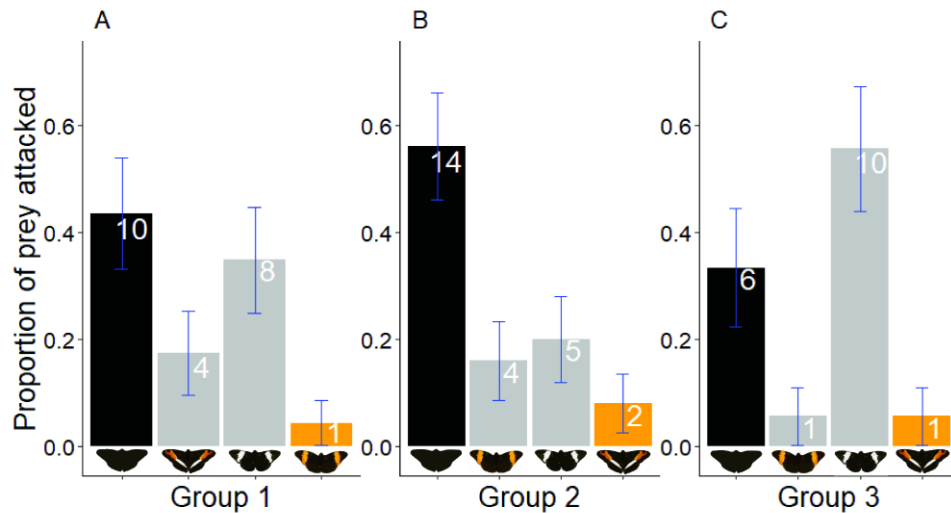

Figure 4. Comparison among observed attack rates during generalisation tests. Bars illustrate the proportion of attacks within groups on the control (black coloured bar), different putative mimics (grey coloured bars) and the perfect mimic (orange coloured bar) after birds learned to avoid the model pattern. Number of attacks are indicated inside the bars (at the top of the bars), as well as standard error bars. Birds from group 1 (A) learned evasive orange prey as the model; group 2 (B) learned orange/white as the model; and group 3 (C) learned distasteful orange/white as the model.

Bird attack frequencies on mimics differed within and among groups (figure 4, electronic supplementary material S2). For group 1 (prey with orange forewing band as evasive model, figure 4A, table 1), in the best scenario (s5) learned avoidance was fully generalised to the imperfect mimic that shared the orange colour with the model (orange/white transverse band), while the other imperfect mimic (white forewing band, which shares the pattern but no colour with the model) was attacked as much as the control. Two additional scenarios could be considered as similarly plausible based on their AICc. One scenario (s7) was similar to the previous, except that the orange/white imperfect mimic was attacked more often than the perfect mimic (but still less than the control), indicating partial generalisation. In the other scenario (s4), only the perfect mimic was attacked less than the control, implying generalisation only to the perfect mimic.

Regarding group 2, (orange/white as evasive model) (figure 4B, table 1), in the best scenario (s3) avoidance was fully generalised to both imperfect mimics, which both shared a colour with the model. Another scenario (s6), where generalisation to the mimics was partial, was within a 2-unit AICc interval with that of the best scenario. In group 3 (orange/white as distasteful model) (figure 4C, table 1), a single scenario stood out as best, in which avoidance was fully generalised to the orange imperfect mimic (s5). See results from all the explored scenarios in electronic supplementary material S3.3.

Table 1. Best scenarios from generalisation based on the AICc value. Scenarios within a 2-unit AICc interval with that of the best scenario are considered plausible as well.

group	best scenario	alternative scenarios	
(1) orange as evasive model	s5 [$P_c=P_w \neq P_o=P_{ow}$] Equal generalisation to the perfect mimic and to the orange/white imperfect mimic	s4 [$P_o \neq P_c=P_{ow}=P_w$] Generalisation only to the perfect mimic	s7 [$P_c=P_w \neq P_o \neq P_{ow}$] Generalisation to the perfect mimic and partial generalisation to the orange/white imperfect mimic
ln(L) - K	-20.239	-20.545	-19.773
AICc	45.079	45.690	46.809
(2) orange/white as the evasive model	s3 [$P_c \neq P_{ow}=P_o=P_w$] Equal generalisation to the perfect mimic and both imperfect mimics	s6 [$P_c \neq P_{ow} \neq P_o=P_w$] Generalisation to the perfect mimic and partial generalisation equally to both imperfect mimics	
ln(L) - K	-21.026	-20.710	
AICc	46.598	48.563	
(3) orange/white as the distasteful model	S5 [$P_c=P_w \neq P_o=P_{ow}$] Equal generalisation to the perfect mimic and to the orange imperfect mimic		
ln(L) - K	-14.095		
AICc	32.990		

Discussion

Learning and generalisation of signals associated with an effective escaping ability

The idea that some butterflies have evolved signalling of evasiveness as an anti-predator defence has a long history [21,24,51–53]. Still, surprisingly few experiments to date have tested the idea of evasive mimicry [25,28–30]. It is therefore unclear whether predators can learn, memorize and generalise naturally occurring signals associated with evasiveness, which is crucial for the evolution of evasive mimicry. Gibson [28,29] and Hancox & Allen [30] presented wild avian predators with artificial prey (i.e. dyed millet seeds, coloured mealworms or pastry models) that disappeared from sight when attacked. After extensive training (approx. 20 days), they observed that birds reduced their attacks on such hard-to-catch prey. We showed that wild birds, with no experience of *Adelpha* butterflies, were able to associate both orange and orange/white patterns with evasiveness within a day of training. Unlike previous experiments [28–30], our birds faced a “simpler” prey scenario [49], with a warningly coloured prey that could be easily discriminated from the non-defended prey, which may explain the reported faster avoidance learning compared to previous studies. In our experiment, birds were more likely to attack the control prey than the aposematic prey in the first trial of the learning phase. This is not surprising since wild birds often avoid colourful prey [54] and part of this bias seems to have a genetic basis [55]. However, our data provide evidence for additional learning on the top of this initial preference since our learning criterion (no more than two attacks in ten consecutive trials) implies that birds that fulfilled this criterion were at least four times more likely to attack control over aposematic butterflies, which is much more than the initial bias (see electronic supplementary material S5).

Our results showed that birds were often able to generalise their learned avoidance to somewhat similar prey that shared either a colour or the pattern with the learned model. Perfect mimics were always strongly avoided but often at a level that could not be distinguished from those of the imperfect mimics. Previous work on distasteful prey found that learning and generalisation of aposematic visual signals by avian predators are primarily driven by colour rather than pattern [43,56–59] and wing shape [60]. Our findings are consistent with these studies for group 2 and partially for group 3 because birds generalised their avoidance to prey that presented a colour in common with the formerly learned model (orange imperfect mimic and white imperfect mimic for group 2; only to orange imperfect mimic for group 3), despite harbouring different wing patterns. Generalisation to imperfect mimics is supported with prey models from

groups 2 and 3 (generalisation to only one imperfect mimic in the latter case). Generalisation to imperfect mimics was unclear for group 1 as results were mixed, possibly due to relatively low sample size and reduced statistical power. The different plausible scenarios for group 1 showed that avoidance was always generalised to the perfect mimic, was never generalised to the white imperfect mimic, and was sometimes generalised to the orange/white imperfect mimic, depending on the scenario. Overall, we showed that birds generalised their learnt association to evasive preys, although the cues used in generalisation remain unclear. Further experiments comparing models with different colours could shed light on whether some colours are better learned and/or generalised than others. The three *Adelpha* species we studied are not regarded as strongly co-mimetic, since a number of other species show much more similar (practically identical) colour patterns, concordant geographic variation and broader sympatry [31]. Preliminary trials from a pilot test suggested that our predators were incapable of distinguishing among the most closely resembling co-mimics of *Adelpha cocala* (e.g., *Adelpha thesprotia*, see electronic supplementary material S1-figure 4), so we expanded our experiment to include more dissimilar species to examine the significance of mimetic accuracy. Our mixed generalisation results do not allow us to assess the extent of selection on mimetic fidelity in *Adelpha*. However, we show that perfect mimicry is at least as good as imperfect mimicry when providing protection to co-mimics since the model (perfect mimic) was always less attacked than the other mimics, although not always significantly so. Future work might include other aspects such as prey community structure, or the predator's level of hunger, that might affect prey mimetic fidelity, as has been studied in classical aposematism based on chemically defended prey [49,61–63].

In the case of *Adelpha*, it would be especially insightful to assess avoidance learning associated with evasiveness in the wild by their natural predators. Neotropical passerine birds tend to live longer than higher-latitude birds [64], which potentially means that they can learn more effectively and pay attention to finer signal details, and thus generalise less broadly to other similar prey. It is also important to keep in mind that not only the community structure of predators (see e.g., [65]), but also prey communities influence the outcome of avoidance learning and generalisation of distasteful prey [49].

Evasiveness versus distastefulness as deterrents to predators

Learning about distastefulness is thought to be generally quicker and easier than evasiveness because prey unprofitability can be determined, unambiguously, from a single experience when

prey is ingested. By contrast, a prey individual might escape capture because of better escaping ability, or just because of chance [19]. There is thus some disagreement about the circumstances under which evasive aposematism and mimicry might occur and the extent to which its evolution might be different from that of aposematism and mimicry based on distastefulness [6].

In our experiments, in contrast to expectations [19], birds learned to avoid evasive prey faster than distasteful prey, and learning seemed to be easier as a higher proportion of birds achieved the learning criterion with evasive prey (94%) compared to distasteful prey (63%). It is well known that distastefulness of aposematic prey widely varies within and between populations [66,67], and that there is intra- and interspecific variation in predator's tolerance to distastefulness [63,68–71]. Signals associated with prey evasiveness may actually provide a more reliable message to birds about unprofitability than does aposematic signalling related to distastefulness. Moreover, catching a prey, even if distasteful, can be more rewarding for a predator than missing a prey completely. It is thus possible that the learning curve for avoiding evasive prey also depends on the physiological needs of a predator (e.g. its hungriness), the costs of pursuing and consuming a prey (i.e., the likelihood to catch, toxicity) and the nutritional benefits associated with a consumed prey. Although capturing an evasive butterfly prey might represent a rich source of nutrients compared to a distasteful prey (i.e., larger thoracic muscles that allow a powerful flight), there might also be a palatability spectrum, which likely affects the cost-benefit ratio. Future experiments should simulate different scenarios to assess the importance of nutritional value of evasive versus a non-evasive prey in learning to avoid prey.

We also found a wider generalisation to imperfect mimics of the evasive prey when it was compared to that of the distasteful prey (i.e., group 2 versus group 3, where blue tits were trained on the same wing colour pattern). In group 2 (evasive treatment), in two out of three best scenarios birds generalised to some extent their learned avoidance toward the prey sharing any of the wing colours with the model, and both imperfect mimics were attacked less than the control. By contrast, in group 3 (distasteful treatment), birds only avoided the orange imperfect mimic, as the white imperfect mimic was highly attacked, despite the fact that the white colour was also present in the model. It has been suggested that selection for accurate mimicry can be affected by different factors [6] such as level of prey distastefulness or unpleasantness [72,73]. Although broad generalisation to imperfect mimics probably occurs when the model is highly distasteful or unpleasant (see in [74]), our results suggest that evasiveness is another powerful dimension of defence that affects a predator's decision whether to attack warningly coloured

prey. Given that a wider generalisation was supported with some prey models, more experiments with different types of predators and signals are needed to examine whether generalisation tends to be broader across mimics where the model is defended by evasiveness rather than distastefulness or toxicity. In addition, a follow-up study to assess the memorability of naturally occurring signals of evasive prey (see [75]) and compare it to that associated to distasteful prey would be very insightful.

Conclusion

Although distastefulness has been considered a prime adaptive defence mechanism against predation in aposematic butterflies, evasiveness is also likely to be important in many groups. Our results give a strong experimental support for the hypothesis, mostly based on field observations, that predators can learn and generalise to some extent naturally occurring colour pattern signals that are associated with the escaping ability of prey. We therefore suggest that evasive mimicry could be a plausible explanation for colour pattern convergence in fast moving prey, such as *Adelpha* butterflies.

Ethics. The Southwest Finland Centre for Economic Development, Transport and Environment (VARELY/294/2015) and National Animal Experimental Board (ESAVI/9114/04.10.07/2014) provided permission to capture and keep wild blue tits (*Cyanistes caeruleus*) in captivity and to use them in behavioural studies.

Data accessibility The dataset and coding necessary to reproduce the results of this study are available in the Dryad Digital Repository (doi:10.5061/dryad.vq83bk3rj).

Author's contribution. JM, KRW, ME and PMM conceived the project. JM, EPV, JV, designed the experimental setup, with input from KRW and ME. EPV, JV, PMM and JM ran the experiments. EPV, JV and ME performed statistical analyses. All authors discussed the protocol and results throughout the study. EPV wrote the paper with contributions from all authors. All authors gave final approval for publication and agree to be held accountable for the work performed therein.

Competing interests. We declare we have no competing interests

Funding. This study was funded by The Academy of Finland (project no. 319124), and additionally supported by the Doctoral School 227 Muséum National d'Histoire Naturelle - Sorbonne Université (TRANSHUMANANCE mobility grant for EPV), and Secretaría de Educación Superior, Ciencia, Tecnología e Innovación Senescyt (graduate fellowship to EPV). PMM. was funded by the Czech Science Foundation (Junior GAČR grant GJ20-18566Y) and the PPLZ program of the Czech Academy of Sciences (fellowship grant L200961951)

Acknowledgments. We acknowledge Helinä Nisu for taking loving care of birds and Konnevesi Research Station for facilities to conduct this experiment. EPV and ME thank Christine Calvas from the

Center of Ecology and Conservation Sciences for kindly handling the funding that allowed EPV to travel to Konnevesi. EPV thanks to Sebastián Mena for designing figure 2 (electronic supplementary material). PMM thank the support of the Department of Ecology (Biology Centre, CAS) and its head, Vojtěch Novotný, for partly covering travel expenses to carry out the behavioural experiments. We thank the organizers of the 8th International Conference on the Biology of Butterflies, held in Bangalore, India, in 2018, where the idea of this project emerged.

Footnotes. Electronic supplementary material is available online at <https://doi.org/10.6084/m9.figshare.c.5320316>.

References

1. Poulton, E. B. 1890 *The colours of animals: their meaning and use. Especially considered in the case of insects*. The international scientific series, 2nd edn. London, UK: Kegan Paul, Trench Trübner, & Co
2. Cott HB. 1940 *Adaptive coloration in animals*. London, UK: Methuen
3. Mappes J, Marples N, Endler JA. 2005 The complex business of survival by aposematism. *Trends Ecol. Evol.* **20**, 598–603
4. Exnerová A, Štys P, Fučíková E, Veselá S, Svádová K, Prokopová M, Jarošík V, Fuchs R, Landová E. 2006 Avoidance of aposematic prey in European tits (Paridae): learned or innate? *Behav. Ecol.* **18**, 148–156. (doi:10.1093/beheco/ar1061)
5. Skelhorn J, Halpin CG, Rowe C. 2016 Learning about aposematic prey. *Behav. Ecol.* **27**, 955–964. (doi:10.1093/beheco/arw009)
6. Ruxton GD, Allen WL, Sherratt TN, Speed MP. 2018 *Avoiding attack: the evolutionary ecology of crypsis, warning signals, and mimicry*. Oxford UK: Oxford University Press
7. Muller F. 1879 *Ituna and Thyridia; a remarkable case of mimicry in butterflies*. *Proc R Ent Soc Lond.* **1879**, xx–xxix
8. Symula R, Schulte R, Summers K. 2001 Molecular phylogenetic evidence for a mimetic radiation in Peruvian poison frogs supports a Müllerian mimicry hypothesis. *Proc. R. Soc. Lond. B* **268**, 2415–2421. (doi:10.1098/rspb.2001.1812)
9. Saporito RA, Zuercher R, Roberts M, Gerow KG, Donnelly MA. 2007 Experimental Evidence for Aposematism in the Dendrobatid Poison Frog *Oophaga pumilio*. *Copeia* **2007**, 1006–1011. (doi:10.1643/0045-8511(2007)7[1006:eefait]2.0.co;2)
10. Marek PE, Bond JE. 2009 A Mullerian mimicry ring in Appalachian millipedes. *Proc. Natl. Acad. Sci.* **106**, 9755–9760. (doi:10.1073/pnas.0810408106)
11. Wilson JS, Jahner JP, Forister ML, Sheehan ES, Williams KA, Pitts JP. 2015 North American velvet ants form one of the world's largest known Müllerian mimicry complexes. *Curr. Biol.* **25**, R704–R706. (doi:10.1016/j.cub.2015.06.053)
12. DeVries PJ. 1987 *The Butterflies of Costa Rica and Their Natural History. Vol. I: Papilionidae, Pieridae, Nymphalidae*. United Kingdom: Princeton University Press
13. Brown KS. 1988 Mimicry, aposematism and crypsis in neotropical Lepidoptera: the importance of dual signals. *Bull. Soc. Zool. Fr.* **113**, 83–101

14. Beccaloni GW. 1997 Ecology, natural history and behaviour of Ithomiine butterflies and their mimics in Ecuador (Lepidoptera: Nymphalidae: Ithomiine). *Trop. Lepid.* **8**, 103–124
15. Mallet J, Mcmillan WO, Jiggins CD. 1988 Mimicry and warning colour at the boundary between races and species. 1998 in: *Endless Forms: Species and Speciation* (eds Howard, DJ. & Berlocher, SH), pp. 390-403. New York, Oxford Univ. Press
16. Willmott KR, Robinson Willmott JC, Elias M, Jiggins CD. 2017 Maintaining mimicry diversity: optimal warning colour patterns differ among microhabitats in Amazonian clearwing butterflies. *Proc. R. Soc. B* **284**: 20170744. (doi:10.1098/rspb.2017.0744)
17. Pinheiro CEG, Freitas AVL, Campos VC, DeVries PJ, Penz CM. 2016 Both Palatable and Unpalatable Butterflies Use Bright Colors to Signal Difficulty of Capture to Predators. *Neotrop. Entomol.* **45**, 107–113. (doi:10.1007/s13744-015-0359-5)
18. Guerra TJ. 2019 Evasive mimicry: too beetle, or not too beetle? *Ecology* **100**, e02773. (doi:10.1002/ecy.2773)
19. Ruxton GD, Speed M, Sherratt TN. 2004 Evasive mimicry: when (if ever) could mimicry based on difficulty of capture evolve? *Proc. R. Soc. Lond. B* **271**, 2135–2142. (doi:10.1098/rspb.2004.2816)
20. Hasson O. 1991 Pursuit-deterrent signals: communication between prey and predator. *Trends Ecol. Evol.* **6**, 325–329
21. Srygley RB. 1999 Incorporating motion into investigations of mimicry. *Evol. Ecol.* **13**, 691–708
22. Cyriac VP, Kodandaramaiah U. 2019 Don't waste your time: predators avoid prey with conspicuous colors that signal long handling time. *Evol. Ecol.* **33**, 625–636. (doi:10.1007/s10682-019-09998-9)
23. Brower JV. 1958 Experimental studies of mimicry in some North American butterflies. 1. The monarch, *Danaus plexippus*, and viceroy, *Limenitis achippus archippus*. *Evolution* **12**, 32–47. (doi:10.2307/2405902)
24. van Someren VGL, Jackson THE. 1959 Some comments on protective resemblance amongst African lepidoptera (Rhopalocera). *J. Lepidopterists' Soc.* **13**, 121–150

25. Pinheiro CEG. 1996 Palatability and escaping ability in Neotropical butterflies: tests with wild kingbirds (*Tyrannus melancholicus*, Tyrannidae). *Biol. J. Linn. Soc.* **59**, 351–365. (doi:10.1111/j.1095-8312.1996.tb01471.x)
26. Pinheiro CEG, Freitas AVL. 2014 Some Possible Cases of Escape Mimicry in Neotropical Butterflies. *Neotrop. Entomol.* **43**,393–398. (doi:10.1007/s13744-014-0240-y)
27. Pinheiro CEG, Campos VC. 2019 The responses of wild jacamars (*Galbula ruficauda* , Galbulidae) to aposematic, aposematic and cryptic, and cryptic butterflies in central Brazil. *Ecol. Entomol.* **44**, 441–450. (doi:10.1111/een.12723)
28. Gibson DO. 1974 Batesian mimicry without distastefulness? *Nature* **250**, 77–79
29. Gibson, DO. 1980 The role of escape in mimicry and polymorphism: I. The response of captive birds to artificial prey. *Biol. J. Linn. Soc.* **14**, 201–214
30. Hancox AP, Allen JA. 1991 A simulation of evasive mimicry in the wild. *J Zool.* **223**, 9–13
31. Willmott KR. 2003 *The Genus Adelpha: Its Systematics, Biology and Biogeography (Lepidoptera: Nymphalidae: Limenitidini)*. Gainesville, FL: Scientific Publishers
32. Willmott KR. 2003 Cladistic analysis of the Neotropical butterfly genus *Adelpha* (Lepidoptera: Nymphalidae), with comments on the subtribal classification of Limenitidini. *Syst Entomol.* **28**, 279–322
33. Ebel ER, DaCosta JM, Sorenson MD, Hill RI, Briscoe AD, Willmott KR, Mullen SP. 2015 Rapid diversification associated with ecological specialization in Neotropical *Adelpha* butterflies. *Mol. Ecol.* **24**, 2392–2405. (doi:10.1111/mec.13168)
34. Aiello A. 1984 *Adelpha* (Nymphalidae): deception on the wing. *Psyche* **91**, 1–45. (doi:10.1155/1984/ 87930)
35. Finkbeiner SD, Salazar PA, Nogales S, Rush CE, Briscoe AD, Hill RI, Kronforst MR, Willmott KR, Mullen SP. 2018 Frequency dependence shapes the adaptive landscape of imperfect Batesian mimicry. *Proc. R. Soc. B.* **285**, 20172786. (doi:10.1098/rspb.2017.2786)
36. Hill RI, Mullen SP. 2019 Adult Feeding as a Potential Mechanism for Unprofitability in Neotropical *Adelpha* (Limenitidini, Limenitidinae, Nymphalidae). *J. Lepid. Soc.* **73**, 66. (doi:10.18473/lepi.73i1.a11)
37. Chai P, Srygley RB. 1990 Predation and the Flight, Morphology, and Temperature of Neotropical Rain-Forest Butterflies. *Am. Nat.* **135**,748–65

38. Finkbeiner SD, Briscoe AD, Mullen SP. 2017 Complex dynamics underlie the evolution of imperfect wing pattern convergence in butterflies. *Evolution* **71**, 949–959. (doi:10.1111/evo.13165)
39. Srygley RB, Dudley R. 1993 Correlations of the Position of Center of Body Mass With Butterfly Escape Tactics. *J. Exp. Biol.* **174**, 155–66
40. Mallet J, Singer MC. 1987 Individual selection, kin selection, and the shifting balance in the evolution of warning colours: the evidence from butterflies. *Biol. J. Linn. Soc.* **32**, 337–350. (doi:10.1111/j. 1095-8312.1987.tb00435.x)
41. Mullen SP, Savage WK, Wahlberg N, Willmott KR. 2011 Rapid diversification and not clade age explains high diversity in neotropical *Adelpha* butterflies. *Proc. R. Soc. B* **278**, 1777–1785. (doi:10.1098/rspb.2010.2140)
42. Kikuchi DW, Mappes J, Sherratt TN, Valkonen JK. 2016 Selection for multicomponent mimicry: equal feature salience and variation in preferred traits. *Behav. Ecol.* **27**, 1515–1521. (doi:10.1093/beheco/arw072)
43. Rönkä K, De Pasqual C, Mappes J, Gordon S, Rojas B. 2018 Colour alone matters: no predator generalization among morphs of an aposematic moth. *Anim. Behav.* **135**, 153–163. (doi:10.1016/j.anbehav.2017.11.015)
44. Rojas B, Mappes J, Burdfield-Steel E. 2019 Multiple modalities in insect warning displays have additive effects against wild avian predators. *Behav. Ecol. Sociobiol.* **73**. (doi:10.1007/s00265-019-2643-6)
45. Hart NS, Partridge JC, Cuthill IC, Bennett ATD. 2000 Visual pigments, oil droplets, ocular media and cone photoreceptor distribution in two species of passerine bird: The blue tit (*Parus caeruleus* L.) and the blackbird (*Turdus merula* L.). *J. Comp. Physiol. A* **186**, 375–87
46. Hart NS, Vorobyev M. 2005 Modelling oil droplet absorption spectra and spectral sensitivities of bird cone photoreceptors. *J. Comp. Physiol. A.* **191**, 381–92
47. Smith HG. 1987 Intraspecific Variation in Migratory Pattern of a Partial Migrant, the Blue Tit (*Parus caeruleus*): An Evaluation of Different Hypotheses. *The Auk* **104**, 109–115. (doi:10.2307/4087239)
48. Hämäläinen L, Mappes J, Rowland HM, Teichmann M, Thorogood R. 2020 Social learning within and across predator species reduces attacks on novel aposematic prey. *J. Anim. Ecol.* **89**, 1153–1164. (doi:10.1111/1365-2656.13180)

49. Ihalainen E, Rowland HM, Speed MP, Ruxton GD, Mappes J. 2012 Prey community structure affects how predators select for Müllerian mimicry. *Proc. R. Soc. B* **279**, 2099–2105. (doi:10.1098/rspb.2011.2360)
50. Mérot C, Frérot B, Leppik E, Joron M. 2015 Beyond magic traits: Multimodal mating cues in *Heliconius* butterflies. *Evolution* **69**, 2891–904. (doi:10.1111/evo.12789)
51. Lindroth CH. 1971 Disappearance as a Protective Factor. A supposed case of Batesian mimicry among beetles (Coleoptera: Carabidae and Chrysomelidae). *Ent. scand.* **2**, 41–48
52. Holm E, Kirsten JF. 1979 Pre-adaptation and speed mimicry among Namib Desert scarabaeids with orange elytra. *J. Arid. Environ.* **2**, 263–271.
53. Srygley RB. Locomotor mimicry in butterflies? 1994 The associations of positions of centres of mass among groups of mimetic, unprofitable prey. *Philos Trans. R. Soc. London B* **343**, 145–55
54. Ham AD, Ihalainen E, Lindström L, Mappes J. 2006 Does colour matter? The importance of colour in avoidance learning, memorability and generalisation. *Behav. Ecol. Sociobiol.* **60**, 482–91
55. Lindstrom L, Alatalo R V, Mappes J. 1999 Reactions of hand-reared and wild-caught predators toward warningly colored, gregarious, and conspicuous prey. *Behav. Ecol.* **10** 317–322
56. Aronsson M, Gamberale-Stille G. 2008 Domestic chicks primarily attend to colour, not pattern, when learning an aposematic coloration. *Anim. Behav.* **75**, 417–423. (doi:10.1016/j.anbehav.2007.05.006)
57. Chittka L, Osorio D. 2007 Cognitive dimensions of predator responses to imperfect mimicry. *PLoS Biol.* **5**, e339. (doi:10.1371/journal.pbio.0050339)
58. Arias M, le Poul Y, Chouteau M, Boisseau R, Rosser N, Théry M, Llaurens V. 2016 Crossing fitness valleys: empirical estimation of a fitness landscape associated with polymorphic mimicry. *Proc. R. Soc. B* **283**: 20160391. (doi:10.1098/rspb.2016.0391)
59. Finkbeiner SD, Briscoe AD, Reed RD. 2014 Warning signals are seductive: relative contributions of color and pattern to predator avoidance and mate attraction in *Heliconius* butterflies. *Evolution* **68**, 3410–3420. (doi:10.1111/evo.12524)

60. Kazemi B, Gamberale-Stille G, Tullberg BS, Leimar O. 2014 Stimulus Saliency as an Explanation for Imperfect Mimicry. *Curr. Biol.* **24**, 965–969. (doi:10.1016/j.cub.2014.02.061)
61. Hetz M, Slobodchikoff CN. 1988 Predation pressure on an imperfect Batesian mimicry complex in the presence of alternative prey. *Oecologia.* **76**, 570–573
62. Beatty CD, Beirinckx K, Sherratt TN. 2004 The evolution of müllerian mimicry in multispecies communities. *Nature* **431**, 63–66. (doi:10.1038/nature02818)
63. Arias M, Mappes J, Théry M, Llaurens V. 2015 Inter-species variation in unpalatability does not explain polymorphism in a mimetic species. *Evol. Ecol.* **30**, 419–433. (doi:10.1007/s10682-015-9815-2)
64. Muñoz AP, Kéry M, Martins PV, Ferraz G. 2018 Age effects on survival of Amazon forest birds and the latitudinal gradient in bird survival. *The Auk* **135**, 299–313. (doi:10.1642/auk-17-91.1)
65. Rönkä K, Valkonen JK, Nokelainen O, Rojas B, Gordon S, Burdfield-Steel E, Mappes J. 2020 Geographic mosaic of selection by avian predators on hindwing warning colour in a polymorphic aposematic moth. *Ecol. Lett.* **23**, 1654–1663. (doi:10.1111/ele.13597)
66. Ritland DB. 1995 Comparative unpalatability of mimetic viceroy butterflies (*Limenitis archippus*) from four south-eastern United States populations. *Oecologia* **103**, 327–336. (doi:10.1007/BF00328621)
67. Brower LP, Ryerson W, Coppinger L, Glazier S. 1968 Ecological Chemistry and the Palatability Spectrum. *Science* **161**, 1349–1351
68. Pinheiro CEG. 2003 Does Müllerian Mimicry Work in Nature? Experiments with Butterflies and Birds (Tyrannidae). *Biotropica.* **35**, 356–364
69. Terhune, E. C. 1977. Components of a visual stimulus used by scrub jays to discriminate a batesian model. *Am. Nat.* **111**, 435–451
70. Endler JA, Mappes J. 2004 Predator Mixes and the Conspicuousness of Aposematic Signals. *Am. Nat.* **163**, 532–547
71. Hämäläinen L, Mappes J, Rowland HM, Thorogood R. 2019 Social information use about novel aposematic prey is not influenced by a predator's previous experience with toxins. *Funct. Ecol.* **33**, 1982–1992. (doi:10.1111/1365-2435.13395)
72. Duncan CJ, Sheppard PM. 1965 Sensory discrimination and its role in the evolution of batesian mimicry. *Behaviour* **24**, 269–282.

73. Goodale MA, Sneddon I. 1977 The effect of distastefulness of the model on the predation of artificial batesian mimics. *Anim. Behav.* **25**, 660–665
74. Lindstrom L, Alatalo RV., Mappes J. 1997 Imperfect Batesian mimicry - the effects of the frequency and the distastefulness of the model. *Proc. R. Soc. Lond. B* **264**, 149–153
75. Brower AV. Locomotor Mimicry in butterflies? A critical review of the evidence. 1995 *Phil. Trans. R. Soc. Lond. B* **347**, 413–25

Supplementary materials

S1. Detailed protocol description

Pre-training phase

The day before experiments, birds were trained in a stepwise manner to handle an artificial prey item bearing a cryptic colour pattern (figure 1e). Pre-training took place in the birds' home cages and started when lights were turned on at 8:40 am. Food trays were removed from the home cages and birds were allowed to eat four sunflower seeds to start the pre-training, which lasted the whole day.

Birds had to accomplish a sequence of 4 tasks to finish this phase. First, they had to consume 4 pieces of almond, placed above pinned pre-training prey. Second, birds had to consume the almond that was under the pre-training prey but half visible. Third, birds had to find the almond that was not visible anymore unless prey was flipped upside down. Finally, the almond was completely hidden (a glued square of paper covered it), and so birds had to rip the paper in order to find the reward.

Experimental procedures

We used 87 birds, divided into 3 treatment groups depending on the prey wing colour pattern and which defence feature (i.e., evasiveness or distastefulness) was being taught to be avoided. Group 1: evasive prey bearing an orange forewing band wing pattern (n=28) (figure 1a). Group 2: evasive prey bearing a transverse orange forewing and white hindwing band wing pattern (n=31) (figure 1b). Group 3: distasteful prey bearing the same wing pattern as in group 2 (n=28) (figure 1b). For the generalisation phase (see below) we used the white forewing band wing pattern (figure 1c) for all groups.



Figure 1. Artificial prey items

Simulation of evasiveness

Prey items were pinned to a plastic holder attached to a thread that was manually pulled from the outside, i.e., making prey glide on the aluminium profile. Prey was immediately pulled away

when the bird was <5 cm from the escape model and displaying a clear intention to attack it, i.e., with the beak aiming at the paper model. Certainly, there was some minor variation (due to the human error) in speed and distance of bird approaches but the variation should be the same for all treatments and aimed to be kept minimum. Video is now available in electronic supplementary materials, S4).

Avoidance learning of evasive prey

Birds were tested individually in the experimental aviary. The day of the experiment, birds were habituated to the experimental aviary (see figure 2) for at least an hour during which they had to eat in a stepwise manner: two sunflower seeds (each one situated next to the aluminium rails), and then two pre-training prey. If birds ate both sunflower seeds and pre-training prey, it was considered they were ready to start the experiment.

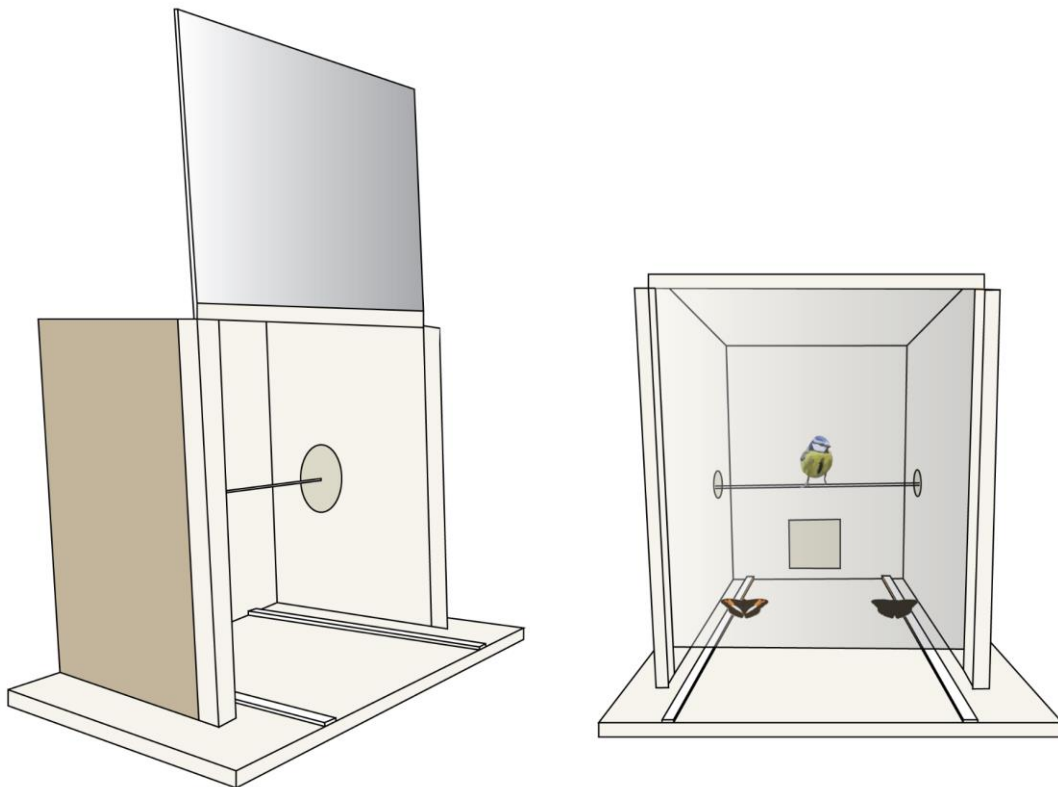

Figure 2. Experimental aviary

Each trial consisted of simultaneously presenting to the bird (and in alternating positions per trial), one non-evasive prey with the control colour pattern and one evasive prey with an Adelpha wing colour pattern according to the treatment group. Each trial time was set to a maximum of 3 minutes.

To make sure that each bird had the opportunity of experiencing both types of prey (i.e. evasive and non-evasive prey), no prey was removed until attacked during the first five trials. After this, the bird had only one opportunity of attack per trial. The bird was allowed to capture and eat only the non-evasive prey (i.e., control), whereas the evasive prey was always rapidly pulled out when attacked. If the bird did not attempt to capture any of the prey for 3 minutes from when the bird first saw both preys, it was offered a pre-training prey to monitor the bird's motivation to continue foraging. If the bird did not attack the pre-training prey, a sunflower seed was offered to avoid starvation and then it received a 10-minute break without any food. After the break, another pre-training prey was offered and if the bird attacked it, presentations of evasive prey and non-evasive prey continued until it learned avoidance (see below), or when the bird reached a maximum of 80 presentations. Based on preliminary trials designed to optimize the experiments, we considered the bird to have learned to avoid the evasive prey when it did not attack this prey (and thus attacked the non-evasive prey) more than twice over ten consecutive trials. Following this learning criterion, "quick" learners (i.e., those that learn after a small number of trials) encountered fewer prey than "slow" learners, although all birds had the same level of learning, which was important for the generalisation test (see below).

When birds had completed this experiment, they had a break of at least 2 hours with 3 sunflower seeds offered each 30 minutes before starting the generalisation test (see below). Birds that took longer to learn thus finished experiments late in the afternoon (around 17h00) and were placed back in their home cages with food ad libitum and water until the next day to continue with the generalisation experiment.

Avoidance learning of distasteful prey

We conducted in parallel both learning and generalisation tests (see below) similarly to evasive prey treatments (group 1 and 2), except that distasteful prey were substituted for evasive prey. Only the transverse forewing orange/hindwing white band pattern was tested.

Generalisation of evasive or distasteful prey

If birds achieved the learning criteria, a 45-min to 1-hour break was set until the generalisation phase get started. Only for birds that end the learning phase after 17h00, generalisation phase started early in the following morning. For this test, four types of prey were presented to birds in a T-shaped tray (figure 3). The positions of different wing patterns were randomised among birds in order to avoid bias to a particular position in the tray. On average, each bird received a 15-minute habituation period to the new type of tray, during which three pre-training prey with

one sunflower seed were offered. When all pre-training prey and the sunflower seeds were consumed, it was considered that the bird was ready to start the test. We simultaneously presented all prey: (i) control, (ii) the model (i.e., wing colour patterns that birds were trained upon during learning phase), (iii) two imperfect mimics novel to the birds which could show the same colours but not pattern (i.e., transverse forewing orange/hindwing white band for group 1; forewing orange band and forewing white band for group 2 and group 3), and only for group 1 the imperfect mimic that had the same pattern but different colour (i.e., forewing white band) than the model was also tested. The first choice of attack was registered for each bird.

A pilot test using a species that closely resembled the model (*Adelpha thesprotia*, see figure 4) showed that birds were incapable of distinguishing between these two species, so for the generalisation experiments we used the same pattern during the learning phase and we introduced patterns that differed either by colour or pattern from the model.









Figure 3. Illustration of prey presentation during the generalisation test

S2. Frequency of prey attacked in the generalisation test for each experimental group

Numbers in bold correspond to the attack counts on each pattern that was used as a model in the learning experiment. Birds from group 1 (evasiveness) learned to avoid the orange band pattern; birds from group 2 (evasiveness) and 3 (distastefulness) learned to avoid the orange/white band pattern. For the generalisation test we used only birds that achieved the learning criterion in previous phase: group 1 $n=23$ out of 28, group 2 $n=25$ out of 31, group 3 $n=18$ out of 28. The number of birds from group 2 that learned is 29 out of 31, but data from

the first four birds that followed a different preliminary protocol for generalisation are not included in this analysis.

Wing patterns learned to avoid		Attacks on wing patterns presented during generalisation test			
					
group 1 - evasive prey		4	8	1	10
group 2 - evasive prey		2	5	4	14
group 3 - distasteful prey		1	10	1	6

S3. Generalisation tests: Likelihood model, scenarios investigated and results

S3.1 Full calculation of the likelihood model

There are 4 types of butterflies (wing patterns): control [C], orange banded [O], white banded [W], orange/white banded [OW]

Parameters that are known for each group experiment:

N : number of trials = total number of butterflies of each type presented

a_c : number of C butterflies attacked

a_o : number of O butterflies attacked

a_w : number of W butterflies attacked

a_{ow} : number of OW butterflies attacked

Parameters to estimate:

P_c : probability of attacking a C butterfly

P_o : probability of attacking a O butterfly

P_w : probability of attacking a W butterfly

P_{ow} : probability of attacking a OW butterfly

Likelihood function:

$$L = \binom{N}{a_c} * \binom{N}{a_o} * \binom{N}{a_w} * \binom{N}{a_{ow}} * P_c^{a_c} * (1 - P_c)^{(N-a_c)} * P_o^{a_o} * (1 - P_o)^{(N-a_o)} * P_w^{a_w} * (1 - P_w)^{(N-a_w)} * P_{ow}^{a_{ow}} * (1 - P_{ow})^{(N-a_{ow})}$$

log-likelihood function:

$$\begin{aligned} \log(L) = & \log \binom{N}{a_c} + \log \binom{N}{a_o} + \log \binom{N}{a_w} + \log \binom{N}{a_{ow}} + a_c * \log(P_c) + (N - a_c) * \log(1 - P_c) \\ & + a_o * \log(P_o) + (N - a_o) * \log(1 - P_o) + a_w * \log(P_w) + (N - a_w) * \log(1 - P_w) \\ & + a_{ow} * \log(P_{ow}) + (N - a_{ow}) * \log(1 - P_{ow}) \end{aligned}$$

$$\log(L) = K + f(P_c, P_o, P_w, P_{ow})$$

where

$$K = \log \binom{N}{a_c} + \log \binom{N}{a_o} + \log \binom{N}{a_w} + \log \binom{N}{a_{ow}}$$

and f is a function of attack probabilities

K is a constant term (it only depends on the experiment results, not on probabilities to be estimated and it is therefore identical in all models tested). K therefore disappears in likelihood, AIC and AICc comparisons. Thus, there is no need to include it in the calculation.

S3.2 Generalisation tests: scenarios investigated and results

The scenarios investigated are:

Scenario 1 (s1): All attack rates are equal: $P_c = P_w = P_o = P_w$. This scenario indicates no generalisation to the perfect mimic neither the imperfect mimic.

Scenario 2 (s2): All attack rates are different: $P_c \neq P_w \neq P_o \neq P_w$. This scenario indicates partial and unequal generalisation on the two imperfect mimics, if P_c is highest and P_o for group 1 or P_w for groups 2 and 3 is lowest. It indicates, as well generalisation to perfect mimic.

Scenario 3 (s3): Only the attack rate on the control is different: $P_c \neq P_w = P_o = P_w$. This scenario indicates equal generalisation to both imperfect mimics if $P_c < P_i$ for each $i \neq c$; and generalisation to the perfect mimic.

Scenario 4 (s4): Only the attack rate on the perfect mimic is different: $P_o \neq P_c = P_w = P_w$ for group 1 and $P_w \neq P_c = P_o = P_w$ for groups 2 and 3. This scenario indicates no generalisation to any of the imperfect mimics if the attack rate of the perfect mimic is higher than that of the other types.

Scenario 5 (s5): The attack of the control and of the white imperfect mimics are equal, and the attack rate of the perfect and the other imperfect mimic are equal, and different from that of the control: $P_c = P_w \neq P_o = P_w$. This scenario indicates equal generalisation to the imperfect mimic that shares the orange colour with the model but not to white imperfect mimic if $P_c > P_o$.

Scenario 6 (s6): The attack rates of the control and the perfect mimic are different; the attack rates of the two imperfect mimics are equal and different from those of the control and the perfect mimic: $P_c \neq P_o \neq P_w = P_w$ for group 1 and $P_c \neq P_w \neq P_o = P_w$ for groups 2 and 3. This scenario indicates

partial generalisation to both imperfect mimics, if the attack rate of the control is highest and that of the perfect mimic is lowest.

Scenario 7 (s7): The attack rate of the control and the white imperfect mimic are equal, and the attack rates of the orange and orange/white are different, and different from that of the control: $P_c = P_w \neq P_o \neq P_{ow}$. This scenario indicates partial generalisation to the imperfect mimic sharing the orange colour with the model, if the attack rate on the control is highest and that on the perfect mimic is lowest.

Scenario 8 (s8): The attack of the perfect mimic and of the white imperfect mimics are equal, and the attack rate of the control and the other imperfect mimic are equal, and different from that of the control: $P_c = P_{ow} \neq P_o = P_w$ for group 1 and $P_c = P_o \neq P_{ow} = P_w$ for groups 2 and 3. This scenario indicates equal generalisation to the white imperfect mimic but not to the other imperfect mimic if $P_c > P_w$.

Scenario 9 (s9): The attack rate of the control and the imperfect mimic with orange are equal, and the attack rates of the perfect mimic and the white imperfect mimic are different, and also different from that of the control: $P_c = P_{ow} \neq P_o \neq P_w$ for group 1 $P_c = P_o \neq P_{ow} \neq P_w$ for groups 2 and 3. This scenario indicates partial generalisation to the white imperfect mimic, if the attack rate on the control is highest and that on the perfect mimic is lowest.

S3.3 Results of the generalisation tests for the three groups

Group 1				scenario 1	scenario 2	scenario 3
orange as the evasive model				$P_c = P_{ow} = P_o = P_w$	$P_c \neq P_{ow} \neq P_o \neq P_w$	$P_c \neq P_{ow} = P_o = P_w$
				no generalisation to the perfect mimic neither imperfect mimics	partial & unequal generalisation to both imperfect mimics. Generalisation to perfect mimic	equal generalisation to the perfect mimic & to both imperfect mimics
	attacked	presented	attack rates			
control	10	23	P_c	0.250	0.435	0.435
orange=model	1	23	P_o	0.250	0.043	0.188
white	8	23	P_w	0.250	0.348	0.188
orange/white	4	23	P_{ow}	0.250	0.174	0.188
	number of parameters (attack rates)			1.000	4.000	2.000
			log(L) - K	-22.468	-19.694	-21.339
			AICc	47.127	49.610	47.279
				scenario 4	scenario 5	scenario 6
				$P_o \neq P_c = P_{ow} = P_w$	$P_c = P_w \neq P_o = P_{ow}$	$P_c \neq P_o \neq P_{ow} = P_w$
				generalisation only to the perfect mimic	equal generalisation to the perfect mimic & to the orange/white imperfect mimic	generalisation to perfect mimic & partial generalisation equally to both imperfect mimic
	attacked	presented	attack rates			
control	10	23	P_c	0.319	0.391	0.435
orange=model	1	23	P_o	0.043	0.109	0.043
white	8	23	P_w	0.319	0.391	0.261
orange/white	4	23	P_{ow}	0.319	0.109	0.261
	number of parameters (attack rates)			2.000	2.000	3.000
			log(L) - K	-20.545	-20.239	-20.091
			AICc	45.690	45.079	47.446
				scenario 7	scenario 8	scenario 9
				$P_c = P_w \neq P_o \neq P_{ow}$	$P_c = P_{ow} \neq P_o = P_w$	$P_c = P_{ow} \neq P_o \neq P_w$
				generalisation to the perfect mimic & partial generalisation to orange/white imperfect mimic	equal generalisation to the perfect mimic & to white imperfect mimic	generalisation to the perfect mimic & partial generalisation to the white imperfect
	attacked	presented	attack rates			
control	10	23	P_c	0.391	0.304	0.304
orange=model	1	23	P_o	0.043	0.196	0.043
white	8	23	P_w	0.391	0.196	0.348
orange/white	4	23	P_{ow}	0.174	0.304	0.304
	number of parameters (attack rates)			3.000	2.000	3.000
			log(L) - K	-19.773	-22.151	-20.516
			AICc	46.809	48.903	48.296

Continuation S3.3

Group 2				scenario 1	scenario 2	scenario 3
orange/white as the evasive model				$P_c = P_{ow} = P_o = P_w$	$P_c \neq P_{ow} \neq P_o \neq P_w$	$P_c \neq P_{ow} = P_o = P_w$
				no generalisation to the perfect mimic neither imperfect mimics	partial & unequal generalisation to both imperfect mimics. Generalisation to perfect mimic	equal generalisation to the perfect mimic & to both imperfect mimics
	attacked	presented	attack rates			
control	14	25	P_c	0.250	0.560	0.435
orange/white=model	2	25	P_{ow}	0.250	0.080	0.188
white	5	25	P_w	0.250	0.200	0.188
orange	4	25	P_o	0.250	0.160	0.188
	25	100				
	number of parameters (attack rates)			1	4	2
			log(L) - K	-24.422	-20.681	-21.026
			AICc	51.018	51.362	46.598
				scenario 4	scenario 5	scenario 6
				$P_{ow} \neq P_c = P_o = P_w$	$P_c = P_w \neq P_o = P_{ow}$	$P_c \neq P_{ow} \neq P_o = P_w$
				generalisation only to the perfect mimic	equal generalisation to the perfect mimic & to the orange imperfect mimic	generalisation to perfect mimic & partial generalisation equally to both imperfect mimic
	attacked	presented	attack rates			
control	14	25	P_c	0.319	0.391	0.560
orange/white=model	2	25	P_{ow}	0.080	0.109	0.080
white	5	25	P_w	0.319	0.391	0.261
orange	4	25	P_o	0.319	0.109	0.261
	25	100				
	number of parameters (attack rates)			2	2	3
			log(L) - K	-23.104	-22.388	-20.710
			AICc	50.754	49.321	48.563
				scenario 7	scenario 8	scenario 9
				$P_c = P_w \neq P_o \neq P_{ow}$	$P_c = P_o \neq P_{ow} = P_w$	$P_c = P_o \neq P_{ow} \neq P_w$
				generalisation to the perfect mimic & partial generalisation to orange imperfect mimic	equal generalisation to the perfect mimic & to white imperfect mimic	generalisation to the perfect mimic & partial generalisation to the white imperfect
	attacked	presented	attack rates			
control	14	25	P_c	0.391	0.304	0.304
orange/white=model	2	25	P_{ow}	0.080	0.196	0.080
white	5	25	P_w	0.391	0.196	0.200
orange	4	25	P_o	0.160	0.304	0.304
	25	100				
	number of parameters (attack rates)			3	2	3
			log(L) - K	-22.220	-22.982	-22.649
			AICc	51.584	50.510	52.440

Continuation S3.3

Group 3				scenario 1	scenario 2	scenario 3
orange/white as the distasteful model				$P_c = P_{ow} = P_o = P_w$	$P_c \neq P_{ow} \neq P_o \neq P_w$	$P_c \neq P_{ow} = P_o = P_w$
				no generalisation to the perfect mimic neither imperfect mimics	partial & unequal generalisation to both imperfect mimics. Generalisation to perfect mimic	equal generalisation to the perfect mimic & to both imperfect mimics
	attacked	presented attack rates				
control	6	18	P_c	0.250	0.333	0.435
orange/white=model	1	18	P_{ow}	0.250	0.056	0.188
white	10	18	P_w	0.250	0.556	0.188
orange	1	18	P_o	0.250	0.056	0.188
	18	72				
	number of parameters (attack rates)			1	4	2
			log(L) - K	-17.584	-13.701	-17.398
			AICc	37.418	38.478	39.597
				scenario 4	scenario 5	scenario 6
				$P_{ow} \neq P_c = P_o = P_w$	$P_c = P_w \neq P_o = P_{ow}$	$P_c \neq P_{ow} \neq P_o = P_w$
				no generalisation to any of the imperfect mimics. Generalisation to perfect mimic	equal generalisation to the perfect mimic & to the orange imperfect mimic	generalisation to perfect mimic & partial generalisation equally to both imperfect mimic
	attacked	presented attack rates				
control	6	18	P_c	0.319	<u>0.391</u>	0.333
orange/white=model	1	18	P_{ow}	0.056	<u>0.109</u>	0.056
white	10	18	P_w	0.319	<u>0.391</u>	0.261
orange	1	18	P_o	0.319	<u>0.109</u>	0.261
	18	72				
	number of parameters (attack rates)			2	<u>2</u>	3
			log(L) - K	-16.285	<u>-14.095</u>	-16.276
			AICc	37.371	<u>32.990</u>	40.267
				scenario 7	scenario 8	scenario 9
				$P_c = P_w \neq P_o \neq P_{ow}$	$P_c = P_o \neq P_{ow} = P_w$	$P_c = P_o \neq P_{ow} \neq P_w$
				generalisation to the perfect mimic & partial generalisation to orange imperfect mimic	equal generalisation to the perfect mimic & to white imperfect mimic	generalisation to the perfect mimic & partial generalisation to the white imperfect
	attacked	presented attack rates				
control	6	18	P_c	0.391	0.304	0.304
orange/white=model	1	18	P_{ow}	0.056	0.196	0.056
white	10	18	P_w	0.391	0.196	0.556
orange	1	18	P_o	0.056	0.304	0.304
	18	72				
	number of parameters (attack rates)			3	2	3
			log(L) - K	-14.095	-17.325	-14.749
			AICc	35.904	39.449	37.213

Scenario numbering correspond to that mentioned above. For each scenario, the hypothesis tested is indicated and an interpretation is given. The table presents the number of attacked and presented prey of each type, and estimates of attack rates under each scenario are given. Ln-likelihood and AICc are given for each scenario.

The best scenario is indicated by bold and underlined formatting, and the alternative scenarios are indicated in bold.

S4. Learning experiment

Video showing a single trial from learning experiment procedure when the prey was evasive.

<https://datadryad.org/stash/share/2HDvDpXrGeiT34RsfoD4oROB04FP96fqJwGmIry>

[HoI](#)

S5. First trial's attack rate. Figure illustrating comparison between first trial's attacks rate on prey during the learning phase within groups (A) and attacks rate during generalisation test (B). Bars represent the proportion of attacks on the control prey (black bar) and the aposematic prey (orange bar) which was evasive orange band for group 1; evasive orange/white band for group 2; and distasteful orange/white band for group 3. Grey bars in generalisation figure (B) represent the imperfect mimics attack rates.

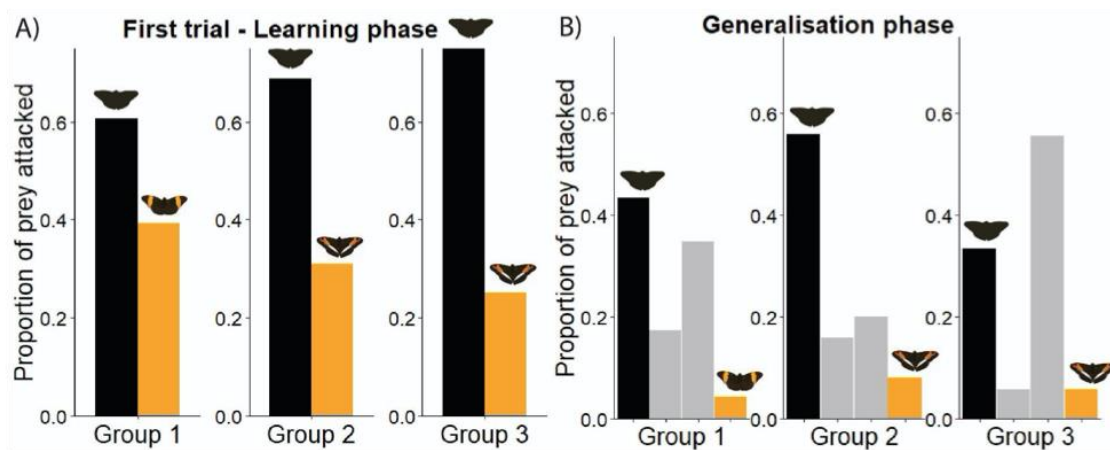



CHAPTER II

Mimicry and species diversification

Phylogeny of the genus *Adelpha* and the role of mimicry in diversification

This manuscript will be submitted in collaboration with Nicolas Chazot, Ryan Hill, Adriana Briscoe, Susan Finkbeiner, Sean Mullen, André V.L. Freitas, Luiza Magaldi, Marianne Elias and Keith Willmott.

In chapter I, we tested empirically the long-debated hypothesis of evasive mimicry. We provided a proof-of-concept using artificial prey that displayed naturally occurring wing colour patterns from butterflies of the Neotropical genus *Adelpha*. In addition, we compared predator learning and generalisation from evasive mimicry to classical mimicry. The main findings of this part of the study were that avian predators can learn to avoid both evasive and unpalatable prey, and can generalise their learned avoidance to novel putative co-mimics. When comparing evasive to classical mimicry, we observed that learning was faster, and generalisation was broader in the scenario where prey signalled for evasiveness.

This experiment provided new evidence that lends plausibility to the hypothesis of wing colour pattern convergence driven by predator selection. Therefore, in the following chapter, we assessed the evolution of evasive mimicry in the highly diverse genus *Adelpha*, and its potential role in speciation. Thus, we firstly inferred the most complete phylogeny for the genus *Adelpha*, and secondly, we reconstructed the ancestral state of mimetic patterns to assess its mode of evolution and its relationship to different species' macroecological traits.

For this study, I performed the different steps for the phylogenetic analyses from sequences generated by collaborators (in addition to extracting sequences of interest from RNA-seq provided by collaborators), and all the statistical analyses.

Introduction

The Neotropical region contains the world's most diverse floras and faunas, and that certainly includes butterflies, which have provided rich opportunities for investigating temporal and spatial patterns of diversification (e.g., Wahlberg and Freitas, 2007; Condamine *et al.*, 2012; Chazot *et al.*, 2019), their underlying mechanisms such as speciation (e.g., Jiggins *et al.*, 2006; McClure *et al.*, 2019), and biotic and abiotic correlates of diversity (e.g., Elias, Gompert, *et al.*, 2009; Erwin, 2009; Pyrcz *et al.*, 2014).

For more than a century, the bright wing patterns of butterflies have provided evolutionary biologists with insights into processes driving biological evolution. This is especially true of mimicry, the convergence of colour patterns that warns, or deceives, predators and thereby benefits the potential prey species, and which is demonstrated perhaps more spectacularly among the butterflies than in any other organisms. Mimicry has been studied in butterflies as a potential driver of speciation (e.g., Jiggins *et al.*, 2006; Mullen, 2006), because colour patterns are under both natural selection by predators (Mallet and Barton 1989) as well as sexual selection (Jiggins *et al.* 2001). Mimicry patterns are also associated with larval host plants (Beccaloni 1997a; Willmott and Mallet 2004), microhabitats (Marianne Elias *et al.* 2008; De Vries 2003), and broader habitats (Chazot *et al.* 2014), and thus shifts in mimetic wing pattern may accompany other ecological shifts that could rapidly drive speciation. The concept of a magic trait, i.e., a trait under divergent selection that also contributes to non-random mating (i.e., pre-mating reproductive isolation) (Servedio *et al.* 2011), has been investigated largely in mimetic butterflies. Specifically, changes in mimicry pattern drive reproductive isolation via assortative mating for colour patterns (Chamberlain *et al.* 2009; Giraldo *et al.* 2008; Merrill *et al.* 2011, 2012), and increased predation on non-mimetic hybrids which harbour intermediate, non-mimetic patterns (Arias *et al.* 2016). Yet, in some cases, limited divergence in mimicry pattern between sister species (Giraldo *et al.* 2008; Mérot *et al.* 2013), suggests, as one might expect, that other factors are also involved in the evolution of reproductive isolation (Estrada and Jiggins 2008).

The nymphalid genus *Adelpha*, with more than 90 species distributed from the temperate western USA to southeastern Brazil, Argentina and Paraguay, is a promising model system to investigate wing pattern evolution and speciation. These butterflies show marked changes in dorsal wing colour pattern both within species and among closely related species (Willmott 2003a), and extreme resemblance among less related species. Convergence on *Adelpha*

warning colour patterns is also seen in more distantly related butterfly groups, such as *Doxocopa* (Apaturinae) and certain Riodinidae (e.g., *Synargis*). Following Aiello (1984), Neild (1996), Willmott (2003a, 2003b) and Ebel *et al.* (2015), we regard convergent similarities in wing pattern in *Adelpha* to likely be the result of mimicry. Such mimicry could be Batesian, based on the putative unpalatability of certain *Adelpha* species (e.g., Aiello, 1984; Ebel *et al.*, 2015), or, perhaps more likely in our opinion, Müllerian mimicry based on the ability to escape predators (Mallet and Singer 1987; Páez *et al.* 2021; Willmott 2003a).

As with the evolution of any other trait that might be involved in speciation, it is instructive to examine factors that might affect the evolution of mimicry pattern. For example, a major hypothesis for the latitudinal gradient in species diversity is the idea that interactions among species are stronger in the tropics. Since dorsal wing patterns in *Adelpha* are potentially involved in signalling both to predators and conspecifics, greater predation pressure or competition for mates in tropical regions could be associated with higher rates of mimicry pattern evolution in such regions. Other factors that might accelerate mimicry pattern evolution include abundance, if rare species are under stronger selection by predators to converge on locally common models; or range-size, if clades containing narrowly distributed species tend to harbour a higher diversity in mimicry patterns because of adaptation to different, locally abundant mimetic communities.

Stronger selection for mimicry in more tropical regions could thus help drive diversification, and previous studies have supported the idea that tropical *Adelpha* clades are diversifying rapidly. *Adelpha* is the only member of the tribe Limenitidini in the American tropics, with a small clade of *Limenitis* species likewise being the tribe's only widespread member in temperate America. Mullen *et al.* (2011) tested the idea that these two clades represented independent colonisations of the Americas, with the greater diversity of *Adelpha* being the result of an earlier colonisation and longer time for speciation. A dated molecular phylogeny refuted this hypothesis, however, and instead supported the hypothesis of more rapid diversification in *Adelpha* (Ebel *et al.* 2015).

One unexpected result of Mullen *et al.*'s (2011) study was the inference that *Adelpha*, as previously conceived by Willmott (2003a, 2003b) and Lamas (2004), was polyphyletic, with a small clade of montane species, known as the *Adelpha alala* group, being sister to Palearctic *Limenitis* (as well as Chazot *et al.*, 2021). Moreover, Hui-Yun *et al.*'s (2022) phylogeny of the Limenitidinae embedded three species of montane *Adelpha* within *Limenitis*. The *A. alala*

group is distinctive among *Adelpha* in their larvae feeding on Caprifoliaceae Juss. (Dipsacales) and making leaf shelters, like some *Limenitis*. The inferred polyphyly of *Adelpha* was further supported by a much larger molecular dataset obtained using genome-wide restriction-site-associated sequencing (Ebel *et al.* 2015), whereas Dhungel and Wahlberg (2018) multi-locus study of Limenitidini failed to resolve these relationships. Ebel *et al.* (2015) built on the theme of rapid diversification in tropical lowland *Adelpha* by mapping larval host plant use and mimicry patterns, and showed that a shift to Rubiaceae might have been a significant event in *Adelpha* evolution, as well as confirming the convergent evolution of *Adelpha* dorsal wing patterns.

Collectively, these studies demonstrate the potential for research on *Adelpha* to provide insights into factors driving diversification in Neotropical butterflies and the latitudinal gradient in species richness, with potentially broad implications for other lineages. Here, we build on these previous studies to firstly attempt to clarify the relationships and classification of *Adelpha*, and secondly examine the role of wing pattern evolution in *Adelpha* diversification. Our goals include the following:

1) Infer the most complete phylogeny to date for the genus to support studies of evolution in the genus and to test whether *Adelpha* is polyphyletic; if it is, then the description of a new genus might potentially be needed for the montane *Adelpha alala* clade. Previous studies have included only about half of the species in the genus, so here we attempted to include at least some sequence data for all species.

2) Capitalise on this nearly complete species-level phylogeny to examine how the evolution of colour patterns may have influenced diversification in *Adelpha*. We examine whether shifts in wing colour pattern are associated with speciation events, we map the rate of mimicry evolution across the tree to test possible abiotic and biotic drivers of the evolution of this trait, and we describe the phylogenetic structure of mimicry rings, which together provide insights into factors potentially affecting spatial gradients in species diversity.

Material and Methods

A time-calibrated phylogeny of *Adelpha* was produced with 966 samples representing 90 out of 93 species (Prudic *et al.*, 2002; Willmott, 2003a, 2003b; Willmott and Hall, 2013; missing species are *A. bredowii*, *A. gavina* and *A. stilesiana*), and 133 subspecies (see supplementary

material S1.1). Four species from the sister genus *Limenitis* (*Limenitis lorquini*, *L. arthemis astyanax*, *L. glorifica*, *L. molthrechtii*), and three other taxa from the tribe Limenitidini (*Moduza urdaneta*, *Pandita sinope* and *Parasarpa zayla*) were included as outgroups to root the tree.

Molecular dataset

We used nucleotide sequences of 16 genes, compiled from published and unpublished studies (see supplementary materials S1.1) which were obtained by two different techniques: a) Sanger sequencing; and b) RNA-Seq. For the latter dataset, sequences of interest were extracted from a *de novo* annotated sample molecular dataset using the Sequence Capture Processor (SECAPR) pipeline (see full process and script in supplementary material S2).

Our final dataset included one fragment from the mitochondrial genome cytochrome oxidase subunit I *COI* (the “DNA barcode” region, 633 bp) and 15 nuclear gene fragments: carbamoyl phosphate synthetase *CAD* (1335 bp), Ribosomal Protein S5 *RpS5* (351 bp), Ribosomal Protein S2 *Rps2* (783 bp), glyceraldehydes-3-phosphate dehydrogenase *GAPDH* (993 bp), Elongation factor 1 alpha *EF-1a* (1389 bp), Arginine Kinase *ArgKin* (1065 bp), Isocitrate dehydrogenase *IDH* (1230 bp) and dopa-decarboxylase *DDC* (1428 bp) Cyclin Y *CycY* (1008 bp), exportin-1-like *Exp1* (3180 bp), sorting nexin-9-like *Nex9* (1617 bp), DNA-directed RNA polymerase II polypeptide *PolIII* (822 bp), suppressor of profiling 2 *ProSup* (1116 bp), proteasome beta subunit *PSb* (696 bp), and UDP glucose6 dehydrogenase *UDPG6DH* (1437 bp), for a total length of 19083 base pairs. All sequence datasets were subjected to verification steps and aligned by gene fragment using Codoncode Aligner.

The list of taxa, Genbank accession codes, and data matrix are available in supplementary material (S1).

Phylogenetic inference

Exploratory analyses in BEAST v1.10.4 inferred an unexpected topology at the subspecies level (e.g., subspecies were not grouped together under the same node), possibly due to a high number of non-overlapping regions in sequences among samples. Therefore, we generated a species-level tree that was used as a backbone tree for the final time-calibrated phylogeny of *Adelpha*. Phylogenetic inference analyses were carried out using a maximum-likelihood (ML) model for the backbone tree and Bayesian inference (BI) method for the time-calibrated comprehensive phylogeny.

Backbone tree – species level

To infer the backbone topology for a total of 97 species (90 species of *Adelpha*, 4 species of *Limenitis* and 3 outgroup species from the tribe Limenitidini), we generated a consensus sequence for each gene for each species, using all the available sequences, using Codoncode Aligner software. Consensus sequences were aligned using PASTA (Mirarab *et al.* 2015) with the default options, and the final concatenated multi-gene dataset was generated using Phyutility version 2.2 (Smith and Dunn 2008). Partitioning scheme and substitution models by gene and codon positions for the phylogenetic analyses were generated by PartitionFinder2 version 2.1.1 (Lanfear *et al.* 2012) on the CIPRES Science Gateway version 3.3. A maximum likelihood tree with branch support values was generated in IQ-tree (Trifinopoulos *et al.* 2016). Branch support values were calculated with 1000 non-parametric ultrafast bootstrap (UFBS) replicates (Hoang *et al.* 2017; Minh *et al.* 2013). The backbone topology of our tree mostly agreed with previous studies (Chazot *et al.*, 2019).

Time-calibrated tree – subspecies level

We then generated a tree that comprised all available individuals, using the backbone tree as a constraint. Sequence alignments, concatenated multi-gene datasets, best scheme partitions and substitution models were produced following the same methodology as used for the backbone tree. Phylogenetic inference analysis was performed using Markov Chain Monte Carlo (MCMC) in MrBayes v3.2.6 (Ronquist, Huelsenbeck, and Teslenko 2011) on XSEDE on the CIPRES Science Gateway v3.3 (Miller, Pfeiffer, and Schwartz 2010). We used a relaxed lognormal clock and a birth-death prior. Since there are no known fossil Limenitidinae (de Jong 2017), we used two secondary calibrations from a comprehensive dated butterfly phylogeny (Chazot, Wahlberg, *et al.* 2019), the age of the common ancestor of *Adelpha* and *Limenitis* 11.44 [8-15] Myr ago, and the age of the common ancestor of *Adelpha*, *Limenitis* and *Parasarpa* 16.27 [12-21] Myr ago. Priors for calibration points were set as uniform.

Species were constrained to be monophyletic, and we also enforced the monophyly of clades that had a 100% support (posterior probability/branch length) in the inferred backbone tree. The block of constraints was generated in R studio version 4.1.3 with the “*CreateMrBayesConstraints*” function from the *paleotree* package.

Two parallel runs of four chains (three heated and one cold) were performed for 30 million generations, with sampling done at every 1,000th generation. Effective Sample Size (ESS) values of the parameters used in the BI and convergence of the parallel MCMC runs were

inspected to assess convergence, using Tracer v1.7 software (Rambaut et al. 2018). Convergence was achieved for most parameters, including likelihood and prior probability.

(Data used to construct the phylogeny is available at https://github.com/ErikaPaezV/Mimicry_ecology-evolution.git)

Statistical analyses

Ancestral state reconstruction

We used a classification of wing colour patterns into mimicry complexes in *Adelpha* (Ebel *et al.* 2015; Willmott 2003a) to code mimicry patterns for all taxa. Several studies have used a similar approach for other groups of butterflies (Beccaloni, 1997b; Jiggins *et al.*, 2006; Doré *et al.* 2021), supported by the fact that birds perceive similarity between species in a similar manner to humans (Dittrich *et al.* 1993). There were 14 mimicry pattern complexes recognised, which were used as character states for the species in all subsequent analyses including within-species polymorphisms: 15 subspecies present 2 different colour patterns; 4 subspecies, 3 different colour patterns; and 2 subspecies, 4 different colour patterns.

Prior to the ancestral state reconstruction (ASR) of wing colour pattern we investigated its mode of evolution, and in particular, whether colour pattern shifts were associated with speciation events (punctuational evolution). Mode of evolution was constructed under a Bayesian framework using BayesTraits, ver. 2.0 (<http://www.evolution.rdg.ac.uk/BayesTraitsV2.html>). We estimated the branch scaling parameter kappa defined by (Pagel 1999), where branch lengths are raised at the power kappa. If kappa = 1, branch lengths are unchanged (gradual evolution). If kappa = 0, all branch lengths are equal (punctuational evolution, i.e., shifts in wing colour patterns are associated with speciation events). If $0 < \text{kappa} < 1$, branch lengths are different but closer to each other than in the actual tree (in-between evolution). Models (kappa = 0, kappa = 1 and kappa estimated) were compared using AICc and the best value of kappa was used to infer ancestral states for colour patterns using a maximum likelihood approach. We used the Multistate method, which is suitable for categorical traits that adopt a finite number of states and that allows for polymorphism (Pagel, Meade, and Barker 2004). To reduce the number of parameters to estimate, we constrained the probability for all state changes to be equal.

We based the ancestral state reconstruction on the topology of the Bayesian consensus tree at the species level (obtained from the subspecies time-calibrated tree where redundant subspecies and outgroups were pruned with the *drop.tip* function from R package *APE*). The command lines for the specified nodes as required by the *addMRCA* command in *BayesTraits* were generated with the program *BayesTrees*, version 1.3 (Meade and Pagel 2011).

Phylogenetic signal on mimetic wing colour patterns – MPD

To assess whether wing colour patterns are conserved or convergent in the phylogeny, we estimated the phylogenetic signal by calculating the mean phylogenetic distance MPD (Chazot *et al.* 2014) between pairs of species for each mimicry ring (9 out of 14 mimicry rings that harbour at least two species). In other words, mimicry rings were considered as pseudo-communities and compared to a null distribution obtained from permutation of the tip mimicry patterns (1000 runs) under the independent swap algorithm. Then we tested whether mimicry rings were phylogenetically more clustered (observed values under the 95% CI or overdispersed (observed values above the 95% CI) than expected at random 95% confidence intervals. These analyses provided some insights into how conserved or convergent were mimicry rings. The *Picante* package from R was used for this analysis.

Traits associated with rate of wing colour pattern evolution

To examine potentially explanatory variables for variation in wing colour pattern evolutionary rate across the tree, we computed the following traits for each species: 1) *Tropicality*, measured as the number of degrees from the equator of the geographic distribution centroid, 2) *Density*, measured by the number of specimens examined per 1000 km² of geographic range, 3) *geographic range size*, and 4) *niche breadth*, calculated using values of mean annual temperature, temperature seasonality [standard deviation x 100], mean annual precipitation, and precipitation seasonality (coefficient of variation) across the range of each species (see supplementary materials S3 for details).

To assess tip rates of evolution of wing colour patterns and their relationship with potential explanatory variables discussed above, we modelled 1000 histories of colour pattern by sampling at every node the state (colour pattern) with a probability equal to that inferred in the ancestral state reconstruction with *BayesTraits* and calculated the median tip rate (number of transitions from root to tip from simulated data) standardised by the number of nodes from root to tip. To investigate the correlation between wing pattern rates of evolution and potential

drivers for rate variation (described above), we performed Phylogenetic Generalized Linear Models (PGLS) using the *ppls* function (Grafen 1989; Martins and Hansen 1997) in the R package *caper* (D. Orme *et al.* 2013). With this function we fitted a linear model controlling for the phylogenetic signal by estimating and applying the branch scaling parameter lambda (Pagel 1999) using maximum likelihood.

R script, BayesTrait command line, and data used to produce the results of statistical analyses are available at https://github.com/ErikaPaezV/Mimicry_ecology-evolution.git

Results

Phylogenetic inference

In both the maximum likelihood tree (species level) and time-calibrated phylogeny (subspecies level) *Adelpha* was recovered as monophyletic (see supplementary materials S4 and S5). The topology was generally well supported, including deep nodes. The inferred crown age of *Adelpha* was 10.15 Ma (95% credibility interval CI = 8.95–12.14) and the divergence time from its sister clade *Limenitis* was 10.47 Ma (CI = 9.22–12.44).

Ancestral state reconstruction and MPD

When inferring the evolution of mimicry patterns, the best model fit was obtained for kappa=1, indicating gradual evolution (Table 1). However, this scenario could not be distinguished from that where kappa was estimated, taking the value of 0.640. Both kappa=1 and kappa estimated to 0.640 provided a significantly better fit to the data than kappa=0, thereby rejecting a fully punctuational model of evolution.

Table 1. Estimates from the ancestral state reconstruction analyses.

Kappa	Likelihood	N	K	AIC	AICc
<i>Estimated = 0.64</i>	-133.14	90	2	270.28	270.42
<i>kappa = 0 (punctuational evolution)</i>	-135.65	90	2	275.31	275.44
<i>kappa = 1 (gradual evolution)</i>	-133.79	90	1	269.58	269.62

Estimation of ancestral states for mimicry colour patterns in *Adelpha* showed that IPHICLUS, a pattern shared by 48 species and widely distributed across the phylogeny, was most likely to be the state of the common ancestor of all *Adelpha* species (probability = 0.996) (figure 1).

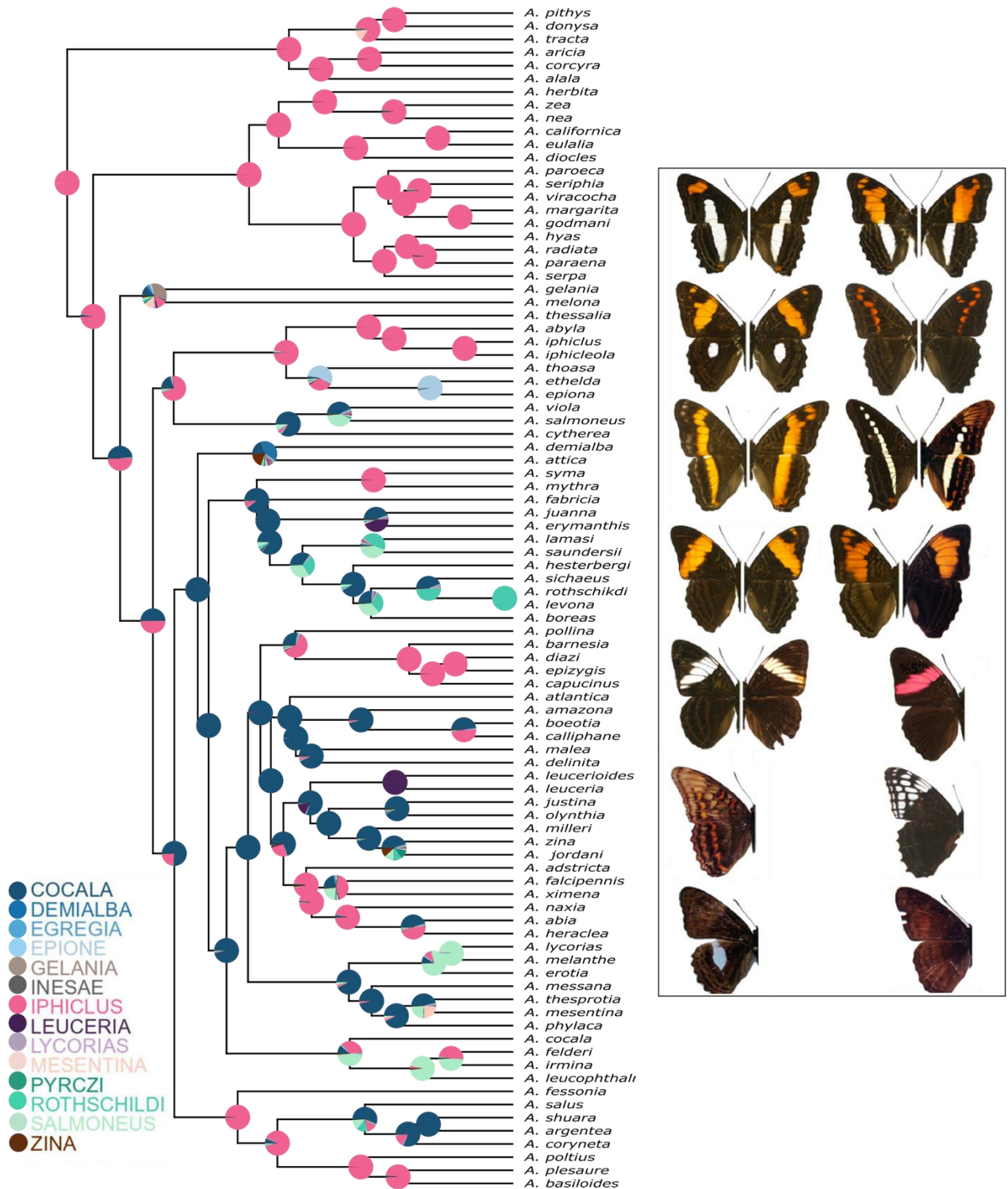

Figure 1. Ancestral state reconstruction based on the Bayesian tree. Pie-charts represent ancestral state probabilities for mimicry patterns, following the same colour code as terminal circles. Mimicry patterns are shown as well, 9 mimicry patterns are composed by more than 1 species (half wing in the image corresponds to different species). First column, from top to bottom: IPHICLUS, ZINA, LEUCERIA, SALMONEUS, EPIONE, EGREGIA, INESAE. Second column: COCALA,

ROTHSCHILDI, GELANIA, MESENTINA, LYCORIAS, DEMIALBA, PYRCZI. Figure of mimicry patterns modified from Ebel *et al* 2015.

The reconstruction of colour pattern changes showed mostly unambiguous character states on internal branches. Multiple shifts in wing colour patterns occur mostly in the lowland clade (see figure 1 and 3). Closely related taxa, with some exceptions, tend to present the same wing colour patterns. Complete results from BayesTraits analysis are available at https://github.com/ErikaPaezV/Mimicry_ecology-evolution.git.

MPD analysis by mimicry pattern showed that comimetic species belonging to COCALA, ROTHSCHILDI, SALMONEUS and ZINA mimicry rings are significantly more closely related than expected at random. By contrast, IPHICLUS and MESENTINA mimicry rings are phylogenetically overdispersed (see table 2, figure 2).

Table 2. Mean phylogenetic distance (MPD). Results from the MPD analysis between pairs of species for each mimicry ring are shown. Values from the MPD calculated for the null distribution (1000 permutations) and p values for both conservatism and overdispersion are included as well. Colour in cells shows the pattern observed (conserved: red; overdispersed: green).

Mimicry ring	N	MPD obs	MPD null	MPD Q5	MPD Q95	P value conserv	P value overdisp	Pattern
<i>COCALA</i>	31	14.34	15.90	15.12	16.60	0.001	1.00	conserved
<i>EPIONE</i>	3	12.18	15.71	11.14	19.00	0.01	0.90	none
<i>GELANIA</i>	2	19.12	15.70	9.22	20.31	0.75	0.24	none
<i>IPHICLUS</i>	48	16.80	15.97	15.44	16.46	0.1	0.001	overdispersed
<i>LEUCERIA</i>	4	13.71	15.71	12.11	18.53	0.16	0.84	none
<i>MESENTINA</i>	3	19.50	15.71	11.14	19.00	0.96	0.03	overdispersed
<i>ROTHSCHILDI</i>	6	12.54	15.75	13.08	17.86	0.03	0.97	conserved
<i>SALMONEUS</i>	12	13.95	15.80	14.20	17.16	0.03	0.97	conserved
<i>ZINA</i>	5	12.58	15.75	12.76	18.18	0.04	0.96	conserved

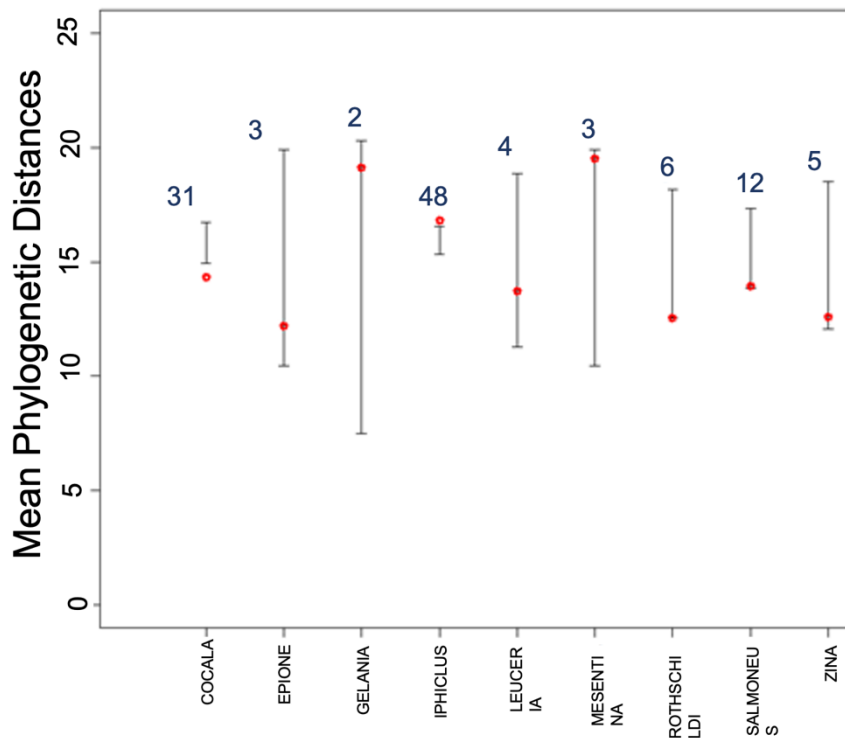

Figure 2. Mean Phylogenetic Distance. Plot showing the distribution of MPD values of the observed data (red circles) for 9 mimicy patterns of *Adelpha*. Observed values (red circles) out of confidence intervals CI indicate significant departure from random distribution of colour patterns with respect to the phylogeny; and position reflects whether mimicy rings are phylogenetically clustered (under the 95% CI) or overdispersed (above the 95% CI). Number of species (in blue) within each mimicy ring are shown as well.

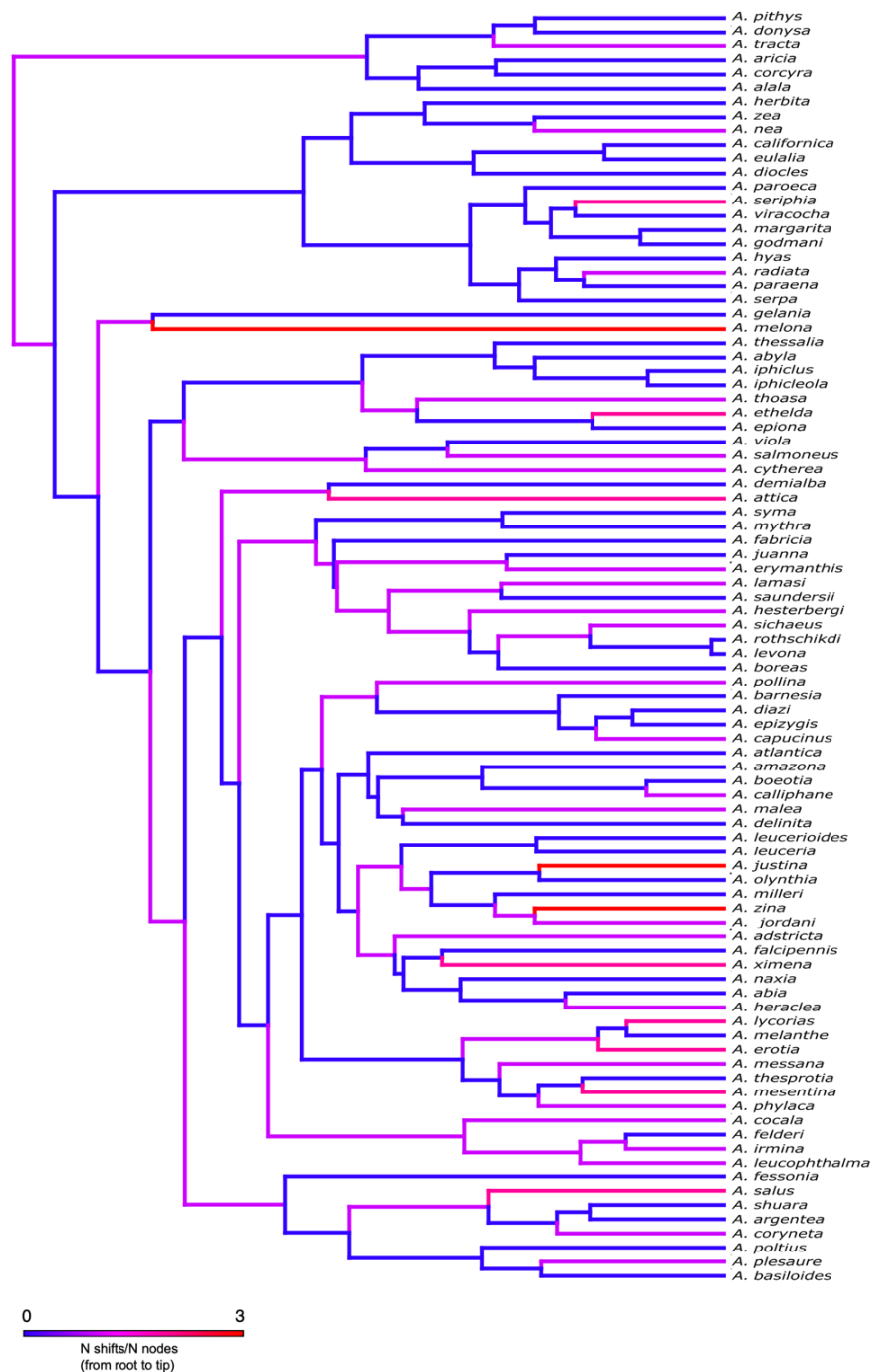

Figure 3. Tip rates of wing colour pattern evolution. Rates are indicated by a colour scale which corresponds to the number of shifts on mimicry patterns from root to tip standardised by the number of nodes from root to tip.

Rate of wing colour pattern evolution and its relationship with species traits

Inferred species wing colour pattern evolutionary rates were heterogeneous across the phylogeny (figure 3, supplementary materials S7), and they were correlated with the measure of tropicality *degrees from the equator*, with higher rates near the equator (Figure 4, Table 3). No significant correlations between mimicry evolution and other traits were detected.

Table 3. Correlates for rates of mimicry pattern evolution and species traits. * Niche width value was log transformed

Predictor	df	r ² (adjusted)	t	lambda	p-value
<i>Niche width*</i>	88	0.01	1.42	0.95	0.16
<i>Density</i>	88	-0.01	-0.46	0.95	0.65
<i>Range size</i>	88	-0.01	0.33	0.95	0.74
<i>Tropicality (degrees to the equator)</i>	88	0.07	-2.81	0.94	0.01

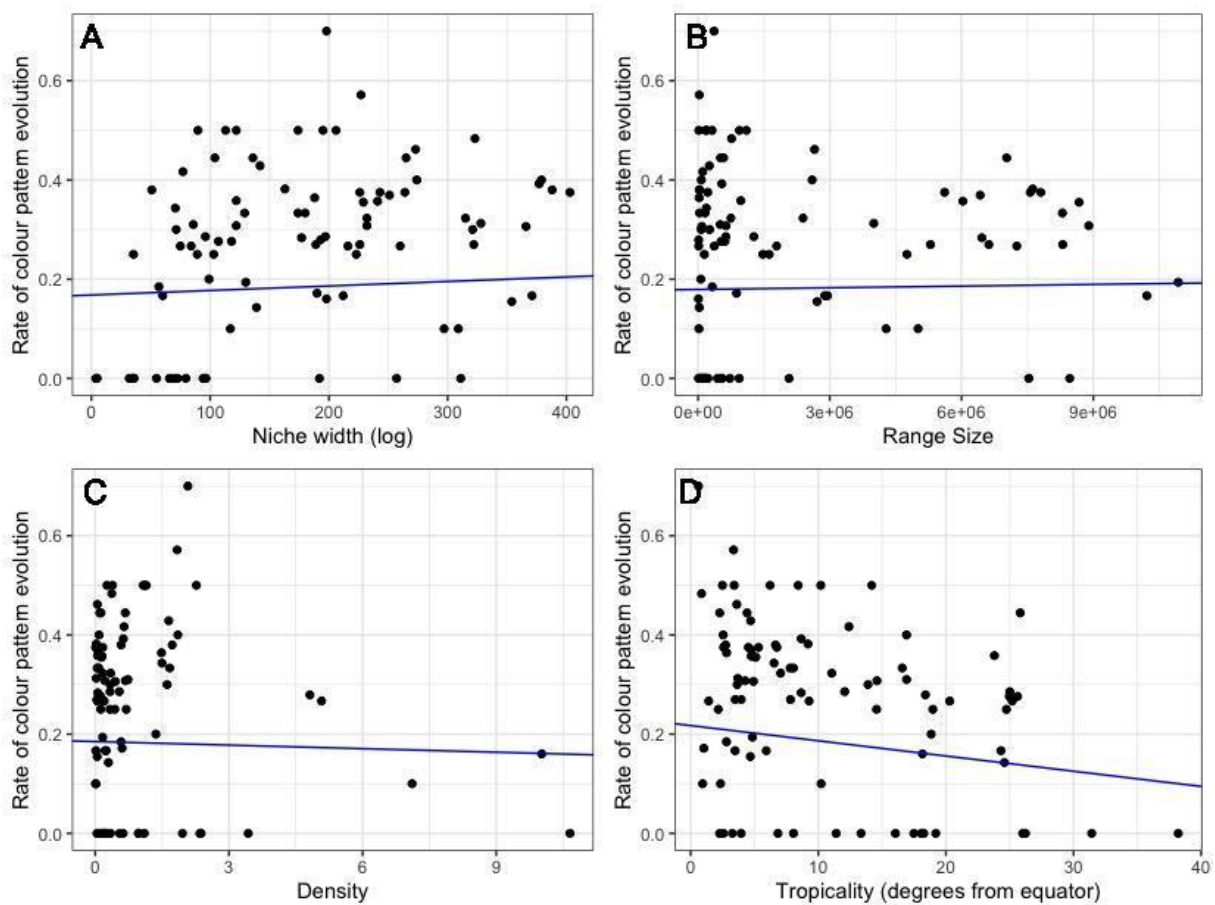

Figure 4. Phylogenetic Generalised Least Squares. Plots showing the relationship between species evolutionary rates and several species traits: Niche width (log transformed values) (A), Range size (B), Density (C), and Tropicality (degrees from the equator) (D). Regression best fit line is indicated by the blue line.

Discussion

We inferred the first taxonomically comprehensive phylogeny for the Neotropical butterfly genus *Adelpha*, which supports earlier studies based on morphology that found *Adelpha* to be

monophyletic (Willmott 2003a). Additionally, we investigated the evolution of the mimetic colour pattern and its role in speciation in *Adelpha*. We found that the white-band-orange-spot IPHICLUS mimetic pattern is the ancestral state for the genus and that shifts in mimetic patterns are not significantly associated with speciation events across the entire tree.

We observed differences among mimicry patterns in the level of phylogenetic signal. Although we found clear evidence for widespread convergence in some rings, most mimicry rings are phylogenetically conserved. Finally, we observed that the rate of evolution of mimicry patterns is heterogeneous among clades, and that the most derived clade exhibits in general higher evolutionary rates. “Tropicality” was the only species’ feature that significantly affected mimetic colour pattern evolutionary rates, with more equatorial species showing higher rates of mimicry pattern evolution.

We propose below some potential explanations for these patterns, but here is still a lot to uncover regarding mimicry evolution in *Adelpha*.

Systematics of the genus *Adelpha*

Inferring the first taxonomically comprehensive molecular phylogeny for *Adelpha* provided unexpected (albeit not especially strong) support for the monophyly of *Adelpha*, as inferred from morphological characters (Willmott, 2003b). This result is particularly surprising since all other molecular studies have failed to recover *Adelpha* as monophyletic (Chazot *et al.* 2021; Dhungel and Wahlberg 2018; Ebel *et al.* 2015; Hui-Yun *et al.* 2022; Mullen *et al.* 2011). Those studies have found the montane *alala*-group to be sister to a clade of temperate *Limenitis* (Ebel *et al.* 2015; Mullen *et al.* 2011)), in an unresolved polytomy between that clade, remaining *Adelpha*, and temperate *Limenitis* (Dhungel and Wahlberg 2018), embedded in a paraphyletic grade of *Limenitis* (Chazot *et al.* 2021), or embedded deep within a monophyletic *Limenitis* (Hui-Yun *et al.* 2022).

Our study shows that the position of the *alala*-group is still not clearly resolved, with this and all previous studies showing only weak support for critical parts of the topology, and results differing depending on the characters used (morphology, nuclear or mitochondrial DNA). We sampled a much larger fraction of the diversity of the genus (90 out of 93 species) compared to the largest previous molecular study (Ebel *et al.* 2015), which included only about half of the species in the genus, while others have included even fewer *Adelpha* species (Chazot *et al.*

2021; Dhungel and Wahlberg 2018; Hui-Yun *et al.* 2022). Thus, our phylogeny represents the most taxonomically comprehensive phylogeny to date for *Adelpha*.

Nevertheless, despite the taxonomic coverage of our study, we conclude that the relationships of the *Adelpha alala*-group still remain to be confidently resolved. As mentioned above, support for different topologies was always weak, and in our study a polyphyletic *Adelpha* was inferred when using a Bayesian model (BEAST analyses [data not shown]). The *alala*-group shares with most *Limenitis* larvae the use of Caprifoliaceae as hostplant (Willmott, 2003a, Ebel *et al.* 2015), and a closer relationship between these species than between the *alala*-group and remaining *Adelpha* certainly seems reasonable. It will therefore be desirable to include more *Limenitis* species (we only used 4 species) and more comprehensive genomic datasets, to confirm whether *Adelpha* is monophyletic or whether further revision to the taxonomic classification of this group is needed.

In our study, molecular data also continued to contribute to refining the species-level classification of *Adelpha*. By sampling comprehensively across *Adelpha*, including subspecies, it was possible to test the current species classification, and we propose the following taxonomic changes:

- *leuceria/juanna*: Samples of *A. leuceria juanna* did not cluster with samples of *A. leuceria leuceria*, but instead were sister to *A. erymanthis*. Moreover, Ichiro Nakamura (pers. comm.) collected both *A. leuceria leuceria* and *A. leuceria juanna* in close proximity in the Serranía de Pirre (Panama, Darién), with *A. leuceria* at slightly higher elevations. We therefore restore the species status of *Adelpha juanna* **rev. stat.** *Adelpha juanna* thus seems to be a South American replacement for *A. erymanthis*, with wing patterns convergent on *A. ethelda ethelda*. Nevertheless, it would be desirable to include additional samples of both *A. erymanthis* and *A. pollina* to confirm these relationships.
- *erymanthis/adstricta*: samples of *A. erymanthis adstricta* did not cluster with those of *A. erymanthis erymanthis*, but instead the former taxon formed a clade with a number of Amazonian and southeast Brazilian lowland species. Furthermore, the recent discovery of the former taxon in Costa Rica by Janzen, Hallwachs and Hill shows that it is broadly sympatric with *A. erymanthis* throughout Costa Rica and western Panama, at least. Willmott (2003a) retained Fruhstorfer (1915) original placement of *adstricta* as a subspecies of *A. erymanthis* based on similarities in the ventral wing pattern, but

only three female specimens, all with vague or incorrect locality data, were available for examination at that time. Since then, additional material from Costa Rica and western Ecuador permitted not only clarification of the relationships of the taxon based on molecular data, but also a better understanding of wing pattern variation. As a result of collecting a series of specimens in western Ecuador which show continuous variation in sympatry between typical *adstricta* and *A. erymanthis fortunata* Willmott (2003a) (also from western Ecuador), we synonymize the latter taxon with the former (**n. syn.**), and raise the former to species as *A. adstricta* **n. stat.**

- *A. hyas/A. viracocha*: Samples of *A. hyas hewitsoni* from eastern Ecuador grouped with *A. seriphia*, far from a single sample of *A. hyas hyas* from southeastern Brazil, which grouped with *A. radiata*. Willmott (2003a) tentatively associated *A. hyas* taxa based on similarities in size and ventral colour pattern, but none of these characters can be considered especially strong in the light of the relationships implied by the molecular data. We therefore regard Brazilian *A. hyas* as a monotypic species and place its two former west Amazonian subspecies as a distinct species, *A. viracocha* **n. stat.** and *A. viracocha hewitsoni* **n. stat.** This hypothesis of relationships must also be considered provisional, given the lack of molecular data for *A. viracocha viracocha*.
- *lycorias/melanthe*: These taxa are part of a clade of very closely related but very phenotypically distinct species. Willmott (2003a) regarded *A. lycorias melanthe* as the Central American replacement for *A. lycorias*, discounting three specimens labelled from Colombia, which would suggest sympatry with the Colombian *A. lycorias melanippe*, as mislabelings. This conclusion seemed reasonable given the presence of numerous examples of mislabeled Colombian specimens in collections, the lack of modern Colombian specimens, and the fact that the taxon is otherwise very common everywhere else within its range. Nevertheless, subsequently at least three reliable records of typical *A. melanthe* occurring in western Colombia have come to light, including a specimen from Tamesis (Antioquia), collected by Bruce Aitken, a specimen from Yanaconas (Valle del Cauca) collected by Haydon Warren-Gash (both pers. comm. to Willmott), and a specimen from Titiribi (Antioquia) photographed by Gabriel Jaramillo Giraldo (<https://www.inaturalist.org/observations/9147567>). The taxon therefore seems to occur widely, if rarely, throughout western Colombia, in broad sympatry with *A. lycorias melanippe*, and we thus treat it once more as a distinct species, *A. melanthe* **n. stat.**

Mimicry pattern evolution

Obtaining a taxonomically comprehensive phylogeny allowed us to explore patterns of speciation. In this particular case, we investigate mimicry pattern evolution and its relationship to speciation and species traits.

Ancestral state reconstruction and the role of shifts of mimetic colour pattern in speciation

We found that the IPHICLUS mimicry pattern was most likely to be the ancestral state for all *Adelpha* species, but also it reappeared several times in less related lineages, suggesting multiple independent origins. It is the most common pattern in the genus (48 species share this pattern). Otherwise, the COCALA mimicry pattern is inferred to be the ancestral state across most of the large, species-rich lowland clade, and most mimicry pattern shifts occurred later in this clade. Our results are in accordance with the pattern observed by Ebel *et al.* (2015). Mullen *et al.* (2011) hypothesised that increased rates of mimicry shifts might have resulted in an increased rate of diversification in the tropical lowland *Adelpha* clade. We did not test whether shifts in wing colour patterns contributed to rapid diversification in *Adelpha*, but instead we investigated if shifts in wing colour pattern are associated with speciation events (e.g., Barraclough *et al.* 1999).

Mimetic wing colour pattern is an example of a trait in which ecological selection driven by predation can lead to divergence, with reproductive isolation and speciation as a side effect (Chamberlain *et al.* 2009; Jiggins 2008; Jiggins *et al.* 2001, 2006; Mallet, Mcmillan, and Jiggins 1998; Merrill *et al.* 2011). These types of traits are called “magic traits” and reproductive isolation occurs via assortative mating, i.e., premating isolation (Chamberlain *et al.* 2009; Jiggins *et al.* 2008; Kronforst *et al.* 2006; Mavárez *et al.* 2006), and postmating isolation as a result of increased predation on non-mimetic, rare hybrids (Arias *et al.* 2016; Mallet and Barton 1989; Pinheiro 2003). In contrast to our expectations, however, in *Adelpha* there is no significant association between shifts in mimicry patterns and speciation, with groups of related species often having similar wing colour patterns (see chapter III). In other groups of mimetic butterflies there are also examples where cladogenesis is not accompanied by a shift in mimetic colour pattern, where pairs of sympatric, closely related species are near-perfect mimics of each other (e.g., *Heliconius* butterflies, Giraldo *et al.*, 2008; Jiggins, 2008; Mérot *et al.*, 2013) or obvious cases such as skipper (Hesperiidae) butterflies (Li *et al.* 2019), suggesting other factors are also involved in the evolution of reproductive

isolation and speciation. It could be possible that speciation may have initially occurred through divergence in factors unrelated to pattern, such as habitat choice at a finer spatial scale, providing the mechanism for strong premating isolation leading to ecological speciation (Jiggins 2008). Another possibility is that mimicry pattern in *Adelpha* may well have evolved from adaptive introgression between sympatric populations rather than common ancestry (Edelman *et al.* 2019; Jiggins *et al.* 2008; Kozak *et al.* 2021; Mavárez *et al.* 2006; Pardo-Diaz Carolina *et al.* 2012; Thawornwattana *et al.* 2021). Some *Heliconius* species potentially have resulted from very recent mimetic convergence between hybridising species possibly through adaptive introgression, rather than speciation without colour pattern shifts (The Heliconius Genome Consortium 2012). In those cases, in response to selection against reproductive interference, other cues may drive reproductive isolation, such as chemical communication i.e., pheromones (e.g., *Heliconius*, Jiggins 2008, Merot *et al.* 2015). Indeed, it has been suggested that closely related mimetic butterflies may rely more on olfactory than visual cues for sexual attraction (Boppre 1978; Poulton 1907; Vane-Wright and Boppre 1993).

In *Adelpha* almost nothing is known about mate recognition, but the extreme resemblance between many species suggests that wing pattern might play only an initial role. Indeed, there are possible hybrid specimens between closely related but phenotypically distinct species e.g., *A. mesentina* and *A. thesprotia* or *A. cocala* and *A. irmina*. Instead, Willmott (2003) suggested that mate recognition and courtship in the genus might be partly mediated by pheromones, noting that *Adelpha* males harbour a dense area of darker scales at the base of the ventral forewing which is lacking in females.

Colonisation of novel host plants may directly lead to reproductive isolation and sympatric speciation within phytophagous insects (e.g., Ehrlich and Raven, 1964; Dres and Mallet, 2002; Janz *et al.*, 2006). In butterflies, an acceleration in diversification rate attributed to shifts to new host-plant lineages or detoxification mechanisms has often been observed (e.g., Miller, 1987; Braby and Trueman, 2006; Willmott and Freitas, 2006; Wheat *et al.*, 2007; Fordyce, 2010; Nylin *et al.*, 2013; Edger *et al.*, 2015; Sahoo *et al.*, 2017). Even at a macroevolutionary scale, host plant shifts have contributed to an increase in global diversification of butterflies through time (Allio *et al.* 2021; Peña and Wahlberg 2008).

It is also possible that speciation in *Adelpha* may have been primarily driven by other ecological factors, such as host plant use. Mullen *et al.* (2011) suggested that the increase in species richness of lowland *Adelpha* might be due to adaptive divergence due to host plant

shifts to Rubiaceae and other families. Additionally, Ebel *et al.* (2015) found phylogenetic evidence for multiple host plant shifts in the species-rich lowland clade, suggesting its possible contribution to rapid adaptive diversification.

Studies have shown that host-plant changes may be correlated with multiple other ecological shifts, such as forest structure, flight height, and warning colour pattern (Beccaloni 1997a; Chazot *et al.* 2014; DeVries, Lande, and Murray 1999; Elias *et al.* 2008; Hill 2010; Jiggins *et al.* 2006; Ortiz-Acevedo *et al.* 2020; Willmott and Mallet 2004), that combined or independently can also lead to speciation. Other abiotic factors, such as geography or climate, are likely linked to host plant shifts accompanying speciation as well (e.g., Slove and Janz, 2011; Lisa De-Silva *et al.*, 2017; Kergoat *et al.*, 2018). Further research should consider the geographical context in host plant-*Adelpha* interactions to investigate whether adaptations to new host plants represent post-speciation events after geographic isolation, rather than the main driver of speciation (e.g., Barraclough, Hogan, and Vogler 1999; Berry *et al.* 2018; Doorenweerd, Van Nieukerken, and Menken 2015; Jousselin *et al.* 2013; Jousselin and Elias 2019).

In *Adelpha*, there is very few evidence for links between microhabitat, hostplant and mimicry pattern (but see Ebel *et al.* 2015), although there are a few cases of dimorphic species (or variable) e.g., *Adelpha erotia*, *A. capucinus* between the two most abundant mimicry patterns i.e., IPHICLUS and COCALA. In ithomiine butterflies, it is unlikely to observe this, at least among patterns that seem to be ecologically distinct. This might suggest that in *Adelpha*, these two major patterns are maintained by other processes rather than ecological differences. Perhaps explained by the Mallet's interpretation of shifting balance hypothesis (Mallet and Singer 1987) i.e., colour patterns being more or less equally fit adaptive peaks may get established due to locally relaxed selection i.e., little pressure for convergence. Thus, local shifts in *Adelpha* are more likely to result in polymorphisms or subspeciation, rather than speciation. Although, this remains speculative and needs to be investigated. Our comprehensive phylogeny will allow further research on these aspects.

Phylogenetic signal and convergence in mimetic colour patterns

In the case of *Adelpha*, it has been hypothesised that convergence in colour patterns is mainly due to mimicry (Willmott 2003 a,b; Ebel *et al.* 2015), but a closer examination of the phylogenetic signal showed heterogeneous modes of evolution among mimicry patterns. Some of the most diverse mimicry rings in *Adelpha*, namely COCALA, ROTHSCHILDI,

SALMONEUS and ZINA, are composed of co-mimetic species that are closely related, with strong phylogenetic signal suggesting many cases of similarity result through common ancestry rather than convergence.

IPHICLUS presents an overdispersed pattern (co-mimetic species are less related than expected from chance), which could mean adaptive convergence, although it could also be explained by IPHICLUS being the ancestral pattern, and thus it is not surprising that it is present in several communities and lineages (both closely and less closely related ones). We need to consider that the observed pattern for the phylogenetic signal could be affected by the level of representation (i.e., number of co-mimic species) of mimicry rings in the phylogeny. Detecting significance will be less likely for poorly represented mimicry rings because they will show high MPD variance values due to fewer randomisations and larger credibility intervals compared to those of highly represented mimicry rings.

Nevertheless, adaptive convergence is clearly more important in wing colour pattern evolution in some *Adelpha* lineages (e.g., MESENTINA mimicry pattern appears repeatedly in less related *Adelpha* species in our phylogeny). Additionally, mimicry with *Adelpha* has also been evidenced in other distantly related taxa such as *Prepona* (Nymphalidae: Charaxinae) and *Doxocopa* (Nymphalidae: Apaturinae) (Willmott 2003a).

Chazot *et al.* (2014) suggested that the age of a mimicry pattern might influence its rate of convergence in the tribe Ithomiini; patterns that appeared earlier might allow higher accumulation of species through either speciation without colour pattern shift or phylogenetic convergence of mimicry pattern. Moreover, different colour patterns may result in different predator selection pressures, e.g., degree of generalisation, and therefore lead to different rates of convergence and conservatism. Furthermore, maintenance of a strong phylogenetic signal in mimetic patterns could happen when a clade diversifies within a single area where butterflies are exposed to the same predator community, and where selection for stability of mimicry pattern is therefore expected.

Mimicry pattern evolution rate increases with tropicality

We found evidence that the rate of mimicry pattern evolution increases at lower latitudes and that this is not mainly due to species common ancestry, representing novel evidence for a latitudinal gradient in mimicry evolution. A number of authors have suggested that there might be latitudinal gradients in biotic interactions (Dobzhansky 1950; Schemske 2002, 2009;

Wallace 1878), such as higher rates of herbivory (Coley and Aide 1991) and insect predation (Janzen 1970; Novotny *et al.* 2006), and mutualistic interactions, in the tropics (Schemske *et al.* 2009). Schemske (2009) suggested that strong biotic interactions in the tropics promote coevolution, and as interacting species coevolve the optimum phenotype constantly changes, which might result in faster adaptation. Moreover, the “aspect diversity” hypothesis suggests that higher predation and selection for predator avoidance in the tropics may cause an increase in the diversity of cryptic prey phenotypes, and presumably the same effect might occur with aposematic phenotypes. (Ricklefs and O' Rourke. 1975) observed a greater variety of sizes, patterns, and shapes in tropical species than in temperate moth species (but see Ricklefs 2009). Therefore, for *Adelpha*, a higher diversity and abundance of predators (and higher predation pressure), greater inter/intra specific competition for mates, and stronger spatial structuring of mimicry patterns, among others, could lead (or allow) more shifts of mimicry patterns in more tropical species. Although we did not find evidence for mimicry pattern shifts frequently being associated with speciation across the entire genus, links between mimicry patterns and elevation or geographic region may have facilitated at least some shifts to new elevations (e.g., *A. jordani/zina*) or new regions (e.g., *A. sichaeus/rothschildi/levona*) in tropical areas, helping to boost tropical diversity.

Conclusion

Mimicry in *Adelpha* is an appealing model system to address questions regarding wing colour pattern diversity evolution, speciation and diversification in Neotropical butterflies. Here, we present the first taxonomically comprehensive phylogeny for the genus *Adelpha*, which allowed us to provide some changes in species systematics. Although our results support the hypothesis of *Adelpha*'s monophyly, we suggest that including more molecular data, especially for the outgroup taxa where relationships are not fully supported, is still essential to confidently resolve relationships. Secondly, we found that mimicry pattern shifts do not seem to be a primary driver of speciation in *Adelpha* since a gradualist model of mimicry evolution was more likely than a punctuational model. Finally, the rate of mimicry pattern evolution was correlated with the tropicity of species, supporting the hypothesis of stronger biotic interactions towards the equator, which may have helped generate and maintain more diverse tropical communities. Collectively, our results encourage further research on additional factors that could help explain patterns of diversity and diversification in this group of butterflies.

Further work should be focused on the spatial dynamics of diversification, which may provide interesting insights into the maintenance of the strong phylogenetic signal in mimetic patterns. In the tropics, speciation is commonly attributed to either vicariance i.e., within climate-induced forest refugia (Brown 1979), or ecological speciation caused by niche adaptation (Jiggins, Emelianov, and Mallet 2004). It would be interesting to explore other aspects of *Adelpha* evolution such as the geographical context of species divergence that might provide support (or not) for vicariant speciation. For example, Willmott (2003a) has suggested that orogeny of the Andes appears to have little effect on *Adelpha* faunas in Ecuador as a vicariant event, but the mountain range constitutes an important barrier to dispersal.

References

- Aiello, A. 1984. *Adelpha* (Nymphalidae): Deception on the Wing. *Psyche* (Stuttg). 91(1–2): 1–45.
- Allio, Rémi et al. 2021. “Genome-Wide Macroevolutionary Signatures of Key Innovations in Butterflies Colonizing New Host Plants.” *Nature Communications* 12(354). <http://dx.doi.org/10.1038/s41467-020-20507-3>.
- Arias, M., le Poul, Y., Chouteau, M., Boisseau, R., Rosser, N., Théry, M. and Llaurens, V. 2016. Crossing fitness valleys: Empirical estimation of a fitness landscape associated with polymorphic mimicry. *Proc. R. Soc. B Biol. Sci.* 283(1829): .
- Barracough, T.G., Hogan, J.E. and Vogler, A.P. 1999. Testing whether ecological factors promote cladogenesis in a group of tiger beetles (Coleoptera: Cicindelidae). *Proc. R. Soc. Lond. B* 266:1061–1067.
- Beccaloni, G.W. 1997a. Vertical stratification of ithomiine butterfly (Nymphalidae: Ithomiinae) mimicry complexes: The relationship between adult flight height and larval host-plant height. *Biol. J. Linn. Soc.* 62(3): 313–341.
- Beccaloni, G.W. 1997b. Ecology, natural history and behaviour of Ithomiine butterflies and their mimics in Ecuador (Lepidoptera: Nymphalidae: Ithomiinae). *Trop. Lepid.* 8(2): 103–124.
- Berry, V., Chevenet, F., Doyon, J.P. and Jousset, E. 2018. A geography-aware reconciliation method to investigate diversification patterns in host/parasite interactions. *Mol. Ecol. Resour.* 18(5): 1173–1184.
- Boppre, M. 1978. Chemical Communication, Plant Relationships, and Mimicry in the Evolution of Danaid Butterflies. *Entomol. Exp. Appl.* 24(3): 264–277.
- Braby, M.F. and Trueman, J.W.H. 2006. Evolution of larval host plant associations and adaptive radiation in pierid butterflies. *J. Evol. Biol.* 19:1677–1690.
- Brown, Keith S. 1979. “Ecologia Geográfica e Evolução Nas Florestas Neotropicais.” Thesis. Universidade Estadual de Campinas.
- Chamberlain, N.L., Hill, R.I., Kapan, D.D., Gilbert, L.E. and Kronforst, M.R. 2009. Polymorphic butterfly reveals the missing link in ecological speciation. *Science*. 326(5954): 847–850.
- Chazot, N., Condamine, F.L., Dudas, G., Peña, C., Kodandaramaiah, U., Matos-maraví, P., Aduse-poku, K., Elias, M., Warren, A.D., Lohman, D.J., Penz, C.M., Devries, P., Fric, Z.F., Nylin, S., Müller, C., Kawahara, A.Y., Vila, R., Vane-wright, R.I., Mullen, S.P.,

- Jiggins, C.D. and Wheat, C.W. 2021. Conserved ancestral tropical niche but different continental histories explain the latitudinal diversity gradient in brush-footed butterflies. *Nat. Commun.* 1–10.
- Chazot, N., Wahlberg, N., Freitas, A.V.L., Mitter, C., Labandeira, C., Sohn, J.C., Sahoo, R.K., Seraphim, N., De Jong, R. and Heikkilä, M. 2019. Priors and Posteriors in Bayesian Timing of Divergence Analyses: The Age of Butterflies Revisited. *Syst. Biol.* 68(5): 797–813.
- Chazot, N., Willmott, K.R., Lamas, G., Freitas, A.V.L., Piron-Prunier, F., Arias, C.F., Mallet, J., De-Silva, D.L. and Elias, M. 2019. Renewed diversification following Miocene landscape turnover in a Neotropical butterfly radiation. *Glob. Ecol. Biogeogr.* 28(8): 1118–1132.
- Chazot, N., Willmott, K.R., Santacruz Endara, P.G., Toporov, A., Hill, R.I., Jiggins, C.D. and Elias, M. 2014. Mutualistic Mimicry and Filtering by Altitude Shape the Structure of Andean Butterfly Communities. *Am. Nat.* 183(1): 26–39.
- Coley, P. and Aide, T. 1991. Comparison of herbivory and plant defenses in temperate and tropical broad-leaved forests. In: *Plant-Animal Interactions: Evolutionary Ecology in Tropical and Temperate Regions* (P. Price, T. Lewinsohn, G. Fernandes and W. Benson, eds.) pp. 25–49. John Wiley and Sons, New York.
- Condamine, F.L., Sperling, F.A.H., Wahlberg, N., Rasplus, J.Y. and Kergoat, G.J. 2012. What causes latitudinal gradients in species diversity? Evolutionary processes and ecological constraints on swallowtail biodiversity. *Ecol. Lett.* 15(3): 267–277.
- DeVries, P.J., Lande, R. and Murray, D. 1999. Associations of co-mimetic ithomiine butterflies on small spatial and temporal scales in a neotropical rainforest. *Biol. J. Linn. Soc.* 67(1): 73–85.
- Dhungel, B. and Wahlberg, N. 2018. Molecular systematics of the subfamily Limenitidinae (Lepidoptera: Nymphalidae). *PeerJ* 6(e4311): 1–17.
- Dittrich, W., Gilbert, F., Green, P., McGregor, P. and Grewcock, D. 1993. Imperfect mimicry: a pigeon's perspective. *Proc. R. Soc. Lond. B* 251:195–200.
- Dobzhansky, T. 1950. EVOLUTION IN THE TROPICS. *Am. Sci.* 38(2): 208–21.
- Doorewaard, C., Van Nieuwerkerken, E.J. and Menken, S.B.J. 2015. A global phylogeny of leafmining Ectoedemia moths (Lepidoptera: Nepticulidae): Exploring host plant family shifts and allopatry as drivers of speciation. *PLoS One* 10(3): 1–20.
- Doré, M., Willmott, K., Leroy, B., Chazot, N., Mallet, J., Freitas, A. V. L., Hall, J. P. W., Lamas, G., Dasmahapatra, K. K., Fontaine, C., & Elias, M. 2021. Ithomiini mimicry

classification. <https://doi.org/10.5281/ZENODO.5564985>

- Dres, M. and Mallet, J. 2002. Host races in plant feeding insects and their importance in sympatric speciation. *Philos. Trans. R. Soc. London B Biol. Sci.* 357:471–492.
- Ebel, E.R., Dacosta, J.M., Sorenson, M.D., Hill, R.I., Briscoe, A.D., Willmott, K.R. and Mullen, S.P. 2015. Rapid diversification associated with ecological specialization in Neotropical *Adelpha* butterflies. *Mol. Ecol.* 24(10): 2392–2405.
- Edelman, N.B., Frandsen, P.B., Miyagi, M., Clavijo, B., Davey, J., Dikow, R.B., García-Accinelli, G., Van Belleghem, S.M., Patterson, N., Neafsey, D.E., Challis, R., Kumar, S., P Moreira, G.R., Salazar, C., Chouteau, M., Counterman, B.A., Papa, R., Blaxter, M., Reed, R.D., Dasmahapatra, K.K., Kronforst, M., Joron, M., Jiggins, C.D., Owen McMillan, W., Di Palma, F., Blumberg, A.J., Wakeley, J., Jaffe, D. and Mallet, J. 2019. Genomic Architecture and Introgression Shape a Butterfly Radiation.” *Science* 366: 594–99.
- Edger, P.P., Heidel-Fischer, H.M., Bekaert, M., Rota, J., Glöckner, G., Platts, A.E., Heckel, D.G., Der, J.P., Wafula, E.K., Tang, M., Hofberger, J.A., Smithson, A., Hall, J.C., Blanchette, M., Bureau, T.E., Wright, S.I., Depamphilis, C.W., Schranz, M.E., Barker, M.S., Conant, G.C., Wahlberg, N., Vogel, H., Pires, J.C., Wheat, C.W., Designed, C.W.W., Bekaert, M., Blanchette, M. and Performed, C.W.W. 2015. The butterfly plant arms-race escalated by gene and genome duplications. *PNAS* 112.
- Ehrlich, P.R. and Raven, P.H. 1964. Butterflies and plants: a study in coevolution. *Evolution.* 18:586–608.
- Elias, M., Gompert, Z., Jiggins, C. and Willmott, K. 2008. Mutualistic interactions drive ecological niche convergence in a diverse butterfly community. *PLoS Biol.* 6(12): .
- Elias, M., Gompert, Z., Willmott, K. and Jiggins, C. 2009. Phylogenetic community ecology needs to take positive interactions into account: Insights from colorful butterflies. *Commun. Integr. Biol.* 2(2): 113–116.
- Erwin, D.H. 2009. Climate as a Driver of Evolutionary Change. *Curr. Biol.* 19(14): R575–R583.
- Estrada, C. and Jiggins, C.D. 2008. Interspecific sexual attraction because of convergence in warning colouration: Is there a conflict between natural and sexual selection in mimetic species? *J. Evol. Biol.* 21(3): 749–760.
- Fordyce, J.A. 2010. Host shifts and evolutionary radiations of butterflies. *Proc. R. Soc. B Biol. Sci.* 277(1701): 3735–3743.
- Fruhstorfer, H. 1915. 49. Gattung *Adelpha* Hbn. In: *Die Gross-Schmetterlinge Der Erde* (A.

- Seitz, ed.) pp. 510–533. Alfred Kernen, Stuttgart.
- Giraldo, N., Salazar, C., Jiggins, C.D., Bermingham, E. and Linares, M. 2008. Two sisters in the same dress: *Heliconius* cryptic species. *BMC Evol. Biol.* 8(1): 1–11.
- Grafen, A. 1989. The Phylogenetic Regression. *Philos. Trans. R. Soc. Lond. B. Biol. Sci.* 326(1233): 119–157.
- Hill, R.I. 2010. Habitat segregation among mimetic ithomiine butterflies (Nymphalidae). *Evol. Ecol.* 24:273–285.
- Hoang, D.T., Chernomor, O., Haeseler, A. Von, Minh, B.Q. and Vinh, L.S. 2017. UFBoot2 : Improving the Ultrafast Bootstrap Approximation 35(2): 518–522.
- Hui-Yun, T., Hideyuki, C., Lohman, D.J., Yen, S.-H., Aduse-Poku, K., Ohshima, Y. and Wu, L.-W. 2022. Out of Asia: Intercontinental dispersals after the Eocene-Oligocene transition shaped the zoogeography of Limenitidinae butterflies (Lepidoptera: Nymphalidae). *Mol. Phylogenet. Evol.* 170(February): 107444.
- Janz, N., Nylin, S. and Wahlberg, N. 2006. Diversity begets diversity : host expansions and the diversification of plant-feeding insects. *BMC Evol. Biol.* 6(4): .
- Janzen, D.H. 1970. Herbivores and the number of tree species in tropical forests. *Am. Nat.* 104(940): .
- Jiggins, C.D. 2008. Ecological speciation in mimetic butterflies. *Bioscience* 58(6): 541–548.
- Jiggins, C.D., Emelianov, I. and Mallet, J. 2004. Pleiotropy promotes speciation: examples from phytophagous moths and mimetic butterflies. In: *Insect Evolutionary Ecology* (M. Fellowes, G. Holloway and J. Rolff, eds.) pp. 451–473. Royal Entomological Society, London.
- Jiggins, C.D., Mallarino, R., Willmott, K.R. and Bermingham, E. 2006. the Phylogenetic Pattern of Speciation and Wing Pattern Change in Neotropical Ithomia Butterflies (Lepidoptera: Nymphalidae). *Evolution.* 60(7): 1454.
- Jiggins, C.D., Naisbit, R.E., Coe, R.L. and Mallet, J. 2001. Reproductive isolation caused by colour pattern mimicry. *Nature* 411:302–305.
- Jiggins, C.D., Salazar, M., Linares and Mavárez, J. 2008. Hybrid speciation in *Heliconius* butterflies. *Philos. Trans. R. Soc. Lond. B* 363:3047–3054.
- de Jong, R. 2017. Fossil butterflies, calibration points and the molecular clock (Lepidoptera: Papilionoidea). *Zootaxa* 4270(1): 1–63.
- Jousselin, E., Cruaud, A., Genson, G., Chevenet, F., Footitt, R.G. and Cœur d’acier, A. 2013. Is ecological speciation a major trend in aphids? Insights from a molecular phylogeny of the conifer-feeding genus *Cinara*. *Front. Zool.* 10(1): 1–18.

- Jousselin, E. and Elias, M. 2019. Testing host-plant driven speciation in phytophagous insects : a phylogenetic perspective prepr. arXiv:1910.09510
- Kergoat, G.J., Condamine, F.L., Toussaint, E.F.A., Capdevielle-Dulac, C., Clamens, A.-L., Barbut, J., Goldstein, P.Z. and Le Ru, B. 2018. Opposite macroevolutionary responses to environmental changes in grasses and insects during the Neogene grassland expansion. *Nat. Commun.* 9, 5089. <https://doi.org/10.1038/s41467-018-07537-8>
- Kozak, K.M., Joron, M., McMillan, W.O. and Jiggins, C.D. 2021. Rampant Genome-Wide Admixture across the Heliconius Radiation. *Genome Biol. Evol.* 13(7): 1–17.
- Kronforst, M.R., Young, L.G., Kapan, D.D., McNeely, C., O'Neill, R.J. and Gilbert, L.E. 2006. Linkage of butterfly mate preference and wing color preference cue at the genomic location of wingless. *Proc. Natl. Acad. Sci.* 103(17): 6575–6580.
- Lamas, G. 2004. Checklist: Part 4A. Hesperioidea-Papilionoidea. In: Atlas of Neotropical Lepidoptera, Vol. 5A (J.B. Heppner, ed.) pp. xxxvi + 439. Association for Tropical Lepidoptera/Scientific Publishers, Gainesville.
- Lanfear, R., Calcott, B., Ho, S.Y.W. and Guindon, S. 2012. PartitionFinder: Combined selection of partitioning schemes and substitution models for phylogenetic analyses. *Mol. Biol. Evol.* 29(6): 1695–1701.
- Li, W., Cong, Q., Shen, J., Zhang, J., Hallwachs, W., Janzen, D.H. and Grishin, N. V. 2019. Genomes of skipper butterflies reveal extensive convergence of wing patterns. *Proc. Natl. Acad. Sci.* 116(13): 6232–6237.
- Lisa De-Silva, D., Mota, L.L., Chazot, N., Mallarino, R., Silva-Brandão, K.L., Piñerez, L.M.G., Freitas, A.V.L., Lamas, G., Joron, M., Mallet, J., Giraldo, C.E., Uribe, S., Särkinen, T., Knapp, S., Jiggins, C.D., Willmott, K.R. and Elias, M. 2017. North Andean origin and diversification of the largest ithomiine butterfly genus. *Sci. Rep.* 71–17.
- M. Pagel. 1999. Inferring the historical patterns of biological evolution. *Nature* 401: 877–884.
- Mallet, J. and Barton, N.H. 1989. Strong natural selection in a warning-color hybrid zone. *Evolution.* 43(2): 421–431.
- Mallet, J., Mcmillan, W.O. and Jiggins, C.D. 1998. Mimicry and Warning Color at the Boundary between Races and Species. In *Endless Forms: Species and Speciation* (Berlocher, S. and Howard, D., eds), pp. 390–403, Oxford University Press
- Mallet, J. and Singer, M. 1987. Individual selection, kin selection, and the shifting balance in the evolution of warning colours: the evidence from butterflies. *Biol. J. Linn. Soc.* 32337–350.

- Martins, E. and Hansen, T. 1997. Phylogenies and the comparative method: a general approach to incorporating phylogenetic information into the analysis of interspecific data. *Am. Nat.* 149(4): 646–667.
- Mavárez, J., Salazar, C.A., Bermingham, E., Salcedo, C., Jiggins, C.D. and Linares, M. 2006. Speciation by hybridization in *Heliconius* butterflies. *Nature* 441(7095): 868–871.
- McClure, M., Mahrouche, L., Houssin, C., Monllor, M., Le Poul, Y., Frérot, B., Furtos, A. and Elias, M. 2019. Does divergent selection predict the evolution of mate preference and reproductive isolation in the tropical butterfly genus *Melinaea* (Nymphalidae: Ithomiini)? *J. Anim. Ecol.* 88(6): 940–952.
- Meade, A. and Pagel, M. 2011. BayesTrees 1.3. <http://www.evolution.reading.ac.uk/BayesTrees.html>
- Mérot, C., Mavárez, J., Evin, A., Dasmahapatra, K.K., Mallet, J., Lamas, G. and Joron, M. 2013. Genetic differentiation without mimicry shift in a pair of hybridizing *Heliconius* species (Lepidoptera: Nymphalidae). *Biol. J. Linn. Soc.* 109(4): 830–847.
- Merrill, R.M., Van Schooten, B., Scott, J.A. and Jiggins, C.D. 2011. Pervasive genetic associations between traits causing reproductive isolation in *Heliconius* butterflies. *Proc. R. Soc. B Biol. Sci.* 278(1705): 511–518.
- Merrill, R.M., Wallbank, R.W.R., Bull, V., Salazar, P.C.A., Mallet, J., Stevens, M. and Jiggins, C.D. 2012. Disruptive ecological selection on a mating cue. *Proc. R. Soc. B Biol. Sci.* 279(1749): 4907–4913.
- Miller, J.S. 1987. Host-Plant Relationships in the Papilionidae (Lepidoptera): Parallel Cladogenesis or Colonization? *Cladistics* 3(2): 105–120.
- Miller, M.A., Pfeiffer, W. and Schwartz, T. 2010. Creating the CIPRES Science Gateway for Inference of Large Phylogenetic Trees. http://www.phylo.org/sub_sections/portal/sc2010_paper.pdf
- Minh, B.Q., Anh, M., Nguyen, T. and Haeseler, A. Von. 2013. Ultrafast Approximation for Phylogenetic Bootstrap 30(5): 1188–1195.
- Mirarab, S., Nguyen, N., Guo, S., Wang, L.S., Kim, J. and Warnow, T. 2015. PASTA: Ultra-large multiple sequence alignment for nucleotide and amino-acid sequences. *J. Comput. Biol.* 22(5): 377–386.
- Mullen, S.P. 2006. Wing pattern evolution and the origins of mimicry among North American admiral butterflies (Nymphalidae: Limenitis). *Mol. Phylogenet. Evol.* 39(3): 747–758.
- Mullen, S.P., Savage, W.K., Wahlberg, N. and Willmott, K.R. 2011. Rapid diversification and not clade age explains high diversity in neotropical *Adelpha* butterflies. *Proc. R. Soc. B*

- Biol. Sci.* 278(1713): 1777–1785.
- Neild, A. 1996. The butterflies of Venezuela. Part 1: Nymphalidae 1 (Limenitidinae, Apaturinae, Charaxinae). A comprehensive guide to the identification of adult Nymphalidae, Papilionidae, and Pieridae. Meridian Publications, London.
- Novotny, V., Drozd, P., Miller, S.E., Kulfan, M., Janda, M., Basset, Y. and Weiblen, G.D. 2006. Why are there so many species of herbivorous insects in tropical rainforests? *Science*. 313(5790): 1115–1118.
- Nylin, S., Slove, J. and Janz, N. 2013. Host plant utilization, host range oscillations and diversification in nymphalid butterflies: a phylogenetic investigation. *Evolution*. 68(1): 105–124.
- Orme, D., Freckleton, R.P., Thomas, G.H., Petzoldt, T., Fritz, S. and Isaac, N. 2013. Caper: Comparative analyses of phylogenetics and evolution in R. R package version 0.5.2 [WWW Document]. URL <https://cran.r-project.org/web/packages/caper/index.html>
- Ortiz-Acevedo, E., Gomez, J.P., Espeland, M., Toussaint, E.F.A. and Willmott, K.R. 2020. The roles of wing color pattern and geography in the evolution of Neotropical Preponini butterflies. *Ecol. Evol.* 10(23): 12801–12816.
- Páez, E., Valkonen, J.K., Willmott, K.R., Matos-Maraví, P., Elias, M. and Mappes, J. 2021. Hard to catch: Experimental evidence supports evasive mimicry. *Proc. R. Soc. B Biol. Sci.* 288(1946): 1–10.
- Pagel, M., Meade, A. and Barker, D. 2004. Bayesian Estimation of Ancestral Character States on Phylogenies. *Syst. Biol.* 53(5): 673–684.
- Pardo-Diaz Carolina, Salazar Camilo, Baxter Simon W, Merot Claire, Figueredo-Ready Wilsea, Joron Mathieu, McMillan Owen W and Jiggins Chris D. 2012. Adaptive Introgression across Species Boundaries in Heliconius Butterflies. *Plos Genet* 8(6): e1002752.
- Peña, C. and Wahlberg, N. 2008. Prehistorical climate change increased diversification of a group of butterflies. *Biol. Lett.* 4(3): 274–278.
- Pinheiro, C.E.G. 2003. Does Mullerian Mimicry Work in Nature? Experiments with Butterflies and Birds (Tyrannidae)1. *Biotropica* 35(3): 356–364.
- Poulton, E.B. 1907. The significance of some secondary sexual characters in butterflies. *Trans. R. Entomol. Soc. Lond.* XI–Xlii.
- Prudic, K.L., Shapiro, A.M. and Clayton, N.S. 2002. Evaluating a putative mimetic relationship between two butterflies, *Adelpha bredowii* and *Limenitis lorquini*. *Ecol. Entomol.* 27:68–75.
- Pyrz, T.W., Willmott, K., Garlacz, R., Boyer, P. and Gareca, Y. 2014. Latitudinal gradient

- and spatial covariance in species richness of tropical Lepidoptera in the Andes. *Insect Conserv. Divers.* 7(4): 355–364.
- Rambaut, A., Drummond, A.J.D., Xie, D., Baele, G. and Suchard, M.A. 2018. Posterior Summarization in Bayesian Phylogenetics Using Tracer 1 . 7. *Syst. Biol.* 67(5): 901–904.
- Ricklefs, R.E. 2009. Aspect diversity in moths revisited. *Am. Nat.* 173(3): 411–416.
- Ricklefs R.E. and K., O' Rourke. 1975. Aspect diversity in moths: temperate-tropical comparison. *Evolution* 29:313–324. 10.1111/j.1558-5646.1975.tb00211.x
- Ronquist, F., Huelsenbeck, J. and Teslenko, M. 2011. MrBayes Version 3.2 Manual: Tutorials and Model Summaries. Man. MrBayes 1–103.
- Sahoo, R.K., Warren, A.D., Collins, S.C. and Kodandaramaiah, U. 2017. Hostplant change and paleoclimatic events explain diversification shifts in skipper butterflies (Family : HesperIIDae) 1–9.
- Schemske, D.W. 2002. Ecological and evolutionary perspectives on the origins of tropical diversity. In: *Foundations of Tropical Forest Biology* (R.. Chazdon and T.. Whitmore, eds.) pp. 163–73. Univ. of Chicago Press, Chicago.
- Schemske, D.W. 2009. Biotic interactions and speciation. In: *Speciation and Patterns of Diversity* (R. Butlin, J. Bridle and D. Schluter, eds.) pp. 219–39. Cambridge Univ. Press, Cambridge, United Kingdom.
- Schemske, D.W., Mittelbach, G.G., Cornell, H. V., Sobel, J.M. and Roy, K. 2009. Is there a latitudinal gradient in the importance of biotic interactions? *Annu. Rev. Ecol. Evol. Syst.* 40:245–269.
- Servedio, M.R., Doorn, G.S. Van, Kopp, M., Frame, A.M. and Nosil, P. 2011. Magic traits in speciation: “magic” but not rare? *Trends Ecol. Evol.* 26(8): 389–397.
- Slove, J. and Janz, N. 2011. The Relationship between Diet Breadth and Geographic Range Size in the Butterfly Subfamily Nymphalinae – A Study of Global Scale. *PLoS One* 6(1): 1–5.
- Smith, S.A. and Dunn, C.W. 2008. Phyutility: A phyloinformatics tool for trees, alignments and molecular data. *Bioinformatics* 24(5): 715–716.
- Thawornwattana, Y., Seixas, F.A., Yang, Z. and Mallet, J. 2021. Complex introgression history of the erato-sara clade of *Heliconius* butterflies. Prepr. doi.org/10.1101/2021.02.10.430600.
- The *Heliconius* Genome Consortium. 2012. Butterfly genome reveals promiscuous exchange

- of mimicry adaptations among species. *Nature* 487(7405): 94–98.
- Trifinopoulos, J., Nguyen, L.-T., von Haeseler, A. and Quang Minh, B. 2016. W-IQ-TREE: a fast online phylogenetic tool for maximum likelihood analysis. *Nucleic Acids Res.* 44: W232–W235.
- Vane-Wright, R.I. and Boppre, M. 1993. Visual and chemical signalling in butterflies: functional and phylogenetic perspectives. *Philos. Trans. - R. Soc. London, B* 340 (1292): 197–205.
- De Vries, P.J. 2003. Tough African Models and Weak Mimics: New Horizons in the Evolution of Bad Taste. *J. Lepid. Soc.* 57(3): 235–238.
- Wahlberg, N. and Freitas, A.V.L. 2007. Colonization of and radiation in South America by butterflies in the subtribe Phyciodina (Lepidoptera: Nymphalidae). *Mol. Phylogenet. Evol.* 44(3): 1257–1272.
- Wallace, A.R. 1878. Tropical nature, and other essays. Macmillan and Co., London and New York.
- Wheat, C.W., Vogel, H., Wittstock, U., Braby, M.F., Underwood, D. and Mitchell-Olds, T. 2007. The genetic basis of a plant-insect coevolutionary key innovation. *PNAS* 104(51): 20427–20431.
- Willmott, K.R. 2003a. The Genus *Adelpha*: Its Systematics, Biology and Biogeography (Lepidoptera: Nymphalidae: Limenitidini). Scientific Publishers.
- Willmott, K.R. 2003b. Cladistic analysis of the Neotropical butterfly genus *Adelpha* (Lepidoptera: Nymphalidae), with comments on the subtribal classification of Limenitidini. *Syst. Entomol.* 28(3): 279–322.
- Willmott, K.R. and Freitas, A.V.L. 2006. Higher-level phylogeny of the Ithomiinae (Lepidoptera: Nymphalidae): Classification, patterns of larval hostplant colonization and diversification. *Cladistics* 22(4): 297–368.
- Willmott, K.R. and Hall, J.P.W. 2013. A new species and two new subspecies of *Adelpha* hubner, [1819] from the tropical Andes (Nymphalidae: Limenitidinae). *J. Lepid. Soc.* 67(4): 241–252.
- Willmott, K.R. and Mallet, J. 2004. Correlations between adult mimicry and larval host plants in ithomiine butterflies. *Proc. R. Soc. B Biol. Sci.* 271 (Suppl 5), S266–S269. <https://doi.org/10.1098/rsbl.2004.0184>

Supplementary material

S1. Molecular data used to reconstruct *Adelphas*'s time calibrated tree.

S1.1 List of taxa used in this study with accession number in case of Genbank sequences and specimen voucher number in the case of sequences that are not already published. Additionally, we include information of locality and source of sequences "S".

Code for source on sequences is the following:

- a. Warren, S. Mullen, A. Briscoe (unpublished)
- b. J.B. Miller, J.M. Marcus (unpublished)
- c. K. Willmott, S. Mullen, S. Finkbeiner (unpublished)
- d. B. R. Prado, C. Pozo, M. Valdez-Moreno, and P. D. N. Hebert, "Beyond the colours: Discovering hidden diversity in the nymphalidae of the Yucatan Peninsula in Mexico through DNA barcoding," PLoS One, vol. 6, no. 11, 2011.
- e. R. Hill, S. Mullen (unpublished)
- f. R. Hill, S. Mullen, S. Finkbeiner (unpublished)
- g. S. Finkbeiner, S. Mullen (unpublished)
- h. S.Mullen, A. Briscoe, A. Rangel (unpublished)
- i. N. Wahlberg, A. V. Z. Brower, and S. Nylin, "Phylogenetic relationships and historical biogeography of tribes and genera in the subfamily Nymphalinae (Lepidoptera: Nymphalidae)," Biol. J. Linn. Soc., vol. 86, no. 2, pp. 227–251, 2005.
- j. N. Wahlberg et al., "Nymphalid butterflies diversify following near demise at the Cretaceous/Tertiary boundary," Proc. R. Soc. B Biol. Sci., vol. 276, pp. 4295–4302, 2009.
- k. K. R. Willmott and J. P. W. Hall, "A New Species and Two New Subspecies of *Adelpha Hübner*, [1819] From the Tropical Andes (Nymphalidae: Limenitidinae)," J. Lepid. Soc., vol. 67, no. 4, pp. 241–252, 2013.
- l. S. Mena, K. M. Kozak, R. E. Cárdenas, and M. F. Checa, "Forest stratification shapes allometry and flight morphology of tropical butterflies," Proc. R. Soc. B Biol. Sci., vol. 287, no. 1937, p. 20201071, 2020.
- m. M. Hajibabaei, M. A. Smith, D. H. Janzen, J. J. Rodriguez, J. B. Whitfield, and P. D. N. Hebert, "A minimalist barcode can identify a specimen whose DNA is degraded," Mol. Ecol. Notes, vol. 6, no. 4, pp. 959–964, 2006.
- n. R. Hill, S. Mullen, A. Briscoe, A. Macias-Munoz (unpublished)

- o. A.V.L. Freitas (unpublished)
- p. Basset et al., “The butterflies of Barro Colorado Island, Panama: Local extinction since the 1930s,” *PLoS One*, vol. 10, no. 8, pp. 1–22, 2015.
- q. K. Willmott (unpublished)
- r. G. S. S. Almeida, R. Raby, L. M. Magaldi, and A. V. L. Freitas, “A new record for the rare atlantic forest endemic butterfly *adelpha atlantica* (Nymphalidae: Limenitidinae),” *J. Lepid. Soc.*, vol. 72, no. 3, pp. 249–251, 2018.
- s. J.B. Miller, J.M. Marcus (unpublished [b])
- t. R. Hill (unpublished)
- u. N. Wahlberg (unpublished)
- v. S. P. Mullen, W. K. Savage, N. Wahlberg, and K. R. Willmott, “RapiREFd diversification and not clade age explains high diversity in neotropical *Adelpha* butterflies,” *Proc. R. Soc. B Biol. Sci.*, vol. 278, no. 1713, pp. 1777–1785, 2011.
- w. P. D. Lavinia et al., “Barcoding the butterflies of southern South America: Species delimitation efficacy, cryptic diversity and geographic patterns of divergence,” *PLoS One*, vol. 12, no. 10, pp. 1–24, 2017.
- x. D.H. Janzen, M. Hajibabaei (unpublished).

S2. Transcriptomic data

RNA extractions, Library Preparation and Sequencing

Transcriptome sequencing, assembly and annotation were done following the protocol of Maytin et al. (2018) by Sean Mullen, Adriana Briscoe, Susan Finkbeiner. Total RNA extraction was obtained from multiple tissues (legs/head/thorax/abdomen) and it was performed with the standard Qiagen RNeasy Kit. Samples extracted were submerged in RNA later for preservation then RNA was isolated with TRIzol Reagent (Invitrogen ®). Homogenization, incubation and separation was done following Casas et al. 2016 protocol. Qiagen's RNeasy Plus kit was used for final clean-up of RNA samples. Libraries were constructed from samples with an optimal RNA integrity number (at least 8) and checked with KAPA's library quantification kit. Finally, mRNA sequence libraries were sequenced with Illumina's HiSeq 2000 platform.

Transcriptome assembling was done using FastQC to assess the quality, then trimmed following Q-score values. Remaining reads after a subsequent trimming with Phred score, were normalised *in silico* using Trinity bioinformatics pipeline (Haas et al 2013). A custom perl script was used for trimming the resulting transcriptome assembly i.e., filtering contigs under 500 base pairs, which improved the N50 of each assembly. BUSCO was then used to assess transcriptome completeness. Finally, contigs were annotated by BLAST sequence homology searches against UniProt and Swiss-Prot NCBI NR protein databases. Annotated sequences were then assigned to Gene Ontology (GO) categories (Blake et al 2015).

Extraction and alignment of transcriptomic sequences with SECAPR pipeline

Transcriptomic sequences of interest were extracted from a *de novo* annotated sample dataset (95 samples containing between 80 000 and 200 000 sequences) using the Sequence Capture Processor (SECAPR) pipeline:

1. To extract the sequences of interest (target contigs), the SECAPR function *find_target_contigs* identifies and extracts those contigs that represent the DNA targets of interest.
2. Using a blast algorithm (LASTZ; Harris, 2007), it searches the contig files for matches (minimum coverage of 80%) with a FASTA-formatted reference library. Our reference library contained five consensus sequences from our Sanger sequences dataset (one per gene: cytochrome oxidase subunit I *COI*, Ribosomal Protein S5 *RpS5*, glyceraldehydes-3-phosphate dehydrogenase *GAPDH*, Elongation factor 1 alpha *EF-1a* (1389 bp), Isocitrate dehydrogenase *IDH*).

3. The SECAPR function *align_sequences*, builds multiple sequence alignments (MSAs) from the target contigs that were identified in the previous step. Separate MSAs are built for each locus with matching contigs for ≥ 3 samples. Alignments were done using MAFFT algorithm implemented in the same pipeline.

In total we obtained 143 sequences from 51 species (48 *Adelpha* species, 1 *Limenitis*, 1 *Pandita* and 1 *Parasarpa*). Sequences were concatenated using *Phyutility* version 2.2 (Smith and Dunn 2008) to obtain a multi-gene alignment per species.

S3. Macroecological trait values for *Adelpha* species

Distribution maps for Adelpha species

Modelling distributions for *Adelpha* species was the first step in deriving macroecological trait values.

1. Locality data for all *Adelpha* species were compiled by Keith Willmott (KW) and Max Woodbury (MW) and georeferenced using Google Earth, published gazetteers, internet searches and other resources. A total of 10,560 unique species-locality points came from the following sources: Willmott (2003) (4,596 records, representing multiple sources), additional collections (1,479 records from 31 collections, but especially the McGuire Center for Lepidoptera and Biodiversity, Florida Museum of Natural History, University of Florida, Gainesville, FL, USA, after curation of the *pro tem* material and databasing of species with limited existing records by MW), field observations in Ecuador by KW and J. P. W. Hall (506 records), personal communication with lepidopterists (152 records), publications (45 records), the Darwin Database of the Tropical Andean Butterfly Diversity Project (134 records, formerly available at www.andeanbutterflies.org), and webpages (3,648 records, including 3,645 from iNaturalist.org where each record was verified by KW).

2. Locality points were plotted onto administrative and topographic base-maps of the Americas using QGIS (<https://qgis.org/en/site/>) and checked by eye for obvious errors or georeferencing mistakes. Elevation data for each point were then extracted from a 2.5 min elevation raster layer and points with unexpectedly high or low elevations were either deleted or examined further for possible georeferencing issues.

3. To provide a training region for distribution modelling, alpha hulls were generated around record points for each species and then buffered by the maximum of either 75 km or the 80%

quantile of the nearest-neighbour distance for each occurrence point. Hulls were then clipped by biogeographical region (east or west of the Andean continental divide) and further manually edited to reflect known species distribution limits. These distributions provided estimates of range limits to be used as training regions for model development.

4. Distribution models were then generated by Hannah Owens (HO) using Maxent (https://biodiversityinformatics.amnh.org/open_source/maxent/) and custom R scripts (<https://www.r-project.org/>) for a subsample of *Adelpha* species occurring at a range of latitudes, elevations and range sizes, using several modelling approaches with different combinations of bioclimatic factors (<https://chelsea-climate.org/bioclim/>). These approaches were compared to select the one with the overall model output that seemed most reasonable based on expert opinion (KW) and this final approach was applied to generate models for all species of *Adelpha*. Resulting models were clipped with an elevation layer to minimum and maximum reliable elevations at which each species was known to occur, and the probabilistic models were then converted to produce final presence-absence distribution maps.

Tropicality: Presence-absence raster maps for each *-Adelpha* species were converted to shapefiles with World Cylindrical Equal Area Projection and centroids for each map were calculated in ArcGIS. The distance in degrees between the centroid latitude and the equator was then calculated for each species.

Geographic range size : Geographic range size was calculated for each *Adelpha* species from their World Cylindrical Equal Area Projection presence-absence shapefile, as described above, using ArcGIS.

Density: For each *Adelpha* species, the number of specimens in the final database divided by the range size (as described above) was used as an approximate measure of density. A total of 29,251 specimens were databased, including 20,796 during comprehensive examination of multiple public and private international collections (as described in Willmott, 2003), followed by subsequent additions to the database as described above under distribution maps. A further 5,653 species-locality records where the number of specimens was not recorded, representing sight records, personal communication, records from publications and webpages, especially iNaturalist, and other sources, were each assumed to represent a single specimen. The sum of specimens recorded was then calculated for each species.

Niche breadth: A measure of niche breadth for each species was calculated by Hannah Owens as the combination of four bioclimatic variables across the species distribution (bio1, mean annual

temperature; bio4, temperature seasonality (standard deviation $\times 100$); bio12, mean annual precipitation; bio15, precipitation seasonality (Coefficient of Variation)). First, variable rasters were centred and scaled. Second, for each species, the 5th and 95th percentile value of each variable within the presence distribution was extracted. Third, these range values were multiplied for each species to obtain a relative measure of niche breadth.

S4. Backbone tree. We generated a consensus sequence for each species with 17 genes. A maximum likelihood tree with branch support values was generated in IQ-tree (Trifinopoulos et al. 2016). Branch support values are included at nodes and they were calculated with 1000 non-parametric ultrafast bootstrap (UFBS) replicates.

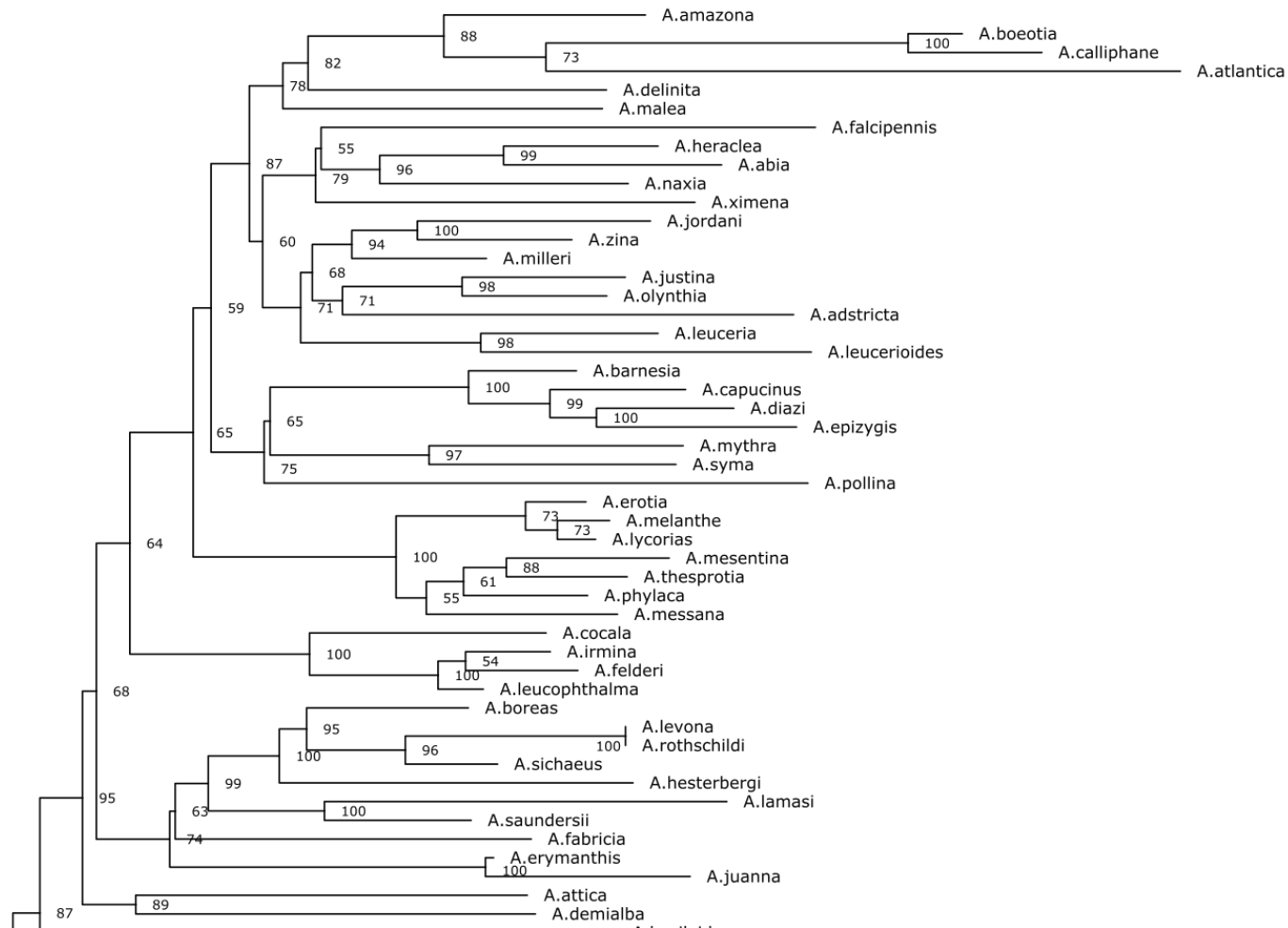

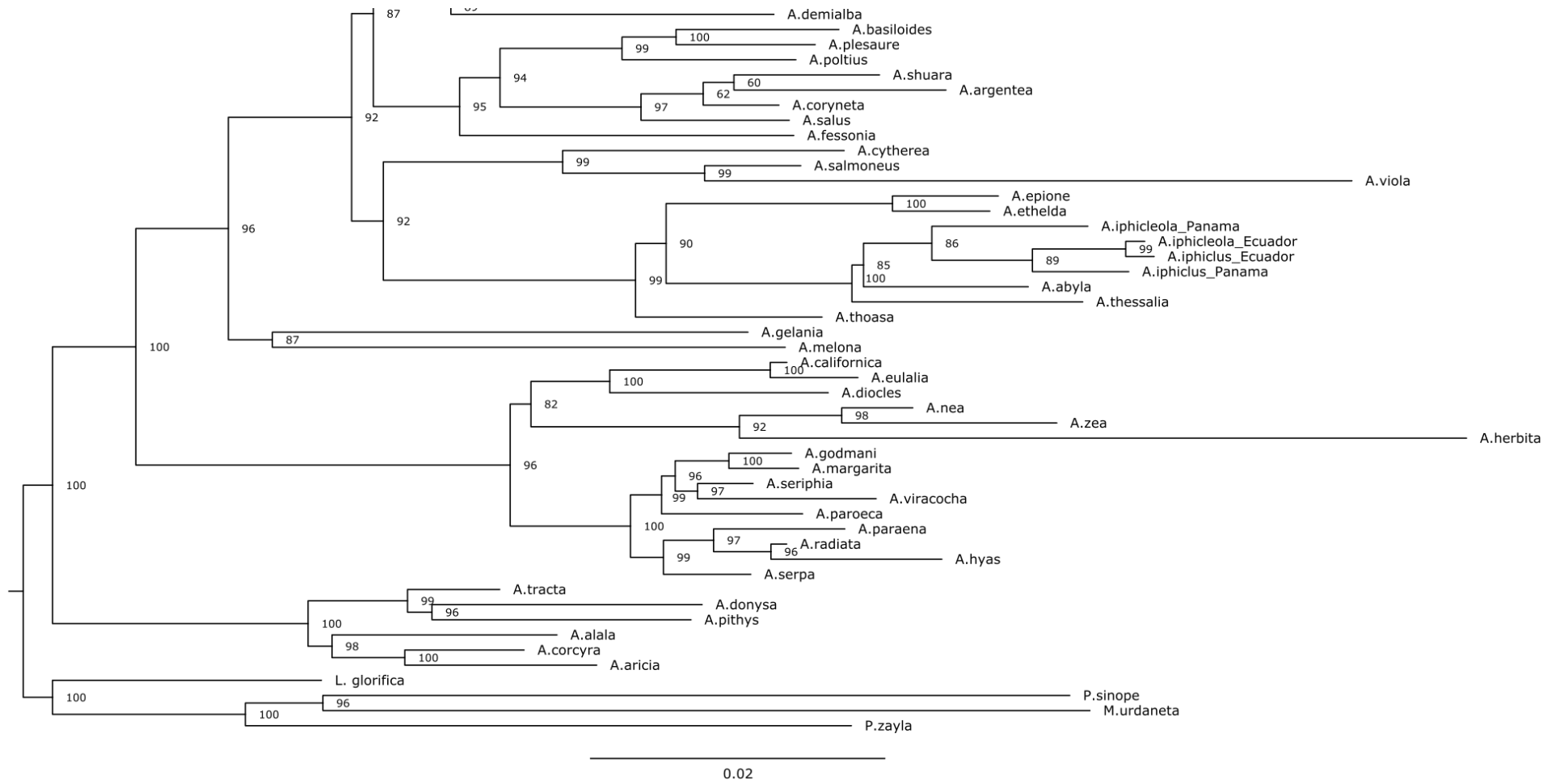

S5. Time calibrated phylogeny (Next page). Phylogenetic tree generated using 1 mitochondrial fragment (*COI*: 633 bp) and 15 nuclear fragments (*CAD*: 1335 bp; *RpS5*: 351 bp; *Rps2*: 783 bp; *GAPDH*: 993 bp; *EF-1a*: 1389 bp; *ArgKin*: 1065 bp; *IDH*: 1230 bp; *DDC*:1428 bp; *CycY* :1008 bp; *Exp1*: 3180 bp; *Nex9*: 1617 bp; *PolIII*: 822 bp; *ProSup*: 1116 bp; *PSb*: 696 bp; *UDPG6DH*:1437 bp) for a total length of 19083 base pairs. We performed two runs of 30,000,000 generations using MrBayes v3.2.6 (Ronquist et al., 2012). We used a relaxed lognormal clock and a birth-death prior. we used two calibrations from a comprehensive dated butterfly phylogeny (Chazot et al 2019), the age of the common ancestor of *Adelpha* and *Limenitis* 11.44 [8-15] Myr ago, and the age of the common ancestor of *Adelpha*, *Limenitis* and *Parasarpa* 16.27 [12-21] Mys ago. Values at nodes are posterior probabilities.

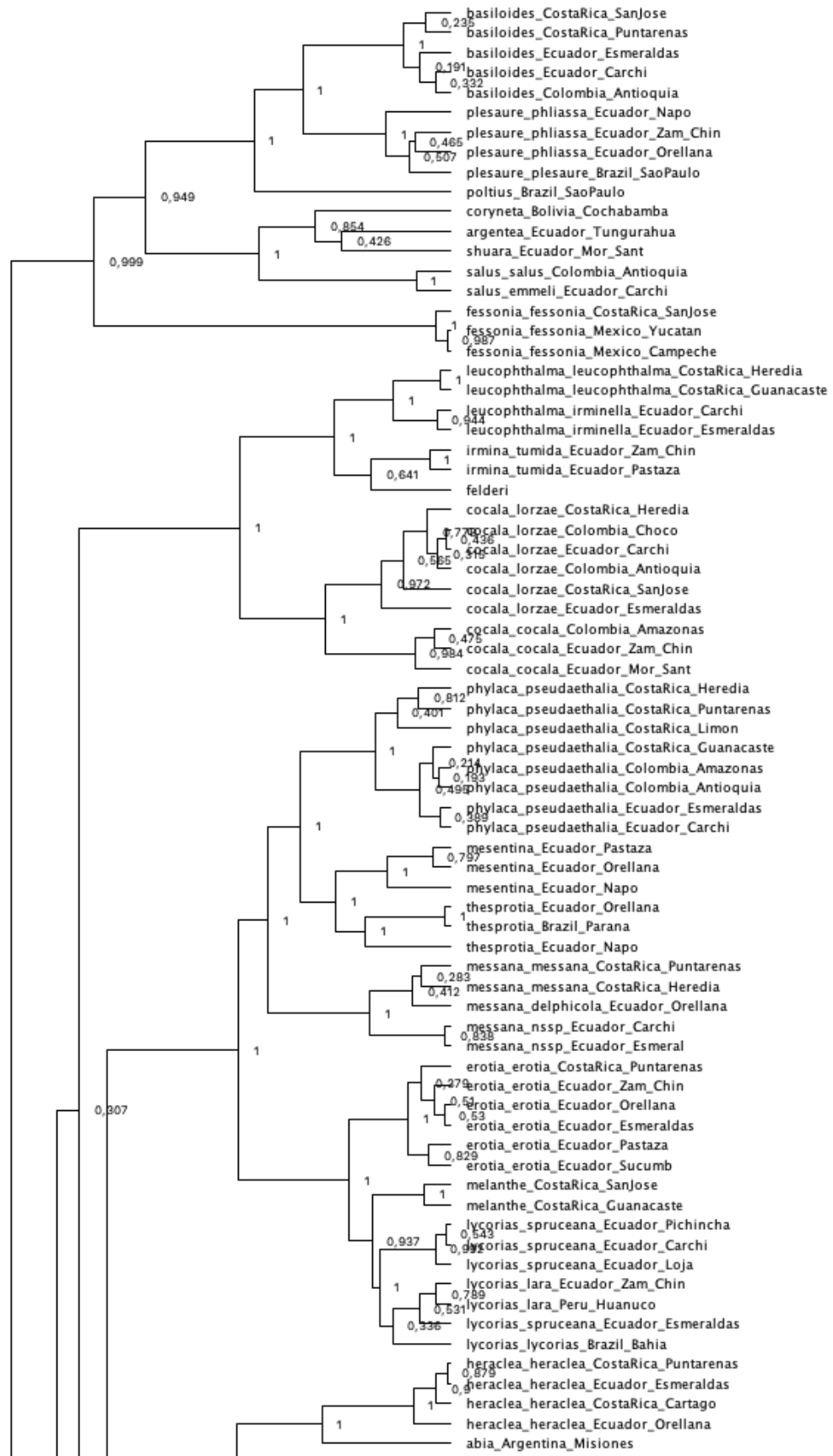

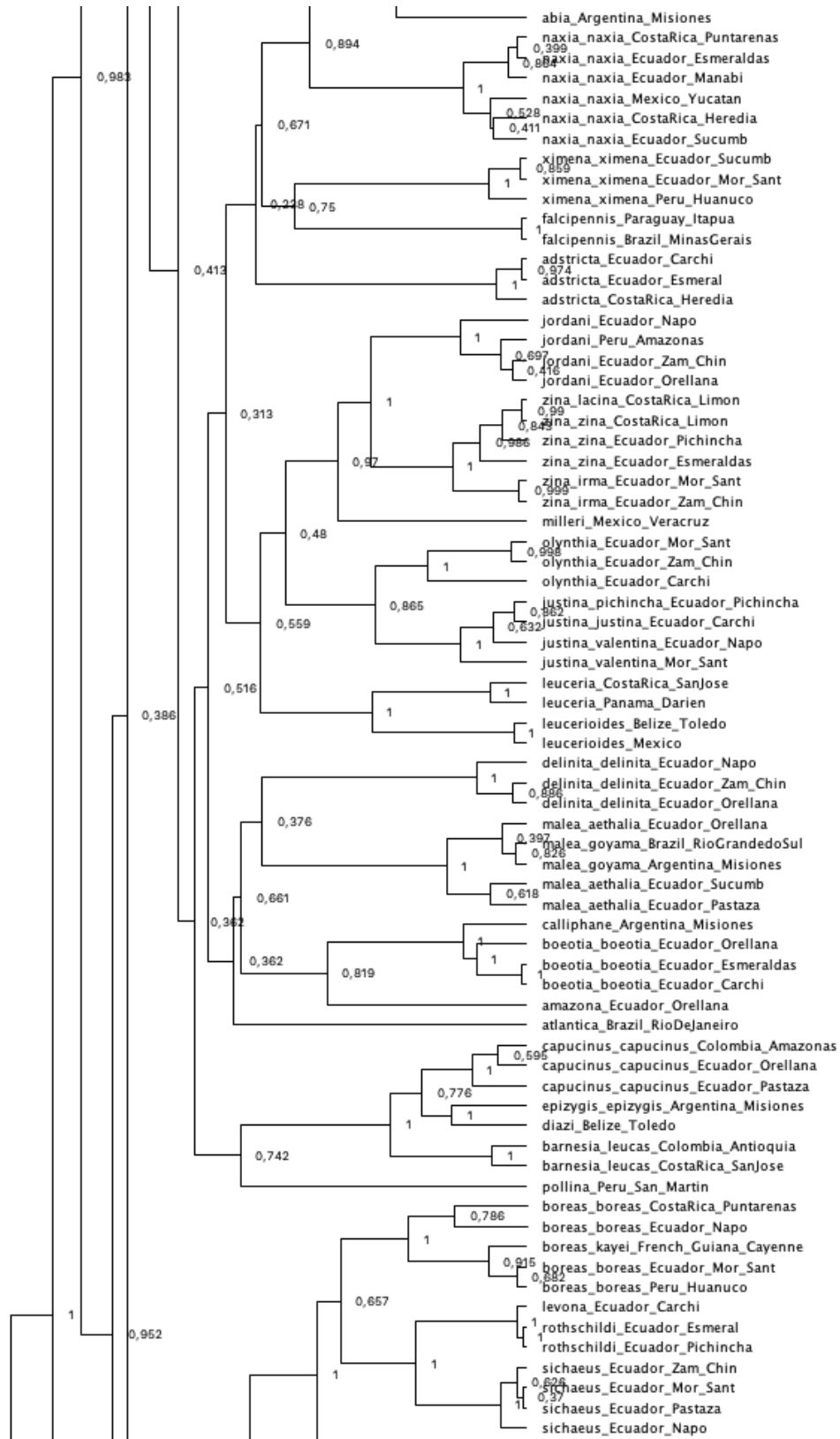

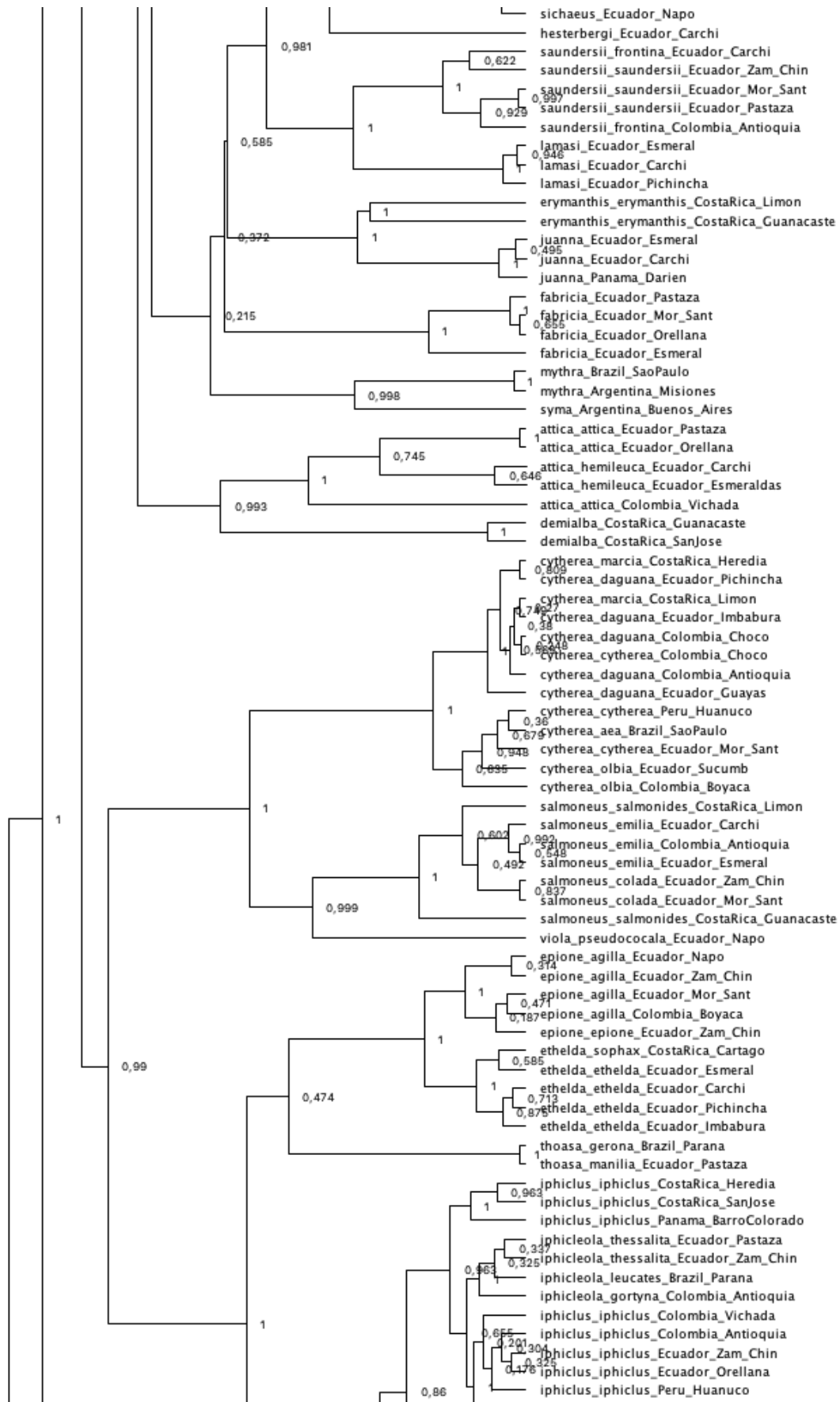

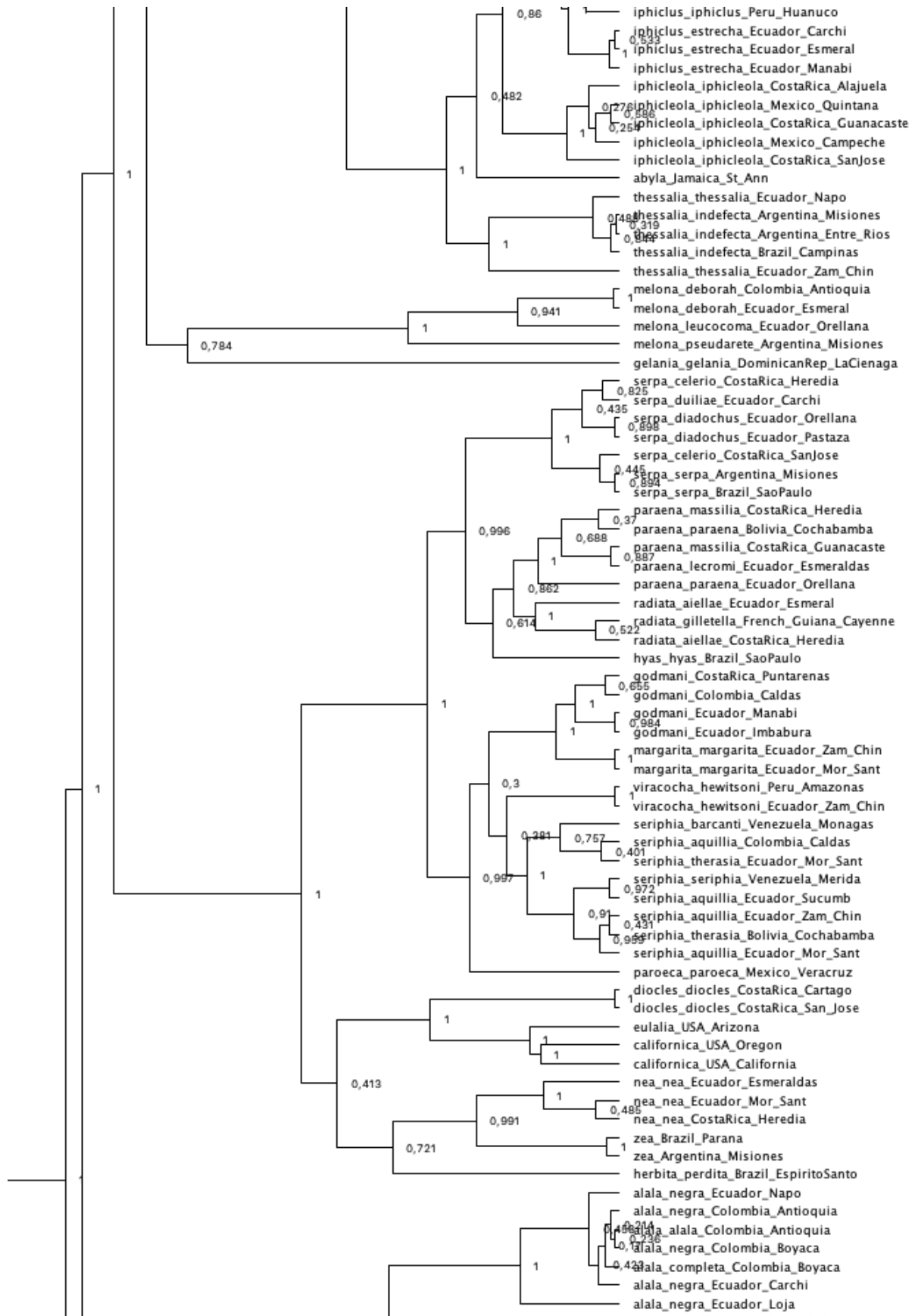

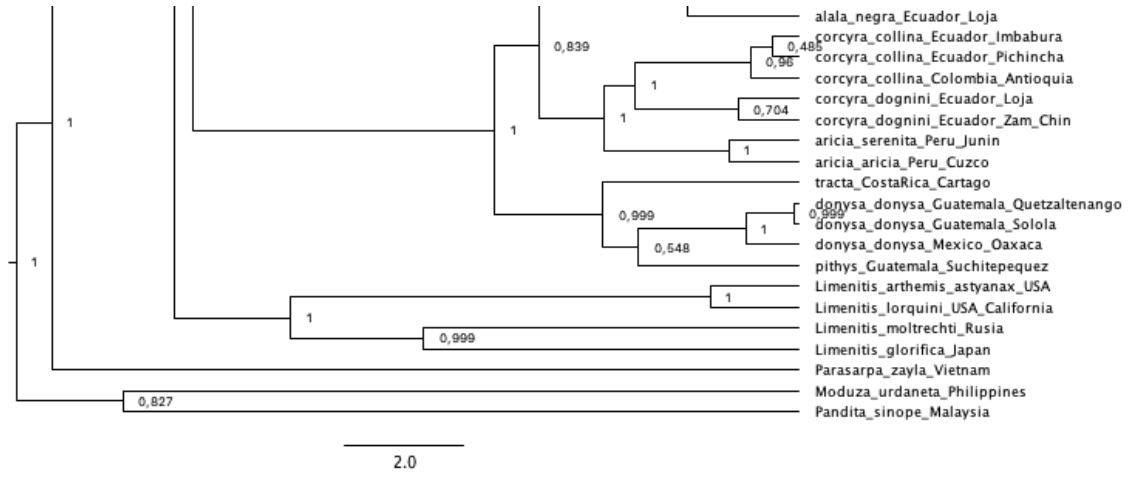

S6. Wing colour pattern rates of evolution. Table summarizing the results from the tip rates inferred. Tip rate was calculated by modelling 1000 times histories of wing colour pattern evolution. Colour pattern state at each node was sampled with a probability equal to that inferred in the ancestral state reconstruction analyses. Then we calculated the median tip rate across the 1000 histories from the number of transitions from root to tip from the simulated data and standardised by the number of nodes from root to tip.

species	tip rates	species	tip rates	species	tip rates
<i>A.basiloides</i>	0.25	<i>A.calliphane</i>	0.276	<i>A.gelania</i>	0.200
<i>A.plesaure</i>	0.333	<i>A.boeotia</i>	0.250	<i>A.serpa</i>	0.000
<i>A.poltius</i>	0.250	<i>A.amazona</i>	0.167	<i>A.paraena</i>	0.000
<i>A.coryneta</i>	0.417	<i>A.atlantica</i>	0.143	<i>A.radiata</i>	0.100
<i>A.argentea</i>	0.380	<i>A.capucinus</i>	0.357	<i>A.hyas</i>	0.000
<i>A.shuara</i>	0.380	<i>A.epizygis</i>	0.276	<i>A.godmani</i>	0.000
<i>A.salus</i>	0.5	<i>A.diazi</i>	0.267	<i>A.margarita</i>	0.000
<i>A.fessonnia</i>	0.222	<i>A.barnesia</i>	0.270	<i>A.viracocha</i>	0.000
<i>A.leucophthalma</i>	0.429	<i>A.pollina</i>	0.313	<i>A.seriphia</i>	0.185
<i>A.irmina</i>	0.444	<i>A.boreas</i>	0.483	<i>A.paroeca</i>	0.000
<i>A.felderi</i>	0.400	<i>A.levona</i>	0.571	<i>A.diocles</i>	0.000
<i>A.cocala</i>	0.355	<i>A.rothschildi</i>	0.500	<i>A.eulalia</i>	0.000
<i>A.phylaca</i>	0.286	<i>A.sichaeus</i>	0.500	<i>A.californica</i>	0.000
<i>A.mesentina</i>	0.375	<i>A.hesterbergi</i>	0.333	<i>A.nea</i>	0.100
<i>A.thesprotia</i>	0.283	<i>A.saundersii</i>	0.343	<i>A.zea</i>	0.000
<i>A.messana</i>	0.270	<i>A.lamasi</i>	0.364	<i>A.herbita</i>	0.000
<i>A.erotia</i>	0.444	<i>A.erymanthis</i>	0.300	<i>A.alala</i>	0.000
<i>A.melanthe</i>	0.308	<i>A.juanna</i>	0.306	<i>A.corcyra</i>	0.000
<i>A.lycorias</i>	0.500	<i>A.fabricia</i>	0.155	<i>A.aricia</i>	0.000
<i>A.heraclea</i>	0.375	<i>A.mythra</i>	0.286	<i>A.tracta</i>	0.100
<i>A.abia</i>	0.358	<i>A.syma</i>	0.267	<i>A.donyssa</i>	0.000
<i>A.naxia</i>	0.267	<i>A.attica</i>	0.400	<i>A.pithys</i>	0.000
<i>A.ximena</i>	0.462	<i>A.demialba</i>	0.267		
<i>A.falcipennis</i>	0.444	<i>A.cytherea</i>	0.308		
<i>A.adstricta</i>	0.375	<i>A.salmoneus</i>	0.323		
<i>A.jordani</i>	0.392	<i>A.viola</i>	0.375		
<i>A.zina</i>	0.700	<i>A.epione</i>	0.323		
<i>A.milleri</i>	0.279	<i>A.ethelda</i>	0.500		
<i>A.olynthia</i>	0.300	<i>A.thoasa</i>	0.382		
<i>A.justina</i>	0.500	<i>A.iphicleola</i>	0.194		
<i>A.leuceria</i>	0.310	<i>A.iphiclus</i>	0.167		
<i>A.leucerioides</i>	0.333	<i>A.abyla</i>	0.160		
<i>A.delinita</i>	0.172	<i>A.thessalia</i>	0.167		
<i>A.malea</i>	0.270	<i>A.melona</i>	0.369		

CHAPTER III

Spatial structure of diversity

The role of evasive mimicry and altitude on structuring butterfly communities from a highly diverse Neotropical region*

This manuscript will be submitted in collaboration with Maël Doré, Fernanda Checa, Sebastián Mena, Sofía Nogales, Karina Torres, Patricio Salazar, Anderson Medina, Keith Willmott and Marianne Elias.

In chapter 2, we produced a time calibrated phylogeny to assess whether shifts of mimicry colour pattern drive the speciation of a highly diverse neotropical genus of butterflies. Shifts in mimicry patterns seem not to be as crucial in speciation as observed previously in classical mimetic systems. Additionally, we observed a significant correlation between species feature “tropicality” (degrees to the equator) and evolutionary rates of mimicry patterns, which increase towards the equator. The latter pattern is in accordance with the hypothesis of a latitudinal and elevational gradient for biotic interactions that suggests a stronger biotic interaction towards the equator. Since ecological and evolutionary processes occur at local scales, where interactions take place, in the next and final chapter, we investigated the phylogenetic structure of communities from one of the most diverse regions in the world, the Neotropics. Additionally, we provided more evidence for the evolution of evasive mimicry by assessing co-occurrence of co-mimics and convergence along an altitudinal gradient.

I participated in collecting trips as a collaborator with the following researchers: Fernanda Checa (Pontificia Universidad Católica del Ecuador), Keith Willmott (University of Florida, USA) and Patricio Salazar (University of Sheffield, UK). In addition I organised two field trips in 2018 and 2019, as part of my thesis, to complete data from less represented localities. Finally, I performed all statistical analyses.

Introduction

One of the major questions in ecology is to understand the mechanisms determining the species composition and the structure of highly diverse biological communities. Phylogenies allow community structure to be examined under the assumption that trait differences between species are typically correlated with time since divergence. In other words, phylogenies can be used as a proxy for species ecological similarity (Webb 2000).

Species distribution and assembly of communities arise from the combination of neutral processes (drift and random dispersal [Hubbell, 2001] and selective processes such as predation, competition, facilitation or mutualism (Alexandrou *et al.* 2011, Bruno, Stachowicz, and Bertness 2003, Elias *et al.* 2008; Kraft *et al.* 2007, Valiente-Banuet and Verdú 2007, Webb 2000). Studies on phylogenetic community ecology have viewed competition as the major force that shapes community assemblages, by promoting divergence in behaviour and habitat, and so allowing more species to coexist (Cavender-Bares *et al.* 2004, Losos *et al.* 2003, Lovette and Hochachka 2006). However, the role of positive interactions (e.g., facilitation or mutualism) has been rarely studied (but see Chazot *et al.* 2014, Elias *et al.* 2008, Valiente-Banuet and Verdú 2007, Willmott *et al.* 2017). Positive interactions among resource competitors may provide an important mechanism for generating species-rich communities by allowing co-existence of species (Doré *et al.* submitted, Gross 2008)

A well-studied example of mutualism is classical Müllerian mimicry (Muller 1879), in which distasteful butterflies converge on their brightly coloured (aposematic) patterns that advertise chemical defences to predators. Species benefit from such convergence because they share the density-dependent cost of educating predators (Sherratt 2008) predators assess palatability (Fisher 1930) of prey by tasting and therefore killing some individuals, and learn to associate their colour pattern with their defence. Most mimetic and unpalatable butterflies typically fly slowly and evenly, and tend to exhibit similar flight patterns (Srygley and Ellington 1999, Pinheiro 1996, 2003). Such slow flight could be because of a relaxed selection on escape ability (and relative lack of predation) due to their secondary defences. Selection for mimicry of slow and regular flight (behavioural mimicry see (Srygley y Ellington 1999b, Hill 2021) may also reinforce learning by predators (Srygley and Ellington 1999, Hill 2021).

In classical systems, mimicry is a powerful force shaping local species assemblages of butterflies by driving convergence among interacting species along multiple ecological axes,

which increases co-occurrence among co-mimics and, consequently, protection against predation. Ecological convergence associated with mimicry has been shown for microhabitat (e.g., Elias *et al.* 2008, Willmott *et al.* 2017), altitudinal niche (e.g., Chazot *et al.* 2014), hostplant (likely via selection on microhabitat, e.g., Willmott and Mallet 2004), and climatic niche (e.g., Doré *et al.* submitted).

Ecological convergence driven by mimicry has been shown to overcome competition within communities (e.g., Elias *et al.* 2008, 2009). (Chazot *et al.* 2014) provided evidence for classical Mullerian mimicry as a strong driver of community structure in Ithomiini at broad scales (the Eastern slopes of the Andes in Ecuador). They showed that different mimicry patterns dominate at different altitudes in the Andes, and that co-mimetic species co-occur at similar altitudes more often than expected by chance. They also showed that although sharing of similar altitudes in co-mimetic species is partly due to phylogenetic relationship, mimicry also reinforces the coexistence of co-mimetic species along the altitudinal gradient, initially when colour pattern converges among coexisting species, and then through convergence in the altitudinal niche of the newly co-mimetic species.

Evasive mimicry (Lindroth 1971, Van Someren and Jackson 1959) is another kind of mutualistic interaction and one that has been largely overlooked until recently (but see Pinheiro *et al.* 2016; Pinheiro and Freitas 2014). Similar to classical mimicry, predator selection on hard-to-catch prey might favour convergence of bright colour patterns that advertise escaping ability. There is growing evidence that this phenomenon may be more common than supposed in nature, including: *i*) the fact that rapid flight is effective for escaping pursuing predators in the wild (Chai and Srygley 1990, Molleman *et al.* 2020, Srygley and Chai 1990), *ii*) experiments showing that predators are able to learn and to generalise warning signals associated with evasiveness (Gibson 1974, 1980, Hancox and Allen 1991, Páez *et al.* 2021, Pinheiro 1996), *iii*) field observations on birds that do not attack known palatable, hard-to-catch prey (Pinheiro and Freitas 2014, Pinheiro *et al.* 2016, Srygley 1999, Vanin and Guerra 2012) and *iv*) mathematical models arguing that this phenomenon is logically possible (Ruxton, Speed, and Sherratt 2004). In the case of evasive mimicry, it is not clear whether selection acts the same way as in classical systems based on unpalatability. Evasive and unpalatable prey might differ in their behaviour, morphology and/or physiological requirements Table 1, and some of these traits might impact how communities are shaped. For example, species-specific physiological requirements (e.g., thermal environment, nutritional resources) for strong flight in evasive prey might be different from those of unpalatable prey (which are typically slow fliers).

Table 1. Comparison of different features between evasive (palatable) and unpalatable prey relevant to predator's defence.

	Evasive (palatable)	Unpalatable
Flight pattern (Carpenter 1941; Marsh, N. 1974; DeVries P.J. 1987)	Fast and erratic flight which likely plays a role in escaping from predators. It might discourage predators by advertising their evasiveness. High energy cost of flight (related to wing morphology).	Slow, heavy, in straight lines to display their bright warning patterns, and deliberate. Lower energy cost of flight relative to palatable species (related to wing morphology).
Centre of body mass position (e.g., Srygley and Dudley 1993; Srygley 1994; Srygley and Chai 1990)	Near to the wing base	Further posterior to the wing base
Wing and body morphology (e.g., Chai and Srygley 1990; Jantzen and Eisner 2008; Srygley and Dudley 1993; Srygley 1994; Kingsolver and Koehl 1985; Ellington 1984)	Large thorax, massive flight muscles, short and hidden abdomen between extended areas at the base of the hindwings (i.e., conserve heat, increase aerodynamic performance, and reduce chance of being seized by the abdomen). Shorter forewings, low aspect ratio. More energy invested in thorax mass.	Thin thorax, long abdomen, slender body, wing position exposing abdomen that may increase discrimination and rejection from predators (but also aerodynamic properties). More energy invested in the abdomen mass. Longer wings, higher aspect ratio.
Thermal properties (e.g., Brown Jr and Vasconcellos Neto 1976; Srygley and Chai 1990; Kingsolver 1985)	Flight is thermally constrained. Mostly active in warmer microhabitats with easier access to sunlight. But also, to restrict activity in the hottest hours of the day.	Less restriction on flight activity by sunlight, active at lower temperatures with thoracic temperatures nearer to ambient temperatures.
Colour pattern (Chai 1988, Jenkins 1983, Pinheiro <i>et al</i> 2006)	Conspicuous colour patterns are exhibited when the wings are open or during flight. They can also harbour cryptic or protective patterns i.e., dead leaf, in the underside of the wings in high-risk situations such as puddling, oviposition.	Bright colour patterns exposed with open and closed wings.
Deflecting traits (Olofsson <i>et al</i> 2010, Pinheiro <i>et al</i> 2014, Prudic <i>et al</i> 2015, Barber <i>et al</i> 2015, Stevens 2005)	Some species potentially involved in evasive mimicry harbour eyespots only in the ventral side of their wings that could be displayed in risk situations. Eyespots, false "head" located at the distal part of the folded hindwings	Absent
Wing toughness (Chai 1987, Srygley 1994, DeVries, 2002, 2003, Chotard <i>et al</i> 2022)	Soft and brittle which allow butterflies to easily escape to predators when captured.	Thought and robust wings that supposedly enable odour and taste assessment by predators without significant damage of the wings.

Physiological responses might influence habitat preference and segregation (Huey 1991), thus affecting the distribution of species along thermal gradients (microhabitat, altitude, latitude). For example, (Okuyama 2015) showed that flight performance associated with body size has implications for habitat segregation in two species of damselflies. Similarly, in *Colias* butterflies, which are small but strong fliers that are potentially involved in evasive mimicry (Pinheiro and Campos 2019), full flight capacity and thus maximum flight activity only develops in the most thermally favourable parts of the day (Tsuji, Kingsolver, and Watt 1986, Watt 1983). It could be possible that in strong fliers there is segregation of species along altitudinal gradients. One might expect that there would be stronger selection for convergence on wing colour pattern in higher altitudes where it is cooler, and escaping ability is more limited for longer periods of the day.

Aside from morphological, physiological and ecological differences between evasive and classical mimicry systems, there may be different selection pressures resulting from differences in the effectiveness of the defence in each system. In evasive systems, the primary defence (evasiveness) may be learned faster and be more broadly generalised than unpalatability (Páez *et al.* 2021). Also, in evasive systems predators do not need to taste (and kill) prey to learn that they are unprofitable, such that the positive frequency-dependent selection that acts on classical mimetic systems and drives wing colour pattern convergence may not be as intense in evasive systems. As a result, we might expect that there would be weaker selection for convergence in colour pattern and habitat in evasive vs classical mimicry systems.

The Neotropical butterflies of the genus *Adelpha* show remarkable similarity in dorsal wing colour patterns among many sympatric species (Willmott 2003a). One hypothesis for this convergence is classical mimicry based on unpalatability (Willmott 2003a, Mullen *et al.* 2011, Ebel *et al.* 2015). Aiello (1984) first speculated that convergence in wing colour pattern in *Adelpha* is due to mimicry associated with chemical defences, with species that feed as larvae on toxic Rubiaceae host plants serving as models for both defended and non-defended mimics. However, evidence for unpalatability in *Adelpha* is lacking; experiments have shown that putative unpalatable species are consumed by avian predators (Srygley and Chai 1990, Pinheiro 1996). Nevertheless, congruent geographic changes in wing colour pattern among co-mimics regardless of relationships, and the derivation of similar mimetic wing colour patterns from apparently distinct wing pattern elements (Willmott 2003a, 2003b), strongly suggest adaptive convergence of wing colour patterns in the genus. Furthermore, mimicry with *Adelpha* can also be observed in some species of *Doxocopa*, a member of another subfamily (Apaturinae).

An alternative hypothesis for convergence in *Adelpha* wing colour patterns is evasive mimicry (Mallet and Singer 1987, Páez *et al.* 2021, Willmott 2003a). Strong and erratic flight in *Adelpha*, paired with their conspicuous wing pattern (which is displayed in both flight and perching), might suggest that *Adelpha* butterflies are unprofitable to pursue and warn predators about their defence.

More broadly, *Adelpha* is an interesting model to study in biodiversity and ecology because it is one of the most diverse genera in the Neotropics, with more than 90 species distributed from northwestern United States to Uruguay (Willmott 2003a; 2003b), and with an altitudinal range from sea level to over 3000 m. *Adelpha* exhibits a marked latitudinal and altitudinal gradient in species richness, which peaks at the base of the eastern Andes. *Adelpha* species are also zoned altitudinally, with distinct lowland and montane faunas, and in the northern Andes at least, somewhat independent patterns of distribution are observed on each Andean slope.

In this study, we therefore investigate the drivers that shape *Adelpha* communities in the Andes of Ecuador, one of the most biodiverse regions on Earth, by assessing the phylogenetic structure of these communities and how it relates to mimicry and altitude. We address the following questions:

1) Is there evidence for habitat filtering in *Adelpha* communities by altitude? 2) Do co-mimetic species co-occur more often than expected at random, and does this correlate with altitude? 3) Are *Adelpha* communities adaptatively assembled along the slopes of the Andes i.e, are the altitudinal niches of co-mimetic species more similar than predicted by the phylogeny? 4) What is the phylogenetic structure of *Adelpha* communities across the slopes of the Andes?

Given the presumed importance of the thermal environment for maintaining fast flight in *Adelpha* (at higher [thus cooler] altitudes, escaping ability is more limited for longer periods of the day), firstly, we expect to find strong filtering by altitude. Secondly, because studies to date suggest evasiveness may be a more effective defence than unpalatability, we expect that convergence in colour pattern and habitat will be milder than in mimicry systems based on unpalatability. Given the lack of an unpalatable control system we cannot formally test this last prediction, but we can still evaluate qualitatively how convergence in *Adelpha* compares to that reported in classical mimicry systems (Chazot *et al.* 2014). Finally, given the Andes has been shown to be an important driver for speciation in mimetic systems, we expect that communities across the Andean slopes are phylogenetically structured.

Material and methods

Data

We analysed two datasets, referred to as incidence and abundance, to assess the phylogenetic and mimetic structures of *Adelpha* communities in Ecuador (Table 2). The incidence dataset (presence/absence) was obtained from the compilation of fieldwork and museum research by K. Willmott and collaborators in the last 25 years in Ecuador, for a total of 41 sites. This dataset comprises 59 species and 76 subspecies, representing all of the species known from Ecuador (Willmott 2003). The abundance dataset consists of 2140 individuals from 49 species, 61 subspecies. It was compiled from QCAZ-PUCE and INABIO museum collections. This dataset was generated using standardised sampling over different periods of time among 8 sites. Butterflies were sampled using Van Someren-Rydon traps (Rydon 1964) baited with shrimp or fish that had been decomposing for 11–20 days, since *Adelpha* adults are strongly attracted to rotting carrion. At each sampling point, two bait traps were set up in two different strata, understory (1.5 m) and canopy (20–27 m).

Table 2. Abundance (Ab) and incidence (In) datasets. Sites sampled, code names, altitude, geographic coordinates, species richness and mimicry richness (number of identified mimicry complexes). The last column is the total number of individuals collected in each site in the abundance dataset.

Site	Code	Alt(m)	Location	Sp. richness		Mim. richness		Nb ind.
				Ab	In	Ab	In	Ab
Yasuni	YS	250	00°39'S, 76°22'W	26	29	4	5	1238
Anangu	ANG	225	00°31'43"S,76°23'41"W	16	22	3	3	60
WildSumaco	WILS	1500	00°37'20.3"S, 77°36'04.6"W	10	10	5	5	95
Arcoiris	ARC	2013	3°59'18"S,79°5'42"W	6	6	4	4	28
ElDurango	ELDD	350	1°2'27"N,78°38'4"W	13	20	4	6	53
Canande	CAN	389	00°28'N, 79°12'W	19	20	6	6	535
Mashpi	MASH	878	00° 9.554'N, 078° 53.052'W	14	13	6	6	125
LosCedros	LOSC	1341	00°18.498'N,078°46.781'W	9	9	5	5	45
TiputiniBS	TP	300	0°42'12"S,76°0'30"W		19		4	
Yaupi	YAU	385	2°51'46"S,77°56'28"W		14		3	
Chichicorrumi	CHI	450	1°4'11"S,77°37'45"W		21		4	
Apuya	APU	600	1°6'18"S,77°46'42"W		23		4	
FincaSanCarlo	FINSC	600	1°5'18"S,77°47'24"W		21		4	
Pimpilala	PIM	600	1°4'31"S,77°56'13"W		25		5	
Bomboiza	BOM	817	3°25'36"S,78°31'W		12		4	
Lumbaqui	LUM	917	00°1'42"N,77°19'W		17		5	
PuyoTenaRd	PUYTR	938	1°19'42"S,77°56'W		15		5	
Shell	SHE	1040	4°6'48"S,78°57'54"W		12		6	

Chorillos	CHO	1150	4°1'55"S,79°0'12"W	13	5
TenaLoreto	TENL	1310	00°42'51"S,77°44'26"W	10	4
RioPalmar	RIOP	1325	00°25'6"N,77°32'12"W	9	4
Zamora	ZAM	1439	4°4'30"S,78°58'7"W	7	4
Topo	TOP	1309	1°24'21"S,78°11'50"W	12	5
Machay	MACH	1687	1°23'20"S,78°16'49"W	8	4
SanRamon	SANR	1735	3°58'12"S,79°3'42"W	8	4
RioAbanico	RIOA	1625	2°15'18"S,78°12'W	14	5
RioSucio	RIOS	1800	00°28'30"N,77°33'18"W	8	4
ElArrayan	ELAA	2021	00°28'22"S,77°52'36"W	4	4
ElGarrapatal	ELGG	2150	00°29'18"N,77°33'12"W	2	2
SanAndres	SANA	2056	4°47'22"S,79°20'20"W	5	4
LaloLoor	LALL	31	00°4'37.2"S, 80°9'12.1"W	3	2
LaChiquita	LACC	50	1°13'49"N,78°45'57"W	6	3
Tundaloma	TUN	100	1°10'40"N,78°44'54"W	7	3
SanFrancisco	SANF	177	1°6'26"N,78°41'55"W	14	4
LaPunta	LAPP	300	1°3'55"N,78°39'W	9	5
Tinalandia	TIN	695	00°18'S,79°4'W	6	5
Alluriquin	ALL	745	00°19'S,78°59'45"W	7	5
Chuchuvi	CHU	812	00°52'51"N,78°30'54"W	20	7
Litaridge	LIT	852	00°53'15"N,78°26'18"W	24	6
Tandapi	TAN	1594	00°27'S,78°46'W	5	3
SantaRosaGolo ndrinas	SANRG	1667	00°49'38"N,78°7'42"W	9	4

In both datasets, elevation across sites ranged from 30 m to 2150 m above sea level. Each *Adelpha* subspecies was assigned to one of 9 out of 14 mimicry patterns based on consideration of pattern similarity following the classification of K. Willmott (Willmott 2003a; Ebel et al. 2015) (Figure 1).

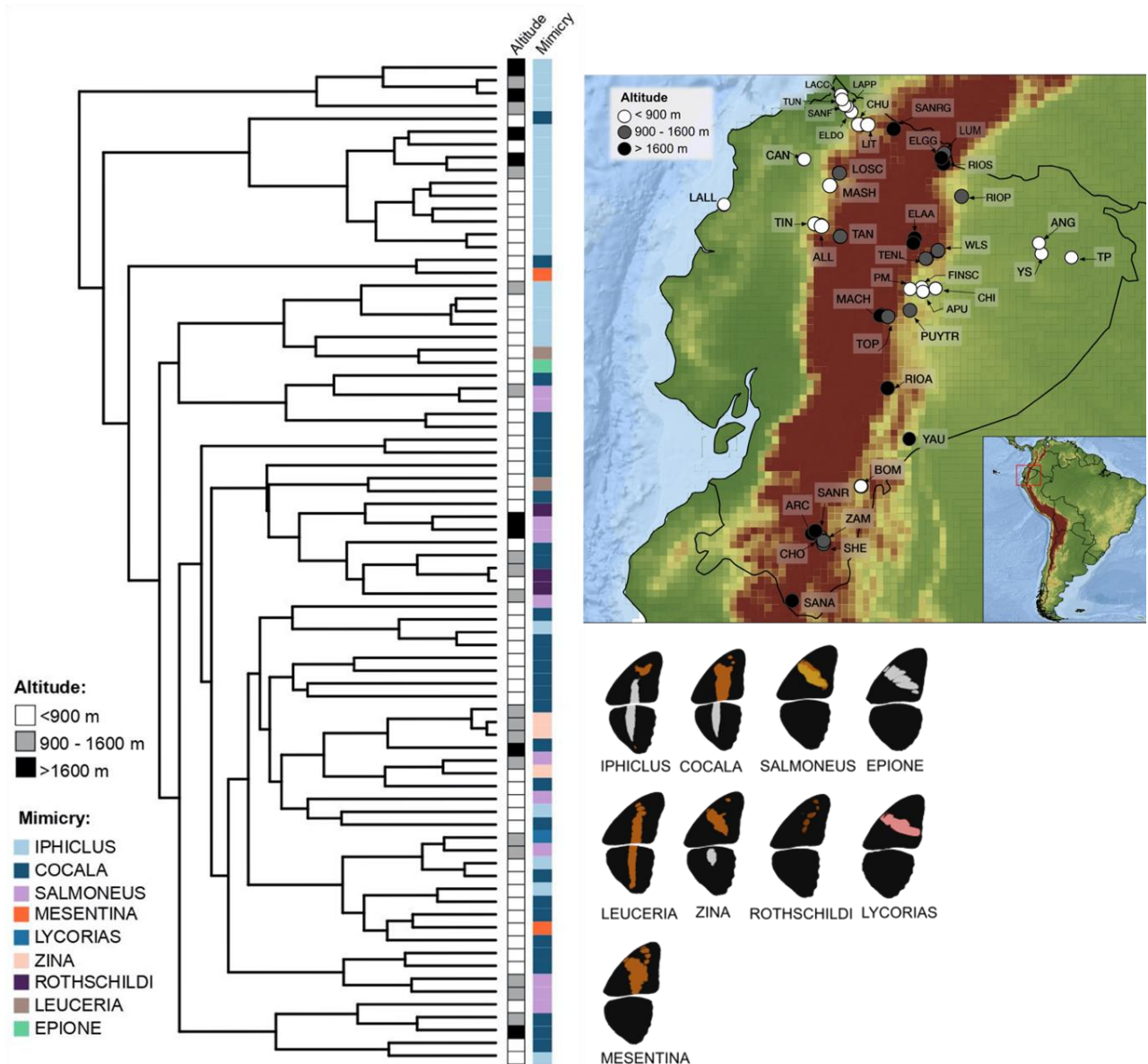

Figure 1. A) *Adelpha* phylogeny for 78 subspecies. Each subspecies was assigned to an altitude interval, based on mean altitude per species, indicated in the first column. Mimicry patterns are indicated in the second column. B) The 41 sites are mapped with the same altitude colour code as in the phylogeny. C) Mimicry patterns shared by *Adelpha* species.

Phylogeny

To examine the phylogenetic and mimicry structure of communities we extracted a tree from a recently generated time-calibrated phylogeny (see Chapter II [supplementary material S5]) to include only species from our datasets. In order to perform the mimicry-related analyses, subspecies with different mimicry patterns and species forms (species where the same subspecies harbour different mimicry patterns that are considered taxonomic forms) were considered as distinct taxa in the phylogeny but with identical sequences (i.e., phylogenetic

distances of zero). In total, 13 species contained 2 subspecies, 1 species contained 3 subspecies, and 7 species contained 2 different mimicry patterns (which in 4 species [*A. lycorias*, *A. melona*, *A. messana*, *A. zina*], each subspecies harbour a different mimicry pattern; in 1 species [*A. justina*] 3 subspecies harbour 2 different mimicry patterns; and 2 species [*A. capucinus* and *A. erotia*] harbour different forms. Although our dataset contains species, subspecies and forms, hereafter, for the sake of clarity, we will refer to these as “*taxa*”.

Statistical analyses

All the analyses were performed in R version 4.1.3. R. Scripts and data used to produce the results of statistical analyses are available at https://github.com/ErikaPaezV/Mimicry_ecology-evolution.git

Whole dataset

Phylogenetic Structure of Communities

We used the community differentiation indexes of Hardy and Senterre (2007): I_{ST} , P_{ST} and Π_{ST} , which allows additive partitioning of the phylogenetic signal into alpha (within-site) and beta (among-site) components. I_{ST} expresses species turnover (community differentiation among sites from species identity), P_{ST} indicates phylogenetic turnover (community differentiation among sites from species phylogeny) and Π_{ST} expresses the gain of the mean phylogenetic distance between species found in different sites compared with species found within sites (Hardy and Senterre 2007). The first two coefficients i.e., I_{ST} and P_{ST} can take abundance data (number of individuals per species per site) into account, while Π_{ST} is computed only in incidence data (presence/absence per species per site).

To detect how communities are structured, we computed the I_{ST} , P_{ST} and Π_{ST} indexes and we performed phylogenetic tree randomizations (999 permutations of species on the tips of the phylogeny) to test for phylogenetic turnover accounting for species turnover. $P_{ST} = I_{ST}$ indicates no phylogenetic community structuring, $P_{ST} > I_{ST}$ indicates phylogenetic clustering, whereas $P_{ST} < I_{ST}$ indicates phylogenetic overdispersion. Likewise, $\Pi_{ST} > 0$ indicates phylogenetic clustering, whereas $\Pi_{ST} < 0$ indicates phylogenetic overdispersion.

To test how phylogenetic structure relates to altitude (following Chazot et al. 2014), we performed partial Mantel tests to assess the relationship between pairwise indexes (P_{ST} or Π_{ST}) and altitudinal distances between pairs of communities considering a possible confounding

effect of geographic distances. We evaluated correlations with the non-parametric Spearman's rho index. All indexes were computed using R.

Mimicry Structure of Communities

In Müllerian mimetic systems, individuals from co-mimetic species benefit from co-occurring and are therefore expected to co-occur more often than expected at random. To test this hypothesis, we computed pairwise Bray-Curtis distances (Bray and Curtis, 1957) between the distributions of all pairs of taxa across all sites and tested if this distance was lower for co-mimetic taxa. We computed the significance of the mean value by permutation of the mimicry patterns among taxa, in both abundance and incidence datasets. Bray-Curtis distances were calculated as follows:

$$BC_{jk} = 1 - \frac{2 \sum_{i=1}^p \min(N_{ij}, N_{ik})}{\sum_{i=1}^p (N_{ij} + N_{ik})}$$

where j and k are two subspecies evaluated, i is one community among the p communities, and N is the subspecies incidence or abundance. Analyses were performed at the global scale, and for each mimicry ring. Bray-Curtis distances were calculated with the R package *vegan* 2.5-4.

To test whether mimicry turnover relates to altitudinal distances, we followed Chazot *et al.* (2014) and performed partial Mantel tests between pairwise I_{ST} using mimicry rings instead of species and pairwise altitudinal distances, while accounting for geographical distances, using Spearman's rho as the measure for non-parametric correlation. I_{ST} for mimicry rings was calculated by using the number of individuals (for the abundance dataset) or *taxa* (for the incidence dataset) in each ring as the measure of abundance. Thus, I_{ST} represents the mimicry turnover over among communities, and a high I_{ST} reflects the spatial clustering of co-mimetics species within communities. The subspecies *Adelpha erotia erotia* exhibits two forms that belong to different mimicry rings, thus they were considered as two different entities (i.e. forms were counted separately). *Adelpha capucinus capucinus* is dimorphic as well (two different forms that belong to different mimicry rings), but both forms occur in approximately equal abundance, so we considered that each form had half the abundance reported in the dataset.

Association between Altitude and Mimicry accounting for the phylogeny

We tested whether mimicry pattern and altitudinal niche were associated more often than predicted by the phylogenetic relatedness of species. We first estimated the degree of phylogenetic signal of these traits using Blomberg's K, for altitude, and a test based on the Mean pairwise Phylogenetic Distance (MPD) for mimicry pattern. Then we assessed the association between mimicry and altitude using different approaches and metrics: i) *Mean Altitudinal Distance (MAD)*, ii) *Phylogenetic Kruskal Wallis & pairwise Wilcoxon*, both approaches using simulated data for considering the phylogeny.

Phylogenetic signal for altitude and mimicry

As a measure of phylogenetic signal, we used the Mean pairwise Phylogenetic Distance (MPD) for colour pattern, and Blomberg's K statistic (Blomberg, Garland, y Ives 2003) for altitude. MPD value among co-mimetic *taxa* was computed and then compared to a null distribution model representing a scenario with no phylogenetic signal, generated via subspecies permutations on the tips of the phylogeny 999 times. The presence of a phylogenetic signal in colour pattern is detected if the observed MPD value is significantly lower than that obtained by the null distribution (one-tailed test, $\alpha = 0.05$).

In the case of altitude (Blomberg's K statistics), $K=0$ means no phylogenetic signal and $K=1$ means character evolution under a Brownian motion model.

Simulation of altitudinal niche considering the effect of phylogeny *

Prior to simulating trait evolution, we tested for the neutral evolutionary model that best fitted the observed altitudinal niche evolution. We estimated Pagel's (1999) Lambda (λ) parameter (*motmot* version 4.0.5 R package), which provides the best fit to our data.

We rescaled our tree according to the best-fitting value of λ and simulated the mean altitudinal niche evolution 999 times. Simulated altitudinal niche values under neutral evolution are used for further analyses. We used the R package *geiger* version 4.0.4 for this analysis.

Mean altitudinal distance - MAD

These analyses provided some insights into how conserved or convergent are mimicry rings. We computed and compared the mean altitudinal distance (MAD) between co-mimics from the observed (MAD_{Obs}) and simulated values (MAD_{Sim}) data. A value of MAD_{Obs} lower (or higher) than 97.5% MAD_{Sim} indicates that co-mimics are altitudinally clustered (or overdispersed) more than expected from the phylogeny. MAD was calculated across all and for each mimicry ring in both abundance and incidence datasets.

Kruskal Wallis & Wilcoxon tests

These analyses aim to test whether mimicry rings have different altitudinal niches after accounting for the phylogeny. First we performed a Kruskal Wallis test between altitude and mimicry ring membership of subspecies. Furthermore, to control for the effect of phylogeny in this association, we performed a phylogenetic Kruskal Wallis test based on the simulated evolution i.e., Brownian model (described above*) of the altitudinal niche: we compared Chi-square statistics calculated on observed ($\text{Chi-square}_{\text{Obs}}$) and simulated ($\text{Chi-square}_{\text{Sim}}$) data. A significantly higher $\text{Chi-square}_{\text{Obs}}$ than 95% of the $\text{Chi-square}_{\text{Sim}}$ values indicates a stronger association between altitudinal niche and mimicry than that expected from the phylogeny. We conducted *post hoc* Pairwise Wilcoxon tests to detect differences on altitudinal niche among pairs of mimicry rings: W statistics from W_{Obs} and W_{Sim} data were compared. We included only mimicry rings with more than four subspecies (COCALA, IPHICLUS, SALMONEUS).

West and East slope as communities

To investigate drivers of community structure at a finer level, we repeated the analyses for phylogenetic structure and some of the analyses for mimicry structure for separate communities from the west and east Andean slopes. We implemented two approaches: i) separate analyses for each slope; and ii) pooling all sites of each of the Andean slopes (i. e., West and East) to contrast these two meta-communities (here called W/E). For both approaches we only used the incidence dataset since abundances from different sites cannot be pooled (in the case of W/E) and sample size (when separating data in W and E slope datasets) is too low to perform statistical analyses of the abundance dataset.

Results

A summary of the results is provided in Table 3 and is compared to Chazot's et al. 2014 study on the phylogenetic and mimicry structure of *Ithomini* communities.

Whole dataset

Phylogenetic Structure of communities

Analyses showed that the phylogenetic structure of communities did not globally depart from random expectations, although values of P_{ST} (computed only in the abundance dataset) and Π_{ST} (calculated on the incidence dataset) tended to be on the low side, suggestive of a pattern of overdispersion. Specifically, the global P_{ST} was not significantly different from I_{ST} ($I_{ST} = 0.191$;

$P_{Stobs} = 0.167$; CI = 0.164; 0.222, $p = 0.076$) and global Π_{ST} was not significantly different from 0 ($\Pi_{STobs} = 0.011$; CI = -0.012; 0.017, $p = 0.154$) (see supplementary materials S1).

Partial Mantel tests showed a significant positive relationship between pairwise P_{ST} (rM = 0.379, $p = 0.020$) and Π_{ST} (rM = 0.391, $p = 0.001$) with altitude, independently of geographic distance (Figure 2A, 2B; see supplementary materials S1).

Table 1. Summary of results and comparison with Chazot *et al.* 2014. “Mutualistic Mimicry and Filtering by Altitude Shape the Structure of Andean Butterfly Communities.” *American Naturalist* 183(1): 26–39.

Test	Statistical analysis	Chazot et al.'s 2014 dataset		whole dataset		W/E dataset	west slope	east slope	
		N sites	incidence	abundance	incidence	abundance	incidence	incidence	incidence
		N sites	15	7	41	8	41	15	26
		N species	155	146	59 (76 ssp)	49 (61 ssp)	59 (76 ssp)	36 (39 ssp)	46 (48 ssp)
		N mimetic patterns	27	25	9	9	9	7	6
		N total ind.	NA	6878	NA	2140	NA	NA	NA
Phylogenetic structure	<i>Global Pst</i>		NA	clustered	NA	random	NA	NA	NA
	<i>Global Pst</i>		clustered	clustered	random	NA	overdispersion	random	random
Mimicry structure	<i>Global Ist</i>		clustered	clustered	random	random	random	random	random
Altitudinal segregation	<i>Pairwise Pst - Partial Mantel test</i>		NA	positive	NA	positive			NA
*not corrected by the phylogenetic effect	<i>Pairwise Pst - Partial Mantel test</i>		positive	positive	positive	NA	NA	positive	positive
	<i>Mimetic Pairwise Ist - Partial Mantel test</i>		positive	positive	positive	positive	positive	positive	random
Co-occurrence of co-mimetic species	<i>Bray Curtis distance - BC [Mimetic Ist (Chazot et al 2014)]</i>		yes	yes	yes	yes	yes	random	random
	<i>per mimicry ring BC</i>		NA	NA	co-occurrence: COCALA, ROTHSCHILDI	co-occurrence: COCALA, ROTHSCHILDI	co-occurrence: COCALA	co-occurrence: ROTHSCHILDI	* COCALA (p= 0.057)
Traits phylogenetic signal	<i>Altitude: Blomberg's K</i>		yes		yes	yes			
	<i>Phylogenetic autocorrelogram (Chazot et al 2014)</i>		yes		yes	yes			
	<i>mimetic pattern: Mean phylogenetic distance - MPD (Mantel test's mimetic vs altitudinal distance [Chazot et al 2014])</i>		yes		yes	yes			NA
	<i>per mimicry ring MPD</i>			NA	clustering: COCALA, ROTHSCHILDI, ZINA	clustering: COCALA, ROTHSCHILDI, ZINA, SALMONEUS			
Convergence among co-mimetic species (association altitude & mimicry)	<i>Mean Altitudinal Distance - MAD (Regression & Simulation [Chazot et al 2014])</i>		yes		no	yes		no	no
	<i>per mimicry rings MAD</i>				clustering: COCALA* (p=0.057)	clustering: COCALA	NA	any	convergence: COCALA
	<i>association altitude / mimicry: KW</i>			NA	no	yes		no	no
	<i>mimicry rings: Wilcoxon</i>				COCALA vs SALMONEUS	COCALA vs SALMONEUS		COCALA vs SALMONEUS; IPHICLUS vs SALMONEUS	COCALA vs SALMONEUS

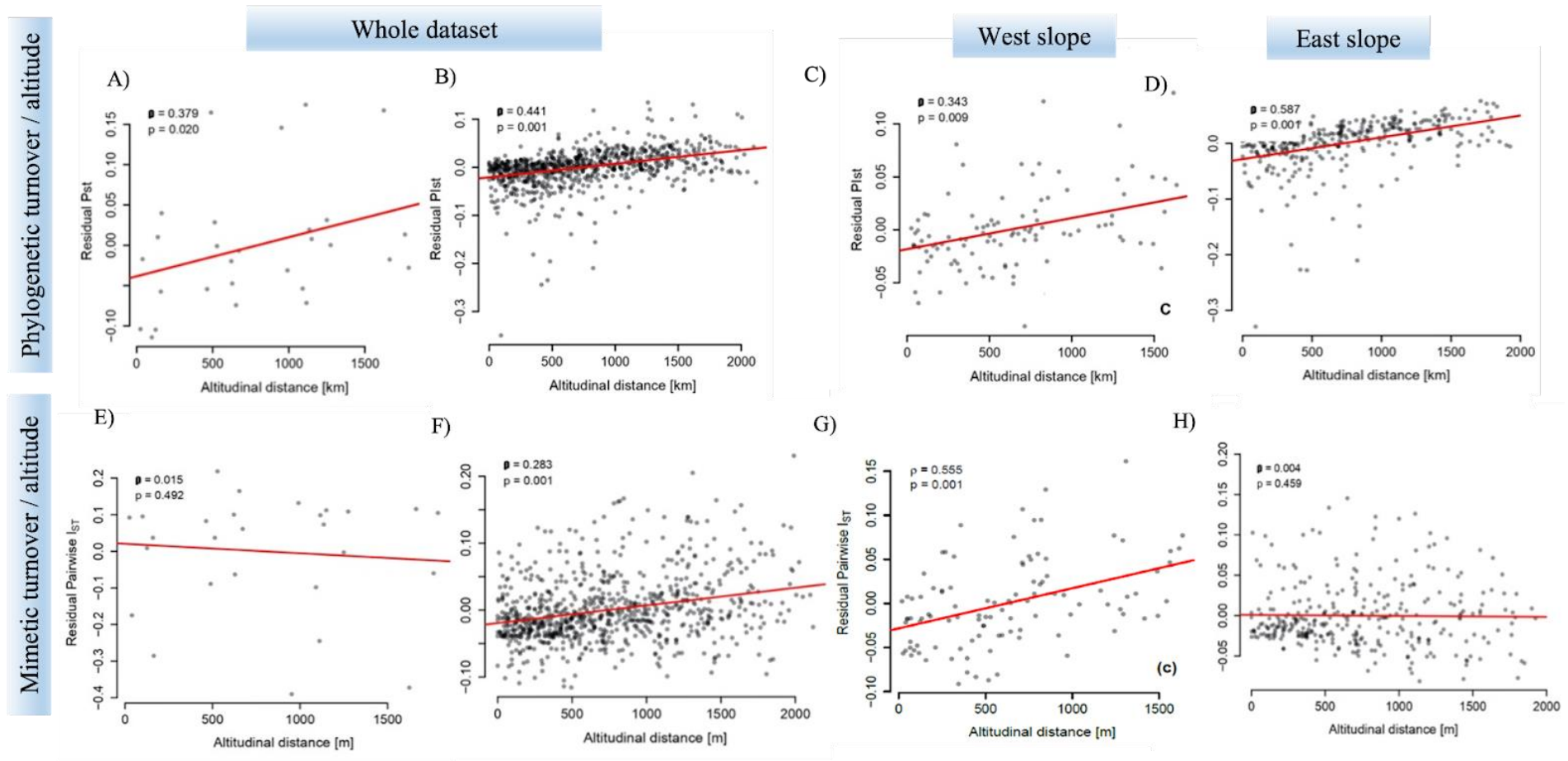

Figure 2. Phylogenetic and mimetic turnover associated with altitude. Plots showing the relationship among the residuals of the regression of pairwise P_{ST} or Π_{STobs} by geographic distances and the standardised pairwise altitudinal distances among communities. Plots from the whole dataset analyses P_{ST} (A) and Π_{STobs} (B). Plots from the Π_{STobs} West (C) and East (D) slopes. Plots showing the relationship among mimetic turnover (residuals of the regression of pairwise I_{ST}) by geographic distances and the standardised pairwise altitudinal distances among communities. Whole dataset: I_{ST} abundance (W) and incidence (F). I_{ST} West (G) and I_{ST} East (H) slopes.

Mimicry Structure of Communities

Analyses of spatial distribution of co-mimetic taxa showed that globally pairs of co-mimetic taxa present significantly lower mean Bray-Curtis distance than expected at random in both abundance ($BC_{obs} = 0.834$, CI 5% = 0.877, $p = 0.001$) and incidence datasets ($BC_{obs} = 0.801$, CI 5% = 0.807, $p = 0.014$), which indicates that co-mimetic taxa co-occur more often than expected at random. Within-mimicry ring analyses showed that co-mimetic *taxa* belonging to COCALA (abundance: $BC_{obs} = 0.797$, CI = 0.857 ; 0.923, $p = 0.001$; incidence: $BC_{obs} = 0.75$, CI = 0.782 ; 0.895, $p = 0.000$) and ROTHSCHILDI (abundance: $BC_{obs} = 0.067$, CI = 0.596 ; 1.00, $p = 0.047$; incidence: $BC_{obs} = 0.278$, CI = 0.396 ; 1.00, $p = 0.006$) mimicry rings co-occur more often than expected at random (see supplementary materials S2).

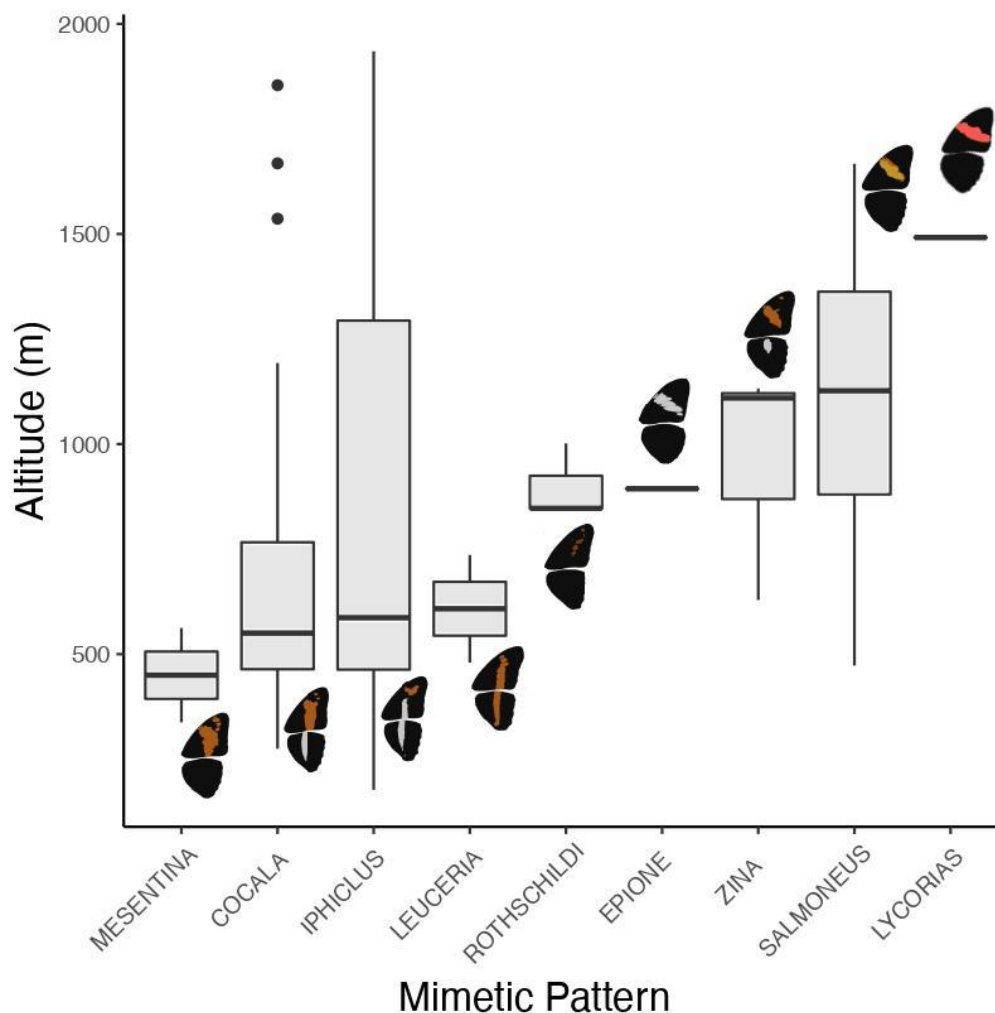

Figure 3. Boxplot of the altitudinal distribution of mimetic patterns in *Adelpha* communities in Ecuador. EPIONE mimetic pattern has a single diagonal white band in the forewing, while the LYCORIAS mimetic pattern harbours a single diagonal pink band in the forewing.

Partial Mantel tests showed that mimetic turnover (pairwise I_{ST}) across sites is positively related with altitudinal distance, independently of geographic distance, indicating mimicry turnover with altitude, but only for the incidence data set ($rM = 0.283$, $p = 0.001$) (Figure 2C, 2D, see supplementary materials S3).

Phylogenetic Signal, Altitude and Mimicry

Mean pairwise Phylogenetic Distance and Blomberg's K tests

Since we found a pattern of mimicry clustering along an altitudinal gradient (Figure 3), we tested whether this pattern could be caused by shared ancestry, or whether selective processes could also explain such convergence. We therefore first tested for phylogenetic signal in both mimicry colour patterns (MPD analysis), and altitudinal niches (Blomberg's K test). We found significant phylogenetic signal in both cases.

MPD between co-mimetic *taxa* was significantly lower than values in the null distribution for both abundance (MPD_{obs} = 14.35, MPD Q5 - 95 = 14.62; , $p = 0.007$), and incidence (MPD_{obs} = 14.98, MPD Q5 - 95 = 15.46; , $p = 0.001$) data sets which means that co-mimetic *taxa* are on average more closely related in our data than expected at random, i.e there is phylogenetic signal in mimicry patterns. Analyses for each mimicry ring indicated that for COCALA, ROTHSCHILDI, SALMONEUS and ZINA mimicry rings (except SALMONEUS for the abundance data set) there is a significant positive phylogenetic signal in the distribution of their mimetic colour pattern in the phylogeny (see supplementary material S4).

Blomberg's K analyses for testing phylogenetic signal on altitude showed that K value observed is higher than expected under the null hypothesis indicating a degree of phylogenetic signal (abundance: $K_{obs} = 0.419$, CI 95% = 0.4 , $p = 0.035$; incidence: $K_{obs} = 0.544$, CI95% = 0.352 , $p = 0.001$) (see supplementary materials S4).

Mean altitudinal distance – MAD

Since we found a phylogenetic signal in both traits, we assessed whether the similarity in altitudinal niche among co-mimetic *taxa* was due to shared ancestry or to convergent evolution. Globally, MAD analyses showed that altitudinal niches were significantly convergent among *Adelpha* co-mimetic *taxa*, but only for the abundance data set (MAD_{obs} = 0.737, CI = 0.887;1.08, $p = 0.001$) (incidence: MAD_{obs} = 0.945, CI = 0.882;1.051, $p = 0.247$). Per mimicry ring analyses showed that only COCALA presents significant convergence in altitudinal niche among *Adelpha* co-mimetic *taxa* for the abundance data set (MAD_{obs} = 0.528,

CI= 0.785;1.08, $p = 0.001$), while it was almost significant for the incidence data set ($MAD_{obs} = 0.77$, CI = 0.763;1.175, $p = 0.057$) (see supplementary materials S5).

Kruskal Wallis & Wilcoxon tests

Comparison between the observed and simulated Chi-square statistics extracted from the Kruskal - Wallis test showed that for COCALA, IPHICLUS and SALMONEUS mimicry rings the association between mimicry and altitudinal niche is stronger than expected under a neutral (λ) evolution model, but only for the abundance data set (Chi-square_{obs} = 9.38, CI 95% = 8.32, $p = 0.03$). The Pairwise Wilcoxon test at the mimicry ring level indicated that the altitudinal niche of co-mimetic taxa is significantly different between COCALA and SALMONEUS in both datasets (abundance: Chi-square_{obs} = 28.50, CI = 60.0;139.0, $p = 0.00$; incidence: Chi-square_{obs} = 67.00, CI = 0.00;107.0, $p = 0.00$), but not between COCALA and IPHICLUS; nor SALMONEUS and IPHICLUS (see supplementary materials S6).

West and East slope communities

Phylogenetic structure of communities

For W/E, the phylogenetic structure analysis (where phylogenetic turnover index [Π_{ST}] was computed only in the incidence dataset) showed phylogenetic overdispersion of species among West and East communities ($\Pi_{STobs} = -0.097$, CI = 0.006; 0.009, $p = 0.025$) (Figure 4, see supplementary materials S1).

For analyses focusing on either West or East slope, we found that on both slopes, communities are not phylogenetically structured: West: $\Pi_{STobs} = 0.005$; CI = -0.012;0.015, $p = 0.241$; East: $\Pi_{STobs} = -0.003$; CI = -0.013;0.018, $p = 0.423$ (see supplementary materials S1).

Yet, the detailed analysis using Partial Mantel tests showed a significant positive relationship between pairwise Π_{ST} and altitude, independently of geographic distance in both West ($rM = 0.343$, $p = 0.009$) and East ($rM = 0.587$, $p = 0.001$) slopes (Figure 2E, 2F, see supplementary materials S1).

Mimicry structure of communities

Bray-Curtis distance analyses for W/E showed that, globally, co-mimetic taxa co-occur more often than expected at random ($BC_{obs} = 0.406$, CI 5% = 0.42, $p = 0.018$), i. e., that the slopes of the Andes are differentiated with regard to mimicry. Per mimicry ring analyses showed co-

occurrence of co-mimetic taxa belonging to the COCALA mimicry ring ($BC_{obs} = 0.358$, $CI = 0.384;0.493$, $p = 0.011$) (see supplementary materials S2).

For separate analyses on either West or East slope, mimicry turnover (pairwise I_{ST}) across West communities is positively related with altitudinal distance, independently of geographic distance ($rM = 0.257$, $p = 0.001$), which is not the case for the East communities ($rM = 0.121$, $p = 0.462$) (see supplementary materials S3).

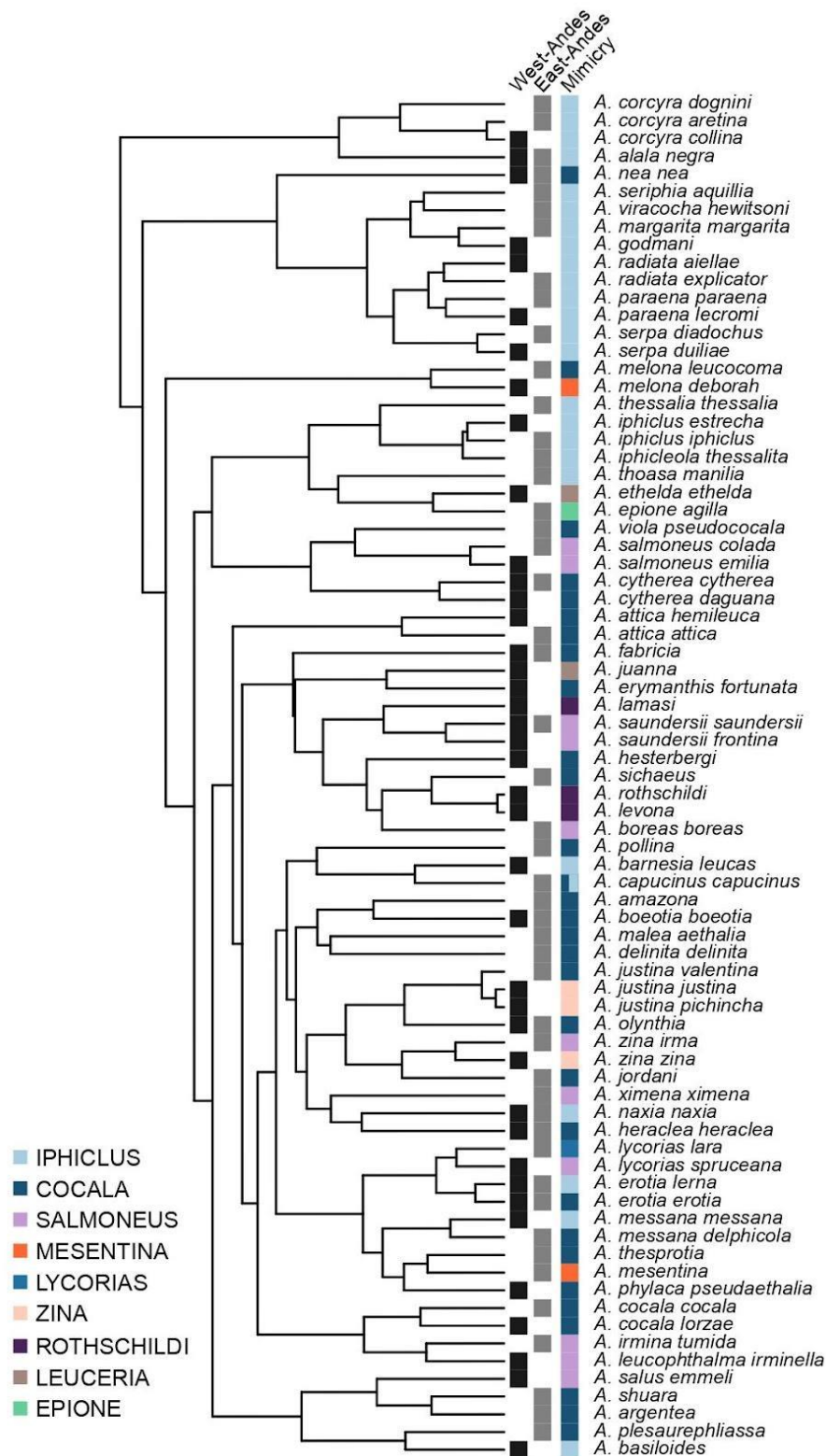

Figure 4. Phylogeny of *Adelpha* showing the distribution of *taxa* across the andean slope (first and second column) and mimicry pattern (third column).

Bray-Curtis distance analyses showed that globally, in both slopes, co-mimetic *taxa* do not co-occur more often than expected at random (West: $BC_{obs} = 0.701$, CI 5% = 0.653, $p = 0.563$; East: $BC_{obs} = 0.681$, CI 5% = 0.671, $p = 0.115$). Analyses per mimicry ring in the West slope showed co-occurrence of co-mimetic *taxa* belonging to the ROTHSCILDI mimicry ring ($BC_{obs} = 0.278$, CI = 0.344;1.00, $p = 0.015$). In the case of the East slope, we did not

found co-occurrence of co-mimetic taxa within mimicry rings (but almost significant for the COCALA mimicry ring ($BC_{obs} = 0.634$, $CI = 0.612;0.77$, $p = 0.057$) (see supplementary materials S2).

Partial Mantel tests showed that mimetic turnover (pairwise I_{ST}) across sites is positively related with altitudinal distance, independently of geographic distance, only for the West slope ($rM = 0.555$, $p = 0.001$) (Figure 2G, 2H, see supplementary materials S3).

Phylogenetic Signal, Altitude and Mimicry

Mean altitudinal distance – MAD

For analyses focusing on either West or East slope, we showed that globally, altitudinal niches among co-mimetic taxa do not differ from those simulated under the neutral evolution model in both slopes : West $MAD_{obs} = 0.962$, $CI = 0.847;1.107$, $p = 0.351$; East $MAD_{obs} = 0.924$, $CI = 0.895;1.073$, $p = 0.105$. Per mimicry ring analyses showed that only COCALA shows significant convergence in altitudinal niche among *Adelpha* co-mimetic taxa in the East slope ($MAD_{obs} = 0.807$, $CI = 0.805;1.165$, $p = 0.053$) (see supplementary materials S5).

Kruskal Wallis & Wilcoxon tests

Globally, the altitudinal niche of co-mimetic taxa is not explained by mimicry ring membership when both slopes West and East are analysed separately. Pairwise Wilcoxon test at the mimicry ring level indicated that altitudinal niche of co-mimetic taxa from West slope is significantly different between COCALA and SALMONEUS ($W_{obs} = 14.0$, $CI = 21.0;57.0$, $p = 0.011$) and SALMONEUS and IPHICLUS ($W_{obs} = 15.0$, $CI = 15.0 ; 57.0$, $p = 0.048$), but not between COCALA and IPHICLUS. In the case of East slope, the altitudinal niche is significantly different only between COCALA and SALMONEUS ($W_{obs} = 29.0$, $CI = 40.0; 105.0$, $p = 0.014$) (see supplementary materials S6).

Discussion

Our study explores for the first time the role of evasive mimicry, a type of positive interaction thus far overlooked in community ecology and evolution studies, in structuring *Adelpha* communities across altitudinal gradients. We found evidence supporting some of the patterns previously observed for the phylogenetic and mimicry structure of classical Müllerian mimetic communities.

Phylogenetic structure of communities, mimicry, and altitudinal clustering

The assembly of communities can be driven by deterministic niche-related processes (e.g., niche differentiation [Stubbs and Wilson 2004] and habitat filtering [e.g., Hoiss *et al.* 2012]); or by stochastic, neutral processes (limited dispersal coupled with demographic stochasticity [e.g. Hubbell 2001, Jabot and Bascompte 2012, Götzenberger *et al.* 2012]). These processes produce specific patterns of trait distribution, which, if traits are phylogenetically conserved, are reflected by specific phylogenetic patterns (overdispersion, clustering and random).

Several studies have demonstrated non-random phylogenetic structure in communities at different scales (e.g., tropical forests [Swenson *et al.* 2006]; bacteria communities [Horner-Devine and Bohannan 2006]), and across diverse taxa (e.g., lizards [Losos *et al.* 2003]; oak trees [Cavender-Bares *et al.* 2004]; tropical ectomycorrhizal fungi [Peay *et al.* 2010]; woody plants [Verdú and Pausas 2007]). In *Adelpha*, the observed global pattern of random phylogenetic structure seems to hide a finer structure along the altitudinal gradient. When looking at the relationship between phylogenetic turnover and altitude, we observed that phylogenetic differences correlate positively with altitudinal differences, i.e., communities are phylogenetically clustered by altitude (see Hall 2005, Willmott, Hall, and Lamas 2001, for counter examples of upward speciation across an elevational gradient in Neotropical butterflies). This is not surprising since butterfly species and communities are dependent on ambient temperature and humidity (Hawkins 2010, Hawkins y DeVries 2009), which are highly correlated with altitude. Thus, altitude might act as a filter to species that harbour specific physiological adaptations to perform in cooler environments, leading to communities that are phylogenetically clustered. In addition, temperature has proven to be a limiting factor for species richness in temperate regions (Hawkins 2010). In *Adelpha*, a sharp decrease in species richness occurs at higher altitudes (Willmott 2003b), which suggests that altitude might act as a filter limiting species distribution. This result is reminiscent of Chazot's *et al.* (2014) study on Andean communities of ithomiine butterflies. They showed that community composition is strongly structured along the Andean altitudinal gradient (see Table 3), with increasing phylogenetic clustering at higher altitudes, suggesting that altitude exerts a strong filter on ithomiine lineages. Similar patterns of phylogenetic clustering at higher altitudes are known in other taxa (e.g., tropical hummingbird communities in the Andes [Graham *et al.* 2009]; ant communities in temperate altitudinal gradients in the USA and in Austria [Machac *et al.* 2011]; bee communities along altitudinal gradients in the Alps, Germany [Hoiss *et al.* 2012], and this is not surprising because colonisation of a new altitudinal niche entails adaptation to various abiotic factors such as temperature, atmospheric pressure, humidity, light,

among others (Hawkins 2010; Hawkins and DeVries 2009). Evasive butterflies, with their powerful flight, might be more sensitive to the thermal environment because of their physiological needs for maintaining their fast flight. Altitude, which is strongly correlated with temperature, might thus result in strong segregation in evasive prey communities.

Interestingly, when comparing West and East slopes, we found that species pools on each side are phylogenetically overdispersed (species within a single slope are on average more distantly related than are species from opposite slopes). In a hypothetical scenario of allopatric speciation in *Adelpha*, this could occur either via: a) dispersal, e.g., from one side of the Andes to the other, followed by speciation; or b) vicariance (e.g., separation of continuous populations through the uplift of the northern Andes and further speciation). For example, in mimetic butterflies from the genus *Ithomia* and *Napeogenes* (Nymphalidae: Ithomiini), it was shown that the Andes played a role in their diversification by vicariance, but also via the intricate topology and environmental gradient of the slopes that offered new areas and habitats that could be rapidly colonised as they became available (Elias *et al.* 2009). In the widespread butterfly subtribe, Oleriina (Nymphalidae: Ithomiini), it was also shown that the Andean uplift had an important role for its diversification, with some events of vicariant speciation, and further dispersal when geological barriers disappeared (De-Silva *et al.* 2016).

Willmott (2003a) explored slope-specific patterns in the Ecuadorian Andes for lowland and montane *Adelpha* species and also compared western Ecuador with the Costa Rica/west Panama communities (the Transandean and Chiriquí biogeographic regions). He did not find strong evidence for the Andean orogeny as a vicariant event contributing to speciation in either lowland or montane *Adelpha*. Although it is not clear whether species have crossed over or dispersed around the northern Andes, our results suggest that montane *Adelpha* have evolved over a relatively long time period from numerous lineages, but that the distribution of species, and often sister or closely related species, on either Andean slope is a relatively recent phenomenon. Migrating lineages could come from a variety of sources: i) from different adjacent regions (e.g., *A. juanna* [Andes]/*A. erymanthis* [Central America]); ii) from adjacent elevations within the same slope (e.g., *A. argentea* [high-elevation]/*shuara* [mid-elevation]; *A. zina* [mid-elevation]/*jordani*(lowland)); iii) from the same slope at the same elevation (*A. levona*/ *A. rothschildi*). Nevertheless, the last two of these mechanisms, which would result in phylogenetic clustering within slopes, seem to be relatively rare. Instead, species at a particular elevation (e.g., 1500 m) on the east slope have a variety of origins (from different montane regions, different elevations, etc.) and as a result species may be relatively distantly related

within the slope. Furthermore, because most *Adelpha* have a large distribution range, species at the same elevation (e.g., 1500m) on the west slopes are often the same species as the east slope (usually represented by different subspecies) or sister species. Closely related species that replace one another on each slope, such as *A. epione* and *A. ethelda*, but are distantly related to other *Adelpha* within their slope support this scenario. In Ithomiini (Doré unpublished analyses) a non-significant trend towards clustering across the Andes was observed (i.e., ithomiine species on the eastern slope tend to be more closely related to each other than they would be to the fauna present at the same elevation on the west slope), probably due to greater importance of within-slope speciation and endemism in ithomiines compared with *Adelpha*.

A historical biogeographic approach with the now-available comprehensive phylogeny is needed to reveal spatio-temporal patterns of diversification and examine the origins of montane *Adelpha* in more detail.

Finally, the global absence of phylogenetic structure is very likely due to two different processes at play and at different levels, i.e., overdispersion across slopes and clustering due to altitudinal filtering within slope. The idea of opposite patterns cancelling out or compensating each other was already proposed by Hardy and Senterre (2007). They suggested that co-occurring clustering and overdispersion patterns at different levels in forest tree communities in Equatorial Guinea might sometimes compensate for each other, leading to an apparent overall absence of community structure.

Other processes, such as competition, operating at various spatial scales, could be shaping these communities as well. For example, in communities of catfish species, co-occurrence of co-mimetic species was observed at a large scale, while ecological divergence (diet partitioning and morphological dissimilarity) was operating at a local scale. In ithomiine butterflies, Elias *et al.* (2008) and Willmott *et al.* (2017) showed microhabitat segregation among species and mimicry rings. *Adelpha* butterflies could also present microhabitat segregation at another scale, since their fast flight requires a sunny environment to perform their strong flight, such as at the canopy level, hilltops or forest gaps, but to date there is limited evidence for such segregation.

Weak selection for convergence in evasive mimicry?

The altitudinal segregation observed in *Adelpha* could be due to phylogenetic inertia or to selection (despite phylogenetic signal). We found evidence for convergence among co-mimetic

Adelpha species in two out of the three mimicry patterns analysed, i.e., COCALA and SALMONEUS (our analyses did not allow us to explore all the mimicry patterns in *Adelpha* due to some being represented only by a very few taxa). Co-occurrence of co-mimetic species and adaptive association between altitude and mimicry has been reported in classical Mullerian mimetic butterflies (e.g., Ithomiini [Chazot *et al* 2014, Doré *et al.* submitted], *Heliconius* (Pérochon *et al* 2021 master's thesis). Chazot *et al* (2014) found that co-mimetic species co-occur more often than expected at random, and found a strong mimicry turnover in ithomiine communities along the east Andean altitudinal gradient (see Table 2). *Adelpha* communities show, to some degree, a similar pattern: Globally, co-mimetic *taxa* tend to co-occur more often than expected (only for Bray Curtis distance analysis). When looking at individual mimicry rings this pattern is only observed in COCALA and ROTHSCHILDI. Since COCALA is the most abundant mimicry ring (and second most species-rich pattern), it is likely that this mimicry ring may be driving the overall pattern. In the case of the IPHICLUS mimicry ring (the most species-rich mimicry ring), we did not find evidence for co-occurrence of co-mimetic taxa (and no phylogenetic signal), possibly because this mimicry pattern is inferred to be ancestral for *Adelpha* (see Chapter II) and is present in multiple lineages and sites. In their theoretical model, (Ruxton, Speed and Sherratt 2004) showed that in an evasive system Müllerian mimicry is more likely to evolve when predators learn slowly. However, predators seem to learn faster to avoid evasive than unpalatable prey, and also to generalise more broadly signals associated with evasiveness (Páez *et al.* 2021). Moreover, predator education in evasive systems does not always entail death - on the contrary, the most successful evasive prey, which should elicit the fastest learning, do not die. As a consequence, selection for colour pattern convergence and co-occurrence might be weaker among evasive than unpalatable species. This may explain why convergence of colour patterns and co-occurrence of co-mimetic species is not as strong as in mimicry systems based on unpalatability (Chazot *et al* 2014). In addition, perhaps convergence of mimicry patterns of communities at high elevation is stronger than in low altitude communities given that escaping ability is more limited for longer periods of the day. Indeed, the mathematical model of (Ruxton, Speed and Sherratt 2004) suggested that evasive mimicry is more likely when evading capture is costly to the prey, which may be the case at higher elevations. Our analyses did not allow us to assess this hypothesis, but indirect evidence, notably the lower number of mimicry rings at higher altitudes, suggests that this might be the case.

***Adelpha*: an excellent example for the conventional hypothesis of universal monomorphic Müllerian mimicry?**

Historically, local and geographic diversity in aposematic signals has been considered paradoxical (Reviewed by (Joron and Mallet 1998). Natural selection is thought to favour monomorphism in warning signals (Poulton 1890) since predators should select for a single warning signal as a result of frequency-dependent learning. Strong predator selection on unfamiliar phenotypes has been supported by many examples in the field (e.g., Mallet and Barton 1989, Chouteau, Arias and Joron 2016, Borer *et al.* 2010). Yet, in practice there is often a high diversity of mimicry patterns in classical mimetic systems. A striking example is the mimetic polymorphism evidenced in *Heliconius numata* which presents a high geographic colour pattern diversity within mimetic species in the Amazon Basin (Brown and Benson 1974, Mathieu Joron *et al.* 1999).

The mechanisms proposed to explain diversity of mimicry patterns can be divided into those that a) select for diversity, notably reproductive interference (e.g., Brown and Wilson 1956, Gröning and Hochkirch 2008, Hochkirch, Gröning and Bückler 2007), sexual harassment (e.g., Merrill *et al.* 2018), optimal foraging (Aubier and Sherratt 2015); b) produce diversity by chance such as shifting balance (Joron and Mallet 1998, Sherratt 2006); and c) further maintain diversity, e.g., heterogeneous predation pressure, microhabitat segregation (Beccaloni 1997, Gompert, Willmott and Elias 2011, Willmott *et al.* 2017a).

We suggested that selection for convergence is weaker in evasive systems, thus it is expected that lower selection for convergence, compared to classical systems, should lead to the maintenance of more mimicry rings, each of them being well defended. However, *Adelpha*'s mimicry ring diversity is low i.e., 9 putative mimicry rings in total (and the same is possibly true in other evasive mimicry complexes e.g., pierids, skipper butterflies [Hesperiidae], *Morpho* butterflies), compared with clades of classical Müllerian mimics (e.g., ithomiine subtribes Dircennina, 101 species, 29 mimicry rings; Oleriina, 63 spp, 24 mimicry rings [Doré *et al.* 2021]).

Two potential explanations for low mimetic diversity on *Adelpha* compared to classical systems could be the following:

- Wider distribution ranges and thus less geographical segregation, which may reduce the possibilities of selection and colour pattern divergence.
- In classical mimetic systems, selection for colour pattern convergence is strong, which may select for colour pattern evolvability. This should lead to pervasive evolution of

new colour patterns, most of which are eliminated by purifying selection, but some of which may get established due to locally relaxed selection (shifting balance, [Mallet and Singer 1987, Chouteau and Angers 2012, an example for mimetic frogs]) or processes that favour shifts in mimicry patterns (Boussens-Dumon and Llaurens 2021). Selection on colour pattern evolvability is therefore likely weaker in evasive mimetic systems, resulting in a lower diversity of mimicry patterns.

Thus, it is possible that the high mimetic diversity within Ithomiini and *Heliconius* is the phenomenon that requires explanation, rather than relatively low mimetic diversity in *Adelpha*.

Conclusion

We assessed the phylogenetic structure of communities of a group of butterflies that are potentially involved in Müllerian mimetic interactions based on evasiveness. Some of our findings are similar to those of previous studies in classical mimicry systems (where prey is unpalatable), such as altitudinal clustering by mimicry (although this pattern is not as strong as classical mimicry), which we attribute to environmental, i.e., thermal, constraints for strong flight in evasive prey. Moreover, the global lack of phylogenetic structure contrary to the clustering pattern observed in previous studies on unpalatable prey might be explained by an antagonist effect of the altitudinal clustering pattern, and the overdispersion pattern observed at a finer scale (when analysing communities across the West/East Andean slopes). An interesting finding was that a large proportion of recent speciation or divergence events in *Adelpha* in Ecuador might have occurred across the Andes, rather than within slopes, whereas deeper divergence events were apparently more diverse in origin, leading to relatively distantly related species within each slope. Finally, we suggest that weak evidence for co-occurrence and for adaptive association between altitude and mimicry could be due to relatively low selection from predation since learning in evasive prey is fast and rarely entails the death of the prey.

It is important to consider that in this study we are necessarily more speculative because the characteristics of evasive mimicry have only recently received more discussion, and hypotheses about mechanisms need to be developed and evaluated. We hope that this chapter will stimulate research to better characterise the features of evasive mimicry and to better understand the mechanistic processes that produce them.

References

- Aiello, Annette. 1984. "Adelpha (Nymphalidae): Deception on the Wing". *Psyche* 91 (1-2): 1-45. <https://doi.org/10.1155/1984/87930>.
- Alexandrou, Markos A., Claudio Oliveira, Marjorie Maillard, Rona A.R. McGill, Jason Newton, Simon Creer, and Martin I. Taylor. 2011. "Competition and phylogeny determine community structure in Müllerian co-mimics". *Nature* 469 (7328): 84-89. <https://doi.org/10.1038/nature09660>.
- Aubier, Thomas G., and Thomas N. Sherratt. 2015. "Diversity in Müllerian mimicry: The optimal predator sampling strategy explains both local and regional polymorphism in prey". *Evolution* 69 (11): 2831-45. <https://doi.org/10.1111/evo.12790>.
- Barber, Jesse R., Brian C. Leavell, Adam L. Keener, Jesse W. Breinholt, Brad A. Chadwell, Christopher J. W. McClure, Geena M. Hill, and Akito Y. Kawahara. 2015. "Moth Tails Divert Bat Attack: Evolution of Acoustic Deflection". *Proceedings of the National Academy of Sciences* 112 (9): 2812-16. <https://doi.org/10.1073/pnas.1421926112>.
- Bates, Henry Walter. 1862. "Contributions to an insect fauna of the Amazon Valley. Lepidoptera: Heliconidae". *Transactions of the Linnean Society of London* 23: 495-566.
- Beccaloni, George W. 1997. "Vertical stratification of ithomiine butterfly (Nymphalidae: Ithomiinae) mimicry complexes: The relationship between adult flight height and larval host-plant height". *Biological Journal of the Linnean Society* 62 (3): 313-41. <https://doi.org/10.1006/bijl.1997.0165>.
- Blomberg, Simon P, Theodore Jr Garland, and Anthony R Ives. 2003. "Testing for phylogenetic signal in comparative data: Behavioural traits are more labile". *Evolution* 57 (4): 717-45.

- Borer, Matthias, Tom Van Noort, Martine Rahier, and Russell E. Naisbit. 2010. "Positive frequency-dependent selection on warning color in alpine leaf beetles". *Evolution* 64 (12): 3629-33. <https://doi.org/10.1111/j.1558-5646.2010.01137.x>.
- Boussens-Dumon, Grégoire, and Violaine Llaurens. 2021. "Sex, competition and mimicry: an eco-evolutionary model reveals unexpected impacts of ecological interactions on the evolution of phenotypes in sympatry". *Oikos* 130 (11): 2028-39. <https://doi.org/10.1111/oik.08139>.
- Bray, J. Roger, and J. T. Curtis. 1957. "An Ordination of the Upland Forest Communities of Southern Wisconsin". *Ecological Monographs* 27 (4): 325-49. <https://doi.org/10.2307/1942268>.
- Brown Jr, Keith S, and João Vasconcellos Neto. 1976. "Predation on Aposematic Ithomiine Butterflies by Tanagers (*Pipraeidea melanonota*)". *Biotropica* 8 (2): 136-41.
- Brown, Keith S., and Woodruff W. Benson. 1974. "Adaptive Polymorphism Associated with Multiple Mullerian Mimicry in *Heliconius numata* (Lepid. Nymph.)". *Biotropica* 6 (4): 205. <https://doi.org/10.2307/2989666>.
- Brown, L.W., y E.O. Wilson. 1956. "Character Displacement". *Systematics Zoology* 5 (2): 49-64.
- Bruno, John F., John J. Stachowicz, and Mark D. Bertness. 2003. "Inclusion of facilitation into ecological theory". *Trends in Ecology and Evolution* 18 (3): 119-25. [https://doi.org/10.1016/S0169-5347\(02\)00045-9](https://doi.org/10.1016/S0169-5347(02)00045-9).
- Carpenter, Hale. 1941. "The Relative Frequency of Beak-marks on Butterflies of Different Edibility to Birds." *Proceedings of the Zoological Society of London* 111 (3-4): 223-31.

- Cavender-Bares, J., D. D. Ackerly, D. A. Baum, and F. A. Bazzaz. 2004. "Phylogenetic overdispersion in Floridian oak communities". *American Naturalist* 163 (6): 823-43. <https://doi.org/10.1086/386375>.
- Chai, Peng. 1988. "Wing Coloration of Free-Flying Neotropical Butterflies as a Signal Learned by a Specialized Avian Predator". *Biotropica* 20 (1): 20-30.
- Chai, Peng, y Robert B Srygley. 1990. "Predation and the Flight, Morphology, and Temperature of Neotropical Rain-Forest Butterflies". *The American Naturalist* 135 (6): 748-65.
- Chazot, Nicolas, Keith R. Willmott, Paola G. Santacruz Endara, Alexandre Toporov, Ryan I. Hill, Chris D. Jiggins and Marianne Elias. 2014. "Mutualistic Mimicry and Filtering by Altitude Shape the Structure of Andean Butterfly Communities". *The American Naturalist* 183 (1): 26-39. <https://doi.org/10.1086/674100>.
- Chouteau, Mathieu, and Bernard Angers. 2012. "Wright's Shifting Balance Theory and the Diversification of Aposematic Signals". Editado por Daniel Ortiz-Barrientos. *PLoS ONE* 7 (3): e34028. <https://doi.org/10.1371/journal.pone.0034028>.
- Chouteau, Mathieu, Mónica Arias, and Mathieu Joron. 2016. "Warning signals are under positive frequency-dependent selection in nature". *Proceedings of the National Academy of Sciences of the United States of America* 113 (8): 2164-69. <https://doi.org/10.2307/26467824>.
- De-Silva, Donna Lisa, Marianne Elias, Keith Willmott, James Mallet, and Julia J. Day. 2016. "Diversification of Clearwing Butterflies with the Rise of the Andes". *Journal of Biogeography* 43 (1): 44-58. <https://doi.org/10.1111/jbi.12611>.
- Devries, Philip J. 2003. "Tough African Models And Weak Mimics: New Horizons In The Evolution Of Bad Taste". *Journal of Lepidopterists' Society* 57 (3): 235-38.

DeVries P.J. 1987. *The butterflies of Costa Rica and their natural history. Vol. I: Papilionidae, Pieridae, Nymphalidae*. Princeton, NJ: Princeton University Press.

Doré, Maël, Keith Willmott, Boris Leroy, Nicolas Chazot, James Mallet, André V. L. Freitas, Jason P. W. Hall, et al. 2021. “Anthropogenic Pressures Coincide with Neotropical Biodiversity Hotspots in a Flagship Butterfly Group”. Editado por Deyan (HOTSP) Ge. *Diversity and Distributions*, diciembre, ddi.13455. <https://doi.org/10.1111/ddi.13455>.

Doré, M., Willmott, K., Leroy, B., Chazot, N., Mallet, J., Freitas, A. V. L., Hall, J. P. W., Lamas, G., Dasmahapatra, K. K., Fontaine, C., and Elias, M. 2021. Ithomiini mimicry classification. <https://doi.org/10.5281/ZENODO.5564985>

Doré, Mäel, Keith R. Willmott, Sebastien Lavergne, Nicolas Chazot, André V.L Freitas, Colin Fontaine, and Marianne Elias. 2022. “Mutualistic interactions shape global spatial congruence and climatic niche evolution in Neotropical mimetic butterflies”. *PNAS*.

Ebel, Emily R., Jeffrey M. Dacosta, Michael D. Sorenson, Ryan I. Hill, Adriana D. Briscoe, Keith R. Willmott, and Sean P. Mullen. 2015. “Rapid diversification associated with ecological specialization in Neotropical Adelpha butterflies”. *Molecular Ecology* 24 (10): 2392-2405. <https://doi.org/10.1111/mec.13168>.

Elias, M., M. Joron, K. Willmott, K. L. Silva-Brandão, V. Kaiser, C. F. Arias, L. M. Gomez Piñerez, et al. 2009. “Out of the Andes: Patterns of diversification in clearwing butterflies”. *Molecular Ecology* 18 (8): 1716-29. <https://doi.org/10.1111/j.1365-294X.2009.04149.x>.

Elias, Marianne, Zachariah Gompert, Chris Jiggins, and Keith Willmott. 2008. “Mutualistic interactions drive ecological niche convergence in a diverse butterfly community.” *PLoS biology* 6 (12). <https://doi.org/10.1371/journal.pbio.0060300>.

Elias, Marianne, Zachariah Gompert, Keith Willmott, and Chris Jiggins. 2009. “Phylogenetic community ecology needs to take positive interactions into account: Insights from

- colorful butterflies”. *Communicative and Integrative Biology* 2 (2): 113-16. <https://doi.org/10.4161/cib.7718>.
- Ellington, C. P. 1984. “The Aerodynamics of Hovering Insect Flight. III. Kinematics”. *Philosophical Transactions of the Royal Society of London. B, Biological Sciences* 305 (1122): 41-78. <https://doi.org/10.1098/rstb.1984.0051>.
- Gibson, Dianne O. 1974. “Batesian mimicry without distastefulness?” *Nature* 250 (julio): 77-79. <https://doi.org/10.1038/250077a0>.
- Gibson, Dianne O. 1980. “The role of escape in mimicry and polymorphism: I. The response of captive birds to artificial prey”. *Biological Journal of the Linnean Society* 14: 201-14. <https://doi.org/10.1111/j.1095-8312.1980.tb00105.x>.
- Gompert, Zachariah, Keith Willmott, and Marianne Elias. 2011. “Heterogeneity in predator micro-habitat use and the maintenance of Müllerian mimetic diversity”. *Journal of Theoretical Biology* 281: 39-46. <https://doi.org/10.1016/j.jtbi.2011.04.024>.
- Götzenberger, Lars, Francesco de Bello, Kari Anne Bråthen, John Davison, Anne Dubuis, Antoine Guisan, Jan Lepš, et al. 2012. “Ecological assembly rules in plant communities-approaches, patterns and prospects”. *Biological Reviews* 87 (1): 111-27. <https://doi.org/10.1111/j.1469-185X.2011.00187.x>.
- Graham, Catherine H., Juan L. Parra, Carsten Rahbek, and Jimmy A. McGuire. 2009. “Phylogenetic structure in tropical hummingbird communities”. *Proceedings of the National Academy of Sciences of the United States of America* 106 (SUPPL. 2): 18435-36. <https://doi.org/10.1073/pnas.0912879107>.
- Gröning, Julia, and Axel Hochkirch. 2008. “Reproductive interference between animal species”. *Quarterly Review of Biology* 83 (3): 257-82. <https://doi.org/10.1086/590510>.

- Gross, Kevin. 2008. "Positive interactions among competitors can produce species-rich communities". *Ecology Letters* 11 (9): 929-36. <https://doi.org/10.1111/j.1461-0248.2008.01204.x>.
- Hall, Jason P.W. 2005. "Montane speciation patterns in Ithomiola butterflies (Lepidoptera: Riodinidae): Are they consistently moving up in the world?" *Proceedings of the Royal Society B: Biological Sciences* 272 (1580): 2457-66. <https://doi.org/10.1098/rspb.2005.3254>.
- Hancox, A. P., and J. A. Allen. 1991. "A simulation of evasive mimicry in the wild". *Journal of Zoology* 223 (1): 9-13. <https://doi.org/10.1111/j.1469-7998.1991.tb04745.x>.
- Hardy, Olivier J., and Bruno Senterre. 2007. "Characterizing the phylogenetic structure of communities by an additive partitioning of phylogenetic diversity". *Journal of Ecology* 95 (3): 493-506. <https://doi.org/10.1111/j.1365-2745.2007.01222.x>.
- Hawkins, Bradford A. 2010. "Multiregional Comparison of the Ecological and Phylogenetic Structure of Butterfly Species Richness Gradients". *Journal of Biogeography* 37 (4): 647-56. <https://doi.org/10.1111/j.1365-2699.2009.02250.x>.
- Hawkins, Bradford A., and Philip J. DeVries. 2009. "Tropical Niche Conservatism and the Species Richness Gradient of North American Butterflies". *Journal of Biogeography* 36 (9): 1698-1711. <https://doi.org/10.1111/j.1365-2699.2009.02119.x>.
- Hill, Ryan I. 2021. "Convergent flight morphology among Müllerian mimic mutualists". *Evolution* 75 (10): 2460-79. <https://doi.org/10.1111/evo.14331>.
- Hochkirch, Axel, Julia Gröning, and Amelie Bucker. 2007. "Sympatry with the devil: Reproductive interference could hamper species coexistence". *Journal of Animal Ecology* 76 (4): 633-42. <https://doi.org/10.1111/j.1365-2656.2007.01241.x>.
- Hoiss, Bernhard, Jochen Krauss, Simon G. Potts, Stuart Roberts, and Ingolf Steffan-Dewenter. 2012. "Altitude acts as an environmental filter on phylogenetic composition, traits and

- diversity in bee communities”. *Proceedings of the Royal Society B: Biological Sciences* 279 (1746): 4447-56. <https://doi.org/10.1098/rspb.2012.1581>.
- Horner-Devine, M. Claire and Brendan J. M. Bohannan. 2006. “Phylogenetic Clustering and Overdispersion in Bacterial Communities”. *Ecology* 87 (7): S100-108.
- Hubbell, Stephen P. 2001. *The Unified Neutral Theory of Biodiversity and Biogeography*. Princeton University Press.
- Huey, Raymond B. 1991. “Physiological Consequences of Habitat Selection”. *The American Naturalist* 137 (junio): S91-115. <https://doi.org/10.1086/285141>.
- Jabot, Franck, and Jordi Bascompte. 2012. “Bitrophic Interactions Shape Biodiversity in Space”. *Proceedings of the National Academy of Sciences* 109 (12): 4521-26. <https://doi.org/10.1073/pnas.1107004109>.
- Jantzen, B., and T. Eisner. 2008. “Hindwings are unnecessary for flight but essential for execution of normal evasive flight in Lepidoptera”. *Proceedings of the National Academy of Sciences* 105 (43): 16636-40. <https://doi.org/10.1073/pnas.0807223105>.
- Jenkins, DW. 1983. “Neotropical Nymphalidae I. Revision of Hamadryas”. *Bull Allyn Mus* 81: 1-46.
- Joron, Mathieu, and James L Mallet. 1998. “Diversity in mimicry: paradox or paradigm?”. *Trends in ecology & evolution* 13 (11): 461-66. [https://doi.org/10.1016/S0169-5347\(98\)01483-9](https://doi.org/10.1016/S0169-5347(98)01483-9).
- Joron, Mathieu, Ian R. Wynne, Gerardo Lamas, and James Mallet. 1999. “Variable selection and the coexistence of multiple mimetic forms of the butterfly *heliconius numata*”. *Evolutionary Ecology* 13 (7-8): 721-54. <https://doi.org/10.1023/A:1010875213123>.
- Kingsolver, Joel G. 1985. “Thermoregulatory significance of wing melanization in *Pieris* butterflies (Lepidoptera: Pieridae): physics, posture, and pattern”. *Oecologia* 66 (4): 546-53. <https://doi.org/10.1007/BF00379348>.

- Kingsolver, Joel G., and M. A. R. Koehl. 1985. "Aerodynamics, Thermoregulation, and the Evolution of Insect Wings: Differential Scaling and Evolutionary Change", *Evolution* 17.
- Kraft, Nathan J.B., William K. Cornwell, Campbell O. Webb, and David D. Ackerly. 2007. "Trait evolution, community assembly, and the phylogenetic structure of ecological communities". *American Naturalist* 170 (2): 271-83. <https://doi.org/10.1086/519400>.
- Lindroth, Carl H. 1971. "Disappearance as a Protective Factor". *Ent. scand.* 2: 41-48.
- Losos, Jonathan B., Manuel Leal, Richard E. Glor, Kevin De Queiroz, Paul E. Hertz, Lourdes Rodríguez Schettino, Ada Chamizo Lara, Todd R. Jackman, and Allan Larson. 2003. "Niche lability in the evolution of a Caribbean lizard community". *Nature* 424 (6948): 542-45. <https://doi.org/10.1038/nature01814>.
- Lovette, Irby J., and Wesley M. Hochachka. 2006. "Simultaneous effects of phylogenetic niche conservatism and competition on avian community structure". *Ecology* 87 (7 SUPPL.): 14-28. [https://doi.org/10.1890/0012-9658\(2006\)87\[14:seopnc\]2.0.co;2](https://doi.org/10.1890/0012-9658(2006)87[14:seopnc]2.0.co;2).
- M. Pagel. 1999. "Inferring the historical patterns of biological evolution". *Nature* 401 (October 1999): 877-84.
- Machac, Antonin, Milan Janda, Robert R. Dunn, and Nathan J. Sanders. 2011. "Elevational gradients in phylogenetic structure of ant communities reveal the interplay of biotic and abiotic constraints on diversity". *Ecography* 34 (3): 364-71. <https://doi.org/10.1111/j.1600-0587.2010.06629.x>.
- Mallet, James, and Nicholas H Barton. 1989. "Strong natural selection a warning-color hybrid zone". *Evolution* 43 (2): 421-31. <https://doi.org/10.1111/j.1558-5646.1989.tb04237.x>.
- Mallet, James, and Michael Singer. 1987. "Individual selection, kin selection, and the shifting balance in the evolution of warning colours: the evidence from butterflies". *Biological*

- Journal of the Linnean Society* 32: 337-50. <https://doi.org/10.1111/j.1095-8312.1987.tb00435.x>.
- Marsh, N., Rothschild, M. 1974. "Aposematic and cryptic lepidoptera tested on mouse". pp. 89-122
- Merrill, Richard M., Sara Neggazi, Colin R. Morrison, Rachel Crisp, and W. Owen McMillan. 2018. "Experimental Manipulation of *Heliconius* Warning Patterns Reduces Harassment of Previously Mated Females". Preprint. *Evolutionary Biology*. <https://doi.org/10.1101/437525>.
- Molleman, Freerk, Juhan Javoš, Robert B. Davis, Melissa R.L. Whitaker, Toomas Tammaru, Andreas Prinzing, Erki Õunap, et al. 2020. "Quantifying the effects of species traits on predation risk in nature: A comparative study of butterfly wing damage". *Journal of Animal Ecology* 89 (3): 716-29. <https://doi.org/10.1111/1365-2656.13139>.
- Mullen, Sean P., Wesley K. Savage, Niklas Wahlberg, and Keith R. Willmott. 2011. "Rapid diversification and not clade age explains high diversity in neotropical Adelpha butterflies". *Proceedings of the Royal Society B: Biological Sciences* 278 (1713): 1777-85. <https://doi.org/10.1098/rspb.2010.2140>.
- Muller, F. 1879. "Ituna and Thyridia; a remarkable case of Mimicry in Butterflies". *Proc. R. Ent. Soc. Lond.*, xx-xxix.
- Okuyama, Toshinori. 2015. "Optimal Foraging Behavior with an Explicit Consideration of Within-Individual Behavioral Variation: An Example of Predation". *Evolutionary Ecology* 29 (4): 599-607. <https://doi.org/10.1007/s10682-015-9758-7>.
- Olofsson, Martin, Adrian Vallin, Sven Jakobsson, and Christer Wiklund. 2010. "Marginal Eyespots on Butterfly Wings Deflect Bird Attacks Under Low Light Intensities with UV Wavelengths". Edited por Tom Pizzari. *PLoS ONE* 5 (5): e10798. <https://doi.org/10.1371/journal.pone.0010798>.

- Páez, Erika, Janne K. Valkonen, Keith R. Willmott, Pável Matos-Maraví, Marianne Elias, and Johanna Mappes. 2021. "Hard to catch: Experimental evidence supports evasive mimicry". *Proceedings of the Royal Society B: Biological Sciences* 288 (1946): 1-10. <https://doi.org/10.1098/rspb.2020.3052>.
- Peay, Kabir G., Peter G. Kennedy, Stuart J. Davies, Sylvester Tan, and Thomas D. Bruns. 2010. "Potential link between plant and fungal distributions in a dipterocarp rainforest: Community and phylogenetic structure of tropical ectomycorrhizal fungi across a plant and soil ecotone". *New Phytologist* 185 (2): 529-42. <https://doi.org/10.1111/j.1469-8137.2009.03075.x>.
- Pinheiro, Carlos E.G. 1996. "Palatability and escaping ability in Neotropical butterflies : tests with wild kingbirds (*Tyrannus melancholicus*, Tyrannidae)". *Biological Journal of the Linnean Society* 59: 351-65.
- Pinheiro, Carlos E. G. 2003. "Does Müllerian Mimicry Work in Nature? Experiments with Butterflies and Birds (Tyrannidae)". *Biotropica* 35 (3): 356-64.
- Pinheiro, Carlos E.G., and Vitor C. Campos. 2019. "The responses of wild jacamars (*Galbula ruficauda*, Galbulidae) to aposematic, aposematic and cryptic, and cryptic butterflies in central Brazil". *Ecological Entomology*. <https://doi.org/10.1111/een.12723>.
- Pinheiro, Carlos E.G., and André V.L. Freitas. 2014. "Some Possible Cases of Escape Mimicry in Neotropical Butterflies". *Neotropical Entomology* 43: 393-98. <https://doi.org/10.1007/s13744-014-0240-y>.
- Pinheiro, Carlos E.G, André V.L. Freitas, Philip J Devries, and Carla M Penz. 2016. "Both Palatable and Unpalatable Butterflies Use Bright Colors to Signal Difficulty of Capture to Predators". *Neotropical Entomology* 45: 107-13. <https://doi.org/10.1007/s13744-015-0359-5>.

- Poulton, Sir Edward Bagnall. 1890. *The colours of animals: their meaning and use especially considered in the case of insects*. Editado por Paul Kegan, Trench Trübner, y Co. London, UK: Trübner & Co Ltd.
- Prudic, Kathleen L., Andrew M. Stoehr, Bethany R. Wasik, y Antónia Monteiro. 2015. “Eyespots Deflect Predator Attack Increasing Fitness and Promoting the Evolution of Phenotypic Plasticity”. *Proceedings of the Royal Society B: Biological Sciences* 282 (1798): 20141531. <https://doi.org/10.1098/rspb.2014.1531>.
- Ruxton, G. D., M. Speed, and T. N. Sherratt. 2004. “Evasive mimicry: When (if ever) could mimicry based on difficulty of capture evolve?” *Proceedings of the Royal Society B: Biological Sciences* 271 (1553): 2135-42. <https://doi.org/10.1098/rspb.2004.2816>.
- Rydon, A. 1964. “Notes on the use of butterfly traps in East Africa”. *Journal of the Lepidopterists’ Society* 18 (1): 51-58.
- Sherratt, Thomas N. 2006. “Spatial mosaic formation through frequency-dependent selection in Müllerian mimicry complexes”. *Journal of Theoretical Biology* 240 (2): 165-74. <https://doi.org/10.1016/j.jtbi.2005.09.017>.
- Sherratt, Thomas N. 2008. “The evolution of Müllerian mimicry”. *Naturwissenschaften* 95 (8): 681-95. <https://doi.org/10.1007/s00114-008-0403-y>.
- Srygley, R. B. 1999. “Incorporating motion into investigations of mimicry”. *Evolutionary Ecology* 13: 691-708. <https://doi.org/10.1023/A:1011046202928>.
- Srygley, R. B., and R Dudley. 1993. “Correlations of the Position of Center of Body Mass With Butterfly Escape Tactics”. *Journal of Experimental Biology* 174 (1): 155-66.
- Srygley, Robert B. 1994. “Locomotor mimicry in butterflies? The associations of positions of centres of mass among groups of mimetic, unprofitable prey”. *Philosophical Transactions Royal Society of London B: Biological Sciences* 343: 145-55.

- Srygley, Robert B, and Peng Chai. 1990. "Flight Morphology of Neotropical Butterflies : Palatability and Distribution of Mass to the Thorax and Abdomen". *Oecologia* 84 (4): 491-99.
- Srygley, Robert B. 1999a. "Discrimination of flying mimetic, passion-vine butterflies Heliconius". *Proceedings of the Royal Society B: Biological Sciences* 266 (1434): 2137-40. <https://doi.org/10.1098/rspb.1999.0899>.
- Srygley, Robert B., and C. P. Ellington. 1999b. "Discrimination of flying mimetic, passion-vine butterflies Heliconius". *Proceedings of the Royal Society B: Biological Sciences* 266 (1434): 2137-40. <https://doi.org/10.1098/rspb.1999.0899>.
- Stevens, Martin. 2005. "The Role of Eyespots as Anti-Predator Mechanisms, Principally Demonstrated in the Lepidoptera". *Biological Reviews* 80 (4): 573-88. <https://doi.org/10.1017/S1464793105006810>.
- Stubbs, Wendy J., and J. Bastow Wilson. 2004. "Evidence for limiting similarity in a sand dune community". *Journal of Ecology* 92 (4): 557-67. <https://doi.org/10.1111/j.0022-0477.2004.00898.x>.
- Swenson, Nathan G., Brian J. Enquist, Jason Pither, Jill Thompson and Jess K. Zimmerman. 2006. "The problem and promise of scale dependency in community phylogenetics". *Ecology* 87 (10): 2418-24. [https://doi.org/10.1890/0012-9658\(2006\)87\[2418:TPAPOS\]2.0.CO;2](https://doi.org/10.1890/0012-9658(2006)87[2418:TPAPOS]2.0.CO;2).
- Tsuji, Joyce S., Joel G. Kingsolver, y Ward B. Watt. 1986. "Thermal physiological ecology of Colias butterflies in flight". *Oecologia* 69 (2): 161-70. <https://doi.org/10.1007/BF00377616>.
- Valiente-Banuet, Alfonso, and Miguel Verdú. 2007. "Facilitation can increase the phylogenetic diversity of plant communities". *Ecology Letters* 10 (11): 1029-36. <https://doi.org/10.1111/j.1461-0248.2007.01100.x>.

- Van Someren, V and T Jackson. 1959. "Some Comments on the Protective Resemblance Amongst African Lepidoptera (Rhopalocera)". *Journal of the Lepidopterists' Society* 13 (3).
- Vanin, Sergio A., and Tadeu J. Guerra. 2012. "A remarkable new species of flesh-fly mimicking weevil (Coleoptera: Curculionidae: Conoderinae) from Southeastern Brazil". *Zootaxa*, n.º 3413: 55-63. <https://doi.org/10.11646/zootaxa.3413.1.5>.
- Verdú, M., and J. G. Pausas. 2007. "Fire drives phylogenetic clustering in Mediterranean Basin woody plant communities". *Journal of Ecology* 95 (6): 1316-23. <https://doi.org/10.1111/j.1365-2745.2007.01300.x>.
- Watt, Ward B. 1983. "Adaptation At Specific Loci. Ii. Demographic and Biochemical Elements in the Maintenance of the *Colias Pgi* Polymorphism". *Genetics* 103 (4): 691-724. <https://doi.org/10.1093/genetics/103.4.691>.
- Webb, Campbell O. 2000a. "Exploring the phylogenetic structure of ecological communities: An example for rain forest trees". *American Naturalist* 156 (2): 145-55. <https://doi.org/10.1086/303378>.
- Webb, Campbell O. 2000b. "Exploring the phylogenetic structure of ecological communities: An example for rain forest trees". *American Naturalist* 156 (2): 145-55. <https://doi.org/10.1086/303378>.
- Willmott, Keith, Jason P.W. Hall, and Gerardo Lamas. 2001. "Systematics of *Hypanartia* (Lepidoptera: Nymphalidae: Nymphalinae), with a test for geographical speciation mechanisms in the Andes". *Systematic Entomology* 26: 369-99.
- Willmott, Keith R. 2003a. "Cladistic analysis of the Neotropical butterfly genus *Adelpha* (Lepidoptera: Nymphalidae), with comments on the subtribal classification of Limenitidini". *Systematic Entomology* 28 (3): 279-322. <https://doi.org/10.1046/j.1365-3113.2003.00209.x>.

Willmott, Keith R. 2003b. *The Genus Adelpha: Its Systematics, Biology and Biogeography (Lepidoptera: Nymphalidae: Limenitidini)*. Scientific Publishers.

Willmott, Keith R., and James Mallet. 2004. "Correlations between adult mimicry and larval host plants in ithomiine butterflies". *Proceedings of the Royal Society B: Biological Sciences* 271 (SUPPL. 5). <https://doi.org/10.1098/rsbl.2004.0184>.

Willmott, Keith R., Julia C. Robinson Willmott, Marianne Elias, and Chris D. Jiggins. 2017a. "Maintaining mimicry diversity: Optimal warning colour patterns differ among microhabitats in Amazonian clearwing butterflies". *Proceedings of the Royal Society B: Biological Sciences* 284 (20170744). <https://doi.org/10.1098/rspb.2017.0744>.

Willmott, Keith R. 2017. "Maintaining mimicry diversity: Optimal warning colour patterns differ among microhabitats in Amazonian clearwing butterflies". *Proceedings of the Royal Society B: Biological Sciences* 284 (20170744). <https://doi.org/10.1098/rspb.2017.0744>.

Supplementary material

S1. Phylogenetic structure and phylogenetic turnover related to altitude. Results summary from the analyses using the I_{ST} , P_{ST} and Π_{ST} index.

Whole dataset				
	<i>Obs</i>	<i>sim</i>	% <i>CI</i> / <i>rM</i>	<i>p</i>
<i>Abundance data set:</i>				
Global P_{ST}	0.17	0.19	CI 5-95%= 0.16; 0.22	0.08
Partial Mantel test (pairwise P_{ST})			rM= 0.38	0.02
<i>Incidence data set</i>				
Global Π_{ST}	-0.01	0.000	CI 5-95%= -0.01 ; 0.02	0.15
Partial Mantel test (pairwise Π_{ST})			rM= 0.44	0.001

West (only incidence dataset)				
	<i>Obs</i>	<i>sim</i>	% <i>CI</i> / <i>rM</i>	<i>p</i>
Global Π_{ST}	0.01	0.000	CI 5-95%= -0.01; 0.02	0.24
Partial Mantel test (pairwise Π_{ST})			rM=0.34	0.01

East (only incidence dataset)				
	<i>Obs</i>	<i>sim</i>	% <i>CI</i> / <i>rM</i>	<i>p</i>
Global Π_{ST}	-0.003	0.000	CI 5-95%= -0.01 ; 0.02	0.42
Partial Mantel test (pairwise Π_{ST})			rM=0.59	0.001

East/West pooled				
<i>Incidence data set</i>	<i>Obs</i>	<i>sim</i>	% <i>CI</i>	<i>p</i>
Global Π_{ST}	-0.007	0.000	CI 5-95%= -0.006 ; 0.009	0.025

S2. Co-occurrence co-mimics: Results summary from the Bray-Curtis distance analyses.

Whole dataset							
<i>Abundance data set:</i>	<i>Obs</i>		<i>sim</i>	<i>% CI</i>		<i>p</i>	
Global Bray-Curtis	0.83		0.89	CI 5%= 0.88		0.001	
Per ring BC	<i>N ssp</i>	<i>N pairs</i>	<i>BC Obs</i>	<i>BC Mean</i>	<i>BC 2.5</i>	<i>BC 97.5</i>	<i>p</i>
COCALA	25	300	0.80	0.89	0.86	0.92	0.001
EPIONE	1	0	NA	NA	NA	NA	NA
IPHICLUS	18	153	0.90	0.89	0.84	0.93	0.55
ALEUCERIA	2	1	0.96	0.9	0.31	1	0.32
LYCORIAS	1	0	NA	NA	NA	NA	NA
MESENTINA	2	1	1	0.89	0.30	1	1
ROTHSCHILD I	3	3	0.67	0.89	0.60	1	0.05
SALMONEUS	8	28	0.90	0.89	0.78	0.96	0.47
ZINA	3	3	0.76	0.89	0.60	1	0.15

Whole dataset							
<i>Incidence data set:</i>	<i>Obs</i>		<i>sim</i>	<i>% CI</i>		<i>p</i>	
Global Bray-Curtis	0.80		0.83	CI 5%= 0.81		0.01	
Per ring BC	<i>N ssp</i>	<i>N pairs</i>	<i>BC Obs</i>	<i>BC Mean</i>	<i>BC 2.5</i>	<i>BC 97.5</i>	<i>p</i>
COCALA	30	435	0.75	0.82	0.78	0.87	0.001
EPIONE	1	0	NA	NA	NA	NA	NA
IPHICLUS	25	300	0.87	0.827	0.77	0.869	0.977
LEUCERIA	2	1	0.43	0.83	0.23	1	0.11
LYCORIAS	1	0	NA	NA	NA	NA	NA
MESENTINA	2	1	1	0.83	0.22	1	1
ROTHSCHILD I	3	3	0.28	0.83	0.40	1	0.01
SALMONEUS	11	55	0.86	0.82	0.71	0.90	0.75
ZINA	3	3	0.75	0.82	0.42	1	0.26

West							
	<i>Obs</i>	<i>sim</i>	<i>% CI</i>		<i>p</i>		
Global Bray-Curtis	0.70	0.70	CI 5%= 0.65		0.56		
Per ring BC	<i>N ssp</i>	<i>N pairs</i>	<i>BC Obs</i>	<i>BC Mean</i>	<i>BC 2.5</i>	<i>BC 97.5</i>	<i>p</i>
COCALA	13	78	0.69	0.70	0.5	0.79	0.40
IPHICLUS	12	66	0.73	0.70	0.57	0.79	0.71
LEUCERIA	2	1	0.43	0.68	0.167	1	0.22
MESENTINA	1	0	NA	NA	NA	NA	NA
ROTHSCHILD I	3	3	0.28	0.70	0.34	1	0.02
SALMONEUS	6	15	0.72	0.69	0.47	0.87	0.59
ZINA	3	3	0.75	0.70	0.33	1	0.58

Continuation S2.

East				
	<i>Obs</i>	<i>sim</i>	% <i>CI</i>	<i>p</i>
Global Bray-Curtis	0.68	0.71	CI 5%= 0.67	0.115

Per ring BC	<i>N ssp</i>	<i>N pairs</i>	<i>BC Obs</i>	<i>BC Mean</i>	<i>BC 2.5</i>	<i>BC 97.5</i>	<i>p</i>
COCALA	24	276	0.63	0.70	0.61	0.77	0.06
EPIONE	1	0	NA	NA	NA	NA	NA
IPHICLUS	16	120	0.79	0.71	0.59	0.80	0.96
LYCORIAS	1	0	NA	NA	NA	NA	NA
MESENTINA	1	0	NA	NA	NA	NA	NA
SALMONEUS	6	15	0.67	0.70	0.43	0.87	0.32

West/East pooled				
	<i>Obs</i>	<i>sim</i>	% <i>CI</i>	<i>p</i>
Global Bray-Curtis	0.41	0.45	CI 5%= 0.42	0.02

Per ring BC	<i>N ssp</i>	<i>N pairs</i>	<i>BC Obs</i>	<i>BC Mean</i>	<i>BC 2.5</i>	<i>BC 97.5</i>	<i>p</i>
COCALA	30	435	0.36	0.45	0.38	0.49	0.01
EPIONE	1	0	NA	NA	NA	NA	NA
IPHICLUS	25	300	0.46	0.45	0.39	0.50	0.70
LEUCERIA	2	1	0	0.44	0	1	0.39
LYCORIAS	1	0	NA	NA	NA	NA	NA
MESENTINA	2	1	1	0.46	0	1	1
ROTHSCHILDI	3	3	0	0.46	0	0.67	0.15
SALMONEUS	11	55	0.52	0.45	0.26	0.55	0.93
ZINA	3	3	0	0.45	0	0.67	0.17

S3. Mimetic turnover and altitude. Results summary from the pairwise Mantel test.

Partial Mantel test (pairwise Ist)	<i>rM</i>	<i>p</i>	
Mimicry/altitude			
Whole dataset	rM= 0.02	0.50	* abundance dataset
	rM= 0.28	0.001	* incidence dataset
West slope	rM= 0.56	0.001	
East slope	rM= 0.004	0.46	

S4. Phylogenetic signal in mimicry patterns (MPD) and altitude (Blomberg's K). Results' summary table from the Mean Phylogenetic Distance (MPD) and Blomberg's K.

<i>Abundance data set</i>	<i>N units</i>	<i>N pairs</i>	<i>K / MPD</i>	<i>Sim MPD</i>	<i>CI MPDQ5</i>	<i>MPDQ9 5</i>	<i>p clustering</i>		
Blomberg's K for altitude			0.419 14.35	0.253		0.4	0.035		
Global MPD			0	15.070	14.620		0.007		
<i>per mimicry ring MPD</i>	<i>N units</i>	<i>N pairs</i>	<i>MPD</i>	<i>Sim MPD</i>	<i>CI 5%</i>	<i>CI 95%</i>	<i>p clust.</i>	<i>p overd.</i>	
			13.80						
COCALA	25	300	9	15.072	14.122	15.856	0.017	0.983	
EPIONE	1	0	NA	NA	NA	NA	NA	NA	
IPHICLUS	17	136	3 15.93	15.112	13.833	16.155	0.894	0.106	
LEUCERIA	2	1	6 16.39	15.062	8.375	19.122	0.678	0.322	
LYCORIAS	1	0	NA 17.89	NA	NA	NA	NA	NA	
MESENTINA	2	1	3	15.164	9.879	19.122	0.768	0.232	
ROTHSCHILDI	3	3	6.502 14.02	15.070	10.827	18.356	0.004	0.996	
SALMONEUS	8	28	3	15.093	13.020	16.815	0.166	0.834	
ZINA	3	3	5.728	14.999	10.821	18.213	0.001	0.999	

<i>Incidence dataset</i>	<i>N units</i>	<i>N pairs</i>	<i>K / MPD</i>	<i>Sim MPD</i>	<i>CI MPDQ5</i>	<i>MPDQ9 5</i>	<i>p clustering</i>		
Blomberg's K for altitude			0.544 14.98	0.245		0.352	0.001		
Global MPD			0	15.800	15.460		0.001		
<i>per mimicry ring MPD</i>	<i>N units</i>	<i>N pairs</i>	<i>MPD</i>	<i>Sim MPD</i>	<i>CI 5%</i>	<i>CI 95%</i>	<i>p clust.</i>	<i>p overd.</i>	
			14.37						
COCALA	30	435	4	15.779	14.966	16.467	0.004	0.996	
EPIONE	1	0	NA	NA	NA	NA	NA	NA	
IPHICLUS	25	300	5 16.20	15.805	14.920	16.554	0.779	0.221	
LEUCERIA	2	1	6 16.39	15.777	10.160	20.306	0.583	0.417	
LYCORIAS	1	0	NA 17.89	NA	NA	NA	NA	NA	
MESENTINA	2	1	3	15.813	8.375	20.306	0.646	0.354	
ROTHSCHILDI	3	3	6.502 13.95	15.729	11.522	19.003	0.002	0.998	
SALMONEUS	11	55	0	15.795	14.133	17.130	0.035	0.965	
ZINA	3	3	5.728	15.947	11.557	19.502	0.003	0.997	

S5. Mean altitudinal Distance. Results' summary table for the Mean Altitudinal Distance analyses.

Whole dataset							
	<i>N ssp</i>	<i>Npairs</i>	<i>Obs MAD</i>	<i>Sim MAD</i>	<i>p</i>	<i>5% CI</i>	<i>95% CI</i>
<i>Abundance data set</i>							
Global MAD			0.737	0.989	0.001	0.887	1.081
per mimicry ring MAD							
COCALA	25	300	0.528	0.982	0.001	0.785	1.183
IPHICLUS	17	136	1.113	1.009	0.26	0.745	1.285
LEUCERIA	2	1	0.885	1.055	0.501	0.104	2.508
MESENTINA	2	1	0.241	1.032	0.14	0.075	2.395
ROTHSCHILDI	3	3	0.534	0.883	0.253	0.21	1.695
SALMONEUS	8	28	1.204	0.989	0.198	0.573	1.413
ZINA	3	3	0.597	0.843	0.325	0.21	1.683
<i>Incidence data set</i>							
Global MAD			0.945	0.977	0.247	0.882	1.051
per mimicry ring MAD							
COCALA	30	435	0.77	0.972	0.057	0.763	1.175
IPHICLUS	25	300	1.211	0.993	0.107	0.744	1.291
LEUCERIA	2	1	0.522	0.993	0.319	0.095	2.387
MESENTINA	2	1	0.457	1.076	0.267	0.079	2.567
ROTHSCHILDI	3	3	0.211	0.74	0.072	0.177	1.553
SALMONEUS	11	55	0.949	0.956	0.509	0.591	1.357
ZINA	3	3	0.684	0.696	0.558	0.135	1.447

WEST							
<i>Incidence</i>			<i>Obs MAD</i>	<i>Sim MAD</i>	<i>p</i>	<i>5% CI</i>	<i>95% CI</i>
Global MAD			0.962	0.988	0.351	0.847	1.107
per mimicry ring MAD	<i>N ssp</i>	<i>Npairs</i>	<i>Obs MAD</i>	<i>Sim MAD</i>	<i>p</i>	<i>5% CI</i>	<i>95% CI</i>
COCALA	13	78	0.842	0.98	0.217	0.671	1.263
IPHICLUS	12	66	1.112	1.039	0.364	0.698	1.389
LEUCERIA	2	1	0.525	0.996	0.323	0.073	2.467
MESENTINA	1	0	NA	NA	NA	0.671	1.263
ROTHSCHILDI	3	3	0.212	0.587	0.181	0.098	1.356
SALMONEUS	6	15	1.163	0.968	0.256	0.475	1.51
ZINA	3	3	0.687	0.549	0.293	0.101	1.275
EAST							
<i>Incidence</i>			<i>Obs MAD</i>	<i>Sim MAD</i>	<i>p</i>	<i>5% CI</i>	<i>95% CI</i>
Global MAD			0.924	0.992	0.105	0.895	1.073
per mimicry ring MAD	<i>N ssp</i>	<i>Npairs</i>	<i>Obs MAD</i>	<i>Sim MAD</i>	<i>p</i>	<i>5% CI</i>	<i>95% CI</i>
COCALA	24	276	0.807	0.99	0.053	0.805	1.165
EPIONE	1	0	NA	NA	NA	0.805	1.165
IPHICLUS	16	120	1.201	0.999	0.11	0.748	1.264

LYCORIAS	1	0	NA	NA	NA	0.805	1.165
MESENTINA	1	0	NA	NA	NA	0.805	1.165
SALMONEUS	6	15	0.845	0.981	0.375	0.511	1.535

S6. Mimicry associated with altitude. Kruskal Wallis & Wilcoxon test. Results summary table from the Kruskal Wallis and Wilcoxon tests.

Whole dataset					
<i>Abundance data set</i>	<i>Obs Chi square/W</i>	<i>Sim Chi square/W</i>	<i>p</i>	<i>5% CI</i>	<i>95% CI</i>
Kruskal Wallis (Global)	9.38	2.78	0.03		8.32
Wilcoxon (pairwise mimicry ring comparison)					
COCALA vs IPHICLUS	156.50	211.50	0.16	128.0	295.0
COCALA vs SALMONEUS	28.50	99.80	0.00	60.0	139.0
IPHICLUS vs SALMONEUS	46.50	68.40	0.14	36.0	101.0
<i>Incidence data set</i>	<i>Obs Chi square/W</i>	<i>Sim Chi square/W</i>	<i>p</i>	<i>5% CI</i>	<i>95% CI</i>
Kruskal Wallis (Global)	6.57	4.54	0.24		13.30
Wilcoxon (pairwise mimicry ring comparison)					
COCALA vs IPHICLUS	367.00	374.10	0.49	203.0	544.0
COCALA vs SALMONEUS	67.0	164.80	0.0	107.0	223.0
IPHICLUS vs SALMONEUS	88.0	138.20	0.14	66.0	208.0

WEST					
<i>Incidence data set</i>	<i>Obs Chi square/W</i>	<i>Sim Chi square/W</i>	<i>p</i>	<i>5% CI</i>	<i>95% CI</i>
Kruskal Wallis (Global)		2.56	0.11		7.04
Wilcoxon (pairwise mimicry ring comparison)					
COCALA vs IPHICLUS	91.00	77.40	0.28	42.0	114.0
COCALA vs SALMONEUS	14.0	36.40	0.0	15.0	57.0
IPHICLUS vs SALMONEUS	15.0	36.40	0.05	15.0	57.0
EAST					
<i>Incidence data set</i>	<i>Obs Chi square/W</i>	<i>Sim Chi square/W</i>	<i>p</i>	<i>5% CI</i>	<i>95% CI</i>
Kruskal Wallis (Global)	4.72	2.74	0.18		8.00
Wilcoxon (pairwise mimicry ring comparison)					
COCALA vs IPHICLUS	154.00	190.90	0.22	115.0	269.0
COCALA vs SALMONEUS	29.0	72.10	0.0	40.0	105.0
IPHICLUS vs SALMONEUS	34.0	48.10	0.19	22.0	74.0

GENERAL DISCUSSION AND PERSPECTIVES



Three species of Ecuadorian Adelpha display a similar bright dorsal wing pattern that may be the result of mimicry to signal their evasiveness to predators. © Andrew Neild

The reasons behind the extreme convergence in wing colour pattern in *Adelpha*, previously supposed to be classical Batesian mimicry, have long been debated. In the first chapter, we provided the first proof-of-concept for an alternative explanation for colour pattern convergence in the genus, known as evasive mimicry. The main findings of that study were that a colour pattern associated with evasiveness was learned faster and generalised more broadly than with unpalatability. Differences between these two types of defences have been previously discussed, but empirical testing of hypotheses has not been done until now. In our study, different patterns of learning and generalisation emerged between evasive and unpalatable prey, and we provided potential explanations for them, such as strength and reliability of the stimulus (evasiveness can be assessed rapidly by predators compared to unpalatability) and variability of predators' tolerance to unpalatability and prey level of unpalatability, which slows learning.

In the second chapter, we explored the evolution of mimicry and its implications for speciation within the genus. *Adelpha* is an excellent case study because it is one of the most species-rich genera of Nymphalidae butterflies, distributed across the Neotropical region and across altitudinal gradients. Firstly, we inferred a comprehensive phylogeny of our study group, which allowed us to update its systematics. Although we could not confidently resolve the long-debated relationship between *Adelpha* and its sister clade *Limenitis*, most relationships among *Adelpha* species were highly supported. Secondly, we tested several hypotheses about speciation and the evolution of mimetic wing colour patterns. We focused on wing patterns because they are obvious phenotypic traits that show rapid evolution, being under multiple selection pressures (e.g., sexual signaling, mate choice, predator defence) and also contributing to reproductive isolation in mimetic butterflies, and they may therefore have a crucial role in speciation. We showed that shifts of mimetic patterns are not related with speciation events, contrary to what has been observed in the better studied mimetic butterflies *Heliconius* and more recently in ithomiine butterflies. Additionally, when looking at different macroecological traits of species (niche width, range size, tropicality and density) we found a correlation between evolutionary rates of mimicry pattern and tropicality i.e., degrees to the equator.

Our results should encourage further research in other groups of mimetic butterflies, since it seems that the generality of colour pattern as a causal factor in speciation still requires testing.

In the last chapter, we assessed the phylogenetic and mimicry structure of *Adelpha* communities, and their relation to altitude. Although we did not detect an overall phylogenetic structure, *Adelpha* communities showed clustering along the Andean altitudinal gradient, and phylogenetic overdispersion across the two sides of the Ecuadorian Andes. Finally, when looking at the mimicry

structure, we found some cases of co-occurrence and convergence of mimicry patterns, in addition to mimetic clustering by altitude, but also strong phylogenetic signals in both mimicry patterns and altitude. However, convergence and co-occurrence is not as strong as observed in classical mimetic systems based on unpalatability. We suggest that selection on warning signals of evasive prey is relaxed compared to unpalatable prey because of the different nature of predator selection on the former type of prey.

Altogether, these results provide support for the hypothesis that palatable, hard-to-catch butterflies might use bright colours to deter pursuit by predators, and that such colour patterns may be involved in mimicry among other fast-flying butterflies. Evasive mimicry adds an extra dimension to the classical view of protective coloration where prey is classified as aposematic or cryptic depending on the colour pattern they exhibit and whether they are chemically defended or not. Therefore, I will first discuss evidence for the existence of evasive mimicry, and I will then contrast some aspects of evasive mimicry with those of classical mimicry. Finally, since this study assessed some evolutionary and ecological aspects of mimicry, I will discuss in the last section the implications of mimicry for the diversification of species.

The existence of evasive mimicry

The hypothesis that prey may use conspicuous coloration to signal difficulty of capture to predators was suggested a long time ago and has since been the subject of intense debate. Many examples have been proposed in Lepidoptera, where palatable and fast-flying butterflies expose their brightly coloured wing surface, rendering them easy to be detected by predators (figure 1). It has also been suggested that hard-to-catch prey may be involved in mimetic interactions similar to classical Batesian and Mullerian mimicry (i.e., involving chemically defended prey), known as evasive mimicry.



Figure 1. Skipper butterflies (Hesperiidae) are a potential case of palatable, evasive prey that are involved in mimetic interactions. Figure from Janzen *et al.* 2009





Van Someren and Jackson (1959) first reported the idea of “*Protective Resemblance*” without distastefulness in African butterflies, as an alternative idea to classical Batesian and Müllerian mimicry. They defined three natural groups that have a defence other than distastefulness (e.g., see figure 2). One of them is the group “*Difficulty of capture*”, where several (rare) species mimic an abundant model species whose characteristics are: “...*elusiveness, quickness of flight low to the ground, obliterative colouration; acute vision and wariness...*”. This group is composed of the Limenitidinae butterflies *Euphaedra*, *Euryphene* and *Euryphura*.



Figure 2. Illustration modified from Van Someren and Jackson (1959) showing mimetic *Euphaedra* species from the group B “Difficulty of capture”. Left column: *Euphaedra ceres* male (A), female (B), *E. themis aureola* (C) male, (D) female. Right column: *E. gausape* (E) male, (F) female; *E. cypris aurata* (G) male, (H) female.

It took more than ten years until Gibson (1974;1980) first simulated an efficient escape mechanism in artificial coloured prey and assessed its effectiveness on selection by avian predators. Both experiments measured the mean feeding latency (time between prey being offered and it being taken or escaping) ratio (model-mimic/non-mimetic) and showed that avian predators were able to discriminate and take longer to attack escaping prey displaying bright colours i.e., the aposematic prey, compared to cryptic escaping prey or non-mimetic prey (Box 1). They suggested that escaping ability is an effective defence that can be signalled to predators. Later, Hancox and Allen (1991) tested in semi-natural conditions if wild birds were able to learn to avoid a brightly coloured escaping prey, i.e. the aposematic prey, over a non-escaping prey and, in a second phase, if avoidance learning was retained when the behaviour of the prey was reversed. They observed that attacks of wild avian predators on aposematic prey decreased through time and that learned avoidance could be reversed to a new escaping prey in the second phase, although the attack rate was still lower than on the control (non-escaping prey) (Box 1). (Pinheiro 1996) tested in the field the rate of attacks on 98 species of aposematic butterflies, some of which were known to be unpalatable while others (palatable) were suspected of being capable of evading capture. This study provided evidence for the ability to escape predators in some butterfly species, as well as the fact that some species were sight-rejected by predators.

Box 1. Summary of experiments testing the evasive mimicry hypothesis.

Experiments	prey	model/mimic	non-mimic, non-escaping prey	predator	mechanism/apparatus simulating escaping	treatments	N birds	N days test	duration of the habituation period to the apparatus / preference test	learning phase	retention/generalisation phase	measurement	results
Gibson 1974		red (aposematic prey) and blue (cryptic prey)	green	Captive wild star finch bird <i>Bathilda ruficauda</i>	Prey dissapeared by a manually operated hinged feeding platform. Platform base was coloured with blue and green dots (seed shaped).	1 treatment	NA	23	Preference test: 3 days, all preys were allowed to be eaten	Day 1-7; model (escaping prey) vs non-mimic (non-escaping prey).	Day 8-16; mimics vs non-mimics (any type of prey dissapeared)	Feeding latency* ratio (model-mimic/non-mimetic ratio of mean feeding latency) *time between prey being offered and it being taken or escaping	Learning phase: Latency ratio was higher for the aposematic (red seed) model/mimic prey (being avoided before and more often overall), than cryptic (blue seed) prey. Retention phase: Latency ratio decline in both mimics until being equal (always higher compared to the non-mimic)
Gibson 1980		orange (aposematic prey), green (cryptic prey)	blue	Captive robins <i>Erithacus rubecula L.</i>	Apparatus same as Gibson 1974 but the platform was coloured with 4 shapes resembling mealworms with blue and green bands, and several brown coloured mealwormn shapes.	1 treatment	6	47	Habituation period: aprox. 1 month preference test: 1 day, all preys where allowed to be eaten	Day 1-10; all types of prey presented but only the non mimetic, non escaping prey (blue banded) allowed to eat.	Day 11-17; retention	Feeding latency ratio (same as Gibson 1974).Upper time limit 180 s	Learning phase: feeding latency ratio was higher for the conspicuous model compared to the cryptic one, but still cryptic mode (escaping too) provided an advantage versus the non-mimetic, non-escaping prey. rapid Retention phase: Decline in the advantage of both the mimics over the control with the conspicuous form retaining an advantage over its cryptic counterpart.
Hancox & Allen 1991		both colours	both colours	Wild robins <i>Erithacus rubecula</i> and blue tits <i>Parus caeruleus</i>	Table with wholes covered with acetate paper. Escaping behaviour was simulated by pulling a cord to remove the acetate paper and the bait felt into the	1 treatment	4 blue tits, 2 robins	49	Habituation period: 1 week preference test: 1 day, all preys where allowed to be eaten	1-20 day: evasive yellow, non-evasive red prey Day 21: control test (non of preys escaping)	Day 22-40: red evasive, yellow non-evasive Day 41: control test (non of preys escaping)	Proportion of baits eaten	Birds learned to avoid escaping prey, even when preys were not escaping anymore (control test). Training was reversible (from day 22)
Páez et al 2021		Evasive and unpalatable preys. (COCALA pattern: FW orange band/HW white band), <i>A. salmoneus</i> (SALMONEUS pattern: single FW orange band), <i>A. epione</i> (EPIONE: single FW white band)	control: full brown wing colour pattern	Wild blue tits (Parus caeruleus)	Experimental box consisting of two rails were prey slide. Escaping behaviour was simulated by pulling out a thread making prey dissapear from sight of birds.	LEARNING: aposematic prey (SALMONEUS group 1 [evasive]; COCALA group 2 [evasive] & 3 [unpalatable] vs control. GENERALISATION: one perfect mimic (SALMONEUS [group 1] COCALA [group 2 & 3]); two imperfect mimics (COCALA [group 1], SALMONEUS [Group 2 & 3], EPIONE [all groups] vs control.	91 birds	2 days per bird	1 day	Day 2 (morning): simultaneous presentation of two types of prey: aposematic vs control; experiment ended when preys achieved learning criteria or until the 80th presentation.	Day 2 (afternoon): four types of prey were presented simultaneously: perfect mimic, two imperfect mimics, 1 control. Only one trial, it was registered the first choice of attack.	Number of trial until the bird achieved the learning criterion (No more than two attacks to the aposematic prey among ten consecutive trials)	No difference in learning and generalisation between different mimicry patterns for the escaping prey treatments (Group 1 & 2) Faster learning and broader generalisation to the escaping prey (group 2) compared to the unpalatable prey (group 3).

Based on field observations, (Pinheiro and Freitas, 2014) proposed several potential cases of evasive mimicry in Neotropical butterflies. Moreover, Pinheiro *et al.* (2016) suggested that butterflies possess different escape tactics that can be signalled to predators through conspicuous coloration, and such signals are used by both palatable and unpalatable butterflies. Pinheiro and Campos (2019) field observations showed that supposed palatable and fast-flying species that have a conspicuous pattern on the dorsal wing surface and a cryptic pattern on the ventral surface elicited sight rejections by wild jacamars (*Galbula ruficauda*, Galbulidae). They suggested that birds can associate butterfly wing colour patterns, and possibly traits like flight pattern and speed, with the difficulty of capture of the prey.

Overall, these experiments and field observations have provided evidence for evasive mimicry, and this thesis project contributes further to investigating the evasive mimicry hypothesis. In particular, we provided an additional proof-of-concept for evasive mimicry. Until our study, naturally occurring wing colour patterns had not been used in laboratory experiments (in contrast to Pinheiro, [1996] field experiments), and with naïve wild predators. Moreover, our experiments contrasted avoidance learning and generalisation to putative mimics between evasive mimicry and classical mimicry, which had never been explored before (we will extend the discussion on this point in the next section). We additionally provided a protocol that can be easily replicated with other types of prey or predator. We found two main limitations in our protocol: 1) artificial prey: manufacture was extremely time consuming (each prey needed to be cut manually) and they were completely destroyed by birds (for the unpalatable treatment). We manufactured a total of ca. 4000 paper butterflies. 2) Sample size of birds: capturing birds can be logistically challenging because of bird availability in the wild. Although we used 91 birds in total (29-31 per treatment), some effects were not significant because of insufficient statistical power.

Future research should focus on further characterising evasive mimicry. We suggest that two aspects need to be empirically investigated:

a. *Evasiveness*

Experimental studies on butterfly flight have shown a positive association between flight speed and wing loading (body mass relative to wing area) (Betts and Wootton, 1988; Dempster *et al.*, 1976; Dudley, 1990; Dudley and Srygley, 1994). Chai and Srygley (1990) found that body shape (thoracic diameter/body length) was a significant predictor of palatability, flight speed and the proportion of unsuccessful attacks by the rufous-tailed jacamar among 53 neotropical

species. Srygley and Dudley's (1993) experiments showed that position of centre of body mass is an indicator for both aerial manoeuvrability and flight speed. Quantification of some of these flight-related traits can be very informative to characterise evasive flight in species that are potentially involved in evasive mimicry.

A more accurate assessment of flight behaviour during escape is also worth exploring. Jantzen and Eisner (2008) experiments showed that a butterfly's evasive flight is erratic and unpredictable, which potentially makes these butterflies hard to catch. More recently, kinematics has been used to document ecologically significant behaviours in butterflies (reviewed by Le Roy *et al.* (2019). Le Roy *et al.* (2021) quantified the three dimensional flight trajectory of *Morpho* butterflies (putatively involved in evasive mimicry [Llaurens *et al.* 2021; Pinheiro, 1996]) in both wild and semi-natural conditions.

b. Predation

Experiments using artificial models in natural conditions will allow testing whether butterflies harbouring local mimicry patterns experience reduced predation rates compared to novel mimetic patterns or easy-to-catch prey. Previous butterfly predation studies in classical mimicry systems (e.g., Alatalo and Mappes, 1996; Holmgren and Enquist, 1999; Kapan, 2001; Mallet and Barton, 1989; Turner, 1977; Wolfgang Wickler, 1968) have shown that species with locally convergent wing patterns are better protected than novel and known palatable butterfly prey. (Finkbeiner *et al.*, 2017, 2018) tested the classical Batesian mimicry hypothesis with artificial models of two *Adelpha* species from Costa Rica and Ecuador, providing evidence for protection from avian predators in the supposedly toxic, Rubiaceae-feeding *Adelpha* species. However, palatability tests as have been done in other classical aposematic prey e.g., *Heliconius* (Arias, Mappes, *et al.* 2016; Chouteau *et al.* 2019) have never been performed. We encourage the performance of palatability experiments, but also the search for toxic chemical compounds (e.g., pyrrolizidine alkaloids in ithomiine butterflies [Massuda and Trigo, 2009]; or cyanogenic glucosides [Pinheiro de Castro *et al.* 2019; Sculfort *et al.* 2020]) in *Adelpha* (and other putative evasive aposematic prey) to reject (or confirm) the long-term time debate about unpalatability. Indeed, Hill and Mullen (2019) report adult feeding on Boraginaceae and Asteraceae plants in some species of *Adelpha*, and based on the role of these plants for unpalatability in other neotropical butterflies, they suggested that it could be the case for some species in *Adelpha*.

Evasive mimicry versus classical mimicry

An important contribution of this study is the comparison between these two types of mutualistic interactions. Although evasive mimicry has been proposed as an explanation for wing pattern convergence in palatable butterflies, a lot more discussion on the differences between this type of mimicry and classical mimicry, and of the implications beyond colour pattern convergence, is needed. In the first chapter we performed predation experiments where we showed differences in learning and generalisation between both mimicry systems (discussed in the previous section). We assessed the role of evasive mimicry in structuring species assemblages, and we found patterns similar to those detected with classical mimicry (previously explored by Chazot et al. (2014) in Andean Ithomiini communities), such as altitudinal segregation, mimetic clustering by altitude, and co-occurrence of comimetic species. However, we observed that the association between mimetic and altitudinal structuring seems to be not as strong as in Ithomiini, suggesting that there is less convergence of colour patterns and co-occurrence of comimetic subspecies in evasive mimicry. This might be explained by differences in the nature of selection between evasive and classical mimicry: during predator education in evasive systems, fewer individuals die or are injured. In fact, faster learning might be elicited by the most successful hard-to-catch prey, i. e., those that do not die. Therefore, the frequency dependence of the selection incurred by predators, which drives the convergence of warning patterns (Muller, 1879) and enhances co-occurrence of co-mimics (Chazot et al 2014), is probably reduced compared to classical mimicry, unless there is another kind of cost (such as shorter life-span incurred by repetitive escapes), as predicted by the model of Ruxton et al. (2004).

The fact that in *Adelpha* there is convergence of wing colour pattern (Chapter II) and evidence for co-occurrence and association between mimicry and altitudinal structuring (Chapter III), but with a weaker signal than observed in Ithomiini, suggests that there is some kind of cost associated with evasiveness, but that this cost is likely outweighed by increased survival of evasive prey.

More experiments contrasting evasive versus unpalatable prey with experienced natural predators and live butterflies in cages will be very insightful to confirm the patterns observed in this study. Information about the primary natural predators of butterflies remains extremely scarce, restricted to observations on jacamars (Benson, 1972; Chai, 1986; Pinheiro and Campos, 2013; Srygley and Chai, 1990), tanagers (Brown Jr and Vasconcellos Neto, 1976), tyrant-flycatchers (Pinheiro, 1996, 2003), ani (Burger and Gochfeld, 2001) and a few other

birds. However, Pinheiro and Cintra (2017) recently provided an extensive list of bird predators of butterflies for Central and South America, which will allow more targeted study of predator-prey interactions, especially with bird species that are specialised at pursuing hard-to-catch prey (figure 3). For example, Paradise Jacamar (*Galbula dea*) displays a fast sally and “acrobatic” flight when pursuing bees, dragonflies and butterflies; or those that, unlike jacamars, are able to catch both flying and resting butterflies e.g., Sunbittern (*Eurypyga helias*), Collared Plover (*Charadrius collaris*) (Pinheiro and Cintra 2017), and Smooth-billed Ani (*Crotophaga ani*) (Burger and Gochfeld 2001).

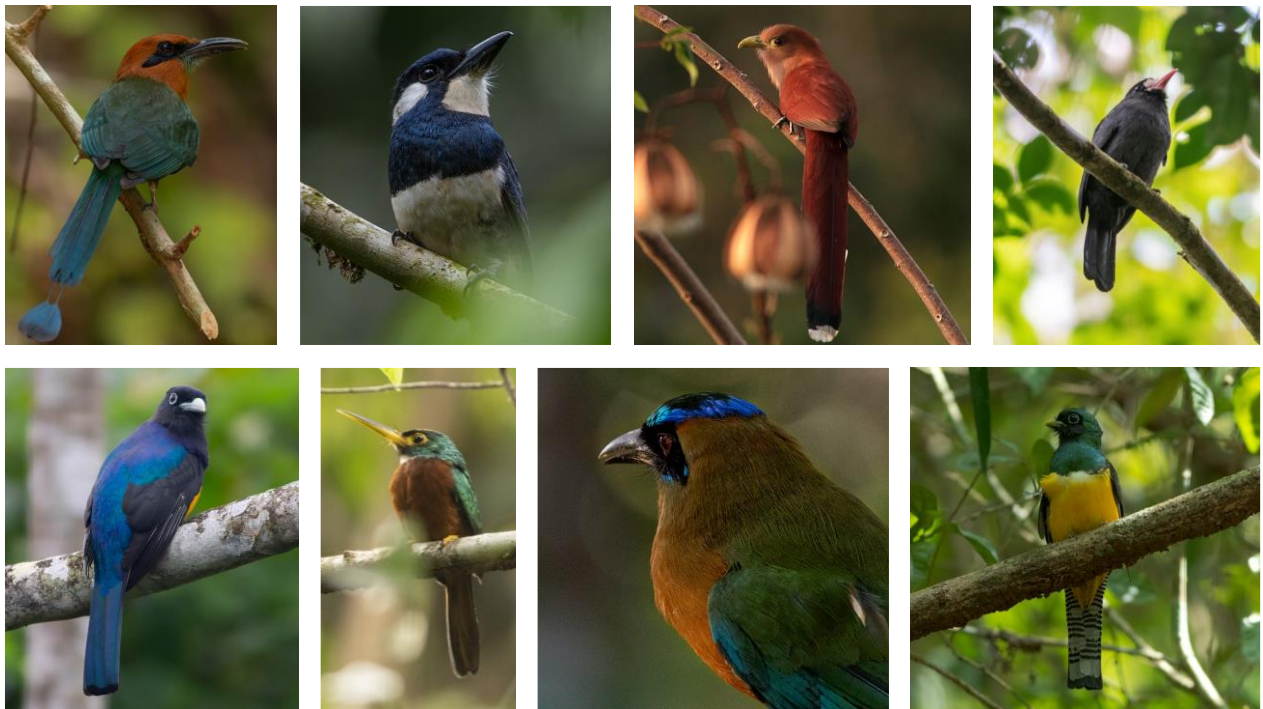

Figure 3. Example of tropical bird predators. From left up to right, first row. *Electron platyrynchum*, *Notharchus pectoralis*, *Piaya cayana*, *Monasa morphoeus*, *Trogon chionurus*, *Galbula albirostris*, *Momotus subrufescens*, *Trogon rufus*. Images ©Sebastián Mena

Additionally, traits involved in escaping predators might be different between palatable (and evasive) and unpalatable prey, which might explain some of the differences in the underlying mechanisms of each system. Some of these traits are listed below:

- a. Flight pattern and body shape: palatable butterfly flight (e.g., as shown by some pierids and nymphalids) has been described as fast and erratic, whereas that of unpalatable butterflies (e.g., Heliconiinae, Danaini and Ithomiini) and their mimics is known to be slow, heavy, fluttery and deliberate (see Bates, 1862; DeVries, 1987). It has been shown that body shape (i.e., thoracic diameter relative to body length) (Chai and Srygley,

1990), and more specifically the position of the centre of body mass, is correlated with butterfly palatability, flight speed and ability to evade predators (Srygley and Dudley, 1993). In palatable butterflies, a large thorax and short abdomen position the centre of the body mass near to the wing base, whereas in distasteful butterflies the body mass is shifted posteriorly.

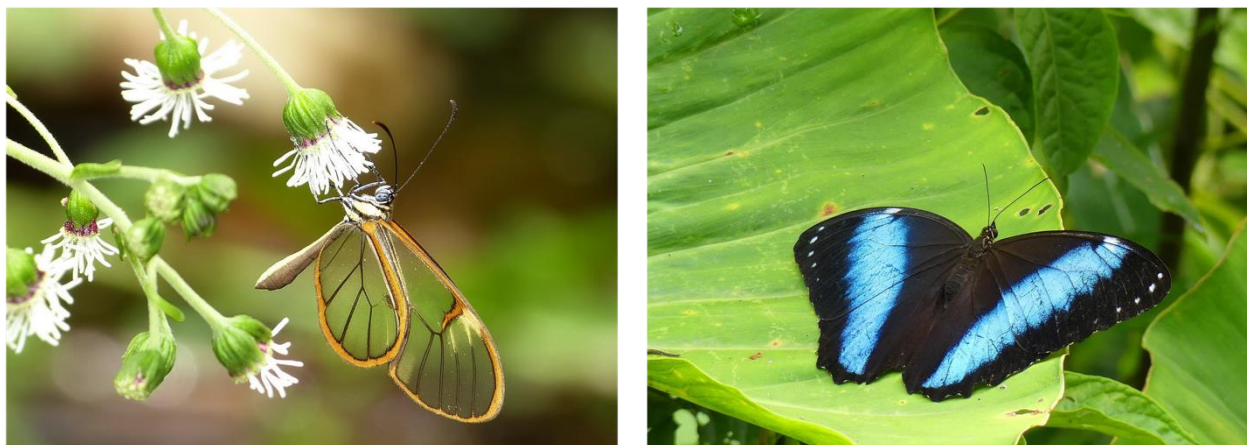

Figure 4. Species with contrasting body and wing shapes. Left: Ithomiine butterfly which is a classical example of an unpalatable butterfly. Right: *Morpho* butterfly which is palatable and strong flyer. Short and broad wings, large thorax among other traits, enables them to perform a fast flight. Images © Andrew Neild

- b. Flight performance: evasive prey with their strong flight may differ in their physiological requirements for flight compared to unpalatable, slow flying butterflies. As ectothermic organisms, temperature affects butterfly habitat preference and segregation of habitat is thus a likely outcome (Heinrich, 1995; Huey, 1991). Thus, in evasive prey, the thermal environment could be a higher constraint compared to unpalatable butterflies.
- c. Colour patterns: chemically defended butterflies expose their bright colour patterns with both open and closed wings. Conversely, palatable butterflies potentially involved in evasive mimicry tend to exhibit conspicuous colour patterns when the wings are open, but a cryptic pattern (or protective resemblance such as a dead leaf pattern [Skelhorn et al., 2010]) on the ventral side of their wings (e.g., Chai, 1988; Jenkins, 1983; Pinheiro *et al.*, 2016), which potentially makes these butterflies harder to detect by predators (e.g., Prudic *et al.*, 2015; Stevens *et al.*, 2008).



Figure 5. Example of colour patterns from an unpalatable prey (left image) *Heliconius* (Heliconiinae) which harbour in both sides of the wings a conspicuous colour patterns (left); and a palatable butterfly *Memphis* (Charaxinae)(right image) with a brightly coloured dorsal wing side, and a cryptic ventral wing side. Images © Andrew Neild.

- d. Wing toughness: unpalatable butterflies exhibit tough wings that presumably enable predators to assess prey unprofitability (capture, smell or taste) without significantly damaging the wings. By contrast, palatable butterflies have relatively soft and brittle wings that allow escape from predator attacks by losing a piece of the wing after being attacked (Carpenter, 1941; De Vries, 2002).
- e. Palatable butterflies may exhibit eyespots on the wings and prominent tails, which potentially enable them to divert bird attacks from vital body regions (e.g., Olofsson *et al.*, 2010; Prudic *et al.*, 2015; Robbins, 1980) (Chotard *et al.* 2022) The learning task is a process where multiple factors (e.g., prey traits, ecological context, among others [reviewed by Marples *et al.* 2018]) might affect a predator's perception of the profitability of prey. Further behavioural experiments should contrast predator learning and generalisation of evasive versus unpalatable butterflies to evaluate some of these factors, such as hunger level, prior experience, foraging strategy (e.g., dietary wariness, generalist/specialist), abundance of alternative prey, competition for prey, and predator's risk of being attacked, among others. Such studies would allow us to better examine the benefits of pursuing and consuming an evasive prey versus consuming a chemically defended prey.

Finally, in Chapter I, we proposed that avoidance learning is faster with evasive prey because of the nutritional benefits of eating a prey with a bad taste versus not eating a prey at all (when a prey escapes), but we wonder whether a toxic (rather than just bad-tasting) prey might result in faster learning compared to evasiveness. For example, predators will continue to consume

prey that is only unpalatable but not toxic (Marples *et al.*, 1989; Oudman *et al.*, 2014; Rowland *et al.*, 2013; Sherratt, 2003), while animals might exhibit faster and longer lasting aversion to toxic components (e.g., Garcia *et al.*, 1955). Perhaps toxicity might represent a stronger stimulus than unpalatability, and may lead to broad generalisation to imperfect mimicry as seen when a prey is highly unpleasant (Duncan and Sheppard, 1965; Lindstrom *et al.*, 1997). Comparison of avoidance learning and generalisation between evasive and toxic prey could be another feature that will be worth exploring in the future.

Mimicry implications for diversification

The world's most diverse ecosystems are tropical, however speciation in this region remains poorly understood. Two major proposed mechanisms are vicariance within climate-induced forest refugia (e.g., aposematic butterflies [Brown, 1982]; birds [Haffer, 1969]) and ecological speciation driven by niche adaptation (Endler, 1977; Fjeldså, 1994; Graham *et al.*, 2004; Schneider *et al.*, 1999). By investigating *Adelpha*, a highly diverse genus which shows extreme wing colour pattern convergence, we present an interesting case study for assessing patterns of diversity in relation to mimicry.

In *Heliconius* butterflies, shifts in colour pattern have been shown to play a major role in speciation (Jiggins *et al.* 2001; 2004; 2006). Mimetic colour patterns are considered magic traits for their dual role as a mating cue and warning signals to predators. Variation in these traits can trigger assortative mating (Chamberlain *et al.*, 2009; Giraldo *et al.*, 2008; Jiggins *et al.*, 2001; Merrill *et al.*, 2011, 2014; Servedio *et al.*, 2011), and disruptive selection by predators for alternative mimicry associations with local species (Arias, le Poul, *et al.*, 2016; Mallet and Barton, 1989; Merrill *et al.*, 2012; Naisbit *et al.*, 2001). Therefore, changes in such magic traits can facilitate ecological speciation by enhancing pre- and post-mating isolation. *Heliconius* butterflies have provided the strongest support for magic traits driving speciation (Servedio *et al.*, 2011), reviewed in (Merrill *et al.*, 2015). For example, Jiggins *et al.* (2001) used paper models to show that two sister species (*H. cydno* and *H. melpomene*) that recently diverged and mimicked different model taxa were under sexual selection pressure as well, since mimetic colouration was a cue for mate choice. A more recent example for the role of mimicry in influencing reproductive isolation in the Mullerian mimetic ithomiine butterflies is that of the parapatric subspecies of *Ithomia salapia* that harbour different wing colour patterns and

that hardly exchange genes (Gauthier *et al.*, 2020). McClure, Monllor and Elias (pers. obs) have also observed strong assortative mating for these taxa.

In *Adelpha*, we did not find macroevolutionary evidence for a link between colour pattern shifts and speciation, as a gradual model of evolution was a better fit than a punctuational model. Jiggins *et al.* (2006) found evidence for the punctuational mode of evolution in the ithomiine genus *Ithomia* in most lineages, except for a few cases, especially between the most recent sympatric species. They suggested an alternative explanation to ecological adaptation, where rapid range movements subsequent to speciation might hide the speciation signal. McClure *et al.*, 2019 also presented some cases where a shift in colour pattern *per se* was not sufficient for reproductive isolation. They suggested that evolution of assortative mating may be explained by selection against maladaptive intermediate phenotypes.

By contrast, the existence of closely related sympatric mimetic forms in *Heliconius* (in *H. cydno*/*H. melpomene* mimetic complex [Giraldo *et al.*, 2008]) is consistent either with speciation without colour pattern shift, or a very recent convergence of colour patterns between hybridising species, possibly due to adaptive introgression (Jiggins, 2008; The Heliconius Genome Consortium, 2012). Mérot *et al.* (2013, 2015) provided more evidence for speciation without a mimetic shift in two closely related, hybridising co-mimetic species *H. melpomene amaryllis* and *H. timareta thelxinoe* (figure 6).



Figure 6. Two closely related, hybridizing co-mimetic species on the eastern slopes of the Andes, *Heliconius timareta thelxinoe* male (up), from the Alto Mayo, Peru; and *H. melpomene amaryllis* male (bottom), from Tarapoto, Peru. Figure from Merot *et al.* 2013.

They suggested that genetic isolation in these species could be due to chemical or behavioural signals, or ecological adaptation along an altitudinal gradient, rather than wing patterns.

The role of colour pattern in reproductive isolation needs to be investigated more thoroughly in *Adelpha* by performing mate choice experiments and predation experiments on hybrids, with both paper models and live butterflies; and captive natural predators. Willmott (2003a) reported potential cases of hybrid specimens between *A. irmina* - *A. cocala*, and *A. mesentina* - *A. thesprotia* (closely related but phenotypically distinct species) that would be worth exploring, as well as the possibility of intraspecific chemical communication for mate recognition and courtship in the genus; *Adelpha* males harbour a dense area of darker scales at the base of the ventral forewing, which might have a role in pheromone dissemination as seen in other mimetic groups (e.g., ithomiine butterflies).

Other causes might have driven adaptive diversification of the genus *Adelpha*. In phytophagous insects, such as butterflies, host plant shifts are assumed to be one of the main drivers of diversification. Three evolutionary scenarios have been proposed: 1) the *escape and radiate* coevolution scenario from Ehrlich and Raven (1964), where the evolution of novel phytochemicals in plants releases them from herbivore pressure by placing them in a new adaptive zone that facilitates evolutionary radiation. Similarly, evolution of a herbivore's trait that enables them to tolerate or sequester plant defences leads to a burst of diversification in the herbivore clade; 2) the *oscillation* hypothesis from Janz and Nylin (2008) proposed that an insect's phenotypic plasticity in relation to host-plants enables an expansion of diet breadth, which is then followed by specialisation to novel host plants; and 3) the *musical chairs* hypothesis (Hardy and Otto, 2014) where speciation is host-driven, i.e., phytophagous insects speciate by the sequential capture of new host-plants. McBride and Singer (2010) provided empirical evidence for incipient speciation driven by host plant shift in a butterfly. Ebel *et al.* (2015) reconstructed the ancestral state of host plants across *Adelpha* and analysed diversification rates related to host plant shifts. They observed a rapid diversification in *Adelpha*'s lowland clade, which was correlated with host plant shift. Additionally, Rubiaceae was inferred to be the ancestral state of this clade, and given that this plant family produces anti-herbivorous, bioactive compounds (e.g., Lopes *et al.*, 2004; Phillipson *et al.*, 1982; Soto-Sobenis *et al.*, 2001), it was suggested that *Adelpha*'s ability to feed on toxic host plants has played an important role in the rapid diversification of the genus (figure 7).



Figure 7. *Adelpha leucophthalma* feeding on *Varronia spinescens* (Boraginaceae). Hill and Mullen 2019 observed this behaviour in some *Adelpha* species which suggested toxicity since plants from the family Boraginaceae play an important role in other unpalatable mimetic butterflies. Figure from Hill and Mullen 2019.

In mimetic butterflies, colour pattern, habitat/microhabitat, and host plants are correlated (Chazot *et al.*, 2014; Elias *et al.*, 2008; Willmott *et al.*, 2017; Willmott and Mallet, 2004), and thus shifts in one of these traits might entail multiple cascading shifts in others, facilitating rapid evolution of reproductive isolation. *Heliconius* diversification is often associated with concordant shifts in colour pattern and habitat use (e.g., Arias *et al.*, 2008; Estrada and Jiggins, 2002; Mallet, 1993). In the species-rich butterfly tribe Ithomiini, co-mimetic species often occupy the same larval host-plant species. Willmott and Mallet (2004) suggested that shifts in mimicry pattern may be directly linked to shifts in microhabitat and altitude which also may facilitate other shifts in habitat or larval host plants. Elias *et al.* (2008) found that mimicry drives convergence in flight height and forest microhabitat, outweighing competition and common ancestry. Moreover, Merrill *et al.* (2010) observed genetic linkage

between colour pattern mate preference and host plant preference that contributes to reproductive and ecological isolation despite persistence of gene flow in *Heliconius* sister species. *Adelpha* has been highly radiating like *Heliconius* and ithomiines. Although we did not find evidence that shifts in mimicry patterns are associated with cladogenesis, we found evidence for an association between mimicry pattern and elevation. The link between mimicry and other ecological variables that may drive reproductive isolation, such as host plant and microhabitat, needs to be investigated.

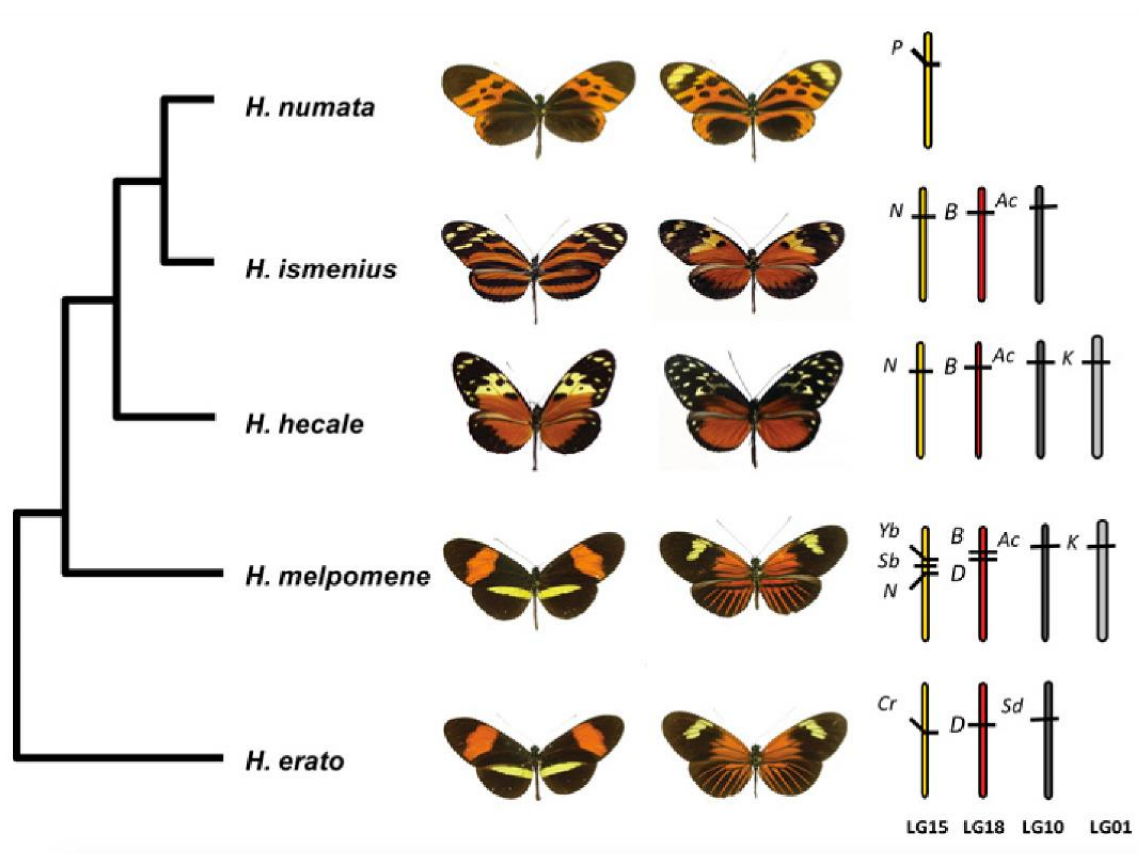

Figure 8. Example of the “wing patterning toolkit” of *Heliconius* butterflies. Homologous regions in four linkage groups (coloured bars) control most of wing pattern convergence and divergence across multiple species. Figure from Elias et Joron 2015.

The genetic architecture of mimetic patterns can provide more clues about the mechanisms underlying adaptive radiation, since it determines how colour patterns are recombined, or not, in the case of hybridization. *Heliconius* butterflies have provided strong evidence for genetic determinism of the diversity of colour patterns and races in the genus: the mimicry ‘tool-kit’ found in *Heliconius* (Joron *et al.*, 2006) (figure8) is a reduced set of five genetic loci, where adaptive combinations of alleles have a large phenotypic effect. Some of the underlying genes have been identified (reviewed in Nadeau *et al.*, 2016; Westerman *et al.*, 2018), which have

enabled functional tests using in situ hybridization and crispR/cas9 KO (Livraghi et al., 2021) (e.g., *optix* [Martin et al., 2014; Reed et al., 2011]; *cortex* [Joron et al., 2006; Nadeau et al., 2016]; *WntA* [Martin et al., 2012; Nadeau et al., 2014]; *Aristaless* (Westerman et al., 2018). This multilocus architecture observed in *Heliconius*, and in individuals with recombinant patterns occurring in hybrid zones contrasts with the unique case of *H. numata*, where all variation in colour pattern is controlled by a single Mendelian locus “P” known as a “supergene” (Joron et al., 2006), with a series of hierarchical dominance (Joron et al., 2011; Le Poul et al., 2014), and where hardly any recombinant forms are produced. Further research should focus on unravelling the genetic architecture of colour patterns in *Adelpha*. It will be worth identifying genes that are known to have an important role in mimetic diversity, such as the gene *cortex*, which is important in multiple lineages for pigmentation patterning (e.g., the well-known case of industrial melanism in the peppered moth *Biston betularia* is caused by the disruption of the *cortex* gene, a gene also involved in colour pattern variation in *Heliconius* [(Hof et al., 2016; Nadeau et al., 2016)]).

Finally, the Andes have been considered an important driver of diversification in the Neotropics, within mountains and for neighbouring regions (Hoorn et al., 2010). Multiple factors can drive speciation in the Andes, such as the ecological gradient along with altitude (Bush, 1994; Chapman, 1917; Endler, 1977). Many abiotic factors correlate with altitude (e.g., temperature, humidity, sunlight), but also biotic factors (e.g., predation, parasitism, herbivory). Speciation driven by adaptation to variations in climatic conditions (Hodkinson, 2005) and species-driven expansion of available resources and niche space, catalysed by different levels of interactions (Schemske et al., 2009), can produce ecological segregation. However, speciation has been observed more often within altitudinal bands (through habitat tracking [e.g., Wiens, 2004]) rather than across altitudinal bands since the altitudinal niche seems to be relatively phylogenetically well conserved (e.g., *Hypanartia* [Willmott et al., 2001], *Lymanopoda* [Casner and Pyrcz, 2010], *Ithomia* and *Napeogenes* butterflies [Elias et al., 2009]). Still, when species succeed in colonising new altitudinal bands, new opportunities for local speciation may occur, for example associated with new host plant communities which also vary in altitude (e.g., Asner et al., 2014; Lieberman et al., 1996). Isolation can also occur across both sides of the Andes or across valleys. For example, exchanges among the Northern and Central Andes were constrained probably due to the marine barrier between these two regions i.e., the Western Andean Portal, which led to the evolution of distinct floras and faunas (Antonelli et al., 2009). In addition, the slopes of the Andes harbour an intricate topography,

with deep valleys which create new opportunities for geographic divergence (Graham *et al.*, 2004; Hughes and Eastwood, 2006). Finally, the uplift of the Andes has triggered diversification by isolating populations on either side (vicariant speciation, e.g., Chapman, 1917).

The Andean orogeny as a driver of species diversification has been extensively studied in vertebrates (e.g., Brumfield and Edwards, 2007; Castroviejo-Fisher *et al.*, 2014; Fouquet *et al.*, 2014; Lynch Alfaro *et al.*, 2015; McGuire *et al.*, 2014; Parada *et al.*, 2015), and plants (e.g., Antonelli and Sanmartín, 2011; Givnish *et al.*, 2015; Hughes and Eastwood, 2006; Lagomarsino *et al.*, 2016). In Neotropical butterflies, a number of recent studies have proposed different biogeographic and diversification scenarios for the role of the Andes orogeny in diversification (e.g., Casner and Pyrcz, 2010; Chazot *et al.*, 2016; Condamine *et al.*, 2012; De-Silva *et al.*, 2016; Elias *et al.*, 2009; Hall, 2005; Matos-Maraví *et al.*, 2013; Mullen *et al.*, 2011; Rosser *et al.*, 2012). Some of the patterns described in butterflies are the following: repeated speciation events across altitudes as well as colonisation events into the Andes in *Ithomiola* (Riodinidae) (Hall, 2005); mid-elevation origin in the Andes (most likely due to common ancestry), followed by colonisation and diversification into the lowlands in *Ithomia* and *Napeogenes* (Nymphalidae: Ithomini) (Elias *et al.*, 2009); in contrast, the tribe Godyridina (Nymphalidae: Ithomini) was ancestrally lowland and subsequently colonised higher altitudes (Chazot *et al.*, 2016); diversification promoted by the accelerating uplift of the Andes in *Taygetis* clade (Nymphalidae: Satyrinae) (Matos-Maraví *et al.*, 2013); the hypothesis of the Amazonia acting as a ‘museum’ for long-term evolution of Troidini butterflies (Papilionidae); prolonged uplift of the Andes having an impact on the diversification of the subtribe Oleriina (Nymphalidae: Ithomini) (De-Silva *et al.*, 2016); the cradle hypothesis in *Heliconius*, where species richness peaked in the eastern slope of the Andes and was characterised by very “young” species (Rosser *et al.*, 2012); among others. Mullen *et al.* (2011) found evidence for the hypothesis that species richness in *Adelpha* peaks in the western Amazon as a result of increased diversification rate in the last 10-15 Mys. This rapid diversification is related to early shifts onto novel host plants (Ebel *et al.* 2015), which could reflect host plant shifts being a key innovation driving adaptive radiation among *Adelpha*.

When analysing the phylogenetic structure of Ecuadorian communities, we detected overdispersion across the Andes. Two scenarios could be possible: recent trans-Andean speciation through dispersal; or only dispersal without speciation (maybe ongoing speciation). When looking at the subspecies distribution among the phylogeny (figure 9, see figure 4

Chapter III), we observed a lower number of species distributed on both slopes, suggesting a pattern of overdispersion due to high trans-Andean speciation rather than speciation within slopes (which might result in clustering).

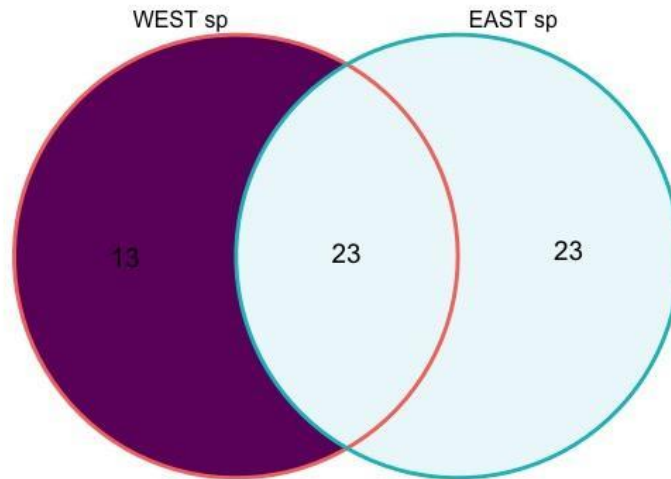

Figure 9. Venn diagram showing the proportion of species shared among slopes.

A historical biogeographic approach, i.e., investigating the spatial pattern of species diversification, could help to confirm this pattern and improve our understanding of the causes for *Adelpha*'s radiation. Chazot *et al.* (2016) proposed a framework which combines historical biogeography, and time- and trait-dependent diversification analyses, to explore the following scenarios for speciation in the Andes, and that could be worth exploring in *Adelpha*: the *cradle* hypothesis (higher speciation rates in the Andean lineages); the *museum* hypothesis (lower extinction rates in the Andean lineages); the *time-for-speciation* hypothesis (earlier colonisation times in the Andes compared to non-andean regions); and the *species-attractor* hypothesis (higher colonisation rates of the Andes from adjacent areas).

Conclusion

In this work we produced a well-resolved phylogeny of the highly diverse *Adelpha* genus, which allowed us to assess different questions regarding the systematics, ecology, and evolution of the genus, notably regarding evasive mimicry. Studies on the evolutionary, ecological, and genetic aspects of classical mimicry in butterflies are largely available, especially in *Heliconius* (and to a lesser extent in *Ithomiini*). But alternative mimetic systems

such as evasive mimicry remain to be explored. The different patterns regarding the evolution of mimicry, its implications on the phylogenetic structure of communities and altitude, suggest that the underlying mechanisms and nature of selection differ from other mimetic systems. This thesis highlights the importance of assessing other mimetic systems, which will help us to evaluate how far previous conclusions on classical mimicry can be generalised, but also the need for examining different taxa to explain general patterns of Neotropical diversification

References

- Alatalo, R. V., and Mappes, J. (1996). Tracking the evolution of warning signals. *Nature*, 382(6593), 708-710. <https://doi.org/10.1038/382708a0>
- Antonelli, A., Nylander, J. A. A., Persson, C., and Sanmartín, I. (2009). Tracing the impact of the Andean uplift on Neotropical plant evolution. *Proceedings of the National Academy of Sciences of the United States of America*, 106(24), 9749-9754. <https://doi.org/10.1073/pnas.0811421106>
- Antonelli, A., and Sanmartín, I. (2011). Why are there so many plant species in the Neotropics? *Taxon*, 60(2), 403-414. <https://doi.org/10.1002/tax.602010>
- Arias, C. F., Muñoz, A. G., Jiggins, C. D., Mavárez, J., Bermingham, E., and Linares, M. (2008). A hybrid zone provides evidence for incipient ecological speciation in *Heliconius* butterflies. *Molecular Ecology*, 17(21), 4699-4712. <https://doi.org/10.1111/j.1365-294X.2008.03934.x>
- Arias, M., le Poul, Y., Chouteau, M., Boisseau, R., Rosser, N., Théry, M., and Llaurens, V. (2016). Crossing fitness valleys: Empirical estimation of a fitness landscape associated with polymorphic mimicry. *Proceedings of the Royal Society B: Biological Sciences*, 283(1829). <https://doi.org/10.1098/rspb.2016.0391>
- Arias, M., Mappes, J., Théry, M., and Llaurens, V. (2016). Inter-species variation in unpalatability does not explain polymorphism in a mimetic species. *Evolutionary Ecology*, 30(3), 419-433. <https://doi.org/10.1007/s10682-015-9815-2>
- Asner, G. P., Anderson, C. B., Martin, R. E., Knapp, D. E., Tupayachi, R., Sinca, F., and Malhi, Y. (2014). Landscape-scale changes in forest structure and functional traits along an Andes-to-Amazon elevation gradient. *Biogeosciences*, 11(3), 843-856. <https://doi.org/10.5194/bg-11-843-2014>
- Bates, H. W. (1862). Contributions to an insect fauna of the Amazon Valley. Lepidoptera: Heliconidae. *Transactions of the Linnean Society of London*, 23, 495-566.

- Benson, W. W. (1972). Natural Selection for Mullerian Mimicry in *Heliconius erato* in Costa Rica. In *Science, New Series* (Vol. 176, 4037, pp. 936-939).
- Betts, C. R., and Wootton, R. J. (1988). Wing Shape And Flight Behaviour In Butterflies (Lepidoptera: Papilionoidea And Hesperioidea): A Preliminary Analysis. *J. Exp. Biol.*, 138, 271-288.
- Brown Jr, K. S., and Vasconcellos Neto, J. (1976). Predation on Aposematic Ithomiine Butterflies by Tanagers (*Pipraeidea melanonota*). *Biotropica*, 8(2), 136-141.
- Brown, K. S. (1982). Historical and ecological factors in the biogeography of aposematic neotropical butterflies. *Integrative and Comparative Biology*, 22(2), 453-471. <https://doi.org/10.1093/icb/22.2.453>
- Brumfield, R. T., and Edwards, S. V. (2007). Evolution into and out of the Andes: a bayesian analysis of historical diversification in *thamnophilus* ants shrikes: evolution into and out of the Andes. *Evolution*, 61(2), 346-367. <https://doi.org/10.1111/j.1558-5646.2007.00039.x>
- Burger, J., and Gochfeld, M. (2001). Smooth-billed Ani (*Crotophaga ani*) predation on butterflies in Mato Grosso, Brazil: Risk decreases with increased group size. *Behav. Ecol. Sociobiol.*, 49, 482-492.
- Bush, M. B. (1994). Amazonian Speciation: A Necessarily Complex Model. *Journal of Biogeography*, 21(1), 5. <https://doi.org/10.2307/2845600>
- Carpenter, H. (1941). The Relative Frequency of Beak-marks on Butterflies of Different Edibility to Birds. *Proceedings of the Zoological Society of London*, 111(3-4), 223-231.
- Casner, K. L., and Pyrcz, T. W. (2010). Patterns and timing of diversification in a tropical montane butterfly genus, *Lymanopoda* (Nymphalidae, Satyrinae). *Ecography*, 33(2), 251-259. <https://doi.org/10.1111/j.1600-0587.2010.06306.x>
- Castroviejo-Fisher, S., Guayasamin, J. M., Gonzalez-Voyer, A., and Vilà, C. (2014). Neotropical diversification seen through glassfrogs. *Journal of Biogeography*, 41(1), 66-80. <https://doi.org/10.1111/jbi.12208>

- Chai, P. (1986). Field observations and feeding experiments on the responses of rufous-tailed jacamars (*Galbula ruficauda*) to free-flying butterflies in a tropical rain forest. *Biol J Linn Soc*, 29, 161-189.
- Chai, P. (1988). Wing Coloration of Free-Flying Neotropical Butterflies as a Signal Learned by a Specialized Avian Predator. *Biotropica*, 20(1), 20-30.
- Chai, P., and Srygley, R. B. (1990). Predation and the Flight, Morphology, and Temperature of Neotropical Rain-Forest Butterflies. *The American Naturalist*, 135(6), 748-765.
- Chamberlain, N. L., Hill, R. I., Kapan, D. D., Gilbert, L. E., and Kronforst, M. R. (2009). Polymorphic butterfly reveals the missing link in ecological speciation. *Science*, 326(5954), 847-850. <https://doi.org/10.1126/science.1179141>
- Chapman, F. M. (1917). The distribution of bird-life in Colombia, a contribution to a biological survey of South America. *Bulletin of the American Museum of Natural History*, 36, 1-659.
- Chazot, N., Willmott, K. R., Condamine, F. L., De-Silva, D. L., Freitas, A. V. L., Lamas, G., Morlon, H., Giraldo, C. E., Jiggins, C. D., Joron, M., Mallet, J., Uribe, S., and Elias, M. (2016). Into the Andes: Multiple independent colonizations drive montane diversity in the Neotropical clearwing butterflies Godyridina. *Molecular Ecology*, 25 (22), 5765-5784. <https://doi.org/10.1111/mec.13773>
- Chazot, N., Willmott, K. R., Santacruz Endara, P. G., Toporov, A., Hill, R. I., Jiggins, C. D., and Elias, M. (2014). Mutualistic Mimicry and Filtering by Altitude Shape the Structure of Andean Butterfly Communities. *The American Naturalist*, 183 (1), 26-39. <https://doi.org/10.1086/674100>
- Chotard A, Ledamoisel J, Decamps T, Herrel A, Chainé A, Llaurens V, Debat V. 2022 Evidence of attack deflection suggests adaptive evolution of wing tails in butterflies. *Proc. R. Soc. B* 20220562. <https://doi.org/10.1098/rspb.2022.0562>
- Chouteau, M., Dezeure, J., Sherratt, T. N., Llaurens, V., and Joron, M. (2019). Similar predator aversion for natural prey with diverse toxicity levels. *Animal Behaviour*, 153, 49-59. <https://doi.org/10.1016/j.anbehav.2019.04.017>

- Condamine, F. L., Silva-Brandão, K. L., Kergoat, G. J., and Sperling, F. A. H. (2012). Biogeographic and diversification patterns of Neotropical Troidini butterflies (Papilionidae) support a museum model of diversity dynamics for Amazonia. *BMC Evolutionary Biology*, 12(1). <https://doi.org/10.1186/1471-2148-12-82>
- De Vries, P. J. (2002). Differential wing toughness in distasteful and palatable butterflies: Direct evidence supports unpalatable theory. *Biotropica*, 34, 176-181.
- Dempster, J. P., King, M. L., and Lakhani, K. H. (1976). The status of the swallowtail butterfly in Britain. *Ecological Entomology*, 1(2), 71-84. <https://doi.org/10.1111/j.1365-2311.1976.tb01207.x>
- De-Silva, D. L., Elias, M., Willmott, K., Mallet, J., and Day, J. J. (2016). Diversification of clearwing butterflies with the rise of the Andes. *Journal of Biogeography*, 43(1), 44-58. <https://doi.org/10.1111/jbi.12611>
- DeVries P.J. (1987). The butterflies of Costa Rica and their natural history. Vol. I: Papilionidae, Pieridae, Nymphalidae. Princeton University Press.
- Dudley, R. (1990). Biomechanics of flight in Neotropical butterflies: Morphometrics and kinematics. *J. Exp. Biol*, 150, 37-53.
- Dudley, R., and Srygley, R. (1994). Flight Physiology of Neotropical Butterflies: Allometry of Airspeeds During Natural Free Flight. *The Journal of Experimental Biology*, 191(1), 125-139.
- Duncan, C. J., and Sheppard, P. M. (1965). Sensory discrimination and its role in the evolution of batesian mimicry. *Behaviour*, 24(3-4), 269-282. <https://doi.org/10.1163/156853965X00066>
- Ehrlich, P. R., and Raven, P. H. (1964). Butterflies and plants: A study in coevolution. *Evolution*, 18, 586-608.
- Elias, M., Gompert, Z., Jiggins, C., and Willmott, K. (2008). Mutualistic interactions drive ecological niche convergence in a diverse butterfly community. *PLoS biology*, 6(12). <https://doi.org/10.1371/journal.pbio.0060300>

- Elias, M., Joron, M., Willmott, K., Silva-Brandão, K. L., Kaiser, V., Arias, C. F., Piñerez, L. M. G., Uribe, S., Brower, A. V. Z., Freitas, A. V. L., and Jiggins, C. D. (2009). Out of the Andes: Patterns of diversification in clearwing butterflies. *Molecular Ecology*, 18(8), 1716-1729. <https://doi.org/10.1111/j.1365-294X.2009.04149.x>
- Endler, J. A. (1977). Geographic Variation, Speciation and Clines. Monographs in population biology, 10, 1-246. <https://doi.org/10.2307/2259234>
- Estrada, C., and Jiggins, C. D. (2002). Patterns of pollen feeding and habitat preference among *Heliconius* species. *Ecological Entomology*, 27(4), 448-456. <https://doi.org/10.1046/j.1365-2311.2002.00434.x>
- Finkbeiner, S. D., Briscoe, A. D., and Mullen, S. P. (2017). Complex dynamics underlie the evolution of imperfect wing pattern convergence in butterflies. *Evolution*, 71(4), 949-959. <https://doi.org/10.1111/evo.13165>
- Finkbeiner, S. D., Salazar, P. A., Nogales, S., Rush, C. E., Briscoe, A. D., Hill, R. I., Kronforst, M. R., Willmott, K. R., and Mullen, S. P. (2018). Frequency dependence shapes the adaptive landscape of imperfect batesian mimicry. *Proceedings of the Royal Society B: Biological Sciences*, 285. <https://doi.org/10.1098/rspb.2017.2786>
- Fjeldså, J. (1994). Geographical patterns for relict and young species of birds in Africa and South America and implications for conservation priorities. *Biodiversity and Conservation*, 3(3), 207-226. <https://doi.org/10.1007/BF00055939>
- Fouquet, A., Santana Cassini, C., Fernando Baptista Haddad, C., Pech, N., and Trefaut Rodrigues, M. (2014). Species delimitation, patterns of diversification and historical biogeography of the Neotropical frog genus *Adenomera* (Anura, Leptodactylidae). *Journal of Biogeography*, 41(5), 855-870. <https://doi.org/10.1111/jbi.12250>
- Garcia J, J., Kimeldorf, D. J., and Koelling, R. A. (1955). Conditioned aversion to saccharin resulting from exposure to gamma radiation. *Science*, 122, 158-158.
- Gauthier, J., Silva, D. L., Gompert, Z., Whibley, A., Houssin, C., Le Poul, Y., McClure, M., Lemaitre, C., Legeai, F., Mallet, J., and Elias, M. (2020). Contrasting genomic and

- phenotypic outcomes of hybridization between pairs of mimetic butterfly taxa across a suture zone. *Molecular Ecology*, 29(7), 1328-1343. <https://doi.org/10.1111/mec.15403>
- Gibson, D. O. (1974). Batesian mimicry without distastefulness? *Nature*, 250, 77-79. <https://doi.org/10.1038/250077a0>
- Gibson, D. O. (1980). The role of escape in mimicry and polymorphism: I. The response of captive birds to artificial prey. *Biological Journal of the Linnean Society*, 14, 201-214. <https://doi.org/10.1111/j.1095-8312.1980.tb00105.x>
- Giraldo, N., Salazar, C., Jiggins, C. D., Bermingham, E., and Linares, M. (2008). Two sisters in the same dress: *Heliconius* cryptic species. *BMC Evolutionary Biology*, 8(1), 1-11. <https://doi.org/10.1186/1471-2148-8-324>
- Givnish, T. J., Spalink, D., Ames, M., Lyon, S. P., Hunter, S. J., Zuluaga, A., Iles, W. J. D., Clements, M. A., Arroyo, M. T. K., Leebens-Mack, J., Endara, L., Kriebel, R., Neubig, K. M., Whitten, W. M., Williams, N. H., and Cameron, K. M. (2015). Orchid phylogenomics and multiple drivers of their extraordinary diversification. *Proceedings of the Royal Society B: Biological Sciences*, 282(1814), 20151553. <https://doi.org/10.1098/rspb.2015.1553>
- Graham, C. H., Ron, S. R., Santos, J. C., Schneider, C. J., and Moritz, C. (2004). Integrating phylogenetics and environmental niche models to explore speciation mechanisms in dendrobatid frogs. *Evolution*, 58(8), 1781-1793. <https://doi.org/10.1111/j.0014-3820.2004.tb00461.x>
- Haffer, J. (1969). Speciation in amazonian forest birds. *Science*, 165(3889), 131-137. <https://doi.org/10.1126/science.165.3889.131>
- Hall, J. P. W. (2005). Montane speciation patterns in *Ithomiola* butterflies (Lepidoptera: Riodinidae): Are they consistently moving up in the world? *Proceedings of the Royal Society B: Biological Sciences*, 272(1580), 2457-2466. <https://doi.org/10.1098/rspb.2005.3254>
- Hancox, A. P., and Allen, J. A. (1991). A simulation of evasive mimicry in the wild. *Journal of Zoology*, 223(1), 9-13. <https://doi.org/10.1111/j.1469-7998.1991.tb04745.x>

- Hardy, N. B., and Otto, S. P. (2014). Specialization and generalization in the diversification of phytophagous insects: Tests of the musical chairs and oscillation hypotheses. *Proceedings of the Royal Society B.*, 281(1795), 20132960. <https://doi.org/10.1098/rspb.2013.2960>
- Heinrich, B. (1995). Insect Thermoregulation. *Endeavour*, 19(1), 28-33.
- Hill, R. I., and Mullen, S. P. (2019). Adult Feeding as a Potential Mechanism for Unprofitability in Neotropical *Adelpha* (Limenitidini, Limenitidinae, Nymphalidae). *The Journal of the Lepidopterists' Society*, 73(1), 66-69. <https://doi.org/10.18473/lepi.73i1.a11>
- Hodkinson, I. D. (2005). Terrestrial insects along elevation gradients: Species and community responses to altitude. *Biological Reviews*, 80(03), 489. <https://doi.org/10.1017/S1464793105006767>
- Hof, A. E. van't, Campagne, P., Rigden, D. J., Yung, C. J., Lingley, J., Quail, M. A., Hall, N., Darby, A. C., and Saccheri, I. J. (2016). The industrial melanism mutation in British peppered moths is a transposable element. *Nature*, 534(7605), 102-105. <https://doi.org/10.1038/nature17951>
- Holmgren, N. M. A., and Enquist, M. (1999). Dynamics of mimicry evolution. *Biological Journal of the Linnean Society*, 66(2), 145-158. <https://doi.org/10.1006/bijl.1998.0269>
- Hoorn, C., Wesselingh, F. P., ter Steege, H., Bermudez, M. A., Mora, A., Sevink, J., Sanmartín, I., Sanchez-Meseguer, A., Anderson, C. L., Figueiredo, J. P., Jaramillo, C., Riff, D., Negri, F. R., Hooghiemstra, H., Lundberg, J., Stadler, T., Särkinen, T., and Antonelli, A. (2010). Amazonia Through Time: Andean. *Science*, 330, 927-931.
- Huey, R. B. (1991). Physiological Consequences of Habitat Selection. *The American Naturalist*, 137, S91-S115. <https://doi.org/10.1086/285141>
- Hughes, C., and Eastwood, R. (2006). Island radiation on a continental scale: Exceptional rates of plant diversification after uplift of the Andes. *Proceedings of the National Academy of Sciences of the United States of America*, 103(27), 10334-10339. <https://doi.org/10.1073/pnas.0601928103>

- Jantzen, B., and Eisner, T. (2008). Hindwings are unnecessary for flight but essential for execution of normal evasive flight in Lepidoptera. *Proceedings of the National Academy of Sciences*, 105(43), 16636-16640. <https://doi.org/10.1073/pnas.0807223105>
- Janz, N., and Nylin, S. (2008). Host plant range and speciation: The oscillation hypothesis. In K. J. Tilmon (Ed.), *Specialization, speciation, and radiation: The Evolutionary Biology of Herbivorous Insects* (pp. 203-215). Univ. of California Press.
- Janzen et al. (2009). Integration of DNA barcoding into an ongoing inventory of complex tropical biodiversity. *Molecular Ecology Resources*, 9, 1-26.
- Jenkins, D. (1983). Neotropical Nymphalidae I. Revision of *Hamadryas*. *Bull Allyn Mus*, 81, 1-46.
- Jiggins, C. D. (2008). Ecological speciation in mimetic butterflies. *BioScience*, 58(6), 541-548. <https://doi.org/10.1641/B580610>
- Jiggins, C. D., Estrada, C., and Rodrigues, A. (2004). Mimicry and the evolution of premating isolation in *Heliconlus melpomene* Linnaeus. *Journal of Evolutionary Biology*, 17(3), 680-691. <https://doi.org/10.1111/j.1420-9101.2004.00675.x>
- Jiggins, C. D., Mallarino, R., Willmott, K. R., and Bermingham, E. (2006). the Phylogenetic Pattern of Speciation and Wing Pattern Change in Neotropical *Ithomia* Butterflies (Lepidoptera: Nymphalidae). *Evolution*, 60(7), 1454. <https://doi.org/10.1554/05-483.1>
- Jiggins, C. D., Naisbit, R. E., Coe, R. L., and Mallet, J. (2001). Reproductive isolation caused by colour pattern mimicry. *Nature*, 411, 302-305. <https://doi.org/10.1038/35077075>
- Joron, M., Frezal, L., Jones, R. T., Chamberlain, N. L., Lee, S. F., Haag, C. R., Whibley, A., Becuwe, M., Baxter, S. W., Ferguson, L., Wilkinson, P. A., Salazar, C., Davidson, C., Clark, R., Quail, M. A., Beasley, H., Glithero, R., Lloyd, C., Sims, S., French-Constant, R. H. (2011). Chromosomal rearrangements maintain a polymorphic supergene controlling butterfly mimicry. *Nature*, 477(7363), 203-206. <https://doi.org/10.1038/nature10341>

Joron, M., Papa, R., Beltrán, M., Chamberlain, N., Mavárez, J., Baxter, S., Abanto, M., Bermingham, E., Humphray, S. J., Rogers, J., Beasley, H., Barlow, K., French-Constant, R. H.,

Mallet, J., McMillan, W. O., and Jiggins, C. D. (2006). A conserved supergene locus controls colour pattern diversity in *Heliconius* butterflies. *PLoS Biology*, 4(10), 1831-1840. <https://doi.org/10.1371/journal.pbio.0040303>

Kapan, D. D. (2001). Three-butterfly system provides a field test of müllerian mimicry. *Nature*, 409(6818), 338-340. <https://doi.org/10.1038/35053066>

Lagomarsino, L. P., Condamine, F. L., Antonelli, A., Mulch, A., and Davis, C. C. (2016). The abiotic and biotic drivers of rapid diversification in Andean bellflowers (Campanulaceae). *New Phytologist*, 210(4), 1430-1442. <https://doi.org/10.1111/nph.13920>

Le Poul, Y., Whibley, A., Chouteau, M., Prunier, F., Llaurens, V., and Joron, M. (2014). Evolution of dominance mechanisms at a butterfly mimicry supergene. *Nature Communications*, 5, 1-8. <https://doi.org/10.1038/ncomms6644>

Le Roy, C., Debat, V., and Llaurens, V. (2019). Adaptive evolution of butterfly wing shape: From morphology to behaviour. *Biological Reviews*, 94(4), 1261-1281. <https://doi.org/10.1111/brv.12500>

Le Roy, C., Roux, C., Authier, E., Parrinello, H., Bastide, H., Debat, V., and Llaurens, V. (2021). Convergent morphology and divergent phenology promote the coexistence of *Morpho* butterfly species. *Nature Communications*, 12(1), 1-9. <https://doi.org/10.1038/s41467-021-27549-1>

Lieberman, D., Lieberman, M., Peralta, R., and Hartshorn, G. S. (1996). Tropical Forest Structure and Composition on a Large-Scale Altitudinal Gradient in Costa Rica. *The Journal of Ecology*, 84(2), 137. <https://doi.org/10.2307/2261350>

Lindstrom, L., Alatalo, R. V., and Mappes, J. (1997). Imperfect Batesian mimicry—The effects of the frequency and the distastefulness of the model. *Proceedings of the Royal Society B: Biological Sciences*, 264(1379), 149-153. <https://doi.org/10.1098/rspb.1997.0022>

- Livraghi, L., Hanly, J. J., Van Bellghem, S. M., Montejo-Kovacevich, G., van der Heijden, E. S., Loh, L. S., Ren, A., Warren, I. A., Lewis, J. J., Concha, C., Hebberecht, L., Wright, C. J., Walker, J. M., Foley, J., Goldberg, Z. H., Arenas-Castro, H., Salazar, C., Perry, M. W., Papa, R., Jiggins, C. D. (2021). Cortex cis-regulatory switches establish scale colour identity and pattern diversity in *Heliconius*. *ELife*, 10, e68549. <https://doi.org/10.7554/eLife.68549>
- Llaurens, V., Le Poul, Y., Puissant, A., Blandin, P., and Debat, V. (2021). Convergence in sympatry: Evolution of blue-banded wing pattern in *Morpho* butterflies. *Journal of Evolutionary Biology*, 34(2), 284-295. <https://doi.org/10.1111/jeb.13726>
- Lopes, S., von Poser, G. L., Kerber, V. A., Farias, F. M., Konrath, E. L., Moreno, P., Sobral, M. E., Zuanazzi, J. A. S., and Henriques, A. T. (2004). Taxonomic significance of alkaloids and iridoid glucosides in the tribe Psychotrieae (Rubiaceae). *Biochemical Systematics and Ecology*, 32(12), 1187-1195. <https://doi.org/10.1016/j.bse.2004.04.015>
- Lynch Alfaro, J. W., Cortés-Ortiz, L., Di Fiore, A., and Boubli, J. P. (2015). Special issue: Comparative biogeography of Neotropical primates. *Molecular Phylogenetics and Evolution*, 82, 518-529. <https://doi.org/10.1016/j.ympev.2014.09.027>
- Mallet, J. (1993). Speciation, raiation, and color pattern evolution in *Heliconius* butterflies: Evidence from hybrid zones. En *Hybrid Zones and the Evolutionary Process* (R.G. Harrison, pp. 226-260). Oxford University Press.
- Mallet, J., and Barton, N. H. (1989). Strong natural selection in a warning-color hybrid zone. *Evolution*, 43(2), 421-431. <https://doi.org/10.1111/j.1558-5646.1989.tb04237.x>
- Marples, N. M., Brakefield, P. M., and Cowie, R. J. (1989). Differences between the 7-spot and 2-spot ladybird beetles (Coccinellidae) in their toxic effects on a bird predator. *Ecological Entomology*, 14(1), 79-84. <https://doi.org/10.1111/j.1365-2311.1989.tb00756.x>
- Marples, N. M., Speed, M. P., and Thomas, R. J. (2018). An individual-based profitability spectrum for understanding interactions between predators and their prey. *Biological*

Journal of the Linnean Society, 125(1), 1-13.
<https://doi.org/10.1093/BIOLINNEAN/BLY088>

- Martin, A., McCulloch, K. J., Patel, N. H., Briscoe, A. D., Gilbert, L. E., and Reed, R. D. (2014). Multiple recent co-options of *Optix* associated with novel traits in adaptive butterfly wing radiations. *EvoDevo*, 5(1). <https://doi.org/10.1186/2041-9139-5-7>
- Martin, A., Papa, R., Nadeau, N. J., Hill, R. I., Counterman, B. A., Halder, G., Jiggins, C. D., Kronforst, M. R., Long, A. D., McMillan, W. O., and Reed, R. D. (2012). Diversification of complex butterfly wing patterns by repeated regulatory evolution of a *Wnt* ligand. *Proceedings of the National Academy of Sciences of the United States of America*, 109(31), 12632-12637. <https://doi.org/10.1073/pnas.1204800109>
- Massuda, K. F., and Trigo, J. R. (2009). Chemical defence of the warningly coloured caterpillars of *Methona themisto* (Lepidoptera: Nymphalidae: Ithomiinae). *European Journal of Entomology*, 106(2), 253-259. <https://doi.org/10.14411/eje.2009.033>
- Matos-Maraví, P. F., Peña, C., Willmott, K. R., Freitas, A. V. L., and Wahlberg, N. (2013). Systematics and evolutionary history of butterflies in the «*Taygetis* clade» (Nymphalidae: Satyrinae: Euptychiina): Towards a better understanding of Neotropical biogeography. *Molecular Phylogenetics and Evolution*, 66(1), 54-68. <https://doi.org/10.1016/j.ympev.2012.09.005>
- McBride, C. S., and Singer, M. C. (2010). Field Studies Reveal Strong Postmating Isolation between Ecologically Divergent Butterfly Populations. *PLoS Biology*, 8(10), e1000529. <https://doi.org/10.1371/journal.pbio.1000529>
- McClure, M., Mahrouche, L., Houssin, C., Monllor, M., Le Poul, Y., Frérot, B., Furtos, A., and Elias, M. (2019). Does divergent selection predict the evolution of mate preference and reproductive isolation in the tropical butterfly genus *Melinaea* (Nymphalidae: Ithomiini)? *Journal of Animal Ecology*, 88(6), 940-952. <https://doi.org/10.1111/1365-2656.12975>
- McGuire, J. A., Witt, C. C., Remsen, J. V., Corl, A., Rabosky, D. L., Altshuler, D. L., and Dudley, R. (2014). Molecular Phylogenetics and the Diversification of Hummingbirds. *Current Biology*, 24(8), 910-916. <https://doi.org/10.1016/j.cub.2014.03.016>

- Mérot, C., Frérot, B., Leppik, E., and Joron, M. (2015). Beyond magic traits: Multimodal mating cues in *Heliconius* butterflies. *Evolution*, 69(11), 2891-2904. <https://doi.org/10.1111/evo.12789>
- Mérot, C., Mavárez, J., Evin, A., Dasmahapatra, K. K., Mallet, J., Lamas, G., and Joron, M. (2013). Genetic differentiation without mimicry shift in a pair of hybridizing *Heliconius* species (Lepidoptera: Nymphalidae). *Biological Journal of the Linnean Society*, 109(4), 830-847. <https://doi.org/10.1111/bij.12091>
- Merrill, R. M., Chia, A., and Nadeau, N. J. (2014). Divergent warning patterns contribute to assortative mating between incipient *Heliconius* species. *Ecology and Evolution*, 4(7), 911-917. <https://doi.org/10.1002/ece3.996>
- Merrill, R. M., Dasmahapatra, K. K., Davey, J. W., Dell'Aglio, D. D., Hanly, J. J., Huber, B., Jiggins, C. D., Joron, M., Kozak, K. M., Llaurens, V., Martin, S. H., Montgomery, S. H., Morris, J., Nadeau, N. J., Pinharanda, A. L., Rosser, N., Thompson, M. J., Vanjari, S., Wallbank, R. W. R., and Yu, Q. (2015). The diversification of *Heliconius* butterflies: What have we learned in 150 years? *Journal of Evolutionary Biology*, 28(8), 1417-1438. <https://doi.org/10.1111/jeb.12672>
- Merrill, R. M., Van Schooten, B., Scott, J. A., and Jiggins, C. D. (2011). Pervasive genetic associations between traits causing reproductive isolation in *Heliconius* butterflies. *Proceedings of the Royal Society B*, 278(1705), 511-518. <https://doi.org/10.1098/rspb.2010.1493>
- Merrill, R. M., Wallbank, R. W. R., Bull, V., Salazar, P. C. A., Mallet, J., Stevens, M., and Jiggins, C. D. (2012). Disruptive ecological selection on a mating cue. *Proceedings of the Royal Society B*, 279(1749), 4907-4913. <https://doi.org/10.1098/rspb.2012.1968>
- Mullen, S. P., Savage, W. K., Wahlberg, N., and Willmott, K. R. (2011). Rapid diversification and not clade age explains high diversity in neotropical *Adelpha* butterflies. *Proceedings of the Royal Society B*, 278(1713), 1777-1785. <https://doi.org/10.1098/rspb.2010.2140>
- Muller, F. (1879). *Ituna* and *Thyridia*; a remarkable case of Mimicry in Butterflies. *Proc. R. Ent. Soc. Lond.*, xx-xxix.

- Nadeau, N. J., Pardo-Diaz, C., Whibley, A., Supple, M. A., Saenko, S. V., Wallbank, R. W. R., Wu, G. C., Maroja, L., Ferguson, L., Hanly, J. J., Hines, H., Salazar, C., Merrill, R. M., Dowling, A. J., French-Constant, R. H., Llaurens, V., Joron, M., McMillan, W. O., and Jiggins, C. D. (2016). The gene *cortex* controls mimicry and crypsis in butterflies and moths. *Nature*, 534(7605), 106-110. <https://doi.org/10.1038/nature17961>
- Nadeau, N. J., Ruiz, M., Salazar, P., Counterman, B., Medina, J. A., Ortiz-Zuazaga, H., Morrison, A., McMillan, W. O., Jiggins, C. D., and Papa, R. (2014). Population genomics of parallel hybrid zones in the mimetic butterflies, *H. melpomene* and *H. erato*. *Genome Research*, 24(8), 1316-1333. <https://doi.org/10.1101/gr.169292.113>
- Naisbit, R. E., Jiggins, C. D., and Mallet, J. (2001). Disruptive sexual selection against hybrids contributes to speciation between *Heliconius cydno* and *Heliconius melpomene*. *Proceedings of the Royal Society B*. 268(1478), 1849-1854. <https://doi.org/10.1098/rspb.2001.1753>
- Olofsson, M., Vallin, A., Jakobsson, S., and Wiklund, C. (2010). Marginal Eyespots on Butterfly Wings Deflect Bird Attacks Under Low Light Intensities with UV Wavelengths. *PLoS ONE*, 5(5), e10798. <https://doi.org/10.1371/journal.pone.0010798>
- Oudman, T., Onrust, J., de Fouw, J., Spaans, B., Piersma, T., and van Gils, J. A. (2014). Digestive capacity and toxicity cause mixed diets in red knots that maximize energy intake rate. *American Naturalist*, 183(5), 650-659. <https://doi.org/10.1086/675759>
- Parada, A., D'Elia, G., and Palma, R. E. (2015). The influence of ecological and geographical context in the radiation of Neotropical sigmodontine rodents. *BMC Evolutionary Biology*, 15(1), 172. <https://doi.org/10.1186/s12862-015-0440-z>
- Phillipson, J. D., Hemingway, S. R., and Ridsdale, C. E. (1982). The chemotaxonomic significance of alkaloids in the *Naucleaeae* s. L. (Rubiaceae). *J Nat Prod*, 45, 145-162.
- Pinheiro, C. E. G. (1996). Palatability and escaping ability in Neotropical butterflies: Tests with wild kingbirds (*Tyrannus melancholicus*, Tyrannidae). *Biological Journal of the Linnean Society*, 59, 351-365.

- Pinheiro, C. E. G. (2003). Does Müllerian Mimicry Work in Nature? Experiments with Butterflies and Birds (Tyrannidae). *Biotropica*, 35(3), 356-364.
- Pinheiro, C. E. G., and Campos, V. C. (2013). Do rufous-tailed jacamars (*Galbula ruficauda*) play with aposematic butterflies? *Ornitologia Neotropical*, 24, 1-3.
- Pinheiro, C. E. G., and Campos, V. C. (2019). The responses of wild jacamars (*Galbula ruficauda*, Galbulidae) to aposematic, aposematic and cryptic, and cryptic butterflies in central Brazil. *Ecological Entomology*. <https://doi.org/10.1111/een.12723>
- Pinheiro, C. E. G., and Cintra, R. (2017). Butterfly Predators in the Neotropics: Which Birds are Involved? *Journal of the Lepidopterists' Society*, 71(2), 109-114. <https://doi.org/10.18473/lepi.71i2.a5>
- Pinheiro, C. E. G., and Freitas, A. V. L. (2014). Some Possible Cases of Escape Mimicry in Neotropical Butterflies. *Neotropical Entomology*, 43, 393-398. <https://doi.org/10.1007/s13744-014-0240-and>
- Pinheiro, C. E. G., Freitas, A. V. L., Devries, P. J., and Penz, C. M. (2016). Both Palatable and Unpalatable Butterflies Use Bright Colors to Signal Difficulty of Capture to Predators. *Neotropical Entomology*, 45, 107-113. <https://doi.org/10.1007/s13744-015-0359-5>
- Pinheiro de Castro, É. C., Zagrobelny, M., Zurano, J. P., Zikan Cardoso, M., Feyereisen, R., and Bak, S. (2019). Sequestration and biosynthesis of cyanogenic glucosides in passion vine butterflies and consequences for the diversification of their host plants. *Ecology and Evolution*, 9(9), 5079-5093. <https://doi.org/10.1002/ece3.5062>
- Prudic, K. L., Stoehr, A. M., Wasik, B. R., and Monteiro, A. (2015). Eyespots deflect predator attack increasing fitness and promoting the evolution of phenotypic plasticity. *Proceedings of the Royal Society B.*, 282(1798), 20141531. <https://doi.org/10.1098/rspb.2014.1531>
- Reed, R. D., Papa, R., Martin, A., Hines, H. M., Counterman, B. A., Pardo-Diaz, C., Jiggins, C. D., Chamberlain, N. L., Kronforst, M. R., Chen, R., Halder, G., Nijhout, H. F., and McMillan, W. O. (2011). *Optix* drives the repeated convergent evolution of butterfly

wing pattern mimicry. *Science*, 333(6046), 1137-1141.
<https://doi.org/10.1126/science.1208227>

Robbins, R. K. (1980). The lycaenid “false head” hypothesis: Historical review and quantitative analysis. *J Lepid Soc*, 34, 194-208.

Rosser, N., Phillimore, A. B., Huertas, B., Willmott, K. R., and Mallet, J. (2012). Testing historical explanations for gradients in species richness in heliconiine butterflies of tropical America. *Biological Journal of the Linnean Society*, 105(3), 479-497.
<https://doi.org/10.1111/j.1095-8312.2011.01814.x>

Rowland, H. M., Ruxton, G. D., and Skelhorn, J. (2013). Bitter taste enhances predatory biases against aggregations of prey with warning coloration. *Behavioral Ecology*, 24(4), 942-948. <https://doi.org/10.1093/beheco/art013>

Ruxton, G. D., Speed, M., and Sherratt, T. N. (2004). Evasive mimicry: When (if ever) could mimicry based on difficulty of capture evolve? *Proceedings of the Royal Society B: Biological Sciences*, 271(1553), 2135-2142. <https://doi.org/10.1098/rspb.2004.2816>

Schemske, D. W., Mittelbach, G. G., Cornell, H. V., Sobel, J. M., and Roy, K. (2009). Is there a latitudinal gradient in the importance of biotic interactions? *Annual Review of Ecology, Evolution, and Systematics*, 40, 245-269.

Schneider, C. J., Smith, T. B., Larison, B., and Moritz, C. (1999). A test of alternative models of diversification in tropical rainforests: Ecological gradients vs. Rainforest refugia. *Proceedings of the National Academy of Sciences of the United States of America*, 96(24), 13869-13873. <https://doi.org/10.1073/pnas.96.24.13869>

Sculfort, O., de Castro, E. C. P., Kozak, K. M., Bak, S., Elias, M., Nay, B., and Llaurens, V. (2020). Variation of chemical compounds in wild Heliconiini reveals ecological factors involved in the evolution of chemical defenses in mimetic butterflies. *Ecology and Evolution*, 10(5), 2677-2694. <https://doi.org/10.1002/ece3.6044>

Servedio, M. R., Doorn, G. S. V., Kopp, M., Frame, A. M., and Nosil, P. (2011). Magic traits in speciation: «magic» but not rare? *Trends in Ecology and Evolution*, 26(8), 389-397. <https://doi.org/10.1016/j.tree.2011.04.005>

- Sherratt, T. N. (2003). State-dependent risk-taking by predators in systems with defended prey. *Oikos*, 103(1), 93-100. <https://doi.org/10.1034/j.1600-0706.2003.12576.x>
- Skelhorn, J., Rowland, H. M., Speed, M. P., and Ruxton, G. D. (2010). Masquerade: Camouflage Without Crypsis. *Science*, 327(5961), 51-51. <https://doi.org/10.1126/science.1181931>
- Soto-Sobenis, A., Castillo, B., Delgado, A., González, A., and Montenegro, R. (2001). Alkaloid Screening of Herbarium Samples of Rubiaceae from Panama. *Pharmaceutical Biology*, 39(3), 161-169. <https://doi.org/10.1076/phbi.39.3.161.5925>
- Srygley, R. B., and Chai, P. (1990). Flight Morphology of Neotropical Butterflies: Palatability and Distribution of Mass to the Thorax and Abdomen. *Oecologia*, 84(4), 491-499.
- Srygley, R. B., and Dudley, R. (1993). Correlations of the Position of Center of Body Mass With Butterfly Escape Tactics. *Journal of Experimental Biology*, 174(1), 155-166.
- Stevens, M., Stubbins, C. L., and Hardman, C. J. (2008). The anti-predator function of “eyespots” on camouflaged and conspicuous prey. *Behav. Ecol. Sociobiol.*, 62, 1787-1793.
- The Heliconius Genome Consortium. (2012). Butterfly genome reveals promiscuous exchange of mimicry adaptations among species. *Nature*, 487(7405), 94-98. <https://doi.org/10.1038/nature11041>
- Turner, J. R. (1977). Butterfly mimicry: The genetical evolution of an adaptation. *Evolutionary Biology*, 10, 163-206.
- Van Someren, V. G. L. J., and Jackson, T. H. E. (1959). Some Comments on the Protective Resemblance Amongst African Lepidoptera (Rhopalocera). *Journal of the Lepidopterists' Society*, 13(3).
- Westerman, E. L., VanKuren, N. W., Massardo, D., Tenger-Trolander, A., Zhang, W., Hill, R. I., Perry, M., Bayala, E., Barr, K., Chamberlain, N., Douglas, T. E., Buerkle, N., Palmer, S. E., and Kronforst, M. R. (2018). Aristaless Controls Butterfly Wing Color Variation

Used in Mimicry and Mate Choice. *Current Biology*, 28(21), 3469-3474.e4.
<https://doi.org/10.1016/j.cub.2018.08.051>

Wiens, J. J. (2004). Speciation and ecology revisited: phylogenetic niche conservatism and the origin of species. *Evolution*, 58(1), 193-197. <https://doi.org/10.1111/j.0014-3820.2004.tb01586.x>

Willmott, K., Hall, J. P. W., and Lamas, G. (2001). Systematics of *Hypanartia* (Lepidoptera: Nymphalidae: Nymphalinae), with a test for geographical speciation mechanisms in the Andes. *Systematic Entomology*, 26, 369-399.

Willmott, K. R., and Mallet, J. (2004). Correlations between adult mimicry and larval host plants in ithomiine butterflies. *Proceedings of the Royal Society B.*, 271(SUPPL. 5).
<https://doi.org/10.1098/rsbl.2004.0184>

Willmott, K. R., Robinson Willmott, J. C., Elias, M., and Jiggins, C. D. (2017). Maintaining mimicry diversity: Optimal warning colour patterns differ among microhabitats in Amazonian clearwing butterflies. *Proceedings of the Royal Society B.*, 284(20170744).
<https://doi.org/10.1098/rspb.2017.0744>

Wolfgang Wickler. (1968). Mimicry in plants and animals. Weidenfeld and Nicolson. Cambridge, UK.

Appendix 1

**Quantifying *Adelpha* wing colour pattern variation using Colour Pattern
Modelling**

Backgrounds

Mimicry occurs when one organism (the mimic) converges on phenotypic traits of another (the model) due to the selective benefits of sharing such a resemblance (Endler, 1991; Kikuchi & Pfennig, 2013; Malcolm, 1990; Mallet & Joron, 1999; Ruxton et al., 2004). Along this thesis, we have considered mimicry rings as fixed and discrete phenotypic entities, although, in nature there is often variation within mimicry rings, which is known as imperfect mimicry (i.e., putative mimics resembling their models inaccurately). Imperfect mimicry has been largely documented (Kikuchi & Pfennig, 2013) and references therein). For example, in wasp (Hymenoptera: Vespidae) - hoverflies (Diptera: Syrphidae) systems, some species present only a superficial resemblance to their models (Gilbert, 2005). Penney et al. (2012) suggested that reduced predation pressure on less profitable prey species (i.e., based on a positive correlation between mimetic fidelity and body size) limits the selection for mimetic perfection. Mimicry rings may even overlap to some extent (Willmott, Doré and Elias pers. obs).

Variation in mimicry rings may be influenced by varied factors such as (a) *genetic/developmental constraints*: a population of imperfect mimics may lack the genetic architecture to evolve accurate resemblance to their models or co-mimics; (b) *relaxed selection*, where mimics are under little selection to evolve closer mimetic patterns because of the risks of predators to mistakenly attacking a model (Duncan & Sheppard, 1965; Penney et al., 2012; Sherratt, 2013); among others (for a summary, see Kikuchi & Pfennig, 2013).

(Ebel et al., 2015) defined 14 mimicry rings for 61 species in *Adelpha* based on the same general rationale as described for other mimetic taxa (e.g., ithomiines [Doré et al., 2021]), which primarily includes geographic variation within phenotypically similar patterns. Examples in *Adelpha* include the orange scaling on the outer edge of the white hindwing band in COCALA in eastern Merida range, or the narrow white bands in IPHICLUS in western Ecuador (discussed by Willmott, 2003). This thesis is the first work where mimicry patterns are defined for all the *Adelpha* taxa (90 species, 133 subspecies).

In *Adelpha*, definition of mimicry rings is quite straightforward compared to other mimetic taxa, although there may be some variation within mimicry rings, which raises a number of questions: does such variation relate to phylogenetic distance between species, which would be suggestive of genetic constraints? Is there evidence that the intensity of selection constrains within-ring variation? In this case we should expect more tropical communities to show stronger convergence, due to more predation. We may also expect narrowly distributed and rare species to be better mimics, since selection on them should be stronger than on more common species.

Analyzing mimicry pattern variation in response to ecological, evolutionary, genetical or developmental processes requires precise and objective quantifications. However, classification into mimicry rings is not always straightforward, and could lead to human-biased perception, especially when fine variation or different elements of colour patterns need to be described. A number of tools for quantification of colour patterns that do not rely on perception are available, including: (a) basic descriptions such as counting the number of spots [Merilaita et al., 2011], or stripes [Rand, 1954]; and (b) more sophisticated descriptions e.g., statistical models that characterise spatial variance of patterns (Khotanzad & Hong, 1990); or spatial frequency using the Fourier transform (e.g., Barbosa et al., 2008; Godfrey et al., 1987); among others. Le Poul et al. (2014), developed a method i.e., Colour Pattern Modelling (CPM), based on automatic image processing techniques. This framework allows the description of the spatial aspect of positional colour pattern variations by pixel-by-pixel.

Here we present preliminary data of quantification of colour variation in *Adelpha* mimicry patterns using Colour Pattern Modelling (Le Poul 2014), which will be used in further analyses in the future.

CPM method for characterization of *Adelpha* mimicry rings

Specifically, this technique allowed us to quantify colour pattern variation in *Adelpha*. The different steps are the following:

- 1) Photographs of the dorsal side of the forewings and hindwings of 314 individuals (5-10 individuals per species, Table S1) were taken under standardised conditions (see Le Poul et al 2014 for details). In total, we analysed 54 species representing the phenotypic range of *Adelpha* species from Ecuador, on which nine mimicry patterns were assigned based on Willmott 2003. Specimens were taken from the collection of QCAZ-Pontificia Universidad Católica del Ecuador, Quito-Ecuador; INABIO, Quito-Ecuador and MNHN, Paris-France. Most of the specimens were conserved in envelopes, thus separation of wings was allowed and done easily. For the specimens pinned with the entire body, image manipulation using imaging software (GIMP) was needed to separate wings from the body prior to the CPM analysis.
- 2) CPM detects and deletes the background from wing images, then attributes a set of colours (i.e., black, light orange, orange, dark orange & red, white) that were previously chosen by the operator to each of the pixel of wing images. Attribution is automatic and simultaneous for the whole set of wings using a threshold on RGB values. Colour attribution is checked

manually to correct errors, which are usually due to minor damages to parts of the wings. This results in the final segmented image.

- 3) Fore and hindwings are aligned separately, and similarity with a wing model that averages all wing images (accounting for wing shape and pattern), is maximised in a recursive way.
- 4) After the alignment, position of each pixel is considered homologous among all individuals, enabling the pixel-by-pixel analysis of colour variation.
- 5) Finally, a binary Principal Component Analysis, where each pixel is transformed into as many bits as the number of colour, each one indicating the presence of one of the possible colour on this pixel, is performed to summarise phenotype variations in a morphological space. PCA uses as variables each pixel common to the entire stack of wings. thus. In this case, the different colours are not ordered, and are treated independently (Le Poul 2012).

Preliminary Results

Average colour patterns

Some mimicry patterns are similar in colour and pattern for one of the wings, e.g., COCALA, MESENTINA (to a lesser extent LEUCERIA and ZINA) (orange forewing band); or COCALA and IPHICLUS (white hindwing band). Others are similar only in pattern such as EPIONE and LYCORIAS.

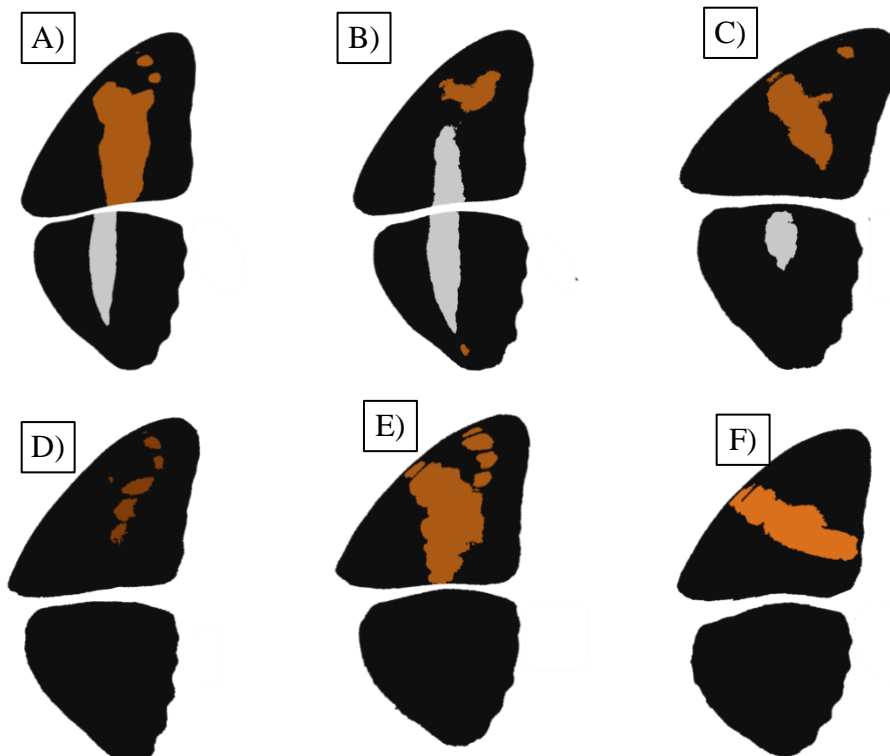

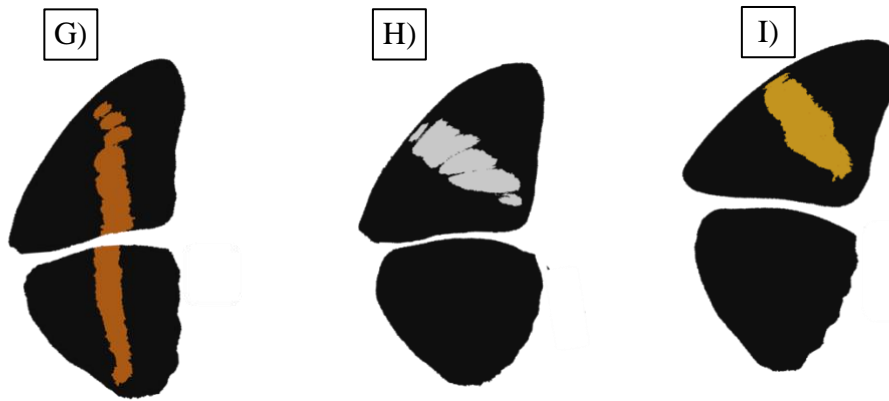

Figure 1. Average phenotypes for each group which corresponds to the mimicry rings defined as (A) COCALA; (B) IPHICLUS; (C) ZINA; (D) ROTHSCILDI; (E) MESENTINA; (F) LYCORIAS; (G) LEUCERIA; (H) EPIONE; (I) SALMONEUS.

Principal Component Modelling and morpho-space

PC1-2 summarises most of the variation of our data (33.7%), and morpho-space is not clearly structured in PC1-3. COCALA and IPHICLUS, the most species-rich mimicry patterns, present most of the variation of PC1 and overlap along this axis, which is not surprising since both have in common a transversal forewing white band. ZINA, which harbours an elongated white spot in the forewing, overlaps as well in PC1 with COCALA and IPHICLUS. The mimicry patterns that comprise less species present opposite distribution in the morpho-space: the least variable are MESENTINA, LYCORIAS and EPIONE. SALMONEUS and (to a lesser extent) LEUCERIA, are highly variable, presenting a split distribution.

Moreover, CPM allows to visualise directly the phenotype associated with a particular region of the morpho-space. Some gaps are observed in the phenotypic space, indicating that some phenotypes are not realised in nature, or at least in our sample. In mimetic systems, such gaps could reflect selection for resemblance, where convergence of similar colour patterns is favoured and intermediate variants are removed. However, here it could be possible that gaps correspond to the mimicry rings not included in this study such as EGREGIA, DEMIALBA, INESAE, PYRCZI, and GELANIA.

Figure 2 (next page). Visualisation in the phenotypic space of the variation in phenotype (PC 1-2 [A]; PC 1-3 [B]); and Principal Component Analysis showing the variation in the colour pattern (PC 1-2 [C]; PC 1-3 [D]) of *Adelpha* species from Ecuador as quantified by colour pattern modelling.

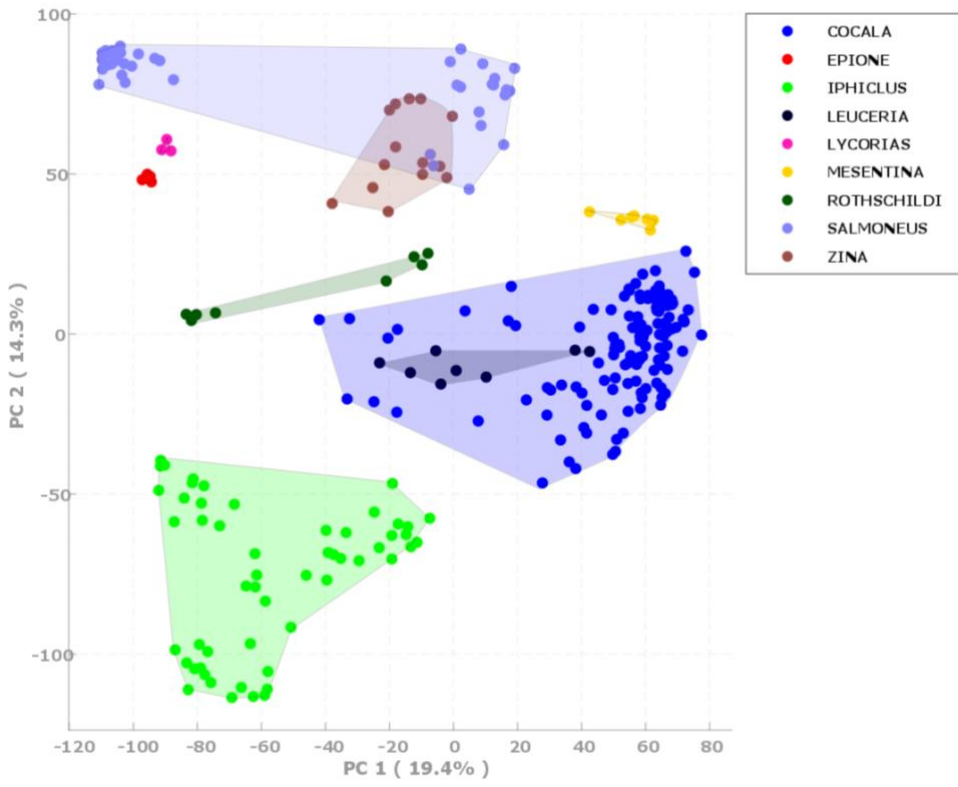

Continuation Figure 2.

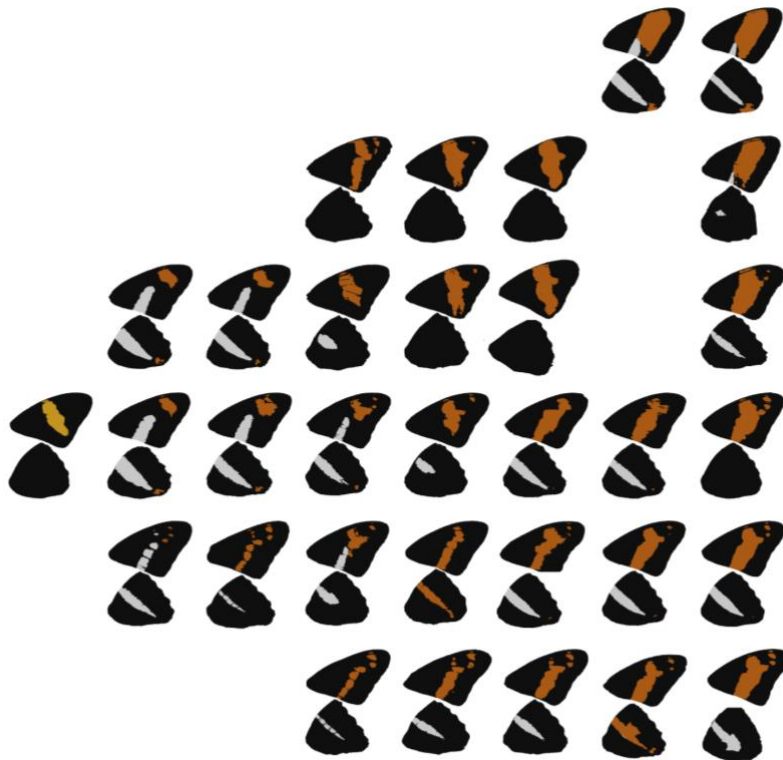
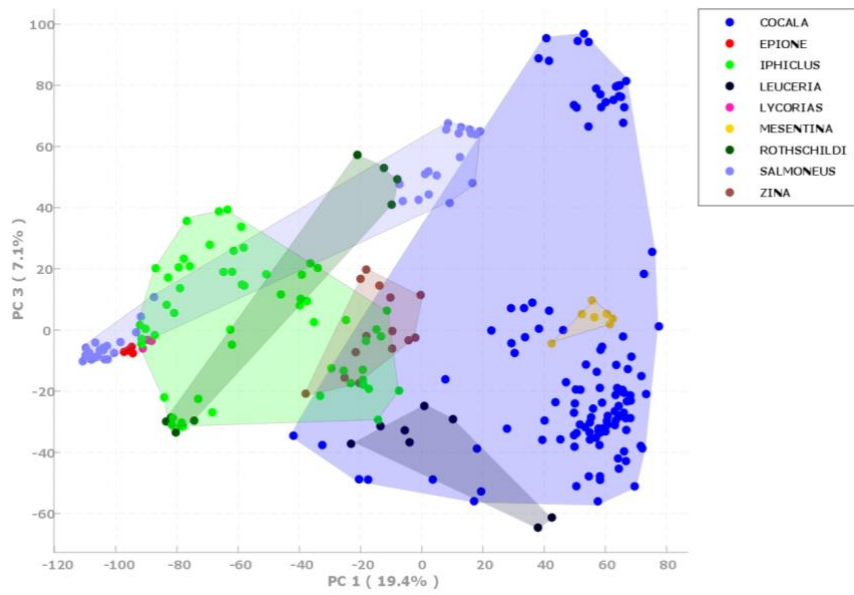

PC axes

As the bPCA treats each colour independently, these contributions are provided for each colour separately, indicating to which extent an increase in the score on the component is associated with the appearance (positive value) or the disappearance (negative value) of each colour. As an illustration, we showed all the layers of the forewing for PC1.

First layer: represents the overall variation i.e., the hotter the colour, the more variable the pixel across wings

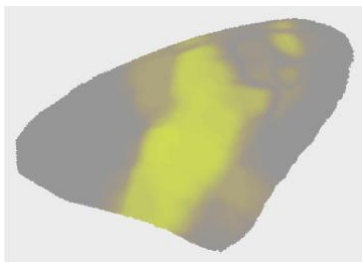

The following layers represent the variation of a single colour each, depicted as a heatmap. Hotter hues indicate that this colour is mostly present towards the positive values of the PC axes; cooler hues indicate that is present towards the negative part of the PC axes.

Second layer: black colour

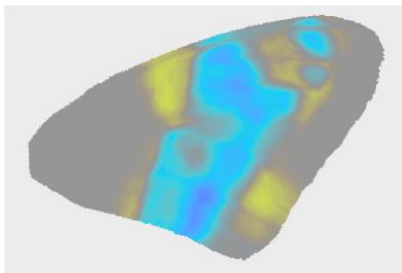

Third layer: dark orange

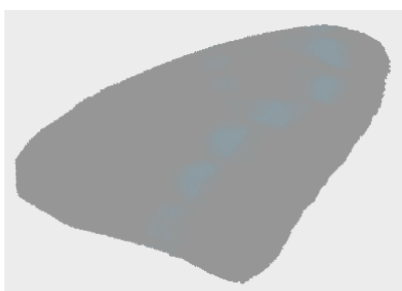

Fourth layer: orange colour

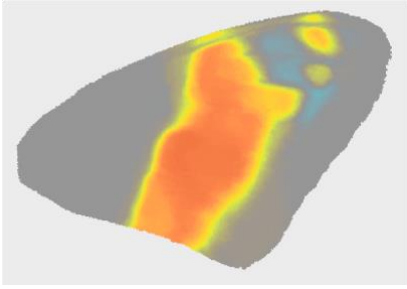

Fifth layer: light orange

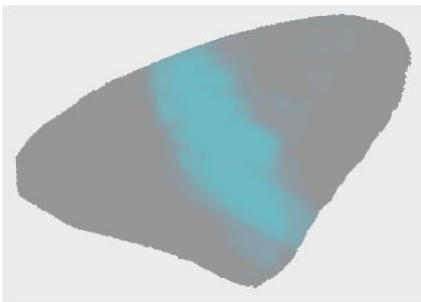

Sixth layer: pink

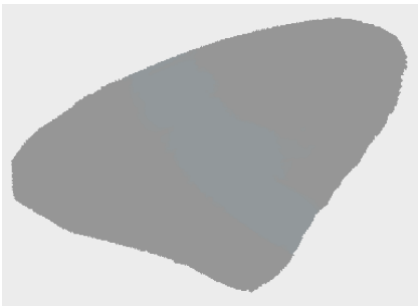

Seventh layer: white colour

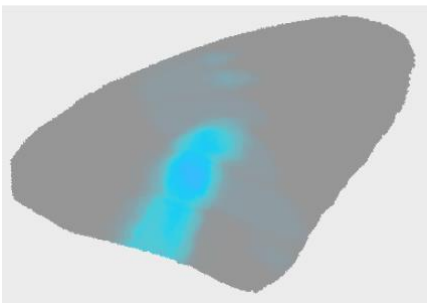

Perspectives

Our preliminary results showed that in some mimicry patterns variation is high, while it is lower in others. Therefore, it would be interesting to see whether this variation is explained by the phylogeny (species phylogenetic distances have been calculated in this work), which would suggest some genetic or developmental constraint. Another factor that might explain observed variation in mimicry patterns could be selection. Biotic interactions, such as predation, increase with tropicality of species (i.e., see chapter II), thus we might expect that more tropical communities show strong convergence. In the case of mimicry along an altitudinal gradient, we would expect that high altitude communities will be under stronger selection than low altitude communities because thermal environment i.e., colder, presumably makes escaping more costly.

Mimicry pattern differentiation can also be related to other aspects such as distribution or abundance, i.e., more narrowly distributed species/rarer species are expected to be better mimics.

Additionally, other aspects can be further explored to support evasive mimicry in *Adelpha* such as testing the correlation between mimicry pattern similarity and wing and body shape similarity while controlling for the phylogeny. We might expect a positive correlation in the case of evasive mimicry if all the species display an efficient mechanism of escape. Finally, we can also incorporate vision models of predators and/or butterflies to compare colour pattern differentiation. For example, Llaurens et al 2014 showed differences on detection of variations of colour patterns between bird predators and conspecifics, suggesting that variation in colour, likely undetectable to birds, might be used by butterflies to distinguish between mates without losing the benefits of mimicry.

References

- Barbosa, A., Mäthger, L. M., Buresch, K. C., Kelly, J., Chubb, C., Chiao, C.-C., & Hanlon, R. T. (2008). Cuttlefish camouflage: The effects of substrate contrast and size in evoking uniform, mottle or disruptive body patterns. *Vision Research*, 48(10), 1242-1253. <https://doi.org/10.1016/j.visres.2008.02.011>
- Doré, M., Willmott, K., Leroy, B., Chazot, N., Mallet, J., Freitas, A. V. L., Hall, J. P. W., Lamas, G., Dasmahapatra, K. K., Fontaine, C., & Elias, M. (2021). Anthropogenic pressures coincide with Neotropical biodiversity hotspots in a flagship butterfly group. *Diversity and Distributions*, ddi.13455. <https://doi.org/10.1111/ddi.13455>
- Duncan, C. J., & Sheppard, P. M. (1965). Sensory discrimination and its role in the evolution of batesian mimicry. *Behaviour*, 24(3-4), 269-282. <https://doi.org/10.1163/156853965X00066>
- Ebel, E. R., Dacosta, J. M., Sorenson, M. D., Hill, R. I., Briscoe, A. D., Willmott, K. R., & Mullen, S. P. (2015). Rapid diversification associated with ecological specialization in Neotropical Adelpha butterflies. *Molecular Ecology*, 24(10), 2392-2405. <https://doi.org/10.1111/mec.13168>
- Endler, J. A. (1991). Interactions between predators and prey. En J. Krebs & N. Davies (Eds.), *Behavioural ecology: An evolutionary approach*, pp. 169-196). Blackwell Scientific.
- Gilbert, F. (2005). The evolution of imperfect mimicry. En Insect evolutionary ecology. M. D. E. Fellowes, G. J. Holloway & J. Rolff (Eds), pp. 231-288. Wallingford, UK, G. J. Holloway & J. Rolff.
- Godfrey, D., Lythgoe, J. N., & Rumball, D. A. (1987). Zebra stripes and tiger stripes: The spatial frequency distribution of the pattern compared to that of the background is significant in display and crypsis. *Biological Journal of the Linnean Society*, 32(4), 427-433. <https://doi.org/10.1111/j.1095-8312.1987.tb00442.x>
- Khotanzad, A., & Hong, Y. H. (1990). Invariant image recognition by Zernike moments. 12(5), 489-497.
- Kikuchi, D. W., & Pfennig, D. W. (2013). Imperfect Mimicry and the Limits of Natural Selection. *The Quarterly Review of Biology*, 88(4), 297-315. <https://doi.org/10.1086/673758>
- Le Poul, Y., Whibley, A., Chouteau, M., Prunier, F., Llaurens, V., & Joron, M. (2014). Evolution of dominance mechanisms at a butterfly mimicry supergene. *Nature Communications*, 5, 1-8. <https://doi.org/10.1038/ncomms6644>
- Malcolm, S. B. (1990). Mimicry: Status of a classical evolutionary paradigm. *Trends in Ecology & Evolution*, 5(2), 57-62. [https://doi.org/10.1016/0169-5347\(90\)90049-J](https://doi.org/10.1016/0169-5347(90)90049-J)

- Mallet, J., & Joron, M. (1999). Evolution of Diversity in Warning Color and Mimicry: Polymorphisms, Shifting Balance, and Speciation. *Annual Review of Ecology and Systematics*, 30(1), 201-233. <https://doi.org/10.1146/annurev.ecolsys.30.1.201>
- Merilaita, S., Vallin, A., Kodandaramaiah, U., Dimitrova, M., Ruuskanen, S., & Laaksonen, T. (2011). Number of eyespots and their intimidating effect on naïve predators in the peacock butterfly. *Behavioral Ecology*, 22(6), 1326-1331. <https://doi.org/10.1093/beheco/arr135>
- Penney, H. D., Hassall, C., Skevington, J. H., Abbott, K. R., & Sherratt, T. N. (2012). A comparative analysis of the evolution of imperfect mimicry. *Nature*, 483(7390), 461-464. <https://doi.org/10.1038/nature10961>
- Rand, A. S. (1954). Variation and Predator Pressure in an Island and a Mainland Population of Lizards. *Copeia*, 1954(4), 260. <https://doi.org/10.2307/1440037>
- Ruxton, G. D., Speed, M., & Sherratt, T. N. (2004). Evasive mimicry: When (if ever) could mimicry based on difficulty of capture evolve? *Proceedings of the Royal Society B: Biological Sciences*, 271(1553), 2135-2142. <https://doi.org/10.1098/rspb.2004.2816>
- Sherratt, T. N. (2013). The evolution of imperfect mimicry. *Behavioral Ecology*, 13(6), 821-826.
- Willmott, K. R. (2003). *The Genus Adelpha: Its Systematics, Biology and Biogeography (Lepidoptera: Nymphalidae: Limenitidini)*. Scientific Publishers.

Supplementary materials

Table S1. List of specimens included in the CPM analysis.

code	species	locality	slope	alt band	mimicry ring
1	<i>A. erotia erotia flerna</i>	Colombia	east_west	low	IPHICLUS
2	<i>A. jordani</i>	Napo	east	low_mid	COCALA
3	<i>A. jordani</i>	Peru	east	low_mid	COCALA
4	<i>A. malea aethalia</i>	Napo	east	low	COCALA
5	<i>A. corcyra collina</i>	Santodomingo	west	mid_high	IPHICLUS
6	<i>A. corcyra collina</i>	na	west	mid_high	IPHICLUS
7	<i>A. corcyra aretina</i>	Colombia	east	mid	IPHICLUS
8	<i>A. alala negra</i>	Banos	east_west	all	IPHICLUS
9	<i>A. alala negra</i>	RioToachi	east_west	all	IPHICLUS
10	<i>A. zina zina</i>	Santodomingo	west	low_mid	ZINA
12	<i>A. justina pichincha</i>	Nanegalito	west	mid_high	ZINA
13	<i>A. cytherea cytherea</i>	Tena	east	low_mid	COCALA
14	<i>A. cytherea cytherea</i>	Misahualli	east	low_mid	COCALA
15	<i>A. cytherea cytherea</i>	Galo Plaza	east	low_mid	COCALA
16	<i>A. cytherea daguana</i>	Guayacan	west	low_mid	COCALA
17	<i>A. cytherea daguana</i>	Guayacan	west	low_mid	COCALA
18	<i>A. cytherea daguana</i>	Santodomingo	west	low_mid	COCALA
19	<i>A. capucinus capucinus</i>	Misahualli	east	low_mid	COCALA
20	<i>A. thessalia thessalia</i>	Galo Plaza	east	all	IPHICLUS
21	<i>A. thoassa manilia</i>	Peru	east	low	IPHICLUS
635	<i>A. barnesia leucas</i>	Canade	west	low	IPHICLUS
754	<i>A. rothschildi</i>	SanLorenzo	na	na	ROTHSCHILDI
755	<i>A. leucophthalma irminella</i>	SanLorenzo	west	low_mid	SALMONEUS
756	<i>A. basiloides</i>	SanLorenzo	west	low_mid	IPHICLUS
757	<i>A. leucophthalma irminella</i>	SanLorenzo	west	low_mid	SALMONEUS
758	<i>A. rothschildi</i>	SanLorenzo	na	na	ROTHSCHILDI
762	<i>A. levona</i>	SanLorenzo	west	low	ROTHSCHILDI
763	<i>A. rothschildi</i>	SanLorenzo	na	na	ROTHSCHILDI
764	<i>A. messana n.ssp</i>	SanLorenzo	na	na	COCALA

766	<i>A. juanna</i>	SanLorenzo	west	low_mid	LEUCERIA
767	<i>A. levona</i>	SanLorenzo	west	low	ROTHSCHILDI
768	<i>A. juanna</i>	SanLorenzo	west	low_mid	LEUCERIA
769	<i>A. thesprotia</i>	VillanoPastaza	east	low	COCALA
770	<i>A. ximena ximena</i>	VillanoPastaza	east	low	SALMONEUS
771	<i>A. lycorias lara</i>	VillanoPastaza	east	all	LYCORIAS
772	<i>A. plesaure phliassa</i>	VillanoPastaza	east	low_mid	COCALA
773	<i>A. iphicleola thessalita</i>	VillanoPastaza	east	low	IPHICLUS
774	<i>A. naxia naxia</i>	VillanoPastaza	east_west	low	IPHICLUS
775	<i>A. epione agilla</i>	VillanoPastaza	east	low_mid	EPIONE
776	<i>A. boreas boreas</i>	VillanoPastaza	east	low_mid	SALMONEUS
778	<i>A. capucinus capucinus</i>	Coca	east	low_mid	COCALA
779	<i>A. ximena ximena</i>	VillanoPastaza	east	low	SALMONEUS
780	<i>A. saundersii saundersii</i>	LimonIndanza	east	all	SALMONEUS
781	<i>A. saundersii saundersii</i>	LimonIndanza	east	all	SALMONEUS
782	<i>A. saundersii saundersii</i>	LimonIndanza	east	all	SALMONEUS
783	<i>A. lycorias lara</i>	Zamora	east	all	LYCORIAS
784	<i>A. lycorias lara</i>	Zamora	east	all	LYCORIAS
785	<i>A. melona leucocoma</i>	PuertoMorona	east	low	COCALA
786	<i>A. iphicleola thessalita</i>	Puerto Morona	east	low	IPHICLUS
787	<i>A. mesentina</i>	PuertoMorona	east	low_mid	MESENTINA
788	<i>A. melona leucocoma</i>	Coca	east	low	COCALA
789	<i>A. boreas boreas</i>	Coca	east	low_mid	SALMONEUS
790	<i>A. mesentina</i>	Sucumbios	east	low_mid	MESENTINA
791	<i>A. alala negra</i>	Puerto Morona	east_west	all	IPHICLUS
792	<i>A. melona leucocoma</i>	Tungurahua	east	low	COCALA
793	<i>A. alala negra</i>	Puerto Morona	east_west	all	IPHICLUS
794	<i>A. paraena paraena</i>	PuertoMorona	east	low	IPHICLUS
798	<i>A. levona</i>	Mashpi	west	low	ROTHSCHILDI
4707	<i>A. cytherea daguana</i>	Canande	west	low_mid	COCALA
4795	<i>A. cytherea daguana</i>	Canande	west	low_mid	COCALA
4796	<i>A. cytherea daguana</i>	Canande	west	low_mid	COCALA
4918	<i>A. cytherea daguana</i>	Canande	west	low_mid	COCALA
EP001BV	<i>A. corcyra collina</i>	Bellavista	west	mid_high	IPHICLUS

EP001HE	<i>A. leucophthalma irminella</i>	LaHesperia	west	low_mid	SALMONEUS
EP001LC	<i>A. boeotia boeotia</i>	LosCedros	east_west	low_mid	COCALA
EP001MQ	<i>A. cytherea daguana</i>	Maquipucuna	west	low_mid	COCALA
EP002BV	<i>A. ethelda ethelda</i>	Bellavista	west	low_mid	LEUCERIA
EP002DR	<i>A. levona</i>	Dracula	west	low	ROTHSCHILDI
EP002HE	<i>A. zina zina</i>	LaHesperia	west	low_mid	ZINA
EP003LC	<i>A. lamasi</i>	LosCedros	west	low_mid	ROTHSCHILDI
EP004HE	<i>A. lycorias spruceana</i>	LaHesperia	west	all	SALMONEUS
EP004LC	<i>A. boeotia boeotia</i>	LosCedros	east_west	low_mid	COCALA
EP004MQ	<i>A. iphiclus estrecha</i>	Maquipucuna	west	low	IPHICLUS
EP005DR	<i>A. delinita delinita</i>	Dracula	east_west	mid_low	COCALA
EP005HE	<i>A. lycorias spruceana</i>	LaHesperia	west	all	SALMONEUS
EP005LC	<i>A. boeotia boeotia</i>	LosCedros	east_west	low_mid	COCALA
EP005MQ	<i>A. lycorias spruceana</i>	Maquipucuna	west	all	SALMONEUS
EP006LC	<i>A. boeotia boeotia</i>	LosCedros	east_west	low_mid	COCALA
EP006MQ	<i>A. cytherea daguana</i>	Maquipucuna	west	low_mid	COCALA
EP007LC	<i>A. lycorias spruceana</i>	LosCedros	west	all	SALMONEUS
EP008LC	<i>A. lycorias spruceana</i>	LosCedros	west	all	SALMONEUS
EP009LC	<i>A. justina justina</i>	LosCedros	west	low_mid	ZINA
EP010LC	<i>A. lamasi</i>	LosCedros	west	low_mid	ROTHSCHILDI
EP010MQ	<i>A. boeotia boeotia</i>	Maquipucuna	east_west	low_mid	COCALA
EP011LC	<i>A. justina justina</i>	LosCedros	west	low_mid	ZINA
EP011MQ	<i>A. boeotia boeotia</i>	Maquipucuna	east_west	low_mid	COCALA
EP012LC	<i>A. rothschildi</i>	LosCedros	west	low_mid	ROTHSCHILDI
EP012MQ	<i>A. boeotia boeotia</i>	Maquipucuna	east_west	low_mid	COCALA
EP013LC	<i>A. lycorias spruceana</i>	LosCedros	west	all	SALMONEUS
EP014LC	<i>A. lycorias spruceana</i>	LosCedros	west	all	SALMONEUS
EP015LC	<i>A. lycorias spruceana</i>	LosCedros	west	all	SALMONEUS
EP016LC	<i>A. lamasi</i>	LosCedros	west	low_mid	ROTHSCHILDI
EP017LC	<i>A. lycorias spruceana</i>	LosCedros	west	all	SALMONEUS
EP018LC	<i>A. boeotia boeotia</i>	LosCedros	east_west	low_mid	COCALA
EP019LC	<i>A. boeotia boeotia</i>	LosCedros	east_west	low_mid	COCALA
EP020LC	<i>A. rothschildi</i>	LosCedros	west	low_mid	ROTHSCHILDI
EP021LC	<i>A. ethelda ethelda</i>	LosCedros	west	low_mid	LEUCERIA

EP022LC	<i>A. boeotia boeotia</i>	Pimpilala	east_west	low_mid	COCALA
EP023LC	<i>A. justina pichincha</i>	Pimpilala	west	mid_high	ZINA
EP025LC	<i>A. lamasi</i>	LosCedros	west	low_mid	ROTHSCHILDI
EP026LC	<i>A. leucophthalma irminella</i>	LosCedros	west	low_mid	SALMONEUS
EP027LC	<i>A. justina pichincha</i>	pichincha	west	mid_high	ZINA
EP028LC	<i>A. justina pichincha</i>	pichincha	west	mid_high	ZINA
EP029LC	<i>A. justina pichincha</i>	pichincha	west	mid_high	ZINA
EP031LC	<i>A. boeotia boeotia</i>	LosCedros	east_west	low_mid	COCALA
EP034LC	<i>A. leucophthalma irminella</i>	LosCedros	west	low_mid	SALMONEUS
EP035LC	<i>A. lycorias spruceana</i>	LosCedros	west	all	SALMONEUS
EP036LC	<i>A. leucophthalma irminella</i>	LosCedros	west	low_mid	SALMONEUS
EP037LC	<i>A. justina pichincha</i>	pichincha	west	mid_high	ZINA
EP040LC	<i>A. boeotia boeotia</i>	LosCedros	east_west	low_mid	COCALA
EP043LC	<i>A. boeotia boeotia</i>	LosCedros	east_west	low_mid	COCALA
EP044LC	<i>A. boeotia boeotia</i>	LosCedros	east_west	low_mid	COCALA
EP045LC	<i>A. lycorias spruceana</i>	LosCedros	west	all	SALMONEUS
EP046LC	<i>A. justina pichincha</i>	pichincha	west	mid_high	ZINA
EP1226	<i>A. erotia erotia flerna</i>	Yasuni	east_west	low	IPHICLUS
EP1529	<i>A. cytherea cytherea</i>	Yasuni	east	low_mid	COCALA
EP1542	<i>A. messana delphicola</i>	Yasuni	east	low	COCALA
EP425	<i>A. attica attica</i>	Yasuni	east	low	COCALA
I001	<i>A. ethelda ethelda</i>	riochuchuvi	west	low_mid	LEUCERIA
I002	<i>A. ethelda ethelda</i>	SanLorenzo	west	low_mid	LEUCERIA
I003	<i>A. ethelda ethelda</i>	SanLorenzo	west	low_mid	LEUCERIA
I004	<i>A. ethelda ethelda</i>	SanLorenzo	west	low_mid	LEUCERIA
I005	<i>A. epione agilla</i>	Sucumbios	east	low_mid	EPIONE
Lep1103	<i>A. malea aethalia</i>	Yasuni	east	low	COCALA
Lep1132	<i>A. plesoure phliassa</i>	Yasuni	east	low_mid	COCALA
Lep1331	<i>A. capucinus capucinus</i>	Yasuni	east	low_mid	COCALA
Lep1532	<i>A. thesprotia</i>	Yasuni	east	low	COCALA
Lep1568	<i>A. attica attica</i>	Yasuni	east	low	COCALA
Lep1661	<i>A. plesoure phliassa</i>	Yasuni	east	low_mid	COCALA
Lep1708	<i>A. thesprotia</i>	Yasuni	east	low	COCALA
Lep1710	<i>A. capucinus capucinus</i>	Yasuni	east	low_mid	COCALA

Lep1791	<i>A. thesprotia</i>	Yasuni	east	low	COCALA
Lep1885	<i>A. capucinus capucinus</i>	Yasuni	east	low_mid	COCALA
Lep1970	<i>A. attica attica</i>	yasuni	east	low	COCALA
Lep2023	<i>A. fabricia</i>	Yasuni	east_west	low	COCALA
Lep2158	<i>A. fabricia</i>	Yasuni	east_west	low	COCALA
Lep2171	<i>A. attica attica</i>	yasuni	east	low	COCALA
Lep2181	<i>A. iphicus iphicus</i>	Yasuni	east	low_mid	IPHICLUS
Lep2207	<i>A. iphicus iphicus</i>	Yasuni	east	low_mid	IPHICLUS
Lep2366	<i>A. iphicus iphicus</i>	Yasuni	east	low_mid	IPHICLUS
Lep2401	<i>A. thesprotia</i>	Yasuni	east	low	COCALA
Lep2642	<i>A. iphicus iphicus</i>	Yasuni	east	low_mid	IPHICLUS
Lep2752	<i>A. erotia erotia f.lerna</i>	Yasuni	east_west	low	IPHICLUS
Lep2790	<i>A. fabricia</i>	Yasuni	east_west	low	COCALA
Lep3248	<i>A. erotia erotia f.lerna</i>	Yasuni	east_west	low	IPHICLUS
Lep3265	<i>A. erotia erotia f.lerna</i>	Yasuni	east_west	low	IPHICLUS
Lep3296	<i>A. erotia erotia f.lerna</i>	Yasuni	east_west	low	IPHICLUS
Lep3673	<i>A. mesentina</i>	Yasuni	east	low_mid	MESENTINA
Lep3699	<i>A. mesentina</i>	Yasuni	east	low_mid	MESENTINA
Lep3732	<i>A. mesentina</i>	Yasuni	east	low_mid	MESENTINA
Lep3737	<i>A. mesentina</i>	Yasuni	east	low_mid	MESENTINA
Lep3838	<i>A. mesentina</i>	Yasuni	east	low_mid	MESENTINA
Lep3904	<i>A. melona leucocoma</i>	Yasuni	east	low	COCALA
Lep3906	<i>A. iphicus iphicus</i>	Yasuni	east	low_mid	IPHICLUS
Lep4155	<i>A. plesaure phliassa</i>	Yasuni	east	low_mid	COCALA
Lep4523	<i>A. erotia erotia f.erotia</i>	Yasuni	east_west	low	COCALA
Lep4802	<i>A. malea aethalia</i>	Yasuni	east	low	COCALA
Lep6073	<i>A. fabricia</i>	Yasuni	east_west	low	COCALA
Lep6731	<i>A. epione agilla</i>	Yasuni	east	low_mid	EPIONE
Lep7049	<i>A. plesaure phliassa</i>	Yasuni	east	low_mid	COCALA
Lep776	<i>A. capucinus capucinus</i>	Yasuni	east	low_mid	COCALA
Lep8175	<i>A. epione agilla</i>	Yasuni	east	low_mid	EPIONE
Lep838	<i>A. attica attica</i>	yasuni	east	low	COCALA
Lep8517	<i>A. fabricia</i>	Yasuni	east_west	low	COCALA
Lep8561	<i>A. epione agilla</i>	Yasuni	east	low_mid	EPIONE

Lep8682	<i>A. malea aethalia</i>	Yasuni	east	low	COCALA
Lep8786	<i>A. thesprotia</i>	Yasuni	east	low	COCALA
Lep882	<i>A. thesprotia</i>	Yasuni	east	low	COCALA
Lep9006	<i>A. melona leucocoma</i>	Yasuni	east	low	COCALA
Lep907	<i>A. capucinus capucinus</i>	Yasuni	east	low_mid	COCALA
Lep9205	<i>A. jordani</i>	Yasuni	east	low_mid	COCALA
Lep999	<i>A. attica attica</i>	Yasuni	east	low	COCALA
MA002	<i>A. justina pichincha</i>	Mashpi	west	mid_high	ZINA
MA004	<i>A. levona</i>	Mashpi	west	low	ROTHSCHILDI
MA0053	<i>A. heraclea heraclea</i>	Mashpi	east_west	low	COCALA
MECN-LD-00282	<i>A. juanna</i>	Durango	west	low_mid	LEUCERIA
MECN-LD-00283	<i>A. juanna</i>	Durango	west	low_mid	LEUCERIA
MECN-LD-00284	<i>A. hesterbergui</i>	Durango	west	low	COCALA
MECN-LD-00285	<i>A. cocala lorzae</i>	Durango	west	low_mid	COCALA
MECN-LD-00321	<i>A. erotia erotia f.erotia</i>	Yasuni	east_west	low	COCALA
MECN-LD-00350	<i>A. cytherea cytherea</i>	Yasuni	east	low_mid	COCALA
MECN-LD-00351	<i>A. cytherea cytherea</i>	Yasuni	east	low_mid	COCALA
MECN-LD-00352	<i>A. cytherea cytherea</i>	Yasuni	east	low_mid	COCALA
MECN-LD-00353	<i>A. cytherea cytherea</i>	Yasuni	east	low_mid	COCALA
MECN-LD-00401	<i>A. messana delphicola</i>	Yasuni	east	low	COCALA
MECN-LD-00402	<i>A. messana delphicola</i>	Yasuni	east	low	COCALA
MECN-LD-00404	<i>A. messana delphicola</i>	Yasuni	east	low	COCALA
MECN-LD-00406	<i>A. messana delphicola</i>	Yasuni	east	low	COCALA
MECN-LD-00409	<i>A. messana delphicola</i>	Yasuni	east	low	COCALA
MECN-LD-00437	<i>A. cytherea cytherea</i>	Yasuni	east	low_mid	COCALA
MECN-LD-00459	<i>A. melona leucocoma</i>	Yasuni	east	low	COCALA
MECN-LD-00504	<i>A. iphicus iphicus</i>	Yasuni	east	low_mid	IPHICLUS
MECN-LD-00506	<i>A. iphicus iphicus</i>	Yasuni	east	low_mid	IPHICLUS
MECN-LD-00513	<i>A. plesaure pliassa</i>	Yasuni	east	low_mid	COCALA
MECN-LD-00518	<i>A. erotia erotia f.lerna</i>	Yasuni	east_west	low	IPHICLUS
MECN-LD-00520	<i>A. erotia erotia f.lerna</i>	Yasuni	east_west	low	IPHICLUS
MECN-LD-00522	<i>A. erotia erotia f.lerna</i>	Yasuni	east_west	low	IPHICLUS
MECN-LD-00534	<i>A. erotia erotia f.erotia</i>	Yasuni	east_west	low	COCALA
MECN-LD-00537	<i>A. erotia erotia f.erotia</i>	Yasuni	east_west	low	COCALA

MECN-LD-00545	<i>A. erotia erotia f.erotia</i>	Yasuni	east_west	low	COCALA
MECN-LD-00546	<i>A. erotia erotia f.erotia</i>	Yasuni	east_west	low	COCALA
MECN-LD-00556	<i>A. erotia erotia f.lerna</i>	Yasuni	east_west	low	IPHICLUS
MECN-LD-00557	<i>A. erotia erotia f.lerna</i>	Yasuni	east_west	low	IPHICLUS
MECN-LD-00564	<i>A. iphicus iphicus</i>	Yasuni	east	low_mid	IPHICLUS
MECN-LD-00566	<i>A. iphicus iphicus</i>	Yasuni	east	low_mid	IPHICLUS
MECN-LD-00567	<i>A. iphicus iphicus</i>	Yasuni	east	low_mid	IPHICLUS
MECN-LD-00641	<i>A. attica attica</i>	Yasuni	east	low	COCALA
MECN-LD-00773	<i>A. salmoneus colada</i>	Sumaco	east	low_mid	SALMONEUS
MECN-LD-00774	<i>A. salmoneus colada</i>	Sumaco	east	low_mid	SALMONEUS
MECN-LD-00775	<i>A. salmoneus colada</i>	Sumaco	east	low_mid	SALMONEUS
MECN-LD-00776	<i>A. saundersii saundersii</i>	Sumaco	east	all	SALMONEUS
MECN-LD-02708	<i>A. basiloides</i>	Upano	west	low_mid	IPHICLUS
MECN-LD-02714	<i>A. iphicleola thessalita</i>	RioHollin	east	low	IPHICLUS
MECN-LD-02715	<i>A. iphicleola thessalita</i>	Tungurahua	east	low	IPHICLUS
MECN-LD-02716	<i>A. iphicleola thessalita</i>	SanJuanRamon	east	low	IPHICLUS
MECN-LD-02979	<i>A. boreas boreas</i>	Tungurahua	east	low_mid	SALMONEUS
MECN-LD-02980	<i>A. boreas boreas</i>	Lita	east	low_mid	SALMONEUS
MECN-LD-02982	<i>A. boreas boreas</i>	Pimpilala	east	low_mid	SALMONEUS
MECN21-301	<i>A. serpa diadochus</i>	na	east	low	IPHICLUS
MECN21-302	<i>A. serpa diadochus</i>	SanJuanRamon	east	low	IPHICLUS
MECN21-303	<i>A. serpa diadochus</i>	Pastaza	east	low	IPHICLUS
MECN21-304	<i>A. serpa diadochus</i>	Zamora	east	low	IPHICLUS
MECN21-306	<i>A. irmina tumida</i>	RioQuilo	east	all	SALMONEUS
MECN21-307	<i>A. saundersii saundersii</i>	MoronaSantiago	east	all	SALMONEUS
MECN21-308	<i>A. irmina tumida</i>	MoronaSantiago	east	all	SALMONEUS
MECN21-309	<i>A. irmina tumida</i>	Tandapi	east	all	SALMONEUS
MECN21-313	<i>A. irmina tumida</i>	na	east	all	SALMONEUS
MECN21-315	<i>A. lycorias lara</i>	Napo	east	all	LYCORIAS
MECN21-320	<i>A. lycorias lara</i>	Napo	east	all	LYCORIAS
MECN21-321	<i>A. lycorias lara</i>	Napo	east	all	LYCORIAS
MECN21-350	<i>A. alala negra</i>	Tungurahua	east_west	all	IPHICLUS
MECN21-354	<i>A. alala negra</i>	Tungurahua	east_west	all	IPHICLUS

MECN21-356	<i>A. alala negra</i>	Yasuni	east_west	all	IPHICLUS
MECN21-358	<i>A. alala negra</i>	Yasuni	east_west	all	IPHICLUS
MECN21-359	<i>A. alala negra</i>	Lasgolondrinas	east_west	all	IPHICLUS
MECN21-361	<i>A. alala negra</i>	Tungurahua	east_west	all	IPHICLUS
MECN21-365	<i>A. sichaeus</i>	Podocarpus	east	low_mid	COCALA
MECN21-407	<i>A. sichaeus</i>	yasuni	east	low_mid	COCALA
MECN21-409	<i>A. sichaeus</i>	yasuni	east	low_mid	COCALA
MECN21-410	<i>A. thessalia thessalia</i>	Saccha	east	low_mid	IPHICLUS
MECN21-411	<i>A. justina valentina</i>	RioAbanico	east	mid_high	COCALA
MECN21-414	<i>A. corcyra aretina</i>	RioAbanico	east	mid	IPHICLUS
MECN21-416	<i>A. sichaeus</i>	Pastaza	east	low_mid	COCALA
MECN21-417	<i>A. justina valentina</i>	Tungurahua	east	mid_high	COCALA
MECN21-422	<i>A. paraena paraena</i>	MoronaSantiago	east	low	IPHICLUS
MECN21-423	<i>A. paraena paraena</i>	Napo	east	low	IPHICLUS
MECN21-425	<i>A. sichaeus</i>	na	na	low_mid	COCALA
MECN21-436	<i>A. leucophthalma irminella</i>	LaPuntaEsmeraldas	west	low_mid	SALMONEUS
MECN21-437	<i>A. boreas boreas</i>	Podocarpus	east	low_mid	SALMONEUS
MECN21-438	<i>A. boreas boreas</i>	MoronaSantiago	east	low_mid	SALMONEUS
MECN21-439	<i>A. boreas boreas</i>	MoronaSantiago	east	low_mid	SALMONEUS
MECN21-440	<i>A. boreas boreas</i>	Archidona	east	low_mid	SALMONEUS
MECN21-442	<i>A. zina zina</i>	RioMachay	west	low_mid	ZINA
MECN21-448	<i>A. justina valentina</i>	MoronaSantiago	east	mid_high	COCALA
MECN21-449	<i>A. sichaeus</i>	Morona	east	low_mid	COCALA
MECN21-450	<i>A. saundersii saundersii</i>	Zamora	east	all	SALMONEUS
MECN21-451	<i>A. saundersii saundersii</i>	Zamora	east	all	SALMONEUS
MECN21-452	<i>A. paraena paraena</i>	Sacha	east	low	IPHICLUS
MECN21-453	<i>A. paraena paraena</i>	Podocarpus	east	low	IPHICLUS
MECN21-458	<i>A. lycorias spruceana</i>	Napo	west	all	SALMONEUS
QCAZ-30021	<i>A. phylaca pseudoaethalia</i>	Canande	west	low	COCALA
QCAZ-30026	<i>A. phylaca pseudoaethalia</i>	Canande	west	low	COCALA
QCAZ-30040	<i>A. barnesia leucas</i>	Canande	west	low	IPHICLUS
QCAZ-30047	<i>A. barnesia leucas</i>	Canande	west	low	IPHICLUS
QCAZ-3005	<i>A. phylaca pseudoaethalia</i>	Canande	west	low	COCALA

QCAZ-30136	<i>A. zina zina</i>	Canande	west	low_mid	ZINA
QCAZ-30147	<i>A. erotia erotia f.lerna</i>	Canande	east_west	low	IPHICLUS
QCAZ-30178	<i>A. heraclea heraclea</i>	Canande	east_west	low	COCALA
QCAZ-30213	<i>A. barnesia leucas</i>	Canande	west	low	IPHICLUS
QCAZ-30214	<i>A. barnesia leucas</i>	Canande	west	low	IPHICLUS
QCAZ-30215	<i>A. zina zina</i>	Canande	west	low_mid	ZINA
QCAZ-30290	<i>A. erotia erotia f.lerna</i>	Canande	east_west	low	IPHICLUS
QCAZ-30320	<i>A. phylaca pseudoaethalia</i>	Canande	west	low	COCALA
QCAZ-30377	<i>A. heraclea heraclea</i>	Canande	east_west	low	COCALA
QCAZ-30461	<i>A. barnesia leucas</i>	Canande	west	low	IPHICLUS
QCAZ-30676	<i>A. phylaca pseudoaethalia</i>	Canande	west	low	COCALA
QCAZ-30688	<i>A. zina zina</i>	Canande	west	low_mid	ZINA
QCAZ-30820	<i>A. barnesia leucas</i>	Canande	west	low	IPHICLUS
QCAZ-31085	<i>A. erotia erotia f.erotia</i>	Canande	east_west	low	COCALA
QCAZ-31327	<i>A. iphiclus estrecha</i>	Canande	west	low	IPHICLUS
QCAZ-31542	<i>A. erotia erotia f.lerna</i>	Canande	east_west	low	IPHICLUS
QCAZ-31561	<i>A. heraclea heraclea</i>	Canande	east_west	low	COCALA
QCAZ-31654	<i>A. erotia erotia f.erotia</i>	Canande	east_west	low	COCALA
QCAZ-31877	<i>A. barnesia leucas</i>	Canande	west	low	IPHICLUS
QCAZ-32094	<i>A. zina zina</i>	Canande	west	low_mid	ZINA
QCAZ-32194	<i>A. naxia naxia</i>	Canande	east_west	low	IPHICLUS
QCAZ-32347	<i>A. iphiclus estrecha</i>	Canande	west	low	IPHICLUS
QCAZ-32430	<i>A. iphiclus estrecha</i>	Canande	west	low	IPHICLUS
QCAZ-32455	<i>A. barnesia leucas</i>	Canande	west	low	IPHICLUS
QCAZ-32473	<i>A. heraclea heraclea</i>	Canande	east_west	low	COCALA
QCAZ-32485	<i>A. iphiclus estrecha</i>	Canande	west	low	IPHICLUS
QCAZ-32528	<i>A. attica hemileuca</i>	Canande	west	low	COCALA
QCAZ-32606	<i>A. barnesia leucas</i>	Canande	west	low	IPHICLUS
QCAZ-32648	<i>A. heraclea heraclea</i>	Canande	east_west	low	COCALA
QCAZ-32719	<i>A. fabricia</i>	Canande	east_west	low	COCALA
QCAZ-33028	<i>A. heraclea heraclea</i>	Canande	east_west	low	COCALA
QCAZ-33156	<i>A. erotia erotia f.erotia</i>	Canande	east_west	low	COCALA
QCAZ-33205	<i>A. heraclea heraclea</i>	Canande	east_west	low	COCALA
QCAZ-33609	<i>A. cocala lorzae</i>	Canande	west	low_mid	COCALA

QCAZ-33828	<i>A. erotia erotia ferotia</i>	Canande	east_west	low	COCALA
QCAZ-33913	<i>A. heraclea heraclea</i>	Canande	east_west	low	COCALA
QCAZ-34486	<i>A. erotia erotia ferotia</i>	Canande	east_west	low	COCALA
QCAZ-4530	<i>A. cytherea daguana</i>	Canande	west	low_mid	COCALA
QCAZ-4576	<i>A. naxia naxia</i>	Canande	east_west	low	IPHICLUS
QCAZ-4707	<i>A. cytherea daguana</i>	Canande	west	low_mid	COCALA
QCAZ-4795	<i>A. cytherea daguana</i>	Canande	west	low_mid	COCALA
QCAZ-4796	<i>A. cytherea daguana</i>	Canande	west	low_mid	COCALA
QCAZ-4918	<i>A. cytherea daguana</i>	Canande	west	low_mid	COCALA
QCAZ-5160	<i>A. cocala lorzae</i>	Canande	west	low_mid	COCALA
QCAZ-5680	<i>A. fabricia</i>	Canande	east_west	low	COCALA
QCAZ-5815	<i>A. naxia naxia</i>	Canande	east_west	low	IPHICLUS
QCAZ-5889	<i>A. naxia naxia</i>	Canande	east_west	low	IPHICLUS
SN2899	<i>A. cocala cocala</i>	Pimpilala	east	low_mid	COCALA
SN2905	<i>A. cocala cocala</i>	Pimpilala	east	low_mid	COCALA

Appendix 2

The evolution and ecology of multiple antipredator defences

(Review submitted on Journal of Evolutionary Biology)



The evolution and ecology of multiple antipredator defences

Journal:	<i>Journal of Evolutionary Biology</i>
Manuscript ID	Draft
Manuscript Type:	Review
Keywords:	secondary defences, defence portfolio, predation sequence, predator cognition, synergy, trade-offs, intraspecific variation

SCHOLARONE™
Manuscripts

The evolution and ecology of multiple antipredator defences

William L. Allen¹, Kevin Arbuckle¹, Thomas G. Aubier², Emmanuelle S. Briolat³, Emily R. Burdfield-Steel⁴, Karen L. Cheney⁵, Klára Daňková⁶, Marianne Elias⁷, Liisa Hämäläinen⁸, Marie E. Herberstein⁸, Thomas J. Hossie⁹, Mathieu Joron¹⁰, Krushnamegh Kunte¹¹, Brian C. Leavell¹², Carita Lindstedt¹³, Ugo Llorioux-Chevalier¹⁴, Mélanie McClure¹⁴, Callum F. McLellan¹⁵, Iliana Medina¹⁶, Viraj Nawge¹¹, Erika Páez⁸, Arka Pal¹¹, Stano Pekár¹⁷, Olivier Penacchio^{18, 19}, Jan Raška⁶, Tom Reader²⁰, Bibiana Rojas^{21, 22}, Katja H. Rönkä^{23, 24}, Daniela Rößler^{25, 26}, Candy Rowe²⁷, Hannah M. Rowland²⁸, Arlety Roy¹⁴, Kaitlin A. Schaal²⁹, Thomas N. Sherratt³⁰, John Skelhorn²⁷, Hannah R. Smart³¹, Ted Stankowich³², Amanda M. Stefan³⁰, Kyle Summers³³, Christopher H. Taylor²⁰, Rose Thorogood^{23, 24}, Kate Umbers³⁴, Anne E. Winters⁴, Justin Yeager³⁵, David W. Kikuchi^{36*,†}, Alice Exnerová^{6,†}

¹Department of Biosciences, Swansea University, Swansea, UK; ²Department of Biology, University of North Carolina at Chapel Hill, Chapel Hill, USA; ³Centre for Ecology and Conservation, College of Life and Environmental Sciences, University of Exeter, Penryn, UK; ⁴Institute of Biodiversity and Ecosystem Dynamics, University of Amsterdam, Amsterdam, The Netherlands; ⁵The University of Queensland, St Lucia, Australia; ⁶Department of Zoology, Faculty of Science, Charles University, Prague, Czech Republic; ⁷Institut de Systématique, Evolution, Biodiversité, CNRS, MNHN, Sorbonne Université, EPHE, Université des Antilles, Paris, France; ⁸School of Natural Sciences, Macquarie University, Sydney, Australia; ⁹Department of Biology, Trent University, Peterborough, Canada; ¹⁰CEFE, Université de Montpellier, CNRS, EPHE, IRD, Montpellier, France; ¹¹National Centre for Biological Sciences, Tata Institute of Fundamental Research, Bengaluru, India; ¹²Department of Biological Sciences, Purdue University, West Lafayette, USA; ¹³Department of Forest Sciences, University of Helsinki, Helsinki, Finland; ¹⁴Laboratoire Écologie, Évolution, Interactions des Systèmes Amazoniens, Université de Guyane, CNRS, IFREMER, Cayenne, France; ¹⁵School of Biological Sciences, University of Bristol, Bristol, UK; ¹⁶School of BioSciences, University of Melbourne, Melbourne, Australia; ¹⁷Department of Botany and Zoology, Faculty of Science, Masaryk University, Brno, Czech Republic; ¹⁸School of Psychology and Neuroscience, University of St Andrews, St Andrews, Fife, UK; ¹⁹Computer Vision

Center, Computer Science Department, Universitat Autònoma de Barcelona, Barcelona, Spain; ²⁰School of Life Sciences, University of Nottingham, Nottingham, UK; ²¹Department of Interdisciplinary Life Sciences, Konrad Lorenz Institute of Ethology, University of Veterinary Medicine, Vienna, Austria; ²²Department of Biology and Environmental Science, University of Jyväskylä, Jyväskylä, Finland; ²³HILIFE Helsinki Institute of Life Sciences, University of Helsinki, Helsinki, Finland; ²⁴Research Programme in Organismal & Evolutionary Biology, Faculty of Biological and Environmental Sciences, University of Helsinki, Helsinki, Finland; ²⁵Zukunftskolleg, University of Konstanz, Konstanz, Germany; ²⁶Department of Collective Behavior, Max Planck Institute of Animal Behavior, Konstanz, Germany; ²⁷Institute of Biosciences, Faculty of Medical Sciences, Newcastle University, Newcastle upon Tyne, UK; ²⁸Max Planck Research Group Predators and Toxic Prey, Max Planck Institute for Chemical Ecology, Jena, Germany; ²⁹Institute of Integrative Biology, ETH Zurich, Zurich, Switzerland; ³⁰Department of Biology, Carleton University, Ottawa, Canada; ³¹Hawkesbury Institute of the Environment, Western Sydney University, Penrith, Australia; ³²Department of Biological Sciences, California State University, Long Beach, USA; ³³Department of Biology, East Carolina University, Greenville, USA; ³⁴School of Science & Hawkesbury Institute for the Environment, Western Sydney University, Hawkesbury, Australia; ³⁵Grupo de Biodiversidad Medio Ambiente y Salud, Universidad de Las Américas, Quito, Ecuador; ³⁶Evolutionary Biology, Universität Bielefeld, Bielefeld, Germany

*Correspondence: David W. Kikuchi, Evolutionary Biology Department, University of Bielefeld, Bielefeld, Germany. E-mail: dwkikuchi@gmail.com

†co-last authors; other authors listed alphabetically

Acknowledgements

We thank ESEB for funding our virtual satellite symposium in the midst of the pandemic, and bringing together our colleagues from across so many continents. We acknowledge support for the publication costs by the Open Access Publication Fund of Bielefeld University, and SFB TRR 212 (NC3) – 316099922.

Conflict of Interest

The authors declare that they have no conflicts of interest.

Data Availability Statement

The data that supports the findings of this study are available in the supplementary material of this article.

1 Article Type: Review

2

3 The evolution and ecology of multiple antipredator defences

4

5

6 Figures: 4

7 Tables: 1

8 Supplementary Figures: 1

9 Supplementary Tables: 1

10 Abstract

11 The various defences of prey against predators have received much study; however, most prey use more
12 than one such defence. We know much less about how these multiple defences are integrated into what we
13 refer to as the defence portfolios of individual prey. Here we synthesize work on prey defence to examine the
14 ecological, evolutionary, and behavioural aspects of defence portfolios. In surveying prey defences, we find
15 that examining the correlation structure of defences within prey portfolios is a promising way to understand
16 their function and evolution. To understand how multiple defences target predator cognition, we review the
17 mechanisms of predator cognitive responses to multiple defences and develop new theory for how predators
18 may select for multiple defences depending on their interactions. We examine the trade-offs that constrain
19 the design of defence portfolios, finding that portfolios are often constrained by resource allocation to other
20 aspects of life history, as well as functional incompatibilities between different defences. We examine the
21 proximate and ultimate mechanisms maintaining variation among individuals in defence portfolios, which can
22 impinge on predator foraging decisions. Finally, we identify major questions in the macroevolutionary and
23 macroecological distribution of defence portfolios, which is an understudied frontier. We provide
24 recommendations for gathering data on the distribution of prey defences across species and geography,
25 measuring the efficacy of multiple defences against relevant predators, and testing the proximate
26 mechanisms by which multiple prey defences impact predator behaviour.

27

28 Key words: secondary defences, defence portfolio, predation sequence, predator cognition, synergy, trade-
29 offs, intraspecific variation

30 1. Introduction

31 Antipredator defences have been the subject of extensive research because of their importance to the
32 fitness of individuals and the dynamics of populations. Iconic examples such as the warning colours of
33 *Heliconius* butterflies, the spines and armour of sticklebacks, and the tetrodotoxin that protects rough-
34 skinned newts are now textbook examples of adaptation (Hanifin *et al.*, 2008; Peichel & Marques, 2017;
35 Jiggins, 2018). These are just a few examples of the dazzling diversity of ways that prey confound would-be
36 predators (Poulton, 1890; Cott, 1940; Caro, 2005; Ruxton *et al.*, 2018). While anti-predator defences have
37 traditionally been studied in isolation, there is an increasing recognition that prey have multiple defences
38 which raises questions as to their independence. In this article, our aim is to summarise briefly the diversity
39 of defence mechanisms used in animals. We then review and synthesise the proximate and ultimate forces
40 that determine how many antipredator defences a single prey expresses and how much it invests in each.

41 We define a defence as a mechanical, chemical, or behavioural trait that has either been wholly or
42 partly selected for its antipredator function, or has aspects of its form maintained by selection for an
43 antipredator function. In studying the defences of any particular organism, one hypothesis is that different
44 defences have evolved as a response to different enemies. There are many examples in the literature where
45 this hypothesis has been supported (Sih *et al.*, 1998; Rojas *et al.*, 2017; Zvereva *et al.*, 2018). Here, we
46 focus on prey defences that deter a particular instance of predation by an individual predator: we ask how
47 defensive traits are functionally integrated to help prey survive that particular predator attack. The subset of
48 defences that deter a single predator type constitute what we call a “defence portfolio”. Prey may have
49 multiple defence portfolios that work against different types of predators, and some defences may work
50 across portfolios. Although our main objective is to explain the functional integration of defences within a
51 single portfolio, in some cases it is necessary to consider the composition of a defence portfolio in the
52 context of the trade-offs with deterring multiple types of predators, as the evolution of multiple defences may
53 be partly driven by both contexts.

54 A useful framework for thinking about multiple defences and their functional integration is the
55 “predation sequence” (Caro, 2005; Ruxton *et al.*, 2018). Endler (1986, 1991) has suggested that the
56 interaction between predator and prey usually consists of six successive stages, namely (1) encounter, (2)
57 detection, (3) identification, (4) approach (attack), (5) subjugation, and (6) consumption. Within this predation
58 sequence, defences are frequently placed into two broad categories: ‘primary defences’, i.e. those that act
59 before the predator initiates any prey-catching behaviour, and ‘secondary defences’, i.e. those that act after
60 a predator has made contact with its prey (Edmunds, 1974; Ruxton *et al.*, 2018). Although there can be

61 ambiguity in exactly which stage in the predation sequence a particular defence acts, or whether it is a
62 primary or secondary defence, this framework remains helpful and as such we refer to it throughout the text.

63 Multiple defences can act simultaneously at the same stage of the predation sequence or they can
64 be deployed sequentially, hindering predator attack at different stages. Since selection may favour different
65 numbers and combinations of multiple defences in each of these situations, we may ask if there are any
66 predictable patterns in the structure of defence portfolios across the predation sequence. With sequentially
67 deployed defences, selection on defences that act later in the predation sequence is hypothesised to be
68 weaker than selection on those that act earlier (Britton *et al.*, 2007; Ruxton *et al.*, 2018). Whether selection
69 favours additional defences may depend on the effectiveness of each defence in question (Broom *et al.*,
70 2010; Kang *et al.*, 2017b).

71 Here we ask five key questions about the composition of defence portfolios: 1) how do mechanical,
72 chemical, and behavioural secondary defences function?, 2) by what mechanisms do multiple defences
73 exploit predator cognition?, 3) how do trade-offs between antipredator defences and other life history traits
74 affect evolution of multiple defences?, 4) what causes individual variation in multiple defences?, and 5) what
75 macroecological factors determine the distribution of multiple defence strategies and what are the resultant
76 macroevolutionary patterns and processes? To address these questions, we synthesise current knowledge
77 of natural history and proximate mechanisms with experimental evidence and theory, provide a conceptual
78 framework for studying multiple defences at various levels from individual predator-prey encounters to
79 macro-evolutionary and ecological patterns, and outline directions for future research.

80

81 2. Types of prey defence

82 When should defences be considered separate? It is helpful to think about the stage in the predation
83 sequence at which a defence acts. When different defensive traits are deployed at different stages of the
84 predation sequence, we consider them separate. We also consider traits that function at the same stage of
85 the predation sequence to be separate defences if they have different mechanisms of action. For example,
86 spikes may be paired with a toxin, with each contributing a separate function to predator deterrence – the
87 spikes by inflicting mechanical damage, and the toxin by eliciting a reaction in the predator's tissues. Finally,
88 a single trait may fulfil different roles at different stages of the predation sequence - for example, a turtle's
89 shell is effective at the stages of both subjugation and consumption. We do not think of these separate
90 functions as multiple defences in and of themselves, yet such a trait with multiple antipredator functions is
91 important to take into account when describing a defence portfolio.

92 What constitutes a single defence is often a matter of empirical resolution, which will be determined
93 by practical constraints and the interests of the researcher. Addressing proximate questions about
94 mechanisms of multiple defences might require a finer resolution level than analysing macro-ecological
95 patterns of defence portfolios. For example, before the application of analytical chemistry to chemical
96 defences, prey were often thought of as chemically defended, or not. After separate compounds were found
97 to comprise those chemical defences, it became interesting to ask about their joint (and separate) functions.
98 Increasingly we are able to probe the genetic underpinnings of defences, opening up new possibilities for the
99 description of traits that were previously indistinguishable from each other. Our perspective here is that of
100 behavioural ecologists and evolutionary biologists, so we are most interested in traits that provide a selective
101 benefit as a result of their defensive functions, which are at least to some degree separate from other traits.

102 In the next section, we briefly describe primary defences. Then in the following section we provide a
103 broad overview of secondary defences, which have not been reviewed recently.

104

105 2.1 Primary defence mechanisms

106 Primary defence mechanisms have been extensively reviewed elsewhere (Poulton, 1890; Cott, 1940; Caro,
107 2005; Stevens & Merilaita, 2011; Magrath *et al.*, 2015; Ruxton *et al.*, 2018). However, to provide the readers
108 with an idea of the primary defences that prey may fill their defence portfolios with, we give examples of
109 different antipredator strategies that function during early stages of the predation sequence.

110 The first step in avoiding predation is to avoid being in the wrong place at the wrong time. If no
111 predator is encountered, further steps in the predation sequence are irrelevant. Adaptations that reduce
112 encounters are so diverse that it is almost impossible to enumerate them all, or to measure their effects on
113 avoiding predators *per se* because they can be so integral to other aspects of life history. Many if not most
114 are behavioural. Habitat choice, circadian rhythms, seasonal fluctuations in abundance patterns, and even
115 modes of locomotion (e.g. swimming) might reduce encounters with predators, and be under selection by
116 predators, but also be selected in relation to other aspects of fitness. Certain adaptations, such as
117 anachoresis (hiding) and vigilance, however, seem highly specific as antipredator defences (FitzGibbon,
118 1989).

119 Next come defences that impede detection, identification, and approach (Ruxton *et al.*, 2018). In
120 recent years there has been an explosion of work on the mechanisms by which prey avoid detection (see
121 Stevens & Merilaita, 2011 for a review). Their strategies are usually classified under the broad umbrella of
122 camouflage.

123 If prey cannot escape detection, other adaptations may prevent predators from correctly classifying
124 them as potential food. Prey may resemble inanimate or otherwise uninteresting objects in their
125 environments (masquerade; Skelhorn, 2015), or they may mimic organisms that are less profitable as food
126 items (de Jager & Anderson, 2019). The latter strategy includes Batesian mimicry, where an undefended
127 species evolves a resemblance to another that has warning signals and secondary defences (Bates, 1862;
128 Ruxton *et al.*, 2018).

129 If a predator successfully detects a prey and identifies it, the final line of primary defence is to keep
130 the predator from approaching and making physical contact. Prey can advertise secondary defences with
131 warning (aposematic) signals (Wallace, 1879; Poulton, 1890; Mappes *et al.*, 2005; Ruxton *et al.*, 2018) or
132 pursuit deterrence signals (Pinheiro, 1996; Páez *et al.*, 2021). Several aposematic prey species may
133 participate in Müllerian mimicry and gain mutual protection from having convergently evolved similar warning
134 signals (Müller, 1879; Sherratt, 2008). Flash displays in cryptic prey can make the prey difficult to find once
135 they have landed (Loeffler-Henry *et al.*, 2018). Prey may also hinder the attack by “dazzle” colour patterns
136 that make the prey appear stationary or moving at a reduced speed (Stevens *et al.*, 2011).

137 Some defences are deployed immediately before a predator makes contact - these blur the lines
138 between primary and secondary defence. They include deflecting the point of attack to its less vulnerable
139 body parts (Stevens, 2005), a great variety of escape behaviours, and many defences typically classed as
140 secondary, such as releasing mechanical or chemical weapons. We delve deeper into secondary defences
141 below.

142

143 2.2 Secondary defence mechanisms

144 Secondary antipredator defences are deployed during, or immediately before contact (Ruxton *et al.*, 2018).
145 They usually belong to one of the broad categories: (1) mechanical defences, e.g. tough integument or sharp
146 spikes, (2) chemical defences, which include repulsive volatiles, toxins and irritating secretions, and (3)
147 behavioural defences such as defensive aggregations or fighting (Ruxton *et al.*, 2018). These categories are
148 somewhat loose, as many prey species combine defences of different types, e.g. defensive secretions and
149 tough integument or gregariousness and warning smells. Moreover, some chemical and mechanical
150 defences are behaviourally deployed (e.g. spraying a defensive secretion). To review the diversity of
151 defences, though, we first treat these three types of secondary defences separately. Then we illustrate how
152 different types of defences may be combined.

153

154 2.2.1 Mechanical defences

155 Mechanical defences of prey are those with physical (rather than chemical) properties that serve to stop or
156 minimise the extent of a predator's attack (Edmunds, 1974; Caro, 2005; Stankowich, 2012). We define three
157 main categories of mechanical defences. **Armour** is a barrier to prevent puncture of the integument or
158 crushing of the body and skeleton. Examples of armour are the carapaces of turtles and armadillos, shells of
159 crustaceans, thickened exoskeletons of insects, and scales of pangolins and many reptiles. **Spikes** are
160 sharp spines, claws, teeth, horns, or quills that may cover part or all of the body, making the prey harmful or
161 painful to handle (Crofts & Stankowich, 2021). Examples of spikes include spines of hedgehogs, lizards,
162 sticklebacks, and porcupines; spicules of sponges; claws and sharp teeth of many vertebrate species; and
163 weaponry used in intrasexual combat but also helpful in defence (e.g., horns, antlers, tusks in hooved
164 mammals). Many of these structures may be actively autotomized or released to lodge them into the body or
165 mouth of an attacker (e.g., porcupine quills, urticating hairs of tarantulas and caterpillars). Spikes may be
166 advertised with aposematic colouration to deter attack (e.g., black-and-white spines of porcupines). Finally,
167 **countermeasures** are substances that are secreted or released by prey that make the prey difficult to
168 handle or restrain (i.e., slippery or awkward shape) or redirect an attack away from the escaping prey.
169 Examples include the mucus of hagfish, lepidopteran scales, sticky secretions and waxes of many insects,
170 pseudomorphs (ink with mucus) of cephalopods, and autotomized tails of lizards and legs of insects.

171 Armour and spikes may be localised to certain body regions (e.g., sticklebacks) or cover most or all
172 of the body (e.g., hedgehogs). Many prey enhance their effectiveness by volvation, i.e. rolling partially or
173 completely into a ball to minimise exposure of unprotected surfaces and to erect spines in a more separated
174 and stiffened position (Crofts & Stankowich, 2021). Mechanical defences can be energetically expensive to
175 produce, maintain, and carry (Emlen, 2008). Mechanically defended prey tend to be slower moving and live
176 in more visually exposed areas (Reimchen, 1992; Lovegrove, 2001; Barrett *et al.*, 2008; Stankowich &
177 Campbell, 2016; Broeckhoven *et al.*, 2018), relying on their formidable defences to survive attacks by
178 predators rather than rapid flight.

179

180 2.2.2 Chemical defences

181 Chemical defences are substances that react with predator tissues to cause damage or activate sensory
182 systems. We define two main categories of chemical defence. One is **weapons**, which cause injury and
183 harm to the predator when actively injected by a bite or a sting (venom), or via the consumption of passively
184 stored compounds (toxins) (also termed class I compounds; Marples *et al.*, 2018). Prey utilising defensive

185 compounds that only act as weapons may initially incur a higher cost of predator education, because the
186 predators need to learn to associate defences with warning signals (Skelhorn & Rowe, 2006b; Zvereva *et al.*,
187 2018). The second category is **deterrents**, which target the olfactory, gustatory, or tactile sensory systems of
188 predators while they are approaching, attacking, or consuming prey (class II compounds; Marples *et al.*,
189 2018). These include pyrazines in the Monarch butterfly, and alkaloids such as quinine. Prey may utilise
190 deterrent, nontoxic compounds when toxins are expensive to synthesise or sequester (Ruxton *et al.*, 2018),
191 and/or the bearer would suffer physiological costs of harbouring toxins (e.g. Berenbaum & Zangerl, 1994;
192 Zalucki *et al.*, 2001). These two categories are not mutually exclusive, and many chemical defences act both
193 as weapons and deterrents (class I&II compounds). Such compounds may better protect prey from predator
194 attacks: deterrents can inform predators not to attack prey before it is consumed.

195 Chemical defences may have different functions against different predators due to variations in
196 physiology. Some compounds may be toxic to certain predators, but act as nontoxic deterrents to others.
197 Defences may also vary in efficacy against different predator taxa: thoracic fluids in wood tiger moths
198 deterred birds but not ants, whereas abdominal fluids deterred ants but not birds (Rojas *et al.*, 2017).
199 Furthermore, chemical extracts from the nudibranch mollusc *Goniobranchus splendidus* were non-toxic to a
200 crustacean (*Artemia* sp.), but moderately toxic and unpalatable to fish (Chan *et al.*, 2021; Winters *et al.*,
201 2022).

202

203 2.2.3 Types of mechanical and chemical defences

204 There are a number of dichotomies that are useful for comparing different types of mechanical and chemical
205 defences.

206 *Origin* - **Endogenous** defences originate or grow from the prey, including mechanical adaptations such as
207 spikes and armour, as well as *de novo* biosynthesis of defensive chemicals. **Exogenous** defences, however,
208 are acquired from external sources and include sequestration of defensive compounds from the diet (with or
209 without structural modification), their supply by microbial symbionts, and acquisition of objects to protect from
210 predators (Ruxton and Stevens 2015, Mima *et al.* 2003). Carrying and maintaining exogenous defences can
211 be costly, but prey do not have to pay to produce them as with endogenous defences. Indeed, some studies
212 have found sequestration to be more cost-effective than *de novo* synthesis (Smilanich *et al.*, 2009;
213 Fürstenberg-Hägg *et al.*, 2014), although other studies have found no differences in costs associated with
214 sequestered versus synthesised chemicals (Zvereva & Kozlov, 2016). Interestingly, the origin of chemical
215 defences had no influence on their effectiveness (Zvereva & Kozlov, 2016).

216 *Visual apparency* – Most mechanical defences are visually **exposed** to predators (excluding internal
217 structures, i.e. skeletons, spicules), and many have dual functions as visual deterrents (primary defences)
218 and as secondary defences (Inbar & Lev-Yadun, 2005; Speed & Ruxton, 2005). In contrast, most chemical
219 defences are **concealed**, and advertising their existence can require separate warning signals (Caro &
220 Ruxton, 2019).

221 *Deployment* – Releasing mechanical (i.e. urticating hairs, porcupine quills) and chemical (i.e. volatile
222 secretions, sprays) defences can increase their efficacy (Zvereva & Kozlov, 2016). However, **released**
223 defences are also depleted in subsequent attacks unless they are replenished, so this deployment can be
224 costly (Zvereva & Kozlov, 2016). Many mechanical defences and some chemical defences can be **retained**
225 (i.e. claws, teeth, spikes, chemicals stored in tissue or haemolymph).

226 *Encounter stage* – Predators can encounter secondary defences at different stages of a predation sequence.
227 While most mechanical and chemical defences only act **upon contact**, defences that are effective **before**
228 **contact** (i.e. volatile odours and irritants) can disrupt attacks sooner than those that are retained (Winters *et al.*,
229 2022). And while most released mechanical defences require physical contact to be deployed, volatile
230 compounds are a common feature in chemical secretions (Rowe & Halpin, 2013).

231 *Profitability to predator* – While there is a spectrum of prey profitability (Marples *et al.*, 2018), in some
232 encounters, defences are so effective against a given predator (i.e. lethal or highly toxic compounds,
233 emetics) that they render the prey entirely unprofitable and the encounter results in a net fitness loss to the
234 predator (Brower & Moffit, 1974; Holen & Sherratt, 2021). These are called “**strong**” defences (Kikuchi *et al.*,
235 2021). By contrast, other defences can be at least partly overcome by motivated predators during an
236 encounter (Glendinning, 2007), and the predator can still receive a net fitness gain after paying costs (Holen
237 & Sherratt, 2021). These are “**weak**” defences (Kikuchi *et al.*, 2021).

238 *Type of cost to predator* - Encounters with prey that have **protective** defences including armour,
239 countermeasures, and non-toxic chemical deterrents are costly to predators only in terms of additional time
240 and energy spent handling the prey (Glendinning 2007). However, encounters with **aggressive** prey
241 defences that include mechanical weapons or toxic chemicals can incur additional costs of injury to the
242 predator, for example through wounds or increased toxin loads (Skelhorn & Rowe, 2007).

243 *Execution* – Chemical and mechanical defences are commonly enhanced by or co-dependent with
244 behaviours (i.e. flicking of porcupine tails, striking of venomous snakes), which are detailed in the following
245 section. These **active** defences can have either an aggressive (i.e. claw, bite, sting) or protective (deflect,

246 escape) function, and contrast with **passive** defences.

247

248 2.2.4 Behavioural defences

249 Behavioural defences are behaviours that are maintained by selection for defensive function, either on their
250 own (e.g. tonic immobility) or in combination with other types of secondary defences (e.g. spraying defensive
251 chemicals). We focus here on defensive behaviours that operate as secondary defences, i.e. immediately
252 before or during an attack.

253 Many behavioural defences are deployed just before the predator attacks, and are on the border
254 between primary and secondary defence. For example, freezing is a common behavioural defence during
255 the approach of a potential predator (Eilam, 2005). Similarly widespread, fleeing can be enhanced by
256 zigzagging, which makes the prey escape trajectory hard to predict (Chai & Srygley, 1990), or motion dazzle
257 (Stevens *et al.*, 2011), whereby colour patterns make it difficult for a predator to capture moving prey. Flash
258 displays involve sudden exposure of previously hidden conspicuous colour patterns, typically in combination
259 with evasive movement (Loeffler-Henry *et al.*, 2018; Murali, 2018). Deimatic displays (Umbers *et al.*, 2017)
260 may function by startling or momentarily distracting predators (Vallin *et al.*, 2005; Kang *et al.*, 2017b).

261 Other behavioural defences hinder prey subjugation and/or consumption. They may enable the prey
262 to escape, such as phragmosis, when animals defend themselves by using their bodies as a barrier to their
263 shelter (Kurosu *et al.*, 2006), and autotomy (Emberts *et al.*, 2019), or cause the predator to break off the
264 attack, such as tonic immobility (Humphreys & Ruxton, 2018). Likewise, behavioural strategies may be
265 deployed to avoid fatal injuries during attack, such as deflection to certain body parts (e.g. Sourakov, 2013),
266 volvation, head-hiding and eye protecting (e.g. Toledo *et al.*, 2011). Potential prey can also use aggressive
267 counter-attacks such as biting, stinging, clawing, kicking, regurgitating, or heat production. They can issue
268 distress calls to recruit other individuals or signal fighting ability (Laiolo *et al.*, 2004). These behaviours are
269 not mutually exclusive, and can be deployed during the same predator encounter, either simultaneously or
270 sequentially, and, as indicated above, oftentimes alongside mechanical and/or chemical defences.

271 Which behavioural defence is deployed and when depends on many factors, including predator type
272 and risk assessment (e.g. McClure & Despland, 2011), as well as ontogenetic stage and perceptual and
273 cognitive abilities of the prey (e.g. Rößler *et al.*, 2021). The “threat sensitivity hypothesis” predicts that anti-
274 predator behaviour is proportionately scaled with the magnitude of predation risk (Sih, 1986; Helfman, 1989).
275 For instance, graded evasive behaviours in frogs depend on the predation risk imposed by the fringe-lipped
276 bat (*Trachops cirrhosus*) (Tuttle *et al.*, 1982), and defensive reactions in armoured ground crickets

277 (*Acanthopplus* spp.) change according to varying degrees of disturbance (Bateman & Fleming, 2013). The
278 flexibility of behavioural defences might be especially beneficial in a fast-changing or unpredictable
279 environment (Caro *et al.*, 2016) or when facing multiple predators (Staudinger *et al.*, 2011). They could also
280 decrease energetic costs of morphological or chemical defences by increasing their precision, such as the
281 targeting of chemical sprays.

282

283 Frequencies of specific defence combinations vary across prey taxa – associations can be explained by
284 factors such as developmental co-dependency or synergistic effects during predator-prey interactions. Figure
285 1 illustrates defence combinations and their relative frequencies in two insect orders, Hemiptera (Fig. 1A)
286 and Lepidoptera (Fig. 1C), along with two species examples (Fig. 1B, 1D). This qualitative figure suggests
287 major differences between the two orders, e.g. mechanical defences being scarce in Lepidoptera relative to
288 Hemiptera, but also parallels between the two taxa, for instance in association between particular types of
289 visual defences and defensive behaviours: while behavioural defences used by aposematic species often
290 serve a signalling function, crypsis is typically associated with a mode of escape.

291

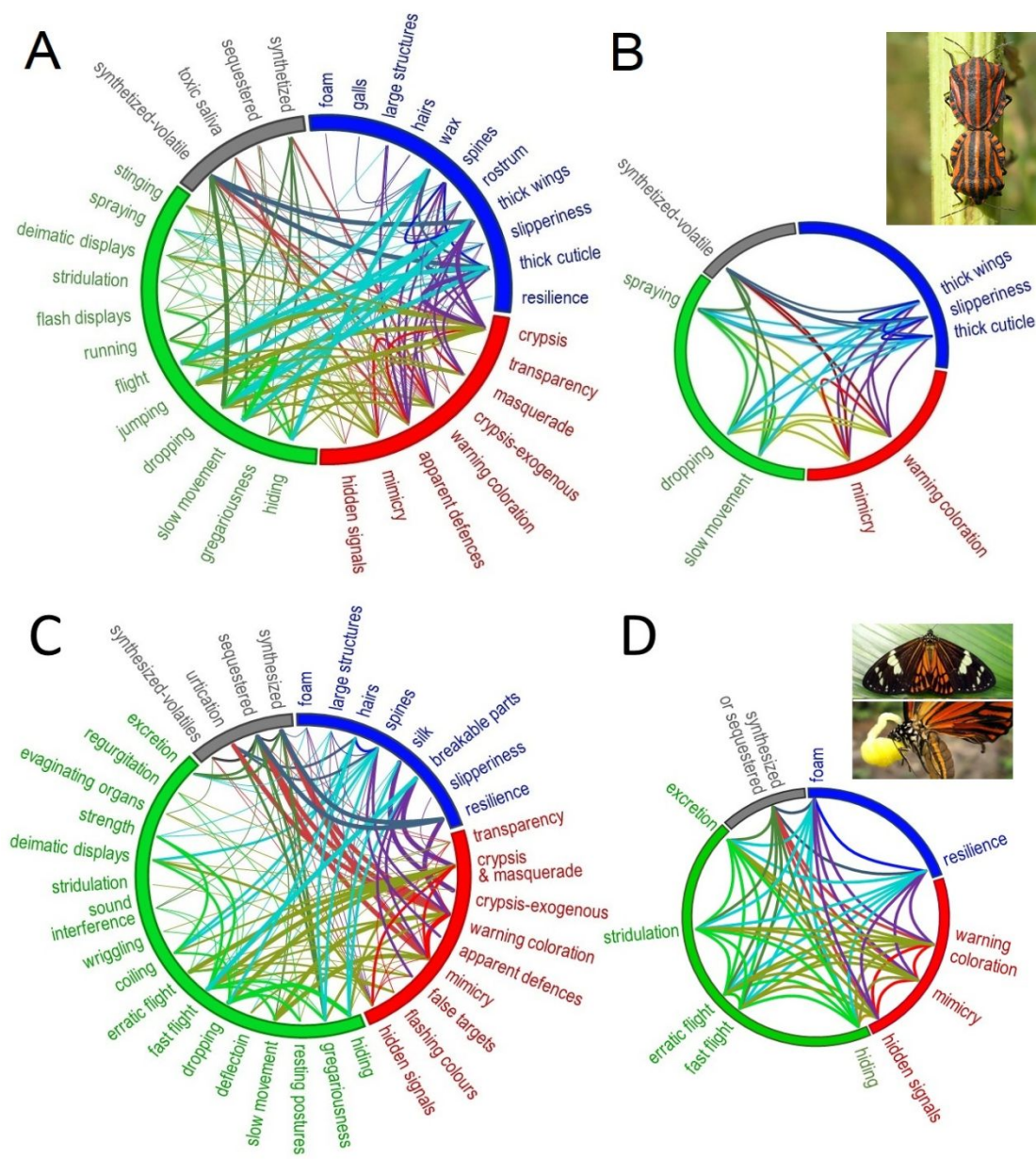

292

293

294

295

296

297

298

299

300

301

302

Fig 1: Combinations of mechanical, visual, behavioural and chemical defences found in larvae and adults of two insect orders, Hemiptera (Fig 1A) and Lepidoptera (Fig. 1C). Lines represent individual combinations of defences found in these taxa and line thickness corresponds to frequency of their occurrence in nature (thick: widespread, medium: common and found in several lineages; thin: specific to certain lineages). Prevalence distribution was chosen to represent a 1:2:4 ratio of the thick:medium:thin lines in each insect order. Within each category, individual defences were arranged according to their position along the predation sequence. Line colours correspond to the defence categories involved in the defence combinations. Figs. 1B and 1D provide examples of defence combinations in representatives of the two insect

303 orders, namely adults of *Graphosoma italicum* (Hemiptera: Heteroptera: Pentatomidae; Fig. 1B)
304 and *Chetone phyleis* (Lepidoptera: Erebidae; Fig. 1D).

305

306 3. How multiple defences interact with predator cognition

307 In this section, we consider the ways in which multiple defences - both primary and secondary - are likely to
308 interact to exploit the cognitive processes of predators, and the consequences this could have for the
309 evolution of prey defences and predator counter-adaptations. We first focus on the survival benefit of multiple
310 defences for the prey and then discuss the corresponding mechanisms at the levels of predator cognition
311 and behaviour. We define predator cognition as any process related to perception, information-processing
312 and decision-making (Shettleworth, 2009), and we focus on the defences deployed either immediately before
313 or upon attack as they usually target multiple sensory modalities and cognitive responses of the predator
314 (Rowe & Halpin, 2013; Rojas *et al.*, 2019). Despite the fact that predator cognition is a key factor driving the
315 evolution of many forms of defence (Skelhorn *et al.*, 2016a; Skelhorn & Rowe, 2016; Umbers *et al.*, 2017),
316 work in this area largely focuses on individual defences. Whilst a number of experiments have established
317 that the benefits of multiple defences can exceed that of a single defence (Skelhorn *et al.*, 2016b; Winters *et al.*
318 *et al.*, 2021), the mechanisms by which multiple defences exploit predator cognition to enhance prey survival
319 are not clear. This is an important knowledge gap as when multiple defences are coordinated to deter
320 individual instances of attack, one form of defence may (or may not) change the efficacy of another, and the
321 mechanisms of interaction between defences may considerably affect prey survival and defence evolution.

322

323 3.1 Independence, synergy, and antergy between defences

324 Two different questions arise when exploring the effects of multiple defences on prey survival.

325 The first question relates to the benefits of multiple defences compared to a single defence. Multiple
326 defences will have a greater survival benefit for the prey whenever their benefit will exceed the maximum of
327 the benefits of any single defence. The second question concerns how defences interact. We say that there
328 is **synergy** between different forms of defence when the benefit of using these defences together is greater
329 than the benefit of these defences acting independently. Theoretically, it is also possible for multiple
330 defences to be **antergistic** if the benefit of using them together is smaller than when they act independently
331 (see Figure 2 for details and mathematical definitions). By **independence** we mean that the probability of the
332 prey surviving when it uses defence B is unchanged whether or not the prey deploys defence A.

333

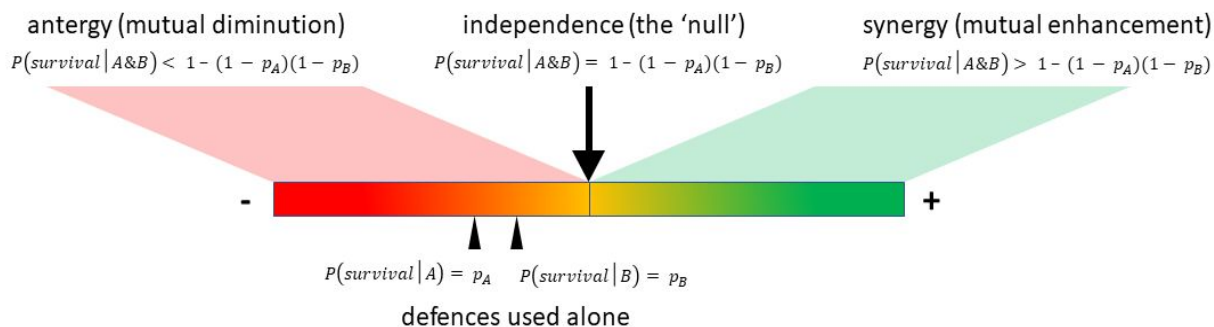

334

335

336

337

338

339

340

341

342

343

344

345

346

347

348

349

350 **A model of simultaneously deployed non-independent defensive strategies**

351

352

353

354

355

356

357

Figure 2. Independence, synergy, and antergy of multiple defences, and comparison with single defences. With p_A (resp., p_B) being the probability of the predator failing to overcome a defence A (resp., B), the two defences A and B act independently if the probability of survival when deploying both is $Pr(\text{survival} | A\&B) = 1 - (1 - p_A)(1 - p_B)$. This value serves as a reference along a continuum of interactions between defences, ranging from a negative interaction (antergy) when $Pr(\text{survival} | A\&B) < 1 - (1 - p_A)(1 - p_B)$ to positive interaction (synergy) when $Pr(\text{survival} | A\&B) > 1 - (1 - p_A)(1 - p_B)$. The same continuum can be used to compare the benefit of multiple defences over single defences; multiple defences will have a greater survival benefit for the prey if $Pr(\text{survival} | A\&B) > \max(p_A, p_B)$.

In Box 1 we consider a simple model of simultaneously deployed defences to illustrate how different defensive strategies would be selected depending on defence effectiveness, rate of potential encounters with predators, defence cost, and level of synergy between defences.

<Box 1 starts here>-----

Consider a prey species with a single reproductive episode at the end of its life (i.e. it is semelparous). The prey has two possible types of anti-predator defence (A and B) at its disposal, which can be simultaneously deployed. Defences A and B come at fecundity costs c_A and c_B , respectively, independent of how often they are deployed. Let the probability of the predator failing to overcome defences A and B when deployed alone be p_A and p_B , such that $Pr(\text{survival}|A) = p_A$ and $Pr(\text{survival}|B) = p_B$. We assume that if no defence is deployed, the prey will not survive an encounter with a predator. We seek to identify the combination of defences (if any) that would be selected for when the defences: (i) work independently to protect the prey, (ii)

358 are synergistic or (iii) antagonistic (see main text for definitions). Following these definitions, we define z as a
 359 measure of the departure of the combined probability of survival assuming complete independence, with $z =$
 360 0 representing a case in which the two defences work independently to protect the prey, such that
 361 $\Pr(\text{survival}|A\&B) = p_{AB} = 1 - \{(1-p_A)(1-p_B)\}^{1+z}$ ($-1 < z < \infty$, $z > 0$ corresponding to synergy between defences, z
 362 < 0 to antagonism).

363 Let predators encounter prey at random, so that putative encounters with individual prey are Poisson
 364 distributed with mean and variance λ . Under these conditions, the expected probability of an individual prey
 365 surviving a series of random encounters with predators is:

$$366 \sum_{i=0}^{\infty} \left(\frac{e^{-\lambda} \lambda^{-i}}{i!} \right) s^i = e^{-\lambda(1-s)},$$

367 where s is the probability of survival per putative encounter. The fitness (w) associated with each
 368 combination of defences will depend on the rate at which predators encounter the prey, the degree to which
 369 the defences protect the prey and the reproductive price they have paid to ensure it, specifically:

$$370 w_{\text{none}} = e^{-\lambda}(b),$$

$$371 w_A = e^{-\lambda(1-p_A)}(b - c_A),$$

$$372 w_B = e^{-\lambda(1-p_B)}(b - c_B),$$

$$373 w_{AB} = e^{-\lambda(1-p_{AB})}(b - c_A - c_B),$$

374 where b is the mean fecundity of surviving prey before paying for any defences. Note that a similar approach
 375 can be used to calculate the fitness of the prey if it continually reproduces, i.e. is iteroparous (e.g. Kang *et*
 376 *al.*, 2017b).

377 We can now identify the strategy that would be selected for at a given level of synergy (z) and mean rate of
 378 encounter with predators (λ). In the figure below for example, we consider the case in which defence A is
 379 better at protecting against the predator, but it costs more (specifically $p_A = 0.4$, $p_B = 0.2$, $c_A = 0.2$, $c_B = 0.05$,
 380 $b = 1$). Having no defence at all is only selected for when the mean rate of encounter of prey with predators λ
 381 is low. As λ increases, the cheaper defence (B) is selected for first. Both defences will be selected for when λ
 382 is high and the two defences are synergistic. By contrast, the more effective yet costlier defence A will be
 383 selected alone when λ is high and the two defences are antagonistic. So, the strength of synergy (or antagonism)
 384 between defences as well as the need for defences, will affect which combination of defences are selected
 385 for. For an illustration of how survival probability of prey depends on the nature of the interaction between its

386 defences, see Figure S1.

387

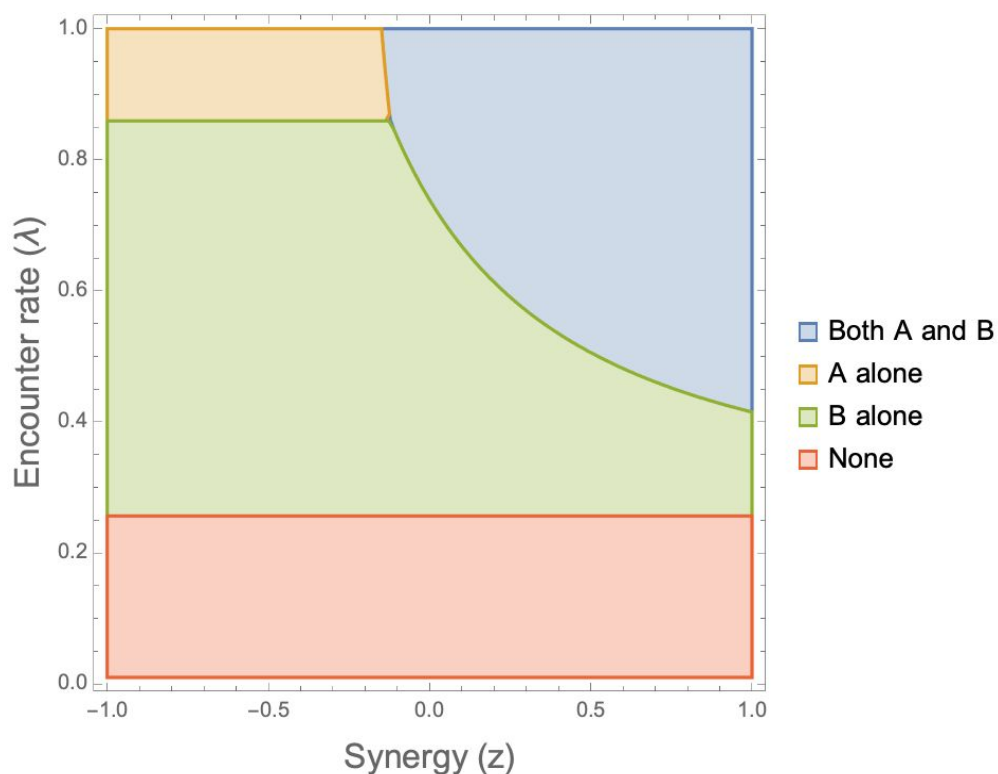

389 <Box 1 ends here>-----

390

391 3.2 Cognitive mechanisms for the interaction of multiple defences

392 We next consider the cognitive mechanisms of predators that could cause defences to interact in the three
 393 ways outlined above, independence, synergy and antergy.

394

395 3.2.1 Independence

396 There are several scenarios in which multiple defences could act independently to protect prey. Different
 397 defences may exploit different aspects of predator cognition or act at different stages of the predation
 398 sequence. For example, crypsis hinders prey detection, whereas mechanical and chemical defences can
 399 prevent subjugation later in the predation sequence when the prey is detected (Gamberale-Stille *et al.*, 2010;
 400 Johansen *et al.*, 2010). Alternatively, each defence may work in a different context or environment. For
 401 instance, camouflage may be effective only against certain backgrounds and when the prey is still, and other
 402 defences, such as releasing ink in cephalopods, can provide protection during prey movement (Staudinger *et*
 403 *al.*, 2011).

404

405 3.2.2 Synergy

406 Not all defences, however, act independently. There are a number of mechanisms through which the efficacy
407 of defences can be enhanced when combined. The potentially synergistic effects of **multisensory**
408 **integration**, i.e. integrating sources of information from different sensory modalities, are well understood at
409 the neuronal level (Stein & Stanford, 2008). Multimodal neurons (i.e. neurons sensitive to stimuli in several
410 modalities) respond more to a multimodal stimulus than to any of its unimodal components (Stein &
411 Meredith, 1993). Moreover, neuronal responses can be superadditive, that is, they exceed the sum of the
412 responses to the unimodal stimuli (Stein & Stanford, 2008). This increase in perceptual sensitivity, called
413 multisensory enhancement, leads to increased stimulus salience, better detection, faster reaction times,
414 more accurate localization, and improved discrimination between stimuli (Stein et al. 2020). These effects on
415 predator perception and cognition may help to explain why multimodal warning signals are so widespread
416 (Rowe & Halpin, 2013). Speeding up a predator's reaction may provide an adaptive advantage by stopping
417 attacks early enough to avoid damage (Rowe, 1999). Multisensory enhancement may also reduce speed-
418 accuracy trade-offs in prey discrimination (Chittka & Osorio, 2007). Enhancing prey salience to predators
419 through multimodal displays is consistent with the importance of conspicuousness in aposematism (Mappes
420 *et al.*, 2005; Stevens & Ruxton, 2012), and probably in other defence strategies such as deimatism (Umbers
421 *et al.*, 2017). Multimodal defences may also exploit predator cognition through their effects on learning and
422 memory. For example, bats learn to avoid chemically defended fireflies faster when they use bimodal signals
423 (sound and bioluminescence) than either of these modalities alone (Leavell *et al.*, 2018). Whilst the neural
424 mechanisms of multimodal enhancement are well-known, showing that these mechanisms are at play in the
425 context of predation will require future work.

426 Another possible mechanism through which multiple defences may exploit predator cognition is
427 **cross-modal correspondence**, where a defence in one modality may change the way a defence in another
428 modality is perceived, producing potentially synergistic effects. Whilst such a mechanism has been
429 demonstrated in humans (Spence, 2011), direct evidence is lacking in the context of predator-prey
430 interactions where cross-modal correspondence may potentially play a role in hidden innate aversions to
431 aposematic displays. For instance, interaction between olfactory and visual warning signals triggers innate
432 aversions to aposematic prey in birds (Rowe & Guilford, 1996) and spiders (Vickers & Taylor, 2020), but the
433 exact cognitive mechanisms responsible for these aversions remain unknown.

434 Defences may also act synergistically if multiple defences are inherently more surprising or less
435 predictable than single defences. Several forms of defence involve a sudden appearance of unexpected

436 stimuli (e.g. display of previously hidden signals; Umbers *et al.* 2017) and may exploit the effects of **surprise**
437 on predator cognition. Since one important function of the brain is to reduce uncertainty about the external
438 world (Clark, 2013), unpredictable stimuli increase the brain load, which increases reaction times to external
439 events (Jakobs *et al.*, 2009). Multi-modal defences are likely to be particularly effective at increasing
440 cognitive-load, and may thus delay or alter predator's decision to attack (Kang *et al.*, 2017b; Holmes *et al.*,
441 2018). Surprising events may also enhance subsequent learning (Courville *et al.*, 2006), increasing the
442 speed at which predators learn to avoid defended prey (Rowe, 2002; Skelhorn & Rowe, 2005; Kang *et al.*,
443 2016). More broadly, possessing multiple defences may make prey more 'unpredictable'. If predators cannot
444 predict which form of defence prey are likely to use, it may be more difficult for them to develop counter-
445 strategies.

446 Sequentially deployed multiple defences are often considered to be a part of a layered defensive
447 strategy, with later-acting defences taking place only if earlier-acting defences fail (Kang *et al.*, 2017a;
448 Ruxton *et al.*, 2018). However, sequential defences may also interact and have potentially synergistic effects.
449 In this case, one stimulus may increase a predator's response to a subsequent stimulus, a mechanism
450 known as **priming** (Shettleworth, 2009). For example, highly volatile pyrazines, which are part of defensive
451 secretions of many aposematic insects (Moore *et al.*, 1990) may increase a predator's subsequent response
452 to distasteful toxins (Siddall & Marples, 2008; Winters *et al.*, 2021).

453

454 3.2.3 Antergy

455 In some cases, prey defences may act antagonistically, with one defence reducing the efficacy of another.
456 Multiple signals may, for instance, compete for predator's attention, and the competition may occur both
457 within the same modality and across modalities (Dukas, 2002). For example, simultaneous processing of two
458 streams of auditory information by foraging bats may lead to decreased performance in both tasks (Barber *et al.*
459 *et al.*, 2003). Multiple signals may also interfere with each other in prey avoidance learning, and this may result
460 in stimulus overshadowing, whereby predators associate prey unprofitability with the most salient of
461 simultaneously presented stimuli (Aronsson & Gamberale-Stille, 2008). Nevertheless, even if defences act
462 antagonistically, having multiple defences can still be beneficial provided the benefit of deploying multiple
463 defences is greater than the benefit of deploying the best defence alone.

464

465 3.3 Evolutionary significance and open questions

466 Investigations of coevolution between predator cognition and prey defences could provide essential insights
467 into why prey transition from a single to multiple defences. Prey defences are under selection to be salient to
468 predators, and ultimately elicit a change in predator behaviour. While our understanding of multisensory
469 integration has increased dramatically (Pickard *et al.*, 2020; Stein *et al.*, 2020), this work has largely focused
470 on proximate mechanisms, and much remains to be learned about the evolution of cognitive processes
471 related to integration of multisensory information. Comparative studies indicate that common principles
472 underlie multisensory integration across vertebrates (Stein *et al.*, 2020), which provides a starting point for
473 evaluating evolutionary patterns and processes. Sensory ecology affords frameworks (e.g. sensory drive;
474 Endler & Basolo, 1998) to study how predators can select for enhanced saliency of multiple defences, and
475 how defences can exploit predator sensory and cognitive biases.

476 One difficulty has been in developing common currencies for predators and prey in the context of
477 predator-prey coevolution (e.g. Kokko *et al.*, 2003). In some instances, defences function against many
478 predators, in other extremes there is a direct co-evolution between a key predator and a prey. Recently,
479 Friedman & Sinervo (2016) used the idea of predator cognitive phenotypes (naive versus averse to warning
480 signals) to evaluate the fitness of potential prey having different defence strategies (aposematism, mimicry,
481 and crypsis). The dynamics of the system result in Red Queen dynamics (Van Valen, 1973) that cause
482 cycles in the fitnesses (and frequencies) of the different strategies over evolutionary time. Hence, even
483 relatively simple variation in cognitive phenotypes of predators can give rise to complex patterns of
484 evolutionary change.

485 Moreover, predators may evolve cognitive and behavioural strategies allowing them to overcome
486 existing prey defences. For instance, perceptual completion of prey outline (Nieder & Wagner, 1999) may
487 help predators overcome disruptive camouflage, search-image formation may reduce the effectiveness of
488 background matching (Bond & Kamil, 2002), and elaborate prey handling may allow predators to selectively
489 discard toxic prey body parts (Brower & Fink, 1985; Mebs *et al.*, 2017). Predators can also make decisions to
490 attack defended prey based on their physiological state (e.g. energy reserves and toxin burden), prey
491 abundance and nutritive value, and the availability of alternative prey (Sherratt *et al.*, 2004; Barnett *et al.*,
492 2007; Skelhorn & Rowe, 2007; Halpin *et al.*, 2014). In this case, continued investment in a single defence
493 may yield diminishing returns, favouring the evolution of multiple defences.

494 Investigating multiple defences in a framework considering the perception and cognition of relevant
495 predators would enable us to determine how interactions of multiple defences influence predator cognition
496 and behaviour, and how this translates into potential effects on prey survival. We acknowledge that these
497 data may not be available in all instances, in which case relevant studies would contribute greatly to the field.

498 This approach would also allow us to address key questions concerning multiple defences and predator
499 cognition: (1) Do defences that are displayed earlier and later in the predation sequence exploit different
500 cognitive responses of predators? (2) Which aspects of predator cognition are targeted in simultaneous
501 versus sequential deployment of multiple defences? (3) When does synergy need synchrony of the multiple
502 defences, and when does it not? (4) How are multiple defences related to the concepts of surprise and
503 uncertainty and to their effects on predator cognition and behaviour? Moreover, understanding the function
504 of synergistic multiple defences can offer novel insights into diverse aspects of predator cognition, including
505 both individual experience and use of social information.

506

507 4. Playing multiple roles: trade-offs and synergies

508 Antipredator defence is likely to be limited by various factors. Prey may have limited resources available to
509 respond to various selective pressures, and moreover, adaptive responses to different selective pressures
510 may be in functional conflict with one another. Such constraints, where a beneficial change in one trait
511 results in a detrimental change in another trait, are called trade-offs (Stearns, 1989). Within a defence
512 portfolio, prey investment in each defence trait is constrained by **resource trade-offs**. When resources are
513 limited, defence may trade off against other life history traits; for instance, defended algal clones exhibit a
514 marked decrease in population growth rate relative to undefended clones (Yoshida *et al.*, 2004).
515 Alternatively, there may be trade-offs among different defences, such as when a chemical is depletable and
516 can have several defensive functions (e.g. a burying beetle may be limited in how much anal fluid secretion it
517 can use to defend a carcass versus protect itself; Lindstedt *et al.*, 2017). The optimal resolution of such
518 resource allocation trade-offs may be modified by functional interactions among defences, i.e. synergy or
519 antagonism. The former is a functional synergy, while the latter is a **functional trade-off** (Table 1).

520 The relative contribution of each defence trait to a portfolio's total deterrent effect will depend on the
521 expression of other defences, i.e. defence value of trait A is conditional upon the value of trait B, particularly
522 when one of these traits acts early in the predation sequence (Broom *et al.*, 2010). In this sense, some traits
523 can render another **functionally redundant** even if they are not in conflict and even if they act at different
524 stages of the attack sequence (Table 1). Resource trade-offs and functional trade-offs may occur between a
525 defensive trait and a non-defensive trait, defence against one type of predator and defence against another,
526 or defences within a single defence portfolio. Trade-offs and synergies between two defences in the same
527 portfolio may occur within or between stages of the predation sequence.

528 Some defensive traits have another, non-defensive function. Large investments in a trait that is
529 particularly important for a non-defensive function can provide a defensive function that appears to be a
530 “free” evolutionary by-product of the first. We call these **multi-role traits**. A multi-role trait is one that benefits
531 an individual's fitness through its role in defensive and non-defensive functions. Traits with predatory
532 functions are often effective as antipredator defences (e.g. Stankowich *et al.*, 2011). For example, in
533 microbes, the predatory soil bacterium *Myxococcus xanthus* produces a range of secondary metabolites
534 used for lysing and digesting prey cells (Thiery & Kaimer, 2020), which have been hypothesised to have a
535 predation-defence role as well (Findlay, 2016; Mayrhofer *et al.*, 2021). Multi-role traits can give rise to potent
536 defences that act late in the predation sequence (e.g. venoms). This may create conditions favouring the
537 evolution of other, earlier-acting defences such as aposematism. Incorporating multi-role traits into existing
538 theory on the evolution of multiple defence may alter predictions about investment into early- versus late-
539 acting defences (Broom *et al.*, 2010; Ruxton *et al.*, 2018; Wang *et al.*, 2019).

540 In the literature, we find that most documented trade-offs fall into three categories: resource trade-
541 offs between a single defence and another life-history trait, functional trade-offs between defences, and
542 functional trade-offs between defences and other life history traits (including defences against another type
543 of predator) (Table 1). Several studies reported resource trade-offs on the basis of experimental
544 manipulations of nutrient levels or allocation to antipredator defence in organisms that respond with plastic
545 defence strategies (Bennett *et al.*, 2013; Ehrlich *et al.*, 2020). Some studies used predator responses to prey
546 defences to test functional trade-offs (Stevens *et al.*, 2011). Correlational studies of behavioural and
547 morphological defences were also used as evidence of trade-offs (Blanchard & Moreau, 2017; Hodge *et al.*,
548 2018). From such purely correlational studies of phenotypes, it is difficult to determine whether trade-offs are
549 functional or resource-based. Finally, we also found cases where no trade-offs were detected (Table S1),
550 and the potential for a “file drawer effect”, where negative results are not reported, makes it hard to
551 generalise about the ubiquity of trade-offs. It would be valuable to have studies where genetic correlations
552 among traits, phenotypic correlations across environments, and the fitness effects of defences are
553 simultaneously measured.

554 Correlations between traits demand some consideration of their genetic basis. While functional
555 trade-offs and synergies can arise from single traits that affect multiple functions, similar correlations can
556 also arise from pleiotropy, in which a single gene affects more than one trait (Lande, 1979; Lande & Arnold,
557 1983). In defence portfolios, as with any other set of traits, pleiotropy has the potential either to facilitate
558 adaptive evolution by maintaining combinations of traits that work well together or to limit the combinations
559 that appear. For instance, pleiotropy has been shown to constrain the evolution of chemical defences in

560 *Boechera stricta*, a wild relative of *Arabidopsis* (Keith & Mitchell-Olds, 2019). Many antipredator traits are
561 likely to be quantitative and polygenic, making it more difficult to understand the links between genotype and
562 phenotype (Kooyers *et al.*, 2020). In species that go through metamorphosis, genetic constraints in defensive
563 traits can also occur between life stages (Lindstedt *et al.*, 2016). Understanding these links is important
564 because they could dictate which combinations of defences are viable, thus determining the distribution of
565 multiple defence strategies.

566 Where we observe variation in defensive portfolios, the temptation is to assume that this variation
567 tells us something about the underlying trade-offs in operation. A negative correlation between traits may be
568 consistent with a trade-off, but does not imply causation. Variation in resource levels among individuals is
569 well known for its potential to lead to *positive* correlations between pairs of resource-dependent defensive
570 traits, regardless of any underlying resource trade-off (van Noordwijk & de Jong, 1986).

571

572 Table 1: Examples of how trade-offs and synergies can affect the presence and expression of
573 predator defence. Trade-offs may reflect resource allocation decisions among defences, or
574 between defences and other non-defensive traits. Limited resources mean that trait
575 combinations must lie at or below the dashed line in the accompanying figure; however, the line
576 can move if resource availability changes. Functionally, defences may be independent,
577 synergistic, antagonistic (functional trade-offs), functionally redundant with each other, or play
578 multiple roles.

579

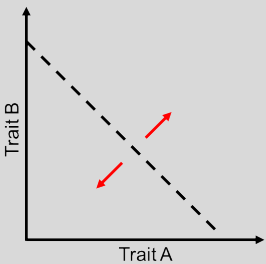
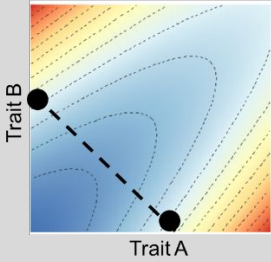
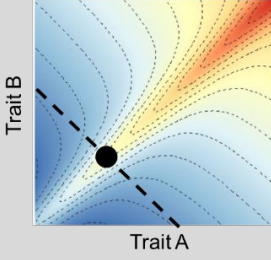
	Definition	Context	Examples
Resource Trade-off		<p>Investment in one defence limits investment in another.</p>	<ul style="list-style-type: none"> • Defensive display + regurgitating decreases chemical defence in pine sawflies (Lindstedt <i>et al.</i>, 2018)
		<p>Investment in defence limits investment in non-defensive trait (e.g., reproduction, growth).</p>	<ul style="list-style-type: none"> • Defence-growth trade-off for algae (Yoshida <i>et al.</i>, 2004) • Tadpoles grow slower around predators (Buskirk, 2000)
Functional Trade-off	<p>Antergy</p> 	<p>Increased efficacy of one defence reduces the efficacy of (or need for) another defence.</p>	<ul style="list-style-type: none"> • Bivalve shells optimized for burrowing reduce crush resistance (Johnson, 2020) • Morphological defences are negatively correlated with escape speed in butterflyfish (Hodge <i>et al.</i>, 2018)
		<p>A defence protects against one predator at the cost of vulnerability to another.</p>	<ul style="list-style-type: none"> • Predator-induced tail shape in tadpoles (Benard, 2006) and behavioural responses in roach (Eklöv & VanKooten, 2001) protect against one predator but reduce protection against others
		<p>Defensive phenotype interferes with non-defensive trait (e.g., mobility, thermoregulation).</p>	<ul style="list-style-type: none"> • Tonic immobility lowers mating success in flour beetles (Nakayama & Miyatake, 2010) • Butterflies with warning signals pay aerodynamic costs (Srygley, 2004)
Synergy	<p>Synergy</p> 	<p>Two defensive traits that provide more protection when possessed together than either separately.</p>	<ul style="list-style-type: none"> • Morphological and behavioural defences positively correlate in tadpoles under predation risk (Hossie <i>et al.</i>, 2017) • Prey using deimatism also benefit from crypsis (Kang <i>et al.</i>, 2017a)
Multi-role traits	<p>Defensive Function ↑ Trait ↓ Non-defensive Function</p>	<p>A defensive trait has non-defensive functions that increase survival or reproduction. The investment does 'double duty'.</p>	<ul style="list-style-type: none"> • Anal fluid in burying beetles aids in parental care and chemical defence (Lindstedt <i>et al.</i>, 2017) • In <i>Heliconius erato</i>, effective aposematism was positively correlated with mating success (Finkbeiner <i>et al.</i>, 2014)

580

581

582 5. Intraspecific variation in defence

583 Within species, individuals can exhibit variation in their defence portfolios (see examples in Figure 3).

584 Individual differences, particularly in behaviours, are often given precise definitions that require individuals to
585 exhibit such differences repeatedly and across contexts (e.g. Dingemanse *et al.*, 2010). Here, we take a
586 broader view, as our focus is on predator deterrence. As predator behaviour may be influenced by the
587 variability they encounter among their prey, we consider any mechanisms that could generate variability
588 among prey at a given point in time, even if prey are otherwise identical. Individuals may vary in the number
589 of different defences they possess or deploy, as well as in the strength or effectiveness of each defence, and
590 variation across multiple defences may be linked in an antagonistic or synergistic way. This diversity can be
591 observed across a range of time scales, from variation in how individual prey choose to respond to a given
592 threat, even if equally capable of mounting a defence, to evolutionarily stable differences in defensive traits
593 between morphs and populations (Figure 3).

594

595 5.1 Proximate mechanisms maintaining variation

596 Mechanistically, variation in defences can be underpinned by both plasticity and genetic factors. Some
597 defences are tightly linked to environmental conditions, as seen in the poison frog *Oophaga pumilio*, whose
598 chemical defences vary according to spatio-temporal availability of the arthropod prey from which they
599 sequester their toxins (Saporito *et al.*, 2006). In other instances, variation in a defensive portfolio is
600 genetically determined. For example, in garter snakes (*Thamnopsis ordinoides*), selection favours a genetic
601 correlation between cryptic or conspicuous colour patterns and different evasive behaviours (Brodie, 1989,
602 1992). Yet even when under genetic control, defences may change over the course of development:
603 lepidopteran larvae can completely switch strategies in their visual defences, from masquerade to crypsis or
604 even aposematism as individuals advance through instars to adulthood (Gaitonde *et al.*, 2018; Medina *et al.*,
605 2020). Finally, individual variation within and between populations can arise from interactions between the
606 genotype and the environment (GxE interactions), whereby genetically distinct individuals respond differently
607 to environmental variation.

608 One important source of variation is prey state, which includes relatively stable characteristics such
609 as sex (Swaigood *et al.*, 2003) and personality (Jones & Godin, 2010), as well as traits that may be more
610 variable during a prey individual's lifetime, such as size (Sandre *et al.*, 2007) and experience (Sih *et al.*,
611 2010). A wide range of environmental factors are also critical, including resource availability (Saporito *et al.*,
612 2006; Cao *et al.*, 2019), exposure to predators (Langridge, 2009; Sepúlveda *et al.*, 2012; Gigliotti *et al.*,

613 2021), and environmental properties shaping competing demands from other critical functions (e.g.
614 thermoregulation; Lindstedt *et al.*, 2009). Ultimately, many of these intertwined drivers of variation are likely
615 to be acting simultaneously, making it difficult to predict individual anti-predator responses (Wirsing *et al.*,
616 2021).

617

618 5.2 The role of diet in generating variation

619 When it comes to multiple defences, we can consider individual variation from several perspectives. One of
620 the best-understood proximate mechanisms for individual-level variation in defences is diet, or resource
621 availability, a key determinant of defences already highlighted in earlier sections of the review. Below we
622 describe how variation through diet comes about, illustrated with examples including both single and multiple
623 defences.

624 Diet quality can contribute to shaping whole suites of defensive traits by affecting development time,
625 and thus modulating the vulnerability of prey to certain types of predators. For example, across a community
626 of 85 species of Lepidoptera in Panama, caterpillars feeding on tougher, more mature leaves grew more
627 slowly, and had more defensive behaviours, visual and morphological defences, as well as chemical
628 protection, evidenced by feeding trials with ants (Coley *et al.*, 2006). Diet can affect both exogenous and
629 endogenous defences. With exogenous defences, effects depend on how effectively herbivores can
630 sequester defences from their diet, and their feeding preferences. These traits may be under genetic control,
631 and show GxE interactions in sequestration ability. Indeed, several studies in *Heliconius* suggest that
632 variation in chemical defence is better explained by genetics, or at least heritability, than by host plant
633 selection (Mattila *et al.*, 2021; Sculfort *et al.*, 2021). Endogenous defences can be buffered against variation
634 in diet quality and quantity (Blount *et al.*, 2012; Burdfield-Steel *et al.*, 2019). In low resource environments,
635 tadpoles appear to prioritise the maintenance of multiple defences, preserving defensive behaviours and tail
636 morphology, despite rising costs in terms of development (Steiner, 2007). However, fully compensating for a
637 poor diet may not always be possible even when defences are endogenous. Prey with multiple defence
638 strategies can also increase their investment in alternative tactics to mitigate risk. In leaf beetles
639 (*Chrysomela lapponica*), individuals forced to synthesise their own defences are more likely to diversify their
640 responses to attacks, more regularly employing defensive behaviours such as evasion and regurgitation
641 (Zvereva *et al.*, 2017). These costs also apply to other types of defences, so diet and resource availability
642 are key determinants of variation across an individual's entire defence portfolio. When resources are scarce,
643 different individuals may manage trade-offs differently depending on their genetics and individual states. How

644 consistently individuals of the same species respond to variation in resources, such as periods of food
645 deprivation, remains unknown.

646

647 5.3 Ultimate mechanisms maintaining variation

648 Evolutionarily relevant variation in multiple defences may be maintained by a number of processes.

649 Individual variation may be a consequence of relaxed selection. In sequential lines of defence, later defences
650 may be more expensive (Jongepier *et al.*, 2014), and therefore show more variability based on individual
651 resource state. If selection on these defences used in later predation stages is also relaxed, then more
652 variability may arise in turn (Carmona *et al.*, 2011; Wang *et al.*, 2019).

653 Alternatively, variation can be a consequence of competing evolutionary strategies within a prey
654 population. One such strategy is automimicry, where some individuals of an aposematic species invest only
655 in the warning signal, but not in the secondary defence it is expected to advertise (Brower *et al.*, 1967).
656 Instead they rely on predators choosing not to attack them, after having learned to avoid their defended
657 conspecifics. In turn, predators can select against automimics by carefully sampling prey individuals
658 (Guilford, 1994; Skelhorn & Rowe, 2006a), so the selective advantage of automimicry depends on the
659 relative predator costs and benefits associated with decisions to attack or avoid. These are dependent on a
660 complex set of factors, including the profitability and relative frequency of defended and undefended prey,
661 and predator traits. It is unclear how variation in the quality and quantity of defence chemicals affects the
662 evolutionary dynamics of automimicry (Speed *et al.*, 2012). Variation between individuals may contribute to
663 predator avoidance and learning in and of itself, as predators have been shown to avoid uncertainty when
664 choosing prey to attack (Sherratt *et al.*, 2004; Barnett *et al.*, 2014). Thus, while variation in aposematic
665 patterns, for example, has previously been assumed to reduce their signalling value, variation in defences
666 within a population may actually increase predator avoidance.

667 Predators themselves can vary in space and time, and distinct predators may be relevant both at
668 different life stages and in different habitats (Ratcliffe & Nydam, 2008), potentially leading to variable
669 selection pressures for defences. Variation in multiple defences may also be greater if one defence can be
670 enhanced to compensate for weaker performance in another. For example, poison frogs *Dendrobates*
671 *tinctorius* show distinct ecotypes with different habitat use and movement patterns that correlate with
672 differences in their anti-predator colouration (Rojas *et al.*, 2014). Notably, frogs with less conspicuous
673 colouration were more likely to avoid open areas and showed greater reactivity to simulated predation
674 events, suggesting they invest more in behavioural defences and less in their warning signal. In sum, the

675 sources of individual variation in defences that we have highlighted above provide the substrate for multiple
 676 species-specific defence strategies to evolve.
 677

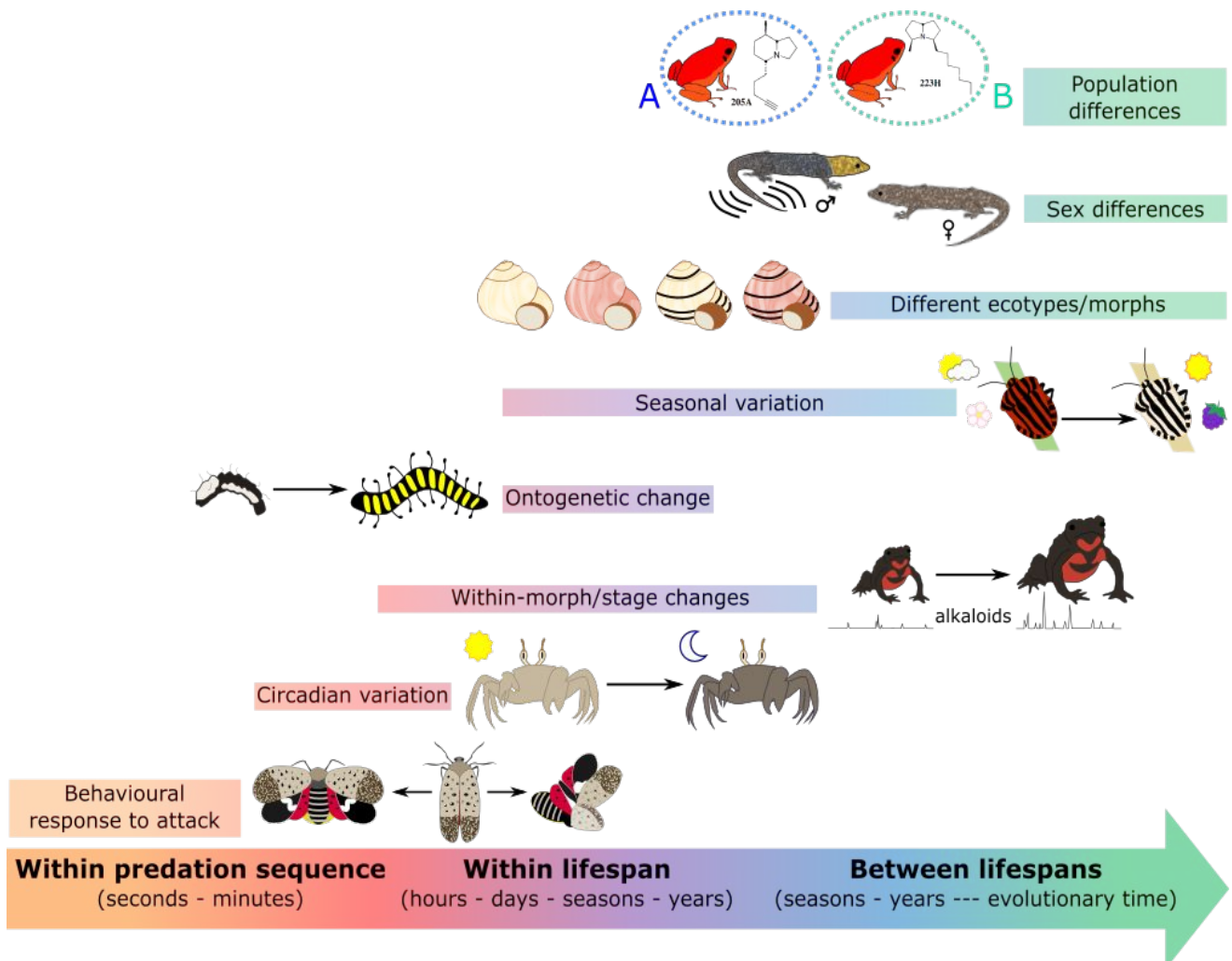

678
 679 Figure 3: Scales at which variation in antipredator defences can be observed. Variation can
 680 occur both within and between individuals, and over a range of increasing time scales, from
 681 choices made within a predation event to differences fixed over evolutionary time. Real-world
 682 examples are as follows, from bottom: individual variation in deployment and duration of startle
 683 display or death feigning in the spotted lanternfly *Lycorma delicatula* (Kang *et al.*, 2017a);
 684 day/night changes in lightness in horned ghost crabs *Ocypode ceratophthalmus* (Stevens *et al.*,
 685 2013); increases in alkaloid defence quantity and richness with size and age respectively in the
 686 Brazilian red-belly toad, *Melanophryniscus moreirae* (Jeckel *et al.*, 2015); shifts in visual
 687 defence strategy from masquerade to aposematism in alder moth *Acrionicta alni* larvae
 688 (Valkonen *et al.*, 2014); seasonal variation in colouration in the striated shieldbug *Graphosoma*
 689 *lineatum* between spring and late summer (Tullberg *et al.*, 2008); morphological variation in

690 shell thickness and strength in *Cepaea nemoralis* snail morphs (Rosin *et al.*, 2013); sex
691 differences in anti-predator tail-waving display in yellow-headed geckos *Gonatodes albogularis*
692 (Bohórquez Alonso *et al.*, 2010); population differences in *Oophaga pumilio* alkaloid defence
693 composition (Saporito *et al.*, 2006).

694

695 6. Macroecology and macroevolution of multiple defences

696 Investigating the ecology and evolution of multiple defences across species and at large spatial and/or
697 temporal scales could help us understand the ultimate causes of different multiple defence strategies and
698 how they work to effectively defend prey from predators (McGill *et al.*, 2019). Typically, macroecological
699 studies make use of regional to global biogeography, meta-analysis, and coordinated distributed
700 experiments (e.g. Carmona *et al.*, 2011; Nielsen *et al.*, 2016; Roslin *et al.*, 2017), while macroevolutionary
701 studies use phylogenetic comparative methods to reconstruct evolution of phenotypic traits, and estimate
702 correlated evolution and diversification rates (e.g. Arbuckle & Speed, 2015; Nielsen *et al.*, 2016; Stankowich
703 & Romero, 2017).

704 Macro approaches have yet to be applied extensively in the context of understanding multiple prey
705 defences. Aposematism, which operates as a multiple defence because it relies on predators associating a
706 warning signal with a secondary defence, provides perhaps the best examples thus far (reviewed in Caro &
707 Ruxton, 2019). For example, Ratcliffe & Nydam (2008) compared 37 chemically defended tiger moth species
708 signalling with visual and/or acoustic cues to bird and bat predators, and suggested that multiple predators
709 contribute to the evolution of multimodal defences. Correlations between defences are also commonly
710 studied as indicators of signal honesty in aposematism (e.g. Sherratt *et al.*, 2005; Stankowich *et al.*, 2011), or
711 in terms of trade-offs between different defences (e.g. defensive behavior and morphology in scorpions; Van
712 Der Meijden *et al.*, 2013). However, less attention has been given to the predictors of investment in two or
713 more defences (Briolat *et al.*, 2019), which is key to understanding multiple defence diversity. Macro
714 approaches have also investigated the evolutionary sequence of defence adaptations. For example, in
715 spiders (Pekár, 2014) and millipedes (Rodriguez *et al.*, 2018) warning colouration only evolves after chemical
716 defence.

717 We are not aware of many other studies that use a macro approach to study the ultimate drivers of
718 multiple defences, and none that treat multiple defence strategy as a composite trait (but see Stankowich &
719 Romero, 2017). The plant defence literature is more advanced in this respect and provides inspiration for
720 research questions and approaches. For example, in a meta-analysis, Carmona *et al.* (2011) collated

721 measurements of genetic correlation between various plant traits susceptibility to herbivory. They then used
722 this dataset, covering 40 species from 19 plant families, to ask which types of traits most strongly predict
723 resistance to herbivores. Secondary metabolites were assumed to be the most important defence in plants,
724 but the results of Carmona et al (2011) suggested an alternative hypothesis: that herbivores exert greater
725 selection pressure on life-history and morphological defence traits, and secondary metabolites experience
726 weaker evolutionary constraints.

727

728 6.1 Open macro questions

729 The most frequent prediction from models of multiple defences is that defences should generally be
730 concentrated early in the predation sequence, but specific exceptions exist (Broom *et al.*, 2010; Bateman *et*
731 *al.*, 2014; Wang *et al.*, 2019). For instance, when late-stage defences are much more effective than early
732 stage defences, then multiple defences should be concentrated later in the predation sequence (Wang *et al.*,
733 2019). Early-stage defences should also be more stable over evolutionary time than late-stage defences, but
734 this again reverses when late-stage defences are more effective (Carmona *et al.*, 2011; Wang *et al.*, 2019).
735 Brodie et al. (1991) predicted that the number of early defences should trade-off with the number of late
736 defences due to increased selection for one strategy reducing selection for the other, and other studies have
737 modelled how these trade-offs should be resolved. Broom et al. (2010) and Bateman et al. (2014) predict
738 that when late-stage defence costs are low, distinct defence syndromes of early vs late-stage specialists
739 should evolve (e.g. Stankowich *et al.*, 2014). We use the term “syndrome” in the sense that it describes
740 patterns of defences that co-occur together (*sensu* Jandt *et al.*, 2014). Moreover, Broom et al. (2010) also
741 highlight the role of the predation environment, where early-stage defences are favoured under generalised
742 predator communities and late-stage defences when specific dominant predators exist. Hence, analyses of
743 empirical data on how multiple defences are distributed across the predation sequence, their relative costs,
744 and the nature of their main predators would enable strong comparative tests of these theoretical predictions.
745 Beyond specific predictions from theoretical work, there are a range of general open ‘macro’ questions
746 concerning multiple defences. We briefly consider five questions that should provide key advances to our
747 understanding.

748 1. How does the diversity of defences accumulate over time? It is possible that multiple defences arise
749 (nearly) simultaneously, as might be expected from diverse and dynamic predator communities, or
750 gradually increase in number, as might be expected under Red Queen dynamics within stable
751 predator-prey systems. Additionally, the number of defences through time could be clustered around

- 752 an optimum number or highly variable. The accumulation of new defences might also be expected to
753 slow down through evolutionary time if there are diminishing returns on survival probability.
- 754 2. Do defences evolve in a predictable pattern, as has been demonstrated for chemical defence
755 evolving before warning colouration in some taxa?
- 756 3. Do multiple defences exist in repeated 'defence syndromes'? If so, how many distinct defence
757 syndromes are there and how strong is convergent evolution towards these combinations?
- 758 4. Assuming defence syndromes exist, how do they vary between taxa? For instance, it could be that
759 hymenopterans have different defence syndromes compared to snakes, or there might be
760 widespread convergence between distantly related taxa.
- 761 5. How does ecological variation influence multiple defence strategies? For instance, does the defence
762 strategy systematically vary with predation risk, latitude, habitat, body size, specialist-generalist axes
763 of the prey or their predators, other attributes of predator communities?

764 Latitudinal gradients in multiple defences is one aspect of this last question where some progress has been
765 made. A comparative analysis of primary defences in spiders revealed that the relative frequency of species
766 using crypsis increases with latitude, but frequency of species using Batesian mimicry decreases (Pekár,
767 2014). This may be because, at lower latitude, spiders are under selection from specialised predators, while
768 at higher latitude spiders are under selection from generalists. If this is a more general pattern, then at lower
769 latitudes prey should be selected to possess a portfolio of defences that are highly effective against a limited
770 number of specialised predators, whereas at higher latitudes multiple defence strategies that are more
771 generally effective should predominate, which might involve an increase in the number of defences with
772 increasing latitude. Another example of how ecological variation might be important in understanding multiple
773 defences is the relationship between multiple defence strategy and life history strategy, which has a key role
774 in many community-level processes such as responses to environmental stochasticity and succession
775 (Connell & Slatyer, 1977). Early-successional species often have 'fast' life history traits, characterised by
776 short life cycles but high reproductive potential, while late-successional species often have 'slow' life histories
777 which prioritise future reproduction. As a result, at early stages of succession, species with limited
778 investment in multiple defence portfolios should occur and over succession be replaced by species with
779 richer and higher-cost portfolios.

780

781 7. Future directions

782 Our understanding of the evolution of defensive trait portfolios is limited by a shortage of data. First, we lack
783 data on the distribution of defences among portfolios of different species. Second, in many systems we lack
784 evidence of the frequency or types of predation that really matter in the wild, and about the mechanisms of
785 how multiple defences act synergistically and exploit predator cognition. Hence, the true effects of the
786 components of a defensive portfolio may be misunderstood (Chouteau *et al.*, 2019; Prudic *et al.*, 2019).
787 Third, understanding how prey invest in defence portfolios is critically dependent on the choice of “currency”
788 with which to measure the adaptive effects of defensive traits, which also depends on understanding other
789 organismal traits and their fitness consequences. We give recommendations for addressing these knowledge
790 gaps below.

791 We need to know how multiple defences are distributed among individuals and species. Previous
792 attempts to quantify multiple prey defences have collapsed traits into one somewhat arbitrary ‘defence score’
793 (Stankowich & Romero, 2017). Studies from plants may help as they use approaches such as principal
794 components analysis, hierarchical cluster analysis and dendrograms to identify defence syndromes and
795 predict how and why multiple trait combinations evolve repeatedly across species (Agrawal, 2011; Moles *et al.*
796 *et al.*, 2013; Sheriff *et al.*, 2020). Particularly, many of the difficulties in the ecology and evolution of multiple
797 defences may be surmounted by implementing an analytical framework that quantifies investment in
798 defences throughout the predation sequence (Figure 4B) followed by ordination to examine variation among
799 defence portfolios (Figure 4C) (Sheriff *et al.*, 2020). Depending on the research question, integrating and
800 summarising information on multiple defence types across species is likely to involve a degree of abstraction
801 - for example, treating investment in different ‘encounter’ stage defences such as nocturnality and fossoriality
802 as equivalent.

803

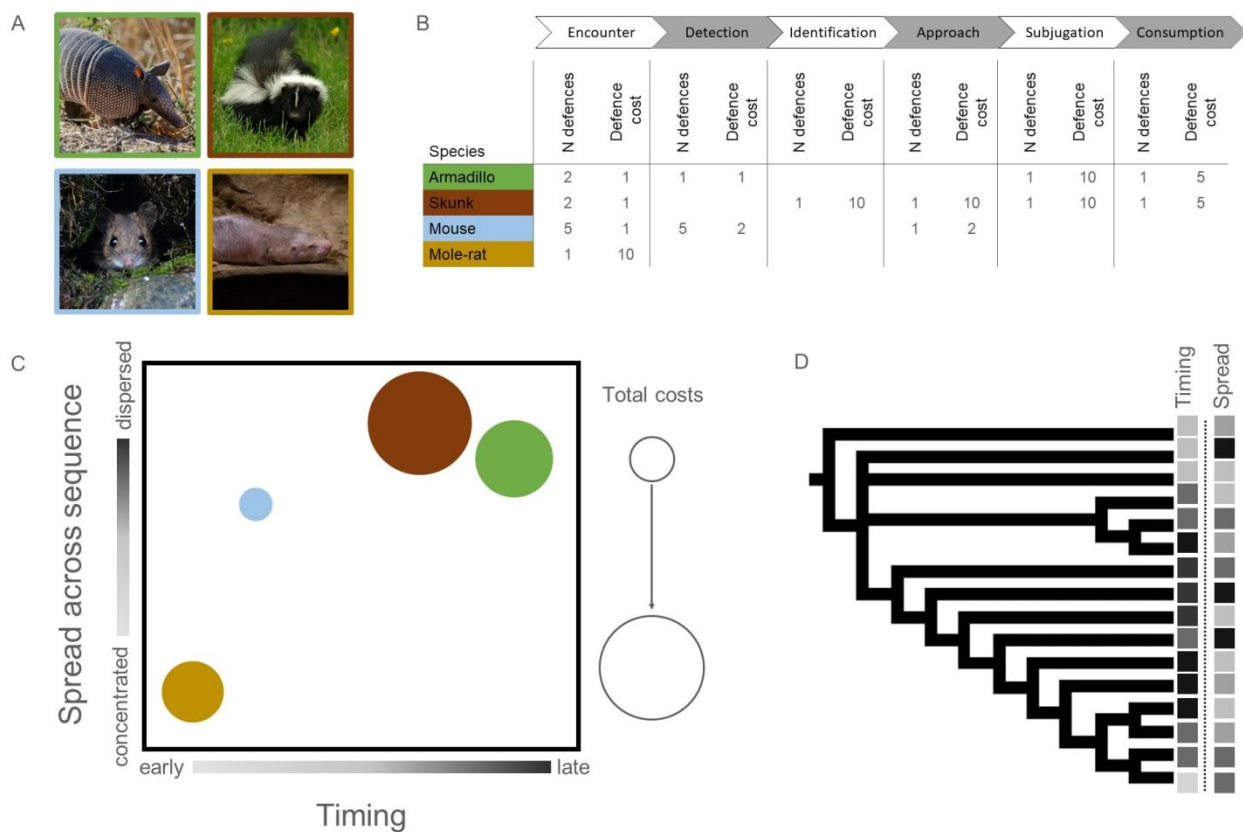

804

805

806

807

808

809

810

811

812

813

814

815

816

817

818

819

820

821

Figure 4: Example comparative framework. Abstracted defence use throughout the predation sequence. A. Four example mammal species. B. Number of defences and defence costs quantified through predation sequence. Data is an illustrative example. Encounter stage defences include nocturnality and fossoriality, which mole rats rely on to avoid predation. Detection stage defences include crypsis, other camouflage strategies and cryptic behaviours. The armour and ball rolling behaviour of armadillos defends against subjugation and consumption but carries significant costs. The aposematic colouration of a skunk is a defence at the identification stage, with noxious spraying deterring approach, subjugation and consumption. For mice, speed of escape is a partially effective defence at the stage of approach. C. Ordination techniques such as PCA could be used to summarise and quantify axes of defence strategy across diverse species. D. These could be used as composite traits in comparative analyses.

We require better information on the ecological relevance of each component of the defence portfolio. Understanding to what extent a defence moderates attack risk requires observation of natural predators. However, direct observations of predator-prey interactions remain rare. Recent technological

822 advances can help fill gaps in our knowledge by allowing us to observe interactions, or to identify predators
823 after the fact. Methods include the use of camera traps to monitor predation events (Akcali *et al.*, 2019; Smith
824 *et al.*, 2020), and eDNA analysis (Rößler *et al.*, 2020). Validation of predation estimates with camera trap
825 data could be particularly useful, as camera footage provides additional information, such as the timings of
826 predator visits and activity patterns of predators, as well as recording the behaviour of predators faced with
827 prey. In particular, they may uncover evidence that predators detect but then reject certain prey items; failure
828 to distinguish this type of response is a major limitation in existing artificial predation experiments (Akcali *et*
829 *al.*, 2019).

830 Another way to measure effectiveness of the defences in a portfolio is using model predators (e.g.
831 Chouteau *et al.*, 2019). As the perception, cognition, and hunting styles of predators can vary greatly, model
832 predators should be as ecologically relevant as possible. Ideally, several different predators would be
833 compared (Rojas *et al.*, 2017). In cases when it would be difficult or unethical to test defences on relevant
834 predators, the strength of particular defences could be compared using semi-natural bioassays, for example
835 *Daphnia* fleas (Arenas *et al.*, 2015) or brine shrimp (Winters *et al.*, 2018; Chan *et al.*, 2021). However, such
836 bioassays must be carefully selected and interpreted (Winters *et al.*, 2018, 2021), and particular attention
837 must be paid to how defences are deployed (Weldon 2017). One way to aid in the selection of suitable
838 bioassays and model predators, would be to predict the role of chemicals based on their structure. Neural
839 networks trained to classify olfactory/gustatory defences provide a means to do this (e.g. Dagan-Wiener *et*
840 *al.*, 2017).

841 Besides identifying and testing relevant predators, a major challenge is to determine how multiple
842 defences exploit (and are constrained by) predator perception and cognition (Munoz & Blumstein, 2012;
843 Skelhorn *et al.*, 2016b). This research can benefit from empirical studies of multisensory integration (Spence,
844 2011; Sherratt *et al.*, 2015; Stein *et al.*, 2020), as well as from theoretical frameworks based on signal
845 detection (Holen & Sherratt, 2021), and Bayesian learning and decision-making (McNamara *et al.*, 2006;
846 Kikuchi & Sherratt, 2015). Testing theoretical predictions about the effects of multiple defences on predator
847 cognition will require carefully designed experiments, partly based on operant training procedures (Rubi &
848 Stephens, 2016), and manipulation of stimulus dimensions as well as costs and benefits associated with
849 predator decisions to attack or avoid (Sherratt & Holen, 2018). Since human respondents frequently
850 substitute for predators in experiments focused on, for instance, prey detectability (Loeffler-Henry *et al.*,
851 2018) or signal categorization (Kikuchi *et al.*, 2019), validating these tests using natural predators would
852 allow for better interpretation and generalisation of their results (Penney *et al.*, 2012).

853 Once we understand the ecological function of a defence, we need to know its adaptive value in the
854 context of the whole organism. It further requires knowledge of the phylogenetic, developmental and genetic
855 constraints in operation. Perhaps only in model organisms such as *Heliconius* are we approaching the level
856 of understanding required to quantify constraints associated with (for example) epistasis and phylogenetic
857 contingency (e.g. Van Belleghem *et al.*, 2020), and yet even here mapping the diverse effects of wing colour
858 pattern and chemical defence on survival and reproductive success to a common measure of fitness is
859 arguably hampered by limited knowledge of the life histories of individuals in the wild. To measure the effects
860 of investment in one defence on the expression of other traits, RNA interference or CRISPR knock outs
861 could be used to decompose the relative contribution of each defence to protection from predation and the
862 costs of generating defences. For example, CRISPR knock-outs in multiple *Heliconius* species have shown
863 that the gene *cortex* is a major determinant of scale cell identity, affecting wing colouration (Livraghi *et al.*,
864 2021). The genetic underpinnings of chemical defences are also known in some systems. In the six-spot
865 burnet moth, *Zygaena filipendulae*, only three genes encode the entire biosynthetic pathway for the
866 production of defensive cyanogenic glucosides (Jensen *et al.*, 2011). These genes could therefore be
867 candidates for knocking out chemical defence; any correlated changes in visual signals and other traits could
868 then be assessed to investigate trade-offs in portfolio investment. Particularly, the genetic basis of
869 behavioural defences is poorly understood, and their study could benefit disproportionately from genetic
870 tools.

871 We began this review describing our knowledge deficit for how multiple prey defences function in
872 concert. We have presented frameworks, conceptual models, and broader contexts that we hope will be
873 useful in refining future work on this topic that has captured our collective imagination. We are optimistic that
874 with the diversity of theoretical and experimental approaches now available or soon to be available this field
875 will progress rapidly to offer a comprehensive picture of the evolution and maintenance of multiple
876 antipredator defences.

877 References

- 878 Agrawal, A.A. 2011. Current trends in the evolutionary ecology of plant defence. *Funct. Ecol.* **25**:
879 420–432.
- 880 Akcali, C.K., Adán Pérez-Mendoza, H., Salazar-Valenzuela, D., Kikuchi, D.W., Guayasamin, J.M.
881 & Pfennig, D.W. 2019. Evaluating the utility of camera traps in field studies of predation.
882 *PeerJ* **7**: e6487.
- 883 Arbuckle, K. & Speed, M.P. 2015. Antipredator defenses predict diversification rates. *Proc. Natl.*
884 *Acad. Sci.* **112**: 13597–13602.
- 885 Arenas, L.M., Walter, D. & Stevens, M. 2015. Signal honesty and predation risk among a closely
886 related group of aposematic species. *Sci. Rep.* **5**: 11021.
- 887 Aronsson, M. & Gamberale-Stille, G. 2008. Domestic chicks primarily attend to colour, not pattern,
888 when learning an aposematic coloration. *Anim. Behav.* **75**: 417–423.
- 889 Barber, J.R., Razak, K.A. & Fuzessery, Z.M. 2003. Can two streams of auditory information be
890 processed simultaneously? Evidence from the gleaning bat *Antrozous pallidus*. *J. Comp.*
891 *Physiol. [A]* **189**: 843–855.
- 892 Barnett, C., Bateson, M. & Rowe, C. 2007. State-dependent decision making: educated predators
893 strategically trade off the costs and benefits of consuming aposematic prey. *Behav. Ecol.*
894 **18**: 645–651.
- 895 Barnett, C.A., Bateson, M. & Rowe, C. 2014. Better the devil you know: avian predators find
896 variation in prey toxicity aversive. *Biol. Lett.* **10**: 20140533.
- 897 Barrett, R.D.H., Rogers, S.M. & Schluter, D. 2008. Natural selection on a major armor gene in
898 threespine stickleback. *Science* **322**: 255–257.
- 899 Bateman, A.W., Vos, M. & Anholt, B.R. 2014. When to defend: antipredator defenses and the
900 predation sequence. *Am. Nat.* **183**: 847–855.
- 901 Bateman, P.W. & Fleming, P.A. 2013. Signaling or not-signaling: variation in vulnerability and
902 defense tactics of armored ground crickets (*Acanthoplus speiseri*: Orthoptera,
903 Tettigoniidae, Heteroptera). *J. Insect Behav.* **26**: 14–22.
- 904 Bates, H.W. 1862. XXXII. Contributions to an insect fauna of the Amazon Valley. Lepidoptera:
905 Heliconidæ. *Trans. Linn. Soc. Lond.* **23**: 495–566.
- 906 Benard, M.F. 2006. Survival trade-offs between two predator-induced phenotypes in pacific
907 treefrogs (*Pseudacris regilla*). *Ecology* **87**: 340–346.
- 908 Bennett, A.M., Pereira, D. & Murray, D.L. 2013. Investment into defensive traits by anuran prey
909 (*Lithobates pipiens*) is mediated by the starvation-predation risk trade-off. *PLoS ONE* **8**:
910 e82344.
- 911 Berenbaum, M.R. & Zangerl, A.R. 1994. Costs of inducible defense: protein limitation, growth, and
912 detoxification in parsnip webworms. *Ecology* **75**: 2311–2317.
- 913 Blanchard, B.D. & Moreau, C.S. 2017. Defensive traits exhibit an evolutionary trade-off and drive
914 diversification in ants. *Evolution* **71**: 315–328.
- 915 Blount, Z.D., Barrick, J.E., Davidson, C.J. & Lenski, R.E. 2012. Genomic analysis of a key
916 innovation in an experimental *Escherichia coli* population. *Nature* **489**: 513–518.

- 917 Bohórquez Alonso, M.L., Martínez Cotrina, J., Aguilar Pardo, D., Font, E. & Molina-Borja, M. 2010.
918 Sex differences in antipredator tail-waving displays of the diurnal yellow-headed gecko
919 *Gonatodes albigularis* from tropical forests of Colombia. *J. Ethol.* **28**: 305–311. Springer.
- 920 Bond, A.B. & Kamil, A.C. 2002. Visual predators select for crypticity and polymorphism in virtual
921 prey. *Nature* **415**: 609–613.
- 922 Briolat, E.S., Burdfield-Steel, E.R., Paul, S.C., Rönkä, K.H., Seymoure, B.M., Stankowich, T., *et al.*
923 2019. Diversity in warning coloration: selective paradox or the norm? *Biol. Rev.* **94**: 388–
924 414.
- 925 Britton, N.F., Planqué, R. & Franks, N.R. 2007. Evolution of defence portfolios in exploiter–victim
926 systems. *Bull. Math. Biol.* **69**: 957–988.
- 927 Brodie, E.D. 1989. Genetic correlations between morphology and antipredator behaviour in natural
928 populations of the garter snake *Thamnophis ordinoides*. *Nature* **342**: 542–543. Nature
929 Publishing Group.
- 930 Brodie, E.D.I. 1992. Correlational selection for color pattern and antipredator behavior in the garter
931 snake *Thamnophis ordinoides*. *Evolution* **46**: 1284–1298.
- 932 Brodie Jr, E.D., Formanowicz Jr, D.R. & Brodie III, E.D. 1991. Predator avoidance and antipredator
933 mechanisms: distinct pathways to survival. *Ethol. Ecol. Evol.* **3**: 73–77.
- 934 Broeckhoven, C., Adak, Y.E., Hui, C., Damme, R.V. & Stankowich, T. 2018. On dangerous ground:
935 the evolution of body armour in cordyline lizards. *Proc. R. Soc. B* **285**: 20180513.
- 936 Broom, M., Higginson, A.D. & Ruxton, G.D. 2010. Optimal investment across different aspects of
937 anti-predator defences. *J. Theor. Biol.* **263**: 579–586.
- 938 Brower, L.P. & Fink, L.S. 1985. A natural toxic defense system: cardenolides in butterflies versus
939 birds. *Ann. N. Y. Acad. Sci.* **443**: 171–188.
- 940 Brower, L.P. & Moffit, C.M. 1974. Palatability dynamics of cardenolides in the monarch butterfly.
941 *Nature* **249**: 280–283.
- 942 Brower, L.P., Van Brower, J. & Corvino, J.M. 1967. Plant poisons in a terrestrial food chain. *Proc.*
943 *Natl. Acad. Sci.* **57**: 893–898.
- 944 Burdfield-Steel, E., Brain, M., Rojas, B. & Mappes, J. 2019. The price of safety: food deprivation in
945 early life influences the efficacy of chemical defence in an aposematic moth. *Oikos* **128**:
946 245–253.
- 947 Buskirk, J.V. 2000. The costs of inducible defense in an anuran larvae. *Ecology* **81**: 2813–2821.
- 948 Cao, Y., Cui, K., Pan, H., Wu, J. & Wang, L. 2019. The impact of multiple climatic and geographic
949 factors on the chemical defences of Asian toads (*Bufo gargarizans* Cantor). *Sci. Rep.* **9**:
950 17236.
- 951 Carmona, D., Lajeunesse, M.J. & Johnson, M.T.J. 2011. Plant traits that predict resistance to
952 herbivores: Traits that predict resistance to herbivores. *Funct. Ecol.* **25**: 358–367.
- 953 Caro, T. 2005. *Antipredator defenses in birds and mammals*. University of Chicago Press.
- 954 Caro, T. & Ruxton, G. 2019. Aposematism: unpacking the defences. *Trends Ecol. Evol.* **34**: 595–
955 604.

- 956 Caro, T., Sherratt, T.N. & Stevens, M. 2016. The ecology of multiple colour defences. *Evol. Ecol.*
957 **30**: 797–809.
- 958 Chai, P. & Srygley, R.B. 1990. Predation and the flight, morphology, and temperature of
959 Neotropical rain-forest butterflies. *Am. Nat.* **135**: 748–765.
- 960 Chan, W., Shaughnessy, A.E.P., van den Berg, C.P., Garson, M.J. & Cheney, K.L. 2021. The
961 validity of brine shrimp (*Artemia* sp.) toxicity assays to assess the ecological function of
962 marine natural products. *J Chem Ecol* **47**: 834–846.
- 963 Chittka, L. & Osorio, D. 2007. Cognitive dimensions of predator responses to imperfect mimicry.
964 *PLoS Biol.* **5**: e339.
- 965 Chouteau, M., Dezeure, J., Sherratt, T.N., Llaurens, V. & Joron, M. 2019. Similar predator aversion
966 for natural prey with diverse toxicity levels. *Anim. Behav.* **153**: 49–59.
- 967 Clark, A. 2013. Whatever next? Predictive brains, situated agents, and the future of cognitive
968 science. *Behav. Brain Sci.* **36**: 181–204.
- 969 Coley, P.D., Bateman, M.L. & Kursar, T.A. 2006. The effects of plant quality on caterpillar growth
970 and defense against natural enemies. *Oikos* **115**: 219–228.
- 971 Connell, J.H. & Slatyer, R.O. 1977. Mechanisms of succession in natural communities and their
972 role in community stability and organization. *Am. Nat.* **111**: 1119–1144.
- 973 Cott, H.B. 1940. Adaptive coloration in animals. Methuen & Co., Ltd.
- 974 Courville, A.C., Daw, N.D. & Touretzky, D.S. 2006. Bayesian theories of conditioning in a changing
975 world. *Trends Cogn. Sci.* **10**: 294–300.
- 976 Crofts, S.B. & Stankowich, T. 2021. Stabbing spines: a review of the biomechanics and evolution
977 of defensive spines. *Integr. Comp. Biol.* **61**: 655–667.
- 978 Dagan-Wiener, A., Nissim, I., Ben Abu, N., Borgonovo, G., Bassoli, A. & Niv, M.Y. 2017. Bitter or
979 not? BitterPredict, a tool for predicting taste from chemical structure. *Sci. Rep.* **7**: 1–13.
- 980 de Jager, M.L. & Anderson, B. 2019. When is resemblance mimicry? *Funct. Ecol.* **33**: 1586–1596.
- 981 Dingemanse, N.J., Kazem, A.J.N., Réale, D. & Wright, J. 2010. Behavioural reaction norms: animal
982 personality meets individual plasticity. *Trends Ecol. Evol.* **25**: 81–89.
- 983 Dukas, R. 2002. Behavioural and ecological consequences of limited attention. *Philos. Trans. R.*
984 *Soc. Lond. B. Biol. Sci.* **357**: 1539–1547.
- 985 Edmunds, M. 1974. *Defence in animals: a survey of anti-predator defences*. Longman Publishing
986 Group.
- 987 Ehrlich, E., Kath, N.J. & Gaedke, U. 2020. The shape of a defense-growth trade-off governs
988 seasonal trait dynamics in natural phytoplankton. *ISME J.* **14**: 1451–1462.
- 989 Eilam, D. 2005. Die hard: a blend of freezing and fleeing as a dynamic defense—implications for
990 the control of defensive behavior. *Neurosci. Biobehav. Rev.* **29**: 1181–1191.
- 991 Eklöv, P. & VanKooten, T. 2001. Facilitation among piscivorous predators: effects of prey habitat
992 use. *Ecology* **82**: 2486–2494.
- 993 Emberts, Z., Escalante, I. & Bateman, P.W. 2019. The ecology and evolution of autotomy. *Biol.*
994 *Rev.* **94**: 1881–1896.

- 995 Emlen, D.J. 2008. The evolution of animal weapons. *Annu. Rev. Ecol. Evol. Syst.* **39**: 387–413.
- 996 Endler, J. & Basolo, A.L. 1998. Sensory ecology, receiver biases and sexual selection. *Trends*
997 *Ecol. Evol.* **13**: 415–420.
- 998 Endler, J.A. 1986. Defense against predators. In: *Predator prey relationships, perspectives and*
999 *approaches from the study of lower vertebrates* (M. E. Feder & G. E. Lauder, eds), pp.
1000 109–134. University of Chicago Press, Chicago, Illinois.
- 1001 Endler, J.A. 1991. Interactions between predator and prey. In: *Behavioural ecology* (J. R. Krebs &
1002 N. B. Davies, eds), pp. 169–196. Blackwell Scientific Publications.
- 1003 Findlay, B.L. 2016. The chemical ecology of predatory soil bacteria. *ACS Chem. Biol.* **11**: 1502–
1004 1510.
- 1005 Finkbeiner, S.D., Briscoe, A.D. & Reed, R.D. 2014. Warning signals are seductive: Relative
1006 contributions of color and pattern to predator avoidance and mate attraction in Heliconius
1007 butterflies. *Evolution* **68**: 3410–3420.
- 1008 FitzGibbon, C.D. 1989. A cost to individuals with reduced vigilance in groups of Thomson's
1009 gazelles hunted by cheetahs. *Anim. Behav.* **37**: 508–510.
- 1010 Friedman, D. & Sinervo, B. 2016. *Evolutionary games in natural, social, and virtual worlds*. Oxford
1011 University Press.
- 1012 Fürstenberg-Hägg, J., Zagobelny, M., Jørgensen, K., Vogel, H., Møller, B.L. & Bak, S. 2014.
1013 Chemical defense balanced by sequestration and de novo biosynthesis in a lepidopteran
1014 specialist. *PLoS ONE* **9**: e108745.
- 1015 Gaitonde, N., Joshi, J. & Kunte, K. 2018. Evolution of ontogenic change in color defenses of
1016 swallowtail butterflies. *Ecol. Evol.* **8**: 9751–9763.
- 1017 Gamberale-Stille, G., Johansen, A.I. & Tullberg, B.S. 2010. Change in protective coloration in the
1018 striated shieldbug *Graphosoma lineatum* (Heteroptera: Pentatomidae): predator avoidance
1019 and generalization among different life stages. *Evol. Ecol.* **24**: 423–432.
- 1020 Gigliotti, L.C., Slotow, R., Sholto-Douglas, C., de Vos, C. & Jachowski, D.S. 2021. Short-term
1021 predation risk and habitat complexity influence cheetah antipredator behaviours. *Anim.*
1022 *Behav.* **178**: 175–184.
- 1023 Gil, M.A., Baskett, M.L. & Schreiber, S.J. 2019. Social information drives ecological outcomes
1024 among competing species. *Ecology* **100**: e02835.
- 1025 Glendinning, J.I. 2007. How do predators cope with chemically defended foods? *Biol. Bull.* **213**:
1026 252–266.
- 1027 Guilford, T. 1994. Go-slow and the problem of automimicry. *J. Theor. Biol.* **170**: 311–316.
- 1028 Halpin, C.G., Skelhorn, J. & Rowe, C. 2014. Increased predation of nutrient-enriched aposematic
1029 prey. *Proc. R. Soc. B Biol. Sci.* **281**: 20133255.
- 1030 Hanifin, C.T., Brodie, E.D. & Brodie, E.D. 2008. Phenotypic mismatches reveal escape from arms-
1031 race coevolution. *PLoS Biol.* **6**: e60.
- 1032 Helfman, G.S. 1989. Threat-sensitive predator avoidance in damselfish-trumpetfish interactions.
1033 *Behav. Ecol. Sociobiol.* **24**: 47–58.

- 1034 Hodge, J.R., Alim, C., Bertrand, N.G., Lee, W., Price, S.A., Tran, B., *et al.* 2018. Ecology shapes
1035 the evolutionary trade-off between predator avoidance and defence in coral reef
1036 butterflyfishes. *Ecol. Lett.* **21**: 1033–1042.
- 1037 Holen, Ø.H. & Sherratt, T.N. 2021. Coping with danger and deception: lessons from signal
1038 detection theory. *Am. Nat.* **197**: 147–163.
- 1039 Holmes, G.G., Delferrière, E., Rowe, C., Troscianko, J. & Skelhorn, J. 2018. Testing the feasibility
1040 of the startle-first route to deimatism. *Sci. Rep.* **8**: 10737.
- 1041 Hossie, T., Landolt, K. & Murray, D.L. 2017. Determinants and co-expression of anti-predator
1042 responses in amphibian tadpoles: a meta-analysis. *Oikos* **126**: 173–184.
- 1043 Humphreys, R.K. & Ruxton, G.D. 2018. A review of thanatosis (death feigning) as an anti-predator
1044 behaviour. *Behav. Ecol. Sociobiol.* **72**: 22.
- 1045 Inbar, M. & Lev-Yadun, S. 2005. Conspicuous and aposematic spines in the animal kingdom.
1046 *Naturwissenschaften* **92**: 170–172.
- 1047 Jakobs, O., Wang, L.E., Dafotakis, M., Grefkes, C., Zilles, K. & Eickhoff, S.B. 2009. Effects of
1048 timing and movement uncertainty implicate the temporo-parietal junction in the prediction of
1049 forthcoming motor actions. *NeuroImage* **47**: 667–677.
- 1050 Jandt, J.M., Bengston, S., Pinter-Wollman, N., Pruitt, J.N., Raine, N.E., Dornhaus, A., *et al.* 2014.
1051 Behavioural syndromes and social insects: personality at multiple levels. *Biol. Rev.* **89**: 48–
1052 67.
- 1053 Jeckel, A.M., Saporito, R.A. & Grant, T. 2015. The relationship between poison frog chemical
1054 defenses and age, body size, and sex. *Front. Zool.* **12**: 1–9.
- 1055 Jensen, N.B., Zagrobelny, M., Hjernø, K., Olsen, C.E., Houghton-Larsen, J., Borch, J., *et al.* 2011.
1056 Convergent evolution in biosynthesis of cyanogenic defence compounds in plants and
1057 insects. *Nat. Commun.* **2**: 1–9.
- 1058 Jiggins, C.D. 2018. *The ecology and evolution of Heliconius butterflies*. Oxford University Press.
- 1059 Johansen, A.I., Exnerová, A., Hotová Svádová, K., Štys, P., Gamberale-Stille, G. & Tullberg, B.S.
1060 2010. Adaptive change in protective coloration in adult striated shieldbugs *Graphosoma*
1061 *lineatum* (Heteroptera: Pentatomidae): test of detectability of two colour forms by avian
1062 predators. *Ecol. Entomol.* **35**: 602–610.
- 1063 Johnson, E.H. 2020. Experimental tests of bivalve shell shape reveal potential tradeoffs between
1064 mechanical and behavioral defenses. *Sci. Rep.* **10**: 19425.
- 1065 Jones, K.A. & Godin, J.-G.J. 2010. Are fast explorers slow reactors? Linking personality type and
1066 anti-predator behaviour. *Proc. R. Soc. B* **277**: 625–632.
- 1067 Jongepier, E., Kleeberg, I., Job, S. & Foitzik, S. 2014. Collective defence portfolios of ant hosts
1068 shift with social parasite pressure. *Proc. R. Soc. B Biol. Sci.* **281**: 20140225.
- 1069 Kang, C., Cho, H.-J., Lee, S.-I. & Jablonski, P.G. 2016. Post-attack aposematic display in prey
1070 facilitates predator avoidance learning. *Front. Ecol. Evol.* **4**: 35.
- 1071 Kang, C., Moon, H., Sherratt, T.N., Lee, S.-I. & Jablonski, P.G. 2017a. Multiple lines of anti-
1072 predator defence in the spotted lanternfly, *Lycorma delicatula* (Hemiptera: Fulgoridae). *Biol.*
1073 *J. Linn. Soc.* **120**: 115–124.

- 1074 Kang, C., Zahiri, R. & Sherratt, T.N. 2017b. Body size affects the evolution of hidden colour signals
1075 in moths. *Proc. R. Soc. B Biol. Sci.* **284**: 20171287.
- 1076 Keith, R.A. & Mitchell-Olds, T. 2019. Antagonistic selection and pleiotropy constrain the evolution
1077 of plant chemical defenses. *Evolution* **73**: 947–960.
- 1078 Kikuchi, D.W., Barfield, M., Herberstein, M.E., Mappes, J. & Holt, R.D. 2022. The effect of predator
1079 population dynamics on Batesian mimicry complexes. *Am. Nat.* **199**: 406–419.
- 1080 Kikuchi, D.W., Dornhaus, A., Gopeechund, V. & Sherratt, T.N. 2019. Signal categorization by
1081 foraging animals depends on ecological diversity. *eLife* **8**: e43965.
- 1082 Kikuchi, D.W., Herberstein, M.E., Barfield, M., Holt, R.D. & Mappes, J. 2021. Why aren't warning
1083 signals everywhere? On the prevalence of aposematism and mimicry in communities. *Biol.*
1084 *Rev.* **96**: 2446–2460.
- 1085 Kikuchi, D.W. & Sherratt, T.N. 2015. Costs of learning and the evolution of mimetic signals. *Am.*
1086 *Nat.* **186**: 321–332.
- 1087 Kokko, H., Mappes, J. & Lindström, L. 2003. Alternative prey can change model-mimic dynamics
1088 between parasitism and mutualism: model-mimic dynamics with alternative prey. *Ecol. Lett.*
1089 **6**: 1068–1076.
- 1090 Kooyers, N.J., Donofrio, A., Blackman, B.K. & Holeski, L.M. 2020. The genetic architecture of plant
1091 defense trade-offs in a common monkeyflower. *J. Hered.* **111**: 333–345.
- 1092 Kurosu, U., Narukawa, J., Buranapanichpan, S. & Aoki, S. 2006. Head-plug defense in a gall
1093 aphid. *Insectes Sociaux* **53**: 86–91.
- 1094 Laiolo, P., Tella, J.L., Carrete, M., Serrano, D. & López, G. 2004. Distress calls may honestly
1095 signal bird quality to predators. *Proc. R. Soc. Lond. B Biol. Sci.* **271**: S513–S515.
- 1096 Lande, R. 1979. Quantitative genetic analysis of multivariate evolution, applied to brain:body size
1097 allometry. *Evolution* **33**: 402–416.
- 1098 Lande, R. & Arnold, S.J. 1983. The measurement of selection on correlated characters. *Evolution*
1099 **37**: 1210–1226.
- 1100 Langridge, K.V. 2009. Cuttlefish use startle displays, but not against large predators. *Anim. Behav.*
1101 **77**: 847–856.
- 1102 Leavell, B.C., Rubin, J.J., McClure, C.J.W., Miner, K.A., Branham, M.A. & Barber, J.R. 2018.
1103 Fireflies thwart bat attack with multisensory warnings. *Sci. Adv.* **4**: eaat6601.
- 1104 Lindstedt, C., Boncoraglio, G., Cotter, S., Gilbert, J. & Kilner, R.M. 2017. Aposematism in the
1105 burying beetle? Dual function of anal fluid in parental care and chemical defense. *Behav.*
1106 *Ecol.* **28**: 1414–1422.
- 1107 Lindstedt, C., Lindström, L. & Mappes, J. 2009. Thermoregulation constrains effective warning
1108 signal expression. *Evolution* **63**: 469–478.
- 1109 Lindstedt, C., Miettinen, A., Freitak, D., Ketola, T., López-Sepulcre, A., Mäntylä, E., *et al.* 2018.
1110 Ecological conditions alter cooperative behaviour and its costs in a chemically defended
1111 sawfly. *Proc. R. Soc. B Biol. Sci.* **285**: 20180466.
- 1112 Lindstedt, C., Schroderus, E., Lindström, L., Mappes, T. & Mappes, J. 2016. Evolutionary
1113 constraints of warning signals: A genetic trade-off between the efficacy of larval and adult
1114 warning coloration can maintain variation in signal expression. *Evolution* **70**: 2562–2572.

- 1115 Livraghi, L., Hanly, J.J., Van Bellghem, S.M., Montejo-Kovacevich, G., van Der Heijden, E.S., Loh,
1116 L.S., *et al.* 2021. Cortex cis-regulatory switches establish scale colour identity and pattern
1117 diversity in *Heliconius*. *eLife* **10**: e68549.
- 1118 Loeffler-Henry, K., Kang, C., Yip, Y., Caro, T. & Sherratt, T.N. 2018. Flash behavior increases prey
1119 survival. *Behav. Ecol.* **29**: 528–533.
- 1120 Lovegrove, B.G. 2001. The evolution of body armor in mammals: plantigrade constraints of large
1121 body size. *Evolution* **55**: 1464–1473.
- 1122 Magrath, R.D., Haff, T.M., Fallow, P.M. & Radford, A.N. 2015. Eavesdropping on heterospecific
1123 alarm calls: from mechanisms to consequences. *Biol. Rev.* **90**: 560–586.
- 1124 Mappes, J., Marples, N. & Endler, J. 2005. The complex business of survival by aposematism.
1125 *Trends Ecol. Evol.* **20**: 598–603.
- 1126 Marples, N.M., Speed, M.P. & Thomas, R.J. 2018. An individual-based profitability spectrum for
1127 understanding interactions between predators and their prey. *Biol. J. Linn. Soc.* **125**: 1–13.
- 1128 Mattila, A.L.K., Jiggins, C.D. & Opedal, Ø.H. 2021. Evolutionary and ecological processes
1129 influencing chemical defense variation in an aposematic and mimetic *Heliconius* butterfly.
1130 *PeerJ* **9**: e11523.
- 1131 Mayrhofer, N., Velicer, G.J., Schaal, K.A. & Vasse, M. 2021. Behavioral interactions between
1132 bacterivorous nematodes and predatory bacteria in a synthetic community. *Microorganisms*
1133 **9**: 1362.
- 1134 McClure, M. & Despland, E. 2011. Defensive responses by a social caterpillar are tailored to
1135 different predators and change with larval instar and group size. *Naturwissenschaften* **98**:
1136 425–434.
- 1137 McGill, B.J., Chase, J.M., Hortal, J., Overcast, I., Rominger, A.J., Rosindell, J., *et al.* 2019. Unifying
1138 macroecology and macroevolution to answer fundamental questions about biodiversity.
1139 *Glob. Ecol. Biogeogr.* **28**: 1925–1936.
- 1140 McNamara, J.M., Green, R.F. & Olsson, O. 2006. Bayes' theorem and its applications in animal
1141 behaviour. *Oikos* **112**: 243–251.
- 1142 Mebs, D., Wunder, C., Pogoda, W. & Toennes, S.W. 2017. Feeding on toxic prey. The praying
1143 mantis (Mantodea) as predator of poisonous butterfly and moth (Lepidoptera) caterpillars.
1144 *Toxicon* **131**: 16–19.
- 1145 Medina, I., Vega-Trejo, R., Wallenius, T., Symonds, M.R.E. & Stuart-Fox, D. 2020. From cryptic to
1146 colorful: Evolutionary decoupling of larval and adult color in butterflies. *Evol. Lett.* **4**: 34–43.
- 1147 Moles, A.T., Peco, B., Wallis, I.R., Foley, W.J., Poore, A.G., Seabloom, E.W., *et al.* 2013.
1148 Correlations between physical and chemical defences in plants: tradeoffs, syndromes, or
1149 just many different ways to skin a herbivorous cat? *New Phytol.* **198**: 252–263.
- 1150 Moore, B.P., Brown, W.V. & Rothschild, M. 1990. Methylalkylpyrazines in aposematic insects, their
1151 hostplants and mimics. *Chemoecology* **1**: 43–51.
- 1152 Müller, F. 1879. Ituna and Thyridia: a remarkable case of mimicry in butterflies. *Trans Entomol Soc*
1153 *Lond* 20–29.
- 1154 Munoz, N.E. & Blumstein, D.T. 2012. Multisensory perception in uncertain environments. *Behav.*
1155 *Ecol.* **23**: 457–462.

- 1156 Murali, G. 2018. Now you see me, now you don't: dynamic flash coloration as an antipredator
1157 strategy in motion. *Anim. Behav.* **142**: 207–220.
- 1158 Nakayama, S. & Miyatake, T. 2010. Genetic trade-off between abilities to avoid attack and to mate:
1159 a cost of tonic immobility. *Biol. Lett.* **6**: 18–20.
- 1160 Nieder, A. & Wagner, H. 1999. Perception and neuronal coding of subjective contours in the owl.
1161 *Nat. Neurosci.* **2**: 660–663.
- 1162 Nielsen, S.V., Oliver, P.M., Laver, R.J., Bauer, A.M. & Noonan, B.P. 2016. Stripes, jewels and
1163 spines: further investigations into the evolution of defensive strategies in a chemically
1164 defended gecko radiation (Strophurus, Diplodactylidae). *Zool. Scr.* **45**: 481–493.
- 1165 Páez, E., Valkonen, J.K., Willmott, K.R., Matos-Maraví, P., Elias, M. & Mappes, J. 2021. Hard to
1166 catch: Experimental evidence supports evasive mimicry. *Proc. R. Soc. B* **288**: 20203052.
- 1167 Peichel, C.L. & Marques, D.A. 2017. The genetic and molecular architecture of phenotypic diversity
1168 in sticklebacks. *Philos. Trans. R. Soc. B Biol. Sci.* **372**: 20150486.
- 1169 Pekár, S. 2014. Comparative analysis of passive defences in spiders (Araneae). *J. Anim. Ecol.* **83**:
1170 779–790.
- 1171 Penney, H.D., Hassall, C., Skevington, J.H., Abbott, K.R. & Sherratt, T.N. 2012. A comparative
1172 analysis of the evolution of imperfect mimicry. *Nature* **483**: 461–464.
- 1173 Pickard, S.C., Quinn, R.D. & Szczecinski, N.S. 2020. A dynamical model exploring sensory
1174 integration in the insect central complex substructures. *Bioinspir. Biomim.* **15**: 026003.
- 1175 Pinheiro, C.E.G. 1996. Palatability and escaping ability in Neotropical butterflies: tests with wild
1176 kingbirds (*Tyrannus melancholicus*, Tyrannidae). *Biol. J. Linn. Soc.* **59**: 351–365.
- 1177 Poulton, E.B. 1890. *The colours of animals: their meaning and use, especially considered in the*
1178 *case of insects*. Kegan Paul, Trench, Trubner & Co., London.
- 1179 Prudic, K.L., Timmermann, B.N., Papaj, D.R., Ritland, D.B. & Oliver, J.C. 2019. Mimicry in viceroy
1180 butterflies is dependent on abundance of the model queen butterfly. *Commun. Biol.* **2**: 68.
- 1181 Ratcliffe, J.M. & Nydam, M.L. 2008. Multimodal warning signals for a multiple predator world.
1182 *Nature* **455**: 96–99.
- 1183 Reimchen, T.E. 1992. Injuries on dtickleback from attacks by a toothed predator (*Oncorhynchus*)
1184 and implications for the evolution of lateral plates. *Evolution* **46**: 1224–1230.
- 1185 Rodriguez, J., Jones, T.H., Sierwald, P., Marek, P.E., Shear, W.A., Brewer, M.S., *et al.* 2018. Step-
1186 wise evolution of complex chemical defenses in millipedes: a phylogenomic approach. *Sci.*
1187 *Rep.* **8**: 1–10.
- 1188 Rojas, B., Burdfield-Steel, E., Pakkanen, H., Suisto, K., Maczka, M., Schulz, S., *et al.* 2017. How to
1189 fight multiple enemies: target-specific chemical defences in an aposematic moth. *Proc. R.*
1190 *Soc. B Biol. Sci.* **284**: 20171424.
- 1191 Rojas, B., Devillechabrolle, J. & Endler, J.A. 2014. Paradox lost: variable colour-pattern geometry
1192 is associated with differences in movement in aposematic frogs. *Biol. Lett.* **10**: 20140193.
- 1193 Rojas, B., Mappes, J. & Burdfield-Steel, E. 2019. Multiple modalities in insect warning displays
1194 have additive effects against wild avian predators. *Behav. Ecol. Sociobiol.* **73**: 37.

- 1195 Rosin, Z.M., Kobak, J., Lesicki, A. & Tryjanowski, P. 2013. Differential shell strength of *Cepaea*
1196 *nemoralis* colour morphs—implications for their anti-predator defence. *Naturwissenschaften*
1197 **100**: 843–851.
- 1198 Roslin, T., Hardwick, B., Novotny, V., Petry, W.K., Andrew, N.R., Asmus, A., *et al.* 2017. Higher
1199 predation risk for insect prey at low latitudes and elevations. *Science* **356**: 742–744.
- 1200 Rößler, D.C., De Agrò, M., Kim, K. & Shamble, P.S. 2021. Static visual predator recognition in
1201 jumping spiders. *Funct. Ecol.* **36**: 561–571.
- 1202 Rößler, D.C., Lötters, S., Veith, M., Fugmann, M., Peters, C., Künzel, S., *et al.* 2020. An amplicon
1203 sequencing protocol for attacker identification from DNA traces left on artificial prey.
1204 *Methods Ecol. Evol.* **11**: 1338–1347.
- 1205 Rowe, C. 1999. Receiver psychology and the evolution of multicomponent signals. *Anim. Behav.*
1206 **58**: 921–931.
- 1207 Rowe, C. 2002. Sound improves visual discrimination learning in avian predators. *Proc. R. Soc.*
1208 *Lond. B Biol. Sci.* **269**: 1353–1357.
- 1209 Rowe, C. & Guilford, T. 1996. Hidden colour aversions in domestic chicks triggered by pyrazine
1210 odours of insect warning displays. *Nature* **383**: 520–522.
- 1211 Rowe, C. & Halpin, C. 2013. Why are warning displays multimodal? *Behav. Ecol. Sociobiol.* **67**:
1212 1425–1439.
- 1213 Rubi, T.L. & Stephens, D.W. 2016. Should receivers follow multiple signal components? An
1214 economic perspective. *Behav. Ecol.* **27**: 36–44.
- 1215 Ruxton, G.D., Allen, W.L., Sherratt, T.N. & Speed, M.P. 2018. *Avoiding attack*, 2nd ed. Oxford
1216 University Press, Oxford, UK.
- 1217 Sandre, S.-L., Tammaru, T. & Mänd, T. 2007. Size-dependent colouration in larvae of *Orgyia*
1218 *antiqua* (Lepidoptera: Lymantriidae): a trade-off between warning effect and detectability?
1219 *Eur. J. Entomol.* **104**: 745–752.
- 1220 Saporito, R.A., Donnelly, M.A., Garraffo, H.M., Spande, T.F. & Daly, J.W. 2006. Geographic and
1221 seasonal variation in alkaloid-based chemical defenses of *Dendrobates pumilio* from Bocas
1222 del Toro, Panama. *J. Chem. Ecol.* **32**: 795–814.
- 1223 Sculfort, O., McClure, M., Nay, B., Elias, M. & Llaurens, V. 2021. Assessing the role of
1224 developmental and environmental factors in chemical defence variation in Heliconiini
1225 butterflies. *J. Chem. Ecol.* **47**: 577–587.
- 1226 Sepúlveda, R.D., Jara, C.G. & Gallardo, C.S. 2012. Morphological analysis of two sympatric
1227 ecotypes and predator-induced phenotypic plasticity in *Acanthina monodon* (Gastropoda:
1228 Muricidae). *J. Molluscan Stud.* **78**: 173–178.
- 1229 Sheriff, M.J., Orrock, J.L., Ferrari, M.C., Karban, R., Preisser, E.L., Sih, A., *et al.* 2020. Proportional
1230 fitness loss and the timing of defensive investment: a cohesive framework across animals
1231 and plants. *Oecologia* **193**: 273–283.
- 1232 Sherratt, T.N. 2008. The evolution of Müllerian mimicry. *Naturwissenschaften* **95**: 681–695.
- 1233 Sherratt, T.N. & Holen, Ø.H. 2018. When should receivers follow multiple signal components? A
1234 closer look at the “flag” model. *Behav. Ecol.* **29**: e6–e8.

- 1235 Sherratt, T.N., Speed, M.P. & Ruxton, G.D. 2004. Natural selection on unpalatable species
1236 imposed by state-dependent foraging behaviour. *J. Theor. Biol.* **228**: 217–226.
- 1237 Sherratt, T.N., Whissell, E., Webster, R. & Kikuchi, D.W. 2015. Hierarchical overshadowing of
1238 stimuli and its role in mimicry evolution. *Anim. Behav.* **108**: 73–79.
- 1239 Sherratt, T.N., Wilkinson, D.M. & Bain, R.S. 2005. Explaining Dioscorides' "double difference": why
1240 are some mushrooms poisonous, and do they signal their unprofitability? *Am. Nat.* **166**: 9.
- 1241 Shettleworth, S.J. 2009. *Cognition, evolution, and behavior*. Oxford university press.
- 1242 Siddall, E.C. & Marples, N.M. 2008. Better to be bimodal: the interaction of color and odor on
1243 learning and memory. *Behav. Ecol.* **19**: 425–432.
- 1244 Sih, A. 1986. Antipredator responses and the perception of danger by mosquito larvae. *Ecology*
1245 **67**: 434–441.
- 1246 Sih, A., Bolnick, D.I., Luttbeg, B., Orrock, J.L., Peacor, S.D., Pintor, L.M., *et al.* 2010. Predator–
1247 prey naïveté, antipredator behavior, and the ecology of predator invasions. *Oikos* **119**: 610–
1248 621.
- 1249 Sih, A., Englund, G. & Wooster, D. 1998. Emergent impacts of multiple predators on prey. *Trends*
1250 *Ecol. Evol.* **13**: 350–355.
- 1251 Skelhorn, J. 2015. Masquerade. *Curr. Biol.* **25**: R643–R644.
- 1252 Skelhorn, J., Halpin, C.G. & Rowe, C. 2016a. Learning about aposematic prey. *Behav. Ecol.* **27**:
1253 955–964.
- 1254 Skelhorn, J., Holmes, G.G., Hossie, T.J. & Sherratt, T.N. 2016b. Multicomponent deceptive signals
1255 reduce the speed at which predators learn that prey are profitable. *Behav. Ecol.* **27**: 141–
1256 147.
- 1257 Skelhorn, J. & Rowe, C. 2006a. Avian predators taste–reject aposematic prey on the basis of their
1258 chemical defence. *Biol. Lett.* **2**: 348–350.
- 1259 Skelhorn, J. & Rowe, C. 2016. Cognition and the evolution of camouflage. *Proc. R. Soc. B Biol.*
1260 *Sci.* **283**: 20152890.
- 1261 Skelhorn, J. & Rowe, C. 2005. Frequency-dependent taste-rejection by avian predation may select
1262 for defence chemical polymorphisms in aposematic prey. *Biol. Lett.* **1**: 500–503.
- 1263 Skelhorn, J. & Rowe, C. 2007. Predators' toxin burdens influence their strategic decisions to eat
1264 toxic prey. *Curr. Biol.* **17**: 1479–1483.
- 1265 Skelhorn, J. & Rowe, C. 2006b. Prey palatability influences predator learning and memory. *Anim.*
1266 *Behav.* **71**: 1111–1118.
- 1267 Smilanich, A.M., Dyer, L.A., Chambers, J.Q. & Bowers, M.D. 2009. Immunological cost of chemical
1268 defence and the evolution of herbivore diet breadth. *Ecol. Lett.* **12**: 612–621.
- 1269 Smith, J.A., Suraci, J.P., Hunter, J.S., Gaynor, K.M., Keller, C.B., Palmer, M.S., *et al.* 2020.
1270 Zooming in on mechanistic predator–prey ecology: Integrating camera traps with
1271 experimental methods to reveal the drivers of ecological interactions. *J. Anim. Ecol.* **89**:
1272 1997–2012.

- 1273 Sourakov, A. 2013. Two heads are better than one: false head allows *Calycopis cecrops*
1274 (Lycaenidae) to escape predation by a Jumping Spider, *Phidippus pulcherrimus*
1275 (Salticidae). *J. Nat. Hist.* **47**: 1047–1054.
- 1276 Speed, M.P. & Ruxton, G.D. 2005. Warning Displays in Spiny Animals: One (more) Evolutionary
1277 Route to Aposematism. *Evolution* **59**: 2499–2508.
- 1278 Speed, M.P., Ruxton, G.D., Mappes, J. & Sherratt, T.N. 2012. Why are defensive toxins so
1279 variable? An evolutionary perspective. *Biol. Rev.* **87**: 874–884.
- 1280 Spence, C. 2011. Crossmodal correspondences: A tutorial review. *Atten. Percept. Psychophys.* **73**:
1281 971–995.
- 1282 Srygley, R.B. 2004. The aerodynamic costs of warning signals in palatable mimetic butterflies and
1283 their distasteful models. *Proc. R. Soc. Lond. B Biol. Sci.* **271**: 589–594.
- 1284 Stankowich, T. 2012. Armed and dangerous: predicting the presence and function of defensive
1285 weaponry in mammals. *Adapt. Behav.* **20**: 32–43.
- 1286 Stankowich, T. & Campbell, L.A. 2016. Living in the danger zone: exposure to predators and the
1287 evolution of spines and body armor in mammals. *Evolution* **70**: 1501–1511.
- 1288 Stankowich, T., Caro, T. & Cox, M. 2011. Bold coloration and the evolution of aposematism in
1289 terrestrial carnivores. *Evolution* **65**: 3090–3099.
- 1290 Stankowich, T., Haverkamp, P.J. & Caro, T. 2014. Ecological drivers of antipredator defenses in
1291 carnivores. *Evolution* **68**: 1415–1425.
- 1292 Stankowich, T. & Romero, A.N. 2017. The correlated evolution of antipredator defences and brain
1293 size in mammals. *Proc. R. Soc. B Biol. Sci.* **284**: 20161857.
- 1294 Staudinger, M.D., Hanlon, R.T. & Juanes, F. 2011. Primary and secondary defences of squid to
1295 cruising and ambush fish predators: variable tactics and their survival value. *Anim. Behav.*
1296 **81**: 585–594.
- 1297 Stearns, S.C. 1989. Trade-offs in life-history evolution. *Funct. Ecol.* **3**: 259–268.
- 1298 Stein, B.E. & Meredith, M.A. 1993. *The merging of the senses*. The MIT press.
- 1299 Stein, B.E. & Stanford, T.R. 2008. Multisensory integration: current issues from the perspective of
1300 the single neuron. *Nat. Rev. Neurosci.* **9**: 255–266.
- 1301 Stein, B.E., Stanford, T.R. & Rowland, B.A. 2020. Multisensory integration and the society for
1302 neuroscience: then and now. *J. Neurosci.* **40**: 3–11.
- 1303 Steiner, U.K. 2007. Investment in defense and cost of predator-induced defense along a resource
1304 gradient. *Oecologia* **152**: 201–210.
- 1305 Stevens, M. 2005. The role of eyespots as anti-predator mechanisms, principally demonstrated in
1306 the Lepidoptera. *Biol. Rev.* **80**: 573–588.
- 1307 Stevens, M. & Merilaita, S. 2011. Animal camouflage: function and mechanisms. In: *Animal*
1308 *camouflage*, pp. 1–16. Cambridge University Press.
- 1309 Stevens, M., Rong, C.P. & Todd, P.A. 2013. Colour change and camouflage in the horned ghost
1310 crab *Ocypode ceratophthalmus*. *Biol. J. Linn. Soc.* **109**: 257–270. Oxford University Press.

- 1311 Stevens, M. & Ruxton, G.D. 2012. Linking the evolution and form of warning coloration in nature.
1312 *Proc. R. Soc. B Biol. Sci.* **279**: 417–426.
- 1313 Stevens, M., Searle, W.T.L., Seymour, J.E., Marshall, K.L. & Ruxton, G.D. 2011. Motion dazzle
1314 and camouflage as distinct anti-predator defenses. *BMC Biol.* **9**: 81.
- 1315 Swaisgood, R.R., Rowe, M.P. & Owings, D.H. 2003. Antipredator responses of California ground
1316 squirrels to rattlesnakes and rattling sounds: the roles of sex, reproductive parity, and
1317 offspring age in assessment and decision-making rules. *Behav. Ecol. Sociobiol.* **55**: 22–31.
- 1318 Thiery, S. & Kaimer, C. 2020. The predation strategy of *Myxococcus xanthus*. *Front. Microbiol.* **11**:
1319 2.
- 1320 Toledo, L.F., Sazima, I. & Haddad, C.F.B. 2011. Behavioural defences of anurans: an overview.
1321 *Ethol. Ecol. Evol.* **23**: 1–25.
- 1322 Tullberg, B.S., Gamberale-Stille, G., Bohlin, T. & Merilaita, S. 2008. Seasonal ontogenetic colour
1323 plasticity in the adult striated shieldbug *Graphosoma lineatum* (Heteroptera) and its effect
1324 on detectability. *Behav. Ecol. Sociobiol.* **62**: 1389–1396.
- 1325 Tuttle, M.D., Taft, L.K. & Ryan, M.J. 1982. Evasive behaviour of a frog in response to bat
1326 predation. *Anim. Behav.* **30**: 393–397.
- 1327 Umbers, K.D.L., De Bona, S., White, T.E., Lehtonen, J., Mappes, J. & Endler, J.A. 2017.
1328 Deimatism: a neglected component of antipredator defence. *Biol. Lett.* **13**: 20160936.
- 1329 Valkonen, J.K., Nokelainen, O., Jokimäki, M., Kuusinen, E., Paloranta, M., Peura, M., *et al.* 2014.
1330 From deception to frankness: benefits of ontogenetic shift in the anti-predator strategy of
1331 alder moth *Acronicta alni* larvae. *Curr. Zool.* **60**: 114–122.
- 1332 Vallin, A., Jakobsson, S., Lind, J. & Wiklund, C. 2005. Prey survival by predator intimidation: an
1333 experimental study of peacock butterfly defence against blue tits. *Proc. R. Soc. B Biol. Sci.*
1334 **272**: 1203–1207.
- 1335 Van Belleghem, S.M., Alicea Roman, P.A., Carbia Gutierrez, H., Counterman, B.A. & Papa, R.
1336 2020. Perfect mimicry between *Heliconius* butterflies is constrained by genetics and
1337 development. *Proc. R. Soc. B* **287**: 20201267.
- 1338 Van Der Meijden, A., Lobo Coelho, P., Sousa, P. & Herrel, A. 2013. Choose your weapon:
1339 defensive behavior is associated with morphology and performance in scorpions. *PLoS One*
1340 **8**: e78955.
- 1341 van Noordwijk, A.J. & de Jong, G. 1986. Acquisition and allocation of resources: their influence on
1342 variation in life history tactics. *Am. Nat.* **128**: 137–142.
- 1343 Van Valen, L. 1973. A new evolutionary law. *Evol. Theory* **1**: 1–30.
- 1344 Vickers, M.E. & Taylor, L.A. 2020. Hemipteran defensive odors trigger predictable color biases in
1345 jumping spider predators. *Sci. Rep.* **10**: 21898.
- 1346 Wallace, A.R. 1879. The protective colours of animals. *Sci. All* 128–132.
- 1347 Wang, L., Ruxton, G.D., Cornell, S.J., Speed, M.P. & Broom, M. 2019. A theory for investment
1348 across defences triggered at different stages of a predator-prey encounter. *J. Theor. Biol.*
1349 **473**: 9–19.

- 1350 Winters, A.E., Chan, W., White, A.M., van den Berg, C.P., Garson, M.J. & Cheney, K.L. 2022.
1351 Weapons or deterrents? Nudibranch molluscs use distinct ecological modes of chemical
1352 defence against predators. *J. Anim. Ecol.* **91**: 831–844.
- 1353 Winters, A.E., Lommi, J., Kirvesoja, J., Nokelainen, O. & Mappes, J. 2021. Multimodal aposematic
1354 defenses through the predation sequence. *Front. Ecol. Evol.* **9**: 657740.
- 1355 Winters, A.E., Wilson, N.G., van den Berg, C.P., How, M.J., Endler, J.A., Marshall, N.J., *et al.*
1356 2018. Toxicity and taste: unequal chemical defences in a mimicry ring. *Proc. R. Soc. B Biol.*
1357 *Sci.* **285**: 20180457.
- 1358 Wirsing, A.J., Heithaus, M.R., Brown, J.S., Kotler, B.P. & Schmitz, O.J. 2021. The context
1359 dependence of non-consumptive predator effects. *Ecol. Lett.* **24**: 113–129.
- 1360 Yoshida, T., Hairston, N.G. & Ellner, S.P. 2004. Evolutionary trade-off between defence against
1361 grazing and competitive ability in a simple unicellular alga, *Chlorella vulgaris*. *Proc. R. Soc.*
1362 *Lond. B Biol. Sci.* **271**: 1947–1953.
- 1363 Zalucki, M.P., Brower, L.P. & Alonso-M, A. 2001. Detrimental effects of latex and cardiac
1364 glycosides on survival and growth of first-instar monarch butterfly larvae *Danaus plexippus*
1365 feeding on the sandhill milkweed *Asclepias humistrata*. *Ecol. Entomol.* **26**: 212–224.
- 1366 Zvereva, E.L., Doktorovová, L., Hotová Svádová, K., Zverev, V., Štys, P., Adamová-Ježová, D., *et*
1367 *al.* 2018. Defence strategies of *Chrysomela lapponica* (Coleoptera: Chrysomelidae) larvae:
1368 relative efficacy of secreted and stored defences against insect and avian predators. *Biol. J.*
1369 *Linn. Soc.* **124**: 533–546.
- 1370 Zvereva, E.L. & Kozlov, M.V. 2016. The costs and effectiveness of chemical defenses in
1371 herbivorous insects: a meta-analysis. *Ecol. Monogr.* **86**: 107–124.
- 1372 Zvereva, E.L., Zverev, V., Kruglova, O.Y. & Kozlov, M.V. 2017. Strategies of chemical anti-predator
1373 defences in leaf beetles: is sequestration of plant toxins less costly than de novo synthesis?
1374 *Oecologia* **183**: 93–106.
- 1375

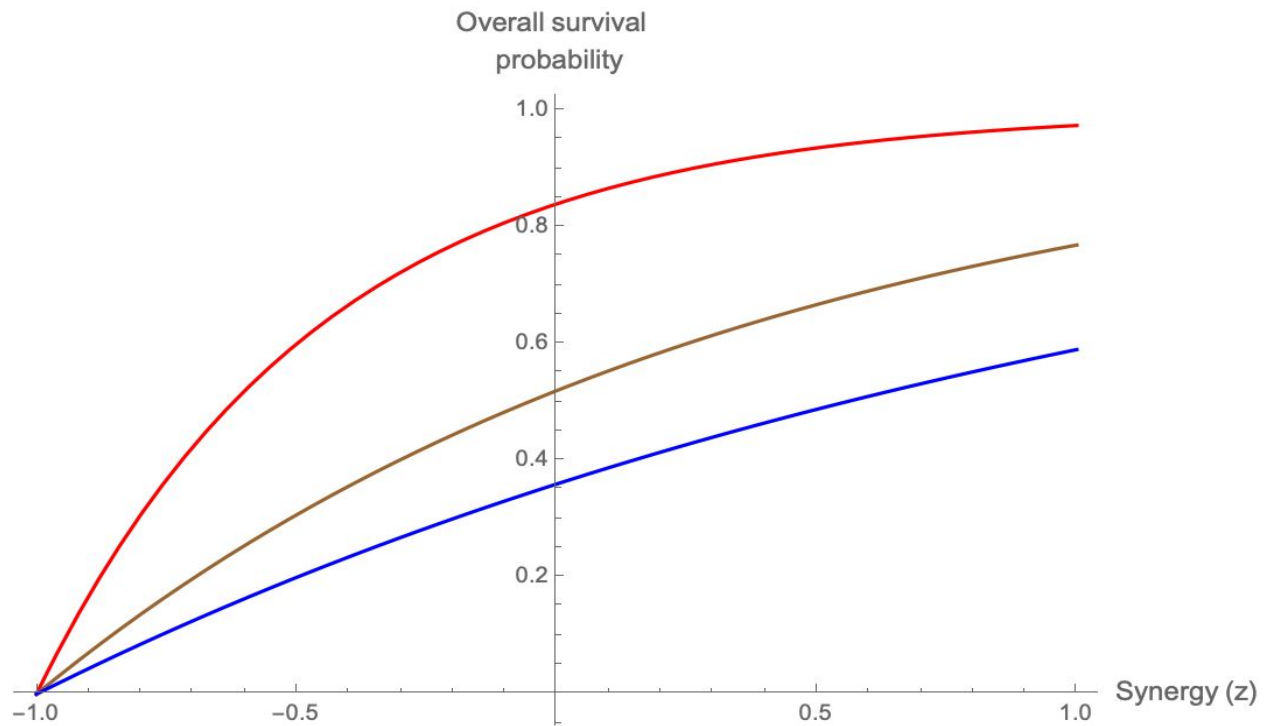

Supplementary Figure 1. Probability of a prey with defences A and B surviving an attack from a predator for different levels of defence synergy z ($z < 0$ implies the probability of survival of a prey with both defences is less than that if they were to act independently; $z > 0$ implies that the combined probability of survival is greater than their independent effects would predict). When $z = -1$, the combined survival probability of a prey with both defences is always 0, when $z = 0$ the defences act independently, and as z increases further the combined survival probability moves towards 1. Here $p_B = 0.2$ and $p_A = 0.8$ (red), 0.4 (brown) or 0.2 (blue). When p_A and/or p_B are low then a much higher level of synergy is required to achieve a given combined survivorship.

	Definitions	Detected	Not detected	Useful References
Resource Trade-off	Increased investment in one defence limits investment in another defence.	<ul style="list-style-type: none"> • Repetitive responsive defence (defensive display and regurgitating defensive fluid) decreases the potency of chemical defence in pine sawflies (Lindstedt <i>et al.</i>, 2018) • Sequestration of defensive chemicals in milkweed bugs trade-offs with their synthesis <i>de novo</i> (Havlikova <i>et al.</i>, 2020) 	<ul style="list-style-type: none"> • Reflexive bleeding did not affect elytral colour in ladybirds (Grill & Moore, 1998) 	(Broom <i>et al.</i> , 2010)
	Investment in defence limits investment in non-defensive trait (e.g., growth, development, securing a mate, thermoregulation, reproduction)	<ul style="list-style-type: none"> • Decreased population growth rate in defended algal clones relative to undefended clones, under resource limitation (Yoshida <i>et al.</i>, 2004) • Concave defense-growth trade-off in lake phytoplankton (Ehrlich <i>et al.</i>, 2020) • Reduction in tadpole growth rate in the presence of predators (Van Buskirk, 2000) • When resources are low, predator-induced morphological and behavioural responses primarily reduce tadpole survival. When resources are high, the cost of defense is reduced development rate and mass (Steiner, 2007) • Under threat of predation (kairomones from phantom midge), body size increases and neck spines grow in <i>Daphnia pulex</i>, but it takes longer to grow to maturity (Tollrian, 1995) • Defence against predators trades off with ability to defend against pathogens in the freshwater snails (Rigby & Jokela, 2000). • Increased allocation to defence against protozoan predation decreases the bacterial virulence (Friman <i>et al.</i>, 2009) and ability to use resources efficiently (Friman <i>et al.</i>, 2008) in <i>Serratia marcescens</i>. • Allocation to responsive defence decreases growth and reproduction in <i>Pieris brassicae</i> larvae (Higginson <i>et al.</i>, 2011). 	<ul style="list-style-type: none"> • Defended and undefended algal clones showed little difference in growth rates when resources were abundant (Yoshida <i>et al.</i>, 2004) • No tendency for a survival cost of responding to predators (Van Buskirk, 2000) • Development of large orange warning signal size does not incur life-history costs for aposematic <i>Arctia plantaginis</i> larvae (Lindstedt <i>et al.</i>, 2016). • Negative genetic trade off between the concentration of defensive chemicals in defensive fluid and growth but not with the volume of fluid and growth (Holloway <i>et al.</i>, 1993). • No phenotypic correlations between the carotenoid pigmentation and performance indices in <i>Orqyia antiqua</i> (Sandre <i>et al.</i>, 2007). 	(de Jong, 1993; Stamp, 2003; Ferrari <i>et al.</i> , 2009)

		<ul style="list-style-type: none">• Trade off between the warning signal efficacy and mating success in aposematic polymorphic <i>Arctia plantaginis</i> males (Nokelainen <i>et al.</i>, 2012).• Environment mediated trade off between body size and signal luminance in <i>Dendrobates auratus</i> (Flores <i>et al.</i>, 2013).		
--	--	--	--	--

F 5	Increased efficacy of one defence reduces the efficacy of (or need for) another defence.	<ul style="list-style-type: none"> • Bivalve shell shape optimized for faster, deeper burrowing to evade predators reduces crush resistance (Johnson, 2020) • Distance run from a predator negatively correlates with body armour in lizards (Losos <i>et al.</i>, 2002) • Defensive sting in ants is negatively correlated with spines, large eye size, and large colony size (Blanchard & Moreau, 2017) • Butterflyfish species with reduced morphological defences possess adaptations for quick escape, forage in familiar areas, and benefit from group vigilance arising from sociality (Hodge <i>et al.</i>, 2018) • Fleeing vs. tonic immobility in beetles. Fleeing increases distance from the threat, whereas tonic immobility reduces predator detection (Cardoso & dos Santos Mendonça, 2019) • In leaf beetles dorsal spines increase risk of attack, but help prevent subjugation by tree frogs (Shinohara & Takami, 2020) • Motion dazzle vs. camouflage. When moving, striped targets are caught less often and missed more often than camouflaged targets. When stationary, striped targets are readily detected, and camouflaged targets are caught less often (Stevens <i>et al.</i>, 2011) • Aposematism versus transparency in butterflies: some toxic butterflies have wing colour patterns combining conspicuous patches and large transparent areas. The existence of mimicry in those systems strongly suggests that those butterflies are aposematic. Transparency makes those butterflies less detectable by predators, but likely decreases the efficacy the whole aposematic/mimetic system (the effective encounter rate by predators is reduced). And obviously the presence of conspicuous elements in wing reduces the efficacy of concealment provided by transparency (Arias <i>et al.</i>, 2019; McClure <i>et al.</i>, 2019). (Note: this trade-off likely occurs for any other type of crypsis, too). 		
-----	--	--	--	--

- | | | | | |
|--|--|--|--|--|
| | | <ul style="list-style-type: none">• Due to negative genetic correlation across life-stages investment in large and more effective warning signal in larval stage trades off with efficient warning signal pigmentation in adult stage (Lindstedt <i>et al.</i>, 2016). | | |
|--|--|--|--|--|

<p>Defence phenotype increases efficacy against one predator, but reduces its efficacy against another.</p>	<ul style="list-style-type: none"> • Tail shape response in tadpoles exposed to one predator (fish vs. dragonfly nymph) increased risk to the other predator (Benard, 2006) • Spines protect dragonfly larvae from fish, but spined individuals experience higher predation by Aeshnidae dragonfly nymphs (Mikolajewski <i>et al.</i>, 2006) • Dorsal spines in leaf beetles were defensive against tree frogs, while explanate margins were defensive against assassin bug and crab spiders (Shinohara & Takami, 2020) • Behavioural response of roach to one predator (pike vs. perch) increases risk to the other predator (Eklöv & VanKooten, 2001) • Behavioural response of mayflies to one predator (stoneflies vs. fish) increases exposure to the other predator (Soluk & Collins, 1988; Soluk, 1993) • The chemical defenses of insect herbivores are effective against generalist predators on average, but not effective against specialist predators and generalist parasitoids, and increases the risk of parasitism by specialist parasitoids (Zvereva & Kozlov, 2016). 		<p>(Sih <i>et al.</i>, 1998; Relyea, 2003)</p>
<p>Defensive phenotype interferes with non-defensive trait (e.g., mobility, thermoregulation).</p>	<ul style="list-style-type: none"> • <i>Piper sp.</i> contain defensive compounds and experience a trade-off between seed dispersal and fruit defense (Whitehead <i>et al.</i>, 2016) • Predator-induced phenotype in tadpoles reduces predation, but increases mortality from other causes (Mccollum & Buskirk, 1996) • Red flour beetles with longer and more frequent tonic immobility have lower mating success (Nakayama & Miyatake, 2010) • Wing transparency in butterflies may reduce hydrophobicity (Perez Goodwyn <i>et al.</i>, 2009) • In mimetic butterflies resemblance in wing colour pattern can cause reproductive interference (individuals are attracted to heterospecific, co-mimetic individuals) (Mérot <i>et al.</i>, 2015) 	<ul style="list-style-type: none"> • No tradeoff between predation resistance and competitive ability in <i>Culex</i> and <i>Aedes</i> mosquitos (Murrell & Juliano, 2013) 	

		<ul style="list-style-type: none"> • Mimetic butterflies and their models experience aerodynamic costs because the slow angular velocity of their wings enhances the defensive colour signal (Srygley, 2004) • Investment in a more effective warning signal trades off with thermoregulation (Lindstedt <i>et al.</i>, 2009). • In milkweed bugs, feeding of toxic host plants increases protection from avian and insect predators but decreases growth and development (Petschenka <i>et al.</i> Am. Nat. accepted) 		
<p style="text-align: center;">Synergy</p>	<p>Two defensive traits that provide more protection when possessed together that either separately.</p>	<ul style="list-style-type: none"> • Magnitude of functionally-independent behavioural and shape-based defences are positively correlated in snails exposed to crayfish (Dewitt <i>et al.</i>, 1999) • Positive correlation in the expression of functionally-independent morphological and behavioural defences in tadpoles exposed to predation risk (Hossie <i>et al.</i>, 2017) • Prey with 'deimatic displays' or flash behaviour, benefit from crypsis prior to attack (Kang <i>et al.</i>, 2017; Umbers <i>et al.</i>, 2017, 2019; Loeffler-Henry <i>et al.</i>, 2018) • Many prey combine morphology and behaviour to enhance mimetic fidelity (Penney <i>et al.</i>, 2014) • Aposematism and gregariousness ensure higher protection against predators (Mappes <i>et al.</i>, 1999; Gamberale-Stille, 2000; Riipi <i>et al.</i>, 2001, but see Sillén-Tullberg, 1990; Reader & Hochuli, 2003) • Unpalatability and escape capacities in butterflies may be advertised by the same signal (Pinheiro <i>et al.</i>, 2016) 	<ul style="list-style-type: none"> • Eyespots and defensive posture both confer protection, but having both traits doesn't increase protection further (Hossie & Sherratt, 2013) • Hairiness together with the aposematic coloration did not increase defence efficacy against birds in <i>Arctia plantaginis</i> larvae (Lindstedt <i>et al.</i>, 2008) 	

Multi-role traits	A defensive trait has additional functions (other than defence) that increase prey survival or reproduction. I.e., Investment in defensive trait does 'double duty'.	<ul style="list-style-type: none"> • Dual function of anal fluid in the burying beetles in parental care and chemical defence (Lindstedt <i>et al.</i>, 2017) • Dual role of chemical defence in defence against predators and parasites in newts (Williams <i>et al.</i>, 2010; Calhoun <i>et al.</i>, 2017) • In <i>Heliconius erato</i>, the effectiveness of an aposematic signal was positively correlated with its effectiveness at inducing mating behaviour (Finkbeiner <i>et al.</i>, 2014) • Various defensive traits in mammals (e.g., thick loose skin, enlarged claws, enlarged teeth, cranial weaponry, venom) also have non-defensive functions (Stankowich <i>et al.</i>, 2011) • Pyrrolizidine alkaloids (PAs) collected from plants are used as precursor for both chemical defenses and pheromones in Ithomiini butterflies. Defensive PAs are possibly part of nuptial gifts to females (Trigo, 2011). Similarly in <i>Utetheisa ornatrix</i> PAs are used in chemical defence, nuptial gifts, protection of eggs and production of pheromones (Eisner & Meinwald, 1995). • Exoproducts produced by <i>Pseudomonas</i> bacteria improve their competitiveness against other bacteria and increase protection against their predators (Jousset <i>et al.</i>, 2008, 2009). 		
--------------------------	---	---	--	--

Arias, M., Mappes, J., Desbois, C., Gordon, S., McClure, M., Elias, M., *et al.* 2019. Transparency reduces predator detection in mimetic clearwing butterflies. *Funct. Ecol.* **33**: 1110–1119.

Benard, M.F. 2006. Survival trade-offs between two predator-Induced phenotypes in pacific treefrogs (*Pseudacris regilla*). *Ecology* **87**: 340–346.

Blanchard, B.D. & Moreau, C.S. 2017. Defensive traits exhibit an evolutionary trade-off and drive diversification in ants. *Evolution* **71**: 315–328.

Broom, M., Higginson, A.D. & Ruxton, G.D. 2010. Optimal investment across different aspects of anti-predator defences. *J. Theor. Biol.* **263**: 579–586.

- Calhoun, D.M., Bucciarelli, G.M., Kats, L.B., Zimmer, R.K. & Johnson, P.T. 2017. Noxious newts and their natural enemies: Experimental effects of tetrodotoxin exposure on trematode parasites and aquatic macroinvertebrates. *Toxicon* **137**: 120–127. Elsevier.
- Cardoso, J.C.F. & dos Santos Mendonça, J. 2019. The trade-off between fleeing and tonic immobility behaviors in an ectothermic animal. *Acta Ethologica* **22**: 129–134.
- de Jong, G. 1993. Covariances between traits deriving from successive allocations of a resource. *Funct. Ecol.* **7**: 75–83. [British Ecological Society, Wiley].
- Dewitt, T.J., Sih, A. & Hucko, J.A. 1999. Trait compensation and cospecialization in a freshwater snail: size, shape and antipredator behaviour. *Anim. Behav.* **58**: 397–407.
- Ehrlich, E., Kath, N.J. & Gaedke, U. 2020. The shape of a defense-growth trade-off governs seasonal trait dynamics in natural phytoplankton. *ISME J.* **14**: 1451–1462.
- Eisner, T. & Meinwald, J. 1995. The chemistry of sexual selection. *Proc. Natl. Aca. Sci.* **92**: 50–55. National Acad Sciences.
- Eklöv, P. & Van Kooten, T. 2001. Facilitation among piscivorous predators: effects of prey habitat use. *Ecology* **82**: 2486–2494.
- Ferrari, M.C., Sih, A. & Chivers, D.P. 2009. The paradox of risk allocation: a review and prospectus. *Anim. Behav.* **78**: 579–585. Elsevier.
- Finkbeiner, S.D., Briscoe, A.D. & Reed, R.D. 2014. Warning signals are seductive: Relative contributions of color and pattern to predator avoidance and mate attraction in *Heliconius* butterflies. *Evolution* **68**: 3410–3420.
- Flores, E.E., Stevens, M., Moore, A.J. & Blount, J.D. 2013. Diet, development and the optimization of warning signals in post-metamorphic green and black poison frogs. *Funct. Ecol.* **27**: 816–829. Wiley Online Library.
- Friman, V.-P., Hiltunen, T., Laakso, J. & Kaitala, V. 2008. Availability of prey resources drives evolution of predator–prey interaction. *Proc. R. Soc. B Biol. Sci.* **275**: 1625–1633. The Royal Society London.
- Friman, V.-P., Lindstedt, C., Hiltunen, T., Laakso, J. & Mappes, J. 2009. Predation on multiple trophic levels shapes the evolution of pathogen virulence. *PloS One* **4**: e6761. Public Library of Science San Francisco, USA.

- Gamberale-Stille, G. 2000. Decision time and prey gregariousness influence attack probability in naive and experienced predators. *Anim. Behav.* **60**: 95–99. Elsevier.
- Grill, C.P. & Moore, A.J. 1998. Effects of a larval antipredator response and larval diet on adult phenotype in an aposematic ladybirdbeetle. *Oecologia* **114**: 274–282. Springer.
- Havlikova, M., Bosakova, T., Petschenka, G., Cabala, R., Exnerova, A. & Bosakova, Z. 2020. Analysis of defensive secretion of amilkweed bug *Lygaeus equestris* by 1D GC-MS and GC×GC-MS: sex differences and host-plant effect. *Sci. Rep.* **10**: 3092.
- Higginson, A.D., Delf, J., Ruxton, G.D. & Speed, M.P. 2011. Growth and reproductive costs of larval defence in the aposematic lepidopteran *Pieris brassicae*. *J. Anim. Ecol.* **80**: 384–392. Wiley Online Library.
- Hodge, J.R., Alim, C., Bertrand, N.G., Lee, W., Price, S.A., Tran, B., *et al.* 2018. Ecology shapes the evolutionary trade-off between predator avoidance and defence in coral reef butterflyfishes. *Ecol. Lett.* **21**: 1033–1042.
- Holloway, G.J., de Jong, P.W. & Ottenheim, M. 1993. The genetics and cost of chemical defense in the two-spot ladybird (*Adalia bipunctata* L.). *Evolution* **47**: 1229–1239. Wiley Online Library.
- Hossie, T., Landolt, K. & Murray, D.L. 2017. Determinants and co-expression of anti-predator responses in amphibian tadpoles: a meta-analysis. *Oikos* **126**: 173–184.
- Hossie, T.J. & Sherratt, T.N. 2013. Defensive posture and eyespots deter avian predators from attacking caterpillar models. *Anim. Behav.* **86**: 383–389.
- Johnson, E.H. 2020. Experimental tests of bivalve shell shape reveal potential tradeoffs between mechanical and behavioral defenses. *Sci. Rep.* **10**: 19425.
- Jousset, A., Rochat, L., Péchy-Tarr, M., Keel, C., Scheu, S. & Bonkowski, M. 2009. Predators promote defence of rhizosphere bacterial populations by selective feeding on non-toxic cheaters. *ISME J.* **3**: 666–674. Nature Publishing Group.
- Jousset, A., Scheu, S. & Bonkowski, M. 2008. Secondary metabolite production facilitates establishment of rhizobacteria by reducing both protozoan predation and the competitive effects of indigenous bacteria. *Funct. Ecol.* **22**: 714–719. Wiley Online Library.
- Kang, C., Moon, H., Sherratt, T.N., Lee, S.-I. & Jablonski, P.G. 2017. Multiple lines of anti-predator defence in the spotted lanternfly, *Lycorma delicatula* (Hemiptera: Fulgoridae). *Biol. J. Linn. Soc.* **120**: 115–124.

- Lindstedt, C., Boncoraglio, G., Cotter, S., Gilbert, J. & Kilner, R.M. 2017. Aposematism in the burying beetle? Dual function of analfluid in parental care and chemical defense. *Behav. Ecol.* **28**: 1414–1422.
- Lindstedt, C., Lindström, L. & Mappes, J. 2008. Hairiness and warning colours as components of antipredator defence: additive or interactive benefits? *Anim. Behav.* **75**: 1703–1713.
- Lindstedt, C., Lindström, L. & Mappes, J. 2009. Thermoregulation constrains effective warning signal expression. *Evolution* **63**: 469–478.
- Lindstedt, C., Miettinen, A., Freitak, D., Ketola, T., López-Sepulcre, A., Mäntylä, E., *et al.* 2018. Ecological conditions alter cooperative behaviour and its costs in a chemically defended sawfly. *Proc. R. Soc. B Biol. Sci.* **285**: 20180466.
- Lindstedt, C., Schroderus, E., Lindström, L., Mappes, T. & Mappes, J. 2016. Evolutionary constraints of warning signals: A genetic trade-off between the efficacy of larval and adult warning coloration can maintain variation in signal expression. *Evolution* **70**: 2562–2572.
- Loeffler-Henry, K., Kang, C., Yip, Y., Caro, T. & Sherratt, T.N. 2018. Flash behavior increases prey survival. *Behav. Ecol.* **29**: 528–533.
- Losos, J.B., Mouton, P.L.F.N., Bickel, R., Cornelius, I. & Ruddock, L. 2002. The effect of body armature on escape behaviour in cordylid lizards. *Anim. Behav.* **64**: 313–321.
- Mappes, J., Tuomi, J. & Alatalo, R.V. 1999. Do palatable prey benefit from aposematic neighbors? *Ecoscience* **6**: 159–162. Taylor & Francis.
- McClure, M., Clerc, C., Desbois, C., Meichanetzoglou, A., Cau, M., Bastin-Héline, L., *et al.* 2019. Why has transparency evolved in aposematic butterflies? Insights from the largest radiation of aposematic butterflies, the Ithomiini. *Proc. R. Soc. B Biol. Sci.* **286**: 20182769.
- Mccollum, S.A. & Buskirk, J.V. 1996. Costs and benefits of a predator-induced polyphenism in the gray treefrog *Hyla chrysoscelis*. *Evolution* **50**: 583–593.
- Mérot, C., Frérot, B., Leppik, E. & Joron, M. 2015. Beyond magic traits: Multimodal mating cues in *Heliconius* butterflies: Sexual isolation on chemical cues in *Heliconius*. *Evolution* **69**: 2891–2904.

- Mikolajewski, D.J., Johansson, F., Wohlfahrt, B. & Stoks, R. 2006. Invertebrate predation selects for the loss of a morphological antipredator trait. *Evolution* **60**: 1306–1310.
- Murrell, E.G. & Juliano, S.A. 2013. Predation resistance does not trade off with competitive ability in early-colonizing mosquitoes. *Oecologia* **173**: 1033–1042.
- Nakayama, S. & Miyatake, T. 2010. Genetic trade-off between abilities to avoid attack and to mate: a cost of tonic immobility. *Biol.Lett.* **6**: 18–20.
- Nokelainen, O., Hegna, R.H., Reudler, J.H., Lindstedt, C. & Mappes, J. 2012. Trade-off between warning signal efficacy and mating success in the wood tiger moth. *Proc. R. Soc. B Biol. Sci.* **279**: 257–265.
- Penney, H.D., Hassall, C., Skevington, J.H., Lamborn, B. & Sherratt, T.N. 2014. The Relationship between Morphological and Behavioral Mimicry in Hover Flies (Diptera: Syrphidae). *Am. Nat.* **183**: 281–289.
- Perez Goodwyn, P., Maezono, Y., Hosoda, N. & Fujisaki, K. 2009. Waterproof and translucent wings at the same time: problems and solutions in butterflies. *Naturwissenschaften* **96**: 781–787.
- Pinheiro, C.E.G., Freitas, A.V.L., Campos, V.C., DeVries, P.J. & Penz, C.M. 2016. Both Palatable and Unpalatable Butterflies Use Bright Colors to Signal Difficulty of Capture to Predators. *Neotrop. Entomol.* **45**: 107–113.
- Reader, T. & Hochuli, D.F. 2003. Understanding gregariousness in a larval Lepidopteran: the roles of host plant, predation, and microclimate: Gregariousness in caterpillars. *Ecol. Entomol.* **28**: 729–737.
- Relyea, R.A. 2003. How prey respond to combined predators: a review and an empirical test. *Ecology* **84**: 1827–1839. Wiley Online Library.
- Rigby, M.C. & Jokela, J. 2000. Predator avoidance and immune defence: costs and trade-offs in snails. *Proc. R. Soc. Lond. B Biol. Sci.* **267**: 171–176. The Royal Society.
- Riipi, M., Alatalo, R.V., Lindström, L. & Mappes, J. 2001. Multiple benefits of gregariousness cover detectability costs in aposematic aggregations. *Nature* **413**: 512–514. Nature Publishing Group.
- Sandre, S.-L., Tammaru, T., Esperk, T., Julkunen-Tiitto, R. & Mappes, J. 2007. Carotenoid-based colour polymorphism in a moth species: search for fitness correlates. *Entomol. Exp. Appl.* **124**: 269–277. Wiley Online Library.

- Shinohara, T. & Takami, Y. 2020. Functional diversity and trade-offs in divergent antipredator morphologies in herbivorous insects. *Ecol. Evol.* **10**: 5089–5096.
- Sih, A., Englund, G. & Wooster, D. 1998. Emergent impacts of multiple predators on prey. *Trends Ecol. Evol.* **13**: 350–355.
- Sillén-Tullberg, B. 1990. Do predators avoid groups of aposematic prey? An experimental test. *Anim. Behav.* **40**: 856–860. Elsevier.
- Soluk, D.A. 1993. Multiple Predator Effects: Predicting Combined Functional Response of Stream Fish and Invertebrate Predators. *Ecology* **74**: 219–225.
- Soluk, D.A. & Collins, N.C. 1988. Balancing risks? Responses and non-responses of mayfly larvae to fish and stonefly predators. *Oecologia* **77**: 370–374. Springer.
- Srygley, R.B. 2004. The aerodynamic costs of warning signals in palatable mimetic butterflies and their distasteful models. *Proc. R.Soc. Lond. B Biol. Sci.* **271**: 589–594.
- Stamp, N. 2003. Out Of The Quagmire Of Plant Defense Hypotheses. *Q. Rev. Biol.* **78**: 23–55.
- Stankowich, T., Caro, T. & Cox, M. 2011. Bold coloration and the evolution of aposematism in terrestrial carnivores. *Evolution* **65**:3090–3099.
- Steiner, U.K. 2007. Investment in defense and cost of predator-induced defense along a resource gradient. *Oecologia* **152**: 201–210.
- Stevens, M., Searle, W.T.L., Seymour, J.E., Marshall, K.L. & Ruxton, G.D. 2011. Motion dazzle and camouflage as distinct anti-predator defenses. *BMC Biol.* **9**: 81.
- Tollrian, R. 1995. Predator-induced morphological defenses: Costs, life history shifts, and maternal effects in *Daphnia pulex*. *Ecology* **76**: 1691–1705. Wiley Online Library.
- Trigo, J.R. 2011. Effects of pyrrolizidine alkaloids through different trophic levels. *Phytochem. Rev.* **10**: 83–98. Springer.
- Umbers, K.D., White, T.E., De Bona, S., Haff, T., Ryeland, J., Drinkwater, E., *et al.* 2019. The protective value of a defensive display varies with the experience of wild predators. *Sci. Rep.* **9**: 1–8. Nature Publishing Group.

- Umbers, K.D.L., De Bona, S., White, T.E., Lehtonen, J., Mappes, J. & Endler, J.A. 2017. Deimatism: a neglected component of antipredator defence. *Biol. Lett.* **13**: 20160936.
- Van Buskirk, J. 2000. The costs of inducible defense in an anuran larvae. *Ecology* **81**: 2813–2821.
- Whitehead, S.R., Quesada, M.F.O. & Bowers, M.D. 2016. Chemical tradeoffs in seed dispersal: defensive metabolites in fruits deter consumption by mutualist bats. *Oikos* **125**: 927–937.
- Williams, B.L., Hanifin, C.T., Brodie, E.D. & Brodie III, E.D. 2010. Tetrodotoxin affects survival probability of rough-skinned newts (*Taricha granulosa*) faced with TTX-resistant garter snake predators (*Thamnophis sirtalis*). *Chemoecology* **20**: 285–290.
- Yoshida, T., Hairston, N.G. & Ellner, S.P. 2004. Evolutionary trade-off between defence against grazing and competitive ability in a simple unicellular alga, *Chlorella vulgaris*. *Proc. R. Soc. Lond. B Biol. Sci.* **271**: 1947–1953.
- Zvereva, E.L. & Kozlov, M.V. 2016. The costs and effectiveness of chemical defenses in herbivorous insects: a meta-analysis. *Ecol. Monogr.* **86**: 107–124.

Ecology and evolution of evasive mimicry in butterflies: insights from the diverse Neotropical genus *Adelpha*

Abstract:

The Neotropical Andes is one of the most diverse regions worldwide, which has been evidenced across many taxa i.e., vertebrates, insects, and plants. Butterflies from the genus *Adelpha* are an excellent example, since it has diversified along a broad latitudinal and altitudinal range in around 96 species and more than 130 subspecies. Therefore, *Adelpha* has been an important object of study on systematics, taxonomy and diversification, but their ecology remains poorly targeted. Recent evidence supports the idea that *Adelpha*'s extreme resemblance of wing colour patterns among distantly related species is a case of convergence, although studies on the ecological role of this convergence are almost inexistant. Two hypotheses have been proposed to explain convergence of wing colour patterns: classical mimicry which can be Müllerian, when several chemical defended prey benefit from sharing the same wing colour pattern that acts as signal of prey's unprofitability; or Batesian where palatable species harbour the wing colour pattern from unpalatable or toxic species, thus gaining protection from predators attacks. Alternatively, it has been proposed the hypothesis of evasive mimicry i.e., convergence of bright, conspicuous colour patterns that signal prey's ability to escape, which seems to be also plausible in many palatable but conspicuous coloured butterflies. The main objective of this thesis is to provide some of the first elements regarding the ecology and evolution of evasive mimicry in a group of Neotropical butterflies. Therefore, this thesis is divided in 3 chapters: first, we provide a proof of concept for some of the key aspects for the evolution of evasive mimicry: predator's learning and generalisation of a visual cue i.e., wing colour patterns, that are associated to evasiveness of prey. We performed predation experiments using naïve and wild blue tits (*Cyanestes caerolus*) and artificial prey harbouring naturally occurring wing patterns. In addition, we compared avoidance learning and generalisation with classical mimicry. In the second chapter, we looked at the evolution of *Adelpha*'s mimicry patterns and its relationship to some species' macroecological traits to better understand what factors can be driving high diversification patterns. For this, we inferred the most comprehensive phylogeny for *Adelpha* and reconstructed the ancestral state of mimicry patterns. Finally, we focused at a finer scale i.e., the community level to investigate if co-mimetic species co-occur and the mimicry structure along the Andean altitudinal gradient.

In addition, assessing the phylogenetic and mimicry structure of *Adelpha* communities allowed us to provide more information about what processes are underlying species assemblages. This thesis explores some of the implications of evasive mimicry at different evolutionary and ecological scales, and provide evidence for some of the key aspects for evasive mimicry such as predator's ability to learn to avoid and associate a visual cue to prey's efficient mechanism to escape, convergence of colour patterns, co-occurrence of co-mimics, clustering of mimicry rings by altitude. Some of these patterns are different, (or not as strong) from those observed in classical mimicry systems, which reflects that the mechanism underlying these two types of mimicry might be different. In addition, we discuss opportunities for further research on the implications of evasive mimicry beyond colour pattern convergence such as on habitat (and microhabitat), genetic architecture, among others. We encourage, as well, research in other groups of butterflies that are potentially involved in evasive mimicry.

Key words: evasive mimicry, phylogeny, ancestral state reconstruction, diversification, phylogenetic community ecology, adaptive convergence, *Adelpha*, Neotropics.

Résumé:

Les Andes néotropicales sont l'une des régions les plus diversifiées du monde, ce qui a été montré pour de nombreux taxons, comme les vertébrés, insectes et plantes. Les papillons néotropicaux du genre *Adelpha* sont un excellent exemple de cette diversité, puisqu'ils se sont diversifiés le long d'un large gradient latitudinale et altitudinale en environ 96 espèces et plus de 130 sous-espèces. Par conséquent, *Adelpha* a été un important objet d'étude sur la systématique, la taxonomie et la diversification, mais son écologie reste peu connue. De récents travaux soutiennent l'idée que l'extrême ressemblance des motifs de coloration des ailes entre espèces distantes chez *Adelpha* est un cas de convergence, mais les études sur le rôle écologique de cette convergence sont presque inexistantes. Deux hypothèses ont été proposées pour expliquer la convergence des motifs de coloration des ailes : le mimétisme classique, qui peut être Müllérien, lorsque plusieurs proies avec une défense chimique bénéficient du partage du même motif de coloration, qui agit comme un signal pour leur défense; ou Batesien, lorsque les espèces comestibles portent le motif de coloration d'espèces non comestibles ou toxiques, se protégeant ainsi des attaques des prédateurs. Alternativement, il a été proposé l'hypothèse d'un mimétisme de fuite, selon laquelle le motif coloré pourrait signaler aux prédateurs que la proie est difficile à attraper, et ainsi les décourager de poursuivre celle-ci, ce qui semble également plausible chez de nombreux papillons comestibles mais aux colorations vives. L'objectif principal de cette thèse est de fournir certains des premiers éléments concernant l'écologie et l'évolution du mimétisme de fuite dans un groupe de papillons néotropicaux. Par conséquent, cette thèse est divisée en 3 chapitres : d'abord, nous fournissons une preuve de concept pour certains des aspects clés de l'évolution du mimétisme de fuite : l'apprentissage et la généralisation par le prédateur d'un indice visuel, c'est-à-dire les motifs de coloration, qui sont associés à l'évasion de la proie. Nous avons réalisé des expériences de prédation en utilisant des mésanges bleues (*Cyanestes caerolus*) naïves et sauvages et des proies artificielles présentant des motifs des ailes présentes dans la nature. En outre, nous avons comparé l'apprentissage et la généralisation de l'évitement de proies difficiles à capturer avec le cas du mimétisme classique. Dans le deuxième chapitre, nous avons examiné l'évolution des motifs mimétiques chez *Adelpha* et sa relation avec les caractéristiques macro écologiques de certaines espèces afin de mieux comprendre les facteurs qui peuvent être à l'origine de la forte diversification. Pour cela, nous avons généré la phylogénie la plus complète à ce jour pour *Adelpha* et reconstruit l'état ancestral des motifs mimétiques. Enfin, nous nous sommes concentrés sur une échelle plus fine, c'est-à-dire le niveau de la communauté, afin d'étudier si

les espèces semblables coexistent au sein des communautés, en particulier le long du gradient altitudinal des Andes. En outre, l'analyse de la structure phylogénétique et mimétique des communautés d'*Adelpha* nous a permis de fournir plus d'informations sur les processus sous-jacents des assemblages d'espèces. Cette thèse explore certaines des implications du mimétisme de fuite à différentes échelles évolutives et écologiques, et fournit des preuves pour certains des aspects clés du mimétisme de fuite, tels que la capacité du prédateur à apprendre à éviter et à associer un signal au mécanisme efficace de la proie pour s'échapper, la convergence des motifs colorés, la coexistence des co-mimes, le regroupement des cercles mimétiques par altitude. Certains effets sont différents (ou moins forts) de ceux observés dans les systèmes de mimétisme classiques, ce qui indique que le mécanisme sous-jacent à ces deux types de mimétisme pourrait être différent. En outre, nous discutons des possibilités de recherches futures sur les implications du mimétisme de fuite au-delà de la convergence des motifs de couleur, comme sur l'habitat (et le microhabitat), l'architecture génétique, entre autres. Nous encourageons également la recherche sur d'autres groupes de papillons qui sont potentiellement impliqués dans le mimétisme de fuite.

Mots clés : mimétisme de fuite, phylogénie, reconstruction de l'état ancestral, diversification, écologie des communautés phylogénétiques, convergence adaptative, Adelpha, Néotropiques