



HAL
open science

Statistical mechanics models via the lens of potential theory

Yijun Wan

► **To cite this version:**

Yijun Wan. Statistical mechanics models via the lens of potential theory. Probability [math.PR]. Université Paris-Saclay, 2022. English. NNT : 2022UPASM022 . tel-04140267

HAL Id: tel-04140267

<https://theses.hal.science/tel-04140267>

Submitted on 25 Jun 2023

HAL is a multi-disciplinary open access archive for the deposit and dissemination of scientific research documents, whether they are published or not. The documents may come from teaching and research institutions in France or abroad, or from public or private research centers.

L'archive ouverte pluridisciplinaire **HAL**, est destinée au dépôt et à la diffusion de documents scientifiques de niveau recherche, publiés ou non, émanant des établissements d'enseignement et de recherche français ou étrangers, des laboratoires publics ou privés.

Statistical mechanics models via the lens of potential theory

*Autour des modèles en mécanique statistique du point de
vue de la théorie du potentiel*

Thèse de doctorat de l'université Paris-Saclay

École doctorale de Mathématiques Hadamard (EDMH) n° 574
Spécialité de doctorat : Mathématiques appliquées
Graduate School : Mathématiques
Référent : Faculté des sciences d'Orsay

Thèse préparée dans l'unité de recherche Département de Mathématiques et
applications (ENS Paris, CNRS), sous la direction de Dmitry CHELKAK,
professeur

Thèse soutenue à Paris, le 26 septembre 2022, par

Yijun WAN

Composition du jury

Nicolas CURIEN Professeur, Université Paris-Saclay	Président
Nathanaël BERESTYCKI Professeur, University of Vienna	Rapporteur & Examineur
Kalle KYTÖLÄ Professeur associé, Aalto University	Rapporteur & Examineur
Laure DUMAZ Chargée de recherche, École Normale supérieure	Examinatrice
Titus LUPU Chargé de recherche, Sorbonne Université	Examineur
Dmitry CHELKAK Professeur, Ecole normale supérieure	Directeur de thèse

Titre : Autour des modèles en mécanique statistique du point de vue de la théorie du potentiel

Mots clés : Marches aléatoires, Evolutions de Schramm-Loewner, Ensembles de boucles, Holomorphie massive.

Résumé : Cette thèse porte sur certains modèles de mécanique statistique et de leurs limites à grande échelle, en utilisant principalement l'analyse asymptotique de la fonction de Green apparaissant dans ces modèles. Dans la première partie, nous nous intéressons aux marches aléatoires. Nous établissons la convergence des marches aléatoires massives à boucles effacées vers les SLE_2 massifs. Ceci généralise le résultat célèbre de Lawler, Schramm et Werner pour les marches aléatoires à boucles effacées. Nous avons ensuite étudié les marches aléatoires branchantes, en obtenant l'asymptotique de leur capacité au-dessus et à la dimension critique. Dans un deuxième temps, nous nous intéressons au modèle d'Ising et de dimères bipartites, qui sont étroitement liés. En perturbant la température du modèle d'Ising de la criticité, nous lui associons une famille de poids massifs de dimères et obtenons la convergence pour les corrélations de densité d'énergie dans le modèle d'Ising et les corrélations des gradients des fluctuations des fonctions de hauteurs dans le modèle de dimères. Nous avons également prouvé une décroissance super-exponentielle des probabilités de croisement pour les ensembles de boucles conformes simples. Il s'agissait d'un ingrédient manquant dans la preuve de la convergence des ensembles de boucles double-dimères vers CLE_4 en termes de probabilités d'événements topologiques macroscopiques.

Title : Statistical mechanics models via the lens of potential theory

Keywords : Random walks, Schramm-Loewner evolutions, Loop ensembles, Massive holomorphicity.

Abstract : This thesis contributes to the understanding of some statistical mechanics models and their large-scale limits, mainly using asymptotic analysis of Green's function appearing in these models. In the first part, we are interested in random walks. We establish the convergence for the loop-erasure of two-dimensional random walks with killing to the so-called massive SLE_2 curves. This generalizes the celebrated result of Lawler, Schramm and Werner for standard loop-erased random walks. Then we investigated the branching random walks, obtaining the asymptotics of its capacity above and at the critical dimension. Another direction of our research is the closely related planar Ising and bipartite dimer models. By perturbing the temperature for the Ising model away from the criticality, we associate to it a family of massive dimer weights and obtain the convergence of correlations of the Ising energy density field and the gradient field of the height functions in the dimer model on hedgehog domains. We also proved a super-exponential decay of the crossing probabilities for simple conformal loop ensembles. This was a missing ingredient in the proof of convergence of the double-dimer loop ensembles to CLE_4 in terms of probabilities of macroscopic topological events, hence our result implies such convergence.

Remerciements

First and foremost, I am deeply indebted to my supervisor Prof. Dmitry Chelkak. All the journeys begin with his course Stochastic Processes in the first semester at ENS. I can still remember how excited and curious I was when hearing about the martingale techniques, the construction of Schramm-Loewner evolution and the magic show of shuffling a deck cards in his lectures. I am extremely lucky to take on this journey with his guidance. In addition to a supervisor's responsibility, what Dmitry brought me most is his critical and phenomenological thinking, getting the question right from the very beginning.

I would like to express my sincere gratitude to Prof. Nathanaël Berestycki and Prof. Kalle Kytola for their interest in my work. Many thanks should go to them for carefully reading the manuscript, explaining me their works and taking time to write the reports. I am also grateful to Prof. Nicolas Curien, Laure Dumaz, Titus Lupu for agreeing to be part of the jury, and to a special guest of the jury, Yilin Wang, for being able to participate, and kindly offering me a visiting position during the following transition period.

My journey in France, especially at ENS cannot begin without the recommendation of Prof. Zhiying Wen and Prof. Jacques Peyrière. I am grateful for their beautiful lectures back in China which aroused my curiosity in mathematics. In particular, I am deeply indebted to Prof. Wen for the decision to pursue mathematical research. Right before the start of my PhD, I had the privilege to visit Prof. Hao Wu at Tsinghua University, who helps me without reservation for the background needed in this thesis.

Despite of the annoying Covid, due to which I spent nearly half of the PhD period at home, I still benefit from facilities at DMA and got a good few chances to participating in conferences and summer schools, with the help of Zaïna Elmir, Fabienne Renia. I am also grateful for the financial support from the ENS foundation.

Taking part in the vulgarisation of my expertise is one of the highlights during the past three years. I am thankful to Prof. Jean-francois Allemend for having hired me despite my poor French and lack of experience in teaching, and for Nicolas Forien and Maxime Berger for exchanging a lot about teaching. I feel honored to be part of the Probability de Demain organisation team. With Sébastien Martineau, Benoit Laslier and Linxiao Chen, we succeeded in maintaining the biweekly seminar targeted at young probabilists during the quarantine time. Except the organisation stuff, they constantly provide without reservation support and criticisms not only about my maths, but also my personality. I am also looking forward to maintaining this culture with the current organisation team.

Out of all the people that I had a chance to work with, Rémy Mahfouf holds an irreplaceable position, with whom we shared an office at DMA. I will never forget those conversations going in that office, especially the phone call at the darkest midnight. This thesis cannot be finished with the help of my collaborators Tianyi Bai and Sung-Chul Park. I cannot remember how many times I was impressed by their expertises and how devoted they are towards math. I also owe lots of respect to Misha Basok, who helped

me with my ongoing problems each time ever since we met.

It is hard to get the works recognised without interactions outside the local community. I would like to acknowledge the help of Prof. Federico Camia who kindly invited me to Abu Dhabi to meet great probabilists there. I wish to thank Prof. Yves Le Jan for warmly explaining me life in Abu Dhabi upon my arrival.

My gratitude goes to Yi Pan, who provided the accommodations and with whom we survived the quarantine period. Thanks to Yi, I was taken good care of in all aspects of life. I also wish to thank the furry Re-Re (Popcorn) under the same roof, who taught how to love without hesitation. My thanks also go to Jo-Jo (Yongchen Pan) for being one of my virtual friends, but still coming to provide accompany each summer vacation whenever I was alone.

I thank my parents and grandparents for their unconditional love and supporting the choices I made financially so that I can pursue what I want. I am also thankful to my cousin Linghao Zeng, who has been my partner since he was born. I owe a debt of gratitude to Wendi Xiao for his constant encouragements and tolerating my occasional bad temper during the last year.

There are also many people who accompanied me during different periods of life. I apologise not to include all their names in this short paragraph. To mention a few, the Beihang Hua Luogeng class, the ENS-SI group, the Antony evangelical church, the Nintendo Switch group, who have witnessed my ups and downs in life.

Table des matières

1	Introduction générale en français	7
1.1	Les limites d'échelle, l'universalité et l'invariance conforme	7
1.2	Les modèles discrets	8
1.3	L'évolution de Schramm-Loewner et l'ensemble de boucles conforme	14
2	Introduction	17
2.1	Scaling, universality and conformal invariance	17
2.2	Loop-erased random walks and uniform spanning trees	18
2.3	Schramm-Loewner evolution and Conformal loop ensemble	22
2.4	Branching random walks	24
2.5	Planar Ising and dimer models	29
3	Massive loop-erased random walk	41
3.1	Introduction	41
3.2	Preliminaries	45
3.2.1	Discrete domains, partition functions and martingale observables	45
3.2.2	Carathéodory convergence of Ω^δ and reparametrization by capacity	47
3.2.3	Chordal SLE(2) and topologies of convergence	49
3.2.4	Convergence of classical LERW to chordal SLE(2)	50
3.2.5	The density of mLERW with respect to the classical LERW	53
3.2.6	Absolute continuity of mSLE(2) with respect to SLE(2)	55
3.3	Convergence of martingale observables	57
3.3.1	Convergence of discrete harmonic functions	57
3.3.2	Boundary behavior of discrete harmonic functions	60
3.3.3	Convergence of the massive Green function	62
3.3.4	Convergence of martingale observables	65
3.4	Estimates and computations in continuum	70
3.4.1	A priori estimates and massive Poisson kernels	70
3.4.2	Hadamard's formula	72
3.4.3	Driving term of mSLE(2)	76
3.4.4	Proof of Theorem 3.1.1	79
4	Capacity of the range of tree-indexed random walk	81
4.1	Introduction	81
4.2	Preliminaries	84
4.2.1	Trees and spatial trees	84
4.2.2	The infinite model	84
4.2.3	Estimates on random walks and Green's functions	88
4.2.4	Capacity	91

4.2.5	Strong mixing property for functions of the Brownian motion	94
4.3	The super-critical dimensions	97
4.3.1	Estimates on Green's functions	98
4.3.2	Limit theorem for the infinite model	99
4.3.3	Proof of Theorem 4.1.1 (1)	100
4.4	The critical dimension	101
4.4.1	Estimates on Green's functions	102
4.4.2	Limit theorem for the infinite model	110
4.4.3	Proof of Theorem 4.1.1 (2)	114
5	Crossing estimates for simple conformal loop ensembles	117
5.1	Introduction	117
5.1.1	Background on CLEs	117
5.1.2	Super-exponential decaying crossing estimates for non-nested simple CLE	118
5.1.3	Convergence of probabilities of cylindrical events for double-dimers	120
5.2	Notations and Preliminaries	122
5.2.1	Clusters, crossing and component number	122
5.2.2	The Brownian loop measure	124
5.2.3	Loop-soup construction of CLE	125
5.2.4	Outline of the proof	126
5.3	Component Number and Cluster Number	127
5.3.1	Component number	127
5.3.2	Cluster number	128
5.3.3	Super-exponential decay of the cluster number	129
5.3.4	Proof of the recursive inequality (5.3.11).	131
5.4	Proof of Theorem 5.1.1	136
5.5	Proof of Corollary 5.1.3	140
5.6	Proof of Corollary 5.1.5	143
6	Massive fermions and their bosonization in rough planar domains	147
6.1	Notations and basic facts	147
6.1.1	Massive s-holomorphicity	148
6.1.2	Regularity estimates of s-holomorphic functions	150
6.2	Continuous Spinors and Convergence	150
6.2.1	Massive holomorphic functions	151
6.2.2	Boundary value problem and uniqueness	152
6.2.3	Convergence of discrete massive s-holomorphic observables	155
6.3	From fermionic observables to energy densities and dimer height fluctuations	158

1 - Introduction générale en français

Cette thèse porte sur l'analyse de certains modèles de mécanique statistique, dans le cadre probabiliste, pour étudier le comportement macroscopique de grands ensembles à partir de leurs descriptions microscopiques. Les techniques principales que nous utilisons dans cette thèse proviennent de la théorie du potentiel, c'est-à-dire des propriétés des fonctions harmoniques, que ce soit en discret ou en continu, du point de vue probabiliste ou analytique. Plus précisément, dans cette thèse, nous étudions

- les limites d'échelle des marches aléatoires massives à boucles effacées en dimension deux ;
- la capacité des marches aléatoires branchantes au-dessus ou à la dimension critique ;
- estimations de croisements pour des ensembles de boucles conformes simples ;
- convergence de densités d'énergie dans le modèle d'Ising proches de la critique et de fluctuations de la hauteur des dimères.

L'étude de chacun des points mentionnés ci-dessus correspond à un chapitre de la thèse. Dans le présent chapitre, nous introduisons les modèles susmentionnés, discutons leurs propriétés et présentons nos principaux résultats.

1.1 . Les limites d'échelle, l'universalité et l'invariance conforme

La limite d'échelle concerne le comportement d'un modèle de grilles dans la limite où la taille de la grille tend vers zéro. Comparés à la complexité de la structure microscopique des systèmes du monde réel, les modèles mathématiques sont inévitablement des " modèles-jouets " : des simplifications et des approximations importantes sont nécessaires pour les études théoriques. Néanmoins, le principe d'universalité observé suggère que les détails microscopiques n'influencent pas le comportement macroscopique des systèmes de mécanique statistique. Par conséquent, il est raisonnable d'utiliser des modèles de mécanique statistique pour décrire et approximer des systèmes du monde réel. Prenons le mouvement brownien comme exemple illustratif. D'après le théorème de Donsker, la somme partielle échelonnée d'une séquence de variables aléatoires i.i.d. de moyenne 0 et de variance 1 se rapprocherait du mouvement brownien. En fait, le théorème de Donsker ne révèle pas seulement l'universalité de la limite d'échelle des modèles discrets, il inspire également l'étude des limites d'échelle dans différentes classes d'universalité. En outre, diverses estimations de la marche aléatoire ou du mouvement brownien s'appliquent également à d'autres modèles : la fonction de Green, le noyau de Poisson, l'estimation de Beurling, etc.

Une grande partie de cette thèse est consacrée à l'étude des limites d'échelle de plusieurs modèles de physique statistique, ce qui constitue un projet global à la fois dans les communautés de physique et de mathématiques. Par conséquent, nous sommes

obligés de nous concentrer sur certains sujets spécifiques, constituant des contributions à la compréhension du comportement d'échelle et des transitions de phase en mécanique statistique. Il est intéressant de noter que ces modèles admettent une limite d'échelle conforme à la criticité, ce qui permet d'utiliser la théorie des champs conforme (CFT) ou les techniques d'évolution de Schramm-Loewner (SLE), même dans le régime quasi-critique. La CFT fournit des prédictions pour des quantités telles que les fonctions de corrélation de certaines observables, qui peuvent en principe être liées à des descriptions géométriques du système continuum limite comme les SLEs.

L'approche probabiliste de la mécanique statistique sur le grille fait appel à l'analyse complexe discrète, qui est accessible au traitement des domaines rugueux et du grille sous-jacent non-régulier, conduisant ainsi à l'universalité des déformations géométriques. Dans cette direction, on commence par une grille finie, en approchant un domaine donné comme la maille allant vers zéro. Contrairement à l'approximation de domaine, on peut aussi prendre d'abord la limite thermodynamique lorsque la taille d'un système fini tend vers l'infini, puis mettre à l'échelle le système entier. Néanmoins, il n'est pas toujours vrai que la limite thermodynamique et la limite d'échelle se commutent.

Les limites de volume infini des modèles discrets sont invariantes par rotation [DCKK+20]. À la criticité, les limites d'échelle présentent une invariance d'échelle, en raison du fait que les longueurs de corrélation des modèles critiques divergent. On peut également s'attendre à ce que les limites d'échelle des modèles critiques ne comportant que des interactions à courte portée soient invariantes par rapport aux mises à l'échelle et aux rotations locales : considérées dans des domaines de grille s'approchant d'un domaine continu Ω , lorsque l'espacement de la grille tend vers 0, elles convergent vers des objets invariants du point de vue de la conformité.

Sous perturbation des paramètres critiques, la longueur de corrélation est finie. Pour obtenir une limite significative du continuum, il faut faire passer le modèle à la criticité à une vitesse appropriée si l'espacement des grilles tend vers 0. Dans cette thèse, nous ne traitons que la température, c'est-à-dire la perturbation thermique, qui entraîne une perturbation de l'harmonicité et de la relation de Cauchy-Riemann.

La présente introduction est structurée de la manière suivante : nous présentons ci-dessous le contexte et nos contributions à certains modèles discrets. Les articles correspondants avec les preuves détaillées constituent les chapitres suivants comme une partie importante de la thèse.

1.2 . Les modèles discrets

Soit $G = (V, E)$ un graphe fini, où V est l'ensemble des sommets (fini ou infini) et E l'ensemble des arêtes. Chaque arête e peut être vue comme une paire de sommets $e = (wv)$, $w, v \in V$. Ici, w et v sont deux points d'extrémité de e . On dit que $w \sim v$ s'il existe $e \in E$ tel que $e = (wv)$. On définit $(\mu_{w,v})_{w,v \in V}$ comme étant la matrice d'adjacence de G , où

$$\mu_{w,v} = \begin{cases} 1 & \text{si } w \sim v \\ 0 & \text{si } w \not\sim v \end{cases} \quad \text{et} \quad \mu_w := \sum_{v \sim w} \mu_{wv}.$$

La marche aléatoire simple sur G associée à \mathcal{P} est un processus aléatoire $X = (X_n)_{n \in \mathbb{N}}$ tel que

$$\mathbb{P}(X_{n+1} = y | X_n = x) = \mu_{xy} / \mu_x.$$

Marche aléatoire à boucles effacées

La marche aléatoire à boucles effacées (LERW) a été introduite par Lawler pour étudier un modèle de polymère auto-évitant, la marche aléatoire avec la contrainte supplémentaire que le chemin ne doit pas se frapper lui-même. Bien que Lawler ait rapidement découvert que les deux objets sont intrinsèquement différents, le modèle LERW était intéressant avec de nombreux attributs d'autres modèles dans les phénomènes critiques : par exemple, il existe une dimension critique supérieure $d = 4$ (au-dessus de laquelle la limite d'échelle est le mouvement brownien) et la limite des petites mailles est conforme invariante en dimension deux.

Soit $\gamma = (x_0, x_1, \dots, x_n)_{n \geq 1}$ un chemin fini dans G , tel que $x_i \sim x_{i+1}$ pour tout $i = 0, \dots, n-1$. On dit que γ est auto-évitant si les points x_0, \dots, x_n sont distincts. L'effacement de boucle de γ , noté par $\mathfrak{L}(\gamma)$, est défini en effaçant les boucles de γ dans l'ordre chronologique :

1. Soit $\gamma_0 = (x_0)$.
2. Pour tout $k = 0, \dots, n-1$, définissez récursivement l'effacement de boucle du chemin (x_0, \dots, x_{k+1}) . Si $\gamma_k + (x_{k+1})$ est auto-évitant, définir $\gamma_{k+1} = \gamma_k + (x_{k+1})$. Sinon, on définit

$$j = \min\{i : y_i = x_{k+1}\} \text{ et } \gamma_{k+1} = (y_0 \dots y_j).$$

3. L'élément $\mathfrak{L}(\gamma)$ est défini par γ_n .

On peut également définir de manière similaire l'effacement de boucle arrière de γ en effectuant la procédure ci-dessus sur le chemin $(x_n, x_{n-1}, \dots, x_0)$. Nous introduisons maintenant la marche aléatoire à boucles effacées : l'effacement de boucle (un chemin aléatoire auto-évitant) de la marche aléatoire simple $X_0 = x, X_1, X_2, \dots$ sur G à partir de x . Pour tout sous-ensemble $A \subset V$, on désigne également par $\text{LERW}(x, A)$ la marche aléatoire à boucles effacées de x à A , qui est l'effacement de boucle de $(X_0, X_1, \dots, X_{T_A})$, avec T_A le temps de première atteinte de A . LERW satisfait également la propriété de Markov de domaine comme d'autres modèles de physique statistique, bien que la preuve ne soit pas complètement triviale, pour laquelle nous devons attacher des boucles dans des domaines propres au chemin simple pour obtenir le poids du chemin sous la mesure de LERW [LJ08, Theorem 4].

LERW représente le premier succès dans l'établissement rigoureux de l'invariance conforme de certains modèles de physique statistique, pour lesquels la limite SLE_κ , $\kappa = 2, 8$, sera définie dans la section 1.3.

Theorem 1.2.1 (Lawler, Schramm et Werner). *Étant donné un domaine borné simplement connexe Ω contenant 0, on considère γ^δ la mesure de boucle d'une marche aléatoire simple dans $\Omega \cap \delta\mathbb{Z}^2$, démarrée de 0 et arrêtée au premier temps de sortie de Ω . Nous dotons l'ensemble des chemins de la métrique uniforme modulo la reparamétrisation temporelle :*

$$d(\gamma, \tilde{\gamma}) = \inf_{\varphi} \sup_{t \geq 0} |\gamma(t) - \tilde{\gamma}(\varphi(t))|$$

où le inf est sur tous les homéomorphismes croissants de $[0, \infty)$. Alors, γ^δ converge faiblement comme $\delta \rightarrow 0$ vers une limite ayant la loi de la SLE₂ dans Ω .

Dans le chapitre 3, nous étudions la marche aléatoire à boucles effacées massives (mLERW), qui est l'effacement de boucles d'une marche aléatoire symétrique sur la grille carrée $\delta\mathbb{Z}^2$ avec un taux de meurtre m , $m \geq 0$. En suivant la stratégie proposée par Makarov et Smirnov [MS10], nous prouvons le résultat suivant.

Theorem 1.2.2. *Soit $(\Omega^\delta; a^\delta, b^\delta)$ des approximations discrètes d'un domaine borné simplement connexe $(\Omega; a, b)$ avec deux points limites marqués a, b . Pour chaque $m > 0$, la limite d'échelle γ de mLERW sur $(\Omega^\delta; a^\delta, b^\delta)$ existe, donnée par une évolution chordale de Schramm-Loewner dont le terme moteur ξ_t satisfait la SDE*

$$d\xi_t = \sqrt{2}dB_t + 2\lambda_t dt, \quad \lambda_t = \frac{\partial}{\partial(g_t(a_t))} \log \frac{P_{\Omega_t}^{(m)}(a_t, z)}{P_{\Omega_t}(a_t, z)} \Big|_{z=b}, \quad (1.2.1)$$

où $P_{\Omega_t}^{(m)}(a_t, \cdot)$ et $P_{\Omega_t}(a_t, \cdot)$ désignent les noyaux de Poisson massif et classique dans le domaine $\Omega_t := \Omega \setminus \gamma[0, t]$, et la dérivée logarithmique par rapport à a_t est prise dans le graphe de Loewner $g_t : \Omega_t \rightarrow \mathbb{H}$.

Remark 1.2.3. La SDE (1.2.1) possède une solution faible unique dont la loi est absolument continue par rapport à $\sqrt{2}B_t$. En d'autres termes, ces limites d'échelle sont absolument continues par rapport à l'évolution classique de Schramm-Loewner avec $\kappa = 2$.

Marches aléatoires branchantes

Les marches aléatoires branchées sont indexées par les processus de Galton-Watson (GW), décrivant la croissance de la population si chaque individu donne naissance indépendamment à un nombre aléatoire de enfants avec la même distribution de descendance μ sur \mathbb{N} et meurt à la génération suivante.

Definition 1.2.4. *Un processus de Galton-Watson $(Z_n)_{n \geq 0}$ est défini de manière récurrente par*

$$Z_0 = 1, \quad Z_{n+1} = \sum_{i=1}^{Z_n} \xi_i^{(n)},$$

où $\{\xi_i^{(n)} : n, i \in \mathbb{N}\}$ est une famille de variables aléatoires évaluées par des nombres naturels, indépendantes et identiquement distribuées selon μ .

Soit L une variable aléatoire suivant la loi μ et

$$m := \mathbb{E}_\mu[L] = \sum_{k \in \mathbb{N}} k\mu(k)$$

est le nombre moyen d'enfants de chaque particule. Le fait le plus fondamental et le plus connu concernant les processus de branchement est que la probabilité d'extinction $\lim_{n \rightarrow \infty} \mathbb{P}[Z_n = 0]$ est égale à 1 si et seulement si $m < 1$ ou $m = 1, \mu(1) < 1$.

Pour chaque processus GW, on peut associer un arbre généalogique à cette croissance de population, que l'on appelle l'arbre de Galton-Watson. Nous rappelons le formalisme de Neveu [Nev86] pour les arbres enracinés ordonnés $T \subset \bigcup_{n \geq 0} \mathbb{N}_+^n$:

- la racine $\emptyset \in T$ avec la convention que $\mathbb{N}_+^0 = \{\emptyset\}$;
- pour une séquence $u = (u_1, \dots, u_{n-1}, u_n) \in T$, son parent $(u_1, \dots, u_{n-1}) \in T$;
- pour chaque séquence (noeud) $u = (u_1, \dots, u_n) \in T$, il existe un entier $k_u(T) \geq 0$ qui est appelé son nombre de descendants, tel que pour chaque $j \in \mathbb{N}$, $(u_1, \dots, u_n, j) \in T$ si et seulement si $1 \leq j \leq k_u(T)$.

Pour une suite $u = (u^1, \dots, u^n) \in T$, nous fixons $|u| = n$ la distance de u à la racine dans T avec la convention $|\{\emptyset\}| = 0$. Nous désignons un ordre partiel pour $u = (u^1, \dots, u^n) \in T$ et $w = (w^1, \dots, w^{n'}) \in T$ appelé ordre généalogique par $u \prec w$ si $n < n'$ et $u^i = w^i, 1 \leq i \leq n$. On considère l'ordre lexicographique sur T : pour $u, v \in T$, on pose $v < u$ si soit $v \prec u$, soit $u = (u^1, \dots, u^k), v = (v^1, \dots, v^k), u^i < v^i$ pour la première position i où les deux séquences se distinguent. Désignons par

$$u_0 = \emptyset, u_1, u_2, \dots, u_{\#(T)-1}$$

les éléments de T énumérés dans l'ordre lexicographique, où $\#(T)$ est la taille de l'arbre.

Si l'on considère chaque noeud de l'arbre T comme un sommet, et que l'on ajoute une arête entre un noeud et son parent, alors on peut voir T comme un graphe abstrait. Si nous attachons un vecteur \mathbf{d}_u dans \mathbb{Z}^d à chaque arête, fixons la position de la racine à $X_\emptyset = 0$ et laissons $X_u = \sum_{u' \preceq u} \mathbf{d}_{u'}$, alors $(X_u)_{u \in T}$ fournit une structure arborescente spatiale. Étant donné une loi de descendance μ sur \mathbb{N} et une loi θ sur \mathbb{Z}^d , la *marche aléatoire branchante* (BRW), dont la loi de probabilité est notée $P_{\mu, \theta}$, est définie par la relation suivante

$$k_u \stackrel{i.i.d.}{\sim} \mu, \mathbf{d}_u \stackrel{i.i.d.}{\sim} \theta.$$

Il est naturel d'étudier les sites de la grille visités par une marche aléatoire branchante, que l'on appelle la *range* de la BRW. L'asymptotique de la cardinalité (nombre de sites distincts) de la range de la BRW a été étudiée récemment.

Theorem 1.2.5 (Le Gall et Lin (2014)). *La dimension critique pour la range de BRW est $d = 4$. Conditionnée à la taille n de l'arbre indexé sous $P_{\mu, \theta}$, soit R_n le nombre de sites distincts visités par la marche aléatoire branchante. Si μ est critique avec une variance finie, et θ est symétrique avec un support fini et n'est pas supporté sur un sous-groupe strict de \mathbb{Z}^d , alors comme $n \rightarrow \infty$,*

- si $d \geq 5$, il existe $c_{\mu, \theta} > 0$ tel que $\frac{1}{n}R_n \rightarrow c_{\mu, \theta}$ en probabilité;
- si $d = 4$, $\frac{\log n}{n}R_n \xrightarrow{L^2} 8\pi^2\sigma^4$, où $\sigma^2 = (\det M_\theta)^{1/4}$, avec M_θ étant la matrice de covariance de θ ;
- if $d \leq 3$, $n^{-d/4}R_n \xrightarrow{(d)} 2^{d/4}\sqrt{\det M_\theta} \lambda_d(\text{supp}\mathcal{I})$, où λ_d représente la mesure de Lebesgue du support de la mesure aléatoire \mathcal{I} sur \mathbb{R}^d connue sous le nom d'Excursion Super-Brownienne Intégrée.

Dans cette direction, nous étudions la BRW du point de vue de la théorie du potentiel par la capacité, qui peut être vue comme une probabilité d'échappement pour les marches aléatoires, dépendant fortement de sa géométrie. Étant donné une loi de probabilité η sur \mathbb{Z}^d , $d \geq 3$, la capacité d'un ensemble fini $A \subseteq \mathbb{Z}^d$ par rapport à η est définie par

$$\text{cap}_\eta A := \sum_{x \in A} P_x^\eta(\tau_A^+ = \infty) = \lim_{|y| \rightarrow \infty} \frac{P_y^\eta(\tau_A < \infty)}{G_d(0, y)},$$

où P_x^η désigne la loi d'une marche aléatoire $(S_n)_{n \in \mathbb{N}}$ issue de x avec probabilités de transition η , $\tau_A := \inf\{n \geq 0 : S_n \in A\}$ et $\tau_A^+ := \inf\{n \geq 1 : S_n \in A\}$. Pour la capacité de une SRW sur \mathbb{Z}^d , il existe une étude systématique par Asselah, Schapira et Sousi (voir [ASS18, ASS19] pour d'autres références et les motivations des interlacements aléatoires).

Dans le chapitre 4, nous étudions la capacité de la range de telles marches aléatoires. En se basant sur la configuration introduite par Le Gall et Lin [LGL15a], nous établissons le résultat suivant en introduisant une nouvelle mesure pour le processus de Galton-Watson infini et en utilisant les probabilités d'intersection des marches aléatoires. En gros, conditionné par l'arbre de Galton-Watson indexé T avec une loi de descendance μ ayant exactement n nœuds, sous certaines hypothèses techniques sur μ, η, θ , nous avons

Theorem 1.2.6. 1. En dimension $d \geq 7$, il existe une constante $C(d, \mu, \theta, \eta) > 0$ telle que sous $P_{\mu, \theta}(\cdot | \#T = n)$, si $n \rightarrow \infty$,

$$\frac{\text{cap}_\eta R}{n} \rightarrow C(d, \mu, \theta, \eta) \text{ en probabilité.}$$

2. En dimension $d = 6$, sous $P_{\mu, \theta}(\cdot | \#T = n)$, si $n \rightarrow \infty$,

$$\frac{\log n}{n} \text{cap}_\eta R \rightarrow 2(C_G)^{-1} \text{ en probabilité,}$$

où

$$C_G = \frac{1}{4\pi^6 \sqrt{\det \Gamma_\eta \det \Gamma_\theta}} \left(\sum_{k=0}^{\infty} (k-1)k\mu(k) \right) C_f,$$

$$C_f = \mathbb{E} \left[\int_1^e dt \int_{\mathbb{R}^6} dx \cdot J_\eta(B_t^\theta + x)^{-4} J_\theta(x)^{-4} \right],$$

$\Gamma_\eta, \Gamma_\theta$ sont les matrices de covariance de η, θ respectivement, $J_{(\cdot)}(x) = \sqrt{x \cdot \Gamma_{(\cdot)}^{-1} x}$, et B_t^θ est le mouvement brownien dans \mathbb{R}^6 avec la matrice de covariance Γ_θ .

Le modèle d'Ising et de dimères

Le modèle *Ising* avec interaction ferromagnétique entre les plus proches voisins est l'un des modèles de grille les plus étudiés dans le contexte des mathématiques et de la physique. Étant donné un graphe fini, *planaire* encastré $G = (V, E, F)$, avec ou sans frontière, la fonction de partition du modèle d'Ising (avec des spins situés sur les faces) avec des constantes de couplage $(J_e)_{e \in E}$ est définie par

$$Z_{\text{Ising}}(G, J) := \sum_{\sigma \in \{-1, 1\}^F} \exp \left(\beta \sum_{u \sim w} J_{(uw)^\circ} \sigma_u \sigma_w \right),$$

où la somme à l'intérieur de l'exponentielle est prise sur toutes les faces adjacentes de G et $(uw)^\circ$ désigne le bord dual correspondant de G . La loi de probabilité sur l'ensemble des configurations de spin $\{-1, 1\}^F$ est donc définie par la mesure de Boltzmann

$$\mathbb{P}_{G, J}[\sigma] = \exp \left(\beta \sum_{u \sim w} J_{(uw)^\circ} \sigma_u \sigma_w \right) \cdot (Z_{\text{Ising}}(G, J))^{-1}, \quad \forall \sigma \in \{-1, 1\}^F.$$

Il a été introduit par Lenz [Len20], et résolu par son doctorant Ising en dimension un [Isi25], suggérant l'absence de transition de phase dans ce cas. Une décennie plus tard, Peierls [Pei36] a confirmé l'existence d'une transition de phase en deux dimensions, contrairement à la croyance commune de l'époque selon laquelle le modèle d'Ising plan n'admet pas de transition de phase. Étant l'un des modèles de grille les plus simples présentant une transition de phase ordre-désordre, le modèle d'Ising planaire est exactement soluble dans un sens très fort. À savoir, en l'absence de champ magnétique externe, sa fonction de partition peut être écrite comme le Pfaffien d'une matrice antisymétrique.

Un autre modèle de physique statistique possédant une caractéristique de solvabilité exacte similaire est le modèle *dimère* des couplages parfaits sur des graphes biparties planaires G , qui représente l'adsorption de molécules diatomiques sur des surfaces cristallines. Étant donné une fonction de poids positive $\nu = (\nu_e)$ attribuée aux arêtes de G , la loi de probabilité sur l'ensemble des configurations de dimères \mathcal{M} est définie par

$$\mathbb{P}_{\text{dimer}}(M) = \frac{\prod_{e \in M} \nu_e}{Z_{\text{dimer}}(G, \nu)}, \quad M \in \mathcal{M},$$

où $Z_{\text{dimer}}(G, \nu) = \sum_M \prod_{e \in M} \nu_e$ avec la somme sur tous les couplages parfaits de G . Outre sa signification physique, le modèle du dimère est populaire en raison de ses correspondances avec le modèle d'Ising planaire et les arbres couvrants uniformes. Pour les graphes planaires, Kasteleyn a montré que la fonction de partition du modèle du dimère peut être exprimée comme le Pfaffien d'une matrice d'adjacence proprement signée et pondérée pour le graphe, c'est-à-dire la matrice de Kasteleyn. Pour une fonction de poids générale (c'est-à-dire pas nécessairement positive) $\nu = (\nu_e)$, on peut également définir la fonction de partition

$$Z_{\text{dimer}}(G^Q, \nu) = \sum_M \prod_{e \in M} \nu_e,$$

bien que dans ce cas, on ne puisse pas obtenir une mesure de probabilité.

1.3 . L'évolution de Schramm-Loewner et l'ensemble de boucles conforme

L'évolution de Schramm-Loewner

L'évolution de Schramm-Loewner $(SLE_\kappa)_{\kappa \geq 0}$ est une famille à un paramètre de mesures de probabilité sur des courbes à croissance continue dans des domaines simplement connectés du plan complexe, avec un point d'arrivée prescrit sur la frontière. Le point d'arrivée peut se trouver soit à l'intérieur, soit sur la frontière, ce qui correspond aux versions radiale et chordale de SLE. La SLE a été introduite de manière révolutionnaire (en changeant la façon dont les mathématiciens et les physiciens voient les phénomènes critiques en deux dimensions) par Oded Schramm en tant que candidat pour les limites d'échelle des interfaces des modèles planaires discrets en physique statistique, parmi lesquels les modèles LERW/SLE₂ mentionnés ci-dessus. On sait également que les interfaces du modèle d'Ising et du modèle FK-Ising convergent vers SLE₃ et SLE _{$\frac{18}{5}$} [CDCH⁺14]; les lignes de niveau du champ libre gaussien discret convergent vers SLE₄ [SS09] et les interfaces de la percolation convergent vers SLE₆ [Smi01]. De plus, en se basant sur la propriété de localité de la marche auto-évitante, si l'existence et l'invariance conforme de sa limite d'échelle sont vraies, elle devrait être décrite par le modèle SLE _{$\frac{8}{3}$} [LSW04b]. Ces modèles présentent la propriété de Markov de domaine et l'invariance conforme à grande échelle à la criticité, prédite précédemment par les physiciens, ce qui inspire et peut être traité comme la définition de SLE. Rappelons qu'une transformation conforme est une bijection entre domaines dans le plan complexe qui préserve les angles. Le théorème de cartographie de Riemann nous dit qu'il existe une carte conforme entre tout domaine non vide et simplement connecté et le demi-plan supérieur \mathbb{H} . Elle est unique en spécifiant l'image d'un point intérieur et d'un point sur la frontière.

L'invariance conforme : Étant donné un domaine simplement connecté Ω , et $\phi : \Omega \rightarrow \mathbb{H}$ conforme, alors la loi de SLE _{κ} ^{Ω} le processus SLE défini sur Ω est préservée sous la transformation :

$$\phi(SLE_\kappa^\Omega) \stackrel{(d)}{=} SLE_\kappa^{\mathbb{H}}.$$

Propriété de Markov de domaine : SLE _{κ} sur \mathbb{H} possède la propriété de Markov de domaine si, conditionnellement à $\gamma[0, t]$, $\gamma[t, \infty) \stackrel{d}{=} \tilde{\gamma}$ où $\tilde{\gamma}$ est la SLE sur $\mathbb{H} \setminus \gamma[0, t]$.

Une définition rigoureuse de SLE consiste à encoder les courbes qui croissent à partir de la frontière par l'équation de Loewner, inventée par Loewner pour résoudre la conjecture de Bieberbach sur les cartes conformes (fonctions holomorphes non équivalentes). Par invariance conforme de la SLE, il suffit de la définir sur le demi-plan supérieur \mathbb{H} , et de l'appliquer de manière conforme à tout domaine simplement connexe du plan complexe par le théorème d'uniformisation de Riemann. La courbe SLE _{κ} γ s'accroissant à partir de 0 peut être paramétrée par la capacité du demi-plan

$$\text{hcap}(\gamma[0, t]) = 2 \lim_{y \rightarrow \infty} y \mathbb{E}_{iy} [\text{Im}(B_{\tau(\gamma[0, t])})],$$

où $\tau(\gamma[0, t])$ est le temps de première atteinte du mouvement brownien parti de iy avant d'atteindre la ligne réelle. Soit g_t la "fonction de sortie" de $\gamma[0, t]$. de $\gamma[0, t]$, c'est-à-dire

l'unique transformation conforme $g_t : \mathbb{H}_t \rightarrow \mathbb{H}$, où \mathbb{H}_t est la composante connexe infinie de $\mathbb{H} \setminus \gamma[0, t]$, avec $g_t(z) = z + \frac{2t}{z} + o(\frac{1}{t})$ comme $z \rightarrow \infty$. Alors g_t satisfait

$$\dot{g}_t(z) = \frac{2}{g_t(z) - \sqrt{\kappa}B_t},$$

où $\sqrt{\kappa}(B_t)_{t \geq 0}$, appelée la fonction de moteur de SLE_{κ} , est une mise à l'échelle par $\sqrt{\kappa}$ du mouvement brownien standard.

La définition de la SLE dépend de l'orientation du tracé de la courbe. Cependant, les modèles discrets suggèrent qu'elle devrait être réversible. Ce fait non trivial a été prouvé pour la première fois par Zhan pour $\kappa \leq 4$ [Zha08a], plus tard Miller et Sheffield l'ont étendu à $\kappa \in (0, 8)$ en considérant les courbes SLE comme des lignes de flux du champ libre gaussien [MS16a, MS16b, MS16c].

Les courbes SLE sont fractales. Pour la limite d'échelle d'un modèle discret à la criticité, le système présente un comportement auto-similaire : la configuration est similaire si l'on "zoome". Remarquablement, si $\kappa < 8$, les trajectoires SLE_{κ} ont une dimension de Hausdorff $d = 1 + \kappa/8$ presque sûrement [Bef08]. La mesure de Hausdorff et d'autres propriétés géométriques des courbes SLE peuvent être mesurées par leurs exposants de bras (exposants exponentiels de la probabilité qu'il existe n traversées disjointes de l'anneau $A_z(r, R) := \{w \in \mathbb{C} : r < |w - z| < R\}$ lorsque $r \rightarrow 0$), calculés rigoureusement par Wu et Zhan [WZ17] via des martingales locales fondamentales associées aux SLE.

Ensemble de boucles conforme

L'ensemble de boucles conforme CLE_{κ} , $\kappa \in (8/3, 8)$, est une famille de la mesure invariante par des transformations conformes sur des collections dénombrables de boucles de type SLE_{κ} dans un domaine simplement connexe. Comme expliqué dans [SW12], si ces boucles sont simples, ce qui correspond à $\kappa \in (8/3, 4)$, CLE_{κ} peut être construit en termes de limites extérieures des amas de boucles les plus extérieurs dans une soupe de boucles browniennes à intensité sous-critique. Une autre construction est due à Sheffield qui utilise des variantes des processus $\text{CLE}_{\kappa}(\kappa - 6)$ pour $8/3 < \kappa < 8$.

Le CLE décrit, dans la limite d'échelle, des modèles de physique statistique à la température critique, qui peuvent être interprétés comme des collections aléatoires de boucles disjointes et non autocroisées. Rappelant les modèles discrets, elle est caractérisée par la *propriété de Markov conforme* : considérons $\text{CLE}_{\kappa}(\mathbb{U})$ sur le disque unitaire \mathbb{U} , et pour un sous-ensemble $U \subset \mathbb{U}$, obtenons \tilde{U} en retirant de Ω toutes les boucles $\text{CLE}(\Omega)$ (et leur intérieur) qui ne restent pas entièrement dans U . Alors dans chaque composante connexe C de \tilde{U} , pour la carte conforme $\phi_C : C \rightarrow \mathbb{U}$, il s'avère que

$$\phi_C(\text{CLE}_{\kappa}(\mathbb{U})) \stackrel{(d)}{=} \text{CLE}_{\kappa}(C)$$

Observez que prendre $U = \emptyset$ donne l'invariance sous transformation de Möbius pour le CLE, ce qui nous permet de définir le CLE sur tout domaine simplement connexe Ω par

$$\text{CLE}_{\kappa}(\Omega) \stackrel{(d)}{=} \phi_{\Omega}^{-1}(\text{CLE}_{\kappa}(\mathbb{U})),$$

où ϕ_Ω est la carte conforme de Ω à \mathbb{U} quitte à prendre transformations de Möbius du disque unitaire.

Il est démontré que CLE_κ est la limite d'échelle du modèle critique d'Ising $\kappa = 3$ [BH19], de la percolation de FK-Ising $\kappa = 16/3$ [KS16], et de la percolation de site critique sur le treillis triangulaire $\kappa = 6$ [CN06]. Pour le modèle Ising/FK-Ising, le couplage Edwards-Sokal est un outil important qui les relie, et qui correspond à $\text{CLE}_3/\text{CLE}_{\frac{16}{3}}$ dans le continuum. Ce couplage a été généralisé pour $\kappa \in (8/3, 4)$ par Miller, Sheffield et Werner pour $\text{CLE}_\kappa/\text{CLE}_{\kappa'}$, $\kappa' = 16/\kappa$ purement dans le contexte des CLEs [MSW20].

Alors que la SLE, encodée par une fonction motrice unidimensionnelle, est accessible au calcul d'Ito, le CLE permet des calculs précis en imposant un champ libre gaussien (GFF) indépendant sur le CLE. Il en résulte une surface de gravité quantique de Liouville (dotée d'une métrique et d'une mesure données par le GFF) décorée de CLE, ce qui rappelle les cartes planaires aléatoires décorées du modèle à boucles $O(n)$, voir [AS21] pour les études concernées.

Dans le chapitre 5, nous obtenons la décroissance super-exponentielle pour le nombre de croisements de CLE. Les outils principaux que nous utilisons sont la propriété de Markov conforme via la construction de la soupe de boucles browniennes des CLEs.

Nos résultats

Dans le chapitre 6, après une analyse des conditions aux bords de type Riemann pour les fonctions holomorphes massives dans des domaines rugueux, nous étendons les résultats de convergence obtenus dans [Par21] pour les observables fermioniques de base à des observables générales. Du point de vue du modèle d'Ising, cela nous permet également de prouver la convergence des corrélateurs de densité d'énergie dans le cas massif. Du point de vue du modèle de dimère associé, les observables fermioniques ne sont rien d'autre que les entrées de la matrice inverse de Kasteleyn (2.5.4). Cela implique que les corrélations des gradients des fluctuations des fonctions de hauteur correspondantes dans les domaines de hérissons peuvent être écrites en termes de corrélateurs fermioniques issus du modèle d'Ising massif. Cela révèle le formalisme de la correspondance de Coleman au point de fermion libre (par exemple, voir [BW21]) et suggère que la limite des fonctions de hauteur en question est donnée par une théorie de sinus-Gordon dans le domaine limite avec des conditions au bord de Dirichlet.

2 - Introduction

This thesis is dedicated to the analysis of some statistical mechanics models, within the probability framework to study macroscopic behavior of large ensembles starting from their microscopic descriptions. The main techniques that we use in this thesis come from the potential theory, i.e., from the properties of harmonic functions, both in discrete and in continuum, from the probabilistic or analytic point of view. More precisely, in this thesis we investigate

- the scaling limits of massive loop-erased random walks in dimension two;
- the capacity of branching random walks above or at the critical dimension;
- crossing estimates for simple conformal loop ensembles;
- convergence of near-critical Ising energy densities and dimer height fluctuations.

The study of each of the items mentioned above corresponds to one chapter of the thesis. In the current chapter, we introduce the aforementioned models, discuss their properties and present our main results.

2.1 . Scaling, universality and conformal invariance

The scaling limit concerns the behavior of a lattice model in the limit as the mesh size goes to zero. Compared with the complexity of microscopic structure of real-world systems, the mathematical models are inevitably "toy-models": significant simplifications and approximations are needed for theoretical studies. Nevertheless, the observed *universality* principle suggests that microscopic details do not influence macroscopic behavior of statistical mechanics systems. Therefore, it is reasonable to use statistical mechanics models to describe and approximate real-world systems. Take Brownian motion as an illustrative example. According to Donsker's theorem, the scaled partial sum of a sequence of i.i.d. random variables with mean 0 and variance 1 would approach the Brownian motion. As a matter of fact, Donsker's theorem not only reveals universality in the scaling limit of discrete models, it also inspires the study of scaling limits in different universality class. Beyond that, various random walk or Brownian motion estimates also apply to other models: Green's function, Poisson kernel, Beurling's estimate, etc..

A large part of this thesis is devoted to the study of the scaling limits of several statistical physics models, which is a comprehensive project both in physics and mathematics communities. Therefore we are forced to concentrate ourselves on some specific topics, constituting contributions to the understanding of the scaling behavior and phase transitions in statistical mechanics. It is worth noting that those models admit a conformally invariant scaling limit at criticality, which allows to use Conformal Field Theory (CFT) or Schramm-Loewner evolution techniques, even in the near-critical regime. CFT provides predictions for quantities like the correlation functions of certain observables, which in

principle can be related to geometric descriptions of the limiting continuum system like SLEs.

The probabilistic approach to statistical mechanics on the lattice involves discrete complex analysis, which is accessible to the treatment of rough domains and non-regular underlying lattice, thus leading to the universality of geometric deformations. In this direction, we start with a finite lattice, approximating a given domain as the mesh size going to zero. Contrast to domain approximation, one can also take first the thermodynamic limit as the size of a finite system goes to infinity and then scale the whole system. Nevertheless, it is not always true that thermodynamic limit and scaling limit commute.

The infinite-volume limits of discrete models are rotationally invariant [DCKK⁺20]. At criticality, the scaling limits exhibit scaling-invariance, due to the fact that the correlation lengths of critical models diverge. One may also expect that the scaling limits of critical models with only short-range interactions enjoy invariance under local scalings and rotations: considered in lattice domains approximating a continuous domain Ω as the lattice spacing goes to 0, they converge to conformally invariant objects.

Under perturbation of the critical parameters, the correlation length is finite. To obtain a meaningful continuum limit, one needs to send the model to criticality at a proper rate if the lattice spacing goes to 0. In this thesis we only tune the temperature, namely the thermal perturbation, which results in a perturbation of the harmonicity and the Cauchy-Riemann relation.

The present introduction is structured as follows: below, we shall provide backgrounds and our contributions to some discrete models. The corresponding papers with detailed proofs constitute the following chapters as a major part of the thesis.

2.2 . Loop-erased random walks and uniform spanning trees

Let $G = (V, E)$ be a finite graph, where V is the set of vertices (finite or countably infinite) and E is the set of edges. Each edge e can be seen as a pair of vertices $e = (wv)$, $w, v \in E$. Here w and v are two endpoints of e . We say $w \sim v$ if there exists $e \in E$ such that $e = (wv)$. Set $(\mu_{w,v})_{w,v \in E}$ to be the adjacency matrix of G , where

$$\mu_{w,v} = \begin{cases} 1 & \text{if } w \sim v \\ 0 & \text{if } w \not\sim v \end{cases} \quad \text{and} \quad \mu_w := \sum_{v \sim w} \mu_{wv}.$$

The simple random walk on G associated with \mathcal{P} is a random process $X = (X_n)_{n \in \mathbb{N}}$ such that

$$\mathbb{P}(X_{n+1} = y | X_n = x) = \mu_{xy} / \mu_x.$$

Loop-erased random walk

Loop-erased random walk (LERW) was introduced by Lawler to study a self-avoiding polymer model, the random walk with the additional constraint that the path must not hit itself [Law80]. Although Lawler soon discovered that the two objects are intrinsically different, LERW was interesting itself with many of the attributes of other models in critical phenomena: for instance, there was an upper critical dimension $d = 4$ (above which

the scaling limit is Brownian motion) and the small-mesh limit is conformally invariant in dimension two.

Let $\gamma = (x_0, x_1, \dots, x_n)_{n \geq 1}$ be a finite path in G , such that $x_i \sim x_{i+1}$ for all $i = 0, \dots, n-1$. We say that γ is self-avoiding if the points x_0, \dots, x_n are distinct. The (forward) loop erasure of γ , denoted by $\mathfrak{L}(\gamma)$, is defined by erasing loops of γ in chronological order:

1. Set $\gamma_0 = (x_0)$.
2. For all $k = 0, \dots, n-1$, define recursively the loop erasure of the path (x_0, \dots, x_{k+1}) . If $\gamma_k + (x_{k+1})$ is self-avoiding, set $\gamma_{k+1} = \gamma_k + (x_{k+1})$. Otherwise set

$$j = \min\{i : y_i = x_{k+1}\} \text{ and } \gamma_{k+1} = (y_0 \dots y_j).$$

3. $\mathfrak{L}(\gamma)$ is set to be γ_n .

One can also define similarly the backward loop erasure of γ by performing the procedure above to the path $(x_n, x_{n-1}, \dots, x_0)$. Now we introduce the loop-erased random walk: the loop-erasure (a random self-avoiding path) of the simple random walk $X_0 = x, X_1, X_2, \dots$ on G started from x . For any $A \subset V$, denote also by $\text{LERW}(x, A)$ the loop-erased random walk from x to A , which is the loop-erasure of $(X_0, X_1, \dots, X_{T_A})$, with T_A to be the first hitting time of A . LERW also satisfies the domain Markov property like other statistical physics models, although the proof is not completely trivial, for which we need to attach loops in proper domains to the simple path to get the path weight under the LERW measure [LJ08, Theorem 4].

The loop-erased random walk is quantitatively related to the simple random walk. Let G be a subgraph of \mathbb{Z}^2 . Denote by ∂G the boundary vertices of G . Given $x^1, \dots, x^k, y^1, \dots, y^k \in \partial G$, denote by $\text{LERW}_G(x^i, y^i)$ the loop-erasure of a SRW, independent of each other, started from x^i , taking its first step into G and then leaving G at y^i . The following Fomin's identity expresses a "crossing probability" for loop-erased random walks as the determinant of simple random walk probabilities:

$$\mathbb{P}[\text{LERW}_G(x^i, y^i), i = 1, \dots, k \text{ are disjoint}] = \det \begin{bmatrix} \frac{h_{\partial G}(x^1, y^1)}{h_{\partial G}(x^1, y^1)} & \dots & \frac{h_{\partial G}(x^1, y^k)}{h_{\partial G}(x^1, y^1)} \\ \vdots & \ddots & \vdots \\ \frac{h_{\partial G}(x^k, y^1)}{h_{\partial G}(x^k, y^k)} & \dots & \frac{h_{\partial G}(x^k, y^k)}{h_{\partial G}(x^k, y^k)} \end{bmatrix}$$

where $h_{\partial G}(x, y)$ denotes the probability that a simple random walk starting at x takes its first step into G and then leaves G at y .

Wilson's algorithm

Wilson's algorithm, generating a random spanning tree using loop-erased random walks, proceeds as follows:

1. Choose an ordering of $\{v_0, v_1, \dots, v_m\}$ of V .
2. Let $\mathcal{V}_0 = \{v_0\}$.

3. Given \mathcal{V}_k , run $\text{LERW}(v_{k+1}, \mathcal{V}_k)$ independently of everything before, and let

$$\mathcal{V}_{k+1} = \mathcal{V}_k \cup \text{LERW}(v_{k+1}, \mathcal{V}_k),$$

with the convention that $\mathcal{V}_{k+1} = \mathcal{V}_k$ if $v_{k+1} \in \mathcal{V}_k$.

4. Stop when there are no vertices left to add, that is $\mathcal{V}_k = V$.

It is clear that Wilson's algorithm generates a random spanning tree. In the simple random walk case, it is well known that Wilson's algorithm returns a spanning tree chosen uniformly at random. In fact, Wilson's algorithm can be used to generate random spanning trees following any reversible random walks for a given family of positive edge weights $\{w_e, e \in E\}$, whose transition probability is defined similarly for $y \sim x$:

$$\mathbb{P}(X_{n+1} = y | X_n = x) = w_{(xy)} / w_x, \quad \text{where } w_x := \sum_{x' \sim x} w_{(xx')}.$$

Then Gibbs weight of the resulting random tree T is given by

$$\mathbb{P}(T) = \frac{1}{Z} \prod_{e \in T} w_e,$$

where $Z = \sum_{T: \text{spanning tree}} \prod_{e \in T} w_e$ is the partition function (the normalizing constant).

Convergence results

LERW and UST represent the first success in establishing rigorously the conformal invariance of certain statistical physics model, for which the limiting SLE_κ , $\kappa = 2, 8$, shall be defined in Section 2.3.

Theorem 2.2.1 (Lawler, Schramm and Werner). *Given a bounded simply connected domain Ω containing 0, consider γ^δ the loop-erasure of a simple random walk in $\Omega \cap \delta\mathbb{Z}^2$, started from 0 and stopped at the first exit time of Ω . We endow the set of paths with the uniform metric modulo time-reparametrization:*

$$d(\gamma, \tilde{\gamma}) = \inf_{\varphi} \sup_{t \geq 0} |\gamma(t) - \tilde{\gamma}(\varphi(t))|$$

where the \inf is over all increasing homeomorphisms of $[0, \infty)$. Then, γ^δ converges weakly as $\delta \rightarrow 0$ to a limit having the law of the radial SLE_2 in Ω .

The description of the convergence for UST contour curves to SLE_8 requires more effort, for which we refer interested readers to [LSW04a].

Since the Hausdorff dimension of the limiting SLE_2 curve is $5/4$, which can be parametrized by $5/4$ -dimensional Minkowski content (called the natural parametrization of SLE_2), it is natural to consider the convergence of curves, parametrized so that each edge is traversed in time a universal constant \tilde{c} (allowed to be lattice dependent) times $\delta^{-5/4}$. Fix a bounded simply connected domain Ω with distinct boundary points a, b and for each δ , we take Ω^δ to be an appropriate simply connected component of $\delta\mathbb{Z}^2 \cap \Omega$ with boundary edges a^δ, b^δ approximating a, b .

Theorem 2.2.2 (Lawler and Viklund). *For each δ , let $(\gamma^\delta(t))_{t \in [0, T_{\gamma^\delta}]}$ be LERW in Ω^δ from a^δ to b^δ viewed as a continuous curve parametrized so that each edge is traversed in time $\check{c}\delta^{5/4}$. Let $(\text{SLE}_2(t))_{t \in [0, T_{\text{SLE}_2}]}$ be chordal SLE_2 in Ω from a to b parametrized by $5/4$ -dimensional Minkowski content. Then there is an explicit sequence $\epsilon_\delta \rightarrow 0$ as $\delta \rightarrow 0$ and a coupling of SLE_2 and γ^δ such that*

$$\mathbb{P}[\rho(\gamma^\delta, \text{SLE}_2) > \epsilon_\delta] < \epsilon_\delta,$$

where ρ is the distance between parametrized curves: if $\gamma : [s_1, t_1] \rightarrow \mathbb{C}$ and $\tilde{\gamma} : [s_2, t_2] \rightarrow \mathbb{C}$ are continuous curves, then

$$\rho(\gamma, \tilde{\gamma}) = \inf_{\varphi} \left\{ \sup_{s_1 \leq t \leq t_1} |\varphi(t) - t| + \sup_{s_1 \leq t \leq s_2} |\tilde{\gamma}(\varphi(t)) - \gamma(t)| \right\}.$$

where the infimum is over all increasing homeomorphisms $\varphi : [s_1, t_1] \rightarrow [s_2, t_2]$. In particular, γ^δ converges to SLE_2 weakly with respect to the metric ρ .

In Chapter 3, we studied the massive loop-erased random walk model (mLERW), which is the loop-erasure of a symmetric random walk on the square lattice $\delta\mathbb{Z}^2$ with killing rate m , $m \geq 0$. Following the strategy proposed by Makarov and Smirnov [MS10], on the identification of the limit by judiciously choosing an observable that forms a martingale when the curve grows, we proved the following result. The main technicalities consist in controlling this observable and showing its convergence in the massive case when the boundary of the domain is very rough, for which discrete harmonic analysis and estimates for Green's functions are indispensable.

Theorem 2.2.3. *Let $(\Omega^\delta; a^\delta, b^\delta)$ be discrete approximations to a bounded simply connected domain $(\Omega; a, b)$ with two marked boundary points (prime ends) a, b . For each $m > 0$, the scaling limit γ of mLERW on $(\Omega^\delta; a^\delta, b^\delta)$ exists and is given by a chordal Schramm-Loewner Evolution whose driving term ξ_t satisfies the SDE*

$$d\xi_t = \sqrt{2}dB_t + 2\lambda_t dt, \quad \lambda_t = \frac{\partial}{\partial(g_t(a_t))} \log \frac{P_{\Omega_t}^{(m)}(a_t, z)}{P_{\Omega_t}(a_t, z)} \Big|_{z=b}, \quad (2.2.1)$$

where $P_{\Omega_t}^{(m)}(a_t, \cdot)$ and $P_{\Omega_t}(a_t, \cdot)$ denote the massive and the classical Poisson kernels in the domain $\Omega_t := \Omega \setminus \gamma[0, t]$, and the logarithmic derivative with respect to a_t is taken in the Loewner chart $g_t : \Omega_t \rightarrow \mathbb{H}$.

Remark 2.2.4. The SDE (2.2.1) has a unique weak solution whose law is absolutely continuous with respect to $\sqrt{2}B_t$. In other words, these scaling limits are absolutely continuous with respect to the classical Schramm-Loewner Evolution with $\kappa = 2$.

We refer the reader to Section 2.3 for a precise definition of Schramm-Loewner Evolutions, and to [CW21] for the driving function (3.1.1) and the mode of convergence. The framework employed in [CW21] is based upon a convolution formula for identifying sub-sequential limits via martingale observables and comparison estimates between continuous functions and their appropriate discrete approximations. It is also amenable to other open questions in [MS10].

2.3 . Schramm-Loewner evolution and Conformal loop ensemble

Schramm-Loewner evolution

The Schramm-Loewner evolution $(\text{SLE}_\kappa)_{\kappa \geq 0}$ is a one-parameter family of probability measures on continuously growing curves in simply-connected domains of the complex plane, with prescribed endpoint on the boundary. The target point can be either in the interior or on the boundary, corresponding to the radial and the chordal versions of SLE. SLE was introduced revolutionally (changing the way mathematicians and physicists see critical phenomena in two dimensions) by Oded Schramm as a candidate for the scaling limits of interfaces of discrete planar models in statistical physics, among which the above-mentioned LERW/ SLE_2 , UST/ SLE_8 . It is also known that interfaces of the Ising model and of the FK-Ising model converge to SLE_3 and $\text{SLE}_{\frac{18}{5}}$ [CDCH⁺14]; the level lines of the discrete Gaussian free field converge to SLE_4 [SS09] and interfaces of the percolation converge to SLE_6 [Smi01]. Besides, based on the locality property of the self-avoiding walk, if the existence and conformal invariance of its scaling limit is true, it should be described by the $\text{SLE}_{8/3}$ [LSW04b]. Those models exhibit domain Markov property and conformal invariance in large scale at criticality, predicted earlier by physicists, which inspires and can be treated as the definition of SLE. Recall that a conformal map is a bijection between domains in the complex plane which preserves angles. Riemann's mapping theorem tells us that there exists a conformal map from any non-empty, simply connected domain to the upper half-plane \mathbb{H} . It is unique by specifying the image of one interior point and a point on the boundary.

Conformal invariance: Given a simply connected domain Ω , and $\phi : \Omega \rightarrow \mathbb{H}$ conformal, then the law of SLE_κ^Ω the SLE process defined on Ω is preserved under the transformation:

$$\phi(\text{SLE}_\kappa^\Omega) \stackrel{(d)}{=} \text{SLE}_\kappa^{\mathbb{H}}.$$

Domain Markov property: Formally, SLE_κ on \mathbb{H} has the domain Markov property if conditional on $\gamma[0, t]$, $\gamma[t, \infty) \stackrel{d}{=} \tilde{\gamma}$ where $\tilde{\gamma}$ is the SLE on $\mathbb{H} \setminus \gamma[0, t]$.

A rigorous definition of SLE involves encoding curves growing from the boundary by Loewner's equation, invented by Loewner to solve Bieberbach's conjecture on conformal maps (univalent holomorphic functions). By conformal invariance of the SLE, it is sufficient to define it on the upper half-plane \mathbb{H} , and conformally map it to any simply connected domain of the complex plane by Riemann's mapping theorem. The SLE_κ curve γ growing from the 0 can be parametrised by the half-plane capacity, that is

$$\text{hcap}(\gamma[0, t]) = 2 \lim_{y \rightarrow \infty} y \mathbb{E}_{iy} [\text{Im}(B_{\tau(\gamma[0, t])})],$$

where $\tau(\gamma[0, t])$ is the first hitting time of the Brownian motion started from iy before hitting the real line. Let g_t be the "mapping-out function" of $\gamma[0, t]$, that is, the unique conformal transformation $g_t : \mathbb{H}_t \rightarrow \mathbb{H}$, where \mathbb{H}_t is the infinite connected component of

$\mathbb{H} \setminus \gamma[0, t]$, with $g_t(z) = z + \frac{2t}{z} + o(\frac{1}{t})$ as $z \rightarrow \infty$. Then g_t satisfies

$$\dot{g}_t(z) = \frac{2}{g_t(z) - \sqrt{\kappa}B_t},$$

where $(\sqrt{\kappa}B_t)_{t \geq 0}$, called the driving function of SLE_{κ} , is a scaling by $\sqrt{\kappa}$ of the standard Brownian motion.

The definition of SLE depends on the orientation of tracing the curve. However discrete models suggest that it should be reversible. This non-trivial fact was first proven by Zhan for $\kappa \leq 4$ [Zha08a], later Miller and Sheffield extended it to $\kappa \in (0, 8)$ by considering SLE curves as flow lines of the Gaussian free field [MS16a, MS16b, MS16c].

The SLE curves are fractal. For the scaling limit of a discrete model at criticality, the system exhibits self-similar behavior: the configuration is similar if one “zooms in”. Remarkably, if $\kappa < 8$, the SLE_{κ} paths have Hausdorff dimension $d = 1 + \kappa/8$ almost surely [Bef08]. The Hausdorff measure and other geometric properties of SLE curves can be measured by its arm exponents (exponential exponents of the probability that there exist n disjoint crossings of the annulus $A_z(r, R) := \{w \in \mathbb{C} : r < |w - z| < R\}$ as $r \rightarrow 0$), calculated rigorously by Wu and Zhan [WZ17] via fundamental local martingales associated to SLEs.

Conformal loop ensemble

Conformal loop ensemble CLE_{κ} , $\kappa \in (8/3, 8)$, is a family of the canonical conformally invariant measure on countable collections of SLE_{κ} -type loops in a simply connected domain. As explained in [SW12], if those loops are simple, corresponding to $\kappa \in (8/3, 4]$, CLE_{κ} can be constructed in terms of outer boundaries of outmost clusters of loops in a Brownian loop soup with subcritical intensity. Another construction is due to Sheffield using variants of $\text{SLE}_{\kappa}(\kappa - 6)$ processes for $8/3 < \kappa < 8$.

The CLE describes in the scaling limit statistical physics models at critical temperature, which can be interpreted as random collections of disjoint, non-self-crossing loops. Reminiscent of discrete models, it is characterised by the *conformal Markov property*: consider $\text{CLE}_{\kappa}(\mathbb{U})$ on the unit disc \mathbb{U} , and for a subset $U \subset \mathbb{U}$, obtain \tilde{U} by removing from Ω all the $\text{CLE}(\Omega)$ loops (and their interior) that do not entirely stay in U . Then in each connected component C of \tilde{U} , for any conformal map $\phi_C : C \rightarrow \mathbb{U}$, it holds that

$$\phi_C(\text{CLE}_{\kappa}(C)) \stackrel{(d)}{=} \text{CLE}_{\kappa}(\mathbb{U})$$

Observe that taking $U = \emptyset$ gives the invariance under Möbius transformation for the CLE, which allows us to define the CLE on any simply connected domain Ω by

$$\text{CLE}_{\kappa}(\Omega) \stackrel{(d)}{=} \phi_{\Omega}^{-1}(\text{CLE}_{\kappa}(\mathbb{U})),$$

where ϕ_{Ω} is the conformal map from Ω to \mathbb{U} up to Möbius transformations of the unit disk.

CLE_κ is shown to be the scaling limit of: critical Ising model $\kappa = 3$ [BH19], FK-Ising percolation $\kappa = 16/3$ [KS16], and critical site percolation on the triangular lattice $\kappa = 6$ [CN06]. For the Ising/FK-Ising model, the Edwards-Sokal coupling is an important tool relating them, which corresponds to $\text{CLE}_3/\text{CLE}_{16/3}$ in the continuum. This coupling was generalized to $\kappa \in (8/3, 4)$ by Miller, Sheffield and Werner for $\text{CLE}_\kappa/\text{CLE}_{\kappa'}$, $\kappa' = 16/\kappa$ purely in the context of the CLEs [MSW20].

While the SLE, encoded by a one-dimensional driving function, is amenable to Ito's calculus, CLE admits precise calculations by imposing an independent Gaussian free field (GFF) on top of the CLE. This results in a Liouville quantum gravity surface (equipped with random metric and measure given by the GFF) decorated with CLE, which is reminiscent of random planar maps decorated with the $O(n)$ loop model, see [AS21] for relevant studies.

In Chapter 5, we obtained the super-exponential decay for the crossing number of non-nested CLEs, which allows us to deduce the convergence of probabilities of topological events of a classical statistical mechanics model - the double-dimer model. The main tools we use is the conformal Markov property via the Brownian loop soup construction of CLEs, and the upper bounds are not sharp.

2.4 . Branching random walks

Galton-Watson processes

A Galton-Watson (GW) process is a discrete stochastic process describing the population growth if each individual gives birth independently to a random number of children with the same offspring distribution μ on \mathbb{N} and die in the next generation.

Definition 2.4.1 (Galton-Watson process). *A Galton-Watson process $(Z_n)_{n \geq 0}$ is defined recurrently by*

$$Z_0 = 1, \quad Z_{n+1} = \sum_{i=1}^{Z_n} \xi_i^{(n)},$$

where $\{\xi_i^{(n)} : n, i \in \mathbb{N}\}$ is a family of natural number-valued random variables, independent and identically distributed according to μ .

Let L stand for a random variable with distribution μ and

$$m := \mathbb{E}_\mu[L] = \sum_{k \in \mathbb{N}} k\mu(k)$$

be the mean number of children per particle. The most basic and well-known fact about branching processes is that the extinction probability

$$q := \lim_{n \rightarrow \infty} \mathbb{P}[Z_n = 0]$$

is equal to 1 if and only if $m < 1$ or $m = 1, \mu(1) < 1$. Moreover, the Athreya-Ney theorem provides us the exact value of q .

Theorem 2.4.2 (Athreya and Ney). *Let $f(x) = \mathbb{E}_\mu[x^L]$ be the generating function of the GW process with offspring distribution μ . If $\mu(0) + \mu(1) < 1$ and $m < \infty$, then the extinction probability q is the smallest non-negative solution of $f(x) = x$. In particular, the case $m > 1$ (therefore $q < 1$) is called supercritical; the cases $m = 1$ and $m < 1$ are called critical and subcritical respectively, in these cases the population becomes extinct almost surely ($q = 1$).*

For the rate of growth of a supercritical branching process, the Kesten-Stigum theorem is a fundamental criterion showing that an $L \log L$ condition is decisive, which implies that

- in the supercritical case, the mean $\mathbb{E}[Z_n] = m^n$ gives the growth rate up to a random factor;
- in the subcritical case, the first moment estimate $\mathbb{P}[Z_n > 0] \leq \mathbb{E}[Z_n] = m^n$ gives the decay rate up to a random factor;
- in the critical case, $\mathbb{P}[Z_n > 0]$, $1/n$ gives the decay rate up to a constant.

For any positive x , write $\log^+ x = \log(\max(1, x))$.

Theorem A: Supercritical Processes (Kesten and Stigum (1966)).

Suppose that $1 < m < \infty$, then

$$M_n := \left(\frac{X_n}{m^n} \right)_{n \geq 0}$$

is a non-negative martingale converging almost surely to a limit M_∞ . Besides, the following are equivalent:

$$(i) \mathbb{P}[M_\infty = 0] = q; \quad (ii) \mathbb{E}[M_\infty] = 1; \quad (iii) \mathbb{E}[L \log^+ L] < \infty.$$

Theorem B: Subcritical Processes (Heathcote, Seneta and Vere-Jones (1967)).

Suppose that $m < 1$, then the sequence $\{\mathbb{P}[Z_n > 0]/m^n\}$ is decreasing and the following are equivalent:

$$(i) \lim_{n \rightarrow \infty} \mathbb{P}[Z_n > 0]/m^n > 0; \quad (ii) \sup \mathbb{E}[Z_n | Z_n > 0] < \infty; \quad (iii) \mathbb{E}[L \log^+ L] < \infty.$$

Theorem C: Critical Processes (Kesten, Ney and Spitzer (1966)).

Suppose that $m = 1$ and let $\sigma^2 := \text{Var}(L) = \mathbb{E}[L^2] - 1 \leq \infty$. Then we have

(i) *Kolmogorov's estimate:*

$$\lim_{n \rightarrow \infty} n \mathbb{P}[Z_n > 0] = \frac{2}{\sigma^2};$$

(ii) *Yaglom's limit law: if $\sigma < \infty$, then the conditional distribution of Z_n/n given $Z_n > 0$ converges as $n \rightarrow \infty$ to an exponential law with mean $\sigma^2/2$. If $\sigma = \infty$, then this conditional distribution converges to infinity.*

Galton-Watson trees

For each GW process, one can associate a genealogical tree to this population growth, which is called the Galton-Watson (GW) tree. We recall Neveu's formalism [Nev86] for ordered rooted trees $T \subset \bigcup_{n \geq 0} \mathbb{N}_+^n$:

- the root $\emptyset \in T$ with the convention that $\mathbb{N}_+^0 = \{\emptyset\}$;
- for a sequence $u = (u^1, \dots, u^{n-1}, u^n) \in T$, its parent $(u_1, \dots, u_{n-1}) \in T$;
- for each sequence (also called node) $u = (u^1, \dots, u^n) \in T$, there exists an integer $k_u(T) \geq 0$ which is called its number of offsprings, such that for every $j \in \mathbb{N}$, $(u^1, \dots, u^n, j) \in T$ if and only if $1 \leq j \leq k_u(T)$.

For a sequence $u = (u^1, \dots, u^n) \in T$, we set $|u| = n$ the distance from u to the root in T with the convention $|\{\emptyset\}| = 0$. We denote a partial order for $u = (u^1, \dots, u^n) \in T$ and $w = (w^1, \dots, w^{n'}) \in T$ called the genealogical order by $u \prec w$ if $n < n'$ and $u^i = w^i$, $1 \leq i \leq n$. We consider the lexicographic order on T : for $u, v \in T$, we set $v < u$ if either $v \prec u$ or $u = (u^1, \dots, u^k)$, $v = (v^1, \dots, v^k)$, $u^i < v^i$ for the first position i where the two sequences differ from each other. Let us denote by

$$u_0 = \emptyset, u_1, u_2, \dots, u_{\#(T)-1},$$

the elements of T listed in lexicographical order, where $\#(T)$ is the size of the tree.

It is useful to encode trees in terms of functions since they are slightly awkward objects to manipulate mathematically. We can reconstruct the GW tree directly from the following exploration processes.

Definition A: Lukasiewicz path.

The Lukasiewicz path is the function $l : \{0, 1, \dots, \#(T)\} \rightarrow \{-1, 0, 1, \dots\}$ defined by

$$l(0) = 0 \text{ and for } 0 \leq i \leq \#(T) - 1, l(i+1) = l(i) + k_{u_i}(T) - 1.$$

Note that $l(\#(T)) = \sum_{i=0}^{\#(T)-1} (k_{u_i}(T) - 1) = -1$. Moreover, $l(i) \geq 0$ for $0 \leq i \leq \#(T) - 1$.

Definition B: height function.

The height function $h : \{0, 1, \dots, \#(T) - 1\} \rightarrow \mathbb{N}$ is defined by

$$h(i) = |u_i|, 0 \leq i \leq \#(T) - 1,$$

recall that $|u_i|$ is the distance from u_i to the root in T .

Definition C: contour function.

The contour function $c : \{0, 1, \dots, 2(\#(T) - 1)\} \rightarrow \mathbb{N}$ is obtained by tracing (started from the root) the "contour" of the tree from left to right at speed 1, see Figure 2.4, such that the value $c(i)$ of the contour function at time $i \in [0, 2(\#(T) - 1)]$ is the distance to the root at time s .

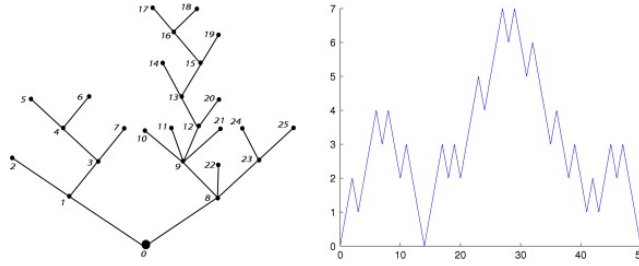

Figure 2.1 – A Galton-Watson tree and its contour function.

In the context of scaling limits, rather than a critical Galton-Watson tree of random size, we would like to consider a critical Galton–Watson tree conditioned to have size n , such that those contour functions of Galton-Watson trees can be rescaled properly to approximate a Brownian excursion. The convergence suggests the existence of a limiting object, encoded by the Brownian excursion, which is known as the Brownian continuum random tree.

Branching random walks

If we consider each node on the tree T as a vertex, and add an edge between a node and its parent, then one can see T as an abstract graph. If we attach a vector \mathbf{d}_u in \mathbb{Z}^d to each edge, fix the position of the root at $X_\emptyset = 0$ and let $X_u = \sum_{u' \prec u} \mathbf{d}_{u'}$, then $(X_u)_{u \in T}$ gives a spatial tree structure. Given an offspring distribution μ on \mathbb{N} and a distribution θ on \mathbb{Z}^d , the *branching random walk* (BRW), whose probability distribution is denoted by $P_{\mu, \theta}$, is defined by setting

$$k_u \stackrel{i.i.d.}{\sim} \mu, \mathbf{d}_u \stackrel{i.i.d.}{\sim} \theta.$$

It is natural to study the lattice sites visited by a branching random walk, which is called the *range* of the BRW. Asymptotics for the cardinality (number of distinct sites) of the range of BRW has been studied recently.

Theorem 2.4.3 (Le Gall and Lin (2014)). *The critical dimension for the range of BRW is $d = 4$. Conditioned on the size n of the indexed tree under $P_{\mu, \theta}$, let R_n be the number of distinct sites visited by the branching random walk. If μ is critical with finite variance, and θ is symmetric with finite support and is not supported on a strict subgroup of \mathbb{Z}^d , then as $n \rightarrow \infty$,*

- if $d \geq 5$, there exists $c_{\mu, \theta} > 0$ such that $\frac{1}{n} R_n \rightarrow c_{\mu, \theta}$ in probability;
- if $d = 4$, $\frac{\log n}{n} R_n \xrightarrow{L^2} 8\pi^2 \sigma^4$, where $\sigma^2 = (\det M_\theta)^{1/4}$, with M_θ denoting the covariance matrix of θ ;
- if $d \leq 3$, $n^{-d/4} R_n \xrightarrow{(d)} 2^{d/4} \sqrt{\det M_\theta} \lambda_d(\text{supp } \mathcal{I})$, where λ_d stands for the Lebesgue measure of the support of the random measure \mathcal{I} on \mathbb{R}^d known as *Integrated Super-Brownian Excursion*.

In this direction, let us study the BRW from the potential theory point of view by the capacity, which can be viewed as an escape probability for random walks, heavily depending on its geometry. Given a probability distribution η on \mathbb{Z}^d , $d \geq 3$, the capacity of a finite set $A \subseteq \mathbb{Z}^d$ with respect to η is defined as

$$\text{cap}_\eta A := \sum_{x \in A} \mathbb{P}_x^\eta(\tau_A^+ = \infty) = \lim_{|y| \rightarrow \infty} \frac{\mathbb{P}_y^\eta(\tau_A < \infty)}{G_d(0, y)},$$

where \mathbb{P}_x^η refers to the law of a random walk $(S_n)_{n \in \mathbb{N}}$ started at x with transition probabilities η , $\tau_A := \inf\{n \geq 0 : S_n \in A\}$, $\tau_A^+ := \inf\{n \geq 1 : S_n \in A\}$ and

$$G_d(0, y) := \sum_{n=0}^{\infty} \mathbb{P}_y^\eta(S_n = 0)$$

. For the capacity of a SRW on \mathbb{Z}^d , there is a systematic study by Asselah, Schapira and Sousi (see [ASS18, ASS19] for further references and motivations from the random interacements).

In Chapter 4, we studied the capacity of the range of such random walks. Based on the setup introduced by Le Gall and Lin [LGL15a], comparing the critical branching walk to a branching process conditioned to be doubly infinite with translation invariance, we establish the following result using intersection probabilities of random walks. The technicalities consist in estimating judiciously quantities related to Green's function for random walks. Loosely speaking, conditioned on the index Galton-Watson tree T with offspring distribution μ having exactly n nodes, under some technical assumptions on μ, η, θ , we prove that

Theorem 2.4.4. 1. *In dimension $d \geq 7$, there is a (non-explicit) constant $C(d, \mu, \theta, \eta) > 0$ such that under $P_{\mu, \theta}(\cdot | \#T = n)$, as $n \rightarrow \infty$,*

$$\frac{\text{cap}_\eta R}{n} \rightarrow C(d, \mu, \theta, \eta) \text{ in probability.}$$

2. *In dimension $d = 6$, under $P_{\mu, \theta}(\cdot | \#T = n)$, as $n \rightarrow \infty$,*

$$\frac{\log n}{n} \text{cap}_\eta R \rightarrow 2(C_G)^{-1} \text{ in probability,}$$

where

$$C_G = \frac{1}{4\pi^6 \sqrt{\det \Gamma_\eta \det \Gamma_\theta}} \left(\sum_{k=0}^{\infty} (k-1)k\mu(k) \right) C_f,$$

$$C_f = \mathbb{E} \left[\int_1^e dt \int_{\mathbb{R}^6} dx \cdot J_\eta(B_t^\theta + x)^{-4} J_\theta(x)^{-4} \right],$$

$\Gamma_\eta, \Gamma_\theta$ are the covariance matrices of η, θ respectively, $J_{(\cdot)}(x) = \sqrt{x \cdot \Gamma_{(\cdot)}^{-1} x}$, and B_t^θ is the Brownian motion in \mathbb{R}^6 with covariance matrix Γ_θ .

2.5 . Planar Ising and dimer models

The *Ising model* (or Lenz-Ising model) with nearest-neighbor ferromagnetic interaction is one of the lattice models most studied in both the mathematics and the physics contexts. Given a finite, *planar* embedded graph $G = (V, E, F)$, with or without boundary, the partition function of the Ising model (with spins located on faces) with coupling constants $(J_e)_{e \in E}$ is defined as follows

$$Z_{\text{Ising}}(G, J) := \sum_{\sigma \in \{-1, 1\}^F} \exp \left(\beta \sum_{u \sim w} J_{(uw)^\circ} \sigma_u \sigma_w \right),$$

where the sum inside the exponential is taken over all adjacent faces of G and $(uw)^\circ$ denotes the corresponding dual edge of G . The probability distribution on the set of spin configurations $\{-1, 1\}^F$ is thus defined by the Boltzmann measure

$$\mathbb{P}_{G, J}[\sigma] = \exp \left(\beta \sum_{u \sim w} J_{(uw)^\circ} \sigma_u \sigma_w \right) \cdot (Z_{\text{Ising}}(G, J))^{-1}, \quad \forall \sigma \in \{-1, 1\}^F.$$

It was introduced by Lenz [Len20], and solved by his PhD student Ising in dimension one [Isi25], suggesting the absence of phase transition in this case. A decade later, Peierls [Pei36] confirmed a phase transition in two dimensions, contrary to the common belief at that time that the planar Ising model also does not admit phase transition. Being one of the simplest lattice models undergoing an order-disorder phase transition, the planar Ising model is exactly solvable in a very strong sense. Namely, in absence of the external magnetic field, its partition function can be written as the Pfaffian of a related skew-symmetric matrix (signed and weighted adjacency matrix of an auxiliary graph).

Another statistical physics model sharing a similar exact solvability feature is the *dimer model* of perfect matchings on planar graphs, which represents the adsorption of diatomic molecules on crystal surfaces. Except for its own physical meaning, the dimer model is popular due to its correspondences with the planar Ising model and uniform spanning trees. For planar graphs, Kasteleyn showed that the partition function of the dimer model can be expressed as the Pfaffian of a properly signed and weighted adjacency matrix for the graph, a.k.a. the Kasteleyn matrix.

In the following, we introduce these two models, discuss correspondences between them and briefly present some remarkable convergence results proved at the critical point within the past decade. The discussion of the massive regime is postponed until Chapter 6. We first introduce the classical Kadanoff-Ceva spin-disorder formalism [KC71] of the Ising model, which allows to define correlations of fermions, spins, disorders and energy-densities i.e., of the primary fields of the corresponding CFT, which is known under the name Ising CFT [CHI21].

Definition 2.5.1 (Kadanoff-Ceva spin-disorder correlation). *Given $n, m \in \mathbb{N}$ and a collection of vertices v_1, \dots, v_{2m} of G , let us fix a collection of m loop-free edge-disjoint*

paths $\gamma^{[v_1, \dots, v_{2m}]}$ linking v_1, \dots, v_{2m} pairwise, whose set of edges is denoted by Γ . Let us define the modified coupling constant $(J_e^{[v_1, \dots, v_{2m}]})_{e \in E}$

$$J_e^{[v_1, \dots, v_{2m}]} = \begin{cases} -J_e & \text{if } e \in \Gamma; \\ J_e & \text{otherwise.} \end{cases}$$

Let

$$\langle \mu_{v_1} \dots \mu_{v_{2m}} \rangle = \frac{Z_{\text{Ising}}(G, J^{[v_1, \dots, v_{2m}]})}{Z_{\text{Ising}}(G, J)},$$

and the Ising order-disorder correlator be defined as follows

$$\langle \sigma_{u_1} \dots \sigma_{u_n} \mu_{v_1} \dots \mu_{v_{2m}} \rangle_{(G, J)} := \mathbb{E}_{G^{[v_1, \dots, v_{2m}]}}[\sigma_{u_1} \dots \sigma_{u_n}] \cdot \langle \mu_{v_1} \dots \mu_{v_{2m}} \rangle,$$

where $\sigma_{u_1}, \dots, \sigma_{u_n}$ are spins of the Ising model (with the edge weights $J_{e'} = J_e/2$, where e is the projecting edge of e' on G) defined on faces of u_1, \dots, u_n of $G^{[v_1, \dots, v_{2m}]}$, the double cover of the graph G with branch set v_1, \dots, v_{2m} , endowed with the involution $u \mapsto u^\sharp$ such that $\sigma_{u^\sharp} = -\sigma_u$.

We list the following observations.

- By the Kramers-Wannier duality of the partition function, $\langle \mu_{v_1} \dots \mu_{v_{2m}} \rangle$ is nothing but the high-temperature expansion (up to a multiplicative constant) of the corresponding spin correlation in the Ising model defined on G^* with spins lying on vertices of G , which implies immediately that $\langle \mu_{v_1} \dots \mu_{v_{2m}} \rangle$ does not depend on the choice of disorder lines $\gamma^{[v_1, \dots, v_{2m}]}$.
- The Ising order-disorder correlator changes sign when one of u_k is replaced by u_k^\sharp . Besides, monodromy may also arise based on the choice of disorder lines $\gamma^{[v_1, \dots, v_{2m}]}$.
- Repeated μ or σ are allowed in the Ising order-disorder correlator with the cancellation effect.

For any planar, simply connected graph G , a *dimer configuration* of G (also called a perfect matching), is a subset of edges such that each vertex is incident to exactly one edge. To define the dimer model associated with the Ising model, let us introduce the bipartite graph $G^Q = (V^Q, E^Q)$ on which the dimer model lives. On top of each edge of G (including boundary edges), put a quadrangle such that none of them intersects. Then G^Q is obtained by adding legs connecting those quadrangles cyclically inside each face and along the boundary outside of G .

Remark 2.5.2. G^Q is indeed bipartite: on both sides of each corner, there are exactly a pair of black and white vertices. One can therefore identify the corner with the nearest black/white vertex of G^Q .

Definition 2.5.3 (Dimer model on G^Q). *Given a positive weight function $\nu = (\nu_e)$ assigned to edges of G^Q , the probability distribution on the set of dimer configurations \mathcal{M} is defined by*

$$\mathbb{P}_{\text{dimer}}(M) = \frac{\prod_{e \in M} \nu_e}{Z_{\text{dimer}}(G^Q, \nu)}, \quad M \in \mathcal{M},$$

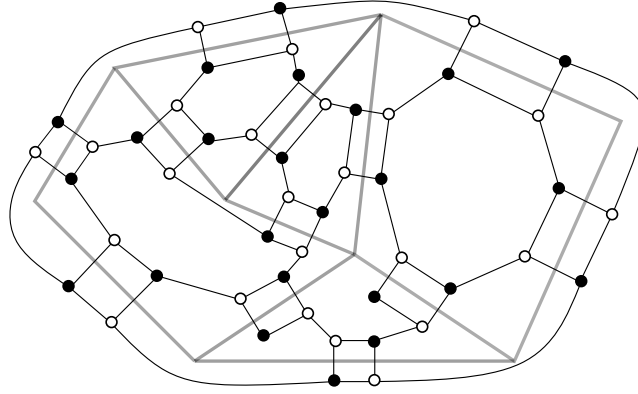

Figure 2.2 – The graph G in grey with its associated bipartite graph G^Q .

where $Z_{\text{dimer}}(G^Q, \nu) = \sum_M \prod_{e \in M} \nu_e$ with the sum taken over all perfect matchings of G^Q .

Remark 2.5.4. For general (i.e., not necessarily positive) weight function $\nu = (\nu_e)$, one can also define the partition function

$$Z_{\text{dimer}}(G^Q, \nu) = \sum_M \prod_{e \in M} \nu_e,$$

although in such case one may not obtain a probability measure.

Dubédat's bosonization identities

At the combinatorial level, the Ising model on the primal graph G and the dimer model on G^Q can be related by Dubédat's bosonization identities, which mimic the notion of the bosonization appearing in the Conformal Field Theory (e.g., see [Z177]). These identities express the squares of Ising correlators in terms of a certain bipartite dimer model. Under this correspondences, if one starts with the critical Ising model on \mathbb{Z}^2 , then then height function of the dimer model converges to the GFF (i.e. to the bosonic free field), hence the name. Let us associate the bipartite graph G^Q with edge weights $\nu(J)$, defined as a function of the Ising coupling constants $(J_e)_{e \in E}$

$$\nu(J)_e = \begin{cases} 1 & \text{if } e \text{ is a leg;} \\ \tanh(2J_e) & \text{if } e \text{ is "parallel" to a primal edge } e \text{ of } G; \\ \cosh^{-1}(2J_e) & \text{if } e \text{ "intersects" a primal edge } e \text{ of } G. \end{cases}$$

Given positive intergers n, m , let u_1, \dots, u_{2n} be $2n$ vertices of G^* and v_1, \dots, v_{2m} be $2m$ vertices of G . Then Dubédat's bosonization identity is the following

$$\langle \sigma_{u_1} \dots \sigma_{u_{2n}} \mu_{v_1} \dots \mu_{v_{2m}} \rangle_{(G, J)}^2 = \left| \frac{Z_{\text{dimer}}(G^Q, \nu(J^{[u_1, \dots, u_{2n}, v_1, \dots, v_{2m}]})}{Z_{\text{dimer}}(G^Q, \nu(J))} \right|,$$

where $J^{[u_1, \dots, u_{2n}, v_1, \dots, v_{2m}]}$ is the modified weight function defined similarly as in Definition 2.5.1 by assigning disjoint n loop-free paths $\gamma_1^*, \dots, \gamma_n^*$ on G^* linking u_1, \dots, u_{2n} pairwise and m loop-free paths $\gamma_1, \dots, \gamma_m$ on G linking v_1, \dots, v_{2m} pairwise:

$$J_e^{[u_1, \dots, u_{2n}, v_1, \dots, v_{2m}]} = \begin{cases} J_e + i\frac{\pi}{2} & \text{if } e^* \in \cup_{i=1}^n \gamma_i^*; \\ -J_e & \text{if } e \in \cup_{i=1}^m \gamma_i; \\ J_e & \text{otherwise .} \end{cases}$$

Note that the choice of sheets for spins on the double cover $G^{[v_1, \dots, v_{2m}]}$ makes no difference and the absolute value on the right-hand side does not depend on the choice of path once u_1, \dots, u_{2n} and v_1, \dots, v_{2m} are fixed. It is worth saying that the identity above is not a correspondence on the level of configurations. Nevertheless, it is known that a planar Ising configuration can be represented by a dimer configuration on a related decorated graph. For example, a Fisher graph or a corner graph, etc. We refer interested readers to [CCK17] for a detailed discussion.

Correspondence of fermionic observables

It is well known (at least in the folklore) that planar dimers are closely related to families of Cauchy-Riemann operators [Dub15]. Besides, certain type of discrete holomorphicity (s-holomorphicity) also arises in the fermionic observables of the planar Ising model. Recently, this point of view has been generalized to the near-critical setup via the propagation equation [CHM19]. Being flexible enough, proper dimer weights can be assigned according to the coefficients in the propagation equation such that dimer observables satisfy the same algebraic identity as the Ising fermionic observables. Moreover, there exists a class of finite domains on \mathbb{Z}^2 , on which boundary conditions of these observables also match. These domains are introduced in [Rus20] under the name hedgehog domains in the dimer model context, the corresponding setup for the Ising model is domains whose boundary turns at each step.

Denote by G^\diamond the *quad-graph*, whose vertices are $V \cup F$, those of G and of G^* . Edges of G^\diamond are also called *corners* of the primal graph G , each of which connects (corresponds to) an adjacent vertex-face pair of G . Those edges are embedded such that they do not intersect the edges of G and G^* .

Definition 2.5.5 (Kadanoff-Ceva fermionic variable). *For edges c of the quad-graph G^\diamond , denote by $v(c), u(c)$ vertices of G, G^* adjacent to c respectively. Then the Kadanoff-Ceva fermionic variable χ_c (evaluated when plugging into a correlator) is formally defined as*

$$\chi_c := \mu_{v(c)} \sigma_{u(c)}.$$

Given n faces u_1, \dots, u_{n-1} and $2m - 1$ vertices v_1, \dots, v_{2m-1} , one can define a formal correlation function

$$F(c) := \langle \chi_c \sigma_{u_1} \dots \sigma_{u_{n-1}} \mu_{v_1} \dots \mu_{v_{2m-1}} \rangle.$$

which has monodromy (gaining a -1 factor when making a loop around a singularity) everywhere on vertices of both G and G^* except $u_1, \dots, u_{n-1}, v_1, \dots, v_{2m-1}$.

It is well-known that the values $F(c)$ of a discrete spinor at any three of the four corners surrounding a given edge e of G satisfy the so-called *propagation equation*. In the following, we consider the Ising model with wired boundary condition. This fits the formalism presented above since a single outer face u_{out} is equivalent to declaring that all the spins located at outer faces are equal to each other. Let us introduce the following parametrization of the interaction constant J_e by θ_e , which also admits a geometric interpretation in the context of rhombic lattices and the related Z-invariant Ising model on them [BdT10, BdT11, CS12]:

$$x_e = \exp(-2\beta J_e) \text{ and } \theta_e := 2 \arctan x_e.$$

Proposition 2.5.6. *For any (directed) edge e of G disjoint from $\{u_1, \dots, u_{n-1}, v_1, \dots, v_{2m-1}\}$, denote by $v^\pm(e)$ the two vertices of e oriented from $v^-(e)$ to $v^+(e)$, and $u^\pm(e)$ the two faces adjacent to e with $u^-(e)$ being to the left and $u^+(e)$ to the right of e (including the boundary faces). Write four corners around e (consecutively adjacent on the double cover) as $c_1 = v^-(e)u^+(e)$, $c_2 = v^+(e)u^+(e)$, $c_3 = v^+(e)u^-(e)$ and $c_4 = v^-(e)u^-(e)$. Then we have the following three-term relation*

$$F(c_2) = \cos \theta_e F(c_3) + \sin \theta_e F(c_1) \quad \text{and} \quad F(c_3) = \cos \theta_e F(c_2) + \sin \theta_e F(c_4). \quad (2.5.2)$$

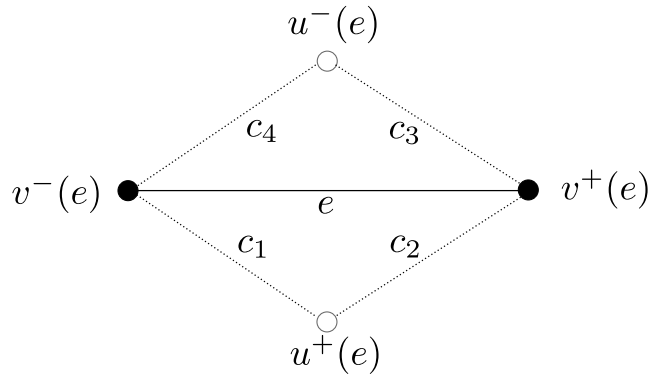

Proof. E.g., see [DD83]. Denote $\varepsilon_e = \sigma_{u^+(e)}\sigma_{u^-(e)} = \pm 1$. By the definition of disorder insertions, we have

$$\begin{aligned} F(c_1) \sin \theta_e &= \langle \mu_{v^-(e)} \mu_{v^+(e)} \mu_{v^+(e)} \sigma_{u^+(e)} \sigma_{u^-(e)} \sigma_{u_1} \dots \sigma_{u_{n-1}} \mu_{v_1} \dots \mu_{v_{2m-1}} \rangle \sin \theta_e \\ &= \langle x^{\varepsilon_e} \mu_{v^+(e)} \sigma_{u^+(e)} \sigma_{u^-(e)} \sigma_{u_1} \dots \sigma_{u_{n-1}} \mu_{v_1} \dots \mu_{v_{2m-1}} \rangle \sin \theta_e. \end{aligned}$$

Since $x_e^{\varepsilon_e} \sin \theta_e = 1 - \varepsilon_e \cos \theta_e$, we have

$$\begin{aligned} F(c_1) \sin \theta_e &= F(c_2) - \cos \theta_e \langle \sigma_{u^+(e)} \sigma_{u^-(e)} \mu_{v^+(e)} \sigma_{u^+(e)} \sigma_{u^-(e)} \sigma_{u_1} \dots \sigma_{u_{n-1}} \mu_{v_1} \dots \mu_{v_{2m-1}} \rangle \\ &= F(c_2) - F(c_3) \cos \theta_e, \end{aligned}$$

which gives us the first identity. The second one follows similarly. \square

Remark 2.5.7. The three-term relation agrees with the branching structure of spinors: the value of F at the corner differs by a sign when writing down the relation around an edge. In our case, admitting (2.5.2) implies that $F(c_1) = -F(c_4) \cos \theta_e + F(c_2) \sin \theta_e$.

Since $F(c)$ branches over all vertices of G, G^* except $u_1, \dots, u_{n-1}, v_1, \dots, v_{2m-1}$, the real-valued function $F(c)$ is sophisticated for tracking and making sense of its scaling limit. Let us introduce another factor which branches literally everywhere to compensate the monodromies.

Definition 2.5.8 (Dirac spinor). *For any planar embedding of the graph G together with its dual G^* , the Dirac spinor (defined as the square root of the corner vector) which branches over all vertices of G and G^* is defined as*

$$\eta_c := \exp(i\pi/4) \exp\left(-\frac{i}{2} \arg(v(c) - u(c))\right).$$

As indicated in the previous paragraph, $\eta_c F(c)$ is defined on the double cover of G^\diamond which branches over $u_1, \dots, u_{n-1}, v_1, \dots, v_{2m-1}$.

Let us introduce complex edge weights to the bipartite graph G^Q based on the propagation equation to relate the weighted adjacency matrix with Ising fermionic observables.

Following Remark 2.5.2, for any corner $c = (u_c v_c)$, $u_c \in G^*$ and $v_c \in G$, denote by w_c, b_c the white, black vertices of G^Q on two sides of c . The entries of the Kasteleyn matrix associated to G^Q , which is Hermitian are defined by setting

$$\tilde{K}_{b_c w_{c'}} = \begin{cases} -\eta_c \bar{\eta}_{c'} \sin(\theta) & \text{if } u_c = u_{c'}, c \neq c'; \\ -\eta_c \bar{\eta}_{c'} \cos(\theta) & \text{if } v_c = v_{c'}, c \neq c'; \\ 1 & \text{if } c = c'. \end{cases}$$

Note that in the definition of the Kasteleyn matrix, η takes consecutive values on the double cover when going from one corner to adjacent ones; $\arg(\eta_c \bar{\eta}_{c'})$ is one half the oriented angle from c to c' . It is univalent even though the Dirac spinor η is not. If equivalently, ηF is viewed as a function defined on the black vertices of G^Q by identifying each black vertex with its nearest corner, then the relation (2.5.2) can be written matrix-wise as

$$(\tilde{K} \eta F)_{b_a} = \sum_{w_c \sim b_a} \tilde{K}(b_a, w_c) \eta_c F(w_c) = 0.$$

Moreover, Proposition 2.5.9 tells us that

$$\tilde{K}^{-1}(w_c, b_d) = \frac{1}{2} \eta_c \langle \chi_c \chi_d \rangle \bar{\eta}_d \quad (2.5.3)$$

Proposition 2.5.9. *If we set $\langle \chi_d \chi_d \rangle = 1$, then*

$$\sum_{w_c \sim b_a} \tilde{K}(b_a, w_c) \eta_c \langle \chi_c \chi_d \rangle \bar{\eta}_d = \begin{cases} 0 & \text{if } d \neq a; \\ 2 & \text{if } d = a. \end{cases}$$

Proof. If $d \neq a$, then the expression $\sum_{w_c \sim b_a} \tilde{K}(b_a, w_c) \eta_c \langle \chi_c \chi_d \rangle \bar{\eta}_d$ vanishes due to (2.5.2).

If $d = a$, one sees that $\sum_{w_c \sim b_a} \tilde{K}(b_a, w_c) \eta_c \langle \chi_c \chi_d \rangle \bar{\eta}_d$ differs from (2.5.2) by

$$\tilde{K}(b_d, w_d) \eta_d \langle \chi_d \chi_d \rangle \bar{\eta}_d + \eta_d \langle \chi_d \chi_d \rangle \bar{\eta}_d = 2.$$

□

Remark 2.5.10. Compared to $\eta_c \langle \chi_x \chi_d \rangle \bar{\eta}_d$, the inverse Kasteleyn matrix is single-valued. The monodromy of the spinor $F(c) = \eta_c \langle \chi_c \chi_d \rangle \bar{\eta}_d$ when going across d can be resolved by fixing $F(d) = \eta_d \langle \chi_d \chi_d \rangle \bar{\eta}_d$ to be 1, which introduces a singularity at d of the Kasteleyn operator \tilde{K} .

In the following, let G be a subgraph of the square grid $\mathbb{C}^\delta := \delta\mathbb{Z}^2$ and equip all edges with spin interaction parameter $x = \tan(\theta/2)$; note that we do not assume $x = x_{\text{crit}}$. Write $\lambda = e^{i\frac{\pi}{4}}$. We now explain how to transform G^Q and the Kasteleyn matrix \tilde{K} to a bipartite graph G^B with proper dimer weights and the associated Kasteleyn matrix K such that K^{-1} is nothing but the restriction of \tilde{K}^{-1} to G^B in a certain sense.

Assume that G has wiggling lattice path boundary: the boundary makes a $\pm\frac{\pi}{2}$ -turn at each boundary vertex. Divide each face of $\delta\mathbb{Z}^2$ into four squares with checkerboard coloring such that each square is the dual face of a corner in G . One can then construct a discrete simply connected domain by taking the union of such squares adjacent to G with black/white vertices corresponding to black/white squares, while the boundary being the outer boundary of the δ -neighborhood of ∂G . Note it has slits inside concave angles of ∂G and belongs to the family of so-called hedgehog domains considered in [Rus20]. Denote by G^B the dual graph of this checkerboard domain, with white/black vertices located at the center of white/black squares, and they are connected by an edge of G^B if and only if the corresponding squares touch each other.

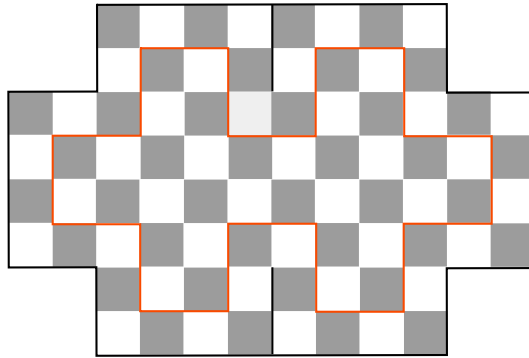

Figure 2.3 – The red loop depicts the boundary of a graph G . The checkerboard domain represents the dual of the associated bipartite graph G^B : black/white squares correspond to black/white vertices.

Denote by W/B the set of white/black vertices of G^B . One can associate periodic dimer weights to G^B as follows: edges intersecting primal edges of G are of weight $\cos \theta$,

while others are of weight $\sin \theta$. The associated Kasteleyn matrix $K : B \times W \rightarrow \mathbb{C}$ of the dimer model on G^B , whose determinant gives the partition function, is defined such that for $b \in B, w \in W$,

$$K(b, w) = \begin{cases} \lambda \sin \theta & \text{if } bw \text{ is horizontal and does not intersect } G; \\ -\lambda \cos \theta & \text{if } bw \text{ is horizontal and intersects } G; \\ -\bar{\lambda} \sin \theta & \text{if } bw \text{ is vertical and does not intersect } G; \\ \bar{\lambda} \cos \theta & \text{if } bw \text{ is vertical and intersects } G. \end{cases} \quad (2.5.4)$$

It is not hard to check that the complex signs of K satisfy Kasteleyn condition.

The reason for the assignment of signed weights in (2.5.4) is as follows. Let $b_1, b_2, \tilde{b}_1, \tilde{b}_2$ be the black vertices of G^Q surrounding a horizontal edge of G as shown in Figure 2.5. For w not adjacent to any of $b_1, b_2, \tilde{b}_1, \tilde{b}_2$, it holds for the inverse of \tilde{K} that

$$\begin{cases} \tilde{K}^{-1}(w, \tilde{b}_1) = \lambda \sin \theta \cdot \tilde{K}^{-1}(w, b_1) + \bar{\lambda} \cos \theta \cdot \tilde{K}^{-1}(w, b_2); \\ \tilde{K}^{-1}(w, \tilde{b}_2) = \bar{\lambda} \cos \theta \cdot \tilde{K}^{-1}(w, b_1) + \lambda \sin \theta \cdot \tilde{K}^{-1}(w, b_2). \end{cases} \quad (2.5.5)$$

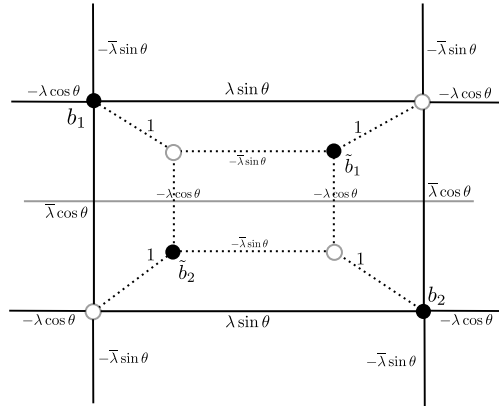

Figure 2.4 – An illustration of the signed Kasteleyn weights $\tilde{K}(b, w)$ on G^Q and $K(b, w)$ on G^B .

If we identify vertices of G^B with one of the vertices of G^Q with the same color as in Remark 2.5.2, for w_0 not on ∂G^B ,

$$\sum_{b \sim w_0} \tilde{K}^{-1}(w, b) K(b, w_0) = \delta_{w, w_0}. \quad (2.5.6)$$

To obtain similar local relations near the boundary, one can split each leg on ∂G^B opposite to a convex angle into three legs with weights $1, \cos \theta, \cos \theta$, connected by a pair of additional white and black vertices, as shown in Figure 2.5. Correspondingly, the values of $\tilde{K}^{-1}(w, \cdot)$ at additional black vertices \tilde{b}_1, \tilde{b}_2 should satisfy

$$\tilde{K}^{-1}(w, \tilde{b}_1) = i \tilde{K}^{-1}(w, b_1), \quad \tilde{K}^{-1}(w, \tilde{b}_2) = \bar{\lambda} (\cos \theta)^{-1} \tilde{K}^{-1}(w, b_2).$$

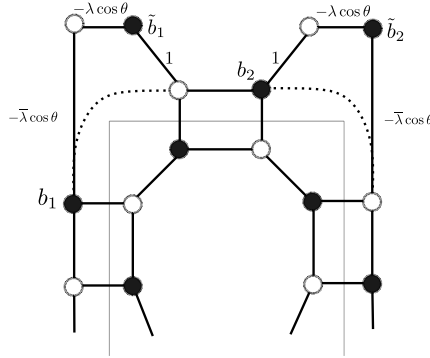

Figure 2.5 – Boundary modification for G^Q and entries of $\tilde{K}(b, w)$ around convex angles of ∂G .

Then one can write down (2.5.6) around horizontal edges of ∂G . It follows from (2.5.5) and the boundary modification that \tilde{K}^{-1} , when restricted to G^B , is the inverse of K . Together with (2.5.3), this implies that if $w \in W, b \in B$ correspond to corners c, d , then

$$K^{-1}(w, b) = \tilde{K}^{-1}(w_c, b_d) = \frac{1}{2} \eta_c \langle \chi_c \chi_d \rangle \bar{\eta}_d \quad (2.5.7)$$

Remark 2.5.11. From the perspective of probability measures, the transformations above also describe equivalent dimer weights on the square lattice of the dimer weights on G^Q : one can find a correspondence of dimer configurations which preserves the probability measure, see e.g. [KLR18] for more detailed illustrations.

Convergence results for the Ising model

In this paragraph, we review briefly the literature on the convergence of the Ising correlations/interfaces and the dimer height functions. This topic is vast and the exposition given below is by no means exhaustive.

Starting with the seminal papers of Belavin, Polyakov and Zamolodchikov [BPZ84a, BPZ84b], it has been conjectured that small mesh size limits of critical lattice models possess the conformal invariance provided the phase transition is continuous. It was only until mid-2000s that substantial progress on the rigorous analysis of the two-dimensional Ising model at criticality has been achieved since the pioneering work of Smirnov [Smi10]. In particular, Smirnov introduced and analyzed the scaling limit of fermionic observables, also known as discrete holomorphic fermions. Later the convergence of such observables for the whole class of critical Z-invariant Ising models on isoradial graphs was proven by Chelkak and Smirnov [CS12]. Expressed explicitly via martingale observables, the driving functions of interfaces in the Loewner evolution therefore converge. In order to obtain convergence of curves, certain crossing (RSW-type) estimates are sufficient following the framework proposed by Kemppainen and Smirnov [KS17]. For the arguments to conclude the convergence of interfaces, see [CDCH⁺14] and references therein. The convergence of the full collection of interfaces requires that of single ones as an input, and one still needs to control the behavior of its double points in the FK-Ising model, which split

the current domain into smaller pieces to be explored using some iterative procedure. This was justified by Kemppainen and Smirnov [KS16], showing the convergence of the full branching tree of interfaces in the FK-representation to $CLE_{16/3}$. In parallel, an exploration process based on the coupling between the Ising model and its FK representation to discover the Ising loops was suggested in [HK13]. Later, via the convergence of the so-called free arc ensemble established in [BDCH16], this convergence to CLE_3 was justified by Benoist and Hongler [BH19].

From the CFT perspective, the conformal symmetry of the 2D Ising model at criticality is understood via the scaling limits of correlation functions. In the past decade, a number of results was obtained in the direction of rigorously establishing these CFT predictions. On the square lattice in bounded simply connected domains, the energy density correlations with locally monochromatic boundary conditions were studied by Hongler and Smirnov [HS13], and the scaling limits of spin correlations were justified by Chelkak, Hongler and Izyurov [CHI15]. This program was complemented by the same authors [CHI21], obtaining a general results concerning scaling limits of all possible correlations of primary fields in the Ising model. Recently, the convergence of spin correlations have been generalized to isoradial graphs and to the near-critical temperature by Chelkak, Mahfouf and Izyurov [CIM21]. In this direction, fermionic observables appearing in the near-critical FK-Ising model were investigated by Park [Par21]. It is also worth mentioning that the convergence of the properly renormalized Ising magnetization field in a certain Sobolev space was shown by Camia, Garban and Newman [CGN15]. The scaling limit is constructed via the so-called conformal measure ensembles that appear as the limits of properly renormalized counting measures in FK-Ising clusters. The analysis of the Ising model at critical temperature with the presence of the magnetic field (introducing a bias for the alignment of the spins) is also an active area of research, for which the magnetization field in this setup was obtained by the same authors [CGN16]. Although the external field breaks down the integrability of the model, Camia, Jiang and Newman [CJN20] proved that the resulting field theory has a mass gap, which confirms the existence of at least one particle with strictly positive mass in Zamolodchikov's scattering theory [Zam89].

Convergence results for the dimer model

Dimer configurations can be described by the so-called Thurston height functions. Given a bipartite graph G , fix a reference perfect matching P_0 of vertices of G . Loosely speaking, a perfect matching of G vertices is in correspondence with the height profile associated to the contour lines formed by P and P_0 , see e.g., the lecture notes [FL].

The investigation of the convergence of height fluctuations of the uniform dimer model on rescaled square grids to the Gaussian Free Field goes back to works of Kenyon [Ken00, Ken01], in the setup of approximating planar domains by the so-called Temperleyan discretizations. The result of Kenyon is based on the observation that entries of the inverse Kasteleyn matrix (also known as the coupling function) for the dimer model on the square grid satisfy a discrete version of the Cauchy-Riemann equation. Later, discrete complex analysis techniques (e.g. s -holomorphicity) originally developed for

the Ising model were successfully employed in the dimer setup to obtain convergence with more general discretizations, within the framework proposed by Chelkak, Laslier and Russkikh [CLR20], see also [CR20, CLR21]. In parallel, universality of the fluctuations of the height function associated to the dimer model was demonstrated by Berestycki, Laslier and Ray [BLR20] following Temperley’s bijection, which relates the height function of a dimer configuration to the winding of branches in an associated uniform spanning tree subject to Temperleyan boundary conditions. The idea is that for any general planar graph, if the simple random walk converges to the Brownian motion, combined with a Russo–Seymour–Welsh type crossing estimate, the windings of the spanning tree generated by Wilson’s algorithm converge to the GFF. However, it is worth emphasizing that the convergence to the GFF does not hold away from criticality, e.g., for the dimer model obtained from the near-critical Ising model as explained above. It was shown by Chhita that the height fluctuations on the full-plane in the scaling limit do not satisfy Wick’s rule for Gaussian variables, hence not Gaussian [Chh12].

Our results

In Chapter 6 following an analysis of the Riemann-type boundary conditions for massive holomorphic functions in arbitrary rough domains, we extend the convergence results obtained in [Par21] for basic fermionic observables to general ones. From the Ising model perspective this also allows us to prove the convergence of energy density correlators in the massive context. From the perspective of the associated dimer model, the fermionic observables are nothing but the entries of the inverse Kasteleyn matrix (2.5.4). This implies that correlations of the gradients of the fluctuations of the corresponding height functions in hedgehog domains can be written in terms of fermionic correlators coming from the massive Ising model. This reveals the formalism of Coleman’s correspondence at the free fermion point (e.g., see [BW21]) and suggests that the limit of height functions in question is given by a sine-Gordon theory in the limiting domain with Dirichlet boundary conditions.

3 - Massive loop-erased random walk

3.1 . Introduction

The classical loop-erased random walk (LERW) in a discrete domain $\Omega^\delta \subset \delta\mathbb{Z}^2$ is a curve obtained from a simple random walk trajectory by erasing the loops in chronological order. In the famous paper [LSW04a] the convergence of such trajectories to the so-called SLE(2) curves (see [Law05, Kem17, BN16] and references therein) was proved by Lawler, Schramm and Werner. Namely, let Ω^δ be discrete approximations to a simply connected domain Ω such that $0 \in \Omega$. Then, LERW obtained from simple random walks on Ω^δ started at 0 and stopped when hitting $\partial\Omega$ converge (in law) to the so-called *radial* SLE(2) process in Ω . This result was generalized by Zhan [Zha08b] for multiply connected domains Ω and also for the *chordal* setup when the random walks are started at a (discrete approximation of) boundary point $a \in \partial\Omega$ and are conditioned to exit Ω^δ through another boundary point $b \in \partial\Omega$. Later on, another generalization appeared in [YY11]: instead of $\delta\mathbb{Z}^2$ one can consider any sequence of graphs Γ^δ such that the simple random walks on Γ^δ converge to the Brownian motion. Since then, variants of the LERW model have become standard examples of lattice systems for which one can rigorously prove the convergence of interfaces to SLE and the Conformal Field Theory (CFT) predictions for correlation functions, e.g. see [AKE20].

In parallel with a great success of studying the (conjectural) conformally invariant limits of *critical* 2D lattice models achieved during the last two decades, a program to study their near-critical perturbations was advocated by Makarov and Smirnov in 2009, with *massive* LERW (mLERW) being one of the cases most amenable for the rigorous analysis, see [MS10]. On square lattice with mesh size δ , given $m > 0$, the *massive random walk* is defined as follows: at each step, the walk moves to one of the four neighboring vertices with probability $\frac{1}{4}(1 - m^2\delta^2)$ or dies with probability $m^2\delta^2$ (which is called the *killing rate*). Then, mLERW in Ω^δ is defined by applying the same loop erasing procedure as above to massive random walks, conditioned to exit from Ω^δ through a fixed boundary point b^δ and not to die before this moment. The following result is given in [MS10, Theorem 2.1]:

Theorem 3.1.1. *Let $(\Omega^\delta; a^\delta, b^\delta)$ be discrete approximations to a bounded simply connected domain $(\Omega; a, b)$ with two marked boundary points (more accurately, degenerate prime ends of Ω ; see Remark 3.1.2(i) below). For each $m > 0$ the scaling limit γ of mLERW on $(\Omega^\delta; a^\delta, b^\delta)$ exists and is given by a chordal stochastic Loewner evolution process (3.2.12) whose driving term ξ_t satisfies the SDE*

$$d\xi_t = \sqrt{2}dB_t + 2\lambda_t dt, \quad \lambda_t = \frac{\partial}{\partial(g_t(a_t))} \log \frac{P_{\Omega_t}^{(m)}(a_t, z)}{P_{\Omega_t}(a_t, z)} \Big|_{z=b}, \quad (3.1.1)$$

where $P_{\Omega_t}^{(m)}(a_t, \cdot)$ and $P_{\Omega_t}(a_t, \cdot)$ denote the massive and the classical Poisson kernels in

the domain $\Omega_t := \Omega \setminus \gamma[0, t]$ and the logarithmic derivative with respect to a_t is taken in the Loewner chart $g_t : \Omega_t \rightarrow \mathbb{H}$; see Remark 3.1.2(ii). Moreover, (3.1.1) has a unique weak solution whose law is absolutely continuous with respect to $\sqrt{2}B_t$. In other words, these scaling limits (known under the name mSLE(2)) are absolutely continuous with respect to the classical Schramm–Loewner Evolutions with $\kappa = 2$.

Remark 3.1.2. (i) We refer the reader to [Pom92, Chapter 2] for basic notions of the geometric function theory in what concerns the boundaries of planar domains and the correspondence between them induced by conformal maps. Loosely speaking, a *degenerate prime end* of Ω should be thought of as an equivalence class of sequences of inner points converging to a point on the (topological) boundary of Ω . Although we only consider the chordal setup in this paper, the convergence of radial mLERW follows from almost the same lines and requires less effort since the normalization of the martingale observable near the target point becomes a trivial statement.

(ii) We write the formula (3.1.1) for the drift term $2\lambda_t dt$ in the same (slightly informal) form as it appeared in [MS10]. The rigorous definition of the quantity

$$\frac{\partial}{\partial(g_t(a_t))} \log \frac{P_{\Omega_t}^{(m)}(a_t, z)}{P_{\Omega_t}(a_t, z)} \Big|_{z=b} := \frac{Q_{\Omega_t}^{(m)}(a_t, z)}{P_{\Omega_t}^{(m)}(a_t, z)} \Big|_{z=b} \quad (3.1.2)$$

is given in Section 3.4. The function $Q_{\Omega_t}^{(m)}(a_t, \cdot)$ (defined by (3.4.9)) can be thought of as the derivative of the massive Poisson kernel $P_{\Omega_t}^{(m)}(a_t, \cdot)$ (defined by (3.4.8)) with respect to the source point a_t (after performing the uniformization $g_t : \Omega_t \rightarrow \mathbb{H}$). If $m = 0$, then $Q_{\Omega_t}(a_t, z)/P_{\Omega_t}(a_t, z) \rightarrow 0$ as $z \rightarrow b$ (see (3.4.1) and (3.4.2)); this is why only the massive term remains in the right-hand side of (3.1.2).

When the article was written, no follow up of [MS10] appeared since then. The goal of this paper is to provide technical details required for the proof of Theorem 3.1.1 as we believe that this might be of interest to the community and as we intend to pursue a rigorous understanding of further steps in the Makarov–Smirnov program (notably, those related to the near-critical Ising model; see [MS10, Sections 2.3 and 2.5] as well as [MS10, Question 4.12] for $\kappa = 3$). It is worth emphasizing that the paper [MS10] contains a lot of intriguing questions and conjectures which remain mostly unexplored since then, some of them most probably being very hard. One of the questions posed in [MS10] is to understand which massive perturbations of the classical SLE(κ) curves are absolutely continuous and which are mutually singular with respect to the unperturbed ones (e.g., see [MS10, Question 4.5]). In this regard, recall that

- The scaling limit of the near-critical percolation is known to be *singular* with respect to the classical SLE(6) curves; see [NW09].
- The scaling limits of the mLERW and of the massive Harmonic Explorer paths are *absolutely continuous* with respect to SLE(2) and to SLE(4), respectively. (As mentioned in [MS10, Section 3.2], the latter case can be analyzed using the same

type of arguments. Though in this case the absolute continuity is less clear *a priori* from the discrete model, it can be derived *a posteriori* from the analysis of the driving process ξ_t ; see also [Sha17].)

- However, the heuristics is controversial already for the scaling limit of the near-critical Ising model interfaces. For a while, this research direction was blocked by the lack of techniques allowing to prove the convergence of massive fermionic observables in rough domains (to the best of our knowledge, [MS10, Sections 2.4, 2.5] had no follow-up). Such techniques were suggested in a recent work of Park [Par18, Par21] (see also an alternative approach to convergence theorems developed in [Che20a, Section 4]); we hope that they will allow to analyze this case in more detail.

We now move back to the main subject of this paper and discuss the setup in which we prove Theorem 3.1.1.

- Ω^δ are assumed to converge to Ω in the *Carathéodory* topology (see Section 3.2.2 for more details). We do not assume any regularity of Ω (or Ω^δ) near degenerate prime ends a, b , except that a^δ, b^δ are supposed to be *close discrete approximations* of a, b in the sense of the recent paper of Karrila [Kar18]. It is worth noting that in [Zha08b] it was assumed that the boundary of Ω is ‘flat’ near the target point b , a technical restriction which was removed in [Uch17] in the general setup of [YY11]. Our approach to this technicality is based upon the tools from [Che16] (see Section 3.3.2 for details), similar uniform estimates were independently obtained by Karrila [Kar20, Appendix A] basing upon the conformal crossing estimates developed for the random walk in [KS17].
- The mode of convergence of discrete random curves γ^δ to continuous ones is provided by the framework of Kemppainen and Smirnov [KS17] (with a recent addition of Karrila [Kar18] in what concerns the vicinities of the endpoints a and b), see Section 3.2.3 for details. Namely, the weak convergence of the law of mLERW to that defined by (3.1.1) holds with respect to each of the following topologies: uniform convergence of curves γ^δ to γ after a reparametrization, convergence of conformal images $\gamma_{\mathbb{H}}^\delta := \phi_{\Omega^\delta}(\gamma^\delta)$ to $\gamma_{\mathbb{H}} := \phi_\Omega(\gamma)$ under the half-plane capacity parametrization, convergence of the driving terms ξ_t^δ in the Loewner equations describing $\gamma_{\mathbb{H}}^\delta$ to ξ_t . Using the result of Lawler and Viklund [LV21] on the convergence of classical LERWs to SLE(2) in the so-called natural parametrization, one can easily deduce the same convergence for massive LERWs from our proof.

There are several known strategies to prove the convergence of discrete random curves to classical SLEs, most of them relying upon the convergence of *discrete martingale observables* $M_{(\Omega^\delta; a^\delta, b^\delta)}^\delta(z)$ to $M_{(\Omega; a, b)}(z)$ as $(\Omega^\delta; a^\delta, b^\delta) \rightarrow (\Omega; a, b)$; see (3.2.6) for the definition of these observables in the LERW case. The approach used in the original papers [LSW04a, Zha08b] on the subject (see also [lzy17] for similar considerations in the Ising model context) relies upon the Skorohod embedding theorem and an approximate version of the Lévy characterization of the Brownian motion. A different viewpoint was advocated by Smirnov in [Smi06]: once the tightness framework of [KS17] is set up,

one gets the martingale property of ξ_t and its quadratic variation from coefficients of the asymptotic expansion of $M_{(\Omega_t; a_t, b)}(z)$ near the *target* point b , e.g. see [Smi06, Section 4.4] or [DCS12, Section 6.3] for sample computations. (Note however that [Zha08b] and [lzy17] rely upon asymptotics of $M_{(\Omega_t; a_t, b)}(z)$ near the *source* point a_t , which are known to be more useful in the multiple SLE context.)

In the massive setup, one does not have conformal invariance, which makes these asymptotics of $M_{\Omega_t}(a_t, z)$ rather sensitive to the local geometry of Ω_t near b or a_t . Moreover, even if we assume that the boundary of Ω is flat near b , these asymptotics are written in terms of Bessel functions instead of powers of $(z-b)$. In this paper we use a combination of the two strategies: we do rely upon the tightness framework of [KS17] but analyze the stochastic processes $M_{(\Omega_t; a_t, b)}(z)$ at *fixed* points $z \in \Omega_t$ instead of discussing their asymptotics; cf. [HK13] or [lzy17, Section 3.1].

In conformally invariant setups, it is known (e.g., see [Wer09] or [HK13]) that one can easily derive the fact that the process ξ_t is a continuous semi-martingale directly from the fact that $M_{(\Omega_t; a_t, b)}(z)$ are continuous (local) martingales, using explicit representations of those via ξ_t . We illustrate this idea in Section 3.2.4 when discussing the convergence of the classical LERW to SLE(2). Despite the lack of explicit formulas, similar arguments *can* be used in the massive setup though being more involved. Nevertheless, we prefer to follow a more conceptual approach suggested in [BBK08, BBC09] and [MS10], which relies upon the Girsanov theorem and the fact that mLERW can (and, arguably, should) be viewed as the classical LERW weighted by an appropriate density caused by the killing rate; in this approach the fact that ξ_t is a semi-martingale does not require any special proof (see Section 3.2.6).

Certainly, the idea of weighting SLE curves by martingales dates back to the very first developments in the subject, e.g. see [Dub07, SW05] or [Wu16, KS18] for more recent examples. Nevertheless, there exist an important difference between the ‘critical/critical’ and ‘the ‘massive/critical’ contexts. In the setup of Theorem 3.1.1, the density of mSLE(2) with respect to the classical SLE(2) does *not* coincide with the ratio of regularized partition functions $P_{\Omega_t}^{(m)}(a_t, b)/P_{\Omega_t}(a_t, b)$ in $\Omega_t := \Omega \setminus \gamma[0, t]$. The reason is that the total mass of massive RW loops attached to the tip a_t is strictly smaller than the mass of the critical ones, which results in a (positive) drift of this ratio; see also [BBK08, Section 4] for a discussion of this effect from the theoretical physics perspective. Nevertheless, the expression for the drift term $2\lambda_t dt$ in (3.1.1) has exactly the same structure as in ‘critical/critical’ setups, see Remark 3.4.11 for additional comments.

The rest of the article is organized as follows. In Section 3.2 we collect preliminaries and discuss the absolute continuity of mLERW with respect to LERW and that of their scaling limits. In Section 3.3 we prove the convergence of discrete martingale observables as $\delta \rightarrow 0$. Section 3.4 is devoted to a priori estimates and computations in continuum. The proof of Theorem 3.1.1 is given at the end of the paper.

3.2 . Preliminaries

3.2.1 . Discrete domains, partition functions and martingale observables

Let $\Omega \subset \mathbb{C}$ be a bounded simply connected domain with two marked degenerate prime ends a, b . We approximate $(\Omega; a, b)$ by simply connected *subgraphs* Ω^δ of the square grids $\delta\mathbb{Z}^2$ and their boundary vertices a^δ, b^δ . More precisely, to each simply connected graph $\Omega^\delta \subset \delta\mathbb{Z}^2$ we associate an open simply connected *polygonal domain* $\widehat{\Omega}^\delta \subset \mathbb{C}$ by taking the union of all open $2\delta \times 2\delta$ squares centered at vertices of Ω^δ . Note that the boundary of $\widehat{\Omega}^\delta$ consists of edges of $\delta\mathbb{Z}^2$; see Fig. 3.1 for an illustration. We set $\text{Int}\Omega^\delta := V(\Omega^\delta)$ and define the boundary $\partial\Omega^\delta$ of Ω^δ as

$$\partial\Omega^\delta := \{(v; (v_{\text{int}}, v)) : v \notin \text{Int}\Omega^\delta, v \sim v_{\text{int}}, v_{\text{int}} \in \text{Int}\Omega^\delta\}, \quad (3.2.3)$$

here and below the notation $v \sim v'$ means that the vertices $v, v' \in \mathbb{Z}^2$ are adjacent to each other. (The reason for this definition of $\partial\Omega^\delta$ is that the same vertex v may be connected to several points $v_{\text{int}} \in \text{Int}\Omega^\delta$. When talking about exiting events of random walks, all such edges (v_{int}, v) correspond to different possibilities to exit Ω^δ .) Usually, we slightly abuse the notation and treat $\partial\Omega^\delta$ as a set of $v \in \delta\mathbb{Z}^2$ without indicating the outgoing edges (v_{int}, v) if no confusion arises. Sometimes we also use the notation $\overline{\Omega}^\delta := \Omega^\delta \cup \partial\Omega^\delta$.

Given $0 < \delta < m^{-1} \leq +\infty$, a discrete domain $\Omega^\delta \subset \delta\mathbb{Z}^2$, and two *interior or boundary* vertices w^δ, z^δ , we define the *partition function* of massive random walks running from w^δ to z^δ in Ω^δ as

$$Z_{\Omega^\delta}^{(m)}(w^\delta, z^\delta) := \sum_{\pi^\delta \in S_{\Omega^\delta}(w^\delta; z^\delta)} \left(\frac{1}{4}(1 - m^2\delta^2)\right)^{\#\pi^\delta}, \quad w^\delta, z^\delta \in \overline{\Omega}^\delta, \quad (3.2.4)$$

where $S_{\Omega^\delta}(w^\delta; z^\delta)$ denotes the set of all lattice paths connecting w^δ and z^δ inside Ω^δ , and $\#\pi^\delta$ is the number of *interior* edges of Ω^δ in π^δ . (In other words, we do *not* count the edges $(w^\delta, w_{\text{int}}^\delta)$ and $(z_{\text{int}}^\delta, z^\delta)$ in $\#\pi^\delta$ if $w^\delta \in \partial\Omega^\delta$ and/or $z^\delta \in \partial\Omega^\delta$.) To simplify the notation, we drop the superscript (m) when speaking about random walks without killing (i.e., $m = 0$). Below we often rely upon the following identity, which relates the partition functions $Z_{\Omega^\delta}^{(m)}$ and Z_{Ω^δ} .

Lemma 3.2.1. *Given a discrete domain Ω^δ , two points $z^\delta, w^\delta \in \overline{\Omega}^\delta$, and $m \in (0, \delta^{-1})$, we have*

$$(1 - m^2\delta^2) \cdot Z_{\Omega^\delta}^{(m)}(w^\delta, z^\delta) = Z_{\Omega^\delta}(w^\delta, z^\delta) - m^2\delta^2 \sum_{v^\delta \in \text{Int}\Omega^\delta} Z_{\Omega^\delta}(w^\delta, v^\delta) Z_{\Omega^\delta}^{(m)}(v^\delta, z^\delta). \quad (3.2.5)$$

Proof. Recall that both $Z_{\Omega^\delta}^{(m)}(w^\delta, z^\delta)$ and $Z_{\Omega^\delta}(w^\delta, z^\delta)$ are defined as sums over random walk trajectories $\pi^\delta \in S_{\Omega^\delta}(w^\delta; z^\delta)$ running from w^δ to z^δ inside Ω^δ . Also, by splitting π^δ into two parts (from w^δ to v^δ and from v^δ to z^δ) and summing over all

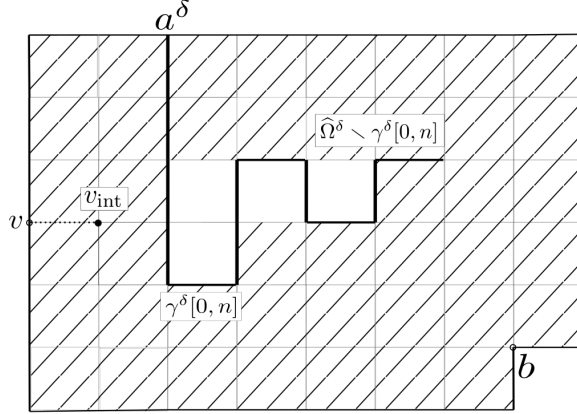

Figure 3.1 – Discrete domain Ω^δ , an example of a boundary vertex $(v; (v_{\text{int}}, v))$, and a slit $\gamma^\delta[0, n]$. The shaded area is the polygonal representation of the subgraph $\Omega^\delta \setminus \gamma^\delta[0, n] \subset \delta\mathbb{Z}^2$. Though this polygonal domain does not coincide with $\widehat{\Omega}^\delta \setminus \gamma^\delta[0, n]$, these two domains are close to each other in the Carathéodory sense (with respect to inner points of $\widehat{\Omega}^\delta$ lying near b).

$\#\pi^\delta + 1$ possible choices of v^δ , one easily sees that

$$\begin{aligned} \sum_{v^\delta \in \text{Int}\Omega^\delta} Z_{\Omega^\delta}(w^\delta, v^\delta) Z_{\Omega^\delta}^{(m)}(v^\delta, z^\delta) &= \sum_{\pi^\delta \in S_{\Omega^\delta}(w^\delta, z^\delta)} \sum_{k=0}^{\#\pi^\delta} \left(\frac{1}{4}\right)^k \left(\frac{1}{4}(1 - m^2\delta^2)\right)^{\#\pi^\delta - k} \\ &= \sum_{\pi^\delta \in S_{\Omega^\delta}(w^\delta, z^\delta)} \left(\frac{1}{4}\right)^{\#\pi^\delta} \cdot \frac{1 - (1 - m^2\delta^2)^{\#\pi^\delta + 1}}{m^2\delta^2}. \end{aligned}$$

Thus, the identity (3.2.5) directly follows from the definition (3.2.4). \square

Let γ^δ be a sample of the (massive or massless) LERW path from a^δ to b^δ in Ω^δ . We denote by $\Omega^\delta \setminus \gamma^\delta[0, n]$ the *connected component* of this graph containing b^δ ; see Fig. 3.1. Let a sequence of vertices $o^\delta \in \text{Int}\Omega^\delta$ be fixed so that $o^\delta \rightarrow 0$ as $\delta \rightarrow 0$. A classical argument (e.g., see [LSW04a, Remark 3.6]) implies that, for each $v^\delta \in \text{Int}\Omega^\delta$, the function

$$M_{\Omega^\delta \setminus \gamma^\delta[0, n]}^{(m), \delta}(v^\delta) := \frac{Z_{\Omega^\delta \setminus \gamma^\delta[0, n]}^{(m)}(\gamma^\delta(n), v^\delta)}{Z_{\Omega^\delta \setminus \gamma^\delta[0, n]}^{(m)}(\gamma^\delta(n), b^\delta)} \cdot Z_{\Omega^\delta}(o^\delta, b^\delta), \quad (3.2.6)$$

is a martingale with respect to the filtration $\mathcal{F}_n := \sigma(\gamma^\delta[0, n])$ generated by first n steps of γ^δ , until v^δ is hit by γ^δ or disconnected from b^δ . The additional normalization factor $Z_{\Omega^\delta}(o^\delta, b^\delta)$ does not depend neither on γ^δ nor on m and is introduced for further convenience. Note that the behavior of this factor (which is nothing but the harmonic measure of b^δ in Ω^δ viewed from o^δ) as $\delta \rightarrow 0$ can be very irregular as we do not require

much about the behavior of the boundary $\partial\Omega^\delta$ near b^δ ; the role of this normalization is to compensate the similar irregularity in the behavior of the denominator of (3.2.6). As in the notation for partition functions, we drop the superscript (m) in (3.2.6) when speaking about classical ($m = 0$) LERW.

3.2.2 . Carathéodory convergence of Ω^δ and reparametrization by capacity

Throughout this paper we assume that all domains under consideration are uniformly bounded (that is, are contained in some $B(0, R)$ for a fixed $R > 0$) and that 0 is contained in all domains. Let $\phi_\Omega : \Omega \rightarrow \mathbb{H}$ be a conformal uniformization of Ω onto the upper half-plane \mathbb{H} such that

$$\phi_\Omega(a) = 0, \quad \phi_\Omega(b) = \infty, \quad \text{and} \quad \text{Im } \phi_\Omega(0) = 1, \quad (3.2.7)$$

note that these conditions define ϕ_Ω uniquely and that one has

$$G_\Omega(0, z) = \frac{1}{2\pi} \log \left| \frac{\phi_\Omega(z) - \phi_\Omega(0)}{\phi_\Omega(z) - \phi_\Omega(b)} \right| \sim -\frac{1}{\pi} \text{Im} \frac{1}{\phi_\Omega(z)} \quad \text{as } z \rightarrow b. \quad (3.2.8)$$

We assume that discrete approximations $(\widehat{\Omega}^\delta; a^\delta, b^\delta)$, with $b^\delta = b$, converge to $(\Omega; a, b)$ in the Carathéodory sense, which means that (e.g., see [Pom92, Chapter 1])

- each inner point $z \in \Omega$ belongs to $\widehat{\Omega}^\delta$ for small enough δ ;
- each boundary point $\zeta \in \partial\Omega$ can be approximated by $\zeta^\delta \in \partial\widehat{\Omega}^\delta$ as $\delta \rightarrow 0$.

Further, we require that a and b are degenerate prime ends of Ω and that a^δ (resp., b^δ) is a *close approximation* of a (resp., of b) as defined by Karrila [Kar18]:

- $a^\delta \rightarrow a$ as $\delta \rightarrow 0$ and, moreover, the following is fulfilled:
- Given $r > 0$ small enough, let S_r be the arc of $\partial B(a, r) \cap \Omega$ disconnecting (in Ω) the prime end a from 0 and from all other arcs of this set; in other words, S_r is the last arc from a (possibly countable) collection $\partial B(a, r) \cap \Omega$ to cross for a path running from 0 to a inside Ω . We require that, for each r small enough and for all sufficiently (depending on r) small δ , the boundary point a^δ of Ω^δ is connected to the midpoint of S_r inside $\widehat{\Omega}^\delta \cap B(a, r)$.

We fix a uniformization $\phi_{\widehat{\Omega}^\delta} : \widehat{\Omega}^\delta \rightarrow \mathbb{H}$ similarly to (3.2.7) so that

$$\phi_{\widehat{\Omega}^\delta}(a^\delta) = 0, \quad \phi_{\widehat{\Omega}^\delta}(b^\delta) = \infty, \quad \text{and} \quad \text{Im } \phi_{\widehat{\Omega}^\delta}(0) = 1,$$

note that the Carathéodory convergence of $\widehat{\Omega}^\delta$ to Ω can be reformulated as

$$\begin{aligned} \phi_{\widehat{\Omega}^\delta} &\rightarrow \phi_\Omega && \text{uniformly on compact subsets of } \Omega, \\ \phi_{\widehat{\Omega}^\delta}^{-1} &\rightarrow \phi_\Omega^{-1} && \text{uniformly on compact subsets of } \mathbb{H}. \end{aligned} \quad (3.2.9)$$

From now onwards we assume (without loss of generality) that the discrete approximations $\widehat{\Omega}^\delta$ are shifted slightly so that the target point $b^\delta = b$ is always the same. Inside

all polygonal domains $\widehat{\Omega}^\delta$ (and similarly inside Ω), one can define the inner distance to the prime end b and the r -vicinities of b as follows:

$$\begin{aligned}\rho_{\widehat{\Omega}^\delta}(b, z) &:= \inf\{r > 0 : z \text{ and } b \text{ are connected in } \widehat{\Omega}^\delta \cap B_{\mathbb{C}}(b, r)\}, \\ B_{\widehat{\Omega}^\delta}(b, r) &:= \{z \in \widehat{\Omega}^\delta : \rho_{\widehat{\Omega}^\delta}(b, z) < r\}.\end{aligned}\tag{3.2.10}$$

Note that $\rho_{\Omega}(b, z)$ is a continuous function of $z \in \Omega$. Moreover,

$$\rho_{\Omega}(b, z) < r \quad \Rightarrow \quad \rho_{\widehat{\Omega}^\delta}(b, z) < r \quad \text{for small enough } \delta \tag{3.2.11}$$

since a path connecting z to b inside $\Omega \cap B_{\mathbb{C}}(b, r)$ eventually belongs to $\widehat{\Omega}^\delta$ except, possibly, a tiny portion near b . As we assume that b^δ is a close approximation of the prime end b , the implication (3.2.11) follows.

Let $\gamma_{\mathbb{H}}^\delta := \phi_{\widehat{\Omega}^\delta}(\gamma^\delta)$ be the conformal images of LERW trajectories γ^δ , considered as continuous paths in the upper half-plane \mathbb{H} . These continuous simple curves can be canonically parameterized by the so-called *half-plane capacity* of their initial segments. Namely, a uniformization map $g_t : \mathbb{H} \setminus \gamma_{\mathbb{H}}^\delta[0, t] \rightarrow \mathbb{H}$ normalized at infinity is required to have the asymptotics $g_t(z) = z + 2tz^{-1} + O(|z|^{-2})$ as $|z| \rightarrow \infty$.

Given $t > 0$ we define a random variable n_t^δ to be the first integer such that the half-plane capacity of $\phi_{\widehat{\Omega}^\delta}(\gamma^\delta[0, n])$ is greater or equal than t . Further, given a small enough $r > 0$ we define $n_{t,r}^\delta$ to be the minimum of n_t^δ and the first integer such that $\gamma^\delta(n) \in B_{\widehat{\Omega}^\delta}(b, r)$. Clearly, both n_t^δ and $n_{t,r}^\delta$ are stopping times with respect to the filtration $\mathcal{F}_n := \sigma(\gamma^\delta[0, n])$. We set Ω_t^δ (resp. $\Omega_{t,r}^\delta$) to be the connected component of $\Omega^\delta \setminus \gamma^\delta[0, n_t^\delta]$ (resp. $\Omega^\delta \setminus \gamma^\delta[0, n_{t,r}^\delta]$) including b and $a_t^\delta := \gamma^\delta(n_t^\delta)$ (resp. $a_{t,r}^\delta := \gamma^\delta(n_{t,r}^\delta)$).

The following lemma guarantees that the change of the parametrization from integers n_t^δ to the half-plane capacity t does not create big jumps. The proof given below is based upon compactness arguments though one can use standard estimates (e.g., see [BN16, Proposition 6.5]) of capacity increments in the upper half-plane \mathbb{H} instead. However, it is worth noting that one does not have an immediate a priori bound of $\text{diam}(\gamma_{\mathbb{H}}^\delta[0, n_{t,r}^\delta])$ in the situation when the curve γ^δ approaches b along the boundary of Ω^δ , which might require to introduce additional stopping times to handle this scenario explicitly.

Lemma 3.2.2. *Let $(\widehat{\Omega}^\delta; a^\delta, b^\delta)$ approximate $(\Omega; a, b)$ as described above. Then, for each $r > 0$, the increments of the half-plane capacities of the slits $\phi_{\widehat{\Omega}^\delta}(\gamma^\delta[0, n])$ are uniformly (in both γ^δ and n) small as $\delta \rightarrow 0$ provided that $\gamma^\delta[0, n]$ do not enter the vicinities $B_{\widehat{\Omega}^\delta}(b, r)$ of the target point b . In particular, the capacities of the slits $\phi_{\widehat{\Omega}^\delta}(\gamma^\delta[0, n_{t,r}^\delta])$ are uniformly bounded by $t + o(1)$ as $\delta \rightarrow 0$.*

Proof. The set of all simply connected domains $\widehat{\Omega}^\delta \setminus \gamma^\delta[0, n]$ under consideration is precompact in the Carathéodory topology (with respect to points near b). Suppose on the contrary that the one-step increments of the half-plane capacities of $\phi_{\widehat{\Omega}^\delta}(\gamma^\delta[0, n])$ do not vanish as $\delta \rightarrow 0$ for a sequence of curves $\gamma^\delta[0, n^\delta]$ such that $\gamma^\delta[0, n^\delta - 1] \cap$

$B_{\widehat{\Omega}^\delta}(b, r) = \emptyset$. By compactness, one can find a subsequence along which $\widehat{\Omega}^\delta \setminus \gamma^\delta[0, n^\delta]$ converge in the Carathéodory sense (with respect to points near b). Clearly, $\widehat{\Omega}^\delta \setminus \gamma^\delta[0, n^\delta - 1]$ converge to the same limit and hence one can find conformal homeomorphisms

$$\widehat{\Omega}^\delta \setminus \gamma^\delta[0, n^\delta] \rightarrow \widehat{\Omega}^\delta \setminus \gamma^\delta[0, n^\delta - 1]$$

that become arbitrary close to the identity on each compact subset $K \subset B_\Omega(b, r)$, note that one necessarily has $K \subset B_{\widehat{\Omega}^\delta}(b, r)$ for small enough δ due to (3.2.11). Due to (3.2.9), this implies that the conformal maps

$$\mathbb{H} \setminus \phi_{\widehat{\Omega}^\delta}(\gamma^\delta[0, n^\delta]) \xrightarrow{\phi_{\widehat{\Omega}^\delta}^{-1}} \widehat{\Omega}^\delta \setminus \gamma^\delta[0, n^\delta] \rightarrow \widehat{\Omega}^\delta \setminus \gamma^\delta[0, n^\delta - 1] \xrightarrow{\phi_{\widehat{\Omega}^\delta}} \mathbb{H} \setminus \phi_{\widehat{\Omega}^\delta}(\gamma^\delta[0, n^\delta - 1])$$

become (as $\delta \rightarrow 0$) arbitrary close to the identity on compact subsets of the fixed vicinity $\phi_\Omega(B_\Omega(b, r))$ of ∞ in the upper half-plane. This contradicts to the assumption that the half-plane capacities of $\phi_{\widehat{\Omega}^\delta}(\gamma^\delta[0, n^\delta - 1])$ and $\phi_{\widehat{\Omega}^\delta}(\gamma^\delta[0, n^\delta])$ differ by a constant amount as $\delta \rightarrow 0$. \square

3.2.3 . Chordal SLE(2) and topologies of convergence

We now discuss a few basic facts on the construction of SLE curves, the interested reader is referred to [BN16, Kem17, Law05] for more details. Let $\gamma_{\mathbb{H}}$ be a continuous non-self-crossing curve in the upper half-plane $\mathbb{H} := \{z \in \mathbb{C} : \text{Im}z > 0\}$, growing from 0 to ∞ . Let $\mathbb{H} \setminus K_t$ denote the connected component of $\mathbb{H} \setminus \gamma_{\mathbb{H}}[0, t]$ containing ∞ (if $\gamma_{\mathbb{H}}$ is not only non-self-crossing but also *non-self-touching*, then $K_t = \gamma_{\mathbb{H}}[0, t]$). Assume that $\gamma_{\mathbb{H}}$ is parameterized by half-plane capacity so that the conformal map $g_t : \mathbb{H} \setminus K_t \rightarrow \mathbb{H}$ (normalized at ∞) has the asymptotics $g_t(z) = z + 2tz^{-1} + O(|z|^{-2})$ as $|z| \rightarrow \infty$. Then there exists a unique real-valued function ξ_t , called the *driving term*, such that the following equation, called the *Loewner evolution equation*, is satisfied:

$$\partial_t g_t(z) = \frac{2}{g_t(z) - \xi_t} \quad \text{for all } z \in \mathbb{H} \setminus K_t, \quad (3.2.12)$$

where we use the shorthand notation ∂_t for the partial derivative in t . Vice versa, given a nice function ξ_t one can reconstruct the growing family K_t and, further (under some assumptions on ξ_t), the curve $\gamma_{\mathbb{H}}$ by solving (3.2.12) with $g_0(z) = z$.

Classical $\text{SLE}_{\mathbb{H}}(2)$ curves in the upper half-plane correspond to *random* driving terms $\xi_t = \sqrt{2}B_t$, where $(B_t)_{t \geq 0}$ is a standard Brownian motion. It is known that

- almost surely, $\text{SLE}_{\mathbb{H}}(2)$ is a simple curve in the upper half plane \mathbb{H} , see [RS05];
 - almost surely, the Hausdorff dimension of $\text{SLE}_{\mathbb{H}}(2)$ is equal to $\frac{5}{4}$, see [Bef08].
- Moreover, one can use the corresponding Minkowski content of the initial segments of $\text{SLE}_{\mathbb{H}}(2)$ to introduce the so-called *natural parametrization* of these curves, see [LR15].

Generally, given a simply connected domain Ω with boundary points (prime ends) $a, b \in \Omega$, chordal SLE_Ω curves from a to b in Ω are defined as preimages of $\text{SLE}_{\mathbb{H}}$ under a conformal uniformization $\phi_\Omega : \Omega \rightarrow \mathbb{H}$ satisfying $\phi_\Omega(a) = 0$ and $\phi_\Omega(b) = \infty$. Note that

this definition does not require to fix a normalization of ϕ_Ω due to the scale invariance of the law of $\text{SLE}_{\mathbb{H}}$ curves.

When speaking about the tightness of random curves in $(\Omega^\delta; a^\delta, b^\delta)$ we rely upon a powerful framework developed by Kemppainen and Smirnov in [KS17] as well as upon a recent work of Karrila [Kar18] (in which the behaviour in vicinities of the endpoints a, b is discussed). Let ξ^δ be a random driving term corresponding via (3.2.12) to the conformal images $\gamma_{\mathbb{H}}^\delta := \phi_{\widehat{\Omega}^\delta}(\gamma^\delta)$ of LERWs in $(\Omega^\delta; a^\delta, b)$. It is known since the work [AB99] of Aizenman and Burchard (see also [LSW04a]) that appropriate *crossing estimates* imply that

1. the family of random curves γ^δ (except maybe in vicinities of endpoints) is tight in the topology induced by the metric $\min_{\psi_1, \psi_2} \|\gamma_1 \circ \psi_1 - \gamma_2 \circ \psi_2\|_\infty$, with minimum taken over all parametrizations ψ_1, ψ_2 of two curves γ_1, γ_2 .

The results of Kemppainen and Smirnov (see [KS17, Theorem 1.5 and Corollary 1.7] as well as [KS17, Section 4.5] where the required crossing estimates are checked for the loop-erased random walks) give much more:

2. the driving terms ξ^δ are tight in the space of continuous functions on $[0, \infty)$ with topology of uniform convergence on compact intervals $[0, T]$;
3. the curves $\gamma_{\mathbb{H}}^\delta$ are tight in the same topology as in (1);
4. the curves $\gamma_{\mathbb{H}}^\delta$, parameterized by capacity, are tight in the space of continuous functions on $[0, \infty)$ with topology of uniform convergence on $[0, T]$.

Moreover, a weak convergence in one of the topologies (2)–(4) imply the convergence in two others. Furthermore, provided that $(\widehat{\Omega}^\delta; a^\delta, b)$ converge to $(\Omega; a, b)$ in the Carathéodory sense so that a^δ and $b^\delta = b$ are close approximations of degenerate prime ends a and b of Ω , the following holds:

5. if a sequence of random curves $\gamma_{\mathbb{H}}^\delta$ converges weakly in the topologies (2)–(4) to a random curve $\gamma_{\mathbb{H}}$ then γ^δ also converges weakly to a random curve which, almost surely, is supported on the limiting domain Ω due to [KS17, Corollary 1.8], and has the same law as $\phi_\Omega^{-1}(\gamma_{\mathbb{H}})$ due to [Kar18, Theorem 4.4].

3.2.4 . Convergence of classical LERW to chordal SLE(2)

To keep the presentation self-contained, in this section we sketch (a variant of the strategy used in [HK13, Wer09]) a proof of the classical result: convergence of the usual loop-erased random walks to SLE(2), in the setup of Theorem 3.1.1 discussed in the introduction.

As discussed above, the family of LERW probability measures on $(\Omega^\delta; a^\delta, b)$ is tight, provided that the curves γ^δ are parameterized by the half-plane capacities of their conformal images $\phi_{\widehat{\Omega}^\delta}(\gamma^\delta)$ in $(\mathbb{H}; 0, \infty)$. Since the space of continuous functions is metrizable and separable, by Skorokhod representation theorem, we can suppose that for each weakly convergent subsequence of these measures we also have $\gamma^\delta \rightarrow \gamma$ almost surely.

Let $\tau_r := \inf\{t > 0 : \gamma(t) \in B_\Omega(b, r)\}$ and τ_r^δ be the similar stopping times (in the half-plane capacity parametrization) for the discrete curves γ^δ . It is not hard to see that

for each (as for now, unknown) law \mathbb{P} of γ on the set of continuous parameterized curves, the following statement holds:

$$\text{for almost all } r > 0 \text{ one almost surely has } \tau_r^\delta \rightarrow \tau_r. \quad (3.2.13)$$

To prove (3.2.13), let us consider a continuous process $t \mapsto \rho_t := \rho_\Omega(b, \gamma(t))$. Since the curves γ^δ converge to γ in the capacity parametrization, one has $\tau_r^\delta \rightarrow \tau_r$ unless ρ_t has a local minimum at level r . (Indeed, note that the inequality $\limsup_{\delta \rightarrow 0} \tau_r^\delta \leq \tau_r$ is trivial: if γ enters the open set $B_\Omega(b, r)$, then so γ^δ (with small enough δ) do; no later than approximately at the same time. On the other hand, if ρ_t does *not* have a local minimum at level r , then for each $\varepsilon > 0$ one can find $\eta(\varepsilon) > 0$ such that $\rho_t \geq r + \eta(\varepsilon)$ for all $t \leq \tau_r - \varepsilon$, which gives $\liminf_{\delta \rightarrow 0} \tau_r^\delta \geq \tau_r - \varepsilon$.) The set of locally minimal values of a continuous function ρ_t is at most countable since each such a value r is the minimum of ρ_t over a rational interval. In particular,

$$\mu_{\text{Leb}}(\{r > 0 : \rho_t \text{ has a local minimum at level } r\}) = 0,$$

for each continuous function $t \mapsto \rho_t$ and thus (almost) surely in the context of random processes under consideration. Therefore,

$$\mathbb{P}[\text{the process } \rho_t \text{ has a local minimum at level } r] = 0 \text{ for almost all } r > 0,$$

due to the Fubini theorem for the product measure $\mathbb{P} \times \mu_{\text{Leb}}$, which implies (3.2.13).

Let $t > 0$ and assume that $r > 0$ is chosen according to (3.2.13) so that, almost surely, $\tau_{s,r}^\delta := s \wedge \tau_r^\delta \rightarrow s \wedge \tau_r$ and hence $\gamma^\delta[0, n_{s,r}^\delta] \rightarrow \gamma[0, s \wedge \tau_r]$ for all $s \in [0, t]$; see Lemma 3.2.2. Let

$$v \in B_\Omega(b, \frac{1}{2}r).$$

The martingale property of the discrete observables (3.2.6) gives

$$\mathbb{E}[M_{\Omega_{t,r}^\delta}^\delta(v^\delta) f(\gamma^\delta[0, n_{s,r}^\delta])] = \mathbb{E}[M_{\Omega_{s,r}^\delta}^\delta(v^\delta) f(\gamma^\delta[0, n_{s,r}^\delta])], \quad (3.2.14)$$

where f is a bounded continuous test function on the space of curves. We now pass to the limit (as $\delta \rightarrow 0$) in this identity using the following two facts:

— If $\gamma^\delta[0, n_{t,r}^\delta] \rightarrow \gamma[0, t \wedge \tau_r]$, then

$$M_{\Omega_{t,r}^\delta}^\delta(v^\delta) \rightarrow P_{\Omega \setminus \gamma[0, t \wedge \tau_r]}(v) := -\frac{1}{\pi} \text{Im} \frac{1}{g_{t \wedge \tau_r}(\phi(v)) - \xi_{t \wedge \tau_r}} \quad (3.2.15)$$

as $\delta \rightarrow 0$. We discuss such convergence results in Section 3.3 (see Proposition 3.3.14 for this concrete statement).

— The martingale observables are uniformly (with respect to δ and all possible realizations of $\gamma^\delta[0, n_{t,r}^\delta]$) bounded. Indeed, Lemma 3.2.4 implies that

$$M_{\Omega_{s,r}^\delta}^\delta(v^\delta) = \frac{Z_{\Omega_{s,r}^\delta}(a_{s,r}^\delta, v^\delta)}{Z_{\Omega_{s,r}^\delta}(a_{s,r}^\delta, b)} \cdot Z_{\Omega^\delta}(o^\delta, b) \leq \text{const} \cdot \frac{Z_{\Omega^\delta}(o^\delta, b)}{Z_{\Omega_{s,r}^\delta}(v^\delta, b)}$$

with a universal multiplicative constant and

$$\frac{Z_{\Omega^\delta}(o^\delta, b)}{Z_{\Omega_{s,r}^\delta}(v^\delta, b)} \leq \frac{Z_{\Omega^\delta}(o^\delta, b)}{Z_{B_{\Omega^\delta}(b,r)}(v^\delta, b)} \rightarrow \frac{G_\Omega(0, b)}{G_{B_\Omega(b,r)}(v, b)} < +\infty$$

as $\delta \rightarrow 0$ due to Corollary 3.3.8 (which allows one to replace b by an inner point $b_{\varepsilon r}$ lying close enough to b , cf. the proof of Proposition 3.3.5) and Corollary 3.3.3 (which provides the convergence of Green's functions); see also (3.3.7) for a discussion of the ratio of two harmonic functions $G_\Omega(0, \cdot)$ and $G_{B_\Omega(b,r)}(v, \cdot)$ at/near the (degenerate) prime end b .

Passing to the limit $\delta \rightarrow 0$ in (3.2.14) we are now able to conclude that, for each $r > 0$, the (continuous, uniformly bounded) process

$$P_{\Omega \setminus \gamma[0, t \wedge \tau_r]}(v) \text{ is a martingale for each } v \in B_\Omega(b, \frac{1}{2}r). \quad (3.2.16)$$

We now claim that the real-valued process $\xi_{t \wedge \tau_r}$ is a continuous local semi-martingale since it can be uniquely reconstructed as a certain deterministic function

$$\left(\frac{\operatorname{Im} Z_1 - \xi}{|Z_1 - \xi|^2}, \frac{\operatorname{Im} Z_2 - \xi}{|Z_2 - \xi|^2}, Z_1, Z_2 \right) \mapsto \xi$$

of continuous martingales (3.2.15) evaluated at two distinct points $v_1, v_2 \in B_\Omega(b, \frac{1}{2}r)$ and differentiable (complex-valued) processes $Z_1 := g_{t \wedge \tau_r}(\phi(v_1))$, $Z_2 := g_{t \wedge \tau_r}(\phi(v_2))$.

In particular, we can apply the Itô calculus to observables (3.2.15). Using the Loewner equation (3.2.12) and Itô's lemma, one gets the following formula:

$$\begin{aligned} dP_{\Omega \setminus \gamma[0, t \wedge \tau_r]}(v) &= -\frac{1}{\pi} d \operatorname{Im} \frac{1}{g_{t \wedge \tau_r}(\phi(v)) - \xi_{t \wedge \tau_r}} \\ &= -\frac{1}{\pi} \operatorname{Im} \left[\frac{d\xi_{t \wedge \tau_r}}{(g_{t \wedge \tau_r}(\phi(v)) - \xi_{t \wedge \tau_r})^2} + \frac{d\langle \xi, \xi \rangle_{t \wedge \tau_r} - 2d(t \wedge \tau_r)}{(g_{t \wedge \tau_r}(\phi(v)) - \xi_{t \wedge \tau_r})^3} \right] \end{aligned}$$

(here and below we use the sign d for the stochastic differential). As this process should be a martingale for each $v \in B_\Omega(b, \frac{1}{2}r)$, the only possibility is that

both processes $\xi_{t \wedge \tau_r}$ and $\langle \xi, \xi \rangle_{t \wedge \tau_r} - 2d(t \wedge \tau_r)$ are (local) martingales.

Since $\tau_r \rightarrow +\infty$ almost surely, one concludes that $\xi_t \stackrel{(d)}{=} \sqrt{2}B_t$ by the Lévy theorem.

Remark 3.2.3. The martingale property (3.2.16) can be directly generalized to the massive setup. Namely, for each subsequential limit (in the same topologies as above) of massive LERW on $(\Omega^\delta; a^\delta, b^\delta)$ and each $v \in B_\Omega(b, \frac{1}{2}r)$ the following holds:

$$\text{the process } t \mapsto P_{\Omega \setminus \gamma[0, t \wedge \tau_r]}^{(m)}(v) \cdot N_{\Omega \setminus \gamma[0, t \wedge \tau_r]}^{(m)} \text{ is a martingale,} \quad (3.2.17)$$

where the *massive Poisson kernels* $P^{(m)}(\cdot)$ are defined by (3.3.12) and the additional (random) *normalization factors* $N^{(m)}$ are given by (3.3.18). In order to prove (3.2.17) one mimics the arguments given above basing upon

- the convergence, as $\delta \rightarrow 0$, of massive martingale observables (3.2.6) to multiplies of massive Poisson kernels $P_{\Omega \setminus \gamma[0, t \wedge \tau_r]}^{(m)}(\cdot)$; this convergence is provided by Proposition 3.3.16;
- the uniform boundedness of massive observables (until time $t \wedge \tau_r$), which follows from Corollary 3.2.8 and the uniform boundedness of massless ones.

We identify the law of ξ_t in the massive setup in Section 3.4.3 using (3.2.17) in the same spirit as discussed above in the classical situation; see Lemma 3.4.9.

3.2.5 . The density of mLERW with respect to the classical LERW

Given a discrete domain $(\Omega^\delta; a^\delta, b^\delta)$ and $m < \delta^{-1}$, denote by $\mathbb{P}_{(\Omega^\delta; a^\delta, b^\delta)}[\gamma^\delta]$ and $\mathbb{P}_{(\Omega^\delta; a^\delta, b^\delta)}^{(m)}[\gamma^\delta]$ the probabilities that a simple lattice path γ^δ running from a^δ to b^δ inside Ω^δ appears as a classical ($m = 0$) or a massive LERW trajectory, respectively.

Lemma 3.2.4. *Let Ω^δ be a simply connected discrete domain, $a^\delta, b^\delta \in \partial\Omega^\delta$ (where the boundary $\partial\Omega^\delta$ of Ω^δ is understood as in (3.2.3)), and $v^\delta \in \text{Int}\Omega^\delta$. Then, the following estimate holds:*

$$\frac{Z_{\Omega^\delta}(a^\delta, v^\delta)Z_{\Omega^\delta}(v^\delta, b^\delta)}{Z_{\Omega^\delta}(a^\delta, b^\delta)} \leq \text{const},$$

with a universal (i.e., independent of $\Omega^\delta, a^\delta, b^\delta$, and v^δ) constant.

Proof. E.g., see [Che16, Proposition 3.1] which claims that the left-hand side is uniformly comparable to the probability that the random walk trajectory started at a^δ and conditioned to exit Ω^δ at b^δ intersects the ball $B(v^\delta, \frac{1}{3}\text{dist}(v^\delta, \partial\Omega^\delta))$. \square

Proposition 3.2.5. *There exists a universal constant $c_0 > 0$ such that, for each discrete domain $\Omega^\delta \subset B(0, R)$, boundary points $a^\delta, b^\delta \in \partial\Omega^\delta$ and $m \leq \frac{1}{2}\delta^{-1}$, one has*

$$Z_{\Omega^\delta}^{(m)}(a^\delta, b^\delta)/Z_{\Omega^\delta}(a^\delta, b^\delta) \geq \exp(-c_0 m^2 R^2), \quad (3.2.18)$$

where the massive random walk partition function $Z_{\Omega^\delta}^{(m)}$ is defined by (3.2.4).

Proof. By Jensen's inequality,

$$\frac{Z_{\Omega^\delta}^{(m)}(a^\delta, b^\delta)}{Z_{\Omega^\delta}(a^\delta, b^\delta)} = \mathbb{E}_{\text{SRW}(\Omega^\delta; a^\delta, b^\delta)}[(1 - m^2 \delta^2)^{\#\pi^\delta}] \geq (1 - m^2 \delta^2)^{\mathbb{E}_{\text{SRW}(\Omega^\delta; a^\delta, b^\delta)}[\#\pi^\delta]},$$

where the expectation is taken over simple random walks (SRW) π^δ started at a^δ and conditioned to exit Ω^δ at b^δ , whereas Lemma 3.2.4 gives

$$\mathbb{E}_{\text{SRW}(\Omega^\delta; a^\delta, b^\delta)}[\#\pi^\delta] + 1 = \sum_{v^\delta \in \text{Int}\Omega^\delta} \frac{Z_{\Omega^\delta}(a^\delta, v^\delta)Z_{\Omega^\delta}(v^\delta, b^\delta)}{Z_{\Omega^\delta}(a^\delta, b^\delta)} \leq \text{const} \cdot \delta^{-2} R^2.$$

The desired uniform estimate (3.2.18) follows easily. \square

Corollary 3.2.6. Let $D_{(\Omega^\delta; a^\delta, b^\delta)}^{(m)}(\gamma^\delta) := \mathbb{P}_{(\Omega^\delta; a^\delta, b^\delta)}^{(m)}(\gamma^\delta) / \mathbb{P}_{(\Omega^\delta; a^\delta, b^\delta)}(\gamma^\delta)$. Then,

(i) $D_{(\Omega^\delta; a^\delta, b^\delta)}^{(m)}(\gamma^\delta) \leq \exp(c_0 m^2 R^2)$, for each simple path γ^δ from a^δ to b^δ in Ω^δ ;

(ii) $\mathbb{E}_{(\Omega^\delta; a^\delta, b^\delta)}[\log D_{(\Omega^\delta; a^\delta, b^\delta)}^{(m)}(\gamma^\delta)] \geq -c_0 m^2 R^2$, where the expectation is taken over the classical LERW measure $\mathbb{P}_{(\Omega^\delta; a^\delta, b^\delta)}$.

Proof. (i) By definition,

$$D_{(\Omega^\delta; a^\delta, b^\delta)}^{(m)}(\gamma^\delta) = \frac{\sum_{\pi^\delta: \text{LE}(\pi^\delta) = \gamma^\delta} (\frac{1}{4}(1 - m^2 \delta^2))^{\#\pi^\delta}}{\sum_{\pi^\delta: \text{LE}(\pi^\delta) = \gamma^\delta} (\frac{1}{4})^{\#\pi^\delta}} \cdot \frac{Z_{\Omega^\delta}(a^\delta; b^\delta)}{Z_{\Omega^\delta}^{(m)}(a^\delta; b^\delta)},$$

where LE denotes the loop-erasure procedure applied to the simple random walk trajectory π^δ . The estimate (3.2.18) gives the desired uniform upper bound.

(ii) By Jensen's inequality and since $Z_{\Omega^\delta}(a^\delta, b^\delta) / Z_{\Omega^\delta}^{(m)}(a^\delta, b^\delta) \geq 1$, one has

$$\mathbb{E}_{(\Omega^\delta; a^\delta, b^\delta)}[\log D_{(\Omega^\delta; a^\delta, b^\delta)}^{(m)}(\gamma^\delta)] \geq \log(1 - m^2 \delta^2) \cdot \mathbb{E}_{\text{SRW}(\Omega^\delta; a^\delta, b^\delta)}[\#\pi^\delta],$$

where the first expectation is taken with respect to the LERW measure while the second is with respect to the *simple* random walk measure on the set $S_{\Omega^\delta}(a^\delta, b^\delta)$. The proof is completed in the same way as the proof of Proposition 3.2.5. \square

Below we also need the following extension of Lemma 3.2.4 and Proposition 3.2.5.

Lemma 3.2.7. Let Ω^δ be a discrete domain, $z^\delta, w^\delta \in \overline{\Omega^\delta}$ and $v^\delta \in \text{Int}\Omega^\delta$. Then,

$$\frac{Z_{\Omega^\delta}(w^\delta, v^\delta) Z_{\Omega^\delta}(v^\delta, z^\delta)}{Z_{\Omega^\delta}(w^\delta, z^\delta)} \leq \text{const} \cdot (1 + Z_{\Omega^\delta}(w^\delta, v^\delta) + Z_{\Omega^\delta}(v^\delta, z^\delta)), \quad (3.2.19)$$

with a universal (i.e., independent of Ω^δ , w^δ , z^δ , and v^δ) constant.

Proof. Denote $d_{\Omega^\delta}(v^\delta) := \text{dist}(v^\delta, \partial\Omega^\delta)$. Standard estimates imply that

$$Z_{\Omega^\delta}(w^\delta, v^\delta) \leq \text{const} \cdot Z_{\Omega^\delta}(w^\delta, z^\delta) \text{ if } |z^\delta - v^\delta| \leq \frac{1}{3} d_{\Omega^\delta}(v^\delta) \text{ and } |z^\delta - v^\delta| \leq |w^\delta - v^\delta|.$$

(Indeed, if $|w^\delta - v^\delta| \geq \frac{2}{3} d_{\Omega^\delta}(v^\delta)$, then both sides are comparable due to the Harnack principle, otherwise one has $Z_{\Omega^\delta}(w^\delta, v^\delta) \leq \text{const} \cdot Z_{\Omega^\delta}(z^\delta, v^\delta) \leq \text{const} \cdot Z_{\Omega^\delta}(z^\delta, w^\delta)$). In particular, this proves the desired estimate in the situation when z^δ (or, similarly, w^δ) is within $\frac{1}{3} d_{\Omega^\delta}(v^\delta)$ distance from v^δ .

To handle the case when both w^δ and z^δ are at least $\frac{1}{3} d_{\Omega^\delta}(v^\delta)$ apart from v^δ , note that the ratio of two positive discrete harmonic functions satisfies the maximum principle: if the inequality $H_1 \leq CH_2$ holds at all neighbors of a given vertex, then it also holds at this vertex since the function $H_1 - CH_2$ is discrete harmonic.

Therefore, the left-hand side of (3.2.19) satisfies the maximum principle in both variables w^δ and z^δ ; is uniformly bounded due to Lemma 3.2.4 if both $w^\delta, z^\delta \in \partial\Omega^\delta$; and is also uniformly bounded if at least one of these two vertices is at distance $\frac{1}{3} d_{\Omega^\delta}(v^\delta)$ from v^δ due to the argument given above. \square

Corollary 3.2.8. *There exists a universal constant $c_0 > 0$ such that, for each discrete domain $\Omega^\delta \subset B(0, R)$, two vertices $w^\delta, z^\delta \in \overline{\Omega}^\delta$ and $m \leq \frac{1}{2}\delta^{-1}$, one has*

$$Z_{\Omega^\delta}^{(m)}(w^\delta, z^\delta) / Z_{\Omega^\delta}(w^\delta, z^\delta) \geq \exp(-c_0 m^2 R^2).$$

Proof. The proof mimics the proof of Proposition 3.2.5. Indeed, one has

$$\mathbb{E}_{\text{SRW}(\Omega^\delta; z^\delta, w^\delta)}[\#\pi^\delta] \leq \text{const} \cdot \sum_{v^\delta \in \text{Int}\Omega^\delta} (1 + Z_{\Omega^\delta}(w^\delta, v^\delta) + Z_{\Omega^\delta}(v^\delta, z^\delta)) \leq \text{const} \cdot \delta^{-2} R^2$$

due to Lemma 3.2.7 and standard estimates of the discrete Green functions. \square

3.2.6 . Absolute continuity of mSLE(2) with respect to SLE(2)

As discussed in Section 3.2.3, the classical LERW probability measures $\mathbb{P}_{(\Omega^\delta; a^\delta, b^\delta)}$ on curves in discrete approximations $(\Omega^\delta; a^\delta, b^\delta)$ are tight. Moreover (see Section 3.2.4), the only possible weak limit of $\mathbb{P}_{(\Omega^\delta; a^\delta, b^\delta)}$, as $\delta \rightarrow 0$, is given by the SLE(2) measure on curves in $(\Omega; a, b)$, which we denote by $\mathbb{P}_{(\Omega; a, b)}$. Due to Corollary 3.2.6(i), the densities

$$D_{(\Omega^\delta; a^\delta, b^\delta)}^{(m)}(\gamma^\delta) = \mathbb{P}_{(\Omega^\delta; a^\delta, b^\delta)}^{(m)}(\gamma^\delta) / \mathbb{P}_{(\Omega^\delta; a^\delta, b^\delta)}(\gamma^\delta)$$

of the massive LERW measures on curves in $(\Omega^\delta; a^\delta, b^\delta)$ with respect to the classical ones are uniformly bounded from above by $\exp(c_0 m^2 R^2)$. Therefore, the measures $\mathbb{P}_{(\Omega^\delta; a^\delta, b^\delta)}^{(m)}$ are also tight in the topologies discussed in Section 3.2.3.

Lemma 3.2.9. (i) *Each subsequential weak limit $\mathbb{P}_{(\Omega; a, b)}^{(m)}$ of the massive LERW measures $\mathbb{P}_{(\Omega^\delta; a^\delta, b^\delta)}^{(m)}$ is absolutely continuous with respect to the SLE(2) measure $\mathbb{P}_{(\Omega; a, b)}$. The Radon–Nikodym derivative $D_{(\Omega; a, b)}^{(m)} := d\mathbb{P}_{(\Omega; a, b)}^{(m)} / d\mathbb{P}_{(\Omega; a, b)}$ is (almost surely) bounded from above by $\exp(c_0 m^2 R^2)$, with the same constant c_0 as in Corollary 3.2.6.*

(ii) *Moreover, one has $\mathbb{E}_{(\Omega; a, b)}[\log D_{(\Omega; a, b)}^{(m)}] \geq -c_0 m^2 R^2$. In particular, the measures $\mathbb{P}_{(\Omega; a, b)}^{(m)}$ and $\mathbb{P}_{(\Omega; a, b)}$ are mutually absolutely continuous.*

Proof. Denote $C := \exp(c_0 m^2 R^2)$. Both results can be easily deduced from Corollary 3.2.6 by passing to the limit $\delta \rightarrow 0$. As probability measures on metrizable spaces are always regular, each Borel set A can be approximated by a compact subset $F \subset A$. In its turn, F can be approximated by its open ε -neighborhood F^ε that can be without loss of generality assumed to be a continuity set for both measures under consideration. The first claim easily follows since

$$\mathbb{P}_\Omega^{(m)}[F^\varepsilon] = \lim_{\delta \rightarrow 0} \mathbb{P}_{\Omega^\delta}^{(m)}[F^\varepsilon] \leq C \cdot \lim_{\delta \rightarrow 0} \mathbb{P}_{\Omega^\delta}[F^\varepsilon] = C \cdot \mathbb{P}_\Omega[F^\varepsilon]$$

for such approximations of A , here and below we write Ω instead of $(\Omega; a, b)$ and Ω^δ instead of $(\Omega^\delta; a^\delta, b^\delta)$ for shortness. Therefore, $\mathbb{P}_\Omega^{(m)}[A] \leq C \cdot \mathbb{P}_\Omega[A]$ for each Borel set A . To prove (ii), note that

$$\mathbb{E}_\Omega[\log D_\Omega^{(m)}] = \inf_{A_k \text{-disjoint} : \mathbb{P}_\Omega(\cup_{k=1}^n A_k) = 1} \left\{ \sum_{k=1}^n \mathbb{P}_\Omega[A_k] \log \frac{\mathbb{P}_\Omega^{(m)}[A_k]}{\mathbb{P}_\Omega[A_k]} \right\}$$

and approximate each A_k by F_k^ε as explained above. Provided that $\varepsilon > 0$ is small enough (depending on the choice of F_k), the sets F_k^ε are still disjoint and hence

$$\mathbb{E}_{\Omega^\delta}[\log D_{\Omega^\delta}^{(m)}] \leq \sum_{k=1}^n \mathbb{P}_{\Omega^\delta}[F_k^\varepsilon] \log \frac{\mathbb{P}_{\Omega^\delta}^{(m)}[F_k^\varepsilon]}{\mathbb{P}_{\Omega^\delta}[F_k^\varepsilon]} + (1 - \mathbb{P}_{\Omega^\delta}[\cup_{k=1}^n F_k^\varepsilon]) \cdot \log C.$$

The proof is completed by applying the uniform estimate $\mathbb{E}_{\Omega^\delta}[\log D_{\Omega^\delta}^{(m)}] \geq -\log C$ provided by Corollary 3.2.6(ii), passing to the limit $\delta \rightarrow 0$, and then passing to the limit in the choice of approximations F_k^ε of a given disjoint collection A_k . \square

We now discuss how the law of the driving term $\xi_t = \sqrt{2}B_t$ of SLE(2) changes when the measure $\mathbb{P}_{(\Omega;a,b)}$ is replaced by $\mathbb{P}_{(\Omega;a,b)}^{(m)}$. Let

$$D_t^{(m)} := \mathbb{E}[D_{(\Omega;a,b)}^{(m)} | \mathcal{F}_t],$$

where \mathcal{F}_t denotes the (completed) canonical filtration of the Brownian motion B_t . Since $D_{(\Omega;a,b)}^{(m)} > 0$ almost surely, $D_t^{(m)}$ is a continuous martingale taking (strictly) positive values (e.g., see [LG13, p. 107]). Therefore (see [LG13, Proposition 5.8]), there exists a unique continuous local martingale $L_t^{(m)}$ such that

$$D_t^{(m)} = \exp\left(L_t^{(m)} - \frac{1}{2}\langle L^{(m)}, L^{(m)} \rangle_t\right) \quad (3.2.20)$$

and the Girsanov theorem (see [LG13, Theorem 5.8]) implies that

$$\xi_t = \sqrt{2} \cdot (B_t + \langle B, L^{(m)} \rangle_t) \quad \text{under } \mathbb{P}_{(\Omega;a,b)}^{(m)}. \quad (3.2.21)$$

Let $\tau_n \rightarrow \infty$ be stopping times that localize $L_t^{(m)}$. Jensen's inequality (which can be applied due to Lemma 3.2.9(i)) and Lemma 3.2.9(ii) imply that

$$\mathbb{E}\left[\frac{1}{2}\langle L^{(m)}, L^{(m)} \rangle_\infty\right] = \lim_{\tau_n \rightarrow \infty} \mathbb{E}[-\log D_{\tau_n}^{(m)}] \leq \mathbb{E}[-\log D_{(\Omega;a,b)}^{(m)}] \leq c_0 m^2 R^2. \quad (3.2.22)$$

In particular, $\langle L^{(m)}, L^{(m)} \rangle_\infty < +\infty$ a.s. In fact, *a posteriori* one can deduce from Theorem 3.1.1 that $\langle L^{(m)}, L^{(m)} \rangle_\infty \leq \text{const}(m, R) < +\infty$ a.s. (see Remark 3.4.10). Note however that we need some *a priori* information on $L^{(m)}$ to prove this theorem.

Remark 3.2.10. By definition, the process $(D_t^{(m)})^{-1}$ is a local martingale under $\mathbb{P}_{(\Omega;a,b)}^{(m)}$. Assume that, for an adapted process λ_t , one has

$$d(D_t^{(m)})^{-1} = -\sqrt{2}\lambda_t \cdot (D_t^{(m)})^{-1} \cdot dB_t \quad \text{under } \mathbb{P}_{(\Omega;a,b)}^{(m)}. \quad (3.2.23)$$

Due to (3.2.20), this implies that the martingale part of the process L_t (which is a semi-martingale under $\mathbb{P}_{(\Omega;a,b)}^{(m)}$) is $\sqrt{2}\lambda_t dB_t$ and hence

$$d\xi_t = \sqrt{2}dB_t + 2\lambda_t dt \quad \text{under } \mathbb{P}_{(\Omega;a,b)}^{(m)}.$$

Therefore, in order to find the law of ξ_t it is enough to identify λ_t in (3.2.23). It is worth noting that in the *massive* setup

$$(D_t^{(m)})^{-1} \neq \lim_{\delta \rightarrow 0} (Z_{\Omega_t^\delta}(a_t^\delta, b^\delta) / Z_{\Omega_t^\delta}^{(m)}(a_t^\delta, b^\delta)) =: N_t^{(m)},$$

a standard identity, e.g., in the *multiple* SLE context. The reason is that the total mass of massive RW loops attached to the tip a_t^δ is strictly smaller than the mass of the critical ones. Because of that, the process $N_t^{(m)}$ actually has a negative drift (which can be computed explicitly, see (3.4.20)) and one cannot easily deduce Theorem 3.1.1 relying only upon the analysis of this process; cf. Remark 3.4.11.

3.3 . Convergence of martingale observables

3.3.1 . Convergence of discrete harmonic functions

In this section we recall two useful results from [CS11]: convergence of the discrete Green functions $Z_{\Omega^\delta}(u^\delta, v^\delta)$ and of the discrete Poisson kernels $Z_{\Omega^\delta}(a^\delta, u^\delta) / Z_{\Omega^\delta}(a^\delta, v^\delta)$ as $\widehat{\Omega}^\delta \rightarrow \Omega$, where u, v are inner points and a is a boundary point (more accurately, a prime end) of Ω . Recall that we denote by $\widehat{\Omega}^\delta$ the polygonal representation of a discrete domain Ω^δ .

Definition 3.3.1. *Let $\Omega \subset \mathbb{C}$ be a simply connected bounded domain and $r > 0$. We say that points $u, v \in \Omega$ are jointly r -inside Ω if they can be connected by a path $L_{uv} \subset \Omega$ such that $\text{dist}(L_{uv}, \partial\Omega) > r$. In other words, u and v belong to the same connected component of the r -interior of Ω .*

In what follows, we assume that all domains under considerations are *uniformly* bounded. This assumption is mostly technical; in particular, it slightly simplify the discussion of subsequential limits of $\widehat{\Omega}^\delta$ in the Carathéodory topology, which is useful when speaking about uniform (with respect to $\widehat{\Omega}^\delta$) estimates; cf. [CS11].

Proposition 3.3.2. *Let $0 < r < R$ be fixed. There exists a function $\varepsilon(\delta) = \varepsilon(\delta, r, R)$, defined for small enough $\delta \leq \delta_0(r, R)$, such that $\varepsilon(\delta) \rightarrow 0$ as $\delta \rightarrow 0$ and that the following is fulfilled for all simply connected discrete domains $\widehat{\Omega}^\delta \subset B(0, R)$ and all pairs of points u^δ, v^δ lying jointly r -inside $\widehat{\Omega}^\delta$ and such that $|u^\delta - v^\delta| \geq r$:*

$$|Z_{\Omega^\delta}(u^\delta, v^\delta) - G_{\widehat{\Omega}^\delta}(u^\delta, v^\delta)| \leq \varepsilon(\delta). \quad (3.3.1)$$

Proof. This follows from (a more general in several aspects) uniform convergence result provided by [CS11, Corollary 3.11] and the convergence of the discrete *full-plane* Green function on the rescaled grid $\delta\mathbb{Z}$ to $-\frac{1}{2\pi} \log |u^\delta - v^\delta|$ (up to a constant) for $r \leq |u^\delta - v^\delta| \leq 2R$ and $\delta \rightarrow 0$, the latter being a standard fact of the discrete potential theory on the square grid. \square

Corollary 3.3.3. *Let $\Omega \subset B(0, R)$ be a simply connected planar domain and $u, v \in \Omega$ be two distinct points of Ω . Assume that discrete domains $\widehat{\Omega}^\delta \subset B(0, R)$ approximate Ω (in the Carathéodory topology with respect to u or v) as $\delta \rightarrow 0$. Then,*

$$Z_{\Omega^\delta}(u^\delta, v^\delta) \rightarrow G_\Omega(u, v) \quad \text{as } \delta \rightarrow 0. \quad (3.3.2)$$

Moreover, for each $r > 0$ this convergence is uniform provided that u and v are jointly r -inside Ω and $|u - v| \geq r$.

Proof. Let $L_{uv} \subset \Omega$ be a path connecting u and v inside Ω and $r := \frac{1}{2} \text{dist}(L_{uv}, \partial\Omega)$. It follows from the Carathéodory convergence of $\widehat{\Omega}^\delta$ to Ω that u^δ and v^δ are jointly r -inside of Ω^δ provided that δ is small enough. Since (the continuous) Green function is conformally invariant, $G_{\widehat{\Omega}^\delta}(u^\delta, v^\delta) \rightarrow G_\Omega(u, v)$ as $\delta \rightarrow 0$ uniformly for such u and v and thus the claim trivially follows from (3.3.1). \square

Remark 3.3.4. In Section 3.3.3 we prove an analogue of (3.3.2) in the massive setup along the lines of [CS11] though do not discuss an analogue of (3.3.1). Note that in [CS11] the uniform estimate (3.3.1) is actually *deduced from* (3.3.2) by compactness arguments; cf. the proofs of Proposition 3.3.5 and Corollary 3.3.6 discussed below.

Proposition 3.3.5. *Let $0 < r < R$ be fixed. There exists a function $\varepsilon(\delta) = \varepsilon(\delta, r, R)$, defined for small enough $\delta \leq \delta_0(r, R)$, such that $\varepsilon(\delta) \rightarrow 0$ as $\delta \rightarrow 0$ and that the following is fulfilled for all simply connected discrete domains $\widehat{\Omega}^\delta \subset B(0, R)$, all boundary points a^δ , and all inner points $u^\delta, v^\delta \in \Omega^\delta$ lying jointly r -inside $\widehat{\Omega}^\delta$:*

$$\left| \frac{Z_{\Omega^\delta}(a^\delta, u^\delta)}{Z_{\Omega^\delta}(a^\delta, v^\delta)} - \frac{P_{\widehat{\Omega}^\delta}(a^\delta, u^\delta)}{P_{\widehat{\Omega}^\delta}(a^\delta, v^\delta)} \right| \leq \varepsilon(\delta), \quad (3.3.3)$$

where $P_{\widehat{\Omega}^\delta}(a^\delta, \cdot)$ denotes the Poisson kernel in the polygonal representation $\widehat{\Omega}^\delta$ with mass at the point $a^\delta \in \partial\widehat{\Omega}^\delta$, note that its normalization is irrelevant for (3.3.3).

Proof. This result is provided (again, in a stronger form) by [CS11, Theorem 3.13]. For completeness of the exposition we sketch the key ingredients of this proof, which goes by contradiction. If the uniform estimate (3.3.3) was wrong, it would fail (for a fixed $\varepsilon_0 > 0$) along a sequence of configurations $(\Omega^\delta; a^\delta, u^\delta, v^\delta)$ with $\delta \rightarrow 0$. As the set of all simply connected domains Λ satisfying $B(u, r) \subset \Lambda \subset B(0, R)$ is compact in the Carathéodory topology, we could pass to a subsequence and assume that $(\widehat{\Omega}^\delta; a^\delta, u^\delta, v^\delta) \rightarrow (\Omega; a, u, v)$ as $\delta \rightarrow 0$ in the Carathéodory sense, with u and v being jointly r -inside Ω . The ratio of Poisson kernels $P_\Lambda(a, u)/P_\Lambda(a, v)$ is conformally invariant and so is stable under this convergence. Thus, it is enough to prove that

$$\frac{Z_{\Omega^\delta}(a^\delta, u^\delta)}{Z_{\Omega^\delta}(a^\delta, v^\delta)} \rightarrow \frac{P_\Omega(a, u)}{P_\Omega(a, v)} \quad \text{as } (\widehat{\Omega}^\delta; a^\delta, u^\delta, v^\delta) \xrightarrow{\text{Cara}} (\Omega; a, u, v) \quad (3.3.4)$$

in order to obtain a contradiction, where $u, v \in \Omega$ and a is a *prime end* of Ω .

Let $d > 0$ be small enough and let a point a_d be chosen so that the circle $\partial B(a_d, \frac{1}{2}d)$ separates the prime end a from u and v in Ω . Since $(\Omega^\delta; a^\delta)$ converges to $(\Omega; a)$, the circle $\partial B(a_d, d)$ then separates a^δ from u^δ and v^δ in $\widehat{\Omega}^\delta$, for all sufficiently small δ . Let $L_d^\delta \subset \partial B(a_d, d)$ denote the arc separating u^δ and v^δ from a^δ and all the other arcs forming the set $\partial B(a_d, d) \cap \widehat{\Omega}^\delta$, in other words this is the first arc of $\partial B(a_d, d) \cap \widehat{\Omega}^\delta$ to cross for a path running from, say, u^δ to a^δ ; see [CS11, Fig. 4].

Denote by Ω_{3d}^δ the connected component of $\Omega^\delta \setminus B(a_d, 3d)$ that contains v^δ . The key argument of the proof is the following uniform (for small enough δ) estimate:

$$\max_{u^\delta \in \Omega_{3d}^\delta} \frac{Z_{\Omega^\delta}(a^\delta, u^\delta)}{Z_{\Omega^\delta}(a^\delta, v^\delta)} \leq C(3d; \Omega, a). \quad (3.3.5)$$

We refer the reader to [CS11, pp. 26–27] for the proof of this statement which is based on the fact that the discrete harmonic measure $\omega^\delta(v^\delta; K_{3d}^\delta; \Omega_d^\delta)$ of each path K_{3d}^δ started in Ω_{3d}^δ and running to L_d^δ is uniformly bounded from below due to [CS11, Theorem 3.12] and [CS11, Lemma 3.14]; note that u^δ is *not* assumed to be located in the r -interior of Ω^δ in (3.3.5).

The proof can be now completed in a standard way. The (uniform in δ) weak-Beurling estimate (see Lemma 3.3.11) allows one to improve the uniform bound (3.3.5) near the boundary of Ω^δ :

$$\frac{Z_{\Omega^\delta}(a^\delta, u^\delta)}{Z_{\Omega^\delta}(a^\delta, v^\delta)} \leq \text{const} \cdot (\text{dist}(u^\delta, \partial\Omega^\delta)/d)^\beta \cdot C(3d; \Omega, a) \quad \text{for } u^\delta \in \Omega_{4d}^\delta.$$

Since uniformly bounded discrete harmonic functions are also equicontinuous (cf. Lemma 3.3.10), one can pass to a subsequence once again to get the (uniform on compact subsets) convergence

$$\frac{Z_{\Omega^\delta}(a^\delta, u^\delta)}{Z_{\Omega^\delta}(a^\delta, v^\delta)} \rightarrow h(u), \quad u \in \bigcup_{d>0} \Omega_{4d} = \Omega.$$

Each subsequential limit h is a positive harmonic function in Ω normalized so that $h(v) = 1$ and satisfies, for each $d > 0$, the same estimate

$$h(u) \leq \text{const} \cdot (\text{dist}(u, \partial\Omega)/d)^\beta \cdot C(3d; \Omega, a) \quad \text{for } u \in \Omega_{4d}.$$

Thus, h has Dirichlet boundary conditions, except at the prime end a . These properties characterize the Poisson kernel $h(u) = P_\Omega(a, u)/P_\Omega(a, v)$ uniquely. \square

Corollary 3.3.6. *Let $\Omega \subset B(0, R)$ be a simply connected planar domain, $a \in \partial\Omega$ be its prime end, and $u, v \in \Omega$ be two, not necessarily distinct, inner points. Assume that discrete domains $\widehat{\Omega}^\delta \subset B(0, R)$ with marked boundary points $a^\delta \in \partial\Omega^\delta$ approximate $(\Omega; a)$ in the Carathéodory topology with respect to u or v . Then,*

$$\frac{Z_{\Omega^\delta}(a^\delta, u^\delta)}{Z_{\Omega^\delta}(a^\delta, v^\delta)} \rightarrow \frac{P_\Omega(a, u)}{P_\Omega(a, v)} \quad \text{as } \delta \rightarrow 0. \quad (3.3.6)$$

Moreover, for each $r > 0$ this convergence is uniform if u, v are jointly r -inside Ω .

Proof. For a fixed pair u, v of points of Ω , this result is given by (3.3.4) and is a key step of the proof of Proposition 3.3.5. The fact that the convergence is uniform provided that u and v are jointly r -inside Ω can be, for instance, deduced from (3.3.3) and the conformal invariance of the Poisson kernel. Indeed, the Carathéodory convergence of $(\widehat{\Omega}^\delta; a^\delta)$ to $(\Omega; a)$ implies that $P_{\widehat{\Omega}^\delta}(a, u)/P_{\widehat{\Omega}^\delta}(a, v) \rightarrow P_\Omega(a, u)/P_\Omega(a, v)$ as $\delta \rightarrow 0$, uniformly for such u and v . \square

3.3.2 . Boundary behavior of discrete harmonic functions

Since we work in the chordal setup, in order to prove the convergence of the martingale observables (3.2.6) we need convergence results for (both classical and massive) Poisson kernels normalized at the boundary. To make the exposition self-contained and accessible to readers who are not familiar with the classical potential theory in 2D, we start this section with a remark on the boundary behavior of continuous harmonic functions defined in a vicinity $B_\Omega(b, r) \subset \Omega$ of its degenerate prime end b and satisfying the zero Dirichlet boundary conditions on $\partial B_\Omega(b, r) \cap \partial\Omega$.

Given two such (positive) functions $h_1, h_2 : B_\Omega(b, r) \rightarrow \mathbb{R}_+$, we claim that their ratio h_1/h_2 is always continuous at b and we slightly abuse the notation by writing

$$\frac{h_1(b)}{h_2(b)} := \lim_{\rho_\Omega(b, z) \rightarrow 0} \frac{h_1(z)}{h_2(z)}, \quad (3.3.7)$$

Indeed, let $\phi : B_\Omega(b, r) \rightarrow \mathbb{H}$ be a conformal uniformization of $B_\Omega(b, r)$ onto the upper half-plane \mathbb{H} such that $\phi(b) = 0$. Both functions $h_{1,2} \circ \phi^{-1}$ are harmonic in the upper half-plane \mathbb{H} and have Dirichlet boundary values near 0. By the Schwarz reflection principle, these functions must behave like $c_{1,2} \operatorname{Im} z + O(|z|^2)$ as $z \rightarrow 0$, which implies the existence of the limit c_1/c_2 in (3.3.7). Below we prove a similar statement in discrete, *uniformly over all possible shapes* of discrete domains Ω^δ near b . To do this, we need additional notation.

Let Ω^δ be a simply connected discrete domain, $o \in \widehat{\Omega}^\delta$, $b \in \partial\Omega^\delta$, and $r > 2\delta$ be such that $o \notin B_{\widehat{\Omega}^\delta}(b, r)$. Consider a collection of arcs $\partial B(b, r) \cap \widehat{\Omega}^\delta$ and denote by $S_o(b, r)$ one of these arcs that separates o from b in $\widehat{\Omega}^\delta$; if there are several such arcs, then we take the closest to b among them as $S_o(b, r)$. (More precisely, we require that $S_o(b, r)$ separates b from all the other arcs from this sub-collection.) Let $\Omega_o^\delta(b, r)$ be the connected component of $\Omega^\delta \setminus B(b, r)$ that contains the point o . Further, let $S_o^\delta(b, r^+), S_o^\delta(b, r^-) \subset \Omega^\delta$ be the sets of vertices that are adjacent to the arc $S_o(b, r)$ from outside and from inside, respectively; see Fig. 3.2.

Lemma 3.3.7. *There exists a universal constant $k < 1$ such that the following is fulfilled. In the setup described above, for each pair of positive discrete harmonic functions $H_1, H_2 : \Omega^\delta \rightarrow \mathbb{R}_+$ satisfying the Dirichlet boundary conditions on $\partial\Omega^\delta \setminus \partial\Omega_o^\delta(b, r)$, one has*

$$\begin{aligned} \max_{u, v \in \Omega^\delta \setminus \Omega_o^\delta(b, \frac{1}{2}r)} & \left| \frac{H_1(u)H_2(v) - H_1(v)H_2(u)}{H_1(u)H_2(v) + H_1(v)H_2(u)} \right| \\ & \leq k \cdot \max_{x, y \in S_o^\delta(b, r^+)} \left| \frac{H_1(x)H_2(y) - H_1(y)H_2(x)}{H_1(x)H_2(y) + H_1(y)H_2(x)} \right|. \end{aligned}$$

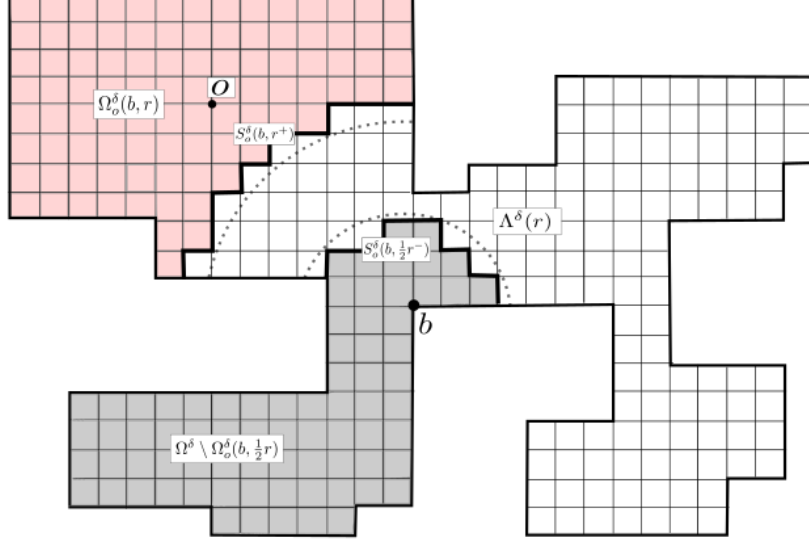

Figure 3.2 – Notation used in Lemma 3.3.7 and Corollary 3.3.8.

Proof. For shortness, denote $\Theta^\delta(r) := \Omega^\delta \setminus \Omega_0^\delta(b, r)$ and $\Lambda^\delta(r) := \Theta^\delta(r) \setminus \Theta^\delta(\frac{1}{2}r)$; see Fig. 3.2. Given a discrete harmonic function $H : \Omega^\delta \rightarrow \mathbb{R}_+$ satisfying the Dirichlet boundary conditions on $\partial\Omega^\delta \setminus \partial\Omega_0^\delta(b, r)$ and a point $u \in \Omega^\delta \setminus \Omega_0^\delta(b, \frac{1}{2}r)$, one can write

$$H(u) = \sum_{x \in S_0^\delta(b, r^+)} Z_{\Theta^\delta(r)}(u, x) H(x) = \sum_{\substack{x \in S_0^\delta(b, r^+) \\ u' \in S_0^\delta(b, \frac{1}{2}r^-)}} Z_{\Theta^\delta(r)}(u, u') Z_{\Lambda^\delta(r)}(u', x) H(x),$$

where u' stands for the last point in $\Theta^\delta(\frac{1}{2}r)$ visited by a random walk trajectory running from u to x . Applying this identity four times (for both functions H_1, H_2 as well as for both points u, v) and rearranging terms one sees that

$$\begin{aligned} H_1(u)H_2(v) &\mp H_1(v)H_2(u) \\ &= \frac{1}{2} \sum_{\substack{x, y \in S_0^\delta(b, r^+) \\ u', v' \in S_0^\delta(b, \frac{1}{2}r^-)}} Z_{\Theta^\delta(r)}(u, u') Z_{\Theta^\delta(r)}(v, v') \\ &\quad \times (Z_{\Lambda^\delta(r)}(u', x) Z_{\Lambda^\delta(r)}(v', y) \mp Z_{\Lambda^\delta(r)}(u', y) Z_{\Lambda^\delta(r)}(v', x)) \\ &\quad \times (H_1(x)H_2(y) \mp H_2(x)H_1(y)). \end{aligned}$$

Let $M := \max_{x, y \in S_0^\delta(b, r^+)} |H_1(x)H_2(y) - H_2(x)H_1(y)| / (H_1(x)H_2(y) + H_2(x)H_1(y))$. Therefore, in order to derive the desired estimate

$$|H_1(u)H_2(v) - H_1(v)H_2(u)| \leq kM \cdot (H_1(u)H_2(v) + H_1(v)H_2(u)),$$

it is enough to prove that (uniformly in all the parameters involved)

$$\left| \frac{Z_{\Lambda^\delta(r)}(u', x) Z_{\Lambda^\delta(r)}(v', y) - Z_{\Lambda^\delta(r)}(u', y) Z_{\Lambda^\delta(r)}(v', x)}{Z_{\Lambda^\delta(r)}(u', x) Z_{\Lambda^\delta(r)}(v', y) + Z_{\Lambda^\delta(r)}(u', y) Z_{\Lambda^\delta(r)}(v', x)} \right| \leq k. \quad (3.3.8)$$

By construction, $\Lambda^\delta(r)$ is a simply connected domain. Without loss of generality, assume that the boundary points u', v', y, x of $\Lambda^\delta(r)$ are listed in the counterclockwise order. Then, (3.3.8) is equivalent to the following uniform lower bound for the *discrete cross-ratio* of the quadrilateral $(\Lambda^\delta(r); u', v', y, x)$:

$$X_{\Lambda^\delta(r)}(u', v'; y, x) := \left[\frac{Z_{\Lambda^\delta(r)}(u', y)Z_{\Lambda^\delta(r)}(v', x)}{Z_{\Lambda^\delta(r)}(u', x)Z_{\Lambda^\delta(r)}(v', y)} \right]^{1/2} \geq \left[\frac{1-k}{1+k} \right]^{1/2}.$$

Due to [Che16, Proposition 4.5] and [Che16, Theorem 7.1], this estimate (with some universal constant $k < 1$) follows from the following uniform lower bound on the *discrete extremal length* (aka effective resistance) between the arcs $[u'v']$ and $[xy]$ in $\Lambda^\delta(r)$:

$$\begin{aligned} L_{\Lambda^\delta(r)}([u'v']_{\Lambda^\delta(r)}; [xy]_{\Lambda^\delta(r)}) &\geq L_{\Lambda^\delta(r)}(S_o^\delta(b, \frac{1}{2}r^-), S_o^\delta(b, r^+)) \\ &\geq \text{const} \cdot \frac{1}{2\pi} \log 2 > 0, \end{aligned}$$

which holds true since the discrete and the continuous extremal lengths are uniformly comparable to each other (e.g., see [Che16, Proposition 6.2]) and one can replace the quadrilateral $(\Lambda^\delta(r); u', v', x, y)$ by the annulus $B(b, r) \setminus B(b, \frac{1}{2}r)$ using monotonicity properties of the extremal length. \square

Corollary 3.3.8. *In the same setup, let $q \in \mathbb{N}$ and $r > 2^q \delta$ be such that $o \notin B_{\hat{\Omega}^\delta}(b, r)$. Let $H_1, H_2 : \Omega^\delta \rightarrow \mathbb{R}_+$ be positive discrete harmonic functions satisfying the Dirichlet boundary conditions on $\partial\Omega^\delta \setminus \partial\Omega_o^\delta(b, r)$. Then, one has*

$$\max_{u, v \in \Omega^\delta \setminus \Omega_o^\delta(b, 2^{-q}r)} \frac{H_1(u)/H_2(u)}{H_1(v)/H_2(v)} \leq \frac{1+k^q}{1-k^q},$$

with the same universal constant $k < 1$ as in Lemma 3.3.7.

Proof. This estimate follows easily by iterating q times the result of Lemma 3.3.7, (note that the ratio inside the absolute value is always less than 1), which gives $|H_1(u)H_2(v) - H_2(u)H_1(v)| \leq k^q \cdot (H_1(u)H_2(v) + H_2(u)H_1(v))$. \square

3.3.3 . Convergence of the massive Green function

In this section we prove an analogue of the uniform convergence (3.3.2) for massive Green functions $Z_{\Omega^\delta}^{(m)}(u^\delta, v^\delta)$. To prove this result, Proposition 3.3.12, we need several preliminary facts.

Lemma 3.3.9. *Let $(X_n)_{n \in \mathbb{N}}$ be a simple random walk with killing rate $m^2 \delta^2$ on $\delta\mathbb{Z}^2$. For an annulus $A = A(v_0, r_1, r_2)$, denote by $E(A)$ the event that X_n , started at $v \in A \cap \delta\mathbb{Z}^2$, makes a non-trivial loop around v_0 before exiting A , that is, there exists $0 \leq s < k < \tau_{\mathbb{C} \setminus A}$ such that $X_s = X_k$ and $X|_{[s, k]}$ is not null-homotopic in A . There exists a universal constant such that one has*

$$\mathbb{P}_v^{(m)}[E(A(v_0, r, 2r))] \geq \text{const} > 0$$

for all $\delta \leq r \leq m^{-1}$ and all $v \in \delta\mathbb{Z}^2$ such that $\frac{3}{2}r - \delta \leq |v - v_0| \leq \frac{3}{2}r + \delta$.

Proof. The desired event can be easily constructed from a few events of a type that a random walk started at the center u of a rectangle $[u - \frac{1}{4}r, u + \frac{1}{4}r] \times [u - \frac{1}{8}r, u + \frac{1}{8}r]$ exists it through a prescribed side *not dying along the way*. As we require that the killing rate $m^2\delta^2$ is scaled accordingly to the mesh size and that $r \leq m^{-1}$, standard estimates imply that the probability of each of these events is uniformly bounded from below by a universal constant, independent of δ and r . \square

Given $m > 0$, we say that a function H is *massive discrete harmonic* at a vertex $v \in \delta\mathbb{Z}^2$ if

$$H(v) = \frac{1 - m^2\delta^2}{4} \sum_{v_1 \in \delta\mathbb{Z}^2: v_1 \sim v} H(v_1). \quad (3.3.9)$$

Trivially, if H is positive, then it satisfies the maximum principle: $H(v)$ cannot be bigger than all four values $H(v_1)$ at $v_1 \sim v$. Using Lemma 3.3.9 one can easily prove a priori regularity of massive discrete harmonic functions on $\delta\mathbb{Z}^2$.

Lemma 3.3.10. *There exists universal constants $C, \beta > 0$ such that the following holds: for each positive massive discrete harmonic function H defined in the disc $B(v_0, 2r) \cap \delta\mathbb{Z}^2$ with $r \leq m^{-1}$ and for each $v_1, v_2 \in B(v_0, r) \cap \delta\mathbb{Z}^2$ one has*

$$|H(v_2) - H(v_1)| \leq C \cdot (|v_2 - v_1|/r)^\beta \cdot \max_{v \in B(v_0, 2r) \cap \delta\mathbb{Z}^2} H(v).$$

Proof. Without loss of generality, assume that $|v_2 - v_1| \leq \frac{1}{4}r$. The maximum principle yields the existence of a path γ connecting v_2 to the boundary of $B(v_0, 2r)$ such that the values of H along γ are larger than $H(v_2)$. Consider a family of concentric annuli

$$A_k := A(v_1, 2^k|v_2 - v_1|, 2^{k+1}|v_2 - v_1|), \quad k = 0, \dots, \lfloor \frac{1}{2} \log_2(r/|v_2 - v_1|) \rfloor.$$

Due to Lemma 3.3.9, for each k the probability that the random walk with killing rate $m^2\delta^2$ started from v_1 is killed or does not hit γ while crossing A_k is uniformly bounded away from 1. At the same time, standard estimates imply that the probability that this random walk is killed before crossing all A_k is uniformly bounded from above by $\text{const} \cdot m^2r|v_2 - v_1| \leq \text{const} \cdot |v_2 - v_1|/r$. Hence, the probability that this random walk hits γ before dying or exiting $B(v_0, 2r)$ is at least $1 - C(|v_2 - v_1|/r)^\beta$. Therefore,

$$H(v_1) \geq [1 - C(|v_2 - v_1|/r)^\beta] \cdot H(v_2),$$

with universal constants $C, \beta > 0$. \square

We also need the so-called weak-Beurling estimate which applies to both discrete massive harmonic and usual ($m = 0$) discrete harmonic functions.

Lemma 3.3.11. *Let $\Omega^\delta \subset \delta\mathbb{Z}^2$ be a simply connected discrete domain, $c^\delta \in \partial\Omega^\delta$ be a boundary point, and $r \leq m^{-1}$. Let H be discrete massive harmonic function defined*

in the r -vicinity $B_{\Omega^\delta}(c, r)$ of c in Ω^δ and let H satisfy the Dirichlet boundary conditions on $\partial B_{\Omega^\delta}(c, r) \cap \partial\Omega^\delta$. There exist universal constants $C, \beta > 0$ such that one has

$$|H(v)| \leq C \cdot (\rho_{\Omega^\delta}(c, v)/r)^\beta \cdot \max_{u \in B_{\Omega^\delta}(c, r)} |H(u)|$$

for all $v \in B_{\Omega^\delta}(c, r)$, where $\rho_{\Omega^\delta}(c, v)$ and $B_{\Omega^\delta}(c, r)$ are defined by (3.2.10).

Proof. The proof is similar to the proof of Lemma 3.3.10: the simple random walk with killing rate $m^2\delta^2$ started at v hits $\partial\Omega^\delta$ or dies before reaching $\partial B_{\Omega^\delta}(c, r) \setminus \partial\Omega^\delta$ with probability at least $1 - C \cdot (\rho_{\Omega^\delta}(c, v)/r)^\beta$. \square

We are now ready to prove an analogue of Proposition 3.3.2 for massive Green functions. Given a simply connected domain $\Lambda \subset \mathbb{C}$ we denote by $G_\Lambda^{(m)}(u, v)$ the integral kernel of the operator $(-\Delta_\Lambda + m^2)^{-1}$, where Δ_Λ stands for the Laplacian in Λ with Dirichlet boundary conditions. In other words, the *massive Green function* $G_\Lambda^{(m)}(u, \cdot)$ is the unique solution to the equation $(-\Delta + m^2)G_\Lambda^{(m)}(u, \cdot) = \delta_u(\cdot)$, understood in the sense of distributions, with Dirichlet boundary conditions at $\partial\Lambda$.

Proposition 3.3.12. *Let $\Omega \subset B(0, R)$ be a simply connected planar domain and $u, v \in \Omega$ be two distinct points of Ω . Assume that discrete domains $\Omega^\delta \subset B(0, R)$ approximate Ω (in the Carathéodory topology with respect to u or v). Then,*

$$Z_{\Omega^\delta}^{(m)}(u^\delta, v^\delta) \rightarrow G_\Omega^{(m)}(u, v) \quad \text{as } \delta \rightarrow 0. \quad (3.3.10)$$

Moreover, for each $r > 0$ this convergence is uniform provided that u and v are jointly r -inside Ω and $|u - v| \geq r$.

Proof. The functions $H^\delta(\cdot) := Z_{\Omega^\delta}^{(m)}(u^\delta, \cdot)$ are uniformly (in δ) bounded on compact subsets of $\Omega \setminus \{u\}$ as

$$0 \leq Z_{\Omega^\delta}^{(m)}(u^\delta, v^\delta) \leq Z_{\Omega^\delta}(u^\delta, v^\delta) \leq \frac{1}{2\pi}(\log R - \log |u^\delta - v^\delta|) + O(1). \quad (3.3.11)$$

Moreover, Lemma 3.3.10 implies that these functions are also equicontinuous and hence one can find a subsequential limit $h : \Omega \setminus \{u\} \rightarrow \mathbb{R}_+$ such that

$$H^\delta(\cdot) \rightarrow h(\cdot) \quad \text{as } \delta = \delta_k \rightarrow 0,$$

uniformly on compact subsets of $\Omega \setminus \{u\}$. Furthermore, it follows from Lemma 3.3.11 that the function $h(\cdot)$ has Dirichlet boundary conditions everywhere at $\partial\Omega$.

It remains to check that $[(-\Delta + m^2)h](\cdot) = \delta_u(\cdot)$ in the sense of distributions. Let $\phi \in C_0^\infty(\Omega)$ be a smooth function such that $\text{supp}\phi \subset \Omega$ and hence $\text{supp}\phi \subset \widehat{\Omega}^\delta$ provided that δ is small enough. For $v^\delta \in \text{Int}\Omega^\delta$, denote

$$[\Delta^\delta \phi](v^\delta) := \frac{1}{4\delta^2} \sum_{v_1^\delta \in \Omega^\delta : v_1^\delta \sim v} (\phi(v_1^\delta) - \phi(v^\delta)).$$

Recall that the function $H^\delta(v^\delta) = Z_{\Omega^\delta}^{(m)}(u^\delta, v^\delta)$ satisfies the massive harmonicity equation (3.3.9) everywhere in Ω^δ except at the vertex u^δ and that the mismatch in (3.3.9) equals to 1 if $v^\delta = u^\delta$. The discrete integration by parts gives the identity

$$\begin{aligned}\phi(u^\delta) &= \delta^2 \sum_{v^\delta \in \text{Int}\Omega^\delta} \phi(v^\delta) \cdot (m^2 H^\delta(v^\delta) - (1 - m^2 \delta^2) [\Delta^\delta H^\delta](v^\delta)) \\ &= \delta^2 \sum_{v^\delta \in \text{Int}\Omega^\delta} H^\delta(v^\delta) \cdot (m^2 \phi(v^\delta) - (1 - m^2 \delta^2) [\Delta^\delta \phi](v^\delta)).\end{aligned}$$

We now pass to the limit $\delta \rightarrow 0$ in this identity; note that the prefactor δ^2 in the right-hand side is nothing but the area of a unit cell on the grid $\delta\mathbb{Z}^2$. Clearly, $[\Delta^\delta \phi](v^\delta) = [\Delta \phi](v^\delta) + O(\delta \cdot \max_{v \in \Omega} |D^3 \phi(v)|)$. The upper bound (3.3.11) implies that the sums over ρ -vicinities of u are uniformly (in δ) small as $\rho \rightarrow 0$. Hence, the convergence of H^δ to h away from u implies that

$$\phi(u) = \int_{\Omega} h(v) (m^2 \phi(v) - [\Delta \phi](v)) dA(v).$$

Therefore, each subsequential limit of the functions H^δ coincides with $G_\Omega^{(m)}(u, \cdot)$, which proves (3.3.10) for fixed u and v . The fact that the convergence is uniform follows from the equicontinuity of functions $Z_{\Omega^\delta}^{(m)}(u^\delta, v^\delta)$ discussed above and the compactness of the set of pairs (u, v) under consideration. \square

Remark 3.3.13. It follows from the convergence (3.3.10) that, for $u, v \in \Omega \subset B(0, R)$, one has

$$\exp(-c_0 m^2 R^2) \cdot G_\Omega(u, v) \leq G_\Omega^{(m)}(u, v) \leq G_\Omega(u, v)$$

due to the similar uniform estimate in discrete provided by Corollary 3.2.8.

3.3.4 . Convergence of martingale observables

Recall that $(\Omega^\delta; a^\delta, b)$ are discrete approximations on scale δ of $(\Omega; a, b)$ in the Carathéodory sense. It follows from the absolute continuity of massive LERW with respect to the massless one (see Section 3.2.6) that the family of mLERW probability measures in $(\Omega^\delta; a^\delta, b)$ is tight, when parameterized by the half-plane capacities of their conformal images (under the mappings $\phi_{\widehat{\Omega}^\delta}$) in $(\mathbb{H}; 0, \infty)$. Using the Skorokhod representation theorem as in Section 3.2.4, we can always assume that, almost surely,

$$(\widehat{\Omega}_{t,r}^\delta; a_{t,r}^\delta) \xrightarrow{\text{Cara}} (\Omega_{t,r}; a_{t,r}) \quad \text{as } \delta \rightarrow 0,$$

where $\Omega_{t,r}^\delta = \Omega^\delta \setminus \gamma^\delta[0, n_{t,r}^\delta]$ and $a_{t,r}^\delta = \gamma^\delta(n_{t,r}^\delta)$. The goal of this section is to show that in this situation the martingale observables (3.2.6), evaluated in the $\frac{1}{2}r$ -vicinity of b , also converge almost surely to their continuous analogues. In other words, Proposition 3.3.14 (for $m = 0$) and Proposition 3.3.16 (for $m \neq 0$) are *deterministic* statements, which we later apply for all possible limiting curves. For shortness, below we drop the second subscript r and simply say that $t \leq \tau_r$ instead.

We start by proving the convergence result for the classical (i.e., massless) LERW observable normalized at the boundary point b .

Proposition 3.3.14. *In the setup described above, let $t \leq \tau_r$ and $v \in B_\Omega(b, \frac{1}{2}r)$. Then*

$$M_{\Omega_t^\delta}(v^\delta) = \frac{Z_{\Omega_t^\delta}(a_t^\delta, v^\delta)}{Z_{\Omega_t^\delta}(a_t^\delta, b)} \cdot Z_{\Omega^\delta}(o^\delta, b) \rightarrow P_{\Omega_t}(a_t, v) \quad \text{as } \delta \rightarrow 0,$$

where the Poisson kernel $P_{\Omega_t}(a_t, \cdot)$ in the domain Ω_t is normalized so that one has $P_{\Omega_t}(a_t, z) \sim P_\Omega(a, z) \sim G_\Omega(0, z)$ as $z \rightarrow b$, see (3.2.8) and Section 3.4.1.

Proof. Given a small $\varepsilon > 0$, pick a point $b_{\varepsilon r} \in B_\Omega(b, \varepsilon r)$. Corollary 3.3.8 implies that

$$\frac{Z_{\Omega_t^\delta}(a_t^\delta, v^\delta)Z_{\Omega^\delta}(o^\delta, b)}{Z_{\Omega_t^\delta}(a_t^\delta, b)} = \frac{Z_{\Omega_t^\delta}(a_t^\delta, v^\delta)Z_{\Omega^\delta}(o^\delta, b_{\varepsilon r}^\delta)}{Z_{\Omega_t^\delta}(a_t^\delta, b_{\varepsilon r}^\delta)} \cdot (1 + O(\varepsilon^\beta)),$$

with a universal exponent $\beta > 0$ and a universal (in particular, uniform in δ) O -bound. For each $\varepsilon > 0$, it follows from Corollary 3.3.6 and Corollary 3.3.3 that

$$\frac{Z_{\Omega_t^\delta}(a_t^\delta, v^\delta)}{Z_{\Omega_t^\delta}(a_t^\delta, b_{\varepsilon r}^\delta)} \xrightarrow{\delta \rightarrow 0} \frac{P_{\Omega_t}(a_t, v)}{P_{\Omega_t}(a_t, b_{\varepsilon r})} \quad \text{and} \quad Z_{\Omega^\delta}(o^\delta, b_{\varepsilon r}^\delta) \xrightarrow{\delta \rightarrow 0} G_\Omega(0, b_{\varepsilon r}).$$

Since we also know that

$$\frac{P_{\Omega_t}(a_t, v)G_\Omega(0, b_{\varepsilon r})}{P_{\Omega_t}(a_t, b_{\varepsilon r})} \xrightarrow{\varepsilon \rightarrow 0} P_{\Omega_t}(a_t, v) \frac{G_\Omega(0, b)}{P_{\Omega_t}(a_t, b)} = P_{\Omega_t}(a_t, v),$$

the claim follows by first sending $\delta \rightarrow 0$ and then $\varepsilon \rightarrow 0$. \square

We now move on to the convergence of the martingale observable in the massive setup. In order to formulate an analogue of Proposition 3.3.14 in this situation, we need to introduce the massive Poisson kernel

$$P_{\Omega_t}^{(m)}(a_t, z) := P_{\Omega_t}(a_t, z) - m^2 \int_{\Omega_t} P_{\Omega_t}(a_t, w) G_{\Omega_t}^{(m)}(w, z) dA(w). \quad (3.3.12)$$

We refer the reader to Section 3.4.1 (more precisely, to Remark 3.4.3(i)), where the convergence of this integral is discussed; note that no regularity assumptions on Ω_t are required for this fact.

Proposition 3.3.15. *In the setup described above, let $z \in \Omega_t$ (note that we do not need to assume that this point is close to b). Then, as $\delta \rightarrow 0$, one has*

$$\frac{Z_{\Omega_t}^{(m)}(a_t^\delta, z^\delta)}{Z_{\Omega_t^\delta}(a_t^\delta, z^\delta)} \rightarrow \frac{P_{\Omega_t}^{(m)}(a_t, z)}{P_{\Omega_t}(a_t, z)} = 1 - m^2 \int_{\Omega_t} \frac{P_{\Omega_t}(a_t, w)}{P_{\Omega_t}(a_t, z)} G_{\Omega_t}^{(m)}(w, z) dA(w).$$

Proof. It follows from Lemma 3.2.1 that

$$1 - \frac{(1 - m^2 \delta^2) Z_{\Omega_t}^{(m)}(a_t^\delta, z^\delta)}{Z_{\Omega_t^\delta}(a_t^\delta, z^\delta)} = m^2 \delta^2 \sum_{w^\delta \in \text{Int}\Omega_t^\delta} \frac{Z_{\Omega_t^\delta}(a_t^\delta, w^\delta)}{Z_{\Omega_t^\delta}(a_t^\delta, z^\delta)} Z_{\Omega_t^\delta}^{(m)}(w^\delta, z^\delta). \quad (3.3.13)$$

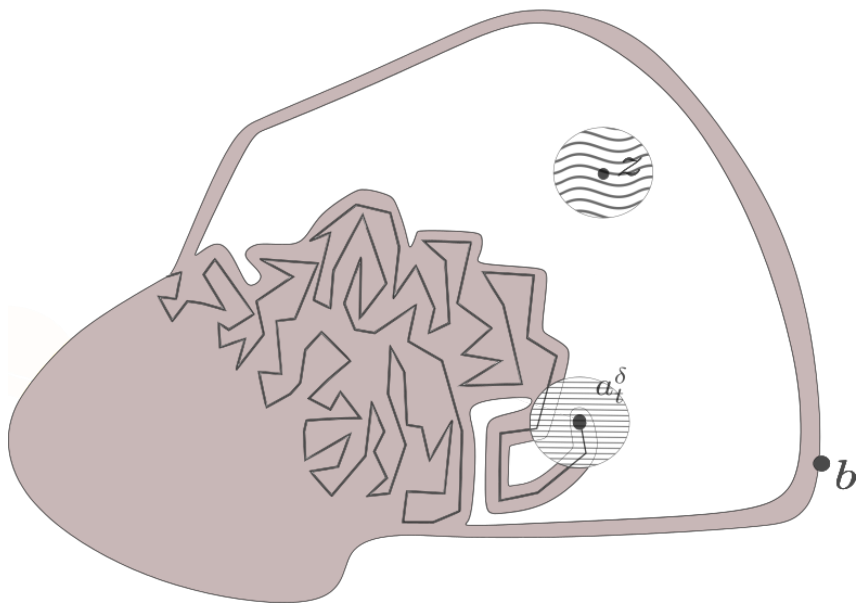

Figure 3.3 – Four parts in the summation (3.3.13) over $w^\delta \in \text{Int}\Omega_t^\delta$: the white region inside the domain is I^δ ; the shaded vicinities of z and a_t^δ are II^δ and III^δ , respectively; the gray region is IV^δ .

We now want to pass to the limit as $\delta \rightarrow 0$ in this expression. For this purpose, we fix small parameters $\rho, \rho_a > 0$ and split the sum into the following four parts I $^\delta$ –IV $^\delta$; see Fig. 3.3 for an illustration:

I $^\delta$: *sum over w^δ lying jointly ρ -inside Ω_t^δ with z but not in $B(z, \rho) \cup B(a_t^\delta, \rho_a)$.* First, note that for $w^\delta \notin B(z, \rho)$ the summands are uniformly bounded from above due to Lemma 3.2.7 since $Z_{\Omega_t^\delta}^{(m)}(w^\delta, z^\delta) \leq Z_{\Omega_t^\delta}(w^\delta, z^\delta)$ and the right-hand side of (3.2.19) is $O(1)$ provided that $v^\delta = a_t^\delta$ and $|w^\delta - z^\delta| \geq \rho$. Thus, on these parts of Ω^δ one can use Corollary 3.3.6 and Proposition 3.3.12 to deduce the convergence

$$I^\delta \rightarrow m^2 \int_{\Omega_t^{(\rho)} \setminus (B(z, \rho) \cup B(a_t, \rho_a))} \frac{P_{\Omega_t}(a_t, w)}{P_{\Omega_t}(a_t, z)} G_{\Omega_t}^{(m)}(w, z) dA(w) \quad \text{as } \delta \rightarrow 0, \quad (3.3.14)$$

where $\Omega_t^{(\rho)}$ denotes the connected component of the ρ -interior of Ω_t that contains z .

II $^\delta$: *sum over w^δ in the ρ -vicinity of z .* Due to the Harnack principle for discrete harmonic functions, the ratios $Z_{\Omega_t^\delta}(a_t^\delta, w^\delta)/Z_{\Omega_t^\delta}(a_t^\delta, z^\delta)$ are uniformly bounded if w^δ is close to z^δ . Therefore, the summands of this part of (3.3.13) are majorated by the Green function $Z_{\Omega_t^\delta}(w^\delta, z^\delta)$ since $Z_{\Omega_t^\delta}^{(m)}(w^\delta, z^\delta) \leq Z_{\Omega_t^\delta}(w^\delta, z^\delta)$. Standard estimates give

$$II^\delta = O(\rho^2 \log \rho) \quad \text{uniformly in } \delta. \quad (3.3.15)$$

III $^\delta$: *sum over the ρ_a -vicinity of a_t .* As already mentioned above, Lemma 3.2.7 implies that on these parts of Ω^δ the summands are uniformly bounded. Therefore,

$$III^\delta = O(\rho_a^2) \quad \text{uniformly in } \delta. \quad (3.3.16)$$

IV $^\delta$: *sum over w^δ that are neither jointly ρ -inside Ω_t^δ with z , nor in the ρ_a -vicinity a_t , nor in the ρ -vicinity of z .* It is worth noting that these parts of Ω_t^δ can be in principle rather big as we require only the Carathéodory convergence of Ω^δ to Ω (and so Ω^δ might contain big fjords that disappear in the limit). Nevertheless, one can easily see that the summands in this part of (3.3.13) are uniformly (in δ) small as $\rho \rightarrow 0$. Indeed, due to (3.3.5) we have a uniform (provided that δ is small enough) upper bound

$$\frac{Z_{\Omega_t^\delta}(a_t^\delta, w^\delta)}{Z_{\Omega_t^\delta}(a_t^\delta, z^\delta)} \leq C(\rho_a; \Omega_t, a_t) \quad \text{for } w^\delta \notin B_{\Omega_t^\delta}(a_t^\delta, \rho_a).$$

At the same time, since w^δ is not ρ -jointly inside Ω_t^δ with z , there exists a ball of radius ρ which intersects the boundary of Ω_t^δ and separates these two points in Ω_t^δ . Therefore, the weak-Beurling estimate (see Lemma 3.3.11) gives that

$$Z_{\Omega_t^\delta}^{(m)}(w^\delta, z^\delta) = O(\rho^\beta),$$

which allows us to conclude that

$$IV^\delta \leq \text{Area}(\Omega_t^\delta) \cdot C(\rho_a; \Omega_t, a_t) \cdot O(\rho^\beta) \quad \text{uniformly in } \delta. \quad (3.3.17)$$

Combining (3.3.14)–(3.3.17) together and sending first $\rho \rightarrow 0$ and then $\rho_a \rightarrow 0$ we get

$$I^\delta + II^\delta + III^\delta + IV^\delta \rightarrow m^2 \int_{\Omega_t} \frac{P_{\Omega_t}(a_t, w)}{P_{\Omega_t}(a_t, z)} G_{\Omega_t}^{(m)}(w, z) dA(w) \quad \text{as } \delta \rightarrow 0$$

since the domains $\Omega_t^{(\rho)} \setminus (B(z, \rho) \cup B(a_t, \rho_a))$ exhaust Ω_t . The proof is completed. \square

We now introduce the quantity

$$N_{\Omega_t}^{(m)} = N_{\Omega_t}^{(m)}(a_t, b) := \left[\frac{P_{\Omega_t}^{(m)}(a_t, b)}{P_{\Omega_t}(a_t, b)} \right]^{-1} = \left[\lim_{z \rightarrow b} \frac{P_{\Omega_t}^{(m)}(a_t, z)}{P_{\Omega_t}(a_t, z)} \right]^{-1}, \quad (3.3.18)$$

which keeps track of the normalization of the massive observable at the point b . The existence of this limit (as $z \rightarrow b$) is discussed in Section 3.4.1; see (3.4.12). The next proposition is the main result of this section. It is worth noting that the convergence (3.3.19) discussed below and Corollary 3.2.8, in particular, imply the uniform estimates $1 \leq N_{\Omega_t}^{(m)}(a_t, b) \leq \exp(c_0 m^2 R^2)$.

Proposition 3.3.16. *In the setup of Proposition 3.3.14 (i.e., $t \leq \tau_r$ and $v \in B_\Omega(b, \frac{1}{2}r)$), the following convergence holds true as $\delta \rightarrow 0$:*

$$M_{\Omega_t^\delta}^{(m)}(v^\delta) = \frac{Z_{\Omega_t^\delta}^{(m)}(a_t^\delta, v^\delta)}{Z_{\Omega_t^\delta}^{(m)}(a_t^\delta, b)} \cdot Z_{\Omega_t^\delta}(o^\delta, b) \rightarrow P_{\Omega_t}^{(m)}(a_t, v) \cdot N_{\Omega_t}^{(m)}(a_t, b) =: M_{\Omega_t}^{(m)}(v),$$

where the quantities in the right-hand side are defined by (3.3.12) and (3.3.18).

Proof. We start by generalizing the result of Proposition 3.3.15 to $z = b$:

$$\frac{Z_{\Omega_t^\delta}^{(m)}(a_t^\delta, b)}{Z_{\Omega_t^\delta}^{(m)}(a_t^\delta, b)} \rightarrow \frac{P_{\Omega_t}^{(m)}(a_t, b)}{P_{\Omega_t}(a_t, b)} = (N_{\Omega_t}^{(m)}(a_t, b))^{-1} \quad \text{as } \delta \rightarrow 0. \quad (3.3.19)$$

We use the same argument as in the proof of Proposition 3.3.14. Given $\varepsilon > 0$ we pick a point $b_{\varepsilon r} \in B_\Omega(b, \varepsilon r)$ and note that due to Lemma 3.2.1 and Corollary 3.3.8 one has

$$\begin{aligned} 1 - \frac{(1 - m^2 \delta^2) Z_{\Omega_t^\delta}^{(m)}(a_t^\delta, b)}{Z_{\Omega_t^\delta}^{(m)}(a_t^\delta, b)} &= m^2 \delta^2 \sum_{w^\delta \in \text{Int} \Omega_t^\delta} \frac{Z_{\Omega_t^\delta}^{(m)}(a_t^\delta, w^\delta) Z_{\Omega_t^\delta}(w^\delta, b)}{Z_{\Omega_t^\delta}^{(m)}(a_t^\delta, b)} \\ &= m^2 \delta^2 \sum_{w^\delta \in \text{Int} \Omega_t^\delta} \frac{Z_{\Omega_t^\delta}^{(m)}(a_t^\delta, w^\delta) Z_{\Omega_t^\delta}(w^\delta, b_{\varepsilon r}^\delta)}{Z_{\Omega_t^\delta}^{(m)}(a_t^\delta, b_{\varepsilon r}^\delta)} \cdot (1 + O(\varepsilon^\beta)) \\ &= \left[1 - \frac{(1 - m^2 \delta^2) Z_{\Omega_t^\delta}^{(m)}(a_t^\delta, b_{\varepsilon r}^\delta)}{Z_{\Omega_t^\delta}^{(m)}(a_t^\delta, b_{\varepsilon r}^\delta)} \right] \cdot (1 + O(\varepsilon^\beta)), \end{aligned}$$

with a universal (and, in particular, uniform in δ) error term $O(\varepsilon^\beta)$. Since $\varepsilon > 0$ can be chosen arbitrary small, Proposition 3.3.15 applied to $z = b_\varepsilon$ implies (3.3.19).

It remains to note that

$$\begin{aligned} M_{\Omega_t^\delta}^{(m)}(v^\delta) &= \frac{Z_{\Omega_t^\delta}^{(m)}(a_t^\delta, v^\delta)}{Z_{\Omega_t^\delta}(a_t^\delta, v^\delta)} \cdot \left[\frac{Z_{\Omega_t^\delta}^{(m)}(a_t^\delta, b)}{Z_{\Omega_t^\delta}(a_t^\delta, b)} \right]^{-1} \cdot \frac{Z_{\Omega_t^\delta}(a_t^\delta, v^\delta) Z_{\Omega_t^\delta}(a_t^\delta, b)}{Z_{\Omega_t^\delta}(a_t^\delta, b)} \\ &\rightarrow \frac{P_{\Omega_t}^{(m)}(a_t, v)}{P_{\Omega_t}(a_t, v)} \cdot N_{\Omega_t}^{(m)}(a_t, b) \cdot P_{\Omega_t}(a_t, v) \quad \text{as } \delta \rightarrow 0 \end{aligned}$$

due to Proposition 3.3.15, convergence (3.3.19), and Proposition 3.3.14, respectively. \square

3.4 . Estimates and computations in continuum

For shortness, from now onwards we drop a boundary point a from the notation of Poisson kernels since there is only one point a_t (tip of the slit) that we are interested in when speaking about domains $\Omega_t = \Omega \setminus \gamma[0, t]$.

3.4.1 . A priori estimates and massive Poisson kernels

Given a simply connected domain $\Lambda \subset B(0, R)$ and its uniformization $\phi_\Lambda : \Lambda \rightarrow \mathbb{H}$, we set

$$P_\Lambda(z) := -\frac{1}{\pi} \operatorname{Im} \frac{1}{\phi_\Lambda(z)}, \quad Q_\Lambda(z) := -\frac{1}{\pi} \operatorname{Im} \frac{1}{(\phi_\Lambda(z))^2}. \quad (3.4.1)$$

It is worth emphasizing that this definition heavily relies upon the choice of ϕ_Λ (namely, on the choice of $a = \phi_\Lambda^{-1}(0)$ and the normalization of ϕ_Λ at $b = \phi_\Lambda^{-1}(\infty)$), which is not mentioned explicitly in the notation. In particular, one has

$$\frac{Q_\Lambda(b)}{P_\Lambda(b)} = \lim_{z \rightarrow b} \frac{Q_\Lambda(z)}{P_\Lambda(z)} = 0 \quad (3.4.2)$$

(see Section 3.3.2 for the discussion of the existence of the limit). Recall that by $G_\Lambda(w, z)$ we denote the *positive* Green function in Λ and that $G_\Lambda^{(m)}(w, z)$ stands for the massive Green function discussed in Section 3.3.3, i.e. the integral kernel of the operator $(-\Delta_\Lambda + m^2)^{-1}$, where Δ_Λ denotes the Laplacian in Λ with Dirichlet boundary conditions. As mentioned in Remark 3.3.13, for all $w, z \in \Lambda$ one has

$$\exp(-c_0 m^2 R^2) \cdot G_\Lambda(w, z) \leq G_\Lambda^{(m)}(w, z) \leq G_\Lambda(w, z) \leq \frac{1}{2\pi} \log \frac{2R}{|w - z|}. \quad (3.4.3)$$

Since $-\Delta G_\Lambda^{(m)}(w, \cdot) = \delta_w(\cdot) - m^2 G_\Lambda^{(m)}(w, \cdot)$, one has the identity

$$G_\Lambda^{(m)}(w, z) = G_\Lambda(w, z) - m^2 \int_\Omega G_\Lambda(w, w') G_\Lambda^{(m)}(w', z) dA(w'). \quad (3.4.4)$$

Note that the identity (3.4.4) is nothing but a continuous counterpart of the similar identity (3.2.5) for the partition functions of random walks discussed in Section 3.2.1.

Lemma 3.4.1. *There exists an absolute constant $C > 0$ such that, for each simply connected domain $\Lambda \subset \mathbb{C}$, its uniformization $\phi_\Lambda : \Lambda \rightarrow \mathbb{H}$, and $z, w \in \Lambda$, the following estimates are fulfilled:*

$$\left| \frac{P_\Lambda(w)}{P_\Lambda(z)} - 1 \right| \cdot G_\Lambda(w, z) \leq C, \quad \left| \frac{Q_\Lambda(w)}{P_\Lambda(w)} - \frac{Q_\Lambda(z)}{P_\Lambda(z)} \right| \cdot \frac{G_\Lambda(w, z)}{P_\Lambda(z)} \leq C. \quad (3.4.5)$$

Proof. It is easy to see that both expressions are invariant under Möbius automorphisms of \mathbb{H} preserving the point 0. Therefore, one can assume $\phi_\Lambda(z) = i$ without loss of generality. In this situation, the required estimates (3.4.5) are nothing but the claim that both functions

$$\begin{aligned} & |\operatorname{Im} \phi_\Lambda(w)^{-1} + 1| \cdot G_{\mathbb{H}}(\phi_\Lambda(w), i) \quad \text{and} \\ & \frac{|\operatorname{Im} \phi_\Lambda(w)^{-2}|}{|\operatorname{Im} \phi_\Lambda(w)^{-1}|} \cdot G_{\mathbb{H}}(\phi_\Lambda(w), i) = \frac{2|\operatorname{Re} \phi_\Lambda(w)|}{|\phi_\Lambda(w)|^3} \cdot G_{\mathbb{H}}(\phi_\Lambda(w), i), \end{aligned}$$

are bounded in the upper half-plane, which is clearly true since both of them are continuous in $\phi = \phi_\Lambda(w) \in \overline{\mathbb{H}}$ (including at the point i) and decay as $|\phi| \rightarrow \infty$. \square

Remark 3.4.2. For later purposes, it is useful to rewrite (3.4.5) as

$$P_\Lambda(w)G_\Lambda(w, z) \leq P_\Lambda(z)G_\Lambda(w, z) + CP_\Lambda(z), \quad (3.4.6)$$

$$\begin{aligned} |Q_\Lambda(w)|G_\Lambda(w, z) &\leq CP_\Lambda(z)P_\Lambda(w) + P_\Lambda(w)G_\Lambda(w, z)(P_\Lambda(z))^{-1}|Q_\Lambda(z)| \\ &\leq CP_\Lambda(z)P_\Lambda(w) + |Q_\Lambda(z)|G_\Lambda(w, z) + C|Q_\Lambda(z)|. \end{aligned} \quad (3.4.7)$$

We now introduce massive counterparts of the functions (3.4.1) as follows:

$$P_\Lambda^{(m)}(z) := P_\Lambda(z) - m^2 \int_\Lambda P_\Lambda(w)G_\Lambda^{(m)}(w, z)dA(w), \quad (3.4.8)$$

$$Q_\Lambda^{(m)}(z) := Q_\Lambda(z) - m^2 \int_\Lambda Q_\Lambda(w)G_\Lambda^{(m)}(w, z)dA(w). \quad (3.4.9)$$

Remark 3.4.3. (i) The estimate (3.4.6) ensures that the massive Poisson kernel $P_\Lambda^{(m)}(z)$ is well-defined since the only possible pathology in the integral is at $w = z$, where the integrand is bounded from above by a multiple of the Green function $G_\Lambda(w, z)$. Moreover, one easily sees that

$$\exp(-c_0 m^2 R^2)P_t(a_t, z) \leq P_t^{(m)}(a_t, z) \leq P_t(a_t, z) \quad (3.4.10)$$

due to Proposition 3.3.15 and similar uniform bounds provided by Corollary 3.2.8.

(ii) On the contrary, (3.4.7) only guarantees that the function $Q_\Lambda^{(m)}$ is well-defined under the additional assumption $\int_\Lambda P_\Lambda(w)dA(w) < +\infty$. Though this is not always true in general, it follows from Corollary 3.4.6(i) given below that this assumption holds for almost all (in t) domains $\Lambda = \Omega_t$ generated by a Loewner evolution in Ω .

Lemma 3.4.4. *The following identity is fulfilled for all $z \in \Lambda$:*

$$P_\Lambda^{(m)}(z) = P_\Lambda(z) - m^2 \int_\Lambda P_\Lambda^{(m)}(w) G_\Lambda(w, z) dA(w). \quad (3.4.11)$$

Proof. Note that the integral converges due to (3.4.6) and since $P_\Lambda^{(m)}(w) \leq P_\Lambda(w)$. Moreover, one has

$$\begin{aligned} & \int_\Lambda P_\Lambda^{(m)}(w) G_\Lambda(w, z) dA(w) \\ &= \int_\Lambda \left[P_\Lambda(w) - m^2 \int_\Lambda P_\Lambda(w') G_\Lambda^{(m)}(w', w) dA(w') \right] G_\Lambda(w, z) dA(w) \\ &= \int_\Lambda P_\Lambda(w) \left[G_\Lambda(w, z) - \int_\Lambda G_\Lambda^{(m)}(w, w') G_\Lambda(w', z) dA(w') \right] dA(w) \\ &= \int_\Lambda P_\Lambda(w) G_\Lambda^{(m)}(w, z) dA(w) = P_\Lambda^{(m)}(z), \end{aligned}$$

where the application of the Fubini theorem in the second equality is based upon the uniform estimate

$$P_\Lambda(w) G_\Lambda^{(m)}(w, w') G_\Lambda(w', z) \leq P_\Lambda(z) (G_\Lambda(w, w') + C) (G_\Lambda(w', z) + C)$$

which follows from (3.4.6). \square

Assume now that $b := \phi_\Lambda^{-1}(\infty)$ is a degenerate prime end of Λ . The representation (3.4.11) together with the discussion given in Section 3.3.2 allows one to define the following quantity (note that here and below we abuse the notation in a way similar to Section 3.3.2 when writing the ratio of two functions, both satisfying Dirichlet boundary conditions, at a boundary point b):

$$\frac{P_\Lambda^{(m)}(b)}{P_\Lambda(b)} := \lim_{z \rightarrow b} \frac{P_\Lambda^{(m)}(z)}{P_\Lambda(z)} = 1 - m^2 \int_\Lambda P_\Lambda^{(m)}(w) \frac{G_\Lambda(w, b)}{P_\Lambda(b)} dA(w). \quad (3.4.12)$$

Indeed, one can exchange the limit $z \rightarrow b$ and the integration over $w \in \Lambda$ due to the uniform estimate (3.4.6), which provides a majorant

$$P_\Lambda^{(m)}(w) \frac{G_\Lambda(w, z)}{P_\Lambda(z)} \leq \frac{P_\Lambda(w) G_\Lambda(w, z)}{P_\Lambda(z)} \leq G_\Lambda(w, z) + C,$$

and the fact that $\max_{z \in B_\Lambda(b, r)} \int_{B_\Lambda(b, 2r)} G_\Lambda(w, z) dA(w) \rightarrow 0$ as $r \rightarrow 0$, which follows from (3.4.3) and allows one to neglect the contributions of vicinities of the point b (where the Green function blows up and thus no uniform in z majorant is available).

3.4.2 . Hadamard's formula

We now move to the Loewner equation setup and assume that a decreasing family of subdomains $\Omega_t \subset \Omega$ is constructed according to (3.2.12) and that their uniformizations onto the upper half-plane are fixed as

$$\phi_t := (g_t - \xi_t) \circ \phi_\Omega : \Omega_t \rightarrow \mathbb{H}$$

so that, in particular, $\phi_t(a_t) = 0$ and $\phi_t(b) = \infty$. For shortness, from now onwards we replace the subscript Ω_t by t , thus we write $G_t(w, z)$ instead of $G_{\Omega_t}(w, z)$, $P_t(z)$ instead of $P_{\Omega_t}(z) = P_{\Omega_t}(a_t, z)$, etc. The following lemma is classical.

Lemma 3.4.5 (Hadamard's formula). *For each $z, w \in \Omega$ the function $G_t(z, w)$ is differentiable in t (until the first moment when either $z \notin \Omega_t$ or $w \notin \Omega_t$) and*

$$\partial_t G_t(w, z) = -2\pi P_t(w)P_t(z). \quad (3.4.13)$$

Proof. Let $w_{\mathbb{H}} := \phi_{\Omega}(w)$ and $z_{\mathbb{H}} := \phi_{\Omega}(z)$, note that one has

$$G_t(w, z) = -\frac{1}{2\pi} \log \left| \frac{g_t(w_{\mathbb{H}}) - g_t(z_{\mathbb{H}})}{g_t(w_{\mathbb{H}}) - \overline{g_t(z_{\mathbb{H}})}} \right|.$$

Since both $g_t(w_{\mathbb{H}})$ and $g_t(z_{\mathbb{H}})$ satisfy the Loewner equation (3.2.12), one easily obtains

$$\begin{aligned} \partial_t G_t(w, z) &= -\frac{1}{2\pi} \operatorname{Re} \left[\frac{\partial_t g_t(w_{\mathbb{H}}) - \partial_t g_t(z_{\mathbb{H}})}{g_t(w_{\mathbb{H}}) - g_t(z_{\mathbb{H}})} - \frac{\partial_t g_t(w_{\mathbb{H}}) - \overline{\partial_t g_t(z_{\mathbb{H}})}}{g_t(w_{\mathbb{H}}) - \overline{g_t(z_{\mathbb{H}})}} \right] \\ &= \frac{1}{\pi} \operatorname{Re} \left[\frac{1}{(g_t(w_{\mathbb{H}}) - \xi_t)(g_t(z_{\mathbb{H}}) - \xi_t)} - \frac{1}{(g_t(w_{\mathbb{H}}) - \xi_t)\overline{(g_t(z_{\mathbb{H}}) - \xi_t)}} \right] \\ &= -\frac{2}{\pi} \operatorname{Im} \left[\frac{1}{g_t(w_{\mathbb{H}}) - \xi_t} \right] \operatorname{Im} \left[\frac{1}{g_t(z_{\mathbb{H}}) - \xi_t} \right] = -2\pi P_t(w)P_t(z). \quad \square \end{aligned}$$

As pointed out in [MS10], it immediately follows from the Hadamard formula that the integrals $\int_{\Omega_t} P_t(w) dA(w)$ converge for almost all t , see the next corollary. In our analysis we also need a stronger estimate which guarantees the convergence of integrals $\int_{\Omega_t} (P_t(w))^2 dA(w)$ for almost all t provided that γ is an SLE(2) curve.

Corollary 3.4.6. (i) *In the same setup, one has*

$$\int_0^{\infty} \left[\int_{\Omega_t} P_t(w) dA(w) \right]^2 dt \leq \frac{1}{2\pi} \int_{\Omega} \int_{\Omega} G_0(w, z) dA(w) dA(z) < +\infty.$$

(ii) *Moreover, if γ is an SLE(κ), $\kappa \leq 4$, curve running from a to b in Ω , then*

$$\int_0^{\infty} \int_{\Omega_t} (P_t(w))^2 dA(w) dt < +\infty \quad \text{almost surely.}$$

Proof. (i) Given a point $z \in \Omega$, let $\tau_z := \inf\{t > 0 : z \notin \Omega_t\}$ be the time when z is hit or swallowed by the curve γ (as usual, we set $\tau_z := +\infty$ if this does not happen). By integrating the Hadamard formula (3.4.13) in t one easily sees that

$$2\pi \int_0^{\tau_w \wedge \tau_z} P_t(w) P_t(z) dt \leq G_0(w, z).$$

The claim follows by integrating this inequality over $w, z \in \Omega$ since

$$\int_{\Omega \times \Omega} \int_0^{\tau_w \wedge \tau_z} P_t(w) P_t(z) dt dA(w) dA(z) = \int_0^{\infty} \int_{\Omega_t \times \Omega_t} P_t(w) P_t(z) dA(w) dA(z) dt.$$

(ii) Given a planar (simply connected) domain Λ and $w \in \Lambda$, let

$$G_\Lambda^*(w, w) := \lim_{z \rightarrow w} (G_\Lambda(w, z) + \frac{1}{2\pi} \log |z - w|) = \frac{1}{2\pi} \log \text{crad}_\Lambda(w),$$

where $\text{crad}_\Omega(w)$ denotes the *conformal radius* of the point w in Ω . A straightforward generalization of Lemma 3.4.5 implies that $\partial_t G_t^*(w, w) = -2\pi(P_t(w))^2$ for $w \in \Omega_t$.

Since SLE(κ) curves with $\kappa \leq 4$ are not self-touching, for all $w \in \Omega$ one almost surely has $w \in \Omega_t = \Omega \setminus \gamma[0, t]$ for all $t \leq \infty$. Applying the Fubini theorem as above, we obtain the identity

$$\int_0^\infty \int_{\Omega_t} (P_t(w))^2 dA(w) dt = \frac{1}{2\pi} \int_\Omega \log \frac{\text{crad}_\Omega(w)}{\text{crad}_{\Omega \setminus \gamma[0, \infty]}(w)} dA(w),$$

where we slightly abuse the notation in the denominator: $\text{crad}_{\Omega \setminus \gamma[0, \infty]}(w)$ stands for the conformal radius of w in one of the two components of $\Omega \setminus \gamma[0, \infty]$ to which this point belongs. Standard estimates (e.g., see [Kem17, Section 5.3.6.2]) for the SLE(κ) curves $\phi_\Omega(\gamma)$ in the upper half-plane \mathbb{H} imply

$$\mathbb{E} \left[\log \frac{\text{crad}_\Omega(w)}{\text{crad}_{\Omega \setminus \gamma[0, \infty]}(w)} \right] = \mathbb{E} \left[\log \frac{\text{crad}_\mathbb{H}(\phi_\Omega(w))}{\text{crad}_{\mathbb{H} \setminus \phi_\Omega(\gamma[0, \infty])}(\phi_\Omega(w))} \right] \leq \text{const},$$

uniformly over $w \in \Omega$. Therefore,

$$\mathbb{E} \left[\int_0^\infty \int_{\Omega_t} (P_t(w))^2 dA(w) dt \right] \leq \text{const} \cdot \text{Area}(\Omega)$$

and, in particular, this integral is finite almost surely. \square

We now derive a counterpart of Lemma 3.4.5 in the massive setup.

Lemma 3.4.7 (massive Hadamard's formula). *In the same setup, the massive Green function $G_t^{(m)}(w, z)$ is differentiable in t (until the first moment when either $z \notin \Omega_t$ or $w \notin \Omega_t$) and*

$$\partial_t G_t^{(m)}(w, z) = -2\pi P_t^{(m)}(w) P_t^{(m)}(z), \quad (3.4.14)$$

where the massive Poisson kernels $P_t^{(m)}(w)$, $P_t^{(m)}(z)$ in Ω_t are given by (3.4.8).

Proof. It is easy to see that the increments of $G_t^{(m)}(w, z)$ are bounded by those of $G_t(w, z)$: e.g., this follows from Proposition 3.3.10, Corollary 3.3.3 and the similar inequality in discrete which is trivial. Therefore, $G_t^{(m)}(w, z)$ is an absolutely continuous function of t , the derivative $\partial_t G_t^{(m)}(w, z)$ exists (given w, z) for almost all t and

$$0 \leq -\partial_t G_t^{(m)}(w, z) \leq -\partial_t G_t(w, z) \leq 2\pi P_t(w) P_t(z). \quad (3.4.15)$$

Due to the Tonelli theorem, for almost all t the derivative $\partial_t G_t^{(m)}(w, z)$ also exists simultaneously for almost all $w, z \in \Omega$. Moreover, note that it is sufficient to prove (3.4.14) for *almost* all t, w, z : if this is done, the same claim for all t, w, z (and,

in particular, the existence of $\partial_t G_t^{(m)}(w, z)$ for *all* t, w, z follows from the continuity of the massive Green function and massive Poisson kernels in (t, w, z) .

Differentiating in t the resolvent identity (see (3.4.4))

$$G_t^{(m)}(w, z) = G_t(w, z) - m^2 \int_{\Omega} G_t(w, w') G_t^{(m)}(w', z) dA(w')$$

(since both $G_t(w, w')$ and $G_t^{(m)}(w', z)$ are monotone in t , this differentiation can be justified by the Tonelli theorem) and using Lemma 3.4.5 one obtains

$$\begin{aligned} \partial_t G_t^{(m)}(w, z) &= -2\pi P_t(w) P_t(z) + 2\pi m^2 \int_{\Omega} P_t(w) P_t(w') G_t^{(m)}(w', z) dA(w') \\ &\quad - m^2 \int_{\Omega} G_t(w, w') \partial_t G_t^{(m)}(w', z) dA(w') \\ &= -2\pi P_t(w) P_t^{(m)}(z) - m^2 \int_{\Omega} G_t(w, w') \partial_t G_t^{(m)}(w', z) dA(w'). \end{aligned}$$

Denote by $\mathfrak{G}_t = (-\Delta)^{-1}$ and $\mathfrak{G}_t^{(m)} = (-\Delta + m^2)^{-1}$ integral operators acting on test function $h : \Omega_t \rightarrow \mathbb{R}$ as follows:

$$\begin{aligned} (\mathfrak{G}_t h)(w) &:= \int_{\Omega_t} h(w') G_t(w', w) dA(w'), \\ (\mathfrak{G}_t^{(m)} h)(w) &:= \int_{\Omega_t} h(w') G_t^{(m)}(w', w) dA(w'). \end{aligned}$$

In this notation, we can rewrite the equation for the derivative $\partial_t G_t^{(m)}(w, z)$ obtained above as

$$(\text{Id} + m^2 \mathfrak{G}_t)(\partial_t G_t^{(m)}(\cdot, z)) = -2\pi P_t(w) P_t^{(m)}(z).$$

The resolvent identity (see (3.4.4)) reads as $\mathfrak{G}_t^{(m)} = \mathfrak{G}_t - m^2 \mathfrak{G}_t^{(m)} \mathfrak{G}_t$, provided that the integrals under consideration converge and that the Fubini theorem can be applied. Therefore,

$$(\text{Id} - m^2 \mathfrak{G}_t^{(m)})(\text{Id} + m^2 \mathfrak{G}_t)h = h, \quad h = \partial_t G_t^{(m)}(\cdot, z),$$

where the use of the Fubini theorem can be justified via the estimates (3.4.15) and (3.4.6). Therefore, for almost all t (and, given t , for almost all w, z), one has

$$\partial_t G_t^{(m)}(w, z) = -2\pi [(\text{Id} - m^2 \mathfrak{G}_t^{(m)}) P_t](w) P_t^{(m)}(z) = -2\pi P_t^{(m)}(w) P_t^{(m)}(z),$$

which is nothing but the identity (3.4.14). As already mentioned above, the similar claim for *all* t, w, z follows from the continuity of the massive Green function and massive Poisson kernels in all the variables t, w, z . \square

3.4.3 . Driving term of mSLE(2)

With the above estimates and Hadamard's formula, we are now prepared to compute the driving term of massive SLE(2) such that the normalized massive Poisson kernel is a martingale. Recall that under each probability measure $\mathbb{P}_{(\Omega;a,b)}^{(m)}$ (obtained as a subsequential weak limit of mLERWs) we have

$$d\xi_t = \sqrt{2}(dB_t + d\langle B, L^{(m)} \rangle_t) = \sqrt{2}dB_t + 2\lambda_t dt,$$

where B_t is a standard Brownian motion and the process $L_t^{(m)}$ comes from the Girsanov theorem as explained in Section 3.2.6. Our goal is to identify the drift term $2\lambda_t dt$; note that we will do this using the martingale property of the processes $t \mapsto M_t^{(m)}(z)$, $z \in \Omega$, and *not* through identifying the process $L_t^{(m)}$; cf. Remark 3.2.10 and Remark 3.4.11. More precisely, following the strategy indicated in [MS10] we

- analyze the random processes $t \mapsto P_t^{(m)}(z)$, $z \in B_\Omega(b, \frac{1}{2})$, relying upon the convolution formula (3.4.8), the massive Hadamard formula (Lemma 3.4.7), and a version of the stochastic Fubini theorem (see Lemma 3.4.8 below);
- use the martingale property of the process $t \mapsto M_t^{(m)}(z) = P_t^{(m)}(z)N_t^{(m)}$ for each $z \in B_\Omega(b, \frac{1}{2}r)$ in order
 - to analyze the process $t \mapsto N_t^{(m)}$ (this is done in Lemma 3.4.9(i)) and
 - to identify the drift term $2\lambda_t dt$ of the process ξ_t (see Lemma 3.4.9(ii)).

Recall that we use the notation d in the stochastic calculus/SDE context and the notation dA for the Lebesgue measure in Ω , over which we often integrate in the following computations. For each $w \in \Omega$, the process $t \mapsto g_t(\phi_\Omega(w))$ satisfies the Loewner equation (3.2.12), thus one has

$$dP_t(w) = -\frac{1}{\pi} \operatorname{Im} \left[\frac{d\xi_t}{(g_t(\phi_\Omega(w)) - \xi_t)^2} + \frac{d\langle \xi, \xi \rangle_t - 2dt}{(g_t(\phi_\Omega(w)) - \xi_t)^3} \right] = Q_t(w) d\xi_t. \quad (3.4.16)$$

We want to substitute this expression (together with the massive Hadamard formula (3.4.14)) into the definition (3.4.8) of the massive Poisson kernel. The following lemma handles the question of interchanging the stochastic integration over the continuous semi-martingale ξ_t with the Lebesgue integration over $w \in \Omega$.

Lemma 3.4.8. *The process $\int_\Omega Q_t(w)G_t^{(m)}(w, z)dA(w)$ is a local semi-martingale. Moreover, almost surely, for all $T > 0$ the following identity is fulfilled:*

$$\int_\Omega \left[\int_0^T Q_t(w)G_t^{(m)}(w, z)d\xi_t \right] dA(w) = \int_0^T \left[\int_\Omega Q_t(w)G_t^{(m)}(w, z)dA(w) \right] d\xi_t.$$

Proof. We use a version of the stochastic Fubini theorem given in [Ver12]. In order to apply this result, one needs to check that the following two conditions hold almost

surely (recall that $d\xi_t = \sqrt{2}(dB_t + d\langle B, L^{(m)} \rangle_t)$; in particular, $d\langle \xi, \xi \rangle_t = 2dt$):

$$\int_{\Omega} \left[\int_0^T |Q_t(w)G_t^{(m)}(w, z)|^2 dt \right]^{1/2} dA(w) < +\infty, \quad (3.4.17)$$

$$\int_{\Omega} \left[\int_0^T |Q_t(w)G_t^{(m)}(w, z)d\langle B, L^{(m)} \rangle_t| \right] dA(w) < +\infty. \quad (3.4.18)$$

The first estimate (3.4.17) can be easily derived from Corollary 3.4.6(ii) (and from the absolute continuity of mSLE(2) with respect to SLE(2) discussed in Section 3.2.6) since the uniform bound (3.4.7) implies

$$\begin{aligned} |Q_t(w)G_t^{(m)}(w, z)|^2 &\leq (CP_t(z)P_t(w) + |Q_t(z)|G_t(w, z) + C|Q_t(z)|)^2 \\ &\leq C(z)(P_t(w)^2 + G_t(w, z)^2 + 1), \end{aligned}$$

where $C(z) := 3C^2 \max_{t \in [0, T]} \{(P_t(z))^2 + |Q_t(z)|^2\} < +\infty$ almost surely. In its turn, the second estimate (3.4.18) follows from (3.4.17) and the Kunita–Watanabe inequality (see [LG13, Proposition 4.5]) as $\langle L^{(m)}, L^{(m)} \rangle_T < +\infty$ almost surely; see (3.2.22). \square

Using (3.4.16), the massive Hadamard formula (3.4.14) and Lemma 3.4.8, we conclude that, for each $z \in \Omega$, the random process $P^{(m)}(z)$ is a local semi-martingale and

$$\begin{aligned} dP_t^{(m)}(z) &= dP_t(z) - m^2 \int_{\Omega_t} \left(G_t^{(m)}(w, z)dP_t(w) + P_t(w)dG_t^{(m)}(w, z) \right) dA(w) \\ &= Q_t(z)d\xi_t - m^2 \int_{\Omega_t} \left(Q_t(w)G_t^{(m)}(w, z)d\xi_t - 2\pi P_t(w)P_t^{(m)}(w)P_t^{(m)}(z)dt \right) dA(w) \\ &= Q_t^{(m)}(z)d\xi_t + 2\pi m^2 P_t^{(m)}(z) \left[\int_{\Omega_t} P_t(w)P_t^{(m)}(w)dA(w) \right] dt. \end{aligned} \quad (3.4.19)$$

We now move to the key part of the computation. Recall that

$$N_t^{(m)} = P_t(b)/P_t^{(m)}(b) = M_t^{(m)}(z)/P_t^{(m)}(z), \quad z \in \Omega_t$$

and note that the process $N_t^{(m)}$ is a semi-martingale since $M_t^{(m)}(z)$ is a martingale and $P_t^{(m)}(z)$ is a (strictly positive) semi-martingale.

Lemma 3.4.9. (i) *The positive semi-martingale $N_t^{(m)}$ satisfies the following SDE:*

$$dN_t^{(m)} = -N_t^{(m)} \left[\frac{Q_t^{(m)}(b)}{P_t^{(m)}(b)} \sqrt{2}dB_t + 2\pi m^2 \left[\int_{\Omega_t} P_t(w)P_t^{(m)}(w)dA(w) \right] dt \right]. \quad (3.4.20)$$

(ii) *The following identity for the drift term of the driving process ξ_t holds:*

$$2\lambda_t dt = -\frac{d\langle \xi, N^{(m)} \rangle_t}{N_t^{(m)}} = 2 \frac{Q_t^{(m)}(b)}{P_t^{(m)}(b)} dt. \quad (3.4.21)$$

Proof. (i) Applying the Itô lemma to the product $M_t^{(m)}(z) = P_t^{(m)}(z)N_t^{(m)}$ and using (3.4.19), one obtains

$$\begin{aligned} dM_t^{(m)}(z) &= P_t^{(m)}(z)dN_t^{(m)} + N_t^{(m)}dP_t^{(m)}(z) + d\langle P^{(m)}(z), N^{(m)} \rangle_t \\ &= P_t^{(m)}(z) \left[dN_t^{(m)} + 2\pi m^2 N_t^{(m)} \left[\int_{\Omega_t} P_t(w)P_t^{(m)}(w)dA(w) \right] dt \right] \end{aligned} \quad (3.4.22)$$

$$+ Q_t^{(m)}(z) [N_t^{(m)} d\xi_t + d\langle \xi, N^{(m)} \rangle_t]. \quad (3.4.23)$$

Recall (see Remark 3.2.3) that the process $dM_{t \wedge \tau_r}^{(m)}(z)$ should be a martingale for each $z \in B_\Omega(b, \frac{1}{2}r)$ and it is obvious that the functions $P_{t \wedge \tau_r}^{(m)}(\cdot)$, $Q_{t \wedge \tau_r}^{(m)}(\cdot)$ are linearly independent. Thus, the only possibility is that

both terms (3.4.22) and (3.4.23) are local martingales

(until the stopping time τ_r which almost surely grows to infinity as $r \rightarrow 0$). The bounded variation (drift) part of $N_t^{(m)}$ can be easily identified from (3.4.22). To identify the martingale part, recall (see (3.3.18) and (3.4.12)) that

$$N_t^{(m)} = \frac{P_t(b)}{P_t^{(m)}(b)} = \left[1 - m^2 \int_{\Omega_t} P_t(w) \frac{G_t^{(m)}(w, b)}{P_t(b)} dA(w) \right]^{-1},$$

where, as usual, we use the shorthand notation

$$\frac{G_t^{(m)}(w, b)}{P_t(b)} := \lim_{w \rightarrow b} \frac{G_t^{(m)}(w, z)}{P_t(z)}.$$

As $Q_t(b)/P_t(b) = 0$ (see (3.4.2)), the massive Hadamard formula (3.4.14) gives

$$d \frac{G_t^{(m)}(w, b)}{P_t(b)} = -X_t(w)dt, \quad \text{where } X_t(w) := 2\pi P_t^{(m)}(w)(N_t^{(m)})^{-1} \leq 2\pi P_t(w).$$

Therefore,

$$d \left[P_t(w) \frac{G_t^{(m)}(w, b)}{P_t(b)} \right] = Q_t(w) \frac{G_t^{(m)}(w, b)}{P_t(b)} d\xi_t - P_t(w) X_t(w) dt.$$

It follows from (3.4.7) that $|Q_t(w)|G_t^{(m)}(w, b)/P_t(b) \leq CP_t(w)$, thus one can apply the stochastic Fubini theorem as in the proof of Lemma 3.4.8 and conclude that

$$d \frac{1}{N_t^{(m)}} = -m^2 \left[\int_{\Omega_t} Q_t(w) \frac{G_t^{(m)}(w, b)}{P_t(b)} dA(w) \right] d\xi_t + m^2 \left[\int_{\Omega_t} P_t(w) X_t(w) dA(w) \right] dt.$$

Since, due to (3.4.9) and (3.4.2), we have

$$-m^2 \int_{\Omega_t} Q_t(w) \frac{G_t^{(m)}(w, b)}{P_t(b)} dA(w) = \frac{Q_t^{(m)}(b)}{P_t(b)} = \frac{Q_t^{(m)}(b)}{P_t^{(m)}(b)} (N_t^{(m)})^{-1},$$

the martingale part of the process $N_t^{(m)}$ coincides with that in the formula (3.4.20). Recall that the bounded variation part of $N_t^{(m)}$ is already identified by (3.4.22).

(ii) Recall that we know that the martingale part of the process ξ_t is given by $\sqrt{2}B_t$. Therefore, we can use the fact that (3.4.23) is a local martingale together with the identification of the (martingale part of the) process $N_t^{(m)}$ made above in order to identify the drift $\lambda_t dt$ of the process ξ_t . This gives the required formula (3.4.21). \square

3.4.4 . Proof of Theorem 3.1.1

For convenience of the reader, we now briefly summarize the proof of Theorem 3.1.1, which consists of the following two parts:

1. The results of Section 3.2.5 imply that the Radon–Nikodym derivatives of massive LERW measures $\mathbb{P}_{(\Omega^\delta; a^\delta, b^\delta)}^{(m)}$ with respect to the classical ($m = 0$) ones are uniformly bounded. Therefore, the discussion of tightness given in Section 3.2.3 also applies to these measures. Moreover, as argued in Section 3.2.5, each subsequential limit $\mathbb{P}_{(\Omega; a, b)}^{(m)}$ of those is necessarily absolutely continuous with respect to the classical SLE(2) measure $\mathbb{P}_{(\Omega; a, b)}$. This justifies the application of the Girsanov theorem and implies that the driving term ξ_t of the Loewner evolution (3.2.12) is a semi-martingale

$$d\xi_t = \sqrt{2}dB_t + 2\lambda_t dt \quad \text{under } \mathbb{P}_{(\Omega; a, b)}^{(m)}.$$

2. Due to Remark 3.2.3, the scaling limits of martingale observables (3.2.6) (provided by Proposition 3.3.16, which is the main result of Section 3.3) are martingales under $\mathbb{P}_{(\Omega; a, b)}^{(m)}$. As shown in Lemma 3.4.9, this property is sufficient to identify the drift term $2\lambda_t dt$ via brute force computations indicated in [MS10] and a priori estimates from Sections 3.4.1 and 3.4.2.

Remark 3.4.10. As mentioned in [MS10], the a priori (weak) uniqueness of a solution to the SDE $d\xi_t = \sqrt{2}dB_t + 2\lambda_t dt$ with $\lambda_t := Q_t^{(m)}(b)/P_t^{(m)}(b)$ follows from the fact that $\int_0^{+\infty} \lambda_t^2 dt \leq \text{const}(m, R) < \infty$ almost surely (which clearly implies the standard Novikov condition $\mathbb{E}[\exp(\frac{1}{2} \int_0^T \lambda_t^2 dt)] < \infty$ for all $T > 0$). Indeed,

$$\lambda_t = -m^2 \left[\int_{\Omega_t} Q_t(w) \frac{G_t^{(m)}(w, b)}{P_t(b)} dA(w) \right] N_t^{(m)},$$

the factor $N_t^{(m)} = P_t(b)/P_t^{(m)}(b)$ is uniformly bounded due to (3.4.10) and hence

$$\int_0^{+\infty} |\lambda_t|^2 dt \leq \text{const}(m, R) \cdot \int_0^{+\infty} \left[\int_{\Omega_t} P_t(w) dA(w) \right]^2 dt \leq \text{const}(m, R) < \infty$$

due to the uniform estimate (3.4.7) and the result of Corollary 3.4.6(i).

Remark 3.4.11. We conclude the paper by coming back to the parallel, already mentioned in Remark 3.2.10, of the ‘massive/critical’ setup discussed in this paper and more standard ‘critical/critical’ ones. Though the process $N_t^{(m)}$ does *not* coincide

with the density $(D_t^{(m)})^{-1}$ and hence one cannot find λ_t directly from (3.2.23), only its martingale part plays a role in the identification of ξ_t via the martingale property of the process $N_t^{(m)}d\xi_t + d\langle \xi, N^{(m)} \rangle_t$; see (3.4.23). This is the reason why the drift term $2\lambda_t dt$ in Theorem 3.1.1 has exactly the same form as, e.g., in [Zhao8b, Izy17, Wu16, KS18].

4 - Capacity of the range of tree-indexed random walk

4.1 . Introduction

Given a probability distribution η on \mathbb{Z}^d ($d \geq 3$), the *capacity* of a finite set $A \subset \mathbb{Z}^d$ with respect to η is defined as

$$\text{cap}_\eta A := \sum_{x \in A} \mathbb{P}_x^\eta(\tau_A^+ = \infty),$$

where \mathbb{P}_x^η refers to the law of a (discrete) random walk (S_n) started at x with transition probability η , and $\tau_A^+ := \inf\{n \geq 1 : S_n \in A\}$ is (S_n) 's first returning time to A .

Let μ be a probability distribution on \mathbb{N} , and θ be a probability distribution on \mathbb{Z}^d . Consider the process that starts with a particle at $0 \in \mathbb{Z}^d$. At each step, the particles die after generating a random number of new particles independently according to the law μ , then these new particles drift away from their precursor independently according to the law θ . This process is called *branching random walk*, whose distribution is denoted by $P_{\mu, \theta}$. The branching random walk is called *critical* if μ has mean 1, in which case, it is well-known that the process dies out in finite time almost surely (except for the trivial case that μ is the Dirac measure at $\{1\}$). The *range* R of this process, i.e. the set of points in \mathbb{Z}^d visited by the branching random walk, is then almost surely finite. Moreover, we denote by $\{\#T = n\}$ the event that the branching random walk generates exactly n particles in total before dying out. The notation T actually stands for the genealogy tree of the process, see Section 4.2 for details.

In this paper, we study the capacity of the range of critical branching random walks in dimensions larger or equal to 6, denoted by $\text{cap}_\eta R$, conditioned on the event $\{\#T = n\}$ as $n \rightarrow \infty$.

Throughout the paper, we shall consider distributions μ on \mathbb{N} and θ, η on \mathbb{Z}^d with the assumptions

$$\left. \begin{array}{l} \mu \text{ has mean 1 and finite variance, and } \mu \neq \delta_1, \\ \theta \text{ is symmetric, aperiodic and irreducible such that } \mathbb{E}_0^\theta \left[e^{\sqrt{|S_1|}} \right] < \infty, \\ \eta \text{ is aperiodic, irreducible with mean 0 and finite } (d+1)\text{-th moment,} \end{array} \right\} \quad (4.1.1)$$

where \mathbb{E}_0^θ refers to taking expectation with respect to the random walk (S_i) started at 0 with transition probability θ .

Theorem 4.1.1. *Let μ, θ, η be probability distributions with the conditions in (4.1.1).*

1. *In dimension $d \geq 7$, there is a constant $C(d, \mu, \theta, \eta) > 0$ such that under $P_{\mu, \theta}(\cdot | \#T = n)$, as $n \rightarrow \infty$,*

$$\frac{\text{cap}_\eta R}{n} \rightarrow C(d, \mu, \theta, \eta) \text{ in probability.}$$

2. In dimension $d = 6$, if μ has finite 5-th moment, then under $P_{\mu,\theta}(\cdot|\#T = n)$, as $n \rightarrow \infty$,

$$\frac{\log n}{n} \text{cap}_\eta R \rightarrow 2C_G^{-1} \text{ in probability,}$$

where

$$C_G = \frac{1}{4\pi^6 \sqrt{\det \Gamma_\eta \det \Gamma_\theta}} \left(\sum_{k=0}^{\infty} (k-1)k\mu(k) \right) C_f,$$

$$C_f = \mathbb{E} \left[\int_1^e dt \int_{\mathbb{R}^6} dx \cdot J_\eta(B_t^\theta + x)^{-4} J_\theta(x)^{-4} \right],$$

$\Gamma_\eta, \Gamma_\theta$ are the covariance matrices of η, θ respectively, $J_{(\cdot)}(x) = \sqrt{x \cdot \Gamma_{(\cdot)}^{-1} x}$, and B_t^θ is the Brownian motion in \mathbb{R}^6 with covariance matrix Γ_θ .

- Remark 4.1.2.*
1. Aperiodicity and irreducibility for θ and η are assumed for convenience of the proofs. In fact the same results in Theorem 4.1.1 hold for η and θ without those assumptions.
 2. For $d \geq 7$, the constant $C(d, \mu, \theta, \eta)$ is implicit. We refer the reader to Remark 4.3.4 for more details.
 3. The finite variance of the offspring distribution μ is required in Lemma 4.3.2 for the high dimensions $d \geq 7$, and the finite 5-th moment of μ is required in Proposition 4.4.5 for the critical dimension $d = 6$.
 4. For the displacement law θ , the moment assumption is required for the dyadic coupling in Lemma 4.2.10, and the symmetry is required for the conversion from our infinite model to finite trees, see Remark 4.2.5 for details. (We use the symmetry of θ a few times elsewhere for convenience, but they are not essential.)
 5. For the random walk distribution η , the moment assumptions are required for the asymptotic estimates of Green's functions in Lemma 4.2.7.
 6. If μ is the geometric distribution with parameter $\frac{1}{2}$, i.e. $\mu(k) = 2^{-k-1}$, then $P_{\mu,\theta}(\cdot|\#T = n)$ is the law of the random walk indices by a uniformly chosen tree of n nodes considered in [LGL16]. In this case, by Lemma 4.4.10 and the methods developed in [LGL16, Section 3.1], the convergence in probability for dimension 6 holds in L^2 -sense.
 7. If μ is the geometric distribution with parameter $\frac{1}{2}$, θ and η are one-step distributions of independent simple random walks, then $C_G = 9\pi^{-3}$. We refer the reader to Proposition 4.4.7 for explicit calculations.

Historically, the study of the capacity of the range of simple random walks dates back to Jain and Orey [JO68], where a law of large numbers was established for $d \geq 3$. Then useful tools were developed in the book of Lawler [Law13]. Recently, numerous studies for the sharper estimates of the capacity appear in Chang [Cha17] for $d = 3$ (scaled

convergence in distribution), Asselah, Schapira and Sousi [ASS18] for $d \geq 6$, [ASS19] for $d = 4$, and Schapira [Sch20] for $d = 5$ (central limit theorem).

If, in the definition of capacity, we simply replace the escape probability by 1, then it gives us (the size of) the range $\#R$, which is a classical object for random walks, widely studied since the work of Dvoretzky and Erdős [DE51], in which a law of large numbers was given for random walks in dimension $d \geq 1$. The corresponding central limit theorem was given by Jain and Orey [JO68] for $d \geq 5$, Jain and Pruitt [JP71] for $d \geq 3$, and Le Gall [LG86] for $d \geq 2$. See also [LGR91] for a general study of random walks in the domain of attraction of a stable distribution (i.e. without finite variance) by Le Gall and Rosen.

For branching random walks, the law of large numbers for (the size of) its range $\#R$ was given by Le Gall and Lin in [LGL16],[LGL15b] for every $d \geq 1$, where in the critical dimension $d = 4$ they restrict to the geometric offspring distribution case. This result (in $d = 4$) was then generalized by Zhu in [Zhu21] for general distributions. See also [LZ10], [LZ11] for a related topic of local times of branching random walks.

We summarize that, in view of law of large numbers, the critical dimension (the largest dimension with sublinear growth) is $d = 2$ for the range of the simple random walk (SRW) [DE51], $d = 4$ for the range of the branching random walk (BRW) [LGL16], also $d = 4$ for the capacity of the SRW [JO68], and $d = 6$ for the capacity of the BRW.

Indeed, the SRW or the BRW can be seen as a sequence of vertices, and one can establish corresponding infinite models for them with translational invariance property, which for the SRW started at 0 is simply

$$(S_i)_{i \in \mathbb{Z}} \stackrel{d}{=} (S_{m+i} - S_m)_{i \in \mathbb{Z}}.$$

Intuitively, this property shows that the SRW (or the BRW) is homogeneous in time. Moreover, either the range or the capacity can be decomposed into the sum over i of the contribution of S_i , therefore, it boils down to a one-point estimate and a second moment estimate for its concentration property. One can express this one-point estimate in terms of Green's functions, and study Green's functions by moment estimates with a careful analysis of the tree (in the case of BRW) and the underlying random walk.

The rest of the chapter is organised as follows. In Section 4.2 we introduce the models and some preliminary results regarding the capacity, the Green's functions and the Brownian motion. The study of capacities of BRWs in high dimensions $d \geq 7$ is discussed in Section 4.3, and the case of critical dimension $d = 6$ is discussed in Section 4.4. In particular, the main model with translational invariance property is established in Section 4.2.2, and the strategy for relating the Green's functions to the capacity is showed in Section 4.2.4. The behavior of the Green's functions is mainly summarized in Lemma 4.3.2 and Corollary 4.4.6. The two parts of Theorem 4.1.1 are proved in Theorem 4.3.7 and Theorem 4.4.12 respectively.

In the sequel, with a slight abuse of notations, each time we write a constant $C(*)$, where $*$ is the set of parameters that this constant depends, it is only used in the current paragraph.

4.2 . Preliminaries

In this section, we present systematically the definitions and models in this paper.

4.2.1 . Trees and spatial trees

A tree is a set $T \subset \cup_{n \geq 0} \mathbb{N}_+^n$, such that

- The root $\emptyset \in T$, where by convention we denote $\mathbb{N}_+^0 = \{\emptyset\}$.
- If a node $u = (u_1, \dots, u_n) \in T$, then its parent $\overleftarrow{u} := (u_1, \dots, u_{n-1}) \in T$.
- For each node $u = (u_1, \dots, u_n) \in T$, there exists an integer $k_u(T) \geq 0$, the number of offspring of u in T , such that for every $j \in \mathbb{N}$, $(u_1, \dots, u_n, j) \in T$ if and only if $1 \leq j \leq k_u(T)$.

We say that $u = (u_1, \dots, u_n) \in T$ is an ancestor of $u' = (u'_1, \dots, u'_{n'}) \in T$ if $n < n'$ and $u_i = u'_i$, $1 \leq i \leq n$, and if this is the case, we will write $u \prec u'$. We also define the height (generation) of a node to be its length as a word, i.e. if $u = (u_1, \dots, u_n)$, then $|u| = n$. Moreover, we denote by $\#T$ the total number of nodes. In the following, we will omit T if it is clear that to which tree the nodes belong from the context.

Since nodes of T are sequences of natural numbers, there exists a natural lexicographical order for them. We can therefore explore T in lexicographic order

$$u_0 = \emptyset, u_1, u_2, \dots$$

We remark that each node appears exactly once in this sequence if the tree is finite, thus if $\#T = n$, the sequence terminates at u_{n-1} .

Consider each node as a vertex, and add an edge between a node u and its parent \overleftarrow{u} , then one can see T as an abstract graph. If we attach a vector \mathbf{d}_u in \mathbb{Z}^d to each directed edge (\overleftarrow{u}, u) , fix the position of the root at $X_\emptyset = 0$ and let $X_u = \sum_{u' \preceq u} \mathbf{d}_{u'}$, then $(X_u)_{u \in T}$ gives a spatial tree structure.

Given a distribution μ on \mathbb{N} and a distribution θ on \mathbb{Z}^d , we can define a probability measure on (spatial) trees, denoted by $P_{\mu, \theta}$, under which we have that

$$k_u \stackrel{i.i.d.}{\sim} \mu, \mathbf{d}_u \stackrel{i.i.d.}{\sim} \theta.$$

The abstract tree T under this law is called the *Galton-Watson tree*, while the spatial tree $(X_u)_{u \in T}$ is called the *branching random walk*.

4.2.2 . The infinite model

In this section, we construct an infinite model based on the Galton-Watson tree that will be used throughout this article and may be of independent interests to other problems. Intuitively, it can be seen as the discrete limit of critical Galton-Watson trees conditioned to be large ([Ald91, Section 2.6]), and our construction generalises the one-sided version of infinite Galton-Watson trees in [LGL16, Section 2.2].

We define a *forest indexed by a spine* to be a sequence of trees, (here \mathcal{T}_i are standard trees as in Section 4.2.1),

$$\mathcal{T} = ((0, \mathcal{T}_0), (1, \mathcal{T}_1), (1, \mathcal{T}_{-1}), (2, \mathcal{T}_2), (2, \mathcal{T}_{-2}) \dots),$$

where the roots $(\pm i, \emptyset)$ of \mathcal{T}_i and \mathcal{T}_{-i} ($i > 0$) are identified (glued together) as one single point on the spine. We write $k_{(i,u)}(\mathcal{T}) = k_u(\mathcal{T}_i)$ for the number of offspring of node $u \in \mathcal{T}_i$, and in particular, $k_{(i,\emptyset)}^+(\mathcal{T}), k_{(i,\emptyset)}^-(\mathcal{T})$ are the numbers of offspring of $(\pm i, \emptyset)$ in the two trees $\mathcal{T}_i, \mathcal{T}_{-i}$, respectively. We call the set of points $\{(i, \emptyset), i \in \mathbb{N}\}$ the *spine* of \mathcal{T} , and $(0, \emptyset)$ the *base point*. Notice that by adding edges between consecutive points on the spine, the forest can also be seen as an abstract tree but the base point does not always play the role of the 'root', see Remark 4.2.5.

We embed this forest in \mathbb{Z}^d , by taking $\mathbf{d}_{(i,u)}(\mathcal{T}) = \mathbf{d}_u(\mathcal{T}_i)$ as the spatial displacement from its parent, and letting $X_{(i,u)}(\mathcal{T})$ be the spatial position of u by summing over all displacements along the path from the base point $(0, \emptyset)$ to (i, u) .

On the set of forests, we define the following probability measure $\mathbf{P}_{\mu,\theta}$:

- Offspring distributions are independent, except for the two offspring distributions of the same node, $k_{(i,\emptyset)}^\pm(\mathcal{T})$. For each $i \geq 0, u \neq \emptyset$,

$$k_{(i,u)}(\mathcal{T}) \stackrel{i.i.d.}{\sim} \mu,$$

moreover,

$$k_{(0,\emptyset)}(\mathcal{T}) \sim \mu,$$

while for other nodes $(\pm i, \emptyset)$ ($i > 0$) on the spine

$$\mathbf{P}_{\mu,\theta}(k_{(i,\emptyset)}^+(\mathcal{T}) = i, k_{(i,\emptyset)}^-(\mathcal{T}) = j) = \mu(i + j + 1).$$

- Displacements $\mathbf{d}_{(i,u)}(\mathcal{T})$ are i.i.d. distributed as θ on each directed edge including edges on the spine, with the base point fixed at the origin, $X_{(0,\emptyset)}(\mathcal{T}) = 0$.

Remark 4.2.1. The law of the spine is indeed well-defined as a probability measure, because $\sum_{i,j \geq 0} \mu(i + j + 1) = \sum_{k \geq 0} k\mu(k) = 1$ for a critical distribution μ .

The lexicographical order of nodes on the forest is illustrated in Figure 4.1. We denote this sequence by

$$\dots, u_{-1}(\mathcal{T}), u_0(\mathcal{T}) = (0, \emptyset), u_1(\mathcal{T}), \dots, u_n(\mathcal{T}), \dots,$$

and the corresponding spatial positions $(X_{u_i}(\mathcal{T}))$ by

$$\dots, v_{-1}(\mathcal{T}), v_0(\mathcal{T}) = 0, v_1(\mathcal{T}), \dots, v_n(\mathcal{T}), \dots \quad (4.2.2)$$

The range is defined as

$$R[i, j](\mathcal{T}) = \{v_i(\mathcal{T}), v_{i+1}(\mathcal{T}), \dots, v_j(\mathcal{T})\}.$$

On the set of spine-indexed forests, we can then establish a shift transformation σ defined by (see Figure 4.2):

$$u_i(\sigma(\mathcal{T})) = u_{i+1}(\mathcal{T}), v_i(\sigma(\mathcal{T})) = v_{i+1}(\mathcal{T}) - v_1(\mathcal{T}). \quad (4.2.3)$$

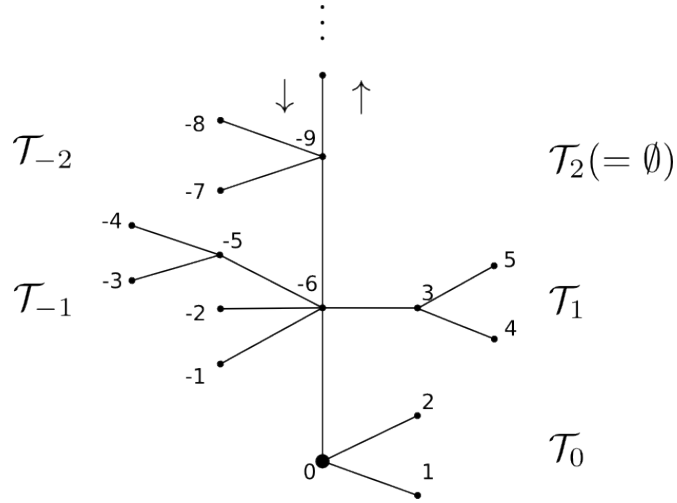

Figure 4.1 – Lexicographical order on the forest indexed by spine.

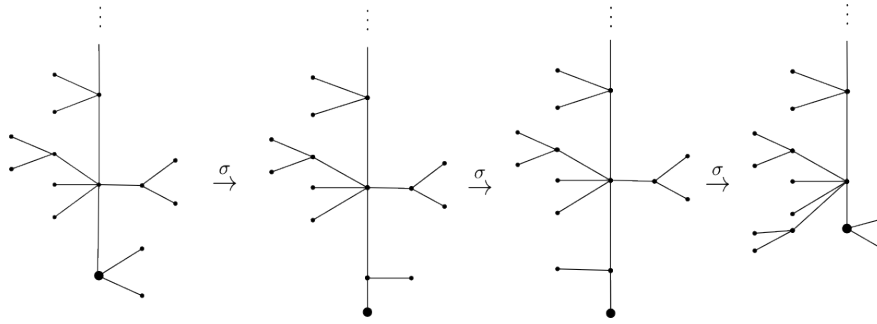

Figure 4.2 – The transform σ on the tree. Base points $(0, \emptyset)$ are marked with bigger circles.

One can easily check that $(u_i(\sigma(\mathcal{T})))_{i \in \mathbb{Z}}$ is the same sequence as $(u_{i+1}(\mathcal{T}))_{i \in \mathbb{Z}}$, and $(v_i(\sigma(\mathcal{T})))_{i \in \mathbb{Z}} = (v_{i+1}(\mathcal{T}) - v_1(\mathcal{T}))_{i \in \mathbb{Z}}$ is the corresponding positions of $(u_i(\sigma(\mathcal{T})))_{i \in \mathbb{Z}}$ in \mathbb{Z}^d , translated such that the base point $(0, \emptyset)$ stays at the origin. Moreover, the transformation is invariant under $\mathbf{P}_{\mu, \theta}$. In other words, for any measurable set A of spine-indexed forests,

$$\mathbf{P}_{\mu, \theta}(\mathcal{T} \in A) = \mathbf{P}_{\mu, \theta}(\sigma(\mathcal{T}) \in A).$$

Proposition 4.2.2. *Given the assumption (4.1.1), the probability measure $\mathbf{P}_{\mu, \theta}$ is invariant and ergodic under σ . Consequently, we have that*

$$(v_i, \dots, v_{n+i}) - v_i \stackrel{d}{=} (v_0, \dots, v_n) \text{ under } \mathbf{P}_{\mu, \theta}, \forall i \in \mathbb{Z}, n \in \mathbb{N}. \quad (4.2.4)$$

In other words,

$$R[i, n+i] - v_i \stackrel{d}{=} R[0, n] \text{ under } \mathbf{P}_{\mu, \theta}, \forall i \in \mathbb{Z}, n \in \mathbb{N}.$$

Proof. Since θ is symmetric, it suffices to study the marginal distribution $\mathbf{P}_{\mu,\theta}$ on the space of infinite trees.

As shown in Figure 4.3, take any node u : if it is the base point or some point not on the spine, then it has k children (thus degree $k + 1$) with probability $\mu(k) = \mu(\deg(u) - 1)$; otherwise, it has i children on the left and j children on the right (thus degree $i + j + 2$) with probability $\mu(i + j + 1) = \mu(\deg(u) - 1)$.

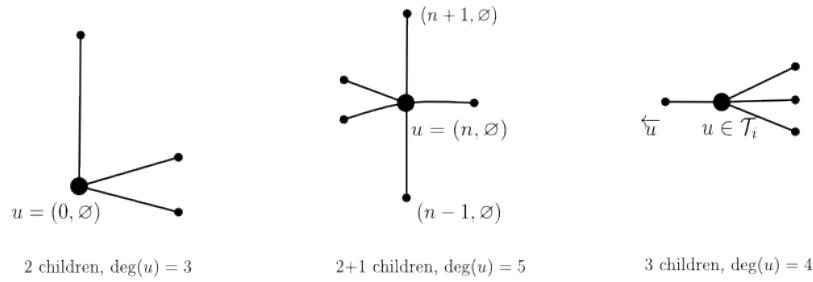

Figure 4.3 – Neighborhood of a single node. Degree means the number of adjacent nodes as in an abstract graph.

Therefore, $\mathbf{P}_{\mu,\theta}$ can be seen as a probability measure on spine-indexed forests such that each node u has degree $k + 1$ with probability $\mu(k)$. That is to say, $\mathbf{P}_{\mu,\theta}$ only takes into account the abstract tree structure, regardless of the base point. For example, denote by t and t' the structures depicted in Figure 4.4, and by A and A' the cylinder sets of forests whose first two or three subtrees are identical to t and t' respectively, then

$$\mathbf{P}_{\mu,\theta}(\mathcal{T} \in A) = \prod_{u \in t} \mu(\deg(u) - 1) = \prod_{u \in t'} \mu(\deg(u) - 1) = \mathbf{P}_{\mu,\theta}(\mathcal{T} \in A').$$

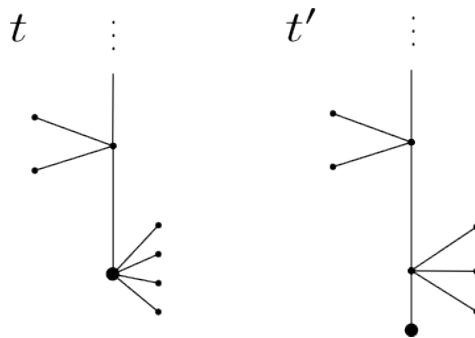

Figure 4.4 – Finite trees t and t' that are only different in the position of base points.

Since σ only changes the base point, it is then invariant with respect to $\mathbf{P}_{\mu,\theta}$. Ergodicity is also clear by construction.

Then (4.2.4) follows easily by applying the invariant transform as illustrated below:

$$\begin{aligned} & \mathbf{P}_{\mu,\theta}(v_2(\mathcal{T}) - v_1(\mathcal{T}) = x) \\ &= \mathbf{P}_{\mu,\theta}(v_1(\sigma(\mathcal{T})) - v_0(\sigma(\mathcal{T})) = x) \\ &= \mathbf{P}_{\mu,\theta}(v_1(\mathcal{T}) - v_0(\mathcal{T}) = x), \end{aligned}$$

where we use the invariance property of σ with respect to $\mathbf{P}_{\mu,\theta}$ in the last line. \square

Remark 4.2.3. If one is only interested in the positive side,

$$((0, \mathcal{T}_0), (1, \mathcal{T}_1), (2, \mathcal{T}_2), \dots),$$

then the spine has offspring distribution

$$\mathbf{P}_{\mu,\theta}(k_{(i,\emptyset)}(\mathcal{T}) = i) = \sum_{j=0}^{\infty} \mathbf{P}_{\mu,\theta}(k_{(i,\emptyset)}^+(\mathcal{T}) = i, k_{(i,\emptyset)}^-(\mathcal{T}) = j) = \sum_{j=0}^{\infty} \mu(i + j + 1),$$

which is consistent with the construction in [LGL16, Section 2.2], for which the invariant transformation can be also induced by the transformation σ defined in (4.2.3).

Remark 4.2.4. If we are interested in trees with n nodes instead of infinite nodes, with the same spirit as in the proof of Proposition 4.2.2, one has the equivalence between Galton-Watson trees conditioned on the total population size and *simply generated trees* in [Ald91, Section 2.1]. For a tree with n nodes, one has to specify a root, while in the infinite case, the 'root' is naturally set at infinity, and the 'base point' is actually redundant.

Remark 4.2.5. If we replace edges in our model by directed edges of distribution θ pointing towards infinity, then Proposition 4.2.2 still holds without assuming that θ is symmetric.

In contrast, the standard branching random walk with asymmetric displacement is constructed by attaching displacements to the directed edges of the Galton-Watson tree pointing towards the root.

Therefore, for asymmetric θ , the role of the base point $(0, \emptyset)$ here and the role of the root in the standard branching random walk are different, and we can no longer compare them by identifying the base point of the infinite model as the root of a standard finite model, which is the method in Lemma 4.3.6. The displacement distribution θ is thus assumed symmetric.

4.2.3 . Estimates on random walks and Green's functions

In this section, we present a few estimates on random walks and Green's function. We denote by P_x^η the law of the random walk started at x with transition probability η , and by (S_n) the random walk under P_x^η (or $S_n^{(i)}$ for its i.i.d. copies). Then the η -Green's function is defined as

$$G_\eta(x, y) = G_\eta(x - y) = \sum_{n=0}^{\infty} P_0^\eta(S_n = x - y).$$

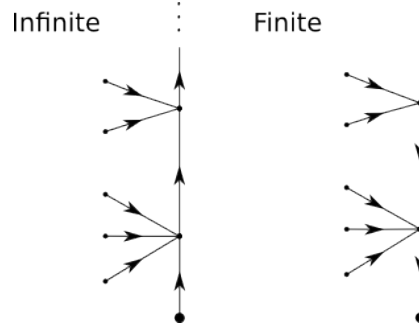

Figure 4.5 – Directed edges for the infinite and finite models. Directions of edges are different on the 'spine'.

Lemma 4.2.6. [LL10, p.24] Let η be an aperiodic and irreducible distribution on \mathbb{Z}^d ($d \geq 1$) with mean 0 and finite third moment. Denote by Γ_η the covariance matrix of η . Then there exists a constant $C(d, \eta) > 0$ such that, uniformly for all $x \in \mathbb{Z}^d$,

$$\left| \mathbb{P}_0^\eta(S_n = x) - \frac{1}{(2\pi n)^{d/2} \sqrt{\det \Gamma_\eta}} e^{-\frac{x \cdot \Gamma_\eta^{-1} x}{2n}} \right| \leq C(d, \eta) n^{-\frac{d+1}{2}}$$

Lemma 4.2.7. [LL10, Theorem 4.3.5] Given an aperiodic and irreducible distribution η on \mathbb{Z}^d ($d \geq 3$) with mean 0 and covariance matrix Γ_η , if it has finite $(d+1)$ -th moment $\mathbb{E}_0^\eta(|S_1|^{d+1}) < \infty$, then

$$G_\eta(x) = \frac{C_{d,\eta}}{J_\eta(x)^{d-2}} + O(|x|^{1-d}),$$

where $C_{d,\eta} = \frac{\Gamma(\frac{d}{2})}{(d-2)\pi^{d/2} \sqrt{\det \Gamma_\eta}}$, $\Gamma(\cdot)$ refers to the Gamma function and $J_\eta(x) = \sqrt{x \cdot \Gamma_\eta^{-1} x}$.

Lemma 4.2.8. Let η be an aperiodic and irreducible distribution on \mathbb{Z}^d ($d \geq 3$) with mean 0 and finite third moment and $1 \leq m \leq d-1$. There exists a constant $C(d, \eta) > 0$ such that uniformly on the starting point $x_0 \in \mathbb{Z}^d$,

$$\mathbb{E}_{x_0}^\eta(|S_n| \vee 1)^{-m} \leq C(d, \eta) n^{-\frac{m}{2}}.$$

Proof. Due to irreducibility of η , we have $J_\eta(x)^2 \geq C_1(d, \eta)|x|^2$. Then by Lemma 4.2.6, we can find $C_2(d, \eta) > 0$ such that

$$\begin{aligned} \mathbb{E}_{x_0}^\eta(|S_n| \vee 1)^{-m} &\leq C_2(d, \eta) \sum_{x \in \mathbb{Z}^d} (|x_0 + x| \vee 1)^{-m} n^{-\frac{d}{2}} e^{-\frac{C_1(d,\eta)|x|^2}{2n}} + O(n^{-\frac{d+1}{2}}) \\ &\leq C_2(d, \eta) n^{-\frac{m}{2}} \sum_{x \in \mathbb{Z}^d / \sqrt{n}} \left(\left| \frac{x_0}{\sqrt{n}} + x \right| \vee \frac{1}{\sqrt{n}} \right)^{-m} n^{-\frac{d}{2}} e^{-\frac{C_1(d,\eta)|x|^2}{2}} + O(n^{-\frac{d+1}{2}}). \end{aligned}$$

Moreover, denote by $B(y; r)$ the ball centered at y with radius r , then

$$\begin{aligned}
& n^{-\frac{d}{2}} \sum_{x \in \mathbb{Z}^d / \sqrt{n}} \left(\left| \frac{x_0}{\sqrt{n}} + x \right| \vee \frac{1}{\sqrt{n}} \right)^{-m} e^{-\frac{C_1(d, \eta) |x|^2}{2}} \\
& \leq n^{-\frac{d}{2}} \left(\sum_{x \in (\mathbb{Z}^d / \sqrt{n}) \cap B(-x_0 / \sqrt{n}; 1)} \left(\left| \frac{x_0}{\sqrt{n}} + x \right| \vee \frac{1}{\sqrt{n}} \right)^{-m} + \sum_{x \in (\mathbb{Z}^d / \sqrt{n}) \setminus B(-x_0 / \sqrt{n}; 1)} e^{-\frac{C_1(d, \eta) |x|^2}{2}} \right) \\
& \xrightarrow{n \rightarrow \infty} \int_{B(0; 1)} |x|^{-m} dx + \int_{\mathbb{R}^d} e^{-\frac{C_1(d, \eta) |x|^2}{2}} dx.
\end{aligned}$$

which is a constant depending only on d and η . \square

Corollary 4.2.9. *Let η be an aperiodic and irreducible distribution on \mathbb{Z}^d ($d \geq 3$) with mean 0 and finite third moment, then for any $m \geq 1$,*

1. *there exists a constant $C(d, \eta, m) > 0$ such that uniformly for $x_0 \in \mathbb{Z}^d$,*

$$\mathbb{E}_{x_0}^{\eta} \left[\left(\sum_{i=0}^n (|S_i| \vee 1)^{-2} \right)^m \right] \leq C(d, \eta, m) (\log n)^m;$$

2. *for any $2 < k \leq d - 1$, there exists a constant $C'(d, \eta, m, k) > 0$ such that uniformly for $x_0 \in \mathbb{Z}^d$,*

$$\mathbb{E}_{x_0}^{\eta} \left[\left(\sum_{i=0}^n (|S_i| \vee 1)^{-k} \right)^m \right] \leq C'(d, \eta, m, k).$$

Proof. The cases $m = 1$ for both $k = 2$ and $k > 2$ are clear by Lemma 4.2.8. For $m \geq 2$, applying Markov's property inductively gives that

$$\begin{aligned}
& \mathbb{E}_{x_0}^{\eta} \left[\left(\sum_{i=0}^n (|S_i| \vee 1)^{-k} \right)^m \right] \\
& \leq C'(d, \eta, m, k) \mathbb{E}_{x_0}^{\eta} \left[\sum_{i=0}^n \left((|S_i| \vee 1)^{-k} \right) \cdot \mathbb{E}_{S_i}^{\eta} \left[\left(\sum_{j=0}^{n-i} (|S'_j| \vee 1)^{-k} \right)^{m-1} \right] \right],
\end{aligned}$$

where (S'_j) denotes a random walk independent of (S_i) . \square

Lemma 4.2.10. *[Ein89, Theorem 4] Let η be a probability distribution in \mathbb{R}^d with mean 0 and covariance matrix Γ_{η} . If $\mathbb{E}_0^{\eta} [e^{\sqrt{|S_1|}}] < \infty$, then one can construct on the same probability space a Brownian motion (B_t) with covariance matrix Γ_{η} such that there exists $C, C' > 0$ depending on d, η such that*

$$\mathbb{P}_0^{\eta} \left(\max_{1 \leq k \leq n} |S_k - B_k| \geq x \right) \leq \frac{Cn}{e^{C' \sqrt{x}}}.$$

4.2.4 . Capacity

Given a distribution η on \mathbb{Z}^d ($d \geq 3$) and a finite set $A \subseteq \mathbb{Z}^d$, recall that the η -capacity is defined as

$$\text{cap}_\eta A = \sum_{x \in A} \mathbb{P}_x^\eta(\tau_A^+ = \infty). \quad (4.2.5)$$

In this section, we give two estimates relating the η -capacity to the η -Green's function, which is defined as

$$G_\eta(x, y) = G_\eta(x - y) = \mathbb{E}_0^\eta \left[\sum_{i=0}^{\infty} \mathbf{1}_{(S_i = x - y)} \right] = \sum_{i=0}^{\infty} \mathbb{P}_0^\eta(S_i = x - y), \quad x, y \in \mathbb{Z}^d.$$

Lemma 4.2.11. *Let $d \geq 3$ and η be any probability distribution on \mathbb{Z}^d . For any finite set $A \subset \mathbb{Z}^d$ and $k \in \mathbb{N}_+$,*

$$\text{cap}_\eta A \geq \frac{\#A}{k+1} - \frac{\sum_{x, y \in A} G_\eta(x, y)}{k(k+1)}.$$

Proof. We define local times $L_A := \sum_{n=1}^{\infty} \mathbf{1}_{(S_n \in A)} \in \mathbb{N} \cup \{\infty\}$ for any finite set $A \subset \mathbb{Z}^d$, then by definition, $\text{cap}_\eta A = \sum_{x \in A} \mathbb{P}_x^\eta(L_A = 0)$.

For any integers $a > 0$ and $b \geq 0$,

$$\begin{aligned} \sum_{x \in A} \mathbb{P}_x^\eta(L_A = a) \mathbb{P}_x^{-\eta}(L_A = b) &= \sum_{x, y \in A} \mathbb{P}_x^\eta(S_{\tau_A^+} = y) \mathbb{P}_y^\eta(L_A = a - 1) \mathbb{P}_x^{-\eta}(L_A = b) \\ &= \sum_{x, y \in A} \mathbb{P}_y^{-\eta}(S_{\tau_A^+} = x) \mathbb{P}_y^\eta(L_A = a - 1) \mathbb{P}_x^{-\eta}(L_A = b) \\ &= \sum_{y \in A} \mathbb{P}_y^\eta(L_A = a - 1) \mathbb{P}_y^{-\eta}(L_A = b + 1), \end{aligned}$$

where $-\eta$ refers to the distribution with $(-\eta)(x) := \eta(-x)$, $\forall x \in \mathbb{Z}^d$.

Thus by induction we have that

$$\sum_{x \in A} \mathbb{P}_x^\eta(L_A = a) \mathbb{P}_x^{-\eta}(L_A = b) = \sum_{x \in A} \mathbb{P}_x^\eta(L_A = 0) \mathbb{P}_x^{-\eta}(L_A = a + b).$$

By summing over $a \leq k$ and $b \geq 0$, it follows that

$$\begin{aligned} \sum_{x \in A} \mathbb{P}_x^\eta(L_A \leq k) &= \sum_{y \in A} \mathbb{P}_y^\eta(L_A = 0) \left(\sum_{a=0}^k \mathbb{P}_y^{-\eta}(L_A \geq a) \right) \\ &\leq (k+1) \sum_{y \in A} \mathbb{P}_y^\eta(L_A = 0). \end{aligned} \quad (4.2.6)$$

Therefore

$$\begin{aligned}
\#A - \sum_{x \in A} \mathbb{P}_x^\eta(L_A > k) &= \sum_{x \in A} (1 - \mathbb{P}_x^\eta(L_A > k)) \\
&= \sum_{x \in A} \mathbb{P}_x^\eta(L_A \leq k) \\
&\leq (k+1) \sum_{y \in A} \mathbb{P}_y^\eta(L_A = 0) = (k+1) \text{cap}_\eta A.
\end{aligned}$$

To conclude, it suffices to notice that $\mathbb{P}_x^\eta(L_A > k) \leq \frac{\sum_{y \in A} G_\eta(x, y)}{k}$, which follows directly from Markov's inequality. \square

Moreover, in our situation, the set $A_n = \{X_0, \dots, X_n\}$ is the trajectory of a stationary process $(X_n)_{n \in \mathbb{Z}}$ up to translation (under some probability space $(\Omega, \mathcal{F}, \mathbb{P})$), in the sense that

$$X_0 = 0, \{X_0, \dots, X_n\} \stackrel{d}{=} \{X_i, \dots, X_{n+i}\} - X_i, \forall i \in \mathbb{Z}, \forall n \in \mathbb{N}, \quad (4.2.7)$$

where $A - x := \{a - x : a \in A\}$ for any set $A \subseteq \mathbb{Z}^d$ and $x \in \mathbb{Z}^d$. We can thus rewrite (4.2.5) as

$$\text{cap}_\eta A_n = \sum_{i=0}^n \mathbf{1}_{\{X_i \notin \{X_{i+1}, \dots, X_n\}\}} \mathbb{P}_{X_i}^\eta(\tau_{A_n}^+ = \infty). \quad (4.2.8)$$

and take expectation to get

$$\begin{aligned}
\mathbb{E} \text{cap}_\eta A_n &= \sum_{i=0}^n \mathbb{E} \left[\mathbf{1}_{\{X_i \notin \{X_{i+1}, \dots, X_n\}\}} \mathbb{P}_{X_i}^\eta(\tau_{\{X_0, \dots, X_n\}}^+ = \infty) \right] \\
&= \sum_{i=0}^n \mathbb{E} \left[\mathbf{1}_{\{X_0 \notin \{X_1, \dots, X_{n-i}\}\}} \mathbb{P}_{X_0}^\eta(\tau_{\{X_{-i}, \dots, X_{n-i}\}}^+ = \infty) \right].
\end{aligned}$$

This sum may be approximated (with a second moment method, for instance) by n times

$$\mathbb{E} \left[\mathbf{1}_{\{X_0 \notin \{X_1, \dots, X_{\xi_n^r}\}\}} \mathbb{P}_{X_0}^\eta \left(\tau_{\{X_{-\xi_n^l}, \dots, X_{\xi_n^r}\}}^+ = \infty \right) \right], \quad (4.2.9)$$

where ξ_n^l and ξ_n^r are geometric killing times with parameter $\frac{1}{n}$.

The following lemma inspired by [Law13, Theorem 3.6.1] then allows us to establish a relation between (4.2.9) and Green's functions. Recall that ξ is a geometric variable with parameter λ if

$$\mathbb{P}(\xi = k) = \lambda(1 - \lambda)^k, \quad k \in \mathbb{N}.$$

Lemma 4.2.12. *Let $(X_n)_{n \in \mathbb{Z}}$ in \mathbb{Z}^d be a stationary process up to translation in (4.2.7). Let $d \geq 3, n \geq 1$, and let ξ_n^l, ξ_n^r, ξ_n be independent geometric random variables with*

parameter $\frac{1}{n}$. If we set

$$\begin{aligned} I_n &= \mathbf{1}_{\{X_0 \neq X_i, 0 < i \leq \xi_n^r\}}, \\ E_n &= \mathbb{P}_{X_0}^\eta \left(\tau_{\{X_{-\xi_n^l}, \dots, X_{\xi_n^r}\}}^+ > \xi_n \right), \\ G_n &= \sum_{i=-\xi_n^l}^{\xi_n^r} G_\eta^{(1-\frac{1}{n})}(X_0, X_i), \end{aligned}$$

where $G_\eta^{(\lambda)}(x) = \sum_{k \geq 0} \lambda^k \mathbb{P}_0^\eta(S_k = x)$ denotes the Green's function with killing rate λ , then

$$\mathbb{E}[E_n G_n I_n] = 1.$$

Proof. For $m \in \mathbb{N}$ and x_1, \dots, x_m in \mathbb{Z}^d , we consider the event

$$B = B(m; x_1, \dots, x_m) := \{\xi_n^l + \xi_n^r = m, X_{i-\xi_n^l} = X_{-\xi_n^l} + x_i, \forall 0 \leq i \leq m\}$$

with the convention that $x_0 = 0$. When m runs through \mathbb{N} and (x_i) runs through all possible finite sequences of \mathbb{Z}^d , we have that

$$\sum_{m \geq 0} \sum_{x_1, \dots, x_m \in \mathbb{Z}^d} \mathbf{1}_{B(m; x_1, \dots, x_m)} = 1.$$

Therefore, it suffices to prove that for any $B = B(m; x_1, \dots, x_m)$,

$$\mathbb{E}[\mathbf{1}_B E_n G_n I_n] = \mathbb{P}(B).$$

Moreover, on a fixed B , we can define

$$B_j = \{\xi_n^l = j, \xi_n^r = m - j, X_i = X_0 + x_i, \forall 0 \leq i \leq m\}, \quad 0 \leq j \leq m,$$

then since E_n, I_n, G_n are all invariant under the translation $(X_i) \rightarrow (X_i - X_{-\xi_n^l})$, we have that

$$\begin{aligned} \mathbb{E}[\mathbf{1}_B E_n G_n I_n] &= \sum_{j=0}^m \mathbb{E}[\mathbf{1}_{B_j} E_n G_n I_n] \\ &= \sum_{j=0}^m \mathbb{P}(B_j) \mathbf{1}_{\{x_j \neq x_i, j < i \leq m\}} \mathbb{P}_{x_j}^\eta \left(\tau_{\{x_0, \dots, x_m\}}^+ > \xi_n \right) \sum_{k=0}^m G_\eta^{(1-\frac{1}{n})}(x_j, x_k). \end{aligned}$$

By the stationary property (4.2.7), we have that

$$\mathbb{P}(B_j) = \frac{\mathbb{P}(B)}{m+1}, \quad \forall 0 \leq j \leq m,$$

thus we can further simplify the equation above to

$$\mathbb{E}[\mathbf{1}_B E_n G_n I_n] = \frac{\mathbb{P}(B)}{m+1} \sum_{k=0}^m \sum_{j=0}^m \mathbf{1}_{\{x_j \neq x_i, j < i \leq m\}} \mathbb{P}_{x_j}^\eta \left(\tau_{\{x_0, \dots, x_m\}}^+ > \xi_n \right) G_\eta^{(1-\frac{1}{n})}(x_j, x_k). \quad (4.2.10)$$

For any $A \subseteq \mathbb{Z}^d, z \in A$, by decomposing the random walk (S_n) started at z at the last time it hits $A \subseteq \mathbb{Z}^d$, it is not hard to see that ([Law13, Proposition 2.4.1 (b)])

$$\sum_{x \in A} \mathbb{P}_x^\eta(\tau_A^+ > \xi_n) G_\eta^{(1-\frac{1}{n})}(z, x) = 1.$$

Take $A = \{x_0, x_1, \dots, x_m\}$, then we have that

$$\sum_{j=0}^m \mathbf{1}_{\{x_j \neq x_i, j < i \leq m\}} \mathbb{P}_{x_j}^\eta(\tau_A^+ > \xi_n) G_\eta^{(1-\frac{1}{n})}(z, x_j) = 1, z \in \{x_0, x_1, \dots, x_m\}.$$

Put this into (4.2.10), then

$$\mathbb{E}[\mathbf{1}_B E_n G_n I_n] = \frac{\mathbb{P}(B)}{m+1} \sum_{k=0}^m 1 = \mathbb{P}(B).$$

The conclusion follows by adding up all choices of $B(m; x_1, \dots, x_m)$. \square

4.2.5 . Strong mixing property for functions of the Brownian motion

The calculation for Green's functions will lead to some estimates of the following form, for which we give a concentration result in advance. This part is inspired partially by [LGL16, Lemma 18, Lemma 19].

In this section, let $d \geq 3$, and we consider a continuous homogeneous functions on $\mathbb{R}^d \setminus \{0\}$ of degree 2, $f : \mathbb{R}^d \setminus \{0\} \rightarrow \mathbb{R}^+$ such that

$$f(\lambda z) = \lambda^{-2} f(z), z \in \mathbb{R}^d \setminus \{0\}, \lambda \in \mathbb{R} \setminus \{0\}. \quad (4.2.11)$$

Then in particular, f is bounded on the unit sphere, and

$$f(z) \asymp |z|^{-2}, z \rightarrow \infty. \quad (4.2.12)$$

Consider the trajectory w of a d -dimensional Brownian motion. Let

$$F(w) = \int_1^e f(w(t)) dt$$

and

$$Tw(t) = \frac{w(et)}{\sqrt{e}}.$$

Then one can easily deduce that:

1. F is almost surely finite;
2. T is invariant and ergodic in the Wiener space equipped with the probability measure of the Brownian motion;
3. $\int_1^{e^n} f(w(t)) dt = F(w) + F(Tw) + \dots + F(T^{n-1}w)$.

Thus by Birkhoff's ergodic theorem, for the Brownian motion (B_t) in \mathbb{R}^d , the following integral converges almost surely to its expectation,

$$\frac{\int_1^{e^n} f(B_t) dt}{n} \rightarrow \mathbb{E} \left[\int_1^e f(B_t) dt \right]. \quad (4.2.13)$$

Moreover, we can improve it to a concentration property,

Proposition 4.2.13. *Let (B_t) be the Brownian motion in \mathbb{R}^d ($d \geq 3$) with non-degenerate covariance matrix Γ . Then for any $\epsilon > 0$, $m > 0$ and f satisfying (4.2.11), there exists a constant $C(d, \epsilon, m, \Gamma) > 0$ such that*

$$\mathbb{P} \left(\left| \frac{\int_1^{e^n} f(B_t) dt}{\log n} - \mathbb{E} \left[\int_1^e f(B_t) dt \right] \right| > \epsilon \right) \leq C(d, \epsilon, m, \Gamma) (\log n)^{-m}, \forall n \geq 1. \quad (4.2.14)$$

To prove this, we need the following moment estimate,

Lemma 4.2.14. *[Yok80, Theorem 1] Let $(X_n)_{n \in \mathbb{Z}}$ be a (strictly) stationary sequence, i.e. a sequence of random variables such that for any $k \in \mathbb{N}$ and $t, t_1, \dots, t_k \in \mathbb{Z}$*

$$(X_{t_1}, \dots, X_{t_k}) \stackrel{d}{=} (X_{t_1+t}, \dots, X_{t_k+t}).$$

Let \mathcal{M}_i^j be the σ -field generated by $\{X_i, X_{i+1}, \dots, X_j\}$, and let

$$\alpha(n) = \sup_{A \in \mathcal{M}_{-\infty}^0, B \in \mathcal{M}_n^\infty} |\mathbb{P}(A \cap B) - \mathbb{P}(A)\mathbb{P}(B)|.$$

For $r > 2$, $\delta > 0$, if $\mathbb{E}X_1 = 0$, $\mathbb{E}|X_1|^{r+\delta} < \infty$ and

$$\sum_{n=0}^{\infty} (n+1)^{\frac{r}{2}-1} \alpha(n)^{\frac{\delta}{r+\delta}} < \infty,$$

then there exists a constant $C(r, \delta) > 0$ such that

$$\mathbb{E}|X_1 + \dots + X_n|^r \leq C(r, \delta) n^{\frac{r}{2}}, \forall n \geq 1.$$

Proof of Proposition 4.2.13. It suffices to prove (4.2.14) for the Brownian motion with covariance I_d . Let

$$X_n = \int_{e^{n-1}}^{e^n} f(B_t) dt - \mathbb{E} \left[\int_1^e f(B_t) dt \right] = F(T^{n-1} B_t) - \mathbb{E} \left[\int_1^e f(B_t) dt \right],$$

then by a change variable from n to e^n , it suffices to show that there exists $C(d, \epsilon, m) > 0$ with

$$\mathbb{P}(|X_1 + \dots + X_n| > \epsilon n) \leq C(d, \epsilon, m) n^{-m}.$$

By (4.2.12), (X_n) is a stationary sequence with mean 0. Moreover, by applying the same trick as in Corollary 4.2.9, we can easily show that it also satisfies the moment

assumption $\mathbb{E}|X_1|^{r+\delta} < \infty$ for all r, δ . Therefore, to apply Lemma 4.2.14, it suffices to prove that for (X_n) we have $\alpha(n) = O(e^{-cn})$ for some $c > 0$.

Since (X_n) only depends on the trajectory of the Brownian motion, which is a Markov process, we have that $\alpha(n)$ is comparable uniformly in n to

$$\sup_{A, B \subseteq \mathbb{R}^6} |\mathbb{P}(B_1 \in A, B_{e^n} \in B) - \mathbb{P}(B_1 \in A)\mathbb{P}(B_{e^n} \in B)|.$$

Clearly, $\mathbb{P}(|B_1| > n) = \mathbb{P}(|B_{e^n}| > ne^{n/2}) = O(e^{-cn})$, so we may consider the supreme restricted to bounded balls in \mathbb{R}^d , $A \subseteq \text{Ball}(0; n)$, $B \subseteq \text{Ball}(0; ne^{n/2})$. Then we expand $\alpha(n)$ by definition,

$$\begin{aligned} & \sup_{\substack{A \subseteq \text{Ball}(0; n) \\ B \subseteq \text{Ball}(0; ne^{n/2})}} |\mathbb{P}(B_1 \in A, B_{e^n} \in B) - \mathbb{P}(B_1 \in A)\mathbb{P}(B_{e^n} \in B)| \\ & \leq \frac{1}{(2\pi)^d} \sup_{\substack{A \subseteq \text{Ball}(0; n) \\ B \subseteq \text{Ball}(0; ne^{n/2})}} \int_A dx \int_B dy \cdot \left| \frac{1}{\sqrt{e^n - 1}} e^{-\frac{|x|^2}{2} - \frac{|y-x|^2}{2(e^n-1)}} - \frac{1}{\sqrt{e^n}} e^{-\frac{|x|^2}{2} - \frac{|y|^2}{2e^n}} \right| \\ & \leq \frac{1}{(2\pi)^d} \sup_{\substack{A \subseteq \text{Ball}(0; n) \\ B \subseteq \text{Ball}(0; ne^{n/2})}} \int_A dx \int_B dy \cdot \frac{1}{\sqrt{e^n}} \left| e^{-\frac{|x|^2}{2} - \frac{|y-x|^2}{2(e^n-1)}} - e^{-\frac{|x|^2}{2} - \frac{|y|^2}{2e^n}} \right| \\ & \quad + \frac{1}{(2\pi)^d} \sup_{\substack{A \subseteq \text{Ball}(0; n) \\ B \subseteq \text{Ball}(0; ne^{n/2})}} \int_A dx \int_B dy \cdot \left| \frac{1}{\sqrt{e^n - 1}} - \frac{1}{\sqrt{e^n}} \right| e^{-\frac{|x|^2}{2} - \frac{|y-x|^2}{2(e^n-1)}} \\ & \leq \frac{1}{(2\pi)^d e^{\frac{n}{2}}} \sup_{\substack{A \subseteq \text{Ball}(0; n) \\ B \subseteq \text{Ball}(0; ne^{n/2})}} \int_A e^{-\frac{|x|^2}{2}} dx \int_B e^{-\frac{|y|^2}{2e^n}} dy \cdot O\left(\left| \frac{|y-x|^2}{2(e^n-1)} - \frac{|y|^2}{2e^n} \right|\right) + O(e^{-n}) \\ & = O(n^2 e^{-n}), \end{aligned}$$

where in the last line, we upper bound the integrals by 1 and use the fact that $|x| \leq n$, $|y| \leq ne^{n/2}$.

In conclusion, we have $\alpha(n) = O(e^{-cn})$ for some $c > 0$, thus the conditions in Lemma 4.2.14 are satisfied. Therefore, let $\delta = \frac{1}{2}$, then for any $r > 2$, there exists a constant $C(r)$ such that

$$\mathbb{E}|X_1 + \dots + X_n|^r \leq C(r)n^{\frac{r}{2}}, \forall n \geq 1,$$

then by a Chebyshev-type inequality,

$$\mathbb{P}\left(|X_1 + \dots + X_n| \geq k(C(r)n^{\frac{r}{2}})^{\frac{1}{r}}\right) \leq k^{-r}.$$

The conclusion follows by taking $r = 2m$ and $k = \epsilon n^{\frac{1}{2}}(C(r))^{-\frac{1}{r}}$. \square

Corollary 4.2.15. *Let η be a distribution satisfying the conditions in Lemma 4.2.10, and recall that f is a function satisfying (4.2.11). Set $f(0) = 0$ so that it is defined on \mathbb{R}^d , then for any $\epsilon > 0$ and $m > 0$, there exists a constant $C(d, \eta, \epsilon, m) > 0$*

$$\mathbb{P}_0^\eta\left(\left|\frac{\sum_{i=0}^n f(S_i)}{\log n} - \mathbb{E}\left[\int_1^e f(B_t)dt\right]\right| > \epsilon\right) \leq C(d, \eta, \epsilon, m)(\log n)^{-m}, \forall n \geq 0.$$

Proof. Extend the discrete process $(S_n)_{n \in \mathbb{N}}$ to a continuous-time process $(S_{\lfloor t \rfloor})_{t \geq 0}$. Using Lemma 4.2.10 and some basic estimates on the Brownian motion, we can find a Brownian motion with the same covariance matrix as S on the same probability space, a constant $C(d, \eta) > 0$, and $k \in \mathbb{N}$ large enough, such that the event

$$F_n := \left\{ \max_{0 \leq t \leq n} |S_t - B_t| < C(d, \eta)(\log n)^2 \right\} \cap \left\{ \inf_{t > (\log n)^k} |B_t| > (\log n)^3 \right\}$$

happens with probability $1 - O((\log n)^{-m})$.

Recall that f is continuous on $\mathbb{R}^d \setminus \{0\}$ and homogeneous of degree 2, we can easily get that for any $\delta > 0$, when n is large enough, for any $x, y \in \mathbb{R}^d$ such that $|y| > (\log n)^3$, $|x - y| < (\log n)^2$,

$$\begin{aligned} |f(x) - f(y)| &\leq \left| |x|^{-2} - |y|^{-2} \right| f\left(\frac{x}{|x|}\right) + |y|^{-2} \left| f\left(\frac{x}{|x|}\right) - f\left(\frac{y}{|y|}\right) \right| \\ &= |y|^{-2} \frac{|x| + |y|}{|x|} \frac{|x| - |y|}{|x|} f\left(\frac{x}{|x|}\right) + |y|^{-2} \left| f\left(\frac{x}{|x|}\right) - f\left(\frac{y}{|y|}\right) \right| \\ &\leq \delta |y|^{-2}. \end{aligned}$$

Therefore, conditioned on the event F_n , if we write $C_f = \mathbb{E}[\int_1^e f(B_t) dt]$ for simplicity, we have that

$$\begin{aligned} &\left| \sum_{i=0}^{n-1} f(S_i) - C_f \log n \right| \\ &\leq \sum_{i=0}^{\lceil (\log n)^k \rceil} f(S_i) + \left| \int_{(\log n)^k}^n f(B_t) dt - C_f \log n \right| + \int_{(\log n)^k}^n |f(B_t) - f(S_t)| dt \\ &\leq \sum_{i=0}^{\lceil (\log n)^k \rceil} f(S_i) + \left| \int_{(\log n)^k}^n f(B_t) dt - C_f \log n \right| + \delta \int_{(\log n)^k}^n |B_t|^{-2} dt. \end{aligned}$$

For the first term, by Corollary 4.2.9, we have that

$$\mathbb{P} \left(\sum_{i=0}^{\lceil (\log n)^k \rceil} f(S_i) > \epsilon \log n \right) \leq C_1(d, \eta, \epsilon, m)(\log n)^{-m}.$$

Similar bounds for the second and the third term follows from Proposition 4.2.13. This completes the proof. \square

4.3 . The super-critical dimensions

In this section, we prove Theorem 4.1.1 for $d \geq 7$ via the infinite model defined in Section 4.2.2. The main strategy is to establish a lower bound for the expectation of capacity using Lemma 4.2.11 and estimates on Green's functions. Then the desired convergence can be obtained for the infinite model with the help of its ergodicity under transformation (4.2.3). Finally extend it to a similar convergence for the branching random walk indexed by the critical Galton-Watson tree conditioned to be large.

4.3.1 . Estimates on Green's functions

Lemma 4.3.1. *If $d \geq 3$ and η, θ are distributions on \mathbb{Z}^d satisfying (4.1.1), then as $n \rightarrow \infty$, there exists a constant $C(d, \eta, \theta) > 0$ such that*

$$\mathbf{E}_0^\theta[G_\eta(S_n)] \leq C(d, \eta, \theta)n^{1-d/2}.$$

Proof. Recall that according to Lemma 4.2.7, there exists $C'(d, \eta, \theta)$ such that

$$(C'(d, \eta, \theta))^{-1}G_\theta(x) \leq G_\eta(x) \leq C'(d, \eta, \theta)G_\theta(x) \quad \text{uniformly for all } x \in \mathbb{Z}^d,$$

then it suffices to show that

$$\mathbf{E}_0^\theta[G_\theta(S_n)] \leq C(d, \theta)n^{1-d/2}.$$

In fact since θ is symmetric,

$$\begin{aligned} \mathbf{E}_0^\theta[G_\theta(S_n)] &= \sum_{x \in \mathbb{Z}^d} \mathbf{P}_0^\theta(S_n = x)G_\theta(x) \\ &= \sum_{x \in \mathbb{Z}^d} \sum_{m \geq 0} \mathbf{P}_0^\theta(S_n = x)\mathbf{P}_0^\theta(S_m = x) \\ &= \sum_{m \geq 0} \mathbf{P}_0^\theta(S_{m+n} = 0) \leq C(d, \theta)n^{1-d/2}, \end{aligned}$$

where the last line follows by taking $x = 0$ in Lemma 4.2.6 and this completes the proof. \square

Lemma 4.3.2. *In dimension $d \geq 7$, recall that μ, θ, η are probability distributions satisfying (4.1.1), and (v_i) is the sequence of vertices of the infinite model is defined in (4.2.2). Then there exists a constant $C(d, \mu, \theta, \eta) > 0$ such that*

$$\mathbf{E}_{\mu, \theta} \left[\sum_{i=-\infty}^{\infty} G_\eta(v_i) \right] \leq C(d, \mu, \theta, \eta).$$

Proof. Recall that (v_i) run through all subtrees denoted by $\mathcal{T}_{\pm n} = \mathcal{T}_n \cup \mathcal{T}_{-n}$, thus

$$\begin{aligned} &\mathbf{E}_{\mu, \theta} \left[\sum_{i=-\infty}^{\infty} G_\eta(v_i) \right] \\ &= \mathbf{E}_{\mu, \theta} \otimes \mathbf{E}_0^\theta \left[\sum_{n=0}^{\infty} \sum_{i=0}^{\infty} \#\{u \in \mathcal{T}_{\pm n} : |u| = i\} G_\eta(S_{n+i}) \right] \\ &= \sum_{n=0}^{\infty} \sum_{i=0}^{\infty} \mathbf{E}_{\mu, \theta}[\#\{u \in \mathcal{T}_{\pm n} : |u| = i\}] \mathbf{E}_0^\theta[G_\eta(S_{n+i})]. \end{aligned}$$

If μ has finite variance, then for all n and i ,

$$\mathbf{E}_{\mu, \theta}[\#\{u \in \mathcal{T}_{\pm n} : |u| = i\}] = \mathbf{E}_{\mu, \theta}[\#\{u \in \mathcal{T}_{\pm n} : |u| = 1\}] = \sum_{i, j \geq 0} (i + j)\mu(i + j + 1),$$

thus we have that

$$\begin{aligned} \mathbf{E}_{\mu,\theta} \left[\sum_{i=-\infty}^{\infty} G_{\eta}(v_i) \right] &\leq C(\mu) \sum_{n=0}^{\infty} \sum_{i=0}^{\infty} \mathbf{E}_0^{\theta}[G_{\eta}(S_{n+i})] \\ &= C(\mu) \sum_{m=0}^{\infty} (m+1) \mathbf{E}_0^{\theta}[G_{\eta}(S_m)] \leq C(\mu, d, \eta, \theta), \end{aligned}$$

where the last line follows from Lemma 4.3.1. \square

4.3.2 . Limit theorem for the infinite model

Proposition 4.3.3. *In dimension $d \geq 7$, μ, θ, η are supposed to satisfy (4.1.1) and recall the range $R[0, n]$ defined in Section 4.2.2. Then there is a constant $C(d, \mu, \theta, \eta) > 0$ such that*

$$\frac{\text{cap}_{\eta}(R[0, n])}{n} \rightarrow C(d, \mu, \theta, \eta) \quad \mathbf{P}_{\mu,\theta}\text{-almost surely.}$$

Proof. By the definition of the capacity, for any finite sets $A, B \subset \mathbb{Z}^d$,

$$\text{cap}_{\eta}(A \cup B) \leq \text{cap}_{\eta}A + \text{cap}_{\eta}B.$$

Recall the ergodic measure-preserving shift σ defined by (4.2.3). In particular we have that

$$\begin{aligned} \text{cap}_{\eta}(R[0, n+m]) &\leq \text{cap}_{\eta}(R[0, n]) + \text{cap}_{\eta}(R[n, n+m]) \\ &= \text{cap}_{\eta}(R[0, n]) + \text{cap}_{\eta}(\sigma^n \circ R[0, m]). \end{aligned}$$

Thus Kingman's subadditive ergodic theorem suggests that there exists a constant $C(d, \mu, \theta, \eta)$ such that

$$\lim_{n \rightarrow \infty} \frac{\text{cap}_{\eta}(R[0, n])}{n} \rightarrow C(d, \mu, \theta, \eta) \quad \mathbf{P}_{\mu,\theta}\text{-almost surely.}$$

Then it remains to prove that the constant

$$C(d, \mu, \theta, \eta) = \lim_{n \rightarrow \infty} \frac{1}{n} \mathbf{E}_{\mu,\theta} [\text{cap}_{\eta}(R[0, n])] \quad (4.3.15)$$

is strictly positive.

In fact by Lemma 4.2.11, for any $k \geq 1$,

$$\frac{1}{n} \mathbf{E}_{\mu,\theta} [\text{cap}_{\eta}(R[0, n])] \geq \frac{\frac{1}{n} \mathbf{E}_{\mu,\theta} [\#R[0, n]]}{k+1} - \frac{\frac{1}{n} \mathbf{E}_{\mu,\theta} \left[\sum_{x,y \in R[0,n]} G_{\eta}(x, y) \right]}{k(k+1)}.$$

The first term $\frac{1}{n} \mathbf{E}_{\mu,\theta} [\#R[0, n]]$ converges to a strictly positive constant by [LGL16, Proposition 5], and the second

$$\frac{1}{n} \mathbf{E}_{\mu,\theta} \left[\sum_{x,y \in R[0,n]} G_{\eta}(x, y) \right] \leq \frac{1}{n} \mathbf{E}_{\mu,\theta} \left[\sum_{i,j=0}^n G_{\eta}(v_i, v_j) \right] \leq \mathbf{E}_{\mu,\theta} \left[\sum_{i=-\infty}^{\infty} G_{\eta}(v_i) \right]$$

is also finite by Lemma 4.3.2. Then (4.3.15) is strictly positive by taking k sufficiently large. \square

Remark 4.3.4. The limiting constant here is implicit. In fact, in the language of Lemma 4.2.12, for high dimensions $d \geq 7$, both $E_n I_n$ and G_n will converge by monotonicity (to some random variables). If we denote by $E_\infty I_\infty$ and G_∞ their limits, then the desired constant is

$$\mathbb{E}[E_\infty I_\infty] = \mathbf{P}_{\mu, \theta} \otimes \mathbf{P}_\eta^0 \left(v_0 \notin \{v_1, v_2, \dots\}, \tau_{\{\dots, v_{-1}, v_0, v_1, \dots\}}^+ = \infty \right).$$

However, the equation $\mathbb{E}[E_\infty I_\infty \cdot G_\infty] = 1$ does not contain enough information to determine this constant, since G_∞ is a non-trivial random variable for $d \geq 7$.

4.3.3 . Proof of Theorem 4.1.1 (1)

In this section, we establish an intermediate structure, via which we can compare the infinite model with large Galton-Watson trees via this new structure as in [Zhu21, p. 19].

To study $R[0, n]$, it suffices to look at (v_i) for $i \geq 0$, thus we consider the model in Remark 4.2.3, i.e. we attach one subtree \mathcal{T}_i to each node (i, \emptyset) on the spine and set

$$k_{(0, \emptyset)} \sim \mu, \mathbf{P}_{\mu, \theta}(k_{(i, \emptyset)} = n) = \mu[n + 1, \infty) = \sum_{j=n+1}^{\infty} \mu(j), i > 0.$$

Now we construct a new probability measure $\mathbf{P}_{\mu, \theta}^I$ such that all nodes on the spine, including the base point $(0, \emptyset)$, have offspring distribution

$$\mathbf{P}_{\mu, \theta}^I(k_{(i, \emptyset)} = n) = \mu[n + 1, \infty), i \geq 0,$$

while all other properties (independence, offspring distribution for nodes not on the spine, and displacements) coincide with $\mathbf{P}_{\mu, \theta}$. Recall that $\mathbf{P}_{\mu, \theta}^I$ and $\mathbf{P}_{\mu, \theta}$ are different only in the first subtree, it follows that

Corollary 4.3.5. *In dimension $d \geq 7$, let μ, θ, η be distributions satisfying the conditions in (4.1.1). There is a constant $C(d, \mu, \theta, \eta) > 0$ such that under $\mathbf{P}_{\mu, \theta}^I$,*

$$\frac{\text{cap}_\eta(R[0, n])}{n} \rightarrow C(d, \mu, \theta, \eta) \text{ in probability.}$$

Moreover, for the measure $\mathbf{P}_{\mu, \theta}^I$ we have

Lemma 4.3.6 ([Zhu21]). *In dimension $d \geq 3$, let μ, θ, η be distributions with the conditions in (4.1.1). Recall that $P_{\mu, \theta}$ is the law of the Galton-Watson tree (cf. Section 4.2.1). Let $a \in (0, 1)$ and let (f_n) be any uniformly bounded sequence of functions on $\mathbb{Z}^{\lfloor an \rfloor + 1}$. Then (with an abuse of the notation (v_i) for positions of nodes under both $P_{\mu, \theta}$ and $\mathbf{P}_{\mu, \theta}^I$)*

$$\lim_{n \rightarrow \infty} \left| E_{\mu, \theta} \left(f_n((v_i)_{0 \leq i \leq \lfloor an \rfloor}) \mid \#T = n \right) - \mathbf{E}_{\mu, \theta}^I \left(f_n((v_i)_{0 \leq i \leq \lfloor an \rfloor}) g_a \left(\frac{L_{\lfloor an \rfloor}}{\sigma n} \right) \right) \right| = 0,$$

where $g_a(x) = (1 - a)^{-\frac{3}{2}} \exp\left(-\frac{x^2}{2(1-a)}\right)$, σ^2 is the variance of μ , and (L_i) is the corresponding Lukasiewicz path defined by (recall that k_u denotes the number of children of u)

$$L_0 = 0, L_{i+1} - L_i = k_{u_i} - 1.$$

Proof. See (5.3), (5.4) and the display that follows in [Zhu21]. \square

Theorem 4.3.7. *In dimension $d \geq 7$, let μ, θ, η be distributions with the conditions in (4.1.1), and let $R[0, n]$ be the range constructed in Section 4.2.2 (abused to denote the range of other trees as well). There is a constant $C = C(d, \mu, \theta, \eta) > 0$ such that under the law of a (standard) Galton-Watson tree conditioned to have $n+1$ nodes, $P_{\mu, \theta}(\cdot | \#T = n+1)$,*

$$\frac{\text{cap}_\eta(R[0, n])}{n} \rightarrow C \text{ in probability.}$$

Proof. For any $\epsilon > 0$, take

$$f_n = \mathbf{1}_{\left| \frac{1}{n} \text{cap}_\eta R[0, an] - aC \right| > \epsilon}$$

in Lemma 4.3.6. Then by Corollary 4.3.5, we have that

$$\lim_{n \rightarrow \infty} P_{\mu, \theta} \left(\left| \frac{1}{n} \text{cap}_\eta R[0, an] - aC \right| > \epsilon \mid \#T = n+1 \right) = 0, \quad (4.3.16)$$

Moreover, since

$$\begin{aligned} & \left| \frac{1}{n} \text{cap}_\eta(R[0, n]) - C \right| \\ & \leq \left| \frac{1}{n} \text{cap}_\eta(R[0, n]) - \frac{1}{n} \text{cap}_\eta(R[0, \lfloor an \rfloor]) \right| + \left| \frac{1}{n} \text{cap}_\eta(R[0, \lfloor an \rfloor]) - aC \right| + |aC - C| \\ & \leq (1-a) + \left| \frac{1}{n} \text{cap}_\eta(R[0, \lfloor an \rfloor]) - aC \right| + (1-a)C, \end{aligned}$$

we have that

$$\begin{aligned} & \lim_{n \rightarrow \infty} P_{\mu, \theta} \left(\left| \frac{1}{n} \text{cap}_\eta(R[0, n]) - C \right| > \epsilon \mid \#T = n+1 \right) \\ & \leq \lim_{n \rightarrow \infty} P_{\mu, \theta} \left(\left| \frac{1}{n} \text{cap}_\eta(R[0, \lfloor an \rfloor]) - aC \right| > \epsilon - (1-a)(1+C) \mid \#T = n+1 \right) = 0, \end{aligned}$$

where the last line holds by (4.3.16) if a is taken sufficiently close to 1. \square

4.4 . The critical dimension

In this section, we consider the critical dimension $d = 6$ in Theorem 4.1.1. The main strategy is to estimate Green's functions for the infinite model introduced in Section 4.2.2, so that we can use Lemma 4.2.12 and a second moment method to get the desired convergence. Similar argument as in Theorem 4.3.7 allows us to prove the convergence result of the capacity for RWs indexed by large Galton-Watson trees.

4.4.1 . Estimates on Green's functions

Proposition 4.4.1. *In dimension $d = 6$, let μ, θ, η be distributions with assumptions in (4.1.1). Let $P_{\mu, \theta}$ be the law of a (standard) branching random walk $(X_u)_{u \in T}$ indexed by a (standard) Galton-Watson tree T (cf. Section 4.2.1). Then*

1. *As $z \rightarrow \infty$, we have that*

$$E_{\mu, \theta} \left[\sum_{u \in T} G_{\eta}(z + X_u) \right] = F_{\eta, \theta}(z) + O(|z|^{-3}),$$

where the function

$$F_{\eta, \theta}(z) := C_{6, \eta} C_{6, \theta} \int_{\mathbb{R}^6} J_{\eta}(z + x)^{-4} J_{\theta}(x)^{-4} dx,$$

is a continuous function defined on $\mathbb{R}^6 \setminus \{0\}$ with $F_{\eta, \theta}(\lambda z) = \lambda^{-2} F(z)$ for all $\lambda > 0$, with $C_{6, (\cdot)}$ and $J_{(\cdot)}$ defined in Lemma 4.2.7.

2. *For any $m \geq 2$, if μ has finite m -th moment, then there exists a constant $C(m, \mu, \theta, \eta) > 0$, so that for any $z \neq 0$,*

$$E_{\mu, \theta} \left[\left(\sum_{u \in T} G_{\eta}(z + X_u) \right)^m \right] \leq C(m, \mu, \theta, \eta) |z|^{-2}.$$

Proof. Because μ is critical, we have $E_{\mu, \theta}[\#\{u \in T : |u| = n\}] = 1$ for all $n \geq 1$. Then

$$\begin{aligned} E_{\mu, \theta} \left[\sum_{u \in T} G_{\eta}(z + X_u) \right] &= E_{\mu, \theta} \left[\sum_{n=0}^{\infty} \#\{u \in T : |u| = n\} E_0^{\theta}[G_{\eta}(z + S_n)] \right] \\ &= \sum_{n=0}^{\infty} E_0^{\theta}[G_{\eta}(z + S_n)] \\ &= \sum_{n=0}^{\infty} \sum_{x \in \mathbb{Z}^6} G_{\eta}(z + x) P_0^{\theta}(S_n = x) \\ &= \sum_{x \in \mathbb{Z}^6} G_{\eta}(z + x) G_{\theta}(x). \end{aligned}$$

By Lemma 4.2.7, we then have

$$\begin{aligned} &\sum_{x \in \mathbb{Z}^6} G_{\eta}(z + x) G_{\theta}(x) \\ &= C_{6, \eta} C_{6, \theta} \sum_{x \in \mathbb{Z}^6} J_{\eta}(z + x)^{-4} J_{\theta}(x)^{-4} + O \left(\sum_{x \in \mathbb{Z}^6} |z + x|^{-5} |x|^{-4} \right), \end{aligned}$$

and it is elementary to show that (by approximating the sum by an integral)

$$O \left(\sum_{x \in \mathbb{Z}^6} |z + x|^{-5} |x|^{-4} \right) = O(|z|^{-3}).$$

Moreover, the difference between $C_{6,\eta}C_{6,\theta} \sum_{x \in \mathbb{Z}^6} J_\eta(z+x)^{-4} J_\theta(x)^{-4}$ and $F_{\eta,\theta}(z)$ is of the same order as $O(\sum_{x \in \mathbb{Z}^6} |z+x|^{-5} |x|^{-4})$ by the mean value theorem. Therefore,

$$E_{\mu,\theta} \left[\sum_{u \in T} G_\eta(z + X_u) \right] = F_{\eta,\theta}(z) + O(|z|^{-3}).$$

The asymptotic and the scaling relation for $F_{\eta,\theta}$ are easy to check by using $J(x) \asymp |x|$, $J(\lambda x) = \lambda J(x)$.

As for Part (2), let $(S_n^{(i)})(1 \leq i \leq k)$ be independent θ -random walks started at o . Given any $z \in \mathbb{Z}^6$, $k \geq 2$, by Part (1) and Lemma 4.2.7,

$$E_0^\theta \left[\prod_{i=1}^k \sum_{j=0}^{\infty} G_\eta(z + S_j^{(i)}) \right] \leq C_1(\theta, \eta) \prod_{i=1}^k (|z| \vee 1)^{-2} \leq C_2(\theta, \eta) G_\eta(z)^{k/2}. \quad (4.4.17)$$

To deal with the second moment, $m = 2$, we need to study the positions of two nodes u, u' . Given that $|u \wedge u'| = k$, $|u| = k + i$, $|u'| = k + j$, where $u \wedge u'$ denotes their youngest common ancestor, then their contribution to the second moment is

$$E_0^\theta G_\eta(z + S_k + S_i^{(1)}) G_\eta(z + S_k + S_j^{(2)}).$$

Summing up all possible tree-structures, we have that

$$\begin{aligned} & E_{\mu,\theta} \left[\left(\sum_{u \in T} G_\eta(z + X_u) \right)^2 \right] \\ &= \sum_{i,j,k=0}^{\infty} E_0^\theta \left[G_\eta(z + S_k + S_i^{(1)}) G_\eta(z + S_k + S_j^{(2)}) \right] E_{\mu,\theta} [N(k; i, j)], \end{aligned}$$

where

$$N(k; i, j) = \#\{u, u' \in T : |u \wedge u'| = k, |u| = k + i, |u'| = k + j\}.$$

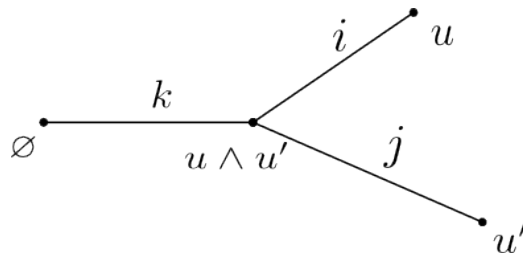

Figure 4.6 – $N(k; i, j)$

We can then count $N(k; i, j)$ as illustrated in Figure 4.6 on critical Galton-Watson trees. Set $Z_n := \#\{u \in T : |u| = n\}$, then

$$E_{\mu,\theta} [N(k; i, j)] = E_{\mu,\theta} [Z_k] E_{\mu,\theta} [Z_1(Z_1 - 1)] E_{\mu,\theta} [Z_{i-1}] E_{\mu,\theta} [Z_{j-1}] = E_{\mu,\theta} [Z_1(Z_1 - 1)]$$

for $i, j \geq 1$, which is finite as long as μ has finite second moment (the case i or $j = 0$ can be easily treated alone). Then we apply (4.4.17) with $k = 2$,

$$\begin{aligned} & E_{\mu, \theta} \left[\left(\sum_{u \in T} G_{\eta}(z + X_u) \right)^2 \right] \\ & \leq E_{\mu, \theta} [Z_1(Z_1 - 1)] \sum_{i, j, k=0}^{\infty} E_0^{\theta} \left[G_{\eta}(z + S_k + S_i^{(1)}) G_{\eta}(z + S_k + S_j^{(2)}) \right] \\ & \leq C(\theta, \eta) E_{\mu, \theta} [Z_1(Z_1 - 1)] \sum_{k=0}^{\infty} E_0^{\theta} [G_{\eta}(z + S_k)] \leq C(\mu, \theta, \eta) |z|^{-2}, \end{aligned}$$

where the last inequality follows from Part (1).

Similar argument works for $m \geq 3$, by counting all possible hierarchy structures of m vertices as for $N(k; i, j)$, and perform (4.4.17) recursively on those structures. \square

Remark 4.4.2. By (4.4.17), one may expect an $O(|z|^{-m})$ result in Part (2), however, $O(|z|^{-2})$ is in fact optimal for all $m \geq 3$. Take $m = 3$ for instance. To estimate the contribution of 'binary' branching structure $u^{(i)} (i = 1, 2, 3)$ with (see Figure 4.7)

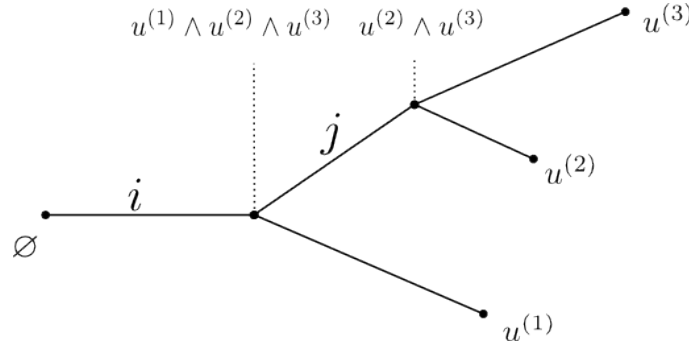

Figure 4.7 - 'binary' branching structures for $k = 3$

$$|u^{(1)} \wedge u^{(2)} \wedge u^{(3)}| = i, |u^{(2)} \wedge u^{(3)}| = i + j > i,$$

we need to perform (4.4.17) with $k = 2$ twice, instead of the equation with $k = 3$:

$$\begin{aligned} & \sum_{i, j, k, l, h=0}^{\infty} E_0^{\theta} \left[G_{\eta}(z + S_i + S_j^{(1)} + S_k^{(2)}) G_{\eta}(z + S_i + S_j^{(1)} + S_l^{(3)}) G_{\eta}(z + S_i + S_h^{(4)}) \right] \\ & \leq C_1(\mu, \theta, \eta) \sum_{i, j, h=0}^{\infty} E_0^{\theta} \left[G_{\eta}(z + S_i + S_j^{(1)}) G_{\eta}(z + S_i + S_h^{(4)}) \right] \\ & \leq C_2(\mu, \theta, \eta) \sum_{i=0}^{\infty} E_0^{\theta} [G_{\eta}(z + S_i)] \leq C_3(\mu, \theta, \eta) |z|^{-2}. \end{aligned}$$

It is only when $u^{(1)}, u^{(2)}, u^{(3)}$ all branch at the same node (i.e. $j = 0$ in Figure 4.7) that one can apply (4.4.17) with $k = 3$. Thus our method gives the bound $O(|z|^{-2})$ for all m -th moment for $m \geq 2$.

Since on the spine the infinite model has offspring distributions different from μ , we include the following corollary, whose proof is clear by that of Proposition 4.4.1.

Corollary 4.4.3. *In the setting of Proposition 4.4.1, take an arbitrary distribution μ^* on \mathbb{N} . Consider a random tree whose offspring distribution of the first generation is μ^* , with the rest remains the same as $P_{\mu, \theta}$. Denote by $P_{\mu, \theta}^*$ the law of the RW associated with this tree, then*

1. As $z \rightarrow \infty$, we have that

$$E_{\mu, \theta}^* \left[\sum_{u \in T} G_{\eta}(z + X_u) \right] = \mathbb{E}[\mu^*] F_{\eta, \theta}(z) + O(|z|^{-3}).$$

2. For any $m \geq 2$, if μ^* and μ have finite m -th moment, then there exists a constant $C(m, \mu, \mu^*, \theta, \eta) > 0$

$$E_{\mu, \theta}^* \left[\left(\sum_{u \in T} G_{\eta}(z + X_u) \right)^m \right] \leq C(m, \mu, \mu^*, \theta, \eta) |z|^{-2}.$$

Before going to the main estimate, we include here a moment estimate for independent random variables.

Lemma 4.4.4. *[FN71, Corollary 4.4] Let $t \geq 2$, and $(X_i), i = 1, \dots, n$ be independent random variables such that*

$$\mathbb{E}X_i = 0, \text{ and } \mathbb{E}|X_i|^t < \infty,$$

then

$$\mathbb{P} \left(\sum_{i=1}^n X_i \geq x \right) \leq C_1 x^{-t} \sum_{i=1}^n \mathbb{E}|X_i|^t + \exp \left(-C_2 x^2 / \sum_{i=1}^n \mathbb{E}|X_i|^2 \right),$$

where $C_1 = (1 + 2/t)^t$, $C_2 = 2(t + 2)^{-1} e^{-t}$.

We are now ready to treat Green's functions for the infinite model.

Proposition 4.4.5. *In dimension $d = 6$, let μ, θ, η be distributions with assumptions in (4.1.1). Recall the infinite model in Section 4.2.2. Let ζ_{-n}, ζ_n be indexes such that*

$$R[\zeta_{-n}, \zeta_n] = \{v_{\zeta_{-n}}, \dots, v_{\zeta_n}\}$$

is the range formed by the displacement of all nodes in

$$\{(0, \mathcal{T}_0), (1, \mathcal{T}_{\pm 1}), \dots, (n, \mathcal{T}_{\pm n})\}.$$

1. If μ has finite 5-th moment, then for any fixed $\epsilon > 0$, as $n \rightarrow \infty$,

$$\mathbf{P}_{\mu,\theta} \left(\left| \sum_{i=\zeta-n}^{\zeta_n} G_\eta(v_i) - C_G \log n \right| > \epsilon \log n \right) = o((\log n)^{-2})$$

where $C_G = \sum_{k=1}^{\infty} (k-1)k\mu(k) \cdot \mathbb{E}[\int_1^e F_{\eta,\theta}(B_t^\theta) dt]$, B_t^θ is a Brownian motion with covariance matrix Γ_θ , and $F_{\eta,\theta}$ is the function defined in Proposition 4.4.1.

2. For any $m \geq 2$, if μ has finite $(m+1)$ -th moment, then as $n \rightarrow \infty$,

$$\mathbf{E}_{\mu,\theta} \left[\left(\sum_{i=\zeta-n}^{\zeta_n} G_\eta(v_i) \right)^m \right] = O((\log n)^m).$$

Proof. We merge the two subtrees $(n, \mathcal{T}_{\pm n})$ into a single tree, whose first generation has offspring distribution $\mu^*(k) := \sum_{\{i,j: i+j=k\}} \mu(i+j+1) = (k+1)\mu(k+1)$. Then since μ has finite $(m+1)$ -th moment, μ^* has finite m -th moment. For simplicity, we denote by $G_\eta(\mathcal{T}_{\pm n})$ the sum of Green's functions over the range of $(n, \mathcal{T}_{\pm n})$, and we denote by $\mathcal{S}_0 = 0, \mathcal{S}_1, \dots, \mathcal{S}_n$ the spatial positions of the spine $(0, \emptyset), \dots, (n, \emptyset)$. Clearly,

$$\sum_{i=\zeta-n}^{\zeta_n} G_\eta(v_i) = G_\eta(\mathcal{T}_0) + \sum_{i=1}^n G_\eta(\mathcal{T}_{\pm i}),$$

and $(G_\eta(\mathcal{T}_{\pm i}))$ are independent conditioned on (\mathcal{S}_i) .

For Part (1), we have that

$$\begin{aligned} \left| \sum_{i=\zeta-n}^{\zeta_n} G_\eta(v_i) - C_G \log n \right| &\leq \left| \sum_{i=0}^n G_\eta(\mathcal{T}_{\pm i}) - \sum_{i=0}^n \mathbf{E}_{\mu,\theta}[G_\eta(\mathcal{T}_{\pm i}) \mid (\mathcal{S}_i)_{0 \leq i \leq n}] \right| \\ &\quad + \left| \sum_{i=0}^n \mathbf{E}_{\mu,\theta}[G_\eta(\mathcal{T}_{\pm i}) \mid (\mathcal{S}_i)_{0 \leq i \leq n}] - \mathbb{E}[\mu^*] \sum_{i=1}^n F_{\eta,\theta}(\mathcal{S}_i) \right| \\ &\quad + \left| \mathbb{E}[\mu^*] \sum_{i=1}^n F_{\eta,\theta}(\mathcal{S}_i) - C_G \log n \right| \end{aligned} \tag{4.4.18}$$

and it suffices to estimate each of the three terms on the right-hand side.

Indeed, for the third term in (4.4.18), by Corollary 4.2.15,

$$\mathbf{P}_{\mu,\theta} \left(\left| \mathbb{E}[\mu^*] \sum_{i=1}^n F_{\eta,\theta}(\mathcal{S}_i) - C_G \log n \right| > \epsilon \log n \right) = o((\log n)^{-2}),$$

For the second term in (4.4.18), by Corollary 4.4.3 we have that

$$\left| \sum_{i=0}^n \mathbf{E}_{\mu,\theta}[G_\eta(\mathcal{T}_{\pm i}) \mid (\mathcal{S}_i)_{0 \leq i \leq n}] - \mathbb{E}[\mu^*] \sum_{i=1}^n F_{\eta,\theta}(\mathcal{S}_i) \right| = O\left(\sum_{i=0}^n (|\mathcal{S}_i| \vee 1)^{-3} \right),$$

which is in turn deduced by Corollary 4.2.9 (2) with $k = 3$, $m = 1, 2, 3$ (and a Chebyshev-type inequality for the 3rd moment),

$$\mathbf{P}_{\mu, \theta} \left(\sum_{i=0}^n (|\mathcal{S}_i| \vee 1)^{-3} > \epsilon \log n \right) = o((\log n)^{-2}).$$

As for the first term in (4.4.18), by Corollary 4.4.3 with $m = 2, 4$ (here we need finite fourth moment for μ^* , thus finite fifth moment for μ), we have that

$$\begin{aligned} \sum_{i=0}^n \mathbf{E}_{\mu, \theta} [(G_\eta(\mathcal{T}_{\pm i}))^2 | (\mathcal{S}_i)_{0 \leq i \leq n}] &\leq C_1(\mu, \theta, \eta) \sum_{i=0}^n (|\mathcal{S}_i| \vee 1)^{-2}, \\ \sum_{i=0}^n \mathbf{E}_{\mu, \theta} [(G_\eta(\mathcal{T}_{\pm i}))^4 | (\mathcal{S}_i)_{0 \leq i \leq n}] &\leq C_2(\mu, \theta, \eta) \sum_{i=0}^n (|\mathcal{S}_i| \vee 1)^{-2}, \end{aligned}$$

so

$$\begin{aligned} \sum_{i=0}^n \mathbf{E}_{\mu, \theta} [(G_\eta(\mathcal{T}_{\pm i}) - \mathbf{E}_{\mu, \theta}[G_\eta(\mathcal{T}_{\pm i}) | (\mathcal{S}_i)_{0 \leq i \leq n}])^2 | (\mathcal{S}_i)_{0 \leq i \leq n}] &\leq C_3(\mu, \theta, \eta) \sum_{i=0}^n (|\mathcal{S}_i| \vee 1)^{-2}, \\ \sum_{i=0}^n \mathbf{E}_{\mu, \theta} [(G_\eta(\mathcal{T}_{\pm i}) - \mathbf{E}_{\mu, \theta}[G_\eta(\mathcal{T}_{\pm i}) | (\mathcal{S}_i)_{0 \leq i \leq n}])^4 | (\mathcal{S}_i)_{0 \leq i \leq n}] &\leq C_4(\mu, \theta, \eta) \sum_{i=0}^n (|\mathcal{S}_i| \vee 1)^{-2}. \end{aligned}$$

Then we apply Lemma 4.4.4 with $X_i = G_\eta(\mathcal{T}_{\pm i}) - \mathbf{E}_{\mu, \theta}[G_\eta(\mathcal{T}_{\pm i}) | (\mathcal{S}_i)_{0 \leq i \leq n}]$, $t = 4$, and $\mathbb{P} = \mathbf{P}_{\mu, \theta}(\cdot | (\mathcal{S}_i)_{0 \leq i \leq n})$,

$$\begin{aligned} &\mathbf{P}_{\mu, \theta} \left(\left| \sum_{i=0}^n G_\eta(\mathcal{T}_{\pm i}) - \mathbf{E}_{\mu, \theta}[G_\eta(\mathcal{T}_{\pm i}) | (\mathcal{S}_i)_{0 \leq i \leq n}] \right| \geq \epsilon \log n \mid (\mathcal{S}_i)_{0 \leq i \leq n} \right) \\ &\leq C_5(\mu, \theta, \eta) \sum_{i=0}^n (|\mathcal{S}_i| \vee 1)^{-2} (\epsilon \log n)^{-4} + \exp \left(-C_6(\mu, \theta, \eta) (\epsilon \log n)^2 / \sum_{i=0}^n (|\mathcal{S}_i| \vee 1)^{-2} \right) \\ &\leq C_5(\mu, \theta, \eta) \sum_{i=0}^n (|\mathcal{S}_i| \vee 1)^{-2} (\epsilon \log n)^{-4} + e^{-C_6(\mu, \theta, \eta) \epsilon^2 \log n / \log \log n} + \mathbf{1}_{\sum_{i=0}^n (|\mathcal{S}_i| \vee 1)^{-2} > \log n \log \log n}, \end{aligned}$$

If we take expectation $\mathbf{E}_{\mu, \theta}$ on both sides, all these terms are $o((\log n)^{-2})$ by Corollary 4.2.9, then we have that

$$\mathbf{P}_{\mu, \theta} \left(\left| \sum_{i=0}^n G_\eta(\mathcal{T}_{\pm i}) - \mathbf{E}_{\mu, \theta}[G_\eta(\mathcal{T}_{\pm i}) | (\mathcal{S}_i)_{0 \leq i \leq n}] \right| \geq \epsilon \log n \right) = o((\log n)^{-2}).$$

The conclusion follows by combining the estimates for the three terms on the right-hand side of (4.4.18) individually.

For the second part, we illustrate the $m = 2$ case, since the proof for m other

than 2 is similar. Indeed,

$$\begin{aligned}
& \mathbf{E}_{\mu,\theta} \left[\left(\sum_{i=\zeta-n}^{\zeta} G_{\eta}(v_i) \right)^2 \middle| (\mathcal{S}_i)_{0 \leq i \leq n} \right] \\
&= \mathbf{E}_{\mu,\theta} \left[\left(\sum_{i=0}^n G_{\eta}(\mathcal{T}_{\pm i}) \right)^2 \middle| (\mathcal{S}_i)_{0 \leq i \leq n} \right] \\
&= \sum_{i=0}^n \mathbf{E}_{\mu,\theta} [G_{\eta}(\mathcal{T}_{\pm i})^2 \mid (\mathcal{S}_i)_{0 \leq i \leq n}] + \\
&\quad 2 \sum_{0 \leq i < j \leq n} \mathbf{E}_{\mu,\theta} [G_{\eta}(\mathcal{T}_{\pm i}) \mid (\mathcal{S}_i)_{0 \leq i \leq n}] \mathbf{E}_{\mu,\theta} [G_{\eta}(\mathcal{T}_{\pm j}) \mid (\mathcal{S}_i)_{0 \leq i \leq n}].
\end{aligned}$$

By Corollary 4.4.3, if μ has finite 3rd moment, then this sum is of the order

$$\begin{aligned}
& \sum_{i=0}^n (|\mathcal{S}_i| \vee 1)^{-2} + 2 \sum_{0 \leq i < j \leq n} (|\mathcal{S}_i| \vee 1)^{-2} (|\mathcal{S}_j| \vee 1)^{-2} \\
&\asymp \sum_{i=0}^n (|\mathcal{S}_i| \vee 1)^{-2} + \left(\sum_{i=0}^n (|\mathcal{S}_i| \vee 1)^{-2} \right)^2,
\end{aligned}$$

We conclude by taking expectation w.r.t. $\mathbf{E}_{\mu,\theta}$ and Corollary 4.2.9. \square

Corollary 4.4.6. *Under the same setting of Proposition 4.4.5 (1),*

$$\mathbf{P}_{\mu,\theta} \left(\left| \sum_{i=-n}^n G_{\eta}(v_i) - \frac{1}{2} C_G \log n \right| > \epsilon \log n \right) = o((\log n)^{-2}).$$

Proof. By standard tools of Kemperman's formula (see e.g. [Dwa69, Section 3]), denote by ζ'_n the total population of n Galton-Watson trees of offspring distribution μ , and by (Y_i) an i.i.d. sequence distributed as $\mu - 1$, then

$$\mathbf{P}_{\mu,\theta}(\zeta'_n = m) = \frac{n}{m} \mathbb{P}(Y_1 + \dots + Y_m = -n).$$

Applying Lemma 4.2.6 with $d = 1$ and the random walk with displacements (Y_i) , we have that

$$\left| \mathbf{P}_{\mu,\theta}(\zeta'_n = m) - \frac{n}{m} \frac{C_1(\mu)}{\sqrt{m}} e^{-\frac{C_2(\mu)n^2}{m}} \right| \leq \frac{n}{m} \frac{C_3(\mu)}{m}.$$

Sum over m , then

$$\mathbf{P}_{\mu,\theta}(\zeta'_n \geq n^2(\log n)^5) = o((\log n)^{-2}).$$

Moreover, by [LL10, Proposition 2.1.2 (a)] with $k = 2$ (guaranteed by the finite fifth moment in Proposition 4.4.5 (1)),

$$\begin{aligned} & \mathbf{P}_{\mu,\theta}(\zeta'_n \leq n^2(\log n)^{-2}) \\ & \leq \sum_{m=1}^{n^2(\log n)^{-2}} \frac{n}{m} \mathbb{P}(Y_1 + \cdots + Y_m = -n) \\ & \leq \left(\sum_{m=1}^{n^2(\log n)^{-2}} \frac{n}{m} \right) \cdot \mathbb{P}\left(\min_{1 \leq j \leq n^2(\log n)^{-2}} Y_1 + \cdots + Y_j \leq -n \right) \\ & = o((\log n)^{-2}). \end{aligned}$$

In summary,

$$\mathbf{P}_{\mu,\theta}(n^2(\log n)^{-2} < \zeta'_n < n^2(\log n)^5) = 1 - o((\log n)^{-2}).$$

Moreover, recall the probability distribution μ^* in the proof of Proposition 4.4.5. Take an i.i.d. sequence (X_i) distributed according to μ^* , then

$$\zeta_n \stackrel{d}{=} \zeta'_{1+X_1+\cdots+X_n}.$$

Apply [LL10, Proposition 2.1.2 (a)] again for the sequence $(X_i - \mathbb{E}X_i)$, we can show that for any constants $0 < C_4(\mu) < \mathbb{E}X_i < C_5(\mu)$,

$$\mathbb{P}(C_4(\mu)n < 1 + X_1 + \cdots + X_n < C_5(\mu)n) = 1 - o((\log n)^{-2}).$$

Thus for any $0 < C_6(\mu) < (\mathbb{E}[X_i])^2 < C_7(\mu)$,

$$\mathbf{P}_{\mu,\theta}(C_6(\mu)n^2(\log n)^{-2} < \zeta_n < C_7(\mu)n^2(\log n)^5) = 1 - o((\log n)^{-2}). \quad (4.4.19)$$

The same estimate holds for ζ_{-n} , thus we conclude by Proposition 4.4.5. \square

Before ending this section, we give a brief calculation of C_G for the simplest case:

Proposition 4.4.7. *If μ is the geometric distribution with parameter $\frac{1}{2}$, i.e. $\mu(k) = 2^{-k-1}$, and θ and η are one-step distributions of independent simple random walks in \mathbb{R}^6 , then $C_G = 9\pi^{-3}$.*

Proof. Recall from Proposition 4.4.5 that

$$C_G = \sum_{k=1}^{\infty} (k-1)k\mu(k) \cdot \mathbb{E} \left[\int_1^e F_{\eta,\theta}(B_t^\theta) dt \right].$$

The first term is just the variance of the geometric distribution,

$$\sum_{k=1}^{\infty} (k-1)k\mu(k) = 2.$$

For the second term, we first determine $F_{\eta,\theta}$. Denote by $(S_n), (\tilde{S}_n)$ two independent simple random walks in \mathbb{R}^6 started from 0, then by Proposition 4.4.1, for $|z| \rightarrow \infty$,

$$\begin{aligned} F_{\eta,\theta}(z) &= E_{\mu,\theta} \left[\sum_{u \in T} G_\eta(z + X_u) \right] + O(|z|^{-3}) \\ &= \mathbb{E} \left[\sum_{n=0}^{\infty} G_\eta(z + S_n) \right] + O(|z|^{-3}) \\ &= \sum_{n=0}^{\infty} \sum_{m=0}^{\infty} \mathbb{P}(\tilde{S}_m = z + S_n) + O(|z|^{-3}) \\ &= \sum_{k=0}^{\infty} (k+1) \mathbb{P}(S_k = z) + O(|z|^{-3}). \end{aligned}$$

Then simplify the sum by Lemma 4.2.6, we have

$$F_{\eta,\theta}(z) = 9\pi^{-3}|z|^{-2} + O(|z|^{-3}).$$

By definition, $F_{\eta,\theta}(\lambda z) = \lambda^{-2}F_{\eta,\theta}(z)$ for any $z \neq 0$, so

$$F_{\eta,\theta}(z) = 9\pi^{-3}|z|^{-2}, \quad z \neq 0.$$

We can then conclude by the fact that for a 6-dimensional Brownian motion with covariance matrix $\frac{1}{6}\mathbb{I}_6$,

$$\mathbb{E} \left[\int_1^e |B_t^\theta|^{-2} dt \right] = \frac{1}{2}.$$

□

4.4.2 . Limit theorem for the infinite model

In this section, we apply the estimates of Green's functions to deduce the estimates for the capacity using Lemma 4.2.12. We begin by estimating the term G_n in Lemma 4.2.12.

Lemma 4.4.8. *In dimension $d = 6$, let η be a distribution with conditions in (4.1.1), and let $G_\eta^{(1-\frac{1}{n})}(x) = \sum_{i>0} (1 - \frac{1}{n})^i P_0^\eta(S_i = x)$ as in Lemma 4.2.12. There exists $C(\eta) > 0$ such that for all $x \in \mathbb{Z}^6$ and $n \geq 1$,*

$$G_\eta(x) - G_\eta^{(1-\frac{1}{n})}(x) \leq \frac{C(\eta)}{n}.$$

Proof. Since $(1 - \frac{k}{n}) \vee 0 \leq (1 - \frac{1}{n})^k$, we have that

$$G_\eta^{(1-\frac{1}{n})}(x) \geq \sum_{k=0}^n (1 - \frac{k}{n}) P_0^\eta(S_k = x) \geq G_\eta(x) - \sum_{k \in \mathbb{N}} \frac{k \wedge n}{n} P_0^\eta(S_k = x).$$

Then the desired estimate follows because there exists $C(\eta) > 0$ such that $P_0^\eta(S_k = x) \leq C(\eta)k^{-3}$ uniformly in $x \in \mathbb{Z}^6$ by Lemma 4.2.6. □

Lemma 4.4.9. *In dimension $d = 6$, let μ, θ, η be distributions with assumptions in (4.1.1) and recall the infinite model in Section 4.2.2. In the setting of Lemma 4.2.12, apply G_n to the sequence (v_i) . If μ has finite 5-th moment, then as $n \rightarrow \infty$,*

$$\mathbf{P}_{\mu, \theta} \left(\left| G_n - \frac{1}{2} C_G \log n \right| > \epsilon \log n \right) = o((\log n)^{-2}),$$

where C_G is the constant in Proposition 4.4.5. If μ has finite $(m + 1)$ -th moment for $m \geq 2$, then as $n \rightarrow \infty$,

$$\mathbf{E}_{\mu, \theta} [(G_n)^m] = O((\log n)^m).$$

Proof. If ξ_n is a geometric random variable with parameter $\frac{1}{n}$, it is not hard to see that

$$\mathbb{P}(n(\log n)^{-3} \leq \xi_n < n \log n) = 1 - o((\log n)^{-2}).$$

Therefore,

$$\begin{aligned} & \mathbf{P}_{\mu, \theta} \left(G_n > \frac{1}{2} C_G \log n + \epsilon \log n \right) \\ &= \mathbf{P}_{\mu, \theta} \left(G_n > \frac{1}{2} C_G \log n + \epsilon \log n, \xi_n^l, \xi_n^r < n \log n \right) + o((\log n)^{-2}) \\ &\leq \mathbf{P}_{\mu, \theta} \left(\sum_{i=-n \log n}^{n \log n} G_\eta(v_i) > \frac{1}{2} C_G \log n + \epsilon \log n \right) + o((\log n)^{-2}) = o((\log n)^{-2}), \end{aligned}$$

where the last line follows from Corollary 4.4.6. For the other side, we have that

$$\begin{aligned} & \mathbf{P}_{\mu, \theta} \left(G_n < \frac{1}{2} C_G \log n - \epsilon \log n \right) \\ &= \mathbf{P}_{\mu, \theta} \left(G_n < \frac{1}{2} C_G \log n - \epsilon \log n, \xi_n^l, \xi_n^r \geq n(\log n)^{-3} \right) + o((\log n)^{-2}) \\ &\leq \mathbf{P}_{\mu, \theta} \left(\sum_{i=-n(\log n)^{-3}}^{n(\log n)^{-3}} G_\eta(v_i) < \frac{1}{2} C_G \log n - \epsilon \log n + 2C(\eta)(\log n)^{-3} \right) + o((\log n)^{-2}) \\ &= o((\log n)^{-2}), \end{aligned}$$

where $C(\eta)$ is the constant in Lemma 4.4.8.

Moreover, by Proposition 4.4.5, the m -th moment is bounded by

$$\begin{aligned} \mathbf{E}_{\mu, \theta} [(G_n)^m] &\leq \mathbf{E}_{\mu, \theta} \left[\left(\sum_{i=-\xi_n^l}^{\xi_n^r} G_\eta(v_i) \right)^m \right] \\ &\leq C_1(\mu, \theta, \eta) \sum_{k \geq 0} \mathbb{P}(\max(\xi_n^l, \xi_n^r) = k) (\log k)^m \leq C_2(\mu, \theta, \eta) (\log n)^m. \end{aligned}$$

□

We are now ready to go from Green's functions to (the contribution of the origin of) the capacity.

Lemma 4.4.10. *In dimension $d = 6$, let μ, θ, η be distributions with assumptions in (4.1.1) and that μ has finite 5-th moment. Recall the infinite model in Section 4.2.2,*

$$\lim_{n \rightarrow \infty} (\log n) \mathbf{P}_0^\eta \otimes \mathbf{P}_{\mu, \theta} \left(0 \notin R[1, n], \tau_{R[-n, n]}^+ = \infty \right) = 2C_G^{-1},$$

where C_G is the constant in Proposition 4.4.5.

Proof. We apply Lemma 4.2.12 to (the displacements of) the infinite model (v_i) . For any fixed $\epsilon > 0$ sufficiently small, let

$$A_{n, \epsilon} = \left\{ \left| G_n - \frac{1}{2} C_G \log n \right| \leq \epsilon \log n \right\},$$

which, by Lemma 4.4.9, happens with probability $1 - o((\log n)^{-2})$.

By Cauchy-Schwarz, we have that

$$\mathbf{E}_{\mu, \theta} [E_n I_n G_n \mathbf{1}_{A_{n, \epsilon}}] \leq \sqrt{\mathbf{P}_{\mu, \theta}(A_{n, \epsilon}^c) \mathbf{E}_{\mu, \theta}(G_n^2)} = o(1),$$

because $0 \leq E_n, I_n \leq 1$ (by definition), $\mathbf{P}_{\mu, \theta}(A_{n, \epsilon}^c) = o((\log n)^{-2})$, and $\mathbf{E}_{\mu, \theta}(G_n^2) = O((\log n)^2)$ by Lemma 4.4.9. This together with Lemma 4.2.12 then shows that

$$\mathbf{E}_{\mu, \theta} [E_n I_n G_n \mathbf{1}_{A_{n, \epsilon}}] = 1 - o(1).$$

Moreover since $0 \leq E_n, I_n \leq 1$, we have that

$$\left(\frac{1}{2} C_G - \epsilon \right) (\log n) \mathbf{E}_{\mu, \theta} [E_n I_n] \leq \mathbf{E}_{\mu, \theta} [E_n I_n G_n \mathbf{1}_{A_{n, \epsilon}}] \leq \left(\frac{1}{2} C_G + \epsilon \right) (\log n) \mathbf{E}_{\mu, \theta} [E_n I_n],$$

thus

$$\begin{aligned} \limsup_{n \rightarrow \infty} \left(\frac{1}{2} C_G - \epsilon \right) (\log n) \mathbf{E}_{\mu, \theta} [E_n I_n] &\leq 1 \\ \liminf_{n \rightarrow \infty} \left(\frac{1}{2} C_G + \epsilon \right) (\log n) \mathbf{E}_{\mu, \theta} [E_n I_n] &\geq 1. \end{aligned}$$

Since this holds for any ϵ , we have $\frac{1}{2} C_G (\log n) \mathbf{E}_{\mu, \theta} [E_n I_n] = 1 + o(1)$. That is to say

$$\mathbf{P}_0^\eta \otimes \mathbf{P}_{\mu, \theta} \left(0 \notin R[1, \xi_n^r], \tau_{R[-\xi_n^l, \xi_n^r]}^+ > \xi_n \right) = \frac{2 + o(1)}{C_G \log n}.$$

Moreover, apply the standard estimate

$$\mathbb{P}(n(\log n)^{-3} \leq \xi_n < n \log n) = 1 - o((\log n)^{-2})$$

for all three random variables ξ_n, ξ_n^l, ξ_n^r , by monotonicity we have that

$$\mathbf{P}_0^\eta \otimes \mathbf{P}_{\mu, \theta} \left(0 \notin R[1, n], \tau_{R[-n, n]}^+ \geq n \right) = \frac{2 + o(1)}{C_G \log n}.$$

The statement of Lemma 4.4.10 now follows since

$$\begin{aligned} \mathbf{P}_0^\eta \otimes \mathbf{P}_{\mu,\theta} \left(n < \tau_{R[-n,n]}^+ < \infty \right) &\leq \sum_{k>n} \mathbf{P}_0^\eta \otimes \mathbf{P}_{\mu,\theta} (S_k \in R[-n,n]) \\ &\lesssim \sum_{k>n} n \sup_{z \in \mathbb{Z}^6} \mathbf{P}_0^\eta (S_k = z) \asymp n^{-1} \end{aligned}$$

is negligible, where in the last line we use Lemma 4.2.6. \square

Finally, we conclude for the capacity of the infinite model by a second moment method, analogue to [LGL16, Theorem 14].

Proposition 4.4.11. *In dimension $d = 6$, let μ, θ, η be distributions with assumptions (4.1.1) and that μ has finite 5-th moment. Recall the infinite model in Section 4.2.2. As $n \rightarrow \infty$, under $\mathbf{P}_{\mu,\theta}$,*

$$\frac{\log n}{n} \text{cap}_\eta R[0, n] \xrightarrow{\mathbb{L}^2} 2C_G^{-1},$$

where C_G is that in Proposition 4.4.5.

Proof. Decompose the capacity as discussed in (4.2.8). By (4.2.4) and Lemma 4.4.10 we have that

$$\begin{aligned} &\frac{\log n}{n} \mathbf{E}_{\mu,\theta} [\text{cap}_\eta R[0, n]] \\ &= \frac{\log n}{n} \sum_{i=0}^n \mathbf{E}_{\mu,\theta} \left[\mathbf{1}_{v_i \notin R[i+1,n]} \mathbf{P}_{v_i}^\eta \left(\tau_{R[0,n]}^+ = \infty \right) \right] \\ &= \frac{\log n}{n} \sum_{i=0}^n \mathbf{E}_{\mu,\theta} \left[\mathbf{1}_{0 \notin R[1,n-i]} \mathbf{P}_0^\eta \left(\tau_{R[-i,n-i]}^+ = \infty \right) \right] \\ &\geq (\log n) \mathbf{P}_0^\eta \otimes \mathbf{P}_{\mu,\theta} \left(0 \notin R[1, n], \tau_{R[-n,n]}^+ = \infty \right) \xrightarrow{n \rightarrow \infty} 2C_G^{-1}. \end{aligned}$$

Then it suffices to show that

$$\limsup_{n \rightarrow \infty} \left(\frac{\log n}{n} \right)^2 \mathbf{E}_{\mu,\theta} [(\text{cap}_\eta R[0, n])^2] \leq (2C_G^{-1})^2. \quad (4.4.20)$$

In fact, for any $\alpha \in (0, \frac{1}{4})$, set

$$D(\alpha) = \{(i, j) : 0 < i < j < n \text{ and } i, j - i, n - j > n^{1-\alpha}\},$$

then

$$\begin{aligned} &\mathbf{E}_{\mu,\theta} [(\text{cap}_\eta R[0, n])^2] \\ &= \sum_{i,j=0}^n \mathbf{E}_{\mu,\theta} \left[\mathbf{1}_{v_i \notin R[i+1,n]} \mathbf{1}_{v_j \notin R[j+1,n]} \mathbf{P}_{v_i}^\eta \left(\tau_{R[0,n]}^+ = \infty \right) \mathbf{P}_{v_j}^\eta \left(\tau_{R[0,n]}^+ = \infty \right) \right] \\ &= 2 \sum_{D(\alpha)} \mathbf{E}_{\mu,\theta} \left[\mathbf{1}_{v_i \notin R[i+1,n]} \mathbf{1}_{v_j \notin R[j+1,n]} \mathbf{P}_{v_i}^\eta \left(\tau_{R[0,n]}^+ = \infty \right) \mathbf{P}_{v_j}^\eta \left(\tau_{R[0,n]}^+ = \infty \right) \right] + o\left(\frac{n^2}{(\log n)^2} \right). \end{aligned}$$

Moreover, write $k = j - i$ for simplicity, then for $(i, j) \in D(\alpha)$, by (4.2.4),

$$\begin{aligned} & \mathbf{E}_{\mu, \theta} \left[\mathbf{1}_{v_i \notin R[i+1, n]} \mathbf{1}_{v_j \notin R[j+1, n]} \mathbf{P}_{v_i}^\eta \left(\tau_{R[0, n]}^+ = \infty \right) \mathbf{P}_{v_j}^\eta \left(\tau_{R[0, n]}^+ = \infty \right) \right] \\ & \leq \mathbf{E}_{\mu, \theta} \left[\mathbf{1}_{0 \notin R[1, n^{1-3\alpha}]} \mathbf{1}_{v_k \notin R[k+1, k+n^{1-3\alpha}]} \times \right. \\ & \quad \left. \mathbf{P}_0^\eta \left(\tau_{R[-n^{1-3\alpha}, n^{1-3\alpha}]}^+ = \infty \right) \mathbf{P}_{v_k}^\eta \left(\tau_{R[k-n^{1-3\alpha}, k+n^{1-3\alpha}]}^+ = \infty \right) \right] \end{aligned}$$

By (4.4.19), with probability $1 - o((\log n)^{-2})$, one has $|\zeta_{\pm n^{\frac{1}{2}-\alpha}}| \in [2n^{1-3\alpha}, n^{1-\alpha}]$. And under this condition, the range $R[-n^{1-3\alpha}, n^{1-3\alpha}]$ and $R[k - n^{1-3\alpha}, k + n^{1-3\alpha}]$ correspond to disjoint subtrees in \mathcal{T} , thus by strong Markov property applied at the node $(n^{\frac{1}{2}-\alpha}, \emptyset)$, we can bound the probability above by

$$\begin{aligned} & \left(\mathbf{P}_0^\eta \otimes \mathbf{P}_{\mu, \theta}(0 \notin R[1, n^{1-3\alpha}], \tau_{R[-n^{1-3\alpha}, n^{1-3\alpha}]}^+ = \infty) \right)^2 + o((\log n)^{-2}) \\ & = \left((2C_G^{-1}(1-3\alpha)^{-1})^2 + o(1) \right) (\log n)^{-2} \end{aligned}$$

using Lemma 4.4.10. Then (4.4.20) follows by summing over all indices in $D(\alpha)$ and let $\alpha \rightarrow 0+$. \square

4.4.3 . Proof of Theorem 4.1.1 (2)

We use the same treatment as for high dimensions to extend the result on the infinite model to that of a standard branching process.

Theorem 4.4.12. *In dimension $d = 6$, let μ, θ, η be distributions with the conditions in (4.1.1) and that μ has finite 5-th moment, and let $R[0, n]$ be the range constructed in Section 4.2.2 (abused to denote the range of other trees as well). Under the law of a (standard) Galton-Watson tree conditioned to have $n + 1$ nodes, $P_{\mu, \theta}(\cdot | \#T = n + 1)$,*

$$\frac{\log n}{n} \text{cap}_\eta(R[0, n]) \rightarrow 2C_G^{-1} \text{ in probability,}$$

where C_G is the constant in Proposition 4.4.5.

Proof. As in the proof of Theorem 4.3.7, we can prove by Lemma 4.3.6 that for any $a \in (0, 1), \epsilon > 0$,

$$\lim_{n \rightarrow \infty} P_{\mu, \theta} \left(\left| \frac{\log n}{n} \text{cap}_\eta(R[0, an]) - 2aC_G^{-1} \right| > \epsilon \mid \#T = n + 1 \right) = 0$$

Take $a \rightarrow 1-$, then we have a lower bound for $\text{cap}_\eta R[0, n]$,

$$\lim_{n \rightarrow \infty} P_{\mu, \theta} \left(\frac{\log n}{n} \text{cap}_\eta(R[0, n]) - 2C_G^{-1} < -\epsilon \mid \#T = n + 1 \right) = 0$$

If we reverse the order for nodes on a tree T , and set the range of its last an nodes by $R[0, an]^-$, then $R[0, an]^-$ will satisfy the same estimate as $R[0, an]$. Moreover, $R[0, n/2], R[0, n/2]^-$ will cover all the tree except for a negligible number of

nodes ([Zhu21, p. 20]), thus

$$\begin{aligned}
& \lim_{n \rightarrow \infty} P_{\mu, \theta} \left(\frac{\log n}{n} \text{cap}_\eta(R[0, n]) - 2C_G^{-1} > \epsilon \mid \#T = n + 1 \right) \\
&= \lim_{n \rightarrow \infty} P_{\mu, \theta} \left(\frac{\log n}{n} \text{cap}_\eta(R[0, n/2] \cup R[0, n/2]^-) - 2C_G^{-1} > \epsilon \mid \#T = n + 1 \right) \\
&\leq \lim_{n \rightarrow \infty} P_{\mu, \theta} \left(\frac{\log n}{n} (\text{cap}_\eta R[0, n/2] + \text{cap}_\eta R[0, n/2]^-) - 2C_G^{-1} > \epsilon \mid \#T = n + 1 \right) = 0.
\end{aligned}$$

□

5 - Crossing estimates for simple conformal loop ensembles

5.1 . Introduction

In statistical physics, crossing-type estimates or regularity properties of the continuum limiting objects can be instrumental to study the scaling limits of certain models. In our paper, we are interested in the crossing numbers of simple conformal loop ensembles CLE_κ , $\frac{8}{3} < \kappa \leq 4$. Let Ω be a simply connected subdomain of the upper half-plane \mathbb{H} and $\text{CLE}_\kappa(\Omega)$ be a non-nested simple conformal loop ensemble in Ω with $\frac{8}{3} < \kappa \leq 4$. The main result of the present paper is on the super-exponential decay, as $n \rightarrow \infty$, of the probability of finding n crossings of a fixed annulus $A(r, R)$ ($\Omega \cap A(r, R)$ needs not to be connected, see Figure 5.1) or of a fixed quad Q with two opposite sides attached to $\partial\Omega$ for $\text{CLE}_\kappa(\Omega)$ (see Figure 5.2).

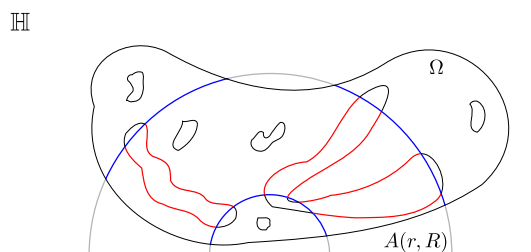

Figure 5.1 – In this illustration, crossings connect the opposite blue arcs of $\partial A(r, R)$, and we have 6 crossings given by the red paths.

5.1.1 . Background on CLEs

Conformal loop ensemble, CLE_κ for $\frac{8}{3} < \kappa < 8$, is a random countable collection of loops in a (simply connected) planar domain $\Omega \neq \mathbb{C}$, which can be viewed as the full-picture version of the Schramm-Loewner evolution (SLE). It was introduced by Sheffield in [She09] as candidates for the scaling limits of certain statistical physics models at critical temperature, which can be interpreted as random collections of disjoint, non-self-crossing loops. CLE_κ is shown to be the scaling limit of : critical Ising model $\kappa = 3$ [BH19], FK-Ising percolation $\kappa = 16/3$ [KS16], and critical site percolation on the triangular lattice $\kappa = 6$ [CN06]. Beyond these, CLE_κ , $\frac{8}{3} < \kappa \leq 4$, is conjectured to describe the scaling limit of the loop $O(n)$ model if $n = -2 \cos(4\pi/\kappa) \in (0, 2]$ while CLE_κ , $4 < \kappa < 8$, is conjectured to be the scaling limit of the FK(q)-percolation model if $q = 4 \cos^2(4\pi/\kappa)$.

CLE is characterized by a parameter $\kappa \in (8/3, 8)$, describing the density of loops in it. All loops of a sample of CLE_κ are simple, do not intersect each other, and do not intersect the domain boundary when $\kappa \in (\frac{8}{3}, 4]$. When $\kappa \in (4, 8)$, the loops are

self-intersecting (but not self-crossing) and may touch (but not cross) other loops and the domain boundary.

Since such critical models are expected to be conformally invariant on large distance scales, CLEs are defined to be conformally invariant: if $\varphi : \Omega \rightarrow \Omega'$ is a conformal map and Γ is a CLE_κ in Ω , then $\varphi(\Gamma)$ is a CLE_κ in Ω' .

For each κ , there are two versions of CLEs: *non-nested* and *nested*, the latter is obtained from the former by recursively iterating the construction inside each loop constructed in the previous step. In this article, we are mainly interested in the non-nested CLE_κ for $\kappa \in (\frac{8}{3}, 4]$ (except for Section 5.6, where we consider nested CLEs). CLEs can be constructed using one of the two natural conformally invariant probability measures on curves, the Brownian motion (BM) and the Schramm-Loewner evolution (SLE). The BM-based construction is the main tool that we will use in this paper, see Section 5.2.2 and Section 5.2.3 below. In this approach, the non-nested simple CLE_κ , $\frac{8}{3} < \kappa \leq 4$, is obtained as the collection of outermost boundaries of clusters appearing in a Poisson process of Brownian loops. It is worth noting that this construction admits a discretization: the scaling limit of outer boundaries of outermost clusters of random walk loop-soup is a CLE. Such convergence was first discovered in [vdBCL16], focusing on the scaling limit of outermost boundaries of clusters of loops with some microscopic loops neglected. Then the convergence of outermost boundaries of clusters of the full loop ensemble was proved in [Lup18], by considering the special case $\kappa = 4$, using its connection to the Gaussian free field (GFF): CLE_4 loops are the “level lines” of the GFF [WW19].

5.1.2 . Super-exponential decaying crossing estimates for non-nested simple CLE

The main result in this paper is the following.

Theorem 5.1.1. *Given a simply connected domain Ω of the upper half-plane $\mathbb{H} = \{z \in \mathbb{C} : \text{Im } z > 0\}$, let $\text{CLE}_\kappa(\Omega)$ be a non-nested simple conformal loop ensemble with $\kappa \in (\frac{8}{3}, 4]$ in Ω . Let $0 < r < R$, denote by $\text{Cross}_{A(r,R)}(\text{CLE}_\kappa(\Omega))$ the number of disjoint arcs in $\text{CLE}_\kappa(\Omega)$ joining the two boundaries of $A(r,R) := \{z \in \mathbb{C} : r < |z| < R\}$, see Figure 5.1. Then for any $s > 0$,*

$$\sup_{\Omega \subseteq \mathbb{H}} \mathbb{P}[\text{Cross}_{A(r,R)}(\text{CLE}_\kappa(\Omega)) \geq n] = O(s^n),$$

where the supremum is taken over all simply connected domains $\Omega \subseteq \mathbb{H}$, and the constant in $O(s^n)$ depends on κ , s and R/r .

Remark 5.1.2. — By the BK’s inequality [vdB96], it is not hard to see that

$$\mathbb{P}[\text{Cross}_{A(r,R)}(\text{CLE}_\kappa(\Omega)) \geq n]$$

decays at least exponentially fast, see e.g. [SW12, Lemma 9.6].

- The domain Markov property of CLEs requires conditioning on entire loops, from which we can only obtain a super-exponential decay of probabilities on the cluster number (of a Brownian loop soup) defined in Section 5.2.1, see

Proposition 5.3.5. Nevertheless, Theorem 5.1.1 can be deduced from Proposition 5.3.5 by our estimates of the component number, see Lemma 5.3.3 and Proposition 5.4.2.

- The arm exponents for SLE discussed in [WZ17] cannot be applied in our circumstance since the asymptotic regime in [WZ17] is different, sending $\frac{R}{r} \rightarrow \infty$ rather than $n \rightarrow \infty$. Using certain martingales for SLEs and the conformal domain Markov property, the methods in [WZ17] involves distortion when conformally mapping the slit domain to the half-plane during each iteration, which gives rise to a super-exponential growing multiplicative factor for the crossing estimates of a fixed quad as the number of crossings goes to infinity.
- We conjecture that the analogue of Theorem 5.1.1 for nested CLEs is valid as well. However, our argument fails in that case because nested CLEs cannot be constructed from a single Brownian loop-soup; besides, the estimates in Theorem 5.1.1 are not enough to deduce that the total crossing number resulted from the branching structure of nested CLEs has super-exponential decay (the expectation of the crossing number for a simple non-nested CLE may be simply larger than one, resulting in a supercritical branching process).

Though the result of Theorem 5.1.1 does not yet have applications to the convergence of loop representations of statistical physics models other than double-dimers to CLE_4 (see Section 5.1.3), it could be used in the same vein if a relevant topological observables framework is developed for $\kappa \leq 4$. It would be also interesting to study similar crossing estimates in the case $\kappa > 4$, which probably should rely upon the branching SLE_κ techniques instead of the Brownian loop-soup. See also [HS01] for a study on similar crossing events of the critical site percolation on the triangular lattice, whose scaling limit is known to be the nested CLE_6 .

Moreover, one can extend the result for the crossing event of $A(r, R)$ to more general quads on any proper domain $\Omega \subset \mathbb{C}$. We define a *crossing-quad* of Ω , denoted by $Q = (V; S_k, k = 0, 1, 2, 3)$, to be a simply connected subset V inside Ω , whose boundary consists of four arcs S_k , $k = 0, 1, 2, 3$ listed in the counterclockwise order, such that $S_1, S_3 \subset \partial\Omega$ (see e.g. Figure 5.2). A natural conformally invariant measurement of the width of a quad Q is the *conformal modulus* $m(Q)$, defined as the unique number for which Q can be conformally mapped onto a rectangle $[0, 1] \times [0, m(Q)]$, such that S_k are mapped to the four sides of the rectangle with S_0 mapped to $[0, 1] \times \{0\}$. We refer interested readers to [Ahl] for more details about properties of these concepts.

We can deduce from Theorem 5.1.1 that

Corollary 5.1.3. *Let $Q = (V; S_k, k = 0, 1, 2, 3)$ be a crossing-quad in a proper subdomain Ω of \mathbb{C} , and denote by $\text{Cross}_Q(\text{CLE}_\kappa(\Omega))$ the number of (disjoint) arcs in $\text{CLE}_\kappa(\Omega)$ joining S_0 and S_2 inside V . Then for any $s > 0$ and $m_0 > 0$,*

$$\sup_{\Omega \subseteq \mathbb{H}} \mathbb{P}[\text{Cross}_Q(\text{CLE}_\kappa(\Omega)) \geq n] = O(s^n)$$

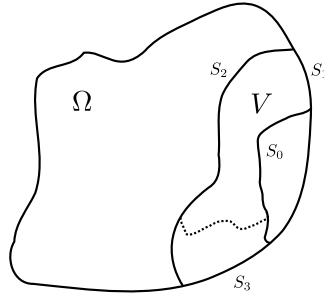

Figure 5.2 – A crossing-quad $(V; S_0, S_1, S_2, S_3)$ in Ω and an (dotted) arc crossing it.

uniformly over the quad Q such that $m(Q) > m_0$, where the constant in $O(s^n)$ depends on κ , m_0 and s .

Remark 5.1.4. The proof of Corollary 5.1.3 (see Section 5.5) also applies to estimating the crossing number of an annulus contained inside the domain, see e.g. Lemma 5.5.1.

5.1.3 . Convergence of probabilities of cylindrical events for double-dimers

Besides studying regularity properties of $\text{CLE}_\kappa(\Omega)$, this paper also serves as a complement to the papers [BC21] and [Dub19] regarding the convergence of double-dimer loop ensembles to CLE_4 . Developing the ideas of Kenyon [Ken14], Dubédat proved the convergence of the so-called *topological observables* of double-dimer loop ensembles in Temperleyan domains to an appropriately defined Jimbo-Miwa-Ueno isomonodromic tau function, see [Dub19]. Later on, based on an analysis of expansions of entire functions (defined on the moduli space of $\text{SL}_2(\mathbb{C})$ -representations of the fundamental group of a punctured domain) with respect to the Fock-Goncharov *lamination basis*, Basok and Chelkak [BC21] proved the convergence of probabilities of cylindrical events for the double-dimer loop ensemble to the coefficients of the (infinite series) expansion of the isomonodromic tau-function via the lamination basis. On the other hand, it was shown by Dubédat [Dub19, Theorem 1] that this tau-function can be obtained by taking the expectation of the product of the traces of loop monodromies over CLE_4 provided that the monodromy is close enough to the identity. By definition, this provides another expansion of the tau-function via the lamination basis, where the coefficients are equal to probabilities of cylindrical events evaluated for CLE_4 . It follows from [BC21, Theorem 1.4] that the equality of two infinite series expansions via the lamination basis implies the equality of their coefficients, provided that the coefficients of both expansions decay super-exponentially. Therefore, if one knows that the probabilities of cylindrical events evaluated for CLE_4 decay super-exponentially, then the results of [BC21] and [Dub19] imply the convergence of probabilities for the double-dimer loop ensembles to those of CLE_4 , see [BC21, Corollary 1.7] and Corollary 5.1.5 below.

Given a Temperleyan simply connected approximation $\Omega^\delta \subseteq \delta Z^2$ of Ω , the double-dimer loop ensemble on Ω^δ is obtained by superimposing two independent uniform dimer

configurations on Ω^δ . This produces a number of loops and double-edges, with the latter withdrawn. Obtained in this manner, we denote by Θ_Ω^δ the random collection of nested simple pairwise disjoint loops on Ω^δ .

Given a collection of pairwise distinct punctures in a simply connected domain, $\lambda_1, \dots, \lambda_N \in \Omega$, a *macroscopic lamination* on $\Omega \setminus \{\lambda_1, \dots, \lambda_N\}$ is a finite collection of disjoint simple loops surrounding at least two punctures considered up to homotopies. We fix once and forever a triangulation of $\Omega \setminus \{\lambda_1, \dots, \lambda_N\}$ with vertices at $\lambda_1, \dots, \lambda_N, \partial\Omega$ (see [BC21] for more details) and define the *complexity* $|\Gamma|$ of a lamination Γ to be the number of intersections of loops in Γ with the edges of the triangulation (computed after resolving all unnecessary intersections). Note that the complexity Γ cannot be estimated via the number of loops in Γ if $N \geq 3$: one can construct a lamination consisting of one loop but having arbitrary large complexity, see Figure 5.3.

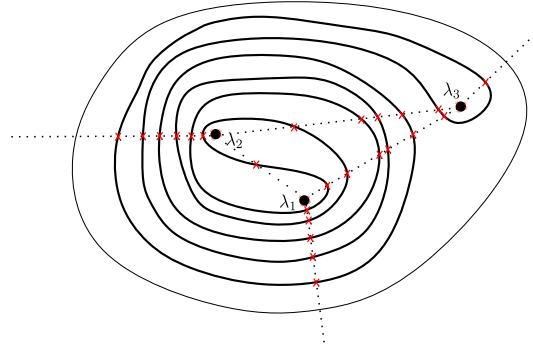

Figure 5.3 – One loop (the bold one) with complexity 24 (the minimal number of crosses of a loop within this homotopy class with the edges of the triangulation).

Corollary 5.1.5 (Convergence of probabilities of cylindrical events of double-dimer configuration). *Let Θ_Ω be a nested CLE_κ in a simply connected domain Ω , $\kappa \in (\frac{8}{3}, 4]$. Let Γ be a macroscopic lamination, and denote by $\Theta_\Omega \sim \Gamma$ the event that Θ_Ω is homotopic to Γ after one removes all loops surrounding at most one puncture. Then for any $s > 0$,*

$$\mathbb{P}_{\text{CLE}_\kappa^{\text{nested}}}[\Theta_\Omega \sim \Gamma] = O(s^{-|\Gamma|}) \text{ as } |\Gamma| \rightarrow \infty.$$

Furthermore, for all macroscopic laminations Γ ,

$$\mathbb{P}_{\text{double-dimer}}[\Theta_\Omega^\delta \sim \Gamma] \rightarrow \mathbb{P}_{\text{CLE}_4^{\text{nested}}}[\Theta_\Omega \sim \Gamma] \text{ as } \delta \rightarrow 0. \quad (5.1.1)$$

It is worth mentioning that the estimate provided in Corollary 5.1.5 is weaker than the super-exponential decay of crossing numbers of nested CLEs. However, it is sufficient for the analysis performed in [BC21].

The rest of the paper is organized as follows: Section 5.2 discusses several quantities related to the crossing number, presents the Brownian loop-soup construction of CLEs,

and gives a proof outline for our main results. Section 5.3 is around some preliminary deterministic results and the technical proof of Proposition 5.3.5. The readers not interested in these details may skip Section 5.3. In the end, the proofs of Theorem 5.1.1, Corollary 5.1.3 and Corollary 5.1.5 are given in Section 5.4, Section 5.5 and Section 5.6 respectively.

5.2 . Notations and Preliminaries

In this section, we fix and discuss some notations for loop ensembles and introduce the Brownian loop-soup construction of the simple CLE.

5.2.1 . Clusters, crossing and component number

Given a simply connected domain Ω , a *loop ensemble* \mathcal{L} in Ω is a countable collection of loops (not necessarily simple or pairwise disjoint) in Ω . Two loops l and l' are in the same cluster if and only if one can find a finite chain of loops l_0, \dots, l_n in \mathcal{L} such that $l_0 = l$, $l_n = l'$ and $l_j \cap l_{j-1} \neq \emptyset$ for all $j = 1, \dots, n$. Given a cluster C , we denote by \overline{C} the closure of the union of all loops in C . Denote by $F(C)$ the filling of C , which is the complement of the unbounded connected component of $\mathbb{C} \setminus \overline{C}$. (Note that $F(C)$ is simply connected). A cluster C is called *outermost* if there exists no cluster C' such that $C \subset F(C')$. Denote by $F(\mathcal{L})$ the family $\{F(C) : C \text{ is a outermost cluster of } \mathcal{L}\}$.

A loop ensemble \mathcal{L} can be divided into two parts by restriction to a subdomain $\Omega' \subset \Omega$,

$$\mathcal{L}(\Omega') := \{l \in \mathcal{L} : l \subset \Omega'\}, \quad \mathcal{L}(\Omega')^\perp := \mathcal{L} \setminus \mathcal{L}(\Omega'),$$

One can also divide \mathcal{L} by considering the loop diameter:

$$\mathcal{L}_{<a} := \{l \in \mathcal{L} : \text{diam}(l) < a\}, \quad \mathcal{L}_{\geq a} := \{l \in \mathcal{L} : \text{diam}(l) \geq a\},$$

where $\text{diam}(l) := \sup_{x,y \in l} \text{dist}(x,y)$.

For all $0 < r < R$ and point $z_0 \in \mathbb{C}$, denote by $A_{z_0}(r, R)$ the annulus of inner and outer radii r and R centered at z_0 ,

$$A_{z_0}(r, R) = \{z \in \mathbb{C}, r < |z - z_0| < R\}, \quad (5.2.2)$$

and denote by $B_r(z_0)$ the disk of radius r centered at z_0 ,

$$B_r(z_0) = \{z \in \mathbb{C}, |z - z_0| \leq r\}. \quad (5.2.3)$$

For the sake of simplicity, we will write $A(r, R)$ and B_r if z_0 is the origin 0 of the complex plane.

We say that a connected set crosses $A = A(r, R)$, if it intersects both boundaries of $\partial A(r, R) = \partial B_R \sqcup \partial B_r$. For a loop ensemble \mathcal{L} , the *crossing number* $\text{Cross}_A(\mathcal{L})$ is the maximum number of disjoint arcs of loops in \mathcal{L} that cross A , see Figure 5.4. From the

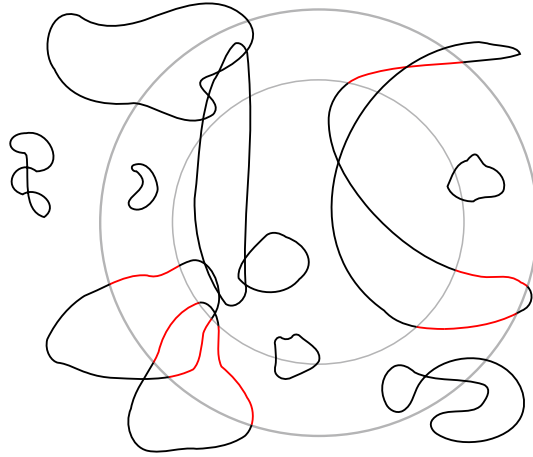

Figure 5.4 - In this configuration, we have $\text{Cross}_A(\mathcal{L}) = 7$ with the 7 paths marked in red. Notice that one can choose only one among the two paths in the top-right part because they intersect each other. Since loops in CLE do not self-intersect, this will never happen for a CLE.

definition, one can easily observe that the crossing number is monotone and subadditive, that is

$$\text{Cross}_A(\mathcal{L}_1) \leq \text{Cross}_A(\mathcal{L}_1 \cup \mathcal{L}_2) \leq \text{Cross}_A(\mathcal{L}_1) + \text{Cross}_A(\mathcal{L}_2). \quad (5.2.4)$$

The *component number* $\text{Comp}_A(\mathcal{L})$ is defined as the number of path-connected components of $\cup_{C \in \{\text{outermost clusters of } \mathcal{L}\}} F(C) \cap A$ that cross A . In particular, if \mathcal{L} is a non-nested simple loop ensemble with disjoint loops, for instance the non-nested CLE_κ , $\frac{8}{3} < \kappa \leq 4$, then

$$\text{Cross}_A(\mathcal{L}) = 2\text{Comp}_A(\mathcal{L}). \quad (5.2.5)$$

In general, we no longer have monotonicity and subadditivity as in (5.2.4) for the component number: adding a new loop may connect two crossing components, resulting in $\text{Comp}_A(\mathcal{L}_1 \cup \mathcal{L}_2) < \text{Comp}_A(\mathcal{L}_1)$; they may also create new components by collaboration, causing $\text{Comp}_A(\mathcal{L}_1 \cup \mathcal{L}_2) > \text{Comp}_A(\mathcal{L}_1) + \text{Comp}_A(\mathcal{L}_2)$, see Figure 5.5.

The *cluster number* $\text{Clus}_A(\mathcal{L})$ is defined as the number of outermost clusters of \mathcal{L} which cross A , see e.g. Figure 5.6. It is immediate that for any loop ensemble \mathcal{L} ,

$$\text{Comp}_A(\mathcal{L}) \geq \text{Clus}_A(\mathcal{L}),$$

and that the cluster number does not have monotonicity and subadditivity with respect to loop ensembles neither.

Finally, if we fix an arbitrary loop ensemble \mathcal{L} , then all three quantities have monotonicity with respect to annuli, i.e. for $A' \subset A$,

$$(\text{Cross}_{A'}(\mathcal{L}), \text{Comp}_{A'}(\mathcal{L}), \text{Clus}_{A'}(\mathcal{L})) \geq (\text{Cross}_A(\mathcal{L}), \text{Comp}_A(\mathcal{L}), \text{Clus}_A(\mathcal{L})).$$

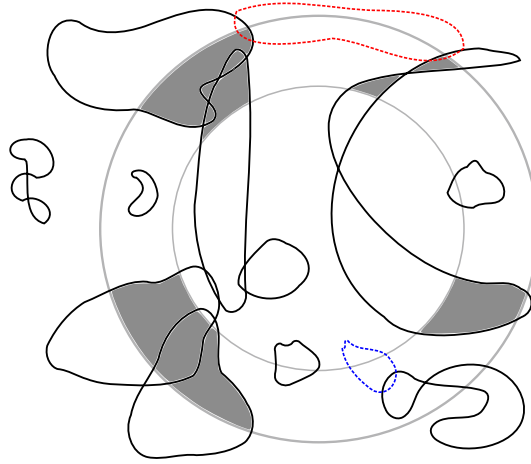

Figure 5.5 - We have 4 crossing components marked in gray, therefore $\text{Comp}_A(\mathcal{L}) = 4$. Adding the red dotted loop would connect two existing crossing connected components, so $\text{Comp}_A(\mathcal{L} \cup \{l_{\text{red}}\}) = 3 < \text{Comp}_A(\mathcal{L})$. Adding the blue dotted loop would create a new crossing connected component, so $\text{Comp}_A(\mathcal{L} \cup \{l_{\text{blue}}\}) = 5 > \text{Comp}_A(\mathcal{L}) + \text{Comp}_A(\{l_{\text{blue}}\})$.

5.2.2 . The Brownian loop measure

Consider a simply connected domain $\Omega \subseteq \mathbb{C}$. The *Brownian loop measure* in Ω was introduced by Lawler and Werner in [LW04], and employed to construct CLE in [SW12]. Let $\mu_{x,\Omega}^t$ be the sub-probability measure on the set of paths in Ω started from $x \in \Omega$, defined from the probability distribution of a Brownian motion started at x on the time interval $[0, t]$, which is killed upon hitting $\partial\Omega$. From this we obtain by disintegration the measures $\mu_{x \rightarrow y, \Omega}^t$ on paths from x to y inside Ω ,

$$\mu_{x,\Omega}^t = \int_{\Omega} \mu_{x \rightarrow y, \Omega}^t d^2y,$$

where d^2y denotes the Lebesgue measure. Then the *Brownian loop measure* on Ω is defined by the following integration: (here we choose the same normalization as in [SW12], which is one half of the Brownian loop measure defined in [LW04] considering the orientation)

$$\mu_{\Omega}^{\text{loop}} = \int_0^{\infty} \frac{dt}{2t} \int_{\Omega} \mu_{x \rightarrow x, \Omega}^t d^2y.$$

Notice that it induces a measure on the traces of unrooted loops by forgetting the root x and the time-parametrization. Considering the fact that Brownian motion is invariant under conformal isomorphism up to a time change, the Brownian loop measure is also conformally invariant because of the time weight which appears in $\mu_{\Omega}^{\text{loop}}$. It is not hard to see from the definition that the Brownian loop measure satisfies the restriction property: if $\Omega' \subset \Omega$, then $\mu_{\Omega'}^{\text{loop}}$ is the restriction of $\mu_{\Omega}^{\text{loop}}$ to the set of loops in Ω' .

Under the Brownian loop measure, the total mass of loops in the whole complex plane \mathbb{C} is infinite (for all positive R , both the mass of loops of diameter greater than R

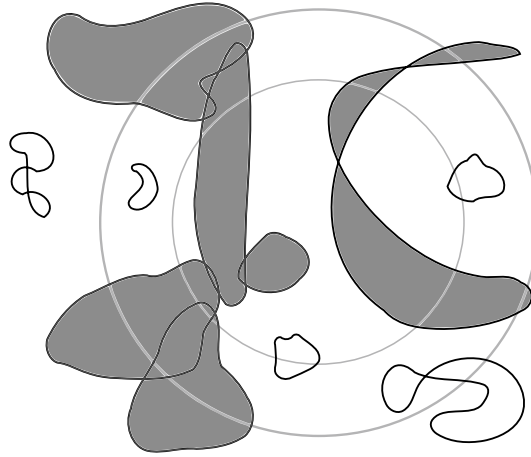

Figure 5.6 – There are 2 crossing clusters in gray, and $\text{Clus}_A(\mathcal{L}) = 2$.

and the mass of loops of diameter smaller than R are infinite), which can be viewed as a consequence of the conformal (scaling) invariance. However, for all $r < R$, the mass of the set of loops which stay in \mathbb{H} intersecting both $r\mathbb{D}$ and $\mathbb{C} \setminus R\mathbb{D}$ is finite, where \mathbb{D} is the unit disk, see the proof of Lemma 13 in [LW04]. This is also true for the Brownian loop measure on any subdomain of \mathbb{H} by the restriction property (see eg. p.5 [LW04]).

5.2.3 . Loop-soup construction of CLE

Nested conformal loop ensemble $\text{CLE}_\kappa(\Omega)$ for $\kappa \in (8/3, 4]$ defined on a simply connected domain Ω is a random collection of disjoint *simple* loops in Ω characterized by the following properties:

- (Conformal invariance) If $\varphi : \Omega \rightarrow \Omega'$ is a conformal map from Ω onto Ω' , then $\varphi(\text{CLE}_\kappa(\Omega))$ has the same distribution as $\text{CLE}_\kappa(\Omega')$.
- (Restriction) If U is a simply connected subset of Ω and \tilde{U} is obtained by removing from Ω all the $\text{CLE}_\kappa(\Omega)$ loops and their interior that do not entirely stay in U , then in each connected component U' of the interior of \tilde{U} , the conditional law of the set of loops that lie entirely in U' is distributed as $\text{CLE}_\kappa(U')$.
- (Locally finiteness) For each $\epsilon > 0$, only finitely many loops have a diameter greater than ϵ .
- (Nesting) Conditioned on a loop γ in $\text{CLE}_\kappa(\Omega)$ and all loops outside γ , the set of loops inside γ is an independent $\text{CLE}_\kappa(\Omega_\gamma)$, where Ω_γ is the interior (finite) domain bounded by Jordan curve γ .

A *Brownian loop soup* $\mathcal{B}^\lambda(\Omega)$ with intensity λ is a Poissonian sample on the set of loops with intensity $\lambda\mu_\Omega^{\text{loop}}$ for $\lambda \in (0, 1]$, which is characterized by the following properties:

- The loop cluster is not unique and not boundary-touching, i.e. $\bar{\mathcal{C}} \cap \partial\Omega = \emptyset$ almost surely.

- For any two disjoint measurable sets of loops \mathcal{L}_1 and \mathcal{L}_2 , $\mathcal{B}^\lambda(\Omega) \cap \mathcal{L}_1$ and $\mathcal{B}^\lambda(\Omega) \cap \mathcal{L}_2$ are independent. In particular, if Ω' is a subdomain of Ω , then $\mathcal{B}^\lambda(\Omega)$ can be decomposed into two independent parts: $\mathcal{B}^\lambda(\Omega')$ (the set of loops staying in Ω' , which is again a Brownian loop soup in Ω') and $\mathcal{B}^\lambda(\Omega')^\perp$ (the set of loops intersecting $\Omega \setminus \Omega'$).
- If $\varphi : \Omega \rightarrow \Omega'$ is a conformal isomorphism between two domains Ω and Ω' , then $\varphi(\mathcal{B}^\lambda(\Omega)) = \{\varphi(l) : l \in \mathcal{B}^\lambda(\Omega)\}$ is distributed as $\mathcal{B}^\lambda(\Omega')$.
- For any measurable set \mathcal{L} such that $\lambda \mu_\Omega^{\text{loop}}(\mathcal{L}) < \infty$, the law of the number of elements in $\mathcal{B}^\lambda(\Omega) \cap \mathcal{L}$ satisfies the Poisson law with mean $\lambda \mu_\Omega^{\text{loop}}(\mathcal{L})$.

For a sample of Brownian loop soup $\mathcal{B}^\lambda(\Omega)$ with intensity λ , as in Section 5.2.1, denote by

$$\partial F(\mathcal{B}^\lambda(\Omega)) = \{\partial F(C) : C \text{ is a cluster and there exists no cluster } C' \text{ such that } C \subseteq F(C')\}$$

the set of boundaries of fillings (the complement of the unbounded connected component of $\mathbb{C} \setminus C$) of all outermost clusters C of $\mathcal{B}^\lambda(\Omega)$. Then it is showed in [SW12, Section 1.3] that $\partial F(\mathcal{B}^\lambda(\Omega))$ has the same distribution as the non-nested $\text{CLE}_\kappa(\Omega)$ with $\lambda = (3\kappa - 8)(6 - \kappa)/2\kappa$. In particular, we have that for $\kappa \in (\frac{8}{3}, 4]$,

$$\text{Cross}_A(\text{CLE}_\kappa(\Omega)) = 2\text{Comp}_A(\text{CLE}_\kappa(\Omega)) \stackrel{d}{=} 2\text{Comp}_A(\mathcal{B}^\lambda(\Omega)) \quad (5.2.6)$$

for any annulus A and simply connected domain Ω .

5.2.4 . Outline of the proof

Here we present the intuition behind the proof of Theorem 5.1.1. To begin with, by (5.2.5) and (5.2.6), it suffices to study $\text{Comp}_{A(r,R)}(\mathcal{B}^\lambda(\Omega))$. Then we divide $\mathcal{L} = \mathcal{B}^\lambda(\Omega)$ into $\mathcal{L}_1 = \mathcal{B}_{<a}^\lambda(\Omega)$ (loops with diameter less than a) and $\mathcal{L}_2 = \mathcal{B}_{\geq a}^\lambda(\Omega)$ (loops with diameter larger or equal to a), and reduce the problem to $\text{Comp}_{A(r,R)}(\mathcal{L}_1)$ and $\text{Comp}_{A(r,R)}(\mathcal{L}_2)$ by Lemma 5.3.2.

Intuitively, loops with small diameter cannot appear in many different crossing connected components of $A(r, R)$, which inspired us to bound $\text{Comp}(\mathcal{L}_1)$ by $\text{Clus}(\mathcal{L}_1)$ in Lemma 5.3.3. The main technicality in this paper consists of dealing with $\text{Clus}(\mathcal{L}_1)$, which will be discussed in Section 5.3.3 and Section 5.3.4 by establishing a recursive inequality using the conformal invariance of the Brownian loop soup.

Moreover, the probability distribution on the number of loops in \mathcal{L}_2 has super-exponential tail since it is a Poisson distribution. Combined with Fomin's identity for non-intersection probabilities for the Brownian paths, we obtain the probabilistic super-exponential decay of $\text{Cross}(\mathcal{L}_2)$ in Proposition 5.4.2.

In conclusion, the desired upper bound for $\text{Comp}(\mathcal{B}^\lambda(\Omega)) = \text{Comp}(\mathcal{L}_1 \cup \mathcal{L}_2)$ follows from estimates of $\text{Clus}(\mathcal{L}_1)$ and $\text{Cross}(\mathcal{L}_2)$. We remark that the annuli subscripts in the above notions of crossing/component/cluster numbers are deliberately omitted, because we need to change the annuli slightly in each step.

Finally, in Section 5.5, we prove Corollary 5.1.3 based on the estimates established in Theorem 5.1.1. In the last Section 5.6, we carefully apply Corollary 5.1.3 to the setup of

the complexity for the convergence of probabilities of cylindrical events for double-dimer configurations.

5.3 . Component Number and Cluster Number

The goal of this section is to explore some deterministic properties and relations of $\text{Comp}_A(\mathcal{L})$ and $\text{Clus}_A(\mathcal{L})$ and present the proof of the super-exponential decay of $\sup_{U \subseteq \mathbb{H}} \mathbb{P} [\text{Clus}_{A(r,R)}(\mathcal{B}_{<a}^\lambda(U)) \geq n]$, $\lambda \leq 1, a > 0$, see Proposition 5.3.5. Here we assume the annuli to be centered at 0 without loss of generality but keep in mind that those relations are translationally invariant. Besides, we only consider loop ensembles with the following properties: for any fixed $r > 0$,

- all loops in \mathcal{L} do not touch (i.e., do not intersect without crossing) $\partial\Omega$, ∂B_r or any other loop in \mathcal{L} ;
- outermost boundaries of clusters of \mathcal{L} do not touch $\partial\Omega$, ∂B_r or any other loop in \mathcal{L}

It is known that $\mathcal{L} = \mathcal{B}^\lambda$ satisfies (5.3) almost surely [SW12]. The assumptions (5.3) also holds for $\mathcal{B}_{<a}^\lambda, \mathcal{B}_{\geq a}^\lambda$, since there is a positive probability that $\mathcal{B}^\lambda = \mathcal{B}_{<a}^\lambda$, and $\mathcal{B}_{<a}^\lambda$ is independent of $\mathcal{B}_{\geq a}^\lambda$.

5.3.1 . Component number

Recall that the component number $\text{Comp}_A(\mathcal{L})$ is the number of connected components of $\cup_{C \in \{\text{outermost clusters of } \mathcal{L}\}} F(C) \cap A$ connecting $\partial B(r)$ and $\partial B(R)$. We first show that for any crossing connected component of $F(C) \cap A$, there is a finite collection of loop arcs whose union crosses A inside D .

Lemma 5.3.1. *Let \mathcal{L} be a loop ensemble satisfying (5.3). For each annulus $A(r, R)$ and crossing connected component D , there exists a path $\gamma \subset D$ comprised of finitely many arcs of loops in \mathcal{L} , such that γ crosses $A(r, R)$. This sequence of loops will be denoted by L_γ .*

Proof. Denote by C the cluster such that $D \subset F(C)$. By (5.3), clusters and loops cannot touch $\partial A(r, R)$. Thus there exist loops $l, l' \in C$ such that l, l' intersect $\partial B(r) \cap D$ and $\partial B(R) \cap D$ respectively.

Since l, l' are in the same cluster C , there exists a finite chain of loops $l_0 = l, l_1, l_2, \dots, l_n = l'$ in \mathcal{L} such that l_i and l_{i+1} are adjacent. We conclude that $\cup_{i=1}^n l_i \cap D$ crosses $A(r, R)$ since $F(C)$ is simply connected (otherwise the union of D with all fillings of chains of loops connecting l and l' encircles a hole). Thus we can draw a crossing path γ out of a crossing chain of finite loops. \square

Using Lemma 5.3.1 for the decomposition of the loop ensemble, the component number can be bounded above by the component number of a smaller annulus as follows.

Lemma 5.3.2. *Let $\mathcal{L}_1, \mathcal{L}_2$ be two disjoint loop ensembles satisfying (5.3). Take $0 < r < r' < R' < R$, then*

$$\begin{aligned} \text{Comp}_{A(r,R)}(\mathcal{L}_1 \cup \mathcal{L}_2) &\leq \text{Comp}_{A(r',R')}(\mathcal{L}_1) + \text{Cross}_{A(r,r')}(\mathcal{L}_2) + \text{Cross}_{A(R',R)}(\mathcal{L}_2) \\ &\quad + \#\{l \in \mathcal{L}_2 : l \cap A(r', R') \neq \emptyset, l \subset A(r, R)\}. \end{aligned} \tag{5.3.7}$$

In particular, if \mathcal{L} is inside \mathbb{H} , $\mathcal{L}_1 = \mathcal{L}(\Omega)$ and $\mathcal{L}_2 = \mathcal{L}(\Omega)^\perp$ for some domain $A(r, R) \cap \mathbb{H} \subset \Omega$, then

$$\text{Comp}_{A(r,R)}(\mathcal{L}) \leq \text{Comp}_{A(r',R')}(\mathcal{L}(\Omega)) + \text{Cross}_{A(r,r')}(\mathcal{L}(\Omega)^\perp) + \text{Cross}_{A(R',R)}(\mathcal{L}(\Omega)^\perp).$$

Proof. For each component D that contributes to $\text{Comp}_{A(r,R)}(\mathcal{L}_1 \cup \mathcal{L}_2)$ which also crosses $A(r', R')$, it follows from Lemma 5.3.1 that there is a path γ crossing $A(r', R')$ within $D \cap A(r', R')$ constituted by finitely many arcs of loops in L_γ , contained in D .

If L_γ is a subset of \mathcal{L}_1 , then it stays in a connected component which contributes to $\text{Comp}_{A(r',R')}(\mathcal{L}_1)$. Otherwise, there exists $l \in \mathcal{L}_2$ such that $l \cap \gamma \neq \emptyset$. In such cases, if $l \subset A(r, R)$, then it contributes to the term $\#\{l \in \mathcal{L}_2 : l \cap A(r', R') \neq \emptyset, l \subset A(r, R)\}$. If $l \not\subset A(r, R)$, then l intersects ∂B_r or ∂B_R , which contributes to $\text{Cross}_{A(R',R)}(\mathcal{L}_2)$ or $\text{Cross}_{A(r,r')}(\mathcal{L}_2)$ since $\gamma \subset A(r', R')$ and $l \cap \gamma \neq \emptyset$. The desired upper bound (5.3.7) is thus proved since for distinctive crossing components D_1, \dots, D_n contributing to the left-hand side of (5.3.7), one can find different crossing components or loops contributing to the right-hand side of (5.3.7) contained in D_1, \dots, D_n , respectively. \square

5.3.2 . Cluster number

For any loop ensemble whose loops have diameter less than a , the component number in $A(r, R)$ can be bounded by the cluster number with respect to an annulus which is a -smaller than $A(r, R)$.

Lemma 5.3.3. *For $0 < r < r + a < R - a < R$, let \mathcal{L} be a loop ensemble such that $\mathcal{L}_{<a}$ satisfies (5.3). we have*

$$\text{Comp}_{A(r,R)}(\mathcal{L}_{<a}) \leq \text{Clus}_{A(r+a,R-a)}(\mathcal{L}_{<a}(A(r, R))).$$

Proof. By Lemma 5.3.1, for each component D that contributes to $\text{Comp}_{A(r,R)}(\mathcal{L}_{<a})$, we can find a path γ in $D \cap A(r + a, R - a)$ from loops in $L_\gamma \subset \mathcal{L}_{<a}$. Since all loops in $\mathcal{L}_{<a}$ have diameter less than a , L_γ is contained in $A(r, R)$. Therefore, L_γ is a subset of a cluster which contributes to $\text{Clus}_{A(r+a,R-a)}(\mathcal{L}_{<a}(A(r, R)))$. Conversely, this cluster is connected and stays within $A(r, R)$, thus it is contained in D , which gives the injectivity of the mapping from $\text{Comp}_{A(r,R)}(\mathcal{L}_{<a})$ to $\text{Clus}_{A(r+a,R-a)}(\mathcal{L}_{<a}(A(r, R)))$. \square

Similarly as Lemma 5.3.2, we obtain the following upper bound for the cluster number.

Lemma 5.3.4. *Let $0 < r \leq r' < R' \leq R$, and $\mathcal{L}_1, \mathcal{L}_2$ be two disjoint loop ensembles satisfying (5.3), then*

$$\begin{aligned} \text{Clus}_{A(r,R)}(\mathcal{L}_1 \cup \mathcal{L}_2) \leq & \text{Clus}_{A(r',R')}(\mathcal{L}_1) + \#\{l \in \mathcal{L}_2 : l \cap A(r', R') \neq \emptyset, l \subset A(r, R)\} \\ & + \#\{l \in \mathcal{L}_2 : l \text{ crosses } A(r, r') \text{ or } A(R', R)\}. \end{aligned}$$

In particular,

$$\text{Clus}_{A(r,R)}(\mathcal{L}_1 \cup \mathcal{L}_2) \leq \text{Clus}_{A(r,R)}(\mathcal{L}_1) + \#\{l \in \mathcal{L}_2 : l \cap A(r, R) \neq \emptyset\}$$

in the degenerate case $r' = r, R' = R$.

Proof. As in the proof of Lemma 5.3.2, if in the beginning we take any cluster C in $\text{Clus}_{A(r,R)}(\mathcal{L}_1 \cup \mathcal{L}_2)$, we can decompose the cluster number depending on whether \mathcal{L}_1 restricted to C gives a crossing of $A(r', R')$ or not. Then the argument follows the same line as the proof of Lemma 5.3.2. \square

Let us briefly mention how results in this section will be used in the probabilistic setting for Poissonian Brownian loops to prove the quasi-multiplicativity of crossing probabilities. Recall that $\mathcal{B}^\lambda(A(r, R))$ is a Brownian loop soup with intensity $\lambda \in (0, 1]$ in $A(r, R)$, and for simplicity, we will write $\mathcal{B}^\lambda(r, R) = \mathcal{B}(A(r, R))$. Let $\rho < r < r' < \rho' < R' < R < P$ and $\epsilon, s > 0$. In the next paragraph, we give an upper bound on $\text{Clus}_{A(r,R)}(\mathcal{B}^\lambda(\rho, P))$.

Firstly, we can upper-bound this cluster number of $A(r, R)$ by the cluster number of $A(r, r')$ and $A(R', R)$, which follows from Lemma 5.3.4 that

$$\begin{aligned} \text{Clus}_{A(r,R)}(\mathcal{B}^\lambda(\rho, P)) \leq & \min\{\text{Clus}_{A(r,r')}(\mathcal{B}^\lambda(\rho, \rho')), \text{Clus}_{A(R',R)}(\mathcal{B}^\lambda(\rho', P))\} \\ & + \#\{l \in \mathcal{B}^\lambda(\rho, P) : l \text{ crosses } A(r', \rho') \text{ or } A(\rho', R')\}. \end{aligned}$$

By the independence of $\mathcal{B}^\lambda(\rho, \rho')$, $\mathcal{B}^\lambda(\rho', P)$ and the Poisson tail of

$$\#\{l \in \mathcal{B}^\lambda(\rho, P) : l \text{ crosses } A(r', \rho') \text{ or } A(\rho', R')\},$$

we have that

$$\begin{aligned} \mathbb{P} \left[\text{Clus}_{A(r,R)}(\mathcal{B}^\lambda(\rho, P)) \geq n \right] \leq & \mathbb{P} \left[\text{Clus}_{A(r,r')}(\mathcal{B}^\lambda(\rho, \rho')) \geq (1 - \epsilon)n \right] \\ & \times \mathbb{P} \left[\text{Clus}_{A(R',R)}(\mathcal{B}^\lambda(\rho', P)) \geq (1 - \epsilon)n \right] + O(s^n). \end{aligned} \quad (5.3.8)$$

The inequality (5.3.8) is a key component for proving the recursive relation (5.3.11), which will result in the desired super-exponential decay.

5.3.3 . Super-exponential decay of the cluster number

In this subsection, we prove that the probability distribution on the cluster number has a super-exponentially tail. It is intuitively not hard to see that crossing clusters occur “disjointly” in a loop ensemble, therefore the probability of finding two crossing clusters should be smaller than the product of their probabilities.

Proposition 5.3.5. *Let $0 < a < r < 1 < R$. Denote by $\mathcal{B}_{<a}^\lambda(U)$ the set of loops with diameter less than a in a Brownian loop soup with intensity $\lambda \in (0, 1]$ in any open set $U \subseteq \mathbb{H}$. Then for each $s > 0$, we have*

$$\sup_{U \subseteq \mathbb{H}} \mathbb{P} \left[\text{Clus}_{A(r,R)}(\mathcal{B}_{<a}^\lambda(U)) \geq n \right] = O(s^n) \text{ as } n \rightarrow \infty, \quad (5.3.9)$$

where the supremum is taken over all open subsets of \mathbb{H} , and the constant in $O(s^n)$ depends on $a, R/r, \lambda$ and s .

Remark 5.3.6. Different from Theorem 5.1.1 and Corollary 5.1.3, the supremum taken in Proposition 5.3.5 is not restricted to simply connected domains. This is validated by the flexibility of the construction of the Brownian loop soup, and it helps to simplify the discussion on the distortion in conformal mappings used in the proof of Proposition 5.3.5.

Strategy of the proof of Proposition 5.3.5. Let us define

$$f(n) := \sup_{U \subseteq \mathbb{H}} \mathbb{P} \left[\text{Clus}_{A(r,R)}(\mathcal{B}_{<a}^\lambda(U)) \geq n \right]. \quad (5.3.10)$$

We estimate $f(n)$ inductively, where the step of induction can be described as follows. Note that intuitively, conditioned on having n crossing clusters, one can expect two scenarios. In the first one, the space remaining to accommodate one more crossing cluster becomes less and less, leading to a multiplying factor tending to 0. In the second scenario, all n crossing clusters cross $A(r, R)$ inside a strictly smaller subset

$$A^{(\eta)}(r, R) := \{z \in A(r, R) : 0 < \arg z < \eta < \pi\}$$

for some fixed η , depending only on s . Then, we can conformally map $A^{(\eta)}(r, R)$ to the annulus $A(r', R')$ with $r' < r < 1 < R < R'$ and, by conformal invariance, get a sample of the Brownian loop soup having n clusters crossing $A(r', R')$. A technical analysis shows that the probability to have such a sample can be upper-bounded by $cq^n \cdot f((1 - \epsilon)n) + O(s^{2n})$. As a result we find out that for all $s, \epsilon \in (0, 1)$, we can find some $c > 0, q < 1$ and any $\epsilon > 0$, the following holds:

$$f(n+1) \leq \frac{s}{2} f(n) + cq^n \cdot f((1 - \epsilon)n) + O(s^{2n}). \quad (5.3.11)$$

Let us mention again here the constants in $O(s^{2n})$ depend on ϵ and s . We claim that (5.3.11) is sufficient for deducing Proposition 5.3.5. In fact, if (5.3.11) holds, we can take ϵ small enough such that $s^{2\epsilon} > q$. Note that for n large enough, $\frac{cq^n}{s^{\epsilon n+1}} < \frac{1}{2}$. Then (5.3.11) divided by s^{n+1} gives that

$$\frac{f(n+1)}{s^{n+1}} \leq \frac{1}{2} \frac{f((1 - \epsilon)n)}{s^{(1 - \epsilon)n}} + \frac{1}{2} \frac{f(n)}{s^n} + O(s^{n-1}),$$

which implies that $\frac{f(n)}{s^n}$ is bounded for all n , hence the super-exponential decay of $f(n)$.

Together with (5.3.11) and (5.3.10), this completes the proof of Proposition 5.3.5 modulo the technical proof of (5.3.11), which is postponed to Section 5.3.4. \square

The following result on the probability of the existence of a crossing cluster inside a (conformally) thin tube will be used in Section 5.3.4.

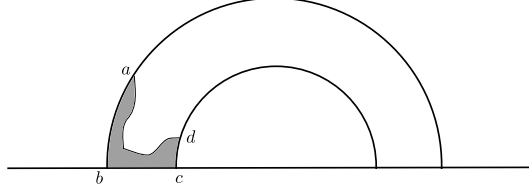

Figure 5.7 – An illustration for $(Q; a, b, c, d)$ in Lemma 5.3.7.

Lemma 5.3.7. *For any $\epsilon > 0$ and $0 < r < R$, there exists $\delta > 0$ such that uniformly for all crossing-quads inside $A(r, R)$ of the form $(Q; a, b, c, d)$ with $b = -R$ and $c = -r$, such that*

$$(ab) \subset \partial B_R, (bc) \subset \mathbb{R}_-, (cd) \subset \partial B_r \text{ and } \inf_{z \in (bc), w \in (ad)} |z - w| < \delta,$$

we have

$$\mathbb{P}[(ab) \text{ and } (cd) \text{ are connected by a chain of loops in } \mathcal{B}^\lambda(\mathbb{H}) \text{ not touching } (bc) \text{ and } (ad)] < \epsilon. \quad (5.3.12)$$

Proof. Suppose the contrary, then there exists a sequence of quads $(Q_\delta; a_\delta, b_\delta, c_\delta, d_\delta) \subset A$ satisfying the same conditions as in the statement, such that the probability that $(a_\delta b_\delta)$ and $(c_\delta d_\delta)$ are connected by a chain of loops in $\mathcal{B}^\lambda(\mathbb{H})$ not touching $(b_\delta c_\delta)$ and $(a_\delta d_\delta)$ is uniformly away from 0. By Kochen-Stone lemma, with positive probability, we can find a sequence of clusters of $\mathcal{B}^\lambda(\mathbb{H})$ arbitrarily close to \mathbb{R}_- . These clusters are of diameter larger than $R - r$, which is not possible in the sub-critical regime of the Brownian loop soup with intensity $\lambda \mu_\Omega^{\text{loop}}$, $\lambda \in (0, 1]$, see e.g. [SW12, Lemma 9.7]. Thus by contradiction we have (5.3.12). \square

5.3.4 . Proof of the recursive inequality (5.3.11).

Throughout this section, we fix the intensity of the Brownian loop soup in (5.3.11) to be some $\lambda \in (0, 1]$ and omit it. Before diving into the technical details of the proof, let us first explain the choice of parameters. For all $A(r, R)$, denote the sector of angle η by

$$A^{(\eta)}(r, R) := A(r, R) \cap \{z \in \mathbb{H} : 0 < \arg z < \eta\}.$$

For any open subset $U \subset \mathbb{H}$, denote the Brownian loop soup on top of it by

$$\mathcal{B}^{(\eta)}(U) = \mathcal{B}(A^{(\eta)}(0, \infty) \cap U),$$

with the mnemonics

$$A(r, R) = A^{(\pi)}(r, R), \mathcal{B}(U) = \mathcal{B}^{(\pi)}(U).$$

For each fixed s , we first choose η sufficiently close to π such that the probability of having a cluster in $\mathcal{B}(\mathbb{H})$ which crosses $A(r, R)$ inside a quad $(Q; a, b, c, d)$ with the arc $(ab) \subset \partial B_R$, $(bc) \subset \partial B_r$, $(cd) \subset \partial B_r$ and (ad) not contained in $A^{(\eta)}(r, R)$ is less than $\frac{s}{2}$ by Lemma 5.3.7. For all $n \in \mathbb{N}$, conditioned on the event that n crossing clusters cross $A(r, R)$ inside $A^{(\eta)}(r, R)$, a family of radii is required for applying Lemma 5.3.4.

Due to the scaling invariance of the Brownian loop soup, we suppose without loss of generality that $0 < r < 1 < R$. Define

$$\begin{aligned} r_\beta &= r^{\frac{(1-\beta)\pi+\beta\eta}{\eta}}, & R_\beta &= R^{\frac{(1-\beta)\pi+\beta\eta}{\eta}} & \text{if } \beta \in [0, 1] \\ r_\beta &= r^{\frac{(2-\beta)\pi+(\beta-1)\eta}{\pi}}, & R_\beta &= R^{\frac{(2-\beta)\pi+(\beta-1)\eta}{\pi}} & \text{if } \beta \in [1, 2]. \end{aligned} \quad (5.3.13)$$

Note that $r_1 = r$, $R_1 = R$, r_β is increasing in β and R_β is decreasing in β . Therefore, $A(r_{\beta_1}, R_{\beta_1}) \subset A(r_{\beta_2}, R_{\beta_2})$ if $\beta_1 > \beta_2$. See Figure 5.9 for an illustration.

For each open subset $U \subseteq \mathbb{H}$, conditioned on the event that $\text{Clus}_{A(r,R)}(\mathcal{B}_{<a}(U)) \geq n$, we can order the clusters counterclockwise by their rightmost crossing connected components, and denote by D_1, \dots, D_n the first n components, from right to left in $A(r, R)$, see e.g. Figure 5.8. Denote by $E_{n,\eta}(U)$, $\tilde{E}_{n,\eta}(U)$ the events that

$$\begin{aligned} E_{n,\eta}(U) &:= \{\mathcal{B}_{<a}(U) \text{ has } n \text{ crossing clusters and } D_n \text{ is inside } A^{(\eta)}(r, R)\}, \\ \tilde{E}_{n,\eta}(U) &:= \{\mathcal{B}_{<a}(U) \text{ has } n \text{ crossing clusters and } D_n \text{ is not contained in } A^{(\eta)}(r, R)\}. \end{aligned} \quad (5.3.14)$$

Note that

$$\tilde{E}_{n,\eta}(U) \cup E_{n,\eta}(U) = \{\text{Clus}_{A(r,R)}(\mathcal{B}_{<a}(U)) \geq n\}, \quad \sup_{U \subseteq \mathbb{H}} \mathbb{P}[\tilde{E}_{n,\eta}(U)] \leq f(n)$$

and conditioned on $E_{n,\eta}(U)$, it may happen that the n -th cluster is not contained in $A^{(\eta)}(r, R)$. Now we can embark on the proof of the recursive inequality (5.3.11).

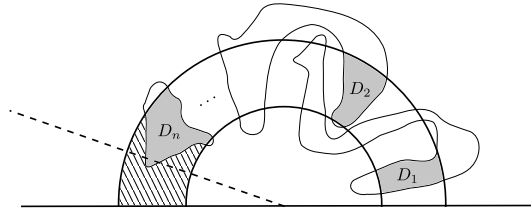

Figure 5.8 – An illustration of the rightmost components (D_i) of crossing clusters. On the event $\tilde{E}_{n,\eta}$, D_n must intersect $A(r, R) \setminus A^{(\eta)}(r, R)$. If D_{n+1} exists, then it must live in the shaded area.

Step 1: Decompose the crossing probability. Let us decompose $f(n+1)$ with respect to $E_{n,\eta}(U)$ and $\tilde{E}_{n,\eta}(U)$. Assume that $\text{Clus}_{A(r,R)}(\mathcal{B}_{<a}(U)) \geq n+1$ and $\tilde{E}_{n,\eta}(U)$ happens. By definition, this means that the rightmost crossing connected component D_n of the n -th cluster is not within $A^{(\eta)}(r, R)$, which implies that the $(n+1)$ -th cluster crosses $A(r, R)$ inside some crossing quad that satisfies the assumptions of Lemma 5.3.7 with

$\epsilon = \frac{s}{2}$ (by the choice of η), as illustrated in Figure 5.8. Conditioned on the event $\tilde{E}_{n,\eta}$, the loops outside the clusters to which D_1, \dots, D_n belong is an independent Brownian loop soup. Then if in addition D_n intersects $A(r, R) \setminus A^{(\eta)}(r, R)$, it follows from Lemma 5.3.7

$$\sup_{U \subseteq \mathbb{H}} \mathbb{P} \left[\text{Clus}_{A(r,R)}(\mathcal{B}_{<a}(U)) \geq n + 1 \mid \tilde{E}_{n,\eta} \right] \leq \frac{s}{2}.$$

Therefore,

$$\begin{aligned} f(n+1) &= \sup_{U \subseteq \mathbb{H}} \mathbb{P} \left[\text{Clus}_{A(r,R)}(\mathcal{B}_{<a}(U)) \geq n + 1 \right] \\ &\leq \sup_{U \subseteq \mathbb{H}} \left(\mathbb{P} \left[\tilde{E}_{n,\eta}, \text{Clus}_{A(r,R)}(\mathcal{B}_{<a}(U)) \geq n + 1 \right] + \mathbb{P} [E_{n,\eta}(U)] \right) \\ &\leq \sup_{U \subseteq \mathbb{H}} \mathbb{P} \left[\text{Clus}_{A(r,R)}(\mathcal{B}_{<a}(U)) \geq n + 1 \mid \tilde{E}_{n,\eta}(U) \right] \mathbb{P}[\tilde{E}_{n,\eta}(U)] + \sup_{U \subseteq \mathbb{H}} \mathbb{P} [E_{n,\eta}(U)] \\ &\leq \frac{s}{2} \cdot f(n) + \sup_{U \subseteq \mathbb{H}} \mathbb{P} [E_{n,\eta}(U)], \end{aligned} \tag{5.3.15}$$

Step 2: Decompose the cluster number in $\mathbb{P} [E_{n,\eta}(U)]$. In this step we aim to show the following alternative: if $E_{n,\eta}$ happens, either the restricted Brownian loop soup $\mathcal{B}_{<a}^{(\eta)}(U)$ has at least $(1 - \epsilon)n$ clusters crossing a slightly thinner annulus $A^{(\eta)}(r_{1.5}, R_{1.5})$, or we are in the setup to apply a Poisson tail estimate.

Similarly to the proof of Lemma 5.3.4, for any crossing cluster C from $\mathcal{B}_{<a}(U)$ whose rightmost crossing component D stays in $A^{(\eta)}(r, R)$, it follows from Lemma 5.3.1 that D contains a path γ crossing $A^{(\eta)}(r_{1.5}, R_{1.5})$ comprised of finitely many arcs of loops in C . If the loops in L_γ (which give the arcs that constitute γ) are part of $\mathcal{B}_{<a}^{(\eta)}(U)$, then C contains a crossing cluster of $A(r_{1.5}, R_{1.5})$. Otherwise, we can find a loop l_C in C that intersects both $A^{(\eta)}(r_{1.5}, R_{1.5})$ and $U \setminus U^{(\eta)}$, where $U^{(\eta)} = \{z \in U : 0 < \arg z < \eta\}$. Recall that D is contained $A^{(\eta)}(r, R)$, therefore l_C crosses $A^{(\eta)}(r, r_{1.5})$ or $A^{(\eta)}(R_{1.5}, R)$ to reach $U \setminus U^{(\eta)}$.

Under $E_{n,\eta}(U)$, all components D_1, \dots, D_n lie in $A^{(\eta)}(r, R)$. Applying this argument to each cluster that $D_i, i = 1, \dots, n$ belongs to, we get that for all $\epsilon' \in (0, 1)$,

$$\begin{aligned} &\mathbb{P} [E_{n,\eta}(U)] \\ &\leq \mathbb{P} \left[\# \left\{ l \in \mathcal{B}_{<a}(U) : l \text{ crosses } A^{(\eta)}(r, r_{1.5}) \text{ or } A^{(\eta)}(R_{1.5}, R) \right\} + \text{Clus}_{A^{(\eta)}(r_{1.5}, R_{1.5})} \left(\mathcal{B}_{<a}^{(\eta)}(U) \right) \geq n \right] \\ &\leq \mathbb{P} \left[\# \left\{ l \in \mathcal{B}_{<a}(U) : l \text{ crosses } A^{(\eta)}(r, r_{1.5}) \text{ or } A^{(\eta)}(R_{1.5}, R) \right\} \geq \epsilon' n \right] \\ &\quad + \mathbb{P} \left[\text{Clus}_{A^{(\eta)}(r_{1.5}, R_{1.5})} \left(\mathcal{B}_{<a}^{(\eta)}(U) \right) \geq (1 - \epsilon') n \right] \\ &\leq \mathbb{P} \left[\text{Clus}_{A^{(\eta)}(r_{1.5}, R_{1.5})} \left(\mathcal{B}_{<a}^{(\eta)}(U) \right) \geq (1 - \epsilon') n \right] + O(s^{2n}), \end{aligned} \tag{5.3.16}$$

where the last line follows from the fact that the term

$$\begin{aligned} &\# \left\{ l \in \mathcal{B}_{<a}(U) : l \text{ crosses } A^{(\eta)}(r, r_{1.5}) \text{ or } A^{(\eta)}(R_{1.5}, R) \right\} \\ &\leq \# \left\{ l \in \mathcal{B}(\mathbb{H}) : l \text{ crosses } A^{(\eta)}(r, r_{1.5}) \text{ or } A^{(\eta)}(R_{1.5}, R) \right\} \end{aligned}$$

has a super-exponentially decaying Poisson tail independent of U .

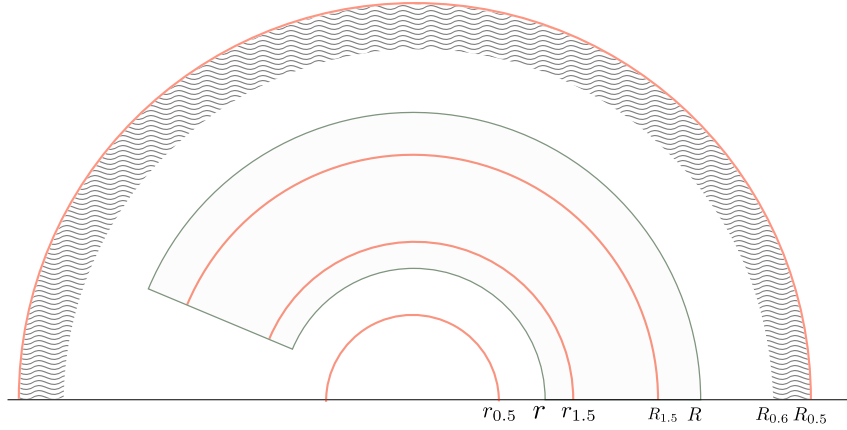

Figure 5.9 – The relation of radii defined in (5.3.13) and corresponding annuli.

The recursive relation (5.3.11) then reduces to

$$\sup_{U \subseteq \mathbb{H}} \mathbb{P} \left[\text{Clus}_{A^{(\eta)}(r_{1.5}, R_{1.5})} \left(\mathcal{B}_{<a}^{(\eta)}(U) \right) \geq (1 - \epsilon')n \right] \leq cq^n \cdot \sup_{U \subseteq \mathbb{H}} \mathbb{P} \left[\text{Clus}_{A(r, R)}(\mathcal{B}_{<a}(U)) \geq (1 - \epsilon)n \right] + O(s^{2n}). \quad (5.3.17)$$

We will prove (5.3.17) in the next two steps. In fact, it follows from (5.3.13) that the conformal modulus of the quad $A^{(\eta)}(r_{1.5}, R_{1.5})$ is strictly bigger than the conformal modulus of $A(r, R) \cap \mathbb{H}$, which is the main reason for the factor q^n to appear on the right-hand side, see (5.3.22). This argument requires a careful justification because $\mathcal{B}_{<a}(U)$ is not conformally invariant, which requires the constant c (see (5.3.20)) and the correction term $O(s^{2n})$ on the right-hand side of (5.3.17).

Step 3: Transform $A^{(\eta)}(r_{1.5}, R_{1.5})$ to $A(r_{0.5}, R_{0.5})$. Define the conformal map from $\mathbb{H}^{(\eta)} = \{z \in \mathbb{H} : 0 < \arg z < \eta\}$ to \mathbb{H}

$$\phi_\eta : z = re^{i\theta} \mapsto r^{\frac{\pi}{\eta}} e^{i\frac{\theta\pi}{\eta}} \text{ for } r > 0, \theta \in (0, \eta),$$

then

$$\phi_\eta(A^{(\eta)}(r_{1.5}, R_{1.5})) = A(r_{0.5}, R_{0.5}),$$

hence,

$$\text{Clus}_{A^{(\eta)}(r_{1.5}, R_{1.5})} \left(\mathcal{B}_{<a}^{(\eta)}(U) \right) = \text{Clus}_{A(r_{0.5}, R_{0.5})} \left(\phi_\eta(\mathcal{B}_{<a}^{(\eta)}(U)) \right).$$

Only loops in $U \cap B_{R+a}$ contribute to the left-hand side of the above relation, therefore we assume without loss of generality that $U \subseteq B_{R+a}$. Then the conformal invariance of the Brownian loop measure and a simple computation on the distortion of ϕ_η give that there exist constants $0 < c_1 < 1 < c_2$ depending on a, η, r, R such that almost surely

$$\mathcal{B}_{<c_1 a}(\phi_\eta(U^{(\eta)})) \subseteq \phi_\eta \left(\mathcal{B}_{<a}^{(\eta)}(U) \right) \subseteq \mathcal{B}_{<c_2 a}(\phi_\eta(U^{(\eta)})), \quad (5.3.18)$$

where $U^{(\eta)} = \{z \in U : 0 < \arg z < \eta\}$. Let $\mathcal{L}' := \mathcal{B}_{[c_1 a, c_2 a]}(\phi_\eta(U^{(\eta)}))$, a sample of Brownian loops within $\phi_\eta(U^{(\eta)})$ whose diameters are in $[c_1 a, c_2 a]$. Then by Lemma 5.3.4 and the Poissonian tail of $\#\mathcal{L}'$, we have that for all $\epsilon' \in (0, 1)$,

$$\begin{aligned}
& \mathbb{P} \left[\text{Clus}_{A^{(\eta)}(r_{1.5}, R_{1.5})} \left(\mathcal{B}_{<a}^{(\eta)}(U) \right) \geq (1 - \epsilon')n \right] \\
&= \mathbb{P} \left[\text{Clus}_{A(r_{0.5}, R_{0.5})} \left(\phi_\eta(\mathcal{B}_{<a}^{(\eta)}(U)) \right) \geq (1 - \epsilon')n \right] \\
&\leq \mathbb{P} \left[\#\{l \in \mathcal{L}' : l \cap A(r_{0.5}, R_{0.5}) \neq \emptyset\} + \text{Clus}_{A(r_{0.5}, R_{0.5})} \left(\mathcal{B}_{<c_1 a}(\phi_\eta(U^{(\eta)})) \right) \geq (1 - \epsilon')n \right] . \\
&\leq \mathbb{P} \left[\#\{l \in \mathcal{L}' : l \cap A(r_{0.5}, R_{0.5}) \neq \emptyset\} \geq \epsilon'n \right] + \mathbb{P} \left[\text{Clus}_{A(r_{0.5}, R_{0.5})} \left(\mathcal{B}_{<c_1 a}(\phi_\eta(U^{(\eta)})) \right) \geq (1 - 2\epsilon')n \right] \\
&\leq \mathbb{P} \left[\text{Clus}_{A(r_{0.5}, R_{0.5})} \left(\mathcal{B}_{<c_1 a}(\phi_\eta(U^{(\eta)})) \right) \geq (1 - 2\epsilon')n \right] + O(s^{2n}).
\end{aligned} \tag{5.3.19}$$

Moreover, we claim that there exists a constant $c = c(a, r, R, \eta)$ (independent of U) such that

$$\begin{aligned}
& \mathbb{P} \left[\text{Clus}_{A(r_{0.5}, R_{0.5})} \left(\mathcal{B}_{<c_1 a}(\phi_\eta(U^{(\eta)})) \right) \geq n \right] \leq \\
& c \cdot \mathbb{P} \left[\text{Clus}_{A(r_{0.5}, R_{0.5})} \left(\mathcal{B}_{<a}(\phi_\eta(U^{(\eta)})) \right) \geq n \right].
\end{aligned} \tag{5.3.20}$$

In fact, the independence of $\mathcal{B}_{\geq c_1 a}(\phi_\eta(U^{(\eta)}))$ and $\mathcal{B}_{<c_1 a}(\phi_\eta(U^{(\eta)}))$ gives that

$$\begin{aligned}
& \mathbb{P}[\text{Clus}_{A(r_{0.5}, R_{0.5})}(\mathcal{B}_{<a}(\phi_\eta(U^{(\eta)}))) \geq n] \\
&\geq \mathbb{P}[\text{Clus}_{A(r_{0.5}, R_{0.5})}(\mathcal{B}_{<c_1 a}(\phi_\eta(U^{(\eta)}))) \geq n, \mathcal{B}_{\geq c_1 a}(\phi_\eta(U^{(\eta)})) = \emptyset] \\
&= \mathbb{P}[\text{Clus}_{A(r_{0.5}, R_{0.5})}(\mathcal{B}_{<c_1 a}(\phi_\eta(U^{(\eta)}))) \geq n] \cdot \mathbb{P}[\mathcal{B}_{\geq c_1 a}(\phi_\eta(U^{(\eta)})) = \emptyset] \\
&\geq \mathbb{P}[\text{Clus}_{A(r_{0.5}, R_{0.5})}(\mathcal{B}_{<c_1 a}(\phi_\eta(U^{(\eta)}))) \geq n] \cdot \mathbb{P}[\mathcal{B}_{\geq c_1 a}(\mathbb{H}) = \emptyset],
\end{aligned}$$

and (5.3.20) follows by taking $c^{-1} = \mathbb{P}[\mathcal{B}_{\geq c_1 a}(\mathbb{H}) = \emptyset] > 0$. Therefore by (5.3.19), (5.3.20) and taking the supremum, we have

$$\sup_{U \subseteq \mathbb{H}} \mathbb{P} \left[\text{Clus}_{A(r_{1.5}, R_{1.5})} \left(\mathcal{B}_{<a}^{(\eta)}(U) \right) \geq (1 - \epsilon')n \right] \leq c \cdot \sup_{U \subseteq \mathbb{H}} \mathbb{P}[\text{Clus}_{A(r_{0.5}, R_{0.5})}(\mathcal{B}_{<a}(U)) \geq (1 - 2\epsilon')n] + O(s^{2n}). \tag{5.3.21}$$

Step 4: Compare the crossing cluster number in $A(r_{0.5}, R_{0.5})$ and $A(r, R)$. In this step, we will show that for any $\epsilon' \in (0, 1)$, there exists $0 < q < 1$ such that

$$\sup_{U \subseteq \mathbb{H}} \mathbb{P}[\text{Clus}_{A(r_{0.5}, R_{0.5})}(\mathcal{B}_{<a}(U)) \geq (1 - 2\epsilon')n] \leq q^n \cdot \sup_{U \subseteq \mathbb{H}} \mathbb{P}[\text{Clus}_{A(r, R)}(\mathcal{B}_{<a}(U)) \geq (1 - 3\epsilon')n] + O(s^{2n}). \tag{5.3.22}$$

Recall that r_θ is increasing in θ , R_θ is decreasing in θ (see (5.3.13)), $r = r_1, R = R_1$, and $A(r, R), A(R_{0.6}, R_{0.5}) \subseteq A(r_{0.5}, R_{0.5})$. Therefore we have

$$\mathbb{P}[\text{Clus}_{A(r_{0.5}, R_{0.5})}(\mathcal{B}_{<a}(U)) \geq n] \leq \mathbb{P}[\text{Clus}_{A(r, R)}(\mathcal{B}_{<a}(U)) \geq n, \text{Clus}_{A(R_{0.6}, R_{0.5})}(\mathcal{B}_{<a}(U)) \geq n].$$

By Lemma 5.3.4, if we write $U' := \{z \in U : |z| < R_{0.8}\}$, we have that

$$\text{Clus}_{A(r,R)}(\mathcal{B}_{<a}(U)) \leq \text{Clus}_{A(r,R)}(\mathcal{B}_{<a}(U')) + \#\{l \in \mathcal{B}_{<a}(U) : l \text{ crosses } A(R, R_{0.8})\},$$

and

$$\text{Clus}_{A(R_{0.6}, R_{0.5})}(\mathcal{B}_{<a}(U)) \leq \text{Clus}_{A(R_{0.6}, R_{0.5})}(\mathcal{B}_{<a}(U \setminus U')) + \#\{l \in \mathcal{B}_{<a}(U) : l \text{ crosses } A(R_{0.8}, R_{0.6})\}.$$

Combined with the fact that $A(r, R) \cap A(R_{0.6}, R_{0.5}) = \emptyset$, we have

$$\begin{aligned} & \mathbb{P} [\text{Clus}_{A(r_{0.5}, R_{0.5})}(\mathcal{B}_{<a}(U))] \geq (1 - 2\epsilon')n] \\ \leq & \mathbb{P} [\text{Clus}_{A(r,R)}(\mathcal{B}_{<a}(U')) \geq (1 - 3\epsilon')n \text{ and } \text{Clus}_{A(R_{0.6}, R_{0.5})}(\mathcal{B}_{<a}(U \setminus U')) \geq (1 - 3\epsilon')n] \\ & + \mathbb{P} [\#\{l \in \mathcal{B}_{<a}(\mathbb{H}) : l \text{ crosses } A(R, R_{0.8}) \text{ or } A(R_{0.8}, R_{0.6})\} \geq \epsilon'n] \\ \leq & \mathbb{P} [\text{Clus}_{A(r,R)}(\mathcal{B}_{<a}(U')) \geq (1 - 3\epsilon')n] \times \mathbb{P} [\text{Clus}_{A(R_{0.6}, R_{0.5})}(\mathcal{B}_{<a}(U \setminus U')) \geq (1 - 3\epsilon')n] + O(s^{2n}), \end{aligned}$$

where the last inequality follows from the independence of Brownian loop soup in disjoint domains and the super-exponential tail of distribution on the number of loops in $\mathcal{B}_{<a}(\mathbb{H})$ which cross $A(R, R_{0.8})$ or $A(R_{0.8}, R_{0.6})$. Also note that once ϵ', η are fixed, there exists $0 < q < 1$ (the smaller ϵ' is, the smaller q is) such that

$$\sup_{U \subseteq \mathbb{H}} \mathbb{P} [\text{Clus}_{A(R_{0.6}, R_{0.5})}(\mathcal{B}_{<a}(U)) \geq (1 - 3\epsilon')n] \leq q^n \quad (5.3.23)$$

due to BK's inequality [vdB96] (as in Lemma 9.6 of [SW12]) for disjoint-occurrence event of a Poissonian sample. This completes the proof of (5.3.22).

Conclusion. To summarize, we deduce (5.3.17) from (5.3.21) and (5.3.22). Then combining (5.3.15), (5.3.16) and (5.3.17), we have that for any $\epsilon' \in (0, 1)$,

$$\begin{aligned} f(n+1) & \leq \frac{s}{2} f(n) + \mathbb{P}[E_{n,\eta}] \\ & \leq \frac{s}{2} f(n) + \sup_{U \subseteq \mathbb{H}} \mathbb{P} [\text{Clus}_{A^{(\eta)}(r_{1.5}, R_{1.5})}(\mathcal{B}_{<a}^{(\eta)}(U)) \geq (1 - \epsilon')n] + O(s^{2n}) \\ & \leq \frac{s}{2} f(n) + c \cdot \sup_{U \subseteq \mathbb{H}} \mathbb{P} [\text{Clus}_{A(r_{0.5}, R_{0.5})}(\mathcal{B}_{<a}(U)) \geq (1 - 2\epsilon')n] + O(s^{2n}) \\ & \leq \frac{s}{2} f(n) + cq^n \cdot \sup_{U \subseteq \mathbb{H}} \mathbb{P} [\text{Clus}_{A(r,R)}(\mathcal{B}_{<a}(U)) \geq (1 - 3\epsilon')n] + O(s^{2n}), \end{aligned}$$

which is exactly (5.3.11) if we take ϵ to be $3\epsilon'$.

5.4 . Proof of Theorem 5.1.1

Denote by $L(r, R)$ the set of all loops in \mathbb{H} crossing $A(r, R)$. Recall that the mass of $L(r, R)$ under the Brownian loop measure is finite, and in the following we denote by μ_L the Brownian loop measure μ restricted to $L(r, R)$. To deal with single loops, we abuse the notation $\text{Cross}_A(l)$ to denote the maximum number of non-overlapping time

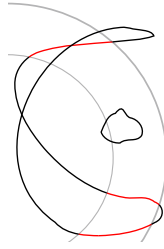

Figure 5.10 – For the loop captured from the top-right corner of Figure 5.4, we have $\text{Cross}(l) = 4$ and $\text{Cross}(\{l\}) = 3$.

intervals whose image under l cross A . In particular, the crossings of a single loop are not necessarily disjoint, and $\text{Cross}_A(\{l\}) \leq \text{Cross}_A(l)$, see Figure 5.10 for an illustration, and see (5.4.25) for the reason to define $\text{Cross}_A(l)$. We start with a coarse estimate on the crossing number of an annulus by a single loop in the Brownian loop soup.

Lemma 5.4.1. *Let $\mathcal{B}(\mathbb{H})$ be the Brownian loop soup with intensity $\lambda \in (0, 1]$ on \mathbb{H} . Then there exists $q = q(r, R, \lambda)$ such that*

$$\mathbb{P} \left[\sum_{l \in \mathcal{B}(\mathbb{H})} \text{Cross}_{A(r,R)}(l) \geq n \right] = O(q^n).$$

Proof. Denote by $\mu_L^\#$ the normalized probability measure on $L(r, R)$ on the trace of an unrooted loop. For the sake of tracing the loop, we can assume that it takes root inside the annulus $A(R, 2R)$ almost surely.

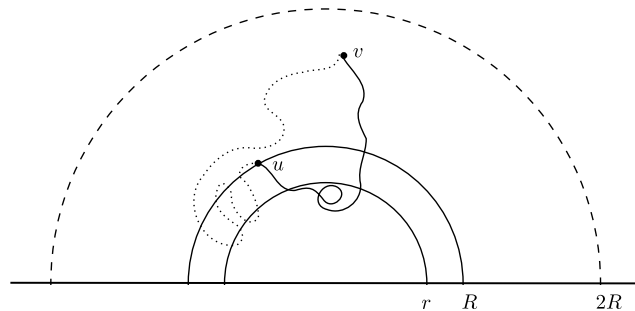

Figure 5.11 – Conditioned on the solid line from the root v to some point u on ∂B_R , we study the remaining (dotted) path in (5.4.24). In particular, since there are already 2 crossings on the solid path, we need $n - 2$ crossings for the dotted path.

Conditioned on the trajectory before first returning to $\partial B_R = \{z : |z| = R\}$ after hitting $\partial B_r = \{z : |z| = r\}$, the remaining part is an independent Brownian motion on \mathbb{H} from the landing point on ∂B_R conditioned on coming back to the root, see

Figure 5.11. Applying the strong Markov property recursively, we have

$$\begin{aligned}
\mathbb{P}_{\mu_L^\#}[\text{Cross}_{A(r,R)}(l) \geq n] &\leq \sup_{\substack{u \in \partial B_R \\ v \in A(R,2R)}} \mathbb{P}_{u \rightarrow v}[W \text{ crosses } A(r,R) \text{ at least } n-2 \text{ times}] \\
&\leq \left(\sup_{\substack{u \in \partial B_R \\ v \in A(R,2R)}} \mathbb{P}_{u \rightarrow v}[W \text{ hits } \partial B_r \text{ before returning to } v] \right)^{\lceil \frac{n}{2} - 1 \rceil} \\
&\leq p^{\frac{n}{2} - 1},
\end{aligned} \tag{5.4.24}$$

where $\mathbb{P}_{u \rightarrow v}$ denotes the normalized (Brownian) interior to interior measure on \mathbb{H} from u to v , W is the trajectory under $\mathbb{P}_{u \rightarrow v}$ and

$$p := \sup_{\substack{u \in \partial B_R \\ v \in A(R,2R)}} \mathbb{P}_{u \rightarrow v}[W \text{ hits } \partial B_r \text{ before returning to } v] < 1.$$

Then Campbell's second theorem tells that for any $\epsilon > 0$,

$$\begin{aligned}
&\mathbb{E} \left[\exp \left(- \left(\frac{1}{2} \log p + \epsilon \right) \cdot \sum_{l \in \mathcal{B}(\mathbb{H})} \text{Cross}_{A(r,R)}(l) \right) \right] \\
&= \mathbb{E} \left[\exp \left(- \left(\frac{1}{2} \log p + \epsilon \right) \cdot \sum_{l \in \mathcal{B}(\mathbb{H}) \cap L(r,R)} \text{Cross}_{A(r,R)}(l) \right) \right] \\
&= \exp \left(- \int_{L(r,R)} \left[1 - \exp \left(- \left(\frac{1}{2} \log p + \epsilon \right) \cdot \text{Cross}_{A(r,R)}(l) \right) \right] d\mu(l) \right) \\
&\leq \exp \left(|\mu_L| \cdot \mathbb{E}_{\mu_L^\#} \left[\exp \left(- \left(\frac{1}{2} \log p + \epsilon \right) \cdot \text{Cross}_{A(r,R)}(l) \right) \right] \right) \\
&\leq p^{-1} \cdot \exp \left(|\mu_L| / (1 - e^{-\epsilon}) \right).
\end{aligned}$$

This implies that

$$\mathbb{P} \left[\sum_{l \in \mathcal{B}(\mathbb{H})} \text{Cross}_{A(r,R)}(l) \geq n \right] = \exp \left(|\mu_L| / (1 - e^{-\epsilon}) \right) p^{\frac{n}{2} - 1} e^{n\epsilon}.$$

Then Lemma 5.4.1 follows by taking ϵ sufficiently small such that $q = \sqrt{p}e^\epsilon < 1$. \square

Further, we show in the next lemma that, the probability on the total crossings of single loops in $\mathcal{B}(\Omega)$ also has super-exponential decay. Notice that $\text{Cross}_{A(r,R)}(\mathcal{B}(\Omega)) \neq \text{Cross}_{A(r,R)}(\text{CLE}(\Omega))$, because for $\text{Cross}_{A(r,R)}(\mathcal{B}(\Omega))$ we only count crossings formed by single loops, not clusters.

Proposition 5.4.2. *Let $\mathcal{B}(\Omega)$ be a Brownian loop soup with intensity $\lambda \in (0, 1]$ inside a simply connected subdomain $\Omega \subseteq \mathbb{H}$, then*

$$\sup_{\Omega \subseteq \mathbb{H}} \mathbb{P}[\text{Cross}_{A(r,R)}(\mathcal{B}(\Omega)) \geq n] \text{ decays super-exponentially.}$$

Proof. By monotonicity of the crossing number (5.2.4), it suffices to show that

$$\mathbb{P}[\text{Cross}_{A(r,R)}(\mathcal{B}(\mathbb{H})) \geq n] \text{ decays super-exponentially.}$$

We can decompose the traces of each loop in $L(r, R)$ into pieces of crossings (from ∂B_r to ∂B_R or from ∂B_R to ∂B_r) and Brownian excursions connecting consecutive crossings by Ito's excursion theory [PY07]. For each crossing, conditioned on its starting point and end point, it is distributed according to the normalized Brownian excursion measure in $A(r, R)$ independent of other parts of the loop. For the purpose of estimating $\text{Cross}_{A(r,R)}(\mathcal{B}(\mathbb{H}))$, by summing over the number of crossings (not necessarily disjoint) of loops in the Brownian loop soup the upper bounds in 5.4.1 and then selecting n disjoint crossings out of them, we have

$$\begin{aligned} \mathbb{P}[\text{Cross}_{A(r,R)}(\mathcal{B}(\mathbb{H})) \geq n] &\leq \sum_{k \geq n} \mathbb{P}\left[\sum_{l \in \mathcal{B}(\mathbb{H})} \text{Cross}_{A(r,R)}(l) = k\right] \cdot \binom{k}{n} \cdot u_n(r, R) \\ &\leq C \cdot u_n(r, R) \cdot \sum_{k \geq n} q^k \cdot \binom{k}{n}, \end{aligned} \tag{5.4.25}$$

where $u_n(r, R) := \sup_{\substack{x_1, \dots, x_n \in \partial B_r \\ y_1, \dots, y_n \in \partial B_R}} \mathbb{P}[\text{Brownian excursions from } x_1, \dots, x_n \text{ to } y_1, \dots, y_n \text{ inside } A(r, R) \text{ are disjoint}]$ and by Lemma 5.4.1, there exists $C > 0$ and $q < 1$ such that

$$\mathbb{P}\left[\sum_{l \in \mathcal{B}(\mathbb{H})} \text{Cross}_{A(r,R)}(l) = k\right] \leq C \cdot q^k.$$

We first look at the factor $v_n := \sum_{k=n}^{\infty} q^k \cdot \binom{k}{n}$ in (5.4.25). In fact,

$$(1 - q)v_n = \sum_{k=n}^{\infty} q^k \cdot \binom{k}{n} - \sum_{k=n}^{\infty} q^{k+1} \cdot \binom{k}{n} = q^n + \sum_{k=n+1}^{\infty} q^k \left(\binom{k}{n} - \binom{k-1}{n} \right) = qv_{n-1},$$

i.e. v_n grows exponentially with exponent $\frac{q}{1-q}$. Therefore to prove the desired super-exponential decay for (5.4.25), it suffices to prove that $u_n(r, R)$ decays super-exponentially. To this end, one can apply the Fomin's identity (for example, see [KL05]) for the non-intersection probability of a random walk excursion and loop-erased random walks (which is obviously larger than the non-intersection probability of random walk excursions). By conformal invariance of the Brownian excursion, we choose a conformal map $\varphi : A(r, R) \cap \mathbb{H} \rightarrow \mathbb{D}$ such that $\varphi(\partial B_R) = \{e^{i\theta} : \theta \in] - \theta_1, \theta_1[\}$ and $\varphi(\partial B_r) = \{e^{i\theta} : \theta \in] - \theta_2 + \pi, \theta_2 + \pi[\}$ for some $\theta_1 + \theta_2 < \pi$. Then

$$\begin{aligned} u_n(r, R) &\leq \sup_{\substack{1 \leq k \leq n, x_k \in] - \theta_1, \theta_1[, \\ y_k \in] - \theta_2 + \pi, \theta_2 + \pi[}} \det \left[\frac{1 - \cos(x_j - y_j)}{1 - \cos(x_j - y_l)} \right]_{1 \leq j, l \leq n} \\ &\leq 2 \sup_{\substack{1 \leq k \leq n, x_k \in] - \theta_1, \theta_1[, \\ y_k \in] - \theta_2 + \pi, \theta_2 + \pi[}} \det \left[\frac{1}{1 - \cos(x_j - y_l)} \right]_{1 \leq j, l \leq n}. \end{aligned}$$

Among the choice x_j , $1 \leq j \leq n$, there exist a pair of indices $i_1 \neq i_2$ such that $|x_{i_1} - x_{i_2}| \leq \frac{2\pi}{n}$. By subtracting the i_1 -th row from the i_2 -th row, the i_2 -th row is the vector

$$\left[\frac{\cos(x_{i_2} - y_l) - \cos(x_{i_1} - y_l)}{(1 - \cos(x_{i_1} - y_l))(1 - \cos(x_{i_2} - y_l))} \right]_{1 \leq l \leq n},$$

whose modulus (L^2 -norm) is less than $\frac{2\pi}{\sqrt{n(1 - \cos(\pi - \theta_1 - \theta_2))^2}}$. By performing the same procedure on the remaining $n - 1$ rows, we have

$$u_n(r, R) \leq \left(\frac{4\pi}{(1 + \cos(\theta_1 + \theta_2))^2} \right)^{n-1} \cdot (n!)^{-\frac{1}{2}},$$

which implies that $u_n(r, R)$ decays super-exponentially fast. The conclusion then follows by (5.4.25). \square

Proof of Theorem 5.1.1. By (5.2.5) and (5.2.6), it suffices to show that for all $s \in (0, 1)$,

$$\sup_{\Omega \subseteq \mathbb{H}} \mathbb{P} \left[\text{Comp}_{A(r,R)}(\mathcal{B}(\Omega)) \geq n \right] = O(s^n).$$

Introduce $a := (R - r)/8$ to divide the Brownian loop soup into two parts according to their diameters, then by Lemma 5.3.2,

$$\begin{aligned} \text{Comp}_{A(r,R)}(\mathcal{B}(\Omega)) &\leq \text{Comp}_{A(r+a,R-a)}(\mathcal{B}_{<a}(\Omega)) + \#\{l \in \mathcal{B}_{\geq a}(\Omega) : l \subset A(r, R)\} \\ &\quad + \text{Cross}_{A(r,r+a)}(\mathcal{B}_{\geq a}(\Omega)) + \text{Cross}_{A(R-a,R)}(\mathcal{B}_{\geq a}(\Omega)). \end{aligned}$$

Besides, Lemma 5.3.3 implies that

$$\text{Comp}_{A(r+a,R-a)}(\mathcal{B}_{<a}(\Omega)) \leq \text{Clus}_{A(r+2a,R-2a)}(\mathcal{B}_{<a}(A(r+a, R-a) \cap \Omega)).$$

Then the conclusion follows by combining Proposition 5.3.5, Proposition 5.4.2 and the Poisson tail of $\#\{l \in \mathcal{B}_{\geq a}(\mathbb{H}) : l \subset A(r, R)\}$. \square

5.5 . Proof of Corollary 5.1.3

In this section, we prove Corollary 5.1.3, which generalizes Theorem 5.1.1 to the crossing estimates of arbitrary quads, with the same spirit as in [KS17]. By conformal invariance of CLEs, without loss of generality, we will assume in the whole section that $\Omega = \mathbb{H}$. First, let us extend the crossing estimated in Theorem 5.1.1 to hold for inner annuli uniformly on their modulus.

Lemma 5.5.1. *Given a non-nested simple $\text{CLE}_\kappa(\mathbb{H})$, $\kappa \in (\frac{8}{3}, 4]$, we have that for all $s \in (0, 1)$, $z_0 \in \mathbb{C}$ and $0 < r < R$,*

$$\mathbb{P} \left[\text{Cross}_{A_{z_0}(r,R)}(\text{CLE}_\kappa(\mathbb{H})) \geq n \right] = O(s^n)$$

where the constant in $O(s^n)$ depends on κ and R/r .

Proof. It readily follows from Theorem 5.1.1 that the result holds for $\text{Im } z_0 \leq 0$. If $\text{Im } z_0 > 0$, by the Brownian loop-soup construction of CLEs and the conformal invariance of Brownian loop soup on \mathbb{H} , it suffices to prove that for $\lambda = (3\kappa - 8)(6 - \kappa)/2\kappa$ and for all $y \geq 0$, $0 < r < 1$ and $s \in (0, 1)$,

$$\mathbb{P} \left[\text{Comp}_{A_{iy}(r,1)}(\mathcal{B}^\lambda(\mathbb{H})) \geq n \right] = O(s^n). \quad (5.5.26)$$

For each $y > 2$ and ϵ sufficiently small, it holds by Lemma 5.3.2 that

$$\begin{aligned} & \mathbb{P} \left[\text{Comp}_{A_{iy}(r,1)}(\mathcal{B}^\lambda(\mathbb{H})) \geq n \right] \\ & \leq \mathbb{P} \left[\text{Comp}_{A_{iy}\left(\frac{3r+1}{4}, \frac{r+3}{4}\right)}(\mathcal{B}^\lambda(\mathbb{H} + i(y-2))) \geq (1-2\epsilon)n \right] \\ & \quad + \mathbb{P} \left[\text{Cross}_{A_{iy}\left(r, \frac{3r+1}{4}\right)}(\mathcal{B}^\lambda(\mathbb{H} + i(y-2))^\perp) \geq \epsilon n \right] \\ & \quad + \mathbb{P} \left[\text{Cross}_{A_{iy}\left(\frac{r+3}{4}, 1\right)}(\mathcal{B}^\lambda(\mathbb{H} + i(y-2))^\perp) \geq \epsilon n \right] \\ & \leq \mathbb{P} \left[\text{Comp}_{A_{2i}\left(\frac{3r+1}{4}, \frac{r+3}{4}\right)}(\mathcal{B}^\lambda(\mathbb{H})) \geq (1-2\epsilon)n \right] + O(s^n), \end{aligned}$$

by shifting $\mathbb{H} + i(y-2)$ downwards by the distance $i(y-2)$, where the term $O(s^n)$ follows from Proposition 5.4.2 because any crossing arc of $A_{iy}\left(\frac{r+3}{4}, 1\right)$ (or $A_{iy}\left(r, \frac{3r+1}{4}\right)$) must intersect both $\mathbb{R} + i(y-2)$ and $A_{iy}\left(\frac{r+3}{4}, 1\right)$, and these arcs are bound to cross one of the annuli in the left picture of Figure 5.12. Similarly, the probability of the event $\{\text{Comp}_{A_{2i}\left(\frac{3r+1}{4}, \frac{r+3}{4}\right)}(\mathcal{B}^\lambda(\mathbb{H})) \geq n\}$ can be bounded by the probability of a union crossing events of annuli centered at the origin, see the left picture of Figure 5.12, which completes the proof of (5.5.26) for $y > 2$.

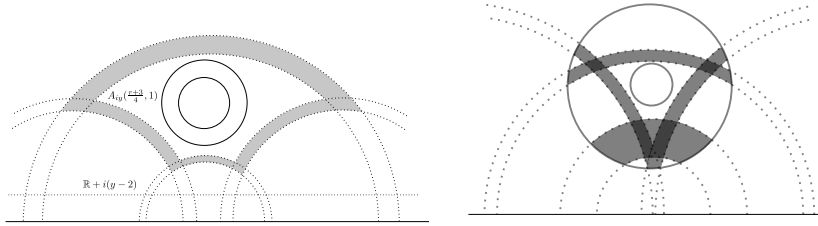

Figure 5.12 – Each crossing is bound to cross one of the shaded annulus sectors.

For $y \in [0, 2]$, we are going to establish (5.5.26) uniformly in y by finding a finite number of annuli A_1, \dots, A_k such that for any $A_{iy}(r, 1)$, there exists at least one $A_j \subseteq A_{iy}(r, 1)$, $j = 1, \dots, k$, therefore it is not hard to see that

$$\mathbb{P} \left[\text{Comp}_{A_{iy}(r,1)}(\mathcal{B}^\lambda(\mathbb{H})) \geq n \right] \leq \max_{1 \leq j \leq k} \mathbb{P} \left[\text{Comp}_{A_j}(\mathcal{B}^\lambda(\mathbb{H})) \geq n \right] = O(s^n), \quad y \in [0, 2],$$

where the $O(s^n)$ term for $j = 1, \dots, k$ can be bounded similarly by the probability of a union of crossing events as illustrated in the right picture of Figure 5.12. Effectively,

if we choose $y_j := (j - 1) \cdot \frac{1-r}{2}$ for $j = 1, \dots, k$, where $k = \lceil \frac{4}{1-r} \rceil + 1$, then

$$A_{iy_j}(r, \frac{r+1}{2}) \subseteq A_{iy}(r, 1) \text{ for all } y \in [y_{j-1}, y_j].$$

This completes the proof of (5.5.26). \square

The proof of Corollary 5.1.3 for generic quads $Q = (V; S_k, k = 0, 1, 2, 3)$ with $S_1, S_3 \subset \mathbb{R}$ proceeds by connecting S_1 and S_3 by a chain of annuli of fixed radii ratio, for which the number of annuli needed depends only on $m(Q)$. To analyze $m(Q)$, we need the concept of the extremal length, which also gives the conformal modulus. Let Γ be a family of locally rectifiable curves in an open set D in the complex plane. If $\rho : D \rightarrow [0, \infty]$ is square-integrable on D , then define

$$A_\rho(D) = \iint_D \rho^2(z) d^2z \quad \text{and} \quad L_\rho(\Gamma) = \inf_{\gamma \in \Gamma} \int_\gamma \rho(z) |dz|,$$

where d^2z denotes the Lebesgue measure on the complex plane and $|dz|$ denotes the Euclidean element of length. Then the extremal length of Γ is defined by

$$m(\Gamma) := \sup_{\rho \in P} \frac{L_\rho(\Gamma)^2}{A_\rho(D)}.$$

From the definition it is clear that the extremal length satisfies a simple monotonicity property: if $\Gamma_1 \subseteq \Gamma_2$, then $m(\Gamma_1) \geq m(\Gamma_2)$. Moreover, it also agrees with the conformal modulus $m(Q)$ we introduced in Section 5.1.2 as the unique number for which Q can be conformally onto a rectangle $[0, 1] \times [0, m(Q)]$ with S_k mapped to the four sides of the rectangle and S_0 mapped to $[0, 1] \times \{0\}$, i.e. (cf. eg. [Ahl])

$$m(\Gamma) = m(Q),$$

where Γ is the family of all curves joining S_0 and S_2 inside $Q = (V; S_k, k = 0, 1, 2, 3)$.

We begin with an estimate on the extremal length following [KS17, pages 719-720].

Lemma 5.5.2. *Suppose that $Q = (V; S_k, k = 0, 1, 2, 3)$ has conformal modulus $m(Q) \geq 36$. Then there exist $z_0 \in \mathbb{C}$ and $r > 0$ such that any curve connecting S_0 and S_2 inside V must cross an annulus $A_{z_0}(r, 2r)$.*

Proof. Let

$$d_1 = \inf\{\text{length}(\gamma) : \gamma \text{ joining } S_1, S_3 \text{ inside } V\}$$

be the distance between S_1 and S_3 in the inner Euclidean metric of Q , and let γ^* be a curve of length $\leq 2d_1$ joining S_1 and S_3 inside V . We are going to show that any crossing γ (joining S_0 and S_2 inside V) of Q has diameter $d \geq 4d_1$. Indeed, working with the extremal length of the dual family of curves

$$\Gamma^* = \{\gamma^* : \gamma^* \text{ connects } S_1 \text{ and } S_3 \text{ inside } V\},$$

take a metric ρ equal to 1 in the d_1 -neighborhood of γ and zero outside the d_1 -neighborhood of γ . Then its area integral is at most $(d + 2d_1)^2$, and any $\gamma^* \in \Gamma^*$ has length at least d_1 since $\gamma \cap \gamma^* \neq \emptyset$ must run through the support of ρ for a length of at least d_1 . Therefore $1/m(Q) = m(\Gamma^*) \geq d_1^2/(d + 2d_1)^2$, hence

$$d \geq (\sqrt{m(Q)} - 2)d_1 \geq 4d_1.$$

Now if we take an annulus A centered at the middle point of γ^* with inner radius d_1 and outer radius $2d_1$, every crossing γ of Q contains a crossing of A because γ has to intersect γ^* , which is contained inside the inner circle of A , and γ has to intersect the outer circle of A if its diameter is larger than $4d_1$. \square

Proof of Corollary 5.1.3. Let us decompose the set of crossings curves (from S_0 to S_2 or from S_2 to S_0 inside V) of the quad $Q = (V; S_k, k = 0, 1, 2, 3)$. In fact, if we map conformally Q onto a rectangle $[0, 1] \times [0, m(Q)]$ by ϕ_Q , we can choose $K > 0$ large enough, which depends only on $m(Q)$, such that for any $0 \leq i, j \leq K - 1$, the set of curves $\Gamma_{i,j}$ connecting $[\frac{i}{K}, \frac{i+1}{K}] \times \{0\}$ and $[\frac{j}{K}, \frac{j+1}{K}] \times \{m(Q)\}$ inside Ω has extremal length larger than 36. Then by Lemma 5.5.2, any curve in $\phi_Q^{-1}(\Gamma_{i,j})$ has to cross an annulus $A_{z_{i,j}}(r_{i,j}, 2r_{i,j})$ for some $z_{i,j} \in \mathbb{C}$ and $r_{i,j} > 0$. In other words, any curve crossing Q has to cross one of the K^2 annuli $(A_{z_{i,j}}(r_{i,j}, 2r_{i,j}))_{0 \leq i, j \leq K-1}$.

Therefore, our crossing event is included in the union of events

$$\{\text{Comp}_{A_{z_{i,j}}(r_{i,j}, 2r_{i,j})}(\text{CLE}_\kappa(\mathbb{H})) > n/K^2\},$$

and we can finish the proof by Lemma 5.5.1. \square

5.6 . Proof of Corollary 5.1.5

Let us now illustrate why our result implies the assumption of [BC21, Corollary 1.7]. Let Ω be a planar simply-connected domain and $\lambda_1, \dots, \lambda_N \in \Omega$ be a collection of pairwise distinct punctures in Ω . Given a loop ensemble in $\Omega \setminus \{\lambda_1, \dots, \lambda_N\}$, we delete all loops surrounding zero or one puncture, and consider the collection of homotopy classes of loops that surround at least two punctures, which is called a *macroscopic lamination*. We are interested in the *complexity* $|\Gamma|_{\mathcal{T}_\Omega}$ of a macroscopic lamination for a fixed triangulation $\mathcal{T}_\Omega = (\{\lambda_1, \dots, \lambda_N, \partial\Omega, \mathcal{E}, \mathcal{F}\})$ of $\Omega \setminus \{\lambda_1, \dots, \lambda_N\}$ whose $N + 1$ vertices are $\lambda_1, \dots, \lambda_N$ and the boundary of Ω . Roughly speaking, $|\Gamma|_{\mathcal{T}_\Omega}$ is the minimal possible (in the free homotopy class) number of intersections of loops in Γ with the edges of \mathcal{T}_Ω . We refer interested readers to [BC21] for detailed discussions and pictures therein. The definition of the complexity depends on the choice of the triangulation \mathcal{T}_Ω , but for each two such choices, the complexities differ by no more than a multiplicative factor independent of Γ . For a fixed triangulation \mathcal{T}_Ω of $\Omega \setminus \{\lambda_1, \dots, \lambda_N\}$, the laminations on $\Omega \setminus \{\lambda_1, \dots, \lambda_N\}$ are parametrized by multi-indices $\mathbf{n} = (n_e) \in \mathbb{N}^{\mathcal{E}}$ (satisfying certain conditions), where $n_e := \#\{\Gamma \cap e\}$. Then the complexity $|\Gamma|_{\mathcal{T}_\Omega}$ (with respect to triangulation \mathcal{T}_Ω) can be expressed as

$$|\Gamma|_{\mathcal{T}_\Omega} = \min_{\Gamma': \Gamma' \text{ is homotopic to } \Gamma} \#\{\Gamma' \cap \mathcal{T}_\Omega\},$$

where $\#\{\Gamma' \cap \mathcal{T}_\Omega\}$ denotes the number of intersections of all loops in Γ' with edges of \mathcal{T}_Ω .

We can assume by the conformal invariance of CLEs that $\Omega = \mathbb{H}$ and $|\lambda_1| < |\lambda_2| < \dots < |\lambda_N|$ up to a re-ordering of punctures. We choose a triangulation $\mathcal{T}_\mathbb{H}$ of $\mathbb{H} \setminus \{\lambda_1, \dots, \lambda_N\}$ such that for any $i < j$, each edge of $\mathcal{T}_\mathbb{H}$ connecting λ_i, λ_j is a path between λ_i and λ_j inside $A(|\lambda_i|, |\lambda_j|)$, and any edge between a puncture λ_i and $\partial\Omega$ is an arc of ∂B_{λ_i} . It is not hard to see that the complexity of any macroscopic lamination is bounded by the sum of crossings up to a multiplicative constant.

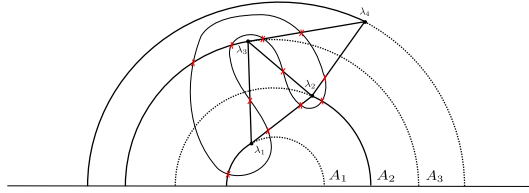

Figure 5.13 – An illustration of the triangulation we adopt and the complexity of a loop. Note that the cross (intersection with segment $(\lambda_3\lambda_4)$) inside A_3 corresponds to a crossing of A_2 in the proof of Lemma 5.6.1

Lemma 5.6.1. *Let Ω' be a simply connected subdomain of \mathbb{H} . For each macroscopic lamination Γ in Ω' , we have*

$$|\Gamma|_{\mathcal{T}_\mathbb{H}} \leq 6(N-1) \sum_{i=1}^{N-1} \text{Cross}_{A_i}(\Gamma).$$

Proof. Suppose that

$$\Gamma' \in \underset{\tilde{\Gamma}: \text{homotopic to } \Gamma}{\text{argmin}} \#\{\tilde{\Gamma} \cap \mathcal{T}_\mathbb{H}\},$$

such that

$$|\Gamma|_{\mathcal{T}_\mathbb{H}} = \sum_{e \in \mathcal{T}_\mathbb{H}} \#\{\Gamma' \cap e\} \text{ and } \text{Cross}_{A_i}(\Gamma') \leq \text{Cross}_{A_i}(\Gamma) \text{ for each } i \leq N-1.$$

For any $e \in \mathcal{T}_\mathbb{H}$ and $x \in \Gamma' \cap e$, denote by l_x the loop in Γ' that x belongs to. Suppose that l_x is rooted at x and l_x is parametrized by \mathbb{R} , denote by

$$t_- := \inf\{t \geq 0 : l_x(-t) \in \cup_{i=1}^N \partial B_{|\lambda_i|}\}$$

and

$$t_+ := \inf\{t \geq 0 : l_x(t) \in \cup_{i=1}^N \partial B_{|\lambda_i|}, |l_x(t)| \neq |l_x(t_-)|\}.$$

It is not hard to see that t_+ exists and by the minimality of Γ' , there is at most one another intersection (if x lies on one of the arcs ∂B_{λ_i}) of $l_x((-t_-, t_+])$ and e except

x . Therefore there exists $i \leq N - 1$ such that $l_x((-t_-, t_+])$ crosses A_i . By summing over all possibilities of i , we have

$$\#(l_x \cap e) \leq 2 \sum_{i=1}^{N-1} \text{Cross}_{A_i}(l_x).$$

Since $\mathcal{T}_{\mathbb{H}}$ has $3(N - 1)$ edges, we further get

$$\sum_{e \in \mathcal{T}_{\mathbb{H}}} \#(l_x \cap e) \leq 6(N - 1) \sum_{i=1}^{N-1} \text{Cross}_{A_i}(l_x).$$

Sum over all the loops in Γ , notice that they are disjoint by definition, then

$$|\mathcal{T}_{\mathbb{H}}| = \sum_{e \in \mathcal{T}_{\mathbb{H}}} \#(\Gamma' \cap e) \leq 6(N - 1) \sum_{i=1}^{N-1} \text{Cross}_{A_i}(\Gamma') \leq 6(N - 1) \sum_{i=1}^{N-1} \text{Cross}_{A_i}(\Gamma).$$

□

Using Lemma 5.6.1 and Theorem 5.1.1, we obtain without difficulty the following super-exponential decay of the probability of the complexity.

Corollary 5.6.2. *For any simply connected subdomain of \mathbb{H} , let $\text{CLE}_{\kappa}(\Omega)$ be a non-nested conformal loop ensemble with $\kappa \in (\frac{8}{3}, 4]$ in Ω . Then for any $s > 0$,*

$$\sup_{\Omega \subseteq \mathbb{H}} \mathbb{P}[|\text{CLE}_{\kappa}(\Omega)|_{\mathcal{T}_{\mathbb{H}}} > n] = O(s^n).$$

Now we are ready to conclude the main application of Theorem 5.1.1. We will add superscripts to distinguish non-nested $\text{CLE}_{\kappa}^{\text{n-nested}}$ and nested $\text{CLE}_{\kappa}^{\text{nested}}$.

Corollary 5.1.5. *Let Θ_{Ω} be a random sample of the nested CLE_{κ} , $\frac{8}{3} < \kappa \leq 4$, in Ω and let Θ_{Ω}^{δ} be the double-dimer loop ensemble on a Temperlean discretization $\Omega^{\delta} \subset \delta\mathbb{Z}^2$ of Ω . Denote by $\Theta \sim \Gamma$ the event that the macroscopic lamination of a loop ensemble Θ is Γ . Then*

$$\mathbb{P}_{\text{CLE}_{\kappa}^{\text{nested}}}[\Theta_{\Omega} \sim \Gamma] = O(R^{-|\Gamma|}) \text{ as } |\Gamma| \rightarrow \infty \text{ for all } R > 0.$$

Therefore by [BC21, Corollary 1.7], $\mathbb{P}_{\text{double-dimer}}[\Theta_{\Omega}^{\delta} \sim \Gamma] \rightarrow \mathbb{P}_{\text{CLE}_{\kappa}^{\text{nested}}}[\Theta_{\Omega} \sim \Gamma]$ as $\delta \rightarrow 0$ for all macroscopic laminations Γ .

Proof. We can upper-bound the complexity of the nested CLE_{κ} by looking separately at the collection of loops $\Gamma_{\Lambda} = \{\gamma_1, \dots, \gamma_N\}$ surrounding the same subset $\Lambda \subseteq \{\lambda_1, \dots, \lambda_N\}$ which contains at least two punctures. In addition, we order loops in Γ_{Λ} such that γ_{i+1} lies inside γ_i . By abusing the notation slightly we denote by $\mathbb{P}[|\gamma_1| = n_1, \dots, |\gamma_i| = n_i]$ the quantity

$$\sup_{\Omega \subseteq \mathbb{H}} \mathbb{P}[\gamma_1, \dots, \gamma_i \in \text{CLE}_{\kappa}^{\text{n-nested}}(\Omega) : \gamma_1, \dots, \gamma_i \text{ encircles } \Lambda$$

$$\text{and } |\gamma_1|_{\mathcal{T}_{\mathbb{H}}} = n_1, \dots, |\gamma_i|_{\mathcal{T}_{\mathbb{H}}} = n_i].$$

Note that the loops in Γ_Λ are homotopic to each other since they do not intersect. In particular, their complexities coincide. Therefore

$$\mathbb{P}[|\gamma_1| = n_1, \dots, |\gamma_j| = n_j] \text{ is non-zero only if } n_1 = \dots = n_j.$$

Using independence of the loop ensemble inside $\gamma_{\lfloor j/2 \rfloor}$, for any $C > 0$, we have

$$\begin{aligned} & \mathbb{P}[|\gamma_1| = \dots = |\gamma_j| = n] \cdot e^{Cjn} \\ & \leq \mathbb{P}[|\gamma_1| > 0, \dots, |\gamma_{\lfloor j/2 \rfloor}| > 0] \cdot \prod_{i=\lfloor j/2 \rfloor+1}^j (\mathbb{P}[|\gamma_i| = n] \cdot e^{2Cn}) \\ & \leq \exp(-c(j/2)^{3/2}) \cdot \prod_{i=\lfloor j/2 \rfloor+1}^j (\mathbb{P}[|\gamma_i| = n] \cdot e^{2Cn}), \end{aligned}$$

where the exponential term is due to [Dub19, Lemma 21] on the tail of the distribution of the number of loops surrounding two points.

Because the complexity of γ_{i+1} is less than the complexity of the non-nested CLE_κ inside γ_i , this implies that

$$\mathbb{E}[\exp(C \cdot |\Gamma_\Lambda|_{\mathcal{T}_\mathbb{H}})] \leq \sum_{j \geq 0} e^{-c(j/2)^{3/2}} \sup_{U \subseteq \Omega} \mathbb{E} \left[\exp \left(2C \cdot |\text{CLE}_\kappa^{\text{n-nested}}(U)|_{\mathcal{T}_\mathbb{H}} \right) \right]^{j/2+1},$$

which is finite due to Theorem 5.1.1 and Lemma 5.6.1. In particular $\mathbb{P}[|\Gamma_\Lambda|_{\mathcal{T}_\mathbb{H}} > n]$ decays super-exponentially by Markov's inequality. Then Corollary 5.1.5 follows by taking the sum of $|\Gamma_\Lambda|$ for all $\Lambda \subseteq \{\lambda_1, \dots, \lambda_N\}$ containing at least two punctures.. \square

6 - Massive fermions and their bosonization in rough planar domains

6.1 . Notations and basic facts

Given a scale factor δ , we work on the graph or subgraphs of the scaled square lattice rotated by 45° ,

$$\mathbb{C}^\delta := \sqrt{2}e^{\frac{i\pi}{4}} \delta\mathbb{Z}^2.$$

Let us denote by $(\mathbb{C}^\delta)^* = \mathbb{C}^\delta + \delta$ the dual graph of \mathbb{C}^δ . Interested in s-holomorphic functions (belonging to the vast category of discrete complex functions), let us introduce the graph carrying them:

- s-holomorphic functions are defined on the *edges* of \mathbb{C}^δ , which will be denoted by $\mathcal{E}(\mathbb{C}^\delta)$;
- the projections of s-holomorphic functions (fake complex-valued functions) are defined on the vertices of the *corner graph* $\mathcal{C}(\mathbb{C}^\delta) = \frac{1}{2}\mathbb{C}^\delta + \frac{1}{2}$;
- square integrations are defined on the *quad-graph* $\Lambda(\mathbb{C}^\delta) = \mathbb{C}^\delta \cup (\mathbb{C}^\delta)^*$, which is the dual to $\mathcal{C}(\mathbb{C}^\delta)$.

By writing Ω^δ , we mean a closed simply connected polygon domain such that $\partial\Omega^\delta$ is a closed lattice path $\partial\Omega^\delta$ on \mathbb{C}^δ (it is possible that $\partial\Omega^\delta$ is self-touching). From Ω^δ , we obtain a subgraph of \mathbb{C}^δ by taking the intersection of Ω^δ with \mathbb{C}^δ . That is to say, the vertex set, edge set, corner set and its dual are respectively

$$\Gamma(\Omega^\delta) := \Omega^\delta \cap \mathbb{C}^\delta, \Gamma^*(\Omega^\delta) := \Omega^\delta \cap (\mathbb{C}^\delta)^*, \text{ and } \star(\Omega^\delta) := \Omega^\delta \cap \star(\mathbb{C}^\delta) \text{ for } \star = \mathcal{E}, \mathcal{C}, \Lambda.$$

By the boundaries $\partial\Gamma(\Omega^\delta)$, $\partial\Gamma^*(\Omega^\delta)$, $\partial\mathcal{E}(\Omega^\delta)$ and $\partial\mathcal{C}(\Omega^\delta)$, we mean those outside Ω^δ but adjacent to Ω^δ (can be connected to Ω^δ by one edge from their corresponding full-plane graphs).

Remark 6.1.1. Each corner c from $\mathcal{C}(\mathbb{C}^\delta)$ can be identified with a segment connecting a vertex $v(c)$ from the primal graph \mathbb{C}^δ and a vertex $u(c)$ from the dual graph $(\mathbb{C}^\delta)^*$, i.e. an edge of $\Lambda(\mathbb{C}^\delta)$. One can also associate to each corner a complex phase of the projected s-holomorphic functions by setting

$$\tau_c := \zeta \exp\left(-\frac{i}{2} \arg(v(c) - u(c))\right) \text{ with } \zeta = \exp(i\pi/4) \text{ and } \arg(\cdot) \in (-\pi, \pi].$$

We say that a corner $c \in \mathcal{C}(\mathbb{C}^\delta)$ is *incident* to an edge $e \in \mathcal{E}(\mathbb{C}^\delta)$ if it corresponds to an edge of $\Lambda(\mathbb{C}^\delta)$ adjacent to e .

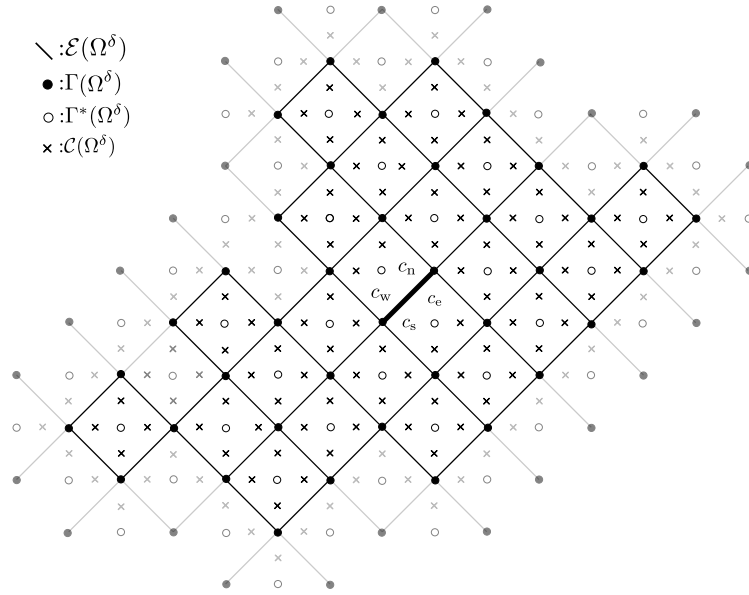

Figure 6.1 – The graph carrying s-holomorphic functions; the bold edge in the graph represents an edge $e \in \mathcal{E}(\Omega^\delta)$, together with the corners surrounding it satisfying (6.1.3).

6.1.1 . Massive s-holomorphicity

In this section, we will introduce and collect some facts about massive s-holomorphic functions without referring to any specific discrete models. The s-holomorphicity criteria for functions on the square lattice relies on the orthogonal projection operator $\text{Proj}_{e^{i\Theta}\mathbb{R}}[x] := \frac{1}{2} [x + e^{2i\Theta}\bar{x}]$, which projects a complex number x to the line $e^{i\Theta}\mathbb{R}$.

Definition 6.1.2. We say that $F : \mathcal{E}(\Omega^\delta) \rightarrow \mathbb{C}$ is massive s-holomorphic at $c \in \mathcal{C}(\mathbb{C}^\delta)$ if

$$e^{-i\Theta}\text{Proj}_{\tau_c e^{i\Theta}} \left[F \left(c - \frac{\delta}{2}\tau_c^{-2} \right) \right] = e^{i\Theta}\text{Proj}_{\tau_c e^{-i\Theta}} \left[F \left(c + \frac{\delta}{2}\tau_c^{-2} \right) \right]. \quad (6.1.1)$$

F is massive s-holomorphic in a domain Ω^δ if it is massive s-holomorphic at all corners inside Ω^δ .

Remark 6.1.3. If the relation (6.1.1) holds at $c \in \mathcal{C}(\Omega^\delta)$, one can extend the function F to c by setting

$$F(c) = e^{-i\Theta}\text{Proj}_{\tau_c e^{i\Theta}} \left[F \left(c - \frac{\delta}{2}\tau_c^{-2} \right) \right].$$

By definition, the value $F(c)$ belongs to the line $\tau_c\mathbb{R}$. Since two distinct projections determine a complex value, we may alternatively consider the values on corners as fundamental and view the existence of suitable edge values satisfying (6.1.1) as precisely the definition of massive s-holomorphicity. Considering instead real values $X(c) := \tau_c^{-1}F(c)$ introduces a natural -1 monodromy around every vertex and

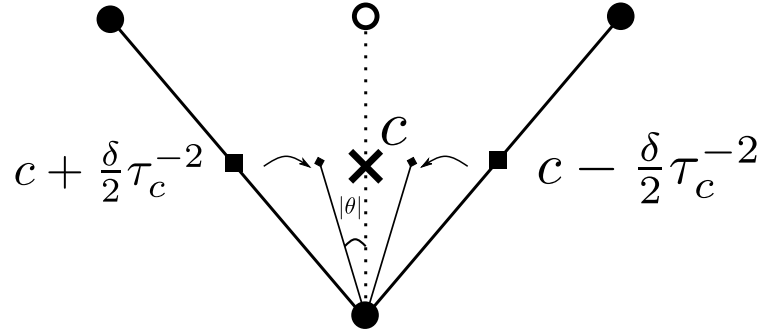

Figure 6.2 – Projection sense in the definition of s-holomorphicity.

face; then (6.1.1) is equivalent to the so-called *propagation equation* (see e.g. [CIM21, (2.6)]).

Massive s-holomorphic functions behave like the continuous massive holomorphic functions, to be introduced in Section 6.2. The crucial tool to study its boundary condition and regularity properties (for both discrete and continuous functions) is by taking the real-valued square integral of them. Given a massive s-holomorphic function F , one can construct locally a function H by setting for adjacent $u \in (\mathbb{C}^\delta)^*$, $v \in \mathbb{C}^\delta$ and $c = (uv)$,

$$H = \text{Im} \int F^2 dz^\delta \text{ satisfying } H(u) - H(v) = 2\delta |F(c)|^2. \quad (6.1.2)$$

It is well-defined locally since around an edge $e \in \mathcal{E}(\mathbb{C}^\delta)$, the values of F evaluated at four adjacent corners defined by (6.1.1), see Figure 6.1, satisfy

$$|F(e)|^2 = |F(c_n)|^2 + |F(c_s)|^2 = |F(c_e)|^2 + |F(c_w)|^2. \quad (6.1.3)$$

Now we present the discrete Riemann-type boundary value problem well adapted to s-holomorphic functions via its square integral. The continuous analogue will be used extensively in Section 6.2 to handle the Riemann boundary value problem for functions on rough domains. It can be also intuitively phrased in terms of boundary phases of the massive s-holomorphic functions, nevertheless this fails in the case of continuous boundary value problems if the domain boundary is not smooth.

Definition 6.1.4. A massive s-holomorphic function F has a discrete (wired) Riemann boundary value at $e \in \partial\mathcal{E}(\Omega^\delta)$ if

$$F(e)\nu_{\text{tan}}(e)^{1/2} \in \mathbb{R}, \quad (6.1.4)$$

where $\nu_{\text{tan}}(e)$ is the (counterclockwise) tangent of Ω^δ at e , i.e. orthogonal direction to e with Ω^δ on the left.

Remark 6.1.5. Note that (6.1.4) implies that the integral of the square $H := \text{Im} \int F^2 dz^\delta$ stays constant across e , i.e. on the two boundary faces in $\partial\Gamma^*(\Omega^\delta)$ having e in the

middle. This may be extended to a whole boundary arc along which F (on edges) has Riemann boundary values.

Accordingly, constant boundary condition for H , in addition to a ‘discrete outer normal derivative’ condition, has been used throughout the literature as an robust form of (6.1.4) for the scaling limit process. We replace the latter part with a pairing with other auxiliary function (see Definition 6.2.5); here we will simply note that the constant boundary condition extends to the pairing $\text{Im} \int F_1 F_2 dz^\delta$ for any two massive s-holomorphic functions F_1, F_2 satisfying (6.1.4).

6.1.2 . Regularity estimates of s-holomorphic functions

We recall the preliminaries in the analysis of massive s-holomorphic functions.

Proposition 6.1.6 ([Par21, Proposition 4.4]). *The integral of the square $H = \text{Im} \int F^2 dz^\delta$ of a massive s-holomorphic function F on Ω^δ satisfies maximum/minimum principles, i.e.*

$$\max_{\Lambda(\Omega^\delta)} H = \max_{\partial\Lambda(\Omega^\delta)} H; \quad \min_{\Lambda(\Omega^\delta)} H = \min_{\partial\Lambda(\Omega^\delta)} H.$$

Near a boundary arc where H is constant thanks to Riemann boundary values, we have a following Hölder continuity up to boundary.

Proposition 6.1.7 ([Par21, Proposition 4.8]). *If $H = \text{Im} \int F^2 dz^\delta$ has constant value (set to 0) on a boundary arc $S^\delta \subset \partial\Gamma^*(\Omega^\delta)$ thanks to Riemann boundary values of a massive s-holomorphic function F , the following estimate holds: for some $\beta > 0$,*

$$|H(z)| \leq \text{const.} \cdot \max_{\partial\Lambda(\Omega^\delta)} |H| \cdot \left(\frac{\text{dist}(z, S^\delta)}{\text{dist}(z, \partial\Gamma^*(\Omega^\delta) \setminus S^\delta)} \right)^\beta, \quad (6.1.5)$$

where $\text{const.} > 0$ depends only on m and the diameter of Ω .

Integral of the square H provides the following estimates for its derivative-square F ; we have the continuum counterpart in Proposition 6.2.2.

Proposition 6.1.8 ([Par21, Proposition 4.6]). *If F is massive holomorphic in a discrete ball $B_r^\delta := B_r \cap \mathbb{C}^\delta$ of radius $r < 1$ and $H = \text{Im} \int F^2 dz^\delta$, the following holds ($\text{osc}_{\Lambda(B_r^\delta)} H := \max_{\Lambda(B_r^\delta)} H - \min_{\Lambda(B_r^\delta)} H$): for $z, z' \in \mathcal{E}(B_{r/2}^\delta)$,*

$$|F(z)| \leq \text{const.} \sqrt{\frac{\text{osc}_{\Lambda(B_r^\delta)} H}{r}}; \quad |F(z) - F(z')| \leq \text{const.} |z - z'| \sqrt{\frac{\text{osc}_{\Lambda(B_r^\delta)} H}{r^3}}, \quad (6.1.6)$$

where $\text{const.} > 0$ depends only on m .

6.2 . Continuous Spinors and Convergence

6.2.1 . Massive holomorphic functions

A (locally Lipschitz continuous) function $f : \Omega \rightarrow \mathbb{C}$ is *massive holomorphic* if

$$\partial_{\bar{z}} f = im\bar{f} \text{ in } \Omega, \quad (6.2.7)$$

in the sense that $\oint_{\partial C} f = 2i \iint_C im\bar{f} d^2z$ for (say) any ball $C \Subset \Omega$. The regularity assumption for f may be relaxed and (6.2.7) may be stated in terms of weak derivatives in local Sobolev spaces, but we note that in any case it turns out that f is locally smooth: see [Par21, Corollary 3.8].

The classical Green-Riemann's theorem implies that the (imaginary part of the) *integral of its square* h may be defined by

$$h(z) := \text{Im} \int_{z_0}^z f^2 dz,$$

whose value is independent of the chosen path from z_0 to z and the choice of the starting point z_0 simply determines a global additive constant. In fact, we may define the integral $g(z) = \text{Im} \int^z f_1 f_2 dz$ of the product of any pair f_1, f_2 of massive holomorphic functions.

As may be verified directly from $\Delta = 4\partial_{\bar{z}}\partial_z$, these real functions have explicit Laplacian

$$\Delta h = 4m|f|^2 = 4m|\nabla h|; \quad \Delta g = 4m \text{Re}(f\bar{g}). \quad (6.2.8)$$

The following *maximum principle* for g is of crucial importance:

Proposition 6.2.1. *Suppose the integral $g(z) = \text{Im} \int^z f_1 f_2 dz$ of the product of massive holomorphic functions f_1, f_2 is continuous up to the boundary of its domain Ω . Then g enjoys the following maximum principle:*

$$\max_{\Omega} g = \max_{\partial\Omega} g; \quad \min_{\Omega} g = \min_{\partial\Omega} g.$$

Equivalently, a comparison principle for the integral of the squares h hold: if two integrals h_1, h_2 satisfy $h_1 \geq h_2$ on $\partial\Omega$, they hold in all of Ω .

Proof. The comparison principle for the integral of the squares h_1, h_2 is proved in [Par21, Lemma 3.6]. For their equivalence simply note that g may be expressed as

$$g(z) = \frac{1}{4} \left[\text{Im} \int^z (f_1 + f_2)^2 dz - \text{Im} \int^z (f_1 - f_2)^2 dz \right].$$

□

We may also consider a conformal map $\varphi : D \rightarrow \Omega$ in order to pullback f onto a smooth bounded domain D (usually fixed to be the unit disk \mathbb{D}). We use the covariance rule

$$f^D(z) := f(\varphi(z)) \cdot (\varphi'(z))^{1/2}, \quad (6.2.9)$$

under which we have $g^D(z) := g \circ \varphi(z) = \text{Im} \int^z f_1^D f_2^D dz$, etc. Consequently, we have

$$m \rightarrow m|\varphi'(z)|,$$

in (6.2.7) and (6.2.8). Note that the $L^2(D)$ -norm of φ' is equal to the area of Ω , and is therefore finite. Therefore f^D satisfies a *Vekua equation* with L^2 mass, for whose analysis we will refer to the extensive treatment of [BBC16].

We close by giving estimates of our massive holomorphic function f , especially in terms of its square integral h . In small scales, massive holomorphic functions (and their pullbacks) satisfy the same estimates as their holomorphic (or harmonic) counterparts, independent of the mass.

Proposition 6.2.2 ([Par21, Proposition 3.9]). *Suppose f is massive holomorphic in the ball B_r of radius $r < 1$ and $h = \text{Im} \int^z f^2 dz$ is its square integral. Then we have $(\text{osc}_{B_r} h := \max_{B_r} h - \min_{B_r} h)$*

$$|f(0)| \leq \text{const.} \sqrt{\frac{\text{osc}_{B_r} h}{r}} \quad (6.2.10)$$

with universal constants.

In addition, $f^D := (f \circ \varphi) \cdot (\varphi')^{1/2}$ satisfies estimates of the same form in its domain of definition.

Proof. The proof of [Par21, Proposition 3.9] also establishes the estimate in terms of the L^2 -norm. Then Koebe distortion (after restricting to a smaller ball) yields the analogous estimate for the domain pullback. \square

6.2.2 . Boundary value problem and uniqueness

This section is devoted to the study of the so-called (continuous) Riemann-Hilbert boundary value problem for massive holomorphic functions f . Naively, this condition says

$$f(z)\nu_{\text{tan}}(z)^{1/2} \in \mathbb{R} \text{ for } z \in \partial\Omega, \quad (6.2.11)$$

where $\nu_{\text{tan}}(z)$ is the (counterclockwise) tangent vector (in \mathbb{C}) to Ω at z . This definition clearly breaks if the boundary $\partial\Omega$ is not smooth or f does not continuously extend to $\partial\Omega$; our need to treat these settings prompts the analysis of this section.

One strategy is to consider $h = \text{Im} \int^z f^2 dz$, in which case (6.2.11) (naively) implies constant boundary value for h . Evidently, this condition is more stable under generalization to non-smooth $\partial\Omega$, and will be used in the scaling limit process. In any case, we need a (possibly stronger) condition which is closed under real linear combinations: the main goal of this section is Proposition 6.2.7, which will be used in the convergence proof of Proposition 6.2.11 to uniquely fix the scaling limit of discrete observables.

As defined above in (6.2.9), We may also consider the pullback f^D onto a smooth bounded domain D . Note that (6.2.11) is preserved under (6.2.9). In particular in the critical case ($m = 0$) the observables are conformally covariant: we may define observables in rough domains simply *by this covariance rule*.

Roughly speaking, what we do is showing that constant boundary condition for h translates to a form of (6.2.11) for f_D ; this was also the viewpoint of [Par21] in dealing with observables coming from the so-called FK-Ising model. However, in contrast to

[Par21] which used specific global properties of those observables, we give a fully local form of the boundary condition which is suitable in more general settings, such as ours. This also eliminates the need for the standard 'outer derivative' condition in distinguishing the wired and free boundary condition.

Nevertheless, these observables coming from the FK representation of the model are crucial in defining this augmented condition. The precise ingredient we need is the following:

Proposition 6.2.3. *For any given simply connected domain Ω and prime ends $a, b \in \partial\Omega$, there exists a massive holomorphic function $f_{FK_{a,b}^m(\Omega)}$ on Ω (the 2-point massive FK-Ising observable with wired boundary condition on (ab) and free boundary condition on (ba)) such that*

$$f_{FK_{a,b}^m(\Omega)}(z) = \exp[s_{FK_{a,b}^m(\Omega)}(z)] \cdot f_{FK_{a,b}^0(\Omega)}(z), \quad (6.2.12)$$

where $f_{FK_{a,b}^0(\Omega)}$ is the critical FK-Ising observable from [CS12, Theorem A] with the same boundary condition, and $s_{FK_{a,b}^m(\Omega)}$ is in the Sobolev space $W_{\mathbb{R}}^{1,2}(\Omega)$ (see below) with purely real trace on $\partial\Omega$.

This observable is uniquely characterized by the fact that its square integral $h_{FK} = \text{Im} \int^z f_{FK}^2 dz$ continuously takes the value 0 on the boundary arc (ab) and 1 on (ba) .

Proof. This is the function defined in [Par21, Definition 5.2]. [Par21, Theorem 1.1] establishes its existence (see also [Par21, Definition 3.4]). \square

Remark 6.2.4. Given that we consider rough domains Ω together with conformal pullback $\varphi : D \rightarrow \Omega$ to smooth domains D , we collect here some easily verified facts related to the pullback procedure defined by (6.2.9).

1. As mentioned before, the critical observable $f_{FK_{a,b}^0(\Omega)}$ is conformally covariant under the transformation (6.2.9). In particular, values on rough domains Ω are transformed to regular (e.g. continuous up to boundary away from $\varphi^{-1}(\{a, b\})$ values).
2. It is easy to see that $s \circ \varphi \in W^{1,2}(D)$ if and only if $s \in W^{1,2}(\Omega)$; so we may define the real trace subspace $W_{\mathbb{R}}^{1,2}(\Omega)$ as the pullback of $W_{\mathbb{R}}^{1,2}(D)$.
3. Accordingly, the pulled-back massive observable $f_{FK_{a,b}^m(\Omega)}^{\mathbb{D}}$ has the factorization analogous to (6.2.12) into the critical observable on the smooth domain D and the exponential of $s_{FK_{a,b}^m(\Omega)}^{\mathbb{D}} := s_{FK_{a,b}^m(\Omega)} \circ \varphi \in W_0^{1,2}(D)$.

Now we give two forms of the Riemann-type boundary condition on a boundary arc $(B_1 B_2) \subset \partial\Omega$. Without loss of generality, we will restrict to a strictly smaller arc $[b_1 b_2] \subset (B_1 B_2)$ where there exist $z_1, z_2 \in \Omega$ and $r > 0$ such that $B_r(z_1), B_r(z_2) \subset \Omega$ and $|z_1 - b_1| = |z_2 - b_2| = r$. Clearly, we may find such arcs around any given prime end in $\partial\Omega$.

Given $(b_1 b_2)$, we cut out a domain $\Omega' \subset \Omega$ which is bounded by $[b_1 b_2]$ and a smooth arc $\gamma = (b_2 z_2) \cup [z_2 z_1] \cup (z_1 b_1) \subset \Omega$, where $(b_2 z_2), (z_1 b_1)$ are straight. Then we may define the FK-observable $f_{FK} := f_{FK_{z_1, z_2}^m(\Omega')}$ on Ω' .

Definition 6.2.5. A massive holomorphic function f on Ω satisfies the (wired) Riemann boundary value problem on $(B_1 B_2)$ if either of the following equivalent conditions holds:

- (h) The integral of the square $h := \operatorname{Im} \int^z f^2 dz$ extends continuously to $(B_1 B_2)$ as a constant. In addition, for each $[b_1 b_2] \subset (B_1 B_2)$ as above, $g := \operatorname{Im} \int^z f f_{FK} dz$ extends continuously to $(b_1 b_2)$ as a constant.
- (f) The pullback to the unit disk $f^{\mathbb{D}}$ defined by (6.2.9) with some fixed $\varphi : \mathbb{D} \rightarrow \Omega'$ satisfies a Hardy space type bound on the concentric circular arcs:

$$\sup_{r < 1} \int_{r[\varphi^{-1}(b_1)\varphi^{-1}(b_2)]} |f^{\mathbb{D}}|^2 |dz| < \infty.$$

The boundary condition (6.2.11) is also satisfied in L^2 sense (or more precisely H^2 sense), i.e.

$$\int_{r[\varphi^{-1}(b_1)\varphi^{-1}(b_2)]} \left| \operatorname{Im} \left[(iz)^{1/2} f^{\mathbb{D}} \right] \right|^2 |dz| \rightarrow 0 \text{ as } r \uparrow 1. \quad (6.2.13)$$

Remark 6.2.6. The comparison principle (Proposition 6.2.1) immediately implies that any massive holomorphic f satisfying Definition 6.2.5(h) along the entire boundary $\partial\Omega$ is identically zero.

In addition, it may be used to derive the following uniform estimate (the constant in the big O notation may depend on the domain) by comparing with h_{FK} , etc.: with boundary constant value set to zero, there is a constant $\beta > 0$ such that

$$h(z) = O(\operatorname{dist}(z, \partial\Omega)^\beta) \text{ for } z \in \Omega' \cup \partial\Omega'. \quad (6.2.14)$$

For functions coming themselves from discrete setting, (the analog of) (6.1.5) directly establishes it.

Proposition 6.2.7. In Definition 6.2.5, the two conditions are equivalent. In particular, Riemann boundary values are preserved under real linear combinations since (f) is.

Proof. The direction (f) \Rightarrow (h) for h in Definition 6.2.5 is rather straightforward to check on \mathbb{D} using the fact that h transforms into $h \circ \varphi$ and massive holomorphic function satisfying Hardy space type bound has non-tangential limit on $\partial\mathbb{D}$ [BBC16, Theorem 5.1].

For the continuous extension of g on $\partial\mathbb{D}$, note that under the assumption f_{FK} satisfies (f) on any subarc $[b'_1 b'_2] \subset \partial\mathbb{D} \setminus \{z_1, z_2\}$, by Remark 6.2.4, in the factorization on \mathbb{D}

$$f_{FK}^{\mathbb{D}}(z) = \exp[s_{FK}^{\mathbb{D}}(z)] \cdot f_{FK}^0_{\varphi^{-1}(b_1), \varphi^{-1}(b_2)}(\mathbb{D})(z),$$

the critical observable extends continuously to $[\varphi^{-1}(b'_1)\varphi^{-1}(b'_2)]$ with boundary values satisfying (6.2.11). Since $s_{FK}^{\mathbb{D}} \in W_{\mathbb{R}}^{1,2}(\mathbb{D})$ has trace on all $L^p(r \cdot \partial\mathbb{D})$ for $p \in (1, \infty)$ with real values for $r = 1$, it is straightforward to check (6.2.13) (e.g. see [BBC16], especially Section 5 and end of Section 2).

The direction (h) \Rightarrow (f) is proved by Park [Par]. □

6.2.3 . Convergence of discrete massive s-holomorphic observables

To present the main convergence statement, we shall need standard massive s-holomorphic functions for which we already have convergence statements. To this end, we assume that $\Theta \sim \frac{m\delta}{2}$ in Definition 6.1.2.

We say that a family of massive s-holomorphic functions F_δ converges locally uniformly to a continuous (massive holomorphic) function f if $|F_\delta - f|$ is uniformly small as $\delta \downarrow 0$ on any compact neighborhood C . We note that a simple sufficient condition for the existence of local uniform subsequential limits is boundedness of its square integral H_δ :

Lemma 6.2.8. *Let $\{F_{\delta_j}\}$ be a sequence of massive s-holomorphic functions on Ω^{δ_j} converging as $\delta_j \downarrow 0$ in Caratheodory sense to $\Omega \subset \mathbb{C}$. Suppose their square integrals $H_{\delta_j} := \text{Im} \int F_{\delta_j}^2 dz^\delta$ is uniformly bounded: $\sup_j \max_{\Lambda(\Omega^{\delta_j})} |H_{\delta_j}| < \infty$.*

Then there is a subsequence $\delta_{j_k} \downarrow 0$ such that $F_{\delta_{j_k}}$ converges locally uniformly to a massive holomorphic function f on Ω .

Proof. Note that, by (6.1.6) and applying Arzelà-Ascoli on (say) piecewise linear extensions of F_{δ_j} restricted to edges, we may establish a uniform subsequential limit for any compact subdomain of Ω . Then the theorem follows by considering a sequence of growing compact subdomains which exhaust Ω .

By [Par21, Lemma A.2], such limit of massive s-holomorphic functions is massive holomorphic. \square

We first introduce the massive s-holomorphic function on the full plane \mathbb{C}^δ which has a single $1/z$ -type singularity and decays (exponentially) at infinity. It is a discrete and massive analog of the Cauchy kernel $1/(z - c)$, and it has an explicit scaling limit in terms of the *modified Bessel functions of the second kind* K_0, K_1 (cf. e.g. [DLMF, Section 10.25]).

Recall from Definition 6.1.2 that a corner c has an associated phase τ_c .

Proposition 6.2.9. *Given a corner $c \in \mathcal{C}(\mathbb{C}^\delta)$ there is a function $F_{(c)}$ on $\mathcal{E}(\mathbb{C}^\delta) \cup \mathcal{C}(\mathbb{C}^\delta)$ such that:*

- massive s-holomorphicity relation (6.1.1) holds on $\mathcal{C}(\mathbb{C}^\delta) \setminus \{c\}$;
- at c , $e^{i\Theta} \text{Proj}_{\tau_c e^{-i\Theta}} [F(c + \frac{\delta}{2} \tau_c^{-2})] = -e^{-i\Theta} \text{Proj}_{\tau_c e^{i\Theta}} [F(c - \frac{\delta}{2} \tau_c^{-2})] = \delta^{-1} \tau_c$.

If a sequence of corners $c^\delta \rightarrow c$ with fixed $\tau_{c^\delta} =: \tau_c$ and $\Theta \sim \frac{m\delta}{2}$, $F_{(c^\delta)}$ converges locally uniformly, away from c and ∞ , to the massive holomorphic (or rather meromorphic) function

$$f_{(c)}(z) := \frac{1}{\pi} [4\overline{\tau_c} |m| e^{-i \arg z} K_1(2|mz|) - 4i\tau_c m K_0(2|mz|)].$$

In particular, near c , $f_{(c)}(z) \sim \frac{2}{\pi} \frac{\overline{\tau_c}}{z-c}$.

Proof. See [CIM21, Proposition 5.8] and [CIM21, (5.30)]. The fact that real data on corners satisfying these two conditions is equivalent to a massive s-holomorphic function has been discussed under Definition 6.1.2. \square

Now we introduce the *discrete FK-Ising observables*, which encode probabilistic information about the FK-Ising model but utilized here primarily as a family of auxiliary discrete functions used to establish the condition Definition 6.2.5(h). Instead of our usual setup where the boundary of the discrete domain Ω^δ is composed of boundary faces (on which Ising plus boundary condition is imposed), consider discrete domains Ω'^δ which has two boundary segments, *wired* ($a^\delta b^\delta$) composed of boundary faces (i.e. as in our original domain Ω^δ) and *free* ($b^\delta a^\delta$) of boundary vertices (that is, a^δ, b^δ are *boundary corners* and the two segments run between the incident faces and vertices to these corners; see [Par21, Section 1.1] for a precise definition).

Lemma 6.2.10 ([Par21, Theorem 1.1]). *There is a massive s-holomorphic discrete function $F_{FK_{a^\delta, b^\delta}}$ on Ω'^δ characterized by the fact that its integral of the square $H_{FK_{a^\delta, b^\delta}}$ satisfies (after a choice of the additive constant):*

$$H_{FK_{a^\delta, b^\delta}} = \begin{cases} 0 & \text{on boundary faces on } (a^\delta b^\delta); \\ 1 & \text{on boundary vertices on } (b^\delta a^\delta), \end{cases}$$

and $0 \leq H_{FK_{a^\delta, b^\delta}} \leq 1$ globally. In particular, it satisfies the discrete Riemann boundary value problem on $(a^\delta b^\delta)$.

If $\Omega'^\delta \rightarrow \Omega'$ and $(a^\delta, b^\delta) \rightarrow (a, b)$ in Caratheodory sense as $\delta \downarrow 0$, $F_{FK_{a^\delta, b^\delta}} \rightarrow f_{FK_{a, b}}^m$ locally uniformly in Ω' .

We now show convergence of discrete massive s-holomorphic observables to continuous massive holomorphic functions. To elaborate, we show that discrete observables satisfying the discrete Riemann boundary value problem converge to continuous functions satisfying the continuous version of the problem.

We adopt the usual strategy of showing precompactness of the discrete functions then uniqueness of the subsequential limit, the latter following directly from the boundary condition thanks to the analysis of the previous section.

Given a simply connected domain Ω^δ and a corner c^δ , we consider massive s-holomorphic functions F_{Ω^δ} satisfying the two conditions

- (1) F_{Ω^δ} satisfies discrete Riemann boundary value problem on the boundary of Ω^δ ;
 - (2) $F_{\Omega^\delta} - F_{(c^\delta)}$ is massive s-holomorphic in Ω^δ .
- (6.2.15)

The uniqueness (which we do not need) of such function is easy to see by square integration (see Remark 6.1.5); existence follows from explicit constructions from the Ising and dimer models in the next section, which also clarifies its physical significance.

Proposition 6.2.11. *If $\Omega^\delta \rightarrow \Omega$ in Caratheodory sense, $c^\delta \rightarrow c$ as $\delta \downarrow 0$, $F_{\Omega^\delta} - F_{(c^\delta)} \rightarrow f_\Omega - f_c$ locally uniformly in Ω , where f_Ω is the unique (continuous) function in Ω which satisfies:*

- f_Ω satisfies Riemann boundary value problem on the boundary of Ω ;
- $f_\Omega - f_{(c)}$ is massive s-holomorphic in Ω .

In particular, $F_{\Omega^\delta} \rightarrow f_\Omega$ locally uniformly away from c .

Proof. We first claim that $\{F_{\Omega^\delta}\}_\delta$ is precompact in $\Omega \setminus \{c\}$, i.e. exhibit a subsequential limit. Consider the integral of the square H_{Ω^δ} , whose constant boundary value is set to zero. Suppose for contradiction that on the discrete circle $S_r^\delta := \Omega^\delta \cap (B_{r+4\delta}(c^\delta) \setminus B_{r-4\delta}(c^\delta))$ of small enough radius $r > 0$ the square integral blows up, i.e. $M_\delta := \max_{S_r^\delta} |H_{\Omega^\delta}| \rightarrow \infty$ along some sequence of $\delta \downarrow 0$.

Then renormalize $\tilde{F}_{\Omega^\delta} := (M_\delta)^{-1/2} F_{\Omega^\delta}$, i.e. set $\max_{S_r^\delta} |\tilde{H}_{\Omega^\delta}| = 1$. By the maximum principle (Proposition 6.1.6) this bounds $\tilde{H}_{\Omega^\delta}$ in $\Omega^\delta \setminus B_{r-4\delta}(c^\delta)$. In particular, by (6.1.6), away from B_r^δ and $\partial\Omega^\delta$, $\tilde{F}_{\Omega^\delta}$ is bounded.

Consider this time $\tilde{F}_{\Omega^\delta}^\dagger = (M_\delta)^{-1/2} (F_{\Omega^\delta} - F_{(c^\delta)})$ and its square integral $\tilde{H}_{\Omega^\delta}^\dagger$. From bulk boundedness of $\tilde{F}_{\Omega^\delta}$, Proposition 6.2.9 and $M_\delta \xrightarrow{\delta \downarrow 0} \infty$, it is easy to see that $\tilde{H}_{\Omega^\delta}^\dagger - \tilde{H}_{\Omega^\delta} \xrightarrow{\delta \downarrow 0} 0$ uniformly on S_{2r}^δ (since $(M_\delta)^{-1/2} F_{(c^\delta)} \xrightarrow{\delta \downarrow 0} 0$ away from c). In particular, $\max_{S_{2r}^\delta} |\tilde{H}_{\Omega^\delta}^\dagger|$ is bounded away from ∞ .

Therefore, $\tilde{H}_{\Omega^\delta}$ is bounded in $\Omega^\delta \setminus B_{r-4\delta}(c^\delta)$ and $\tilde{H}_{\Omega^\delta}^\dagger$ is bounded in $\Omega^\delta \cap B_{2r-4\delta}$. Using Lemma 6.2.8, we can extract a subsequential limit \tilde{f}_Ω on Ω such that

- (1) $\tilde{F}_{\Omega^\delta} \rightarrow \tilde{f}_\Omega$ locally uniformly in $\Omega \setminus B_r(c)$;
- (2) $\tilde{F}_{\Omega^\delta}^\dagger \rightarrow \tilde{f}_\Omega$ locally uniformly in $B_{2r}(c)$.

Also note from (6.1.5) the uniform a priori bound

$$\tilde{H}_{\Omega^\delta}(z) = O(\text{dist}(z, \partial\Omega^\delta)^\beta) \text{ in } \Omega^\delta \setminus B_{r-4\delta}(c^\delta). \quad (6.2.16)$$

Then \tilde{f}_Ω is a massive holomorphic function on Ω whose square integral (approximating continuum line integral by discrete line integrals) $\tilde{h} := \text{Im} \int^z f^2 dz$ extends continuously to $\partial\Omega$ by zero; this contradicts $\max_{S_r^\delta} |\tilde{H}_{\Omega^\delta}| = 1$ by the maximum principle.

Therefore, M_δ stays bounded away from ∞ . This means that we may repeat the above argument, not with the renormalized function $\tilde{F}_{\Omega^\delta}$ but with the original F_{Ω^δ} . This yields almost the same result, except that the term $F_{(c^\delta)}$ survives: there is a subsequential limit f_Ω such that

- $F_{\Omega^\delta} \rightarrow f_\Omega$ locally uniformly in $\Omega \setminus B_r(c)$,
- $F_{\Omega^\delta} - F_{(c^\delta)} \rightarrow f_\Omega - f_{(c)}$ locally uniformly $B_{2r}(c)$.

Since we already know $F_{(c^\delta)}$ converges locally uniformly away from c , we have the desired modes of convergence along subsequences.

It remains to check the boundary condition **(h)** in Definition 6.2.5 to show uniqueness of the limit and therefore convergence. In fact, suppose that there are two such limits f_Ω and \tilde{f}_Ω , then the linearity of the Riemann boundary value condition implies that $f_\Omega - \tilde{f}_\Omega$ is s-holomorphic in Ω , satisfying the Riemann boundary value problem. It should be identically zero due to Remark 6.2.6. For the Dirichlet boundary value of h_Ω , we already have (6.2.16) and it survives when passing to the limit.

On the other side, suppose a subdomain Ω' and b_1, b_2, z_1, z_2 as in Definition 6.2.5(**h**) is chosen. Define discretizations Ω'^δ , etc. using restriction from Ω^δ such that the boundary segment $(z_1^\delta z_2^\delta)$ is wired and $(z_2^\delta z_1^\delta)$ is free as in Lemma 6.2.10. Consider the FK observable $F_{\text{FK}} := F_{\text{FK}_{z_1^\delta, z_2^\delta}}$, which converges locally uniformly to $f_{\text{FK}} = f_{\text{FK}_{z_1, z_2}}^m$ in Ω' .

In addition, the discrete integral $G_{\Omega^\delta} := \text{Im} \int F_{\Omega^\delta} F_{\text{FK}} dz^\delta$ has constant boundary condition along b_1^δ, b_2^δ . For strict subintervals $[b_1' b_2'] \subset (b_1 b_2)$, estimates of type (6.2.16) for $H_{\Omega^\delta}, H_{\text{FK}}$ yield

$$F_{\Omega^\delta}(z), F_{\text{FK}}(z) = O(\text{dist}(z, [b_1' b_2']^{-1/2+\beta/2}).$$

So we may derive $G_{\Omega^\delta}(z) = O(\text{dist}(z, [b_1' b_2']^\beta)$, which survives for the continuum g_Ω . This completes the verification of (**h**) in Definition 6.2.5. \square

6.3 . From fermionic observables to energy densities and dimer height fluctuations

In this section we use the convergence of fermionic observables discussed above to prove the convergence of energy density correlations in the Ising model on Ω^δ in the near-critical regime and those of the gradients of the height fluctuations in the dimer model on a particular class of weighted graphs, see Remark 6.3.2.

The planar Ising model without external magnetic field for spins on faces of the square grid is defined by associating to each configuration $(\sigma_u)_{u \in \Gamma^*(\Omega^\delta)}$ a weight $\prod_{e \in \mathcal{E}(\Omega^\delta)} x^{-\xi(e)}$ with $\xi(e) := \sigma_{e_+} \sigma_{e_-}$ being the product of two nearby spins of e for some Ising interaction factor $x = \exp(-\beta J) \in (0, 1)$, such that the probability measure on the set of spin configurations is proportional to their weights. We rely upon the Definitions 2.5.1 and 2.5.5 of fermionic observables in the Ising model through the Kadanoff-Ceva spin-disorder formalism (we refer readers to [CCK17] for more details, and also [Che20b] as notations therein coincide). Generally speaking, it consists in associating a "disorder" variable to $v \in \Gamma(\Omega^\delta)$ which amounts to applying the Kramers-Wannier transformation to the Ising spin variable.

Given $d \in \mathcal{C}(\Omega)$, the real-valued correlation function $X(c) := \langle \chi_c \chi_d \rangle$ branches (gaining a -1 factor when making a loop) around all vertices of both $\Gamma(\Omega^\delta)$ and $\Gamma^*(\Omega^\delta)$ except $v(d), u(d)$, making it sophisticated for tracking and making sense of its scaling limit. Note that the square root of the corner vector, known under the name Dirac spinor and defined as

$$\eta_c := \exp(i\pi/4) \exp\left(-\frac{i}{2} \arg(v(c) - u(c))\right),$$

branches over *all* vertices of $\Gamma(\Omega^\delta), \Gamma^*(\Omega^\delta)$ (the phase τ_c at a corner c in Remark 6.1.1 is nothing but a representative of η_c by fixing the sign). Therefore, the complex-valued product

$$F(c) = \eta_c X(c), \quad X(c) = \langle \chi_c \chi_d \rangle \tag{6.3.17}$$

branches over $v(d)$ and $u(d)$ only. Following trigonometric calculations based upon the propagation equation discussed in (2.5.2), $F(c)$ is s-holomorphic on $\mathcal{C}(\Omega^\delta) \setminus \{d\}$.

In the following, we consider the Ising model with wired boundary condition, which is to say that the sign of the spins located at the outer face (which is unique because Ω^δ is simply connected) have the same value. Clearly $\bar{\eta}_a F(a) = \bar{\eta}_b F(b)$ for $a, b \in \partial\mathcal{C}(\Omega^\delta)$ if $v(a) = v(b)$ and the signs of η_a and η_b are taken by rotating a towards b around $v(a) = v(b)$ outside Ω^δ (since spins located near a, b satisfy $\sigma_{u(a)} = \sigma_{u(b)}$). One can check without difficulty that the boundary values of F on $\partial\mathcal{C}(\Omega^\delta)$ satisfy Definition 6.1.4.

Let us send the square of the interaction parameter x of the Ising model to $\sqrt{2}-1$ such that in the propagation equation (2.5.2) which (6.3.17) satisfies, $\theta - \pi/4 = 2 \arctan(x^2) - \pi/4 \sim m\delta/2$. The fermionic observable (6.3.17) satisfies the conditions (6.2.15), and in this regime, it converges to the limit given in Proposition 6.2.11 when $\delta \rightarrow 0$.

Following notations for continuous fermionic observables as in [CHI21], denote by $f_\Omega^{[\eta]}(a, z)$ the unique massive holomorphic function on $\Omega \setminus \{a\}$ with Riemann boundary values on $\partial\Omega$ such that

$$f_\Omega^{[\eta]}(a, z) \sim \frac{\bar{\eta}}{z-a} \text{ as } z \rightarrow a.$$

Set up accordingly the notation $f^{[\eta]}(a, z) = \frac{1}{2}(\bar{\eta} \cdot f(a, z) + \eta f^*(a, z))$ (here we rely upon the real linearity of $f^{[\eta]}$ with respect to η) and

$$\begin{aligned} \langle \psi_{z_2} \psi_{z_1} \rangle &:= f(z_1, z_2), & \langle \psi_{z_2} \psi_{z_1}^* \rangle &:= f^*(z_1, z_2), \\ \langle \psi_{z_2}^* \psi_{z_1}^* \rangle &:= \overline{f(z_1, z_2)}, & \langle \psi_{z_2}^* \psi_{z_1} \rangle &:= \overline{f^*(z_1, z_2)}. \end{aligned}$$

The same analysis as in [CHI21] for the critical Ising model (see also Remark 1.4(i) and the discussion at the end of Section 3.6 in [CCK17]) allows us to deduce from Proposition 6.2.11 the following:

Theorem 6.3.1 (Convergence of energy densities in the massive Ising model). *Define the energy density at an edge $e \in \mathcal{E}(\Omega^\delta)$ as $\varepsilon_e = \sqrt{2}\sigma_{e_+}\sigma_{e_-} - 1$, where e_+ and e_- are two faces adjacent to e . Then,*

$$\delta^{-n} \cdot \mathbb{E}[\varepsilon_{z_1} \dots \varepsilon_{z_n}] \rightarrow \left(\frac{i}{\pi}\right)^n \langle \psi_{z_1} \psi_{z_1}^* \dots \psi_{z_n} \psi_{z_n}^* \rangle = \left(\frac{i}{\pi}\right)^n \cdot \text{Pf}[A_{ij}]_{i,j=1}^{2n}$$

as $\delta \rightarrow 0$, where the (i, j) -entries, $i \neq j$, of the antisymmetric matrix

$$A_{ij} = \begin{cases} \langle \psi_{z_k} \psi_{z_l} \rangle & \text{if } i = 2k - 1 \quad \text{and } j = 2l - 1; \\ \langle \psi_{z_k} \psi_{z_l}^* \rangle & \text{if } i = 2k - 1 \quad \text{and } j = 2l; \\ \langle \psi_{z_k}^* \psi_{z_l} \rangle & \text{if } i = 2k \quad \text{and } j = 2l - 1; \\ \langle \psi_{z_k} \psi_{z_l} \rangle & \text{if } i = 2k \quad \text{and } j = 2l \end{cases}$$

are the corresponding two-point fermionic correlators defined above.

The second corollary of Proposition 6.2.11 is the convergence of the gradients of the fluctuations of height functions associated with dimer configurations introduced in Section 2.5. One can deduce this result via the classical arguments of Kenyon [Ken00, Proposition 20] following the identification of the inverse Kasteleyn matrix of the massive dimer model on hedgehog domains and the fermionic observable (2.5.7).

Remark 6.3.2. Recall that the edge weights on the square grid alternate between $\cos \theta$ and $\sin \theta$ along vertical and horizontal lines with $\theta = 2 \arctan(x)$; the edges along convex boundary angles or opposite to concave boundary angles are with weight $\cos \theta$.

Theorem 6.3.3 (Convergence of height gradients field correlations in the massive dimer model on hedgehog domains). *The correlations of two-step increments of the height function fluctuations*

$$\mathbb{E}[\mathrm{d}h^\delta(z_1) \dots \mathrm{d}h^\delta(z_n)]$$

converge uniformly on all compact subsets of Ω to

$$(1/4i\pi)^n \cdot \sum_{s_1, \dots, s_n \in \{\pm\}} \det[\mathbf{1}_{j \neq k} f^{[s_j, s_k]}(z_j, z_k)]_{j, k=1}^n \prod_{k=1}^n \mathrm{d}z_k^{[s_k]},$$

where $f^{[++]}(z_j, z_k) = \overline{f^{[--]}(z_j, z_k)} := \langle \psi_{z_k} \psi_{z_j} \rangle \sim 2/(z_k - z_j)$ and $f^{[-+]}(z_j, z_k) = \overline{f^{[+-]}(z_j, z_k)} := \langle \psi_{z_k} \psi_{z_j}^* \rangle$ are the fermionic correlators as in the massive Ising model.

Remark 6.3.4. In a recent work [BW21], Bauerschmidt and Webb have rigorously shown that the fermions correlations equal the truncated correlation function of the gradient fields associated with the infinite-volume limit of the sine-Gordon model (non-Gaussian) on the plane, known as bosonization. Our result provides an example of bosonization in finite domains, where the bosonic theory describes the limit of height fluctuations of the massive dimer model. In particular, this sheds light on an observation of Chhita [Chh12] that the height fluctuations for massive dimer models are not Gaussian.

Bibliography

- [AB99] Michael Aizenman and Almut Burchard. Hölder regularity and dimension bounds for random curves. *Duke Math. J.*, 99(3):419–453, 1999.
- [Ahl] Lars Ahlfors. *Lectures on Quasiconformal Mappings*.
- [AKE20] Karrila Alex, Kytölä Kalle, and Peltola Eveliina. Boundary correlations in planar LERW and UST. *Comm. Math. Phys.*, 376(3):2065–2145, 2020.
- [Ald91] David Aldous. The continuum random tree II: an overview. *Stoch. anal.*, 167:23–70, 1991.
- [AS21] Morris Ang and Xin Sun. Integrability of the conformal loop ensemble, 2021.
- [ASS18] Amine Asselah, Bruno Schapira, and Perla Sousi. Capacity of the range of random walk on \mathbb{Z}^d . *Trans. Am. Math. Soc.*, 370(11):7627–7645, 2018.
- [ASS19] Amine Asselah, Bruno Schapira, and Perla Sousi. Capacity of the range of random walk on \mathbb{Z}^4 . *Ann. Probab.*, 47(3):1447–1497, 2019.
- [BBC09] Michel Bauer, Denis Bernard, and Luigi Cantini. Off-critical SLE(2) and SLE(4): a field theory approach. *J. Stat. Mech. Theory Exp.*, 2009:P07037, 2009.
- [BBC16] Laurent Baratchart, Alexander Borichev, and Slah Chaabi. Pseudo-holomorphic functions at the critical exponent. *J. Eur. Math. Soc.*, 18(9):1919–1960, 2016.
- [BBK08] Michel Bauer, Denis Bernard, and Kalle Kytölä. LERW as an example of off-critical SLEs. *J. Stat. Phys.*, 132(4):721–754, 2008.
- [BC21] Mikhail Basok and Dmitry Chelkak. Tau-functions à la Dubédat and probabilities of cylindrical events for double-dimers and CLE(4). *J. Eur. Math. Soc.*, Electronically published on 2021.
- [BDCH16] Stéphane Benoist, Hugo Duminil-Copin, and Clément Hongler. Conformal invariance of crossing probabilities for the Ising model with free boundary conditions. *Annales de l’Institut Henri Poincaré, Probabilités et Statistiques*, 52(4):1784 – 1798, 2016.
- [BdT10] Cédric Boutillier and Béatrice de Tilière. The critical Z-invariant Ising model via dimers: the periodic case. *Probab. Theory Relat. Fields*, 147:379–413, 2010.
- [BdT11] C. Boutillier and B de Tilière. The critical Z-invariant Ising model via dimers: locality property. *Comm. Math. Phys.*, 301(2):473–516, 2011.
- [Bef08] Vincent Beffara. The dimension of the SLE curves. *The Annals of Probability*, 36(4):1421 – 1452, 2008.
- [BH19] Stéphane Benoist and Clément Hongler. The scaling limit of critical ising interfaces is cle(3). *Ann. Probab.*, 47(4):2049–2086, 2019.
- [BLR20] Nathanaël Berestycki, Benoît Laslier, and Gourab Ray. Dimers and imaginary geometry. *The Annals of Probability*, 48(1):1 – 52, 2020.

- [BN16] Nathanael Berestycki and James Norris. Lectures on Schramm–Loewner Evolution. <http://www.statslab.cam.ac.uk/~james/Lectures/sle.pdf>, 2016.
- [BPZ84a] A.A. Belavin, A.M. Polyakov, and A.B. Zamolodchikov. Infinite conformal symmetry in two-dimensional quantum field theory. *Nuclear Physics B*, 241(2):333–380, 1984.
- [BPZ84b] A.A. Belavin, A.M. Polyakov, and A.B. Zamolodchikov. Infinite conformal symmetry of critical fluctuations in two dimensions. *J. Stat. Phys.*, 34(2):763–774, 1984.
- [BW21] Roland Bauerschmidt and Christian Webb. The coleman correspondence at the free fermion point. *J. Eur. Math. Soc.*, 2021. to appear.
- [CCK17] Dmitry Chelkak, David Cimasoni, and Adrien Kassel. Revisiting the combinatorics of the 2D Ising model. *Ann. Inst. Henri Poincaré D*, 4(3):309–385, 2017.
- [CDCH⁺14] Dmitry Chelkak, Hugo Duminil-Copin, Clément Hongler, Antti Kemppainen, , and Stanislav Smirnov. Convergence of ising interfaces to schramm’s sle curves. *C. R. Acad. Sci. Paris Sér. I Math.*, 352(2):157–161, 2014.
- [CGN15] Federico Camia, Christophe Garban, and Charles M. Newman. Planar Ising magnetization field I. Uniqueness of the critical scaling limit. *The Annals of Probability*, 43(2):528 – 571, 2015.
- [CGN16] Federico Camia, Christophe Garban, and Charles M. Newman. Planar Ising magnetization field II. Properties of the critical and near-critical scaling limits. *Annales de l’Institut Henri Poincaré, Probabilités et Statistiques*, 52(1):146 – 161, 2016.
- [Cha17] Yinshan Chang. Two observations on the capacity of the range of simple random walks on \mathbb{Z}^3 and \mathbb{Z}^4 . *Electron. Commun. Probab.*, 22:25, 2017.
- [Che16] Dmitry Chelkak. Robust discrete complex analysis: a toolbox. *Ann. Probab.*, 44(1):628–683, 2016.
- [Che20a] Dmitry Chelkak. Ising model and s-embeddings of planar graphs. *arXiv e-prints*, 2020.
- [Che20b] Dmitry Chelkak. Ising model and s-embeddings of planar graphs, 2020.
- [Chh12] Sunil Chhita. The height fluctuations of an off-critical dimer model on the square grid. *J. Stat. Phys.*, 148:67–88, 2012.
- [CHI15] Dmitry Chelkak, Clément Hongler, and Konstantin Izyurov. Conformal invariance of spin correlations in the planar ising model. *Annals of Mathematics*, 181(3):1087–1138, 2015.
- [CHI21] Dmitry Chelkak, Clément Hongler, and Konstantin Izyurov. Correlations of primary fields in the critical Ising model, 2021.
- [CHM19] Dmitry Chelkak, Clément Hongler, and Rémy Mahfouf. Magnetization in the zig-zag layered Ising model and orthogonal polynomials, 2019.
- [CIM21] Dmitry Chelkak, Konstantin Izyurov, and Rémy Mahfouf. Universality of spin correlations in the Ising model on isoradial graphs. *Ann. Probab.*, 2021. to appear.

- [CJN20] Federico Camia, Jianping Jiang, and Charles M. Newman. Exponential decay for the near-critical scaling limit of the planar Ising model. *Communications on Pure and Applied Mathematics*, 73(7):1371–1405, 2020.
- [CLR20] Dmitry Chelkak, Benoît Laslier, and Marianna Russkikh. Dimer model and holomorphic functions on t -embeddings of planar graphs, 2020.
- [CLR21] Dmitry Chelkak, Benoît Laslier, and Marianna Russkikh. Bipartite dimer model: perfect t -embeddings and Lorentz-minimal surfaces, 2021.
- [CN06] Federico Camia and Charles M. Newman. Two-dimensional critical percolation: The full scaling limit. *Commun. Math. Phys.*, 268:1–38, 2006.
- [CR20] Dmitry Chelkak and Sanjay Ramassamy. Fluctuations in the Aztec diamonds via a Lorentz-minimal surface, 2020.
- [CS11] Dmitry Chelkak and Stanislav Smirnov. Discrete complex analysis on isoradial graphs. *Adv. Math.*, 228(3):1590–1630, 2011.
- [CS12] Dmitry Chelkak and Stanislav Smirnov. Universality in the 2D Ising model and conformal invariance of fermionic observables. *Invent. Math.*, 189:515–580, 2012.
- [CW21] Dmitry Chelkak and Yijun Wan. On the convergence of massive loop-erased random walks to massive SLE(2) curves. *Electronic Journal of Probability*, 26(none):1–35, 2021.
- [DCKK⁺20] Hugo Duminil-Copin, Karol Kajetan Kozłowski, Dmitry Krachun, Ioan Manolescu, and Mendes Oulamara. Rotational invariance in critical planar lattice models, 2020.
- [DCS12] Hugo Duminil-Copin and Stanislav Smirnov. Conformal invariance of lattice models. *Probability and statistical physics in two and more dimensions*, 15:213–276, 2012.
- [DD83] Viktor S. Dotsenko and Vladimir S. Dotsenko. Critical behaviour of the phase transition in the 2D Ising Model with impurities. *Adv. in Phys.*, 32(2):129–172, 1983.
- [DE51] Aryeh Dvoretzky and Paul Erdős. Some problems on random walk in space. In *Proc. 2nd Berkeley Symp.*, pages 353–367, 1951.
- [DLMF] *NIST Digital Library of Mathematical Functions*. <http://dlmf.nist.gov/>, Release 1.1.5 of 2022-03-15. F. W. J. Olver, A. B. Olde Daalhuis, D. W. Lozier, B. I. Schneider, R. F. Boisvert, C. W. Clark, B. R. Miller, B. V. Saunders, H. S. Cohl, and M. A. McClain, eds.
- [Dub07] Julien Dubédat. Commutation relations for Schramm-Loewner evolutions. *Comm. Pure Appl. Math.*, 60(12):1792–1847, 2007.
- [Dub15] Julien Dubédat. Dimers and families of Cauchy-Riemann operators I. *Journal of the American Mathematical Society*, 28(4):1063–1167, 2015.
- [Dub19] Julien Dubédat. Double dimers, conformal loop ensembles and isomonodromic deformations. *J. Eur. Math. Soc.*, 21(1):1–54, 2019.

- [Dwa69] M. Dwass. The total progeny in a branching process and a related random walk. *J. Appl. Probab.*, 6:682–686, 1969.
- [Ein89] Uwe Einmahl. Extensions of results of Komlós, Major, and Tusnády to the multivariate case. *J. Multivariate Anal.*, 28(1):20–68, 1989.
- [FL] Toninelli Fabio Lucio. Lectures on the dimer model. http://math.univ-lyon1.fr/homes-www/toninelli/noteDimeri_latest.pdf.
- [FN71] Dao Kh. Fuk and Sergey V. Nagaev. Probability inequalities for sums of independent random variables. *Theory Probab. Its Appl.*, 16(4):643–660, 1971.
- [HK13] Clément Hongler and Kalle Kytölä. Ising interfaces and free boundary conditions. *J. Amer. Math. Soc.*, 26(4):1107–1189, 2013.
- [HS01] Clément Hongler and Stanislav Smirnov. Critical percolation: the expected number of clusters in a rectangle. *Probab. Theory Related Fields*, 151(3-4):735–756, 2001.
- [HS13] Clément Hongler and Stanislav Smirnov. The energy density in the planar Ising model. *Acta Mathematica*, 211(2):191 – 225, 2013.
- [Isi25] Ernest Ising. Beitrag zur theorie des ferromagnetismus. *Z. Physik*, 31:253–258, 1925.
- [Izy17] Konstantin Izyurov. Critical Ising interfaces in multiply-connected domains. *Probab. Theory Related Fields*, 167(1-2):379–415, 2017.
- [JO68] Naresh Jain and Steven Orey. On the range of random walk. *Israel J. Math.*, 6(4):373–380, 1968.
- [JP71] Naresh C. Jain and William E. Pruitt. The range of transient random walk. *J. Anal. Math.*, 24:369–393, 1971.
- [Kar18] Alex Karrila. Limits of conformal images and conformal images of limits for planar random curves. *arXiv e-prints*, 2018.
- [Kar20] Alex Karrila. UST branches, martingales, and multiple SLE(2). *arXiv e-prints*, 2020.
- [KC71] Leo P. Kadanoff and Horacio Ceva. Determination of an operator algebra for the two-dimensional Ising model. *Phys. Rev. B*, 3:3918–3939, Jun 1971.
- [Kem17] Antti Kemppainen. Schramm-Loewner evolution. volume 24 of *SpringerBriefs in Mathematical Physics*. 2017.
- [Ken00] Richard Kenyon. Conformal invariance of domino tiling. *The Annals of Probability*, 28(2):759 – 795, 2000.
- [Ken01] Richard Kenyon. Dominos and the Gaussian Free Field. *The Annals of Probability*, 29(3):1128 – 1137, 2001.
- [Ken14] Richard Kenyon. Conformal invariance of loops in the double-dimer model. *Commun. Math. Phys.*, 326:477–497, 2014.

- [KL05] Michael Kozdron and Gregory Lawler. Estimates of random walk exit probabilities and application to loop-erased random walk. *Electron. J. Probab.*, 10:1442–1467, 2005.
- [KLRR18] Richard Kenyon, Wai Yeung Lam, Sanjay Ramassamy, and Marianna Russkikh. Dimers and circle patterns. *Ann. Sci. Éc. Norm. Supér.*, 2018. to appear.
- [KS16] Antti Kemppainen and Stanislav Smirnov. Conformal invariance in random cluster models. II. full scaling limit as a branching SLE. *arXiv e-prints*, 2016.
- [KS17] Antti Kemppainen and Stanislav Smirnov. Random curves, scaling limits and Loewner evolutions. *The Annals of Probability*, 45(2):698 – 779, 2017.
- [KS18] Antti Kemppainen and Stanislav Smirnov. Configurations of FK Ising interfaces and hypergeometric SLE. *Math. Res. Lett.*, 25(3):875–889, 2018.
- [Law80] Gregory F. Lawler. A self-avoiding random walk. *Duke Mathematical Journal*, 47:655–694, 1980.
- [Law05] Gregory F. Lawler. Conformally invariant processes in the plane. volume 114 of *Mathematical Surveys and Monographs*. 2005.
- [Law13] Gregory F. Lawler. *Intersections of random walks*. 2013.
- [LG86] Jean-François Le Gall. Propriétés d’intersection des marches aléatoires. I: Convergence vers le temps local d’intersection. *Commun. Math. Phys.*, 104:471–507, 1986.
- [LG13] Jean-François Le Gall. Mouvement brownien, martingales et calcul stochastique. volume 71 of *Mathématiques & Applications (Berlin) [Mathematics & Applications]*. Springer, Heidelberg, 2013.
- [LGL15a] Jean-François Le Gall and Shen Lin. The range of tree-indexed random walk in low dimensions. *The Annals of Probability*, 43(5):2701 – 2728, 2015.
- [LGL15b] Jean-François Le Gall and Shen Lin. The range of tree-indexed random walk in low dimensions. *Ann. Probab.*, 43(5):2701–2728, 2015.
- [LGL16] Jean-François Le Gall and Shen Lin. The range of tree-indexed random walk. *J. Inst. Math. Jussieu*, 15(2):271–317, 2016.
- [LGR91] Jean-François Le Gall and Jay Rosen. The range of stable random walks. *Ann. Probab.*, 19(2):650–705, 1991.
- [LJ08] Yves Le Jan. In *Markov Paths, Loops and Fields*, École d’été de Probabilités de Saint-Flour XXXVIII. 2008.
- [LL10] Gregory F. Lawler and Vlada Limic. *Random walk: A modern introduction*. 2010.
- [LR15] Gregory F. Lawler and Mohammad A. Rezaei. Minkowski content and natural parameterization for the Schramm-Loewner evolution. *Ann. Probab.*, 43(3):1082–1120, 2015.
- [LSW04a] Gregory F. Lawler, Oded Schramm, and Wendelin Werner. Conformal invariance of planar loop-erased random walks and uniform spanning trees. *The Annals of Probability*, 32(1):939–995, 2004.

- [LSW04b] Gregory F. Lawler, Oded Schramm, and Wendelin Werner. On the scaling limit of planar self-avoiding walk. *Proc. Symposia Pure Math.*, 72:339–364, 2004.
- [Lup18] Titus Lupu. Convergence of the two-dimensional random walk loop-soup clusters to CLE. *J. Eur. Math. Soc.*, 21(4):1201—1227, 2018.
- [LV21] Gregory F. Lawler and Fredrik Viklund. Convergence of loop-erased random walk in the natural parameterization. *Duke Mathematical Journal*, 170(10):2289–2370, 2021.
- [LW04] Gregory Lawler and Werner Wendelin. The brownian loop soup. *Probability theory and related fields*, 128(4):565–588, 2004.
- [LZ10] Steven P. Lalley and Xinghua Zheng. Spatial epidemics and local times for critical branching random walks in dimensions 2 and 3. *Probab. Theory Relat. Fields*, 148(3-4):527–566, 2010.
- [LZ11] Steven P. Lalley and Xinghua Zheng. Occupation statistics of critical branching random walks in two or higher dimensions. *Ann. Probab.*, 39(1):327–368, 2011.
- [MS10] Nikolai Makarov and Stanislav Smirnov. Off-critical lattice models and massive sles. *XVIth International Congress on Mathematical Physics*, pages 362—371, 2010.
- [MS16a] Jason Miller and Scott Sheffield. Imaginary geometry I: interacting SLEs. *Probab. Theory Related Fields*, 164(3-4):553–705, 2016.
- [MS16b] Jason Miller and Scott Sheffield. Imaginary geometry II: Reversibility of $SLE_{\kappa}(\rho_1; \rho_2)$ for $\kappa \in (0, 4)$. *Ann. Probab.*, 44(3):1647–1722, 2016.
- [MS16c] Jason Miller and Scott Sheffield. Imaginary geometry III: reversibility of SLE_{κ} for $\kappa \in (4, 8)$. *Ann. Probab.*, 184(2):455–485, 2016.
- [MSW20] Jason Miller, Scott Sheffield, and Wendelin Werner. Non-simple conformal loop ensembles on Liouville quantum gravity and the law of CLE percolation interfaces, 2020.
- [Nev86] Jacques Neveu. Arbres et processus de galton-watson. *Annales De L Institut Henri Poincare-probabilites Et Statistiques*, 22:199–207, 1986.
- [NW09] Pierre Nolin and Wendelin Werner. Asymmetry of near-critical percolation interfaces. *J. Amer. Math. Soc.*, 22(3):797–819, 2009.
- [Par] S. C. Park. Personal communication.
- [Par18] S. C. Park. Massive scaling limit of the Ising model: Subcritical analysis and isomonodromy. *arXiv e-prints*, 2018.
- [Par21] S. C. Park. Convergence of fermionic observables in the massive planar FK-Ising model. *arXiv e-prints*, 2021.
- [Pei36] R. Peierls. On Ising's model of ferromagnetism. *Mathematical Proceedings of the Cambridge Philosophical Society*, 32(3):477–481, 1936.

- [Pom92] Christian Pommerenke. Boundary behaviour of conformal maps. volume 299 of *Grundlehren der Mathematischen Wissenschaften [Fundamental Principles of Mathematical Sciences]*. Springer Berlin, Heidelberg, 1 edition, 1992.
- [PY07] Jim Pitman and Marc Yor. Ito's excursion theory and its applications. *Japan. J. Math.*, 2:83–96, 2007.
- [RS05] Steffen Rohde and Oded Schramm. Basic properties of SLE. *Ann. of Math.*, 161(2):883–924, 2005.
- [Rus20] Marianna Russkikh. Dominos in hedgehog domains. *Annales de l'Institut Henri Poincaré D*, 2020.
- [Sch20] Bruno Schapira. Capacity of the range in dimension 5. *Ann. Probab.*, 48(6):2988–3040, 2020.
- [Sha17] Chengyang Shao. On the convergence of massive harmonic explorers to $mSLE_4$ curves. *unpublished*, 2017.
- [She09] Scott Sheffield. Exploration trees and conformal loop ensembles. *Duke Math. J.*, 147(1):79–129, 2009.
- [Smi01] Stanislav Smirnov. Critical percolation in the plane: conformal invariance, cardy's formula, scaling limits. *Comptes Rendus de l'Académie des Sciences - Series I - Mathematics*, 333(3):239–244, 2001.
- [Smi06] Stanislav Smirnov. Towards conformal invariance of 2D lattice models. *International Congress of Mathematicians*, II:1421–1451, 2006.
- [Smi10] Stanislav Smirnov. Conformal invariance in random cluster models. I. holomorphic fermions in the Ising model. *Annals of Mathematics*, 172(2):1435–1467, 2010.
- [SS09] Oded Schramm and Scott Sheffield. Contour lines of the two-dimensional discrete Gaussian free field. *Acta Mathematica*, 202(1):21 – 137, 2009.
- [SW05] Oded Schramm and David B. Wilson. SLE coordinate changes. *New York J. Math.*, 11:659–669, 2005.
- [SW12] Scott Sheffield and Wendelin Werner. Conformal loop ensembles: the markovian characterization and the loop-soup construction. *Annals of Mathematics*, 176(3):1827–1917, 2012.
- [Uch17] Kohei Uchiyama. Boundary behaviour of RW's on planar graphs and convergence of LERW to chordal SLE_2 . *arXiv e-prints*, 2017.
- [vdB96] J. van den Berg. A note on disjoint-occurrence inequalities for marked poisson point processes. *J. Appl. Prob.*, 30(2):420–426, 1996.
- [vdBCL16] Tim van de Brug, Federico Camia, and Marcin Lis. Random walk loop soups and conformal loop ensembles. *Probab. Theory Relat. Fields*, 166:553–584, 2016.
- [Ver12] Mark Veraar. The stochastic Fubini theorem revisited. *Stochastics*, 84(4):543–551, 2012.
- [Wer09] Wendelin Werner. Percolation et modèle d'Ising. volume 16 of *Cours spécialisés*. 2009.

- [Wu16] Hao Wu. Convergence of the critical planar ising interfaces to hypergeometric SLE. *arXiv e-prints*, 2016.
- [WW19] Qian Wei and Wendelin Werner. Decomposition of Brownian loop-soup clusters. *J. Eur. Math. Soc.*, pages 3225–3253, 2019.
- [WZ17] Hao Wu and Dapeng Zhan. Boundary arm exponents for SLE. *Electronic Journal of Probability*, 22(none):1–26, 2017.
- [Yok80] Ryozyo Yokoyama. Moment bounds for stationary mixing sequences. *Z. Wahrscheinlichkeitstheor. Verw. Geb.*, 52:45–57, 1980.
- [YY11] Ariel Yadin and Amir Yehudayoff. Loop-erased random walk and Poisson kernel on planar graphs. *Ann. Probab.*, 39(4):1243–1285, 2011.
- [Zam89] A. B. Zamolodchikov. Integrals of Motion and S Matrix of the (Scaled) $T=T(c)$ Ising Model with Magnetic Field. *Int. J. Mod. Phys. A*, 4:4235, 1989.
- [Zha08a] Dapeng Zhan. Reversibility of chordal SLE. *The Annals of Probability*, 36(4):1472 – 1494, 2008.
- [Zha08b] Dapeng Zhan. The scaling limits of planar LERW in finitely connected domains. *Ann. Probab.*, 36(2):467–529, 2008.
- [Zhu21] Qingsan Zhu. On the critical branching random walk III: The critical dimension. *Ann. Inst. H. Poincaré Probab. Statist.*, 57(1):73 – 93, 2021.
- [ZI77] J. B. Zuber and C. Itzykson. Quantum field theory and the two-dimensional Ising model. *Phys. Rev. D*, 15:2875–2884, May 1977.