



HAL
open science

Effets de la chicorée sur la santé animale

Céline Pouille

► **To cite this version:**

Céline Pouille. Effets de la chicorée sur la santé animale. Alimentation et Nutrition. Université de Lille, 2022. Français. NNT : 2022ULILR076 . tel-04142987

HAL Id: tel-04142987

<https://theses.hal.science/tel-04142987>

Submitted on 27 Jun 2023

HAL is a multi-disciplinary open access archive for the deposit and dissemination of scientific research documents, whether they are published or not. The documents may come from teaching and research institutions in France or abroad, or from public or private research centers.

L'archive ouverte pluridisciplinaire **HAL**, est destinée au dépôt et à la diffusion de documents scientifiques de niveau recherche, publiés ou non, émanant des établissements d'enseignement et de recherche français ou étrangers, des laboratoires publics ou privés.

Faculté des Sciences et Technologies de Lille

Ecole Doctorale Sciences de la Matière, du Rayonnement et de l'Environnement

THESE

Pour l'obtention du grade de Docteur en Sciences de l'Université de
Lille

Ingénierie des Fonctions Biologiques



Effets de la chicorée sur la santé animale



Par Céline Pouille



Soutenue le 15 décembre 2022 devant la commission d'examen :

Rozenn Ravallec, *Professeure*, Université de Lille

Nadia Everaert, *Professeure*, KU Leuven

Yves Desjardins, *Professeur*, Université Laval, Québec, Canada

Jérôme Crouzet, *Maître de conférences*, Université de Reims Champagne-Ardenne

Romain Larbat, *Chargé de recherche*, Université de Lorraine

Jean-Louis Hilbert, *Professeur*, Université de Lille

Anca Lucau-Danila, *Maître de conférences*, Université de Lille

Benoit Cudennec, *Maître de conférences*, Université de Lille

Présidente de jury

Rapporteuse

Rapporteur

Examineur

Examineur

Examineur

Directrice de thèse

Co-directeur de thèse

Faculté des Sciences et Technologies de Lille

Ecole Doctorale Sciences de la Matière, du Rayonnement et de l'Environnement

THESE

Pour l'obtention du grade de Docteur en Sciences de l'Université de
Lille

Ingénierie des Fonctions Biologiques



Effets de la chicorée sur la santé animale



Par Céline Pouille



Soutenue le 15 décembre 2022 devant la commission d'examen :

Rozenn Ravallec, *Professeure*, Université de Lille

Nadia Everaert, *Professeure*, KU Leuven

Yves Desjardins, *Professeur*, Université de Laval

Jérôme Crouzet, *Maître de conférences*, Université de Reims Champagne-Ardenne

Romain Larbat, *Chargé de recherche*, Université de Lorraine

Jean-Louis Hilbert, *Professeur*, Université de Lille

Anca Lucau-Danila, *Maître de conférences*, Université de Lille

Benoit Cudennec, *Maître de conférences*, Université de Lille

Présidente de jury

Rapporteuse

Rapporteur

Examineur

Examineur

Examineur

Directrice de thèse

Co-directeur de thèse

RESUME

Ce projet s'inscrit dans une problématique globale qui concerne la caractérisation du potentiel nutrition-santé des produits agro-alimentaires issus de la biodiversité naturelle de la chicorée ainsi que des variétés améliorées de celle-ci. L'enjeu consiste à valoriser les produits conventionnels et surtout ceux à valeur d'aliment fonctionnel, qui procurent, au-delà des fonctions nutritionnelles de base, des bienfaits physiologiques et qui réduisent le risque de maladies chroniques.

L'objectif de ce projet de thèse a été de tester différents produits issus de la chicorée industrielle (*Cichorium intybus* var. *sativum*), notamment des farines produites à partir des racines, ainsi que différentes classes de molécules qui entrent dans la composition de la plante, pour analyser leurs effets sur la santé animale et humaine. Ce projet a inclus trois étapes de développement: i) la caractérisation du potentiel fonctionnel des produits alimentaires (farines de chicorée et inuline) au travers d'analyses nutriginomiques, physiologiques et métagénomiques chez la souris; ii) l'identification, *in vivo* et *in vitro*, des différentes classes de molécules responsables des effets santé observés (fructose, acides chlorogéniques et lactones sesquiterpéniques), et iii) l'évaluation de l'impact de la digestion gastro-intestinale simulée *in vitro* sur le statut fonctionnel des farines et de leurs composés. Les résultats obtenus ont mis en évidence les effets antitumoraux, anti-inflammatoires, antimicrobiens, antioxydants, sur le microbiote intestinal murin et l'activité potentiellement régulatrice de l'homéostasie énergétique, de la farine de chicorée et de ses composés bioactifs (Pouille *et al.*, 2020; Pouille *et al.*, 2022).

ABSTRACT

This project is part of a broad issue concerning the characterization of the health and nutrition potential of agri-food products derived from the natural biodiversity of chicory as well as its improved varieties. This issue aims to promote conventional products and especially those with functional food value, which therefore provide, beyond basic nutritional functions, physiological benefits and reduce the risk of chronic diseases.

The objective of this thesis work was to test different products from industrial chicory (*Cichorium intybus* var. *sativum*), in particular flours produced from the roots, as well as different classes of molecules that enter the composition of the plant, to analyze their effects on animal and human health. This project included three stages of development: i) the characterization of the functional potential of food products (chicory flours and inulin) through nutrigenomic, physiological and metagenomic analyses in mice; ii) an *in vivo* and *in vitro* identification of the different classes of molecules responsible for the health effects observed (fructose, chlorogenic acids and sesquiterpene lactones), and iii) the evaluation of the impact of the *in vitro* simulated gastrointestinal digestion on the functional status of the flours and their compounds. The results obtained highlighted the antitumoral, anti-inflammatory, antimicrobial, antioxidant, on mice gut microbiota and the potential regulatory activity of energy homeostasis, of chicory flour and its bioactive compounds (Pouille *et al.*, 2020; Pouille *et al.*, 2022).

REMERCIEMENTS

Je tiens à remercier Mesdames et Messieurs les membres de Jury, rapporteurs et examinateurs, d'avoir bien voulu juger ces travaux.

Merci également aux membres de comité de thèse, Michèle Bastide, Benoît Foligné et Romain Larbat pour vos conseils qui m'ont permis d'avancer dans mon projet.

Je remercie Jean-Louis Hilbert et Rozenn Ravallec de m'avoir accueillie au sein de leurs équipes ces trois dernières années. Cela aura été un réel plaisir de pouvoir travailler parmi vous.

Je tiens aussi à remercier toutes les personnes qui ont participé, de près comme de loin, à la réalisation de ce projet. Merci à Rezak Mendil et Cyril Raveschot pour vos formations en culture cellulaire, à Matthieu Duban pour ton aide avec la TapeStation, à Roland Molinié et à Jean-Xavier Fontaine, membres du laboratoire BIOPI d'Amiens, pour votre expertise en métabolomique, ainsi qu'à David Gagneul et plus récemment Cécile Palaric, pour votre implication dans ces travaux.

Merci à Bruno Desprez, président de la société Florimond Desprez Veuve et Fils, pour ses conseils et critiques constructives lors de nos réunions Chic41H.

Un grand merci à ma directrice de thèse Anca Lucau-Danila pour m'avoir encadrée durant ces trois dernières années. Merci de m'avoir poussée et encouragée à présenter mes travaux à de nombreuses reprises. Je me souviendrai longtemps de ce voyage à Parme ! J'ai aussi énormément appris à votre contact. Merci pour vos nombreux conseils, votre expertise, et votre aide particulièrement précieuse lors de ces longs mois de rédaction.

Merci à mon co-directeur de thèse Benoit Cudennec, pour les très nombreuses idées qui ont pu ressortir lors de nos réunions et pour les conseils apportés tout au long de cette thèse. Merci également pour ton aide lors de cette rédaction. Merci surtout de m'avoir fait découvrir la culture cellulaire que je ne pensais pas aimer à ce point !

Merci à Thierry Cadalen de m'avoir fait connaître la recherche lorsque je n'étais encore qu'en première année de Master, quelque part c'est aussi grâce à vous si je me suis lancée dans une thèse !

Je remercie aussi Caroline Rambaud et Philippe Hance, pour vos conseils et votre écoute.

Merci aux secrétaires Cathy Oublion et Julie Duhayon pour votre aide logistique lors de tous mes congrès, qui étaient une galère sans nom à organiser, et pour toutes les commandes que j'ai pu passer !

Merci aux stagiaires, Doriane, Souad, Elise, que j'ai pu encadrer au long de cette thèse et qui ont permis de faire avancer le projet et les analyses métagénomiques en particulier.

Un très très grand merci aux filles du 3^e étage. Merci à Justine, Audrey, Vanessa, Harmony, Abigaël et Amandine, pour tous ces moments de partage, ces discussions à n'en plus finir, et de m'avoir laissée me plaindre à de (très) nombreuses reprises. Merci pour vos conseils, votre écoute, votre présence et votre gentillesse, cette thèse n'aurait pas été la même sans vous. ☺

Merci à toutes les personnes du rez-de-chaussée avec qui j'ai passé énormément de temps : Mathie, Hairati, Sandy, et plus récemment Pauline et Magalie. Merci Camille pour ton aide, particulièrement lors de mes toutes premières manip. Grâce à toi, ces digestions *in vitro* n'ont plus de secret pour moi ! Merci Elodie et Mouna pour votre aide énorme avec ces *chères* U937 et la culture cell en général. Merci à toutes de m'avoir supportée pendant trois ans, ça a dû être très long pour vous. ☺ Merci pour ces super moments passés avec vous en culture cell, les discussions sérieuses, et celles qui l'étaient beaucoup moins !

Enfin, le plus grand des mercis à mon papa, à ma maman et à ma grande sœur d'avoir toujours été là pour moi dans tout ce que j'ai pu entreprendre. De m'avoir aidée, encouragée et épaulée pendant cette thèse et surtout d'être là, tous les jours, pour moi. Si j'en suis là aujourd'hui, c'est grâce à vous. ❤

ABREVIATIONS

1-FEH	Fructane 1-exohydrolase
1-FFT	Fructane:fructane 1-fructosyl transférase
1-SST	Sucrose:sucrose 1-fructosyl transférase
3,5-CGA	Acide 3,5- <i>O</i> -di-caféoylquinique
3CLpro	Protéase 3C-like
3-CGA	Acide 3- <i>O</i> -mono-caféoylquinique
4CL	4-coumaroyl CoA ligase
A2780	<i>Human ovarian carcinoma cell line</i>
ACHN	<i>Human renal adenocarcinoma cell line</i>
ADN	Acide désoxyribonucléique
AP-1	<i>Activator protein-1</i>
ARN	Acide ribonucléique
ARNr	ARN ribosomique
BCRP	<i>Breast cancer resistance proteins</i>
C3'H	<i>Para</i> -coumaroyl ester 3'-hydroxylase
C32	<i>Human amelanotic melanoma cell line</i>
C4H	Cinnamate 4-hydroxylase
CCK-8	<i>Cell Counting kit-8</i>
CD14	<i>Cluster of differentiation 14</i>
CGA	Acides chlorogéniques
COS	Costunolide synthase
COX	Cyclooxygénase
CSE	Caféoyl shikimate estérase
Dexa	Déxaméthasone
DHLc	11,13 β -dihydrolactucine
DHLp	11,13 β -dihydrolactucopicrine
dLc	8-déoxylactucine
dLp	8-déoxylactucopicrine
DMEM	<i>Dulbecco's modified Eagle's Medium</i>
DP	Degré de polymérisation
FBS	<i>Fœtal Bovine Serum</i>
FDA	<i>Food and Drug Administration</i>
FOS	Fructooligosaccharide
FPP	Farnésyl diphosphate
G[FFF]	1-kestotriose
G-1-P	Glucose-1-phosphate
G-6-P	Glucose-6-phosphate
GAO	Germacrène A oxydase
GAS	Germacrène A synthase
GFF	1-kestose
GRAS	Généralement reconnu comme sans danger

HbA1c	Hémoglobine glyquée
HBV	Virus de l'hépatite B
HCT	Hydroxycinnamoyl-CoA shikimate/quinate hydroxycinnamoyl transférase
HDL-c	Lipoprotéine de haute densité
HeLa	<i>Human cervix adenocarcinoma cell line</i>
HK	Hexokinase
HL-60	<i>Human acute promyelocytic leukemia cell line</i>
HQT	Hydroxycinnamoyl-CoA quinate hydroxycinnamoyl transférase
IL	Interleukine
IOS	Inulooligosaccharide
Lc	Lactucine
LC	Chromatographie liquide
LDL-c	Lipoprotéine de faible densité
LNCaP	<i>Human prostate carcinoma cell line</i>
Lp	Lactucopicine
LPS	Lipopolysaccharide
MCF-7	<i>Human breast carcinoma cell line</i>
MRP	<i>Multidrug resistance-associated proteins</i>
MS	Spectrométrie de masse
NFκB	<i>Nuclear factor-kappa B</i>
p65	<i>Transcription factor p65</i>
PAL	Phénylalanine ammonia lyase
PBS	<i>Phosphate buffered saline</i>
PC-3	<i>Human grade IV prostate adenocarcinoma cell line</i>
PCR	<i>Polymerase Chain Reaction</i>
PLpro	Protéase de type papaïne
PMA	Phorbol 12-myristate 13-acétate
RKO	<i>Human colon carcinoma cell line</i>
RMN	Raisonnance Magnétique Nucléaire
ROS	Espèce réactive de l'oxygène
RPMI	<i>Roswell Park Memorial Institute</i>
RT	Rétrotranscription
SCFA	Acides gras à chaînes courtes
SKBR3	<i>Human breast adenocarcinoma cell line</i>
SPP	Sucrose phosphate phosphatase
SPS	Sucrose phosphate synthétase
STL	Lactones sesquiterpéniques
T47D	<i>Human breast ductal carcinoma cell line</i>
TG	Triglycéride
TNF-α	<i>Tumor necrosis factor-alpha</i>
UV	Ultraviolets
VIH	Virus de l'immunodéficience humaine

SOMMAIRE

LISTE DES FIGURES	13
LISTE DES TABLEAUX	17
INTRODUCTION GÉNÉRALE.....	20
CONTEXTE DE LA THESE	21
INTRODUCTION BIBLIOGRAPHIQUE	23
1. Taxonomie & utilisations industrielles de la chicorée	23
1.1. Les chicorées à feuilles de l'espèce <i>Cichorium intybus</i> L.	24
1.2. Les chicorées à racine de l'espèce <i>Cichorium intybus</i> L.....	25
2. Utilisations traditionnelles de la chicorée	27
3. Composition de la racine de chicorée	31
3.1. L'inuline	31
3.1.1. Rôle chez la plante et biosynthèse.....	31
3.1.2. Disponibilité, absorption et modifications post-digestion de l'inuline	33
3.1.3. Effets santé de l'inuline.....	34
3.1.4. Utilisations industrielles de l'inuline.....	36
3.2. Le fructose.....	37
3.3. Les acides chlorogéniques.....	38
3.3.1. Rôle chez la plante et biosynthèse.....	38
3.3.2. Disponibilité, absorption et modifications post-digestion des CGA.....	41
3.3.3. Effet santé des CGA	42
3.4. Les lactones sesquiterpéniques.....	44
3.4.1. Rôle chez la plante et biosynthèse.....	44
3.4.2. Disponibilité, absorption et modifications post-digestion des STL	47
3.4.3. Effets santé des STL.....	49
OBJECTIFS DE LA THESE	52

CHAPITRE 1 – ANALYSE DU STATUT FONCTIONNEL DE LA FARINE DE CHICOREE.....	56
AVANT-PROPOS	57
PUBLICATION	59
RESULTATS COMPLEMENTAIRES.....	70
ELEMENTS COMPLEMENTAIRES	79
CHAPITRE 2 – ETUDE DES COMPOSES RESPONSABLES DES EFFETS FONCTIONNELS DE LA CHICOREE	85
AVANT-PROPOS	86
PUBLICATION	88
RÉSULTATS COMPLÉMENTAIRES.....	113
CHAPITRE 3 – ETUDE <i>IN VITRO</i> DES EFFETS DE LA DIGESTION GASTRO-INTESTINALE SUR LA COMPOSITION ET LES PROPRIETES BIOACTIVES DE LA CHICOREE	133
AVANT-PROPOS	134
ROLE OF GASTROINTESTINAL DIGESTION ON FUNCTIONAL OPERATIVE MODE OF THE CHICORY	136
Introduction	138
Materials and Methods	139
<i>Simulated GastroIntestinal Digestion (SGID) method</i>	139
<i>Metabolomic analysis</i>	140
<i>In vitro cytotoxic effect</i>	142
<i>In vitro secretion assay</i>	142
<i>In vitro inflammatory cytokines secretion assay</i>	143
<i>Cell-free systems evaluating antioxidative sample effects</i>	143
Results	143
<i>Effect of in vitro digestion on chicory composition</i>	144
<i>In vitro antioxidant effect</i>	146

<i>Cytotoxic effect</i>	147
<i>In vitro intestinal hormone secretion regulation</i>	149
<i>In vitro evaluation of the anti-inflammatory effect</i>	150
Discussion	151
<i>The chicory composition changes during in vitro digestion</i>	151
<i>SGID potentiates ROS scavenging effect of chicory decoction</i>	153
<i>Anti-inflammatory and intestinal hormone secretion stimulation effects of chicory were preserved after SGID</i>	154
Conclusion.....	155
References	156
CONCLUSION GENERALE & PERSPECTIVES.....	163
REFERENCES	168

LISTE DES FIGURES

INTRODUCTION GENERALE

Figure i.1. Différentes variétés de chicorées consommées exclusivement pour leurs feuilles (page 24)

Figure i.2. Comparaison de la chicorée industrielle et de la chicorée sauvage (page 26)

Figure i.3. Gamme de produits à base de chicorée proposée par la marque Leroux® (page 27)

Figure i.4. Structure chimique des sucres impliqués dans la voie de biosynthèse de l'inuline (d'après Van Laere & Van den Ende, 2002) (page 31)

Figure i.5. Modèle de voie de biosynthèse des oligofructoses et de l'inuline (Van Laere & Van den Ende, 2002) (page 32)

Figure i.6. Classification des polyphénols alimentaires (d'après Tsao, 2010 ; Crozier *et al.*, 2009 ; Wojtunik-Kulesza *et al.*, 2020) (page 39)

Figure i.7. Voie de biosynthèse des acides chlorogéniques (Legrand *et al.*, 2016) (page 40)

Figure i.8. Structure de la lactucine et de ses dérivés (d'après Sessa *et al.*, 2000) (page 45)

Figure i.9. Structure de la lactucopicrine (page 45)

Figure i.10. Voie de biosynthèse des STL de type guaianolide de *Cichorium intybus* L. (Bogdanović *et al.*, 2019) (page 46)

Figure i.11. Différence structurale entre le costunolide et le déhydrocostus lactone (page 48)

Figure i.12. Récapitulatif des analyses *in vivo* visant à déterminer les effets fonctionnels de la farine de chicorée (page 52)

Figure i.13. Récapitulatif des analyses visant à déterminer les effecteurs de la farine de chicorée. (page 53)

Figure i.14. Récapitulatif des analyses visant à déterminer l'impact de la digestion sur le statut fonctionnel de la farine de chicorée. (page 54)

CHAPITRE 1 – ANALYSE DU STATUT FONCTIONNEL DE LA FARINE DE CHICOREE

Fig. 1. Gene expression profiles in hepatic tissue of mice after chicory and inulin diet. (*publication*)

Fig. 2. GLP-1, PYY, and leptin level in mice plasma, after 30 days of chicory (G12, G35) and inulin supplemented diet, and assayed after 30 min of oral administration of the different diets at D30. (*publication*)

Fig. 3. Microbial diversity in fecal microbiota of mice after chicory and inulin diet. (A) Alpha diversity was illustrated by the Shannon index. (B) Principal Coordinates Analysis (PCoA) plots (beta-diversity) of affected taxa during different diets. (*publication*)

Fig. 4. Changes in bacterial phyla abundance. (A) Relative abundance (%) of phyla in mice microbiota before (D0) and after 30 days of chicory and inulin diet (D30). (B) Standardized abundance ratio relative to D0 of *Firmicutes* and *Bacteroidetes*. (*publication*)

Fig. 5. Relative abundance of main genera in mice fecal microbiota after chicory (G12, G35) and inulin diet. (A) Relative abundance of genera (%) are indicated. (B) Heatmap representing the fold change of standardized abundance ratio. (*publication*)

Supplementary file 5. Body weight evolution during chicory (G12, G35) and inulin diet in male (M) and female (F) mice during 30 days with a week of resilience (D36). (page 79)

Figure 1.1. Heatmap représentant les profils d'expression génique dans le tissu hépatique des souris après un régime alimentaire supplémenté en farine de chicorée, inuline et farine de blé. (page 80)

Figure 1.2. Niveaux de GLP-1, PYY et leptine dans le plasma de souris après 30 jours de supplémentation en chicorée (G12, G35), inuline et blé, et évalués 30 minutes après leur administration orale au jour 30. (page 82)

Figure 1.3. Abondances relatives des principaux genres bactériens retrouvés dans les fèces de souris après une supplémentation en chicorée (G12, G35), inuline et blé. (page 83)

CHAPITRE 2 – ETUDE DES COMPOSES RESPONSABLES DES EFFETS FONCTIONNELS DE LA CHICOREE

Figure 1. Gene expression profiles in hepatic tissue, ileum cells and caecum of mice after different diets. (*publication*)

Figure 2. Leptin (A) and GIP (B) level in mice plasma after 30 days of chicory, fructose, CGA and STL supplemented diet. (*publication*)

Figure 3. Microbial diversity in fecal microbiota of mice after chicory (Chic), fructose (Fru), chlorogenic acids (CGA) or sesquiterpene lactones (STL) supplemented diet. (A) Alpha diversity was illustrated by the Shannon index (B) Principal Coordinates Analysis (PCoA) plots (beta-diversity) of affected taxa during different diets. (*publication*)

Figure 4. Changes in bacterial phyla abundance. (A) Relative abundance (%) of phyla in mice microbiota before (D0) and after 30 days (D30) of chicory (Chic), fructose (Fru), chlorogenic acids (CGA) or sesquiterpene lactones (STL) supplemented diet. (B) Standardized abundance ratio relative to D0 of *Firmicutes* and *Bacteroidetes*. (*publication*)

Figure 5. Relative abundance of main genera in mice fecal microbiota after chicory flour (Chic), fructose (Fru), chlorogenic acids (CGA) or sesquiterpene lactones (STL) diet. (A) Relative abundances of genera (%) are indicated. (B) Heatmap representing the fold change of standardized abundance ratio. (*publication*)

Figure 6. Dot plots illustrating the apoptotic effect of chicory flour and its compounds on HepG2 cells. HepG2 cells were treated for 24 h with chicory decoction (Chic), fructose (Fru), CGA and STL solutions at different concentrations and analyzed using propidium iodide and Annexin V. (*publication*)

Figure 7. Apoptosis induction on HepG2 cells. (*publication*)

Figure 8. Effects of chicory and its compounds on TNF- α , IL-1 β and IL-8 production by human U937 macrophages. (*publication*)

Figure 9. Antioxidative effects of chicory flour. Superoxide anion inhibition (A) and hydroxyl radical inhibition (B) of chicory flour decoction were observed. (*publication*)

Figure 10. Venn diagram illustrating an estimation of the most important effects of the chicory and its tested compounds: fructose (Fru), chlorogenic acids (CGA) and sesquiterpene lactones (STL). (*publication*)

File S1. Mice body weight evolution (A) and standard food consumption (B) during chicory (Chic), fructose (Fru), chlorogenic acids (CGA) and sesquiterpene lactones (STL) supplemented diet for 30 days. (page 113-114)

File S2. Heatmap of metabolite signals. (page 115)

Figure S7_1. Relative abundance of *Firmicutes* and *Bacteroidetes* in mice microbiota after different diets. (page 128)

Figure S7_2. Relative abundance of four bacterial taxa from gut microbiota of mice, impacted by chicory, fructose, CGA or STL supplemented diet. (page 129)

CHAPITRE 3 – ÉTUDE *IN VITRO* DES EFFETS DE LA DIGESTION GASTRO-INTESTINALE SUR LA COMPOSITION ET LES PROPRIÉTÉS BIOACTIVES DE LA CHICORÉE

Figure 3.1. Principal component analysis of the chicory decoction (n = 6) after Simulated GastroIntestinal Digestion. (page 145)

Figure 3.2. Oxygen free radicals inhibition by chicory in a cell-free model before and after SGID. (page 146)

Figure 3.3. Cytotoxic effect of chicory decoction and its compounds on differentiated macrophages before and after SGID. (page 147)

Figure 3.4. Cytotoxic effect of chicory decoction and its compounds on enteroendocrine cells before and after SGID. (page 148)

Figure 3.5. Effect of chicory on cholecystokinin secretion by STC-1 cells. (page 149)

Figure 3.6. Effects of chicory decoction on LPS-induced secretion of interleukin-1 β (IL-1 β) and interleukin-8 (IL-8) in human U937-macrophages before and after SGID. (page 150)

LISTE DES TABLEAUX

INTRODUCTION BIBLIOGRAPHIQUE

Tableau 1.1 : Composition métabolique de la racine de *Cichorium intybus* L. (complété de Leclercq, 1992). (page 30)

CHAPITRE 1 – ANALYSE DU STATUT FONCTIONNEL DE LA FARINE DE CHICOREE

Table 1. Major metabolites analysed by quantitative ^1H NMR in chicory root flours. (*publication*)

Table 2. Composition of aqueous decoctions of chicory root flours. Chlorogenic acids and sesquiterpene lactones previously described in chicory roots were detected in aqueous decoctions by LC-UV quantification. (*publication*)

Supplementary file 1. Gene expression profiles in mice liver tissue during chicory and inulin diet (2 parties, pages 70-71)

Supplementary file 2. GLP-1, PYY and leptin level in mice plasma, after 30 days of chicory (G12, G35) and inulin supplemented diet. (page 72)

Supplementary file 3. The operational taxonomic units (OTUs) identified with an abundance > 0.1 % in fecal microbiota of male (M) and female (F) mice after chicory (G12 and G35) and inulin (Inu) diet. (5 parties, pages 73-77)

Supplementary file 4. Standardized abundance ratio (relative to D0) for Firmicutes and Bacteroidetes phyla after 30 days of diet in male (M) and female (F) mice. (page 78)

CHAPITRE 2 – ETUDE DES COMPOSES RESPONSABLES DES EFFETS FONCTIONNELS DE LA CHICOREE

Table 1. Composition of Fru, CGA and STL solutions used for feeding mice. (*publication*)

Table 2. Major metabolites analysed by quantitative ¹H-NMR and UPLC/ESI-HRMS in chicory root flour and decoction. (*publication*)

File S3. Gene expression profiles in mice liver tissue, ileum cells and caecum of mice during different diets. (4 parties, pages 116-119)

File S4. GIP and leptin level in mice plasma, after 30 days of chicory, fructose, CGA and STL diet. (page 120)

File S5. The operational taxonomic units (OTUs) identified with an abundance > 0.1 % in fecal microbiota of mice after different diets. (5 parties, pages 121-125)

File S6. Standardized abundance ratio (relative to D0) for Firmicutes and Bacteroidetes phyla after 30 days of diet in mice. (page 126)

Table S7_1. Primer sequences for qPCR (page 128)

File S8. Estimation of the most important effects of the chicory and its tested compounds: fructose (Fru), chlorogenic acids (CGA) and sesquiterpene lactones (STL). (page 131)



INTRODUCTION GÉNÉRALE



CONTEXTE DE LA THESE

Appartenant à la famille des Astéracées, la chicorée sauvage (*Cichorium intybus* L.) est une plante originaire du bassin méditerranéen qui s'est largement répandue en Eurasie et certains pays d'Afrique. Les premières utilisations de cette plante remontent à l'Antiquité où anciens Egyptiens, puis Romains et Grecs l'utilisaient pour ses propriétés médicinales. La médecine traditionnelle en fait par la suite un remède de choix contre les troubles digestifs, urinaires ou du foie, mais aussi contre certaines infections. Cette utilisation se perd peu à peu au fil du temps, et ce n'est qu'à la fin du 16^e siècle que les premiers usages de la racine torréfiée sont retranscrits. Au début, uniquement valorisée en tant que substitut au café, elle devient populaire pour son goût unique. Les feuilles sont également utilisées et peuvent être données comme complément d'alimentation au bétail avec l'avantage de leur apporter un effet vermifuge. Depuis, de nouvelles applications pour la racine de chicorée ont vu le jour. L'inuline en est extraite et est utilisée dans l'industrie agroalimentaire pour ses propriétés physicochimiques ou pour substituer le sucre et le gras. Le très faible indice glycémique de l'inuline en fait un ingrédient bioactif de choix pour les personnes diabétiques. Considérée également comme une fibre prébiotique elle promeut le développement des bifidobactéries et lactobacilles au détriment de celui des pathogènes. Son impact sur la santé humaine et sur les maladies chroniques en particulier font d'elle un aliment qu'on qualifie de fonctionnel. Elle apporte ainsi des bienfaits qui vont bien au-delà de ses qualités nutritives. D'autres composés de la racine de chicorée sont qualifiés de bioactifs. Les oligofructoses et le fructose sont associés à des bienfaits sur la digestion. Aux effets hypoglycémiant, antioxydants et antibactériens de cette plante a été associée sa composition en acides chlorogéniques (CGA). On lie également aux lactones sesquiterpéniques (STL) ses propriétés antiparasitaires et antiprolifératives sur des lignées cellulaires cancéreuses. Malgré cela, les mécanismes d'action de ces composés sont assez mal connus et la chicorée commence à peine à être reconnue comme un aliment fonctionnel.

Nous avons ainsi choisi de travailler sur un produit caractéristique de la région Hauts-de-France, la chicorée, d'en analyser les effets sur la santé, et d'identifier les composés responsables de ces effets que nous appellerons effecteurs. La chicorée nous a été fournie par l'entreprise Florimond Desprez Veuve et Fils, sélectionneur et semencier basé à Cappelle-en-Pévèle dans les Hauts-de-France. Ce travail de thèse a été réalisé dans le cadre du projet d'équipe mixte Chic41H avec l'Institut Charles Viollette dont une partie des laboratoires se situe à l'Université de Lille où j'ai travaillé durant ces trois dernières années. Une formation à l'expérimentation

animale diplômante que j'ai suivie au cours de mon doctorat m'a permis de travailler sur le modèle murin.

Une première étude exploratoire concernant l'effet de la racine de chicorée torréfiée sur le microbiote intestinal des souris avait été réalisée au laboratoire avant mon arrivée (Fouré *et al.*, 2018). Cette étude m'a beaucoup enseigné sur les possibilités de tester un produit alimentaire *in vivo* et m'a orientée vers d'autres perspectives d'analyse. Je me suis intéressée non pas à la chicorée torréfiée mais à la farine de chicorée, produit alimentaire avantageux pour la panification car très riche en goût, pouvant remplacer le sel et compléter d'autres farines. Obtenue directement de la racine de chicorée par broyage, la farine respecte la composition chimique de la plante sans subir beaucoup de transformations. Parmi les génotypes de chicorée qui étaient obtenus par l'entreprise Florimond Desprez et disponibles pour l'analyse, j'ai utilisé initialement deux génotypes notés G12 et G35, qui étaient les plus contrastés en ce qui concerne la composition en inuline, CGA et STL. En plus des dosages hormonaux et analyses du microbiote *in vivo*, j'ai initié des analyses nutriginomiques, pour observer les modifications des profils d'expression des gènes durant l'alimentation avec ces produits. Passer du modèle murin au modèle humain *in vivo* n'était pas possible durant ces trois années à cause de la situation sanitaire particulière. J'ai pu, par contre, aborder l'analyse des effets sur des cellules humaines *in vitro* et avancer dans l'identification des réponses fonctionnelles de la farine de chicorée et des molécules responsables de ces activités spécifiques. *In vivo*, les activités fonctionnelles d'un produit alimentaire ne peuvent être observées qu'après son ingestion et ses transformations subséquentes dans le tractus gastro-intestinal. Par conséquent, je me suis également intéressée à l'impact de la digestion sur la fonctionnalité de la chicorée et pour cela j'ai utilisé un système statique de digestion *in vitro* ainsi que des analyses métabolomiques.

Les résultats obtenus ont été partiellement publiés dans deux articles scientifiques (Pouille *et al.*, 2020 ; Pouille *et al.*, 2022) qui font l'objet des deux premiers chapitres. Un troisième article est en cours de finalisation et fait l'objet du troisième chapitre. Ces trois chapitres sont précédés d'une introduction bibliographique. Le manuscrit se termine par une conclusion générale dans laquelle sont repris les résultats les plus marquants de ce travail et les perspectives exposées.

INTRODUCTION BIBLIOGRAPHIQUE

1. Taxonomie & utilisations industrielles de la chicorée

La famille des Astéracées ou *Asteraceae* est l'une des plus grandes du règne végétal. Parmi les plus de 1600 genres représentés sont retrouvés un nombre conséquent de plantes ornementales (chrysanthèmes, marguerites, achillées...) mais aussi de plantes d'intérêt médical ou agroalimentaire telles que l'armoise (*Artemisia annua* L.), le tournesol (*Helianthus annuus* L.), l'artichaut (*Cynara scolymus* L.), la laitue (*Lactuca sativa* L.), ou la chicorée (*Cichorium intybus* L.) (Rolnik *et al.*, 2021).

Le genre *Cichorium* regroupe six espèces différentes parmi lesquelles on retrouve *C. intybus* L., *C. endivia* L., *C. spinosum* L., *C. calvum* Sch. Bip. ex Asch., *C. bottae* Deflers. et *C. pumilum* Jacq.. Les espèces *C. intybus*, *C. endivia*, *C. spinosum*, *C. pumilum* sont toutes quatre retrouvées en Europe, tandis que *C. calvum* n'est retrouvée qu'à l'état sauvage dans certains pays asiatiques (Irak, Israël, Pakistan) et *C. bottae* au Yémen et en Arabie Saoudite. *C. spinosum* est une plante originaire de la Grèce où elle est particulièrement appréciée. Parmi ces six espèces, seules *C. endivia* et *C. intybus* sont cultivées. (Kiers *et al.*, 2000, www.npgsweb.ars-grin.gov consulté le 29.07.2022)

L'espèce *Cichorium endivia* compte deux variétés obtenues par sélection ou cultivars, *C. endivia* var. *latifolia* ou 'chicorées scaroles' représentée par des individus à feuilles larges et *C. endivia* var. *crispa* ou 'chicorées frisées' par des plantes à feuilles étroites. Les deux sont principalement commercialisées en zone méditerranéenne et seules leurs feuilles sont consommées.

Les variétés de l'espèce *Cichorium intybus* L. peuvent être classées selon leur utilisation. La chicorée industrielle ou à racine (*Cichorium intybus* L. var. *sativum*) est surtout utilisée sous forme torréfiée comme substitut au café. Elle est aussi cultivée pour produire de l'inuline ou des oligofructoses à l'échelle industrielle. Les autres variétés de *Cichorium intybus* dites 'chicorées à feuilles' sont, elles, consommées en salade (*C. intybus* L. var. *foliosum* ou issues d'un croisement *C. intybus* L. var. *foliosum* × *C. endivia* L. var. *latifolium*).

1.1. Les chicorées à feuilles de l'espèce *Cichorium intybus* L.

Ces chicorées peuvent être séparées en 4 groupes différents : 'Radicchio', 'Witloof', 'Catalogne' et 'Pain de sucre' (**Figure i.1**).

Les chicorées 'Radicchio' sont très diverses et l'Italie en est encore le principal producteur. Elles se différencient par la couleur et la forme de leurs feuilles. Il en existe à feuilles rouges ('Chioggia', 'Treviso', 'Verona', 'Goriziana', 'Veneto', 'Isontina'...), vertes ('Grumolo', 'Spadona Da Taglio'...), ou encore panachées ('Castelfranco', 'Lusia'...) (**Figure i.1**).



Figure i.1. Différentes variétés de chicorées consommées exclusivement pour leurs feuilles

(Toutes les photos proviennent du site internet www.graines-baumaux.fr)

En haut les chicorées du groupe 'Radicchio' (*Cichorium intybus* var. *foliosum*) avec de gauche à droite : 'Rossa di Chioggia', 'Grumolo', 'Variegato di castelfranco', 'Variegato di Lusia'

En bas, de gauche à droit : 'Catalogne' (*Cichorium intybus* var. *sylvestre*), 'Pain de sucre' (*Cichorium intybus* var. *porphyreum*), 'Witloof' (*Cichorium intybus* var. *foliosum*)

Elles peuvent être consommées crues ou cuites pour apporter une note amère et acidulée à certains plats. La classification de ces chicorées est généralement confuse et mal renseignée. Le sous-groupe des chicorées 'Radicchio' sera nommé *C. intybus* var. *sylvestre* (Žnidarčič *et al.*, 2004), *C. intybus* var. *latifolium* (Barcaccia *et al.*, 2016) ou *C. intybus* var. *foliosum* (Lucchin

et al., 2008) selon les auteurs. Cette confusion pourrait trouver sa cause dans l'origine des chicorées 'Radicchio'. Les chicorées à feuilles rouges dériveraient d'individus *Cichorium intybus* var. *foliosum* tandis que les types 'panachés' proviendraient de croisements contrôlés avec l'espèce *Cichorium endivia* var. *latifolium* (Barcaccia *et al.*, 2003).

Aussi appelée chicon ou endive belge (**Figure i.1**), la chicorée 'Witloof' trouverait son origine en Belgique à Schaerbeek, d'un fermier voulant protéger ses chicorées durant la révolution belge de 1830. Cachées sous une couche de terre, les racines développèrent des feuilles blanches imbriquées. Officiellement, cependant, c'est Franz Brazier, un employé du Jardin botanique de Bruxelles qui serait à l'origine de la création de ce nouveau légume dans les années 1850. Ce n'est que dans les années 1870 que le chicon arrive sur le marché français où il devint rapidement populaire (Lecoq, 1879). Provenant directement des plantations de 'chicorée sauvage à grosse racine de Bruxelles' ou 'chicorée de Magdebourg' qui se sont établies au cours des 18^e et 19^e siècles, la 'Witloof' devrait appartenir à la variété *Cichorium intybus* var. *sativum* mais la majorité des auteurs se réfère à elle comme appartenant à la variété *foliosum*.

Le groupe des 'Catalogne' inclut plusieurs variétés dont la partie foliaire consiste en de nombreuses pousses, d'où son surnom de 'chicorée asperge' (**Figure i.1**). Cette plante est native de l'Asie et est aujourd'hui surtout cultivée et consommée dans la région des Pouilles et le Latium (Elia & Santamaria, 2013). Le groupe des chicorées 'Pain de sucre' comprend des cultivars à feuilles vertes (**Figure i.1**) surtout cultivés au Nord-Ouest de l'Europe. Les types dits 'Catalogne' et 'Pain de sucre' appartiennent respectivement aux variétés *C. intybus* var. *sylvestre*, et *C. intybus* var. *porphyreum*.

1.2. Les chicorées à racine de l'espèce *Cichorium intybus* L.

Cette catégorie regroupe les chicorées dont la racine est utilisée sous forme torréfiée dans des boissons chaudes ainsi que celles dont on extrait inuline et oligofructoses. Les racines peuvent aussi être séchées et broyées pour fabriquer une farine pouvant être incluse dans des recettes boulangères, pâtisseries ou des en-cas enrichis en chicorée (Bokić *et al.*, 2022). Les Néerlandais J. Kops et P.M.E Gevers Deijnoot sont d'ailleurs les premiers à rapporter l'utilisation d'une farine de racine de chicorée dans la fabrication du pain (Kops & Gevers Deijnoot, 1853).

Le plus gros producteur actuel de racines de chicorée reste la Belgique avec une production annuelle s'élevant à plus de 300 000 tonnes en 2017 (données officielles www.fao.org consulté

le 18.08.2022). En seconde position viennent les Pays-Bas (54 000 t), suivis de près par la France (50 000 t).

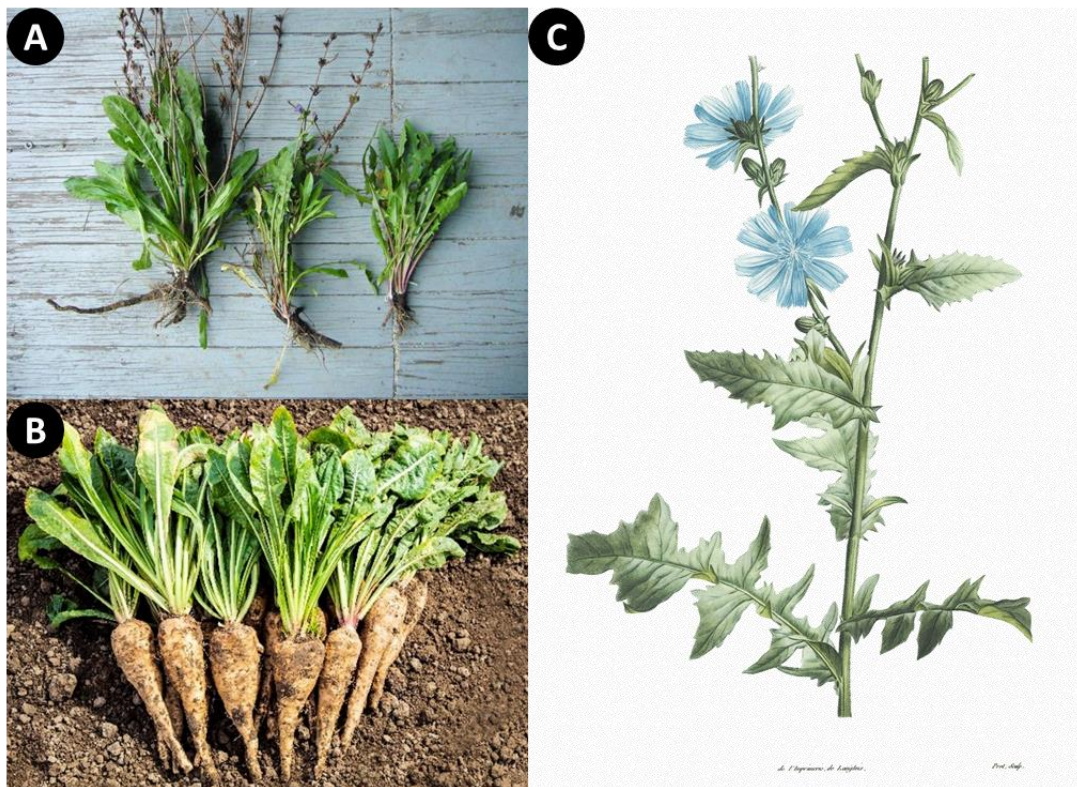

Figure i.2. Comparaison de la chicorée industrielle et de la chicorée sauvage

(A) Chicorée sauvage déracinée (*Cichorium intybus* L.)

(B) Racines de chicorées industrielles (*Cichorium intybus* var. *sativum*)

(C) Planche illustrant la chicorée sauvage en fleur (*Cichorium intybus* L.) issue de l'ouvrage *La Botanique* (1805) de Jean-Jacques Rousseau et aquarellée par Pierre-Joseph Redouté. Les chicorées industrielles sont récoltées avant la floraison mais présenteraient les mêmes fleurs bleues.

La chicorée à racine est utilisée depuis le 16^e siècle pour son goût particulier. Depuis, elle a été améliorée de façon à promouvoir un développement plus important de la partie racinaire au détriment des tissus lignifiés. Son cycle naturellement annuel a ainsi été modifié pour passer à un cycle bisannuel (Leroux, 1987). Ces modifications ont permis d'obtenir des plantes industrielles (*Cichorium intybus* var. *sativum*) à racines plus volumineuses (**Figure i.2**). Celles-ci sont lavées puis découpées en cossettes. Une fois grillées à 150 °C, elles sont alors concassées en plus fines particules pour former la chicorée torréfiée en grains que l'on connaît aujourd'hui. Autrefois uniquement commercialisée sous cette forme, la gamme de produits à base de chicorée s'est depuis diversifiée. On la retrouve notamment sous forme de poudre à solubiliser

dans de l'eau chaude, avec ou sans café, ou sous forme de sirop à incorporer dans diverses préparations (**Figure i.3**).



Figure i.3. Gamme de produits à base de chicorée proposée par la marque Leroux® (images issues du site internet www.leroux.fr)

De gauche à droite: Chicorée torréfiée en grains, Chicorée soluble Nature, Chicorée soluble Bio composée à 40 % de Café, Chicorée soluble Bio composée à 41,1 % de Céréales torréfiées (orge, malt d'orge, seigle), Chicorée soluble aux arômes naturels de Caramel, Chicorée liquide Nature.

2. Utilisations traditionnelles de la chicorée

La chicorée (*Cichorium intybus* L.) est utilisée depuis des millénaires pour ses qualités gustatives comme pour ses propriétés pharmacologiques. Dans l'Antiquité, la plante entière sauvage est consommée en tant que légume ou en salade pour ses bienfaits sur la digestion et l'appétit. Dès le 1^e siècle après J.-C., l'écrivain Pline l'ancien et le médecin et botaniste Pedanius Dioscoride vantent ses bénéfices sur le foie, les reins et l'estomac dans *Naturalis historia* (Ajasson de Grandsagne, 1832) et *De Materia medica* (Osbaldesdon & Wood, 2000). A l'époque, les Romains et les Grecs, mais aussi les Arabes la consomment en salade pour ses propriétés gustatives mais aussi pour apaiser maux de tête, problèmes urinaires et digestifs. Certains lui attribuent également des vertus magiques (Kiers, 2000). Au 8^e siècle, Charlemagne rédige le *Capitulare de Villis* qui délivre des recommandations et ordres à l'ensemble de ses gouverneurs. Il ordonne ainsi la culture de près d'une centaine de plantes au sein des domaines royaux parmi lesquels on retrouve des Astéracées, notamment l'artichaut 'Cardones', la laitue 'Lactuca' ou la chicorée 'Intubas' (Guérard, 1853).

Lors de la Renaissance, l'utilisation de la chicorée se popularise et différentes parties de la plante sont incluses dans les préparations traditionnelles, particulièrement en Eurasie et dans certains pays d'Afrique. Les médecines traditionnelles ayurvédique, perse, africaine et

européenne, l'utilisent comme tonique pour ses effets hépatoprotecteurs, mais aussi pour purifier le sang, réduire les troubles digestifs, augmenter l'appétit et comme remède contre la jaunisse (Memariani *et al.*, 2020). On lui reconnaît aussi des propriétés cicatrisantes, effet qui a pu être vérifié *in vivo* chez le rat (Süntar *et al.*, 2012). En Afghanistan, la décoction de racine de chicorée est reconnue comme traitement antipaludéen (Bischoff *et al.*, 2004). Des effets plus anecdotiques tels que l'amélioration d'une mauvaise vision et l'atténuation des douleurs menstruelles sont aussi rapportés (Bakhru, 1992).

Au fil des siècles, l'utilisation médicinale de la chicorée se perd. La première mention de chicorée torréfiée remonterait à 1592 lorsque le médecin et botaniste italien Prospero Alpini compare l'infusion de chicorée au café récemment disponible. A la fin du 17^e siècle, les hollandais utilisent déjà la chicorée pour remplacer le café (Leroux, 1987). La chicorée fût par la suite le premier substitut de café utilisé à grande échelle. Au cours du 18^e siècle, Frédéric le Grand tente de restreindre la consommation de café au bénéfice de la bière en Prusse. En réponse à la diminution drastique de l'importation de café, des cultures substitutives telles que la chicorée, l'orge ou le seigle, se développent rapidement. De façon similaire, le blocus continental mis en place par Napoléon 1^{er} quelques décennies plus tard, provoque un développement considérable de l'industrie de la chicorée en France pour pallier au manque de café (Davies, 2008). Cette habitude de consommation se propage aux colonies françaises où l'utilisation de la chicorée comme substitut était à l'époque critiquée, particulièrement par les planteurs de café, tandis que d'autres louaient sa capacité à améliorer un café de basse qualité (Wilkinson, 1849). En réponse aux plaintes des diverses parties, la taxation sur les plantes importées augmente ce qui ne fait, au final, qu'accélérer le développement d'exploitations en Europe (Law, 1850). La culture de la chicorée se développe ainsi surtout en France, Belgique, Allemagne, Autriche et aux Pays-Bas. L'entre-deux guerres voit une nouvelle explosion de la consommation de ce type de boisson, avec une production allemande de 250 000 tonnes de substituts au café en 1938, chiffre divisé par dix moins de 30 ans plus tard lorsque le café devint prédominant (Maier, 1987).

La chicorée a aujourd'hui gagné une nouvelle popularité grâce à ses propriétés, son goût amer et son absence de caféine. Elle est aussi bien utilisée pour la consommation humaine que comme complément d'alimentation pour le bétail et ceci depuis le siècle dernier (Rumball, 1986). La chicorée ne demande que peu d'entretien, est assez résistante aux sols acides et à une sécheresse modérée, et est surtout une très bonne source de nutriments et minéraux. En complément de l'alimentation de base, accompagnée ou non de trèfles et/ou plantain, elle promet notamment

une croissance importante et une prise de poids rapide des animaux, une qualité supérieure de la viande ou des œufs et une production plus élevée de lait (Cranston *et al.*, 2015, Rodríguez *et al.*, 2020, Somasiri *et al.*, 2015, Zheng *et al.*, 2019, Zammerini *et al.*, 2012).

Les effets pharmacologiques, reconnus depuis de nombreux siècles, peuvent désormais être liés à la composition métabolomique de la chicorée. Sa racine séchée est composée à plus de 80 % de polysaccharides, dont la large majorité est représentée par l'inuline (~70 % de la masse totale), mais aussi de protéines (~6 %) et lipides (entre 0,1 et 0,6 %), 5 % de cellulose, 4 % de cendres et 3 % d'autres métabolites (Nwafor *et al.*, 2017). Parmi ces 3 % de phytoconstitués sont retrouvés des molécules organiques volatiles, des polyphénols de type acides phénoliques, flavonoïdes et tannins, et pour principaux terpénoïdes des lactones sesquiterpéniques (Janda *et al.*, 2021, Perović *et al.*, 2021). Le **tableau i.1** indique la composition non exhaustive des racines de chicorée.

Parmi les molécules ou les classes de molécules contenues dans la plante de chicorée et qui ont montré des effets sur la santé animale et humaine, les plus connues sont l'inuline, le fructose, les acides chlorogéniques (CGA) et les lactones sesquiterpéniques (STL). Les voies de biosynthèse, les rôles chez la plante, et les effets santé de ces quatre classes de molécules seront abordées dans la suite de ce manuscrit.

Tableau i.1. Composition métabolique de la racine de *Cichorium intybus* L. (complété de Leclercq, 1992)

Classification	Exemples de composés	Quantité (g/100 g de matière sèche)	Références
Carbohydrates de stockage	Inuline	60 - 91,5	Mhalla <i>et al.</i> , 2009; Vandoorne <i>et al.</i> , 2014; Willemann, 2016
	Saccharose	2,3-3,42	
	monosaccharides	0,67-0,95	Shad <i>et al.</i> 2013; Willemann, 2016
Carbohydrates de structure	Cellulose	4-5	
	Hémicellulose	NP	Pazola, 1987; Hageman, 1983; Leroux, 1987
	Pectine	6-10	
Lipides	Acides palmitique, linoléique, linoléanique, n-pentadécanolique, oléique	0,1-0,2	Campagnac <i>et al.</i> , 2010; Pazola, 1987; Sannai <i>et al.</i> , 1982
	NP	6-9	Pazola, 1987; Leroux, 1987; Kim <i>et al.</i> , 1978
Acides aminés et protéines	Acide citrique	0,96-1,38	
	Acide malique	0,24-0,956	Gaber & Maier, 1989; Pazola, 1987; Willemann, 2016
Acides organiques	Acides formique, fumarique, acétique, quinique, lactique, hydroxyacétique, phosphorique, pyroglutamique	NP	
	Octane, n-nonadécane, Pentadécane, Hexadécane, Pentylsalicylate, β -Elemene, (E)-Caryophyllène, β -Ylangène, Geranyl acetone	NP	Judzenienė & Buidienė, 2008
Composés volatiles	Cendres	3-8-6	JurgonSKI <i>et al.</i> 2011; Pazola, 1987; Kim <i>et al.</i> , 1978
	Minéraux	Potassium, Sodium, Calcium, Magnésium, Phosphore, Fer, Zinc, Cuivre	
Flavonoïdes	NP	0,02-0,08	
	acides phénoliques	monoCGA, diCGA, triCGA, caféique, protocatéchique, coumarique, isovanillique	Nandagopal & Ranjitha Kumari, 2007; Shad <i>et al.</i> , 2013; Willemann, 2016
	tannins	NP	
Polyphténols	coumarines	Cichorine	Pazola, 1987; Rees & Harborne, 1985
	guaianolides	Lc Ip, dlc, DHLc, DHLp, DHdlc, Crépidaside B, Cichorioside B, Ixerioside D	Seto <i>et al.</i> , 1988; Pyrek, 1985; Van Beek <i>et al.</i> , 1990; Kisiel & Zielińska, 2001; Schmidt, 1940; Willemann, 2016
	sesquiterpéniques	germanacrolides eudesmanolides	0,11-0,81
Lactones	germanacrolides		
	eudesmanolides	Sonchuside C, Cichorioside A, Magnoliolide	

CGA : acides chlorogéniques, Lc : Lactucine, Ip : Lactucopictine, dlc : 8-déoxylactucine, DHLc : 11 β -13-dihydroxylactucine, DHLp : 11 β -13-dihydroxylactucopictine

NP : non précisé par les auteurs

3. Composition de la racine de chicorée

3.1. L'inuline

3.1.1. Rôle chez la plante et biosynthèse

L'inuline est constituée d'une répétition d'unités de fructose liées entre elles par liaisons $\beta(2-1)$ et se terminant par une molécule de glucose. Ce polymère hydrosoluble est généralement stocké comme réserve d'énergie dans des organes spécialisés de la plante, comme à titre d'exemples, le capitule de l'artichaut, la racine pivotante de la chicorée ou encore le bulbe de dahlia (Branca *et al.*, 2022). Accumulée dans la vacuole des cellules végétales, l'inuline joue un rôle important dans le maintien du potentiel osmotique et la stabilisation de la membrane cellulaire. Ces caractéristiques permettent à la plante de gagner une meilleure tolérance au froid ou à la sécheresse (Livingston *et al.*, 2009, Rao *et al.*, 2011).

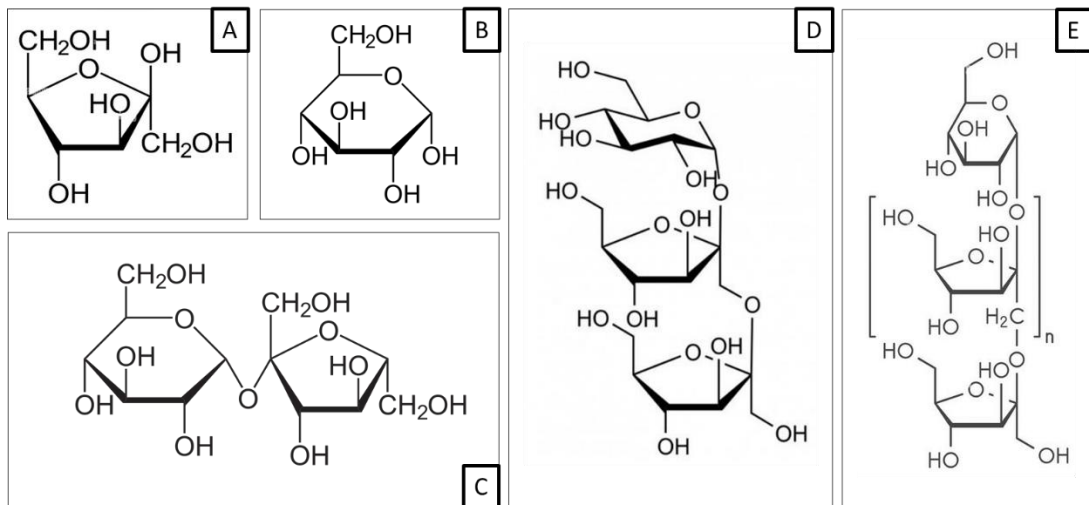

Figure i.4. Structure chimique des sucres impliqués dans la voie de biosynthèse de l'inuline (d'après Van Laere & Van den Ende, 2002).

Le fructose (A) et le glucose (B) forment le saccharose (C) par réaction de condensation dans le cytosol. La 1-SST transfère un monomère de fructose provenant d'une molécule de saccharose sur une autre molécule de saccharose pour former le 1-kestose (D). La 1-FFT continue la polymérisation pour former des oligofructoses ou l'inuline (E).

Elle pourrait aussi être impliquée dans la repousse post-défoliation et la floraison au début du printemps (Morvan-Bertrand *et al.*, 2001, Vergauwen *et al.*, 2000). Plusieurs facteurs endo- et

exogènes impactent l'accumulation des fructanes : pourcentage de CO₂, conditions environnementales, stade de développement de la plante (Oliveira *et al.*, 2010, Valluru & Van den Ende, 2008).

Au sein des plantes capables d'en produire, la synthèse des oligofructoses et de l'inuline se fait à partir du saccharose (**Figure i.4**) et implique deux enzymes, la sucrose:sucrose 1-fructosyl transférase (1-SST) et la fructane:fructane 1-fructosyl transférase (1-FFT) (Van der Meer *et al.*, 1998). Cette voie de biosynthèse est schématisée dans la **Figure i.5**, et les composants principaux dans la **Figure i.4**. Brièvement, le saccharose (GF) (**Figure i.4C**) apporté ou synthétisé dans la vacuole est pris en charge par la 1-SST et la 1-FFT.

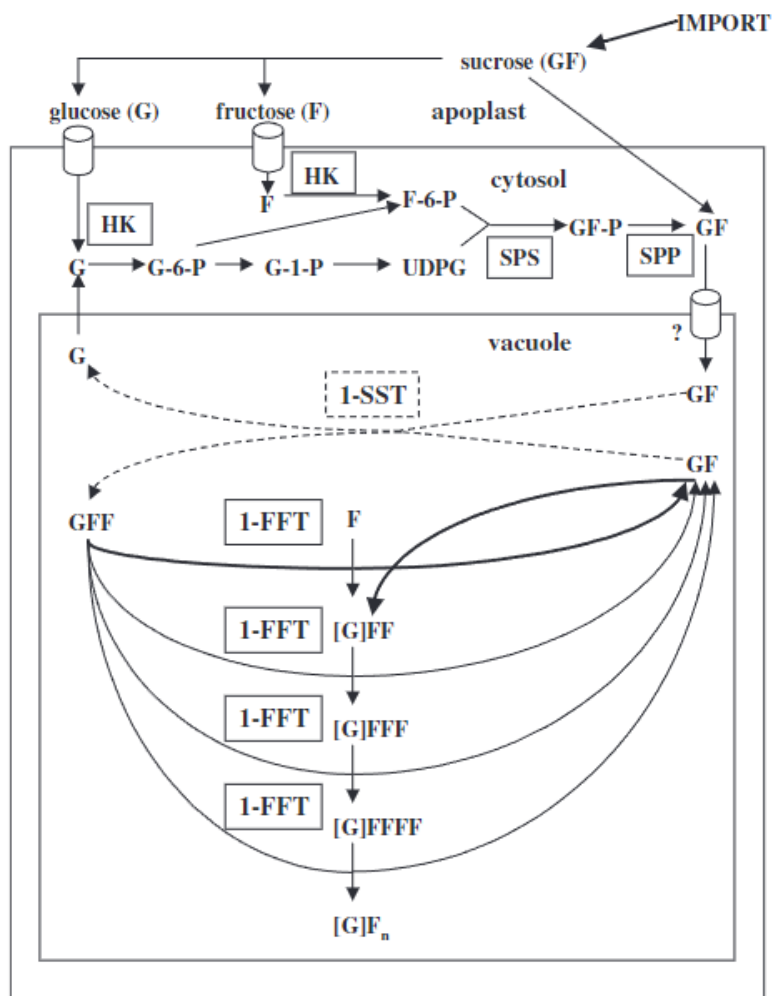

Figure i.5. Modèle de voie de biosynthèse des oligofructoses et de l'inuline (Van Laere & Van den Ende, 2002).

Les enzymes impliquées sont encadrées. 1-SST : sucrose:sucrose 1-fructosyltransférase ; 1-FFT : fructane:fructane 1-fructosyltransférase ; HK : hexokinase ; SPS : sucrose phosphate synthétase ; SPP : sucrose phosphate phosphatase. G-6-P : glucose-6-phosphate ; G-1-P : glucose-1-phosphate ; [G]F_n : inuline.

La 1-SST va produire du glucose (G) (**Figure i.4B**) et du 1-kestose (GFF) (**Figure i.4D**) à partir de deux molécules de GF. La 1-FFT transfère ensuite une molécule de fructose (F) (**Figure i.4A**) sur le GFF pour former le 1-kestotriose ([G]FFF). La polymérisation se poursuit de la même façon, par transferts successifs de F sur un nouvel accepteur jusqu'à atteindre un degré de polymérisation suffisamment élevé ($DP \geq 10$) pour pouvoir parler d'inuline (**Figure i.4E**) (Apolinario *et al.*, 2014). Ce DP peut notamment être modulé par certaines phytohormones comme l'éthylène, l'auxine et l'acide abscissique (Mohammadi *et al.*, 2021). La dégradation de l'inuline est, elle, catalysée par des enzymes de type fructane exohydrolases comme la 1-FEH, libérant à nouveau des fructoses libres dans la vacuole (Edelman *et al.*, 1968).

Bien que ce polymère soit essentiellement linéaire chez les plantes, l'inuline contient toujours un faible pourcentage (1-5 % selon l'origine) de branchements en $\beta(2-6)$ (De Leenheer & Hoebregs, 1994). Seules les bactéries, capables de produire des polymères de 10 000 à 100 000 monomères, donnent des structures hautement branchées (> 15 %) (Franck & De Leenheer, 2004).

Il existe deux types d'inulines, celle constituée exclusivement de molécules de fructose appelée inulooligosaccharide (IOS) et celle se terminant par une unité de glucose liée en $\alpha(1-2)$ que l'on appelle fructooligosaccharide (FOS) (Ronkart *et al.*, 2007)

3.1.2. Disponibilité, absorption et modifications post-digestion de l'inuline

Les liaisons $\beta(2-1)$ liant les unités de fructose entre elles rendent l'inuline indigestible par les enzymes du tractus digestif humain spécifiques des liaisons α -glycosidiques. Cette caractéristique est responsable de la faible valeur calorique de l'inuline ainsi que de son comportement de fibre alimentaire (Roberfroid & Slavin, 2000). L'inuline est ainsi uniquement dégradée par les microorganismes présents au sein du côlon (Kleessen *et al.*, 2001, Roberfroid, 1997). Les bactéries et les champignons, dont les levures, produisent des inulinases capables de rompre ces liaisons $\beta(2-1)$. Les exoinulinases catalysent alors l'hydrolyse de la dernière liaison, tandis que les endoinulinases coupent au centre de la chaîne, produisant des oligosaccharides plus ou moins longs (Chi *et al.*, 2009). Les β -fructosidases présentes à la surface membranaire de *Lactobacillus paracasei* sont capables d'hydrolyser l'inuline en FOS (Goh *et al.*, 2007). Ces FOS sont alors immédiatement disponibles pour d'autres lactobacilles et bifidobactéries producteurs d'acides gras à chaînes courtes (SCFA) qui, au départ, sont incapables de dégrader des chaînes à DP élevé (Moens *et al.*, 2016). L'inuline peut ainsi être

partiellement ou totalement métabolisée par les enzymes du microbiote intestinal en acétate, propionate, butyrate, mais aussi en acide lactique et dioxyde de carbone (Hartzell *et al.*, 2013, Rivière *et al.*, 2016).

3.1.3. Effets santé de l'inuline

L'inuline de chicorée est reconnue pour ses effets bénéfiques sur le métabolisme et le transit intestinal. De nombreuses études ont à ce jour été publiées sur l'impact des fibres alimentaires sur la santé humaine et animale (Carlson *et al.*, 2018, Cui *et al.*, 2019) et l'effet néfaste de leur insuffisance alimentaire (Kaye *et al.*, 2020, O'Keefe, 2019). L'inuline pourrait ainsi freiner le développement de certaines maladies gastro-intestinales et métaboliques tout en changeant les propriétés organoleptiques d'un aliment, tout ceci à faible coût. Cette fibre alimentaire est alors qualifiée d'aliment fonctionnel (Roberfroid, 2007), c'est-à-dire considérée comme aliment qui, au-delà de ses qualités nutritionnelles caractéristiques, affecte une ou plusieurs fonctions de l'organisme de manière à améliorer l'état de santé et le bien-être et/ou réduire les risques de développement de maladies chez le consommateur. Ces effets bénéfiques doivent, par ailleurs, être apportés par une consommation alimentaire normale du produit en question.

L'ensemble des activités de l'inuline découle directement de son effet prébiotique. Sont uniquement qualifiés de prébiotiques les aliments dégradés par le microbiote intestinal et capables d'induire des modifications spécifiques et bénéfiques dans sa composition et son activité. Il a en effet été démontré que même administrée en faible quantité, l'inuline gardait sa capacité à stimuler la croissance des bactéries bénéfiques *Bifidobacterium* (Nagy *et al.*, 2022). Son effet bifidogénique est souvent accompagné de l'augmentation de bien d'autres taxons bactériens bénéfiques, en particulier *Faecalibacterium* (Healey *et al.*, 2018), *Anaerostipes* (Vandeputte *et al.*, 2017) et *Lactobacillus* (Dewulf *et al.*, 2012).

La fermentation intestinale d'aliments prébiotiques et de fibres alimentaires solubles est à l'origine de la production de SCFA. Une quantité importante d'acétate, propionate et butyrate dans le côlon a été corrélée avec une diminution du pH intraluminal qui a pour conséquence d'empêcher l'installation de pathogènes, en particulier de certains *Clostridium* (Wong *et al.*, 2006), et d'augmenter l'absorption intestinale du calcium chez les adolescents comme chez les adultes (Bakirhan & Karabudak, 2021). Les bienfaits des fibres prébiotiques ont aussi été démontrés chez l'individu en surpoids. Un mélange d'inuline/fructose (50:50) administré quotidiennement durant 3 mois à des femmes en surcharge pondérale, a permis de mettre en

évidence une augmentation de la proportion des taxons bactériens *Bifidobacterium*, *Lactobacillus* spp., *Faecalibacterium prausnitzii*. L'augmentation additionnelle de la proportion du genre *Collinsella* a été positivement corrélée avec l'augmentation de la quantité d'hippurate dans les urines (Dewulf *et al.*, 2012). Son dérivé, l'hippurate de méthénamine, est reconnu pour son efficacité bactériostatique dans le cas d'infections urinaires (Lee *et al.*, 2012).

Une autre étude consistant à déterminer l'effet de deux fibres alimentaires, a permis de mettre en évidence les bénéfices qu'apportait un prébiotique comme l'inuline par rapport à la cellulose, insoluble et faiblement fermentable. Ces effets sont suivis d'une diminution de l'expression de gènes impliqués dans le métabolisme des lipides (Weitkunat *et al.*, 2015). Une diminution de certains marqueurs lipidiques, tels que les triglycérides (TG) libres, le cholestérol et les lipoprotéines de faible densité (LDL-c), ainsi qu'une élévation du taux de lipoprotéines de haute densité (HDL-c) ont pu être observées après 2 mois d'administration d'inuline à des patientes en surpoids (Dehghan *et al.*, 2013). Un ratio élevé TG/HDL-c a été fortement corrélé avec une résistance à l'insuline et un état diabétique (Lin *et al.*, 2018), l'inversion de cette tendance pourrait donc signifier un retour à la normale. Ceci est corroboré par une diminution significative de la quantité d'hémoglobines glyquées HbA1c dans le sang de ces mêmes patientes (Dehghan *et al.*, 2013).

Ces effets hypoglycémiant et hypolipémiant de l'inuline pourraient être un frein au développement du diabète de type 2 chez les personnes à risque. Le diabète est aujourd'hui un problème de santé publique majeur dont la prévalence augmente d'année en année (Ogurtsova *et al.*, 2017). En 2050, jusqu'à 1 milliard de personnes pourraient en être atteint (projection mondiale www.ined.fr). Cette maladie résulte en l'apparition de complications spécifiques graves telles que le développement de cardiopathies, rétinopathies, néphropathies, neuropathies (Harding *et al.*, 2018) et peut notamment augmenter le risque de mortalité chez les patients atteints d'un cancer (Vigneri *et al.*, 2009, Stein *et al.*, 2010). Beaucoup de traitements antidiabétiques ont un coût élevé et provoquent une variété d'effets secondaires indésirables (Purnell *et al.*, 2014, Sterrett *et al.*, 2016), d'où l'intérêt grandissant pour des traitements plus naturels et économiques à base de plantes.

Comme évoqué précédemment, via la production de SCFA, l'inuline provoque une diminution du pH au niveau de la lumière du tube digestif. Ceci lui confère un rôle particulièrement important dans l'homéostasie et le transport du calcium. Les mécanismes impliqués incluent une augmentation de l'expression des transporteurs du calcium au niveau de la barrière

intestinale, la stimulation de la croissance de *Lactobacillus* et *Bifidobacterium* capables de métaboliser des isoflavones en composés directement impliqués dans le maintien de la densité osseuse, et une réduction de l'activité de la phosphatase alcaline notamment impliquée dans la décalcification des os chez les femmes ménopausées (Bakirhan & Karabudak, 2021). L'inuline pourrait ainsi diminuer les risques de développement d'ostéoporose.

D'autre part, l'inuline par son action prébiotique et par la production de SCFA qui en résulte, joue un rôle dans le processus de régénération de la barrière épithéliale intestinale et la modulation de l'inflammation. Elle apporte aussi un effet bénéfique sur le tractus digestif global en réduisant significativement les symptômes de constipation (Micka *et al.*, 2017). L'administration de racines de chicorée séchées apporte des bienfaits similaires (Puhlmann *et al.*, 2022).

Chez la souris, Du *et al.*, (2020) ont démontré que l'inuline à haut degré de polymérisation (DP ≥ 23), suite à son effet prébiotique, réduisait les symptômes de stéatose hépatique et améliorait la tolérance au glucose, par une baisse du taux de lipides circulants et une réduction de leur accumulation dans les adipocytes, ainsi que par une modulation des phénomènes de stress oxydatif, d'inflammation et de résistance à l'insuline engendrés par un régime alimentaire riche en graisses. L'inuline, par son action sur le microbiote intestinal, pourrait inhiber la production d'endotoxines par les microorganismes pathogènes et par conséquent réduire leur activité délétère, ceci se traduirait dans l'organisme par une diminution des marqueurs de l'inflammation (Li *et al.*, 2020). Le même type d'observation a été faite chez l'homme où l'inuline était capable de mitiger la production de cytokines et pourrait ainsi soulager les symptômes de maladies inflammatoires de l'intestin (Akram *et al.*, 2019) ou d'inflammation chronique chez des patients obèses (Girgiss Nicola *et al.*, 2018).

3.1.4. Utilisations industrielles de l'inuline

L'inuline, composé majoritaire de la racine de chicorée, est produite dans un certain nombre d'autres plantes telles que le blé, le soja, l'artichaut, l'oignon, l'ail, le poireau ou encore l'asperge (Van Loo *et al.*, 1995). Seuls les racines de chicorée et les artichauts en contiennent assez pour que son extraction soit économiquement rentable (15-20% de la masse humide). Des cossettes de racines de chicorée propres et sèches permettent de produire un sirop brut qui, par des étapes de purification et de séchage, est transformé en une poudre blanche commercialisable. L'inuline, les FOS mais aussi la farine de chicorée ont été étiquetés comme

« généralement reconnu comme sans danger » (« Generally Recognized As Safe » GRAS) par la Food and Drug Administration (FDA) (www.fda.gov). Aujourd'hui, l'industrie agroalimentaire utilise l'inuline pour ses propriétés texturantes et rhéologiques et sa capacité à stabiliser des émulsions. Son faible indice glycémique en fait un ingrédient particulièrement intéressant pour remplacer le sucre et le gras dans des produits transformés tels que les pâtisseries, les produits laitiers ou les desserts glacés (Ismail *et al.*, 2013, Pasephol *et al.*, 2008, Tsatsaragkou *et al.*, 2021). La dégradation contrôlée de l'inuline permet de fabriquer des oligofructoses, des sirops de fructose purs à 95 % et de l'éthanol (Chi *et al.*, 2009). Outre son utilisation agro-alimentaire, l'inuline est intégrée à des formulations cosmétiques (INUTEC®) pour ses propriétés surfactantes ou utilisée pour mesurer la capacité des reins à filtrer le sang (Tripodo & Mandracchia, 2019). D'autres applications ont vu le jour depuis. L'inuline pourrait, par exemple, être utilisée en temps qu'excipient pour obtenir une meilleure stabilité et un relargage contrôlé de substances actives (Usman *et al.*, 2021, Gupta *et al.*, 2019). Elle pourrait aussi être employée dans la création de matériaux absorbants à moindre coût (Hernández-Martínez *et al.*, 2017, Mohd Yusop *et al.*, 2021).

3.2. Le fructose

Comme tous les hexoses (CH₂O)₆, le fructose est produit lors de la photosynthèse par l'apport d'énergie lumineuse selon la réaction générale : $6\text{H}_2\text{O} + 6\text{CO}_2 \rightarrow (\text{CH}_2\text{O})_6 + 6\text{O}_2$ (Voet & Voet, 2016). La structure chimique du fructose est représentée dans la **Figure i.4A**.

Dans le cas de la chicorée, le fructose-6-phosphate ainsi produit est majoritairement utilisé dans la synthèse d'inuline (**Figure i.5**) ou combiné à une molécule de glucose-1-phosphate pour former le saccharose (Voet & Voet, 2016). De la même façon que l'inuline, le fructose est impliqué dans la plante dans le maintien de l'homéostasie cellulaire et la protection des tissus contre le stress oxydatif induit par le froid (Bogdanović *et al.*, 2008).

Chez l'Homme, lorsque le fructose est ingéré en tant qu'aliment en faible quantité (0,25-0,5 g/kg), celui-ci est majoritairement éliminé ou transformé en glucose, lactate et glycérate au niveau de la partie supérieure de l'intestin et en SCFA par le microbiote intestinal (Jang *et al.*, 2018). L'impact du relargage de faibles quantités de glycérate au niveau intestinal est encore inconnu mais le L-lactate produit par les cellules de mammifères induit une cicatrisation plus rapide de la barrière intestinale et pourrait soulager les symptômes de colite chez la souris (Yu, Y. *et al.*, 2021). Il s'avère également que dans des quantités alimentaires, le fructose induit une

augmentation de l'activité de la glucokinase (Watford, 2002, Shiota *et al.*, 1998) mécanisme qui augmente la synthèse de glycogène hépatique chez les personnes avec une glycémie normale (Peterson *et al.*, 2001), et réduit significativement la production endogène de glucose chez les personnes diabétiques en hyperglycémie (Hawkins *et al.*, 2002). En faible quantité le fructose pourrait donc permettre un meilleur contrôle de la glycémie sans affecter le niveau de triglycérides plasmatiques (Evans *et al.*, 2017).

Dès lors que les systèmes d'absorption et d'élimination du fructose commencent à saturer (prise alimentaire > 1 g/kg), l'effet du fructose s'inverse et devient délétère pour le foie (Jang *et al.*, 2018) et l'organisme (Wang *et al.*, 2020).

3.3. Les acides chlorogéniques

3.3.1. Rôle chez la plante et biosynthèse

Les CGA font partie de la classe des polyphénols qui regroupe plusieurs milliers de molécules différentes. La définition d'un polyphénol est parfois difficile mais Quideau *et al.* (2011) considèrent qu'un composé de cette classe doit impérativement dériver de la voie des phénylpropanoïdes, et être ainsi caractérisé par la présence de plusieurs groupements hydroxyles, et cycles aromatiques, et par l'absence de fonctions azotées même dans les composés dont ils dérivent (ex : acides aminés). Cette définition permet ainsi d'éliminer certains terpènes et alcaloïdes (Quideau *et al.*, 2011).

Les polyphénols peuvent être séparés en sept classes différentes : les flavonoïdes, les acides phénoliques, les tannins, les stilbènes, les lignanes, les coumarines et les curcuminoïdes (**Figure i.6**). Les CGA font partie du groupe des acides phénoliques et plus particulièrement des acides hydroxycinnamiques (**Figure i.6**). Chez les plantes, ces CGA sont principalement impliqués dans des mécanismes de défense contre les agresseurs de types pathogènes et herbivores (Bollina *et al.*, 2011, Kundu & Vadassery, 2019) et auraient également un rôle protecteur contre divers stress abiotiques tels que les radiations UV, les métaux lourds, le froid, la chaleur ou la sécheresse (Reine Judesse Soviguidi *et al.*, 2022).

Les composés les plus répandus parmi les CGA sont les acides caféique, férulique, *p*-coumarique et leurs formes plus complexes, les acides caféoyl-, dicaféoyl-, féruloyl- et coumaroylquinique (Tajik *et al.*, 2017). Les acides 3-*O*-mono-caféoylquinique (3-CGA) et 3,5-*O*-di-caféoylquinique (3,5-CGA), présents dans la racine de chicorée, sont des composés issus

de l'estérification d'une molécule d'acide quinique avec respectivement un ou deux acides caféiques (**Figure i.7**)

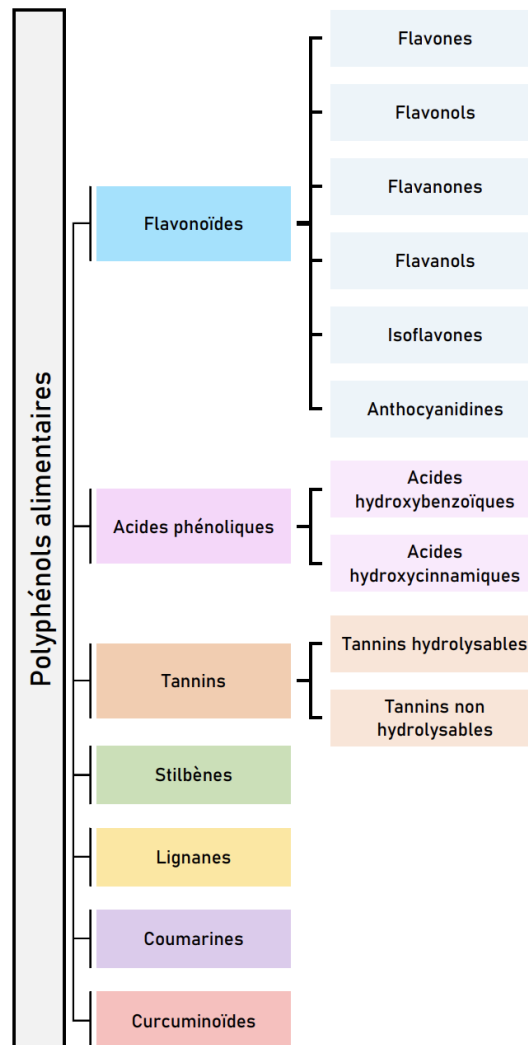

Figure i.6. Classification des polyphénols alimentaires (d'après Tsao, 2010, Crozier *et al.*, 2009, Wojtunik-Kulesza *et al.*, 2020). Les acides chlorogéniques de la chicorée font partie des acides hydroxycinnamiques.

Ces molécules dérivent toutes deux de la phénylalanine (**Figure i.7**). La première réaction amenant à la formation de ces composés est catalysée par les enzymes hydroxycinnamoyl-CoA shikimate/quinate hydroxycinnamoyl transférase (HCT) et hydroxycinnamoyl-CoA quinate hydroxycinnamoyl transférase (HQT). L'acide coumaroylquinique ainsi formé est hydroxylé par la *para*-coumaroyl ester 3'-hydroxylase (C3'H) pour former le 3-CGA (acide chlorogénique). L'enzyme amenant à la formation du 3,5-CGA (acide isochlorogénique) à partir du 3-CGA n'a pas encore été identifiée chez la chicorée. Des essais réalisés chez la patate

douce, la tomate et l'artichaut, révèlent que des enzymes de type GDSL-lipase like (Miguel *et al.*, 2020) ou HCT-HQT (Moglia *et al.*, 2014, Moglia *et al.*, 2016) pourraient être impliquées.

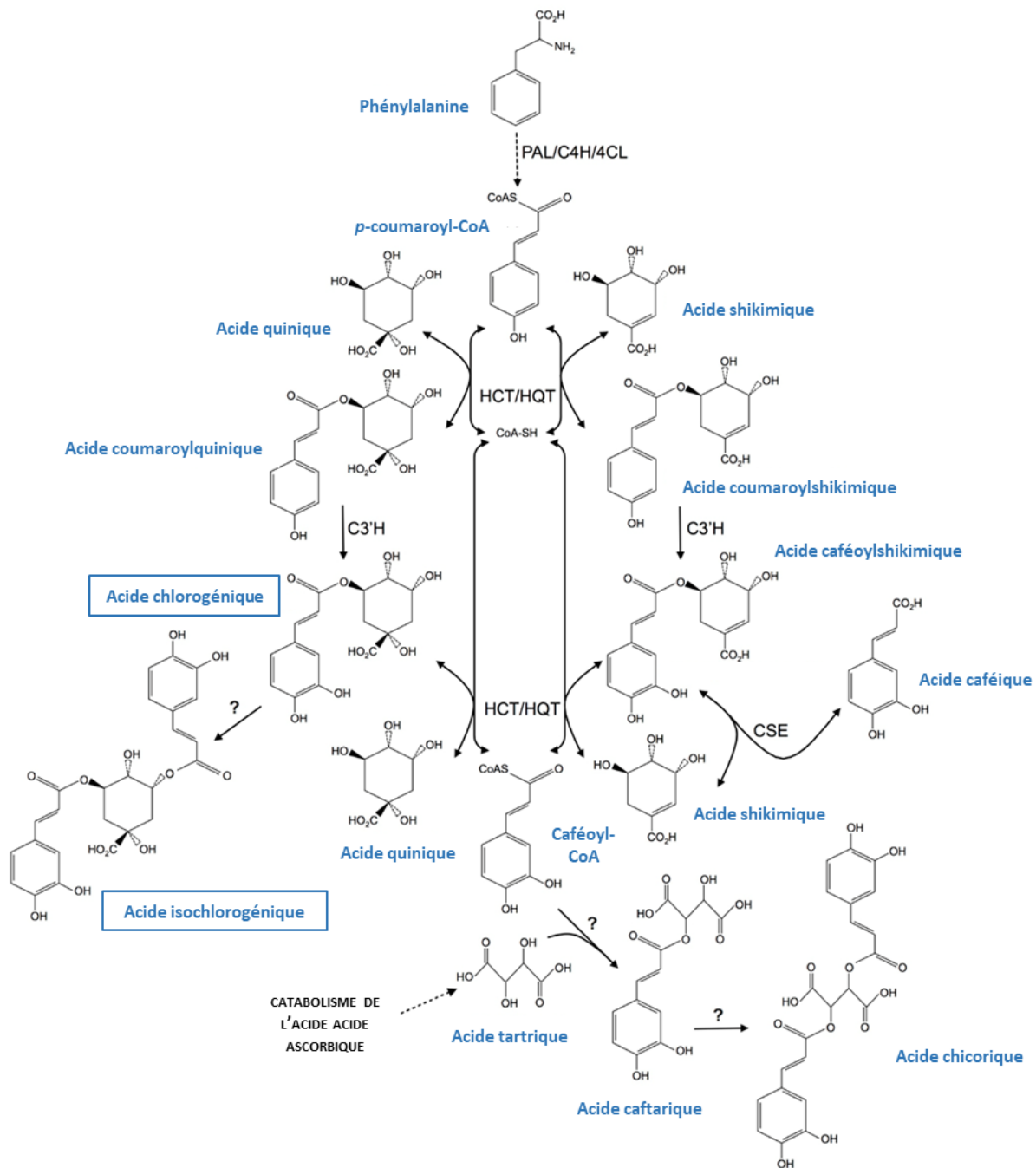

Figure i.7. Voie de biosynthèse des acides chlorogéniques (Legrand *et al.*, 2016).

Les intermédiaires de réactions sont écrits en bleu, les composés phénoliques retrouvés dans la racine de chicorée sont encadrés. Les enzymes impliquées sont : PAL : phénylalanine ammonia lyase ; C4H : cinnamate 4-hydroxylase ; 4CL : 4-coumaroyl CoA ligase; HCT : hydroxycinnamoyl-CoA shikimate/quinate hydroxycinnamoyl transférase; HQT : hydroxycinnamoyl-CoA quinate hydroxycinnamoyl transférase; C3'H : *p*-coumaroyl ester 3'-hydroxylase; CSE, caféoyl shikimate estérase.

En dehors des fruits et jus de fruits, les céréales, le chou, l'aubergine, l'artichaut, le cacao, le café et le thé sont d'excellentes sources de polyphénols et en particulier d'acides chlorogéniques (El-Seedi *et al.*, 2012). Ces composés sont rarement retrouvés sous forme libre, et sont généralement liés aux polysaccharides et aux protéines structurales de la paroi cellulaire ou à d'autres acides organiques (De la Rosa *et al.*, 2018, Buanafina, 2009, Mueller-Harvey *et al.*, 1986), ce qui les rend généralement faiblement disponibles dans l'organisme.

3.3.2. Disponibilité, absorption et modifications post-digestion des CGA

La matrice alimentaire est dégradée tout au long de son trajet au sein du tractus gastro-intestinal par les conditions mécaniques (mastication, péristaltisme de l'intestin) et physicochimiques (enzymes hydrolysantes, variations de pH) de celui-ci. Les CGA piégés au sein de cette matrice sont progressivement libérés mais ne sont pas ou peu modifiés par les conditions physiologiques (Baeza *et al.*, 2017). Entre 20 et 40 % de ce contenu passerait ainsi dans la circulation systémique via la partie supérieure de l'intestin (Farah & de Paula Lima, 2019). Les composés non absorbés qui arrivent au niveau de l'intestin sont glucuronidés, sulfatés ou méthylés par les enzymes présentes à la surface des entérocytes, ces modifications chimiques peuvent grandement améliorer ou, au contraire, altérer leur activité biologique (Heleno *et al.*, 2015). Les CGA libres peuvent facilement passer à travers l'épithélium, mais l'estérification de l'acide caféique en 3-CGA semble réduire drastiquement son absorption. Ces composés exerceraient donc la majorité de leurs bienfaits au niveau de l'intestin. Les CGA moins complexes, comme l'acide caféique, passeraient plus facilement la barrière intestinale. Selon une étude de López-Froilán *et al.*, (2016), visant à étudier le taux d'absorption du contenu phénolique du café après une digestion *in vitro* et dialyse, 74 à 83 % de ces composés ne sont pas absorbés au niveau de la barrière intestinale et pourraient atteindre le côlon. Des résultats similaires ont été obtenus chez l'Homme, chez qui 67 % des CGA et 5 % des acides caféiques ingérés étaient excrétés (Olthof *et al.*, 2001). Quelle que soit la quantité de CGA présente dans le café consommé, 70 % de ce contenu ne passe pas la barrière intestinale et est excrété. D'autre part, la proportion en dérivés conjugués formés diminue avec l'augmentation de la dose administrée. La capacité de transport et/ou l'activité enzymatique pourraient donc atteindre un seuil de saturation. La matrice semble aussi avoir un impact sur le taux d'excrétion iléale des CGA. Selon la boisson consommée, cette proportion peut varier de 26 % (jus de pomme trouble) à 77 % (smoothie de pommes). Ce résultat a été lié à une variation du pH intestinal et à la quantité de débris

cellulaires contenus dans le jus de pomme trouble (Clifford *et al.*, 2017). Les CGA qui n'ont pas été absorbés, atteignent le côlon où ils sont métabolisés par le microbiote (Gonthier *et al.*, 2006). Cette dégradation est particulièrement impactée par la composition du microbiote intestinal et peut donc varier d'un individu à l'autre (Tomas-Barberan *et al.*, 2013). Malgré cela, les CGA sont majoritairement catabolisés par le microbiote en acides dihydrocaféique, dihydrofêrulique et phénylpropionique (Ludwig *et al.*, 2013) qui seront réabsorbés et finiront par atteindre le foie (Clifford *et al.*, 2020). Une partie des molécules absorbées est excrétée dans les fèces et l'urine (Gómez-Juaristi *et al.*, 2018). Malgré la faible biodisponibilité des polyphénols en général, la plupart atteignent des quantités pharmacologiquement actives dans les organes périphériques (Luca *et al.*, 2020).

3.3.3. Effet santé des CGA

Le stress oxydatif pourrait être défini comme un état dans lequel la production d'espèces réactives de l'oxygène (ROS) excède la capacité du corps à se débarrasser de ces radicaux libres et à réparer les tissus cellulaires qui sont par conséquent endommagés. Ces ROS (anion superoxyde O_2^- , peroxyde d'hydrogène H_2O_2 , radical hydroxyle HO^\bullet) peuvent causer des dommages majeurs aux macromolécules et aux cellules elles-mêmes (Juan *et al.*, 2021). La réponse inflammatoire cellulaire induite (Babior, 2000) provoque le mouvement de leucocytes, plasma et fluides vers la zone lésée qui précède le relargage de molécules impliquées dans le processus d'inflammation (Abdulkhaleq *et al.*, 2018). Parmi ces médiateurs de l'inflammation, les peptides et amines vasoactifs participent à l'augmentation de la perméabilité vasculaire (Headland & Norling, 2015), les cytokines, acteurs majeurs dans l'inflammation, sont en mesure d'activer et de promouvoir la prolifération de certaines cellules immunitaires tandis que les chimiokines sont, elles, directement impliquées dans la migration et l'infiltration des cellules de l'inflammation (Zhao *et al.*, 2021). Au final, ces perturbations entraînent l'apparition de pathologies graves telles que des maladies cardiovasculaires (Pignatelli *et al.*, 2018) et neurodégénératives (Simpson & Oliver, 2020), cancers (Klaunig, 2019), diabète de type 2 (Yaribeygi *et al.*, 2020) et arthrite (Phull *et al.*, 2018). Un déclin dans la sécrétion de certains de ces médiateurs peut donc être associé à une modulation de la réaction inflammatoire et une diminution du risque de développement de maladies associées.

Les CGA ont été reconnus comme des molécules bioactives avec des effets antioxydants, anti-inflammatoires, antimicrobiens et impliquées dans la régulation métabolique.

Le 3-CGA est reconnu pour ses propriétés antioxydantes et anti-inflammatoires dans de nombreux modèles (Ruiz-Crespo *et al.*, 2012, Peres *et al.*, 2013, Bonetti *et al.*, 2016, Chansriniyom *et al.*, 2021, Wu *et al.*, 2021). Il intervient aussi dans la neuroinflammation, provoquant la désactivation de la tyrosine kinase c-Src, enzyme nécessaire à l'activation des microgliocytes (Socodato *et al.*, 2014). Cet acide chlorogénique empêche ainsi la production d'espèces réactives de l'oxygène et de glutamate prévenant de ce fait des dommages supplémentaires au niveau du système nerveux central (Socodato *et al.*, 2015). Des effets antidépresseurs, anti-épileptiques, et anti-apoptotiques ont aussi été rapportés avec le 3-CGA et ses métabolites (Szwajgier *et al.*, 2017).

Hormis son effet neurodégénératif, une supplémentation alimentaire de type 'high-fat diet' engendre aussi l'apparition d'un syndrome métabolique, avec l'émergence d'une résistance à l'insuline, d'hypertension, et d'une obésité. Ce syndrome atteint également les reins, le foie, le pancréas et augmente de manière drastique les risques de maladies cardiovasculaires et de diabète de type 2 (Panchal *et al.*, 2012). Les CGA dérivant de l'acide caféique (acides cafféoylquiniques : 3-CGA, 3,5-CGA, 5-CGA, 4-CGA...) ont montré des effets prometteurs sur l'ensemble de ces troubles métaboliques. Chez la souris, le rat, mais aussi l'être humain, ils réduisent l'accumulation de graisse viscérale, amoindrissent la stéatose hépatique, modulent les niveaux d'hormones plasmatiques et l'accumulation de lipides, inhibent l'expression génique d'enzymes impliquées dans la glycolyse, améliorent l'homéostasie, la tolérance au glucose, et la fonction vasculaire générale (Di Lorenzo *et al.*, 2021, Santana- Gálvez *et al.*, 2017).

Des facteurs environnementaux tels qu'un stress abiotique ou l'infection par des pathogènes induisent un dysfonctionnement de la barrière intestinale, un changement dans la composition du microbiote et à terme une inflammation chronique. *In vitro*, il a été démontré que le 3-CGA était capable, dans une certaine mesure, de protéger la barrière intestinale des dommages causés par les lipopolysaccharides (LPS) bactériens. Cet acide chlorogénique inhibe ainsi l'activation de la voie du NFκB par l'intermédiaire de CD14 et p65, ce qui a pour conséquences de réduire le niveau et l'expression de cytokines pro-inflammatoires de type TNFα, IL-1β et IL-6 et de restaurer partiellement l'imperméabilité naturelle de l'épithélium intestinal (Yu, L. *et al.*, 2021). Les niveaux intracellulaire et extracellulaire d'espèces réactives de l'oxygène sont aussi retrouvés réduits (Palócz *et al.*, 2016). Les modèles *in vivo* montrent des effets semblables. L'administration des CGA à des poules ayant subi un stress thermique aigu permet de moduler la réponse inflammatoire et oxydative au niveau intestinal, et d'augmenter la proportion de bactéries productrices de SCFA ou avec une action immunomodulatrice (Chen *et al.*, 2021).

Cette fonction protectrice des CGA est aussi retrouvée chez plusieurs modèles d'animaux atteints d'inflammation, comme la souris atteinte d'hyperuricémie (Zhou *et al.*, 2021) ou de rectocolite hémorragique (Zhang *et al.*, 2017), le rat obèse (Xie *et al.*, 2021) et le porc sevré (Chen *et al.*, 2018).

Des extraits de chicorée et les composés phénoliques qu'ils contiennent ont aussi montré des effets inhibiteurs sur la prolifération de pathogènes de type *Listeria monocytogenes*, *Salmonella enteritidis*, *Salmonella typhi*, *Helicobacter pylori*, *Bacillus cereus*, *Bacillus subtilis*, *Escherichia coli*, *Pseudomonas aeruginosa* ou *Staphylococcus aureus* (Faiku *et al.*, 2016, Wan *et al.*, 2020). Ces polyphénols pourraient notamment interférer dans la formation de biofilms et l'adhérence des pathogènes aux cellules épithéliales (Bezerra *et al.*, 2022). Ces extraits ont aussi montré un effet synergique avec des antibiotiques couramment utilisés (Stefanović *et al.*, 2012). L'extrait de plante entière pourrait d'autre part faire office de conservateur pour des produits alimentaires comme le lait, la viande ou l'huile (El-Mehy, 2018, Jeong *et al.*, 2016).

Outre leurs effets antibactériens, les polyphénols de la chicorée ont montré une activité antivirale non négligeable. L'acide chicorique extrait de la partie foliaire de la chicorée, en plus d'inhiber significativement la réplication du virus de l'hépatite B (HBV), réduit aussi nettement son taux d'antigènes (Zhang *et al.*, 2014). Certains acides dicafféoylquiniques (3,5-CGA, 3,4-CGA, 4,5-CGA) ainsi que l'acide chicorique et ses analogues présentent une activité anti-VIH en inhibant la réplication et les intégrases du virus de l'immunodéficience humaine (McDougall *et al.*, 1998, Crosby *et al.*, 2010, Reinke *et al.*, 2002).

3.4. Les lactones sesquiterpéniques

3.4.1. Rôle chez la plante et biosynthèse

Les STL majoritaires de la chicorée sont des guaianolides qui dérivent tous de la germacrène A. Les plus abondants sont la lactucine (Lc), la lactucopicrine (Lp), la 11 β -13-dihydrolactucin (DHLc) et la 11 β -13-dihydrolactucopirine (DHLp). Ces molécules sont retrouvées sous d'autres formes hydroxyle (8-déoxy-Lc, Jacquilenine), oxalate (Lp-15-oxalate, Lc-15-oxalate, 8-déoxyLc-15-oxalate) ou glycosyle (Lp-15-glycoside, Picriside A, Crepidiaside A). La liste non exhaustive des structures des dérivés de la Lc est représentée par la **Figure i.8**, la structure de la Lp par la **Figure i.9**.

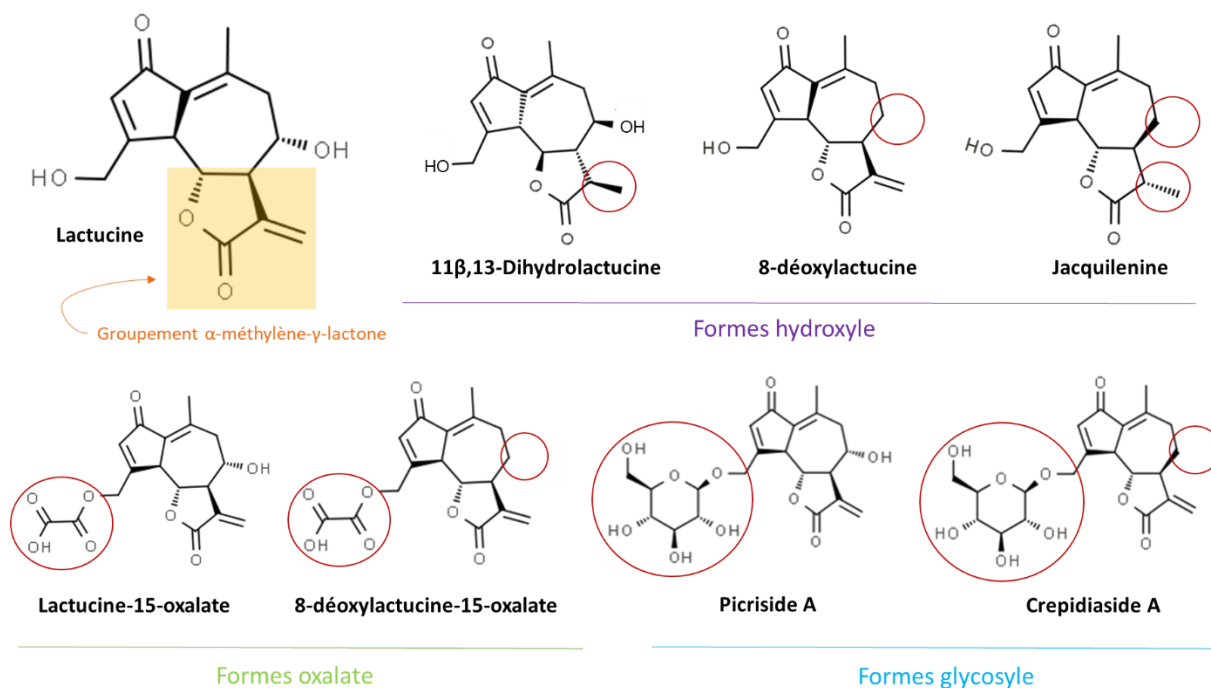

Figure i.8. Structure de la lactucine et de ses dérivés (d'après Sessa *et al.*, 2000).

La lactucine existe sous différentes formes hydroxyle, oxalate et glycosyle. Sont entourés en rouge les groupements modifiés par rapport à la Lactucine. La fonction active α -méthylène- γ -lactone a été encadrée. La Jacquilenine peut également être appelée 11 β ,13-Dihydro-8-déoxylactucine (DHLc), la Picriside A a pour autre nom la Lactucine-15-glycoside et la Crepidiaside A est en réalité la 8-déoxylactucine-15-glycoside. La Jacquilenine existe aussi sous forme glycosyle (non représentée ici).

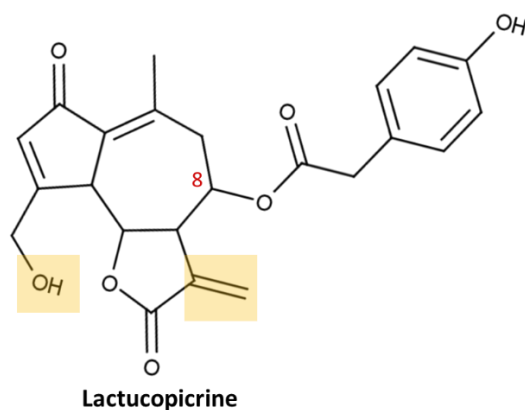

Figure i.9. Structure de la lactucopicrine

Tout comme la lactucine, la lactucopicrine existe sous d'autres formes hydroxyle, oxalate, glycosyle. Les fonctions pouvant être modifiées sont encadrées. Etant donné la structure de la molécule, la forme 8-déoxy- ne peut pas exister chez la lactucopicrine.

La voie de biosynthèse des lactones sesquiterpéniques de type guaianolides présentes dans la chicorée a été en partie résolue. La germacrène A synthase (GAS) convertit la farnésyl diphosphate (FPP) en germacrène A. La germacrène A oxydase (GAO) oxyde ce sesquiterpène en son acide. La costunolide synthase (COS) convertit à son tour cet acide en costunolide. Les réactions précédant la formation de la Lc, de la Lp et de leurs dérivés sont encore inconnues (**Figure i.10**).

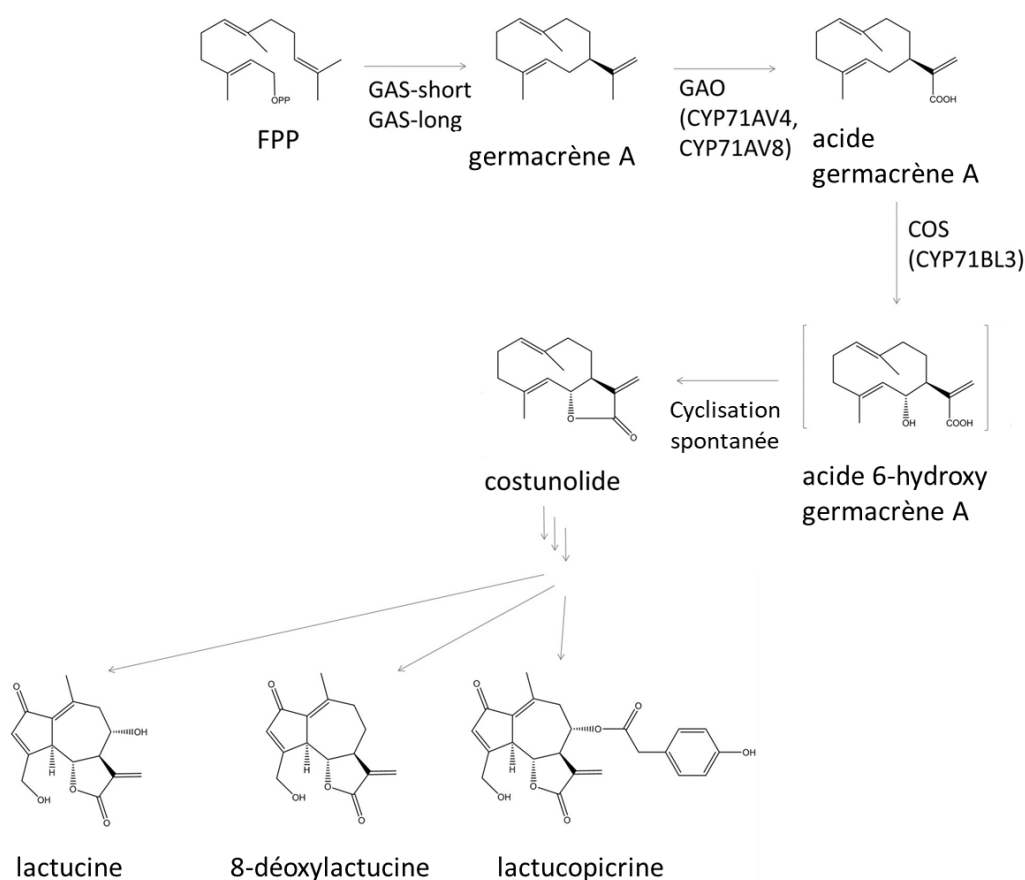

Figure i.10. Voie de biosynthèse des STL de type guaianolide de *Cichorium intybus* L. (Bogdanović *et al.*, 2019).

FPP: farnésyl diphosphate; GAS: germacrène A synthase; GAO: germacrène A oxydase, COS: costunolide synthase. La lactucine, la 8-déoxylactucine et la lactucopicrine subissent d'autres modifications pour prendre leur forme dihydro-, oxalate ou glycosyle. Ces voies sont encore à l'étude.

Hormis pour les formes dihydro- (DHLc, DHLp), les STL de la chicorée possèdent toutes un groupement α -méthylène- γ -lactone (**Figure i.8**) qui est souvent considéré comme essentiel dans leur fonction cytotoxique, tandis que les autres groupes en altèrent l'activité par un changement

de conformation stérique ou par modification chimique (Chadwick *et al.*, 2013). Responsables de la saveur amère de la chicorée (Van Beek *et al.*, 1990, Price *et al.*, 1990), ces lactones sesquiterpéniques ont, chez la plante, un rôle dissuasif contre les herbivores et les plantes compétitrices, ou au contraire un effet attractif pour les prédateurs de parasites. Elles agissent en tant que composés antimicrobiens en perturbant la membrane cellulaire des microorganismes pathogènes de la plante et possèdent également un effet protecteur contre les dommages aux UV et à l'ozone (Chadwick *et al.*, 2013).

3.4.2. Disponibilité, absorption et modifications post-digestion des STL

Contrairement aux polyphénols, la pharmacocinétique des STL n'est qu'en partie élucidée.

Les STL libérées de la matrice alimentaire par les conditions physiologiques et mécaniques du tractus gastro-intestinal sont sensibles à l'hydrolyse acide et alcaline. Au cours de leur transit dans l'estomac et l'intestin, ces molécules subissent donc un certain nombre de transformations. Des composés comme l'alantolactone ou le costunolide sont rapidement dégradés, d'autres comme les ginkgolides nécessitent une hydrolyse pour prendre une forme plus soluble et stable (Yu *et al.*, 2020).

Les STL en général, dont celles possédant un cycle α -méthylène- γ -lactone, sont souvent oxydées en composés plus polaires, mais toujours actifs, par les cytochromes P450 lors de la 1^{ère} phase du métabolisme. Lors de la 2^e phase du métabolisme, les composés subissent des modifications supplémentaires visant à les rendre plus polaires encore, donc plus facilement excrétables dans les urines. Il est également à noter que malgré des similarités structurales importantes et une fonction active commune (**Figure i.11**), des composés comme le costunolide et le déhydrocostus lactone ne subissent pas les mêmes phases du métabolisme (Peng *et al.*, 2014). Il en serait donc potentiellement de même pour des composés comme la Lc, la Lp et tous leurs dérivés. Ces transformations/inactivations se font dans les conditions de pH physiologique de l'intestin ou par réaction enzymatique dans le foie qui est le premier organe de métabolisation des STL (Yu *et al.*, 2020).

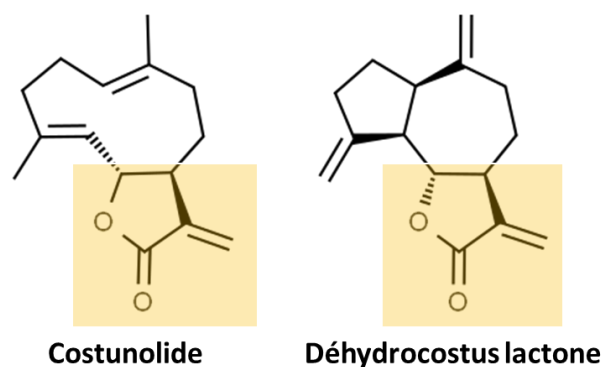

Figure i.11. Différence structurale entre le costunolide et le déhydrocostus lactone.

Les deux molécules possèdent une fonction α -méthylène- γ -lactone (encadrée). Le déhydrocostus lactone n'est pas présent chez *Cichorium intybus* L. mais a été utilisé pour étudier la réduction de la double liaison C₁₁-C₁₃ chez ses STL (De Kraker *et al.*, 2002).

La majorité des composés liposolubles passent la barrière intestinale via diffusion passive, mais sont aussi à même d'être aussitôt transportés en dehors des cellules par des transporteurs à efflux, leur donnant une faible biodisponibilité. Les STL, elles-mêmes lipophiles, sont en grande partie éliminées grâce à des transporteurs à efflux de type glycoprotéine P, breast cancer resistance proteins (BCRP) ou multidrug resistance-associated proteins (MRP) (Yu *et al.*, 2020). Presque la moitié du contenu en STL de la chicorée witloof est au final excrétée dans les urines et les fèces (Weng *et al.*, 2020). Dans trois modèles de prédiction *in silico*, dont l'un de passage à travers la barrière hémato-encéphalique, les Lc et DHLc semblent néanmoins faire partie des STL de la chicorée les plus facilement absorbées et passeraient la barrière par voie paracellulaire (Matos *et al.*, 2020).

Les STL non absorbées atteignent le côlon, où elles sont transformées par la machinerie enzymatique du microbiote intestinal. Deux modèles de fermentation fécale *in vitro* ont montré que les lactones de la chicorée subiraient alors une gamme étendue de réactions cataboliques : hydrolyses, déhydroxylation, réductions, déglycosylations (García *et al.*, 2020, Weng *et al.*, 2020). Ces composés pourraient alors subir des réactions de type glucuronidation, sulfatation ou conjugaison qui les rendent inactifs et plus polaires encore pour leur excrétion dans les urines (García *et al.*, 2020, Yu *et al.*, 2020).

3.4.3. Effets santé des STL

Plusieurs études ont montré les propriétés nématocides naturelles des feuilles de chicorée utilisées comme fourrage pour le bétail. Aussi efficace ensilée que fraîche, la chicorée réduit fortement et de façon significative le niveau d'infection des bovins, agneaux et porcs (Peña-Espinoza *et al.*, 2018). Cet effet a souvent été rattaché à sa composition en tannins et STL. Ceux-ci sont, par exemple, liés à une diminution de la motilité des larves des parasites *Distyocaulus viviparus* et *Dictyocaulus eckerti* responsables de la bronchite vermineuse chez le bovin et le cerf (Molan *et al.*, 2003, Schreurs *et al.*, 2002). Des extraits de cultivars de chicorée enrichis en STL ont montré un effet inhibiteur conséquent sur l'éclosion d'œufs de *Haemonchus contortus* (Foster *et al.*, 2011), un pathogène répandu chez les caprins et ovins.

La pulpe de racine de chicorée, co-produit de production de l'inuline, pourrait être revalorisée en tant qu'anthelminthique. Riche en STL, elle est particulièrement efficace contre les nématodes *Caenorhabditis elegans* et *Ascaris suum* avec peu d'effets cytotoxiques *in vitro* (Peña-Espinoza *et al.*, 2020).

Les STL ont montré un effet antiparasitaires plus large encore et font partie des potentielles pistes pour de nouvelles thérapies plus efficaces et moins lourdes contre certaines maladies tropicales négligées. Plusieurs STL issues d'Astéracées ont montré une activité trypanocide, leishmanicide, antipaludéenne parfois plus efficace que certains traitements actuels, par le blocage de l'internalisation du parasite ou par l'inhibition de la croissance de chacun des stades parasitaires *in vitro* et *in vivo* (Diovu *et al.*, 2022, Peña-Espinoza *et al.*, 2022, Wulsten *et al.*, 2017, Chaniad *et al.*, 2021).

L'effet spécifique des STL de chicorée sur les protozoaires parasites de l'Homme n'a été que très peu étudié. La décoction de racine de chicorée est connue pour son action antipaludéenne en Afghanistan (Amini & Hamdam, 2017), mais peu de recherches ont permis de confirmer ou infirmer cette activité et de déterminer ses effecteurs. Seule l'étude de Bischoff *et al.*, (2004) a permis de lier l'inhibition de *Plasmodium falciparum in vitro* à la Lc et la Lp. Le potentiel trypanocide d'extraits racinaires et foliaires de cultivars de chicorée n'a été testé que récemment *in vitro*. Peña-Espinoza *et al.*, (2022) ont ainsi mis en évidence l'effet dose-dépendant de la chicorée contre plusieurs stades de développement de *Trypanosoma cruzi*, parasite responsable de la maladie de Chagas. Les STL, en particulier la Lc, mais aussi quelques flavonoïdes pourraient être responsables. L'action préventive de la chicorée a aussi été démontrée contre les vecteurs de maladies tropicales négligées. Parmi les extraits testés, les extraits

méthanoliques de racines ont montré l'effet larvicide le plus puissant contre les insectes porteurs de la dengue, de la malaria et de la filariose mais les composés en cause ne sont pas encore déterminés (Ali *et al.*, 2018). D'après Rojas-Silva (2014), la Lp semble être la seule STL de la racine de chicorée efficace contre le stade infectieux de *Leishmania tarentolae*.

Outre cet effet antiparasitaire, plusieurs études ont laissé sous-entendre l'effet antiviral des STL de la chicorée, mais seule leur action contre le virus SARS-CoV-2 a pu être récemment confirmée. Les STL les plus abondantes de la chicorée affichent un effet indirect sur la réplication du génome viral et la transcription du virus dans les cellules en inhibant l'activité des protéases 3CLpro et PLpro (Ávila-Gálvez *et al.*, 2022).

Tout comme les CGA, les STL sont reconnues pour leur effet immunomodulateur lors des phases aiguë et chronique de l'inflammation. L'activité anti-inflammatoire de la chicorée a été testée sur des modèles animaux et cellulaires. Des tests à base d'extrait de racine de chicorée ont montré que les STL, particulièrement la DHLp et la 8-déoxylactucine (dLc), agiraient directement sur l'expression du gène de la cyclooxygénase (COX-2). Ces molécules ont aussi un rôle antioxydant en atténuant le niveau d'expression de l'oxyde nitrique synthase et de deux cytokines pro-inflammatoires (Ripoll *et al.*, 2007). Une autre étude semble apporter un poids supplémentaire au rôle majeur de la dLc dans l'effet immunomodulateur de la chicorée à partir d'un modèle cellulaire (Cavin *et al.*, 2005). Une autre STL, la Lp, inhiberait l'importine $\alpha 3$ protéine nécessaire à la translocation de la forme active de NF κ B dans le noyau. Ainsi bloqué, le système inhibe l'expression de protéines d'adhésion des monocytes à l'épithélium vasculaire, réduisant ainsi la réponse inflammatoire (Weng *et al.*, 2021). En plus de moduler les voies de l'inflammation, les STL de la chicorée réduisent drastiquement la formation d'œdème (Ripoll *et al.*, 2007) et la sensation douloureuse chez la souris (Wesołowska *et al.*, 2006).

L'activité pro-apoptotique de la chicorée a été largement étudiée, particulièrement *in vitro* (Al-Snafi, 2016). Les extraits de racines, feuilles ou graines de chicorée sont cytotoxiques pour de très nombreuses lignées cellulaires cancéreuses : sein (MCF-7, T47D, SKBR3), col de l'utérus (HeLa), ovaire (A2780), prostate (LNCaP et PC-3), côlon (RKO), rein (ACHN), leucémie (Jurkat, HL-60), et peau (C32) (Kandil *et al.*, 2019, Conforti *et al.*, 2008, Nawab *et al.*, 2011, Mehrandish *et al.*, 2016, Mohammad *et al.*, 2014, Esmailbeig *et al.*, 2015, Lee *et al.*, 2000, Zhou *et al.*, 2012). Cette activité potentiellement antitumorale a été confirmée à quelques reprises chez le rongeur (Hafez *et al.*, 2014, Hazra *et al.*, 2002, Hughes & Rowland, 2001, Pool-Zobel, 2005). Les propriétés chimiothérapeutiques de ces extraits sont pour la plupart attribuées

à la composition de la chicorée en lactones sesquiterpéniques et en polyphénols (Imam *et al.*, 2019).

Chez la DHLc et DHLp, le cycle α -méthylène- γ -lactone de la Lc et Lp est remplacé par un groupement ester. Cette différence semble leur apporter une activité antiproliférative supplémentaire contre des lignées cellulaires de cancer hépatique et nasopharyngique (Ren *et al.*, 2005). La Lc est capable d'induire l'apoptose de cellules rénales cancéreuses via la cascade oxydative qui induit l'activation de la voie des caspases, protéines à cystéine indispensables à l'amplification du signal de mort cellulaire (Jang *et al.*, 2021).

OBJECTIFS DE LA THESE

L'objectif principal de ce travail a été de déterminer le rôle fonctionnel de la chicorée pour sa valorisation future au travers de nouvelles applications en alimentation humaine et animale. L'ensemble des expérimentations a été réalisé avec la farine de chicorée, un produit non conventionnel issu de la racine. Les effets sur la santé et les mécanismes d'action de la farine de chicorée et de ses composés bioactifs ont été analysés en trois étapes qui ont constitué ce travail de thèse.

La première partie du projet a été consacrée à l'analyse *in vivo* du statut fonctionnel de la farine de chicorée dans un modèle murin. Pour cela, deux génotypes de chicorée ont été utilisés, G12 et G35, sélectionnés comme étant les plus contrastés du point de vue de leur composition. Les effets de la farine de chicorée ont été comparés en parallèle avec ceux de l'inuline, composé de la racine de chicorée reconnu pour son effet prébiotique, et avec ceux de la farine de blé. Les études ont porté sur l'expression génique (analyses nutriginomiques réalisées avec des microarrays ADN), sur les modifications du microbiote intestinal (analyses métagénomiques réalisées par séquençage 16S RNA) et sur la sécrétion d'hormones plasmatiques (dosages réalisés en multiplex par le système Luminex) (**Figure i.12**).

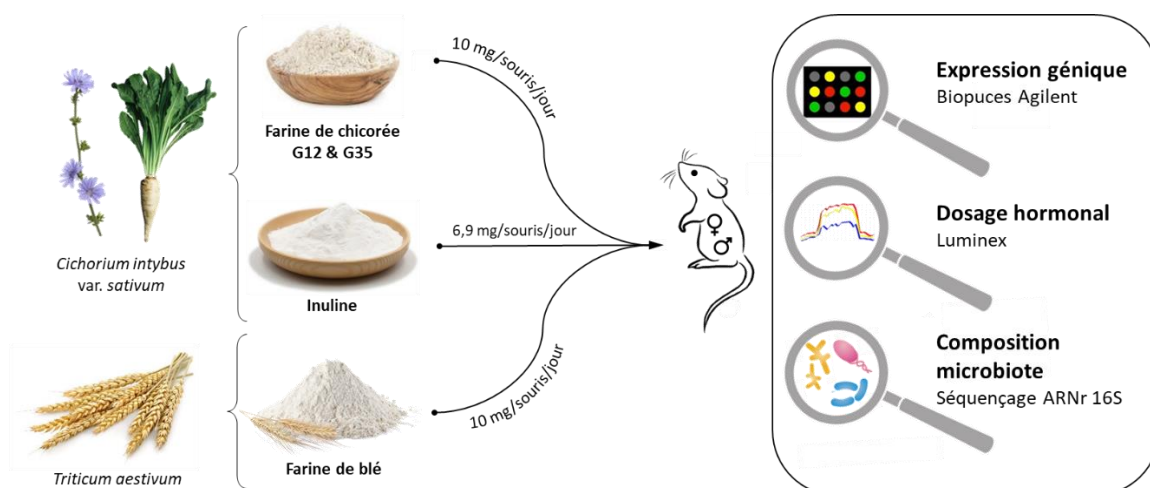

Figure i.12. Récapitulatif des analyses *in vivo* visant à déterminer les effets fonctionnels de la farine de chicorée. L'expression des gènes a été analysée avec des microarrays ADN, le dosage des hormones circulantes réalisé par le système d'analyse multiplex Luminex et la composition du microbiote intestinal caractérisée par metabarcoding avec séquençage du gène de l'ARNr 16S bactérien.

La deuxième partie du projet a consisté, grâce à la mise en place d'une démarche expérimentale originale, à déterminer quels étaient les composés, autres que l'inuline, responsables des effets fonctionnels de la chicorée. Nous nous sommes ainsi focalisés sur trois classes de molécules présentes dans la racine: le fructose, les CGA et les STL. Ces composés ont, de la même façon, été testés *in vivo* chez la souris. Les résultats obtenus ont été accompagnés d'essais *in vitro* visant à valider les activités pro-apoptotiques, anti-inflammatoires et antioxydantes de ces composés bioactifs (**Figure i.13**).

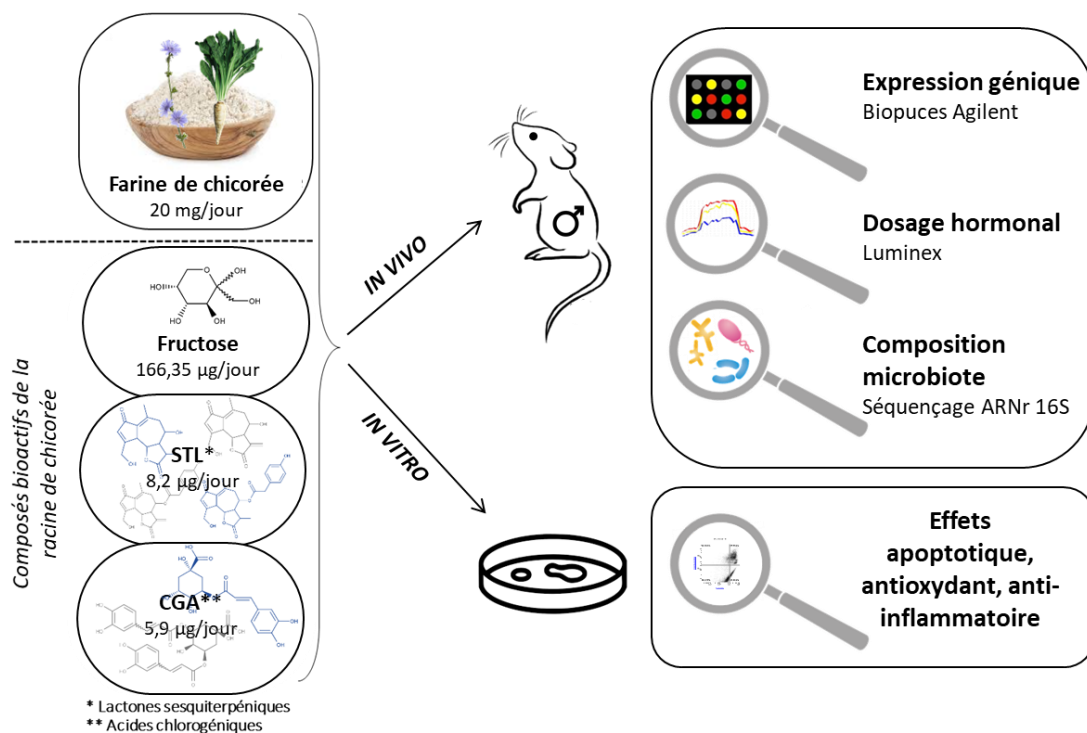

Figure i.13. Récapitulatif des analyses visant à déterminer les effecteurs de la farine de chicorée.

L'expression des gènes a été analysée avec des microarrays ADN, le dosage des hormones circulantes réalisé par le système d'analyse multiplex Luminex et la composition du microbiote intestinal caractérisée par metabarcoding avec séquençage du gène de l'ARNr 16S bactérien. L'effet apoptotique a été déterminé par cytométrie en flux, l'activité antioxydante par mesure de l'inhibition des espèces réactives de l'oxygène, et l'action anti-inflammatoire par un dosage Luminex et ELISA de la production de cytokines par une lignée cellulaire de macrophages.

Dans un troisième temps, l'impact de la digestion gastro-intestinale sur le statut fonctionnel de la chicorée a été déterminé *in vitro* grâce à l'utilisation du protocole consensuel de digestion *in vitro* statique INFOGEST (Brodkorb *et al.*, 2019). Cette méthode permet de mimer les trois premiers compartiments du tractus gastro-intestinal humain (bouche, estomac, intestin) et leurs conditions physiologiques. Les produits de digestion de la farine et des trois composés bioactifs

caractérisés lors des expérimentations précédentes (fructose, CGA et STL) ont été testés de la même façon *in vitro*, afin de comparer les effets des produits de digestion avec ceux des produits bruts (**Figure i.14**).

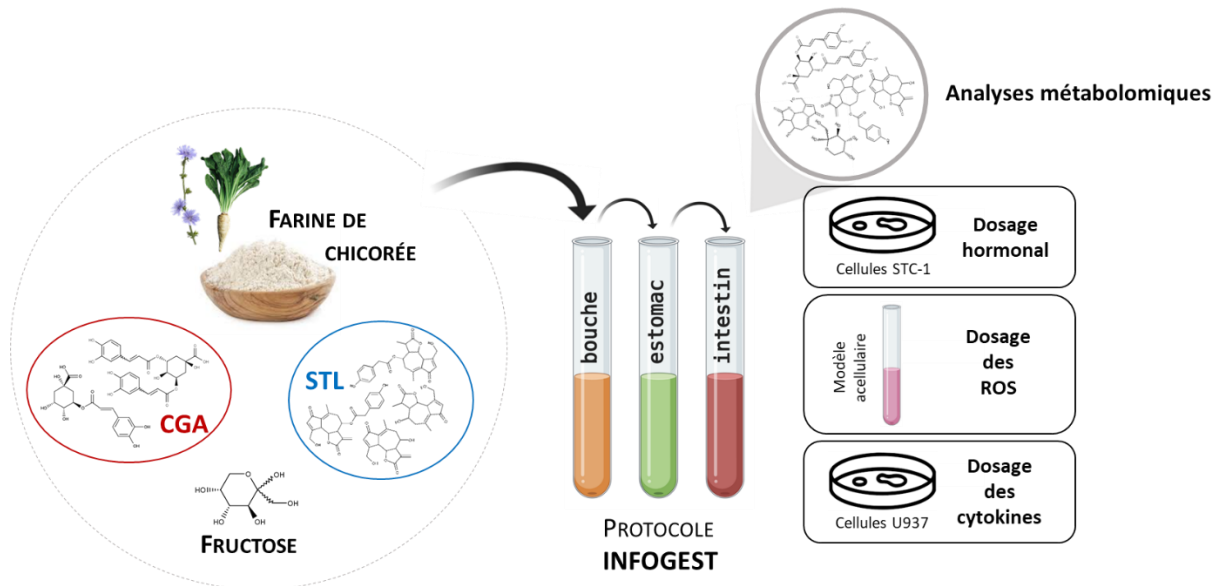

Figure i.14. Récapitulatif des analyses visant à déterminer l'impact de la digestion sur le statut fonctionnel de la farine de chicorée. L'effet sur la sécrétion de cholécystokinine a été déterminé par dosage EIA, l'activité antioxydante par mesure de l'inhibition des espèces réactives de l'oxygène, et l'action anti-inflammatoire par un dosage multiplex Luminex et ELISA de la production de cytokines par une lignée cellulaire de macrophages. En parallèle, des analyses de la composition métabolique des digestats de décoction de farine de chicorée ont été réalisées par ^1H -RMN et UPLC-HRMS dans les différents compartiments digestifs.



**CHAPITRE 1 – ANALYSE DU STATUT
FONCTIONNEL DE LA FARINE DE CHICOREE**



AVANT-PROPOS

Dans le but de déterminer le rôle fonctionnel de la farine de chicorée, nous nous sommes basés sur des résultats obtenus dans un précédent travail concernant la chicorée torréfiée (Fouré *et al.* 2018). Les profils métaboliques de neuf génotypes de chicorée industrielle avaient été analysés et leur comparaison avait permis de faire ressortir deux génotypes (G12 et G35) dont la composition était contrastée. La chicorée G35 était significativement plus riche en inuline, saccharose, fructose, 3-CGA et DHdLc que le génotype G12. Les deux génotypes avaient par la suite été testés chez la souris pour déterminer les effets nutrition-santé de la racine torréfiée. Les résultats de ce travail nous ont servi de base pour analyser la farine de chicorée.

Les racines de ces deux génotypes de chicorée contrastés G12 et G35 ont été transformées en farines par séchage et broyage. Pour être administrée aux souris par gavage, la farine a été préparée sous forme de décoction aqueuse dont la composition a été analysée et comparée avec celle de la farine d'origine pour s'assurer que tous les métabolites étaient présents suite à la préparation. La dose journalière administrée aux animaux a été calculée par rapport à une consommation humaine modérée. En parallèle de la farine de chicorée, l'inuline a été administrée aux souris sous forme de solution, à une dose comparable à celle contenue dans la farine G35. L'inuline a été utilisée comme contrôle positif à cause de son rôle prébiotique déjà avéré. Pour avoir comme contrôle un repère alimentaire connu, un autre lot de souris a été gavé en parallèle avec de la farine de blé préparée de la même façon que la farine de chicorée. Un dernier contrôle négatif a été réalisé avec un groupe de souris gavé avec de l'eau. Pour avoir une liste plus complète des réponses, les tests ont été effectués pour chaque condition sur des souris mâles et femelles.

Après 30 jours de gavage quotidien, le foie, les fèces et le sang ont été prélevés chez les animaux sacrifiés, suite à quoi plusieurs analyses à grande échelle ont été réalisées. Une analyse nutriginomique a visé l'impact de l'ingestion des différents produits alimentaires sur l'expression génique grâce à des puces à ADN. La composition de la communauté microbienne intestinale a aussi été caractérisée de façon à déterminer si la farine de chicorée modifiait l'abondance des taxons bactériens et si les modifications étaient nuancées en fonction de la composition des deux génotypes de chicorée testés. Tester l'inuline en parallèle nous a également permis de soustraire l'effet de cette fibre alimentaire à celui de la matrice complète, et d'évaluer si la farine apportait des effets supplémentaires. Certaines hormones impliquées

dans l'homéostasie énergétique ont également été dosées dans le plasma des souris pour compléter le tableau des effets métaboliques.

Ce travail effectué pour la première fois sur la farine de chicorée a permis de mettre en avant un nombre conséquent de ses effets pour la santé (effet antitumoral, antimicrobien, anti-inflammatoire, antioxydant, de régulation métabolique) et d'estimer les mécanismes d'action, que ce soit au niveau de la régulation de l'expression génique ou au niveau du microbiote intestinal. Si la farine de chicorée s'avère un aliment fonctionnel dont l'effet peut être légèrement modulé par sa composition chimique, l'inuline présente essentiellement un effet prébiotique. D'autres composés chimiques, comme les CGA, STL ou le fructose, pourraient alors être considérés responsables des effets fonctionnels. Nous avons pu remarquer un effet fonctionnel plus important de la farine de chicorée chez les animaux mâles que chez les femelles et cette différence a été discutée par rapport aux particularités métaboliques et hormonales des deux sexes. Les résultats obtenus sur la valeur fonctionnelle de la farine de chicorée et de l'inuline ont été valorisés dans un article publié dans la revue *Journal of Functional Foods* en août 2020. La comparaison avec la farine de blé sera discutée dans les éléments complémentaires présentés en fin de chapitre.



Contents lists available at ScienceDirect

Journal of Functional Foods

journal homepage: www.elsevier.com/locate/jff

Chicory root flour – A functional food with potential multiple health benefits evaluated in a mice model



Céline L. Pouille^a, Doriane Jegou^a, Camille Dugardin^a, Benoit Cudennec^a, Rozenn Ravallec^a, Philippe Hance^{a,b}, Caroline Rambaud^{a,b}, Jean-Louis Hilbert^{a,b}, Anca Lucau-Danila^{a,b,*}

^a BioEcoAgro N° 1158, Univ. Lille, INRAE, Univ. Liège, UPJV, YNCREA, Univ. Artois, Univ. Littoral Côte d'Opale, ICV – Institut Charles Viollette, F-59000 Lille, France

^b Joint Laboratory University of Lille – Florimond-Desprez CHIC41Health, France

ARTICLE INFO

Keywords:

Cichorium intybus
Chicory root flour
Cancer protection
Antimicrobial protection
Metabolic regulation
Prebiotics

ABSTRACT

Industrial chicory roots (*Cichorium intybus* var. *sativum*) have been the subject of many different studies investigating their supposed nutritional and medicinal benefits. Although an impressive number of clinical evidences has supported the health effects of this plant, the molecular mechanisms remain poorly understood. In this work, we looked at chicory flour that is proposed as an ingredient for pastries and a water extract of chicory root flour was tested. We experimented on the murine model and highlighted new mechanisms by which the chicory roots brings health benefits. For this purpose, a nutrigenomic analysis was associated with a metabolic hormone dosage and a metagenomic analysis. New potential mechanisms by which the chicory acts on cancer prevention on antibacterial and antiviral defense, on hypoglycemic and hypolipidemic effect as well as on the antioxidant effect were identified. Also, the prebiotic effect of the chicory root flour was discussed by comparison with inulin. In general, almost all effects were found to be more pronounced in male mice than in female mice.

1. Introduction

Chicory (*Cichorium intybus* L.) is mostly known for its multiple uses in the food industry and herbal medicine. This plant has long been consumed as a vegetable by humans. Leaves and root have been used for thousands of years for nutritional purposes (Puhlmann & De Vos, 2020) and since the end of the 16th century and the reign of Napoleon, roasted roots have been used as a substitute to coffee beans (Lucchin, Varotto, Barcaccia, & Parrini, 2008).

Chicory roots are rich in fiber and bioactive compounds. Inulin is the main storage carbohydrate consisting of fructose molecules whose linkage cannot be broken down by human intestinal enzymes and was classified as dietary fiber. Nowadays, chicory inulin is used as food ingredient for its gelling, texturing and stabilizing properties (Arkel et al., 2012), acting as a fat (Keenan, Resconi, Kerry, & Hamill, 2014) or sugar substitute (González-Tomás et al., 2009). Chicory inulin was also defined as a prebiotic because this substrate is selectively used by the gut microorganisms and confers a health benefit (Gibson et al., 2017). This benefit includes the stimulatory effect mainly on bifidobacteria and the increase in short-chain fatty acids (SCFA) production (Le Bastard et al., 2020).

Chicory was already cultivated as a medicinal plant by the ancient Egyptians and is still used in traditional dishes in various parts of the world (Puhlmann & De Vos, 2020). Liv-52 and Jigrine, two traditional Indian formulations containing parts of this plant are largely used for their hepatoprotective effects (Huseini, Alavian, Heshmat, Heydari, & Abolmaali, 2005). In addition to being used as a tonic in the form of syrup, chicory roots are conventionally taken to relieve different digestive disorders (Judžentienė & Būdienė, 2008). The whole plant is also known for its hypoglycemic (Roberfroid, Loo, & Gibson, 1998) and hypolipidemic properties, hypothetically due to the chlorogenic acids (CGA) content of chicory (Jackson, Rathinasabapathy, Esposito, & Komarnytsky, 2017). Extracts of chicory roots have also been stated to have antimicrobial (Liu, Wang, Liu, Chen, & Cui, 2013), immunomodulatory (Amirghofran, Azadbakht, & Karimi, 2000), anti-inflammatory (Lee et al., 2015), and anti-cancer properties (Behboodi, Baghbani-Arani, Abdalan, & Shandiz, 2019). Historically used in Afghanistan as a remedy for malarial fevers, chicory has proven to be a promising antimalarial agent, due to its bitter compounds such as lactucin, lactucopicrin, 8-deoxylactucin and their derivatives (Bischoff et al., 2004). Due to its content in sesquiterpene lactones (STL), chicory presents also anthelmintic activity in animals (Jensen et al., 2011).

* Corresponding author at: BioEcoAgro N° 1158, ICV – Institut Charles Viollette, Cité Scientifique, F-59655 Villeneuve d'Ascq, France.
E-mail address: anca.lucau@univ-lille.fr (A. Lucau-Danila).

<https://doi.org/10.1016/j.jff.2020.104174>

Received 5 June 2020; Received in revised form 17 July 2020; Accepted 21 August 2020

1756-4646/© 2020 The Author(s). Published by Elsevier Ltd. This is an open access article under the CC BY license (<http://creativecommons.org/licenses/by/4.0/>).

In recent years, functional foods have developed as part of health and wellness programs because they are highly nutritious and associated with several powerful health benefits at the same time. Inulin was adopted as a functional ingredient and various studies evaluated its efficacy as prebiotic, for promoting good digestive health, for influencing lipid metabolism and for its beneficial roles in optimum plasmatic levels of glucose and insulin maintaining (Ahmed & Rashid, 2017).

As chicory roots contain inulin but also many other bioactive compounds, we considered the whole root as a potential functional food and investigated the molecular mechanisms of its effects on health. To distinguish the effect of the complete food matrix from that of inulin, a murine model was used and a force-feeding was performed with chicory root flour or inulin. The distinct effects in males and females were also examined. We analyzed changes in gene expression profiles, in plasmatic metabolism marker levels and also in gut microbiota composition, in order to correlate the different observations with respective effects on health.

2. Materials and methods

2.1. Chicory flour production and composition

Two industrial chicory genotypes (*Cichorium intybus* var. *sativum*) were used to produce fresh chicory roots. These genotypes named G12 and G35 were selected by Florimond-Desprez Veuve et Fils SAS (Capelle-en-Pévèle, France). Roots were processed by Leroux SAS (Orchies, France) to provide corresponding flour. Samples were freeze-dried (48 h) and ground (ball mill, Retsch, Eragny sur Oise, France) for 30 min at room temperature using 50 mL wells and 25 mm balls to obtain a fine powder. Flour composition of both G12 and G35 chicory genotypes was identical with root composition and it is indicated in Table 1 as previously quantified (Fouré et al., 2018). Mice were fed with an aqueous decoction of the dried powders from the two selected genotypes (G12 and G35). Hundred milliliters of warm water (85 °C) were added to a 150 mL glass tube containing 3 g of powder. The mixture was incubated for 20 min at 80 °C under weak agitation. The solution was filtered through a coffee filter, filtrates were centrifuged at 30,000g for 10 min at 4 °C and the supernatants were stored at −80 °C

Table 1
Major metabolites analysed by quantitative ¹H NMR in chicory root flours.

Compounds (mg/g dry matter)	G12	G35
Glucose	18.31a	15.11a
Fructose	15.43b	20.65a
Sucrose	17.91b	26.54a
Mannose	2.91a	2.11a
Inulin	105.80b	250.33a
Citrate	6.88a	4.37b
Fumarate	0.13a	0.08b
Malate	3.10a	2.70a
Lactate	0.80a	0.34b
Formate	0.47a	0.31b
Pyroglutamic acid	5.68a	4.41a
Acetate	0.23a	0.13b
Trigonelline	0.053a	0.070a
Cholin	0.47a	0.36a
Scyllitol	0.90a	0.71a
Inositol	3.06a	2.08b
3-cqa	0.293b	0.343a
3,5-dicqa	0.066a	0.070a
DHdLc	0.011b	0.014a
dLc	0.004a	0.003a
Lp	0.003a	0.003a

Statistically significant differences measured by ANOVA (*p*-value < 0.05) according to genotype are showed with different letters in the same column (Tukey's test).

3-cqa: 3-mono-*O*-caffeoylquinic acid; 3,5-dicqa: 3,5-di-*O*-caffeoylquinic acid; DHdLc: 11,13-dihydro-8-deoxylactucin; dLc: 8-deoxylactucin; Lp: lactucopiricin.

Table 2

Composition of aqueous decoctions of chicory root flours. Chlorogenic acids and sesquiterpene lactones previously described in chicory roots were detected in aqueous decoctions by LC-UV quantification.

Compounds mg/g dry matter	Decoction G12	Decoction G35
3-cqa	0.142 ± 0.0076	0.148 ± 0.0080
3,5-dicqa	0.015 ± 0.0005	0.008 ± 0.0003
DHdLc	0.167 ± 0.0063	0.203 ± 0.0077
dLc	0.035 ± 0.0033	0.024 ± 0.0022
Lp	0.084 ± 0.0041	0.107 ± 0.0052

3-cqa: 3-mono-*O*-caffeoylquinic acid; 3,5-dicqa: 3,5-di-*O*-dicaffeoylquinic acid; DHdLc: 11,13-dihydro-8-deoxylactucin; dLc: 8-deoxylactucin; Lp: lactucopiricin.

until feeding. The concentration of the decoctions was normalized to 20 ± 0.5 mg/ml and their composition was assessed for CGA and STL levels by LC-UV analyses performed according to Willeman et al. (2014). The composition of both decoctions was considered stable for these compounds, which are fully or partially soluble in water (Table 2). Nevertheless, nonpolar and hydrophobic compounds will not be present in the resulting aqueous extract, and will remain in the sediment not diluted in water. Inulin water solution was prepared with 2 g inulin (Inulin from chicory, Sigma-Aldrich) for 150 mL warm water (85 °C), incubated for 20 min at 80 °C under weak agitation and filtered as flour decoctions.

2.2. Animal experiments and ethics statements

Male and female BALB/c BYJ mice were used for experiments in agreement with Directive 2010/63/ EEC for the protection of animals used for fine scientists and in accordance with Law 2012–10 (2012) and 2013–118 (2013). The protocol was approved by the Ethics Committee for the experiment on animals. The mice were randomly divided into groups (*n* = 6/group) and housed in a controlled environment (with a temperature of 22 °C, a 12 h/12 h light/dark cycle and *ad libitum* access to standardized food and water). Mice were fed with an aqueous decoction of roots flour from two selected chicory genotypes (G12 and G35) and with an inulin solution (I2255 Sigma Aldrich, MO, USA). The mice gavages consisted in a daily force-feeding of 500 µL of stemming solution decoctions of chicory flour or inulin water solution besides the standard chow (Diet A04C-10, Scientific Animal Food and Engineering, Augy, France). For the chicory flour, the decoction corresponded to 10 mg root powder/mouse/day that was considered to be the human equivalent weight/body mass for a moderated alimentary dose (Fouré et al., 2018). The administered dose of inulin was calculated to correspond to the concentration of inulin in the G35 aqueous extract of roots for the daily consumption, and was estimated at 6.9 mg/mouse/day. Controls underwent an equivalent force-feeding with water. As experiments were conducted sequentially for two different periods of time, two control sets were used: first control group (Ctr1) in parallel with G12 and G13 diet and a second control group (Ctr2) in parallel with the inulin diet. Six mice for each gender per condition were used for 30 days followed by a week of resilience. Individual body weight was regularly registered. Three mice for each condition were sacrificed before the beginning of the treatment (D0), after 30 days of treatment (D30) and after washout period (D36) and the central core of the liver left lobe was cut into cubes and frozen as individual samples at −80 °C for transcriptomics. The feces were individually harvested before the beginning of the treatment (D0) after 30 days of treatment (D30) and after washout period (D36), and stored at −80 °C for microbiota analyses. For hormonal assays 100 µL of blood from the caudal vein was sampled from each animal 30 min after gavage at D30. The blood from each mouse was collected in tubes containing 20 µL EDTA 10% anticoagulant solution and 1 µL dipeptidyl peptidase-4 inhibitor (DPP4-010, Marck, Milipore, Darmstadt, Germany), then centrifuged at 14,000 rpm

for 10 min, the plasma containing supernatants collected and stored at -80°C .

2.3. RNA isolation and microarrays analysis

Total RNA was extracted from hepatic tissues using RNeasy spin columns (Macherey-Nagel). RNA quality was observed with Nanodrop and absorbance ratios A260/280 and A260/230 were found between 2.0 and 2.2. RNA quality was also examined with Bioanalyzer 2100 (Agilent, Les Ulis, France) and a minimal RNA integrity number (RIN) of 0.8 was required for all samples.

For the microarray analysis, groups of mice ($n = 3$) for both genders were used: i) a group that received a decoction of chicory flour G12 for 30 days as previously described, ii) a group that received a decoction of chicory flour G35 for 30 days, iii) a group that received a solution of inulin for 30 days, and iv) two control groups with standard drinking water as mentioned before.

Agilent *Mus musculus* Sure Print GE 4x44 v2 microarrays with oligonucleotide 45,220 probes were used to study the gene expression profile. RNA amplification, staining, hybridization and washing were conducted according to the manufacturer's specifications. Slides were scanned at $5\ \mu\text{m}/\text{pixel}$ resolution using the GenePix 4000B scanner (Molecular Devices Corporation, Sunnyvale, CA, USA). Images were used for grid alignment and expression data digitization with GenePix Pro 6.0 software. Expression data were normalized by Quantile algorithm. The 3 control samples were filtered for p value < 0.05 and the average was calculated for each gene. A fold change (FC) value was calculated between individual treated samples and the mean of corresponding controls. Differentially expressed genes (DEGs) were selected for a threshold > 2.0 or < 0.5 . Functional annotation of DEGs was based on NCBI GenBank and related-genes physiological processes were assigned with NCBI, AmiGO 2 Gene Ontology and UniProt. KEGG pathway analysis was also used to identify relevant biological pathways of selected genes. All microarray data have been submitted to the NCBI GEO: archive for functional genomics data with the accession number GSE150218.

2.4. In vivo hormone detection

Plasma concentrations of Glucagon-like peptide-1 (GLP-1), gut hormone peptide YY (PYY) and leptin were assessed using antibody-immobilized beads specific to each hormone in a Milliplex[®] Map Kit (Millipore Corporation, Billerica, MA, USA) according to the manufacturer's instructions. Kit sensitivity was 19 pg/mL for leptin, 23 pg/mL for GLP-1, and 5 pg/mL for PYY. The quantification was carried out using the Luminex[®] 100/200 (Luminex Corporation, Austin, USA) system and the Luminex xPONENT[®] for LX100/200 software.

2.5. Microbiota analysis

DNA extraction was carried out on 200 mg of mouse feces according to QIAamp stool DNA Kit (Qiagen, France). 16S targeted metagenomic analysis, and bioinformatics analyses were achieved according to optimized and standardized protocol developed by the company Genoscreen, Lille, France as described previously (Foligné et al., 2019). Microbial diversity and taxonomic composition of samples were determined for each sample using the so-called metagenomic targeted methodology. Briefly, a fragment of the 16S rRNA gene framing the V3 and V4 hypervariable regions was amplified from 5 ng of gDNA of the samples according to an optimized and standardized amplicon library preparation protocol Metabiot[®] (Genoscreen, France). The final amplification products (each containing a nucleotide index to differentiate the samples as well as the adapters necessary for carrying out the sequencing) were purified on beads and then finally mixed in equal concentrations. The sequencing was performed with the 2[×] 250 bp chemistry on the Illumina MiSeq platform (Illumina, San Diego) at

Genoscreen. The resulting raw sequences were subjected to a cleaning process comprising i) sorting the sequences according to the indexes and according to the 16S primers ii) the "trimming" of the sequences by truncating the bases from the 3' end with a Phred threshold of 30 (iii) assembly of the two paired sequences according to a minimum overlap of 30 bases and at least 97% identity over the overlapping area.

The computer analysis was carried out on a fully automated (Metabiot[®] OnLine) pipeline built around the QIIME v 1.9.1 software (Breton et al., 2013). Following the steps of pre-processing, the full-length 16S rRNA gene sequences go through a step in which chimera sequences are detected and eliminated (in-house method based on the use of Usearch 6.1). Then, a clustering step is performed in order to group similar sequences with a nucleic identity defined threshold (97% identity for an affiliation at the genus level on the V3-V4 regions of the 16S rRNA gene) with Uclust v1.2.22q (Cresci, Thangaraju, Mellinger, Liu, & Ganapathy, 2010) through an open-reference OTU picking process and complete-linkage method, finally creating groups of sequences or "Operational Taxonomic Units" (OTUs). The most abundant sequence of each OTUs is therefore considered as the reference sequence of its OTU and is then taxonomically compared to a reference database (Greengenes database, release 13.8; www.greengenes.gov) by the RDP classifier method v2.2 (Lahiri & Abraham, 2014). A final table listing all the created OTUs was generated comprising the number of sequences for each sample related to each OTU and their respective taxonomic affiliation.

All analyses were performed by comparing experimental groups to their respective controls. Normality was controlled with the Shapiro-Wilk test and homogeneity of variances with Bartlett's test. Statistical paired differences were assessed by ANOVA and Tukey's test using PRISM 7 (GraphPad Prism 6.0, California, USA) and differences were considered significant for a p value of < 0.05 . All the biosample raw reads have been deposited at the National Center for Biotechnology Information (NCBI) and are available under BioProject accession number PRJNA631462.

3. Results

Two chicory genotypes G12 and G35 were used here for the different analyses. These two genotypes were selected from a previous study because they presented important differences in roots metabolite composition. The G12 genotype had significantly more citrate, fumarate, lactate, formate, acetate, and inositol than G35. Conversely, roots of the G35 genotype were richer in inulin, sucrose, and fructose as well as in 3-mono-*O*-caffeoylquinic acid and 11,13-dihydro-8-deoxylactucin (Fouré et al., 2018). Aqueous extracts of root flours from chicory G12 and G35 were used to feed mice in order to detect the different health effects and to compare with an inulin water solution. For this purpose, many investigations were performed: a whole transcriptomic analysis using Agilent DNA microarrays, a hormonal level measurement using Luminex technology and a fecal microbiota metabarcoding analysis by Illumina 16S rDNA sequencing.

3.1. Chicory diet-driven profiles of gene expression

Diet-induced gene expression profiles were analyzed in the liver of mice after 30 days of chicory flours or inulin ingestion. A total number of 28 profiles were found differentially expressed during the chicory diet, with an unbalanced pattern between male and female subjects for 39% of profiles (Fig. 1, Supplementary file 1). DEGs modified by the chicory diet are involved in cell growth arrest and apoptosis, immunity system, glucose and lipid homeostasis, xenobiotic metabolism and antioxidant activity. As a trend, all effects except antibacterial ones were more pronounced in male than in female mice. Despite quantitative differences in flour composition, the G12 and G35 chicory flour modulated similarly the gene expression. An obvious difference between chicory and inulin effects was observed as only 4 DEGs were

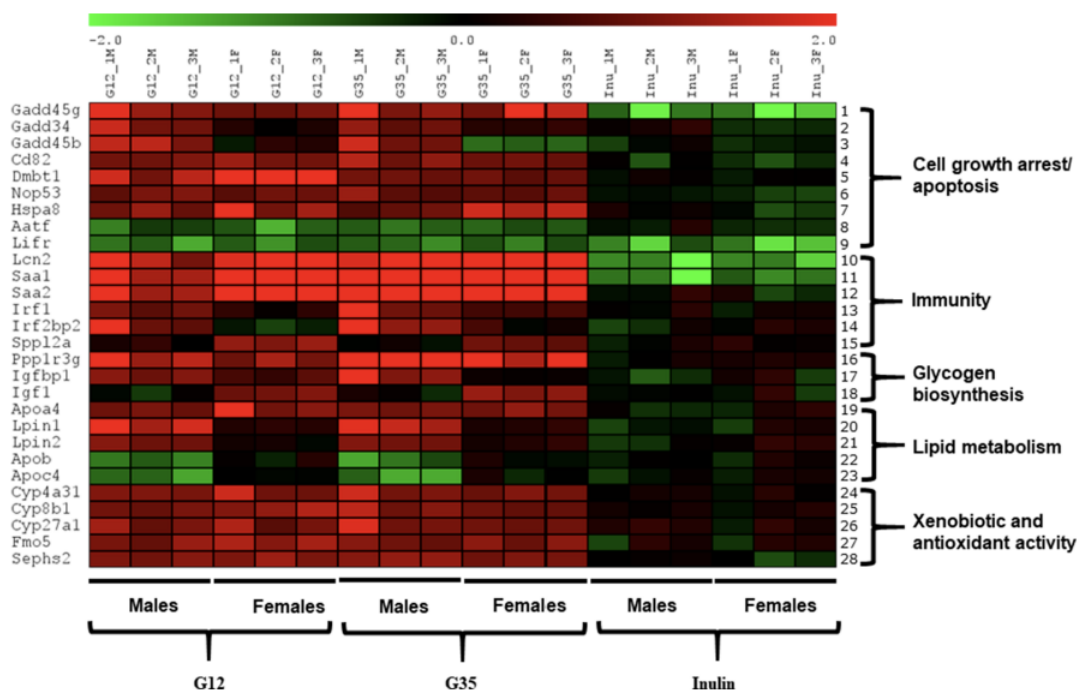

Fig. 1. Gene expression profiles in hepatic tissue of mice after chicory and inulin diet. Log₂ fold change of gene expression was represented individually for mice (1–3) and gene-related physiological processes are represented on the right part of the graph.

found differentially expressed during inulin intake. These observations suggest that bioactive constituents of chicory roots other than inulin could be involved in the observed effects, alternatively the combined effect of inulin and these different compounds. After 7 days of resilience, all genes were found to be expressed at the same level as the controls, regardless of diet (Supplementary file 1).

3.2. Plasma level of hormones

Despite that no significant differences were observed in plasmatic hormone levels, several tendencies must be highlighted. Using the MILLIPLEX® MAP Kit a multiple-fold increase of GLP-1 and PYY was registered in plasma of male subjects after chicory uptake (Fig. 2 and Supplementary file 2). Inulin was found to induce an increase of PYY in male mice only. As for gene expression level, the hormonal level seems to be more impacted in male than in female mice. Leptin level was found to be decreased between 1.3 and 2.1 times in plasma of all mice fed with chicory flour either G12 or G35 but not during inulin diet.

3.3. Microbial diversity

16S-rRNA gene-targeted metagenomic analysis was performed in individual fecal samples of male and female mice ($n = 6$) for each dietary requirement, allowing comparison of the overall bacterial richness and phylogenetic composition of the microbiota. After sequence processing, a total of 29 different operational taxonomic units (OTUs) were identified with an abundance $> 0.1\%$ (Supplementary file 3). The average number of OTUs per individual was 264 ± 44 for males and 362 ± 43 for females and agrees with other studies in mice fecal microbiota (Foligné et al., 2019). The alpha diversity Shannon index indicated a stabilized diversity for all subject groups and no disruptive modifications were found during the chicory or inulin diet (Fig. 3A). Beta diversity among different conditions as a measure of genera turnover was considered by Principal Coordinate Analysis for

affected taxa during different diets. This revealed a common but also a specific effect of chicory and inulin diet (Fig. 3B).

3.4. Microbial characteristics

The community composition representing the bacterial phyla and genus level rankings for major OTU present in the subjects are shown in Figs. 4 and 5 respectively. The most abundant phyla across all young subjects were *Firmicutes*, *Bacteroidetes*, *Actinobacteria*, *Proteobacteria*, *TM7* and *Tenericutes* (Fig. 4A). The ratio *Firmicutes/Bacteroidetes* (F/B) was found diminished after 30 days of G35 chicory diet only, due to a significant increase in *Bacteroidetes* abundance in male and decrease of *Firmicutes* abundance in female mice (Fig. 4B and Supplementary file 4).

At the genus level, all changes observed in the relative abundance after 30 days of chicory or inulin treatment are represented in Fig. 5. No qualitative changes were observed but quantitative modifications appeared in the abundance of several taxa after chicory or inulin diet (Fig. 5A). These modifications were closely followed as fold change of standardized abundance ratio (condition vs control) (Fig. 5B). Three taxa appeared to increase in abundance during both G12 and G35 treatments: *Butyricoccus*, *Anaerostipes* and *Dorea*. *Bacteroidales_unclassified* was more abundant in G35 condition only, and *Oscillospira* in male mice only, during the administration of both chicory diets. Conversely, abundance of *Peptococcaceae*, *Coprococcus* or *Clostridium* was diminished when chicory was administered. *Lactobacillus* increased specifically when inulin alone was consumed.

4. Discussion

Many studies have already been done on the health effects of inulin (Le Bastard et al., 2020) or roasted roots of chicory (Fouré et al., 2018). In this study we were interested in another known foodstuff obtained from chicory roots: the flour. Known to provide nutritional and medicinal benefits for not only livestock (Nwafor, Shale, & Achilonu, 2017)

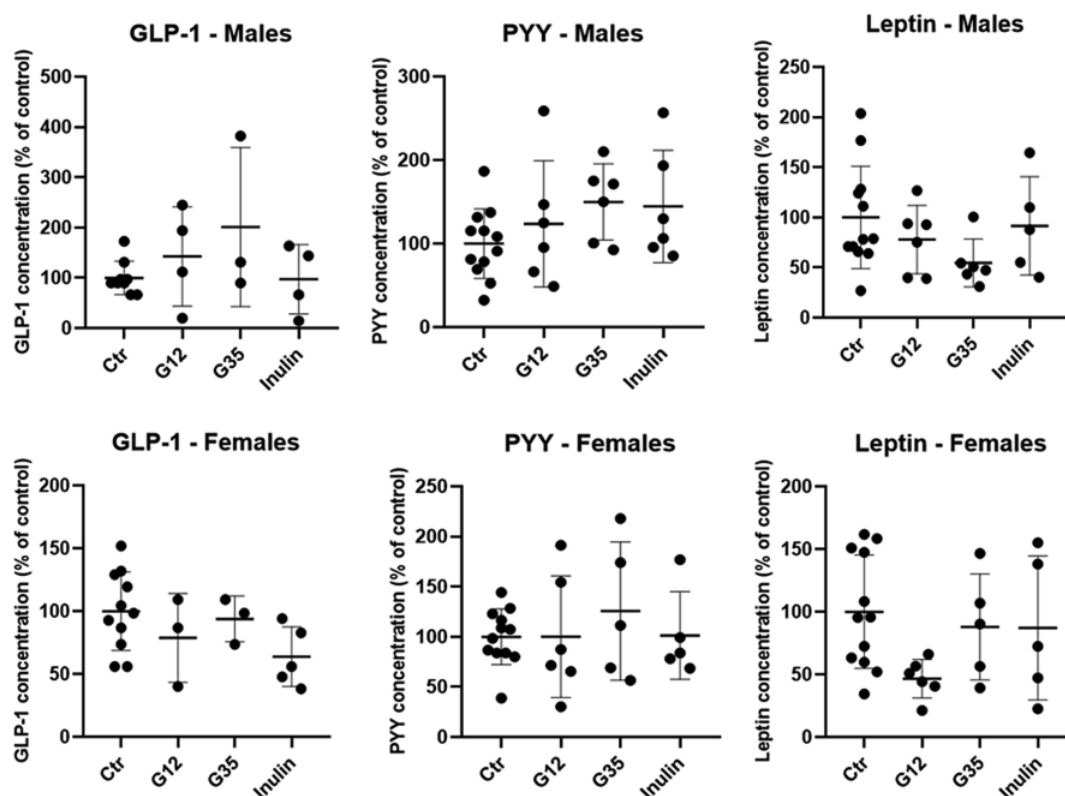

Fig. 2. GLP-1, PYY, and leptin level in mice plasma, after 30 days of chicory (G12, G35) and inulin supplemented diet, and assayed after 30 min of oral administration of the different diets at D30. Control values were pooled together (Ctr). Plasmatic hormone levels were expressed as % of the control level. Statistical analysis was performed using one-way ANOVA and Sidak's multiple comparisons test.

but also for humans (Puhmann & De Vos, 2020), chicory flour was proposed to complement other bread-making ingredients in consumer-friendly products and in products adapted to coeliac patients (Makovicky, Volek, Uhlířová, & Makovicky, 2018). To understand the mechanisms by which the aqueous extract of chicory root flour impacts health, we used the murine model and analyzed changes registered in gene expression profiles, in metabolic hormones level and also in gut microbiota composition during chicory diet. Our results revealed several major molecular mechanisms by which the whole roots of chicory – as opposed to inulin alone – could trigger an anticancer and antimicrobial action, glucose and lipid regulatory influence as well as a xenobiotic and antioxidant effect. A prebiotic but in part distinct effect was detected for both flour and inulin diet. These results are discussed below in support of previously published clinical results.

4.1. Activity on gene expression related with cell growth and apoptosis

Nine genes involved in cell growth arrest and apoptosis regulation were found differentially expressed during chicory intake (Fig. 1) suggesting the potential capacity of the aqueous extract of chicory roots consumption to protect against cancer by increasing the expression of pro-apoptosis factors and avoiding the proliferation of cancerous cells.

Gene coding for the growth arrest and DNA damage-inducible protein GADD45 beta (*Gadd45B*) was found up-regulated in both male and female mice after the chicory diet, instead of *Gadd45G* that was found up-regulated in only male mice (Fig. 1, lines 1–2). GADD45 proteins serve as tumor suppressors and their pro-apoptotic activities have positioned these proteins as essential players in oncogenesis (Tamura et al., 2012). They belong to the universe of the p53 target

genes that was described as the “guardian of the genome”, being involved in response to DNA damage, apoptosis and cell cycle regulation (Levine, Hu, & Feng, 2006). Another p53-related gene coding for the protein phosphatase 1 regulatory subunit 15A (*Ppp1r15a* or *Gadd34*) was found up-regulated in male mice only, after chicory intake (Fig. 1, line 3). This protein is involved in cell growth suppression and apoptosis of carcinoma (Lum et al., 2006). Still belonging to the p53 universe (Jackson et al., 2003), the *Cd82* (cluster of differentiation 82) was found up-regulated by the chicory diet in all mice (Fig. 1, line 4). It acts as a metastasis suppressor (Tonoli & Barrett, 2005) and was described as a solid biomarker for malignant tumors (Zöller, 2009). Similarly, *Dmbt1* (Deleted in malignant brain tumors 1 protein) (Fig. 1, line 5) that codes for a tumor suppressor promoting apoptosis (Zhang, 2019). Gene coding for the ribosome biogenesis factor NOP53 was also found up-regulated (Fig. 1, line 6) and is known to be engaged in tumor repression (Cho et al., 2016) and in the p53 stabilization in response to stress (Lee et al., 2012). This was also the case of *Hspa8* (Fig. 1, line 7) that codes for a heat shock protein contributing to apoptosis, autophagy, cell growth and differentiation (Mayer & Bukau, 2005). Its confirmed role in autophagy seems essential in cancer protection, cell senescence and aging (Xilouri & Stefanis, 2016).

Two genes promoting tumor growth were found down-regulated in all mice during chicory diet: the apoptosis-antagonizing transcription factor (*Aatf*) and the leukemia inhibitory factor receptor (*Lifr*) (Fig. 1, lines 8–9). AATF was described to repress apoptosis (Höpker et al., 2012) and promote tumor progression (Welcker et al., 2018) by targeting genes p53-related. *Lifr* was identified as a promoter of chemoresistance in various types of carcinoma (Lv et al., 2018).

Summing up these aspects, we observed here for the first time

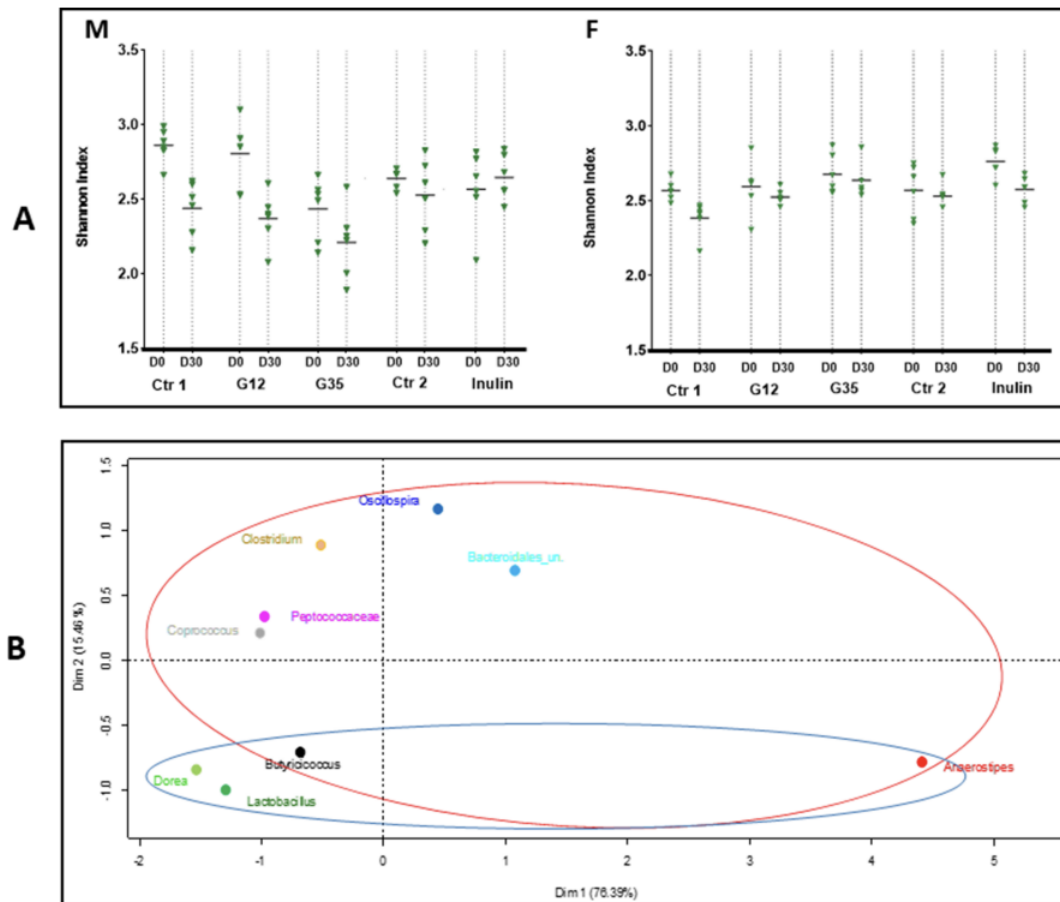

Fig. 3. Microbial diversity in fecal microbiota of mice after chicory and inulin diet. (A) Alpha diversity was illustrated by the Shannon index that indicates a stabilized diversity for all subject groups ($p > 0.05$). (B) Principal Coordinates Analysis (PCoA) plots (beta-diversity) of affected taxa during different diets. Relative abundance obtained from sequencing the 16s rRNA gene in fecal samples was represented for taxa providing differences over all samples. Red circle mainly delimits the chicory effect (including G12 and G35) and blue circle delimits the inulin effect. M – male, F – female. (For interpretation of the references to colour in this figure legend, the reader is referred to the web version of this article.)

evidence of the modulation by chicory root flour administration of gene expression linked with an anti-proliferative effect. This strengthens the findings of previous studies (Behboodi et al., 2019; Saleem et al., 2014; Hazra et al., 2002) and could provide an answer related to the mechanism of this valuable effect. Unexpectedly, inulin intake did not trigger similar effects. Only *Gadd45B* and *Lifr* were found down-regulated in mice (Fig. 1 lines 1 and 9). It would appear that the anticancer protective effect of the chicory is obviously not attributable to inulin only but to other water-soluble chicory compounds present in the aqueous extract.

4.2. Activity on expression of immune genes

Chicory was already found responsible for various antimicrobial effects (Puhlmann & De Vos, 2020) and in our experiments we found that the expression of several genes related to immunity and displaying antibacterial and antiviral activity could be responsible for these effects. Thus, an important up-regulation of *Lipocalin 2* (*Lcn2*) was detected in male and female mice after chicory food intake (Fig. 1, line 10). This gene mediates an innate immune response to bacterial infection. It codes for a secreted protein stimulated by Toll-like receptors upon infection, which is able to sequester catechol-like

siderophores and therefore renders bacteria unable to expand (Flo et al., 2004). This role seems essential for antibacterial defense as the lipocalin 2 deficiency was lethal in acute infections with *Escherichia coli* H9049 (Flo et al., 2004). In addition to its antibacterial activity, LCN2 play an important role in inflammation reducing by regulating the recruitment of immune cells to the site of inflammation (Shashidharamurthy et al., 2013). Genes coding for serum amyloid A1 and A2 (*Saa1* and *Saa2*) were also found to be strongly up-regulated after chicory extract administration (Fig. 1, lines 11–12). SAA1 can bind to the outer membrane protein A present on the surface of Gram-negative bacteria, enabling an increasing immunopathological response against invasive bacteria (Shah, Hari-Dass, & Raynes, 2006). Both SAA1 and SAA2 were found to play an important role in immunity and regulation of inflammation (Sun et al., 2015).

The antiviral effect of the chicory was suggested by the up-regulation of genes coding for interferon regulatory factor 1 (*Irf1*) and interferon regulatory factor 2 binding protein 2 (*Irf2bp2*) and was observed mainly in male mice (Fig. 1, lines 13–14). IRF1 was described as crucial in innate immunity (Honda, Takaoka, & Taniguchi, 2006) and essential for defense against viruses⁴⁷. The gene coding for interferon regulatory factor 2 binding protein 2 (*Irf2bp2*) was reported to play a major role in the transcriptional regulation of type I interferon genes in response to

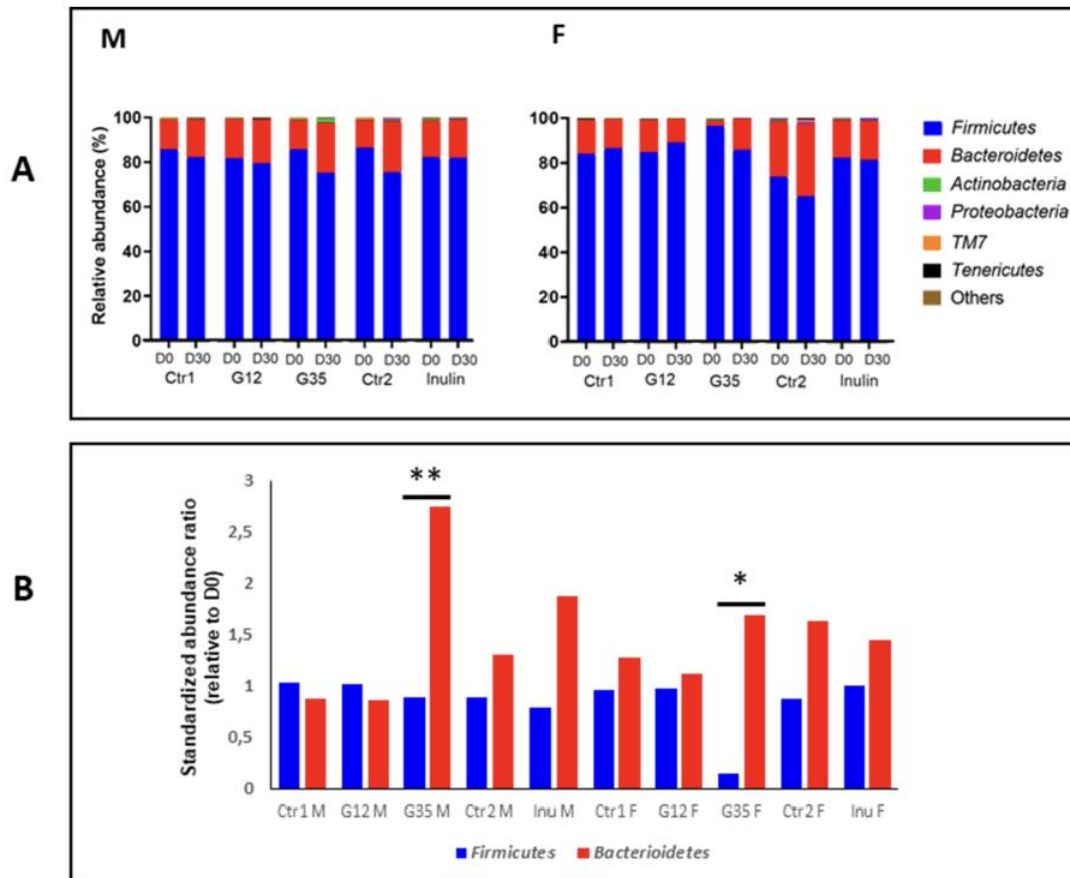

Fig. 4. Changes in bacterial phyla abundance. (A) Relative abundance (%) of phyla in mice microbiota before (D0) and after 30 days of chicory and inulin diet (D30). Relative abundances detected by NGS is expressed as means. Phyla with abundance under 0.1% are grouped in "Others". (B) Standardized abundance ratio relative to D0 of *Firmicutes* and *Bacteroidetes* (Tukey's test, $n = 6/\text{group}$, * for $p < 0.05$, ** for $p < 0.01$). M – male; F – female; G12, G35 – chicory flours; Inu – inulin; Ctr1 – control related to G12 and G35; Ctr2 – control related to inulin diet.

viral infection (Childs & Goodbourn, 2003) and also in anti-inflammatory responses (Chen et al., 2015).

In female mice only, the up-regulation of the gene coding for signal peptide peptidase like 2A (*Spp12a*) was observed after chicory food intake (Fig. 1, line 15). This gene plays a critical function in the regulation of innate and adaptive immunity. It catalyzes the cleavage of tumor necrosis factor alpha (TNF α) (Friedmann et al., 2006) and equally is directly involved in B cell maturation and survival (Beisner et al., 2013).

Any significant effect of inulin was registered otherwise slight down-regulation of *Lcn2* and *Saa1* suggesting a light decrease of the antibacterial defense on mice after inulin food intake (Fig. 1 lines 10–11).

4.3. Activity on gene expression related to glycemia and lipidemia regulation

Many clinical evidences supported the anti-hyperglycemic (Jackson et al., 2017) or hypolipidemic effect of the chicory (Keshk & Noeman, 2015), but molecular mechanisms of these effects continue to remain poorly understood. Our experiment provides a possible answer in this way, as several genes involved in glycogen biosynthesis and lipidemia regulation were deregulated after the chicory diet. Thus, protein phosphatase 1, regulatory subunit 3G (*Ppp1r3g*), insulin-like growth factor 1 (*Igf1*) and its regulatory binding protein *Igf1bp1* genes, were

found up-regulated following sex-dependent pathway particularities and suggesting a protective effect of chicory against hyperglycemia and weight gain (Fig. 1, lines 16–18). PPP1R3G plays a significant role in both postprandial glucose homeostasis and lipid metabolism. It stimulates hepatic glycogen accumulation and decreasing hepatic triglyceride level after a meal, and has the additional benefit of reducing fat mass without changing metabolic rate (Zhang et al., 2014). IGF1 induces similar metabolic effects to insulin (Monzavi & Cohen, 2002) and is involved in glycogen synthesis (Dean & Rose, 2018). IGFBP1 can either act as an autocrine and paracrine regulator of IGF1, being involved in glucose metabolism modulation (Wheatcroft & Kearney, 2009), insulin resistance suppression, fat mass reducing as well as leptin levels decreasing (Rajkumar, Modric, & Murphy, 1999). Indeed, the up-regulation of *Igf1* and *Igf1bp* genes could be linked to the decreasing tendency of leptin levels in plasmatic leptin levels of G12 ($p = 0.682$) and G35 ($p = 0.132$) male groups and G12 female group ($p = 0.059$) (Fig. 2).

Apoa4 coding for the apolipoprotein A-IV was found up-regulated in both male and female mice after G12 and G35 chicory diet (Fig. 1, line 19) and was described as an anti-atherogenic factor (Culnan, Cooney, Stanley, & Lynch, 2009) protecting against atherosclerosis and diabetes (Qu, Ko, Tso, & Bhargava, 2019). The *Lpin1* and *Lpin2* genes were found up-regulated in male mice only by the chicory diet (Fig. 1, lines 20–21) and are involved in lipid homeostasis regulation (Dwyer et al., 2012).

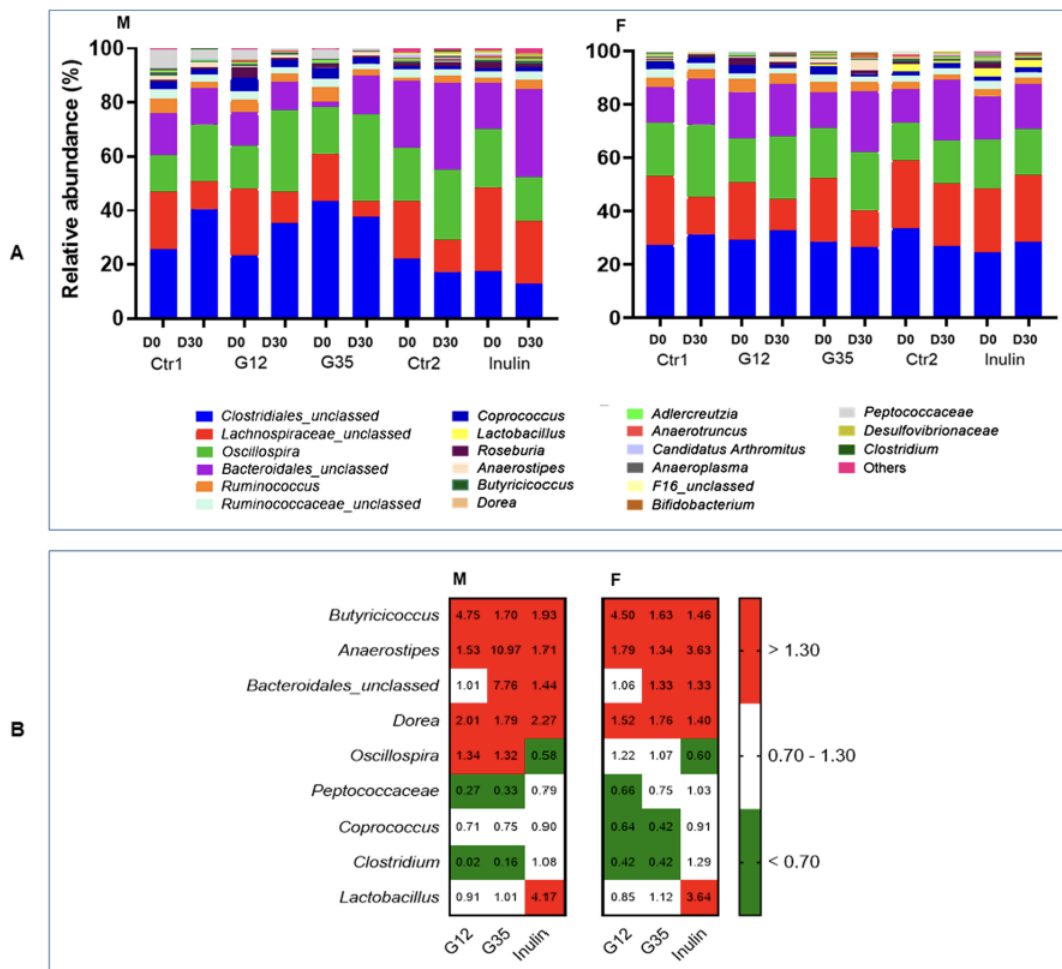

Fig. 5. Relative abundance of main genera in mice fecal microbiota after chicory (G12, G35) and inulin diet. (A) Relative abundance of genera (%) are indicated when their values are > 0.1%. Genera with a low relative abundance were assigned as “Others”. (B) Heatmap representing the fold change of standardized abundance ratio. Increased abundance compared to control was considered when FC > 1.30, and decreased when < 0.70. M – male, F – female.

Two other genes coding for apolipoprotein B (*Apob*) and apolipoprotein C-IV (*Apoc4*) were found down-regulated in only male mice (Fig. 1, lines 22–23). These genes were described to be involved in atherosclerosis (Borén & Williams, 2016) and liver steatosis (Kim et al., 2008) and their down-regulation suggests a protective effect against these chronic illnesses.

The level of different metabolic markers detected in mice plasma indicated no statistical differences but noticeable variations suggesting a beneficial metabolic effect of the chicory diet. Thus, GLP-1 which is known to regulate the appetite and food intake (Holst, 2007), and PYY which is a short-term food intake marker and thus an anorexigenic hormone (Woods & D’Alessio, 2008) were increased in mainly male mice during chicory diet (Fig. 2). Leptin, which is a long-term food intake marker and an indicator of the body fat level (Brennan & Mantzoros, 2006), was found to decrease in both male and female mice after G12 or G35 chicory food intake. Both trends, the appetite regulation and the decrease of the body fat, could be associated with gene expression to explain the worthwhile consequences of chicory consumption. These effects must be rather protective than curative as in our study no significant body weight modifications were observed during different diets (Supplementary file 5).

4.4. Effect on expression of genes related to xenobiotic and antioxidant activity

An important antioxidant effect was already attributed to the chicory root extract that showed a radical scavenging activity dependent more like on its content of caffeoylquinic acids (Liu et al., 2013). In our study we found that consumption of chicory triggered the up-regulation of several genes coding for drug metabolizing enzymes such as cytochrome P450 (*Cyp4a31*, *Cyp8b1*, *Cyp27a1*) and flavin containing monooxygenase (*Fmo5*), or for proteins involved in oxidative stress protection as selenophosphate synthetase 2 (*Seps2*) (Fig. 1, lines 24–28). Cytochrome P450 and *Fmo5* are well known for their capacity to monooxygenize a large panel of organic compounds (Chen, 2020). SEPHS2 is involved in synthesis of selenoproteins (Oudouhou, Casu, Puemi, Sygusch, & Baron, 2017) that are typically involved in cellular redox balance and include glutathione peroxidase and thioredoxin reductase (Steinbrenner and Sies, 2009). As no effect of inulin was registered at this level, it is very likely that the caffeoylquinic acids and probably other bioactive molecules present in chicory roots must be responsible for this effect.

4.5. Prebiotic effect on gut microbiota

The microbial community diversity remained stable in fecal microbiota among all samples (Fig. 3A). Only a few taxa registered quantitative changes during chicory or inulin diet (Fig. 3B). *Bacteroidetes* and *Firmicutes* were the most prevalent phyla (Fig. 4A) but their ratio changed during the chicory diet. A significant lower F/B ratio was induced by the G35 chicory genotype in males and in female mice as well (Fig. 4B) and this result is in accord with previous observations on chicory roasted roots effects (Fouré et al., 2018). We observed here that inulin alone administrated at the same concentration as in G35 flour did not completely explain this change of F/B (Fig. 4B). Most likely other compounds that are more represented in G35 must be responsible for this disproportion, however, this remains to be demonstrated. All the same, F/B is considered as an indicator of gut microbiota status (Ley, Turnbaugh, Klein, & Gordon, 2006) as a reduced F/B is correlated to a beneficial effect on obesity physiopathology (Turnbaugh, Bäckhed, Fulton, & Gordon, 2008; Barlow, Yu, & Mathur, 2015).

This beneficial effect of G35 flour was confirmed at the genera level (Fig. 5). *Bacteroidales* unclassified belonging to *Bacteroidetes* strongly increased in abundance mainly in male mice after G35 flour intake. The order *Bacteroidales* is the most abundant Gram-negative bacteria colonizing the human gut (Zitomersky, Coyne, & Comstock, 2011) and among the predominant genera are *Bacteroides* and *Prevotella*. Both of them are well known as dietary fiber fermenters and SCFA producers (Chen et al., 2017). Other taxa known as SCFA producers also increased in abundance during both G12 and G35 treatments: *Butyrivibrio*, *Anaerostipes* and *Oscillospira* (Fig. 5B). All these were found to generate butyrate that has been reported to play an important role in cancer prevention of the colon by promoting cell differentiation, cell-cycle arrest and apoptosis of transformed colonocytes (Wong, Souza, Kendall, Emam, & Jenkins, 2006). It was also reported that the butyrate is able to induce the production of GLP-1 and thus reducing food intake (Lin et al., 2012). These aspects are totally consistent with our results on gene expression profiles and hormonal dosages.

On the other side, several *Firmicutes* taxa as *Peptococcaceae* and *Clostridium* were drastically diminished when chicory was ingested. These taxa are mainly Gram-positive obligate anaerobes and may frequently include pathogens (Topiel & Simon, 1986; Gibbs, 2009). This way we can then suggest that chicory food intake could induce several protective changes against pathogens not only through changes in gene expression but also in the intestinal microbiota.

Interestingly, consumption of inulin triggered the same stimulating effects on butyrate-producing bacteria, but not on the limitation of suspected pathogenic taxa. A particular action of inulin was reflected in strongly increased in abundance of *Lactobacillus*. Inulin was already depicted as a functional ingredient with a prebiotic effect, capable of producing changes in lactobacilli and bifidobacteria abundance on human gut microbiota (Slavin, 2013). The murine experimental model does not offer the possibility to study bifidobacteria (Hugenholtz & Vos, 2018) but the observed changes in lactobacilli are entirely consistent with previous studies on the effect of inulin. If inulin has the same prebiotic effect for both genders, chicory flour appears to be more effective in males than in females.

5. Conclusions

To provide functional support to the many clinical studies that have highlighted the effects of chicory on health, we looked at the mechanisms of action of this plant and more specifically those of the chicory roots processed into flour. For this purpose, we experimented on the murine model and performed a nutrigenomic analysis that was associated with a metabolic hormone assay and a metagenomic analysis. A prominent effect of the chicory on cancer prevention was demonstrated by the deregulation of a large number of genes involved in cell-cycle arrest and apoptosis (*Gadd45B*, *Gadd45G*, *Gadd34*, *Cd82*,

Dmbt1, *Nop53*, *Hspa8*, *Aatf*, *Lifr*). Genes involved in antibacterial and antiviral defense, such as *Lcn2*, *Saa1*, *Saa2*, *Irf1* and *Irf2bp2*, were strongly up-regulated during chicory diet. The hypoglycemic and hypolipidemic effects of the chicory were associated with deregulation of *Ppp1r3g*, *Igf1*, *Igf1p1*, *Apoa4*, *Lpin1*, *Lpin2*, *Apob*, *Apoc4*, and also with modifications of GLP-1, PYY and leptin release. Finally, the antioxidant effect was revealed by the up-regulation of *Cyp4a31*, *Cyp8b1*, *Cyp27a1*, *Fmo5* and *Seps2*. The prebiotic effect of chicory roots was revealed for butyrate producers like *Butyrivibrio*, *Anaerostipes* and *Oscillospira* which increased in abundance. In contrast, taxa with putative pathogenic potential like *Peptococcaceae* and *Clostridium*, drastically decreased in abundance. Except the prebiotic effect that is partially shared with inulin, other effects were principally attributed to the chicory flour intake. In general, almost all effects were found to be more pronounced in male mice than in female mice. Together, the new mechanisms detected by this study provide strong arguments for the health effects of chicory. As these findings are based on an aqueous decoction of chicory root flour, further experiments should evaluate the effect of the whole chicory root flour to elucidate the potential of chicory as a functional food.

6. Ethics statements

Male and female BALB/c BYJ mice were used for experiments in agreement with Directive 2010/63/EEC for the protection of animals used for fine scientists and in accordance with Law 2012-10 (2012) and 2013-118 (2013). The protocol was approved by the Ethics Committee for the experiment on animals.

CRedit authorship contribution statement

Céline L. Pouille: Formal analysis, Writing - original draft. Doriane Jegou: Data curation, Formal analysis. Camille Dugardin: Formal analysis. Benoit Cudennec: Supervision, Validation. Rozenn Ravallec: Supervision, Methodology. Philippe Hance: Formal analysis. Caroline Rambaud: Project administration. Jean-Louis Hilbert: Supervision, Funding acquisition. Anca Lucau-Danila: Conceptualization, Methodology, Writing - review & editing.

Declaration of Competing Interest

The authors declare that they have no known competing financial interests or personal relationships that could have appeared to influence the work reported in this paper.

Acknowledgements

The authors wish to thank Florimond Desprez SA and Leroux for support and for providing genetic material and chicory products. Equally, authors express their gratitude to Abigael Delporte that contributed to chicory decoction preparation, to Camille Broché, Xavier Gromada and Sandy Theysgeur that participated for mice experiments, and to Stéphanie Ferreira, Nathalie Adèle, David Robil, Hélène Blanquart and Ruxandra Dumitrescu from Genoscreen (Lille, France) that helped with sequencing. The authors would like to thank Julian Villafuerte Diaz for his critical reading of the manuscript.

Funding

This work has been supported by the Région des Hauts-de-France via ALIBIOTECH CPER/FEDER 2016-2021 and FEDER for CHIC41H 2019-2021 programs.

CP was supported by a doctoral fellowship from the doctoral school SMRE 104, University of Lille. DG was supported by Florimond Desprez SA.

Appendix A. Supplementary data

Supplementary data to this article can be found online at <https://doi.org/10.1016/j.jff.2020.104174>.

References

- Ahmed, W., & Rashid, S. (2017). Functional and therapeutic potential of inulin: A comprehensive review. *Critical Reviews in Food Science and Nutrition*, 59(1), 1–13. <https://doi.org/10.1080/10408398.2017.1355775>.
- Amirghofran, Z., Azadbakht, M., & Karimi, M. H. (2000). Evaluation of the immunomodulatory effects of five herbal plants. *Journal of Ethnopharmacology*, 72(1–2), 167–172. [https://doi.org/10.1016/S0378-8741\(00\)00234-8](https://doi.org/10.1016/S0378-8741(00)00234-8).
- Arkel, J. V., Vergauwen, R., Sévénier, R., Hakkert, J. C., Laere, A. V., & Bouwmeester, H. J. (2012). Carbohydrate status in field grown chicory (*Cichorium intybus* L.). *Journal of Plant Physiology*, 169(15), 1520–1529. <https://doi.org/10.1016/j.jplph.2012.06.005>.
- Barlow, G. M., Yu, A., & Mathur, R. (2015). Role of the gut microbiome in obesity and diabetes mellitus. *Nutrition in Clinical Practice*, 30(6), 787–797. <https://doi.org/10.1177/0884533615609896>.
- Behboodi, S., Baghban-Arani, F., Abdalan, S., & Shandiz, S. A. S. (2019). Green engineered biomolecule-capped silver nanoparticles fabricated from *Cichorium intybus* Extract. *In vitro* assessment on apoptosis properties toward human breast cancer (MCF-7) cells. *Biological Trace Element Research*, 187(2), 392–402. <https://doi.org/10.1007/s12011-018-1392-0>.
- Beisner, D. R., Langerak, P., Parker, A. E., Dahlberg, C., Otero, F. J., Sutton, S. E., ... Cooke, M. P. (2013). The intramembrane protease Sps12a is required for B cell and DC development and survival via cleavage of the invariant chain. *Journal of Experimental Medicine*, 210(1), 23–30. <https://doi.org/10.1084/jem.20121072>.
- Bischoff, T. A., Kelley, C. J., Karchesy, Y., Laurantos, M., Nguyen-Dinh, P., & Arefi, A. G. (2004). Antimalarial activity of Lactucin and Lactucopicrin: Sesquiterpene lactones isolated from *Cichorium intybus* L. *Journal of Ethnopharmacology*, 95(2–3), 455–457. <https://doi.org/10.1016/j.jep.2004.06.031>.
- Borén, J., & Williams, K. J. (2016). The central role of arterial retention of cholesterol-rich apolipoprotein-B-containing lipoproteins in the pathogenesis of atherosclerosis: A triumph of simplicity. *Current Opinion in Lipidology*, 27(5), 473–483. <https://doi.org/10.1097/MOL.0000000000000330>.
- Brennan, A. M., & Mantzoros, C. S. (2006). Drug Insight: The role of leptin in human physiology and pathophysiology—Emerging clinical applications. *Nature Clinical Practice Endocrinology & Metabolism*, 2(6), 318–327. <https://doi.org/10.1038/ncpendmet0196>.
- Breton, J., Daniel, C., Dewulf, J., Pothion, S., Froux, N., Sauty, M., ... Foligné, B. (2013). Gut microbiota limits heavy metals burden caused by chronic oral exposure. *Toxicology Letters*, 222(2), 132–138. <https://doi.org/10.1016/j.toxlet.2013.07.021>.
- Chen, G. (2020). Xenobiotic metabolism and disposition. In C. N. Pope, & J. Liu (Eds.). *An introduction to interdisciplinary toxicology: From molecules to man* (pp. 31–42). United States: Academic Press.
- Chen, H.-H., Keyhanian, K., Zhou, X., Vilmundarson, R. O., Almontashiri, N. A., Cruz, S. A., ... Stewart, A. F. R. (2015). IRF2BP2 reduces macrophage inflammation and susceptibility to atherosclerosis. *Circulation Research*, 117(8), 671–683. <https://doi.org/10.1161/CIRCRESAHA.114.305777>.
- Chen, T., Long, W., Zhang, C., Liu, S., Zhao, L., & Hamaker, B. R. (2017). Fiber-utilizing capacity varies in *Prevotella*- versus *Bacteroides*-dominated gut microbiota. *Scientific Reports*, 7(1), 2594. <https://doi.org/10.1038/s41598-017-02995-4>.
- Childs, K. S., & Goodbourn, S. (2003). Identification of novel co-repressor molecules for Interferon Regulatory Factor-2. *Nucleic Acids Research*, 31(12), 3016–3026. <https://doi.org/10.1093/nar/gkg431>.
- Cho, Y.-E., Lee, H.-L., Lim, S.-J., Kim, Y.-W., Choe, B. K., Lee, S., & Park, J.-H. (2016). Suppression of GLTSCR2 expression in renal cell carcinomas. *Pathology – Research and Practice*, 212(2), 120–124. <https://doi.org/10.1016/j.prp.2015.12.005>.
- Cresci, G. A., Thangaraju, M., Mellinger, J. D., Liu, K., & Ganapathy, V. (2010). Colonic gene expression in conventional and germ-free mice with a focus on the butyrate receptor GPR109A and the butyrate transporter SLC5A8. *Journal of Gastrointestinal Surgery*, 14(3), 449–461. <https://doi.org/10.1007/s11605-009-1045-x>.
- Culnan, D. M., Cooney, R. N., Stanley, B., & Lynch, C. J. (2009). Apolipoprotein A-IV, a putative satiety/antiatherogenic factor, rises after gastric bypass. *Obesity*, 17(1), 46–52. <https://doi.org/10.1038/oby.2008.428>.
- Dean, M., & Rose, J. (2018). Activation of the IGF1 receptor stimulates glycogen synthesis by mink uterine epithelial cells. *Molecular Reproduction & Development*, 85(5), 449–458. <https://doi.org/10.1002/mrd.22981>.
- Dwyer, J. R., Donkor, J., Zhang, P., Csaki, L. S., Vergnes, L., Lee, J. M., ... Reue, K. (2012). Mouse lipin-1 and lipin-2 cooperate to maintain glycerolipid homeostasis in liver and aging cerebellum. *Proceedings of the National Academy of Sciences*, 109(37), E2486–E2495. <https://doi.org/10.1073/pnas.1205221109>.
- Flo, T. H., Smith, K. D., Sato, S., Rodriguez, D. J., Holmes, M. A., Strong, R. K., ... Aderem, A. (2004). Lipocalin 2 mediates an innate immune response to bacterial infection by sequestering iron. *Nature*, 432(7019), 917–921. <https://doi.org/10.1038/nature03104>.
- Foligné, B., Plé, C., Titécant, M., Dendooven, A., Pagny, A., Daniel, C., ... Standaert, A. (2019). Contribution of the gut microbiota in P28GST-mediated anti-inflammatory effects: Experimental and clinical insights. *Cells*, 8(6), 577. <https://doi.org/10.3390/cells8060577>.
- Fouré, M., Dugardin, C., Foligné, B., Hance, P., Cadalen, T., Delcourt, A., ... Lucau-Danila, A. (2018). Chicory roots for prebiotics and appetite regulation: A pilot study in mice. *Journal of Agriculture and Food Chemistry*, 66(25), 6439–6449. <https://doi.org/10.1021/acs.jafc.8b01055>.
- Friedmann, E., Hauben, E., Maylandt, K., Schleegeer, S., Vreugde, S., Lichtenthaler, S. F., ... Martoglio, B. (2006). SPPL2a and SPPL2b promote intramembrane proteolysis of TNF α in activated dendritic cells to trigger IL-12 production. *Nature Cell Biology*, 8(8), 843–848. <https://doi.org/10.1038/ncb1440>.
- Gibbs, P. (2009). Pathogenic *Clostridium* species. In C. W. Blackburn, & P. J. McClure (Eds.). *Foodborne Pathogens 2nd Edition – Hazards, risk analysis and control* (pp. 820–843). UK: Woodhead Publishing.
- Gibson, G. R., Hutkins, R., Sanders, M. E., Prescott, S. L., Reimer, R. A., Salminen, S. J., ... Reid, G. (2017). Expert consensus document: The International Scientific Association for Probiotics and Prebiotics (ISAPP) consensus statement on the definition and scope of prebiotics. *Nature Reviews Gastroenterology & Hepatology*, 14(8), 491–502. <https://doi.org/10.1038/nrgastro.2017.75>.
- González-Tomás, L., Bayarri, S., Coll-Marqués, J., & Costell, E. (2009). Flow behaviour of inulin-enriched dairy desserts: Influence of inulin average chain length. *International Journal of Food Science & Technology*, 44(6), 1214–1222. <https://doi.org/10.1111/j.1365-2621.2009.01949.x>.
- Hazra, B., Sarkar, R., Bhattacharyya, S., & Roy, P. (2002). Tumour inhibitory activity of chicory root extract against Ehrlich ascites carcinoma in mice. *Fitoterapia*, 73(7–8), 730–733. [https://doi.org/10.1016/S0367-326X\(02\)00232-0](https://doi.org/10.1016/S0367-326X(02)00232-0).
- Holst, J. J. (2007). The physiology of glucagon-like peptide 1. *Physiological Reviews*, 87(4), 1409–1439. <https://doi.org/10.1152/physrev.00034.2006>.
- Honda, K., Takaoka, A., & Taniguchi, T. (2006). Type I interferon gene induction by the interferon regulatory factor family of transcription factors. *Immunity*, 25(3), 349–360. <https://doi.org/10.1016/j.immuni.2006.10.004>.
- Höpker, K., Hagmann, H., Khurshid, S., Chen, S., Hasskamp, P., Seeger-Nukpezah, T., ... Benzing, T. (2012). AATF/Che-1 acts as a phosphorylation-dependent molecular modulator to repress p53-driven apoptosis. *EMBO Journal*, 31(20), 3961–3975. <https://doi.org/10.1038/emboj.2012.236>.
- Hugenholz, F., & Vos, W. M. D. (2018). Mouse models for human intestinal microbiota research: A critical evaluation. *Cellular and Molecular Life Sciences*, 75(1), 149–160. <https://doi.org/10.1007/s00018-017-2693-8>.
- Huseini, H. F., Alavian, S., Heshmat, R., Heydari, M., & Abolmaali, K. (2005). The efficacy of Liv-52 on liver cirrhotic patients: A randomized, double-blind, placebo-controlled first approach. *Phytomedicine*, 12(9), 619–624. <https://doi.org/10.1016/j.phymed.2004.10.003>.
- Jackson, K. M. P., Rathinasabapathy, T., Esposito, D., & Komarovsky, S. (2017). Structural constraints and importance of caffeic acid moiety for anti-hyperglycemic effects of caffeoylquinic acids from chicory. *Molecular Nutrition & Food Research*, 61(9), <https://doi.org/10.1002/mnfr.201601118>.
- Jackson, P., Ow, K., Yardley, G., Delprado, W., Quinn, D. I., Yang, J.-L., & Russell, P. J. (2003). Downregulation of KAI1 mRNA in localised prostate cancer and its bony metastases does not correlate with p53 overexpression. *Prostate Cancer and Prostatic Diseases*, 6(2), 174–181. <https://doi.org/10.1038/sj.pcan.4500634>.
- Jensen, A. N., Mejer, H., Mølbak, L., Langkjær, M., Jensen, T. K., Angen, Ø., ... Roepstorff, A. (2011). The effect of a diet with fructan-rich chicory roots on intestinal helminths and microbiota with special focus on *Bifidobacteria* and *Campylobacter* in piglets around weaning. *Animal*, 5(6), 851–860. <https://doi.org/10.1017/S175713111000251X>.
- Judžentienė, A., & Būdienė, J. (2008). Volatile constituents from aerial parts and roots of *Cichorium intybus* L. (chicory) grown in Lithuania. *Chemija*, 19(2), 25–28.
- Keenan, D. F., Resconi, V. C., Kerry, J. P., & Hamill, R. M. (2014). Modelling the influence of inulin as a fat substitute in comminuted meat products on their physico-chemical characteristics and eating quality using a mixture design approach. *Meat Science*, 96(3), 1384–1394. <https://doi.org/10.1016/j.meatsci.2013.11.025>.
- Keshk, W. A., & Noeman, S. A. (2015). Impact of chicory-supplemented diet on HMG-CoA reductase, acetyl-CoA carboxylase, visfatin and anti-oxidant status in triton WR-1339-induced hyperlipidemia. *Journal of Food Biochemistry*, 39(2), 164–172. <https://doi.org/10.1111/jfbc.12115>.
- Kim, E., Li, K., Lieu, C., Tong, S., Kawai, S., Fukutomi, T., ... Li, J. (2008). Expression of apolipoprotein C-IV is regulated by Ku antigen/peroxisome proliferator-activated receptor γ complex and correlates with liver steatosis. *Journal of Hepatology*, 49(5), 787–798. <https://doi.org/10.1016/j.jhep.2008.06.029>.
- Lahiri, A., & Abraham, C. (2014). Activation of pattern recognition receptors up-regulates metallothioneins, thereby increasing intracellular accumulation of zinc, autophagy, and bacterial clearance by macrophages. *Gastroenterology*, 147(4), 835–846. <https://doi.org/10.1053/j.gastro.2014.06.024>.
- Le Bastard, Q., Chapelet, G., Javaudin, F., Lepelletier, D., Batard, E., & Montassier, E. (2020). The effects of inulin on gut microbial composition: A systematic review of evidence from human studies. *European Journal of Clinical Microbiology & Infectious Diseases*, 39(3), 403–413. <https://doi.org/10.1007/s10096-019-03721-w>.
- Lee, N. Y., Chung, K.-S., Jin, J. S., Bang, K. S., Eom, Y.-J., Hong, C.-H., ... An, H.-J. (2015). Effect of chicoric acid on mast cell-mediated allergic inflammation in vitro and in vivo. *Journal of Natural Products*, 78(12), 2956–2962. <https://doi.org/10.1021/acs.jnatprod.5b00668>.
- Lee, S., Kim, J.-Y., Kim, Y.-J., Seok, K.-O., Kim, J.-H., Chang, Y.-J., ... Park, J.-H. (2012). Nuclear protein GLTSCR2 stabilizes p53 in response to ribosomal stresses. *Cell Death & Differentiation*, 19(10), 1613–1622. <https://doi.org/10.1038/cdd.2012.40>.
- Levine, A. J., Hu, W., & Feng, Z. (2006). The P53 pathway: What questions remain to be explored? *Cell Death & Differentiation*, 13(6), 1027–1036. <https://doi.org/10.1038/sj.cdd.4401910>.
- Ley, R. E., Turnbaugh, P. J., Klein, S., & Gordon, J. I. (2006). Microbial ecology: Human gut microbes associated with obesity. *Nature*, 444(7122), 1022–1023. <https://doi.org/10.1038/4441022a>.
- Lin, H. V., Frassetto, A., Kowalik, E. J., Jr., Nawrocki, A. R., Lu, M. M., Kosinski, J. R., ...

- Marsh, D. J. (2012). Butyrate and propionate protect against diet-induced obesity and regulate gut hormones via free fatty acid receptor 3-independent mechanisms. *PLoS ONE*, 7(4), <https://doi.org/10.1371/journal.pone.0035240>.
- Liu, H., Wang, Q., Liu, Y., Chen, G., & Cui, J. (2013). Antimicrobial and antioxidant activities of cichorium intybus root extract using orthogonal matrix design. *Journal of Food Science*, 78(2), M258–M263. <https://doi.org/10.1111/1750-3841.12040>.
- Lucchin, M., Varotto, S., Barcaccia, G., & Parrini, P. (2008). Chicory and endive. In J. Prohens, & F. Nuez (Eds.), *Vegetables I. Handbook of Plant Breeding* (pp. 1–46). New York, NY: Springer.
- Lum, C. T., Yang, Z. F., Li, H. Y., Sun, R. W.-Y., Fan, S. T., Poon, R. T. P., ... Kung, H. F. (2006). Gold(III) compound is a novel chemocytotoxic agent for hepatocellular carcinoma. *International Journal of Cancer*, 118(6), 1527–1538. <https://doi.org/10.1002/ijc.21484>.
- Lv, S., Ji, L., Chen, B., Liu, S., Lei, C., Liu, X., ... Lu, L. (2018). Histone methyltransferase KMT2D sustains prostate carcinogenesis and metastasis via epigenetically activating LIFR and KLF4. *Oncogene*, 37(10), 1354–1368. <https://doi.org/10.1038/s41388-017-0026-x>.
- Makovicky, P., Volek, Z., Uhlírova, L., & Makovicky, P. (2018). The influences of dried Chicory root and White lupine added to food on jejunal morphology: Experimental study. *Gastroenterology and Hepatology From Bed to Bench*, 11(3), 233–238.
- Mayer, M. P., & Bukau, B. (2005). Hsp70 chaperones: Cellular functions and molecular mechanism. *Cellular and Molecular Life Sciences*, 62(6), 670–684. <https://doi.org/10.1007/s00018-004-4464-6>.
- Monzavi, R., & Cohen, P. (2002). IGFs and IGFFBPs: Role in health and disease. *Best Practice & Research Clinical Endocrinology & Metabolism*, 16(3), 433–447. <https://doi.org/10.1053/beem.2002.0212>.
- Nwafor, I. C., Shale, K., & Achilonu, M. C. (2017). Chemical composition and nutritive benefits of chicory (*Cichorium intybus*) as an ideal complementary and/or alternative livestock feed supplement. *The Scientific World Journal*, 2017, 1–11. <https://doi.org/10.1155/2017/7343928>.
- Oudouhou, F., Casu, B., Puemi, A. S. D., Sygusch, J., & Baron, C. (2017). Analysis of novel interactions between components of the selenocysteine biosynthesis pathway, SEPHS1, SEPHS2, SEPSECS, and SECP43. *Biochemistry*, 56(17), 2261–2270. <https://doi.org/10.1021/acs.biochem.6b01116>.
- Puhlmann, M.-L., & De Vos, W. M. (2020). Back to the roots: Revisiting the use of the fiber-rich *Cichorium intybus* L. taproots. *Advances Nutrition*, nmaa025. <https://doi.org/10.1093/advances/nmaa025>.
- Qu, J., Ko, C.-W., Tso, P., & Bhargava, A. (2019). Apolipoprotein A-IV: A multifunctional protein involved in protection against atherosclerosis and diabetes. *Cells*, 8(4), 319. <https://doi.org/10.3390/cells8040319>.
- Rajkumar, K., Modric, T., & Murphy, L. (1999). Impaired adipogenesis in insulin-like growth factor binding protein-1 transgenic mice. *Journal of Endocrinology*, 162(3), 457–465. <https://doi.org/10.1677/joe.0.1620457>.
- Roberfroid, M. B., Loo, J. A. E. V., & Gibson, G. R. (1998). The bifidogenic nature of chicory inulin and its hydrolysis products. *The Journal of Nutrition*, 128(1), 11–19. <https://doi.org/10.1093/jn/128.1.11>.
- Saleem, M., Abbas, K., Naseer, F., Ahmad, M., Syed, N., Javed, F., ... Asima, S. (2014). Anticancer activity of n-hexane extract of *Cichorium intybus* on lymphoblastic leukemia cells (Jurkat cells). *African Journal of Plant Science*, 8(6), 315–319. <https://doi.org/10.5897/AJPS2013.1021>.
- Shah, C., Hari-Dass, R., & Raynes, J. G. (2006). Serum amyloid A is an innate immune opsonin for Gram-negative bacteria. *Blood*, 108(5), 1751–1757. <https://doi.org/10.1182/blood-2005-11-011932>.
- Shashidharamurthy, R., Machiah, D., Aitken, J. D., Putty, K., Srinivasan, G., Chassaing, B., ... Vijay-Kumar, M. (2013). Differential role of lipocalin 2 during immune complex-mediated acute and chronic inflammation in mice. *Arthritis & Rheumatology*, 65(4), 1064–1073. <https://doi.org/10.1002/art.37840>.
- Slavin, J. (2013). Fiber and prebiotics: Mechanisms and health benefits. *Nutrients*, 5(4), 1417–1435. <https://doi.org/10.3390/nu5041417>.
- Steinbrenner, H., & Sies, H. (2009). Protection against reactive oxygen species by selenoproteins. *Biochimica et Biophysica Acta (BBA) - General Subjects*, 1790(11), 1478–1485. <https://doi.org/10.1016/j.bbagen.2009.02.014>.
- Sun, L., Zhou, H., Zhu, Z., Yan, Q., Wang, L., Liang, Q., & Ye, R. D. (2015). Ex vivo and in vitro effect of serum amyloid A in the induction of macrophage M2 markers and efferocytosis of apoptotic neutrophils. *The Journal of Immunology*, 194(10), 4891–4900. <https://doi.org/10.4049/jimmunol.1402164>.
- Tamura, R. E., Vasconcellos, J. F. D., Sarkar, D., Libermann, T. A., Fisher, P. B., & Zerbini, L. F. (2012). GADD45 proteins: Central players in tumorigenesis. *Current Molecular Medicine*, 12(5), 634–651. <https://doi.org/10.2174/156652412800619978>.
- Tonoli, H., & Barrett, J. C. (2005). CD82 metastasis suppressor gene: A potential target for new therapeutics? *Trends in Molecular Medicine*, 11(12), 563–570. <https://doi.org/10.1016/j.molmed.2005.10.002>.
- Topiel, M. S., & Simon, G. L. (1986). *Peptococcaceae* bacteremia. *Diagnostic Microbiology and Infectious Disease*, 4(2), 109–117. [https://doi.org/10.1016/0732-8893\(86\)90144-6](https://doi.org/10.1016/0732-8893(86)90144-6).
- Turnbaugh, P. J., Backhed, F., Fulton, L., & Gordon, J. I. (2008). Diet-induced obesity is linked to marked but reversible alterations in the mouse distal gut microbiome. *Cell Host & Microbe*, 3(4), 213–223. <https://doi.org/10.1016/j.chom.2008.02.015>.
- Welcker, D., Jain, M., Khurshid, S., Jokić, M., Höhne, M., Schmitt, A., ... Höpker, K. (2018). AATF suppresses apoptosis, promotes proliferation and is critical for Kras-driven lung cancer. *Oncogene*, 37(11), 1503–1518. <https://doi.org/10.1038/s41388-017-0054-6>.
- Wheatcroft, S. B., & Kearney, M. T. (2009). IGF-dependent and IGF-independent actions of IGF-binding protein-1 and -2: Implications for metabolic homeostasis. *Trends in Endocrinology & Metabolism*, 20(4), 153–162. <https://doi.org/10.1016/j.tem.2009.01.002>.
- Willeman, H., Hance, P., Fertin, A., Voedts, N., Duhal, N., Goossens, J. F., & Hilbert, J. L. (2014). A method for the simultaneous determination of chlorogenic acid and sesquiterpene lactone content in industrial chicory root foodstuffs. *The Scientific World Journal*, 2014, Article 583180. <https://doi.org/10.1155/2014/583180>.
- Wong, J. M. W., Souza, R. D., Kendall, C. W. C., Emam, A., & Jenkins, D. J. A. (2006). Colonic health: Fermentation and short chain fatty acids. *Journal of Clinical Gastroenterology*, 40(3), 235–243. <https://doi.org/10.1097/00004836-200603000-00015>.
- Woods, S. C., & D'Alessio, D. A. (2008). Central control of body weight and appetite. *The Journal of Clinical Endocrinology & Metabolism*, 93(11S1), S37–S50. <https://doi.org/10.1210/jc.2008-1630>.
- Xilouri, M., & Stefanis, L. (2016). Chaperone mediated autophagy in aging: Starve to prosper. *Ageing Research Reviews*, 32, 13–21. <https://doi.org/10.1016/j.arr.2016.07.001>.
- Zhang, C. X. (2019). The protective role of DMBT1 in cervical squamous cell carcinoma. *The Kaohsiung Journal of Medical Sciences*, 35(12), 739–749. <https://doi.org/10.1002/kjm2.12117>.
- Zhang, Y., Xu, D., Huang, H., Chen, S., Wang, L., Zhu, L., ... Chen, Y. (2014). Regulation of glucose homeostasis and lipid metabolism by PPP1R3G mediated hepatic glycogenesis. *Molecular Endocrinology*, 28(1), 116–126. <https://doi.org/10.1210/me.2013-1268>.
- Zitomersky, N. L., Coyne, M. J., & Comstock, L. E. (2011). Longitudinal analysis of the prevalence, maintenance, and IgA response to species of the order *Bacteroidales* in the human gut. *Infection and Immunity*, 79(5), 2012–2020. <https://doi.org/10.1128/IAI.01348-10>.
- Zöller, M. (2009). Tetraspanins: Push and pull in suppressing and promoting metastasis. *Nature Reviews Cancer*, 9(1), 40–55. <https://doi.org/10.1038/nrc2543>.

RESULTATS COMPLEMENTAIRES

Le tableau *Supplementary file 1* a été séparé en deux parties pour en faciliter la lecture.

Supplementary file 1. Part 1. Gene expression profiles in mice liver tissue during chicory and inulin diet
Individual FC (mouse 1-3) for up- and down-regulated genes in male (M) and female (F) mice feed with chicory flour G12, G35 or inulin solution (Inu).

Bank name	Gene name	G12 diet						G35 diet						Inu diet						Process/pathway
		1M	2M	3M	1F	2F	3F	1M	2M	3M	1F	2F	3F	1M	2M	3M	1F	2F	3F	
Cell growth arrest/ apoptosis																				
NM_011817	Gadd45g	3.87	2.48	2.20	1.91	1.87	2.06	5.45	2.08	2.42	1.98	5.01	3.25	0.58	0.26	0.51	0.51	0.11	0.32	Cellular growth arrest/ Apoptosis
NM_008654	Gadd34	3.32	1.99	1.95	1.25	1.02	1.20	2.42	1.74	1.94	1.27	1.27	1.37	1.06	1.16	1.34	0.78	0.76	0.80	Cellular growth arrest/ Apoptosis
NM_008655	Gadd45b	3.13	3.08	2.05	0.86	1.32	1.24	3.42	1.94	1.96	0.55	0.59	0.57	0.71	0.96	1.10	0.77	0.84	0.90	Cellular growth arrest/ DNA repair
NM_001271432	Cd82	1.98	1.95	2.00	2.52	2.01	1.98	2.98	1.90	2.34	1.90	1.98	1.84	1.04	0.63	1.02	0.78	0.63	0.79	Tumor suppression
NM_001347632	Dmbt1	3.42	1.96	3.03	4.00	6.87	6.46	1.99	1.95	1.85	1.96	1.72	1.84	0.92	1.12	1.04	0.86	1.03	1.00	Tumor suppression
NM_133831	Nop53	1.75	2.06	2.00	1.70	1.96	1.89	2.49	1.73	1.65	1.74	1.69	1.89	0.91	0.94	0.88	0.83	0.70	0.69	Apoptotic process regulation
NM_031165	Hspa8	1.93	2.49	1.84	3.99	1.97	2.65	1.63	1.80	1.95	3.44	2.86	3.15	1.19	0.98	1.09	0.96	0.65	0.73	Apoptotic process regulation
NM_019816	Aif1	0.49	0.73	0.70	0.63	0.37	0.59	0.61	0.52	0.59	0.57	0.66	0.62	0.92	0.85	1.26	0.82	0.77	0.77	Cell death signaling
NM_001113386	Ufr	0.53	0.61	0.39	0.61	0.45	0.66	0.61	0.57	0.46	0.63	0.49	0.66	0.49	0.31	0.66	0.53	0.28	0.34	Cellular differentiation, proliferation and survival
Innate and adaptive immunity																				
NM_008491	Lcn2	4.34	3.12	2.01	3.69	4.66	4.17	3.65	4.98	5.75	8.73	4.98	9.85	0.47	0.49	0.16	0.48	0.50	0.32	Antimicrobial peptide / Immunity system
NM_009117	Saa1	4.26	2.66	2.68	11.47	12.13	12.02	15.72	17.70	17.33	15.52	17.77	18.15	0.53	0.51	0.25	0.61	0.47	0.53	Antimicrobial activity / Immunity system
NM_011314	Saa2	4.01	2.53	2.65	12.41	10.30	13.07	21.60	18.26	23.94	16.51	11.83	13.67	0.92	0.93	1.35	1.20	0.68	0.80	Antimicrobial activity / Immunity system
NM_008390	Ifi1	2.12	1.71	1.95	1.35	1.05	1.32	6.49	1.97	1.90	1.50	1.49	1.55	1.03	0.96	1.30	0.84	1.14	1.13	Innate immunity
NM_001164598	Ifitbp2	4.63	1.88	1.74	0.89	0.70	0.84	4.23	2.35	2.40	1.53	0.97	1.12	0.69	0.77	1.12	0.97	1.28	1.18	Negative regulator of inflammation
NM_023220	Spl2a	1.17	1.37	1.00	2.38	2.13	2.49	0.99	1.11	0.91	1.95	1.83	1.74	0.83	0.98	1.19	1.31	1.03	1.06	Innate and adaptive immunity/ Anti-inflammatory process
Glucose homeostasis																				
NM_029628	Ppp13g	4.24	2.49	3.05	1.91	2.74	2.00	9.42	8.76	5.18	6.19	2.83	4.01	0.85	1.01	1.16	1.16	1.22	1.20	Glycogen biosynthesis
NM_001314010	Igf1	0.96	0.73	1.04	1.88	1.98	2.17	1.18	1.05	0.79	2.47	2.14	2.31	0.94	0.98	1.01	0.91	1.36	0.72	Glycogen biosynthesis
NM_008341	Igfbp1	2.26	1.89	2.18	1.53	1.37	1.72	4.65	2.13	2.32	1.09	1.05	1.07	0.89	0.61	0.78	1.13	1.33	0.72	Glycogen biosynthesis
Lipid metabolism																				
NM_007468	Apoa4	1.91	2.07	1.86	4.03	1.90	2.26	2.08	1.95	2.08	1.93	2.40	2.00	1.05	0.76	0.80	0.81	1.21	1.32	Cholesterol homeostasis
NM_001130412	Lpnl1	4.94	2.63	3.52	1.23	1.32	1.26	3.81	3.24	2.66	1.18	1.24	1.35	0.69	0.89	0.93	0.71	1.23	1.16	Triglyceride synthesis
NM_001164885	Lpnl2	2.23	1.91	1.93	1.13	1.15	0.96	2.17	1.98	1.97	1.15	1.24	1.34	0.73	0.76	1.04	1.05	1.35	1.29	Triglyceride synthesis
NM_009693	ApoB	0.52	0.61	0.49	1.04	0.83	1.26	0.40	0.52	0.67	1.21	0.96	0.93	0.83	1.03	1.01	0.78	1.23	1.08	Cholesterol homeostasis
NM_007385	ApoC4	0.57	0.58	0.40	1.00	0.97	0.98	0.59	0.39	0.39	1.18	0.80	0.99	0.72	0.91	1.05	0.85	1.17	1.13	Lipid metabolism
Xenobiotic metabolism and antioxidant																				
NM_001252539	Cyp4a31	2.16	2.14	2.04	3.38	1.94	1.91	3.41	1.99	2.11	1.86	2.17	1.99	1.02	1.14	1.15	0.92	1.27	1.03	Xenobiotic metabolism
NM_010012	Cyp8b1	1.97	1.85	2.06	2.17	2.39	2.89	3.07	1.92	2.23	1.91	1.79	1.82	1.14	1.04	1.16	0.91	1.15	1.25	Xenobiotic metabolism
NM_024264	Cyp27a1	2.61	1.81	2.07	2.84	1.70	2.03	3.73	1.94	2.02	1.96	1.86	1.94	1.22	1.37	1.24	0.85	1.35	1.15	Xenobiotic metabolism
NM_001161765	Fmo5	2.04	1.82	2.47	2.80	2.21	2.67	2.24	1.95	1.82	2.30	1.87	2.28	0.69	1.32	1.15	0.76	1.26	1.23	Xenobiotic metabolism
NM_009266	Sephs2	2.12	1.97	2.24	2.12	2.54	2.09	2.24	2.40	2.41	1.94	2.14	2.04	1.01	1.05	1.08	1.00	0.66	0.78	Antioxidative activity

Supplementary file 1. Part 2. Gene expression profiles in mice liver tissue during chicory and inulin diet

Individual FC (mouse 1-3) for up- and down-regulated genes in male (M) and female (F) mice feed with chicory flour G12, G35 or inulin solution (Inu).

Bank name	Gene name	Functional annotation
Cell growth arrest/ apoptosis		
NM_011817	Gadd45g	growth arrest and DNA-damage-inducible 45 gamma
NM_008654	Gadd34	protein phosphatase 1, regulatory (inhibitor) subunit 15A (Ppp1r15a)
NM_008655	Gadd45b	growth arrest and DNA-damage-inducible 45 beta
NM_001271432	Cd82	CD82 antigen
NM_001347632	Dmbt1	deleted in malignant brain tumors 1
NM_133831	Nop53	glioma tumor suppressor candidate region gene 2 (Gltscr2)
NM_031165	Hspa8	heat shock protein 8
NM_019816	Aatf	apoptosis antagonizing transcription factor
NM_00113386	Lifr	leukemia inhibitory factor receptor
Innate and adaptive immunity		
NM_008491	Len2	lipocalin 2
NM_009117	Saa1	serum amyloid A 1
NM_011314	Saa2	serum amyloid A 2
NM_008390	Ifi1	interferon regulatory factor 1
NM_001164598	Ifi2bp2	interferon regulatory factor 2 binding protein 2
NM_023220	Sppi2a	signal peptide peptidase like 2A
Glucose homeostasis		
NM_029628	Ppp1r3g	protein phosphatase 1, regulatory (inhibitor) subunit 3G
NM_001314010	Igf1	insulin-like growth factor 1
NM_008341	Igfbp1	insulin-like growth factor binding protein 1
Lipid metabolism		
NM_007468	Apoa4	apolipoprotein A-IV
NM_001130412	Lpin1	lipin 1
NM_001164885	Lpin2	lipin 2
NM_009693	ApoB	apolipoprotein B
NM_007385	ApoC4	apolipoprotein C-IV
Xenobiotic metabolism and antioxidant activity		
NM_001252539	Cyp4a31	cytochrome P450, family 4, subfamily a, polypeptide 31
NM_010012	Cyp8b1	cytochrome P450, family 8, subfamily b, polypeptide 1
NM_024264	Cyp27a1	cytochrome P450, family 27, subfamily a, polypeptide 1
NM_001161765	Fmo5	flavin containing monooxygenase 5
NM_009266	Sephs2	selenophosphate synthetase 2

Supplementary file 2. GLP-1, PYY and leptin level in mice plasma, after 30 days of chicory (G12, G35) and inulin supplemented diet.

Statistical analysis was carried out using One-way ANOVA and Sidak's multiple comparisons test. Means \pm SD were calculated ($n \geq 3$) for each treatment. Mean values of all controls were standardized at a 100% value.

		Control males	G12 males	G35 males	Inulin males	Control females	G12 females	G35 females	Inulin females
GLP-1 (pg/mL)	n	9	4	3	4	11	3	3	5
	mean \pm SD	100 \pm 33,24	142.6 \pm 98,59	201.0 \pm 158,4	97.09 \pm 69,15	100 \pm 31,23	78.69 \pm 35,34	93.81 \pm 18,31	63.73 \pm 23,72
	p-val	X	0.7720	0.2125	0.9999	X	0.6182	0.9839	0.0945
PYY (pg/mL)	n	12	6	6	6	12	6	5	5
	mean \pm SD	100 \pm 41,65	123.5 \pm 75,51	149.9 \pm 45,67	145.5 \pm 67,1	100 \pm 27,87	100.1 \pm 60,56	125.8 \pm 69	101.4 \pm 43,71
	p-val	X	0.7901	0.2325	0.3220	X	>0.9999	0.6793	>0.9999
Leptin (pg/mL)	n	12	6	6	5	12	6	5	5
	mean \pm SD	100 \pm 50.9	77.93 \pm 34.1	54.63 \pm 23.86	91.52 \pm 49.07	100 \pm 45.21	46.59 \pm 15.36	87.88 \pm 42.34	87.08 \pm 57.43
	p-val	X	0.6820	0.1324	0.9770	X	0.0586	0.9360	0.9238

Le tableau *Supplementary file 3* a été séparé en cinq parties pour en faciliter la lecture.

Supplementary file 3. Part 1. The operational taxonomic units (OTUs) identified with an abundance >0.1% in fecal microbiota of male (M) and female (F) mice after chicory (G12 and G35) and inulin (Inu) diet. Ctrl1 is for mice receiving water instead of a chicory diet and Ctrl2 is for mice receiving water instead of an inulin diet.

HOTU ID	Ctrl1_males_D0						Ctrl1_females_D0						Ctrl1_males_D30						Ctrl1_females_D30					
	1	2	3	4	5	6	7	8	9	10	11	12	1	2	3	4	5	6	7	8	9	10	11	12
k__Bacteri__Actinobacteria_c__Actinobacteria_o__Bifidobacteriales_f__Bifidobacteriaceae_g__Bifidobacterium	0.00	0.00	0.00	0.00	0.00	0.00	0.00	0.03	0.06	0.00	0.32	0.00	0.00	0.00	0.00	0.00	0.00	0.00	0.12	0.04	0.00	0.27	0.01	1.06
k__Bacteri__Actinobacteria_c__Coriobacteriales_f__Coriobacteriaceae_g__Adlercreutzia	0.24	0.33	0.08	0.23	0.16	0.10	0.04	0.27	0.50	0.23	0.83	0.49	0.07	0.17	0.02	0.10	0.08	0.11	0.03	0.07	0.09	0.08	0.04	0.10
k__Bacteri__Bacteroidetes_c__Bacteroidia_o__Bacteroidales_f__Rikenellaceae_g__	14.60	15.19	8.06	19.35	8.05	22.13	11.24	18.77	15.82	5.89	3.64	9.43	13.83	14.06	13.57	9.41	19.81	4.91	16.10	8.95	7.66	25.00	16.55	5.12
k__Bacteri__Bacteroidetes_c__Bacteroidia_o__Bacteroidales_f__S24_7_R__	1.08	0.80	0.40	1.00	0.31	1.61	3.99	3.43	2.91	0.57	2.57	1.82	1.08	0.72	0.80	0.97	0.77	0.60	0.76	3.95	4.25	8.60	4.18	0.93
k__Bacteri__Firmicutes_c__Clostridia_o__Clostridiales_f__Lactobacillaceae_g__Lactobacillus	0.08	0.11	0.04	0.07	0.00	0.03	0.03	0.39	0.05	0.30	0.33	0.38	0.03	0.00	0.00	0.02	0.03	0.00	0.03	0.10	0.07	0.15	0.11	0.09
k__Bacteri__Firmicutes_c__Clostridia_o__Clostridiales_f__Other	2.53	1.05	4.49	0.80	1.96	1.36	3.05	1.97	1.00	3.26	2.69	5.40	6.63	2.24	0.69	1.05	0.76	2.70	2.25	1.33	7.11	0.44	0.61	4.23
k__Bacteri__Firmicutes_c__Clostridia_o__Clostridiales_f__R__	19.36	22.91	21.67	32.91	28.42	15.93	25.06	29.51	27.96	9.84	28.47	24.17	55.04	28.90	43.14	39.12	37.32	31.29	26.11	47.39	13.30	31.24	36.66	17.33
k__Bacteri__Firmicutes_c__Clostridia_o__Clostridiales_f__Clostridiaceae_g__Other	0.00	0.00	0.00	0.00	0.00	0.00	0.03	0.26	0.74	0.00	0.06	0.02	0.00	0.00	0.00	0.00	0.00	0.00	0.36	0.04	0.07	0.06	0.02	0.04
k__Bacteri__Firmicutes_c__Clostridia_o__Clostridiales_f__Clostridiaceae_g__Candidatus Arthromitus	0.04	0.16	0.11	0.09	0.03	0.00	0.14	0.15	0.03	0.02	0.07	0.27	0.00	0.04	0.12	0.05	0.00	0.00	0.04	0.07	0.02	0.01	0.01	0.01
k__Bacteri__Firmicutes_c__Clostridia_o__Clostridiales_f__Clostridiaceae_g__Clostridium	0.00	0.04	0.00	0.00	0.03	0.18	0.09	0.05	0.25	0.02	0.02	0.08	0.04	0.00	0.02	0.04	0.11	0.03	0.00	0.00	0.01	0.02	0.05	0.00
k__Bacteri__Firmicutes_c__Clostridia_o__Clostridiales_f__Lachnospiraceae_g__Other	1.99	3.27	2.51	3.00	3.02	2.46	1.05	1.20	1.53	1.44	2.21	1.18	1.70	1.04	1.07	1.93	2.14	1.48	2.60	0.58	0.98	1.62	2.16	0.63
k__Bacteri__Firmicutes_c__Clostridia_o__Clostridiales_f__Lachnospiraceae_g__	18.30	14.08	19.65	9.68	18.35	16.24	25.22	12.79	16.85	30.94	25.48	20.13	3.41	5.52	7.40	6.66	6.62	17.32	11.09	10.32	15.45	5.27	8.38	16.75
k__Bacteri__Firmicutes_c__Clostridia_o__Clostridiales_f__Lachnospiraceae_g__	3.00	1.62	3.72	1.03	4.57	0.74	0.53	3.29	1.92	2.67	4.42	2.38	0.45	2.85	0.37	0.70	0.48	0.52	1.54	1.32	1.46	0.84	0.64	1.20
k__Bacteri__Firmicutes_c__Clostridia_o__Clostridiales_f__Lachnospiraceae_g__	0.00	0.00	2.46	0.06	0.06	7.02	0.57	0.00	0.00	0.00	0.00	0.00	5.39	1.09	3.95	0.37	0.03	1.13	0.00	0.00	0.00	0.00	0.73	0.84
k__Bacteri__Firmicutes_c__Clostridia_o__Clostridiales_f__Lachnospiraceae_g__Anaerostipes	4.16	1.84	4.30	0.98	3.40	1.66	0.55	2.81	6.17	2.27	4.03	2.45	1.49	3.06	0.82	1.50	1.51	2.66	1.45	1.51	1.12	3.79	1.04	1.69
k__Bacteri__Firmicutes_c__Clostridia_o__Clostridiales_f__Lachnospiraceae_g__Dorea	0.29	0.25	0.34	0.45	1.51	0.18	0.28	0.21	0.78	1.33	1.00	0.75	0.14	0.30	0.05	0.12	0.09	0.29	0.00	0.03	0.04	0.28	0.09	0.05
k__Bacteri__Firmicutes_c__Clostridia_o__Clostridiales_f__Lachnospiraceae_g__Roseburia	0.11	1.81	0.38	0.12	1.21	1.54	1.12	0.93	0.19	0.89	0.38	0.26	0.05	1.25	0.14	0.31	3.04	0.55	0.08	0.12	0.14	2.11	0.26	1.73
k__Bacteri__Firmicutes_c__Clostridia_o__Clostridiales_f__Lachnospiraceae_g__	0.20	0.08	0.12	0.07	0.11	0.26	0.12	0.10	0.16	0.13	0.10	0.08	0.10	0.03	0.08	0.07	0.10	0.33	0.28	0.16	0.16	0.15	0.06	0.13
k__Bacteri__Firmicutes_c__Clostridia_o__Clostridiales_f__Peptococcaceae_g__rc4-4	5.55	11.34	2.37	9.08	2.43	11.61	0.01	0.01	0.07	0.00	0.07	0.07	1.63	1.61	11.81	1.89	3.47	1.65	0.00	0.00	0.00	0.04	0.00	0.00
k__Bacteri__Firmicutes_c__Clostridia_o__Clostridiales_f__Ruminococcaceae_g__	2.95	2.66	3.07	2.88	2.73	1.89	2.06	2.06	2.62	1.01	1.89	3.77	2.63	2.81	2.20	1.41	3.79	2.05	2.39	1.38	1.88	3.03	2.44	2.14
k__Bacteri__Firmicutes_c__Clostridia_o__Clostridiales_f__Mogibacteriaceae_g__	0.88	0.83	0.72	0.55	1.00	0.65	0.28	1.08	1.03	0.79	1.40	1.08	0.39	0.38	0.27	0.42	0.77	0.55	0.45	0.27	0.34	0.47	0.23	0.36
k__Bacteri__Firmicutes_c__Clostridia_o__Clostridiales_f__Ruminococcaceae_g__Anaerotruncus	0.15	0.29	0.63	0.08	0.50	0.19	0.26	0.13	0.11	0.20	0.36	0.14	0.14	0.11	0.02	0.24	0.04	1.33	0.39	0.02	0.55	0.20	0.12	0.40
k__Bacteri__Firmicutes_c__Clostridia_o__Clostridiales_f__Ruminococcaceae_g__	0.63	0.47	1.94	0.16	2.83	0.17	0.31	0.68	0.50	0.53	0.53	0.50	0.13	0.87	0.03	0.09	0.06	0.63	0.12	0.00	0.32	0.25	0.13	0.21
k__Bacteri__Firmicutes_c__Clostridia_o__Clostridiales_f__Ruminococcaceae_g__Butyrivibrio	17.02	11.14	16.85	11.38	14.94	10.33	20.92	17.66	15.47	28.68	15.70	22.56	10.61	30.00	12.48	31.22	17.75	24.63	31.20	18.04	38.82	13.89	20.68	41.25
k__Bacteri__Firmicutes_c__Clostridia_o__Clostridiales_f__Ruminococcaceae_g__Oscillospira	6.43	9.40	5.71	5.80	3.61	2.05	2.68	1.92	2.95	8.60	2.92	2.04	0.90	2.92	0.71	1.97	0.90	5.05	2.13	4.12	5.05	1.81	4.32	3.36
k__Bacteri__Proteobacteria_c__Deltaferritobacteriales_f__Desulfotribionaceae_g__	0.00	0.00	0.00	0.00	0.00	0.00	0.00	0.00	0.00	0.00	0.00	0.00	0.00	0.00	0.00	0.00	0.00	0.00	0.00	0.00	0.00	0.00	0.00	0.00
k__Bacteri__TM7_c__TM7_3_o__CW040f__Flg6_g__	0.08	0.07	0.04	0.03	0.02	0.09	0.19	0.09	0.18	0.17	0.31	0.18	0.02	0.00	0.05	0.02	0.02	0.07	0.20	0.02	0.10	0.01	0.15	0.05
k__Bacteri__Tenericutes_c__Mollicutes_o__Anaeroplasmatales_f__Anaeroplasmataceae_g__Anaeroplasma	0.17	0.04	0.24	0.00	0.54	1.44	0.02	0.00	0.00	0.13	0.02	0.07	0.00	0.00	0.15	0.04	0.11	0.00	0.04	0.02	0.87	0.00	0.14	0.15
Autres bactéries	0.15	0.24	0.11	0.20	0.22	0.16	0.16	0.20	0.16	0.08	0.20	0.29	0.09	0.05	0.04	0.28	0.20	0.16	0.26	0.14	0.13	0.36	0.19	0.15

Supplementary file 3. Part 2. The operational taxonomic units (OTUs) identified with an abundance >0.1% in fecal microbiota of male (M) and female (F) mice after chichory (G12 and G35) and Inulin (Inu) diet. Chr1 is for mice receiving water instead of a chichory diet and Chr2 is for mice receiving water instead of an inulin diet.

#OTUID	G12 males D0						G12 females D0						G12 males D30						G12 females D30					
	1	2	3	4	5	6	7	8	9	10	11	12	1	2	3	4	5	6	7	8	9	10	11	12
k__Bacteri__Actinobacteria__Actinobacteria_o__Bifidobacteriales_f__Bifidobacteriaceae_g__Bifidobacterium	0.00	0.00	0.00	0.00	0.00	0.00	0.00	0.28	0.24	0.17	0.50	0.14	0.04	0.00	0.02	0.00	0.02	0.11	0.07	0.03	0.10	0.09	0.13	0.13
k__Bacteri__Actinobacteria__Coriobacteriia_o__Coriobacteriales_f__Coriobacteriaceae_g__Adlercreutzia	0.28	0.26	0.22	0.12	0.75	0.75	0.41	0.28	0.24	0.17	0.50	0.14	0.04	0.00	0.02	0.00	0.02	0.11	0.07	0.03	0.10	0.09	0.13	0.13
k__Bacteri__Bacteroidetes__Bacteroidia_o__Bacteroidales_f__Rikenellaceae_g__	0.82	14.00	19.84	22.72	5.89	6.22	13.66	10.41	14.68	25.32	8.57	10.97	11.22	12.17	9.42	13.26	8.96	3.83	16.81	9.15	19.10	24.01	15.34	11.83
k__Bacteri__Bacteroidetes__Bacteroidia_o__Bacteroidales_f__S24-7_g__	0.33	0.48	1.09	0.67	0.47	0.36	2.79	9.75	2.03	4.43	1.18	1.67	0.72	0.47	1.34	1.68	0.37	0.73	2.11	4.24	6.70	3.38	2.29	2.61
k__Bacteri__Firmicutes__Bacilli_o__Lactobacillales_f__Lactobacillaceae_g__Lactobacillus	0.00	0.18	0.02	0.11	0.02	0.02	0.14	0.25	0.27	0.09	0.06	0.13	0.05	0.00	0.00	0.04	0.10	0.02	0.05	0.08	0.03	0.01	0.08	0.04
k__Bacteri__Firmicutes__Clostridia_o__Clostridiales_f__Other	1.57	3.08	1.69	0.92	2.67	2.79	3.49	0.23	0.78	1.44	0.25	1.88	0.57	1.17	2.85	1.09	0.78	1.18	1.94	1.92	4.15	1.70	0.66	1.89
k__Bacteri__Firmicutes__Clostridia_o__Clostridiales_f__g__	24.93	19.68	18.58	35.26	13.60	15.55	27.98	37.60	29.43	35.16	16.13	21.14	45.98	17.87	40.11	32.84	48.82	19.30	34.61	27.99	27.22	25.27	36.71	32.06
k__Bacteri__Firmicutes__Clostridia_o__Clostridiales_f__Clostridiaceae_g__Other	0.00	0.00	0.00	0.00	0.00	0.00	0.06	0.00	0.06	0.00	0.00	0.00	0.00	0.00	0.00	0.00	0.00	0.00	0.00	0.00	0.00	0.00	0.00	0.00
k__Bacteri__Firmicutes__Clostridia_o__Clostridiales_f__Clostridiaceae_g__Candidatus Arthronitus	0.03	0.07	0.08	0.21	0.05	0.04	0.56	0.13	0.17	0.57	0.04	0.01	0.02	0.00	0.02	0.07	0.00	0.00	0.02	0.02	0.04	0.10	0.00	0.00
k__Bacteri__Firmicutes__Clostridia_o__Clostridiales_f__Lachnospiraceae_g__	0.00	0.00	0.00	0.10	0.33	0.36	0.15	0.10	0.02	0.02	0.00	0.02	0.02	0.00	0.00	0.00	0.00	0.00	0.00	0.18	0.00	0.00	0.00	0.01
k__Bacteri__Firmicutes__Clostridia_o__Clostridiales_f__Lachnospiraceae_g__	2.28	3.14	1.41	1.96	4.20	4.81	3.04	0.69	1.75	0.86	1.83	1.95	2.52	1.51	1.42	2.97	1.93	1.27	0.67	2.25	1.05	0.51	0.61	1.37
k__Bacteri__Firmicutes__Clostridia_o__Clostridiales_f__Lachnospiraceae_g__	30.69	16.90	12.81	13.32	21.13	22.48	12.40	13.50	15.79	14.62	23.50	24.23	5.52	7.81	5.66	14.58	5.99	13.61	4.90	11.09	10.01	11.21	9.88	11.12
k__Bacteri__Firmicutes__Clostridia_o__Clostridiales_f__Lachnospiraceae_g__Ruminococcus	0.00	0.00	0.31	0.00	0.00	0.00	0.01	0.66	1.99	0.01	0.05	0.00	5.25	0.58	0.17	0.13	0.00	0.19	3.27	1.96	2.22	0.73	5.20	0.00
k__Bacteri__Firmicutes__Clostridia_o__Clostridiales_f__Lachnospiraceae_g__Ruminococcus	5.84	2.32	4.84	1.29	7.48	8.61	3.46	1.88	4.96	1.75	2.52	3.72	2.00	1.65	2.55	5.06	1.84	3.17	1.42	0.99	0.59	0.74	1.31	3.15
k__Bacteri__Firmicutes__Clostridia_o__Clostridiales_f__Lachnospiraceae_g__Dorea	0.49	0.37	0.45	0.09	0.97	0.70	0.25	0.69	0.74	0.27	0.69	0.74	0.20	0.54	0.29	0.18	0.30	0.54	0.05	0.05	0.17	0.07	0.08	0.18
k__Bacteri__Firmicutes__Clostridia_o__Clostridiales_f__Lachnospiraceae_g__Roseburia	0.07	0.21	1.43	0.26	10.26	10.43	0.10	8.21	6.48	0.23	0.00	0.65	0.14	1.08	1.34	0.24	0.02	1.39	0.51	0.25	1.03	1.50	0.78	0.98
k__Bacteri__Firmicutes__Clostridia_o__Clostridiales_f__Peptococcaceae_g__	0.18	0.14	0.11	0.08	0.16	0.13	0.10	0.09	0.11	0.07	0.07	0.14	0.03	0.07	0.15	0.11	0.11	0.32	0.08	0.11	0.12	0.12	0.06	0.19
k__Bacteri__Firmicutes__Clostridia_o__Clostridiales_f__Peptococcaceae_g__rc4-4	2.58	6.50	6.74	5.38	0.19	0.14	0.02	0.45	0.00	0.06	0.00	0.05	0.11	0.03	0.83	1.23	0.10	0.06	0.00	0.11	0.00	0.00	0.02	0.01
k__Bacteri__Firmicutes__Clostridia_o__Clostridiales_f__Ruminococcaceae_g__	2.15	1.98	3.73	1.69	1.85	1.79	1.57	1.56	1.86	1.70	0.91	1.74	2.50	1.40	1.71	3.19	1.22	2.20	2.27	1.60	1.29	1.65	1.79	2.35
k__Bacteri__Firmicutes__Clostridia_o__Clostridiales_f__Mogibacteriaceae_g__	1.03	0.84	1.55	0.65	1.34	1.67	0.45	0.62	0.57	0.48	0.63	0.43	0.40	0.24	0.47	0.56	0.59	0.50	0.30	0.25	0.25	0.15	0.33	0.32
k__Bacteri__Firmicutes__Clostridia_o__Clostridiales_f__Ruminococcaceae_g__Anaerotruncus	0.77	0.37	0.42	0.33	0.73	0.85	0.05	0.08	0.16	0.05	0.23	0.05	0.18	0.92	0.23	0.26	0.14	0.31	0.01	0.66	0.08	0.11	0.07	0.14
k__Bacteri__Firmicutes__Clostridia_o__Clostridiales_f__Butyrivibrio	1.25	0.89	0.61	0.21	0.36	0.46	0.73	0.25	0.16	0.12	0.96	0.37	0.45	2.90	0.52	0.37	0.79	0.21	0.29	2.26	0.17	0.07	0.38	0.77
k__Bacteri__Firmicutes__Clostridia_o__Clostridiales_f__Ruminococcaceae_g__Oscillospira	16.66	19.71	13.33	10.70	19.90	14.75	16.58	10.35	12.50	9.88	28.76	19.04	18.41	44.64	28.30	18.07	25.58	45.01	25.72	29.02	18.16	23.57	19.98	25.38
k__Bacteri__Firmicutes__Clostridia_o__Clostridiales_f__Ruminococcaceae_g__	4.59	6.58	5.60	3.42	3.94	3.48	6.94	1.00	3.49	1.65	7.65	7.96	2.48	4.18	2.06	3.07	1.61	4.04	3.12	4.66	5.03	2.55	2.62	4.11
k__Bacteri__Proteobacteria__Deltaproteobacteria_o__Desulfotribionales_f__Desulfotribionaceae_g__	0.00	0.00	0.00	0.00	0.00	0.00	0.00	0.00	0.00	0.00	0.00	0.00	0.00	0.00	0.00	0.00	0.00	0.00	0.00	0.00	0.00	0.00	0.00	0.00
k__Bacteri__TM7__TM7-3_o__CW040_f__Fl6_g__	0.02	0.07	0.03	0.00	0.05	0.07	0.06	0.26	0.08	0.14	0.18	0.07	0.00	0.00	0.07	0.10	0.08	0.12	0.16	0.05	0.12	0.07	0.11	0.07
k__Bacteri__Feniferutes__Mollicutes__Anaeroplasmatales_f__Anaeroplasmataceae_g__Anaeroplasmata	0.15	0.43	0.05	0.04	0.00	0.00	0.05	0.09	0.07	0.05	0.00	0.00	0.00	0.00	0.00	0.08	0.00	0.04	0.68	0.00	0.00	1.42	0.30	0.02
Autres bactéries	0.23	0.08	0.35	0.18	0.29	0.38	0.17	0.16	0.16	0.17	0.14	0.14	0.23	0.00	0.12	0.12	0.16	0.15	0.23	0.15	0.16	0.33	0.42	0.14

Supplementary file 3, Part 3. The operational taxonomic units (OTUs) identified with an abundance >0.1% in fecal microbiota of male (M) and female (F) mice after chicory (G12 and G35) and inulin (Inu) diet. Ctr1 is for mice receiving water instead of a chicory diet and Ctr2 is for mice receiving water instead of an inulin diet.

#OTU ID	G35 males D0						G35 females D0						G35 males D30						G35 females D30					
	1	2	3	4	5	6	7	8	9	10	11	12	1	2	3	4	5	6	7	9	10	11	12	
k__Bacteri__Actinobacteria__Actinobacteria__Bifidobacteriales__Bifidobacteriaceae__Bifidobacterium	0.00	0.00	0.00	0.00	0.00	0.00	0.01	0.00	0.00	0.31	0.00	0.00	0.00	0.00	0.00	0.00	0.00	0.00	2.13	0.84	4.47	0.40	0.28	
k__Bacteri__Actinobacteria__Coriobacteriales__Coriobacteriaceae__Adlercreutzia	0.12	0.88	0.40	0.56	0.22	0.37	0.27	0.27	0.41	0.41	0.39	0.32	0.09	0.10	0.07	0.09	0.09	0.00	0.09	0.08	0.10	0.07	0.13	
k__Bacteri__Bacteroidetes__Bacteroidia__Bacteroidales__Rikenellaceae__	0.82	0.92	3.91	0.70	0.35	0.53	10.68	8.87	11.25	11.91	7.97	14.64	15.78	13.82	22.13	6.05	8.12	13.57	11.74	30.36	16.67	19.19	16.88	
k__Bacteri__Bacteroidetes__Bacteroidia__Bacteroidales__S24-7__	0.49	1.66	1.02	1.12	0.18	0.77	4.22	1.87	0.99	3.60	0.92	3.83	1.15	1.11	0.77	0.35	0.84	0.50	4.33	2.64	2.29	1.48	8.33	
k__Bacteri__Firmicutes__Bacilli__Lactobacillales__Lactobacillaceae__Lactobacillus	0.00	0.05	0.06	0.17	0.02	0.02	0.17	0.08	0.05	0.46	2.14	3.15	0.00	0.02	0.01	0.00	0.00	0.00	0.05	0.03	0.24	0.20	0.05	
k__Bacteri__Firmicutes__Clostridia__Clostridiales__Other	0.45	0.80	0.74	1.12	1.29	1.04	1.27	1.67	1.58	2.05	1.50	1.42	0.33	0.49	0.29	0.45	0.72	0.72	1.51	0.50	1.17	0.99	0.38	
k__Bacteri__Firmicutes__Clostridia__Clostridiales__g__	59.12	39.25	42.91	57.67	21.23	33.77	36.41	25.19	20.03	36.06	23.41	21.39	36.63	42.90	23.50	46.46	19.83	54.08	39.42	19.85	29.02	20.48	19.73	
k__Bacteri__Firmicutes__Clostridia__Clostridiales__Clostridiales__Other	0.00	0.00	0.00	0.00	0.00	0.00	0.00	0.00	0.01	0.00	0.00	0.00	0.00	0.00	0.00	0.00	0.00	0.00	0.00	0.00	0.00	0.00	0.00	
k__Bacteri__Firmicutes__Clostridia__Clostridiales__Clostridiales__g__Candidatus Arthronitus	0.19	0.06	0.06	0.23	0.05	0.04	0.25	0.10	0.06	0.23	0.18	0.17	0.04	0.00	0.06	0.12	0.08	0.00	0.08	0.00	0.20	0.05	0.01	
k__Bacteri__Firmicutes__Clostridia__Clostridiales__Clostridiales__g__Clostridium	0.10	0.04	0.00	0.00	0.13	0.11	0.07	0.19	0.14	0.09	0.15	0.19	0.00	0.00	0.00	0.00	0.00	0.00	0.02	0.02	0.01	0.00	0.00	
k__Bacteri__Firmicutes__Clostridia__Clostridiales__Clostridiales__g__Clostridium	0.90	2.07	2.48	1.85	3.65	1.90	2.06	2.24	2.14	2.31	1.02	0.79	0.42	0.79	0.82	0.70	0.75	0.34	0.94	1.01	1.19	0.94	0.43	
k__Bacteri__Firmicutes__Clostridia__Clostridiales__Lachnospiraceae__g__	8.70	13.09	13.30	9.16	25.25	14.68	12.08	22.75	12.11	12.66	26.95	22.15	4.52	4.89	8.44	1.31	4.64	3.45	7.31	10.95	6.66	14.61	21.02	
k__Bacteri__Firmicutes__Clostridia__Clostridiales__Lachnospiraceae__g__Ruminococcus	0.47	1.86	0.62	1.70	2.93	1.94	1.86	6.99	6.26	4.25	1.16	1.24	0.33	0.29	0.46	0.87	0.71	0.17	0.56	0.91	1.12	0.69	0.64	
k__Bacteri__Firmicutes__Clostridia__Clostridiales__Lachnospiraceae__g__Anaerostipes	0.05	0.00	0.00	0.00	0.00	0.00	2.38	0.01	6.56	0.00	0.00	0.00	0.00	0.00	3.14	3.97	0.00	0.00	3.81	4.18	3.81	0.00	8.94	
k__Bacteri__Firmicutes__Clostridia__Clostridiales__Lachnospiraceae__g__Dorea	0.29	0.16	0.06	1.20	0.34	0.34	3.51	1.72	3.39	3.68	3.08	3.18	2.17	2.78	2.85	2.70	1.73	1.54	0.54	0.30	1.16	1.40	0.37	
k__Bacteri__Firmicutes__Clostridia__Clostridiales__Lachnospiraceae__g__Roseburia	1.67	0.40	2.19	1.59	0.90	2.15	0.17	0.19	0.00	0.39	0.50	0.51	0.36	2.29	0.55	0.06	0.04	0.43	1.50	0.75	2.60	1.45	0.10	
k__Bacteri__Firmicutes__Clostridia__Clostridiales__Peptococcaceae__g__	0.03	0.09	0.07	0.04	0.05	0.04	0.10	0.16	0.11	0.07	0.07	0.11	0.13	0.14	0.07	0.17	0.15	0.04	0.11	0.09	0.10	0.17	0.08	
k__Bacteri__Firmicutes__Clostridia__Clostridiales__Peptococcaceae__g__c4-4	5.39	2.81	3.96	1.39	3.15	4.26	0.03	0.09	0.00	0.04	0.05	0.03	0.77	0.47	0.24	1.00	0.39	0.16	0.03	0.03	0.01	0.00	0.00	
k__Bacteri__Firmicutes__Clostridia__Clostridiales__Ruminococcaceae__g__	2.59	2.55	2.56	2.50	1.56	2.14	2.29	1.52	2.24	2.29	1.60	1.75	2.19	1.55	1.70	1.67	2.10	1.07	2.34	1.24	2.18	1.59	1.63	
k__Bacteri__Firmicutes__Clostridia__Clostridiales__Mogibacteriaceae__g__	0.36	1.27	0.67	1.67	0.74	0.66	0.60	1.05	0.48	0.83	0.67	0.81	0.51	0.48	0.59	0.53	0.48	0.20	0.23	0.14	0.35	0.24	0.24	
k__Bacteri__Firmicutes__Clostridia__Clostridiales__Ruminococcaceae__g__Anaerotruncus	0.08	0.08	0.47	0.12	0.27	0.05	0.28	0.27	0.20	0.09	0.29	0.12	0.12	0.02	0.05	0.04	0.09	0.06	0.02	0.31	0.30	0.62	0.43	
k__Bacteri__Firmicutes__Clostridia__Clostridiales__Ruminococcaceae__g__Butyrivibrio	0.09	0.77	0.18	1.28	0.43	0.30	0.66	1.38	0.86	0.37	0.35	0.33	0.14	0.13	0.15	0.25	0.22	0.03	0.57	0.57	0.19	0.43	0.05	
k__Bacteri__Firmicutes__Clostridia__Clostridiales__Ruminococcaceae__g__Oscillospira	9.90	20.95	15.41	11.10	26.17	19.77	17.69	18.72	23.52	14.05	22.11	17.84	30.80	25.61	30.16	29.48	55.68	21.84	19.28	18.68	21.36	31.07	18.04	
k__Bacteri__Firmicutes__Clostridia__Clostridiales__Ruminococcaceae__g__	5.63	3.35	6.38	1.47	6.64	7.82	2.48	2.69	6.40	2.91	4.10	4.08	2.72	2.04	3.08	2.59	3.02	1.43	2.78	5.90	3.84	3.65	1.78	
k__Bacteri__Proteobacteria__Delta__Proteobacteria__Desulfotomobacteriales__Desulfotomobacteriaceae__g__	0.00	0.00	0.00	0.00	0.00	0.00	0.00	0.00	0.00	0.00	0.00	0.00	0.00	0.00	0.00	0.00	0.00	0.00	0.00	0.00	0.00	0.00	0.00	
k__Bacteri__TM7__TM7-3__CW040__f__F16__	0.04	0.07	0.05	0.10	0.00	0.04	0.12	0.09	0.19	0.12	0.24	0.49	0.02	0.00	0.00	0.02	0.00	0.00	0.05	0.02	0.07	0.05	0.00	
k__Bacteri__TM7__TM7-3__CW040__f__F16__	0.11	0.12	0.36	1.01	0.02	0.00	0.00	0.30	0.05	0.02	0.22	0.11	0.50	0.00	0.24	0.00	0.09	0.17	0.18	0.20	0.43	0.04	0.01	
k__Bacteri__TM7__TM7-3__CW040__f__F16__	0.25	0.10	0.18	0.41	0.10	0.14	0.18	0.10	0.23	0.19	0.16	0.27	0.23	0.07	0.22	0.34	0.11	0.14	0.26	0.13	0.28	0.10	0.30	

Supplementary file 3. Part 4. The operational taxonomic units (OTUs) identified with an abundance >0.1% in fecal microbiota of male (M) and female (F) mice after chicory (G12 and G35) and inulin (Inu) diet. Chr1 is for mice receiving water instead of a chicory diet and Chr2 is for mice receiving water instead of an inulin diet.

#OTU ID	Chr2 males_D0						Chr2 females_D0						Chr2 males_D30						Chr2 females_D30					
	1	2	3	4	5	6	7	8	9	10	11	12	1	2	3	4	5	6	7	8	9	10	11	12
k__Bacteria;p__Actinobacteria;c__Actinobacteria;o__Bifidobacteriales;f__Bifidobacteriaceae;g__Bifidobacterium	0.00	0.00	0.00	0.00	0.00	0.00	0.00	0.00	0.00	0.00	0.00	0.00	0.00	0.00	0.00	0.00	0.00	0.00	0.00	0.00	0.00	0.00	0.00	0.00
k__Bacteria;p__Actinobacteria;c__Coriobacteriia;o__Coriobacteriales;f__Coriobacteriaceae;g__Adlercreutzia	0.39	0.38	0.57	0.32	0.38	0.34	0.11	0.17	0.40	0.30	0.40	0.53	0.03	0.00	0.37	0.00	0.03	0.03	0.17	0.54	1.01	0.10	0.32	0.63
k__Bacteria;p__Bacteroidetes;c__Bacteroidia;o__Bacteroidales;f__Rikenellaceae;g__	19.39	25.66	22.09	24.41	26.20	26.98	18.58	8.13	15.18	6.43	9.78	3.67	30.47	28.73	24.06	41.75	28.19	33.61	20.88	29.96	27.58	12.07	14.84	21.13
k__Bacteria;p__Bacteroidetes;c__Bacteroidia;o__Bacteroidales;f__S24-7g__	0.35	0.39	0.82	0.42	0.83	0.66	3.67	1.01	3.76	1.75	2.36	0.76	1.10	1.32	0.35	0.26	1.07	1.45	1.18	2.33	3.95	0.23	0.46	2.41
k__Bacteria;p__Firmicutes;c__Clostridia;o__Clostridiales;f__Lactobacillales;g__Lactobacillus	0.16	0.04	0.11	0.06	0.08	0.08	2.23	0.50	5.51	2.75	6.34	0.86	0.00	0.02	0.31	0.00	0.00	0.00	0.79	1.68	0.80	0.54	0.17	0.26
k__Bacteria;p__Firmicutes;c__Clostridia;o__Clostridiales;f__Other	0.94	6.32	1.29	8.04	1.99	4.47	0.92	1.43	0.90	2.22	1.03	1.80	1.68	1.73	4.24	1.79	0.69	1.42	0.31	0.63	0.97	1.45	2.14	0.81
k__Bacteria;p__Firmicutes;c__Clostridia;o__Clostridiales;f__g__	14.05	17.12	35.99	14.70	10.70	17.66	25.80	34.45	49.39	28.15	30.69	24.10	17.12	4.58	17.37	18.66	11.84	21.79	31.01	27.72	26.72	15.63	29.25	24.98
k__Bacteria;p__Firmicutes;c__Clostridia;o__Clostridiales;f__Clostridiaceae;g__Other	0.06	0.02	0.13	0.00	0.06	0.00	0.00	0.00	0.00	0.00	0.00	0.00	0.13	0.00	0.06	0.00	0.00	0.20	0.00	0.00	0.00	0.00	0.00	0.00
k__Bacteria;p__Firmicutes;c__Clostridia;o__Clostridiales;f__Clostridiaceae;g__Candidatus Arthromitus	0.11	0.82	0.87	1.88	1.45	1.23	0.80	0.08	1.46	0.11	0.54	0.04	0.00	0.15	0.37	0.04	0.14	0.02	0.06	0.04	0.17	0.00	0.01	0.00
k__Bacteria;p__Firmicutes;c__Clostridia;o__Clostridiales;f__Clostridiaceae;g__Clostridium	0.04	0.11	0.25	0.14	0.02	0.02	0.20	0.05	0.16	0.09	0.09	0.02	0.06	0.02	0.17	0.16	0.00	1.37	0.00	0.05	0.08	0.03	0.14	0.05
k__Bacteria;p__Firmicutes;c__Clostridia;o__Clostridiales;f__Lachnospiraceae;g__Other	8.74	3.26	0.53	3.41	2.44	3.05	0.96	2.48	0.61	2.71	2.35	3.31	1.23	0.93	2.27	0.61	0.35	1.34	1.63	1.16	1.54	2.87	2.41	2.51
k__Bacteria;p__Firmicutes;c__Clostridia;o__Clostridiales;f__Lachnospiraceae;g__	19.03	14.86	6.40	17.08	21.12	17.08	19.47	20.71	9.11	27.90	18.33	37.78	12.77	8.30	15.90	6.19	9.57	7.46	14.41	11.49	17.99	28.49	24.06	19.60
k__Bacteria;p__Firmicutes;c__Clostridia;o__Clostridiales;f__Lachnospiraceae;g__Ruminococcus	2.81	1.38	1.10	1.28	1.79	1.59	0.73	1.24	0.44	1.32	1.93	2.26	0.22	0.52	1.43	0.40	0.77	0.22	1.03	2.18	1.85	2.83	2.68	2.84
k__Bacteria;p__Firmicutes;c__Clostridia;o__Clostridiales;f__Lachnospiraceae;g__Anaerostipes	0.13	0.00	0.02	0.02	0.00	0.36	0.00	0.00	0.00	0.00	0.02	0.00	0.00	0.00	0.00	0.00	0.00	0.31	0.00	0.00	0.02	0.00	0.00	0.00
k__Bacteria;p__Firmicutes;c__Clostridia;o__Clostridiales;f__Lachnospiraceae;g__Coprocooccus	1.83	1.01	0.89	1.11	1.54	1.05	1.87	2.31	0.56	0.97	1.21	1.35	1.12	0.49	1.74	0.33	0.21	1.09	3.06	2.53	1.14	2.24	1.58	0.77
k__Bacteria;p__Firmicutes;c__Clostridia;o__Clostridiales;f__Lachnospiraceae;g__Dorea	0.14	0.08	0.12	0.10	0.16	0.26	0.57	2.31	0.41	0.38	0.32	1.00	0.05	0.08	0.11	0.07	0.08	0.04	0.60	0.48	0.46	0.51	0.22	0.23
k__Bacteria;p__Firmicutes;c__Clostridia;o__Clostridiales;f__Lachnospiraceae;g__Roseburia	1.29	0.36	0.18	1.69	2.33	0.95	0.95	1.22	0.33	0.79	0.70	0.67	0.14	6.34	4.53	0.18	0.00	0.12	0.18	0.34	0.24	0.17	0.07	0.14
k__Bacteria;p__Firmicutes;c__Clostridia;o__Clostridiales;f__Peptococcaceae;g__	0.06	0.13	0.06	0.03	0.09	0.06	0.15	0.13	0.03	0.09	0.17	0.14	0.05	0.12	0.04	0.04	0.03	0.07	0.14	0.18	0.03	0.15	0.22	0.11
k__Bacteria;p__Firmicutes;c__Clostridia;o__Clostridiales;f__Peptococcaceae;g__c4-4	0.00	0.00	0.09	0.00	0.04	0.00	0.00	0.00	0.00	0.00	0.00	0.00	0.03	0.00	0.00	0.00	0.00	0.02	0.00	0.00	0.00	0.00	0.00	0.00
k__Bacteria;p__Firmicutes;c__Clostridia;o__Clostridiales;f__Ruminococcaceae;g__	2.41	2.09	3.67	1.43	2.72	1.93	2.02	1.78	2.35	1.76	2.07	1.45	2.49	1.84	3.42	1.42	1.49	3.63	1.82	2.94	1.88	1.52	1.75	1.57
k__Bacteria;p__Firmicutes;c__Clostridia;o__Clostridiales;f__Mogibacteriaceae;g__	0.26	0.72	1.96	0.49	0.44	0.29	0.62	0.53	0.51	0.53	0.53	0.57	0.26	0.37	0.39	0.10	0.36	0.34	0.29	0.53	0.56	0.41	0.41	0.51
k__Bacteria;p__Firmicutes;c__Clostridia;o__Clostridiales;f__Ruminococcaceae;g__Anaerotruncus	0.50	0.53	0.15	0.36	0.80	0.25	0.11	1.43	0.19	0.93	0.22	0.30	0.36	1.11	0.37	0.28	0.17	0.17	0.08	0.17	0.30	0.95	1.02	0.32
k__Bacteria;p__Firmicutes;c__Clostridia;o__Clostridiales;f__Ruminococcaceae;g__Butyrivibrio	1.04	0.89	0.38	0.69	0.96	1.32	0.93	0.47	0.18	1.20	0.66	1.86	0.30	0.64	0.71	0.37	1.05	0.29	0.71	0.29	0.50	1.79	0.89	0.23
k__Bacteria;p__Firmicutes;c__Clostridia;o__Clostridiales;f__Ruminococcaceae;g__Oscillospira	22.06	21.09	18.13	19.12	21.11	17.09	15.62	13.97	6.40	16.86	16.52	14.15	25.34	33.17	17.39	24.05	39.35	17.23	18.45	13.20	8.35	22.19	15.15	18.17
k__Bacteria;p__Firmicutes;c__Clostridia;o__Clostridiales;f__Ruminococcaceae;g__	1.81	1.11	0.60	0.85	1.26	0.82	3.46	5.17	1.09	2.23	2.37	3.12	1.18	2.51	2.22	1.67	2.74	5.17	3.04	1.22	0.97	2.94	1.87	1.56
k__Bacteria;p__Proteobacteria;c__Deltaiproteobacteria;o__Desulfotribionales;f__Desulfotribionaceae;g__	0.40	0.29	0.58	0.18	0.34	0.34	0.00	0.00	0.00	0.00	0.00	0.00	2.33	0.81	0.75	0.20	0.35	0.65	0.00	0.01	2.34	1.99	0.90	1.01
k__Bacteria;p__TM7;c__TM7-3;o__CW040;f__F16;g__	0.37	0.29	0.58	0.33	0.30	0.45	0.03	0.29	0.71	0.10	0.92	0.04	0.56	2.71	0.21	0.75	0.42	0.93	0.07	0.08	0.19	0.05	0.09	0.05
k__Bacteria;p__Tenericutes;c__Mollicutes;o__Anaeroplasmatales;f__Anaeroplasmataceae;g__Anaeroplasma	0.13	0.00	0.06	0.31	0.02	0.25	0.04	0.03	0.10	0.16	0.19	0.06	0.57	2.61	0.07	0.46	0.64	0.15	0.00	0.09	0.22	0.74	0.09	0.00
Autres bactéries	1.51	1.07	2.13	1.56	0.79	1.43	0.17	0.11	0.21	0.28	0.26	0.17	0.39	0.90	1.16	0.20	0.47	0.91	0.10	0.17	0.16	0.10	0.17	0.10

Supplementary file 3, Part 5. The operational taxonomic units (OTUs) identified with an abundance >0.1% in fecal microbiota of male (M) and female (F) mice after chloxy (G12 and G35) and inulin (Inu) diet. CH1 is for mice receiving water instead of a chloxy diet and CH2 is for mice receiving water instead of an inulin diet.

MOTU ID	Inu_males_D0						Inu_females_D0						Inu_males_D30						Inu_females_D30					
	1	2	3	4	5	6	7	8	9	10	11	12	1	2	3	4	5	6	7	8	9	10	11	12
k__Bacteri__Actinobacteria__Actinobacteria__Bifidobacteriales__Bifidobacteriaceae__Bifidobacterium	0.00	0.00	0.00	0.00	0.00	0.00	0.00	0.00	0.00	0.00	0.00	0.00	0.00	0.00	0.00	0.00	0.00	0.00	0.00	0.00	0.00	0.00	0.00	0.00
k__Bacteri__Actinobacteria__Coriobacteri__Coriobacteriales__Coriobacteriaceae__Adlercreutzia	0.25	0.24	0.15	0.39	0.22	0.18	0.74	0.73	0.77	0.37	0.68	0.77	0.21	0.33	0.80	0.54	0.21	0.29	0.36	0.91	0.33	0.24	0.29	0.32
k__Bacteri__Bacteroidetes__Bacteroidia__Bacteroidales__Rikenellaceae__	38.28	15.37	8.29	13.72	11.22	15.35	7.97	21.73	8.36	18.31	18.98	9.94	35.53	22.67	42.67	23.22	37.70	27.11	11.43	12.96	14.46	25.63	11.41	17.00
k__Bacteri__Bacteroidetes__Bacteroidia__Bacteroidales__S24.7__	0.44	0.21	0.36	0.32	0.29	0.30	2.68	3.02	1.22	1.16	2.01	1.68	0.40	0.60	1.90	0.88	1.07	1.45	0.95	3.64	1.63	0.62	0.75	0.88
k__Bacteri__Firmicutes__Bacilli__Lactobacillales__Lactobacillaceae__Lactobacillus	0.05	0.02	0.02	0.18	0.16	0.06	2.33	5.05	6.47	0.48	4.61	0.60	0.11	0.12	0.32	0.28	0.20	0.22	0.26	9.51	1.83	2.71	0.45	1.81
k__Bacteri__Firmicutes__Clostridia__Clostridiales__Other	2.17	7.56	0.86	3.10	0.68	3.37	1.68	0.43	1.00	1.24	1.22	1.22	0.49	0.71	0.30	0.47	0.69	0.86	0.88	0.67	1.08	1.06	0.43	0.82
k__Bacteri__Firmicutes__Clostridia__Clostridiales__g__	14.15	16.22	7.68	14.16	17.95	16.93	20.93	18.62	27.99	21.80	33.45	17.36	16.52	15.75	4.93	10.04	9.96	16.22	33.24	31.54	34.60	18.25	17.39	31.09
k__Bacteri__Firmicutes__Clostridia__Clostridiales__Candidatus Arthromitus	0.00	0.00	0.00	0.05	0.00	0.03	0.00	0.00	0.00	0.00	0.00	0.00	0.00	0.00	0.05	0.00	0.06	0.12	0.00	0.00	0.00	0.00	0.00	0.00
k__Bacteri__Firmicutes__Clostridia__Clostridiales__Clostridiaceae__Clostridium	2.29	0.31	0.06	0.60	0.15	0.59	0.15	0.65	0.39	0.74	0.61	0.08	0.12	0.16	0.00	0.03	0.07	0.19	0.14	0.12	0.02	0.15	0.09	0.07
k__Bacteri__Firmicutes__Clostridia__Clostridiales__Lachnospiraceae__	0.10	0.02	0.02	0.00	0.07	0.20	0.09	0.17	0.25	0.12	0.12	0.08	0.39	0.56	0.08	0.00	0.26	0.02	0.06	0.15	0.08	0.05	0.16	0.29
k__Bacteri__Firmicutes__Clostridia__Clostridiales__Lachnospiraceae__	9.81	22.82	18.73	17.54	31.01	17.74	22.40	21.75	18.61	15.69	10.83	31.92	16.06	22.12	7.65	18.79	16.00	16.88	18.15	18.31	13.97	27.85	31.37	14.02
k__Bacteri__Firmicutes__Clostridia__Clostridiales__Lachnospiraceae__Ruminococcus	1.14	1.21	1.28	1.59	1.16	1.73	3.13	1.08	1.47	1.30	1.28	3.92	1.02	1.31	0.60	1.15	2.56	0.63	2.19	2.10	1.37	1.81	3.42	1.93
k__Bacteri__Firmicutes__Clostridia__Clostridiales__Lachnospiraceae__Dorea	0.00	0.00	0.00	0.00	0.00	0.00	0.00	0.00	0.00	0.00	0.00	0.00	0.00	0.00	0.00	0.00	0.00	0.00	0.00	0.00	0.00	0.00	0.00	0.00
k__Bacteri__Firmicutes__Clostridia__Clostridiales__Lachnospiraceae__Coproccoccus	0.78	0.60	1.22	1.54	0.71	1.53	2.34	0.71	0.73	0.98	2.04	2.69	1.88	2.52	0.86	0.78	1.56	1.13	1.28	1.55	3.81	1.19	1.70	1.14
k__Bacteri__Firmicutes__Clostridia__Clostridiales__Lachnospiraceae__Roseburia	0.15	0.37	0.36	0.79	0.12	0.21	2.90	0.38	0.37	0.48	0.44	0.35	0.60	0.38	0.25	0.23	0.43	0.33	0.68	0.33	0.30	0.15	0.71	0.44
k__Bacteri__Firmicutes__Clostridia__Clostridiales__Peptococcaceae__g__	0.45	3.33	0.40	4.09	1.73	3.67	0.36	0.74	1.18	6.85	2.32	0.79	0.11	3.09	0.47	1.94	0.08	2.13	0.46	0.14	0.47	0.21	0.35	0.10
k__Bacteri__Firmicutes__Clostridia__Clostridiales__Ruminococcaceae__rc4.4	0.02	0.00	0.00	0.00	0.00	0.02	0.12	0.06	0.19	0.28	0.08	0.13	0.07	0.05	0.02	0.06	0.06	0.09	0.12	0.06	0.29	0.17	0.22	0.09
k__Bacteri__Firmicutes__Clostridia__Clostridiales__Ruminococcaceae__g__	2.62	1.69	1.39	2.10	2.56	2.48	2.09	2.42	2.29	3.02	1.24	1.87	0.00	0.00	0.00	0.00	0.00	0.00	0.00	0.00	0.00	0.00	0.00	0.00
k__Bacteri__Firmicutes__Clostridia__Clostridiales__Mogibacteriaceae__g__	0.59	0.34	0.55	0.36	0.36	0.50	0.66	0.50	1.18	0.61	0.51	0.91	1.79	1.49	4.84	3.08	1.54	3.62	1.56	1.60	2.41	1.39	1.48	1.69
k__Bacteri__Firmicutes__Clostridia__Clostridiales__Ruminococcaceae__Anaerotruncus	0.37	1.50	0.70	0.71	1.75	0.69	0.28	0.38	0.33	0.13	0.13	0.87	0.22	0.34	0.43	0.24	0.52	0.26	0.27	0.59	0.21	0.31	1.37	0.37
k__Bacteri__Firmicutes__Clostridia__Clostridiales__Ruminococcaceae__Butyrivibrio	0.47	1.59	0.78	0.59	1.32	0.70	1.56	0.97	0.49	0.52	0.73	0.60	0.43	1.43	0.23	1.27	1.61	1.76	0.37	0.31	0.86	0.44	0.90	1.02
k__Bacteri__Firmicutes__Clostridia__Clostridiales__Ruminococcaceae__Oscillospira	18.60	20.57	16.82	25.89	21.89	24.47	19.10	18.15	20.85	19.35	15.06	17.78	15.92	16.82	14.72	18.99	14.82	17.33	20.46	12.59	17.14	13.40	19.96	20.20
k__Bacteri__Firmicutes__Clostridia__Clostridiales__Ruminococcaceae__g__	1.89	1.12	1.64	1.31	1.01	2.66	4.82	0.86	2.24	4.33	1.76	2.82	2.60	2.71	8.88	2.70	0.74	3.88	3.42	0.87	2.29	1.34	4.94	1.47
k__Bacteri__Firmicutes__Clostridia__Clostridiales__Ruminococcaceae__g__	0.21	0.61	1.24	0.89	0.73	0.64	0.00	0.00	0.00	0.00	0.00	0.00	0.55	0.33	1.84	1.47	0.47	0.86	0.00	0.17	0.00	0.00	0.01	0.07
k__Bacteri__Firmicutes__Clostridia__Clostridiales__Desulfotribionales__Desulfotribionaceae__g__	0.35	0.17	0.00	0.23	0.05	0.38	0.34	0.02	0.07	0.11	0.08	0.04	0.23	0.48	0.05	0.22	0.24	0.20	0.08	0.57	0.17	0.06	0.02	0.14
k__Bacteri__Firmicutes__Clostridia__Clostridiales__Desulfotribionales__Desulfotribionaceae__g__	0.02	0.04	0.00	0.28	0.00	0.03	0.37	0.24	0.39	0.02	0.15	0.62	0.06	0.07	0.00	0.02	0.07	0.08	0.35	0.00	0.29	0.03	0.11	0.91
k__Bacteri__Firmicutes__Mollicutes__Anaeroplasmatales__Anaeroplasmataceae__Anaeroplasmata	1.33	0.27	0.41	1.06	0.16	1.56	0.19	0.26	1.83	0.22	0.45	0.23	1.64	1.39	1.84	1.46	1.66	2.67	0.10	0.19	0.10	0.17	0.13	0.13

Supplementary file 4. Standardized abundance ratio (relative to D0) for *Firmicutes* and *Bacteroidetes* phyla after 30 days of diet in male (M) and female (F) mice. Standard error of mean (SEM) were calculated for each phylum abundance ratio (D30 vs. D0), and statistically significant differences were measured by ANOVA and Tukey's test ($p < 0.05$).

Abundance ratio	Ctr1 M			G12 M			G35 M		
	Mean	SEM	p-val	Mean	SEM	p-val	Mean	SEM	p-val
<i>Firmicutes</i>	1.0302	0.06	/	1.022	0.06	ns p>0.9999	0.882	0.02	ns p=0.1156
<i>Bacteroidetes</i>	0.8697	0.33	/	0.8692	0.33	ns p>0.9999	2.7451	0.22	** p=0.0026

Abundance ratio	Ctr1 F			G12 F			G35 F		
	Mean	SEM	p-val	Mean	SEM	p-val	Mean	SEM	p-val
<i>Firmicutes</i>	0.958	0.06	/	0.9726	0.03	ns p>0.9999	0.1402	0.04	* p=0.0385
<i>Bacteroidetes</i>	1.2741	0.79	/	1.1149	0.17	ns p>0.9999	1.6924	0.41	ns p=0.5843

Abundance ratio	Ctr2 M			Inulin M		
	Mean	SEM	p-val	Mean	SEM	p-val
<i>Firmicutes</i>	0.8908	0.03	/	0.7947	0.07	ns p>0.9999
<i>Bacteroidetes</i>	1.2979	0.11	/	1.8738	0.64	ns p=0.9756

Abundance ratio	Ctr2 F			Inulin F		
	Mean	SEM	p-val	Mean	SEM	p-val
<i>Firmicutes</i>	0.8714	0.04	/	0.9982	0.04	ns p=0.2692
<i>Bacteroidetes</i>	1.8257	0.69	/	1.0438	0.18	ns p=0.5926

Supplementary file 5. Body weight evolution during chicory (G12, G35) and inulin diet in male (M) and female (F) mice during 30 days with a week of resilience (D36).

Body weight (grams) was continuously assessed during diet (n = 6 animals per group D0-D30 and n = 3 animals per group for D36). Data are expressed as means.

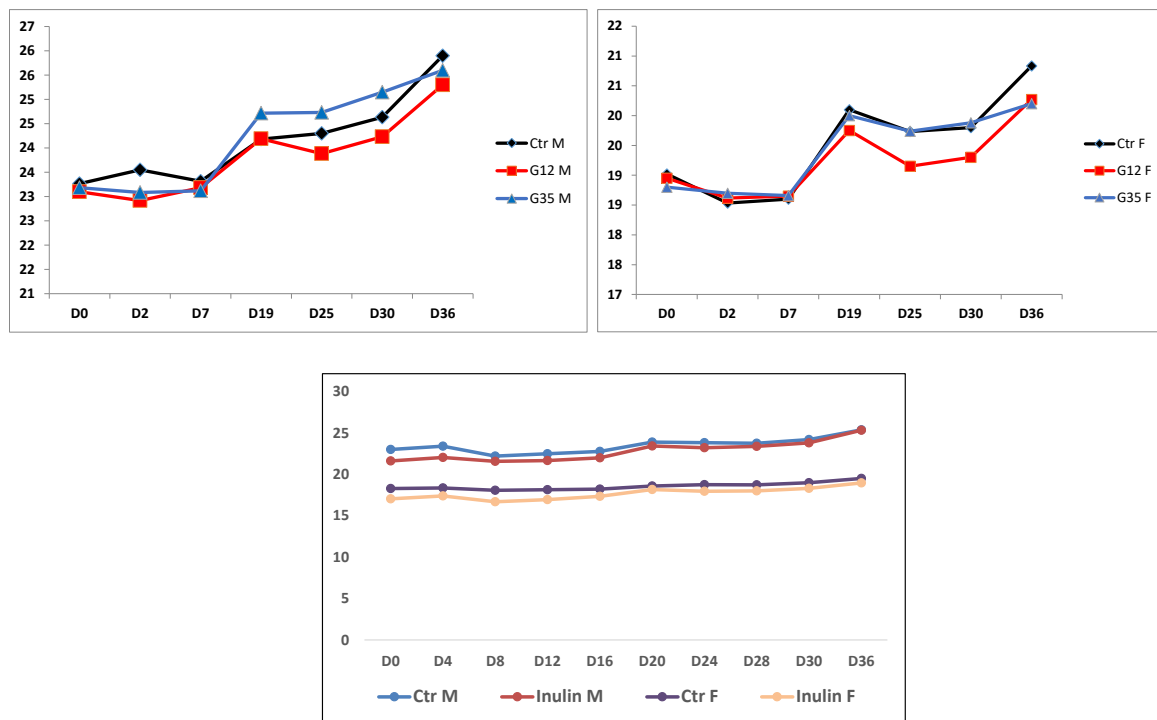

Diet with G12 chicory flour seems to trigger a no significant but sustained decrease of body weight in both male and female mice after 19 days of forced feeding.

G35 chicory flour generates a slight increase of weight in males but after resilience the body weight remains under the control level in both males and females.

Inulin diet doesn't engender body weight modifications.

ELEMENTS COMPLEMENTAIRES

Pour ajouter aux analyses réalisées et discutées précédemment, les éléments présentés ci-après prennent en compte la condition « farine de blé » qui n'a pas été prise en compte dans l'article pour des raisons simplificatrices, notamment dues au fait que la composition chimique et l'origine de la farine n'étaient pas suffisamment documentées. Néanmoins, les résultats préliminaires sont remarquables et méritent d'être discutés car ils ouvrent des perspectives de recherche pour la filière blé.

La farine de blé commerciale Francine type 45 s'est avérée un aliment énergétique mais peu fonctionnel par rapport à la farine de chicorée. Lors de l'analyse nutriginomique, les souris dont l'alimentation a été supplémentée en farine de blé ont montré une dérégulation seulement pour 6 gènes (**Figure 1.1**) : *Gadd45g*, *Dmbt1*, *Lcn2*, *Irf1*, *Irf2bp2* chez les deux sexes et *Igfbp1* chez les mâles uniquement.

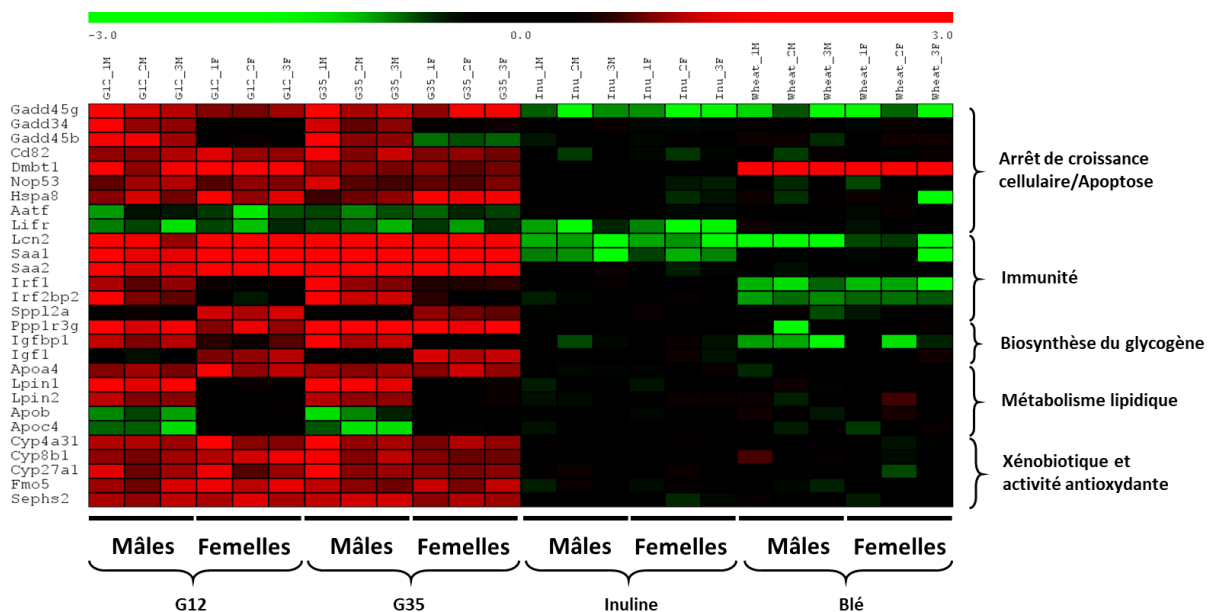

Figure 1.1. Heatmap représentant les profils d'expression génique dans le tissu hépatique des souris après un régime alimentaire supplémenté en farine de chicorée, inuline et farine de blé. Le Log2 ratio de l'expression génique est représenté pour chaque souris (1-3), les processus physiologiques associés sont représentés sur la partie droite du graphique. G12, G35: farines de chicorée.

Seul *Dmbt1* montre une expression différentielle comparable à l'expression observée après un régime alimentaire supplémenté en chicorée. La forte surexpression de ce dernier gène chez l'ensemble des individus témoigne un potentiel antitumoral de la farine de blé non négligeable, car *Dmbt1* promeut l'apoptose de cellules malignes (Zhang, 2019). D'autre part, ce régime alimentaire entraîne la sous-expression de *Gadd45g* qui serait impliqué dans la réparation de l'ADN ainsi que dans la régulation de la prolifération cellulaire (Levine *et al.*, 2006) et de l'oncogenèse (Tamura *et al.*, 2012).

La farine de blé semblerait également intervenir dans la régulation des défenses de l'organisme contre les infections bactériennes et virales par la sous-expression des gènes *Lcn2*, *Irf1* et *Irf2bp2* connus comme très importants dans la défense immunitaire. La protéine LCN2, par sa capacité à séquestrer les sidérophores indispensables à la survie de certaines bactéries pathogènes (Flo *et al.*, 2004) et son rôle dans la régulation du recrutement des cellules immunitaires sur le lieu d'infection (Shashidharamurthy *et al.*, 2013), a été associée à un effet antibactérien et anti-inflammatoire. Les gènes *Irf1* et *Irf2bp2* ont, eux, tous-deux été décrits comme cruciaux dans la réponse inflammatoire et la défense contre l'infection virale (Honda *et al.*, 2006, Childs & Goodbourn, 2003, Chen *et al.*, 2015).

IGFBP1 par son action régulatrice sur IGF1, est liée à l'homéostasie du glucose (Wheatcroft & Kearney, 2009) et une modulation de l'accumulation de lipides (Rajkumar *et al.*, 1999). Le fait que son expression diminue chez les individus mâles après une supplémentation en farine de blé pourrait suggérer une tendance à l'augmentation de la glycémie et une prise de poids facilitée chez ces animaux. L'ensemble de ces réponses transcriptomiques induites par la farine de blé nécessite plus de validations moléculaires et cliniques, d'autant plus que les réponses semblent dans certains cas variables d'un individu à un autre.

Le dosage des hormones plasmatiques GLP-1, PYY et de la leptine pour les souris nourries avec un régime alimentaire supplémenté en farine de blé n'a pas montré de différences remarquables par rapport au contrôle (**Figure 1.2**).

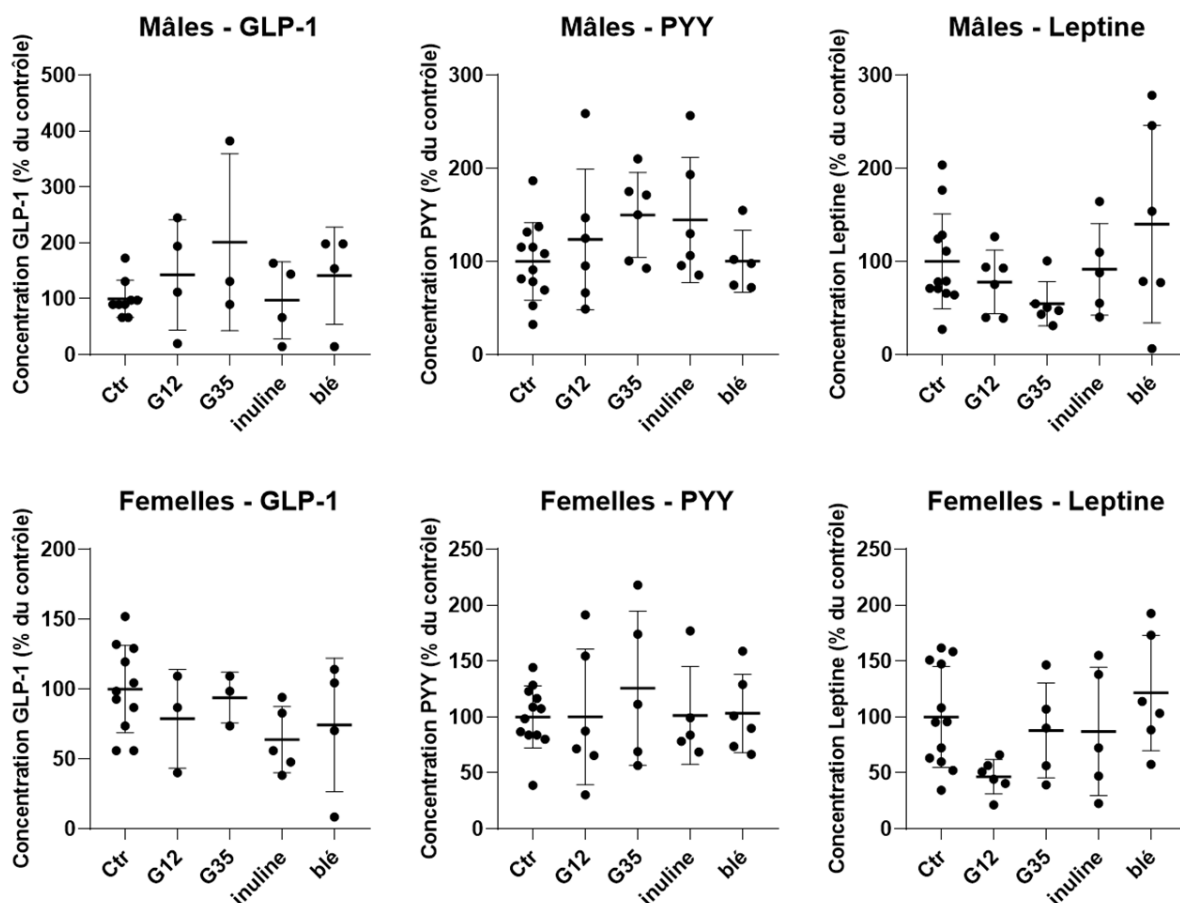

Figure 1.2. Niveaux de GLP-1, PYY et leptine dans le plasma de souris après 30 jours de supplémentation en chicorée (G12, G35), inuline et blé, et évalués 30 minutes après leur administration orale au jour 30. Les contrôles ont été regroupés (Ctr). Les niveaux plasmatiques d’hormones sont exprimés en pourcentage (%) des niveaux contrôles. Une analyse statistique a été réalisée: one-way ANOVA et test de comparaisons multiples de Sidak.

L’analyse de la composition du microbiote intestinal semble associer le régime alimentaire supplémenté en farine de blé, à un effet partiellement bénéfique. En effet, cette supplémentation chez les individus mâles fait plus que doubler l’abondance des genres bactériens *Butyricoccus*, *Anaerostipes* et *Dorea* (**Figure 1.3**), reconnus pour leur capacité à produire des SCFA (Chen *et al.*, 2017), par rapport à la farine de chicorée. Cet effet de la farine de blé a déjà pu être observé dans un modèle de fermentation *in vitro* (Yang, 2015). A l’inverse de la farine de chicorée, la farine de blé fait jusqu’à tripler la quantité de *Clostridium*, genre incluant un nombre important d’espèces pathogènes (Gibbs, 2009). Des études plus précises seraient nécessaires pour préciser les espèces de *Clostridium* pour mieux évaluer l’effet prébiotique de ce produit alimentaire.

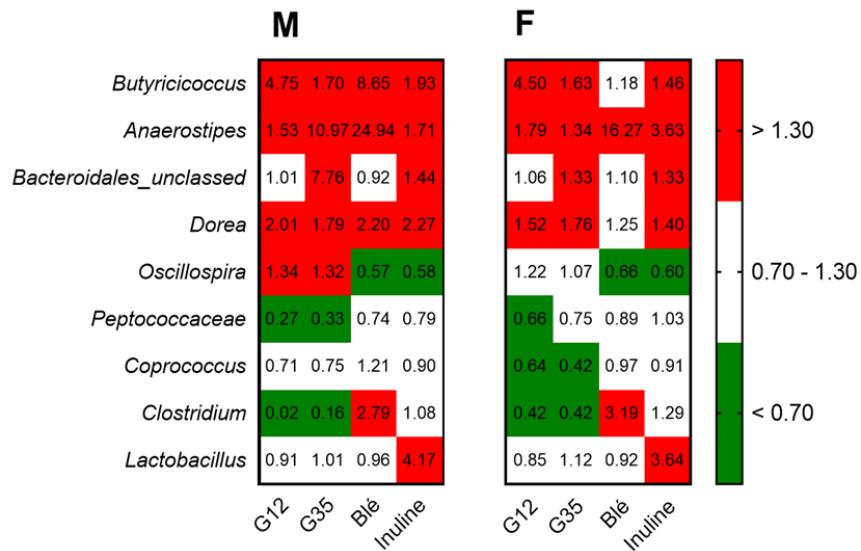



Figure 1.3. Abondances relatives des principaux genres bactériens retrouvés dans les fèces de souris après une supplémentation en chicorée (G12, G35), inuline et blé. Heatmap représentant les abondances standardisées par rapport au contrôle. L'abondance augmente lorsque le rapport est > 1,30 et diminue lorsqu'il est < 0,70. M – mâles; F – femelles.

La farine de blé n'a donc finalement que peu d'effets bénéfiques sur la santé murine, ce qui fait de la farine de chicorée, par ses effets bénéfiques multiples, un complément intéressant à sa consommation.



**CHAPITRE 2 – ETUDE DES COMPOSES
RESPONSABLES DES EFFETS FONCTIONNELS
DE LA CHICOREE**



AVANT-PROPOS

L'étude décrite dans le chapitre précédent confirme la valeur fonctionnelle de la farine de chicorée et ceci quelle que soit sa composition métabolique. Un effet plus prononcé au niveau de l'expression des gènes, synthèse hormonale et activité prébiotique a été observé pour le génotype G35 qui est le plus riche en inuline, fructose, CGA et STL. Pour expliquer les effets fonctionnels de la farine de chicorée nous nous sommes orientés vers ces composés présents dans la racine. Concernant l'inuline, nos résultats ont montré que ses effets fonctionnels se manifesteraient exclusivement de manière indirecte, via l'activité du microbiote intestinal (Pouille *et al.*, 2020). Nous nous sommes alors orientés vers le fructose, les CGA et STL. Comme détaillé dans l'introduction bibliographique de ce manuscrit, ces composés sont connus pour leurs effets pharmacologiques multiples, mais peu d'études ont été réalisées sur leurs activités fonctionnelles lorsqu'ils sont consommés dans des proportions alimentaires.

De la même façon que lors de l'étude précédente, ces composés ont donc été testés *in vivo* chez la souris, dans le but de caractériser les effets sur l'expression génique, sur la sécrétion d'hormones et sur la composition du microbiote intestinal. Les méthodes d'analyses *in vivo* ont été sensiblement les mêmes. Le régime alimentaire des souris a été supplémenté cette fois avec une solution de fructose (166,35 µg/souris/jour), une solution de CGA (3-CGA à 2,52 µg/souris/jour et 3,5-CGA à 3,44 µg/souris/jour) et une solution de STL (DHLc à 1,83 µg/souris/jour; Lc à 3,88 µg/souris/jour; DHLp à 0,29 µg/souris/jour et Lp à 2,22 µg/souris/jour). L'analyse nutriginomique a inclus en plus du foie, la muqueuse iléale et le caecum, ce qui nous a permis de balayer les effets dans plusieurs régions du tractus gastro-intestinal. Le contrôle négatif a été représenté par un lot de souris gavé avec de l'eau en plus du régime alimentaire, et le contrôle positif a été représenté par un lot de souris gavé avec une décoction aqueuse de farine de chicorée commerciale, fabriquée à partir d'un mélange de génotypes différents.

Les souris femelles et mâles avaient présenté des différences remarquables dans leur réponse à la farine de chicorée, les réponses les plus prononcées étant enregistrées chez les mâles. Dans un souci de respect de la règle 3R (réduire, remplacer, raffiner), seuls des individus mâles dont les réponses étaient les plus prononcées, ont été utilisés dans cette nouvelle expérimentation.











En parallèle de ces expérimentations, des essais *in vitro* ont été réalisés pour extrapoler dans un modèle humain les résultats obtenus chez la souris, et aussi pour valider les effets majeurs de

la chicorée et de ses molécules bioactives. L'activité pro-apoptotique a été testée sur des cellules hépatiques cancéreuses HepG2, l'activité anti-inflammatoire sur la lignée cellulaire U937 de monocytes différenciés avec du PMA et inflammés avec du LPS bactérien, et l'activité antioxydante à l'aide d'un test biochimique acellulaire concernant les espèces réactives de l'oxygène.

Ces travaux nous ont permis d'évaluer la part de responsabilité de chaque classe de molécules dans les effets de la chicorée et ont été publiés dans la revue *Nutrients* en février 2022.

Article

Chicory: Understanding the Effects and Effectors of This Functional Food

Céline L. Pouille ^{1,2}, Souad Ouaza ^{1,2}, Elise Roels ^{1,2} , Josette Behra ¹, Melissa Tourret ¹, Roland Molinié ³ , Jean-Xavier Fontaine ³ , David Mathiron ⁴ , David Gagneul ^{1,2} , Bernard Taminiau ⁵, Georges Daube ⁵ , Rozenn Ravallec ¹ , Caroline Rambaud ^{1,2} , Jean-Louis Hilbert ^{1,2} , Benoit Cudennec ¹  and Anca Lucau-Danila ^{1,2,*} 

¹ UMR Transfrontalière BioEcoAgro N° 1158, Univ. Lille, INRAE, Univ. Liège, UPJV, JUNIA, Univ. Artois, Univ. Littoral Côte d'Opale, ICV, SFR Condorcet FR CNRS 3417—Institut Charles Viollette, 59655 Villeneuve d'Ascq, France; celine.pouille.etu@univ-lille.fr (C.L.P.); souad.ouaza.etu@univ-lille.fr (S.O.); elise.roels@oniris-nantes.fr (E.R.); josette.behra@univ-lille.fr (J.B.); melissa.tourret@univ-lille.fr (M.T.); david.gagneul@univ-lille.fr (D.G.); rozenn.ravallec@univ-lille.fr (R.R.); caroline.rambaud@univ-lille.fr (C.R.); jean-louis.hilbert@univ-lille.fr (J.-L.H.); benoit.cudennec@univ-lille.fr (B.C.)

² Joint Laboratory CHIC41H University of Lille-Florimond-Desprez, Cité scientifique, 59655 Villeneuve d'Ascq, France

³ UMR Transfrontalière BioEcoAgro N° 1158, Univ. Lille, INRAE, Univ. Liège, UPJV, JUNIA, Univ. Artois, Univ. Littoral Côte d'Opale, ICV, SFR Condorcet FR CNRS 3417—BIOlogie des Plantes et Innovation (BIOPI), 80025 Amiens, France; roland.molinie@u-picardie.fr (R.M.); jean-xavier.fontaine@u-picardie.fr (J.-X.F.)

⁴ Plateforme Analytique UFR des Sciences, UPJV, Bâtiment Serres-Transfert Rue Dallery-Passage du Sourire d'Avril, 80039 Amiens, France; david.mathiron@u-picardie.fr

⁵ Department of Food Sciences—Microbiology, FARAH, University of Liege, 4000 Liege, Belgium; bernard.taminiau@uliege.be (B.T.); georges.daube@uliege.be (G.D.)

* Correspondence: anca.lucau@univ-lille.fr



Citation: Pouille, C.L.; Ouaza, S.; Roels, E.; Behra, J.; Tourret, M.; Molinié, R.; Fontaine, J.-X.; Mathiron, D.; Gagneul, D.; Taminiau, B.; et al. Chicory: Understanding the Effects and Effectors of This Functional Food. *Nutrients* **2022**, *14*, 957. <https://doi.org/10.3390/nu14050957>

Academic Editors: Wojciech Kolanowski and Anna Gramza-Michałowska

Received: 2 February 2022

Accepted: 22 February 2022

Published: 23 February 2022

Publisher's Note: MDPI stays neutral with regard to jurisdictional claims in published maps and institutional affiliations.



Copyright: © 2022 by the authors. Licensee MDPI, Basel, Switzerland. This article is an open access article distributed under the terms and conditions of the Creative Commons Attribution (CC BY) license (<https://creativecommons.org/licenses/by/4.0/>).

Abstract: Industrial chicory has been the subject of numerous studies, most of which provide clinical observations on its health effects. Whether it is the roasted root, the flour obtained from the roots or the different classes of molecules that enter into the composition of this plant, understanding the molecular mechanisms of action on the human organism remains incomplete. In this study, we were interested in three molecules or classes of molecules present in chicory root: fructose, chlorogenic acids, and sesquiterpene lactones. We conducted experiments on the murine model and performed a nutrigenomic analysis, a metabolic hormone assay and a gut microbiota analysis, associated with in vitro observations for different responses. We have highlighted a large number of effects of all these classes of molecules that suggest a pro-apoptotic activity, an anti-inflammatory, antimicrobial, antioxidant, hypolipidemic and hypoglycemic effect and also an important role in appetite regulation. A significant prebiotic activity was also identified. Fructose seems to be the most involved in these activities, contributing to approximately 83% of recorded responses, but the other classes of tested molecules have shown a specific role for these different effects, with an estimated contribution of 23–24%.

Keywords: chicory; transcriptomics; hormone assay; gut microbiota; in vitro apoptosis; in vitro pro-inflammatory cytokines

1. Introduction

Industrial chicory (*Cichorium intybus* var. *sativum*) has been analyzed for its various dietary and medicinal effects. A substantial amount of clinical evidence depicts chicory to be anti-diabetic, immunomodulatory, anti-tumor, antioxidant, anthelmintic, and prebiotic. In addition, chicory has been shown to promote good digestion, to regulate appetite, and to decrease the risk of gastrointestinal diseases [1].

The chicory root, processed into flour and used as an ingredient for pastries, has been proposed as a functional food; potential mechanisms by which the chicory acts on

cancer prevention, antibacterial and antiviral defense, hypoglycemic, hypolipidemic and antioxidant effects have been identified [2]. Among the major compounds of chicory root, inulin has been the subject of multiple studies concerning its prebiotic effect [2,3], but less is known about the specific mechanisms of other molecules that enter the composition of roots. The hydrolysis products of inulin, fructose and oligofructose, have been described to have multiple beneficial effects on bowel functions [4]. Chlorogenic acids (CGA) have been described to improve the insulin sensitivity in diabetic rats [5] and were also associated with major in vivo antioxidant properties [6] and an in vitro antibacterial activity [7]. Sesquiterpene lactones (STL), from the chicory leaves and roots, are known for their strong inhibitory effect on some nematodes infecting livestock [8–10], and more generally, STL are known for their antitumor, antimicrobial, antioxidant, hepatoprotective, antiprotozoal, and antiaging properties [11]. Both CGA and STL were also studied for their anti-inflammatory effect in vitro as well as in vivo [6,12]. Some other molecules present in chicory roots and leaves, such as flavonoids or tannins, were studied for their specific health effects and their contents correlated with antioxidant [13] and anti-nematode [14] properties.

In this work, we looked at three classes of molecules that are part of the composition of the chicory flour: fructose, CGA and STL. We experimented on the murine model and performed a nutrigenomic analysis, a metabolic hormone assay and a metagenomic analysis of the gut microbiota, to target the major health effects and molecular mechanisms of action in these compounds. Results were supported by in vitro apoptosis detection on human hepatocellular carcinoma HepG2 cells, using flow cytometry, by in vitro inflammatory cytokines secretion assay on promonocytic human cell line U937, differentiated into macrophages, and by a cell-free system antioxidant assay.

2. Materials and Methods

Chicory product obtaining and chemical analysis of their composition

Roots from industrial chicory (*Cichorium intybus* var. *sativum*) provided by Florimond-Desprez Veuve et Fils SAS (Cappelle-en-Pévèle, France) were processed by Leroux SAS (Orchies, France) and the corresponding flour was delivered by Waast Mill (Mons-en-Pévèle, France). This flour is a trade product that comes from a mixture of several genotypes with a significantly different chemical composition. An aqueous decoction of this flour was produced to feed the mice as described by Pouille et al. [2]. A mixture of water/methanol (1:1) was added to either 100 mg of a randomized sample of chicory flour or 100 mg of dry residue obtained after lyophilisation of chicory decoction. The samples were mixed for 10 min at 80 °C, using a ThermoMixer® (Eppendorf AG, Hamburg, Germany) at 2000 rpm, followed by 10 min of sonication at 80 °C using an ultrasonic bath at 35 kHz. The samples were centrifuged at 4 °C for 10 min at 12,000 rpm. The supernatant was diluted 20 times with methanol/water (50/50). All samples were filtered through 0.22 µm PTFE membrane filters before analysis by ultra-performance liquid chromatography coupled to high-resolution mass spectrometry (UPLC-HRMS) and nuclear magnetic resonance (NMR). UPLC-HRMS analysis was performed on an ACQUITY UPLC I-class chain coupled with the Vion IMS Q-TOF high resolution mass spectrometer, equipped with an electrospray (ESI) (Waters, Manchester, UK) ionization source (Z-spray) and an additional spray for the reference compound (Lock Spray). A double detection in the positive and negative mode was performed by ESI mass spectrometry (range 50–2000 Da) and by a PDA diode array detector (UV detection between 190–500 nm). Separation was performed using a KINETEX Biphenyl (100 × 2.1 mm, 1.7 µm) column (Phenomenex) heated at 55 °C with a mobile phase (solvent A (0.1% formic acid in water) and solvent B (0.1% formic acid in methanol)) flow (0.55 mL·min⁻¹) and the same gradient elution as our previous study [15]. The spectra obtained were acquired and processed with UNIFI software (version 1.9.4, Waters) and enabled us to generate the data matrix for untargeted metabolomics analyses with classical parameters. Calibration mixture solution of target metabolites at concentrations of 0.5, 1, 1.5, 2, 2.5, 3, 3.5, 4, 4.5 and 5 µM were prepared by dilution in three replicates. Area values

of the extracted ion chromatograms were transferred to Excel (Microsoft Excel 2011 v. 14.7.2, Microsoft, Redmond, WA, USA).

The NMR untargeted metabolomics protocol was adapted from our previous study [16]. Briefly, the supernatant (500 μL) was dried under vacuum and then dissolved in 800 μL of deuterated solvent prepared in a mixture of (1:1) Methanol- d_4 : KH_2PO_4 buffer (0.1 M) in D_2O at pH 6.0 with TMS P (0.0125%), NaN_3 (0.6 $\text{mg}\cdot\text{mL}^{-1}$), and maleic acid (1 mM). Then, the samples were briefly vortexed, sonicated, and centrifuged. The supernatant was placed in 5-mm NMR tubes and then used for NMR analysis. All NMR spectra were acquired at 300 K with a Bruker Avance III 600 MHz spectrometer operating at 600.13 MHz for ^1H , and 150.91 MHz for ^{13}C , using a 5-mm double resonance broadband probe, equipped with z-gradient (BBFO 5 mm tube). For quantitative analysis, classical 1D ^1H -NMR spectra were collected using 128 scans of 131 K data points and a spectral width of 8417 Hz with a relaxation delay of 25 s. For metabolomics profiling, a NOESY-1D water suppression pulse sequence was used and generated spectra were collected using 256 scans of 131 K data points and a spectral width of 8417 Hz with a relaxation delay of 25 s. NMRProcFlow web application [17] was used to generate the untargeted metabolomics data matrix and the quantitative ^1H -NMR data. Bins with the lowest overlapping signals were kept (0.9 to 3.25 ppm and 4.5 to 8.5 ppm). Signals of maleic acid were used to calculate the absolute concentration of targeted metabolites. A combined data matrix with NMR (161 bins) and UPLC-HRMS (positive (77 ions) and negative (71 ions) data) untargeted analyses were generated. The percentage of the relative standard deviation (% RSD) was calculated for all metabolic features in each condition and the features with % RSD greater than 25% were removed due to variability. Metabolite pick areas were expressed in percentage (100% corresponds to the mean for chicory flour). Heatmap data was clustered (Ward's method was used to form hierarchical clustering) and visualized (using the pheatmap-package, version 1.0.12).

Animal experiments and ethical statements

Male BALB/cOlaHsd 8-week-old mice were used for experiments in agreement with Directive 2010/63/EEC for the protection of animals used for scientists and in accordance with Law 2012-10 (2012) and 2013-118 (2013). The protocol was approved by the Ethics Committee in charge of animal experiments. The mice were randomly divided into six groups ($n = 5/\text{group}$) and housed in a controlled environment (with a temperature of 22 $^\circ\text{C}$, a 12 h/12 h light/dark cycle and ad libitum access to standardized food and water). Mice were fed with an aqueous decoction of root flour (Chic) and with three other molecules or classes of molecules: fructose (Fru), CGA and STL water solution as indicated in Table 1. The mice gavages consisted in a daily force-feeding of 500 μL of Chic, Fru, CGA or STL besides the standard chow (Diet A04C-10, Scientific Animal Food and Engineering, Augy, France). For the chicory flour, the decoction corresponded to 30 mg root powder/mouse/day that was considered close to human equivalent weight/body mass for a moderated alimentary dose [18]. The administered dose of Fru, CGA and STL was calculated to correspond to the concentration of these compounds in the aqueous extract of chicory flour for daily consumption. This estimation was performed taking into account the variability of these compounds in 5 different chicory genotypes [19] as indicated in Table 1. Controls underwent an equivalent force-feeding with water (Ctr1), the solvent used for chicory decoction and fructose solution, and with 0.83% DMSO (Ctr2) as CGA and STL solutions were prepared with this diluent [20,21]. Six groups of mice were used (Ctr1, Ctr2, Chic, Fru, CGA and STL), nourished for 30 days and individual body weight was regularly registered (File S1). At the end of this period, mice for each condition were sacrificed, the central core of the liver left lobe was cut into cubes, a short segment (1 cm) of the colon was also cut and enterocytes were harvested from upper ileal segments by mucosa scraping method. These tissues were immediately frozen in liquid nitrogen and stored as individual samples at -80°C for transcriptomics. The feces were individually harvested before the treatment (D0) and after 30 days (D30), and were stored at -80°C for microbiota analyses. For hormonal assays, 100 μL of blood from the caudal

vein was sampled from each animal 30 min after gavage at D30. The blood from each mouse was collected in tubes containing 20 μ L 10% EDTA anticoagulant solution and 1 μ L dipeptidyl peptidase-4 inhibitor (DPP4-010, Marck, Milipore, Darmstadt, Germany), then centrifuged at 14,000 rpm for 10 min, the plasma containing supernatants collected and stored at -80°C .

Table 1. Composition of Fru, CGA and STL solutions used for feeding mice.

Treatment	Fru	CGA		STL			
Compound	Fructose	3-CGA	3,5-CGA	DHLc	Lc	DHLp	Lp
$\mu\text{g/day}$ of each compound	166.35	2.52	3.44	1.83	3.88	0.29	2.22
$\mu\text{g/day}$ of total mix	166.35	5.90		8.20			

3-CGA: 3-mono-*O*-caffeoylquinic acid; 3,5-CGA: 3,5-di-*O*-caffeoylquinic acid; DHLc: 11 β ,13-Dihydrolactucin; Lc: Lactucin; DHLp: 11 β ,13-Dihydrolactucopiricin; Lp: Lactucopiricin. The administered doses are based on results obtained for the content of chicory roots and reported to 30 mg/day of chicory flour.

2.1. RNA Extraction and Microarray Analysis

Total RNAs were extracted from hepatic and colon tissues using RNeasy spin columns (Macherey-Nagel, Düren, Germany). For ileum cells, the NucleoZOL (Macherey-Nagel) kit was used. RNA quality was checked with Nanodrop and absorbance ratios A260/280 and A260/230 were found between 2.0 and 2.2. RNA quality was also examined by RNA ScreenTape Analysis (Agilent) and a minimal RNA integrity number (RIN) of 0.8 was required for all samples.

For the microarray analysis, groups of mice ($n = 3$) were used for each treatment: (1) a group that received a decoction of chicory flour for 30 days as previously described, (2) a group that received a solution of fructose (Fru) for 30 days, (3) a group that received a solution of CGA for 30 days, (4) a group that received a solution of STL for 30 days, (5) two control groups with standard drinking water (Ctr1 and Ctr2) as mentioned before. Three tissues were analyzed: liver, ileum enterocytes and caecum.

Agilent Whole Mouse Genome Microarray Sure Print GE 4 \times 44 v2 with oligonucleotide 45,220 probes was used to study the gene expression profile. RNA amplification, staining, hybridization and washing were conducted according to the manufacturer's specifications. Slides were scanned at 5 μm /pixel resolution using the GenePix 4000B scanner (Molecular Devices Corporation, Sunnyvale, CA, USA). Images were used for grid alignment and expression data digitization with GenePix Pro 6.0 software. Expression data were normalized by Quantile algorithm. The 3 control samples were filtered for p value < 0.05 and the average was calculated for each gene. A fold change (FC) value was calculated between individual treated samples and the mean of corresponding controls. Differentially expressed genes (DEGs) were selected for a threshold >2.0 or <0.5 . Functional annotation of DEGs was based on NCBI GenBank and related genes' physiological processes were assigned with NCBI, AmiGO 2 Gene Ontology and UniProt. KEGG pathway analysis was also used to identify relevant biological pathways of selected genes. All microarray data have been submitted to the NCBI GEO archive for functional genomics data with the accession number GSE190056.

2.2. In Vivo Hormone Detection

Plasma concentrations of leptin and GIP (glucose-dependent insulinotropic polypeptide) were assessed using antibody-immobilized beads specific to each hormone in a Milliplex[®] Map Kit (Millipore Corporation, Billerica, MA, USA) according to the manufacturer's instructions. Kit sensitivity was 19 pg·mL⁻¹ for leptin and 1 pg·mL⁻¹ for GIP. The quantification was carried out using the Luminex[®] 100/200 (Luminex Corporation, Austin, TX, USA) system and the Luminex xPONENT[®] for LX100/200 software.

2.3. Microbiota Analysis

Total DNA content from mice feces was extracted according to NucleoSpin DNA Stool Kit (Macherey-Nagel, Düren, Germany). The sequencing was done by the GIGA genoproteomic platform of Liège University (Belgium). For sequencing the amplification of the V1-V3 region of the 16S rDNA and the library preparation were performed with the following primers: direct (5'-GAGAGTTTGATYMTGGCTCAG-3') and inverse (5'-GAGAGTTTGCTCAG-3'). Each PCR product was purified with the Agencourt AMPure XP Ball Kit (Beckman Coulter, Pasadena, CA, USA), and subjected to a second round of PCR for indexing, using Nextera XT index 1 and 2 primers. After purification, the PCR products were quantitated using the Quant-IT PicoGreen (Thermo-Fisher Scientific, Waltham, MA, USA) and diluted to 10 ng·µL⁻¹. A final qPCR quantification of each library sample was performed using the KAPA SYBR FAST qPCR Kit (KapaBiosystems, Wilmington, NC, USA) before standardization, pooling, and sequencing on a MiSeq sequencer using v3 reagents (ILLUMINA, San Diego, CA, USA).

Data processing was performed using, respectively, the MOTHUR v1.44 package and the VSearch algorithm [22] for alignment, clustering and chimera detection as previously described by Gérard et al. [23]. After cleaning process, sequences were clustered into operational taxonomic units (OTUs) at 97% of identity. Alignment and taxonomical identification were performed with MOTHUR using SILVA v1.32 database of full-length 16S rDNA gene sequences. A rarefied table of 10,000 reads by sample was used for further analysis. Reads were finally aggregated into phylotypes at the phylum and genus taxonomic level.

All analyses were performed by comparing experimental groups to their respective controls. Normality was controlled with the Shapiro–Wilk test and homogeneity of variances with Bartlett's test. Statistical paired differences were assessed by ANOVA and Tukey's test.

PRISM 7 (GraphPad Prism 6.0, Windows Inc., San Diego, CA, USA) was used and differences were considered significant for a *p* value < 0.05. All the biosample raw reads have been deposited at the National Center for Biotechnology Information (NCBI) and are available under BioProject accession number PRJNA799887. Data obtained from NGS analysis were analyzed for the alpha diversity with Shannon index and graphical representations were performed using GraphPad Prism version 8.00 for windows, GraphPad Software, and beta-diversity with the principal component analysis (PCoA) using the FactoMineR package in R version 3.5.2 (r-project.org).

2.4. In Vitro Cytotoxicity Studies

The cytotoxic effect of samples was analyzed to determine the maximum concentrations that could be used for the other tests. The cytotoxic effect was performed using the cell counting assay-8 (CCK-8) (CK04, Tebu-Bio). The kit was used according to the manufacturer's instructions. HepG2 and U937 cells were seeded in 96-well culture plates at 8×10^4 cells·cm⁻² and 3×10^5 cells·cm⁻² respectively. After reaching confluency, the growing medium was replaced by samples diluted at increasing concentrations in Dulbecco's modified Eagle's medium (DMEM, 4.5 g·L⁻¹ glucose) or in Roswell Park Memorial Institute medium (RPMI-1640). Culture medium was used as a negative control of cytotoxicity. The cells were incubated at 37 °C for 24 h and the cytotoxic effect of samples was immediately determined.

2.5. In Vitro Apoptosis Assay

The human hepatocellular carcinoma HepG2 cells were grown at 37 °C, 5% CO₂ atmosphere, in DMEM supplemented with 10% fetal bovine serum (FBS), 100 U·mL⁻¹ penicillin, 100 µg·mL⁻¹ streptomycin, and 2 mM glutamine. After reaching 80–90% confluency, HepG2 cells were seeded into 24-well culture plates at 8×10^4 cells·cm⁻² six days before experiment. The culture medium was discarded and cells were washed with PBS. Apoptosis was induced by adding different amounts of lyophilized chicory decoction or D-fructose powder (0.2%, 0.5%, 1%, 2% and 3%, *m/v*), and different concentrations of CQA

or STL (5, 10, 20, 50, 75 and 100 μM). Resveratrol at a concentration of 200 μM [24] was used as a positive control and DMEM medium as a negative one. The cells were then incubated at 37 °C for 24 h. Early and late apoptotic events were analyzed by flow cytometry (Invitrogen™ Attune™ NxT Flow Cytometer) with the Alexa Fluor 488 annexin V/Dead Cell Apoptosis Kit (Invitrogen, Waltham, MA, USA) according to the manufacturer's kit manual.

2.6. In Vitro Inflammatory Cytokines Secretion Assay

The promonocytic human cell line U937 was cultured in RPMI 1640 medium supplemented with 10% FBS, 100 $\text{U}\cdot\text{mL}^{-1}$ penicillin, 100 $\mu\text{g}\cdot\text{mL}^{-1}$ streptomycin, and 2 mM glutamine in a humidified 5% CO_2 atmosphere at 37 °C. For macrophage differentiation, U937 cells were seeded at approximately 3×10^5 cells· cm^{-2} in 24-well plates with 60 $\text{ng}\cdot\text{mL}^{-1}$ phorbol-12-myristate-13-acetate (PMA) for 48 h. Adherent cells were washed with PBS before a 2 h incubation with LPS (10 $\mu\text{g}\cdot\text{mL}^{-1}$; LPS from *E. coli* O26:B6, Millipore Corporation) and samples. Cell supernatants were collected on ice and centrifuged (1500 rpm 5 min) to eliminate cell debris. The supernatants were aliquoted and stored at −80 °C until further analysis. Secreted IL-1 β and TNF- α were quantified using Millipore Human High Sensitivity T Cell kit (EMD Millipore, Darmstadt, Germany) according to the manufacturer's instructions. The quantification was carried out using the Luminex® 100/200 (Luminex Corporation, Austin, TX, USA) system and the Luminex xPONENT® for LX100/200 software. The cytokine IL-8 was quantified using a human IL-8/CXCL8 Quantikine® ELISA kit (R&D Systems, Inc., Minneapolis, MN, USA). Medium samples were diluted 100-fold according to the kit recommendations.

2.7. Cell-Free Systems Evaluating Antioxidative Sample Effects

All reagents were purchased from Sigma (Saint-Quentin Fallavier, France). The concentration of the starting samples to be diluted was standardized at 10 mg of dry matter per mL. After all assays, the maximal percentage of inhibition obtained for each reactive oxygen species (ROS) at the highest concentration for each sample was also calculated and half-maximal inhibitory concentration (IC_{50}) was determined when practicable.

The superoxide anion inhibition was estimated in a cell-free model adapted from that previously described by Aruoma et al. [25]. Briefly, O_2^- was produced by the xanthine (0.1 mM)/xanthine oxidase (50 $\text{mU}\cdot\text{mL}^{-1}$) system in a Hank's HEPES buffer (HH) (pH 7.42) and then incubated at 25 °C for 15 min with increasing sample concentrations ranging from 0 to 100 $\mu\text{L}\cdot\text{mL}^{-1}$ of reaction mixture (equivalent to 0 to 1 mg of dry matter per final mL) and with 0.017 mM equine ferricytochrome c (FerC). The appearance of pink coloration corresponds to the FerC reduction (into ferrocytochrome C) by the remaining superoxide anions non-inhibited by the samples. An inhibition control cuvette also contained 300 μM cysteine. Spectrophotometry method was used to measure the absorbance at the wavelength of 550 nm. Then, O_2^- concentrations were calculated thanks the Beer-Lambert law using the ferrocytochrome C extinction coefficient ($21.1 \times 10^3 \text{ L}\cdot\text{mol}^{-1}\cdot\text{cm}^{-1}$). All measurements were performed against a blank cuvette, containing all reagents and samples except xanthine oxidase to avoid any interference. Results were converted into $\text{nmol}\cdot\text{mL}^{-1}$ and expressed in bar diagrams \pm SD according to the sample volumes involved per mL of reaction mixture. The hydroxyl radical inhibition by the control solutions or sample studied was assayed using a method adapted from that described by Halliwell, Gutteridge and Aruoma [26]. $\text{HO}\cdot$ was produced in each tube in 20 mM KH_2PO_4 buffer at pH 7.4 with 10^{-11} nmol of hydrogen peroxide per mL. For that, Fenton's reaction was initiated by adding $\text{EDTA}\cdot\text{Fe}^{2+}$ (100 μM FeCl_3 , 104 μM ethylene diamine tetraacetic acid and 100 μM ascorbic acid). The solutions/sample concentrations (the same as above described for H_2O_2) were added for $\text{HO}\cdot$ to be then inhibited at least partially. Deoxyribose (3 mM) was added to be degraded by the remaining hydroxyl radicals. After boiling for 20 min, malondialdehyde (MDA) was generated as a result of 14 mM thiobarbituric acid and 147 mM trichloroacetic acid. The resulting pink chromogen was measured by spectrophotometry (532 nm). $\text{HO}\cdot$ inhibition control tubes were also made with 300 μM cysteine.

HO \cdot was expressed in nmol·mL⁻¹, using a standard curve obtained from increasing H₂O₂ concentrations. The data was presented as bar diagrams \pm SD according to the sample volumes involved per mL of reaction mixture. Statistical analysis was conducted using 6 independent assays (GraphPad Prism 7 software for Windows, Inc., San Diego, CA, USA). Provided the population was normal (Shapiro–Wilk’s test at the 5% level) as well as variance homogeneity obtained (non-significative Bartlett’s test at the 5% level), ANOVA was performed (overall Fisher’s test, $p < 0.05$, followed by the ad-hoc Tukey’s test, $p < 0.05$). When ANOVA was not applicable, the non-parametric test of Kruskal–Wallis ($p < 0.05$) followed by Dunn’s test ($p < 0.05$) were performed.

3. Results

Whole chicory flour (Chic) and three compounds of chicory roots (Fru, CGA and STL) were separately analyzed for their health effects in mice. A whole transcriptomic analysis was conducted using Agilent DNA microarrays to investigate their nutrigenomic effects, the plasmatic hormonal levels were assayed using Luminex technology, and a fecal microbiota metabarcoding analysis was realized by Illumina 16S rDNA sequencing. We carried out parallel in vitro analyses to investigate apoptotic, anti-inflammatory and antioxidant effects of these different compounds.

3.1. Composition of Chicory Products

An untargeted metabolomic approach was conducted using UPLC-HRMS and ¹H-NMR data, obtained from the analysis of two types of preparation i.e., chicory flour and its decoction. Similar metabolite profiles were observed when comparing both preparations. However, metabolomic fingerprinting revealed that the extraction of the metabolites during the preparation of the decoction from the chicory flour was slightly less effective. We estimated that during the decoction preparation, several metabolites were extracted in proportion to 70–80% compared to their content in the flour (considered to be 100%) (File S2). A possible explanation may be that in the decoction, the extraction of metabolites in hot water could be incomplete, in particular for hydrophobic compounds; the stirring could also play an important role in the observed results. Metabolites that were used in this work for animal feed were subsequently targeted by quantitative ¹H-NMR and also by UPLC-HRMS and results are presented in Table 2. The content of CGA and STL in the decoction seems, generally, similar to that of flour. We found that only lactucin content was higher in the decoction, while the content of fructose was slightly lower in the latter. Despite these minor quantitative differences, the quality composition of the chicory decoction remains identical to that of the chicory flour and, therefore, its use for a mouse diet could be relevant for evaluating the chicory roots effects.

Table 2. Major metabolites analysed by quantitative ¹H-NMR and UPLC/ESI-HRMS in chicory root flour and decoction.

Compounds (mg/g Dry Matter)	Flour		Decoction	
	Mean	SD	Mean	SD
Fructose ^a	3.43	0.12	2.60	0.26
3-CGA ^b	0.55	0.02	0.66	0.01
3,5-diCGA ^b	0.43	0.01	0.43	0.01
Lc ^c	0.05	0.01	0.11	0.01
Lp ^c	0.23	0.02	0.21	0.01
DHLc ^c	0.14	0.01	0.17	0.01
DHLp ^c	0.05	0.01	0.03	0.01

^a quantitative ¹H-NMR, bin (3.54) corresponding to ¹H linked to C1, ^b UPLC/ESI-HRMS in negative ionization mode and ^c in positive ionization mode. 3-CGA: 3-mono-*O*-caffeoylquinic acid, m/z 353.0878 at RT 1.08 min; 3,5-diCGA: 3,5-di-*O*-caffeoylquinic acid, m/z 515.1195 at RT 4.27 min; Lc: Lactucin, m/z 299.0889 at RT 3.02 min; Lp: Lactucopicrin, m/z 433.1257 at RT 5.77 min; DHLc: 11 β ,13-Dihydro-lactucin, m/z 279.1227 at RT 2.59 min; DHLp: 11 β ,13-Dihydro-lactucopicrin, m/z 435.1414 at RT 5.72 min.

3.2. Nutrigenomic Analyses

Diet-induced gene expression profiles were analyzed in the liver, ileum enterocytes and caecum of mice after 30 days of daily ingestion of aqueous extracts of Chic, Fru, CGA or STL solutions. A total of 57 profiles were found differentially expressed during the chicory diet in these different tissues (Figure 1, File S3). A first group of nine DEGs, modified by the chicory diet, is involved in cell proliferation and apoptosis, and their deregulation suggests a cell growth arrest and a putative anti-cancer effect. A second group of 12 DEGs is involved in immune response, and this gene deregulation suggests a putative anti-inflammatory effect and a strong response to bacteria and viruses. An important group of 14 DEGs (group 3) is involved in digestion and metabolism, pointing to bile acid biosynthesis, hypolipidemic and hypoglycemic effects, appetite regulation and intestinal absorption increase. In the 4th group, we noticed a stimulation of the neural and sensory development, suggested by the up-regulation of 13 genes involved in neuron differentiation and development, memory, smell and visual perception, and also in circadian rhythm regulation. The anti-xenobiotic and putative antioxidant effects were indicated by six DEGs (group 5), and finally, we found three genes involved in energy metabolism and calcium transport that were also deregulated, but their putative health effect could be less discernible (group 6). When following these profiles in the other diet conditions (Fru, CGA and STL), we observed that in the vast majority of cases, the fructose offers similar deregulation as the chicory (48 DEGs with similar profile), reflecting the importance of fructose for the functional effect of the chicory flour. CGA and STL are also involved in these deregulations, as CGA induces a similar profile as the chicory flour for 18 genes and STL also for 18 genes. We noticed only four opposite profiles between chicory flour and CGA or STL diets, probably due to the administration of these compounds apart from the food matrix. We observed that the same functions appear to be deregulated in the three analyzed tissues, even if different genes respond specifically in each of them; only two genes (Rwdd3 and Pex11a) were found similarly expressed in the liver and ileum and were separately recorded.

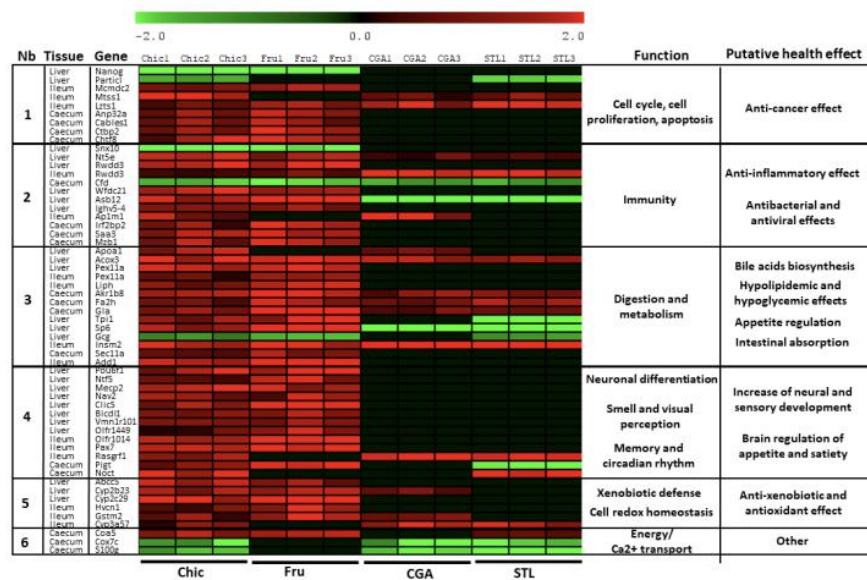

Figure 1. Gene expression profiles in hepatic tissue, ileum cells and caecum of mice after different diets. Log2 fold change of gene expression was represented individually for mice (1–3) and gene-related physiological processes and putative health effect are represented on the right part of the graph. Chic—chicory flour diet; Fru—fructose diet; CGA—chlorogenic acids treatment; STL—sesquiterpene lactones treatment.

3.3. In Vivo Hormonal Assays

Slight differences were observed in plasmatic hormone levels following chicory flour intake. These differences were not significant in the Chic condition, but other compounds have proven to be significantly involved in these modifications. Thus, CGA decreased circulating leptin level and STL increased GIP level (Figure 2, File S4). The decrease in leptin level could be associated with a hypolipidemic effect, and GIP increase, with a hypoglycemic effect. These effects were equated with the mice body weight evolution and standard food consumption during the diets (File S1).

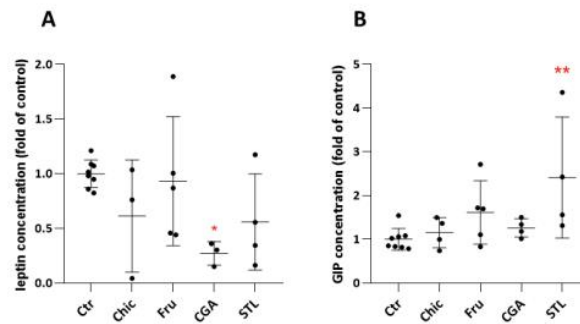

Figure 2. Leptin (A) and GIP (B) level in mice plasma after 30 days of chicory, fructose, CGA and STL supplemented diet. Control values were pooled together (Ctr). Plasmatic hormone levels were expressed as a ratio of the control level. Statistical analysis was performed using one-way ANOVA and Dunnett's multiple comparisons test (* $p < 0.05$; ** $p < 0.01$ against control).

3.4. Metagenetic Analysis of Mice Microbiota

16S-rRNA gene-targeted metagenomic analysis was performed in the individual fecal samples of mice ($n = 5$) for each diet and the bacterial richness and phylogenetic composition of the microbiota were then estimated. After sequence processing, a total of 68 different operational taxonomic units (OTUs) were identified with an abundance $> 0.1\%$ and the average number of OTUs per individual was 703 ± 60 (File S5). The alpha diversity Shannon index indicated a stabilized diversity to the average of 2.8–3.5 for all sample groups, and no significant modifications were found during the Chic, Fru, CGA or STL diets (Figure 3A). Beta diversity among different conditions, as a comparison of taxa abundance, was considered by Principal Coordinate Analysis, which revealed a common but also specific effect of the chicory flour compounds (Figure 3B). Fructose impacted a larger number of taxa but CGA and STL also share an important role in these changes and present several particular effects.

The bacterial composition representing the phylum and genus relative abundance for major OTU is shown in Figures 4 and 5, respectively. The most abundant phyla across all young subjects were *Firmicutes*, *Bacteroidetes*, *Patescibacteria*, *Proteobacteria*, *Actinobacteria*, *Cyanobacteria* and *Desulfobacteria* (Figure 4A). The most present were *Firmicutes* and *Bacteroidetes* and the ratio *Firmicutes/Bacteroidetes* (F/B) was found to be slightly diminished after 30 days of the chicory diet, probably due to the STL activity, as the only STL diet was found to induce a significant decrease (Figure 4B and File S6).

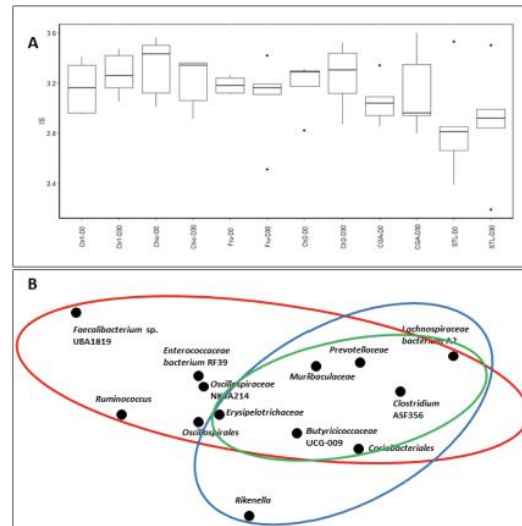

Figure 3. Microbial diversity in fecal microbiota of mice after chicory (Chic), fructose (Fru), chlorogenic acids (CGA) or sesquiterpene lactones (STL) supplemented diet. (A) Alpha diversity was illustrated by the Shannon index (IS) that indicates a stabilized diversity for all subject groups ($p > 0.05$). (B) Principal Coordinates Analysis (PCoA) plots (beta-diversity) of affected taxa during different diets. Relative abundance obtained from sequencing the 16s rRNA gene in fecal samples was represented for taxa providing differences during chicory flour diet. Red circle mainly delimits the fructose effect, blue circle delimits the STL effect and green circle the CGA effect.

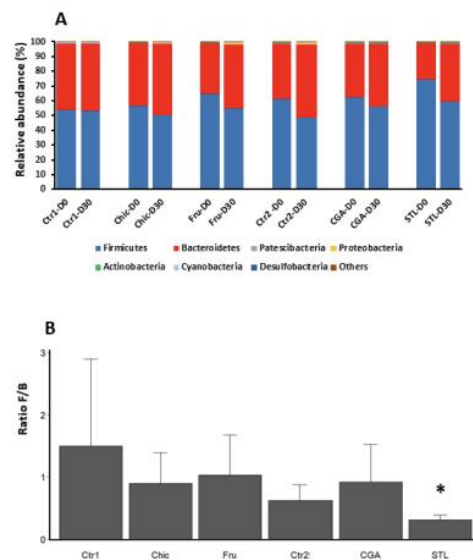

Figure 4. Changes in bacterial phyla abundance. (A) Relative abundance (%) of phyla in mice microbiota before (D0) and after 30 days (D30) of chicory (Chic), fructose (Fru), chlorogenic acids (CGA) or sesquiterpene lactones (STL) supplemented diet. Relative abundances detected by NGS are expressed as means. Phyla with abundance under 0.1% are grouped in “Others”. (B) Standardized abundance ratio relative to D0 of *Firmicutes* and *Bacteroidetes* (Tukey’s test, $n = 5$ /group, * for $p < 0.1$). Chic—chicory flour; Fru—fructose; CGA—chlorogenic acids; STL—sesquiterpene lactones; Ctr1—control related to Chic and Fru diet; Ctr2—control related to CGA and STL diet.

At the genus level, all changes observed in the relative abundance after 30 days of different treatments are represented in Figure 5. Quantitative modifications were observed in the abundance of several taxa after the different diets (Figure 5A). These modifications were closely followed as fold change of standardized abundance ratio (condition vs. control) (Figure 5B). Of the taxa, 13 were filtered for their relative abundance (>0.1%) consistently, in all samples, and presented modifications during the different diets. Six of them increased in abundance during the chicory diet, and seven of them decreased. The three analyzed compounds of the chicory flour (Fru, CGA and STL) triggered a similar increase in the relative abundance as the chicory flour for three taxa (*Prevotellaceae*, *Lachnospiraceae bacterium A2* and *Clostridium ASF356*). Fructose alone impacted 5 taxa (*Butyricococcaceae UCG-009*, *Oscillospiraceae NK4A214*, *Ruminococcus*, *Faecalibacterium* sp. UBA1819, and *Enterococccaceae bacterium RF39*), while CGA affected only the *Erysipelotrichaceae*. The results showed that, sometimes, two different classes of molecules could be involved together in changes in the abundance, as for *Muribaculaceae*, *Coriobacteriales*, *Oscillospirales* and *Rikenella*. A basic part of these results was validated by qPCR (File S7).

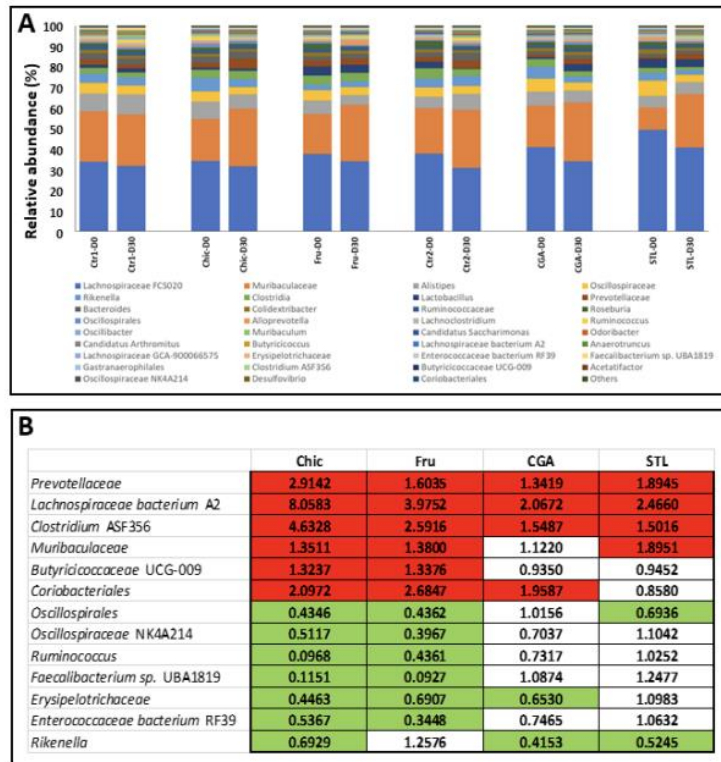

Figure 5. Relative abundance of main genera in mice fecal microbiota after chicory flour (Chic), fructose (Fru), chlorogenic acids (CGA) or sesquiterpene lactones (STL) diet. (A) Relative abundances of genera (%) are indicated when their values are >0.1%. Genera with a low relative abundance were assigned as “Others”. (B) Heatmap representing the fold change of standardized abundance ratio. Increased abundance compared to control was considered when FC > 1.30 (red squares) and decreased when <0.70 (green squares).

3.5. In Vitro Evaluation of the Apoptotic Effect

The effect of raw chicory flour decoction on apoptosis was studied by labelling HepG2 cells with Annexin V and propidium iodide and analyzed by flow cytometry. The amount of total apoptotic cells was calculated by considering both cells in early and late apoptosis

(Figure 6); each value was reported to their respective control (DMEM). The chicory decoction induced a concentration-dependent increase in the number of apoptotic cells. Fru, CGA and STL were also tested separately and results showed that only STL at 75 μ M and 100 μ M induced a significant apoptotic effect (Figure 7).

3.6. In Vitro Anti-Inflammatory Effect

Chicory and its compounds at the highest non-cytotoxic concentration (data not shown) were screened for their anti-inflammatory activity in vitro using U937 cells, differentiated in macrophages and their capacity to secrete cytokines. Three pro-inflammatory cytokines (TNF- α , IL-8, IL-1 β) were quantified in the cell media. As a control, stimulation with LPS significantly increased the secretion of TNF- α , and interleukin IL-8, ($p < 0.0001$) and IL-1 β ($p < 0.05$) (Figure 8). The addition of the chicory decoction markedly reduced the secretion of all cytokines ($p < 0.005$) in inflamed cells. The decrease in interleukin levels seems to be due to CGA and STL effect and the reduction of TNF- α can probably be linked to the fructose effect.

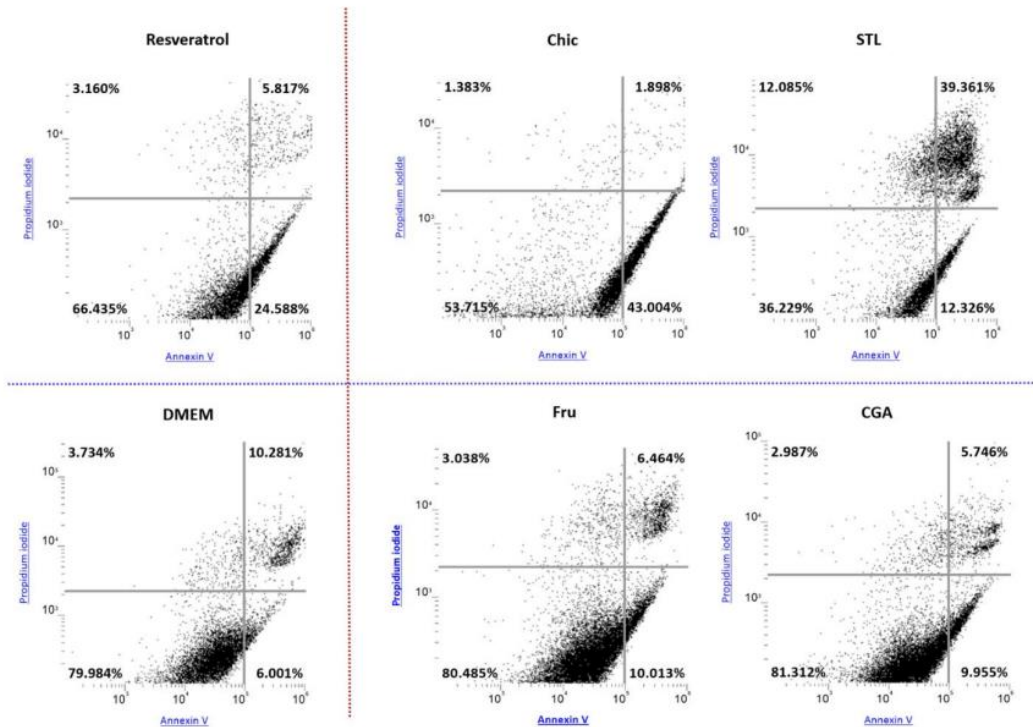

Figure 6. Dot plots illustrating the apoptotic effect of chicory flour and its compounds on HepG2 cells. HepG2 cells were treated for 24 h with chicory decoction (Chic), fructose (Fru), CGA and STL solutions at different concentrations and analyzed using propidium iodide and Annexin V. Representations were selected among the most elevated concentration of each compound (3% for Chic and Fru; 100 μ M for CGA and STL). Resveratrol at a concentration of 200 μ M was used as a positive control, and DMEM as a negative one. The top left quadrant of each plot represents unviable cells, the top right quadrant represents necrotic cells or cells in late apoptosis. The bottom left quadrant represents viable cells and the bottom right quadrant represents early apoptotic cells. Total apoptotic cells were calculated by adding the top right and bottom right quadrant’s content. Samples illustrated in the top of the figure (Resveratrol, Chic and STL) provided an increased apoptotic effect compared to the other samples.

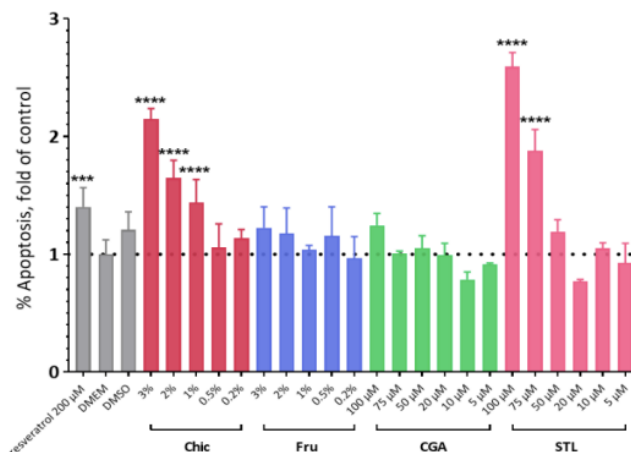

Figure 7. Apoptosis induction on HepG2 cells. HepG2 cells were treated with various concentrations of a chicory flour decoction (Chic) or D-fructose solution (Fru) (from 0.2% to 3%), and also with chlorogenic acids (CGA) or sesquiterpene lactones (STL) (from 5 μ M to 100 μ M) for 24 h. Resveratrol at a concentration of 200 μ M was used as a positive control and DMEM and DMSO as negative ones. As no significant variations were registered between negative controls, the apoptosis induction in each condition was compared to the DMEM control and expressed as a ratio. Statistical analysis was performed using one-way ANOVA and Dunnett’s multiple comparisons test (**** $p < 0.0001$; *** $p < 0.0005$ compared with the DMEM control).

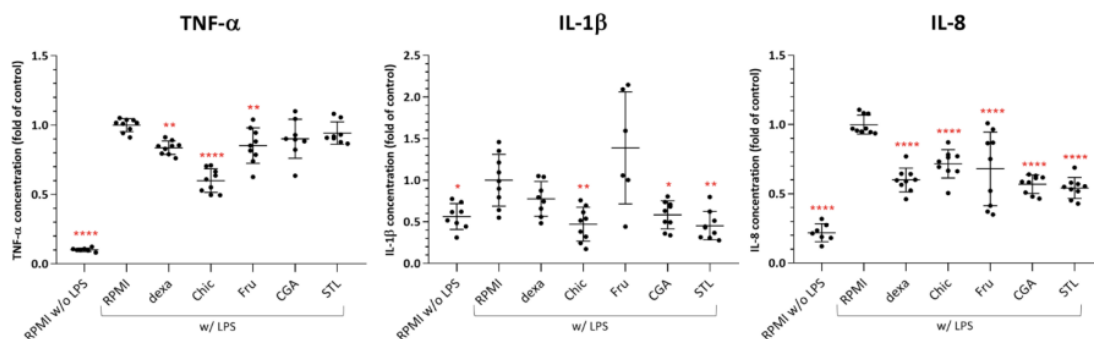

Figure 8. Effects of chicory and its compounds on TNF- α , IL-1 β and IL-8 production by human U937 macrophages. U937 were differentiated with PMA before being inflamed with LPS (w/LPS) and put in contact with samples for 2 h. Dexamethasone (dexa) was used as a negative control of inflammation. Efficiency of LPS inflammation was controlled (RPMI w/o LPS) in each test. Cytokine levels were expressed as a ratio of the control (RPMI w/LPS) level. Statistical analysis was performed using one-way ANOVA and Dunnett’s multiple comparisons test (* $p < 0.05$; ** $p < 0.005$; **** $p < 0.0001$ against control). dexa: 20 μ M of dexamethasone; chic: 1% of chicory flour decoction; Fru: 1% of D-fructose; CGA: 20 μ M of chlorogenic acids mix; STL: 20 μ M of sesquiterpene lactone mix.

3.7. In Vitro Antioxidant Effect

The antioxidant effect of the chicory flour was checked in a cell-free model for the superoxide anion and hydroxyl radical inhibition. The aqueous extracts of chicory flour triggered a significant decrease in superoxide anions, beginning from 0.5 mg·mL⁻¹, and also a decrease in hydroxyl radicals that became significant, beginning from 1 mg·mL⁻¹ (Figure 9).

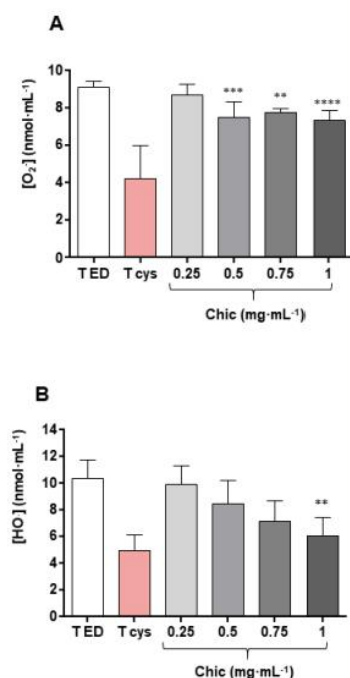

Figure 9. Antioxidative effects of chicory flour. Superoxide anion inhibition (**A**) and hydroxyl radical inhibition (**B**) of chicory flour decoction were observed by contrast with the effect of the negative control (TED) containing distilled water, and the positive control containing cysteine (Tcys). The sample decoction of chicory flour (Chic) was tested at increasing concentrations, ranging from 0.25 to 1 mg of dry matter equivalent per final mL. Statistical analysis for $n = 6$ independent assays were performed with ANOVA: overall Fisher's test, $p < 0.0001$; Tukey's test, ** $p < 0.01$, *** $p < 0.001$, **** $p < 0.0001$ (**A**) and Kruskal-Wallis test, $p = 0.0017$; Dunn's test, ** $p < 0.01$ (**B**).

4. Discussion

Chicory flour is a food product used in pastry and, at the same time, a functional food with multiple health benefits [2]. Several molecules or classes of molecules that enter the composition of chicory flour are possible effectors in these effects. This work was carried out to decompose the effects of chicory flour and to better understand the role of three of its components, Fru, CGA and STL. To do this, *in vivo* murine experimental analyses were carried out using an aqueous decoction of chicory, whose composition was found similar and quantitatively close (up to 70–80%) to that of flour. Analyses were performed to intercept nutrigenomic, hormonal and metagenomic changes that were subsequently correlated with events observed *in vitro* on human cells or in acellular systems.

4.1. The Anti-Cancer Effect of the Chicory Roots as Observed in an *In Vivo* Murine and *In Vitro* Human Cell Models

A chicory supplemented diet triggered the deregulation of nine genes involved in cell proliferation and apoptosis (Figure 1). In addition, this diet induced an apoptotic effect in HepG2 cells *in vitro* (Figures 6 and 7). To determine which compound from chicory is responsible for this effect, we looked at the role of Fru, CGA and STL on gene expression and on HepG2 cells phenotype.

In liver tissue, we found two down-regulated genes under chicory treatment. The first one, *Nanog*, is a transcriptional factor that helps embryonic stem cells to maintain pluripotency by suppressing cell determination factors [27]. As it is highly expressed in cancer stem cells, this gene functions as an oncogene to promote carcinogenesis [28,29],

being described as a prognostic and predictive cancer biomarker [30]. Its down-regulation in Chic and Fru dietary conditions suggests that chicory flour, via its fructose content, can lead to the arrest of cells engaged in cancer proliferation. The second gene in this group, *Particl*, is involved in the response to irradiation and affords an RNA binding platform for genomic silencers, such as DNA methyltransferase 1 and histone tri-methyltransferases, to reign in the expression of tumor suppressors [31]. This gene was correlated to the expression of tumor suppressor genes, as it operates an active feedback silencing mechanism upon the putative tumor suppressor *mat2a*, to limit its expression [32]. The knockdown of this gene resulted in inverse changes in *Wwox* transcripts levels, which is also known as coding for a tumor suppressor [33]. As we found the *Particl* gene down-regulated by the Chic and STL diets, we can suggest that chicory flour, via its STL content, can lead to an increase in tumor suppression, probably by apoptosis [34]. Our results on HepG2 cells indicated that only STL induced a significant apoptotic effect that could be related to *Particl* gene down-regulation.

In ileum cells, we found three up-regulated genes under the Chic diet. *Mcmdc2* is an essential gene for meiotic recombination-mediated repair [35] and fructose seemed to be the compound responsible for its up-regulation. *Mtss1* plays an important role in metastasis blocking, by governing the metastatic nature of cancer cells [36,37], and its up-regulation was led by the CGA and STL diets. *Lzts1* codes for a tumor suppressor that may stabilize the active CDC2-cyclin B1 complex and thereby contributes to the regulation of the cell cycle and the prevention of uncontrolled cell proliferation [38]. All chicory compounds (Fru, CGA and STL) seemed to participate in the up-regulation of this gene.

In caecum tissue, four genes were up-regulated during the chicory diet. *Anp32a* codes for a protein that has been found to be decreased or absent in malignant tumors, and to modulate cell growth by regulating p38 and AKT activity [39]. *Cables1* codes for a vital cell cycle regulator, dysregulation of which has been associated with a large number of human malignancies [40]. *Ctbp2* codes for a negative regulator of cell proliferation, and *Chtf8* is also involved in the cell cycle and, equally, in telomere maintenance via semi-conservative replication [41]. These genes were found to be up-regulated by the chicory diet, and fructose seems to be the bioactive component for all of them.

We observed that fructose plays a major role in the deregulation of genes involved in cell proliferation regulation, but CGA and STL can also impact several key genes, especially those involved in metastasis suppression. STL alone seems to be responsible for one important apoptosis-related gene expression, and this observation could be associated with in vitro results (Figure 8), showing a significant apoptotic effect of STL on HepG2 cells. Our observations are consistent with other studies showing the effect of chicory extracts on the regulation of cell proliferation and apoptosis in different human cancer cell lines [42,43].

4.2. The Anti-Inflammatory Effect as Observed in an In Vivo Murine and In Vitro Human Cell Models

All three analyzed tissues responded by an increase in the anti-inflammatory effect during the chicory diet. The liver responded by the deregulation of *Snx10*, *Nt5e* and *Rwdd3*, ileum, also by the *Rwdd3* deregulation and the caecum by the *Cfd* gene deregulation (Figure 1). SNX10 presents a crucial role in macrophage polarization and inflammation, and the loss of SNX10 function was proposed to be a potentially promising therapeutic strategy for inflammatory bowel disease [44]. The down-regulation of this gene suggests an anti-inflammatory effect, triggered by the chicory flour, and among its components by the fructose only. NT5E is a marker of lymphocyte differentiation, and this enzyme contributes to the anti-inflammatory properties of afferent lymphatic endothelial cells in humans and mice [45]. Fructose, but also CGA and STL, could induce an up-regulation of the gene coding for this enzyme. RWDD3 is involved in the negative regulation of NF- κ B transcription factor activity [46] and its up-regulation by the chicory diet could be attributed to the fructose in the liver. In ileum cells, in addition to fructose, CGA and STL also increased the expression of this gene. CFD is a component of the alternative complement pathway [47], involved in the inflammatory response. Its down-regulation

during the chicory diet could be attributed to all analyzed compounds: fructose, CGA and STL.

An anti-inflammatory response from chicory roots has already been observed by Ripoll et al. [48] and Matos et al. [49], who investigated the immunomodulatory mechanisms of STL across the modulation of inflammatory pathways in vivo, on rat and mouse models and, respectively, in vitro, on human intestinal mucosa Caco-2 cells. Our observations in vivo were performed over nutrigenomic analyses, under chicory flour, fructose, CGA and STL supplementation (Figure 1) and indicated a deregulation of four genes involved in anti-inflammatory responses. Thereafter, our in vitro observations (Figure 8) showed that chicory supplementation in mice led to a decrease in TNF- α , IL-1 β , IL-8 levels. The fructose, CGA and STL were pointed as effector molecules. CGA and STL seemed to be affecting IL-1 β and IL-8 levels more, and fructose was responsible for TNF- α reduction.

4.3. Antibacterial and Antiviral Effect as Observed in an In Vivo Murine Model

During the chicory diet, seven genes involved in the antimicrobial effect and innate immune system were impacted (Figure 1). Thus, *Wfdc21*, *Asb12*, *Ighv5-4*, *Ap1m1*, *Irf2bp2*, *Saa3* and *Mzb1* were found up-regulated under the Chic diet, except *Ap1m1*, which was impacted by the CGA, while all the others were up-regulated by the fructose intake. The antibacterial effect of a CGA-rich extract on several common pathogens was already suggested by in vitro experiment [7] and the honey containing fructose was also described as a potential anti-bacterial agent [50].

4.4. Hypolipidemic and Hypoglycemic Effects, Appetite Regulation and Intestinal Absorption as Observed in an In Vivo Murine Model

Chicory has been described as a digestive remedy for both humans [51,52] and animals [53–55]. Hypolipidemic and hypoglycemic effects were already observed in mice [2]. We support these data with new in vivo nutrigenomic and hormonal effects in the present study. Liver tissue, ileum enterocytes and caecum tissue responded to the chicory flour diet by the up-regulation of seven genes, resulting in lipid metabolism modifications with, consequently, hypolipidemic effects (*Apoa1*, *Acox3*, *Pex11a*, *Akr1b8*, *Fa2h* and *Gla*), the deregulation of five genes, triggering a hypoglycemic effect and affecting the appetite regulation (*Tpi1*, *Sp6*, *Gcg*, *Insm2*, *Sec11a*), and also a gene playing an important role in intestinal absorption (*Add1*) (Figure 1).

Gene coding for APOA1, which is the major component of the high-density lipoprotein complex, playing a key role in the metabolism of triglycerides [56] and clear fats, including cholesterol [57], was found up-regulated under the CGA diet. Gene coding for ACOX3 is essential for bile acid formation [58], with a role in lipid destructure, and was up-regulated by all chicory compounds (Fru, CGA and STL). Gene coding for LIPH, which is also involved in the triglyceride catabolism [59], and for PEX11A that is known to have a major impact on lipid metabolism [60,61], were found deregulated in both liver and ileum, being impacted by the fructose only. AKR1B8, that regulates fatty acid synthesis [62], FA2H, that is involved in galactosphingolipid synthesis [63], and GLA, that is involved in sphingolipids metabolism [64], were also impacted by all bioactive effectors: fructose, CGA and STL (Figure 1). All these deregulations could trigger a hypolipidemic effect, and this consequence is also suggested by in vivo Luminex assay (Figure 2). The circulating level of leptin was reduced after 30 days of chicory supplementation and significantly altered by the CGA diet. Being directly linked to the body fat distribution [65], a decrease in plasmatic leptin could be associated to the hypolipidemic effect. In our study, body weight was not significantly altered (Supplementary File S1), however, a slight decrease in body weight was observed for Chic fed mice.

Concerning glycemic effect, we observed that gene coding for TPI1, which is involved in glycolysis [66], and for SP6, involved in hepatic gluconeogenesis [67], were up-regulated during the chicory diet. The responsible bioactive compound seems to be the fructose that induced the same deregulation as the chicory flour when administrated alone. We know

that honey containing fructose exerts a hypoglycemic effect [68], and so, obviously, the fructose contained in the chicory could act similarly.

The appetite regulation was already described as an important effect in chicory root consumption [2,18]. We found *Gcg* gene coding for pro-glucagon to be down-regulated. This gene, which plays a key role in glucose metabolism and homeostasis [69], was impacted by the fructose and STL. The gene coding for INSM2 that stimulates the pancreatic endocrine cell differentiation and, thus, the insulin biosynthesis [70], was up-regulated by all chicory compounds. We also found that gene coding for *Sec11a*, involved in incretin synthesis [71], was up-regulated under the chicory diet and that fructose seems to be the bioactive compound that impacts this gene. More than that, the circulating GIP level was increased after chicory consumption and significantly higher with STL supplementation (Figure 2). It is known that GIP is a primary incretin hormone, secreted from the intestine, to stimulate insulin secretion from pancreatic β cells and, thus, plays an important role in glucose metabolism [72].

Finally, the intestinal absorption was already observed to be impacted by a chicory supplementation [73], but the mechanism was unidentified. We found that gene coding for *ADD1*, which is involved in actin cytoskeleton organization [74], and consequently in various intestinal functions as cell motility, endothelial adhesion junctions, absorption, etc. [75], was up-regulated under chicory flour and, respectively, fructose bioactive action.

4.5. Neural and Sensory Development as Observed in an In Vivo Murine Model

This study highlighted the effect of chicory on the neural and sensory development by nutrigenomic analyses. A group of 13 genes was up-regulated under chicory intake (Figure 1). Among these genes, we note that the one coding for *POU6F1* is involved in brain development and neural plasticity [76], *NTF5* related to formation and maintenance of neuronal connections [77] and to taste development [78], *MECP2* is essential for the normal function of nerve cells [79], and *BICDL1* is a key component of vesicular transport in developing neurons [80]. Further, in this group, we found the gene coding for *NAV2* that is involved in the development of different sensory organs [81], *CLIC5*, which is required for normal hearing [82], *VMN1R101*, *OLFR1449* and *OLFR1014*, with a role in smell perception [83,84]. Another worth noting is the deregulation of gene coding for *PAX7*, which plays a role in neural crest development [85], *RASGRF1*, known for its role in long-term memory [86] and *PIGT*, described as implied in neuron differentiation [87]. Surprisingly, we also found a significant up-regulation in gene coding for *NOCT*, which is involved in the circadian rhythm regulation [88]. Other than *Rasgrf1*, which was up-regulated under CGA, and *Noct*, which was up-regulated under CGA bioactive impact, the rest of the genes were deregulated under fructose impact. Excess fructose consumption has been related to metabolic syndrome and obesity, and more generally, to the feeding behavior and a hunger-like state in the brain [89]. In chicory plants, the fructose is present in a low quantity in roots (3–6 mg/g dry matter depending on genotype). Its regular consumption, enclosed in the food matrix, was assimilated to a benefit as appetite booster [90] or appetite regulator [18] and the mechanism of its action could most probably interfere with genes involved in neural and sensory development.

4.6. Anti-Xenobiotic and Antioxidant Effect as Observed in Both In Vivo Murine and In Vitro Cell-Free Models

The chicory decoction triggered an up-regulation of genes involved in anti-xenobiotic and antioxidant effects, such as *Abcc5*, which codes for a transmembrane pump essential for the elimination of certain toxins [91], *Hvcn1* and *Gstm2*, which are involved in the maintenance of redox homeostasis [92,93], and also several genes coding for cytochrome P450 polypeptides, such as *CYP2B23*, *CYP2C29* and *CYP3A57*, that are known to be involved in xenobiotic metabolism [94]. Fructose was found to be the bioactive compound involved in this effect for four genes, but also CGA (for three genes) and STL (for one gene) (Figure 1). We also observed an important effect of the chicory decoction on the hydroxyl

radical and on the superoxide anion (Figure 9). All these observations are in agreement with other studies and confirm the antioxidant effect of the chicory, most likely due to fructose, CGA and STL [6,11,95].

4.7. Microbiota Modifications

Fecal specimens were used for a 16S RNA targeted metagenomics analysis to estimate gut microbiota changes during the different diets. The alpha diversity indicates a relative homogeneity of responses, and the beta diversity indicates that the different chicory compounds trigger common, but also specific, modifications in bacterial taxa abundance (Figure 3). The ratio between the *Firmicutes* and *Bacteroidetes* phyla was calculated for different treatments, and a decrease in this ratio was registered for the Chic diet, probably due to the STL effect as the STL diet triggered a significant decrease in the F/B ratio (Figure 4). A change of F/B ratio may be important because this was described to be correlated with digestion and metabolic processes. In humans, this ratio was found to be significantly increased in patients developing type 1 diabetes and also obesity [96,97]. In mice, this ratio was already observed to be impacted by the chicory diet [2,18], which is also in accordance with our observations. In addition to this, we were able to detect that STL is the class of molecules that mostly modifies this ratio.

Daily feeding with the chicory flour decoction triggered changes in the relative abundance of several bacterial genera (Figure 5). Several taxa increased in abundance (*Prevotellaceae*, *Lachnospiraceae bacterium A2*, *Clostridium ASF356*, *Muribaculaceae*, *Butyricicoccaceae UCG-009*, *Coriobacteriales*), while others decreased (*Oscillospirales*, *Oscillospiraceae NK4A214*, *Ruminococcus*, *Faecalibacterium sp. UBA1819*, *Erysipelotrichaceae*, *Enterococcaceae bacterium RF39*, *Rikenella*) and these variations were tracked in Fru, CGA and STL diets to understand the role of these compounds in the different modifications.

Thus, the abundance of *Prevotellaceae* was found to be increased in the Chic diet and similarly impacted by all tested compounds. This gut bacterial taxon was found in humans, correlated with Parkinson's Disease [98,99], its decrease indicating a disease state. *Prevotellaceae* was assigned as a psychobiotic [100], in other words, a group of beneficial bacteria that influences bacteria–brain relationships and exerts anxiolytic and antidepressant effects, characterized by changes in emotional, cognitive, systemic, and neural indices [101]. Short chain fatty acid (SCFA) producers were also recognized as psychobiotics [100], and we noticed in our study at least four bacterial taxa, known as butyrate, and other SCFA producers that were impacted by chicory flour and their abundance were found increased during fructose but also by the CGA and/or STL: *Lachnospiraceae bacterium A2*, *Clostridium ASF356*, *Muribaculaceae*, *Butyricicoccaceae UCG-009* [102,103]. These observations go near the neural and sensory development, suggested by the nutrigenomic analysis, and suggest an improvement of neuronal functions during a chicory supplemented diet.

Coriobacteriaceae seemed to be positively affected under chicory uptake conditions and mainly influenced by fructose and CGA. These bacteria carry out functions of importance, such as the conversion of bile salts and steroids, as well as the activation of dietary polyphenols [104] and its modifications could be associated to the hypolipidemic effect of the chicory that was also observed across the nutrigenomic analysis. Our study showed that *Oscillospirales*, *Oscillospiraceae NK4A214* and *Ruminococcus* taxa were negatively impacted by the chicory and fructose diets. These taxa were described as being negatively associated with high fatty liver index (FLI) and connected with the non-alcoholic fatty liver disease (NAFLD) [105–107], and their decrease in our study supports even more the hypolipidemic and hepatoprotector effect of the chicory, and especially of the fructose.

Faecalibacterium sp. UBA1819, a succinate-producing bacterium that was described to be involved in the increase in sleep fragmentation and blood pressure [108], was found with a diminished abundance during the chicory diet, probably due to the fructose content. This observation suggests a hypotensive effect of the chicory uptake.

The chicory diet across fructose, but also CGA and STL, triggered the decrease in the abundance of several taxa, known as mainly pathogenic or inflammatory factors, such as *Erysipelotrichaceae*, *Enterococcaceae* bacterium RF39 and *Rikenella* [109,110].

We can conclude for the microbiota analysis that together, these modifications in taxa composition surprisingly merged with many nutrigenomic impacts of the chicory uptake: effects on the neural development (by the psychobiotics as *Prevotellaceae* or different SCFAs producers increased abundance), hypolipidemic effects (by the *Coriobacteriaceae* increased abundance, and *Oscillospirales*, *Oscillospiraceae* NK4A214 and *Ruminococcus* decreased abundance), anti-inflammatory and anti-pathogenic effects (suggested by the *Erysipelotrichaceae*, *Enterococcaceae* bacterium RF39 and *Rikenella* decreased abundance). A hypotensive effect was also suggested by the *Faecalibacterium* sp. UBA1819 decreased abundance. As for the transcriptomic analyses, the fructose was found to play an important role in bacterial richness, being involved in the abundance modification of 12 bacterial taxa. The CGA was also observed to exert a noticeable influence for six taxa, and the STL for the other six taxa.

5. Conclusions

Chicory as a functional food has been studied in the form of root, transformed into flour, for pastry or bakery use, or more generally in the food industry. To identify the main effector molecules of the chicory, we split the composition of this flour into several classes of molecules. Inulin, the main component of the chicory root, has already been the subject of studies, showing its exclusively prebiotic effect [2]. In this work, fructose, CGA and STL were tested in daily administration in mice, and a set of analyses were performed. The gene expression profile of the experimental animals, following the different diets, indicated several deregulated biological functions, leading to several putative health effects: anti-cancer, anti-inflammatory, antimicrobial effect, and metabolic effect concerning bile acid biosynthesis, lipid and carbohydrate metabolism, appetite regulation and intestinal absorption. A regulatory effect has also been observed in many genes affecting neuronal and sensory development, suggesting a regulation of energy homeostasis. In addition, anti-xenobiotic and antioxidant effects were also observed. All these effects seem similar in the three different analyzed tissues, even though different genes appear to govern these responses in each tissue.

These effects were then recognized by complementary *in vivo* analyses, such as hormonal assay, and also by *in vitro* analyses on cultured cells or on acellular assays, to highlight the apoptotic, anti-inflammatory and antioxidant effects. A 16S RNA targeted metagenomic analysis completed the panel of health effects of the chicory flour and its components, and showed the role of fructose, CGA and STL in the development of several SCFA producers, with a psychobiotic role, bacteria with hypolipidemic, hepatoprotective and also a hypotensive role.

Hence, our study explicitly targeted these effects on gene expression, hormone-releasing and microbiota modifications and pointed out the role of different effector molecules contained in chicory roots: fructose, CGA and STL. All these responses are summarized in Figure 10 and File S8. Fructose seems to be the most involved in these activities, contributing to approximately 83% of all recorded responses. Almost half of the fructose effects were observed at the metabolism level and brain appetite regulation. CGA and STL have shown a specific role for all different effects, with an estimated 23 and 24% contribution, respectively. Further studies are certainly needed to test the role of other classes of molecules, as well as the defined role of the food matrix. Chicory genotype breeding and/or CRISPR-Cas9 tool [111] should be able to guide us even more quickly in the complete deciphering of different effects and effectors of chicory flour on health.

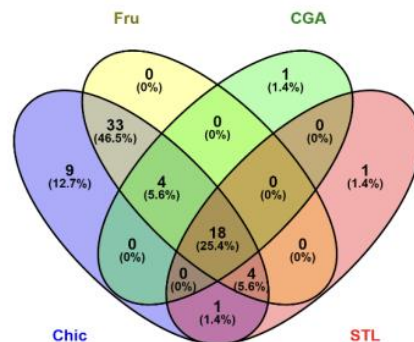

Figure 10. Venn diagram illustrating an estimation of the most important effects of the chicory and its tested compounds: fructose (Fru), chlorogenic acids (CGA) and sesquiterpene lactones (STL). Number of DEGs was considered in transcriptome analysis, and number of modified taxa in metagenetic analysis. Results of hormone assay were constricted to significant modification as well as for in vitro analyses as significant response was considered 1 and a non-significant one was considered 0. A score was calculated by totaling these events for each diet. The Venn diagram's platform (<http://bioinfo.gp.cnb.csic.es/tools/venny/index.html> accessed on 21 January 2022) was used to cross the data.

Supplementary Materials: The following supporting information can be downloaded at: <https://www.mdpi.com/article/10.3390/nu14050957/s1>, File S1. Mice body weight evolution (A) and standard food consumption (B) during chicory (Chic), fructose (Fru), chlorogenic acids (CGA) and sesquiterpene lactones (STL) supplemented diet for 30 days. File S2. Heatmap of metabolite signals. File S3. Gene expression profiles in mice liver tissue, ileum cells and caecum of mice during different diets. File S4. GIP and leptin level in mice plasma, after 30 days of chicory, fructose, CGA and STL diet. File S5. The operational taxonomic units (OTUs) identified with an abundance >0.1% in fecal microbiota of mice after different diets. Diets were supplemented with chicory flour (Chic), fructose (Fru), chlorogenic acids (CGA) and sesquiterpene lactones. File S6. Standardized abundance ratio (relative to D0) for Firmicutes and Bacteroidetes phyla after 30 days of diet in mice. File S7. Microbial profiling using quantitative PCR. File S8. Estimation of the most important effects of the chicory and its tested compounds: fructose (Fru), chlorogenic acids (CGA) and sesquiterpene lactones (STL).

Author Contributions: Conceptualization, A.L.-D. and B.C.; Methodology, A.L.-D., B.C., J.B., B.T. and R.M.; Formal analysis, C.L.P., A.L.-D., E.R., S.O., B.T., M.T. and D.M.; Validation, S.O.; Data curation, B.T., J.-X.F., D.M. and R.M.; Writing—Original Draft Preparation, A.L.-D. and C.L.P.; Writing—Review and Editing, B.C., C.R., J.-L.H., B.T., G.D., J.B., R.M., D.G. and D.M.; Supervision, R.R., G.D., J.-L.H., D.G. and C.R.; Project administration, C.R.; Funding acquisition, C.R. and J.-L.H. All authors have read and agreed to the published version of the manuscript.

Funding: This work has been supported by the Région des Hauts-de-France via ALIBIOTECH CPER/FEDER 2016–2021 and FEDER for CHIC41H 2019–2021 programs.

Institutional Review Board Statement: The study was conducted according to the Directive 2010/63/EEC for the protection of animals used for fine scientists and in accordance with Law 2012-10 (2012) and 2013-118 (2013). The protocol was approved by the Ethics Committee in charge of animal experiments (C2EA-75, France, date of approval: 8 September 2020).

Informed Consent Statement: Not applicable.

Data Availability Statement: Transcriptomic and metagenomics data are archived in GEO database and NCBI's Sequence Archive and will be publicly accessible at the same time as the publication of the article.

Conflicts of Interest: The authors declare no conflict of interest.

References

1. Perović, J.; Tumbas Šaponjac, V.; Kojić, J.; Krulj, J.; Moreno, D.A.; García-Viguera, C.; Bodroža-Solarov, M.; Ilić, N. Chicory (*Cichorium intybus* L.) as a food ingredient—Nutritional composition, bioactivity, safety, and health claims: A review. *Food Chem.* **2021**, *336*, 127676. [CrossRef] [PubMed]
2. Pouille, C.L.; Jegou, D.; Dugardin, C.; Cudennec, B.; Ravallec, R.; Hance, P.; Rambaud, C.; Hilbert, J.L.; Lucau-Danila, A. Chicory root flour—A functional food with potential multiple health benefits evaluated in a mice model. *J. Funct. Foods* **2020**, *74*, 104174. [CrossRef]
3. Reimer, R.A.; Soto-Vaca, A.; Nicolucci, A.C.; Mayengbam, S.; Park, H.; Madsen, K.L.; Menon, R.; Vaughan, E.E. Effect of chicory inulin-type fructan-containing snack bars on the human gut microbiota in low dietary fiber consumers in a randomized crossover trial. *Am. J. Clin. Nutr.* **2020**, *111*, 1286–1296. [CrossRef]
4. EFSA Panel on Nutrition, Novel Foods and Food Allergens (NDA). Frutalose®, a mixture of fructans obtained from enzymatic hydrolysis of chicory inulin, and normal defecation: Evaluation of a health claim pursuant to Article 13 of Regulation (EC) No 1924/2006. *EFSA J.* **2021**, *19*, e06775. [CrossRef]
5. Ferrare, K.; Bidel, L.P.; Awwad, A.; Pouchet, P.; Cazals, G.; Lazennec, F.; Azay-Milhau, J.; Tournier, M.; Lajoix, A.D.; Tousch, D. Increase in insulin sensitivity by the association of chicoric acid and chlorogenic acid contained in a natural chicoric acid extract (NCRAE) of chicory (*Cichorium intybus* L.) for an antidiabetic effect. *J. Ethnopharmacol.* **2018**, *215*, 241–248. [CrossRef] [PubMed]
6. Epure, A.; Pâravu, A.E.; Vlase, L.; Benedec, D.; Hanganu, D.; Gheldiu, A.M.; Toma, V.A.; Oniga, I. Phytochemical profile, antioxidant, cardioprotective and nephroprotective activity of romanian chicory extract. *Plants* **2021**, *10*, 64. [CrossRef] [PubMed]
7. Bernard, G.; Alves Dos Santos, H.A.D.; Etienne, A.; Samaillie, J.; Neut, C.; Sahpaz, S.; Hilbert, J.L.; Gagneul, D.; Jullian, N.; Tahrioui, A.; et al. MeJA elicitation of chicory hairy roots promotes efficient increase of 3,5-diCQA accumulation, a potent antioxidant and antibacterial molecule. *Antibiotics* **2020**, *9*, 659. [CrossRef]
8. Peña-Espinoza, M.; Williams, A.R.; Thamsborg, S.M.; Simonsen, H.T.; Enemark, H.L. Anthelmintic effects of forage chicory (*Cichorium intybus*) against free-living and parasitic stages of Cooperia oncophora. *Vet. Parasitol.* **2017**, *243*, 204–207. [CrossRef]
9. Peña-Espinoza, M.; Valente, A.H.; Bornancin, L.; Simonsen, H.T.; Thamsborg, S.M.; Williams, A.R.; López-Muñoz, R. Anthelmintic and metabolomic analyses of chicory (*Cichorium intybus*) identify an industrial by-product with potent in vitro antinematodal activity. *Vet. Parasitol.* **2020**, *280*, 109088. [CrossRef]
10. Valente, A.H.; de Roode, M.; Ernst, M.; Peña-Espinoza, M.; Bornancin, L.; Bonde, C.S.; Martínez-Valladares, M.; Ramünke, S.; Krücken, J.; Simonsen, H.T.; et al. Identification of compounds responsible for the anthelmintic effects of chicory (*Cichorium intybus*) by molecular networking and bio-guided fractionation. *Int. J. Parasitol. Drugs Drug Resist.* **2021**, *15*, 105–114. [CrossRef]
11. Karadeniz, F.; Oh, J.H.; Kong, C.-S. Sesquiterpene lactones: A review of biological activities. *J. Life Sci.* **2021**, *31*, 430–441. [CrossRef]
12. Matos, M.S.; Anastácio, J.D.; Santos, C.N.D. Sesquiterpene lactones: Promising natural compounds to fight inflammation. *Pharmaceutics* **2021**, *13*, 991. [CrossRef]
13. Abbas, Z.K.; Saggi, S.; Sakeran, M.I.; Zidan, N.; Rehman, H.; Ansari, A.A. Phytochemical, antioxidant and mineral composition of hydroalcoholic extract of chicory (*Cichorium intybus* L.) leaves. *Saudi J. Biol. Sci.* **2015**, *22*, 322–326. [CrossRef] [PubMed]
14. Hoste, H.; Jackson, F.; Athanasiadou, S.; Thamsborg, S.M.; Hoskin, S.O. The effects of tannin-rich plants on parasitic nematodes in ruminants. *Trends Parasitol.* **2006**, *22*, 253–261. [CrossRef] [PubMed]
15. Tchoumchoua, J.; Mathiron, D.; Pontarin, N.; Gagneul, D.; van Bohemen, A.-I.; Otogo N’ngang, E.; Mesnard, F.; Petit, E.; Fontaine, J.-X.; Molinié, R.; et al. Phenolic profiling of flax highlights contrasting patterns in winter and spring varieties. *Molecules* **2019**, *24*, 4303. [CrossRef] [PubMed]
16. Deborde, C.; Fontaine, J.-X.; Jacob, D.; Botana, A.; Nicaise, V.; Richard-Forget, F.; Lecomte, S.; Decourtil, C.; Hamade, K.; Mesnard, F.; et al. Optimizing 1D 1H-NMR profiling of plant samples for high throughput analysis: Extract preparation, standardization, automation and spectra processing. *Metabolomics* **2019**, *15*, 28. [CrossRef] [PubMed]
17. Jacob, D.; Deborde, C.; Lefebvre, M.; Maucourt, M.; Moing, A. NMRProcFlow: A graphical and interactive tool dedicated to 1D spectra processing for NMR-based metabolomics. *Metabolomics* **2017**, *13*, 36. [CrossRef] [PubMed]
18. Fouré, M.; Dugardin, C.; Foligné, B.; Hance, P.; Cadalen, T.; Delcourt, A.; Taminiau, B.; Daube, G.; Ravallec, R.; Cudennec, B.; et al. Chicory roots for prebiotics and appetite regulation: A pilot study in mice. *J. Agric. Food Chem.* **2018**, *66*, 6439–6449. [CrossRef]
19. Willeman, H. Contribution à la Recherche des Composés Impliqués dans L’amertume de la Racine de Chicorée: Approches Métabolomique et Sensorielle de L’influence de la Torréfaction. Ph.D. Thesis, University of Lille, Lille, France, 2016. Available online: <https://www.theses.fr/2016LIL10222> (accessed on 21 January 2022).
20. Obafemi, C.A.; Sulaimon, T.O.; Akinpelu, D.A.; Olugbade, T.A. Antimicrobial activity of extracts and a germacranolidetype sesquiterpene lactone from *Tithonia diversifolia* leaf extract. *Afr. J. Biotechnol.* **2006**, *5*, 1254–1258. [CrossRef]
21. Passos, C.P.; Costa, R.M.; Ferreira, S.S.; Lopes, G.R.; Cruz, M.T.; Coimbra, M.A. Role of coffee caffeine and chlorogenic acids adsorption to polysaccharides with impact on brew immunomodulation effects. *Foods* **2021**, *10*, 378. [CrossRef]
22. Rognes, T.; Flouri, T.; Nichols, B.; Quince, C.; Mahé, F. VSEARCH: A versatile open source tool for metagenomics. *Peer J.* **2016**, *4*, e2584. [CrossRef] [PubMed]
23. Gérard, A.; El-Hajjaji, S.; Burteau, S.; Fall, P.A.; Pirard, B.; Taminiau, B.; Daube, G.; Sindic, M. Study of the microbial diversity of a panel of Belgian artisanal cheeses associated with challenge studies for *Listeria monocytogenes*. *Food Microbiol.* **2021**, *100*, 103861. [CrossRef] [PubMed]

24. Ma, X.; Tian, X.; Huang, X.; Yan, F.; Qiao, D. Resveratrol-induced mitochondrial dysfunction and apoptosis are associated with Ca²⁺ and mCICR-mediated MPT activation in HepG2 cells. *Mol. Cell. Biochem.* **2007**, *302*, 99–109. [[CrossRef](#)] [[PubMed](#)]
25. Aruoma, O.I.; Halliwell, B.; Hoey, B.M.; Butler, J. The antioxidant action of N-acetylcysteine: Its reaction with hydrogen peroxide, hydroxyl radical, superoxide, and hypochlorous acid. *Free Radical Biol. Med.* **1989**, *6*, 593–597. [[CrossRef](#)]
26. Halliwell, B.; Gutteridge, J.M.; Aruoma, O.I. The deoxyribose method: A simple “test-tube” assay for determination of rate constants for reactions of hydroxyl radicals. *Anal. Biochem.* **1987**, *165*, 215–219. [[CrossRef](#)]
27. Heurtier, V.; Owens, N.; Gonzalez, L.; Mueller, F.; Proux, C.; Mornico, D.; Clerc, P.; Dubois, A.; Navarro, P. The molecular logic of Nanog-induced self-renewal in mouse embryonic stem cells. *Nat. Commun.* **2019**, *10*, 1109. [[CrossRef](#)]
28. Gong, S.; Li, Q.; Jeter, C.R.; Fan, Q.; Tang, D.G.; Liu, B. Regulation of NANOG in cancer cells. *Mol. Carcinog.* **2015**, *54*, 679–687. [[CrossRef](#)]
29. Gawlik-Rzemieniewska, N.; Bednarek, I. The role of NANOG transcriptional factor in the development of malignant phenotype of cancer cells. *Cancer Biol. Ther.* **2016**, *17*, 1–10. [[CrossRef](#)]
30. Santaliz-Ruiz, L.E.; Xie, X.; Old, M.; Teknos, T.N.; Pan, Q. Emerging role of nanog in tumorigenesis and cancer stem cells. *Int. J. Cancer* **2014**, *135*, 2741–2748. [[CrossRef](#)]
31. O’Leary, V.B.; Ovsepian, S.V.; Smida, J.; Atkinson, M.J. PARTICLE—The RNA podium for genomic silencers. *J. Cell. Physiol.* **2019**, *234*, 19464–19470. [[CrossRef](#)]
32. O’Leary, V.B.; Hain, S.; Maugg, D.; Smida, J.; Azimzadeh, O.; Tapio, S.; Ovsepian, S.V.; Atkinson, M.J. Long non-coding RNA PARTICLE bridges histone and DNA methylation. *Sci. Rep.* **2017**, *7*, 1790. [[CrossRef](#)] [[PubMed](#)]
33. O’Leary, V.B.; Smida, J.; Buske, F.A.; Carrascosa, L.G.; Azimzadeh, O.; Maugg, D.; Hain, S.; Tapio, S.; Heidenreich, W.; Kerr, J.; et al. PARTICLE triplexes cluster in the tumor suppressor WWOX and may extend throughout the human genome. *Sci. Rep.* **2017**, *7*, 7163. [[CrossRef](#)] [[PubMed](#)]
34. Delbridge, A.R.D.; Valente, L.J.; Strasser, A. The role of the apoptotic machinery in tumor suppression. *Cold Spring Harbor Perspect. Biol.* **2012**, *4*, a008789. [[CrossRef](#)] [[PubMed](#)]
35. Finsterbusch, F.; Ravindranathan, R.; Dereli, I.; Stanzione, M.; Tränkner, D.; Tóth, A. Alignment of homologous chromosomes and effective repair of programmed DNA double-strand breaks during mouse meiosis require the minichromosome maintenance domain containing 2 (MCMDC2) protein. *PLoS Genet.* **2016**, *12*, e1006393. [[CrossRef](#)]
36. Parr, C.; Jiang, W.G. Metastasis suppressor 1 (MTSS1) demonstrates prognostic value and anti-metastatic properties in breast cancer. *Eur. J. Cancer* **2009**, *45*, 1673–1683. [[CrossRef](#)] [[PubMed](#)]
37. Du, P.; Ye, L.; Yang, Y.; Jiang, W.G. The tumour suppressive role of metastasis suppressor-1, MTSS1, in human kidney cancer, a possible connection with the SHH pathway. *J. Exp. Ther. Oncol.* **2012**, *10*, 91–99.
38. Wang, X.X.; Liu, B.B.; Wu, X.; Su, D.; Zhu, Z.; Fu, L. Loss of leucine zipper putative tumor suppressor 1 (LZTS1) expression contributes to lymph node metastasis of breast invasive micropapillary carcinoma. *Pathol. Oncol. Res.* **2015**, *21*, 1021–1026. [[CrossRef](#)]
39. Yan, W.; Bai, Z.; Wang, J.; Li, X.; Chi, B.; Chen, X. ANP32A modulates cell growth by regulating p38 and Akt activity in colorectal cancer. *Oncol. Rep.* **2017**, *38*, 1605–1612. [[CrossRef](#)]
40. Shi, Z.; Li, Z.; Li, Z.J.; Cheng, K.; Du, Y.; Fu, H.; Khuri, F.R. Cables1 controls p21/Cip1 protein stability by antagonizing proteasome subunit alpha type 3. *Oncogene* **2015**, *34*, 2538–2545. [[CrossRef](#)]
41. Murakami, T.; Takano, R.; Takeo, S.; Taniguchi, R.; Ogawa, K.; Ohashi, E.; Tsurimoto, T. Stable interaction between the human proliferating cell nuclear antigen loader complex Ctf18-replication factor C (RFC) and DNA polymerase ϵ is mediated by the cohesion-specific subunits, Ctf18, Dcc1, and Ctf8. *J. Biol. Chem.* **2010**, *285*, 34608–34615. [[CrossRef](#)]
42. Saleem, M.; Abbas, K.; Naseer, F.; Ahmad, M.; Syed, N.H.; Javed, F.; Hussain, K.; Asima, S. Anticancer activity of n-hexane extract of *Cichorium intybus* on lymphoblastic leukemia cells (*Jurkat cells*). *Afr. J. Plant Sci.* **2014**, *8*, 315–319. [[CrossRef](#)]
43. Mehmandish, R.; Awasat Mellati, A.; Rahimpour, A.; Dehghan Nayeri, N. Anti-cancer activity of methanol extracts of *Cichorium intybus* on human breast cancer SKBR3 cell line. *Razavi Int. J. Med.* **2016**, *5*, 1–4. [[CrossRef](#)]
44. You, Y.; Zhou, C.; Li, D.; Cao, Z.L.; Shen, W.; Li, W.Z.; Zhang, S.; Hu, B.; Shen, X. Sorting nexin 10 acting as a novel regulator of macrophage polarization mediates inflammatory response in experimental mouse colitis. *Sci. Rep.* **2016**, *6*, 20630. [[CrossRef](#)] [[PubMed](#)]
45. Eichin, D.; Pessia, A.; Takeda, A.; Laakkonen, J.; Bellmann, L.; Kankainen, M.; Imhof, B.A.; Stoitznner, P.; Tang, J.; Salmi, M.; et al. CD73 contributes to anti-inflammatory properties of afferent lymphatic endothelial cells in humans and mice. *Eur. J. Immunol.* **2021**, *51*, 231–246. [[CrossRef](#)] [[PubMed](#)]
46. Liu, B.; Yang, R.; Wong, K.A.; Getman, C.; Stein, N.; Teitell, M.A.; Cheng, G.; Wu, H.; Shuai, K. Negative regulation of NF- κ B signaling by PIAS1. *Mol. Cell Biol.* **2005**, *25*, 1113–1123. [[CrossRef](#)]
47. Narayana, S.V.; Carson, M.; el-Kabbani, O.; Kilpatrick, J.M.; Moore, D.; Chen, X.; Bugg, C.E.; Volanakis, J.E.; DeLucas, L.J. Structure of human factor D. A complement system protein at 2.0 Å resolution. *J. Mol. Biol.* **1994**, *235*, 695–708. [[CrossRef](#)]
48. Ripoll, C.; Schmidt, B.M.; Ilic, N.; Poulev, A.; Dey, M.; Kurmukov, A.G.; Raskin, I. Anti-inflammatory effects of a sesquiterpene lactone extract from chicory (*Cichorium intybus* L.) roots. *Nat. Prod. Commun.* **2007**, *2*, 1934578X0700200. [[CrossRef](#)]
49. Matos, M.S.; Anastácio, J.D.; Allwood, J.W.; Carregosa, D.; Marques, D.; Sungurtas, J.; McDougall, G.J.; Menezes, R.; Matias, A.A.; Stewart, D.; et al. Assessing the intestinal permeability and anti-inflammatory potential of sesquiterpene lactones from chicory. *Nutrients* **2020**, *12*, 3547. [[CrossRef](#)]

50. Meo, S.A.; Al-Asiri, S.A.; Mahesar, A.L.; Ansari, M.J. Role of honey in modern medicine. *Saudi J. Biol. Sci.* **2017**, *24*, 975–978. [[CrossRef](#)]
51. Nowrouzi, P.; Mazani, M.; Rezagholizadeh, L.; Banaei, S. Mechanism and clinical aspects of the effects of chicory on diabetes. *Asian J. Res. Med. Pharm. Sci.* **2017**, *1*, 1–11. [[CrossRef](#)]
52. Nishimura, M.; Ohkawara, T.; Kanayama, T.; Kitagawa, K.; Nishimura, H.; Nishihira, J. Effects of the extract from roasted chicory (*Cichorium intybus* L.) root containing inulin-type fructans on blood glucose, lipid metabolism, and fecal properties. *J. Tradit. Complement. Med.* **2015**, *5*, 161–167. [[CrossRef](#)] [[PubMed](#)]
53. Minné, E.; Waghorn, G.; Lee, J.; Clark, C. Including chicory or plantain in a perennial ryegrass/white clover-based diet of dairy cattle in late lactation: Feed intake, milk production and rumen digestion. *Anim. Feed Sci. Technol.* **2017**, *227*, 52–61. [[CrossRef](#)]
54. Niderkorn, V.; Martin, C.; Bernard, M.; le Morvan, A.; Rochette, Y.; Baumont, R. Effect of increasing the proportion of chicory in forage-based diets on intake and digestion by sheep. *Animal* **2019**, *13*, 718–726. [[CrossRef](#)] [[PubMed](#)]
55. Khoobani, M.; Hasheminezhad, S.H.; Javandel, F.; Nosrati, M.; Seidavi, A.; Kadim, I.T.; Laudadio, V.; Tufarelli, V. Effects of dietary chicory (*Chicorium intybus* L.) and probiotic blend as natural feed additives on performance traits, blood biochemistry, and gut microbiota of broiler chickens. *Antibiotics* **2019**, *9*, 5. [[CrossRef](#)] [[PubMed](#)]
56. Chien, K.L.; Fang, W.H.; Wen, H.C.; Lin, H.P.; Lin, Y.L.; Lin, S.W.; Wu, J.H.; Kao, J.T. APOA1/C3/A5 haplotype and risk of hypertriglyceridemia in Taiwanese. *Clin. Chim. Acta* **2008**, *390*, 56–62. [[CrossRef](#)]
57. Plump, A.S.; Azrolan, N.; Odaka, H.; Wu, L.; Jiang, X.; Tall, A.; Eisenberg, S.; Breslow, J.L. ApoA-I knockout mice: Characterization of HDL metabolism in homozygotes and identification of a post-RNA mechanism of apoA-I up-regulation in heterozygotes. *J. Lipid Res.* **1997**, *38*, 1033–1047. [[CrossRef](#)]
58. Vanhooren, J.C.T.; Fransen, M.; Bethune, B.; Baumgart, E.; Baes, M.; Torrekens, S.; Leuven, F.; Mannaerts, G.P.; Veldhoven, P.P. Rat Pristanoyl-CoA Oxidase. cDNA Cloning and recognition of its C-Terminal (SQL) by the peroxisomal-targeting signal 1 receptor. *Eur. J. Biochem.* **1996**, *239*, 302–309. [[CrossRef](#)]
59. Aoki, J.; Inoue, A.; Okudaira, S. Two pathways for lysophosphatidic acid production. *Biochim. Biophys. Acta Mol. Cell Biol. Lipids* **2008**, *1781*, 513–518. [[CrossRef](#)]
60. Chen, C.; Wang, H.; Chen, B.; Chen, D.; Lu, C.; Li, H.; Qian, Y.; Tan, Y.; Weng, H.; Cai, L. Pex11a deficiency causes dyslipidaemia and obesity in mice. *J. Cell. Mol. Med.* **2018**, *23*, 2020–2031. [[CrossRef](#)]
61. Weng, H.; Ji, X.; Naito, Y.; Endo, K.; Ma, X.; Takahashi, R.; Shen, C.; Hirokawa, G.; Fukushima, Y.; Iwai, N. Pex11 α deficiency impairs peroxisome elongation and division and contributes to nonalcoholic fatty liver in mice. *Am. J. Physiol. Endocrinol. Metab.* **2013**, *304*, E187–E196. [[CrossRef](#)]
62. Joshi, A.; Rajput, S.; Wang, C.; Ma, J.; Cao, D. Murine aldo-keto reductase family 1 subfamily B: Identification of AKR1B8 as an ortholog of human AKR1B10. *Biol. Chem.* **2010**, *391*, 1371–1378. [[CrossRef](#)] [[PubMed](#)]
63. Zoöller, I.; Meixner, M.; Hartmann, D.; Bussow, H.; Meyer, R.; Gieselmann, V.; Eckhardt, M. Absence of 2-hydroxylated sphingolipids is compatible with normal neural development but causes late-onset axon and myelin sheath degeneration. *J. Neurosci.* **2008**, *28*, 9741–9754. [[CrossRef](#)] [[PubMed](#)]
64. Garman, S.C.; Garboczi, D.N. The molecular defect leading to Fabry disease: Structure of human α -galactosidase. *J. Mol. Biol.* **2004**, *337*, 319–335. [[CrossRef](#)] [[PubMed](#)]
65. Prolo, P.; Wong, M.L.; Licinio, J. Leptin. *Int. J. Biochem. Cell Biol.* **1998**, *30*, 1285–1290. [[CrossRef](#)]
66. van Wijk, R.; van Solinge, W.W. The energy-less red blood cell is lost: Erythrocyte enzyme abnormalities of glycolysis. *Blood* **2005**, *106*, 4034–4042. [[CrossRef](#)]
67. Wang, L.; Tong, X.; Gu, F.; Zhang, L.; Chen, W.; Cheng, X.; Xie, L.; Chang, Y.; Zhang, H. The KLF14 transcription factor regulates hepatic gluconeogenesis in mice. *J. Biol. Chem.* **2017**, *292*, 21631–21642. [[CrossRef](#)]
68. Erejuwa, O.O.; Sulaiman, S.A.; Wahab, M.S.A. Fructose might contribute to the hypoglycemic effect of honey. *Molecules* **2012**, *17*, 1900–1915. [[CrossRef](#)]
69. Jin, T. Mechanisms underlying proglucagon gene expression. *J. Endocrinol.* **2008**, *198*, 17–28. [[CrossRef](#)]
70. Cai, T.; Chen, X.; Wang, R.; Xu, H.; You, Y.; Zhang, T.; Lan, M.S.; Notkins, A.L. Expression of insulinoma-associated 2 (INSM2) in pancreatic islet cells is regulated by the transcription factors Ngn3 and NeuroD1. *Endocrinology* **2011**, *152*, 1961–1969. [[CrossRef](#)]
71. Jassal, B.; Matthews, L.; Viteri, G.; Gong, C.; Lorente, P.; Fabregat, A.; Sidiropoulos, K.; Cook, J.; Gillespie, M.; Haw, R.; et al. The reactome pathway knowledgebase. *Nucleic Acids Res.* **2020**, *48*, D498–D503. [[CrossRef](#)]
72. Seino, Y.; Fukushima, M.; Yabe, D. GIP and GLP-1, the two incretin hormones: Similarities and differences. *J. Diabetes Investig.* **2010**, *1*, 8–23. [[CrossRef](#)] [[PubMed](#)]
73. Lepczyński, A.; Herosimczyk, A.; Ożgo, M.; Barszcz, M.; Taciak, M.; Skomial, J. Modification of ileal proteome in growing pigs by dietary supplementation with inulin or dried chicory root. *J. Anim. Feed Sci.* **2019**, *28*, 177–186. [[CrossRef](#)]
74. Matsuoka, Y.; Li, X.; Bennett, V. Adducin: Structure, function and regulation. *Cell. Mol. Life Sci.* **2000**, *57*, 884–895. [[CrossRef](#)] [[PubMed](#)]
75. Kiang, K.M.Y.; Leung, G.K.K. A review on adducin from functional to pathological mechanisms: Future direction in cancer. *BioMed Res. Int.* **2018**, *2018*, 3465929. [[CrossRef](#)] [[PubMed](#)]
76. McClard, C.K.; Kochukov, M.Y.; Herman, I.; Liu, Z.; Eblimit, A.; Moayed, Y.; Ortiz-Guzman, J.; Colchado, D.; Pekarek, B.; Panneerselvam, S.; et al. POU6f1 mediates neuropeptide-dependent plasticity in the adult brain. *J. Neurosci.* **2018**, *38*, 1443–1461. [[CrossRef](#)]

77. Berkemeier, L.R.; Winslow, J.W.; Kaplan, D.R.; Nikolics, K.; Goeddel, D.V.; Rosenthal, A. Neurotrophin-5: A novel neurotrophic factor that activates trk and trkB. *Neuron* **1991**, *7*, 857–866. [[CrossRef](#)]
78. Liebl, D.J.; Mbiene, J.P.; Parada, L.F. NT4/5 mutant mice have deficiency in gustatory papillae and taste bud formation. *Dev. Biol.* **1999**, *213*, 378–389. [[CrossRef](#)]
79. Moretti, P.; Levenson, J.M.; Battaglia, F.; Atkinson, R.; Teague, R.; Antalffy, B.; Armstrong, D.; Arancio, O.; Sweatt, J.D.; Zoghbi, H.Y. Learning and memory and synaptic plasticity are impaired in a mouse model of Rett syndrome. *J. Neurosci.* **2006**, *26*, 319–327. [[CrossRef](#)]
80. Schlager, M.A.; Kapitein, L.C.; Grigoriev, I.; Burzynski, G.M.; Wulf, P.S.; Keijzer, N.; de Graaf, E.; Fukuda, M.; Shepherd, I.T.; Akhmanova, A.; et al. Pericentrosomal targeting of Rab6 secretory vesicles by bicaudal-D-related protein 1 (BICDR-1) regulates neurogenesis. *EMBO J.* **2010**, *29*, 1637–1651. [[CrossRef](#)]
81. Peeters, P.J.; Baker, A.; Goris, I.; Daneels, G.; Verhasselt, P.; Luyten, W.H.; Geysen, J.J.; Kass, S.U.; Moechars, D.W. Sensory deficits in mice hypomorphic for a mammalian homologue of unc-53. *Dev. Brain Res.* **2004**, *150*, 89–101. [[CrossRef](#)]
82. Seco, C.Z.; Oonk, A.M.; Domínguez-Ruiz, M.; Draaisma, J.M.; Gandía, M.; Oostrik, J.; Neveling, K.; Kunst, H.P.; Hoefsloot, L.H.; del Castillo, I.; et al. Progressive hearing loss and vestibular dysfunction caused by a homozygous nonsense mutation in CLIC5. *Eur. J. Hum. Genet.* **2014**, *23*, 189–194. [[CrossRef](#)] [[PubMed](#)]
83. Shirokova, E.; Raguse, J.D.; Meyerhof, W.; Krautwurst, D. The human vomeronasal type-1 receptor family—Detection of volatiles and cAMP signaling in HeLa/Olf cells. *FASEB J.* **2008**, *22*, 1416–1425. [[CrossRef](#)] [[PubMed](#)]
84. Young, J.M.; Shykind, B.M.; Lane, R.P.; Tonnes-Priddy, L.; Ross, J.A.; Walker, M.; Williams, E.M.; Trask, B.J. Odorant receptor expressed sequence tags demonstrate olfactory expression of over 400 genes, extensive alternate splicing and unequal expression levels. *Genome Biol.* **2003**, *4*, R71. [[CrossRef](#)] [[PubMed](#)]
85. Basch, M.L.; Bronner-Fraser, M.; García-Castro, M.I. Specification of the neural crest occurs during gastrulation and requires Pax7. *Nature* **2006**, *441*, 218–222. [[CrossRef](#)] [[PubMed](#)]
86. Barman, A.; Assmann, A.; Richter, S.; Soch, J.; Schütze, H.; Wüstenberg, T.; Deibele, A.; Klein, M.; Richter, A.; Behnisch, G.; et al. Genetic variation of the RASGRF1 regulatory region affects human hippocampus-dependent memory. *Front. Hum. Neurosci.* **2014**, *8*, 260. [[CrossRef](#)] [[PubMed](#)]
87. Li, H.L.; Li, Z.; Qin, L.Y.; Liu, S.; Lau, L.T.; Han, J.S.; Yu, A.C.H. The novel neurotrophin-regulated neuronal development-associated protein, NDAP, mediates apoptosis. *FEBS Lett.* **2006**, *580*, 1723–1728. [[CrossRef](#)] [[PubMed](#)]
88. Niu, S.; Shingle, D.L.; Garbarino-Pico, E.; Kojima, S.; Gilbert, M.; Green, C.B. The circadian deadenylase nocturnin is necessary for stabilization of the iNOS mRNA in mice. *PLoS ONE* **2011**, *6*, e26954. [[CrossRef](#)]
89. Payant, M.A.; Chee, M.J. Neural mechanisms underlying the role of fructose in overfeeding. *Neurosci. Biobehav. Rev.* **2021**, *128*, 346–357. [[CrossRef](#)]
90. Wijlens, A.; Mars, M.; Dull, D.; de Graaf, K. Short term effect of chicory root fibre on appetite ratings and energy intake. *Appetite* **2013**, *71*, 490. [[CrossRef](#)]
91. Crean, D.; Bellwon, P.; Aschauer, L.; Limonciel, A.; Moenks, K.; Hewitt, P.; Schmidt, T.; Herrgen, K.; Dekant, W.; Lukas, A.; et al. Development of an in vitro renal epithelial disease state model for xenobiotic toxicity testing. *Toxicol. Vitro.* **2015**, *30*, 128–137. [[CrossRef](#)]
92. Capasso, M.; Bhamrah, M.K.; Henley, T.; Boyd, R.S.; Langlais, C.; Cain, K.; Dinsdale, D.; Pulford, K.; Khan, M.; Musset, B.; et al. HVCN1 modulates BCR signal strength via regulation of BCR-dependent generation of reactive oxygen species. *Nat. Immunol.* **2010**, *11*, 265–272. [[CrossRef](#)] [[PubMed](#)]
93. Zhou, S.G.; Wang, P.; Pi, R.B.; Gao, J.; Fu, J.J.; Fang, J.; Qin, J.; Zhang, H.J.; Li, R.F.; Chen, S.R.; et al. Reduced expression of GSTM2 and increased oxidative stress in spontaneously hypertensive rat. *Mol. Cell. Biochem.* **2008**, *309*, 99–107. [[CrossRef](#)] [[PubMed](#)]
94. Tornio, A.; Backman, J.T. Cytochrome P450 in pharmacogenetics: An update. *Adv. Pharmacol.* **2018**, *83*, 3–32. [[CrossRef](#)] [[PubMed](#)]
95. Jasim, R.S. Antioxidant, antimicrobial activities and phytochemical constituents of *Cichorium intybus* L. *Aerial Parts. Int. J. Bot.* **2018**, *14*, 24–29. [[CrossRef](#)]
96. Turnbaugh, P.J.; Bäckhed, F.; Fulton, L.; Gordon, J.I. Diet-induced obesity is linked to marked but reversible alterations in the mouse distal gut microbiome. *Cell Host Microbe* **2008**, *3*, 213–223. [[CrossRef](#)]
97. Wen, L.; Ley, R.E.; Volchkov, P.Y.; Stranges, P.B.; Avanesyan, L.; Stonebraker, A.C.; Hu, C.; Wong, F.S.; Szot, G.L.; Bluestone, J.A.; et al. Innate immunity and intestinal microbiota in the development of Type 1 diabetes. *Nature* **2008**, *455*, 1109–1113. [[CrossRef](#)]
98. Braak, H.; de Vos, R.A.; Bohl, J.; del Tredici, K. Gastric α -synuclein immunoreactive inclusions in Meissner’s and Auerbach’s plexuses in cases staged for Parkinson’s disease-related brain pathology. *Neurosci. Lett.* **2006**, *396*, 67–72. [[CrossRef](#)]
99. Jin, M.; Li, J.; Liu, F.; Lyu, N.; Wang, K.; Wang, L.; Liang, S.; Tao, H.; Zhu, B.; Alkassir, R. Analysis of the gut microflora in patients with Parkinson’s disease. *Front. Neurosci.* **2019**, *13*, 1184. [[CrossRef](#)]
100. Trzeciak, P.; Herbet, M. Role of the Intestinal microbiome, intestinal barrier and psychobiotics in depression. *Nutrients* **2021**, *13*, 927. [[CrossRef](#)]
101. Sarkar, A.; Lehto, S.M.; Harty, S.; Dinan, T.G.; Cryan, J.F.; Burnet, P.W. Psychobiotics and the manipulation of bacteria–gut–brain signals. *Trends Neurosci.* **2016**, *39*, 763–781. [[CrossRef](#)]
102. Medlock, G.L.; Carey, M.A.; McDuffie, D.G.; Mundy, M.B.; Giallourou, N.; Swann, J.R.; Kolling, G.L.; Papin, J.A. Inferring metabolic mechanisms of interaction within a defined gut microbiota. *Cell Syst.* **2018**, *7*, 245–257.e7. [[CrossRef](#)]

103. Ignacio, A.; Fernandes-Terra, F.; Watanabe, I.; Basso, P.J.; Câmara, N. Role of the microbiome in intestinal barrier function and immune defense. In *Microbiome and Metabolome in Diagnosis, Therapy, and Other Strategic Applications*, 1st ed.; Faintuch, J., Faintuch, S., Eds.; Academic Press: Boston, MA, USA, 2019; pp. 127–138. [[CrossRef](#)]
104. Clavel, T.; Lepage, P.; Charrier, C. The family Coriobacteriaceae. In *The Prokaryotes*, 1st ed.; Rosenberg, E., DeLong, E.F., Lory, S., Stackebrandt, E., Thompson, F., Eds.; Springer: Berlin/Heidelberg, Germany, 2014; pp. 201–238. [[CrossRef](#)]
105. Kim, H.N.; Joo, E.J.; Cheong, H.S.; Kim, Y.; Kim, H.L.; Shin, H.; Chang, Y.; Ryu, S. Gut microbiota and risk of persistent nonalcoholic fatty liver diseases. *J. Clin. Med.* **2019**, *8*, 1089. [[CrossRef](#)] [[PubMed](#)]
106. Liu, G.; Zhao, Q.; Wei, H. Characteristics of intestinal bacteria with fatty liver diseases and cirrhosis. *Ann. Hepatol.* **2019**, *18*, 796–803. [[CrossRef](#)]
107. Ruuskanen, M.O.; Åberg, F.; Männistö, V.; Havulinna, A.S.; Méric, G.; Liu, Y.; Loomba, R.; Vázquez-Baeza, Y.; Tripathi, A.; Valsta, L.M.; et al. Links between gut microbiome composition and fatty liver disease in a large population sample. *Gut Microbes* **2021**, *13*, 1–22. [[CrossRef](#)] [[PubMed](#)]
108. Maki, K.A.; Burke, L.A.; Calik, M.W.; Watanabe-Chailland, M.; Sweeney, D.; Romick-Rosendale, L.E.; Green, S.J.; Fink, A.M. Sleep fragmentation increases blood pressure and is associated with alterations in the gut microbiome and fecal metabolome in rats. *Physiol. Genom.* **2020**, *52*, 280–292. [[CrossRef](#)]
109. Kaakoush, N.O. Insights into the role of Erysipelotrichaceae in the human host. *Front. Cell. Infect. Microbiol.* **2015**, *5*, 84. [[CrossRef](#)]
110. Dinh, D.M.; Volpe, G.E.; Duffalo, C.; Bhalchandra, S.; Tai, A.K.; Kane, A.V.; Wanke, C.A.; Ward, H.D. Intestinal microbiota, microbial translocation, and systemic inflammation in chronic HIV infection. *J. Infect. Dis.* **2015**, *211*, 19–27. [[CrossRef](#)]
111. Bernard, G.; Gagneul, D.; Alves Dos Santos, H.; Etienne, A.; Hilbert, J.L.; Rambaud, C. Efficient genome editing using CRISPR/Cas9 technology in chicory. *Int. J. Mol. Sci.* **2019**, *20*, 1155. [[CrossRef](#)]

RÉSULTATS COMPLÉMENTAIRES

File S1. Mice body weight evolution (A) and standard food consumption (B) during chicory (Chic), fructose (Fru), chlorogenic acids (CGA) and sesquiterpene lactones (STL) supplemented diet for 30 days.

Body weight (grams) was continuously assessed during diet (n = 5 animals per group D0-D30). Data are expressed as means.

A

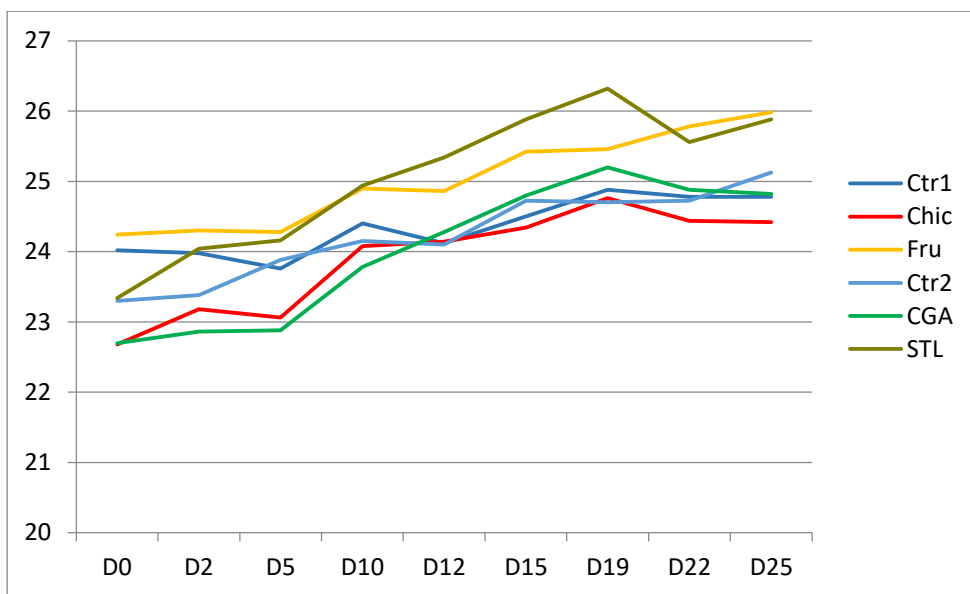

(A) Diet with chicory flour seems to trigger a no significant but sustained decrease in body weight in mice after 10 days of forced feeding. Fructose and STL administrated alone, as a supplement to the diet, generate a slight increase in weight in mice after 5-10 days of forced feeding.

B

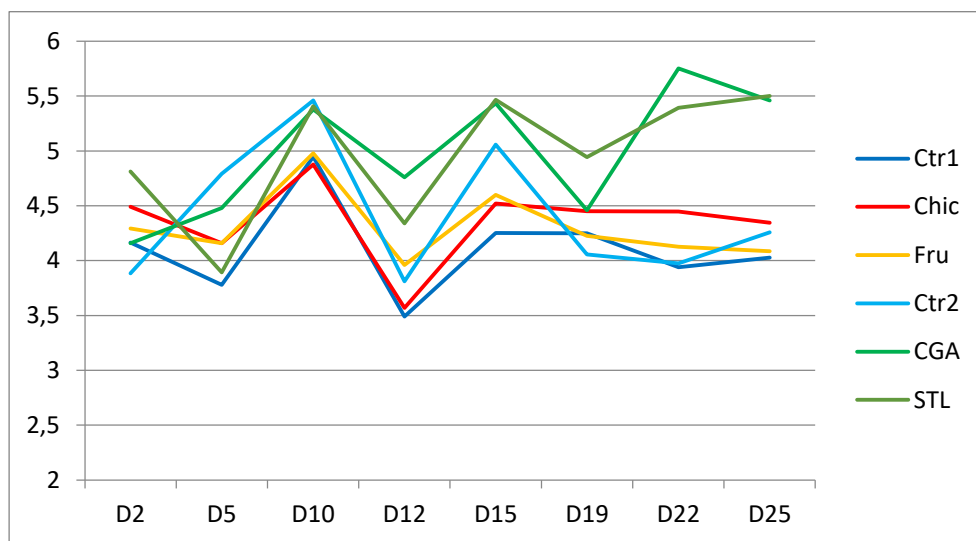

(B) When CGA and STL were administrated alone, mice increased progressively their food consumption. There was no increase observed for chicory or fructose-supplemented diets.

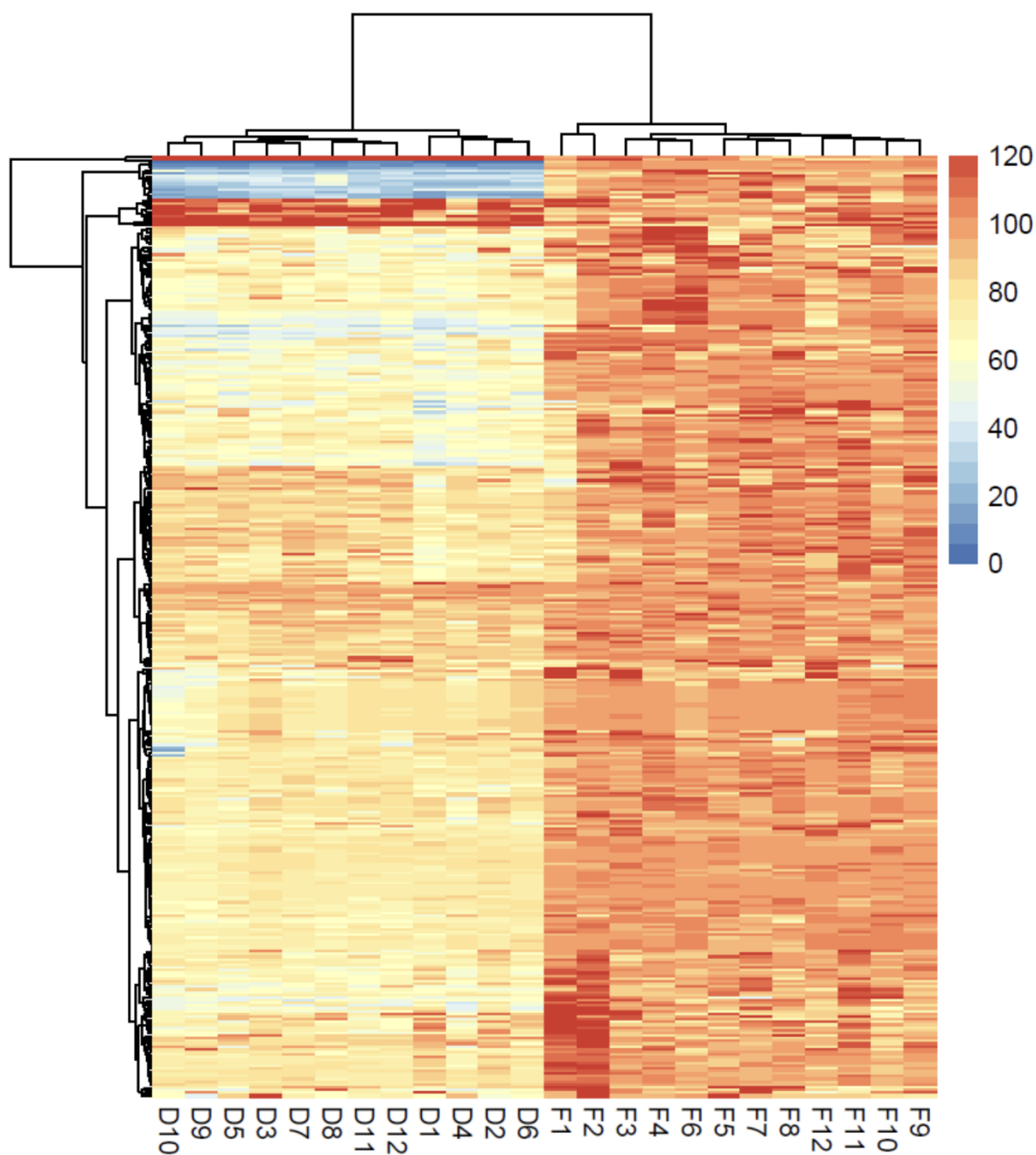

File S2. Heatmap of metabolite signals. A number of 161 metabolite signals were generated by $^1\text{H-NMR}$ and 148 signals by UPLC-HRMS (77 by positive and 71 by negative mode) for twelve replicates (1-12) of chicory flour (F) and decoction (D). Metabolite pick areas were expressed in percentage (100 % correspond to the mean for chicory flour) in the heatmap hierarchical clustering with the Ward's method.

Le tableau *File S3* a été séparé en quatre parties pour en faciliter la lecture.

File S3. Part 1. Gene expression profiles in mice liver tissue, ileum cells and caecum of mice during different diets
 Individual log₂FC (mouse 1-3) for up- and down-regulated genes in mice feed with chicory (Chic), fructose (Fru), chlorogenic acids (CGA) and lactone sesquiterpenes (STL) supplemented diet

Tissue	Name	GeneName	Chic			Fru			CGA			STL			Function	
			1	2	3	1	2	3	1	2	3	1	2	3		
Anti-cancer effect																
Liver	NM_028016	Nanog	-2.67	-2.94	-2.41	-2.45	-2.15	-2.53	0.00	0.00	0.00	0.00	0.00	0.00	0.00	Cell proliferation
Liver	NR_046011	Partcl	-0.73	-0.65	-0.75	0.00	0.00	0.00	0.00	0.00	0.00	-0.98	-0.92	-1.02	0.00	Apoptosis
Ileum	ENSMUST00000052843	Mcmrdc2	0.64	0.56	0.69	0.76	0.99	0.89	0.00	0.00	0.00	0.00	0.00	0.00	0.00	Cell cycle/ DNA repair
Ileum	NM_144800	Mtss1	1.24	1.48	0.88	0.00	0.00	0.00	0.53	0.65	0.29	0.51	0.82	0.53	0.00	Cell proliferation
Ileum	ENSMUST00000184961	Ltst1	0.42	0.65	0.50	0.84	0.95	0.60	0.88	1.43	0.61	1.33	1.21	1.08	0.00	Cell proliferation
Caecum	NM_009672	Anp32a	0.51	0.89	0.57	1.07	0.90	0.71	0.00	0.00	0.00	0.00	0.00	0.00	0.00	Cell proliferation
Caecum	NM_022021	Cablest1	0.54	0.90	0.58	1.06	0.81	0.50	0.00	0.00	0.00	0.00	0.00	0.00	0.00	Cell proliferation
Caecum	NM_009980	Ctbp2	0.55	0.87	0.58	1.23	0.96	0.80	0.00	0.00	0.00	0.00	0.00	0.00	0.00	Cell proliferation
Caecum	NM_145412	Chtf8	0.41	0.86	1.56	1.21	1.01	0.78	0.00	0.00	0.00	0.00	0.00	0.00	0.00	Cell cycle
Anti-inflammatory effect																
Liver	NM_028035	Srx10	-1.62	-1.41	-1.37	-1.18	-1.01	-1.36	0.00	0.00	0.00	0.00	0.00	0.00	0.00	Immunity/ Inflammation
Liver	NM_011851	Nt5e	1.06	0.94	1.15	0.62	0.93	1.01	0.37	0.29	0.64	0.42	0.49	0.40	0.00	Immunity/ Inflammation
Liver	ENSMUST00000098650	Rwdd3	0.91	0.97	1.37	0.86	2.12	1.69	0.00	0.00	0.00	0.00	0.00	0.00	0.00	Immunity/ Inflammation
Ileum	ENSMUST00000098650	Rwdd3	0.39	0.34	0.41	0.47	0.71	0.44	1.79	1.60	1.06	1.53	1.75	1.02	0.00	Immunity/ Inflammation
Caecum	NM_013459	Cfd	-0.78	-0.74	-0.98	-1.62	-1.04	-0.86	-0.78	-0.60	-0.60	-0.81	-0.60	-0.55	0.00	Immunity/ Inflammation
Antibacterial and antiviral effects																
Liver	NM_183249	Wfdc21	0.81	1.06	1.40	0.77	0.80	0.89	0.00	0.00	0.00	0.00	0.00	0.00	0.00	Innate mmunity
Liver	NM_001313743	Asb12	1.14	0.72	0.92	2.06	2.12	2.26	-2.20	-1.44	-2.19	-2.28	-2.43	-2.34	0.00	Innate mmunity
Liver	ENSMUST00000103444	Ighv5-4	0.68	0.71	0.66	0.66	0.88	0.56	0.00	0.00	0.00	0.00	0.00	0.00	0.00	Innate mmunity
Ileum	NM_007456	Aplm1	1.07	0.59	0.47	0.00	0.00	0.00	1.86	1.28	0.63	0.00	0.00	0.00	0.00	Host-virus interaction
Caecum	NM_001164598	If2bp2	0.59	0.86	0.33	1.41	1.04	0.85	0.00	0.00	0.00	0.00	0.00	0.00	0.00	Innate mmunity
Caecum	NM_011315	Saas3	0.64	1.02	0.95	1.14	0.84	0.90	0.00	0.00	0.00	0.00	0.00	0.00	0.00	Response to bacterium
Caecum	NM_027222	Mzbl1	0.57	1.04	0.50	1.20	1.01	0.79	0.00	0.00	0.00	0.00	0.00	0.00	0.00	Response to bacterium
Hypolipidemic effect																
Liver	NM_009692	Apoa1	0.61	0.97	1.09	0.00	0.00	0.00	0.51	0.67	0.53	0.00	0.00	0.00	0.00	Lipid metabolism
Liver	ENSMUST00000068563	Acox3	1.28	0.78	1.83	1.09	1.39	1.11	1.01	1.04	0.73	0.73	0.86	0.74	0.00	Lipid metabolism
Liver	NM_011068	Pex11a	1.15	1.04	0.80	1.07	1.32	0.99	0.00	0.00	0.00	0.00	0.00	0.00	0.00	Lipid metabolism
Ileum	NM_011068	Pex11a	0.52	0.62	0.29	0.80	0.77	0.81	0.00	0.00	0.00	0.00	0.00	0.00	0.00	Lipid metabolism
Ileum	NM_153404	Lipf	0.75	0.50	0.63	0.94	1.11	1.14	0.00	0.00	0.00	0.00	0.00	0.00	0.00	Lipid metabolism
Caecum	NM_178086	Fah	0.59	0.64	0.42	1.14	0.92	0.65	0.57	0.49	0.63	0.98	0.74	0.86	0.00	Lipid metabolism
Caecum	NM_008012	Akt1b8	0.82	0.91	0.96	1.40	1.21	0.98	0.42	0.76	0.85	0.74	0.57	0.58	0.00	Lipid metabolism

File S3. Part 2. Gene expression profiles in mice liver tissue, ileum cells and caecum of mice during different diets

Individual log2FC (mouse 1-3) for up- and down-regulated genes in mice feed with chicory (Chic), fructose (Fru), chlorogenic acids (CGA) and lactone sesquiterpenes (STL) supplemented diet

Tissue	Name	GeneName	Chic			Fru			CGA			STL			Function
			1	2	3	1	2	3	1	2	3	1	2	3	
Hypoglycemic effect															
Liver	NM_009415	Tp11	0.78	0.54	0.89	0.66	1.42	1.44	0.00	0.00	0.00	-1.71	-1.81	-1.68	Glycolysis/ Gluconeogenesis
Liver	NM_031183	Sp6	0.96	0.65	0.79	2.25	2.46	2.29	-2.09	-2.23	-2.09	-2.81	-2.47	-2.45	Hepatic gluconeogenesis
Liver	NM_008100	Gcg	-0.52	-0.63	-0.46	-0.77	-0.84	-0.86	0.00	0.00	0.00	-0.58	-0.61	-0.68	Glycemic regulation
Ileum	NM_020287	Insmt2	1.20	0.92	0.83	1.35	1.42	0.81	1.59	1.35	1.24	1.35	1.30	1.29	Pancreatic endocrine cell differentiation
Caecum	NM_013463	Gla	0.62	0.85	0.60	1.32	1.37	1.41	0.46	0.43	0.70	0.57	0.56	0.57	Galactose metabolism
Appetite regulation															
Caecum	NM_019951	Sec11a	0.54	0.48	0.46	0.96	0.61	0.66	0.00	0.00	0.00	0.00	0.00	0.00	Incretin synthesis/ GLP-1 synthesis/ Ghrelin synthesis
Intestinal absorption / Endoocytosis															
Ileum	NM_001331080	Add1	1.09	0.91	0.81	1.90	1.56	1.60	0.00	0.00	0.00	0.00	0.00	0.00	Actin cytoskeleton organization/ Actin filament bundle assembly
Neural and sensory development															
Liver	NM_010127	Pou6f1	0.55	0.95	1.26	0.81	1.39	1.29	0.00	0.00	0.00	0.00	0.00	0.00	Brain/ heart/muscle development
Liver	NM_198190	Ntf5	0.57	0.47	0.39	1.01	1.18	0.60	0.00	0.00	0.00	0.00	0.00	0.00	Neuronal development
Liver	NM_010788	Mecp2	0.89	1.04	1.47	1.15	0.68	0.88	0.00	0.00	0.00	0.00	0.00	0.00	Neuronal development
Liver	NM_175272	Naz2	0.90	0.83	0.52	0.42	1.12	0.82	0.00	0.00	0.00	0.00	0.00	0.00	Neuronal development
Liver	ENSMUST00000117847	Bicd11	0.66	0.59	0.72	0.65	0.98	0.68	0.00	0.00	0.00	0.00	0.00	0.00	Neuronal development
Liver	NM_172621	Clic5	0.55	0.95	0.68	1.33	1.69	1.20	0.00	0.00	0.00	0.00	0.00	0.00	Visual perception
Liver	NM_001166836	Vmn1r101	0.67	0.71	0.64	0.57	0.89	0.69	0.00	0.00	0.00	0.00	0.00	0.00	Smell/ pheromones perception
Liver	NM_146303	Olf11449	0.26	0.31	0.62	0.72	1.13	0.68	0.00	0.00	0.00	0.00	0.00	0.00	Smell perception
Ileum	NM_146569	Olf11014	0.99	0.84	0.85	1.33	1.21	1.37	0.00	0.00	0.00	0.00	0.00	0.00	Neural and sensory development
Ileum	NM_011039	Pax7	0.97	1.09	0.93	1.25	1.07	1.22	0.00	0.00	0.00	0.00	0.00	0.00	Neural crest development
Ileum	NM_001039655	Rasgr1	0.73	0.63	0.93	0.00	0.00	0.00	1.12	1.92	1.50	1.09	1.40	1.13	Long-term memory
Caecum	NM_133779	Pigt	0.51	0.73	0.75	1.17	1.08	1.50	0.00	0.00	0.00	-1.12	-1.23	-1.18	Neuron differentiation
Caecum	ENSMUST00000144826	Noct	1.33	0.81	1.22	0.00	0.00	0.00	0.00	0.00	0.00	1.95	1.06	1.57	Circadian rhythm
Anti-xenobiotic and antioxidant effect															
Liver	NM_013790	Abcc5	1.08	0.76	1.05	0.67	0.90	0.51	0.00	0.00	0.00	0.00	0.00	0.00	Xenobiotic defense
Liver	NM_001081148	Cyp2b23	0.92	0.62	0.96	0.74	1.01	0.98	0.52	0.68	0.45	0.00	0.00	0.00	Xenobiotic defense/ Redox metabolism
Liver	NM_007815	Cyp2c29	1.37	1.27	0.78	1.60	1.71	1.43	0.00	0.00	0.00	0.00	0.00	0.00	Xenobiotic defense/ Redox metabolism
Liver	NM_001042489	Hvtn1	0.47	0.37	0.68	0.70	1.46	0.85	0.00	0.00	0.00	0.00	0.00	0.00	Cell redox homeostasis
Ileum	NM_008183	Gstm2	0.49	0.85	0.34	0.75	1.26	0.95	0.55	0.61	0.70	0.00	0.00	0.00	Cell redox homeostasis
Ileum	NM_001100180	Cyp3a57	0.28	0.77	0.67	0.00	0.00	0.00	0.73	1.30	0.93	1.16	0.95	0.68	Xenobiotic defense
Other															
Ileum	NM_198006	Coa5	0.67	1.00	0.65	0.85	0.95	1.01	0.00	0.00	0.00	0.49	0.56	0.49	Respiratory chain
Caecum	NM_007749	Cox7c	-0.62	-0.56	-1.33	0.00	0.00	0.00	-0.55	-1.84	-1.21	-1.24	-0.93	-0.79	Respiratory chain
Caecum	NM_009789	S100g	-0.58	-0.86	-0.87	0.00	0.00	0.00	-0.84	-1.15	-0.97	-1.88	-2.02	-1.95	Ca2+ transport

File S3. Part 3. Gene expression profiles in mice liver tissue, ileum cells and caecum of mice during different diets

Individual log2FC (mouse 1-3) for up- and down-regulated genes in mice feed with chicory (Chic), fructose (Fru), chlorogenic acids (CGA) and lactone sesquiterpenes (STL) supplemented diet

Name	GeneName	Description
Anti-cancer effect		
NM_028016	Nanog	nanog homeobox
NR_046011	Partcl	promoter of Mat2a antisense radiation induced circulating long non-coding RNA
ENSMUST0000052843	Mcmndc2	minichromosome maintenance domain containing 2
NM_144800	Mts1	metastasis suppressor 1
ENSMUST0000184961	Lzts1	leucine zipper, putative tumor suppressor 1
NM_009672	Amp32a	acidic (leucine-rich) nuclear phosphoprotein 32 family, member A
NM_022021	Cables1	CDK5 and Abl enzyme substrate 1
NM_009980	Ctbp2	C-terminal binding protein 2
NM_145412	Ctff8	CTF8, chromosome transmission fidelity factor 8
Anti-inflammatory effect		
NM_028035	Snx10	sorting nexin 10
NM_011851	Nt5e	5' nucleotidase, ecto
ENSMUST0000098650	Rwdd3	RWD domain containing 3
ENSMUST0000098650	Rwdd3	RWD domain containing 3
NM_013459	Cfd	complement factor D (adipsin)
Antibacterial and antiviral effects		
NM_183249	Wfdc21	WAP four-disulfide core domain 21
NM_001313743	Asb12	ankyrin repeat and SOCS box-containing 12
ENSMUST00000103444	Ighv5-4	immunoglobulin heavy variable 5-4
NM_007456	Ap1m1	adaptor-related protein complex AP-1, mu subunit 1
NM_001164598	Irf2bp2	interferon regulatory factor 2 binding protein 2
NM_011315	Saa3	serum amyloid A 3
NM_027222	Mzb1	marginal zone B and B1 cell-specific protein 1
Hypolipidemic effect		
NM_009692	Apoa1	apolipoprotein A-1
ENSMUST0000068563	Acox3	pristanoyl-CoA oxidase
NM_011068	Pex11a	peroxisomal biogenesis factor 11 alpha
NM_011068	Pex11a	peroxisomal biogenesis factor 11 alpha
NM_153404	Liph	lipase, member H
NM_178086	Fzh	fatty acid 2-hydroxylase
NM_008012	Akr1b8	aldo-keto reductase family 1, member B8

File S3. Part 4. Gene expression profiles in mice liver tissue, ileum cells and caecum of mice during different diets

Individual log2FC (mouse 1-3) for up- and down-regulated genes in mice feed with chicory (Chic), fructose (Fru), chlorogenic acids (CGA) and lactone sesquiterpenes (STL) supplemented diet

Name	GeneName	Description
Hypoglycemic effect		
NM_009415	Tpi1	triosephosphate isomerase 1
NM_031183	Sp6	trans-acting transcription factor 6
NM_008100	Gcg	glucagon
NM_020287	Insrn2	insulinoma-associated 2
NM_013463	Gla	galactosidase, alpha
Appetite regulation		
NM_019951	Sec11a	SEC11 homolog A, signal peptidase complex subunit
Intestinal absorption / Endocytosis		
NM_001331080	Add1	adducin 1 (alpha)
Neural and sensory development		
NM_010127	Pou6f1	POU domain, class 6, transcription factor 1
NM_198190	Ntf5	neurotrophin 5
NM_010788	Mecp2	methyl CPG binding protein 2
NM_175272	Nav2	neuron navigator 2
ENSMUST00000117847	Bicd11	BICD family like cargo adaptor 1
NM_172621	Clic5	chloride intracellular channel 5
NM_001166836	Vmn1r101	vomeronasal 1 receptor 101
NM_146303	Olf1.449	olfactory receptor 1449
NM_146569	Olf1.014	olfactory receptor 1014
NM_011039	Pax7	paired box 7
NM_001039655	Rasgrf1	RAS protein-specific guanine nucleotide-releasing factor 1
NM_133779	Pigt	phosphatidylinositol glycan anchor biosynthesis, class T
ENSMUST00000144826	Noct	nocturnin
Anti-xenobiotic and antioxidant effect		
NM_013790	Abcc5	ATP-binding cassette, sub-family C (CFTR/MRP), member 5
NM_001081148	Cyp2b23	cytochrome P450, family 2, subfamily b, polypeptide 23
NM_007815	Cyp2c29	cytochrome P450, family 2, subfamily c, polypeptide 29
NM_001042489	Hvnc1	hydrogen voltage-gated channel 1
NM_008183	Gstm2	glutathione S-transferase, mu 2
NM_001100180	Cyp3a57	cytochrome P450, family 3, subfamily a, polypeptide 57
Other		
NM_198006	Coa5	cytochrome C oxidase assembly factor 5
NM_007749	Cox7c	cytochrome C oxidase subunit VIIc
NM_009789	S100g	S100 calcium binding protein G

File S4. GIP and leptin level in mice plasma, after 30 days of chicory, fructose, CGA and STL diet.

Statistical analysis was carried out using One-way ANOVA and Sidak's multiple comparisons test. Means \pm SD were calculated ($n \geq 3$) for each treatment. The mean values of all controls were standardized at 1 value.

		Control	Chic	Fru	CGA	STL
Leptin	n	8	3	5	3	4
	mean \pm SD	1 \pm 0.1259	0.6133 \pm 0.5126	0.9323 \pm 0.59	0.2716 \pm 0.1083	0.5588 \pm 0.4403
	p-val	X	0.4378	0.9953	0.0414	0.2415
GIP	n	8	4	5	4	4
	mean \pm SD	1 \pm 0,2492	1,15 \pm 0,3461	1,614 \pm 0,7258	1,26 \pm 0,2095	2,416 \pm 1,383
	p-val	X	0.9903	0.3544	0.9324	0.0086

Le tableau File S5 a été séparé en cinq parties pour en faciliter la lecture.

File S5 - Part 1. The operational taxonomic units (OTUs) identified with an abundance >0.1% in fecal microbiota of mice after different diets
Diets were supplemented with chicory flour (Chic), fructose (Fru), chloregenic acids (CGA) and lactone sesquiterpenes. CR1 – control related to Chic and Fru diet; CR2 – control related to CGA and STL diet (mice number 1-5).

Genus	CR1_D0					CR1_D30					Chic_D0					Chic_D30					Fru_D0					Fru_D30					
	1	2	3	4	5	1	2	3	4	5	1	2	3	4	5	1	2	3	4	5	1	2	3	4	5	1	2	3	4	5	
Coriobacteriales_gre	0.01	0.06	0.04	0.13	0.01	0.01	0.02	0.00	0.17	0.00	0.08	0.14	0.12	0.07	0.09	0.04	0.05	0.21	0.08	0.46	0.22	0.04	0.02	0.08	0.04	0.06	0.15	0.13	0.16	0.36	
Eggerthellaceae_gre	0.00	0.07	0.01	0.12	0.02	0.00	0.02	0.01	0.07	0.00	0.03	0.06	0.00	0.07	0.01	0.03	0.02	0.01	0.02	0.11	0.01	0.01	0.03	0.08	0.05	0.01	0.00	0.07	0.03	0.03	
Enterorhabdus	0.00	0.07	0.01	0.03	0.02	0.01	0.01	0.00	0.04	0.00	0.02	0.00	0.00	0.02	0.00	0.00	0.00	0.00	0.04	0.00	0.00	0.01	0.02	0.01	0.02	0.00	0.01	0.00	0.05	0.00	
Bacteroides	2.88	1.49	0.95	1.48	8.43	1.49	1.75	2.29	0.58	6.99	4.15	3.57	3.38	1.74	2.37	2.53	3.71	2.09	4.07	3.87	3.90	1.47	1.52	1.27	2.62	1.02	1.06	6.33	6.68	1.97	
Bacteroidales_gre	0.18	0.04	0.05	0.10	0.12	0.14	0.10	0.19	0.16	0.06	0.05	0.09	0.07	0.05	0.07	0.07	0.07	0.12	0.06	0.11	0.11	0.16	0.00	0.12	0.15	0.12	0.09	0.21	0.12	0.09	
Odoribacter	0.29	0.29	0.43	0.21	0.74	0.35	0.61	0.51	0.17	0.26	0.48	0.13	0.30	0.16	0.33	0.67	0.42	0.91	1.05	0.28	0.20	0.11	0.33	0.67	0.44	0.07	0.41	0.16	0.29	0.35	
Muribaculaceae_gre	41.25	15.41	12.39	26.90	25.91	17.18	15.75	32.61	34.28	23.93	14.25	24.19	23.49	19.13	20.35	27.05	30.22	21.85	19.73	40.50	18.86	24.10	6.24	15.90	31.60	34.41	16.70	44.76	10.08	29.58	
Muribaculum	0.68	0.20	0.09	0.51	0.34	0.78	0.32	3.08	2.18	0.00	0.73	0.52	1.38	0.56	0.11	0.30	1.11	1.50	0.31	0.26	0.17	0.34	0.09	0.08	0.36	0.89	0.02	0.46	0.14	0.81	
Alloprevotella	0.70	1.57	0.46	1.23	1.27	0.17	0.82	2.79	0.77	0.00	1.23	1.24	1.08	1.04	0.43	0.68	0.75	0.27	0.06	0.46	0.33	0.87	0.18	0.37	1.50	1.66	0.53	7.93	1.09	0.39	
Prevotellaceae_gre	0.07	0.00	0.01	0.00	0.01	0.00	0.01	0.00	0.02	0.00	0.04	0.01	0.03	0.00	0.00	0.11	0.00	0.00	0.01	0.00	0.00	0.02	0.01	0.01	0.00	0.01	0.00	0.00	0.01	0.01	
Prevotellaceae_UCG-001	5.04	2.08	1.14	1.40	3.20	1.85	1.43	0.60	4.65	1.02	2.52	2.99	4.45	1.18	0.03	9.42	4.31	5.66	3.28	1.47	2.96	2.30	0.73	1.37	5.67	3.95	2.57	2.46	1.12	5.37	
Alistipes	8.38	6.46	6.20	6.50	14.77	8.27	11.80	12.98	5.21	9.43	6.41	7.13	10.70	7.19	10.33	8.90	9.76	6.06	6.26	2.38	7.77	4.57	5.02	6.59	8.33	4.84	7.10	2.81	3.01	4.89	
Rikenella	0.40	0.30	0.64	0.40	0.31	1.11	0.46	0.60	0.28	0.06	0.77	0.39	0.76	0.57	0.58	0.68	0.44	0.23	1.12	0.47	0.30	0.55	0.42	0.45	0.39	0.74	0.52	0.54	0.25	0.36	
Rikenellaceae_RC9_gut_group	8.39	3.46	3.15	3.22	2.27	3.07	3.56	6.79	2.32	1.49	6.91	4.85	8.69	4.02	4.21	3.64	3.22	1.90	3.31	4.25	2.61	2.07	1.44	1.44	3.37	4.40	1.82	3.93	0.57	1.24	
Parabacteroides	0.06	0.03	0.01	0.09	0.38	0.02	0.06	0.04	0.28	0.07	0.03	0.37	0.08	0.01	0.01	0.13	0.03	0.03	0.03	0.05	0.01	0.06	0.00	0.01	0.02	0.11	0.01	0.03	0.00	0.18	
Tannerellaceae_gre	0.02	0.01	0.00	0.01	0.03	0.00	0.01	0.00	0.03	0.18	0.00	0.03	0.00	0.00	0.00	0.02	0.00	0.14	0.05	0.03	0.01	0.00	0.00	0.00	0.00	0.04	0.00	0.00	0.00	0.00	
Bacteroidia_gre	0.00	0.00	0.00	0.02	0.00	0.10	0.01	0.10	0.00	0.13	0.04	0.02	0.09	0.03	0.07	0.01	0.00	0.01	0.05	0.02	0.00	0.07	0.14	0.06	0.07	0.06	0.03	0.06	0.10	0.04	
Gastreaerophilales_gre	0.14	0.05	0.14	1.09	0.03	0.35	0.06	0.40	0.10	0.00	0.04	0.02	0.08	0.06	0.19	0.74	0.17	0.21	0.11	0.25	0.09	0.02	0.05	0.08	0.05	0.72	0.02	0.21	0.15	0.75	
Blifollia	0.01	0.09	0.14	0.02	0.05	0.10	0.01	0.10	0.00	0.13	0.01	0.00	0.08	0.03	0.00	0.01	0.00	0.01	0.05	0.02	0.00	0.07	0.14	0.06	0.07	0.06	0.03	0.06	0.10	0.04	
Desulfotribrio	0.07	0.13	0.23	0.14	0.05	0.13	0.07	0.14	0.10	0.21	0.08	0.01	0.16	0.06	0.13	0.03	0.05	0.16	0.07	0.20	0.05	0.22	0.19	0.12	0.03	0.08	0.10	0.14	0.13	0.09	
Anaeroplasma	0.01	0.08	0.08	0.04	0.04	0.03	0.07	0.27	0.03	0.31	0.01	0.00	0.08	0.03	0.00	0.22	0.05	0.01	0.30	0.08	0.30	0.31	0.08	0.19	0.19	0.51	0.09	0.14	0.35	0.08	
Evispidoirichaceae_gre	0.29	0.16	0.24	0.20	0.35	0.20	0.07	1.33	0.11	0.17	0.30	0.16	0.12	0.14	0.61	0.10	0.41	0.12	0.14	0.13	0.30	0.31	0.08	0.19	0.19	0.51	0.09	0.14	0.35	0.08	
Enterococcus	0.06	0.01	0.02	0.02	0.01	0.23	0.09	0.02	0.13	0.07	0.17	0.02	0.00	0.18	0.03	0.03	0.08	0.13	0.00	0.13	0.04	0.01	0.00	0.09	0.00	0.11	0.04	0.00	0.00	0.12	
Lactobacillus	0.79	0.91	2.75	2.11	0.91	1.33	0.50	0.78	5.75	1.39	1.47	0.65	1.25	1.56	0.65	0.90	0.81	0.99	1.16	1.46	0.80	2.45	17.31	1.66	0.03	2.21	10.29	1.08	0.48	5.20	
Streptococcus	0.03	0.03	0.01	0.00	0.01	0.03	0.01	0.02	0.04	0.09	0.06	0.09	0.09	0.01	0.05	0.00	0.04	0.04	0.02	0.02	0.02	0.07	0.01	0.05	0.04	0.04	0.06	0.00	0.00	0.01	
R39_gre	0.02	0.32	0.02	0.12	0.13	0.22	0.13	0.02	0.39	0.14	0.23	0.24	0.14	0.38	0.31	0.32	0.43	0.09	0.15	0.04	0.22	0.49	0.21	0.64	0.64	0.01	0.43	0.08	0.19	0.41	
Caldicoproba	0.00	0.00	0.00	0.01	0.03	0.01	0.09	0.00	0.05	0.00	0.00	0.09	0.00	0.00	0.01	0.07	0.06	0.05	0.00	0.02	0.01	0.00	0.00	0.00	0.00	0.01	0.00	0.02	0.00	0.00	0.12
Christensenellaceae_R-7_group	0.00	0.07	0.00	0.00	0.04	0.07	0.03	0.01	0.00	0.30	0.06	0.04	0.03	0.02	0.02	0.04	0.03	0.03	0.02	0.03	0.00	0.00	0.00	0.01	0.01	0.00	0.04	0.04	0.01	0.20	
Clostridia_gre	0.02	0.06	0.10	0.04	0.06	0.14	0.01	0.06	0.07	0.06	0.13	0.07	0.15	0.03	0.05	0.03	0.03	0.03	0.02	0.07	0.03	0.02	0.03	0.01	0.01	0.02	0.06	0.06	0.08	0.05	
Clostridia_UCG-014_gre	0.00	3.09	0.45	1.22	1.14	0.30	2.64	0.03	3.13	0.16	1.81	4.32	2.90	5.09	0.15	2.30	8.27	2.10	0.01	0.25	2.49	3.47	1.51	5.35	7.02	0.01	5.19	2.17	3.08	5.29	
Clostridia_yadinB60_group_gre	0.68	2.17	2.07	1.20	1.13	1.17	1.27	1.20	0.30	1.44	1.99	0.39	0.74	0.70	0.99	1.03	0.78	1.44	2.00	1.01	0.52	0.41	0.80	0.49	0.47	0.52	0.70	0.61	0.47	0.46	
Clostridium_yadinB60_group_gre	0.57	0.34	0.06	0.29	0.52	1.17	0.38	0.22	0.15	0.77	0.95	0.28	0.26	0.23	0.82	1.03	0.56	1.44	2.55	0.09	1.01	0.38	0.26	0.48	0.30	0.19	0.09	0.16	0.44	0.33	
Candidatus_Arthronomus	A2	0.07	1.93	0.22	0.17	0.09	0.16	0.08	0.22	0.15	0.12	0.05	0.09	0.10	0.24	0.02	0.11	0.21	1.25	0.07	0.03	0.14	0.40	0.26	0.05	0.16	0.26	0.18	0.34	0.09	
Acetatifactor	0.50	0.06	0.62	0.18	0.06	0.37	0.14	0.41	0.07	0.07	0.28	0.16	0.12	0.04	0.09	0.08	0.06	0.00	0.48	0.11	0.12	0.09	0.13	0.12	0.08	0.25	0.06	0.02	0.11	0.03	

File S5. Part 2. The operational taxonomic units (OTUs) identified with an abundance >0.1% in fecal microbiota of mice after different diets

Diets were supplemented with chicory flour (Chic), fructose (Fru), chlorogenic acids (CGA) and lactone sesquiterpenes. Ctr1 – control related to Chic and Fru diet; Ctr2 – control related to CGA and STL diet (mice)

Genus	Ctr2_D0					Ctr2_D30					CGA_D0					CGA_D30					STL_D0					STL_D30				
	1	2	4	5		1	2	4	5		1	2	3	4	5	1	2	3	4	5	1	2	3	4	5	1	2	3	4	5
Coriobacteriales_ge	0.14	0.28	0.03	0.09		0.02	0.20	0.25	0.26		0.12	0.06	0.05	0.07	0.04	0.09	0.09	0.00	0.10	0.62	0.16	0.04	0.28	0.11	0.02	0.10	0.08	0.13	0.04	0.11
Eggerthellaceae_ge	0.08	0.04	0.07	0.04		0.05	0.03	0.05	0.02		0.03	0.00	0.04	0.06	0.05	0.11	0.06	0.04	0.01	0.17	0.08	0.14	0.02	0.02	0.07	0.14	0.07	0.02	0.06	0.13
Enterorhabdus	0.06	0.04	0.07	0.05		0.02	0.00	0.01	0.01		0.01	0.02	0.03	0.01	0.00	0.05	0.08	0.01	0.03	0.06	0.00	0.02	0.04	0.01	0.00	0.15	0.05	0.04	0.00	0.03
Bacteroides	3.10	2.11	2.17	0.93		2.72	3.82	7.27	1.00		1.45	0.93	1.53	4.45	0.54	0.62	3.63	0.99	4.13	0.62	2.99	0.92	0.50	0.43	2.45	1.53	4.29	0.33	1.07	1.57
Bacteroidales_ge	0.09	0.22	0.04	0.07		0.21	0.09	0.06	0.08		0.02	0.11	0.11	0.15	0.00	0.08	0.12	0.20	0.08	0.12	0.05	0.01	0.02	0.03	0.03	0.26	0.15	0.00	0.08	0.00
Odoribacter	0.05	0.04	0.31	0.34		0.36	1.10	0.34	0.57		0.46	0.17	0.51	0.25	0.14	0.35	0.11	0.13	0.96	0.23	0.28	0.22	0.24	0.36	0.13	0.44	0.31	0.62	0.50	0.21
Muribaculaceae_ge	30.84	23.36	14.16	19.41		34.71	29.18	30.88	16.38		26.14	20.15	15.08	21.53	17.00	17.62	28.61	25.32	25.48	44.90	13.67	9.22	6.56	8.16	16.04	49.24	27.62	14.69	25.11	12.10
Muribaculum	0.38	0.52	0.05	0.08		0.50	1.11	0.67	0.08		0.55	0.21	0.10	0.40	0.02	0.32	0.36	0.25	0.76	0.77	0.40	0.06	0.04	0.13	0.58	0.95	0.44	0.07	0.39	0.23
Alloprevotella	0.98	1.84	0.61	0.49		0.27	1.35	1.13	0.07		0.11	0.99	0.22	0.39	0.36	0.13	0.93	0.00	1.51	0.91	1.29	0.07	0.20	0.15	6.41	0.40	0.54	0.01	0.79	0.20
Prevotellaceae_ge	0.00	0.07	0.02	0.00		0.00	0.00	0.02	0.00		0.00	0.00	0.02	0.02	0.00	0.03	0.03	0.05	0.02	0.01	0.00	0.01	0.00	0.01	0.00	0.00	0.00	0.02	0.01	0.00
Prevotellaceae_UCG-001	3.49	3.63	1.08	0.53		3.31	7.13	2.79	1.08		0.01	0.26	1.49	3.04	0.37	1.84	2.64	2.50	2.21	2.03	0.03	1.09	0.01	1.57	1.32	2.07	5.02	0.57	3.08	1.66
Alistipes	6.05	4.02	5.50	6.94		7.36	6.56	4.27	12.13		6.31	6.29	6.38	7.68	6.67	3.84	7.19	5.29	9.45	2.20	4.29	5.16	2.95	4.53	11.15	4.22	6.46	10.92	3.45	3.63
Rikenella	0.46	1.01	0.66	1.35		0.27	0.19	0.34	0.80		1.03	0.84	1.02	0.51	0.41	0.39	0.51	0.20	0.76	0.34	0.16	0.37	0.39	0.41	0.13	0.10	0.34	0.57	0.31	0.16
Rikenellaceae_RCG_gut_group	2.14	3.11	2.49	5.69		5.39	6.00	2.85	3.30		6.72	4.82	4.10	8.33	1.52	1.15	2.08	0.66	6.71	0.96	2.29	3.63	2.30	2.53	6.55	1.75	3.65	2.04	0.93	1.28
Parabacteroides	0.02	0.02	0.01	0.00		0.09	0.32	0.05	0.06		0.03	0.00	0.01	0.10	0.00	0.04	0.05	0.00	0.07	0.01	0.05	0.01	0.00	0.00	0.12	0.10	0.09	0.02	0.07	0.01
Tannerellaceae_ge	0.00	0.00	0.00	0.00		0.00	0.00	0.00	0.00		0.01	0.00	0.01	0.02	0.00	0.01	0.01	0.00	0.00	0.03	0.00	0.00	0.00	0.00	0.04	0.02	0.01	0.00	0.04	0.00
Bacteroidia_ge	0.00	0.00	0.00	0.00		0.00	0.00	0.00	0.00		0.00	0.00	0.00	0.00	0.00	0.00	0.01	0.00	0.00	0.00	0.00	0.00	0.00	0.00	0.00	0.01	0.00	0.00	0.00	0.00
Gastranaerophilales_ge	0.00	0.01	0.06	0.15		0.06	1.21	0.37	0.22		0.02	0.08	0.12	0.11	0.05	0.01	0.20	0.01	0.15	0.07	0.38	0.02	0.11	0.00	0.04	0.08	0.06	0.27	0.19	0.06
Bilophila	0.02	0.01	0.05	0.04		0.00	0.00	0.00	0.10		0.05	0.02	0.03	0.03	0.05	0.07	0.06	0.06	0.17	0.05	0.09	0.10	0.04	0.14	0.00	0.04	0.02	0.10	0.02	0.15
Desulfovibrio	0.16	0.09	0.15	0.09		0.06	0.04	0.02	0.19		0.20	0.08	0.08	0.21	0.18	0.10	0.06	0.08	0.24	0.11	0.13	0.33	0.07	0.12	0.02	0.12	0.06	0.16	0.04	0.15
Anaeroplasma	0.01	0.00	0.03	0.04		0.10	0.06	0.13	0.09		0.05	0.00	0.03	0.00	0.06	0.10	0.05	0.08	0.57	0.09	0.00	0.01	0.00	0.01	0.15	0.01	0.25	0.04	0.00	0.10
Erysipelotrichaceae_ge	0.13	0.09	0.10	0.21		0.26	0.21	0.47	0.12		0.20	0.22	0.30	0.04	0.22	0.32	0.41	0.28	0.04	0.23	0.24	0.10	0.11	0.03	0.09	0.29	0.42	1.09	0.08	0.17
Enterococcus	0.01	0.01	0.02	0.11		0.18	0.03	0.28	0.00		0.03	0.04	0.03	0.01	0.00	0.07	0.06	0.00	0.00	0.06	0.01	0.03	0.09	0.00	0.00	0.00	0.09	0.23	0.00	0.00
Lactobacillus	1.35	2.70	1.06	7.60		0.14	0.37	0.53	0.34		1.18	1.74	0.34	1.03	0.44	1.44	6.10	4.30	2.16	3.61	1.00	1.30	18.30	0.95	0.99	3.44	2.93	8.13	0.94	3.07
Streptococcus	0.06	0.10	0.01	0.07		0.04	0.03	0.05	0.05		0.13	0.03	0.02	0.05	0.07	0.05	0.07	0.06	0.01	0.02	0.00	0.04	0.01	0.00	0.06	0.13	0.00	0.05	0.00	0.00
RF39_ge	0.46	0.44	0.34	0.47		0.17	0.39	0.36	0.34		0.00	0.39	0.30	0.30	0.23	0.01	0.28	0.19	0.01	0.19	0.00	0.20	0.05	0.19	0.39	0.12	0.28	0.00	0.00	0.25
Caldicoprobacter	0.05	0.00	0.01	0.00		0.01	0.05	0.00	0.00		0.02	0.00	0.00	0.01	0.00	0.04	0.09	0.00	0.00	0.00	0.00	0.00	0.00	0.00	0.05	0.00	0.00	0.00	0.00	0.01
Christensenellaceae_R-7_group	0.07	0.01	0.03	0.04		0.05	0.00	0.06	0.05		0.01	0.01	0.02	0.08	0.01	0.05	0.07	0.07	0.10	0.11	0.00	0.03	0.00	0.01	0.03	0.12	0.09	0.00	0.01	0.01
Clostridia_ge	0.04	0.02	0.08	0.08		0.02	0.03	0.03	0.14		0.06	0.07	0.10	0.17	0.06	0.06	0.04	0.11	0.04	0.02	0.08	0.10	0.06	0.05	0.04	0.01	0.01	0.02	0.04	0.01
Clostridia_UCG-014_ge	2.17	4.38	5.19	4.81		0.96	2.52	3.05	1.28		0.09	4.31	4.70	3.27	0.96	0.00	1.78	0.61	0.01	1.83	0.20	2.44	0.68	1.92	2.20	0.55	0.55	0.00	0.13	1.82
Clostridia_vadinBB60_group_ge	0.77	0.47	0.63	1.74		0.46	1.29	0.73	2.57		0.48	0.45	1.55	0.72	1.55	1.35	0.50	0.66	5.25	0.86	0.63	1.34	0.48	1.12	0.59	0.63	0.67	0.57	0.65	1.71
Clostridia_vadinBB60_group_ge	0.72	0.04	0.25	0.63		0.37	0.10	0.47	0.17		0.88	1.43	0.15	0.53	0.61	0.18	0.50	0.27	0.17	0.57	0.03	0.04	0.03	0.00	0.60	0.24	0.75	0.26	0.06	0.23
Candidatus_Arthronitus	A2	0.19	0.08	0.09	0.13	0.25	0.02	0.13	0.08	0.36	0.13	0.07	0.28	0.35	0.33	0.27	0.58	0.63	0.60	0.42	0.69	0.04	0.32	0.00	1.00	0.66	0.33	0.04	1.52	
Acetatifactor	0.03	0.10	0.15	0.16		0.24	0.00	0.13	0.04		0.23	0.10	0.26	0.06	0.10	0.13	0.04	0.10	0.18	0.04	0.08	0.04	0.14	0.06	0.00	0.10	0.14	0.38	0.08	0.57

File S5. Part 4. The operational taxonomic units (OTUs) identified with an abundance >0.1% in fecal microbiota of mice after different diets

Diets were supplemented with chicory flour (Chic), fructose (Fru), chlorogenic acids (CGA) and lactone sesquiterpenes. Ctr1 – control related to Chic and Fru diet; Ctr2 – control related to CGA and STL diet (mice 1

Genus	Ctr2_D0					Ctr2_D30					CGA_D0					CGA_D30					STL_D0					STL_D30					
	1	2	4	5		1	2	4	5		1	2	3	4	5	1	2	3	4	5	1	2	3	4	5	1	2	3	4	5	
ASF356	0.26	0.17	0.17	0.25		0.06	0.00	0.13	0.04		0.25	0.17	0.27	0.18	0.80	0.08	0.14	0.00	0.37	0.11	0.49	0.41	0.05	0.33	0.00	0.13	0.10	0.19	0.04	0.06	
Coprococcus	0.00	0.01	0.00	0.00		0.00	0.00	0.00	0.00		0.00	0.00	0.00	0.00	0.00	0.00	0.00	0.00	0.00	0.00	0.00	0.00	0.00	0.00	0.00	0.00	0.00	0.00	0.00		
GCA-900066575	0.32	0.24	0.32	0.08		0.05	0.21	0.31	0.17		0.14	0.21	0.34	0.29	0.24	0.18	0.11	0.23	0.04	0.19	0.35	0.34	0.59	0.53	0.52	0.08	0.09	0.08	0.09	0.41	
Lachnospiraceae_FCS020_group	1.13	0.93	0.60	0.46		0.42	1.08	0.74	0.65		1.56	0.67	0.68	0.95	0.59	1.29	0.57	1.59	2.86	0.68	0.65	0.98	0.95	0.92	1.32	0.62	0.32	2.64	0.21	1.45	
Lachnospiraceae_gg	0.07	0.02	0.00	0.00		0.04	0.06	0.01	0.07		0.05	0.08	0.05	0.04	0.06	0.08	0.04	0.00	0.07	0.04	0.16	0.06	0.01	0.05	0.06	0.04	0.13	0.09	0.01	0.07	
Lachnospiraceae_NK4A136_group	17.30	14.87	11.99	13.71		11.67	10.35	12.62	14.02		21.03	13.51	17.62	14.65	22.22	18.04	13.36	21.20	16.35	9.82	25.70	25.72	21.59	23.43	18.26	11.39	12.29	19.45	10.10	18.71	
Lachnospiraceae_UCG-001	9.24	16.55	37.28	16.94		13.99	9.35	10.94	29.16		12.47	27.21	21.08	15.32	17.26	27.48	12.82	16.01	2.05	12.89	12.60	24.04	24.75	36.34	3.86	9.62	14.38	10.72	44.99	28.07	
Lachnospiraceae_UCG-006	1.18	1.94	1.11	1.99		0.04	0.30	0.00	1.18		4.18	1.01	3.20	1.04	4.63	4.99	1.11	3.72	0.00	0.63	8.33	2.51	1.90	2.20	0.89	0.00	0.01	10.75	0.51	5.20	
Roseburia	0.91	1.34	1.38	1.25		0.61	2.28	2.46	1.46		1.31	0.73	1.58	1.08	1.72	1.39	0.79	1.06	2.78	0.53	3.62	1.89	1.26	1.09	4.94	0.42	0.60	2.15	0.39	0.98	
Tuzzerella	2.58	4.65	2.05	1.41		1.22	0.51	0.58	0.54		1.21	0.60	1.51	1.28	2.65	1.60	3.53	1.45	1.09	1.36	1.61	2.76	1.65	2.65	0.10	1.08	1.76	1.33	0.87	0.52	
Morganellabius	0.02	0.01	0.02	0.04		0.07	0.04	0.08	0.06		0.04	0.01	0.09	0.04	0.07	0.04	0.01	0.00	0.04	0.04	0.07	0.08	0.10	0.04	0.07	0.03	0.08	0.06	0.00	0.05	
Butyricicoccus	0.11	0.12	0.08	0.52		0.13	0.02	0.00	0.05		0.07	0.27	0.19	0.05	0.12	0.01	0.40	0.44	0.00	0.05	0.02	0.06	0.01	0.06	0.03	0.22	0.02	0.21	0.02	0.04	
Butyricicoccaceae_UCG-009	0.15	0.20	0.35	0.31		0.17	0.14	0.10	0.22		0.19	0.19	0.29	0.11	0.30	0.42	0.00	0.00	0.09	0.12	0.24	0.21	0.10	0.04	0.36	0.06	0.10	0.10	0.15	0.18	
Colidextribacter	0.36	0.14	0.07	0.18		0.34	0.72	0.53	0.25		0.35	0.32	0.22	0.10	0.30	0.81	0.56	0.48	0.03	0.09	1.06	0.29	0.22	0.17	0.77	0.14	0.30	0.24	0.16	0.89	
NK4A214_group	1.71	1.49	2.03	1.58		0.99	1.64	2.05	0.89		1.80	1.63	1.92	1.37	1.69	1.86	0.91	2.11	1.56	1.46	2.28	1.86	3.09	1.20	3.49	0.79	1.53	1.63	0.79	1.63	
Oscillibacter	0.07	0.21	0.11	0.22		0.24	0.07	0.20	0.14		0.04	0.31	0.15	0.15	0.03	0.12	0.21	0.05	0.05	0.08	0.14	0.07	0.10	0.11	0.04	0.16	0.21	0.21	0.00	0.17	
Oscillospiraceae_gg	0.88	0.17	0.46	0.31		0.40	0.19	0.35	0.94		1.36	0.47	0.59	0.57	0.78	1.22	0.40	0.35	0.59	0.65	1.16	0.97	0.61	0.44	0.85	0.34	1.18	0.71	0.16	1.12	
Oscillospiraceae_UCG-003	4.59	4.09	2.93	4.85		2.51	3.62	4.23	4.78		3.81	3.80	6.61	4.92	11.48	4.52	3.61	2.69	5.24	2.83	9.07	6.25	6.82	4.24	9.50	1.42	2.98	5.62	1.72	4.23	
Oscillospiraceae_UCG-005	0.26	0.08	0.14	0.27		0.06	0.25	0.03	0.19		0.16	0.09	0.11	0.16	0.07	0.27	0.09	0.39	0.02	0.05	0.26	0.12	0.14	0.08	0.36	0.00	0.21	0.08	0.01	0.58	
Oscillospirales_gg	0.01	0.06	0.12	0.13		0.00	0.01	0.16	0.03		0.03	0.10	0.15	0.07	0.03	0.01	0.01	0.10	0.00	0.06	0.02	0.06	0.02	0.04	0.00	0.20	0.00	0.00	0.04	0.27	
Oscillospirales_UCG-010_gg	0.62	0.20	0.41	0.26		0.40	0.42	0.85	0.46		0.04	1.01	0.98	0.57	0.45	0.05	1.29	0.99	0.12	1.00	0.41	0.62	0.33	0.27	1.15	1.26	1.03	0.00	0.04	0.26	
Anaerotruncus	0.54	0.15	0.14	0.13		0.73	0.26	0.62	0.30		0.22	0.30	0.24	0.22	0.00	0.66	0.81	0.38	0.42	1.03	0.04	0.12	0.02	0.04	0.12	0.55	0.27	0.06	0.41	0.15	
Negativibacillus	0.35	0.15	0.14	0.31		0.28	0.05	0.72	0.40		0.51	0.09	0.17	0.08	0.41	0.30	0.11	0.19	0.31	0.49	0.22	0.38	0.08	0.44	0.18	0.37	0.23	0.47	0.08	0.31	
Paludicola	0.04	0.06	0.08	0.11		0.08	0.14	0.06	0.11		0.06	0.00	0.01	0.02	0.04	0.10	0.02	0.13	0.08	0.09	0.00	0.10	0.05	0.01	0.19	0.05	0.04	0.00	0.00	0.04	
Ruminococcaceae_gg	0.00	0.00	0.00	0.00		0.01	0.02	0.01	0.02		0.00	0.02	0.00	0.00	0.00	0.00	0.01	0.01	0.04	0.00	0.00	0.00	0.00	0.00	0.00	0.00	0.05	0.05	0.00	0.00	0.00
Ruminococcus	1.24	1.25	1.27	1.14		1.57	1.52	0.98	1.21		1.40	1.12	1.81	1.27	0.86	1.68	0.63	1.47	3.07	0.79	1.91	1.41	1.43	1.32	1.50	1.16	1.58	1.05	0.86	1.24	
UBA1819	0.57	0.51	0.13	0.01		3.10	0.60	2.25	0.00		0.09	0.01	0.02	0.53	0.00	0.88	0.00	0.00	0.01	1.43	0.00	0.00	0.01	0.01	0.21	0.00	2.69	0.00	0.00	1.04	
Peptococcaceae_gg	0.05	0.17	0.26	0.27		0.11	0.10	0.23	0.21		0.40	0.22	0.04	0.03	0.14	0.51	0.05	0.46	0.04	0.01	0.03	0.03	0.04	0.09	0.02	0.07	0.32	0.07	0.00	0.04	
Anaerovorticaceae_gg	0.13	0.06	0.10	0.03		0.03	0.08	0.03	0.07		0.03	0.04	0.01	0.12	0.02	0.09	0.04	0.08	0.14	0.05	0.15	0.05	0.04	0.04	0.14	0.06	0.03	0.03	0.02	0.09	
Candidatus_Saccharimonas	0.82	0.90	0.49	0.55		0.26	0.16	0.10	0.10		0.02	0.14	0.13	0.10	0.00	0.07	0.11	0.20	0.09	0.04	0.07	0.11	0.03	0.04	0.05	0.27	0.11	0.05	0.01	0.12	
Rhodospirillales_fa_gg	0.00	0.02	0.03	0.00		0.00	0.09	0.57	0.62	0.43	0.00	1.39	0.83	0.39	0.75	0.00	0.88	0.79	0.00	0.64	0.00	0.52	0.02	0.18	0.36	0.17	0.41	0.00	0.08	0.46	
Parasutterella	0.01	0.06	0.02	0.00		0.09	0.04	0.02	0.01		0.00	0.00	0.00	0.01	0.00	0.02	0.00	0.00	0.00	0.00	0.00	0.00	0.00	0.00	0.02	0.41	0.46	0.00	0.00	0.03	
Hafnia-Obesumbacterium	0.00	0.00	0.00	0.00		0.09	0.04	0.02	0.01		0.01	0.02	0.00	0.02	0.01	0.02	0.03	0.04	0.07	0.06	0.02	0.00	0.00	0.00	0.00	0.21	0.05	0.00	0.01	0.00	
Others	0.00	0.00	0.00	0.00		0.00	0.00	0.00	0.00		0.00	0.00	0.00	0.00	0.00	0.00	0.00	0.00	0.00	0.00	0.00	0.00	0.00	0.00	0.00	0.00	0.00	0.00	0.00	0.00	
	0.21	0.21	0.13	0.19		0.38	0.42	0.13	0.21		0.17	0.28	0.29	0.34	0.21	0.21	0.23	0.27	0.35	0.22	0.27	0.18	0.21	0.22	0.30	0.29	0.31	0.23	0.13	0.36	

File S5. Part 5. The operational taxonomic units (OTUs) identified with an abundance > 0.1% in fecal microbiota of mice after different diets.

Kingdom	Phylum	Class	Order	Family	Genus	
Bacteria	Actinobacteria	Coriobacteriia	Coriobacteriales	Coriobacteriales_fa	Coriobacteriales_ge	
				Eggerthellaceae	Eggerthellaceae_ge	
	Bacteroidetes	Bacteroidia	Bacteroidales	Bacteroidaceae	Bacteroides	
				Bacteroidales_fa	Bacteroidales_ge	
				Marinifilaceae	Odoribacter	
				Muribaculaceae	Muribaculaceae_ge	
				Muribaculum		
				Prevotellaceae	Alloprevotella	
				Prevotellaceae_ge	Prevotellaceae_ge	
				Prevotellaceae_UCG-001	Prevotellaceae_UCG-001	
				Rikenellaceae	Alistipes	
				Rikenella	Rikenella	
	Rikenellaceae_RC9_gut_group	Rikenellaceae_RC9_gut_group				
	Tannerellaceae	Parabacteroides				
	Tannerellaceae_ge	Tannerellaceae_ge				
	Bacteroidia_or	Bacteroidia_fa	Bacteroidia_ge			
	Cyanobacteria	Vampirivibrionia	Gastranaerophilales	Gastranaerophilales_fa	Gastranaerophilales_ge	
	Desulfobacteria	Desulfovibrionia	Desulfovibrionales	Desulfovibrionaceae	Desulfovibrio	
	Firmicutes	Bacilli	Acholeplasmatales	Acholeplasmataceae	Anaeroplasmata	
			Erysipelotrichales	Erysipelotrichaceae	Erysipelotrichaceae_ge	
			Lactobacillales	Enterococcaceae	Enterococcus	
				Lactobacillaceae	Lactobacillus	
				Streptococcaceae	Streptococcus	
				RF39	RF39_fa	RF39_ge
			Clostridia	Caldicoprobacteriales	Caldicoprobacteraceae	Caldicoprobacter
				Christensenellales	Christensenellaceae	Christensenellaceae_R-7_group
				Clostridia_or	Clostridia_fa	Clostridia_ge
				Clostridia_UCG-014	Clostridia_UCG-014_fa	Clostridia_UCG-014_ge
		Clostridia_vadinBB60_group		Clostridia_vadinBB60_group_fa	Clostridia_vadinBB60_group_ge	
		Clostridiales		Clostridiaceae	Candidatus_Arthromitus	
		Lachnospirales		Lachnospiraceae	A2	
					Acetatifactor	
					ASF356	
					Coprococcus	
			GCA-900066575			
			Lachnoclostridium			
			Lachnospiraceae_FCS020_group			
			Lachnospiraceae_ge			
			Lachnospiraceae_NK4A136_group			
			Lachnospiraceae_UCG-001			
		Lachnospiraceae_UCG-006				
		Roseburia				
Tuzzerella						
Monoglobales		Monoglobaceae	Monoglobus			
Oscillospirales		Butyricocccaceae	Butyricocccaceae_UCG-009	Butyricococcus		
			Oscillospiraceae	Colidextribacter		
		NK4A214_group				
		Oscillibacter				
	Oscillospiraceae_ge					
	Oscillospiraceae_UCG-003					
	Oscillospiraceae_UCG-005					
	Oscillospirales_fa	Oscillospirales_ge				
	Oscillospirales_UCG-010	Oscillospirales_UCG-010_ge				
	Ruminococcaceae	Anaerotruncus				
Negativibacillus						
Paludicola						
Ruminococcaceae_ge						
Ruminococcus						
UBA1819						
Peptococcales	Peptococcaceae	Peptococcaceae_ge				
Peptostreptococcales-Tissierellales	Anaerovoracaceae	Anaerovoracaceae_ge				
Patescibacteria	Saccharimonadia	Saccharimonadales	Saccharimonadaceae	Candidatus_Saccharimonas		
Proteobacteria	Alphaproteobacteria	Rhodospirillales	Rhodospirillales_fa	Rhodospirillales_fa_ge		
	Gammaproteobacteria	Burkholderiales	Sutterellaceae	Parasutterella		
		Enterobacteriales	Hafniaceae	Hafnia-Obesumbacterium		

File S6. Standardized abundance ratio (relative to D0) for *Firmicutes* and *Bacteroidetes* phyla after 30 days of diet in mice.
Standard error of mean (SEM) were calculated for each phylum abundance ratio (D30 vs. D0), and statistically significant differences were measured by ANOVA and Tukey's test ($p < 0.1$).

Abundance ratio	Ctr1			Chic			Fru		
	Mean	SEM	P-value	Mean	SEM	P-value	Mean	SEM	P-value
<i>Firmicutes</i>	1.11	0.62	/	0.94	0.27	ns p=0.5733	0.9	0.37	ns p=0.5167
<i>Bacteroidetes</i>	1.22	0.75	/	1.17	0.28	ns p=0.9077	1.61	1.56	ns p=0.6268
Ratio	1.5	1.57	/	0.9	0.55	ns p=0.4443	1.038	0.73	ns p=0.5681

Abundance ratio	Ctr2			CGA			STL		
	Mean	SEM	P-value	Mean	SEM	P-value	Mean	SEM	P-value
<i>Firmicutes</i>	0.77	0.17	/	0.91	0.24	ns p=0.3759	0.82	0.35	ns p=0.807
<i>Bacteroidetes</i>	1.36	0.38	/	1.24	0.49	ns p=0.6927	1.89	0.81	ns p=0.2756
Ratio	0.625	0.29	/	0.924	0.67	ns p=0.4389	0.307	0.08	* p=0.08

File S7. Microbial profiling using quantitative PCR.

In order to validate results obtained by Illumina sequencing, the abundance of 2 phyla (*Firmicutes* and *Bacteroidetes*) and 4 genera (*Prevotellaceae*, *Clostridium* ASF356, *Oscillospira*, and *Ruminococcus*) were checked by qPCR method. Total bacterial DNA was extracted from ~40 mg of fecal sample using according to NucleoSpin DNA Stool Kit (Macherey-Nagel, Germany). The relative amount of bacterial phyla of interest was checked by measuring DNA abundance of the 16S rRNA gene sequences of each group of bacteria using the AriaMx Real-Time PCR system (Agilent, USA) and group-specific primers following previously described protocols (Parnell & Reimer, 2012, Chaplin *et al.*, 2015). The group-specific primers are shown in Table S7_1. Primers were verified with Multalin software (Corpet, 1988), and Primer3 (Untergasser *et al.*, 2012) and finally *in silico* checked with the Probe Match tool in RDP (Ribosomal Database Project) (Cole *et al.*, 2013). Primer specificity, amplification efficiency and the limit of detection were determined using serial dilutions of a standard DNA. Quantitative PCR was performed in AriaMx Real-Time PCR System (Agilent), on 96-well microplates. Amplifications were carried out in a final volume of 15 μ L containing 0.75 μ L of each primer (10 μ M) (Sigma-Aldrich, USA), 7.5 μ L iQ SYBR Green Supermix (Biorad) and either 6 μ L of DNA or water (no-template control). The thermal cycling conditions were as follows: an initial denaturation step at 95 °C for 3 min followed by 40 cycles of denaturation at 95 °C for 15s, primer annealing at 60 °C for 30s, extension at 72 °C for 30s and a fluorescence acquisition step at 72 °C for 10 min. DNAs extracted from fecal samples were amplified in triplicate for each primer set and the mean value was used for statistical analysis. For each pair of primers, a melting curve was made to verify the specificity of the amplification. The efficiency and threshold cycle (Ct) were calculated with the Agilent AriaMx software. Total Bacteria is a broad-range primer that identifies the conserved region of the 16S rRNA encoding gene for a wide range of bacteria. Data obtained by this qPCR reaction gives the amount of total bacteria present in the sample. Then the relative quantification of each target bacteria or group was normalized with the total bacteria content in the sample, following the mathematical model defined by Livak K., & Schmittgen T. (2001). Data were calculated as $2^{-\Delta\Delta C_t}$ means and comparisons were performed using one-way ANOVA with Tukey's and Student's tests (* $p < 0.1$, ** $p < 0.05$).

Table S7_1. Primer sequences for qPCR

Specificity	Primer	Sequence (5' - 3')	Amplicon length (bp)	Tm (°C)	Reference	
Total bacteria	Forward	ACTCCTACGGGAGGCAG	194	55	Amann <i>et al.</i> , 1990	
	Reverse	GTATTACCGCGGCTGCTG		59		
<i>Firmicutes</i>	Forward	TGAAACTAAAGGAATTGACG	135	53		Luu <i>et al.</i> , 2017
	Reverse	ACCATGCACCACCTGTC		53		
<i>Bacteroidetes</i>	Forward	GGAACATGTGGTTTAATTGATG	187	57		Luu <i>et al.</i> , 2017
	Reverse	AGCTGACGACAACCATGCAG		57		
<i>Prevotellaceae</i>	Forward	CGAAAGGTTTAGCGGTGAAG	140	57	Song <i>et al.</i> , 2020	
	Reverse	CGTAGGAGTTTGGACCGTGT		59		
<i>Oscillospira</i>	Forward	ACGGTACCCCTGAATAAGCC	162	60	Walker <i>et al.</i> , 2010	
	Reverse	TCCCCGCACACCTAGTATTG		60		
<i>Clostridium</i> ASF356	Forward	GATGCCTCCTAAGAACCGTATGC	151	60	Erny <i>et al.</i> , 2015	
	Reverse	GCGGACGGGTGAGTAACTG		60		
<i>Ruminococcus</i>	Forward	TTAACACAATAAGTWATCCACCTGG	314	57	Tang <i>et al.</i> , 2021	
	Reverse	ACCTTCCTCGTTTTGTCAAC		58		

Results

qPCR analysis confirmed results obtained by metagenomic analysis. Chic diet showed a slight decrease of the F/B ratio due probably to the STL content as STL diet triggered a significant decrease of this ratio (Figure S7_1).

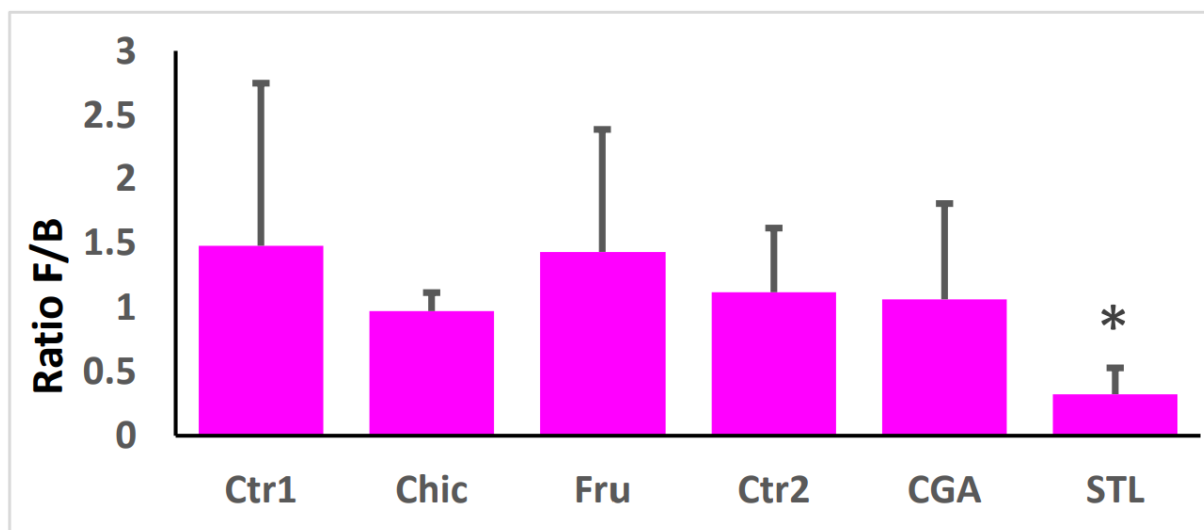

Figure S7_1. Relative abundance of *Firmicutes* and *Bacteroidetes* in mice microbiota after different diets. qPCR results expressed as ratio $\Delta\text{Ct } Firmicutes / \Delta\text{Ct } Bacteroidetes$, mean \pm SD (Tukey's test, n=5/group, * p < 0.05).

The diet-dependent abundance of the four bacterial taxa showed similar tendencies as those observed in metagenomic analysis (Figure S7_2). *Prevotellaceae* and *Clostridium* ASF 356 abundance was found slightly increased during Chic, CGA and STL diets. *Oscillospira* and *Ruminococcus* were found with a decreased abundance during Chic and Fru but also CGA and STL diets. Although Fru and CGA appear to be implicated in microbiota changes, STL were found to play the most pregnant role.

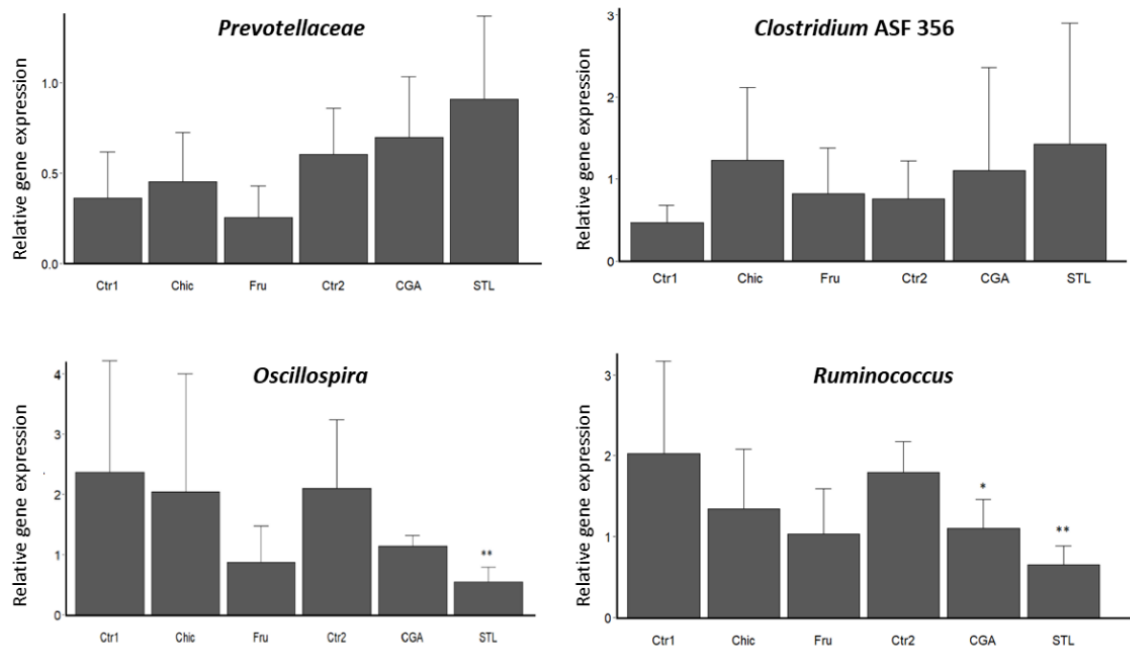

Figure S7_2. Relative abundance of four bacterial taxa from gut microbiota of mice, impacted by chicory, fructose, CGA or STL supplemented diet. qPCR results expressed as the $2^{-\Delta\Delta Ct}$ mean \pm SE (Student's test, n=5/group, * $p < 0.1$, ** $p < 0.05$).

References

- Amann, R. I., Binder, B. J., Olson, R. J., Chisholm, S. W., Devereux, R., & Stahl, D. A. (1990). Combination of 16S rRNA-targeted oligonucleotide probes with flow cytometry for analyzing mixed microbial populations. *Applied and Environmental Microbiology*, *56*(6), 1919–1925. <https://doi.org/10.1128/aem.56.6.1919-1925.1990>
- Chaplin, A., Parra, P., Laraichi, S., Serra, F., & Palou, A. (2015). Calcium supplementation modulates gut microbiota in a prebiotic manner in dietary obese mice. *Molecular Nutrition & Food Research*, *60*(2), 468–480. <https://doi.org/10.1002/mnfr.201500480>
- Cole, J. R., Wang, Q., Fish, J. A., Chai, B., McGarrell, D. M., Sun, Y., . . . Tiedje, J. M. (2013). Ribosomal Database Project: data and tools for high throughput rRNA analysis. *Nucleic Acids Research*, *42*(D1), D633–D642. <https://doi.org/10.1093/nar/gkt1244>
- Corpet, F. (1988). Multiple sequence alignment with hierarchical clustering. *Nucleic Acids Research*, *16*(22), 10881–10890. <https://doi.org/10.1093/nar/16.22.10881>

- Duan, C., Cui, Y., Zhao, Y., Zhai, J., Zhang, B., Zhang, K., . . . Chen, H. (2016). Evaluation of *Faecalibacterium* 16S rDNA genetic markers for accurate identification of swine faecal waste by quantitative PCR. *Journal of Environmental Management*, *181*, 193–200. <https://doi.org/10.1016/j.jenvman.2016.06.022>
- Erny, D., Hrabě de Angelis, A. L., Jaitin, D., Wieghofer, P., Staszewski, O., David, E., . . . Prinz, M. (2015). Host microbiota constantly control maturation and function of microglia in the CNS. *Nature Neuroscience*, *18*(7), 965–977. <https://doi.org/10.1038/nn.4030>
- Livak, K. J., & Schmittgen, T. D. (2001). Analysis of relative gene expression data using real-time quantitative PCR and the $2^{-\Delta\Delta CT}$ method. *Methods*, *25*(4), 402–408. <https://doi.org/10.1006/meth.2001.1262>
- Luu, T. H., Michel, C., Bard, J. M., Dravet, F., Nazih, H., & Bobin-Dubigeon, C. (2017). Intestinal proportion of *Blautia* sp. is associated with clinical stage and histoprognostic grade in patients with early-stage breast cancer. *Nutrition and Cancer*, *69*(2), 267–275. <https://doi.org/10.1080/01635581.2017.1263750>
- Parnell, A.J., & Reimer, R. (2012). Prebiotic fiber modulation of the gut microbiota improves risk factors for obesity and the metabolic syndrome. *Gut Microbes*, *3*(1), 29–34. <https://doi.org/10.4161/gmic.19246>
- Song, S., Liu, J., Zhang, F., & Hong, J. S. (2020). Norepinephrine depleting toxin DSP-4 and LPS alter gut microbiota and induce neurotoxicity in α -synuclein mutant mice. *Scientific Reports*, *10*(1). <https://doi.org/10.1038/s41598-020-72202-4>
- Tang, S., Cheng, Y., Wu, T., Hu, F., Pan, S., & Xu, X. (2021). Effect of *Lactobacillus plantarum*-fermented mulberry pomace on antioxidant properties and fecal microbial community. *LWT*, *147*, 111651. <https://doi.org/10.1016/j.lwt.2021.111651>
- Untergasser, A., Cutcutache, I., Koressaar, T., Ye, J., Faircloth, B. C., Remm, M., & Rozen, S. G. (2012). Primer3—new capabilities and interfaces. *Nucleic Acids Research*, *40*(15), e115–e115. <https://doi.org/10.1093/nar/gks596>
- Walker, A. W., Ince, J., Duncan, S. H., Webster, L. M., Holtrop, G., Ze, X., . . . Flint, H. J. (2010). Dominant and diet-responsive groups of bacteria within the human colonic microbiota. *The ISME Journal*, *5*(2), 220–230. <https://doi.org/10.1038/ismej.2010.118>

File S8. Estimation of the most important effects of the chicory and its tested compounds: fructose (Fru), chlorogenic acids (CGA) and sesquiterpene lactones (STL)

Number of DEGs was considered in transcriptome analysis, and number of modified taxa in metagenetic analysis. Results of hormone assay were constricted to significant modifications as well as for *in vitro* analyses.

A score was calculated by totaling these modifications for each diet. A significant response (yes) was considered 1 and a non-significant one (no) was considered 0.

Fructose could be estimated to trigger 85% of the chicory effects, CGA to contribute for 33% and STL for 35% of these effects.

Health effect	Analytical method	Chic	Fru	CGA	STL
Anti-cancer	gene expression (nb of DEGs)	9	7	2	3
	<i>in vitro</i> apoptotic effect	yes	no	no	yes
Anti-inflammatory	gene expression (nb of DEGs)	4	4	2	2
	<i>in vitro</i> cytokine assay (nb of cytokine)	3	2	2	2
Antibacterial	gene expression (nb of DEGs)	7	6	2	1
	metagenetics (nb of modified taxa)	3	2	2	1
Digestion and metabolism a) hypoglycemic b) hypolipidemic	gene expression (nb of DEGs)	12	11	4	5
	GIP hormonal assay	no	no	no	yes
	metagenetics (nb of modified taxa)	4	4	1	1
	leptin hormonal assay	no	no	yes	no
Neural and sensorial	gene expression (nb of DEGs)	15	13	1	2
	metagenetics (nb of modified taxa)	4	4	3	4
Anti-xenobiotic and antioxidant	gene expression (nb of DEGs)	6	5	3	1
Hypotensive	metagenetics (nb of modified taxa)	1	1	0	0
<i>Score</i>		69	59	23	24
<i>Contribution</i>		100%	85%	33%	35%



**CHAPITRE 3 – ETUDE *IN VITRO* DES
EFFETS DE LA DIGESTION GASTRO-
INTESTINALE SUR LA COMPOSITION ET LES
PROPRIETES BIOACTIVES DE LA CHICOREE**



AVANT-PROPOS

Ces travaux se sont jusqu'ici focalisés sur l'étude des caractéristiques de la farine issue de la racine de chicorée, ses activités nutrition-santé et la détermination des classes de molécules responsables des effets observés. Cependant, les molécules actives qui composent cette farine sont présentes en faible quantité, et sont majoritairement piégées dans la matrice alimentaire. La farine de chicorée va, comme tout autre aliment, subir un certain nombre de modifications chimiques et enzymatiques lors de son passage dans le tube digestif, ce qui a pour conséquences de modifier ses composants actifs, leurs activités, leur bioaccessibilité ainsi que leur biodisponibilité pour le reste de l'organisme. L'étude de la fonctionnalité de la chicorée nécessite donc de connaître son devenir après ingestion.

A part le suivi de l'inuline, peu d'études ont décrit l'impact de la digestion gastro-intestinale sur la fonctionnalité de la chicorée en tant que matrice alimentaire, et de ses effecteurs principaux (fructose, STL, CGA). Nous nous sommes proposés de suivre la digestion de la farine de chicorée et de ses molécules bioactives et pour cela, de travailler avec le protocole de digestion *in vitro* INFOGEST répliquant les conditions physiologiques (pH, température, sels) et enzymatiques de trois des compartiments du tube digestif : bouche, estomac, intestin grêle. Pour se rapprocher des conditions de gavage des souris des études précédentes, nous avons choisi d'étudier l'impact de la digestion sur une décoction aqueuse de farine de chicorée, et pour contrôler précisément la masse de produit à digérer, celle-ci a été utilisée sous forme lyophilisée. Le devenir des composés de la chicorée a ensuite été suivi par ¹H-RMN et UPLC-HRMS dans les trois compartiments pour voir à quel niveau les modifications s'effectuaient. Le produit de digestion intestinale étant le plus affecté dans sa composition, celui-ci a par la suite été testé dans un modèle acellulaire permettant de mesurer son pouvoir inhibiteur sur la production d'espèces réactives de l'oxygène (ROS). Pour estimer l'activité anti-inflammatoire et métabolique sur des cellules *in vitro*, nous avons testé les produits de digestion *in vitro* de la décoction de chicorée et de ses effecteurs (fructose, CGA et STL) sur des cellules U937 et STC-1 respectivement. Pour cela, nous avons d'abord vérifié la cytotoxicité de chaque produit brut et de digestion pour pouvoir les tester à la plus haute concentration non toxique pour nos modèles cellulaires. Nous avons ensuite fait le choix d'examiner leurs effets sur la sécrétion des deux cytokines pro-inflammatoires IL-8 et IL-1 β (pour l'effet anti-inflammatoire) et la sécrétion de l'hormone cholécystokinine (CCK) impliquée dans la prise alimentaire.

Les analyses métabolomiques ont permis de mettre en évidence l'impact des conditions physiologiques et enzymatiques du tractus gastro-intestinal sur la composition de la décoction. Celle-ci a vu son profil métabolique changer au cours de son transit dans le tube digestif et être particulièrement impactée par la digestion intestinale. Le produit de cette digestion a donc été utilisé dans les expérimentations *in vitro* qui ont suivi. Les tests en question ont montré une accentuation des effets antioxydants, anti-inflammatoires et sur la sécrétion d'hormone de la décoction et de ses bioactifs après leur digestion.

Ce travail a permis de mettre en avant l'importance des activités de la partie supérieure de l'intestin sur la fonctionnalité de la farine de chicorée et de ses molécules bioactives ainsi que le rôle de la matrice alimentaire. Deux mécanismes d'action ont été proposés: i) l'activité directe sur les cellules suite à l'absorption intestinale et ii) l'activité indirecte via le microbiote intestinal et ses métabolites. Les résultats obtenus seront prochainement valorisés dans une revue internationale.

ROLE OF GASTROINTESTINAL DIGESTION ON FUNCTIONAL OPERATIVE MODE OF THE CHICORY

Céline L. Pouille^{1,2}, Josette Behra¹, Melissa Tourret¹, Roland Molinié³, Jean-Xavier Fontaine³, David Mathiron⁴, Cécile Palaric^{1,2}, David Gagneul^{1,2}, Rozenn Ravallec¹, Caroline Rambaud^{1,2}, Jean-Louis Hilbert^{1,2}, Anca Lucau-Danila^{1,2} and Benoit Cudennec¹

¹ UMR Transfrontalière BioEcoAgro N° 1158, Univ. Lille, INRAE, Univ. Liège, UPJV, JUNIA, Univ. Artois, Univ. Littoral Côte d'Opale, ICV, SFR Condorcet FR CNRS 3417—Institut Charles Viollette, 59655 Villeneuve d'Ascq, France; celine.pouille.etu@univ-lille.fr (C.L.P.); josette.behra@univ-lille.fr (J.B.); melissa.tourret@univ-lille.fr (M.T.); cecile.palaric@univ-lille.fr (C.P.); david.gagneul@univ-lille.fr (D.G.); rozenn.ravallec@univ-lille.fr (R.R.); caroline.rambaud@univ-lille.fr (C.R.); jean-louis.hilbert@univ-lille.fr (J.-L.H.); anca.lucau@univ-lille.fr (A.L.); benoit.cudennec@univ-lille.fr (B.C.)

² Joint Laboratory CHIC41H University of Lille-Florimond-Desprez, Cité scientifique, 59655 Villeneuve d'Ascq, France

³ UMR Transfontalière BioEcoAgro N° 1158, Univ. Lille, INRAE, Univ. Liège, UPJV, JUNIA, Univ. Artois, Univ. Littoral Côte d'Opale, ICV, SFR Condorcet FR CNRS 3417—BIOlogie des Plantes et Innovation (BIOPI), 80025 Amiens, France; roland.molinie@u-picardie.fr (R.M.); jean-xavier.fontaine@u-picardie.fr (J.-X.F.)

⁴ Plateforme Analytique UFR des Sciences, UPJV, Bâtiment Serres-Transfert Rue Dallery-Passage du Sourire d'Avril, 80039 Amiens, France; david.mathiron@u-picardie (D.M.).

Abstract

The chicory as a functional food is increasingly studied, as well as the role of each class of molecules that enters its composition. This study aimed to understand *in vitro* the role of gastrointestinal digestion on the composition and the beneficial effects of chicory. To come closer to food and physiological conditions, the chicory flour obtained from the roots was transformed into an aqueous decoction and subjected to human static *in vitro* digestion under the INFOGEST protocol. The effect of digestion in the different compartments (oral, gastric and intestinal) was determined by a metabolomic analysis for the flour decoction, to follow its impact on some classes of bioactive molecules (fructose, chlorogenic acids and sesquiterpene lactones). The comparison before and after digestion of the antioxidant, anti-inflammatory and intestinal hormone secretion regulation effects was then carried out *in vitro*. The results showed that the transformation of chicory flour takes place mainly at the small intestine level which potentiates its functional effects. Bioactive molecules also kept or showed a more pronounced activity after digestion. Following these results, more targeted studies could be carried out to decipher the transformations, but also absorption and mechanisms of action of chicory bioactive molecules.

Keywords: chicory, *in vitro* digestion, anti-inflammatory cytokines, antioxidant, hormone secretion.

Introduction

Understanding the fate of food products in the human gastrointestinal tract is essential to assess the bioaccessibility and effects of naturally present bioactive compounds. Industrial chicory (*Cichorium intybus* var. *sativum*) and the different classes of molecules which compose its root were the objects of numerous studies (Perović *et al.*, 2021, Janda *et al.*, 2021). Classified as a functional food, chicory root flour has proven its anticancer, anti-inflammatory, antioxidant, antimicrobial and prebiotic effects *in vivo* and also *in vitro* in mouse models (Pouille *et al.*, 2020, Pouille *et al.*, 2022). The fate of some chicory effectors during their digestion and absorption is well known. For instance, the inulin fiber crosses the small intestine without modifications and acts as a prebiotic in the colon (Kleessen *et al.*, 2001, Roberfroid, 1997). Fructose (Fru) is primarily absorbed by gut epithelial cells where it is converted to glucose, glycerate or lactate. These organic compounds are mostly metabolized by colonic microbiota in essential amino acids or short-chain fatty acids (Jang *et al.*, 2018) which may in turn impact the global metabolism of the host (Morrison & Preston, 2016). Chlorogenic acids (CGA) absorption seems to follow several key pathways. A third of CGA consumption seems to be immediately absorbed in its intact form in the stomach and the upper part of the small intestine (Lafay *et al.*, 2006). The rest is either hydrolyzed to caffeic acid and its derivatives before passing through epithelial cells or reaching the colon where it is metabolized by the microbiota (Olthof *et al.*, 2003, D'Antuono *et al.*, 2015). Once entering the bloodstream compounds reach the liver where they are further metabolized (Azzini *et al.* 2007). Most of the sesquiterpene lactones (STL) compounds are extensively metabolized to other bioactive compounds by the intestinal mucosa and microbiota (Rocchetti *et al.*, 2020, Weng *et al.*, 2020, García *et al.*, 2020) or degraded due to gastrointestinal tract conditions (Colantuono *et al.*, 2018). *In vitro* and *in silico* models showed STL to be able to cross the intestinal barrier by passive diffusion and active transports (Xu *et al.*, 2019) to biologically effective concentrations in the organism (Matos *et al.*, 2020).

Three classes of molecules described as effectors of the chicory (Pouille *et al.*, 2022) and exhibiting modifications during digestion and partial absorption in the gastrointestinal tract, have caught our attention: fructose, CGA and STL. To estimate the level of transformation of the chicory flour and of these compounds during digestion, we followed the consensual *in vitro* static INFOGEST protocol that is largely used for the study of the digestibility of various micro- and macronutrients (Colombo *et al.*, 2021). As chicory flour and its aqueous decoction show similar qualitative metabolomics profiles (Pouille *et al.*, 2022), only decoction and chicory

effectors were used in this work. Metabolic modifications were followed in the three first compartments of the gastrointestinal tract simulated by the protocol: mouth, stomach and small intestine. These transformations were then confronted with the antioxidant, anti-inflammatory and CCK secretion regulation effects of the digested samples, evaluated with acellular- and cell-based assays.

Materials and Methods

Simulated GastroIntestinal Digestion (SGID) method

Roots from industrial chicory (*Cichorium intybus* var. *sativum*) provided by Florimond Desprez Veuve et Fils SAS (Cappelle-en-Pévèle, France) were processed by Leroux SAS (Orchies, France) and the corresponding flour was delivered by Waast Mill (Mons-en-Pévèle, France). As previously described this flour comes from a mixture of several genotypes of chicory with significantly different chemical compositions (Pouille *et al.*, 2022). An aqueous decoction of this flour was produced according to Pouille *et al.*, (2020) and lyophilized for 72 h to ensure complete dehydration.

Two g (dry weight) of the lyophilized chicory decoction were submitted to an *in vitro* simulated gastrointestinal digestion (SGID) as described by Brodkorb *et al.*, (2019). The first three steps of digestion were simulated (mouth, stomach, and duodenum), and three fluids were prepared to mimic the physiological conditions of each one. The whole digestion process was performed in a 200 mL reactor controlled at 37 °C under constant stirring. Briefly, oral digestion of chicory decoction was performed in 1.6 mL simulated salivary fluid (SSF), 0.010 mL of CaCl₂ (0.3M) and 0.390 mL of amylase (75 IU.mL⁻¹ final concentration) (A3176, Merck, Darmstadt, Germany) for 2 min. The reaction was stopped by the addition of 3.2 mL of simulated gastric fluid (SGF). The solution was adjusted to pH 3.0 with HCl (10 M) and to 8.0 mL final volume with 0.002 mL of CaCl₂ (0.3 M) and pepsin enzyme (2000 U.mL⁻¹ final concentration) (P6887, Merck, Darmstadt, Germany). After 2 h of incubation, 3.4 mL of simulated intestinal fluid (SIF) and 0.016 mL of CaCl₂ (0.3 M) were added to the reactor and pH adjusted to 7.0 with NaOH (10 M). The intestinal digestion was carried out in a final volume of 16.0 mL for 2 h by the addition of pancreatin (100 U of trypsin.mL of SIF⁻¹ final concentration) (P1750, Merck, Darmstadt, Germany) and bile (10 mmol.L of SIF⁻¹) (bile bovine powder, Thermo-Fisher Scientific, Waltham, MA, USA). For metabolomic analysis, to separate the impacts of

physiological conditions (bile, pH, temperature, mixing) from the effects of digestive enzymes, digestions without enzymes (inactive) were performed in the same volume, salt and temperature conditions as the ones with enzymes (active). Inactive steps were achieved without amylase for the inactive oral step, with amylase but without pepsin for the inactive gastric step, and with amylase and pepsin but without pancreatin and bile for the inactive intestinal step. Sampling for metabolomics analyses was done at the end of each step of SGID, immediately frozen in liquid nitrogen then lyophilized for 72 hours. The digestion was repeated five more times (n = 6) as well as the control (blank digestion) that was performed under the same conditions but without chicory decoction.

For cell-based *in vitro* tests, the SGID was performed in a separate experiment where oral and gastric digestions were prepared with active enzymes as described above. To avoid changes in the cell membranes (Akare & Martinez, 2005), intestinal digestion was performed bile-free. Starting material for SGID was in this case the lyophilized chicory decoction, fructose, CGA and STL. For chicory decoction and fructose, 2 g (dry weight) were solubilized in a final volume of 16 mL (125 g·L⁻¹ dry matter). CGA and STL were mixed respecting the proportions in the chicory roots (Pouille *et al.*, 2022), and digested in a final volume of 8 mL for a final concentration of 125 µM. Samples collected at the end of the intestinal digestion step were heated at 95 °C for 10 min and centrifuged at 13,000 rpm for 2 min at room temperature. Supernatants were collected and frozen at – 20 °C before *in vitro* tests. A control (blank digestion) was performed under the same conditions but without chicory decoction, fructose, CGA and STL.

Metabolomic analysis

Metabolic analysis was performed for each sample obtained after *in vitro* active and inactive digestion of chicory decoction, and for each step (oral, gastric and intestinal digestion) as well as for blank digestions. A mixture of water/methanol (1:1) was added to 100 mg of a randomized sample of digestate or 100 mg of dry residue obtained after lyophilisation of chicory decoction. The samples were mixed for 10 min at 80 °C, using a ThermoMixer® (Eppendorf AG, Hamburg, Germany) at 2000 rpm, followed by 10 min of sonication at 80 °C using an ultrasonic bath at 35 kHz. The samples were centrifuged at 4 °C for 10 min at 12,000 rpm. The supernatant was diluted 20 times with methanol/water (50/50). As previously described (Pouille *et al.*, 2022), all samples were filtered through 0.22 µm PTFE membrane filters before analysis by ultra-performance liquid chromatography coupled to high-resolution

mass spectrometry (UPLC-HRMS) and nuclear magnetic resonance (NMR). UPLC-HRMS analysis was performed on an ACQUITY UPLC I-class chain coupled with the Vion IMS Q-TOF high-resolution mass spectrometer, equipped with an electrospray (ESI) (Waters, Manchester, UK) ionization source (Z-spray) and an additional spray for the reference compound (Lock Spray). A double detection in the positive and negative mode was performed by ESI mass spectrometry (range 50–2000 Da) and by a PDA diode array detector (UV detection between 190–500 nm). Separation was performed using a KINETEX Biphenyl (100 × 2.1 mm, 1.7 μm) column (Phenomenex) heated at 55 °C with a mobile phase (solvent A (0.1 % formic acid in water) and solvent B (0.1 % formic acid in methanol)) flow (0.55 mL·min⁻¹) and the same gradient elution as our previous study (Tchoumtchoua *et al.*, 2019). The spectra obtained were acquired and processed with UNIFI software (version 1.9.4, Waters) and enabled us to generate the data matrix for untargeted metabolomics analyses with classical parameters. Calibration mixture solution of target metabolites at concentrations of 0.5, 1, 1.5, 2, 2.5, 3, 3.5, 4, 4.5 and 5 μM were prepared by dilution in three replicates. Area values of the extracted ion chromatograms were transferred to Excel (Microsoft Excel 2011 v. 14.7.2, Microsoft, Redmond, WA, USA). The NMR untargeted metabolomics protocol was adapted from our previous study (Deborde *et al.*, 2019). Briefly, the supernatant (500 μL) was dried under vacuum and then dissolved in 800 μL of deuterated solvent prepared in a mixture of (1:1) Methanol-d₄: KH₂PO₄ buffer (0.1 M) in D₂O at pH 6.0 with TMSP (0.0125%), NaN₃ (0.6 mg·mL⁻¹), and maleic acid (1 mM). Then, the samples were briefly vortexed, sonicated, and centrifuged. The supernatant was placed in 5-mm NMR tubes and then used for NMR analysis. All NMR spectra were acquired at 300 K with a Bruker Avance III 600 MHz spectrometer operating at 600.13 MHz for ¹H, and 150.91 MHz for ¹³C, using a 5-mm double resonance broadband probe, equipped with z-gradient (BBFO 5 mm tube). For quantitative analysis, classical 1D ¹H-NMR spectra were collected using 128 scans of 131 K data points and a spectral width of 8417 Hz with a relaxation delay of 25 s. For metabolomics profiling, a NOESY-1D water suppression pulse sequence was used and generated spectra were collected using 256 scans of 131 K data points and a spectral width of 8417 Hz with a relaxation delay of 25 s. NMRProcFlow web application (Jacob *et al.*, 2017) was used to generate the untargeted metabolomics data matrix and the quantitative ¹H-NMR data. Bins with the lowest overlapping signals were kept (0.9 to 3.25 ppm and 4.5 to 8.5 ppm). Signals of maleic acid were used to calculate the absolute concentration of targeted metabolites. A combined data matrix with NMR and UPLC-HRMS untargeted analyses were generated. The percentage of the relative standard deviation (% RSD) was calculated for all metabolic features in each condition and the features

with % RSD greater than 25 % were removed due to variability. Metabolite pick areas were expressed in percentage (100 % corresponds to the mean for chicory decoction). Heatmap data was clustered (Ward's method was used to form hierarchical clustering) and visualized (using the pheatmap-package, version 1.0.12).

In vitro cytotoxic effect

The cytotoxic effect of samples was analyzed to determine the maximum concentrations that could be used for the other tests. The cytotoxic effect was performed using the cell counting assay-8 (CCK-8) (CK04, Tebu-Bio), according to the manufacturer's instructions. STC-1 and U937 cells were seeded in 96-well culture plates at 2×10^4 cells.cm⁻² and 3×10^5 cells.cm⁻², respectively. After reaching confluency, the growing medium was replaced by samples diluted at increasing concentrations in Dulbecco's modified Eagle's medium (DMEM, 4.5 g.L⁻¹ glucose) or in Roswell Park Memorial Institute medium (RPMI-1640). Culture medium was used as a negative control of cytotoxicity. The cells were incubated at 37 °C for 24 h and WST-8 was added at a final concentration of 5 % and cells were incubated at 37 °C for 90 min. WST-8 was reduced at the intracellular level into formazan for which the amount was directly proportional to viable cell number. Absorbance was measured at 450 nm using a microplate spectrophotometer (Xenius, Safas, Monaco) and the cytotoxic effect of the digested samples was determined.

In vitro secretion assay

The murine enteroendocrine STC-1 cells were seeded into 24-well culture plates at 2×10^4 cells.cm⁻² containing Dulbecco's modified Eagle's medium (DMEM, 4.5 g.L⁻¹ glucose) supplemented with 10 % fetal bovine serum (FBS), 100 U.mL⁻¹ penicillin, 100 µg.mL⁻¹ streptomycin, and 2 mM glutamine. When sub-confluence was reached, the medium was replaced by increasing concentrations of the digested samples or control effectors diluted in the medium. The cells were then incubated at 37 °C for 2 hours; the incubation medium was collected on ice and centrifuged (1,200 rpm for 5 min) and the supernatants were kept at -80 °C before cholecystokinin (CCK) determination. The amount of CCK released in the medium was determined using an Enzyme Immuno Assay kit (EK-069-04CE, Phoenix Pharmaceuticals, Burlingame, USA).

In vitro inflammatory cytokines secretion assay

Inflammation was induced with LPS on macrophage PMA-differentiated U937 cells according to Pouille *et al.*, (2022). Secreted IL-1 β was quantified using Millipore Human High Sensitivity T Cell kit (EMD Millipore, Darmstadt, Germany) according to the manufacturer's instructions. The quantification was carried out using the Luminex® 100/200 (Luminex Corporation, Austin, TX, USA) system and the Luminex xPONENT® for LX100/200 software. The cytokine IL-8 was quantified using a human IL-8/CXCL8 Quantikine® ELISA kit (R&D Systems, Inc., Minneapolis, MN, USA) and medium samples were diluted 100-fold according to the kit recommendations.

Cell-free systems evaluating antioxidative sample effects

The superoxide anion (O₂⁻) and hydroxyl radical (HO[•]) inhibitions were estimated in cell-free models (Pouille *et al.*, 2022). The concentration of the starting samples was standardized at 10 mg of dry matter per mL. After all assays, the maximal percentage of inhibition obtained for each reactive oxygen species (ROS) at the highest concentration for each sample was calculated. All measurements were performed against a blank cuvette, containing all reagents and samples. Inhibition control cuvettes contained 300 μ M cysteine. Results were converted into nmol.mL⁻¹ and expressed in bar diagrams \pm SD according to the sample volumes involved per mL of the reaction mixture.

Statistical analysis was conducted using 6 independent assays (GraphPad Prism 7 software for Windows, Inc., San Diego, CA, USA). Provided the population was normal (Shapiro–Wilk's test at the 5 % level) as well as variance homogeneity obtained (non-significative Bartlett's test at the 5 % level), ANOVA was performed (overall Fisher's test, $p < 0.05$, followed by the ad-hoc Tukey's test, $p < 0.05$). When ANOVA was not applicable, the non-parametric test of Kruskal–Wallis ($p < 0.05$) followed by Dunn's test ($p < 0.05$) were performed.

Results

The impact of the passage of chicory and its functional effectors (Fru, CGA and STL) through the digestive tract on their functional potential was determined by a series of analyses. To get as close as possible to the dietary conditions followed in a previous study (Pouille *et al.*, 2022), all analyses were performed with an aqueous decoction of chicory flour (Chic). To determine

how the environmental conditions of the three first compartments of the gastrointestinal tract exert modifications on this functional food, Chic underwent SGID before its metabolomic profile was analyzed by ¹H-NMR and UPLC-HRMS. The intestinal sample was then examined for its inhibitory activity on ROS production in a cell-free model. In parallel, digested Chic, Fru, CGA and STL were tested on STC-1 and U937 cell lines. The levels of cholecystokinin and pro-inflammatory cytokines were assayed by precision quantification methods and compared to those obtained with non-digested samples.

Effect of in vitro digestion on chicory composition

The chicory flour decoction was compared before and after SGID with principal component analysis of the results obtained with an untargeted metabolomics approach using UPLC-HRMS in negative and positive modes, and ¹H-RMN analyses. In total, 693, 689 and 289 variables were respectively kept after sorting out profiles and subtracting blank digested sample profile (data not shown). Similar pattern profiles were obtained with the three different methods (**Figure 3.1**). To understand the impact of the physiological conditions of each digestive compartment, two conditions were analyzed: an active one where chemical (enzymes) and physiological conditions (temperature, pH, mixing, salts concentrations) were respected, and an inactive one where enzymes were excluded and only physiological conditions were respected. The oral step of SGID did not trigger any change in the composition of chicory raw decoction according to UPLC-HRMS methods (**Figure 3.1A and 3.1B**) and a slight modification according to ¹H-RMN results (**Figure 3.1C**). Limited differences were also observed between active and inactive gastric conditions where the two signals overlap more or less depending on the type of analysis. The intestinal phase led to the most important changes compared to the non-digested decoction. Physico-chemical conditions of the intestinal environment (temperature, pH and salts) participated in these transformations as evidenced by the different clusters obtained with UPLC-HRMS analysis (**Figure 3.1A and 3.1B**) but intestinal enzymes were the major vectors of modification as evidenced by the segregation of the intestinal-active enzyme condition data clusters obtained with the three methods used.

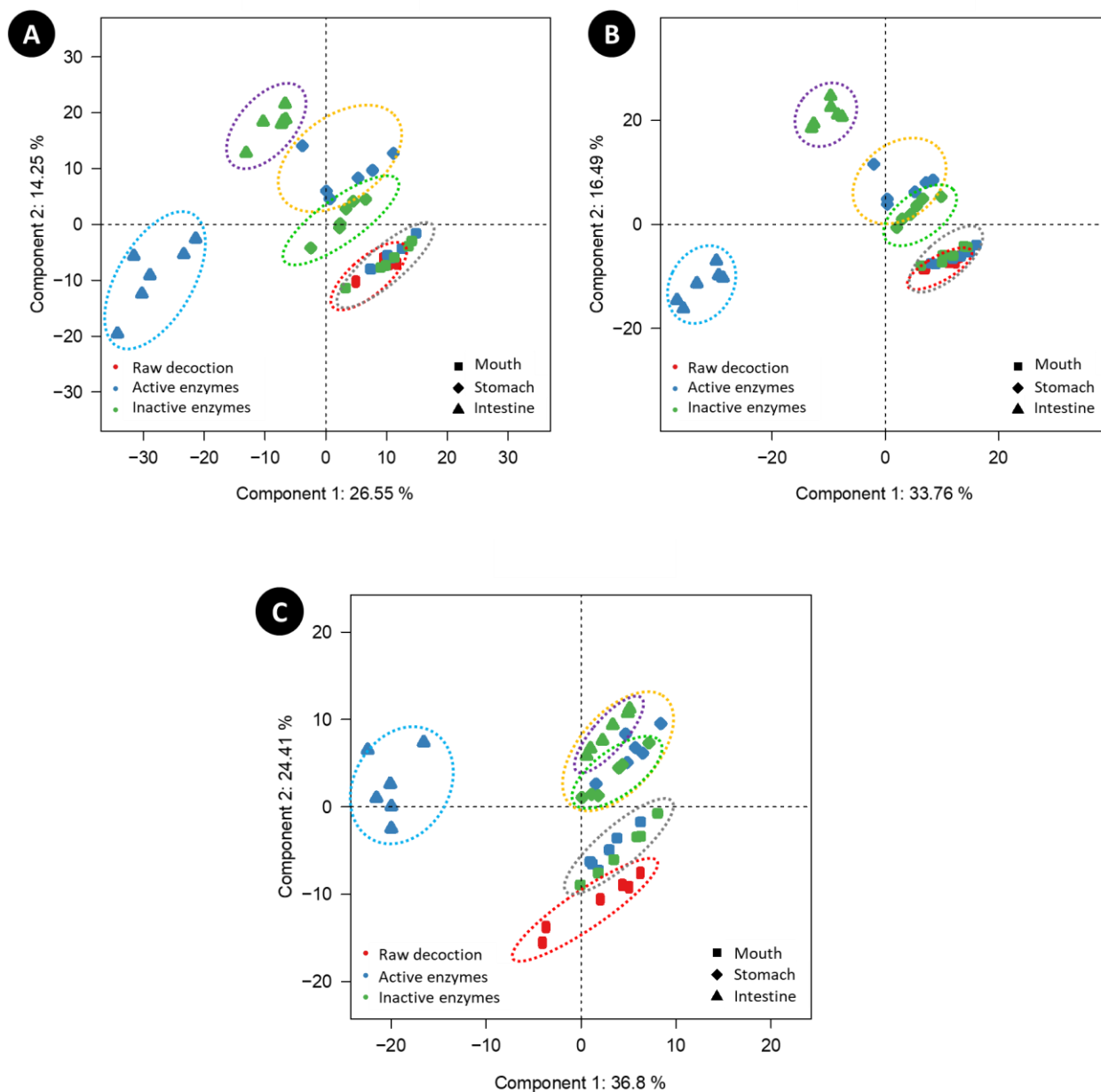

Figure 3.1. Principal component analysis of the chicory decoction (n = 6) after Simulated GastroIntestinal Digestion. Compounds were detected by UPLC-HRMS in (A) negative mode and (B) positive mode, and by (C) $^1\text{H-RMN}$ analysis. Results were pre-sorted to eliminate the blank digested sample signals. The oral, gastric, and intestinal phases of the SGID were represented by squares, diamonds and triangles, respectively. The non-digested decoction is identified in red. Digestion done with active enzymes is represented in blue, and without enzymes in green. The clusters delimited by dotted lines are only indicative of shifts in metabolomics profiles due to the conditions of digestion. Red-dotted: raw Chic; Grey-dotted: Oral digested samples; Green-dotted: Gastric samples digested without enzymes; Yellow-dotted: Gastric samples digested with active enzymes; Purple-dotted: Intestinal samples digested without enzymes; Blue-dotted: Intestinal samples digested with active enzymes.

In vitro antioxidant effect

The antioxidant effects of chicory decoction were measured in a cell-free model for the superoxide anion and hydroxyl radical inhibition before and after SGID (Figure 3.2). *In vitro* digestion did not impact the already high inhibitory effect of chicory decoction on superoxide anion production (Figure 3.2A and 3.2B) but drastically increased the inhibition of hydroxyl radical beginning from 0.5 mg.mL⁻¹ (Figure 3.2C and 3.2D).

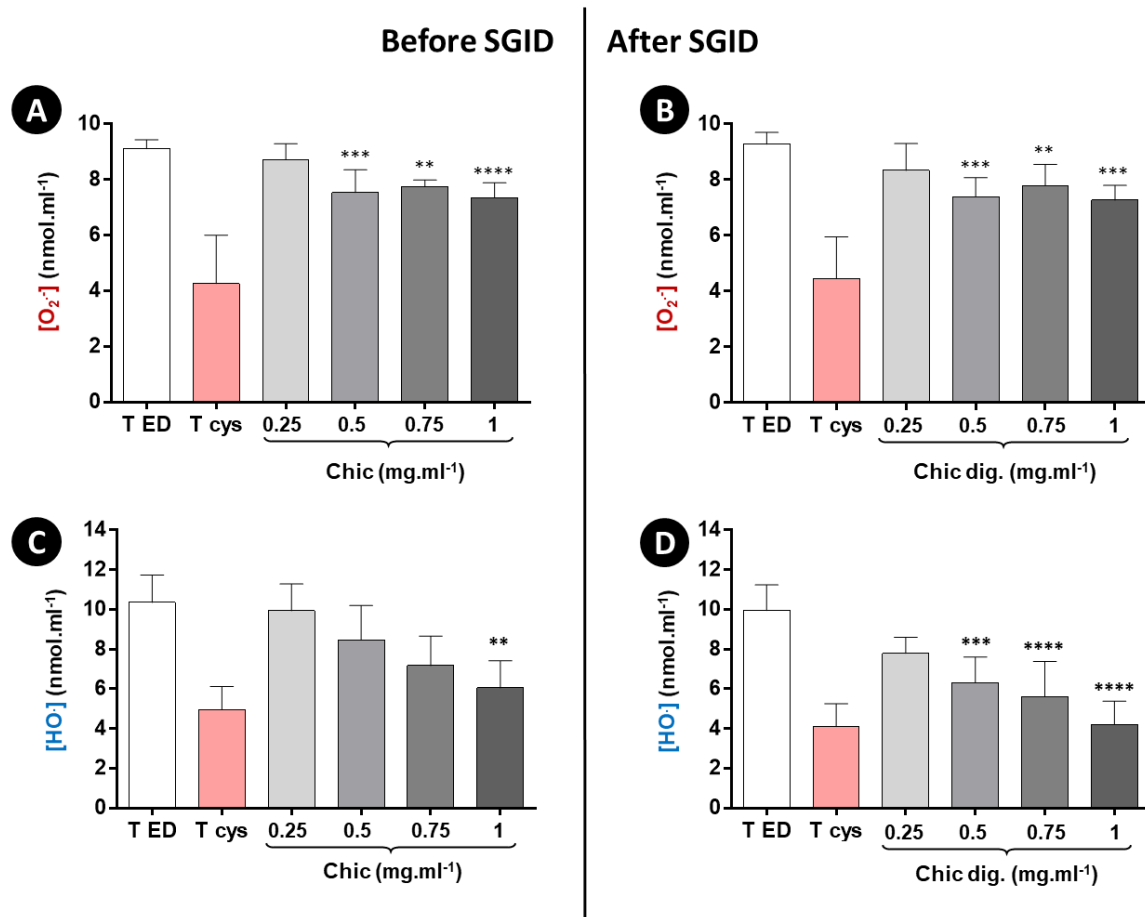

Figure 3.2. Oxygen free radicals inhibition by chicory in a cell-free model before and after SGID.

Superoxide anion (top graphs) and hydroxyl radical (bottom graphs) inhibition by raw decoction (A and C) and digested chicory decoction (B and D) were observed by contrast with the effect of the negative control (T ED) containing distilled water and the positive control containing cysteine (T cys). Each sample was tested at increasing concentrations ranging from 0.25 to 1 mg of dry matter equivalent per final mL. Statistical analysis for $n = 6$ independent assays were performed with ANOVA: Fisher's test, $p < 0.0005$ (A and B), $p < 0.05$ (C and D); Tukey's test, * $p < 0.05$, ** $p < 0.01$, *** $p < 0.001$, **** $p < 0.0001$ (A, B and D) and Kruskal-Wallis test, $p = 0.0017$; Dunn's test, ** $p < 0.01$ (C).

Cytotoxic effect

Before testing the effects of the different intestinal samples on cell-based assays, we performed cytotoxic analyses on STC-1 and U937 cells to determine the highest non-cytotoxic concentrations (**Figures 3.3 and 3.4**). Both cell lines were cultured in 96-well plates until sub-confluence and then put in contact with digested and non-digested samples for 24 h. Statistical analyses were performed to distinguish real cytotoxicity from apparent ones.

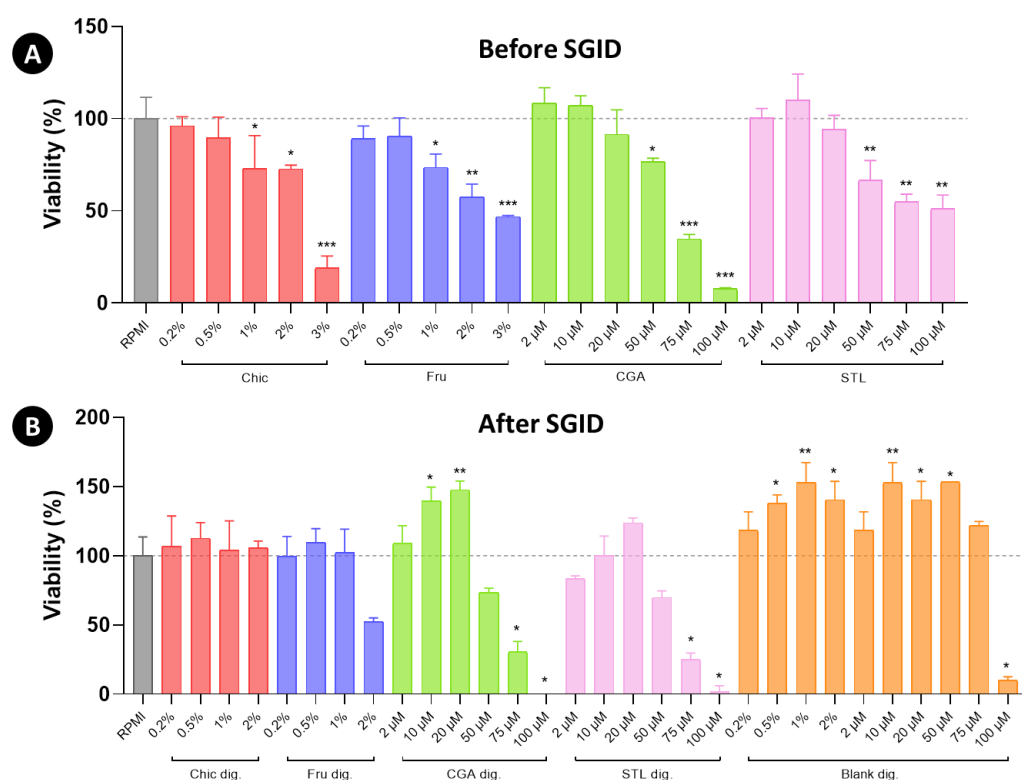

Figure 3.3. Cytotoxic effect of chicory decoction and its compounds on differentiated macrophages before and after SGID.

U937 cells were differentiated with PMA before being treated with increasing concentrations of raw chicory decoction (Chic), non-digested fructose (Fru), non-digested chlorogenic acids (CGA) and non-digested sesquiterpene lactones (STL) for 24 h (**A**). Samples underwent an *in vitro* simulated gastrointestinal digestion and intestinal samples were put in contact with U937 cells for 24h (**B**). Control digestion (Blank dig.) was performed under the same conditions. The cytotoxicity of samples was determined by a cell counting assay-8 and is expressed as a percentage of the control (RPMI medium) viability. Statistical analyses were performed using Kruskal-Wallis and Dunn's multiple comparisons tests (* $p < 0.05$; ** $p < 0.005$; *** $p < 0.0005$; **** $p < 0.0001$ against RPMI control). dig.: digested sample.

Viability was measured by CCK-8 test and showed that U937 cell line could endure Chic and Fru samples until 0.5 % (w/v) concentration (**Figure 3.3**) while STC-1 cells could withstand two times more (1 % w/v) (**Figure 3.4**). Compounds such as CGA and STL mixes could be tested at a maximum concentration of 20 μ M in both cell lines.

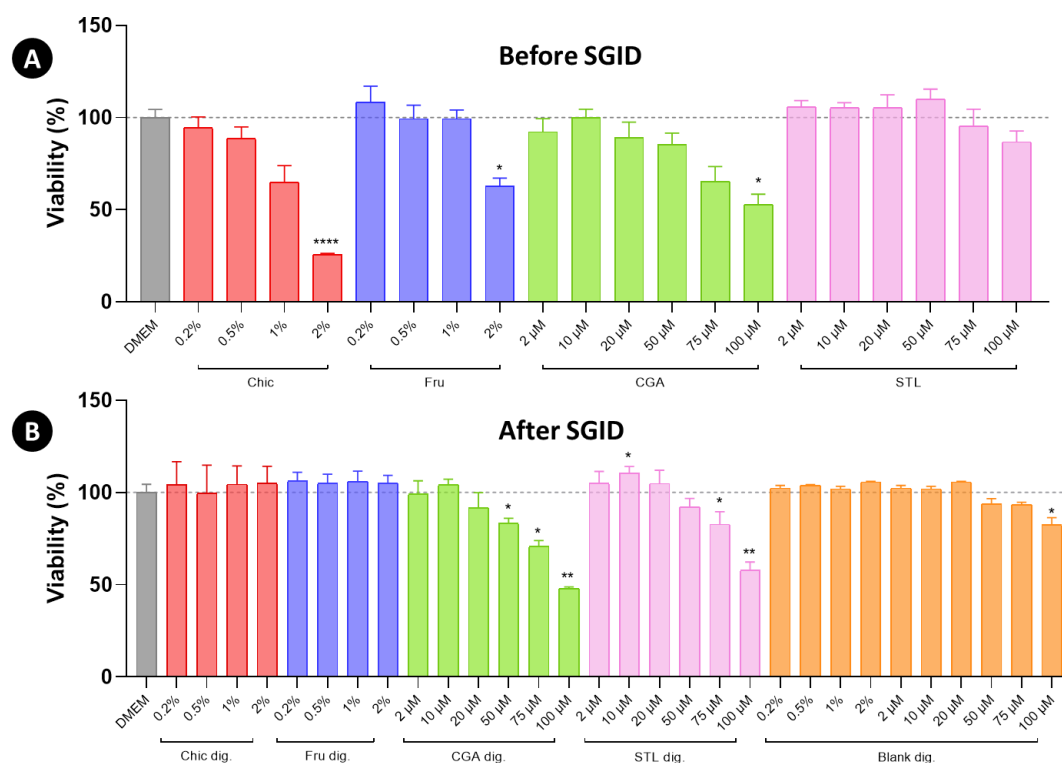

Figure 3.4. Cytotoxic effect of chicory decoction and its compounds on enteroendocrine cells before and after SGID.

STC-1 cells were treated with increasing concentrations of raw chicory decoction (Chic), non-digested fructose (Fru), non-digested chlorogenic acids (CGA) and non-digested sesquiterpene lactones (STL) for 24 h (**A**). Samples underwent an *in vitro* simulated gastrointestinal digestion and intestinal samples were put in contact with STC-1 cells for 24 h (**B**). Control digestion (Blank dig.) was performed under the same conditions. The cytotoxicity of samples was determined by a cell counting assay-8 and is expressed as a percentage of the control (DMEM medium) viability. Statistical analyses were performed using Brown-Forsythe and Welch ANOVA with Dunnett's multiple comparisons tests (**A**) and Kruskal-Wallis and Dunn's multiple comparisons tests (**B**) (* $p < 0.05$; ** $p < 0.005$; *** $p < 0.0005$; **** $p < 0.0001$ against DMEM control). dig.: digested sample.

In vitro intestinal hormone secretion regulation

The chicory flour decoction and its components (CGA, STL, Fru) were tested for their ability to stimulate CCK secretion in STC-1 cells before and after SGID at the previously determined highest non-cytotoxic concentration (**Figure 3.4**). Results showed that SGID does not affect the capacity of the chicory decoction to increase the CCK secretion but that it significantly provided it for STL and tended to for Fru ($p = 0.0525$) (**Figure 3.5**).

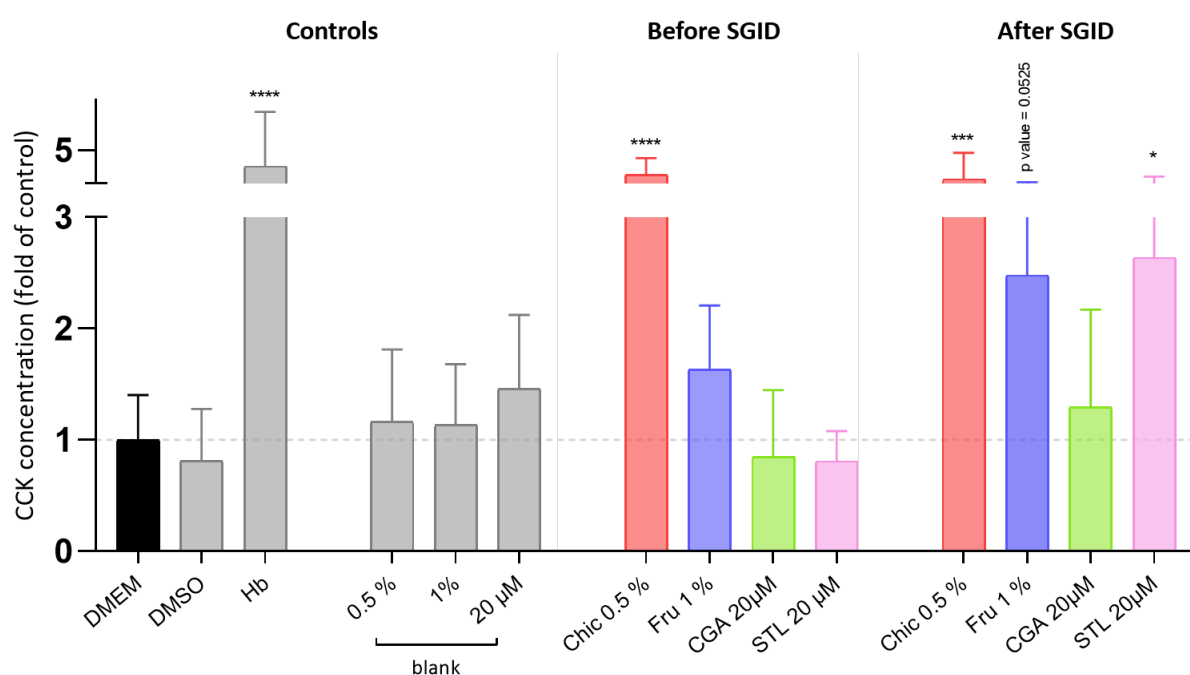

Figure 3.5. Effect of chicory on cholecystokinin secretion by STC-1 cells.

STC-1 cells were incubated for 2 h with different final concentrations of chicory decoction (Chic), fructose (Fru), chlorogenic acids (CGA) and sesquiterpene lactones (STL) before and after SGID, in DMEM. Digested bovine hemoglobin (Hb, 0.5% dry matter final concentration) was used as positive control. DMEM and DMSO were used as medium controls, and blank as control of digestion. CCK level was determined in cell media by EIA and expressed as fold of control (DMEM) levels. Statistical analysis was performed using one-way ANOVA and Dunnett's multiple comparisons test (* $p < 0.05$, *** $p = 0.0001$, **** $p < 0.0001$ against DMEM control). Blank 0.5 %: control associated with Chic; Blank 1 % control associated with Fru; Blank 20 µM: control associated with STL and CGA.

In vitro evaluation of the anti-inflammatory effect

To evaluate the potential anti-inflammatory effect of chicory decoction and its effectors, the secretion of the pro-inflammatory cytokines (IL-1 β and IL-8) was determined in LPS-induced macrophage at their highest non-cytotoxic concentration afore determined (**Figure 3.3**).

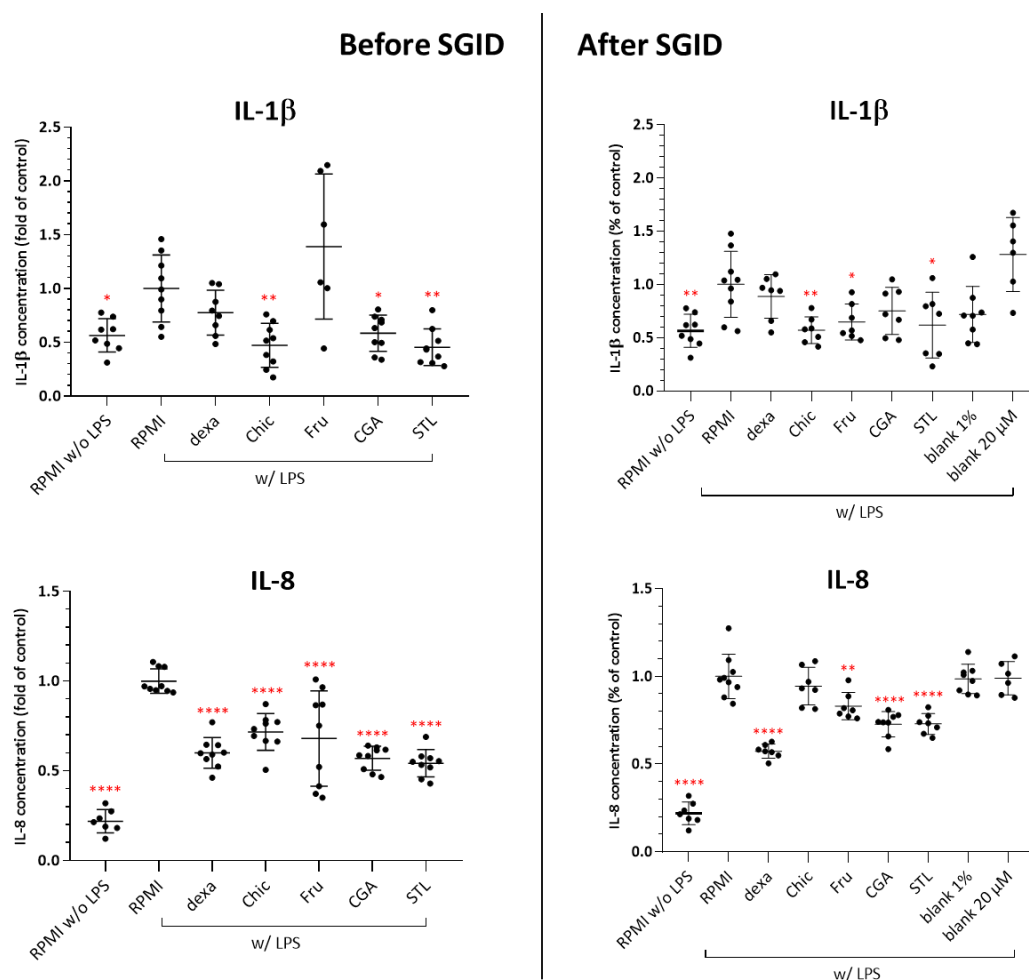

Figure 3.6. Effects of chicory decoction on LPS-induced secretion of interleukin-1 β (IL-1 β) and interleukin-8 (IL-8) in human U937-macrophages before and after SGID. U937 were differentiated with 60 ng.mL⁻¹ of PMA for 48h before being put in contact with the different samples. Cytokine production was measured after 2 h of incubation with culture medium (RPMI), LPS at 50 μ g.mL⁻¹, or with a positive inflammation inhibition control (LPS at 50 μ g.mL⁻¹ + dexamethasone at 20 μ M) or with LPS (50 μ g.mL⁻¹) + tested samples (N = 3). Statistical analysis of the data was performed with one-way ANOVA and Dunnett's multiple comparisons tests to compare the LPS-RPMI control to the dexamethasone control and samples with GraphPad Prism software (* $p < 0.05$; ** $p < 0.005$; *** $p < 0.001$; **** $p < 0.0001$). Chic: 1 % of chicory decoction; Fru: 1 % of fructose; CGA: 20 μ M of chlorogenic acids mix; STL: 20 μ M of sesquiterpene lactones mix; blank 1%: control of digestion associated with Chic and Fru; blank 20 μ M: control of digestion associated with CGA and STL.

Results showed that whatever the considered experiment, the secretion of the two cytokines studied was increased by exposure to LPS alone compared to the non-inflamed control (**Figure 3.6**). The IL-8 pro-inflammatory cytokine was significantly downregulated by the addition of glucocorticoid dexamethasone at the concentration of 20 μ M but not the IL-1 β despite a slight decrease. Before SGID, the chicory decoction and its effectors all decreased the IL-8 secretion similarly to the dexamethasone control. The levels of IL-1 β were decreased in the presence of chicory decoction and CGA and STL to comparable levels obtained to that of non-LPS-inflamed condition. Fru did not induce any modification in the IL-1 β secretion by macrophages when compared to the LPS-RPMI control condition. After SGID, as expected, both digestion controls did not induce any anti-inflammatory effect. Regarding the IL-8 secretion, the same anti-inflammatory effect as before SGID was observed for chicory effectors but not for chicory decoction. Chicory decoction, Fru, and STL decreased IL-1 β secretion after SGID at a comparable level to that of the LPS-RPMI control condition.

Discussion

Chicory flour was already described as a functional food in upper studies (Pouille *et al.*, 2020; Pouille *et al.*, 2022) but little is known about its fate in the digestive tract. This work was carried out to determine the extent to which gastrointestinal digestion has an impact on the composition and the potential health effects of chicory and its major bioactive compounds (Fru, CGA, STL). The INFOGEST consensus protocol was implemented to mimic the first three compartments of the gastrointestinal tract in their physiological conditions and enzyme activities. Digested chicory decoction obtained in active- and inactive-enzyme conditions in the oral, gastric and intestinal compartments were analyzed for metabolomic profiling by ¹H-NMR and UPLC-HRMS. Full-digested (intestinal compartment) chicory decoction, fructose, CGA and STL were tested *in vitro* for their inhibitory action on ROS and cytokines production, and their effect on CCK secretion.

The chicory composition changes during in vitro digestion

Metabolic analyses showed a compartment-dependent effect as the physicochemical and enzyme conditions variably contributed to the specific modifications of the chicory decoction compounds. *In vivo*, during digestion, the release of bioactive molecules from food begins in the oral compartment. Food is first exposed to salivary α -amylase which degrades starch, and

lipase which is responsible for triglycerides degradation (Pedersen *et al.*, 2018). Mastication also helps in breaking the ingested food matrix down into smaller portions making macromolecules more accessible to enzyme action (Zou *et al.*, 2016). In comparison, in this study, this compartment was simulated with amylase at a neutral pH and a constant stirring. No lipase was used according to the INFOGEST protocol (Brodkorb *et al.*, 2019). The mastication did not have to be simulated here because the chicory decoction and its effectors were in suspension and solution and not incorporated into a solid matrix. Very minor modifications of metabolomic profiles were observed after this phase of *in vitro* digestion (**Figure 3.1**).

The second step of digestion takes place in the stomach where operate four types of cells: neuroendocrine, parietal, chief and foveolar cells. The neuroendocrine cells are responsible for the secretion of histamine, gastrin, somatostatin, and the tight regulation of the production of gastric acids by the parietal cells. In turn, chief cells cleave the pepsinogen into active pepsin protease. The foveolar cells produce mucus protecting the gastric mucosa against gastric acids (Hsu *et al.*, 2022). Not all these conditions could be reproduced using the static INFOGEST protocol. Gastric movements involved in the further breaking down of the food matrix could not be reproduced either. Only physiological conditions such as pH, salts concentrations and pepsin enzyme activity were emulated (Brodkorb *et al.*, 2019). In our study, physiological conditions but not enzymes of the gastric compartment triggered a shift in metabolomics profiles (**Figure 3.1**). Indeed, the protein content of chicory decoction is very low (6 to 9 % of dry weight) and the impact of pepsin activity therefore limited. Regarding the effectors studied, it has been reported that fructose is not affected by the gastric environment (Dholariya *et al.*, 2021), and little is known about the fate of chicory STL in this compartment. Stomach acidity is known to trigger a rapid degradation of alantolactone and costunolide (Yu *et al.*, 2020) but not of CGA, which seems to be stable in acidic conditions (Olthof *et al.*, 2001, Baeza *et al.*, 2018).

After gastric digestion, the chyme reaches the small intestine where the large majority of metabolism and absorption of bioactive molecules happens (Ogobuiro *et al.*, 2022). The small intestine is constituted of three different segments: duodenum, jejunum and ileum, where the intestinal mucosa is folded in villi of varying lengths. On their surface are present enterocytes involved in the absorption of food nutrients, goblet cells producing the mucus, enteroendocrine cells secreting hormones and Paneth cells exerting a protective action against pathogens (Kong *et al.*, 2018). When the food bolus enters the first segment of the intestine, it is mixed with both duodenum and pancreas secretion including pancreatic amylases, lipases, proteases and

peptidases. Trypsinogen, chymotrypsinogen, procarboxypeptidase and proelastase are then converted to their active form by the action of the duodenum enterokinases. The liver also delivers bile that emulsifies hydrophobic lipids and helps the action of the hydrophilic pancreatic lipases (Patricia *et al.*, 2021). Not all intestinal conditions could be replicated *in vitro* but the pH was adjusted to a physiological one (pH = 7-7.5) (Evans *et al.*, 1988), and the chyme was incubated in the presence of bile and pancreatin which is a mix of lipases, amylases and proteases. Our results indicated that in this phase of digestion, enzymatic activity and/or alkaline medium notably changed the metabolic profile of the chicory (**Figure 3.1**).

Concerning bioactive molecules of chicory, it is already known that fructose is transformed in the small intestinal tract only, and converted into glucose and organic acids (Jang *et al.*, 2018). Depending on their structure, the STL are partially transformed during digestion. Some compounds may be bioavailable in their original forms (Rocchetti *et al.*, 2020) but also in a transformed form due to interactions with plasma proteins, intracellular glutathione binding or gut microbiota metabolism (Matos *et al.*, 2021). Thus, it is estimated that a third of cyanopicrin is degraded in the intestine as it was described *in vitro* (Colantuono *et al.*, 2018), and that an important amount of chicory lactucin and lactucopicrin is transformed in the large intestine by microbial activities (García *et al.*, 2020). CGA were found to be degraded up to 50 % in the small intestine (Crozier *et al.*, 2010) through the slightly alkaline pH, and to form less complex compounds such as caffeic, ferulic, quinic and coumaric acids (Selma *et al.*, 2009, Vamanu *et al.*, 2020, Wojtunik-Kulesza *et al.*, 2020). Non-absorbed phenolic compounds can reach the colon where they are metabolized by microbiota's enzymes to molecules with a lower molecular weight making them more easily absorbable (Quatrin *et al.*, 2020). Some CGA were described as completely transformed during gastrointestinal digestion (Baeza *et al.*, 2018).

SGID potentiates ROS scavenging effect of chicory decoction

As the intestine is the seat of nutrient sensing and absorption, the intestinal digested chicory was considered the most physiologically relevant to measure its capacity to inhibit the production of ROS in a cell-free model. Raw and digested chicory decoction were thus compared and results showed their comparable effect on superoxide anion production (**Figures 3.2A and 3.2B**). However, a much more important inhibitory activity was observed on hydroxyl radical (**Figures 3.2C and 3.2D**) which is known to be the most reactive ROS (Das & Roychoudhury, 2014). The antiradical effect of many *Asteraceae* was associated with their caffeoyl derivatives content (Fraisse *et al.*, 2011), so we hypothesize that 3-mono-*O*-

caffeoylquinic and 3,5-di-*O*-caffeoylquinic acids, two polyphenols already detected in chicory decoction (Pouille *et al.*, 2022), are the main bioactive molecules responsible for this effect. Most studies showed an increase in the scavenging activity of foodstuffs containing dietary polyphenols during the digestion process (Ovando-Martínez *et al.*, 2018, Chen *et al.*, 2017, Cañas *et al.*, 2022). This activity was directly linked to polyphenol content and mostly to CGA (Mawalagedera *et al.*, 2016). All together we could then presume that the release of CGA from the chicory matrix and/or their transformation in a more scavenging form, occurs during the intestinal phase of digestion and triggers an increased antioxidant activity of digestates.

Anti-inflammatory and intestinal hormone secretion stimulation effects of chicory were preserved after SGID

The ability of chicory and its effectors to stimulate CCK secretion in enteroendocrine cells was studied here as previous results on digested roasted chicory had shown promising results (Fouré *et al.*, 2018). In the present study, the SGID did not modify the already high efficiency of chicory to stimulate CCK secretion in STC-1 enteroendocrine cells but raised the activity of effectors, especially of the STL which trigger a significant increase of CCK after digestion (**Figure 3.5**). CCK is known to be released from endocrine L-cells localized in the upper intestinal tract mostly through lipid and protein intake (Dockray, 2012). This hormone is involved in various physiological mechanisms of the digestive tract (Rehfeld, 2004), and highly contributes to the regulation of food intake (Morton *et al.*, 2006). Chicory flour seems to exert a secretagogue effect on CCK *in vitro*. Being more active after digestion, all tested bioactive molecules, especially STL, seem involved in this effect. We cannot exclude that other constituents of the chicory could also be involved, such as lipids (< 0.2 % dry weight) or proteins (6 - 9 % dry weight) (Leclercq, 1992). These preliminary results highlight the potential implication of chicory in the regulation of food intake via intestinal nutrient sensing. Further investigations have to be done to confirm *in vivo* this effect and to identify the responsible molecules and the molecular mechanisms involved.

The effects of chicory decoction and its effectors at non-cytotoxic concentrations on inflammation were studied before and after SGID by measuring the production of two pro-inflammatory cytokines, IL-8 and IL-1 β , in U937 monocytes differentiated into macrophages and stimulated by LPS. Chicory flour, CGA and STL triggered a significant reduction of IL-1 β and IL-8 secretion before SGID (**Figure 3.6**) and preserved this action after SGID. Fructose showed an inhibitory effect on IL-1 β after digestion only. In the gastrointestinal tract fructose

is transformed to organic acids such as lactate (Jang *et al.*, 2018) which could exert anti-inflammatory effects at low-dose (Zwaag *et al.*, 2020) and explain this gain of activity.

The interleukin-1 β plays a major role in the initiation and amplification of the inflammatory response (Böcker *et al.*, 1998) and is implicated in mediator release and leucocyte recruitment (Martin & Wallace, 2006), while IL-8 is secreted in response to inflammatory stimuli and is involved in the recruitment of neutrophils, basophils, T lymphocytes and polynuclear cells, and also in neutrophil activation (Henkels *et al.*, 2010). Nevertheless, cytokine production in excessive quantity results for instance in tissue damage, toxicity and cell death in the case of chronic inflammation (Iyer & Cheng, 2012). In our study, the glucocorticoid dexamethasone was used as a positive control of inhibition inflammation. Glucocorticoids are widely used for the treatment of inflammation as they exert protective and anti-inflammatory actions notably because they inhibit gene expression of pro-inflammatory cytokines (Medzhitov, 2010).

The results obtained are very encouraging as the effects of certain bioactive compounds are comparable to those obtained with dexamethasone and as chicory and its effectors present very interesting anti-inflammatory profiles before and after SGID.

Conclusion

Untargeted ¹H-NMR and UPLC-HRMS analyses were carried out on chicory decoction after an oral, gastric and intestinal *in vitro* digestion to determine the impact of the gastrointestinal tract on its metabolomic profile. Although the *in vitro* digestion is an imperfect simulation of the *in vivo* process, we can observe the importance of physiological conditions of different compartments and the one of digestive enzymes at the intestinal level for the release and/or the transformation of the chicory matrix into more active molecules. *In vitro* tests for antioxidant effect of chicory showed an increase of this effect after digestion. The anti-inflammatory effect and the release of CCK hormone were also increased on *in vitro* cells after the chicory digestion and also after several bioactive molecules digestion (fructose, CGA and STL). We can thus presume that after digestion, the different absorbed molecules released from the chicory flour matrix could better trigger their health effect. The colonic bacteria represent a second mechanism of the chicory flour action and of its bioactives (Pouille *et al.*, 2020, Pouille *et al.*, 2022). To be complete, future studies should make use of the SHIME® system and look at the bioaccessibility of various chicory molecules.

References

- Akare, S., & Martinez, J. D. (2005). Bile acid induces hydrophobicity-dependent membrane alterations. *Biochimica Et Biophysica Acta (BBA) - Molecular and Cell Biology of Lipids*, 1735(1), 59–67. <https://doi.org/10.1016/j.bbalip.2005.04.006>
- Azzini, E., Bugianesi, R., Romano, F., Di Venere, D., Miccadei, S., Durazzo, A., . . . Maiani, G. (2007). Absorption and metabolism of bioactive molecules after oral consumption of cooked edible heads of *Cynara scolymus* L. (cultivar Violetto di Provenza) in human subjects: a pilot study. *British Journal of Nutrition*, 97(5), 963–969. <https://doi.org/10.1017/s0007114507617218>
- Baeza, G., Sarriá, B., Bravo, L., & Mateos, R. (2018). Polyphenol content, *in vitro* bioaccessibility and antioxidant capacity of widely consumed beverages. *Journal of the Science of Food and Agriculture*, 98(4), 1397–1406. <https://doi.org/10.1002/jsfa.8607>
- Böcker, U., Damião, A., Holt, L., Han, D. S., Jobin, C., Panja, A., . . . Sartor, R. (1998). Differential expression of interleukin 1 receptor antagonist isoforms in human intestinal epithelial cells. *Gastroenterology*, 115(6), 1426–1438. [https://doi.org/10.1016/s0016-5085\(98\)70021-6](https://doi.org/10.1016/s0016-5085(98)70021-6)
- Brodkorb, A., Egger, L., Alminger, M., Alvito, P., Assunção, R., Ballance, S., . . . Recio, I. (2019). INFOGEST static *in vitro* simulation of gastrointestinal food digestion. *Nature Protocols*, 14(4), 991–1014. <https://doi.org/10.1038/s41596-018-0119-1>
- Cañas, S., Rebollo-Hernanz, M., Aguilera, Y., Braojos, C., Benítez, V., Gil-Ramírez, A., . . . Martín-Cabrejas, M. A. (2022). Gastrointestinal digestion and absorption of antioxidant phenolic compounds and caffeine from the coffee pulp under simulated conditions. *IECN 2022*. <https://doi.org/10.3390/iecn2022-12395>
- Chen, Y., Fu, Z. F., Tu, Z. C., Wang, H., Zhang, L., Xie, X., & Liu, G. (2017). Influence of *in vitro* gastrointestinal digestion on the bioavailability and antioxidant activity of polyphenols from *Ipomoea batatas* leaves. *International Journal of Food Science & Technology*, 52(5), 1131–1137. <https://doi.org/10.1111/ijfs.13377>
- Colantuono, A., Ferracane, R., & Vitaglione, P. (2018). Potential bioaccessibility and functionality of polyphenols and cynaropicrin from breads enriched with artichoke stem. *Food Chemistry*, 245, 838–844. <https://doi.org/10.1016/j.foodchem.2017.11.099>
- Colombo, R., Ferron, L., Frosi, I., & Papetti, A. (2021). Advances in static *in vitro* digestion models after the COST action Infogest consensus protocol. *Food & Function*, 12(17), 7619–7636. <https://doi.org/10.1039/d1fo01089a>

- Crozier, A., Del Rio, D., & Clifford, M. N. (2010). Bioavailability of dietary flavonoids and phenolic compounds. *Molecular Aspects of Medicine*, 31(6), 446–467. <https://doi.org/10.1016/j.mam.2010.09.007>
- D’Antuono, I., Garbetta, A., Linsalata, V., Minervini, F., & Cardinali, A. (2015). Polyphenols from artichoke heads (*Cynara cardunculus* (L.) subsp. *scolymus* Hayek): *in vitro* bio-accessibility, intestinal uptake and bioavailability. *Food & Function*, 6(4), 1268–1277. <https://doi.org/10.1039/c5fo00137d>
- Das, K., & Roychoudhury, A. (2014). Reactive oxygen species (ROS) and response of antioxidants as ROS-scavengers during environmental stress in plants. *Frontiers in Environmental Science*, 2. <https://doi.org/10.3389/fenvs.2014.00053>
- Deborde, C., Fontaine, J. X., Jacob, D., Botana, A., Nicaise, V., Richard-Forget, F., . . . Molinié, R. (2019). Optimizing 1D ¹H-NMR profiling of plant samples for high throughput analysis: extract preparation, standardization, automation and spectra processing. *Metabolomics*, 15(3), 28. <https://doi.org/10.1007/s11306-019-1488-3>
- Dholariya, S.J., & Orrick, J.A. (2021). Biochemistry, Fructose metabolism. In StatPearls (Ed.). StatPearls Publishing. Retrieved October 5, 2022 from <https://www.ncbi.nlm.nih.gov/books/NBK576428/>
- Dockray, G. J. (2012). Cholecystokinin. *Current Opinion in Endocrinology, Diabetes & Obesity*, 19(1), 8–12. <https://doi.org/10.1097/med.0b013e32834eb77d>
- Evans, D. F., Pye, G., Bramley, R., Clark, A. G., Dyson, T. J., & Hardcastle, J. D. (1988). Measurement of gastrointestinal pH profiles in normal ambulant human subjects. *Gut*, 29(8), 1035–1041. <https://doi.org/10.1136/gut.29.8.1035>
- Fouré, M., Dugardin, C., Foligné, B., Hance, P., Cadalen, T., Delcourt, A., . . . Lucau-Danila, A. (2018). Chicory roots for prebiotics and appetite regulation: a pilot study in mice. *Journal of Agricultural and Food Chemistry*, 66(25), 6439–6449. <https://doi.org/10.1021/acs.jafc.8b01055>
- Fraisse, D., Felgines, C., Texier, O., & Lamaison, J. L. (2011). Caffeoyl derivatives: major antioxidant compounds of some wild herbs of the *Asteraceae* family. *Food and Nutrition Sciences*, 02(03), 181–192. <https://doi.org/10.4236/fns.2011.230025>
- García, C. J., Beltrán, D., & Tomás-Barberán, F. A. (2020). Human gut microbiota metabolism of dietary sesquiterpene lactones: untargeted metabolomics study of lactucopicrin and lactucin conversion *in vitro* and *in vivo*. *Molecular Nutrition & Food Research*, 64(21), 2000619. <https://doi.org/10.1002/mnfr.202000619>

- Henkels, K. M., Frondorf, K., Gonzalez-Mejia, M. E., Doseff, A. L., & Gomez-Cambronero, J. (2010). IL-8-induced neutrophil chemotaxis is mediated by Janus kinase 3 (JAK3). *FEBS Letters*, *585*(1), 159–166. <https://doi.org/10.1016/j.febslet.2010.11.031>
- Hsu, M., Safadi, A.O., & Lui, F. (2022). Physiology, Stomach. In StatPearls (Ed.). StatPearls Publishing. Retrieved October 2, 2022 from <https://www.ncbi.nlm.nih.gov/books/NBK535425/>
- Iyer, S. S., & Cheng, G. (2012). Role of Interleukin 10 transcriptional regulation in inflammation and autoimmune disease. *Critical ReviewsTM in Immunology*, *32*(1), 23–63. <https://doi.org/10.1615/critrevimmunol.v32.i1.30>
- Jacob, D., Deborde, C., Lefebvre, M., Maucourt, M., & Moing, A. (2017). NMRProcFlow: a graphical and interactive tool dedicated to 1D spectra processing for NMR-based metabolomics. *Metabolomics*, *13*(4), 36. <https://doi.org/10.1007/s11306-017-1178-y>
- Janda, K., Gutowska, I., Geszke-Moritz, M., & Jakubczyk, K. (2021). The common Cichory (*Cichorium intybus* L.) as a source of extracts with health-promoting properties—A Review. *Molecules*, *26*(6), 1814. <https://doi.org/10.3390/molecules26061814>
- Jang, C., Hui, S., Lu, W., Cowan, A. J., Morscher, R. J., Lee, G., . . . Rabinowitz, J. D. (2018). The small intestine converts dietary fructose into glucose and organic acids. *Cell Metabolism*, *27*(2), 351–361. <https://doi.org/10.1016/j.cmet.2017.12.016>
- Kleessen, B., Hartmann, L., & Blaut, M. (2001). Oligofructose and long-chain inulin: influence on the gut microbial ecology of rats associated with a human faecal flora. *British Journal of Nutrition*, *86*(2), 291–300. <https://doi.org/10.1079/bjn2001403>
- Kong, S., Zhang, Y. H., & Zhang, W. (2018). Regulation of intestinal epithelial cells properties and functions by amino acids. *BioMed Research International*, *2018*, 2819154. <https://doi.org/10.1155/2018/2819154>
- Lafay, S., Gil-Izquierdo, A., Manach, C., Morand, C., Besson, C., & Scalbert, A. (2006). Chlorogenic acid is absorbed in its intact form in the stomach of rats. *The Journal of Nutrition*, *136*(5), 1192–1197. <https://doi.org/10.1093/jn/136.5.1192>
- Leclercq, E. (1992). *Sesquiterpene lactones and inulin from chicory roots: extraction, identification, enzymatic release and sensory analysis*. (Doctoral dissertation, Landbouwniversiteit te Wageningen, Wageningen). Retrieved from <https://edepot.wur.nl/203004>

- Martin, G. R., & Wallace, J. L. (2006). Gastrointestinal inflammation: A central component of mucosal defense and repair. *Experimental Biology and Medicine*, 231(2), 130–137. <https://doi.org/10.1177/153537020623100202>
- Matos, M. S., Anastácio, J. D., Allwood, J. W., Carregosa, D., Marques, D., Sungurtas, J., . . . Santos, C. N. D. (2020). Assessing the intestinal permeability and anti-inflammatory potential of sesquiterpene lactones from chicory. *Nutrients*, 12(11), 3547. <https://doi.org/10.3390/nu12113547>
- Matos, M. S., Anastácio, J. D., & Nunes dos Santos, C. (2021). Sesquiterpene lactones: promising natural compounds to fight inflammation. *Pharmaceutics*, 13(7), 991. <https://doi.org/10.3390/pharmaceutics13070991>
- Mawalagedera, S. M. M. R., Ou, Z. Q., McDowell, A., & Gould, K. S. (2016). Effects of boiling and *in vitro* gastrointestinal digestion on the antioxidant activity of *Sonchus oleraceus* leaves. *Food & Function*, 7(3), 1515–1522. <https://doi.org/10.1039/c5fo01508a>
- Medzhitov, R. (2010). Inflammation 2010: New adventures of an old flame. *Cell*, 140(6), 771–776. <https://doi.org/10.1016/j.cell.2010.03.006>
- Morrison, D. J., & Preston, T. (2016). Formation of short chain fatty acids by the gut microbiota and their impact on human metabolism. *Gut Microbes*, 7(3), 189–200. <https://doi.org/10.1080/19490976.2015.1134082>
- Morton, G. J., Cummings, D. E., Baskin, D. G., Barsh, G. S., & Schwartz, M. W. (2006). Central nervous system control of food intake and body weight. *Nature*, 443(7109), 289–295. <https://doi.org/10.1038/nature05026>
- Ogobuiro, I., Gonzales, J., & Tuma, F. (2022). Physiology, Gastrointestinal. In StatPearls (Ed.). StatPearls Publishing. Retrieved October 5, 2022 from <https://www.ncbi.nlm.nih.gov/books/NBK537103/?report=classic>
- Olthof, M. R., Hollman, P. C. H., Buijsman, M. N., van Amelsvoort, J. M. M., & Katan, M. B. (2003). Chlorogenic acid, quercetin-3-rutinoside and black tea phenols are extensively metabolized in humans. *The Journal of Nutrition*, 133(6), 1806–1814. <https://doi.org/10.1093/jn/133.6.1806>
- Olthof, M. R., Hollman, P. C. H., & Katan, M. B. (2001). Chlorogenic acid and caffeic acid are absorbed in humans. *The Journal of Nutrition*, 131(1), 66–71. <https://doi.org/10.1093/jn/131.1.66>
- Ovando-Martínez, M., Gámez-Meza, N., Molina-Domínguez, C. C., Hayano-Kanashiro, C., & Medina-Juárez, L. A. (2018). Simulated gastrointestinal digestion, bioaccessibility and antioxidant capacity of polyphenols

- from red chiltepin (*Capsicum annuum* L. var. *glabriusculum*) grown in northwest Mexico. *Plant Foods for Human Nutrition*, 73(2), 116–121. <https://doi.org/10.1007/s11130-018-0669-y>
- Patricia, J.J., & Dhamoon, A.S. (2021). Physiology, Digestion. In StatPearls (Ed.). StatPearls Publishing. Retrieved October 5, 2022 from <https://www.ncbi.nlm.nih.gov/books/NBK544242/?report=classic>
- Pedersen, A., Sørensen, C., Proctor, G., & Carpenter, G. (2018). Salivary functions in mastication, taste and textural perception, swallowing and initial digestion. *Oral Diseases*, 24(8), 1399–1416. <https://doi.org/10.1111/odi.12867>
- Perović, J., Tumbas Šaponjac, V., Kojić, J., Krulj, J., Moreno, D. A., García-Viguera, C., . . . Ilić, N. (2021). Chicory (*Cichorium intybus* L.) as a food ingredient – Nutritional composition, bioactivity, safety, and health claims: A review. *Food Chemistry*, 336, 127676. <https://doi.org/10.1016/j.foodchem.2020.127676>
- Pouille, C. L., Jegou, D., Dugardin, C., Cudennec, B., Ravallec, R., Hance, P., . . . Lucau-Danila, A. (2020). Chicory root flour – A functional food with potential multiple health benefits evaluated in a mice model. *Journal of Functional Foods*, 74, 104174. <https://doi.org/10.1016/j.jff.2020.104174>
- Pouille, C. L., Ouaza, S., Roels, E., Behra, J., Turret, M., Molinié, R., . . . Lucau-Danila, A. (2022). Chicory: Understanding the Effects and Effectors of This Functional Food. *Nutrients*, 14(5), 957. <https://doi.org/10.3390/nu14050957>
- Quatrin, A., Rampelotto, C., Pauletto, R., Maurer, L. H., Nichelle, S. M., Klein, B., . . . Emanuelli, T. (2020). Bioaccessibility and catabolism of phenolic compounds from jaboticaba (*Myrciaria trunciflora*) fruit peel during *in vitro* gastrointestinal digestion and colonic fermentation. *Journal of Functional Foods*, 65, 103714. <https://doi.org/10.1016/j.jff.2019.103714>
- Rehfeld, J. F. (2004). Cholecystokinin. *Best Practice & Research Clinical Endocrinology & Metabolism*, 18(4), 569–586. <https://doi.org/10.1016/j.beem.2004.07.002>
- Roberfroid, M. B. (1997). Health benefits of non-digestible oligosaccharides. *Advances in Experimental Medicine and Biology*, 427, 211–219. https://doi.org/10.1007/978-1-4615-5967-2_22
- Rocchetti, G., Giuberti, G., Lucchini, F., & Lucini, L. (2020). Polyphenols and sesquiterpene lactones from artichoke heads: modulation of starch digestion, gut bioaccessibility, and bioavailability following *in vitro* digestion and large intestine fermentation. *Antioxidants*, 9(4), 306. <https://doi.org/10.3390/antiox9040306>

- Selma, M. V., Espín, J. C., & Tomás-Barberán, F. A. (2009). Interaction between phenolics and gut microbiota: role in human health. *Journal of Agricultural and Food Chemistry*, *57*(15), 6485–6501. <https://doi.org/10.1021/jf902107d>
- Tchoumtchoua, J., Mathiron, D., Pontarin, N., Gagneul, D., van Bohemen, A. I., Ootogo N'ngang, E., . . . Quéro, A. (2019). Phenolic profiling of flax highlights contrasting patterns in winter and spring varieties. *Molecules*, *24*(23), 4303. <https://doi.org/10.3390/molecules24234303>
- Vamanu, E., Gatea, F., & Pelinescu, D. R. (2020). Bioavailability and bioactivities of polyphenols eco extracts from coffee grounds after *in vitro* digestion. *Foods*, *9*(9), 1281. <https://doi.org/10.3390/foods9091281>
- Weng, H., He, L., Zheng, J., Li, Q., Liu, X., & Wang, D. (2020). Low oral bioavailability and partial gut microbiotic and phase ii metabolism of brussels/witloof chicory sesquiterpene lactones in healthy humans. *Nutrients*, *12*(12), 3675. <https://doi.org/10.3390/nu12123675>
- Wojtunik-Kulesza, K., Oniszczyk, A., Oniszczyk, T., Combrzyński, M., Nowakowska, D., & Matwijczuk, A. (2020). Influence of *in vitro* digestion on composition, bioaccessibility and antioxidant activity of food polyphenols—a non-systematic review. *Nutrients*, *12*(5), 1401. <https://doi.org/10.3390/nu12051401>
- Xu, R., Peng, Y., Wang, M., & Li, X. (2019). Intestinal absorption of isoalantolactone and alantolactone, two sesquiterpene lactones from *Radix inulae*, using Caco-2 cells. *European Journal of Drug Metabolism and Pharmacokinetics*, *44*(2), 295–303. <https://doi.org/10.1007/s13318-018-0510-x>
- Yu, Z., Chen, Z., Li, Q., Yang, K., Huang, Z., Wang, W., . . . Hu, H. (2020). What dominates the changeable pharmacokinetics of natural sesquiterpene lactones and diterpene lactones: a review focusing on absorption and metabolism. *Drug Metabolism Reviews*, *53*(1), 122–140. <https://doi.org/10.1080/03602532.2020.1853151>
- Zou, W., Sissons, M., Warren, F. J., Gidley, M. J., & Gilbert, R. G. (2016). Compact structure and proteins of pasta retard *in vitro* digestive evolution of branched starch molecular structure. *Carbohydrate Polymers*, *152*, 441–449. <https://doi.org/10.1016/j.carbpol.2016.06.016>
- Zwaag, J., ter Horst, R., Blaženović, I., Stoessel, D., Ratter, J., Worseck, J. M., . . . Kox, M. (2020). Involvement of lactate and pyruvate in the anti-inflammatory effects exerted by voluntary activation of the sympathetic nervous system. *Metabolites*, *10*(4), 148. <https://doi.org/10.3390/metabo10040148>



**CONCLUSION GENERALE &
PERSPECTIVES**



Ce travail porte sur une plante d'intérêt alimentaire des Hauts-de-France, la chicorée industrielle (*Cichorium intybus* var. *sativum*). L'ensemble des travaux a été réalisé avec la farine de chicorée, un produit agroalimentaire encore peu commercialisé en Europe mais qui, à terme, pourrait être incorporé dans des recettes boulangères, pâtisseries ou des encas pour leur apporter une nouvelle saveur, texture et des bienfaits sur la santé.

Nous avons pu démontrer le statut fonctionnel de la farine de chicorée. En travaillant avec deux génotypes contrastés de chicorée (G12 et G35), nous avons pu démontrer que les deux engendraient les mêmes effets au niveau de l'expression des gènes, sécrétion hormonale et modification du microbiote intestinal chez la souris, mais que le génotype plus riche en fructose, CGA, STL et inuline avait des effets plus nuancés.

L'inuline testée séparément s'est avérée un prébiotique très efficace. Sortant intacte du processus de digestion, l'inuline affecte très peu le profil d'expression des gènes, son principal mécanisme d'action passant probablement par les SCFA générés par les taxons microbiens.

Parmi les autres effecteurs fonctionnels potentiels de la chicorée, nous avons ciblé le fructose, CGA et STL qui se sont avérés des composés bioactifs avec des effets partiellement redondants et complémentaires. Nous avons pu prouver leurs effets *in vivo* sur le modèle murin mais aussi *in vitro* sur des cellules humaines. Ces composés administrés seuls ou dans la matrice alimentaire sous forme de décoction aqueuse de farine, pourraient exercer des effets antitumoraux, antimicrobiens, anti-inflammatoires, antioxydants et impliqués dans la régulation de l'homéostasie énergétique. Des modifications de la sécrétion de marqueurs hormonaux liés à la régulation de la prise alimentaire à long (leptine) et court (CCK) terme ont aussi été observées. Au niveau du microbiote intestinal les effets sont bénéfiques pour certaines bactéries productrices de butyrate et autres SCFA ainsi que délétères pour certaines bactéries à potentiel pathogène.

Suite à ces travaux, plusieurs perspectives à court terme ont été envisagées. Les techniques et méthodes proposées au laboratoire n'ont pas permis de vérifier l'impact des microorganismes du côlon sur l'activité des composés actifs de la chicorée. Le système dynamique SHIME® ou Simulator of the Human Intestinal Microbial Ecosystem qui inclue l'incorporation d'un microbiote intestinal à la digestion, a donc été envisagé (Van de Wiele *et al.*, 2015). Ce protocole de digestion *in vitro*, nous permettrait d'effectuer une digestion colique en supplément de ce qui a déjà été mis en place. Cette méthode nous aiderait en trois points: évaluer les modifications apportées aux composés par RMN et LC-MS, déterminer par qPCR les

variations de composition d'une communauté microbienne connue, et quantifier par GC-MS les SCFA produits par un microbiote sain favorisé par l'ajout de chicorée. Il serait également judicieux de compléter les informations connues sur l'absorption de ses composés. Il pourrait donc être envisagé d'effectuer un passage des produits de digestion à travers un modèle de barrière intestinale *in vitro*. Le modèle en question, développé au sein du laboratoire par le Dr Elodie Dussert, consiste en une co-culture de cellules entériques (Caco-2), d'une lignée de cellules capables de produire du mucus (HT29-MTX) et de macrophages (U937) (données non publiées). Cette culture permet alors d'estimer le taux de passage (biodisponibilité) des composés phénoliques et terpéniques dans le compartiment basolatéral, et leur impact sur la réponse inflammatoire dans un système complexe plus proche de la réalité physiologique. Une analyse de l'expression génique dans ces cellules pourrait également être associée à ce protocole, et nous donnerait de plus amples informations sur les gènes et sur les mécanismes moléculaires impliqués dans les effets observés prenant naissance au niveau intestinal.

A plus long terme, d'autres modèles expérimentaux pourraient être utilisés pour approfondir les connaissances sur le potentiel nutrition-santé de la chicorée et les mécanismes mis en jeu.

De nos jours de nombreux modèles animaux sont déjà utilisés en recherche, et dans le but de respecter au mieux la règle des 3R, des modèles de plus en plus sophistiqués sont mis au point pour les remplacer. Il existe ainsi des modèles d'organoïdes qui miment au plus près les conditions physiologiques d'un véritable organe dans une culture 3D. Ces organes miniatures sont issus des connaissances sur la capacité des cellules souches pluripotentes à s'autoorganiser en constructions multicellulaires et permettent des applications majeures comme l'induction de pathologies par édition de génome ou la recherche de nouveaux composés thérapeutiques en pharmacologie. De tels modèles ont été créés pour répliquer la morphologie et les pathologies de l'intestin (Angus *et al.*, 2020), du foie (Ramachandran *et al.*, 2015), des reins (Ding *et al.*, 2020) et bien plus encore. Des tissus micro-fabriqués sur puces, les « organoïdes sur puce » ('organoids-on-a-chip'), ont vu le jour depuis quelques années et permettraient d'explorer les mêmes aspects dans un environnement plus contrôlé (Park *et al.*, 2019). Ainsi, ces modèles, bien qu'onéreux, seraient un plus dans l'étude des effets de la chicorée et de ses composés.

En dehors du rôle fonctionnel de la chicorée, son effet pharmacologique pourrait aussi être caractérisé plus en détail. Des modèles murins pathologiques, telles que les souris C57BL/6JolaHsd, sont utilisés dans l'étude de pathologies telles que l'obésité, le diabète, les maladies cardiovasculaires, le cancer... (www.envigo.com/model/c57bl-6jolahsd).

Malgré cela, le modèle murin a ses limites. La pathogénèse (Rangarajan & Weinberg, 2003, Mestas Hughes, 2004), le métabolisme (Bergen & Mersmann, 2005, Kowalski & Bruce, 2014) et le microbiote (Nguyen *et al.*, 2015) de l'être humain et de la souris sont différents bien qu'ils aient été estimés suffisamment proches pour être comparés. Pour exemple, souris et Hommes possèdent un microbiote intestinal différent dans leur composition, tandis que leurs fonctions clés demeurent similaires (Beresford-Jones *et al.*, 2021). Pour remplacer le rongeur, des tests pourraient alors être réalisés chez le modèle porcin, plus proche de l'être humain (Vodicka *et al.*, 2005). Une dernière perspective serait, dans l'idéal, de tester les effets de la chicorée directement chez l'Homme.

REFERENCES

- Abdulkhaleq, L. A., Assi, M. A., Abdullah, R., Zamri-Saad, M., Taufiq-Yap, Y. H., & Hezme, M. N. M. (2018). The crucial roles of inflammatory mediators in inflammation: A review. *Veterinary World*, *11*(5), 627–635. <https://doi.org/10.14202/vetworld.2018.627-635>
- Ajasson de Grandsagne, M. (1832). De la chicorée. In C.L.F. Panckoucke (Ed.). *Histoire Naturelle de Pline: traduction nouvelle, Tome 13, Livre 20* (pp. 49-51). Paris, France: Imprimerie de C.L.F. Panckoucke.
- Akram, W., Garud, N., & Joshi, R. (2019). Role of inulin as prebiotics on inflammatory bowel disease. *Drug Discoveries & Therapeutics*, *13*(1), 1–8. <https://doi.org/10.5582/ddt.2019.01000>
- Ali, S. I., Gopalakrishnan, B., & Venkatesalu, V. (2018). Chicory (*Cichorium intybus*) and wormwood (*Artemisia absinthium*) extracts exhibit strong larvicidal activity against mosquito vectors of malaria, dengue fever, and filariasis. *Parasitology International*, *67*(6), 781–786. <https://doi.org/10.1016/j.parint.2018.08.005>
- Al-Snafi, A. E. (2016). Medical importance of *Cichorium intybus* – A review. *IOSR Journal of Pharmacy*, *6*(3), 41–56.
- Amini, M. H., & Hamdam, S. M. (2017). Medicinal plants used traditionally in gul dara district of Kabul, Afghanistan. *International Journal of Pharmacognosy; Chinese Medicine*, *1*(3), 000118. <https://doi.org/10.23880/ipcm-16000118>
- Angus, H. C. K., Butt, A. G., Schultz, M., & Kemp, R. A. (2020). Intestinal organoids as a tool for inflammatory bowel disease research. *Frontiers in Medicine*, *6*. <https://doi.org/10.3389/fmed.2019.00334>
- Apolinário, A. C., de Lima Damasceno, B. P. G., de Macêdo Beltrão, N. E., Pessoa, A., Converti, A., & da Silva, J. A. (2014). Inulin-type fructans: A review on different aspects of biochemical and pharmaceutical technology. *Carbohydrate Polymers*, *101*, 368–378. <https://doi.org/10.1016/j.carbpol.2013.09.081>
- Ávila-Gálvez, M. N., Rafael-Pita, C., Fernández, N., Baixinho, J., Anastácio, J. D., Cankar, K., . . . Nunes dos Santos, C. (2022). Targeting proteases involved in the viral replication of SARS-CoV-2 by sesquiterpene lactones from chicory (*Cichorium intybus* L.). *Food & Function*, *13*(17), 8977–8988. <https://doi.org/10.1039/d2fo00933a>
- Babior, B. M. (2000). Phagocytes and oxidative stress. *The American Journal of Medicine*, *109*(1), 33–44. [https://doi.org/10.1016/s0002-9343\(00\)00481-2](https://doi.org/10.1016/s0002-9343(00)00481-2)
- Baeza, G., Sarriá, B., Bravo, L., & Mateos, R. (2017). Polyphenol content, *in vitro* bioaccessibility and antioxidant capacity of widely consumed beverages. *Journal of the Science of Food and Agriculture*, *98*(4), 1397–1406. <https://doi.org/10.1002/jsfa.8607>

- Bakirhan, H., & Karabudak, E. (2021). Effects of inulin on calcium metabolism and bone health. *International Journal for Vitamin and Nutrition Research*, 1–12. <https://doi.org/10.1024/0300-9831/a000700>
- Bakhr, H.K. (1992). *Herbs that Heal: Natural Remedies for Good Health*. Orient Paperbacks.
- Barcaccia, G., Ghedina, A., & Lucchin, M. (2016). Current advances in genomics and breeding of leaf chicory (*Cichorium intybus* L.). *Agriculture*, 6(4), 50. <https://doi.org/10.3390/agriculture6040050>
- Barcaccia, G., Lucchin, M., Lazzarin, R., & Parrini, P. (2003). *Relationships among radicchio (Cichorium intybus L.) types grown in Veneto and diversity between local varieties and selected lines as assessed by molecular markers* [Conference Paper]. Noordwijkerhout, The Netherlands.
- Beresford-Jones, B. S., Forster, S. C., Stares, M. D., Notley, G., Viciani, E., Browne, H. P., . . . Pedicord, V. A. (2021). The mouse gastrointestinal bacteria catalogue enables translation between the mouse and human gut microbiotas via functional mapping. *Cell Host & Microbe*, 30(1), 124-138.e8. <https://doi.org/10.1016/j.chom.2021.12.003>
- Bergen, W. G., & Mersmann, H. J. (2005). Comparative aspects of lipid metabolism: impact on contemporary research and use of animal models. *Journal of Nutrition*, 135(11), 2499–2502. <https://doi.org/10.1093/jn/135.11.2499>
- Bezerra, M. S., Zeferino, K. S., Menezes, L. D., Bezerra, A. S., Lopes, L. Q. S., Marquezan, F. K., & Marquezan, P. K. (2022). Antimicrobial and antibiofilm activities of *Cichorium intybus*: a review. *Research, Society and Development*, 11(2), e10911225384. <https://doi.org/10.33448/rsd-v11i2.25384>
- Bischoff, T. A., Kelley, C. J., Karchesy, Y., Laurantos, M., Nguyen-Dinh, P., & Arefi, A. G. (2004). Antimalarial activity of Lactucin and Lactucopicrin: sesquiterpene lactones isolated from *Cichorium intybus* L. *Journal of Ethnopharmacology*, 95(2–3), 455–457. <https://doi.org/10.1016/j.jep.2004.06.031>
- Bogdanović, J., Mojović, M., Milosavić, N., Mitrović, A., Vučinić, & Spasojević, I. (2008). Role of fructose in the adaptation of plants to cold-induced oxidative stress. *European Biophysics Journal*, 37(7), 1241–1246. <https://doi.org/10.1007/s00249-008-0260-9>
- Bogdanović, M., Cankar, K., Todorović, S., Dragicević, M., Simonović, A., van Houwelingen, A., . . . Beekwilder, J. (2019). Tissue specific expression and genomic organization of bitter sesquiterpene lactone biosynthesis in *Cichorium intybus* L. (Asteraceae). *Industrial Crops and Products*, 129, 253–260. <https://doi.org/10.1016/j.indcrop.2018.12.011>

- Bokić, J., Kojić, J., Krulj, J., Pezo, L., Banjac, V., Škrobot, D., . . . Bodroža-Solarov, M. (2022). Development of a novel rice-based snack enriched with chicory root: physicochemical and sensory properties. *Foods*, *11*(16), 2393. <https://doi.org/10.3390/foods11162393>
- Bollina, V., Kushalappa, A. C., Choo, T. M., Dion, Y., & Rioux, S. (2011). Identification of metabolites related to mechanisms of resistance in barley against *Fusarium graminearum*, based on mass spectrometry. *Plant Molecular Biology*, *77*(4–5), 355–370. <https://doi.org/10.1007/s11103-011-9815-8>
- Bonetti, G., Tedeschi, P., Meca, G., Bertelli, D., Mañes, J., Brandolini, V., & Maietti, A. (2016). *In vitro* bioaccessibility, transepithelial transport and antioxidant activity of *Urtica dioica* L. phenolic compounds in nettle based food products. *Food & Function*, *7*(10), 4222–4230. <https://doi.org/10.1039/c6fo01096b>
- Branca, F., Argento, S., Paoletti, A. M., & Melilli, M. G. (2022). The physiological role of inulin in wild cardoon (*Cynara cardunculus* L. var. *sylvestris* Lam.). *Agronomy*, *12*(2), 290. <https://doi.org/10.3390/agronomy12020290>
- Brodkorb, A., Egger, L., Alminger, M., Alvito, P., Assunção, R., Ballance, S., . . . Recio, I. (2019). INFOGEST static *in vitro* simulation of gastrointestinal food digestion. *Nature Protocols*, *14*(4), 991–1014. <https://doi.org/10.1038/s41596-018-0119-1>
- Buanafina, M.M.O. (2009). Feruloylation in grasses: current and future perspectives. *Molecular Plant*, *2*(5), 861–872. <https://doi.org/10.1093/mp/ssp067>
- Campagnac, E., Lounès-Hadj Sahraoui, A., Debiane, D., Fontaine, J., Laruelle, F., Garçon, G., . . . Grandmougin-Ferjani, A. (2010). Arbuscular mycorrhiza partially protect chicory roots against oxidative stress induced by two fungicides, fenpropimorph and fenhexamid. *Mycorrhiza*, *20*(3), 167–178. <https://doi.org/10.1007/s00572-009-0267-9>
- Carlson, J. L., Erickson, J. M., Lloyd, B. B., & Slavin, J. L. (2018). Health effects and sources of prebiotic dietary fiber. *Current Developments in Nutrition*, *2*(3), nzy005. <https://doi.org/10.1093/cdn/nzy005>
- Cavin, C., Delannoy, M., Malnoe, A., Debeve, E., Touché, A., Courtois, D., & Schilter, B. (2005). Inhibition of the expression and activity of cyclooxygenase-2 by chicory extract. *Biochemical and Biophysical Research Communications*, *327*(3), 742–749. <https://doi.org/10.1016/j.bbrc.2004.12.061>
- Chadwick, M., Trewin, H., Gawthrop, F., & Wagstaff, C. (2013). Sesquiterpenoids lactones: benefits to plants and people. *International Journal of Molecular Sciences*, *14*(6), 12780–12805. <https://doi.org/10.3390/ijms140612780>

- Chaniad, P., Techarang, T., Phuwanaroanpong, A., Na-ek, P., Viriyavejakul, P., & Punsawad, C. (2021). *In vivo* antimalarial activity and toxicity study of extracts of *Tagetes erecta* L. and *Synedrella nodiflora* (L.) Gaertn. from the *Asteraceae* family. *Evidence-Based Complementary and Alternative Medicine*, 2021, 1–9. <https://doi.org/10.1155/2021/1270902>
- Chansriniyom, C., Nooin, R., Nuengchamnong, N., Wongwanakul, R., Petpiroon, N., Srinuanchai, W., . . . Nuchuchua, O. (2021). Tandem mass spectrometry of aqueous extract from *Ficus dubia* sap and its cell-based assessments for use as a skin antioxidant. *Scientific Reports*, 11(1), 16899. <https://doi.org/10.1038/s41598-021-96261-3>
- Chen, F., Zhang, H., Zhao, N., Yang, X., Du, E., Huang, S., . . . Wei, J. (2021). Effect of chlorogenic acid on intestinal inflammation, antioxidant status, and microbial community of young hens challenged with acute heat stress. *Animal Science Journal*, 92(1), e13619. <https://doi.org/10.1111/asj.13619>
- Chen, H.-H., Keyhanian, K., Zhou, X., Vilmundarson, R. O., Almontashiri, N. A., Cruz, S. A., . . . Stewart, A. F. R. (2015). IRF2BP2 reduces macrophage inflammation and susceptibility to atherosclerosis. *Circulation Research*, 117(8), 671–683. <https://doi.org/10.1161/CIRCRESAHA.114.305777>
- Chen, J., Yu, B., Chen, D., Huang, Z., Mao, X., Zheng, P., . . . He, J. (2018). Chlorogenic acid improves intestinal barrier functions by suppressing mucosa inflammation and improving antioxidant capacity in weaned pigs. *The Journal of Nutritional Biochemistry*, 59, 84–92. <https://doi.org/10.1016/j.jnutbio.2018.06.005>
- Chen, T., Long, W., Zhang, C., Liu, S., Zhao, L., & Hamaker, B. R. (2017). Fiber-utilizing capacity varies in *Prevotella*- versus *Bacteroides*-dominated gut microbiota. *Scientific Reports*, 7(1), 2594. <https://doi.org/10.1038/s41598-017-02995-4>.
- Childs, K. S., & Goodbourn, S. (2003). Identification of novel co-repressor molecules for Interferon Regulatory Factor-2. *Nucleic Acids Research*, 31(12), 3016–3026. <https://doi.org/10.1093/nar/gkg431>
- Chi, Z., Chi, Z., Zhang, T., Liu, G., & Yue, L. (2009). Inulinase-expressing microorganisms and applications of inulinases. *Applied Microbiology and Biotechnology*, 82(2), 211–220. <https://doi.org/10.1007/s00253-008-1827-1>
- Clifford, M., Jaganath, I. B., Ludwig, I. A., & Crozier, A. (2017). Chlorogenic acids and the acyl-quinic acids: discovery, biosynthesis, bioavailability and bioactivity. *Natural Product Reports*, 34(12), 1391–1421. <https://doi.org/10.1039/c7np00030h>

- Clifford, M. N., Kerimi, A., & Williamson, G. (2020). Bioavailability and metabolism of chlorogenic acids (acyl-quinic acids) in humans. *Comprehensive Reviews in Food Science and Food Safety*, 19(4), 1299–1352. <https://doi.org/10.1111/1541-4337.12518>
- Conforti, F., Ioele, G., Statti, G., Marrelli, M., Ragno, G., & Menichini, F. (2008). Antiproliferative activity against human tumor cell lines and toxicity test on Mediterranean dietary plants. *Food and Chemical Toxicology*, 46(10), 3325–3332. <https://doi.org/10.1016/j.fct.2008.08.004>
- Cranston, L., Kenyon, P., Morris, S., & Kemp, P. (2015). A review of the use of chicory, plantain, red clover and white clover in a sward mix for increased sheep and beef production. *Journal of New Zealand Grasslands*, 77, 89–94. <https://doi.org/10.33584/jnzg.2015.77.475>
- Crosby, D. C., Lei, X., Gibbs, C. G., McDougall, B. R., Robinson, W. E., & Reinecke, M. G. (2010). Design, Synthesis, and biological evaluation of novel hybrid dicaffeoyltartaric/diketo acid and tetrazole-substituted L-chicoric acid analogue inhibitors of Human Immunodeficiency Virus type 1 integrase. *Journal of Medicinal Chemistry*, 53(22), 8161–8175. <https://doi.org/10.1021/jm1010594>
- Crozier, A., Jaganath, I. B., & Clifford, M. N. (2009). Dietary phenolics: chemistry, bioavailability and effects on health. *Natural Product Reports*, 26(8), 1001. <https://doi.org/10.1039/b802662a>
- Cui, J., Lian, Y., Zhao, C., Du, H., Han, Y., Gao, W., . . . Zheng, J. (2019). Dietary fibers from fruits and vegetables and their health benefits via modulation of gut microbiota. *Comprehensive Reviews in Food Science and Food Safety*, 18(5), 1514–1532. <https://doi.org/10.1111/1541-4337.12489>
- Davies, P. (2008). French Island ruins: An archaeology of chicory production in Western Port, Victoria. *The Artefact*, 31, 4-13.
- De Kraker, J. W., Franssen, M. C., Joerink, M., de Groot, A., & Bouwmeester, H. J. (2002). Biosynthesis of costunolide, dihydrocostunolide, and leucodin. Demonstration of cytochrome p450-catalyzed formation of the lactone ring present in sesquiterpene lactones of chicory. *Plant Physiology*, 129(1), 257–268. <https://doi.org/10.1104/pp.010957>
- De la Rosa, L.A., Moreno-Escamilla, J.O., Rodrigo-García, J., & Alvarez-Parrilla, E. (2018). Phenolic compounds. In E. Yahia, & A. Carrillo-López (Eds.). *Postharvest Physiology and Biochemistry of Fruits and Vegetables* (pp. 253–271). Amsterdam, The Netherlands: Elsevier Inc.
- De Leenheer, L., & Hoebregs, H. (1994). Progress in the elucidation of the composition of chicory inulin. *Starch*, 46(5), 193–196.

- Dehghan, P., Pourghassem Gargari, B., & Asgharijafarabadi, M. (2013). Effects of high performance inulin supplementation on glycemic status and lipid profile in women with type 2 diabetes: a randomized, placebo-controlled clinical trial. *Health Promotion Perspectives, 3*(1), 55–63. <https://doi.org/10.5681/hpp.2013.007>
- Dewulf, E. M., Cani, P. D., Claus, S. P., Fuentes, S., Puylaert, P. G., Neyrinck, A. M., . . . Delzenne, N. M. (2012). Insight into the prebiotic concept: lessons from an exploratory, double blind intervention study with inulin-type fructans in obese women. *Gut, 62*(8), 1112–1121. <https://doi.org/10.1136/gutjnl-2012-303304>
- Di Lorenzo, C., Colombo, F., Biella, S., Stockley, C., & Restani, P. (2021). Polyphenols and human health: the role of bioavailability. *Nutrients, 13*(1), 273. <https://doi.org/10.3390/nu13010273>
- Ding, B., Sun, G., Liu, S., Peng, E., Wan, M., Chen, L., . . . Atala, A. (2020). Three-dimensional renal organoids from whole kidney cells: generation, optimization, and potential application in nephrotoxicology *in vitro*. *Cell Transplantation, 29*, 096368971989706. <https://doi.org/10.1177/0963689719897066>
- Diovu, E. O., Onah, C. O., Odo, K. E., Amaechina, I. N., Akpadolu, U. D., Nwodo, A. J., . . . Nnadi, C. O. (2022). Sesquiterpene lactone-rich extract of *Tithonia diversifolia* (Hemsley) A. Gray (*Asteraceae*) suppresses *Trypanosoma brucei brucei* in both *in vivo* and *in vitro* experimental models. *Tropical Journal of Natural Product Research, 6*(8), 1268–1273. <https://doi.org/10.26538/tjnpr/v6i8.18>
- Du, H., Zhao, A., Wang, Q., Yang, X., & Ren, D. (2020). Supplementation of inulin with various degree of polymerization ameliorates liver injury and gut microbiota dysbiosis in high fat-fed obese mice. *Journal of Agricultural and Food Chemistry, 68*(3), 779–787. <https://doi.org/10.1021/acs.jafc.9b06571>
- Edelman, J., & Jefford, T. G. (1968). The mechanism of fructosan metabolism in higher plants as exemplified in *Helianthus tuberosus*. *New Phytologist, 67*(3), 517–531. <https://doi.org/10.1111/j.1469-8137.1968.tb05480.x>
- Elia, A., & Santamaria, P. (2013). Biodiversity in vegetable crops, a heritage to save: the case of Puglia region. *Italian Journal of Agronomy, 8*(1), e4. <https://doi.org/10.4081/ija.2013.e4>
- El-Mehy, M. E. M. (2018). *Studies on using extracts of chicory (Cichorium intybus) herb treated by gamma irradiation in some food products* (thèse de doctorat). Benha University.
- El-Seedi, H. R., El-Said, A. M. A., Khalifa, S. A. M., Göransson, U., Bohlin, L., Borg-Karlson, A. K., & Verpoorte, R. (2012). Biosynthesis, natural sources, dietary intake, pharmacokinetic properties, and biological activities of hydroxycinnamic acids. *Journal of Agricultural and Food Chemistry, 60*(44), 10877–10895. <https://doi.org/10.1021/jf301807g>

- Esmailbeig, M., Kouhpayeh, S. A., & Amirghofran, Z. (2015). An investigation of the growth inhibitory capacity of several medicinal plants from Iran on tumor cell lines. *Iranian Journal of Cancer Prevention*, 8(5), e4032. <https://doi.org/10.17795/ijcp-4032>
- Evans, R. A., Frese, M., Romero, J., Cunningham, J. H., & Mills, K. E. (2017). Fructose replacement of glucose or sucrose in food or beverages lowers postprandial glucose and insulin without raising triglycerides: a systematic review and meta-analysis. *The American Journal of Clinical Nutrition*, 106(2), 506–518. <https://doi.org/10.3945/ajcn.116.145151>
- Faiku, F., Haziri, A., Mehmeti, I., Bajrami, D., & Haziri, I. (2016). Evaluation of antibacterial activity of different solvent extracts of *Cichorium intybus* (L.) growing wild in east part of Kosovo. *Journal of Animal and Plant Sciences*, 26(5), 1486–1491.
- Farah, A., & de Paula Lima, J. (2019). Consumption of chlorogenic acids through coffee and health implications. *Beverages*, 5(1), 11. <https://doi.org/10.3390/beverages5010011>
- Flo, T. H., Smith, K. D., Sato, S., Rodriguez, D. J., Holmes, M. A., Strong, R. K., ... Aderem, A. (2004). Lipocalin 2 mediates an innate immune response to bacterial infection by sequestering iron. *Nature*, 432(7019), 917–921. <https://doi.org/10.1038/nature03104>.
- Foster, J. G., Cassida, K. A., & Turner, K. E. (2011). *In vitro* analysis of the anthelmintic activity of forage chicory (*Cichorium intybus* L.) sesquiterpene lactones against a predominantly *Haemonchus contortus* egg population. *Veterinary Parasitology*, 180(3–4), 298–306. <https://doi.org/10.1016/j.vetpar.2011.03.013>
- Fouré, M., Dugardin, C., Foligné, B., Hance, P., Cadalen, T., Delcourt, A., . . . Lucau-Danila, A. (2018). Chicory roots for prebiotics and appetite regulation: a pilot study in mice. *Journal of Agricultural and Food Chemistry*, 66(25), 6439–6449. <https://doi.org/10.1021/acs.jafc.8b01055>
- Franck, A., & De Leenheer, L. (2004). *Polysaccharides II: Polysaccharides from Eukaryotes*. New York, USA: Wiley.
- Gaber, C., & Maier, H. G. (1989). Säuren der Zichorienwurzel. II. Veränderung der Gehalte an den Hauptsäuren bei feuchter Lagerung von Röstzichorie und beim Warmhalten des Getränks. *Zeitschrift Fuer Lebensmittel-Untersuchung Und -Forschung*, 190(1), 40–43.
- García, C. J., Beltrán, D., & Tomás-Barberán, F. A. (2020). Human gut microbiota metabolism of dietary sesquiterpene lactones: untargeted metabolomics study of lactucopicrin and lactucin conversion *in vitro* and *in vivo*. *Molecular Nutrition & Food Research*, 64(21), 2000619. <https://doi.org/10.1002/mnfr.202000619>

- Gibbs, P. (2009). Pathogenic *Clostridium* species. In C. W. Blackburn, & P. J. McClure (Eds.). *Foodborne Pathogens 2nd Edition – Hazards, risk analysis and control* (pp. 820– 843). UK: Woodhead Publishing.
- Girgiss Nicola, W., Wassef Girgiss, M., Mohamed Ezz El-Arab, A., Ahmed, A., & Refaat Youness, E. (2018). Role of inulin in the protection and management of metabolic inflammation in humans. *Biomedical and Pharmacology Journal*, *11*(2), 1083–1090. <https://doi.org/10.13005/bpj/1469>
- Goh, Y. J., Lee, J. H., & Hutkins, R. W. (2007). Functional analysis of the fructooligosaccharide utilization operon in *Lactobacillus paracasei* 1195. *Applied and Environmental Microbiology*, *73*(18), 5716–5724. <https://doi.org/10.1128/aem.00805-07>
- Gómez-Juaristi, M., Martínez-López, S., Sarria, B., Bravo, L., & Mateos, R. (2018). Bioavailability of hydroxycinnamates in an instant green/roasted coffee blend in humans. Identification of novel colonic metabolites. *Food & Function*, *9*(1), 331–343. <https://doi.org/10.1039/c7fo01553d>
- Gonthier, M. P., Remesy, C., Scalbert, A., Cheynier, V., Souquet, J. M., Poutanen, K., & Aura, A. M. (2006). Microbial metabolism of caffeic acid and its esters chlorogenic and caftaric acids by human faecal microbiota *in vitro*. *Biomedicine & Pharmacotherapy*, *60*(9), 536–540. <https://doi.org/10.1016/j.biopha.2006.07.084>
- Guérard, M. (1853). *Explication du Capitulaire de villis*. Firmin Didot frères.
- Gupta, N., Jangid, A. K., Pooja, D., & Kulhari, H. (2019). Inulin: A novel and stretchy polysaccharide tool for biomedical and nutritional applications. *International Journal of Biological Macromolecules*, *132*, 852–863. <https://doi.org/10.1016/j.ijbiomac.2019.03.188>
- Hafez, E.-S. E., Badr, E. A., Mabrouk, Y. M., Seehy, M. A., & Aggag, S. A. (2014). Expression of tumor-markers and cytokines in response to *Cichorium endivia* L. in cancerous mice. *International Journal of Life Science Biotechnology and Pharma Research*, *3*(4).
- Hageman, G. J. (1983). *Witlofwortels als fructosebron* (thèse de doctorat). Wageningen University.
- Harding, J. L., Pavkov, M. E., Magliano, D. J., Shaw, J. E., & Gregg, E. W. (2018). Global trends in diabetes complications: a review of current evidence. *Diabetologia*, *62*(1), 3–16. <https://doi.org/10.1007/s00125-018-4711-2>
- Hartzell, A. L., Maldonado-Gómez, M. X., Hutkins, R. W., & Rose, D. J. (2013). Synthesis and *in vitro* digestion and fermentation of acylated inulin. *Bioactive Carbohydrates and Dietary Fibre*, *1*(1), 81–88. <https://doi.org/10.1016/j.bcdf.2013.01.004>

- Hawkins, M., Gabriely, I., Wozniak, R., Vilcu, C., Shamoon, H., & Rossetti, L. (2002). Fructose improves the ability of hyperglycemia per se to regulate glucose production in type 2 diabetes. *Diabetes*, *51*(3), 606–614. <https://doi.org/10.2337/diabetes.51.3.606>
- Hazra, B., Sarkar, R., Bhattacharyya, S., & Roy, P. (2002). Tumour inhibitory activity of chicory root extract against Ehrlich ascites carcinoma in mice. *Fitoterapia*, *73*(7–8), 730–733. [https://doi.org/10.1016/s0367-326x\(02\)00232-0](https://doi.org/10.1016/s0367-326x(02)00232-0)
- Headland, S. E., & Norling, L. V. (2015). The resolution of inflammation: Principles and challenges. *Seminars in Immunology*, *27*(3), 149–160. <https://doi.org/10.1016/j.smim.2015.03.014>
- Healey, G., Murphy, R., Butts, C., Brough, L., Whelan, K., & Coad, J. (2018). Habitual dietary fibre intake influences gut microbiota response to an inulin-type fructan prebiotic: a randomised, double-blind, placebo-controlled, cross-over, human intervention study. *British Journal of Nutrition*, *119*(2), 176–189. <https://doi.org/10.1017/s0007114517003440>
- Heleno, S. A., Martins, A., Queiroz, M. J. R., & Ferreira, I. C. (2015). Bioactivity of phenolic acids: Metabolites versus parent compounds: A review. *Food Chemistry*, *173*, 501–513. <https://doi.org/10.1016/j.foodchem.2014.10.057>
- Hernández-Martínez, A., Molina, G., Jiménez-Hernández, L., Oskam, A., Fonseca, G., & Estevez, M. (2017). Evaluation of inulin replacing chitosan in a polyurethane/polysaccharide material for Pb²⁺ removal. *Molecules*, *22*(12), 2093. <https://doi.org/10.3390/molecules22122093>
- Honda, K., Takaoka, A., & Taniguchi, T. (2006). Type I interferon gene induction by the interferon regulatory factor family of transcription factors. *Immunity*, *25*(3), 349–360. <https://doi.org/10.1016/j.immuni.2006.10.004>
- Hughes, R., & Rowland, I. R. (2001). Stimulation of apoptosis by two prebiotic chicory fructans in the rat colon. *Carcinogenesis*, *22*(1), 43–47. <https://doi.org/10.1093/carcin/22.1.43>
- Imam, K., Xie, Y., Liu, Y., Wang, F., & Xin, F. (2019). Cytotoxicity of *Cichorium intybus* L. metabolites (Review). *Oncology Reports*, *42*(6), 2196–2212. <https://doi.org/10.3892/or.2019.7336>
- Ismail, E. A., Al-Saleh, A. A., & Metwalli, A. M. (2013). Effect of inulin supplementation on rheological properties of low-fat ice cream. *Life Science Journal*, *10*(3), 1742–1746.
- Janda, K., Gutowska, I., Geszke-Moritz, M., & Jakubczyk, K. (2021). The common cichory (*Cichorium intybus* L.) as a source of extracts with health-promoting properties—a review. *Molecules*, *26*(6), 1814. <https://doi.org/10.3390/molecules26061814>

- Jang, C., Hui, S., Lu, W., Cowan, A. J., Morscher, R. J., Lee, G., . . . Rabinowitz, J. D. (2018). The small intestine converts dietary fructose into glucose and organic acids. *Cell Metabolism*, 27(2), 351-361.e3. <https://doi.org/10.1016/j.cmet.2017.12.016>
- Jang, J. H., Park, C. Y., Sung, E. G., Song, I. H., Kim, J. Y., Jung, C., . . . Lee, T. J. (2021). Lactucin induces apoptosis through reactive oxygen species-mediated BCL-2 and CFLARL downregulation in Caki-1 cells. *Genes & Genomics*, 43(10), 1199–1207. <https://doi.org/10.1007/s13258-021-01142-8>
- Jeong, D., Kim, D. H., Chon¹, J. W., Kim, H., Kim, H. S., Song, K. Y., . . . Seo, K. H. (2016). The antimicrobial activity of the crude extracts from *Cichorium intybus* L. (Chicory) against *Bacillus cereus* in various dairy foods. *Journal of Milk Science and Biotechnology*, 34(4), 239–244. <https://doi.org/10.22424/jmsb.2016.34.4.239>
- Juan, C. A., Pérez de la Lastra, J. M., Plou, F. J., & Pérez-Lebeña, E. (2021). The chemistry of reactive oxygen species (ROS) revisited: outlining their role in biological macromolecules (DNA, lipids and proteins) and induced pathologies. *International Journal of Molecular Sciences*, 22(9), 4642. <https://doi.org/10.3390/ijms22094642>
- Judžentienė, B., & Būdienė, J. (2008). Volatile constituents from aerial parts and roots of *Cichorium intybus* L. (chicory) grown in Lithuania. *Chemija*, 19(2), 25–28.
- Jurgoński, A., Milala, J., Juśkiewicz, J., Zduńczyk, Z., & Król, B. (2011). Composition of chicory root, peel, seed and leaf ethanol extracts and biological properties of their non-inulin fractions. *Food Technology and Biotechnology*, 49(1), 40–47.
- Kandil, A. S., Abou-Elella, F., & El Shemy, H. A. (2019). Cytotoxic profile activities of ethanolic and methanolic extracts of chicory plant (*Cichorium intybus* L.). *Journal of Radiation Research and Applied Sciences*, 12(1), 106–111. <https://doi.org/10.1080/16878507.2019.1594136>
- Kaye, D. M., Shihata, W. A., Jama, H. A., Tsyganov, K., Ziemann, M., Kiriazis, H., . . . Marques, F. Z. (2020). Deficiency of prebiotic fiber and insufficient signaling through gut metabolite-sensing receptors leads to cardiovascular disease. *Circulation*, 141(17), 1393–1403. <https://doi.org/10.1161/circulationaha.119.043081>
- Kiers, A.M. (2000). Endive, Chicory, and their wild relatives. A systematic and phylogenetic study of *Cichorium* (Asteraceae). *Gorteria Dutch Botanical Archives - Supplement*, 5(1), 1–77.

- Kiers, A. M., Mes, T. H., Meijden, R. V. D., & Bachmann, K. (2000). A search for diagnostic AFLP markers in *Cichorium* species with emphasis on endive and chicory cultivar groups. *Genome*, *43*(3), 470–476. <https://doi.org/10.1139/g00-024>
- Kim, T. Y., Yoon, Y. L., & Lee, K. W. (1978). Studies on the constituents of chicory roots. *Korean Journal of Food Science and Technology*, *10*, 258–262.
- Kisiel, W., & Zielińska, K. (2001). Guaianolides from *Cichorium intybus* and structure revision of *Cichorium* sesquiterpene lactones. *Phytochemistry*, *57*(4), 523–527. [https://doi.org/10.1016/s0031-9422\(01\)00072-3](https://doi.org/10.1016/s0031-9422(01)00072-3)
- Klaunig, J. E. (2019). Oxidative stress and cancer. *Current Pharmaceutical Design*, *24*(40), 4771–4778. <https://doi.org/10.2174/1381612825666190215121712>
- Kleessen, B., Hartmann, L., & Blaut, M. (2001). Oligofructose and long-chain inulin: influence on the gut microbial ecology of rats associated with a human faecal flora. *British Journal of Nutrition*, *86*(2), 291–300. <https://doi.org/10.1079/bjn2001403>
- Kops, J., & Gevers Deijnoot, P.M.E. (1853) *Flora Batava of Afbeelding en Beschrijving van Nederlandsche Gewassen, XI. Deel*. Amsterdam, The Netherlands: J.C. Sepp en Zoon.
- Kowalski, G. M., & Bruce, C. R. (2014). The regulation of glucose metabolism: implications and considerations for the assessment of glucose homeostasis in rodents. *American Journal of Physiology-endocrinology and Metabolism*, *307*(10), E859–E871. <https://doi.org/10.1152/ajpendo.00165.2014>
- Kundu, A., & Vadassery, J. (2019). Chlorogenic acid-mediated chemical defence of plants against insect herbivores. *Plant Biology*, *21*(2), 185–189. <https://doi.org/10.1111/plb.12947>
- Law, W. (1850). *The history of coffee, including a chapter on chicory*. Edinburgh, Scotland: William and George Law, 544 New Oxford Street, and 31 St. Andrew's Square.
- Leclercq, E. (1992). *Sesquiterpene Lactones and Inulin from Chicory Roots: Extraction, Identification, Enzymatic Release and Sensory Analysis* (thèse de doctorat). Wageningen University.
- Lecoq, H. (1879). Witloof, chicorée à grosse racine de Bruxelles. In A., Paillieux, & D., Bois (Eds.) *Nouveaux légumes d'hiver: expériences d'étiollement pratiquées en chambre obscure sur 100 plantes bisannuelles ou vivaces, spontanées ou cultivées* (pp. 103-110). Paris, France : Librairie agricole de la maison rustique.
- Lee, B. S. B., Bhuta, T., Simpson, J. M., & Craig, J. C. (2012). Methenamine hippurate for preventing urinary tract infections. *Cochrane Database of Systematic Reviews*, *10*(10), CD003265. <https://doi.org/10.1002/14651858.cd003265.pub3>

- Lee, K. T., Kim, J. I., Park, H. J., Yoo, K. O., Han, Y. N., & Miyamoto, K. I. (2000). Differentiation-inducing effect of magnolialide, a 1 β -hydroxyeudesmanolide isolated from *Cichorium intybus*, on human leukemia cells. *Biological and Pharmaceutical Bulletin*, 23(8), 1005–1007. <https://doi.org/10.1248/bpb.23.1005>
- Legrand, G., Delporte, M., Khelifi, C., Harant, A., Vuylsteker, C., Mörchen, M., . . . Gagneul, D. (2016). Identification and characterization of five BAHD acyltransferases involved in hydroxycinnamoyl ester metabolism in chicory. *Frontiers in Plant Science*, 7. <https://doi.org/10.3389/fpls.2016.00741>
- Leroux, A. (1987). Chapter 8: Various aspects of chicory. In R.J., Clarke, & R., Macrae, (Eds.). *Coffee: Related beverages, volume 5* (pp. 193-205). Essex, England: Elsevier applied science.
- Levine, A. J., Hu, W., & Feng, Z. (2006). The P53 pathway: What questions remain to be explored? *Cell Death & Differentiation*, 13(6), 1027–1036. <https://doi.org/10.1038/sj.cdd.4401910>.
- Li, L. L., Wang, Y. T., Zhu, L. M., Liu, Z. Y., Ye, C. Q., & Qin, S. (2020). Inulin with different degrees of polymerization protects against diet-induced endotoxemia and inflammation in association with gut microbiota regulation in mice. *Scientific Reports*, 10(1), 978. <https://doi.org/10.1038/s41598-020-58048-w>
- Lin, D., Qi, Y., Huang, C., Wu, M., Wang, C., Li, F., . . . Sun, K. (2018). Associations of lipid parameters with insulin resistance and diabetes: A population-based study. *Clinical Nutrition*, 37(4), 1423–1429. <https://doi.org/10.1016/j.clnu.2017.06.018>
- Livingston, D. P., Hinch, D. K., & Heyer, A. G. (2009). Fructan and its relationship to abiotic stress tolerance in plants. *Cellular and Molecular Life Sciences*, 66(13), 2007–2023. <https://doi.org/10.1007/s00018-009-0002-x>
- López-Froilán, R., Ramírez-Moreno, E., Podio, N. S., Pérez-Rodríguez, M. L., Cámara, M., Baroni, M. V., . . . Sánchez-Mata, M. C. (2016). *In vitro* assessment of potential intestinal absorption of some phenolic families and carboxylic acids from commercial instant coffee samples. *Food & Function*, 7(6), 2706–2711. <https://doi.org/10.1039/c6fo00315j>
- Luca, S. V., Macovei, I., Bujor, A., Miron, A., Skalicka-Woźniak, K., Aprotosoia, A. C., & Trifan, A. (2020). Bioactivity of dietary polyphenols: The role of metabolites. *Critical Reviews in Food Science and Nutrition*, 60(4), 626–659. <https://doi.org/10.1080/10408398.2018.1546669>
- Lucchin, M., Varotto, S., Barcaccia, G., & Parrini, P. (2008). Chicory and Endive. In J., Prohens, & F., Nuez (Eds.). *Vegetables I. Handbook of Plant Breeding* (pp. 3-48). New York, USA: Springer. https://doi.org/10.1007/978-0-387-30443-4_1

- Ludwig, I. A., Paz de Peña, M., Concepción, C., & Alan, C. (2013). Catabolism of coffee chlorogenic acids by human colonic microbiota. *BioFactors*, 39(6), 623–632. <https://doi.org/10.1002/biof.1124>
- Maier, H.G. (1987). Chapter 1: Introduction. In R.J., Clarke, & R., Macrae (Eds.). *Coffee: Related beverages, volume 5* (pp. 1-17). Essex, England: Elsevier applied science.
- Matos, M. S., Anastácio, J. D., Allwood, J. W., Carregosa, D., Marques, D., Sungurtas, J., . . . Santos, C. N. D. (2020). Assessing the intestinal permeability and anti-inflammatory potential of sesquiterpene lactones from chicory. *Nutrients*, 12(11), 3547. <https://doi.org/10.3390/nu12113547>
- McDougall, B., King, P. J., Wu, B. W., Hostomsky, Z., Reinecke, M. G., & Robinson, W. E. (1998). Dicafeoylquinic and dicafeoyltartaric acids are selective inhibitors of human immunodeficiency virus type 1 integrase. *Antimicrobial Agents and Chemotherapy*, 42(1), 140–146. <https://doi.org/10.1128/aac.42.1.140>
- Mehrandish, R., Awsat Mellati, A., Rahimpour, A., & Dehghan Nayeri, N. (2016). Anti-cancer activity of methanol extracts of *Cichorium intybus* on human breast cancer SKBR3 cell line. *Razavi International Journal of Medicine*, 5(1). <https://doi.org/10.5812/rijm.38369>
- Memariani, Z., Gorji, N., Moeini, R., & Farzaei, M. H. (2020) Traditional uses. In S.M., Nabavi, I., Santar, D., Barreca, & H., Khan (Eds.). *Phytonutrients in food: From traditional to rational usage* (pp. 23-66). Duxford, UK: Woodhead Publishing.
- Mestas, J., & Hughes, C. C. (2004). Of mice and not men: differences between mouse and human immunology. *Journal of Immunology*, 172(5), 2731–2738. <https://doi.org/10.4049/jimmunol.172.5.2731>
- Micka, A., Siepelmeyer, A., Holz, A., Theis, S., & Schön, C. (2017). Effect of consumption of chicory inulin on bowel function in healthy subjects with constipation: a randomized, double-blind, placebo-controlled trial. *International Journal of Food Sciences and Nutrition*, 68(1), 82–89. <https://doi.org/10.1080/09637486.2016.1212819>
- Miguel, S., Legrand, G., Duriot, L., Delporte, M., Menin, B., Michel, C., . . . Gagneul, D. (2020). A GDSL lipase-like from *Ipomoea batatas* catalyzes efficient production of 3,5-diCQA when expressed in *Pichia pastoris*. *Communications Biology*, 3(1). <https://doi.org/10.1038/s42003-020-01387-1>
- Milala, J., Grzelak, K., Król, B., Juśkiewicz, J., & Zduńczyk, Z. (2009). Composition and properties of chicory extracts rich in fructans and polyphenols. *Polish Journal of Food and Nutrition Sciences*, 59(1), 35–43.
- Moens, F., Verce, M., & De Vuyst, L. (2016). Lactate- and acetate-based cross-feeding interactions between selected strains of lactobacilli, bifidobacteria and colon bacteria in the presence of inulin-type fructans.

International Journal of Food Microbiology, 241, 225–236.
<https://doi.org/10.1016/j.ijfoodmicro.2016.10.019>

- Moglia, A., Acquadro, A., Eljounaidi, K., Milani, A. M., Cagliero, C., Rubiolo, P., . . . Comino, C. (2016). Genome-wide identification of BAHD acyltransferases and *in vivo* characterization of HQT-like enzymes involved in caffeoylquinic acid synthesis in globe artichoke. *Frontiers in Plant Science*, 7, 1424. <https://doi.org/10.3389/fpls.2016.01424>
- Moglia, A., Lanteri, S., Comino, C., Hill, L., Kneivitt, D., Cagliero, C., . . . Martin, C. (2014). Dual catalytic activity of hydroxycinnamoyl-coenzyme a quinate transferase from tomato allows it to moonlight in the synthesis of both mono- and dicaffeoylquinic acids. *Plant Physiology*, 166(4), 1777–1787. <https://doi.org/10.1104/pp.114.251371>
- Mohammad, S., Khizar, A., Faiza, N., Mobasher, A., Nawazish-i-Husain, S., Fatima, J., . . . Samia, A. (2014). Anticancer activity of n-hexane extract of *Cichorium intybus* on lymphoblastic leukemia cells (Jurkat cells). *African Journal of Plant Science*, 8(6), 315–319. <https://doi.org/10.5897/ajps2013.1021>
- Mohammadi, F., Naghavi, M. R., Peighambari, S. A., Khosravi Dehaghi, N., Khaldari, I., Bravi, E., . . . Perretti, G. (2021). Abscisic acid crosstalk with auxin and ethylene in biosynthesis and degradation of inulin-type fructans in chicory. *Plant Biology*, 23(4), 636–642. <https://doi.org/10.1111/plb.13252>
- Mohd Yusop, H., Mohd Ismail, A. I. H., & Wan Ismail, W. N. (2021). Preparation and characterization of new sol–gel hybrid inulin–TEOS adsorbent. *Polymers*, 13(8), 1295. <https://doi.org/10.3390/polym13081295>
- Molan, A. L., Duncan, A. J., Barry, T. N., & McNabb, W. C. (2003). Effects of condensed tannins and crude sesquiterpene lactones extracted from chicory on the motility of larvae of deer lungworm and gastrointestinal nematodes. *Parasitology International*, 52(3), 209–218. [https://doi.org/10.1016/s1383-5769\(03\)00011-4](https://doi.org/10.1016/s1383-5769(03)00011-4)
- Morvan-Bertrand, A., Boucaud, J., Le Saos, J., & Prud'homme, M. P. (2001). Roles of the fructans from leaf sheaths and from the elongating leaf bases in the regrowth following defoliation of *Lolium perenne* L. *Planta*, 213(1), 109–120. <https://doi.org/10.1007/s004250000478>
- Mueller-Harvey, I., Hartley, R. D., Harris, P. J., & Curzon, E. H. (1986). Linkage of *p*-coumaroyl and feruloyl groups to cell-wall polysaccharides of barley straw. *Carbohydrate Research*, 148(1), 71–85. [https://doi.org/10.1016/0008-6215\(86\)80038-6](https://doi.org/10.1016/0008-6215(86)80038-6)
- Nagy, D. U., Sándor-Bajusz, K. A., Bódy, B., Decsi, T., Van Harsseelaar, J., Theis, S., & Lohner, S. (2022). Effect of chicory-derived inulin-type fructans on abundance of *Bifidobacterium* and on bowel function: a

- systematic review with meta-analyses. *Critical Reviews in Food Science and Nutrition*, 1–18.
<https://doi.org/10.1080/10408398.2022.2098246>
- Nandagopal, S., & Ranjitha Kumari, B. D. (2007). Phytochemical and antibacterial studies of chicory (*Cichorium intybus* L.) - a multipurpose medicinal plant. *Advances in Biological Research*, 1(1–2), 17–21.
- Nawab, A., Yunus, M., Mahdi, A., & Gupta, S. (2011). Evaluation of anticancer properties of medicinal plants from the Indian Sub-Continent. *Molecular and Cellular Pharmacology*, 3(1), 21–29.
- Nguyen, T. H. O., Vieira-Silva, S., Liston, A., & Raes, J. (2015). How informative is the mouse for human gut microbiota research? *Disease Models & Mechanisms*, 8(1), 1–16. <https://doi.org/10.1242/dmm.017400>
- Nwafor, I. C., Shale, K., & Achilonu, M. C. (2017). Chemical composition and nutritive benefits of chicory (*Cichorium intybus*) as an ideal complementary and/or alternative livestock feed supplement. *The Scientific World Journal*, 2017, e7343928. <https://doi.org/10.1155/2017/7343928>
- Ogurtsova, K., da Rocha Fernandes, J., Huang, Y., Linnenkamp, U., Guariguata, L., Cho, N., . . . Makaroff, L. (2017). IDF Diabetes Atlas: Global estimates for the prevalence of diabetes for 2015 and 2040. *Diabetes Research and Clinical Practice*, 128, 40–50. <https://doi.org/10.1016/j.diabres.2017.03.024>
- O’Keefe, S. J. (2019). The association between dietary fibre deficiency and high-income lifestyle-associated diseases: Burkitt’s hypothesis revisited. *The Lancet Gastroenterology & Hepatology*, 4(12), 984–996. [https://doi.org/10.1016/s2468-1253\(19\)30257-2](https://doi.org/10.1016/s2468-1253(19)30257-2)
- Oliveira, V. F., Zaidan, L. B. P., Braga, M. R., Aidar, M. P. M., & Carvalho, M. A. M. (2010). Elevated CO₂ atmosphere promotes plant growth and inulin production in the cerrado species *Vernonia herbacea*. *Functional Plant Biology*, 37(3), 223. <https://doi.org/10.1071/fp09164>
- Olthof, M. R., Hollman, P. C. H., & Katan, M. B. (2001). Chlorogenic acid and caffeic acid are absorbed in humans. *The Journal of Nutrition*, 131(1), 66–71. <https://doi.org/10.1093/jn/131.1.66>
- Osbaldeston, T.A., & Wood, R.P. (2000) Seris. In T.A., Osbaldeston, & R.P., Wood (Eds.). *The Herbal of Dioscorides the greek* (pp. 287). Johannesburg, South Africa: Ibis Press.
- Palócz, O., Pászti-Gere, E., Gálfi, P., & Farkas, O. (2016). Chlorogenic acid combined with *Lactobacillus plantarum* 2142 reduced LPS-induced intestinal inflammation and oxidative stress in IPEC-J2 cells. *PLOS ONE*, 11(11), e0166642. <https://doi.org/10.1371/journal.pone.0166642>
- Panchal, S. K., Poudyal, H., Iyer, A., Nazer, R., Alam, M. A., Diwan, V., . . . Brown, L. (2012). High-carbohydrate, high-fat diet-induced metabolic syndrome and cardiovascular remodeling in rats. *Journal of Cardiovascular Pharmacology*, 57(5), 611–624. <https://doi.org/10.1097/fjc.0b013e31821b1379>

- Park, S., Georgescu, A., & Huh, D. (2019). Organoids-on-a-chip. *Science*, *364*(6444), 960–965. <https://doi.org/10.1126/science.aaw7894>
- Pasephol, T., Small, D. M., & Sherkat, F. (2008). Rheology and texture of set yogurt as affected by inulin addition. *Journal of Texture Studies*, *39*(6), 617–634. <https://doi.org/10.1111/j.1745-4603.2008.00161.x>
- Pazola, Z. (1987). The chemistry of chicory and chicory-product beverages. In R.J., Clarke, & R., Macrae (Eds.). *Coffee: Related beverages, volume 5* (pp.19-57). Essex, England: Elsevier applied science.
- Peña-Espinoza, M., Romero-Uzqueda, Y., Valente, A. H., de Roode, M., Simonsen, H. T., Thamsborg, S. M., . . . López-Muñoz, R. (2022). Anti-protozoal activity and metabolomic analyses of *Cichorium intybus* L. against *Trypanosoma cruzi*. *International Journal for Parasitology: Drugs and Drug Resistance*, *20*, 43–53. <https://doi.org/10.1016/j.ijpddr.2022.08.002>
- Peña-Espinoza, M., Valente, A. H., Bornancin, L., Simonsen, H. T., Thamsborg, S. M., Williams, A. R., & López-Muñoz, R. (2020). Anthelmintic and metabolomic analyses of chicory (*Cichorium intybus*) identify an industrial by-product with potent *in vitro* antinematodal activity. *Veterinary Parasitology*, *280*, 109088. <https://doi.org/10.1016/j.vetpar.2020.109088>
- Peña-Espinoza, M., Valente, A. H., Thamsborg, S. M., Simonsen, H. T., Boas, U., Enemark, H. L., . . . Williams, A. R. (2018). Antiparasitic activity of chicory (*Cichorium intybus*) and its natural bioactive compounds in livestock: a review. *Parasites & Vectors*, *11*(1), 475. <https://doi.org/10.1186/s13071-018-3012-4>
- Peng, Z., Wang, Y., Gu, X., Guo, X., & Yan, C. (2014). Study on the pharmacokinetics and metabolism of costunolide and dehydrocostus lactone in rats by HPLC-UV and UPLC-Q-TOF/MS. *Biomedical Chromatography*, *28*(10), 1325–1334. <https://doi.org/10.1002/bmc.3167>
- Peres, R., Tonin, F., Tavares, M., & Rodriguez-Amaya, D. (2013). HPLC-DAD-ESI/MS identification and quantification of phenolic compounds in *Ilex paraguariensis* beverages and on-line evaluation of individual antioxidant activity. *Molecules*, *18*(4), 3859–3871. <https://doi.org/10.3390/molecules18043859>
- Perović, J., Tumbas Šaponjac, V., Kojić, J., Krulj, J., Moreno, D. A., García-Viguera, C., . . . Ilić, N. (2021). Chicory (*Cichorium intybus* L.) as a food ingredient – Nutritional composition, bioactivity, safety, and health claims: A review. *Food Chemistry*, *336*, 127676. <https://doi.org/10.1016/j.foodchem.2020.127676>
- Petersen, K. F., Laurent, D., Yu, C., Cline, G. W., & Shulman, G. I. (2001). Stimulating effects of low-dose fructose on insulin-stimulated hepatic glycogen synthesis in humans. *Diabetes*, *50*(6), 1263–1268. <https://doi.org/10.2337/diabetes.50.6.1263>

- Phull, A. R., Nasir, B., Haq, I. U., & Kim, S. J. (2018). Oxidative stress, consequences and ROS mediated cellular signaling in rheumatoid arthritis. *Chemico-Biological Interactions*, 281, 121–136. <https://doi.org/10.1016/j.cbi.2017.12.024>
- Pignatelli, P., Menichelli, D., Pastori, D., & Violi, F. (2018). Oxidative stress and cardiovascular disease: new insights. *Kardiologia Polska*, 76(4), 713–722. <https://doi.org/10.5603/kp.a2018.0071>
- Pool-Zobel, B. L. (2005). Inulin-type fructans and reduction in colon cancer risk: review of experimental and human data. *British Journal of Nutrition*, 93(S1), S73–S90. <https://doi.org/10.1079/bjn20041349>
- Pouille, C. L., Jegou, D., Dugardin, C., Cudennec, B., Ravallec, R., Hance, P., . . . Lucau-Danila, A. (2020). Chicory root flour – A functional food with potential multiple health benefits evaluated in a mice model. *Journal of Functional Foods*, 74, 104174. <https://doi.org/10.1016/j.jff.2020.104174>
- Pouille, C. L., Ouaza, S., Roels, E., Behra, J., Turret, M., Molinié, R., . . . Lucau-Danila, A. (2022). Chicory: understanding the effects and effectors of this functional food. *Nutrients*, 14(5), 957. <https://doi.org/10.3390/nu14050957>
- Price, K. R., Dupont, M. S., Shepherd, R., Chan, H. W. S., & Fenwick, G. R. (1990). Relationship between the chemical and sensory properties of exotic salad crops—coloured lettuce (*Lactuca sativa*) and chicory (*Cichorium intybus*). *Journal of the Science of Food and Agriculture*, 53(2), 185–192. <https://doi.org/10.1002/jsfa.2740530206>
- Puhlmann, M. L., Jokela, R., van Dongen, K. C. W., Bui, T. P. N., Hangelbroek, R. W. J. V., Smidt, H., . . . Feskens, E. J. M. (2022). Dried chicory root improves bowel function, benefits intestinal microbial trophic chains and increases faecal and circulating short chain fatty acids in subjects at risk for type 2 diabetes. *Gut Microbiome*, 3, e4. <https://doi.org/10.1017/gmb.2022.4>
- Purnell, T. S., Joy, S., Little, E., Bridges, J. F., & Maruthur, N. (2014). Patient preferences for noninsulin diabetes medications: a systematic review. *Diabetes Care*, 37(7), 2055–2062. <https://doi.org/10.2337/dc13-2527>
- Pyrek, J.S. (1985). Sesquiterpene lactones of *Cichorium intybus* and *Leontodon autumnalis*. *Phytochemistry*, 24(3) 186-188.
- Quideau, S., Deffieux, D., Douat-Casassus, C., & Pouységu, L. (2011). Plant polyphenols: Chemical properties, biological activities, and synthesis. *Angewandte Chemie International Edition*, 50(3), 586–621. <https://doi.org/10.1002/anie.201000044>

- Rajkumar, K., Modric, T., & Murphy, L. (1999). Impaired adipogenesis in insulin-like growth factor binding protein-1 transgenic mice. *Journal of Endocrinology*, *162*(3), 457–465. <https://doi.org/10.1677/joe.0.1620457>.
- Ramachandran, S. D., Schirmer, K., Müntz, B., Heinz, S., Ghafoory, S., Wöfl, S., . . . Breitkopf-Heinlein, K. (2015). *In vitro* generation of functional liver organoid-like structures using adult human cells. *PLOS ONE*, *10*(10), e0139345. <https://doi.org/10.1371/journal.pone.0139345>
- Rangarajan, A., & Weinberg, R. A. (2003). Comparative biology of mouse versus human cells: modelling human cancer in mice. *Nature Reviews Cancer*, *3*(12), 952–959. <https://doi.org/10.1038/nrc1235>
- Rao, R. S. P., Andersen, J. R., Dionisio, G., & Boelt, B. (2011). Fructan accumulation and transcription of candidate genes during cold acclimation in three varieties of *Poa pratensis*. *Journal of Plant Physiology*, *168*(4), 344–351. <https://doi.org/10.1016/j.jplph.2010.07.019>
- Rees, S. B., & Harborne, J. B. (1985). The role of sesquiterpene lactones and phenolics in the chemical defence of the chicory plant. *Phytochemistry*, *24*(10), 2225–2231.
- Reine Judesse Soviguidi, D., Pan, R., Liu, Y., Rao, L., Zhang, W., & Yang, X. (2022). Chlorogenic acid metabolism: the evolution and roles in plant response to abiotic stress. *Phyton*, *91*(2), 239–255. <https://doi.org/10.32604/phyton.2022.018284>
- Reinke, R. A., King, P. J., Victoria, J. G., McDougall, B. R., Ma, G., Mao, Y., . . . Robinson, W. E. (2002). Dicafeoyltartaric acid analogues inhibit Human Immunodeficiency Virus type 1 (HIV-1) integrase and HIV-1 replication at nontoxic concentrations. *Journal of Medicinal Chemistry*, *45*(17), 3669–3683. <https://doi.org/10.1021/jm010359d>
- Ren, Y., Zhou, Y., Chen, X., & Ye, Y. (2005). Discovery, structural determination and anticancer activities of lactucin-like guaianolides. *Letters in Drug Design & Discovery*, *2*(6), 444–450. <https://doi.org/10.2174/1570180054771581>
- Ripoll, C., Schmidt, B. M., Ilic, N., Poulev, A., Dey, M., Kurmukov, A. G., & Raskin, I. (2007). Anti-inflammatory effects of a sesquiterpene lactone extract from chicory (*Cichorium intybus* L.) roots. *Natural Product Communications*, *2*(7), 717–727. <https://doi.org/10.1177/1934578x0700200702>
- Rivière, A., Selak, M., Lantin, D., Leroy, F., & De Vuyst, L. (2016). Bifidobacteria and butyrate-producing colon bacteria: importance and strategies for their stimulation in the human gut. *Frontiers in Microbiology*, *7*, 979. <https://doi.org/10.3389/fmicb.2016.00979>

- Roberfroid, M. B. (1997). Health benefits of non-digestible oligosaccharides. *Advances in Experimental Medical Biology*, 427, 211–219. https://doi.org/10.1007/978-1-4615-5967-2_22
- Roberfroid, M. B. (2007). Inulin-type fructans: functional food ingredients. *The Journal of Nutrition*, 137(11), 2493S–2502S. <https://doi.org/10.1093/jn/137.11.2493s>
- Roberfroid, M., & Slavin, J. (2000). Nondigestible oligosaccharides. *Critical Reviews in Food Science and Nutrition*, 40(6), 461–480. <https://doi.org/10.1080/10408690091189239>
- Rodríguez, R., Alomar, D., & Morales, R. (2020). Milk and meat fatty acids from sheep fed a plantain–chicory mixture or a grass-based permanent sward. *Animal*, 14(5), 1102–1109. <https://doi.org/10.1017/s1751731119002611>
- Rojas-Silva, P. (2014). *Leishmanicidal, anti-inflammatory and anti-obesity properties of natural products from common medicinal and edible plants* (thèse de doctorat). The State University of New Jersey.
- Rolnik, A., & Olas, B. (2021). The Plants of the Asteraceae family as agents in the protection of human health. *International Journal of Molecular Sciences*, 22(6), 3009. <https://doi.org/10.3390/ijms22063009>
- Ronkart, S. N., Blecker, C. S., Fourmanoir, H., Fougny, C., Deroanne, C., Van Herck, J. C., & Paquot, M. (2007). Isolation and identification of inulooligosaccharides resulting from inulin hydrolysis. *Analytica Chimica Acta*, 604(1), 81–87. <https://doi.org/10.1016/j.aca.2007.07.073>
- Ruiz-Crespo, S., Trejo-Gabriel-Galan, J. M., Cavia-Saiz, M., & Muñiz, P. (2012). Coffee component 3-caffeoylquinic acid increases antioxidant capacity but not polyphenol content in experimental cerebral infarction. *Neurochemical Research*, 37(5), 1085–1090. <https://doi.org/10.1007/s11064-012-0711-7>
- Rumball, W. (1986). Grasslands Puna’ chicory (*Cichorium intybus*L.). *New Zealand Journal of Experimental Agriculture*, 14(1), 105–107. <https://doi.org/10.1080/03015521.1986.10426133>
- Sannai, A., Fujimori, T., & Kato, K. (1982). Studies on flavor components of roasted chicory roots. *Agricultural and Biological Chemistry*, 46, 429–433.
- Santana-Gálvez, J., Cisneros-Zevallos, L., & Jacobo-Velázquez, D. (2017). Chlorogenic acid: recent advances on its dual role as a food additive and a nutraceutical against metabolic syndrome. *Molecules*, 22(3), 358. <https://doi.org/10.3390/molecules22030358>
- Schmidt, A. (1940). Die quantitative bestimmung des lactucopikrins und lactucins bei compositen, insbesondere bei *Lactuca virosa*. *Botanisches Archiv*, 40, 516–559.
- Schreurs, N. M., Lopez-Villalobos, N., Barry, T. N., Molan, A. L., & McNabb, W. C. (2002). Effects of grazing undrenched weaner deer on chicory or perennial ryegrass/white clover pasture on the viability of

- gastrointestinal nematodes and lungworms. *Veterinary Record*, 151(12), 348–353.
<https://doi.org/10.1136/vr.151.12.348>
- Sessa, R. A., Bennett, M. H., Lewis, M. J., Mansfield, J. W., & Beale, M. H. (2000). Metabolite profiling of sesquiterpene lactones from *Lactuca* species. Major latex components are novel oxalate and sulfate conjugates of lactucin and its derivatives. *Journal of Biological Chemistry*, 275(35), 26877–26884.
<https://doi.org/10.1074/jbc.m000244200>
- Seto, M., Miyase, T., Umehara, K., Ueno, A., Hirano, Y., & Otani, N. (1988). Sesquiterpene lactones from *Cichorium endivia* L. and *C. intybus* L. and cytotoxic activity. *Chemical & Pharmaceutical Bulletin*, 36(7), 2423–2429.
- Shad, M. A., Nawaz, H., Rehman, T., & Ikram, N. (2010). Determination of some biochemicals, phytochemicals and antioxidant properties of different parts of *Cichorium intybus* L.: A comparative study. *Journal of Animal and Plant Sciences*, 23(4), 1060–1066.
- Shashidharamurthy, R., Machiah, D., Aitken, J. D., Putty, K., Srinivasan, G., Chassaing, B., ... Vijay-Kumar, M. (2013). Differential role of lipocalin 2 during immune complex-mediated acute and chronic inflammation in mice. *Arthritis & Rheumatology*, 65(4), 1064–1073. <https://doi.org/10.1002/art.37840>.
- Shiota, M., Galassetti, P., Monohan, M., Neal, D. W., & Cherrington, A. D. (1998). Small amounts of fructose markedly augment net hepatic glucose uptake in the conscious dog. *Diabetes*, 47(6), 867–873.
<https://doi.org/10.2337/diabetes.47.6.867>
- Simpson, D. S. A., & Oliver, P. L. (2020). ROS generation in microglia: understanding oxidative stress and inflammation in neurodegenerative disease. *Antioxidants*, 9(8), 743.
<https://doi.org/10.3390/antiox9080743>
- Socodato, R., Portugal, C. C., Canedo, T., Domith, I., Oliveira, N. A., Paes-de-Carvalho, R., . . . Cossenza, M. (2015). c-Src deactivation by the polyphenol 3-*O*-caffeoylquinic acid abrogates reactive oxygen species-mediated glutamate release from microglia and neuronal excitotoxicity. *Free Radical Biology and Medicine*, 79, 45–55. <https://doi.org/10.1016/j.freeradbiomed.2014.11.019>
- Socodato, R., Portugal, C. C., Domith, I., Oliveira, N. A., Coreixas, V. S. M., Loiola, E. C., . . . Relvas, J. B. (2014). c-Src function is necessary and sufficient for triggering microglial cell activation. *Glia*, 63(3), 497–511. <https://doi.org/10.1002/glia.22767>
- Somasiri, S. C., Kenyon, P. R., Kemp, P. D., Morel, P. C. H., & Morris, S. T. (2015). Mixtures of clovers with plantain and chicory improve lamb production performance compared to a ryegrass-white clover sward

- in the late spring and early summer period. *Grass and Forage Science*, 71(2), 270–280.
<https://doi.org/10.1111/gfs.12173>
- Stefanović, O. D., Stanojević, D. D., & Comić, L. R. (2012). Synergistic antibacterial activity of *Salvia officinalis* and *Cichorium intybus* extracts and antibiotics. *Acta Poloniae Pharmaceutica*, 69(3), 457–463.
- Stein, K. B., Snyder, C. F., Barone, B. B., Yeh, H. C., Peairs, K. S., Derr, R. L., . . . Brancati, F. L. (2010). Colorectal cancer outcomes, recurrence, and complications in persons with and without diabetes mellitus: a systematic review and meta-analysis. *Digestive Diseases and Sciences*, 55(7), 1839–1851.
<https://doi.org/10.1007/s10620-009-0944-8>
- Sterrett, J. J., Bragg, S., & Weart, C. W. (2016). Type 2 diabetes medication review. *The American Journal of the Medical Sciences*, 351(4), 342–355. <https://doi.org/10.1016/j.amjms.2016.01.019>
- Süntar, I., Küpeli Akkol, E., Keles, H., Yesilada, E., Sarker, S. D., & Baykal, T. (2012). Comparative evaluation of traditional prescriptions from *Cichorium intybus* L. for wound healing: Stepwise isolation of an active component by *in vivo* bioassay and its mode of activity. *Journal of Ethnopharmacology*, 143(1), 299–309. <https://doi.org/10.1016/j.jep.2012.06.036>
- Szwajgier, D., Borowiec, K., & Pustelniak, K. (2017). The neuroprotective effects of phenolic acids: molecular mechanism of action. *Nutrients*, 9(5), 477. <https://doi.org/10.3390/nu9050477>
- Tajik, N., Tajik, M., Mack, I., & Enck, P. (2017). The potential effects of chlorogenic acid, the main phenolic components in coffee, on health: a comprehensive review of the literature. *European Journal of Nutrition*, 56(7), 2215–2244. <https://doi.org/10.1007/s00394-017-1379-1>
- Tamura, R. E., Vasconcellos, J. F. D., Sarkar, D., Libermann, T. A., Fisher, P. B., & Zerbini, L. F. (2012). GADD45 proteins: Central players in tumorigenesis. *Current Molecular Medicine*, 12(5), 634–651.
<https://doi.org/10.2174/156652412800619978>.
- Tomas-Barberan, F., García-Villalba, R., Quartieri, A., Raimondi, S., Amaretti, A., Leonardi, A., & Rossi, M. (2013). *In vitro* transformation of chlorogenic acid by human gut microbiota. *Molecular Nutrition & Food Research*, 58(5), 1122–1131. <https://doi.org/10.1002/mnfr.201300441>
- Tripodo, G., & Mandracchia, D. (2019). Inulin as a multifaceted (active) substance and its chemical functionalization: From plant extraction to applications in pharmacy, cosmetics and food. *European Journal of Pharmaceutics and Biopharmaceutics*, 141, 21–36. <https://doi.org/10.1016/j.ejpb.2019.05.011>
- Tsao, R. (2010). Chemistry and biochemistry of dietary polyphenols. *Nutrients*, 2(12), 1231–1246.
<https://doi.org/10.3390/nu2121231>

- Tsatsaragkou, K., Methven, L., Chatzifragkou, A., & Rodriguez-Garcia, J. (2021). The functionality of inulin as a sugar replacer in cakes and biscuits; highlighting the influence of differences in degree of polymerisation on the properties of cake batter and product. *Foods*, *10*(5), 951. <https://doi.org/10.3390/foods10050951>
- Usman, M., Zhang, C., Patil, P. J., Mehmood, A., Li, X., Bilal, M., . . . Ahmad, S. (2021). Potential applications of hydrophobically modified inulin as an active ingredient in functional foods and drugs - A review. *Carbohydrate Polymers*, *252*, 117176. <https://doi.org/10.1016/j.carbpol.2020.117176>
- Valluru, R., & Van den Ende, W. (2008). Plant fructans in stress environments: emerging concepts and future prospects. *Journal of Experimental Botany*, *59*(11), 2905–2916. <https://doi.org/10.1093/jxb/ern164>
- Van Beek, T. A., Maas, P., King, B. M., Leclercq, E., Voragen, A. G. J., & De Groot, A. (1990). Bitter sesquiterpene lactones from chicory roots. *Journal of Agricultural and Food Chemistry*, *38*(4), 1035–1038. <https://doi.org/10.1021/jf00094a026>
- Van Der Meer, I. M., Koops, A. J., Hakkert, J. C., & Van Tunen, A. J. (1998). Cloning of the fructan biosynthesis pathway of Jerusalem artichoke. *The Plant Journal*, *15*(4), 489–500. <https://doi.org/10.1046/j.1365-313x.1998.00230.x>
- Van De Wiele, T., Van Den Abbeele, P., Ossieur, W., Possemiers, S., & Marzorati, M. (2015). The Simulator of the Human Intestinal Microbial Ecosystem (SHIME®). *Springer International Publishing eBooks*, 305–317. https://doi.org/10.1007/978-3-319-16104-4_27
- Van Laere, A., & Van Den Ende, W. (2002). Inulin metabolism in dicots: chicory as a model system. *Plant, Cell & Environment*, *25*(6), 803–813. <https://doi.org/10.1046/j.1365-3040.2002.00865.x>
- Van Loo, J., Coussement, P., De Leenheer, L., Hoebregs, H., & Smits, G. (1995). On the presence of inulin and oligofructose as natural ingredients in the western diet. *Critical Reviews in Food Science and Nutrition*, *35*(6), 525–552. <https://doi.org/10.1080/10408399509527714>
- Vandeputte, D., Falony, G., Vieira-Silva, S., Wang, J., Sailer, M., Theis, S., . . . Raes, J. (2017). Prebiotic inulin-type fructans induce specific changes in the human gut microbiota. *Gut*, *66*(11), 1968–1974. <https://doi.org/10.1136/gutjnl-2016-313271>
- Vandoorne, B., Descamps, C., Mathieu, A. S., Van den Ende, W., Vergauwen, R., Javaux, M., & Lutts, S. (2014). Long term intermittent flooding stress affects plant growth and inulin synthesis of *Cichorium intybus* (var. *sativum*). *Plant and Soil*, *376*(1–2), 291–305. <https://doi.org/10.1007/s11104-013-1933-4>

- Vergauwen, R., Van den Ende, W., & Van Laere, A. (2000). The role of fructan in flowering of *Campanula rapunculoides*. *Journal of Experimental Botany*, *51*(348), 1261–1266. <https://doi.org/10.1093/jexbot/51.348.1261>
- Vigneri, P., Frasca, F., Sciacca, L., Pandini, G., & Vigneri, R. (2009). Diabetes and cancer. *Endocrine-Related Cancer*, *16*(4), 1103–1123. <https://doi.org/10.1677/erc-09-0087>
- Vodicka, P., Smetana, K., Dvořánková, B., Emerick, T., Xu, Y., Ourednik, J., . . . Motlik, J. (2005). The miniature pig as an animal model in biomedical research. *Annals of the New York Academy of Sciences*, *1049*(1), 161–171. <https://doi.org/10.1196/annals.1334.015>
- Voet, J., & Voet, D. (2016) La photosynthèse. In De Boeck Supérieur (Ed.). *Biochimie, 3rd edition* (pp. 901-939). Louvain-la-Neuve, Belgique: De Boeck Supérieur.
- Wan, M. L. Y., Co, V. A., & El-Nezami, H. (2020). Dietary polyphenol impact on gut health and microbiota. *Critical Reviews in Food Science and Nutrition*, *61*(4), 690–711. <https://doi.org/10.1080/10408398.2020.1744512>
- Wang, Y., Qi, W., Song, G., Pang, S., Peng, Z., Li, Y., & Wang, P. (2020). High-fructose diet increases inflammatory cytokines and alters gut microbiota composition in rats. *Mediators of Inflammation*, *2020*, 6672636. <https://doi.org/10.1155/2020/6672636>
- Watford, M. (2002). Small amounts of dietary fructose dramatically increase hepatic glucose uptake through a novel mechanism of glucokinase activation. *Nutrition Reviews*, *60*(8), 253–257. <https://doi.org/10.1301/002966402320289377>
- Weitkunat, K., Schumann, S., Petzke, K. J., Blaut, M., Loh, G., & Klaus, S. (2015). Effects of dietary inulin on bacterial growth, short-chain fatty acid production and hepatic lipid metabolism in gnotobiotic mice. *The Journal of Nutritional Biochemistry*, *26*(9), 929–937. <https://doi.org/10.1016/j.jnutbio.2015.03.010>
- Weng, H., He, L., Liu, X., Li, Q., Du, Y., Zheng, J., & Wang, D. (2021). Natural lactucopicrin alleviates importin- α 3-mediated NF- κ B activation in inflamed endothelial cells and improves sepsis in mice. *Biochemical Pharmacology*, *186*, 114501. <https://doi.org/10.1016/j.bcp.2021.114501>
- Weng, H., He, L., Zheng, J., Li, Q., Liu, X., & Wang, D. (2020). Low oral bioavailability and partial gut microbiotic and phase ii metabolism of brussels/witloof chicory sesquiterpene lactones in healthy humans. *Nutrients*, *12*(12), 3675. <https://doi.org/10.3390/nu12123675>

- Wesołowska, A., Nikiforuk, A., Michalska, K., Kisiel, W., & Chojnacka-Wójcik, E. (2006). Analgesic and sedative activities of lactucin and some lactucin-like guaianolides in mice. *Journal of Ethnopharmacology*, *107*(2), 254–258. <https://doi.org/10.1016/j.jep.2006.03.003>
- Wheatcroft, S. B., & Kearney, M. T. (2009). IGF-dependent and IGF-independent actions of IGF-binding protein-1 and -2: Implications for metabolic homeostasis. *Trends in Endocrinology & Metabolism*, *20*(4), 153–162. <https://doi.org/10.1016/j.tem.2009.01.002>
- Wilkinson, G. (1849). On the growth and manufacture of chicory. *Proceedings of the Yorkshire Geological Society*, *3*(1), 75–78. <https://doi.org/10.1144/pygs.3.75>
- Willeman, H. (2016). *Contribution à la recherche des composés impliqués dans l'amertume de la racine de chicorée – Approches métabolomique et sensorielle de l'influence de la torréfaction* (thèse de doctorat). Université de Lille.
- Wojtunik-Kulesza, K., Oniszczyk, A., Oniszczyk, T., Combrzyński, M., Nowakowska, D., & Matwijczuk, A. (2020). Influence of *in vitro* digestion on composition, bioaccessibility and antioxidant activity of food polyphenols—a non-systematic review. *Nutrients*, *12*(5), 1401. <https://doi.org/10.3390/nu12051401>
- Wong, J. M. W., de Souza, R., Kendall, C. W. C., Emam, A., & Jenkins, D. J. A. (2006). Colonic health: fermentation and short chain fatty acids. *Journal of Clinical Gastroenterology*, *40*(3), 235–243. <https://doi.org/10.1097/00004836-200603000-00015>
- Wu, T., Wang, X., Xiong, H., Deng, Z., Peng, X., Xiao, L., . . . Sun, Y. (2021). Bioactives and their metabolites from *Tetrastigma hemsleyanum* leaves ameliorate DSS-induced colitis *via* protecting the intestinal barrier, mitigating oxidative stress and regulating the gut microbiota. *Food & Function*, *12*(23), 11760–11776. <https://doi.org/10.1039/d1fo02588k>
- Wulsten, I., Costa-Silva, T., Mesquita, J., Lima, M., Galuppo, M., Taniwaki, N., . . . Tempone, A. (2017). Investigation of the anti-leishmania (*Leishmania infantum*) activity of some natural sesquiterpene lactones. *Molecules*, *22*(5), 685. <https://doi.org/10.3390/molecules22050685>
- Xie, M. G., Fei, Y. Q., Wang, Y., Wang, W. Y., & Wang, Z. (2021). Chlorogenic acid alleviates colon mucosal damage induced by a high-fat diet *via* gut microflora adjustment to increase short-chain fatty acid accumulation in rats. *Oxidative Medicine and Cellular Longevity*, *2021*, 1–18. <https://doi.org/10.1155/2021/3456542>
- Yang, J. (2015). *Influence of native and processed cereal grain fibers on gut health* (thèse de doctorat). University of Nebraska.

- Yaribeygi, H., Sathyapalan, T., Atkin, S. L., & Sahebkar, A. (2020). Molecular mechanisms linking oxidative stress and diabetes mellitus. *Oxidative Medicine and Cellular Longevity*, 2020, 1–13. <https://doi.org/10.1155/2020/8609213>
- Yu, L. M., Mao, L. Q., Wu, C. Y., Ye, W., & Wang, X. (2021). Chlorogenic acid improves intestinal barrier function by downregulating CD14 to inhibit the NF- κ B signaling pathway. *Journal of Functional Foods*, 85, 104640. <https://doi.org/10.1016/j.jff.2021.104640>
- Yu, Y., Yang, W., Bilotta, A. J., Zhao, X., Cong, Y., & Li, Y. (2021). L-lactate promotes intestinal epithelial cell migration to inhibit colitis. *The FASEB Journal*, 35(4). <https://doi.org/10.1096/fj.202100095r>
- Yu, Z., Chen, Z., Li, Q., Yang, K., Huang, Z., Wang, W., . . . Hu, H. (2020). What dominates the changeable pharmacokinetics of natural sesquiterpene lactones and diterpene lactones: a review focusing on absorption and metabolism. *Drug Metabolism Reviews*, 53(1), 122–140. <https://doi.org/10.1080/03602532.2020.1853151>
- Zammerini, D., Wood, J., Whittington, F., Nute, G., Hughes, S., Hazzledine, M., & Matthews, K. (2012). Effect of dietary chicory on boar taint. *Meat Science*, 91(4), 396–401. <https://doi.org/10.1016/j.meatsci.2012.01.020>
- Zhang, C. X. (2019). The protective role of DMBT1 in cervical squamous cell carcinoma. *The Kaohsiung Journal of Medical Sciences*, 35(12), 739–749. <https://doi.org/10.1002/kjm2.12117>.
- Zhang, H. L., Dai, L. H., Wu, Y. H., Yu, X. P., Zhang, Y. Y., Guan, R. F., . . . Zhao, J. (2014). Evaluation of hepatocyteprotective and anti-hepatitis B virus properties of Cichoric acid from *Cichorium intybus* leaves in cell culture. *Biological and Pharmaceutical Bulletin*, 37(7), 1214–1220. <https://doi.org/10.1248/bpb.b14-00137>
- Zhang, Z., Wu, X., Cao, S., Cromie, M., Shen, Y., Feng, Y., . . . Li, L. (2017). Chlorogenic acid ameliorates experimental colitis by promoting growth of *Akkermansia* in mice. *Nutrients*, 9(7), 677. <https://doi.org/10.3390/nu9070677>
- Zhao, H., Wu, L., Yan, G., Chen, Y., Zhou, M., Wu, Y., & Li, Y. (2021). Inflammation and tumor progression: signaling pathways and targeted intervention. *Signal Transduction and Targeted Therapy*, 6(1), 1–46. <https://doi.org/10.1038/s41392-021-00658-5>
- Zheng, M., Mao, P., Tian, X., & Meng, L. (2019). Growth performance, carcass characteristics, meat and egg quality, and intestinal microbiota in Beijing-you chicken on diets with inclusion of fresh chicory forage. *Italian Journal of Animal Science*, 18(1), 1310–1320. <https://doi.org/10.1080/1828051x.2019.1643794>

- Zhou, C. X., Zou, L., Zhao, Z. Z., Zhu, H., He, Q. J., Yang, B., & Gan, L. S. (2012). Terpenoids from *Cichorium intybus*. *Natural Product Communications*, 7(8), 1934578X1200700. <https://doi.org/10.1177/1934578x1200700801>
- Zhou, X., Zhang, B., Zhao, X., Lin, Y., Wang, J., Wang, X., . . . Wang, S. (2021). Chlorogenic acid supplementation ameliorates hyperuricemia, relieves renal inflammation, and modulates intestinal homeostasis. *Food & Function*, 12(12), 5637–5649. <https://doi.org/10.1039/d0fo03199b>
- Žnidarčič, D., Osvald, J., & Trdan, S. (2004). Plant characteristic for distinction of red chicory (*Cichorium intybus* L. var. *silvestre* Bisch.) cultivars grown in central Slovenia. *Acta Agriculturae Slovenica*, 83, 251–260.

RESUME

Ce projet s'inscrit dans une problématique globale qui concerne la caractérisation du potentiel nutrition-santé des produits agro-alimentaires issus de la biodiversité naturelle de la chicorée ainsi que des variétés améliorées de celle-ci. L'enjeu consiste à valoriser les produits conventionnels et surtout ceux à valeur d'aliment fonctionnel, qui procurent, au-delà des fonctions nutritionnelles de base, des bienfaits physiologiques et qui réduisent le risque de maladies chroniques.

L'objectif de ce projet de thèse a été de tester différents produits issus de la chicorée industrielle (*Cichorium intybus* var. *sativum*), notamment des farines produites à partir des racines, ainsi que différentes classes de molécules qui entrent dans la composition de la plante, pour analyser leurs effets sur la santé animale et humaine. Ce projet a inclus trois étapes de développement : i) la caractérisation du potentiel fonctionnel des produits alimentaires (farines de chicorée et inuline) au travers d'analyses nutriginomiques, physiologiques et métagénomiques chez la souris; ii) l'identification, *in vivo* et *in vitro*, des différentes classes de molécules responsables des effets santé observés (fructose, acides chlorogéniques et lactones sesquiterpéniques), et iii) l'évaluation de l'impact de la digestion gastro-intestinale simulée *in vitro* sur le statut fonctionnel des farines et de leurs composés. Les résultats obtenus ont mis en évidence les effets antitumoraux, anti-inflammatoires, antimicrobiens, antioxydants, sur le microbiote intestinal murin et l'activité potentiellement régulatrice de l'homéostasie énergétique, de la farine de chicorée et de ses composés bioactifs (Pouille *et al.*, 2020; Pouille *et al.*, 2022).

ABSTRACT

This project is part of a broad issue concerning the characterization of the health and nutrition potential of agri-food products derived from the natural biodiversity of chicory as well as its improved varieties. This issue aims to promote conventional products and especially those with functional food value, which therefore provide, beyond basic nutritional functions, physiological benefits and reduce the risk of chronic diseases.

The objective of this thesis work was to test different products from industrial chicory (*Cichorium intybus* var. *sativum*), in particular flours produced from the roots, as well as different classes of molecules that enter the composition of the plant, to analyze their effects on animal and human health. This project included three stages of development: i) the characterization of the functional potential of food products (chicory flour and inulin) through nutrigenomic, physiological and metagenomic analyses in mice; ii) an *in vivo* and *in vitro* identification of the different classes of molecules responsible for the health effects observed (fructose, chlorogenic acids and sesquiterpene lactones), and iii) the evaluation of the impact of the *in vitro* simulated gastrointestinal digestion on the functional status of the flours and their compounds. The results obtained highlighted the antitumoral, anti-inflammatory, antimicrobial, antioxidant, on mice gut microbiota and the potential regulatory activity of energy homeostasis, of chicory flour and its bioactive compounds (Pouille *et al.*, 2020; Pouille *et al.*, 2022).