



HAL
open science

Glucocorticoid receptor activity in triple negative breast cancer

Lara Nouredine

► **To cite this version:**

Lara Nouredine. Glucocorticoid receptor activity in triple negative breast cancer. Molecular biology. Université Claude Bernard - Lyon I; Université Libanaise, 2022. English. NNT : 2022LYO10075 . tel-04147744

HAL Id: tel-04147744

<https://theses.hal.science/tel-04147744v1>

Submitted on 1 Jul 2023

HAL is a multi-disciplinary open access archive for the deposit and dissemination of scientific research documents, whether they are published or not. The documents may come from teaching and research institutions in France or abroad, or from public or private research centers.

L'archive ouverte pluridisciplinaire **HAL**, est destinée au dépôt et à la diffusion de documents scientifiques de niveau recherche, publiés ou non, émanant des établissements d'enseignement et de recherche français ou étrangers, des laboratoires publics ou privés.



THESE de DOCTORAT DE L'UNIVERSITE CLAUDE BERNARD LYON 1

**Ecole Doctorale N° 340
Biologie Moléculaire Intégrative et Cellulaire (ED BMIC)**

Discipline : Biologie moléculaire et cellulaire

Soutenue publiquement le 25/10/2022, par :
Lara NOUREDDINE

Etude de l'activité du récepteur aux glucocorticoïdes dans le cancer de sein triple négatif

Devant le jury composé de :

Mme. Caroline MOYRET LALLE, Professeure, Université Claude Bernard Lyon 1 Présidente

M. Vincent CAVAILLES, DR, Université de Montpellier

Rapporteur

Mme. Rihab NASR, Professeure, Université Américaine de Beyrouth

Rapporteuse

M. Nicolas REYNOIRD, CRCN, Université de Grenoble Alpes

Examineur

M. Rabih TALHOUK, Professeur, Université Américaine de Beyrouth

Examineur

Mme. Muriel LE ROMANCER, DR, Université Claude Bernard Lyon 1

Directrice de thèse

Mme. Coralie POULARD, CRCN, Université Claude Bernard Lyon 1

Co-directrice de thèse

M. Nader HUSSEIN, Professeur, Université Libanaise

Directeur de thèse

M. Bassam BADRAN, Professeur, Université Libanaise

Invité



THESE de doctorat en Cotutelle

Pour obtenir le grade de Docteur délivré par

L'Université Libanaise

L'Ecole Doctorale des Sciences et Technologie

Spécialité : Cancérologie

Présentée et soutenue publiquement par

Lara NOUREDDINE

Le 25 Octobre 2022

Etude de l'activité du récepteur aux glucocorticoïdes dans le cancer de sein triple négatif

Membres du Jury

Mme. Caroline MOYRET LALLE, Professeure, Université Claude Bernard Lyon 1 Présidente

M. Vincent CAVAILLES, DR, Université de Montpellier

Rapporteur

Mme. Rihab NASR, Professeure, Université Américaine de Beyrouth

Rapporteuse

M. Nicolas REYNOIRD, CRCN, Université de Grenoble Alpes

Examineur

M. Rabih TALHOUK, Professeur, Université Américaine de Beyrouth

Examineur

Mme. Muriel LE ROMANCER, DR, Université Claude Bernard Lyon 1

Directrice de thèse

Mme. Coralie POULARD, CRCN, Université Claude Bernard Lyon 1

Co-directrice de thèse

M. Nader HUSSEIN, Professeur, Université Libanais

Directeur de thèse

M. Bassam BADRAN, Professeur, Université Libanais

Invité

Université Claude Bernard – LYON 1

Président de l'Université

Président du Conseil Académique

Vice-Président du Conseil d'Administration

Vice-Président du Conseil des Etudes et de la Vie Universitaire

Vice-Président de la Commission de Recherche

Directeur Général des Services

M. Frédéric FLEURY

M. Hamda BEN HADID

M. Didier REVEL

Mme Céline BROCHIER

M. Petru MIRONESCU

M. Pierre ROLLAND

COMPOSANTE SANTE

Département de Formation et Centre de Recherche
en Biologie Humaine

Faculté d'Odontologie

Faculté de Médecine et Maïeutique Lyon Sud - Charles
Mérieux

Faculté de Médecine Lyon-Est

Institut des Sciences et Techniques de la Réadaptation (ISTR)

Institut des Sciences Pharmaceutiques et Biologiques (ISBP)

Directrice : Mme Anne-Marie SCHOTT

Doyenne: Mme Dominique SEUX

Doyenne: Mme Carole BURILLON

Doyen: M. Gilles RODE

Doyen: M. Xavier PERROT

Doyen: M. Claude DUSSART

COMPOSANTES & DEPARTEMENTS DE SCIENCES & TECHNOLOGIE

Département Génie Electrique et des Procédés (GEP)

Département Informatique

Département Mécanique

Ecole Supérieure de Chimie, Physique, Electronique (CPE
Lyon)

Institut de Science Financière et d'Assurances (ISFA)

Institut National du Professorat et de l'Education

Institut Universitaire de Technologie de Lyon 1

Observatoire de Lyon

Polytechnique Lyon

UFR Biosciences

UFR des Sciences et Techniques des Activités Physiques et
Sportives (STAPS)

UFR Faculté des Sciences

Directrice : Mme Rosaria FERRIGNO

Directeur : M. Behzad SHARIAT

Directeur : M. Marc BUFFAT

Directeur : Gérard PIGNAULT

Directeur : M. Nicolas LEBOISNE

Directeur : M. Pierre CHAREYRON

Directeur : M. Christophe VITON

Directrice : Mme Isabelle DANIEL

Directeur : Emmanuel PERRIN

Administratrice provisoire : Mme Kathrin GIESELER

Directeur : M. Yannick VANPOULLE

Directeur : M. Bruno ANDRIOLETT

Acknowledgement

The PhD journey I had with the "Endocrine Resistance, Methylation, and Breast Cancer" Team was a fantastic opportunity for learning and professional development. Therefore, I consider myself as a very fortunate person because I was given the chance to be a part of it.

There are many people who were instrumental in my three-year PHD journey and contributed to make it easier for me. It would have been challenging for me to get here without them. Individuals from inside and outside my lab team, as well as from my small and big family. People whom I am immensely grateful to, and I would like to acknowledge.

First and foremost, I would like to express my great sense of gratitude to my thesis directors in France. Dr. Muriel LE ROMANCER, the co-director of my thesis and our team leader. Many thanks for picking me as a stage student for my Master-2 since you are a compassionate and open-minded person who is receptive to the notion of having Lebanese students in your team. Once again, I am grateful that you have chosen me to join your team as a PhD in Cotutelle between Lebanon and France. Your constructive criticism as a co-director of my thesis helped a lot to keep me going. In fact, I was so lucky to have such a supportive person like you by my side during the difficult circumstances we had in Lebanon.

I would like to thank Dr. Coralie POULARD, my director. Thanks for choosing me as a PHD student. You are an ideal director. You are a diligent worker who is enthusiastic about your career, so I learnt a lot from you. From scratch, you taught me every single skill I required. Someone with a plethora of knowledge who could respond to any question I posed. Most of the time, you assigned me extra tasks to complete in order to help me develop scientifically, and you followed up with every step I did. You were incredibly supportive and drafting a review paper helped make my time in Lebanon productive. I sincerely appreciate the great efforts you made to help me in obtaining a fund for my PhD's fourth year so I could make up for the time I lost due to the COVID pandemic. I wish you long-lasting success, and I wish you achieve higher ranks. I hope our project keeps progressing in the direction you desire.

With an immense sense of gratitude and respect, I would also like to thank my thesis directors in Lebanon, Prof. Nader HUSSEIN, and Prof. Bassam BADRAN. Dr. Nader HUSSEIN, among all of your students you chose me to be your student during the Master 2 internship in France.

So, I would like to express my sincere gratitude to you. You are a friend to me, not just a mentor. You always encourage me, pay attention to my concerns when they arise, and provide me advice. You have my utmost respect and admiration, and I wish you the best of luck in your profession and future endeavors.

My co-director in Lebanon and president of the Lebanese university in Beirut, Prof. BADRAN, deserves a special thank you. Since I was your student in class, you have been and always will be my role model. You were constantly there for the students, offering them assistance and resolving their issues. For me and all the university students, your solidarity and support meant a lot. In addition, I want to express my heartfelt gratitude to you for helping me get my PHD scholarship.

Olivier TREDAN, the co-director of the team, thank you for joining our team. Especially by bringing the clinical experience to our initiatives, you significantly improved the team when you arrived.

A big thank you to the jury members. I appreciate each of you agreeing to participate in my defense. I am so thankful to Dr. Vincent CAVAILLES and Pr. Rihab NASR for accepting my request for reviewing my thesis manuscript. I am also grateful that Pr. Rabih TALHOUK and Dr. Nicolas REYNOIRD as well as Prof. Caroline MOYRET LALLE have agreed to be examiners for my thesis manuscript.

Additionally, I would like to express my sincere gratitude to Dr. Raphael METIVIER and Dr. Arnaud VIGNERON of the CST (Comite Suivi de Thèse) members for following me up with my experiments through the past three years. You offered me great assistance in making the proper decisions for my project. My project was thoroughly discussed by the highly qualified jury, who prepared me for my thesis defense by asking me a variety of logical, interrogative, and disputed questions. The jury members were quite supportive and motivating. Their thoughtful remarks gave me the information I needed to move on with my study and steer clear of problems that typically plague researchers working on projects using these cell lines, methodologies, and others like them. Furthermore, they have provided me with fresh perspectives and advice that I took into consideration for my paper, which received positive feedback and validations, thanks to their extensive knowledge in the sector. All in all, the CST

presentation was a positive inflection and an additive value to my research project and my research paper.

I would also like to thank Dr. Isabelle TREILLEUX, a pathologist from CRCL and Dr. Elisabetta MARANGONI, a researcher from institute Curie Paris. We appreciate your contribution to the project's *in vivo* section. Also thank you Dr. Julien ABLAIN for your assistance with the zebra fish project. I am deeply thankful to Dr. Hichem MERTANI for teaching me the xCELLigence technique and for being available to answer all my inquiries. Once again, thank you for approving the dates for my schedule-compatible machine reservations. Many thanks also to Dr. Mounira CHALABI for all the assistance and support you have provided for my xCELLigence experiments. You are a kind and truthful person, your support is greatly appreciated.

With an immense sense of gratitude and respect, I would like to thank ARC foundation fund for the fourth consecutive year. I appreciate you picking out and accepting my project from among all the others that the students submitted. Thanks for providing me a fund for the entire year.

I would also like to thank AZM & Saade foundation, the Lebanese fund, for financing my first year PHD as well as the modest contributions you made on my behalf during my second and third years of my PhD despite the country's economic difficulties.

Special thanks go to Dr. Hurbert LINCET, my director during my Master-2 thesis. You were such a cheerful, caring, and supportive person. Considering that we couldn't communicate effectively due to language barriers, you were incredibly kind to me. I owe you a huge debt of gratitude for inspiring me to seek a PhD.

In addition, I want to thank Dr. Laura CORBO, Dr. Virginie VLAEMINCK, and Dr. Chang ZHANG for their contributions to the team in the prior years. You were wise people who constantly provided good advice to the students.

Words cannot describe how grateful I am to Ausra SURMIELIOVA, my teammates' greatest friend and my constant supporter in the lab. We shared many pleasant memories, meals, and secrets. You are a lovely, smart, and mature person. I constantly take your counsel into consideration and regard you as a strong supporter in France.

Cecile LANGUILAIRE and Farida NASRI, you are like our mothers in the lab. You spread and enhance a positive atmosphere and support the students psychologically. Cecile, we had a wonderful friendship. You were my French instructor and a friend who I can rely on in the lab. I hope you will recover soon so you can get back to work. Your support is greatly appreciated. Farida, when you come to the lab every Tuesday, you spread a lovely atmosphere. You enquire about everyone, including my relatives in Lebanon. Thanks for being such a caring, admirable and generous person.

Dr. Martine CROSET, you are a very good person. Despite the fact that we didn't have enough time to get to know each other well, you are a talented researcher who has had a lengthy career. It is now time for you to take a break and focus on taking care of your health. In the upcoming days, you ought to be courageous. I wish you many years of happiness and health.

Another important team member whom I would like to thank is Julien JACQUEMENTTON. I am thankful for your assistance with the orders and the fact that you always find a solution to any issues I encounter with the software that we use.

Dr. Ha PHAM and Dr. Yakun LUO, my friends during the first three years of my PHD with whom I shared a lot of wonderful times and laughs. We used to enjoy spending time and having meals together during lunch breaks. I missed you a lot especially during the fourth year of my PhD. I wish you a bright future and hope you achieve all what you desire. Yakun, when I visit China, I'll contact you and we will visit the Great Wall of China together. Chau, you've been the closest to me. My neighbor and my companion in my outings. It's time for you to take a rest after your defense and take care of your baby.

I would like to thank a person without whom the lab would have been a boring place. No suspense, no old music and no one to laugh with. Thank you, Dr. Razan ABO ZIKI, for all the enjoyable moments we shared, your advice and the delicious food you prepared. Wish you all the best in your new journey.

I am deeply grateful to Dr. Diana FARHAT, who was my Master-2 trainer, for the professional guidance and valuable support. Thank you for being a good friend. You helped me in settling down when I first arrived in Lyon. Together, we visited a lot of places and had a great time. I wish you the best because you are such a strong and intelligent young lady.

I have a special thought for Dr. Henri-Philippe KONAN, Dr. Ali CHOUCAIR, and Dr. Lucie MALBETEAU. You used to foster a friendly workplace environment. Thank you for all your guidance and the knowledge you imparted to me. I miss those old days.

Ludivine PRUVOST, you are such a nice and helpful girl with a gentle spirit. Thank you for all the cells you've set up for me and the French language corrections you have made to my emails and letters. I hope your PhD journey will be successful.

I want to express my gratitude to Louisane EVE for all of our enjoyable times together, for the French lessons, and for always assisting me with French paperwork. You deserve the finest things in life since you are such a kind person.

Dr. Charlene THIEBEAUT, you are a smart and cooperative person who likes to help everybody. I wish you a prosperous future and that all of your dreams come true.

Last but not least, despite the great efforts I have made during these three years, I would not have achieved this success without the support of my big and small family and my friends. Mom and Dad, I can't thank you enough for your advice, unconditional support, and continuous encouragement. I dedicate this success to you. You have devoted your life working hard for us, I hope you consider your hard work fruitful. I wish I have fulfilled your ambition and made you proud of me.

Dr. Rasha NOUREDDINE, my sister, I am really grateful to you. You followed up with my PHD, listened to my issues, and provided me your insight and counsel in the field and the relationships with others. You are a big part of my achievement since you were my idol when I was a kid. I hope you're able to realize all of your goals. You deserve every bit of good fortune and achievement in your endeavors.

Special thanks to my best friend and husband who stood by my side through ups and downs during these four years. I wouldn't have done it if you were not by my side. Being with me on this particular day is a dream come true. We will be able to conquer all the challenges and hardships we will have in our future lives and we will stick together forever because we were able to maintain our long-distance relationship successfully, and because you were able to withstand the stress that we experienced over the last few months. Love you to the moon and back.

I would also like to thank you Rowaida, my new friend during the year 2021/2022. I got used to share all my thoughts, anecdotes, and secrets with you. Thanks for being the best aunt one can have.

Thank you, all my Lebanese friends, in Lyon and Lebanon for standing by my side and sharing a lot of unforgettable moments. Dr. Khaldoun GHARZEDDINE, Ali HAIDAR, Dr. Reem BAYAA, Shaymaa SHHEIMI, Nawal HAJ SLEIMAN, Coline KERBAJ, Nawras ABIDI, Zaher HADDAD, Naima AL ABYAD, Sana SALAMI, Halima MAKAREM and Lina GHARZEDDINE, please accept my deep gratitude. I am sorry if I forgot anyone by mistake.

Moreover, I am so grateful to “AL HAZIME” Mahmoud and Layal for all the support, nice moments, and laughs. Thank you for being good listeners to my nagging and for always cheering me up. You resemble my elder sister and brother, who always tolerate me, give me positive energy and delight me. More memories are yet to come. We are incredibly grateful for the wonderful friends life has given us.

Table of Contents

Acknowledgement.....	4
Table of Contents	10
Publications	13
List of Figures and Tables	14
List of Abbreviations.....	16
Abstract	20
Résumé	22
Introduction.....	24
Chapter I: Breast Cancer	25
1. BC Prevalence: Worldwide, France and Lebanon	25
2. Normal Breast Tissue: Structure and Anatomy	27
3. Different Classification of Breast Cancer	29
3.1. Histological Types:.....	29
3.2. Histological Grades:.....	30
3.3. Tumor Size, Nodal Status, and Distant Metastasis Staging:.....	31
3.4. Molecular Classifications:.....	31
4. Risk Factors of Breast Cancer	35
4.1. Non-Modifiable Risk Factors:	36
4.2. Modifiable Risk Factors:	38
5. Breast Cancer Treatments	41
5.1. Surgery:	41
5.2. Radiotherapy:.....	42
5.3. Endocrine therapy/ Hormonal therapy:.....	42
5.4. Targeted therapy.....	43
5.5. Chemotherapy.....	43
Chapter II: Glucocorticoids (GCs).....	45
1. Endogenous Glucocorticoids	45
1.1. Regulation of GCs Synthesis	45
1.2. Synthesis and Metabolism of GCs	47

1.3.	Biological Roles of GCs	52
1.3.1.	Role of GCs in Glucose Metabolism	53
1.3.2.	Role of GCs in Immune System	55
1.3.3.	Role of GCs in Cardiovascular System.....	56
1.3.4.	Role of GCs in Lung Development.....	56
1.3.5.	Role of GCs in Bone Development	57
2.	Synthetic Glucocorticoids (GCs)	57
2.1.	Types and Characteristics.....	57
2.2.	GCs in Clinics.....	60
2.2.1.	Cancer	60
2.2.2.	Respiratory Diseases	61
2.2.3.	Rheumatoid Disorders	62
2.2.4.	Gastrointestinal Diseases.....	62
2.2.5.	Organ Transplantation	63
2.3.	GCs Adverse Side-Effects.....	63
2.3.1.	Metabolic Dysfunction	63
2.3.2.	Hypothalamic-pituitary-adrenal (HPA) axis suppression	64
2.3.3.	Effects on Gonads	64
2.3.4.	Mineralocorticoid Effects.....	64
2.3.5.	Musculoskeletal Effects	65
2.3.6.	Effects on Immune System	65
2.3.7.	Psychological Effects	66
3.	OCDO	66
Chapter III: Glucocorticoids Receptor		70
1.	Genomic Structure of the Human-GR Gene	70
2.	Protein Structure of GR	70
3.	Different GR Isoforms	72
3.1.	Isoforms Generated by Alternative Splicing	72
3.2.	Isoforms Generated by Alternative Translational Initiation	74
4.	GR mechanism of action.....	76
4.1.	GR Activation and Nuclear Translocation	76

4.2. GR Genomic Activity	78
4.3. GR Non-Genomic Activity	80
5. GR Plasticity	81
Chapter IV: Glucocorticoids Receptor Coregulators	86
1. Coregulators	86
2. GR-Coregulators Functional Groups.....	87
3. Specific Actions of GR Coregulators	90
4. GR Coregulators Regulations	94
5. GR Physiological Coregulator Code	95
Chapter V: Glucocorticoids Receptor Role in Mammary Gland	98
1. GR's Function in Normal Breast Tissue.....	98
2. GR's Function in Breast Cancer Progression.....	99
2.1. ER α -Positive Breast Cancers.....	100
2.2. ER α -Negative Breast Cancers	102
Results	107
1. Introduction	108
2. Article.....	110
Discussion and Future Perspectives	111
Annex I.....	115
Annex II.....	137
Bibliography.....	167

Publications

1. Scientific Articles:

“Glucocorticoids trigger cell migration via PRMT5 and HP1γ coactivator properties in Triple Negative Breast cancer”.

To be submitted on date and journal

Noureddine LM, Julien Ablain, Ausra Surmieliová-Garnès, Julien Jacquemetton, Elisabetta Marangoni, Bassam Badran, Isabelle Treilleux, Olivier Trédan, Nader Hussein, Muriel Le Romancer and Coralie Poulard.

2. Review Papers:

i. *“Structure, Activity, and Function of the Protein Methyltransferase G9a”.*

Life (Basel). 2021 Oct 14;11(10):1082. PMID: 34685453.

Poulard C, **Noureddine LM**, Pruvost L, Le Romancer M.

ii. *“Glucocorticoid Receptor: A Multifaceted Actor in Breast Cancer”.*

Int J Mol Sci. 2021 April 24;22(9):4446. PMID: 33923160.

Noureddine LM, Tredan O, Hussein N, Badran B, Le Romancer M, Poulard C.

List of Figures and Tables

– Figures:

Figure 1 : Number of new incident cases and death cases of breast cancer in 2020, worldwide.	25
Figure 2 : Incidence and mortality age-standardized rates in high/very high human development index (HDI) countries versus low/medium HDI countries in women in 2020.	26
Figure 3 : Number of new incident cases of breast cancer in France in 2020.	26
Figure 4 : Normal breast tissue anatomy and histology.	28
Figure 5 : Traditional histological classification of breast cancers.	30
Figure 6 : Intrinsic molecular subtypes of breast cancer and their main treatments.	33
Figure 7 : Molecular subtypes of triple negative breast cancers (TNBCs).	34
Figure 8 : Number of new incident cases of breast cancer in women below 40 years old in 2020, worldwide.	35
Figure 9 : Different modifiable and non-modifiable lifestyle risk factors of breast cancer.	36
Figure 10 : Different local and systemic treatments of breast cancer.	41
Figure 11 : Biosynthesis of glucocorticoids in the adrenal gland.	50
Figure 12 : Metabolism of glucocorticoids and OCDO.	52
Figure 13 : Actions of GCs in Health and Disease.	53
Figure 14 : The structure of the synthetic GCs with red rings showing the differential functional modifications compared to cortisol, or cortisone in case of prednisone.	60
Figure 15 : Genomic structure of the human glucocorticoid receptor (GR) <i>NR3C1</i> gene.	70
Figure 16 : Structure of the human glucocorticoid receptor (GR) protein.	71
Figure 17 : Alternative splicing variants of the GR protein.	73
Figure 18 : Translational initiation splicing variants of the GR protein.	75
Figure 19 : Chaperone-mediated GR maturation and activation in the cytosol.	77
Figure 20 : Genomic and Non-genomic signaling pathways of Glucocorticoid Receptor.	79
Figure 21 : Post translational modifications of the glucocorticoid receptor (GR) protein.	83

Figure 22 : Coregulators modulate GR transcriptional activity via modulating chromatin structure. **86**

Figure 23 : Contribution of Coregulators to Transcriptional Regulation by Glucocorticoid Receptor..... **87**

Figure 24 : The Gene-Specific Actions of GR Coregulators is Associated with Specific Physiological Pathways. **92**

Figure 25 : The GR Physiological Coregulators Code..... **97**

Figure 26 : Glucocorticoid Receptor Role in normal breast Tissue and in Breast Cancer Progression.**100**

– **Tables:**

Table 1 : Some of the Functional Groups of Coregulators Regulating GR Transcriptional Activity. **90**

List of Abbreviations

11 β -HSD1: 11 β -hydroxysteroid dehydrogenase 1	BRG1: Brahma related gene 1
11 β -HSD2: 11 β -hydroxysteroid dehydrogenase 2	BRM: Brahma
3'-UTRs: 3'-Untranslated regions	BCS: Breast-conserving surgery
3 β -HSD: 3 β -Hydroxysteroid Dehydrogenase	cAMP: Cyclic Adenosine Monophosphate
5,6-ECs: Cholesterol-5,6-epoxides	CBG: Corticosteroid-binding globulin
5'-UTRs: 5'-Untranslated regions	CDH1: Cadherin-1 or Epithelial cadherin (E-cadherin)
ACAT: Acyl-coenzyme A cholesterol acyl transferase	AURKB: Aurora kinase B
Acetyl-CoA: Acetyl coenzyme A	CDK9: Cyclin-dependent protein kinase 9
ACTH: Adrenocorticotrop hormone	Ch25h: Cholesterol 25-hydroxylase
AD3: N-terminal bHLH-PAS domain	CK2: Casein Kinase 2
AF-1: Activation function 1	CLOCK: Circadian locomotor output cycles kaput
AF-2: Activation function 2	CoCoA: Coiled-coil coactivator
AJCC: American Joint Committee on Cancer	COPD: Chronic obstructive pulmonary disease
AKT: Serine/threonine kinase 1	CRCs: Chromatin-remodeling complexes
AP1: Activating Protein-1	CREB: cAMP-response element binding protein
APCs: Antigen presenting cells	CRH: Corticotrophin-releasing hormone
AR: Androgen receptor	CRH-R1: CRH Receptor 1
B-ALL: B-acute lymphoblastic leukemia	CRT: Calreticulin
BC: Breast cancer	Cry1: Cryptochrome gene 1
BCL2: B-cell lymphoma 2	CT: Cholestane-3 β ,5 α ,6 β -triol
BL1: Basal cell-like type 1	CT: Cycle Threshold
BL2: Basal cell-like type 2	CTD: C-terminal domain
BLBC: Basal-like breast cancers	CTL: Cytolytic T Lymphocytes
BM: Basement membrane	DBD: DNA-binding domain
BMI: Body mass index	D-box: Distal box
BRCA1: BReast CAncer gene 1	DCIS: Ductal carcinoma in situ
BRCA2: BReast CAncer gene 2	DDA: Dendrogenin A

Dex: Dexamethasone

DMH: Dorsomedial hypothalamus

ECM: Extracellular matrix

EGFR: Epidermal growth factor receptor

EMT: Epithelial–mesenchymal transition

ER: Endoplasmic reticulum

ERE: ER-response elements

ERK1/2: Extracellularly Regulated Kinase-1 and -2

ER α : Estrogen receptor-alpha

FDA: Food and drug administration

FKBP51/FKBP52: FK506-binding proteins

FSH: follicle-stimulating hormone

G9a/EHMT2: Lysine methyltransferase

GBS: Glucocorticoid-binding sites

GCO: Global Cancer Observatory

GCs: Synthetic glucocorticoids

GLP/EHMT1: G9a-like protein

GR: Glucocorticoid receptor

GREs: Glucocorticoid-responsive elements

GR α : GR alpha

GR β : GR beta

GSK-3 β : Glycogen synthase kinase-3 β

HATs: Histone acetyltransferases

HDAC: Histone deacetylase

HDI: Human development index

HDL: High density lipoprotein

HER2: Human epidermal growth factor receptor 2

h-GR: Human Glucocorticoid receptor

Hic-5: Hydrogen peroxide-inducible clone-5

hIFN α -2b: Human interferon α -2b

HMTs: Histone methyltransferases

HP1 γ : Heterochromatin protein

HPA: Hypothalamus-pituitary gland-adrenal gland axis

HSL: Hormone-sensitive lipase

Hsp40/70/90: Heat shock protein 40/70/90

HTMP: Hormone therapy after menopause

I1-FFL: Incoherent type1 feed-forward loop

IARC: International Agency for Research on Cancer

IDC-NST: Infiltrating ductal carcinoma of no specific type

IFN: Interferon

IHC: Immunohistochemistry

IL-10/IL-12/IL-18: Interleukin-10, -12 and -18

ILC: Invasive lobular carcinomas

IM: Immunomodulatory subtype

IMM: Inner mitochondrial membrane

IRF: Interferon regulatory factor

IR-GBS: Inverted repeats GR-binding sequences

IR-nGREs: Inverted repeats negative GR-binding sequences

IRS-1: Insulin receptor substrate 1

JNK: c-Jun N-terminal kinase

KLF5: Krüppel-like factor 5

LAR: Luminal androgen receptor subtype

LasB: *P. aeruginosa* elastase

LBD: Ligand-binding domain

LCIS: Lobular carcinoma in situ

LDL: Low density lipoprotein

LECs: Luminal epithelial cells

LH: Luteinizing Hormone
 LXRs: Liver-X-receptors
 M: Mesenchymal subtype
 MaBC: Male breast cancer
 MAPK: Mitogen-activated protein kinase
 MaSCs: Mammary stem cells
 MC2R: Melanocortin 2 receptor
 Mdm2: Murine double minute 2
 MECs: Myoepithelial cells
 MED1: Mediator Complex Subunit 1
 MED14: Mediator Complex Subunit 14
 MIR: Mortality-to-incidence ratio
 MKP-1: MAPK phosphatase-1
 MMP: Metalloproteinase
 MMP1: Collagenase/Matrix
 Metalloproteinase-1
 MpBC: Metaplastic breast cancer
 MR: Mineralocorticoid receptor
 MSL: Mesenchymal stem cell-like subtype
 NADPH: Nicotinamide adenine dinucleotide
 phosphate
 NCoR: Nuclear receptor co-repressor
 NES: Nuclear export signal
 NF- κ B: Nuclear factor kappa-light-chain-
 enhancer of activated B cells
 NGS: Nottingham Grading System
 NHR: Nuclear hormone receptor
 NK: Natural killer cells
 NLS1: Nuclear localization signal 1
 NLS2: Nuclear localization signal 2
 NR3C1: Nuclear receptor subfamily 3 group c
 member 1
 NRs: Nuclear receptors
 NRS: nuclear retention signals
 NTD: N-terminal domain
 OCDO: 6-oxo-cholestan-3,5-diol
 OMM: Outer mitochondrial membrane
 p300/CBP: CREB-binding protein
 p300: E1A-binding protein p300
 PAM50: Prediction Analysis of Microarray
 using 50 classifier genes
 P-box: Proximal box
 PCAF: p300/CBP-associated factor
 PD-L1: Programmed cell death ligand 1
 PEPCCK: Phosphoenolpyruvate carboxykinase
 Per2: Period circadian homologue 2
 PGC-1: PPAR γ coactivator-1
 PI3K: Phosphoinositide 3-kinase
 PKA: Protein Kinase A
 PR: Progesterone Receptor
 PRMT1/ HRMT1L2: Protein arginine
 methyltransferase 1
 PRMT4/CARM1: Protein arginine
 methyltransferase 4
 PRMT5: Protein arginine methyltransferase 5
 PTK6: Protein tyrosine kinase 6
 PTMs: Post-translational modifications
 PVN: Paraventricular nucleus
 RA: Rheumatoid arthritis
 RID: Receptor interaction domain
 RNA pol II: RNA polymerase II
 ROR: Receptor-related orphan receptor
 RU-486: Mifepristone/ GR antagonist
 SAM: S-Adenosyl Methionine

SCN: Suprachiasmatic nucleus	TAZ: Transcriptional co-activator with PDZ binding motif
sDMA: Symmetrical di-methylation	T-bet/ TBX21: T-box transcription factor
SEGRAM: Selective GR Agonists and Modulators	TBP: TATA-binding protein
Ser: Serine amino acid	TEAD-4: TEA Domain Transcription Factor 4
SGK1: Serum and glucocorticoid-regulated kinase-1	TFs: Transcription factors
SLE: Systemic lupus erythematosus	TGFβ-1: Transforming growth factor beta-1
SMRT: Silencing mediator of retinoic and thyroid receptors	Th1: T-Helper 1
SPR: Surface plasmon resonance	Th17: T-Helper 17
SR-B1: Scavenger receptor B1	Th2: T-Helper 2
SRC: non-receptor tyrosine kinase protein	TNBC: Triple negative breast cancers
SRC-2/GRIP1: Glutamate receptor-interacting protein 1	TNM: The tumor, node, metastasis
SRC-3: Steroid receptor coactivator-3	TP53: Tumor protein p53
StAR: Steroidogenic acute regulatory protein	Trop-2 protein: Trophoblast antigen protein 2
StARD1: START domain-containing protein 1	TSS: Transcription start site
SUMO-1: Small ubiquitin-related modifier-1	TXNIP: Thioredoxin interacting protein
TAFII: TBP-associated proteins	Ubc9: Ubiquitin-conjugating enzyme 9
	WHO: World Health Organization
	YAP: Yes-associated protein

Abstract

Breast cancer (BC) is the most common and fatal cancer in women worldwide. Among the different types of BCs, Triple negative breast cancers (TNBC: ER α -, PR-, HER2-) which represent 10-15% of all BC cases are the most aggressive with no efficient targeted therapy available. Until now, TNBC patients are predominantly treated with conventional cytotoxic chemotherapy and radiotherapy. Synthetic glucocorticoids (GCs), dexamethasone (Dex), are given as adjuvant drugs with chemotherapy to alleviate its side effects such as hypersensitivity, nausea, and vomiting. However, recent investigations demonstrated that GCs are promoting metastasis formation and chemotherapy resistance in TNBC and the mechanisms remain elusive. Lipophilic GCs diffuse through the cell membrane and possess their function through binding glucocorticoid receptor (GR), a ligand-dependent transcription factor. GR regulates the transcription of its target genes by recruiting different sets of coregulatory proteins. Coregulators remodel chromatin structure and promote or inhibit the recruitment and activation of RNA polymerase II. Targeting GR activity in BC is not an option due to its pleiotropic activity. However, targeting set of coregulators involved specifically in deleterious effects of GR should keep the beneficial ones on GCs.

In light of this, we identified a novel complex of GR coregulators linked to the oncogenic capabilities of GCs in TNBC. In fact, following dexamethasone administration, GR interacts with the heterochromatin protein HP1 γ through the arginine methyltransferase PRMT5 in multiple TNBC cell lines and patient tumor samples, in order to activate RNA polymerase II. In TNBC cells, we revealed that PRMT5 and HP1 γ acts as GR coregulators on chromatin to enhance the transcriptional activation of a specific subset of GR target genes implicated in cell migration. Lastly, we confirmed the engagement of GR/PRMT5/HP1 γ in metastasis formation in-vivo in Zebrafish model. Worth noting, we demonstrated that PRMT5 is regulating cellular migration driven by GCs independently of its methyltransferase activity. GR expression is correlated with metastases formation and may serve as a predictive marker for relapse in TNBC. Hence, targeting this coregulator complex could prevent tumor metastasis formation in TNBC patients.

Keywords: Breast Cancer; Triple Negative Breast Cancer, Glucocorticoids, Cell Migration, Glucocorticoid Receptor, Coregulators, PRMT5, HP1 γ .

Résumé

Le cancer du sein (CS) est le cancer le plus fréquent et le plus mortel chez la femme dans le monde. Parmi les différents types de cancer du sein, les cancers du sein triple négatif (TNBC : ER α -, PR-, HER2-), qui représentent 10 à 15 % de tous les cas de cancer du sein, sont les plus agressifs et ne font l'objet d'aucune thérapie ciblée efficace. Jusqu'à présent, les patients atteints de cancer du sein triple négatif sont principalement traités par chimiothérapie cytotoxique conventionnelle et par radiothérapie. Les glucocorticoïdes synthétiques (GCs), comme la dexaméthasone (Dex), sont administrés comme médicaments adjuvants pour contrecarrer les effets secondaires de la chimiothérapie tels que l'hypersensibilité, les nausées et les vomissements. Cependant, des études récentes ont démontré que dans les TNBC, les GCs favorisent la formation de métastases et participe à la résistance aux drogues, cependant les mécanismes mis en jeu ne sont pas clairement établis.

Les GCs lipophiles diffusent à travers la membrane cellulaire et exercent leur fonction en se liant au récepteur aux glucocorticoïdes (GR), un facteur de transcription dépendant du ligand. GR régule la transcription de ses gènes cibles en recrutant différents ensembles de protéines corégulatrices. Les corégulateurs remodelent la structure de la chromatine et induisent ou inhibent le recrutement et l'activation de l'ARN polymérase II. Cibler l'activité du GR dans le cancer du sein n'est pas envisageable du fait de son action pléiotrope. Cependant, cibler un ensemble de corégulateurs impliqués spécifiquement dans les effets délétères de GR devrait permettre de conserver les effets bénéfiques des GCs.

Dans cette optique, nous avons identifié un nouveau complexe de corégulateurs du GR lié aux effets oncogéniques des GCs dans le TNBC. En effet, suite à l'administration de dexaméthasone, GR interagit avec la protéine de l'hétérochromatine HP1 γ par l'intermédiaire de l'arginine méthyltransférase PRMT5 dans de multiples lignées cellulaires TNBC et des échantillons de tumeurs mammaires, afin d'activer l'ARN polymérase II. Dans les TNBC, nous avons montré que PRMT5 et HP1 γ agissent comme des corégulateurs de GR pour favoriser l'activation transcriptionnelle d'un sous-type spécifique de gènes cibles de GR impliqués dans la migration cellulaire. Enfin, nous avons confirmé l'engagement du complexe GR/PRMT5/HP1 γ dans le développement des métastases *in-vivo* dans le modèle Zebrafish. Il convient de noter que nous avons démontré que PRMT5 régule la migration cellulaire induite

par les GCs indépendamment de son activité méthyltransférase. L'expression de GR est corrélée à la formation de métastases et peut servir de marqueur prédictif de rechute dans les TNBC. Par conséquent, le fait de cibler ce complexe corégulateur pourrait prévenir la formation de métastases chez les patientes atteintes de TNBC.

Mots-clés : Cancer du sein ; cancer du sein triple négatif, glucocorticoïdes, migration cellulaire, récepteur des glucocorticoïdes, corégulateurs, PRMT5, HP1 γ .

Introduction

Chapter I: Breast Cancer

1. BC Prevalence: Worldwide, France and Lebanon

Cancer is a major cause of morbidity and mortality worldwide accounting for 19.3 million new cases and nearly 10 million deaths in 2020 according to the International Agency for Research on Cancer (IARC), thus, one of the global heaviest burdens (Sung *et al.*, 2021).

Almost 2.3 million of the new cases (11.7% of total cases) in 2020 were diagnosed with female breast cancer (BC), turning it out to be the most common incident cancer among both sexes worldwide, followed by lung (11.4%) and colorectal (10.0%). In women, breast cancer is the most prevailing cancer constituting 24.2% of all female cancers and the most fatal cancer causing the death of 684,996 women annually (Sung *et al.*, 2021) (Figure 1).

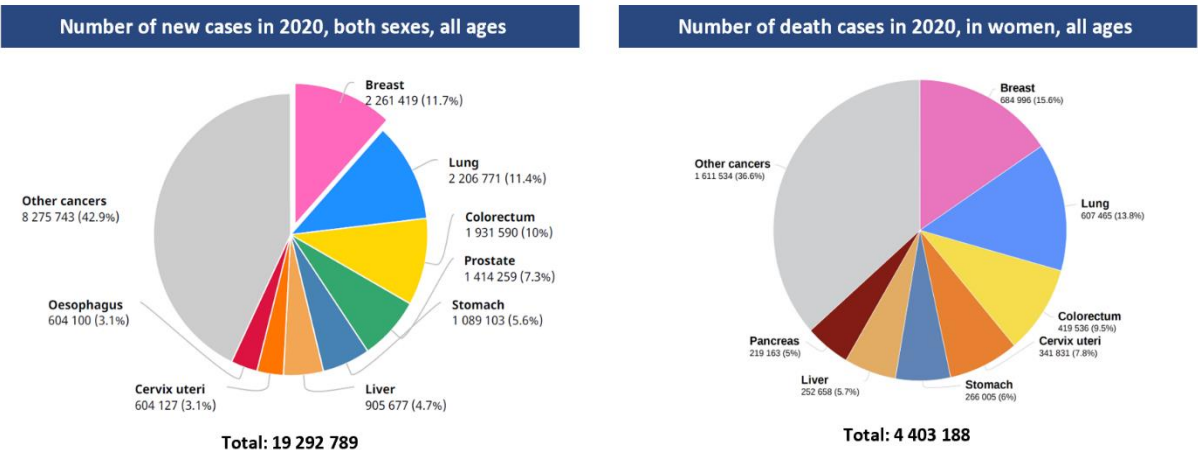

GLOBOCAN 2020, IARC (Cancer Today)

Figure 1 : Number of new incident cases and death cases of breast cancer in 2020, worldwide.

Interestingly, the Global Cancer Observatory (GCO) registry reported that the incidence rates are 88% higher in populations with high socioeconomic standards (transitioned countries, high Human Development Index (HDI), due to plenty of factors, including reproductive and hormonal risk factors (early age at menarche, later age at menopause, advanced age at first birth, fewer number of children, less breastfeeding, menopausal hormone therapy, oral contraceptives), lifestyle risk factors (alcohol intake, excess body weight, physical inactivity) and increased early detection. Whereas mortality and deaths are 17% higher in populations with low socioeconomic standards (transitioning countries, low HDI), because of late diagnosis

and inaccessibility to novel treatments (Konieczny *et al.*, 2020; Sung *et al.*, 2021) ((Sung *et al.*, 2021)

Figure 2).

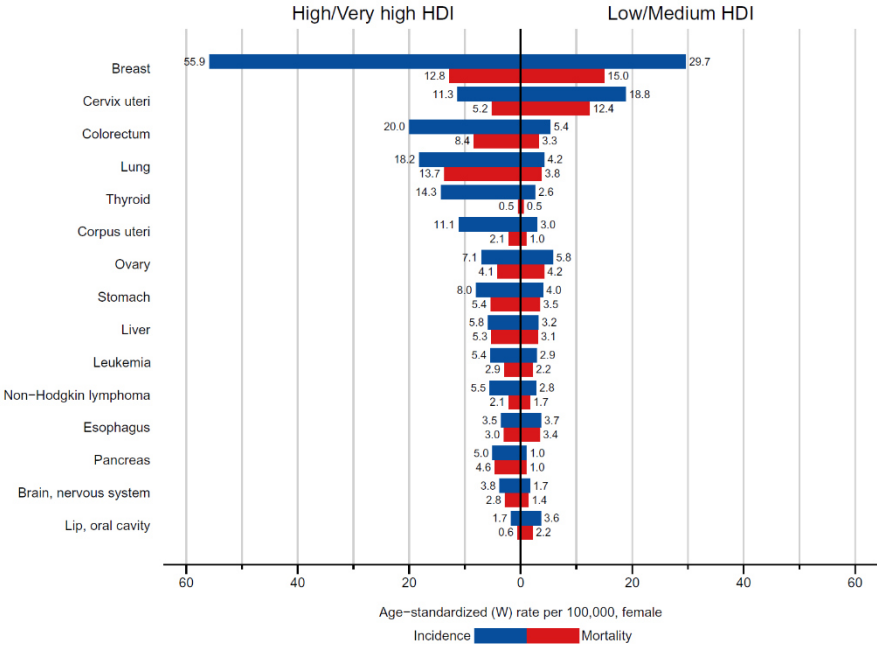

(Sung *et al.*, 2021)

Figure 2 : Incidence and mortality age-standardized rates in high/very high human development index (HDI) countries versus low/medium HDI countries in women in 2020.

In France and oppositely to the worldwide statistics, breast cancer is the second most incident cancer after prostate cancer. Despite that, France is ranked the third country in Europe with 14 183 breast cancer death cases in 2020 according to the IARC, World Health Organization (WHO) (*Cancer Today*) (Figure 3).

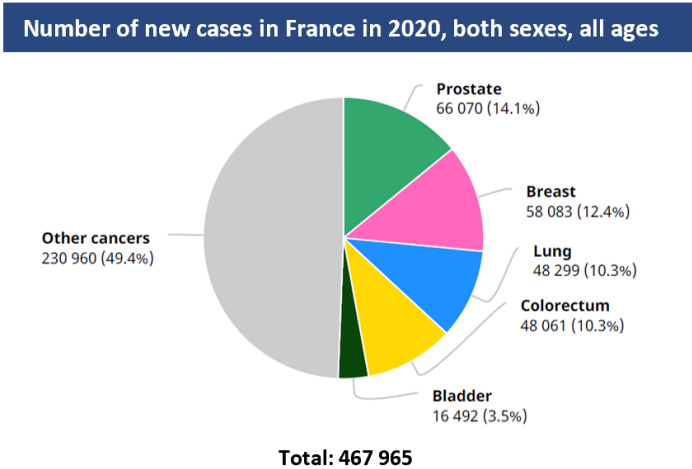

GLOBOCAN 2020, IARC (*Cancer Today*)

Figure 3 : Number of new incident cases of breast cancer in France in 2020.

Breast cancer is also prominent in Lebanon, a middle-income Middle Eastern country, accountable for nearly 37% of female cancer cases and 20% for total cancer cases (Fares *et al.*, 2019; Elias *et al.*, 2021), surpassing the incidence rates in Arab nations and approaching the highest in the world (Jawad Hashim *et al.*, 2018). In 2018, Lebanon ranked the sixth highest incidence rate for breast cancer in the world and the seventh highest breast cancer mortality rate (Elias *et al.*, 2021). Also, from 2018 till 2020, its average Mortality-to-incidence ratio unfavorably increased from 0.47 to 0.51 compared with 0.48 globally (Mahdi *et al.*, 2022). In contrary to other countries, breast cancer is diagnosed at younger ages in Lebanon with an average of 53 years (Fares *et al.*, 2019; Elias *et al.*, 2021). This increase in the incidence rates in Lebanon is a consequence of lifestyle changes, where the average marital age raised to 28.3 in 2007 and the fertility rates decreased to 1.5 births per woman in 2015. As well as delayed first pregnancy, increased obesity and smoking, and improved use of mammography has contributed to this increase (Jawad Hashim *et al.*, 2018; Fares *et al.*, 2019).

2. Normal Breast Tissue: Structure and Anatomy

The mammary gland, the medical name of breast, is a highly evolved exocrine gland that exclusively develops in mammals. It is present in pairs with one on each side of the anterior chest wall. The organ's primary function in females is to produce and secrete milk for the nourishment of newborns. While male's mammary gland is rudimentary.

The development and functional differentiation of the mammary gland is a complex multi-step process controlled by tight hormonal regulations. The mammary gland development starts postnatally at puberty and reaches its full function during pregnancy and lactation, where it undergoes several drastic epithelial remodeling to transform the gland into a milk-secretory organ.

Breast consists of glandular (secretory), and adipose (fatty) tissue embedded in a loose framework of dense connective fibrous tissue called Cooper's ligaments.

The breast glandular tissue is constituted of 15 to 20 lobes that are further divided into 20 to 40 lobules. Each lobules contain 10-100 alveoli of 0.12 mm diameter, these small bulb-like glands secrete milk in response to prolactin. The space between these lobes is filled with

adipose tissue. Further ductal system will store and transport milk to the nipple during lactation from the secretory tissue. Herein, there are 15 to 25 extralobular ducts that drain the alveoli and then merge into one main duct known as lactiferous duct emerging from each lobe. The lactiferous duct dilates into lactiferous sinus beneath the areola, the pigmented area surrounding the nipple, and then narrows and connects to the exterior through constricted orifice in the nipple (**Figure 4**).

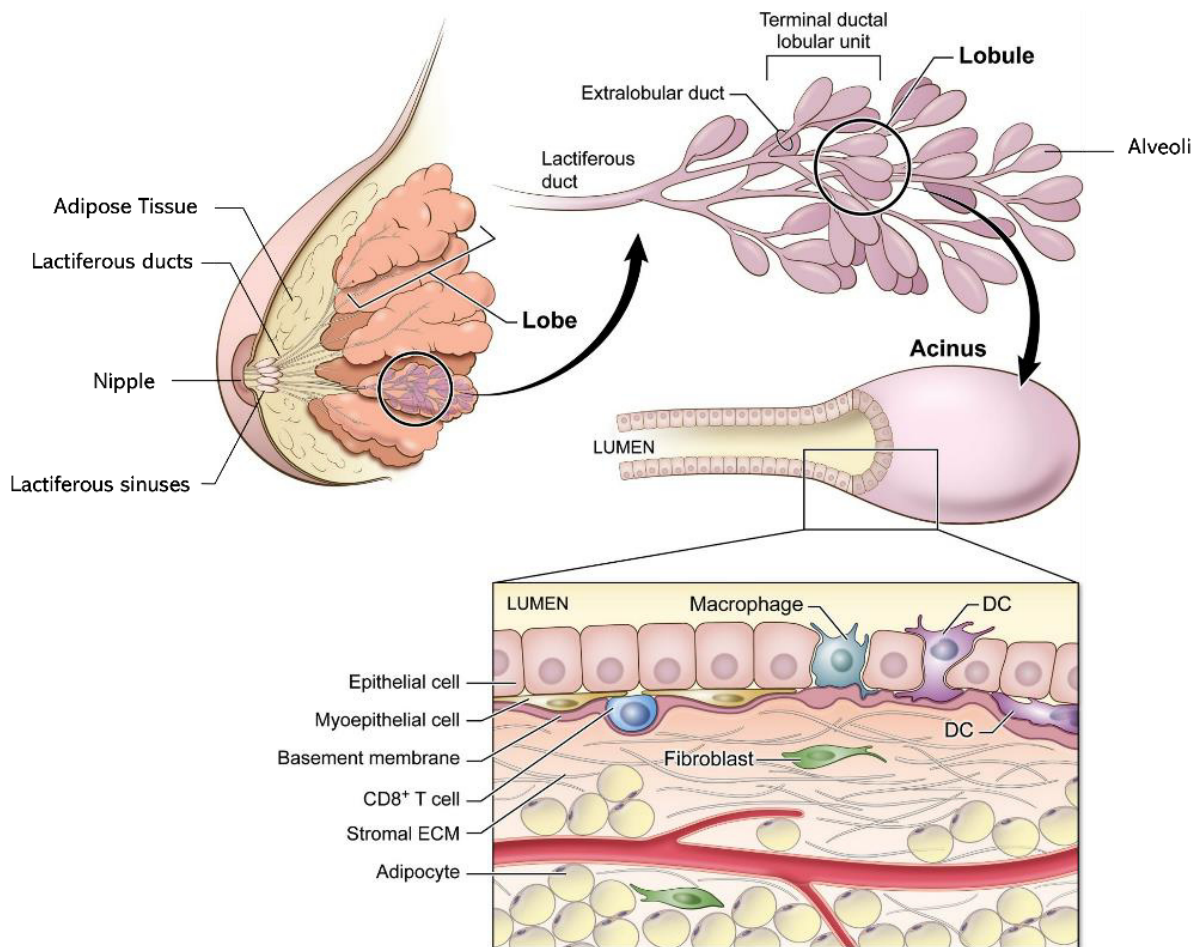

Adopted from: (Goff and Danforth, 2021)

Figure 4 : Normal breast tissue anatomy and histology.

The ductal network is lined by epithelial bilayer of cells: an inner layer encapsulating the hollow lumen containing luminal cuboidal epithelial cells having the capacity to differentiate into milk-secreting cells (lactocytes) during lactation, and an outer/ basal layer of contractile spindle-shaped myoepithelial cells having the properties of smooth muscle cells and participate in milk ejection during lactation. Also, the basal layer harbors bi-potent mammary stem cells (MaSCs) which can differentiate into both luminal and myoepithelial cells

characterized by CD49^{high}/CD29⁺/CD24^{low} profile. This epithelial component forms up to 15% of mammary gland volume (**Figure 4**).

The epithelial bilayer is surrounded by stromal connective tissue composed of extracellular matrix (ECM), adipocytes, fibroblasts, vascular endothelial cells, and a variety of innate immune cells. One of the main types of ECM is the basement membrane (BM) that encloses the epithelium, separates it from the stroma and influences the development of the mammary gland (**Figure 4**).

The adipocytes forming the mammary fat pad are the major constituents of the stromal connective tissue. This adipose tissue provides physical support to the epithelial bilayer of the gland, as well as it regulates the gland homeostasis participating in epithelial growth, angiogenesis, and intercellular communication. Besides, it functions as a reservoir for the locally derived molecules such as the breastfeeding hormone prolactin. The volume of adipose tissue accounts for the variation in the size and density of breast among individuals.

As well, the fibroblasts have several important roles in stroma such as growth factor synthesis, metalloproteinase (MMP) production, ECM deposition and hematopoietic system support (Geddes, 2007; Pandya and Moore, 2011; Hassiotou and Geddes, 2013; Biswas *et al.*, 2022)

3. Different Classification of Breast Cancer

Breast cancer is a complex heterogenous disease, encompassing variable molecular and morphological features, and consequently variable clinical behaviors and outcomes. Breast cancer classification evolved over years from traditional to molecular classification, aiming to provide better diagnosis, prognosis, and treatment of the disease.

3.1. Histological Types:

Breast cancer is classified into non-invasive (in situ) and invasive (infiltrating) carcinoma based on a wide range of features such as tumor cell type, extracellular secretion, and architectural features. In situ breast carcinoma is subdivided into Ductal carcinoma in situ (DCIS) and Lobular carcinoma in situ (LCIS), with the former being more common and further subclassified into five main subtypes: comedo, cribriform, micropapillary, papillary and solid. As well, Invasive breast carcinoma encompasses over 20 different histological subtypes

including the infiltrating ductal carcinoma of no specific type (IDC-NST) accounting for 70-80% of all invasive cancers (most frequent), followed by the invasive lobular carcinomas (ILC) (~10%) and 17 other rare special types including ductal/lobular, mucinous (colloid), tubular, metaplastic, apocrine, medullary, and papillary carcinomas (Malhotra *et al.*, 2010; Tsang and Tse, 2020). Among these rare types, the tubular, cribriform and mucinous carcinomas have a very good prognosis, while the high-grade metaplastic carcinoma and micropapillary carcinoma have the poorest clinical outcomes (Harbeck *et al.*, 2019). With considering all these different histological subtypes, ductal carcinomas are the most common types with 81.4% (Albrektsen, Heuch and Thoresen, 2010; Pandit *et al.*, 2020) (Figure 5).

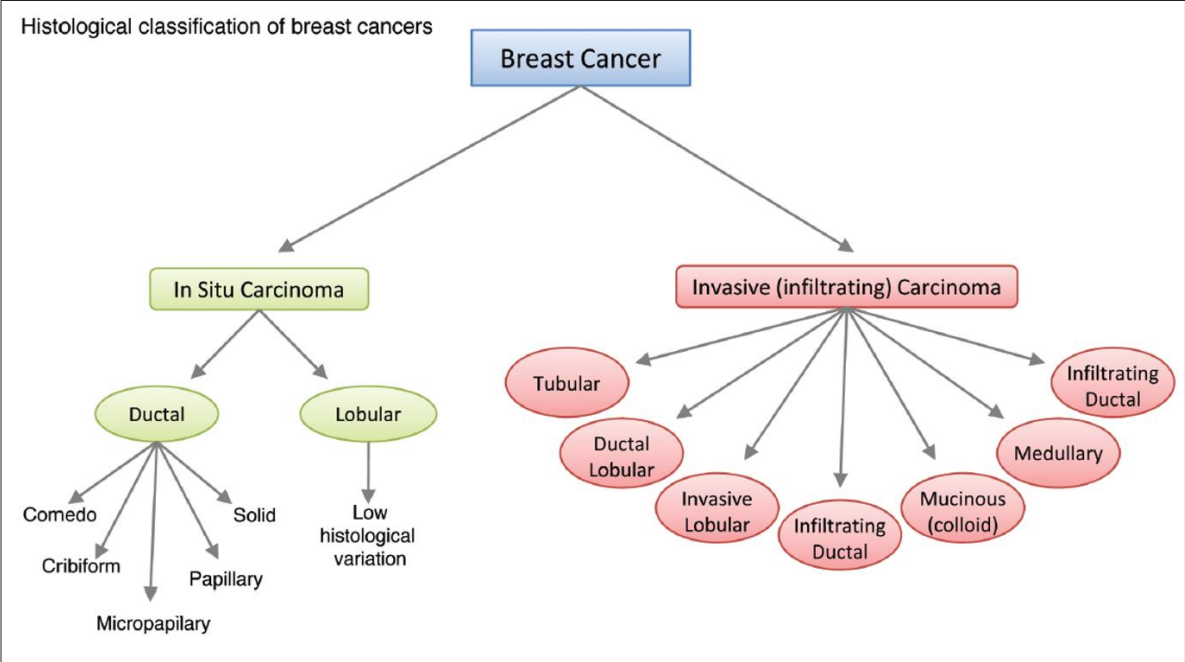

(Malhotra *et al.*, 2010)

Figure 5 : Traditional histological classification of breast cancers.

3.2. Histological Grades:

The widely accepted grading system for the assessment of histological grade of breast tumor is the Bloom and Richardson (Bloom and Richardson, 1957), modified by Elston and Ellis (Elston and Ellis, 2002), and well known as the Nottingham Grading System (NGS). NGS is based on the microscopic evaluation of three morphological and cytological features of tumor cells: the degree of tubule formation, the nuclear pleomorphism and the mitotic count. Each parameter is assigned with a numerical score from 1 to 3, with score 3 representing poor tubule formation, high degree of pleomorphism and high mitotic count. Then, the sum of the

parameter's individual scores divides breast tumors into: Grade 1 (G1 - total score 3 to 5) well-differentiated slow growing, Grade 2 (G2 - total score 6 to 7) moderately differentiated, and Grade 3 (G3 - total score 8 to 9) poorly differentiated highly proliferative tumors. Patients with high-grade breast tumor tends to have recurrence and early metastasis, while patients with low-grade tumors have good clinical outcomes (Rakha *et al.*, 2010). Tumor grade is a potent prognostic factor, and it is an integral component in the clinical decision-making tools like the Nottingham Prognostic Index and Adjuvant Online (Blamey *et al.*, 2007; Mook *et al.*, 2009)

3.3. Tumor Size, Nodal Status, and Distant Metastasis Staging:

The tumor, node, metastasis (TNM) staging system for breast cancer published by the American Joint Committee on Cancer (AJCC) is widely used to determine the extent of the disease and to help in treatment guidance and management. This system stratifies breast cancer into five stages (0, I, II, III, and IV) based on clinical and pathological parameters such as the tumor size (T), the status of regional lymph nodes (N), and distant metastases (M) (Edge and Compton, 2010). The AJCC-TNM 8th edition, effective on January 2018, is a new prognostic staging system that incorporates the status of Estrogen receptor (ER), Progesterone receptor (PR) and Human epidermal growth factor receptor-2 (HER2) to the TNM staging. It provides more accurate prognostic information, and it bypasses the limitation of evaluation of the anatomical disease extent alone (Weiss *et al.*, 2018).

3.4. Molecular Classifications:

Breast cancer is molecularly classified based on the expression of the most common traditional biomarkers: the estrogen/progesterone hormone receptors (ER α /PR) and the human epidermal growth factor receptor-2 (HER2) (Vuong *et al.*, 2014). The first microarray-based gene expression profiling analysis divided breast cancer into two fundamentally distinct types: ER α -positive and ER α -negative cancers. Further hierarchical cluster analysis of genes divided breast cancer into five intrinsic subtypes: Luminal A, Luminal B, HER2-overexpressing, Basal-like breast cancers (BLBC) and normal-like tumors, with luminal tumors being ER α -positive and HER2-overexpressing, Basal-like breast cancers (BLBC) and normal-like tumors are ER α -negative (Perou *et al.*, 2000; Sørlie *et al.*, 2001). Normal-like breast tumors, suggested to be an artefact, are still poorly characterized and yet no clinical significance is determined. This type shares a lot of similarities with fibroadenoma and normal breast samples and is

enriched with genes expressed in adipose tissues (Wirapati *et al.*, 2008; Correa Geyer and Reis-Filho, 2009; Geyer *et al.*, 2009).

Currently applied classification, based on PAM50 (Prediction Analysis of Microarray using 50 classifier genes plus 5 reference genes) and IHC-based surrogate molecular classification, classified breast cancer into four intrinsic molecular subtypes: luminal A, luminal B, HER2-enriched, and Triple Negative breast cancer/BLBC (Bertucci *et al.*, 2008; Sotiriou and Pusztai, 2009; Boyle, 2012; Tang *et al.*, 2016) (**Figure 6**).

Luminal A tumors are the most common molecular subtype accounting for 40-50% of breast cancers. Usually, it is associated with low grade, ER α -positive, PR-positive, and HER2-negative tumor. Luminal A tumors have high expression levels of ER-activated genes and low expression levels of proliferation-related genes. They are associated with excellent prognosis and better survival rates among all intrinsic subtypes. Whereas Luminal B tumors are distinguished by high expression of Ki67, higher histological grade oftenly, higher proliferation rates and significantly worse prognosis than Luminal A tumors. Luminal B tumors account for ~20% of breast cancer cases, and they are PR-positive or PR-negative, and HER2-positive or HER2-negative tumors (Perou *et al.*, 2000; Sørlie *et al.*, 2001, 2003; Cheang *et al.*, 2009; Correa Geyer and Reis-Filho, 2009; Geyer *et al.*, 2009; Voduc *et al.*, 2010).

HER2-enriched subtype, comprising ~15% of all breast cancers, is characterized by the overexpression of the human epidermal growth factor receptor-2 (HER2) on the cell surface and HER2 signaling-related genes. Typically, HER2-enriched tumors are associated with high grade and possess aggressive clinical behavior. Though the majority of HER2-enriched tumors are ER-negative, a significant number of HER2-enriched tumors are ER-positive and fall into Luminal B subtype (Dandachi, Dietze and Hauser-Kronberger, 2002; Bernard *et al.*, 2009; Cheang *et al.*, 2009; Voduc *et al.*, 2010; Perou, 2011).

Triple negative breast cancers (TNBC) lack the expression of ER, PR and HER2-low (Schettini *et al.*, 2021). They represent 10-15% of all breast cancers, and consistently expresses high molecular weight cytokeratins such as CK5/6, CK14 and CK17 that are normally expressed in normal basal/myoepithelial cells of the breast, along with epidermal growth factor receptor (EGFR). This subtype is the most diverse subtype at the level of histopathological features, mutation profiles, metastatic behavior, and clinical outcomes. Generally, TNBCs are

associated with high histological grade (grade 3) and high proliferation index, and subsequently associate with poor prognosis, aggressive clinical behavior, low relapse-free rates, and poor overall survival rates (Fulford *et al.*, 2006; Hu *et al.*, 2006; Bosch *et al.*, 2010; Rakha *et al.*, 2010; Voduc *et al.*, 2010; Perou, 2011; Valentin *et al.*, 2012).

	Intrinsic Subtypes	Characteristics	Major Treatments
Good Low	Luminal A ~ 40-50%	HR+ (ER+ and PR+/-), HER2- Low Ki67	– Endocrine Therapy Tamoxifen, Fulvestrant, Aromatase inhibitors
	Luminal B ~ 20%	HR+ (ER+ and PR+/-) HER2+/- High Ki67	– Chemotherapy
	HER2-enriched ~ 15%	HR- (ER- ; PR-), HER2+++	– Targeted Therapy Trastuzumab – Chemotherapy
Bad High Low	Triple Negative ~ 10-15%	HR- (ER- ; PR-), HER2 low	– Chemotherapy

Figure 6 : Intrinsic molecular subtypes of breast cancer and their main treatments.

Besides these intrinsic subtypes of tumors, further molecular ER-negative groups are identified such as claudin-low, molecular apocrine and interferon-related groups. Claudin-low group is characterized by low expression of luminal markers (cell–cell adhesion genes), high expression of epithelial–mesenchymal transition (EMT) genes, and stem cell-like gene expression patterns (Herschkowitz *et al.*, 2007; Hennessy *et al.*, 2010; Prat *et al.*, 2010; Dias *et al.*, 2017). Molecular apocrine group is similar to HER2 positive/ER-negative subtype yet distinguished by Androgen receptor (AR) expression and AR-related pathways activation (Lehmann-Che *et al.*, 2013)(Farmer *et al.*, 2005). The interferon subtype is recognized by high expression of Interferon (IFN)-regulated genes like STAT1 (Hu *et al.*, 2006).

Remarkably, TNBC is the most heterogenous subtype, mRNA expression profiling clustering subdivided furtherly TNBC into six subtypes: basal cell-like type 1 (BL1), basal cell Like type 2 (BL2), immunomodulatory subtype (IM), mesenchymal subtype (M), mesenchymal stem cell-

like subtype (MSL), and luminal androgen receptor subtype (LAR). These six subtypes possess different gene expression profiles related to different signaling pathways. BL1 tumors have high expression of genes involved in cell proliferation and DNA damage repair system, while BL2 tumors have high expression of genes associated with growth factor signaling pathways and metabolism. BL1 and BL2 subtypes comprise 30% of all TNBCs. IM tumors enriched with genes related to immune and cytokine signal pathways. M and MSL tumors have high levels of epithelial mesenchymal transition (EMT) and cell differentiation genes. M subtype differs from MSL subtype by the low mitotic index and the low expression of cell proliferation protein and tight junction protein. LAR tumors are rich in hormone-regulated signaling pathways, including the androgen receptor signaling pathways (Lehmann *et al.*, 2011; Li *et al.*, 2021; Derakhshan and Reis-Filho, 2022) (**Figure 7**).

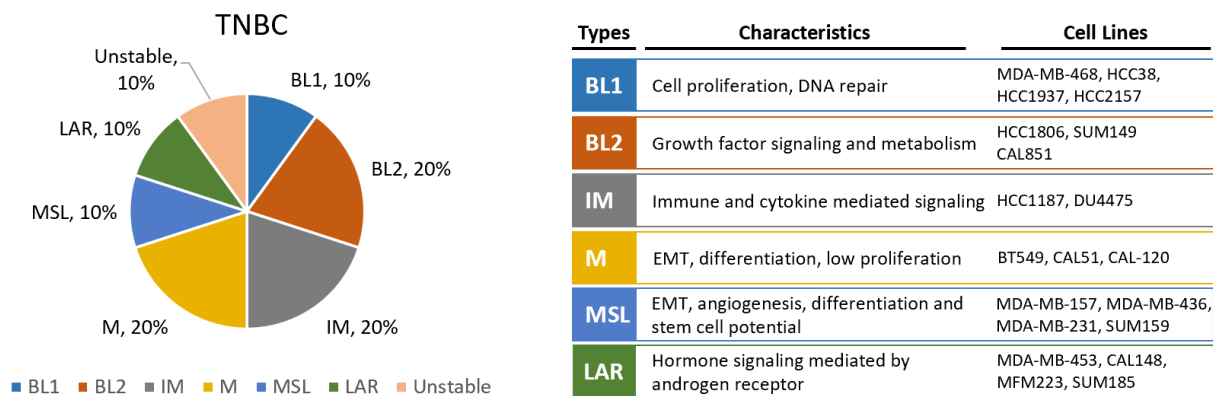

Figure 7 : Molecular subtypes of triple negative breast cancers (TNBCs).

In addition to the above-mentioned breast cancer subtypes, metaplastic breast cancer (MpBC) is highly rare and aggressive type accounting for approximately 1% of all breast cancer cases [WHO]. MpBC is histologically characterized by the presence of epithelial and/or mesenchymal cells (Weigelt *et al.*, 2014). MpBC is often high-grade tumors with triple-negative phenotype, where 85-89% of cases lack the expression of ER, PR and HER2 (Reis-Filho *et al.*, 2006; Weigelt *et al.*, 2014; Rakha *et al.*, 2017). However, MpBC has worse prognosis and decreased disease-free/overall survival compared to non-metaplastic TNBC (Jung *et al.*, 2010; Nelson *et al.*, 2015; El Zein *et al.*, 2017; Schroeder *et al.*, 2018). MpBC is shown to have more stem cell-like features, high level of EMT markers, overexpression of epidermal growth factor receptor (EGFR), more phosphoinositide 3-kinase (PI3K) mutations, enhanced nitric oxide signaling,

abnormal β -catenin expression, elevated PD-L1 expression and mutations in TP53 promoter (Reddy *et al.*, 2020). Moreover, MpBC has no standardized treatment guidelines and shows poor response to cytotoxic chemotherapy medications (Wong *et al.*, 2021). The overexpression of PD-L1 could be a good therapeutic target for MpBC patients (Kim *et al.*, 2021).

4. Risk Factors of Breast Cancer

Breast cancer is a multifactorial disease presenting a critical challenge on the society. IARC statistics in 2020 prevailed that the average age of breast cancer incidence declined, with 247 953 new cases in women aged less than 40 years (approximately 11% of total cases) and therefore, increasing the public interest in improving breast cancer treatments and preventions (*Cancer Today*) (Figure 8).

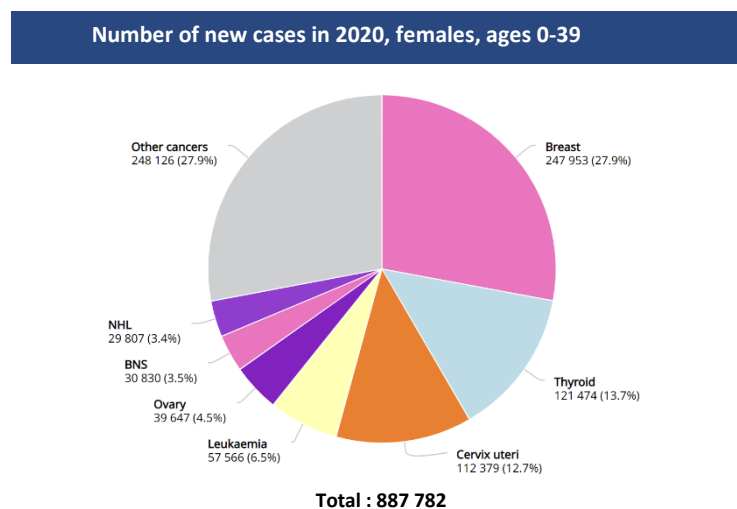

GLOBOCAN 2020, IARC (Cancer Today)

Figure 8 : Number of new incident cases of breast cancer in women below 40 years old in 2020, worldwide.

BC incidence, mortality and survival rates is varying among the worldwide countries due to the variation of lifestyle, genetic, and environmental factors. The changes in these diverse risk factors are leading to an increase in BC prevalence. Accordingly, the full understanding of all contributing risk factors is required to develop an effective prevention strategy (Figure 9).

Risk Factors of Breast Cancer

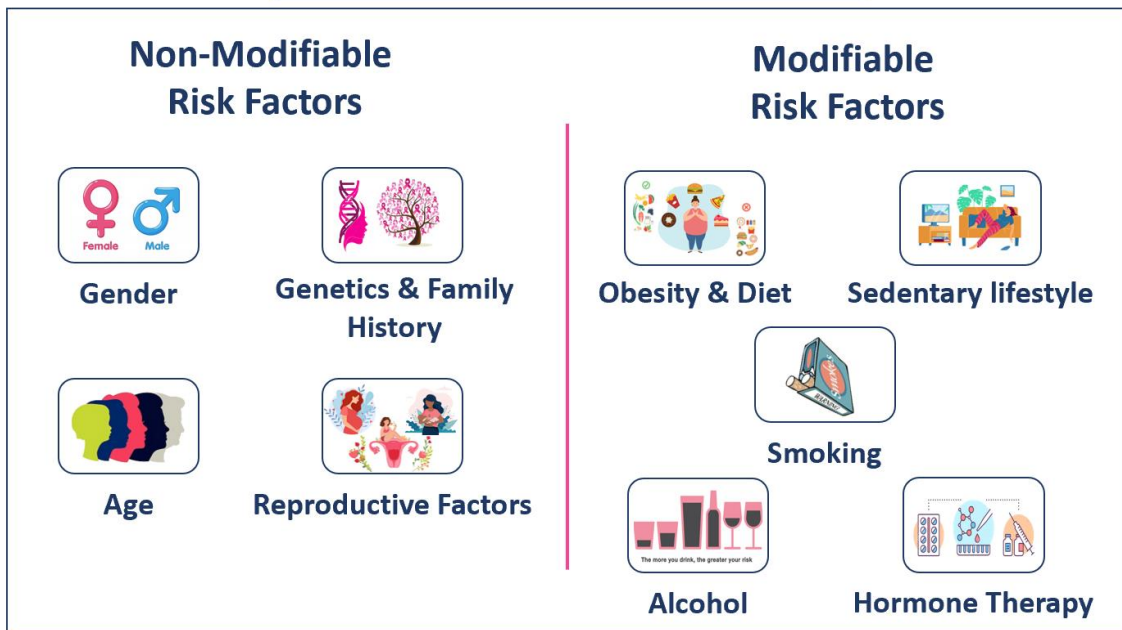

Figure 9 : Different modifiable and non-modifiable lifestyle risk factors of breast cancer.

4.1. Non-Modifiable Risk Factors:

There are different intrinsic risk factors that cannot be modified, including being a woman and getting older.

Gender. Breast cancer is predominantly known as a female disease. Though it is considered as a rare malignancy in men, male breast cancer (MaBC) accounts for almost 1% of diagnosed breast cancer cases (Baroni and Makdissi, 2022). 90% of MaBC is hormone receptor positive and often occurs in older adult males having mutations in BRCA2 gene, family history for BC, hormonal imbalance or radiation exposure (Phelan *et al.*, 1996; Gómez-Raposo *et al.*, 2010; Khan and Tirona, 2021).

Age. Age is the foremost known risk factor for BC, where the incidence rate increases with age and reaches the summit at menopause age and declines thereafter (Kim, Yoo and Goodman, 2015) (Petracci *et al.*, 2011). Majority of BC diagnosed patients were above 40 years old. Breast tumors in young women associates with larger size, advanced stage, hormone receptor negativity and low overall survival (Assi *et al.*, 2013; Shah *et al.*, 2022).

Reproductive factors. First, menarche at young age less than 15 years increases the risk of BC by double (Lubin *et al.*, 1981; Helmrich *et al.*, 1983; Thakur *et al.*, 2017). Different studies reported that the menarche at younger age is associated mainly with hormone receptor positive breast tumors and less significantly with triple negative and Her2-enriched tumors (Anderson, Schwab and Martinez, 2014).

Second, giving birth for the first time at age more than 25 years old increases the BC risk, whereas early maternal age reduced the risk by 27% (Helmrich *et al.*, 1983; Ma *et al.*, 2006). Old age at first delivery is associated with aggressive breast tumors with advanced grade, high levels of cyclin D1 and low levels of p27 (Butt *et al.*, 2009; Williams *et al.*, 2018). Also, different studies reveal that increased age at first birth is positively correlated with hormone receptor positive and Her2-enriched tumors and inversely correlated with triple negative tumors (Anderson, Schwab and Martinez, 2014).

Third, increased parity or increased number of births is associated with decreased breast cancer risk (Clavel-Chapelon *et al.*, 1995; Ma *et al.*, 2010). Parity is inversely associated with hormone receptor positive breast cancer in 19 different studies, where each birth estimated to reduce the risk of hormone positive BC (Ma *et al.*, 2006, 2010; Anderson, Schwab and Martinez, 2014). Whereas nulliparity is significantly correlated with large aggressive tumor subtypes possessing high levels of KI67, cyclin D1 and Her2 expression (Butt *et al.*, 2009).

Fourth, breastfeeding plays a protective role in breast cancer (Kelsey, Gammon and John, 1993)(Ma *et al.*, 2006). Longer duration of lactation decreased the risk of developing hormone receptor positive, triple negative and Her2-enriched breast tumor (Anderson, Schwab and Martinez, 2014; Barnard, Boeke and Tamimi, 2015).

Finally, older age at menopause is positively correlated with breast cancer risk due to longer lifetime exposure to estrogen (Hamajima *et al.*, 2012; Thakur *et al.*, 2017). Few studies show that late menopause associates with higher risk in developing hormone receptor positive and Her2 enriched breast tumors (Anderson, Schwab and Martinez, 2014). Increased BMI > 24 has an additive effect on the early onset of breast cancer in menopausal women (Yang *et al.*, 2022).

Hereditary factors. Hereditary predisposition contributes up to 10% of all breast cancer cases at early age. 50% of these hereditary cases are due to mutation in the two well-known breast cancer susceptibility genes, BRCA1 and BRCA2 (Cobain, Milliron and Merajver, 2016; Abu-Helalah *et al.*, 2020). The breast cancer cumulative risk for mutation carriers is 57% and 72% for BRCA1 carriers by age 70 and 80 respectively. Also, 49% and 69% for BRCA2 carriers by age 70 and 80 respectively (Chen and Parmigiani, 2007; Kuchenbaecker *et al.*, 2017). Further studies reveal different breast cancer susceptibility genes, such as human interferon α -2b (hIFN α -2b) and matrix metalloproteinase (MMP-2 C-735T) (Yari *et al.*, 2014; Ahmed *et al.*, 2016).

Moreover, a positive family history of breast cancer is a major risk factor. Women with a strong family history of breast cancer (two or more cases) are at almost 11 times more lifetime risk, independently of the identified genetic mutations (Metcalf *et al.*, 2009; Ahern *et al.*, 2017; Bravi, Decarli and Russo, 2018). However, the family history is not associated with breast cancer severity at time of prognosis nor with its mortality (Melvin *et al.*, 2016).

4.2. Modifiable Risk Factors:

Besides, there are several important modifiable lifestyle risk factors that could be optimized to prevent the incidence of breast cancer and thereby to decrease the overall cases. Developing a healthy lifestyle offers an opportunity to complement conventional therapies.

Obesity and diet. Obesity and physical inactivity associate with increased risk of breast cancer development and progression in postmenopausal women (Friedenreich, 2010; Demark-Wahnefried *et al.*, 2012). Overweight women with body mass index (BMI) above 25 and above 30 had a higher postmenopausal BC relative risk in comparison with normal-weight women (La Vecchia *et al.*, 2011; Chan *et al.*, 2014). Also, recent meta-analysis shows that increased BMI is associated with poor overall BC survival in pre and postmenopausal women (Chan *et al.*, 2014). Over and above, obesity induces breast cancer progression by changing the tumor microenvironment into proinflammatory where it activates effector proteins promoting metastasis (Mubtasim, Moustaid-Moussa and Gollahon, 2022). So, a well-balanced diet with high vegetables/fruits, high fibers, and low fats and carbs plays an essential role in lessening the risk of BC (Albuquerque, Baltar and Marchioni, 2014).

Alcohol. Alcohol consumption associates with increased risk of BC in pre and most menopausal women due to increased level of estrogen in blood. Light levels of alcohol intake (one alcoholic drink/day) increase BC risk by 4% (Seitz *et al.*, 2012; Bagnardi *et al.*, 2013). This increase in BC risk is related to alcohol in a dose dependent manner where a 10% increase in risk is recorded for every additional 10g of ethanol. Further heavy consumption (three or more drinks/day) results in 40–50% increased risk (Smith-Warner *et al.*, 1998; Zhang *et al.*, 2007; Seitz *et al.*, 2012). Moreover, elevated levels of alcohol consumption resulted in increased the risk of BC recurrence in pre-menopausal women (Gou *et al.*, 2013).

Hormonal factors. The risk of developing breast cancer is 9.5 times higher in women consuming oral contraceptive pills (Calle *et al.*, 1997; Bhadoria *et al.*, 2013). As well, continuous combined hormone therapy after menopause (HTMP) with estrogen and progesterone, a therapy used for menopausal symptoms, protects women against heart diseases and osteoporosis yet significantly increases the risk and the mortality rate of BC (Crosignani, 2003; Marjoribanks *et al.*, 2012). The discontinuity of the combined hormonal therapy quickly reduces BC risk, and this risk takes 5 years in postmenopausal women and 5-10 years in premenopausal women of discontinuity to be completely diminished (Calle *et al.*, 1997; Chlebowski *et al.*, 2009; Zolfaroli, Tarín and Cano, 2018).

Smoking. Smoking tobacco, a well-known carcinogen, is associated with higher risk of BC development in actively smoking women especially those who initiated smoking before their first delivery or being in menopause (Xue *et al.*, 2011; Gaudet *et al.*, 2013). Also, there is a positive dose-response correlation between the smoking duration (in years) before the first childbirth and breast cancer risk in short- and long-term smokers. Likewise, breast cancer risk increases in a dose-dependent manner in women smoking with an average more than 10 cigarettes per day (Bjerkaas *et al.*, 2013).

Physical activity. On the contrary, physical activity reduces the risk of breast cancer development in premenopausal and postmenopausal women by reducing the body fats, excessive estrogen production and inflammatory markers (McTiernan *et al.*, 2004; Hildebrand *et al.*, 2013). Additionally, it improves the survival outcomes in breast cancer patients, where the risk of BC specific mortality in young physically active women was less compared to young inactive women (Abrahamson *et al.*, 2006). Likewise in old/postmenopausal women, women

engaged with minimum 10 hours of physical activity per week has reduced risk of breast cancer specific mortality in comparison with less active old women (Beasley *et al.*, 2012).

Other factors. A large European study suggested an association between long-term ambient air pollution exposure and incidence of breast cancer in postmenopausal women (Andersen *et al.*, 2017). Also, time trends conclusions showed that higher incidence rates of breast cancer occurred in high emission regions in the United States (US), where emissions of nitrogen oxides, carbon monoxide, sulfur dioxide, and volatile organic compounds were positively associated with breast cancer incidence (Wei, Davis and Bina, 2012).

Moreover, diabetes (especially Type II diabetes) affects the incidence of breast cancer through interfering with different biological pathways such as insulin and insulin-like-growth factor pathways and its complications in return affect the outcome of patient's therapy and screening (Wolf *et al.*, 2005). Diabetes tends to increase the risk of developing breast cancer in postmenopausal women with higher BMI and additional meta-analysis confirmed that women with type II diabetes are significantly at 20% higher risk (Larsson, Mantzoros and Wolk, 2007; Tabassum, Mahmood and Faheem, 2016)

Furthermore, the risk of breast cancer in women who experienced large number of radiations due to previous cancer therapy, tuberculosis screening or pneumonia monitoring are two to three times at higher risk (John *et al.*, 2007). Women treated with whole-lung irradiation for their childhood cancer have a higher risk of developing breast cancer compared to those who didn't receive whole-chest irradiation and these individuals are associated with a significantly higher breast cancer mortality rates (Moskowitz *et al.*, 2014). Also, women who received sarcoma or leukemia treatment during their childhood, who received high dose alkylator and anthracycline chemotherapy, are at higher risk of developing breast cancer at a younger age (Henderson *et al.*, 2016).

Finally, lights must be shed on psychological and psychosocial stress as a potential risk factor (Mohan, Huybrechts and Michels, 2022). Life-induced stress disturbing the circadian rhythms such as the quality and quantity of sleeping may increase the risk of BC development in women and affect the survival outcomes of BC patients (Davis and Mirick, 2006; Kennaway, 2014). Recent study demonstrates that women with higher quality of life have a higher level of illness acceptance (optimistic disposition) and subsequently experiencing a lower intensity of breast

cancer symptoms and treatment related symptoms compared to those having low level of illness acceptance (pessimistic disposition) (Ośmiałowska *et al.*, 2022).

5. Breast Cancer Treatments

Several therapeutic strategies are available in order to cover this significant heterogeneity among breast tumors. Treatments are classified as local (surgery and radiotherapy) or systemic (endocrine therapy, targeted therapy, and chemotherapy) that can be before (neoadjuvant) or after (adjuvant) surgery (**Figure 10**). Treatment option differs depending on several factors such as the cancer stage and the tumor molecular characteristics (Veronesi *et al.*, 2005; Ganesh N. Sharma, Rahul Dave, Jyotsana Sanadya, Piush Sharma, 2010; Waks and Winer, 2019)

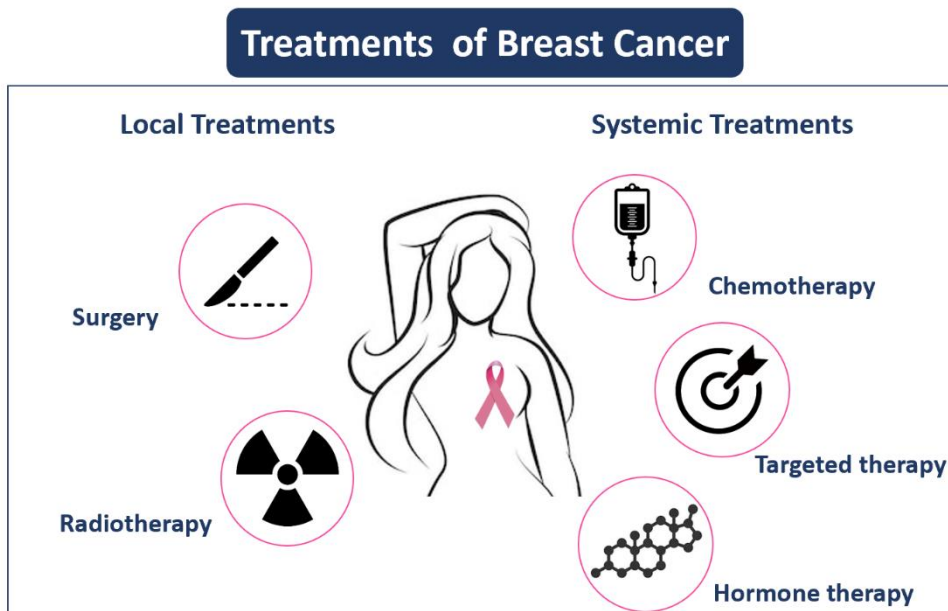

Figure 10 : Different local and systemic treatments of breast cancer.

5.1. Surgery:

Surgical resection of primary breast tumors is a first choice of treatment or a second after neoadjuvant systemic therapy regardless the tumor molecular subtype. Based on tumor size, different surgical resection is performed (Riis, 2020):

- **Mastectomy**: surgical removal of the entire breast, with the possibility of conserving some skin and the nipple-areolar complex for reconstruction. It is

performed for multicentric invasive carcinoma, inflammatory carcinoma, or extensive intraductal carcinomas.

- **Breast-conserving surgery:** most common type substituting mastectomy, includes lumpectomy or wide local excision, and it involves the removal of the tumor along with a margin of the surrounding normal tissue while conserving the cosmetic appearance of the breast. It is performed for locally invasive tumors and large primary tumors after being subjected to preoperative systemic therapy and reduced in size.
- **Axillary lymph node dissection:** surgical removal of the draining lymph nodes into the breast to avoid metastasis, along with mastectomy or BCS.

5.2. Radiotherapy:

Radiation therapy uses high energy X-rays or gamma-rays to target cancer cells that may remain or recur after surgery. Strong enough dose (starting from 1Gy up to ≥ 25 Gy) is delivered to the whole breast or a portion of the breast, the chest wall, and the regional lymph nodes. Radiation therapy reduces breast cancer recurrence and improves overall survival for patients (Ernard *et al.*, 2002; Rubino *et al.*, 2003; Vaidya *et al.*, 2004; Valachis *et al.*, 2010).

5.3. Endocrine therapy/ Hormonal therapy:

Hormone therapy slows or stops the estrogen-promoted tumor growth. It is a primary systemic treatment for all ER α -positive, and/or PR-positive tumors, given as adjuvant therapy for five years for early-stage ER α -positive breast cancer or as first line therapy for metastatic ER α -positive breast cancer. Hormonal drugs possess their function through blocking the synthesis of estrogen by the body or through inhibiting the effect of estrogen on cancer cells. Herein, several hormonal drugs are available: anti-estrogens (such as Tamoxifen and Fulvestrant) that competitively binds ER and inhibits estrogen binding, and aromatase inhibitors (such as Anastrozole, Exemestane, and Letrozole) that decreases circulating estrogen through binding the Aromatase enzyme, known as estrogen synthase, and inhibiting its enzymatic activity which convert androgens to estrogen (Miller, 2003; Ranger, 2005; Altundag and Ibrahim, 2006; Osborne and Schiff, 2020).

5.4. Targeted therapy.

Targeted drug therapy is directed against a specific abnormal protein on breast cancer cells (such as HER2) that helps cancer cells grow and spread. Trastuzumab is a humanized monoclonal antibody that targets the extracellular domain of HER2, entered clinical trials in 1990s and now is a standard therapy for luminal and non-luminal HER2-positive early breast cancer (Piccart-Gebhart *et al.*, 2005; Gianni *et al.*, 2016; Montagna and Colleoni, 2019).

5.5. Chemotherapy.

Chemotherapy are cytotoxic drugs that target rapidly dividing cells, such as doxorubicin, docetaxel, and paclitaxel. They can be given as neoadjuvant to shrink the breast tumor or adjuvant therapy to prevent relapse of breast cancer. Chemotherapy is the standard and typical treatment for TNBC until now (Gluz *et al.*, 2009; Bosch *et al.*, 2010; Santana-davila and Perez, 2010). However, several therapies are delivered in combination with chemotherapy for TNBC patients, such as:

- **Anti-PD-L1 (immunotherapy).** A humanized monoclonal antibody developed immunotherapy drug (such as Pembrolizumab) that stimulates the immune system against cancer cells through targeting the PD-L1 (Programmed cell death-ligand 1) agent (Planes-Laine *et al.*, 2019).
- **PARP inhibitors.** PARP inhibitors (such as olaparib) target PARP enzyme, key enzyme for repairing broken DNA single strands. They are recently FDA approved as possible treatments for BRCA1/2 mutated breast cancer through preventing the self-repair of DNA breakage and thus accelerate apoptosis of tumor cells (Robson *et al.*, 2017)(Li *et al.*, 2021).
- **Trodelyv** (chemical name: Sacituzumab govitecan-hziy). A recent antibody-drug conjugate immune targeted medicine, made up of Sacituzumab a humanized monoclonal antibody that targets the Trop-2 protein which is found in more than 90% of TNBCs linked with the cytotoxic molecule SN-38 which is a topoisomerase I inhibitor. Sacituzumab delivers chemotherapeutic agent specifically to TNBC and not normal cells, thus being more effective and less toxic, used to treat patients with advanced or

metastatic TNBC (Maltoni and Bravaccini, 2022; Michaleas *et al.*, 2022; O'Shaughnessy *et al.*, 2022)

- **Adjuvant Therapy.** Synthetic glucocorticoids (GCs) such as dexamethasone (dex), cortisone, methylprednisolone, hydrocortisone, ketoprogesterone, fluorometholone, prednisone, and prednisolone derived from steroidal endogenous glucocorticoids, are widely used before, during or after chemotherapy at various doses in BC treatment. These adjuvant drugs reduce the hypersensitivity reactions accompanying chemotherapy including nausea and vomiting through binding the glucocorticoid receptor (GR). Also, they protect normal tissues from the long-term side effects of cytotoxic drugs. Moreover, GCs alleviate tumor-associated effects on patient's health such as loss of appetite, pain, edema, electrolyte balance and inflammation, hence helping patients not to abandon their therapy's (Goldhirsch *et al.*, 1985; Henzi, Walder and Trame, 2000; Rutz, 2002; Wang *et al.*, 2004; Keith, 2008; Chen *et al.*, 2016; de Castro Baccarin *et al.*, 2019; Barroso-Sousa *et al.*, 2021)

Chapter II: Glucocorticoids (GCs)

1. Endogenous Glucocorticoids

GCs are 21-carbon steroid hormones synthesized and released into the circulation via the adrenal gland. They were named GCs due to their important role in glucose metabolism (K. Lin and Wang, 2016).

Initially, GCs were discovered as part of the adrenal extracts which was shown to ameliorate the condition of people with adrenal insufficiency, named later as Addison's Disease (Timmermans, Souffriau and Libert, 2019). In 1946, cortisol, the major GC found in humans, was isolated for the first time from other steroids produced by the adrenal gland by Edward Kendall (Simoni, Hill and Vaughan, 2002). Three years later, cortisol was proved to have therapeutic potential in patients with rheumatoid arthritis due to its anti-inflammatory action (Timmermans, Souffriau and Libert, 2019).

Although GCs have important role in the immune system and glucose homeostasis, their function covers a large repertoire of physiological processes. Also, they are recognized as stress hormones due to their critical role during periods of physiological or emotional stress (Oakley and Cidlowski, 2013).

1.1. Regulation of GCs Synthesis

GCs are produced in the zona fasciculata of the adrenal cortex from cholesterol through a series of enzymatic reactions. Unlike peptide hormones which are synthesized and stored inside the cells until stimulation, GCs are synthesized *de novo* and released upon stimulation [Spiga F 2014]. The hypothalamus-pituitary gland-adrenal gland (HPA) axis is the main pathway by which GCs synthesis is regulated. This axis is mainly characterized by the secretion of corticotrophin-releasing hormone (CRH) from the paraventricular nucleus (PVN) of the hypothalamus, which is transported to the anterior pituitary through the portal circulation. At the level of the anterior pituitary gland, CRH binds to its receptor (CRH-R1) and induce the secretion of adrenocorticotrophic Hormone (ACTH) into the circulation, by which it reaches the adrenal gland and induces the synthesis and secretion of GCs (Oakley and Cidlowski, 2013; Spiga *et al.*, 2014; Timmermans, Souffriau and Libert, 2019).

GC synthesis is regulated in a circadian rhythm. Accordingly, the level of GCs is the highest during the active time which is in the early morning in case of humans and during the first hours of night in case of rats, mice and other nocturnal animals (Haller *et al.*, 2000; Spiga *et al.*, 2014). The suprachiasmatic nucleus (SCN) is the region of the hypothalamus which is involved in directing the circadian cycle and is considered the major pacemaker (Maywood *et al.*, 2007; Mohawk and Takahashi, 2011; Kalsbeek *et al.*, 2012). During inactive time, SCN neurons release vasopressin into the PVN which inhibits the release of CRH from this region. SCN can also indirectly regulate the CRH secretion by PVN via acting through the dorsomedial hypothalamus (DMH), another region of the hypothalamus. During active phase, upon perception of light, in case of humans, messages are transported from the retina to the SCN region of the hypothalamus, through the retino-hypothalamus tract, inhibiting the release of vasopressin from SCN neurons to the PVN region and thus inducing the secretion of CRH (Kalsbeek *et al.*, 1996; Kalsbeek, Van Der Vliet and Buijs, 1996; Spiga *et al.*, 2014). There is evidence that SCN can regulate the synthesis of GCs by the adrenal gland directly through multi-synaptic neural connection via the thoracic splanchnic nerve (Kalsbeek *et al.*, 2012; Spiga *et al.*, 2014)

In addition to the regulation by the major pacemaker, SCN, the synthesis of GCs is regulated by intra-adrenal clock genes. Oster *et al.* discovered several canonical clock genes that show circadian rhythmic expression (Ishida *et al.*, 2005; Oster, Damerow, Hut, *et al.*, 2006; Fahrenkrug, Hannibal and Georg, 2008; Gi *et al.*, 2008). Among which, 2 genes, *Per2* and *Cry1*, were shown to abolish the rhythmic expression of all the other clock genes when they are knocked out. Thus, in the same study, *Per2/Cry1* double-knockout mice were generated, in which the rhythmic expression of GCs was abolished. In a complementation experiment, the transplantation of wild type adrenal gland into mutant mice, reproduced the circadian rhythm of GCs synthesis, but their concentrations reached lower levels than those observed in wild type mice. Similarly, the transplantation of mutant adrenal glands into wild type host produced the same results with similar amplitude of GC level. This study proves the presence and the importance of intra-adrenal clock genes in regulating GCs rhythmic expression (Oster, Damerow, Kiessling, *et al.*, 2006).

Beside the circadian rhythm, GC secretion also follow an ultradian rhythm characterized by cycles of around 1 hour. Also, the level of GCs was found to increase during periods of

physiological or emotional stress. Thus, they are considered among the major stress hormones (Spiga *et al.*, 2014).

It is worth mentioning that GCs controls the HPA axis in a negative feedback manner. GCs act on PVN and inhibit the expression of CRH. They also act at the level of the anterior pituitary to inhibit the transcription of CRH receptor and ACTH precursor. GCs can act in a non-genomic and more rapid pathway to inhibit the secretion of CRH and ACTH (Jones, Brush and Neame, 1972; Jones, Tiptaft and Brush, 1973; Hinz and Hirschelmann, 2000; Spiga *et al.*, 2014; Gjerstad, Lightman and Spiga, 2018; Timmermans, Souffriau and Libert, 2019).

Today, there are growing evidence of extra-adrenal GC synthesis in different tissues including Intestine, thymus, skin and possibly blood vessels and brain (Noti, Sidler and Brunner, 2009; Taves, Gomez-Sanchez and Soma, 2011; Jozic *et al.*, 2014; Talaber, Jondal and Okret, 2015; Mittelstadt, Taves and Ashwell, 2018). However, GC synthesis in those tissues is not regulated by the central HPA axis, and GCs produced by these tissues play only local rather than systemic roles. The regulators of GC production are specific to each tissue. For example, in the skin, GC production is regulated by a local HPA axis, where CRH and ACTH were shown to be produced locally. GC production in this tissue is mainly stimulated by UV radiation and other types of stresses including mechanical or chemical injury, and inflammation (Phan, Merk and Brunner, 2019). On the other hand, in the thymus, the highest GC synthesis is seen in early postnatal life, when the level of systemic GCs is low, but they are needed for the maturation of thymocytes (Taves, Gomez-Sanchez and Soma, 2011). In the intestine, GCs synthesis is mainly induced by inflammation and immune activation at the level of both the adaptive and the innate immune system (Taves, Gomez-Sanchez and Soma, 2011; Phan, Merk and Brunner, 2019). Although less studies focused on GCs synthesis in blood vessels and brain, there is some evidence of local synthesis, which may be more pronounced in pathological conditions. As an example, in the brain, GCs were shown to be synthesized in response to alcohol injection, alcohol withdrawal, hypoxia and social stresses (Talabér, Jondal and Okret, 2013).

1.2. Synthesis and Metabolism of GCs

The synthesis of GCs occurs in the cells in the zona Fasciculata of the adrenal cortex. At the level of these cells, ACTH binds to its G-protein coupled receptor, MC2R, which undergoes conformational change and induces the activation of adenylyl cyclase which leads to an

increase in the level of cytoplasmic cAMP and the subsequent activation of PKA (Mountjoy *et al.*, 1994; Spiga *et al.*, 2014). PKA activates GCs synthesis mainly by enhancing the gene expression and activation of a key mediator, steroidogenic acute regulatory protein (StAR), also called START domain-containing protein 1 (StARD1). StAR is a protein that mediate the delivery of cholesterol into the mitochondrial inner membrane, which is considered the rate limiting step for GCs synthesis (Lin *et al.*, 1995; Stocco and Clark, 1996b, 1996a). PKA activates cAMP-response element binding protein (CREB) which in its turn activates the transcription of StAR. Additionally, PKA activates StAR by post-translational phosphorylation (Arakane *et al.*, 1997).

GCs are synthesized through a series of enzymatic reactions that use cholesterol as a precursor (Miller, 2009). Although cholesterol can be synthesized *de novo* in the adrenal gland from acetate, this remains a minor pathway. Dietary cholesterol is transported to the adrenal gland bound to lipoproteins. In humans, cholesterol for GC synthesis is mainly taken up from LDL via LDL receptor-mediated endocytosis, while in rodents, HDL is the main source, due to the presence of a receptor called scavenger receptor B1 (SR-B1) (Gwynne and Strauss, 1982; Horton, Goldstein and Brown, 2002). Cholesterol is taken up as cholesterol ester, and it needs de-esterification by hormone-sensitive lipase (HSL) to be in a free active form which is required for GC synthesis. Cholesterol can be then esterified again by acyl-coenzyme A: cholesterol acyl transferase (ACAT) and stored in lipid droplets, as an additional step to regulate its intracellular bioavailability. Thus, the balance between ACAT and HSL activities determines the cholesterol availability (Brown, Kovanen and Goldstein, 1979; Kraemer, 2007; Miller and Auchus, 2011). ACTH acts on different levels to increase the intracellular bioavailability of cholesterol. It maximizes cholesterol intake from LDL through LDL receptors, it activates HSL and inhibit the activity of ACAT (Lehoux *et al.*, 1989; Miller and Auchus, 2011). Additionally, ACTH induces the transcription of steroidogenic enzymes (Sewer, Dammer and Jagarlapudi, 2007).

Cholesterol can integrate in the outer mitochondrial membrane (OMM) due to its lipophilic nature. Because the first steroidogenic enzyme, which catalyzes the rate-limiting step of steroidogenesis, is present in the inner mitochondrial membrane (IMM), the action of steroidogenic acute regulatory protein (StAR) is needed for transporting cholesterol from the OMM to IMM [Miller WL. 2007, Miller WL 2010]. At this level, the side chain cleavage enzyme

(P450scc), also called CYP11A1, cleaves cholesterol sidechain leaving a 21-Carbon steroid precursor, Pregnenolone. This reaction is common to all steroid hormone biogenesis, and the presence of P450scc is required for a cell to be considered steroidogenic (Miller and Auchus, 2011) (**Figure 11**).

The following steps of GCs synthesis occur at the level of the smooth endoplasmic reticulum (ER). In humans, a hydroxylation reaction is carried out on carbon 17 by P450c17 to produce 17 α -hydroxypregnenolone. Rodents do not possess P450c17 enzyme, thus the next steps are carried on directly on Pregnenolone. This is the reason for the difference in the GCs found in humans and rodents. The rest of the steps are catalyzed by the same enzymes in both organisms (Miller and Auchus, 2011) (**Figure 11**).

A dehydrogenation reaction carried out by a 3 β -Hydroxysteroid Dehydrogenase (3 β -HSD) transforms Pregnenolone into progesterone, and 17 α -hydroxypregnenolone into 17 α -hydroxyprogesterone (in humans but not in rodents). This is followed by a hydroxylation step on carbon 21 by P450c21, producing deoxy-corticosterone and 11-deoxycortisol, respectively. Then, the latter products are transported to the mitochondria again where P450c11 β enzyme resides. A hydroxylation step is carried out by this enzyme transforming deoxy-corticosterone into corticosterone (the principal GC in rodents), and 11-deoxycortisol into cortisol (the principal GC in humans) (**Figure 11**) (Miller and Auchus, 2011). Both GCs has 21 Carbons with 4 hydrocarbon rings, a ketone group at C3, a hydroxyl group at C11, and a double bond in carbon ring A, all of which are important for GC activity (Buchwald and Bodor, 2004).

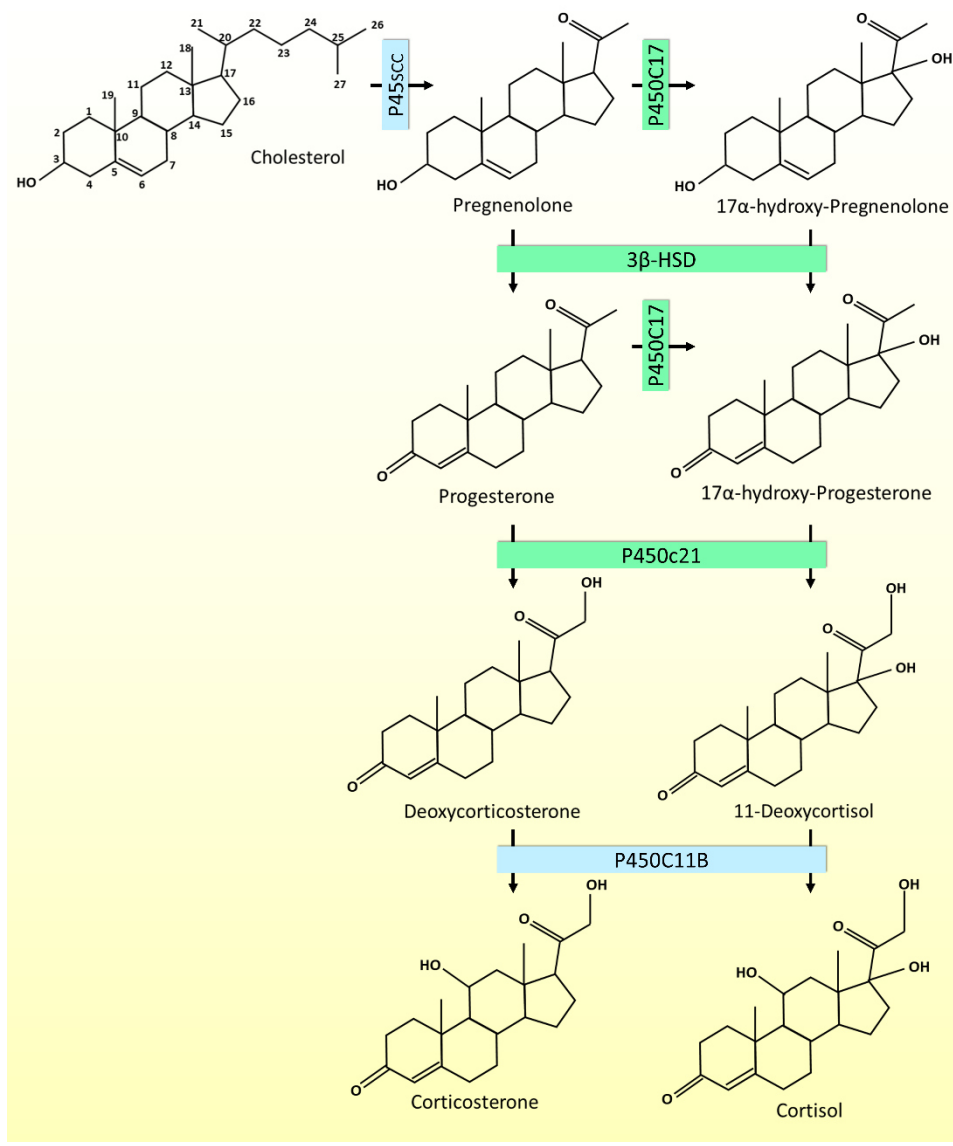

Figure 11 : Biosynthesis of glucocorticoids in the adrenal gland. In blue: mitochondrial enzymes, in green: ER enzymes

When released from the adrenal cortex, GCs circulate in the blood bound to carrier proteins (Meyer *et al.*, 2016). Corticosteroid-binding globulin (CBG) is the major carrier protein and it binds to about 80% of GCs. Albumin also binds to about 15% of GCs. Only about 5% are found free and biologically available (Lewis *et al.*, 2005). At target sites, CBG is cleaved and GCs are rendered free to penetrate into target cells. Neutrophil elastase is one of the proteases that cleaves CBG, thus increasing the bioavailability of GCs at sites of inflammation (Klieber *et al.*, 2007; Zhou *et al.*, 2008). In addition, CBG can be cleaved directly by pathogen proteases like *P. aeruginosa* elastase (LasB) which is produced by *Pseudomonas aeruginosa* (Simard *et al.*, 2014). Alternatively, CBG can undergo conformational change decreasing its affinity to GCs

upon temperature increase. This could be an additional mechanism to deliver GCs to inflamed regions (Lin, Muller and Hammond, 2010; Lewis *et al.*, 2016).

Once free, GCs can easily penetrate through the cellular membrane. In target cells, active GCs (cortisol in humans and corticosterone in rodents) can be metabolized into inactive forms (cortisone in humans and 11-dehydrocorticosterone in rodents) via the action of 11 β -HSD2. The inactive form can be metabolized back to its active form via the action of 11 β -HSD1 (**Figure 12**). In vitro, 11 β -HSD1 can also work in the opposite direction. The factor determining the direction in which this enzyme works is the co-factor. In the cells, 11 β -HSD1 is localized to the lumen of the endoplasmic reticulum (ER), where NADPH, the cofactor, is found in high concentrations due to the action of ER-resident enzymes. The balance in the expression of these 2 enzymes is critical to determine the intracellular bioavailability of GCs, and it determines GC effect in a certain tissue. Thus, their expression changes among tissues and cell types (Draper and Stewart, 2005).

Active GCs bind to the intracellular GC receptor (GR). GR can then translocate to the nucleus and regulate the expression of target genes. Also, GCs can exert non-genomic effect. The signaling of GR will be detailed in the following parts and chapters.

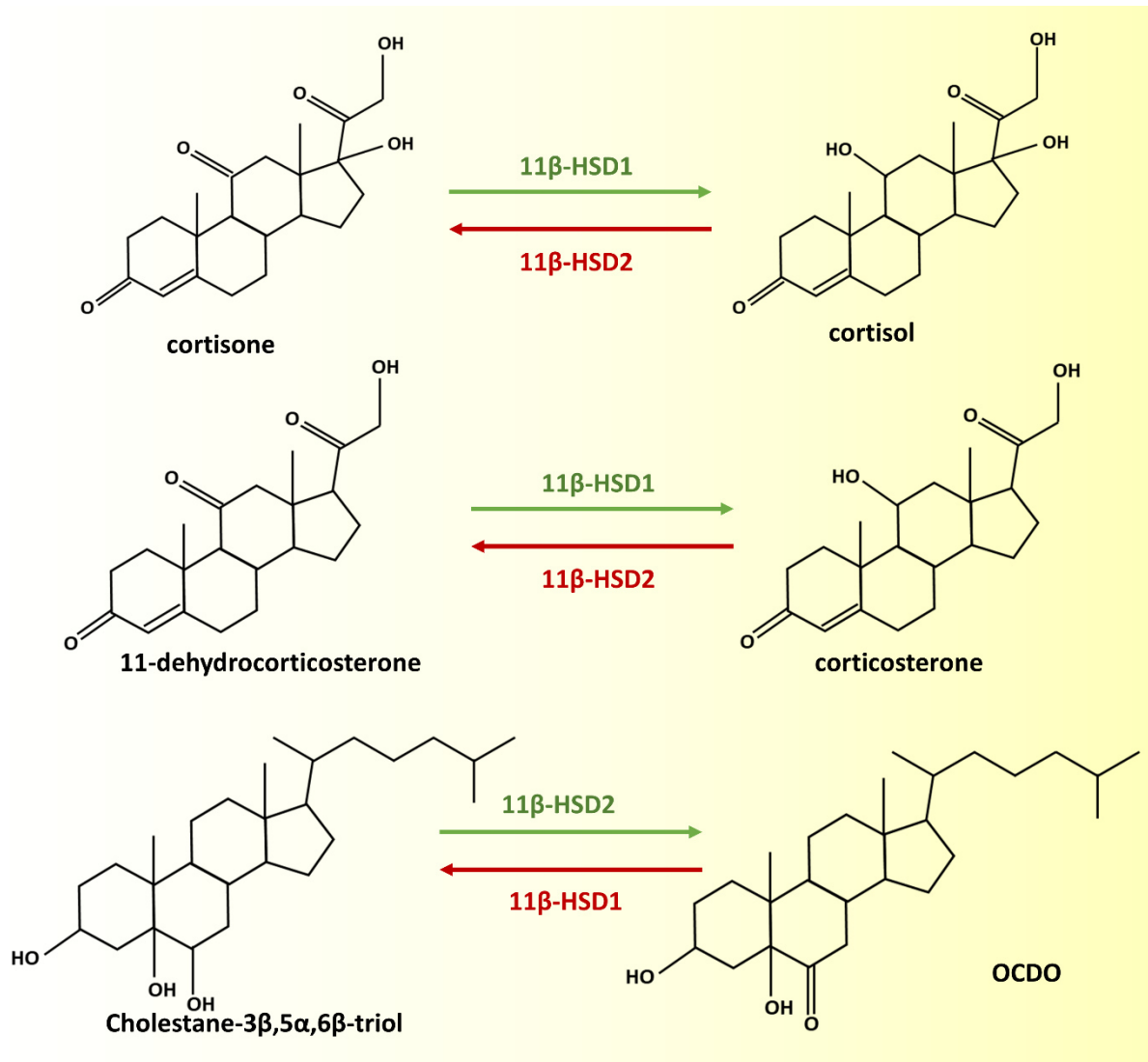
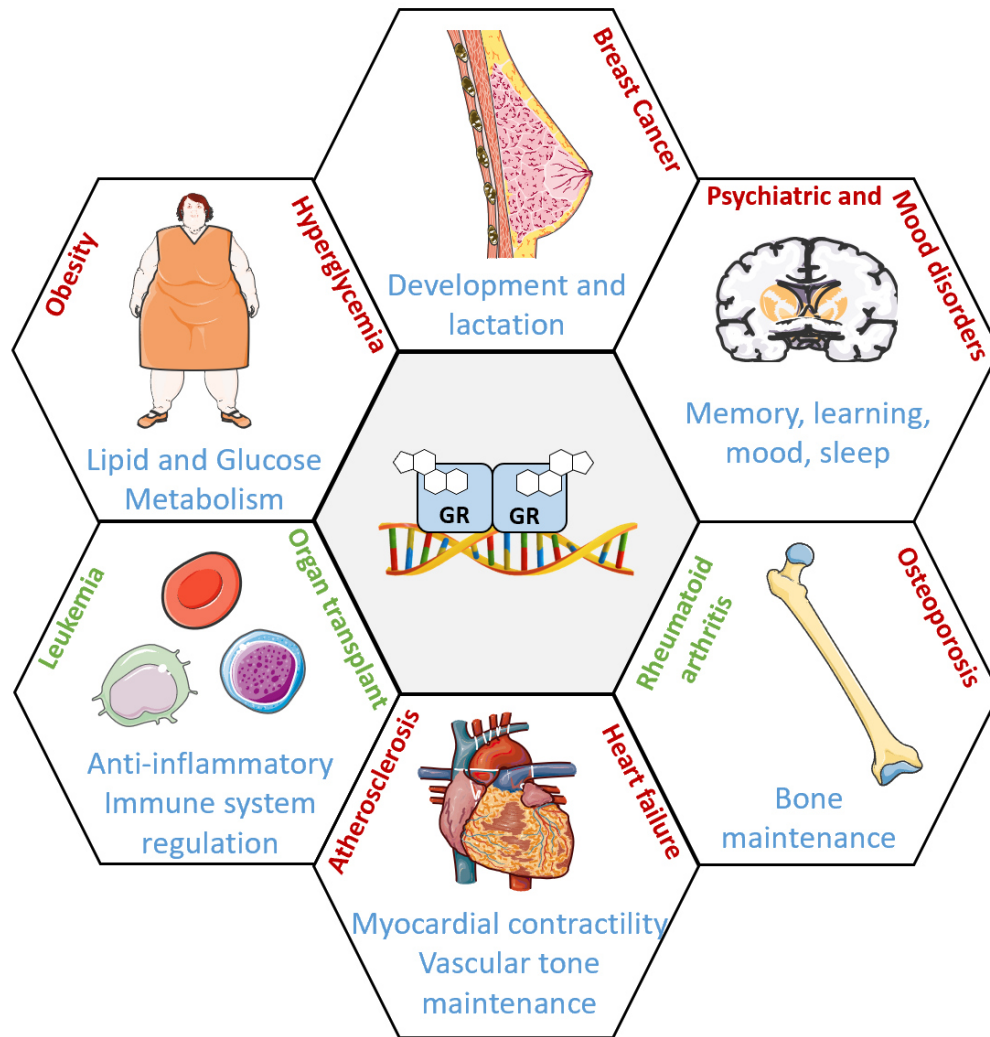

Figure 12 : Metabolism of glucocorticoids and OCDO.

1.3. Biological Roles of GCs

Glucocorticoid receptor is nearly expressed in every cell type which reflects the role of GCs in every biological function. Endogenous GC level is tightly regulated to ensure correct development, function and maintenance of the body organs and systems. Thus, the increase of GC level in late prenatal life, in active periods of the day, and as response to stresses, has physiological and indispensable effects on body health. GCs have important role in embryo implementation and early development, late fetal organ maturation, post-natal development, and homeostasis maintenance (Busada and Cidlowski, 2017) (Figure 13).



(Noureddine et al., 2021)

Figure 13 : Actions of GCs in Health and Disease. Beneficial effects are presented in blue, effects of GC treatment are presented in green, and their side effects are in red.

1.3.1. Role of GCs in Glucose Metabolism

GCs got their name because of their key role in glucose metabolism. GCs manipulate blood glucose concentration and regulate glucose metabolism at many levels. Primarily, GCs act on different organs to finally increase the circulating blood sugar, a process which is critical during active times and periods of stress, like fasting or starvation. GCs act on skeletal muscles and white adipose tissue to reduce the uptake of glucose mainly by interfering with insulin signaling, thus decreasing insulin sensitivity in these organs (Saad *et al.*, 1993; Kuo *et al.*, 2012a, 2012b, 2015a)

On the other hand, GCs act at the level of liver to upregulate the enzymes involved in gluconeogenesis, a process of glucose synthesis from non-carbohydrate precursors including gluconeogenic amino acids, glycerol, and lactate (Kuo *et al.*, 2015a). It was shown that in absence of GCs *in vivo* in adrenalectomized rats, the permissive effect of epinephrine and glucagon on gluconeogenesis is disrupted, and it is only restored after re-introduction of GCs. GCs can also activate gluconeogenesis by providing higher level of its precursors. They act on muscles to activate protein degradation, thus providing gluconeogenic amino acids, and they act on white adipose tissue to activate lipolysis, thus providing glycerol (Exton *et al.*, 1972; Kuo *et al.*, 2015a).

GCs can also modulate glycogen metabolism, however in a tissue specific manner, although the final output was shown to be an increase in glycogen in all cases. At the level of liver, GC was found to increase glycogen synthesis possibly by activation of the phosphatase involved in glycogen synthase activation (de Wulf and Hers, 1967; Vanstapel, Dopere and Stalmans, 1980; Kuo *et al.*, 2015a). However, at the level of muscles, GCs seem to be a mediator of the epinephrine-induced glycogenolysis and an inhibitor of insulin-stimulated glycogen synthesis. This suggests that the level of glycogen may decrease in muscles in response to GCs, however an increase was reported, although the mechanism of this increase was not clear (Coderre, Srivastava and Chiasson, 1991; Ruzzin, Wagman and Jensen, 2005; Kuo *et al.*, 2015a).

Additionally, GCs have a direct effect on beta cells of the pancreas, which are responsible for insulin secretion. The effect of GCs on these cells is still controversial as there are many discrepancies between *in vitro* and *in vivo* models. *In vitro*, treatment of beta cells with GCs induced apoptosis through different pathways that are dependent on GR activation. Moreover, GCs inhibited the release of insulin from beta cells (Beaupere *et al.*, 2021).

However, *in vivo*, the results were controversial. Some studies reported disruption of insulin release in response to GCs, while others reported a proliferation in beta islet cells which re-establish the amount of insulin secreted and regulates serum glucose. This compensatory mechanism fails when high level of GCs was maintained for long intervals due to an enormous increase in insulin resistance. Thus, the effect of GCs, especially of endogenous origin, on insulin secretion is not yet clear and needs more investigations, especially *in vivo* (Beaupere *et al.*, 2021).

1.3.2. Role of GCs in Immune System

GCs are well known for their immunosuppressive action which made synthetic GCs widely used to attenuate excessive inflammation, allergic and autoimmune diseases, as will be detailed in the following section. Yet, in the past two decades, endogenous GCs were shown to have both immunosuppressive and immune activation activities. The conclusions concerning endogenous GCs were mainly obtained using cell-specific GR knock-out in mice. In these studies, GCs were shown to inhibit cytokine production by different cells of the innate and the adaptive immune system (Bhattacharyya *et al.*, 2007; Kugler *et al.*, 2013; Li *et al.*, 2015; Quatrini *et al.*, 2017, 2018; Acharya *et al.*, 2020; Shimba and Ikuta, 2021).

In fact, GCs can inhibit Th1 cells differentiation by a direct interaction between GR and a transcription factor indispensable for Th1 phenotype, T-bet, thus abolishing its transcriptional activity (Liberman *et al.*, 2007). Also, they inhibit IL-12 and IL-18 secretion by antigen presenting cells (APCs), which are 2 cytokines important for the differentiation into Th1 phenotype (Blotta, DeKruyff and Umetsu, 1997; Kodama *et al.*, 2002; Shimba and Ikuta, 2021).

Moreover, GCs were found to attenuate inflammation via acting on non-immune cells, such as lung epithelial cells and endothelial cells (Goodwin *et al.*, 2013; Gibbs *et al.*, 2014).

Thus, physiologically, endogenous GCs can protect against excessive inflammation and over-activation of the cell-mediated adaptive immunity upon stimulation.

In the past few decades, GCs were also found to have immune enhancing roles. In contrast to the role of GCs in inhibition of various cytokine production, they were found to enhance the expression of cytokine receptors in different cell types, which was characterized with a more robust immune response in active compared to non-active periods (Wiegers and Reul, 1998; Franchimont *et al.*, 2002; H.-C. Lee *et al.*, 2005; Shimba *et al.*, 2018). Thus, GCs can aid in the survival and activation of T cells. Additionally, Shimba *et al.* described an important role for GCs in the differentiation of Th2 subset and, subsequently, in the induction of the humoral immune response. Also, GCs were proved to have a positive effect on the survival and maintenance of Th2 memory cells, thus confirming a huge contribution to the humoral immune response (Shimba *et al.*, 2018).

Although synthetic GCs are prescribed to attenuate inflammation, endogenous GCs may be contributors to autoimmune and inflammatory diseases in response to long-term stress. Actually, it was shown that GCs exerts a permissive role on Th17 cell differentiation and function, which contributes to the development of autoimmune diseases (Marchetti *et al.*, 2001; de Castro Kroner *et al.*, 2018).

Therefore, GCs have pleotropic effect on the immune system. Although it was initially thought that they act as immuno-suppressors, they were then found to have immune activation roles. The final output of GC action may depend on their level, the microenvironment, and the target effector cell.

1.3.3. Role of GCs in Cardiovascular System

Several studies provided evidence for a role of GCs in fetal heart development. In fact, GC surge from the mother to fetus occurs in many mammals during late fetal life, and it was shown to have major role in the development and maturation of different organs (Fowden, Li and Forhead, 1998). In different models, exogenous GCs administration during fetal life, or shortly after birth, improved structural and functional maturity of the heart (Song *et al.*, 2019). GR knockout studies highlighted the role of endogenous GCs in cardiac function. Interestingly, mice with conditional deletion of GR in cardiomyocytes were born normally but gradually developed left ventricular hypertrophy and a deterioration in systolic function leading to heart failure and premature death (Oakley *et al.*, 2013).

GCs, at physiological level, also aid in the protection of the cardiovascular system at different levels in response to stress. GCs were found to be critical for cardiac repair after tissue injury and for the survival of cardiomyocytes in stress conditions (Tokudome *et al.*, 2009; Galuppo *et al.*, 2017). Moreover, endogenous GCs were shown to be important for the short-term stress response by the cardiovascular system manifested by increasing of heart rate and blood pressure (Bencze *et al.*, 2020).

Thus, physiological level of GCs is important for the development, maturation and maintenance of the cardiovascular system.

1.3.4. Role of GCs in Lung Development

Mice with global GR knockout showed an impairment of lung development. They die shortly after birth with symptoms of respiratory failure. Histological examination of lung from GR-/- mice provided evidence for dysfunctional development of the lung (Cole *et al.*, 1995, 2004; Bird *et al.*, 2007; Daniel Bird *et al.*, 2015).

Mechanistic studies showed that GCs act on mesenchymal by promoting the development of lungs to provide paracrine signal for the correct differentiation and maturation of different alveolar epithelial cells. On the level of mesenchymal cells themselves, GR signaling inhibits proliferation and induces elastin synthesis. All these events happen in late fetal life and contribute largely to the formation of functional alveolar sacs (Daniel Bird *et al.*, 2015).

1.3.5. Role of GCs in Bone Development

GCs play pleiotropic but important role on bone homeostasis, which is largely determined by their level. At physiological level, GCs are important in the development and the maintenance of bone mass. However, at higher pathological or exogenous levels, GCs disrupt bone homeostasis, as will be clarified in the next subsection [Martin 2021]. Studies with GC signaling disruption showed decreased bone mass *in vivo* and mineralization capacity of osteoblasts *in vitro* (Sher *et al.*, 2006; Kalak *et al.*, 2009; Rauch *et al.*, 2010; Yang *et al.*, 2010)

2. Synthetic Glucocorticoids (GCs)

Synthetic GCs are a group of drugs structurally and functionally related to the endogenous GC hormone “cortisol”. They are widely used as treatments for various health conditions and diseases (Parente, 2001; Timmermans, Souffriau and Libert, 2019).

2.1. Types and Characteristics

Synthetic GCs share structural similarities with the cortisol molecule with few chemical modifications that improve the therapeutic activities of these drugs and reduce their side effects compared to their endogenous counterparts (**Figure 14**) (Parente, 2001; Bourdeau and Stratakis, 2003; Adcock and Mumby, 2016). Early treatments used endogenous GCs to treat different health conditions. However, half-life of these molecules was short and they had many side effects. Thus, different modifications were introduced to the structure, and the structure-activity relationship was thoroughly studied, to finally obtain GC molecules with

enhanced potency. The structural modifications of synthetic GC improve biological potency via affecting drug absorption, protein binding capacity, metabolic transformation rate, excretion rate, membranes traverse ability and intrinsic effectiveness of the molecule. Moreover, synthetic GCs have greater GR activation abilities, and most of them act specifically via GR rather than mineralocorticoid receptor (MR), unlike endogenous GC which can activate both. Also, most of these molecules are not susceptible to inactivation by the endogenous enzymes that regulate endogenous GC bioavailability.

The first modification was done by the introduction of a fluorine group at C9- α (compared to cortisol structure) which enhanced drug potency and increased its binding affinity to GR, this molecule was called fludrocortisone (**Figure 14**). This drug, which was introduced in 1954, was used in mineralocorticoid replacement therapy because of its potent mineralocorticoid (increased 125-fold relative to cortisol) alongside glucocorticoid activity (increased 10-fold relative to cortisol). On the other hand, the introduction of a double bond between C-1 and C-2 (compared to the cortisone structure) as in prednisone increased anti-inflammatory activity of about five-fold because it is metabolized more slowly as it requires activation by 11 β -HSD1 to be in its active form, prednisolone (**Figure 14**). Interestingly, this drug demonstrated reduced MR activation abilities compared to cortisone, and thus it had fewer side effects. In 1956, a methyl group was added at position C6- α of prednisolone to obtain methylprednisolone which has a greater anti-inflammatory effect and even lower mineralocorticoid activity than prednisolone (**Figure 14**) (Bourdeau and Stratakis, 2003).

A combination of C9- α fluorination with the introduction of double bond between C-1 and C-2 and insertion of 16 α -hydroxyl group (compared to the structure of cortisol) led to the synthesis of triamcinolone in 1958 that shows similar potency compared to methylprednisolone. Further studies were done showing that the introduction of a methyl group at position C-16 increases the stability of drugs in human plasma, intensify the anti-inflammatory activity and reduces mineralocorticoid activity. Thus, two anti-inflammatory GC with very high potency were developed in 1958. These molecules had a methyl group in position C16- α & β for dexamethasone (Dex) (compared to the structure of fludrocortisone) and betamethasone (compared to the structure of triamcinolone) respectively, in addition to a fluorine atom in position C9- α which further increases glucocorticoid activity. These steroids

are 25-fold more potent than cortisol as anti-inflammatory compounds and have a longer half-life (**Figure 14**) (Bourdeau and Stratakis, 2003).

A modification of Dex was done in order to reduce the electrolyte loss, obtaining a new drug in 1960, called Paramethasone acetate that retains the 16 α -methyl group but the fluorine group is moved from 9 α to 6 α position. After this many new modifications were introduced so that nowadays we have a repertoire of synthetic GCs used for the treatment of wide range of health conditions (Parente, 2001; Mohammadi *et al.*, 2020) (**Figure 14**).

Synthetic GCs can be divided into short-acting, mid-acting and long-acting drugs, based on their half-life. Duration of action of cortisone is between 8 and 12 hours, whereas prednisone, prednisolone, methylprednisolone and triamcinolone have longer duration of action that is between 12 and 36 hours. Dex and betamethasone have the longest half-lives, with a duration of action that ranges from 36 to 54 hours (Timmermans, Souffriau and Libert, 2019; Yang and Yu, 2021).

Synthetic GCs can be classified based on their mode of administration. Exogenous GCs can be administered systemically, using oral or intra-venous route, or non-systemically according to the target organ. Non-systemic GC treatments are either applied topically, inhaled, or administered intra-articularly (Bourdeau and Stratakis, 2003; Adcock and Mumby, 2016; Paragliola *et al.*, 2017).

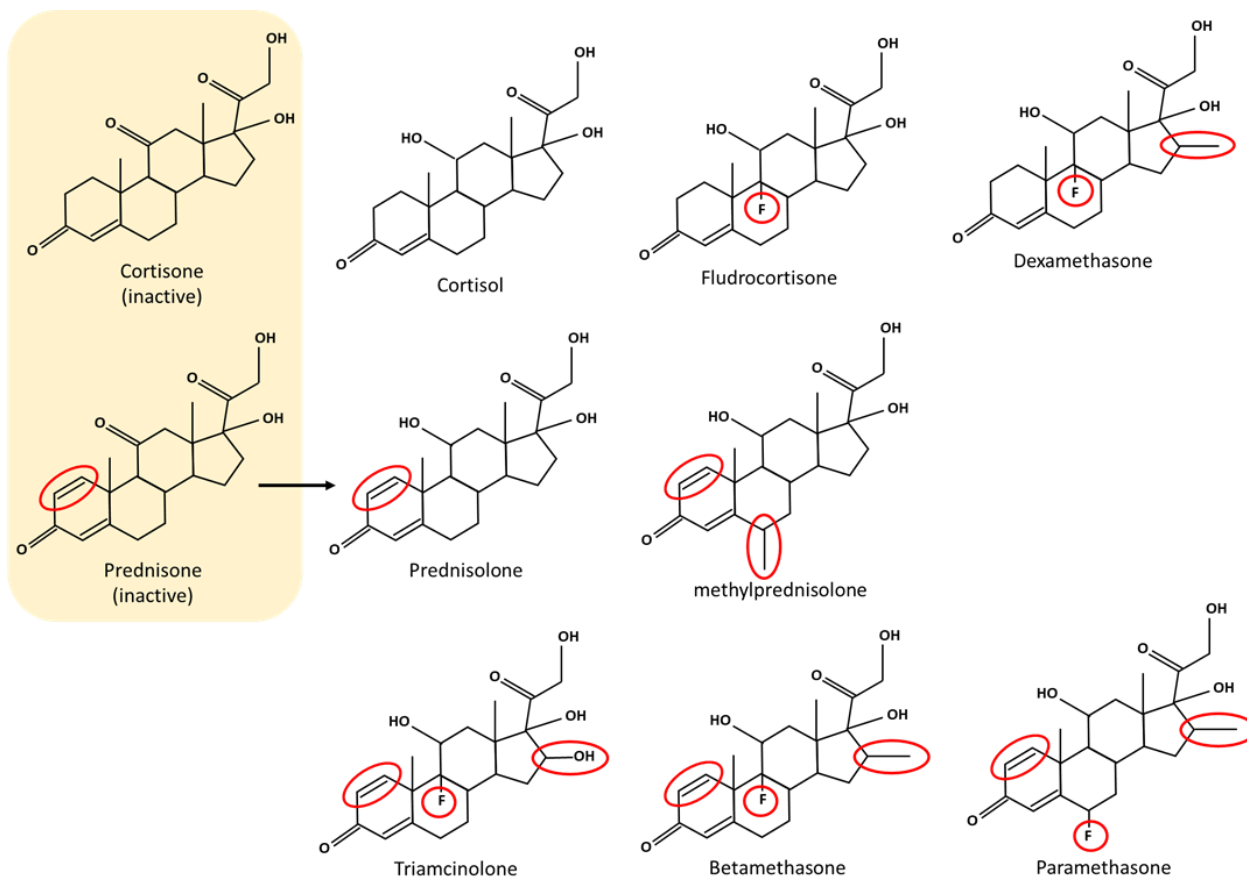

Figure 14 : The structure of the synthetic GCs with red rings showing the differential functional modifications compared to cortisol, or cortisone in case of prednisone.

2.2. GCs in Clinics

Synthetic GCs possess potent anti-inflammatory and immunosuppressive actions. Due to these two main actions, they are considered important drugs in the treatment of autoimmune and inflammatory conditions. Also, they were shown to have anti-cancer effects. Thus, they are now also used in cancer treatment (Parente, 2001; Bourdeau and Stratakis, 2003). In this part, the most common condition for which GC treatment is prescribed are highlighted, although they are nowadays used for a wider range of conditions.

2.2.1. Cancer

Synthetic GCs are administered as adjuvants in the treatment of different types of cancer in combination with chemotherapy, radiotherapy or immunotherapy thanks to their powerful role in reducing the side effects of these therapies.

GCs are also used to treat the hematopoietic malignancies of the lymphoid lineage, such as multiple myeloma, acute lymphoblastic leukemia, chronic lymphocytic leukemia, Hodgkin's and non-Hodgkin's lymphomas. In these cancer cells, they were shown to induce cell cycle arrest and apoptosis via several pathways, including activation of the pro-apoptotic protein, BIM, and down-regulation of the anti-apoptotic protein, BCL2. Also, through inhibiting the action of activator protein 1 (AP-1) and nuclear factor kappa B (NFkB), GCs inhibit the expressive of survival cytokines. Moreover, GCs up-regulate thioredoxin interacting protein (TXNIP), which results in accumulation of reactive oxygen species leading to apoptosis.

In non-hematopoietic malignancies, GC treatment showed controversial effects concerning the inhibition of tumor progression and metastasis. The output of these therapies largely depends on cancer type and stage, GR expression level and GC administered dose. In ovarian, prostate and breast cancer, some studies showed that GC can suppress tumor growth, metastasis and angiogenesis, through multiple signaling pathway, part of which involves the modulation of microRNA expression (Lin *et al.*, 2015; Pufall, 2015; K. T. Lin and Wang, 2016; Yang and Yu, 2021).

2.2.2. Respiratory Diseases

Respiratory diseases are mainly characterized with increased inflammation and over-reaction of the immune system, which lead to adverse health effects and even death. Thus, due to their anti-inflammatory and immunosuppressive properties, synthetic GCs were used widely for treatment of severe immune-related diseases affecting the lungs.

GCs are used, as monotherapy or in combination with other drugs, in the treatment of asthma and chronic obstructive pulmonary disease (COPD). They target various cells implicated in asthmatic inflammation and thus considered as the most successful anti-inflammatory treatment used for this disease. Budesonide is a potent inhaled glucocorticoid, and it is one of the most widely used treatments for asthma. It can be administered by nebulization which makes it a suitable treatment in infants, elderly, and in intensive-care settings. Budesonide showed high efficiency as a monotherapy in both adults and children and in a broad range of asthma severities and dose regimens. Its efficacy was increased when combined with formoterol, a bronchodilator (Adcock and Mumby, 2016; Tashkin, Lipworth and Brattsand, 2019).

With the onset of COVID-19 pandemic, many studies addressed the usage of GC as a treatment, especially in severe cases. On 2 September 2020, WHO recommended GCs as standard treatment for severe COVID-19 cases. In COVID-19 patients, Dex (at a dose of 6 mg per day) was shown to reduce the number of deaths in ventilated patients by one-third, and in patients receiving oxygen therapy, by one-fifth. On the other hand, no benefits were seen in patients with less severe COVID-19 cases. Simultaneously, another study showed that a low-dose of methylprednisolone (40 mg per day for 3-4 days followed by 20 mg per day for 3-4 days) was successful in improving the clinical tests and chest CT images in 7 out of 9 patients with severe or critical COVID-19 cases (Braz-de-Melo *et al.*, 2021; Yang and Yu, 2021).

Other types of synthetic GCs showed effective therapeutic results in less severe COVID-19 cases, among which is budesonide which showed high efficacy when inhaled for a short period (Ramakrishnan *et al.*, 2021).

2.2.3. Rheumatoid Disorders

Rheumatological disorders are autoimmune diseases mainly affecting the joints and characterized with high level of inflammation. Thus, GCs were widely used as a treatment for this condition.

Because of their strong anti-inflammatory effect and long half-life, prednisolone and methylprednisolone are mainly used in the treatment of rheumatoid immunological diseases. As anti-rheumatic drug, a lower dose of these drugs was required compared to cortisol, and it induced fewer side effects (Parente, 2001; Yang and Yu, 2021). Also, the usage of prednisone as a monotherapy in a dose of 10 mg per day for 6 months was able to inhibit the progression of joints damage (Van Everdingen *et al.*, 2002). Studies also showed that deflazacort, another synthetic GC is as effective as prednisone or methylprednisolone for both short- and long-term therapies of rheumatoid arthritis and other Rheumatological disorders like juvenile chronic arthritis, sarcoidosis, polymyalgia rheumatica (Parente, 2001, 2017).

2.2.4. Gastrointestinal Diseases

The gastrointestinal tract is susceptible to a range of inflammatory and autoimmune diseases, which make GCs efficient therapeutic candidates. Budesonide, for example, is an effective GC treatment for various chronic gastrointestinal diseases including Crohn's disease, ulcerative

colitis, and microscopic colitis. Budesonide is a recommended and approved drug for reducing the symptoms of Crohn's disease with different degrees of severity. Compared to prednisolone, which can also be used, it has same efficacy with fewer side effects, thus making it a better drug candidate for this disease. In ulcerative colitis, Budesonide was shown to be an effective treatment when given either systematically or by using rectal foam and enemas which require lower doses and thus exert fewer side effects. Budesonide is also used for decreasing the symptoms of microscopic colitis and postponing the relapse of symptoms (Odonnell and Omorain, 2010).

2.2.5. Organ Transplantation

Due to their immunosuppressive, anti-inflammatory and lympholytic effects, GCs were widely administered to patients receiving organ transplantation to minimize the risk of organ rejection. Mainly, two GCs, methylprednisolone and prednisone, are used as part of the immunosuppressive regimen in case of organ transplantation. In case of kidney transplantation, the common protocol consists of the administration of intravenous dose of methylprednisolone perioperatively, followed by a transition to oral administration of prednisone for 3 to 5 post-operative days (Steiner and Awdishu, 2011).

2.3. GCs Adverse Side-Effects

GC beneficial health effects made them great candidate drugs for different diseases. However, they can exert adverse side effects on different systems and tissues specially when administered in high doses and for long time. Side effects observed in case of synthetic GCs are similar to those observed in case of pathological elevation of endogenous GCs. GCs side effects varies from mild to severe depending on time and dosage of the treatment, alongside other factors including age, co-morbidities and the simultaneous administration with other drugs. Severe side effects could be life-threatening and thus GCs should be prescribed with caution (Bourdeau and Stratakis, 2003; Yasir, Goyal and Sonthalia, 2022). Herein, some of the GCs adverse side effects are mentioned.

2.3.1. Metabolic Dysfunction

Depending on the dose and the co-morbidities, GC treatments can induce hyperglycemia and insulin resistance, a phenotype similar to that seen in type 2 diabetes. As mentioned earlier,

GCs act at the level of muscles, liver and white adipose tissue, to increase glucose blood concentration via interfering with insulin signaling. After the cessation of the treatment, blood glucose can return to its basal level, in case of short-term therapy and the absence of co-morbidities. On the other hand, GCs also activate lipolysis in white adipose tissue thus inducing dyslipidemia. Actually, obesity is one of the most known side effects of GC treatments which is accompanied by a great increase in appetite. The latter could be important in some cases as when GCs are given with other therapies to attenuate the loss of appetite, but it is not beneficial in other conditions (Noetzelin *et al.*, 2022).

2.3.2. Hypothalamic-pituitary-adrenal (HPA) axis suppression

GCs, especially at supra-physiological plasma level, exert a negative feedback on the HPA axis thus decreasing the secretion of CRH from the hypothalamus, ACTH from the anterior pituitary gland and endogenous cortisol from adrenal gland. After stopping GC treatment, the restoration of normal cortisol secretion by the HPA axis may take up to a year or two. Thus, an abrupt cessation of LONG-TERM glucocorticoids administration will lead to a lack in both exogenous and endogenous GCs, and thus may have adverse health effects. Among synthetic GC types, dexamethasone is the most potent ACTH suppressor, however prednisone, prednisolone, methylprednisolone and triamcinolone are moderately suppressive of the HPA axis (Bourdeau and Stratakis, 2003; Paragliola *et al.*, 2017; Gjerstad, Lightman and Spiga, 2018).

2.3.3. Effects on Gonads

High level of GCs disrupts the endocrine signaling pathways in the hypothalamic-pituitary-gonadal axis. It inhibits the secretion of gonadotropins (FSH and LH) by the pituitary gland and thus suppress the production of sex steroids by the gonads. Chronic treatment with GCs induces hypogonadism that can lead to infertility in men and menstrual irregularities in women (Bourdeau and Stratakis, 2003; Whirledge and Cidlowski, 2010).

2.3.4. Mineralocorticoid Effects

GCs had a mineralocorticoid activity resulting from their high affinity to mineralocorticoid receptor (MR), which is usually considered as a side effect of GC treatment. the activation of MR by GCs induces an increase in sodium retention and in kidney excretion of both potassium

and hydrogen ions, which leads, in severe cases, to hypertension and hypokalemic alkalosis. Among the synthetic glucocorticoids, Dexamethasone and betamethasone have minimal mineralocorticoid activity, whereas prednisone and prednisolone have some, but very limited, activity (Bourdeau and Stratakis, 2003).

2.3.5. Musculoskeletal Effects

Patients exposed to high levels of GCs were found to have low bone mineral density. GCs induce osteoporosis by increasing bone resorption and reducing bone formation. Bone formation is decreased via several mechanisms including direct inhibition of osteoblast activity and induction of osteoblast and osteocyte apoptosis. On the other hand, GCs act directly and indirectly to induce osteoclast activation. Indirectly, in a paracrine way, through stimulating osteoblasts which in turn activate nearby osteoclast. Moreover, GCs can activate bone resorption by reducing androgen and estrogen secretion through the hypothalamic-pituitary-gonadal axis (Bourdeau and Stratakis, 2003; Kondo *et al.*, 2008; Martin, Cooper and Hardy, 2021; Yasir, Goyal and Sonthalia, 2022).

Furthermore, GCs induced myopathy which is a reversible painless condition characterized by muscle atrophy. This results from increased protein breakdown and decreased protein synthesis in response to the catabolic action of GC (Schakman *et al.*, 2013; Yasir, Goyal and Sonthalia, 2022).

2.3.6. Effects on Immune System

GC administration affects the immune system via acting on various immune cells and functions. GCs decrease the neutrophil adherence to the vascular endothelium which inhibits them from passing toward the inflammatory sites or the bone marrow, which leads to the increase of circulating neutrophils within hours after GC administration. Also, they inhibit antigen processing by macrophages, which lead to a failure in early recognition of infection, a suppression in T-cell helper function and an inhibition in cytokine synthesis. All these effects place the patient under high risk of infections (Bourdeau and Stratakis, 2003; Yasir, Goyal and Sonthalia, 2022).

2.3.7. Psychological Effects

GCs exerts pleiotropic effects on the nervous system. In physiological settings, endogenous GCs bind to MR in the brain rather than GR due to its greater affinity. Those receptors may exert differential functions and they are expressed in different regions of the brain. Also, the blood-brain barrier controls the passage of GCs. However, in the case high doses of endogenous GC under certain stresses, this equation changes, and GCs can pass to the brain and activate GR, thus affecting cognition, mood and memory. Synthetic GCs can act differentially according to their affinity to MR, their ability to cross the blood-brain barrier and their ability to inhibit the production of endogenous GCs. Thus, according to the dosage and the type of synthetic GCs used, they may affect brain structure and function. In different settings, GC treatment was shown to increase the risk of memory defects and mood changes including depression, irritability, anxiety and social withdrawal. However, these effects were not obtained in all studies (Bourdeau and Stratakis, 2003; Fardet, Nazareth and Petersen, 2008; van der Goes, Jacobs and Bijlsma, 2014; Hill and Spencer-Segal, 2021; Yasir, Goyal and Sonthalia, 2022).

3. OCDO

6-oxo-cholestan-3,5-diol (OCDO), also known as cholestane-6-oxo-3,5-diol or Yakkasterone (CAS N 13027-33-3), is an oxysterol that has been recently identified as a GR-ligand [Poirot M 2018, Voisin M, 2017]. Oxysterols are oxidation products of cholesterol that are generated by enzymatic and/or autoxidation processes. Principally, these oxysterols are implicated in the modulation of different nuclear receptor activities, including the liver x receptor (LXR), retinoid acid receptor-related orphan receptor (ROR), estrogen receptors (ER), and glucocorticoid receptors (GR). Oxysterols have various physiological properties, and deregulation of their metabolism is associated with several pathologies, including cancer (Oikkonen, Béaslas and Nissilä, 2012; Silvente-Poirot, Dalenc and Poirot, 2018). Identifying new oxysterols, such as OCDO, and understanding their metabolic pathways, is therefore critical for improved diagnosis and for the development of novel anticancer agents.

The evaluation of cells from various healthy mouse tissues showed that OCDO is not produced in normal tissues. Medina Et al. described, for the first time, OCDO as a compound with

oncogenic properties (*Methods for determining the oncogenic condition of cell, uses thereof, and methods for treating cancer - Patent US-2012100124-A1 - PubChem*).

The metabolic process that leads to OCDO synthesis involves multiple enzymes. In 1949, the synthesis of OCDO *in vitro* via oxidation of Cholestane-3 β ,5 α ,6 β -triol (CT) by N-Bromo succinimide was described (Fieser and Rajagopalan, 1949). Later, in 1971, a study reported the production of OCDO as a metabolite of CT *in vivo*. OCDO was isolated and identified in the feces of rats fed on CT (Roscoe and Fahrenbach, 1971). Recently in 2017, Voisin et al. identified 11 β -HSD2 as the enzyme responsible for the final step in the conversion of CT to OCDO (**Figure 12**) (Voisin *et al.*, 2017). Correspondingly, in a panel of breast cancer cell lines that produce OCDO, 11 β -HSD2 mRNA and protein expression were detected, but not that of 11 β -HSD1. Moreover, when incubated with [14C]-CT, HEK293 cells transfected with a plasmid encoding 11 β -HSD2, produced significantly higher levels of OCDO in comparison with cells transfected with a plasmid encoding the empty vector. As mentioned earlier, 11 β -HSD2 regulates glucocorticoid metabolism by converting active cortisol to inactive cortisol. Interestingly, results also showed that biosynthesis of OCDO by 11 β -HSD2 could also be reversed back into CT by 11 β -HSD1, the same enzyme involved in cortisone transformation into cortisol (Voisin *et al.*, 2017) (**Figure 12**). In mammalian cells, it is well established that cholesterol-5,6-epoxide hydrolase (ChEH) mediates the conversion of cholesterol-5,6-epoxides (5,6-ECs) to the carcinogenic CT. Indeed, several studies showed that inhibiting ChEH abrogates OCDO production in breast cancer cells (*Methods for determining the oncogenic condition of cell, uses thereof, and methods for treating cancer - Patent US-2012100124-A1 - PubChem*; Voisin *et al.*, 2017). 5,6-ECs were reported to be biosynthesized from cholesterol via the oxidation of cholesterol by free radicals (Griffiths *et al.*, 2019; Wang, Yutuc and Griffiths, 2021). Besides CT and its putative metabolite OCDO in tumor cells, 5,6-ECs can generate Dendrogenin A (DDA). DDA, which is identified as a tumor suppressor, is the product of the conjugation of 5,6 α -epoxy-cholesterol and histamine and is a selective inhibitor of ChEH (Poirot and Silvente-Poirot, 2018).

Alongside cancer cells, OCDO can also be produced in the lung with ozone toxicity. The levels of 5,6-ECbeta and its metabolite OCDO in the lungs of mice exposed to ozone increased in comparison with control mice in a dose-dependent manner (Pulfer *et al.*, 2005).

In vitro, the treatment with OCDO increases the proliferation of the human medullary thyroid carcinoma cell line in a concentration-dependent manner. *In vivo*, the subcutaneous injection of these same carcinomic cells, after their recovery, into female mice showed that OCDO treatment significantly accelerates tumor growth; the tumor volume in the animals treated with OCDO is almost three times larger than in control animal treated with the solvent. Histological analyses showed more invasion of the lymph nodes in the animals treated with OCDO compared with the animals treated with the solvent. Treatment with OCDO was also shown to decrease the production of the immunostimulatory cytokine IL-12 and increase the production of the immune suppressive cytokine, IL-10 in THP1 (human myeloid cell line). This could explain the cause of OCDO invasive capacities in vivo (*Methods for determining the oncogenic condition of cell, uses thereof, and methods for treating cancer - Patent US-2012100124-A1 - PubChem*).

In addition, OCDO was found to significantly enhance breast cancer (BC) cell proliferation independently of ER α expression status in vitro and in vivo, in tumors grafted into mice. As OCDO is structurally related to cortisol, the possibility of its binding to GR was investigated. Indeed, surface plasmon resonance (SPR) assays showed that OCDO binds to the ligand binding domain (LBD) of the GR. Also, it is structurally related to another cholesterol metabolite, the oxysterol 27-hydroxycholesterol, which exerts a proliferative effect on breast cancer cells through binding to ER α and the liver-X-receptors (LXRs). However, it was found that OCDO interacts with the LBD of LXRs but not with ER α (2). By binding to the GR, OCDO acts as a competitive inhibitor of cortisol, as shown by competition binding assays. Like cortisol, OCDO activates GR nuclear localization, as shown by the increased level of GR nuclear localization in MDA-MB231 cells treated with OCDO. Cell cycle analysis by flow cytometry of MDA-MB231 cells showed that OCDO induced cell cycle progression by decreasing the percentage of the G0/G1 phase and increasing the S and G2/M phases, explaining the mechanism of GR-dependent promotion of tumor cell proliferation by OCDO (Voisin *et al.*, 2017).

Although both OCDO and endogenous GCs activate the same receptor, the gene expression profiles altered after treatment of MDA-MB231 cells with OCDO appear to be distinct from those observed in the case of cortisol or dexamethasone treatment. Although the mechanism behind these differential profiles is not yet understood, it may be the reason behind the

opposite actions of these steroid molecules on cancer cells. For example, OCDO had no effect on the transcription of canonical endogenous genes normally regulated by GR after cortisol and DEX binding. On the other hand, OCDO significantly increased MMP1 gene transcription which is significantly inhibited by cortisol and DEX. The knock-down of GR in MDA-MB231 cells abolished OCDO-induced upregulation of matrix metalloprotease 1 (MMP1), confirming that OCDO activating MMP1 expression by activating GR (Voisin *et al.*, 2017).

Interestingly, studies on human samples confirmed the effect of OCDO on tumor proliferation. Significantly higher levels of OCDO and its synthesizing enzymes ChEH and 11HSD2 were detected in BC patient samples compared to normal tissues, and mRNA database studies revealed that overexpression of these enzymes was associated with a poor prognosis. Correspondingly, by using ChEH inhibitors (e.g., Dendrogenin A, DDA), by 11 β HSD2 silencing or by antagonizing GR (with mifepristone), OCDO effects and tumor growth were reduced (Voisin *et al.*, 2017).

In addition, OCDO can contribute to tumor growth in vivo via action on other cell types. In fact, OCDO was shown to inhibit the activity of natural killer cells and cytotoxic T lymphocytes which are important factors in anti-tumor immune response. Previously, in the spleen of mice enriched to produce natural killer (NK) cells and cytolytic T Lymphocytes (CTL), among 7 distinct oxysterols, OCDO showed the strongest inhibition of NK cell-mediated cytotoxicity and CTL cells activity (Kucuk *et al.*, 1992; Küçük *et al.*, 1994).

Chapter III: Glucocorticoids Receptor

1. Genomic Structure of the Human-GR Gene

Human Glucocorticoid receptor (h-GR) is encoded by a single gene the “nuclear receptor subfamily 3 group c member 1” (*NR3C1*) localized in the chromosome 5 short arm (5q31.3) (Hollenberg *et al.*, 1985). The *NR3C1* gene is composed of 9 exons, in which exons 2-9 encode for the GR protein (Charmandari, Kino and Chrousos, 2004; Nicolaidis, Charmandari and Chrousos, 2018). Exon 1 encodes for the 5'-untranslated region (5'-UTR) known as the promoter region of GR. This region has distinct features as it lacks TATA or CAT boxes and presents an extensively GC-rich motif (Zong, Ashraf and Thompson, 1990). Far so, there are 13 h-GR exon 1 variants different in the upstream promoter regions (Breslin, Geng and Vedeckis, 2001; Turner and Muller, 2005; Bockühl *et al.*, 2011). The existence of these alternative promoters is responsible for the different expression levels of GR protein isoforms among tissues and cells (Presul *et al.*, 2007). Moreover, these promoter regions possess various binding sites for transcription factors (TFs) such as AP1 and IRF (Breslin and Vedeckis, 1996; Nunez *et al.*, 2005; Vandevyver, Dejager and Libert, 2014; Nicolaidis, Charmandari and Chrousos, 2018) (Figure 15).

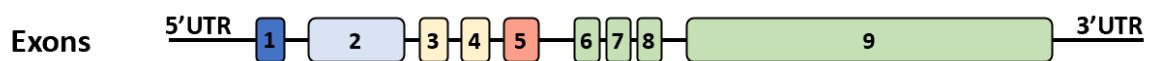

Figure 15: Genomic structure of the human glucocorticoid receptor (GR) *NR3C1* gene.

2. Protein Structure of GR

Human Glucocorticoid receptor (GR, *NR3C1*) was initially isolated in 1985 from the human breast cancer cell line MCF-7 by the group of Pierre Chambon (Govindan *et al.*, 1985). GR is a protein of 94-98kDa molecular weight that belongs to the nuclear hormone receptor (NHR) family and functions as a ligand-dependent transcription factor (Gehring and Hotz, 1983; Reichman *et al.*, 1984; Westphal *et al.*, 1984). GR is ubiquitously expressed throughout the body to perform the various functions necessary for lifetime, GR sensitivity varies among

individuals, within tissues of the same individual and even within the same cell during different cell cycle stages (Hollenberg *et al.*, 1985; Wang *et al.*, 2013; Matthews *et al.*, 2015).

Analogous to other nuclear receptors (NRs), GR protein displays the common three functional domains, namely a highly conserved DNA-binding domain (DBD), the ligand-binding domain (LBD), and other regulatory N- and C-terminal domains. Distinct short motifs engaged in dimerization, nuclear localization and protein interactions are present within these domains (Gigu *et al.*, 1986) (**Figure 16**).

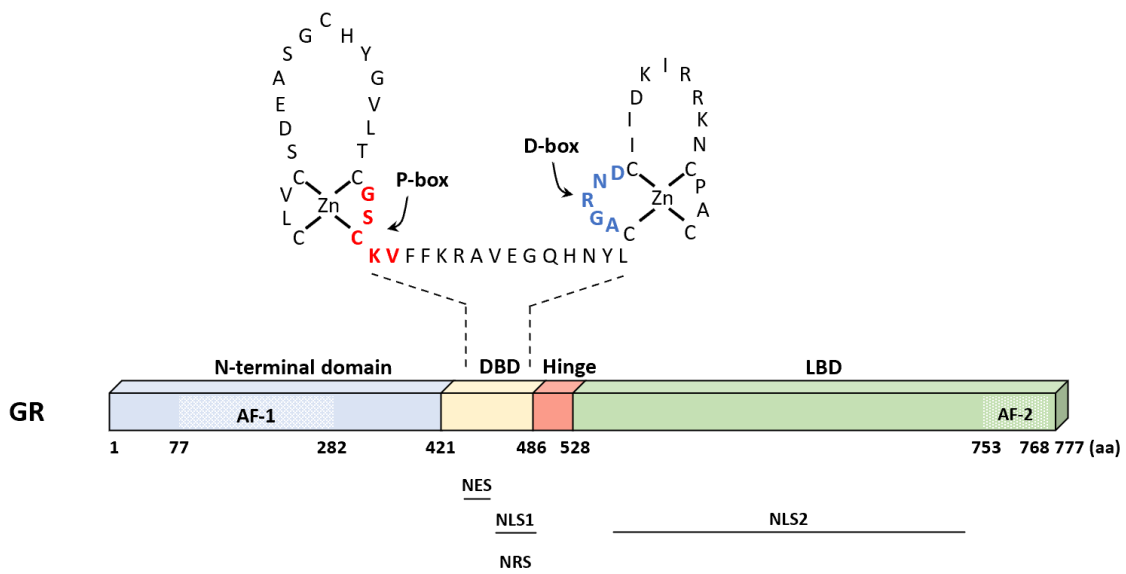

Figure 16 : Structure of the human glucocorticoid receptor (GR) protein. NLS: Nuclear Localization Signal, NRS: Nuclear Retention Signal, NES: Nuclear Export Signal.

- The amino-terminal transactivation domain (NTD) encoded by exon 2 is a poorly conserved region important in transcription regulation; it hosts the ligand-independent activation function 1 (AF-1) between amino acids 77 and 268. AF-1 binds coregulators, chromatin modulators and basal transcription machinery (Almlöf *et al.*, 1998; Kumar and Thompson, 2003; Kumar *et al.*, 2004; Khan *et al.*, 2012).
- The DBD encoded by exon 3 and 4 is a highly conserved domain in the center of the protein encompassing two zinc finger motifs. Very few amino acids within the first zinc finger, called Proximal box (P-box), specifically recognize, and bind glucocorticoid-responsive elements (GREs) on target genes. Also, P-box is involved in GR dimerization. Another set of amino acids within the second zinc finger, called Distal box (D-box) are involved in GR

dimerization (Luisi *et al.*, 1991). Further nuclear localization signal 1 (NLS1), nuclear export (NES), and nuclear retention signals (NRS) exist at the DBD responsible for subcellular distribution of GR. The NES is located between the two zing finger motifs while NLS1 and NRS are present at the DBD/hinge region junction (Tang *et al.*, 1998; Black *et al.*, 2001; Carrigan *et al.*, 2007).

- The hinge region and the C-terminal LBD are encoded by exons 5-9. The hinge region is a flexible region which separates the DBD and LBD (Carlstedt-Duke *et al.*, 1987).
- The LBD mediates (i) hormone binding through a hydrophobic pocket consisted of 12 α -helices and four β -sheets, where the lack of helix 12 inhibits GCs binding in case of GR β , (ii) receptor dimerization, (iii) transcriptional activation via the ligand-dependent activation function 2 (AF2), and (iv) nuclear localization through nuclear localization signal 2 (NLS2) (Tang *et al.*, 1998; Randy K Bledsoe *et al.*, 2002; Bledsoe, Stewart and Pearce, 2004).

3. Different GR Isoforms

3.1. Isoforms Generated by Alternative Splicing

The alternative splicing at the 3'-UTR of the primary h-GR mRNA have yielded multiple GR protein isoforms (**Figure 17**). There are two mostly known splice variants, the classical 777 amino acid GR α and the 742 amino acids long GR β . The latter exist at lower level compared to GR α . Both isoforms possess identical amino acids up to amino acid 727, but then differ with GR α containing 50 non-homologous AA in its C-terminus, whereas GR β only exhibits 15 AA (Hollenberg *et al.*, 1985; Lu and Cidlowski, 2004). This difference at the C-terminus confers special features to the GR β isoform. GR β is neither capable of binding endogenous GCs nor activating glucocorticoid-responsive reporter/endogenous genes and mainly residing in cell nucleus (Oakley *et al.*, 1999). Nevertheless, GR β works as an antagonist to GR α isoform. Several studies demonstrated its dominant-negative impact on GR α -induced transcriptional activity via competing on GR-responsive elements (GRE) and co-regulators binding and forming functionally inactive GR α /GR β heterodimers (Bamberger *et al.*, 1995; Oakley, Sar and Cidlowski, 1996; Yudit *et al.*, 2003; Charmandari, Kino and Chrousos, 2004; Kelly *et al.*, 2008). Moreover, elevated levels of GR β lead to tissue-specific GC resistance in different disorders such as asthma, rheumatoid arthritis (RA), sepsis, ulcerative colitis, nasal polyposis, systemic lupus erythematosus (SLE), ankylosing spondylitis acute lymphoblastic leukemia and chronic

lymphocytic leukemia. Formerly, GR β is showed to bind GR-antagonist (RU-468) and change its activity, thus proposing another theory of GC resistance if GR β is also capable of binding other GR synthetic agonists given for patients (Lewis-Tuffin and Cidlowski, 2006; Lewis-Tuffin *et al.*, 2007; Kino *et al.*, 2009)

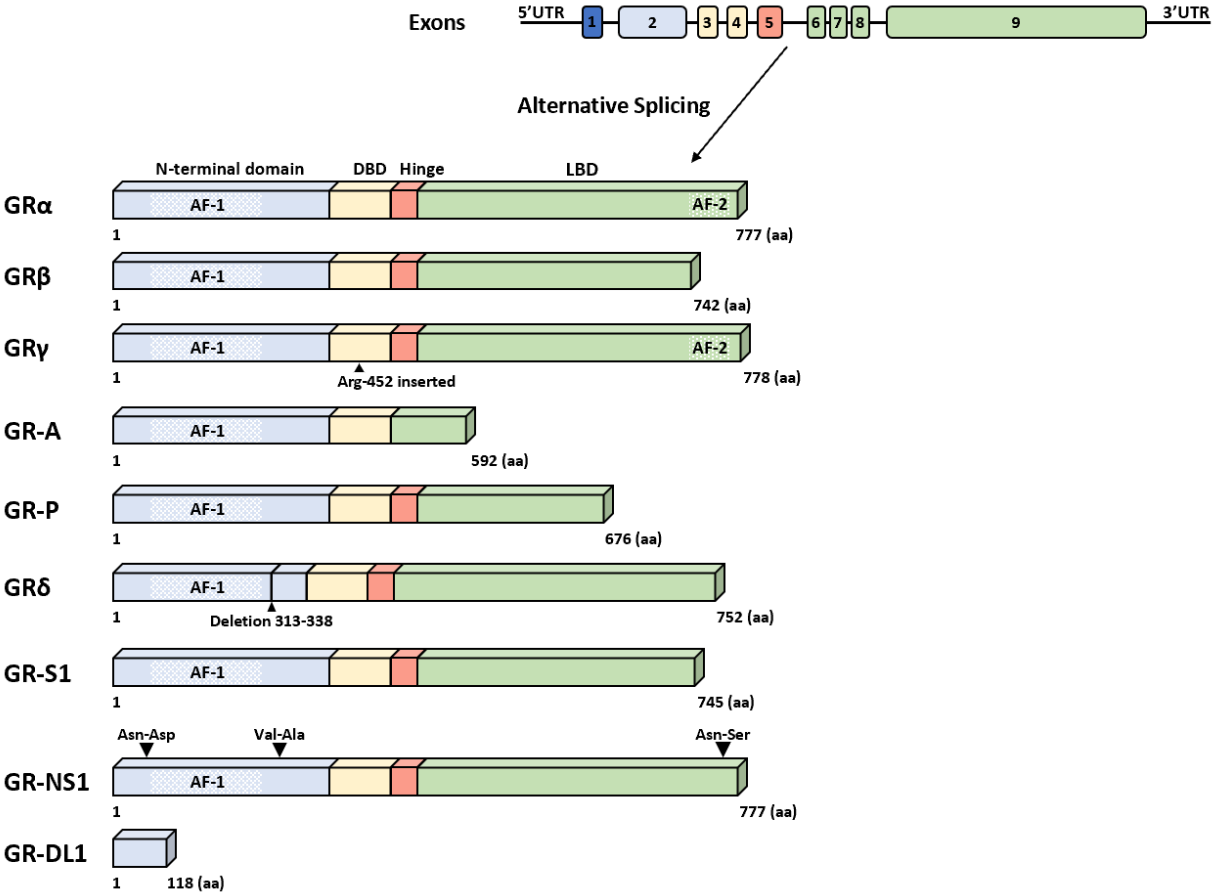

Figure 17 : Alternative splicing variants of the GR protein.

Next to GR α and GR β , alternative splicing results in additional isoforms of the h-GR including GR γ , GR-A, GR-P, GR δ , GR-S1, GR-NS1 and GR-DL1. GR γ is a widely expressed splice variant with an insertion of a single arginine residue between the two zinc finger motifs in the DBD. GR γ binds glucocorticoids and DNA in a similar affinity to GR α , but it has a different transcriptional profile as it has a compromised ability to stimulate glucocorticoid responsive reporter genes. Furthermore, GR γ expression associates with GCs resistance corticotroph adenomas, small-cell lung carcinoma and childhood acute lymphoblastic leukemia (Ray *et al.*, 1996; Rivers *et al.*, 1999; Beger *et al.*, 2003; Sánchez-Vega *et al.*, 2006; Meijnsing *et al.*, 2009a)

GR-A lacks the exons 5 through 7 encoding for the amino-terminal half of the LBD. GR-P lacks the exons 8 and 9 encoding for the carboxyl-terminal half of the LBD. These changes in the LBD of GR-A and GR-P resulted in the loss of their binding ability to GCs. Till now, little is known about GR-A, but GR-P is found to be expressed in several tissues and to be predominantly expressed in several GC-insensitive cancer cell types (Moalli *et al.*, 1993; Gaitan *et al.*, 1995; Krett *et al.*, 1995; De Lange *et al.*, 2001; Sánchez-Vega *et al.*, 2006)

GR δ (hGR Δ 313–338) contains a deletion in exon 2. This variant displays an altered GC-induced transactivation profile because the deleted region possesses different potential phosphorylation sites important for the transactivation potential of h-GR. GR δ is expressed in several tissues including lung, liver, skin, and heart muscle (Turner *et al.*, 2007).

GR-S1, GR-NS1 and GR-DL1 are recently identified. GR-S1 retains intron H between exon 8 and 9, resulting in an early termination site due to the presence of a stop codon in this intron. Therefore, this splice variant give rise to a truncated protein of 745 amino acids with a lower transactivation potential compared to GR α due to weaker ligand binding (Baker *et al.*, 2012). GR-NS1 includes three nonsynonymous single-nucleotide polymorphisms, corresponding to three amino acids changes at position 72 (asparagine to aspartic acid), position 321 (valine to alanine), and position 766 (asparagine to serine). GR-DL1 is a truncated isoform with an early termination at amino acid 118 because of a single nucleotide deletion in exon 2. This isoform lacks most of exon 2 and all of exons 3 through 9. Interestingly, GR-NS1 activity is at least double of that of GR α , however GR-DL1 activity is only 10% of GR α activity (Tung *et al.*, 2011).

As the GR α isoform is responsible for most GC-mediated transcriptional activities, we will focus on GR α in this report, and will refer to it as GR.

3.2. Isoforms Generated by Alternative Translational Initiation

Further diverse group of h-GR proteins are produced as a result of alternative translational initiation from a single GR α mRNA transcript. Eight alternative initiation sites (AUG codons) present in exon 2 result in eight different h-GR α translational isoforms named GR α -A, GR α -B, GR α -C1, GR α -C2, GR α -C3, GR α -D1, GR α -D2, and GR α -D3 with gradually shortened NTDs (Yudt and Cidlowski, 2001; Lu and Cidlowski, 2005; Duma, Jewell and Cidlowski, 2006) (**Figure 18**). These N-terminal truncated isoforms are produced as a consequence of leaky ribosomal scanning and ribosomal shunting (Lu and Cidlowski, 2005). Also, it is expected that each of the

splice variants discussed above (such as GR β , GR γ , GR-A, and GR-P) to contain identical set of initiation codons and therefore to have similar set of translational isoforms (Chrousos and Kino, 2005).

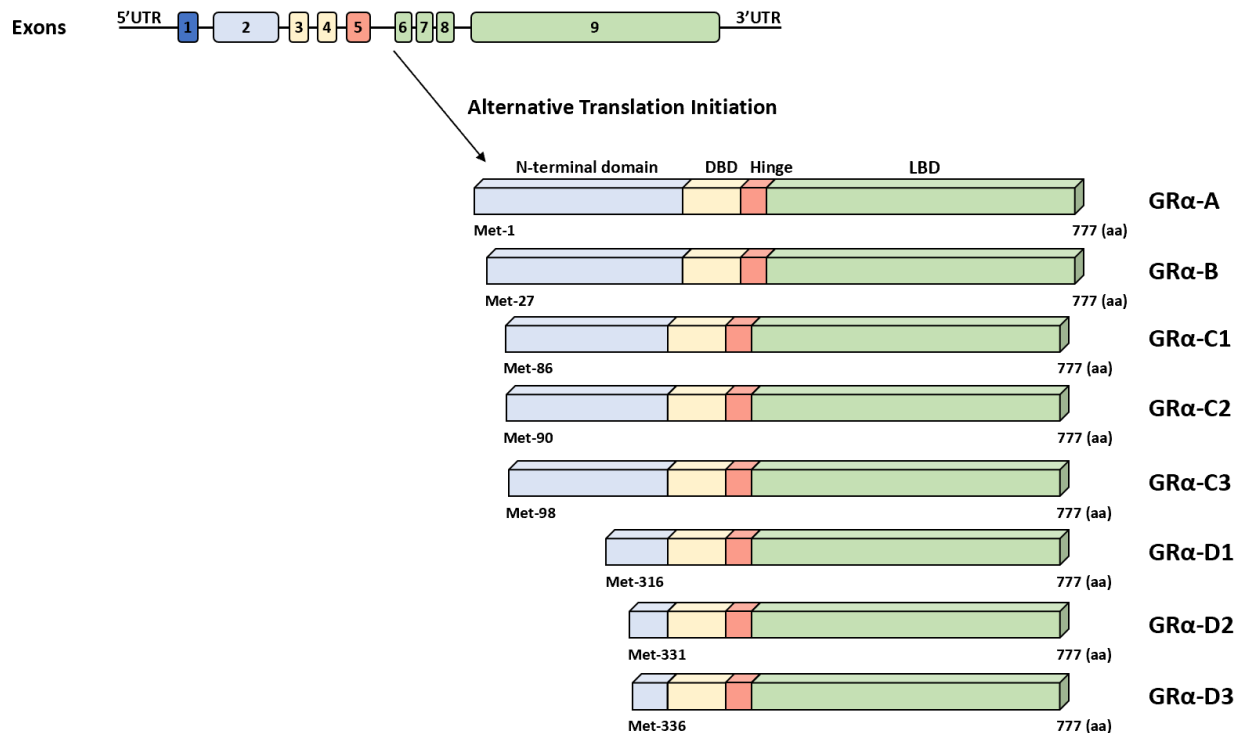

Figure 18 : Translational initiation splicing variants of the GR protein.

The GR α -A is the classical full-length protein that is generated from the first initiator codon. Though GR α translational isoforms have similar affinity to bind GCs and GREs following ligand activation, they still have distinguished properties (Lu and Cidlowski, 2005; Lu *et al.*, 2007).

These isoforms possess different subcellular distribution and unique transcriptional activity in response to GCs. GR α -A, GR α -B, and GR α -C1 isoforms are localized in the cytosol of the cells in the absence of ligand and translocate to the nucleus upon GCs binding. Whereas GR α -D isoforms reside mainly in the nucleus of the cells, where they associate with GRE-containing promoter of target genes independent of GCs (Lu and Cidlowski, 2005).

More surprisingly, each GR α translational isoform regulates a distinct subset of genes when individually expressed in osteosarcoma or T-lymphoblastic leukemia cells. Where less than 10% of the genes are commonly regulated by all the isoforms, suggesting that most of the genes are selectively regulated by the different GR α isoforms. GR α -C3 isoforms is mainly

involved in inducing the expression of proapoptotic genes making the GR α -C expressing cells more sensitive to the cell killing effects of GCs (Lu *et al.*, 2007; Wu *et al.*, 2013). GR α -C3 isoforms have enhanced transcriptional activity compared to other isoforms due to its higher efficiency in recruiting various coactivators to the GREs of target genes and this is linked to its N-terminal motif (residues 98-115) that increase the activity of its N-terminal AF1 domain (Lu and Cidlowski, 2005; Bender, Cao and Lu, 2013). Oppositely, GR α -D isoforms lacking the N-terminal AF1 domain have a reduced transcriptional activity. For instance, GR α -D does not efficiently repress the expression of the multiple anti-apoptotic genes because it is unable to interact with the p65 subunit of NF- κ B needed for its recruitment to the desired GREs (Lu and Cidlowski, 2005; Gross *et al.*, 2011).

Moreover, GR α translational isoforms displays tissue-specific expression that is conserved among different species. GR α -A and GR α -B are the most abundant isoforms of GR protein in several cell types, however GR α -C and GR α -D are preferentially expressed in the trabecular meshwork cells of the human eye (Nehmé *et al.*, 2009). Also, immature dendritic cells predominantly express the GR α -D isoforms while mature dendritic cells predominantly express the GR α -A subtype (Cao *et al.*, 2013). As well, GR α -D isoforms are higher in spleen and lungs whereas GR α -C isoforms are higher in pancreas and colon (Lu and Cidlowski, 2005). Furthermore, the tissue specific expression of these GR α isoforms changes in response to different signals. GR α -D isoforms increases in differentiated murine skeletal muscle cells treated with selective estrogen related receptor β/γ agonist (Wang *et al.*, 2010), and GR α -C isoforms are particularly upregulated in human primary T cells upon mitogen activation (Wu *et al.*, 2013). Besides, variations in the expression of these isoforms in the brain are observed during human development and aging (D. Sinclair *et al.*, 2011). As well, higher expression of GR α -D is observed in specific brain regions of patients with schizophrenia and bipolar disorder (Duncan Sinclair *et al.*, 2011; Sinclair *et al.*, 2012).

4. GR mechanism of action

4.1. GR Activation and Nuclear Translocation

GR mediates its functions in cells through the binding of its endogenous or exogenous ligands. In the absence of ligand, the GR monomer resides predominantly in the cell cytoplasm in a resting state as a part of a multiprotein complex (Pratt and Toft, 1997). This complex plays an

important role in GR maturation, activation, and nuclear transport. The composition of this complex changes depending on GR maturation/activation states (Grad and Picard, 2007; Vandevyver, Dejager and Libert, 2012). After GR translation, GR is bound by Hsp70 and Hsp40 chaperone proteins to help in the folding process. Once the folding process is completed, GR is transferred from Hsp70/Hsp40 to Hsp90 by Hop (Smith and Toft, 1993; Chen and Smith, 1998; Morishima *et al.*, 2000). Then p23 and FKBP51 immunophilin protein are recruited to the multiprotein complex driving the maturation of GR-chaperon complex into a new conformation with a very high affinity for GR ligands (Morishima *et al.*, 2003). Hormone binding switches FKBP51 by FKBP52 and triggers GR conformational change and activation, thus exposing its two nuclear localization signals (NLS) (Riggs *et al.*, 2003). Herein, nucleoporin and importins bind these NLSs and translocate GR into the nucleus via its pores where it binds specific regions on DNA to either activate or repress genes (Helfand *et al.*, 2004; Echeverría *et al.*, 2009). After mediating its transcriptional activity in the nucleus, GR is bound by exportins and calreticulin at its nuclear export signal (NES) motif, therefore disrupting GR-DNA binding, inhibiting GR transcriptional activity, and exporting GR back to the cytoplasm (Holaska *et al.*, 2001, 2002) (Figure 19).

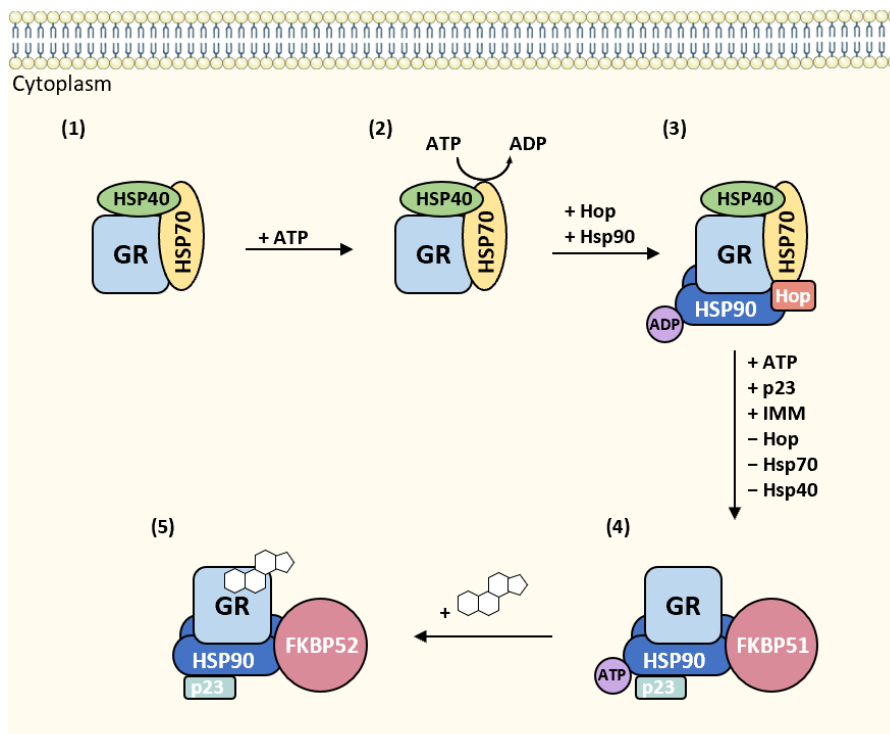

Figure 19 : Chaperone-mediated GR maturation and activation in the cytosol.

4.2. GR Genomic Activity

Once in nucleus, GR activates or represses the expression of target genes through binding to DNA either directly at high-affinity chromosomal sites known as GREs or indirectly through other TFs via protein-protein interactions. Direct GR-DNA interactions occur in multiple ways (**Figure 20**) (Yamamoto, 1985; Nouredine *et al.*, 2021). (i) Classically, GR binds as a homodimer to glucocorticoid-binding sites (GBS) on DNA in head-to-tail fashion; the GBS is a 15 bp long sequence composed of two imperfect inverted palindromic repeats of 6 bp separated by a 3bp spacer (AGAACA_nTTGTTCT) (Bf *et al.*, 1991; Randy K. Bledsoe *et al.*, 2002), (ii) GR binds as one monomer to either GBS-half sites (AGAACA or its reverse complement TGTTC) (Schiller *et al.*, 2014) or as two monomers on the opposite sides of DNA to the inverted-repeat GBS CTCC(n)GAGAG consensus, these sites are known as negative GRE sites mainly accompanied with transcriptional repression (Surjit *et al.*, 2011; Hudson, Youn and Ortlund, 2012), (iii) GR binds directly to GREs and physically interacts with other non-GR TFs on a neighbor DNA site in a composite manner (Diamond *et al.*, 1990), or (iv) GR binds indirectly to GREs and activates transcription after physical interaction with other TFs, such as the proinflammatory TF AP-1 (Activator protein-1) and NF- κ B (Rao *et al.*, 2011; Weikum *et al.*, 2017). Besides, it is relevant to mention that GR is discovered to bind DNA as a tetramer but the importance of this tetramer at the transcriptional regulation level is not well understood yet (Presman and Hager, 2017). Through all these mechanisms, GR was shown to regulate up to 10–20% of the human genome in different cell types (Boettner, Ehrhart-bornstein and Shea, 2002).

In addition to the classical genomic ligand-dependent GR pathway, several studies have reported that unliganded GR also modulates cell signaling (**Figure 20**). Interestingly unliganded GR was described to display a protective role in BC, as it was shown to bind to the promoter region of a tumor suppressor gene, BRCA1, upregulating its expression in nonmalignant mammary cells. Conversely, exposure to GCs induces a loss of GR recruitment to the BRCA1 promoter concomitant to a decrease in BRCA1 expression, highlighting the role of GCs in inducing BC (Ritter, Antonova and Mueller, 2012). Moreover, gene expression microarray analysis identified 343 target genes upregulated and 260 downregulated by unliganded GR in mammary epithelial cells. Some of the positively regulated genes were involved in pro-apoptotic signals. Moreover, unliganded GR regulated the cholesterol 25-hydroxylase (Ch25h)

gene in a similar manner to BRCA1, as the association of unliganded GR to the promoter of Ch25h gene was disrupted by GCs (Ritter and Mueller, 2014). Liganded and unliganded GR could work as a balance for controlling differentiation and apoptosis, where unliganded GR may be a mechanism for reducing BC risk by eliminating abnormal cells.

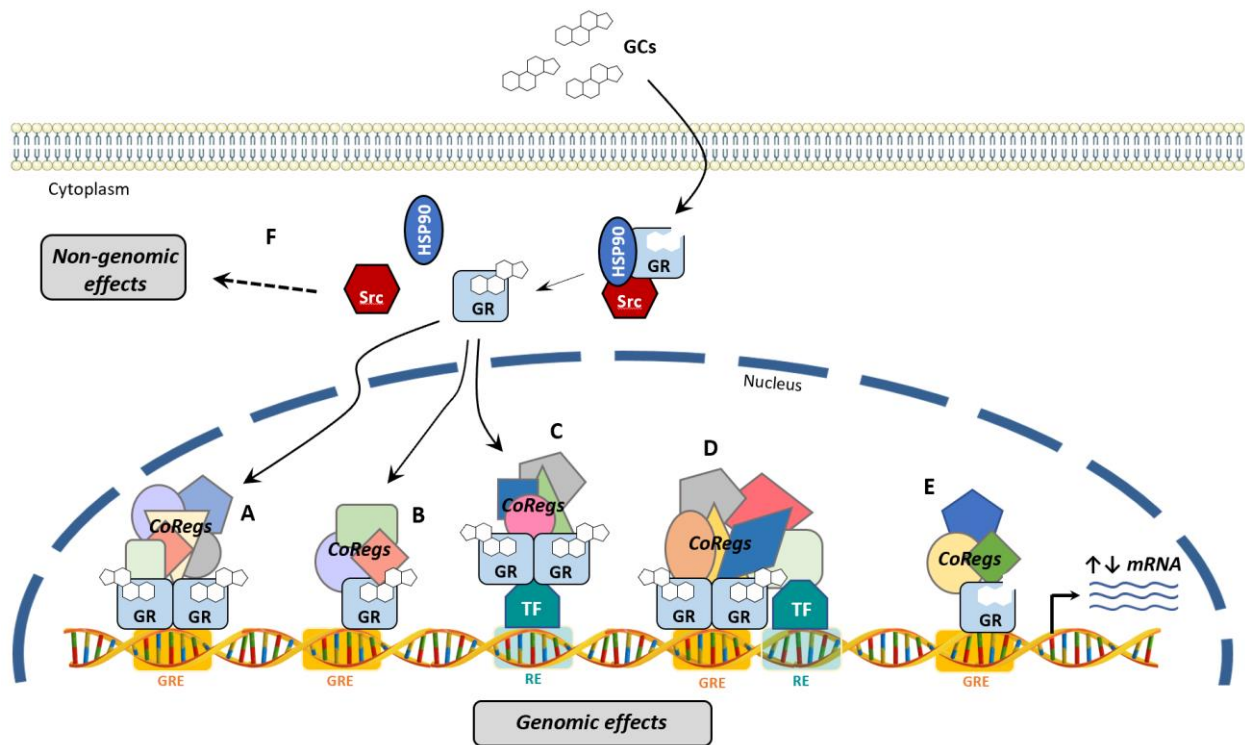

(Noureddine *et al.*, 2021)

Figure 20 : Genomic and Non-genomic signaling pathways of Glucocorticoid Receptor. GR can bind directly to DNA as a dimer on a specific GR response element (GRE) (A), as a monomer through a simple GRE (B), through other transcription factors (TFs) by tethering itself to the TF (C), or in a composite manner by directly binding to GRE (D). Unliganded GR modulates cell signaling in the absence of GCs (E). In addition to the genomic action of GR in the nucleus (A–E), when GR dissociates from its cytoplasmic complex upon GCs treatment, it can also regulate non-genomic effects (F).

DNA-bound GR regulate the expression of its target genes through modulating the RNA polymerase II (RNAPolIII) activity at their promoter region after recruiting transcriptional preinitiation complexes. This transcriptional preinitiation complexes are formed via interactions of liganded-GR with other basal transcription factors (TF), TATA-binding protein (TBP), TBP-associated proteins (TAFIIs) and coregulators (Beato *et al.*, 1987). Coregulators recruited by liganded-GR regulate the formation and activation of these transcription complexes at the transcription start site (TSS) of target genes. Coregulators can function as

corepressors or coactivators, resulting in local chromatin compaction (gene transcription repression) or local chromatin relaxation (gene transcription activation), respectively (Lan, Glass and Rosenfeld, 1999; Jenkins, Pullen and Darimont, 2001; Wolf *et al.*, 2008).

4.3. GR Non-Genomic Activity

Though the main functions of GR are genomic occurring in the nucleus, GR can also mediate rapid nongenomic activities to elicit fast cellular responses within few seconds to minutes and without requiring any transcriptional or translational changes in genes expression (Samarasinghe *et al.*, 2011; Groeneweg *et al.*, 2012) (**Figure 20**). Non-genomic functions of GR that involve modulating the signaling pathways controlled by different kinases such as PI3K, AKT, and MAPKs are mediated by components released from GR chaperone complex upon GCs binding or by membrane-bound GRs (Hafezi-Moghadam *et al.*, 2002a; Song and Buttgereit, 2006; Strehl *et al.*, 2011). For instance, the release of the accessory protein Src (non-receptor tyrosine kinase) associated with the unliganded GR in the cytosol activates multiple kinase cascades leading to the phosphorylation of annexin 1, inhibition of cytosolic phospholipase A2 activity, and impaired release of arachidonic acid (Croxtall, Choudhury and Flower, 2000; Solito *et al.*, 2003). Also, membrane-bound GRs activated by GCs regulate gap junction intercellular communication and neural progenitor cell proliferation via a process that needs Src and a site-specific MAPK-dependent phosphorylation of connexin 34 (Samarasinghe *et al.*, 2011). Further non genomic effects of GR include its translocation and residing in mitochondria in a ligand-independent manner. Mitochondrial GR is able to bind GRE-like elements present on mitochondrial chromosomes alone or in a complex with other factors and regulate gene transcription (Scheller *et al.*, 2000; Du *et al.*, 2009; Du, McEwen and Manji, 2009; Psarra and Sekeris, 2011). located in the mitochondria is shown to play an important role in regulating cell energy metabolism (Morgan *et al.*, 2016).

Altogether these GR non-genomic mechanisms mediate GC's effects such as: (i) fast negative feedback to suppress adrenocorticotrophic hormone (ACTH) release by the pituitary gland (Hinz and Hirschelmann, 2000), (ii) immunosuppression in T cells (Löwenberg *et al.*, 2006), and (iii) vasorelaxation in patients with myocardial or brain ischemia (Hafezi-Moghadam *et al.*, 2002b).

5. GR Plasticity

Though GR is constitutively expressed throughout the body, it works in a cell and context specific manner displaying plasticity. GR plasticity is not only due to the different expression of GR isoforms but also due to other signals that regulate GR transcriptional activity differentially among cells and tissues. Four main signals are depicted to affect GR's function: DNA binding sequences, ligand availability and binding, post-translational modifications and partner proteins recruited.

- First, DNA-binding sequences act as an allosteric regulator of GR. It is a broad array of DNA sequences that present at the GR responsible elements (GREs) of GR target genes. These sequences that bind GR specifically differ among GREs of different target genes, thus resulting in different transcriptional outcomes (Meijsing *et al.*, 2009b; Lisa C Watson *et al.*, 2013). GREs may differ among tissues, for instance inverted repeats GR-binding sequences (IR-GBS) are widespread in fibroblasts but are sparsely available in other cell types (Surjit *et al.*, 2011; Presman *et al.*, 2014; Starick *et al.*, 2015). Also, variations in GRE sequences such as mutation or deletion even in single base pair affects GR transcriptional activity. For example, a short deletion in the GRE sequence, 25kb downstream the transcription start site, of period circadian homologue 2 (Per2) abolished its GR-mediated induction of expression in mesenchymal stem cells (So *et al.*, 2009; Uhlenhaut *et al.*, 2013). Indeed, not only allosteric changes are provoked by each hexamer half site of the palindromic sequences but also the three-base-pair spacer between these hexamers at certain GREs play a significant role in GR conformation and dimerization. This spacer sequence can alter the DNA conformation which in turn propagate through zinc finger motifs and alter the conformation of GR's D-box, consequently modulating GR activity (Lisa C. Watson *et al.*, 2013; Thomas-Chollier *et al.*, 2013). As well, the sequences at the +8 and -8 positions surrounding the GR binding sites are shown to affect DNA conformation and GR DBD structure (Schöne *et al.*, 2016). Moreover, a recent study revealed the 'toggle-switch'-like behavior of GREs in U2OS cells, where a set of genes are activated at low levels of GR activity and then subjected to repression in a dramatic way as GR activity increased. This regulatory mode is known as incoherent type1 feed-forward loop (I1-FFL) logic (Mangan and Alon, 2003).

- Second, GR ligands hold different physiological and pharmacological effects due to their different allosteric regulations on GR transcriptional output. Ligand binding results in helix-12 disclosure, DNA conformational change and cofactors recruitment to the AF2 in the LBD. Thus, depending on the ligand, the DNA will adopt different conformation and will recruit different cofactors resulting in different outcomes (Kauppi *et al.*, 2003; Ricketson *et al.*, 2007). Regardless of the high specificity in ligand binding, ligands such as Cortisol or Dexamethasone do not occupy 100% of the ligand binding pocket leaving an additional volume that can be potentially occupied by a wide range of modulatory ligands. For instance, the GR antagonist RU-486 is revealed to bind cortisol-bound LBD, leading to ligand-specific alterations in GR outcomes (Kauppi *et al.*, 2003; Wang *et al.*, 2006; He *et al.*, 2014). This concept embarks the basis of the research for “Selective GR Agonists and Modulators” (SEGRAM). Additionally, ligand’s bioavailability plays a key role in regulating GR activity. For instance, GCs bioavailability is tissue specific, less GCs are present in kidney, colon, pancreas, and placenta due to the high expression of 11 β -hydroxysteroid dehydrogenase 2 (11 β -HSD2) which converts active GCs (cortisol) into inactive metabolite (cortisone), while in other tissues 11 β -hydroxysteroid dehydrogenase 1 (11 β -HSD1) converts inactive cortisone into active cortisol. This pre-receptor level affects GR-mediated functions in a tissue specific manner (Stewart and Krozowski, 1997). Although a similar amount of 11 β -HSD2 is available in liver and thymus tissue, cells are responding differently to GCs, emphasizing that GR plasticity cannot be solely due to ligand availability (Rhen and Cidlowski, 2005). Moreover, transporter proteins present on cell membrane such as the ligand effect modulator 1, an ATP-binding-cassette transporter, controls GCs bioavailability through actively and specifically exporting Dexamethasone from cells (Kralli, Bohlen and Yamamoto, 1995).
- Third GR activity is tightly regulated by several potential post-translational modifications (PTMs) that can affect its localization, stability, DNA binding, ligand response and regulatory function. To date, the function of GR is known to be affected by numerous phosphorylation events, but also by other modifications such as acetylation, ubiquitination, sumoylation, and methylation (**Figure 21**).

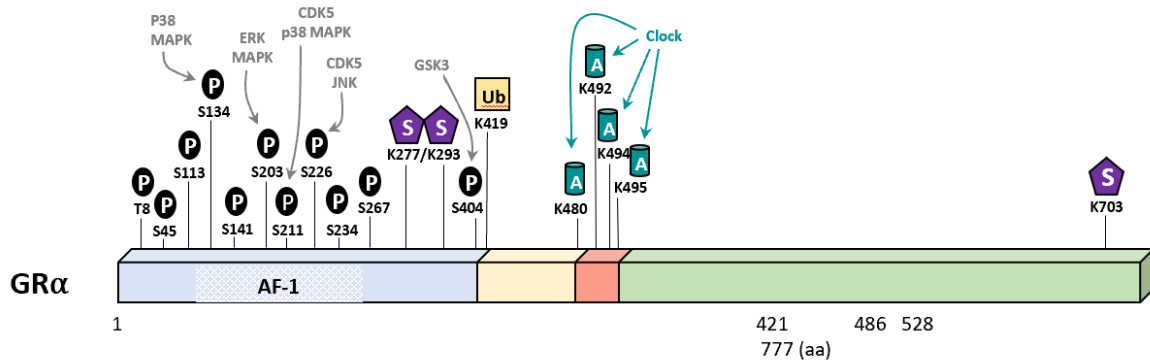

(Nouredine *et al.*, 2021)

Figure 21 : Post translational modifications of the glucocorticoid receptor (GR) protein.

Phosphorylation occurs generally on Serine, Threonine or Tyrosine residues. In most cases, GR is phosphorylated at a basal level and becomes hyperphosphorylated upon ligand binding (Wang, Frederick and Garabedian, 2002; Avenant *et al.*, 2010). MAPKs, cyclin-dependent kinases, and Glycogen synthase kinase-3 β (GSK-3 β) are the main kinases involved in GR phosphorylation. The specific site of GR phosphorylation determines the subsequent effect on its function. Till now, there are seven experimentally proved phosphorylation sites within the NTD of GR: Ser113, Ser134, Ser141, Ser203, Ser211, Ser226 and Ser404 (Ismaili and Garabedian, 2004). These residues are conserved among humans, mice, and rats (Bodwell *et al.*, 1998). For instance, GR phosphorylated on S211 is a transcriptionally active form of the receptor (Miller *et al.*, 2005). Conversely, phosphorylation on S226 by c-Jun N-terminal kinase (JNK), a member of the MAPK family, was shown to abrogate GC-dependent transcriptional activity (Itoh *et al.*, 2002; Wang, Frederick and Garabedian, 2002; Chen *et al.*, 2008; Takabe, Mochizuki and Goda, 2008). S404 phosphorylation by glycogen synthase kinase 3 β impairs GR signaling (Galliher-Beckley *et al.*, 2008). In most cases, these phosphorylation sites alter the recruitment of major coregulators impairing GR transcriptional activity. For example, S211 phosphorylation catalyzed by p38 MAPK induces a conformational change, which facilitates coactivator recruitment (i.e., MED14) resulting in an increase in the transcriptional activity of GR (Miller *et al.*, 2005; Chen *et al.*, 2008). Inversely, phosphorylation of S404 impedes GR coregulator recruitment of p300/CBP and the p65 subunit of NF-Kb (Galliher-Beckley *et al.*, 2008). GR phosphorylation also modifies its

localization. For example, S203 is phosphorylated by MAPK ERK1/2 in order to maintain GR in the cytoplasm and prevent its binding to the promoters of its target genes (Wang, Frederick and Garabedian, 2002; Takabe, Mochizuki and Goda, 2008). Furthermore, phosphorylation of GR at S134 and S226 prevents its translocation to the nucleus, impairing GC-induced gene expression (Itoh *et al.*, 2002; Piovan *et al.*, 2013).

After ligand binding, GR is acetylated by the acetyltransferase Clock (circadian locomotor output cycles kaput) on K480, K492, K494, and K495 present in the hinge region, reducing its binding of GR to the GRE of specific target genes, impairing its transcriptional activity (Nader, Chrousos and Kino, 2009; Kino and Chrousos, 2011). GR deacetylation by HDAC2 is required for NF- κ B-mediated repression of inflammatory target genes (Ito *et al.*, 2006).

The stability of the receptor is also regulated by ubiquitinylation and sumoylation. GR is ubiquitinated at K419, 8.5kDa ubiquitin polypeptide is covalently attached to Lysine 419, targeting GR for degradation by the 26S proteasome (Wallace and Cidlowski, 2001; Deroo *et al.*, 2002; Wallace *et al.*, 2010). The E3 ligase CHIP (carboxy terminus of heat shock protein 70-interacting protein) was reported to be involved in this process where it modulates expression levels and activity of GR (Wang and DeFranco, 2005).

Additionally, GR is exposed to sumoylation, which is the addition of a small ubiquitin-related modifier-1 (SUMO-1) to lysine residues. GR sumoylation at K277, K293, and K703, is catalyzed by SUMO-1- conjugating E2 enzyme Ubc9 can regulate GR transcriptional activity on specific subsets of GR target genes (Le Drian *et al.*, 2002; Tian *et al.*, 2002). Precisely, Lys293 sumoylation is needed for the IR-GBS-mediated repression, and it promotes the recruitment of silencing mediator of retinoic and thyroid receptors (SMRT) and nuclear receptor co-repressor (NCoR) (Hua, Paulen and Chambon, 2016). GR sumoylation is not dependent on the ligand-binding but is rather influenced by environmental changes (Holmstrom *et al.*, 2008).

Recently, an arginine methylated-GR is detected in-vitro and predominantly present in cell nucleus. PRMT5 the major type II methyltransferase enzyme is catalyzing the symmetrical dimethylation (sDMA) of an arginine residue on GR. Though this arginine residue is not yet identified, its methylation could contribute to important physiological process (Poulard *et al.*, 2020; Malbeteau *et al.*, 2022).

- Finally, the GR transcriptional outcome is determined by the composition of cofactor complex recruited to the GREs of target genes (Petta *et al.*, 2016). Eventually, the composition of this complex relies on the cell-specific expression levels of transcription factors and cofactors, in addition to the above-mentioned signals (Rosenfeld, Lunyak and Glass, 2006). For example, the p160 cofactors family mentioned before, serves as an adaptor protein between GR and other cofactors (such as p300 and CBP) is widely expressed among cells and tissue-type, yet it is regulating GR activity in a tissue-specific manner (Tsai and Fondell, 2004; Lonard and O'Malley, 2005).

Chapter IV: Glucocorticoids Receptor Coregulators

1. Coregulators

Transcriptional coregulators are proteins that bind transcription factors such as GR and assemble with other proteins to form transcription regulatory complexes at the transcription start sites (TSS) of target genes. These coregulators modulate gene expression through modifying the chromatin conformation, hence making it more or less accessible for the basal transcription machinery (Collingwood, Urnov and Wolffe, 1999; Glass and Rosenfeld, 2000; Rosenfeld, Lunyak and Glass, 2006) (**Figure 22**). Hundreds of coregulators are identified in human body and are shown to display broad functions (Jenkins, Pullen and Darimont, 2001; Schaefer, Schmeier and Bajic, 2011). As we mentioned before, these coregulators can function as coactivators that activate gene transcription or as corepressor that repress gene transcription (Lan, Glass and Rosenfeld, 1999; Wolf *et al.*, 2008). Many coregulators are identified to both activate and repress gene transcription depending on the specific gene and cellular environment (Millard *et al.*, 2013; Stallcup and Poulard, 2020a).

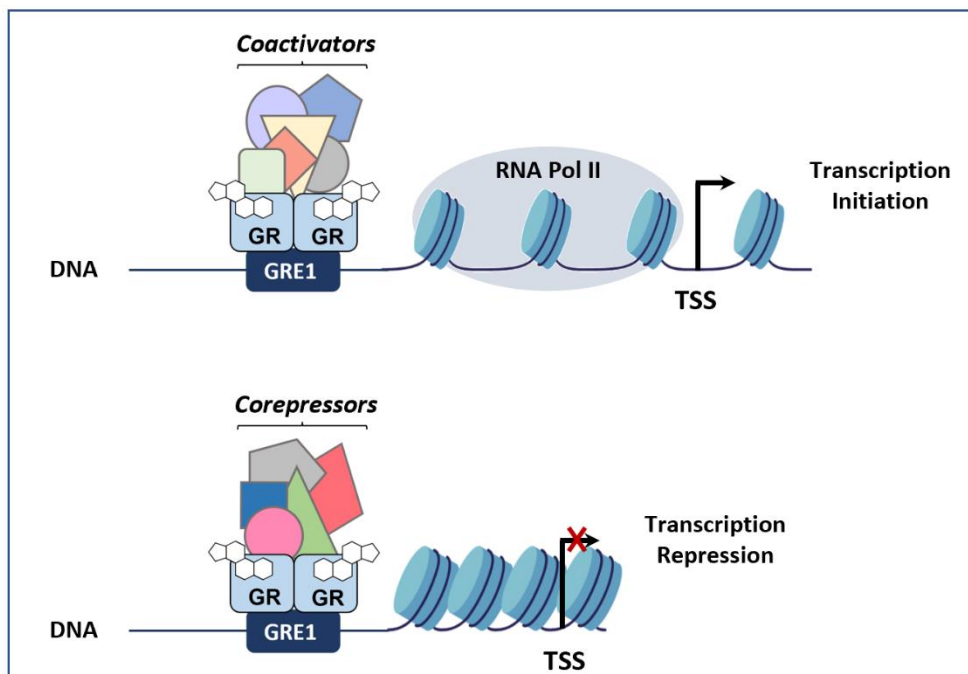
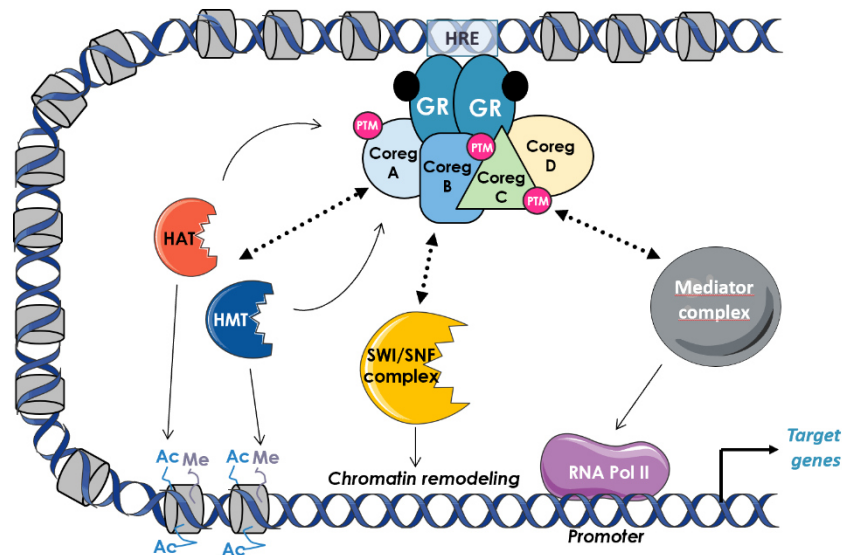

Figure 22 : Coregulators modulate GR transcriptional activity via modulating chromatin structure.

2. GR-Coregulators Functional Groups

GR coregulators are classified into different groups based on their diverse mechanisms of actions in transcriptional regulation (**Figure 23** and **Table 1**).



Adopted from: (Stallcup and Poulard, 2020a)

Figure 23 : Contribution of Coregulators to Transcriptional Regulation by Glucocorticoid Receptor.

The first group of coregulators include the scaffold proteins that participate in transcriptional regulation by recruiting different coregulators through their multiple protein-interaction domains (Rosenfeld, Lunyak and Glass, 2006; Wolf *et al.*, 2008). A well-known example is the p160 steroid receptor coactivator SRC family which consist of three members: SRC-1/NCoA-1, SRC-2/NCoA-2/TIF2/GRIP1, and SRC-3/NCoA-3/ACTR/pCIP/AIBI/TRAM (McKenna *et al.*, 1999). These 160-kDa proteins function as coactivators that interact with the AF2 domain of GC-bound GR via the LXXLL motifs present in their central receptor interaction domain (RID) (Heery *et al.*, 1997; Darimont *et al.*, 1998; Ding *et al.*, 1998). Further interactions are made through their different activation domains (AD) for recruiting other coregulators such as histone acetyltransferases (HATs) and histone methyltransferases (HMTs) to GREs or specific enhancer (Xu, Wu and O'Malley, 2009). For instance, the N-terminal bHLH-PAS domain (AD3) recruits coiled-coil coactivator (CoCoA) coregulator (Kim, Li and Stallcup, 2003), the C-terminal conserved activation domain 2 (AD2) recruits the Coactivator Associated Arginine Methyltransferase 1 (CARM1/PRMT4) (Chen *et al.*, 1999a; Stallcup *et al.*, 2003; Y. H. Lee *et al.*, 2005), while the adjacent activation domain 1 (AD1) recruits CBP/p300 (Yao *et al.*, 1996;

Torchia *et al.*, 1997; Chen *et al.*, 1999a). Knocking down of individual SRC proteins show a context-specific effect in modulating GR-mediated transcription (Szapary, Huang and Simons, 1999; Trousson *et al.*, 2007). Among all p160 SRC family, GR interacts preferentially with SRC-2, where GR is shown to be recruited to SRC-2 formed foci in the nuclei upon Dex treatment and not RU-486 (Darimont *et al.*, 1998; Li *et al.*, 2003; Ogawa *et al.*, 2004; Ronacher *et al.*, 2009). However, SRC-2/GRIP2 but not SRC-1 or SRC-3, is shown to display additional corepression domains required for the GR-mediated repression at NF- κ B/AP1 tethering GREs (Rogatsky *et al.*, 2002; Chinenov *et al.*, 2008).

The second group includes the histone-modifying enzymes that are responsible for adding or removing post-translational modifications on histone proteins and thereby epigenetically controlling gene's transcription (Jenuwein and Allis, 2001; Rothbart and Strahl, 2014). These enzymes do not bind DNA directly, rather they bind transcription factors (e.g., GR), other chromatin proteins or PTMs of histones (Rothbart and Strahl, 2014). Moreover, they are able to modify other coregulators, adding another layer of complexity.

- Histone methyltransferases (HMTs) catalyze the transfer of one or more methyl groups to a lysine or arginine residues of histone proteins from the methyl donor S-Adenosyl methionine (SAM) (Sawan and Herceg, 2010). Histone methylation affects the level of chromatin compaction depending on the site of methylation (Kouzarides, 2007). For instance, the protein lysine methyltransferase G9a (known as EHMT2), the protein arginine methyltransferase PRMT4 (known as CARM1), or the protein arginine methyltransferase PRMT1 (known as HRMT1L2) interacts with GR directly or with GR-bound coregulators (such as p160 or p300) to either activate or repress GR target genes (Chen *et al.*, 1999b; Van Galen *et al.*, 2010; Bittencourt, D. Wu, *et al.*, 2012; Shankar *et al.*, 2013).
- Histone acetyltransferases (HATs) acetylate histone proteins at lysine residues by delivering acetyl group from the acetyl coenzyme A (acetyl-CoA) (Lee and Workman, 2007; Luan *et al.*, 2015). Histone acetylation causes local chromatin to relax, making it more accessible for transcription initiation (Kee, Arias and Montminy, 1996). Also, hyperacetylated regions on DNA are shown to be actively transcribed compared to hypoacetylated regions (Pazin and Kadonaga, 1997). Among the diverse HATs families, CREB-binding protein (CBP), E1A-binding protein p300 (p300), and p300/CBP-

associated factor (PCAF) interacts with GR either directly through its AF1 domain or indirectly through the GR-bound p160-coactivators (Ogryzko *et al.*, 1996, 1998; Yao *et al.*, 1996; Chen *et al.*, 1997; Almlöf *et al.*, 1998; Voegel *et al.*, 1998; Wallberg *et al.*, 2000).

- Histone deacetylases (HDACs) catalyze the removal of acetyl groups from lysine residues in a zinc- or NAD⁺-dependent mechanism (Seto and Yoshida, 2014). HDACs oppose the function of HATs, whereby deacetylating histones results in compacting DNA, decreasing chromatin accessibility, and repressing gene expression (Chen and Evans, 1995; Milazzo *et al.*, 2020). Herein, nuclear receptor co-repressor (NCoR) and silencing mediator of retinoic and thyroid receptors (SMRT) corepressors are recruited to GR-target genes promoter regions through an interaction between their CoNRN boxes and GR LBD. NCoR and SMRT associates with HDACs and form multi-protein complexes to actively repress GR-target genes transcription (Stewart and Wong, 2009). SUMOylated GR at Lysine 293 recruits NCoR and SMRT corepressor complexes to IR-nGREs or to NF- κ B/AP1 tethered-GORs to mediate GC-induced repression of target genes (Hua, Ganti and Chambon, 2016; Hua, Paulen and Chambon, 2016). Moreover, RU486-bound GR is shown to preferentially interact with NCoR corepressor over GCs-bound GR (Ronacher *et al.*, 2009).

Finally, the third group of coregulators include a large family of ATP-dependent SWI/SNF chromatin-remodeling complexes (CRCs). SWI/SNF CRCs regulate transcription by catalyzing the repositioning of nucleosomes on DNA causing changes in the structure of chromatin, thereby increasing TF accessibility (Ostlund Farrant *et al.*, 1997; Pazin MJ, 1997; Clapier and Cairns, 2009; Narlikar, Sundaramoorthy and Owen-hughes, 2013). SWI/SNF CRCs are multiprotein complexes consisting of 10 to 15 subunits among of which the ATPase core subunits and other non-core subunits. Based on their subunit composition, several families of SWI/SNF CRCs may exist in a cell at a given time (Wu, Lessard and Crabtree, 2009). Furthermore, the composition and the activity of the SWI/SNF complex subunits is shown to be cell and tissue specific (Wang *et al.*, 1996).

Among the core subunits of SWI/SNF CRCs, Brahma (BRM) encoded by SMARCA2 gene and brahma related gene 1 (BRG1) encoded by SMARCA4 gene are predominant in cells and are responsible for providing the ATPase activity of CRCs (Fryer and Archer, 1998; Phelan *et al.*,

1999; Hargreaves and Crabtree, 2011). BRM and BRG1 are identified among the first coactivators for GR, where GR interacts with these core subunits directly through its DBD, LBD and AF1 domains in a context-specific manner (Wallberg *et al.*, 2000; Engel and Yamamoto, 2011; Muratcioglu *et al.*, 2015).

In addition, the multi-subunit mediator complex which forms a physical link between GR and the transcription machinery appears to be required for regulating gene transcription by affecting RNA Polymerase II activity (Allen and Taatjes, 2015). The interaction of the mediator complex with GR-LBD results in the formation of a mediator pocket domain which in turn induces the interaction between the mediator and RNA polymerase II (Knuesel and Taatjes, 2011). GR target gene transcriptional regulation is dependent on the two distinct mediator subunits MED1 and MED14 which it binds to (Chen, Rogatsky and Garabedian, 2006). MED1 mediator subunit (Mediator of RNA polymerase II transcription subunit 1) that binds the LBD of GC-bound GR via its LXXLL motifs and MED14 mediator subunit that binds the AF1 domain of GR in a ligand-independent manner (Hittelman *et al.*, 1999).

Functional Groups	Name	Gene Name	Role
Chromatin Remodeling Factors	BRG1 BRM	SMARCA4 SMARCA2	Catalytic ATPases subunit of SWI/SNF complex that hydrolyse ATP to slide/eject nucleosome from DNA.
Histone Methyltransferases	G9a	EHMT2	Lysine mono or di- methyltransferase with broad context-specific functions.
	PRMT1 PRMT4	HRMT1L2 CARM1	Asymmetrical arginine di-methyltransferases with broad context-specific functions.
Histone Acetyltransferases	CBP p300	CREBBP EP300	Recruit RNA polymerase II to target gene promoter .
	PCAF	KAT2B	Component of ADA and SAGA transcriptional coactivator complexes.
Histone De-acetyltransferases	NCoR SMRT	NCoR-1 NCoR-2	Promote chromatin condensation and transcription repression.
P160 SRC Family	SRC-1, NCoA-1	NCOA1	Scaffold proteins mediating coactivation function of GR via multiple protein interactions.
	SRC-3, TRAM NCoA3, ACTR, AIB1	NCOA3	
	SRC-2, GRIP1, TIF2, NCoA-2	NCOA2	Scaffold protein mediating coactivation and corepression function of GR via multiple protein interactions.

Table 1 : Some of the Functional Groups of Coregulators Regulating GR Transcriptional Activity.

3. Specific Actions of GR Coregulators

Coregulators are able to interact with several partner proteins and function with multiple transcription factors (such as GR) (Malovannaya *et al.*, 2010), (Malovannaya *et al.*, 2011).

Despite of that, transcriptional coregulators work in a highly gene-specific manner i.e., each coregulator is required to regulate only a subset of target genes of GR in a given cell type (Rogatsky *et al.*, 2002; Bittencourt, D. Wu, *et al.*, 2012; Chodankar *et al.*, 2014; Wu *et al.*, 2014; Poulard *et al.*, 2017). For instance, a genome-wide analysis of four different GR coregulators in A549 lung adenocarcinoma cells confirms that each coregulator is regulating the transcription of different set of GR target genes. Also, genome-wide analysis shows that G9a/EHMT2 methyltransferase or its homologue G9a-like protein (GLP) /EHMT1 coregulators are regulating the transcription of different subsets of genes in A549 lung adenocarcinoma cells or in Nalm6 B-acute lymphoblastic leukemia cell lines (Poulard *et al.*, 2017, 2018). All this suggests that each coregulator is modulating specific subset of genes regulated by GR (Wu *et al.*, 2014; Poulard *et al.*, 2017, 2018).

Moreover, each subset of these genes represents certain physiological pathway, emphasizing that the gene-specific activities of coregulators is associated with specific physiological pathways (Wu *et al.*, 2014; Poulard *et al.*, 2017, 2019). The three homologous members of p160 coregulator family (SRC-1, SRC-2, and SRC-3) appears to be a good example. Though they have many target genes in common, the whole-body knockout of these three coregulators in mice result in different phenotypes, proving that each SRC is regulating distinct physiological pathways (Xu and Li, 2003). For example, among the three SRC proteins only SRC-2/GRIP1 serves as corepressor for GR-regulated cytokine genes in macrophages, facilitating the anti-inflammatory effects of glucocorticoids *in vivo* (Chinenov *et al.*, 2012). More interestingly, the previously mentioned G9a/GLP coregulators are also good evidence, as they participate in regulating GR-target genes involved in specific pathways in different cell type. G9a/GLP-dependent GR target genes are enriched for cellular migration pathways in A549 lung adenocarcinoma cells, and depleting G9a or GLP inhibits GCs-blocked cell migration of A549 cells (Poulard *et al.*, 2017). Whereas in Nalm6 B-acute lymphoblastic leukemia cells, G9a/GLP-dependent GR target genes are enriched for cell proliferation and cell death pathways, and their depletion desensitizes Nalm6 cells GCs-induced cell death (Poulard *et al.*, 2019).

Therefore, GR target genes belonging to different physiological pathways, such as anti-inflammatory genes, metabolic genes, or tissue-remodeling genes, require different sets of coregulators (colored rectangles) (**Figure 24**). Whereas GR target genes belonging to same physiological pathway require similar subset of coregulators (**Figure 24**). Additionally, each

coregulator can be exposed to post-translational modifications in response to external signals. In turn these modifications can modify the function of the corresponding coregulator. This diversity in coregulators requirement represent an opportunity to modulate the hormone response by selectively promoting or inhibiting specific GC-regulated pathways through modulating the activity of one (or a subset of) coregulator(s) (Stallcup and Poulard, 2020a).

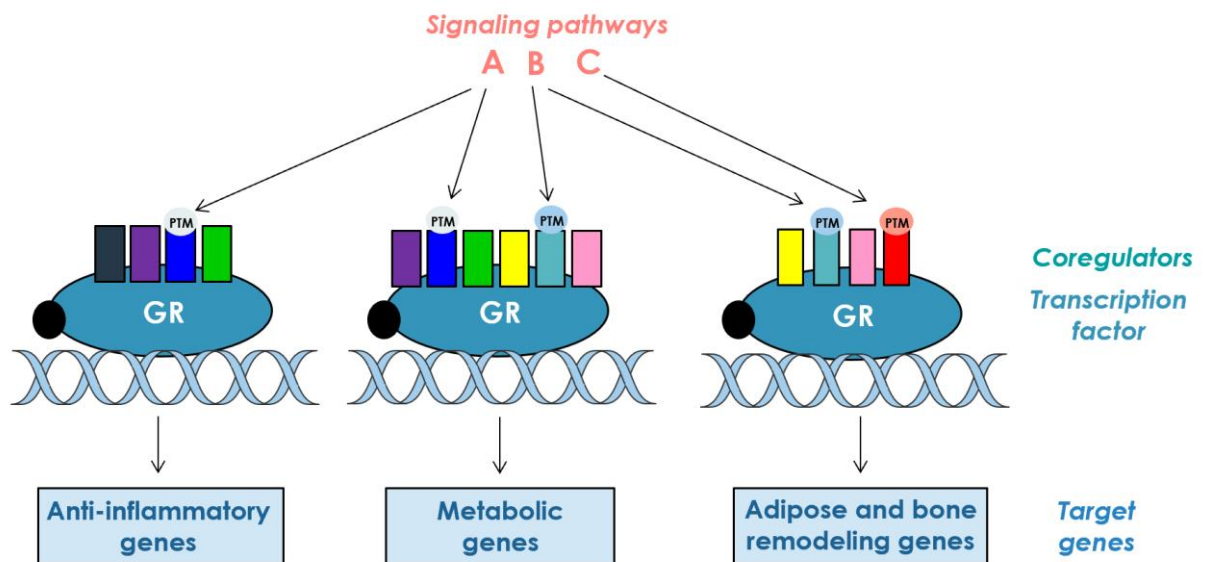

(Stallcup and Poulard, 2020a)

Figure 24 : The Gene-Specific Actions of GR Coregulators is Associated with Specific Physiological Pathways.

Additionally, many coregulators possess dual role in gene regulation i.e., a given coregulator can function as coactivator or corepressor for a TF in the same cell type. GRIP1, G9a, and Hic-5 represents a good example in activating and repressing direct target genes of GR. GRIP1 (Src-2) which is a well-known coactivator for GR, also functions as a corepressor for GR-target proinflammatory genes (Hong *et al.*, 1996; Chinenov *et al.*, 2012) that is recruited by the hormone-activated GR to the GR-responsible elements on DNA is required to positively regulate some genes and negatively regulate others, yet it is not required for the regulation of a third set of GR target genes within the same cell (Purcell *et al.*, 2011; Bittencourt, D. Y. Wu, *et al.*, 2012; Poulard *et al.*, 2017, 2018). Hic-5 (hydrogen peroxide-inducible clone-5) coregulator displays more complex gene-specific mechanisms. In addition to its coactivator and corepressor activities, Hic-5 opposes the effect of hormone-activated GR on other target genes. For instance, depleting Hic-5 enhances further the Dex-induced expression or Dex-

induced repression of target genes. Also, another set of genes are not regulated by activated-GR except when Hic-5 is depleted (Chodankar *et al.*, 2014).

Coregulators exert these diverse effects by using different mechanisms of action on different target genes of GR within a cell. Coregulators such as GRIP1 use their different multi-protein interaction domains as discussed above to either activate or repress target genes (Rogatsky *et al.*, 2002). For example, G9a suppresses target genes by using its C-terminal SET domain to add repressive methyl marks on histone H3 at Lysine 9 (Tachibana *et al.*, 2002). Also, it suppresses genes by using its ankyrin repeat domain to recruit DNA methyltransferase (Epsztejn-Litman *et al.*, 2008). In opposite, G9a uses its N-terminal domain (NTD) to exert its coactivator function. G9a induces GR-target gene expression through self-methylation of a lysine residue in the NTD, which results in the recruitment of HP1 γ (Heterochromatin Protein 1 γ), and thereby recruitment of RNA polymerase II (Purcell *et al.*, 2011; Poulard *et al.*, 2017). Hic-5 which binds the hinge region of GR have different mechanism of action (Yang *et al.*, 2000). Once recruited to genomic GR binding sites, Hic-5 promotes the recruitment of the Mediator complex and RNA polymerase II for activating the transcription of GR-regulated genes. Whereas it blocks GR interaction with some chromatin remodeling complexes, preventing the efficient GR association with genomic binding sites and the hormonal activation of other genes (Chodankar *et al.*, 2014; Lee and Stallcup, 2017).

Several factors determine the specific-gene requirements for coregulators via establishing a unique regulatory environment for each gene. Different target genes of GR demand different sets of coregulators due to their unique DNA regulatory sequences and chromatin environment. The fine differences in these DNA regulatory sequences to which GR binds affect GR conformation and activity, leading to distinctive recruitment of coregulators (Lefstin and Yamamoto, 1998; Meijnsing *et al.*, 2009a). Each target gene has distinct sets of regulatory elements on DNA, thus the recruited GR and coregulators come up with unique set of protein-protein interactions. As well, the different synthetic ligands of GR can influence its conformation, bringing on different coregulators (Meijer, Koorneef and Kroon, 2018). Moreover, chromatin conformation at a specific gene locus requires specific set of coregulators to modify its positioning to a less or more accessible conformation for transcriptional complexes. Finally, PTMs that are made by enzymatic coregulators can also influence the actions of GR and coregulators present (Stallcup and Poulard, 2020a).

4. GR Coregulators Regulations

Coregulator proteins are targets of extracellular and intracellular regulatory signals. These signals regulate the activity of coregulators by stimulating the addition or removal of post-translational modifications (PTMs) or by modulating the amount of coregulators. These alternations can promote or inhibit protein-protein interactions, change the composition of protein complexes, and allow the transmission of external signals rapidly, thereby adding another layer of gene regulation. Based on that, regulating the level of coregulator or its activity can help in fine-tuning the actions of GR by selectively enhancing or inhibiting specific targeted pathways that require this coregulator (Millard *et al.*, 2013; Stallcup and Poulard, 2020a). Several PTMs stimulated by different signaling pathways are identified to alter GR-coregulators activities. For example:

I) Phosphorylation of GRIP1/SRC-2 by CK2 and CDK9 at several sites is mandatory for regulating a subset of GR-target genes upon GCs binding (Dobrovolna *et al.*, 2012). Moreover, phosphorylation of the N-terminus of SRC-2 by CDK9 in macrophages is requisite to induce GCs-regulated anti-inflammatory genes expression. This phosphorylation occurs at specific GR-binding sites to potentiate SRC-2 coactivator activity and not its corepressor activity (Rollins *et al.*, 2017).

II) Self-methylation of G9a and its homodimer GLP on the lysine residue presents in their N-terminal activation domains is required for their full coactivator activity upon binding GC-bound GR. This methylation provides a binding site for the heterochromatin protein 1 gamma (HP1 γ) (Poulard *et al.*, 2017). Mechanistically, HP1 γ phosphorylation of serine 93 facilitates the interaction with RNA polymerase II, stimulating the coactivator functions of HP1 γ and preventing its repressive action widely described (Koike *et al.*, 2000; Lomberk *et al.*, 2006). In contrast, phosphorylation of the adjacent threonine by Aurora kinase B (AURKB) prevents binding to HP1 γ and blocks the coactivator function of G9a and GLP (Poulard *et al.*, 2017). This molecular switch controls selected physiological responses of GR among multiple pathways that it regulates. Indeed, this molecular switch regulates GC-repression of cell migration in the lung cancer cell line as it induces the expression of migration-inhibitory genes such as CDH1 (encoding E-cadherin) (Poulard *et al.*, 2017), and GC-induced cell death in B-acute lymphoblastic leukemia (B-ALL) as it induces the expression of cell death pathway genes

(Poulard *et al.*, 2018, 2019). Further inhibition of AURKB or lysine demethylases increases G9a/GLP methylation and enhance the transcription of G9a/GLP/HP1 γ -dependent GR target genes resulting in enhanced cell death in B-ALL and reduced cell migration in lung cancer cell line.

In addition, the modulation of coregulator amounts due to external signals is shown to alter GR actions on targeted pathways. For instance, the transcriptional coactivator PGC-1 (PPAR γ coactivator-1), known as coactivator for multiple nuclear receptors, is shown to bind GR and coactivate the transcription of its target genes (Knutti and Kralli, 2001). PGC-1 protein levels are upregulated in response to thermal and nutritional signals (Puigserver *et al.*, 1998; Yoon *et al.*, 2001). PGC-1 protein levels are induced in liver under fasting conditions to upregulate the expression of gluconeogenic such as phosphoenolpyruvate carboxykinase (PEPCK) through GR and in a hormone-dependent manner (Yoon *et al.*, 2001). Therefore, glucose production under fasting conditions is induced by PGC-1 upregulation.

Moreover, the properties of coregulators can be altered by the alternative mRNA splicing which is altered by hormonal and metabolic signals. Ncor1 and Ncor2 genes encoding for NCoR and SMRT GR-corepressors are subjected to alternative splicing, giving rise to different coregulator variants with highly distinct functions. NCoR splice variants are essential in driving normal adipocyte differentiation and excess-calories storage during normal development. The specific knock out of these splice-variants in mice result in different phenotypes, thus revealing their different functions (Goodson *et al.*, 2014). Also, appropriate alternative splicing of Ncor1 mRNA is induced by dexamethasone to promote normal differentiation of adipocytes in-vitro. Moreover, dietary variations in mice can also modulate the alternative splicing of Ncor1 gene (Snyder *et al.*, 2015).

5. GR Physiological Coregulator Code

As displayed above, the gene-specific actions of coregulators are actually physiologically pathway-specific. Such evidence proposes the presence of 'physiological coregulator code', whereby regulating the level or activity of a coregulator will modulate the transcription of genes associated with one or more specific physiological pathways regulated by transcription

factor such as GR. This 'physiological coregulator code' represents the coregulators as potential therapeutic targets in clinic (Stallcup and Poulard, 2020b).

One more time the glucocorticoids (GCs) represent a perfect example, as they maintain homeostasis of many physiological pathways in diverse tissues by regulating the transcription of specific subsets of target genes (Figure 4). As mentioned in previous chapter, cortisol regulates various physiological pathways involved in inflammation, glucose and lipid metabolism, bone maintenance, etc. (Figure 4) in response to external stress such as hunger (low glucose levels), cold (low body temperature), fear, and illness (increased inflammation) (Bodine and Furlow, 2015; de Guia and Herzig, 2015; Frenkel, White and Tuckermann, 2015; Kuo *et al.*, 2015b; Oppong and Cato, 2015; Kalafatakis, Russell and Lightman, 2019). GCs respond to stress require a specific set of coregulators to regulate the transcription of a specific subset of genes associated with a specific physiological pathway. For example, low blood sugar requires a set of coregulators for GCs to maintain normal glucose level, whereas inflammation requires a set of coregulators for GCs to attain its anti-inflammatory actions, etc. (**Figure 25**). Therefore, regulating the activity of a coregulator will affect a selective physiological pathway controlled by GCs without affecting the others, due to its gene- and pathway-specific actions.

Inhibiting the coregulator enzymatic activity or the enzymes responsible for regulating coregulators by PTMs are important therapeutical approaches. For instance, inhibitor of histone methyltransferase and histone deacetylases are being tested in clinic (Chan, Tse and Kwong, 2017; Laubach *et al.*, 2017; Fioravanti *et al.*, 2018). Also, targeting the PTMs of G9a/GLP by inhibiting lysine demethylases or Aurora kinase B enhances G9a/GLP coactivator activity and promotes GCs-induced cell death in B-ALL (Poulard *et al.*, 2018, 2019).

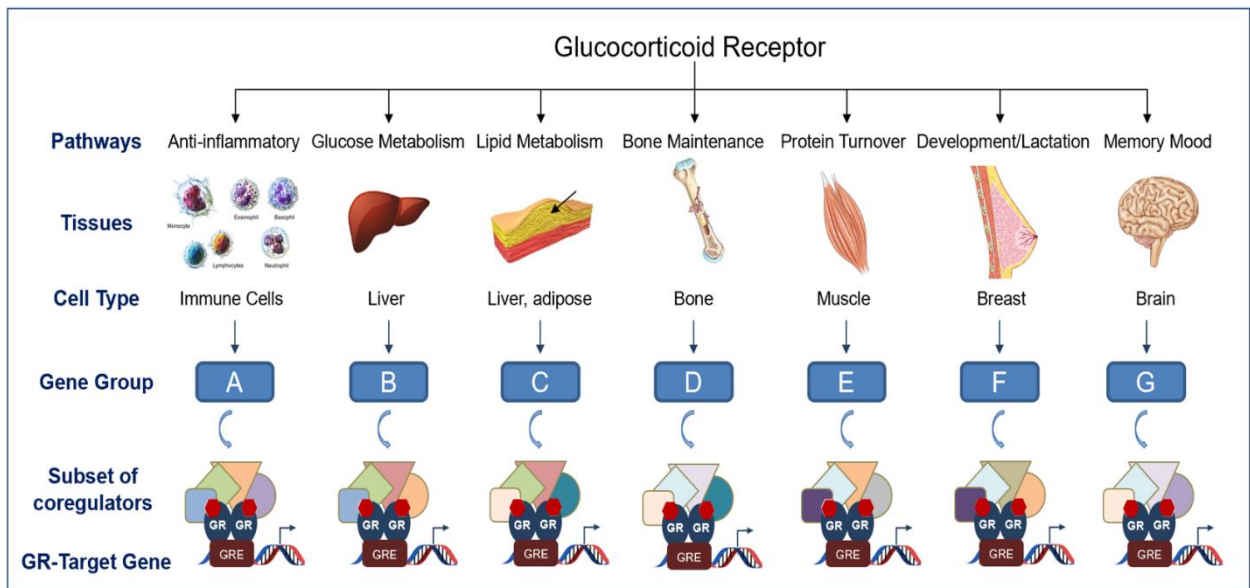

Figure 25 : The GR Physiological Coregulators Code.

Chapter V: Glucocorticoids Receptor Role in Mammary Gland

1. GR's Function in Normal Breast Tissue

In normal breast tissue, GR is predominantly expressed in the nuclear compartments of human myoepithelial cells (MECs) surrounding the lobular and ducts units. On the other hand, the luminal epithelial cells (LECs) did not express GR (Lien *et al.*, 2006; Buxant, Engohan-Aloghe and Noël, 2010). Further slight expression of GR was detected in some stromal cells, endothelial cells, and leukocytes (Lien *et al.*, 2006). Glucocorticoids (GCs) were found to contribute to the development and differentiation of mammary epithelium at puberty and during pregnancy (Murtagh *et al.*, 2004; Wintermantel *et al.*, 2005). GCs are essential for the formation and maintenance of the 3D organization of mammary epithelial acini due to their ability to promote the expression of the extracellular protein β 4-integrin (Murtagh *et al.*, 2004).

As GR knockout mice are not viable, multiple approaches were adopted by researchers in order to investigate the role of GR in mammary gland function and development in adult mice (Reichardt *et al.*, 1998, 2001; Wintermantel *et al.*, 2005). Studies revealed that GR has a substantial role in the mammary gland. The selective deletion of GR gene in epithelial cells using the Cre-LoxP models demonstrated that GR function is important for cell proliferation during lobulo-alveolar development but is not essential for alveolar differentiation and milk secretion (Wintermantel *et al.*, 2005). Moreover, the ductal development of the mice mammary gland is impaired in virgin females deficient lacking the DNA binding functions of GR. Contrarily, lactating females of these mice are completely capable of producing milk proteins and have properly differentiated mammary glands (Reichardt *et al.*, 2001). The explanation for this, according to authors, is because DNA binding-defective GR may still interact with phosphorylated Stat5 protein, which is implicated in the production of milk proteins.

During normal lactation, GCs have been found to prevent mammary gland apoptosis (Berg, Dharmarajan and Waddell, 2002; Bertucci *et al.*, 2010). Additionally, GCs are involved in

regulating the early involution of mammary glands through modulating the cross talk between GR, Stat5 and Stat3 pathways. For instance, during lactation, GR synergizes with Stat5 to induce milk protein expression genes (Bertucci *et al.*, 2010). In fact, synthetic GCs administration within the first 48 hours after stopping breastfeeding modulates Stat5 and Stat3 signaling and prevent the onset of apoptosis in post-lactating mice.

2. GR's Function in Breast Cancer Progression

Numerous investigations have been made to understand how GR affects BC cell survival and progression on a cellular and biological level. However, depending on ER α expression and activity, the role of GR can be either proliferative or anti-proliferative ((**Noureddine** *et al.*, 2021)

Figure 26). In fact, the prognostic significance of GR expression varies depending on the BC subtype, with higher GR expression being associated with a worse prognosis in TNBC and a better prognosis in early-stage ER α -positive BCs (Pan, Kocherginsky and Conzen, 2011; Abduljabbar *et al.*, 2015; West *et al.*, 2016). The evidence converges to show that GC promotes the expression of pro-tumorigenic genes in BCs that are ER α -negative (Chen *et al.*, 2015; Sorrentino *et al.*, 2017a) whereas GR suppresses ER α transcriptional activity and E2-mediated cell proliferation in BCs that are ER α -positive (Lippman, Bolan and Huff, 1976; Karmakar, Jin and Nagaich, 2013; Yang *et al.*, 2017a)

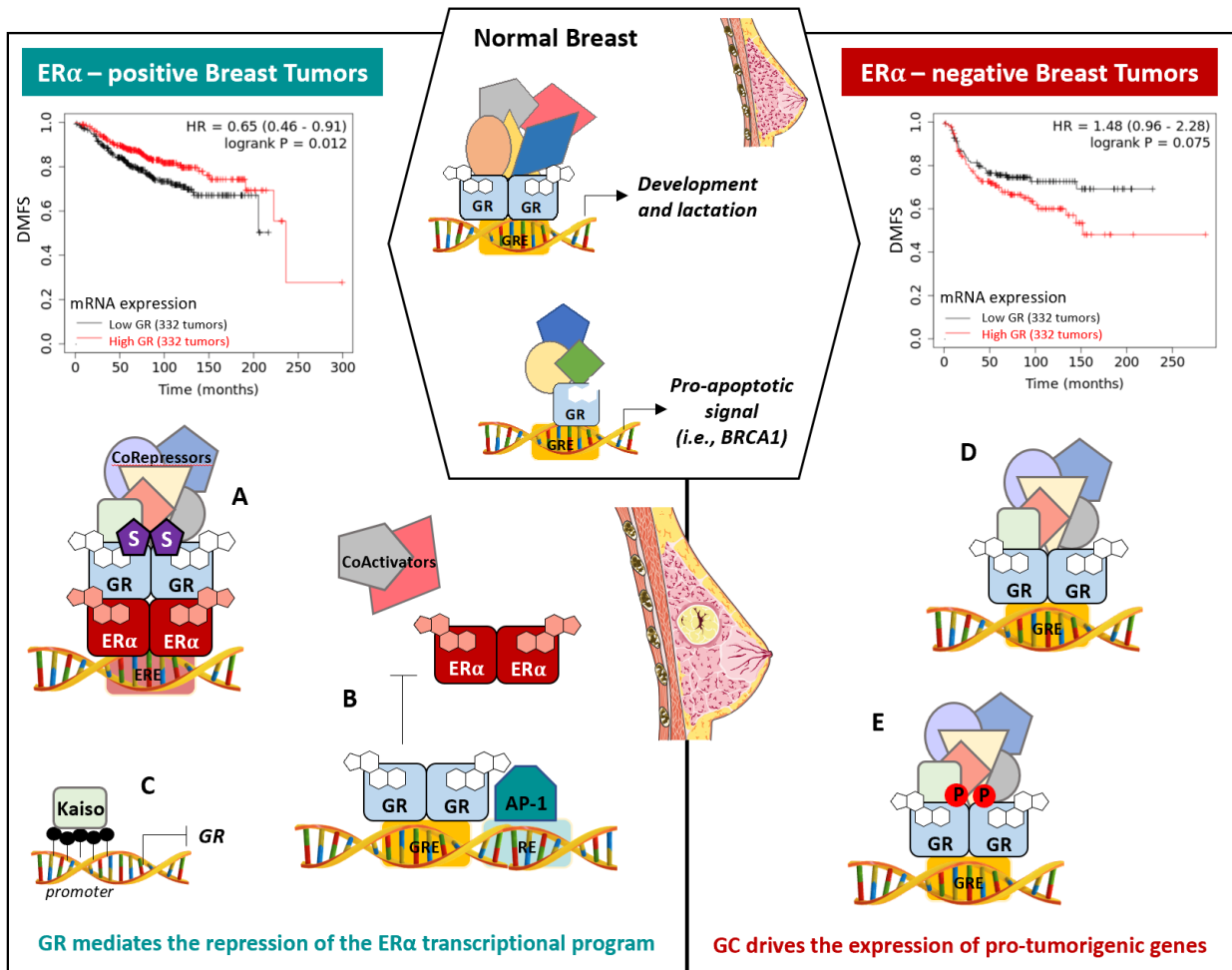

(Noureddine et al., 2021)

Figure 26 : Glucocorticoid Receptor Role in normal breast Tissue and in Breast Cancer Progression. Role of GR in normal breast are presented in the middle white box, Role of GR in ERα-positive are presented to the right in green, and its role in ERα-negative are presented to the left in red.

2.1. ERα-Positive Breast Cancers

For ERα-positive BC patients, the high expression of GR in the tumor is associated with a better prognosis and relapse-free survival (RFS) outcome in the early stages of the disease (Pan, Kocherginsky and Conzen, 2011; Abduljabbar et al., 2015; West et al., 2016) ((Noureddine et al., 2021)

Figure 26A). *In vitro* studies showed that GCs can hinder the proliferation of ERα-positive BC MCF-7 cell lines through disrupting cell cycle progression (Lippman, Bolan and Huff, 1976)(Goya et al., 1993). Collectively, investigations revealed that the GR-DNA binding domain's direct interaction with the ERα is the molecular mechanism underlying the controlled ERα transcriptional activity by GR and, in turn, E2-stimulated proliferation

(Karmakar, Jin and Nagaich, 2013; West *et al.*, 2016; Yang *et al.*, 2017b; Tonsing-Carter *et al.*, 2019). Additional analysis using Chromatin Immunoprecipitation (ChIP) experiments in MCF-7 cells showed that GR interfered with ER α activity by competing with ER α and the coactivator SRC3 at the ER-response elements (ERE) of specific target genes, either directly by binding to the ERE or indirectly by binding to other factors like AP-1 (Karmakar, Jin and Nagaich, 2013; Miranda *et al.*, 2013; Swinstead *et al.*, 2016) ((**Noureddine** *et al.*, 2021)

Figure 26B). Further investigations revealed that GR and ER α coactivation increased GR binding to GR- and ER-responsible elements (GRE and ERE), leading to an increase in pro-differentiating genes and negative regulators of pro-oncogenic Wnt signaling, as well as a decrease in the expression of genes related to mesenchymal transition (EMT), which improved relapse-free survival in ER α -positive BCs (West *et al.*, 2016). Furthermore, a recently published study showed that liganded GR inhibited E2-mediated proliferation by preventing the association of ER α with chromatin at the enhancer region of E2-induced pro-proliferative genes, thereby lowering their expression and regardless of the ligand's nature (i.e., GR agonist or GR antagonist) (Tonsing-Carter *et al.*, 2019). This process also incorporates GR sumoylation. Yang *et al.* did in fact illustrate that GR recruitment to the ER α enhancer requires GR sumoylation on K277, K293 and K703, which then triggers the recruitment of the NCoR/SMRT/HDAC3 corepressor complex, which suppresses the estrogen (E2) program ((**Noureddine** *et al.*, 2021)

Figure 26A). Furthermore, E2 treatment induces PP5 phosphatase expression, which results in the dephosphorylation of GR on S211 and a reduction in GR activity on certain GR target genes implicated in cell growth arrest (Zhang *et al.*, 2009).

Additional assessments in T47D cells showed that dex administration suppresses cell migration via altering the AKT/mTOR/RhoA pathway, which in turn disrupts the cytoskeletal dynamic architecture of the cells (Meng and Yue, 2014). The precise mechanism underpinning this process, however, were not clarified.

It is well established that the two different mechanisms: promoter methylation at CpG islands (Nesset, Perri and Mueller, 2014; Snider *et al.*, 2019) and proteasomal degradation (Kinyamu and Archer, 2003) are responsible for the GR expression repression predominantly in ER α -positive breast cancers. Notably, Kaiso, a Pox Virus and Zinc Finger (transcription factor) binds

to methyl-CpG islands present in the GR promoter region, suppressing GR expression in ER α -positive breast cancer cell lines (MCF-7 and T47D), and decreasing GR anti-apoptotic efficacy (Zhou *et al.*, 2016) ((**Noureddine** *et al.*, 2021)

Figure 26C). Besides that, Archer's team demonstrated utilizing an engineered MCF-7/GR cell line that estrogen agonists, but not ER α antagonists, promote the proteasomal degradation of GR via Mdm2, affecting its transcriptional activity (Kinyamu and Archer, 2003). However, additional research will be required to validate this finding in a more physiological environment, as this cell line expresses 100,000 times more GR than MCF-7 cells.

Collectively, these findings imply that, in ER α -positive BCs, GR mediates the suppression of the ER α transcriptional program through a crosstalk with ER α .

2.2. ER α -Negative Breast Cancers

When compared to ER α -positive breast cancer, GR expression in human ER α -negative BCs was linked to a poor outcome, a shorter breast cancer-specific survival, and an earlier relapse at early stages (Pan, Kocherginsky and Conzen, 2011; Abduljabbar *et al.*, 2015; Chen *et al.*, 2015). For instance, whether receiving adjuvant chemotherapy or not, a high tumoral GR expression was significantly associated with a shorter relapse-free survival in 1,378 early-stage ER α -negative BCs and 623 TNBC patients, according to a retrospective meta-analysis (Pan, Kocherginsky and Conzen, 2011; West *et al.*, 2018). Additionally, over the past several years, mounting data has sufficiently revealed the tumorigenic effects of GCs in ER α -negative BCs, as exemplified by resistance to chemotherapy and metastatic development (Skor *et al.*, 2013; Chen *et al.*, 2015; Obradović *et al.*, 2019). A genome-wide analysis revealed specific dex-induced GR target genes implicated in epithelial cell/inflammatory cell interactions, EMT, chromatin remodeling, tumor cell survival, and chemotherapy resistance. This indicates that GR might indeed play a significant role in the aggressive behavior of ER α -negative BCs (Pan, Kocherginsky and Conzen, 2011). Furthermore, a recent signature of a specific subset of GR target genes that are involved in cell survival, cell invasion, and chemoresistance was determined by analysis of global gene expression and GR ChIP-sequencing data (West *et al.*, 2018) ((**Noureddine** *et al.*, 2021)

Figure 26D).

To better understand the role of GR in increasing tumor progression in ER-negative BCs, numerous mechanistic investigations are currently being conducted. One of them have shown that cellular stress, such as oxidative stress or hypoxia, increases the phosphorylation of GR on S134 in primary TNBCs or ER-negative BC cell lines, stimulating stress signaling mediated by GR activation and increasing the expression of breast tumor kinase BRK, also known as protein tyrosine kinase 6 (PTK6), which is crucial for aggressive BC phenotypes (Regan Anderson *et al.*, 2016). Moreover, TNBCs exhibit higher levels of functionally active pS134-GR than luminal BCs, which may account for the worse prognosis associated with GR expression in TNBCs compared to luminal BCs (Perez Kerkvliet *et al.*, 2020) ((**Noureddine** *et al.*, 2021)

Figure 26E). According to a recent study on patients and TNBC cell line-derived xenograft models, GR activation at distant metastatic sites, caused by an increase in GC levels, stimulates BC colonization and decreases overall survival by upregulating the expression of ROR-1 kinase, a receptor tyrosine kinase-like orphan receptor-1 that has earlier been found to be associated with BC (Zhang *et al.*, 2012; Chien *et al.*, 2016; Obradović *et al.*, 2019). In fact, silencing ROR-1 expression by shRNAs inhibits tumor metastatic potential and improves the survival in mice models. These findings are compatible with previous expression microarray analyses that proposed multiple kinases as potential targets for the therapy of ER α -negative BC (Speers *et al.*, 2009; Cui *et al.*, 2013). Additional research established that GR activation by dex disrupted the Hippo pathway through augmenting the transcriptional activity, nuclear accumulation, and protein/RNA levels of YAP and TEAD-4 (Sorrentino *et al.*, 2017a; He *et al.*, 2019). Previous findings showed that the disruption of the oncosuppressor Hippo pathway, which is primarily comprised of kinase complexes, transcriptional cofactors Yes associated protein (YAP) and its paralog WW domain containing transcription regulator 1 (TAZ), and TEA domain transcription factors (TEAD1-4), is coupled to BC progression and chemoresistance. Indeed, the elevated expression level and transcriptional activity of YAP/TEAD-4 was demonstrated to play an important role in promoting BC cell survival and metastasis (Lamar *et al.*, 2012). Physiologically, GCs' activation of YAP and TEAD-4 induced BC cells' survival, metastasis, resistance to chemotherapy, and maintenance of breast cancer stem cells both *in vitro* and *in vivo* (Sorrentino *et al.*, 2017b; He *et al.*, 2019). TEAD-4 was one of nine genes identified to be overexpressed in high grade ER α -negative tumors, together with its coactivator, the pro-survival transcription factor (Krüppel-like factor 5; KLF5) (Ben-Porath *et*

al., 2008). In BC patients, their high expression level was attributed to a poorer prognosis and shorter survival (Tong *et al.*, 2006; He *et al.*, 2019). Additionally, it was demonstrated that TEAD-4 associates with KLF5 to produce a complex that stimulates TNBC cell proliferation by impeding p27 gene transcription (Wang *et al.*, 2015). Remarkably, GR activation by dex increases KLF5 expression in TNBCs, and elevated KLF5 consequently results in both *in vitro* and *in vivo* cisplatin resistance (Li *et al.*, 2017).

Multiple pro-survival genes, including MKP-1 (MAPK phosphatase-1), SGK1 (Serum and glucocorticoid-regulated kinase-1), and others, were shown to be upregulated in a global gene expression analysis in MDA-MB-231 cells upon dex administration (Mikosz *et al.*, 2001; Wu *et al.*, 2004, 2005). The same cell line's ChIP-seq analysis also determined that dex-liganded GR binds to the GREs of pro-tumorigenic genes, promoting drug resistance and the progression of TNBC (Sorrentino *et al.*, 2017a). Due to GR's transcriptional upregulation of these pro-survival genes upon dex treatment, MDA-MB-231 cells are less likely to undergo apoptosis triggered by paclitaxel or doxorubicin (Chen *et al.*, 2015) (Wu *et al.*, 2004). On the other hand, the Hsp90 inhibitor, was demonstrated to improve TNBC sensitivity to paclitaxel *in vitro* and *in vivo* by degrading GR and disrupting its anti-apoptotic signaling (Agyeman *et al.*, 2016).

Moreover, investigations *in vivo* were performed to address the prospective inhibitory impact of GCs on anti-tumor paclitaxel action. In light of this, pre-treatment with dex dramatically reduced the therapeutic effectiveness of paclitaxel in human tumor xenografts established by grafting human ER α -negative BCs into nude mice (Pang *et al.*, 2006; Sui *et al.*, 2006; Agyeman *et al.*, 2016; Li *et al.*, 2017). In contrast, pre-treating TNBCs with the GR antagonist Mifepristone concurrently with dexamethasone and Paclitaxel enhanced the cytotoxic effectiveness of the chemotherapy by provoking caspase-3/PARP cleavage-mediated cell death and obstructing GR-mediated survival signaling through hindering GR-induced SGK1 and MKP1 gene expression. More interestingly, it was documented that mifepristone pre-treatment slowed the growth of MDA-MB-231 xenograft tumors (Skor *et al.*, 2013). In accordance with these findings, a randomized Phase I clinical trial reported that patients with GR α -positive and triple-negative tumors responded to the combination of GR antagonism (mifepristone) and paclitaxel, demonstrating that GR is a potential target in TNBCs (Nanda *et al.*, 2016).

Recently, researchers revealed that GR is required for BCs' activation of EMT and metastasis. They discovered that insulin receptor substrate 1 (IRS-1), a cytoplasmic adaptor protein that mediates insulin/insulin-like growth factor signals, has its transcription inhibited by high GR expression levels. The suppression of IRS-1 by GR leads to the activation of ERK2 (extracellular regulated protein kinase 2) and the induction of EMT [Shi W 2019]. Furthermore, they showed that GR is transcriptionally activated in TNBCs in the absence of GR ligands through its phosphorylation on S134 by p38 in response to homeostatic sensing of intrinsic stress or exogenous stimuli (like TGF β -1). Phospho-S134-GR stimulates the p38 MAPK stress signaling pathway, triggering the anchorage-independent proliferation and migration of TNBC cells (Perez Kerkvliet *et al.*, 2020) ((**Noureddine** *et al.*, 2021)

Figure 26E).

Noteworthy, Danish epidemiological research on a cohort of BC patients found no association between GC usage and BC recurrence, regardless of the method of administration or the use of combination treatment (Lietzen *et al.*, 2014). However, more epidemiological investigations to validate these findings in different patient populations will be necessary. Furthermore, an increasing number of studies show the effects of stressful situations on the risk of BC. Acute stress events can really raise the incidence of BC, as the Women Health Initiative Study revealed (Michael *et al.*, 2009). For instance, rats subjected to external stressors such as chronic social isolation displayed higher levels of corticosterone as well as a disruption in the subcellular localization of GR. In fact, GR was more commonly detected in the nucleus than the cytoplasm in tumor samples from socially isolated animals, and these rats also had more aggressive breast tumors (Hermes *et al.*, 2009).

This chapter emphasizes the important role of GR and its ligands in BC biology and physiology despite its well-defined contributions to numerous normal and pathological processes. The high level of complexity that was not anticipated is illustrated by the fact that GR expression has various prognostic values depending on the BC subtype. Despite great advancements in our understanding of BC and the crucial role that GR plays in the pathophysiology, this area of research still confronts numerous challenges. Although this chapter focuses primarily on the impact of GCs on tumor cells, we cannot rule out the fact that they can have an impact on the tumor microenvironment. Following the characterization of the tumor status, taking into

consideration GR expression in the tumor environment may be of the highest relevance and may offer an interesting target in the modulation of the tumoral breast microenvironment.

In addition, as we discussed in Chapter II, GR exhibited proliferative effects on BC cells *in vivo* and *in vitro* regardless their hormonal status upon binding OCDO, the recently identified GR-ligand (Voisin *et al.*, 2017). Nevertheless, the transcriptional program of OCDO in the distinct BC subtypes has not yet been described, which might offer insights to fully comprehend its carcinogenic features. A more thorough examination of the expression of OCDO-producing enzymes following the status of BCs, in addition to the cholesterolemia status of patients, is of the utmost relevance to fully comprehend the effects of OCDO, an oncometabolite derived from cholesterol, on breast tumorigenesis in ER α -positive vs ER α -negative BCs.

Furthermore, new information emphasizes the significance of ER beta (ER β), a second kind of estrogen receptor, in breast cancer biology (Zhou and Liu, 2020). In light of a study conducted in the central nucleus of the amygdala, which disclosed that ER β activation forbids glucocorticoid-induced anxiety behaviors and decreases plasma cortisol levels in rats compared to animals implanted with vehicle or GR agonist (Weiser, Foradori and Handa, 2010), additional studies will be required to examine the potential crosstalk between ER β and GR in BC.

Results

1. Introduction

Breast cancer (BC) is the most common and most fatal cancer in women worldwide causing the death of 684,996 women yearly (Sung *et al.*, 2021). Breast cancer is generally classified based on the expression profile of estrogen receptor (ER), progesterone receptor (PR) and human epidermal growth factor receptor 2 (HER2) into four main molecular subtypes: Luminal A (ER+ and/or PR+, and HER2-), Luminal B (ER+ and/or PR+, and HER2+), HER2 enriched (ER+, PR-, and HER2+++ or Triple Positive) or Triple Negative (ER-, PR-, and HER2-) (Tang *et al.*, 2016). Among these different subtypes, Triple negative breast cancer (TNBC) representing 10-15% of all breast cancer cases is associated with poor overall survival, higher rates of recurrence and worse prognosis (Sotiriou and Pusztai, 2009; Bosch *et al.*, 2010). Because TNBCs lack the expression of hormone receptors and HER2 receptors, there are no targeted biological agents clinically available for their treatment (Yadav, Chanana and Jhamb, 2015). Till now, the predominant clinical strategy for treating TNBC patients is the systemic cytotoxic chemotherapy which frequently causes allergic reactions (Santana-davila and Perez, 2010)(Bosch *et al.*, 2010).

Synthetic glucocorticoids (GCs) such as dexamethasone (Dex), which are derived from steroidal endogenous glucocorticoids, are widely used as adjuvant therapy in BC treatment to decrease the allergic reactions accompanying cytotoxic chemotherapy including nausea and vomiting. Also, GCs reduces tumor-associated effects on patient's health such as loss of appetite, pain, edema, electrolyte balance and inflammation (Henzi, Walder and Trame, 2000; Wang *et al.*, 2004; Chen *et al.*, 2016; de Castro Baccarin *et al.*, 2019). The endogenous natural form of GCs is cortisol; a cholesterol-derived hormone, synthesized and released by the adrenal cortex in response to the adrenocorticotrophic hormone (ACTH) produced by the anterior pituitary. GCs are secreted in a circadian manner; however, their secretion increases in response to physiological stress (i.e., increased immune response) and emotional stress such as hunger, cold and fear (Spiga *et al.*, 2014; Kalafatakis, Russell and Lightman, 2019). Though GCs are often used in BC for their antiemetic and anti-inflammatory effects, investigations have shown that GCs treatment in TNBC is inducing cancer metastasis and chemoresistance, thus raising new concerns about GCs application in TNBC patients' therapy (Skor *et al.*, 2013; Obradović *et al.*, 2019).

GCs diffuse through the cell membrane and function through binding the ligand-dependent transcription factor glucocorticoid receptor (GR) in the cytosol. GR is a member of the nuclear hormone receptor (NHR) superfamily. Similar to other NHRs, GR displays the common functional domains: DNA-binding domain (DBD), ligand-binding domain (LBD), and other regulatory N- and C-terminal domains (Gigu *et al.*, 1986; Whitfield *et al.*, 1999). GR α , referred to as GR, is the major GR isoform responsible for most GC-mediated transcriptional activities and is ubiquitously expressed throughout the body (Hollenberg *et al.*, 1985). GC-bound GR translocate to nucleus where it binds specific responsible elements (REs) present in the promoter region of target genes and recruit different sets of coregulators to enhance or repress their transcription (Noureddine *et al.*, 2021). GR regulates genes involved in a broad range of physiological pathways such as inflammation, glucose and lipid metabolism, bone maintenance, etc. Different sets of coregulators are required to regulate the transcription of different GR target genes. GR target genes belonging to same physiological pathway demand similar sets of coregulators, while GR target genes belonging to distinct physiological pathways demand different sets of coregulators (Stallcup and Poulard, 2020a).

Based on that, our project aims to decipher the GR-regulated pathways resulting in the adverse side effects of GCs (i.e., metastasis and chemoresistance) in TNBC, and identify the sets of coregulators involved in these pathways. Therefore, reaching the main goal which is preventing the deleterious effects of GCs in TNBC through targeting the specific GR coregulators implicated without affecting the beneficial ones.

2. Article

PRMT5 Triggers Glucocorticoid-Induced Cell Migration of Triple Negative Breast Cancer Independently of its Enzymatic Activity

Lara Malik Nouredine, Julien Ablain, Ausra Surmieliova-Garnès, Julien Jacquemetton, Elisabetta Marangoni, Bassam Badran, Isabelle Treilleux, Olivier Trédan, Nader Hussein, Muriel Le Romancer and Coralie Poulard

PRMT5 triggers glucocorticoid-induced cell migration of Triple Negative Breast cancer independently of its enzymatic activity

Lara Malik Nouredine^{1,2,3,4}, Julien Ablain^{1,2,3}, Ausra Surmieliova-Garnès^{1,2,3}, Julien Jacquemetton^{1,2,3}, Elisabetta Marangoni⁵, Bassam Badran⁴, Isabelle Treilleux^{1,2,6}, Olivier Trédan^{1,2,3,7}, Nader Hussein⁴, Muriel Le Romancer^{#1,2,3} and Coralie Poulard^{**1,2,3}

1. Université de Lyon, F-69000 Lyon, France
2. Inserm U1052, Centre de Recherche en Cancérologie de Lyon, F-69000 Lyon, France
3. CNRS UMR5286, Centre de Recherche en Cancérologie de Lyon, F-69000 Lyon, France
4. Lebanese University, Faculty of Sciences, Laboratory of Cancer Biology and Molecular Immunology, Hadat-Beirut, Lebanon
5. Institut Curie, Translational Research Department, PSL University 75005 Paris, France
6. Centre Leon Bérard, Pathology Department, Lyon, France
7. Centre Leon Bérard, Oncology Department, Lyon, France

Correspondence: coralie.poulard@lyon.unicancer.fr; Tel.: 00 33 4 78 78 66 63

Authors contributed equally to this work

Keywords: Glucocorticoids, cell migration, breast cancer, Glucocorticoid receptor, Coregulators, PRMT5, HP1 γ

Abstract

Triple negative breast cancers (TNBCs: ER α -, PR-, HER2-) are the most aggressive, and therapeutic options solely rely on conventional chemotherapy. To alleviate the side effects of chemotherapy, synthetic glucocorticoids (GCs) are routinely given as a complementary medication. However, GCs were recently associated with adverse effects such as metastases formation and resistance to chemotherapy, though the mechanisms involved remain elusive. Since the effects of GCs are mediated by the binding of the glucocorticoid receptor (GR) to a specific set of coregulatory proteins, we searched for key coregulators of GR that could potentially be modulated to specifically target its deleterious effects. Here, we identified that the arginine methyltransferase PRMT5 acts as a scaffold protein to recruit HP1 γ and the RNA polymerase II to regulate the transcription of genes involved in cell migration. Of note, we confirmed that PRMT5 regulates these processes independently of its methyltransferase activity. Moreover, the GR/PRMT5/HP1 γ complex triggers cell migration induced by GCs *in vitro* and *in vivo* in the Zebrafish model. In conclusion, our results strongly support that targeting the formation of the GR/PRMT5/HP1 γ complex could prevent the development of metastases in TNBC patients.

Introduction

Breast cancer (BC) is a leading cause of death in women worldwide. In 2020, 2.3 million women were diagnosed with BC and around 685,000 deaths were recorded according to the International Agency for Research on Cancer (Sung *et al*, 2021). BCs are classified according to the expression of three markers: estrogen receptor α (ER α), progesterone receptor (PR) and human epidermal growth factor receptor HER2. The different subgroups include Luminal A (ER α + / PR+ / HER2-), Luminal B (ER α + / PR+ / HER2+), HER2 positive (ER α - / PR- / HER2+) and triple negative BC (TNBC) (ER α - / PR- / HER2-). TNBCs represent around 15% of BCs and are the most aggressive mainly due to the lack of targeted therapies. Patients are treated with conventional chemotherapy and radiotherapy, which are associated with a high level of toxicity and numerous side effects. Synthetic GCs are routinely given as complementary medication with chemotherapy for their antiemetic, anti-inflammatory, and energy and appetite stimulating properties and to reduce side effects. However, GCs have recently been associated with adverse effects such as the development of metastases and resistance to chemotherapy (Chen *et al*, 2015b; Obradović *et al*, 2019; Nouredine *et al*, 2021), though the mechanisms involved are poorly understood.

Over the last 20 years, research on steroid receptors and breast cancer has focused on ER α and PR. More recently, the activity of the glucocorticoid receptor (GR) was shown to play an important role in BC. Its expression has different prognostic values depending on the BC subtype; a high GR expression is correlated with a better prognosis in early-stage ER α + BC but with a worse prognosis in TNBC (West *et al*, 2016; Pan *et al*, 2011). Likewise, at the transcriptional level, GCs inhibit ER α transcriptional activity and E2-mediated cell proliferation in ER α + BC (Yang *et al*, 2017; Karmakar *et al*, 2013; West *et al*, 2016), but drive the expression of pro-tumorigenic genes in TNBC (Chen *et al*, 2015b).

GR, as well as ER α , are hormone-regulated transcription factors that regulate transcription by recruiting coregulator proteins to the promoter/enhancer regions of their target genes. Coregulators remodel chromatin structure and promote or inhibit the recruitment and activation of RNA polymerase II. Most of the known coregulators were discovered either for their role in transcriptional activation or repression. However, many coregulators endorse both functions, depending on the specific gene targeted and cellular environment (Stallcup & Poulard, 2020). HP1 γ (CBX3), mainly known for its role in transcriptional repression, was also shown to act as a coactivator (Kwon *et al*, 2010; Lomberk *et al*, 2006; Poulard *et al*, 2017; Koike *et al*, 2000). It was previously demonstrated that HP1 γ is recruited by the automethylation of the histone methyltransferases G9a/GLP (EHMT1/2) as a coactivator in order to regulate migration of lung cancer cells A549 (Poulard *et al*, 2017), and GC-induced cell death in leukemia (Poulard *et al*, 2019, 2018).

Recent studies on GR and other transcription factors have demonstrated that specific coregulators are preferentially required for genes involved in selected physiological responses among multiple pathways that are regulated by a given transcription factor (Wu *et al*, 2014; Stallcup & Poulard, 2020). The three homologous members of the p160 coregulator family (SRC-1, SRC-2, and SRC-3) represent a good example of this concept. Even if they have many target genes in common, the knockout of these three coregulators in mice results in different phenotypes, indicating that each SRC protein regulates distinct physiological pathways (Xu & Li, 2003). For example, among them, only SRC-2/GRIP1 serves as corepressor for GR-regulated cytokine genes in macrophages, facilitating the anti-inflammatory effects of GC *in vivo* (Chinenov *et al*, 2012). Modulating the activity of a specific coregulator could affect GC regulation of only the subset of GR target genes that require the specific coregulator for a specific physiological pathway. Thus, deciphering the mechanisms that control the gene-specific actions of GR coregulators in BC is of utmost importance for the identification of possibly druggable physiological functions. It is now well established that GR may have oncogenic properties in breast tumors and particularly in TNBC. However, directly targeting GR activity is not an option due to its pleiotropic effects in the homeostasis of the organism. For these reasons, we aimed to decipher the molecular mechanisms associated with the deleterious effects of GR, with a particular focus on key coregulators. Here, we demonstrate that the arginine methyltransferase PRMT5 acts as a key coregulator of GR, independently of its catalytic activity, allowing the recruitment of HP1 γ and subsequently RNA polymerase II in TNBC. Interestingly, we highlight that the GR/PRMT5/HP1 γ complex drives the migratory properties induced by GCs *in vitro* and *in vivo* through a specific transcriptional program.

Results

HP1 γ is a bona fide coactivator of GR in TNBC

To identify GR coregulators, we initially combined the analyses of GEO, EGA and TCGA databases, with Kaplan-Meier plotting software of patient relapse-free survival (Gyórfy, 2021). Among the different candidates examined, HP1 γ was the only coregulator, when combined with GR, to significantly impact patient survival (Fig 1A-Fig EV1A-I). Indeed, although the individual expression of GR or HP1 γ was not associated with patient survival (Fig 1B-C), their combined high expression was significantly associated with a shorter relapse-survival in TNBC patients ($p = 0.004$) (Fig 1A), suggesting the involvement of HP1 γ in GR signaling.

We then searched for GR/HP1 γ interactions in different subtypes of TNBC cell lines using PLA. Upon treatment with dexamethasone (Dex), a synthetic GC, GR interacted significantly with HP1 γ in the nucleus of all TNBC cell types, independently of the level of GR protein within cells (Fig 1D). The specificity of these interactions was validated using an siRNA approach in two cell lines displaying high (MDA-MB-231) and low (HCC-1937) GR levels (Fig EV2A-B). Moreover, the addition of other agonists (prednisolone and hydrocortisone) led to similar results as Dex (Fig EV2C), whereas the addition of the GR antagonist RU486 significantly disrupted these interactions (Fig EV2C).

Though HP1 γ is mainly described as a corepressor, several reports indicate that the protein functions as a coactivator when it is phosphorylated on S93 (Koike *et al*, 2000; Kwon *et al*, 2010; Lomberk *et al*, 2006; Poulard *et al*, 2017). To decipher which of its functions is involved in GR signaling, we analyzed GR/p-S93-HP1 γ interactions by PLA and found that they increased upon Dex treatment (Fig 1E). Depletion of either protein by siRNA eliminated most of the signal, validating the specificity of these interactions (Fig 1E). As p-S93-HP1 γ was shown to interact with RNA polymerase II phosphorylated on S5 of the C-terminal domain (Kwon *et al*, 2010), we analyzed the interaction between GR and p-S5-RNA polymerase II by PLA upon Dex treatment. This interaction (i) strongly increased after treatment, (ii) was abolished upon depletion of GR and (iii) significantly decreased after HP1 γ depletion (Fig 1F). Altogether, these data support that HP1 γ acts as a coactivator of GR in TNBC.

PRMT5 is required for HP1 γ recruitment on GR, independently of its enzymatic activity

We previously demonstrated that HP1 γ functions as a coactivator of GR after its recruitment through the histone lysine methyltransferases G9a and GLP (*EHMT2 and EHMT1* respectively) in lung

adenocarcinoma and B-cell acute lymphoblastic leukemia (Poulard *et al*, 2018, 2019, 2017). To test this model in BC, we depleted G9a or GLP in two different TNBC cell lines and studied their impact on GR/HP1 γ interactions. Surprisingly, conversely to what was observed in other cancers, in TNBC, G9a and GLP were not essential for these interactions (Fig EV3). Next, using a GST pull-down approach, we observed that GR does not directly bind to HP1 γ (Fig 2A). We then used a global mass spectrometry approach to identify common partners of GR and HP1 γ following Dex treatment, and identified PRMT5. We validated this finding using PLA, which unveiled that this interaction occurred in the cytoplasm of MDA-MB-231 cells without ligand and was translocated to the nucleus upon hormone treatment (Fig 2B). We also confirmed via a siRNA approach that PRMT5 interacts specifically with HP1 γ after Dex treatment (Fig 2C). To ascertain that GR forms a tripartite complex with PRMT5 and HP1 γ , we used both co-immunoprecipitation (CoIP) and GST pull-down experiments. These revealed that HP1 γ interacted both with GR and PRMT5 (Fig 2D) by CoIP, and that PRMT5 interacted directly with GR (Fig 2E) and HP1 γ (Fig 2F) by GST pull-down. These data indicate that PRMT5 and HP1 γ interact with GR in MDA-MB-231 cells upon Dex treatment.

Having shown that HP1 γ does not interact directly with GR (Fig 2A), we investigated whether PRMT5 could mediate this interaction, by depleting PRMT5 in MDA-MB-231 and HCC-1937 cells (Fig 3A-B). Interestingly, we observed a strong decrease in GR/HP1 γ interactions, indicating that PRMT5 triggered the interaction between these two proteins. As previously demonstrated for HP1 γ , PRMT5 is also essential for the interaction between GR and p-S5-RNA polymerase II following Dex treatment (Fig 3C). As (i) methylation often constitutes a platform for protein recruitment and (ii) PRMT5 was shown to methylate GR (Poulard *et al*, 2020), we then tested whether this event is involved in the formation of this complex. Surprisingly, our results demonstrated that the catalytic activity of PRMT5 was not involved in HP1 γ recruitment on GR (Fig 3D). Indeed, GSK595 treatment inhibited the general symmetric dimethylation of the proteins without affecting GR/HP1 γ interactions.

PRMT5 and HP1 γ are involved in the migratory function of GC

To characterize the effect of PRMT5 and HP1 γ on endogenous target genes that are induced by Dex-activated GR, we performed RNA interference and RNA-sequencing experiments. RNAs were prepared from the MDA-MB-231 cell line expressing siRNA against HP1 γ , PRMT5 or a non-specific sequence (siNS) and treated either with 100 nM Dex or vehicle ethanol for 8 h. In three biological replicates, HP1 γ and PRMT5 were efficiently depleted by the relevant siRNA (Fig EV4A). We identified 275 genes for which mRNA levels changed significantly and by at least 1.5-fold in siNS cells after 8 h of Dex

treatment (Fig 4A, comparison A, red circle). We then identified a subset of Dex-regulated genes that require HP1 γ and PRMT5. As previously described (Poulard *et al*, 2018), the Dex-induced phenotype is determined by the levels of gene products after Dex treatment more than the Dex-induced fold change. Hence, we analyzed the effect of PRMT5 and HP1 γ depletion by comparing gene expression in siNS versus siHP1 γ (Fig 4A, comparison B, green circle) or siPRMT5 (Fig 4A, comparison C, blue circle). Differentially expressed genes are defined as those with a significant p-value ($p < 0.05$) and no fold change cutoff, in order to maximize the number of genes discovered and gain more statistical power for subsequent analyses. By overlapping the three set of genes, we identified 89 overlapping genes (Fig 4A, central red area), classified as Dex-regulated, HP1 γ /PRMT5-dependent genes.

A gene ontology analysis of these 89 genes unveiled an enrichment in genes involved in cell migration and locomotion (Fig 4B), including specific genes involved in migratory or invasive properties of tumor cells, such as Serpine 1, CCBE1, IGFBP3 or PLAT. Of these, Serpine 1 (also called Plasminogen activator inhibitor 1 (PAI1)) was reported to promote actin cytoskeletal reorganization in TNBC (Humphries *et al*, 2019), and was identified as a key driver of cancer cell migration and chemotaxis in TNBC using a single-cell microfluidic device that separates migratory and non-migratory subpopulations of tumor cells (Chen *et al*, 2015a). CCBE1 (collagen and calcium-binding EGF domain-1) is a secretory molecule involved in lymphangiogenesis that stimulates angiogenesis (le Guen *et al*, 2014), promoting CRC lymphangiogenesis and lymphatic metastasis (Song *et al*, 2020). Lastly, PLAT or tissue-plasminogen activator (t-PA) generates plasmin inducing annexin II-dependent cell migration and neoangiogenesis (Sharma *et al*, 2010). Quantitative RT-qPCR analyses confirmed that depletion of PRMT5 and HP1 γ significantly decreased Dex-induced expression levels of Serpine1, CCBE1, PLAT and IGFBP3, which were identified as PRMT5- and HP1 γ -dependent in the RNA-seq analysis (Fig 4C). Moreover, we confirmed that these target genes are GR-dependent, as the induction of their expression was abolished after GR depletion (Fig EV4B). Finally, we investigated whether the catalytic activity of PRMT5 could be involved in the regulation of these target genes, through PRMT5 methylation of its histone targets or GR itself (Motolani *et al*, 2021; Poulard *et al*, 2020). However, the catalytic activity of PRMT5 was not involved in this process (Fig 4D), suggesting that PRMT5 recruits HP1 γ independently of its catalytic activity, likely by functioning as a scaffold protein.

Next, to determine if these genes were direct targets of HP1 γ and PRMT5 coregulators, we initially validated the Dex-induced binding of GR to neighboring GR response elements (GRE) identified on published GR ChIP-seq databases using ChIP-qPCR (Fig 5A). Using PRMT5 and HP1 γ antibodies, we found that they were also recruited to the same GR response elements after Dex treatment (Fig 5B-C). We previously demonstrated that HP1 γ and PRMT5 are responsible for the Dex-induced interaction

between RNA polymerase II and GR (Fig 1F-3C). As p-S93-HP1 γ was shown to recruit RNA polymerase II, we analyzed the Dex-induced occupancy by RNA polymerase II at the transcription start site (TSS) of PRMT5/HP1 γ -dependent GR target genes. We found that this recruitment was strongly reduced by depleting HP1 γ (Fig 5D). This result indicates that Dex induces binding of the GR/PRMT5/HP1 γ complex on chromatin in order to facilitate the recruitment of RNA polymerase II to the TSS for the full transcriptional activation of these genes.

GCs were shown to drive metastasis formation in TNBC, specifically in MDA-MB-231 cells (Obradović *et al*, 2019). As our results clearly demonstrate that the GR/PRMT5/HP1 γ complex regulates a subset of Dex-regulated target genes involved in cell migration, we monitored the cell migratory properties of MDA-MB-231 cells under Dex treatment, following the depletion of our proteins of interest, by X-Celligence. This method records the cell migratory process in real time without requiring any labeling. When the cells migrate from the upper chamber through the membrane into the bottom chamber, cells create contacts and adhere to the electronic sensors under the membrane, increasing the impedance. As changes in impedance are continuously recorded by the RTCA instrument, cell migration can be monitored in real time via the cell-index profile (Bird & Kirstein, 2009). We first validated Dex-induced migration of MDA-MB-231 cells using this technique, and unveiled that GR depletion abolished this effect, demonstrating that the cell migratory property induced by GCs was driven by GR (Fig 6A). We then depleted HP1 γ or PRMT5, and observed that both depletions significantly decreased cell migration induced by Dex (Fig 6B-C), strongly suggesting that the three proteins (GR, PRMT5 and HP1 γ) are involved in cell migration induced by GCs. Furthermore, we confirmed once again that the catalytic activity of PRMT5 was not involved in this process (Fig 6D).

We then transposed our results *in vivo*, based on a zebrafish model (*Danio rerio*), which has become a pertinent model to follow cell migration and invasion in a functional circulatory system within a couple of days (Roth *et al*, 2021). However, as a major actor of chromatin stability, the stable depletion of HP1 γ was not an option for such studies. MDA-MB-231 cells were thus transiently transfected by siRNA against HP1 γ and PRMT5 and treated or not with Dex. The four population of cells were then stained using DiO and injected into zebrafish embryos (Fig 6E), where they migrated from the site of injection in the yolk sac throughout the tail within 48 h of the xenograft (Fig 6F). We monitored by immunofluorescence the number of metastatic cells that were able to evade the yolk sac, demonstrating invasive properties, in each embryo. Our results demonstrated that Dex induced a greater cell migration and invasion potential compared to control cells (Fig 6G). In addition, depletion of HP1 γ and PRMT5 significantly decreased the number of metastatic cells (Fig 6G). As indicated in Fig 6E, at D3, a pool of stained cells from each condition was plated in order to monitor protein expression

on the day where cell migration was assessed (D5) (Fig EV5). In conclusion, after validation of protein depletion, we demonstrated the involvement of GR/PRMT5/HP1 γ complex in the migratory properties of TNBC cells under GCs treatment.

Study of GR/PRMT5/HP1 γ complex expression in BC

Based on our results, we decided to study the expression of GR, PRMT5, HP1 γ and their interactions in two cohorts of BC patients. In 148 patient-derived xenograft (PDX) models established and characterized previously (Marangoni *et al*, 2007), we analyzed GR mRNA expression and found that it remained constant in the major BC subgroups (Fig 7A). Given our findings, we decided to focus on the TNBC subgroup and observed that GR mRNA expression is higher in metaplastic and apocrine TNBCs in comparison to unspecialized TNBCs (Fig 7B). Metaplastic BC represents a rare and aggressive subtype of TNBC with a higher rate of developing distant metastasis compared to other TNBCs (Reddy *et al*, 2020). Likewise, the mRNA expression of GR was higher in PDXs engrafted from metastasis in comparison to those engrafted from primary tumors (Fig 7C).

We then analyzed GR expression by immunohistochemistry, as well as GR/HP1 γ and GR/PRMT5 interactions by PLA, in a cohort of 485 BC patients. Representative images of the signals obtained for each parameter are shown in Fig 7D. GR was mainly expressed in the nucleus of cells and varied among tumor types. The interactions between GR and HP1 γ , as well as GR and PRMT5, thus exist in tumors.

Discussion

In the present study, we unveiled new coactivators of GR involved in cell migration in TNBC. Indeed, we demonstrated that upon Dex treatment PRMT5 plays a key role in the transcriptional activity of GR via the recruitment of HP1 γ , independently of its enzymatic activity. Our data clearly establish the GR/PRMT5/ HP1 γ complex as a major mediator of the effects of GCs on cell migration *in vitro* and *in vivo*.

PRMT5 is the major type II methyltransferase depositing the symmetric dimethylarginine mark within proteins. It was shown to methylate many proteins including histones, with some marks correlated with transcriptional activation, while others repress transcription (Chen *et al*, 2017; Motolani *et al*, 2021; Stopa *et al*, 2015). Dysregulated PRMT5 expression has been described in a variety of cancers; overexpression being correlated with poor survival rates (Lattouf *et al*, 2019b). However, the role of PRMT5 in tumorigenesis seems to be dependent on its subcellular localization. PRMT5 has been localized in the nucleus, cytoplasm, as well as near the cell membrane (Koh *et al*, 2015). Our group showed that in the case of BC, nuclear PRMT5 expression in ER α + tumors was associated with prolonged disease-free survival (Lattouf *et al*, 2019a). The cytoplasmic level of PRMT5 is higher in the TNBC compared to other BC subtypes (Vinet *et al*, 2019). In the present study, we validated that in TNBC, PRMT5 interacts with GR in the cytoplasm and upon Dex treatment the two proteins interact in the nucleus where they regulate the expression of GR target genes involved in cell migration and locomotion.

As PRMT5 possesses oncogenic properties in various solid cancers (Shailesh *et al*, 2018), industrial companies have developed specific inhibitors, with promising anti-tumoral effects (Chan-Penebre *et al*, 2015; Lin *et al*, 2019). Among PRMT5 inhibitors, GSK3326595 and JNJ64619178 are currently being assessed in the clinic. GSK3326595 phase-II clinical trials for BC and acute myeloid leukemia are ongoing (Wu *et al*, 2021). As we found that PRMT5 is required for the interaction between GR and HP1 γ , we hypothesized that its catalytic activity could be involved, particularly because PRMT5 was described to methylate members of the nuclear receptor family (Malbeteau *et al*, 2022). Our team recently demonstrated that PRMT5 triggers GR methylation, although the functional consequences have not yet been unveiled (Poulard *et al*, 2020). However, in the present study, we demonstrated that the PRMT5 inhibitor GSK3326595 does not affect (i) GR and HP1 γ interaction, (ii) Dex-regulated target genes (PRMT5 and HP1 γ dependent) and (iii) cell migration induced by GC. These observations clearly demonstrate that the role of PRMT5 in GC-induced cell migration is not due to its enzymatic activity but rather as a scaffold coregulator of GR, participating in its transcriptional activation. Another way for targeting PRMT5 could be via the proteolysis targeting chimera (PROTAC) technology. This

technology, triggering PRMT5 degradation, could be an opportunity of targeting the oncogenic activity of GR in TNBC through PRMT5 scaffolding capacity (Shen *et al*, 2020). The PROTAC PRMT5 inhibitor (MS4322) is a valuable chemical tool for targeting both the catalytic activity of PRMT5 and its scaffolding capacity. Preliminary data on MS4322 demonstrated a good plasma exposure in mice, indicating that MS4322 could potentially be transposed to clinical trials. It will be an asset for targeting the cell migration induced by GC highlighted in our current work, and could be used for other potential applications. Indeed, similar observations were made for the role of PRMT5 in vascular morphogenesis (Quillien *et al*, 2021). Authors found that the catalytic activity of PRMT5 was required for blood cell formation but not for vessel formation by promoting a proper chromatin conformation.

Most coregulators were discovered for their role in either transcriptional activation or repression; by definition, coregulators that help to activate genes are called coactivators, and corepressors help to repress genes. However, many coregulators function in both activation and repression of transcription, depending on the specific gene and the cellular environment. Several reports demonstrated that this switch could involve post-translational modifications (PTMs). Likewise, the lysine methyltransferase G9a and GLP catalyze the methylation of H3K9, a well-known repressive mark, but can also act as a coactivator for GR, ER α and other transcription factors (Purcell *et al*, 2011; Chaturvedi *et al*, 2009; Bittencourt *et al*, 2012). Recent data showed that the coactivator activity of G9a/GLP is modulated by a methylation/phosphorylation switch (Poulard *et al*, 2017). The coactivator function requires G9a/GLP self-methylation to provide a binding site for the coregulator HP1 γ , which is required as a cooperating coactivator for G9a and GLP. In contrast, G9a/GLP phosphorylation of the threonine adjacent to the methylation site by Aurora kinase B (AURKB) prevents binding to HP1 γ and reduces the coactivator function of G9a and GLP. In contrast to what was reported in the lung adenocarcinoma cell line A549 and B-cell acute lymphoblastic leukemia Nalm6, G9a and GLP are not involved in GR/HP1 γ interaction in TNBC cells, highlighting that GR transcription factors regulate functions in a tissue-dependent manner through the recruitment of different sets of coregulators (Poulard *et al*, 2019, 2017). In TNBC, we showed that HP1 γ is recruited on GR through PRMT5 (Fig 7E).

As the GR/HP1 γ interaction is induced by GC treatment and associated with a poor prognosis in TNBC, we investigated the molecular mechanisms associated with the deleterious effects of GR in this context. Our RNA-seq analysis demonstrated that PRMT5 is a major coregulator of GR as it regulates 63% of the Dex-regulated genes in a large-scale analysis. In comparison HP1 γ regulates 48% of the Dex-regulated genes. Among the Dex-regulated genes, 32% of required both HP1 γ and PRMT5. Interestingly, we showed that these genes are enriched in cell migration and locomotion pathways. For instance, Serpine-1 is a protein that promotes cytoskeletal rearrangement driving cellular

migration, actin-rich migratory structures, and reduced actin stress fibers (Humphries et al, 2019). Finally, we demonstrated that this complex GR/PRMT5/HP1 γ drives the migratory properties induced by GCs in the TNBCs both in vitro and in vivo in the zebrafish model.

Materials and Methods

Cell culture

MDA-MB-231, BT549, BT20, HCC-1937, MDA-MB-453 and Cos-7 cells were cultured with specific medium and 10% fetal bovine serum at 37°C and 5% CO₂. Prior to experiments, cells were grown in phenol red-free medium supplemented with 10% charcoal-stripped serum (Biowest).

When indicated, cells were treated with 100 nM dexamethasone (Dex, Sigma), 100 nM prednisolone (Selleckchem), 1 μ M hydrocortisone (Selleckchem), 1 μ M RU486 (Selleckchem) or with 0.5 μ M PRMT5 inhibitor GSK3326595 (Selleckchem) for the indicated time.

SMART-pool siRNAs (Dharmacon) used for the depletion of GR, HP1 γ , PRMT5, G9a, GLP and non-specific (siNS) were transfected into indicated cells using Lipofectamine siRNAi max (Invitrogen) according to the manufacturer's protocol.

Proximity ligation assays

The experiments were performed using reagents from the PLA Kit (Sigma, DUO92004, DUO92002, DUO92007, DUO82049, DUO82040) previously described [Poulard 2020]. Cells were seeded onto coverslips in 12-well plates, fixed in methanol for 2 min, and then washed twice in 1X-PBS. Fixed cells can be stored at 4°C for subsequent staining or saturated with the blocking solution for 1 h at 37°C. Cells were then incubated with different pairs of primary antibodies (GR (Santa Cruz sc-393232), HP1 γ (Abcam ab10480), p-S93-HP1 γ (Abcam ab45270), PRMT5 (Millipore 07-405) and p-S5-RNAPolIII (Cell signaling #4735)) for 1 h at 37°C. After three washes in Buffer A, the PLA minus and plus probes which contain the secondary antibodies conjugated with complementary oligonucleotides were added and incubated 1 h at 37°C. Again, cells were washed three times in Buffer A and incubated with T4 DNA ligase in diluted ligase buffer for 30 min at 37°C. Subsequently, after three washes with Buffer A, cells were incubated with DNA polymerase in dilution polymerase buffer containing red fluorescent-labeled oligonucleotides for 100 min at 37°C. Finally, cells were washed twice with 1X-Buffer B for 10 min at room temperature, then 1 min with 0.01X Buffer B. The samples were mounted using Duolink in situ

mounting medium containing DAPI. The edges of the coverslips were sealed using nail polish. Slides were then be stored in the dark at 4°C for a short-term or visualized under a Nikon Fluorescence Microscope, and interactions were counted using ImageJ software. For each sample, interactions were counted for at least 1,000 cells using ImageJ software (Poulard *et al*, 2020).

GST pull down experiments

psg5-V5-PRMT5 and pcdna3.1-GR expressing plasmids were transcribed and translated using *in vitro* T7-coupled reticulocyte lysate. GST, GST-HP1 γ and GST-PRMT5 proteins were incubated with labeled proteins in 200 μ L binding buffer (Tris 20 mM pH 7.4, NaCl 0.1 M, EDTA 1 mM, glycerol 10%, Igepal 0.25% with 1 mM DTT and 1% milk) for 2 h at room temperature. After washing, bound proteins were separated by SDS-PAGE and visualized by Western blot.

Immunoprecipitation and Western blot analysis

Cos-7 cells were seeded onto 10-cm² dishes the day before transfection. The following plasmids psg5-V5-PRMT5 and pcdna3.1-GR were transfected into Cos-7 cells using Lipofectamine 2000 (Invitrogen) according to the manufacturer's protocol. Forty-eight hours after transfection, cells were treated (or not) with Dex for 24 h, and cell extracts were prepared in RIPA buffer (50 mM Tris-HCl, pH 8.0, 150 mM NaCl, 1 mM EDTA, 1% NP-40, and 0.25% deoxycholate) supplemented with protease inhibitor tablets and phosphatase inhibitors (1 mM NaF, 1 mM Na₃VO₄, and 1 mM β -glycerophosphate). Protein extracts were incubated with HP1 γ primary antibody (Abcam ab10480) over night at 4°C under agitation. Protein A Agarose (Millipore) beads were then added, and the mixture was incubated 2 h at 4°C. The immunoprecipitates were separated on SDS-PAGE. Immunoblotting was conducted with primary antibodies against GR G-5 (Santa Cruz sc-393232), HP1 γ (Abcam ab10480) and PRMT5 (Millipore 07-405). Secondary antibodies were used for chemiluminescence detection using the ECL detection reagent (Roche Molecular Biochemicals) according to the manufacturer's instructions. For immunoprecipitation experiments, 3% of the input of each sample was analyzed by immunoblot.

RT-qPCR analysis

Total RNA was extracted using the TRIzol (Invitrogen) in accordance with the manufacturer's instructions. cDNA was synthesized by reverse transcription using Superscript III (Invitrogen) according

to the manufacturer's specifications with 1 µg total RNA as a template. Quantitative PCR amplification of the resulting complementary DNA (cDNA) was performed on a Bio-Rad CFX Real-Time PCR System using SYBR green supermix (Bio-Rad). mRNA levels were normalized against the level of 28S mRNA. For amplification of cDNA, primer sequences are listed in Table 1.

Table 1: List of primers used in qPCR

Primer	Forward Sequence (5'-3')	Reverse Sequence (5'-3')
CCBE1	GCCTTGCTTAATGTGGGACA	CACCAGGACCAAAGGGAAG
HP1 γ	ACTGCCATCACAGCAGGTTT	CTAAGGAATGGCCCGCTAGG
IGFBP3	AACTTTGTAGCGCTGGCTGT	TGCTAGTGAGTCGGAGGAAGA
PLAT	GAGAATCCAGCAGGAGCTGA	AGACAGTACAGCCAGCCTCA
PRMT5	CGGGGACTGCAGATAGTCTT	GTGCAGTTCATCATCACAGG
SERPINE1	TCTTTGGTGAAGGGTCTGCT	CTGGGTTTCTCCTCTGTTG
28S	CGATCCATCATCCGAATG	AGCCAAGCTCAGCGCAAC

Chromatin immunoprecipitation

ChIP assays were performed using the 'Simple ChIP Plus Enzymatic Chromatin IP Kit' (Cell Signaling) according to the protocol described. Briefly, MDA-MB-231 cells were transfected with siNS or siHP1 γ when specified and were subjected to hormonal treatment (100 nM Dex) for 2 h. Cells were then cross-linked using 1% formaldehyde (Sigma) in 15 cm culture dishes containing 20 mL medium and incubated for 10 min at room temperature. Then, 2 mL of 10X glycine (Cell signaling) was added to each 15 cm dish and cells were further incubated for 5 min at room temperature to stop the cross-linking. Cell extracts were then prepared, and chromatin digested and sonicated. Immunoprecipitation of sonicated chromatin solutions was conducted overnight at 4°C with the following antibodies: normal rabbit IgG (Cell Signaling technology #2729), anti-GR/D6H2L (Cell Signaling technology #12041), anti-HP1 γ (Abcam ab10480), anti-PRMT5 (Sigma 07-405), and p-S2/S5 RNA pol II (Cell signaling technology #4735). Cross-linking was reversed by heating, and immunoprecipitated DNA was purified and analyzed by qPCR as described above. Results are expressed relative to the signal obtained from input chromatin. Primer sequences are indicated in Table 2.

Table 2: List of primers used for ChIP experiments

Primer	Forward Sequence (5'-3')	Reverse Sequence (5'-3')
CCBE1 GRE	CCCTGGTTGAAGGAAAGGAT	ATGTTGGGTACCAACCCTCA
CCBE1 GRE (2)	TCCACTGATAGGGGCAAAA	CAGGAAGGTCCGTGGTAAT
CCBE1 TSS	GGGGAAAATGAGGCTAGGA	TCCAGCAAGTCTGTCAATCG
PLAT GRE	CTTTGGGAGAGCGGCCAAAG	CGAGTCCTGTGATGCCATGG
SERPINE1 GRE	GAGAGATCGCTGTGGTCCAT	GTGCAAAGGAGGAGAGATC
SERPINE1 GRE-TSS	CAGAGGGCAGAAAGGTCAA	CTCTGGGAGTCCGTCTGAA

RNA sequencing

RNA-sequencing experiments were performed using MDA-MB-231 cells. Cells were transfected with siNS, siPRMT5 and siHP1 γ (25 nM) for 48 h and treated with Dex (100 nM) for 8 h before RNA extraction. A total of 18 high-quality samples (6 conditions x 3 replicates each) were submitted to the IGFL (Institute of Functional Genomic of Lyon) Sequencing Platform for library preparation and sequencing. cDNA libraries were prepared using the RNA-seq library prep kits with UDIs (Lexogen, Vienna Austria). All libraries were sequenced on an Illumina Nextseq500 and mapped on the hg38 version of the human genome using Bowtie2 (Galaxy Version 2.4.2 Galaxy 0). Count tables were prepared using htseq-count (Galaxy version 0.9.1). Differential gene expression analysis was performed with DEseq2 (Galaxy Version 2.11.40.7 galaxy1) using different thresholds. RNA-sequencing data have been submitted to the Gene Expression Omnibus (GEO).

Xcelligence analysis

The Roche xCELLigence Real-Time Cell Analyzer (RTCA) DP instrument was used to monitor and record real-time cellular migration without labeling cells. xCELLigence assays were performed using a CIM (cellular invasion/migration)-Plate 16 (Agilent) which contains microelectronic sensors integrated to the underside of the microporous polyethylene terephthalate (PET) membrane of a Boyden-like chamber, in accordance with the manufacturer's guidelines. First, 160 μ L of complete red medium containing 100 nM Dex or its vehicle ethanol were added to the lower chamber of the CIM-plate and placed for 1 h in a CO₂ incubator at 37°C. Then, MDA-MB-231 cells transfected with siNS, siGR, siHP1 γ

or siPRMT5 or treated with 500 nM of GSK595 for 72 h and subjected to hormonal treatment (100 nM Dex) for 24 h prior to assay were trypsinized, resuspended and counted. Next, 150 μ L of complete red medium containing approximately 40,000 MDA-MB-231 cells and 100 nM Dex was added to the upper chamber of the CIM-plate. The CIM-Plates were assembled by placing the top chamber onto the bottom chamber and placed for 30 min in the CO₂ incubator at 37°C to let cells settle down. The CIM-Plate was placed into the xCELLigence analyzer and incubated for 24 h at 37°C and 5% CO₂. Cells migrating from the upper chamber through the PET membrane to the lower chamber in response to Dex adhere to electronic sensors, resulting in an increase in impedance. Increased impedance is correlated with an increased number of cells migrating, and cell-index (CI) values reflecting the changes in impedance were automatically recorded every 15 min, and the time point closer to 14 h (above or below) was used for data analysis.

Human breast cancer sample collection

The tumors from 485 patients of the Centre Léon Bérard (CLB) with invasive BC, whose clinical and biological data were available from the regularly updated institutional database, were analyzed. Written informed consent was obtained from each patient. The study protocol was approved by the institutional ethics committee.

In vivo dissemination assay in zebrafish larvae

Immediately prior to transplantation, MDA-MB-231 cells were labelled with DiO fluorescent dye (Invitrogen Molecular Probes) according to manufacturer's instructions and resuspended in PBS at a final concentration of 60 000 cells/ μ L. Two-day old zebrafish larvae of the casper strain were anesthetized with tricaine (MS-222). 10 nL containing approximately 300 MDA-MB-231 cells were injected in the middle of the yolk sack with a microinjector. After transplantation, larvae were recovered in E3 medium and incubated at 34 degrees. Viable larvae with fluorescent signal in the yolk sack were sorted 6-10 hours post-transplantation and transferred to individual wells of a 24-well plate containing E3 medium. Plates were incubated at 34 degrees. Three days post-transplantation, larvae were imaged with a Nikon SMZ18 fluorescent stereoscope.

Author contributions

CP and MLR conceived the study and wrote the manuscript. CP designed the experiments. LMN and ASG performed the experiments. JJ performed the PLA studies in tissues. JA performed the zebrafish experiments. YD conducted the statistical analyses of human tumor study. IT was in charge of the IHC analysis. EM provided the PDX samples and performed statistical analyses. OT participated in the discussions. BB and NH revised it.

Acknowledgements

We deeply thank C. Languilaire, F. Nasri and S. Ensenlaz for technical support. We also thank B. Manship and MR. Stallcup for proofreading the manuscript and constructive discussions.

Conflict of interest

The authors have no conflicts of interest to disclose.

Funding

We thank the Fondation ARC Cancer, “La Ligue contre le Cancer”, the association “Cancer du sein parlons en”. L.M.N. was supported by a fellowship from AZM & Saadeh Association and Lebanese University.

Figure Legends

Figure 1: HP1 γ acts as a coactivator of GR in TNBC

(A-C) Relapse-free survival in a cohort of 846 patients with basal breast cancers (BC), with low (black) or high (red) **(A)** GR and HP1 γ expression, **(B)** GR expression alone, or **(C)** HP1 γ expression alone. Kaplan-Meier analyses conducted on GEO, EGA, and TCGA datasets.

(D) PLA was conducted in different TNBC cell lines to analyze the interaction of endogenous GR and HP1 γ . Cells were treated with 100 nM dexamethasone (Dex) or the equivalent volume of vehicle ethanol (Eth) for 2 h. After cell fixation, PLA with antibodies against GR and HP1 γ was performed. The detected interactions are indicated by red dots. The nuclei were counterstained with DAPI (blue). The number of interactions detected by ImageJ analysis is shown as the mean \pm SEM of three independent experiments. P-value was determined using a paired t-test. ***P \leq 0.001, **P \leq 0.01. Whole-cell extracts were analyzed for GR, HP1 γ and GAPDH expression by immunoblot.

(E) PLA was conducted to analyze the interaction of endogenous GR and p-S93-HP1 γ after transfection of MDA-MB-231 cells with SMART-pool siRNA targeting GR (siGR), HP1 γ (siHP1 γ), or non-specific siRNA (siNS), and following treatment with 100 nM Dex or the equivalent volume of Eth for 2 h. Detected interactions are shown as the mean \pm SEM of three independent experiments. P-value was determined using a paired t-test. *P \leq 0.05, **P \leq 0.01. Whole-cell extracts were analyzed for GR, HP1 γ , p-S93-HP1 γ and GAPDH expression by immunoblot.

(F) PLA was conducted to analyze the interaction of endogenous GR and p-S5-RNApol II after transfection of MDA-MB-231 cells with SMART-pool siRNA targeting GR (siGR), HP1 γ (siHP1 γ), or non-specific siRNA (siNS), and following treatment with 100 nM Dex or the equivalent volume of Eth for 2 h. Detected interactions are shown as the mean \pm SEM of three independent experiments. P-value was determined using a paired t-test. **P \leq 0.01.

Figure 2: GR forms a tripartite complex with HP1 γ and PRMT5

(A) GST and GST-HP1 γ fusion proteins were incubated with *in vitro*-translated GR, the interaction was then visualized by Western blotting using an anti-GR antibody. The corresponding Coomassie-stained gel is shown in the panel below.

(B) To analyze the interaction of endogenous GR and PRMT5 by PLA, MDA-MB-231 cells were transfected with SMART-pool siRNA targeting GR (siGR), PRMT5 (PRMT5), or non-specific siRNA (siNS) and treated with 100 nM dexamethasone (Dex) or the equivalent volume of vehicle ethanol (Eth) for 2 h. After cell fixation, PLA was performed with antibodies against GR and PRMT5. The detected interactions are indicated by red dots. The nuclei were counterstained with DAPI (blue). The number

of interactions in the nucleus and cytosol detected by ImageJ analysis is shown as the mean \pm SEM of three independent experiments. P-value was determined using a paired t-test. *P \leq 0.05, **P \leq 0.01. Whole-cell extracts were analyzed for GR, PRMT5 and GAPDH expression by immunoblot.

(C) PLA was conducted to analyze endogenous interactions between HP1 γ and PRMT5. MDA-MB-231 cells were transfected with SMART-pool siRNA targeting HP1 γ (siHP1 γ), PRMT5 (PRMT5), or non-specific siRNA (siNS) and treated with 100 nM Dex or the equivalent Eth for 2 h. Detected interactions are shown as the mean \pm SEM of three independent experiments. P-value was determined using a paired t-test. **P \leq 0.01. Whole-cell extracts were analyzed for PRMT5, HP1 γ and GAPDH expression by immunoblot.

(D) Cos-7 cells were transfected with empty plasmids or plasmids encoding PRMT5 and GR. Lysates were immunoprecipitated (IP) with HP1 γ antibody and immunoblotted with GR, PRMT5 and HP1 γ antibodies. Expression of GR, PRMT5, HP1 γ and GAPDH in the unfractionated extracts is shown at the bottom (Input).

(E) GST and GST-PRMT5 fusion proteins were incubated with *in vitro*-translated GR (TIV GR), in addition to Dex (100 nM) when indicated and the interaction was then visualized by Western blotting using an anti-GR antibody. The corresponding Coomassie-stained gel is shown in the panel below.

(F) GST and GST-HP1 γ fusion proteins were incubated with *in vitro*-translated PRMT5, the interaction was then visualized by Western blotting using an anti-PRMT5 antibody. The corresponding Coomassie-stained gel is shown in the panel below.

Figure 3: PRMT5 triggers GR and HP1 γ interaction

(A) PLA was conducted to analyze the interaction of endogenous GR and HP1 γ after transfection of MDA-MB-231 cells with a SMART-pool siRNA targeting PRMT5 (siPRMT5) or non-specific siRNA (siNS), and following treatment with 100 nM dexamethasone (Dex) or the equivalent volume of vehicle ethanol (Eth) for 2 h. The detected interactions are indicated by red dots. The nuclei were counterstained with DAPI (blue). The number of interactions in the nucleus detected by ImageJ analysis is shown as the mean \pm SEM of three independent experiments. P-value was determined using a paired t-test. *P \leq 0.05. Whole-cell extracts were analyzed for PRMT5, HP1 γ and Tubulin expression by immunoblot.

(B) PLA was conducted as in (A) after transfection of HCC1937 cells with SMART-pool siRNA targeting PRMT5 (siPRMT5) or non-specific siRNA (siNS), and following treatment with 100 nM Dex or the equivalent volume of Eth for 2 h. The number of interactions by ImageJ analysis is shown as the mean \pm SEM of three independent experiments. P-value was determined using a paired t-test. *P \leq 0.05, **P \leq 0.01. Whole-cell extracts were analyzed for PRMT5, HP1 γ and Tubulin expression by immunoblot.

(C) PLA was conducted to analyze the interaction of endogenous GR and p-S5-RNApol II as in (A) after transfection of MDA-MB-231 cells with SMART-pool siRNA targeting PRMT5 (siPRMT5) or non-specific siRNA (siNS), and following treatment with 100 nM Dex or the equivalent volume of Eth for 2 h. The number of interactions by ImageJ analysis is shown as the mean \pm SEM of three independent experiments. P-value was determined using a paired t-test. *P \leq 0.05, **P \leq 0.01. Whole-cell extracts were analyzed for PRMT5, GR and Tubulin expression by immunoblot.

(D) PLA was conducted as in (A) after treatment of MDA-MB-231 cells with 500 nM of the PRMT5 inhibitor, GSK595, or the equivalent volume of vehicle DMSO for 48 h, and 100 nM Dex or the equivalent volume of Eth for 2 h. The number of interactions by ImageJ analysis is shown as the mean \pm SEM of three independent experiments. P-value was determined using a paired t-test. ns: non-significant, **P \leq 0.01. Whole-cell extracts were analyzed for GR, HP1 γ , SDMA and GAPDH expression by immunoblot.

Figure 4: HP1 γ and PRMT5 regulate a subset of GR target genes

Genome-wide RNA-sequencing analysis was performed on MDA-MB-231 cells to identify the genes dependent on PRMT5 and HP1 γ for dexamethasone-regulated expression.

(A) Hypothetical results of gene expression profiles for a given gene, illustrating how specific pairwise comparisons between datasets for individual samples were performed. Each bar represents hypothetical mRNA levels from RNA-seq data for cells expressing the indicated siRNAs (PRMT5 or HP1 γ or siNS) and treated for 8 h with ethanol (Eth) or dexamethasone (Dex, 100 nM). Colored letters represent pairwise comparisons performed to determine sets of genes for which mRNA levels were significantly different between the samples. For instance, comparison A = set of Dex-regulated genes (fold change \geq 2, adjusted p < 0.01), comparison B = set of HP1 γ -dependent genes (no FC, adjusted p < 0.05), comparison C = set of PRMT5-dependent genes (no FC, adjusted p < 0.05). Venn diagram was obtained using these comparisons. Overlap area (89 genes in red) indicates the number of genes shared among sets.

(B) Gene Ontology Analysis using GSEA identifies Dex-regulated genes networks dependent upon PRMT5 and HP1 γ . Gene sets are ranked according to their normalized enrichment score (NES). The false discovery rate (FDR) is the estimated probability that a gene set with a given NES represents a false-positive.

(C) MDA-MB-231 cells transfected with non-specific siRNA (siNS) or with SMART-pool siRNA targeting PRMT5 (siPRMT5) or HP1 γ (si HP1 γ) were treated with 100 nM Dex or the equivalent volume of Eth for 8 h. mRNA levels for the indicated GR target genes were measured by reverse transcriptase followed

by qPCR and normalized against 28S mRNA levels. Results shown are mean \pm SEM of four independent experiments. P-value was calculated using a paired t-test. *P \leq 0.05, **P \leq 0.01, ***P \leq 0.001.

(D) mRNA levels for the indicated GR target genes were determined as in (C), MDA-MB-231 cells were treated with 500 nM of the PRMT5 inhibitor, GSK595, or the equivalent volume of vehicle DMSO for 48 h, and then with 100 nM Dex or the equivalent volume of Eth for 8 h. Results shown are mean \pm SEM of four independent experiments. P-value was calculated using a paired t-test. ns: non-significant, **P \leq 0.01.

Figure 5: Occupancy of GR, HP1 γ and PRMT5 on GRE of GR target genes

(A-C) MDA-MB-231 were treated with 100 nM dexamethasone (Dex) or an equivalent volume of vehicle ethanol (Eth) for 2 h. ChIP was performed with **(A)** GR, **(B)** HP1 γ or **(C)** PRMT5 antibodies and immunoprecipitated DNA was analyzed by qPCR using primers specific for the GBRs associated with the indicated genes. Results are normalized against input chromatin, and the mean \pm SEM of the ratio between 2 h Dex or Eth treatment for three independent experiments is shown. P-value was calculated using a paired t-test. *P \leq 0.05, **P \leq 0.01.

(D) MDA-MB-231 were transfected with non-specific siRNA (siNS) or with SMART-pool siRNA targeting HP1 γ (siHP1 γ) and treated with 100 nM Dex or Eth for 2 h. ChIP was performed with an antibody against RNA polymerase II phosphorylated on S2 and S5 of the C-terminal domain repeats (p-S2/S5-RNAPol II), and immunoprecipitated DNA was analyzed by qPCR using primers that amplify the transcription start site (TSS) associated with the indicated GR target genes. Results are normalized against input chromatin and shown as mean \pm SEM of three independent experiments. P-value was calculated using a paired t-test. *P \leq 0.05, **P \leq 0.01.

Figure 6: HP1 γ and PRMT5 regulates cell migration.

(A) MDA-MB-231 were transfected with non-specific siRNA (siNS) or with SMART-pool siRNA targeting GR (siGR) and treated with 100 nM dexamethasone (Dex) or an equivalent volume of ethanol (Eth) for 24 h. 40,000 cells were seeded per well in the 16-well Real-Time Cell Analyzer (RTCA) plate. Cell index (CI) values are presented as means \pm SD of at least two (up to three) independent wells, calculated by xCELLigence. Graph of one representative experiment is shown (left panel). Histogram showing the results of three independent experiments and P-value was calculated using a paired t-test. *P \leq 0.05, **P \leq 0.01. Whole-cell extracts were analyzed for GR and Tubulin expression by immunoblot.

(B) X-CELLigence was performed and analyzed as in (A) after transfection of MDA-MB-231 with non-specific siRNA (siNS) or with SMART-pool siRNA targeting HP1 γ (siHP1 γ) and treated with 100 nM Dex or Eth for 24 h. Whole-cell extracts were analyzed for HP1 γ and Tubulin expression by immunoblot.

(C) X-Celligence was performed and analyzed as in (A) after transfection of MDA-MB-231 with non-specific siRNA (siNS) or with SMART-pool siRNA targeting PRMT5 (siPRMT5) and treated with 100 nM Dex or Eth for 24 h. Whole-cell extracts were analyzed for PRMT5 and GAPDH expression by immunoblot.

(D) X-Celligence was performed and analyzed as in (A) after treatment of MDA-MB-231 with 500nM of GSK595, or the equivalent volume of vehicle DMSO for 72 h and treated with 100 nM Dex or ethanol for 24 h. Whole-cell extracts were analyzed for sDMA and GAPDH expression by immunoblot.

(E) Working diagram of the zebrafish model. MDA-MB-231 were transfected with non-specific siRNA (siNS), with SMART-pool siRNA targeting PRMT5 (siPRMT5) or with SMART-pool siRNA targeting HP1 γ (siHP1 γ), treated with Dex 24 h prior to injection into the embryos. MDA-MB-231 cells were labeled using DiO at the injection time and injected into the yolk sac. Hpf : hours post-fertilization.

(F) A representative epifluorescence image of the caudal blood vessels shows invasion of cancer cells.

(G) Quantification of invaded metastatic cells per embryo in different conditions. P-value was calculated using unpaired t-test *P \leq 0.05, **P \leq 0.01.

Figure 7: Study of GR/PRMT5/HP1 γ complex expression in breast cancer patients

(A) GR expression was analyzed in a cohort of 148 patient-derived xenograft (PDX) models stratified in ER+, HER2+ or TNBC following their molecular subtypes. P-value was calculated using unpaired t-test.

(B) GR expression was analyzed in the TNBC subtype divided into different clinical subtypes. P-value was calculated using unpaired t-test ***P \leq 0.001.

(C) GR expression was analyzed in PDX engrafted from metastatic tumors or primary tumors. P-value was calculated using unpaired t-test **P \leq 0.01.

(D) GR expression, GR/HP1 γ and GR/PRMT5 interactions were analyzed by PLA or IHC on formalin-fixed human tumors. Two examples of different staining profiles are shown. (Obj: X40).

(E) Model of PRMT5 activity in TNBC following GC treatment.

References

- Bird C & Kirstein S (2009) Real-time, label-free monitoring of cellular invasion and migration with the xCELLigence system. *Nature Methods* 2009 6:8 6: v–vi
- Bittencourt D, Wu DY, Jeong KW, Gerke DS, Herviou L, Ianculescu I, Chodankar R, Siegmund KD & Stallcup MR (2012) G9a functions as a molecular scaffold for assembly of transcriptional coactivators on a subset of Glucocorticoid Receptor target genes. *Proc Natl Acad Sci U S A* 109: 19673–19678
- Chan-Penebre E, Kuplast KG, Majer CR, Boriack-Sjodin PA, Wigle TJ, Johnston LD, Rioux N, Munchhof MJ, Jin L, Jacques SL, *et al* (2015) A selective inhibitor of PRMT5 with in vivo and in vitro potency in MCL models. *Nature Chemical Biology* 2015 11:6 11: 432–437
- Chaturvedi CP, Hosey AM, Palii C, Perez-Iratxeta C, Nakatani Y, Ranish JA, Dilworth FJ & Brand M (2009) Dual role for the methyltransferase G9a in the maintenance of beta-globin gene transcription in adult erythroid cells. *Proc Natl Acad Sci U S A* 106: 18303–18308
- Chen H, Lorton B, Gupta V & Shechter D (2017) A TGFβ-PRMT5-MEP50 Axis Regulates Cancer Cell Invasion through Histone H3 and H4 Arginine Methylation Coupled Transcriptional Activation and Repression. *Oncogene* 36: 373
- Chen YC, Allen SG, Ingram PN, Buckanovich R, Merajver SD & Yoon E (2015a) Single-cell Migration Chip for Chemotaxis-based Microfluidic Selection of Heterogeneous Cell Populations. *Scientific Reports* 2015 5:1 5: 1–13
- Chen Z, Lan X, Wu D, Sunkel B, Ye Z, Huang J, Liu Z, Clinton SK, Jin VX & Wang Q (2015b) Ligand-dependent genomic function of glucocorticoid receptor in triple-negative breast cancer. *Nature Communications* 2015 6:1 6: 1–8
- Chinenov Y, Gupte R, Dobrovolna J, Flammer JR, Liu B, Michelassi FE & Rogatsky I (2012) Role of transcriptional coregulator GRIP1 in the anti-inflammatory actions of glucocorticoids. *Proc Natl Acad Sci U S A* 109: 11776–11781
- Dobrovolna J, Chinenov Y, Kennedy MA, Liu B & Rogatsky I (2012) Glucocorticoid-dependent phosphorylation of the transcriptional coregulator GRIP1. *Mol Cell Biol* 32: 730–739
- le Guen L, Karpanen T, Schulte D, Harris NC, Koltowska K, Roukens G, Bower NI, van Impel A, Stacker SA, Achen MG, *et al* (2014) Ccbe1 regulates Vegfc-mediated induction of Vegfr3 signaling during embryonic lymphangiogenesis. *Development* 141: 1239–1249
- Györfy B (2021) Survival analysis across the entire transcriptome identifies biomarkers with the highest prognostic power in breast cancer. *Comput Struct Biotechnol J* 19: 4101–4109
- Humphries BA, Buschhaus JM, Chen YC, Haley HR, Qyli T, Chiang B, Shen N, Rajendran S, Cutter A, Cheng YH, *et al* (2019) Plasminogen activator inhibitor 1 (PAI1) promotes actin cytoskeleton reorganization and glycolytic metabolism in triple-negative breast cancer. *Molecular Cancer Research* 17: 1142–1154

- Karmakar S, Jin Y & Nagaich AK (2013) Interaction of glucocorticoid receptor (GR) with estrogen receptor (ER) α and activator protein 1 (AP1) in dexamethasone-mediated interference of ER α activity. *J Biol Chem* 288: 24020–24034
- Koh CM, Bezzi M & Guccione E (2015) The Where and the How of PRMT5. *Current Molecular Biology Reports* 2015 1:1 1: 19–28
- Koike N, Maita H, Taira T, Ariga H & Iguchi-Arigo SMM (2000) Identification of heterochromatin protein 1 (HP1) as a phosphorylation target by Pim-1 kinase and the effect of phosphorylation on the transcriptional repression function of HP1. *FEBS Letters* 467: 17–21
- Kwon SH, Florens L, Swanson SK, Washburn MP, Abmayr SM & Workman JL (2010) Heterochromatin protein 1 (HP1) connects the FACT histone chaperone complex to the phosphorylated CTD of RNA polymerase II. *Genes & Development* 24: 2133–2145
- Lattouf H, Kassem L, Jacquemetton J, Choucair A, Poulard C, Trédan O, Corbo L, Diab-Assaf M, Hussein N, Treilleux I, *et al* (2019a) LKB1 regulates PRMT5 activity in breast cancer. *Int J Cancer* 144: 595–606
- Lattouf H, Poulard C & le Romancer M (2019b) PRMT5 prognostic value in cancer. *Oncotarget* 10: 3151–3153
- Lin H, Wang M, Zhang YW, Tong S, Leal RA, Shetty R, Vaddi K & Luengo JI (2019) Discovery of Potent and Selective Covalent Protein Arginine Methyltransferase 5 (PRMT5) Inhibitors. *ACS Med Chem Lett* 10: 1033–1038
- Lomberk G, Bensi D, Fernandez-Zapico ME & Urrutia R (2006) Evidence for the existence of an HP1-mediated subcode within the histone code. *Nat Cell Biol* 8: 407–415
- Malbeteau L, Pham HT, Eve L, Stallcup MR, Poulard C & le Romancer M (2022) How Protein Methylation Regulates Steroid Receptor Function. *Endocrine Reviews* 43: 160
- Marangoni E, Vincent-Salomon A, Auger N, Degeorges A, Assayag F, de Cremoux P, de Plater L, Guyader C, de Pinieux G, Judde JG, *et al* (2007) A New Model of Patient Tumor-Derived Breast Cancer Xenografts for Preclinical Assays. *Clinical Cancer Research* 13: 3989–3998
- Motolani A, Martin M, Sun M & Lu T (2021) The Structure and Functions of PRMT5 in Human Diseases. *Life (Basel)* 11
- Noureddine LM, Trédan O, Hussein N, Badran B, le Romancer M & Poulard C (2021) Glucocorticoid Receptor: A Multifaceted Actor in Breast Cancer. *International Journal of Molecular Sciences* 2021, Vol 22, Page 4446 22: 4446
- Obradović MMS, Hamelin B, Manevski N, Couto JP, Sethi A, Coissieux MM, Müntz S, Okamoto R, Kohler H, Schmidt A, *et al* (2019) Glucocorticoids promote breast cancer metastasis. *Nature* 567: 540–544
- Pan D, Kocherginsky M & Conzen SD (2011) Activation of the glucocorticoid receptor is associated with poor prognosis in estrogen receptor-negative breast cancer. *Cancer Research* 71: 6360–6370
- Poulard C, Baulu E, Lee BH, Pufall MA & Stallcup MR (2018) Increasing G9a automethylation sensitizes B acute lymphoblastic leukemia cells to glucocorticoid-induced death. *Cell Death and Disease* 9

- Poulard C, Bittencourt D, Wu D, Hu Y, Gerke DS & Stallcup MR (2017) A post-translational modification switch controls coactivator function of histone methyltransferases G9a and GLP. *EMBO Rep* 18: 1442–1459
- Poulard C, Jacquemetton J, Pham TH & le Romancer M (2020) Using proximity ligation assay to detect protein arginine methylation. *Methods* 175: 66–71
- Poulard C, Kim HN, Fang M, Kruth K, Gagnieux C, Gerke DS, Bhojwani D, Kim YM, Kampmann M, Stallcup MR, *et al* (2019) Relapse-associated AURKB blunts the glucocorticoid sensitivity of B cell acute lymphoblastic leukemia. *Proc Natl Acad Sci U S A* 116: 3052–3061
- Purcell DJ, Jeong KW, Bittencourt D, Gerke DS & Stallcup MR (2011) A distinct mechanism for coactivator versus corepressor function by histone methyltransferase G9a in transcriptional regulation. *Journal of Biological Chemistry* 286: 41963–41971
- Quillien A, Gilbert G, Boulet M, Ethuin S, Waltzer L & Vandell L (2021) Prmt5 promotes vascular morphogenesis independently of its methyltransferase activity. *PLoS Genet* 17
- Reddy TP, Rosato RR, Li X, Moulder S, Piwnica-Worms H & Chang JC (2020) A comprehensive overview of metaplastic breast cancer: clinical features and molecular aberrations. *Breast Cancer Research* 22: 1–11
- Rollins DA, Kharlyngdoh JB, Coppo M, Tharmalingam B, Mimouna S, Guo Z, Sacta MA, Pufall MA, Fisher RP, Hu X, *et al* (2017) Glucocorticoid-induced phosphorylation by CDK9 modulates the coactivator functions of transcriptional cofactor GRIP1 in macrophages. *Nature Communications* 8
- Roth SM, Berens EB, Sharif GM, Glasgow E & Wellstein A (2021) Cancer cell invasion and metastasis in zebrafish models (*Danio rerio*). *Methods Mol Biol* 2294: 3
- Shailesh H, Zakaria ZZ, Baiocchi R & Sif S (2018) Protein arginine methyltransferase 5 (PRMT5) dysregulation in cancer. *Oncotarget* 9: 36705–36718
- Sharma M, Ownbey RT & Sharma MC (2010) Breast cancer cell surface annexin II induces cell migration and neoangiogenesis via tPA dependent plasmin generation. *Exp Mol Pathol* 88: 278–286
- Shen Y, Gao G, Yu X, Kim H, Wang L, Xie L, Schwarz M, Chen X, Guccione E, Liu J, *et al* (2020) Discovery of First-in-Class Protein Arginine Methyltransferase 5 (PRMT5) Degradable. *J Med Chem* 63: 9977–9989
- Song J, Chen W, Cui X, Huang Z, Wen D, Yang Y, Yu W, Cui L & Liu CY (2020) CCBE1 promotes tumor lymphangiogenesis and is negatively regulated by TGF β signaling in colorectal cancer. *Theranostics* 10: 2327–2341
- Stallcup MR & Poulard C (2020) Gene-Specific Actions of Transcriptional Coregulators Facilitate Physiological Plasticity: Evidence for a Physiological Coregulator Code.
- Stopa N, Krebs JE & Shechter D (2015) The PRMT5 arginine methyltransferase: many roles in development, cancer and beyond. *Cell Mol Life Sci* 72: 2041–2059

- Sung H, Ferlay J, Siegel RL, Laversanne M, Soerjomataram I, Jemal A & Bray F (2021) Global Cancer Statistics 2020: GLOBOCAN Estimates of Incidence and Mortality Worldwide for 36 Cancers in 185 Countries. *CA Cancer J Clin* 71: 209–249
- Vinet M, Suresh S, Maire V, Monchecourt C, Némati F, Lesage L, Pierre F, Ye M, Lescure A, Brisson A, *et al* (2019) Protein arginine methyltransferase 5: A novel therapeutic target for triple-negative breast cancers. *Cancer Med* 8: 2414–2428
- West DC, Pan D, Tonsing-Carter EY, Hernandez KM, Pierce CF, Styke SC, Bowie KR, Garcia TI, Kocherginsky M & Conzen SD (2016) GR and ER Coactivation Alters the Expression of Differentiation Genes and Associates with Improved ER+ Breast Cancer Outcome. *Mol Cancer Res* 14: 707–719
- Wu DY, Ou CY, Chodankar R, Siegmund KD & Stallcup MR (2014) Distinct, genome-wide, gene-specific selectivity patterns of four glucocorticoid receptor coregulators. *Nucl Recept Signal* 12: e002
- Wu Q, Schapira M, Arrowsmith CH & Barsyte-Lovejoy D (2021) Protein arginine methylation: from enigmatic functions to therapeutic targeting. *Nat Rev Drug Discov* 20: 509–530
- Xu J & Li Q (2003) Review of the in vivo functions of the p160 steroid receptor coactivator family. *Mol Endocrinol* 17: 1681–1692
- Yang F, Ma Q, Liu Z, Li W, Tan Y, Jin C, Ma W, Hu Y, Shen J, Ohgi KA, *et al* (2017) Glucocorticoid Receptor:MegaTrans Switching Mediates the Repression of an ER α -Regulated Transcriptional Program. *Mol Cell* 66: 321-331.e6

Figure 1

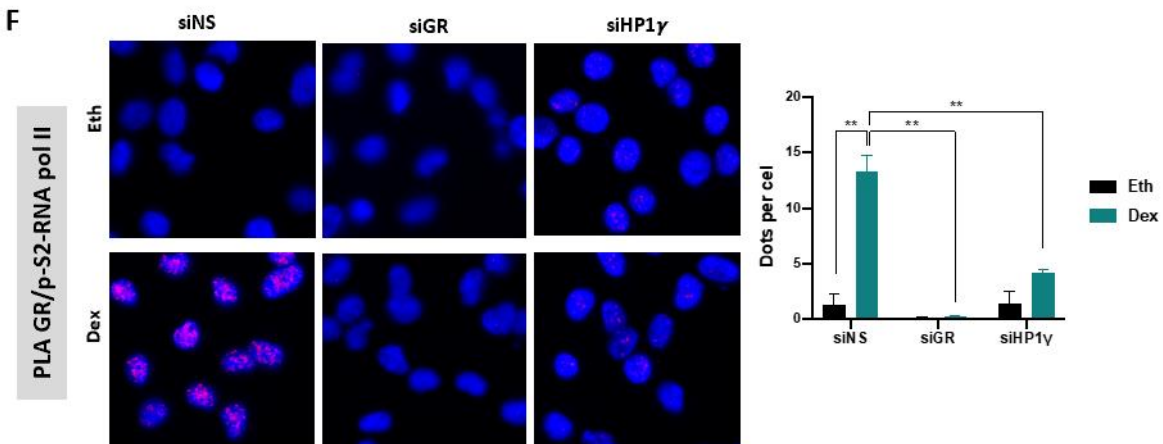
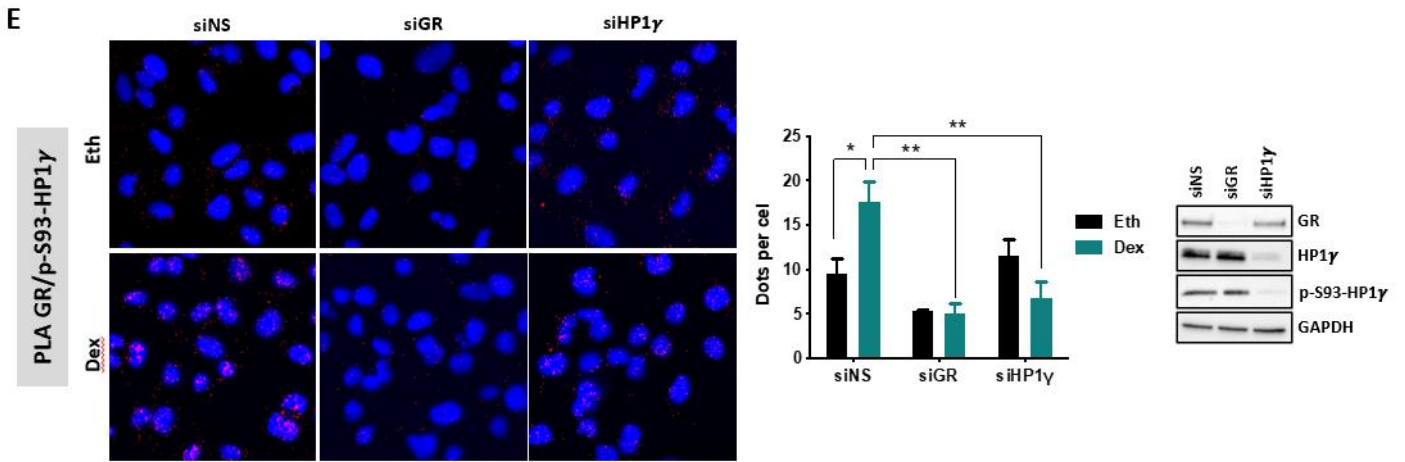
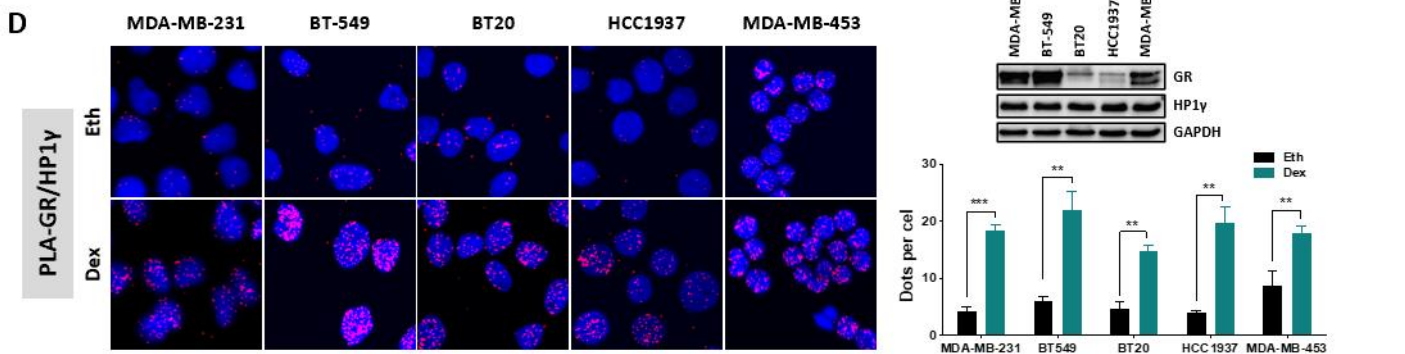
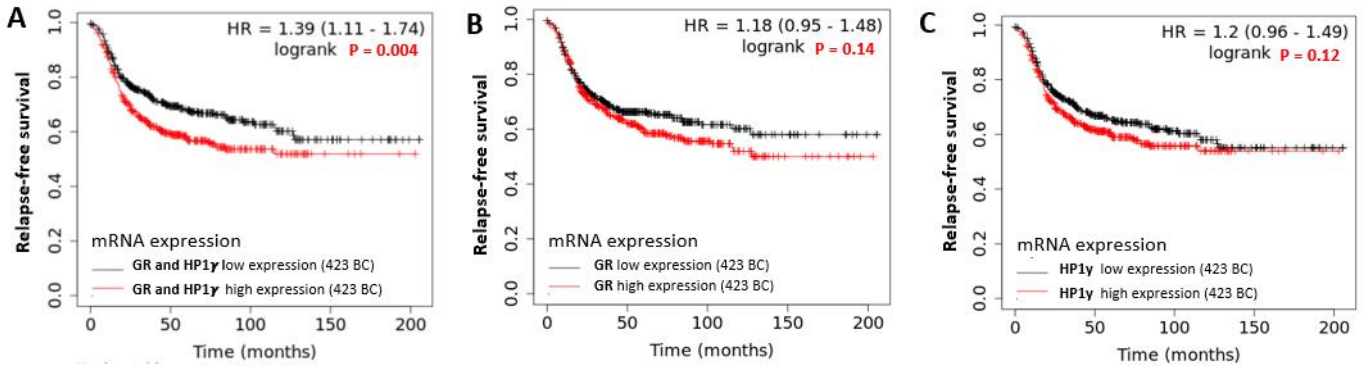

Figure 2

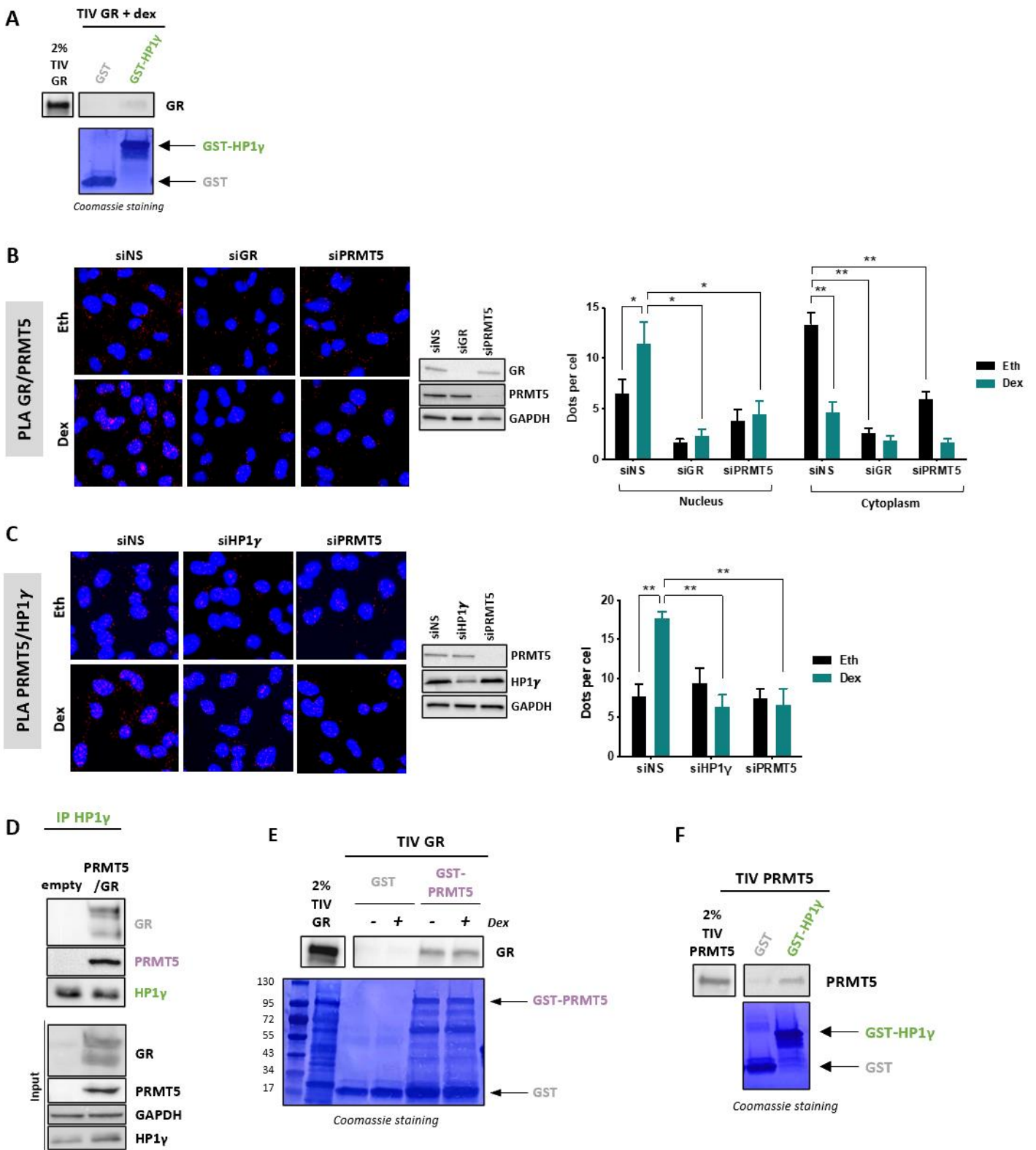

Figure 3

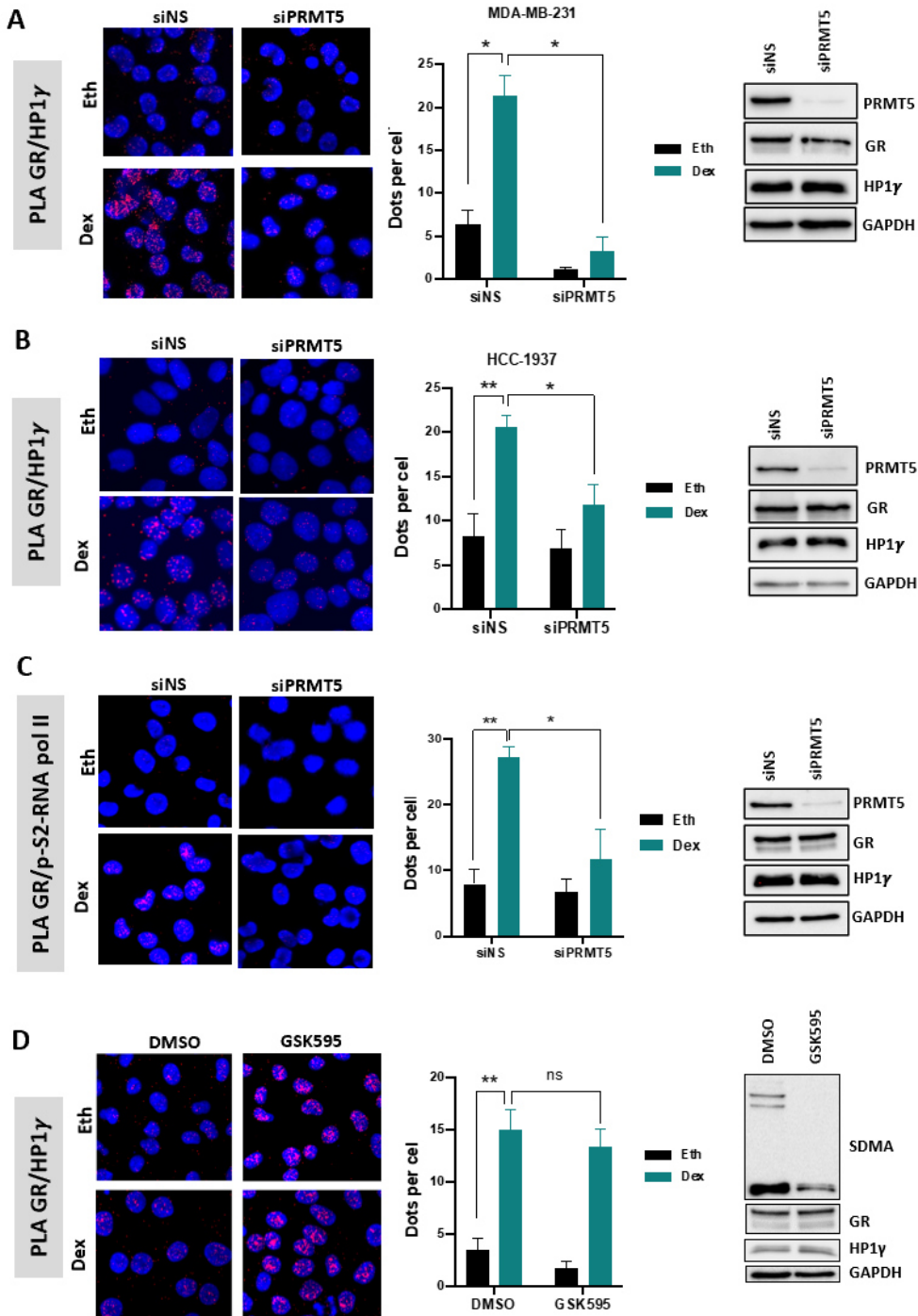

Figure 4

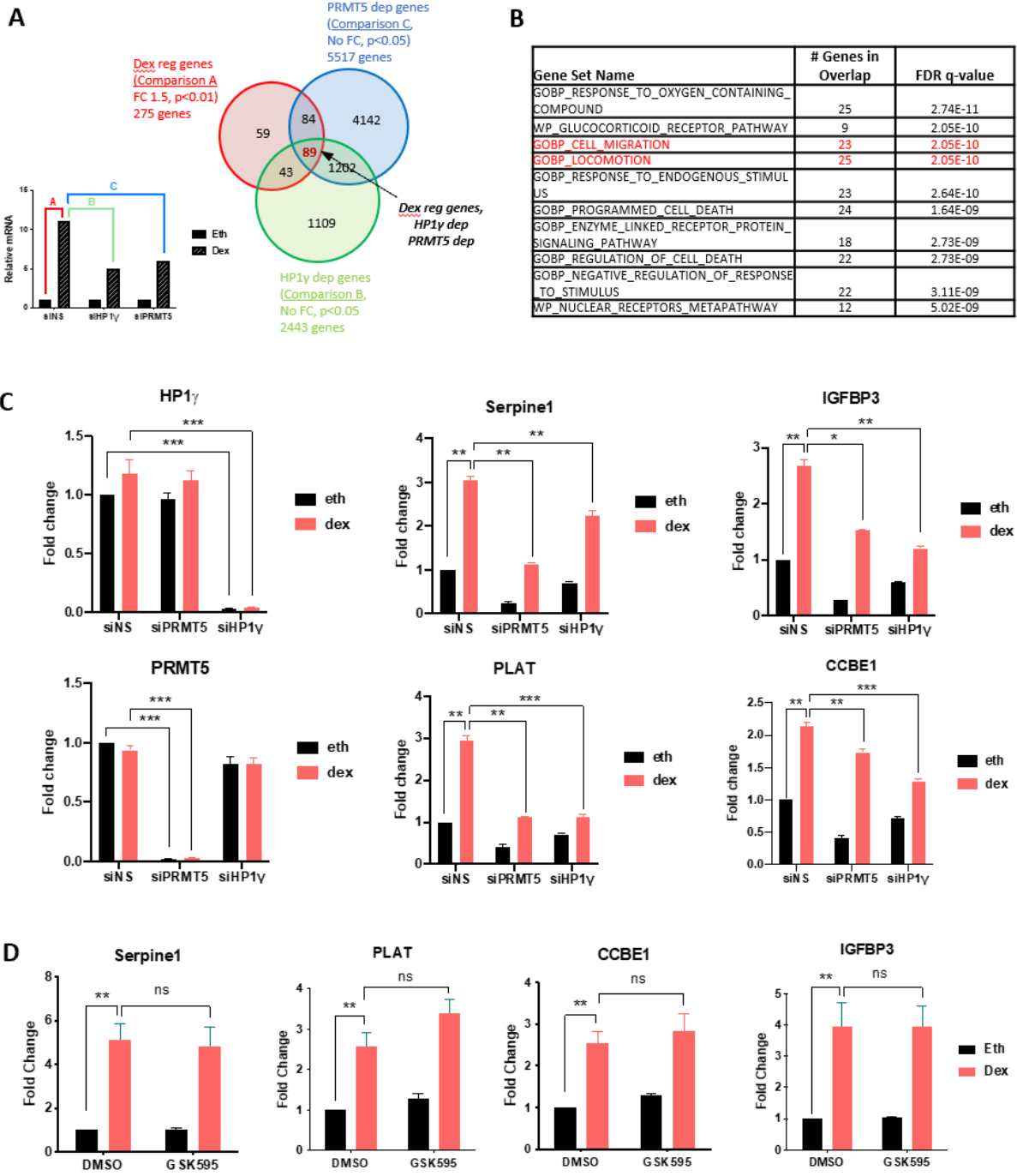

Figure 5

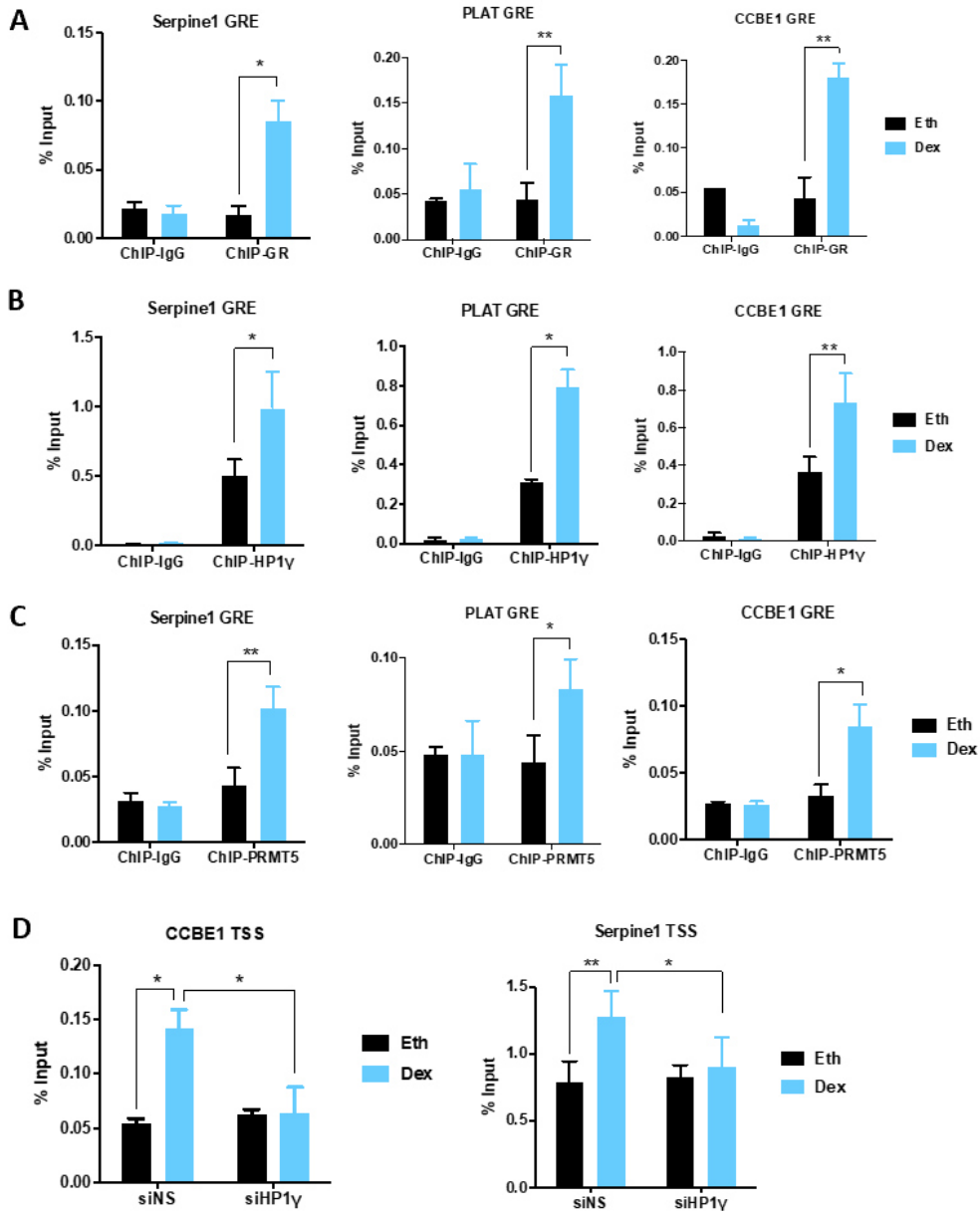

Figure 6

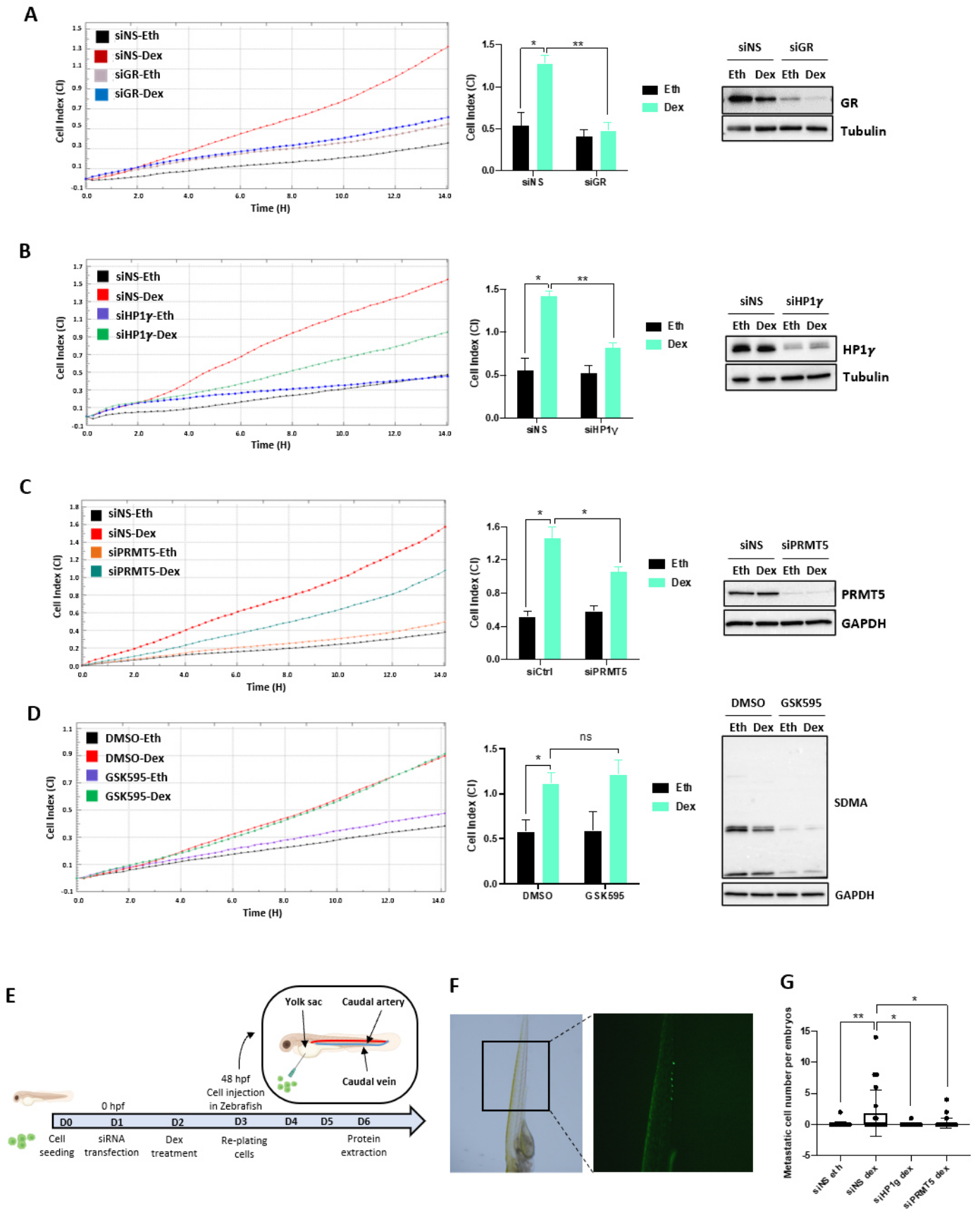
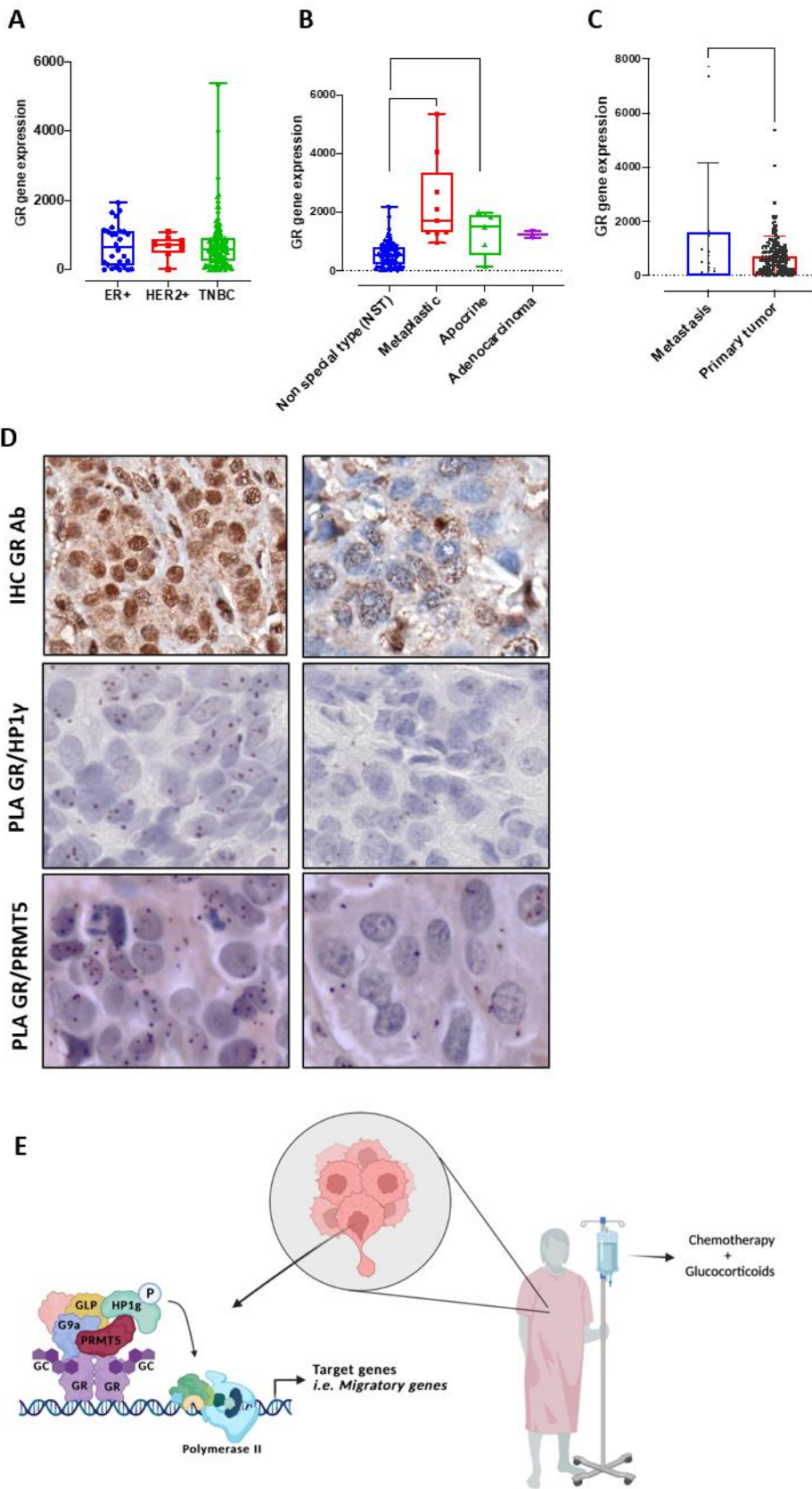

Figure 7



Supplemental Methods

Cell culture

When indicated, cells were treated with 100 nM of dexamethasone (Dex, Sigma), 100 nM of prednisolone (Selleckchem), 1 μ M of hydrocortisone (Selleckchem), 1 μ M of RU486 (Selleckchem) or with 0.5 μ M of PRMT5 inhibitor GSK3326595 (Selleckchem) for the indicated time.

Supplemental Figures

Sup Figure 1

(A-I) Relapse-free survival in a cohort of 846 patients with basal breast cancers (BC), with low (black) or high (red) **(A)** GR and G9a, **(B)** GR and CoCoA, **(C)** GR and Carm1, **(D)** GR and SRC1, **(E)** GR and SRC2, **(F)** GR and SRC3, **(G)** GR and RIP140, **(H)** GR and BRM and **(I)** GR and BRG1. Kaplan-Meier analyses conducted on GEO, EGA, and TCGA datasets.

Sup Figure 2

PLA was conducted to analyze the specificity of the interaction between GR and HP1 γ in **(A)** MDA-MB-231 and **(B)** HCC-1937 cells transfected with a SMART-pool siRNA for GR (siGR), HP1 γ (siHP1 γ), or non-specific siRNA (siNS) and treated with 100 nM dexamethasone (Dex) or the equivalent volume of vehicle ethanol (Eth) for 2 h. The detected interactions are indicated by red dots. Nuclei were counterstained with DAPI (blue). The number of interactions in the nucleus and cytosol detected by ImageJ analysis is shown as the mean \pm SEM of three independent experiments. P-value was determined using a paired t-test. *P \leq 0.05, **P \leq 0.01. Whole-cell extracts were analyzed for GR, HP1 γ and tubulin expression by immunoblot (right panel). **(C)** PLA was performed to analyze GR and HP1 γ interactions in MDA-MB-231 cells following treatment with different GR agonists (100 nM Dex, 100 nM Prednisolone (Pred), 1 μ M Hydrocortisone (Hydro)), with the RU486 antagonist (1 μ M Mifepristone), or with the equivalent volume of Eth for 2 h. Detected interactions are shown as the mean \pm SEM of three independent experiments. P-value was determined using a paired t-test. *P \leq 0.05, **P \leq 0.01. Whole-cell extracts were analyzed for GR, HP1 γ and GAPDH expression by immunoblot.

Sup Figure 3

GR and HP1 γ interaction was analyzed by PLA in MDA-MB-231 and HCC1937 cells transfected with non-specific siRNA (siNS) or SMART-pool siRNA targeting G9a (siG9a) **(A)** or SMART-pool siRNA targeting GLP (siGLP) **(B)** treated with 100 nM dex or ethanol (Eth) for 2 h. Detected interactions are shown as the mean \pm SEM of three independent experiments. P-value was determined using a paired t-test. *P \leq 0.05. Whole-cell extracts from MDA-MB-231 and HCC-1937 were analyzed for G9a, GR, HP1 γ , and tubulin expression by immunoblot.

Sup Figure 4

(A) MDA-MB-231 cells used in RNA-seq experiments, which were transfected with SMART-pool siRNA targeting PRMT5, HP1 γ or non-specific siRNA (siNS), were analyzed by RT-qPCR for the indicated mRNAs after treatment with 100 nM dexamethasone (Dex) or the equivalent volume of ethanol (Eth) for 8 h. RT-qPCR was performed on total RNA. mRNA levels are shown relative to β -actin mRNA for each of the three replicates and are mean \pm SD from three technical qPCR replicates. **(B)** MDA-MB-231 cells transfected with non-specific siRNA (siNS) or with siRNA against GR (siGR) and treated with 100 nM Dex or the equivalent volume of Eth for 8 h. mRNA levels for the indicated GR target genes were measured by reverse transcriptase followed by qPCR and normalized against 28S mRNA levels. Results shown are mean \pm SEM for four independent experiments. P-value was calculated using a paired t-test. *P \leq 0.05, **P \leq 0.01.

Sup Figure 5

Validation of siRNA efficacy for Zebrafish experiments. Immunoblot showing GR, PRMT5, HP1 γ , and Tubulin protein levels in whole-cell extracts from MDA-MB-231 cells transfected with siRNA against HP1 γ (siHP1 γ), PRMT5 (siPRMT5) or non-specific siRNA (siNS) for 96 h and treated with 100 nM dexamethasone (Dex) or ethanol (Eth) for 24 h.

Sup Figure 1

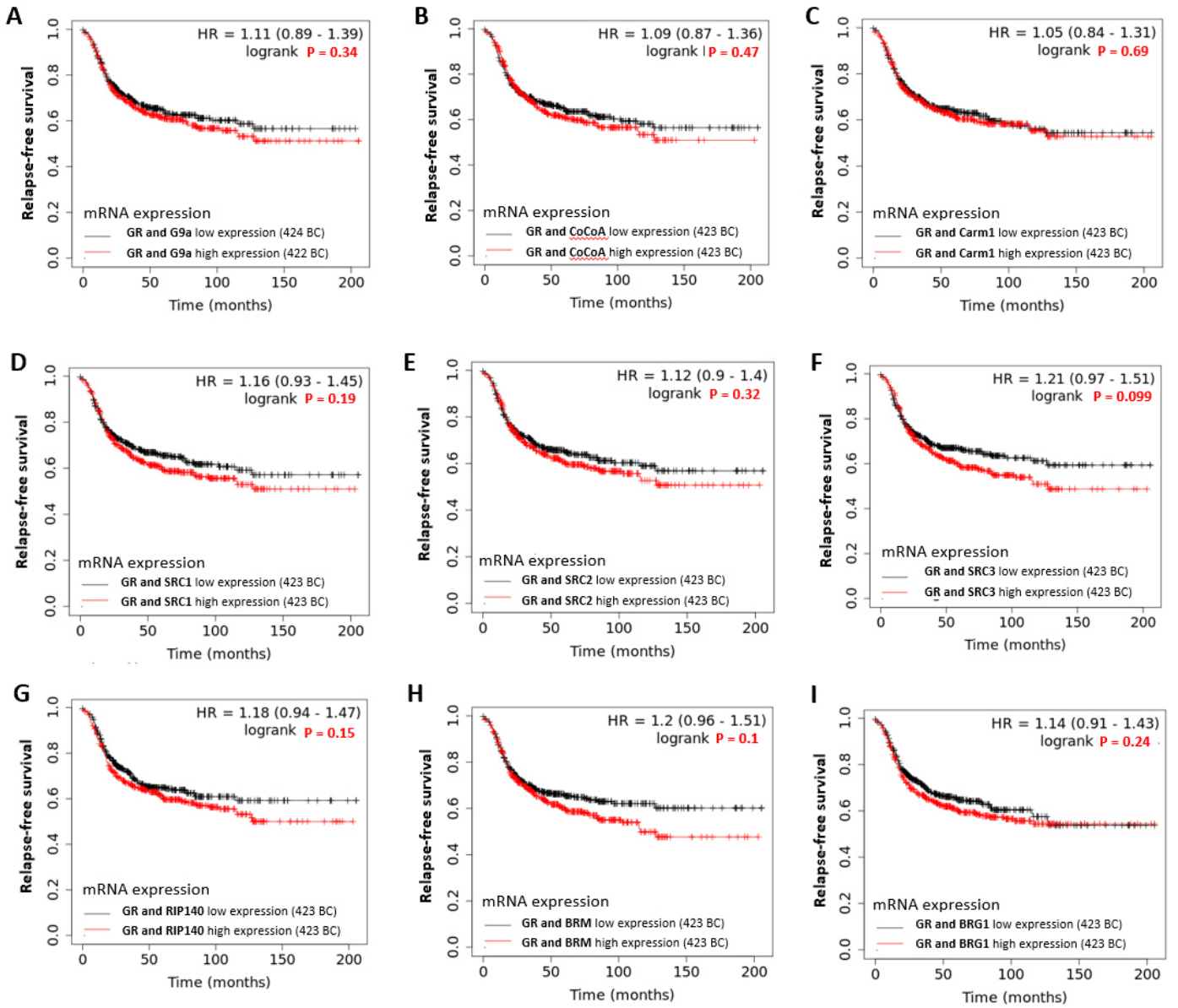

Sup Figure 2

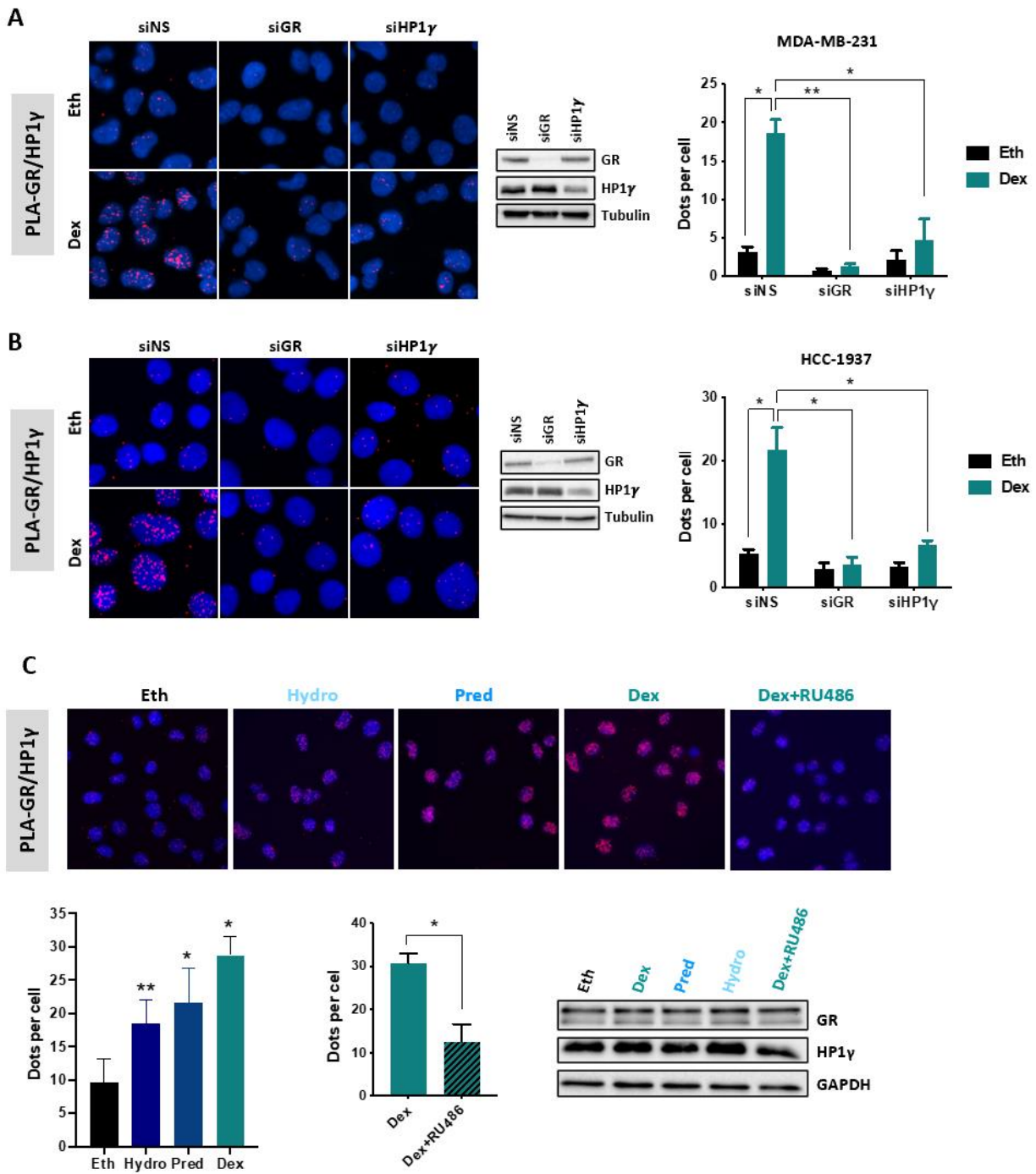

Sup Figure 3

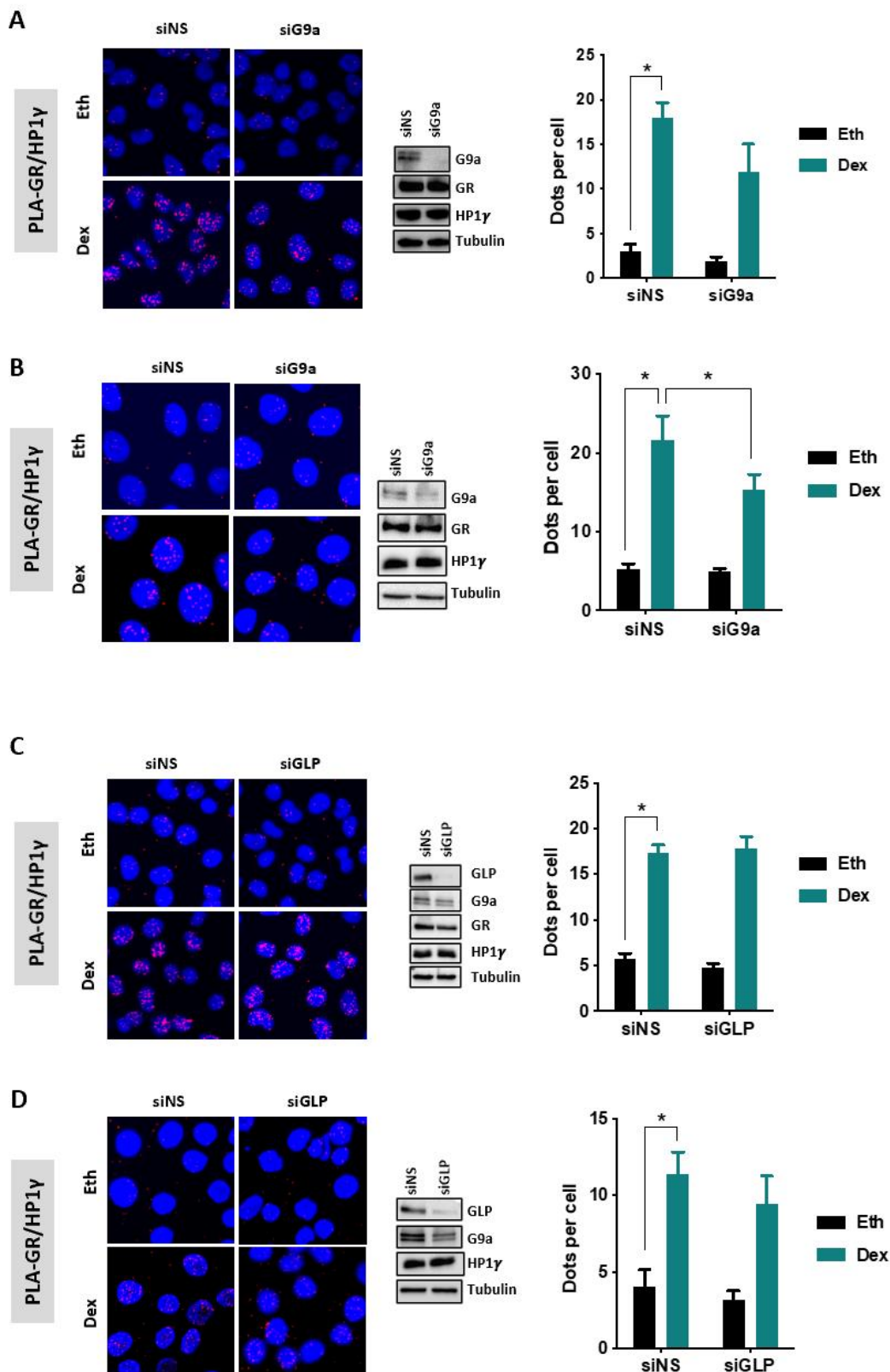

Sup Figure 4

A

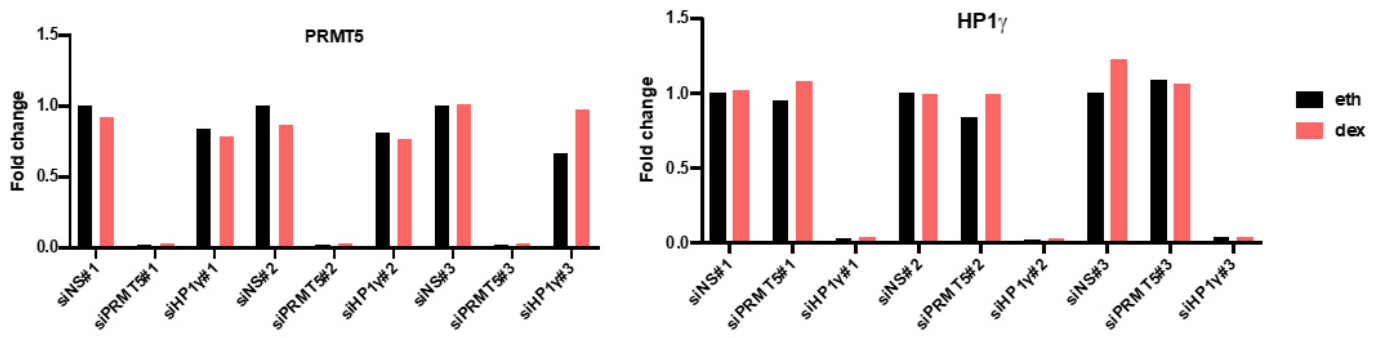

B

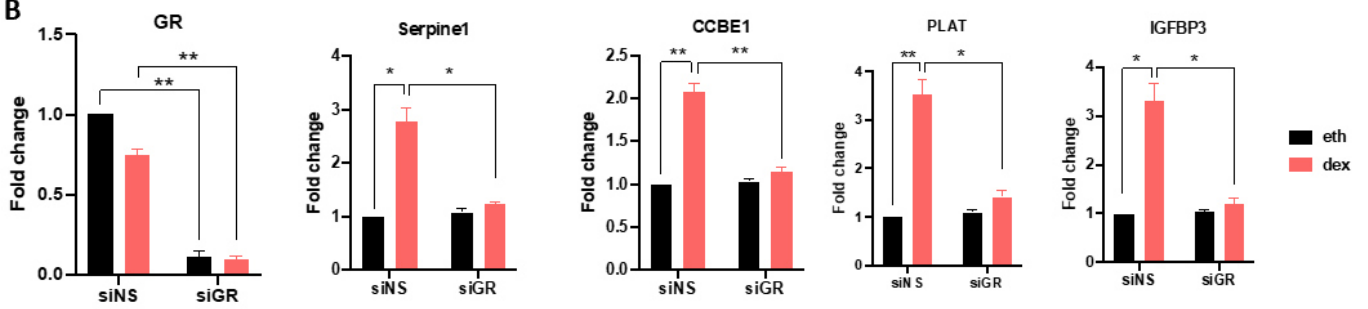

Sup Figure 5

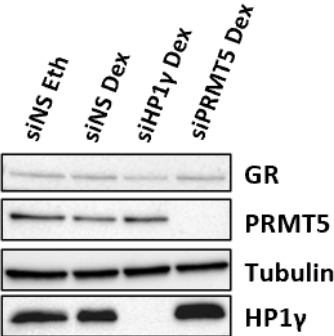

Discussion and Future Perspectives

Breast cancer is a serious health concern, especially TNBCs, which are the most malignant subtypes. As TNBCs lack the expression of either ER or HER2, targeted therapies are ineffective and TNBC patients mainly receive systemic chemotherapy. Cytotoxic chemotherapy targets rapidly dividing tumor and normal cells resulting in adverse side effects such as nausea, vomiting, loss of appetite, etc. GCs are given as adjuvant therapy along with chemotherapy to decrease its side effects. However, investigations have shown that GCs are unlikely inducing metastasis and chemoresistance in TNBCs, raising new concerns about their application in TNBC patients' therapy. GCs possess their distinct functions through binding the ligand-activated nuclear receptor transcription factor glucocorticoid receptor (GR). GR regulates different genes involved in different physiological pathways by recruiting specific sets of coregulators. In this study, we identified a new complex of coregulators (GR/PRMT5/HP1 γ) associated with the oncogenic properties of GR in TNBC.

Our results demonstrated that GR and HP1 γ interacts in-vitro and in-vivo in TNBC tumors and this interaction is induced by dex in different TNBC cell lines. Heterochromatin Protein 1 gamma (HP1 γ) is known to be associated with transcriptional repression (Minc, Courvalin and Buendia, 2000; Mateescu *et al.*, 2004). However, recent studies have represented HP1 γ as transcriptional coactivator for GR target genes (Poulard *et al.*, 2017, 2018). This coactivator activity of HP1 γ requires its phosphorylation at Serine93 (Lomberk *et al.*, 2006; Kwon and Workman, 2011). In A549 lung adenocarcinoma cell line and Nalm6 B-acute lymphoblastic leukemia (B-ALL), phosphorylated form of HP1 γ is recruited to the GRE of GR target genes and is required for binding and recruiting RNA polymerase II (Poulard *et al.*, 2017, 2019). Similarly, in this study we demonstrated GR/ph-S93-HP1 γ interaction is induced upon GR activation by Dexamethasone (Dex) in different TNBC cell lines. Moreover, we found that the GR/ph-S2-RNA polymerase II interaction upon dex treatment is impaired upon knocking down HP1 γ , compatible with previously published work.

HP1 γ is recruited to the GR binding sites (GBS) of target genes in A549 lung cancer cells and Nalm6 B-ALL in a ternary complex with GR and its coregulators G9a and GLP (Poulard *et al.*, 2017, 2018). G9a and GLP which are lysine methyltransferases catalyzing the methylation of H3K9, a well-known repressive mark, displayed a coactivator function in regulating GR target

genes (Tachibana *et al.*, 2002; Barski *et al.*, 2007; Bittencourt, D. Wu, *et al.*, 2012). formation of this ternary complex (GR/G9a/GLP/HP1 γ) were further regulated by a post translational modification switch of G9a/GLP. Self-methylation of G9a/GLP provides a binding site for HP1 γ , resulting in complex formation and transcriptional activation of GR target genes. Whereas the phosphorylation of G9a/GLP by Aurora Kinase B on the threonine residue adjacent to its self-methylation site hinders recruitment of HP1 γ and prevents complex formation (Poulard *et al.*, 2017). In this study, we found that G9a is slightly involved in GR/HP1 γ interaction in a some TNBC cell lines but not all of them, whereas GLP is totally unconcerned in this interaction. Opposite to what was reported in A549 cells and Nalm6, G9a or GLP are not involved in GR/HP1 γ interaction in TNBC cells, highlighting that GR transcription factor regulate functions in a tissue-dependent manner through recruiting different sets of coregulators.

In our study, in TNBC, we displayed a new model of recruiting HP1 γ to GBSs through the arginine methyltransferase PRMT5. PRMT5 is the major type II methyltransferase that catalyzes the formation of symmetric dimethylarginine residues in histone and non-histone proteins (Bedford and Clarke, 2009). PRMT5 expression levels are dysregulated in distinct types of cancer, and a higher expression level observed in breast cancer tissues and cell lines is associated with poor prognosis and survival rates (Wang *et al.*, 2004; Motolani *et al.*, 2021). The subcellular localization of PRMT5 seems to regulate its tumorigenic activity. For instance, our team showed that the nuclear expression of PRMT5 in ER α + tumors was associated with prolonged disease free and overall survival (Lattouf *et al.*, 2019). Whereas in TNBC, cytoplasmic PRMT5 is expressed at higher levels compared to other BC subtypes and associates with poor prognosis (Vinet *et al.*, 2019). In the current study, we revealed that PRMT5 and GR interacts in the cytoplasm and upon Dex treatment GR/PRMT5 translocate to nucleus in order to regulate GR target genes.

In view of TCGA (The Cancer Genomic Atlas) database outcome we obtained, where the high expression of HP1 γ and GR together is significantly associated with a decrease in the relapse-free survival probability in TNBC tumors, we inspected the molecular mechanisms regulated by this complex (GR/ HP1 γ /PRMT5) associated with the undesirable side effects of GCs in TNBC tumors. Our RNA-seq analysis displayed that PRMT5 is a major coregulator of GR as it regulates 173 of the 275 dex-regulated genes, whereas HP1 γ regulates 132 of the 275 dex-regulated genes. In a large-scale analysis, the 89 dex-regulated genes overlapped with the PRMT5-

regulated and HP1 γ -regulated gene sets are significantly enriched in cell migration and locomotion pathways. Among the dex-regulated HP1 γ /PRMT5 genes, we found that GR, HP1 γ and PRMT5 are recruited to the GREs of SERPINE-1, CCBE1, IGFBP-3 and PLAT upon dex treatment. For instance, SERPINE-1 or Plasminogen activator inhibitor 1 (PAI1) is a protein that promotes actin cytoskeletal rearrangement driving cellular migration (Humphries *et al.*, 2019), CCBE1 (collagen- and calcium-binding EGF domains 1) is a protein that binds extracellular matrix components and enhances lymphangiogenesis facilitating cellular migration (Bos *et al.*, 2011), IGFBP-3 (Insulin-like growth factor -binding protein 3) is a protein that upregulate the expression level of vascular cell adhesion molecule 1 VCAM-1 promoting cellular migration and its high expression is correlated with poor clinical outcomes in breast cancer (Yu *et al.*, 1996; Chao *et al.*, 2021), PLAT or tissue-plasminogen activator (t-PA) is a protein that generates plasmin inducing annexin II-dependent cell migration and neoangiogenesis (Sharma, Ownbey and Sharma, 2010). Herein, our experiments represented GR/PRMT5/HP1 γ coregulator complex is triggering GCs-induced TNBC cell migration in-vitro and in-vivo in zebrafish model.

Since metastasis formation is a major barrier in treating triple negative breast cancer patients and targeting GR in breast cancer is not an option due to its pleotropic activity, we thought of targeting this complex as a therapeutic approach in TNBC patients in the future. Recent findings suggested PRMT5 as potential therapeutic target in cancers and several potent inhibitors against it have been developed with promising effects (Sharma, Ownbey and Sharma, 2010). For instance, GSK3326595 and JNJ64619178 are currently being assessed in clinic, and GSK3326595 phase-II clinical trials for BC and acute myeloid leukemia are also ongoing (Sharma, Ownbey and Sharma, 2010; Wu *et al.*, 2021). Additionally, our team previously described that PRMT5 is capable of methylating GR (Poulard *et al.*, 2020). As we presented that PRMT5 is required for GR/HP1 γ interaction, we hypothesized that PRMT5 catalytic activity could be inhibited to prevent the adverse side effects of GCs in TNBCs. However, in the present study, inhibiting PRMT5 catalytic activity by GSK3326595 did not affect: (i) GR and HP1 γ interaction, (ii) dex-regulated and PRMT5 and HP1 γ dependent target genes and (iii) cell migration induced by GC. Therefore, PRMT5 role in GC-induced cell migration is independent of its catalytic activity. Suggesting that PRMT5 in this coregulator complex is functioning as a scaffold coregulator protein to maintain GR and HP1 γ interaction.

Whereas our recent unpublished data shows that PRMT5 catalytic activity seems to be involved in other undesirable side effects such as GC-induced chemoresistance in TNBC.

On purpose to target this complex and prevent the deleterious effects of GCs on TNBC patients, we proposed two strategies for our future investigations. First strategy aims to target PRMT5 scaffold protein itself as its catalytic activity is not required in regulating GC-induced cell migration. This could be accomplished by using the proteolysis targeting chimera (PROTAC) technology which selectively induces the global proteasomal degradation of PRMT5. The PROTAC PRMT5 inhibitor (MS4322) which targets both the catalytic activity of PRMT5 and its scaffolding capacity could be an opportunity of targeting the oncogenic activity of GR in TNBC (Shen *et al.*, 2021). Further data displayed that MS4322 exhibit a good plasma exposure in mice, implying that MS4322 could be eligible to undergo clinical trials. Second strategy aims to target the kinase catalyzing the phosphorylation of HP1 γ and its activation. Previous investigations performed in B-Acute lymphoblastic leukemia (B-ALL) showed that Aurora kinase (AURKB) is responsible for HP1 γ phosphorylation, and its inhibition enhanced the GC-induced cytotoxicity in relapsed B-ALL patient samples (Poulard *et al.*, 2019). Interestingly, AURKB seems not to be catalyzing the phosphorylating of HP1 γ in TNBC. Therefore, examining other potential kinases such as Pim1, PKA, Aurora-Kinas A should be conducted (Koike *et al.*, 2000; Lomberk *et al.*, 2006)

Moreover, our recent data from Curie Institute in Paris on a small cohort of PDX tumors shows that GR expression is higher in TNBC patient-derived xenografts (PDX) compared to ER α + and HER2+ PDXs, and especially in metaplastic subtype among the different TNBC subtypes. More interestingly we found that GR expression is higher in PDX tumors engrafted from metastatic tumors compared to the ones engrafted from primary tumors. Confirming that GR could be an important predictive biomarker in TNBC patients. Currently, we are studying the expression of GR and PRMT5 and the interaction between GR/HP1g and GR/P5 in a large cohort of 500 tumors patients from Centre Léon Bérard to check if GR/PRMT5/HP1g complex could be considered as a predictive marker of relapse in TNBC.

Annex I

1. Review 1

Glucocorticoid Receptor: A Multifaceted Actor in Breast Cancer

Lara Malik Nouredine, Olivier Trédan, Nader Hussein, Bassam Badran, Muriel Le Romancer and Coralie Poulard

Published in International Journal of Molecular Sciences in April 2021.



Review

Glucocorticoid Receptor: A Multifaceted Actor in Breast Cancer

Lara Malik Nouredine ^{1,2,3,4}, Olivier Trédan ^{1,2,3,5}, Nader Hussein ⁴, Bassam Badran ⁴, Muriel Le Romancer ^{1,2,3} and Coralie Poulard ^{1,2,3,*} 



Citation: Nouredine, L.M.; Trédan, O.; Hussein, N.; Badran, B.; Le Romancer, M.; Poulard, C. Glucocorticoid Receptor: A Multifaceted Actor in Breast Cancer. *Int. J. Mol. Sci.* **2021**, *22*, 4446. <https://doi.org/10.3390/ijms22094446>

Academic Editor: Filippo Acconcia

Received: 17 March 2021

Accepted: 21 April 2021

Published: 24 April 2021

Publisher's Note: MDPI stays neutral with regard to jurisdictional claims in published maps and institutional affiliations.



Copyright: © 2021 by the authors. Licensee MDPI, Basel, Switzerland. This article is an open access article distributed under the terms and conditions of the Creative Commons Attribution (CC BY) license (<https://creativecommons.org/licenses/by/4.0/>).

- ¹ Université de Lyon, F-69000 Lyon, France; Lara.nouredine@lyon.unicancer.fr (L.M.N.); olivier.tredan@lyon.unicancer.fr (O.T.); Muriel.LEROMANCER-CHERIFI@lyon.unicancer.fr (M.L.R.)
- ² Inserm U1052, Centre de Recherche en Cancérologie de Lyon, F-69000 Lyon, France
- ³ CNRS UMR5286, Centre de Recherche en Cancérologie de Lyon, F-69000 Lyon, France
- ⁴ Laboratory of Cancer Biology and Molecular Immunology, Faculty of Sciences, Lebanese University, Hadat-Beirut 90656, Lebanon; nader_hussein@yahoo.com (N.H.); pr.bassambadran@gmail.com (B.B.)
- ⁵ Centre Leon Bérard, Oncology Department, F-69000 Lyon, France
- * Correspondence: coralie.poulard@lyon.unicancer.fr; Tel.: +33-478-786-663; Fax: +33-478-782-720

Abstract: Breast cancer (BC) is one of the most common cancers in women worldwide. Even though the role of estrogen receptor alpha (ER α) is extensively documented in the development of breast tumors, other members of the nuclear receptor family have emerged as important players. Synthetic glucocorticoids (GCs) such as dexamethasone (dex) are commonly used in BC for their antiemetic, anti-inflammatory, as well as energy and appetite stimulating properties, and to manage the side effects of chemotherapy. However, dex triggers different effects depending on the BC subtype. The glucocorticoid receptor (GR) is also an important marker in BC, as high GR expression is correlated with a poor and good prognosis in ER α -negative and ER α -positive BCs, respectively. Indeed, though it drives the expression of pro-tumorigenic genes in ER α -negative BCs and is involved in resistance to chemotherapy and metastasis formation, dex inhibits estrogen-mediated cell proliferation in ER α -positive BCs. Recently, a new natural ligand for GR called OCDO was identified. OCDO is a cholesterol metabolite with oncogenic properties, triggering mammary cell proliferation in vitro and in vivo. In this review, we summarize recent data on GR signaling and its involvement in tumoral breast tissue, via its different ligands.

Keywords: breast cancer; glucocorticoid receptor; glucocorticoids; OCDO; coregulators

1. Introduction

Breast cancer (BC) is the deadliest cancer among women worldwide, followed by lung and colorectal cancer. The International Agency for Research on Cancer (IARC) approximated that BC accounted for the death of over 626,679 women worldwide in 2018 and estimated the diagnosis of 2 million new cases [1]. It is predicted that one in eight women will develop BC during their life.

BC is a complex heterogeneous disease that encompasses a variety of subtypes with diverse clinical, morphological, and molecular features [2,3]. BC is molecularly classified based on the expression of common biomarkers: estrogen/progesterone receptors (ER α /PR) and human epidermal growth factor receptor-2 (HER2) [4], and is further subclassified into: Luminal A, Luminal B, HER2-enriched, and triple-negative breast cancer (TNBC) (including Basal-like and Claudin-low). Luminal A and B are the most predominant ER α /PR-positive tumors, and the Luminal B subtype is distinguished by the high expression of Ki67 (proliferation marker) and occurrence of HER2-positivity. HER2-enriched tumors are characterized by high HER2 cell surface expression. TNBCs are defined as ER α -negative, PR-negative, and HER2-negative, among which the Basal-like subtype is frequently associated with BRCA1-mutations [5–7]. Hence, different treatment strategies are required. Currently, surgical resection (lumpectomy, mastectomy) is the most common localized therapy for patients with non-metastatic BC. In parallel, systemic therapy is established for BC based on its subtype. ER α -positive breast tumors receive endocrine therapy to block ER α activity, including anti-estrogens such as selective ER α modulators (SERM) (i.e., tamoxifen), selective downregulators (SERD), such as fulvestrant, or estrogen synthesis inhibitors such as aromatase inhibitors. The standard endocrine treatment for premenopausal patients is 5 years of tamoxifen, or 5 years of aromatase inhibitors for postmenopausal patients. HER2/ERBB2-positive breast tumors receive intravenous medicine that specifically targets the HER2 protein, such as Trastuzumab, combined with chemotherapy. However, TNBC have no specific treatment and mainly receive cytotoxic intravenous chemotherapy [8,9].

Synthetic glucocorticoids (GCs) such as dexamethasone (dex), derived from steroidal endogenous glucocorticoids, are widely used as an adjuvant for chemotherapy in BC treatment to prevent hypersensitivity reactions through binding to its glucocorticoid receptor (GR) [10]. Recent studies demonstrated that GCs decrease estrogen-induced cell proliferation in ER α -positive BCs [11]. While other investigations stated that glucocorticoid treatment in TNBCs inhibits chemotherapy-induced cell apoptosis [12], and induces metastasis [13], thus raising new concerns.

This review summarizes the various effects of glucocorticoid receptor, and its ligands on breast tumor progression, and aims to further decipher how GR-signaling is regulated in BC.

2. Glucocorticoid Receptor

Human GR was initially isolated in 1985 from the BC cell line MCF-7 by the group of Pierre Chambon [14]. Human GR (h-GR) is encoded by a single gene the “nuclear receptor subfamily 3 group c member 1” (*NR3C1*) localized in the chromosome 5 short arm (5q31.3) [15]. The *NR3C1* gene is composed of 9 exons, in which exons 2-9 encode for the GR protein [16]. Exon 1 encodes for the 5⁰-untranslated region (5⁰-UTR) known as the promoter region of GR. This region has distinct features as it lacks TATA or CAT boxes and presents an extensively GC-rich motif. Moreover, this region possesses various binding sites for transcription factors (TFs) [17]. Alternative splicing and translation initiation have yielded multiple GR protein isoforms, including the classical 777 amino acid GR α and the 742 amino acid long GR β (Figure 1A). The latter exists at a lower level compared to GR α . Both isoforms possess identical amino acids up to amino acid 727, but then differ with GR α containing 50 non-homologous AA in its C-terminus, whereas GR β only exhibits 15 AA [18,19]. This difference at the C-terminus levels confers special features to the GR β isoform. GR β is neither able to bind to endogenous GCs nor to activate glucocorticoid-responsive reporter/endogenous genes and mainly resides in the cell nucleus [20]. Additionally, GR β works as an antagonist of GR α . Indeed, several studies demonstrated its dominant-negative impact on GR α -induced transcriptional

activity by competing on GR-responsive elements (GRE) and through the binding of coregulators and formation of functionally inactive GR α /GR β heterodimers [21,22]. As the GR α isoform is responsible for most GC-mediated transcriptional activities, we will focus on GR α in this review, and will hereafter refer to it as GR.

GR is a protein ubiquitously expressed in the body [18,23–25]. GR belongs to the nuclear hormone receptor (NHR) superfamily and displays the common three functional domains, namely a highly conserved DNA-binding domain (DBD), the ligand-binding domain (LBD), and other regulatory N- and C-terminal domains (Figure 1A). Most of the post-translational modifications of GR occur in its N-terminal domain (Figure 1B).

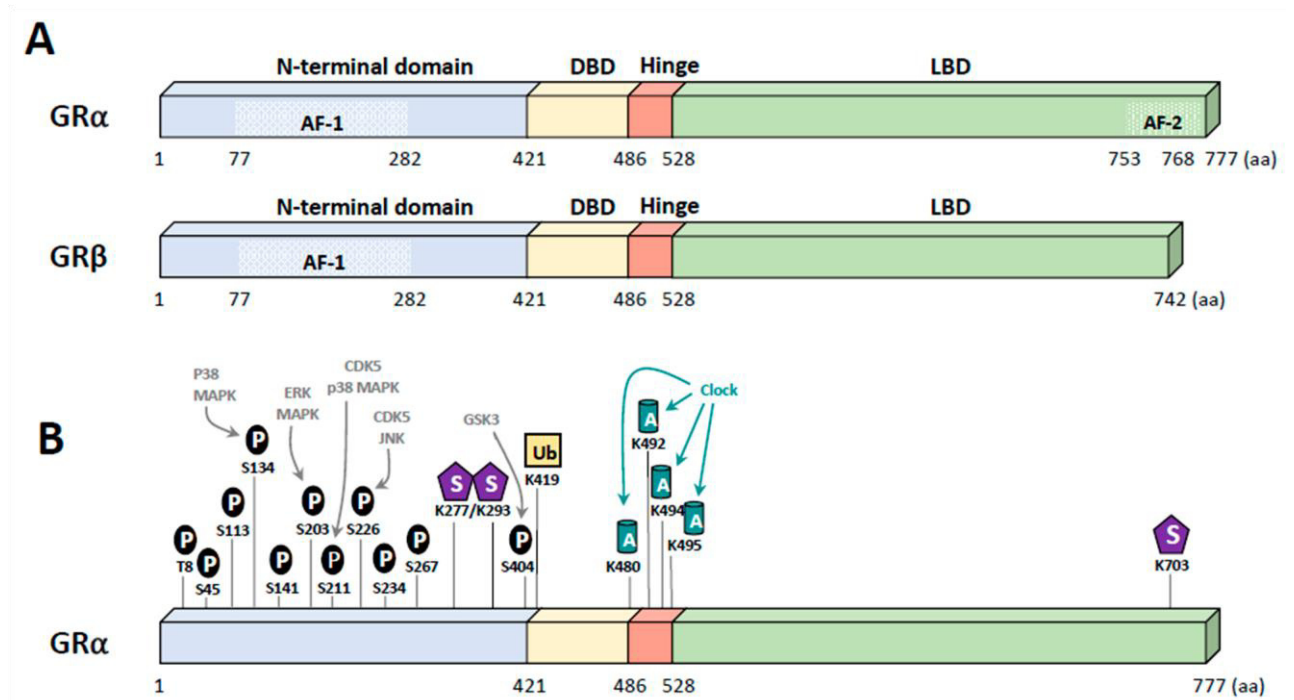

Figure 1. Structure of human glucocorticoid receptor (GR). **(A)** Alternative splicing of exon 9 results in two isoforms of GR; GR α and GR β . GR contains different domains: the N-terminal domain (NTD), DNA binding domain (DBD), the flexible Hinge region and the ligand binding domain (LBD). GR encompasses two activation functions (AF-1 and AF-2) allowing the recruitment of coregulators and the transcriptional machinery. **(B)** GR α undergoes numerous post-translational modifications including phosphorylation of various residues (mainly serine residues) (P), sumoylation (S), acetylation (A) and ubiquitylation (Ub).

3. GR Ligands

3.1. Glucocorticoids (GCs)

The natural GC cortisol is a cholesterol-derived hormone, named based on its role in maintaining glucose homeostasis. GCs are primarily synthesized and secreted by the adrenal gland cortex upon cytokine stimulation of the hypothalamic-pituitary-adrenal (HPA) axis, where the corticotropin-releasing hormone (CRH) secreted by the hypothalamus acts on the anterior-pituitary to produce adrenocorticotropic hormone (ACTH). This latter in turn triggers GC secretion by the adrenal gland. During basal and unstressed conditions, GCs are secreted in a circadian manner, however, their release is further increased due to physiological (i.e., increased immune response) and emotional stress [26,27]. Once released into the circulation, plasma proteins bind and transport inactive GCs into tissues. Most of the secreted GCs (around 90%) bind to corticosteroid-

binding globulin (CBG) [28]. Their lipophilic nature allows them to diffuse passively through the plasma membrane into the cytosol. However, a balance between active and inactive forms of GCs controls the amount of GC available. Two enzymes regulate GC availability in the cytoplasm, namely the 11 β -hydroxysteroid dehydrogenase-1 (11 β -HSD1) that converts cortisone (inactive) to cortisol (active), and the 11 β -hydroxysteroid dehydrogenase-2 (11 β -HSD2) which drives the opposite reaction [29,30] (Figure 2).

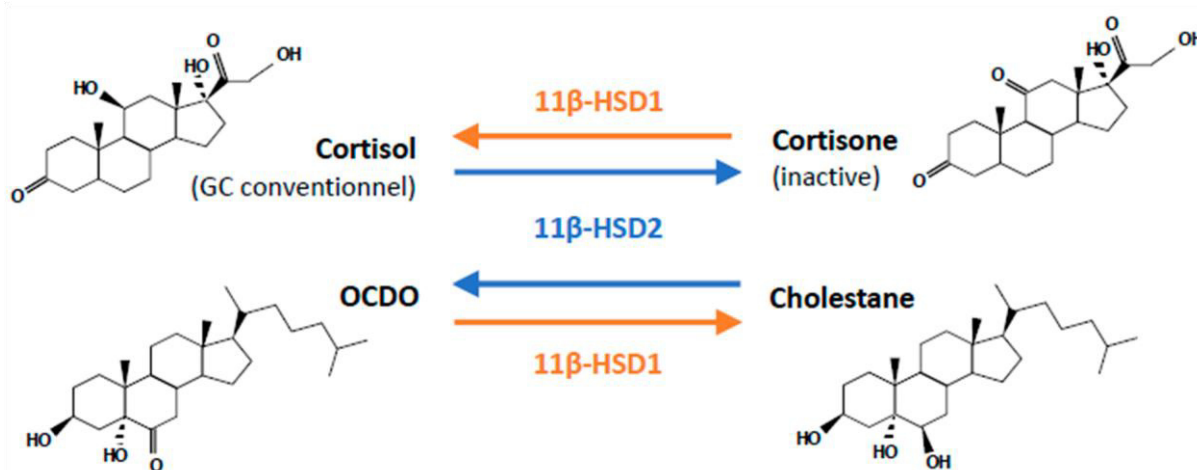

Figure 2. Structure of natural GR ligands. The natural form of glucocorticoid is cortisol that can be converted into inactive cortisone by the 11 β -HSD2 enzyme. The same enzyme metabolizes cholestane-3 β ,5 α ,6 β -triol (CT) into 6-oxo-cholestan-3 β ,5 α -diol (OCDO).

Biologically active GCs bind to GR to exert their broad physiological roles on many different cells, tissues, and organs. GCs regulate many different physiological pathways including glucose metabolism, immune response, central nervous system (cognition, mood, sleep), reproduction, cardiovascular function, development, cell death, and maintenance of vascular tone [31] (Figure 3).

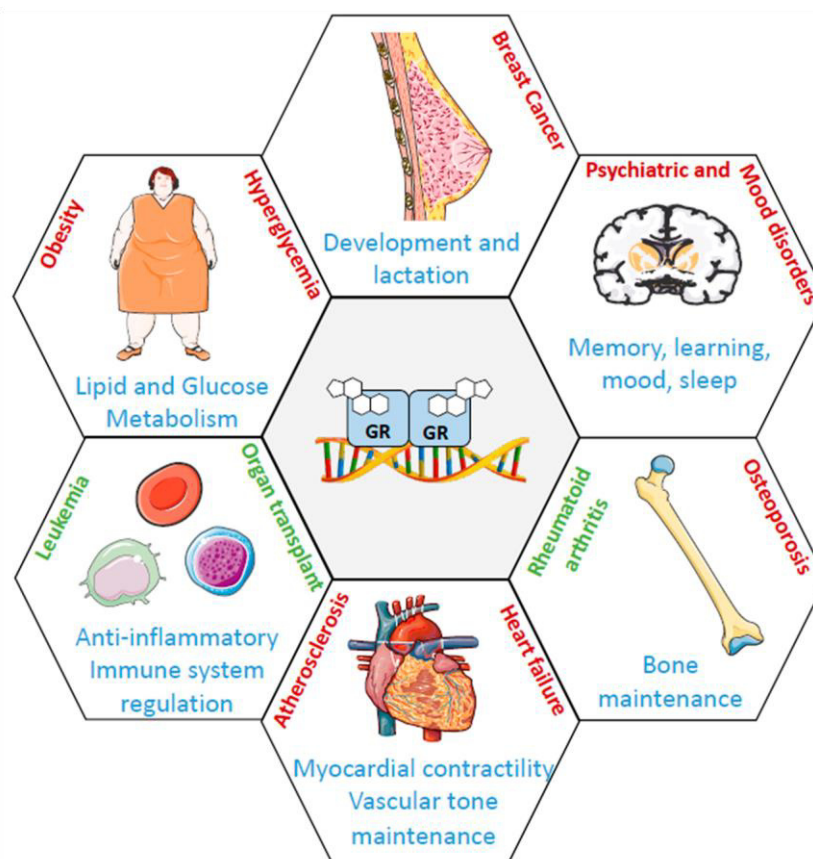

Figure 3. GR involvement in human health and disease. The schematic diagram represents the roles of GR in major systems (blue label) with beneficial roles of synthetic GCs used in clinics (green label) and adverse effects of GCs (red label).

3.2. Synthetic GCs

GCs were used for the first time in the late 1940s by Dr. Philip Hench to treat rheumatoid arthritis. Dr. Hench received the Nobel Prize in Medicine for this discovery [32]. Pharmaceutical industries have since developed various synthetic GCs, including Prednisolone, Methylprednisolone, Fluticasone, Budesonide, and Dexamethasone, used as treatments for several diseases. All of these synthetic GCs share a similar structure to that of endogenous GCs, albeit with optimized features. Indeed, they are more (i) potency; synthetic variants activate GR better than cortisol, (ii) specific; synthetic GCs such as dexamethasone (dex) exclusively bind to GR, whereas endogenous GCs can activate both GR and Mineralocorticoid Receptor, and (iii) controllable; synthetic GCs can be processed by 11β -HSD1/2 (like dex) or not (like prednisolone), thus controlling their availability [33,34].

GCs are mainly known as anti-inflammatory and immunosuppressive therapeutics, used to treat asthma, allergies, rheumatoid arthritis, multiple sclerosis, and systemic lupus erythematosus. Moreover, they are used to prevent transplant rejection. Nevertheless, their success is hindered by two major drawbacks: the long-term high dose treatment induces (i) adverse side effects such as hypertension, skin atrophy, hyperglycemia, growth retardation, osteoporosis, cardiovascular diseases, and (ii) tissue-specific glucocorticoid resistance due to chronic GC treatment [34–36].

Besides, they have been used in clinical oncology for nearly 70 years [37]. They are routinely administered to treat hematological malignancies to foster cell apoptosis by inducing pro-apoptotic genes and inhibiting survival genes [38,39]. In non-hematological cancers, such as breast and prostate cancers, GCs are used as chemotherapy or radiotherapy adjuvants to alleviate side effects. For instance, GC treatment increases appetite, reduces fatigue, and prevents vomiting and allergic reactions [40].

3.3. OCDO

Recently, a cholesterol-derived oncometabolite, the 6-oxo-cholestan-3 β ,5 α -diol (OCDO), also called cholestane-6-oxo-3,5-diol or yakkasterone (CAS N^o 13027-33-3), was identified as a GR-ligand [41,42]. OCDO is the oxidative product of the carcinogenic cholestane 3 β ,5 α ,6 β -triol (CT) catalyzed by 11 β -hydroxysteroid-dehydrogenase-type-2 (11 β HSD2), the enzyme inactivating cortisol into cortisone [42] (Figure 2). CT is generated from cholesterol-5,6-epoxides (5,6-ECs) through cholesterol-5,6-epoxide hydrolase (ChEH) [43]. OCDO was shown to promote BC cell proliferation in vitro and in vivo independently of ER α by activating the nuclear localization of GR, regulating its transcriptional activity, and consequently inducing cell cycle progression [42]. Moreover, higher levels of OCDO and its synthesizing enzymes ChEH and 11 β HSD2 were detected in BC patient samples compared to normal tissues, and further mRNA database analyses indicated that the overexpression of these enzymes was correlated with a higher risk of patient death [42]. In normal breast, the concentration of OCDO was measured at 25 nM, whereas a concentration of 1 μ M was reported in breast tumors [42]. The effects of OCDO can be inhibited by impairing its synthesis with ChEH inhibitors (e.g., Dendrogenin A, DDA) and 11 β HSD2 silencing or by antagonizing GR with mifepristone [42,44].

4. GR Signaling

GR mediates its functions in cells through the binding of its ligands. Without ligand binding, the GR monomer resides predominantly in the cell cytoplasm in a resting state as a part of a multiprotein complex with chaperons and FK506 immunophilins proteins in a high ligand binding affinity conformation. This complex is also implicated in GR maturation, activation, and nuclear transport. Hormone binding triggers GR conformational change and activation, thus liberating GR from the chaperone-associated proteins and exposing its two NLS [45,46]. GR then translocates into the nucleus via its pores and binds to DNA either directly at high-affinity chromosomal sites known as GREs or indirectly through other TFs via protein-protein interactions (Figure 4). Direct GR-DNA interactions occur in multiple ways. (i) GR binds as a homodimer to glucocorticoid-binding sites (GBS) on DNA, (ii) GR binds as a monomer to inverted-repeat GBS on DNA, also known as negative GRE sites mainly accompanied with transcriptional repression, (iii) GR binds directly to GREs and physically interacts with other non-GR TFs on a neighbor DNA site in a composite manner, or (iv) GR activates transcription after physical interaction with other TFs, such as the proinflammatory TF AP-1 (Activator protein-1) and NF- κ B [47–50]. Through all these mechanisms, GR was shown to regulate up to 10–20% of the human genome in different cell types [51].

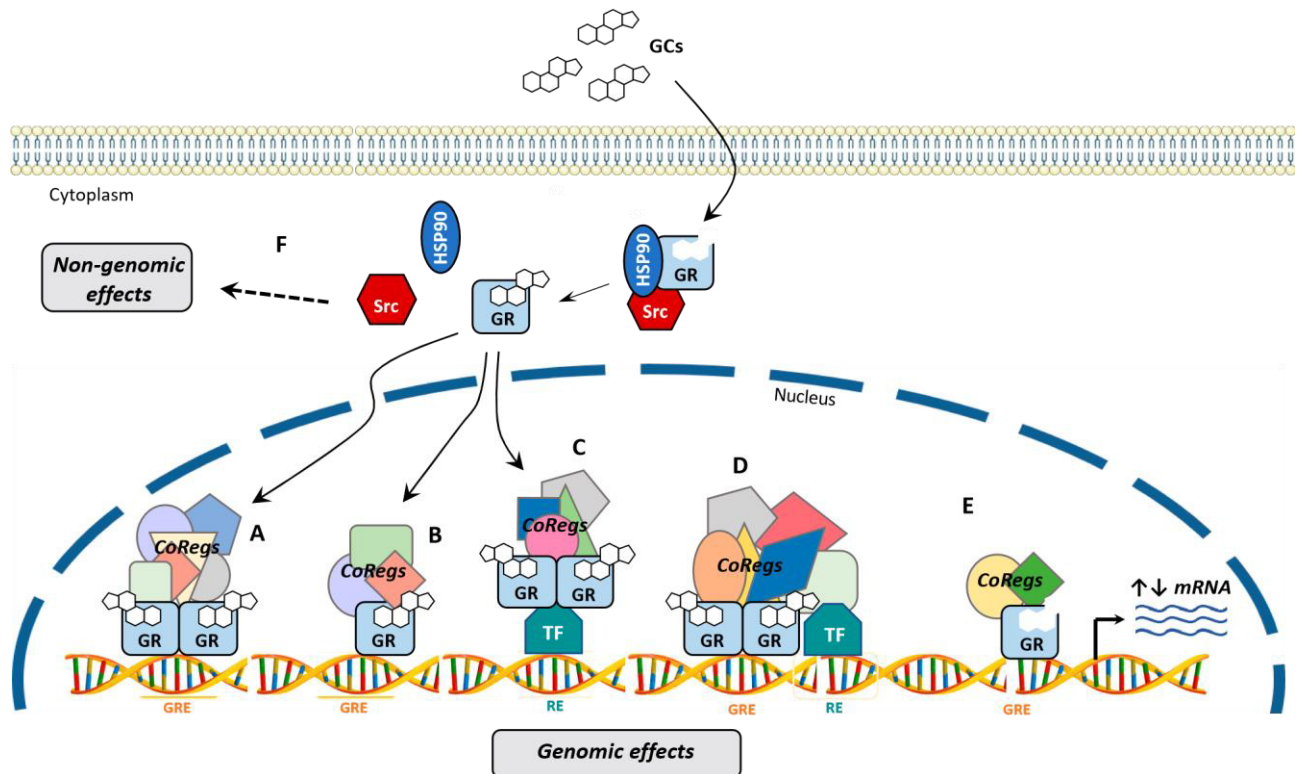

Figure 4. Genomic GR signaling. Upon ligand binding, GR undergoes a conformational change, dissociates from chaperone proteins (HSP90), and translocates into the nucleus, where it can bind directly to DNA as a dimer on a specific GR response element (GRE) (A), as a monomer through a simple GRE (B), through other transcription factors (TFs) by tethering itself to the TF (C), or in a composite manner by directly binding to GRE (D). Unliganded GR modulates cell signaling in the absence of GCs (E). In addition to the genomic action of GR in the nucleus (A–E), when GR dissociates from its cytoplasmic complex upon GCs treatment, it can also regulate non-genomic effects (F). Specific sets of coregulators are recruited, resulting in the activation or repression of target genes, regulating specific biological functions.

In addition to the classical genomic ligand-dependent GR pathway, several studies have reported that unliganded GR also modulates cell signaling (Figure 4). Interestingly unliganded GR was described to display a protective role in BC, as it was shown to bind to the promoter region of a tumor suppressor gene, *BRCA1*, upregulating its expression in nonmalignant mammary cells. Conversely, exposure to GCs induces a loss of GR recruitment to the *BRCA1* promoter concomitant to a decrease in *BRCA1* expression, highlighting the role of GCs in inducing BC [52]. Moreover, gene expression microarray analysis identified 343 target genes upregulated and 260 downregulated by unliganded GR in mammary epithelial cells. Some of the positively regulated genes were involved in pro-apoptotic signals. Moreover, unliganded GR regulated the cholesterol 25-hydroxylase (*Ch25h*) gene in a similar manner to *BRCA1*, as the association of unliganded GR to the promoter of *Ch25h* gene was disrupted by GCs [53]. Liganded and unliganded GR could work as a balance for controlling differentiation and apoptosis, where unliganded GR may be a mechanism for reducing BC risk by eliminating abnormal cells.

DNA-bound GR recruits coregulator complexes forming transcription regulatory complexes. These coregulators can function as corepressors or coactivators, resulting in local chromatin compaction (gene transcription repression) or local chromatin relaxation (gene transcription activation), respectively [54,55]. However, many coregulators function in both activation and repression of transcription, depending on the specific gene and cellular

environment [56]. Coregulators are classified into different functional groups. The first group includes the ATP-dependent SWI-SNF chromatin-remodeling complex that catalyzes the repositioning of nucleosomes on DNA and thereby increases TF accessibility [57] where GR interacts specifically with the core subunits Brahma and BRG1 (also known as SMARCA4) of the SWI-SNF complex through its DBD, LBD and AF1 domains [58–61]. The second group consists of the histone-modifying enzymes that are responsible for adding or removing histone modifications [62,63]. These include histone methyltransferases such as PRMT4 Arginine-methyltransferase (known as CARM1) and G9a Lysine-methyltransferases (known as EHMT2) [64,65], histone acetyltransferases such as P300/CBP-PCAF and SAGA complexes [66], and histone deacetylases (HDACs) such as NCOR/SMRT-HDAC complexes [67]. However, these enzymes are able to modify other coregulators, adding another layer of complexity. Additionally, GR recruits other groups of coregulators that function as scaffold proteins responsible for recruiting other coregulators through their multiple protein-interaction domains, a well-known example is the p160 SRC family (SRC-1, SRC-2, and SRC3), which preferentially interacts with SRC-2 (also called NCoA-2, TIF2 or GRIP1) [68].

Several hundred coregulators have been identified, indicating a high level of complexity in this process. Although each coregulator functions with multiple TFs, their actions are gene-specific, i.e., each coregulator is required only for a subset of the genes regulated by a specific TF (such as GR). These coregulator-specific gene subsets often represent selected physiological responses among multiple pathways targeted by a given transcription factor. Modulating the activity of one (or a subset of) coregulator(s) would therefore affect GC regulation of only the subset of GR target genes that requires this coregulator, thus modulating the hormone response to selectively promote or inhibit specific GC-regulated pathways [56].

Of note, GCs were described to foster non-genomic activities of GR mainly through the mitogen-activated protein kinase (MAPK) pathway in cardiovascular, immune, and neuroendocrine systems [69]. In addition, in BC, GCs increase the levels of reactive oxygen species (ROS) and reactive nitrogen species (RNS), inducing DNA damage and reducing DNA repair by dissociating GR from Src [70].

5. Post-Translational Modifications of GR

It is well known that the activity of proteins is tightly regulated by post-translational modifications (PTMs), which can be controlled by specific signaling pathways. To date, the function of GR is known to be affected by numerous phosphorylation events, but also by other modifications such as acetylation, ubiquitination, sumoylation, and methylation (Figure 1B). Here, we chose to focus on specific PTMs that could be relevant in BC.

5.1. Phosphorylation

In most cases, GR is phosphorylated at a basal level and becomes hyperphosphorylated upon ligand binding [71,72]. MAPKs, cyclin-dependent kinases, and Glycogen synthase kinase-3 β (GSK-3 β) are the main kinases involved in GR phosphorylation and widely implicated in BC. The specific site of GR phosphorylation determines the subsequent effect on its function. For instance, GR phosphorylated on S211 is a transcriptionally active form of the receptor [73]. Conversely, phosphorylation on S226 by c-Jun N-terminal kinase (JNK), a member of the MAPK family, was shown to abrogate GC-dependent

transcriptional activity [71,74–76]. S404 phosphorylation by glycogen synthase kinase 3 β impairs GR signaling [77]. In most cases, these phosphorylation sites alter the recruitment of major coregulators impairing GR transcriptional activity. For example, S211 phosphorylation catalyzed by p38 MAPK induces a conformational change, which facilitates coactivator recruitment (i.e., MED14) resulting in an increase in the transcriptional activity of GR [73,74]. Inversely, phosphorylation of S404 impedes GR coregulator recruitment of p300/CBP and the p65 subunit of NF- κ B [77].

GR phosphorylation also modifies its localization. For example, S203 is phosphorylated by MAPK ERK1/2 in order to maintain GR in the cytoplasm and prevent its binding to the promoters of its target genes [71,76]. Furthermore, phosphorylation of GR at S134 and S226 prevents its translocation to the nucleus, impairing GC-induced gene expression [75,78].

5.2. Other Modifications

After ligand binding, GR is acetylated by the acetyltransferase Clock (circadian locomotor output cycles kaput) on K480, K492, K494, and K495, reducing its binding of GR to the GRE of specific target genes, impairing its transcriptional activity (Figure 1B) [79,80].

The stability of the receptor is also regulated by ubiquitinylation and sumoylation. GR is ubiquitinated at K419, targeting GR for degradation by the proteasome [81,82]. The E3 ligase CHIP (carboxy terminus of heat shock protein 70-interacting protein) was reported to be involved in this process where it modulates expression levels and activity of GR [83]. Additionally, sumoylation of GR at K277, K293, and K703, catalyzed by SUMO-1conjugating E2 enzyme Ubc9, can regulate GR transcriptional activity on specific subsets of GR target genes [84,85]. GR sumoylation is not dependent on the ligand-binding but is rather influenced by environmental changes, potentially deregulated in BC [86].

Finally, we reported that GR is methylated by the arginine methyltransferase PRMT5 in the ER α -positive breast cancer cell line MCF-7 [87], although the targeted arginine remains to be identified.

6. The Role of GR in Breast Tissue

In normal breast tissue, GR is present in the nuclei and in the cytoplasm of luminal epithelial cells [88,89]. GR was also detected in the nuclei of adipocytes and of myoepithelial cells surrounding lobular and duct units. Additionally, GR is slightly expressed in the nuclei of stromal and endothelial cells. GCs were shown to be involved in the development of the mammary gland at puberty and during pregnancy [90,91]. Mechanistically, GCs stimulate the expression of β 4-integrin, an extracellular protein essential for the spatial organization of the mammary epithelial acini [91].

Because GR knockout mice are not viable, authors used different approaches in order to study the role of GR in mammary gland function and development in adult mice [90,92,93]. Studies demonstrated that GR is strongly implicated in the mammary gland, though it has no effect on milk production and secretion. Cre-LoxP models in which the GR gene was specifically deleted in epithelial cells, revealed that GR is essential for cell proliferation during lobuloalveolar development [93]. Furthermore, mice lacking the DNA binding function of GR show an impairment in the ductal development of the mammary gland in virgin females, but no problem in the milk protein production. Authors suggest that DNA binding-defective GR is still able to interact with phosphorylated Stat5 proteins, involved in milk protein synthesis [92].

GCs were shown to inhibit mammary gland apoptosis during normal lactation [94]. In addition, Bertucci et al. demonstrated that GCs modulate early involution of the mammary gland. Stat5 and GR synergize to stimulate the expression of milk protein genes during lactation and act as survival factors [95]. Indeed, synthetic GCs regulate Stat5 and Stat3 signaling and inhibit apoptosis induction when administered within the first 48 h upon cessation of suckling.

7. The Role of GR in Breast Cancer Progression

Extensive studies have been carried out to understand the cellular and biological effects of GR on BC cell survival and progression. However, the role of GR ranges from proliferative to anti-proliferative based on ER α expression and activity (Figure 5). Indeed, GR expression has different prognostic values depending on the BC subtypes, with a high expression of GR being correlated with a worse prognosis in TNBC and with a better prognosis in early-stage ER α -positive BCs [11,96,97]. At the transcriptional level, literature converges to establish that GC drives the expression of pro-tumorigenic genes in ER α -negative BCs [98,99], but inhibits ER α transcriptional activity and E2-mediated cell proliferation in ER α -positive BCs [100–102].

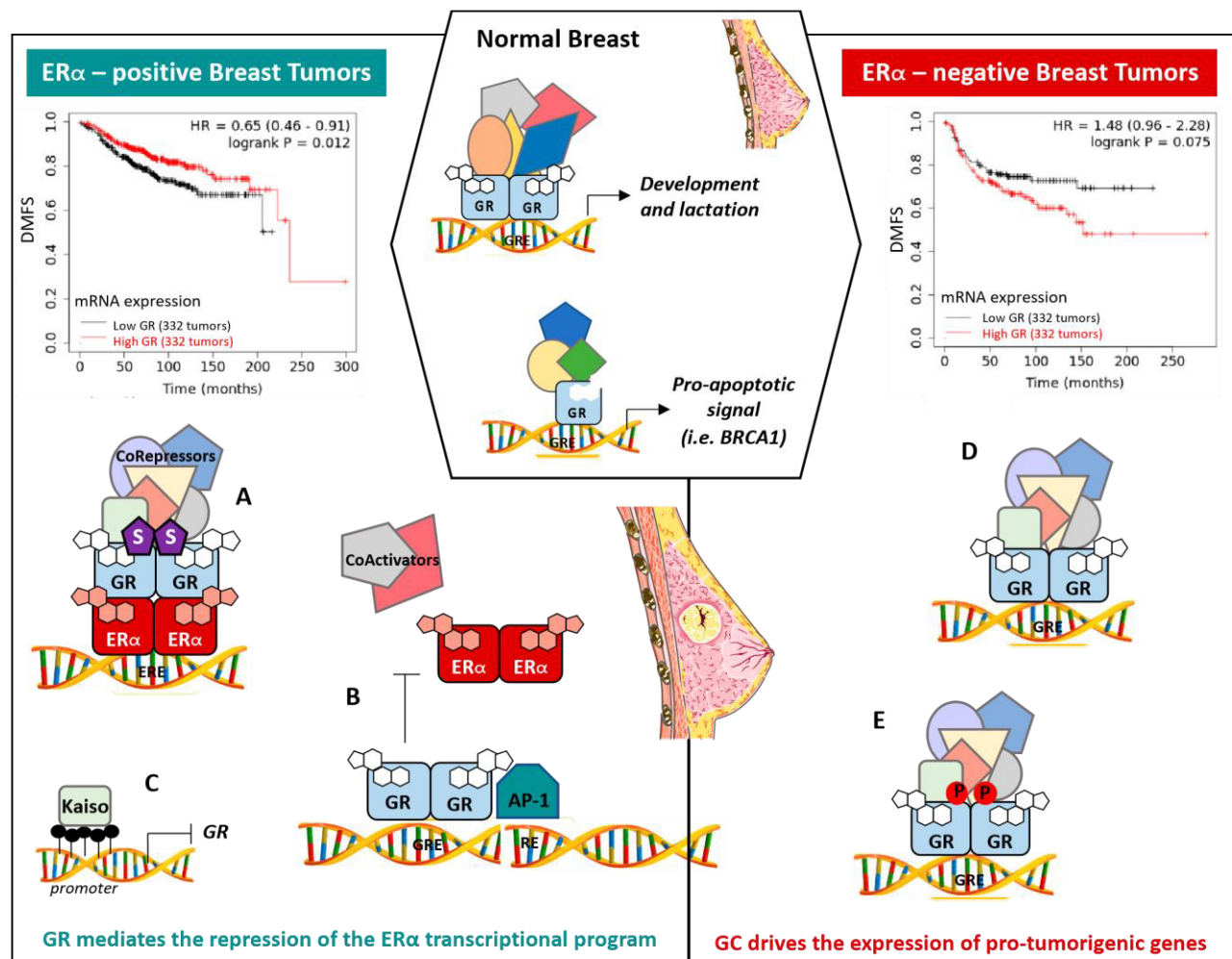

Figure 5. GR involvement in physiological and pathophysiological breast functions. Mammary gland development and lactation are regulated by GR in normal breasts. In addition, unliganded GR binds to the promoter region of some proapoptotic genes, such as *BRCA1*, upregulating their expression in non-malignant mammary cells. GR controls the outcome of BC depending on the ER α status of the tumor. In ER α -positive BCs, GR regulates the

repression of the ER α transcriptional program by directly binding to ER α , promoting its sumoylation (S) and recruitment of corepressors (A), or in a composite manner by directly binding to AP-1 (B). In addition, in ER α -positive breast cancer cells, methyl-CpG islands in the GR promoter work as a binding site for Kaiso, resulting in the repression of GR expression (C). Conversely, in ER α -negative BCs, GR regulates pro-tumorigenic genes and is associated with a worse prognosis (D), and pS134-GR is found to be higher in TNBC in comparison with luminal BCs and associated with a migratory phenotype (E). Kaplan–Meier curves were built using KM plotter database [103].

7.1. ER α -Positive BCs

A high expression of GR in BCs is correlated with a better prognosis and relapse-free survival outcome in early stages for ER α -positive BC patients [11,96,97] (Figure 5A). In vitro experiments demonstrated the ability of GRs to inhibit the proliferation of ER α -positive BC MCF-7 models by altering cell cycle progression [102,104]. Mechanistically, this should occur by a direct interaction of ER α with GR, through the GR DNA-binding domain, regulating ER α transcriptional activity and therefore E2-stimulated proliferation [11,100,101,105]. Further assessments using Chromatin Immunoprecipitation (ChIP) experiments in MCF-7 cells revealed that GR displaced ER α and the coactivator SRC3 at the ER α -response elements (ERE) of specific target genes, either by direct recognition of ERE or through indirect binding with other factors such as AP-1, thus antagonizing ER α activity [101,106,107] (Figure 5B). Further studies reported that GR and ER α coactivation enhanced GR binding to GR- and ER α -responsible elements (GRE and ERE), resulting in an increase in pro-differentiating genes and negative regulators of pro-oncogenic Wnt signaling, and a decrease in mesenchymal transition related genes expression, thus improving relapse-free survival in ER α -positive BCs [11]. Moreover, a recent study demonstrated that liganded GR, regardless of the nature of the ligand (i.e., GR agonist or GR antagonist) decreased E2-mediated proliferation by suppressing the association between ER α and chromatin at the enhancer region of E2-induced pro-proliferative genes, subsequently reducing their expression [105]. GR sumoylation is also involved in this process. Indeed, Yang et al. demonstrated that GR recruitment to the ER α enhancer requires GR sumoylation on K277, K293, and K703, and subsequent recruitment of the NCoR/SMRT/HDAC3 corepressor complex, repressing the estrogen (E2) program (Figure 5A). In addition, E2 treatment promotes the expression of the PP5 phosphatase, inducing the dephosphorylation of GR on S211, decreasing the activity of GR on specific GR target genes involved in cell growth arrest [108]. Further studies in T47D cells demonstrated that dex treatment inhibits cell migration by disrupting their cytoskeletal dynamic organization by impairing the AKT/mTOR/RhoA pathway [109]. However, the specific mechanisms underlying this process were not elucidated.

It is known that GR expression is repressed predominantly in ER α -positive breast tumors due to two distinct mechanisms: methylation of its promoter at CpG islands [110,111] and proteasomal degradation [112]. Interestingly, methyl-CpG islands in the GR promoter work as a binding site for Kaiso, a pox virus, and zinc finger (transcription factor), resulting in the repression of GR expression in ER α -positive breast cancer cells (MCF-7 and T47D), attenuating GR anti-apoptotic activity [113]. In addition, using an engineered MCF-7/GR cell line, Archer's group showed that estrogen agonists, but not ER α antagonists enhance proteasomal degradation of GR via Mdm2, impacting its transcriptional activity [112]. However, as this cell line expresses 100,000 times more GR than MCF-7

cells, additional experiments will be needed to confirm this result in a more physiological context.

Altogether, these data suggest that GR mediates the repression of the transcriptional program of ER α in ER α -positive BCs via a crosstalk between GR and ER α .

7.2. ER α -Negative BCs

In contrast to ER α -positive breast cancer, GR expression was associated with poor outcome, shorter BC-specific survival, and earlier relapse at early-stages of human ER α -negative BCs [96–98]. Indeed, a retrospective meta-analysis of 1378 early stage ER α -negative BCs and 623 TNBCs confirmed that a high tumoral GR expression was significantly correlated with a shorter relapse-free survival in BC patients, whether undergoing treated or not with adjuvant chemotherapy [96,114]. Furthermore, in the last few years, a growing body of evidence clearly demonstrated the tumorigenic effects of GCs in ER α -negative BCs, as evidenced by resistance to chemotherapy and metastasis formation [12,13,98]. A genome-wide study identified specific dex-induced GR target genes, involved in tumor cell survival and chemotherapy resistance, EMT, chromatin remodeling, and epithelial cell/inflammatory cell interactions, suggesting the involvement of GR in the aggressive behavior of ER α -negative BCs [96]. Recently, global gene expression and GR ChIP-sequencing analyses identified a signature of a specific subset of GR target genes involved in cell survival, cell invasion, and chemoresistance [114] (Figure 5C).

Different mechanistic investigations are ongoing to further understand the role of GR in driving tumor progression in ER α -negative BCs. Among them, it was demonstrated that cellular stress, such as oxidative stress or hypoxia, in primary TNBCs or ER α -negative BC cell lines, increases the phosphorylation of GR on S134, thus potentiating stress signaling mediated by GR activation leading to an increase in the expression of breast tumor kinase BRK, known as protein tyrosine kinase 6 (PTK6), essential for aggressive BC phenotypes [115]. In addition, TNBCs express high levels of functionally active pS134-GR in comparison to luminal BCs, which could explain why GR expression is correlated with a better prognosis in luminal BCs than in TNBCs [116]. Recently, research on patients and TNBC cell line-derived xenograft models, revealed that GR activation at distant metastatic sites, due to an increase in GC levels, promotes BC colonization and reduces the overall survival by upregulating the expression of ROR-1 kinase, a receptor tyrosine kinase-like orphan receptor-1, previously shown to be implicated in BC [13,117,118]. Indeed, downregulation of ROR-1 by shRNAs decreases metastasis and prolongs survival in mouse models. These studies support previously published expression microarray analyses that identified several kinases as promising targets for in ER α -negative BC treatment [119,120].

Additional investigations linked BC progression and chemoresistance to the disruption of the oncosuppressor Hippo pathway, which is mainly composed of kinase complexes, transcriptional cofactor Yes associated-protein (YAP) and its paralog WW domain-containing transcription regulator 1 (TAZ), and TEA domain transcription factors (TEAD1-4). The high expression and activity of YAP/TEAD-4 was reported to contribute to BC cell survival and progression [121]. Recent studies demonstrated that GR activation by dex dysregulated the Hippo pathway by inducing the transcriptional activity, nuclear accumulation, and protein/RNA levels of YAP and TEAD-4. Functionally, this activation of YAP and TEAD-4 led to cell survival, metastasis, chemo-resistance, and cancer stem cell self-renewal in vitro and in vivo [99,122]. TEAD-4 along with its coactivator, the

Krüppel-like factor 5 (KLF5), a pro-survival TF, were among the nine genes reported to be overexpressed in high-grade ER α -negative tumors [123] and their high expression level was associated with poor prognosis and shorter survival in BC patients [122,124]. Moreover, it was shown that TEAD-4 forms a complex with KLF5 and promotes TNBC cell proliferation by inhibiting p27 gene transcription [125]. Interestingly, GR activation by dex upregulates KLF5 expression in TNBCs, and high KLF5, in turn, induces cisplatin resistance in vitro and in vivo [126].

Global gene expression analyses in MDA-MB-231 cells revealed that several prosurvival genes were induced by dex treatment (i.e., SGK1 (Serum and glucocorticoidregulated kinase-1), MKP-1 (MAPK phosphatase-1)) [127–129]. Additionally, ChIP-seq analyses on the same cell line revealed that dex-liganded GR binds to GREs of pro-tumorigenic genes driving drug resistance and TNBC progression [99]. The transcriptional activation of these pro-survival genes by GR upon dex treatment contributes to inhibiting paclitaxel or doxorubicin-induced apoptosis in MDA-MB-231 cells [98,128]. Conversely, the degradation of GR and disruption of its anti-apoptotic signaling using the Hsp90 inhibitor was shown to enhance TNBC sensitivity to paclitaxel in vitro and in vivo [130].

Furthermore, in vivo studies were carried out to investigate the potential inhibitory effect of GCs on anti-tumoral paclitaxel activity. Accordingly, the pre-treatment with dex significantly attenuated the therapeutic efficacy of paclitaxel on human tumor xenografts established from transplanting human ER α -negative BCs into nude mice [126,130–132]. However, the pre-treatment of TNBCs with the GR antagonist Mifepristone in parallel to dex and Paclitaxel potentiated the cytotoxic efficacy of the chemotherapy, by inducing caspase-3/PARP cleavage-mediated cell death and blocking GR-mediated survival signaling by antagonizing GR-induced SGK1 and MKP1 gene expression. In addition, it was reported that mifepristone pre-treatment decreased MDA-MB-231 xenograft tumor growth [12]. Consistent with these observations, a randomized Phase I clinical trial showed that GR is a promising target in TNBCs, as patients with GR-positive and triple-negative tumors responded to the combination of GR antagonism (mifepristone) and paclitaxel [133].

Lately, investigators reported that GR is essential for EMT and metastasis induction in BCs. They found that high GR expression levels suppress the transcription of insulin receptor substrate 1 (IRS-1), which is a cytoplasmic adaptor protein that transmits insulin/insulin-like growth factor signals. IRS-1 suppression by GR activates extracellular regulated protein kinase 2 (ERK2) and induces EMT [134]. Moreover, they showed that in the absence of GR ligands, GR is transcriptionally activated in TNBCs through its phosphorylation on S134 by p38, following the homeostatic sensing of intrinsic stress or extrinsic factors (like TGF β 1). Phospho-S134-GR activates the p38 MAPK stress-signaling pathway, leading to TNBC cell anchorage-independent growth and migration [116].

8. Concluding Remarks

This review underlines the implication of GR and its ligands in BC biology and physiology. The fact that GR expression has different prognostic values depending on the BC subtypes, highlights an unanticipated level of complexity. The repression of the ER α transcriptional program in ER α -positive BCs is known to be linked to a crosstalk between GR and ER α . However, a growing body of evidence clearly demonstrates the tumorigenic effects of GR in ER α -negative BCs, as evidenced by resistance to chemotherapy and metastasis formation. In

addition, proliferative effects of OCDO are GR-dependent regardless of the hormonal status of the BC. However, the transcriptional program of OCDO in the different subtypes of BCs has so far not yet been identified and could provide clues to its oncogenic properties. In addition, because OCDO is a cholesterol-derived oncometabolite, a more global analysis of the expression of enzymes producing OCDO is of utmost importance following the status of BCs, in addition to the cholesterolemia status of patients, to fully understand the impact of OCDO on breast tumorigenesis in ER α -positive vs. ER α -negative BCs.

In BC treatment, synthetic GCs are commonly used for their antiemetic, antiinflammatory, and energy and appetite-stimulating properties, and thus help to manage the side effects of chemotherapy. However, in the last few years, increasing evidence clearly shows the tumorigenic effects of GR in ER α -negative BCs, including resistance to chemotherapy and metastasis formation. Targeting GR activity is not an option because of its pleiotropic activity. However, GCs are often the only option for patients to counteract the effects of chemotherapy. Because coregulator-specific gene subsets are often unique to selected physiological responses among the multiple pathways regulated by a TFs [58], modulating the activity of one (or a subset of) coregulator(s) could therefore affect GC regulation of only selected GR target genes requiring this coregulator, and may enable the modulation of the hormonal response to selectively promote or inhibit specific GC-regulated pathways. To illustrate this concept, we demonstrated that coactivator activity of the GR coregulator G9a is modulated by methylation/phosphorylation, which regulates distinct physiological pathways, including migration of the lung cancer cell line A549 [135] and GC-induced cell death in leukemia [136,137].

Of interest in this field, in a cohort of BC patients, a Danish epidemiological study reported no impact of GC use on BC recurrence, irrespective of the route of administration or combined chemotherapy [138]. Because GCs are prescribed to counteract the side effect of chemotherapy depending on the level of discomfort, the doses of GCs received cannot be fully monitored. Additional epidemiological studies will be interesting to confirm these observations in different patient cohorts. Moreover, a growing body of evidence suggests the impact of stressful events on BC risk. Indeed, the Women Health Initiative Study showed that an acute stress event can be associated with increased BC risk [139]. Rats stressed by chronic social isolation present higher levels of corticosterone, associated with a dysregulated GR distribution. Among socially-isolated animals, GR was more often found in the nucleus compared to the cytoplasm in tumor samples, and these rats harbored more aggressive mammary tumors [140].

Even though this review mainly presents the effect of GCs on tumor cells, we cannot exclude that they also affect the tumor microenvironment, particularly cancer-associated fibroblasts [141,142]. GCs were shown to regulate the proliferation of myofibroblasts and have major roles in wound healing [143]. Moreover, Catteau et al. found that GR is expressed in 73% of CAFs in BC [144], associated with tumoral grade or Ki67 expression. Taking in account GR expression in the tumor environment following the classification of tumor status, could be utmost importance and may serve as an interesting target in the regulation of the tumoral breast microenvironment.

Emerging data are highlighting the importance of a second form of estrogen receptor, ER beta (ER β), in breast cancer biology (for review [145]). As a study performed in the central nucleus of amygdala showed that ER β activation prevents glucocorticoid-induced anxiety behaviors and reduced cortisol levels in the plasma of rats compared to animals implanted with vehicle

or GR agonist [146], further studies will be needed to investigate the potential cross-talk between ER β and GR in BC.

Despite incredible breakthroughs in our understanding of BC, and the key role of GR in the pathology, major challenges in this field of research still remain.

Author Contributions: L.M.N., C.P., O.T. and M.L.R. wrote and criticized the manuscript. N.H. and B.B. revised it. All authors have read and agreed to the published version of the manuscript.

Funding: M.L.R., L.M.N. and C.P.'s laboratory is funded with grants from "La Ligue contre le Cancer" and the "Fondation ARC Cancer", Fondation de France, The association "Cancer du sein, parlons en". L.M.N. was supported by a fellowship from AZM & Saadeh Association and Lebanese University.

Institutional Review Board Statement: Not applicable.

Informed Consent Statement: Not applicable.

Data Availability Statement: Not applicable.

Acknowledgments: We thank B. Manship for proofreading the manuscript. The illustrations were created using Servier Medical Art.

Conflicts of Interest: The authors declare no conflict of interest.

8

1. Bray, F.; Ferlay, J.; Soerjomataram, I.; Siegel, R.L.; Torre, L.A.; Jemal, A. Global cancer statistics 2018: GLOBOCAN estimates of incidence and mortality worldwide for 36 cancers in 185 countries. *CA Cancer J. Clin.* **2018**, *68*, 394–424. [[CrossRef](#)]
2. Henderson, I.; Patek, A. The relationship between prognostic and predictive factors in the management of breast cancer. *Breast Cancer Res Treat.* **1998**, *52*, 261–288. [[CrossRef](#)] [[PubMed](#)]
3. Anderson, W.F.; Rosenberg, P.S.; Prat, A.; Perou, C.M.; Sherman, M.E. How many etiological subtypes of breast cancer: Two, three, four, or more? *J. Natl. Cancer Inst.* **2014**, *106*, 1–11. [[CrossRef](#)] [[PubMed](#)]
4. Vuong, D.; Simpson, P.T.; Green, B.; Cummings, M.C.; Lakhani, S.R. Molecular classification of breast cancer. *Virchows Arch.* **2014**, *465*, 1–14. [[CrossRef](#)] [[PubMed](#)]
5. Boyle, P. Triple-negative breast cancer: Epidemiological considerations and recommendations. *Ann. Oncol.* **2012**, *23* (Suppl. S6), vi7–vi12. [[CrossRef](#)]
6. Temian, D.C.; Pop, L.A.; Irimie, A.I.; Berindan-Neagoe, I. The epigenetics of triple-negative and basal-like breast cancer: Current knowledge. *J. Breast Cancer* **2018**, *21*, 233–243. [[CrossRef](#)]
7. Toft, D.J.; Cryns, V.L. Minireview: Basal-like breast cancer: From molecular profiles to targeted therapies. *Mol. Endocrinol.* **2011**, *25*, 199–211. [[CrossRef](#)] [[PubMed](#)]
8. Waks, A.G.; Winer, E.P. Breast Cancer Treatment: A Review. *JAMA J. Am. Med. Assoc.* **2019**, *321*, 288–300. [[CrossRef](#)] [[PubMed](#)]
9. Jamdade, V.S.; Sethi, N.; Mundhe, N.A.; Kumar, P.; Lahkar, M.; Sinha, N. Therapeutic targets of triple-negative breast cancer: A review. *Br. J. Pharmacol.* **2015**, *172*, 4228–4237. [[CrossRef](#)]
10. Chen, F.; Wang, L.; Zheng, X.; Zhang, X.; Zhang, J. Meta-analysis of the effects of oral and intravenous dexamethasone premedication in the prevention of paclitaxel-induced allergic reactions. *Oncotarget* **2017**, *8*, 19236–19243. [[CrossRef](#)]
11. West, D.C.; Pan, D.; Tonsing-Carter, E.Y.; Hernandez, K.M.; Pierce, C.F.; Styke, S.C.; Bowie, K.R.; Garcia, T.I.; Kocherginsky, M.; Conzen, S.D. GR and ER coactivation alters the expression of differentiation genes and associates with improved ER+ breast cancer outcome. *Mol. Cancer Res.* **2016**, *14*, 707–719. [[CrossRef](#)]
12. Skor, M.N.; Wonder, E.L.; Kocherginsky, M.; Goyal, A.; Hall, B.A.; Cai, Y.; Conzen, S.D. Glucocorticoid receptor antagonism as a novel therapy for triple-negative breast cancer. *Clin. Cancer Res.* **2013**, *19*, 6163–6172. [[CrossRef](#)]
13. Obradovic, M.M.S.; Hamelin, B.; Manevski, N.; Couto, J.P.; Sethi, A.; Coissieux, M.M.; Münst, S.; Okamoto, R.; Kohler, H.; Schmidt, A.; et al. Glucocorticoids promote breast cancer metastasis. *Nature* **2019**, *567*, 540–544. [[CrossRef](#)] [[PubMed](#)]
14. Govindan, M.V.; Devic, M.; Green, S.; Gronemeyer, H.; Chambon, P. Cloning of the human glucocorticoid receptor cDNA. *Nucleic Acids Res.* **1985**, *13*, 8293–8304. [[CrossRef](#)] [[PubMed](#)]

15. Timmermans, S.; Souffriau, J.; Libert, C. A general introduction to glucocorticoid biology. *Front. Immunol.* **2019**, *10*, 1545. [CrossRef]
16. Vandevyver, S.; Dejager, L.; Libert, C. Comprehensive overview of the structure and regulation of the glucocorticoid receptor. *Endocr. Rev.* **2014**, *35*, 671–693. [CrossRef]
17. Giguère, V.; Hollenberg, S.M.; Rosenfeld, M.G.; Evans, R.M. Functional domains of the human glucocorticoid receptor. *Cell* **1986**, *46*, 645–652. [CrossRef]
18. Hollenberg, S.M.; Weinberger, C.; Ong, E.S.; Cerelli, G.; Oro, A.; Lebo, R.; Thompson, E.B.; Rosenfeld, M.G.; Evans, R.M. Primary structure and expression of a functional human glucocorticoid receptor cDNA. *Nature* **1985**, *318*, 635–641. [CrossRef]
19. Nick, Z.L.U.; Cidlowski, J.A. The origin and functions of multiple human glucocorticoid receptor isoforms. *Ann. N. Y. Acad. Sci.* **2004**, *1024*, 102–123. [CrossRef]
20. Oakley, R.H.; Jewell, C.M.; Yudit, M.R.; Bofetiado, D.M.; Cidlowski, J.A. The dominant negative activity of the human glucocorticoid receptor β isoform. Specificity and mechanisms of action. *J. Biol. Chem.* **1999**, *274*, 27857–27866. [CrossRef]
21. Oakley, R.H.; Sar, M.; Cidlowski, J.A. The human glucocorticoid receptor β isoform: Expression, biochemical properties, and putative function. *J. Biol. Chem.* **1996**, *271*, 9550–9559. [CrossRef] [PubMed]
22. Kino, T.; Manoli, I.; Kelkar, S.; Wang, Y.; Su, Y.A.; Chrousos, G.P. Glucocorticoid receptor (GR) β has intrinsic, GR α -independent transcriptional activity. *Biochem. Biophys. Res. Commun.* **2009**, *381*, 671–675. [CrossRef] [PubMed]
23. Matthews, L.C.; Berry, A.A.; Morgan, D.J.; Poolman, T.M.; Bauer, K.; Kramer, F.; Spiller, D.G.; Richardson, R.V.; Chapman, K.E.; Farrow, S.N.; et al. Glucocorticoid receptor regulates accurate chromosome segregation and is associated with malignancy. *Proc. Natl. Acad. Sci. USA* **2015**, *112*, 5479–5484. [CrossRef] [PubMed]
24. Wang, Q.; Van Heerikhuizen, J.; Aronica, E.; Kawata, M.; Seress, L.; Joels, M.; Swaab, D.F.; Lucassen, P.J. Glucocorticoid receptor protein expression in human hippocampus; stability with age. *Neurobiol. Aging* **2013**, *34*, 1662–1673. [CrossRef]
25. ATLAS. Available online: <https://atlasbar.sg/> (accessed on 13 October 2020).
26. Spiga, F.; Walker, J.J.; Terry, J.R.; Lightman, S.L. HPA axis-rhythms. *Compr. Physiol.* **2014**, *4*, 1273–1298. [CrossRef]
27. Miller, W.L. Androgen synthesis in adrenarcho. *Rev. Endocr. Metab. Disord.* **2009**, *10*, 3–17. [CrossRef]
28. Hammond, G.L. Plasma steroid-binding proteins: Primary gatekeepers of steroid hormone action. *J. Endocrinol.* **2016**, *230*, R13–R25. [CrossRef]
29. Draper, N.; Stewart, P.M. 11 β -Hydroxysteroid Dehydrogenase and the Pre-Receptor Regulation of Corticosteroid Hormone Action. *J. Endocrinol.* **2005**, *186*, 251–271. [CrossRef]
30. Seckl, J.R. 11 beta-hydroxysteroid dehydrogenases: Changing glucocorticoid action. *Curr. Opin. Pharmacol.* **2004**, *4*, 597–602. [CrossRef]
31. Nicolaidis, N.C.; Galata, Z.; Kino, T.; Chrousos, G.P.; Charmandari, E. The human glucocorticoid receptor: Molecular basis of biologic function. *Steroids* **2010**, *75*, 1–12. [CrossRef]
32. Buttgerit, F. A fresh look at glucocorticoids: How to use an old ally more effectively. *Bull. NYU Hosp. Jt. Dis.* **2012**, *70*, 26–29.
33. Adcock, I.M.; Mumby, S. Glucocorticoids. *Handb. Exp. Pharmacol.* **2016**, *237*, 171–196.
34. Daley-Yates, P. Inhaled corticosteroids: Potency, dose equivalence and therapeutic index. *Br. J. Clin. Pharmacol.* **2015**, *80*, 372–380. [CrossRef] [PubMed]
35. Cheng, Q.; Morand, E.; Yang, Y.H. Development of novel treatment strategies for inflammatory diseases—Similarities and divergence between glucocorticoids and GILZ. *Front. Pharmacol.* **2014**, *17*, 169. [CrossRef]
36. Barnes, P.J. Glucocorticosteroids: Current and future directions. *Br. J. Pharmacol.* **2011**, *163*, 29–43. [CrossRef] [PubMed]
37. Greenstein, S.; Ghias, K.; Krett, N.L.; Rosen, S.T. Mechanisms of glucocorticoid-mediated apoptosis in hematological malignancies. *Clin. Cancer Res.* **2002**, *8*, 1681–1694.
38. Lin, K.T.; Wang, L.H. New dimension of glucocorticoids in cancer treatment. *Steroids* **2016**, *111*, 84–88. [CrossRef] [PubMed]
39. Wang, Z.; Malone, M.H.; He, H.; McColl, K.S.; Distelhorst, C.W. Microarray analysis uncovers the induction of the proapoptotic BH3-only protein Bim in multiple models of glucocorticoid-induced apoptosis. *J. Biol. Chem.* **2003**, *278*, 23861–23867. [CrossRef]
40. Keith, B.D. Systematic review of the clinical effect of glucocorticoids on nonhematologic malignancy. *BMC Cancer* **2008**, *8*, 1–19. [CrossRef]
41. Poirot, M.; Soules, R.; Mallinger, A.; Dalenc, F.; Silvente-Poirot, S. Chemistry, biochemistry, metabolic fate and mechanism of action of 6-oxo-cholestan-3 β ,5 α -diol (OCDO), a tumor promoter and cholesterol metabolite. *Biochimie* **2018**, *153*, 139–149. [CrossRef]

42. Voisin, M.; De Medina, P.; Mallinger, A.; Dalenc, F.; Huc-Claustre, E.; Leignadier, J.; Serhan, N.; Soules, R.; Ségala, G.; Mougel, A.; et al. Identification of a tumor-promoter cholesterol metabolite in human breast cancers acting through the glucocorticoid receptor. *Proc. Natl. Acad. Sci. USA* **2017**, *114*, E9346–E9355. [[CrossRef](#)]
43. Voisin, M.; Silvente-poirot, S.; Poirot, M. Biochemical and Biophysical Research Communications One step synthesis of 6-oxocholestan-3 β , 5 α -diol. *Biochem. Biophys. Res. Commun.* **2014**, *446*, 782–785. [[CrossRef](#)] [[PubMed](#)]
44. Poirot, M.; Silvente-Poirot, S. The tumor-suppressor cholesterol metabolite, dendrogenin A, is a new class of LXR modulator activating lethal autophagy in cancers. *Biochem. Pharmacol.* **2018**, *153*, 75–81. [[CrossRef](#)] [[PubMed](#)]
45. Grad, I.; Picard, D. The glucocorticoid responses are shaped by molecular chaperones. *Mol. Cell. Endocrinol.* **2007**, *275*, 2–12. [[CrossRef](#)] [[PubMed](#)]
46. Pratt, W.B.; Toft, D.O. Steroid receptor interactions with heat shock protein and immunophilin chaperones. *Endocr. Rev.* **1997**, *18*, 306–360. [[CrossRef](#)]
47. Weikum, E.R.; Knuesel, M.T.; Ortlund, E.A.; Yamamoto, K.R. Glucocorticoid receptor control of transcription: Precision and plasticity via allostery. *Nat. Rev. Mol. Cell Biol.* **2017**, *18*, 159–174. [[CrossRef](#)]
48. Presman, D.M.; Hager, G.L. More than meets the dimer: What is the quaternary structure of the glucocorticoid receptor? *Transcription* **2017**, *8*, 32–39. [[CrossRef](#)]
49. Yamamoto, K.R. Steroid receptor regulated transcription of specific genes and gene networks. *Annu. Rev. Genet.* **1985**, *19*, 209–252. [[CrossRef](#)]
50. Oakley, R.H.; Cidlowski, J.A. The biology of the glucocorticoid receptor: New signaling mechanisms in health and disease. *J. Allergy Clin. Immunol.* **2013**, *132*, 1033–1044. [[CrossRef](#)]
51. Galon, J.; Franchimont, D.; Hiroi, N.; Frey, G.; Boettner, A.; Ehrhart-Bornstein, M.; O'shea, J.J.; Chrousos, G.P.; Bornstein, S.R. Gene profiling reveals unknown enhancing and suppressive actions of glucocorticoids on immune cells. *FASEB J.* **2002**, *16*, 61–71. [[CrossRef](#)]
52. Ritter, H.D.; Antonova, L.; Mueller, C.R. The unliganded glucocorticoid receptor positively regulates the tumor suppressor gene BRCA1 through GABP beta. *Mol. Cancer Res.* **2012**, *10*, 558–569. [[CrossRef](#)] [[PubMed](#)]
53. Ritter, H.D.; Mueller, C.R. Expression microarray identifies the unliganded glucocorticoid receptor as a regulator of gene expression in mammary epithelial cells. *BMC Cancer* **2014**, *14*, 1–19. [[CrossRef](#)] [[PubMed](#)]
54. Xu, L.; Glass, C.K.; Rosenfeld, M.G. Coactivator and corepressor complexes in nuclear receptor function. *Curr Opin Genet Dev.* **1999**, *9*, 140–147. [[CrossRef](#)]
55. Wolf, I.M.; Heitzer, M.D.; Grubisha, M.; DeFranco, D.B. Coactivators and nuclear receptor transactivation. *J. Cell. Biochem.* **2008**, *104*, 1580–1586. [[CrossRef](#)]
56. Stallcup, M.R.; Poulard, C. Gene-Specific Actions of Transcriptional Coregulators Facilitate Physiological Plasticity: Evidence for a Physiological Coregulator Code. *Trends Biochem. Sci.* **2020**, *45*, 497–510. [[CrossRef](#)]
57. Pazin, M.J.; Kardonaga, J.T. SWI2/SNF2 and related proteins: ATP-driven motors that disrupt protein-DNA interactions? *Cell* **1997**, *88*, 737–740. [[CrossRef](#)]
58. Fryer, C.J.; Archer, T.K. Chromatin remodelling by the glucocorticoid receptor requires the BRG1 complex. *Nature* **1998**, *393*, 88–91. [[CrossRef](#)]
59. Engel, K.B.; Yamamoto, K.R. The Glucocorticoid Receptor and the Coregulator Brm Selectively Modulate Each Other's Occupancy and Activity in a Gene-Specific Manner. *Mol. Cell. Biol.* **2011**, *31*, 3267–3276. [[CrossRef](#)]
60. Wallberg, A.E.; Neely, K.E.; Hassan, A.H.; Gustafsson, J.-Å.; Workman, J.L.; Wright, A.P.H. Recruitment of the SWI-SNF Chromatin Remodeling Complex as a Mechanism of Gene Activation by the Glucocorticoid Receptor τ 1 Activation Domain. *Mol. Cell. Biol.* **2000**, *20*, 2004–2013. [[CrossRef](#)] [[PubMed](#)]
61. Muratcioglu, S.; Presman, D.M.; Pooley, J.R.; Grøntved, L.; Hager, G.L.; Nussinov, R.; Keskin, O.; Gursoy, A. Structural Modeling of GR Interactions with the SWI/SNF Chromatin Remodeling Complex and C/EBP. *Biophys. J.* **2015**, *109*, 1227–1239. [[CrossRef](#)] [[PubMed](#)]
62. Rothbart, S.B.; Strahl, B.D. Interpreting the language of histone and DNA modifications. *Biochim. Biophys. Acta Gene Regul. Mech.* **2014**, *1839*, 627–643. [[CrossRef](#)] [[PubMed](#)]
63. Jenuwein, T.; Allis, C.D. Translating the histone code. *Science* **2001**, *293*, 1074–1080. [[CrossRef](#)]
64. Chen, D.; Ma, M.; Hong, H.; Koh, S.S.; Huang, S.M.; Schurter, B.T.; Aswad, D.W.; Stallcup, M.R. Regulation of transcription by a protein methyltransferase. *Science* **1999**, *284*, 2174–2177. [[CrossRef](#)] [[PubMed](#)]
65. Bittencourt, D.; Wu, D.Y.; Jeong, K.W.; Gerke, D.S.; Herviou, L.; Ianculescu, I.; Chodankar, R.; Siegmund, K.D.; Stallcup, M.R. G9a functions as a molecular scaffold for assembly of transcriptional coactivators on a subset of Glucocorticoid Receptor target genes. *Proc. Natl. Acad. Sci. USA* **2012**, *109*, 19673–19678. [[CrossRef](#)] [[PubMed](#)]
66. Wallberg, A.E.; Neely, K.E.; Gustafsson, J.-Å.; Workman, J.L.; Wright, A.P.H.; Grant, P.A. Histone Acetyltransferase Complexes Can Mediate Transcriptional Activation by the Major Glucocorticoid Receptor Activation Domain. *Mol. Cell. Biol.* **1999**, *19*, 5952–5959. [[CrossRef](#)] [[PubMed](#)]
67. Stewart, M.D.; Wang, J. *Nuclear Receptor Repression: Regulatory Mechanisms and Physiological Implications*, 1st ed.; Elsevier Inc.: Amsterdam, The Netherlands, 2009; Volume 87.

68. Ronacher, K.; Hadley, K.; Avenant, C.; Stubbsrud, E.; Simons, S.S., Jr.; Louw, A.; Hapgood, J.P. Ligand-selective transactivation and transrepression via the glucocorticoid receptor: Role of cofactor interaction. *Mol. Cell. Endocrinol.* **2009**, *299*, 219–231. [[CrossRef](#)]
69. Song, R.; Hu, X.Q.; Zhang, L. Glucocorticoids and programming of the microenvironment in heart. *J. Endocrinol.* **2019**, *242*, 139–148. [[CrossRef](#)] [[PubMed](#)]
70. Flaherty, R.L.; Owen, M.; Fagan-Murphy, A.; Intabli, H.; Healy, D.; Patel, A.; Allen, M.C.; Patel, B.A.; Flint, M.S. Glucocorticoids induce production of reactive oxygen species/reactive nitrogen species and DNA damage through an iNOS mediated pathway in breast cancer. *Breast Cancer Res.* **2017**, *19*, 1–13. [[CrossRef](#)]
71. Wang, Z.; Frederick, J.; Garabedian, M.J. Deciphering the phosphorylation “code” of the glucocorticoid receptor in vivo. *J. Biol. Chem.* **2002**, *277*, 26573–26580. [[CrossRef](#)]
72. Avenant, C.; Ronacher, K.; Stubbsrud, E.; Louw, A.; Hapgood, J.P. Role of ligand-dependent GR phosphorylation and half-life in determination of ligand-specific transcriptional activity. *Mol. Cell. Endocrinol.* **2010**, *327*, 72–88. [[CrossRef](#)]
73. Miller, A.L.; Webb, M.S.; Copik, A.J.; Wang, Y.; Johnson, B.H.; Kumar, R.; Thompson, E.B. p38 mitogen-activated protein kinase (MAPK) is a key mediator in glucocorticoid-induced apoptosis of lymphoid cells: Correlation between p38 MAPK activation and site-specific phosphorylation of the human glucocorticoid receptor at serine 211. *Mol. Endocrinol.* **2005**, *19*, 1569–1583. [[CrossRef](#)] [[PubMed](#)]
74. Chen, W.; Dang, T.; Blind, R.D.; Wang, Z.; Cavasotto, C.N.; Hittelman, A.B.; Rogatsky, I.; Logan, S.K.; Garabedian, M.J. Glucocorticoid receptor phosphorylation differentially affects target gene expression. *Mol. Endocrinol.* **2008**, *22*, 1754–1766. [[CrossRef](#)] [[PubMed](#)]
75. Itoh, M.; Adachi, M.; Yasui, H.; Takekawa, M.; Tanaka, H.; Imai, K. Nuclear export of glucocorticoid receptor is enhanced by c-Jun N-terminal kinase-mediated phosphorylation. *Mol. Endocrinol.* **2002**, *16*, 2382–2392. [[CrossRef](#)] [[PubMed](#)]
76. Takabe, S.; Mochizuki, K.; Goda, T. De-phosphorylation of GR at Ser203 in nuclei associates with GR nuclear translocation and GLUT5 gene expression in Caco-2 cells. *Arch. Biochem. Biophys.* **2008**, *475*, 1–6. [[CrossRef](#)]
77. Galliher-Beckley, A.J.; Williams, J.G.; Collins, J.B.; Cidlowski, J.A. Glycogen Synthase Kinase 3 β -Mediated Serine Phosphorylation of the Human Glucocorticoid Receptor Redirects Gene Expression Profiles. *Mol. Cell. Biol.* **2008**, *28*, 7309–7322. [[CrossRef](#)]
78. Piovani, E.; Yu, J.; Tosello, V.; Herranz, D.; Ambesi-Impiombato, A.; DaSilva, A.C.; Sanchez-Martin, M.; Perez-Garcia, A.; Rigo, I.; Castillo, M.; et al. Direct Reversal of Glucocorticoid Resistance by AKT Inhibition in Acute Lymphoblastic Leukemia. *Cancer Cell* **2013**, *24*, 766–776. [[CrossRef](#)]
79. Ito, K.; Yamamura, S.; Essilfie-Quaye, S.; Cosio, B.; Ito, M.; Barnes, P.J.; Adcock, I.M. Histone deacetylase 2-mediated deacetylation of the glucocorticoid receptor enables NF- κ B suppression. *J. Exp. Med.* **2006**, *203*, 7–13. [[CrossRef](#)]
80. Nader, N.; Chrousos, G.P.; Kino, T. Circadian rhythm transcription factor CLOCK regulates the transcriptional activity of the glucocorticoid receptor by acetylating its hinge region lysine cluster: Potential physiological implications. *FASEB J.* **2009**, *23*, 1572–1583. [[CrossRef](#)]
81. Wallace, A.D.; Cidlowski, J.A. Proteasome-mediated Glucocorticoid Receptor Degradation Restricts Transcriptional Signaling by Glucocorticoids. *J. Biol. Chem.* **2001**, *276*, 42714–42721. [[CrossRef](#)]
82. Wallace, A.D.; Cao, Y.; Chandramouleeswaran, S.; Cidlowski, J.A. Lysine 419 targets human glucocorticoid receptor for proteasomal degradation. *Steroids* **2010**, *75*, 1016–1023. [[CrossRef](#)]
83. Wang, X.; DeFranco, D.B. Alternative effects of the ubiquitin-proteasome pathway on glucocorticoid receptor down-regulation and transactivation are mediated by CHIP, an E3 ligase. *Mol. Endocrinol.* **2005**, *19*, 1474–1482. [[CrossRef](#)]
84. Tian, S.; Poukka, H.; Palvimo, J.J.; Jänne, O.A. Small ubiquitin-related modifier-1 (SUMO-1) modification of the glucocorticoid receptor. *Biochem. J.* **2002**, *367*, 907–911. [[CrossRef](#)] [[PubMed](#)]
85. Le Drean, Y.; Mincheneau, N.; Le Goff, P.; Michel, D. Potentiation of glucocorticoid receptor transcriptional activity by sumoylation. *Endocrinology* **2002**, *143*, 3482–3489. [[CrossRef](#)] [[PubMed](#)]
86. Holmstrom, S.R.; Chupreta, S.; So, A.Y.L.; Iñiguez-Lluhí, J.A. SUMO-mediated inhibition of glucocorticoid receptor synergistic activity depends on stable assembly at the promoter but not on DAXX. *Mol. Endocrinol.* **2008**, *22*, 2061–2075. [[CrossRef](#)] [[PubMed](#)]
87. Poulard, C.; Jacquemetton, J.; Pham, T.H.; Le Romancer, M. Using proximity ligation assay to detect protein arginine methylation. *Methods* **2020**, *175*, 66–71. [[CrossRef](#)] [[PubMed](#)]
88. Lien, H.C.; Lu, Y.S.; Cheng, A.L.; Chang, W.C.; Jeng, Y.M.; Kuo, Y.H.; Huang, C.S.; Chang, K.J.; Yao, Y.T. Differential expression of glucocorticoid receptor in human breast tissues and related neoplasms. *J. Pathol.* **2006**, *209*, 317–327. [[CrossRef](#)]
89. Buxant, F.; Engohan-Aloghe, C.; Noël, J.C. Estrogen receptor, progesterone receptor, and glucocorticoid receptor expression in normal breast tissue, breast in situ carcinoma, and invasive breast cancer. *Appl. Immunohistochem. Mol. Morphol.* **2010**, *18*, 254–257. [[CrossRef](#)]

90. Wintermantel, T.M.; Bock, D.; Fleig, V.; Greiner, E.F.; Schütz, G. The epithelial glucocorticoid receptor is required for the normal timing of cell proliferation during mammary lobuloalveolar development but is dispensable for milk production. *Mol. Endocrinol.* **2005**, *19*, 340–349. [[CrossRef](#)]
91. Murtagh, J.; McArdle, E.; Gilligan, E.; Thornton, L.; Furlong, F.; Martin, F. Organization of mammary epithelial cells into 3D acinar structures requires glucocorticoid and JNK signaling. *J. Cell Biol.* **2004**, *166*, 133–143. [[CrossRef](#)]
92. Reichardt, H.M.; Horsch, K.; Gröne, H.J.; Kolbus, A.; Beug, H.; Hynes, N.; Schütz, G. Mammary gland development and lactation are controlled by different glucocorticoid receptor activities. *Eur. J. Endocrinol.* **2001**, *145*, 519–527. [[CrossRef](#)]
93. Reichardt, H.M.; Kaestner, K.H.; Tuckermann, J.; Kretz, O.; Wessely, O.; Bock, R.; Gass, P.; Schmid, W.; Herrlich, P.; Angel, P.; et al. DNA binding of the glucocorticoid receptor is not essential for survival. *Cell* **1998**, *93*, 531–541. [[CrossRef](#)]
94. Berg, M.N.; Dharmarajan, A.M.; Waddell, B.J. Glucocorticoids and progesterone prevent apoptosis in the lactating rat mammary gland. *Endocrinology* **2002**, *143*, 222–227. [[CrossRef](#)] [[PubMed](#)]
95. Bertucci, P.Y.; Quaglino, A.; Pozzi, A.G.; Kordon, E.C.; Pecci, A. Glucocorticoid-induced impairment of mammary gland involution is associated with STAT5 and STAT3 signaling modulation. *Endocrinology* **2010**, *151*, 5730–5740. [[CrossRef](#)] [[PubMed](#)]
96. Pan, D.; Kocherginsky, M.; Conzen, S.D. Activation of the glucocorticoid receptor is associated with poor prognosis in estrogen receptor-negative breast cancer. *Cancer Res.* **2011**, *71*, 6360–6370. [[CrossRef](#)] [[PubMed](#)]
97. Abduljabbar, R.; Negm, O.H.; Lai, C.F.; Jerjees, D.A.; Al-Kaabi, M.; Hamed, M.R.; Tighe, P.J.; Buluwela, L.; Mukherjee, A.; Green, A.R.; et al. Clinical and biological significance of glucocorticoid receptor (GR) expression in breast cancer. *Breast Cancer Res. Treat.* **2015**, *150*, 335–346. [[CrossRef](#)]
98. Chen, Z.; Lan, X.; Wu, D.; Sunkel, B.; Ye, Z.; Huang, J.; Liu, Z.; Clinton, S.K.; Jin, V.X.; Wang, Q. Ligand-dependent genomic function of glucocorticoid receptor in triple-negative breast cancer. *Nat. Commun.* **2015**, *6*, 1–8. [[CrossRef](#)] [[PubMed](#)]
99. Sorrentino, G.; Ruggeri, N.; Zannini, A.; Ingallina, E.; Bertolio, R.; Marotta, C.; Neri, C.; Cappuzzello, E.; Forcato, M.; Rosato, A.; et al. Glucocorticoid receptor signalling activates YAP in breast cancer. *Nat. Commun.* **2017**, *8*, 1–14. [[CrossRef](#)]
100. Yang, F.; Ma, Q.; Liu, Z.; Li, W.; Tan, Y.; Jin, C.; Ma, W.; Hu, Y.; Shen, J.; Ohgi, K.A.; et al. Glucocorticoid Receptor:MegaTrans Switching Mediates the Repression of an ER α -Regulated Transcriptional Program. *Mol. Cell* **2017**, *66*, 321–331.e6. [[CrossRef](#)] [[PubMed](#)]
101. Karmakar, S.; Jin, Y.; Nagaich, A.K. Interaction of glucocorticoid receptor (GR) with estrogen receptor (ER) α and activator protein 1 (AP1) in dexamethasone-mediated interference of ER α activity. *J. Biol. Chem.* **2013**, *288*, 24020–24034. [[CrossRef](#)] [[PubMed](#)]
102. Lippman, M.; Bolan, G.; Huff, K. The Effects of Glucocorticoids and Progesterone on Hormonerresponsive Human Breast Cancer in Long-Term Tissue Culture. *Cancer Res.* **1976**, *36*, 4602–4609.
103. Györfy, B.; Lanczky, A.; Eklund, A.C.; Denkert, C.; Budczies, J.; Li, Q.; Szallasi, Z. An online survival analysis tool to rapidly assess the effect of 22,277 genes on breast cancer prognosis using microarray data of 1,809 patients. *Breast Cancer Res. Treat.* **2010**, *123*, 725–731. [[CrossRef](#)]
104. Goya, L.; Maiyar, A.C.; Ge, Y.; Firestone, G.L. Glucocorticoids induce a G1/G0 cell cycle arrest of Con8 rat mammary tumor cells that is synchronously reversed by steroid withdrawal or addition of transforming growth factor- α . *Mol. Endocrinol.* **1993**, *7*, 1121–1132. [[CrossRef](#)]
105. Tonsing-Carter, E.; Hernandez, K.M.; Kim, C.R.; Harkless, R.V.; Oh, A.; Bowie, K.R.; West-Szymanski, D.C.; Betancourt-Ponce, M.A.; Green, B.D.; Lastra, R.R.; et al. Glucocorticoid receptor modulation decreases ER-positive breast cancer cell proliferation and suppresses wild-type and mutant ER chromatin association. *Breast Cancer Res.* **2019**, *21*, 82. [[CrossRef](#)]
106. Miranda, T.B.; Voss, T.C.; Sung, M.H.; Baek, S.; John, S.; Hawkins, M.; Grøntved, L.; Schiltz, R.L.; Hager, G.L. Reprogramming the chromatin landscape: Interplay of the estrogen and glucocorticoid receptors at the genomic level. *Cancer Res.* **2013**, *73*, 5130–5139. [[CrossRef](#)] [[PubMed](#)]
107. Swinstead, E.E.; Miranda, T.B.; Paakinaho, V.; Baek, S.; Goldstein, I.; Hawkins, M.; Karpova, T.S.; Ball, D.; Mazza, D.; Lavis, L.D.; et al. Steroid Receptors Reprogram FoxA1 Occupancy through Dynamic Chromatin Transitions. *Cell* **2016**, *165*, 593–605. [[CrossRef](#)] [[PubMed](#)]
108. Zhang, Y.; Leung, D.Y.M.; Nordeen, S.K.; Goleva, E. Estrogen inhibits glucocorticoid action via protein phosphatase 5 (PP5)mediated glucocorticoid receptor dephosphorylation. *J. Biol. Chem.* **2009**, *284*, 24542–24552. [[CrossRef](#)]
109. Meng, X.G.; Yue, S.W. Dexamethasone disrupts cytoskeleton organization and migration of T47D human breast cancer cells by modulating the AKT/mTOR/RhoA pathway. *Asian Pac. J. Cancer Prev.* **2014**, *15*, 10245–10250. [[CrossRef](#)]

110. Nasset, K.A.; Perri, A.M.; Mueller, C.R. Frequent promoter hypermethylation and expression reduction of the glucocorticoid receptor gene in breast tumors. *Epigenetics* **2014**, *9*, 851–859. [[CrossRef](#)]
111. Snider, H.; Villavarajan, B.; Peng, Y.; Shepherd, L.E.; Robinson, A.C.; Mueller, C.R. Region-specific glucocorticoid receptor promoter methylation has both positive and negative prognostic value in patients with estrogen receptor-positive breast cancer. *Clin. Epigenetics* **2019**, *11*, 1–20. [[CrossRef](#)]
112. Kinyamu, H.K.; Archer, T.K. Estrogen Receptor-Dependent Proteasomal Degradation of the Glucocorticoid Receptor Is Coupled to an Increase in Mdm2 Protein Expression. *Mol. Cell. Biol.* **2003**, *23*, 5867–5881. [[CrossRef](#)] [[PubMed](#)]
113. Zhou, L.; Zhong, Y.; Yang, F.H.; Li, Z.B.; Zhou, J.; Liu, X.H.; Li, M.; Hu, F. Kaiso represses the expression of glucocorticoid receptor via a methylation-dependent mechanism and attenuates the anti-apoptotic activity of glucocorticoids in breast cancer cells. *BMB Rep.* **2016**, *49*, 167–172. [[CrossRef](#)]
114. West, D.C.; Kocherginsky, M.; Tonsing-Carter, E.Y.; Dolcen, D.N.; Hosfield, D.J.; Lastra, R.R.; Sinnwell, J.P.; Thompson, K.J.; Bowie, K.R.; Harkless, R.V.; et al. Discovery of a Glucocorticoid Receptor (GR) Activity Signature Using Selective GR Antagonism in ER-Negative Breast Cancer. *Clin. Cancer Res.* **2018**, *24*, 3433–3446. [[CrossRef](#)] [[PubMed](#)]
115. Regan Anderson, T.M.; Ma, S.H.; Raj, G.V.; Cidlowski, J.A.; Helle, T.M.; Knutson, T.P.; Krutilina, R.I.; Seagroves, T.N.; Lange, C.A. Breast tumor kinase (Brk/PTK6) is induced by HIF, glucocorticoid receptor, and PELP1-mediated stress signaling in triple-negative breast cancer. *Cancer Res.* **2016**, *76*, 1653–1663. [[CrossRef](#)] [[PubMed](#)]
116. Perez Kerkvliet, C.; Dwyer, A.R.; Diep, C.H.; Oakley, R.H.; Liddle, C.; Cidlowski, J.A.; Lange, C.A. Glucocorticoid receptors are required effectors of TGFβ1-induced p38 MAPK signaling to advanced cancer phenotypes in triple-negative breast cancer. *Breast Cancer Res.* **2020**, *22*, 1–23. [[CrossRef](#)]
117. Chien, H.P.; Ueng, S.H.; Chen, S.C.; Chang, Y.S.; Lin, Y.C.; Lo, Y.F.; Chang, H.K.; Chuang, W.Y.; Huang, Y.T.; Cheung, Y.C.; et al. Expression of ROR1 has prognostic significance in triple negative breast cancer. *Virchows Arch.* **2016**, *468*, 589–595. [[CrossRef](#)]
118. Zhang, S.; Chen, L.; Cui, B.; Chuang, H.Y.; Yu, J.; Wang-Rodriguez, J.; Tang, L.; Chen, G.; Basak, G.W.; Kipps, T.J. ROR1 is expressed in human breast cancer and associated with enhanced tumor-cell growth. *PLoS ONE* **2012**, *7*, e31127. [[CrossRef](#)] [[PubMed](#)]
119. Cui, B.; Zhang, S.; Chen, L.; Yu, J.; Widhopf, G.F.; Fecteau, J.F.; Rassenti, L.Z.; Kipps, T.J. Targeting ROR1 inhibits epithelial-mesenchymal transition and metastasis. *Cancer Res.* **2013**, *73*, 3649–3660. [[CrossRef](#)]
120. Speers, C.; Tsimelzon, A.; Sexton, K.; Herrick, A.M.; Gutierrez, C.; Culhane, A.; Quackenbush, J.; Hilsenbeck, S.; Chang, J.; Brown, P. Identification of novel kinase targets for the treatment of estrogen receptor-negative breast cancer. *Clin. Cancer Res.* **2009**, *15*, 6327–6340. [[CrossRef](#)]
121. Lamar, J.M.; Stern, P.; Liu, H.; Schindler, J.W.; Jiang, Z.G.; Hynes, R.O. The Hippo pathway target, YAP, promotes metastasis through its TEAD-interaction domain. *Proc. Natl. Acad. Sci. USA* **2012**, *109*, 2441–2450. [[CrossRef](#)]
122. He, L.; Yuan, L.; Sun, Y.; Wang, P.; Zhang, H.; Feng, X.; Wang, Z.; Zhang, W.; Yang, C.; Zeng, Y.A.; et al. Glucocorticoid receptor signaling activates TEAD4 to promote breast cancer progression. *Cancer Res.* **2019**, *79*, 4399–4411. [[CrossRef](#)]
123. Ben-Porath, I.; Thomson, M.W.; Carey, V.J.; Ge, R.; Bell, G.W.; Regev, A.; Weinberg, R.A. An embryonic stem cell-like gene expression signature in poorly differentiated aggressive human tumors. *Nat. Genet.* **2008**, *40*, 499–507. [[CrossRef](#)]
124. Tong, D.; Czerwenka, K.; Heinze, G.; Ryffel, M.; Schuster, E.; Witt, A.; Leodolter, S.; Zeillinger, R. Expression of KLF5 is a prognostic factor for disease-free survival and overall survival in patients with breast cancer. *Clin. Cancer Res.* **2006**, *12*, 2442–2448. [[CrossRef](#)]
125. Wang, C.; Nie, Z.; Zhou, Z.; Zhang, H.; Liu, R.; Wu, J.; Qin, J.; Ma, Y.; Chen, L.; Li, S.; et al. The interplay between TEAD4 and KLF5 promotes breast cancer partially through inhibiting the transcription of p27Kip1. *Oncotarget* **2015**, *6*, 17685–17697. [[CrossRef](#)]
126. Li, Z.; Dong, J.; Zou, T.; Du, C.; Li, S.; Chen, C.; Liu, R.; Wang, K. Dexamethasone induces docetaxel and cisplatin resistance partially through up-regulating Krüppel-like factor 5 in triplenegative breast cancer. *Oncotarget* **2017**, *8*, 11555–11565. [[CrossRef](#)] [[PubMed](#)]
127. Mikosz, C.A.; Brickley, D.R.; Sharkey, M.S.; Moran, T.W.; Conzen, S.D. Glucocorticoid Receptor-mediated Protection from Apoptosis Is Associated with Induction of the Serine/Threonine Survival Kinase Gene, *sgk-1*. *J. Biol. Chem.* **2001**, *276*, 16649–16654. [[CrossRef](#)] [[PubMed](#)]
128. Wu, W.; Chaudhuri, S.; Brickley, D.R.; Pang, D.; Karrison, T.; Conzen, S.D. Microarray Analysis Reveals Glucocorticoid-Regulated Survival Genes That Are Associated with Inhibition of Apoptosis in Breast Epithelial Cells. *Cancer Res.* **2004**, *64*, 1757–1764. [[CrossRef](#)]
129. Wu, W.; Pew, T.; Zou, M.; Pang, D.; Conzen, S.D. Glucocorticoid receptor-induced MAPK phosphatase-1 (MPK-1) expression inhibits paclitaxel-associated MAPK activation and contributes to breast cancer cell survival. *J. Biol. Chem.* **2005**, *280*, 4117–4124. [[CrossRef](#)] [[PubMed](#)]

130. Agyeman, A.S.; Jun, W.J.; Proia, D.A.; Kim, C.R.; Skor, M.N.; Kocherginsky, M.; Conzen, S.D. Hsp90 Inhibition Results in Glucocorticoid Receptor Degradation in Association with Increased Sensitivity to Paclitaxel in Triple-Negative Breast Cancer. *Horm. Cancer* **2016**, *7*, 114–126. [[CrossRef](#)] [[PubMed](#)]
131. Sui, M.; Chen, F.; Chen, Z.; Fan, W. Glucocorticoids interfere with therapeutic efficacy of paclitaxel against human breast and ovarian xenograft tumors. *Int. J. Cancer* **2006**, *119*, 712–717. [[CrossRef](#)]
132. Pang, D.; Kocherginsky, M.; Krausz, T.; Kim, S.Y.; Conzen, S.D. Dexamethasone decreases xenograft response to paclitaxel through inhibition of tumor cell apoptosis. *Cancer Biol. Ther.* **2006**, *5*, 933–940. [[CrossRef](#)]
133. Nanda, R.; Stringer-Reasor, E.M.; Saha, P.; Kocherginsky, M.; Gibson, J.; Libao, B.; Hoffman, P.C.; Obeid, E.; Merkel, D.E.; Khramtsova, G.; et al. A randomized phase I trial of nanoparticle albumin-bound paclitaxel with or without mifepristone for advanced breast cancer. *Springerplus* **2016**, *5*, 1–9. [[CrossRef](#)] [[PubMed](#)]
134. Shi, W.; Wang, D.; Yuan, X.; Liu, Y.; Guo, X.; Li, J.; Song, J. Glucocorticoid receptor-IRS-1 axis controls EMT and the metastasis of breast cancers. *J. Mol. Cell Biol.* **2019**, *11*, 1042–1055. [[CrossRef](#)]
135. Poulard, C.; Bittencourt, D.; Wu, D.; Hu, Y.; Gerke, D.S.; Stallcup, M.R. A post-translational modification switch controls coactivator function of histone methyltransferases G9a and GLP. *EMBO Rep.* **2017**, *18*, 1442–1459. [[CrossRef](#)]
136. Poulard, C.; Kim, H.N.; Fang, M.; Kruth, K.; Gagnieux, C.; Gerke, D.S.; Bhojwani, D.; Kim, Y.M.; Kampmann, M.; Stallcup, M.R.; et al. Relapse-associated AURKB blunts the glucocorticoid sensitivity of B cell acute lymphoblastic leukemia. *Proc. Natl. Acad. Sci. USA* **2019**, *116*, 3052–3061. [[CrossRef](#)] [[PubMed](#)]
137. Poulard, C.; Baulu, E.; Lee, B.H.; Pufall, M.A.; Stallcup, M.R. Increasing G9a automethylation sensitizes B acute lymphoblastic leukemia cells to glucocorticoid-induced death. *Cell Death Dis.* **2018**, *9*. [[CrossRef](#)]
138. Lietzen, L.W.; Ahern, T.; Christiansen, P.; Jensen, A.B.; Sørensen, H.T.; Lash, T.L.; Cronin-Fenton, D.P. Glucocorticoid prescriptions and breast cancer recurrence: A Danish nationwide prospective cohort study. *Ann. Oncol.* **2014**, *25*, 2419–2425. [[CrossRef](#)]
139. Michael, Y.L.; Carlson, N.E.; Chlebowski, R.T.; Aickin, M.; Karen, L.; Ockene, J.K.; Bowen, D.J.; Ritenbaugh, C. Influence of stressors on breast cancer incidence in the Women’s Health Initiative. *Health Psychol.* **2009**, *28*, 137–146. [[CrossRef](#)] [[PubMed](#)]
140. Hermes, G.L.; Delgado, B.; Tretiakova, M.; Cavigelli, S.A.; Krausz, T.; Conzen, S.D.; McClintock, M.K. Social isolation dysregulates endocrine and behavioral stress while increasing malignant burden of spontaneous mammary tumors. *Proc. Natl. Acad. Sci. USA* **2009**, *106*, 22393–22398. [[CrossRef](#)]
141. Otranto, M.; Sarrazy, V.; Bonté, F.; Hinz, B.; Gabbiani, G.; Desmoulière, A. The role of the myofibroblast in tumor stroma remodeling. *Cell Adhes. Migr.* **2012**, *6*, 203–219. [[CrossRef](#)]
142. Gandellini, P.; Andriani, F.; Merlino, G.; D’Aiuto, F.; Roz, L.; Callari, M. Complexity in the tumour microenvironment: Cancer associated fibroblast gene expression patterns identify both common and unique features of tumour-stroma crosstalk across cancer types. *Semin. Cancer Biol.* **2015**, *35*, 96–106. [[CrossRef](#)]
143. Grose, R.; Werner, S.; Kessler, D.; Tuckermann, J.; Huggel, K.; Durka, S.; Reichardt, H.M.; Werner, S. A role for endogenous glucocorticoids in wound repair. *EMBO Rep.* **2002**, *3*, 575–582. [[CrossRef](#)] [[PubMed](#)]
144. Catteau, X.; Simon, P.; Buxant, F.; Noël, J.-C. Expression of the glucocorticoid receptor in breast cancer-associated fibroblasts. *Mol. Clin. Oncol.* **2016**, *5*, 372–376. [[CrossRef](#)] [[PubMed](#)]
145. Zhou, Y.; Liu, X. The role of estrogen receptor beta in breast cancer. *Biomark. Res.* **2020**, *8*, 1–12. [[CrossRef](#)] [[PubMed](#)]
146. Weiser, M.J.; Foradori, C.D.; Handa, R.J. Estrogen receptor beta activation prevents glucocorticoid receptor-dependent effects of the central nucleus of the amygdala on behavior and neuroendocrine function. *Brain Res.* **2010**, *1336*, 78–88. [[CrossRef](#)] [[PubMed](#)]

Annex II

2. Review 2

Structure, Activity, and Function of the Protein Lysine Methyltransferase G9a

Coralie Poulard, **Lara Malik Noureddine**, Ludivine Pruvost and Muriel Le Romancer

Published in Life in October 2021.



Review

Structure, Activity, and Function of the Protein Lysine Methyltransferase G9a

Coralie Poulard ^{1,2,3,*}, Lara M. Nouredine ^{1,2,3,4}, Ludivine Pruvost ^{1,2,3} and Muriel Le Romancer ^{1,2,3}



Citation: Poulard, C.; Nouredine, L.M.; Pruvost, L.; Le Romancer, M. Structure, Activity, and Function of the Protein Lysine Methyltransferase G9a. *Life* **2021**, *11*, 1082. <https://doi.org/10.3390/life11101082>

Academic Editors: Albert Jeltsch and Arunkumar Dhayalan

Received: 2 September 2021 Accepted: 8 October 2021
Published: 14 October 2021

Publisher's Note: MDPI stays neutral with regard to jurisdictional claims in published maps and institutional affiliations.



Copyright: © 2021 by the authors. Licensee MDPI, Basel, Switzerland. This article is an open access article distributed under the terms and conditions of the Creative Commons Attribution (CC BY) license (<https://creativecommons.org/licenses/by/4.0/>).

- 1 Cancer Research Cancer of Lyon, Université de Lyon, F-69000 Lyon, France; noureddinelara@gmail.com (L.M.N.); ludivine.pruvost@etu.univ-lyon1.fr (L.P.); Muriel.LEROMANCER-CHERIFI@lyon.unicancer.fr (M.L.R.)
 - 2 Inserm U1052, Centre de Recherche en Cancérologie de Lyon, F-69000 Lyon, France
 - 3 CNRS UMR5286, Centre de Recherche en Cancérologie de Lyon, F-69000 Lyon, France
 - 4 Laboratory of Cancer Biology and Molecular Immunology, Faculty of Sciences, Lebanese University, Hadat-Beirut 90565, Lebanon
- * Correspondence: coralie.poulard@lyon.unicancer.fr

Abstract: G9a is a lysine methyltransferase catalyzing the majority of histone H3 mono- and dimethylation at Lys-9 (H3K9), responsible for transcriptional repression events in euchromatin. G9a has been shown to methylate various lysine residues of non-histone proteins and acts as a coactivator for several transcription factors. This review will provide an overview of the structural features of G9a and its paralog called G9a-like protein (GLP), explore the biochemical features of G9a, and describe its post-translational modifications and the specific inhibitors available to target its catalytic activity. Aside from its role on histone substrates, the review will highlight some non-histone targets of G9a, in order gain insight into their role in specific cellular mechanisms. Indeed, G9a was largely described to be involved in embryonic development, hypoxia, and DNA repair. Finally, the involvement of G9a in cancer biology will be presented.

Keywords: G9a; GLP; H3K9 methylation; protein lysine methylation; EHMT2; EHMT1; protein post-translational modification; cancer

1. Introduction

Protein lysine methylation is a dynamic post-translational modification (PTM) regulating protein stability and function. Lysine methylation of histone proteins can modulate transcriptional activity without affecting the DNA sequence itself, enabling dynamic gene transcription patterns in response to environmental stimuli [1]. Lysine methylation is deposited by writer enzymes called protein lysine methyltransferases (PKMTs), removed by eraser enzymes called lysine demethylases (PKDMs) and interpreted by reader proteins that bind to lysine methylation marks. PKMTs catalyze the transfer of the methyl group from the S-adenosyl-L-methionine (AdoMet) donor to the ε-nitrogen of a lysine residue on protein substrates [1]. The lysine ε-amino group of proteins can accept up to three methyl groups, resulting in either mono-, di-, or trimethyl lysines. To date, more than 50 PKMTs have been reported, with sequence and product specificity. Two PKMT families have been identified: the SET lysine methyltransferases containing the majority of PKMTs [2] and the Seven β-strand methyltransferase (7βS) or class I family [3]. Histones are methylated on several lysine residues. A growing number of reports also describe the methylation of non-histone proteins on lysine residues [1].

G9a was identified and sequenced in the 1990s [4]. It belongs to the SET PKMT family. G9a was extensively studied as a key enzyme in the mono- and dimethylation of lysine 9 of histone H3 (H3K9me1 and H3K9me2, respectively) in euchromatin [5]. Since the H3K9me2 mark is associated with transcriptional repression, G9a was primarily considered to be an epigenetic repressor [5–7]. Its role as a coactivator of several transcription factors

emerged more recently [8–12]. Though G9a is the most commonly used term for this lysine methyltransferase, it is also known as lysine methyltransferase-1C (KMT1C), euchromatic histone N-methyltransferase 2 (EHMT2), or BAT8 (HLA-B associated transcript 8).

The current review will provide an overview of the structural features of the protein with a particular focus on its paralog GLP (G9a-like protein). The biochemical features of G9a will also be detailed with a special emphasis on the key PTMs affecting G9a and regulating its activity and function. Finally, among the large number of G9a substrates described, including histone and non-histone substrates, the present report will focus on their involvement in specific physiological pathways and their connection to cancer.

2. Structural Features

2.1. Structure and Domain Architecture

In human cells, G9a exists as two isoforms: a full-length isoform of 1210 amino acids (called isoform A) derived from 24 exons of the G9a gene and a splice variant of 1176 amino acids (isoform B) that arises from the excision of exon 10 (Figure 1a). The alternative splicing of G9a is conserved in different species, tissues, and cell lines [13]. Even if the two isoforms are ubiquitously found in different tissues, the ratio between them varies. For example, isoform A is preponderant in the kidney, thymus, and testis, and, interestingly, is more abundant in epithelial cell lines compared to mesenchymal cell lines and more transformed cell lines [13]. Mauger et al. reported that the two isoforms display similar methyltransferase activities and subcellular localizations. Likewise, Fiszbein et al. showed that isoform B expression increased during neuronal differentiation [14]. They did not report any change in G9a catalytic activity following exon 10 inclusion, but demonstrated that exon 10 inclusion increases G9a nuclear localization in a neuronal cell line [14]. Mouse G9a is also subjected to alternative splicing. Full-length mouse G9a protein contains 1263 amino acids and shares more than 90% homology with human G9a [15].

G9a belongs to the Su(var)3-9 family of methyltransferases, which was first identified in *Drosophila melanogaster* [16]. The main characteristic of this family of proteins is the presence of a highly conserved SET domain [17]. SET, an acronym for Su(var)3-9, Enhancer-of-zeste and Trithorax, is a long sequence of 130 to 140 amino acids, characterized in 1998, that has a unique structural fold [17]. The SET domain is composed of a series of β strands that fold into three sheets and surround a knot-like structure [18]. The conserved core of the SET domain is flanked by a pre-SET (nSET) domain providing structural stability by interacting with different surfaces of the core SET domain, and a post-SET (cSET) domain responsible of the formation of a hydrophobic channel via an aromatic residue [19]. Neither pre-SET nor post-SET domains are conserved across KTM SET domains, as they vary in size and tertiary structure [20]. In the core SET domain, G9a contains an inserted i-SET domain (Figure 1a). The i-SET domain forms a rigid docking platform and a substrate binding groove with the post-SET domain in three-dimensional structures [21]. The G9a SET domain contains four structural zinc fingers for proper folding and enzymatic activity. A cluster of three Zn^{2+} ions is chelated by nine cysteines, whereas the fourth Zn^{2+} ion, adjacent to the S-adenosylmethionine (SAM)-binding site, is chelated by four cysteines [22]. The binding of AdoMet and the protein substrate occurs on opposite sides of the SET domain. AdoMet binds and positions its methyl group

at the base of the channel, while the side chain of the target lysine protrudes into the channel [20]. Within the SET domain, the tyrosine residue Y1154 was demonstrated to be essential for the catalytic activity of G9a [23]. The tyrosine may allow deprotonation of the positively charged ammonium group in order to favor methylation.

G9a also contains a cysteine-rich region, a polyglutamate region and seven ankyrin repeats of 33 amino acids (Figure 1a). The ankyrin repeat domain was reported to be a mono- and dimethyllysine binding module, a reader domain important for protein-protein interactions [24]. The specificity of the G9a ankyrin repeat domain is comparable to the specificity of other groups of reader proteins recognizing methyl binding protein modules, such as the chromodomain, the tudor domain, or the PHD finger domain [24]. G9a was the first protein described to harbor within a single polypeptide, the signal to catalyze and read the same epigenetic marks, H3K9me1, and H3K9me2 [24].

A nuclear localization signal was identified in the N-terminal region of human G9a [25], and amino acids 1-280 of human G9a were shown to act as a coactivator domain in transient reporter gene assays [10] (Figure 1a).

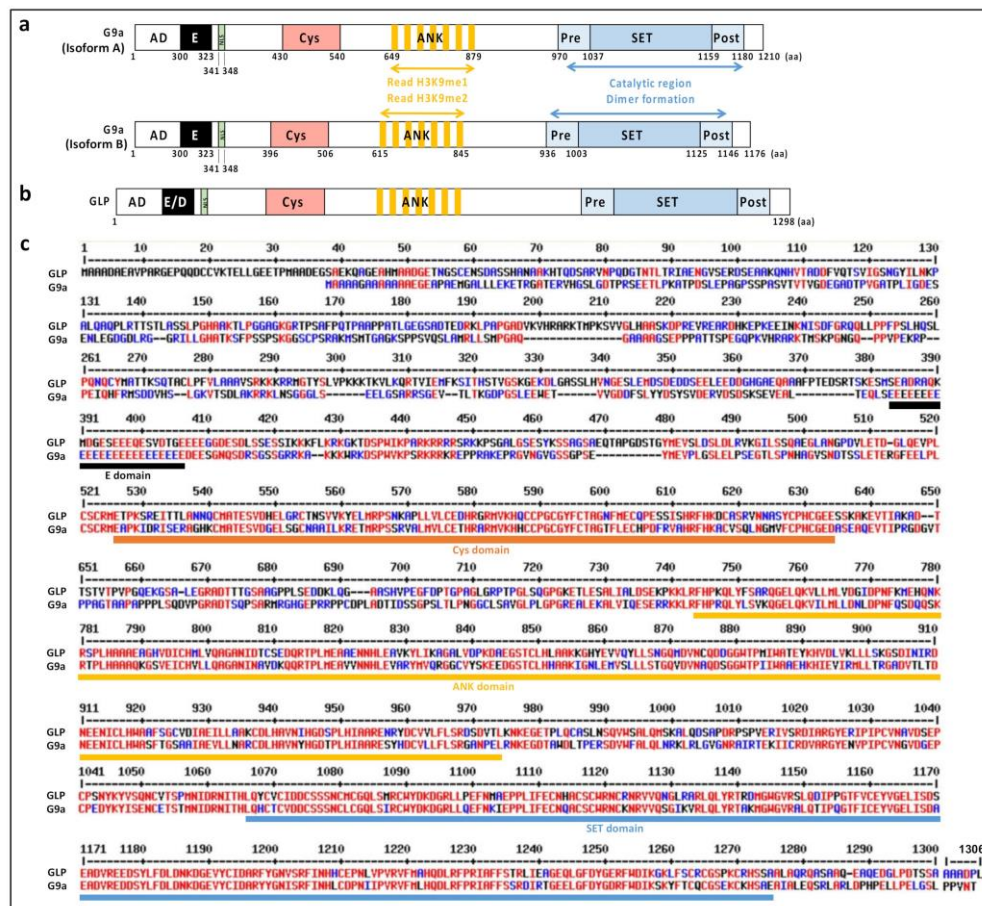

Figure 1. Schematic representation of the structure and domains of human G9a (a) and GLP (b). G9a and GLP contain different domains: an activation domain (AD), a Cys-rich region (Cys), an ankyrin repeat domain (ANK), and a SET domain composed of a core SET domain associated with pre- and a post-SET domains. G9a and GLP contain a nuclear localization signal (NLS). G9a also contains a Glu-rich region (E) and GLP a Glu/Asp-rich region (E/D). (c) Sequence alignment of G9a (NP_006700.3) and GLP (NP_079033.4). The alignment was performed using the MultAlin program [26] (<http://multalin.toulouse.inra.fr/multalin>) (accessed on 7 October 2021). Amino acids with 100% and >60% conservation are shown in red and blue, respectively.

2.2. GLP, a G9a Paralog

A paralog of G9a was identified and called G9a-like protein (GLP), though it is also termed lysine methyltransferase-1D (KMT1D) or euchromatic histone N-methyltransferase 1 (EHMT1) (Figure 1b). G9a and GLP share 45% sequence identity and around 70% sequence similarity (Figure 1c) [2]. They differ primarily in the N-terminus, and present a high level of conservation in the SET domain with over 80% shared sequence identity (Figure 1c) [27]. The main difference in structure between the two proteins concerns the E-rich domain of G9a, which is composed of a sequence of repeated glutamic and aspartic acid residues in the case of GLP (Figure 1b,c). In addition, binding affinities of the ankyrin domains of G9a and GLP for H3K9 differ, as GLP and G9a preferentially bind to mono and dimethylated H3K9, respectively [24,28].

G9a and GLP form homo- and heterodimers via their SET domains in complex with ZNF644 and WIZ [6,29–31]. In the endogenous complex, they act mainly as heterodimers in a large variety of human cells [6]. However, in vitro, independently of each other, G9a and GLP are able to catalyze lysine methylation by forming homodimers. Extensive research has focused on G9a, albeit GLP seems to be equally important for most biological phenomena ascribed to G9a. Indeed, GLP generally possesses similar catalytic activities as G9a [29]. However, the individual effects of G9a and GLP are hard to study, as G9a depletion destabilizes GLP [6,32].

3. Biochemical Features

3.1. Sequence Specificity

The majority of studies conducted on G9a sequence specificity focused on Histone H3. In vitro, the minimum substrate recognition site of seven amino acids of H3 is composed of residues 6 to 11 (TARKSTG), with a consensus methylation site encompassing RK/ARK [33]. The arginine residue adjacent to the lysine residue is essential for G9a activity [33]. G9a preferentially acts when a hydrophobic amino acid is positioned before the arginine residue, such as alanine. After the lysine residue, G9a favors a hydrophilic residue followed by a hydrophobic one. This G9a recognition site is present in several non-histone proteins, as well as on its N-terminal domain [34–36].

Several biochemical studies have shown that specific PTMs affect the catalytic activity of G9a. For instance, phosphorylation of S10 or T11 of H3 impairs G9a catalytic efficacy [33,36]. In addition, R8 of H3 can be methylated by the arginine methyltransferase PRMT5 in vivo, and this event impairs methylation of H3K9 by G9a [36]. Indeed, a decrease in methylation of over 80% was reported for peptides carrying an asymmetric dimethylation of R8, a methylation mark catalyzed by PRMT5 [36].

3.2. Product Specificity

G9a mainly catalyzes mono- and dimethylation events, as illustrated with H3K9 [6,24]. However, several reports demonstrated that G9a also generates, after a long incubation time, trimethylation of H3K9 (H3K9me3) [25,37]. Investigations on G9a-deficient cells demonstrated that G9a is the major H3K9me1 and H3K9me2 methyltransferase of euchromatin [5].

Biochemically, the specificity of G9a methylation for a particular state is largely due to a tyrosine residue in its active site. Indeed, Y1067 controls whether G9a catalyzes mono-, di- or trimethylation of lysines; Y1067 mutation to F1067 allowing G9a trimethylation of H3K9 [21]. Mechanistically, Y1067 forms hydrogen bonds with the nitrogen atom of the ϵ -amino group of the target lysine residue [21].

3.3. Regulation

3.3.1. PTMs

As for most proteins, G9a is subjected by many PTMs that regulate its ability to bind new partners and impact its cellular functions (Figure 2). Further details about their cellular features will be given in the corresponding sections below.

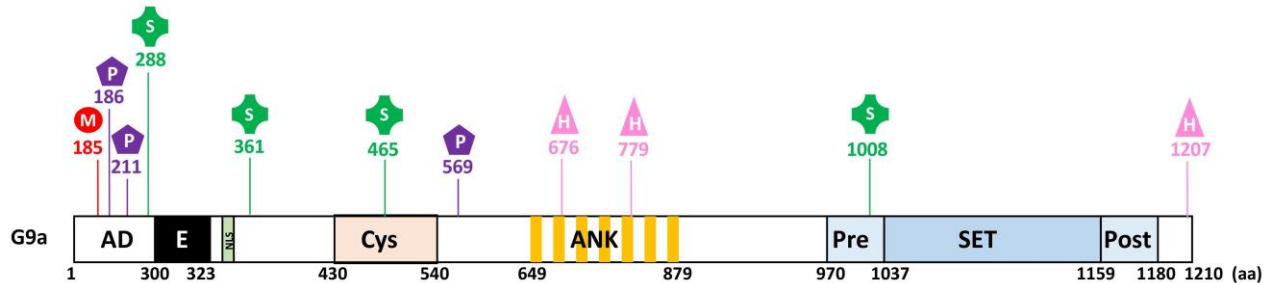

Figure 2. G9a undergoes several post-translational modifications including methylation (M), phosphorylation (P), sumoylation (S), and hydroxylation (H). The numbers indicate amino acid (aa) residues.

G9a was shown to be auto-methylated on lysine 185 (K185) and phosphorylated by the Aurora kinase B (AurKB) on the adjacent threonine 186 (T186) in the N-terminal domain of the protein [35] (Figure 2). Heterochromatin protein 1 proteins (HP1 α , HP1 β , HP1 γ) and CDYL (chromodomain Y-like) were identified as specific partners that bind methylated G9a [34,35]. These proteins contain chromodomains functioning as methyl-lysine binding modules. Of note, a similar methylation and phosphorylation switch on adjacent residues was previously demonstrated for the histone H3 [38,39]. H3K9me2 methylated by G9a recruits HP1 proteins, whereas H3 phosphorylated on S10 by AurKB has an opposite effect [38,39]. Like G9a, GLP is also auto-methylated on lysine 205 (K205) and phosphorylated by AurKB on threonine 206 (T206) [32]. Both G9a and GLP auto-methylation sites can be demethylated by the KDM4 lysine demethylase family [40]. Sampath et al. found no evidence of a role for G9a auto-methylation in the regulation of G9a enzymatic activity [35].

Additionally, G9a was shown to be phosphorylated on two serine residues involved in DNA damage repair, namely Serine 211 (S211) phosphorylated by casein kinase 2 (CK2) and serine 569 (S569) phosphorylated by ATM kinase (Figure 2) [41,42]. Interestingly, phosphorylation of G9a on S211 does not change its methyltransferase activity and G9a catalytic inhibitor does not affect G9a phosphorylation on S569 [41,42].

G9a is sumoylated in skeletal myoblasts in order to regulate its transcriptional activity [43]. This event acts as a signal for the recruitment of the histone acetyltransferase PCAF (p300/CBP-associated factor) to E2F1 target genes, implicated in cell cycle progression by increasing the level of histone H3 lysine 9 acetylation [43].

Casciello et al. demonstrated that G9a stability is regulated by proline hydroxylation catalyzed by oxygen sensors, as inhibition of the latter increased protein stability [44]. Authors showed that G9a hydroxylation is detected in normoxic conditions, whereas it is not detected under hypoxia. Proline hydroxylation occurs on proline residues 676 (P676) and 1207 (P1207) in consensus hydroxylation motifs LXXLAP and leads to efficient degradation by the proteasome (Figure 2) [44]. G9a is also hydroxylated in the ankyrin repeat domain of G9a on asparagine 779 (N779) by the asparaginyl hydroxylase factor inhibiting HIF (FIH) (Figure 2) [45]. This event impedes G9a binding to methylated H3K9 products and to di- and trimethylated H3K9. Hydroxylation of N779 destabilizes the interaction of H3K9me2 with the ankyrin repeat domain

of G9a by disrupting the structural pocket that facilitates methyl binding [24,45]. Likewise, GLP is hydroxylated on N867 [45].

3.3.2. Stability

G9a protein stability relies on the presence of GLP, as GLP depletion also decreases G9a expression [6,32]. Using G9a^{-/-} and GLP^{-/-} embryonic stem cells, Tachibana et al. reported that G9a is more stable in the G9a/GLP heteromeric complex. This observation did not apply to GLP [6]. The protein WIZ was reported to be a key partner of both G9a and GLP to stabilize the G9a/GLP heteromeric complex [30]. Both WIZ and GLP depletion decreases G9a protein levels, suggesting that the WIZ/G9a/GLP complex protects G9a from degradation [30]. Later, Bian et al. mapped the specific sequence of WIZ interacting with G9a/GLP. They showed that WIZ only interacts directly with the NTD of GLP [31]. Its interaction with G9a might be indirect and mediated by the fact that G9a and GLP form heterodimers. WIZ contains multiple zinc finger motifs, targeting the G9a/GLP complex to chromatin in order to mediate H3K9 methylation [31].

3.4. Substrates

3.4.1. Histone Substrates

In 2001, Tachibana et al. identified the first substrates of G9a as histone proteins [46] (Table 1). They demonstrated that G9a was able to add methyl groups to H3 on lysine 9 and lysine 27 [46]. Since then, G9a has largely been described as the major PKMT catalyzing the mono- and dimethylation of H3K9 [5], and, to a lesser extent, H3K9 trimethylation [25,37]. Though H3K9 methylation is well known for its role in transcriptional silencing [6,47], the impact of H3K27 methylation by G9a emerged more recently. Wu et al. demonstrated in 2011 that even though H3K27me_{2/3} is not affected in G9a^{-/-} ES cells, H3K27me₁ levels were clearly lower in these cells [48]. G9a also methylates H3 on lysine 56 (H3K56me₁) in order to maintain proper DNA replication [49], a methylation event that was shown to be induced by DNA damage [41].

Table 1. List of histone substrates of G9a and their biological outcome. Nd: not determined.

Histone Types	Sites	Biological Outcome	References
Histone H3	H3K9me1 H3K9me2 H3K9me3	Transcriptional repression Heterochromatin formation	[5,25,37]
Histone H3	H3K27me1	Transcriptional repression Heterochromatin formation	[46,48]
Histone H3	H3K56me1	DNA replication	[49]
Histone H1.2	H1.2K187me	nd	[51]
Histone H1.4	H1.4K26me1 H1.4K26me2	Transcriptional repression Chromatin structure	[50]

G9a methylates histone H1 in a variant-specific manner. Human cells have 11 H1 variants, two of which were shown to be methylated by G9a, namely isotype 2 (H1.2) and isotype 4 (H1.4) [50,51]. H1.4 was reported to be mono- and dimethylated on H1.4K26. This event provides a recognition site for HP1 binding, establishing a proper chromatin surface and suggesting a role for H1.4K26me_{1/2} in transcriptional repression [50]. G9a methylates H1.2 on K187 in vitro and in vivo. However, H1.2K187me₂ is not recognized by HP1 proteins,

demonstrating selective recognition by these proteins [51]. Weiss et al. demonstrated that G9a does not directly bind to methylated histone variants, suggesting a different mechanism from that observed in H3K9me1/2 to achieve methylation [51].

3.4.2. Non-Histone Substrates

G9a also methylates a large number of non-histone proteins involved in several biological functions listed in Table 2. Most of these are linked with transcriptional regulation, as G9a methylates numerous transcription factors, chromatin remodeling factors, and coregulators.

3.5. Inhibitors

Among the numerous G9a inhibitors, there are three different types: (i) substrate competitive inhibitors, (ii) SAM cofactor competitive inhibitors and (iii) inhibitors by ejection of Zn^{2+} ions. Substrate competitive inhibitors act by binding to G9a substrate binding sites, while SAM inhibitors prevent G9a-mediated methylation by interacting with SAM binding sites on G9a [52]. Most of these inhibitors also impact GLP [53].

3.5.1. Substrate Competitive Inhibitors

Substrate competitive inhibitors specifically bind to the substrate binding site of G9a. The first substrate competitive inhibitor discovered was BIX01294, a quinazolin derivative able to inhibit H3K9me2 [70]. Many studies then sought to optimize this inhibitor by enhancing its G9a specificity, efficacy and by reducing cell toxicity. Based on StructureActivity Relationship studies (SAR), modifications of BIX01294 provided more specific and powerful G9a inhibitors including UNC0224, UNC0321, UNC0638, UNC0646 [52]. The majority of G9a substrate competitive inhibitors impede G9a activity by interacting with two G9a aspartate residues in the SET domain (D1074 and D1083) [71,72]. Recently, by adding and expanding the 1,4 benzodiazepine cycle, Milite et al. improved UNC0638 potency and named it EML741 [73].

Table 2. List of substrates of G9a categorized by their biological functions. Nd: not determined.

Functions	Substrates	Site	Biological Outcome	References
Transcription Factors	C/EBPb	K39	Inhibits transcriptional activity by repressing C/EBPb transactivation	[54]
	MyoD	K104me1/2	Inhibits MyoD transcriptional activity	[55]
	MEF2D	K267me1/2	Inhibits MEF2D transcriptional activity by preventing its recruitment on chromatin	[56]
	p53	K373me2	Inhibits transcriptional activity and p53-dependent apoptosis	[57]
	ER α	K235me2	Induces transcriptional activity by recruiting the PHF20/MOF HAT complex	[58]

Chromatin remodeling factors and coregulators	Foxo1	K273me1/2	Induces Foxo1 degradation	[59]
	KLF12	K313	nd	[36]
	G9a	K185me2/3	Induces specific glucocorticoid receptor transcriptional activity by recruiting HP1 γ	[32,34,35]
	GLP	K205me2	Induces specific glucocorticoid receptor transcriptional activity by recruiting HP1 γ	[32]
	Sirt1	K662	nd	[60]
	Pontin	K265, K267, K268, K274, K281, K285	Induces HIF-1 transcriptional activity by enhancing p300 recruitment	[61]
	Reptin	K67me1	Inhibits HIF transcriptional activity by recruiting corepressors	[62]
	HDAC1	K432	nd	[36]
	HIF α	K674me1/2	Inhibits HIF-1 transcriptional activity	[63]
	CSB	K170, K297, K448, K1054	nd	[36]
MTA1	K532me1	Inhibits transcription by recruiting the assembly of the NuRD repressive complex	[64]	
ATF7IP (hAM)	K16me3	Induces transgene silencing by recruiting MPP8	[65]	

Table 2. Cont.

Functions	Substrates	Site	Biological Outcome	References
Chromatin binding protein	CDYL1	K135me3	Decreases its interaction with H3K9me3	[36]
	WIZ	K305me3	nd	[36]
	DNMT1	K70me2	nd	[36]
DNA methyltransferases	DNMT3	K47me2	Inhibits transcription by recruiting MPP8/DNMT3/G9a/GLP repressive complex	[66]
Others	Acinus	K654me2	nd	[36]

MDC1	K45me2	Induces ATM accumulation on damage sites	[67]
Plk1	K209me1	Antagonizes T210 phosphorylation to inhibit Plk1 activity on DNA replication	[68]
Lig1	K126me2/3	Maintenance in DNA methylation by promoting UHRF1 recruitment to replication foci	[69]

3.5.2. SAM Competitive Inhibitors

The cofactor SAM is the methyl donor essential for G9a-mediated methylation. SAM competitive inhibitors compete with SAM to bind to the SAM binding site of G9a. The first inhibitor of this class to be identified by Kubicek et al. was BIX01338, discovered around the same time as BIX01294 [70]. Analogous inhibitors were then synthesized with similar structures, such as BRD9536 and BRD4770 [74]. However, this type of inhibitor remains less specific than substrate competitive inhibitors, as it also downregulates the enzymatic activity of several other PKMTs [52].

3.5.3. Inhibition by Ejection of Structural Zn²⁺

Lastly, Lenstra et al. reported that structural zinc ions are essential to maintain the enzymatic activity of the methyltransferases G9a/GLP [22]. By using selenium- or sulfurcontaining proteins able to eject the fourth structural zinc ions, they demonstrated that G9a methyltransferase activity could be inhibited. Molecules used clinically such as ebselen, disulfiram, and cisplatin work specifically as inhibitors of G9a and GLP. These findings may offer new perspectives to develop further G9a-specific inhibitors [22].

4. Cellular Features

4.1. Connection with Chromatin Regulation

4.1.1. G9a Corepressor Functions

As mentioned above, G9a is a coregulator with an essential role in repression of gene transcription. Functionally, G9a is involved in several mechanisms, primarily the methylation of the histone H3 N-terminal tail in order to close chromatin (Table 1).

- G9a in Euchromatin

Numerous studies have shown that G9a is recruited to specific target genes as a corepressor by transcription factors, such as CCAAT displacement protein/cut (CDP/cut) [75], growth factor independent 1 (Gfi1) [76], positive regulatory domain I-binding factor 1 (PRDI-BF1) [77], neuron restrictive silencing factor (NRSF) (also known as REST) [78], multi-domain protein UHRF1 [79], and the noncoding RNA Air [80], in order to remodel chromatin structure. G9a also represses active gene transcription by recruiting other corepressors. For example, in euchromatin, G9a interacts with Polycomb Repressive Complex 2-proteins, including the PKMT EZH2, in order to transcriptionally silence specific regions within the genome (Figure 3a) [81].

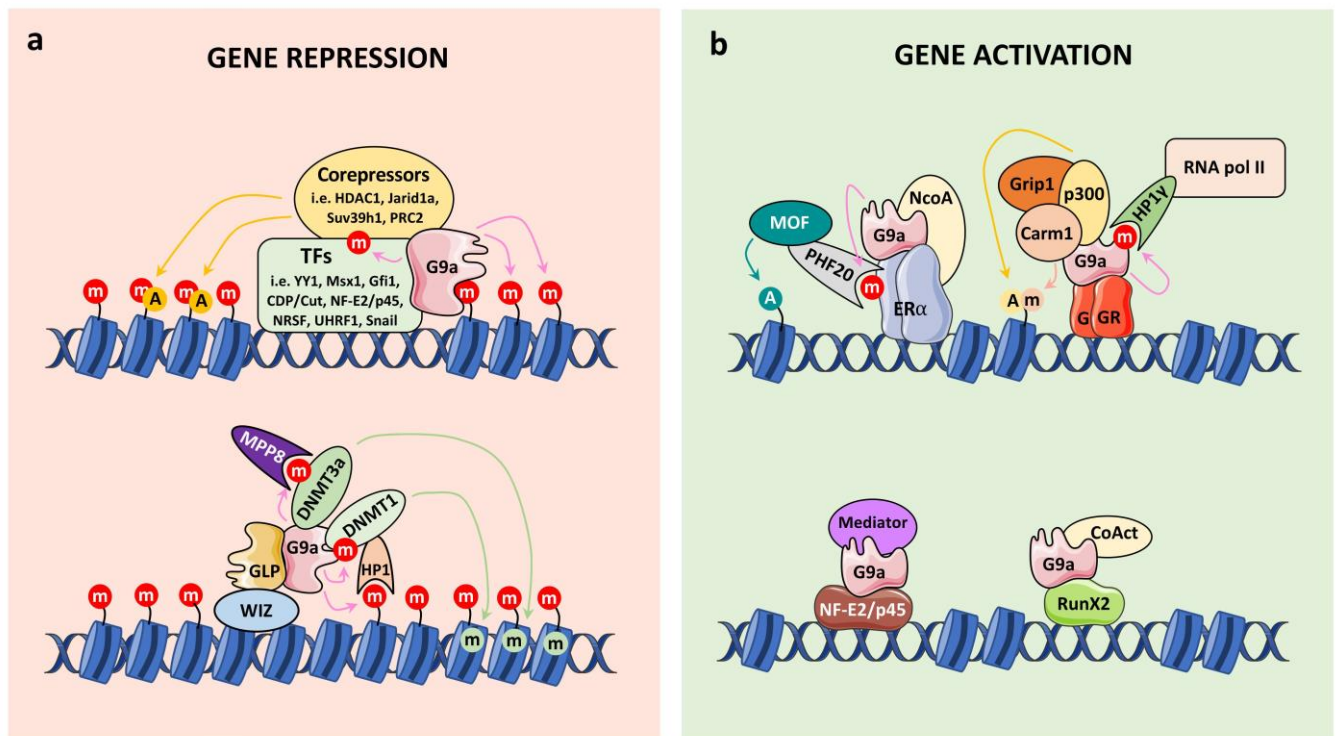

Figure 3. G9a acts as a transcriptional coregulator, either as a corepressor (a) or coactivator (b). (a) After G9a recruitment by some transcription factors (TFs), G9a methylates histones (red circles) leading to chromatin remodeling and gene repression. G9a also recruits corepressor proteins (i.e., other PKMTs and chromatin remodelers) and DNA methyltransferases (i.e., DNMT3a and DNMT1) in order to fully repress transcription via histone modifications (i.e., acetylation (orange circles) and DNA methylation (green circles)). Of note, G9a also methylates some TFs and DNA methyltransferases modulating their functions. (b) Conversely, G9a recruitment by the glucocorticoid receptor (GR), estrogen receptor (ER α), RunX2 and NF-E2/p45 leads to gene activation through the recruitment of specific coactivators (CoAct) (i.e., histone acetyltransferases and methyltransferases) and the transcription machinery (i.e., Mediator complex or RNA polymerase II).

- G9a in heterochromatin

In heterochromatin, G9a drives silencing mechanisms by serving as a platform for the formation of repressive complexes. Methylation of H3K9 leads to the recruitment of proteins such as HP1, which can bind to methylated H3K9 via their chromodomains [38,39]. This recruitment is crucial for heterochromatin formation and gene silencing [82]. In addition, G9a also recognizes H3K9 methylation via its ankyrin repeat in order to work as a scaffold for the recruitment of other corepressors [24]. It was shown for instance that G9a interacts with the PKMT Suv39h and SETDB1 in specific regions of heterochromatin to maintain chromosomal stability (Figure 3a) [83].

- G9a and DNA methylation

Other mechanisms underlying G9a repressive function have been identified. For example, the ankyrin repeat domain of G9a was reported to contribute to DNA methylation-mediated repression of transcription by recruiting DNA methyltransferases (DNMT3a and DNMT3b), and by recognizing the H3K9me2 histone mark [24,84]. A specific residue of the ankyrin repeat domain (Asp905) has also been associated with this co-repressive function by maintaining H3K9me2 levels and establishing DNA methylation [85]. In addition, Chang et al. demonstrated that G9a dimethylates DNMT3a on K47, allowing its recognition by the MPP8 chromodomain [66]. This event results in a silencing

complex containing DNMT3a/MPP8/G9a on chromatin that could in part explain the co-occurrence of DNA methylation and H3K9 methylation in chromatin (Figure 3a). Additionally, Smallwood et al reported that HP1 proteins, the readers of H3K9 methylation, target DNMT1 enzyme to euchromatic sites, providing a basis for the generation of CpG methylation [86]. Finally, DNMT1 is methylated by G9a reinforcing the whole model [36] (Figure 3a).

4.1.2. G9a Coactivator Functions

In addition to the well-studied and established co-repressive function of G9a, reports have emerged on its function as a coactivator, by contributing to the activation of gene expression [9–12,32,87,88].

It was suggested that different binding partners may play critical roles in the switch between the coactivator and corepressor functions of G9a. Indeed, G9a stabilizes the occupancy of the Mediator complex on the promoter of the adult β globin gene in a NFE2/p45-dependent manner to exert its coactivator function, while it recruits the H3K4 demethylase Jarid1a to the promoter of the embryonic β globin gene and results in transcription repression [12,89] (Figure 3b). It has also been shown that G9a is recruited to the promoter or enhancer regions of its positively regulated target genes, indicating that G9a may act directly on their expression [8–12,32,87–89]. In addition, G9a was reported to bind to RNA polymerase II, indicating that G9a may be involved in the establishment of a preinitiation or initiation complex during transcription [12].

The G9a activation domain (AD) (amino acid 1–280 in human G9a) was first identified by Dr. Stallcup's group using transient reporter gene assay [10] (Figure 1). G9a AD is sufficient and required for its coactivator function [10] and contains an autonomous activation domain [9]. Recently, we demonstrated the importance of G9a auto-methylation in the G9a AD for its coactivator function. Indeed, auto-methylation of G9a (K185) is required for its coactivator function with the glucocorticoid receptor (GR), by facilitating the binding of HP1 γ and the subsequent recruitment of RNA pol II [32]. Inversely, G9a phosphorylation

(T186) by AurKB antagonizes these effects (Figure 3b). Thus, these adjacent modifications regulate coactivator functions and contribute to determining whether G9a act as a coactivator or corepressor [32]. At the physiological level, we demonstrated that the coactivator activity of G9a regulates migration of the lung cancer cell line, A549 [32], and GC-induced cell death in leukemia [32,88]. In addition, G9a was reported to function as a scaffold protein to recruit the coactivators p300 and CARM1 on a subset of GR target genes, leading to transcriptional activation [8,9].

G9a also acts as a coactivator by specifically methylating the estrogen receptor alpha (ER α) on K235 [58]. This event is recognized by the Tudor domain of PHF20, which recruits the MOF histone acetyltransferase complex in order to acetylate H4K16 and promote active transcription (Figure 3b). Through this mechanism, G9a regulates a specific subset of ER α target genes [58].

4.2. Cellular Roles and Functions

4.2.1. Embryonic Development

Most PKMTs are essential for the formation of healthy embryo, as they remodel histones and control chromatin packaging and transcriptional accessibility along the genome [1]. Hence, it came as no surprise that G9a knockout impacted embryonic development [5]. Embryo of mice genetically engineered to be G9a-deficient displayed delayed development, growth arrest by the earliest stages monitored, and were no longer viable by embryonic day 9.5 [5]. Histones extracted from G9a-deficient embryos showed a strong

decrease in H3K9me2 [5,6] Later studies, then reported the importance of G9a in specific developing tissues and organs based on different analyses.

- Germ Cell Development

Germ line-specific G9a knockout mice were shown to be sterile due to a drastic loss of mature gametes [90]. In addition, completion of meiosis was not observed in either gender. In G9a-deficient germ cells, H3K9me1/2 decreased during meiosis, suggesting that gene silencing induced by G9a is crucial for proper meiotic prophase progression [90].

- Cardiac Development

Engineered mice in which GLP was knocked out and G9a knocked down in cardiomyocytes showed neonatal lethality and atrioventricular septal defects, strongly implicating G9a and GLP in cardiomyocyte function for atrioventricular septum formation [91]. However, cardiomyocyte-specific G9a knockout mice were normal and the loss of G9a induced only a slight decrease in H3K9me2 levels in cardiomyocytes, indicating that adequate H3K9me2 can be performed by enzymes other than G9a in cardiomyocytes [91].

- Neuronal Development

Neuron-specific deficiency of G9a did not reveal obvious neuronal developmental or architectural defects [92]. However, these mice displayed various abnormal phenotypes, including defects in cognition and adaptive behaviors, such as difficulties in learning, motivation and environmental adaptation [92]. Authors demonstrated that multiple non-adult neuronal and non-neuronal progenitor genes were derepressed in the forebrain of these mice deficient for G9a [92]. Using pharmacological inhibition of G9a/GLP activity, it was demonstrated that G9a/GLP are required in the dorsal hippocampus for the transcriptional switch from short-term to long-term spatial memory formation [93]. Repression of G9a and H3K9 methylation has been described in postmortem nucleus accumbens of human cocaine addicts, indicating a clinical relevance of G9a in human addiction [94]. Through extended analyses, Maze et al. demonstrated a role for G9a in neuronal subtype identity in the adult central nervous system, and a critical function for G9a and H3K9 methylation in the regulation of behavioral responses to environmental stimuli [95].

- Bone Formation

G9a protein levels and H3K9me2 were reported to increase during developmental progression in tooth and growth plate cartilage [96]. G9a methyltransferase activity regulates cell proliferation and differentiation in dental mesenchyme in order to promote proper tooth development [96].

Using two different models of conditional G9a knockout mice, G9a was shown to be involved in cranial bone formation, since mutant mice had severe defects in cranial vault bones with opened fontanelles [97,98]. Mechanistically, the effect of G9a on cranial bone formation relies on its function as repressor of Twist expression during osteoblastic differentiation and as coactivator of RunX2 [97,98]. Stallcup's group demonstrated that G9a is able to enhance RunX2-mediated transcription in transient reporter gene assays by acting as a coactivator of RunX2 [11]. RunX2 is a key transcription factor of bone-forming cells by regulating osteoblastic differentiation [99]. Later, Ideno et al. showed that G9a enhances RunX2 transcriptional activity in mesodermal cells through binding and activation of RunX2 [97].

- Other Mechanisms

G9a knockdown or inhibition through pharmacological inhibitors in adult erythroid cells induces re-emergence of a fetal gene program, illustrated by the switch in expression from adult to fetal β -globin isoforms [12,89] (Figure 3).

Conditional knockout of G9a in the skeletal muscle lineage highlighted that G9a has little effect on skeletal myogenesis [100].

Targeted depletion of G9a in the developing mouse retina generated disorganized tissues [101]. According to the authors this was due to the fact that retinal progenitor cells depleted for G9a were highly proliferative and were not able to mature into the specialized components of the retina [101]. Similar results were obtained in zebrafish embryos knocked down for G9a using morpholino antisense oligos [102].

These different studies clearly demonstrated that G9a has a major impact on embryonic development, with roles in various pathologies, including neurological disorders, cardiac pathogenesis, immune cell development, and cancer progression.

4.2.2. Hypoxia

In mammalian cell lines, G9a activity was reported to increase under hypoxic conditions, concomitant to an increase in total H3K9me2 levels, resulting in gene silencing [103]. In G9a^{-/-} mouse embryonic stem cells under hypoxic conditions, the level of H3K9me2 was significantly lower, demonstrating that G9a was involved in hypoxia-induced H3K9me2 [103]. The hypoxic upregulation of G9a was attributed to specific PTMs (Figure 4). As described previously, G9a is hydroxylated at residues P676 and P1207 by PHD1 in order to target G9a toward proteasome degradation via ubiquitinylation [44]. Hypoxia induces PHD1 inhibition and a subsequent upregulation of G9a, leading to an increase in H3K9me2 and the silencing of a specific subset of target genes. Casciello et al demonstrated that G9a inhibition decreases proliferation, migration, and in vivo tumor growth [44]. Likewise, in ovarian cancer, FIH reaction was limited under hypoxia, leading to a reduced expression of metastasis-suppressor genes via H3K9 methylation [45]. Mechanistically, FIH induces hydroxylation of G9a on N779, impairing its ability to bind mono- and dimethylated H3K9, and thus methylate H3K9 [45] (Figure 4).

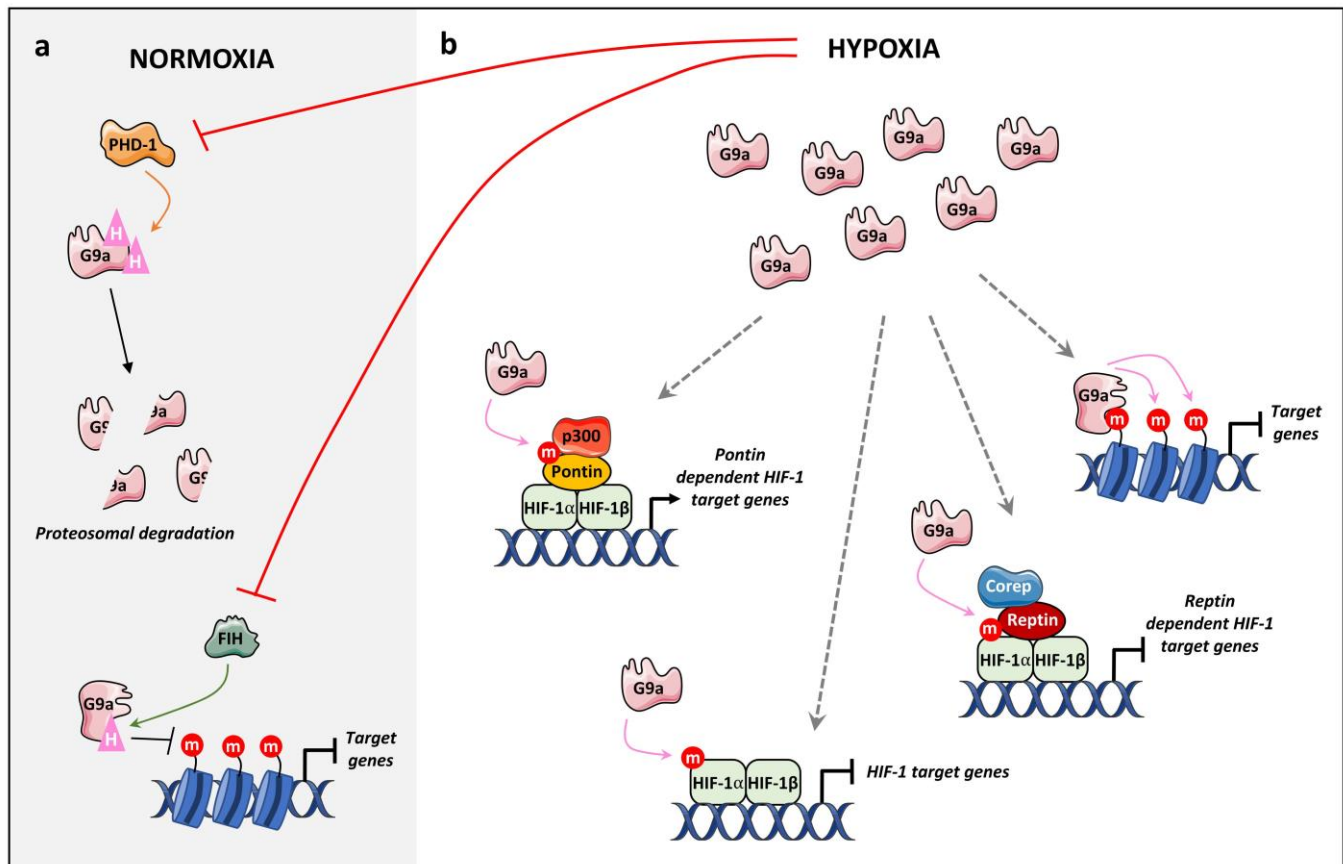

Figure 4. The role of G9a in hypoxia. (a) In normoxia, PHD-1 hydroxylates G9a on P676 and P1207 leading to proteasomal degradation. Likewise, FIH hydroxylates G9a on N779 impairing its ability to bind to H3K9me1/2 products. These hydroxylation processes are inhibited under hypoxic conditions resulting in an increase in the global level of G9a protein and H3K9me2. (b) In addition, under hypoxia, G9a methylates histones and non-histone targets. Hypoxia increases G9a-dependent H3K9me2 at the promoter regions of several genes leading to their repression. In addition, G9a methylates HIF-1 α coregulators Pontin and Reptin during hypoxic stress, leading to the activation and repression of HIF-1 α target genes. Finally, HIF-1 methylation by G9a suppresses HIF-1 α transcriptional activity under hypoxia.

However, the role of G9a under hypoxia is likely more extensive, as G9a methylates many protein substrates involved in hypoxia, namely Pontin, Reptin, and HIF-1 α [61–63] (Figure 4). Bao et al. demonstrated that HIF-1 α , a master regulator of the hypoxic response, is mono- and dimethylated by G9a on K674 [63]. They demonstrated that G9a is able to methylate HIF-1 α in an oxygen-independent manner. However, endogenous HIF-1 α is unstable and degraded under normoxic conditions, indicating that HIF-1 α is unlikely to be methylated in normoxia [63]. HIF-1 α K674me1/2 suppresses HIF-1 α transcriptional activity under hypoxia and expression of its downstream target genes (Figure 4). These authors also demonstrated that HIF α methylation by G9a decreases HIF-1-dependent migration of glioblastoma cells [63]. In addition, G9a methylates Reptin and Pontin, two chromatin remodelers involved in hypoxia, known to bind to HIF-1 proteins [61,62]. Under hypoxia, G9a monomethylates Reptin on K67 (K67me1), this methylation negatively regulates a subset of hypoxia target genes via the recruitment of Reptin K67me1 to their promoters and an enhanced binding to HIF-1 α [62]. In addition, Reptin K67me1 leads to the recruitment of corepressors such as HDAC1 to hypoxia-responsive gene promoters in order to decrease HIF-1 α transcriptional activity [62] (Figure 4). Conversely, under hypoxia, G9a methylates Pontin on six lysine residues (K265, K267, K268, K274, K281, K285), enhancing p300 coactivator recruitment on the

promoters of HIF-1 α target genes, resulting in an increase in HIF-1 transcriptional activity [62] (Figure 4). Although Reptin and Pontin share similarities in their structures, they act as coactivator or corepressor of HIF-1 depending on their subset of target genes in order to modulate cellular responses to hypoxia [61,62].

The ability of G9a to repress genes under hypoxic conditions suggests a key role for G9a in cell survival processes in this condition, especially in solid tumors where hypoxia is a common microenvironmental state.

4.2.3. DNA Damage and DNA Repair

Two reports demonstrated that G9a was recruited to DNA-damage sites, mainly through G9a phosphorylation [41,42]. G9a is phosphorylated by casein kinase 2 (CK2) at S211 in response to DNA double-strand breaks (DSBs), promoting G9a recruitment to sites of DNA damage by increasing its interaction with chromatin, where it can directly interact with replication protein A (RPA) [42]. In turn, binding of G9a to RPA modulates RPA and Rad51 foci formation, allowing efficient homologous recombination of DSBs and cell survival [42]. In parallel, Ginjala et al. demonstrated that G9a is phosphorylated by ATM kinase on S569 [41]. This event also leads to its recruitment to sites of DNA breaks. Authors demonstrated that the catalytic activity of G9a is critical for early recruitment of 53BP1 and BRCA1 to DNA lesions, but dispensable for their late recruitment. Induction of DSBs leads to an increase in H3K9me2 and H3K56me1 in their neighboring chromatin, two histone targets of G9a [41]. Inhibition of the catalytic activity of G9a decreases these modifications, suggesting that G9a could be recruited to DNA breaks in order to induce local histone methylation and subsequent local transcriptional silencing. Finally, using GFP-based reporters of homologous repair (HR) or non-homologous end-joining repair (NHEJ), they demonstrated that the catalytic activity of G9a impairs both mechanisms, HR and NHEJ [41]. Moreover, phosphorylation of S211 and S569 appears to be essential for proper DNA repair [41,42].

G9a may also methylate specific non-histone proteins involved in DNA repair mechanisms, such as Polo-like kinase 1 (Plk1) and p53 [57,68]. Plk1 phosphorylation on T210 is required during DNA damage repair and checkpoint recovery [104]. Recently Li et al. demonstrated that the activity of Plk1 is controlled by a switch between methylation and phosphorylation, as for G9a and GLP [68]. Authors showed that under DNA damage stress conditions, the interaction between G9a and Plk1 is enhanced and G9a monomethylation on K209 of Plk1 is increased [68]. Interestingly, Plk1 methylation by G9a is not necessary for its recruitment to DNA lesions or for the assembly of the DNA repair machinery via RPA and Rad51 recruitment. However, this methylation is crucial for the timely removal of this DNA repair machinery from DNA lesions, which is essential for the proper completion of DNA damage repair [68]. The tumor suppressor p53 was also demonstrated to be a substrate for G9a on K373 [57]. However, p53 methylation seems to be linked with inactive p53, as the level of methylated p53 during DNA damage does not change even though the total level of p53 increases dramatically [57]. This data is consistent with the fact that catalytic inhibition of G9a using inhibitors under low DNA damage conditions impairs DNA DSB repair in a p53-independent manner [105]. However, it is interesting to note that G9a dimethylation of p53 at K373 increases Plk1 expression and promotes colorectal cancer [106].

These reports clearly demonstrate the relevance of G9a in the maintenance of genome integrity, implicating G9a in cancer biology.

5. G9a in Cancer

5.1. G9a Oncogenic Role

Recently, dysregulations in the PTMs of both DNA and histones were shown to contribute to cancer initiation and progression [107]. These epigenetic modifications, which result in altered chromatin structure and gene expression were reported in different types of cancers [108] (Figure 3). G9a was overexpressed in breast, gastric, ovarian, cervical, endometrial, prostate, lung, colorectal, liver, urinary bladder, and brain cancers, as well as in hematological malignancies, melanoma, and cholangiocarcinoma, leading to aberrant H3K9 methylation [109–122]. One of the main reasons for this increase in G9a expression and H3K9 methylation is hypoxia [103]. The molecular mechanisms associated with this phenomenon are described in a previous section (Figure 4). Furthermore, high levels of G9a expression were associated with poor prognosis and shorter survival in cancer patients [57,123–127]. G9a involvement in cancer biology is likely due to its pivotal role in tumor cell proliferation, survival, and metastasis primarily by controlling several transcription programs (Table 3).

5.1.1. Breast Cancer

High G9a-mediated H3K9 methylation triggers the proliferation and progression of breast cancer (Table 3) [109,128,129]. For instance, G9a overexpression was shown to downregulate the expression of some tumor suppressor genes, such as ARNTL, CEACAM7, GATA2, HHEX, KLRG1, and OGN. Blocking G9a methyltransferase activity was sufficient to re-express these genes, and consequently inhibit breast cancer cell proliferation and migration in vitro and tumor growth in vivo [44]. G9a was also demonstrated to interact with MYC and suppress its target genes by favoring H3K9me2, in order to stimulate MYC-dependent breast tumor growth [129]. G9a may also contribute to enhancing breast tumor metastasis by silencing several genes implicated in epithelial-mesenchymal transition (EMT), namely the two anti-metastatic tumor suppressor genes, desmocollin 3 (DSC3), belonging to the cadherin superfamily, and the protease inhibitor MASPIN, which were transcriptionally reactivated in a dose-dependent manner upon inhibition of G9a activity, concomitantly to a significant decrease in global H3K9 dimethylation [130]. In addition, in EMT, G9a was shown to repress the expression of E-cadherin, a cell adhesion factor, upon association with the SNAIL transcription factor and to induce H3K9me2 of its promoter [131]. Depletion of G9a restored E-cadherin expression and inhibited breast cancer cell migration and invasion in vitro and in vivo [131]. G9a also silenced the expression of the type-II cadherin CDH10 through histone methylation, stimulating hypoxia-mediated cellular motility; and its inhibition prevented cellular movement and breast cancer cell colonization in the lungs [123]. G9a methyltransferase activity was further reported to (i) collaborate with the transcription factor YY1 and HDAC1 to disrupt cellular iron homeostasis by repressing ferroxidase hephaestin, resulting in iron accumulation and breast cancer progression [109], (ii) induce breast cancer cell autophagy by modulating the AMPK-mTOR pathways [132], and (iii) promote breast cancer recurrence through the suppression of pro-inflammatory genes [133].

5.1.2. Gastric Cancer

In gastric cancer, G9a activation reduces apoptosis and promotes tumor cell growth (Table 3) [134]. For instance, blocking the catalytic activity of G9a reduces cell growth and autophagy by downregulating the mechanistic target of rapamycin (mTOR) pathways. Authors showed that G9a activates mTOR through H3K9 monomethylation at the mTOR promoter [125]. G9a inhibition by (i) kaempferol, a flavonoid present in fruits and vegetables [135], (ii) SH003, an herbal

formulation [136], or (iii) cinnamaldehyde (CA), the bioactive ingredient in *Cinnamomum* [137], stimulated autophagic gastric cancer cell death. Increase in H3K9 methylation under hypoxia also mediated the silencing of the tumor suppressor gene, runt-domain transcription factor 3 (RUNX3) [138]. Finally, G9a overexpression was shown to upregulate the expression of ITGB3, an integrin family member, in an enzyme-independent manner inducing gastric cancer metastasis [139].

5.1.3. Human Reproductive Cancers

Alterations in G9a expression were also associated with human reproductive cancers (Table 3). In ovarian cancer (OCa), high G9a expression levels were correlated with late stage, high grade, and a decreased overall survival in OCa patients [111,140]. An elevation in the level of G9a was observed in vitro in invasive cell lines ES-2, SKOV-3, TOV-21G, OV-90, and OVCAR-3, and in vivo in metastatic lesions in comparison with less aggressive tumor cells and primary tumors [111]. Depletion of G9a inhibited cellular adhesion, migration, invasion, and anoikis-resistance of OCa cell lines in vitro and suppressed OCa metastasis in vivo [111]. Further investigations revealed that several tumor suppressor genes were repressed in OCa by G9a, such as DUSP5, SPRY4, CDH1, and PPP1R15A. PARP inhibitor-resistant high-grade serous ovarian carcinoma (HGSOC) displayed an increase in H3K9me2 associated with an increase in the overall expression of G9a [140]. Similar observations were made in vivo on patient-derived xenografts, indicating that a high G9a expression maintains resistance to PARP inhibitors [140]. Interestingly, inhibition of G9a displayed synergistic anti-tumor effects in combination with DNA methylation inhibitors in OCa cell lines, where authors induced cell death by upregulating endogenous retroviruses (ERVs), consequently activating the viral immune response [141].

In cervical cancer, G9a induces the expression of angiogenic factors including angiogenin, interleukin-8, and C-X-C motif chemokine ligand-16, prompting angiogenesis and cancer cell invasion, and decreasing patient survival [142]. Interestingly, depletion of G9a decreased the expression of oncogenic proteins such as Bcl-2, Mcl-1, and Survivin, and increased the expression of E-cadherin inhibiting cell adhesion and invasion [112].

Likewise, in endometrial cancer, G9a-mediated H3K9 methylation induced tumor invasion in vitro and in vivo via the silencing of the E-cadherin [113]. Indeed, G9a depletion reduces H3K9me2 levels, restores E-cadherin expression and decreases E-cadherin promoter DNA methyltransferase recruitment. G9a expression is higher in endometrial cancer tissues and its expression is correlated with deep myometrial invasion [113].

Finally, in prostate cancer, high G9a expression was associated with high pathological grade and poor overall survival. In this model, G9a promoted cancer proliferation by inhibiting PI3K/AKT/mTOR pathway [114].

5.1.4. Lung Cancer

In lung cancer, G9a possesses proliferative and metastatic properties (Table 3) [114]. Highly invasive lung cancer cell lines were reported to display higher G9a protein levels, in comparison with weakly invasive cells. Overexpressing G9a increased cell motility and invasiveness [143]. Different reports demonstrated that G9a induced tumor growth, invasion, and migration by (i) silencing specific EMT-regulating genes, including caspase-1 and the epithelial cell adhesion molecule Ep-CAM [124,144], (ii) mediating the Snail2-induced E-cadherin suppression [145], and/or (iii) activating the focal adhesion kinase signaling pathway [146]. Depletion of G9a abolished lung cancer cell

migration and invasion in vitro and metastasis in vivo [124,144,146]. G9a also induced cell proliferation through the activation of the WNT signaling pathway by suppressing WNT signaling inhibitors like DKK1, APC2, and WIF1 [121]. Moreover, G9a was shown to play an important role in maintaining lung cancer cell stemness by maintaining DNA methylation of multiple lung cancer stem cell genes and their subsequent expression [147].

5.1.5. Colorectal Cancer

In colorectal cancer (CRC), high levels of G9a are associated with tumor initiation, maintenance, and proliferation (Table 3) [59,106,148]. In primary CRC patient samples, transcriptome profiling revealed the co-enrichment of G9a and H3K9me2 of multiple genes involved in the negative regulation of the WNT signaling pathway, in repression of EMT and extracellular matrix organization, leading to their repression in CRC [148]. G9a also methylates two non-histone substrates involved in CRC cell proliferation, FOXO1 (Forkhead family transcription factor) and p53 [59,106]. FOXO1 is methylated by G9a on K273, increasing the interaction between FOXO1 and the E3 ligase SKP2. This event decreases FOXO1 protein stability and promotes cellular proliferation in colon cancer [59]. These authors also demonstrated that G9a protein expression is increased in human colon cancer patient tissue samples associated with a decrease in FOXO1 protein level [59]. Likewise, G9a-mediated p53 dimethylation at lysine 373 was shown to increase Plk1 expression and consequently CRC cell growth [106].

5.1.6. Hepatocellular Carcinoma

In hepatocellular carcinoma (HCC), targeting G9a is suggested as a novel therapy for HCC treatment as it drives tumorigenesis and aggressiveness (Table 3) [149,150]. Indeed, G9a is upregulated in HCC, which leads to the epigenetic silencing of the retinoic acid receptor responder protein 3 (RARRES3) tumor suppressor gene, thus triggering HCC proliferation and metastasis in vitro and in vivo [116]. Moreover, G9a was shown to enhance metastasis formation through an epigenetic regulation of EMT, as it interacts with SNAIL2 and HDACs at the E-cadherin promoter in order to inhibit E-cadherin transcription [151]. A recent study showed that G9a contributes to HCC initiation by escaping p53-induced apoptosis in DNA-damaged hepatocytes via the repression of Bcl-2 expression, a pro-apoptotic Bcl-2 family member [152].

5.1.7. Urinary Bladder Cancer

G9a was reported to be upregulated or amplified in urinary bladder cancer (UBC) [153]. G9a represents a promising therapeutic target for UBC as various G9a inhibitors decrease cell proliferation and increase cell death through the endoplasmic reticulum stress pathway [153]. Likewise, targeting G9a and DNMT methyltransferase activity with a novel dual inhibitor called CM-272 induces cell apoptosis and immunogenic cell death [153].

5.1.8. Hematological Cancers

G9a is upregulated in hematological malignancies, for which G9a inhibitors have been identified as promising targets for patient management (Table 3) [154–158]. In Tlymphoblastic leukemia cells (T-ALL), inhibiting G9a activity suppresses cellular proliferation and induces apoptosis by downregulating the expression of Bcl-2 and upregulating the expression of Bax and caspase-3 [155]. Likewise, in chronic lymphocytic leukemia, targeting G9a and GLP was shown to stimulate cancer cell death [154]. In multiple myeloma, G9a fosters RelB-

dependent cancer growth and survival, whereas its depletion reduces the expression of RelB and increases the expression of pro-apoptotic genes, such as Bim and BMF [118]. In acute myeloid leukemia (AML), G9a inhibition attenuates the transcriptional activity of the leukemogenic transcription factor HoxA9 and thus promotes AML proliferation, progression, and self-renewal [157]. In childhood acute lymphoblastic leukemia, G9a is reported to enhance the ability of cancer cells to migrate [159].

Table 3. Role of G9a in Cancer Biology.

G9a Roles	Cancer Types	G9a Biological Roles	References
Oncogenic	Breast Cancer	Suppresses tumor suppressor genes	[44,130]
		Enhances EMT	[123,131]
		Disrupts iron homeostasis	[109]
		Inhibits autophagy	[132]
	Gastric Cancer	Suppresses tumor suppressor genes	[138]
		Inhibits apoptosis and autophagy	[125,135–137]
		Promotes metastasis	[139]
	Ovarian Cancer	Promotes metastasis	[111]
		Suppresses tumor suppressor genes	[45,111]
		Maintains PARP-inhibitor resistance	[140]
	Cervical Cancer	Induces angiogenesis	[142]
		Enhances tissue invasion	[112]
	Endometrial Cancer	Enhances tissue invasion	[113]
	Prostate Cancer	Stimulates proliferation	[114]
	Lung Cancer	Enhances EMT	[124,144,145,160]
Activates WNT signaling pathway			
Maintains lung cancer stemness			
Supports resistance to radiotherapy			
Colorectal Cancer	Stimulates proliferation	[59,106]	
	Enhances self-renewal and stemness		
	Promotes resistance to chemotherapy		
Liver Cancer	Suppresses tumor suppressor genes	[116]	
	Enhances EMT	[151]	
	Inhibits cell apoptosis	[152]	
Bladder Cancer	Inhibits cell apoptosis and autophagy	[122,153]	
Brain Cancer	Stimulates proliferation Inhibits autophagy	[117,163] [164]	

		Enhances self-renewal and stemness	[157]
	Hematological malignancies	Promotes migration	[159]
		Inhibits apoptosis and stimulates proliferation	[118,155]
	Skin Cancer	Promotes progression	[119,165]
	Head and Neck Cancer	Enhances EMT	[166]
	Bile duct Cancer	Suppresses tumor suppressor genes	[120]
	Lung Cancer	Inhibits cancer progression	[167]
Antioncogenic	Brain Cancer	Inhibits HIF-induced migration Inhibits cancer stemness	[63]

5.1.9. Other Cancers

G9a represents an intriguing target in various other types of cancers (Table 3). In medulloblastoma, G9a drives H3K9me1/2/3 at the promoter of ubiquitin-specific protease 37 (USP37) to repress its gene expression [163]. USP37 controls cell proliferation by regulating the stability of the cyclin-dependent kinase inhibitor 1B (CDKN1B/p27Kip1) in cell cycle. Thus, blocking G9a inhibits cellular proliferation and tumorigenic potential of medulloblastoma cells [163]. Pre- or post-treatment of glioma cells with a G9a inhibitor sensitizes these cells to Temozolomide (TMZ), the first line therapy for glioblastoma patients, and increases its cytotoxicity [168]. Interestingly, authors demonstrated that the G9a inhibitor reprograms glioma cells and glioma stem-like cells to increase sensitivity to TMZ [164,168]. As previously described in breast cancer, HCC, and lung cancer, G9a interacts with SNAIL in order to mediate repression of E-cadherin and EMT in head and neck squamous cell carcinoma (HNSCC) [166]. Additionally, G9a was associated with cholangiocarcinoma, a highly malignant epithelial tumor of the biliary tree, where G9a-mediated H3K9 methylation suppressed the expression of the tumor suppressor gene LATS2, leading to the subsequent activation of the oncogenic YAP signaling pathway [120]. Recently in melanoma, elevated G9a levels promoted cancer progression through the activation of the WNT/ β -catenin signaling by epigenetic silencing of the WNT antagonist DKK1 gene [165], or through the upregulation of the Notch1 signaling pathway, that further stimulates PI3K/AKT pathway [119].

5.2. G9a Tumor Suppressive Role

In stark contrast to its oncogenic roles, several studies demonstrated that G9a also promotes tumor suppressive functions. For example, G9a depletion increased the aggressiveness of lung tumor propagating cells (TPC) and accelerated disease progression and metastasis [167]. Inhibition of G9a derepresses genes that regulate the extracellular matrix. Patients with high levels of G9a displayed a better survival in early-stage lung cancer [167]. Interestingly, in glioblastoma, G9a inhibited HIF-1 α -mediated migration via the methylation of the alpha subunit at lysine 674 [63].

6. Outlook

Over the last three decades since G9a was discovered, extensive studies were conducted to gain further insight into its physiological and pathophysiological roles. Aside from its key role in epigenetic repression

through H3K9 methylation, G9a displays many biological functions, notably in gene expression, associated with its methylation of histone and non-histone substrates. Furthermore, a growing body of evidence indicates that G9a acts as a coregulator of transcription factors and steroid receptors, and could hence endorse other functions through these properties. Owing to its broad implication in biological activities, dysregulation of G9a expression is common to many types of cancers, and, as such, G9a represents a promising target for anti-cancer agents. Indeed, many inhibitors of G9a inhibitors have been synthesized and characterized, and could represent interesting therapeutic agents.

Author Contributions: C.P., L.M.N. and L.P. wrote the manuscript. M.L.R. revised it. All authors have read and agreed to the published version of the manuscript.

Funding: M.L.R., L.M.N., L.P. and C.P.'s laboratory is funded with grants from “La Ligue contre le Cancer”, the “Fondation ARC Cancer” and the association “Cancer du sein, parlons en”. L.M.N. was supported by a fellowship from AZM & Saadeh Association and Lebanese University.

Acknowledgments: We thank B. Manship for proofreading the manuscript. The illustrations were created by using Servier Medical Art.

Conflicts of Interest: The authors declare no conflict of interest.

References

1. Wu, Z.; Connolly, J.; Biggar, K.K. Beyond Histones—The Expanding Roles of Protein Lysine Methylation. *FEBS J.* **2017**, *284*, 2732–2744. [[CrossRef](#)] [[PubMed](#)]
2. Dillon, S.C.; Zhang, X.; Trievel, R.C.; Cheng, X. The SET-Domain Protein Superfamily: Protein Lysine Methyltransferases. *Genome Biol.* **2005**, *6*, 1–10. [[CrossRef](#)] [[PubMed](#)]
3. Falnes, P.; Jakobsson, M.E.; Davydova, E.; Ho, A.; Malecki, J. Protein Lysine Methylation by Seven- β -Strand Methyltransferases. *Biochem. J.* **2016**, *473*, 1995–2009. [[CrossRef](#)] [[PubMed](#)]
4. Milner, C.M.; Campbell, R.D. The G9a Gene in the Human Major Histocompatibility Complex Encodes a Novel Protein Containing Ankyrin-like Repeats the Class III Region of the Human Major Histocompatibility Complex Spans Approx. *Biochem. J.* **1993**, *290*, 811–818. [[CrossRef](#)]
5. Tachibana, M.; Sugimoto, K.; Nozaki, M.; Ueda, J.; Ohta, T.; Ohki, M.; Fukuda, M.; Takeda, N.; Niida, H.; Kato, H.; et al. G9a Histone Methyltransferase Plays a Dominant Role in Euchromatic Histone H3 Lysine 9 Methylation and Is Essential for Early Embryogenesis. *Genes Dev.* **2002**, *16*, 1779–1791. [[CrossRef](#)]
6. Tachibana, M.; Ueda, J.; Fukuda, M.; Takeda, N.; Ohta, T.; Iwanari, H.; Sakihama, T.; Kodama, T.; Hamakubo, T.; Shinkai, Y. Histone Methyltransferases G9a and GLP Form Heteromeric Complexes and Are Both Crucial for Methylation of Euchromatin at H3-K9. *Genes Dev.* **2005**, *19*, 815–826. [[CrossRef](#)]
7. Tachibana, M.; Matsumura, Y.; Fukuda, M.; Kimura, H.; Shinkai, Y. G9a/GLP Complexes Independently Mediate H3K9 and DNA Methylation to Silence Transcription. *EMBO J.* **2008**, *27*, 2681–2690. [[CrossRef](#)]
8. Bittencourt, D.; Wu, D.Y.; Jeong, K.W.; Gerke, D.S.; Herviou, L.; Ianculescu, I.; Chodankar, R.; Siegmund, K.D.; Stallcup, M.R. G9a Functions as a Molecular Scaffold for Assembly of Transcriptional Coactivators on a Subset of Glucocorticoid Receptor Target Genes. *Proc. Natl. Acad. Sci. USA* **2012**, *109*, 19673–19678. [[CrossRef](#)]
9. Lee, D.Y.; Northrop, J.P.; Kuo, M.H.; Stallcup, M.R. Histone H3 Lysine 9 Methyltransferase G9a Is a Transcriptional Coactivator for Nuclear Receptors. *J. Biol. Chem.* **2006**, *281*, 8476–8485. [[CrossRef](#)]
10. Purcell, D.J.; Jeong, K.W.; Bittencourt, D.; Gerke, D.S.; Stallcup, M.R. A Distinct Mechanism for Coactivator versus Corepressor Function by Histone Methyltransferase G9a in Transcriptional Regulation. *J. Biol. Chem.* **2011**, *286*, 41963–41971. [[CrossRef](#)]
11. Purcell, D.J.; Khalid, O.; Ou, C.Y.; Little, G.H.; Frenkel, B.; Baniwal, S.K.; Stallcup, M.R. Recruitment of Coregulator G9a by Runx2 for Selective Enhancement or Suppression of Transcription. *J. Cell. Biochem.* **2012**, *113*, 2406–2414. [[CrossRef](#)] [[PubMed](#)]
12. Chaturvedi, C.P.; Hosey, A.M.; Palii, C.; Perez-Iratxeta, C.; Nakatani, Y.; Ranish, J.A.; Dilworth, F.J.; Brand, M. Dual Role for the Methyltransferase G9a in the Maintenance of β -Globin Gene Transcription in Adult Erythroid Cells. *Proc. Natl. Acad. Sci. USA* **2009**, *106*, 18303–18308. [[CrossRef](#)] [[PubMed](#)]

13. Mauger, O.; Klinck, R.; Chabot, B.; Muchardt, C.; Allemand, E.; Batschébatsch' batsché, E. Alternative Splicing Regulates the Expression of G9A and SUV39H2 Methyltransferases, and Dramatically Changes SUV39H2 Functions. *Nucleic Acids Res.* **2015**, *43*, 1869–1882. [[CrossRef](#)]
14. Fiszbein, A.; Giono, L.E.; Quaglino, A.; Berardino, B.G.; Sigaut, L.; von Bilderling, C.; Schor, I.E.; Steinberg, J.H.E.; Rossi, M.; Pietrasanta, L.I.; et al. Alternative Splicing of G9a Regulates Neuronal Differentiation. *Cell Rep.* **2016**, *14*, 2797–2808. [[CrossRef](#)]
15. Shankar, S.R.; Bahirvani, A.G.; Rao, V.K.; Bharathy, N.; Ow, J.R.; Taneja, R. G9a, a Multipotent Regulator of Gene Expression. *Epigenetics* **2013**, *8*, 16–22. [[CrossRef](#)] [[PubMed](#)]
16. Schotta, G.; Ebert, A.; Krauss, V.; Fischer, A.; Hoffmann, J.; Rea, S.; Jenuwein, T.; Dorn, R.; Reuter, G. Central Role of Drosophila SU(VAR)3–9 in Histone H3-K9 Methylation and Heterochromatic Gene Silencing. *EMBO J.* **2002**, *21*, 1121–1131. [[CrossRef](#)]
17. Jenuwein, T.; Laible, G.; Dorn, R.; Reuter, G. SET Domain Proteins Modulate Chromatin Domains in Eu- and Heterochromatin. *Cell. Mol. Life Sci* **1998**, *54*, 80–93. [[CrossRef](#)]
18. Taylor, W.R.; Xiao, B.; Gamblin, S.J.; Lin, K. A Knot or Not a Knot? SETting the Record 'Straight' on Proteins. *Comput. Biol. Chem.* **2003**, *27*, 11–15. [[CrossRef](#)]
19. Trievel, R.C.; Beach, B.M.; Dirk, L.M.A.; Houtz, R.L.; Hurley, J.H. Structure and Catalytic Mechanism of a SET Domain Protein Methyltransferase. *Cell* **2002**, *111*, 91–103. [[CrossRef](#)]
20. Qian, C.; Zhou, M.M. SET Domain Protein Lysine Methyltransferases: Structure, Specificity and Catalysis. *Cell. Mol. Life Sci.* **2006**, *63*, 2755–2763. [[CrossRef](#)] [[PubMed](#)]
21. Wu, H.; Min, J.; Lunin, V.V.; Antoshenko, T.; Dombrovski, L.; Zeng, H.; Allali-Hassani, A.; Campagna-Slater, V.; Vedadi, M.; Arrowsmith, C.H.; et al. Structural Biology of Human H3K9 Methyltransferases. *PLoS ONE* **2010**, *5*, e8570. [[CrossRef](#)]
22. Lenstra, D.C.; al Temimi, A.H.K.; Mecinovic', J. Inhibition of Histone Lysine Methyltransferases G9a and GLP by Ejection of Structural Zn(II). *Bioorganic Med. Chem. Lett.* **2018**, *28*, 1234–1238. [[CrossRef](#)]
23. Schapira, M. Structural Chemistry of Human SET Domain Protein Methyltransferases. *Curr. Chem. Genom.* **2011**, *5*, 85–94. [[CrossRef](#)]
24. Collins, R.E.; Northrop, J.P.; Horton, J.R.; Lee, D.Y.; Zhang, X.; Stallcup, M.R.; Cheng, X. The Ankyrin Repeats of G9a and GLP Histone Methyltransferases Are Mono- and Dimethyllysine Binding Modules. *Nat. Struct. Mol. Biol.* **2008**, *15*, 245–250. [[CrossRef](#)]
25. Estève, P.O.; Patnaik, D.; Chin, H.G.; Benner, J.; Teitell, M.A.; Pradhan, S. Functional Analysis of the N- and C-Terminus of Mammalian G9a Histone H3 Methyltransferase. *Nucleic Acids Res.* **2005**, *33*, 3211–3223. [[CrossRef](#)] [[PubMed](#)]
26. Corpet, F. Multiple Sequence Alignment with Hierarchical Clustering. *Nucleic Acids Res.* **1988**, *16*, 10881. [[CrossRef](#)] [[PubMed](#)]
27. Chang, Y.; Zhang, X.; Horton, J.R.; Upadhyay, A.K.; Spannhoff, A.; Liu, J.; Snyder, J.P.; Bedford, M.T.; Cheng, X. Structural Basis for G9a-like Protein Lysine Methyltransferase Inhibition by BIX-01294. *Nat. Struct. Mol. Biol.* **2009**, *16*, 312–317. [[CrossRef](#)]
28. Liu, N.; Zhang, Z.; Wu, H.; Jiang, Y.; Meng, L.; Xiong, J.; Zhao, Z.; Zhou, X.; Li, J.; Li, H.; et al. Recognition of H3K9 Methylation by GLP Is Required for Efficient Establishment of H3K9 Methylation, Rapid Target Gene Repression, and Mouse Viability. *Genes Dev.* **2015**, *29*, 379–393. [[CrossRef](#)]
29. Shinkai, Y.; Tachibana, M. H3K9 Methyltransferase G9a and the Related Molecule GLP. *Genes Dev.* **2011**, *25*, 781–788. [[CrossRef](#)] [[PubMed](#)]
30. Ueda, J.; Tachibana, M.; Ikura, T.; Shinkai, Y. Zinc Finger Protein Wiz Links G9a/GLP Histone Methyltransferases to the Co-Repressor Molecule CtBP. *J. Biol. Chem.* **2006**, *281*, 20120–20128. [[CrossRef](#)]
31. Bian, C.; Chen, Q.; Yu, X. The Zinc Finger Proteins ZNF644 and WIZ Regulate the G9a/GLP Complex for Gene Repression. *eLife* **2015**, *4*, e05606. [[CrossRef](#)] [[PubMed](#)]
32. Poulard, C.; Bittencourt, D.; Wu, D.; Hu, Y.; Gerke, D.S.; Stallcup, M.R. A Post-translational Modification Switch Controls Coactivator Function of Histone Methyltransferases G9a and GLP. *EMBO Rep.* **2017**, *18*, 1442–1459. [[CrossRef](#)] [[PubMed](#)]
33. Chin, H.G.; Pradhan, M.; Estève, P.O.; Patnaik, D.; Evans, T.C.; Pradhan, S. Sequence Specificity and Role of Proximal Amino Acids of the Histone H3 Tail on Catalysis of Murine G9a Lysine 9 Histone H3 Methyltransferase. *Biochemistry* **2005**, *44*, 12998–13006. [[CrossRef](#)] [[PubMed](#)]
34. Chin, H.G.; Estève, P.O.; Pradhan, M.; Benner, J.; Patnaik, D.; Carey, M.F.; Pradhan, S. Automethylation of G9a and Its Implication in Wider Substrate Specificity and HP1 Binding. *Nucleic Acids Res.* **2007**, *35*, 7313–7323. [[CrossRef](#)] [[PubMed](#)]
35. Sampath, S.C.; Marazzi, I.; Yap, K.L.; Sampath, S.C.; Krutchinsky, A.N.; Mecklenbräuker, I.; Viale, A.; Rudensky, E.; Zhou, M.M.; Chait, B.T.; et al. Methylation of a Histone Mimic within the Histone Methyltransferase G9a Regulates Protein Complex Assembly. *Mol. Cell* **2007**, *27*, 596–608. [[CrossRef](#)] [[PubMed](#)]

36. Rathert, P.; Dhayalan, A.; Murakami, M.; Zhang, X.; Tamas, R.; Jurkowska, R.; Komatsu, Y.; Shinkai, Y.; Cheng, X.; Jeltsch, A. Protein Lysine Methyltransferase G9a Acts on Non-Histone Targets. *Nat. Chem. Biol.* **2008**, *4*, 344–346. [[CrossRef](#)]
37. Patnaik, D.; Hang, G.C.; Estève, P.O.; Benner, J.; Jacobsen, S.E.; Pradhan, S. Substrate Specificity and Kinetic Mechanism of Mammalian G9a Histone H3 Methyltransferase. *J. Biol. Chem.* **2004**, *279*, 53248–53258. [[CrossRef](#)]
38. Fischle, W.; Tseng, B.S.; Dormann, H.L.; Ueberheide, B.M.; Garcia, B.A.; Shabanowitz, J.; Hunt, D.F.; Funabiki, H.; Allis, C.D. Regulation of HP1–Chromatin Binding by Histone H3 Methylation and Phosphorylation. *Nature* **2005**, *438*, 1116–1122. [[CrossRef](#)] [[PubMed](#)]
39. Hirota, T.; Lipp, J.J.; Toh, B.-H.; Peters, J.-M. Histone H3 Serine 10 Phosphorylation by Aurora B Causes HP1 Dissociation from Heterochromatin. *Nature* **2005**, *438*, 1176–1180. [[CrossRef](#)]
40. Poulard, C.; Baulu, E.; Lee, B.H.; Pufall, M.A.; Stallcup, M.R. Increasing G9a Automethylation Sensitizes B Acute Lymphoblastic Leukemia Cells to Glucocorticoid-Induced Death. *Cell Death Dis.* **2018**, *9*, 1–13. [[CrossRef](#)]
41. Ginjala, V.; Rodriguez-Colon, L.; Ganguly, B.; Gangidi, P.; Gallina, P.; Al-Hraishawi, H.; Kulkarni, A.; Tang, J.; Gheeya, J.; Simhadri, S.; et al. Protein-Lysine Methyltransferases G9a and GLP1 Promote Responses to DNA Damage. *Sci. Rep.* **2017**, *7*, 1–12. [[CrossRef](#)]
42. Yang, Q.; Zhu, Q.; Lu, X.; Du, Y.; Cao, L.; Shen, C.; Hou, T.; Li, M.; Li, Z.; Liu, C.; et al. G9a Coordinates with the RPA Complex to Promote DNA Damage Repair and Cell Survival. *Proc. Natl. Acad. Sci. USA* **2017**, *114*, E6054–E6063. [[CrossRef](#)]
43. Srinivasan, S.; Shankar, S.R.; Wang, Y.; Taneja, R. SUMOylation of G9a Regulates Its Function as an Activator of Myoblast Proliferation. *Cell Death Dis.* **2019**, *10*, 1–15. [[CrossRef](#)]
44. Casciello, F.; Al-Ejeh, F.; Kelly, G.; Brennan, D.J.; Ngiow, S.F.; Young, A.; Stoll, T.; Windloch, K.; Hill, M.M.; Smyth, M.J.; et al. G9a Drives Hypoxia-Mediated Gene Repression for Breast Cancer Cell Survival and Tumorigenesis. *Proc. Natl. Acad. Sci. USA* **2017**, *114*, 7077–7082. [[CrossRef](#)]
45. Kang, J.; Shin, S.H.; Yoon, H.; Huh, J.; Shin, H.W.; Chun, Y.S.; Park, J.W. FIH Is an Oxygen Sensor in Ovarian Cancer for G9a/GLP-Driven Epigenetic Regulation of Metastasis-Related Genes. *Cancer Res.* **2018**, *78*, 1184–1199. [[CrossRef](#)] [[PubMed](#)]
46. Tachibana, M.; Sugimoto, K.; Fukushima, T.; Shinkai, Y. SET Domain-Containing Protein, G9a, Is a Novel Lysine-Preferring Mammalian Histone Methyltransferase with Hyperactivity and Specific Selectivity to Lysines 9 and 27 of Histone H3. *J. Biol. Chem.* **2001**, *276*, 25309–25317. [[CrossRef](#)]
47. Richards, E.J.; Elgin, S.C.R. Epigenetic Codes for Heterochromatin Formation and Silencing: Rounding up the Usual Suspects. *Cell* **2002**, *108*, 489–500. [[CrossRef](#)]
48. Wu, H.; Chen, X.; Xiong, J.; Li, Y.; Li, H.; Ding, X.; Liu, S.; Chen, S.; Gao, S.; Zhu, B. Histone Methyltransferase G9a Contributes to H3K27 Methylation in vivo. *Cell Res.* **2011**, *21*, 365–367. [[CrossRef](#)] [[PubMed](#)]
49. Yu, Y.; Song, C.; Zhang, Q.; DiMaggio, P.A.; Garcia, B.A.; York, A.; Carey, M.F.; Grunstein, M. Histone H3 Lysine 56 Methylation Regulates DNA Replication through Its Interaction with PCNA. *Mol. Cell* **2012**, *46*, 7–17. [[CrossRef](#)]
50. Trojer, P.; Zhang, J.; Yonezawa, M.; Schmidt, A.; Zheng, H.; Jenuwein, T.; Reinberg, D. Dynamic Histone H1 Isozyme 4 Methylation and Demethylation by Histone Lysine Methyltransferase G9a/KMT1C and the Jumonji Domain-Containing JMJD2/KDM4 Proteins. *J. Biol. Chem.* **2009**, *284*, 8395–8405. [[CrossRef](#)]
51. Weiss, T.; Hergeth, S.; Zeissler, U.; Izzo, A.; Tropberger, P.; Zee, B.M.; Dunder, M.; Garcia, B.A.; Daujat, S.; Schneider, R. Histone H1 Variant-Specific Lysine Methylation by G9a/KMT1C and Glp1/KMT1D. *Epigenetics Chromatin* **2010**, *3*, 1–13. [[CrossRef](#)]
52. Cao, H.; Li, L.; Deying, Y.; Liming, Z.; Yewei, X.; Yu, B.; Liao, G.; Chen, J. Recent Progress in Histone Methyltransferase (G9a) Inhibitors as Anticancer Agents. *Eur. J. Med. Chem.* **2019**, *179*, 537–546. [[CrossRef](#)]
53. Xiong, Y.; Li, F.; Babault, N.; Wu, H.; Dong, A.; Zeng, H.; Chen, X.; Arrowsmith, C.H.; Brown, P.J.; Liu, J.; et al. Structure-Activity Relationship Studies of G9a-like Protein (GLP) Inhibitors. *Bioorg. Med. Chem.* **2017**, *25*, 4414–4423. [[CrossRef](#)]
54. Pless, O.; Kowenz-Leutz, E.; Knoblich, M.; Lausen, J.; Beyermann, M.; Walsh, M.J.; Leutz, A. G9a-Mediated Lysine Methylation Alters the Function of CCAAT/Enhancer-Binding Protein- β . *J. Biol. Chem.* **2008**, *283*, 26357–26363. [[CrossRef](#)]
55. Ling, B.M.T.; Bharathy, N.; Chung, T.-K.; Kok, W.K.; Li, S.; Tan, Y.H.; Rao, V.K.; Gopinadhan, S.; Sartorelli, V.; Walsh, M.J.; et al. Lysine Methyltransferase G9a Methylates the Transcription Factor MyoD and Regulates Skeletal Muscle Differentiation. *Proc. Natl. Acad. Sci. USA* **2012**, *109*, 841–846. [[CrossRef](#)] [[PubMed](#)]
56. Choi, J.; Jang, H.; Kim, H.; Lee, J.H.; Kim, S.T.; Cho, E.J.; Youn, H.D. Modulation of Lysine Methylation in Myocyte Enhancer Factor 2 during Skeletal Muscle Cell Differentiation. *Nucleic Acids Res.* **2014**, *42*, 224–234. [[CrossRef](#)] [[PubMed](#)]
57. Huang, J.; Dorsey, J.; Chuikov, S.; Zhang, X.; Jenuwein, T.; Reinberg, D.; Berger, S.L. G9a and Glp Methylate Lysine 373 in the Tumor Suppressor P53. *J. Biol. Chem.* **2010**, *285*, 9636–9641. [[CrossRef](#)] [[PubMed](#)]

58. Zhang, X.; Peng, D.; Xi, Y.; Yuan, C.; Sagum, C.A.; Klein, B.J.; Tanaka, K.; Wen, H.; Kutateladze, T.G.; Li, W.; et al. G9a-Mediated Methylation of ER α Links the PHF20/MOF Histone Acetyltransferase Complex to Hormonal Gene Expression. *Nat. Commun.* **2016**, *7*, 1–12. [[CrossRef](#)] [[PubMed](#)]
59. Chae, Y.C.; Kim, J.Y.; Park, J.W.; Kim, K.B.; Oh, H.; Lee, K.H.; Seo, S.B. FOXO1 Degradation via G9a-Mediated Methylation Promotes Cell Proliferation in Colon Cancer. *Nucleic Acids Res.* **2019**, *47*, 1692–1705. [[CrossRef](#)] [[PubMed](#)]
60. Moore, K.E.; Carlson, S.M.; Camp, N.D.; Cheung, P.; James, R.G.; Chua, K.F.; Wolf-Yadlin, A.; Gozani, O. A General Molecular Affinity Strategy for Global Detection and Proteomic Analysis of Lysine Methylation. *Mol. Cell* **2013**, *50*, 444–456. [[CrossRef](#)]
61. Lee, J.S.; Kim, Y.; Bhin, J.; Shin, H.-J.R.; Nam, H.J.; Lee, H.; Yoon, J.-B.; Binda, O.; Hwang, D.; Baek, S.H. Hypoxia-Induced Methylation of a Pontin Chromatin Remodeling Factor. *Proc. Natl. Acad. Sci. USA* **2011**, *108*, 13510–13515. [[CrossRef](#)] [[PubMed](#)]
62. Lee, J.S.; Kim, Y.; Kim, I.S.; Kim, B.; Choi, H.J.; Lee, J.M.; Shin, H.J.R.; Kim, J.H.; Kim, J.Y.; Seo, S.B.; et al. Negative Regulation of Hypoxic Responses via Induced Reptin Methylation. *Mol. Cell* **2010**, *39*, 71–85. [[CrossRef](#)] [[PubMed](#)]
63. Bao, L.; Chen, Y.; Lai, H.T.; Wu, S.Y.; Wang, J.E.; Hatanpaa, K.J.; Raisanen, J.M.; Fontenot, M.; Lega, B.; Chiang, C.M.; et al. Methylation of Hypoxia-Inducible Factor (HIF)-1 α by G9a/GLP Inhibits HIF-1 Transcriptional Activity and Cell Migration. *Nucleic Acids Res.* **2018**, *46*, 6576–6591. [[CrossRef](#)] [[PubMed](#)]
64. Nair, S.S.; Li, D.Q.; Kumar, R. A Core Chromatin Remodeling Factor Instructs Global Chromatin Signaling through Multivalent Reading of Nucleosome Codes. *Mol. Cell* **2013**, *49*, 704–718. [[CrossRef](#)]
65. Tsusaka, T.; Kikuchi, M.; Shimazu, T.; Suzuki, T.; Sohtome, Y.; Akakabe, M.; Sodeoka, M.; Dohmae, N.; Umehara, T.; Shinkai, Y. Tri-Methylation of ATF7IP by G9a/GLP Recruits the Chromodomain Protein MPP8. *Epigenetics Chromatin* **2018**, *11*, 1–16. [[CrossRef](#)]
66. Chang, Y.; Sun, L.; Kokura, K.; Horton, J.R.; Fukuda, M.; Espejo, A.; Izumi, V.; Koomen, J.M.; Bedford, M.T.; Zhang, X.; et al. MPP8 Mediates the Interactions between DNA Methyltransferase Dnmt3a and H3K9 Methyltransferase GLP/G9a. *Nat. Commun.* **2011**, *2*, 1–10. [[CrossRef](#)]
67. Watanabe, S.; Iimori, M.; Chan, D.V.; Hara, E.; Kitao, H.; Maehara, Y. MDC1 Methylation Mediated by Lysine Methyltransferases EHMT1 and EHMT2 Regulates Active ATM Accumulation Flanking DNA Damage Sites. *Sci. Rep.* **2018**, *8*, 1–10. [[CrossRef](#)]
68. Li, W.; Wang, H.-Y.; Zhao, X.; Duan, H.; Cheng, B.; Liu, Y.; Zhao, M.; Shu, W.; Mei, Y.; Wen, Z.; et al. A Methylation-Phosphorylation Switch Determines Plk1 Kinase Activity and Function in DNA Damage Repair. *Sci. Adv.* **2019**, *5*, eaau7566. [[CrossRef](#)]
69. Ferry, L.; Fournier, A.; Tsusaka, T.; Adelmant, G.; Shimazu, T.; Matano, S.; Kirsh, O.; Amouroux, R.; Dohmae, N.; Suzuki, T.; et al. Methylation of DNA Ligase 1 by G9a/GLP Recruits UHRF1 to Replicating DNA and Regulates DNA Methylation. *Mol. Cell* **2017**, *67*, 550–565. [[CrossRef](#)]
70. Kubicek, S.; O'Sullivan, R.J.; August, E.M.; Hickey, E.R.; Zhang, Q.; Teodoro, M.L.L.; Rea, S.; Mechtler, K.; Kowalski, J.A.; Honan, C.A.; et al. Reversal of H3K9me2 by a Small-Molecule Inhibitor for the G9a Histone Methyltransferase. *Mol. Cell* **2007**, *25*, 473–481. [[CrossRef](#)]
71. Liu, F.; Chen, X.; Allali-Hassani, A.; Quinn, A.M.; Wasney, G.A.; Dong, A.; Barsyte, D.; Kozieradzki, I.; Senisterra, G.; Chau, I.; et al. Discovery of a 2,4-Diamino-7-Aminoalkoxyquinazoline as a Potent and Selective Inhibitor of Histone Lysine Methyltransferase G9a. *J. Med. Chem.* **2009**, *52*, 7950–7953. [[CrossRef](#)] [[PubMed](#)]
72. Vedadi, M.; Barsyte-Lovejoy, D.; Liu, F.; Rival-Gervier, S.; Allali-Hassani, A.; Labrie, V.; Wigle, T.J.; DiMaggio, P.A.; Wasney, G.A.; Siarheyeva, A.; et al. A Chemical Probe Selectively Inhibits G9a and GLP Methyltransferase Activity in Cells. *Nat. Chem. Biol.* **2011**, *7*, 566–574. [[CrossRef](#)] [[PubMed](#)]
73. Milite, C.; Feoli, A.; Horton, J.R.; Rescigno, D.; Cipriano, A.; Pisapia, V.; Viviano, M.; Pepe, G.; Amendola, G.; Novellino, E.; et al. Discovery of a Novel Chemotype of Histone Lysine Methyltransferase EHMT1/2 (GLP/G9a) Inhibitors: Rational Design, Synthesis, Biological Evaluation, and Co-Crystal Structure. *J. Med. Chem.* **2019**, *62*, 2666–2689. [[CrossRef](#)] [[PubMed](#)]
74. Yuan, Y.; Wang, Q.; Paulk, J.; Kubicek, S.; Kemp, M.M.; Adams, D.J.; Shamji, A.F.; Wagner, B.K.; Schreiber, S.L. A Small-Molecule Probe of the Histone Methyltransferase G9a Induces Cellular Senescence in Pancreatic Adenocarcinoma. *ACS Chem. Biol.* **2012**, *7*, 1152–1157. [[CrossRef](#)] [[PubMed](#)]
75. Nishio, H.; Walsh, M.J. CCAAT Displacement Protein/Cut Homolog Recruits G9a Histone Lysine Methyltransferase to Repress Transcription. *Proc. Natl. Acad. Sci. USA* **2004**, *101*, 11257–11262. [[CrossRef](#)]

76. Duan, Z.; Zarebski, A.; Montoya-Durango, D.; Grimes, H.L.; Horwitz, M. Gfi1 Coordinates Epigenetic Repression of *P21^{Cip1/WAF1}* by Recruitment of Histone Lysine Methyltransferase G9a and Histone Deacetylase 1. *Mol. Cell. Biol.* **2005**, *25*, 10338–10351. [\[CrossRef\]](#)
77. Gyo'ry, I.; Wu, J.; Fejér, G.; Seto, E.; Wright, K.L. PRDI-BF1 Recruits the Histone H3 Methyltransferase G9a in Transcriptional Silencing. *Nat. Immunol.* **2004**, *5*, 299–308. [\[CrossRef\]](#)
78. Roopra, A.; Qazi, R.; Schoenike, B.; Daley, T.J.; Morrison, J.F. Localized Domains of G9a-Mediated Histone Methylation Are Required for Silencing of Neuronal Genes. *Mol. Cell* **2004**, *14*, 727–738. [\[CrossRef\]](#)
79. Kim, J.K.; Estève, P.O.; Jacobsen, S.E.; Pradhan, S. UHRF1 Binds G9a and Participates in P21 Transcriptional Regulation in Mammalian Cells. *Nucleic Acids Res.* **2009**, *37*, 493–505. [\[CrossRef\]](#)
80. Nagano, T.; Mitchell, J.A.; Sanz, L.A.; Pauler, F.M.; Ferguson-Smith, A.C.; Feil, R.; Fraser, P. The Air Noncoding RNA Epigenetically Silences Transcription by Targeting G9a to Chromatin. *Science* **2008**, *322*, 1717–1720. [\[CrossRef\]](#)
81. Mozzetta, C.; Pontis, J.; Fritsch, L.; Robin, P.; Portoso, M.; Proux, C.; Margueron, R.; Ait-Si-Ali, S. The Histone H3 Lysine 9 Methyltransferases G9a and GLP Regulate Polycomb Repressive Complex 2-Mediated Gene Silencing. *Mol. Cell* **2014**, *53*, 277–289. [\[CrossRef\]](#) [\[PubMed\]](#)
82. Lomber, G.; Wallrath, L.; Urrutia, R. The Heterochromatin Protein 1 Family. *Genome Biol.* **2006**, *7*, 1–8. [\[CrossRef\]](#) [\[PubMed\]](#)
83. Fritsch, L.; Robin, P.; Mathieu, J.R.R.; Souidi, M.; Hinaux, H.; Rougeulle, C.; Harel-Bellan, A.; Ameyar-Zazoua, M.; Ait-Si-Ali, S. A Subset of the Histone H3 Lysine 9 Methyltransferases Suv39h1, G9a, GLP, and SETDB1 Participate in a Multimeric Complex. *Mol. Cell* **2010**, *37*, 46–56. [\[CrossRef\]](#) [\[PubMed\]](#)
84. Epsztejn-Litman, S.; Feldman, N.; Abu-Remaileh, M.; Shufaro, Y.; Gerson, A.; Ueda, J.; Deplus, R.; Fuks, F.; Shinkai, Y.; Cedar, H.; et al. De Novo DNA Methylation Promoted by G9a Prevents Reprogramming of Embryonically Silenced Genes. *Nat. Struct. Mol. Biol.* **2008**, *15*, 1176–1183. [\[CrossRef\]](#) [\[PubMed\]](#)
85. Bittencourt, D.; Lee, B.H.; Gao, L.; Gerke, D.S.; Stallcup, M.R. Role of Distinct Surfaces of the G9a Ankyrin Repeat Domain in Histone and DNA Methylation during Embryonic Stem Cell Self-Renewal and Differentiation. *Epigenetics Chromatin* **2014**, *7*, 1–12. [\[CrossRef\]](#)
86. Smallwood, A.; Estève, P.O.; Pradhan, S.; Carey, M. Functional Cooperation between HP1 and DNMT1 Mediates Gene Silencing. *Genes Dev.* **2007**, *21*, 1169–1178. [\[CrossRef\]](#) [\[PubMed\]](#)
87. Oh, S.T.; Kim, K.B.; Chae, Y.C.; Kang, J.Y.; Hahn, Y.; Seo, S.B. H3K9 Histone Methyltransferase G9a-Mediated Transcriptional Activation of P21. *FEBS Lett.* **2014**, *588*, 685–691. [\[CrossRef\]](#)
88. Poulard, C.; Kim, H.N.; Fang, M.; Kruth, K.; Gagnieux, C.; Gerke, D.S.; Bhojwani, D.; Kim, Y.M.; Kampmann, M.; Stallcup, M.R.; et al. Relapse-Associated AURKB Blunts the Glucocorticoid Sensitivity of B Cell Acute Lymphoblastic Leukemia. *Proc. Natl. Acad. Sci. USA* **2019**, *116*, 3052–3061. [\[CrossRef\]](#)
89. Chaturvedi, C.P.; Somasundaram, B.; Singh, K.; Carpenedo, R.L.; Stanford, W.L.; Dilworth, F.J.; Brand, M. Maintenance of Gene Silencing by the Coordinate Action of the H3K9 Methyltransferase G9a/KMT1C and the H3K4 Demethylase Jarid1a/KDM5A. *Proc. Natl. Acad. Sci. USA* **2012**, *109*, 18845–18850. [\[CrossRef\]](#)
90. Tachibana, M.; Nozaki, M.; Takeda, N.; Shinkai, Y. Functional Dynamics of H3K9 Methylation during Meiotic Prophase Progression. *EMBO J.* **2007**, *26*, 3346–3359. [\[CrossRef\]](#)
91. Inagawa, M.; Nakajima, K.; Makino, T.; Ogawa, S.; Kojima, M.; Ito, S.; Ikenishi, A.; Hayashi, T.; Schwartz, R.J.; Nakamura, K.; et al. Histone H3 Lysine 9 Methyltransferases, G9a and GLP Are Essential for Cardiac Morphogenesis. *Mech. Dev.* **2013**, *130*, 519–531. [\[CrossRef\]](#) [\[PubMed\]](#)
92. Schaefer, A.; Sampath, S.C.; Intrator, A.; Min, A.; Gertler, T.S.; Surmeier, D.J.; Tarakhovskiy, A.; Greengard, P. Control of Cognition and Adaptive Behavior by the GLP/G9a Epigenetic Suppressor Complex. *Neuron* **2009**, *64*, 678–691. [\[CrossRef\]](#) [\[PubMed\]](#)
93. Nicolay-Kritter, K.; Lassalle, J.; Guillou, J.L.; Mons, N. The Histone H3 Lysine 9 Methyltransferase G9a/GLP Complex Activity Is Required for Long-Term Consolidation of Spatial Memory in Mice. *Neurobiol. Learn. Mem.* **2021**, *179*, 107406. [\[CrossRef\]](#)
94. Maze, I.; Covington, H.E.; Dietz, D.M.; LaPlant, Q.; Renthal, W.; Russo, S.J.; Mechanic, M.; Mouzon, E.; Neve, R.L.; Haggarty, S.J.; et al. Essential Role of the Histone Methyltransferase G9a in Cocaine-Induced Plasticity. *Science* **2010**, *327*, 213–216. [\[CrossRef\]](#)
95. Maze, I.; Chaudhury, D.; Dietz, D.M.; von Schimmelmann, M.; Kennedy, P.J.; Lobo, M.K.; Sullivan, S.E.; Miller, M.L.; Bagot, R.C.; Sun, H.; et al. G9a Influences Neuronal Subtype Specification in Striatum. *Nat. Neurosci.* **2014**, *17*, 533–539. [\[CrossRef\]](#) [\[PubMed\]](#)

96. Kamiunten, T.; Ideno, H.; Shimada, A.; Arai, Y.; Terashima, T.; Tomooka, Y.; Nakamura, Y.; Nakashima, K.; Kimura, H.; Shinkai, Y.; et al. Essential Roles of G9a in Cell Proliferation and Differentiation during Tooth Development. *Exp. Cell Res.* **2017**, *357*, 202–210. [[CrossRef](#)]
97. Ideno, H.; Nakashima, K.; Komatsu, K.; Araki, R.; Abe, M.; Arai, Y.; Kimura, H.; Shinkai, Y.; Tachibana, M.; Nifuji, A. G9a Is Involved in the Regulation of Cranial Bone Formation through Activation of Runx2 Function during Development. *Bone* **2020**, *137*, 115332. [[CrossRef](#)] [[PubMed](#)]
98. Higashihori, N.; Lehnertz, B.; Sampaio, A.; Underhill, T.M.; Rossi, F.; Richman, J.M. Methyltransferase G9a Regulates Osteogenesis via Twist Gene Repression. *J. Dent. Res.* **2017**, *96*, 1136–1144. [[CrossRef](#)]
99. Komori, T. Regulation of Proliferation, Differentiation and Functions of Osteoblasts by Runx2. *Int. J. Mol. Sci.* **2019**, *20*, 1694. [[CrossRef](#)]
100. Zhang, R.H.; Judson, R.N.; Liu, D.Y.; Kast, J.; Rossi, F.M.V. The Lysine Methyltransferase Ehmt2/G9a Is Dispensable for Skeletal Muscle Development and Regeneration. *Skelet. Muscle* **2016**, *6*, 1–10. [[CrossRef](#)]
101. Kato, K.; Yamazaki, R.; Onishi, A.; Sanuki, R.; Furukawa, T. G9a Histone Methyltransferase Activity in Retinal Progenitors Is Essential for Proper Differentiation and Survival of Mouse Retinal Cells. *J. Neurosci.* **2012**, *32*, 17658–17670. [[CrossRef](#)]
102. Olsen, J.B.; Wong, L.; Deimling, S.; Miles, A.; Guo, H.; Li, Y.; Zhang, Z.; Greenblatt, J.F.; Emili, A.; Tropepe, V. G9a and ZNF644 Physically Associate to Suppress Progenitor Gene Expression during Neurogenesis. *Stem Cell Rep.* **2016**, *7*, 454–470. [[CrossRef](#)]
103. Chen, H.; Yan, Y.; Davidson, T.L.; Shinkai, Y.; Costa, M. Hypoxic Stress Induces Dimethylated Histone H3 Lysine 9 through Histone Methyltransferase G9a in Mammalian Cells. *Cancer Res.* **2006**, *66*, 9009–9016. [[CrossRef](#)]
104. Macuerek, L.; Lindqvist, A.; Lim, D.; Lampson, M.A.; Klompaker, R.; Freire, R.; Clouin, C.; Taylor, S.S.; Yaffe, M.B.; Medema, R.H. Polo-like Kinase-1 Is Activated by Aurora A to Promote Checkpoint Recovery. *Nature* **2008**, *455*, 119–123. [[CrossRef](#)]
105. Agarwal, P.; Jackson, S.P. G9a Inhibition Potentiates the Anti-Tumour Activity of DNA Double-Strand Break Inducing Agents by Impairing DNA Repair Independent of P53 Status. *Cancer Lett.* **2016**, *380*, 467–475. [[CrossRef](#)]
106. Zhang, J.; Wang, Y.; Shen, Y.; He, P.; Ding, J.; Chen, Y. G9a Stimulates CRC Growth by Inducing P53 Lys373 Dimethylation-Dependent Activation of Plk1. *Theranostics* **2018**, *8*, 2884–2895. [[CrossRef](#)]
107. Sharma, S.; Kelly, T.K.; Jones, P.A. Epigenetics in Cancer. *Carcinogenesis* **2010**, *31*, 27–36. [[CrossRef](#)] [[PubMed](#)]
108. Campbell, M.J.; Turner, B.M. Altered Histone Modifications in Cancer. *Adv. Exp. Med. Biol.* **2013**, *754*, 81–107. [[CrossRef](#)] [[PubMed](#)]
109. Wang, Y.; Zhang, J.; Su, Y.; Shen, Y.; Jiang, D.; Hou, Y.; Geng, M.; Ding, J.; Chen, Y. G9a Regulates Breast Cancer Growth by Modulating Iron Homeostasis through the Repression of Ferroxidase Hephaestin. *Nat. Commun.* **2017**, *8*, 1–14. [[CrossRef](#)] [[PubMed](#)]
110. Chen, P.; Qian, Q.; Zhu, Z.; Shen, X.; Yu, S.; Yu, Z.; Sun, R.; Li, Y.; Guo, D.; Fan, H. Increased Expression of EHMT2 Associated with H3K9me2 Level Contributes to the Poor Prognosis of Gastric Cancer. *Oncol. Lett.* **2020**, *20*, 1734–1742. [[CrossRef](#)]
111. Hua, K.-T.; Wang, M.-Y.; Chen, M.-W.; Wei, L.-H.; Chen, C.-K.; Ko, C.-H.; Jeng, Y.-M.; Sung, P.-L.; Jan, Y.-H.; Hsiao, M.; et al. The H3K9 Methyltransferase G9a Is a Marker of Aggressive Ovarian Cancer That Promotes Peritoneal Metastasis. *Mol. Cancer* **2014**, *13*, 1–13. [[CrossRef](#)]
112. Chen, G.; Yu, X.; Zhang, M.; Zheng, A.; Wang, Z.; Zuo, Y.; Liang, Q.; Jiang, D.; Chen, Y.; Zhao, L.; et al. Inhibition of Euchromatic Histone Lysine Methyltransferase 2 (EHMT2) Suppresses the Proliferation and Invasion of Cervical Cancer Cells. *Cytogenet. Genome Res.* **2019**, *158*, 205–212. [[CrossRef](#)]
113. Hsiao, S.M.; Chen, M.W.; Chen, C.A.; Chien, M.H.; Hua, K.T.; Hsiao, M.; Kuo, M.L.; Wei, L.H. The H3K9 Methyltransferase G9a Represses E-Cadherin and Is Associated with Myometrial Invasion in Endometrial Cancer. *Ann. Surg. Oncol.* **2015**, *22*, 1556–1565. [[CrossRef](#)]
114. Fan, H.T.; Shi, Y.Y.; Lin, Y.; Yang, X.P. EHMT2 Promotes the Development of Prostate Cancer by Inhibiting PI3K/AKT/MTOR Pathway. *Eur. Rev. Med. Pharmacol. Sci.* **2019**, *23*, 7808–7815. [[CrossRef](#)]
115. Qin, J.; Zeng, Z.; Luo, T.; Li, Q.; Hao, Y.; Chen, L. Clinicopathological Significance of G9a Expression in Colorectal Carcinoma. *Oncol. Lett.* **2018**, *15*, 8611–8619. [[CrossRef](#)] [[PubMed](#)]
116. Wei, L.; Chiu, D.K.C.; Tsang, F.H.C.; Law, C.T.; Cheng, C.L.H.; Au, S.L.K.; Lee, J.M.F.; Wong, C.C.L.; Ng, I.O.L.; Wong, C.M. Histone Methyltransferase G9a Promotes Liver Cancer Development by Epigenetic Silencing of Tumor Suppressor Gene RARRES3. *J. Hepatol.* **2017**, *67*, 758–769. [[CrossRef](#)]
117. Guo, A.S.; Huang, Y.Q.; Ma, X.D.; Lin, R.S. Mechanism of G9a Inhibitor BIX-01294 Acting on U251 Glioma Cells. *Mol. Med. Rep.* **2016**, *14*, 4613–4621. [[CrossRef](#)] [[PubMed](#)]

118. Zhang, X.Y.; Rajagopalan, D.; Chung, T.H.; Hooi, L.; Toh, T.B.; Tian, J.S.; Rashid, M.B.M.A.; Sahib, N.R.B.M.; Gu, M.; Lim, J.J.; et al. Frequent Upregulation of G9a Promotes RelB-Dependent Proliferation and Survival in Multiple Myeloma. *Exp. Hematol. Oncol.* **2020**, *9*, 8. [[CrossRef](#)] [[PubMed](#)]
119. Dang, N.N.; Jiao, J.; Meng, X.; An, Y.; Han, C.; Huang, S. Abnormal Overexpression of G9a in Melanoma Cells Promotes Cancer Progression via Upregulation of the Notch1 Signaling Pathway. *Aging* **2020**, *12*, 2393–2407. [[CrossRef](#)]
120. Ma, W.; Han, C.; Zhang, J.; Song, K.; Chen, W.; Kwon, H.; Wu, T. The Histone Methyltransferase G9a Promotes Cholangiocarcinogenesis through Regulation of the Hippo Pathway Kinase LATS2 and YAP Signaling Pathway. *FASEB J.* **2020**, *34*, 1283–1297. [[CrossRef](#)]
121. Zhang, K.; Wang, J.; Yang, L.; Yuan, Y.-C.; Tong, T.R.; Wu, J.; Yun, X.; Bonner, M.; Pangen, R.; Liu, Z.; et al. Targeting Histone Methyltransferase G9a Inhibits Growth and Wnt Signaling Pathway by Epigenetically Regulating HP1 α and APC2 Gene Expression in Non-Small Cell Lung Cancer. *Mol. Cancer* **2018**, *17*, 1–15. [[CrossRef](#)]
122. Cui, J.; Sun, W.; Hao, X.; Wei, M.; Su, X.; Zhang, Y.; Su, L.; Liu, X. EHMT2 Inhibitor BIX-01294 Induces Apoptosis through PMAIP1-USP9X-MCL1 Axis in Human Bladder Cancer Cells. *Cancer Cell Int.* **2015**, *15*, 1–9. [[CrossRef](#)]
123. Casciello, F.; Al-Ejeh, F.; Miranda, M.; Kelly, G.; Baxter, E.; Windloch, K.; Gannon, F.; Lee, J.S. G9a-Mediated Repression of CDH10 in Hypoxia Enhances Breast Tumour Cell Motility and Associates with Poor Survival Outcome. *Theranostics* **2020**, *10*, 4515–4529. [[CrossRef](#)]
124. Chen, M.-W.; Hua, K.-T.; Kao, H.-J.; Chi, C.-C.; Wei, L.-H.; Johansson, G.; Shiah, S.-G.; Chen, P.-S.; Jeng, Y.-M.; Cheng, T.-Y.; et al. H3K9 Histone Methyltransferase G9a Promotes Lung Cancer Invasion and Metastasis by Silencing the Cell Adhesion Molecule Ep-CAM. *Cancer Res.* **2010**, *70*, 7830–7840. [[CrossRef](#)]
125. Yin, C.; Ke, X.; Zhang, R.; Hou, J.; Dong, Z.; Wang, F.; Zhang, K.; Zhong, X.; Yang, L.; Cui, H. G9a Promotes Cell Proliferation and Suppresses Autophagy in Gastric Cancer by Directly Activating MTOR. *FASEB J.* **2019**, *33*, 14036–14050. [[CrossRef](#)]
126. Zhong, X.; Chen, X.; Guan, X.; Zhang, H.; Ma, Y.; Zhang, S.; Wang, E.; Zhang, L.; Han, Y. Overexpression of G9a and MCM7 in Oesophageal Squamous Cell Carcinoma Is Associated with Poor Prognosis. *Histopathology* **2015**, *66*, 192–200. [[CrossRef](#)]
127. Ho, J.C.; Abdullah, L.N.; Pang, Q.Y.; Jha, S.; Chow, E.K.H.; Yang, H.; Kato, H.; Poellinger, L.; Ueda, J.; Lee, K.L. Inhibition of the H3K9 Methyltransferase G9a Attenuates Oncogenicity and Activates the Hypoxia Signaling Pathway. *PLoS ONE* **2017**, *12*, e0188051. [[CrossRef](#)]
128. Liu, X.R.; Zhou, L.H.; Hu, J.X.; Liu, L.M.; Wan, H.P.; Zhang, X.Q. UNC0638, a G9a Inhibitor, Suppresses Epithelial-Mesenchymal Transition-Mediated Cellular Migration and Invasion in Triple Negative Breast Cancer. *Mol. Med. Rep.* **2018**, *17*, 2239–2244. [[CrossRef](#)] [[PubMed](#)]
129. Tu, W.B.; Shiah, Y.J.; Lourenco, C.; Mullen, P.J.; Dingar, D.; Redel, C.; Tamachi, A.; Ba-Alawi, W.; Aman, A.; Al-awar, R.; et al. MYC Interacts with the G9a Histone Methyltransferase to Drive Transcriptional Repression and Tumorigenesis. *Cancer Cell* **2018**, *34*, 579–595. [[CrossRef](#)] [[PubMed](#)]
130. Wozniak, R.J.; Klimecki, W.T.; Lau, S.S.; Feinstein, Y.; Futscher, B.W. 5-Aza-2⁰-Deoxycytidine-Mediated Reductions in G9a Histone Methyltransferase and Histone H3 K9 Di-Methylation Levels Are Linked to Tumor Suppressor Gene Reactivation. *Oncogene* **2007**, *26*, 77–90. [[CrossRef](#)] [[PubMed](#)]
131. Dong, C.; Wu, Y.; Yao, J.; Wang, Y.; Yu, Y.; Rychahou, P.G.; Evers, B.M.; Zhou, B.P. G9a Interacts with Snail and Is Critical for Snail-Mediated E-Cadherin Repression in Human Breast Cancer. *J. Clin. Investig.* **2012**, *122*, 1469–1486. [[CrossRef](#)] [[PubMed](#)]
132. Zhang, J.; Yao, D.; Jiang, Y.; Huang, J.; Yang, S.; Wang, J. Synthesis and Biological Evaluation of Benzimidazole Derivatives as the G9a Histone Methyltransferase Inhibitors That Induce Autophagy and Apoptosis of Breast Cancer Cells. *Bioorg. Chem.* **2017**, *72*, 168–181. [[CrossRef](#)]
133. Mabe, N.W.; Garcia, N.M.G.; Wolery, S.E.; Newcomb, R.; Meingasner, R.C.; Vilona, B.A.; Lupo, R.; Lin, C.C.; Chi, J.T.; Alvarez, J.V. G9a Promotes Breast Cancer Recurrence through Repression of a Pro-Inflammatory Program. *Cell Rep.* **2020**, *33*, 108341. [[CrossRef](#)]
134. Lin, X.; Huang, Y.; Zou, Y.; Chen, X.; Ma, X. Depletion of G9a Gene Induces Cell Apoptosis in Human Gastric Carcinoma. *Oncol. Rep.* **2016**, *35*, 3041–3049. [[CrossRef](#)] [[PubMed](#)]
135. Kim, T.W.; Lee, S.Y.; Kim, M.; Cheon, C.; Ko, S.-G. Kaempferol Induces Autophagic Cell Death via IRE1-JNK-CHOP Pathway and Inhibition of G9a in Gastric Cancer Cells. *Cell Death Dis.* **2018**, *9*, 1–14. [[CrossRef](#)]
136. Kim, T.W.; Cheon, C.; Ko, S.-G. SH003 Activates Autophagic Cell Death by Activating ATF4 and Inhibiting G9a under Hypoxia in Gastric Cancer Cells. *Cell Death Dis.* **2020**, *11*, 1–14. [[CrossRef](#)] [[PubMed](#)]

137. Kim, T.W. Cinnamaldehyde Induces Autophagy-Mediated Cell Death through ER Stress and Epigenetic Modification in Gastric Cancer Cells. *Acta Pharmacol. Sin.* **2021**, *2021*, 1–12. [[CrossRef](#)]
138. Lee, S.H.; Kim, J.; Kim, W.-H.; Lee, Y.M. Hypoxic Silencing of Tumor Suppressor RUNX3 by Histone Modification in Gastric Cancer Cells. *Oncogene* **2009**, *28*, 184–194. [[CrossRef](#)]
139. Hu, L.; Zang, M.; Wang, H.; Zhang, B.; Wang, Z.; Fan, Z.; Wu, H.; Li, J.; Su, L.; Yan, M.; et al. G9A Promotes Gastric Cancer Metastasis by Upregulating ITGB3 in a SET Domain-Independent Manner. *Cell Death Dis.* **2018**, *9*, 1–14. [[CrossRef](#)]
140. Watson, Z.L.; Yamamoto, T.M.; McMellen, A.; Kim, H.; Hughes, C.J.; Wheeler, L.J.; Post, M.D.; Behbakht, K.; Bitler, B.G. Histone Methyltransferases EHMT1 and EHMT2 (GLP/G9A) Maintain PARP Inhibitor Resistance in High-Grade Serous Ovarian Carcinoma. *Clin. Epigenetics* **2019**, *11*, 1–16. [[CrossRef](#)]
141. Liu, M.; Thomas, S.L.; DeWitt, A.K.; Zhou, W.; Madaj, Z.B.; Ohtani, H.; Baylin, S.B.; Liang, G.; Jones, P.A. Dual Inhibition of DNA and Histone Methyltransferases Increases Viral Mimicry in Ovarian Cancer Cells. *Cancer Res.* **2018**, *78*, 5754–5766. [[CrossRef](#)] [[PubMed](#)]
142. Chen, R.-J.; Shun, C.-T.; Yen, M.-L.; Chou, C.-H.; Lin, M.-C.; Chen, R.-J.; Shun, C.-T.; Yen, M.-L.; Chou, C.-H.; Lin, M.-C. Methyltransferase G9a Promotes Cervical Cancer Angiogenesis and Decreases Patient Survival. *Oncotarget* **2017**, *8*, 62081–62098. [[CrossRef](#)] [[PubMed](#)]
143. Watanabe, H.; Soejima, K.; Yasuda, H.; Kawada, I.; Nakachi, I.; Yoda, S.; Naoki, K.; Ishizaka, A. Dereglulation of Histone Lysine Methyltransferases Contributes to Oncogenic Transformation of Human Bronchoepithelial Cells. *Cancer Cell Int.* **2008**, *8*, 1–12. [[CrossRef](#)]
144. Huang, T.; Zhang, P.; Li, W.; Zhao, T.; Zhang, Z.; Chen, S.; Yang, Y.; Feng, Y.; Li, F.; Shirley Liu, X.; et al. G9A Promotes Tumor Cell Growth and Invasion by Silencing CASP1 in Non-Small-Cell Lung Cancer Cells. *Cell Death Dis.* **2017**, *8*, e2726. [[CrossRef](#)]
145. Hu, Y.; Zheng, Y.; Dai, M.; Wu, J.; Yu, B.; Zhang, H.; Kong, W.; Wu, H.; Yu, X. Snail2 Induced E-Cadherin Suppression and Metastasis in Lung Carcinoma Facilitated by G9a and HDACs. *Cell Adhes. Migr.* **2019**, *13*, 285–292. [[CrossRef](#)]
146. Sun, T.; Zhang, K.; Pangeni, R.P.; Wu, J.; Li, W.; Du, Y.; Guo, Y.; Chaurasiya, S.; Arvanitis, L.; Raz, D.J. G9a Promotes Invasion and Metastasis of Non-Small Cell Lung Cancer through Enhancing Focal Adhesion Kinase Activation via NF-KB Signaling Pathway. *Mol. Cancer Res.* **2021**, *19*, 429–440. [[CrossRef](#)] [[PubMed](#)]
147. Pangeni, R.P.; Yang, L.; Zhang, K.; Wang, J.; Li, W.; Guo, C.; Yun, X.; Sun, T.; Wang, J.; Raz, D.J. G9a Regulates Tumorigenicity and Stemness through Genome-Wide DNA Methylation Reprogramming in Non-Small Cell Lung Cancer. *Clin. Epigenetics* **2020**, *12*, 1–17. [[CrossRef](#)] [[PubMed](#)]
148. Bergin, C.J.; Zouggar, A.; Haebe, J.R.; Masibag, A.N.; Desrochers, F.M.; Reilley, S.Y.; Agrawal, G.; Benoit, Y.D. G9a Controls Pluripotent-like Identity and Tumor-Initiating Function in Human Colorectal Cancer. *Oncogene* **2020**, *40*, 1191–1202. [[CrossRef](#)]
149. Bárcena-Varela, M.; Caruso, S.; Llerena, S.; Álvarez-Sola, G.; Uriarte, I.; Latasa, M.U.; Urtasun, R.; Rebouissou, S.; Alvarez, L.; Jimenez, M.; et al. Dual Targeting of Histone Methyltransferase G9a and DNA-Methyltransferase 1 for the Treatment of Experimental Hepatocellular Carcinoma. *Hepatology* **2019**, *69*, 587–603. [[CrossRef](#)]
150. Yokoyama, M.; Chiba, T.; Zen, Y.; Oshima, M.; Kusakabe, Y.; Noguchi, Y.; Yuki, K.; Koide, S.; Tara, S.; Saraya, A.; et al. Histone Lysine Methyltransferase G9a Is a Novel Epigenetic Target for the Treatment of Hepatocellular Carcinoma. *Oncotarget* **2017**, *8*, 21315–21326. [[CrossRef](#)]
151. Hu, Y.; Zheng, Y.; Dai, M.; Wang, X.; Wu, J.; Yu, B.; Zhang, H.; Cui, Y.; Kong, W.; Wu, H.; et al. G9a and Histone Deacetylases Are Crucial for Snail2-Mediated E-Cadherin Repression and Metastasis in Hepatocellular Carcinoma. *Cancer Sci.* **2019**, *110*, 3442–3452. [[CrossRef](#)]
152. Nakatsuka, T.; Tateishi, K.; Kato, H.; Fujiwara, H.; Yamamoto, K.; Kudo, Y.; Nakagawa, H.; Tanaka, Y.; Ijichi, H.; Ikenoue, T.; et al. Inhibition of Histone Methyltransferase G9a Attenuates Liver Cancer Initiation by Sensitizing DNA-Damaged Hepatocytes to P53-Induced Apoptosis. *Cell Death Dis.* **2021**, *12*, 1–13. [[CrossRef](#)]
153. Segovia, C.; San José-Enériz, E.; Munera-Maravilla, E.; Martínez-Fernández, M.; Garate, L.; Miranda, E.; Vilas-Zornoza, A.; Lodewijk, I.; Rubio, C.; Segrelles, C.; et al. Inhibition of a G9a/DNMT Network Triggers Immune-Mediated Bladder Cancer Regression. *Nat. Med.* **2019**, *25*, 1073–1081. [[CrossRef](#)] [[PubMed](#)]
154. Alves-Silva, J.C.; de Carvalho, J.L.; Rabello, D.A.; Serejo, T.R.T.; Rego, E.M.; Neves, F.A.R.; Lucena-Araujo, A.R.; Pittella-Silva, F.; Saldanha-Araujo, F. GLP Overexpression Is Associated with Poor Prognosis in Chronic Lymphocytic Leukemia and Its Inhibition Induces Leukemic Cell Death. *Investig. New Drugs* **2018**, *36*, 955–960. [[CrossRef](#)]
155. Huang, Y.; Zou, Y.; Lin, L.; Ma, X.; Huang, X. Effect of BIX-01294 on Proliferation, Apoptosis and Histone Methylation of Acute T Lymphoblastic Leukemia Cells. *Leuk. Res.* **2017**, *62*, 34–39. [[CrossRef](#)] [[PubMed](#)]

156. Kondengaden, S.M.; Luo, L.F.; Huang, K.; Zhu, M.; Zang, L.; Bataba, E.; Wang, R.; Luo, C.; Wang, B.; Li, K.K.; et al. Discovery of Novel Small Molecule Inhibitors of Lysine Methyltransferase G9a and Their Mechanism in Leukemia Cell Lines. *Eur. J. Med. Chem.* **2016**, *122*, 382–393. [[CrossRef](#)]
157. Lehnertz, B.; Pabst, C.; Su, L.; Miller, M.; Liu, F.; Yi, L.; Zhang, R.; Krosli, J.; Yung, E.; Kirschner, J.; et al. The Methyltransferase G9a Regulates HoxA9-Dependent Transcription in AML. *Genes Dev.* **2014**, *28*, 317–327. [[CrossRef](#)]
158. San José-Enériz, E.; Agirre, X.; Rabal, O.; Vilas-Zornoza, A.; Sanchez-Arias, J.A.; Miranda, E.; Ugarte, A.; Roa, S.; Paiva, B.; Estella-Hermoso de Mendoza, A.; et al. Discovery of First-in-Class Reversible Dual Small Molecule Inhibitors against G9a and DNMTs in Hematological Malignancies. *Nat. Commun.* **2017**, *8*, 1–10. [[CrossRef](#)]
159. Madrazo, E.; Ruano, D.; Abad, L.; Alonso-Gómez, E.; Sánchez-Valdepeñas, C.; González-Murillo, Á.; Ramírez, M.; RedondoMuñoz, J. G9a Correlates with VLA-4 Integrin and Influences the Migration of Childhood Acute Lymphoblastic Leukemia Cells. *Cancers* **2018**, *10*, 325. [[CrossRef](#)]
160. Nagaraja, S.G.S.; Subramanian, U.; Nagarajan, D. Radiation-Induced H3K9 Methylation on E-Cadherin Promoter Mediated by ROS/Snail Axis: Role of G9a Signaling during Lung Epithelial-Mesenchymal Transition. *Toxicol. Vitro.* **2021**, *70*, 105037. [[CrossRef](#)] [[PubMed](#)]
161. Li, Y.; Chen, Z.; Cao, K.; Zhang, L.; Ma, Y.; Yu, S.; Jin, H.; Liu, X.; Li, W. G9a Regulates Cell Sensitivity to Radiotherapy via Histone H3 Lysine 9 Trimethylation and Ccnd8 in Lung Cancer. *Oncotargets Ther.* **2021**, *14*, 3721–3728. [[CrossRef](#)]
162. Luo, C.W.; Wang, J.Y.; Hung, W.C.; Peng, G.; Tsai, Y.L.; Chang, T.M.; Chai, C.Y.; Lin, C.H.; Pan, M.R. G9a Governs Colon Cancer Stem Cell Phenotype and Chemoradioresistance through PP2A-RPA Axis-Mediated DNA Damage Response. *Radiother. Oncol.* **2017**, *124*, 395–402. [[CrossRef](#)]
163. Dobson, T.H.W.; Hatcher, R.J.; Swaminathan, J.; Das, C.M.; Shaik, S.; Tao, R.-H.; Milite, C.; Castellano, S.; Taylor, P.H.; Sbardella, G.; et al. Regulation of USP37 Expression by REST-Associated G9a-Dependent Histone Methylation. *Mol. Cancer Res.* **2017**, *15*, 1073–1084. [[CrossRef](#)] [[PubMed](#)]
164. Ciechomska, I.A.; Przanowski, P.; Jackl, J.; Wojtas, B.; Kaminska, B. BIX01294, an Inhibitor of Histone Methyltransferase, Induces Autophagy-Dependent Differentiation of Glioma Stem-like Cells. *Sci. Rep.* **2016**, *6*, 1–15. [[CrossRef](#)]
165. Kato, S.; Weng, Q.Y.; Insko, M.L.; Chen, K.Y.; Muralidhar, S.; Pozniak, J.; Diaz, J.M.S.; Drier, Y.; Nguyen, N.; Lo, J.A.; et al. Gain-of-Function Genetic Alterations of G9a Drive Oncogenesis. *Cancer Discov.* **2020**, *10*, 980–997. [[CrossRef](#)]
166. Liu, S.; Ye, D.; Guo, W.; Yu, W.; He, Y.; Hu, J.; Wang, Y.; Zhang, L.; Liao, Y.; Song, H.; et al. G9a Is Essential for EMT-Mediated Metastasis and Maintenance of Cancer Stem Cell-like Characters in Head and Neck Squamous Cell Carcinoma. *Oncotarget* **2015**, *6*, 6887–6901. [[CrossRef](#)] [[PubMed](#)]
167. Rowbotham, S.P.; Li, F.; Dost, A.F.M.; Louie, S.M.; Marsh, B.P.; Pessina, P.; Anbarasu, C.R.; Brainson, C.F.; Tuminello, S.J.; Lieberman, A.; et al. H3K9 Methyltransferases and Demethylases Control Lung Tumor-Propagating Cells and Lung Cancer Progression. *Nat. Commun.* **2018**, *9*, 1–13. [[CrossRef](#)] [[PubMed](#)]
168. Ciechomska, I.A.; Marciniak, M.P.; Jackl, J.; Kaminska, B. Pre-Treatment or Post-Treatment of Human Glioma Cells with BIX01294, the Inhibitor of Histone Methyltransferase G9a, Sensitizes Cells to Temozolomide. *Front. Pharmacol.* **2018**, *9*, 1271. [[CrossRef](#)]

Bibliography

- Abduljabbar, R. *et al.* (2015) 'Clinical and biological significance of glucocorticoid receptor (GR) expression in breast cancer', *Breast Cancer Res Treat.*, 150(2), pp. 335–346. doi: 10.1007/s10549-015-3335-1.
- Abrahamson, P. E. *et al.* (2006) 'Recreational physical activity and survival among young women with breast cancer', *Cancer*, 107(8), pp. 1777–1785. doi: 10.1002/cncr.22201.
- Abu-Helalah, M. *et al.* (2020) 'BRCA1 and BRCA2 genes mutations among high risk breast cancer patients in Jordan', *Scientific Reports*, 10(1), pp. 1–9. doi: 10.1038/s41598-020-74250-2.
- Acharya, N. *et al.* (2020) 'Endogenous Glucocorticoid Signaling Regulates CD8+ T Cell Differentiation and Development of Dysfunction in the Tumor Microenvironment', *Immunity*, 53(3), pp. 658-671.e6. doi: 10.1016/J.IMMUNI.2020.08.005.
- Adcock, I. M. and Mumby, S. (2016) 'Glucocorticoids', *Handbook of Experimental Pharmacology*, 237, pp. 171–196. doi: 10.1007/164_2016_98/COVER.
- Agyeman, A. S. *et al.* (2016) 'Hsp90 Inhibition Results in Glucocorticoid Receptor Degradation in Association with Increased Sensitivity to Paclitaxel in Triple-Negative Breast Cancer', *Hormones and Cancer*, 7(2), pp. 114–126. doi: 10.1007/s12672-016-0251-8.Hsp90.
- Ahern, T. P. *et al.* (2017) 'Family history of breast cancer, breast density, and breast cancer risk in a U.S. breast cancer screening population', *Cancer Epidemiology Biomarkers and Prevention*, 26(6), pp. 938–944. doi: 10.1158/1055-9965.EPI-16-0801/69111/AM/FAMILY-HISTORY-OF-BREAST-CANCER-BREAST-DENSITY-AND.
- Ahmed, F. *et al.* (2016) 'Mutations in Human Interferon α 2b Gene and Potential as Risk Factor Associated with Female Breast Cancer', *Cancer Biotherapy and Radiopharmaceuticals*, 31(6), pp. 199–208. doi: 10.1089/cbr.2016.2046.
- Albrektsen, G., Heuch, I. and Thoresen, S. T. (2010) 'Histological type and grade of breast cancer tumors by parity, age at birth, and time since birth: A register-based study in Norway', *BMC Cancer*, 10. doi: 10.1186/1471-2407-10-226.
- Albuquerque, R. C. R., Baltar, V. T. and Marchioni, D. M. L. (2014) 'Breast cancer and dietary patterns: A systematic review', *Nutrition Reviews*, 72(1), pp. 1–17. doi: 10.1111/nure.12083.
- Allen, B. L. and Taatjes, D. J. (2015) 'The Mediator complex: A central integrator of transcription', *Nature Reviews Molecular Cell Biology*, 16(3), pp. 155–166. doi: 10.1038/nrm3951.
- Almlöf, T. *et al.* (1998) 'Role of important hydrophobic amino acids in the interaction between the glucocorticoid receptor τ 1-core activation domain and target factors', *Biochemistry*, 37(26), pp. 9586–9594. doi: 10.1021/bi973029x.
- Altundag, K. and Ibrahim, N. K. (2006) 'Aromatase Inhibitors in Breast Cancer: An Overview', *The Oncologist*, 11(6), pp. 553–562. doi: 10.1634/theoncologist.11-6-553.
- Andersen, Z. J. *et al.* (2017) 'Long-term exposure to ambient air pollution and incidence of postmenopausal breast cancer in 15 European cohorts within the ESCAPE project', *Environmental Health Perspectives*, 125(10), pp. 1–14. doi: 10.1289/EHP1742.

- Anderson, K. N., Schwab, R. B. and Martinez, M. E. (2014) 'Reproductive risk factors and breast cancer subtypes: A review of the literature', *Breast Cancer Research and Treatment*, 144(1), pp. 1–10. doi: 10.1007/s10549-014-2852-7.
- Arakane, F. *et al.* (1997) 'Phosphorylation of steroidogenic acute regulatory protein (StAR) modulates its steroidogenic activity', *Journal of Biological Chemistry*, 272(51), pp. 32656–32662. doi: 10.1074/jbc.272.51.32656.
- Assi, H. A. *et al.* (2013) 'Epidemiology and prognosis of breast cancer in young women', *Journal of Thoracic Disease*, 5(1). doi: 10.3978/J.ISSN.2072-1439.2013.05.24.
- Avenant, C. *et al.* (2010) 'Role of ligand-dependent GR phosphorylation and half-life in determination of ligand-specific transcriptional activity', *Molecular and Cellular Endocrinology*, 327(1–2), pp. 72–88. doi: 10.1016/j.mce.2010.06.007.
- Bagnardi, V. *et al.* (2013) 'Light alcohol drinking and cancer: A meta-analysis', *Annals of Oncology*, 24(2), pp. 301–308. doi: 10.1093/annonc/mds337.
- Baker, A. C. *et al.* (2012) 'Enhanced steroid response of a human glucocorticoid receptor splice variant', *Shock*, 38(1), pp. 11–17. doi: 10.1097/SHK.0b013e318257c0c0.
- Bamberger, C. M. *et al.* (1995) 'Glucocorticoid receptor β , a potential endogenous inhibitor of glucocorticoid action in humans', *Journal of Clinical Investigation*, 95(6), pp. 2435–2441. doi: 10.1172/JCI117943.
- Barnard, M. E., Boeke, C. E. and Tamimi, R. M. (2015) 'Established breast cancer risk factors and risk of intrinsic tumor subtypes', *Biochimica et Biophysica Acta - Reviews on Cancer*, 1856(1), pp. 73–85. doi: 10.1016/j.bbcan.2015.06.002.
- Baroni, F. and Makdissi, A. (2022) 'An introduction to male breast cancer for urologists : epidemiology , diagnosis , principles of treatment , and special situations _____', 48(x), pp. 1–11. doi: 10.1590/S1677-5538.IBJU.2021.0828.
- Barroso-Sousa, R. *et al.* (2021) 'Prospective Study Testing a Simplified Paclitaxel Premedication Regimen in Patients with Early Breast Cancer', *Oncologist*, 26(11), pp. 927–933. doi: 10.1002/onco.13960.
- Barski, A. *et al.* (2007) 'High-Resolution Profiling of Histone Methylations in the Human Genome', *Cell*, 129(4), pp. 823–837. doi: 10.1016/j.cell.2007.05.009.
- Beasley, J. M. *et al.* (2012) 'Meeting the physical activity guidelines and survival after breast cancer: Findings from the after breast cancer pooling project', *Breast Cancer Research and Treatment*, 131(2), pp. 637–643. doi: 10.1007/S10549-011-1770-1/TABLES/5.
- Beato, M. *et al.* (1987) 'Gene regulation by steroid hormones', *Journal of Steroid Biochemistry*, 27(1–3), pp. 9–14. doi: 10.1016/0022-4731(87)90288-3.
- Beaupere, C. *et al.* (2021) 'Molecular mechanisms of glucocorticoid-induced insulin resistance', *International Journal of Molecular Sciences*, 22(2), pp. 1–30. doi: 10.3390/ijms22020623.
- Bedford, M. T. and Clarke, S. G. (2009) 'Protein Arginine Methylation in Mammals: Who, What, and Why', *Molecular Cell*, 33(1), pp. 1–13. doi: 10.1016/j.molcel.2008.12.013.
- Beger, C. *et al.* (2003) 'Expression and structural analysis of glucocorticoid receptor isoform gamma

in human leukaemia cells using an isoform-specific real-time polymerase chain reaction approach', *British Journal of Haematology*, 122(2), pp. 245–252. doi: 10.1046/j.1365-2141.2003.04426.x.

Ben-Porath, I. *et al.* (2008) 'An embryonic stem cell-like gene expression signature in poorly differentiated aggressive human tumors', *Nature Genetics* 2008 40:5, 40(5), pp. 499–507. doi: 10.1038/ng.127.

Bencze, M. *et al.* (2020) 'Pharmacological suppression of endogenous glucocorticoid synthesis attenuated blood pressure and heart rate response to acute restraint in wistar rats', *Physiological Research*, 69(1951), pp. 415–426. doi: 10.33549/PHYSIOLRES.934432.

Bender, I. K., Cao, Y. and Lu, N. Z. (2013) 'Determinants of the heightened activity of glucocorticoid receptor translational isoforms', *Molecular Endocrinology*, 27(9), pp. 1577–1587. doi: 10.1210/me.2013-1009.

Berg, M. N., Dharmarajan, A. M. and Waddell, B. J. (2002) 'Glucocorticoids and progesterone prevent apoptosis in the lactating rat mammary gland', *Endocrinology*, 143(1), pp. 222–227. doi: 10.1210/endo.143.1.8584.

Bernard, P. S. *et al.* (2009) 'Supervised risk predictor of breast cancer based on intrinsic subtypes', *Journal of Clinical Oncology*, 27(8), pp. 1160–1167. doi: 10.1200/JCO.2008.18.1370.

Bertucci, F. *et al.* (2008) 'How basal are triple-negative breast cancers?', *International Journal of Cancer*, 123(1), pp. 236–240. doi: 10.1002/ijc.23518.

Bertucci, P. Y. *et al.* (2010) 'Glucocorticoid-induced impairment of mammary gland involution is associated with STAT5 and STAT3 signaling modulation', *Endocrinology*, 151(12), pp. 5730–5740. doi: 10.1210/en.2010-0517.

Bf, L. *et al.* (1991) 'Crystallographic analysis of the interaction of the glucocorticoid receptor with DNA. Nature 352:497-505', *Rastinejad F, Perlmann T, Evans RM, Sigler PB*, 375(Table 1), pp. 190–91.

Bhadoria, A. S. *et al.* (2013) 'Reproductive factors and breast cancer: A case-control study in tertiary care hospital of North India', *Indian Journal of Cancer*, 50(4), pp. 316–321. doi: 10.4103/0019-509X.123606.

Bhattacharyya, S. *et al.* (2007) 'Macrophage glucocorticoid receptors regulate Toll-like receptor 4-mediated inflammatory responses by selective inhibition of p38 MAP kinase', *Blood*, 109(10), pp. 4313–4319. doi: 10.1182/blood-2006-10-048215.

Bird, A. D. *et al.* (2007) 'Identification of glucocorticoid-regulated genes that control cell proliferation during murine respiratory development', *Journal of Physiology*, 585(1), pp. 187–201. doi: 10.1113/jphysiol.2007.136796.

Biswas, S. K. *et al.* (2022) 'The Mammary Gland: Basic Structure and Molecular Signaling during Development', *International Journal of Molecular Sciences*, 23(7), p. 3883. doi: 10.3390/ijms23073883.

Bittencourt, D., Wu, D., *et al.* (2012) 'G9a functions as a molecular scaffold for assembly of transcriptional coactivators on a subset of Glucocorticoid Receptor target genes', *Proceedings of the National Academy of Sciences of the United States of America*, 109(48), pp. 19673–19678. doi: 10.1073/pnas.1211803109.

Bittencourt, D., Wu, D. Y., *et al.* (2012) 'G9a functions as a molecular scaffold for assembly of transcriptional coactivators on a subset of Glucocorticoid Receptor target genes', *Proceedings of the*

- National Academy of Sciences of the United States of America*, 109(48), pp. 19673–19678. doi: 10.1073/pnas.1211803109.
- Bjerkaas, E. *et al.* (2013) 'Smoking duration before first childbirth: An emerging risk factor for breast cancer? Results from 302,865 Norwegian women', *Cancer Causes and Control*, 24(7), pp. 1347–1356. doi: 10.1007/s10552-013-0213-1.
- Black, B. E. *et al.* (2001) 'DNA binding domains in diverse nuclear receptors function as nuclear export signals', *Current Biology*, 11(22), pp. 1749–1758. doi: 10.1016/S0960-9822(01)00537-1.
- Blamey, R. W. *et al.* (2007) 'Reading the prognosis of the individual with breast cancer', *European Journal of Cancer*, 43(10), pp. 1545–1547. doi: 10.1016/j.ejca.2007.01.003.
- Bledsoe, Randy K. *et al.* (2002) 'Crystal structure of the glucocorticoid receptor ligand binding domain reveals a novel mode of receptor dimerization and coactivator recognition', *Cell*, 110(1), pp. 93–105. doi: 10.1016/S0092-8674(02)00817-6.
- Bledsoe, Randy K *et al.* (2002) 'Crystal Structure of the Glucocorticoid Receptor Ligand Binding Domain Reveals a Novel Mode of Receptor Dimerization and Coactivator Recognition', 110, pp. 93–105.
- Bledsoe, R. K., Stewart, E. L. and Pearce, K. H. (2004) 'Structure and Function of the Glucocorticoid Receptor Ligand Binding Domain', 68.
- Bloom, H. J. and Richardson, W. W. (1957) 'Histological grading and prognosis in breast cancer a study of 1409 cases of which 359 have been followed for 15 years', *British Journal of Cancer*, 11(3), pp. 359–377. doi: 10.1038/bjc.1957.43.
- Blotta, M. H., DeKruyff, R. H. and Umetsu, D. T. (1997) 'Corticosteroids inhibit IL-12 production in human monocytes and enhance their capacity to induce IL-4 synthesis in CD4+ lymphocytes.', *Journal of immunology (Baltimore, Md. : 1950)*, 158(12), pp. 5589–95. Available at: <http://www.ncbi.nlm.nih.gov/pubmed/9190905>.
- Bockühl, Y. *et al.* (2011) 'Differential regulation and function of 5 'untranslated GR-exon 1 transcripts', *Molecular Endocrinology*, 25(7), pp. 1100–1110. doi: 10.1210/me.2010-0436.
- Bodine, S. C. and Furlow, J. D. (2015) *Glucocorticoids and skeletal muscle*, *Advances in Experimental Medicine and Biology*. doi: 10.1007/978-1-4939-2895-8_7.
- Bodwell, J. E. *et al.* (1998) 'Glucocorticoid receptor phosphorylation: Overview, function and cell cycle-dependence', *Journal of Steroid Biochemistry and Molecular Biology*, 65(1–6), pp. 91–99. doi: 10.1016/S0960-0760(97)00185-4.
- Boettner, A., Ehrhart-bornstein, M. and Shea, J. J. O. (2002) 'Gene profiling reveals unknown enhancing and suppressive actions of glucocorticoids on immune cells', *FASEB J.*, 16(1), pp. 61–71. doi: 10.1096/fj.01-0245com.
- Bos, F. L. *et al.* (2011) 'CCBE1 Is essential for mammalian lymphatic vascular development and enhances the lymphangiogenic effect of vascular endothelial growth factor-c in vivo', *Circulation Research*, 109(5), pp. 486–491. doi: 10.1161/CIRCRESAHA.111.250738.
- Bosch, A. *et al.* (2010) 'Triple-negative breast cancer: Molecular features, pathogenesis, treatment and current lines of research', *Cancer Treatment Reviews*, 36(3), pp. 206–215. doi: 10.1016/j.ctrv.2009.12.002.

- Bourdeau, I. and Stratakis, C. A. (2003) 'Glucocorticoids, Pharmacology of', *Encyclopedia of Hormones*, pp. 142–150. doi: 10.1016/B0-12-341103-3/00122-4.
- Boyle, P. (2012) 'Triple-negative breast cancer : epidemiological considerations and recommendations research article', *Virchows Arch.*, 23(Supplement 6), pp. 8–13. doi: 10.1093/annonc/mds187.
- Bravi, F., Decarli, A. and Russo, A. G. (2018) 'Risk factors for breast cancer in a cohort of mammographic screening program: a nested case–control study within the FRiCaM study', *Cancer Medicine*, 7(5), pp. 2145–2152. doi: 10.1002/cam4.1427.
- Braz-de-Melo, H. A. *et al.* (2021) 'The Use of the Anticoagulant Heparin and Corticosteroid Dexamethasone as Prominent Treatments for COVID-19', *Frontiers in Medicine*, 8(April), pp. 1–11. doi: 10.3389/fmed.2021.615333.
- Breslin, M. B., Geng, C. D. and Vedeckis, W. V. (2001) 'Multiple promoters exist in the human GR gene, one of which is activated by glucocorticoids', *Molecular Endocrinology*, 15(8), pp. 1381–1395. doi: 10.1210/mend.15.8.0696.
- Breslin, M. B. and Vedeckis, W. V. (1996) 'The glucocorticoid receptor and c-jun promoters contain AP-1 sites that bind different AP-1 transcription factors', *Endocrine*, 5(1), pp. 15–22. doi: 10.1007/bf02738651.
- Brown, M. S., Kovanen, P. T. and Goldstein, J. L. (1979) *Receptor-mediated uptake of lipoprotein-cholesterol and its utilization for steroid synthesis in the adrenal cortex*, *Recent Progress in Hormone Research*. ACADEMIC PRESS, INC. doi: 10.1016/b978-0-12-571135-7.50009-6.
- Buchwald, P. and Bodor, N. (2004) 'Soft glucocorticoid design: Structural elements and physicochemical parameters determining receptor-binding affinity', *Pharmazie*, 59(5), pp. 396–404.
- Busada, J. T. and Cidlowski, J. A. (2017) *Mechanisms of Glucocorticoid Action During Development*. 1st edn, *Current Topics in Developmental Biology*. 1st edn. Elsevier Inc. doi: 10.1016/bs.ctdb.2016.12.004.
- Butt, S. *et al.* (2009) 'Parity and age at first childbirth in relation to the risk of different breast cancer subgroups', *International Journal of Cancer*, 125(8), pp. 1926–1934. doi: 10.1002/ijc.24494.
- Buxant, F., Engohan-Aloghe, C. and Noël, J. C. (2010) 'Estrogen receptor, progesterone receptor, and glucocorticoid receptor expression in normal breast tissue, breast in situ carcinoma, and invasive breast cancer', *Applied Immunohistochemistry and Molecular Morphology*, 18(3), pp. 254–257. doi: 10.1097/PAI.0b013e3181c10180.
- Calle, E. E. *et al.* (1997) 'Breast cancer and hormone replacement therapy: collaborative reanalysis of data from 51 epidemiological studies of 52 705 women with breast cancer and 108 411 women without breast cancer', *The Lancet*, 350(9084), pp. 1047–1059. doi: 10.1016/S0140-6736(97)08233-0.
- Cancer Today* (no date). Available at: <https://gco.iarc.fr/today/home> (Accessed: 10 August 2022).
- Cao, Y. *et al.* (2013) 'Glucocorticoid receptor translational isoforms underlie maturational stage-specific glucocorticoid sensitivities of dendritic cells in mice and humans', *Blood*, 121(9), pp. 1553–1562. doi: 10.1182/blood-2012-05-432336.
- Carlstedt-Duke, J. *et al.* (1987) 'Domain structure of the glucocorticoid receptor protein.', *Proceedings of the National Academy of Sciences of the United States of America*, 84(13), pp. 4437–4440. doi: 10.1073/pnas.84.13.4437.

- Carrigan, A. *et al.* (2007) 'An active nuclear retention signal in the glucocorticoid receptor functions as a strong inducer of transcriptional activation', *Journal of Biological Chemistry*, 282(15), pp. 10963–10971. doi: 10.1074/jbc.M602931200.
- de Castro Baccarin, A. L. *et al.* (2019) 'The feasibility of dexamethasone omission in weekly paclitaxel treatment for breast cancer patients', *Supportive Care in Cancer*, 27(3), pp. 927–931. doi: 10.1007/s00520-018-4381-0.
- de Castro Kroner, J. *et al.* (2018) 'Glucocorticoids promote intrinsic human TH17 differentiation', *Journal of Allergy and Clinical Immunology*, 142(5), pp. 1669-1673.e11. doi: 10.1016/j.jaci.2018.07.019.
- Chan, D. S. M. *et al.* (2014) 'Body mass index and survival in women with breast cancer—systematic literature review and meta-analysis of 82 follow-up studies', *Annals of Oncology*, 25(10), pp. 1901–1914. doi: 10.1093/annonc/mdu042.
- Chan, T. S., Tse, E. and Kwong, Y. L. (2017) 'Chidamide in the treatment of peripheral T-cell lymphoma', *OncoTargets and Therapy*, 10, pp. 347–352. doi: 10.2147/OTT.S93528.
- Chao, C. C. *et al.* (2021) 'IGFBP-3 stimulates human osteosarcoma cell migration by upregulating VCAM-1 expression', *Life Sciences*, 265(July 2020), p. 118758. doi: 10.1016/j.lfs.2020.118758.
- Charmandari, E., Kino, T. and Chrousos, G. P. (2004) 'Glucocorticoid Receptor', *Encyclopedia of Endocrine Diseases*, pp. 229–234. doi: 10.1016/B0-12-475570-4/00535-7.
- Cheang, M. C. U. *et al.* (2009) 'Ki67 index, HER2 status, and prognosis of patients with luminal B breast cancer', *Journal of the National Cancer Institute*, 101(10), pp. 736–750. doi: 10.1093/jnci/djp082.
- Chen, D. *et al.* (1999a) 'Regulation of transcription by a protein methyltransferase', *Science*, 284(5423), pp. 2174–2177. doi: 10.1126/science.284.5423.2174.
- Chen, D. *et al.* (1999b) 'Regulation of Transcription by a Protein Methyltransferase', *Science*, 284(5423), pp. 2174–2177. doi: 10.1126/SCIENCE.284.5423.2174.
- Chen, F. *et al.* (2016) 'Meta-analysis of the effects of oral and intravenous dexamethasone premedication in the prevention of paclitaxel- induced allergic reactions', *Oncotarget*, 8(12), pp. 19326–19243. doi: 10.18632/ONCOTARGET.13705.
- Chen, H. *et al.* (1997) 'Nuclear receptor coactivator ACTR is a novel histone acetyltransferase and forms a multimeric activation complex with P/CAF and CBP/p300', *Cell*, 90(3), pp. 569–580. doi: 10.1016/S0092-8674(00)80516-4.
- Chen, J. D. and Evans, R. M. (1995) 'A transcriptional co-repressor that interacts with nuclear hormone receptors', *Nature*, 377(6548), pp. 454–457. doi: 10.1038/377454a0.
- Chen, S. and Parmigiani, G. (2007) 'Meta- Analysis of BRAC1 and BRAC2 Penetrance', *Journal of Clinical Oncology*, 25(11), pp. 1329–33. Available at: <https://www.ncbi.nlm.nih.gov/pmc/articles/PMC2267287/pdf/nihms41827.pdf>.
- Chen, S. and Smith, D. F. (1998) 'Hop as an adaptor in the heat shock protein 70 (Hsp70) and Hsp90 chaperone machinery', *Journal of Biological Chemistry*, 273(52), pp. 35194–35200. doi: 10.1074/jbc.273.52.35194.
- Chen, W. *et al.* (2008) 'Glucocorticoid receptor phosphorylation differentially affects target gene

- expression', *Molecular Endocrinology*, 22(8), pp. 1754–1766. doi: 10.1210/me.2007-0219.
- Chen, W., Rogatsky, I. and Garabedian, M. J. (2006) 'MED14 and MED1 differentially regulate target-specific gene activation by the glucocorticoid receptor', *Molecular Endocrinology*, 20(3), pp. 560–572. doi: 10.1210/me.2005-0318.
- Chen, Z. *et al.* (2015) 'Ligand-dependent genomic function of glucocorticoid receptor in triple-negative breast cancer', *Nature Communications*, 6, pp. 1–8. doi: 10.1038/ncomms9323.
- Chien, H. P. *et al.* (2016) 'Expression of ROR1 has prognostic significance in triple negative breast cancer', *Virchows Archiv*, 468(5), pp. 589–595. doi: 10.1007/s00428-016-1911-3.
- Chinenov, Y. *et al.* (2008) 'GRIP1-associated SET-domain methyltransferase in glucocorticoid receptor target gene expression', *Proceedings of the National Academy of Sciences of the United States of America*, 105(51), pp. 20185–20190. doi: 10.1073/pnas.0810863105.
- Chinenov, Y. *et al.* (2012) 'Role of transcriptional coregulator GRIP1 in the anti-inflammatory actions of glucocorticoids', *Proceedings of the National Academy of Sciences of the United States of America*, 109(29), pp. 11776–11781. doi: 10.1073/pnas.1206059109.
- Chlebowski, R. T. *et al.* (2009) 'Breast Cancer after Use of Estrogen plus Progestin in Postmenopausal Women', <https://doi.org/10.1056/NEJMoa0807684>, 360(6), pp. 573–587. doi: 10.1056/NEJMoa0807684.
- Chodankar, R. *et al.* (2014) 'Hic-5 is a transcription coregulator that acts before and/or after glucocorticoid receptor genome occupancy in a gene-selective manner', *Proceedings of the National Academy of Sciences of the United States of America*, 111(11), pp. 4007–4012. doi: 10.1073/pnas.1400522111.
- Chrousos, G. P. and Kino, T. (2005) 'Intracellular glucocorticoid signaling: a formerly simple system turns stochastic.', *Science's STKE : signal transduction knowledge environment*, 2005(304), pp. 1–7. doi: 10.1126/stke.3042005pe48.
- Clapier, C. R. and Cairns, B. R. (2009) 'The biology of chromatin remodeling complexes', *Annual Review of Biochemistry*, 78, pp. 273–304. doi: 10.1146/annurev.biochem.77.062706.153223.
- Clavel-Chapelon, F. *et al.* (1995) 'Reproductive factors and breast cancer risk: Effect of age at diagnosis', *Annals of Epidemiology*, 5(4), pp. 315–320. doi: 10.1016/1047-2797(95)00099-5.
- Cobain, E. F., Milliron, K. J. and Merajver, S. D. (2016) 'Updates on breast cancer genetics: Clinical implications of detecting syndromes of inherited increased susceptibility to breast cancer', *Seminars in Oncology*, 43(5), pp. 528–535. doi: 10.1053/j.seminoncol.2016.10.001.
- Coderre, L., Srivastava, A. K. and Chiasson, J. L. (1991) 'Role of glucocorticoid in the regulation of glycogen metabolism in skeletal muscle', *American Journal of Physiology - Endocrinology and Metabolism*, 260(6 23/6). doi: 10.1152/ajpendo.1991.260.6.e927.
- Cole, T. J. *et al.* (1995) 'Targeted disruption of the glucocorticoid receptor gene blocks adrenergic chromaffin cell development and severely retards lung maturation', *Genes and Development*, 9(13), pp. 1608–1621. doi: 10.1101/gad.9.13.1608.
- Cole, T. J. *et al.* (2004) 'Altered epithelial cell proportions in the fetal lung of glucocorticoid receptor null mice', *American Journal of Respiratory Cell and Molecular Biology*, 30(5), pp. 613–619. doi: 10.1165/rcmb.2003-0236OC.

- Collingwood, T. N., Urnov, F. D. and Wolffe, A. P. (1999) 'Nuclear receptors: Coactivators, corepressors and chromatin remodeling in the control of transcription', *Journal of Molecular Endocrinology*, 23(3), pp. 255–275. doi: 10.1677/jme.0.0230255.
- Correa Geyer, F. and Reis-Filho, J. S. (2009) 'Microarray-based gene expression profiling as a clinical tool for breast cancer management: Are we there yet?', *International Journal of Surgical Pathology*, 17(4), pp. 285–302. doi: 10.1177/1066896908328577.
- Crosignani, P. G. (2003) 'Breast cancer and hormone-replacement therapy in the Million Women Study', *Maturitas*, 46(2), pp. 91–92. doi: 10.1016/j.maturitas.2003.09.002.
- Croxtall, J. D., Choudhury, Q. and Flower, R. J. (2000) 'Glucocorticoids act within minutes to inhibit recruitment of signalling factors to activated EGF receptors through a receptor-dependent, transcription-independent mechanism', *British Journal of Pharmacology*, 130(2), pp. 289–298. doi: 10.1038/sj.bjp.0703272.
- Cui, B. *et al.* (2013) 'Targeting ROR1 Inhibits Epithelial–Mesenchymal Transition and Metastasis', *Cancer Research*, 73(12), pp. 3649–3660. doi: 10.1158/0008-5472.CAN-12-3832.
- Dandachi, N., Dietze, O. and Hauser-Kronberger, C. (2002) 'Chromogenic in situ hybridization: A novel approach to a practical and sensitive method for the detection of HER2 oncogene in archival human breast carcinoma', *Laboratory Investigation*, 82(8), pp. 1007–1014. doi: 10.1097/01.LAB.0000024360.48464.A4.
- Daniel Bird, A. *et al.* (2015) 'Minireview: Glucocorticoid regulation of lung development: Lessons learned from conditional GR knockout mice', *Molecular Endocrinology*, 29(2), pp. 158–171. doi: 10.1210/me.2014-1362.
- Darimont, B. D. *et al.* (1998) 'Structure and specificity of nuclear receptor–coactivator interactions', *Genes & Development*, 12(21), pp. 3343–3356. doi: 10.1101/GAD.12.21.3343.
- Davis, S. and Mirick, D. K. (2006) 'Circadian disruption, shift work and the risk of cancer: A summary of the evidence and studies in Seattle', *Cancer Causes and Control*, 17(4), pp. 539–545. doi: 10.1007/s10552-005-9010-9.
- Demark-Wahnefried, W. *et al.* (2012) 'The role of obesity in cancer survival and recurrence', *Cancer Epidemiology Biomarkers and Prevention*, 21(8), pp. 1244–1259. doi: 10.1158/1055-9965.EPI-12-0485.
- Derakhshan, F. and Reis-Filho, J. S. (2022) 'Pathogenesis of Triple-Negative Breast Cancer', *Annual review of pathology*, 17, pp. 181–204. doi: 10.1146/ANNUREV-PATHOL-042420-093238.
- Deroo, B. J. *et al.* (2002) 'Proteasomal Inhibition Enhances Glucocorticoid Receptor Transactivation and Alters Its Subnuclear Trafficking', *Molecular and Cellular Biology*, 22(12), pp. 4113–4123. doi: 10.1128/mcb.22.12.4113-4123.2002.
- Diamond, M. I. *et al.* (1990) 'Transcription factor interactions: Selectors of positive or negative regulation from a single DNA element', *Science*, 249(4974), pp. 1266–1272. doi: 10.1126/science.2119054.
- Dias, K. *et al.* (2017) 'Claudin-Low Breast Cancer ; Clinical & Pathological Characteristics', pp. 1–17. doi: 10.1371/journal.pone.0168669.
- Ding, X. F. *et al.* (1998) 'Nuclear receptor-binding sites of coactivators glucocorticoid receptor interacting protein 1 (GRIP1) and steroid receptor coactivator 1 (SRC-1): Multiple motifs with

different binding specificities', *Molecular Endocrinology*, 12(2), pp. 302–313. doi: 10.1210/mend.12.2.0065.

Dobrovolska, J. *et al.* (2012) 'Glucocorticoid-Dependent Phosphorylation of the Transcriptional Coregulator GRIP1', *Molecular and Cellular Biology*, 32(4), pp. 730–739. doi: 10.1128/mcb.06473-11.

Draper, N. and Stewart, P. M. (2005) 'STARLING REVIEW 11 -Hydroxysteroid dehydrogenase and the pre-receptor regulation of corticosteroid hormone action', pp. 251–271. doi: 10.1677/joe.1.06019.

Le Drean, Y. *et al.* (2002) 'Potentiation of glucocorticoid receptor transcriptional activity by sumoylation', *Endocrinology*, 143(9), pp. 3482–3489. doi: 10.1210/en.2002-220135.

Du, J. *et al.* (2009) 'Dynamic regulation of mitochondrial function by glucocorticoids', *Proceedings of the National Academy of Sciences of the United States of America*, 106(9), pp. 3543–3548. doi: 10.1073/pnas.0812671106.

Du, J., McEwen, B. and Manji, H. K. (2009) 'Glucocorticoid receptors modulate mitochondrial function: A novel mechanism for neuroprotection', *Communicative and Integrative Biology*, 2(4), pp. 350–352. doi: 10.4161/cib.2.4.8554.

Duma, D., Jewell, C. M. and Cidlowski, J. A. (2006) 'Multiple glucocorticoid receptor isoforms and mechanisms of post-translational modification', *Journal of Steroid Biochemistry and Molecular Biology*, 102(1-5 SPEC. ISS.), pp. 11–21. doi: 10.1016/j.jsbmb.2006.09.009.

Echeverría, P. C. *et al.* (2009) 'Nuclear Import of the Glucocorticoid Receptor-hsp90 Complex through the Nuclear Pore Complex Is Mediated by Its Interaction with Nup62 and Importin β ', *Molecular and Cellular Biology*, 29(17), pp. 4788–4797. doi: 10.1128/mcb.00649-09.

Edge, S. B. and Compton, C. C. (2010) 'The american joint committee on cancer: The 7th edition of the AJCC cancer staging manual and the future of TNM', *Annals of Surgical Oncology*, 17(6), pp. 1471–1474. doi: 10.1245/s10434-010-0985-4.

Elias, F. *et al.* (2021) 'Effectiveness of breast cancer screening campaigns from 2012 to 2017 by analysis of stage at diagnosis, lebanon', *Eastern Mediterranean Health Journal*, 27(6), pp. 580–586. doi: 10.26719/emhj.21.013.

Elston, C. W. and Ellis, I. O. (2002) 'Pathological prognostic factors in breast cancer. I. The value of histological grade in breast cancer: Experience from a large study with long-term follow-up. C. W. Elston & I. O. Ellis. *Histopathology* 1991; 19; 403-410 - Author commentary', *Histopathology*, 41(3 A), p. 151. doi: 10.1046/j.1365-2559.2002.14691.x.

Engel, K. B. and Yamamoto, K. R. (2011) 'The Glucocorticoid Receptor and the Coregulator Brm Selectively Modulate Each Other's Occupancy and Activity in a Gene-Specific Manner', *Molecular and Cellular Biology*, 31(16), pp. 3267–3276. doi: 10.1128/mcb.05351-11.

Epsztejn-Litman, S. *et al.* (2008) 'De novo DNA methylation promoted by G9a prevents reprogramming of embryonically silenced genes', *Nature Structural and Molecular Biology*, 15(11), pp. 1176–1183. doi: 10.1038/nsmb.1476.

Ernard, B. *et al.* (2002) 'Twenty-Year Follow-up of a Randomized Trial Comparing Total Mastectomy, Lumpectomy, and Lumpectomy plus Irradiation for the Treatment of Invasive Breast Cancer', <https://doi.org/10.1056/NEJMoa022152>, 347(16), pp. 1233–1241. doi: 10.1056/NEJMoa022152.

Van Everdingen, A. A. *et al.* (2002) 'Low-dose prednisone therapy for patients with early active rheumatoid arthritis: Clinical efficacy, disease-modifying properties, and side effects. A randomized,

double-blind, placebo-controlled clinical trial', *Annals of Internal Medicine*, 136(1), pp. 1–12. doi: 10.7326/0003-4819-136-1-200201010-00006.

Exton, J. H. *et al.* (1972) 'Interaction of glucocorticoids with glucagon and epinephrine in the control of gluconeogenesis and glycogenolysis in liver and of lipolysis in adipose tissue.', *Journal of Biological Chemistry*, 247(11), pp. 3579–3588. doi: 10.1016/s0021-9258(19)45180-6.

Fahrenkrug, J., Hannibal, J. and Georg, B. (2008) 'Diurnal rhythmicity of the canonical clock genes Per1, Per2 and Bmal1 in the rat adrenal gland is unaltered after hypophysectomy', *Journal of Neuroendocrinology*, 20(3), pp. 323–329. doi: 10.1111/j.1365-2826.2008.01651.x.

Fardet, L., Nazareth, I. and Petersen, I. (2008) 'Suicidal behavior and severe neuropsychiatric disorders following glucocorticoid therapy in primary care', *Am J Psychiatry*, 169(17), pp. 491–497. Available at: http://newpsi.bvs-psi.org.br/ebooks2010/pt/Acervo_files/depression-cuba.pdf.

Fares, M. Y. *et al.* (2019) 'Breast cancer epidemiology among lebanese women: An 11-year analysis', *Medicina (Lithuania)*, 55(8), pp. 1–10. doi: 10.3390/medicina55080463.

Farmer, P. *et al.* (2005) 'Identification of molecular apocrine breast tumours by microarray analysis', *Oncogene*, 24(29), pp. 4660–4671. doi: 10.1038/sj.onc.1208561.

Fieser, L. F. and Rajagopalan, S. (1949) 'Selective Oxidation with N-Bromosuccinimide. II. Cholestane-3 β ,5 α ,6 β -triol', *Journal of the American Chemical Society*, 71(12), pp. 3938–3941. doi: 10.1021/ja01180a016.

Fioravanti, R. *et al.* (2018) 'Six Years (2012–2018) of Researches on Catalytic EZH2 Inhibitors: The Boom of the 2-Pyridone Compounds', *The Chemical Record*, 18(12), pp. 1818–1832. doi: 10.1002/TCR.201800091.

Fowden, A. L., Li, J. and Forhead, A. J. (1998) 'Glucocorticoids and the preparation for life after birth: are there long-term consequences of the life insurance?', *Proceedings of the Nutrition Society*, 57(01), pp. 113–122. doi: 10.1079/pns19980017.

Franchimont, D. *et al.* (2002) 'Positive Effects of Glucocorticoids on T Cell Function by Up-Regulation of IL-7 Receptor α ', *The Journal of Immunology*, 168(5), pp. 2212–2218. doi: 10.4049/jimmunol.168.5.2212.

Frenkel, B., White, W. and Tuckermann, J. (2015) 'Glucocorticoid-Induced osteoporosis', *Advances in Experimental Medicine and Biology*, 872, pp. 179–215. doi: 10.1007/978-1-4939-2895-8_8/COVER.

Friedenreich, C. M. (2010) 'The role of physical activity in breast cancer etiology', *Seminars in Oncology*, 37(3), pp. 297–302. doi: 10.1053/j.seminoncol.2010.05.008.

Fryer, C. J. and Archer, T. K. (1998) 'Chromatin remodelling by the glucocorticoid receptor requires the BRG1 complex', *Nature* 1998 393:6680, 393(6680), pp. 88–91. doi: 10.1038/30032.

Fulford, L. G. *et al.* (2006) 'Specific morphological features predictive for the basal phenotype in grade 3 invasive ductal carcinoma of breast', *Histopathology*, 49(1), pp. 22–34. doi: 10.1111/j.1365-2559.2006.02453.x.

Gaitan, D. *et al.* (1995) 'Glucocorticoid receptor structure and function in an adrenocorticotropin-secreting small cell lung cancer.', *Molecular Endocrinology*, 9(9), pp. 1193–1201. doi: 10.1210/MEND.9.9.7491111.

Van Galen, J. C. *et al.* (2010) 'BTG1 regulates glucocorticoid receptor autoinduction in acute

- lymphoblastic leukemia', *Blood*, 115(23), pp. 4810–4819. doi: 10.1182/blood-2009-05-223081.
- Gallagher-Beckley, A. J. *et al.* (2008) 'Glycogen Synthase Kinase 3 β -Mediated Serine Phosphorylation of the Human Glucocorticoid Receptor Redirects Gene Expression Profiles', *Molecular and Cellular Biology*, 28(24), pp. 7309–7322. doi: 10.1128/mcb.00808-08.
- Galuppo, P. *et al.* (2017) 'The glucocorticoid receptor in monocyte-derived macrophages is critical for cardiac infarct repair and remodeling', *FASEB Journal*, 31(11), pp. 5122–5132. doi: 10.1096/fj.201700317R.
- Ganesh N. Sharma, Rahul Dave, Jyotsana Sanadya, Piush Sharma, K. K. S. (2010) 'March 2010 Revised: 19', 1(2), pp. 109–126.
- Gaudet, M. M. *et al.* (2013) 'Active smoking and breast cancer risk: Original cohort data and meta-analysis', *Journal of the National Cancer Institute*, 105(8), pp. 515–525. doi: 10.1093/jnci/djt023.
- Geddes, D. T. (2007) 'Inside the Lactating Breast: The Latest Anatomy Research', *Journal of Midwifery and Women's Health*, 52(6), pp. 556–563. doi: 10.1016/j.jmwh.2007.05.004.
- Gehring, U. and Hotz, A. (1983) 'Photoaffinity Labeling and Partial Proteolysis of Wild-Type and Variant Glucocorticoid Receptor st', (1976), pp. 4013–4018.
- Geyer, F. C. *et al.* (2009) 'Genetic characterization of breast cancer and implications for clinical management', *Journal of Cellular and Molecular Medicine*, 13(10), pp. 4090–4103. doi: 10.1111/j.1582-4934.2009.00906.x.
- Gi, H. S. *et al.* (2008) 'Adrenal peripheral clock controls the autonomous circadian rhythm of glucocorticoid by causing rhythmic steroid production', *Proceedings of the National Academy of Sciences of the United States of America*, 105(52), pp. 20970–20975. doi: 10.1073/pnas.0806962106.
- Gianni, L. *et al.* (2016) '5-year analysis of neoadjuvant pertuzumab and trastuzumab in patients with locally advanced, inflammatory, or early-stage HER2-positive breast cancer (NeoSphere): a multicentre, open-label, phase 2 randomised trial', *The Lancet Oncology*, 17(6), pp. 791–800. doi: 10.1016/S1470-2045(16)00163-7.
- Gibbs, J. *et al.* (2014) 'An epithelial circadian clock controls pulmonary inflammation and glucocorticoid action', *Nature Medicine*, 20(8), pp. 919–926. doi: 10.1038/nm.3599.
- Gigu, V. *et al.* (1986) 'Functional domains of the human glucocorticoid receptor', *Cell*, 46(5), pp. 645–652. doi: 10.1016/0092-8674(86)90339-9.
- Gjerstad, J. K., Lightman, S. L. and Spiga, F. (2018) 'Role of glucocorticoid negative feedback in the regulation of HPA axis pulsatility', *Stress*, 21(5), pp. 403–416. doi: 10.1080/10253890.2018.1470238.
- Glass, C. K. and Rosenfeld, M. G. (2000) 'The coregulator exchange in transcriptional functions of nuclear receptors', *Genes and Development*, 14(2), pp. 121–141. doi: 10.1101/gad.14.2.121.
- Gluz, O. *et al.* (2009) 'future directions', *Annals of Oncology*, 20(12), pp. 1913–1927. doi: 10.1093/annonc/mdp492.
- van der Goes, M. C., Jacobs, J. W. and Bijlsma, J. W. (2014) 'The value of glucocorticoid co-therapy in different rheumatic diseases - positive and adverse effects', *Arthritis Research and Therapy*, 16(Suppl 2). doi: 10.1186/ar4686.
- Goff, S. L. and Danforth, D. N. (2021) 'The Role of Immune Cells in Breast Tissue and Immunotherapy for the Treatment of Breast Cancer', *Clinical Breast Cancer*, 21(1), pp. e63–e73. doi:

10.1016/j.clbc.2020.06.011.

Goldhirsch, A. *et al.* (1985) 'A Randomized Trial of Adjuvant Combination Chemotherapy With Or Without Prednisone in Premenopausal Breast Cancer Patients With Metastases in One to Three Axillary Lymph Nodes', *Cancer Research*, 45(9), pp. 4454–4459.

Gómez-Raposo, C. *et al.* (2010) 'Male breast cancer', *Cancer Treatment Reviews*, 36(6), pp. 451–457. doi: 10.1016/j.ctrv.2010.02.002.

Goodson, M. L. *et al.* (2014) 'Alteration of NCoR Corepressor Splicing in Mice Causes Increased Body Weight and Hepatosteatosis without Glucose Intolerance', *Molecular and Cellular Biology*, 34(22), pp. 4104–4114. doi: 10.1128/mcb.00554-14.

Goodwin, J. E. *et al.* (2013) 'Endothelial glucocorticoid receptor is required for protection against sepsis', *Proceedings of the National Academy of Sciences of the United States of America*, 110(1), pp. 306–311. doi: 10.1073/pnas.1210200110.

Gou, Y. J. *et al.* (2013) 'Alcohol consumption and breast cancer survival: A meta-analysis of cohort studies', *Asian Pacific Journal of Cancer Prevention*, 14(8), pp. 4785–4790. doi: 10.7314/APJCP.2013.14.8.4785.

Govindan, M. V. *et al.* (1985) 'Cloning of the human glucocorticoid receptor cDNA', *Nucleic Acids Research*, 13(23), pp. 8293–8304. doi: 10.1093/nar/13.23.8293.

Goya, L. *et al.* (1993) 'Glucocorticoids induce a G1/G0 cell cycle arrest of Con8 rat mammary tumor cells that is synchronously reversed by steroid withdrawal or addition of transforming growth factor- α ', *Molecular Endocrinology*, 7(9), pp. 1121–1132. doi: 10.1210/mend.7.9.8247014.

Grad, I. and Picard, D. (2007) 'The glucocorticoid responses are shaped by molecular chaperones', *Molecular and Cellular Endocrinology*, 275(1–2), pp. 2–12. doi: 10.1016/j.mce.2007.05.018.

Griffiths, W. J. *et al.* (2019) 'Metabolism of Non-Enzymatically Derived Oxysterols: Clues from sterol metabolic disorders', *Free Radical Biology and Medicine*, 144(April), pp. 124–133. doi: 10.1016/j.freeradbiomed.2019.04.020.

Groeneweg, F. L. *et al.* (2012) 'Mineralocorticoid and glucocorticoid receptors at the neuronal membrane, regulators of nongenomic corticosteroid signalling', *Molecular and Cellular Endocrinology*, 350(2), pp. 299–309. doi: 10.1016/j.mce.2011.06.020.

Gross, K. L. *et al.* (2011) 'Glucocorticoid receptor α isoform-selective regulation of antiapoptotic genes in osteosarcoma cells: A new mechanism for glucocorticoid resistance', *Molecular Endocrinology*, 25(7), pp. 1087–1099. doi: 10.1210/me.2010-0051.

de Guia, R. M. and Herzig, S. (2015) 'How do glucocorticoids regulate lipid metabolism?', *Advances in Experimental Medicine and Biology*, 872, pp. 127–144. doi: 10.1007/978-1-4939-2895-8_6.

Gwynne, J. T. and Strauss, J. F. (1982) 'The role of lipoproteins in steroidogenesis and cholesterol metabolism in steroidogenic glands', *Endocrine Reviews*, 3(3), pp. 299–329. doi: 10.1210/edrv-3-3-299.

Hafezi-Moghadam, A. *et al.* (2002a) 'Acute cardiovascular protective effects of corticosteroids are mediated by non-transcriptional activation of endothelial nitric oxide synthase', *Nature Medicine* 2002 8:5, 8(5), pp. 473–479. doi: 10.1038/nm0502-473.

Hafezi-Moghadam, A. *et al.* (2002b) 'Acute cardiovascular protective effects of corticosteroids are

- mediated by non-transcriptional activation of endothelial nitric oxide synthase', *Nature Medicine* 2002 8:5, 8(5), pp. 473–479. doi: 10.1038/nm0502-473.
- Haller, J. *et al.* (2000) 'The active phase-related increase in corticosterone and aggression are linked', *Journal of Neuroendocrinology*, 12(5), pp. 431–436. doi: 10.1046/j.1365-2826.2000.00470.x.
- Hamajima, N. *et al.* (2012) 'Menarche, menopause, and breast cancer risk: Individual participant meta-analysis, including 118 964 women with breast cancer from 117 epidemiological studies', *The Lancet Oncology*, 13(11), pp. 1141–1151. doi: 10.1016/S1470-2045(12)70425-4.
- Harbeck, N. *et al.* (2019) *Breast cancer*, *Nature Reviews Disease Primers*. doi: 10.1038/s41572-019-0111-2.
- Hargreaves, D. C. and Crabtree, G. R. (2011) 'ATP-dependent chromatin remodeling: Genetics, genomics and mechanisms', *Cell Research*, 21(3), pp. 396–420. doi: 10.1038/cr.2011.32.
- Hassiotou, F. and Geddes, D. (2013) 'Anatomy of the human mammary gland: Current status of knowledge', *Clinical Anatomy*, 26(1), pp. 29–48. doi: 10.1002/ca.22165.
- He, L. *et al.* (2019) 'Glucocorticoid receptor signaling activates TEAD4 to promote breast cancer progression', *Cancer Research*, 79(17), pp. 4399–4411. doi: 10.1158/0008-5472.CAN-19-0012.
- He, Y. *et al.* (2014) 'Structures and mechanism for the design of highly potent glucocorticoids', *Cell Research*, 24(6), pp. 713–726. doi: 10.1038/cr.2014.52.
- Heery, D. M. *et al.* (1997) 'A signature motif in transcriptional co-activators mediates binding to nuclear receptors', *Nature* 1997 387:6634, 387(6634), pp. 733–736. doi: 10.1038/42750.
- Helfand, B. T. *et al.* (2004) 'Importin 7 and importin alpha/importin beta are nuclear import receptors for the glucocorticoid receptor.', *Molecular Biology of the Cell*, 15(5), pp. 2276–86. doi: 10.1091/mbc.e03-11-0839.
- Helmrich, S. P. *et al.* (1983) 'RISK FACTORS FOR BREAST CANCER', *American Journal of Epidemiology*, 117(1), pp. 35–45. doi: 10.1093/OXFORDJOURNALS.AJE.A113513.
- Henderson, T. O. *et al.* (2016) 'Breast cancer risk in childhood cancer survivors without a history of chest radiotherapy: A report from the childhood cancer survivor study', *Journal of Clinical Oncology*, 34(9), pp. 910–918. doi: 10.1200/JCO.2015.62.3314.
- Hennessy, B. T. *et al.* (2010) 'NIH Public Access', 69(10), pp. 4116–4124. doi: 10.1158/0008-5472.CAN-08-3441.Characterization.
- Henzi, I., Walder, B. and Trame, M. R. (2000) 'Dexamethasone for the prevention of postoperative nausea and vomiting: a quantitative systematic review', *Anesthesia and Analgesia*, 90(1), pp. 186–194. doi: 10.1097/00000539-200001000-00038.
- Hermes, G. L. *et al.* (2009) 'Social isolation dysregulates endocrine and behavioral stress while increasing malignant burden of spontaneous mammary tumors', *Proceedings of the National Academy of Sciences of the United States of America*, 106(52), pp. 22393–22398. doi: 10.1073/pnas.0910753106.
- Herschkowitz, J. I. *et al.* (2007) 'Identification of conserved gene expression features between murine mammary carcinoma models and human breast tumors', *Genome Biology*, 8(5), pp. 1–17. doi: 10.1186/gb-2007-8-5-r76.
- Hildebrand, J. S. *et al.* (2013) 'Recreational physical activity and leisure-time sitting in relation to

postmenopausal breast cancer risk', *Cancer Epidemiology Biomarkers and Prevention*, 22(10), pp. 1906–1912. doi: 10.1158/1055-9965.EPI-13-0407.

Hill, A. R. and Spencer-Segal, J. L. (2021) 'Glucocorticoids and the Brain after Critical Illness', *Endocrinology (United States)*, 162(3), pp. 1–14. doi: 10.1210/endocr/bqaa242.

Hinz, B. and Hirschelmann, R. (2000) 'Rapid non-genomic feedback effects of glucocorticoids on CRF-induced ACTH secretion in rats', *Pharmaceutical Research*, 17(10), pp. 1273–1277. doi: 10.1023/A:1026499604848.

Hittelman, A. B. *et al.* (1999) 'Differential regulation of glucocorticoid receptor transcriptional activation via AF-1-associated proteins', *EMBO Journal*, 18(19), pp. 5380–5388. doi: 10.1093/emboj/18.19.5380.

Holaska, J. M. *et al.* (2001) 'Calreticulin is a receptor for nuclear export', *Journal of Cell Biology*, 152(1), pp. 127–140. doi: 10.1083/jcb.152.1.127.

Holaska, J. M. *et al.* (2002) 'Ca²⁺-Dependent Nuclear Export Mediated by Calreticulin', *Molecular and Cellular Biology*, 22(17), pp. 6286–6297. doi: 10.1128/mcb.22.17.6286-6297.2002.

Hollenberg, S. M. *et al.* (1985) 'Primary structure and expression of a functional human glucocorticoid receptor cDNA', *Nature* 1985 318:6047, 318(6047), pp. 635–641. doi: 10.1038/318635a0.

Holmstrom, S. R. *et al.* (2008) 'SUMO-mediated inhibition of glucocorticoid receptor synergistic activity depends on stable assembly at the promoter but not on DAXX', *Molecular Endocrinology*, 22(9), pp. 2061–2075. doi: 10.1210/me.2007-0581.

Hong, H. *et al.* (1996) 'GRIP1, a novel mouse protein that serves as a transcriptional coactivator in yeast for the hormone binding domains of steroid receptors', *Proceedings of the National Academy of Sciences of the United States of America*, 93(10), pp. 4948–4952. doi: 10.1073/pnas.93.10.4948.

Horton, J. D., Goldstein, J. L. and Brown, M. S. (2002) 'SREBPs: activators of the complete program of cholesterol and fatty acid synthesis in the liver', *The Journal of Clinical Investigation*, 109(9), pp. 1125–1131. doi: 10.1172/JCI15593.

Hu, Z. *et al.* (2006) 'The molecular portraits of breast tumors are conserved across microarray platforms', *BMC Genomics*, 7, pp. 1–12. doi: 10.1186/1471-2164-7-96.

Hua, G., Ganti, K. P. and Chambon, P. (2016) 'Glucocorticoid-induced tethered transrepression requires SUMOylation of GR and formation of a SUMO-SMRT/NCoR1-HDAC3 repressing complex', *Proceedings of the National Academy of Sciences of the United States of America*, 113(5), pp. E635–E643. doi: 10.1073/pnas.1522826113.

Hua, G., Paulen, L. and Chambon, P. (2016) 'GR SUMOylation and formation of an SUMO-SMRT/NCoR1-HDAC3 repressing complex is mandatory for GC-induced IR nGRE-mediated transrepression', *Proceedings of the National Academy of Sciences of the United States of America*, 113(5), pp. E626–E634. doi: 10.1073/pnas.1522821113.

Hudson, W. H., Youn, C. and Ortlund, E. A. (2012) 'The structural basis of direct glucocorticoid-mediated transrepression', *Nature Structural & Molecular Biology* 2012 20:1, 20(1), pp. 53–58. doi: 10.1038/nsmb.2456.

Humphries, B. A. *et al.* (2019) 'Plasminogen activator inhibitor 1 (PAI1) promotes actin cytoskeleton reorganization and glycolytic metabolism in triple-negative breast cancer', *Molecular Cancer Research*, 17(5), pp. 1142–1154. doi: 10.1158/1541-7786.MCR-18-0836.

- Ishida, A. *et al.* (2005) 'Light activates the adrenal gland: Timing of gene expression and glucocorticoid release', *Cell Metabolism*, 2(5), pp. 297–307. doi: 10.1016/j.cmet.2005.09.009.
- Ismaili, N. and Garabedian, M. J. (2004) 'Modulation of glucocorticoid receptor function via phosphorylation', *Annals of the New York Academy of Sciences*, 1024, pp. 86–101. doi: 10.1196/annals.1321.007.
- Ito, K. *et al.* (2006) 'Histone deacetylase 2-mediated deacetylation of the glucocorticoid receptor enables NF- κ B suppression', *Journal of Experimental Medicine*, 203(1), pp. 7–13. doi: 10.1084/JEM.20050466.
- Itoh, M. *et al.* (2002) 'Nuclear export of glucocorticoid receptor is enhanced by c-Jun N-terminal kinase-mediated phosphorylation', *Molecular Endocrinology*, 16(10), pp. 2382–2392. doi: 10.1210/me.2002-0144.
- Jawad Hashim, M. *et al.* (2018) 'Burden of breast cancer in the Arab world: Findings from global burden of disease, 2016', *Journal of Epidemiology and Global Health*, 8(1–2), pp. 54–58. doi: 10.2991/j.jegh.2018.09.003.
- Jenkins, B. D., Pullen, C. B. and Darimont, B. D. (2001) 'Novel glucocorticoid receptor coactivator effector mechanisms', *Trends in Endocrinology and Metabolism*, 12(3), pp. 122–126. doi: 10.1016/S1043-2760(00)00357-X.
- Jenuwein, T. and Allis, C. D. (2001) 'Translating the Histone Code', *Science*, 293(5532), pp. 1074–1080. doi: 10.1126/science.1063127.
- John, E. M. *et al.* (2007) 'Medical radiation exposure and breast cancer risk: Findings from the Breast Cancer Family Registry', *International Journal of Cancer*, 121(2), pp. 386–394. doi: 10.1002/ijc.22668.
- Jones, M. T., Brush, F. R. and Neame, R. L. (1972) 'Characteristics of fast feedback control of corticotrophin release by corticosteroids.', *The Journal of endocrinology*, 55(3), pp. 489–497. doi: 10.1677/joe.0.0550489.
- Jones, M. T., Tiptaft, E. M. and Brush, F. R. (1973) 'CORTICOSTEROID-RECEPTOR MECHANISMS IN THE FEEDBACK CONTROL OF ADRENOCORTICOTROPHIN SECRETION'.
- Jozic, I. *et al.* (2014) 'Stressing the steroids in skin: Paradox or fine-tuning', *Journal of Investigative Dermatology*, 134(12), pp. 2869–2872. doi: 10.1038/jid.2014.363.
- Jung, S. Y. *et al.* (2010) 'Worse prognosis of metaplastic breast cancer patients than other patients with triple-negative breast cancer', *Breast Cancer Research and Treatment*, 120(3), pp. 627–637. doi: 10.1007/s10549-010-0780-8.
- Kalafatakis, K., Russell, G. M. and Lightman, S. L. (2019) 'Mechanisms in endocrinology: Does circadian and ultradian glucocorticoid exposure affect the brain?', *European Journal of Endocrinology*, 180(2), pp. R73–R89. doi: 10.1530/EJE-18-0853.
- Kalak, R. *et al.* (2009) 'Endogenous glucocorticoid signalling in osteoblasts is necessary to maintain normal bone structure in mice', *Bone*, 45(1), pp. 61–67. doi: 10.1016/j.bone.2009.03.673.
- Kalsbeek, A. *et al.* (1996) 'A diurnal rhythm of stimulatory input to the hypothalamo-pituitary-adrenal system as revealed by timed intrahypothalamic administration of the vasopressin V1 antagonist', *Journal of Neuroscience*, 16(17), pp. 5555–5565. doi: 10.1523/jneurosci.16-17-05555.1996.

- Kalsbeek, A. *et al.* (2012) 'Circadian rhythms in the hypothalamo-pituitary-adrenal (HPA) axis', *Molecular and Cellular Endocrinology*, 349(1), pp. 20–29. doi: 10.1016/j.mce.2011.06.042.
- Kalsbeek, A., Van Der Vliet, J. and Buijs, R. M. (1996) 'Decrease of endogenous vasopressin release necessary for expression of the circadian rise in plasma corticosterone: A reverse microdialysis study', *Journal of Neuroendocrinology*, 8(4), pp. 299–307. doi: 10.1046/j.1365-2826.1996.04597.x.
- Karmakar, S., Jin, Y. and Nagaich, A. K. (2013) 'Interaction of Glucocorticoid Receptor (GR) with Estrogen Receptor (ER) α and Activator Protein 1 (AP1) in Dexamethasone-mediated Interference of ER α Activity *', *Journal of Biological Chemistry*, 288(33), pp. 24020–24034. doi: 10.1074/jbc.M113.473819.
- Kauppi, B. *et al.* (2003) 'The three-dimensional structures of antagonistic and agonistic forms of the glucocorticoid receptor ligand-binding domain: RU-486 induces a transconformation that leads to active antagonism', *Journal of Biological Chemistry*, 278(25), pp. 22748–22754. doi: 10.1074/jbc.M212711200.
- Kee, B. L., Arias, J. and Montminy, M. R. (1996) 'Adaptor-mediated recruitment of RNA polymerase II to a signal-dependent activator', *Journal of Biological Chemistry*, 271(5), pp. 2373–2375. doi: 10.1074/jbc.271.5.2373.
- Keith, B. D. (2008) 'Systematic review of the clinical effect of glucocorticoids on nonhematologic malignancy', 19, pp. 1–19. doi: 10.1186/1471-2407-8-84.
- Kelly, A. *et al.* (2008) 'The glucocorticoid receptor β isoform can mediate transcriptional repression by recruiting histone deacetylases', *Journal of Allergy and Clinical Immunology*, 121(1), pp. 203–209. doi: 10.1016/j.jaci.2007.09.010.
- Kelsey, J. L., Gammon, M. D. and John, E. M. (1993) 'Reproductive factors and breast cancer', *Epidemiologic Reviews*, 15(1), pp. 36–47. doi: 10.1093/oxfordjournals.epirev.a036115.
- Kennaway, D. J. (2014) 'Light at night, melatonin and breast cancer', *Chronobiology International*, 31(2), pp. 297–298. doi: 10.3109/07420528.2013.865642.
- Khan, N. A. J. and Tirona, M. (2021) 'An updated review of epidemiology, risk factors, and management of male breast cancer', *Medical oncology (Northwood, London, England)*, 38(4). doi: 10.1007/S12032-021-01486-X.
- Khan, S. H. *et al.* (2012) 'Binding of the N-terminal region of coactivator TIF2 to the intrinsically disordered AF1 domain of the glucocorticoid receptor is accompanied by conformational reorganizations', *Journal of Biological Chemistry*, 287(53), pp. 44546–44560. doi: 10.1074/jbc.M112.411330.
- Kim, I. *et al.* (2021) 'A Case Series of Metastatic Metaplastic Breast Carcinoma Treated With Anti-PD-1 Therapy', *Frontiers in Oncology*, 11(June), pp. 1–17. doi: 10.3389/fonc.2021.635237.
- Kim, J. H., Li, H. and Stallcup, M. R. (2003) 'CoCoA, a Nuclear Receptor Coactivator which Acts through an N-Terminal Activation Domain of p160 Coactivators', *Molecular Cell*, 12(6), pp. 1537–1549. doi: 10.1016/S1097-2765(03)00450-7.
- Kim, Y., Yoo, K. Y. and Goodman, M. T. (2015) 'Differences in incidence, mortality and survival of breast cancer by regions and countries in Asia and contributing factors', *Asian Pacific Journal of Cancer Prevention*, 16(7), pp. 2857–2870. doi: 10.7314/APJCP.2015.16.7.2857.
- Kino, T. *et al.* (2009) 'Glucocorticoid receptor (GR) β has intrinsic, GR α -independent transcriptional

- activity', *Biochemical and Biophysical Research Communications*, 381(4), pp. 671–675. doi: 10.1016/J.BBRC.2009.02.110.
- Kino, T. and Chrousos, G. P. (2011) 'Acetylation-mediated epigenetic regulation of glucocorticoid receptor activity: Circadian rhythm-associated alterations of glucocorticoid actions in target tissues', *Molecular and Cellular Endocrinology*, 336(1–2), pp. 23–30. doi: 10.1016/J.MCE.2010.12.001.
- Kinyamu, H. K. and Archer, T. K. (2003) 'Estrogen Receptor-Dependent Proteasomal Degradation of the Glucocorticoid Receptor Is Coupled to an Increase in Mdm2 Protein Expression', *Molecular and Cellular Biology*, 23(16), pp. 5867–5881. doi: 10.1128/mcb.23.16.5867-5881.2003.
- Klieber, M. A. *et al.* (2007) 'Corticosteroid-binding Globulin, a Structural Basis for Steroid Transport and Proteinase-triggered Release', *Journal of Biological Chemistry*, 282(40), pp. 29594–29603. doi: 10.1074/jbc.M705014200.
- Knuesel, M. T. and Taatjes, D. J. (2011) 'Mediator and post-recruitment regulation of RNA polymerase II', *Transcription*, 2(1), pp. 28–31. doi: 10.4161/trns.2.1.13950.
- Knutti, D. and Kralli, A. (2001) 'PGC-1, a versatile coactivator', *Trends in Endocrinology and Metabolism*, 12(8), pp. 360–365. doi: 10.1016/S1043-2760(01)00457-X.
- Kodama, M. *et al.* (2002) 'Effect of steroids on lipopolysaccharide/interleukin 2-induced interleukin 18 production in peripheral blood mononuclear cells', *Journal of International Medical Research*, 30(2), pp. 144–160. doi: 10.1177/147323000203000207.
- Koike, N. *et al.* (2000) 'Identification of heterochromatin protein 1 (HP1) as a phosphorylation target by Pim-1 kinase and the effect of phosphorylation on the transcriptional repression function of HP1', *FEBS Letters*, 467(1), pp. 17–21. doi: 10.1016/S0014-5793(00)01105-4.
- Kondo, T. *et al.* (2008) 'Dexamethasone promotes osteoclastogenesis by inhibiting osteoprotegerin through multiple levels', *Journal of Cellular Biochemistry*, 103(1), pp. 335–345. doi: 10.1002/jcb.21414.
- Konieczny, M. *et al.* (2020) 'Quality of life of women with breast cancer and socio-demographic factors', *Asian Pacific Journal of Cancer Prevention*, 21(1), pp. 185–193. doi: 10.31557/APJCP.2020.21.1.185.
- Kouzarides, T. (2007) 'Chromatin Modifications and Their Function', *Cell*, 128(4), pp. 693–705. doi: 10.1016/j.cell.2007.02.005.
- Kraemer, F. B. (2007) 'Adrenal cholesterol utilization', *Molecular and Cellular Endocrinology*, 265–266(SUPPL.), pp. 42–45. doi: 10.1016/j.mce.2006.12.001.
- Kralli, A., Bohen, S. P. and Yamamoto, K. R. (1995) 'LEM1, an ATP-binding-cassette transporter, selectively modulates the biological potency of steroid hormones', *Proceedings of the National Academy of Sciences of the United States of America*, 92(10), pp. 4701–4705. doi: 10.1073/pnas.92.10.4701.
- Krett, N. L. *et al.* (1995) 'A variant glucocorticoid receptor messenger RNA is expressed in multiple myeloma patients.', *Cancer research*, 55(13), pp. 2727–9. Available at: <https://www.semanticscholar.org/paper/A-variant-glucocorticoid-receptor-messenger-RNA-is-Krett-Pillay/3b3dfc251fce64a88f4b31826e59e9b72bc0e253> (Accessed: 11 August 2022).
- Kuchenbaecker, K. B. *et al.* (2017) 'Risks of breast, ovarian, and contralateral breast cancer for BRCA1 and BRCA2 mutation carriers', *JAMA - Journal of the American Medical Association*, 317(23), pp.

2402–2416. doi: 10.1001/jama.2017.7112.

Kucuk, O. *et al.* (1992) 'Inhibition of NK cell-mediated cytotoxicity by oxysterols', *Cellular Immunology*, 139(2), pp. 541–549. doi: 10.1016/0008-8749(92)90091-3.

Küçük, Ö. *et al.* (1994) 'Inhibition of cytolytic T lymphocyte activity by oxysterols', *Lipids*, 29(9), pp. 657–660. doi: 10.1007/BF02536101.

Kugler, D. G. *et al.* (2013) 'CD4+ T cells are trigger and target of the glucocorticoid response that prevents lethal immunopathology in toxoplasma infection', *Journal of Experimental Medicine*, 210(10), pp. 1919–1927. doi: 10.1084/jem.20122300.

Kumar, R. *et al.* (2004) 'TATA box binding protein induces structure in the recombinant glucocorticoid receptor AF1 domain', *Proceedings of the National Academy of Sciences of the United States of America*, 101(47), pp. 16425–16430. doi: 10.1073/pnas.0407160101.

Kumar, R. and Thompson, E. B. (2003) 'Transactivation Functions of the N-Terminal Domains of Nuclear Hormone Receptors: Protein Folding and Coactivator Interactions', *Molecular Endocrinology*, 17(1), pp. 1–10. doi: 10.1210/ME.2002-0258.

Kuo, T. *et al.* (2012a) 'Genome-wide analysis of glucocorticoid receptor-binding sites in myotubes identifies gene networks modulating insulin signaling', *Proceedings of the National Academy of Sciences of the United States of America*, 109(28), pp. 11160–11165. doi: 10.1073/PNAS.1111334109/SUPPL_FILE/SD05.XLSX.

Kuo, T. *et al.* (2012b) 'Genome-wide analysis of glucocorticoid receptor-binding sites in myotubes identifies gene networks modulating insulin signaling', *Proceedings of the National Academy of Sciences of the United States of America*, 109(28), pp. 11160–11165. doi: 10.1073/pnas.1111334109.

Kuo, T. *et al.* (2015a) 'Regulation of glucose homeostasis by glucocorticoids', *Advances in Experimental Medicine and Biology*, 872, pp. 99–126. doi: 10.1007/978-1-4939-2895-8_5/COVER.

Kuo, T. *et al.* (2015b) 'Regulation of glucose homeostasis by glucocorticoids', *Advances in Experimental Medicine and Biology*, 872, pp. 99–126. doi: 10.1007/978-1-4939-2895-8_5/COVER.

Kwon, S. H. and Workman, J. L. (2011) 'The changing faces of HP1: From heterochromatin formation and gene silencing to euchromatic gene expression: HP1 acts as a positive regulator of transcription', *BioEssays*, 33(4), pp. 280–289. doi: 10.1002/bies.201000138.

Lamar, J. M. *et al.* (2012) 'The Hippo pathway target, YAP, promotes metastasis through its TEAD-interaction domain', *Proceedings of the National Academy of Sciences of the United States of America*, 109(37), pp. 2441–2450. doi: 10.1073/pnas.1212021109.

Lan, X., Glass, C. K. and Rosenfeld, M. G. (1999) 'Coactivator and corepressor complexes in nuclear receptor function', *Current Opinion in Genetics and Development*, 9(2), pp. 140–147. doi: 10.1016/S0959-437X(99)80021-5.

De Lange, P. *et al.* (2001) 'Expression in hematological malignancies of a glucocorticoid receptor splice variant that augments glucocorticoid receptor-mediated effects in transfected cells', *Cancer Research*, 61(10), pp. 3937–3941. doi: 10.1158/0008-5472.3937.61.10.

Larsson, S. C., Mantzoros, C. S. and Wolk, A. (2007) 'Diabetes mellitus and risk of breast cancer: A meta-analysis', *International Journal of Cancer*, 121(4), pp. 856–862. doi: 10.1002/ijc.22717.

Lattouf, H. *et al.* (2019) 'LKB1 regulates PRMT5 activity in breast cancer', *International Journal of*

Cancer, 144(3), pp. 595–606. doi: 10.1002/ijc.31909.

Laubach, J. P. *et al.* (2017) 'Deacetylase inhibitors: an advance in myeloma therapy?', *Expert Review of Hematology*, 10(3), pp. 229–237. doi: 10.1080/17474086.2017.1280388.

Lee, B. H. and Stallcup, M. R. (2017) 'Glucocorticoid receptor binding to chromatin is selectively controlled by the coregulator Hic-5 and chromatin remodeling enzymes', *Journal of Biological Chemistry*, 292(22), pp. 9320–9334. doi: 10.1074/jbc.M117.782607.

Lee, H.-C. *et al.* (2005) 'Transcriptional Regulation of the Mouse IL-7 Receptor α Promoter by Glucocorticoid Receptor', *The Journal of Immunology*, 174(12), pp. 7800–7806. doi: 10.4049/jimmunol.174.12.7800.

Lee, K. K. and Workman, J. L. (2007) 'Histone acetyltransferase complexes: One size doesn't fit all', *Nature Reviews Molecular Cell Biology*, 8(4), pp. 284–295. doi: 10.1038/nrm2145.

Lee, Y. H. *et al.* (2005) 'Regulation of coactivator complex assembly and function by protein arginine methylation and demethylation', *Proceedings of the National Academy of Sciences of the United States of America*, 102(10), pp. 3611–3616. doi: 10.1073/pnas.0407159102.

Lefstin, J. A. and Yamamoto, K. R. (1998) 'Allosteric effects of DNA on transcriptional regulators', *Nature*, 392(6679), pp. 885–888. doi: 10.1038/31860.

Lehmann-Che, J. *et al.* (2013) 'Molecular apocrine breast cancers are aggressive estrogen receptor negative tumors overexpressing either HER2 or GCDPF15', *Breast Cancer Research*, 15(3). doi: 10.1186/bcr3421.

Lehmann, B. D. *et al.* (2011) 'Identification of human triple-negative breast cancer subtypes and preclinical models for selection of targeted therapies', *The Journal of clinical investigation*, 121(7), pp. 2750–2767. doi: 10.1172/JCI45014.

Lehoux, J. G. *et al.* (1989) 'Hormonal regulation of 3-hydroxy-3-methylglutaryl coenzyme a reductase mRNA in the rat adrenal gland', *Journal of Steroid Biochemistry*, 34(1–6), pp. 379–384. doi: 10.1016/0022-4731(89)90112-X.

Lewis-Tuffin, L. J. *et al.* (2007) 'Human Glucocorticoid Receptor β Binds RU-486 and Is Transcriptionally Active', *Molecular and Cellular Biology*, 27(6), pp. 2266–2282. doi: 10.1128/MCB.01439-06/ASSET/3C4519B1-AB2F-4720-8583-C6228B8B8566/ASSETS/GRAPHIC/ZMB0060766380008.JPEG.

Lewis-Tuffin, L. J. and Cidlowski, J. A. (2006) 'The Physiology of Human Glucocorticoid Receptor β (hGR β) and Glucocorticoid Resistance', *Annals of the New York Academy of Sciences*, 1069(1), pp. 1–9. doi: 10.1196/ANNALS.1351.001.

Lewis, J. G. *et al.* (2005) 'Plasma free cortisol fraction reflects levels of functioning corticosteroid-binding globulin', *Clinica Chimica Acta*, 359(1–2), pp. 189–194. doi: 10.1016/j.cccn.2005.03.044.

Lewis, J. G. *et al.* (2016) 'Corticosteroid-binding globulin (CBG) reactive centre loop antibodies and surface plasmon resonance interrogate the proposed heat dependent "flip-flop" mechanism of human CBG', *Journal of Steroid Biochemistry and Molecular Biology*, 158, pp. 38–45. doi: 10.1016/j.jsbmb.2016.01.013.

Li, C. C. *et al.* (2015) 'Suppression of Dendritic Cell-Derived IL-12 by Endogenous Glucocorticoids Is Protective in LPS-Induced Sepsis', *PLoS Biology*, 13(10), pp. 1–16. doi: 10.1371/journal.pbio.1002269.

- Li, C. J. *et al.* (2021) 'Pathogenesis and potential therapeutic targets for triple-negative breast cancer', *Cancers*, 13(12), pp. 1–21. doi: 10.3390/cancers13122978.
- Li, X. *et al.* (2003) 'Progesterone and Glucocorticoid Receptors Recruit Distinct Coactivator Complexes and Promote Distinct Patterns of Local Chromatin Modification', *Molecular and Cellular Biology*, 23(11), pp. 3763–3773. doi: 10.1128/mcb.23.11.3763-3773.2003.
- Li, Z. *et al.* (2017) 'Dexamethasone induces docetaxel and cisplatin resistance partially through up-regulating Krüppel-like factor 5 in triplenegative breast cancer', *Oncotarget*, 8(7), pp. 11555–11565. doi: 10.18632/oncotarget.14135.
- Lieberman, A. C. *et al.* (2007) 'The activated glucocorticoid receptor inhibits the transcription factor T-bet by direct protein-protein interaction', *The FASEB Journal*, 21(4), pp. 1177–1188. doi: 10.1096/fj.06-7452com.
- Lien, H. C. *et al.* (2006) 'Differential expression of glucocorticoid receptor in human breast tissues and related neoplasms', *Journal of Pathology*, 209(3), pp. 317–327. doi: 10.1002/path.1982.
- Lietzen, L. W. *et al.* (2014) 'Glucocorticoid prescriptions and breast cancer recurrence: A Danish nationwide prospective cohort study', *Annals of Oncology*, 25(12), pp. 2419–2425. doi: 10.1093/annonc/mdu453.
- Lin, D. *et al.* (1995) 'Role of steroidogenic acute regulatory protein in adrenal and gonadal steroidogenesis', *Science*, 67(5205), pp. 1828–1831. doi: 10.1126/science.7892608.
- Lin, H. Y., Muller, Y. A. and Hammond, G. L. (2010) 'Molecular and structural basis of steroid hormone binding and release from corticosteroid-binding globulin', *Molecular and Cellular Endocrinology*, 316(1), pp. 3–12. doi: 10.1016/j.mce.2009.06.015.
- Lin, K. T. *et al.* (2015) 'Glucocorticoids mediate induction of microRNA-708 to suppress ovarian cancer metastasis through targeting Rap1B', *Nature Communications*, 6(201), pp. 1–13. doi: 10.1038/ncomms6917.
- Lin, K. T. and Wang, L. H. (2016) 'New dimension of glucocorticoids in cancer treatment', *Steroids*, 111, pp. 84–88. doi: 10.1016/j.steroids.2016.02.019.
- Lin, K. and Wang, L. (2016) 'New dimension of glucocorticoids in cancer treatment', 111, pp. 84–88. doi: 10.1016/j.steroids.2016.02.019.
- Lippman, M., Bolan, G. and Huff, K. (1976) 'The Effects of Androgens and Antiandrogens on Hormone-responsive Human Breast Cancer in Long-Term Tissue Culture', *Cancer Research*, 36(12), pp. 4610–4618.
- Lomberk, G. *et al.* (2006) 'Evidence for the existence of an HP1-mediated subcode within the histone code', *Nature Cell Biology*, 8(4), pp. 407–415. doi: 10.1038/ncb1383.
- Lonard, D. M. and O'Malley, B. W. (2005) 'Expanding functional diversity of the coactivators', *Trends in Biochemical Sciences*, 30(3), pp. 126–132. doi: 10.1016/j.tibs.2005.01.001.
- Löwenberg, M. *et al.* (2006) 'Glucocorticoids cause rapid dissociation of a T-cell-receptor-associated protein complex containing LCK and FYN', *EMBO Reports*, 7(10), pp. 1023–1029. doi: 10.1038/sj.embor.7400775.
- Lu, N. Z. *et al.* (2007) 'Selective Regulation of Bone Cell Apoptosis by Translational Isoforms of the Glucocorticoid Receptor', *Molecular and Cellular Biology*, 27(20), pp. 7143–7160. doi:

10.1128/mcb.00253-07.

Lu, N. Z. and Cidlowski, J. A. (2004) 'The Origin and Functions of Multiple Human Glucocorticoid Receptor Isoforms', 123, pp. 102–123. doi: 10.1196/annals.1321.008.

Lu, N. Z. and Cidlowski, J. A. (2005) 'Translational regulatory mechanisms generate N-terminal glucocorticoid receptor isoforms with unique transcriptional target genes', *Molecular Cell*, 18(3), pp. 331–342. doi: 10.1016/j.molcel.2005.03.025.

Luan, Y. *et al.* (2015) *Histone Acetyltransferases: Enzymes, Assays, and Inhibitors, Epigenetic Technological Applications*. Elsevier Inc. doi: 10.1016/B978-0-12-801080-8.00014-4.

Lubin, J. H. *et al.* (1981) 'Dietary factors and breast cancer risk', *International Journal of Cancer*, 28(6), pp. 685–689. doi: 10.1002/ijc.2910280605.

Luisi, B. F. *et al.* (1991) 'Crystallographic analysis of the interaction of the glucocorticoid receptor with DNA', *Nature* 1991 352:6335, 352(6335), pp. 497–505. doi: 10.1038/352497a0.

Ma, H. *et al.* (2006) 'Reproductive factors and breast cancer risk according to joint estrogen and progesterone receptor status: A meta-analysis of epidemiological studies', *Breast Cancer Research*, 8(4), pp. 1–11. doi: 10.1186/bcr1525.

Ma, H. *et al.* (2010) 'Pregnancy-related factors and the risk of breast carcinoma in situ and invasive breast cancer among postmenopausal women in the California Teachers Study cohort', *Breast Cancer Research*, 12(3). doi: 10.1186/bcr2589.

Mahdi, H. *et al.* (2022) 'Cancer Burden Among Arab-World Females in 2020: Working Toward Improving Outcomes', *JCO Global Oncology*, (8), pp. 1–10. doi: 10.1200/go.21.00415.

Malbeteau, L. *et al.* (2022) 'How Protein Methylation Regulates Steroid Receptor Function', *Endocrine reviews*, 43(1), pp. 160–197. doi: 10.1210/endrev/bnab014.

Malhotra, G. K. *et al.* (2010) 'Histological, molecular and functional subtypes of breast cancers', *Cancer Biology and Therapy*, 10(10), pp. 955–960. doi: 10.4161/cbt.10.10.13879.

Malovannaya, A. *et al.* (2010) 'Streamlined analysis schema for high-throughput identification of endogenous protein complexes', *Proceedings of the National Academy of Sciences of the United States of America*, 107(6), pp. 2431–2436. doi: 10.1073/pnas.0912599106.

Malovannaya, A. *et al.* (2011) 'Analysis of the human endogenous coregulator complexome', *cell*, 145(5), pp. 787–799. doi: 10.1016/j.cell.2011.05.006.

Maltoni, R. and Bravaccini, S. (2022) 'Sacituzumab govitecan: a new opportunity in the treatment of refractory metastatic triple-negative breast cancer', *Annals of Translational Medicine*, 10(7), pp. 389–389. doi: 10.21037/atm-21-6999.

Mangan, S. and Alon, U. (2003) 'Structure and function of the feed-forward loop network motif', *Proceedings of the National Academy of Sciences of the United States of America*, 100(21), pp. 11980–11985. doi: 10.1073/pnas.2133841100.

Marchetti, B. *et al.* (2001) 'Stress, the immune system and vulnerability to degenerative disorders of the central nervous system in transgenic mice expressing glucocorticoid receptor antisense RNA', *Brain Research Reviews*, 37(1–3), pp. 259–272. doi: 10.1016/S0165-0173(01)00130-8.

Marjoribanks, J. *et al.* (2012) 'Long term hormone therapy for perimenopausal and postmenopausal women', *Cochrane Database of Systematic Reviews*, (7). doi: 10.1002/14651858.CD004143.PUB4.

- Martin, C. S., Cooper, M. S. and Hardy, R. S. (2021) 'Endogenous Glucocorticoid Metabolism in Bone: Friend or Foe', *Frontiers in Endocrinology*, 12(August), pp. 1–13. doi: 10.3389/fendo.2021.733611.
- Mateescu, B. *et al.* (2004) 'Tethering of HP1 proteins to chromatin is relieved by phosphoacetylation of histone H3', *EMBO Reports*, 5(5), pp. 490–496. doi: 10.1038/sj.embor.7400139.
- Matthews, L. C. *et al.* (2015) 'Glucocorticoid receptor regulates accurate chromosome segregation and is associated with malignancy', *Proceedings of the National Academy of Sciences of the United States of America*, 112(17), pp. 5479–5484. doi: 10.1073/pnas.1411356112.
- Maywood, E. S. *et al.* (2007) 'Minireview: The circadian clockwork of the suprachiasmatic nuclei - Analysis of a cellular oscillator that drives endocrine rhythms', *Endocrinology*, 148(12), pp. 5624–5634. doi: 10.1210/en.2007-0660.
- McKenna, N. J. *et al.* (1999) 'Nuclear receptor coactivators: Multiple enzymes, multiple complexes, multiple functions', *Journal of Steroid Biochemistry and Molecular Biology*, 69(1–6), pp. 3–12. doi: 10.1016/S0960-0760(98)00144-7.
- McTiernan, A. *et al.* (2004) 'Recreational physical activity and the risk of breast cancer in postmenopausal women: The women's health initiative cohort study', *Breast Diseases*, 15(1), pp. 25–26. doi: 10.1097/01.ogx.0000115859.71446.89.
- Meijer, O. C., Koorneef, L. L. and Kroon, J. (2018) 'Glucocorticoid receptor modulators', *Annales d'Endocrinologie*, 79(3), pp. 107–111. doi: 10.1016/j.ando.2018.03.004.
- Meijsing, S. H. *et al.* (2009a) 'DNA binding site sequence directs glucocorticoid receptor structure and activity', *Science*, 324(5925), pp. 407–410. doi: 10.1126/SCIENCE.1164265.
- Meijsing, S. H. *et al.* (2009b) 'DNA binding site sequence directs glucocorticoid receptor structure and activity', *Science*, 324(5925), pp. 407–410. doi: 10.1126/science.1164265.
- Melvin, J. C. *et al.* (2016) 'Family history of breast cancer and its association with disease severity and mortality', *Cancer Medicine*, 5(5), pp. 942–949. doi: 10.1002/cam4.648.
- Meng, X. G. and Yue, S. W. (2014) 'Dexamethasone disrupts cytoskeleton organization and migration of T47D human breast cancer cells by modulating the AKT/mTOR/RhoA pathway', *Asian Pacific Journal of Cancer Prevention*, 15(23), pp. 10245–10250. doi: 10.7314/APJCP.2014.15.23.10245.
- Metcalfe, K. A. *et al.* (2009) 'Breast cancer risks in women with a family history of breast or ovarian cancer who have tested negative for a BRCA1 or BRCA2 mutation', *British Journal of Cancer*, 100(2), pp. 421–425. doi: 10.1038/sj.bjc.6604830.
- Methods for determining the oncogenic condition of cell, uses thereof, and methods for treating cancer - Patent US-2012100124-A1 - PubChem* (no date). Available at: <https://pubchem.ncbi.nlm.nih.gov/patent/US-2012100124-A1> (Accessed: 11 August 2022).
- Meyer, E. J. *et al.* (2016) 'Corticosteroid-Binding Globulin: A Review of Basic and Clinical Advances', *Hormone and Metabolic Research*, 48(6), pp. 359–371. doi: 10.1055/s-0042-108071.
- Michael, Y. L. *et al.* (2009) 'Influence of Stressors on Breast Cancer Incidence in the Women's Health Initiative', *Health Psychology*, 28(2), pp. 137–146. doi: 10.1037/a0012982.
- Michaleas, S. *et al.* (2022) 'The European Medicines Agency review of sacituzumab govitecan for the treatment of triple-negative breast cancer', *ESMO Open*, 7(3), p. 100497. doi: 10.1016/j.esmoop.2022.100497.

- Mikosz, C. A. *et al.* (2001) 'Glucocorticoid Receptor-mediated Protection from Apoptosis Is Associated with Induction of the Serine/Threonine Survival Kinase Gene, *sgk-1*', *Journal of Biological Chemistry*, 276(20), pp. 16649–16654. doi: 10.1074/jbc.M010842200.
- Milazzo, G. *et al.* (2020) 'Histone deacetylases (HDACs): Evolution, specificity, role in transcriptional complexes, and pharmacological actionability', *Genes*, 11(5). doi: 10.3390/genes11050556.
- Millard, C. J. *et al.* (2013) 'An evolving understanding of nuclear receptor coregulator proteins', *Journal of Molecular Endocrinology*, 51(3). doi: 10.1530/JME-13-0227.
- Miller, A. L. *et al.* (2005) 'p38 mitogen-activated protein kinase (MAPK) is a key mediator in glucocorticoid-induced apoptosis of lymphoid cells: Correlation between p38 MAPK activation and site-specific phosphorylation of the human glucocorticoid receptor at serine 211', *Molecular Endocrinology*, 19(6), pp. 1569–1583. doi: 10.1210/me.2004-0528.
- Miller, W. L. (2009) 'Androgen synthesis in adrenarche', *Rev Endocr Metab Disord.*, 10(1), pp. 3–17. doi: 10.1007/s11154-008-9102-4.
- Miller, W. L. and Auchus, R. J. (2011) 'The molecular biology, biochemistry, and physiology of human steroidogenesis and its disorders', *Endocrine Reviews*, 32(1), pp. 81–151. doi: 10.1210/er.2010-0013.
- Miller, W. R. (2003) 'Catalysis, Structure and Reactivity Effect of Cu content on the bimetallic Pt-Cu catalysts for propane dehydrogenation', *Seminars in Oncology*, 30(4), pp. 3–11. doi: 10.1016/S0093-7754(04)00302-6.
- Minc, E., Courvalin, J. C. and Buendia, B. (2000) 'HP1 γ associates with euchromatin and heterochromatin in mammalian nuclei and chromosomes', *Cytogenetics and Cell Genetics*, 90(3–4), pp. 279–284. doi: 10.1159/000056789.
- Miranda, T. B. *et al.* (2013) 'Reprogramming the chromatin landscape: Interplay of the estrogen and glucocorticoid receptors at the genomic level', *Cancer Res.*, 73(16), pp. 5130–5139. doi: 10.1158/0008-5472.CAN-13-0742.
- Mittelstadt, P. R., Taves, M. D. and Ashwell, J. D. (2018) 'Cutting Edge: De Novo Glucocorticoid Synthesis by Thymic Epithelial Cells Regulates Antigen-Specific Thymocyte Selection', *The Journal of Immunology*, 200(6), pp. 1988–1994. doi: 10.4049/JIMMUNOL.1701328/-/DCSUPPLEMENTAL.
- Moalli, P. A. *et al.* (1993) 'Alternatively Spliced Glucocorticoid Receptor Messenger RNAs in Glucocorticoid-resistant Human Multiple Myeloma Cells', *Cancer Research*, 53(17), pp. 3877–3879.
- Mohammadi, L. *et al.* (2020) 'Correlation Between Dexamethasone and miRNAs in the Regulation of Apoptosis, Drug-resistance, and Metastasis of Cancer Cell', *Current Molecular Medicine*, 21(5), pp. 392–401. doi: 10.2174/1566524020666200925155614.
- Mohan, A., Huybrechts, I. and Michels, N. (2022) 'Psychosocial stress and cancer risk: a narrative review', *European Journal of Cancer Prevention*, Publish Ah, pp. 1–15. doi: 10.1097/cej.0000000000000752.
- Mohawk, J. A. and Takahashi, J. S. (2011) 'Cell autonomy and synchrony of suprachiasmatic nucleus circadian oscillators', *Trends in Neurosciences*, 34(7), pp. 349–358. doi: 10.1016/J.TINS.2011.05.003.
- Montagna, E. and Colleoni, M. (2019) 'Hormonal treatment combined with targeted therapies in endocrine-responsive and HER2-positive metastatic breast cancer', pp. 1–10. doi: 10.1177/https.
- Mook, S. *et al.* (2009) 'Calibration and discriminatory accuracy of prognosis calculation for breast

- cancer with the online Adjuvant! program: a hospital-based retrospective cohort study', *The Lancet Oncology*, 10(11), pp. 1070–1076. doi: 10.1016/S1470-2045(09)70254-2.
- Morgan, D. J. *et al.* (2016) 'Glucocorticoid receptor isoforms direct distinct mitochondrial programs to regulate ATP production', *Scientific Reports*, 6(April), pp. 1–10. doi: 10.1038/srep26419.
- Morishima, Y. *et al.* (2000) 'Stepwise assembly of a glucocorticoid receptor-hsp90 heterocomplex resolves two sequential ATP-dependent events involving first hsp70 and then hsp90 in opening of the steroid binding pocket', *Journal of Biological Chemistry*, 275(24), pp. 18054–18060. doi: 10.1074/jbc.M000434200.
- Morishima, Y. *et al.* (2003) 'The Hsp90 cochaperone p23 is the limiting component of the multiprotein Hsp90/Hsp70-based chaperone system in vivo where it acts to stabilize the client protein-Hsp90 complex', *Journal of Biological Chemistry*, 278(49), pp. 48754–48763. doi: 10.1074/jbc.M309814200.
- Moskowitz, C. S. *et al.* (2014) 'Breast cancer after chest radiation therapy for childhood cancer', *Journal of Clinical Oncology*, 32(21), pp. 2217–2223. doi: 10.1200/JCO.2013.54.4601.
- Motolani, A. *et al.* (2021) 'The structure and functions of prmt5 in human diseases', *Life*, 11(10), pp. 1–16. doi: 10.3390/life11101074.
- Mountjoy, K. G. *et al.* (1994) 'Localization of the melanocortin-4 receptor (MC4-R) in neuroendocrine and autonomic control circuits in the brain', *Molecular Endocrinology*, 8(10), pp. 1298–1308. doi: 10.1210/me.8.10.1298.
- Mubtasim, N., Moustaid-Moussa, N. and Gollahon, L. (2022) 'The Complex Biology of the Obesity-Induced, Metastasis-Promoting Tumor Microenvironment in Breast Cancer', *International Journal of Molecular Sciences*, 23(5). doi: 10.3390/ijms23052480.
- Muratcioglu, S. *et al.* (2015) 'Article Structural Modeling of GR Interactions with the SWI / SNF Chromatin', *Biophysj*, 109(6), pp. 1227–1239. doi: 10.1016/j.bpj.2015.06.044.
- Murtagh, J. *et al.* (2004) 'Organization of mammary epithelial cells into 3D acinar structures requires glucocorticoid and JNK signaling', *Journal of Cell Biology*, 166(1), pp. 133–143. doi: 10.1083/jcb.200403020.
- Nader, N., Chrousos, G. P. and Kino, T. (2009) 'Circadian rhythm transcription factor CLOCK regulates the transcriptional activity of the glucocorticoid receptor by acetylating its hinge region lysine cluster: potential physiological implications', *The FASEB Journal*, 23(5), pp. 1572–1583. doi: 10.1096/FJ.08-117697.
- Nanda, R. *et al.* (2016) 'A randomized phase I trial of nanoparticle albumin - bound paclitaxel with or without mifepristone for advanced breast cancer', *SpringerPlus*, 5(1), pp. 1–9. doi: 10.1186/s40064-016-2457-1.
- Narlikar, G. J., Sundaramoorthy, R. and Owen-hughes, T. (2013) 'Review Mechanisms and Functions of ATP-Dependent Chromatin-Remodeling Enzymes', *Cell*, 154(3), pp. 490–503. doi: 10.1016/j.cell.2013.07.011.
- Nehmé, A. *et al.* (2009) 'Glucocorticoids with different chemical structures but similar glucocorticoid receptor potency regulate subsets of common and unique genes in human trabecular meshwork cells', *BMC Medical Genomics*, 2, pp. 1–14. doi: 10.1186/1755-8794-2-58.
- Nelson, R. A. *et al.* (2015) 'Survival Outcomes of Metaplastic Breast Cancer Patients: Results from a

US Population-based Analysis', *Annals of Surgical Oncology*, 22(1), pp. 24–31. doi: 10.1245/s10434-014-3890-4.

Nesset, K. A., Perri, A. M. and Mueller, C. R. (2014) 'Frequent promoter hypermethylation and expression reduction of the glucocorticoid receptor gene in breast tumors', *Epigenetics*, 9(6), pp. 851–859. doi: 10.4161/epi.28484.

Nicolaidis, N. C., Charmandari, E. and Chrousos, G. P. (2018) 'Glucocorticoid receptor', *Encyclopedia of Endocrine Diseases*, 3, pp. 104–111. doi: 10.1016/B978-0-12-801238-3.95740-4.

Noetzelin, S. *et al.* (2022) 'Short-term glucocorticoid-related side effects and adverse reactions: a narrative review and practical approach', *Swiss medical weekly*, 152(January), p. w30088. doi: 10.4414/smw.2022.w30088.

Noti, M., Sidler, D. and Brunner, T. (2009) 'Extra-adrenal glucocorticoid synthesis in the intestinal epithelium: More than a drop in the ocean?', *Seminars in Immunopathology*, 31(2), pp. 237–248. doi: 10.1007/s00281-009-0159-2.

Nouredine, L. M. *et al.* (2021) 'Glucocorticoid receptor: A multifaceted actor in breast cancer', *International Journal of Molecular Sciences*, 22(9), pp. 1–19. doi: 10.3390/ijms22094446.

Nunez, B. S. *et al.* (2005) 'Interaction between the interferon signaling pathway and the human glucocorticoid receptor gene 1A promoter', *Endocrinology*, 146(3), pp. 1449–1457. doi: 10.1210/en.2004-0672.

O'Shaughnessy, J. *et al.* (2022) 'Analysis of patients without and with an initial triple-negative breast cancer diagnosis in the phase 3 randomized ASCENT study of sacituzumab govitecan in metastatic triple-negative breast cancer', *Breast Cancer Research and Treatment*, 2(0123456789). doi: 10.1007/s10549-022-06602-7.

Oakley, R. H. *et al.* (1999) 'The Dominant Negative Activity of the Human Glucocorticoid Receptor α Isoform', 274(39), pp. 27857–27866.

Oakley, R. H. *et al.* (2013) 'Essential role of stress hormone signaling in cardiomyocytes for the prevention of heart disease', *Proceedings of the National Academy of Sciences of the United States of America*, 110(42), pp. 17035–17040. doi: 10.1073/pnas.1302546110.

Oakley, R. H. and Cidlowski, J. A. (2013) 'The biology of the glucocorticoid receptor: New signaling mechanisms in health and disease', *Journal of Allergy and Clinical Immunology*, 132(5), pp. 1033–1044. doi: 10.1016/J.JACI.2013.09.007.

Oakley, R. H., Sar, M. and Cidlowski, J. A. (1996) 'The Human Glucocorticoid Receptor β Isoform: EXPRESSION, BIOCHEMICAL PROPERTIES, AND PUTATIVE FUNCTION (*)', *Journal of Biological Chemistry*, 271(16), pp. 9550–9559. doi: 10.1074/JBC.271.16.9550.

Obradović, M. M. S. *et al.* (2019) 'Glucocorticoids promote breast cancer metastasis', *Nature*, 567(7749), pp. 540–544. doi: 10.1038/s41586-019-1019-4.

O'Donnell, S. and Omorain, C. A. (2010) 'Therapeutic benefits of budesonide in gastroenterology', *Therapeutic Advances in Chronic Disease*, 1(4), pp. 177–186. doi: 10.1177/2040622310379293.

Ogawa, H. *et al.* (2004) 'Nuclear structure-associated TIF2 recruits glucocorticoid receptor and its target DNA', *Biochemical and Biophysical Research Communications*, 320(1), pp. 218–225. doi: 10.1016/j.bbrc.2004.05.161.

- Ogryzko, V. V. *et al.* (1996) 'The transcriptional coactivators p300 and CBP are histone acetyltransferases', *Cell*, 87(5), pp. 953–959. doi: 10.1016/S0092-8674(00)82001-2.
- Ogryzko, V. V. *et al.* (1998) 'Histone-like TAFs within the PCAF histone acetylase complex', *Cell*, 94(1), pp. 35–44. doi: 10.1016/S0092-8674(00)81219-2.
- Olkkonen, V. M., Béaslas, O. and Nissilä, E. (2012) 'Oxysterols and their cellular effectors', *Biomolecules*, 2(1), pp. 76–103. doi: 10.3390/biom2010076.
- Oppong, E. and Cato, A. C. B. (2015) 'Effects of glucocorticoids in the immune system', *Advances in Experimental Medicine and Biology*, 872, pp. 217–233. doi: 10.1007/978-1-4939-2895-8_9.
- Osborne, C. K. and Schiff, R. (2020) 'Estrogen-Receptor Biology : Continuing Progress and Therapeutic Implications', 23(8). doi: 10.1200/JCO.2005.10.036.
- Ośmiałowska, E. *et al.* (2022) 'Illness Perception and Quality of Life in Patients with Breast Cancer', *Cancers*, 14(5), pp. 1–22. doi: 10.3390/cancers14051214.
- Oster, H., Damerow, S., Kiessling, S., *et al.* (2006) 'The circadian rhythm of glucocorticoids is regulated by a gating mechanism residing in the adrenal cortical clock', *Cell Metabolism*, 4(2), pp. 163–173. doi: 10.1016/j.cmet.2006.07.002.
- Oster, H., Damerow, S., Hut, R. A., *et al.* (2006) 'Transcriptional profiling in the adrenal gland reveals circadian regulation of hormone biosynthesis genes and nucleosome assembly genes', *Journal of Biological Rhythms*, 21(5), pp. 350–361. doi: 10.1177/0748730406293053.
- Ostlund Farrants, A. K. *et al.* (1997) 'Glucocorticoid receptor-glucocorticoid response element binding stimulates nucleosome disruption by the SWI/SNF complex', *Molecular and Cellular Biology*, 17(2), pp. 895–905. doi: 10.1128/mcb.17.2.895.
- Pan, D., Kocherginsky, M. and Conzen, S. D. (2011) 'Activation of the glucocorticoid receptor is associated with poor prognosis in estrogen receptor-negative breast cancer', *Cancer Res.*, 71(20), pp. 6360–6370. doi: 10.1158/0008-5472.CAN-11-0362.
- Pandit, P. *et al.* (2020) 'Prevalence of Molecular Subtypes of Breast Cancer: A Single Institutional Experience of 2062 Patients', *European Journal of Breast Health*, 16(1), pp. 39–43. doi: 10.5152/ejbh.2019.4997.
- Pandya, S. and Moore, R. G. (2011) 'Breast development and anatomy', *Clinical Obstetrics and Gynecology*, 54(1), pp. 91–95. doi: 10.1097/GRF.0b013e318207ffe9.
- Pang, D. *et al.* (2006) 'Dexamethasone decreases xenograft response to paclitaxel through inhibition of tumor cell apoptosis', *Cancer Biology and Therapy*, 5(8), pp. 933–940. doi: 10.4161/CBT.5.8.2875.
- Paragliola, R. M. *et al.* (2017) 'Treatment with synthetic glucocorticoids and the hypothalamus-pituitary-adrenal axis', *International Journal of Molecular Sciences*, 18(10). doi: 10.3390/ijms18102201.
- Parente, L. (2001) 'The development of synthetic glucocorticoids', *Glucocorticoids*, (i), pp. 35–51. doi: 10.1007/978-3-0348-8348-1_3.
- Parente, L. (2017) 'Deflazacort: Therapeutic index, relative potency and equivalent doses versus other corticosteroids', *BMC Pharmacology and Toxicology*, 18(1), pp. 1–8. doi: 10.1186/s40360-016-0111-8.
- Pazin, M. J. and Kadonaga, J. T. (1997) 'What's up and down with histone deacetylation and

transcription?', *Cell*, 89(3), pp. 325–328. doi: 10.1016/S0092-8674(00)80211-1.

Pazin MJ, K. J. (1997) 'SWI2/SNF2 and related proteins: ATP-driven motors that disrupt protein-DNA interactions?', *Cell.*, 88(6), pp. 737–740. doi: 10.1016/s0092-8674(00)81918-2.

Perez Kerkvliet, C. *et al.* (2020) 'Glucocorticoid receptors are required effectors of TGFβ1-induced p38 MAPK signaling to advanced cancer phenotypes in triple-negative breast cancer', *Breast Cancer Research*, 22(1), pp. 1–23. doi: 10.1186/s13058-020-01277-8.

Perou, C. M. *et al.* (2000) 'Molecular portraits of human breast tumours. letters to nature 748', *Nature*, 533(May), pp. 747–752. Available at: www.stanford.edu/molecularportraits/.

Perou, C. M. (2011) 'Molecular Stratification of Triple-Negative Breast Cancers', *The Oncologist*, 16(S1), pp. 61–70. doi: 10.1634/theoncologist.2011-s1-61.

Petracci, E. *et al.* (2011) 'Risk factor modification and projections of absolute breast cancer risk', *Journal of the National Cancer Institute*, 103(13), pp. 1037–1048. doi: 10.1093/jnci/djr172.

Petta, I. *et al.* (2016) 'The Interactome of the Glucocorticoid Receptor and Its Influence on the Actions of Glucocorticoids in Combatting Inflammatory and Infectious Diseases', *Microbiology and Molecular Biology Reviews*, 80(2), pp. 495–522. doi: 10.1128/mubr.00064-15.

Phan, T. S., Merk, V. M. and Brunner, T. (2019) 'Extra-adrenal glucocorticoid synthesis at epithelial barriers', *Genes and Immunity*, 20(8), pp. 627–640. doi: 10.1038/s41435-019-0058-z.

Phelan, C. M. *et al.* (1996) 'Mutation analysis of the BRCA2 gene in 49 site-specific breast cancer families', *Nature Genetics* 1996 13:1, 13(1), pp. 120–122. doi: 10.1038/ng0596-120.

Phelan, M. L. *et al.* (1999) 'Reconstitution of a core chromatin remodeling complex from SWI/SNF subunits', *Molecular Cell*, 3(2), pp. 247–253. doi: 10.1016/S1097-2765(00)80315-9.

Piccart-Gebhart, M. J. *et al.* (2005) 'Trastuzumab after Adjuvant Chemotherapy in HER2-Positive Breast Cancer', *New England Journal of Medicine*, 353(16), pp. 1659–1672. doi: 10.1056/NEJMOA052306/SUPPL_FILE/NEJM_PICCART_1659SA1-2.PDF.

Piovan, E. *et al.* (2013) 'Direct Reversal of Glucocorticoid Resistance by AKT Inhibition in Acute Lymphoblastic Leukemia', *Cancer Cell*, 24(6), pp. 766–776. doi: 10.1016/j.ccr.2013.10.022.

Planes-Laine, G. *et al.* (2019) 'PD-1/PD-L1 targeting in breast cancer: The first clinical evidences are emerging. a literature review', *Cancers*, 11(7), pp. 1–25. doi: 10.3390/cancers11071033.

Poirot, M. and Silvente-Poirot, S. (2018) 'The tumor-suppressor cholesterol metabolite, dendrogenin A, is a new class of LXR modulator activating lethal autophagy in cancers', *Biochemical Pharmacology*, 153(February), pp. 75–81. doi: 10.1016/j.bcp.2018.01.046.

Poulard, C. *et al.* (2017) 'A post-translational modification switch controls coactivator function of histone methyltransferases G9a and GLP', *EMBO reports*, 18(8), pp. 1442–1459. doi: 10.15252/embr.201744060.

Poulard, C. *et al.* (2018) 'Increasing G9a automethylation sensitizes B acute lymphoblastic leukemia cells to glucocorticoid-induced death', *Cell Death and Disease*, 9(10), p. 1038. doi: 10.1038/s41419-018-1110-z.

Poulard, C. *et al.* (2019) 'Relapse-associated AURKB blunts the glucocorticoid sensitivity of B cell acute lymphoblastic leukemia', *Proceedings of the National Academy of Sciences of the United States of America*, 116(8), pp. 3052–3061. doi: 10.1073/pnas.1816254116.

- Poulard, C. *et al.* (2020) 'Using proximity ligation assay to detect protein arginine methylation', *Methods*, 175(September 2019), pp. 66–71. doi: 10.1016/j.ymeth.2019.09.007.
- Prat, A. *et al.* (2010) 'Phenotypic and molecular characterization of the claudin-low intrinsic subtype of breast cancer', *Breast Cancer Research*, 12(5). doi: 10.1186/bcr2635.
- Pratt, W. B. and Toft, D. O. (1997) 'Steroid Receptor Interactions with Heat Shock Protein and Immunophilin Chaperones', *Endocrine Reviews*, 18(3), pp. 306–360. doi: 10.1210/EDRV.18.3.0303.
- Presman, D. M. *et al.* (2014) 'Live Cell Imaging Unveils Multiple Domain Requirements for In Vivo Dimerization of the Glucocorticoid Receptor', *PLoS Biology*, 12(3). doi: 10.1371/journal.pbio.1001813.
- Presman, D. M. and Hager, G. L. (2017) 'More than meets the dimer: What is the quaternary structure of the glucocorticoid receptor?', *Transcription*, 8(1), pp. 32–39. doi: 10.1080/21541264.2016.1249045.
- Presul, E. *et al.* (2007) 'Identification, tissue expression, and glucocorticoid responsiveness of alternative first exons of the human glucocorticoid receptor', *Journal of Molecular Endocrinology*, 38(1–2), pp. 79–90. doi: 10.1677/jme.1.02183.
- Psarra, A. M. G. and Sekeris, C. E. (2011) 'Glucocorticoids induce mitochondrial gene transcription in HepG2 cells. Role of the mitochondrial glucocorticoid receptor', *Biochimica et Biophysica Acta - Molecular Cell Research*, 1813(10), pp. 1814–1821. doi: 10.1016/j.bbamcr.2011.05.014.
- Pufall, M. A. (2015) 'Glucocorticoids and cancer', *Advances in Experimental Medicine and Biology*, 872, pp. 315–333. doi: 10.1007/978-1-4939-2895-8_14/COVER.
- Puigserver, P. *et al.* (1998) 'A cold-inducible coactivator of nuclear receptors linked to adaptive thermogenesis', *Cell*, 92(6), pp. 829–839. doi: 10.1016/S0092-8674(00)81410-5.
- Pulfer, M. K. *et al.* (2005) 'Ozone exposure in vivo and formation of biologically active oxysterols in the lung', *Journal of Pharmacology and Experimental Therapeutics*, 312(1), pp. 256–264. doi: 10.1124/jpet.104.073437.
- Purcell, D. J. *et al.* (2011) 'A distinct mechanism for coactivator versus corepressor function by histone methyltransferase G9a in transcriptional regulation', *Journal of Biological Chemistry*, 286(49), pp. 41963–41971. doi: 10.1074/jbc.M111.298463.
- Quatrini, L. *et al.* (2017) 'Host resistance to endotoxic shock requires the neuroendocrine regulation of group 1 innate lymphoid cells', *Journal of Experimental Medicine*, 214(12), pp. 3531–3541. doi: 10.1084/jem.20171048.
- Quatrini, L. *et al.* (2018) 'Endogenous glucocorticoids control host resistance to viral infection through the tissue-specific regulation of PD-1 expression on NK cells', *Nature Immunology* 2018 19:9, 19(9), pp. 954–962. doi: 10.1038/s41590-018-0185-0.
- Rakha, E. A. *et al.* (2010) 'Breast cancer prognostic classification in the molecular era: The role of histological grade', *Breast Cancer Research*, 12(4). doi: 10.1186/bcr2607.
- Rakha, E. A. *et al.* (2017) 'Immunoprofile of metaplastic carcinomas of the breast', *Histopathology*, 70(6), pp. 975–985. doi: 10.1111/his.13159.
- Ramakrishnan, S. *et al.* (2021) 'Inhaled budesonide in the treatment of early COVID-19 (STOIC): a phase 2, open-label, randomised controlled trial', *The Lancet Respiratory Medicine*, 9(7), pp. 763–

772. doi: 10.1016/S2213-2600(21)00160-0/ATTACHMENT/2F77BF03-304A-44A9-ABD5-7ABFF1F801C6/MMC1.PDF.

Ranger, G. S. (2005) 'Current concepts in the endocrine therapy of breast cancer: Tamoxifen and aromatase inhibitors', *Journal of Clinical Pharmacy and Therapeutics*, 30(4), pp. 313–317. doi: 10.1111/j.1365-2710.2005.00655.x.

Rao, N. A. S. *et al.* (2011) 'Coactivation of GR and NFKB alters the repertoire of their binding sites and target genes', *Genome Research*, 21(9), pp. 1404–1416. doi: 10.1101/gr.118042.110.

Rauch, A. *et al.* (2010) 'Glucocorticoids suppress bone formation by attenuating osteoblast differentiation via the monomeric glucocorticoid receptor', *Cell Metabolism*, 11(6), pp. 517–531. doi: 10.1016/j.cmet.2010.05.005.

Ray, D. W. *et al.* (1996) 'Glucocorticoid receptor structure and function in glucocorticoid-resistant small cell lung carcinoma cells', *Cancer Research*, 56(14), pp. 3276–3280.

Reddy, T. P. *et al.* (2020) 'A comprehensive overview of metaplastic breast cancer: clinical features and molecular aberrations', *Breast Cancer Research*, 22(1), pp. 1–11. doi: 10.1186/s13058-020-01353-z.

Regan Anderson, T. M. *et al.* (2016) 'Breast tumor kinase (Brk/PTK6) is induced by HIF, glucocorticoid receptor, and PELP1-mediated stress signaling in triple-negative breast cancer', *Cancer Res.*, 76(6), pp. 1635–1663. doi: 10.1158/0008-5472.CAN-15-2510.

Reichardt, H. M. *et al.* (1998) 'DNA binding of the glucocorticoid receptor is not essential for survival', *Cell*, 93(4), pp. 531–541. doi: 10.1016/S0092-8674(00)81183-6.

Reichardt, H. M. *et al.* (2001) 'Mammary gland development and lactation are controlled by different glucocorticoid receptor activities', *European Journal of Endocrinology*, 145(4), pp. 519–527. doi: 10.1530/eje.0.1450519.

Reichman, M. E. *et al.* (1984) 'Limited Proteolysis of Covalently Labeled Glucocorticoid Receptors as a Probe of Receptor Structure', *Biochemistry*, 23(22), pp. 5376–5384. doi: 10.1021/BI00317A042/ASSET/BI00317A042.FP.PNG_V03.

Reis-Filho, J. S. *et al.* (2006) 'Metaplastic breast carcinomas are basal-like tumours', *Histopathology*, 49(1), pp. 10–21. doi: 10.1111/j.1365-2559.2006.02467.x.

Rhen, T. and Cidlowski, J. A. (2005) 'Antiinflammatory Action of Glucocorticoids — New Mechanisms for Old Drugs', *New England Journal of Medicine*, 353(16), pp. 1711–1723. doi: 10.1056/nejmra050541.

Ricketson, D. *et al.* (2007) 'A Conformational Switch in the Ligand-binding Domain Regulates the Dependence of the Glucocorticoid Receptor on Hsp90', *Journal of Molecular Biology*, 368(3), pp. 729–741. doi: 10.1016/J.JMB.2007.02.057.

Riggs, D. L. *et al.* (2003) 'The Hsp90-binding peptidylprolyl isomerase FKBP52 potentiates glucocorticoid signaling in vivo', *The EMBO Journal*, 22(5), pp. 1158–1167. doi: 10.1093/EMBOJ/CDG108.

Riis, M. (2020) 'Modern surgical treatment of breast cancer', *Annals of Medicine and Surgery*, 56(June), pp. 95–107. doi: 10.1016/j.amsu.2020.06.016.

Ritter, H. D., Antonova, L. and Mueller, C. R. (2012) 'The unliganded glucocorticoid receptor positively

regulates the tumor suppressor gene BRCA1 through GABP beta', *Molecular Cancer Research*, 10(4), pp. 558–569. doi: 10.1158/1541-7786.MCR-11-0423-T.

Ritter, H. D. and Mueller, C. R. (2014) 'Expression microarray identifies the unliganded glucocorticoid receptor as a regulator of gene expression in mammary epithelial cells', *BMC Cancer*, 14(1), pp. 1–19. doi: 10.1186/1471-2407-14-275.

Rivers, C. *et al.* (1999) 'Insertion of an Amino Acid in the DNA-Binding Domain of the Glucocorticoid Receptor as a Result of Alternative Splicing', *The Journal of Clinical Endocrinology & Metabolism*, 84(11), pp. 4283–4286. doi: 10.1210/JCEM.84.11.6235.

Robson, M. *et al.* (2017) 'Olaparib for Metastatic Breast Cancer in Patients with a Germline BRCA Mutation', *New England Journal of Medicine*, 377(6), pp. 523–533. doi: 10.1056/nejmoa1706450.

Rogatsky, I. *et al.* (2002) 'Alternate surfaces of transcriptional coregulator GRIP1 function in different glucocorticoid receptor activation and repression contexts', *Proceedings of the National Academy of Sciences of the United States of America*, 99(26), pp. 16701–16706. doi: 10.1073/pnas.262671599.

Rollins, D. A. *et al.* (2017) 'Glucocorticoid-induced phosphorylation by CDK9 modulates the coactivator functions of transcriptional cofactor GRIP1 in macrophages', *Nature Communications*, 8(1), pp. 1–14. doi: 10.1038/s41467-017-01569-2.

Ronacher, K. *et al.* (2009) 'Ligand-selective transactivation and transrepression via the glucocorticoid receptor: Role of cofactor interaction', *Molecular and Cellular Endocrinology*, 299(2), pp. 219–231. doi: 10.1016/j.mce.2008.10.008.

Roscoe, H. G. and Fahrenbach, M. J. (1971) '11 . Identification of two major neutral metabolites in the rat', *Journal Lipid Research*, 12(1), pp. 17–23. doi: 10.1016/S0022-2275(20)39541-9.

Rosenfeld, M. G., Lunyak, V. V. and Glass, C. K. (2006) 'Sensors and signals: A coactivator/corepressor/epigenetic code for integrating signal-dependent programs of transcriptional response', *Genes and Development*, 20(11), pp. 1405–1428. doi: 10.1101/gad.1424806.

Rothbart, S. B. and Strahl, B. D. (2014) 'Interpreting the language of histone and DNA modifications.', *Biochim Biophys Acta.*, 1839(8), pp. 627–43. doi: 10.1016/j.bbagr.2014.03.001.

Rubino, C. *et al.* (2003) 'Radiation dose, chemotherapy, hormonal treatment and risk of second cancer after breast cancer treatment', *British Journal of Cancer*, 89(5), pp. 840–846. doi: 10.1038/sj.bjc.6601138.

Rutz, H. P. (2002) 'Effects of corticosteroid use on treatment of solid tumours', *Lancet*, 360(9349), pp. 1969–1970. doi: 10.1016/S0140-6736(02)11922-2.

Ruzzin, J., Wagman, A. S. and Jensen, J. (2005) 'Glucocorticoid-induced insulin resistance in skeletal muscles: Defects in insulin signalling and the effects of a selective glycogen synthase kinase-3 inhibitor', *Diabetologia*, 48(10), pp. 2119–2130. doi: 10.1007/s00125-005-1886-0.

Saad, M. J. A. *et al.* (1993) 'Modulation of insulin receptor, insulin receptor substrate-1, and phosphatidylinositol 3-kinase in liver and muscle of dexamethasone-treated rats', *Journal of Clinical Investigation*, 92(4), pp. 2065–2072. doi: 10.1172/JCI116803.

Samarasinghe, R. A. *et al.* (2011) 'Nongenomic glucocorticoid receptor action regulates gap junction intercellular communication and neural progenitor cell proliferation', *Proceedings of the National Academy of Sciences of the United States of America*, 108(40), pp. 16657–16662. doi:

10.1073/pnas.1102821108.

Sánchez-Vega, B. *et al.* (2006) 'Glucocorticoid receptor transcriptional isoforms and resistance in multiple myeloma cells', *Molecular Cancer Therapeutics*, 5(12), pp. 3062–3070. doi: 10.1158/1535-7163.MCT-06-0344.

Santana-davila, R. and Perez, E. A. (2010) 'Treatment options for patients with triple-negative breast cancer', *Journal of Hematology and Oncology*, 3(1), pp. 1–11. doi: 10.1186/1756-8722-3-42/TABLES/1.

Sawan, C. and Herceg, Z. (2010) *Histone modifications and cancer*. 1st edn, *Adv Genet*. 1st edn. Elsevier Inc. doi: 10.1016/B978-0-12-380866-0.60003-4.

Schaefer, U., Schmeier, S. and Bajic, V. B. (2011) 'TcoF-DB: Dragon database for human transcription co-factors and transcription factor interacting proteins', *Nucleic Acids Research*, 39(SUPPL. 1), pp. 106–110. doi: 10.1093/nar/gkq945.

Schakman, O. *et al.* (2013) 'Glucocorticoid-induced skeletal muscle atrophy', *International Journal of Biochemistry and Cell Biology*, 45(10), pp. 2163–2172. doi: 10.1016/j.biocel.2013.05.036.

Scheller, K. *et al.* (2000) 'Localization of glucocorticoid hormone receptors in mitochondria of human cells', *European Journal of Cell Biology*, 79(5), pp. 299–307. doi: 10.1078/S0171-9335(04)70033-3.

Schettini, F. *et al.* (2021) 'Clinical, pathological, and PAM50 gene expression features of HER2-low breast cancer', *npg Breast Cancer*, 7(1). doi: 10.1038/s41523-020-00208-2.

Schiller, B. J. *et al.* (2014) 'Glucocorticoid receptor binds half sites as a monomer and regulates specific target genes', *Genome Biology*, 15(7), pp. 1–16. doi: 10.1186/s13059-014-0418-y.

Schöne, S. *et al.* (2016) 'Sequences flanking the core-binding site modulate glucocorticoid receptor structure and activity', *Nature Communications*, 7(1), pp. 1–13. doi: 10.1038/ncomms12621.

Schroeder, M. C. *et al.* (2018) 'Early and Locally Advanced Metaplastic Breast Cancer: Presentation and Survival by Receptor Status in Surveillance, Epidemiology, and End Results (SEER) 2010–2014', *The Oncologist*, 23(4), pp. 481–488. doi: 10.1634/theoncologist.2017-0398.

Seitz, H. K. *et al.* (2012) 'Epidemiology and pathophysiology of alcohol and breast cancer: Update 2012', *Alcohol and Alcoholism*, 47(3), pp. 204–212. doi: 10.1093/alcalc/ags011.

Seto, E. and Yoshida, M. (2014) 'Erasers of histone acetylation: the histone deacetylase enzymes', *Cold Spring Harbor Perspectives in Biology*, 6(4), p. a018713. doi: 10.1101/CSHPERSPECT.A018713.

Sewer, M. B., Dammer, E. B. and Jagarlapudi, S. (2007) 'Transcriptional regulation of adrenocortical steroidogenic gene expression', *Drug Metabolism Reviews*, 39(2–3), pp. 371–388. doi: 10.1080/03602530701498828.

Shah, A. *et al.* (2022) 'Correlation Between Age and Hormone Receptor Status in Women With Breast Cancer', *Cureus*, 14(1), pp. 6–13. doi: 10.7759/cureus.21652.

Shankar, S. R. *et al.* (2013) 'G9a, a multipotent regulator of gene expression', *Epigenetics*, 8(1), pp. 16–22. doi: 10.4161/epi.23331.

Sharma, M., Ownbey, R. T. and Sharma, M. C. (2010) 'Breast cancer cell surface annexin II induces cell migration and neoangiogenesis via tPA dependent plasmin generation', *Experimental and Molecular Pathology*, 88(2), pp. 278–286. doi: 10.1016/j.yexmp.2010.01.001.

- Shen, Y. *et al.* (2021) 'Discovery of First-in-Class Protein Arginine Methyltransferase 5 (PRMT5) Degraders', *Journal of Medicinal Chemistry*, 63(17), pp. 9977–9989. doi: 10.1021/ACS.JMEDCHEM.0C01111/SUPPL_FILE/JM0C01111_SI_002.CSV.
- Sher, L. B. *et al.* (2006) 'Impaired cortical bone acquisition and osteoblast differentiation in mice with osteoblast-targeted disruption of glucocorticoid signaling', *Calcified Tissue International*, 79(2), pp. 118–125. doi: 10.1007/s00223-005-0297-z.
- Shimba, A. *et al.* (2018) 'Glucocorticoids Drive Diurnal Oscillations in T Cell Distribution and Responses by Inducing Interleukin-7 Receptor and CXCR4', *Immunity*, 48(2), pp. 286–298.e6. doi: 10.1016/j.immuni.2018.01.004.
- Shimba, A. and Ikuta, K. (2021) 'Immune-enhancing effects of glucocorticoids in response to day-night cycles and stress', *International Immunology*, 32(11), pp. 703–708. doi: 10.1093/INTIMM/DXAA048.
- Silvente-Poirot, S., Dalenc, F. and Poirot, M. (2018) 'The effects of cholesterol-derived oncometabolites on nuclear receptor function in cancer', *Cancer Research*, 78(17), pp. 4803–4808. doi: 10.1158/0008-5472.CAN-18-1487.
- Simard, M. *et al.* (2014) 'Pseudomonas aeruginosa elastase disrupts the cortisol-binding activity of corticosteroid-binding globulin', *Endocrinology*, 155(8), pp. 2900–2908. doi: 10.1210/en.2014-1055.
- Simoni, R. D., Hill, R. L. and Vaughan, M. (2002) 'The Isolation of Thyroxine and Cortisone: the Work of Edward C. Kendall', *Journal of Biological Chemistry*, 277(21), pp. 21–22. doi: 10.1016/S0021-9258(20)85219-3.
- Sinclair, Duncan *et al.* (2011) 'Abnormal glucocorticoid receptor mRNA and protein isoform expression in the prefrontal cortex in psychiatric illness', *Neuropsychopharmacology*, 36(13), pp. 2698–2709. doi: 10.1038/npp.2011.160.
- Sinclair, D. *et al.* (2011) 'Dynamic molecular and anatomical changes in the glucocorticoid receptor in human cortical development', *Molecular Psychiatry*, 16(5), pp. 504–515. doi: 10.1038/mp.2010.28.
- Sinclair, D. *et al.* (2012) 'Glucocorticoid receptor mRNA and protein isoform alterations in the orbitofrontal cortex in schizophrenia and bipolar disorder', *BMC Psychiatry*, 12(1), p. 1. doi: 10.1186/1471-244X-12-84.
- Skor, M. N. *et al.* (2013) 'Glucocorticoid receptor antagonism as a novel therapy for triple-negative breast cancer', *Clinical Cancer Research*, 19(22), pp. 6163–6172. doi: 10.1158/1078-0432.CCR-12-3826.
- Smith-Warner, S. A. *et al.* (1998) 'Alcohol and breast cancer in women: A pooled analysis of cohort studies', *Journal of the American Medical Association*, 279(7), pp. 535–540. doi: 10.1001/jama.279.7.535.
- Smith, D. F. and Toft, D. O. (1993) 'Steroid receptors and their associated proteins', *Molecular Endocrinology*, 7(1), pp. 4–11. doi: 10.1210/me.7.1.4.
- Snider, H. *et al.* (2019) 'Region-specific glucocorticoid receptor promoter methylation has both positive and negative prognostic value in patients with estrogen receptor-positive breast cancer', *Clinical Epigenetics*, 11(1), pp. 1–20. doi: 10.1186/s13148-019-0750-x.
- Snyder, C. A. *et al.* (2015) 'Regulation of corepressor alternative mRNA splicing by hormonal and metabolic signaling', *Molecular and Cellular Endocrinology*, 413, pp. 228–235. doi: 10.1016/J.MCE.2015.06.036.

- So, A. Y. L. *et al.* (2009) 'Glucocorticoid regulation of the circadian clock modulates glucose homeostasis', *Proceedings of the National Academy of Sciences of the United States of America*, 106(41), pp. 17582–17587. doi: 10.1073/pnas.0909733106.
- Solito, E. *et al.* (2003) 'Dexamethasone induces rapid serine-phosphorylation and membrane translocation of annexin 1 in a human folliculostellate cell line via a novel nongenomic mechanism involving the glucocorticoid receptor, protein kinase C, phosphatidylinositol 3-kinase, and ', *Endocrinology*, 144(4), pp. 1164–1174. doi: 10.1210/en.2002-220592.
- Song, I. H. and Buttgereit, F. (2006) 'Non-genomic glucocorticoid effects to provide the basis for new drug developments', *Molecular and Cellular Endocrinology*, 246(1–2), pp. 142–146. doi: 10.1016/j.mce.2005.11.012.
- Song, R. *et al.* (2019) 'Glucocorticoids and programming of the microenvironment in heart', *Journal of Endocrinology*, 242(1), pp. T121–T133. doi: 10.1530/JOE-18-0672.
- Sørliie, T. *et al.* (2001) 'Gene expression patterns of breast carcinomas distinguish tumor subclasses with clinical implications', 98(19).
- Sørliie, T. *et al.* (2003) 'Repeated observation of breast tumor subtypes in independent gene expression data sets', *Proceedings of the National Academy of Sciences of the United States of America*, 100(14), pp. 8418–8423. doi: 10.1073/pnas.0932692100.
- Sorrentino, G. *et al.* (2017a) 'Glucocorticoid receptor signalling activates YAP in breast cancer', *Nature Communications*, 8, pp. 1–14. doi: 10.1038/ncomms14073.
- Sorrentino, G. *et al.* (2017b) 'Glucocorticoid receptor signalling activates YAP in breast cancer', *Nature Communications*, 8, pp. 1–14. doi: 10.1038/ncomms14073.
- Sotiriou, C. and Pusztai, L. (2009) 'Gene-Expression Signatures in Breast Cancer', *New England Journal of Medicine*, 360(8), pp. 790–800. doi: 10.1056/nejmra0801289.
- Speers, C. *et al.* (2009) 'Identification of novel kinase targets for the treatment of estrogen receptor-negative breast cancer', *Clinical Cancer Research*, 15(20), pp. 6327–6340. doi: 10.1158/1078-0432.CCR-09-1107.
- Spiga, F. *et al.* (2014) 'HPA axis-rhythms', *Comprehensive Physiology*, 4(3), pp. 1273–1298. doi: 10.1002/cphy.c140003.
- Stallcup, M. R. *et al.* (2003) 'The roles of protein-protein interactions and protein methylation in transcriptional activation by nuclear receptors and their coactivators', *Journal of Steroid Biochemistry and Molecular Biology*, 85(2–5), pp. 139–145. doi: 10.1016/S0960-0760(03)00222-X.
- Stallcup, M. R. and Poulard, C. (2020a) 'Gene-Specific Actions of Transcriptional Coregulators Facilitate Physiological Plasticity: Evidence for a Physiological Coregulator Code', *Trends in Biochemical Sciences*, 45(6), pp. 497–510. doi: 10.1016/J.TIBS.2020.02.006.
- Stallcup, M. R. and Poulard, C. (2020b) 'Gene-Specific Actions of Transcriptional Coregulators Facilitate Physiological Plasticity: Evidence for a Physiological Coregulator Code', *Trends in Biochemical Sciences*, 45(6), pp. 497–510. doi: 10.1016/j.tibs.2020.02.006.
- Starick, S. R. *et al.* (2015) 'ChIP-exo signal associated with DNA-binding motifs provides insight into the genomic binding of the glucocorticoid receptor and cooperating transcription factors', *Genome Research*, 25(6), pp. 825–835. doi: 10.1101/gr.185157.114.

- Steiner, R. W. and Awdishu, L. (2011) 'Steroids in kidney transplant patients', *Seminars in Immunopathology*, 33(2), pp. 157–167. doi: 10.1007/s00281-011-0259-7.
- Stewart, M. D. and Wong, J. (2009) *Chapter 7 Nuclear Receptor Repression. Regulatory Mechanisms and Physiological Implications*. 1st edn, *Progress in Molecular Biology and Translational Science*. 1st edn. Elsevier Inc. doi: 10.1016/S1877-1173(09)87007-5.
- Stewart, P. M. and Krozowski, Z. S. (1997) '11 β -Hydroxysteroid Dehydrogenase', *Vitamins and Hormones*, 57(C), pp. 249–324. doi: 10.1016/S0083-6729(08)60646-9.
- Stocco, D. M. and Clark, B. J. (1996a) 'Regulation of the acute production of steroids in steroidogenic cells', *Endocrine Reviews*, 17(3), pp. 221–244. doi: 10.1210/er.17.3.221.
- Stocco, D. M. and Clark, B. J. (1996b) 'Role of the steroidogenic acute regulatory protein (StAR) in steroidogenesis', *Biochemical Pharmacology*, 51(3), pp. 197–205. doi: 10.1016/0006-2952(95)02093-4.
- Strehl, C. *et al.* (2011) 'Origin and functional activity of the membrane-bound glucocorticoid receptor', *Arthritis and Rheumatism*, 63(12), pp. 3779–3788. doi: 10.1002/art.30637.
- Sui, M. *et al.* (2006) 'Glucocorticoids interfere with therapeutic efficacy of paclitaxel against human breast and ovarian xenograft tumors', *International Journal of Cancer*, 119(3), pp. 712–717. doi: 10.1002/ijc.21743.
- Sung, H. *et al.* (2021) 'Global Cancer Statistics 2020: GLOBOCAN Estimates of Incidence and Mortality Worldwide for 36 Cancers in 185 Countries', *CA: A Cancer Journal for Clinicians*, 71(3), pp. 209–249. doi: 10.3322/caac.21660.
- Surjit, M. *et al.* (2011) 'Widespread negative response elements mediate direct repression by agonist-liganded glucocorticoid receptor', *Cell*, 145(2), pp. 224–241. doi: 10.1016/j.cell.2011.03.027.
- Swinstead, E. E. *et al.* (2016) 'Steroid Receptors Reprogram FoxA1 Occupancy through Dynamic Chromatin Transitions', *Cell*, 165(3), pp. 593–605. doi: 10.1016/j.cell.2016.02.067.
- Szapary, D., Huang, Y. and Simons, S. S. (1999) 'Opposing effects of corepressor and coactivators in determining the dose-response curve of agonists, and residual agonist activity of antagonists, for glucocorticoid receptor-regulated gene expression', *Molecular Endocrinology*, 13(12), pp. 2108–2121. doi: 10.1210/mend.13.12.0384.
- Tabassum, I., Mahmood, H. and Faheem, M. (2016) 'Type 2 diabetes mellitus as a risk factor for female breast cancer in the population of northern Pakistan', *Asian Pacific Journal of Cancer Prevention*, 17(7), pp. 3255–3258.
- Tachibana, M. *et al.* (2002) 'G9a histone methyltransferase plays a dominant role in euchromatic histone H3 lysine 9 methylation and is essential for early embryogenesis', *Genes and Development*, 16(14), pp. 1779–1791. doi: 10.1101/gad.989402.
- Takabe, S., Mochizuki, K. and Goda, T. (2008) 'De-phosphorylation of GR at Ser203 in nuclei associates with GR nuclear translocation and GLUT5 gene expression in Caco-2 cells', *Archives of Biochemistry and Biophysics*, 475(1), pp. 1–6. doi: 10.1016/j.abb.2008.03.036.
- Talaber, G., Jondal, M. and Okret, S. (2015) 'Local glucocorticoid production in the thymus', *Steroids*, 103, pp. 58–63. doi: 10.1016/j.steroids.2015.06.010.
- Talabér, G., Jondal, M. and Okret, S. (2013) 'Extra-adrenal glucocorticoid synthesis: Immune

regulation and aspects on local organ homeostasis', *Molecular and Cellular Endocrinology*, 380(1–2), pp. 89–98. doi: 10.1016/j.mce.2013.05.007.

Tang, Y. *et al.* (1998) 'The DNA-Binding and $\tau 2$ Transactivation Domains of the Rat Glucocorticoid Receptor Constitute a Nuclear Matrix-Targeting Signal', *Molecular Endocrinology*, 12(9), pp. 1420–1431. doi: 10.1210/mend.12.9.0169.

Tang, Y. *et al.* (2016) 'Classification, Treatment Strategy, and Associated Drug Resistance in Breast Cancer', *Clinical Breast Cancer*, 16(5), pp. 335–343. doi: 10.1016/j.clbc.2016.05.012.

Tashkin, D. P., Lipworth, B. and Brattsand, R. (2019) 'Benefit:Risk Profile of Budesonide in Obstructive Airways Disease', *Drugs*, 79(16), pp. 1757–1775. doi: 10.1007/s40265-019-01198-7.

Taves, M. D., Gomez-Sanchez, C. E. and Soma, K. K. (2011) 'Extra-adrenal glucocorticoids and mineralocorticoids: Evidence for local synthesis, regulation, and function', *American Journal of Physiology - Endocrinology and Metabolism*, 301(1). doi: 10.1152/ajpendo.00100.2011.

Thakur, P. *et al.* (2017) 'Breast cancer risk factor evaluation in a Western Himalayan state: A case–control study and comparison with the Western World', *South Asian Journal of Cancer*, 6(3), p. 106. doi: 10.4103/SAJC.SAJC_157_16.

Thomas-Chollier, M. *et al.* (2013) 'A naturally occurring insertion of a single amino acid rewires transcriptional regulation by glucocorticoid receptor isoforms', *Proceedings of the National Academy of Sciences of the United States of America*, 110(44), pp. 17826–17831. doi: 10.1073/pnas.1316235110.

Tian, S. *et al.* (2002) 'Small ubiquitin-related modifier-1 (SUMO-1) modification of the glucocorticoid receptor', *Biochemical Journal*, 367(3), pp. 907–911. doi: 10.1042/BJ20021085.

Timmermans, S., Souffriau, J. and Libert, C. (2019) 'A General Introduction to Glucocorticoid Biology', *Front Immunol.*, 10(July). doi: 10.3389/fimmu.2019.01545.

Tokudome, S. *et al.* (2009) 'Glucocorticoid protects rodent hearts from ischemia/reperfusion injury by activating lipocalin-type prostaglandin D synthase-derived PGD2 biosynthesis', *Journal of Clinical Investigation*, 119(6), pp. 1477–1488. doi: 10.1172/JCI37413.

Tong, D. *et al.* (2006) 'Expression of KLF5 is a prognostic factor for disease-free survival and overall survival in patients with breast cancer', *Clinical Cancer Research*, 12(8), pp. 2442–2448. doi: 10.1158/1078-0432.CCR-05-0964.

Tonsing-Carter, E. *et al.* (2019) 'Glucocorticoid receptor modulation decreases ER-positive breast cancer cell proliferation and suppresses wild-type and mutant ER chromatin association', *Breast cancer research : BCR*, 21(1), p. 82. doi: 10.1186/s13058-019-1164-6.

Torchia, J. *et al.* (1997) 'The transcriptional co-activator p/CIP binds CBP and mediates nuclear-receptor function', *Nature*, 387(6634), pp. 677–684. doi: 10.1038/42652.

Trousseau, A. *et al.* (2007) 'Recruitment of the p160 coactivators by the glucocorticoid receptor: Dependence on the promoter context and cell type but not hypoxic conditions', *Journal of Steroid Biochemistry and Molecular Biology*, 104(3–5), pp. 305–311. doi: 10.1016/j.jsbmb.2007.03.018.

Tsai, C. and Fondell, J. D. (2004) 'Chih-Cheng Tsai and Joseph D. Fondell', *Vitamins And Hormones*, 68, pp. 93–122.

Tsang, J. Y. S. and Tse, G. M. (2020) 'Molecular Classification of Breast Cancer', *Advances in Anatomic*

Pathology, 27(1), pp. 27–35. doi: 10.1097/PAP.000000000000232.

Tung, K. *et al.* (2011) 'Novel hyperactive glucocorticoid receptor isoform identified within a human population', *Shock*, 36(4), pp. 339–344. doi: 10.1097/SHK.0b013e318228eca7.

Turner, J. D. *et al.* (2007) 'A new transcript splice variant of the human glucocorticoid receptor: Identification and tissue distribution of hGR Δ 313-338, an alternative exon 2 transactivation domain isoform', *Annals of the New York Academy of Sciences*, 1095, pp. 334–341. doi: 10.1196/annals.1397.037.

Turner, J. D. and Muller, C. P. (2005) 'Structure of the glucocorticoid receptor (NR3C1) gene 5' untranslated region: Identification, and tissue distribution of multiple new human exon 1', *Journal of Molecular Endocrinology*, 35(2), pp. 283–292. doi: 10.1677/jme.1.01822.

Uhlenhaut, N. H. *et al.* (2013) 'Insights into Negative Regulation by the Glucocorticoid Receptor from Genome-wide Profiling of Inflammatory Cistromes', *Molecular Cell*, 49(1), pp. 158–171. doi: 10.1016/J.MOLCEL.2012.10.013/ATTACHMENT/97E7B046-F298-466C-80E1-97967A2F9FC6/MMC1.PDF.

Vaidya, J. S. *et al.* (2004) 'Intraoperative radiotherapy for breast cancer', *Lancet Oncology*, 5(3), pp. 165–173. doi: 10.1016/S1470-2045(04)01412-3.

Valachis, A. *et al.* (2010) 'Partial breast irradiation or whole breast radiotherapy for early breast cancer: A meta-analysis of randomized controlled trials', *Breast Journal*, 16(3), pp. 245–251. doi: 10.1111/j.1524-4741.2010.00905.x.

Valentin, M. D. *et al.* (2012) 'Molecular insights on basal-like breast cancer', *Breast Cancer Research and Treatment*, 134(1), pp. 21–30. doi: 10.1007/s10549-011-1934-z.

Vandevyver, S., Dejager, L. and Libert, C. (2012) 'On the Trail of the Glucocorticoid Receptor: Into the Nucleus and Back', *Traffic*, 13(3), pp. 364–374. doi: 10.1111/j.1600-0854.2011.01288.x.

Vandevyver, S., Dejager, L. and Libert, C. (2014) 'Comprehensive Overview of the Structure and Regulation of the Glucocorticoid Receptor', 35(August), pp. 671–693. doi: 10.1210/er.2014-1010.

Vanstapel, F., Dopere, F. and Stalmans, W. (1980) 'The role of glycogen synthase phosphatase in the glucocorticoid-induced deposition of glycogen in foetal rat liver', *Biochemical Journal*, 192(2), pp. 607–612. doi: 10.1042/bj1920607.

La Vecchia, C. *et al.* (2011) 'Overweight, Obesity, Diabetes, and Risk of Breast Cancer: Interlocking Pieces of the Puzzle', *The Oncologist*, 16(6), pp. 726–729. doi: 10.1634/theoncologist.2011-0050.

Veronesi, U. *et al.* (2005) 'Breast cancer', *The Lancet*, 365(9472), pp. 1727–1741. doi: 10.1016/S0140-6736(05)66546-4.

Vinet, M. *et al.* (2019) 'Protein arginine methyltransferase 5: A novel therapeutic target for triple-negative breast cancers', *Cancer Medicine*, 8(5), pp. 2414–2428. doi: 10.1002/cam4.2114.

Voduc, K. D. *et al.* (2010) 'Breast cancer subtypes and the risk of local and regional relapse', *Journal of Clinical Oncology*, 28(10), pp. 1684–1691. doi: 10.1200/JCO.2009.24.9284.

Voegel, J. J. *et al.* (1998) 'The coactivator TIF2 contains three nuclear receptor-binding motifs and mediates transactivation through CBP binding-dependent and -independent pathways', *EMBO Journal*, 17(2), pp. 507–519. doi: 10.1093/emboj/17.2.507.

Voisin, M. *et al.* (2017) 'Identification of a tumor-promoter cholesterol metabolite in human breast

cancers acting through the glucocorticoid receptor', *Proceedings of the National Academy of Sciences of the United States of America*, 114(44), pp. E9346–E9355. doi: 10.1073/pnas.1707965114.

Vuong, D. *et al.* (2014) 'Molecular classification of breast cancer', pp. 1–14. doi: 10.1007/s00428-014-1593-7.

Waks, A. G. and Winer, E. P. (2019) 'Breast Cancer Treatment: A Review', *JAMA*, 321(3), pp. 288–300. doi: 10.1001/JAMA.2018.19323.

Wallace, A. D. *et al.* (2010) 'Lysine 419 targets human glucocorticoid receptor for proteasomal degradation', *Steroids*, 75(12), pp. 1016–1023. doi: 10.1016/J.STEROIDS.2010.06.015.

Wallace, A. D. and Cidlowski, J. A. (2001) 'Proteasome-mediated Glucocorticoid Receptor Degradation Restricts Transcriptional Signaling by Glucocorticoids', *Journal of Biological Chemistry*, 276(46), pp. 42714–42721. doi: 10.1074/jbc.M106033200.

Wallberg, A. E. *et al.* (2000) 'Recruitment of the SWI-SNF Chromatin Remodeling Complex as a Mechanism of Gene Activation by the Glucocorticoid Receptor τ 1 Activation Domain', *Molecular and Cellular Biology*, 20(6), pp. 2004–2013. doi: 10.1128/mcb.20.6.2004-2013.2000.

Wang, C. *et al.* (2015) 'The interplay between TEAD4 and KLF5 promotes breast cancer partially through inhibiting the transcription of p27 Kip1', *Oncology Reports*, 6(19), pp. 17685–17697. doi: 10.18632/oncotarget.3779.

Wang, H. *et al.* (2004) 'Dexamethasone as a chemoprotectant in cancer chemotherapy: Hematoprotective effects and altered pharmacokinetics and tissue distribution of carboplatin and gemcitabine', *Cancer Chemotherapy and Pharmacology*, 53(6), pp. 459–467. doi: 10.1007/s00280-003-0759-9.

Wang, J. C. *et al.* (2006) 'Novel arylpyrazole compounds selectively modulate glucocorticoid receptor regulatory activity', *Genes and Development*, 20(6), pp. 689–699. doi: 10.1101/gad.1400506.

Wang, Q. *et al.* (2013) 'Glucocorticoid receptor protein expression in human hippocampus; stability with age', *Neurobiology of Aging*, 34(6), pp. 1662–1673. doi: 10.1016/j.neurobiolaging.2012.11.019.

Wang, S. C. M. *et al.* (2010) 'An $ERR\beta/\gamma$ agonist modulates $GR\alpha$ expression, and glucocorticoid responsive gene expression in skeletal muscle cells', *Molecular and Cellular Endocrinology*, 315(1–2), pp. 146–152. doi: 10.1016/j.mce.2009.07.012.

Wang, W. *et al.* (1996) 'Purification and biochemical heterogeneity of the mammalian SWI-SNF complex', *EMBO Journal*, 15(19), pp. 5370–5382. doi: 10.1002/j.1460-2075.1996.tb00921.x.

Wang, X. and DeFranco, D. B. (2005) 'Alternative effects of the ubiquitin-proteasome pathway on glucocorticoid receptor down-regulation and transactivation are mediated by CHIP, an E3 ligase', *Molecular Endocrinology*, 19(6), pp. 1474–1482. doi: 10.1210/me.2004-0383.

Wang, Y., Yutuc, E. and Griffiths, W. J. (2021) 'Cholesterol metabolism pathways – are the intermediates more important than the products?', *FEBS Journal*, 288(12), pp. 3727–3745. doi: 10.1111/febs.15727.

Wang, Z., Frederick, J. and Garabedian, M. J. (2002) 'Deciphering the phosphorylation "code" of the glucocorticoid receptor in vivo', *Journal of Biological Chemistry*, 277(29), pp. 26573–26580. doi: 10.1074/jbc.M110530200.

Watson, Lisa C *et al.* (2013) 'The glucocorticoid receptor dimer interface allosterically transmits

- sequence-specific DNA signals.', *Nat Struct Mol Biol.*, 20(7), pp. 876–883. doi: 10.1038/nsmb.2595.The.
- Watson, Lisa C. *et al.* (2013) 'The glucocorticoid receptor dimer interface allosterically transmits sequence-specific DNA signals', *Nature Structural & Molecular Biology* 2013 20:7, 20(7), pp. 876–883. doi: 10.1038/nsmb.2595.
- Wei, Y., Davis, J. and Bina, W. F. (2012) 'Ambient air pollution is associated with the increased incidence of breast cancer in US', *International Journal of Environmental Health Research*, 22(1), pp. 12–21. doi: 10.1080/09603123.2011.588321.
- Weigelt, B. *et al.* (2014) 'Metaplastic breast carcinoma: More than a special type', *Nature Reviews Cancer*, 14(3), pp. 147–148. doi: 10.1038/nrc3637.
- Weikum, E. R. *et al.* (2017) 'Tethering not required: The glucocorticoid receptor binds directly to activator protein-1 recognition motifs to repress inflammatory genes', *Nucleic Acids Research*, 45(14), pp. 8596–8608. doi: 10.1093/nar/gkx509.
- Weiser, M. J., Foradori, C. D. and Handa, R. J. (2010) 'Estrogen receptor beta activation prevents glucocorticoid receptor-dependent effects of the central nucleus of the amygdala on behavior and neuroendocrine function', *Brain Research*, 1336, pp. 78–88. doi: 10.1016/j.brainres.2010.03.098.
- Weiss, A. *et al.* (2018) 'Validation study of the American joint committee on cancer eighth edition prognostic stage compared with the anatomic stage in breast cancer', *JAMA Oncology*, 4(2), pp. 203–209. doi: 10.1001/jamaoncol.2017.4298.
- West, D. C. *et al.* (2016) 'GR and ER coactivation alters the expression of differentiation genes and associates with improved ER+ breast cancer outcome', *Molecular Cancer Research*, 14(8), pp. 707–719. doi: 10.1158/1541-7786.MCR-15-0433.
- West, D. C. *et al.* (2018) 'Discovery of a Glucocorticoid Receptor (GR) Activity Signature Using Selective GR Antagonism in ER-Negative Breast Cancer.', *Clinical Cancer Research*, 24(14), pp. 3433–3446. doi: 10.1158/1078-0432.CCR-17-2793.
- Westphal, H. M. *et al.* (1984) 'Immunochemical characterization of wild-type and variant glucocorticoid receptors by monoclonal antibodies', 3(7), pp. 1493–1498.
- Whirledge, S. and Cidlowski, J. A. (2010) 'Glucocorticoids, stress, and fertility', *Minerva Endocrinologica*, 35(2), pp. 109–125.
- Whitfield, G. K. *et al.* (1999) 'Steroid hormone receptors: Evolution, ligands, and molecular basis of biologic function', *Journal of Cellular Biochemistry*, 76(SUPPL. 32/33), pp. 110–122. doi: 10.1002/(sici)1097-4644(1999)75:32+<110::aid-jcb14>3.0.co;2-t.
- Wiegers, G. J. and Reul, J. M. H. M. (1998) 'Induction of cytokine receptors by glucocorticoids: Functional and pathological significance', *Trends in Pharmacological Sciences*, 19(8), pp. 317–321. doi: 10.1016/S0165-6147(98)01229-2.
- Williams, L. A. *et al.* (2018) 'Reproductive risk factor associations with lobular and ductal carcinoma in the Carolina Breast Cancer Study', *Cancer Causes and Control*, 29(1), pp. 25–32. doi: 10.1007/s10552-017-0977-9.
- Wintermantel, T. M. *et al.* (2005) 'The epithelial glucocorticoid receptor is required for the normal timing of cell proliferation during mammary lobuloalveolar development but is dispensable for milk production', *Molecular Endocrinology*, 19(2), pp. 340–349. doi: 10.1210/me.2004-0068.

- Wirapati, P. *et al.* (2008) 'Meta-analysis of gene expression profiles in breast cancer : toward a unified understanding of breast cancer subtyping and prognosis signatures', *Breast Cancer Res.*, 10(4), pp. 1–11. doi: 10.1186/bcr2124.
- Wolf, I. *et al.* (2005) 'Diabetes mellitus and breast cancer', *The Lancet Oncology*, 6(2), pp. 103–111. doi: 10.1016/S1470-2045(05)01736-5.
- Wolf, I. M. *et al.* (2008) 'Coactivators and nuclear receptor transactivation', *Journal of Cellular Biochemistry*, 104(5), pp. 1580–1586. doi: 10.1002/jcb.21755.
- Wong, W. *et al.* (2021) 'Poor response to neoadjuvant chemotherapy in metaplastic breast carcinoma', *npj Breast Cancer*, 7(1), pp. 1–7. doi: 10.1038/s41523-021-00302-z.
- Wu, D. Y. *et al.* (2014) 'Distinct, genome-wide, gene-specific selectivity patterns of four glucocorticoid receptor coregulators', *Nuclear receptor signaling*, 12, p. e002. doi: 10.1621/nrs.12002.
- Wu, I. *et al.* (2013) 'Selective glucocorticoid receptor translational isoforms reveal glucocorticoid-induced apoptotic transcriptomes', *Cell Death and Disease*, 4(1), pp. 1–12. doi: 10.1038/cddis.2012.193.
- Wu, J. I., Lessard, J. and Crabtree, G. R. (2009) 'Understanding the words of chromatin regulation', *Cell*, 136(2), pp. 200–206. doi: 10.1016/J.CELL.2009.01.009.
- Wu, Q. *et al.* (2021) 'Protein arginine methylation: from enigmatic functions to therapeutic targeting', *Nature Reviews Drug Discovery*, 20(7), pp. 509–530. doi: 10.1038/s41573-021-00159-8.
- Wu, W. *et al.* (2004) 'Microarray Analysis Reveals Glucocorticoid-Regulated Survival Genes That Are Associated with Inhibition of Apoptosis in Breast Epithelial Cells', *Cancer Research*, 64(5), pp. 1757–1764. doi: 10.1158/0008-5472.CAN-03-2546.
- Wu, W. *et al.* (2005) 'Glucocorticoid receptor-induced MAPK phosphatase-1 (MPK-1) expression inhibits paclitaxel-associated MAPK activation and contributes to breast cancer cell survival', *Journal of Biological Chemistry*, 280(6), pp. 4117–4124. doi: 10.1074/jbc.M411200200.
- de Wulf, H. and Hers, H. G. (1967) 'The Stimulation of Glycogen Synthesis and of Glycogen Synthetase in the Liver by the Administration of Glucose', *European Journal of Biochemistry*, 2(1), pp. 50–56. doi: 10.1111/j.1432-1033.1967.tb00104.x.
- Xu, J. and Li, Q. (2003) 'Review of the in Vivo functions of the p160 steroid receptor coactivator family', *Molecular Endocrinology*, 17(9), pp. 1681–1692. doi: 10.1210/me.2003-0116.
- Xu, J., Wu, R. C. and O'Malley, B. W. (2009) 'Normal and cancer-related functions of the p160 steroid receptor co-activator (SRC) family', *Nature Reviews Cancer*, 9(9), pp. 615–630. doi: 10.1038/nrc2695.
- Xue, F. *et al.* (2011) 'Cigarette smoking and the incidence of breast cancer', *Archives of Internal Medicine*, 171(2), pp. 125–133. doi: 10.1001/archinternmed.2010.503.
- Yadav, B. S., Chanana, P. and Jhamb, S. (2015) 'Biomarkers in triple negative breast cancer: A review', *World Journal of Clinical Oncology*, 6(6), pp. 252–263. doi: 10.5306/wjco.v6.i6.252.
- Yamamoto, K. R. (1985) 'STEROID RECEPTOR REGULATED TRANSCRIPTION OF SPECIFIC GENES AND GENE NETWORKS', *Annu Rev Genet*, 19, pp. 209–252. doi: 10.1146/annurev.ge.19.120185.001233.
- Yang, F. *et al.* (2017a) 'Glucocorticoid Receptor:MegaTrans Switching Mediates the Repression of an ER α -Regulated Transcriptional Program', *Molecular Cell*, 66(3), pp. 321–331. doi: 10.1016/j.molcel.2017.03.019.

- Yang, F. *et al.* (2017b) 'Glucocorticoid Receptor:MegaTrans Switching Mediates the Repression of an ER α -Regulated Transcriptional Program', *Molecular Cell*, 66(3), pp. 321–331.e6. doi: 10.1016/j.molcel.2017.03.019.
- Yang, L. *et al.* (2000) 'Interaction of the τ 2 transcriptional activation domain of glucocorticoid receptor with a novel steroid receptor coactivator, Hic-5, which localizes to both focal adhesions and the nuclear matrix', *Molecular Biology of the Cell*, 11(6), pp. 2007–2018. doi: 10.1091/mbc.11.6.2007.
- Yang, M. *et al.* (2010) 'Col3.6-HSD2 transgenic mice: A glucocorticoid loss-of-function model spanning early and late osteoblast differentiation', *Bone*, 47(3), pp. 573–582. doi: 10.1016/J.BONE.2010.06.002.
- Yang, P. J. *et al.* (2022) 'Association of early-onset breast cancer with body mass index, menarche, and menopause in Taiwan', *BMC Cancer*, 22(1), pp. 1–11. doi: 10.1186/s12885-022-09361-2.
- Yang, R. and Yu, Y. (2021) 'Glucocorticoids are double-edged sword in the treatment of covid-19 and cancers', *International Journal of Biological Sciences*, 17(6), pp. 1530–1537. doi: 10.7150/ijbs.58695.
- Yao, T. P. *et al.* (1996) 'The nuclear hormone receptor coactivator SRC-1 is a specific target of p300', *Proceedings of the National Academy of Sciences of the United States of America*, 93(20), pp. 10626–10631. doi: 10.1073/pnas.93.20.10626.
- Yari, K. *et al.* (2014) 'The MMP-2-735 C allele is a risk factor for susceptibility to breast cancer', *Asian Pacific Journal of Cancer Prevention*, 15(15), pp. 6199–6203. doi: 10.7314/APJCP.2014.15.15.6199.
- Yasir, M., Goyal, A. and Sonthalia, S. (2022) 'Corticosteroid Adverse Effects', *StatPearls*. Available at: <https://www.ncbi.nlm.nih.gov/books/NBK531462/> (Accessed: 11 August 2022).
- Yoon, J. C. *et al.* (2001) 'Control of hepatic gluconeogenesis through the transcriptional coactivator PGC-1', *Nature*, 413(6852), pp. 131–138. doi: 10.1038/35093050.
- Yu, H. *et al.* (1996) 'Associations between insulin-like growth factors and their binding proteins and other prognostic indicators in breast cancer', *British Journal of Cancer*, 74(8), pp. 1242–1247. doi: 10.1038/bjc.1996.523.
- Yudt, M. R. *et al.* (2003) 'Molecular Origins for the Dominant Negative Function of Human Glucocorticoid Receptor Beta', *Molecular and Cellular Biology*, 23(12), pp. 4319–4330. doi: 10.1128/mcb.23.12.4319-4330.2003.
- Yudt, M. R. and Cidlowski, J. A. (2001) 'Molecular identification and characterization of A and B forms of the glucocorticoid receptor', *Molecular Endocrinology*, 15(7), pp. 1093–1103. doi: 10.1210/mend.15.7.0667.
- El Zein, D. *et al.* (2017) 'Metaplastic Carcinoma of the Breast Is More Aggressive Than Triple-negative Breast Cancer: A Study From a Single Institution and Review of Literature', *Clinical Breast Cancer*, 17(5), pp. 382–391. doi: 10.1016/j.clbc.2017.04.009.
- Zhang, S. *et al.* (2012) 'ROR1 is expressed in human breast cancer and associated with enhanced tumor-cell growth', *PLoS ONE*, 7(3). doi: 10.1371/journal.pone.0031127.
- Zhang, S. M. *et al.* (2007) 'Alcohol consumption and breast cancer risk in the women's health study', *American Journal of Epidemiology*, 165(6), pp. 667–676. doi: 10.1093/aje/kwk054.
- Zhang, Y. *et al.* (2009) 'Estrogen inhibits glucocorticoid action via protein phosphatase 5 (PP5)-mediated glucocorticoid receptor dephosphorylation', *Journal of Biological Chemistry*, 284(36), pp.

24542–24552. doi: 10.1074/jbc.M109.021469.

Zhou, A. *et al.* (2008) 'The S-to-R Transition of Corticosteroid-Binding Globulin and the Mechanism of Hormone Release', *Journal of Molecular Biology*, 380(1), pp. 244–251. doi: 10.1016/j.jmb.2008.05.012.

Zhou, L. *et al.* (2016) 'Kaiso represses the expression of glucocorticoid receptor via a methylation-dependent mechanism and attenuates the anti-apoptotic activity of glucocorticoids in breast cancer cells', *BMB Reports*, 49(3), pp. 167–172. doi: 10.5483/BMBRep.2016.49.3.151.

Zhou, Y. and Liu, X. (2020) 'The role of estrogen receptor beta in breast cancer', *Biomarker Research*, 8(1), pp. 1–12. doi: 10.1186/s40364-020-00223-2.

Zolfaroli, I., Tarín, J. J. and Cano, A. (2018) 'Hormonal contraceptives and breast cancer: Clinical data', *European Journal of Obstetrics and Gynecology and Reproductive Biology*, 230, pp. 212–216. doi: 10.1016/j.ejogrb.2018.03.058.

Zong, J., Ashraf, J. and Thompson, E. B. (1990) 'The promoter and first, untranslated exon of the human glucocorticoid receptor gene are GC rich but lack consensus glucocorticoid receptor element sites', *Molecular and Cellular Biology*, 10(10), pp. 5580–5585. doi: 10.1128/mcb.10.10.5580-5585.1990.