



**HAL**  
open science

# New approaches to the synthesis of S/Se-glycosides and alkynyl C-nucleosides

Mingxiang Zhu

► **To cite this version:**

Mingxiang Zhu. New approaches to the synthesis of S/Se-glycosides and alkynyl C-nucleosides. Catalysis. Université Paris-Saclay, 2022. English. NNT : 2022UPASQ030 . tel-04153055

**HAL Id: tel-04153055**

**<https://theses.hal.science/tel-04153055>**

Submitted on 6 Jul 2023

**HAL** is a multi-disciplinary open access archive for the deposit and dissemination of scientific research documents, whether they are published or not. The documents may come from teaching and research institutions in France or abroad, or from public or private research centers.

L'archive ouverte pluridisciplinaire **HAL**, est destinée au dépôt et à la diffusion de documents scientifiques de niveau recherche, publiés ou non, émanant des établissements d'enseignement et de recherche français ou étrangers, des laboratoires publics ou privés.

# New approaches to the synthesis of S/Se-glycosides and alkynyl C-nucleosides

*De nouvelles approches pour la synthèse de S/Se-glycosides et d'alcynyl C-nucléosides*

## Thèse de doctorat de l'université Paris-Saclay

École doctorale n°569 innovation thérapeutique du fondamental à l'appliqué (ITFA)

Spécialité de doctorat : Chimie thérapeutique

Graduate School : Santé et médicaments. Référent : Faculté de pharmacie

Thèse préparée dans l'unité de recherche **BioCIS (Université Paris-Saclay, CNRS)**,

sous la direction de **Samir MESSAOUDI**, directeur de recherche

Thèse soutenue à Paris-Saclay, le 05 Juillet 2022, par

**Mingxiang ZHU**

## Composition du Jury

**Emmanuel MAGNIER**

Directeur de recherche, Université de Versailles Saint-Quentin-en-Yvelines

Président

**Thomas LECOURT**

Professeur des universités, Université de Rouen Normandie

Examineur

**Geraldine MASSON**

Directeur de recherche, Institut de Chimie des Substances Naturelles

Examineur

**Matthieu SOLLOGOUB**

Professeur des universités, Sorbonne Université

Rapporteur & Examineur

**Anis TLILI**

Chargé de recherche, Université Claude Bernard - Lyon 1

Rapporteur & Examinatrice

**Samir MESSAOUDI**

Directeur de recherche, Université Paris-Saclay

Directeur de thèse



# CONTENT

<b>Acknowledgement</b> .....	<b>1</b>
<b>List of abbreviations</b> .....	<b>3</b>
<b>General introduction</b> .....	<b>6</b>
<b>Chapter 1: Arylation, Alkenylation and Alkynylation of 1-Thiosugars/ 1-Selenoglycosides.</b> .....	<b>11</b>
<b>1.1 Part 1 General Introduction</b> .....	<b>11</b>
A) S-glycosides synthesis .....	11
B) Se-glycosides synthesis .....	22
<b>1.2 Part 2 Room Temperature Pd-Catalyzed Synthesis of 1-Selenoglycosides</b> .....	<b>27</b>
A) Background .....	27
B) Results and discussion .....	29
C) Conclusion and perspectives .....	41
D) Experimental part .....	41
<b>1.3 Part 3 Synthesize of aryl thioglycosides by using a photoredox dual-catalysis</b> .....	<b>54</b>
A) Introduction .....	54
B) Publication .....	56
C) Conclusion and perspectives .....	68
D) Experimental part .....	68
<b>1.4 Part 4 Electrochemical Nickel-Catalyzed Migita Cross-Coupling of Thiosugars with Aryl, alkenyl and alkynyl Bromides</b> .....	<b>84</b>
A) Introduction .....	84
B) Publication .....	86
C) Conclusion and perspectives .....	98
D) Experimental part .....	99
<b>1.5 Part 5 Visible-Light-Mediated Stadler-Ziegler Arylation of Thiosugars with Anilines</b> .....	<b>116</b>
A) Introduction .....	116
B) Publication .....	119
C) Conclusion and perspectives .....	131

D) Experimental part .....	132
<b>Chapter 2: Diastereoselective Decarboxylative Alkynylation of Anomeric Carboxylic Acids Using Cu/Photoredox Dual Catalysis.....</b>	<b>153</b>
A) Introduction.....	153
B) Publication.....	161
C) Conclusion and perspectives .....	180
D) Experiment Part.....	180
<b>General conclusion.....</b>	<b>216</b>
<b>Conclusion Générale .....</b>	<b>220</b>

## Acknowledgement

This thesis work was carried out at the Faculty of Pharmacy of University Paris-Saclay in Châtenay-Malabry, within the team of *Conception et Synthèse de Molécules d'Intérêt Thérapeutique* (CosMIT) attached to BioCIS (UMR CNRS 8076). The team is now co-directed by Dr. Samir Messaoudi (Research director of CNRS) and Professor Abdallah Hamze (Professor of University Paris-Saclay). It is really pleasure for me to work in this lab.

First of all, I would like to thank Chinese Scholarship Council (CSC) for the scholarship and University Paris-Saclay for the Ph.D. position.

I want to show my grateful to pre-leader of the CoSMIT Mouad Alami, for his welcoming me to his laboratory.

I would particularly like to express my appreciation to my supervisor Dr. Samir Messaoudi. First of all, I want to thanks for your trust and your encouragement during my darkest hour. Without this, I can never keep me on the path way of research. Your unique knowledge and understanding in scientific research showed me a new exciting universe in chemistry, which has motivated me to try and never afraid of making mistakes, encouraged me to explore the beauty of chemistry. Thanks for your humor, your kindness and your patience, those good behaviors let me not only be a good scientist, but also be a good person. It is really my luck to work with you.

I am also appreciative of all the jury members Pr. Thomas Lecourt, Dr. Emmanuel Magnier, Dr. Geraldine Masson, Pr. Matthieu Sollogoub and Dr. Anis Tlili. Thank you for aggreging to evaluate my work. Your presence is an honour to me.

The completion of my thesis benefited from support of many people.

My Ph.D. life would be hard without the other permanent members in our lab. Miss. Christine Tran, Mr. Olivier Provot, Mr. Abdallah Hamze and Mr. Franck Lebideau, thank you for the help and support. I would like to thank Karine Leblanc for the LC-MS, GC-MS, HRMS analysis, as well as Dr. Rémi Franco and Dr. Jean-Christophe Jullian for the NMR analysis.

I would like to thank all my colleagues for your friendly, help, encourage, discussing and suggesting. All of you treat me as family. Ranking from the oldest to the youngest: Gilles Galvani, Boris Letribot, Diana Lamaa, Nejwa Ben, Estelle Messe, Juba

Ghouilem, Shannon Pecnard, Sokna Bazzi, Camille Hauguel, Fatthalla Maha, Dmytro Ryzhakov, Mayssa Zayene, Jessica Vieira Mende, Celia Lequeurre and my Chinese colleagues, Hsin-Ping Lin, Guangkuan Zhao, Kena Zhang, Yunxin Yao, Linhua Shen, Jun Yan, Linlin Li and Xinya Liu. Thanks for met you during this four-year period.

I would like thanks all my friends who give accompany, encourage, energy and support.

At last, I really want to show my appreciation to my family. Thank you for your understanding, supporting, trust, and love. Thank you, my mother and farther, you always be my firm support. With you encourage and support, I get the chance to achieve my dream, to study in France and to explore the world. Thanks for you accompany my love Xiaochan Wang. Thanks for you come to Paris to be my side in all circumstances. Even though chemistry may be a bit abstract for you, you always tried your best to encourage and support me.

Many thanks to all the people appearing in my life. Hope you have a good future and everything going well.

## List of abbreviations

**Ac:** Acetyl  
**Aq.:** aqueous  
**Bn:** Benzyl  
**Boc:** *tert*-Butyloxycarbonyl  
**bpy:** 2,2'-Bipyridine  
**Cbz:** Carbobenzyloxy  
**Cy:** Cyclohexane  
**DMAP:** 4-Dimethylaminopyridine  
**dba:** Dibenzylideneacetone  
**DCE:** 1,2-Dichloroethane  
**DCM:** Dichloromethane  
**DIPEA:** *N,N*-Diisopropylethylamine  
**DMDO:** Dimethyldioxirane  
**DME:** Dimethoxyethane  
**DMF:** *N,N*-Dimethylformamide  
**DMSO:** Dimethylsulfoxide  
**Dppb:** 1,4-Bis(diphenylphosphino)butane  
**Dppe:** 1,2-Bis(diphenylphosphino)ethane  
**Dppf:** 1,1'-Ferrocenediyl-bis(diphenylphosphine)  
**Dppp:** 1,3-Bis(diphenylphosphino)propane  
**EA:** ethyl acetate  
**eq./equiv.:** Equivalent  
**ESI:** Electrospray ionization  
**Et:** Ethyl  
**EWG:** Electron-withdrawing group  
**FDA:** food and drug administration  
**FG:** Functional group  
**h/hr:** hour  
**HAT:** Hydrogen Atom Transfer  
**HRMS:** high resolution mass spectrum  
**IR:** Infrared radiation  
**LED:** light-emitting diode  
**Me:** methyl  
**Min:** minute  
**MS:** molecular sieve  
**MW:** Microwave  
**m.p.:** melting point  
**NMR:** Nuclear magnetic resonance  
**OTf:** trifluoromethanesulfonate, triflate  
**OTs:** Toluenesulfonyl/Tosyl



**PG:** protecting group

**Ph:** phenyl

**ppm:** Parts per million

**ppy:** 2-phenylpyridine

**TBAF(*t*BuOH)<sub>4</sub>:** Tetrabutylammonium Tetra(*tert*-Butyl Alcohol)

**rt:** Room temperature

**TEA:** triethylamine

**TFA:** Trifluoroacetic acid

**TEMPO:** (2,2,6,6-Tetramethylpiperidin-1-yl)oxyl

**THF:** Tetrahydrofuran

**TLC:** thin-layer chromatography

**XantPhos:** 4,5-Bis(diphenylphosphino)-9,9-dimethylxanthene

**XantPhosPdG3:** [(4,5-Bis(diphenylphosphino)-9,9-dimethylxanthene)-2-(2'-amino-1,1'-biphenyl)]palladium(II) methanesulfonate

**Xphos:** Dicyclohexyl[2',4',6'-tris(propan-2-yl)[1,1'-biphenyl]-2-yl]phosphane

**4CZPIN:** 1,2,3,5-Tetrakis(carbazol-9-yl)-4,6-dicyanobenzene, 2,4,5,6-Tetrakis(9H-carbazol-9-yl)isophthalonitrile

## **General introduction**

---

## General introduction

Carbohydrates which are essential biomolecules are known to be not only the main source of energy for metabolism, but also act as building blocks to generate glycoconjugates (glycopeptides, glycoproteins, glycolipides...etc.) involved in a wide range of biological processes.<sup>1</sup>

Most carbohydrates found in nature or used in therapeutics exist as glycoconjugates, an association of sugar moieties with aglycones through *N*- or *O*-anomeric bonds. However, these bonds are sensitive to hydrolysis under enzymatic conditions leading to a less efficiency in the case of using these glycosides as therapeutics. In this context, 1-thioglycosides/1-selenoglycosides and *C*-glycosides have emerged as privileged classes of glycosides with a diverse range of potential applications owing to the greater resistance of these glycomimetics to glycosidase cleavage under biological media. Such compounds are therefore in increasing demand and their preparation in significant quantities now require the development of new synthetic methodologies.

Since their first synthesis by Fisher in 1909, thioglycosides became a privileged class of glycosides with a diverse range of potential application<sup>2</sup> including anti-rheumatoid arthritis drug, auranofin, hSGLT1 inhibitor, ligand of lectine A, cytotoxic Hsp90 inhibitor, galactosidase and glycosidase inhibitors, antimicrobial agent as well as galactin-3-inhibitors.

In another hand, Since the discovery of the first selenoglycoside in rat and human urine as a hepatic Se-metabolite,<sup>3</sup> the design and synthesis of bioactive seleglycosides have gained more attention within the chemistry community<sup>4</sup> including Se-KRN7000<sup>5</sup> (analogue of the potent immunostimulant  $\alpha$ -GalCer (KRN7000), and the

---

<sup>1</sup> Bertozzi, C. M.; Kiessling, L. L., *Science*, **2001**, *291*, 2357-2364.

<sup>2</sup> a) Driguez, H.; *Glycoscience Synthesis Of Substrate Analogs And Mimetics*. **1997**, *187*, 85-116; b) Pachamuthu, K.; Schmidt, R. R.; *Chem. Rev.*, **2006**, *106*, 160-187.

<sup>3</sup> Kobayashi, Y.; Ogra, Y.; Ishiwata, K.; Takayama, H.; Aimi, N.; Suzuki, K. T., *Proc. Natl. Acad. Sci. USA*, **2002**, *99*, 15932-15936.

<sup>4</sup> a) Zhu, F.; O'Neill, S.; Rodriguez, J.; Walczak, M. A., *Angew. Chem., Int. Ed.*, **2018**, *57*, 7091-7095; b) Guan, Y.; Townsend, S. D., *Org. Lett.* **2017**, *19*, 5252-5255.

<sup>5</sup> McDonagh, A. W.; Mahon, M. F.; Murphy, P. V., *Org. Lett.*, **2016**, *18*, 552-555.

selenoglycoside AcSG<sup>6</sup> (anticancer agent). From the organic synthesis point of view, thio- and selenoglycosides have been investigated as unique glycosyl donors in glycosylation reactions.<sup>7</sup>

Besides, the other series of glycomimetics largely found in nature and used as therapeutics in various diseases is C-glycosides. These derivatives in which the anomeric bond is replaced by a C–C bond, are known to be more resistant towards hydrolysis under biological conditions.<sup>8</sup>

During this PhD research program, we were interested to develop new efficient catalytic approaches to synthesis of S/Se-glycosides and C-nucleosides. Therefore, this manuscript will be divided into two chapters as follow:

The **chapter 1** is dedicated to the functionalization of 1-thiosugars/ 1-Selenoglycosides by using different methods. After a representative literature related to the new methodologies developed recently to arylation of 1-thiosugars/ 1-selenoglycosides, 4 methodologies will be presented:

**Methodology 1:** We will address during this methodology 1 the Pd-catalyzed synthesis of 1-selenoglycosides at room temperature. We combined here the use of the PdG3 Xantphos catalyst in the presence of two bases to perform the cross-coupling of the *in situ* generated glycosyl selenolates and a broad range of (hetero)aryl and alkenyl iodides in excellent yields (**Figure 1**).

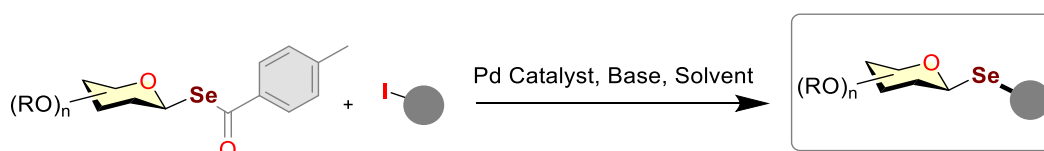

**Figure 1.** Pd-catalyzed synthesis of 1-selenoglycosides

---

<sup>6</sup> Kónya, Z.; Bécsi, B.; Kiss, A.; Tamás, I.; Lontay, B.; Szilágyi, L.; Kövér, K. E.; Erdódi, F., *Bioorg. Med. Chem.*, **2018**, *26*, 1875-1884.

<sup>7</sup> a) Witczak, Z. J.; Czernecki, S., *Adv. Carbohydr. Chem. Biochem.* **1998**, *53*, 143-199; b) van Well, R. M.; Kärkkäinen, T. S.; Kartha, K. P.; Field, R. A., *Carbohydr. Res.* **2006**, *341*, 1391-1397; c) Tsegay, S.; Williams, R. J.; Williams, S. J. J., *Carbohydr. Res.*, **2012**, *357*, 16-22.

<sup>8</sup> a) Dwek, R. A., *Chem. Rev.*, **1996**, *96*, 683-720; b) Nicotra, F., *Top. Curr. Chem.*, **1997**, *187*, 55-83.

**Methodology 2:** We report herein a new method to the synthesis of S-glycosides by using a dual photoredox reaction. After the examination of various of reaction conditions, the C-S bond coupling has been achieved successfully by dual catalytic system of Ni(II) and Ru(II) (**Figure 2**).

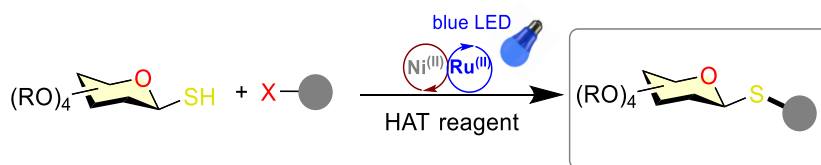

**Figure 2.** Synthesize of S-glycosides by photoredox reaction

**Methodology 3:** In this part, we will describe the electrochemical nickel-catalyzed Migita cross-coupling of thiosugars with aryl, alkenyl and alkynyl bromides and iodides. During our previously reported studies on thioglycosides synthesis, we observed that aryl bromides were less reactive as coupling partners. So, we were interesting to develop a new method for functionalization of glycosyl thiols by using aryl, alkenyl or alkynyl bromides. Here we report a simple route towards the synthesis of thioglycosides, in which electrochemical cross-coupling is used to form the S–C bond from simple protected and unprotected thiosugars with aryl bromides under base free conditions (**Figure 3**).

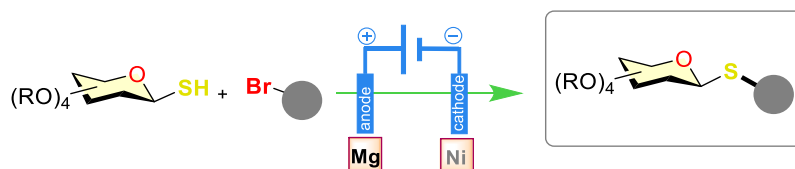

**Figure 3.** Synthesize of S-glycosides by electrochemistry

**Methodology 4:** The previously reported dual photoredox methodology to synthesize thioglycosides was extended to a one-pot Stadler-Ziegler reaction by using the commercially available anilines and (un)protected 1-glycosyl thiols as coupling partners. During this reaction, [Ru(bpy)<sub>3</sub>](PF<sub>6</sub>)<sub>2</sub> was used as the photocatalyst. The aryl diazonium salt was formed *in situ* from arylamines, and reacts with glycosyl thiols to generate the desired aryl thioglycosides (**Figure 4**).

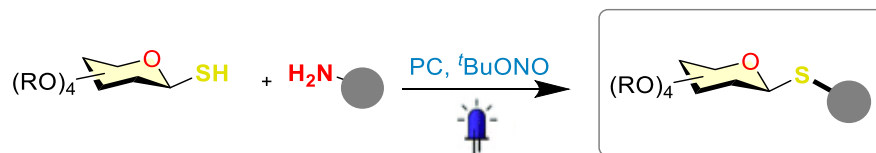

**Figure 4.** Synthesis of 1-thioglycosides by Stadler-Ziegler reaction

**Chapter 2:** The chapter 2 will be dedicated to the development of decarboxylative alkylation of anomeric carboxylic acids using Cu/photoredox dual catalysis. Here we report for the first time a simple route towards the synthesis of alkynyl C-nucleosides from simple and stable furanosyl carboxylic acids and terminal alkynes under low-cost and non-toxic copper catalysis. The approach that we report here demonstrates the power of Cu/photoredox dual catalysis to access highly complex glycosides under mild conditions (**Figure 5**).

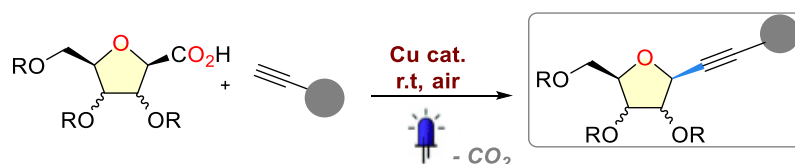

**Figure 5.** Alkylation of anomeric carboxylic acids

The manuscript will be presented as different articles. For each article provided in this manuscript will be added a general introduction, discussions and a conclusion.

# **Chapter 1: Arylation, Alkenylation and Alkynylation of 1-Thiosugars/ 1-Selenoglycosides**

---

## Chapter 1: Arylation, Alkenylation and Alkynylation of 1-Thiosugars/ 1-Selenoglycosides.

### 1.1 Part 1 General Introduction

#### A) S-glycosides synthesis

Thioglycosides are found in many important bioactive compounds. These derivatives have been used as bio-mimetics of *O*-glycosides. As they are known to be more resistant to enzymatic hydrolysis.

Owing to the biological significance of thioglycosides, there is a strong impetus to discover new chemical transformations for their efficient synthesis. From the view point of atom-economy, among the methods commonly used, we can mention that in general two strategies are possible (**Scheme 1**) which consist in bringing the thiol function onto an activated electrophilic sugar (Route A) or in synthesizing the thioglycoside unit and using it as a nucleophile on an electrophilic aglycone (Route B).

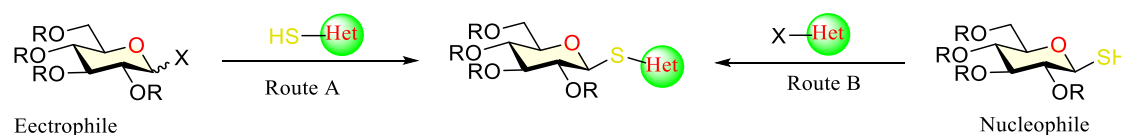

**Scheme 1.** Classic glycosylation strategy

The review literatures revealed that, the strategy using route **B** is extremely poorly studied and therefore it was interesting to develop a general and effective method using this strategy.

Thioglycosides may be prepared from the corresponding peracetylated sugar with a thiol in the presence of Lew acid ( $\text{BF}_3 \cdot \text{Et}_2\text{O}$ ,<sup>9</sup>  $\text{ZrCl}_4$ ,<sup>10</sup>  $\text{ZnCl}_2$ ,<sup>11</sup>  $\text{InCl}_3$ ,<sup>12</sup>...) (**Scheme 2**) by reaction with a nucleophilic thiol.

---

<sup>9</sup> Wang, Z.; Zhou, L.; El-Boubbou, K.; Ye, X.; Huang, X. *J. Org. Chem.*, **2007**, 72, 6409-6420.

<sup>10</sup> Ding, Y. *Synth. Commun.*, **1999**, 29, 3541-3546.

<sup>11</sup> Balavoine, G.; Gref, A.; Fischer, J.-C.; Lubineau, A. *Tetrahedron Lett.*, **1990**, 31, 5761-5764.

<sup>12</sup> Das, S. K.; Roy, J.; Reddy, K. A.; Abbineni, C. *Carbohydr. Res.*, **2003**, 338, 2237-2240.



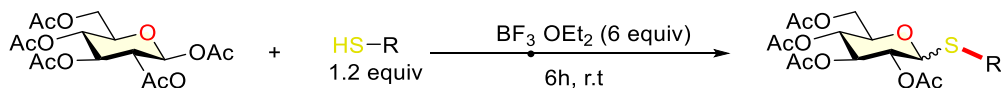

**Scheme 2.** Thioglycosylation catalyzed by Lewis acid

The advantage of this motif is that it is stable under many conditions, which makes it easier to modify the different positions of the sugar. It is a polyvalent compound which can be used as a glycosyl donor or acceptor depending on the reaction conditions.

These methods generally produce an average to good selectivity at the anomeric position and the Lewis acids used in stoichiometric amounts are not compatible with certain functional groups.

The arylthioglycoside compounds can also be obtained by reaction of the  $S_N2$  type of a thiophenol with a brominated sugar in a basic medium (**Scheme 3**).<sup>13</sup> This method makes it possible in particular to access molecules of therapeutic interest; Imberty, Roy *et al.*<sup>14</sup> synthesized various thiogalactosides to evaluate their activities on the LecA factor.

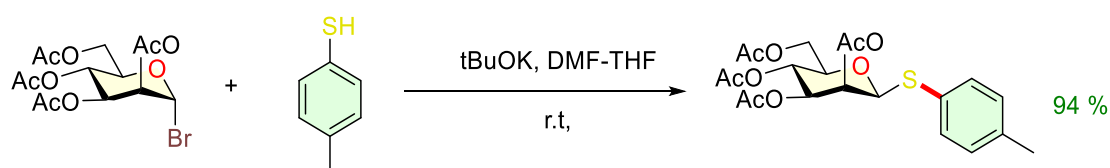

**Scheme 3.** thioglycosylation by  $S_N2$

Although widely used, these methods suffer from:

- The availability of thiophenol partners. In fact, very few thiophenols are commercially available. Moreover, their preparation is not an easy task and

<sup>13</sup> Yu, H. N.; Furukawa, J.; Ikeda T., Wong, C.-H. *Org. Lett.*, **2004**, *6*, 723-726.

<sup>14</sup> Rodrigue, J.; Ganne, G.; Blanchard, B.; Saucier, C.; Giguère, D.; Shiao, T. C.; Varrot, A.; Imberty, A.; Roy, R. *Org. Biomol. Chem.*, **2013**, *11*, 6906-6918.

the use of sulfur reagents uncomfortable, very toxic and a foul-smelling odor limiting access to the variously substituted aryl-thioglycosyls.

- The use of Lewis acids in stoichiometric amounts, sensitivity to moisture and are not very compatible with various functional groups.
- The possibility of obtaining of anomeric mixtures sometimes which are difficult to be separated on a chromatographic column.

The idea would then be to use sugar not as an electrophile but as a nucleophile, reacting it with halogenated (electrophilic) aglycones with transition metals (**Scheme 4**).

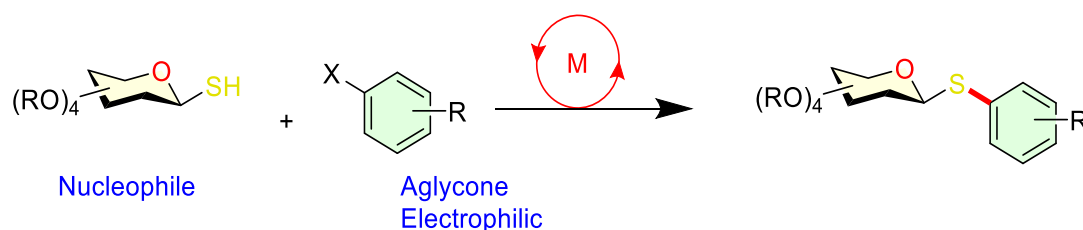

**Scheme 4.** Reverse strategy for thioheteroside formation

The inverse strategy of using sugar as the nucleophile and the aglycone part as electrophilic is little studied. Few publications report the formation of S-Csp<sup>2</sup> bonds using nucleophilic sugars. Given the laboratory's expertise in metalcatalyzed couplings, we are exploring this strategy via organometallic catalysis.

Few methods describe this strategy for the formation of thioglycosides using metalcatalyst. Nevertheless, attention should be made of the aromatic nucleophilic substitution reaction which requires no metal but is limited to electron-poor aryls.

The first protocol using a metal and a glycosylated thiol is reported by Guy *et al.* In 2000 but only concerns one example (**scheme 5**).<sup>15</sup>

---

<sup>15</sup> Herradura, P. S.; Pendola, K. A.; Guy, R. K. *Org. Lett.*, **2000**, 2, 2019-2022.

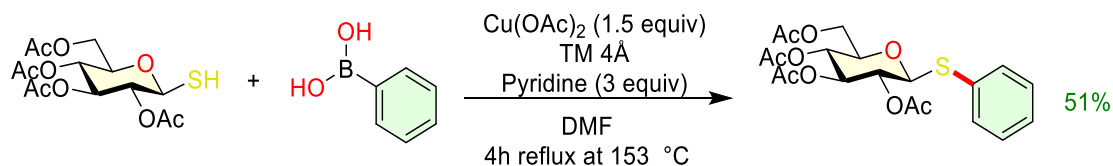

**Scheme 5.** Coupling of Chan-Lam with 1-β-D-thioglucopyranose

During their study, they showed that it was possible to use peracetyl-thioglucopyranose as nucleophile during a coupling of Chan-Lam assisted by (1.5 equiv) of  $\text{Cu(OAc)}_2$  in the presence of pyridine under reflux of DMF. Yield, although modest (51 %), is an interesting proof of concept despite the stoichiometric use of copper and elevated temperature. However, the authors did not provide the experimental data of the product (neither NMR nor mass spectrum).

A second protocol was developed by Naus et al in 2003 (**Scheme 6**).<sup>16</sup> This Ullmann coupling allows the formation of thioheterosides through the use of a stoichiometric amount of  $\text{CuI}$  (1.0 equiv) in the presence of  $\text{K}_2\text{CO}_3$  and pyridine in acetonitrile. Under these conditions, various thiosugars were coupled with good yields and good control of the anomeric configuration. It should be noted that the triazene function is indispensable for coupling, which limits its scope.

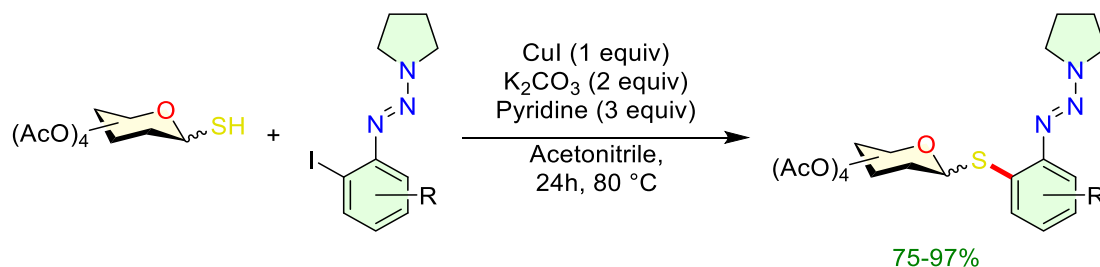

**Scheme 6.** Ullmann Coupling Directed by the Triazene Function

Although interesting, these two protocols suffer from significant disadvantages which leave the possibility of new developments.

<sup>16</sup> Nauš, P.; Lešetický, L.; Smrček, S.; Tišlerová, I.; Šticha, M. *Synlett*, **2003**, *2003*, 2117-2122.

In 2003, our group<sup>17</sup> reported the first Pd-catalyzed cross-coupling reaction of thiosugars with (hetero) aryl halides. This method which involves the use of Pd(OAc)<sub>2</sub>/XantPhos as the catalytic system, NEt<sub>3</sub> as the base in dioxane at 100 °C, furnished a series of S-glycosides. Interestingly, unprotected thioglucose also works under these reaction conditions without any formation of a by-product arising from O-arylation under Pd-catalysis. Unfortunately, a relatively high temperature 100 °C is required under these conditions, which lead to narrow scope of application. To solve this issue, efforts of our group was devoted ourselves to find more moderate reaction conditions (**Scheme 7**).

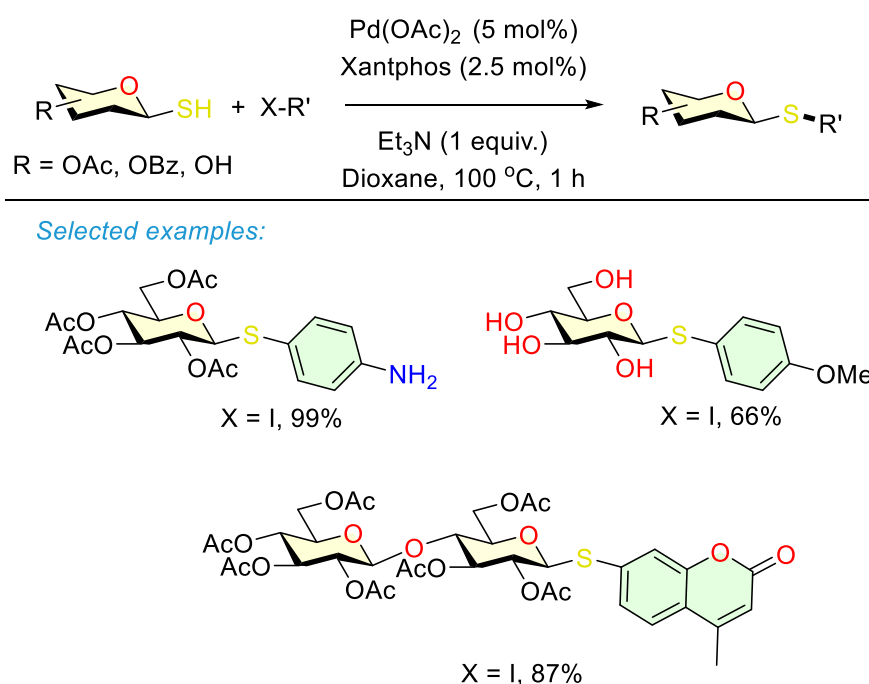

**Scheme 7.** The first Pd-catalyzed cross-coupling reaction of thiosugars with (hetero) aryl halides

<sup>17</sup> a) Brachet, E.; Brion, J.-D.; Messaoudi, S.; Alami, M., *Adv. Synth. Catal.*, **2013**, 355, 477– 490; b) Brachet, E.; Brion, J.-D.; Alami, M.; Messaoudi, S., *Adv. Synth. Catal.*, **2013**, 355, 2627-2636.

Our lab, in 2013 reported the first method for the arylation, alkenylation, and alkynylation of unprotected glycosyl thiols at room temperature under nickel catalysis (**Scheme 8**).<sup>18</sup>

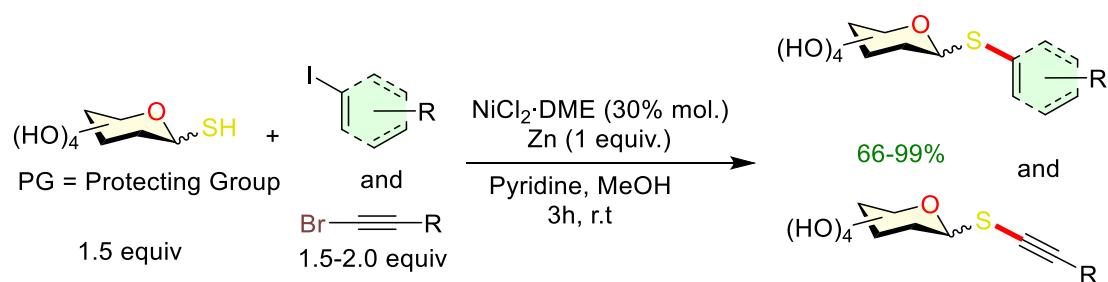

**Scheme 8.** Coupling of deprotected glycosyl thiols with aryl halides under nickel catalysis.

In 2015<sup>19</sup>, by using the biphenyl palladacycle precatalyst PdG3Xantphos, our group succeeded in promoting the C-S bond forming reaction between (hetero)aryl halides and thiosugars. By using only 1 mol% of PdG3Xantphos, 1 equiv. of Et<sub>3</sub>N in dioxane or THF at rt for 5-60 min, the desired products were isolated in yields up to 99% (**Scheme 9**). The PdG<sub>3</sub>Xantphos precatalyst can be activated under mild conditions using a weak base such as NEt<sub>3</sub> to generate the highly active 12-electron Pd<sup>0</sup> species.

---

<sup>18</sup> Brachet, E.; Brion, J.-D.; Alami, M.; Messaoudi, S. *Chem. Eur. J.*, **2013**, *19*, 15276-15280.

<sup>19</sup> Bruneau, A.; Roche, M.; Hamze, A.; Brion, J.-D.; Alami, M.; Messaoudi, S., *Chem. Eur. J.*, **2015**, *21*, 1-6.

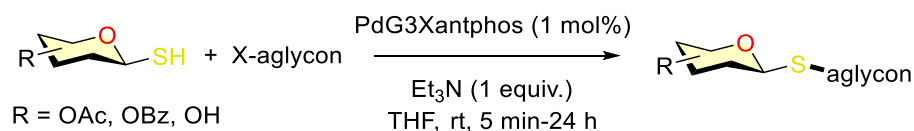

Selected examples:

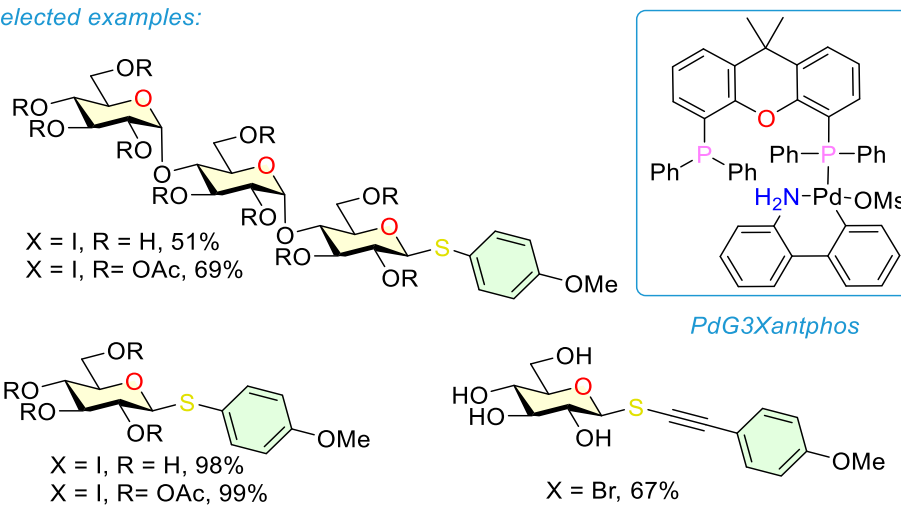

Mechanism of activation of the precatalyst

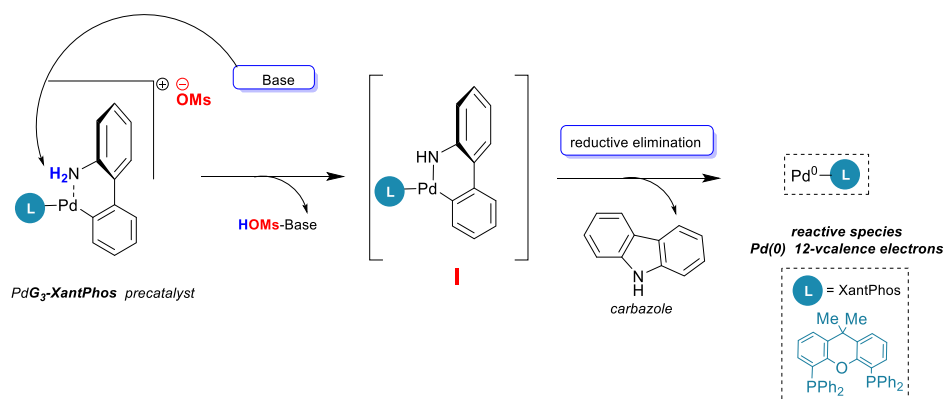

**Scheme 9.** Cross-coupling reaction of thiosugars with (hetero) aryl halides by PdG3Xantphos

The mild reaction conditions of this Migita-cross coupling provide us a easy access to a range of S-glycosides including thioglycopeptides,<sup>20</sup> oligonucleotides,<sup>21</sup>

<sup>20</sup> Montoir, D.; Amoura, M.; Ababsa, Z.E.-A.; Vishwanath, T. M.; Yen-Pon, E.; Robert, V.; Beltramo, M.; Piller, V.; Alami, M.; Aucagne, A.; Messaoudi, S., *Chem.Sci.*, **2018**, *9*, 8753-8759.

<sup>21</sup> Probst, N.; Lartia, R.; Théry, O.; Alami, M.; Defrancq, E.; Messaoudi, S., *Chem. Eur. J.*, **2018**, *24*, 1795-1800.

biarylthioglycosides,<sup>22</sup> (1→2)-S-linked saccharides,<sup>23</sup> azolium thioglycosides<sup>24</sup> and sulfoximine thioglycosides (Scheme 10).<sup>25</sup>

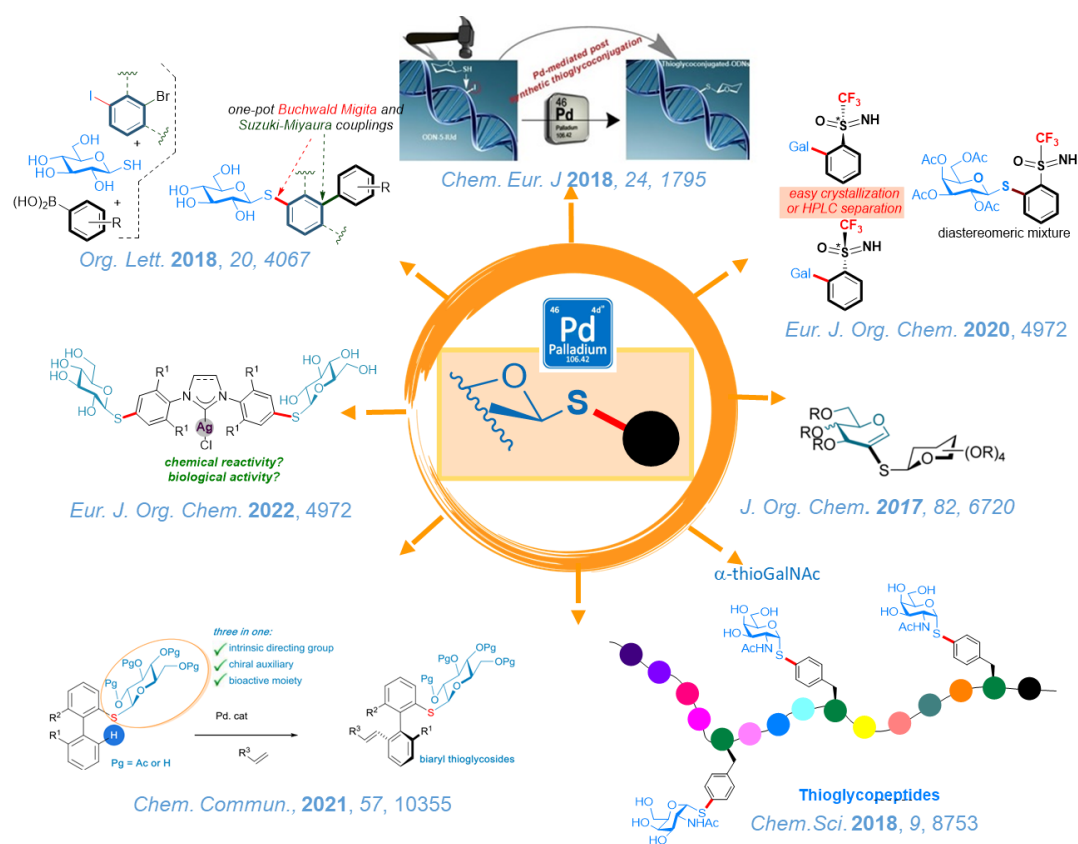

**Scheme 10.** Cross-coupling reactions powered by PdG3Xantphos

In 2016,<sup>26</sup> our group reported the first thioglycosylation of Csp<sup>2</sup>-H bonds of benzamides with thiosugars. By using the bidentate directing group 8-aminoquinoline, Cu(OAc)<sub>2</sub> as a catalyst and Ag<sub>2</sub>CO<sub>3</sub> as additive, various aryl thioglycosides could be prepared in good to excellent yield with high  $\beta$ -selectivity. From the point of view of the mechanism,

<sup>22</sup> Benmahdjoub, S.; Ibrahim, N.; Benmerad, B.; Alami, M.; Messaoudi S., *Org. Lett.*, **2018**, *20*, 4067–4071

<sup>23</sup> AL-Shuaeeb, R. A. A.; Montoir, D.; Alami, M.; Messaoudi, S., *J. Org. Chem.*, **2017**, *82*, 6720–6728.

<sup>24</sup> Ryzhakov, D.; Beillard, A.; Le Bideau, F.; Al-Shuaeeb, R. A. A.; Alami, M.; Bantreil, X.; Bonnemoy, A.; Gautier, A.; Gautier, F.; Messaoudi, S., *Eur. J. Org. Chem.*, **2022**, 10.1002/ejoc.202101499.

<sup>25</sup> Bennai, N.; Ibrahim, N.; Marrot, J.; Belkadi, M.; Alami, M.; Magnier, E.; Anselmi, E.; Messaoudi, S., *Eur. J. Org. Chem.*, **2020**, *31*, 4972–4981.

<sup>26</sup> Chabrier, A.; Bruneau, A.; Benmahdjoub, S.; Benmerad, B.; Belaid, S.; Brion, J.; Alami, M.; Messaoudi, S., *Chem. Eur. J.*, **2016**, *22*, 15006–15010.

intermediate complex (**I**) is formed by the coordination of **1a** to  $\text{Cu}(\text{OAc})_2$  and ligand exchange. Later, the reaction through C-H activation mechanism to give a copper(II) complex (**II**). Oxidation of **II** activated by  $\text{Cu}(\text{OAc})_2$  produces a copper(III) complex (**III**), which reacts with glycosyl thiol to afford copper(III) complex (**IV**). And finally, reductive elimination of **VI** produces thioglycosides product (**Scheme 11**).

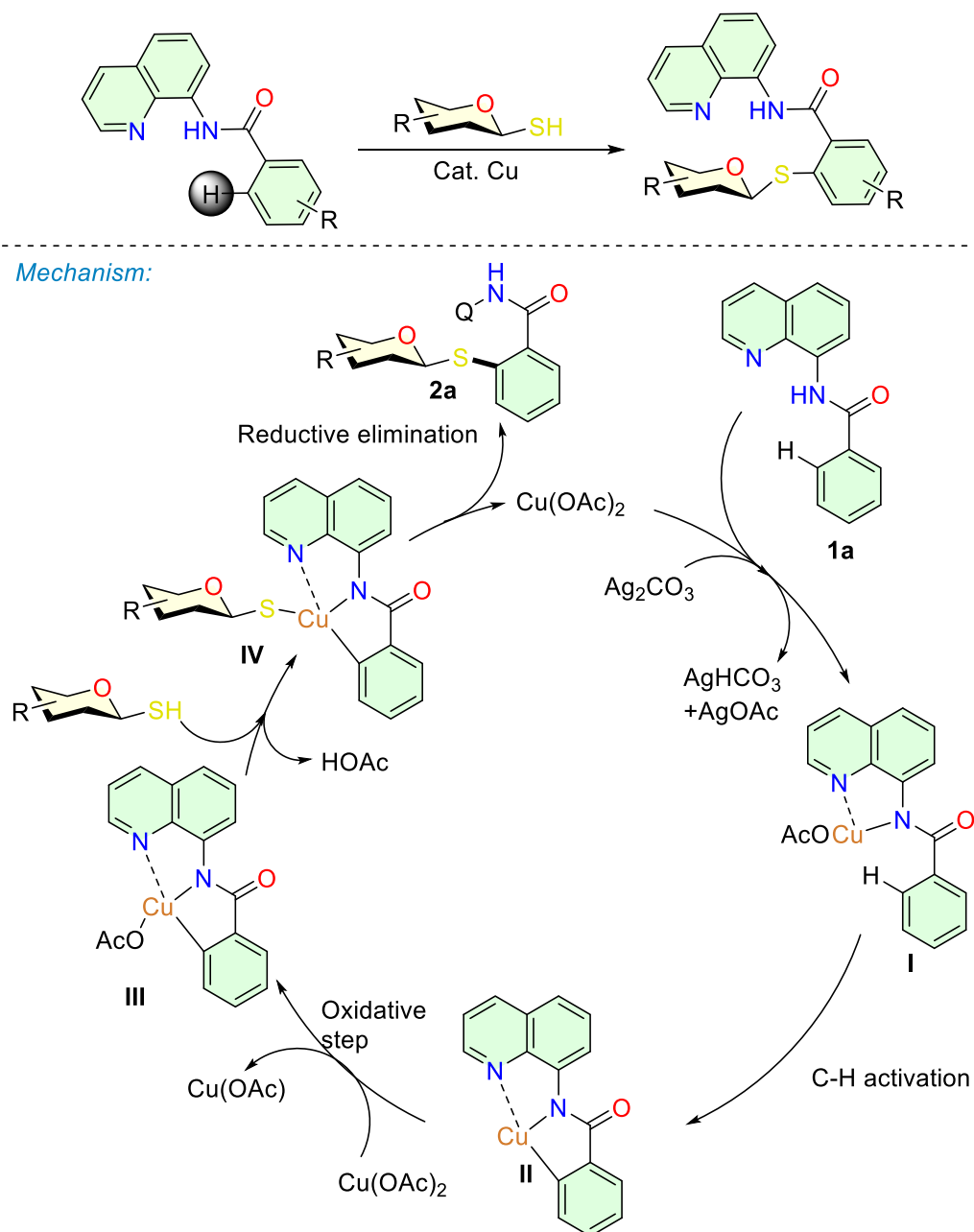

**Scheme 11.** C-H activation of of benzamides with thiosugars



In 2021, Yao's group<sup>27</sup> reported a regiodivergent Tsuji-Trost protocol to synthesis of 1- and 3-thioglycosides by palladium and cobalt catalysis, respectively. When Pd<sub>2</sub>(dba)<sub>3</sub> was used, the β-1- thioglycosides were obtained from 3,4-O-carbonateglycals and various thiols. Meanwhile, when Co(BF<sub>4</sub>)<sub>2</sub> was used as a catalyst, only (3S)-3-thioglycosides can be get from reaction of 3,4-O-carbonateglycals and various thiols. 75 examples with various different functions were synthesized (**Scheme 12**).

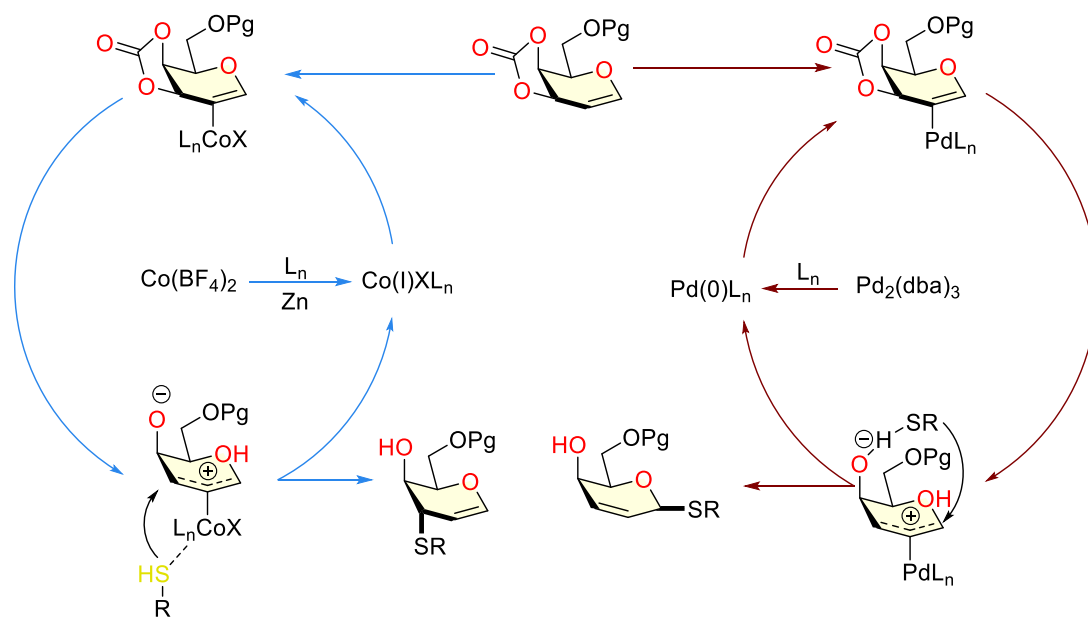

**Scheme 12.** Synthesis of 1- and 3- thioglycosides by palladium and cobalt catalysis

A novel Pd-catalyzed Catellani reaction for the synthesis of (hetero)aryl thio/selenoglycosides from (hetero)aryl iodides and thioacyl- and selenoacylglycosides have been reported recently by Liang and co-workers.<sup>28</sup> The C-S/C-Se and C-C bonds formation were achieved by the use of Pd(TFA)<sub>2</sub> as the catalyst combined with norbornene and K<sub>3</sub>PO<sub>4</sub> (or conditions B). Under these conditions, upon the installation of the thiosugar/selenosugar nucleus, the acyle group could be transferred through an ortho-C–H activation process (**Scheme 13**).

<sup>27</sup> Liu, Y.; Jiao, Y.; Luo, H.; Huang, N.; Lai, M.; Zou, K.; Yao, H., *ACS Catal.*, **2021**, *11*, 5287–5293.

<sup>28</sup> Ding, Y.; Huang, Y.; Shi, W.; Zheng, N.; Wang, C.; Chen, X.; An, Y.; Zhang, Z.; Liang, Y., *Org. Lett.*, **2021**, *23*, 5641-5646.

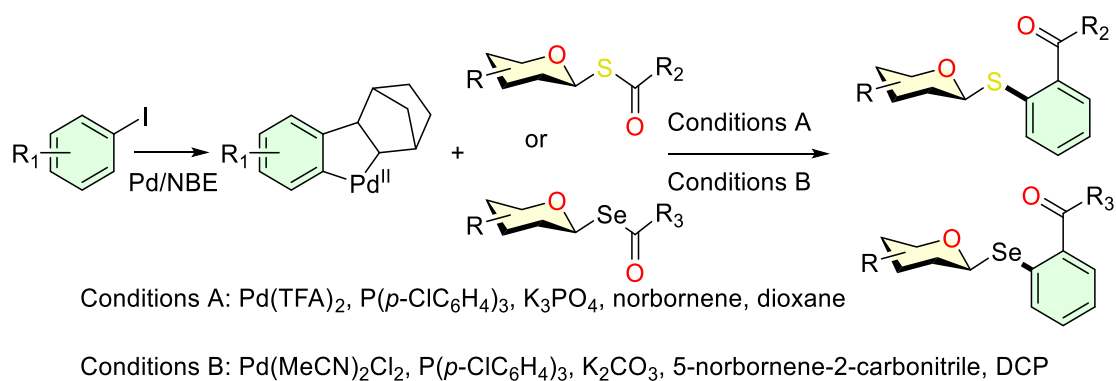

**Scheme 13.** Pd-catalyzed Catellani reaction for the synthesis of (hetero)aryl thio/selenoglycosides

A metal free method to access thioglycosides was reported by the group of Liao.<sup>29</sup> Starting from (trimethylsilyl)aryl triflates as aryl donors, and TBAF(*t*-BuOH)<sub>4</sub> as additive, various monosaccharide and disaccharide substrates react successfully under these conditions. However, some issues remain such as the regioselectivity when substituted arynes were used (**Scheme 14**).

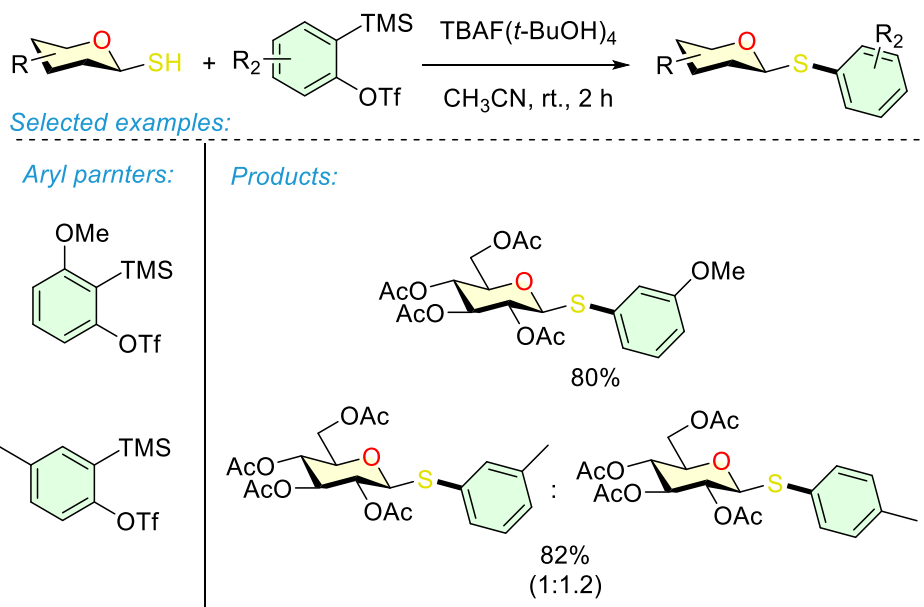

**Scheme 14.** A metal free method to access thioglycosides

<sup>29</sup> Liu, Y.; Yu, X.; Zhang, X.; Zhong, Q.; Liao, L.; Yan, N., *RSC Adv.*, **2021**, *11*, 26666–26671.

## B) Se-glycosides synthesis

The usual approach employed for the synthesis of selenoglycosides relies on the use of selenium sources in the nucleophilic substitution of 1-halosugars. In 2002, Masayuki Sato<sup>30</sup> and co-workers reported a new procedure for the synthesis of phenyl 2- $\alpha$ -selenoglycosides of Neu5Ac.  $\alpha$ -Selenoglycosides can be successfully synthesized through S<sub>N</sub>2 displacement of the chloro group in chloroglycosides with phenylselenol in the presence of *N,N*-di-isopropylethylamine. Moreover, in 2003, the group of David Crich<sup>31</sup> reported the synthesis of selenoglycosides by using bromoglycosides and diphenyl diselenide in the presence of reducing agent NaBH<sub>4</sub>. However, selenium nucleophiles both of phenylselenol and diphenyl diselenide are high toxic, unstable and repulsive. And when diphenyl diselenide used, reducing agent NaBH<sub>4</sub> has to be used which is not environmentally friendly (**Scheme 15**).

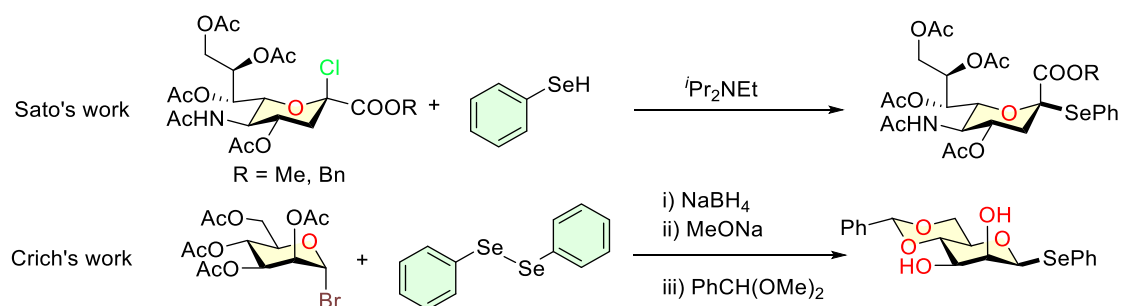

**Scheme 15.** Nucleophilic substitution of 1-halosugars

In 2005, Etzer's group<sup>32</sup> reported a new reaction for synthesized of 2-deoxy-1-seleno-R-D-glucopyranose derivatives from glycols by using pre-prepared selenocarboxylic acids reagent. At first, the Woollins' reagent<sup>33</sup> [PhP(dSe)Se]<sub>2</sub> was used to converts

<sup>30</sup> Ikeda, K.; Sugiyama, Y.; Tanaka, K.; Sato, M., *Bioorg. Med. Chem. Lett.*, **2002**, *12*, 2309-2311.

<sup>31</sup> Crich, D.; Suk, D.; Sun, S., *Tetrahedron: Asymmetry*, **2003**, *14*, 2861-2864.

<sup>32</sup> Knapp, S.; Etzer, D., *Org. Lett.*, **2005**, *7*, 203-206.

<sup>33</sup> a) Fitzmaurice, J. C.; Williams, D. J.; Wood, P. T.; Woollins, J. D. J., *Chem. Soc. Chem. Commun.*, **1988**, 741-743;

b) Grossmann, G.; Ohms, G.; Kru"ger, K.; Karaghiosoff, K.; Eskstein, K.; Hahn, J.; Hopp, A.; Malkina, O. L.; Hrobarik, P. *Zeitschr. Anorg. Allg. Chem.*, **2001**, *627*, 1269-1278.

carboxylic acids to a corresponding selenocarboxylic acid in the solution of toluene. And then, the selenylation of 2-deoxy-D-glucopyranose occurred and led to a single product in the exist of selenocarboxylic acid at  $-5\text{ }^{\circ}\text{C}$  for 16 h. This reaction required no additional catalyst, but the pre-formed selenocarboxylic acids reagents are not commercially available and must be prepared freshly, which limited the using of this reaction (**Scheme 16**).

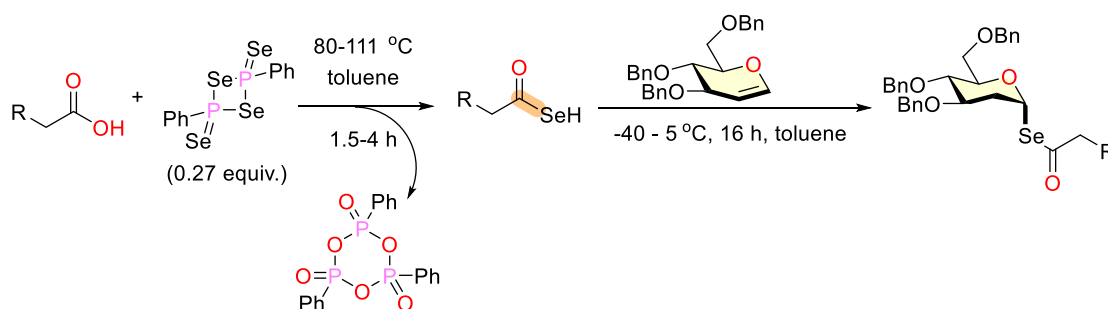

**Scheme 16.** Synthesized of 2-deoxy-1-seleno-R-D-glucopyranose derivatives

In 2017, a on pot, metal-free glycosylation procedure to synthesize selenoglycosides from bromoglycosides has been reported by Townsend's group.<sup>34</sup> The first step of the reaction is the arylation of potassium selenocyanate (KSeCN) with an iodonium reagent to produce an arylselenocyanate under the solvent of EtOAc at 80 °C. Then, the reduction of the Se–CN bond was achieved by adding sodium borohydride, and form the Se-nucleophilic. Meanwhile, the electrophile glycosyl halide is added to the reaction and form the selenoglycosides. Under these conditions, both of peracetylated  $\alpha$ -glucosyl and  $\alpha$ -galactosyl bromides can providing the desired products in good yields and form the  $\beta$ -anomers only. The major drawback of this approach is the use of very toxic and unpleasantly smelling reagent potassium selenocyanate (KSeCN) in excess amount, which is also dangerous of environment (**Scheme 17**).

<sup>34</sup> Guan, Y.; Townsend, S. D., *Org. Lett.*, **2017**, *19*, 5252-5255.

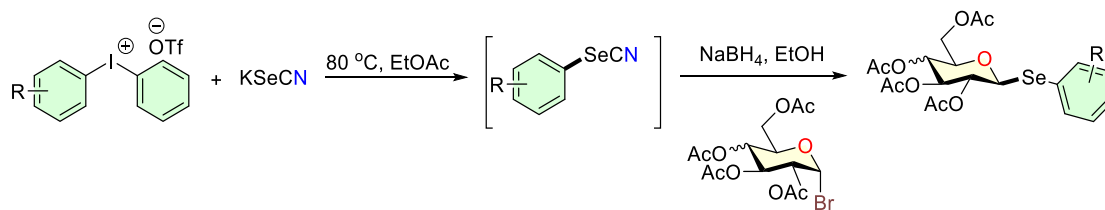

**Scheme 17.** Synthesize selenoglycosides reported by Townsend's group

In 2010, Crotti and co-workers<sup>35</sup> reported a new method to stereoselective synthesis of phenylselenoglycosides from glycals.  $\beta$ -Phenylselenoglycoside anomers have been stereoselectively obtained by direct oxidative glycosylation of benzeneselenolate  $\text{PhSe}^-$  (from  $\text{PhSeH}$  and  $\text{Et}_3\text{N}$ ) with glycals. This result is opposite to the  $\alpha$ -selectivity reported by Danishefsky<sup>36</sup> in the ring-opening of epoxy glycals with benzeneselenol ( $\text{PhSeH}$ ). The completely opposite stereoselective results obtained in the glycosylation of  $\text{PhSeH}$  with glycals by Danishefsky's protocol ( $\alpha$ -selenoglycosylation) and Gin's<sup>37</sup> modified direct oxidative protocol ( $\beta$ -selenoglycosylation) are simply due to the nature of the nucleophile ( $\text{PhSeH}$  or  $\text{PhSe}^-$ ). The authors explain that the different nucleophile determines a different ring-opening process (retention with  $\text{PhSeH}$  and inversion with  $\text{PhSe}^-$ ) of the intermediate  $\alpha$ -epoxy glycal. Under Danishefsky's conditions (Pathway A),  $\text{PhSeH}$  is in the state of undissociated form, which is acidic enough to protonate the oxygen of oxirane and form A2 under acid condition. By an internal rearrangement, the more carbocationic nucleophile-separated ion-dipole pair A5 formed. Subsequent, C(1) of A5 is more easier be attack by internal nucleophile than by external nucleophile, because of entropically favored during internal nucleophile attack is higher than external nucleophile pathway. In this case, only  $\alpha$ -phenylselenoglycoside can be synthesized by this pathway. On the other hand (Pathway B or C), when the protocol of Gin is used, an excess amount of  $\text{Et}_3\text{N}$  is presence in the system. In this case, the nucleophile ( $\text{PhSeH}$ ) is existed in corresponding deprotonated form ( $\text{PhSe}^-$ ). This kind of anion is strong enough to open the oxirane ring of B1 in an  $\text{S}_{\text{N}}2$  fashion. And the  $\beta$  anomer would be the only reaction product (**Scheme 18**).

<sup>35</sup> Bussolo, V. D.; Fiasella, A.; Balzano, F.; Barretta, G. U.; Crotti, P., *J. Org. Chem.*, **2010**, 75, 4284–4287.

<sup>36</sup> Gordon, D. M.; Danishefsky, S., *J. Carbohydr. Res.*, **1990**, 206, 361–366.

<sup>37</sup> Honda, E.; Gin, D. Y., *J. Am. Chem. Soc.*, **2002**, 124, 7343–7352.

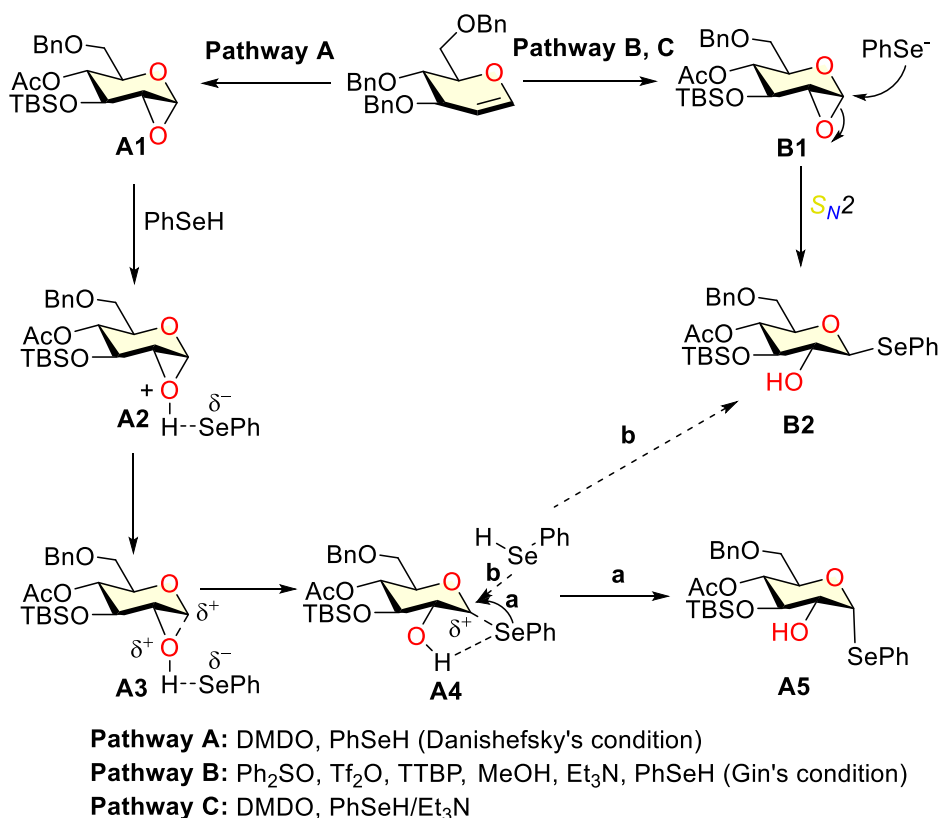

**Scheme 18.** Mechanism of synthesis of phenylselenoglycosides

Another elegant method to synthesize selenoglycosides was reported by Nifantiev and co-workers<sup>38</sup> in 2004. The author developed an efficient azidophenylselenylation of glycals by using a mixture of Ph<sub>2</sub>Se<sub>2</sub>, TMSN<sub>3</sub> and PhI(OAc)<sub>2</sub>. Ph<sub>2</sub>Se<sub>2</sub> is used as the seleno-donor, and TMSN<sub>3</sub> as an organic azide reagent instead of NaN<sub>3</sub>. Although when both of these two azide reagents are used, the same yield can be obtained in 0.1 g scale reaction. Due to the insolubility of sodium azide in dichloromethane, the yield is really low when sodium azide is used instead of TMSN<sub>3</sub> in gram scale reaction (53% vs 92% yields). However, with trimethylsilyl azide, whatever the reaction scale is, the yields of the desired compounds are higher and the reaction time is shorter (4 h vs 48 h) (**Scheme 19**).

<sup>38</sup> Mironov, Y. V.; Sherman, A. A.; Nifantiev, N. E., *Tetrahedron Lett.*, **2004**, 45, 9107–9110.

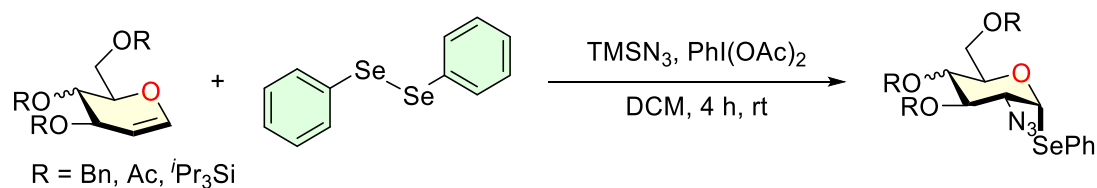

**Scheme 19.** Nifantiev's protocol to Synthesis of selenoglycosides

The transition-metal catalysis was applied Walczak group<sup>39</sup> for the synthesis of selenoglycosides. The cross-coupling reaction occurs between anomeric stannanes and symmetrical diselenides to results selenoglycosides in exclusive anomeric control and good yield. The authors proposed the reaction mechanism as follow: the anomeric stannanes activated by fluoride ion and form the intermediate A and the insoluble Bu<sub>3</sub>SnF salts. Then, a transmetalation step produces the copper complex B which evolve through an intramolecular rearrangement to furnishe the desired selenoglycoside and byproduct R'-Se-Cu-L<sub>n</sub>. All of the mono-, di- and trisaccharides and peptides are good partners under this condition which tolerate free hydroxyl groups. This method is clearly attractive; however, it necessitates a high reaction temperature (110 °C) and requires the use of the toxic alkyltin species in a multistep approach to prepare the starting 1-stannylated sugars (**Scheme 20**).

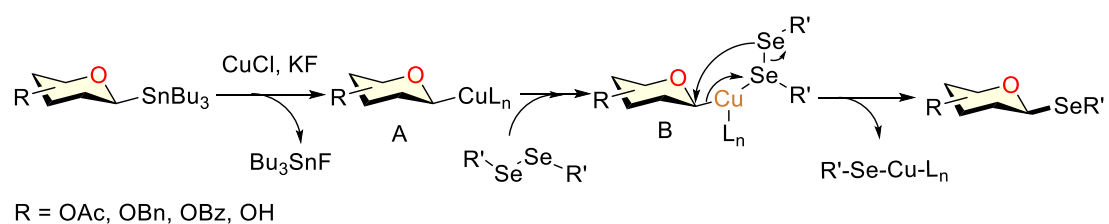

*Selected examples:*

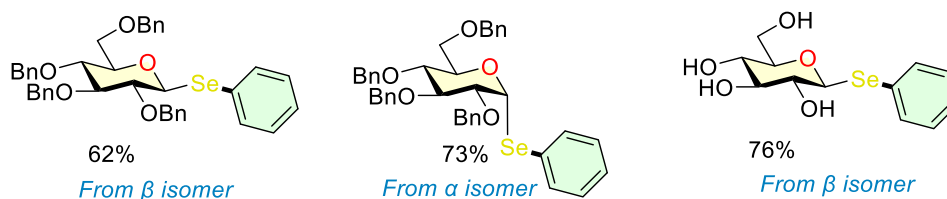

**Scheme 20.** Synthesis of selenoglycosides reported by Walczak group

<sup>39</sup> Zhu, F.; O'Neill, S.; Rodriguez, J.; Walczak, M.A., *Angew Chem. Int. Ed.*, **2018**, 57, 7091-7095.

## 1.2 Part 2 Room Temperature Pd-Catalyzed Synthesis of 1-Selenoglycosides

### Room-Temperature Pd-Catalyzed Synthesis of 1-(Hetero)aryl Selenoglycosides

Mingxiang Zhu, Mouad Alami, and Samir Messaoudi\*

Cite This: <https://dx.doi.org/10.1021/acs.orglett.0c02352>

Read Online

ACCESS |

Metrics & More

Article Recommendations

Supporting Information

ONLINE on August 6, 2020 at 14:27:31 (UTC).  
nes for options on how to legitimately share published articles.

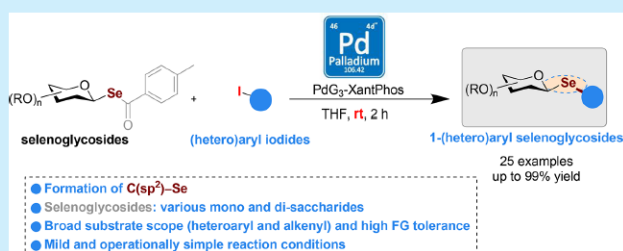

**ABSTRACT:** A general protocol for functionalization of an anomeric selenate anion at room temperature has been reported. By using the PdG3 XantPhos catalyst, the cross-coupling between the *in situ*-generated glycosyl selenolate and a broad range of (hetero)aryl and alkenyl iodides furnished a series of functionalized selenoglycosides in excellent yields with perfect control of the anomeric configuration.

### A) Background

An interesting no metal catalyst SN<sub>2</sub> procedure for various alkyl β-selenoglycosides synthesis by using methylbenzoyl selenoglycoside as the selenating unit has been reported by Ishihara's group<sup>40</sup> in 2005 (**Scheme 14**). The authors reported that β-p-methylbenzoylselenoglycoside is activated by a secondary amine piperazine and Cs<sub>2</sub>CO<sub>3</sub> to produce *in situ* the β-selenolate anion which reacts with various electrophiles (alkyl halides (Cl, Br and I)) to yield β-selenoglycosides exclusively. In 2007, the same group reported the synthesis of α-selenoglycosides by using the same approach (**Scheme 21**).<sup>41</sup>

<sup>40</sup> Kawai, Y.; Ando, H.; Ozeki, H.; Koketsu, M.; Ishihara, H., *Org. Lett.*, **2005**, *7*, 4653-4656.

<sup>41</sup> Nanami, M.; Ando, H.; Kawai, Y.; Koketsu, M.; Ishihara, H., *Tetrahedron Lett.*, **2007**, *48*, 1113-1116.



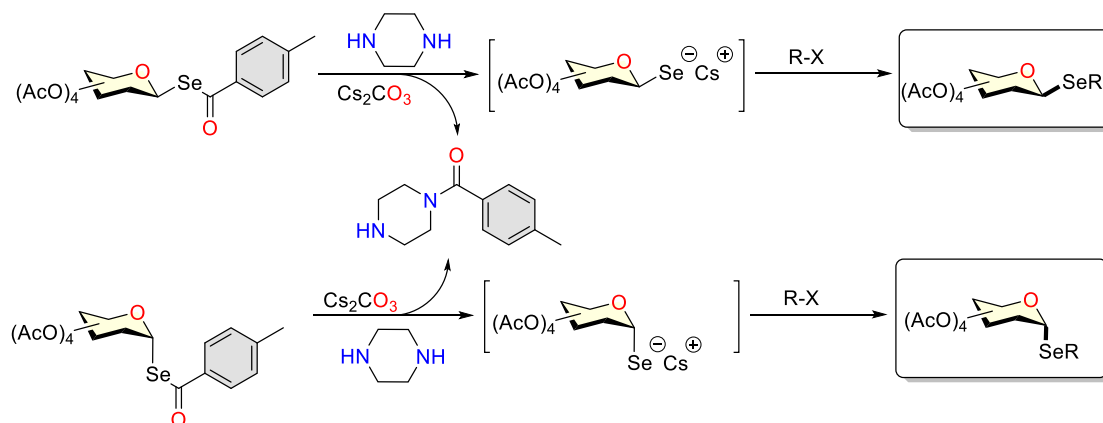

**Scheme 21.** Synthesis of selenoglycosides reported by Ishihara's group

However, this method is limited to only alkyl halides. Only one example for the synthesis of aryl-selenoglycoside was reported by this approach using the highly activated 4-nitro fluorobenzene substrate in a nucleophilic aromatic substitution reaction ( $S_NAr$ ).

To fully harness the potential of this class of carbohydrates there is a strong impetus to develop mild and general reactions for the synthesis of complex aryl selenoglycosides. As part of our interest to explore the reactivity of sugars under transition-metal catalysis,<sup>42</sup> combined with the lack of general method to aryl Se-glycosides, we became interested in developing an efficient and simple Pd-catalyzed cross-coupling protocol for the preparation of (hetero)aryl-selenoglycosides which may occur under mild reaction conditions. Catalytic methods generally avoid the use of harsh reaction conditions and maintain the compatibility with most organic functions. However, the use of Pd-catalysts is highly challenging for selenium nucleophilic partners as they are detrimental to the Pd(0)/Pd(II) catalytic cycle due to the poisoning of the catalyst through the formation of off-cycle Pd(II)-ate complexes.<sup>43</sup>

<sup>42</sup> For a recent review, see: a) Ibrahim, N.; Alami, M.; Messaoudi, S., *Asian. J. Org. Chem.*, **2018**, 7, 2026-2038; b) Brachet, E.; Brion, J.-D.; Messaoudi, S.; Alami, M., *Adv. Synth. Catal.*, **2013**, 355, 2627-2636; c) Brachet, E.; Brion, J.-B.; Messaoudi, S.; Alami, M., *Adv. Synth. Catal.*, **2013**, 355, 477-490; d) Bruneau, A.; Roche, M.; Hamze, A.; Brion, J.-D.; Alami, M.; Messaoudi, S., *Chem. Eur. J.*, **2015**, 21, 8375-8379.

<sup>43</sup> a) Oderinde, M. S.; Frenette, M.; Robbins, D. W.; Aquila, B.; Johannes, J. W., *J. Am. Chem. Soc.*, **2016**, 138, 1760-1763; b) Valente, C.; Pompeo, M.; Sayah, M.; Organ, M. G., *Org. Process Res. Dev.*, **2014**, 18, 180-190.

As reported by Ishihara's group,  $\beta$ -glycosyl *p*-methylselenobenzoates are easily prepared from potassium *p*-methylselenobenzoate and glucosyl bromide, under the phase-transfer catalyst *tetra-n*-butylammonium hydrogen sulfate. Crystalline  $\beta$ -glycosyl *p*-methylselenobenzoates are stable enough to stock in a freezer for 6 months. Due to the above-mentioned advantages, we became interested to use glycosyl *p*-methylselenobenzoate as coupling partners. Herein we report a direct and programmable synthesis of selenoglycosides via Pd-G3-XantPhos catalyzed coupling of an in situ generated anomeric selenolate-anion with various (hetero)aryl and alkenyl iodides at room temperature.

## B) Results and discussion

### Condition selection

In the first part of this study, the coupling of tetra-*O*-acetylated  $\beta$ -*p*-methylbenzoylselenoglycoside **1a** (1 equiv) with *p*-iodoanisole **2a** (2 equiv) was used as a model study, and various reaction conditions were examined.

### Catalyst and ligand effects (Table 1):

The coupling of **1a** with **2a** was first investigated under our previously reported protocol for the coupling of thiosugars<sup>44</sup> using PdG3-XantPhos precatalyst (10 mol%). Cs<sub>2</sub>CO<sub>3</sub> (3 equiv) and piperazine (1.2 equiv) were added and the reaction was performed in THF at room temperature (**Table 1, entry 1**). By the action of piperazine and Cs<sub>2</sub>CO<sub>3</sub>, the  $\beta$ -selenolate anomer anion was readily generated *in situ* (according to the Ando and Ishihira method<sup>45</sup>) and fully converted under our conditions to the  $\beta$ -selenoglycoside **3a** in 95% yield as a single  $\beta$ -anomer ( $J_{1,2} = 9$  Hz). Decreasing the catalyst loading from 10 mol% to 5 mol% led to **3a** in a slightly lower yield (**81% yield, entry 3**). control experiments showed that the catalyst is necessary since no reaction occurred in the absence of Pd-catalyst. Moreover, the use of the palladacycle precatalyst PdG3 XantPhos is determinantal for this coupling as performing the coupling by a simple mixing

---

<sup>44</sup> Bruneau, A.; Roche, M.; Hamze, A.; Brion, J. -D.; Alami, M.; Messaoudi, S., *Chem. Eur. J.* 2015, 21, 8375-8379.

<sup>45</sup> a) Kawai, Y.; Ando, H.; Ozeki, H.; Koketsu, M.; Ishihara, H., *Org. Lett.* 2005, 7, 4653-4656; b) Nanami, M.; Ando, H.; Kawai, Y.; Koketsu, M.; Ishihara, H., *Tetrahedron Lett.* 2007, 48, 1113-1116.

of Pd(OAc)<sub>2</sub> or PdCl<sub>2</sub> and Xantphos in 10:10 mol% ratio (entry 4-5), failed (**Table 1, entry 4-5**).

**Table 1.** Selected of Catalyst and ligand

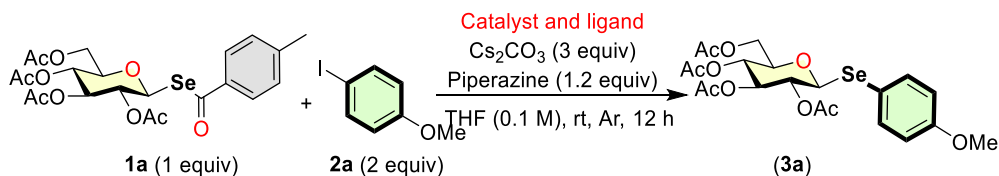

Entry	Catalyst	Ligand	Yields
<b>1</b>	PdG <sub>3</sub> Xantphos 10 mol%	-	<b>95%</b>
<b>2</b>	-	-	0%
<b>3</b>	PdG <sub>3</sub> Xantphos 5 mol%	-	81%
<b>4</b>	Pd(OAc) <sub>2</sub> 10 mol%	Xantphos 10 mol%	trace
<b>5</b>	PdCl <sub>2</sub> 10 mol%	Xantphos 10 mol%	trace

Reaction conditions: A sealable tube was charged with  $\beta$ -*p*-methylbenzoylselenoglycoside **1a** (1 equiv, 0.1 mmol), **2** (2 equiv), catalyst and ligand, piperazine (1.2 equiv), Cs<sub>2</sub>CO<sub>3</sub> (3 equiv) in dry and degassed THF (0.1M). <sup>a</sup> Yield of isolated product.

### Reaction time and solvent effects (Table 2):

The reaction time and solvent effects have been examined. As we can see in table 2, performing the reaction for 1h furnished **3a** in only 80% yield (**Table 2, entry 2**), while 95 % yield was obtained when the reaction time adjusted to 2 h (**Table 2, entry 3**). Moreover, we showed that the cross-coupling tolerates various solvents such as dioxane, DCE or DMF producing the desired product **3a** in yield ranging from 83% and 95% (**Table 2, entry 4-6**). The use of DMF may be useful in some cases when one or both coupling partners are not enough soluble in THF.

**Table 2.** Selected of reaction time and solvent

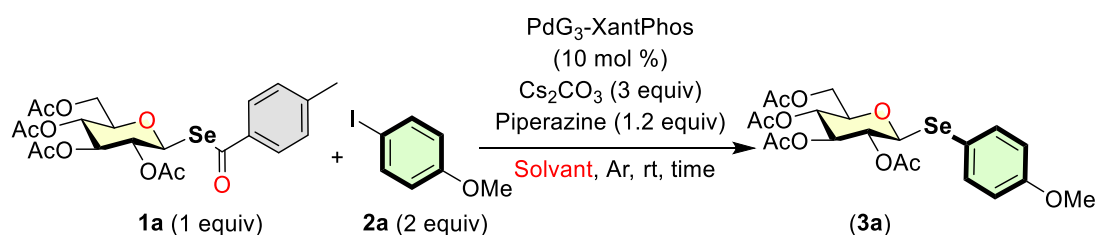

Entry	Solvent	Time	Yields
<b>1</b>	THF	2h	95%
<b>2</b>	THF	1h	85%
<b>3</b>	THF	3h	95%
<b>4</b>	Dioxane	2h	95%
<b>5</b>	DCE	2h	83%
<b>6</b>	DMF	2h	89%

Reaction conditions: A sealable tube was charged with  $\beta$ -*p*-methylbenzoylselenoglycoside **1a** (1 equiv, 0.1 mmol), **2** (2 equiv), PdG<sub>3</sub>-XantPhos precatalyst (10 mol %), piperazine (1.2 equiv), Cs<sub>2</sub>CO<sub>3</sub> (3 equiv) in solvent. <sup>a</sup> Yield of isolated product.

### Base effects (Table 3):

During this study, we observed that the use of two bases (amine + carbonate) is necessary. When 1.2 equiv of piperazine and Cs<sub>2</sub>CO<sub>3</sub> (3 equiv) the best yield of 95% was obtained (**Table 3, entry 3**). Tentatives of reducing the amount of one or both bases lead to the desired compound in lower yields. We confirmed that Cs<sub>2</sub>CO<sub>3</sub> is the base of choice since the use of CsF or NaOAc produced the desired selenoglycoside **3a** in 83% and 65% yields (**Table 3, entry 6 and 7**).

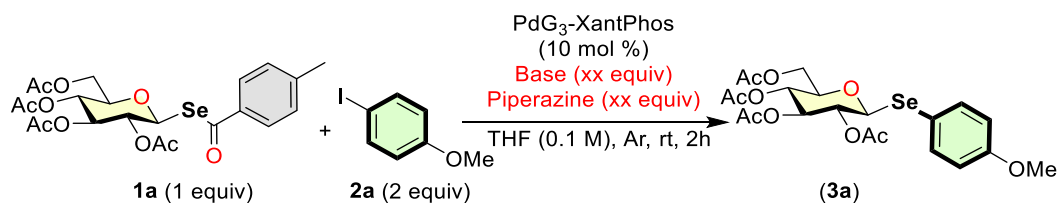
**Table 3.** Selected of Base

Entry	Base1	Base2	Yields
1	Cs <sub>2</sub> CO <sub>3</sub> 3eq	Piperazine 1.0 eq	72%
2	Cs <sub>2</sub> CO <sub>3</sub> 3eq	Piperazine 1.5 eq	95%
2	Cs <sub>2</sub> CO <sub>3</sub> 3eq	Piperazine 1.2 eq	95%
3	Cs <sub>2</sub> CO <sub>3</sub> 2eq	Piperazine 1.2 eq	72%
4	Cs <sub>2</sub> CO <sub>3</sub> 4eq	Piperazine 1.2 eq	95%
5	CsF 3eq	Piperazine 1.2 eq	83%
6	NaOAc 3eq	Piperazine 1.2 eq	65%

Reaction conditions: A sealable tube was charged with  $\beta$ -*p*-methylbenzoylselenoglycoside **1a** (1 equiv, 0.1 mmol), **2** (2 equiv), PdG<sub>3</sub>-XantPhos precatalyst (10 mol %), base in dry and degassed THF (0.1M). <sup>a</sup> Yield of isolated product.

#### Amount of **2a** (xx equiv) effects (Table 4):

Finally, the amount of *p*-iodo anisole partner **2a** has been examined and showed that using of 2 equiv of **2a** for 1 equiv of **1a** is the best ratio (95% yield). Decreasing the amount of **2a** from 2 equiv to 1 equiv led to the lowering the yield up to 70% (Table 4, entry 1-4). Of note, the coupling of **1a** and **2a** under inert atmosphere (Argon) is necessary since performing the reaction under air or oxygen failed (entry 5-6).

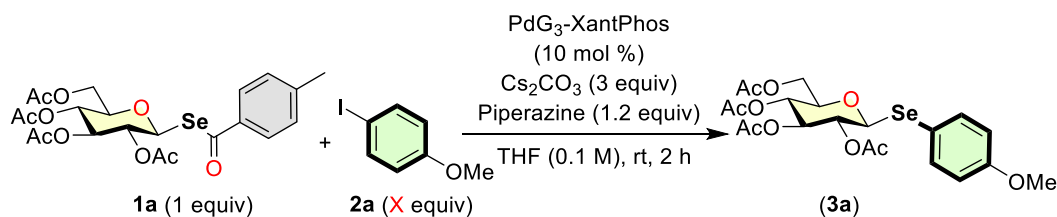
**Table 4.** The amount of thiosugar and aryl iodo.

Entry	Amount of 2a	Atmosphere	Yields
1	1 eq	Ar	70%
2	1.2 eq	Ar	80%
3	1.5 eq	Ar	88%
4	2 eq	Ar	95%
5	2 eq	Air	Trace
6	2 eq	O <sub>2</sub>	Trace

Reaction conditions: A sealable tube was charged with  $\beta$ -*p*-methylbenzoylselenoglycoside **1a** (1 equiv, 0.1 mmol), **2** (x equiv), PdG<sub>3</sub>-XantPhos precatalyst (10 mol %), piperazine (1.2 equiv), Cs<sub>2</sub>CO<sub>3</sub> (3 equiv) in dry and degassed THF (0.1M). <sup>a</sup> Yield of isolated product.

### Scope of Coupling of Thioglucosides **1** with Halo(hetero)arenes and Alkenyl Halides **2**

With the best reaction conditions in hand, **1a** (1 equiv, 0.1 mmol), **2** (2 equiv), PdG<sub>3</sub>-XantPhos precatalyst (10 mol %), piperazine (1.2 equiv), Cs<sub>2</sub>CO<sub>3</sub> (3 equiv) in dry and degassed THF (0.1M), we investigated the scope for this coupling by varying the nature of the aryl iodide partner **2** and the *p*-methylbenzoylselenyl glycosides **1a-f** (Table 5). At first, various of electron-donating groups has been tested. Both of *p*-methoxy iodobenzene **2a** and *p*-methyl iodobenzene **2b** underwent reaction with  $\beta$ -*p*-methylbenzoylselenoglycoside **1a** in excellent yields, up to 99%. When *meta*-methoxy iodobenzene **2c** has been used the desired product was obtained in slightly lower yield (73%). This reaction can also works with other coupling partners such as the isopropyl aryl **2f** or naphthalene **2e** in 87%, 73% respectively. Moreover, the coupling is not limited to aryl halides, but works also with halogenated alkenes such as *E*- $\beta$ -styryl iodide (compound **3g**, 65% yield) (Table 5).

**Table 5.** Scope of Coupling of Thioglucoside with Electron-donating Alkenyl Halides

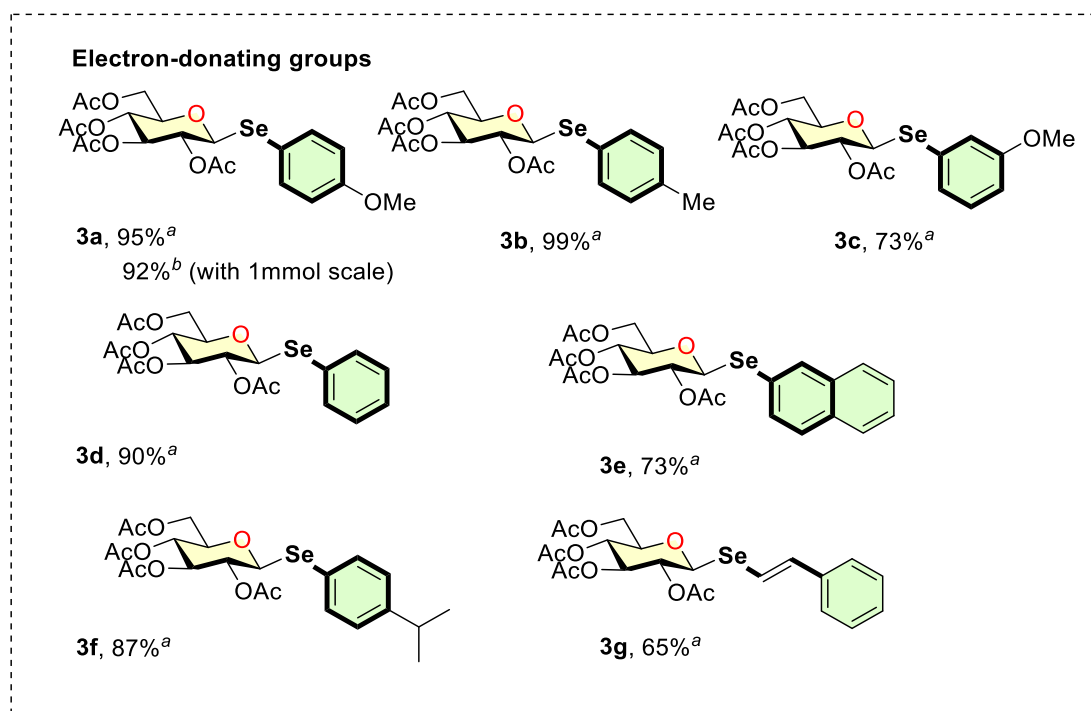
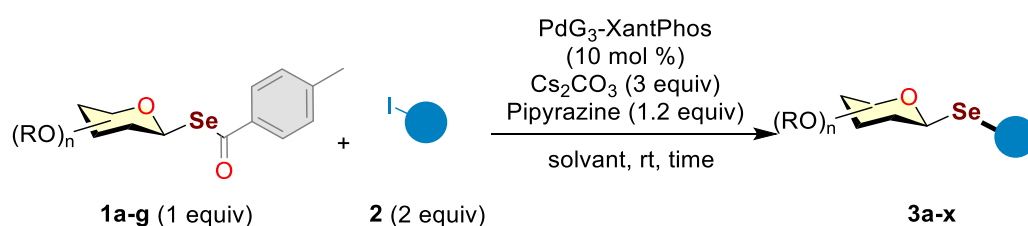

Reaction conditions: A sealable tube was charged with  $\beta$ -*p*-methylbenzoylselenoglycoside **1a** (1 equiv, 0.1 mmol), **2** (2 equiv), PdG3-XantPhos precatalyst (10 mol %), piperazine (1.2 equiv),  $\text{Cs}_2\text{CO}_3$  (3 equiv) in dry and degassed THF (0.1M) for 2 h. <sup>a</sup> Yield of isolated product.

Besides the electron-donating groups, this cross-coupling tolerates also various electron-withdrawing groups on the aromatic partner at both meta or the para positions. For example, the coupling with halides bearing a nitrile **2h**, trifluoromethyl **2i**, nitro **2k**, aldehyde **2l**, ketone **2o** and ester **2m**, **n** were successfully used with  $\beta$ -*p*-methylbenzoylselenoglycoside **1a** in yields ranging from 85% to 99% (**Table 6**).

**Table 6.** Scope of Coupling of Thioglucoside with Electron-withdrawing Alkenyl Halides

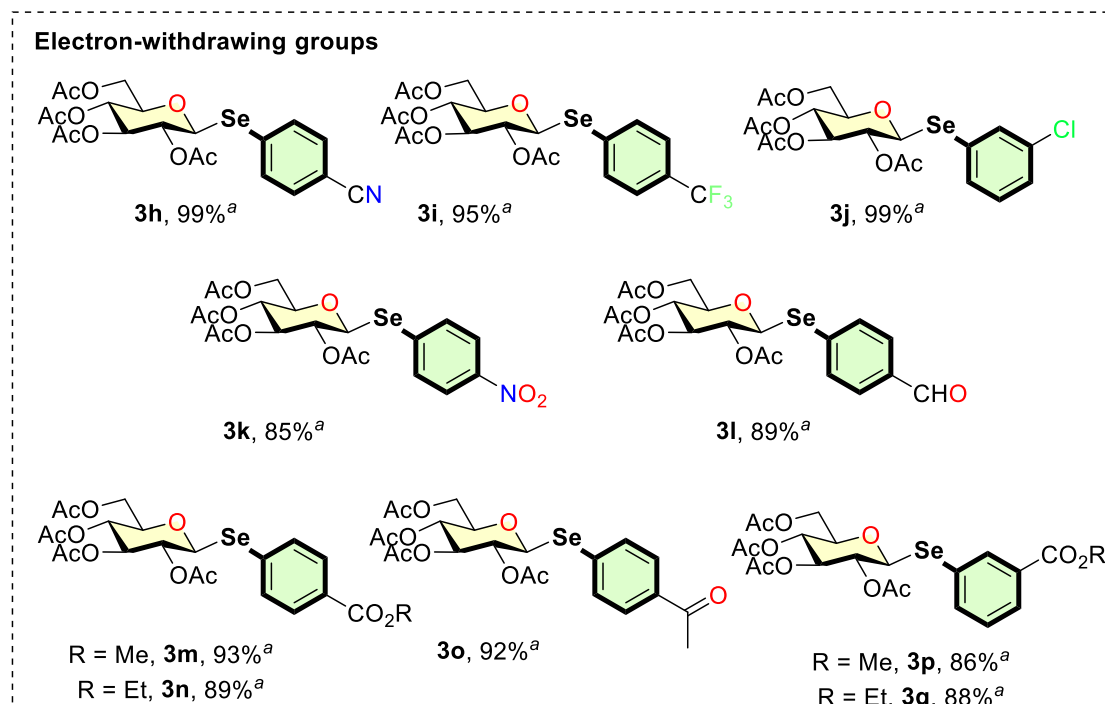
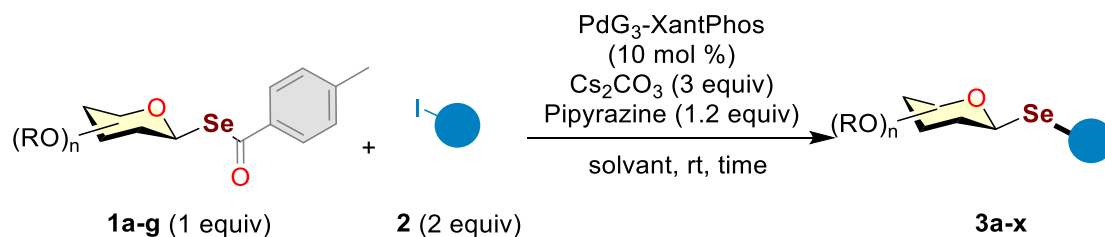

Reaction conditions: A sealable tube was charged with  $\beta$ -*p*-methylbenzoylselenoglycoside **1a** (1 equiv, 0.1 mmol), **2** (2 equiv), PdG<sub>3</sub>-XantPhos precatalyst (10 mol %), piperazine (1.2 equiv), Cs<sub>2</sub>CO<sub>3</sub> (3 equiv) in dry and degassed THF (0.1M) for 2 h. <sup>a</sup> Yield of isolated product.

Interestingly, the reaction of **1a** with heteroaryl halides such as 4-iodopyridine and 5-iodoindole have been performed successfully, furnishing **3r-s** in 87% and 85% yield, respectively (**Table 7**).



**Table 7.** Scope of Coupling of Thioglucoside with Heterocycles Halides

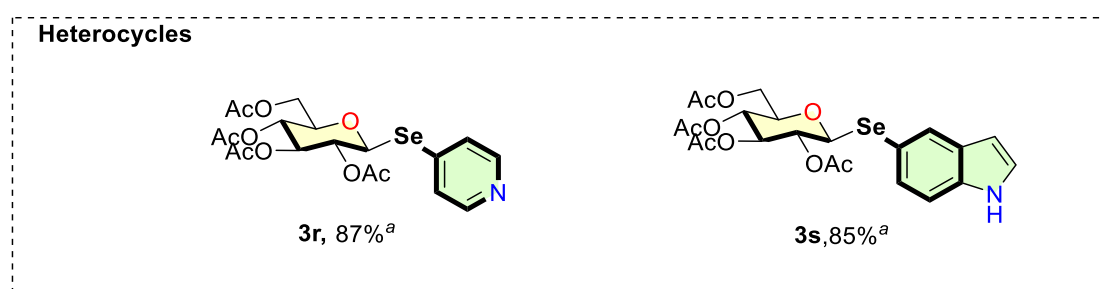
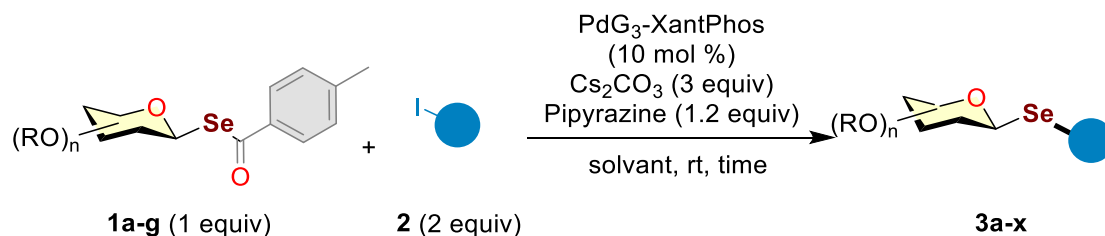

Reaction conditions: A sealable tube was charged with  $\beta$ -*p*-methylbenzoylselenoglycoside **1a** (1 equiv, 0.1 mmol), **2** (2 equiv), PdG<sub>3</sub>-XantPhos precatalyst (10 mol %), piperazine (1.2 equiv), Cs<sub>2</sub>CO<sub>3</sub> (3 equiv) in dry and degassed THF (0.1M) for 2 h. <sup>a</sup> Yield of isolated product.

Finally, this method tolerates other *selenosugars* such  $\beta$ -selenogalactose,  $\beta$ -selenofucose,  $\beta$ -selenocellobiose and  $\alpha$ -*p*-methylbenzoylselenoglycoside which were successfully coupled with **2a** or **2d** to give Se-glycosides **3t-v** in good yields (**Table 8**).

**Table 8.** Scope of Coupling of Thioglucosides with Alkenyl Halides

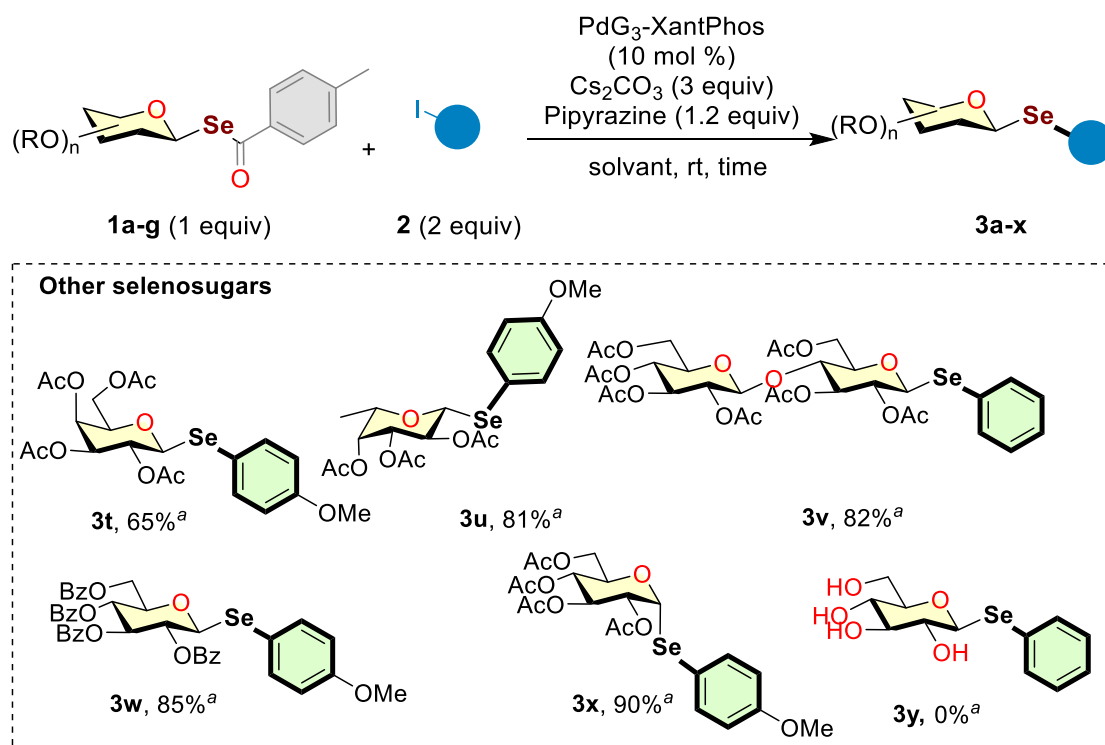

Reaction conditions: A sealable tube was charged with  $\beta$ -*p*-methylbenzoylselenoglycoside **1a** (1 equiv, 0.1 mmol), **2** (2 equiv), PdG<sub>3</sub>-XantPhos precatalyst (10 mol %), piperazine (1.2 equiv), Cs<sub>2</sub>CO<sub>3</sub> (3 equiv) in dry and degassed THF (0.1M) for 2 h. <sup>a</sup> Yield of isolated product.

While this method showed a large tolerance to functional groups and high efficiency, some limitations remain (**Table 9**). At first, this coupling is not compatible with aryl halides bearing chemical functions at the ortho-position **3w-3ad** of the aromatic ring probably due to the hindrance effects. The second limitation of this reaction is unfortunately the non-tolerance of unprotected sugar partners (**Table 8**).

We also observed that some heterocycles such as 3-iodopyridine failed in this coupling while 4-iodopyridine partner furnished the desired product in 87% yield (**Table 7**).

**Table 9.** Unsuitable structures

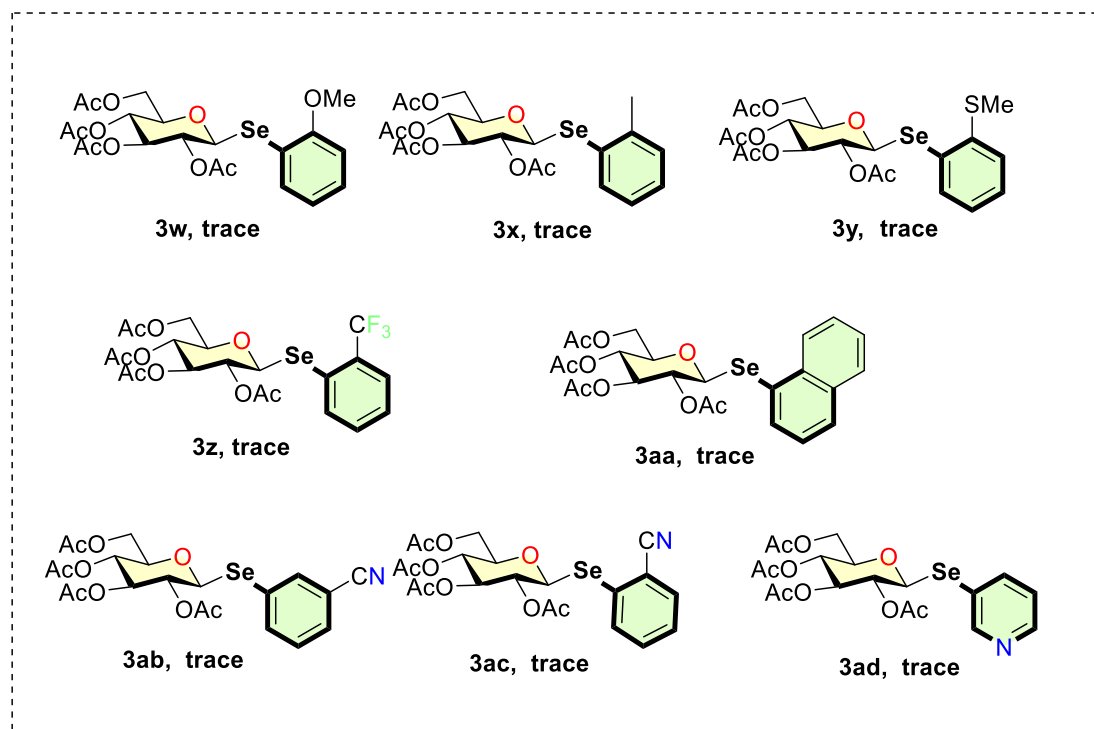
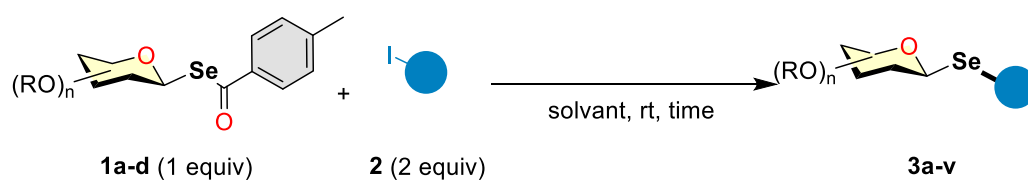

Reaction conditions: A sealable tube was charged with  $\beta$ -*p*-methylbenzoylselenoglycoside **1a** (1 equiv, 0.1 mmol), **2** (2 equiv), PdG3-XantPhos precatalyst (10 mol %), piperazine (1.2 equiv), Cs<sub>2</sub>CO<sub>3</sub> (3 equiv) in dry and degassed THF (0.1M) for 2 h. <sup>a</sup> Yield of isolated product.

In a next part of this study, we focused our attention on demonstrating whether our cross-coupling could be employed with functionalized aryl iodides bearing a secondary amino group (**Table 10**). We may assume that these bis-electrophilic -nucleophilic partners could be involved in two concomitant reactions: at first by a nucleophilic action, the secondary amine traps the *p*-methylbenzoyl group of the selenoglycoside **1a** and generates the anomeric selenolate anion. Then, this later will react with the electrophilic part (C–I bond) *via* the Pd-catalyzed Se–C(sp<sup>2</sup>) bond forming reaction. By this way, all the atoms of the reactants will be incorporated into the final desired products, resulting in high atom economy and environmental process which avoid the generation of wastes.

**Table 10.** Strategy for the trapping of the *p*-methylbenzoyl group of **1a** by using a double action (electrophilic-nucleophilic) of the partner

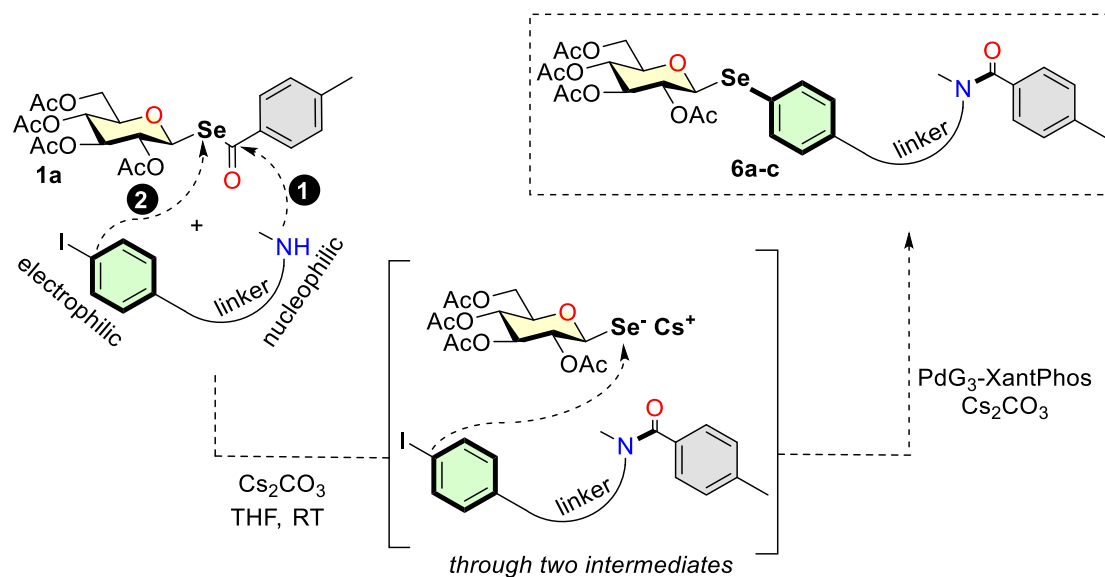

As shown in **Table 10 and 11**, the proof-of-concept of this green process was demonstrated by coupling of bis-electrophilic-nucleophilic partners **5a-c** with *p*-methylbenzoylselenoglycoside **1a** in the presence of PdG3-XantPhos (10 mol%),  $\text{Cs}_2\text{CO}_3$  (3 equiv) in THF at room temperature. Under these conditions, the synthesis of functionalized selenoglycosides **6a-c** was achieved with excellent yields (82% to 95%).

**Table 11.** Scope of Coupling of **1a** with functionalized aryl iodides bearing a secondary amino group

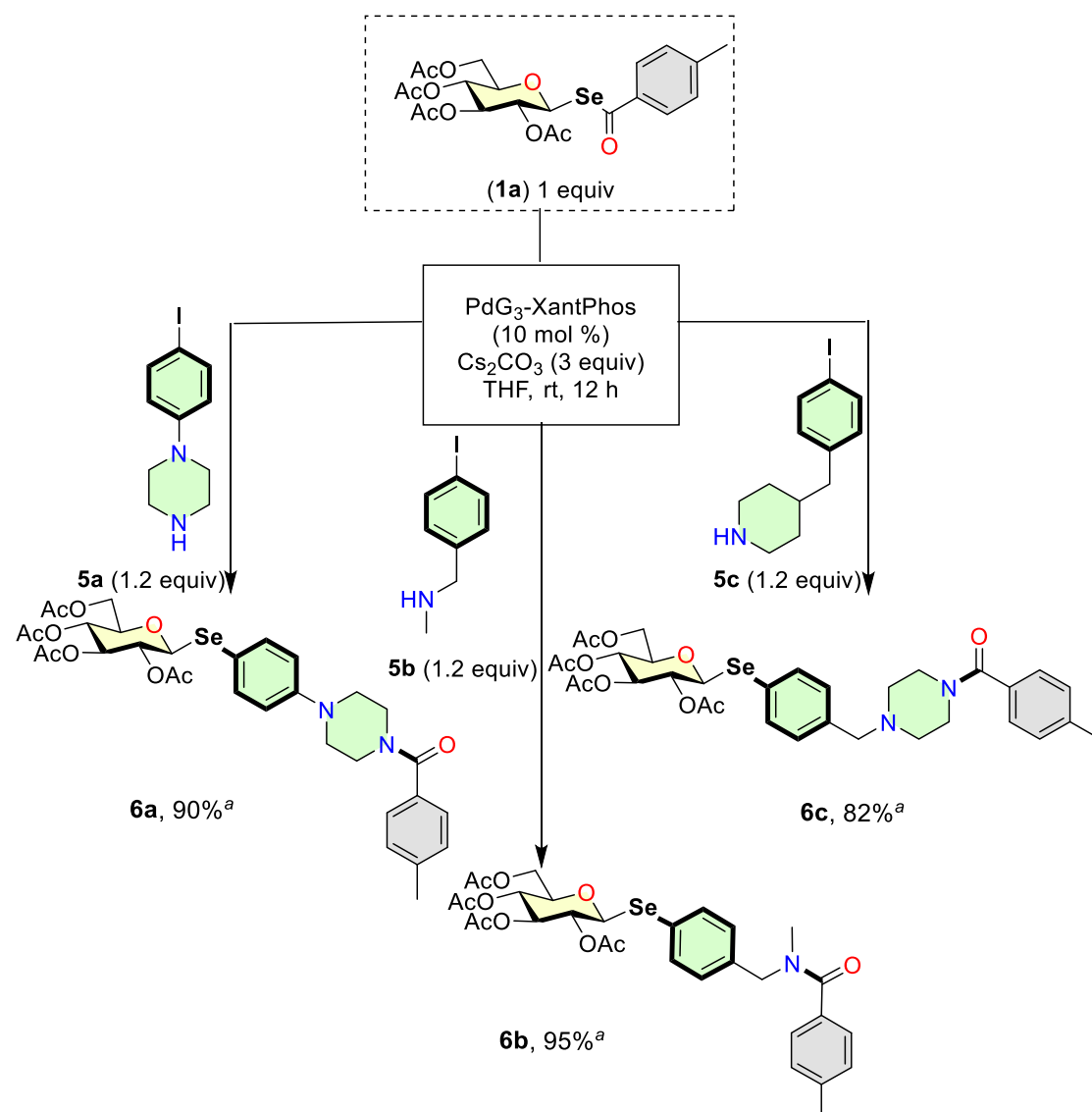

Reaction conditions: A sealable tube was charged with  $\beta$ -*p*-methylbenzoylselenoglycoside **1a** (1 equiv, 0.1 mmol), **5a-c** (1.2 equiv), PdG<sub>3</sub>-XantPhos precatalyst (10 mol %), Cs<sub>2</sub>CO<sub>3</sub> (3 equiv) in dry and degassed THF (0.1M) for 12 h. <sup>a</sup> Yield of isolated product **6a-c**.

### C) Conclusion and perspectives

In summary, we have shown that anomeric selenolate anions are valuable nucleophilic partners in the Pd-catalyzed cross-coupling reactions. To the best of our knowledge the C(sp<sup>2</sup>)-Se bond of (hetero)aryl selenoglycosides was formed, for the first time, directly by a Pd-catalyzed cross-coupling of selenosugar with aryl halides at room temperature. Because of the mildness of the reaction conditions, this protocol tolerates a wide range of functional groups and proceeds in good to excellent yields. In addition, a variety of selenosugars could be used. This method opens new opportunities for using glycosyl selenolate in synthetic methodology and medicinal chemistry.

In this project, only protected thiosugars was suitable to the optimized reaction conditions. And ortho-aryl halides failed to give the desired product. It would be exciting if a more convenient catalytic system could be developed, which is tolerated to various ortho-aryl halides and unprotected thiosugars. Also, the extension of this method to the coupling of selenosialic acids with aryl iodide is ongoing in our group.

### D) Experimental part

#### General information

Solvents and reagents are obtained from commercial suppliers and were used without further purification. Analytical TLC was performed using Merck silica gel F254 (230-400 mesh) plates and analyzed by UV light or by staining upon heating with vanilin solution (15 g of vanilin in 250 mL ethanol and 2.5 mL of concentrated sulfuric acid). For silica gel chromatography, the flash chromatography technique was used, with Merck silica gel 60 (230-400 mesh) and p.a. grade solvents unless otherwise noted. The <sup>1</sup>H NMR and <sup>13</sup>C NMR spectra were recorded in either CDCl<sub>3</sub> or MeOD-d<sub>4</sub> on Bruker Avance 300 spectrometers. The chemical shifts of <sup>1</sup>H and <sup>13</sup>C are reported in ppm relative to the solvent residual peaks. IR spectra were measured on a Bruker Vector 22 spectrophotometer.

Merck silica gel 60 (0.015–0.040 mm) was used for column chromatography. Melting points were recorded on a Büchi B-450 apparatus and are uncorrected. High resolution mass spectra (HR-MS) were recorded on a MicroMass LCT Premier Spectrometer spectrometer. Optical rotations were obtained with a PolAAR 32 polarimeter.

All Selenosugars were synthesized as according the following protocols.<sup>46</sup>

### General Procedures

A vial (5 mL) with a stir bar was charged with thiosugar (0.1 mmol, 1 eq), aryl halide (if solid) (0.2 mmol, 2eq), PdG<sub>3</sub>Xantphos (0.01 mmol, 10 mol%), piperazine 0.12 mmol, 1.2 eq) and Cs<sub>2</sub>CO<sub>3</sub> (0.3 mmol, 3 eq). The vial was then evacuated and backfilled with an argon balloon. And then, aryl halide (if liqued) (0.3 mmol, 1 eq), 1 mL dry THF was added. The reaction mixture stir intensely under Ar and room temperature for two hours. After the reaction finished, the reaction mixture was extracted with DCM, and the organic layer was washed with brine, dried over Na<sub>2</sub>SO<sub>4</sub> and concentrated. The residue was purified with column chromatography on silica gel (from pure n-hexane to EtOAc:n-hexane = 3/7) to give the product.

### Experimental data

(2*R*,3*R*,4*S*,5*R*,6*S*)-2-(acetoxymethyl)-6-((4-methoxyphenyl)selanyl)tetrahydro-2*H*-pyran-3,4,5-triyl triacetate (**3a**)

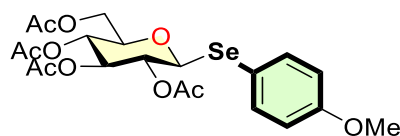

R<sub>f</sub> = 0.3 (EtOAc /cyclohexane: 3/7); 49.2 mg, 95%, White solid. m. p.: 103.9-104.8 °C; [α]<sub>D</sub><sup>18</sup> = - 23.5 (c, 0.75, CHCl<sub>3</sub>); <sup>1</sup>H NMR (300 MHz, (CD<sub>3</sub>)<sub>2</sub>CO-d<sub>6</sub>) δ 7.54-7.58 (m, 2H), 6.87-6.93 (m, 2H), 5.27 (t, *J* = 9.0 Hz, 1H), 5.11 (d, *J* = 12.0 Hz, 1H), 4.88-4.99 (m, 2H), 4.13-4.24 (m, 2H), 3.92-3.97 (m, 1H), 3.83 (s, 3H), 2.04 (s, 3H), 2.03 (s, 3H), 1.99 (s, 3H), 1.93 (s, 3H); <sup>13</sup>C NMR (75 MHz, (CD<sub>3</sub>)<sub>2</sub>CO-d<sub>6</sub>) δ 170.6 (C), 170.2 (C), 169.9 (C), 169.7 (C), 161.3 (C), 138.2 (2CH), 117.6 (C), 115.5 (2CH), 81.2 (CH), 77.2 (CH), 74.4 (CH), 71.7 (CH), 69.2 (CH), 62.9 (CH<sub>2</sub>), 55.6 (CH<sub>3</sub>), 20.7 (2CH<sub>3</sub>), 20.5 (2CH<sub>3</sub>); IR (neat): 2360, 2341, 1754, 1746, 1591, 1492, 1461, 1440, 1366, 1287, 1247, 1215, 117, 1059, 1030, 911, 828, 733 cm<sup>-1</sup>; HRMS (ESI): *m/z* calc. for C<sub>21</sub>H<sub>30</sub>NO<sub>10</sub>Se [M+NH<sub>4</sub>]<sup>+</sup> 536.1029; found 536.1039.

(2*R*,3*R*,4*S*,5*R*,6*S*)-2-(acetoxymethyl)-6-(*p*-tolylselanyl)tetrahydro-2*H*-pyran-3,4,5-triyl triacetate (**3b**)

---

<sup>46</sup> a) McDonagh, A. W.; Mahon, M. F.; Murphy, P. V., *Org. Lett.* **2016**, *18*, 552–555; b) Kawai, Y.; Ando, H.; Ozeki, H.; Koketsu, M.; Ishihara, H., *Org. Lett.* **2005**, *7*, 4653-4656.

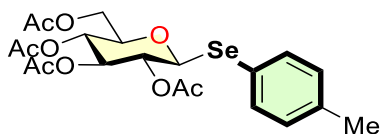

R<sub>f</sub> = 0.3 (EtOAc /cyclohexane: 3/7); 50.1 mg, 99%, White solid. m. p.: 125.1-126.0 °C; [α]<sub>D</sub><sup>18</sup> = - 22.6 (c, 0.31, CHCl<sub>3</sub>); <sup>1</sup>H NMR (300 MHz, CDCl<sub>3</sub>) δ 7.47-7.50 (m, 2H), 7.09-7.11 (m, 2H), 5.17 (t, *J* = 9.0 Hz, 1H), 4.93-5.03 (m, 2H), 4.82 (d, *J* = 9.0 Hz, 1H), 4.17-4.18 (m, 2H), 3.63-3.69 (m, 1H), 2.35 (s, 3H), 2.06 (s, 3H), 2.06 (s, 3H), 2.00 (s, 3H), 1.97 (s, 3H); <sup>13</sup>C NMR (75 MHz, CDCl<sub>3</sub>) δ 170.5 (C), 170.1 (C), 169.3 (C), 169.2 (C), 138.8 (C), 135.7 (2CH), 129.8 (2CH), 122.9 (C), 80.8 (CH), 76.8 (CH), 73.9 (CH), 70.8 (CH), 68.2 (CH), 62.1 (CH<sub>2</sub>), 21.2 (CH<sub>3</sub>), 20.8 (CH<sub>3</sub>), 20.7 (CH<sub>3</sub>), 20.5 (2CH<sub>3</sub>); IR (neat): 1755, 1479, 1439, 1367, 1249, 1217, 1088, 1060, 1038, 911, 743, 693 cm<sup>-1</sup>; HRMS (ESI): *m/z* calc. for C<sub>21</sub>H<sub>30</sub>NO<sub>9</sub>Se [M+NH<sub>4</sub>]<sup>+</sup> 520.1080; found 520.1085.

(2*R*,3*R*,4*S*,5*R*,6*S*)-2-(acetoxymethyl)-6-((3-methoxyphenyl)selanyl)tetrahydro-2*H*-pyran-3,4,5-triyl triacetate (**3c**)

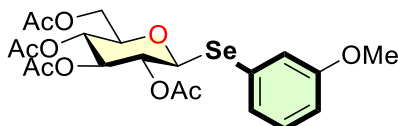

R<sub>f</sub> = 0.3 (EtOAc /cyclohexane: 3/7); 37.7 mg, 73%, White solid. m. p.: 124.6-125.1 °C; [α]<sub>D</sub><sup>18</sup> = - 16.7 (c, 0.36, CHCl<sub>3</sub>); <sup>1</sup>H NMR (300 MHz, CDCl<sub>3</sub>) δ 7.15-7.23 (m, 3H), 6.86-6.89 (m, 1H), 5.19 (t, *J* = 9.0 Hz, 1H), 5.02 (dt, *J* = 3.0, 9.0 Hz, 2H), 4.91 (d, *J* = 9.0 Hz, 1H), 4.14-4.24 (m, 2H), 3.81 (s, 3H), 3.67-3.73 (m, 1H), 2.06 (s, 3H), 2.06 (s, 3H), 2.01 (s, 3H), 1.98 (s, 3H); <sup>13</sup>C NMR (75 MHz, CDCl<sub>3</sub>) δ 170.6 (C), 170.1 (C), 169.3 (C), 169.2 (C), 159.6 (C), 129.7 (CH), 127.8 (C), 127.2 (CH), 120.5 (CH), 114.3 (CH), 81.0 (CH), 76.9 (CH), 73.9 (CH), 70.8 (CH), 68.2 (CH), 62.1 (CH<sub>2</sub>), 55.3 (CH<sub>3</sub>), 20.8 (CH<sub>3</sub>), 20.6 (3CH<sub>3</sub>); IR (neat): 2360, 2341, 2327, 1754, 1589, 1478, 1367, 1247, 1038, 911, 733 cm<sup>-1</sup>; HRMS (ESI): *m/z* calc. for C<sub>21</sub>H<sub>30</sub>NO<sub>10</sub>Se [M+NH<sub>4</sub>]<sup>+</sup> 536.1029; found 536.1031.

(2*R*,3*R*,4*S*,5*R*,6*S*)-2-(acetoxymethyl)-6-(phenylselanyl)tetrahydro-2*H*-pyran-3,4,5-triyl triacetate (**3d**)<sup>47</sup>

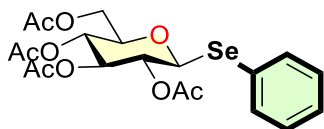

<sup>47</sup> Valerio, S.; Iadonisi, A.; Adinolfi, M.; Ravidà, A.; *J. Org. Chem.* **2007**, *72*, 6097-6106



R<sub>f</sub> = 0.3 (EtOAc /cyclohexane: 3/7); 43.9 mg, 90%, White solid. m. p.: 133.2-133.6 °C; [α]<sub>D</sub><sup>18</sup> = - 38.1 (c, 0.21, CHCl<sub>3</sub>); <sup>1</sup>H NMR (300 MHz, CDCl<sub>3</sub>) δ 7.61-7.64 (m, 2H), 7.28-7.40 (m, 3H), 5.21 (t, *J* = 9.0 Hz, 1H), 5.02 (td, *J* = 6.0, 12.0 Hz, 2H), 4.91 (d, *J* = 12.0 Hz, 1H), 4.15-4.26 (m, 2H), 3.47-3.68 (m, 1H), 2.09 (s, 3H), 2.09 (s, 3H), 2.03 (s, 3H), 2.00 (s, 3H). IR (neat): 1755, 1479, 1439, 1367, 1249, 1217, 1088, 1060, 1038, 911, 743, 693 cm<sup>-1</sup>; HRMS (ESI): *m/z* calc. for C<sub>20</sub>H<sub>28</sub>NO<sub>9</sub>Se [M+NH<sub>4</sub>]<sup>+</sup> 506.0924; found 506.0920.

(2*R*,3*R*,4*S*,5*R*,6*S*)-2-(acetoxymethyl)-6-(naphthalen-2-ylselanyl)tetrahydro-2*H*-pyran-3,4,5-triyl triacetate (**3e**)

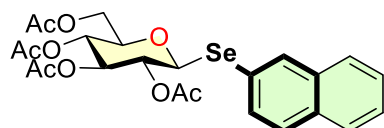

R<sub>f</sub> = 0.3 (EtOAc /cyclohexane: 3/7); 39.4 mg, 73%, White solid. m. p.: 103.5-103.8 °C; [α]<sub>D</sub><sup>18</sup> = - 41.4 (c, 0.29, CHCl<sub>3</sub>); <sup>1</sup>H NMR (300 MHz, CDCl<sub>3</sub>) δ 8.04-8.20 (m, H), 7.61-7.84 (m, 4H), 7.49-7.52 (m, 2H), 5.20 (t, *J* = 9.0 Hz, 1H), 4.89-5.08 (m, 3H), 3.98-4.37 (m, 2H), 3.60-3.72 (m, 1H), 2.09 (s, 3H), 2.00 (s, 3H), 2.00 (s, 3H), 1.97 (s, 3H); <sup>13</sup>C NMR (75 MHz, CDCl<sub>3</sub>) δ 170.5 (C), 170.1 (C), 169.3 (2C), 135.1 (CH), 133.7 (C), 133.0 (C), 132.2 (CH), 128.4 (CH), 127.7 (2CH), 126.8 (CH), 126.5 (CH), 124.1 (C), 81.0 (CH), 77.0 (CH), 73.9 (CH), 70.9 (CH), 68.2 (CH), 62.1 (CH<sub>2</sub>), 20.8 (CH<sub>3</sub>), 20.6 (CH<sub>3</sub>), 20.5 (CH<sub>3</sub>), 20.5 (CH<sub>3</sub>); IR (neat): 2360, 1754, 1746, 1586, 1501, 1432, 1367, 1248, 1214, 1060, 911, 817, 747 cm<sup>-1</sup>; HRMS (ESI): *m/z* calc. for C<sub>24</sub>H<sub>30</sub>NO<sub>9</sub>Se [M+NH<sub>4</sub>]<sup>+</sup> 556.1080; found 556.1093.

(2*R*,3*R*,4*S*,5*R*,6*S*)-2-(acetoxymethyl)-6-((4-isopropylphenyl)selanyl)tetrahydro-2*H*-pyran-3,4,5-triyl triacetate (**3f**)

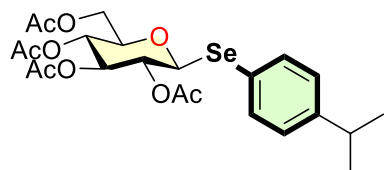

R<sub>f</sub> = 0.3 (EtOAc /cyclohexane: 3/7); 46.2 mg, 87%, White solid. m. p.: 120.0-121.3 °C; [α]<sub>D</sub><sup>18</sup> = - 23.5 (c, 0.34, CHCl<sub>3</sub>); <sup>1</sup>H NMR (300 MHz, CDCl<sub>3</sub>) δ 7.50-7.53 (m, 2H), 7.14-7.16 (m, 2H), 5.18 (t, *J* = 9.0 Hz, 1H), 5.01 (td, *J* = 6.0, 9.0 Hz, 2H), 4.85 (d, *J* = 9.0 Hz, 1H), 4.18 (d, *J* = 3.0 Hz, 2H), 3.65-3.70 (m, 1H), 2.85-2.94 (m, 1H), 2.06 (s, 3H), 2.06 (s, 3H), 2.00 (s, 3H), 1.98 (s, 3H), 1.26 (s, 3H), 1.24 (s, 3H); <sup>13</sup>C NMR (75 MHz, CDCl<sub>3</sub>) δ 170.5 (C), 170.1 (C), 169.4 (C), 169.3 (C), 149.6 (C), 135.6 (2CH), 127.2 (2CH), 123.5 (C), 81.0 (CH), 76.8 (CH), 73.9 (CH), 70.9 (CH), 68.2 (CH), 62.1 (CH<sub>2</sub>), 33.9 (CH), 23.8 (2CH<sub>3</sub>), 20.8 (CH<sub>3</sub>), 20.7 (CH<sub>3</sub>), 20.5 (2CH<sub>3</sub>); IR (neat): 2961, 2360, 2341, 1755, 1366, 1248, 1217, 1060, 1039, 910, 826, 773, 670 cm<sup>-1</sup>; HRMS (ESI): *m/z* calc. for C<sub>23</sub>H<sub>34</sub>NO<sub>9</sub>Se [M+NH<sub>4</sub>]<sup>+</sup> 548.1393; found 548.1386.

(2*R*,3*R*,4*S*,5*R*,6*S*)-2-(acetoxymethyl)-6-(((*E*)-styryl)selanyl)tetrahydro-2*H*-pyran-3,4,5-triyl triacetate (**3g**)

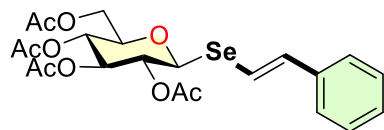

R<sub>f</sub> = 0.3 (EtOAc /cyclohexane: 3/7); 33.4 mg, 65%, White solid. m. p.: 103.5-103.8 °C; [α]<sub>D</sub><sup>18</sup> = - 41.4 (c, 0.29, CHCl<sub>3</sub>); <sup>1</sup>H NMR (300 MHz, CDCl<sub>3</sub>) δ 7.26-7.35 (m, 5H), 7.08 (d, *J* = 15.0 Hz, 1H), 6.96 (d, *J* = 15.0 Hz, 1H), 5.11-5.29 (m, 3H), 4.87 (d, *J* = 15.0 Hz, 1H), 4.14-4.29 (m, 2H), 3.71-3.79 (m, H), 2.06 (s, 3H), 2.04 (s, 3H), 2.03 (s, 3H), 2.00 (s, 3H); <sup>13</sup>C NMR (75 MHz, CDCl<sub>3</sub>) δ 170.6 (C), 170.1 (C), 169.3 (C), 169.3 (C), 138.9 (CH), 136.7 (CH), 128.7 (2CH), 128.1 (CH), 126.3 (2CH), 113.8 (CH), 79.0 (CH), 77.2 (CH), 73.8 (CH), 70.9 (CH), 68.2 (CH), 62.1 (CH<sub>2</sub>), 61.2 (CH<sub>2</sub>), 20.7 (2CH<sub>3</sub>), 20.6 (2CH<sub>3</sub>); IR (neat): 2925, 2360, 2326, 1755, 1367, 1216, 1087, 1060, 1034, 773 cm<sup>-1</sup>; HRMS (ESI): *m/z* calc. for C<sub>22</sub>H<sub>30</sub>NO<sub>9</sub>Se [M+NH<sub>4</sub>]<sup>+</sup> 532.1080; found 532.1088.

(2*R*,3*R*,4*S*,5*R*,6*S*)-2-(acetoxymethyl)-6-((4-cyanophenyl)selanyl)tetrahydro-2*H*-pyran-3,4,5-triyl triacetate (**3h**)

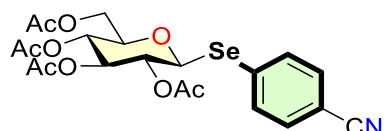

R<sub>f</sub> = 0.3 (EtOAc /cyclohexane: 3/7); 50.9 mg, 99%, White solid. m. p.: 164.1-165.3 °C; [α]<sub>D</sub><sup>18</sup> = - 36.4 (c, 0.22, CHCl<sub>3</sub>); <sup>1</sup>H NMR (300 MHz, CDCl<sub>3</sub>) δ 7.68-7.71 (m, 2H), 7.53-7.57 (m, 2H), 5.21 (t, *J* = 12.0 Hz, 1H), 4.97-5.06 (m, 3H), 4.15-4.25 (m, 2H), 3.72-3.77 (m, 1H), 2.07 (s, 3H), 2.07 (s, 3H), 2.05 (s, 3H), 2.05 (s, 3H); <sup>13</sup>C NMR (75 MHz, CDCl<sub>3</sub>) δ 170.3 (C), 170.0 (C), 169.3 (C), 169.2 (C), 134.7 (2CH), 134.1 (C), 132.2 (2CH), 118.3 (C), 112.1 (C), 80.5 (CH), 77.1 (CH), 73.6 (CH), 70.5 (CH), 68.0 (CH), 62.0 (CH<sub>2</sub>), 20.7 (2CH<sub>3</sub>), 20.5 (2CH<sub>3</sub>); IR (neat): 2360, 2341, 1754, 1433, 1367, 1217, 1060, 1041, 911, 769 cm<sup>-1</sup>; HRMS (ESI): *m/z* calc. for C<sub>21</sub>H<sub>23</sub>NO<sub>9</sub>NaSe [M+Na]<sup>+</sup> 536.0436; found 536.0446.

(2*R*,3*R*,4*S*,5*R*,6*S*)-2-(acetoxymethyl)-6-((4-(trifluoromethyl)phenyl)selanyl)tetrahydro-2*H*-pyran-3,4,5-triyl triacetate (**3i**)

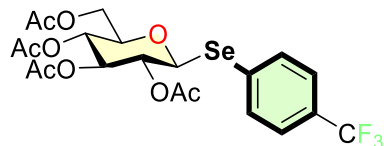

R<sub>f</sub> = 0.3 (EtOAc /cyclohexane: 3/7); 52.7 mg, 95%, White solid. m. p.: 150.1-151.3 °C; [α]<sub>D</sub><sup>18</sup> = - 25.0 (c, 0.40, CHCl<sub>3</sub>); <sup>1</sup>H NMR (300 MHz, CDCl<sub>3</sub>) δ 7.71-7.73 (m, 2H), 7.52-7.55 (m, 2H), 5.21 (t, *J* = 9.0 Hz, 1H), 4.91-5.06 (m, 3H), 4.18-4.20 (m, 2H), 3.69-3.74 (m, 1H), 2.07 (s, 3H), 2.06 (s, 3H), 2.02 (s, 3H), 1.99 (s, 3H); <sup>13</sup>C NMR (75 MHz,

CDCl<sub>3</sub>) δ 170.4 (C), 170.1 (C), 169.3 (2C), 135.1 (2CH), 131.7 (C), 125.6 (2CH, *J* = 3 Hz), 121.9 (C, *J* = 30 Hz), 110.35 (C, *J* = 277 Hz), 80.5 (CH), 77.0 (CH), 73.6 (CH), 70.6 (CH), 68.0 (CH), 62.0 (CH<sub>2</sub>), 20.7 (2CH<sub>3</sub>), 20.6 (2CH<sub>3</sub>); IR (neat): 2360, 2341, 2326, 1752, 1603, 1368, 1248, 1166, 1080, 1059, 911, 773 cm<sup>-1</sup>; HRMS (ESI): *m/z* calc. for C<sub>21</sub>H<sub>23</sub>F<sub>3</sub>NaO<sub>9</sub>Se [M+Na]<sup>+</sup> 579.0357; found 579.0347.

(2*R*,3*R*,4*S*,5*R*,6*S*)-2-(acetoxymethyl)-6-((4-(trifluoromethyl)phenyl)selanyl)tetrahydro-2*H*-pyran-3,4,5-triyl triacetate (**3j**)

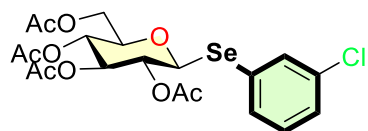

R<sub>f</sub> = 0.3 (EtOAc /cyclohexane: 3/7); 51.7 mg, 99%, White solid. m. p.: 77.2-77.4 °C; [α]<sub>D</sub><sup>18</sup> = - 36.4 (c, 0.66, CHCl<sub>3</sub>); <sup>1</sup>H NMR (300 MHz, CDCl<sub>3</sub>) δ 7.63 (s, 1H), 7.46-7.49 (m, 1H), 7.20-7.34 (m, 2H), 5.20 (t, *J* = 9.0 Hz, 1H), 4.88-5.06 (m, 3H), 4.14-4.25 (m, 2H), 3.68-3.74 (m, 1H), 2.09 (s, 3H), 2.07 (s, 3H), 2.01 (s, 3H), 1.98 (s, 3H); <sup>13</sup>C NMR (75 MHz, CDCl<sub>3</sub>) δ 170.6 (C), 170.1 (C), 169.3 (C), 169.2 (C), 134.7 (CH), 134.4 (CH), 133.1 (CH), 130.0 (CH), 128.8 (CH), 128.4 (C), 80.9 (CH), 77.0 (CH), 73.7 (CH), 70.7 (CH), 68.1 (CH), 62.1 (CH<sub>2</sub>), 20.7 (2CH<sub>3</sub>), 20.5 (2CH<sub>3</sub>); IR (neat): 2360, 2341, 1748, 1570, 1461, 1367, 1248, 1215, 1085, 1060, 1040, 911, 775, 681 cm<sup>-1</sup>; HRMS (ESI): *m/z* calc. for C<sub>20</sub>H<sub>27</sub>NO<sub>9</sub>ClSe [M+NH<sub>4</sub>]<sup>+</sup> 540.0540; found 540.0539.

(2*R*,3*R*,4*S*,5*R*,6*S*)-2-(acetoxymethyl)-6-((4-nitrophenyl)selanyl)tetrahydro-2*H*-pyran-3,4,5-triyl triacetate (**3k**)

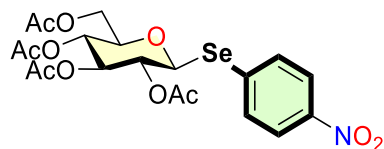

R<sub>f</sub> = 0.3 (EtOAc /cyclohexane: 1/1); 42.4 mg, 85%, White solid. m. p.: 166.4-167.1 °C; [α]<sub>D</sub><sup>18</sup> = - 36.8 (c, 0.76, CHCl<sub>3</sub>); <sup>1</sup>H NMR (300 MHz, CDCl<sub>3</sub>) δ 8.10-8.13 (m, 2H), 7.72-7.75 (m, 2H), 5.18-5.29 (m, 1H), 5.00-5.06 (m, 3H), 4.11-4.26 (m, 2H), 3.73-3.79 (m, 1H), 2.08 (s, 3H), 2.06 (s, 3H), 2.01 (s, 3H), 1.98 (s, 3H); <sup>13</sup>C NMR (75 MHz, CDCl<sub>3</sub>) δ 170.3 (C), 170.0 (C), 169.2 (2C), 147.7 (C), 136.7 (C), 134.4 (2CH), 123.7 (2CH), 80.5 (CH), 77.2 (CH), 73.5 (CH), 70.5 (CH), 68.0 (CH), 62.0 (CH<sub>2</sub>), 20.7 (2CH<sub>3</sub>), 20.5 (2CH<sub>3</sub>); IR (neat): 2360, 1746, 1598, 1576, 1520, 1368, 1346, 1247, 1034, 911, 773, 683 cm<sup>-1</sup>; HRMS (ESI): *m/z* calc. for C<sub>20</sub>H<sub>27</sub>N<sub>2</sub>O<sub>11</sub>Se [M+NH<sub>4</sub>]<sup>+</sup> 551.0775; found 551.0785.

(2*R*,3*R*,4*S*,5*R*,6*S*)-2-(acetoxymethyl)-6-((4-formylphenyl)selanyl)tetrahydro-2*H*-pyran-3,4,5-triyl triacetate (**3l**)

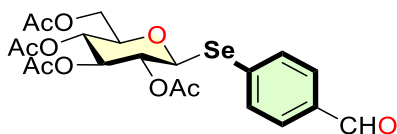

R<sub>f</sub> = 0.3 (EtOAc /cyclohexane: 3/7); 45.9 mg, 89%, White solid. m. p.: 74.6-75.6 °C; [α]<sub>D</sub><sup>18</sup> = - 10.3 (c, 0.29, CHCl<sub>3</sub>); <sup>1</sup>H NMR (300 MHz, CDCl<sub>3</sub>) δ 9.99 (s, 1H), 7.60-7.79 (m, 4H), 5.22 (t, *J* = 9.0 Hz, 1H), 4.99-5.08 (m, 3H), 4.16-4.24 (m, 2H), 3.71-3.79 (m, 1H), 2.08 (s, 3H), 2.05 (s, 3H), 2.02 (s, 3H), 1.98 (s, 3H); <sup>13</sup>C NMR (75 MHz, CDCl<sub>3</sub>) δ 191.4 (CH), 170.4 (C), 170.0 (C), 169.3 (C), 169.2 (C), 136.2 (C), 134.1 (2CH), 129.8 (2CH), 80.7 (CH), 77.1 (CH), 73.6 (CH), 70.6 (CH), 68.1 (CH), 62.1 (CH<sub>2</sub>), 20.7 (2CH<sub>3</sub>), 20.5 (2CH<sub>3</sub>); IR (neat): 2360, 2341, 1748, 1699, 1589, 1564, 1433, 1367, 1248, 1213, 1172, 1060, 1039, 911, 835, 817, 773, 681 cm<sup>-1</sup>; HRMS (ESI): m/z calc. for C<sub>21</sub>H<sub>28</sub>NO<sub>10</sub>Se [M+NH<sub>4</sub>]<sup>+</sup> 534.0873; found 534.0888.

(2*R*,3*R*,4*S*,5*R*,6*S*)-2-(acetoxymethyl)-6-((4-(methoxycarbonyl)phenyl)selanyl)tetrahydro-2*H*-pyran-3,4,5-triyl triacetate (**3m**)

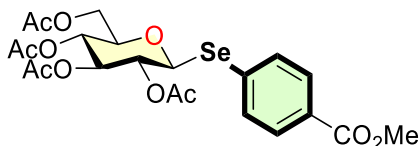

R<sub>f</sub> = 0.3 (EtOAc /cyclohexane: 3/7); 50.7 mg, 93%, White solid. m. p.: 140.3-142.4 °C; [α]<sub>D</sub><sup>18</sup> = - 26.1 (c, 0.69, CHCl<sub>3</sub>); <sup>1</sup>H NMR (300 MHz, CDCl<sub>3</sub>) δ 7.92-7.94 (m, 2H), 7.63-7.66 (m, 2H), 5.21 (t, *J* = 9.0 Hz, 1H), 4.95-5.06 (m, 3H), 4.14-4.24 (m, 2H), 3.91 (s, 3H), 3.70-3.75 (m, H), 2.07 (s, 3H), 2.05 (s, 3H), 2.01 (s, 3H), 1.98 (s, 3H); <sup>13</sup>C NMR (75 MHz, CDCl<sub>3</sub>) δ 170.5 (C), 170.1 (C), 169.3 (C), 169.2 (C), 166.6 (C), 139.8 (C), 133.9 (2CH), 129.9 (2C), 127.7 (C), 80.8 (CH), 77.0 (CH), 73.7 (CH), 70.7 (CH), 68.1 (CH), 62.1 (CH<sub>2</sub>), 52.2 (CH<sub>3</sub>), 20.7 (2CH<sub>3</sub>), 20.5 (2CH<sub>3</sub>); IR (neat): 2360, 2341, 1749, 1593, 1435, 1367, 1247, 1109, 1059, 911, 825, 759 cm<sup>-1</sup>; HRMS (ESI): m/z calc. for C<sub>22</sub>H<sub>30</sub>NO<sub>11</sub>Se [M+NH<sub>4</sub>]<sup>+</sup> 564.0979; found 564.0995.

(2*R*,3*R*,4*S*,5*R*,6*S*)-2-(acetoxymethyl)-6-((4-(ethoxycarbonyl)phenyl)selanyl)tetrahydro-2*H*-pyran-3,4,5-triyl triacetate (**3n**)

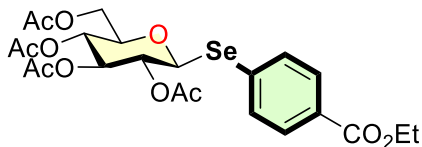

R<sub>f</sub> = 0.3 (EtOAc /cyclohexane: 3/7); 49.7 mg, 89%, White solid. m. p.: 123.2-123.3 °C; [α]<sub>D</sub><sup>18</sup> = - 25.6 (c, 0.43, CHCl<sub>3</sub>); <sup>1</sup>H NMR (300 MHz, CDCl<sub>3</sub>) δ 7.92-7.95 (m, 2H), 7.63-7.66 (m, 2H), 5.20 (t, *J* = 9.0 Hz, 1H), 4.94-5.06 (m, 3H), 4.37 (q, *J* = 6.0 Hz, 2H), 4.15-4.24 (m, 2H), 3.69-3.74 (m, 1H), 2.07 (s, 3H), 2.05 (s, 3H), 2.01 (s, 3H), 1.98 (s, 3H), 1.39 (t, *J* = 6.0 Hz, 3H); <sup>13</sup>C NMR (75 MHz, CDCl<sub>3</sub>) δ 170.5 (C), 170.1 (C), 169.3 (C), 169.2 (C), 166.1 (C), 134.0 (2CH), 133.5 (C), 130.3 (C), 129.9 (2CH), 80.7 (CH),

77.0 (CH), 73.7 (CH), 70.7 (CH), 68.1 (CH), 62.1 (CH<sub>2</sub>), 61.1 (CH<sub>2</sub>), 20.7 (2CH<sub>3</sub>), 20.5 (2CH<sub>3</sub>), 14.3 (CH<sub>3</sub>); IR (neat): 2998, 2360, 2341, 1753, 1715, 1593, 1367, 1285, 1107, 1058, 911, 774, 759, 670cm<sup>-1</sup>; HRMS (ESI): m/z calc. for C<sub>23</sub>H<sub>32</sub>NO<sub>11</sub>Se [M+NH<sub>4</sub>]<sup>+</sup> 578.1135; found 578.1138.

(2*R*,3*R*,4*S*,5*R*,6*S*)-2-(acetoxymethyl)-6-((4-acetylphenyl)selanyl)tetrahydro-2*H*-pyran-3,4,5-triyl triacetate (**3o**)

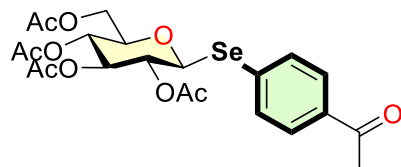

R<sub>f</sub> = 0.3 (EtOAc /cyclohexane: 3/7); 48.8 mg, 92%, White solid. m. p.: 129.5-130.2 °C; [α]<sub>D</sub><sup>18</sup> = - 21.7 (c, 0.46, CHCl<sub>3</sub>); <sup>1</sup>H NMR (300 MHz, CDCl<sub>3</sub>) δ 7.83-7.86 (m, 2H), 7.65-7.67 (m, 2H), 5.20 (t, *J* = 9.0 Hz, 1H), 4.94-5.06 (m, 3H), 4.10-4.25 (m, 2H), 3.68-3.78 (m, 1H), 2.58 (s, 3H), 2.07 (s, 3H), 2.05 (s, 3H), 2.01 (s, 3H), 1.97 (s, 3H); <sup>13</sup>C NMR (75 MHz, CDCl<sub>3</sub>) δ 197.3 (C), 170.4 (C), 170.0 (C), 169.3 (C), 169.2 (C), 136.7 (C), 134.2 (2CH), 134.0 (C), 128.6 (2CH), 80.6 (CH), 77.0 (CH), 73.7 (CH), 70.6 (CH), 68.1 (CH), 62.1 (CH<sub>2</sub>), 26.5 (CH<sub>3</sub>), 20.7 (2CH<sub>3</sub>), 20.5 (2CH<sub>3</sub>); IR (neat): 2360, 2341, 2326, 1753, 1683, 1588, 1433, 1375, 1247, 1217, 1085, 1059, 1040, 958, 911, 773 cm<sup>-1</sup>; HRMS (ESI): m/z calc. for C<sub>22</sub>H<sub>26</sub>O<sub>10</sub>NaSe [M+Na]<sup>+</sup> 553.0589; found 553.0592.

(2*R*,3*R*,4*S*,5*R*,6*S*)-2-(acetoxymethyl)-6-((3-(methoxycarbonyl)phenyl)selanyl)tetrahydro-2*H*-pyran-3,4,5-triyl triacetate (**3p**)

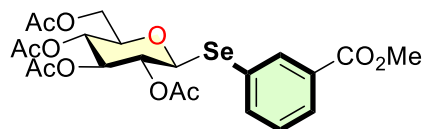

R<sub>f</sub> = 0.3 (EtOAc /cyclohexane: 3/7); 47.0 mg, 86%, White solid. m. p.: 97.5-98.7 °C; [α]<sub>D</sub><sup>18</sup> = - 29.2 (c, 0.48, CHCl<sub>3</sub>); <sup>1</sup>H NMR (300 MHz, CDCl<sub>3</sub>) δ 8.28 (s, 1H), 8.00 (d, *J* = 9.0 Hz, 1H), 7.79 (d, *J* = 9.0 Hz, 1H), 7.37 (t, *J* = 6.0 Hz, 1H), 5.19 (t, *J* = 12.0 Hz, 1H), 4.89-5.06 (m, 3H), 4.13-4.25 (m, 2H), 3.92 (s, 3H), 3.65-3.73 (m, 1H), 20.7 (s, 3H), 20.6 (s, 3H), 20.0 (s, 3H), 1.98 (s, 3H); <sup>13</sup>C NMR (75 MHz, CDCl<sub>3</sub>) δ 170.5 (C), 170.1 (C), 169.3 (C), 169.3 (C), 166.2 (C), 139.4 (CH), 136.1 (CH), 131.0 (C), 129.6 (CH), 128.9 (CH), 127.4 (C), 80.9 (CH), 77.0 (CH), 73.8 (CH), 70.8 (CH), 68.1 (CH), 62.1 (CH<sub>2</sub>), 52.3 (CH<sub>3</sub>), 20.7 (CH<sub>3</sub>), 20.6 (CH<sub>3</sub>), 20.5 (2CH<sub>3</sub>); IR (neat): 2954, 2360, 2341, 1755, 1722, 1367, 1285, 1264, 1088, 977, 773, 750 cm<sup>-1</sup>; HRMS (ESI): m/z calc. for C<sub>22</sub>H<sub>30</sub>NO<sub>11</sub>Se [M+NH<sub>4</sub>]<sup>+</sup> 564.0979; found 564.0980.

(2*R*,3*R*,4*S*,5*R*,6*S*)-2-(acetoxymethyl)-6-((3-(ethoxycarbonyl)phenyl)selanyl)tetrahydro-2*H*-pyran-3,4,5-triyl triacetate (**3q**)

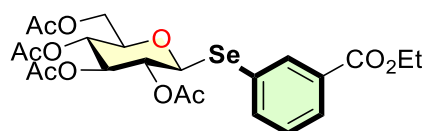

Rf = 0.3 (EtOAc /cyclohexane: 3/7); 49.2 mg, 88%, White solid. m. p.: 86.4-87.3 °C;  $[\alpha]_D^{18} = -24.1$  (c, 0.29, CHCl<sub>3</sub>); <sup>1</sup>H NMR (300 MHz, CDCl<sub>3</sub>) δ 8.27 (s, 1H), 8.01 (d, *J* = 6.0 Hz, 1H), 7.78 (d, *J* = 6.0 Hz, 1H), 7.37 (t, *J* = 6.0 Hz, 1H), 5.19 (t, *J* = 9.0 Hz, 1H), 4.97-5.06 (m, 2H), 4.98 (d, *J* = 9.0 Hz, 1H), 4.38 (q, *J* = 6.0 Hz, 1H), 4.12-4.25 (m, 2H), 3.67-3.72 (m, 1H), 2.07 (s, 3H), 2.04 (s, 3H), 2.00 (s, 3H), 1.97 (s, 3H), 1.39 (t, *J* = 6.0 Hz, 3H); <sup>13</sup>C NMR (75 MHz, CDCl<sub>3</sub>) δ 170.5 (C), 170.1 (C), 169.3 (C), 169.2 (C), 165.7 (C), 139.3 (CH), 136.0 (CH), 131.0 (C), 129.6 (CH), 128.9 (CH), 127.3 (C), 80.9 (CH), 77.0 (CH), 73.8 (CH), 70.8 (CH), 68.1 (CH), 62.1 (CH<sub>2</sub>), 61.2 (CH<sub>2</sub>), 20.7 (CH<sub>3</sub>), 20.6 (CH<sub>3</sub>), 20.5 (2CH<sub>3</sub>), 14.3 (CH<sub>3</sub>); IR (neat): 2360, 2327, 1755, 1718, 1367, 1262, 1088, 910, 773, 750 cm<sup>-1</sup>; HRMS (ESI): *m/z* calc. for C<sub>23</sub>H<sub>32</sub>NO<sub>11</sub>Se [M+NH<sub>4</sub>]<sup>+</sup> 578.1135; found 578.1147.

(2*R*,3*R*,4*S*,5*R*,6*S*)-2-(acetoxymethyl)-6-(pyridin-4-ylselanyl)tetrahydro-2*H*-pyran-3,4,5-triyl triacetate (**3r**)

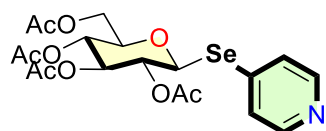

Rf = 0.3 (EtOAc /cyclohexane: 1/1); 42.6 mg, 87%, White solid. m. p.: 120.5-121.9 °C;  $[\alpha]_D^{18} = -22.1$  (c, 0.95, CHCl<sub>3</sub>); <sup>1</sup>H NMR (300 MHz, CDCl<sub>3</sub>) δ 8.44-8.46 (m, 2H), 7.42-7.44 (m, 2H), 5.20-5.27 (m, 1H), 5.03-5.12 (m, 3H), 4.14-4.25 (m, 2H), 3.74-3.80 (m, 1H), 2.07 (s, 3H), 2.04 (s, 3H), 2.02 (s, 3H), 1.99 (s, 3H); <sup>13</sup>C NMR (75 MHz, CDCl<sub>3</sub>) δ 170.4 (C), 170.0 (C), 169.3 (C), 169.3 (C), 149.7 (2CH), 139.7 (C), 127.2 (2CH), 80.2 (CH), 77.2 (CH), 73.5 (CH), 70.5 (CH), 68.1 (CH), 62.1 (CH<sub>2</sub>), 20.7 (2CH<sub>3</sub>), 20.5 (2CH<sub>3</sub>); IR (neat): 2360, 2341, 1746, 1570, 1543, 1407, 1248, 1212, 1086, 1060, 1039, 911, 806, 773 cm<sup>-1</sup>; HRMS (ESI): *m/z* calc. for C<sub>19</sub>H<sub>24</sub>NO<sub>9</sub>Se [M+NH<sub>4</sub>]<sup>+</sup> 490.0616; found 490.0610.

(2*S*,3*R*,4*S*,5*R*,6*R*)-2-((1*H*-indol-5-yl)selanyl)-6-(acetoxymethyl)tetrahydro-2*H*-pyran-3,4,5-triyl triacetate (**3s**)

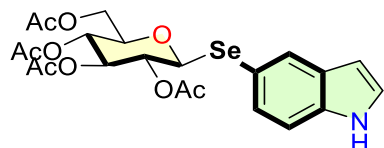

Rf = 0.3 (EtOAc /cyclohexane: 1/1); 44.6 mg, 85%, White solid. m. p.: 128.9-129.4 °C;  $[\alpha]_D^{18} = -33.3$  (c, 0.45, CHCl<sub>3</sub>); <sup>1</sup>H NMR (300 MHz, CDCl<sub>3</sub>) δ 8.30-8.38 (m, 1H), 7.94-7.96 (m, 1H), 7.23-7.46 (m, 3H), 6.54-6.59 (m, 1H), 4.84-5.22 (m, 4H), 4.20-4.21 (m, 2H), 3.64-3.68 (m, 1H), 2.11 (s, 3H), 2.04 (s, 3H), 2.01 (s, 3H), 1.98 (s, 3H); <sup>13</sup>C

NMR (75 MHz, CDCl<sub>3</sub>)  $\delta$  170.6 (C), 170.2 (C), 169.4 (2C), 135.9 (C), 129.8 (CH), 129.3 (CH), 128.8 (C), 125.0 (CH), 116.1 (C), 111.5 (CH), 102.7 (CH), 81.3 (CH), 76.8 (CH), 74.0 (CH), 71.0 (CH), 68.3 (CH), 62.2 (CH<sub>2</sub>), 20.9 (CH<sub>3</sub>), 20.7 (CH<sub>3</sub>), 20.6 (2CH<sub>3</sub>); IR (neat): 2360, 2341, 1755, 1454, 1366, 1250, 1219, 1062, 1039, 912, 772, 669 cm<sup>-1</sup>; HRMS (ESI): *m/z* calc. for C<sub>22</sub>H<sub>29</sub>N<sub>2</sub>O<sub>9</sub>Se [M+NH<sub>4</sub>]<sup>+</sup> 545.1038; found 545.1031.

(2*R*,3*S*,4*S*,5*R*,6*S*)-2-(acetoxymethyl)-6-((4-methoxyphenyl)selanyl)tetrahydro-2*H*-pyran-3,4,5-triyl triacetate (**3t**)

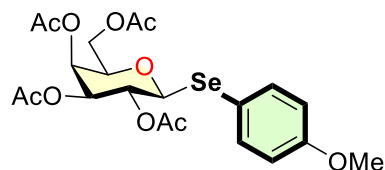

R<sub>f</sub> = 0.3 (EtOAc /cyclohexane: 3/7); 33.8 mg, 65%, White solid. m. p.: 102.3-102.9 °C; [α]<sub>D</sub><sup>18</sup> = -7.9 (c, 0.38, CHCl<sub>3</sub>); <sup>1</sup>H NMR (300 MHz, CDCl<sub>3</sub>)  $\delta$  7.54-7.57 (m, 2H), 6.82-6.85 (m, 2H), 5.37-5.39 (m, 1H), 5.21 (t, *J* = 9.0 Hz, 1H), 4.97-5.02 (m, 1H), 4.78 (d, *J* = 9.0 Hz, 1H), 4.04-4.18 (m, 2H), 3.84-3.88 (m, 1H), 3.80 (s, 3H), 2.08 (s, 3H), 2.06 (s, 3H), 2.03 (s, 3H), 1.96 (s, 3H); <sup>13</sup>C NMR (75 MHz, CDCl<sub>3</sub>)  $\delta$  170.3 (C), 170.1 (C), 170.0 (C), 169.4 (C), 160.3 (C), 137.5 (2CH), 117.2 (C), 114.5 (2CH), 81.7 (CH), 75.4 (CH), 71.9 (CH), 68.1 (CH), 67.3 (CH), 61.5 (CH<sub>2</sub>), 55.3 (CH<sub>3</sub>), 20.9 (CH<sub>3</sub>), 20.6 (CH<sub>3</sub>), 20.6 (CH<sub>3</sub>), 20.6 (CH<sub>3</sub>); IR (neat): 2360, 2341, 2325, 1748, 1492, 1373, 1247, 1219, 1081, 1054, 826, 773, 669 cm<sup>-1</sup>; HRMS (ESI): *m/z* calc. for C<sub>21</sub>H<sub>30</sub>NO<sub>10</sub>Se [M+NH<sub>4</sub>]<sup>+</sup> 536.1029; found 536.1033.

(2*R*,3*S*,4*R*,5*R*,6*S*)-2-((4-methoxyphenyl)selanyl)-6-methyltetrahydro-2*H*-pyran-3,4,5-triyl triacetate (**3u**)

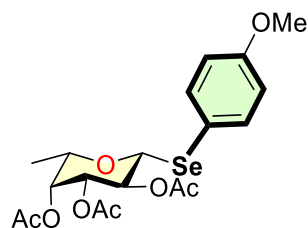

R<sub>f</sub> = 0.3 (EtOAc /cyclohexane: 3/7); 37.1 mg, 81%, White solid. m. p.: 69.5-70.6 °C; [α]<sub>D</sub><sup>18</sup> = +21.7 (c, 0.23, CHCl<sub>3</sub>); <sup>1</sup>H NMR (300 MHz, CDCl<sub>3</sub>)  $\delta$  7.54-7.57 (m, 2H), 6.82-6.85 (m, 2H), 5.16-5.22 (m, 2H), 4.97-5.01 (m, 1H), 4.76 (d, *J* = 9.0 Hz, 1H), 3.80 (s, 3H), 3.72-3.76 (m, 1H), 2.08 (s, 3H), 2.07 (s, 3H), 1.95 (s, 3H), 1.17-1.22 (m, 3H); <sup>13</sup>C NMR (75 MHz, CDCl<sub>3</sub>)  $\delta$  170.5 (C), 170.1 (C), 169.5 (C), 160.1 (C), 137.3 (2CH), 117.7 (C), 114.5 (2CH), 81.9 (CH), 74.2 (CH), 72.3 (CH), 70.5 (CH), 68.2 (CH), 55.2 (CH<sub>3</sub>), 20.9 (CH<sub>3</sub>), 20.6 (2CH<sub>3</sub>), 16.4 (CH<sub>3</sub>); IR (neat): 2922, 2359, 2340, 1749, 1492, 1368, 1287, 1246, 1082, 1059, 1030, 913, 759, 626 cm<sup>-1</sup>; HRMS (ESI): *m/z* calc. for C<sub>19</sub>H<sub>28</sub>NO<sub>8</sub>Se [M+NH<sub>4</sub>]<sup>+</sup> 478.0980; found 478.0980.

(2*R*,3*R*,4*S*,5*R*,6*S*)-2-(acetoxymethyl)-6-(((2*R*,3*R*,4*S*,5*R*,6*S*)-4,5-diacetoxy-2-(acetoxymethyl)-6-(phenylselanyl)tetrahydro-2*H*-pyran-3-yl)oxy)tetrahydro-2*H*-pyran-3,4,5-triyl triacetate (**3v**)<sup>48</sup>

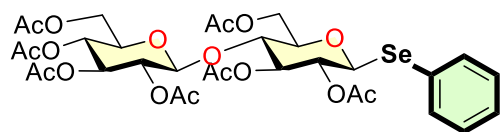

R<sub>f</sub> = 0.3 (EtOAc /cyclohexane: 1/1); 63.6 mg, 82%, White solid. m. p.: 186.5-189.1 °C; [α]<sub>D</sub><sup>18</sup> = - 22.9 (c, 0.35, CHCl<sub>3</sub>); <sup>1</sup>H NMR (300 MHz, CDCl<sub>3</sub>) δ 7.89-7.92 (m, 1H), 7.58-7.60 (m, 1H), 7.23-7.34 (m, 3H), 4.83-5.23 (m, 5H), 4.35-4.58 (m, 3H), 3.87-4.17 (m, 4H), 3.62-3.71 (m, 2H), 2.11 (s, 3H), 2.06 (s, 3H), 2.05 (s, 3H), 2.02 (s, 3H), 2.00 (s, 3H), 1.99 (s, 3H), 1.98 (s, 3H); IR (neat): 2460, 2369, 2340, 1749, 1702, 1481, 1373, 1301, 1287, 1246, 1082, 1060, 1059, 1030, 928, 773, 619 cm<sup>-1</sup>; HRMS (ESI): m/z calc. for C<sub>32</sub>H<sub>44</sub>NO<sub>17</sub>Se [M+NH<sub>4</sub>]<sup>+</sup> 794.1769; found 794.1776.

(2*R*,3*R*,4*S*,5*R*,6*S*)-2-((benzyloxy)methyl)-6-((4-methoxyphenyl)selanyl)tetrahydro-2*H*-pyran-3,4,5-triyl tribenzoate (**3w**)

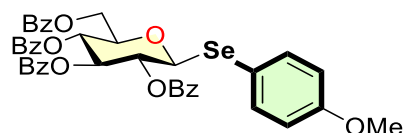

R<sub>f</sub> = 0.3 (EtOAc /cyclohexane: 2/8); 65.3 mg, 85%, White solid. m. p.: 100.0-100.4 °C; [α]<sub>D</sub><sup>18</sup> = + 24.5 (c, 0.16, CHCl<sub>3</sub>); <sup>1</sup>H NMR (300 MHz, CDCl<sub>3</sub>) δ 7.87-8.07 (m, 10H), 7.21-7.56 (m, 14H), 6.30-6.34 (m, 1H), 6.03-6.08 (m, 1H), 5.81-5.91 (m, 1H), 4.66-4.71 (m, 1H), 4.51-4.56 (m, 1H), 4.40-4.45 (m, 1H), 2.39 (s, 3H); <sup>13</sup>C NMR (75 MHz, CDCl<sub>3</sub>) δ 166.1 (C), 165.7 (C), 165.1 (C), 164.6 (C), 144.7 (C), 133.5 (CH), 133.4 (CH), 133.3 (CH), 133.0 (CH), 131.8 (C), 130.7 (C), 130.2 (CH), 129.8 (2CH), 129.6 (CH), 128.7 (C), 128.4 (2CH), 128.3 (2CH), 125.7 (C), 124.6 (C), 92.6 (CH), 73.2 (CH), 72.9 (CH), 70.9 (CH), 69.2 (CH), 62.7 (CH<sub>2</sub>), 21.7 (CH<sub>3</sub>). IR (neat): 2365, 2343, 2325, 1732, 1266, 1069, 773 cm<sup>-1</sup>; HRMS (ESI): m/z calc. for C<sub>41</sub>H<sub>34</sub>NO<sub>10</sub>Se [M+NH<sub>4</sub>]<sup>+</sup> 784.1655; found 784.1652.

(2*R*,3*R*,4*S*,5*R*,6*R*)-2-(acetoxymethyl)-6-((4-methoxyphenyl)selanyl)tetrahydro-2*H*-pyran-3,4,5-triyl triacetate (**3x**)

<sup>48</sup> Sau, A.; Misra, A. K., *Synlett* **2011**, 13, 1905-1911.



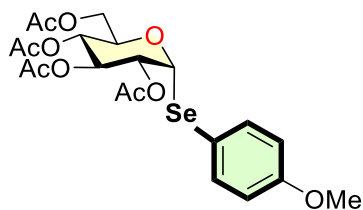

Rf = 0.3 (EtOAc /cyclohexane: 3/7); 46.6 mg, 90%, White solid. m. p.: 129.5-130.2 °C;  $[\alpha]_D^{18} = +226.1$  (c, 0.23, CHCl<sub>3</sub>); <sup>1</sup>H NMR (300 MHz, CDCl<sub>3</sub>) δ 7.44-7.48 (m, 2H), 6.80-6.85 (m, 2H), 6.06 (d, *J* = 6.0 Hz, 1H), 5.39 (t, *J* = 9.0 Hz, 1H), 5.00-5.11 (m, 2H), 4.49-4.55 (m, 1H), 4.25-4.30 (m, 1H), 3.96-4.01 (m, 1H), 3.79 (s, 3H), 2.10 (s, 3H), 2.05 (s, 3H), 2.04 (s, 3H), 2.03 (s, 3H); <sup>13</sup>C NMR (75 MHz, CDCl<sub>3</sub>) δ 170.5 (C), 169.9 (C), 169.7 (C), 169.5 (C), 136.7 (2CH), 135.0 (C), 117.2 (C), 115.0 (2CH), 83.3 (CH), 71.3 (CH), 71.1 (CH), 69.6 (CH), 68.4 (CH), 61.9 (CH<sub>2</sub>), 55.3 (CH<sub>3</sub>), 20.8 (CH<sub>3</sub>), 20.6 (CH<sub>3</sub>), 20.6 (CH<sub>3</sub>); IR (neat): 2460, 2362, 1749, 1244, 1223, 1038, 778 cm<sup>-1</sup>; HRMS (ESI): *m/z* calc. for C<sub>21</sub>H<sub>26</sub>NO<sub>10</sub>Se [M+NH<sub>4</sub>]<sup>+</sup> 536.1029; found 536.1029

(2*R*,3*R*,4*S*,5*R*,6*S*)-2-(acetoxymethyl)-6-((4-(4-(4-methylbenzoyl)piperazin-1-yl)phenyl)selanyl)tetrahydro-2*H*-pyran-3,4,5-triyl triacetate (**6a**)

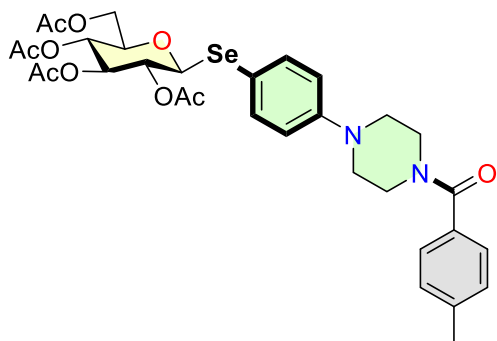

Rf = 0.2 (EtOAc /cyclohexane: 1/1); 62.0 mg, 90 %, White solid. m. p.: 135.1-136.1 °C;  $[\alpha]_D^{18} = -29.2$  (c, 0.24, CHCl<sub>3</sub>); <sup>1</sup>H NMR (300 MHz, CDCl<sub>3</sub>) δ 7.50-7.52 (m, 2H), 7.35-7.38 (m, 2H), 7.24-7.28 (m, 2H), 6.82-6.85 (m, 2H), 5.18 (t, *J* = 12.0 Hz, 1H), 4.91-5.03 (m, 2H), 4.76-4.79 (m, 1H), 4.13-4.20 (m, 2H), 3.65-3.78 (m, 5H), 3.22-3.33 (m, 4H), 2.41 (s, 3H), 2.10 (s, 3H), 2.09 (s, 3H), 2.02 (s, 3H), 1.99 (s, 3H); <sup>13</sup>C NMR (75 MHz, CDCl<sub>3</sub>) δ 170.6 (C), 170.5 (C), 170.2 (C), 169.4 (C), 169.2 (C), 151.3 (C), 140.1 (C), 137.7 (2CH), 132.5 (C), 129.2 (2CH), 127.3 (2CH), 116.4 (2CH), 115.2 (2CH), 80.4 (CH), 76.8 (CH), 73.9 (CH), 70.7 (CH), 68.2 (CH), 62.1 (CH<sub>2</sub>), 49.0 (2CH<sub>2</sub>), 48.9 (2CH<sub>2</sub>), 21.4 (CH<sub>3</sub>), 20.8 (2CH<sub>3</sub>), 20.6 (CH<sub>3</sub>); IR (neat): 2360, 2341, 2327, 1755, 1589, 1366, 1290, 1156, 1058, 1040, 910, 830, 773 cm<sup>-1</sup>; HRMS (ESI): *m/z* calc. for C<sub>32</sub>H<sub>39</sub>N<sub>2</sub>O<sub>10</sub>Se [M+NH<sub>4</sub>]<sup>+</sup> 691.1770; found 691.1785.

(2*R*,3*R*,4*S*,5*R*,6*S*)-2-(acetoxymethyl)-6-((4-(*N*,4-dimethylbenzamido)methyl)phenyl)selanyl) tetrahydro-2*H*-pyran-3,4,5-triyl triacetate (**6b**)

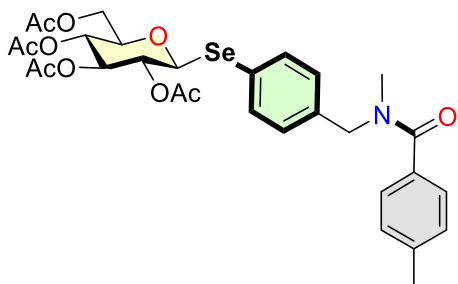

R<sub>f</sub> = 0.2 (EtOAc /cyclohexane: 1/1); 58.3 mg, 95%, White solid. m. p.: 157.6-158.1 °C; [α]<sub>D</sub><sup>18</sup> = - 8.5 (c, 0.59, CHCl<sub>3</sub>); <sup>1</sup>H NMR (300 MHz, CDCl<sub>3</sub>) δ 7.59-7.62 (m, 2H), 7.20-7.38 (m, 6H), 5.21 (t, *J* = 9.0 Hz, 1H), 4.88-5.08 (m, 2H), 4.91-4.98 (m, 1H), 4.51-4.88 (m, 2H), 4.12-4.27 (m, 2H), 3.69-3.75 (m, 1H), 2.81-3.09 (m, 3H), 2.38 (s, 3H), 2.09 (s, 3H), 2.09 (s, 3H), 2.03 (s, 3H), 2.00 (s, 3H); <sup>13</sup>C NMR (75 MHz, CDCl<sub>3</sub>) δ 170.5 (C), 170.1 (C), 169.6 (C), 169.4 (C), 167.7 (C), 139.9 (C), 135.6 (2CH), 133.1 (C), 129.1 (4CH), 127.0 (2CH), 125.9 (C), 124.8 (C), 80.9 (CH), 76.9 (CH), 73.8 (CH), 70.8 (CH), 68.2 (CH), 62.1 (CH<sub>2</sub>), 29.7 (CH<sub>2</sub>), 21.3 (CH<sub>3</sub>), 20.8 (2CH<sub>3</sub>), 20.7 (CH<sub>3</sub>), 20.5 (CH<sub>3</sub>), 20.5 (CH<sub>3</sub>), 20.5 (CH<sub>3</sub>); IR (neat): 2360, 2341, 1755, 1606, 1368, 1326, 1248, 1213, 1126, 1095, 1063, 1037, 1014, 980, 914, 830, 776 cm<sup>-1</sup>; HRMS (ESI): *m/z* calc. for C<sub>30</sub>H<sub>36</sub>NO<sub>10</sub>Se [M+NH<sub>4</sub>]<sup>+</sup> 650.1520; found 650.1520.

(2*R*,3*R*,4*S*,5*R*,6*S*)-2-(acetoxymethyl)-6-((4-((4-(4-methylbenzoyl)piperazin-1-yl)methyl) phenyl)selenanyl)tetrahydro-2*H*-pyran-3,4,5-triyl triacetate (**6c**)

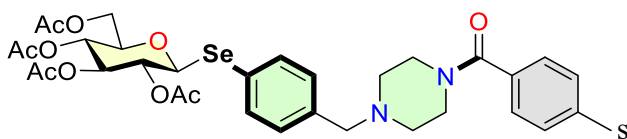

R<sub>f</sub> = 0.2 (EtOAc /cyclohexane: 1/1); 57.9 mg, 82%, White solid. m. p.: 133.3-134.4 °C; [α]<sub>D</sub><sup>18</sup> = - 8.3 (c, 0.24, CHCl<sub>3</sub>); <sup>1</sup>H NMR (300 MHz, CDCl<sub>3</sub>) δ 7.54-7.57 (m, 2H), 7.18-7.32 (m, 6H), 5.20 (t, *J* = 9.0 Hz, 1H), 4.96-5.06 (m, 2H), 4.86-4.90 (m, 1H), 4.11-4.25 (m, 2H), 3.53-3.73 (m, 7H), 2.41-2.55 (m, 4H), 2.37 (s, 3H), 2.08 (s, 3H), 2.07 (s, 3H), 2.02 (s, 3H), 1.98 (s, 3H); <sup>13</sup>C NMR (75 MHz, CDCl<sub>3</sub>) δ 170.5 (C), 170.5 (C), 170.1 (C), 169.4 (C), 169.2 (C), 139.8 (C), 138.5 (C), 135.3 (2CH), 132.9 (C), 129.6 (2CH), 129.0 (2CH), 127.2 (2CH), 125.5 (C), 80.9 (CH), 76.9 (CH), 73.8 (CH), 70.7 (CH), 68.2 (CH), 62.4 (CH<sub>2</sub>), 62.1 (CH<sub>2</sub>), 53.1 (4CH<sub>2</sub>), 21.3 (CH<sub>3</sub>), 20.7 (2CH<sub>3</sub>), 20.5 (CH<sub>3</sub>); IR (neat): 2360, 2341, 2327, 1755, 1632, 1459, 1299, 1248, 1059, 1040, 1001, 911, 753 cm<sup>-1</sup>; HRMS (ESI): *m/z* calc. for C<sub>33</sub>H<sub>41</sub>N<sub>2</sub>O<sub>10</sub>Se [M+NH<sub>4</sub>]<sup>+</sup> 705.1917; found 705.1917.

### 1.3 Part 3 Synthesize of aryl thioglycosides by using a photoredox dual-catalysis

#### A) Introduction

Light is a kind of natural resource. Inspired by photosynthesis, in 1912, Giacomo Ciamician<sup>49</sup> put forward the idea of solar energy can be an important reaction driver instead of heat. Recently, due to the rapid development of the chemical industry, more and more scientists face on energy and environmental issues. In this context, the research of new activation processes in organic synthesis became one of the most important challenges during this decade.

At early-stage development of photocatalysis reactions, the UV light was used to promote the formation of new bonds of organic molecules. But due to the high energy of UV light, special reaction tube and system be required, which lead to complex reaction operation and experiment cost. What's more, side reaction cannot be controlled by effect of UV light. So, more and more scientists want to apply low energy visible light in photocatalysis instead of UV light. The pioneers of scientists in this field are Joseph Priestley<sup>50</sup> and Nicholas Theodore de Saussure<sup>51</sup>. Recently, the group of MacMillan and Yoon whos reported various complex (**Scheme 22**) such as Eosin Y, DPA or Ru- and Ir-complexes which can be acted as photocatalysts in various reactions. Compared with traditional organic reaction, visible light catalytic reaction has the advantage of mild reaction condition, high reaction efficiency, and less side reaction. Usually, visible light catalytic reactions occur at room temperature, and tolerate various sensitive chemical functions.

---

<sup>49</sup> Ciamician, G., *Science*, **1912**, *36*, 385-394.

<sup>50</sup> Roth, H. D., *Angew. Chem. Int. Ed.* **1989**, *28*, 1193–1207.

<sup>51</sup> (a) Priestley, J., *Experiments and Observations on Different Kinds of Air*, Birmingham, **1790**; (b) Ihde, A. J. *The Development of Modern Chemistry*, New York, **1964**.

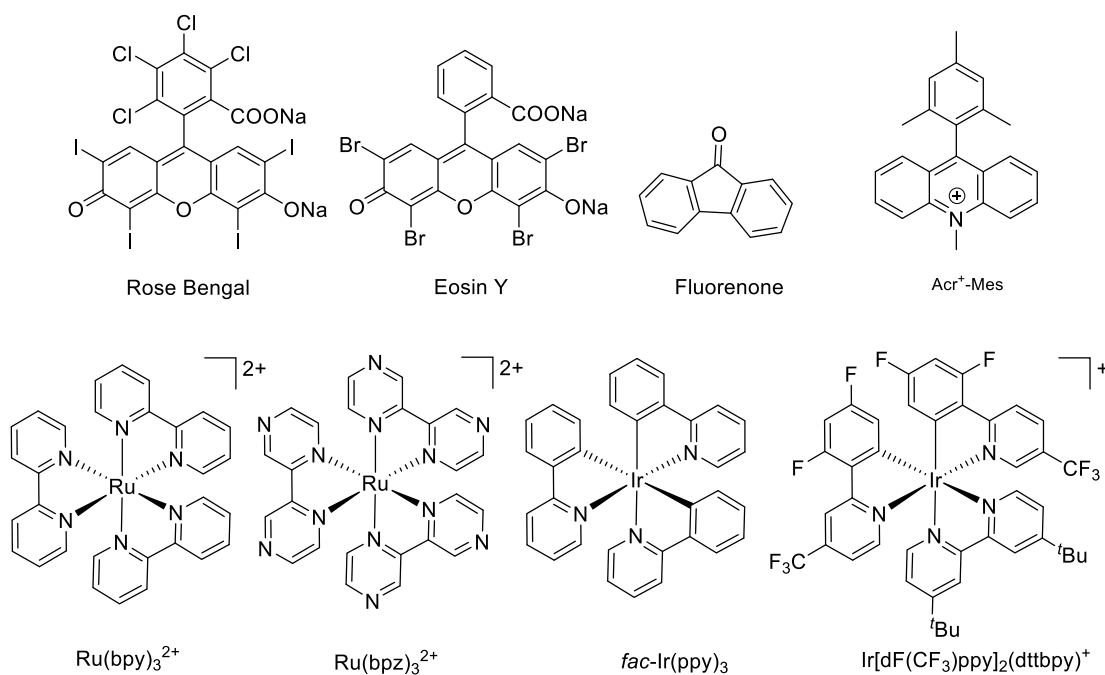

**Scheme 22.** Photoredox catalyst

At present, there are two pathways of known mechanism of photocatalysis reaction (**Table 12**):

1. Electron transfer mechanism: ground state photocatalyst (PC) be activated by visible light, and forms the excited state photocatalyst (PC\*). This later possess both characteristic of oxidant and reductant. When PC\* activates the substrate in a reductive quenching cycle, lower valence photocatalyst (PC<sup>n-1</sup>) and cationic radical (ST<sup>•+</sup>) formed; however, under the oxidative quenching cycle, PC\* react with a substrate to produce a higher valence photocatalyst (PC<sup>n+1</sup>) and anion radical (ST<sup>•-</sup>).
2. Energy transfer mechanism: in this case, the excited state photocatalyst (PC\*) can react with reagent (ST), the energy from PC\* be transferred to ST and form the ST\*.

**(a) Electron Transfer**

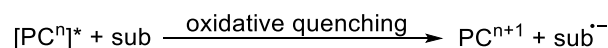
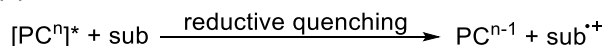

**(b) Energy Transfer**

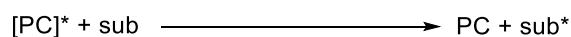

**Table 12.** Several common photoreaction mechanisms

Based on these recent achievements on the Pd-catalyzed synthesis of thioglycosides and on our ongoing interests in metal-catalyzed functionalization of thiosugars, we were interesting to develop new approaches involving earth abundant metal catalysts (Cu, Co, Ni and etc.). We were inspired by the work of the group of Molander<sup>52</sup> who reported the thioarylation of unprotected peptides under Ni/photoredox catalysis. Thus, we decided to explore the Ni/photoredox-dual-catalysis approach to perform the coupling between thiosugars and aryl halides. This study was performed in collaboration with E. Magnier @ILV, UVSQ, Versailles.

## B) Publication

### Ni/Photoredox-Dual-Catalyzed (Hetero)Arylation, Alkenylation and Alkynylation of 1-Thiosugars

Mingxiang Zhu,<sup>a</sup> Guillaume Dagusset,<sup>b</sup> Mouad Alami,<sup>a</sup> Emmanuel Magnier<sup>b</sup> and Samir Messaoudi<sup>a</sup>

<sup>a</sup> BioCIS, Univ. Paris-Sud, CNRS, University Paris-Saclay, Châtenay-Malabry, France

<sup>b</sup> Institut Lavoisier de Versailles, UMR 8180, Université de Versailles Saint-Quentin 78035 Versailles Cedex, France

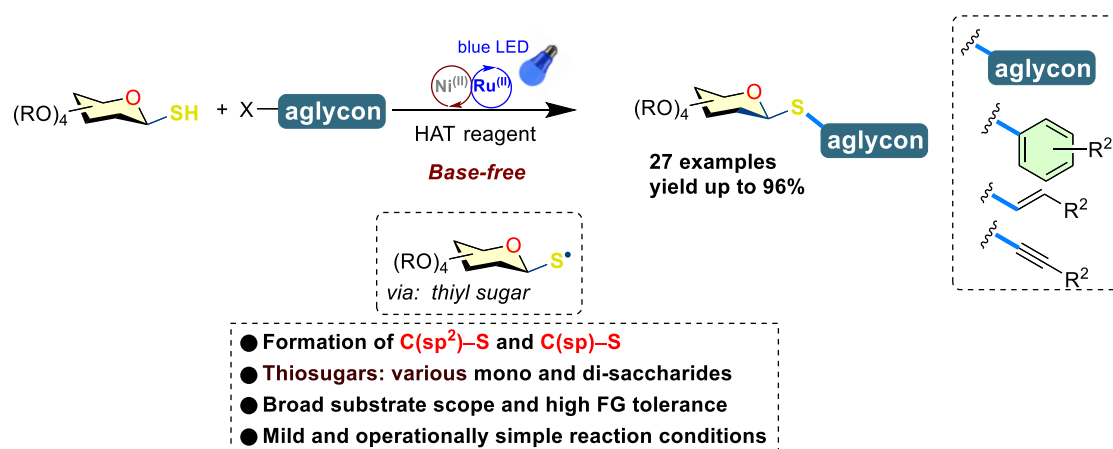

*Org. Lett.* **2019**, *21*, 13, 5132-5137, DOI: 10.1021/acs.orglett.9b01730.

**ABSTRACT:** A general protocol for functionalization of glycosyl thiols has been reported. This protocol is based on a single-electron Ni/photoredox dual-catalyzed cross-coupling between 1-thiosugars and a broad range of arylbromides and iodides as

<sup>52</sup> Vara, B. A.; Li, X.; Berritt, S.; Walters, C. R.; Peterssona, E. J.; Molander, G. A., *Chem. Sci.*, **2018**, *9*, 336-344.

well as alkenyl and alkynyl halides. This base-free method gives access to a series of functionalized thioglycosides in moderate to excellent yields with a perfect control of the anomeric configuration. Moreover, we demonstrated that this methodology maybe transporte successfully to the continuous-flow photoredox chemistry.

1-Thioglycosides are of great and are found in many important medicinal compounds.<sup>53</sup> These derivatives have been investigated as mimetics of biologically relevant *O*-glycosides as they are known to be stable under both basic and acidic aqueous conditions and resistant towards enzymatic hydrolysis.<sup>54</sup> Examples in **Figure 1** highlight some biological activities of selected 1-thioglycosides, including hSGLT1 inhibitor, ligand of lectine A, cytotoxic Hsp90 inhibitor, galactosidase and glycosidase inhibitors, as well as antimicrobial agent. In addition, thioglycosides are considered as versatile intermediates in organic synthesis.<sup>55</sup>

---

<sup>53</sup> a) For general reviews, see: a) Driguez, H. *Glycoscience Synthesis of Substrate Analogs And Mimetics*. **1997**, 187, 85-116; b) Witczak, Z. J. T., *Curr. Med. Chem.* **1999**, 6, 165-178; c) Pachamuthu, K.; Schmidt, R. R., *Chem. Rev.* **2006**, 106, 160-187; d) Samuni-Blank, M.; Izhaki, I.; Dearing, M. D.; Gerchman, Y.; Trabelcy, B.; Karasov, A. L. W. H.; Arad, Z., *Curr. Biol.* **2012**, 22, 1218-1220; e) Lian, G.; Zhang, X.; Yu, B., *Carbohydr. Res.* **2015**, 403, 13-22. For Selected articles: f) Castaneda, F.; Burse, A.; Boland, W.; Kinne, R. K. H., *Int. J. Med. Sci.* **2007**, 4, 131-139; g) Rodrigue, J.; Ganne, G.; Blanchard, B.; Saucier, C.; Giguere, D.; Shiao, T. C.; Varrot, A.; Imberty, A.; Roy, R., *Org. Biomol. Chem.* **2013**, 11, 6906-6918; h) Elgemeie, G. H.; Farag, A. B.; Amin, K. M.; El-Badry, O. M.; Hassan, G. S., *Med. Chem.* **2014**, 4, 814-820; i) Aouad, M. R., *Nucleos. Nucleot. Nucl.* **2016**, 35, 1-15; j) Kato, E.; Nagano, H.; Yamamura, S.; Ueda, M., *Tetrahedron*, **2003**, 59, 5909-5917; k) Schnabelrauch, M.; Vasella, A.; Withers, S. G., *Helv. Chim. Acta.* **1994**, 77, 778-799; l) Adinolfi, M.; d'Ischia, M.; Iadonisi, A.; Leone, L.; Pezzella, A.; Valerio, S., *Eur. J. Org. Chem.* **2012**, 23, 4333-4338; m) Shiota, K.; Kato, Y.; Suzuki, K.; Sugiyama, Y., *J. Pharmacol. Exp. Ther.* **2001**, 299, 459-467; n) Caraballo, R.; Sakulsombat, M.; Ramström, O., *ChemBioChem* **2010**, 11, 1600-1606.

<sup>54</sup> a) Rye, C. S.; Withers, S. G., *Carbohydr. Res.* **2004**, 339, 699-703; b) Metaferia, B. B.; Fetterolf, B. J.; Shazad-ul-Hussan, S.; Moravec, M.; Smith, J. A.; Ray, S.; Gutierrez-Lugo, M.-T.; Bewley, C. A., *J. Med. Chem.* **2007**, 50, 6326-6336; c) Castaneda, F.; Burse, A.; Boland, W.; Kinne, R. K.-H., *Int. J. Med. Sci.* **2007**, 4, 131-139.

<sup>55</sup> a) Codee, J. D. C.; Litjens, R. E. J. N.; van den Bos, L. J.; Overkleeft, H. S.; van der Marel, G. A., *Chem. Soc. Rev.* **2005**, 34, 769-782; for selected examples, see: b) Johannes, M.; Reindl, M.; Gerlitzki, B.; Schmitt, E.; Hoffmann-Rçder, A., *Beilstein J. Org. Chem.* **2015**, 11, 155-161; c) Budhadev, D.; Mukhopadhyay, B., *Carbohydr. Res.* **2014**, 384, 51-55; d) Basu, N.; Kumar Maity, S.; Ghosh, R., *RSC Adv.* **2012**, 2, 12661-12664; e) Verma, P.; Raj, R.; Roy, B.; Mukhopadhyay, B., *Tetrahedron: Asymmetry* **2010**, 21, 2413-2418; f) D. Xiong, C.; Zhang, L. H.; Ye, X. S., *Adv. Synth. Catal.* **2008**, 350, 1696-1700; g) Roy, B.; Pramanik, K.; Mukhopadhyay, B., *Glycoconjugate J.* **2008**, 25, 157-166; h) Zeng, Y.; Wang, Z.; Whitfield, D.; Huang, X., *J. Org. Chem.* **2008**, 73, 7952-7962; i) Fridman, M.; Belakhov,

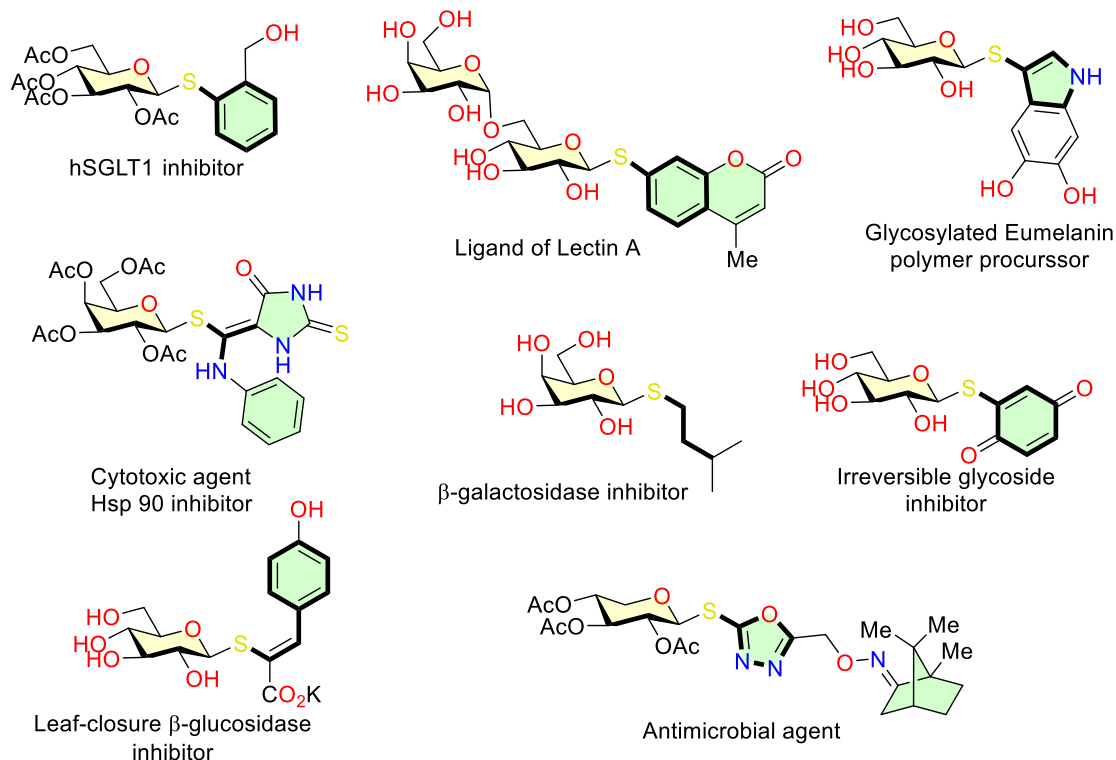

**Figure 1.** Example of Biologically Active Thioglycosides

Despite their potential interest in medicinal chemistry, little attention has been devoted to synthesis of (hetero)arylthioglycosides. Usually, they are prepared by treating per-*O*-acetylated glycosyls with a thiophenol in the presence of a Lewis acid,<sup>56</sup> or by substituting the halogen atom of an acetohaloglycoside with a thiolate anion.<sup>57</sup> These procedures suffer from the use of an excess of harsh acidic reagents, and are generally

---

V.; Lee, L. V.; Liang, F.-S.; Wong, C.-H.; Baasov, T., *Angew. Chem. Int. Ed.* **2005**, *44*, 447-452; *Angew. Chem.* **2005**, *117*, 451-456.

<sup>56</sup> a) Furneaux, R. H.; Ferrier, R. J., *Methods Carbohydr. Chem.* **1980**, *8*, 251-253; b) Nicolaou, K. C.; Randall, J. L.; Furst, G. T., *J. Am. Chem. Soc.* **1985**, *107*, 5556-5558; c) Das, S. K.; Roy, J.; Reddy, K. A.; Abbineni, C., *Carbohydr. Res.* **2003**, *338*, 2237-2240; d) Tai, C.-A.; Kulkarni, S. S.; Hung, S.-C., *J. Org. Chem.* **2003**, *68*, 8719-8722; e) Agnihotri, G.; Tiwari, P.; Misra, A. K., *Carbohydr. Res.* **2005**, *340*, 1393-1396.

<sup>57</sup> a) Fischer, E.; Delbrueck, K., *Ber. Dtsch. Chem. Ges.* **1909**, *42*, 1476-1482; b) Blanc-Muesser, M.; Defaye, J.; Driguez, H., *Carbohydr. Res.* **1978**, *67*, 305-328; c) Apparau, M.; Blanc-Muesser, M.; Defaye, J.; Driguez, H., *Can. J. Chem.* **1981**, *59*, 314-320.

restricted in substrate scope with respect to thiophenols. Various Pd-,<sup>58</sup> Ni-,<sup>59</sup> or Cu-catalyzed<sup>60</sup> S-arylations of glycosyl thiols with aryl iodides were developed independently by Sticha, Xue, and our group.<sup>61</sup> However, demanding reaction conditions such as high catalyst loadings (30 mol% in the case of Ni-catalysis), specialized phosphine ligands for the Pd-catalysis, elevated reaction temperatures (80-120 °C cases of Pd- or Cu-catalysis), and long reaction times often limit the practicability or the scope of substrates. Moreover, in all these cases the coupling is effective with only aryl iodides, however the cross-coupling with aryl bromides is rather unexplored. Owing to the significant importance of functionalized thioglycosides, there is a strong impetus to discover new chemical transformations, general, mild, and efficient for their efficient synthesis and functionalization (**Figure 2a**).

Dual nickel photocatalysis has emerged as a powerful strategy and a remarkably efficient tool for organic cross-coupling reactions in the last years.<sup>62</sup> This approach was used successfully for the C–C and C–heteroatom bond forming reactions. Very recently, Molander *et al.* reported the first Ni/photoredox cross-coupling reaction for the S-arylation of cysteine-containing unprotected peptides.<sup>63</sup> The authors showed that the

---

<sup>58</sup> a) Brachet, E.; Brion, J.-D.; Messaoudi, S.; Alami, M., *Adv. Synth. Catal.* **2013**, *355*, 2627-2636; b) Brachet, E.; Brion, J.-B.; Messaoudi, S.; Alami, M., *Adv. Synth. Catal.* **2013**, *355*, 477-490; c) Bruneau, A.; Roche, M.; Hamze, A.; Brion, J.-D.; Alami, M.; Messaoudi, S., *Chem. Eur. J.* **2015**, *21*, 8375-8379; d) AL-Shuaeeb, R. A. A.; Montoir, D.; Alami, M.; Messaoudi, S., *J. Org. Chem.* **2017**, *82*, 6720-6728; e) Probst, N.; Lartia, R.; Théry, O.; Alami, M.; Defrancq, E.; Messaoudi, S., *Chem. Eur. J.* **2018**, *24*, 1795-1800; f) Montoir, D.; Amoura, M.; Ababsa, Z. E.-A.; Vishwanath, T. M.; Yen-Pon, E.; Robert, V.; Beltramo, M.; Piller, V.; Alami, M.; Aucagne, A.; Messaoudi, S., *Chem. Sci.*, **2018**, *9*, 8753-8759. g) Benmahdjoub, S.; Ibrahim, N.; Benmerad, B.; Alami, M.; Messaoudi S., *Org. Lett.* **2018**, *20*, 4067-4071.

<sup>59</sup> Brachet, E.; Brion, J.-D.; Alami, M.; Messaoudi, S., *Chem. Eur. J.* **2013**, *19*, 15276-15280.

<sup>60</sup> a) Nauš, P.; Lešetický, L.; Smrček, S.; Tišlerová, I.; Šticha, M., *Synlett* **2003**, *14*, 2117-2122; b) Chabrier, A.; Bruneau, A.; Benmahdjoub, S.; Benmerad, B.; Belaid, S.; Brion, J.-D.; Alami, M.; Messaoudi, S., *Chem. Eur. J.* **2016**, *22*, 15006-15010. c) Yuan, X.; Kou, Y.; Yu, L.; Zhang, Z.-X.; Xue, W., *Org. Chem. Front.* **2015**, *2*, 1604-1607.

<sup>61</sup> For a recent review, see: Ibrahim, N.; Alami, M.; Messaoudi, S., *Asian. J. Org. Chem.* **2018**, *7*, 2026-2038.

<sup>62</sup> selected review, see: Prier, C. K.; Rankic, D. A.; MacMillan, D. W. C. *Chem. Rev.* **2013**, *113*, 5322-5363; b) Twilton, J.; Le, C. (C.); Zhang, P.; Shaw, M. H.; Evans, R. W.; MacMillan, D. W. C., *Nature Reviews Chemistry*, **2017**, *1*, 0052 c) Megan Shaw, H.; Twilton, J.; MacMillan, D. W. C., *J. Org. Chem.*, **2016**, *81*, 6898-6926; d) Milligan, J. A.; Phelan, J. P.; Badir, S. O.; Molander, G. A., *Angew. Chem. Int. Ed.* **2019**, *58*, 6152-6163.

<sup>63</sup> Vara, B. A.; Li, X.; Berritt, S.; Walters, C. R.; Petersson, E. J.; Molander, G. A., *Chem. Sci.*, **2018**, *9*, 336-344.



## (I) Metal catalyzed cross-couplings

### a) Buchwald-Hartwig-Migita coupling

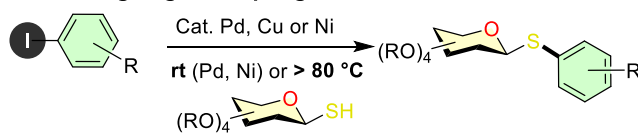

### b) C(sp<sup>2</sup>)-H thioarylation

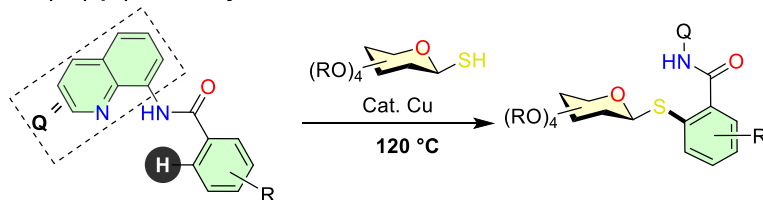

### c) This work: Ni/photoredox-dual catalysis

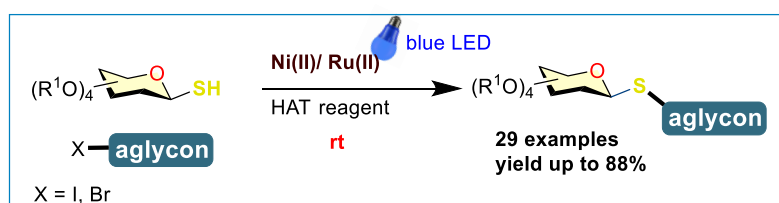

## (II) Proposed mechanism pathway and catalyst combination

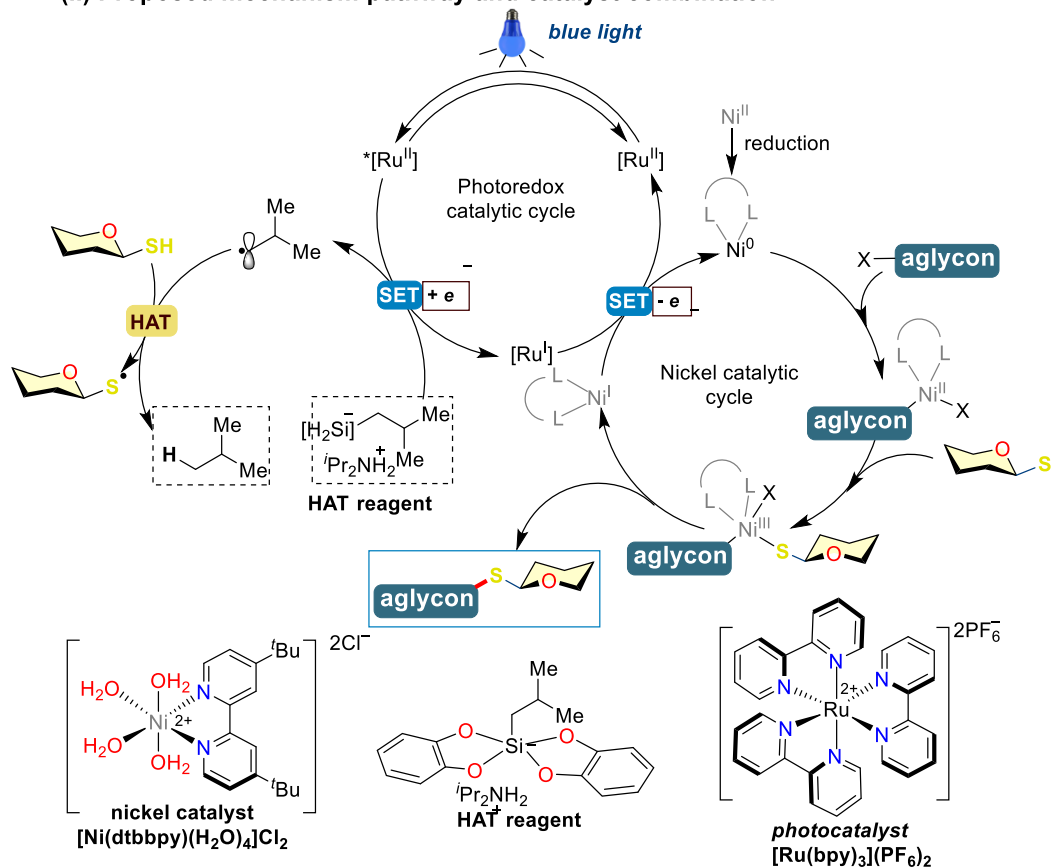

**Figure 2.** (Ia and b) traditional metal catalyzed cross-coupling methods for the synthesis of thioglycosides (Ic) Dual nickel photocatalyzed approach, (II) proposed mechanism

mildness of this approach allows late-stage functionalization of complex biomolecules.

In continuation of our study on the reactivity of thiosugars under transition metal catalysis, we became interested in whether the S-(hetero)arylation of 1-thiosugars could be realized by the single-electron dual Ni/photocatalysis (**Figure 2**). We considered that 1-thiosugars may be suitable substrates for such a strategy, keeping in mind that a practical synthetic method should work not only with aryl iodides but also with aryl bromides as well as alkenyl- and alkynylbromides. We could assume that the catalytic cycle may be initiated by photon absorption, generating excited state Ru photocatalyst, followed by oxidation of the HAT reagent via single electron transfer (SET) (**Figure 2**). In this context, ammonium bis(catechol)alkylsilicates were recently found to be effective hydrogen atom transfer (HAT) reagents for Csp<sup>2</sup>-S coupling under the Ni/photoredox processes.<sup>64</sup> Rapid H atom abstraction from the glycosyl sulfhydryl group generates a glycosyl thiyl radical. This later adds to Ni(II) which arises from Ni(0) oxidative addition with the aglycon halide. In a possible alternative of the catalytic cycle, Molander, Kozlowski, and co-workers reported that the thiyl radical metalation may precede the oxidative addition step.<sup>65</sup> Reductive elimination from Ni(III) affords the desired thioglycoside, and the dual catalytic cycles are closed by a final SET.

In the first set of experiments, we examined the coupling of tetra-*O*-acetylated 1-thio- $\beta$ -D-glucopyranose **1a** with 1-bromobenzonitrile **2a** as a model study under various reaction conditions. Representative results from this study are summarized in Table 1. The reaction of **1a** (1 equiv) with **2a** (1 equiv) was first investigated under the Molander's conditions using 5 mol% of a nickel(II) dtbbpy (dtbbpy = 4, 4'-di-tert-butyl-2, 2'-bipyridine) precatalyst, 2 mol% of a commercially available [Ru(bpy)<sub>3</sub>(PF<sub>6</sub>)<sub>2</sub>] photocatalyst in the presence of ammonium bis(catechol)alkylsilicate (1.3 equiv) as a HAT reagent under blue light emitting diode (LED) irradiation (Table 1, entry 1). Pleasingly, this protocol afforded the desired thioglycoside **3a** in a moderate 59% yield as a single  $\beta$ -anomer ( $J_{1,2} = 9$  Hz). Increasing the amount of the bromide partner **2a** from 1 equiv to 1.3 equiv furnished **3a** in a good 79% yield (**Table 13, entry 2**). Moreover, the yield was increased up to 85% yield when 1.5 equiv of **2a** were used

---

<sup>64</sup> Jouffroy, M.; Kelly, C. B.; Molander, G. A., *Org. Lett.* **2016**, *18*, 876.

<sup>65</sup> Gutierrez, O.; Tellis, J. C.; Primer, D. N.; Molander, G. A.; Kozlowski, M. C. *J. Am. Chem. Soc.* **2015**, *137*, 4896.

(Table 13, entry 3). The optimization reaction conditions was continued with respect to solvent, however, no significant improvement of the yield of **3a** was observed when DMA, DMSO, MeCN and THF were used (Table 13, entries 5-8). Finally, performing the coupling reaction with the iodobenzonitrile instead the bromide led to **3a** in 90% yield (Table 13, entry 9). Extensive examinations of the other reaction parameters revealed that the use of molecular sieves plays an important role in the outcome of the C(sp<sup>2</sup>)-S bond formation. The yield of **3a** was improved up to 95% with complete retention of the anomeric configuration when the reaction was conducted in the presence of molecular sieves (Table 13, entry 10).

**Table 13.** Optimization of the Coupling Reaction of Tetraacetylated  $\beta$ -thiogucose **1a** with **2a**<sup>a</sup>

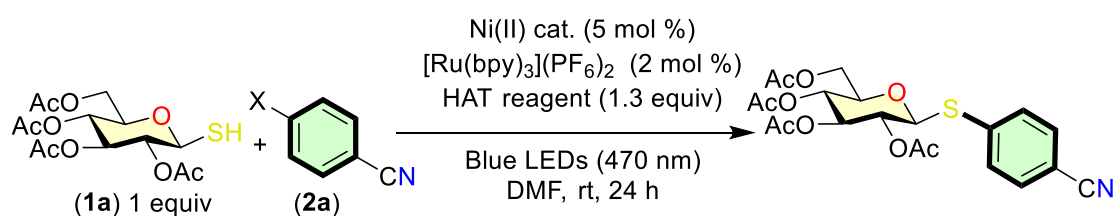

Entry	X	equiv of 2a	Solvent	4a (%) <sup>b</sup>
1	Br	1	DMF	59
2	Br	1.3	DMF	79
3	Br	1.5	DMF	85
4	Br	2	DMF	81
5	Br	2	DMA	32
6	Br	2	DMSO	54
7	Br	2	MeCN	40
8	Br	2	THF	19
9	I	1.5	DMF	90
10	I	1.5	DMF	95 <sup>c</sup>

<sup>a</sup>A sealable tube was charged with thiosugar **1a** (1 equiv, 0.2 mmol), 1-bromo-4-benzonitrile **2a** (xx equiv), [Ni(dtbbpy)(H<sub>2</sub>O)<sub>4</sub>]Cl<sub>2</sub> precatalyst (5 mol %), [Ru(bpy)<sub>3</sub>](PF<sub>6</sub>)<sub>2</sub> (2 mol%), HAT reagent (diisopropylammonium bis(catechol)isobutylsilicate) (1.3 equiv) in dry and degassed DMF (1.0 mL). <sup>b</sup>Yield of isolated product. <sup>c</sup>150 mg of molecular sieves were added.

Motivated by these exciting results, we subsequently investigated the substrate scope for this dual Ni/photocatalysis process by systematically varying the electrophile

partner **2** and the thiosugar substrates **1a-e** (**Scheme 23**). Gratifyingly, all the coupling proceeded cleanly and selectively in good yields. As illustrated in Scheme 1, a variety of electron-deficient and electron-rich aryl iodides having *para*- and *meta*-substitution effectively underwent reaction with *tetra-O*-acetylated 1-thio- $\beta$ -D-glucopyranose **1a** in yields up to 96% (products **3a-o**). Various reactive functional groups were tolerated, such as nitrile (**3a**), ester (**3g**), halogens (**3b-d**, **3h**), isobutyl (**3n**) and aminoacid (**3o**). In addition, the sterically demanding *ortho* substitution patterns engaged in the coupling reaction of **1a**, furnishing compounds **3d**, **3l** and **3m** having an *ortho* substituent groups in 88%, 73% and 85% yields, respectively.

Aside from aryl iodides, aryl bromides can also serve as coupling partners under Ni-photocatalysis. For example, cross-coupling of aryl bromides bearing various functions (-CN, -Cl, -F and -OMe) have been successfully achieved under room temperature to afford the corresponding thioglycosides (**3a-b**, **3h**, **3i**, **3k,l**) in moderate to good yields with no changes to the standard reaction conditions. However, we can note that aryl bromides are less reactive than their iodide congeners in this cross-coupling protocol. Interestingly, couplings with heteroaryl halides derived from quinolinone, pyridine, and indole have also been successful, furnishing **3p-r** in excellent yields (87% to 95%). In addition, *para*-iodophenylalanine (NH-Boc) can be employed as a coupling partner (compound **3o**). One can note that across a number of substrates, coupling products were afforded in comparable yields to those obtained under palladium-catalyzed (thermal) conditions.

**Scheme 23.** Scope of Coupling of Thioglucose **1a** with haloarenes **2**

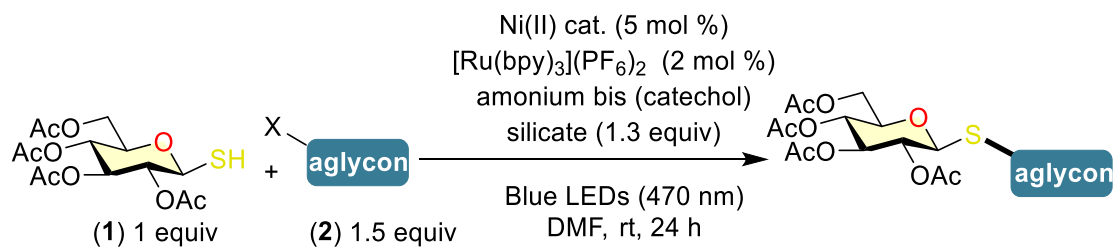

### Electron-withdrawing groups

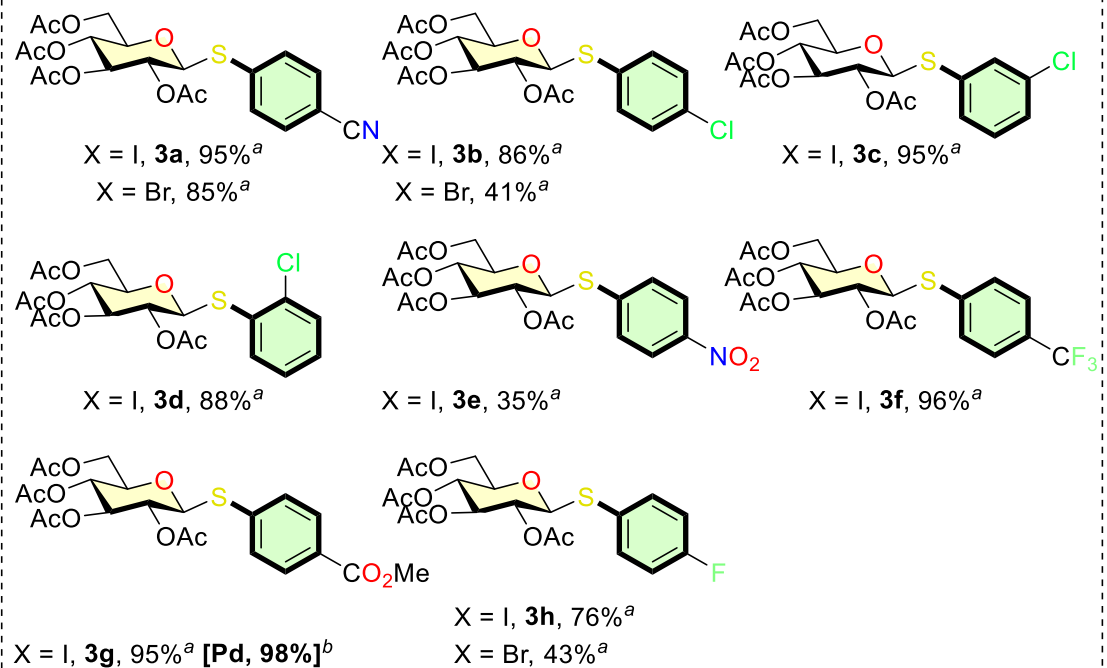

### Electron-donating groups

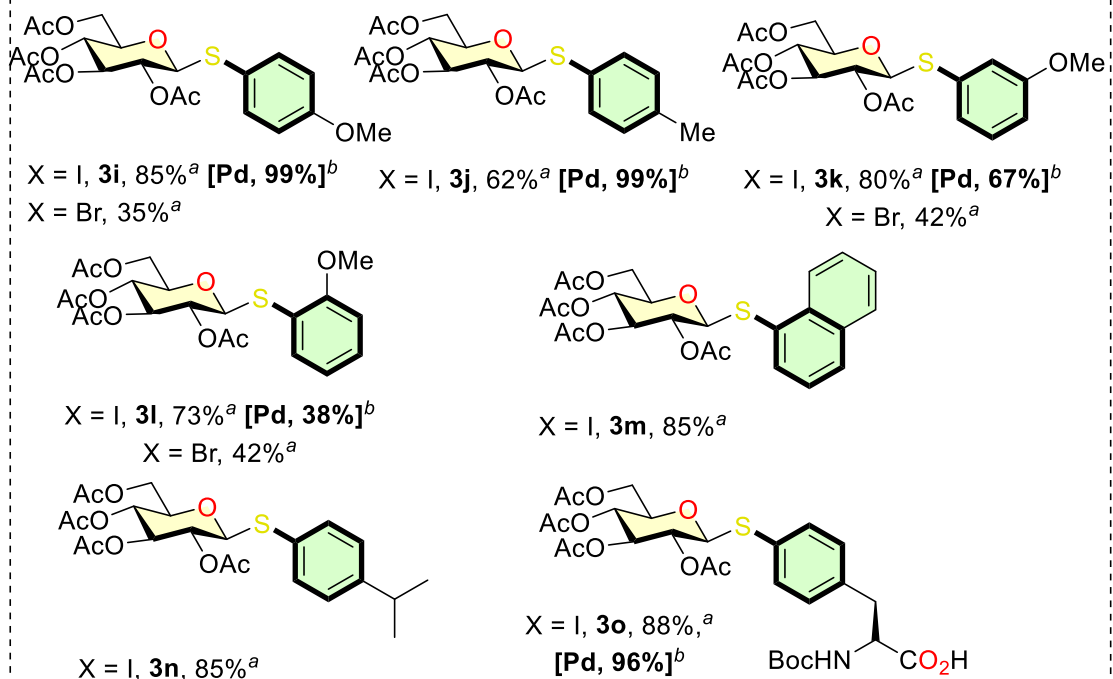

### Heterocycles

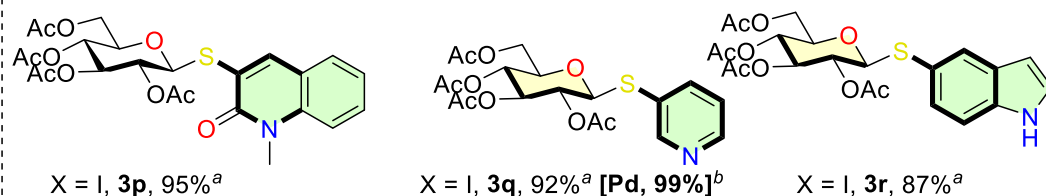

### Alkenyl- and alkynyl-halides

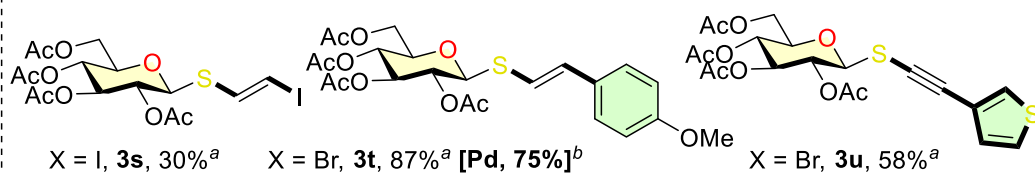

### Application to bioactive compound

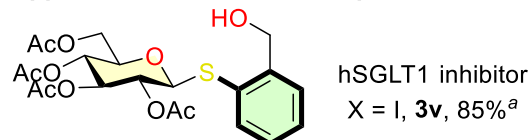

Reaction conditions: A sealable tube was charged with thiosugar 1a (1 equiv, 0.2 mmol), aryl halide 2a (1.5 equiv), [Ni(dtbbpy)(H<sub>2</sub>O)<sub>4</sub>]Cl<sub>2</sub> precatalyst (5 mol %), [Ru(bpy)<sub>3</sub>](PF<sub>6</sub>)<sub>2</sub> (2 mol%), HAT reagent (diisopropylammonium bis(catechol)isobutylsilicate) (1.3 equiv) in dry and degassed DMF (1.0 mL). a Yield of isolated product. b Comparison with results obtained by Pd-catalysis reported in Ref. [7a, 7b and 7c].

In hope of further pushing the limit of this Ni-photocatalysis S-arylation, we examined the coupling of *tetra-O*-acetylated 1-thio- $\beta$ -D-glucopyranose **1a** with alkenyl- and alkynyl halides as aglycon partners. Delightfully, when *E*- $\beta$ -styryl bromide was employed, the coupling with **1a** afforded stereoselectively the desired alkenylthioglycoside derivative **3t** in 87% yields. Moreover, alkynylated thioglycoside product **3u** was obtained in a 58% yield when 4-(bromoethynyl)thiophene was used as the coupling partner. Of note that in all the studied cases, compounds **3a-u** were isolated as single anomers, clearly indicating that the Ni/photoredox process is stereoretentive with respect to the anomeric configuration of the sugar moiety (**Scheme 23**).

**Scheme 24.** Scope of Thiosugars **1b-g** Coupling With Iodo-bromoarenes **3a-d**

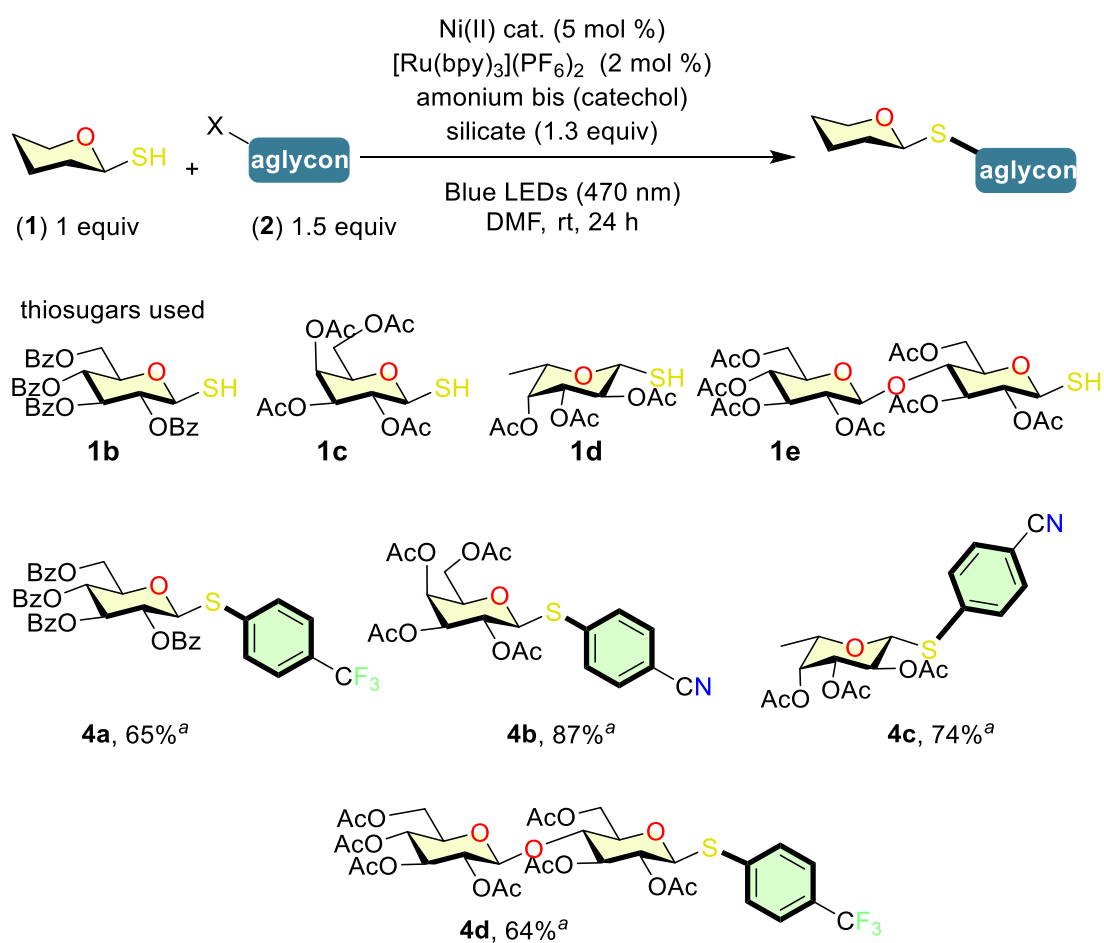

Reaction conditions: A sealable tube was charged with thiosugar **1a** (1 equiv, 0.2 mmol), aryl halide **2a** (1.5 equiv), [Ni(dtbbpy)(H<sub>2</sub>O)<sub>4</sub>]Cl<sub>2</sub> precatalyst (5 mol %), [Ru(bpy)<sub>3</sub>](PF<sub>6</sub>)<sub>2</sub> (2 mol %), HAT reagent (diisopropylammonium bis(catechol)isobutylsilicate) (1.3 equiv) in dry and degassed DMF (1.0 mL). <sup>a</sup> Yield of isolated product.

Next, we turned our attention to the generality of the method with respect to glycosyl thiols. As depicted in Scheme 2, this coupling reaction tolerates a large variety of glycosylthiols **1a-e**: *O*-benzoylated 1-thio- $\beta$ -D-glucopyranose **1b** *O*-acetylated 1-thio- $\beta$ -D-galactopyranose **1c** and *O*-acetylated 1-thio- $\beta$ -D-fucopyranose **1d** all coupled with the 4-iodobenzonitrile **2a** to give thioglycosides **4a-c** in good yields. Moreover, the reaction is not limited to monosaccharides, but can be applied to more complex disaccharide derivatives. Thus, 1-thio- $\beta$ -D-cellobiose **1e** was efficiently reacted with **2a** to give **4a** in 64% yield. Importantly, the stereochemistry of the  $\beta$ -1, 4'-*O*-glycosidic bond in the disaccharides remained intact (**Scheme 24**).

Recently, continuous flow synthetic methodologies combined to photochemistry has become an emerging field. This combination could allow the development of fully automated process with an increased efficiency and, in many cases, improved sustainability. The great peculiarity of a flow photoredox system is a very efficient irradiation that allows to speed the reaction rate up so that productivity is generally greatly improved with respect to the batch system. Indeed, reaction scale up is usually easy to perform with high yields. In order to accelerate our coupling process, we attempted to transport the continuous-flow techniques to our reaction. We were pleased to see that the thioarylation of **1a** with **2a** in a large-scale version (0.8 mmol scale, 4 fold), could be carried out under the same conditions at a residence time of 20 min at 25 °C. Remarkably, run smoothly with complete conversion and the desired product was isolated in 79% yield (**Scheme 25**).

**Scheme 25.** Continuous flow Coupling of Thioglucose **1a** with **2a**

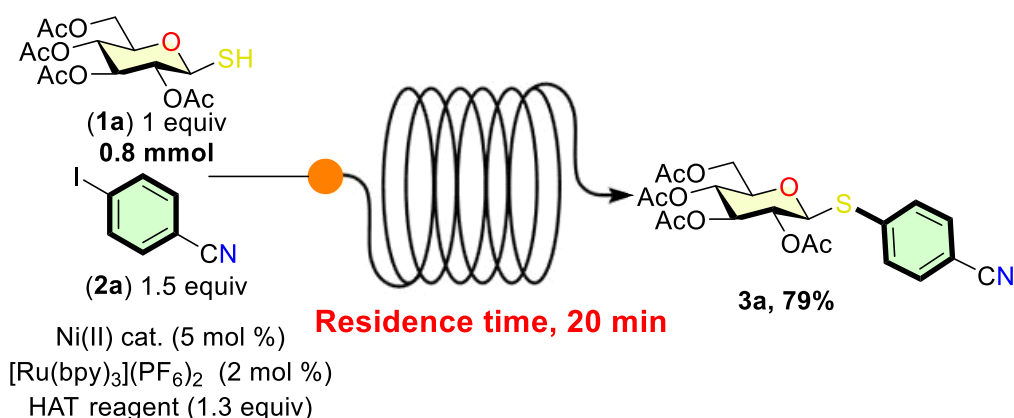

In summary, we have shown that 1-thiosugars are competent nucleophile partners in the Ni/photoredox-dual-catalyzed cross-coupling reactions, and developed a general



method for the synthesis of thioglycosides. The method tolerates a wide range of functional groups such as aryl, heteroaryl, alkenyl and alkynyl bromides and iodides. In addition, a variety of glycosyl thiols could be used. We expect this simple and general method to be of broad utility for the synthesis and development of new medicinal agents.

### C) Conclusion and perspectives

A new photoredox cross-coupling between 1-thiosugars and aryl, alkenyl and alkynyl halides in mild reaction condition has been developed. The reaction conditions involve the use of only 5 mol% of the Ni catalyst and 2 mol% of the photocatalyst under base free conditions. By using of flow chemistry technology, the gram-scale reaction could be completed efficiently in only 20 min.

Unfortunately, there are still two shortcomings with this coupling : (i) no tolerance to unprotected thiosugars, and (ii) the reactivity of aryl bromides (yield < 50%) still.

### D) Experimental part

#### General information

Solvents and reagents are obtained from commercial suppliers and were used without further purification. Analytical TLC was performed using Merck silica gel F254 (230-400 mesh) plates and analyzed by UV light or by staining upon heating with vanilin solution (15 g of vanilin in 250 mL ethanol and 2.5 mL of concentrated sulfuric acid). For silica gel chromatography, the flash chromatography technique was used, with Merck silica gel 60 (230-400 mesh) and p.a. grade solvents unless otherwise noted. The  $^1\text{H}$  NMR and  $^{13}\text{C}$  NMR spectra were recorded in either  $\text{CDCl}_3$ , acetone- $d_6$ , or DMSO- $d_6$  on Bruker Avance 300 spectrometers. The chemical shifts of  $^1\text{H}$  and  $^{13}\text{C}$  are reported in ppm relative to the solvent residual peaks. IR spectra were measured on a Bruker Vector 22 spectrophotometer.

Merck silica gel 60 (0.015–0.040 mm) was used for column chromatography. Melting points were recorded on a Büchi B-450 apparatus and are uncorrected. High resolution mass spectra (HR-MS) were recorded on a MicroMass LCT Premier Spectrometer spectrometer. Optical rotations were obtained with a PolAAR 32 polarimeter. Thiosugars were synthesized as according the following protocols.<sup>66</sup> The

---

<sup>66</sup> a) Floyd, N.; Vijayakrishnan, B.; Koeppel, J. R.; Davis, B. G., *Angew. Chem., Int. Ed.*, **2009**, *48*, 7798-7802. b)

diisopropylammonium bis(catechol)isobutylsilicate was synthesized according to literature protocol.<sup>67</sup> The  $[\text{Ni}(\text{dtbbpy})(\text{H}_2\text{O})_4]\text{Cl}_2$  precatalyst was synthesized according to literature protocol.<sup>68</sup>

Photochemistry: Photoredox reactions were irradiated with blue LED ( $\sim 470$  nm) strips, and the temperature ( $\sim 25$  °C) was controlled using one external desk fan set up  $\sim 15$ -20 cm away from this photoreactor bed (**Figure 2**).



**Figure 2** photoreactor bed

Flow experiments were conducted thanks to an easyPhotochem E-Series system from Vapourtec with a 10 mL reactor irradiated with a 450 nm blue LED system.

### **General Procedures for the coupling of Thiosugars 1a-e with haloarenes 2**

A sealable tube purged with argon equipped with a cap was charged with thiosugar **1a-e** (1 equiv), aryl halide (if solid) (1.5 equiv),  $[\text{Ni}(\text{dtbbpy})(\text{H}_2\text{O})_4]\text{Cl}_2$  (5 mol%),  $[\text{Ru}(\text{bpy})_3](\text{PF}_6)_2$  (2 mol%), HAT reagent (diisopropylammonium bis(catechol)isobutylsilicate) (1.3 equiv), the tube was flushed again with Argon, aryl halide (if liquid) (1.5 equiv) and dry DMF (0.2 M) was added. The mixture was stirred

---

Gamblin, D. P.; Garnier, P.; van Kasteren, S.; Oldham, N. J.; Fairbanks, A. J.; Davis, B. G., *Angew. Chem., Int. Ed.*, **2004**, *43*, 828-833.

<sup>67</sup> Lin, K.; Kelly, C. B.; Jouffroy, M.; Molander, G. A.; *Org. Synth.*, **2017**, *94*, 16-33.

<sup>68</sup> Gutiérrez-Bonet, Á.; Tellis, J. C.; Matsui, J. K.; Vara, B. A.; Molander, G. A., *ACS Catal.*, **2016**, *6*, 12, 8004-8008.

for 5 min. And then, the mixture was placed in the photoreactor vessel ~5-7 cm away from the blue LEDs, and allowed to stirred vigorously for 12-48 h at rt. The temperature of the reaction was maintained at approximately 25 °C via a fan. Purification was performed with flash chromatography on silica gel.

### Procedures for continuous flow coupling of thioglucose **1a** with **2a**

A sealable tube purged with argon equipped with a cap was charged with thiosugar **1a** (0.8 mmol, 1 equiv), iodobenzonitrile **2a** (1.5 equiv), [Ni(dtbbpy)(H<sub>2</sub>O)<sub>4</sub>]Cl<sub>2</sub> (5 mol%), [Ru(bpy)<sub>3</sub>](PF<sub>6</sub>)<sub>2</sub> (2 mol%), HAT reagent (diisopropylammonium bis(catechol)isobutylsilicate) (1.3 equiv), the tube was flushed again with Argon and dry DMF (4 mL, 0.2 M) was added. The mixture was stirred for 5 min. Then, using an easy-Photochem E-Series system from Vapourtec with a 10 mL reactor irradiated with a 450 nm blue LED system, the solution was pumped at a flow rate of 0.5 mL.min<sup>-1</sup> at 25°C. After collecting the reaction mixture, the solvent was removed *in vacuo*, and the crude product was purified by a flash chromatography on silica gel to afford the desired pure thioglycoside **3a** in 79% yield.

### Unsuccessful substrates

#### Thiosugars:

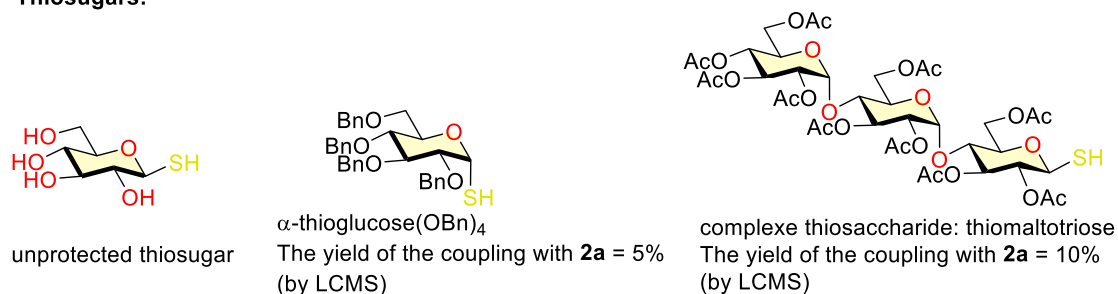

#### Electrophilic partners:

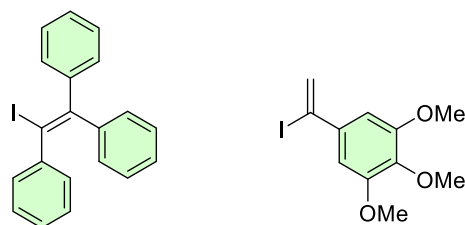
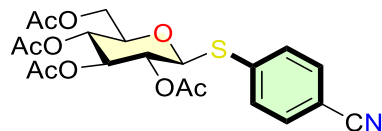

Figure 3 Unsuccessful substrates

## Experimental data

### (2R,3R,4S,5R,6S)-2-(acetoxymethyl)-6-((4-cyanophenyl)thio)tetrahydro-2H-pyran-3,4,5-triyl triacetate 3a



R<sub>f</sub> = 0.3 (EtOAc /cyclohexane: 3/7); White solid (88.1 mg, 95%), m. p.: 170.0 – 171.3 °C; [α]<sub>D</sub><sup>18</sup> = –28.1(c, 0.21, CHCl<sub>3</sub>); <sup>1</sup>H NMR (300 MHz, CDCl<sub>3</sub>) δ 7.51-7.58 (m, 4H), 5.24 (t, *J* = 9.0 Hz, 1H), 5.01 (td, *J* = 12.0, 9.0 Hz, 2H), 4.81 (d, *J* = 9.0 Hz, 1H), 4.13-4.25 (m, 2H), 3.75-3.81 (m, 1H), 2.06 (s, 3H), 2.04 (s, 3H), 2.01 (s, 3H), 1.97 (s, 3H); <sup>13</sup>C NMR (75 MHz, CDCl<sub>3</sub>) δ 170.3 (C), 170.0 (C), 169.3 (C), 169.1 (C), 139.2 (CH<sub>2</sub>), 132.3 (2CH), 131.5 (2CH), 118.2 (C), 111.4 (C), 84.5 (CH), 76.1 (CH), 73.6 (CH), 69.7 (CH), 68.1 (CH), 62.1 (C), 20.7 (CH<sub>3</sub>), 20.6 (CH<sub>3</sub>), 20.5 (2CH<sub>3</sub>); IR (neat): 2360, 2341, 1755, 1248, 1088, 773 cm<sup>-1</sup>; HRMS (ESI): *m/z* calc. for C<sub>21</sub>H<sub>23</sub>NNaO<sub>9</sub>S [M+Na]<sup>+</sup> 488.0986; found 488.0993.

**Larger scale experiment:** Prepared according to the general procedure A using 1 mmol of the *O*-acetylated β-thioglucose. This desired product was obtained as a white solid in 83% yield after flash column chromatography (Cyclohexane / EtOAc: 7/3).

### (2R,3R,4S,5R,6S)-2-(acetoxymethyl)-6-((4-chlorophenyl)thio)tetrahydro-2H-pyran-3,4,5-triyl triacetate 3b<sup>69</sup>

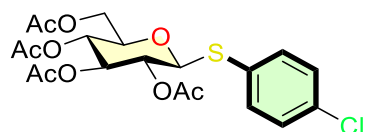

R<sub>f</sub> = 0.2 (EtOAc /cyclohexane: 3/7); White solid (81.2 mg, 86%), <sup>1</sup>H NMR (300 MHz,

---

<sup>69</sup> Weng, S.; Lin, Y.; Chen, C., *Org. Lett.*, **2006**, *8*, 5633-5636.

CDCl<sub>3</sub>)  $\delta$  7.43 (d,  $J = 9.0$  Hz, 2H), 7.27 (d,  $J = 9.0$  Hz, 2H), 5.20 (t,  $J = 9.0$  Hz, 1H), 4.96 (td,  $J = 24.0, 12.0$  Hz, 2H), 4.64 (d,  $J = 9.0$  Hz, 1H), 4.13-4.23 (m, 2H), 3.67-3.73 (m, 1H), 2.07 (s, 3H), 2.06 (s, 3H), 2.00 (s, 3H), 1.97 (s, 3H); HRMS (ESI):  $m/z$  calc. for C<sub>20</sub>H<sub>23</sub>ClNaO<sub>9</sub>S [M+Na]<sup>+</sup> 497.0644; found 497.0652.

**(2R,3R,4S,5R,6S)-2-(acetoxymethyl)-6-((3-chlorophenyl)thio)tetrahydro-2H-pyran-3,4,5-triyl triacetate 3c**

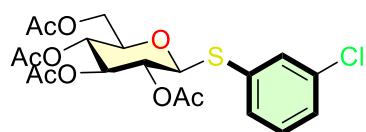

R<sub>f</sub> = 0.2 (EtOAc /cyclohexane: 3/7); White solid (90.0 mg, 95%), m. p.: 85.6-86.6 °C; [ $\alpha$ ]<sub>D</sub><sup>18</sup> = -29.6 (c, 0.24, CHCl<sub>3</sub>); <sup>1</sup>H NMR (300 MHz, CDCl<sub>3</sub>)  $\delta$  7.53 (m, 1H), 7.23-7.38 (m, 3H), 5.25 (t,  $J = 9.0$  Hz, 1H), 5.02 (td,  $J = 21.0, 12.0$  Hz, 2H), 4.74 (d,  $J = 12.0$  Hz, 1H), 4.17-4.28 (m, 2H), 3.74-3.81 (m, 1H), 2.11 (s, 3H), 2.10 (s, 3H), 2.04 (s, 3H), 2.01 (s, 3H); <sup>13</sup>C NMR (75 MHz, CDCl<sub>3</sub>)  $\delta$  170.6 (C), 170.1 (C), 169.3 (C), 169.2 (C), 134.6 (C), 133.7 (C), 132.3 (CH), 130.8 (CH), 129.9 (CH), 128.5 (CH), 85.4 (CH), 76.0 (CH), 73.9 (CH), 69.8 (CH), 68.1 (CH), 62.1 (CH<sub>2</sub>), 20.7 (2CH<sub>3</sub>), 20.5 (2CH<sub>3</sub>); IR (neat): 2360, 2341, 1750, 1558, 1219, 1040, 774, 682 cm<sup>-1</sup>; HRMS (ESI):  $m/z$  calc. for C<sub>20</sub>H<sub>23</sub>ClNaO<sub>9</sub>S [M+Na]<sup>+</sup> 497.0644; found 497.0651.

**(2R,3R,4S,5R,6S)-2-(acetoxymethyl)-6-((2-chlorophenyl)thio)tetrahydro-2H-pyran-3,4,5-triyl triacetate 3d**

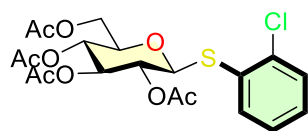

R<sub>f</sub> = 0.2 (EtOAc /cyclohexane: 3/7); White solid (83.6 mg, 95%), m. p.: 136.9-137.6 °C; [ $\alpha$ ]<sub>D</sub><sup>18</sup> = -35.3 (c, 0.23, CHCl<sub>3</sub>); <sup>1</sup>H NMR (300 MHz, CDCl<sub>3</sub>)  $\delta$  7.58-7.61 (m, 1H), 7.39-7.42 (m, 1H), 7.22-7.26 (m, 2H), 5.25 (t,  $J = 9.0$  Hz, 1H), 5.07 (td,  $J = 9.0, 6.0$  Hz, 2H), 4.79 (d,  $J = 12.0$  Hz, 1H), 4.12-4.26 (m, 2H), 3.73-3.77 (m, 1H), 2.07 (s, 3H), 2.06 (s, 3H), 2.02 (s, 3H), 1.99 (s, 3H); <sup>13</sup>C NMR (75 MHz, CDCl<sub>3</sub>)  $\delta$  170.4 (C), 170.1 (C),

169.3 (2C), 136.1 (C), 133.1 (CH), 132.0 (C), 130.0 (CH), 129.1 (CH), 127.2 (CH), 85.1 (CH), 75.9 (CH), 73.9 (CH), 69.8 (CH), 68.3 (CH), 62.2 (CH<sub>2</sub>), 20.7 (2CH<sub>3</sub>), 20.5 (2CH<sub>3</sub>); IR (neat): 2361, 2341, 1756, 1455, 433, 1248, 1090, 1034, 828. 774 cm<sup>-1</sup>; HRMS (ESI): m/z calc. for C<sub>20</sub>H<sub>23</sub>ClNaO<sub>9</sub>S [M+Na]<sup>+</sup> 497.0644; found 497.0645.

**(2R,3R,4S,5R,6S)-2-(acetoxymethyl)-6-((4-nitrophenyl)thio)tetrahydro-2H-pyran-3,4,5-triyl triacetate 3e**<sup>70</sup>

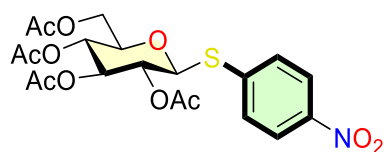

R<sub>f</sub> = 0.2 (EtOAc /cyclohexane: 2/1); White solid (33.8 mg, 35%), <sup>1</sup>H NMR (300 MHz, CDCl<sub>3</sub>) δ 8.16 (d, *J* = 9.0 Hz, 2H), 7.59 (d, *J* = 9.0 Hz, 2H), 5.27 (t, *J* = 9.0 Hz, 1H), 5.06 (td, *J* = 9.0, 9.0 Hz, 2H), 4.86 (d, *J* = 12.0 Hz, 1H), 4.17-4.29 (m, 2H), 3.78-3.87 (m, 1H), 2.10 (s, 3H), 2.08 (s, 3H), 2.04 (s, 3H), 2.00 (s, 3H); HRMS (ESI): m/z calc. for C<sub>20</sub>H<sub>23</sub>NNaO<sub>11</sub>S [M+Na]<sup>+</sup> 508.0884; found 508.0888.

**(2R,3R,4S,5R,6S)-2-(acetoxymethyl)-6-((4-(trifluoromethyl)phenyl)thio)tetrahydro-2H-pyran-3,4,5-triyl triacetate 3f**

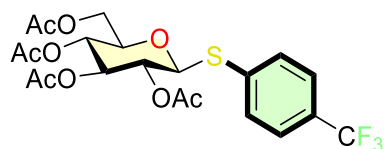

R<sub>f</sub> = 0.2 (EtOAc /cyclohexane: 3/7); White solid (97.7 mg, 95%), m. p.: 153.8-154.9 °C; [α]<sub>D</sub><sup>18</sup> = - 17.8 (c, 0.34, CHCl<sub>3</sub>); <sup>1</sup>H NMR (300 MHz, CDCl<sub>3</sub>) δ 7.53-7.60 (m, 4H), 5.23 (t, *J* = 12.0 Hz, 1H), 5.01 (td, *J* = 9.0, 12.0 Hz, 2H), 4.77 (d, *J* = 9.0 Hz, 1H), 4.14-4.25 (m, 2H), 3.72-3.78 (m, 1H), 2.06 (s, 3H), 2.05 (s, 3H), 2.01 (s, 3H), 1.98 (s, 3H);

<sup>70</sup> Sau, A.; Misra, A. K., *Synlett*, **2011**, 13, 1905-1911.

$^{13}\text{C}$  NMR (75 MHz,  $\text{CDCl}_3$ )  $\delta$  170.4 (C), 170.0 (C), 169.3 (C), 169.2 (C), 136.8 (C), 132.3 (2CH), 130.2 (q,  $J = 30$  Hz) (C), 125.7 (2CH), 120.3 (q,  $J = 270$  Hz) (C), 84.9 (CH), 76.0 (CH), 73.8 (CH), 69.8 (CH), 68.1 (CH), 62.1 ( $\text{CH}_2$ ), 20.6 (2 $\text{CH}_3$ ), 20.5 (2 $\text{CH}_3$ ); IR (neat): 2361, 2341, 1156, 1367, 1326, 1248, 1127, 1095, 1039, 830, 116, 670  $\text{cm}^{-1}$ ; HRMS (ESI):  $m/z$  calc. for  $\text{C}_{21}\text{H}_{23}\text{F}_3\text{NaO}_9\text{S}$   $[\text{M}+\text{Na}]^+$  531.0907; found 531.0897.

**(2R,3R,4S,5R,6S)-2-(acetoxymethyl)-6-((4-(methoxycarbonyl)phenyl)thio)tetrahydro-2H-pyran-3,4,5-triyl triacetate 3g<sup>71</sup>**

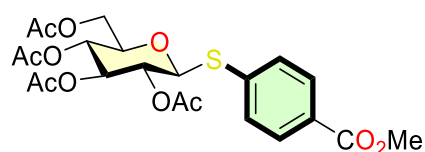

$R_f = 0.2$  (EtOAc /cyclohexane: 7/3); White solid (94.4 mg, 95%),  $^1\text{H}$  NMR (300 MHz,  $\text{CDCl}_3$ )  $\delta$  7.95 (d,  $J = 9.0$  Hz, 2H), 7.50 (d,  $J = 9.0$  Hz, 2H), 5.24 (t,  $J = 12.0$  Hz, 1H), 5.03 (td,  $J = 9.0, 12.0$  Hz, 2H), 4.82 (d,  $J = 9.0$  Hz, 1H), 4.14-4.26 (m, 2H), 3.90 (s, 3H), 3.75-3.80 (m, 1H), 2.08 (s, 3H), 2.06 (s, 3H), 2.01 (s, 3H), 1.98 (s, 3H); HRMS (ESI):  $m/z$  calc. for  $\text{C}_{22}\text{H}_{26}\text{NaO}_{11}\text{S}$   $[\text{M}+\text{Na}]^+$  521.1088; found 521.1088.

**(2R,3R,4S,5R,6S)-2-(acetoxymethyl)-6-((4-fluorophenyl)thio)tetrahydro-2H-pyran-3,4,5-triyl triacetate 3h**

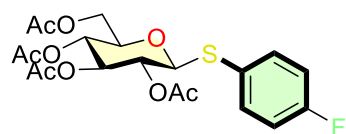

$R_f = 0.2$  (EtOAc /cyclohexane: 3/7); White solid (69.7 mg, 76%), m. p.: 86.8-88.7  $^\circ\text{C}$ ;  $[\alpha]_D^{18} = -24.2$  (c, 0.33,  $\text{CHCl}_3$ );  $^1\text{H}$  NMR (300 MHz,  $\text{CDCl}_3$ )  $\delta$  7.46-7.51 (m, 2H),

<sup>71</sup> Bruneau, A.; Roche, M.; Hamze, A.; Brion, J.; Alami, M.; Messaoudi, S., *Chem. Eur. J.*, **2015**, *21*, 8375-8379.

6.97-7.03 (m, 2H), 5.19 (t,  $J = 9.0$  Hz, 1H), 4.94 (td,  $J = 9.0, 30.0$  Hz, 2H), 4.59 (d,  $J = 12.0$  Hz, 1H), 4.13-4.23 (m, 2H), 3.65-3.71 (m, 1H), 2.08 (s, 3H), 2.05 (s, 3H), 1.99 (s, 3H), 1.97 (s, 3H);  $^{13}\text{C}$  NMR (75 MHz,  $\text{CDCl}_3$ )  $\delta$  170.4 (C), 170.1 (C), 169.3 (C), 169.2 (C), 163.2 (d,  $J = 247$  Hz) (C), 136.4 (q,  $J = 8$  Hz) (2CH), 125.8 (C), 116.0 (q,  $J = 23$  Hz) (2CH), 85.3 (CH), 75.9 (CH), 73.9 (CH), 69.8 (CH), 68.1 (CH), 62.0 ( $\text{CH}_2$ ), 20.7 (2 $\text{CH}_3$ ), 20.5 (2 $\text{CH}_3$ ); IR (neat): 2968, 2361, 2341, 1755, 1558, 1456, 1366, 1251, 1089, 837, 773, 670  $\text{cm}^{-1}$ ; HRMS (ESI):  $m/z$  calc. for  $\text{C}_{20}\text{H}_{23}\text{FNaO}_9\text{S}$   $[\text{M}+\text{Na}]^+$  481.0939; found 481.0937.

**(2R,3R,4S,5R,6S)-2-(acetoxymethyl)-6-((4-methoxyphenyl)thio)tetrahydro-2H-pyran-3,4,5-triyl triacetate 3i**<sup>7</sup>

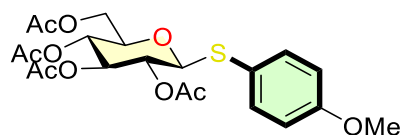

$R_f = 0.2$  (EtOAc /cyclohexane: 7/3); White solid (80.1 mg, 85%),  $^1\text{H}$  NMR (300 MHz,  $\text{CDCl}_3$ )  $\delta$  7.42 (d,  $J = 9.0$  Hz, 2H), 6.83 (d,  $J = 9.0$  Hz, 2H), 5.18 (t,  $J = 9.0$  Hz, 1H), 4.93 (td,  $J = 12.0, 30.0$  Hz, 2H), 4.54 (d,  $J = 9.0$  Hz, 1H), 4.14-4.24 (m, 2H), 3.80 (s, 3H), 3.63-3.69 (m, 1H), 2.08 (s, 3H), 2.06 (s, 3H), 1.99 (s, 3H), 1.96 (s, 3H); HRMS (ESI):  $m/z$  calc. for  $\text{C}_{21}\text{H}_{26}\text{NaO}_{10}\text{S}$   $[\text{M}+\text{Na}]^+$  493.1139; found 493.1148.

**(2R,3R,4S,5R,6S)-2-(acetoxymethyl)-6-(p-tolylthio)tetrahydro-2H-pyran-3,4,5-triyl triacetate 3j**<sup>7</sup>

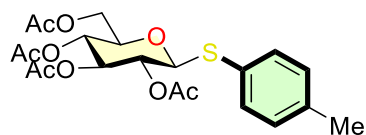

$R_f = 0.2$  (EtOAc /cyclohexane: 7/3); White solid (56.4 mg, 62%),  $^1\text{H}$  NMR (300 MHz,  $\text{CDCl}_3$ )  $\delta$  7.38 (d,  $J = 6.0$  Hz, 2H), 7.11 (d,  $J = 6.0$  Hz, 2H), 5.20 (t,  $J = 9.0$  Hz, 1H), 4.97 (td,  $J = 9.0, 27.0$  Hz, 2H), 4.62 (d,  $J = 9.0$  Hz, 1H), 4.13-4.24 (m, 2H), 3.66-3.72 (m, 1H), 2.34 (s, 3H), 2.08 (s, 3H), 2.07 (s, 3H), 2.00 (s, 3H), 1.97 (s, 3H); HRMS (ESI):  $m/z$  calc. for  $\text{C}_{21}\text{H}_{26}\text{NaO}_9\text{S}$   $[\text{M}+\text{Na}]^+$  477.1190; found 477.1183.



**(2R,3R,4S,5R,6S)-2-(acetoxymethyl)-6-((3-methoxyphenyl)thio)tetrahydro-2H-pyran-3,4,5-triyl triacetate 3k**<sup>7</sup>

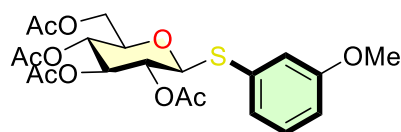

R<sub>f</sub> = 0.2 (EtOAc /cyclohexane: 7/3); White solid (75.3 mg, 80%), <sup>1</sup>H NMR (300 MHz, CDCl<sub>3</sub>) δ 7.20-7.28 (m, 1H), 7.05-7.08 (m, 2H), 6.85-6.89 (m, H), 5.24 (t, *J* = 9.0 Hz, 1H), 5.03 (td, *J* = 12.0, 15.0 Hz, 2H), 4.74 (d, *J* = 9.0 Hz, 1H), 4.16-4.27 (m, 2H), 3.81 (s, 3H), 3.72-3.78 (m, H), 2.09 (s, 3H), 2.09 (s, 3H), 2.03 (s, 3H), 2.00 (s, 3H); HRMS (ESI): *m/z* calc. for C<sub>21</sub>H<sub>26</sub>NaO<sub>10</sub>S [M+Na]<sup>+</sup> 493.1139; found 493.1131.

**(2R,3R,4S,5R,6S)-2-(acetoxymethyl)-6-((2-methoxyphenyl)thio)tetrahydro-2H-pyran-3,4,5-triyl triacetate 3l**<sup>7</sup>

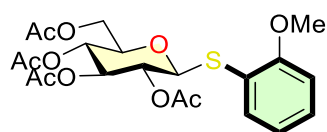

R<sub>f</sub> = 0.2 (EtOAc /cyclohexane: 7/3); White solid (68.6 mg, 73%), <sup>1</sup>H NMR (300 MHz, CDCl<sub>3</sub>) δ 7.47-7.50 (m, 1H), 7.28-7.33 (m, H), 6.88-6.95 (m, 2H), 5.24 (t, *J* = 9.0 Hz, 1H), 5.04 (td, *J* = 9.0, 18.0 Hz, 2H), 4.82 (d, *J* = 12.0 Hz, 1H), 4.12-4.26 (m, 2H), 3.86 (s, 3H), 3.71-3.77 (m, H), 2.07 (s, 3H), 2.07 (s, 3H), 2.03 (s, 3H), 2.00 (s, 3H); HRMS (ESI): *m/z* calc. for C<sub>21</sub>H<sub>26</sub>NaO<sub>10</sub>S [M+Na]<sup>+</sup> 493.1139; found 493.1136.

**(2R,3R,4S,5R,6S)-2-(acetoxymethyl)-6-(naphthalen-1-ylthio)tetrahydro-2H-pyran-3,4,5-triyl triacetate 3m**

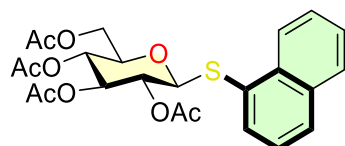

R<sub>f</sub> = 0.2 (EtOAc /cyclohexane: 3/7); White solid (83.2 mg, 85%), m. p.: 145.0-146.2 °C;

$[\alpha]_D^{18} = -20.5$  (c, 0.29,  $\text{CHCl}_3$ );  $^1\text{H NMR}$  (300 MHz,  $\text{CDCl}_3$ )  $\delta$  8.46 (d,  $J = 6.0$  Hz, 1H), 7.81-7.88 (m, 3H), 7.40-7.58 (m, 3H), 5.19 (t,  $J = 9.0$  Hz, 1H), 5.02-5.10 (m, 2H), 4.71 (d,  $J = 9.0$  Hz, 1H), 4.06-4.21 (m, 2H), 3.57-3.63 (m, H), 2.11 (s, 3H), 2.00 (s, 3H), 1.99 (s, 3H), 1.98 (s, 3H);  $^{13}\text{C NMR}$  (75 MHz,  $\text{CDCl}_3$ )  $\delta$  170.5 (C), 170.1 (C), 169.3 (2C), 134.3 (C), 134.1 (C), 133.5 (CH), 129.9 (CH), 129.2 (C), 128.5 (CH), 126.8 (CH), 126.4 (CH), 125.8 (CH), 125.5 (CH), 86.6 (CH), 75.8 (CH), 74.1 (CH), 70.4 (CH), 68.3 (CH), 62.2 ( $\text{CH}_2$ ), 20.8 ( $\text{CH}_3$ ), 20.6 (2 $\text{CH}_3$ ), 20.5 ( $\text{CH}_3$ ); IR (neat): 2361, 2341, 1756, 1366, 1250, 1090, 801  $\text{cm}^{-1}$ ; HRMS (ESI):  $m/z$  calc. for  $\text{C}_{24}\text{H}_{26}\text{NaO}_9\text{S}$   $[\text{M}+\text{Na}]^+$  513.1190; found 513.1195.

**(2R,3R,4S,5R,6S)-2-(acetoxymethyl)-6-((4-isopropylphenyl)thio)tetrahydro-2H-pyran-3,4,5-triyl triacetate 3n**

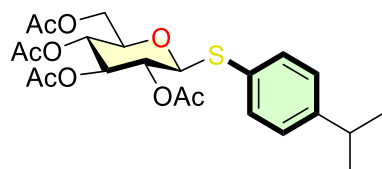

$R_f = 0.2$  (EtOAc /cyclohexane: 3/7); White solid (81.8 mg, 85%), m. p.: 143.5-143.9 °C;  $[\alpha]_D^{18} = -18.0$  (c, 0.17,  $\text{CHCl}_3$ );  $^1\text{H NMR}$  (300 MHz,  $\text{CDCl}_3$ )  $\delta$  7.41 (d,  $J = 6.0$  Hz, 2H), 7.16 (d,  $J = 6.0$  Hz, 2H), 5.21 (t,  $J = 9.0$  Hz, 1H), 4.99 (td,  $J = 9.0, 24.0$  Hz, 2H), 4.65 (d,  $J = 12.0$  Hz, 1H), 4.14-4.25 (m, 2H), 3.67-3.73 (m, H), 2.85-2.94 (m, 1H), 2.08 (s, 3H), 2.07 (s, 3H), 2.01 (s, 3H), 1.98 (s, 3H), 1.25 (s, 3H), 1.23 (s, 3H);  $^{13}\text{C NMR}$  (75 MHz,  $\text{CDCl}_3$ )  $\delta$  170.5 (C), 170.1 (C), 169.4 (C), 169.2 (C), 133.7 (2CH), 128.1 (C), 127.1 (2CH), 85.9 (CH), 75.8 (CH), 74.0 (CH), 70.1 (CH), 68.3 (CH), 62.2 ( $\text{CH}_2$ ), 33.8 (CH), 23.8 (2 $\text{CH}_3$ ), 20.7 (2 $\text{CH}_3$ ), 20.5 (2 $\text{CH}_3$ ); IR (neat): 2361, 2341, 1757, 1375, 1247, 1039, 913, 670  $\text{cm}^{-1}$ ; HRMS (ESI):  $m/z$  calc. for  $\text{C}_{23}\text{H}_{30}\text{NaO}_9\text{S}$   $[\text{M}+\text{Na}]^+$  505.1503; found 505.1502.

**(R)-2-((tert-butoxycarbonyl)amino)-3-(4-(((2S,3R,4S,5R,6R)-3,4,5-triacetoxy-6-(acetoxymethyl)tetrahydro-2H-pyran-2-yl)thio)phenyl)propanoic acid 3o<sup>7</sup>**

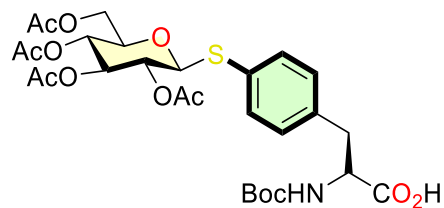

R<sub>f</sub> = 0.2 (CH<sub>2</sub>Cl<sub>2</sub> /MeOH: 99/1); White solid (110.5 mg, 88%), <sup>1</sup>H NMR (300 MHz, CDCl<sub>3</sub>) δ 8.29 (s, 1H), 7.39 (d, *J* = 9.0 Hz, 2H), 7.13 (d, *J* = 9.0 Hz, 2H), 5.20 (t, *J* = 12.0 Hz, 1H), 4.90-5.06 (m, 3H), 4.91 (d, *J* = 9.0 Hz, 1H), 4.05-4.25 (m, 2H), 3.69-3.73 (m, 1H), 2.05 (s, 3H), 2.05 (s, 3H), 1.99 (s, 3H), 1.96 (s, 3H), 1.38 (s, 9H); HRMS (ESI): *m/z* calc. for C<sub>28</sub>H<sub>37</sub>NO<sub>13</sub>SNa [M+Na]<sup>+</sup> 650.1883; found 650.1889.

**(2R,3R,4S,5R,6S)-2-(acetoxymethyl)-6-((1-methyl-2-oxo-1,2-dihydroquinolin-3-yl)thio)tetrahydro-2H-pyran-3,4,5-triyl triacetate 3p**

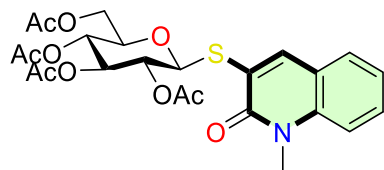

R<sub>f</sub> = 0.2 (EtOAc /cyclohexane: 3/7); White solid (99.2 mg, 95%), m. p.: 110.2-110.8 °C; [α]<sub>D</sub><sup>18</sup> = -47.1 (c, 0.17, CHCl<sub>3</sub>); <sup>1</sup>H NMR (300 MHz, CDCl<sub>3</sub>) δ 7.83 (s, 3H), 7.53-7.60 (m, 2H), 7.37 (d, *J* = 9.0 Hz, 1H), 7.24-7.29 (m, 1H), 5.27-5.36 (m, 1H), 5.09-5.22 (m, 3H), 4.22-4.33 (m, 1H), 4.14 (d, *J* = 12.0 Hz, 1H), 3.84-3.89 (m, 1H), 3.77 (s, 3H), 2.07 (s, 3H), 2.05 (s, 3H), 2.02 (s, 3H), 2.01 (s, 3H); <sup>13</sup>C NMR (75 MHz, CDCl<sub>3</sub>) δ 170.5 (C), 170.1 (C), 169.4 (2C), 160.0 (C), 138.9 (C), 137.2 (CH), 130.4 (CH), 128.1 (CH), 127.5 (C), 122.5 (CH), 120.5 (C), 114.2 (CH), 82.3 (CH), 75.8 (CH), 73.9 (CH), 69.9 (CH), 68.5 (CH), 62.4 (CH<sub>2</sub>), 30.2 (CH<sub>3</sub>), 20.7 (2CH<sub>3</sub>), 20.6 (2CH<sub>3</sub>); IR (neat): 2957, 2360, 2341, 1756, 1633, 1592, 1541, 1375, 149, 1039, 914, 769, 754, 670 cm<sup>-1</sup>; HRMS (ESI): *m/z* calc. for C<sub>24</sub>H<sub>27</sub>NNaO<sub>10</sub>S [M+Na]<sup>+</sup> 544.1248; found 544.1249.

**(2R,3R,4S,5R,6S)-2-(acetoxymethyl)-6-(pyridin-3-ylthio)tetrahydro-2H-pyran-3,4,5-triyl triacetate 3q<sup>7</sup>**

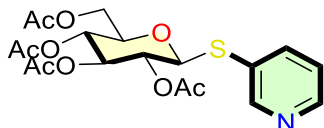

R<sub>f</sub> = 0.3 (EtOAc /cyclohexane: 1/1); White solid (83.6 mg, 92%), <sup>1</sup>H NMR (300 MHz, CDCl<sub>3</sub>) δ 8.72 (s, 1H), 8.59 (d, *J* = 3.0 Hz, 1H), 7.86 (d, *J* = 6.0 Hz, 1H), 7.28 (t, *J* = 6.0 Hz, 1H), 5.23 (t, *J* = 9.0 Hz, 1H), 4.97 (td, *J* = 12.0, 21.0 Hz, 2H), 4.67 (d, *J* = 9.0 Hz, 1H), 4.16-4.25 (m, 2H), 3.70-3.76 (m, 1H), 2.10 (s, 3H), 2.09 (s, 3H), 2.02 (s, 3H), 1.99 (s, 3H); HRMS (ESI): *m/z* calc. for C<sub>19</sub>H<sub>24</sub>NO<sub>9</sub>S [M+H] 442.1172; found 442.1182.

**(2S,3R,4S,5R,6R)-2-((1H-indol-5-yl)thio)-6-(acetoxymethyl)tetrahydro-2H-pyran-3,4,5-triyl triacetate 3r**

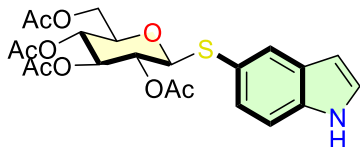

R<sub>f</sub> = 0.2 (EtOAc /cyclohexane: 3/7); White solid (83.5 mg, 87%), m. p.: 60.8-61.5 °C; [α]<sub>D</sub><sup>18</sup> = -26.3 (c, 0.19, CHCl<sub>3</sub>); <sup>1</sup>H NMR (300 MHz, CDCl<sub>3</sub>) δ 8.47 (s, 1H), 7.85-7.88 (m, 1H), 7.34-7.39 (m, 2H), 7.24-7.31 (m, 1H), 6.54 (s, 1H), 5.22 (t, *J* = 9.0 Hz, 1H), 4.93-5.06 (m, 2H), 4.65 (d, *J* = 12.0 Hz, 1H), 4.11-4.26 (m, 2H), 3.64 -3.70 (m, 1H), 2.14 (s, 3H), 2.06 (s, 3H), 2.01 (s, 3H), 1.98 (s, 3H); <sup>13</sup>C NMR (75 MHz, CDCl<sub>3</sub>) δ 170.7 (C), 170.2 (C), 169.4 (2C), 136.0 (C), 128.5 (C), 128.5 (CH), 127.9 (CH), 125.2 (CH), 120.5 (C), 111.4 (CH), 102.7 (CH), 86.7 (CH), 75.7 (CH), 74.2 (CH), 70.2 (CH), 68.3 (CH), 62.2 (CH<sub>2</sub>), 20.8 (CH<sub>3</sub>), 20.7 (CH<sub>3</sub>), 20.6 (2CH<sub>3</sub>); IR (neat): 2958, 2931, 2858, 1757, 1311, 1094, 893, 801, 769 cm<sup>-1</sup>; HRMS (ESI): *m/z* calc. for C<sub>22</sub>H<sub>25</sub>NNaO<sub>9</sub>S [M+Na]<sup>+</sup> 502.1142; found 502.1142.

**(2R,3R,4S,5R,6S)-2-(acetoxymethyl)-6-(((E)-2-iodovinyl)thio)tetrahydro-2H-pyran-3,4,5-triyl triacetate 3s**

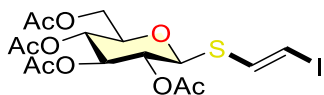

R<sub>f</sub> = 0.2 (EtOAc /cyclohexane: 3/7); White solid (30.8 mg, 30%), m. p.: 117.5-119.0 °C;

$[\alpha]_D^{18} = -20.5$  (c, 0.15,  $\text{CHCl}_3$ );  $^1\text{H NMR}$  (300 MHz,  $\text{CDCl}_3$ )  $\delta$  7.02 (d,  $J = 12.0$  Hz, 1H), 6.52 (d,  $J = 12.0$  Hz, 1H), 5.23 (t,  $J = 9.0$  Hz, 1H), 5.01-5.11 (m, 2H), 4.57 (d,  $J = 9.0$  Hz, 1H), 4.14-4.26 (m, 2H), 3.74-3.78 (m, 1H), 2.11 (s, 3H), 2.05 (s, 3H), 2.03 (s, 3H), 2.01 (s, 3H);  $^{13}\text{C NMR}$  (75 MHz,  $\text{CDCl}_3$ )  $\delta$  170.2 (C), 170.1 (C), 169.1 (C), 168.3 (C), 130.0 (CH), 83.2 (CH), 78.2 (CH), 76.2 (CH), 73.6 (CH), 69.8 (CH), 68.1 (CH), 62.0 ( $\text{CH}_2$ ), 20.8 ( $\text{CH}_3$ ), 20.6 ( $\text{CH}_3$ ), 20.5 (2 $\text{CH}_3$ ); IR (neat): 2360, 2341, 1755, 1375, 1248, 1090, 774, 684  $\text{cm}^{-1}$ ; HRMS (ESI):  $m/z$  calc. for  $\text{C}_{16}\text{H}_{21}\text{INaO}_9\text{S}$   $[\text{M}+\text{Na}]^+$  538.9843; found 538.9868.

**(2R,3R,4S,5R,6S)-2-(acetoxymethyl)-6-(((E)-4-methoxystyryl)thio)tetrahydro-2H-pyran-3,4,5-triyl triacetate 3t**<sup>7</sup>

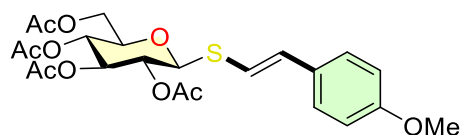

$R_f = 0.3$  (EtOAc /cyclohexane: 1/1); White solid (86.5 mg, 87%),  $^1\text{H NMR}$  (300 MHz,  $\text{CDCl}_3$ )  $\delta$  7.30 (d,  $J = 9.0$  Hz, 2H), 6.87 (d,  $J = 9.0$  Hz, 2H), 6.76 (d,  $J = 15.0$  Hz, 1H), 6.59 (d,  $J = 15.0$  Hz, 1H), 5.27 (t,  $J = 9.0$  Hz, 1H), 5.08-5.16 (m, 2H), 4.62 (d,  $J = 9.0$  Hz, 1H), 4.16-4.31 (m, 2H), 3.83 (s, 3H), 3.76-3.80 (m, 1H), 2.09 (s, 3H), 2.09 (s, 3H), 2.04 (s, 3H), 2.02 (s, 3H); HRMS (ESI):  $m/z$  calc. for  $\text{C}_{23}\text{H}_{28}\text{NaO}_{10}\text{S}$   $[\text{M}+\text{Na}]^+$  519.1295; found 519.1307.

**(2R,3R,4S,5R,6S)-2-(acetoxymethyl)-6-((thiophen-3-ylethynyl)thio)tetrahydro-2H-pyran-3,4,5-triyl triacetate 3u**

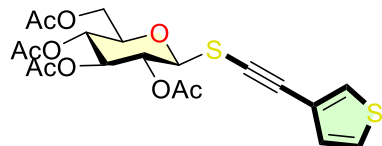

$R_f = 0.2$  (EtOAc /cyclohexane: 3/7); White solid (54.6 mg, 58%), m. p.: 124.3-125.7  $^\circ\text{C}$ ;  $[\alpha]_D^{18} = -63.8$  (c, 0.16,  $\text{CHCl}_3$ );  $^1\text{H NMR}$  (300 MHz,  $\text{CDCl}_3$ )  $\delta$  7.58-7.59 (m, 1H), 7.27-7.29 (m, 1H), 7.17-7.19 (m, 1H), 5.24-5.35 (m, 2H), 5.14 (t,  $J = 9.0$  Hz, 1H), 4.62 (d,  $J = 6.0$  Hz, 1H), 4.17-4.30 (m, 2H), 3.77-3.82 (m, 1H), 2.11 (s, 3H), 2.07 (s, 3H),

2.04 (s, 3H), 2.03 (s, 3H);  $^{13}\text{C}$  NMR (75 MHz,  $\text{CDCl}_3$ )  $\delta$  170.6 (C), 170.2 (C), 169.3 (C), 169.0 (C), 130.8 (CH), 130.2 (CH), 125.3 (CH), 121.8 (C), 92.2 (C), 84.5 (CH), 76.5 (CH), 73.9 (CH), 72.2 (C), 69.8 (CH), 67.9 (CH), 62.0 ( $\text{CH}_2$ ), 20.7 ( $\text{CH}_3$ ), 20.6 ( $\text{CH}_3$ ), 20.5 (2 $\text{CH}_3$ ); IR (neat): 2360, 2341, 1757, 1375, 1249, 1063, 773  $\text{cm}^{-1}$ ; HRMS (ESI):  $m/z$  calc. for  $\text{C}_{20}\text{H}_{22}\text{NaO}_9\text{S}_2$   $[\text{M}+\text{Na}]^+$  493.0597; found 493.0615

**2R,3R,4S,5R,6S)-2-(acetoxymethyl)-6-((2-(hydroxymethyl)phenyl)thio)tetrahydro-2H-pyran-3,4,5-triyl triacetate 3v**

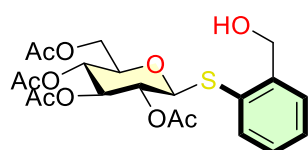

$R_f$  = 0.3 (EtOAc/cyclohexane: 1/1); White solid (80.1 mg, 85%), m. p.: 101.0-101.3  $^\circ\text{C}$ ,  $[\alpha]_D^{18} = -13.5$  (c, 0.52,  $\text{CHCl}_3$ );  $^1\text{H}$  NMR (300 MHz,  $\text{CDCl}_3$ )  $\delta$  7.58 (d,  $J = 6.0$  Hz, 1H), 7.49 (d,  $J = 6.0$  Hz, 1H), 7.40 (t,  $J = 6.0$  Hz, 1H), 7.30 (t,  $J = 6.0$  Hz, 1H), 5.21 (t,  $J = 9.0$  Hz, 1H), 5.02 (t,  $J = 9.0$  Hz, 2H), 4.85-4.91 (m, 1H), 4.63-4.72 (m, 2H), 4.09-4.20 (m, 2H), 3.61-3.67 (m, 1H), 2.69 (t,  $J = 9.0$  Hz, 1H), 2.13 (s, 3H), 2.04 (s, 3H), 2.00 (s, 3H), 2.00 (s, 3H);  $^{13}\text{C}$  NMR (75 MHz,  $\text{CDCl}_3$ )  $\delta$  170.6 (C), 170.1 (C), 169.4 (C), 169.3 (C), 145.3 ( $\text{CH}_2$ ), 136.1 (CH), 129.9 (CH), 129.5 (CH), 128.6 (CH), 86.9 (CH), 76.0 (CH), 73.9 (CH), 70.3 (CH), 68.0 (CH), 63.6 ( $\text{CH}_2$ ), 61.7 ( $\text{CH}_2$ ), 20.8 ( $\text{CH}_3$ ), 20.6 ( $\text{CH}_3$ ), 20.5 (2 $\text{CH}_3$ ); IR (neat): 2962, 2359, 1755, 1441, 1366, , 1209, 1031, 915, 800, 756  $\text{cm}^{-1}$ ; HRMS (ESI):  $m/z$  calc. for  $\text{C}_{21}\text{H}_{26}\text{NaO}_{10}\text{S}$   $[\text{M}+\text{Na}]^+$  493.1144; found 493.1148.

**(2R,3R,4S,5R,6S)-2-((benzoyloxy)methyl)-6-((4-(trifluoromethyl)phenyl)thio)tetrahydro-2H-pyran-3,4,5-triyl tribenzoate 4a**

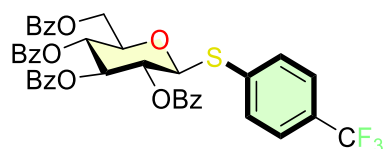

$R_f$  = 0.2 (EtOAc/cyclohexane: 3/7); White solid (98.5 mg, 65%), m. p.: 185.4-185.7  $^\circ\text{C}$ ;  $[\alpha]_D^{18} = +44.3$  (c, 0.38,  $\text{CHCl}_3$ );  $^1\text{H}$  NMR (300 MHz,  $\text{CDCl}_3$ )  $\delta$  8.10 (d,  $J = 9.0$  Hz,

2H), 7.95-8.01 (m, 4H), 7.84 (d,  $J = 9.0$  Hz, 2H), 7.26-7.67 (m, 16H), 6.01 (t,  $J = 9.0$  Hz, 1H), 5.62 (td,  $J = 12.0, 27.0$  Hz, 2H), 5.17 (d,  $J = 9.0$  Hz, 1H), 4.74-4.79 (m, 1H), 4.52-4.58 (m, 1H), 4.28-4.34 (m, 1H);  $^{13}\text{C}$  NMR (75 MHz,  $\text{CDCl}_3$ )  $\delta$  166.0 (C), 165.8 (C), 165.2 (C), 165.1 (C), 137.1 (C), 133.6 (CH), 133.5 (CH), 133.4 (CH), 132.0 (2CH), 129.9 (4CH), 129.8 (4CH), 129.0 (2C), 128.7 (C), 128.6 (C), 128.5 (6CH), 128.3 (3CH), 125.7 (2CH), 120.2 (q,  $J = 270$  Hz) (C), 85.4 (CH), 76.6 (CH), 74.0 (CH), 70.5 (CH), 69.3 (CH), 63.1 ( $\text{CH}_2$ ); IR (neat): 3071, 2360, 2341, 1733, 1603, 1492, 1402, 1327, 1264, 1178, 1164, 801, 774  $\text{cm}^{-1}$ ; HRMS (ESI):  $m/z$  calc. for  $\text{C}_{41}\text{H}_{31}\text{F}_3\text{NaO}_9\text{S}$   $[\text{M}+\text{Na}]^+$  779.1533; found 779.1543.

**(2R,3S,4S,5R,6S)-2-(acetoxymethyl)-6-((4-cyanophenyl)thio)tetrahydro-2H-pyran-3,4,5-triyl triacetate 4b**

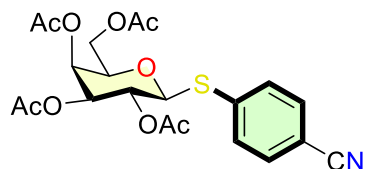

$R_f = 0.2$  (EtOAc /cyclohexane: 3/7); White solid (81.0 mg, 87%), m. p.: 119.3-119.6  $^{\circ}\text{C}$ ;  $[\alpha]_D^{18} = +23.1$  (c, 0.26,  $\text{CHCl}_3$ );  $^1\text{H}$  NMR (300 MHz,  $\text{CDCl}_3$ )  $\delta$  7.55-7.57 (m, 4H), 5.43 (d,  $J = 3.0$  Hz, 1H), 5.24 (t,  $J = 9.0$  Hz, 1H), 5.07 (dd,  $J = 3.0, 9.0$  Hz, 1H), 4.81 (d,  $J = 12.0$  Hz, 1H), 4.08-4.21 (m, 2H), 3.98-4.02 (m, 1H), 2.12 (s, 3H), 2.06 (s, 3H), 2.04 (s, 3H), 1.96 (s, 3H);  $^{13}\text{C}$  NMR (75 MHz,  $\text{CDCl}_3$ )  $\delta$  170.2 (C), 170.0 (C), 169.9 (C), 169.3 (C), 132.2 (2CH), 131.0 (2CH), 118.3 (C), 111.1 (C), 85.0 (CH), 74.8 (CH), 71.7 (CH), 67.1 (CH), 66.8 (CH), 61.6 ( $\text{CH}_2$ ), 20.7 ( $\text{CH}_3$ ), 20.6 (2 $\text{CH}_3$ ), 20.5 ( $\text{CH}_3$ ); IR (neat): 2360, 2341, 2229, 1751, 1368, 1246, 1154, 1085, 774  $\text{cm}^{-1}$ ; HRMS (ESI):  $m/z$  calc. for  $\text{C}_{21}\text{H}_{23}\text{NNaO}_9\text{S}$   $[\text{M}+\text{Na}]^+$  488.0986; found 488.0988.

**(2S,3R,4S,5S,6R)-2-((4-cyanophenyl)thio)-6-methyltetrahydro-2H-pyran-3,4,5-triyl triacetate 4c**

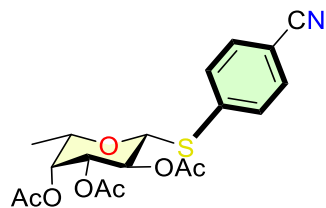

R<sub>f</sub> = 0.2 (EtOAc /cyclohexane: 3/7); White solid (81.5 mg, 74%), m. p.: 126.5-127.3 °C; [α]<sub>D</sub><sup>18</sup> = + 50.7 (c, 0.24, CHCl<sub>3</sub>); <sup>1</sup>H NMR (300 MHz, CDCl<sub>3</sub>) δ 7.52-7.61 (m, 4H), 5.29 (d, *J* = 3.0 Hz, 1H), 5.24 (t, *J* = 9.0 Hz, 1H), 5.08 (dd, *J* = 3.0, 9.0 Hz, 1H), 4.79 (d, *J* = 9.0 Hz, 1H), 3.90 (q, *J* = 6.0 Hz, 1H), 2.16 (s, 3H), 2.06 (s, 3H), 1.97 (s, 3H), 1.25 (d, *J* = 9.0 Hz, 3H); <sup>13</sup>C NMR (75 MHz, CDCl<sub>3</sub>) δ 170.4 (C), 170.0 (C), 169.4 (C), 140.2 (C), 132.2 (2CH), 130.8 (2CH), 118.4 (C), 110.9 (C), 84.7 (CH), 73.5 (CH), 72.2 (CH), 70.1 (CH), 66.9 (CH), 20.7 (CH<sub>3</sub>), 20.6 (CH<sub>3</sub>), 20.5 (CH<sub>3</sub>), 16.5 (CH<sub>3</sub>); IR (neat): 2938, 2360, 2228, 1751, 1594, 1487, 1369, 1245, 1221, 1084, 1058, 970, 917, 897 cm<sup>-1</sup>; HRMS (ESI): m/z calc. for C<sub>19</sub>H<sub>21</sub>NNaO<sub>7</sub>S [M+Na]<sup>+</sup> 430.0931; found 430.0933.

**(2R,3R,4S,5R,6S)-2-(acetoxymethyl)-6-(((2R,3R,4S,5R,6S)-4,5-diacetoxy-2-(acetoxymethyl)-6-((4-(trifluoromethyl)phenyl)thio)tetrahydro-2H-pyran-3-yl)oxy)tetrahydro-2H-pyran-3,4,5-triyl triacetate 4d**

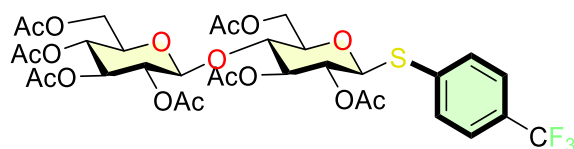

R<sub>f</sub> = 0.2 (EtOAc /cyclohexane: 1/1); White solid (102.1 mg, 64%), m. p. 245.5-246.4 °C; [α]<sub>D</sub><sup>18</sup> = - 22.8 (c, 0.26, CHCl<sub>3</sub>); <sup>1</sup>H NMR (300 MHz, CDCl<sub>3</sub>) δ 7.50-7.56 (m, 4H), 5.00-5.22 (m, 3H), 4.86-4.93 (m, 2H), 4.72 (d, *J* = 9.0 Hz, 1H), 4.47-4.56 (m, 2H), 4.33 (dd, *J* = 3.0, 18.0 Hz, 1H), 3.99-4.11 (m, 2H), 3.62-3.75 (m, 3H), 2.07 (s, 3H), 2.05 (s, 3H), 2.04 (s, 3H), 2.00 (s, 3H), 1.99 (s, 3H), 1.98 (s, 3H), 1.95 (s, 3H); <sup>13</sup>C NMR (75 MHz, CDCl<sub>3</sub>) δ 170.4 (C), 170.1 (C), 170.0 (C), 169.6 (C), 169.4 (C), 169.2 (C), 168.9 (C), 136.9 (C), 132.3 (2CH), 130.0 (q, *J* = 12 Hz) (C), 125.6 (CH<sub>2</sub>), 123.6 (q, *J* = 270 Hz) (C), 100.7 (CH), 84.6 (CH), 76.9 (CH), 76.2 (CH), 73.4 (CH), 72.9 (CH), 72.0 (CH), 71.6 (CH), 70.0 (CH), 67.8 (CH), 61.9 (CH<sub>2</sub>), 61.5 (CH<sub>2</sub>), 20.7 (CH<sub>3</sub>), 20.6 (2CH<sub>3</sub>), 20.5 (4CH<sub>3</sub>); IR (neat): 2360, 2341, 1746, 1380, 1366, 1228, 1216, 1167, 1125, 1097, 1043, 830, 774 cm<sup>-1</sup>; HRMS (ESI): m/z calc. for C<sub>33</sub>H<sub>39</sub>F<sub>3</sub>NaO<sub>17</sub>S [M+Na]<sup>+</sup> 819.1752; found 819.1774.



## 1.4 Part 4 Electrochemical Nickel-Catalyzed Migita Cross-Coupling of Thiosugars with Aryl, alkenyl and alkynyl Bromides

### A) Introduction

As the rise in the people's living standards, more and more people force on the environmental protection. Chemistry is like a kind of double-edged sword. The time they created civilization, they destroyed it also. The destruction of the planet by traditional chemistry industry is really serious, substantial wastes were produced every day which not only threat to environment, but also threat to humanity. Because of this, the concept of green chemistry is emerged and moree and more scientists devoted themselves to discover environment friendly reaction. Notably, electrosynthetic methodologies became a shining star.

Electrosynthesis is an emerging green approach for the construction of C-C and C-heteroatom bonds by using of a current instead of transitional oxidant or reductant. H. Kolbe<sup>72</sup> reported the famous electrochemical Kolbe reaction. Decomposition of valeric acid by an electric current, the *n*-octane could be synthesized directly. In addition, long-chain hydrocarbons were easily synthesized from the fatty acids under theses electrosynthetic conditions. This electrolytic decarboxylation may be regarded as the first industry available reaction in the history of electrochemistry (**Scheme 26**).

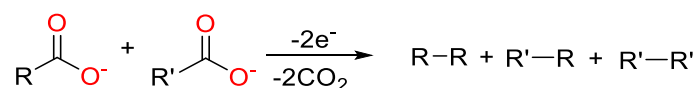

**Scheme 26.** Electrochemical Kolbe reaction

Due to the limitation of the technical level, the development of electrochemistry stagnated for a long time. Up to 1961, the scientist Baizer from Monsanto company<sup>73</sup> discovered that the adiponitrile can be synthesized by acrylonitrile through electrolytic reducing reaction. After that, the development of electrochemistry become faster (**Scheme 27**).

---

<sup>72</sup> Utley, J. *Chem. Soc. Rev.*, **1997**, 26, 157-167.

<sup>73</sup> Baizer, M. M., *J. Electrochem. Soc.*, **1964**, 111, 215-222.

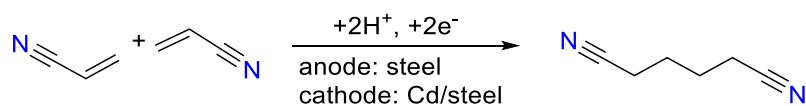

**Scheme 27.** synthesis of adiponitrile

In the previous study, we succeeded for the first time to perform the cross-coupling of 1-thiosugars with aryl, alkenyl and alkynyl iodide under base-free photoredox dual catalysis. However, we observed that the less expensive aryl bromides are less efficient during this study. Moreover, only protected thiosugars are tolerated as the coupling partners. To overcome these limitations, we started to examine the possibility of using electrochemistry as a solution to the cross-coupling of aryl bromide with (un)protected thiosugars. If we reach this goal, it will be an important advance in the field of glycochemistry. In 2019, the group of Mei<sup>74</sup> reported an elegant electro-nickel-catalyzed thiolation of aryl bromides and chlorides (**Scheme 28**). The reaction involves the use of NiBr<sub>2</sub>·glyme 10 mol% as a catalyst, di-<sup>t</sup>Bubpy 10 mol% as the ligand, LiBr 4 equiv as electrolyte in DMF. A sacrificial magnesium (Mg) anode and a Ni foam cathode were used at 4 mA for 6 h. 47 examples were reported with the yield up to 95%. This work inspired us to examine a practical solution to reach our goal.

---

<sup>74</sup> Liu, D.; Ma, H.; Fang, P.; Mei, T., *Angew. Chem. Int. Ed.*, **2019**, 58, 5033-5037.

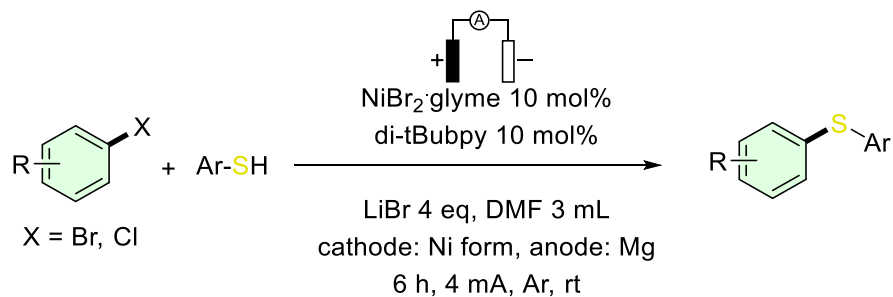

*Selected examples:*

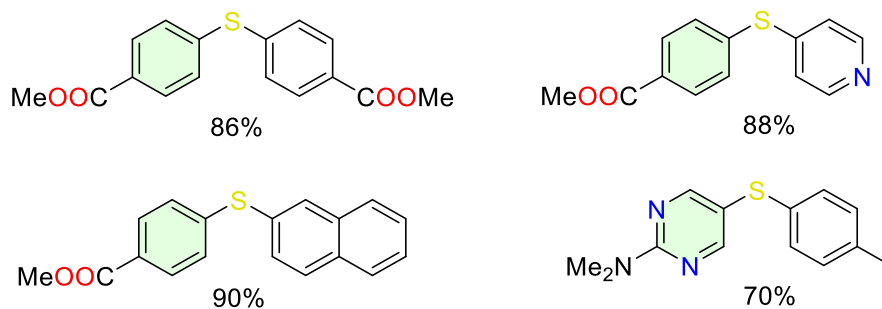

**Scheme 28.** Electro-nickel-catalyzed thiolation

## B) Publication

### Electrochemical nickel-catalyzed Migita cross-coupling of 1-thiosugars with aryl, alkenyl and alkynyl bromides

Mingxiang Zhu, Mouad Alami and Samir Messaoudi

**Abstract:** Here we report a simple route towards the synthesis of thioglycosides, in which electrochemical cross-coupling is used to form a S–C glycosidic bond from protected and unprotected thiosugars with functionalized aryl bromides under base free conditions. The reaction manifold that we report here demonstrates the power of electrochemistry to access highly complex glycosides under mild conditions.

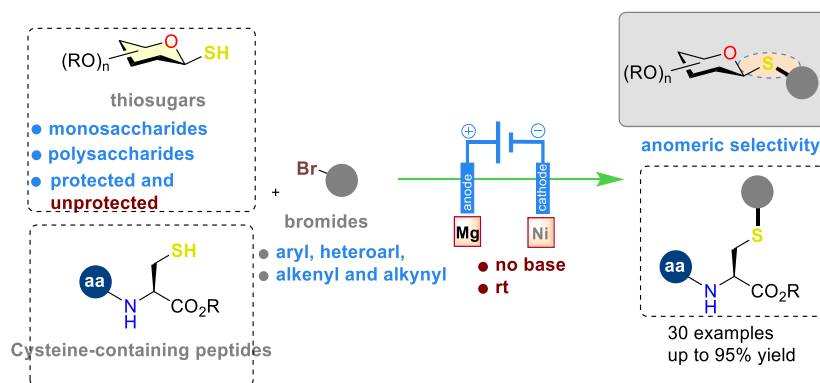

*Chem. Commun.*, **2020**, 56, 4464-4467. DOI: 10.1039/d0cc01126f.

1-Thioglycosides have emerged as a privileged class of glycosides with a diverse range of potential applications.<sup>75</sup> These glycomimetics are known to be more robust towards enzymatic cleavage under biological conditions.<sup>76</sup> Representative active glycosides with a thioether linkage are disclosed in **Figure 4**, including the hSGLT1 inhibitor, ligand of lectin A, cytotoxic Hsp90 inhibitor, antimicrobial agent and galactin-3-

<sup>75</sup> (a) For general reviews, see: a) Driguez, H., *Glycoscience Synthesis Of Substrate Analogs And Mimetics*. **1997**, 187, 85-116; b) Witczak, Z. J., *Curr. Med. Chem.* **1999**, 6, 165-178; c) Pachamuthu, K.; Schmidt, R. R., *Chem. Rev.* **2006**, 106, 160-187; d) Samuni-Blank, M.; Izhaki, I.; Dearing, M. D.; Gerchman, Y.; Trabelcy, B.; Karasov, A. L. W. H.; Arad, Z., *Curr. Biol.* **2012**, 22, 1218-1220; e) Lian, G.; Zhang, X.; Yu, B., *Carbohydr. Res.* **2015**, 403, 13-22. For Selected articles: f) Castaneda, F.; Burse, A.; Boland, W.; Kinne, R. K. H., *Int. J. Med. Sci.* **2007**, 4, 131-139; g) Rodrigue, J.; Ganne, G.; Blanchard, B.; Saucier, C.; Giguere, D.; Shiao, T. C.; Varrot, A.; Imberty, A.; Roy, R., *Org. Biomol. Chem.* **2013**, 11, 6906-6918; h) Elgemeie, G. H.; Farag, A. B.; Amin, K. M.; El-Badry, O. M.; Hassan, G. S., *Eur. J. Med. Chem.* **2014**, 4, 814-833; i) Aouad, M. R., *Nucleos. Nucleot. Nucl.* **2016**, 35, 1-15; j) Kato, E.; Nagano, H.; Yamamura, S.; Ueda, M., *Tetrahedron*, **2003**, 59, 5909-5917; k) Schnabelrauch, M.; Vasella, A.; Withers, S. G., *Helv. Chim. Acta.* **1994**, 77, 778-799; l) Adinolfi, M.; d'Ischia, M.; Iadonisi, A.; Leone, L.; Pezzella, A.; Valerio, S., *Eur. J. Org. Chem.* **2012**, 23, 4333-4338; m) Shirota, K.; Kato, Y.; Suzuki, K.; Sugiyama, Y., *J. Pharmacol. Exp. Ther.* **2001**, 299, 459-467; n) Caraballo, R.; Sakulsombat, M.; Ramström, O., *ChemBioChem* **2010**, 11, 1600-1606.

<sup>76</sup> a) Rye, C. S.; Withers, S. G., *Carbohydr. Res.* **2004**, 339, 699-703; b) Metaferia, B. B.; Fetterolf, B. J.; Shazad-ul-Hussan, S.; Moravec, M.; Smith, J. A.; Ray, S.; Gutierrez-Lugo, M. -T.; Bewley, C. A., *J. Med. Chem.* **2007**, 50, 6326-6336; c) Castaneda, F.; Burse, A.; Boland, W.; Kinne, R. K.-H., *Int. J. Med. Sci.* **2007**, 4, 131-139.

inhibitors. Moreover, thioglycosides are well known to be useful and versatile reactive intermediates in organic synthesis.<sup>77</sup>

At present, for the functionalization of glycosyl thiols, various catalytic systems based on palladium,<sup>78</sup> nickel<sup>79</sup> and copper<sup>80</sup> have been reported (**Figure 5, a and b**).<sup>81</sup> Despite high interest in them, these methods require the use of basic conditions with high catalyst loadings (30 mol% in the case of Ni-catalysis) or precious metals such as Pd-catalysts with specially designed ligands.<sup>82</sup> In addition, an increased reaction

---

<sup>77</sup> a) Codee, J. D. C.; Litjens, R. E. J. N.; van den Bos, L. J.; Overkleeft, H. S.; van der Marel, G. A., *Chem. Soc. Rev.* **2005**, *34*, 769-782; for selected examples, see: b) Johannes, M.; Reindl, M.; Gerlitzki, B.; Schmitt, E.; Hoffmann-Rçder, A., *Beilstein J. Org. Chem.* **2015**, *11*, 155-161; c) Budhadev, D.; Mukhopadhyay, B., *Carbohydr. Res.* **2014**, *384*, 51-55; d) Basu, N., Kumar Maity, S.; Ghosh, R., *RSC Adv.* **2012**, *2*, 12661-12664; e) Verma, P.; Raj, R.; Roy, B., *Tetrahedron: Asymmetry* **2010**, *21*, 2413-2418; f) Xiong, C. D.; Zhang, L. H.; Ye, X. S., *Adv. Synth. Catal.* **2008**, *350*, 1696-1700; g) Roy, B.; Pramanik, K.; Mukhopadhyay, B., *Glycoconjugate J.* **2008**, *25*, 157-166; h) Zeng, Y.; Wang, Z.; Whitfield, D.; Huang, X., *J. Org. Chem.* **2008**, *73*, 7952-7962; i) Fridman, M.; Belakhov, V.; Lee, L. V.; Liang, F. -S.; Wong, C. -H.; Baasov, T., *Angew. Chem. Int. Ed.* **2005**, *44*, 447-452; *Angew. Chem.* **2005**, *117*, 451-456.

<sup>78</sup> a) Brachet, E.; Brion, J. -D.; Messaoudi, S.; Alami, M., *Adv. Synth. Catal.* **2013**, *355*, 2627-2636; (b) Brachet, E.; Brion, J. -D.; Messaoudi, S.; Alami, M., *Adv. Synth. Catal.* **2013**, *355*, 477-490; c) Bruneau, A.; Roche, M.; Hamze, A.; Brion, J. -D.; Alami, M.; Messaoudi, S., *Chem. Eur. J.* **2015**, *21*, 8375-8379; d) AL-Shuaeeb, R. A. A.; Montoir, D.; Alami, M.; Messaoudi, S., *J. Org. Chem.* **2017**, *82*, 6720-6728; e) Probst, N.; Lartia, R.; Théry, O.; Alami, M.; Defrancq, E.; Messaoudi, S., *Chem. Eur. J.* **2018**, *24*, 1795-1800; f) Montoir, D.; Amoura, M.; Ababsa, Z. E. -A.; Vishwanath, T. M.; Yen-Pon, E.; Robert, V.; Beltramo, M.; Piller, V.; Alami, M.; Aucagne, A.; Messaoudi, S., *Chem. Sci.*, **2018**, *9*, 8753-8759; g) Benmahdjoub, S.; Ibrahim, N.; Benmerad, B.; Alami, M.; Messaoudi, S. *Org. Lett.* **2018**, *20*, 4067-4071.

<sup>79</sup> Brachet, E.; Brion, J.-D.; Alami, M.; Messaoudi, S., *Chem. Eur. J.* **2013**, *19*, 15276-15280.

<sup>80</sup> (a) Nauš, P.; Lešetický, L.; Smrček, S.; Tišlerová, I.; Štícha, M., *Synlett* **2003**, *14*, 2117-2122; b) Chabrier, A.; Bruneau, A.; Benmahdjoub, S.; Benmerad, B.; Belaid, S.; Brion, J.-D.; Alami, M.; Messaoudi, S., *Chem. Eur. J.* **2016**, *22*, 15006-15010; c) Yuan, X.; Kou, Y.; Yu, L.; Zhang, Z.-X.; Xue, W., *Org. Chem. Front.* **2015**, *2*, 1604-1607.

<sup>81</sup> For a recent review, see: Ibrahim, N.; Alami, M.; Messaoudi, S., *Asian. J. Org. Chem.* **2018**, *7*, 2026-2038

<sup>82</sup> For selected Pd-catalyzed thiolation, see: a) Sayah, M.; Organ, M. G., *Chem. Eur. J.* **2013**, *19*, 16196-16199; b) Alvaro, E.; Hartwig, J. F., *J. Am. Chem. Soc.* **2009**, *131*, 7858-7868; c) Shen, M. A.; Hartwig, J. F., *J. Am. Chem. Soc.* **2006**, *128*, 2180-2181; d) Murata, M.; Buchwald, S. L., *Tetrahedron* **2004**, *60*, 7397-7403; e) Mann, G.; Baranano, D.; Hartwig, J. F.; Rheingold, A. L.; Guzei, I. A., *J. Am. Chem. Soc.* **1998**, *120*, 9205-9219; f) Migita,

temperature (up to 120 °C in the case of Pd- or Cu-catalysis) and long reaction times often limit the practicability or the scope of substrates. Moreover, in all these cases the coupling is effective with only aryl iodides, however the cross-coupling with aryl bromides is rather unexplored. To address these issues, we have reported recently a Ni/Ru dual photocatalyzed arylation of thiosugars with aryl iodides under base-free conditions (**Figure 5, c**).<sup>83</sup> However, the more available and less expensive aryl bromides are still unreactive under these photoredox conditions. Only a few examples were reported with the yield never exceeding 43%. Moreover, this method was limited to only protected thiosugars. This set of limitations clearly indicates that glycosyl thiols often behave as a rather special and challenging class of thiol nucleophiles for transition metal-catalyzed thiol-functionalization.

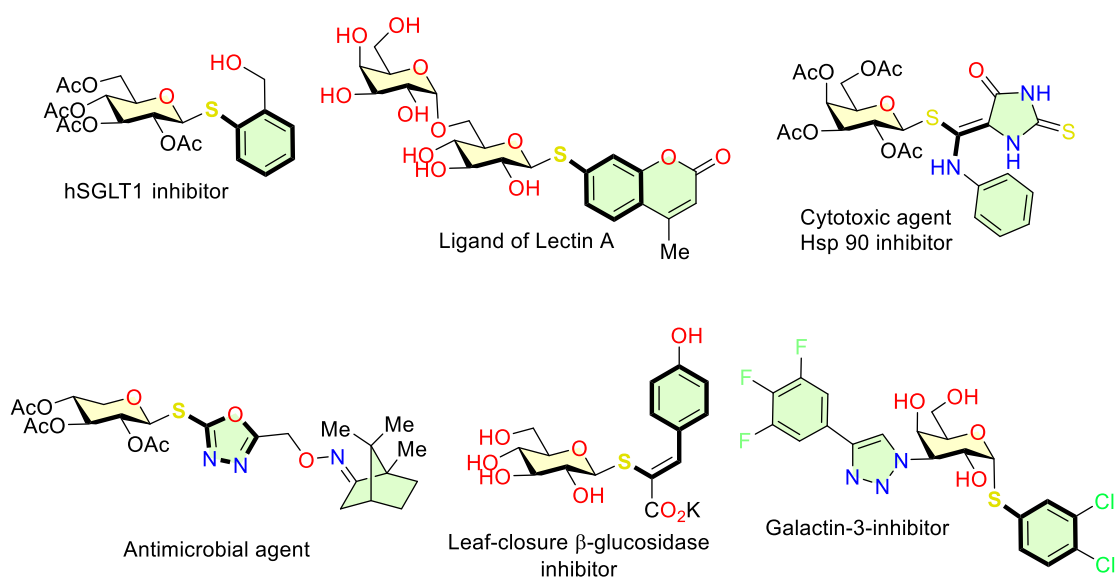

**Figure 4.** Potential applications of 1- thioglycosides

Because of the high importance of thioglycosides, the development of a general method for the coupling of both aryl bromides and iodides to protected and unprotected thiosugars at room temperature and without an external base remains a challenging task.

T.; Shimizu, T.; Asami, Y.; Shiobara, J.-I.; Kato, Y.; Kosugi, M., *Bull. Chem. Soc. Jpn.* **1980**, *53*, 1385-1389; g) Kosugi, M.; Shimizu, T.; Migita, T., *Chem. Lett.* **1978**, 13-14.

<sup>83</sup> Zhu, M.; Dagousset, G.; Alami, M.; Magnier, E.; Messaoudi, S., *Org. Lett.* **2019**, *21*, 5132-5137.

In recent years, electrocatalysis<sup>84</sup> has emerged as a remarkably efficient tool for organic cross-coupling reactions through the use of less precious catalysts and waste-free and inexpensive electric current, thereby avoiding stoichiometric amounts of toxic and costly chemical reagents limiting our impact on the environment. Usually, this method was used successfully in the C–H activation process for the formation of C–C and C–heteroatom bonds (C–O, C–P, and C–N) through the directing group strategy.<sup>85</sup> However, electrochemical C–heteroatom bond formation via cross coupling of nucleophiles with aryl (pseudo)halides was less explored.<sup>86</sup> In particular, methods which use electrocatalysis to form C–S bonds are rare. To the best of our knowledge, only one study by Mei et al. reported the cross-coupling reaction of thiophenols with aryl halides.<sup>87</sup> The authors showed elegantly that this approach allows thiolation of aryl halides. However, this method exhibited several limitations with regard to potential applications: (i) the use of a large excess of the thiophenol partner (3 equiv.) which can

---

<sup>84</sup> For selected reviews on electrocatalysis: a) Ackermann, L., *Acc. Chem. Res.* **2020**, *53*, 84-104; b) Cong, M.; Ping, F.; Tian-Sheng, M., *ACS Catal.* **2018**, *8*, 7179-7189; c) Sauerbrey, N.; Meyer, T. H.; Qiu, Y.; Ackermann, L., *ACS Catal.* **2018**, *8*, 7086-7103; d) Sauer, G. S.; Lin, S., *ACS Catal.* **2018**, *8*, 5175-5187; e) Tang, S.; Liu, Y.; Lei, A., *Chem* **2018**, *4*, 27-45; f) Jiang, Y.; Xu, K.; Zeng, C., *Chem. Rev.* **2018**, *118*, 4485-4540; g) Waldvogel, S. R.; Lips, S.; Selt, M.; Riehl, B.; Kampf, C. J., *Chem. Rev.* **2018**, *118*, 6706-6765; h) Moeller, K. D., *Chem. Rev.* **2018**, *118*, 4817-4833; i) Ma, C.; Fang, P.; Mei, T.-S., *ACS Catal.* **2018**, *8*, 7179-7189; j) Yan, M.; Kawamata, Y.; Baran, P. S., *Chem. Rev.* **2017**, *117*, 13230-13319; k) Hou, Z. -W.; Mao, Z. -Y.; Xu, H. -C., *Synlett* **2017**, *28*, 1867-1872.

<sup>85</sup> For selected C–heteroatom bond through electrocatalysis: a) Zhang, S. -K.; Struwe, J.; Hu, L.; Ackermann, L., *Angew. Chem. Int. Ed.* **2020**, *132*, 1-7; b) Yang, Q. -L.; Wang, X. -Y.; Lu, J. -Y.; Zhang, L. -P.; Fang, P.; Mei, T. -S., *J. Am. Chem. Soc.* **2018**, *140*, 11487-11494; c) Ma, C.; Zhao, C. -Q.; Li, Y. -Q.; Zhang, L. -P.; Xu, X. -T.; Zhang, K.; Mei, T. -S., *Chem. Commun.* **2017**, *53*, 12189-12192; d) Li, Y. -Q.; Yang, Q. -L.; Fang, P.; Mei, T. -S.; Zhang, D., *Org. Lett.* **2017**, *19*, 2905-2908; e) Yang, Q. -L.; Li, Y. -Q.; Ma, C.; Fang, P.; Zhang, X. -J.; Mei, T. -S., *J. Am. Chem. Soc.* **2017**, *139*, 3293-3298; f) Jiao, K. -J.; Li, Z. -M.; Xu, X. -T.; Zhang, L. -P.; Li, Y. -Q.; Zhang, K.; Mei, T. -S., *Org. Chem. Front.* **2018**, *5*, 2244-2248; g) Bai, Y.; Liu, N.; Wang, S.; Wang, S.; Ning, S.; Shi, L.; Cui, L.; Zhang, Z.; Xiang, J., *Org. Lett.* **2019**, *21*, 6835-6838.

<sup>86</sup> a) Xiang, J.; Shang, M.; Kawamata, Y.; Lundberg, H.; Reisberg, S.; Chen, M.; Mykhailiuk, P.; Beutner, G.; Collins, M.; Davies, A.; Del Bel, M.; Gallego, G.; Spangler, J.; Starr, J. T.; Yang, S.; Blackmond, D.; Baran, P. S., *Nature* **2019**, *573*, 398-402; b) Kawamata, Y.; Vantourout, J. C.; Hickey, D. P.; Bai, P.; Chen, L.; Hou, Q.; Qiao, W.; Barman, K.; Edwards, M. A.; Garrido-Castro, A. F.; deGruyter, J. N.; Nakamura, H.; Knouse, K.; Qin, C.; Clay, K. J.; Bao, D.; Li, C.; Starr, J. T.; Garcia-Irizarry, C.; Sach, N.; White, H. S.; Neurock, M.; Minter, S. D.; Baran, P. S., *J. Am. Chem. Soc.* **2019**, *141*, 6392-6402; c) Li, C.; Kawamata, Y.; Nakamura, H.; Vantourout, J. C.; Liu, Z.; Hou, Q.; Bao, D.; Starr, J. T.; Chen, J.; Yan, M.; Baran, P. S., *Angew. Chem. Int. Ed.* **2017**, *56*, 13088-13093.

<sup>87</sup> Liu, D.; Ma, H.; Fang, P.; Mei, T., *Angew. Chem. Int. Ed.* **2019**, *58*, 5033-5037.

be prohibitive for larger scale reactions and (ii) the scope with respect to the thiols was limited to unfunctionalized thiophenols, thus precluding many synthetic applications. Moreover, the S-arylation of functionalized and complex alkyl thiols bearing free hydroxyl or amino groups such as thiosugars under electrochemistry has never been studied, probably because of the polyhydroxylated complexity of carbohydrates. Herein, we became interested in whether the S-(hetero)arylation of 1-thiosugars could be performed by the electrochemical process. The present study is presented (**Figure 3**).

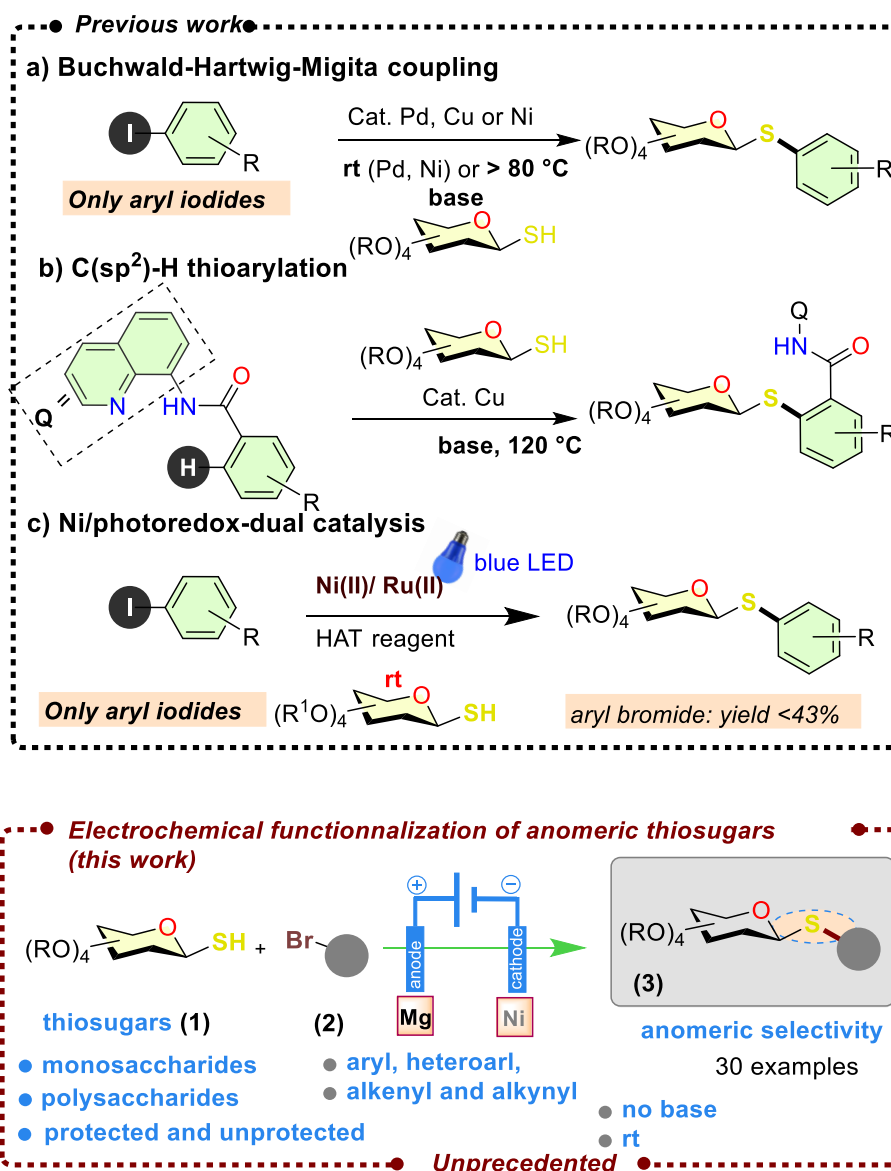

**Figure 5.** Catalytic strategies for the synthesis of thioglycosides

To initiate this study, we conducted this electrochemical thioglycosylation by coupling tetra-O-acetylated 1-thio-β-D-glucopyranose **1a** with 4-bromobenzotrifluoride **2a** as a



model study under various reaction conditions. Representative results from this study are summarized in **Table 14**. The reaction of **1a** (1 equiv.) with **2a** (3 equiv.) was first investigated by using constant-current electrolysis at 4.0 mA in the presence of NiBr<sub>2</sub>·diglyme (10 mol%), 4,4'-di-tertbutyl-2,2'-bipyridine (di-tBubpy) (10 mol%), and LiBr (4 equiv.) in DMF at room temperature for 6 h within an undivided cell (**Table 14, entry 2**). Pleasingly, these conditions afforded **3a** in a moderate 54% yield as a single b-anomer ( $J_{1,2} = 9$  Hz) (see experimental part). Interestingly, decreasing the amount of the bromide partner **2a** from 3 equiv. to 1 equiv. furnished the thioglucoside **3a** in a good 74% yield (**Table 14, entry 1**). Using other anodes such as Zn was not effective (**Table 14, entry 9**). Under these conditions, large amount of disulfide product was formed (see the mechanism, **p 93**). In addition, reaction with DMA instead of DMF was less efficient and gave product **3a** in only 47% yield (**Table 14, entry 11**). Interestingly, when the current was increased up to 8 mA, the reaction time was shortened to 3 h and **3a** was isolated in 74% yield (**Table 14, entry 5**). Finally, performing the coupling reaction with 20 mol% of NiBr<sub>2</sub>·diglyme and 20 mol% of di-tBubpy furnished **3a** in 80% yield (**Table 14, entry 10**). Negative controlling experiments demonstrated that catalyst, LiBr and current are necessary (**Table 14, entries 6–8**).

**Table 14.** Optimization of the coupling reaction of **1a**<sup>[a]</sup>

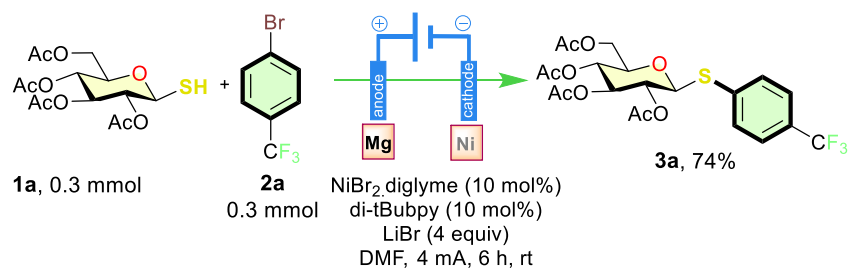

Entry	Deviation from the standard conditions	Yield (%) <sup>b</sup>
1	none	74
2	0.3 mmol of <b>1a</b> and 0.9 mmol of <b>2a</b>	54
3	0.6 mmol of <b>1a</b> and 0.3 mmol of <b>2a</b>	73
4	2 mA, 12 h	71
5	8 mA, 3 h	74
6	No LiBr	0
7	No catalyst	trace
8	No electric current	0
9	Zn instead of Mg	28
10	20 mol% Ni.cat and 20 mol% Dttbpy	80
11	DMA instead of DMF	47

<sup>a</sup> Reactions conditions: Mg anode, Ni foam cathode, **1a** (0.3 mmol), **2** (0.3 mmol), NiBr<sub>2</sub>.diglyme (10 mol%), di-tBubpy (10 mol%), LiBr (1.2 mmol), DMF (0.3 M), undivided cell, constant current = 4 mA, (Ar) room temperature, 6 h. <sup>b</sup> Isolated yield.

With these encouraging results, we investigated next the scope and limitations for this electrochemical process by systematically varying the nature of the bromide electrophile **2**. As shown in **Scheme 29**, all the S-arylations of tetra-O-acetylated 1-thio- $\beta$ -D-glucopyranose **1a** proceeded cleanly and selectively in good yields. Cross-coupling of **1a** with aryl bromides bearing various functional groups (-CN, -Cl, -F, -CF<sub>3</sub>, -CHO and -OMe) has been successfully achieved at room temperature to afford the corresponding thioglycosides (**3a–m**) in yields up to 87%. In addition, the presence of an ortho substitution at the aromatic ring of the coupling partner does not affect the coupling process as compounds **3h** and **3k** were obtained in 80% and 77% yields, respectively. It is noteworthy that a selectivity was observed when a tribromobenzene was used, and only a di-glycosylated product **3m** was obtained in 70% yield even after running the coupling reaction for longer reaction time (6 h) and using 6 equiv. of **1a**. One can note that 3-bromonaphthalene is less reactive under current conditions than 2-bromonaphthalene giving the desired S-naphthylglycoside **3j** in only 22% yield (vs. 77% with 2-bromonaphthalene). However, this yield could be increased significantly (73% yield) when 3-iodonaphthalene was used. The same low reactivity was observed with *p*-bromoanisole vs. *p*-iodoanisole (compound **3l**, 15% vs. 83%). Interestingly, coupling reactions with heteroaryl bromides derived from quinoline and pyridine have also been successful, furnishing **3n, o** in 46% and 86% yields, respectively. Next, we moved on to investigate the reactivity of a series of alkene and alkyne bromides. Pleasantly, both aryl- and alkyl-substituted alkene bromides ((*E*)-1-(2-bromovinyl)-4-methoxybenzene, *E*- $\beta$ -styryliodide, and (*E*)-1-bromo-1-octene) and 2-bromo-1H-indene were transformed efficiently into alkenyl thioglycosides **3p–s** in excellent yields. Finally, alkynyl-thioglycosides **3t–u** were also easily prepared in good yields from the corresponding 1-(bromoethynyl)-4-methoxybenzene and 3-(bromoethynyl)thiophene by this electrochemical method. One can note that benzyl- or PMB-protecting groups on thiosugars are not tolerated.

**Scheme 29.** Scope of Coupling of Thioglucose **1a** with Halo(hetero)arenes, Alkenyl Halides and Alkynyl Bromides **2**

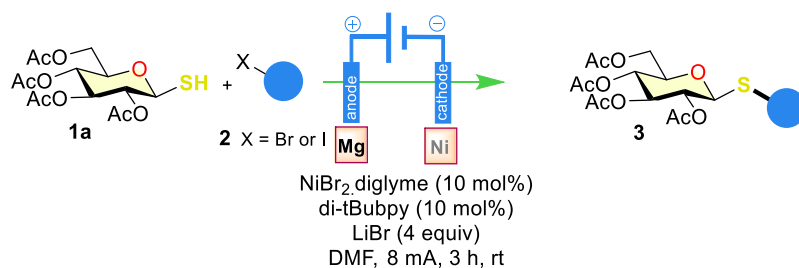

**electron withdrawing groups**

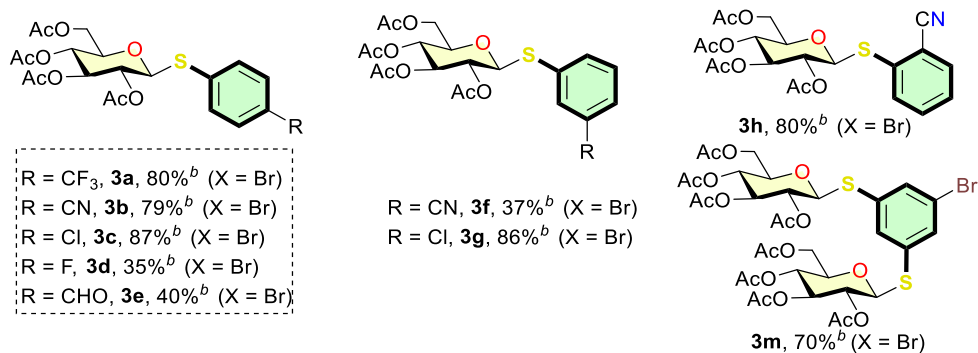

**electron donating groups**

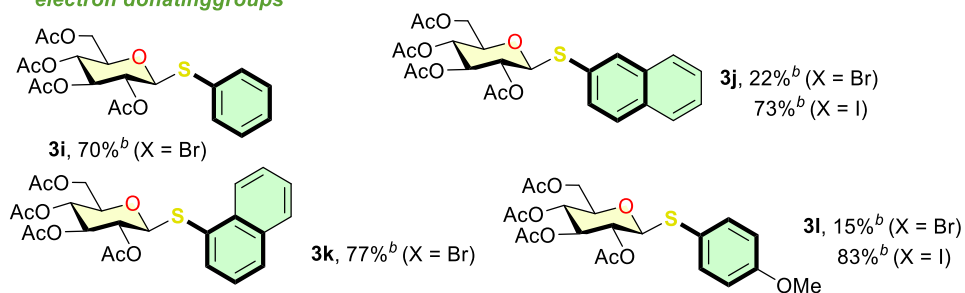

**heterocycles**

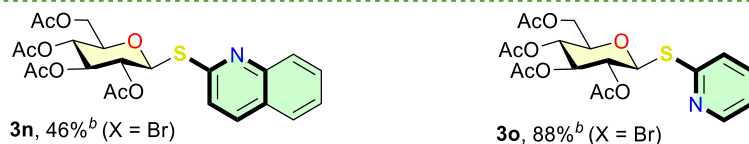

### alkenyles and alkynes

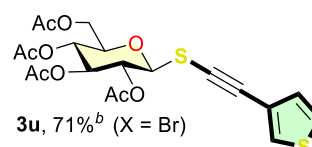
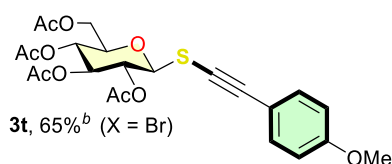
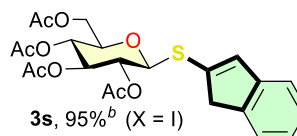
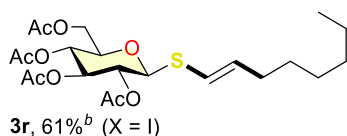
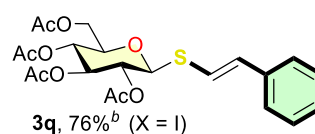
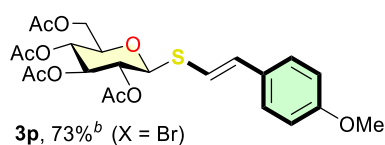

<sup>a</sup> Reactions conditions: Mg anode, Ni foam cathode, **1a** (0.3 mmol), **2** (0.3 mmol), NiBr<sub>2</sub>.diglyme (10 mol%), di-tBubpy (10 mol%), LiBr (1.2 mmol), DMF (0.3 M), undivided cell, constant current = 8 mA, N<sub>2</sub> protection, room temperature, 3 h. <sup>b</sup> Isolated yield.

The successful synthesis of thioglycosides **3a–u** from tetraO-acetylated 1-thio-β-D-glucopyranose **1a** and various aryl bromides under our optimized electrochemical conditions encouraged us to investigate other glycosyl thiols. As depicted in **Scheme 30**, this coupling reaction tolerates different sugars such as O-benzoylated 1-thio-β-D-glucopyranose, thio-β-D-galactopyranose and 1-thio-β-D-fucopyranose, which furnished the thioglycosides **4a–c** in yields up to 95%. In addition, this coupling could be applied successfully to the more complex and biologically relevant saccharide derivatives thio-β-D-cellobiose and thio-β-D-maltotriose delivering **4d** and **4e** in 90% and 88% yields, respectively.

**Scheme 30.** Scope of 1 thio- $\beta$ -glycosyls **1b-g**<sup>a</sup>

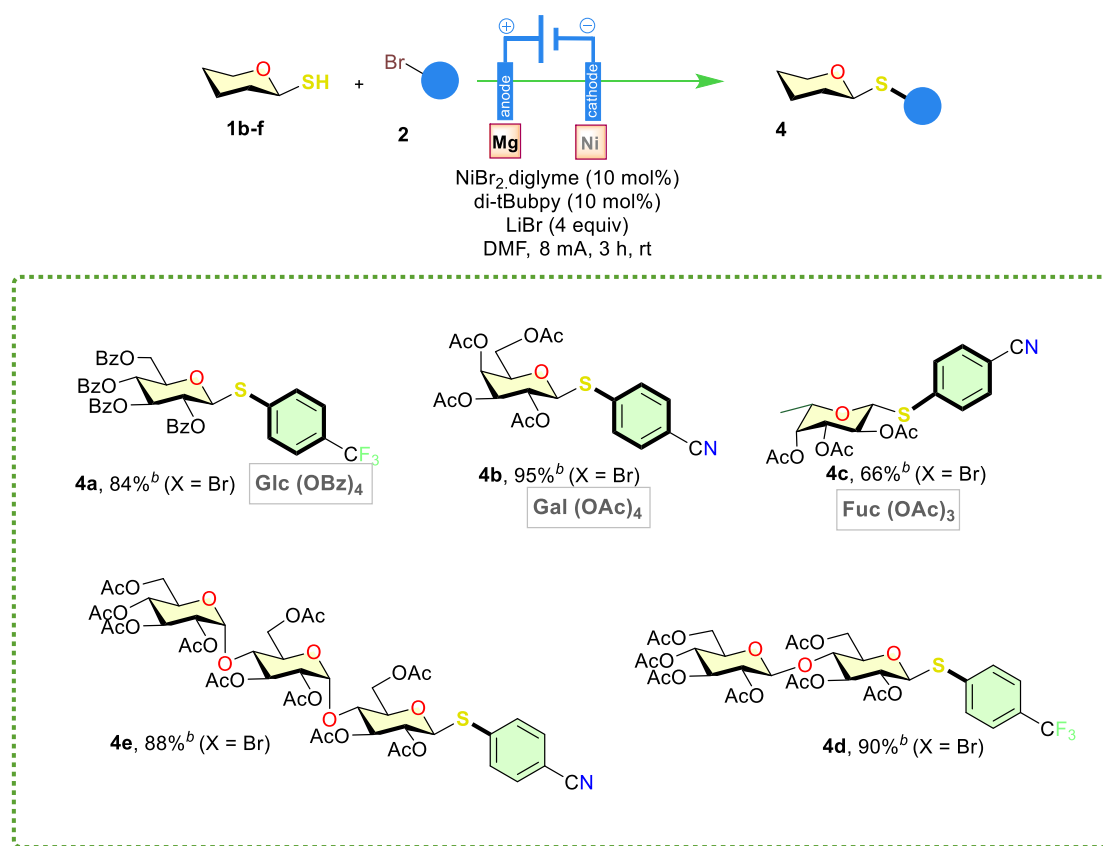

<sup>a</sup> Reactions conditions: Mg anode, Ni foam cathode, **1b-f** (0.3 mmol), **2** (0.3 mmol), NiBr<sub>2</sub>.diglyme (10 mol%), di-tBubpy (10 mol%), LiBr (1.2 mmol), DMF (0.3 M), undivided cell, constant current = 8 mA, N<sub>2</sub> protection, room temperature, 3 h. <sup>b</sup>Isolated yield.

One of the most important tasks in the area of organometallic chemistry is to discover mild and general methods for the easy functionalization of polyhydroxylated compounds with high selectivity without using any protection/deprotection sequence. To further show the synthetic use of our protocol, we evaluated whether the S-arylation of unprotected thiosugars could be realized by this electrochemical method. To our delight, the reaction of unprotected thio- $\beta$ -D-glucose and thio- $\beta$ -D-cellobiose yielded the respective products **5a** and **5b** in good yields, and no side products arising from the O-arylation were observed (**Scheme 31**).

Finally, as part of our interest in developing new methods for peptide and protein bioconjugation, we considered it worthwhile to investigate the reaction of cysteine

amino acid with aryl bromides (**Scheme 31**). Direct arylation of cysteine-containing peptides has only been reported using precious Pd-catalysts.<sup>88</sup> To this end, we tested the reaction of L-cysteine with p-cyanophenyl bromide and we were pleased to observe the formation of the S-arylated cysteine **5c** in 67% yield (**Scheme 31**). This result represents the first example of diversification of cysteine using the electrochemical approach and may open a new way to the bioconjugation of peptides and proteins through this methodology.

**Scheme 31.** Unprotected thiosugars and cysteine-containing peptides as challenging functionalyzed thiols

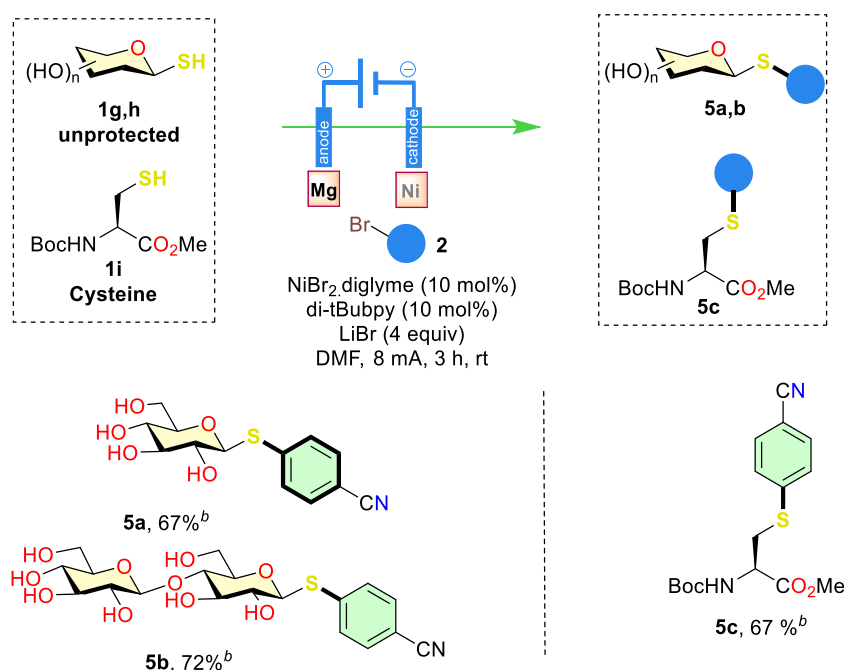

<sup>a</sup> Reactions conditions: Mg anode, Ni foam cathode, **1g-i** (0.3 mmol), **2a** (0.3 mmol),  $\text{NiBr}_2 \cdot \text{diglyme}$  (10 mol%), di-tBubpy (10 mol%), LiBr (1.2 mmol), DMF (0.3 M), undivided cell, constant current = 8 mA,  $\text{N}_2$  protection, room temperature, 3 h. <sup>b</sup> Isolated yield.

<sup>88</sup> a) Vinogradova, E. V.; Zhang, C.; Spokoyniy, A. M.; Pentelute, B. L.; Buchwald, S. L., *Nature* **2015**, 526, 687-691; b) Al-Shuaieeb, R. A.; Kolodych, S.; Koniev, O.; Delacroix, S.; Erb, S.; Nicolaÿ, S.; Cintrat, J. C.; Brion, J. D.; Cianfèrari, S.; Alami, M.; Wagner, A.; Messaoudi, S., *Chem. Eur. J.* **2016**, 22, 11365-11370; c) Willwacher, J.; Raj, R.; Mohammed, S.; Davis, B. G., *J. Am. Chem. Soc.* **2016**, 138, 8678-8681.

From a mechanistic point of view, we could assume that catalytic cycle may be initiated by cathodic reduction of Ni(II) to Ni(0) (**Scheme 32**). In another hand, glycosyl sulfhydryl group generates a glycosyl thiolate from a cathodic reduction. This later reacts with the complex (**I**) which arises from Ni(0) oxidative addition (OA) with the aryl bromide, to led to a complex (**II**). Reductive elimination (RE) delivers the S-arylated sugar. In a possible alternative of the catalytic cycle, the addition of a formed thiyl radical to the complex (**I**) to generate a Ni(III) complex may be envisioned. Consider that the main reaction happened on the cathode, and the side reaction happened on anode, maybe the higher yield we can get if divided cells is used for this reaction. But complex operation is required.

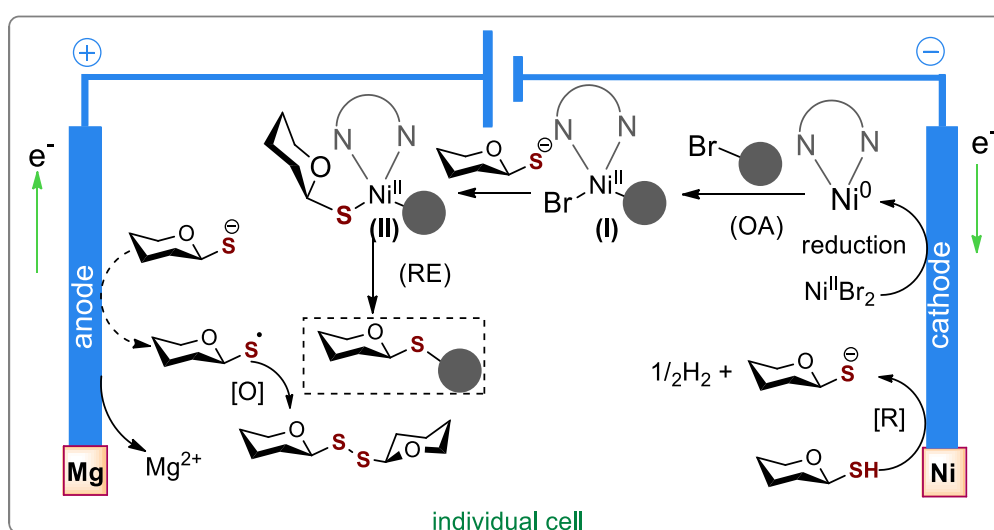

**Scheme 32.** Proposed mechanism

### C) Conclusion and perspectives.

In summary, we described here the first electrochemical method for coupling various anomeric glycosyl thiols with aryl bromides. This method demonstrates unprecedented reactivity with regard to bromide partners (heteroaryl, alkenynyl and alkenyl bromides) and selectivity, including reactions with unprotected thiosugars, and cysteine amino acid. Further studies on the applications of this method in the S-arylation of more complex polysaccharides and cysteine containing peptides are ongoing.

## D) Experimental part

### General information

Solvents and reagents are obtained from commercial suppliers and were used without further purification. Analytical TLC was performed using Merck silica gel F254 (230-400 mesh) plates and analyzed by UV light or by staining upon heating with vanilin solution (15 g of vanilin in 250 mL ethanol and 2.5 mL of concentrated sulfuric acid). For silica gel chromatography, the flash chromatography technique was used, with Merck silica gel 60 (230-400 mesh) and p.a. grade solvents unless otherwise noted. The  $^1\text{H}$  NMR and  $^{13}\text{C}$  NMR spectra were recorded in either  $\text{CDCl}_3$  or  $\text{MeOD-d}_4$  on Bruker Avance 300 spectrometers. The chemical shifts of  $^1\text{H}$  and  $^{13}\text{C}$  are reported in ppm relative to the solvent residual peaks. IR spectra were measured on a Bruker Vector 22 spectrophotometer.

Merck silica gel 60 (0.015–0.040 mm) was used for column chromatography. Melting points were recorded on a Büchi B-450 apparatus and are uncorrected. High resolution mass spectra (HR-MS) were recorded on a MicroMass LCT Premier Spectrometer spectrometer. Optical rotations were obtained with a PolAAr 32 polarimeter. Thiosugars were synthesized as according the following protocols.<sup>89</sup>

ElectraSyn 2.0 Package used is from IKA

### Electrode materials and dimensions

The Mg electrodes were purchased from commercial Mg block (purchased from IKA) and Ni foam electrodes were furnished from Nickel Foam (purchased from IKA).

### General Procedures

**The preparation of Solution A:** A screwed-capped tube with stir bar charged with Ni catalyst (6 mmol) and dtbbpy (6 mmol) were dissolved in 20 mL of DMF under Ar. The solution was stirred for 1 h at 60 °C before usage.

---

<sup>89</sup> a) Floyd, N.; Vijayakrishnan, B.; Koeppel, J. R.; Davis, B. G., *Angew. Chem., Int. Ed.*, **2009**, *48*, 7798. b) Gamblin, D. P.; Garnier, P.; van Kasteren, S.; Oldham, N. J.; Fairbanks, A. J.; Davis, B. G., *Angew. Chem., Int. Ed.*, **2004**, *43*, 828.



**The preparation of Solution B:** A screwed-capped tube with a stir bar charged with LiBr (8 mmol) was flame-dried under vacuum until the disappearance of water deposit on the walls. The tube was backfilled with an argon balloon and 20 mL of DMF. The solution was stirring for 1 h under room temperature before usage.

An ElectraSyn vial (5 mL) with a stir bar was charged with thiosugar (0.3 mmol, 1 eq), arly halide (if solid) (0.3 mmol, 1eq). The ElectraSyn vial cap equipped with anode (Mg) and cathode (Ni foam) were inserted into the mixture. The vial was then evacuated and backfilled with an argon balloon. And then, arly halide (if liqued) (0.3 mmol, 1 eq), 1 mL of **Solution A** and 2 mL of **Solution B** was added. The reaction mixture was electrolyzed under a constant current of 8 mA for 3 h at rt. The mixture was dissolved in water and DCM. The layers were separated and the aqueous solution was extracted with further DCM (3×50 mL). The combined organic layers were dried with MgSO<sub>4</sub> and the solvent was removed under reduced pressure. Purification was performed with flash chromatograpy on silica gel.

### Graphical guide for electrochemical C-S thiolation

#### Step to step:

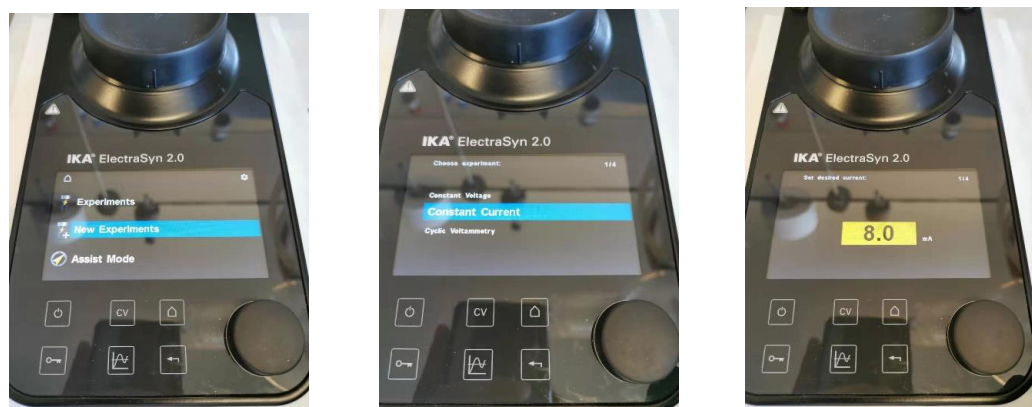

**Figure 6.** Left. Chose “New Experiments”. Middle. Chose “Constant Current”. Right. Select “8.0 mA”.



**Figure 7.** Left. “Reference electrodes:” chose “No”. Middle. Chose “Time”. Right. Select “3 hours”.



**Figure 8.** Left. Chose “0.30”. Middle. “Polarity” Chose “No”. Right. Chose “Start”.



**Figure 9.** Left. Electrode, Mg and Ni form. Middle. The mixture before reaction. Right. The mixture after reaction.

## Experimental data

### (2R,3R,4S,5R,6S)-2-(acetoxymethyl)-6-((4-(trifluoromethyl)phenyl)thio)tetrahydro-2H-pyran-3,4,5-triyl triacetate **3a**<sup>90</sup>

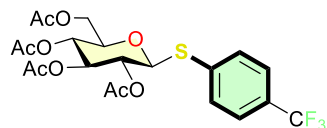

R<sub>f</sub> = 0.2 (EtOAc /cyclohexane: 3/7); White solid, <sup>1</sup>H NMR (300 MHz, CDCl<sub>3</sub>) δ 7.53-7.60 (m, 4H), 5.23 (t, *J* = 12.0 Hz, 1H), 5.01 (td, *J* = 9.0, 12.0 Hz, 2H), 4.77 (d, *J* = 9.0 Hz, 1H), 4.14-4.25 (m, 2H), 3.72-3.78 (m, 1H), 2.06 (s, 3H), 2.05 (s, 3H), 2.01 (s, 3H), 1.98 (s, 3H). HRMS (ESI): *m/z* calc. for C<sub>21</sub>H<sub>23</sub>F<sub>3</sub>NaO<sub>9</sub>S [M+Na]<sup>+</sup> 531.0907; found 531.0897.

### (2R,3R,4S,5R,6S)-2-(acetoxymethyl)-6-((4-cyanophenyl)thio)tetrahydro-2H-pyran-3,4,5-triyl triacetate **3b**<sup>78</sup>

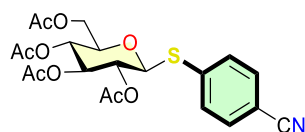

R<sub>f</sub> = 0.3 (EtOAc /cyclohexane: 3/7); White solid, <sup>1</sup>H NMR (300 MHz, CDCl<sub>3</sub>) δ 7.51-7.58 (m, 4H), 5.24 (t, *J* = 9.0 Hz, 1H), 5.01 (td, *J* = 12.0, 9.0 Hz, 2H), 4.81 (d, *J* = 9.0 Hz, 1H), 4.13-4.25 (m, 2H), 3.75-3.81 (m, 1H), 2.06 (s, 3H), 2.04 (s, 3H), 2.01 (s, 3H), 1.97 (s, 3H). HRMS (ESI): *m/z* calc. for C<sub>21</sub>H<sub>23</sub>NNaO<sub>9</sub>S [M+Na]<sup>+</sup> 488.0986; found 488.0993.

---

<sup>90</sup> Zhu, M.; Dagousset, G.; Alami, M.; Magnier, E.; Messaoudi, S., *Org. Lett.*, **2019**, *21*, 5132- 5137

**(2R,3R,4S,5R,6S)-2-(acetoxymethyl)-6-((4-chlorophenyl)thio)tetrahydro-2H-pyran-3,4,5-triyl triacetate 3c**<sup>78</sup>

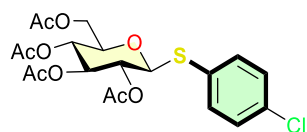

R<sub>f</sub> = 0.2 (EtOAc /cyclohexane: 3/7); <sup>1</sup>H NMR (300 MHz, CDCl<sub>3</sub>) δ 7.43 (d, *J* = 9.0 Hz, 2H), 7.27 (d, *J* = 9.0 Hz, 2H), 5.20 (t, *J* = 9.0 Hz, 1H), 4.96 (td, *J* = 24.0, 12.0 Hz, 2H), 4.64 (d, *J* = 9.0 Hz, 1H), 4.13-4.23 (m, 2H), 3.67-3.73 (m, 1H), 2.07 (s, 3H), 2.06 (s, 3H), 2.00 (s, 3H), 1.97 (s, 3H); HRMS (ESI): *m/z* calc. for C<sub>20</sub>H<sub>23</sub>ClNaO<sub>9</sub>S [M+Na]<sup>+</sup> 497.0644; found 497.0652.

**(2R,3R,4S,5R,6S)-2-(acetoxymethyl)-6-((4-fluorophenyl)thio)tetrahydro-2H-pyran-3,4,5-triyl triacetate 3d**<sup>78</sup>

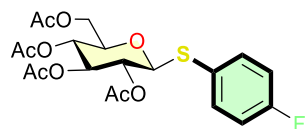

R<sub>f</sub> = 0.2 (EtOAc /cyclohexane: 3/7); White solid. <sup>1</sup>H NMR (300 MHz, CDCl<sub>3</sub>) δ 7.46-7.51 (m, 2H), 6.97-7.03 (m, 2H), 5.19 (t, *J* = 9.0 Hz, 1H), 4.94 (td, *J* = 9.0, 30.0 Hz, 2H), 4.59 (d, *J* = 12.0 Hz, 1H), 4.13-4.23 (m, 2H), 3.65-3.71 (m, 1H), 2.08 (s, 3H), 2.05 (s, 3H), 1.99 (s, 3H), 1.97 (s, 3H). HRMS (ESI): *m/z* calc. for C<sub>20</sub>H<sub>23</sub>FNaO<sub>9</sub>S [M+Na]<sup>+</sup> 481.0939; found 481.0937.

**(2R,3R,4S,5R,6S)-2-(acetoxymethyl)-6-((4-formylphenyl)thio)tetrahydro-2H-pyran-3,4,5-triyl triacetate 3e**

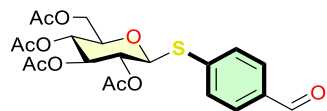

R<sub>f</sub> = 0.3 (EtOAc /cyclohexane: 1/1); colorless oil. <sup>1</sup>H NMR (300 MHz, CDCl<sub>3</sub>) δ 9.97 (s, 1H), 7.80 (d, *J* = 9.0 Hz, 2H), 7.57 (d, *J* = 9.0 Hz, 2H), 5.26 (t, *J* = 9.0 Hz, 1H), 5.05

(td,  $J = 6.0, 9.0$  Hz, 2H), 4.86 (d,  $J = 12.0$  Hz, 1H), 4.15-4.27 (m, 2H), 3.78-3.83 (m, 1H), 2.08 (s, 3H), 2.06 (s, 3H), 2.02 (s, 3H), 1.98 (s, 3H);  $^{13}\text{C}$  NMR (75 MHz,  $\text{CDCl}_3$ )  $\delta$  191.2 (CH), 170.4 (C), 170.0 (C), 169.3 (C), 169.2 (C), 140.9 (C), 135.3 (C), 130.9 (2CH), 129.9 (2CH), 84.6 (CH), 76.0 (CH), 73.7 (CH), 69.7 (CH), 68.1 (CH), 62.1 (CH<sub>2</sub>), 20.7 (CH<sub>3</sub>), 20.6 (CH<sub>3</sub>), 20.5 (2CH<sub>3</sub>); IR (neat): 2360, 1755, 1700, 1593, 1564, 1368, 1248, 1173, 1089, 1037, 915, 837, 711  $\text{cm}^{-1}$ ; HRMS (ESI):  $m/z$  calc. for  $\text{C}_{21}\text{H}_{24}\text{NaO}_{10}\text{S}$   $[\text{M}+\text{Na}]^+$  491.0988; found 491.0991.

**(2R,3R,4S,5R,6S)-2-(acetoxymethyl)-6-((3-cyanophenyl)thio)tetrahydro-2H-pyran-3,4,5-triyl triacetate 3f**

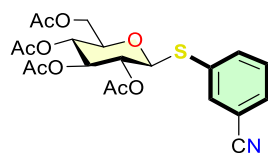

$R_f = 0.3$  (EtOAc /cyclohexane: 3/7); White solid, m. p.: 133.2-133.6  $^{\circ}\text{C}$ ;  $[\alpha]_{\text{D}}^{18} = -29.0$  (c, 0.31,  $\text{CHCl}_3$ );  $^1\text{H}$  NMR (300 MHz,  $\text{CDCl}_3$ )  $\delta$  7.82 (s, 1H), 7.70 (d,  $J = 6.0$  Hz, 1H), 7.61 (d,  $J = 9.0$  Hz, 1H), 7.43 (t,  $J = 9.0$  Hz, 1H), 5.24 (t,  $J = 9.0$  Hz, 1H), 4.98 (td,  $J = 9.0$  Hz, 21.0 Hz, 2H), 4.72 (d,  $J = 9.0$  Hz, 1H), 4.16-4.27 (m, 2H), 3.74-3.80 (m, 1H), 2.12 (s, 3H), 2.09 (s, 3H), 2.02 (s, 3H), 1.99 (s, 3H);  $^{13}\text{C}$  NMR (75 MHz,  $\text{CDCl}_3$ )  $\delta$  170.6 (C), 170.0 (C), 169.3 (C), 169.1 (C), 137.1 (CH), 135.9 (CH), 133.7 (C), 131.8 (CH), 129.5 (CH), 118.0 (C), 113.4 (C), 84.8 (CH), 76.1 (CH), 73.7 (CH), 69.7 (CH), 68.0 (CH), 62.0 (CH<sub>2</sub>), 20.7 (2CH<sub>3</sub>), 20.5 (2CH<sub>3</sub>); IR (neat): 2988, 2901, 2361, 1754, 1248, 1086, 915, 798  $\text{cm}^{-1}$ ; HRMS (ESI):  $m/z$  calc. for  $\text{C}_{21}\text{H}_{23}\text{NNaO}_9\text{S}$   $[\text{M}+\text{Na}]^+$  488.0986; found 488.0993.

**(2R,3R,4S,5R,6S)-2-(acetoxymethyl)-6-((3-chlorophenyl)thio)tetrahydro-2H-pyran-3,4,5-triyl triacetate 3g <sup>78</sup>**

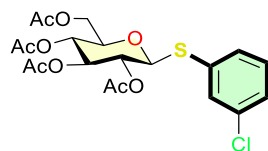

R<sub>f</sub> = 0.2 (EtOAc /cyclohexane: 3/7); White solid. <sup>1</sup>H NMR (300 MHz, CDCl<sub>3</sub>) δ 7.53 (m, 1H), 7.23-7.38 (m, 3H), 5.25 (t, *J* = 9.0 Hz, 1H), 5.02 (td, *J* = 21.0, 12.0 Hz, 2H), 4.74 (d, *J* = 12.0 Hz, 1H), 4.17-4.28 (m, 2H), 3.74-3.81 (m, 1H), 2.11 (s, 3H), 2.10 (s, 3H), 2.04 (s, 3H), 2.01 (s, 3H). HRMS (ESI): *m/z* calc. for C<sub>20</sub>H<sub>23</sub>ClNaO<sub>9</sub>S [M+Na]<sup>+</sup> 497.0644; found 497.0651.

**(2R,3R,4S,5R,6S)-2-(acetoxymethyl)-6-((2-cyanophenyl)thio)tetrahydro-2H-pyran-3,4,5-triyl triacetate 3h**



R<sub>f</sub> = 0.3 (EtOAc /cyclohexane: 3/7); White solid, m. p.: 69.1-70.8 °C; [α]<sub>D</sub><sup>18</sup> = -27.9 (c, 0.43, CHCl<sub>3</sub>); <sup>1</sup>H NMR (300 MHz, CDCl<sub>3</sub>) δ 7.80 (d, *J* = 9.0 Hz, 1H), 7.68 (d, *J* = 9.0 Hz, 1H), 7.55 (t, *J* = 6.0 Hz, 1H), 7.45 (t, *J* = 9.0 Hz, 1H), 5.22 (t, *J* = 9.0 Hz, 1H), 4.96 (td, *J* = 9.0 Hz, 30.0 Hz, 2H), 4.75 (d, *J* = 9.0 Hz, 1H), 4.12-4.26 (m, 2H), 3.70-3.76 (m, 2H), 2.12 (s, 3H), 2.07 (s, 3H), 2.00 (s, 3H), 1.97 (s, 3H); <sup>13</sup>C NMR (75 MHz, CDCl<sub>3</sub>) δ 170.4 (C), 170.0 (C), 169.5 (C), 169.3 (C), 135.3 (CH), 134.8 (C), 133.7 (CH), 132.8 (CH), 129.2 (CH), 118.1 (C), 116.9 (C), 85.1 (CH), 76.1 (CH), 73.8 (CH), 69.4 (CH), 68.1 (CH), 62.0 (CH<sub>2</sub>), 20.7 (2CH<sub>3</sub>), 20.5 (2CH<sub>3</sub>); IR (neat): 2360, 2228, 1755, 1469, 1435, 1367, 1248, 1213, 1090, 1062, 1036, 914, 824, 765 cm<sup>-1</sup>; HRMS (ESI): *m/z* calc. for C<sub>21</sub>H<sub>23</sub>NNaO<sub>9</sub>S [M+Na]<sup>+</sup> 488.0986; found 488.0990.

**(2R,3R,4S,5R,6S)-2-(acetoxymethyl)-6-(phenylthio)tetrahydro-2H-pyran-3,4,5-triyl triacetate 3i<sup>91</sup>**

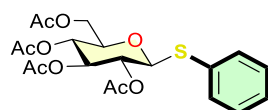

<sup>91</sup> Thomas, H. G.; Mieusset, J., *Tetrahedron*, **2008**, *64*, 5124-5131.

Rf = 0.2 (EtOAc /cyclohexane: 3/7); White solid.  $^1\text{H}$  NMR (300 MHz,  $\text{CDCl}_3$ )  $\delta$  7.47-7.50 (m, 2H), 7.28-7.31 (m, 3H), 5.21 (t,  $J = 9.0$  Hz, 1H), 4.99 (td,  $J = 9.0$  Hz, 18.0 Hz, 2H), 4.69 (d,  $J = 9.0$  Hz, 1H), 4.13-4.24 (m, 2H), 4.69 (d,  $J = 9.0$  Hz, 1H), 4.13-4.24 (m, 2H), 3.68-3.75 (m, 1H), 2.07 (s, 3H), 2.06 (s, 3H), 2.00 (s, 3H), 1.97 (s, 3H). HRMS (ESI):  $m/z$  calc. for  $\text{C}_{20}\text{H}_{24}\text{NaO}_9\text{S}$   $[\text{M}+\text{Na}]^+$  463.1039; found 463.1038.

**(2R,3R,4S,5R,6S)-2-(acetoxymethyl)-6-(naphthalen-2-ylthio)tetrahydro-2H-pyran-3,4,5-triyl triacetate 3j**

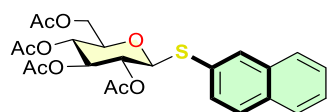

Rf = 0.3 (EtOAc /cyclohexane: 3/7); White solid, m. p.: 112.4-113.1  $^\circ\text{C}$ ;  $[\alpha]_{\text{D}}^{18} = -16.0$  (c, 0.38,  $\text{CHCl}_3$ );  $^1\text{H}$  NMR (300 MHz,  $\text{CDCl}_3$ )  $\delta$  7.98 (s, 1H), 7.75-7.82 (m, 3H), 7.47-7.56 (m, 3H), 5.23 (t,  $J = 9.0$  Hz, 1H), 5.02 (td,  $J = 6.0, 9.0$  Hz, 2H), 4.78 (d,  $J = 9.0$  Hz, 1H), 4.14-4.26 (m, 2H), 3.69-3.74 (m, 1H), 2.10 (s, 3H), 2.01 (s, 3H), 2.00 (s, 3H), 1.97 (s, 3H);  $^{13}\text{C}$  NMR (75 MHz,  $\text{CDCl}_3$ )  $\delta$  170.5 (C), 170.1 (C), 169.3 (C), 169.2 (C), 133.5 (C), 132.9 (C), 132.7 (CH), 130.2 (CH), 128.8 (C), 128.5 (CH), 127.7 (2CH), 126.7 (2CH), 85.7 (CH), 75.9 (CH), 74.0 (CH), 70.1 (CH), 68.2 (CH), 62.1 ( $\text{CH}_2$ ), 20.8 ( $\text{CH}_3$ ), 20.7 ( $\text{CH}_3$ ), 20.5 (2 $\text{CH}_3$ ); IR (neat): 1755, 1367, 1249, 1215, 1091, 1062, 1037, 915, 861, 818, 749  $\text{cm}^{-1}$ ; HRMS (ESI):  $m/z$  calc. for  $\text{C}_{24}\text{H}_{26}\text{NaO}_9\text{S}$   $[\text{M}+\text{Na}]^+$  513.1195; found 513.1193.

**(2R,3R,4S,5R,6S)-2-(acetoxymethyl)-6-(naphthalen-1-ylthio)tetrahydro-2H-pyran-3,4,5-triyl triacetate 3k <sup>78</sup>**

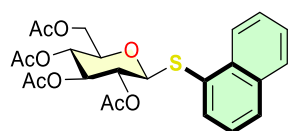

Rf = 0.2 (EtOAc /cyclohexane: 3/7); White solid.  $^1\text{H}$  NMR (300 MHz,  $\text{CDCl}_3$ )  $\delta$  8.46 (d,  $J = 6.0$  Hz, 1H), 7.81-7.88 (m, 3H), 7.40-7.58 (m, 3H), 5.19 (t,  $J = 9.0$  Hz, 1H), 5.02-5.10 (m, 2H), 4.71 (d,  $J = 9.0$  Hz, 1H), 4.06-4.21 (m, 2H), 3.57-3.63 (m, H), 2.11

(s, 3H), 2.00 (s, 3H), 1.99 (s, 3H), 1.98 (s, 3H). HRMS (ESI):  $m/z$  calc. for  $C_{24}H_{26}NaO_9S$   $[M+Na]^+$  513.1190; found 513.1195.

**(2R,3R,4S,5R,6S)-2-(acetoxymethyl)-6-((4-methoxyphenyl)thio)tetrahydro-2H-pyran-3,4,5-triyl triacetate 31<sup>78</sup>**

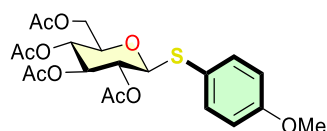

$R_f$  = 0.2 (EtOAc /cyclohexane: 7/3);  $^1H$  NMR (300 MHz,  $CDCl_3$ )  $\delta$  7.42 (d,  $J$  = 9.0 Hz, 2H), 6.83 (d,  $J$  = 9.0 Hz, 2H), 5.18 (t,  $J$  = 9.0 Hz, 1H), 4.93 (td,  $J$  = 12.0, 30.0 Hz, 2H), 4.54 (d,  $J$  = 9.0 Hz, 1H), 4.14-4.24 (m, 2H), 3.80 (s, 3H), 3.63-3.69 (m, 1H), 2.08 (s, 3H), 2.06 (s, 3H), 1.99 (s, 3H), 1.96 (s, 3H); HRMS (ESI):  $m/z$  calc. for  $C_{21}H_{26}NaO_{10}S$   $[M+Na]^+$  493.1139; found 493.1148.

**2-(acetoxymethyl)-6-((3-bromo-5-(((2S,3R,4S,5R,6R)-3,4,5-triacetoxy-6-(acetoxymethyl)tetrahydro-2H-pyran-2-yl)thio)phenyl)thio)tetrahydro-2H-pyran-3,4,5-triyl triacetate 3m**

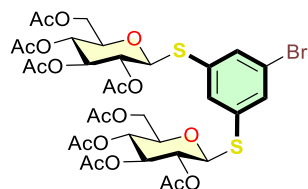

$R_f$  = 0.3 (EtOAc /cyclohexane: 3/7); White solid, m. p.: 151.1-151.3 °C;  $[\alpha]_D^{18}$  = -26.9 (c, 1.0,  $CHCl_3$ );  $^1H$  NMR (300 MHz,  $CDCl_3$ )  $\delta$  7.61 (s, 2H), 7.44 (s, 1H), 5.23 (t,  $J$  = 9.0 Hz, 2H), 4.97 (td,  $J$  = 9.0, 27.0 Hz, 4H), 4.75 (d,  $J$  = 9.0 Hz, 2H), 4.13-4.26 (m, 4H), 3.75-3.80 (m, 2H), 2.10 (s, 6H), 2.07 (s, 6H), 2.00 (s, 6H), 1.97 (s, 6H);  $^{13}C$  NMR (75 MHz,  $CDCl_3$ )  $\delta$  170.6 (2C), 170.0 (2C), 169.3 (2C), 169.1 (2C), 135.2 (CH), 135.0 (2CH), 134.3 (2C), 122.5 (C), 85.1 (2CH), 76.0 (2CH), 73.8 (2CH), 69.8 (2CH), 68.0 (2CH), 62.0 (2CH<sub>2</sub>), 20.8 (2CH<sub>3</sub>), 20.6 (2CH<sub>3</sub>), 20.5 (4CH<sub>3</sub>); IR (neat): 2359, 1755, 1740, 1367, 1089, 980, 827, 758  $cm^{-1}$ ; HRMS (ESI):  $m/z$  calc. for  $C_{34}H_{41}BrNaO_{18}S_2$   $[M+Na]^+$  903.0815; found 903.0821.



**(2R,3R,4S,5R,6S)-2-(acetoxymethyl)-6-(quinolin-2-ylthio)tetrahydro-2H-pyran-3,4,5-triyl triacetate 3n**

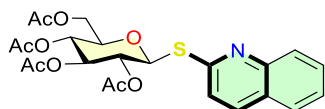

R<sub>f</sub> = 0.3 (EtOAc /cyclohexane: 3/7); White solid, m. p.: 155.9-156.4 °C; [α]<sub>D</sub><sup>18</sup> = +2.6(c, 0.38, CHCl<sub>3</sub>); <sup>1</sup>H NMR (300 MHz, CDCl<sub>3</sub>) δ 7.91-7.96 (m, 2H), 7.63-7.75 (m, 2H), 7.46 (t, *J* = 9.0 Hz, 1H), 7.19 (d, *J* = 9.0 Hz, 1H), 6.13 (d, *J* = 9.0 Hz, 1H), 5.43 (t, *J* = 9.0 Hz, 1H), 5.28 (t, *J* = 9.0 Hz, 1H), 5.17 (t, *J* = 9.0 Hz, 1H), 4.25 (dd, *J* = 3.0, 12.0 Hz, 1H), 4.04-4.14 (m, 1H), 3.98-4.01 (m, 1H); <sup>13</sup>C NMR (75 MHz, CDCl<sub>3</sub>) δ 170.6 (C), 170.2 (C), 169.5 (2C), 155.3 (C), 148.1 (C), 136.2 (CH), 129.9 (CH), 128.3 (CH), 127.7 (CH), 126.5 (C), 125.9 (CH), 121.0 (CH), 81.1 (CH), 76.1 (CH), 74.3 (CH), 69.4 (CH), 68.6 (CH), 62.1 (CH<sub>2</sub>), 20.6 (4CH<sub>3</sub>). IR (neat): 2360, 1755, 1296, 1090, 1062, 825, 772 cm<sup>-1</sup>; HRMS (ESI): *m/z* calc. for C<sub>23</sub>H<sub>25</sub>NNaO<sub>9</sub>S [M+Na]<sup>+</sup> 514.1148; found 514.1151.

**(2R,3R,4S,5R,6S)-2-(acetoxymethyl)-6-(pyridin-2-ylthio)tetrahydro-2H-pyran-3,4,5-triyl triacetate 3o**<sup>92</sup>

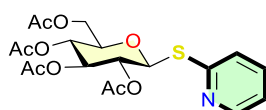

R<sub>f</sub> = 0.2 (EtOAc /cyclohexane: 1/1); White solid. <sup>1</sup>H NMR (300 MHz, CDCl<sub>3</sub>) δ 8.38 (m, 1H), 7.45-7.51 (m, 1H), 7.14-7.17 (m, 1H), 6.99-7.03 (m, 1H), 5.77 (d, *J* = 12.0 Hz, 1H), 5.30 (t, *J* = 9.0 Hz, 1H), 5.12 (td, *J* = 12.0 Hz, 21.0 Hz, 2H), 4.20 (dd, *J* = 3.0, 12.0 Hz, 1H), 4.01-4.06 (m, 1H), 3.80-3.86 (m, 1H), 1.97 (s, 3H), 1.96 (s, 3H), 1.95 (s, 3H), 1.94 (s, 3H). HRMS (ESI): *m/z* calc. for C<sub>19</sub>H<sub>23</sub>NNaO<sub>9</sub>S [M+Na]<sup>+</sup> 464.0991; found 464.0996.

---

<sup>92</sup> Khodair, A. I.; Al-Masoudi, N.; Gesson, J., *Nucleos. Nucleot. Nucl.*, **2003**, *21*, 2061-2076.

**(2R,3R,4S,5R,6S)-2-(acetoxymethyl)-6-(((E)-4-methoxystyryl)thio)tetrahydro-2H-pyran-3,4,5-triyl triacetate 3p**<sup>78</sup>

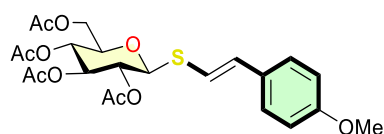

R<sub>f</sub> = 0.3 (EtOAc /cyclohexane: 1/1); <sup>1</sup>H NMR (300 MHz, CDCl<sub>3</sub>) δ 7.30 (d, *J* = 9.0 Hz, 2H), 6.87 (d, *J* = 9.0 Hz, 2H), 6.76 (d, *J* = 15.0 Hz, 1H), 6.59 (d, *J* = 15.0 Hz, 1H), 5.27 (t, *J* = 9.0 Hz, 1H), 5.08-5.16 (m, 2H), 4.62 (d, *J* = 9.0 Hz, 1H), 4.16-4.31 (m, 2H), 3.83 (s, 3H), 3.76-3.80 (m, 1H), 2.09 (s, 3H), 2.09 (s, 3H), 2.04 (s, 3H), 2.02 (s, 3H); HRMS (ESI): *m/z* calc. for C<sub>23</sub>H<sub>28</sub>NaO<sub>10</sub>S [M+Na]<sup>+</sup> 519.1295; found 519.1307.

**(2R,3R,4S,5R,6S)-2-(acetoxymethyl)-6-(((E)-styryl)thio)tetrahydro-2H-pyran-3,4,5-triyl triacetate 3q**

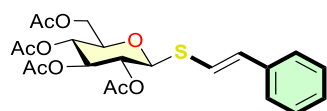

R<sub>f</sub> = 0.3 (EtOAc /cyclohexane: 3/7); White solid, m. p.: 114.3-115.5 °C; [α]<sub>D</sub><sup>18</sup> = -42.3 (c, 0.36, CHCl<sub>3</sub>); <sup>1</sup>H NMR (300 MHz, CDCl<sub>3</sub>) δ 7.27-7.28 (m, 2H), 7.15-7.23 (m, 2H), 6.70 (s, 2H), 5.21 (t, *J* = 9.0 Hz, 1H), 5.02-5.11 (m, 2H), 4.61 (d, *J* = 9.0 Hz, 1H), 4.09-4.24 (m, 2H), 3.70-3.76 (m, 1H), 2.01 (s, 3H), 2.00 (s, 3H), 1.97 (s, 3H), 1.95 (s, 3H); <sup>13</sup>C NMR (75 MHz, CDCl<sub>3</sub>) δ 170.5 (C), 170.1 (C), 169.3 (C), 169.2 (C), 136.3 (C), 134.8 (CH), 128.7 (2CH), 128.0 (CH), 126.2 (2CH), 118.3 (CH), 83.6 (CH), 76.1 (CH), 73.8 (CH), 69.9 (CH), 68.2 (CH), 62.1 (CH<sub>2</sub>), 20.6 (2CH<sub>3</sub>), 20.5 (2CH<sub>3</sub>). IR (neat): 2360, 1755, 1433, 1248, 1091, 1062, 915, 773 cm<sup>-1</sup>; HRMS (ESI): *m/z* calc. for C<sub>22</sub>H<sub>26</sub>NaO<sub>9</sub>S [M+Na]<sup>+</sup> 489.1195; found 489.1198.

**(2R,3R,4S,5R,6S)-2-(acetoxymethyl)-6-(((E)-hept-1-en-1-yl)thio)tetrahydro-2H-pyran-3,4,5-triyl triacetate 3r**

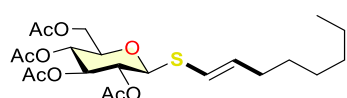

Mixture of *E* and *Z*. Rf = 0.3 (EtOAc /cyclohexane: 1/1); White solid. <sup>1</sup>H NMR (300 MHz, CDCl<sub>3</sub>) δ 5.74-6.06 (m, 2H), 5.21 (t, *J* = 9.0 Hz, 1H), 5.01-5.12 (m, 2H), 4.54 (d, *J* = 12.0 Hz, 0.4H), 4.48 (d, *J* = 12.0 Hz, 0.6H), 4.10-4.24 (m, 2H), 3.70-3.75 (m, 1H), 2.10-2.14 (m, 2H), 2.07 (s, 3H), 2.04 (s, 3H), 2.02 (s, 3H), 1.99 (s, 3H), 1.27-1.44 (m, 6H), 0.85-0.91 (m, 3H). <sup>13</sup>C NMR (75 MHz, CDCl<sub>3</sub>) δ 170.6 (C), 170.2 (C), 169.4 (C), 169.1 (C), 140.2 (CH), 134.7 (CH), 118.0 (CH), 116.2 (CH), 83.8 (CH), 83.5 (CH), 76.1 (CH), 76.0 (CH), 74.0 (CH), 73.9 (CH), 70.1 (CH), 69.8 (CH), 68.3 (CH), 62.1 (CH<sub>2</sub>), 33.2 (CH<sub>2</sub>), 31.4 (CH<sub>2</sub>), 31.3 (CH<sub>2</sub>), 29.2 (CH<sub>2</sub>), 28.5 (CH<sub>2</sub>), 28.4 (CH<sub>2</sub>), 22.4 (CH<sub>2</sub>), 20.7 (CH<sub>3</sub>), 20.6 (3CH<sub>3</sub>), 14.0 (CH<sub>3</sub>). IR (neat): 2959, 2930, 2856, 1757, 1433, 1367, 1248, 1214, 1092, 1036, 915 cm<sup>-1</sup>; HRMS (ESI): *m/z* calc. for C<sub>21</sub>H<sub>32</sub>NaO<sub>9</sub>S [M+Na]<sup>+</sup> 483.1665; found 483.1656.

**(2S,3R,4S,5R,6R)-2-((1H-inden-2-yl)thio)-6-(acetoxymethyl)tetrahydro-2H-pyran-3,4,5-triyl triacetate 3s**

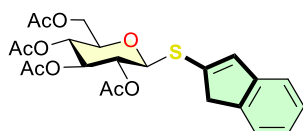

Rf = 0.3 (EtOAc /cyclohexane: 3/7); White solid, m. p.: 92.0-93.6 °C; [ $\alpha$ ]<sub>D</sub><sup>18</sup> = -46.9 (c, 0.40, CHCl<sub>3</sub>); <sup>1</sup>H NMR (300 MHz, CDCl<sub>3</sub>) δ 7.39 (d, *J* = 6.0 Hz, 1H), 7.24-7.33 (m, 2H), 7.15-7.20 (m, H), 6.92 (s, 1H), 5.28 (t, *J* = 9.0 Hz, 1H), 5.10 (td, *J* = 6.0, 9.0 Hz, 2H), 4.79 (d, *J* = 9.0 Hz, 1H), 4.18-4.29 (m, 2H), 3.78-3.84 (m, 1H), 3.49-3.66 (m, 2H), 2.09 (s, 3H), 2.08 (s, 3H), 2.05 (s, 3H), 2.02 (s, 3H); <sup>13</sup>C NMR (75 MHz, CDCl<sub>3</sub>) δ 170.5 (C), 170.1 (C), 169.3 (C), 169.2 (C), 144.1 (C), 143.4 (C), 136.8 (C), 133.7 (CH), 126.7 (CH), 124.9 (CH), 123.2 (CH), 120.4 (CH), 84.2 (CH), 76.0 (CH), 73.8 (CH), 70.0 (CH), 68.3 (CH), 62.2 (CH<sub>2</sub>), 43.7 (CH<sub>2</sub>), 20.7 (2CH<sub>3</sub>), 20.5 (2CH<sub>3</sub>); IR (neat): 2360, 1755, 1457, 1367, 1248, 1090, 925, 754 cm<sup>-1</sup>; HRMS (ESI): *m/z* calc. for C<sub>23</sub>H<sub>26</sub>NaO<sub>9</sub>S [M+Na]<sup>+</sup> 501.1195; found 501.1189.

**(2R,3R,4S,5R,6S)-2-(acetoxymethyl)-6-(((4-methoxyphenyl)ethynyl)thio)tetrahydro-2H-pyran-3,4,5-triyl triacetate 3t**

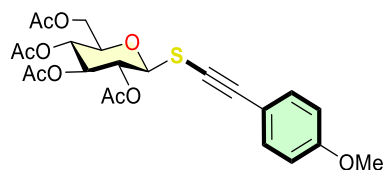

R<sub>f</sub> = 0.3 (EtOAc /cyclohexane: 3/7); White solid, m. p.: 78.7-79.8 °C;  $[\alpha]_D^{18} = -41.7$  (c, 0.24, CHCl<sub>3</sub>); <sup>1</sup>H NMR (300 MHz, CDCl<sub>3</sub>) δ 7.33-7.46 (m, 2H), 6.83-6.89 (m, 2H), 5.21-5.34 (m, 2H), 5.12 (t, *J* = 9.0 Hz, 1H), 4.59 (d, *J* = 12.0 Hz, 1H), 4.13-4.29 (m, 2H), 3.81 (s, 3H), 3.75-3.81 (m, 1H), 2.10 (s, 3H), 2.05 (s, 3H), 2.02 (s, 3H), 2.01 (s, 3H); <sup>13</sup>C NMR (75 MHz, CDCl<sub>3</sub>) δ 170.6 (C), 170.2 (C), 169.3 (C), 169.0 (C), 160.3 (C), 134.1 (2CH), 114.7 (C), 114.0 (2CH), 97.1 (C), 84.6 (CH), 80.6 (C), 76.5 (CH), 74.0 (CH), 69.8 (CH), 68.0 (CH), 62.0 (CH<sub>2</sub>), 55.3 (CH<sub>3</sub>), 20.7 (CH<sub>3</sub>), 20.6 (CH<sub>3</sub>), 20.5 (2CH<sub>3</sub>). IR (neat): 2360, 1756, 1605, 1509, 1442, 1367, 1292, 1251, 1214, 1174, 1091, 1061, 1033, 913, 836, 775 cm<sup>-1</sup>; HRMS (ESI): *m/z* calc. for C<sub>23</sub>H<sub>26</sub>NaO<sub>10</sub>S [M+Na]<sup>+</sup> 517.1144; found 517.1139.

**(2R,3R,4S,5R,6S)-2-(acetoxymethyl)-6-((thiophen-3-ylethynyl)thio)tetrahydro-2H-pyran-3,4,5-triyl triacetate 3u**<sup>78</sup>

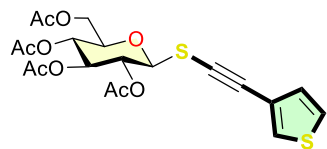

R<sub>f</sub> = 0.2 (EtOAc /cyclohexane: 3/7); White solid. <sup>1</sup>H NMR (300 MHz, CDCl<sub>3</sub>) δ 7.58-7.59 (m, 1H), 7.27-7.29 (m, 1H), 7.17-7.19 (m, 1H), 5.24-5.35 (m, 2H), 5.14 (t, *J* = 9.0 Hz, 1H), 4.62 (d, *J* = 6.0 Hz, 1H), 4.17-4.30 (m, 2H), 3.77-3.82 (m, 1H), 2.11 (s, 3H), 2.07 (s, 3H), 2.04 (s, 3H), 2.03 (s, 3H). HRMS (ESI): *m/z* calc. for C<sub>20</sub>H<sub>22</sub>NaO<sub>9</sub>S<sub>2</sub> [M+Na]<sup>+</sup> 493.0597; found 493.0615.

**(2R,3R,4S,5R,6S)-2-((benzoyloxy)methyl)-6-((4-(trifluoromethyl)phenyl)thio)tetrahydro-2H-pyran-3,4,5-triyl tribenzoate 4a**<sup>78</sup>

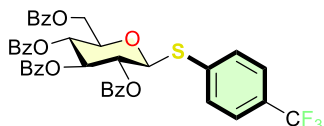

R<sub>f</sub> = 0.2 (EtOAc /cyclohexane: 3/7); White solid. <sup>1</sup>H NMR (300 MHz, CDCl<sub>3</sub>) δ 8.10 (d, *J* = 9.0 Hz, 2H), 7.95-8.01 (m, 4H), 7.84 (d, *J* = 9.0 Hz, 2H), 7.26-7.67 (m, 16H), 6.01 (t, *J* = 9.0 Hz, 1H), 5.62 (td, *J* = 12.0, 27.0 Hz, 2H), 5.17 (d, *J* = 9.0 Hz, 1H), 4.74-4.79 (m, 1H), 4.52-4.58 (m, 1H), 4.28-4.34 (m, 1H). HRMS (ESI): *m/z* calc. for C<sub>41</sub>H<sub>31</sub>F<sub>3</sub>NaO<sub>9</sub>S [M+Na]<sup>+</sup> 779.1533; found 779.1543.

**(2R,3S,4S,5R,6S)-2-(acetoxymethyl)-6-((4-cyanophenyl)thio)tetrahydro-2H-pyran-3,4,5-triyl triacetate 4b**<sup>78</sup>

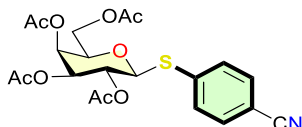

R<sub>f</sub> = 0.2 (EtOAc /cyclohexane: 3/7); White solid. <sup>1</sup>H NMR (300 MHz, CDCl<sub>3</sub>) δ 7.55-7.57 (m, 4H), 5.43 (d, *J* = 3.0 Hz, 1H), 5.24 (t, *J* = 9.0 Hz, 1H), 5.07 (dd, *J* = 3.0, 9.0 Hz, 1H), 4.81 (d, *J* = 12.0 Hz, 1H), 4.08-4.21 (m, 2H), 3.98-4.02 (m, 1H), 2.12 (s, 3H), 2.06 (s, 3H), 2.04 (s, 3H), 1.96 (s, 3H). HRMS (ESI): *m/z* calc. for C<sub>21</sub>H<sub>23</sub>NNaO<sub>9</sub>S [M+Na]<sup>+</sup> 488.0986; found 488.0988.

**(2S,3R,4S,5S,6R)-2-((4-cyanophenyl)thio)-6-methyltetrahydro-2H-pyran-3,4,5-triyl triacetate 4c**<sup>78</sup>

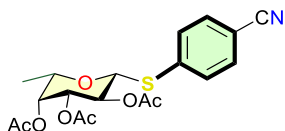

R<sub>f</sub> = 0.2 (EtOAc /cyclohexane: 3/7); White solid. <sup>1</sup>H NMR (300 MHz, CDCl<sub>3</sub>) δ 7.52-7.61 (m, 4H), 5.29 (d, *J* = 3.0 Hz, 1H), 5.24 (t, *J* = 9.0 Hz, 1H), 5.08 (dd, *J* = 3.0, 9.0 Hz, 1H), 4.79 (d, *J* = 9.0 Hz, 1H), 3.90 (q, *J* = 6.0 Hz, 1H), 2.16 (s, 3H), 2.06 (s, 3H),

1.97 (s, 3H), 1.25 (d,  $J = 9.0$  Hz, 3H). HRMS (ESI):  $m/z$  calc. for  $C_{19}H_{21}NNaO_7S$   $[M+Na]^+$  430.0931; found 430.0933.

**(2R,3R,4S,5R,6S)-2-(acetoxymethyl)-6-(((2R,3R,4S,5R,6S)-4,5-diacetoxy-2-(acetoxymethyl)-6-((4-(trifluoromethyl)phenyl)thio)tetrahydro-2H-pyran-3-yl)oxy)tetrahydro-2H-pyran-3,4,5-triyl triacetate 4d**<sup>78</sup>

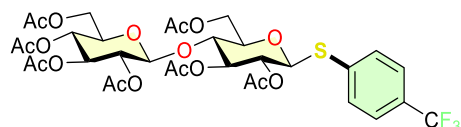

$R_f = 0.2$  (EtOAc /cyclohexane: 1/1); White solid.  $^1H$  NMR (300 MHz,  $CDCl_3$ )  $\delta$  7.50-7.56 (m, 4H), 5.00-5.22 (m, 3H), 4.86-4.93 (m, 2H), 4.72 (d,  $J = 9.0$  Hz, 1H), 4.47-4.56 (m, 2H), 4.33 (dd,  $J = 3.0, 18.0$  Hz, 1H), 3.99-4.11 (m, 2H), 3.62-3.75 (m, 3H), 2.07 (s, 3H), 2.05 (s, 3H), 2.04 (s, 3H), 2.00 (s, 3H), 1.99 (s, 3H), 1.98 (s, 3H), 1.95 (s, 3H). HRMS (ESI):  $m/z$  calc. for  $C_{33}H_{39}F_3NaO_{17}S$   $[M+Na]^+$  819.1752; found 819.1774.

**(2R,3R,4S,5R,6S)-2-(acetoxymethyl)-6-(((2R,3R,4S,5R,6S)-4,5-diacetoxy-2-(acetoxymethyl)-6-(((2R,3R,4S,5R,6S)-4,5-diacetoxy-2-(acetoxymethyl)-6-((4-cyanophenyl)thio)tetrahydro-2H-pyran-3-yl)oxy)tetrahydro-2H-pyran-3-yl)oxy)tetrahydro-2H-pyran-3,4,5-triyl triacetate 4e**

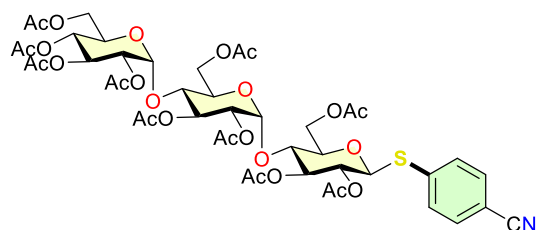

$R_f = 0.3$  (EtOAc /cyclohexane: 1/1); White solid, m. p.: 128.1-130.6 °C;  $[\alpha]_D^{18} = -77.6$  (c, 0.34,  $CHCl_3$ );  $^1H$  NMR (300 MHz,  $CDCl_3$ )  $\delta$  7.46-7.54 (m, 4H), 5.18-5.34 (m, 5H), 4.99 (t,  $J = 9.0$  Hz, 1H), 4.76-4.81 (m, 3H), 4.64-4.69 (m, 1H), 4.38-4.48 (m, 2H), 4.19-4.28 (m, 4H), 3.77-3.97 (m, 4H), 3.74-3.77 (m, 1H), 2.09 (s, 3H), 2.08 (s, 3H), 2.02 (s, 3H), 1.98 (s, 3H), 1.97 (s, 3H), 1.96 (s, 3H), 1.94 (s, 3H), 1.93 (s, 3H), 1.93 (s, 3H), 1.91 (s, 3H);  $^{13}C$  NMR (75 MHz,  $CDCl_3$ )  $\delta$  170.5 (2C), 170.4 (C), 170.2 (C), 170.1

(C), 169.8 (2C), 169.6 (C), 169.4 (C), 169.3 (C), 138.9 (C), 132.3 (C), 131.7 (2CH), 118.2 (C), 111.4 (C), 95.8 (CH), 95.6 (CH), 83.8 (CH), 76.3 (CH), 75.9 (CH), 73.6 (CH), 72.6 (CH), 71.6 (CH), 70.4 (2CH), 70.0 (CH), 69.3 (CH), 69.1 (CH), 68.5 (CH), 67.9 (CH), 62.9 (CH<sub>2</sub>), 62.3 (CH<sub>2</sub>), 61.4 (CH<sub>2</sub>), 20.8 (3CH<sub>3</sub>), 20.7 (2CH<sub>3</sub>), 20.5 (5CH<sub>3</sub>). IR (neat): 2230, 1756, 1747, 1432, 1368, 1239, 1222, 1031, 900, 753 cm<sup>-1</sup>; HRMS (ESI): m/z calc. for C<sub>45</sub>H<sub>55</sub>NNaO<sub>25</sub>S [M+Na]<sup>+</sup> 1064.2682; found 1064.2688.

**4-(((2S,3R,4S,5S,6R)-3,4,5-trihydroxy-6-(hydroxymethyl)tetrahydro-2H-pyran-2-yl)thio)benzonitrile 5a**

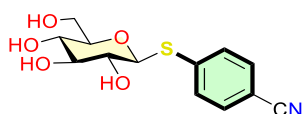

R<sub>f</sub> = 0.3 (EtOAc /MeOH: 9/1); colorless oil <sup>1</sup>H NMR (300 MHz, MeOD-d<sub>4</sub>) δ 7.63-7.64 (m, 4H), 4.83 (d, *J* = 9.0 Hz, 1H), 3.89-3.94 (m, 1H), 3.61-3.72 (m, 1H), 3.30-3.47 (m, 4H); <sup>13</sup>C NMR (75 MHz, MeOD-d<sub>4</sub>) δ 144.0 (C), 133.6 (C), 130.6 (2CH), 119.7 (C), 110.5 (C), 87.8 (CH), 82.2 (CH), 79.7 (CH), 73.8 (CH), 71.3 (CH), 62.8 (CH<sub>2</sub>). IR (neat): 3300, 1754, 1635, 1284, 1102 cm<sup>-1</sup>; HRMS (ESI): m/z calc. for C<sub>13</sub>H<sub>15</sub>NNaO<sub>5</sub>S [M+Na]<sup>+</sup> 320.0569; found 320.0573.

**4-(((2S,3R,4R,5S,6R)-3,4-dihydroxy-6-(hydroxymethyl)-5-(((2S,3R,4S,5S,6R)-3,4,5-trihydroxy-6-(hydroxymethyl)tetrahydro-2H-pyran-2-yl)oxy)tetrahydro-2H-pyran-2-yl)thio)benzonitrile 5b**

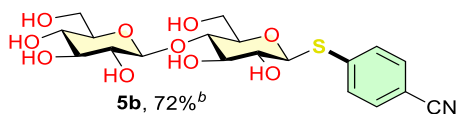

R<sub>f</sub> = 0.3 (EtOAc /MeOH: 5/1); White solid, m. p.: 228.5-231.8 °C; [α]<sub>D</sub><sup>18</sup> = - 74.7 (c, 0.73, MeOH); <sup>1</sup>H NMR (300 MHz, MeOD-d<sub>4</sub>) δ 7.59-7.60 (m, 4H), 4.82 (d, *J* = 9.0 Hz, 1H), 4.40 (d, *J* = 6.0 Hz, 1H), 3.83-3.92 (m, 3H), 3.51-3.66 (m, 4H), 3.33-3.38 (m, 2H), 3.18-3.27 (m, 3H); <sup>13</sup>C NMR (75 MHz, MeOD-d<sub>4</sub>) δ 143.7 (C), 133.4 (2CH), 130.8 (2CH), 119.7 (C), 110.6 (C), 104.5 (CH), 87.5 (CH), 80.6 (CH), 80.1 (CH), 78.1 (CH), 78.0 (CH), 77.9 (CH), 74.9 (CH), 73.6 (CH), 71.4 (CH), 62.5 (CH<sub>2</sub>), 61.9 (CH<sub>2</sub>). IR

(neat): 3186, 2970, 2406, 1406, 1228, 1025, 926, 740  $\text{cm}^{-1}$ ; HRMS (ESI):  $m/z$  calc. for  $\text{C}_{19}\text{H}_{25}\text{NNaO}_{10}\text{S}$   $[\text{M}+\text{Na}]^+$  482.1097; found 482.1088.

### Methyl N-(tert-butoxycarbonyl)-S-(4-cyanophenyl)-L-cysteinate 5c

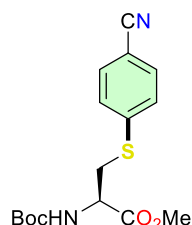

$R_f = 0.3$  (EtOAc /cyclohexane: 1/1); colorless oil;  $[\alpha]_D^{18} = +32.0$  (c, 1.00,  $\text{CHCl}_3$ ).  $^1\text{H}$  NMR (300 MHz,  $\text{CDCl}_3$ )  $\delta$  7.51-7.54 (m, 2H), 7.26-7.38 (m, 2H), 5.30-5.32 (m, 1H), 4.59-4.62 (m, 1H), 3.67 (s, 3H), 3.51 (dd,  $J = 3.0, 12.0$  Hz, 1H), 3.39 (dd,  $J = 3.0, 12.0$  Hz, 1H), 1.41 (s, 9H);  $^{13}\text{C}$  NMR (75 MHz,  $\text{CDCl}_3$ )  $\delta$  170.6 (C), 154.9 (C), 142.9 (C), 132.3 (2 $\text{CH}_2$ ), 128.4 (2 $\text{CH}_2$ ), 118.5 (C), 109.4 (C), 53.3 (CH), 52.7 ( $\text{CH}_3$ ), 41.2 (C), 35.2 ( $\text{CH}_3$ ), 28.2 (2 $\text{CH}_3$ ). IR (neat): 2360, 2227, 1748, 1714, 1594, 1487, 1437, 1368, 1255, 1216, 1164, 1088, 1052, 1014, 823, 624  $\text{cm}^{-1}$ ; HRMS (ESI):  $m/z$  calc. for  $\text{C}_{16}\text{H}_{20}\text{N}_2\text{NaO}_4\text{S}$   $[\text{M}+\text{Na}]^+$  359.1041; found 359.1035.



## 1.5 Part 5 Visible-Light-Mediated Stadler-Ziegler Arylation of Thiosugars with Anilines

### A) Introduction

In a previous study, we reported the cross-coupling reaction of thiosugars with aryl, alkenyl and alkynyl bromide or iodine under photoredox catalysis. As an extension of this study, we were wondering if aryl diazonium salts could be used coupling partners instead of aryl halides. These later maybe prepared from the more available and less expensive anilines starting materials.

In 2013, Timothy Noël and co-workers<sup>93</sup> reported an elegant one-pot reaction to building C-S bonds under visible light Ru-photoredox catalysis. The cross-coupling reaction occurs between arylamines and thiolates under the effect of 20 W fluorescent light bulb to synthesis of corresponding arylsulfides. By using of nitrite source *t*BuONO, the corresponding aryl diazonium are formed in situ and the process eliminates the need for isolate the unstable diazonium salt. Moreover, a scalable continuous-flow protocol has been successfully used during this study within only 15 s residence time. One limitation of this reaction was the poor yield around 20 % obtained, when heteroaryl amines were used (**Scheme 33**).

---

<sup>93</sup> Wang, X.; Cuny, G. D.; Noël, T., *Angew. Chem. Int. Ed.*, **2013**, *52*, 7860-7864.

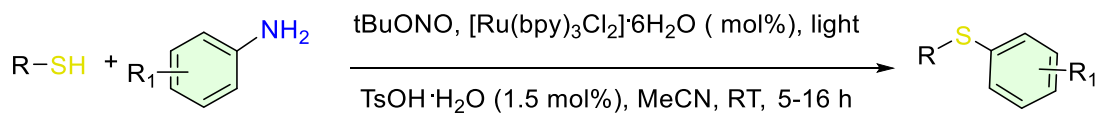

Selected examples:

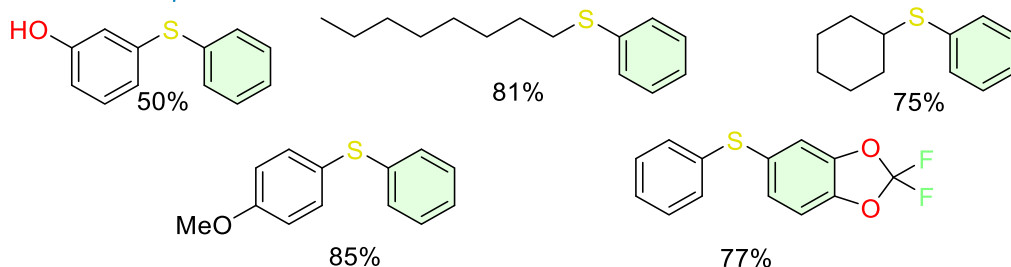

**Scheme 33.** Stadler-Ziegler reaction reported by Timothy Noël's group

The same approach was used by Chin-Fa Lee and co-workers<sup>94</sup> for the synthesis of arylsulfides from anilines under blue led under metal-free, solvent free and acid free conditions; only 2 equiv of tBuONO were required for this coupling. The high functional group tolerance is also an advantage of this reaction. It is interesting that, a gram scale reaction has been performed between arylamine and thiolate in presence of natural sunlight without stirring and result in good yield compared with bench reaction. Unfortunately, heteroaryl amines still not suitable in this condition (**Scheme 34**).

<sup>94</sup> Shieh, Y.; Du, K.; Basha, R. S.; Xue, Y.; Shih, B.; Li, L.; Lee, C., *J. Org. Chem.*, **2019**, *84*, 6223-6231.

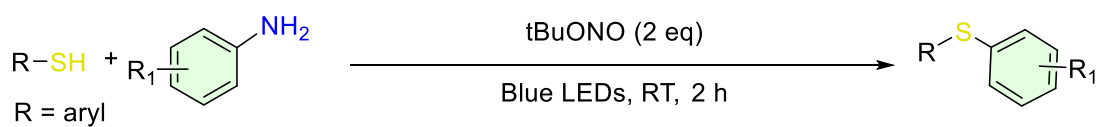

Selected examples:

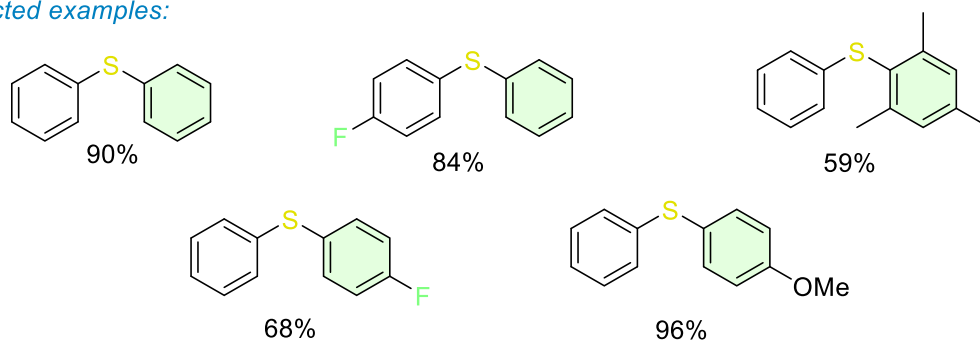

**Scheme 34.** Synthesis of arylsulfides

Finally, Brindaban Ranu group<sup>95</sup> solved the issue of coupling with heteroaryl amines and reported a new Stadler-Ziegler reaction to synthesis of heteroaryl sulfides. The coupling involve the use of 1.3 equiv of aniline, 1 equiv of heteroaryl thiols, rose bengal as a photocatalysis (5 mol%), diazolation reagent *t*BuONO 2 equiv, TsOH·H<sub>2</sub>O 1.5 mol% in MeCN and blue led for 8 h. This procedure produced the desired compounds in good yield and propose a new way to diverse heteroaryl sulfides which is really useful for further application (**Scheme 35**).

<sup>95</sup>Panja, S.; Sahu, P.; Ranu, B. C., *Indian J. Chem.*, **2019**, 58, 183-191.

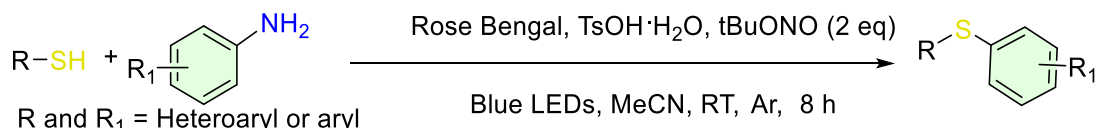

*Selected examples:*

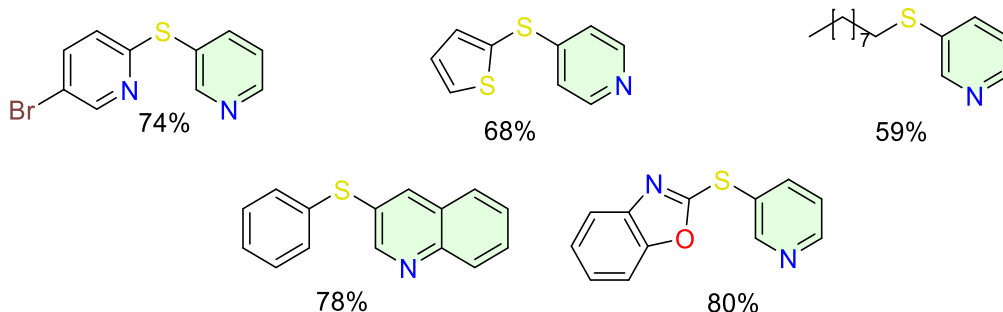

**Scheme 35.** synthesis of heteroaryl sulfides by Stadler-Ziegler reaction

As we can see from above protocol, Stadler-Ziegler reaction is a powerful approach to C-S bond formation. However, Herein we propose to explore the possibility to develop a such approach to the synthesis of thioglycosides.

## B) Publication

### Visible-Light-Mediated Stadler-Ziegler Arylation of Thiosugars with Anilines

Mingxiang Zhu, Juba Gouilem, and Samir Messaoudi

Université Paris-Saclay, CNRS, BioCIS, 92290, Châtenay-Malabry, France.

**ABSTRACT:** Here we report a one-pot Stadler–Ziegler reaction towards the synthesis of 1-thioglycosides in good yield from commercially available anilines and (un)protected 1-glycosyl thiols. This simple and mild approach employs the photoredox catalyst [Ru(bpy)<sub>3</sub>](PF<sub>6</sub>)<sub>2</sub> under visible light.

**KEYWORDS:** Photoredox, thiosugars, aryl diazoniums, Stadler-Ziegler reaction, thioglycosides, anilines, C-glycosides.

Many glycosides containing a C–S anomeric bond display properties offering access to a broad array of fields, including drug discovery and chemical biology.<sup>96</sup> These glycomimetics are known to be more resistant to the metabolic hydrolysis than their *O*-glycoside congeners under biological conditions.<sup>97</sup> **Figure 10A** displays representative examples of bioactive 1-thioglycosides including FDA-approved antibiotic Clindamycin used in the treatment of a variety of serious infections<sup>98</sup> and GB1107, an orally active inhibitor of Galectin-3 which reduces lung adenocarcinoma growth and blocks metastasis.<sup>99</sup> Besides, different other biological activities are well explored with thioglycosides including hSGLT1,<sup>100</sup> lectine A<sup>101</sup> and Hsp90 inhibitions.<sup>102</sup> On the

---

<sup>96</sup> a) Driguez, H., Thiooligosaccharides in glycobiology. In *Glycoscience Synthesis Of Substrate Analogs And Mimetics*; Springer Verlag: Berlin, **1997**; 187, 85-116; b) Witczak, Z. *J. Curr. Med. Chem.* **1999**, *6*, 165–178; c) Pachamuthu, K.; Schmidt, R. R. *Chem. Rev.* **2006**, *106*, 160–187; d) Samuni-Blank, M.; Izhaki, I.; Dearing, M. D.; Gerchman, Y.; Trabelcy, B.; Karasov, A. L. W. H.; Arad, Z., *Curr. Biol.* **2012**, *22*, 1218–1220; e) Lian, G.; Zhang, X.; Yu, B., *Carbohydr. Res.* **2015**, *403*, 13–22. f) Castaneda, F.; Burse, A.; Boland, W.; Kinne, R. K. H., *Int. J. Med. Sci.* **2007**, *4*, 131-139; g) Rodrigue, J.; Ganne, G.; Blanchard, B.; Saucier, C.; Giguere, D.; Shiao, T. C.; Varrot, A.; Imberty, A.; Roy, R., *Org. Biomol. Chem.* **2013**, *11*, 6906–6918; h) Elgemeie, G. H.; Farag, A. B.; Amin, K. M.; El-Badry, O. M.; Hassan, G. S., *Eur. J. Med. Chem.* **2014**, *4*, 814–833; i) Aouad, M. R., *Nucleos. Nucleot. Nucl.* **2016**, *35*, 1–15; j) Kato, E.; Nagano, H.; Yamamura, S.; Ueda, M., *Tetrahedron* **2003**, *59*, 5909-5917; k) Schnabelrauch, M.; Vasella, A.; Withers, S. G., *Helv. Chim. Acta.* **1994**, *77*, 778-799; l) Adinolfi, M.; d'Ischia, M.; Iadonisi, A.; Leone, L.; Pezzella, A.; Valerio, S., *Eur. J. Org. Chem.* **2012**, *23*, 4333-4338; m) Shirota, K.; Kato, Y.; Suzuki, K.; Sugiyama, Y., *J. Pharmacol. Exp. Ther.* **2001**, *299*, 459–467; n) Caraballo, R.; Sakulsombat, M.; Ramström, O., *ChemBioChem* **2010**, *11*, 1600–1606.

<sup>97</sup> a) Rye, C. S.; Withers, S. G., *Carbohydr. Res.* **2004**, *339*, 699–703; b) Metaferia, B. B.; Fetterolf, B. J.; Shazad-ul-Hussan, S.; Moravec, M.; Smith, J. A.; Ray, S.; Gutierrez-Lugo, M. -T.; Bewley, C. A., *J. Med. Chem.* **2007**, *50*, 6326–6336; c) Castaneda, F.; Burse, A.; Boland, W.; Kinne, R. K.-H., *Int. J. Med. Sci.* **2007**, *4*, 131–139.

<sup>98</sup> Matzov, D.; Eyal, Z.; Benhamou, R. I.; Shalev-Benami, M.; Halfon, Y.; Krupkin, M.; Zimmerman, E.; Rozenberg, H.; Bashan, A.; Fridman, M.; Yonath, A., *Nucleic Acids Res.* **2017**, *45*, 10284-10292.

<sup>99</sup> Delaine, T.; Collins, P.; MacKinnon, A.; Sharma, G.; Stegmayr, J.; Rajput, V. K.; Mandal, S.; Cumpstey, I.; Larumbe, A.; Salameh, B. A.; Kahl-Knutsson, B.; vanHattum, H.; vanScherpenzeel, M.; Pieters, R. J.; Sethi, T.; Schambye, H.; Oredsson, S.; Leffler, H.; Blanchard, H.; Nilsson, J., *ChemBioChem* **2016**, *17*, 1759-1770

<sup>100</sup> Feng, G.; Wang, S.; Lv, J.; Luo, T.; Wu, Y.; Dong, H., *Eur. J. Org. Chem.* **2021**, *2021*, 2940-2949.

<sup>101</sup> Rodrigue, J.; Ganne, G.; Blanchard, B.; Saucier, C.; Giguere, D.; Shiao, T. C.; Varrot, A.; Imberty, A. Roy, R., *Org. Biomol. Chem.* **2013**, *11*, 6906.

<sup>102</sup> a) Mielczarek-Lewandowska, A.; Hartman, M. L.; Czyz, M., *Apoptosis* **2020**, *25*, 12–28. b) Li, L.; Chen, N.-N.; You, Q.-D.; Xu, X.-L., *Expert Opin. Ther. Pat.* **2021**, *31*, 67–80.

other side, thioglycosides are largely used as versatile and reactive intermediates in polysaccharide assembly tactics through iterative glycosylations (**Figure 10B**).<sup>103</sup>

Due to their key role in many biological processes, the development of methods towards an efficient and stereoselective synthesis of 1-arylthioglycosides is considered to be of great importance.<sup>104</sup> A well-known strategy largely applied toward these target S-arylated glycosides is the cross-coupling reaction typically catalyzed by the Pd<sup>105</sup>, Ni,<sup>106</sup> Cu<sup>107</sup> transition metals, in which an aryl halide reacts with a glycosyl thiols leading to the desired thioglycoside derivative (**Figure 10C**). Despite their high interest, these methods required the use of expensive catalysts or a high temperature and a long reaction time, limiting thus the practicability or the scope of substrates. Liao and Yan reported an efficient transition-metal-free protocol for the synthesis of aryl 1-thioglycosides *via* an *in situ* arynes generation (**Figure 10C**).<sup>108</sup> Although efficient, some limitations persisted such as a lack of regioselectivity with non-symmetrical

---

<sup>103</sup> a) Codee, J. D. C.; Litjens, R. E. J. N.; van den Bos, L. J.; Overkleeft, H. S.; van der Marel, G. A., *Chem. Soc. Rev.* **2005**, *34*, 769–782; b) Johannes, M.; Reindl, M.; Gerlitzki, B.; Schmitt, E.; Hoffmann-Rçder, A., *Beilstein J. Org. Chem.* **2015**, *11*, 155–161; c) Budhadev, D.; Mukhopadhyay, B., *Carbohydr. Res.* **2014**, *384*, 51–55; d) Basu, N.; Maity, S. K.; Ghosh, R., *RSC Adv.* **2012**, *2*, 12661–12664; e) Verma, P.; Raj, R.; Roy, B., *Tetrahedron: Asymmetry* **2010**, *21*, 2413–2418; f) Xiong, C. D.; Zhang, L. H.; Ye, X. S., *Adv. Synth. Catal.* **2008**, *350*, 1696–1700; g) Roy, B.; Pramanik, K.; Mukhopadhyay, B., *Glycoconjugate J.* **2008**, *25*, 157–166; h) Zeng, Y.; Wang, Z.; Whitfield, D.; Huang, X., *J. Org. Chem.* **2008**, *73*, 7952–7962; i) Fridman, M.; Belakhov, V.; Lee, L. V.; Liang, F. - S.; Wong, C. -H.; Baasov, T., *Angew. Chem. Int. Ed.* **2005**, *44*, 447–452.

<sup>104</sup> a) Ibrahim, N.; Alami, M.; Messaoudi, S., *Asian. J. Org. Chem.* **2018**, *7*, 2026–2038. b) Qiao, M.; Zhang, L.; Jiao, R.; Zhang, S.; Li, B.; Zhang, X., *Tetrahedron* **2021**, *81*, 13192;

<sup>105</sup> a) Brachet, E.; Brion, J. -D.; Messaoudi, S.; Alami, M., *Adv. Synth. Catal.* **2013**, *355*, 2627–2636; b) Brachet, E.; Brion, J. -B.; Messaoudi, S.; Alami, M., *Adv. Synth. Catal.* **2013**, *355*, 477–490; c) Ding, Y.; Huang, Y.; Shi, W.; Zheng, N.; Wang, C.; Chen, X.; An, Y.; Zhang, Z.; Liang, Y., *Org. Lett.* **2021**, *23*, 5641–5646; d) Li, J.; Wang, M.; Jiang, X., *Org. Lett.* **2021**, *23*, 9053–9057.

<sup>106</sup> Brachet, E.; Brion, J. D.; Alami, M.; Messaoudi, S., *Chem.-Eur. J.* **2013**, *19*, 15276–15280.

<sup>107</sup> a) Chabrier, A.; Bruneau, A.; Benmahdjoub, S.; Benmerad, B.; Belaid, S.; Brion, J. D.; Alami, M.; Messaoudi, S. Stereoretentive Copper-Catalyzed Directed Thioglycosylation of C(sp<sup>2</sup>)-H Bonds of Benzamides. *Chem.-Eur. J.* **2016**, *22*, 15006–15010; (41) Nauš, P.; Lešetický, L.; Smrček, S.; Tišlerová, I.; Štícha, M., *Synlett* **2003**, *14*, 2117–2122; b) Yuan, X.; Kou, Y.; Yu, L.; Zhang, Z.-X.; Xue, W., *Org. Chem. Front.* **2015**, *2*, 1604–1607; c) Zhu, F., Miller, E., Zhang, S. Q., Yi, D., O'Neill, S., Hong, X.; Walczak, M. A., *J. Am. Chem. Soc.* **2018**, *140*, 18140–18150.

<sup>108</sup> Liu, Y.; Yu, X.; Zhang, X.; Zhong, Q.; Liao, L.; Yan, N., *RSC Adv.* **2021**, *11*, 26666–26671.

arynes or the limited tolerance for functional groups. Recently, our group developed the first electrochemical method for coupling various glycosyl thiols with aryl iodides and bromides under base-free conditions (**Figure 10C**).<sup>109</sup> Highly complex thioglycosides could be prepared under this ecofriendly method including unprotected thiosugars. In addition, we developed another protocol for the synthesis of aryl 1-thioglycosides *via* a Ni/Ru photoredox dual catalyzed cross-coupling of thiosugars with aryl iodides (**Figure 10C**).<sup>110</sup> Suitable for only protected thiosugars, this method did not also tolerate the more available and less expensive aryl bromides are still non-suitable partners under these photoredox conditions.

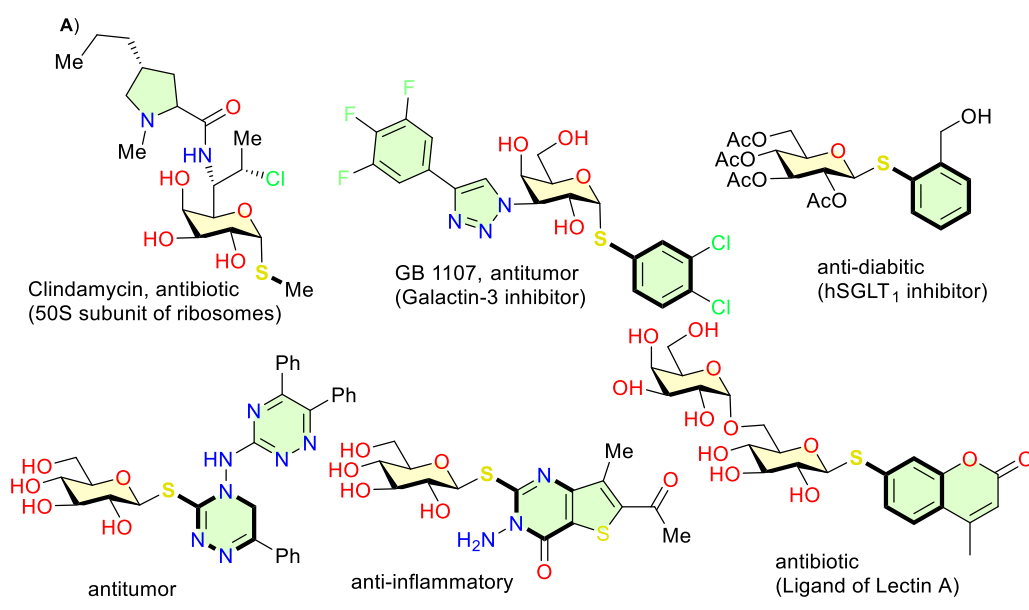

<sup>109</sup> Zhu, M.; Alami, M.; Messaoudi, S., *Chem. Commun.*, **2020**, 56, 4464–4467.

<sup>110</sup> Zhu, M.; Dagousset, G.; Alami, M.; Magnier, E.; Messaoudi, S., *Org. Lett.* **2019**, 21, 5132–5137

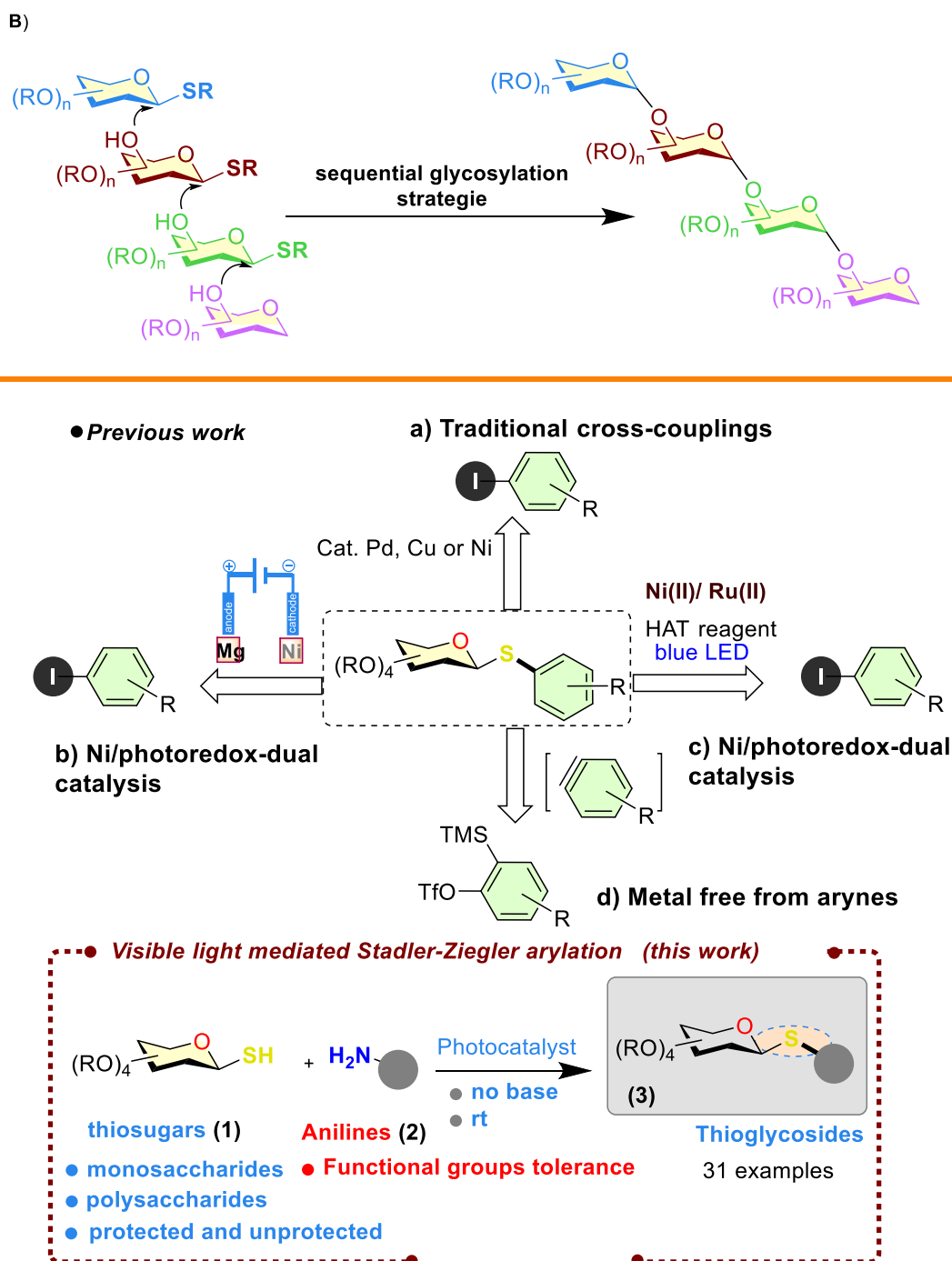

**Figure 10.** (A) Examples of bioactive thioglycosides, (B) Utility of thioglycosides in sequential glycosylation reaction (C) catalytic strategies to access to thioglycosides **3**.

Owing to the high importance of thioglycosides, there is a strong impetus to develop a mild and general photoredox reaction for their efficient synthesis. We wish to identify more suitable partners than bromides and iodides able to react efficiently with thiosugars under a simple photoredox protocol to generate the desired thioglycoside.



Specifically, we focused our attention on the introduction of an approach that tolerates reactive functions on the aryl partners such as halogens, carboxylic acids, or alcohols, which may be subjected to further functionalization. Since arylamines are usually more readily available and less expensive than the corresponding aryl halides, we were interested in using them as coupling partners in the famous Stadler–Ziegler reaction.<sup>111</sup> We hypothesized that highly reactive aryl diazonium salts generated from arylamines would be suitable as arylating agents, able to easily generate aryl radicals which could then be trapped by the thiosugar nucleus. Since the pioneering work by Stadler<sup>99a</sup> and by Ziegler,<sup>99b</sup> this process has been used in various applications for the synthesis of arylsulfides including industrial manufacturing.<sup>112</sup> Recently, various groups reported modifications of this protocol to achieve improved yields and milder reaction conditions. Among them, the group of Noël reported a mild procedure for the synthesis of arylsulfides by using photoredox catalysis.<sup>113</sup> To avoid the isolation of diazonium salts and to enhance the reaction efficiency, the authors established an elegant one-pot protocol from aryl amines combining the diazotization and coupling steps.<sup>101a,b</sup>

Based on these recent achievements, and on our ongoing interests in metal-catalyzed functionalization of thiosugars,<sup>114</sup> we propose herein a catalytic photoredox method for

---

<sup>111</sup> a) Stadler, O., *Ber. Dtsch. Chem. Ges.* **1884**, *17*, 2075–2081; b) Ziegler, J. H., *Ber. Dtsch. Chem. Ges.* **1890**, *23*, 2469–2472; c) Abeywickrema, A. N.; Beckwith, A. L. J., *J. Am. Chem. Soc.* **1986**, *108*, 8227–8229; d) Hilbert, G. E.; Johnson, T. B., *J. Am. Chem. Soc.*, **1929**, *51*, 1526–1536.

<sup>112</sup> a) Barbero, M.; Degani, I.; Diulgheroff, N.; Dughera, S.; Fochi, R.; Migliaccio, M., *J. Org. Chem.* **2000**, *65*, 5600–5608; b) Petrillo, G.; Novi, M.; Garbarino, G.; Carlo, D. E., *Tetrahedron* **1986**, *42*, 4007–4016; c) Perumal, S.; Chandrasekaran, R.; Vijayabaskar, V.; Wilson, D. A., *Magn. Reson. Chem.* **1995**, *33*, 779–790; d) Smith, G.; Ruhland, T.; Mikkelsen, G.; Andersen, K.; Christoffersen, C. T.; Alifrangis, L. H.; Mørk, A.; Wren, S. P.; Harris, N.; Wyman, B. M.; Brandt, G., *Bioorg. Med. Chem.* **2004**, *14*, 4027–4030; e) Smith, G.; Mikkelsen, G.; Eskildsen, J.; Bundgaard, C., *Bioorg. Med. Chem.* **2006**, *16*, 3981–3984; f) Subir, P.; Puneshwar, S.; Brindaban C, R., *Indian J. Chem.* **2019**, *58B*, 183–191; g) Jiang, M.; Li, H.; Yang, H.; Fu, H., *Angew. Chem. Int. Ed.* **2017**, *56*, 874–879; h) Naveen, N.; Sengupta, S.; Chandrasekaran, S. *J. Org. Chem.* **2018**, *83*, 3562–3569; i) Sengupta, S.; Chandrasekaran, S., *Org. Biomol. Chem.* **2019**, *17*, 8308–8329.

<sup>113</sup> a) Wang, X.; Cuny, G. D.; Noël, T., *Angew. Chem. Int. Ed.* **2013**, *52*, 7860–7864. b) Bottecchia, C.; Rubens, M.; Gunnoo, S.; Hessel, V.; Maddar, A.; Noël, T., *Angew. Chem. Int. Ed.* **2017**, *56*, 12701–12707. c) Bartolomeu, A. de A.; Silva, R. C.; Brocksom, T. J.; Noël, T.; de Oliveira, K. T., *J. Org. Chem.* **2019**, *84*, 10459–10471.

<sup>114</sup> a) AL-Shuaeeb, R. A. A.; Montoir, D.; Alami, M.; Messaoudi, S., *J. Org. Chem.* **2017**, *82*, 6720–6728; b) Probst, N.; Lartia, R.; Théry, O.; Alami, M.; Defrancq, E.; Messaoudi, S., *Chem. Eur. J.* **2018**, *24*, 1795–1800; c) Montoir,

the arylation of protected and unprotected thiosugars with various anilines (**Figure 10C**). If successful, this approach would provide not only an excellent complementary pathway to the established S-arylation methods but also immediate access to a reactive platform that can be engaged in numerous postfunctionalizations.

To examine the feasibility of this study, we chose the coupling of tetra-O-acetylated 1-thio- $\beta$ -D-glucopyranose **1a** with a commercially available 4-cyanoaniline **2a** as a model study under various reaction conditions (**Table 15 and Table 16 in experiment part**). The reaction of **1a** (1 equiv.) with **2a** (1.2 equiv) was first investigated by using 1 mol% of a commercially available Ru(bpy)<sub>2</sub>PF<sub>6</sub> photocatalyst in the presence of tBuONO (2 equiv) as a diazotization reagent in acetonitrile under a white light-emitting diode (LED) irradiation at room temperature for 24 h (**Table 16 in experiment part, entry 1**). Accordingly, these conditions afforded the expected product **3a** in an encouraging 67% yield as a single  $\beta$ -anomer ( $J_{1,2} = 9.0$  Hz) (See ESI). Increasing the amount of the aniline partner **2a** from 1.2 equiv to 2 equiv furnished **3a** in a slightly lower yield (**57%, Table 16 in experiment part, entry 2**). Pleasantly, switching from white to blue light furnished **3a** in 77% yield (Table S1, entry 3, ESI). Interestingly, reducing the reaction time to only 1h instead of 24 h led to the thioglucoside **3a** in a good 77% yield (**Table 15, entry 1**). The reaction time was fixed at 1h and we decided to examine the other reaction parameters. The reaction with the organophotocatalyst 4CzIPN ( $E_{(PC^*/PC^-)} = +1.43$  V) instead of Ru(bpy)<sub>2</sub>PF<sub>6</sub> was less efficient and gave **3a** in a 66% yield (entry 2). Decreasing amounts of the photocatalyst to 0.5 mol% gave **3a** in a still good yield of 70% (**Table 15, entry 3**). However, tentative to remove traces of water from the reaction medium by adding molecular sieves (4 Å) led to complete inhibition of any reactivity (**Table 15, entry 4**). The influence of the solvent was also examined and revealed that MeCN was the solvent of choice since the other solvents such as DMSO, DMA, DMF and MeOH were completely incompatible with this coupling (**Table 15, entry 5**) or less efficient in the case of dioxane (**43%, Table 15, entry 6**). Negative controlling experiments demonstrated that both the Ru-photocatalyst and light are crucial for this reaction (**Table 15, entries 7–9**).

---

D.; Amoura, M.; Ababsa, Z. E. -A.; Vishwanath, T. M.; Yen-Pon, E.; Robert, V.; Beltramo, M.; Piller, V.; Alami, M.; Aucagne, A.; Messaoudi, S., *Chem. Sci.* 2018, **9**, 8753–8759. d) Zhu, M.; Alami, M.; Messaoudi, S., *Org. Lett.* **2020**, *22*, 6584-6589; e) Bennai, N.; Ibrahim, N.; Marrot, J.; Belkadi, M.; Alami, M.; Magnier, E.; Anselmi, E.; Messaoudi, S., *Eur. J. Org. Chem.* **2020**, 4972-4981.

With these encouraging results, we investigated next, the scope and limitations for this Stadler-Ziegler reaction by using a series of commercially available aryl amines **2** bearing different functional groups. As showed in **Scheme 36**, cross-couplings of tetra-O-acetylated 1-thio- $\beta$ -D-glucopyranose **1a** with aryl amines bearing various functions (-CN, -Cl, -Br -I, -CF<sub>3</sub>, -NO<sub>2</sub>, -CO<sub>2</sub>Me, -C(O)Me, -OMe, -Me, -tBu, -Ph) at para or meta positions have been successfully achieved to afford the corresponding thioglycosides (**3a-j** and **3o-s**) in yields up to 85%. Interestingly, reactive C-halogen

**Table 15** Optimization of the coupling reaction of **1a** with **2a**<sup>[a]</sup>

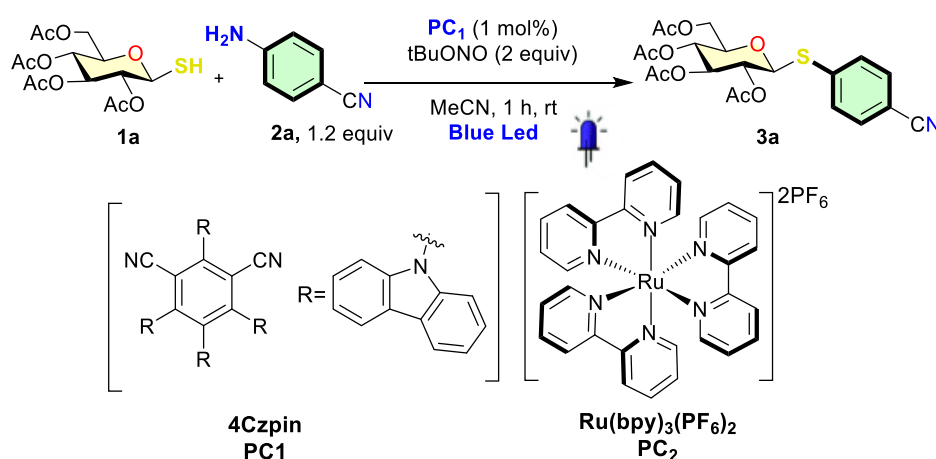

Entry	Deviation from the standard conditions	Yield <b>3a</b> (%) <sup>b</sup>
<b>1</b>	none	<b>77</b>
<b>2</b>	PC1 instead PC2	<b>66</b>
<b>3</b>	PC2 0.5 mol%	<b>70</b>
<b>4</b>	+ molecular sieves 4 Å	<b>trace</b>
<b>5</b>	DMSO or DMF or DMA or MeOH instead of MeCN	<b>traces</b>
<b>6</b>	Dioxane instead of MeCN	<b>43</b>
<b>7</b>	No photocatalyst PC1	<b>17</b>
<b>8</b>	No LED	<b>17</b>
<b>9</b>	No photocatalyst PC1 and LED	<b>17</b>

<sup>a</sup> Reactions conditions: **1a** (0.3 mmol), **2a** (0.36 mmol), *t*BuONO (0.6 mmol), MeCN (2.0 mL), blue LEDs (4.5 W, irradiation). <sup>b</sup> Isolated yield.

bonds (e.g., I, Br, Cl) were tolerated in this photoredox reaction affording compounds **3c-e**, **3j**, **3l**, **3m**, **3n** in acceptable yields. The presence of halogen substituents in these products provided a handle for further structural diversifications using metal-catalyzed cross-coupling reactions. In addition, the presence of an *ortho* substitution at the aromatic ring of the aniline partner affects slightly but doesn't inhibit completely the

coupling process, as compounds **3k-n** were obtained in yields ranging between 28% and 78% depending on the electronic effect of the functional group.

**Scheme 36.** Scope and limitation of the coupling of **1a** with alkylamines **2**.<sup>a</sup>

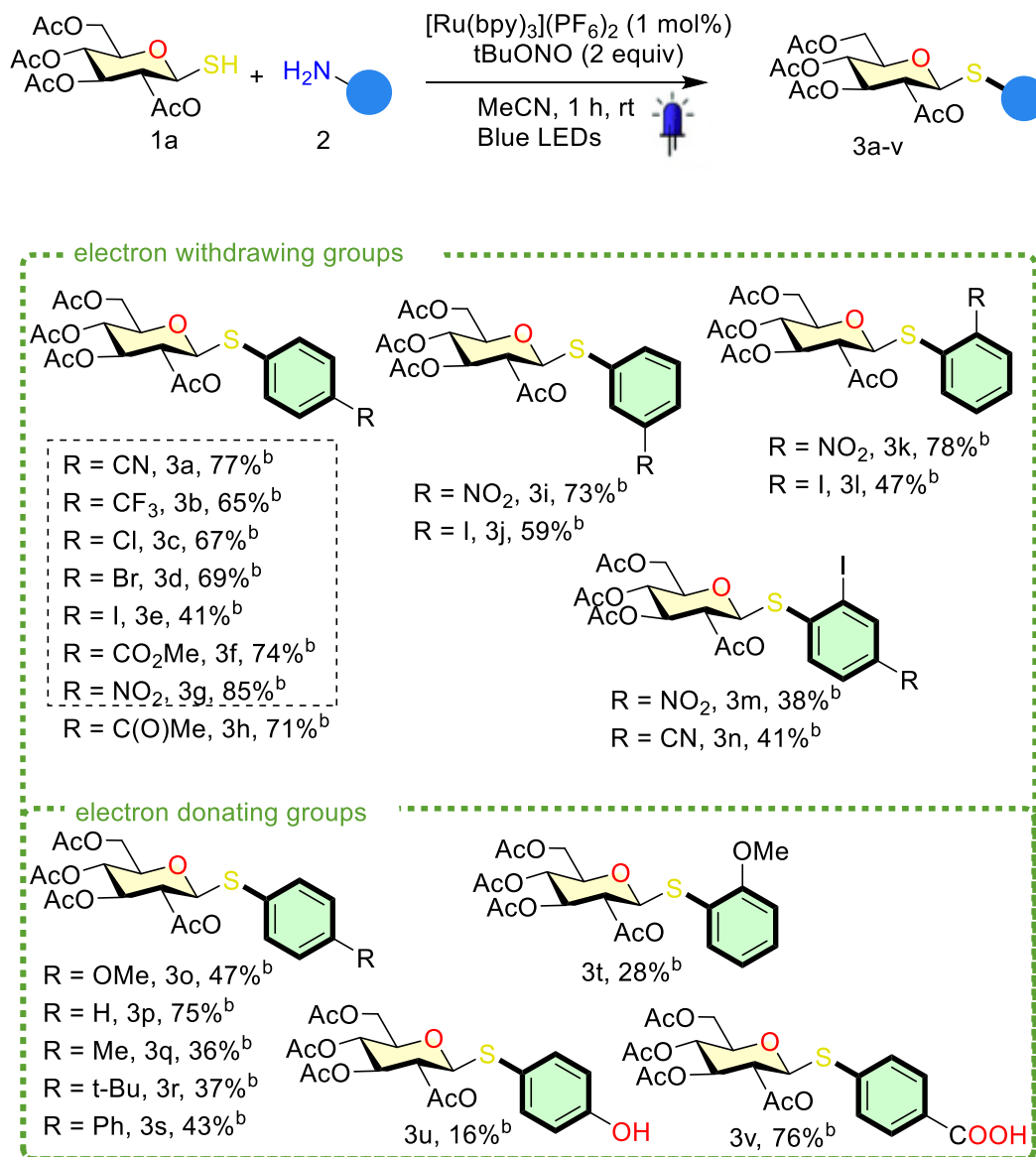

<sup>a</sup> Reactions conditions: **1a** (0.3 mmol), **2** (0.36 mmol), *t*BuONO (0.6 mmol), MeCN (2.0 mL), blue LEDs (4.5 W, irradiation). <sup>b</sup> Isolated yield.

Of note, the presence of a polar function on the aniline such as a carboxylic acid **2v** is well tolerated furnishing the desired compound **3v** in 76% yield. However, the yield drops down to only 16% when the coupling of **1a** was conducted with a *p*-hydroxy aniline (compound **3u**).

**Scheme 37.** Scope and limitation of the coupling of glycosyl thiols **1b-h** with the aniline **2g**.

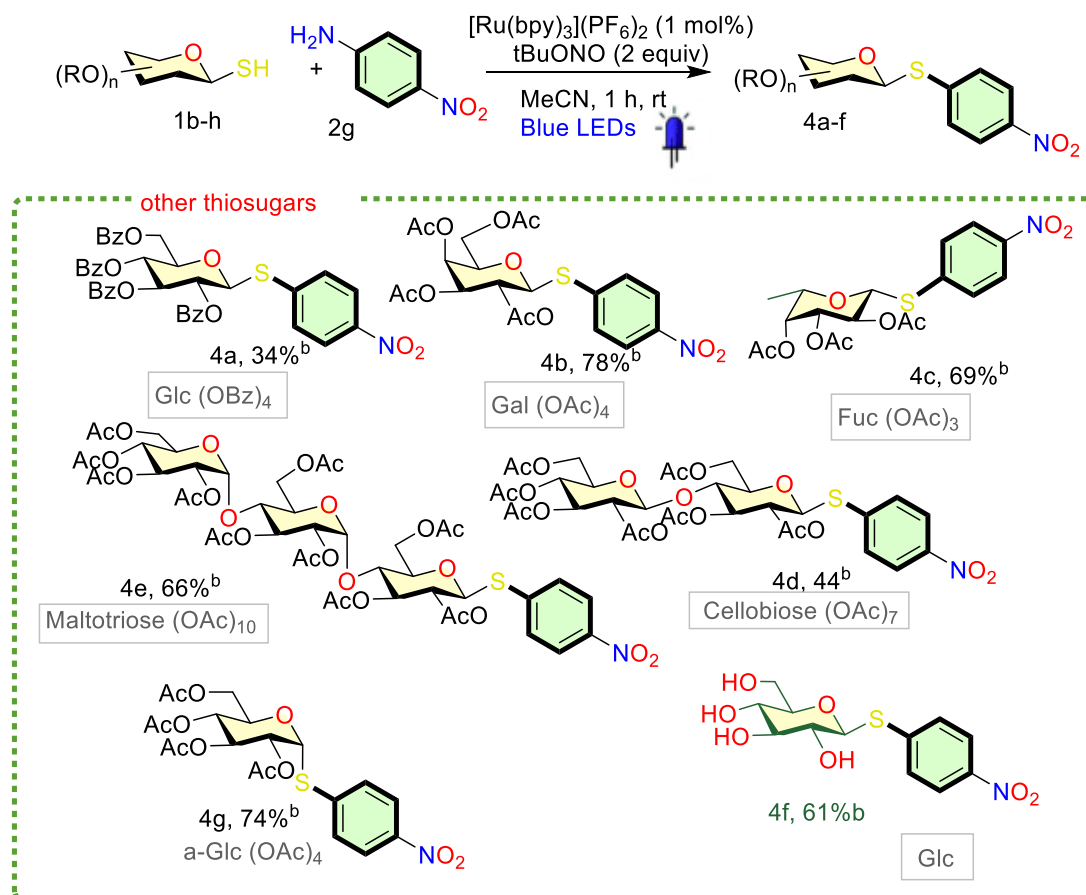

<sup>a</sup> Reactions conditions: **1b-h** (0.3 mmol), **2g** (0.36 mmol), *t*BuONO (0.6 mmol), MeCN (2.0 mL), blue LEDs (4.5 W, irradiation). <sup>b</sup> Isolated yield.

This successful study with the tetra-*O*-acetylated 1-thio- $\beta$ -D-glucopyranose **1a** encouraged us to examine the feasibility of this coupling with different other glycosyl thiols **1b-h**. As depicted in **Scheme 37**, this coupling reaction tolerates different glycosylthiols such as *O*-benzoylated 1-thio- $\beta$ -D-glucopyranose **1b**, *O*-acetylated 1-thio- $\beta$ -D-galactopyranose **1c**, and *O*-acetylated 1-thio- $\beta$ -D-fucopyranose **1d** which react smoothly with the *p*-nitro aniline **2g** to lead to thioglycosides **4a-c** in yields up to 78%. In addition, this protocol could be extended to more complex and biologically relevant saccharide derivatives such as thio- $\beta$ -D-cellobiose disaccharide **1e** and thio- $\beta$ -D-maltotriose trisaccharide **1f** delivering **4d** and **4e** in 44% and 66% yields, respectively. More interestingly, we observed that our protocol is compatible with unprotected thiosugars since the reaction of unprotected thio- $\beta$ -D-glucose **1g** with **2g** yielded the thioglycoside **4f** in a good 61% yield, and no side products arising from the

*O*-arylation were observed (**Scheme 37**). This is another important input compared to our previously reported photoredox approach to functionalize thiosugars with aryl halides. Finally, besides  $\beta$ -glycosyl thiols,  $\alpha$ -anomers are also effective coupling partners for this photoredox coupling as the  $\alpha$ -thioglycoside furnishes the  $\alpha$ -thioglycosides **4g** in 74% yield.

**Scheme 38.** Gram scale reaction and functionalization

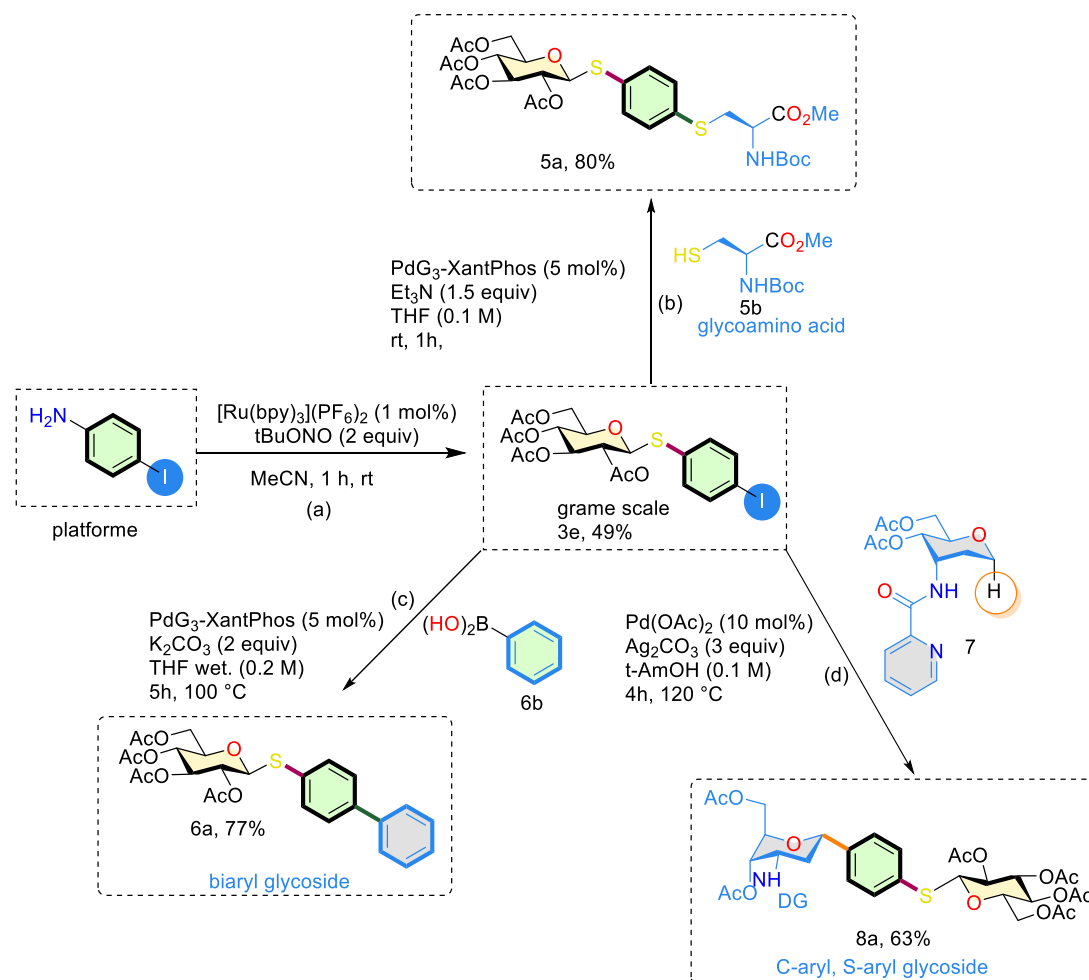

<sup>a</sup> Reactions conditions: (a) **1a** (3 mmol), **2e** (1.2 eq), [Ru(bpy)<sub>3</sub>](PF<sub>6</sub>)<sub>2</sub> (1 mol%), MeCN 20 mL, *t*BuONO (2 eq), Blue led, rt, 1 h. (b) **3e** (0.1 mmol), **5b** (0.1 mmol), PdG<sub>3</sub> XantPhos (5 mol%), Et<sub>3</sub>N (1.5 equiv), in THF (0.1 M) at rt for 1 h. (c) **3e** (0.1 mmol), **6b** (0.2 mmol), PdG<sub>3</sub> XantPhos (5 mol%), K<sub>2</sub>CO<sub>3</sub> (2 equiv), in wet THF (0.2 M) at 100 °C for 5 h. (d) **3e** (0.2 mmol), **7** (0.4 mmol), Pd(OAc)<sub>2</sub> (10 mol%), Ag<sub>2</sub>CO<sub>3</sub> (3 equiv), in *t*-AmOH (0.1 M) at 120 °C for 4 h. <sup>b</sup>Isolated yield.

To further show the synthetic utility of our protocol, we carried out studies on whether the iodinated substrate **3e** could be used as a platform to access more complex

thioglycosides through metal-catalyzed transformations of the C–I bond (**Scheme 38**). To this end, **3e** was firstly prepared on a gram scale with a slightly higher yield demonstrating the scalability of our protocol. Thus, with substantial amounts of **3e** in hand, we examined next its coupling with the cysteine substrate under our previously reported Pd-catalyzed methodology.<sup>115</sup> When PdG3-XantPhos was used as a catalyst in the presence of Et<sub>3</sub>N, the glycoamino acid **5a** was isolated in an excellent yield. This later may be used as a building block in the SPPS peptide synthesis (**Scheme 38**). In addition, **3e** was converted to the biaryl **5b** in good yield through a Suzuki-Miyaura cross-coupling with the phenylboronic<sup>116</sup> (**Scheme 38**). Finally, **3e** was engaged in a Csp<sup>3</sup>–H activation process of the anomeric C–H bond of substrate **7** under our recently reported protocol.<sup>117</sup> The di-glycoside **8a** bearing two different sugars linked through C–C and C–S bonds was obtained in 63 % yield (**Scheme 38**).

From the point of view of mechanistic considerations, based on the literature reports we may assume that the reaction starts by the *in situ* formation of the diazo salt from aniline and *t*BuONO reagent, followed by the formation of the diazosulfide (I) (**Figure 11**). Noël and co-workers suggested in their early mechanistic studies that this intermediate is the reactive photo-labile species in the photocatalytic cycle of the photocatalyzed Stadler-Ziegler process.<sup>101a</sup> A single electron transfer (SET) from the excited state Ru photocatalyst to the diazosulfide (I) leads to N<sub>2</sub> extrusion and the formation of the thiolate (III) and aryl radical (II). These two intermediates evolve into the formation of the thioether radical anion (IV) which produces the final thioglycoside and close the Ru-catalytic cycles by a final SET.

---

<sup>115</sup> Al-Shuaeeb, A. A.; Kolodych, S.; Koniev, O.; Delacroix, S.; Erb, S.; Nicolay, S.; Cintrat, J.-C.; Brion, J.-D.; Cianféroni, S.; Alami, M.; Wagner, A.; Messaoudi, S., *Chem. Eur. J.* **2016**, *22*, 11365-11370.

<sup>116</sup> Benmahdjoub, S.; Ibrahim, N.; Benmerad, B.; Alami, M.; Messaoudi, S., *Org. Lett.* **2018**, *20*, 4067–4071.

<sup>117</sup> Ghouilem, G.; Tran, C.; Grimblat, N.; Retailleau, P.; Alami, M.; Gandon, V.; Messaoudi, S., *ACS Catalysis* **2021**, *11*, 1818–1826.

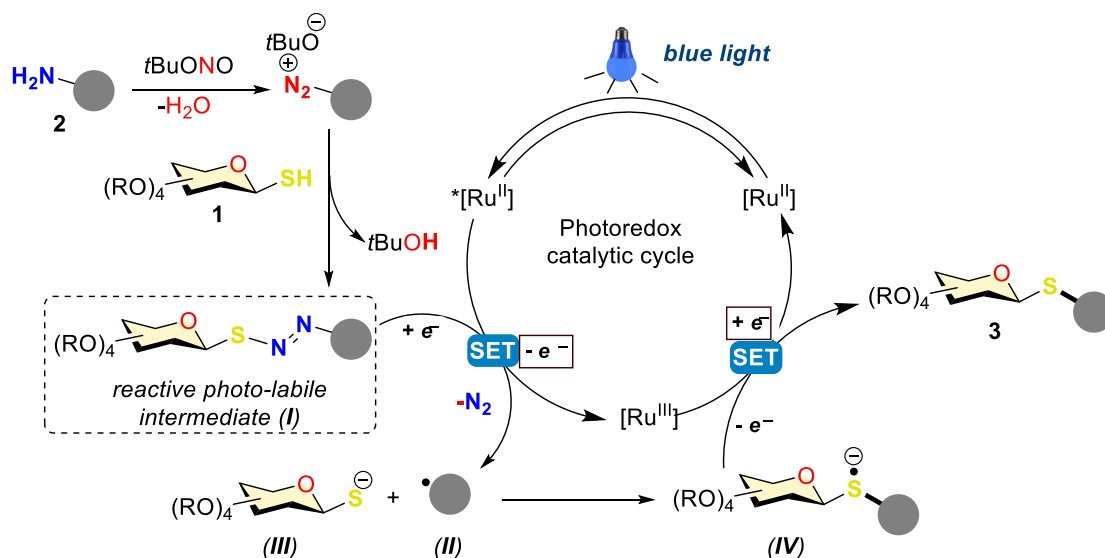

**Figure 11.** A proposed mechanism

In summary, we reported here a new approach for the S-arylation of anomeric glycosyl thiols with various aryl amines *via* a cooperative photoredox strategy. This method provides unprecedented access to functionalized thioglycosides under mild conditions with high efficiency and selectivity. We anticipate that this mild synthetic protocol will find numerous applications in organic synthesis as well as in medicinal chemistry.

### C) Conclusion and perspectives

The objectives achieved during this work are as follows: A new one-pot reaction sequence between glycosyl thiols and arylamines, giving to thioglycosides derivatives in good yields, has been reported. The process eliminates the need for isolate the unstable diazonium salt, which led to easy use and operation. Halide thioglycosides derivatives can be synthesized by this protocol, overcome the limitation of previous protocol. Gram scale has been done in this protocol, and result the desired product in good yield compared with bench reaction. Three types of cross-coupling reaction between iodine thioglycosides and other reagents has been done, including Pd-catalyst reaction between iodine thioglycosides and cysteine, Suzuki reaction and C-H activation reaction. In addition, this coupling tolerates the presence of functional groups such as iodine, bromide, carboxylic acid, nitrile and fluorine. The presence of a functional group on the final molecules allows us to carry out further transformations.



Our protocol shows a large functional group tolerance, however, the limitation with heteroaryl amines as reported previously remains: the coupling with pyridine or thiophene failed. Studies on the applications of this method in the S-arylation of more complex polysaccharides are ongoing in our group.

## D) Experimental part

### General information

Solvents and reagents are obtained from commercial suppliers and were used without further purification. Analytical TLC was performed using Merck silica gel F254 (230-400 mesh) plates and analyzed by UV light or by staining upon heating with vanillin solution (15 g of vanillin in 250 mL ethanol and 2.5 mL of concentrated sulfuric acid). For silica gel chromatography, the flash chromatography technique was used, with Merck silica gel 60 (230-400 mesh) and p.a. grade solvents unless otherwise noted. The  $^1\text{H}$  NMR and  $^{13}\text{C}$  NMR J-MOD spectra were recorded in either  $\text{CDCl}_3$  on Bruker Avance 300 spectrometers. The  $^{19}\text{F}$  NMR Decoupled spectra were recorded in either  $\text{CDCl}_3$  on Bruker Avance 200 spectrometers. The chemical shifts of  $^1\text{H}$ ,  $^{13}\text{C}$  and  $^{19}\text{F}$  are reported in ppm relative to the solvent residual peaks. Merck silica gel 60 (0.015–0.040 mm) was used for column chromatography. Melting points were recorded on a Büchi B-450 apparatus and are uncorrected. High resolution mass spectra (HR-MS) were recorded on a Micro Mass LCT Premier Spectrometer. Optical rotations were obtained with a PolAAR 32 polarimeter. Arylamine, tert-Butyl nitrite and photocatalyst was commercial availability from Aldrich. Thiosugars were synthesized as according the following protocols.<sup>118</sup>

Photochemistry: Photoredox reactions were irradiated with blue LED (~470 nm) strips, and the temperature (~25 °C) was controlled using one external desk fan set up ~ 15-20 cm away from this photoreactor bed.

### General Procedures

---

<sup>118</sup>a) Floyd, N.; Vijayakrishnan, B.; Koeppe, J. R.; Davis, B. G., *Angew. Chem., Int. Ed.*, **2009**, *48*, 7798-7802; b) Gamblin, D. P.; Garnier, P.; van Kasteren, S.; Oldham, N. J.; Fairbanks, A. J.; Davis, B. G., *Angew. Chem., Int. Ed.*, **2004**, *43*, 828-833

A sealable tube purged with argon equipped with a cap was charged with thiosugar (1 equiv), arylamine (if solid) (1.2 equiv), [Ru(bpy)<sub>3</sub>](PF<sub>6</sub>)<sub>2</sub> (1 mol%), the tube was flushed again with Argon, arylamine (if liquid) (1.2 equiv) and MeCN (0.15 M) was added. The mixture was stirred for 5 min. And then, the mixture was placed in the photoreactor vessel ~5-7 cm away from the blue LEDs. Tert-Butyl nitrite (2 equiv.) was added into the tube drop by drop, and the mixture allowed to stirred vigorously for 1 h at rt. The temperature of the reaction was maintained at approximately 25 °C via a fan. Purification was performed with flash chromatography on silica gel.

#### **Gram scale reaction:**

A 50 mL round-bottom flask purged with argon equipped with a cap was charged with thiosugar **1a** (1 equiv, 3 mmol, 1090 mg), 4-Iodoaniline (1.2 equiv, 0.854 mg), [Ru(bpy)<sub>3</sub>](PF<sub>6</sub>)<sub>2</sub> (1 mol%, 35mg), the flask was flushed again with Argon, MeCN (20 mL) was added. The mixture was stirred for 5 min. And then, the mixture was placed in the photoreactor vessel ~5-7 cm away from the blue LEDs. Tert-Butyl nitrite (2equiv, 0.75 mL) was added into the tube drop by drop, and the mixture allowed to stirred vigorously for 1 h at rt. The temperature of the reaction was maintained at approximately 25 °C via a fan. Purification was performed with flash chromatography on silica gel (PE/EA = 4/1) and obtain the product (49%, 820 mg) in white solid.

#### **Palladium-catalyzed cross-coupling reaction of N-L-cysteine methyl ester and (2*R*,3*R*,4*S*,5*R*,6*S*)-2-(acetoxymethyl)-6-((4-iodophenyl)thio)tetrahydro-2H-pyran-3,4,5-triyl triacetate**

A sealable tube purged with argon equipped with a cap was charged with (2*R*,3*R*,4*S*,5*R*,6*S*)-2-(acetoxymethyl)-6-((4-iodophenyl)thio)tetrahydro-2H-pyran-3,4,5-triyl triacetate (1 equiv, 0.1 mmol, 56.6mg), N-L-cysteine methyl ester (1 equiv, 0.1 mmol, 23.5 mg), PdG<sub>3</sub>Xantphos (5 mmol%, 5 mg), the tube was flushed again with Argon, THF (1 mL) was added. The mixture was stirred for 5 min. And then, Et<sub>3</sub>N (1.5 equiv, 21 uL) was added into the tube drop by drop, and the mixture allowed to stirred vigorously for 1 h at rt. Purification was performed with flash chromatography on silica gel (PE/EA = 2/1), and obtain the product (80%, 54 mg) in white solid.

**Suzuki reaction of (2*R*,3*R*,4*S*,5*R*,6*S*)-2-(acetoxymethyl)-6-((4-iodophenyl)thio)tetrahydro-2H-pyran-3,4,5-triyl triacetate and Phenylboronic acid**

A sealable tube purged with argon equipped with a cap was charged with (2*R*,3*R*,4*S*,5*R*,6*S*)-2-(acetoxymethyl)-6-((4-iodophenyl)thio)tetrahydro-2H-pyran-3,4,5-triyl triacetate (1 equiv, 0.1 mmol, 56.6mg), Phenylboronic acid (2 equiv, 0.2 mmol, 24.4 mg), PdG<sub>3</sub>Xantphos (5 mmol%, 5 mg), K<sub>2</sub>CO<sub>3</sub> (4 eq, 55.3 mg), the tube was flushed again with Argon, THF (0.5 mL) and 1 drop of water was added. The mixture was stirred for 5 min. and the mixture allowed to stirred vigorously for 5 h at 100 °C. Purification was performed with flash chromatography on silica gel (PE/EA = 4/1), and obtain the product (77%, 40 mg) in white solid.

**C-H activation reaction of N-((2*R*,4*aR*,8*S*,8*aS*)-2-Phenylhexahydropyrano[3,2-*d*] [1,3] dioxin-8-yl) picolinamide and (2*R*,3*R*,4*S*,5*R*,6*S*)-2-(acetoxymethyl)-6-((4-iodophenyl)thio)tetrahydro-2H-pyran-3,4,5-triyl triacetate:**

A sealable tube was charged with the N-((2*R*,4*aR*,8*S*,8*aS*)-2-Phenylhexahydropyrano[3,2-*d*] [1,3] dioxin-8-yl) picolinamide (0.2 mmol, 67.2 mg, 1.0 equiv), Pd (OAc)<sub>2</sub> (4.5 mg, 10 mol%), Ag<sub>2</sub>CO<sub>3</sub> (3.0 equiv, 165.4 mg), the (2*R*,3*R*,4*S*,5*R*,6*S*)-2-(acetoxymethyl)-6-((4-iodophenyl)thio)tetrahydro-2H-pyran-3,4,5-triyl triacetate (2.0 equiv, 226.4 mg) and *t*-AmOH ( 2 mL). The reaction vessel was purged with argon and sealed, then placed in an oil bath (preheated at 120 °C) for 4h. The reaction mixture was then allowed to cool to rt and EtOAc (10 mL) was added. The resulting solution was filtered through a pad of Celite, eluting with further EtOAc (2 × 10 mL). The solvent was removed under reduced pressure, and the crude material was purified by flash column chromatography (PE/EA = 2/1 with 0.1% Et<sub>3</sub>N), and obtain the product (63%, 97.5 mg) in light yellow solid.

## Condition selection

**Table 16.** Condition selection

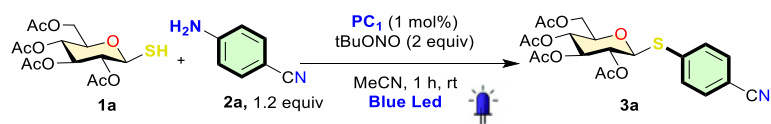

Entry	A	B	Cat.	tBuONO	Led	solvent	time	yield
1	0.3mmol	1.2eq	Ru(bpy) <sub>2</sub> PF <sub>6</sub> 1 mol %	2 eq	white	MeCN	24h	67%
2	0.3mmol	2eq	Ru(bpy) <sub>2</sub> PF <sub>6</sub> 1 mol %	2 eq	white	MeCN	24h	57%
3	0.3mmol	1.2eq	Ru(bpy) <sub>2</sub> PF <sub>6</sub> 1 mol %	2 eq	blue	MeCN	24h	77%
4	0.3mmol	1.2eq	Ir(dFCF <sub>3</sub> )dttbpyPF <sub>6</sub> 1 mol %	2 eq	blue	MeCN	24h	65%
5	0.3mmol	1.2eq	Ru(bpy) <sub>2</sub> PF <sub>6</sub> 5 mol %	2 eq	blue	MeCN	24h	75%
6	0.3mmol	1.2eq	Ru(bpy) <sub>2</sub> PF <sub>6</sub> 1 mol %	2 eq	blue	MeCN	1h	77%
7	0.3mmol	1.2eq	Ru(bpy) <sub>2</sub> PF <sub>6</sub> 1 mol %	2 eq	blue	MeCN	30 min	56%
8	0.3mmol	1.2eq	Ru(bpy) <sub>2</sub> PF <sub>6</sub> 1 mol %	2 eq	blue	MeCN	1h	77%
9	0.3mmol	1.2eq	Ru(bpy) <sub>2</sub> PF <sub>6</sub> 1 mol %	1.5 eq	blue	MeCN	1h	62%
10	0.3mmol	1.2eq	Ru(bpy) <sub>2</sub> PF <sub>6</sub> 1 mol %	3 eq	blue	MeCN	1h	72%

<sup>a</sup> Reactions conditions: **1a** (0.3 mmol), **2a** (0.36 mmol), *t*BuONO (0.6 mmol), MeCN (2.0 mL), blue LEDs (4.5 W, irradiation). <sup>b</sup>Isolated yield.

## Experimental data

**(2*R*,3*R*,4*S*,5*R*,6*S*)-2-(acetoxymethyl)-6-((4-cyanophenyl)thio)tetrahydro-2H-pyran-3,4,5-triyl triacetate**<sup>119</sup>

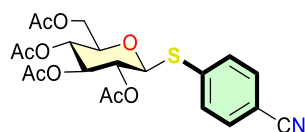

Product **3a** was isolated after flash chromatography as a white solid (129.3 mg, 77%); **Rf** = 0.3 (EtOAc /cyclohexane: 1/2); **<sup>1</sup>H NMR (300 MHz, CDCl<sub>3</sub>)** δ 7.51-7.58 (m, 4H), 5.21-5.27 (m, 1H), 4.96-5.06 (m, 2H), 4.81 (d, *J* = 12.0 Hz, 1H), 4.13-4.25 (m, 2H), 3.75-3.81 (m, 1H), 2.06 (s, 3H), 2.04 (s, 3H), 2.00 (s, 3H), 1.97 (s, 3H); **HRMS (ESI)**: *m/z* calc. for C<sub>21</sub>H<sub>23</sub>NNaO<sub>9</sub>S [M+Na]<sup>+</sup> 488.0991; found 488.0996.

**(2*R*,3*R*,4*S*,5*R*,6*S*)-2-(acetoxymethyl)-6-((4-(trifluoromethyl)phenyl)thio)tetrahydro-2H-pyran-3,4,5-triyl triacetate**<sup>107</sup>

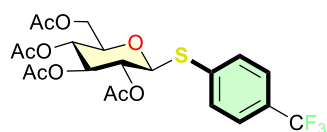

Product **3b** was isolated after flash chromatography as a white solid (99.3 mg, 65%); **Rf** = 0.3 (EtOAc /cyclohexane: 1/2); **<sup>1</sup>H NMR (300 MHz, CDCl<sub>3</sub>)** δ 7.53-7.60 (m, 4H), 5.24 (t, *J* = 9.0 Hz, 1H), 4.96-5.07 (m, 2H), 4.77 (d, *J* = 12.0 Hz, 1H), 4.15-4.22 (m, 2H), 3.73-3.79 (m, 1H), 2.07 (s, 3H), 2.06 (s, 3H), 2.02 (s, 3H), 1.99 (s, 3H); **HRMS (ESI)**: *m/z* calc. for C<sub>21</sub>H<sub>23</sub>F<sub>3</sub>NaO<sub>9</sub>S [M+Na]<sup>+</sup> 531.0913; found 531.0907.

**(2*R*,3*R*,4*S*,5*R*,6*S*)-2-(acetoxymethyl)-6-((4-chlorophenyl)thio)tetrahydro-2H-pyran-3,4,5-triyl triacetate**<sup>107</sup>

---

<sup>119</sup> Zhu, M.; Dagousset, G.; Alami, M.; Magnier, E.; Messaoudi, S., *Org. Lett.* **2019**, *21*, 5132-5137.

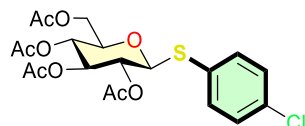

Product **3c** was isolated after flash chromatography as a white solid (95.6 mg, 67%); **Rf** = 0.3 (EtOAc /cyclohexane: 1/2); **<sup>1</sup>H NMR (300 MHz, CDCl<sub>3</sub>)** δ 7.43-7.46 (m, 2H), 7.27-7.30 (m, 2H), 5.22 (t, *J* = 9.0 Hz, 1H), 4.90-5.04 (m, 2H), 4.65 (d, *J* = 9.0 Hz, 1H), 4.19-4.25 (m, 2H), 3.69-3.75 (m, 1H), 2.08 (s, 3H), 2.07 (s, 3H), 2.01 (s, 3H), 1.99 (s, 3H); **HRMS (ESI)**: *m/z* calc. for C<sub>20</sub>H<sub>23</sub>ClNaO<sub>9</sub>S [M+Na]<sup>+</sup> 497.0649; found 497.0642.

**(2*R*,3*R*,4*S*,5*R*,6*S*)-2-(acetoxymethyl)-6-((4-bromophenyl)thio)tetrahydro-2H-pyran-3,4,5-triyl triacetate**<sup>120</sup>

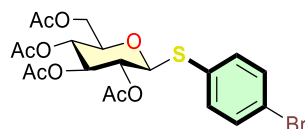

Product **3d** was isolated after flash chromatography as a white solid (107.5 mg, 69%); **Rf** = 0.3 (EtOAc /cyclohexane: 1/2); **<sup>1</sup>H NMR (300 MHz, CDCl<sub>3</sub>)** δ 7.40-7.44 (m, 2H), 7.34-7.37 (m, 2H), 5.20 (t, *J* = 9.0 Hz, 1H), 4.88-5.03 (m, 2H), 4.64 (d, *J* = 12.0 Hz, 1H), 4.13-4.23 (m, 2H), 3.67-3.73 (m, 1H), 2.06 (s, 3H), 2.06 (s, 3H), 2.00 (s, 3H), 1.97 (s, 3H); **HRMS (ESI)**: *m/z* calc. for C<sub>20</sub>H<sub>23</sub>BrNaO<sub>9</sub>S [M+Na]<sup>+</sup> 541.0144; found 541.0149.

**(2*R*,3*R*,4*S*,5*R*,6*S*)-2-(acetoxymethyl)-6-((4-iodophenyl)thio)tetrahydro-2H-pyran-3,4,5-triyl triacetate**

---

<sup>120</sup> Bruneau, A.; Roche, M.; Hamze, A.; Brion, J.; Alami, M.; Messaoudi, S., *Chem. Eur. J.* **2015**, *21*, 8375-8379.

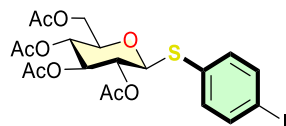

Product **3e** was isolated after flash chromatography as a white solid (69.9 mg, 41%). **Rf** = 0.3 (EtOAc /cyclohexane: 1/2); **m. p.:** 139.6-140.5 °C; **[ $\alpha$ ]<sub>D</sub><sup>18</sup>** = – 22.7 (c, 0.66, CHCl<sub>3</sub>); **<sup>1</sup>H NMR (300 MHz, CDCl<sub>3</sub>)**  $\delta$  7.64-7.67 (m, 2H), 7.23-7.28 (m, 2H), 5.02-5.27 (m, 1H), 4.93-5.07 (m, 2H), 4.67 (d, *J* = 9.0 Hz, 1H), 4.17-4.26 (m, 2H), 3.70-3.76 (m, 1H), 2.10 (s, 3H), 2.10 (s, 3H), 2.04 (s, 3H), 2.01 (s, 3H); **<sup>13</sup>C NMR (75 MHz, CDCl<sub>3</sub>)**  $\delta$  170.5 (C), 170.1 (C), 169.4 (C), 169.2 (C), 138.0 (2CH), 135.1 (2CH), 131.2 (C), 94.6 (C), 85.1 (CH), 75.9 (CH), 73.8 (CH), 69.8 (CH), 68.1 (CH), 62.0 (CH<sub>2</sub>), 2.07 (2CH<sub>3</sub>), 2.06 (2CH<sub>3</sub>); **IR (neat):** 1758, 1360, 1223, 1017, 1003, 916, 813, 796 cm<sup>-1</sup>; **HRMS (ESI):** m/z calc. for C<sub>20</sub>H<sub>23</sub>INaO<sub>9</sub>S [M+Na]<sup>+</sup> 589.0005; found 589.0009.

**(2R,3R,4S,5R,6S)-2-(acetoxymethyl)-6-((4-methoxycarbonyl)phenyl)thio)tetrahydro-2H-pyran-3,4,5-triyl triacetate<sup>107</sup>**

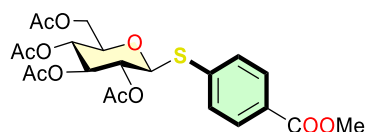

Product **3f** was isolated after flash chromatography as a white solid (111.3 mg, 74%); **Rf** = 0.3 (EtOAc /cyclohexane: 1/2); **<sup>1</sup>H NMR (300 MHz, CDCl<sub>3</sub>)**  $\delta$  7.93-7.96 (m, 2H), 7.48-7.51 (m, 2H), 5.24 (t, *J* = 9.0 Hz, 1H), 4.98-5.08 (m, 2H), 4.82 (d, *J* = 9.0 Hz, 1H), 4.14-4.26 (m, 2H), 3.90 (s, 3H), 3.74-3.80 (m, 1H), 2.08 (s, 3H), 2.06 (s, 3H), 2.01 (s, 3H), 1.98 (s, 3H); **HRMS (ESI):** m/z calc. for C<sub>22</sub>H<sub>26</sub>NaO<sub>11</sub>S [M+Na]<sup>+</sup> 521.1094; found 521.1088.

**(2R,3R,4S,5R,6S)-2-(acetoxymethyl)-6-((4-nitrophenyl)thio)tetrahydro-2H-pyran-3,4,5-triyl triacetate<sup>121</sup>**

<sup>121</sup>Brachet, E.; Brion, J.; Messaoudi, S.; Alami, M., *Adv. Syn. Cat.* **2013**, 355, 477-490.

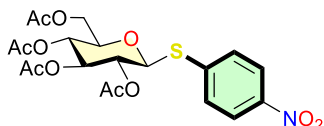

Product **3g** was isolated after flash chromatography as a white solid (116.7 mg, 85%). **Rf** = 0.4 (EtOAc /cyclohexane: 1/2); **<sup>1</sup>H NMR (300 MHz, CDCl<sub>3</sub>)** δ 8.13-8.16 (m, 2H), 7.56-7.59 (m, 2H), 5.26 (t, *J* = 9.0 Hz, 1H), 5.00-5.09 (m, 2H), 4.86 (d, *J* = 12.0 Hz, 1H), 4.15-4.27 (m, 2H), 3.79-3.85 (m, 1H), 2.09 (s, 3H), 2.06 (s, 3H), 2.02 (s, 3H), 1.99 (s, 3H); **HRMS (ESI)**: *m/z* calc. for C<sub>20</sub>H<sub>23</sub>NNaO<sub>11</sub>S [M+Na]<sup>+</sup> 508.0890; found 508.0882.

**(2R,3R,4S,5R,6S)-2-(acetoxymethyl)-6-((4-acetylphenyl)thio)tetrahydro-2H-pyran-3,4,5-triyl triacetate**<sup>109</sup>

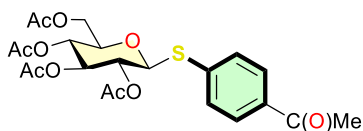

Product **3h** was isolated after flash chromatography as a white solid (102.8 mg, 71%); **Rf** = 0.3 (EtOAc /cyclohexane: 1/2); **<sup>1</sup>H NMR (300 MHz, CDCl<sub>3</sub>)** δ 7.87-7.90 (m, 2H), 7.52-7.55 (m, 2H), 5.26 (t, *J* = 9.0 Hz, 1H), 4.99-5.09 (m, 2H), 4.82 (d, *J* = 9.0 Hz, 1H), 4.16-4.28 (m, 2H), 3.76-3.82 (m, 1H), 2.59 (s, 3H), 2.09 (s, 3H), 2.07 (s, 3H), 2.03 (s, 3H), 1.99 (s, 3H); **HRMS (ESI)**: *m/z* calc. for C<sub>22</sub>H<sub>26</sub>NaO<sub>10</sub>S [M+Na]<sup>+</sup> 505.1144; found 505.1137.

**(2R,3R,4S,5R,6S)-2-(acetoxymethyl)-6-((3-nitrophenyl)thio)tetrahydro-2H-pyran-3,4,5-triyl triacetate**

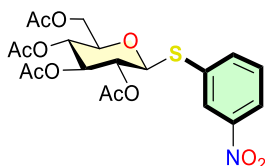



Product **3i** was isolated after flash chromatography as a white solid (106.5 mg, 73%); **Rf** = 0.3 (EtOAc /cyclohexane: 1/2); **m. p.:** 132.8-132.9 °C; **[ $\alpha$ ]<sub>D</sub><sup>18</sup>** = – 65.6 (c, 0.66, CHCl<sub>3</sub>); **<sup>1</sup>H NMR (300 MHz, CDCl<sub>3</sub>)**  $\delta$  8.35-8.36 (m, 1H), 8.13-8.17 (m, 1H), 7.75-7.78 (m, 1H), 7.46-7.51 (m, 1H), 5.23 (t, *J* = 9.0 Hz, 1H), 4.91-5.05 (m, 2H), 4.77 (d, *J* = 9.0 Hz, 1H), 4.16-4.27 (m, 2H), 3.76-3.82 (m, 1H), 2.07 (s, 3H), 2.06 (s, 3H), 2.00 (s, 3H), 1.96 (s, 3H); **<sup>13</sup>C NMR (75 MHz, CDCl<sub>3</sub>)**  $\delta$  170.6 (C), 170.0 (C), 169.3 (C), 169.1 (C), 148.4 (C), 138.3 (CH), 134.2 (C), 129.6 (CH), 127.0 (CH), 123.1 (CH), 84.7 (CH), 76.2 (CH), 73.7 (CH), 69.6 (CH), 68.0 (CH), 62.0 (CH<sub>2</sub>), 20.6 (CH<sub>3</sub>), 20.6 (CH<sub>3</sub>), 20.5 (CH<sub>3</sub>), 20.5 (CH<sub>3</sub>); **IR (neat):** 1755, 1558, 1400, 1385, 1216, 1018, 916, 758 cm<sup>-1</sup>; **HRMS (ESI):** *m/z* calc. for C<sub>20</sub>H<sub>23</sub>NNaO<sub>11</sub>S [M+Na]<sup>+</sup> 508.0890; found 508.0891.

**(2*R*,3*R*,4*S*,5*R*,6*S*)-2-(acetoxymethyl)-6-((3-iodophenyl)thio)tetrahydro-2H-pyran-3,4,5-triyl triacetate**<sup>122</sup>

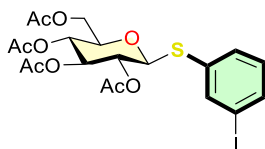

Product **3j** was isolated after flash chromatography as a white solid (98.7 mg, 59%); **Rf** = 0.3 (EtOAc /cyclohexane: 1/2); **<sup>1</sup>H NMR (300 MHz, CDCl<sub>3</sub>)**  $\delta$  7.84-7.58 (m, 1H), 7.63-7.66 (m, 1H), 7.42-7.46 (m, 1H), 7.01-7.06 (m, 1H), 5.22 (t, *J* = 9.0 Hz, 1H), 4.92-5.06 (m, 2H), 4.69 (d, *J* = 9.0 Hz, 1H), 4.13-4.26 (m, 2H), 3.63-3.77 (m, 1H), 2.10 (s, 3H), 2.07 (s, 3H), 2.01 (s, 3H), 1.98 (s, 3H); **HRMS (ESI):** *m/z* calc. for C<sub>20</sub>H<sub>23</sub>INaO<sub>9</sub>S [M+Na]<sup>+</sup> 589.0005; found 589.0002.

**(2*R*,3*R*,4*S*,5*R*,6*S*)-2-(acetoxymethyl)-6-((2-nitrophenyl)thio)tetrahydro-2H-pyran-3,4,5-triyl triacetate**<sup>11</sup>

<sup>122</sup> Naus, P.; Leseticky, L.; Smrcek, S.; Tislerova, I.; Sticha, M., *Synlett* **2003**, 14, 2117-2122.

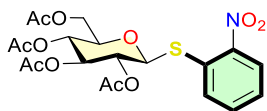

Product **3k** was isolated after flash chromatography as a white solid (113.8 mg, 78%); **Rf** = 0.3 (EtOAc /cyclohexane: 1/2); **<sup>1</sup>H NMR (300 MHz, CDCl<sub>3</sub>)** δ 8.04-8.08 (m, 1H), 7.74-7.77 (m, 1H), 7.53-7.59 (m, 1H), 7.37-7.42 (m, 1H), 5.24-5.30 (m, 1H), 5.10 (t, *J* = 9.0 Hz, 1H), 4.86 (d, *J* = 9.0 Hz, 1H), 4.15-4.27 (m, 2H), 3.81-3.87 (m, 1H), 2.08 (s, 3H), 2.03 (s, 3H), 2.01 (s, 3H), 1.99 (s, 3H); **HRMS (ESI)**: *m/z* calc. for C<sub>20</sub>H<sub>23</sub>NNaO<sub>11</sub>S [M+Na]<sup>+</sup> 508.0890; found 508.0885.

**(2*R*,3*R*,4*S*,5*R*,6*S*)-2-(acetoxymethyl)-6-((2-iodophenyl)thio)tetrahydro-2H-pyran-3,4,5-triyl triacetate**<sup>3</sup>

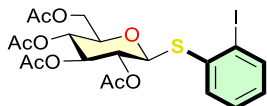

Product **3l** was isolated after flash chromatography as a white solid (78.6 mg, 47%); **Rf** = 0.3 (EtOAc /cyclohexane: 1/2); **<sup>1</sup>H NMR (300 MHz, CDCl<sub>3</sub>)** δ 7.85-7.88 (m, 1H), 7.61-7.65 (m, 1H), 7.29-7.34 (m, 1H), 6.95-7.00 (m, 1H), 5.28 (t, *J* = 9.0 Hz, 1H), 5.11 (t, *J* = 9.0 Hz, 1H), 4.77 (d, *J* = 9.0 Hz, 1H), 4.15-4.29 (m, 2H), 3.72-3.78 (m, 1H), 2.13 (s, 3H), 2.09 (s, 3H), 2.04 (s, 3H), 2.02 (s, 3H); **HRMS (ESI)**: *m/z* calc. for C<sub>20</sub>H<sub>23</sub>INaO<sub>9</sub>S [M+Na]<sup>+</sup> 589.0005; found 588.9997.

**(2*R*,3*R*,4*S*,5*R*,6*S*)-2-(acetoxymethyl)-6-((2-iodo-4-nitrophenyl)thio)tetrahydro-2H-pyran-3,4,5-triyl triacetate**

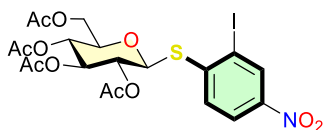

Product **3m** was isolated after flash chromatography as a white solid (69.7 mg, 38%); **Rf** = 0.3 (EtOAc /cyclohexane: 1/2); **m. p.**: 163.4-163.6 °C; **[α]<sub>D</sub><sup>18</sup>** = - 59.3 (c, 0.27, CHCl<sub>3</sub>); **<sup>1</sup>H NMR (300 MHz, CDCl<sub>3</sub>)** δ 8.63-8.64 (m, 1H), 8.14-8.18 (m, 1H), 7.60-

7.63 (m, 1H), 5.30 (t,  $J = 9.0$  Hz, 1H), 5.09-5.20 (m, 2H), 4.90 (d,  $J = 9.0$  Hz, 1H), 4.15-4.29 (m, 2H), 3.82-3.88 (m, 1H), 2.09 (s, 3H), 2.09 (s, 3H), 2.04 (s, 3H), 2.01 (s, 3H);  $^{13}\text{C}$  NMR (75 MHz,  $\text{CDCl}_3$ )  $\delta$  170.3 (C), 170.0 (C), 169.3 (C), 169.2 (C), 148.2 (C), 146.1 (C), 134.3 (CH), 128.2 (CH), 123.3 (CH), 98.6 (C), 84.8 (CH), 76.3 (CH), 73.6 (CH), 69.3 (CH), 68.1 (CH), 62.1 ( $\text{CH}_2$ ), 20.7 ( $\text{CH}_3$ ), 20.7 ( $\text{CH}_3$ ), 20.5 ( $\text{CH}_3$ ), 20.5 ( $\text{CH}_3$ ); IR (neat): 1768, 1516, 1400, 1385, 1218, 1017, 916, 789  $\text{cm}^{-1}$ ; HRMS (ESI):  $m/z$  calc. for  $\text{C}_{20}\text{H}_{22}\text{INNaO}_{11}\text{S}$   $[\text{M}+\text{Na}]^+$  633.9856; found 633.9858.

**(2R,3R,4S,5R,6S)-2-(acetoxymethyl)-6-((4-cyano-2-iodophenyl)thio)tetrahydro-2H-pyran-3,4,5-triyl triacetate**

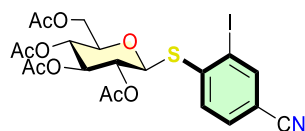

Product **3n** was isolated after flash chromatography as a white solid (72.9 mg, 41%);  $R_f = 0.3$  (EtOAc /cyclohexane: 1/2); **m. p.:** 92.5-93.6  $^{\circ}\text{C}$ ;  $[\alpha]_{\text{D}}^{18} = -45.2$  (c, 0.47,  $\text{CHCl}_3$ );  $^1\text{H}$  NMR (300 MHz,  $\text{CDCl}_3$ )  $\delta$  8.05-8.04 (m, 1H), 7.56-7.58 (m, 2H), 5.28 (t,  $J = 9.0$  Hz, 1H), 5.06-5.16 (m, 2H), 4.85 (d,  $J = 9.0$  Hz, 1H), 4.13-4.26 (m, 2H), 3.79-3.85 (m, 1H), 2.07 (s, 3H), 2.07 (s, 3H), 2.03 (s, 3H), 2.00 (s, 3H);  $^{13}\text{C}$  NMR (75 MHz,  $\text{CDCl}_3$ )  $\delta$  170.3 (C), 170.0 (C), 169.3 (C), 169.2 (C), 145.9 (C), 142.3 (CH), 131.8 (CH), 128.9 (CH), 116.7 (C), 111.7 (C), 99.7 (C), 84.9 (CH), 76.2 (CH), 73.6 (CH), 69.3 (CH), 68.1 (CH), 62.1 ( $\text{CH}_2$ ), 20.7 ( $\text{CH}_3$ ), 20.7 ( $\text{CH}_3$ ), 20.5 ( $\text{CH}_3$ ), 20.5 ( $\text{CH}_3$ ); IR (neat): 2223, 1756, 1387, 1228, 1023, 916, 758  $\text{cm}^{-1}$ ; HRMS (ESI):  $m/z$  calc. for  $\text{C}_{21}\text{H}_{22}\text{INNaO}_9\text{S}$   $[\text{M}+\text{Na}]^+$  613.9958; found 613.9949.

**(2R,3R,4S,5R,6S)-2-(acetoxymethyl)-6-((4-methoxyphenyl)thio)tetrahydro-2H-pyran-3,4,5-triyl triacetate**<sup>108</sup>

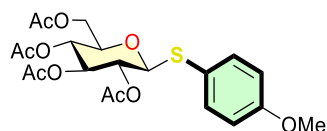

Product **3o** was isolated after flash chromatography as a white solid (68.1 mg, 47%). **Rf** = 0.3 (EtOAc /cyclohexane: 1/2); **<sup>1</sup>H NMR (300 MHz, CDCl<sub>3</sub>)** δ 7.42-7.45 (m, 2H), 6.83-6.88 (m, 2H), 5.16-5.22 (m, 1H), 4.85-5.02 (m, 2H), 4.55 (d, *J* = 12.0 Hz, 1H), 4.18-4.19 (m, 2H), 3.81 (s, 3H), 3.66-3.70 (m, 1H), 2.10 (s, 3H), 2.07 (s, 3H), 2.01 (s, 3H), 1.98 (s, 3H); **HRMS (ESI)**: *m/z* calc. for C<sub>21</sub>H<sub>26</sub>NaO<sub>10</sub>S [M+Na]<sup>+</sup> 493.1144; found 493.1138.

**(2*R*,3*R*,4*S*,5*R*,6*S*)-2-(acetoxymethyl)-6-(phenylthio)tetrahydro-2H-pyran-3,4,5-triyl triacetate**<sup>123</sup>

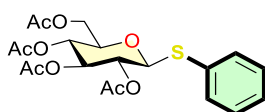

Product **3p** was isolated after flash chromatography as a white solid (99.2 mg, 75%); **Rf** = 0.3 (EtOAc /cyclohexane: 1/2); **<sup>1</sup>H NMR (300 MHz, CDCl<sub>3</sub>)** δ 7.48-7.51 (m, 2H), 7.314-7.33 (m, 3H), 5.22-5.29 (m, 1H), 4.94-5.07 (m, 2H), 4.70 (d, *J* = 9.0 Hz, 1H), 4.15-4.25 (m, 2H), 3.69-3.75 (m, 1H), 2.08 (s, 3H), 2.08 (s, 3H), 2.01 (s, 3H), 1.99 (s, 3H); **HRMS (ESI)**: *m/z* calc. for C<sub>20</sub>H<sub>24</sub>NaO<sub>9</sub>S [M+Na]<sup>+</sup> 463.1039; found 463.1035.

**(2*R*,3*R*,4*S*,5*R*,6*S*)-2-(acetoxymethyl)-6-(p-tolylthio)tetrahydro-2H-pyran-3,4,5-triyl triacetate**<sup>107</sup>

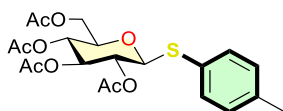

Product **3q** was isolated after flash chromatography as a white solid (49.8 mg, 36%); **Rf** = 0.3 (EtOAc /cyclohexane: 1/2); **<sup>1</sup>H NMR (300 MHz, CDCl<sub>3</sub>)** δ 7.37-7.40 (m, 2H), 7.11-7.13 (m, 2H), 5.02-5.24 (m, 1H), 4.90-4.99 (m, 2H), 4.63 (d, *J* = 12.0 Hz, 1H), 4.14-4.24 (m, 2H), 3.68-3.73 (m, 1H), 2.35 (s, 3H), 2.09 (s, 3H), 2.08 (s, 3H), 2.01 (s,

---

<sup>123</sup> Zhu, M.; Alami, M.; Messaoudi, S., *Chem. Commun.* **2020**, 56, 4464-4467.

3H), 1.98 (s, 3H); **HRMS** (ESI):  $m/z$  calc. for  $C_{21}H_{26}NaO_9S$   $[M+Na]^+$  477.1195; found 477.1190.

**(2R,3R,4S,5R,6S)-2-(acetoxymethyl)-6-((4-(tert-butyl)phenyl)thio)tetrahydro-2H-pyran-3,4,5-triyl triacetate**<sup>124</sup>

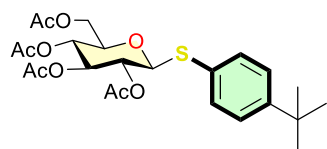

Product **3r** was isolated after flash chromatography as a white solid (98.4 mg, 66%); **Rf** = 0.3 (EtOAc /cyclohexane: 1/2); **<sup>1</sup>H NMR** (300 MHz,  $CDCl_3$ )  $\delta$  7.41-7.43 (m, 2H), 7.31-7.34 (m, 2H), 5.21 (t,  $J$  = 9.0 Hz, 1H), 4.93-5.07 (m, 2H), 4.66 (d,  $J$  = 9.0 Hz, 1H), 4.15-4.25 (m, 2H), 3.68-3.74 (m, 1H), 2.08 (s, 3H), 2.07 (s, 3H), 2.01 (s, 3H), 1.99 (s, 3H), 1.31 (s, 9H); **HRMS** (ESI):  $m/z$  calc. for  $C_{24}H_{32}NaO_9S$   $[M+Na]^+$  519.1665; found 519.1659.

**(2R,3R,4S,5R,6S)-2-([1,1'-biphenyl]-4-ylthio)-6-(acetoxymethyl)tetrahydro-2H-pyran-3,4,5-triyl triacetate**

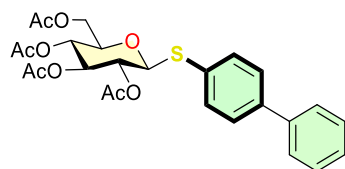

Product **3s** was isolated after flash chromatography as a white solid (66.8 mg, 43%); **Rf** = 0.3 (EtOAc /cyclohexane: 1/2); **m. p.:** 148.7-149.1 °C;  **$[\alpha]_D^{18}$**  = - 28.6 (c, 0.39,  $CHCl_3$ ); **<sup>1</sup>H NMR** (300 MHz,  $CDCl_3$ )  $\delta$  7.52-7.59 (m, 6H), 7.33-7.50 (m, 4H), 5.25 (t,  $J$  = 12.0 Hz, 1H), 4.98-5.09 (m, 2H), 4.73 (d,  $J$  = 9.0 Hz, 1H), 4.71-4.28 (m, 2H), 3.72-3.78 (m, 1H), 2.10 (s, 3H), 2.08 (s, 3H), 2.02 (s, 3H), 2.00 (s, 3H). **<sup>13</sup>C NMR** (75 MHz,  $CDCl_3$ )  $\delta$  170.5 (C), 170.1 (C), 169.3 (C), 169.2 (C), 141.4 (C), 140.2 (C), 133.6 (CH),

---

<sup>124</sup> Shimadate, T.; Chiba, S.; Inouye, K.; Iino, T.; Hosoyama, Y., *Bull. Chem. Soc. Jpn.* **1982**, *55*, 3552-3554

130.5 (C), 128.9 (CH), 127.7 (CH), 127.6 (CH), 127.0 (CH), 85.7 (CH), 75.9 (CH), 74.0 (CH), 70.1 (CH), 68.3 (CH), 62.2 (CH<sub>2</sub>), 20.7 (CH<sub>2</sub>), 20.7 (CH<sub>2</sub>), 20.6 (CH<sub>2</sub>), 20.6 (CH<sub>2</sub>). **IR (neat)**: 1758, 1496, 1386, 1228, 1190, 916, 758 cm<sup>-1</sup>; **HRMS (ESI)**: m/z calc. for C<sub>26</sub>H<sub>28</sub>NaO<sub>9</sub>S [M+Na]<sup>+</sup> 539.1352; found 539.1346.

**(2R,3R,4S,5R,6S)-2-(acetoxymethyl)-6-((2-methoxyphenyl)thio)tetrahydro-2H-pyran-3,4,5-triyl triacetate**<sup>107</sup>



Product **3t** was isolated after flash chromatography as a white solid (39.6 mg, 28%); **Rf** = 0.3 (EtOAc /cyclohexane: 1/2); **<sup>1</sup>H NMR (300 MHz, CDCl<sub>3</sub>)** δ 7.48-7.45 (m, 1H), 7.29-7.32 (m, 1H), 6.86-6.92 (m, 2H), 5.23 (t, *J* = 9.0 Hz, 1H), 4.97-5.09 (m, 2H), 4.70 (d, *J* = 9.0 Hz, 1H), 4.11-4.25 (m, 2H), 3.85 (s, 3H), 3.369-3.75 (m, 1H), 2.06 (s, 3H), 2.05 (s, 3H), 2.01 (s, 3H), 1.99 (s, 3H); **HRMS (ESI)**: m/z calc. for C<sub>21</sub>H<sub>26</sub>NaO<sub>10</sub>S [M+Na]<sup>+</sup> 493.1144; found 493.1141.

**(2R,3R,4S,5R,6S)-2-(acetoxymethyl)-6-((4-hydroxyphenyl)thio)tetrahydro-2H-pyran-3,4,5-triyl triacetate**<sup>125</sup>

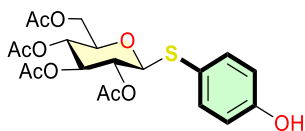

Product **3u** was isolated after flash chromatography as a white solid (21.9 mg, 16%). **Rf** = 0.3 (EtOAc /cyclohexane: 1/1); **<sup>1</sup>H NMR (300 MHz, CDCl<sub>3</sub>)** δ 7.36-7.51 (m, 1H), 6.77-6.80 (m, 2H), 6.20 (t, *J* = 9.0 Hz, 1H), 4.85-5.02 (m, 2H), 4.54 (d, *J* = 9.0 Hz, 1H),

---

<sup>125</sup> Wagner, G.; Kuhmstedt, H., *Archiv der Pharmazie und Berichte der Deutschen Pharmazeutischen Gesellschaft*. **1961**, *294*, 117-131.

4.11-4.20 (m, 2H), 3.65-3.70 (m, 1H), 2.10 (s, 3H), 2.08 (s, 3H), 2.01 (s, 3H), 1.98 (s, 3H); **HRMS** (ESI):  $m/z$  calc. for  $C_{20}H_{24}O_{10}NaS$   $[M+Na]^+$  479.0988; found 479.0983.

**4-(((2R,3R,4S,5R,6S)-3,4,5-triacetoxy-6-(acetoxymethyl)tetrahydro-2H-pyran-2-yl)thio) benzoic acid**

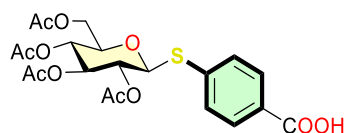

Product **3v** was isolated after flash chromatography as a white solid (110.6 mg, 76%); **Rf** = 0.3 (MeOH /DCM: 5/100); **m. p.:** 177.3-177.9 °C;  $[\alpha]_D^{18} = -20.7$  (c, 0.58,  $CHCl_3$ );  **$^1H$  NMR (300 MHz,  $CDCl_3$ )**  $\delta$  8.02-8.04 (m, 2H), 7.53-7.55 (m, 2H), 5.24-5.30 (m, 1H), 5.02-5.11 (m, 2H), 4.86 (d,  $J=9.0$  Hz, 1H), 4.17-4.28 (m, 2H), 3.78-3.84 (m, 1H), 2.10 (s, 3H), 2.08 (s, 3H), 2.03 (s, 3H), 2.00 (s, 3H);  **$^{13}C$  NMR (75 MHz,  $CDCl_3$ )**  $\delta$  170.5 (C), 170.5 (C), 170.1 (C), 169.4 (C), 169.2 (C), 140.0 (C), 130.7 (2CH), 130.6 (2CH), 128.4 (C), 84.8 (CH), 76.0 (CH), 73.8 (CH), 69.8 (CH), 68.2 (CH), 62.2 (CH<sub>2</sub>), 20.7 (CH<sub>3</sub>), 20.6 (CH<sub>3</sub>), 20.5 (CH<sub>3</sub>), 20.5 (CH<sub>3</sub>); **IR (neat):** 2984, 1755, 1600, 1395, 1216, 1018, 916, 758  $cm^{-1}$ ; **HRMS** (ESI):  $m/z$  calc. for  $C_{21}H_{24}O_{11}NaS$   $[M+Na]^+$  507.0937; found 507.0941.

**(2R,3R,4S,5R,6S)-2-((benzoyloxy)methyl)-6-((4-nitrophenyl)thio)tetrahydro-2H-pyran-3,4,5-triyl tribenzoate**<sup>126</sup>

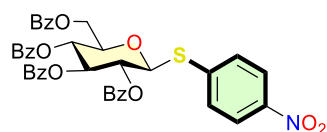

Product **4a** was isolated after flash chromatography as a white solid (49.6 mg, 34%); **Rf** = 0.3 (EtOAc /cyclohexane: 1/2);  **$^1H$  NMR (300 MHz,  $CDCl_3$ )**  $\delta$  8.06-8.09 (m, 2H), 7.89-8.00 (m, 6H), 7.81-7.84 (m, 2H), 7.63-7.69 (m, 1H), 7.46-7.60 (m, 6H), 7.36-7.43

<sup>126</sup> Sliedregt, L. A. J. M.; van der Marel, G. A.; van Boom, J. H., *Tetrahedron Lett.* **1994**, 35, 4015-4018.

(m, 5H), 7.26-7.31 (m, 2H), 6.03 (t,  $J = 9.0$  Hz, 1H), 5.57-5.71 (m, 2H), 5.24 (d,  $J = 12.0$  Hz, 1H), 4.74-4.79 (m, 1H), 4.52-4.58 (m, 1H), 4.32-4.38 (m, 1H); **HRMS** (ESI):  $m/z$  calc. for  $C_{40}H_{31}NNaO_{11}S$   $[M+Na]^+$  756.1516; found 756.1519.

**(2R,3S,4S,5R,6S)-2-(acetoxymethyl)-6-((4-nitrophenyl)thio)tetrahydro-2H-pyran-3,4,5-triyl triacetate**<sup>127</sup>

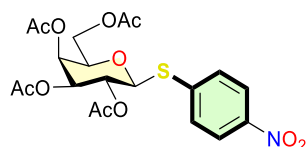

Product **4b** was isolated after flash chromatography as a white solid (113.5 mg, 78%).  $R_f = 0.2$  (EtOAc /cyclohexane: 1/2);  $^1H$  NMR (300 MHz,  $CDCl_3$ )  $\delta$  8.14-8.17 (m, 2H), 7.60-7.63 (m, 2H), 5.46-5.48 (m, 1H), 5.29 (t,  $J = 9.0$  Hz, 1H), 5.08-5.12 (m, 1H), 4.86 (d,  $J = 12.0$  Hz, 1H), 4.13-4.22 (m, 2H), 4.01-4.06 (m, 1H), 2.15 (s, 3H), 2.08 (s, 3H), 2.07 (s, 3H), 1.98 (s, 3H); **RMS** (ESI):  $m/z$  calc. for  $C_{20}H_{23}NNaO_{11}S$   $[M+Na]^+$  508.0890; found 508.0884.

**(2R,3R,4S,5R,6S)-2-methyl-6-((4-nitrophenyl)thio)tetrahydro-2H-pyran-3,4,5-triyl triacetate**<sup>128</sup>

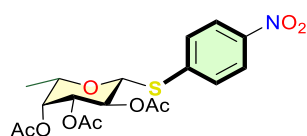

Product **4c** was isolated after flash chromatography as a white solid (88.6 mg, 69%);  $R_f = 0.3$  (EtOAc /cyclohexane: 1/2);  $^1H$  NMR (300 MHz,  $CDCl_3$ )  $\delta$  8.12-8.15 (m, 2H), 7.57-7.60 (m, 2H), 5.22-5.30 (m, 2H), 5.06-5.11 (m, 1H), 4.83 (d,  $J = 9.0$  Hz, 1H), 3.90-3.96 (m, 1H), 2.16 (s, 3H), 2.04 (s, 3H), 1.96 (s, 3H), 1.25 (d,  $J = 6.0$  Hz, 3H); **HRMS** (ESI):  $m/z$  calc. for  $C_{18}H_{21}NNaO_9S$   $[M+Na]^+$  450.0835; found 445.1277.

<sup>127</sup> Cao, S.; Meunier, S. J.; Andersson, F. O.; Letellier, M.; Roy, R., *Tetrahedron: Asymmetry* **1994**, *11*, 2303-2312.

<sup>128</sup> Chawla, M. L.; Bahl, O. P., *Carbohydr. Res.* **1974**, *32*, 25-29.



(2*R*,3*R*,4*S*,5*R*,6*S*)-2-(acetoxymethyl)-6-(((2*R*,4*S*,5*R*,6*S*)-4,5-diacetoxy-2-(acetoxymethyl)-6-((4-nitrophenyl)thio)tetrahydro-2*H*-pyran-3-yl)oxy)tetrahydro-2*H*-pyran-3,4,5-triyl triacetate <sup>129</sup>

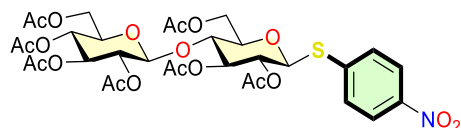

Product **4d** was isolated after flash chromatography as a white solid (102.4 mg, 44%); **R<sub>f</sub>** = 0.3 (EtOAc /cyclohexane: 1/1); <sup>1</sup>H NMR (300 MHz, CDCl<sub>3</sub>) δ 8.11-8.14 (m, 2H), 7.54-7.57 (m, 2H), 4.80-5.25 (m, 6H), 4.50-4.58 (m, 2H), 4.32-4.38 (m, 1H), 4.01-4.14 (m, 2H), 3.63-3.79 (m, 3H), 2.11 (s, 3H), 2.06 (s, 3H), 2.05 (s, 3H), 2.02 (s, 3H), 2.00 (s, 3H), 1.99 (s, 3H), 1.97 (s, 3H); HRMS (ESI): m/z calc. for C<sub>32</sub>H<sub>39</sub>NNaO<sub>19</sub>S [M+Na]<sup>+</sup> 796.1735; found 796.1730.

(2*R*,3*R*,4*S*,5*R*,6*S*)-2-(acetoxymethyl)-6-(((2*R*,4*S*,5*R*,6*S*)-4,5-diacetoxy-2-(acetoxymethyl)-6-(((2*R*,4*S*,5*R*,6*S*)-4,5-diacetoxy-2-(acetoxymethyl)-6-((4-nitrophenyl)thio)tetrahydro-2*H*-pyran-3-yl)oxy)tetrahydro-2*H*-pyran-3-yl)oxy)tetrahydro-2*H*-pyran-3,4,5-triyl triacetate

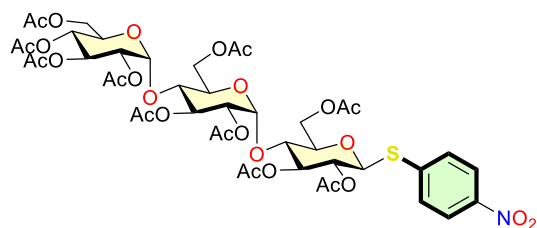

Product **4e** was isolated after flash chromatography as a white solid (0.1 mmol scale, 70.2 mg, 66%); **R<sub>f</sub>** = 0.3 (EtOAc /cyclohexane: 2/1); **m. p.**: 184.9-185.2 °C; [α]<sub>D</sub><sup>18</sup> = + 60.0 (c, 0.30, CHCl<sub>3</sub>); <sup>1</sup>H NMR (300 MHz, CDCl<sub>3</sub>) δ 8.14-8.18 (m, 2H), 7.56-7.59 (m, 2H), 5.24-5.41 (m, 5H), 5.05 (t, *J* = 9.0 Hz, 1H), 4.81-4.91 (m, 3H), 4.70-4.75 (m, 1H), 4.44-4.56 (m, 2H), 4.16-4.35 (m, 3H), 3.81-4.10 (m, 6H), 2.16 (s, 3H), 2.14 (s,

<sup>129</sup> Tropper, F. D.; Andersson, F. O.; Grand-Maitre, C.; Roy, R., *Carbohydr. Res.* **1992**, *229*, 149-154.

3H), 2.08 (s, 3H), 2.04 (s, 3H), 2.04 (s, 3H), 2.02 (s, 3H), 2.00 (s, 3H), 1.99 (s, 3H), 1.99 (s, 3H), 1.98 (s, 3H);  $^{13}\text{C}$  NMR (75 MHz,  $\text{CDCl}_3$ )  $\delta$  170.5 (C), 170.5 (C), 170.4 (C), 170.3 (C), 170.2 (C), 169.9 (C), 169.8 (C), 169.6 (C), 169.4 (C), 169.4 (C), 147.2 (C), 141.4 (C), 131.4 (2CH), 123.8 (2CH), 95.9 (CH), 95.7 (CH), 83.8 (CH), 76.4 (CH), 75.9 (CH), 73.7 (CH), 72.6 (CH), 71.7 (CH), 70.5 (CH), 70.4 (CH), 70.1 (CH), 69.4 (CH), 69.2 (CH), 68.6 (CH), 68.0 (CH), 62.9 ( $\text{CH}_2$ ), 62.4 ( $\text{CH}_2$ ), 61.4 ( $\text{CH}_2$ ), 20.8 ( $\text{CH}_3$ ), 20.8 ( $\text{CH}_3$ ), 20.8 ( $\text{CH}_3$ ), 20.7 ( $\text{CH}_3$ ), 20.6 ( $\text{CH}_3$ ), 20.6 ( $\text{CH}_3$ ), 20.5 ( $\text{CH}_3$ ), 20.5 ( $\text{CH}_3$ ), 20.5 ( $\text{CH}_3$ ), 20.5 ( $\text{CH}_3$ ); IR (neat): 1758, 1380, 1367, 1230, 1056  $\text{cm}^{-1}$ ; HRMS (ESI):  $m/z$  calc. for  $\text{C}_{44}\text{H}_{55}\text{NNaO}_{27}\text{S}$   $[\text{M}+\text{Na}]^+$  1084.2580; found 1084.2587.

**(2R,3S,4S,5R,6S)-2-(hydroxymethyl)-6-((4-nitrophenyl)thio)tetrahydro-2H-pyran-3,4,5-triol**<sup>130</sup>

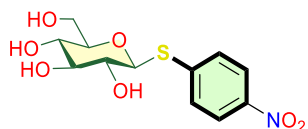

Product **4f** was isolated after flash chromatography as a colorless oil (58.0 mg, 61%);  $R_f$  = 0.3 (DCM/MeOH: 95/5);  $^1\text{H}$  NMR (300 MHz,  $\text{MeOD-d}_4$ )  $\delta$  8.13-8.16 (m, 2H), 7.65-7.67 (m, 2H), 4.87 (d,  $J$  = 12.0 Hz, 1H), 3.91 (dd,  $J_1$  = 3.0 Hz,  $J_2$  = 18.0 Hz, 1H), 3.65-3.71 (m, 1H), 3.33-3.47 (m, 4H). HRMS (ESI):  $m/z$  calc. for  $\text{C}_{12}\text{H}_{15}\text{NNaO}_7\text{S}$   $[\text{M}+\text{Na}]^+$  340.0467; found 340.0466.

**(2S,3R,4S,5R,6S)-2-(acetoxymethyl)-6-((4-nitrophenyl)thio)tetrahydro-2H-pyran-3,4,5-triyl triacetate**

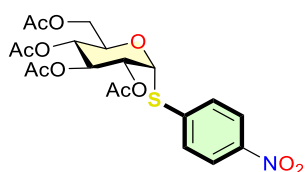

<sup>130</sup> Gantt, R. W.; Peltier-Pain, P.; Cournoyer, W. J.; Thorson, J. S., *Nat. Chem. Biol.* **2011**, 7, 685-691.

Product **4g** was isolated after flash chromatography as a white solid (0.1 mmol scale, 70.2 mg, 66%); **Rf** = 0.3 (EtOAc /cyclohexane: 2/1); **m. p.:** 118.9-119.0 °C;  $[\alpha]_D^{18} = +178.7$  (c, 0.21, CHCl<sub>3</sub>); **<sup>1</sup>H NMR (300 MHz, CDCl<sub>3</sub>)**  $\delta$  8.14-8.17 (m, 2H), 7.55-7.58 (m, 2H), 6.13 (d, *J* = 6.0 Hz, 1H), 5.44 (t, *J* = 9.0 Hz, 1H), 5.07-5.19 (m, 2H), 4.40-4.46 (m, 1H), 4.26 (dd, *J* = 6.0 Hz, *J* = 12.0 Hz, 1H), 4.04 (dd, *J* = 3.0 Hz, *J* = 12.0 Hz, 1H), 2.10 (s, 3H), 2.05 (s, 3H), 2.05 (s, 3H), 2.00 (s, 3H).

**<sup>13</sup>C NMR (75 MHz, CDCl<sub>3</sub>)**  $\delta$  170.3 (C), 169.8 (C), 169.7 (C), 169.5 (C), 129.4 (2CH), 124.0 (2CH), 83.4 (CH), 70.4 (CH), 70.2 (CH), 68.9 (CH), 68.3 (CH), 61.7 (CH<sub>2</sub>), 20.6 (CH<sub>3</sub>), 20.6 (CH<sub>3</sub>), 20.6 (CH<sub>3</sub>), 20.5 (CH<sub>3</sub>). **IR (neat):** 2924, 1747, 1597, 1577, 1367, 1083, 894, 742, 667 cm<sup>-1</sup>.

**(2*R*,3*R*,4*S*,5*R*,6*S*)-2-(acetoxymethyl)-6-((4-(((*R*)-2-((tert-butoxycarbonyl)amino)-3-methoxy-3-oxopropyl)thio)phenyl)thio)tetrahydro-2H-pyran-3,4,5-triyl triacetate**

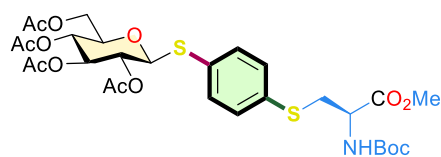

Product **5a** was isolated after flash chromatography as a white solid (66.8 mg, 43%). **Rf** = 0.5 (EtOAc /cyclohexane: 1/1); **m. p.:** 81.6-82.4 °C;  $[\alpha]_D^{18} = +2.6$  (c, 0.38, CHCl<sub>3</sub>); **<sup>1</sup>H NMR (300 MHz, CDCl<sub>3</sub>)**  $\delta$  7.38-7.41 (m, 2H), 7.29-7.32 (m, 2H), 5.30 (s, 1H), 5.21 (t, *J* = 9.0 Hz, 1H), 4.90-5.04 (m, 2H), 4.66 (d, *J* = 9.0 Hz, 1H), 4.53-4.56 (m, 1H), 4.10-4.25 (m, 2H), 3.67-3.73 (m, 1H), 3.61 (s, 3H), 3.29-3.43 (m, 2H), 2.08 (s, 3H), 2.07 (s, 3H), 2.00 (s, 3H), 1.97 (s, 3H), 1.41 (s, 9H). **<sup>13</sup>C NMR (75 MHz, CDCl<sub>3</sub>)**  $\delta$  170.8 (C), 170.4 (C), 170.0 (C), 170.0 (C), 169.3 (C), 169.1 (C), 136.0 (C), 133.7 (2CH), 130.5 (2CH), 130.0 (C), 85.5 (CH), 75.9 (CH), 73.9 (CH), 70.0 (CH), 68.2 (CH), 62.1 (CH<sub>2</sub>), 53.3 (CH), 52.4 (CH<sub>3</sub>), 36.8 (CH<sub>2</sub>), 28.3 (3CH<sub>3</sub>), 20.7 (2CH<sub>3</sub>), 20.5 (2CH<sub>3</sub>). **IR (neat):** 1756, 1720, 1380, 1228, 1196, 1023, 916, 758 cm<sup>-1</sup>; **HRMS (ESI):** *m/z* calc. for C<sub>29</sub>H<sub>40</sub>NO<sub>13</sub>S<sub>2</sub> [M+H]<sup>+</sup> 674.1941; found 674.1940.

**(2*R*,3*R*,4*S*,5*R*,6*S*)-2-(acetoxymethyl)-6-((4-(((*R*)-2-((tert-butoxycarbonyl)amino)-3-methoxy-3-oxopropyl)thio)phenyl)thio)tetrahydro-2H-pyran-3,4,5-triyl triacetate**

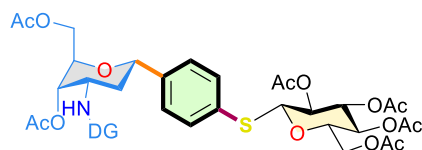

Product **8a** was isolated after flash chromatography as a white solid (66.8 mg, 43%). **Rf** = 0.2 (EtOAc /cyclohexane: 1/1) **m. p.:** 94.1-94.5 °C;  $[\alpha]_D^{18} = -10.3$  (c, 0.29, CHCl<sub>3</sub>); **<sup>1</sup>H NMR (300 MHz, CDCl<sub>3</sub>)**  $\delta$  8.53 (d,  $J = 3.9$  Hz, 1H), 8.21 (t,  $J = 8.7$  Hz, 2H), 7.87 (t,  $J = 7.6$  Hz, 1H), 7.51 (d,  $J = 7.9$  Hz, 3H), 7.36 (d,  $J = 7.8$  Hz, 2H), 5.23 (t,  $J = 9.3$  Hz, 1H), 5.14 – 5.04 (m, 2H), 5.04 – 4.90 (m, 2H), 4.84 – 4.64 (m, 3H), 4.48 – 4.40 (m, 1H), 4.30 – 4.10 (m, 3H), 3.77 – 3.67 (m, 1H), 2.20 (s, 3H), 2.12 (s, 3H), 2.08 (s, 3H), 2.08 (s, 3H), 2.01 (s, 3H), 1.98 (s, 3H). **<sup>13</sup>C NMR (75 MHz, CDCl<sub>3</sub>)**  $\delta$  170.5 (C), 170.4 (C), 170.1 (C), 169.3 (C), 169.2 (C), 163.5 (C), 149.2 (C), 148.0 (CH), 141.5 (C), 137.6 (CH), 133.4 (2CH), 131.1(C), 126.6 (2CH), 126.5 (CH), 122.5 (CH), 85.9 (CH), 75.9 (CH), 74.5 (CH), 74.0 (CH), 72.0 (CH), 70.0 (CH), 68.8 (CH), 68.3 (CH), 62.1 (CH<sub>2</sub>), 61.2 (CH<sub>2</sub>), 44.6 (CH), 34.1 (CH<sub>2</sub>), 21.1 (CH<sub>3</sub>), 20.8 (CH<sub>3</sub>), 20.7 (2CH<sub>3</sub>), 20.5 (2CH<sub>3</sub>). **IR (neat):** 1758, 1223, 1068, 758, 674 cm<sup>-1</sup>; **HRMS (ESI):** m/z calc. for C<sub>36</sub>H<sub>43</sub>N<sub>2</sub>O<sub>15</sub>S<sub>2</sub> [M+H]<sup>+</sup> 775.2384; found 775.2391.

## **Chapter 2: Diastereoselective Decarboxylative Alkynylation of Anomeric Carboxylic Acids Using Cu/Photoredox Dual Catalysis**

---

## Chapter 2: Diastereoselective Decarboxylative Alkynylation of Anomeric Carboxylic Acids Using Cu/Photoredox Dual Catalysis

### A) Introduction

Nucleosides are a very important family of *N*-glycosides which play various key roles in many biological processes. Although the C–N glycosidic bond in this series is stable under physiological conditions, cleavage of the bond is common and is highly dependent on the nature of the nucleoside and local pH. Thus, replacing the hemiaminal (C–N) connectivity with a C–C bond results in a class of compounds called “C-nucleosides” which are known to be more resistant to enzymatic hydrolysis. Because of these changes, C-nucleosides have been largely used in the study of RNA and DNA processing enzymes, as well as drug design.<sup>131</sup>

Example of C-nucleosides feature (hetero)aryl aromatic groups such as 9-deazapurines, pyrazole, maleimide or other heterocycles connected by a C–C bond to a sugar (or sugar mimic) as shown in **Figure 12**. Pseudouridine is a naturally occurring C-nucleoside that was first discovered in the 1950s. Subsequently, many more C-nucleosides were discovered and their medicinal properties evaluated such as the natural antibiotics showdomycin, minimycin and pyrazofurin<sup>132</sup> (**Figure 12**). In addition, the (+)-varitriol isolated from a marine-derived strain of *Emericella varicolor*, Displays various biological activities in renal, CNS and Breast cancer cell.<sup>133</sup> Synthetic C-nucleosides also show the high medicinal potential such as the antiviral remdesivir with a broad-spectrum antiviral activity. Interestingly, during the Covid-19 pandemic, remdesivir was used against SARS COV-2 by the world health organization.

---

<sup>131</sup> a) Boettcher, T.; Sieber, S. A., *J. Am. Chem. Soc.* **2010**, *132*, 6964-6972; b) De Clercq, E., *J. Med. Chem.* **2016**, *59*, 2301-2311; c) Teo, Y. N.; Kool, E. T., *Chem. Rev.*, **2012**, *112*, 4221-4245.

<sup>132</sup> Shiraishi, T.; Kuzuyama, T., *J. Antibiot.* **2019**, *72*, 913–923.

<sup>133</sup> Sudhakar, G.; Raghavaiah, J., *J. Org. Chem.*, **2013**, *78*, 8840-8846.

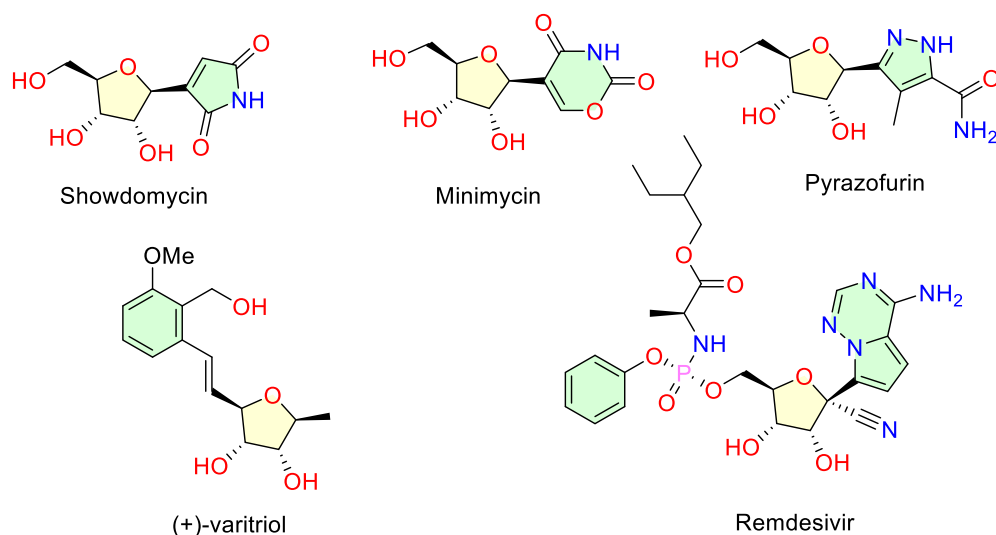

**Figure 12.** Bioactive C-nucleosides

Due to advances in synthetic methodologies over the years, the repertoire of C-nucleosides has since expanded and has enabled the discovery of clinically useful molecules. In this context, alkynyl C-nucleosides has emerged as potentially valuable bioactive compounds. Moreover, they may be considered as intermediates of choice for the synthesis of C-nucleosides through functionalization of the triple bond. However, methods to access to C-alkyl nucleosides are rare and only few methods reported the synthesis of alkynyl C-nucleosides.

In 1972, Haruo Ogura and co-workers<sup>134</sup> achieved the first synthesis of alkynyl C-nucleosides by using of alkynyl lithium reagents and sugar lactones. Due to these conditions are lack of anomeric selectivity and high efficiency. Many efficient methodologies for synthesis of alkynyl C-nucleosides have been reported recently.

In 2017, N. Lubin-Germain and co-workers<sup>135</sup> reported the synthesis of alkynyl C-nucleosides by cross-coupling of protected acetyl riboside and ethyl iodopropionate

<sup>134</sup> Ogura, H.; Takahashi, H.; Itoh, T., *J. Org. Chem.*, **1972**, *37*, 72-75.

<sup>135</sup> Solarte, C.; Santos, Gonzalez, M. D. S.; Miranda, L. S. M.; Guillot, R.; Ferry, A.; Gallier, F.; Uziel, J.; Lubin-Germain, N., *Synthesis*, **2017**, *49*, 1993-2002.

reacted with an excess of indium(0) at 90 °C. Under these conditions, only the  $\beta$ -anomer was obtained (**Scheme 39**).

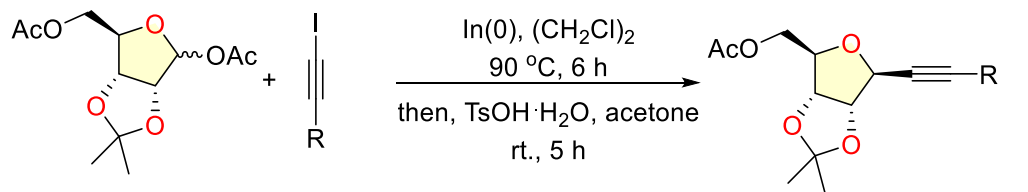

Selected examples:

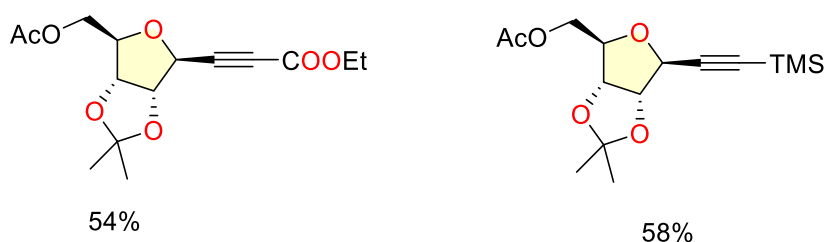

**Scheme 39.** Work of N. Lubin-Germain's group

Another method to synthesis alkynyl C-nucleosides was reported in 2014 by the group of Dubreuil's<sup>136</sup> reported (**Scheme 40**). The authors used alkynyl Grignard's reagents in a 1,2 addition on the carbonyl of the open form of the sugar. The  $\beta$ -isomer was found to be the major isomer in this condition ( $\beta$ :  $\alpha$ =8: 2). The authors reported also the use of lithium reagent to synthesis of alkynyl C-nucleosides.<sup>137</sup> Under these conditions, the glycosylation is performed at -5 °C to 10 °C. As the same protocol of Grignard's reagents, the second step of this reaction involves the use TsCl and pyridine at 60 °C to remove the hydroxyl group at C1 position. However, the ratio of  $\beta$  and  $\alpha$  isomer is 1:1 (**Scheme 40**).

<sup>136</sup> Joshi, U.; Josse, S.; Pipelier, M.; Chevallier, F.; Pradère, J.; Hazard, R.; Legoupy, S.; Huetc, F.; Dubreuil, D., *Tetrahedron Lett.*, **2004**, 45, 1031–1033.

<sup>137</sup> Naud, S.; Pipelier, M.; Chaumette, C.; Viault, G.; Huet, F.; Legoupy, S.; Dubreuil, D., *Synlett.*, **2007**, 3, 403–406.



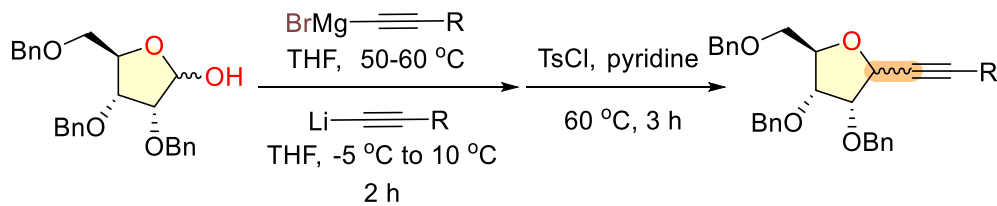

**Scheme 40** Reactions of Dubreuil's group

The group of Samir Zard reported a contribution to this reaction by using the ketone glycoside and alkynyl lithium reagent. A mixture of  $\text{BF}_3\text{Et}_2\text{O}/\text{Et}_3\text{SiH}$  was used in this case to remove the hydroxyl group at C1 position as second step (**Scheme 41**).<sup>138</sup>

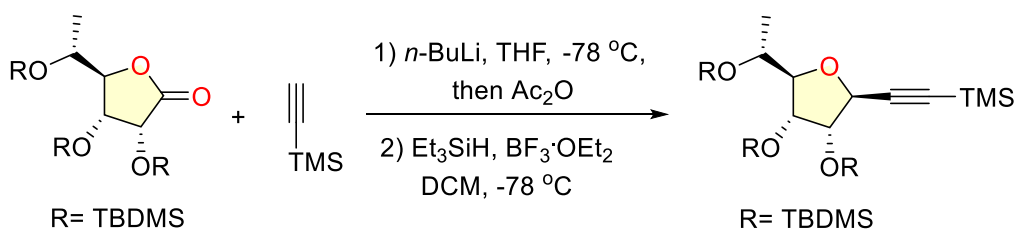

**Scheme 41** Reactions of Zard's group

A stereoselective and efficient approach to alkyne C-nucleosides by using of organotrifluoroborates and ribofuranosyl fluorides has been reported by Liu and co-workers<sup>139</sup>. Under the influence of promoter  $\text{BF}_3\text{OEt}_2$  1.3 equiv, the cross-coupling of organotrifluoroborates and ribofuranosyl fluorides was performed in 0.3 h at room temperature, and in most of case, the product is obtained in high yield and good  $\alpha$ -selectivity (**Scheme 42**).

<sup>138</sup> Cordero-Vargas, A.; Quiclet-Sire, B.; Zard, S. Z., *Org. Biomol. Chem.*, **2005**, 3, 4432–4443.

<sup>139</sup> Zeng, J.; Vedachalam, S.; Xiang, S.; Liu, X., *Org. Lett.*, **2011**, 13, 42-45.

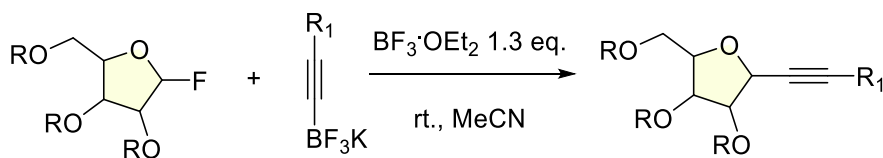

*Selected examples:*

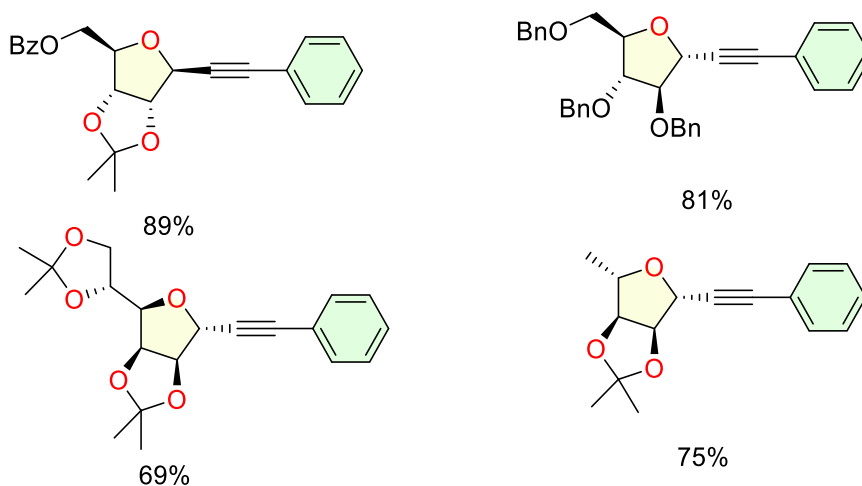

**Scheme 42.** Synthesis of alkynyl C-nucleosides by using of organotrifluoroborates

A multi-steps transformation of ribofuranosyl aldehydes into alkynyl C-nucleosides was reported by Shinya Harusawa and coworkers.<sup>140</sup> This transformation involves the formation of cyanophosphates as key intermediates which react with  $\text{NaN}_3\text{-Et}_3\text{N}\cdot\text{HCl}$  to result in the formation of azidotetrazoles. Under microwave irradiation, successive fragmentation of the azidotetrazoles generates alkylidene carbenes that undergo [1,2]-rearrangement and then transformed into alkynes. Treatment with  $\text{TMSN}_3$  and  $\text{Bu}_2\text{SnO}$  as catalyst in toluene at reflux can also directly yields the corresponding alkynyl C-glycosides (**Scheme 43**).

<sup>140</sup> Yoneyama, H.; Numata, M.; Uemura, K.; Usami, Y.; Harusawa, S., *J. Org. Chem.*, **2017**, *82*, 5538-5556.

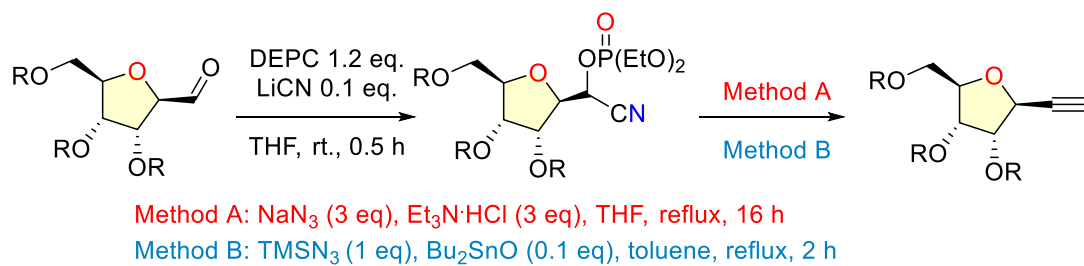

Selected examples:

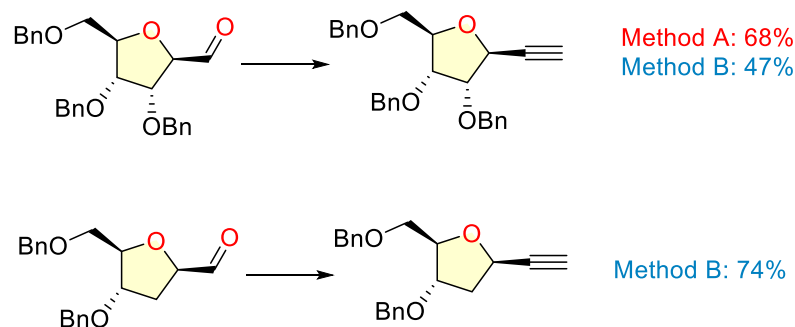

**Scheme 43.** Work of Shinya Harusawa's group

Because of the limited methods to synthesis alkynyl C-nucleosides, which usually involve the use of a stoichiometric amount of organometallic alkynyl partners [Mg, L, B, Sn], we envisioned to develop a simple and efficient method to access this target molecules.

Recently, the resurgence of visible-light photoredox catalysis has disclosed unprecedented opportunities in the generation of radical intermediates by selective activation of small organic molecules under mild reaction conditions. Especially, the photoredox decarboxylative cross-coupling reaction is regarded as a kind of powerful methodology to synthesis of various of useful compounds. And this methodology has been successfully applied to variety of  $\alpha$ -oxy and  $\alpha$ -amino acids, as well as simple hydrocarbon-substituted acids.<sup>141</sup>

<sup>141</sup> (a) Jin, Y.; Fu, H., *Asian J. Org. Chem.* **2017**, *6*, 368-385; (b) Schwarz, J.; König B., *Green Chem.*, **2018**, *20*, 323-361.

To this end we were interested in exploring an alkylation reaction under photoredox catalysis.

During our study, Yongqiang Zhang and co-workers<sup>142</sup> reported a photoredox decarboxylative protocol for synthesized of aryl/heteroaryl-C-nucleosides with anomeric ribosyl acids and a variety of aryl/heteroaryl bromides by 4CzIPN/NiBr<sub>2</sub> catalysis system. It is a powerful protocol to synthesized of stereoselective aryl C-nucleosides under mild condition and good anomeric selectivity (**Scheme 44**).

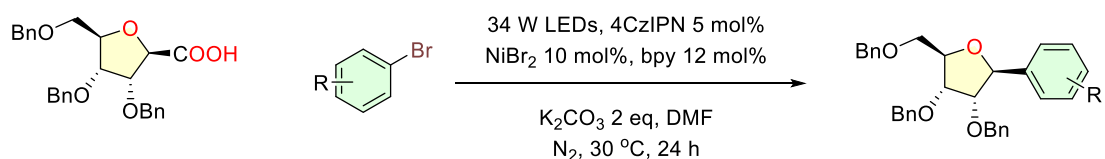

Selected examples:

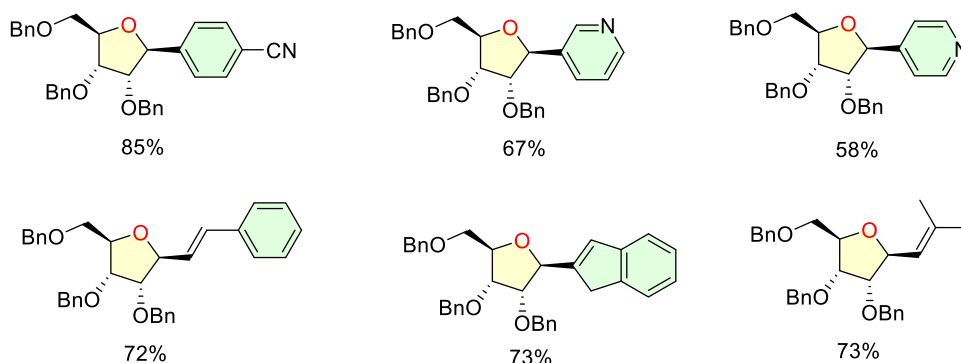

**Scheme 44.** Work of Yongqiang Zhang's group

Later, after the publication of method, the same group reported a highly stereoselective decarboxylative C-alkynylation of anomeric carboxyl acids by using photocatalysis.<sup>143</sup> The reaction was performed in the presence of ethynylbenziodoxolones (EBXs) as alkynyl donor reagents. Excellent  $\beta$  selectivity was observed with good functional group tolerance. However, EBXs reagents necessitate their synthesis, and during the

<sup>142</sup> Ma, Y.; Liu, S.; Xi, Y.; Li, H.; Yang, K.; Cheng, Z.; Wang, W.; Zhang, Y., *Chem. Commun.*, **2019**, 55, 14657-14660.

<sup>143</sup> Lu, K.; Ma, Y.; Liu, S.; Guo, S.; Zhang, Y., *Chin. J. Chem.*, **2022**, 40, 681-686.

process 2-iodobenzoic acid was generated as byproduct, which is not in line with green chemistry concept (**Scheme 45**).

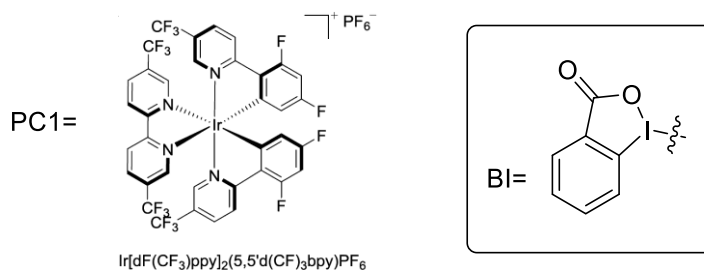
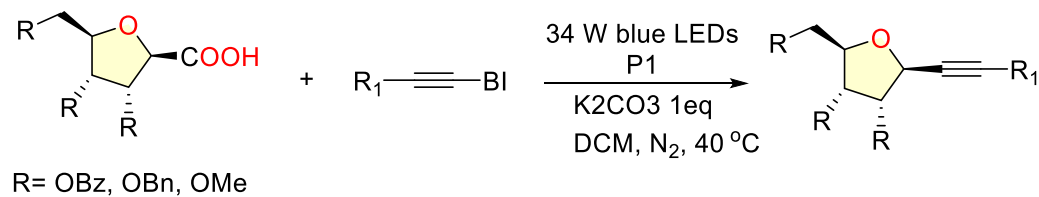

**Scheme 45.** C-alkynylation of anomeric carboxylic acids

In our group, we started the study of the decarboxylative alkylation of anomeric carboxylic acids using Cu/photoredox dual catalysis before the work the Yongqiang Zhang work.<sup>144</sup> Our our result was reported in the publication bellow:

<sup>144</sup> Lu, K.; Ma, Y.; Liu, S.; Guo, S.; Zhang, Y., *Chin. J. Chem.*, **2022**, *40*, 681-686.

## B) Publication

### Diastereoselective Decarboxylative Alkynylation of Anomeric Carboxylic Acids Using Cu/Photoredox Dual Catalysis

Mingxiang Zhu and Samir Messaoudi

**KEYWORDS.** Anomeric radicals • Copper • dual photoredox catalysis • glycosyl carboxylic acids • Alkynyl C-nucleosides

**ABSTRACT:** Alkynyl C-nucleosides are of high value for various applications; however, their synthesis remains underexplored. Here we report a simple route towards the synthesis of alkynyl C-nucleosides from simple and stable furanosyl carboxylic acids and terminal alkynes under low-cost and non-toxic copper catalysis. The approach that we report here demonstrates the power of Cu/photoredox dual catalysis to access highly complex glycosides under mild conditions.

C-Nucleosides has emerged as a promising class of bioactive glycosides most notably in the fields of virology and cancer therapy.<sup>145</sup> These derivatives in which the anomeric

---

<sup>145</sup> a) Jordheim, L. P.; Durantel, D.; Zoulim, F.; Dumontet, C., *Nat. Rev. Drug Discovery* **2013**, *12*, 447–464. b) Coats, S. J.; Garnier-Amblard, E. C.; Amblard, F.; Ehteshami, M.; Amiralaie, S.; Zhang, H.; Zhou, L.; Boucle, S. R. L.; Lu, X.; Bondada, L.; Shelton, J. R.; Li, H.; Liu, P.; Li, C.; Cho, J. H.; Chavre, S. N.; Zhou, S.; Mathew, J.; Schinazi, R. F. *Antiviral Res.* **2014**, *102*, 119–147. c) Pradere, U.; Garnier-Amblard, E. C.; Coats, S. J.; Amblard, F.; Schinazi, R. F. *Chem. Rev.* **2014**, *114*, 9154–9218. d) DeClercq, E. *J. Med. Chem.* **2016**, *59*, 2301–2311. e) Draffan, A. G.; Frey, B.; Pool, B.; Gannon, C.; Tyndall, E. M.; Lilly, M.; Francom, P.; Hufton, R.; Halim, R.; Jahangiri, S.; Bond, S.; Nguyen, V. T. T.; Jeynes, T. P.; Wirth, V.; Luttick, A.; Tilmanis, D.; Thomas, J. D.; Pryor, M.; Porter, K.; Morton, C. J.; Lin, B.; Duan, J.; Kukulj, G.; Simoneau, B.; McKercher, G.; Lagacé, L.; Amad, M.; Bethell, R. C.; Tucker, S. P. *ACS Med. Chem. Lett.* **2014**, *5*, 679–684. f) Wang, G.; Wan, J.; Hu, Y.; Wu, X.; Prhave, M.; Dyatkina, N.; Rajwanshi, V. K.; Smith, D. B.; Jekle, A.; Kinkade, A.; Symons, J. A.; Jin, Z.; Deval, J.; Zhang, Q.; Tam, Y.; Chanda, S.; Blattand, L.; Beigelman, L. *J. Med. Chem.* **2016**, *59*, 4611–4624. g) Franchetti, P.; Cappellacci, L.; Grifantini, M.; Barzi, A.; Nocentini, G.; Yang, H.; O'Connor, A.; Jayaram, H. N.; Carrell, C.; Goldstein, B. M. *J. Med. Chem.* **1995**, *38*, 3829–3837. h) Krohn, K.; Heinsand, H.; Wielckens, K. *J. Med. Chem.* **1992**, *35*, 511–517. i) Feldman, A. W.; Romesberg, F. E.; *Acc. Chem. Res.*, **2018**, *51*, 394–403. j) Subadolnik, R. J. *Nucleoside Antibiotics*, Wiley Interscience, New York, **1970**. k) Marquez, V. E.; Lim, M. I.; Carbocyclic Nucleosides. *Med. Res. Rev.* **1986**, *6*, 1–40. l) Levy, D. E.; Tang, C. *The Chemistry of C-Glycosides*, Pergamon, Oxford, **1995**. m) Ritchie, G. E.; Moffatt, B. E.; Sim, R. B.; Morgan,

C–N nucleosidic bond is replaced by a C–C bond, are considered as glycomimetics of natural nucleosides as they are known to be more resistant towards hydrolysis under biological conditions.<sup>146</sup> Representative natural and synthetic C-nucleosides are disclosed in **Figure 13a**, including varitriol<sup>147</sup> and showdomycin<sup>148</sup> (natural nucleosides), ribavirin analogs<sup>149</sup> such as pyrazomycin<sup>150</sup> or SO91<sup>151</sup> (antitumor agent), and benzamide ribonucleotide<sup>152</sup> (BAR, IMP dehydrogenase inhibitor). Recently, the

---

B. P.; Dwek, R. A.; Rudd, P. M. *Chem. Rev.* **2002**, *102*, 305–320. n) Hanessian, S.; Lou, B. *Chem. Rev.* **2000**, *100*, 4495–4538.

<sup>146</sup> a) Dwek, R. A. *Chem. Rev.* **1996**, *96*, 683–720. b) Nicotra, F. *Top. Curr. Chem.* **1997**, *187*, 55–83. c) Weatherman, R. V.; Mortell, K. H.; Chervenak, M.; Kiessling, L. L.; Toone, E. J. *Biochemistry* **1996**, *35*, 3619–3624. d) Davis, F. F.; Allen, F. W. *J. Biol. Chem.* **1957**, *227*, 807–810. e) Michelson, A. M.; Cohn, W. E. *Biochemistry* **1962**, *1*, 490–495. f) Cortese, R.; Kammen, H. O.; Spengler, S. J.; Ames, B. N. *J. Biol. Chem.* **1974**, *249*, 1103–1108. g) Daves, G. D.; Cheng, C. C. *Prog. Med. Chem.* **1976**, *13*, 303–349. h) Hacksell, U.; Daves, G. D. *Prog. Med. Chem.* **1985**, *22*, 1–65. i) Samuelsson, T.; Boren, T.; Johansen, T. I.; Lustig, F. *J. Biol. Chem.* **1988**, *263*, 13692–13699. j) Townsend L. B. *Chemistry of Nucleosides and Nucleotides*; **1994**; Vol. 3.

<sup>147</sup> Kumar, V.; Shaw, A. K. *J. Org. Chem.* **2008**, *73*, 7526–7531.

<sup>148</sup> a) Roy-Burman, S.; Roy-Burman, P.; Visser, D. W. *Cancer Res.* **1968**, *28*, 1605–1610. b) Palmu, K.; Rosenqvist, P.; Thapa, K.; Ilina, Y.; Siitonen, V.; Baral, B.; Mäkinen, J.; Belogurov, G.; Virta, P.; Niemi, J.; Metsä-Ketelä, M. *ACS Chem Biol.* **2017**, *16*, 1472–1477. c) Böttcher, T.; Sieber, S. A. *J. Am. Chem. Soc.* **2010**, *132*, 6964–6972.

<sup>149</sup> a) Witkowski, J. T.; Robins, R. K.; Sidwell, R. W.; Simon, L. N. *J. Med. Chem.* **1972**, *15*, 1150–1154. b) Sidwell, R. W.; Huffman, J. H.; Khare, G. P.; Allen, L. B.; Witkowski, J. T.; Robins, R. K. *Science* **1972**, *177*, 705–706. c) Choo, Q. L.; Kuo, G.; Weiner, A. J.; Overby, L. R.; Bradley, D. W.; Houghton, M. *Science* **1989**, *244*, 359–362.

<sup>150</sup> a) Sweeney, M. J.; Davis, F. A.; Gutowski, G. E.; Marnili, R. L.; Hoffman, D. H.; Poore, G. A. *Cancer Res.* **1973**, *33*, 2619–2623. b) Gutowski, G. E.; Chaney, M. O.; Jones, N. D.; Hamill, R. L.; Davis, F. A.; Miller, R. D. *Biochem. and Biophys. Res. Commun.* **1973**, *51*, 312–317.

<sup>151</sup> a) Sabat, N.; Migianu-Griffoni, E.; Tudela, T.; Lecouvey, M.; Kellouche, S.; Carreiras, F.; Gallier, F.; Uziel, J.; Lubin-Germain, N. *Eur. J. Med. Chem.* **2020**, *188*, 112009–11016. b) Solarte, C.; Dos Santos, M.; Gonzalez, S.; Miranda, L. S. M.; Guillot, R.; Ferry, A.; Gallier, F.; Uziel, J.; Lubin-Germain, N. *Synthesis* **2017**, *49*, 1993–2002. c) Youcef, R.; Santos, M.; Roussel, S.; Baltaze, J.; Lubin-Germain, N.; Uziel, J. *J. Org. Chem.* **2009**, *74*, 4318–4323.

<sup>152</sup> a) Krohn, K.; Heins, H.; Wielckens, K. *J. Med. Chem.* **1992**, *35*, 511–517. b) Jayaram, H. N.; Gharehbaghi, K.; Jayaram, N. H.; Rieser, J.; Krohn, K.; Paull, K. D. *Biochem. Biophys. Res. Commun.* **1992**, *186*, 1600–1606. c) Gharehbaghi, K.; Paull, K. D.; Kelley, J. A.; Barchi, J. J.; Marquez, V. E.; Cooney, D. A.; Monks, A.; Scudiero, D.; Krohn, K.; Jayaram, H. N. *Int. J. Cancer* **1994**, *56*, 892–899. d) Saunders, P. P.; Arimilli, S.; Krohn, K.; Muhs, M. A.; Alvarez, E.; Survelyer, R. *AntiCancer Drugs* **1996**, *7*, 93–99. e) Grush, M.; Rosenberger, G.; Fuhrman, G.; Braun,

remdesivir C-nucleoside metabolite GS-441524 (**Figure 13a**) was reported as a potential inhibitor of SARS-CoV-2 by binding to the nsP3 macrodomain of the virus.<sup>153</sup> Moreover, C-nucleosides have been used to study RNA and DNA processing enzymes with the aim to extend the genetic alphabet and designing new therapeutic proteins.<sup>154</sup> Because of their key role in many biological processes, the development of methods towards an efficient and stereoselective synthesis of C-nucleosides is considered to be of great importance.<sup>155</sup> Various chemical scaffolds such as aromatics, heteroaromatics, alkyls, alkenyls and alkynyls were introduced at the anomeric pentose sugar position. Among all these architectures, alkynylated nucleosides (called also sugar acetylene) are particularly important as they offer a unique opportunity to increase the complexity of the targeted C-nucleoside, due to the numerous possible transformations of the C–C triple bond (**Figure 13b**).<sup>156</sup> For instance, the alkyne function may be subjected to partial or total reduction, hydrometallation<sup>157</sup> followed by a selective functionalization

---

K.; Titscher, B.; Szekeres, T.; Fritzer-Szekeres, M.; Oberhuber, G.; Krohn, K.; Hengstschlaeger, M.; Krupitza, G.; Jayaram, H. N. *Cell Death Differ.* **1999**, *8*, 736–744. f) Krohn, K.; Dorner, H.; Zukowski, M. *Curr. Med. Chem.* **2002**, *9*, 727–731. g) Gharehbaghi, K.; Grunberger, W.; Jayaram, H. N. *Curr. Med. Chem.* **2002**, *9*, 743–748.

<sup>153</sup> Ni, X.; Schröder, M.; Olieric, V.; Sharpe, M. E.; Hernandez-Olmos, V.; Proschak, E.; Merk, D.; Knapp, S.; Chaikuad, A. *ACS Med. Chem. Lett.* **2021**, *12*, 603–609.

<sup>154</sup> a) Dhami, K.; Malyshev, D. A.; Ordoukhanian, P.; Kubelka, T.; Hocek, M.; Romesberg, F. E. *Nucleic Acids Res.* **2014**, *42*, 10235–10244. b) Feldman, A. W.; Dien, V. T.; Karadeema, R. J.; Fischer, E. C.; You, Y.; Anderson, B. A.; Krishnamurthy, R.; Chen, J. S.; Li, L.; Romesberg, F. E. *J. Am. Chem. Soc.* **2019**, *141*, 10644–10653. c) Lavergne, T.; Degardin, M.; Malyshev, D. A.; Quach, H. T.; Dhami, K.; Ordoukhanian, P.; Romesberg, F. E. *J. Am. Chem. Soc.* **2013**, *135*, 5408–5419. d) Malyshev, D. A.; Dhami, K.; Lavergne, T.; Chen, T.; Dai, N.; Foster, J. M.; Corrêa, I. R.; Romesberg, F. E. *Nature* **2014**, *509*, 385–388. e) Guo, J.; Wang, S.; Dai, N.; Teo, Y. N.; Kool, E. T. *Proc. Natl. Acad. Sci.* **2011**, *108*, 3493–3498.

<sup>155</sup> a) Temburnikar, K.; Seley-Radtke, K. L. *Beilstein J. Org. Chem.* **2018**, *14*, 772–785. b) Tatina, M. B.; Hussain, A.; Dhas, A. K.; Mukherjee, D. *RSC Adv.* **2016**, *6*, 75960–75972.

<sup>156</sup> Selected review: a) Song, G.; Fen, W.; Li, X. *Chem. Soc. Rev.* **2012**, *41*, 3651–3678. b) Song, X.; Qiu, Y.; Liu, X.; Liang, Y. *Org. Biomol. Chem.* **2016**, *14*, 11317–11331. c) Severin, R.; Doye, S. *Chem. Soc. Rev.* **2007**, *36*, 1407–1420. d) Pohlki, F.; Doye, S. *Chem. Soc. Rev.* **2003**, *32*, 104–114. e) Alonso, F.; Beletskaya, I. P.; Yus, M. *Chem. Rev.* **2004**, *104*, 3079–3160. e) Müller, T. E.; Beller, M. *Chem. Rev.* **1998**, *98*, 675–704.

<sup>157</sup> Alami, M.; Hamze, A.; Provot, O. *ACS Catalysis* **2019**, *9*, 3437–3466.



(a) Example of natural and bioactive C-Nucleosides

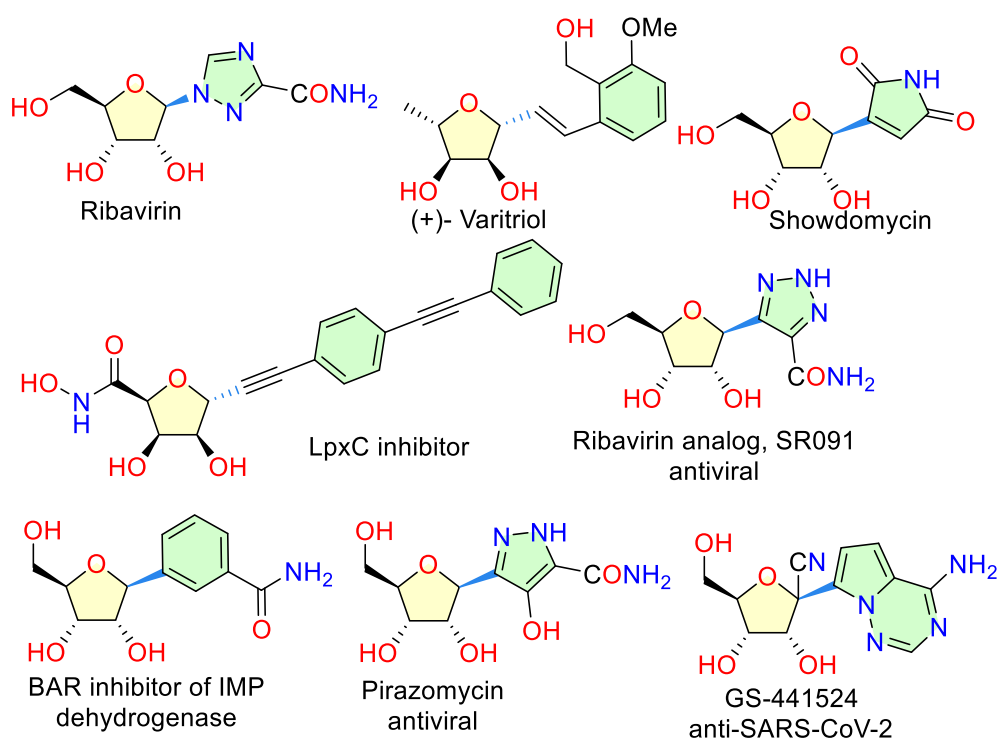

(b) Possible further functionalizations of alkyne C-Nucleosides

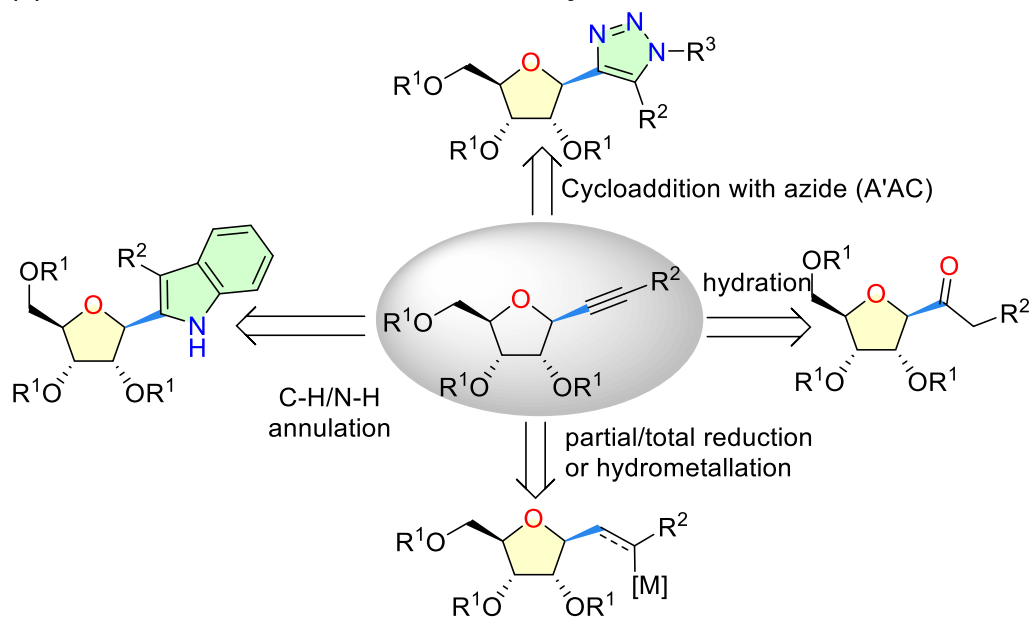

Figure 13. (a) natural and bioactive C-nucleosides, (b) examples of possible transformations of alkynyl C-nucleosides

or (4+2) cycloaddition with azides to produce triazoles<sup>158</sup> or with dienes<sup>159</sup> to access to aromatic nucleosides (**Figure 13b**). Besides, C-alkynyl nucleosides may be used as partners in a C–H activation/annulation process with anilines to afford a variety of substituted C-furanosyl indoles.<sup>160</sup> Otherwise, C-ethynyl furanosides are also reported as a promising antibiotic by acting against Zn<sup>2+</sup>-dependent enzyme LpxC<sup>161</sup> (**Figure 14a**). Despite these possibilities, their use is underdeveloped, and only few methods for their synthesis are reported (**Figure 14a**).<sup>141</sup> Among them, the introduction of the alkynyl function at the anomeric position involves the reaction of furanosyl halides or acetates with alkyne iodides mediated by indium.<sup>162</sup> Organometallic alkynes such as alkynyl trifluoroborates<sup>163</sup> or alkynyltin species<sup>164</sup> are well known to be good partners in the glycosylation of furanosyl fluorides and bromides in the presence of Lewis acids such as boron trifluoride or zinc chloride. Grignard alkynyl reagents are also used as nucleophiles in the coupling with acetals.<sup>165</sup> Although their high interest, these methods require the use of harsh conditions (high temperature and excess of the metal in the case of indium coupling) and overstoichiometric amounts of air and moisture sensitive alkynyl organometallics as well as the nature of the used Lewis acidic used. These issues often limit the practicability of the scope of substrates. Moreover, a mixture of both anomers is mainly observed in numerous reported methods. Then, developing new, mild and catalytic conditions to access diastereoselectively alkynyl C-nucleosides is still one of the highly challenging topics in glycochemistry. In light of the

---

<sup>158</sup> Ma, J.; Ding, S. *Asian J. Org. Chem.* **2020**, *9*, 1872–1888.

<sup>159</sup> a) Ackermann, L. *Acc. Chem. Res.* **2014**, *47*, 281–295. b) Guo, T. L.; Huang, F.; Yu, L. K.; Yu, Z. K. *Tetrahedron Lett.* **2015**, *56*, 296–302. c) Kumar, I.; Kumar, R.; Sharma, U. *Synthesis* **2018**, *50*, 2655–2677. d) Mancuso, R.; Dalpozzo, R. *Catalysts* **2018**, *8*, 458–464.

<sup>160</sup> Hilt, G.; Danz, M. *Synthesis* **2008**, *14*, 2257–2263.

<sup>161</sup> Jana, K. S.; Löppenber, M.; Daniliuc, C. G.; Holl, R. *Tetrahedron* **2015**, *71*, 956–966.

<sup>162</sup> Germain, N. L.; Baltaze, J. P.; Coste, A.; Hallonet, A.; Lauréano, H.; Legrave, G.; Uziel, J.; Auge, J. *Org. Lett.* **2008**, *10*, 725–728.

<sup>163</sup> a) Zeng, J.; Vedachalam, S.; Xiang S.; Liu, X.-W. *Org. Lett.* **2011**, *13*, 42–45. b) Asano, N. *Glycobiology* **2003**, *13*, 93R–104R. c) Asano, N.; Nash, R. J.; Molyneux, R. J.; Fleet, G. W. J. *Tetrahedron: Asymmetry* **2000**, *11*, 1645–1680.

<sup>164</sup> Zhai, D.; Zhai, W.; Williams, R. M. *J. Am. Chem. Soc.* **1988**, *110*, 2501–2505.

<sup>165</sup> Buchanan, J.G.; Edgar, A.R.; Power, M. J. *J. Chem. Soc. Perkin Trans. I* **1974**, 1943–1949.

aforementioned challenges, we were intrigued to develop an efficient catalytic method to perform a decarboxylative alkynylation of ribosyl radicals under dual photoredox<sup>166</sup> catalysis conditions (**Figure 14**). In this context, anomeric radicals have recently been manipulated in conjunction with Ni/Ru or Ir photoredox dual catalysis for the synthesis of alkyl-, (hetero)aryl- and acyl-C-glycosides.<sup>167</sup> Gagnée and co-workers used this approach to generate anomeric radicals from pyranosyl bromides which react with alkenes to produce exclusively alkyl  $\alpha$ -C-glycopyranosides.<sup>168</sup> Molander group reported a range of glycosyl-based radicals generated from dihydropyridyl glycoside precursors and coupled with activated carboxylic acids to synthesize non-anomeric C-acyl glycosides.<sup>169</sup> This approach was applied recently to carbohydrate substrates bearing the dihydropyridine (DHP) as an activating anomeric group to prepare C-aryl glycosides, including nucleosides and 2-deoxysugars.<sup>170</sup> Very recently, 2-deoxyglycosyl boronic acid derivatives were used as radical sources to synthesize a series  $\alpha$ -C-glycosides mediated by a photoredox/nickel dual catalytic system.<sup>171</sup> Finally, Wang, Zhang and co-workers<sup>172</sup> demonstrated for the first time, that ribosyl acids are valuable partners in the photoredox/nickel dual-catalyzed cross-coupling with heteroaryl and vinyl bromides, furnishing various  $\beta$ -selective heteroaryl-C-nucleosides in good yields. Based on this exceptional reactivity of anomeric radicals, we considered them to be well-suited for the development of an alkynylation photoredox cross-coupling process with terminal alkynes. Indeed, pioneer studies demonstrated recently that copper acetylide which could be formed from terminal alkyne and copper salt under mild conditions, were compatible with a photoredox process in the alkynylation of N-

---

<sup>166</sup> a) Vaillant, F. L.; Waser, J. *Chem. Sci.* **2019**, *10*, 8909–8923. b) Vaillant, F. L.; Courant, T.; Waser, J. *Angew. Chem. Int. Ed.* **2015**, *54*, 11200–11356.

<sup>167</sup> a) Xu, L.; Fana, N.; Hu, X. *Org. Biomol. Chem.* **2020**, *18*, 5095–5109. b) Ghouilem, J.; Robichon, M. D.; Bideau, F. L.; Ferry, A.; Messaoudi, S. *Chem. Eur. J.* **2021**, *27*, 491–511.

<sup>168</sup> a) Andrews, R. S.; Becker J. J.; Gagné, M. R. *Angew. Chem. Int. Ed.* **2010**, *49*, 7274–7276. b) Andrews, R. S.; Becker, J. J.; Gagné, M. R. *Angew. Chem. Int. Ed.* **2012**, *51*, 4140–4143.

<sup>169</sup> Dumoulin, A.; Matsui, J. K.; Gutiérrez-Bonet, A.; Molander, G. A. *Angew. Chem. Int. Ed.* **2018**, *57*, 6614–6728.

<sup>170</sup> Wei, Y.; Benzvi, B.; Diao, T. *Angew. Chem. Int. Ed.* **2021**, *60*, 9433–9438.

<sup>171</sup> Takeda, D.; Yoritake, M.; Yasutomi, H.; Chiba, S.; Moriyama, T.; Yokoo, A.; Usui, K.; Hirai, G. *Org. Lett.* **2021**, *23*, 1940–1944.

<sup>172</sup> Ma, Y.; Liu, S.; Xi, Y.; Li, H.; Yang, K.; Cheng, Z.; Wang, W.; Zhang, Y. *Chem. Commun.* **2019**, *55*, 14657–14660.

hydroxy phthalimide esters.<sup>173</sup> Based on all these observations and our ongoing interests in metal-catalyzed functionalization of sugar motifs,<sup>174</sup> we propose herein a catalytic method for the decarboxylative alkylation of ribosyl carboxylic acids with terminal alkynes under copper/photoredox dual catalysis (**Figure 14b**). This approach which proceeds via anomeric radical intermediate, exhibits many advantages over the conventional methods: (i) the use of bench-stable and easily handled sugar carboxylic acids, (ii) the use of earthabundant and low cost- transition metal copper catalyst, (iii) mild reaction conditions (RT) and (iv) large functional groups tolerance. If successful, this approach would provide not only an excellent complementary pathway to the established alkylation methods but also immediate access to a reactive platform that can be engaged in numerous postfunctionalization.

---

<sup>173</sup> a) Xia, H.-D.; Li, Z.; Gu, Q.; Dong, X.-Y.; Fang, J.; Du, X.; Wang, L.; Liu, X. *Angew. Chem. Int. Ed.* **2020**, *59*, 16926–16932; b) Mao, Y.; Zhao, W.; Lu, S.; Yu, L.; Wang, Y.; Liang, Y.; Ni, S.; Pan, Y. *Chem. Sci.*, **2020**, *11*, 4939–4947.

<sup>174</sup> Selected articles: a) Ghouilem, J.; Tran, C.; Grimblat, N.; Retailleau, P.; Alami, M.; Gandon, V.; Messaoudi, S. *ACS Catal.* **2021**, *11*, 1818–1826. b) Zhu, M.; Alami, M.; Messaoudi, S. *Chem. Chomm.* **2020**, *56*, 4464–4467. c) Ghouillem, J.; Franco, R.; Retailleau, P.; Alami, M.; Gandon, V.; Messaoudi, S. *Chem. Commun.* **2020**, *56*, 7175–7178. d) Zhu, M.; Dagousset, G.; Alami, M.; Magnier, E.; Messaoudi, S. *Org. Lett.* **2019**, *21*, 5132–5137. e) Montoir, D.; Amoura, M.; Ababsa, Z. E. -A.; Vishwanath, T. M.; Yen-Pon, E.; Robert, V.; Beltramo, M.; Piller, V.; Alami, M.; Aucagne, A.; Messaoudi, S. *Chem. Sci.* **2018**, *9*, 8753–8759. f) Probst, N.; Grelier, G.; Dahaoui, S.; Alami, M.; Gandon, V.; Messaoudi, S. *ACS. Catal.* **2018**, *8*, 7781–7786. g) Probst, N.; Grelier, G.; Ghermani, N.; Gandon, V.; Alami, M.; Messaoudi, S. *Org. Lett.* **2017**, *19*, 5038–5041. h) Bruneau, A.; Roche, M.; Hamze, A.; Brion, J. D.; Alami, M.; Messaoudi, S. *Chem. Eur. J.* **2015**, *21*, 8375–8379.

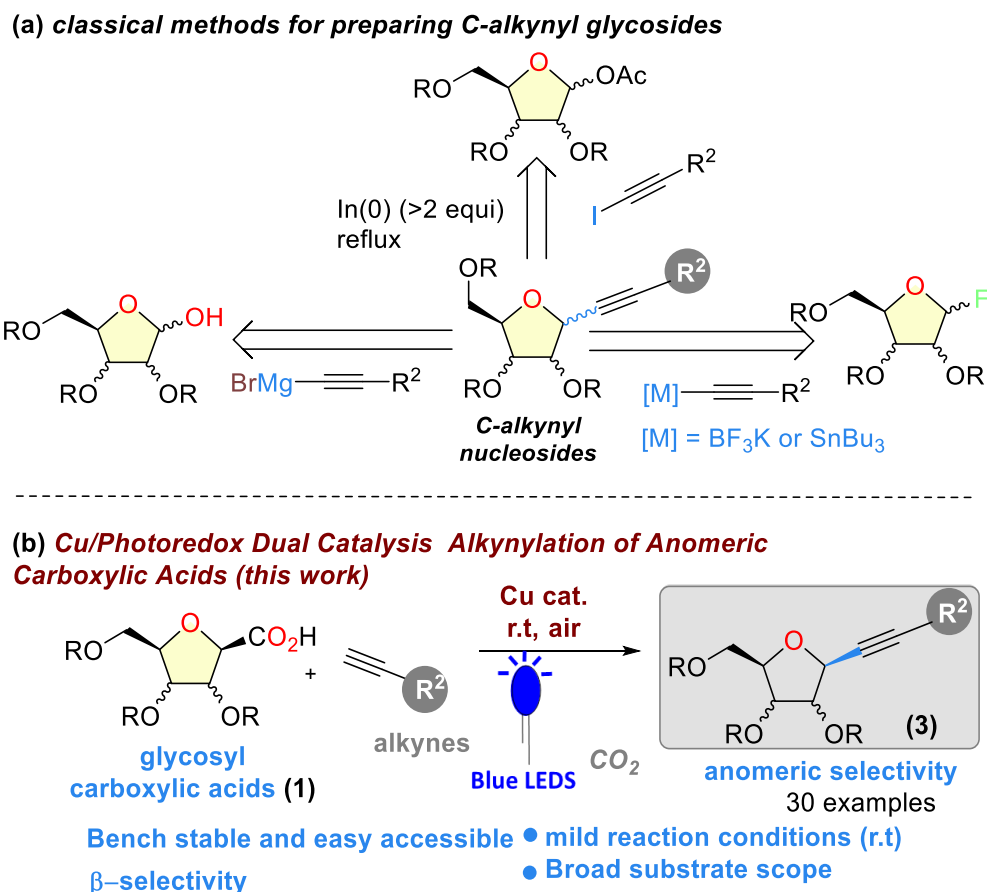

**Figure 14.** (a) strategies for the synthesis of alkyne C-nucleosides, (b) Cu/photoredox approach developed herein

To initiate this study, we chose the coupling of tri-*O*-benzylated 1- $\beta$ -D-glucopyranose **1a** with 4-methoxyphenylacetylene **2a** as a model study under various reaction conditions. Representative results from this optimization study are summarized in Table 1. The reaction of *O*-benzylated-furanose **1a** (1 equiv,  $E_{1/2\text{furanose}(\text{OBn})_3} = +1.15$  V vs SCE in MeCN) with **2a** (3 equiv) was first investigated by using 20 mol% of CuOAc, 2.5 mol% of a commercially available 4CzIPN photocatalyst ( $E_{1/2(\text{PC}^*/\text{PC}^-)} = +1.35$  V vs SCE in MeCN) in the presence of CsOAc (2 equiv) as a base in DMA under blue light emitting diode (LED) irradiation (Table 18, entry 1, see Experiment part). Surprisingly, performing the reaction under argon led to the formation of a mixture of three products: the alkynylated glycoside **3a** in 50% yield contaminated with *Z*- and *E*-alkenyl glycosides **3a'** and **3a''**. The formation of the undesired alkenyl C-nucleosides is in total agreement with the recently reported study of Pericas et al. on the decarboxylative

hydroalkylation of alkynes via dual copper-photoredox catalysis.<sup>175</sup> This first result indicates clearly that under these conditions, two possible pathways are running concomitantly leading to the formation of alkynyl (**3a**) and alkenyl (**3a'**, **3a''**) products. Importantly, conducting the same reaction under air instead of argon produces exclusively the  $\beta$ -C-alkynyl nucleoside **3a** in 60% yield (**Table 21, entry 1, see Exprement part**). This second observation demonstrates that the presence of oxygen inhibits the alkenylation pathway in favor of the C(sp)-C(sp<sup>3</sup>) bond formation. Nevertheless, a subtle amount of oxygen is necessary for the efficiency of the coupling since running the reaction under pure oxygen did not produce **3a** (**Table 21, entry 2, see Exprement part**). Although at this stage we don't have any explanation, we can speculate that the high concentration of O<sub>2</sub> may induce side reactions involving radical oxygen species. This outcome inspired us to explore this alkynylation reaction under air. Thus, increasing the amount of the 4-methoxyphenylacetylene **2a** up to 5 equiv furnished **3a** in only 37% yield (Table 22, entry 2, see Exprement part). Fine adjusting the ratio between **1a/2a** to 2:1 under otherwise the same conditions produces selectively **3a** in an excellent 78% yield (**Table 17, entry 2**). Also, reaction with Ir[dF(CF<sub>3</sub>)ppy]<sub>2</sub>(dtbbpy) PF<sub>6</sub> photocatalyst (PC<sub>2</sub>, E<sub>1/2(PC\*/PC<sup>-</sup>)</sub> = +1.21 V vs SCE in MeCN) instead of 4CzIPN was more efficient and gave the product **3a** in an excellent 96% yield (**Table 17, entry 1**). Tentative to decrease amounts of the photocatalyst to 1 mol% or the copper-catalyst to 10 mol% led to low yields (**50% and 61% yields respectively, Table 17, entries 3 and 4**). Using other photocatalysts such as Ir(pCF<sub>3</sub>-ppy)<sub>3</sub>, IrMe(Me)ppy<sub>2</sub>(dtbpy)PF<sub>6</sub> or tris(2-phenylpyridinato-C<sub>2</sub>-Niridium(III)) failed (**Table 23, entries 3- 5, see Exprement part**). The influence of the copper *N, N*-ligands was also examined by a screening of different ligands, but only L5 revealed to be efficient since the other ligands were less reactive (**L6-8, Table 17, entries 6-8**) or completely inactive (**L1-4, Table 17, entries 2- 5**). Negative controlling experiments demonstrated the Cucatalyst, the Ir-photocatalyst and the light are necessary (**Table 17, entries 8-10**) anticipating the cooperative Cu/Ir dual photocatalysis mechanism rather than a photoinduced Cucatalysis one. Of note, the anomeric configuration of  $\beta$ -Calkynyl

---

<sup>175</sup> Mastandrea, M. M.; Cellas, S.; Caldentey, X.; Pericàs, M. A. *ACS Catal.* **2020**, *10*, 6402–6408.

nucleoside **3a** was unambiguously assigned by the coupling constant  $J_{1,2} = 4.5$  Hz and confirmed for **3b** ( $J_{1,2} = 4.3$  Hz) by comparison with literature NMR data.<sup>176</sup>

**Table 17.** Optimization of the coupling reaction of **1a** with **2a**<sup>[a]</sup>

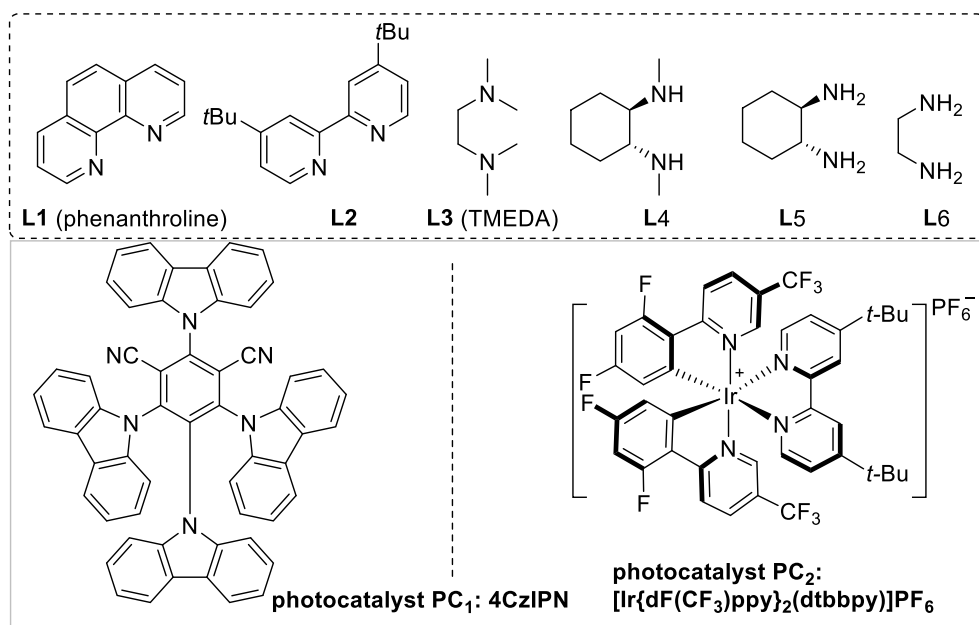
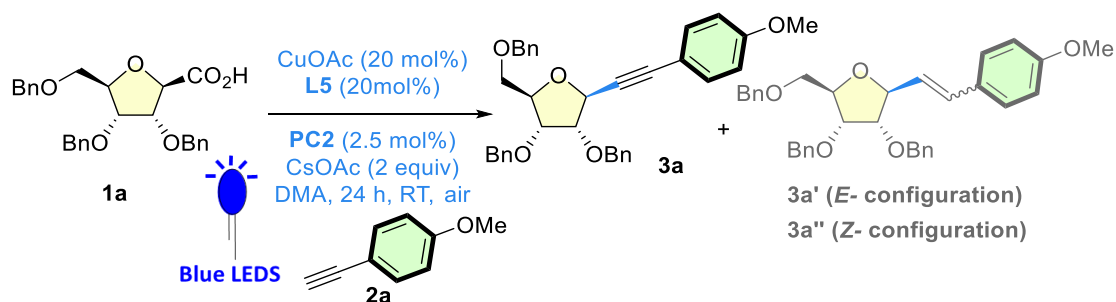

<sup>176</sup> a) Zhai, D.; Zhai, W.; Williams, R. M. *J. Am. Chem. Soc.* **1988**, *110*, 2501-2505; b) Naud, S.; Pipelier, M.; Viault, G.; Adjou, A.; Huet, F.; Legoupy, S.; Aubertin, A.; Evain, M.; Dubreuil, D. *Eur. J. Org. Chem.*, **2007**, *20*, 3296-3310; (c) Naud, S.; Pipelier, M.; Chaumette, C.; Viault, G.; Huet, F.; Legoupy, S.; Dubreuil, D. *Synlett*, **2007**, *3*, 403-406.

Entry	Deviation from the standard conditions	Yield <b>3a</b> (%) <sup>b</sup>
<b>1</b>	none	<b>96</b>
<b>2</b>	<b>PC1</b> instead <b>PC2</b>	<b>78</b>
<b>3</b>	<b>PC2</b> 1mol%	<b>50</b>
<b>4</b>	CuOAc 10 mol%	<b>61</b>
<b>5</b>	<b>L1</b> or <b>L2</b> or <b>L3</b> or <b>L4</b> instead of <b>L5</b>	<b>traces</b>
<b>6</b>	<b>L6</b> insteadn of <b>L5</b>	<b>48</b>
<b>7</b>	<b>1a</b> (1equiv) and <b>2a</b> (5 equiv)	<b>40</b>
<b>8</b>	No photocatalyst <b>PC</b>	<b>0</b>
<b>9</b>	No Cu-catalyst	<b>0</b>
<b>10</b>	<b>dark</b>	<b>0</b>

<sup>a</sup> Reactions conditions: **1a** (0.4 mmol), **2a** (0.2 mmol), CsOAc (0.4 mmol), DMA (2.0 mL), blue LEDs (4.5 W, irradiation). <sup>b</sup>Isolated yield.

Encouraged by these results, we investigated next the scope and limitations of this dual Cu/photocatalysis process by systematically varying the nature of the alkyne **2** and the sugar **1**. The substrate scope for alkynes was first explored keeping furanosyl acid **1a** as the substrate (**Scheme 46**). Aryl-substituted alkynes bearing electron-withdrawing and electron-donating groups in ortho, meta or para positions (–OMe, –Cl, –F, –CF<sub>3</sub>, –COMe and –CO<sub>2</sub>Me) were successfully reacted under our conditions to afford the corresponding alkynyl C-nucleosides (**3a-p**) in yields up to 96%. In addition, the enyne substrate **2q** was employed successfully in the reaction to produce **3q** in 64% yield. Moreover, challenging heteroaromatic alkynes could be used in the coupling as compounds **3r** and **3s** obtained in 70% and 56% yields, respectively. More interestingly, aliphatic alkynes which are known to be less reactive such as 1-pentyne, 1-hexyne, cyclohexyne, cyclopropyne as well as but-3-yn-1-yl benzene were also successful, furnishing **3t-x** in yields ranging from 52% to 93%. Finally, the substituted 5-chloropent-1-yne was employed successfully in this reaction and its C(sp<sup>3</sup>)–Cl survived during the process (C-nucleoside **3y**).

Next, we investigated the reactivity of a series of sugar carboxylic acids (**Scheme 46**). At first, we studied the scope of the coupling of ribofuranoses bearing various common protecting groups. Thus, substrate **1b** bearing benzoyl and acetonide protecting groups underwent an efficient alkynylation to produce C-nucleoside **3z** in 54% yield and in an anticipated  $\alpha/\beta$  ratio of 4:1 as reported recently.<sup>26</sup> Otherwise, using the disarming OAc-protecting groups did not provide the desired product **3aa** under our optimized conditions.



It is well established that the substituent at the C2 position of anomeric ribofuranoses plays a critical role in controlling the anomeric configuration. Thus, under our conditions the coupling of **2a** with benzyl protected 2-deoxy-D-ribose  $\beta$ -1d furnished **3ab** in 45 % yield and a ratio  $\alpha/\beta$  of 6:1 in favor of the  $\alpha$ -anomer. The same reactivity was recently observed on the arylation of furanosyl radicals under photoredox Nicatalysis.<sup>27,28</sup> Of note, both  $\alpha$ - and  $\beta$ -anomers were separated through a simple column chromatography. Interestingly, the anomeric configuration does not play any important role in the stereoselectivity of the reaction since running the same reaction starting from the  $\alpha$ -**1d** anomer led to the same ratio of  $\alpha/\beta$  (7:1). Interestingly, alkynylation of the non-anomeric furanosyl acid **1e** was proved to be effective furnishing the reversed alkynyl C-nucleoside **3ac** in good yield and excellent diastereoselectivity. Finally, decarboxylative alkynylation of tetrahydrofuran was less efficient under our conditions and provided the desired alkynylated product **3ae** in only 10% yield. Furthermore OBn-protected glucopyranosyl acid **1h** turned out to be an unsuitable substrate for this reaction as it failed to produce the corresponding alkynylated C-pyranoside. This finding demonstrates clearly that generation and reactivities of furanosyl and pyranosyl radicals are different under these photoredox conditions. This may be explained partially, by the significant difference of the reduction potential ( $E_{1/2}$ ) between the furanosyl and pyranosyl carboxylate salts ( $E_{1/2\text{furanose(OBn)3}} = +1.15$  V,  $E_{1/2\text{pyranose(OBn)4}} = +1.32$  V, respectively)<sup>28</sup>. Thus, we attempted to perform the coupling of **1a** and **2a** by using a photocatalyst having a higher oxidative potential than PC<sub>2</sub> ( $E_{1/2(\text{PC}^*/\text{PC}^-)} = +1.21$  V vs SCE in MeCN) such as 4CzIPN ( $E_{1/2(\text{PC}^*/\text{PC}^-)} = +1.35$  V vs SCE in MeCN). However, under these conditions, the reaction failed.

Alkynes are highly valuable intermediates in organic synthesis as they can be involved in a wide range of transformations at triple bonds. To further show the synthetic utility of our protocol, we evaluated whether the alkyne function of **3a** could be used as a platform to access more complex C-nucleosides through simple transformations of the C $\equiv$ C bond (**Scheme 47**). To our delight, complete hydrogenation of **3a** afford a pure alkyl  $\beta$ -C-nucleoside **4a** in an excellent yield. In addition, **3a** was converted to pyridazine C-nucleosides **4b** in good yield through inverse demand hetero Diels–Alder

reaction with dimethyl 1,2,4,5- tetrazine-3,6-dicarboxylate (**Scheme 47**).<sup>177</sup> This is an immediate application to the synthesis of pyrrole C- nucleoside analogs of biological interest.<sup>178</sup> Finally, hydration of the alkyne **3a** by PTSA<sup>179</sup> gave the corresponding ketone C- nucleosides **4c/4c'** in a 1:3 mixture of both regioisomers (**73% yield, Scheme 47**).

**Scheme 46.** Scope and limitation of the coupling of furanosyl carboxylic acids **1a-f** with alkynes **2**.<sup>a</sup>

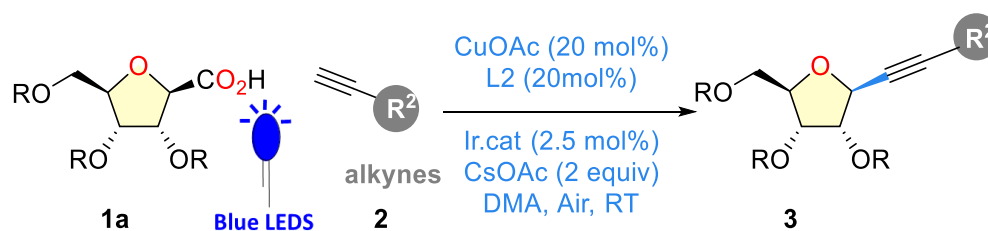

<sup>177</sup> Joshi, U.; Josse, S.; Pipelier, M.; Chevallier, F.; Pradère, J. -P.; Hazard, R.; Legoupy, S.; Huet, F.; Dubreuil, D. *Tetrahedron Lett.* **2004**, *45*, 1031–1033.

<sup>178</sup> a) Lam, K. S.; Glersaye, S.; Patel, K.; Najmi, S.; Burnham, B. S. Abstracts of Papers, 225th ACS National Meeting, New Orleans, LA, United States, March 23–27, **2003**. b) Krishna, P. R.; Reddy, V. V. Reddy, Srinivas, R. *Tetrahedron* **2007**, *63*, 9871–9888. c) Nichols, R.; Andrews, P. C.; Zhang, P.; Bergstrom, D. E. *Nature* **1994**, *369*, 492–493. d) Bergstrom, D. E.; Zhang, P.; Toma, P. H.; Andrews, P. C.; Nichols, R. *J. Am. Chem. Soc.* **1995**, *117*, 1201–1209. e) Klewer, D. A.; Hoskins, A.; Zhang, P.; Davisson, V. J.; Bergstrom, D. E.; LiWang, A. C. *Nucleic Acids Res.* **2000**, *28*, 4514–4522. f) Harki, D. A.; Graci, J. D.; Korneeva, V. S.; Ghosh, S. K. B.; Hong, Z.; Cameron, C. E.; Peterson, B. R. *Biochemistry* **2002**, *41*, 9026–9033.

<sup>179</sup> Jacubert, M.; Provot, O.; Peyrat, J. F.; Hamze, A.; Brion, J. D.; Alami, M. *Tetrahedron* **2010**, *66*, 3775–3787.

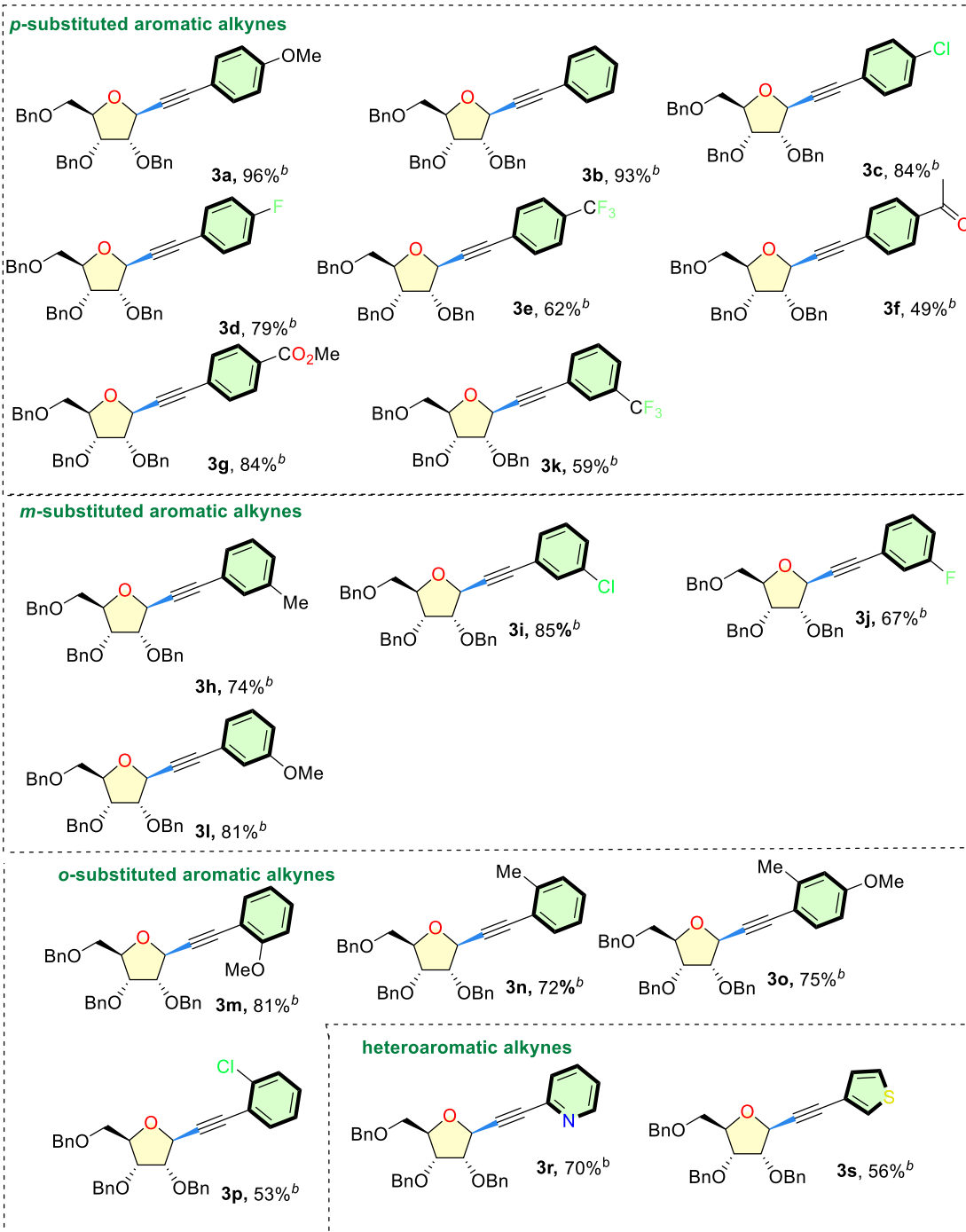

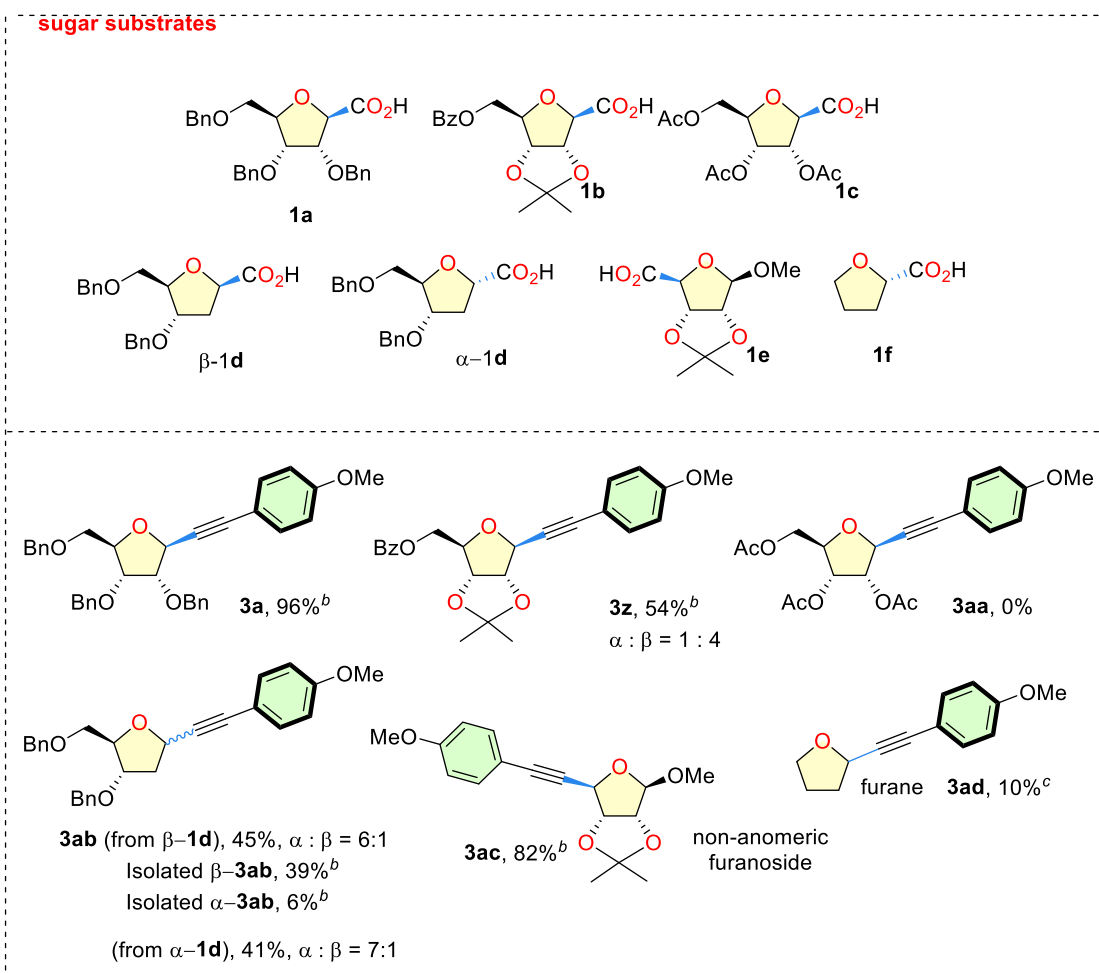
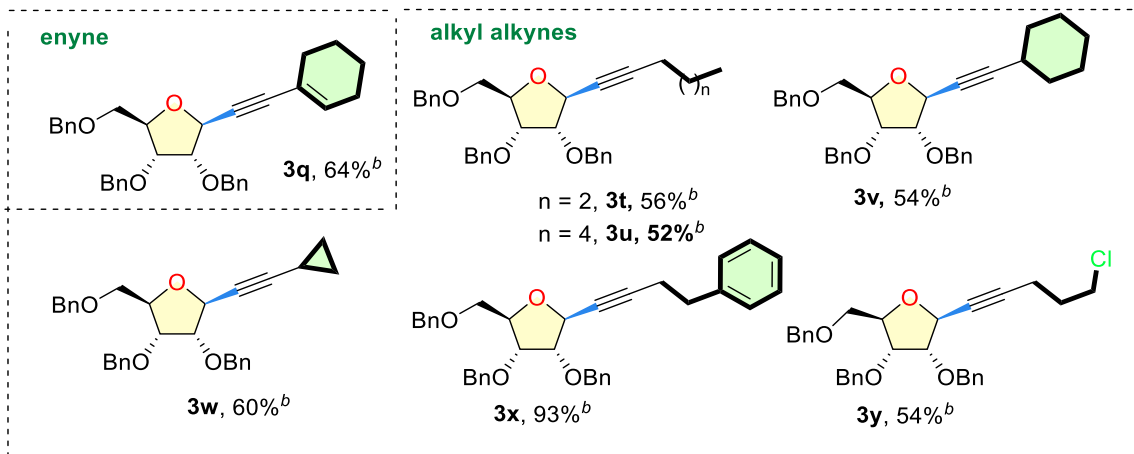

<sup>a</sup> Reaction conditions: **1a** (0.4 mmol), **2** (0.2 mmol), CuOAc (20 mol%), L5 (20 mol%), PC2 (2.5 mol%) and CsOAc (0.4 mmol) in DMA (2.0 mL) under air and blue LEDs (4.5 W, irradiation) for 24 h. <sup>b</sup>Isolated yield. <sup>c</sup>estimated by LCMS.

**Scheme 47.** Furthers functionalization of the triple bond.<sup>a</sup>

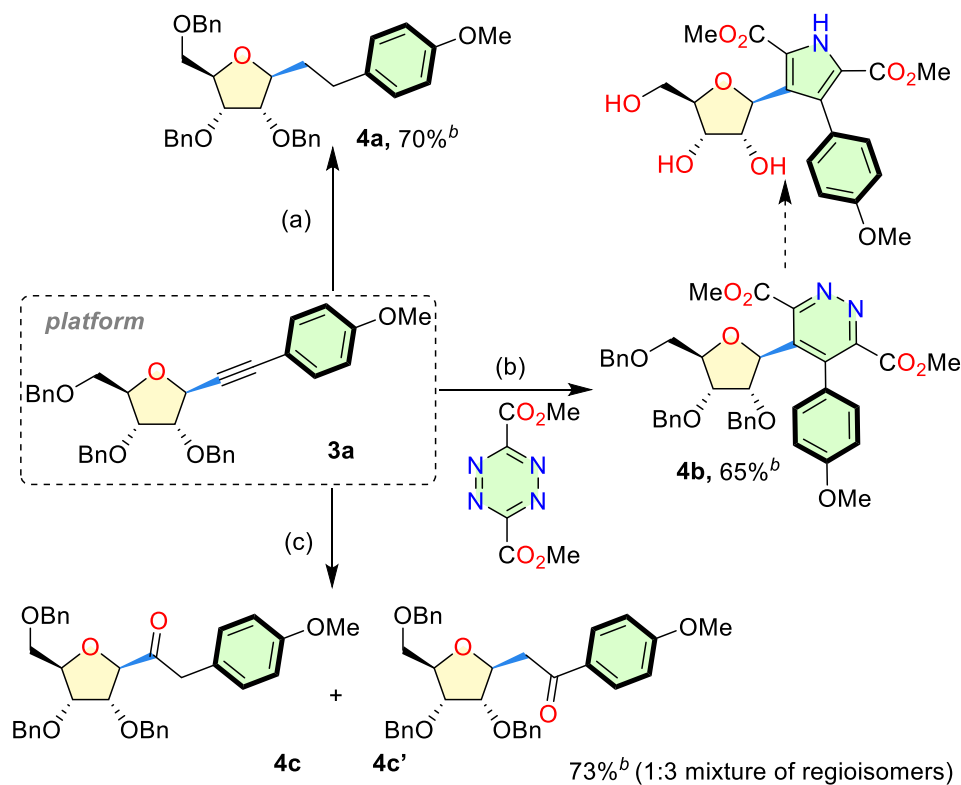

<sup>a</sup> Reactions conditions: (a) **3a** (0.1 mmol) and Pd/C 10 wt% in MeOH (0.1 M) at rt for overnight. (b) **3a** (0.2 mmol), Dimethyl 1,2,4,5-tetrazine-3,6-dicarboxylate (0.3 mmol, 1.5 equiv ) in toluene (0.1 M), reflux. (c) **3a** (0.1 mmol) and PTSA (0.2 eq) in EtOH (0.4 M) at 120 °C, (MW) for 30 min. <sup>b</sup>Isolated yield.

Based on recent literature reports,<sup>152a,1588,159a</sup> reasonable mechanism is proposed in **Scheme 48**. The photocatalytic cycle would start by the activation of the iridium catalyst to the excited state Ir\* by the means of visible light followed by the oxidation of carboxylic acid (or cesium carboxylate) leading to the formation of the anomeric radical A and reduced iridium(II) complex. Simultaneously, the reaction of the Cu(I) catalyst and alkyne **2a** in the presence of the base generates the monomeric Cu(I)-

acetylene complex II.<sup>159,180</sup> Then, single electron transfer (SET) of this later led to the Cu(II) complex III.<sup>166</sup> At this stage, two pathways may be involved (i) oxidation of the Cu(I) complex by oxygen as a terminal niddle<sup>166b</sup> or (ii) by the means of photoexcitation of [LCu(I)] to [LCu(I)\*]<sup>181</sup> followed by an electron transfer mechanism.<sup>159,166b</sup> Later, the anomeric radical A, can be captured by LCu(II)-acetylene III to form the high-valent transient Cu(III) species IV through the radical relay mechanism.<sup>182</sup> Reductive elimination would deliver the final  $\beta$ -alkynyl nucleoside **3a** and regenerate the Cu(I) catalyst for the next catalytic cycle. The final key step cycle would be then the reoxidation of iridium(II) complex by a molecule of dioxygen<sup>166b,183</sup> to generate the ground-state Ir-photocatalyst and close the catalytic cycle.

---

<sup>180</sup> a) Dong, X.-Y.; Cheng, J.-T.; Zhang, Y.-F.; Li, Z.-L.; Zhan, T.-Y.; Chen, J.-J.; Wang, F.-L.; Yang, N.-Y.; Ye, L.; Gu, Q.-S.; Liu, X.-Y. *J. Am. Chem. Soc.* **2020**, *142*, 9501–9509. b) Zhao, X.; MacMillan, D. W. C. *J. Am. Chem. Soc.* **2020**, *142*, 19480–19486. c) Cao, Z.; Li, J.; Sun, Y.; Zhang, H.; Mo, X.; Cao, X.; Zhang, G. *Chem.Sci.* **2021**, *12*, 4836–4840.

<sup>181</sup> Representative examples: a) Sagadevan, A.; Pampana, V. K. K.; Hwang, K. C. *Angew.Chem. Int. Ed.* **2019**, *58*, 3838–3842. b) Hazra, A.; Lee, M. T.; Chiu, J. F.; Lalic, G. *Angew. Chem. Int. Ed.* **2018**, *57*, 5492–5496. c) Sagadevan, A.; Charpe, V. P.; Ragupathi, A.; Hwang, K. C. *J. Am. Chem. Soc.* **2017**, *139*, 2896–2899. d) Sagadevan, A.; Ragupathi, A.; Hwang, K. C. *Angew.Chem. Int. Ed.* **2015**, *54*, 13896–13901. e) Sagadevan, A.; Ragupathi, A.; Lin, C. C.; Hwu, J. R.; Hwang, K. C. *Green Chem.* **2015**, *17*, 1113–1119. f) Sagadevan, A.; Hwang, K. C. *Adv. Synth. Catal.* **2012**, *354*, 3421–3427.

<sup>182</sup> a) Zhang, W.; Wang, F.; McCann, S. D.; Wang, D.; Chen, P.; Stahl, S. S.; Liu, G. *Science*, **2016**, *353*, 1014–1018. b) Lu, F.; Liu, D.; Zhu, L.; Lu, L.; Yang, Q.; Zhou, Q.; Wei, Y.; Lan, Y.; Xiao, W. *J. Am. Chem. Soc.* **2019**, *141*, 6167–6172. c) Lin, J.-S.; Wang, F.-L.; Dong, X.-Y.; He, W.-W.; Yuan, Y.; Chen, S.; Liu, X.-Y. *Nat. Commun.* **2017**, *8*, 14841–14851. d) Cao, Y.-X.; Dong, X.-Y.; Yang, J.; Jiang, S.-P.; Zhou, S.; Li, Z.-L.; Chen, G.-Q.; Liu, X.-Y. *Adv. Synth. Catal.* **2020**, *362*, 2280–2284.

<sup>183</sup> Selected references for the oxygen oxidation of Ir-photocatalysts, see a) Condie, A. G.; Gonzalez-Gomez, J. C.; Stephenson, C. R. J. *J. Am. Chem. Soc.* **2010**, *132*, 1464–1465. Related article on singlet O<sub>2</sub> sensitization by Ir photocatalyst, see: b) Demas, J. N.; Harris, J. E. W.; McBride, R. P. *J. Am. Chem. Soc.* **1977**, *99*, 3547–3551. c) Gao, R.; Ho, D. G.; Hernandez, B.; Selke, M.; Murphy, D.; Djurovich, P. I.; Thompson, M. E. *J. Am. Chem. Soc.* **2002**, *124*, 14828–14829. d) Huang, C.; Liang, C.; Sadhukhan, T.; Banerjee, S.; Fan, Z.; Li, T.; Zhu, Z.; Zhang, P.; Raghavachari, K.; Huang, H. *Angew. Chem. Int. Ed.* **2021**, *60*, 9474–9479. Related article on oxygen oxidation of Ru photocatalysts, see: e) Tyson, E. L.; Ament, M. S.; Yoon, T. P. *J. Org. Chem.* **2013**, *78*, 2046–2050. f) Ischay, M. A.; Ament, M. S.; Yoon, T. P. *Chem. Sci.*, **2012**, *3*, 2807–2811.

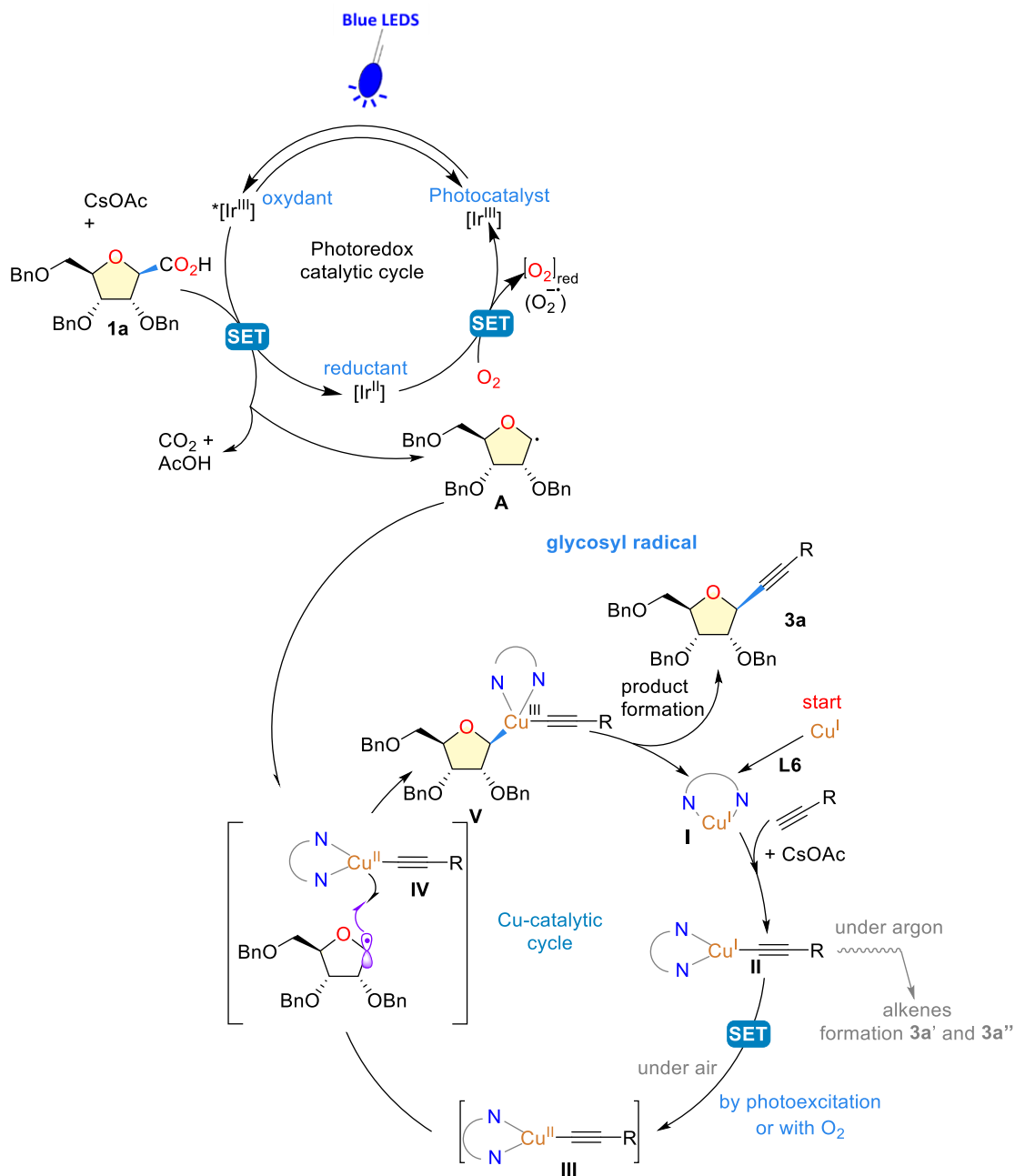

**Scheme 48.** Proposed mechanism for the dual copper-photoredox catalyzed alkylation of anomeric radicals

**Additional comments of the reaction mechanism:**

If this reaction reacted under Ar, Cu(I)-acetylene complex **II** was activated by photoexcitation to lead to the excited state Cu(I)-acetylene complex **VI**. The radical addition to the triple bond led to the vinyl intermediate **VII**. Reoxidation of iridium(II)

complex followed by proton trapping would deliver the final products **3a'**, **3a''** and regenerate the Cu(I) catalyst for the next catalytic cycle (**Scheme 49**).<sup>184</sup>

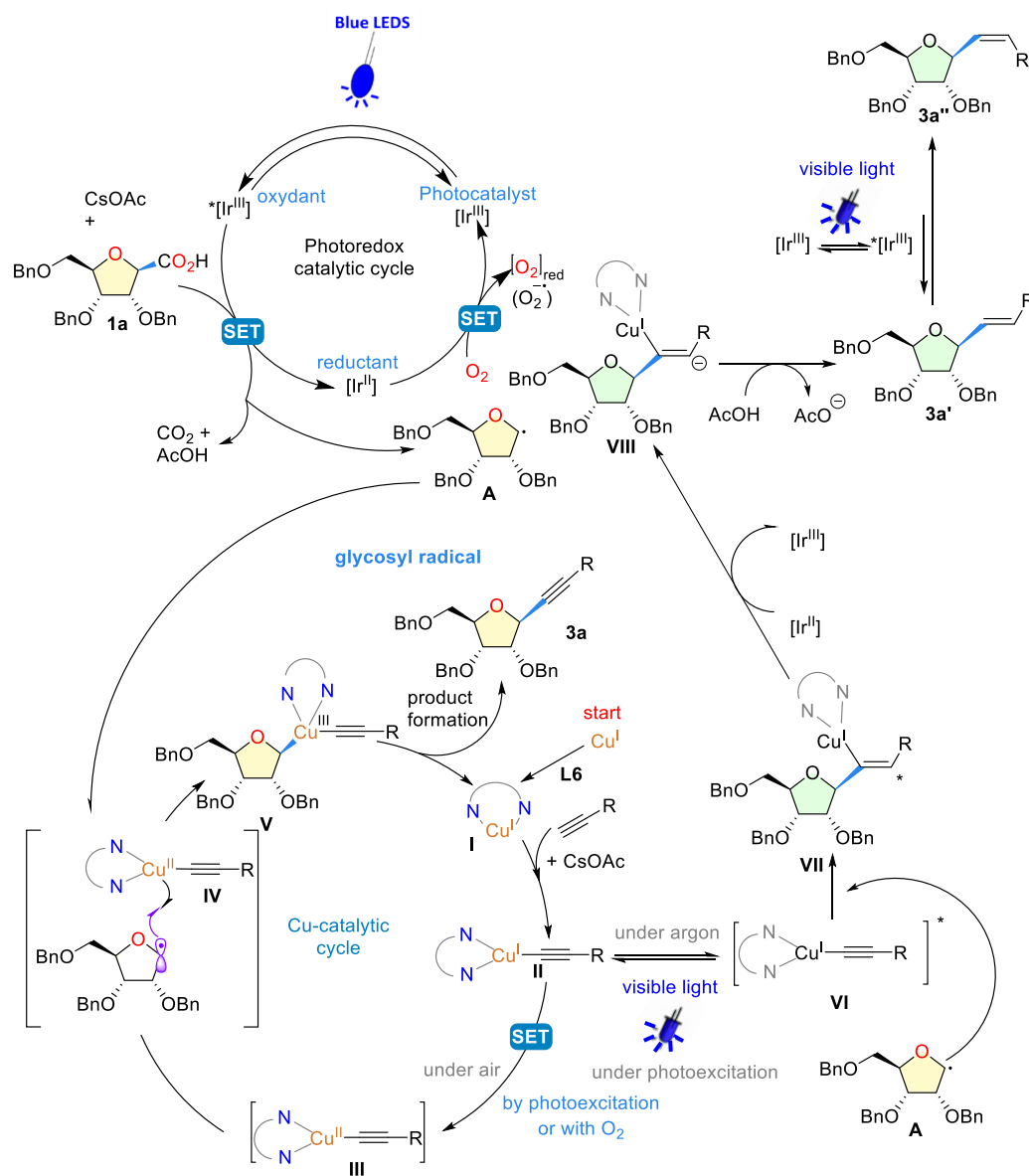

**Scheme 49.** A proposed mechanism

<sup>184</sup> Mastandrea, M. M.; Cellas, S.; Caldentey, X.; Pericàs, M. A., *ACS Catal.*, **2020**, *10*, 6402–6408



## C) Conclusion and perspectives

In summary, we described here the first catalytic approach for the alkylation of anomeric furanosyls with various terminal alkynes via a cooperative photoredox/copper catalysis strategy. This method provides an unprecedented access to alkynyl C-nucleosides under mild conditions with high efficiency and diastereoselectivity. Further mechanistic investigations of this reaction are currently underway. We believe that this method not only opens a new way for catalytic alkylation of furanosides, but also provides a versatile and convergent approach for the synthesis of complex C-nucleosides through further functionalizations of the tripe bond.

While this is a new and easy method to access alkynyl C-nucleosides, there are some limitations in regard of sugar substrates: (i) unprotected sugars (ii) OAc-protected sugars and (iii) pyranose carboxylic acids are not suitable substrates under our reaction conditions.

## D) Experiment Part

### General information

Solvents and reagents are obtained from commercial suppliers and were used without further purification. Analytical TLC was performed using Merck silica gel F254 (230-400 mesh) plates and analyzed by UV light or by staining upon heating with vanillin solution (15 g of vanillin in 250 mL ethanol and 2.5 mL of concentrated sulfuric acid). For silica gel chromatography, the flash chromatography technique was used, with Merck silica gel 60 (230-400 mesh) and p.a. grade solvents unless otherwise noted. The  $^1\text{H}$  NMR and  $^{13}\text{C}$  NMR J-MOD spectra were recorded in either  $\text{CDCl}_3$  on Bruker Avance 300 spectrometers. The  $^{19}\text{F}$  NMR Decoupled spectra were recorded in either  $\text{CDCl}_3$  on Bruker Avance 200 spectrometers. The chemical shifts of  $^1\text{H}$ ,  $^{13}\text{C}$  and  $^{19}\text{F}$  are reported in ppm relative to the solvent residual peaks. Syringe needle bought from Bbraun, size: 1.2x40 mm BC/SB, REF: 4665120. Reaction tube bought from Kimble 13x100 mm (Borosilicate glass), REF:73500-13100. Merck silica gel 60 (0.015–0.040 mm) was used for column chromatography. Melting points were recorded on a Büchi B-450 apparatus and are uncorrected. High resolution mass spectra (HR-MS) were recorded on a Micro Mass LCT Premier Spectrometer. Optical rotations were obtained with a PolAAR 32 polarimeter. Glucosidyl/ribosyl/deoxyribosyl acids were synthesized as according the following protocols.

Photochemistry: Photoredox reactions were irradiated with blue LED (~470 nm) strips, and the temperature (~25 °C) was controlled using one external desk fan set up ~15-20 cm away from this photoreactor bed. **(Figure 15, middle)**

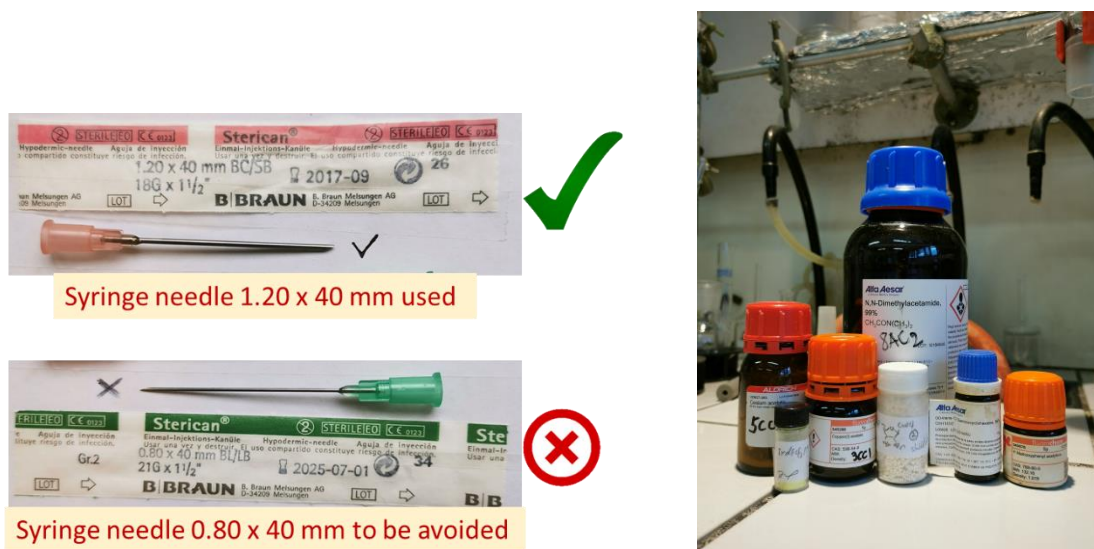

**Figure 15** The needle size which must be used in this study **(Left)**. Reaction reagents **(Right)**

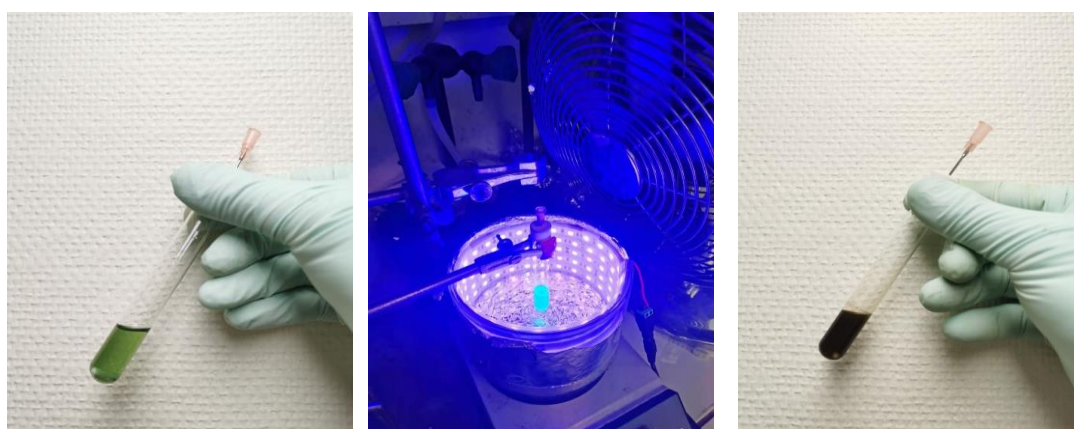

**Figure 16** Mixture before reaction **(Left)**; Photoreactor bed **(Middle)**; Mixture after reaction **(Right)**.

### Reaction Optimization

A glass tube equipped with a stir bar was covered by a rubber with syringe needle (size: 1.2x40 mm) which was charged with **1a** (179.4 mg, 0.4 mmol, 2 equiv), 1-ethynyl-4-

methoxybenzene **2a** (26.4 mg, 0.2 mmol, 1.0 equiv),  $[\text{Ir}\{\text{dF}(\text{CF}_3)\text{ppy}\}_2(\text{dtbbpy})]\text{PF}_6$  (5.6 mg, 2.5 mol%),  $\text{CuOAc}$  (4.6 mg, 20 mol%),  $\text{CsOAc}$  (78 mg, 2 equiv), ( $\pm$ )-trans-1,2-Diaminocyclohexane (4.9 mg, 20 mol%), and then DMA (2 mL) was added. The mixture was pre-mixed for 1 min at room temperature. After that, the mixture was placed in the photoreactor vessel ~5-7 cm away from the blue LEDs, and allowed to stirred vigorously for 24 h at rt. Afterward,  $\text{H}_2\text{O}$  (10 mL) was added to the crude and the mixture was extracted with  $\text{EtOAc}$  (3 x 10 mL), washed with brine (3 x 10 mL). Organic layers were dried by  $\text{Na}_2\text{SO}_4$ , filtration, concentrated under vacuo. Purification was performed with flash chromatography on silica gel (Ethyl acetate : Cyclohexane = 0→1 : 10).

### Optimization Data:

### Ligands and photocatalysts used in this study

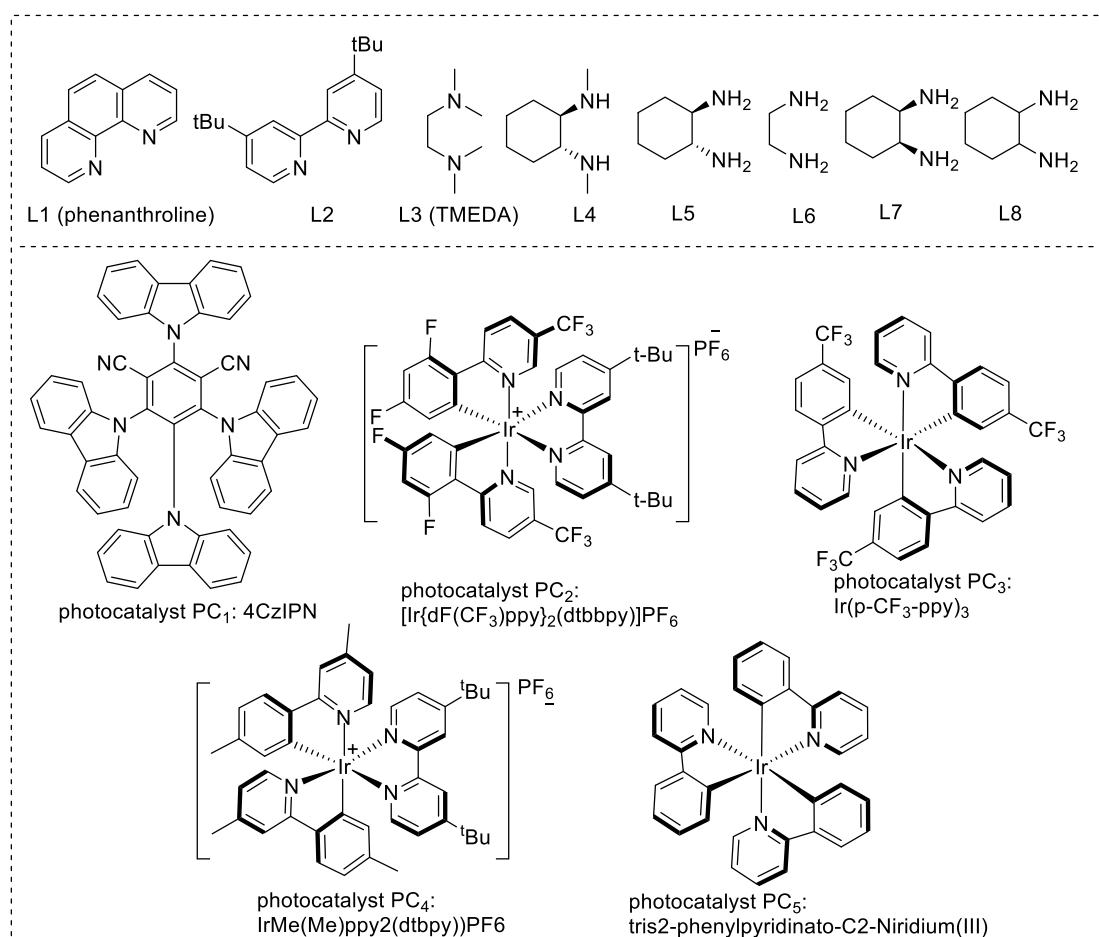

**Figure 17.** Ligand and Photocatalyst

**Table 18.** Screening catalyst

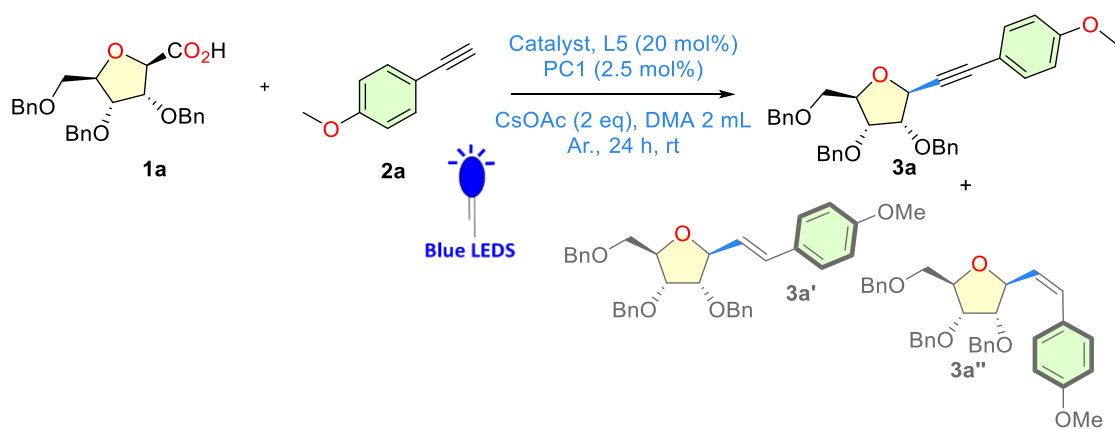

Entry	Catalyst	Yield <b>3a</b> (%) <sup>b</sup>	Yield <sup>b</sup> <b>3a'</b> and <b>3a''</b> (%)
<b>1</b>	CuOAc	32	<b>31</b>
<b>2</b>	Cu(OAc) <sub>2</sub>	30	<b>20</b>
<b>3</b>	Fe(OAc) <sub>2</sub>	traces	<b>traces</b>
<b>4</b>	Pd(OAc) <sub>2</sub>	traces	<b>traces</b>
<b>5</b>	Co(OAc) <sub>2</sub>	traces	<b>traces</b>
<b>6</b>	Ag(OAc) <sub>2</sub>	traces	<b>traces</b>
<b>7</b>	----	<b>traces</b>	<b>traces</b>

<sup>a</sup> Reactions conditions: **1a** (0.3 mmol), **2a** (0.2 mmol), PC1 (2.5 mol%), Catalyst (20 mol%), L5 (20 mol%), CsOAc (0.4 mmol), DMA (2.0 mL), blue LEDs (4.5 W, irradiation). <sup>b</sup> Isolated yield.

**Table 19.** Screening Solvent

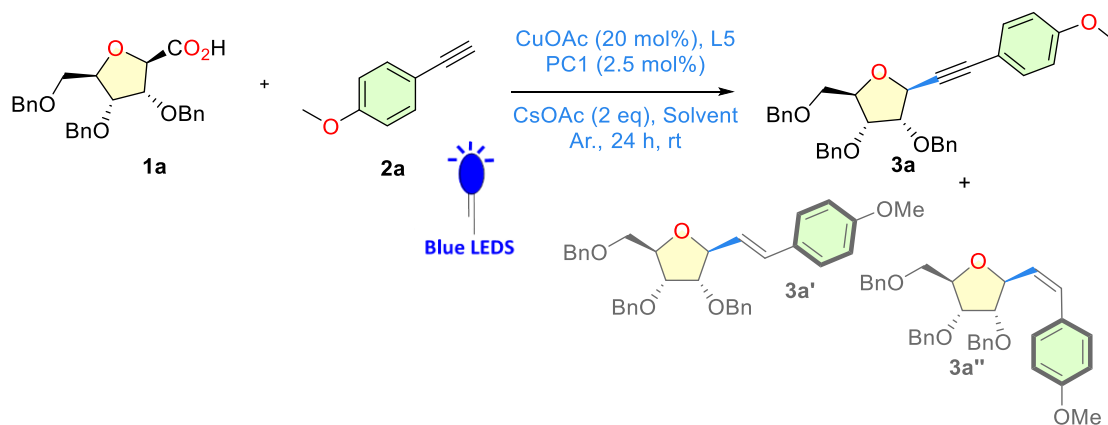

Entry	Solvent	Yield 3a (%) <sup>b</sup>	Yield b 3a' and 3a'' (%)
<b>1</b>	DMA	32	<b>31</b>
<b>2</b>	DMF	30	<b>10</b>
<b>3</b>	DMSO	11	<b>15</b>
<b>4</b>	DMA: H <sub>2</sub> O (20:1)	traces	<b>traces</b>
<b>5</b>	PCBTF	traces	<b>traces</b>
<b>6</b>	DCE	traces	<b>traces</b>
<b>7</b>	MeCN	<b>traces</b>	<b>traces</b>

<sup>a</sup> Reactions conditions: **1a** (0.3 mmol), **2a** (0.2 mmol), PC1 (2.5 mol%), CuOAc (20 mol%), L5 (20 mol%), CsOAc (0.4 mmol), Solvent (2.0 mL), blue LEDs (4.5 W, irradiation). <sup>b</sup> Isolated yield.

**Table 20.** Screening Base

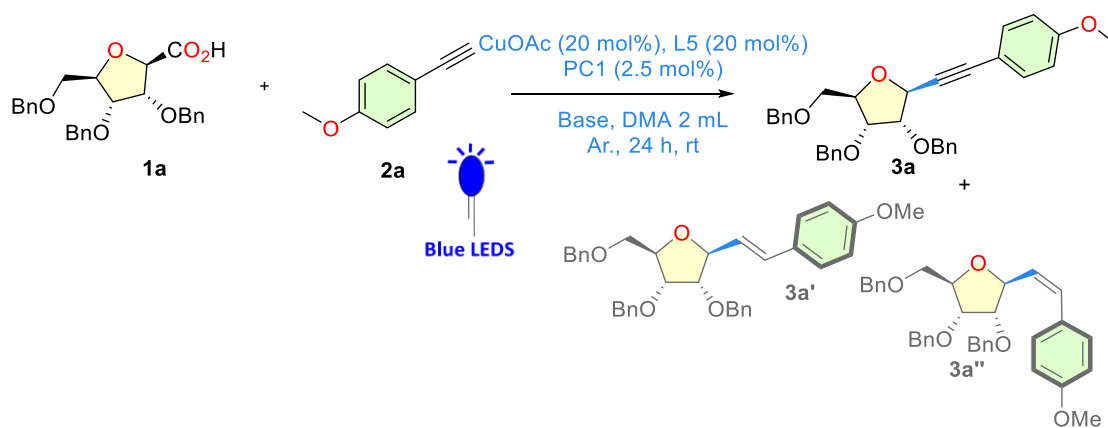

Entry	Base	Yield 3a (%) <sup>b</sup>	Yield <sup>b</sup> 3a' and 3a'' (%)
1	CsOAc 2 eq	32	<b>31</b>
2	AgOAc 2 eq	traces	<b>traces</b>
3	KOAc 2 eq	30	<b>21</b>
4	CsF 2 eq	traces	<b>traces</b>
5	---	<b>8</b>	<b>7</b>

<sup>a</sup> Reactions conditions: **1a** (0.3 mmol), **2a** (0.2 mmol), PC1 (2.5 mol%), CuOAc (20 mol%), L5 (20 mol%), Base (0.4 mmol), DMA (2.0 mL), blue LEDs (4.5 W, irradiation). <sup>b</sup>Isolated yield.

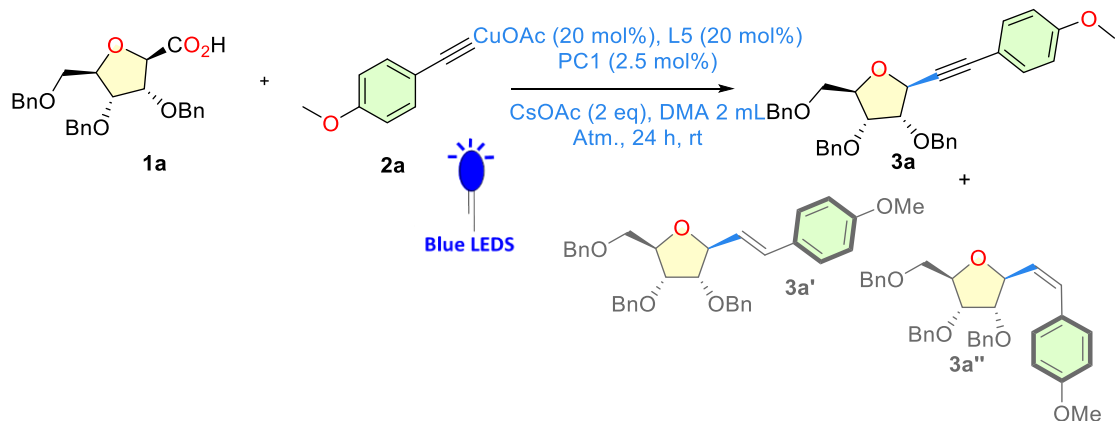
**Table 21.** Screening Atm.

Entry	Atm.	Yield <b>3a</b> (%) <sup>b</sup>	Yield <b>3a'</b> and <b>3a''</b> (%)
<b>1</b>	Air	60	<b>Only 3a 60% was found</b>
<b>2</b>	O <sub>2</sub>	traces	<b>traces</b>
<b>3</b>	Ar	<b>32</b>	<b>31</b>

<sup>a</sup> Reactions conditions: **1a** (0.3 mmol), **2a** (0.2 mmol), **PC1** (2.5 mol%), **CuOAc** (20 mol%), **L5** (20 mol%), **CsOAc** (0.4 mmol), **DMA** (2.0 mL), blue LEDs (4.5 W, irradiation). <sup>b</sup> Isolated yield.

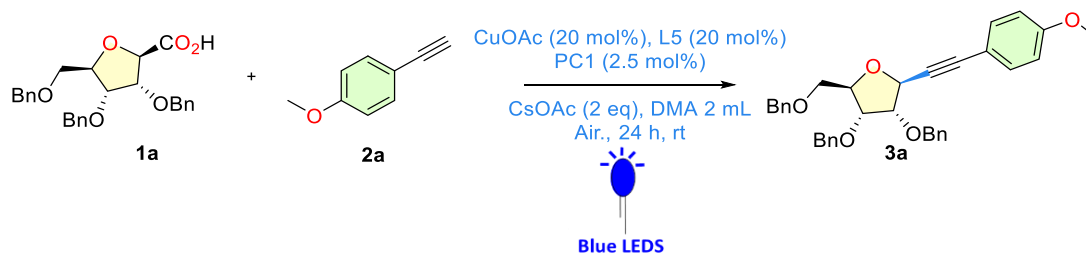
**Table 22.** Screening amount of **1a** and **2a**

Entry	Amount of <b>1a</b>	Amount of <b>2a</b>	Yield <b>3a</b> (%) <sup>b</sup>
<b>1</b>	0.4 mmol	0.2 mmol	<b>78</b>

<b>2</b>	0.2 mmol	1.0 mmol	<b>40</b>
<b>3</b>	0.3 mmol	<b>0.2 mmol</b>	<b>32</b>

<sup>a</sup> Reactions conditions: **1a** (x mmol), **2a** (x mmol), PC1 (2.5 mol%), CuOAc (20 mol%), L5 (20 mol%), CsOAc (0.4 mmol), DMA (2.0 mL), blue LEDs (4.5 W, irradiation). <sup>b</sup>Isolated yield.

**Table 23.** Screening photocatalyst

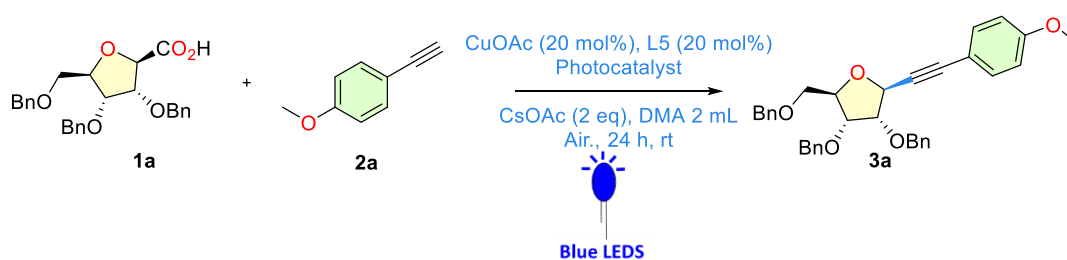

Entry	Photocatalyst	Yield 3a (%) <sup>b</sup>
<b>1</b>	PC2 (2.5 mol%)	<b>96</b>
<b>2</b>	PC 1 (2.5 mol%)	<b>78</b>
<b>3</b>	PC 3 (2.5 mol%)	<b>traces</b>
<b>4</b>	PC 4 (2.5 mol%)	<b>traces</b>
<b>5</b>	PC 5 (2.5 mol%)	<b>traces</b>
<b>6</b>	PC 2 (1.0 mol%)	<b>50</b>
<b>7</b>	PC 2 (5.0 mol%)	<b>50</b>
<b>8</b>	---	<b>traces</b>

<sup>a</sup> Reactions conditions: **1a** (0.4 mmol), **2a** (0.2 mmol), Photocatalyst (n mol%), CuOAc (20 mol%), L5 (20 mol%), CsOAc (0.4 mmol), DMA (2.0 mL), blue LEDs (4.5 W, irradiation). <sup>b</sup>Isolated yield.



**Table 24.** Screening Ligand

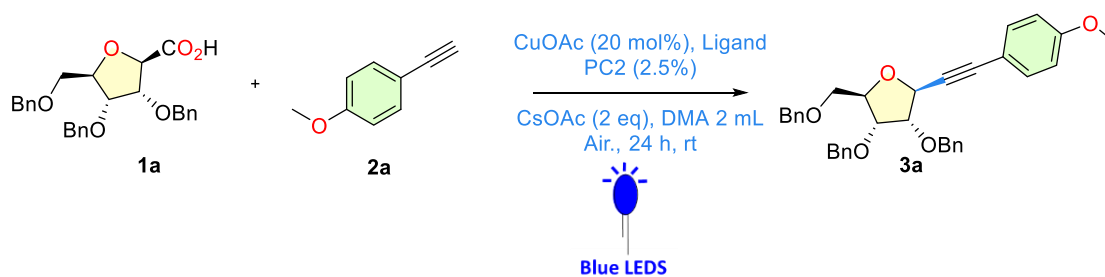

Entry	Ligand	Yield <b>3a</b> (%) <sup>b</sup>
<b>1</b>	L5 (20 mol%)	<b>96</b>
<b>2</b>	L2 (20 mol%)	<b>traces</b>
<b>3</b>	L3 (20 mol%)	<b>traces</b>
<b>4</b>	L4 (20 mol%)	<b>traces</b>
<b>5</b>	L1 (20 mol%)	<b>traces</b>
<b>6</b>	L6 (20 mol%)	<b>48</b>
<b>7</b>	L7 (20 mol%)	<b>75</b>
<b>8</b>	L8 (20 mol%)	<b>78</b>
<b>9</b>	L5 (10 mol%)	<b>61</b>
<b>10</b>	L5 (30 mol%)	<b>32</b>
<b>11</b>	-	<b>traces</b>

<sup>a</sup> Reactions conditions: **1a** (0.4 mmol), **2a** (0.2 mmol), PC2 (2.5 mol%), CuOAc (20 mol%), Ligand (n mol%), CsOAc (0.4 mmol), DMA (2.0 mL), blue LEDs (4.5 W, irradiation). <sup>b</sup> Isolated yield.

**Table 25.** Screening load of base and time of reaction

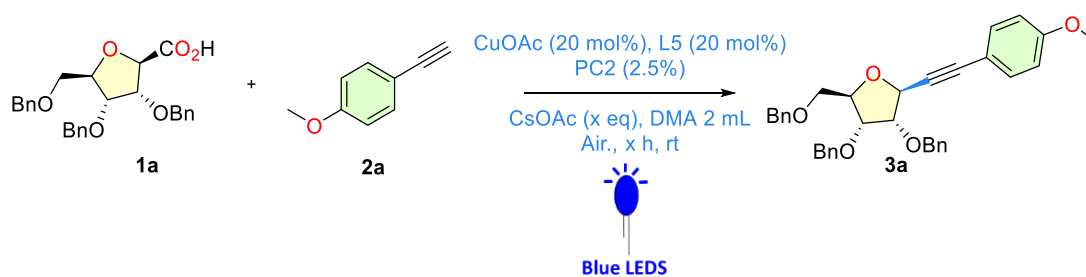

Entry	Amount of Base (eq)	Time	Yield <b>3a</b> (%) <sup>b</sup>
<b>1</b>	2	24 h	<b>96</b>
<b>2</b>	1	24 h	<b>61</b>
<b>3</b>	4	24 h	<b>96</b>
<b>4</b>	2	18 h	<b>83</b>
<b>5</b>	2	<b>36 h</b>	<b>92</b>

<sup>a</sup> Reactions conditions: **1a** (0.4 mmol), **2a** (0.2 mmol), **PC2** (2.5 mol%), **CuOAc** (20 mol%), **L5** (20 mol%), **CsOAc** (n mmol), **DMA** (2.0 mL), blue LEDs (4.5 W, irradiation). <sup>b</sup> Isolated yield.

## Synthesis of Carbohydrate carboxylic acids

**Scheme 50.** Synthesis of O-benzyl protected anomeric ribosyl acid (**1a**)<sup>185</sup>

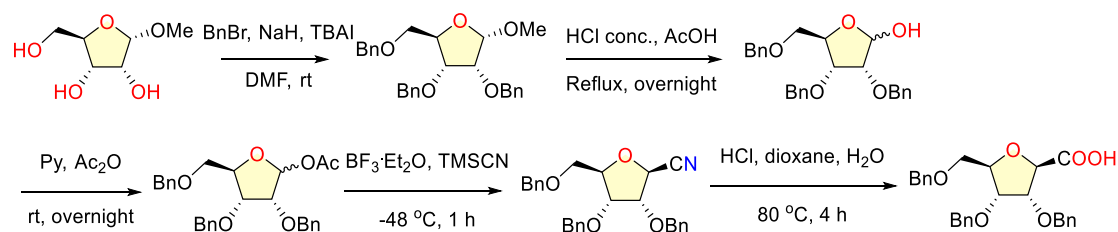

**Scheme 51.** Synthesis of O-Bz protected anomeric β-ribose acid (**1b**)<sup>186</sup>

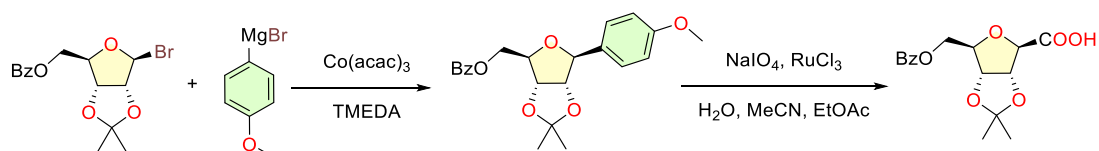

**Scheme 52.** Synthesis of O-Ac protected anomeric β-ribose acid (**1c**)<sup>171</sup>

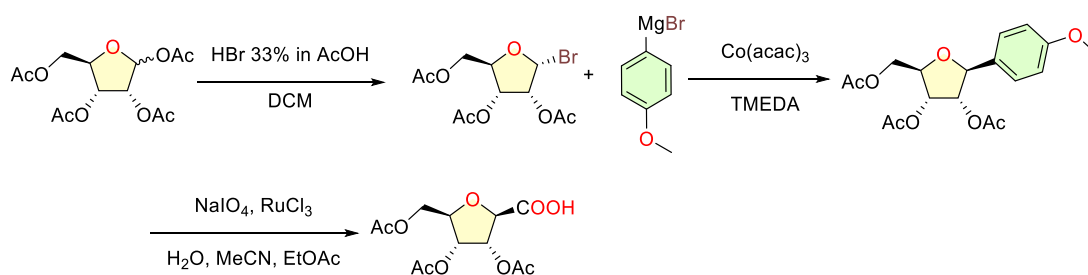

<sup>185</sup> a) Togo, H.; Ishigami, S.; Fujii, M.; Ikuma, T.; Yokoyama, M. *J. Chem. Soc. Perkin Trans. 1* **1994**, 2931–2942. b) Van Rijssel, E. R.; Van Delft, P.; Lodder, G.; Overkleeft, H. S.; Van der Marel, G. A.; Filippov, D. V.; Codée, J. D. *C. Angew. Chem. Int. Ed.* **2014**, *53*, 10381–10385. c) Araki, L.; Morita, K.; Yamaguchi, M.; Zhao, Z.-Y.; Wilson, T. J.; Lilley, D. M. J.; Harusawa, S., *J. Org. Chem.* **2009**, *74*, 2350–2356. d) Adlington, R. M.; Baldwin, J. E.; Pritchard, G. J.; Spencer, K. C. *Tetrahedron Lett.* **2000**, *41*, 575–578.

<sup>186</sup> Zou, L.; Pan, Q.; Li, C.; Zhang, Z.; Zhang, X.; Hu, X. *Org. Lett.* **2020**, *22*, 8302–8306.

**Scheme 53.** Synthesis of O-benzyl protected anomeric  $\beta$ -deoxyribose acid ( **$\beta$ -1d,  $\alpha$ -1d**)<sup>187</sup>

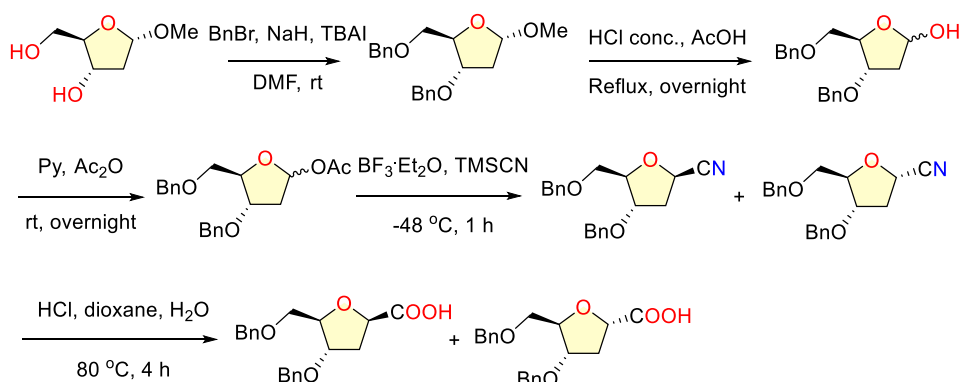

**Scheme 54.** Synthesis of non-anomeric furanoside acid (**1e**)<sup>188</sup>

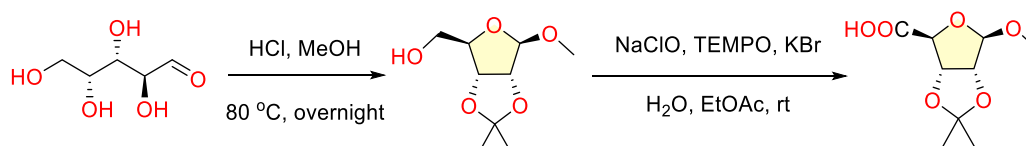

## General Procedures

A glass tube equipped with a stir bar was covered by a rubber with syringe needle (size: 1.2x40 mm) which was charged with carbohydrate acid (2 equiv), alkyne (1 equiv), [Ir{dF(CF<sub>3</sub>)ppy}<sub>2</sub>(dtbbpy)]PF<sub>6</sub> (2.5 mol%), CuOAc (20 mol%), CsOAc (2 equiv), ( $\pm$ )-trans-1, 2-Diaminocyclohexane (20 mol%), and then DMA (0.1 M) was added. The mixture was pre-mixed for 1 min at room temperature. After that, the mixture was placed in the photoreactor vessel ~5-7 cm away from the blue LEDs, and allowed to stirred vigorously for 24 h at rt. The temperature of the reaction was maintained at approximately 25 °C via a fan. Afterward, H<sub>2</sub>O (10 mL) was added to the crude and the mixture was extracted with EtOAc (3 x 10 mL), washed with brine (3 x 10 mL). Organic

<sup>187</sup> a) Adlington, R. M.; Baldwin, J. E.; Pritchard, G. J.; Spencer, K. C. *Tetrahedron Lett.* **2000**, *41*, 575–578. b) Takase, M.; Morikawa, T.; Abe, H.; Inouye, M. *Org. Lett.* **2003**, *5*, 625–628. c) Zou, L.; Pan, Q.; Li, C.; Zhang, Z.; Zhang, X.; Hu, X. *Org. Lett.* **2020**, *22*, 8302–8306.

<sup>188</sup> Hollibaugh, R.; Yu, X.; Brabander, J. K. D. *Tetrahedron*, **2020**, *76*, 131673-131677.

layers were dried by Na<sub>2</sub>SO<sub>4</sub>, filtration, concentrated under vacuo. Purification was performed with flash chromatography on silica gel.

Note: The size of syringe is important. When 1.2 mm needle was used, the best yield was got. When thin needle was used (for example 0.8 mm needle), a lot of alkene product was formed. When this reaction reacted without rubber, the reaction result was exactly same with the reaction react covered by a rubber with syringe needle (1.2 mm).

### Unsuccessful substrates

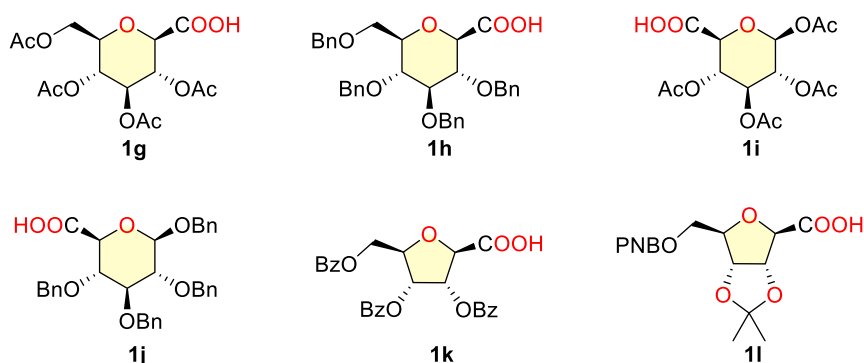
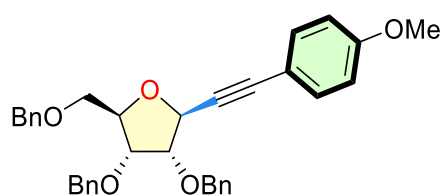

Figure 18. Unsuccessful substrates

### Expremental Data:

(2*R*,3*R*,4*S*,5*S*)-3,4-bis(benzyloxy)-2-((benzyloxy)methyl)-5-((4-methoxyphenyl)ethynyl) tetrahydrofuran (**3a**):



According to general procedure, (2*R*, 3*R*, 4*S*, 5*S*)- 3, 4-bis (benzyloxy)- 5 -((benzyloxy) methyl) tetrahydrofuran-2-carboxylic acid **1a** (179.4 mg, 0.4 mmol, 2 equiv) and 1-ethynyl-4-methoxybenzene **2a** (26.4 mg, 0.2 mmol, 1.0 equiv) were allowed to react for 24 h. Product **3a** was isolated after flash chromatography as a colorless oil (102.6 mg, 96%). *R<sub>f</sub>* = 0.3 (EtOAc /cyclohexane: 1/4); [ $\alpha$ ]<sub>D</sub><sup>18</sup> = – 45.0 (c, 0.07, CHCl<sub>3</sub>); <sup>1</sup>H NMR (300 MHz, CDCl<sub>3</sub>)  $\delta$  7.17-7.29 (m, 17H), 6.72-6.75 (m, 2H), 4.80 (d, *J* = 4.5

Hz, 1H), 4.59-4.71 (m, 2H), 4.52-4.55 (d,  $J = 9.0$  Hz, 2H), 4.43-4.48 (m, 2H), 4.13-4.17 (m, 1H), 3.99-4.04 (m, 2H), 3.73 (s, 3H);  $^{13}\text{C}$  NMR (J-MOD, 75 MHz,  $\text{CDCl}_3$ )  $\delta$  159.8 (C), 138.3 (C), 137.9 (C), 137.8 (C), 133.3 (2CH), 128.4 (4CH), 128.3 (2CH), 128.1 (CH), 128.0 (CH), 127.9 (2CH), 127.8 (2CH), 127.6 (2CH), 127.5 (2CH), 114.6 (C), 113.9 (CH), 86.7 (C), 85.3 (C), 82.1 (CH), 81.4 (CH), 78.2 (CH), 73.5 ( $\text{CH}_2$ ), 72.3 (2 $\text{CH}_2$ ), 71.7 (CH), 70.2 ( $\text{CH}_2$ ), 55.3 ( $\text{CH}_3$ ). HRMS (ESI):  $m/z$  calc. for  $\text{C}_{35}\text{H}_{38}\text{NO}_5$   $[\text{M}+\text{NH}_4]^+$  552.2750; found 552.2755.

**(2R,3R,4S,5S)-3,4-bis(benzyloxy)-2-((benzyloxy)methyl)-5-(phenylethynyl)tetrahydrofuran (3b)<sup>189</sup>:**

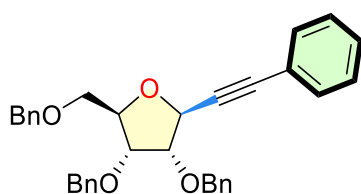

According to general procedure, (2R, 3R, 4S, 5S)- 3, 4-bis (benzyloxy)- 5 -((benzyloxy) methyl) tetrahydrofuran-2-carboxylic acid **1a** (179.4 mg, 0.4 mmol, 2 equiv) and ethynylbenzene **2b** (20.4 mg, 0.2 mmol, 1.0 equiv) were allowed to react for 24 h. Product **3b** was isolated after flash chromatography as a colorless oil (93.8 mg, 93%).  $R_f = 0.3$  (EtOAc /cyclohexane: 1/4); colorless oil;  $[\alpha]_D^{18} = -40.0$  (c, 0.10,  $\text{CHCl}_3$ );  $^1\text{H}$  NMR (300 MHz,  $\text{CDCl}_3$ )  $\delta$  7.28-7.43 (m, 20H), 4.93 (d,  $J = 4.3$  Hz, 1H), 4.54-4.82 (m, 6H), 4.26-4.30 (m, 1H), 4.43-4.48 (m, 2H), 4.11-4.17 (m, 2H), 3.61-3.72 (m, 2H);  $^{13}\text{C}$  NMR (J-MOD, 75 MHz,  $\text{CDCl}_3$ )  $\delta$  138.2 (C), 137.9 (C), 137.7 (C), 131.8 (CH), 128.5 (4CH), 128.4 (2CH), 128.3 (3CH), 128.0 (2CH), 127.9 (2CH), 127.8 (2CH), 127.6 (2CH), 127.5 (2CH), 122.5 (C), 86.7 (2C), 82.0 (CH), 81.5 (CH), 78.1 (CH), 73.5

---

<sup>189</sup> a) Naud, S.; Pipelier, M.; Viault, G.; Adjou, A.; Huet, F.; Legoupy, S.; Aubertin, A.; Evain, M.; Dubreuil, D., *Eur. J. Org. Chem.*, **2007**, 20, 3296–3310; b) Zhai, D.; Zhai, W.; Williams, R. M. *J. Am. Chem. Soc.* **1988**, 110, 2501–2505; c) Naud, S.; Pipelier, M.; Chaumette, C.; Viault, G.; Huet, F.; Legoupy, S.; Dubreuil, D. *Synlett*, **2007**, 3, 403–406.

(CH<sub>2</sub>), 72.3 (2CH<sub>2</sub>), 71.6 (CH), 70.1 (CH<sub>2</sub>). **HRMS** (ESI): *m/z* calc. for C<sub>34</sub>H<sub>36</sub>NO<sub>4</sub> [M+NH<sub>4</sub>]<sup>+</sup> 522.2644; found 522.2643.

NB. The product is contaminated with small amount (3%) of C-vinyl-nucleoside

**(2*R*,3*R*,4*S*,5*S*)-3,4-bis(benzyloxy)-2-((benzyloxy)methyl)-5-((4-chlorophenyl)ethynyl) tetrahydrofuran (3c):**

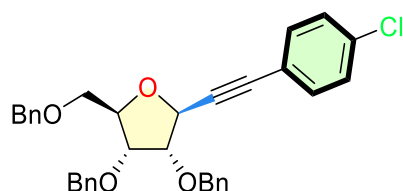

According to general procedure, (2*R*, 3*R*, 4*S*, 5*S*)- 3, 4-bis (benzyloxy)- 5 -((benzyloxy) methyl) tetrahydrofuran-2-carboxylic acid **1a** (179.4 mg, 0.4 mmol, 2 equiv) and 1-chloro-4-ethynylbenzene **2c** (27.3 mg, 0.2 mmol, 1.0 equiv) were allowed to react for 24 h. Product **3c** was isolated after flash chromatography as a colorless oil (90.4 mg, 84%). **R<sub>f</sub>** = 0.3 (EtOAc /cyclohexane: 1/4); colorless oil; [α]<sub>D</sub><sup>18</sup> = – 14.5 (c, 1.03, CHCl<sub>3</sub>); **<sup>1</sup>H NMR (300 MHz, CDCl<sub>3</sub>)** δ 7.28-7.43 (m, 19H), 4.90 (d, *J* = 4.5 Hz, 1H), 4.54-4.84 (m, 6H), 4.25-4.29 (m, 1H), 4.11-4.16 (m, 2H), 3.61-3.71(m, 2H); **<sup>13</sup>C NMR (J-MOD, 75 MHz, CDCl<sub>3</sub>)** δ 138.2 (C), 137.9 (C), 137.7 (C), 134.6 (C), 133.0 (CH), 128.6 (CH), 128.4 (4CH), 128.2 (2CH), 128.0 (2CH), 127.9 (3CH), 127.8 (CH), 127.7 (CH), 127.6 (2CH), 127.5 (CH), 121.0 (C), 87.7 (C), 85.5 (C), 82.1 (CH), 81.6 (CH), 78.0 (CH), 73.5 (CH<sub>2</sub>), 72.4 (2CH<sub>2</sub>), 71.5 (CH), 70.1 (CH<sub>2</sub>). **HRMS** (ESI): *m/z* calc. for C<sub>34</sub>H<sub>35</sub>ClNO<sub>4</sub> [M+NH<sub>4</sub>]<sup>+</sup> 556.2255; found 556.2254.

NB. The product is contaminated with small amount (6%) of C-vinyl-nucleoside

**(2*R*,3*R*,4*S*,5*S*)-3,4-bis(benzyloxy)-2-((benzyloxy)methyl)-5-((4-fluorophenyl)ethynyl) tetrahydrofuran (3d):**

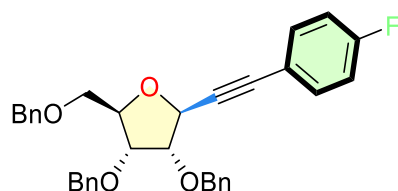

According to general procedure, (2*R*, 3*R*, 4*S*, 5*S*)- 3, 4-bis (benzyloxy)- 5 -((benzyloxy) methyl) tetrahydrofuran-2-carboxylic acid **1a** (179.4 mg, 0.4 mmol, 2 equiv) and 1-ethynyl-4-fluorobenzene **2d** (24.0 mg, 0.2 mmol, 1.0 equiv) were allowed to react for 24 h. Product **3d** was isolated after flash chromatography as a colorless oil (82.6 mg, 79%). **R<sub>f</sub>** = 0.3 (EtOAc /cyclohexane: 1/4); colorless oil; [ $\alpha$ ]<sub>D</sub><sup>18</sup> = – 15.3 (c, 0.39, CHCl<sub>3</sub>); <sup>1</sup>H NMR (300 MHz, CDCl<sub>3</sub>)  $\delta$  7.28-7.43 (m, 17H), 6.99-7.04 (m, 2H), 4.91 (d, *J* = 4.2 Hz, 1H), 4.54-4.81 (m, 6H), 4.26-4.30 (m, 1H), 4.12-4.17 (m, 2H), 3.62-3.72(m, 2H); <sup>13</sup>C NMR (J-MOD, 75 MHz, CDCl<sub>3</sub>)  $\delta$  162.7 (C, *J* = 248 Hz), 138.3 (C), 137.9 (C), 137.7 (C), 133.8 (CH), 133.6 (CH), 128.4 (4CH), 128.3 (CH), 128.0 (2CH), 127.9 (4CH), 127.8 (CH), 127.6 (2CH), 127.5 (CH), 118.6 (C), 115.7 (CH), 115.4 (CH), 86.4 (C), 85.6 (C), 82.1 (CH), 81.6 (CH), 78.0 (CH), 73.5 (CH<sub>2</sub>), 72.4 (CH<sub>2</sub>), 71.5 (CH), 70.1 (CH<sub>2</sub>); <sup>19</sup>F NMR (Decoupled, 188 MHz, CDCl<sub>3</sub>)  $\delta$  -110.53 (F). HRMS (ESI): *m/z* calc. for C<sub>34</sub>H<sub>35</sub>FNO<sub>4</sub> [M+NH<sub>4</sub>]<sup>+</sup> 540.2550; found 540.2552.

**(2*R*,3*R*,4*S*,5*S*)-3,4-bis(benzyloxy)-2-((benzyloxy)methyl)-5-( 4-(trifluoromethyl) phenyl)ethynyl) tetrahydrofuran (3e):**

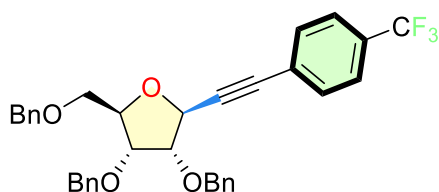

According to general procedure, (2*R*, 3*R*, 4*S*, 5*S*)- 3, 4-bis (benzyloxy)- 5 -((benzyloxy) methyl) tetrahydrofuran-2-carboxylic acid **1a** (179.4 mg, 0.4 mmol, 2 equiv) and 1-ethynyl-4-(trifluoromethyl)benzene **2e** (34.1 mg, 0.2 mmol, 1.0 equiv) were allowed to react for 24 h. Product **3e** was isolated after flash chromatography as a colorless oil (71.0 mg, 62 %). **R<sub>f</sub>** = 0.3 (EtOAc /cyclohexane: 1/4); colorless oil; [ $\alpha$ ]<sub>D</sub><sup>18</sup> = – 9.3 (c, 0.96, CHCl<sub>3</sub>); <sup>1</sup>H NMR (300 MHz, CDCl<sub>3</sub>)  $\delta$  7.44-7.47 (m, 2H), 7.35-7.38 (m, 2H), 7.16-7.29 (m, 15H), 4.81 (d, *J* = 4.5 Hz, 1H), 4.42-4.64 (m, 6H), 4.15-4.18 (m, 1H), 4.01-4.07 (m, 2H), 3.50-3.60 (m, 2H); <sup>13</sup>C NMR (J-MOD, 75 MHz, CDCl<sub>3</sub>)  $\delta$  138.2 (C), 137.8 (C), 137.6 (C), 132.0 (2CH), 130.3 (C, *J* = 30 Hz), 128.5 (2CH), 128.4 (2CH), 128.3 (2CH), 128.0 (2CH), 127.9 (4CH), 127.6 (3CH), 126.3 (C), 125.1 (2CH, *J* = 8 Hz), 124.0 (C, *J* = 263 Hz), 89.2 (C), 85.2 (C), 82.1 (CH), 81.7 (CH), 77.9 (CH), 73.5 (CH<sub>2</sub>), 72.4 (2CH<sub>2</sub>), 71.4 (CH), 70.0 (CH<sub>2</sub>); <sup>19</sup>F NMR (Decoupled, 188 MHz, CDCl<sub>3</sub>)



$\delta$  -62.89 (CF<sub>3</sub>). **HRMS** (ESI):  $m/z$  calc. for C<sub>35</sub>H<sub>35</sub>F<sub>3</sub>NO<sub>4</sub> [M+NH<sub>4</sub>]<sup>+</sup> 590.2518; found 590.2511.

NB. The product is contaminated with small amount (7%) of C-vinyl-nucleoside

**1-(4-(((2*S*,3*S*,4*R*,5*R*)-3,4-bis(benzyloxy)-5-((benzyloxy)methyl)tetrahydrofuran-2-yl)ethynyl) phenyl) ethan-1-one (3f):**

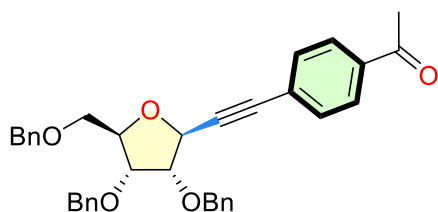

According to general procedure, (2*R*, 3*R*, 4*S*, 5*S*)- 3, 4-bis (benzyloxy)- 5 -((benzyloxy) methyl) tetrahydrofuran-2-carboxylic acid **1a** (179.4 mg, 0.4 mmol, 2 equiv) and 1-(4-ethynylphenyl)ethan-1-one **2f** (29.0 mg, 0.2 mmol, 1.0 equiv) were allowed to react for 24 h. Product **3f** was isolated after flash chromatography as a colorless oil (53.5 mg, 49%). **R<sub>f</sub>** = 0.3 (EtOAc /cyclohexane: 1/4); colorless oil; [ $\alpha$ ]<sub>D</sub><sup>18</sup> = - 6.8 (c, 0.15, CHCl<sub>3</sub>); **<sup>1</sup>H NMR (300 MHz, CDCl<sub>3</sub>)**  $\delta$  7.79-7.82 (m, 2H), 7.35-7.38 (m, 2H), 7.18-7.27 (m, 15H), 4.82 (d, *J* = 4.8 Hz, 1H), 4.43-4.65 (m, 6H), 4.15-4.20 (m, 1H), 4.00-4.07 (m, 2H), 3.38-3.63 (m, 2H), 2.52 (s, 3H); **<sup>13</sup>C NMR (J-MOD, 75 MHz, CDCl<sub>3</sub>)**  $\delta$  196.6 (C), 144.3 (C), 139.5 (C), 136.5 (2C), 131.9 (CH), 133.2 (CH), 28.4 (4CH), 128.3 (2CH), 128.1 (2CH), 128.0 (2CH), 127.9 (3CH), 127.8 (CH), 127.6 (2CH), 127.5 (CH), 121.4 (C), 96.2 (C), 90.0 (C), 82.1 (CH), 81.7 (CH), 78.0 (CH), 73.5 (CH<sub>2</sub>), 72.4 (2CH<sub>2</sub>), 71.4 (CH), 70.0 (CH<sub>2</sub>), 26.6 (CH<sub>3</sub>). **HRMS** (ESI):  $m/z$  calc. for C<sub>36</sub>H<sub>38</sub>NO<sub>5</sub> [M+NH<sub>4</sub>]<sup>+</sup> 564.2750; found 564.2743.

**Methyl 4-(((2*S*,3*S*,4*R*,5*R*)-3,4-bis(benzyloxy)-5-((benzyloxy)methyl)tetrahydrofuran-2-yl)ethynyl) benzoate (3g):**

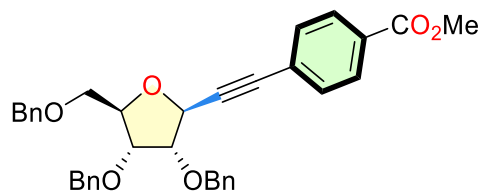

According to general procedure, (2*R*, 3*R*, 4*S*, 5*S*)- 3, 4-bis (benzyloxy)- 5 -((benzyloxy) methyl) tetrahydrofuran-2-carboxylic acid **1a** (179.4 mg, 0.4 mmol, 2 equiv) and methyl 4-ethynylbenzoate **2g** (32.2 mg, 0.2 mmol, 1.0 equiv) were allowed to react for 24 h. Product **3g** was isolated after flash chromatography as a colorless oil (94.5 mg, 84%). **R<sub>f</sub>** = 0.3 (EtOAc /cyclohexane: 1/4); colorless oil; **[α]<sub>D</sub><sup>18</sup>** = – 4.1 (c, 0.25, CHCl<sub>3</sub>); **<sup>1</sup>H NMR (300 MHz, CDCl<sub>3</sub>)** δ 7.86-7.90 (m, 2H), 7.17-7.35 (m, 17H), 4.81 (d, *J* = 4.5 Hz, 1H), 4.43-4.65 (m, 6H), 4.15-4.19 (m, 1H), 4.01-4.07 (m, 2H), 3.84 (s, 3H), 3.50-3.60 (m, 2H); **<sup>13</sup>C NMR (J-MOD, 75 MHz, CDCl<sub>3</sub>)** δ 160.0 (C), 138.2 (C), 137.8 (C), 137.6 (C), 131.7 (2CH), 129.8 (C), 129.4 (2CH), 128.5 (2CH), 128.4 (2CH), 128.3 (2CH), 128.0 (2CH), 127.9 (2CH), 127.8 (2CH), 127.6 (2CH), 127.5 (CH), 127.1 (C), 89.7 (C), 85.8 (C), 82.1 (CH), 81.7 (CH), 78.0 (CH), 73.5 (CH<sub>2</sub>), 72.4 (2CH<sub>2</sub>), 71.5 (CH), 70.1 (CH<sub>2</sub>), 52.2 (CH<sub>3</sub>); **HRMS (ESI):** m/z calc. for C<sub>36</sub>H<sub>38</sub>NO<sub>5</sub> [M+NH<sub>4</sub>]<sup>+</sup> 580.2699; found 580.2697

NB. The product is contaminated with small amount (6%) of C-vinyl-nucleoside

**(2*R*,3*R*,4*S*,5*S*)-3,4-bis(benzyloxy)-2-((benzyloxy)methyl)-5-(m-tolyethynyl)tetrahydrofuran (**3h**):**

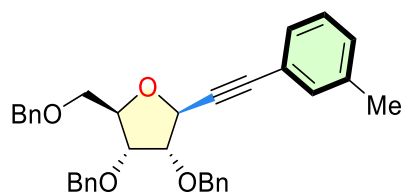

According to general procedure, (2*R*, 3*R*, 4*S*, 5*S*)- 3, 4-bis (benzyloxy)- 5 -((benzyloxy) methyl) tetrahydrofuran-2-carboxylic acid **1a** (179.4 mg, 0.4 mmol, 2 equiv) and 1-ethynyl-3-methylbenzene **2h** (23.2 mg, 0.2 mmol, 1.0 equiv) were allowed to react for 24 h. Product **3h** was isolated after flash chromatography as a colorless oil (76.7 mg, 74%). **R<sub>f</sub>** = 0.3 (EtOAc /cyclohexane: 1/4); colorless oil; **[α]<sub>D</sub><sup>18</sup>** = – 21.2 (c, 0.85,

CHCl<sub>3</sub>); <sup>1</sup>H NMR (300 MHz, CDCl<sub>3</sub>) δ 7.15-7.44 (m, 19H), 4.92 (d, *J* = 4.5 Hz, 1H), 4.71-4.82 (m, 2H), 4.64-4.68 (m, 2H), 4.43-4.48 (m, 2H), 4.55-4.60 (m, 2H), 4.25-4.30 (m, 2H), 4.11-4.17 (m, 2H), 3.62-3.72 (m, 2H), 3.73 (s, 3H); <sup>13</sup>C NMR (J-MOD, 75 MHz, CDCl<sub>3</sub>) δ 138.3 (C), 137.9 (2C), 137.8 (C), 132.4 (2CH), 129.4 (2CH), 128.8 (2CH), 128.4 (4CH), 128.3 (2CH), 128.1 (CH), 128.0 (CH), 127.9 (CH), 127.8 (2CH), 127.6 (CH), 127.5 (CH), 122.3 (C), 86.9 (C), 86.3 (C), 82.1 (CH), 81.5 (CH), 78.2 (CH), 73.5 (CH<sub>2</sub>), 72.4 (2CH<sub>2</sub>), 71.6 (CH), 70.2 (CH<sub>2</sub>), 21.2 (CH<sub>3</sub>). HRMS (ESI): *m/z* calc. for C<sub>35</sub>H<sub>38</sub>NO<sub>4</sub> [M+NH<sub>4</sub>]<sup>+</sup> 536.2801; found 536.2798.

**(2*R*,3*R*,4*S*,5*S*)-3,4-bis(benzyloxy)-2-((benzyloxy)methyl)-5-((3-chlorophenyl)ethynyl) tetrahydrofuran (3i):**

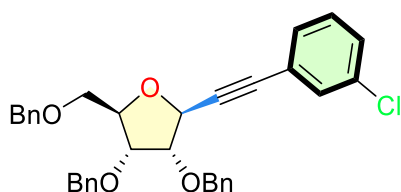

According to general procedure, (2*R*, 3*R*, 4*S*, 5*S*)- 3, 4-bis (benzyloxy)- 5 -((benzyloxy) methyl) tetrahydrofuran-2-carboxylic acid **1a** (179.4 mg, 0.4 mmol, 2 equiv) and 1-chloro-3-ethynylbenzene **2i** (27.2 mg, 0.2 mmol, 1.0 equiv) were allowed to react for 24 h. Product **3i** was isolated after flash chromatography as a colorless oil (91.5 mg, 85%). *R<sub>f</sub>* = 0.3 (EtOAc /cyclohexane: 1/4); colorless oil; [α]<sub>D</sub><sup>18</sup> = – 10.7 (c, 0.09, CHCl<sub>3</sub>); <sup>1</sup>H NMR (300 MHz, CDCl<sub>3</sub>) δ 7.24-7.41 (m, 19H), 4.30 (d, *J* = 4.5 Hz, 1H), 4.54-4.79 (m, 6H), 4.26-4.30 (m, 1H), 4.11-4.16 (m, 2H), 3.57-3.71 (m, 2H); <sup>13</sup>C NMR (J-MOD, 75 MHz, CDCl<sub>3</sub>) δ 138.2 (C), 137.8 (C), 137.6 (C), 134.1 (C), 131.6 (CH), 129.9 (CH), 129.5 (CH), 128.8 (CH), 128.5 (2CH), 128.4 (2CH), 128.3 (2CH), 128.0 (2CH), 127.9 (2CH), 127.8 (2CH), 127.6 (2CH), 127.5 (CH), 124.2 (C), 88.0 (C), 85.2 (C), 82.1 (CH), 81.6 (CH), 78.0 (CH), 73.5 (CH<sub>2</sub>), 72.4 (2CH<sub>2</sub>), 71.4 (CH), 70.1 (CH<sub>2</sub>); HRMS (ESI): *m/z* calc. for C<sub>34</sub>H<sub>35</sub>ClNO<sub>4</sub> [M+NH<sub>4</sub>]<sup>+</sup> 556.2255; found 556.2250.

**(2*R*,3*R*,4*S*,5*S*)-3,4-bis(benzyloxy)-2-((benzyloxy)methyl)-5-((3-fluorophenyl)ethynyl) tetrahydrofuran (3j):**

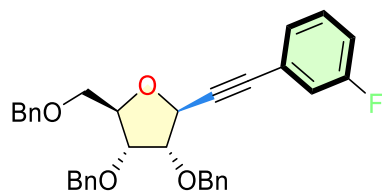

According to general procedure, (2*R*, 3*R*, 4*S*, 5*S*)- 3, 4-bis (benzyloxy)- 5 -((benzyloxy) methyl) tetrahydrofuran-2-carboxylic acid **1a** (179.4 mg, 0.4 mmol, 2 equiv) and 1-ethynyl-3-fluorobenzene **2j** (24.0 mg, 0.2 mmol, 1.0 equiv) were allowed to react for 24 h. Product **3j** was isolated after flash chromatography as a colorless oil (70.0 mg, 67%). *R<sub>f</sub>* = 0.3 (EtOAc /cyclohexane: 1/4); colorless oil; [ $\alpha$ ]<sub>D</sub><sup>18</sup> = – 11.1 (c, 0.09, CHCl<sub>3</sub>); <sup>1</sup>H NMR (300 MHz, CDCl<sub>3</sub>) δ 7.18-7.34 (m, 17H), 7.03-7.12 (m, 2H), 4.93 (d, *J* = 4.5 Hz, 1H), 4.55-4.82 (m, 6H), 4.25-4.32 (m, 1H), 4.13-4.19 (m, 2H), 3.60-3.73 (m, 2H); <sup>13</sup>C NMR (J-MOD, 75 MHz, CDCl<sub>3</sub>) δ 162.3 (C, *J* = 240 Hz), 138.2 (C), 137.9 (C), 137.7 (C), 129.8 (CH, *J* = 8 Hz), 128.5 (2CH), 128.4 (2CH), 128.3 (2CH), 128.0 (2CH), 127.9 (2CH), 127.8 (CH), 127.7 (CH), 127.6 (3CH), 118.5 (CH, *J* = 23 Hz), 115.9 (CH, *J* = 15 Hz), 87.7 (C), 85.4 (C), 82.1 (CH), 81.7 (CH), 77.5 (CH), 73.5 (CH<sub>2</sub>), 72.4 (2CH<sub>2</sub>), 71.4 (CH), 70.1 (CH<sub>2</sub>); <sup>19</sup>F NMR (Decoupled, 188 MHz, CDCl<sub>3</sub>) δ -112.94 (F). HRMS (ESI): *m/z* calc. for C<sub>34</sub>H<sub>35</sub>FNO<sub>4</sub> [M+NH<sub>4</sub>]<sup>+</sup> 540.2550; found 540.2550.

NB. The product is contaminated with small amount (6%) of C-vinyl-nucleoside

(2*R*,3*R*,4*S*,5*S*)-3,4-bis(benzyloxy)-2-((benzyloxy)methyl)-5-(trifluoromethyl)phenyl ethynyl tetrahydrofuran (**3k**):

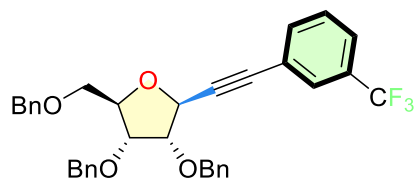

According to general procedure, (2*R*, 3*R*, 4*S*, 5*S*)- 3, 4-bis (benzyloxy)- 5 -((benzyloxy) methyl) tetrahydrofuran-2-carboxylic acid **1a** (179.4 mg, 0.4 mmol, 2 equiv) and

(bromoethynyl)triisopropylsilane **2k** (34.0 mg, 0.2 mmol, 1.0 equiv) were allowed to react for 24 h. Product **3k** was isolated after flash chromatography as a colorless oil (67.6 mg, 59%). **Rf** = 0.3 (EtOAc /cyclohexane: 1/4); colorless oil;  $[\alpha]_D^{18} = -5.9$  (c, 0.17, CHCl<sub>3</sub>); <sup>1</sup>H NMR (300 MHz, CDCl<sub>3</sub>) δ 7.58-7.66 (m, 2H), 7.44-7.57 (m, 2H), 7.28-7.41 (m, 15H), 4.91 (d, *J* = 4.5 Hz, 1H), 4.54-4.75 (m, 6H), 4.26-4.30 (m, 1H), 4.11-4.17 (m, 2H), 3.56-3.74 (m, 2H); <sup>13</sup>C NMR (J-MOD, 75 MHz, CDCl<sub>3</sub>) δ 138.1 (C, *J* = 8 Hz), 137.8 (C), 137.6 (C), 134.9 (CH), 131.9 (CH, *J* = 23 Hz), 128.8 (CH), 128.6 (2CH), 128.5 (2CH), 128.4 (CH), 128.3 (2CH), 128.0 (2CH), 127.9 (3CH), 127.7 (CH), 127.6 (2CH), 125.0 (C, *J* = 8 Hz), 123.4 (C), 111.5 (C, *J* = 278 Hz), 88.4 (C), 85.0 (C), 82.1 (CH), 81.7 (CH), 77.9 (CH), 73.5 (CH<sub>2</sub>), 72.4 (2CH<sub>2</sub>), 71.4 (CH), 70.1 (CH<sub>2</sub>); <sup>19</sup>F NMR (Decoupled, 188 MHz, CDCl<sub>3</sub>) δ -62.95 (CF<sub>3</sub>). HRMS (ESI): *m/z* calc. for C<sub>35</sub>H<sub>35</sub>F<sub>3</sub>NO<sub>4</sub> [M+NH<sub>4</sub>]<sup>+</sup> 590.2518; found 590.2520

**(2*R*,3*R*,4*S*,5*S*)-3,4-bis(benzyloxy)-2-((benzyloxy)methyl)-5-((3-methoxyphenyl)ethynyl) tetrahydrofuran (**3l**):**

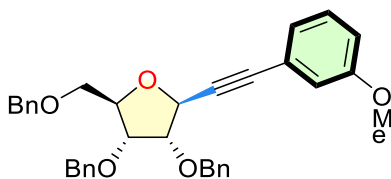

According to general procedure, (2*R*, 3*R*, 4*S*, 5*S*)- 3, 4-bis (benzyloxy)- 5 -((benzyloxy) methyl) tetrahydrofuran-2-carboxylic acid **1a** (179.4 mg, 0.4 mmol, 2 equiv) and 1-ethynyl-3-methoxybenzene **2l** (26.4 mg, 0.2 mmol, 1.0 equiv) were allowed to react for 24 h. Product **3l** was isolated after flash chromatography as a colorless oil (86.6 mg, 81%). **Rf** = 0.3 (EtOAc /cyclohexane: 1/4); colorless oil;  $[\alpha]_D^{18} = -15.2$  (c, 0.33, CHCl<sub>3</sub>); <sup>1</sup>H NMR (300 MHz, CDCl<sub>3</sub>) δ 7.26-7.44 (m, 15H), 7.21-7.24 (m, 1H), 7.01-7.04(m, 1H), 6.97-6.98(m, 1H), 6.98-6.93(m, 1H), 4.92 (d, *J* = 4.5 Hz, 1H), 4.55-4.82 (m, 6H), 4.26-4.30 (m, 1H), 4.11-4.17 (m, 2H), 3.81 (s, 3H), 3.62-3.72 (m, 2H); <sup>13</sup>C NMR (J-MOD, 75 MHz, CDCl<sub>3</sub>) δ 159.3 (C), 138.2 (C), 137.9 (C), 137.7 (C), 129.3 (CH), 128.4 (4CH), 128.3 (2CH), 128.0 (2CH), 127.9 (2CH), 127.8 (2CH), 127.6 (2CH), 127.5 (CH), 124.3 (CH), 123.5 (C), 116.6 (CH), 115.2 (CH), 86.6 (C), 86.5 (C),

82.1 (CH), 81.6 (CH), 78.1 (CH), 73.5 (CH<sub>2</sub>), 72.4 (2CH<sub>2</sub>), 71.6 (CH), 70.2 (CH<sub>2</sub>), 55.3 (CH<sub>3</sub>); **HRMS** (ESI): *m/z* calc. for C<sub>35</sub>H<sub>38</sub>NO<sub>5</sub> [M+NH<sub>4</sub>]<sup>+</sup> 552.2750; found 552.2753.

**(2*R*,3*R*,4*S*,5*S*)-3,4-bis(benzyloxy)-2-((benzyloxy)methyl)-5-((2-methoxyphenyl)ethynyl) tetrahydrofuran (**3m**):**

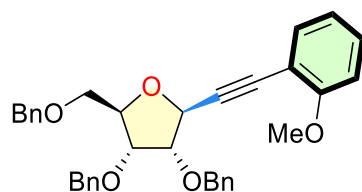

According to general procedure, (2*R*, 3*R*, 4*S*, 5*S*)- 3, 4-bis (benzyloxy)- 5 -((benzyloxy) methyl) tetrahydrofuran-2-carboxylic acid **1a** (179.4 mg, 0.4 mmol, 2 equiv) and 1-ethynyl-2-methoxybenzene **2m** (26.4 mg, 0.2 mmol, 1.0 equiv) were allowed to react for 24 h. Product **3m** was isolated after flash chromatography as a colorless oil (86.5 mg, 81%). *R<sub>f</sub>* = 0.3 (EtOAc /cyclohexane: 1/4); colorless oil; [ $\alpha$ ]<sub>D</sub><sup>18</sup> = - 3.2 (c, 0.32, CHCl<sub>3</sub>); <sup>1</sup>H NMR (300 MHz, CDCl<sub>3</sub>)  $\delta$  7.15-7.34 (m, 17H), 6.74-6.82 (m, 2H), 4.86 (d, *J* = 4.5 Hz, 1H), 4.44-4.77 (m, 6H), 4.14-4.17 (m, 1H), 4.01-4.09 (m, 2H), 3.71 (s, 3H), 3.55-3.57 (m, 2H); <sup>13</sup>C NMR (J-MOD, 75 MHz, CDCl<sub>3</sub>)  $\delta$  160.3 (C), 138.4 (C), 138.0 (C), 137.9 (C), 133.7 (CH), 130.0 (CH), 128.4 (4CH), 128.3 (2CH), 128.0 (2CH), 127.9 (2CH), 127.8 (2CH), 127.7 (2CH), 127.5 (CH), 120.4 (CH), 111.8 (C), 110.7 (CH), 90.8 (C), 83.3 (C), 82.1 (CH), 81.5 (CH), 78.5 (CH), 73.5 (CH<sub>2</sub>), 72.4 (2CH<sub>2</sub>), 71.8 (CH), 70.4 (CH<sub>2</sub>), 55.7 (CH<sub>3</sub>); **HRMS** (ESI): *m/z* calc. for C<sub>35</sub>H<sub>38</sub>NO<sub>5</sub> [M+NH<sub>4</sub>]<sup>+</sup> 552.2750; found 552.2748.

**(2*R*,3*R*,4*S*,5*S*)-3,4-bis(benzyloxy)-2-((benzyloxy)methyl)-5-(*o*-tolylethynyl)tetrahydrofuran (**3n**):**

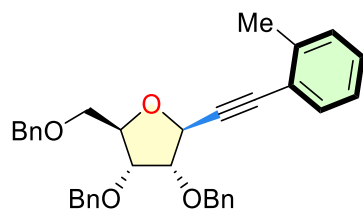

According to general procedure, (2*R*, 3*R*, 4*S*, 5*S*)- 3, 4-bis (benzyloxy)- 5 -((benzyloxy) methyl) tetrahydrofuran-2-carboxylic acid **1a** (179.4 mg, 0.4 mmol, 2 equiv) and 1-ethynyl-2-methylbenzene **2n** (23.2 mg, 0.2 mmol, 1.0 equiv) were allowed to react for 24 h. Product **3n** was isolated after flash chromatography as a colorless oil (74.6 mg, 72%). **R<sub>f</sub>** = 0.3 (EtOAc /cyclohexane: 1/4); colorless oil; **[α]<sub>D</sub><sup>18</sup>** = − 3.2 (c, 0.32 CHCl<sub>3</sub>); **<sup>1</sup>H NMR (300 MHz, CDCl<sub>3</sub>)** δ 7.15-7.44 (m, 19H), 4.97 (d, *J* = 4.2 Hz, 1H), 4.56-4.83 (m, 6H), 4.28-4.32 (m, 1H), 4.14-4.18 (m, 2H), 3.60-3.73 (m, 2H), 2.39 (s, 3H); **<sup>13</sup>C NMR (J-MOD, 75 MHz, CDCl<sub>3</sub>)** δ 140.4 (C), 138.3 (C), 137.9 (C), 137.7 (C), 132.1 (CH), 129.4 (CH), 128.5 (CH), 128.4 (4CH), 128.3 (2CH), 128.0 (2CH), 127.9 (2CH), 127.8 (2CH), 127.6 (2CH), 127.5 (CH), 125.5 (2CH), 123.3 (C), 90.6 (C), 85.5 (C), 82.3 (CH), 81.4 (CH), 78.1 (CH), 73.5 (CH<sub>2</sub>), 72.4 (2CH<sub>2</sub>), 71.6 (CH), 70.2 (CH<sub>2</sub>), 20.6 (CH<sub>3</sub>); **HRMS (ESI):** m/z calc. for C<sub>35</sub>H<sub>38</sub>NO<sub>4</sub> [M+NH<sub>4</sub>]<sup>+</sup> 536.2801; found 536.2803.

**(2*R*,3*R*,4*S*,5*S*)-3,4-bis(benzyloxy)-2-((benzyloxy)methyl)-5-((4-methoxy-2-methylphenyl) ethynyl) tetrahydrofuran (**3o**):**

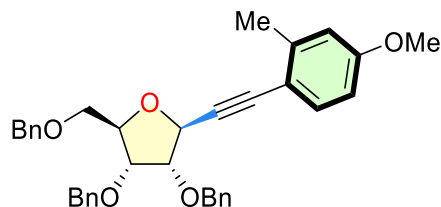

According to general procedure, (2*R*, 3*R*, 4*S*, 5*S*)- 3, 4-bis (benzyloxy)- 5 -((benzyloxy) methyl) tetrahydrofuran-2-carboxylic acid **1a** (179.4 mg, 0.4 mmol, 2 equiv) and 1-ethynyl-4-methoxy-2-methylbenzene **2o** (29.2 mg, 0.2 mmol, 1.0 equiv) were allowed to react for 24 h. Product **3o** was isolated after flash chromatography as a colorless oil (82.2 mg, 75%). **R<sub>f</sub>** = 0.3 (EtOAc /cyclohexane: 1/4); colorless oil; **[α]<sub>D</sub><sup>18</sup>** = − 22.5 (c, 0.84, CHCl<sub>3</sub>); **<sup>1</sup>H NMR (300 MHz, CDCl<sub>3</sub>)** δ 7.15-7.31 (m, 17H), 6.55-6.63 (m, 2H), 4.83 (d, *J* = 4.2 Hz, 1H), 4.43-4.84 (m, 6H), 4.14-4.19 (m, 1H), 3.99-4.04 (m, 2H), 3.70 (s, 3H), 3.50-3.60 (m, 2H), 2.24 (s, 3H); **<sup>13</sup>C NMR (J-MOD, 75 MHz, CDCl<sub>3</sub>)** δ 159.8

(C), 142.2 (C), 138.3 (C), 137.9 (C), 137.8 (C), 133.5 (CH), 128.4 (4CH), 128.3 (2CH), 128.0 (2CH), 127.9 (2CH), 127.8 (2CH), 127.6 (2CH), 127.5 (2CH), 115.0 (CH), 114.6 (C), 111.2 (CH), 89.1 (C), 85.7 (C), 82.3 (CH), 81.4 (CH), 78.2 (CH), 73.5 (CH<sub>2</sub>), 72.4 (2CH<sub>2</sub>), 71.7 (CH), 70.3 (CH<sub>2</sub>), 55.2 (CH<sub>3</sub>), 20.9 (CH<sub>3</sub>). **HRMS** (ESI): *m/z* calc. for C<sub>36</sub>H<sub>40</sub>NO<sub>5</sub> [M+NH<sub>4</sub>]<sup>+</sup> 566.2906; found 566.2901.

**(2*R*,3*R*,4*S*,5*S*)-3,4-bis(benzyloxy)-2-((benzyloxy)methyl)-5-((2-chlorophenyl)ethynyl) tetrahydrofuran (3p):**

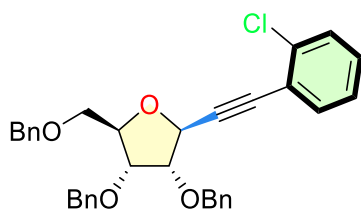

According to general procedure, (2*R*, 3*R*, 4*S*, 5*S*)- 3, 4-bis (benzyloxy)- 5 -((benzyloxy) methyl) tetrahydrofuran-2-carboxylic acid **1a** (179.4 mg, 0.4 mmol, 2 equiv) and 1-chloro-2-ethynylbenzene **2p** (27.2 mg, 0.2 mmol, 1.0 equiv) were allowed to react for 24 h. Product **3p** was isolated after flash chromatography as a colorless oil (57.0 mg, 53%). *R<sub>f</sub>* = 0.3 (EtOAc /cyclohexane: 1/4); colorless oil; [α]<sub>D</sub><sup>18</sup> = − 8.5 (c, 0.47, CHCl<sub>3</sub>); <sup>1</sup>H NMR (300 MHz, CDCl<sub>3</sub>) δ 7.21-7.46 (m, 19H), 4.96 (d, *J* = 4.5 Hz, 1H), 4.55-4.85 (m, 6H), 4.27-4.32 (m, 1H), 4.15-4.22 (m, 2H), 3.63-3.72 (m, 2H); <sup>13</sup>C NMR (J-MOD, 75 MHz, CDCl<sub>3</sub>) δ 138.3 (C), 137.9 (C), 137.7 (C), 136.2 (C), 133.5 (CH), 129.6 (CH), 129.2 (CH), 128.4 (4CH), 128.3 (2CH), 128.0 (4CH), 127.8 (2CH), 127.6 (2CH), 127.5 (CH), 126.4 (CH), 122.4 (C), 92.0 (C), 83.5 (C), 82.2 (CH), 81.6 (CH), 77.4 (CH), 73.5 (CH<sub>2</sub>), 72.5 (CH<sub>2</sub>), 72.4 (CH<sub>2</sub>), 71.6 (CH), 70.3 (CH<sub>2</sub>); **HRMS** (ESI): *m/z* calc. for C<sub>34</sub>H<sub>35</sub>ClNO<sub>4</sub> [M+NH<sub>4</sub>]<sup>+</sup> 556.2255; found 556.2254.

**(2*R*,3*R*,4*S*,5*S*)-3,4-bis(benzyloxy)-2-((benzyloxy)methyl)-5-(cyclohex-1-en-1-ylethynyl) tetrahydrofuran (3q):**



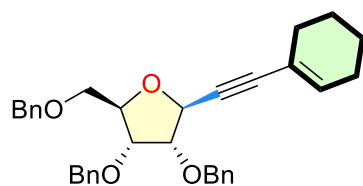

According to general procedure, (2*R*, 3*R*, 4*S*, 5*S*)- 3, 4-bis (benzyloxy)- 5 -((benzyloxy) methyl) tetrahydrofuran-2-carboxylic acid **1a** (179.4 mg, 0.4 mmol, 2 equiv) and 1-ethynylcyclohex-1-ene **2q** (21.2 mg, 0.2 mmol, 1.0 equiv) were allowed to react for 24 h. Product **3q** was isolated after flash chromatography as a colorless oil (65.1 mg, 64%). **R<sub>f</sub>** = 0.4 (EtOAc /cyclohexane: 1/4); colorless oil; **[α]<sub>D</sub><sup>18</sup>** = – 8.3 (c, 0.12, CHCl<sub>3</sub>); **<sup>1</sup>H NMR (300 MHz, CDCl<sub>3</sub>)** δ 7.27-7.42 (m, 15H), 6.10-6.12 (m, 1H), 4.79-4.82 (m, 1H), 4.54-4.75 (m, 6H), 4.20-4.25 (m, 1H), 4.02-4.09 (m, 2H), 3.59-3.68 (m, 2H), 2.09-2.13 (m, 4H), 1.59-1.67 (m, 4H); **<sup>13</sup>C NMR (J-MOD, 75 MHz, CDCl<sub>3</sub>)** δ 138.3 (C), 138.0 (C), 137.8 (C), 135.6 (CH), 128.4 (CH), 128.3 (3CH), 127.9 (4CH), 127.8 (2CH), 127.3 (3CH), 127.5 (2CH), 120.1 (C), 88.6 (C), 83.9 (C), 82.1 (CH), 81.3 (CH), 78.2 (CH), 73.5 (CH<sub>2</sub>), 72.3 (CH<sub>2</sub>), 72.2 (CH<sub>2</sub>), 71.6 (CH), 70.3 (CH<sub>2</sub>), 29.0 (CH<sub>2</sub>), 25.6 (CH<sub>2</sub>), 22.2 (CH<sub>2</sub>), 21.5 (CH<sub>2</sub>); **HRMS (ESI):** m/z calc. for C<sub>34</sub>H<sub>36</sub>O<sub>4</sub> [M+NH<sub>4</sub>]<sup>+</sup> 508.2614, found 508.2611.

**2-(((2*S*,3*S*,4*R*,5*R*)-3,4-bis(benzyloxy)-5-((benzyloxy)methyl)tetrahydrofuran-2-yl)ethynyl) pyridine (**3r**):**

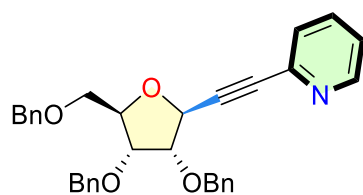

According to general procedure, (2*R*, 3*R*, 4*S*, 5*S*)- 3, 4-bis (benzyloxy)- 5 -((benzyloxy) methyl) tetrahydrofuran-2-carboxylic acid **1a** (179.4 mg, 0.4 mmol, 2 equiv) and 2-ethynylpyridine **2r** (20.6 mg, 0.2 mmol, 1.0 equiv) were allowed to react for 24 h. Product **3r** was isolated after flash chromatography as a colorless oil (70.7 mg, 70%). **R<sub>f</sub>** = 0.3 (EtOAc /cyclohexane: 1/1); colorless oil; **[α]<sub>D</sub><sup>18</sup>** = 156.6 (c, 0.08, CHCl<sub>3</sub>); **<sup>1</sup>H NMR (300 MHz, CDCl<sub>3</sub>)** δ 7.28-7.38 (m, 15H), 7.11 (dd, *J*<sub>1</sub> = 3.0 Hz, *J*<sub>2</sub> = 9.0 Hz, 1H), 6.86 (dd, *J*<sub>1</sub> = 3.0 Hz, *J*<sub>2</sub> = 9.0 Hz, 1H), 6.47 (dd, *J*<sub>1</sub> = 3.0 Hz, *J*<sub>2</sub> = 12.0 Hz, 1H),

6.37 (dd,  $J_1 = 3.0$  Hz,  $J_2 = 12.0$  Hz, 1H), 4.79 (m, 2H), 4.48-4.62 (m, 4H), 4.07-4.20 (m, 3H), 3.88-3.91 (m, 1H), 3.67 (m, 1H), 3.75 (m, 1H), 3.54 (dd,  $J_1 = 3.0$  Hz,  $J_2 = 12.0$  Hz, 1H);  $^{13}\text{C}$  NMR (J-MOD, 75 MHz,  $\text{CDCl}_3$ )  $\delta$  147.3 (CH), 146.2 (CH), 145.9 (C), 137.6 (C), 136.1 (C), 132.0 (CH), 129.8 (CH), 128.7 (CH), 128.5 (2CH), 128.4 (2CH), 128.3 (CH), 128.0 (3CH), 127.8 (CH), 127.7 (4CH), 127.4 (CH), 89.6 (C), 84.0 (C), 82.6 (CH), 82.0 (CH), 79.6 (CH), 75.7 ( $\text{CH}_2$ ), 73.6 ( $\text{CH}_2$ ), 75.5 ( $\text{CH}_2$ ), 75.5 (C), 69.8 ( $\text{CH}_2$ ); HRMS (ESI):  $m/z$  calc. for  $\text{C}_{33}\text{H}_{35}\text{N}_2\text{O}_5$   $[\text{M}+\text{NH}_4]^+$  523.2597; found 523.2599

**(2*R*,3*R*,4*S*,5*S*)-3,4-bis(benzyloxy)-2-((benzyloxy)methyl)-5-(thiophen-3-ylethynyl) tetrahydrofuran (3s):**

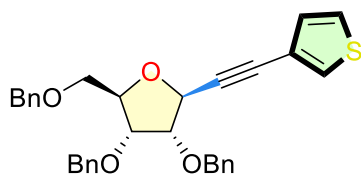

According to general procedure, (2*R*, 3*R*, 4*S*, 5*S*)- 3, 4-bis (benzyloxy)- 5 -((benzyloxy) methyl) tetrahydrofuran-2-carboxylic acid **1a** (179.4 mg, 0.4 mmol, 2 equiv) and 3-ethynylthiophene **2s** (21.6 mg, 0.2 mmol, 1.0 equiv) were allowed to react for 24 h. Product **3s** was isolated after flash chromatography as a colorless oil (57.2 mg, 56%). **Rf** = 0.3 (EtOAc /cyclohexane: 1/4); colorless oil;  $[\alpha]_{\text{D}}^{18} = -26.7$  (c, 0.22,  $\text{CHCl}_3$ );  $^1\text{H}$  NMR (300 MHz,  $\text{CDCl}_3$ )  $\delta$  7.26-7.42 (m, 17H), 7.08-7.10 (m, 1H), 4.90 (d,  $J = 4.2$  Hz, 1H), 4.54-4.81 (m, 6H), 4.25-4.29 (m, 1H), 4.11-4.16 (m, 2H), 3.62-3.71 (m, 2H);  $^{13}\text{C}$  NMR (J-MOD, 75 MHz,  $\text{CDCl}_3$ )  $\delta$  138.3 (C), 137.9 (C), 137.7 (C), 129.9 (CH), 129.2 (CH), 128.4 (4CH), 128.3 (2CH), 128.0 (2CH), 127.9 (2CH), 127.8 (2CH), 127.6 (2CH), 127.5 (CH), 125.2 (CH), 121.6 (C), 86.3 (C), 82.0 (CH), 81.9 (C), 81.5 (CH), 78.1 (CH), 73.5 ( $\text{CH}_2$ ), 72.4 (2 $\text{CH}_2$ ), 71.6 (CH), 70.1 ( $\text{CH}_2$ ); HRMS (ESI):  $m/z$  calc. for  $\text{C}_{32}\text{H}_{34}\text{NO}_4\text{S}$   $[\text{M}+\text{NH}_4]^+$  528.2209; found 528.2210.

**(2*R*,3*R*,4*S*,5*S*)-3,4-bis(benzyloxy)-2-((benzyloxy)methyl)-5-(hex-1-yn-1-yl)tetrahydrofuran (3t):**

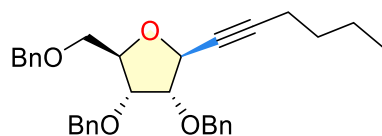

According to general procedure, (2*R*, 3*R*, 4*S*, 5*S*)- 3, 4-bis (benzyloxy)- 5 -((benzyloxy) methyl) tetrahydrofuran-2-carboxylic acid **1a** (179.4 mg, 0.4 mmol, 2 equiv) and hex-1-yne **2t** (16.2 mg, 0.2 mmol, 1.0 equiv) were allowed to react for 24 h. Product **3t** was isolated after flash chromatography as a colorless oil (52.3 mg, 54%). **R<sub>f</sub>** = 0.4 (EtOAc /cyclohexane: 1/4); colorless oil;  $[\alpha]_D^{18} = -3.3$  (c, 0.61, CHCl<sub>3</sub>); **<sup>1</sup>H NMR (300 MHz, CDCl<sub>3</sub>)**  $\delta$  7.28-7.60 (m, 15H), 4.74-4.78 (m, 1H), 4.53-4.70 (m, 6H), 4.16-4.22 (m, 1H), 3.97-4.06 (m, 2H), 3.58-3.67 (m, 2H), 2.22 (dt,  $J_1 = 3.0$  Hz,  $J_2 = 6.0$  Hz, 2H), 1.35-1.55 (m, 4H), 0.93 (t,  $J = 6.0$  Hz, 3H); **<sup>13</sup>C NMR (J-MOD, 75 MHz, CDCl<sub>3</sub>)**  $\delta$  138.3 (C), 138.0 (C), 137.9 (C), 128.4 (2CH), 128.3 (3CH), 127.9 (4CH), 127.7 (2CH), 127.6 (2CH), 127.5 (2CH), 87.7 (C), 82.2 (CH), 81.3 (CH), 78.1 (CH), 77.7 (C), 73.4 (CH<sub>2</sub>), 72.2 (2CH<sub>2</sub>), 71.3 (CH), 70.3 (CH<sub>2</sub>), 30.5 (CH<sub>2</sub>), 21.9 (CH<sub>2</sub>), 18.5 (CH<sub>2</sub>), 13.6 (CH<sub>3</sub>); **HRMS (ESI):** m/z calc. for C<sub>32</sub>H<sub>36</sub>O<sub>4</sub> [M+NH<sub>4</sub>]<sup>+</sup> 484.2614 found 484.2613.

**(2*R*,3*R*,4*S*,5*S*)-3,4-bis(benzyloxy)-2-((benzyloxy)methyl)-5-(oct-1-yn-1-yl)tetrahydrofuran (3u):**

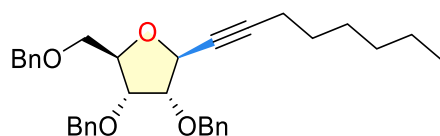

According to general procedure, (2*R*, 3*R*, 4*S*, 5*S*)- 3, 4-bis (benzyloxy)- 5 -((benzyloxy) methyl) tetrahydrofuran-2-carboxylic acid **1a** (179.4 mg, 0.4 mmol, 2 equiv) and oct-1-yne **2u** (22.0 mg, 0.2 mmol, 1.0 equiv) were allowed to react for 24 h. Product **3u** was isolated after flash chromatography as a colorless oil (53.3 mg, 52%). **R<sub>f</sub>** = 0.4 (EtOAc /cyclohexane: 1/4); colorless oil;  $[\alpha]_D^{18} = -6.5$  (c, 0.77, CHCl<sub>3</sub>); **<sup>1</sup>H NMR (300 MHz, CDCl<sub>3</sub>)**  $\delta$  7.28-7.40 (m, 15H), 4.75-4.78 (m, 1H), 4.53-4.70 (m, 6H), 4.18-4.22 (m, 1H), 3.97-4.06 (m, 2H), 3.58-3.67 (m, 2H), 2.21 (dt,  $J_1 = 3.0$  Hz,  $J_2 = 6.0$  Hz,

2H), 1.26-1.56 (m, 8H), 0.92 (t,  $J = 6.0$  Hz, 3H);  $^{13}\text{C}$  NMR (J-MOD, 75 MHz,  $\text{CDCl}_3$ )  $\delta$  138.3 (C), 138.0 (C), 137.9 (C), 128.4 (2CH), 128.3 (2CH), 128.3 (CH), 127.9 (4CH), 127.7 (2CH), 127.6 (2CH), 127.5 (2CH), 87.7 (C), 82.2 (CH), 81.3 (CH), 78.2 (CH), 77.7 (C), 73.4 ( $\text{CH}_2$ ), 72.2 (2 $\text{CH}_2$ ), 71.3 (CH), 70.3 ( $\text{CH}_2$ ), 31.3 ( $\text{CH}_2$ ), 28.5 ( $\text{CH}_2$ ), 28.4 ( $\text{CH}_2$ ), 22.5 ( $\text{CH}_2$ ), 18.9 ( $\text{CH}_2$ ), 14.0 ( $\text{CH}_3$ ); HRMS (ESI):  $m/z$  calc. for  $\text{C}_{34}\text{H}_{40}\text{O}_4$   $[\text{M}+\text{NH}_4]^+$  512.2927 found 512.2921.

**(2R,3R,4S,5S)-3, 4-bis(benzyloxy) -2- ((benzyloxy)methyl) -5-(cyclohexylethynyl) tetrahydrofuran (3v):**

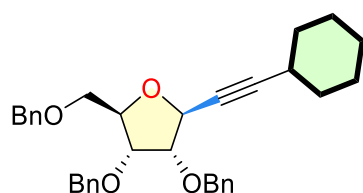

According to general procedure, (2R, 3R, 4S, 5S)- 3, 4-bis (benzyloxy)- 5 -((benzyloxy) methyl) tetrahydrofuran-2-carboxylic acid **1a** (179.4 mg, 0.4 mmol, 2 equiv) and ethynylcyclohexane **2v** (21.6 mg, 0.2 mmol, 1.0 equiv) were allowed to react for 24 h. Product **3v** was isolated after flash chromatography as a colorless oil (55.1 mg, 54%).  $R_f = 0.4$  (EtOAc /cyclohexane: 1/4); colorless oil;  $[\alpha]_D^{18} = 11.3$  (c, 0.18,  $\text{CHCl}_3$ );  $^1\text{H}$  NMR (300 MHz,  $\text{CDCl}_3$ )  $\delta$  7.28-7.40 (m, 15H), 4.75-4.79 (m, 1H), 4.53-4.71 (m, 6H), 4.17-4.22 (m, 1H), 4.04 (t,  $J = 6.0$  Hz, 1H), 3.98 (t,  $J = 6.0$  Hz, 1H), 3.58-3.67 (m, 2H), 2.36-2.44 (m, 1H), 1.27-1.81 (m, 10H);  $^{13}\text{C}$  NMR (J-MOD, 75 MHz,  $\text{CDCl}_3$ )  $\delta$  138.4 (C), 138.0 (C), 137.9 (C), 128.4 (2CH), 128.3 (3CH), 128.0 (2CH), 127.9 (2CH), 127.7 (3CH), 127.6 (2CH), 127.5 (CH), 91.6 (C), 82.2 (CH), 81.3 (CH), 78.1 (CH), 77.8 (C), 73.4 ( $\text{CH}_2$ ), 72.3 ( $\text{CH}_2$ ), 72.2 ( $\text{CH}_2$ ), 71.3 (CH), 70.3 ( $\text{CH}_2$ ), 32.4 (2 $\text{CH}_2$ ), 29.1 (CH), 25.9 (2 $\text{CH}_2$ ), 24.8 ( $\text{CH}_2$ ); HRMS (ESI):  $m/z$  calc. for  $\text{C}_{34}\text{H}_{42}\text{NO}_4$   $[\text{M}+\text{NH}_4]^+$  528.3114 found 528.3110.

NB. The product is contaminated with small amount (5%) of C-vinyl-nucleoside

**(2R,3R,4S,5S)-3,4-bis(benzyloxy)-2-((benzyloxy)methyl)-5-(cyclopropylethynyl) tetrahydrofuran (3w):**

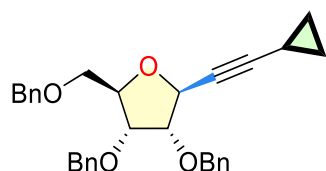

According to general procedure, (2*R*, 3*R*, 4*S*, 5*S*)- 3, 4-bis (benzyloxy)- 5 -((benzyloxy) methyl) tetrahydrofuran-2-carboxylic acid **1a** (179.4 mg, 0.4 mmol, 2 equiv) and (bromoethynyl)triisopropylsilane **2w** (13.2 mg, 0.2 mmol, 1.0 equiv) were allowed to react for 24 h. Product **3w** was isolated after flash chromatography as a colorless oil (56.2 mg, 60%). **Rf** = 0.4 (EtOAc /cyclohexane: 1/4); colorless oil;  $[\alpha]_D^{18} = 32.1$  (c, 0.09, CHCl<sub>3</sub>); <sup>1</sup>H NMR (300 MHz, CDCl<sub>3</sub>) δ 7.28-7.39 (m, 15H), 4.72-4.76 (m, 1H), 4.52-4.69 (m, 6H), 4.16-4.20 (m, 1H), 3.95-4.04 (m, 2H), 3.56-3.66 (m, 2H), 1.22-1.31 (m, 1H), 0.73-0.81 (m, 2H), 0.65-0.71 (m, 2H); <sup>13</sup>C NMR (J-MOD, 75 MHz, CDCl<sub>3</sub>) δ 138.7 (C), 138.3 (C), 138.2 (C), 128.7 (2CH), 128.6 (3CH), 128.3 (4CH), 128.2 (2CH), 128.1 (2CH), 128.0 (CH), 127.8 (CH), 91.0 (C), 84.6 (C), 82.4 (CH), 81.6 (CH), 78.4 (CH), 73.8 (CH<sub>2</sub>), 72.5 (2CH<sub>2</sub>), 71.7 (CH), 70.6 (CH<sub>2</sub>), 8.5 (2CH<sub>2</sub>), 0.1 (CH); HRMS (ESI): m/z calc. for C<sub>31</sub>H<sub>36</sub>NO<sub>4</sub> [M+NH<sub>4</sub>]<sup>+</sup> 486.2644 found 486.2654.

**(2*R*,3*R*,4*S*,5*S*)-3,4-bis(benzyloxy)-2-((benzyloxy)methyl)-5-(4-phenylbut-1-yn-1-yl) tetrahydrofuran (3x):**

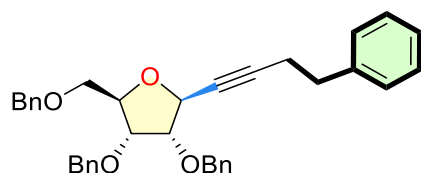

According to general procedure, (2*R*, 3*R*, 4*S*, 5*S*)- 3, 4-bis (benzyloxy)- 5 -((benzyloxy) methyl) tetrahydrofuran-2-carboxylic acid **1a** (179.4 mg, 0.4 mmol, 2 equiv) and but-3-yn-1-ylbenzene **2x** (26.0 mg, 0.2 mmol, 1.0 equiv) were allowed to react for 24 h. Product **3x** was isolated after flash chromatography as a colorless oil (99.0 mg, 93%). **Rf** = 0.3 (EtOAc /cyclohexane: 1/4); colorless oil;  $[\alpha]_D^{18} = 7.8$  (c, 1.53, CHCl<sub>3</sub>); <sup>1</sup>H NMR (300 MHz, CDCl<sub>3</sub>) δ 7.21-7.39 (m, 20H), 4.69-4.74 (m, 1H), 4.52-4.69 (m, 6H), 4.20-4.24 (m, 1H), 4.03 (t, *J* = 6.0 Hz, 1H), 3.97(t, *J* = 6.0 Hz, 1H), 3.55-3.67 (m, 2H), 2.84 (t, *J* = 6.0 Hz, 2H), 2.53 (dt, *J*<sub>1</sub> = 6.0 Hz, *J*<sub>2</sub> = 6.0 Hz, 2H); <sup>13</sup>C NMR (J-MOD, 75 MHz, CDCl<sub>3</sub>) δ 140.6 (C), 138.4 (C), 138.0 (C), 137.9 (C), 128.5 (2CH), 128.4

(4CH), 128.3 (2CH), 127.9 (4CH), 127.8 (2CH), 127.6 (3CH), 127.5 (2CH), 126.3 (CH), 86.8 (C), 82.1 (C), 81.3 (CH), 78.6 (C), 78.2 (CH), 73.4 (CH<sub>2</sub>), 72.2 (2CH<sub>2</sub>), 71.3 (CH), 70.3 (CH<sub>2</sub>), 34.8 (CH<sub>2</sub>), 21.0 (CH<sub>2</sub>); **HRMS** (ESI): *m/z* calc. for C<sub>36</sub>H<sub>40</sub>NO<sub>4</sub> [M+NH<sub>4</sub>]<sup>+</sup> 550.2957 found 550.2955.

**(2*R*,3*R*,4*S*,5*S*)-3,4-bis(benzyloxy)-2-((benzyloxy)methyl)-5-(5-chloropent-1-yn-1-yl) tetrahydrofuran (3y):**

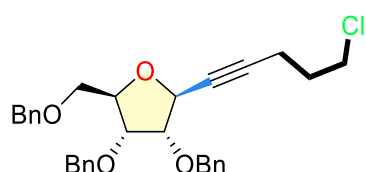

According to general procedure, (2*R*, 3*R*, 4*S*, 5*S*)- 3, 4-bis (benzyloxy)- 5 -((benzyloxy) methyl) tetrahydrofuran-2-carboxylic acid **1a** (179.4 mg, 0.4 mmol, 2 equiv) and 5-chloropent-1-yne **2y** (20.4 mg, 0.2 mmol, 1.0 equiv) were allowed to react for 24 h. Product **3y** was isolated after flash chromatography as a colorless oil (54.5 mg, 54%). **R<sub>f</sub>** = 0.4 (EtOAc /cyclohexane: 1/4); colorless oil; [ $\alpha$ ]<sub>D</sub><sup>18</sup> = 31.3 (c, 0.22, CHCl<sub>3</sub>); **<sup>1</sup>H NMR (300 MHz, CDCl<sub>3</sub>)**  $\delta$  7.28-7.39 (m, 15H), 4.52-4.75 (m, 7H), 4.18-4.22 (m, 1H), 4.05 (t, *J* = 6.0 Hz, 1H), 3.96 (t, *J* = 6.0 Hz, 1H), 3.58-3.63 (m, 4H), 2.40 (td, *J*<sub>1</sub> = 3.0 Hz, *J*<sub>2</sub> = 6.0 Hz, 2H), 1.89-1.97 (m, 2H); **<sup>13</sup>C NMR (J-MOD, 75 MHz, CDCl<sub>3</sub>)**  $\delta$  138.3 (C), 137.9 (C), 137.7 (C), 128.4 (2CH), 128.3 (4CH), 127.9 (4CH), 127.8 (2CH), 127.6 (2CH), 127.5 (CH), 85.5 (C), 82.1 (CH), 81.4 (CH), 78.8 (C), 77.9 (CH), 73.4 (CH<sub>2</sub>), 72.3 (2CH<sub>2</sub>), 71.2 (CH), 70.1 (CH<sub>2</sub>), 43.6 (CH<sub>2</sub>), 31.1 (CH<sub>2</sub>), 16.3 (CH<sub>2</sub>); **HRMS** (ESI): *m/z* calc. for C<sub>31</sub>H<sub>22</sub>ClO<sub>4</sub> [M+NH<sub>4</sub>]<sup>+</sup> 527.1965 found 527.1959.

**((3*aR*,4*R*,6*aS*)-6-((4-methoxyphenyl)ethynyl)-2,2-dimethyltetrahydrofuro[3,4-d][1,3]dioxol-4-yl)methyl benzoate (3z):**

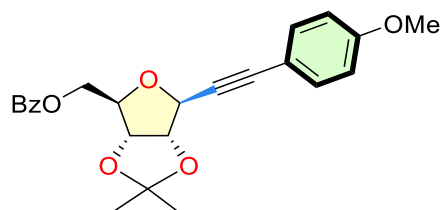

According to general procedure, (3*aR*, 4*R*, 6*R*, 6*aR*)-6-((benzyloxy)methyl)-2, 2-dimethyltetrahydrofuro[3, b4-d][1, 3]dioxole-4-carboxylic acid **1e** (128.9 mg, 0.4 mmol, 2 equiv) and 1-ethynyl-4-methoxybenzene **2a** (26.4 mg, 0.2 mmol, 1.0 equiv) were allowed to react for 24 h. Product **3ea** was isolated after flash chromatography as a colorless oil (44.1 mg, 54%). **Rf** = 0.4 (EtOAc /cyclohexane: 1/4); colorless oil; **<sup>1</sup>H NMR (300 MHz, CDCl<sub>3</sub>)** δ 7.92-8.02 (m, 2H), 7.44-7.51 (m, 1H), 7.30-7.37 (m, 2H), 7.18-7.26 (m, 2H), 6.72-6.79 (m, 2H), 4.85-4.89 (m, 1H), 4.77 (dd, *J*<sub>1</sub> = 3.0 Hz, *J*<sub>2</sub> = 6.0 Hz, 0.2H), 4.66 (dd, *J*<sub>1</sub> = 6.0 Hz, *J*<sub>2</sub> = 9.0 Hz, 0.8H), 4.41-4.56 (m, 3H), 4.33 (q, *J* = 6.0 Hz, 1H), 3.72 (s, 0.6H), 3.70 (s, 2.4H), 1.56 (s, 3H), 1.28 (s, 3H); **<sup>13</sup>C NMR (J-MOD, 75 MHz, CDCl<sub>3</sub>)** δ 166.3 (C), 159.4 (C), 133.1 (C), 131.7 (C), 129.8 (CH), 129.7 (CH), 128.4 (2CH), 127.0 (2CH), 120.5 (C), 114.9 (C), 114.0 (2CH), 87.3 (C), 87.1 (CH), 86.6(CH'), 85.7 (CH), 84.9 (C), 83.6 (CH'), 83.0 (CH'), 82.0 (CH), 82.0 (CH), 75.5 (CH'), 64.6 (CH<sub>2</sub>), 55.3 (CH<sub>3</sub>), 27.6 (CH<sub>3</sub>), 25.6 (CH<sub>3</sub>); **HRMS (ESI):** m/z calc. for C<sub>24</sub>H<sub>25</sub>O<sub>6</sub> [M+H]<sup>+</sup> 409.1651 found 409.1655.

**(2*R*,3*S*,5*R*)-3-(benzyloxy)-2-((benzyloxy) methyl)-5-((4-methoxyphenyl) ethynyl) tetrahydrofuran (3ab-β):**

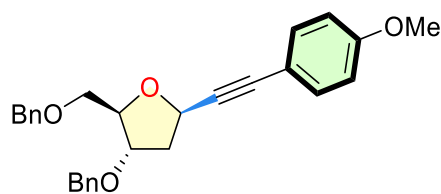

According to general procedure, (2*R*, 4*S*, 5*R*)-4-(benzyloxy)-5-((benzyloxy)methyl)tetrahydrofuran-2-carboxylic acid (β form) **1c** (136.9 mg, 0.4 mmol, 2 equiv) and 1-ethynyl-4-methoxybenzene **2a** (26.4 mg, 0.2 mmol, 1.0 equiv) were allowed to react for 24 h. Product **3caβ** was isolated after flash chromatography as a colorless oil (5.5 mg, 6.4%). According to general procedure, (2*R*, 4*S*, 5*R*)-4-(benzyloxy)-5-((benzyloxy)methyl)tetrahydrofuran-2-carboxylic acid (α form) **1d** (136.9 mg, 0.4 mmol, 2 equiv) and 1-ethynyl-4-methoxybenzene **2a** (26.4 mg, 0.2 mmol, 1.0 equiv) were allowed to react for 24 h. Product **3daβ** was isolated after flash chromatography as a colorless oil (4.5 mg, 5.3%). **Rf** = 0.3 (EtOAc /cyclohexane: 1/4); colorless oil; **[α]<sub>D</sub><sup>18</sup>** = − 4.5 (c, 0.22, CHCl<sub>3</sub>); **<sup>1</sup>H NMR (300 MHz, CDCl<sub>3</sub>)** δ 7.21-7.29 (m, 12H), 6.72-6.75 (m, 2H), 4.88 (dd, *J*<sub>1</sub> = 6.0 Hz, *J*<sub>2</sub> = 9.0 Hz, 1H), 4.44-4.52

(m, 4H), 4.05-4.13 (m, 2H), 3.73 (s, 3H), 3.55-3.60 (m, 1H), 3.44-3.49 (m, 1H), 2.25-2.32 (m, 1H), 2.05-2.15 (m, 1H);  $^{13}\text{C}$  NMR (J-MOD, 75 MHz,  $\text{CDCl}_3$ )  $\delta$  158.9 (C), 138.2 (C), 137.7 (C), 133.2 (2CH), 128.4 (4CH), 127.7 (4CH), 127.6 (2CH), 120.8 (C), 113.8 (2CH), 86.4 (C), 85.2 (C), 83.7 (CH), 81.0 (CH), 73.5 ( $\text{CH}_2$ ), 71.2 ( $\text{CH}_2$ ), 70.8 ( $\text{CH}_2$ ), 68.4 (CH), 55.2 ( $\text{CH}_3$ ), 39.8 ( $\text{CH}_2$ ). HRMS (ESI):  $m/z$  calc. for  $\text{C}_{28}\text{H}_{32}\text{NO}_4$   $[\text{M}+\text{NH}_4]^+$  446.2331; found 446.2333.

**(2R,3S,5S)-3-(benzyloxy)-2-((benzyloxy)methyl)-5-((4-methoxyphenyl)ethynyl) tetrahydrofuran (3ab- $\alpha$ ):**

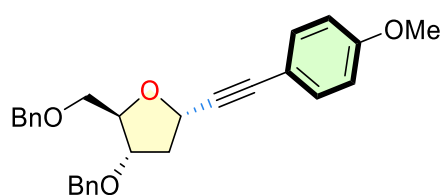

According to general procedure, (2R, 4S, 5R)-4-(benzyloxy)-5-((benzyloxy)methyl)tetrahydrofuran-2-carboxylic acid ( $\beta$  form) **1c** (136.9 mg, 0.4 mmol, 2 equiv) and 1-ethynyl-4-methoxybenzene **2a** (26.4 mg, 0.2 mmol, 1.0 equiv) were allowed to react for 24 h. Product **3ca $\alpha$**  was isolated after flash chromatography as a colorless oil (33 mg, 38.6%). According to general procedure, (2R, 4S, 5R)-4-(benzyloxy)-5-((benzyloxy)methyl)tetrahydrofuran-2-carboxylic acid ( $\alpha$  form) **1d** (136.9 mg, 0.4 mmol, 2 equiv) and 1-ethynyl-4-methoxybenzene **2a** (26.4 mg, 0.2 mmol, 1.0 equiv) were allowed to react for 24 h. Product **3da $\alpha$**  was isolated after flash chromatography as a colorless oil (31.5 mg, 36.7%).  $R_f$  = 0.3 (EtOAc /cyclohexane: 1/4); colorless oil;  $[\alpha]_{\text{D}}^{18}$  = 45.5 (c, 0.11,  $\text{CHCl}_3$ );  $^1\text{H}$  NMR (300 MHz,  $\text{CDCl}_3$ )  $\delta$  7.28-7.38 (m, 12H), 6.81-6.84 (m, 2H), 5.02 (dd,  $J_1$  = 6.0 Hz,  $J_2$  = 6.0 Hz, 1H), 4.51-4.63 (m, 4H), 4.33-4.37 (m, 1H), 4.17-4.22 (m, 1H), 3.82 (s, 3H), 3.61-3.63 (m, 2H), 2.47-2.56 (m, 1H), 2.25-2.32 (m, 1H);  $^{13}\text{C}$  NMR (J-MOD, 75 MHz,  $\text{CDCl}_3$ )  $\delta$  158.2 (C), 144.5 (C), 141.9 (C), 133.2 (2CH), 128.3 (4CH), 127.6 (4CH), 115.0 (C), 113.8 (4CH), 94.7 (C), 87.4 (C), 82.6 (CH), 80.0 (CH), 73.5 ( $\text{CH}_2$ ), 71.6 ( $\text{CH}_2$ ), 70.4 ( $\text{CH}_2$ ), 68.4 (CH), 55.2 ( $\text{CH}_3$ ), 39.6 ( $\text{CH}_2$ ). HRMS (ESI):  $m/z$  calc. for  $\text{C}_{28}\text{H}_{32}\text{NO}_4$   $[\text{M}+\text{NH}_4]^+$  446.2331; found 446.2328.



**(3*aR*,4*R*,6*R*,6*aR*)-4-methoxy-6-((4-methoxyphenyl)ethynyl)-2,2-dimethyltetrahydrofuro[3,4-*d*][1,3]dioxole (3*a*):**

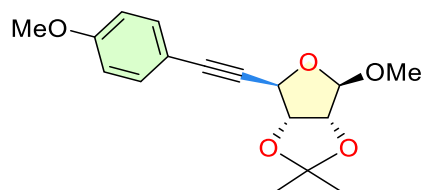

According to general procedure, (2*R*, 3*R*, 4*R*, 5*R*)-3, 4-bis (benzyloxy)- 5 -((benzyloxy) methyl) tetrahydrofuran-2-carboxylic acid **1f** (87.2 mg, 0.4 mmol, 2 equiv) and 1-ethynyl-4-methoxybenzene **2a** (26.4 mg, 0.2 mmol, 1.0 equiv) were allowed to react for 24 h. Product **3fa** was isolated after flash chromatography as a colorless oil (49.9 mg, 82%). **Rf** = 0.3 (EtOAc /cyclohexane: 1/9); colorless oil;  $[\alpha]_D^{18} = -39.4$  (c, 0.53, CHCl<sub>3</sub>); **<sup>1</sup>H NMR (300 MHz, CDCl<sub>3</sub>)** δ 7.25-7.28 (m, 2H), 6.73-6.76 (m, 2H), 5.00 (s, 1H), 4.93 (s, 1H), 4.89 (d, *J* = 6.0 Hz, 1H), 4.65 (d, *J* = 3.0 Hz, 1H), 3.73 (s, 3H), 3.35 (s, 3H), 1.41 (s, 3H), 1.25 (s, 3H); **<sup>13</sup>C NMR (J-MOD, 75 MHz, CDCl<sub>3</sub>)** δ 159.7 (C), 133.0 (2CH), 144.7 (C), 113.9 (2CH), 112.7 (C), 109.3 (CH), 85.8 (C), 85.6 (CH), 85.5 (C), 85.4 (CH), 75.8 (CH), 55.3 (CH<sub>3</sub>), 54.3 (CH<sub>3</sub>), 26.4 (CH<sub>3</sub>), 25.0 (CH<sub>3</sub>). **HRMS (ESI):** m/z calc. for C<sub>17</sub>H<sub>20</sub>O<sub>5</sub> [M+H]<sup>+</sup> 304.1311 found 304.1310.

**(2*R*,3*R*,4*S*,5*S*)-3,4-bis(benzyloxy)-2-((benzyloxy)methyl)-5-(4-methoxyphenethyl) tetrahydrofuran (4*a*):**

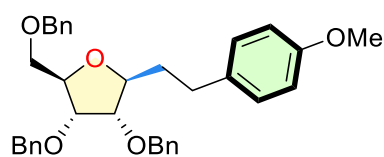

To an oven dried 10 mL Schlenk tube equipped with a stirring bar, (2*R*, 3*R*, 4*S*, 5*S*)-3,4-bis(benzyloxy)-2-((benzyloxy)methyl)-5-((4-methoxyphenyl)ethynyl)tetrahydrofuran **3a** (53.4 mg, 0.1 mmol, 1 equiv) and Pd/C 10 wt% 5 mg and MeOH 0.5 mL was added. The reaction mixture stir intensely under H<sub>2</sub> balloon and room temperature for overnight. After the reaction finished, the reaction mixture filter through Diatomaceous earth and washed with MeOH. After that, filtrate was concentrated unver vaccum. Product **4a** was isolated after flash chromatography as a colorless oil (37.7 mg, 70%). **Rf** = 0.3 (EtOAc

/cyclohexane: 1/4); colorless oil;  $[\alpha]_D^{18} = -24.7$  (c, 0.35,  $\text{CHCl}_3$ );  $^1\text{H NMR}$  (300 MHz,  $\text{CDCl}_3$ )  $\delta$  7.31-7.37 (m, 15H), 7.08-7.11 (m, 2H), 6.82-6.85 (m, 2H), 4.47-4.64 (m, 6H), 4.23 (q,  $J = 6.0$  Hz, 1H), 4.04-4.10 (m, 1H), 3.94 (t,  $J = 6.0$  Hz, 1H), 3.80 (s, 3H), 3.55-3.64 (m, 3H), 2.57-2.78 (m, 2H), 1.71-1.95 (m, 2H);  $^{13}\text{C NMR}$  (J-MOD, 75 MHz,  $\text{CDCl}_3$ )  $\delta$  157.8 (C), 138.3 (C), 138.0 (2C), 134.2 (C), 129.3 (2CH), 128.4 (4CH), 128.1 (2CH), 127.9 (2CH), 127.7 (4CH), 127.6 (3CH), 113.8 (2CH), 81.3 (CH), 81.0 (CH), 80.4 (CH), 77.7 (CH), 73.5 ( $\text{CH}_2$ ), 72.1 ( $\text{CH}_2$ ), 71.9 ( $\text{CH}_2$ ), 70.6 ( $\text{CH}_2$ ), 55.3 ( $\text{CH}_3$ ), 35.8 ( $\text{CH}_2$ ), 31.0 ( $\text{CH}_2$ ). HRMS (ESI):  $m/z$  calc. for  $\text{C}_{35}\text{H}_{39}\text{O}_5$   $[\text{M}+\text{H}]^+$  539.2797; found 539.2801.

**4-((2*S*,3*S*,4*R*,5*R*)-3,4-bis(benzyloxy)-5-((benzyloxy)methyl)tetrahydrofuran-2-yl)-5-(4-methoxyphenyl)-3,6-dimethylpyridazine (4b):**

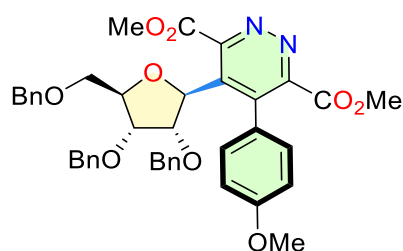

To an oven dried 10 mL Schlenk tube equipped with a stirring bar, (2*R*, 3*R*, 4*S*, 5*S*)-3,4-bis(benzyloxy)-2-((benzyloxy)methyl)-5-((4-methoxyphenyl)ethynyl)tetrahydrofuran **3a** (106.8 mg, 0.2 mmol, 1 equiv) and 3,6-Bis(methoxycarbonyl)-1,2,4,5-tetrazine (59.5 mg, 0.3 mmol, 1.5 eq) and Toluene 3 mL was added. The reaction mixture stir intensely under Ar balloon and reflux at 125 °C for 24 h. After the reaction finished, the reaction mixture was washed with NaCl aq and dry over under  $\text{NaSO}_4$ . After that, filtrate was concentrated under vacuum. Product **4a** was isolated after flash chromatography as a yellow oil (91.2 mg, 65%).  $\text{Rf} = 0.3$  (EtOAc /cyclohexane/ $\text{Et}_3\text{N}$ : 1/2/0.003); yellow oil;  $^1\text{H NMR}$  (300 MHz,  $\text{CDCl}_3$ )  $\delta$  7.08-7.28 (m, 16H), 6.91-6.97 (m, 1H), 6.75-6.81 (m, 1H), 6.52-6.57 (m, 1H), 4.92 (d,  $J = 9.0$  Hz, 1H), 4.37-4.52 (m, 6H), 4.21 (d,  $J = 9.0$  Hz, 1H), 3.97 (q,  $J = 6.0$  Hz, 1H), 3.80-3.82 (m, 1H), 3.78 (s, 3H), 3.68 (s, 3H), 3.62 (s, 3H), 3.40 (d,  $J = 6.0$  Hz, 2H);  $^{13}\text{C NMR}$  (J-MOD, 75 MHz,  $\text{CDCl}_3$ )  $\delta$  166.4 (C), 165.2 (C), 160.3 (C), 154.8 (C), 153.8 (C), 139.3 (C), 137.8 (C), 137.7 (C), 137.4 (C), 135.4 (C), 132.4 (CH), 129.4 (CH), 128.5 (CH), 128.3 (4CH), 128.0 (2CH), 127.9 (2CH), 127.8 (6CH), 113.7 (2CH), 123.6 (C), 82.8 (CH), 82.2 (CH),

77.6 (CH), 77.4 (CH), 73.3 (CH<sub>2</sub>), 73.0 (CH<sub>2</sub>), 72.6 (CH<sub>2</sub>), 69.4 (CH<sub>2</sub>), 55.2 (CH<sub>3</sub>), 53.0 (CH<sub>3</sub>), 52.9 (CH<sub>3</sub>). **HRMS** (ESI): *m/z* calc. for C<sub>40</sub>H<sub>41</sub>N<sub>2</sub>NaO<sub>9</sub> [M+Na]<sup>+</sup> 727.2632; found 727.2635.

**1-((2*R*,3*R*,4*R*,5*R*)-3,4-bis(benzyloxy)-5-((benzyloxy)methyl)tetrahydrofuran-2-yl)-2-(4-methoxyphenyl)ethan-1-one compound with 2-((2*S*,3*S*,4*R*,5*R*)-3,4-bis(benzyloxy)-5-((benzyloxy)methyl)tetrahydrofuran-2-yl)-1-(4-methoxyphenyl)ethan-1-one (1:1) (4c and 4c')**:

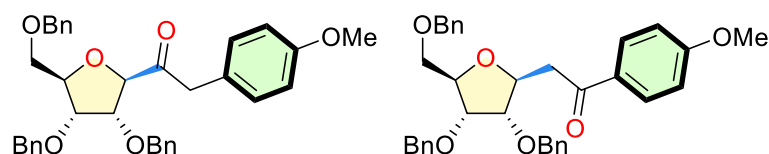

To an Emrys Optimizer 0.2-0.5 mL pyrex reaction vessel equipped with a stirring bar, (2*R*, 3*R*, 4*S*, 5*S*)-3, 4-bis(benzyloxy)-2-((benzyloxy)methyl)-5-((4-methoxyphenyl)ethynyl)tetrahydrofuran **3a** (53.4 mg, 0.1 mmol, 1 equiv) and PTSA (3.5 mg, 20 mol%) and EtOH 0.25 mL was added. The reaction vessel was then placed in the Emrys Optimizer and exposed to microwaves irradiation. According to the following specifications: Time: 30 min, Temperature: 120 °C, Fixed hold time: on, Sample absorption: high, Pre-stirring: 60s. After cooling to room temperature, H<sub>2</sub>O (10 mL) was added to the crude and the mixture was extracted with EtOAc (3 x 10 mL). Organic layers were dried, concentrated. Product **4b and 4b'** was isolated after flash chromatography as a colorless oil (40.3 mg, 73%). *R<sub>f</sub>* = 0.3 (EtOAc /cyclohexane: 1/4); colorless oil; <sup>1</sup>H NMR (300 MHz, CDCl<sub>3</sub>) δ 7.87-7.95 (m, 2H), 7.27-7.40 (m, 15H), 6.88-6.93 (m, 2H), 4.45-4.77 (m, 6.5H), 4.23-4.30 (m, 1.5H), 4.12-4.16 (m, 0.5H), 4.01 (t, *J* = 6.0 Hz, 1H), 3.87 (s, 3H), 3.50-3.67 (m, 2H), 3.27-3.50 (m, 0.5H), 3.02-3.21 (m, 1H); <sup>13</sup>C NMR (J-MOD, 75 MHz, CDCl<sub>3</sub>) δ 197.2 (C), 196.3 (C), 163.5 (C), 138.3 (C), 138.3 (C), 138.1 (C), 138.0 (C), 138.0 (C), 130.6 (CH), 130.4 (CH), 130.2 (C), 128.4 (CH), 128.3 (4CH), 128.1 (2CH), 128.0 (2CH), 127.8 (2CH), 127.7 (2CH), 127.5 (2CH), 113.7 (2CH), 81.1 (CH), 80.3 (CH), 80.2 (CH), 79.4 (CH), 77.9 (CH), 77.9 (CH), 77.5 (CH<sub>2</sub>), 77.1 (CH), 77.0 (CH<sub>2</sub>), 76.9 (CH), 76.6 (CH<sub>2</sub>), 73.6 (CH<sub>2</sub>), 73.5 (CH<sub>2</sub>), 72.7 (CH<sub>2</sub>), 71.8 (CH<sub>2</sub>), 70.3 (CH<sub>2</sub>), 70.2 (CH<sub>2</sub>), 55.4 (CH<sub>3</sub>), 42.4 (CH<sub>2</sub>), 38.7 (CH<sub>2</sub>). **HRMS** (ESI): *m/z* calc. for C<sub>35</sub>H<sub>37</sub>O<sub>6</sub> [M+H]<sup>+</sup> 553.2590; found 553.2597.

## **General conclusion**

---

## General conclusion

Glycosides show a diverse range of potential applications in chemical biology and medicine chemistry. During my PhD research program, I was focused on developing new methodologies to synthesis thio/selenoglycosides as well as alkynyl C-glycosides from easy prepared or commercially available coupling partners (such as aryl/alkenyl/alkynyl halides, amines or alkynes). These methods involve the use of versatile synthetic tools such as photoredox reaction, electro-chemistry and traditional Pd-catalysis reaction. Finally, we are able now to propose a tool-box to the chemistry community and particularly for the glycochemistry for the synthesis of these family of glycosides.

In chapter 1, a Pd-catalyzed synthesis of 1-(Hetero)aryl Selenoglycosides reaction has been reported in methodology 1. To the best of our knowledge the C(sp<sup>2</sup>)-Se bond of (hetero)aryl selenoglycosides was formed, for the first time, directly by a Pd-catalyzed cross-coupling of selenosugar with aryl halides at room temperature. Because of the mildness of the reaction conditions, this protocol tolerates a wide range of functional groups and proceeds in good to excellent yields. This method opens new opportunities for using glycosyl selenolate in synthetic methodology and medicinal chemistry.

Sialylated glycoconjugates play important roles in biological, immunological and pathological processes. However, due to the hindered and disfavored tertiary anomeric center, sialylation was regarded as one of the most challenging reactions. Because our reported mild reaction conditions tolerate various of functional groups and showed good anomeric selectivity, the perspective of this study is the extension of this method to the coupling of selenosialic acids with aryl iodide or p-I-Phe-containing peptides (**Scheme 55**).

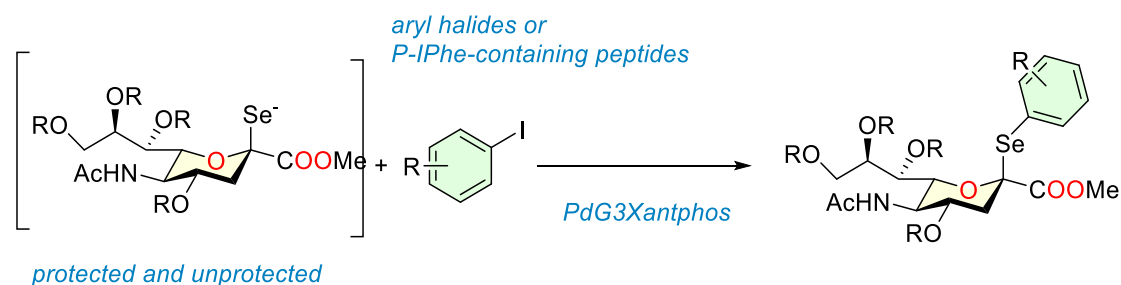

**Scheme 55.** The coupling of selenosialic acids with aryl iodide

In a second part, we were interested in the reactivity of thiosugars under various activating processes. At first, a new photoredox cross-coupling between 1-thiosugars and aryl, alkenyl and alkynyl halides in mild reaction conditions has been developed. The reaction conditions involve the use of only Ni(dtbbpy)(H<sub>2</sub>O)<sub>4</sub>Cl<sub>2</sub> as catalyst, Ru(bpy)<sub>3</sub>(PF<sub>6</sub>)<sub>2</sub> as photocatalyst under base free conditions. By using of flow chemistry technology, the gram-scale reaction could be completed efficiently in only 20 min (instead of 24h in batch). 27 examples have been achieved with yields up to 96%.

Extension of this approach to a Stadler-Ziegler arylation of thiosugars with various aryl amines *via* a cooperative photoredox strategy has been examined. This method provides unprecedented access to functionalized thioglycosides under mild conditions with high efficiency and selectivity. The tolerance to functional groups on the aniline partner is high including halides (iodides, bromides and chlorides) which were involved in further transition metal catalyzed functionalizations through the C-X bond (Suzuki-coupling, Migita-coupling and C-H activation). 31 examples, up to 85% yield shows us the large scope of this condition.

A second activation process was developed involving electrochemical coupling of various anomeric glycosyl thiols with aryl bromides. This method demonstrates unprecedented reactivity with regard to bromide partners (heteroaryl, alkenynyl and alkenyl bromides) and selectivity, including reactions with unprotected thiosugars, and cysteine amino acid.

Due to extreme challenges for functionalization of peptides and proteins, the powerful protocols for modification of peptides is required. The reactions we reported opened a new way to the late-stage functionalization of peptides and proteins. Studies on the applications of this method in the S-arylation of more complex polysaccharides and cysteine containing peptides are ongoing in the group (**Scheme 56**).

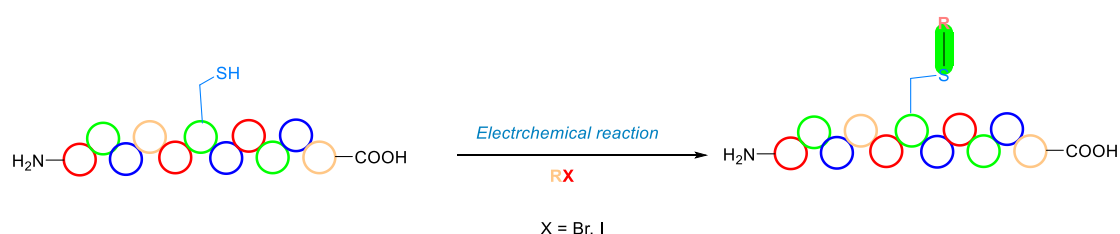

**Scheme 56.** Functionalization of peptides and proteins

Due to thiosialic acids shows excellent properties in cell-adhesion and tissue-engineering applications. There is a strong impetus to develop a mild and efficient protocol for synthesis of thiosialic acids. As another perspective, the extension of these methods (photoredox reaction and electrochemical reaction) to the functionalization of thiosialic acids is ongoing (**Scheme 57**).

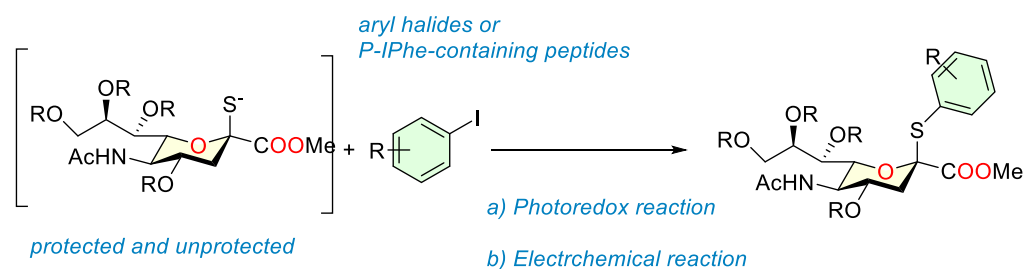

**Scheme 57.** Synthesis of thiosialic acids

In Chapter 2, we described the first catalytic approach for the alkynylation of anomeric furanosyls with various terminal alkynes via a cooperative photoredox/copper catalysis strategy. This method provides an unprecedented access to alkynyl C-nucleosides under mild conditions with high efficiency and diastereoselectivity (30 example and yield up to 96%.)

We could see that when pyranosyl carboxylic acids derived were employed during this decarboxylation reaction, there is no desired compound formed. Thus, while the efficiency of this protocol depends on the structure of carboxylic acids, we could find a new decarboxylative alkynylation system to achieve alkynylation of pyranosyl carboxylic acids successfully. In this case, the perspective of this study will be focused in exploring the reactivity of pyranosyl carboxylic acids as the source of anomeric radicals to achieve alkynylation as well as arylation reaction under photoredox or electrochemical conditions (**Scheme 58**).

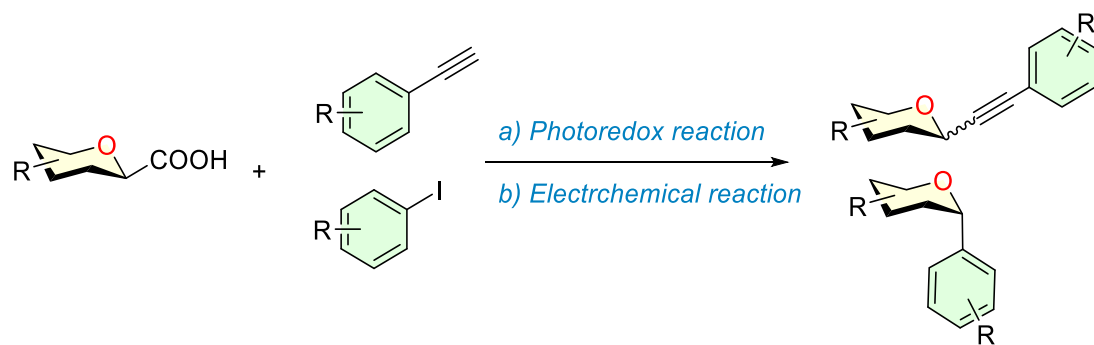

**Scheme 58.** Decarboxylative alkylation of pyranosyl carboxylic acids



## Conclusion Générale

Les glycosides présentent une gamme variée d'applications potentielles en biologie chimique et en chimie médicale. Au cours de mon programme de recherche doctorale, je me suis concentré sur le développement de nouvelles méthodologies pour la synthèse de thio/sélénoglycosides ainsi que d'alcynyl C-glycosides à partir de partenaires de couplage faciles à préparer ou disponibles dans le commerce (tels que les halogénures d'aryle/alcényle/alcynyle, les amines ou les alcynes). Ces méthodes impliquent l'utilisation d'outils synthétiques polyvalents tels que la réaction photoredox, l'électrochimie et la réaction traditionnelle de catalyse au Pd. Enfin, nous sommes maintenant en mesure de proposer une boîte à outils à la communauté de la chimie et particulièrement de la glycochimie pour la synthèse de cette famille de glycosides.

Dans le chapitre 1, une réaction de synthèse catalysée par Pd de 1-(hétéro)aryl sélénoglycosides a été rapportée dans la méthodologie 1. À notre connaissance, la liaison C(sp<sup>2</sup>)-Se des (hétéro)aryl sélénoglycosides a été formée, pour la première fois, directement par un couplage croisé catalysé au Pd de sélénosucre avec des halogénures d'aryle à température ambiante. En raison de la douceur des conditions de réaction, ce protocole tolère une large gamme de groupes fonctionnels et procède à des rendements bons à excellents. Cette méthode ouvre de nouvelles opportunités pour l'utilisation du sélénoate de glycosyle dans la méthodologie de synthèse et la chimie médicinale.

Dans une seconde partie, nous nous sommes intéressés à la réactivité des thiosucres sous divers processus activateurs. Dans un premier temps, un nouveau couplage croisé photoredox entre les 1-thiosucres et les halogénures d'aryle, d'alcényle et d'alcynyle dans des conditions de réaction douces a été développé. Les conditions de réaction impliquent l'utilisation de seulement Ni(dtbbpy)(H<sub>2</sub>O)<sub>4</sub>Cl<sub>2</sub> comme catalyseur, Ru(bpy)<sub>3</sub>(PF<sub>6</sub>)<sub>2</sub> comme photocatalyseur dans des conditions sans base. En utilisant la technologie de la chimie en flux, la réaction à l'échelle du gramme a pu être achevée efficacement en seulement 20 minutes (au lieu de 24 h en batch). 27 exemples ont été réalisés avec des rendements allant jusqu'à 96%.

L'extension de cette approche à une arylation de Stadler-Ziegler de thiosucres avec diverses amines aryliques via une stratégie photoredox coopérative a été examinée. Cette méthode offre un accès sans précédent aux thioglycosides fonctionnalisés dans des conditions douces avec une efficacité et une sélectivité élevées. La tolérance aux groupes fonctionnels sur le partenaire aniline est élevée, y compris les halogénures

(iodures, bromures et chlorures) qui ont été impliqués dans d'autres fonctionnalisations catalysées par les métaux de transition via la liaison C-X (couplage Suzuki, couplage Migita et activation C-H). 31 exemples, jusqu'à 85% de rendement nous montrent l'ampleur de cette condition.

Un deuxième processus d'activation a été développé impliquant le couplage électrochimique de divers glycosylthiols anomères avec des bromures d'aryle. Cette méthode démontre une réactivité sans précédent vis-à-vis des partenaires bromures (bromures d'hétéroaryle, d'alcényle et d'alcényle) et une sélectivité, y compris des réactions avec les thiosucres non protégés et l'acide aminé cystéine.

Dans le chapitre 2, nous avons décrit la première approche catalytique pour l'alcynylation de furanosyles anomères avec divers alcynes terminaux via une stratégie de catalyse coopérative photoredox/cuivre. Cette méthode offre un accès sans précédent aux alcynyl C-nucléosides dans des conditions douces avec une efficacité et une diastéréosélectivité élevées (30 exemples et rendement jusqu'à 96%).

**Titre :** De nouvelles approches pour la synthèse de S/Se-glycosides et d'alcynyl C-nucléosides

**Mots clés :** Hétérosides, Réaction photoredox, Électrochimie, Acides glycosylcarboxyliques, Alcynyl C-nucléosides, Réaction de décarboxylation

**Résumé :** Les glycosides sont des composés doués de plusieurs activités biologiques pouvant affecter les activités vitales de tous les organismes vivants. En particulier, les analogues de type S/Se-glycosides et alcynyl-C-nucléosides sont des glycomimétiques très résistant à l'hydrolyse dans les milieux biologiques et sont considérés prometteurs pour la conception de nouveaux candidats médicaments. La synthèse de ces derniers fait appel à des réactions de glycosylations classiques qui nécessitent plusieurs étapes (activation de la position anomérique, protections et déprotection des autres hydroxyles, introduction d'un groupement participant en C2...etc), ce qui limite leur utilisation à grande échelle. De plus, dans certains cas, un mélange d'anomères est obtenu, ce qui nécessite des étapes de purifications supplémentaires. Il est donc intéressant de développer de nouvelles méthodes d'accès à ces glycosides en limitant le nombre d'étapes. L'objectif de cette thèse de doctorat est de développer de nouvelles approches efficaces et sélectives d'accès aux S/Se-glycosides et d'alcynyl C-nucléosides. Dans une première partie de ce travail, nous nous sommes intéressés à la fonctionnalisation de thiosucres et de

sélenosucres.

Dans ce cadre nous avons développé trois méthodes de fonctionnalisation : la première qui fait appel à la catalyse au Pd, a permis de coupler divers aryles iodés avec des selenosucres protégés ou pas à température ambiante. Lors de la deuxième étude, nous avons utilisé la photoredox duale (Ni + Ru) pour pouvoir réaliser le couplage S-C entre des aryles bromés et iodés avec des thiosucres à température ambiante sans l'utilisation d'une base. Nous avons étendu cette méthode aux diazo aryles générés in situ à partir d'anilines. Quant à dernière la méthode, nous avons utilisé du courant électrique (électrosynthèse) pour réaliser le couplage.

Dans une autre étude, nous nous sommes intéressés à la synthèse d'alcynyl C-nucléosides à partir d'acides carboxyliques furanosyles et d'alcynes terminaux par une réaction photoredox. En utilisant un catalyseur au Cu peu toxique et peu coûteux, cette réaction présente une bonne sélectivité  $\beta$  et une large portée de substrat. La triple liaison a été ensuite post-fonctionnaliser.

**Title :** New approaches to the synthesis of S/Se-glycosides and alkynyl C-nucleosides

**Keywords :** S/Se-glycosides, Photoredox reaction, Electrochemistry, Glycosyl carboxylic acids, s, Decarboxylative reaction

**Abstract :** Glycoside is one of the most important compounds can affect life activities of all living organism. Especially the S/Se-glycosides and alkynyl C-nucleosides derivatives are essential components in organic synthesis, biology chemistry and medicinal chemistry. Among various synthetic protocols reported, the traditional metal catalysis cross-coupling reactions are regarded as an efferece and powerful pathway to synthesis of S/Se-glycosides and alkynyl C-nucleosides derivatives. Although the traditional cross-cropping reactions are regarded as powerful approaches to those compounds. The harsh conditions, such as Lewis acid or base, high temperature and large loading of catalysis, cause the low application and high cost of this type reaction. In this case, it is emergency to development of efficient, high application and low cost processes for S/Se-glycosides and alkynyl C-nucleosides modification.

The aim of this PhD thesis is to develop novel approach to synthesis of S/Se-glycosides and alkynyl C-nucleosides in innovative and high applicability.

At first, we are focused on the development of new strategy for synthesis of S/Se-glycosides. After the discovery of new Pd-catalysis cross-coupling reaction protocol to synthesis of Se-glycosides in room temperature and high yield, the photoredox cross-coupling reaction between

thiosugars and a broad range of aryl iodides as well as alkenyl and alkynyl halides has been developed. This base free condition shows broad substrate scope and high FG tolerance.

To overcome the short coming of last reaction, the aryl bromides and unprotected thiosugars are unreactive. The electro-coupling of both aryl bromides and iodides to protected and unprotected thiosugars under room temperature and without an external base has been done.

After that, we reported a novel photoredox approach for the S-arylation of anomeric glycosyl thiols with various aryl amines. These conditions tolerate various group functions as well as the use of protected and unprotected sugars. In advantage of using aryl amines, the future functionalization available iodinated thioglycosides have been synthesized, which are really useful in organic chemistry and medicinal chemistry.

Another method for synthesis of alkynyl C-nucleosides from simple and stable furanosyl carboxylic acids and terminal alkynes by photoredox reaction has been developed. By using of low toxic and low-cost Cu catalyst, this reaction shows good  $\beta$ -selectivity and broad substrate scope. What's more, this reaction provides various of alkynyl C-nucleosides under air, open us a new way to synthesis of complex C-nucleosides through further functionalization of the tripe bond.

---