



HAL
open science

Development of localised haptic feedback on interactive surfaces with the Inverse Filter method and its evaluation on a Perkins Braille reading case study

Lucie Pantera

► **To cite this version:**

Lucie Pantera. Development of localised haptic feedback on interactive surfaces with the Inverse Filter method and its evaluation on a Perkins Braille reading case study. Acoustics [physics.class-ph]. Sorbonne Université, 2022. English. NNT : 2022SORUS159 . tel-04162069

HAL Id: tel-04162069

<https://theses.hal.science/tel-04162069>

Submitted on 14 Jul 2023

HAL is a multi-disciplinary open access archive for the deposit and dissemination of scientific research documents, whether they are published or not. The documents may come from teaching and research institutions in France or abroad, or from public or private research centers.

L'archive ouverte pluridisciplinaire **HAL**, est destinée au dépôt et à la diffusion de documents scientifiques de niveau recherche, publiés ou non, émanant des établissements d'enseignement et de recherche français ou étrangers, des laboratoires publics ou privés.



THÈSE de DOCTORAT DE SORBONNE UNIVERSITÉ

Ecole Doctorale 391

Science Mécanique, Acoustique, Electronique et Robotique de Paris

Spécialité de doctorat : acoustique

Discipline : haptique

Development of localised haptic feedback on interactive surfaces with the Inverse Filter method and its evaluation on a Perkins Braille reading case study.

Présenté par Lucie Pantera

Le 13 Juillet 2022

Devant le jury composé de :

ZIAT Mounia

Associate Professor, Bentley University

GIRAUD Frédéric

Maître de conférence HDR, Université de Lille

HAYWARD Vincent

Professeur, Sorbonne Université

HALIYO Sinan

Maître de conférence HDR, Sorbonne Université

JOUFFRAIS Christophe

Director of Research CNRS

ZARADER Jean-Luc

Professeur, Sorbonne Université

HUDIN Charles

Ingénieur/Chercheur, CEA

PANÈELS Sabrina

Ingénieur/Chercheur, CEA

Rapporteure

Rapporteur

Examineur

Examineur

Examineur

Directeur de thèse

Encadrant de thèse

Encadrante de thèse

” Sans la curiosité de l’esprit, que serions-nous ? Telle est la beauté et la noblesse de la science : un désir sans fin de repousser les frontières du savoir, de traquer les secrets de la matière et de la vie sans idée préconçue des conséquences éventuelles.”

Marie CURIE

Contents

Abstract	7
Résumé	8
Remerciements	14
Mathematical notations	16
List of figures	21
Introduction	22
1. Methods for localised and multitouch haptic feedback on a surface	27
1.1. Multitouch feedback technology outside the surface	28
1.2. Multitouch feedback technology on a deformable surface	29
1.3. Multitouch localised feedback on non-deformable surfaces	33
1.3.1. Different types of feedback on touch surfaces	33
1.3.2. Localisation methods for static feedback on surfaces	34
1.3.2.1. Control of vibrations in the surface	34
1.3.2.2. Combination of the vibration modes of a plate	36
1.3.2.3. Non-propagative approach	38
1.3.2.4. Electro vibration	39
1.4. Conclusion	39
2. Localisation of the vibrations by the Inverse Filter method	41
2.1. Introduction	41
2.2. Mathematical principle	41
2.3. Inverse Filter method to localise haptic feedbacks at calibration points . .	43
2.3.1. Description of the prototype 1	44
2.3.2. Calibration of the prototype 1	46
2.3.3. Validation of the Inverse Filter method for two control points . . .	47

Contents

- 2.3.4. Characteristics of the prototype 51
 - 2.3.4.1. Spatial resolution of the prototype 1 51
 - 2.3.4.2. Achievable vibration amplitude with the Prototype 1 . . 53
- 2.3.5. Conclusion 55
- 2.4. Realtime rendering at any points with a touchscreen 55
 - 2.4.1. Description of the prototype 2 56
 - 2.4.2. Calibration of the prototype 2 with the multiple sweep method . . 56
 - 2.4.3. Fourier interpolation method 59
 - 2.4.4. Characteristics of the prototype 2 62
 - 2.4.4.1. Spatial resolution of the prototype 62
 - 2.4.4.2. Global displacement of the plate submitted to the Inverse Filter method 64
 - 2.4.4.3. Study on the peak amplitude obtainable with the prototype 2 67
 - 2.4.4.4. Finger damping effect 70
 - 2.4.5. Conclusion 71
- 2.5. Conclusion 72
- 3. Braille: a challenging case study 74**
 - 3.1. History of the Braille 74
 - 3.2. Tools for reading and writing Braille 76
 - 3.3. Other ways of rendering Braille 80
 - 3.3.1. Braille directly on the hand 81
 - 3.3.1.1. Ultrasound technology 81
 - 3.3.1.2. Actuators on the hand 82
 - 3.3.2. Braille on a tactile surface 84
 - 3.3.2.1. One finger stimulated at a time 85
 - 3.3.2.2. Several fingers stimulated at a time 87
 - 3.4. Conclusion 87
- 4. Evaluation of LotusBraille as a method for reading Braille on a screen 90**
 - 4.1. Two-point haptic pattern recognition 91
 - 4.1.1. Participants 91
 - 4.1.2. Description of the experimental setup 91
 - 4.1.3. Protocol 92

Contents

4.1.4.	Results	93
4.1.4.1.	Recognition Rates	93
4.1.4.2.	Response Times	95
4.1.4.3.	Qualitative Feedback	96
4.1.5.	Discussion	98
4.2.	Perkins Braille alphabet rendering on a glass surface	98
4.2.1.	Participants	99
4.2.2.	Setup and Conditions	99
4.2.3.	Protocol	101
4.2.4.	Results	102
4.2.4.1.	Sequential method	102
4.2.4.2.	Hybrid method	105
4.2.4.3.	Simultaneous method	107
4.2.5.	Overall feedback from participants	110
4.3.	Different vibration frequencies for the fingers of the same hand	112
4.3.1.	Description of the experimental study	112
4.3.2.	Results	114
4.4.	Perkins Braille rendering on a glass surface with longer presentation times	115
4.4.1.	Participants and setup	115
4.4.2.	Protocol	116
4.4.3.	Results	117
4.4.3.1.	Sequential method	117
4.4.3.2.	Semi-simultaneous method	118
4.4.4.	Conclusion	121
4.5.	Reading of words	122
4.5.1.	Participants and setup	122
4.5.2.	Protocol	123
4.5.3.	Results	123
4.5.4.	Conclusion	125
5.	Conclusion	127
5.1.	Summary of contributions	127
5.1.1.	Implementation and evaluation of localised haptics surface technology	127
5.1.2.	Lessons and guidelines for localised haptics on tactile surfaces . . .	130

Contents

5.2. Leads for future work	131
5.2.1. Typology of actuators under the surface	131
5.2.2. Integration into touchscreen devices such as smartphones	132
5.2.3. LotusBraille as a Braille display	133
Appendices	136
Appendix A. Likert Scale Questionnaire	137
Appendix B. System Usability Scale (SUS)	138
Appendix C. List of words	139
Bibliography	152

Abstract

Our interaction with touchscreens is limited, relying mostly on sight and hearing. Yet, providing tactile feedback can greatly enhance interaction, making it more natural and immersive, for example for keyboard typing or texture rendering. However, providing rich vibratory feedback on a surface is technically difficult. Standard approaches (i.e. present in our smartphones) vibrate the entire screen: the vibrations are therefore not localised and it is therefore impossible to provide a distinct vibratory feedback for each finger in contact with the surface, which limits the possible feedbacks and thus their diversity and richness. In this thesis, a new method called the Inverse Filter method is proposed, which, coupled with an array of piezoelectric actuators glued under a glass surface, allows to localise vibrations on this surface. It can achieve a resolution from 5 mm to 15 mm and the different parameters of the vibrations, namely the waveform, amplitude and location of the vibration, can be controlled to tune the vibration. By adding a capacitive screen to the glass surface and combined with an interpolation method, it is possible to retrieve the position of the fingers and send a localised vibratory feedback to different fingers in realtime. Beyond the development of the technology, user studies have been conducted. Indeed, this technology can not only improve the interaction with our smartphones and tablets, but especially benefit visually impaired people. Currently, it is not possible to display Braille on a touchscreen with vibrations because it requires a resolution of 2 mm. On the other hand, it is possible to display Perkins Braille, normally used for writing, which mobilises the index, middle and ring fingers of both hands (and thus a resolution of 1 cm). A user study, validated by the ethics committee of Paris-Saclay, was conducted in different stages to test different methods of presenting the letters of the alphabet and eventually convey words, and to gather feedback from the visually impaired users. The user study demonstrated the potential for the technology, as visually impaired participants managed to read both letters and words, but also the need to find the suitable presentation methods and parameters. Overall, the technology was well accepted by the users, who foresaw an interest for short messages such as time or notifications, for e.g. at bus stops.

Résumé

Les surfaces tactiles ont envahi notre quotidien. Dans les voitures, les tableaux de bord de voiture avec des boutons physiques ont laissé place à un écran tactile. Lorsque nous faisons nos courses, les caisses automatiques sont également équipées d'un écran tactile. La plupart des smartphones sont désormais presque entièrement tactiles. Même à l'intérieur de notre maison, les appareils électroménagers tels que nos plaques de cuisson, le four, la machine à laver, voient leurs boutons physiques disparaître progressivement et être remplacés par une surface tactile lisse. Cet abandon des boutons physiques offre plusieurs avantages, parmi lesquels une interaction plus directe et naturelle, une esthétique et des designs plus futuristes (par exemple pour les cockpits de voitures et d'avions), moins de problèmes de maintenance avec les pièces mobiles et un nettoyage et une hygiène plus faciles [1]. Malheureusement, ces surfaces tactiles sont inertes et manquent de retour haptique riche, de sorte que l'utilisateur est contraint d'interagir principalement par la vision. Cela peut être problématique dans les situations où le sens visuel est surchargé, comme pendant la conduite, ou indisponible, par exemple pour les malvoyants, et reste loin de l'idéal des interfaces utilisateur naturelles. En effet, le retour haptique et notamment le retour vibratoire pourrait apporter une multitude d'informations. Il pourrait, par exemple, permettre au conducteur d'interagir avec le tableau de bord de sa voiture uniquement par le toucher et, en réduisant la distraction visuelle, contribuer ainsi à réduire les accidents de la route. Il pourrait également améliorer l'interaction avec le smartphone. En effet, l'ajout d'un retour haptique à chaque touche du clavier peut réduire les erreurs de frappe [2]. De manière générale, il a le potentiel d'améliorer l'exploration des listes, des icônes/boutons ou des cibles. Il a démontré d'autres avantages, notamment l'agrément de l'interaction, la rapidité d'exécution de la tâche et la réduction de la charge cognitive [3, 4, 5, 6]. Il a également le potentiel d'ajouter la tangibilité manquante, par exemple pour les boutons numériques en permettant une sensation d'effet de profondeur lorsque l'utilisateur appuie sur le bouton. Actuellement, ces interactions avec les écrans tactiles sont le plus souvent réalisées avec un seul doigt. Cependant, il

Résumé

serait avantageux de pouvoir interagir avec plusieurs doigts en même temps pour effectuer une tâche. En effet, l'interaction avec plusieurs doigts permet aux utilisateurs de travailler plus rapidement et avec plus de fluidité que les méthodes traditionnelles d'interaction à un seul point [7]. Actuellement, les smartphones peuvent être dotés d'une entrée multi-doigts mais ne peuvent pas combiner un retour vibratoire avec cette entrée multi-doigts. Ils fournissent un retour sous la forme d'une vibration globale, c'est-à-dire que la vibration se propage dans la surface et que deux doigts en contact simultanément sur la surface reçoivent la même information vibratoire. Pouvoir faire un rendu localisé des feedbacks haptiques pourrait ouvrir de nouvelles possibilités d'interaction. Deux personnes utilisant simultanément le même écran pourraient ressentir des vibrations très indépendantes. Le retour haptique localisé pourrait également permettre de ressentir des textures en faisant glisser son ou ses doigts sur la surface. Il serait ainsi possible de sentir les matériaux lors d'achats en ligne par exemple. Il serait également possible de sentir les contours et de pouvoir se guider sur la surface. Cela serait particulièrement utile pour les personnes malvoyantes, qui pourraient enfin "sentir" les informations sur leur écran graphique numérique. Cependant, l'ajout d'un tel retour vibrotactile multitouch localisé à un écran tactile n'est pas simple, en raison des problèmes de vibration, de propagation, de réverbération et d'atténuation. Par conséquent, la question de recherche abordée par cette thèse est de savoir comment localiser physiquement ces vibrations pour obtenir un rendu multitouch sur une surface tactile, en vue d'une intégration future dans des dispositifs couramment utilisés. Il existe différentes technologies permettant un retour vibratoire localisé. Cependant, elles présentent des inconvénients tels que la forte puissance électrique à fournir, le manque de choix des paramètres pour régler le retour ou la difficulté de mise en œuvre. Cette thèse a donc étudié et développé une nouvelle méthode de retour vibratoire multitouch localisé pour résoudre ces problèmes. Cette approche est basée sur le contrôle actif des vibrations qui se propagent dans la surface. En effet, comme mentionné précédemment, lorsque le doigt touche la surface, il va recevoir un retour vibratoire. Cependant, cette vibration ne reste pas concentrée au point de contact mais se propage dans toute la surface, se réverbère et finit par s'éteindre. En effet, la longueur d'onde dans une surface de verre de 1 mm d'épaisseur à une fréquence de 250 Hz est d'environ 15 cm, il n'est donc pas possible de faire un rendu localisé en dessous de cette longueur d'onde. L'objectif de cette thèse était de dépasser cette limite afin d'obtenir une résolution plus fine de l'ordre du centimètre, c'est-à-dire de la taille du bout du doigt. L'approche décrite dans cette thèse, appelée

Résumé

méthode du Filtre Inverse, a permis de dépasser cette limite et de localiser les vibrations avec une résolution de 1 cm, bien en dessous de la longueur d'onde.

Un premier prototype a été développé avec 14 actionneurs piézoélectriques de diamètre 20 mm, collés sous la surface pour appliquer la méthode du Filtre Inverse, bien connue dans le domaine médical par exemple, au domaine de l'haptique. La méthode du Filtre Inverse est une technique de contrôle des vibrations, qui permet de contrôler la valeur du champ acoustique à des positions choisies. A travers ce travail de thèse, la méthode du Filtre Inverse a été appliquée pour la première fois dans le domaine de l'haptique afin de localiser les vibrations en tout point d'une plaque et pas seulement au-dessus des actionneurs piézoélectriques, comme cela avait été réalisé précédemment [8, 9]. Les résultats ont démontré qu'il était effectivement possible de rendre un retour vibrotactile indépendant à plusieurs endroits prédéfinis simultanés, autres qu'au-dessus des actionneurs. Les premières expériences sur le prototype ont montré qu'il était également possible de choisir les caractéristiques du retour vibrotactile, contrairement aux travaux existants où seuls certains paramètres sont variables. Ces caractéristiques comprennent l'emplacement des stimuli n'importe où sur la surface, l'amplitude [0 à 8 μm], la fréquence [250 à 1000 Hz], la forme du signal [carré, fenêtre de Hanning, etc.] et la durée [1 ms à n'importe quelle durée].

Un deuxième prototype a été développé pour appliquer la méthode du filtre inverse en tout point d'une plaque et pas seulement en des points prédéfinis. En effet, dans le premier prototype, la position des points était prédéfinie alors que dans ce second prototype, les doigts peuvent être placés n'importe où sur la surface et le calcul du signal vibratoire s'effectue en temps réel grâce à une base de données vibratoires. Un écran tactile a été utilisé pour récupérer la position des doigts de l'utilisateur sur l'écran en temps réel, avec 11 actionneurs plus grands [diamètre = 35 mm] collés sous la surface. La base de données vibratoire a été couplée à une interpolation de Fourier pour réduire le temps de calcul et permettre un retour haptique multi doigts en temps réel. Cette base de données comprend les réponses impulsionnelles de chaque point calibré de la plaque et permet de calculer les signaux à envoyer aux différents actionneurs pour obtenir le retour vibratoire souhaité. Une expérience a été réalisée pour connaître l'amplitude maximale que le prototype peut fournir en prenant des points aléatoires sur la plaque et en mesurant l'amplitude maximale pouvant être obtenue en fonction du nombre de points choisis. En outre, sa résolution a été mesurée en prenant la distance minimale entre chaque point de contrôle afin d'appliquer la méthode du filtre inverse. En comparant les deux prototypes, les résultats ont montré

Résumé

que le second prototype avec des actionneurs plus grands était moins efficace en termes d'amplitude ($4\ \mu\text{m}$ contre $8\ \mu\text{m}$) et de résolution ($1,5\ \text{cm}$ contre $1\ \text{cm}$) que le premier prototype.

Ce type de technologie est au cœur de la recherche visant à améliorer l'interaction des utilisateurs avec les surfaces tactiles. De plus, elle est particulièrement pertinente dans le domaine de l'accessibilité et notamment pour les personnes malvoyantes. En effet, ces dernières rencontrent encore des difficultés pour accéder aux contenus numériques, notamment dans les contextes mobiles. Deux options principales s'offrent à elles aujourd'hui : la synthèse vocale ou le braille. La synthèse vocale permet de traduire le contenu de l'écran en paroles. Cette méthode est largement utilisée car elle est simple et ne nécessite pas l'apprentissage d'un alphabet. Cependant, son principal inconvénient est qu'elle peut affecter l'alphabetisation, en particulier la parole omet la grammaire, l'orthographe, le genre et elle n'applique pas non plus les intonations de la voix pour distinguer les questions des déclarations par exemple. Une autre solution consiste à utiliser le braille, qui est un alphabet que l'on peut sentir grâce à six points en creux sous le bout du doigt. La lecture et l'écriture dynamiques du braille sont réalisées à l'aide d'un afficheur braille rafraîchissable, qui comprend une barre braille pour la lecture du braille et un clavier Perkins pour l'écriture du braille. Une lettre braille en lecture est composée de six points (deux colonnes de trois points) et chaque point est espacé de $2\ \text{mm}$. L'utilisateur lit le braille avec son index. Quant au braille de Perkins, il se compose de six touches, chacune correspondant à un point, et l'utilisateur utilise son index, son majeur et son annulaire des deux mains pour l'écrire. De nombreux chercheurs ont travaillé sur le rendu du braille sur un écran tactile, mais il est difficile d'atteindre une résolution en mm . Les chercheurs ont donc développé des méthodes pour contourner cette limitation, par exemple en apprenant une nouvelle langue [10] ou en utilisant des dispositifs externes supplémentaires tels que des wearables [11, 12]. Les prototypes développés dans cette thèse ne permettent pas d'atteindre une résolution de $2\ \text{mm}$ pour un rendu braille classique mais il est possible d'atteindre une résolution de $1\ \text{cm}$ pour réaliser un rendu braille Perkins. L'utilisateur peut poser ses six doigts (index, majeur et annulaire) des deux mains sur l'écran et peut ressentir des vibrations indépendantes dans les différents doigts qu'il peut ensuite traduire en lettres. En outre, la technologie présentée présente un potentiel d'intégration dans les dispositifs tactiles courants actuels, sans nécessiter de périphériques supplémentaires ni l'apprentissage d'un nouveau langage.

Nous avons donc utilisé notre solution prototype basée sur la méthode du filtre inverse

Résumé

pour transférer des lettres, puis des mots, à des personnes malvoyantes par le biais d'un feedback localisé. Avant de transmettre des lettres à la personne malvoyante, une première étude a été réalisée pour vérifier qu'un utilisateur pouvait correctement distinguer deux vibrations simultanées sur des doigts différents. Une étude de discrimination a été menée avec 10 participants voyants et quatre conditions randomisées (0, 100, 200 et 300 ms) où les participants devaient signaler les deux doigts stimulés parmi les quatre doigts ainsi que leur condition préférée. L'étude a montré que les utilisateurs pouvaient correctement distinguer deux vibrations, qu'elles soient jouées simultanément (82 % de taux de reconnaissance) sur deux doigts différents ou séquentiellement (91 % de taux de reconnaissance), mais avec une durée d'intervalle optimale de 200 ms.

Une deuxième expérience, divisée en plusieurs études et approuvée par le comité d'éthique de Paris Saclay, a été réalisée pour évaluer si notre feedback localisé sur une surface pouvait être utilisé pour transmettre l'alphabet braille et éventuellement des mots à des personnes malvoyantes. Pour ce faire, la disposition Perkins a été utilisée. Initialement utilisée comme un clavier impliquant trois doigts de chaque main, chacun étant associé à un point braille pour taper un caractère, la disposition a été conservée mais cette fois pour "recevoir" tactilement la lettre à lire. Trois méthodes de présentation ont été testées : simultanée (tous les doigts vibrent en même temps), séquentielle (les doigts vibrent l'un après l'autre) et hybride (les doigts symétriques de chaque main vibrent deux par deux). Six participants malvoyants ont d'abord testé la méthode séquentielle, puis la méthode hybride et enfin la méthode simultanée avec les 26 lettres de l'alphabet latin. Les résultats ont montré que la méthode simultanée (taux de reconnaissance de 23 %) était trop compliquée car tous les doigts vibraient en même temps et les participants ne pouvaient pas les distinguer. Pourtant, cette méthode est la plus proche de la manière traditionnelle de lire le braille et les participants ne l'ont pas rejetée, estimant qu'elle pouvait être apprise mais qu'elle nécessiterait probablement beaucoup d'entraînement. La méthode hybride (taux de reconnaissance de 54 %) a été jugée peu naturelle par les participants, car parfois l'index de la main droite vibrait avant le majeur de la main gauche, ce qui ne respecte pas le code braille. La méthode séquentielle a obtenu le meilleur taux de reconnaissance de 58 % et a été considérée comme la plus facile. Après cette étude, les résultats ont mis en évidence qu'il était possible de transférer l'alphabet braille, mais que le taux de reconnaissance était plutôt faible, notamment en comparaison avec la littérature utilisant d'autres technologies. Dans la littérature, en plus des méthodes de

Résumé

présentation, d'autres stratégies ont été employées pour améliorer la reconnaissance, comme l'utilisation de différentes caractéristiques de vibration sous chaque doigt ou des durées plus longues, que nous avons évaluées dans des études ultérieures.

Une étude évaluant des durées de présentation plus longues pour la reconnaissance des lettres a été menée avec la méthode séquentielle. La durée totale des stimuli est passée de 300 ms dans l'étude de la section EtudeBraillePerkins (avec 100 ms de durée de stimulus et 200 ms de durée inter-stimuli) à 600 ms (avec 300 ms de durée de stimulus et 300 ms de durée inter-stimuli). Cette étude a été menée avec six participants malvoyants et leurs résultats ont mis en évidence que cela n'a pas amélioré de manière significative le taux de reconnaissance (75 % avec et 78% sans), mais que les personnes se sentaient plus confiantes.

Une nouvelle étude évaluant des temps de présentation plus longs (passés de 300 ms : 200 ms de stimuli et 100 ms de pause à 600 ms : 300 ms de stimuli et 300 ms de pause) avec la méthode séquentielle, menée avec six participants malvoyants, a mis en évidence que des temps de présentation plus longs amélioreraient significativement le taux de reconnaissance (88 % vs 58 %). Les participants ont trouvé que les temps plus longs facilitaient la lecture et qu'ils avaient plus de temps pour sentir les vibrations et les localiser correctement.

La dernière étude menée visait à transférer des mots, avec quatre participants malvoyants. Les participants devaient reconnaître des mots de 5 lettres, parmi une liste de 40 mots livrés aléatoirement. Les participants ont obtenu un score moyen de 74 % de réponses correctes. Les participants ont déclaré que la tâche demandait beaucoup de concentration et que le rythme était lent pour lire un mot entier, mais qu'avec de la pratique, le transfert de mots pourrait être plus rapide.

Dans l'ensemble, la technologie a été assez bien acceptée par les participants et a démontré que non seulement il était important de trouver la combinaison adéquate de paramètres (c'est-à-dire la durée des stimuli et des inter-stimuli, la fréquence, etc.) mais aussi que les utilisateurs ont des préférences et des courbes d'apprentissage différentes.), mais aussi que les utilisateurs ont des préférences et des courbes d'apprentissage différentes. Ainsi, il sera important de fournir diverses méthodes de présentation et de réglage des durées afin que les utilisateurs puissent se familiariser avec elles et les régler en fonction de leurs besoins.

Remerciements

Je tiens tout d'abord à remercier les membres du Jury, les professeurs Ziat et Giraud qui ont accepté d'être mes rapporteurs et pour leur lecture attentive de mon manuscrit et les corrections qu'ils m'ont suggérées ainsi que les retours constructifs. Je remercie également le professeur Jouffrais et le Docteur Haliyo pour avoir participé à mon jury de thèse. Je tiens aussi à remercier le professeur Hayward qui n'a malheureusement pas pu être parmi nous aujourd'hui mais qui a tout du long suivi mes travaux.

Je voudrais aussi remercier mon directeur de thèse Monsieur Jean-Luc Zarader qui a su être présent au bon moment et a su m'accompagner tout du long.

Je tiens aussi à remercier mes encadrants de thèse. Charles Hudin pour son accompagnement et ses conseils avisés sur la partie développement du Filtre Inverse. Sabrina Pannëls pour son encadrement et sa transmission de connaissances sur la partie étude utilisateur. Elle m'a donné goût à la recherche et n'a cessé d'être de bon conseil. Au près d'elle j'ai pu développer mes points forts mais aussi mes points faibles. Je tiens aussi à la remercier pour son dévouement et sa patience à toute épreuve. Sans elle, rien de tout ceci n'aurait été possible. Je tiens aussi à les remercier de m'avoir confronté aux exigences scientifiques en me poussant dans mes retranchements ce qui m'a permis d'aboutir à cette thèse.

Je souhaite également remercier Monsieur Moustapha Hafez et Madame Margarita Anastasova, qui ont rendu ce travail possible, par la confiance qu'ils m'ont témoignée. Mes remerciements vont également à tous les membres du LISA pour la bonne ambiance et aussi les échanges scientifiques. Je tiens aussi à les remercier pour le temps consacré autour d'un café à me soumettre des idées ou des conseils avisés en électronique et mécanique.

Un grand merci à mon acolyte le docteur Ayoub Ben Dhiab pour tous nos échanges. Ces années de thèse n'auraient pas été les mêmes sans toi, entre les conférences et le voyage au Japon, on a su être là l'un pour l'autre et je pense qu'on ressort grandi de cette expérience.

Je tiens aussi à remercier les membres de l'ISIR pour leur réunion sur l'haptique où les

Remerciements

échanges étaient riches et où l'on pouvait s'inspirer des plus grands (Michael Wiertlewski, Vincent Hayward, Sinan Haliyo ...) ainsi que des doctorants (Basil, Thomas ...). Je tiens tout particulièrement d'ailleurs à remercier le docteur Basil Duvernoy. Ma rencontre avec lui a été un élément déclencheur pour la suite de mes travaux de thèse. Je le remercie de transmettre sans avarice sa passion scientifique qui l'habite. C'est grâce à lui et à son prototype que j'ai pu voir ce qu'on pouvait apporter dans le monde de l'inclusion. Cette rencontre m'a bouleversée tant sur le plan personnel que professionnel.

Je tiens aussi à remercier l'association apiDV qui permet d'accompagner, de promouvoir, d'intégrer les Déficiants Visuels. Et je tiens tout particulièrement à remercier un membre de cette association Thibault Demartimprey qui a cru au projet et nous à mis en relation avec un grand nombre des participants que je remercie d'ailleurs. Je souhaite aussi remercier l'Institut national des jeunes aveugles (INJA) et tout particulièrement Stéphane Hagues qui a lui aussi cru au projet.

Je tiens aussi à remercier Monsieur Philippe Doré qui a cru dans le projet dès le début et nous a aidé à monter nos protocoles, nous a soumis des idées, des remarques. Je tiens aussi à le remercier pour sa bonne humeur et tout le prêt de matériel et de m'avoir offert la machine Perkins de son enfance qui trône dans ma bibliothèque. Encore merci vraiment du fond du cœur.

Je voudrais aussi remercier l'ensemble de mes collègues de l'équipe GI3 au sein du cabinet Deloitte Société d'Avocat pour leur soutien sans faille sur ces derniers mois qui n'ont pas été facile.

Je souhaite remercier tous mes amis éparpillés un peu partout Québec, Toulouse, Montpellier, Saint Etienne, Marseille et j'en passe pour leur soutien tout au long de ce périple et ceux qui sont présents ici physiquement.

Je remercie aussi ma belle-famille pour leur soutien et ma famille ainsi que mes parents qui m'accompagnent depuis le début. C'est en parti aussi grâce à eux que je suis là aujourd'hui. Je leur en suis entièrement reconnaissante.

Je voudrais terminer ces remerciements en remerciant la plus importante des personnes mon futur mari, Pierre-Alexandre, qui partage ma vie depuis maintenant un peu plus de 3 ans. C'est la personne qui a été présente du début jusqu'à la fin de cette aventure et qui a su trouver la patience et les mots pour toujours me remettre d'aplomb et ne rien lâcher dans cette aventure hors du commun. C'est une aventure qui se termine et j'espère qu'il y en aura encore pleins d'autres à tes cotés ...

Mathematical notations

- C : Number of calibration points, index c ,
- Q : Number of actuators, index q ,
- F : Number of fingers (= number of control points), index f
- N_h : Number of samples of the calibrated impulse response,
- N_s : Number of samples of the stimulus,
- h : Impulse response of control points in the time domain,
- H : Transfer function of control points,
- F_s : Sampling frequency,
- \hat{h} : Impulse response of calibration point in the time domain.

List of Figures

1.1. The UltraHaptics system: Left: the setup. Centre: an example of two focal points in the air. Right: user receiving two independent stimulation. Source: images from [13].	29
1.2. Idea of the setup with mechanical feedback (Source: image from [14]) . . .	30
1.3. Localised feedback based on water jets and a flexible screen (Source: image from [15])	31
1.4. On the left: the setup of the MudPad. On the right: the technological composition of the setup. Source: images from [16]	32
1.5. The Time-Reversal approach [17]. Source: Image reproduced with the permission of Dr. Hudin.	35
1.6. Illustration of Haptable (a), (b) rear and (c) front views. Source: images from [18]	36
1.7. Illustration of the prototype for vibration rendering on a thin plate. Source: image from [19]	37
1.8. Illustration of the prototype of wave confinement. Source: image reproduced with the permission of Ben-Dhiab et al. [8, 20]	38
1.9. Illustration of the electrovibration method. Source: image from [21]	39
2.1. Illustration of the Inverse Filter method: Q actuators allowing to control F control points.	42
2.2. First prototype to validate the Inverse Filter method.	43
2.3. Different configurations of the piezoelectric elements.	45
2.4. The touchscreen where the 14 piezoelectric actuators are glued, and the electronic interface of the prototype, with the acquisition device NI-9264 and NI-9205, the electronic support cDAQ-9174, and the piezo haptic drivers that drive the piezoelectric actuators.	46
2.5. Recording of the displacement and creation of the impulse response matrix.	47

List of Figures

2.6.	Target displacement: the first control point activated with a 250 Hz burst and the second control point activated with a 350 Hz burst and a delay of 100 ms.	48
2.7.	Calculated signal $s(t)$ using the Inverse Filter method: these signals will be sent to the actuators to create the target displacements chosen in Fig. 2.6.	49
2.8.	Measurement of the displacement of the two control points obtained thanks to the control signal $s(t)$ in Fig. 2.5	50
2.9.	Displacement in micrometer of two control points where the Inverse Filter method is applied according to the distance between these two points: 2, 1.5, 1.0 and 0.5 cm.	52
2.10.	Average amplitude over 50 random positions for each number of control points activated as a function of the total number of control points.	54
2.11.	Electronic interface of the prototype: an acquisition device NI-9264 and NI-9205, an electronic support cDAQ-9174, piezo haptic drivers that drive the piezoelectric actuators and the touchscreen where are glued the eleven piezoelectric actuators and the capacitive screen.	57
2.12.	Frame that enables to recover the number of control points as well as their respective positions.	57
2.13.	Dot grid for the calibration of the plate: 3555 control points and the corresponding \hat{H}_c	58
2.14.	Explanation of the construction of the matrix $\hat{h}_{cq}(t)$ thanks to the multiple sweep method.	59
2.15.	Calculation of the impulse response matrix using the Fourier interpolation method for a given finger position.	59
2.16.	The figure shows the difference between the impulse response h measured above a control point and the impulse response h interpolated at that same control point.	60
2.17.	Control output: the first control point is activated with a 250 Hz burst, the second and third control points are not activated.	61
2.18.	Measurement of the displacement at the three control points with a correlation coefficient of 0.99.	62
2.19.	Time calculation of the Inverse Filter method in function of the number of control points and the number of samples with $F_s = 10$ kHz. 20 samples correspond to a burst with 1 cycle at 500 Hz and 2600 samples correspond to a burst with 26 cycles at 100 Hz.	63

List of Figures

2.20. Displacement in micrometer of two control points where the Inverse Filter method is applied according to the distance between these two points: 2.5, 2.0, 1.5 and 1.0 cm.	64
2.21. Calculated peak displacement in μm above all the calibration points of the screen when the displacement is maximum. The first control point is activated with a 250 Hz burst and the second control point is not activated, i.e. set to zero.	65
2.22. σ_1 is the deviation of the first control point and σ_2 is the deviation of the second control point. The red circle has a diameter of 7.5 mm, it represents the surface of a finger.	66
2.23. Explanation of the $r_{f,c}$ distance which enables us to calculate the evolution of the deviation criterion.	67
2.24. Evolution of the deviation on 100 random draws for two control points.	68
2.25. Average amplitude over 50 random position draws for each number of control points activated as a function of the total number of control points.	70
2.26. On the left: Setup measuring the displacement under the control point. On the right: Difference between the haptic feedback signals when a finger applied an interaction force on the plate and without the finger on the plate.	71
3.1. Night writing invented by Charles Barbier de La Serres. Source: image from ligue Braille [22]	75
3.2. Braille alphabet created by Louis Braille. Source: image from Musée des sciences et de la technologie du Canada [23]	75
3.3. Rules of Braille.	76
3.4. The first way to write Braille.	76
3.5. Perkins machine. Source: image from Catawiki [24]	77
3.6. The Digicassette invented by Pierre Schneider-Maunoury. Source: image from Museum of the American Printing House for the Blind [25]	78
3.7. Pantobaille. Source: image from [26]	79
3.8. Vital. Source: image from [27]	79
3.9. Pneumatic. Source: image from [28]	80
3.10. Haptiread device. Source: image from [29]	81
3.11. Prototype Ubibraille: six vibrotactile actuators directly to the fingers. Source: image from [11]	83

List of Figures

3.12. Wearable setup of the glove. Source: image from [12]	85
3.13. Morse code in order to render Braille characters. Source: image from [10]	86
3.14. Nokia 770 internet tablet, which allows presenting the vibrations thanks to a stylus. Source: image from [30]	87
3.15. Prototype of HoliBraille. Source: image from [31]	88
4.1. Left: experimental setup. Right: finger positions of the participants. (the photo was reproduced with the authorisation of the participant)	92
4.2. Stimulation number corresponding to the stimulated fingers.	93
4.3. Average performance (in %).	94
4.4. Confusion matrices. From left to right: 0 ms, 100 ms, 200 ms and 300 ms.	96
4.5. Average response time (in s).	97
4.6. Prototype of the experimental study	99
4.7. Illustration of the three methods of presentation.	100
4.8. Progress of the user study.	102
4.9. Confusion matrix for the sequential method averaged across participants. The darker the color, the higher the recognition rate. Confusions are indicated outside of the diagonal.	103
4.10. Qualitative feedback from participants for the sequential method using a Likert scale. The negative answers were grouped on the left side of the pictures (gradient of orange colours for the level) and similarly the positive answers were grouped on the right side (gradient of green colours). The x-axis represents the total number of answers for a given type.	105
4.11. Confusion matrix for the hybrid method averaged across participants. The darker the color, the higher the recognition rate. Confusions are indicated outside of the diagonal.	106
4.12. Qualitative feedback from participants for the hybrid method using a Likert scale. The negative answers were grouped on the left side of the pictures and similarly the positive answers were grouped on the right side. The x-axis represents the total number of answers for a given type.	107
4.13. Confusion matrix for the simultaneous method averaged across participants. The darker the color, the higher the recognition rate. Confusions are indicated outside of the diagonal.	108

List of Figures

4.14. Qualitative feedback from participants for the simultaneous method using a Likert scale. The negative answers were grouped on the left side of the pictures (gradient of orange colours for the level) and similarly the positive answers were grouped on the right side (gradient of green colours). The x-axis represents the total number of answers for a given type. 109

4.15. Recognition rate per participant according to the different methods: sequential, hybrid and simultaneous. 110

4.16. Letters used for the frequency study 113

4.17. Differences in recognition rates with and without different frequencies among participants. 114

4.18. Illustration of the two methods: sequential and semi-simultaneous. 116

4.19. Results of the study with longer presentation times. 119

4.20. Confusion matrix for the semi simultaneous method averaged across participants. The darker the color, the higher the recognition rate. Confusions are indicated outside of the diagonal. 120

4.21. Qualitative feedback from participants for the semi simultaneous method using a Likert scale. 121

5.1. Possible layout of the sensors on the hand to measure vibration propagation. 134

Introduction

Tactile surfaces have pervaded our daily life. In cars, the dashboard with physical buttons has given way to a touchscreen. When we do our shopping, the automatic cash registers are also equipped with a touchscreen. Most smartphones are now nearly entirely tactile. Even inside our home, household appliances such as our hotplates, the oven, the washing machine, have their physical buttons gradually disappear and replaced by a smooth tactile surface. This abandonment of the physical buttons offers several advantages, amongst which a more direct and natural interaction, aesthetics and more futuristic designs (e.g. for cars and planes cockpits), less maintenance issues with mobile parts and easier cleaning and hygiene [1]. Woefully, these tactile surfaces are inert and lack rich haptic feedback so the user is forced to interact mainly using vision. This can be problematic in situations where the visual sense is overloaded, such as during driving, or unavailable, e.g. for the visually impaired, and remains far from the ideal of natural user interfaces. In fact, haptic feedback and particularly vibratory feedback could bring a multitude of information. It could, for example, allow the driver to interact with their car dashboard solely through touch and by reducing visual distraction, consequently contribute to reducing road accidents. It could also improve the interaction with the smartphone. Indeed, adding a haptic feedback to each key of the keyboard can reduce typing errors [2]. Generally, it has the potential to improve exploration of lists, icons/buttons or targets. It has demonstrated other benefits, including pleasantness of the interaction, rapidity of task completion and reduction of cognitive load [3, 4, 5, 6]. It also has the potential to add the missing tangibility, for example for digital buttons by allowing a sensation of depth effect when the user presses on the button. Currently, these interactions with touchscreens are mostly achieved with a single finger. However, it would be beneficial to be able to interact with several fingers at the same time to perform a task. Indeed, the interaction with several fingers enables users to work faster and more fluently than do traditional single-point interaction methods [7]. Currently smartphones can have multi-finger input but cannot combine vibratory feedback with this multi-finger input. They

Introduction

provide feedback in the form of a global vibration, that is to say that the vibration will propagate in the surface and two fingers in contact simultaneously on the surface will receive the same vibratory information. Being able to make a localised rendering of the haptic feedbacks could open up new possibilities for interaction. Two people using simultaneously the same screen could feel very independent vibrations. Localised haptic feedback could also allow feeling textures by sliding one's finger(s) on the surface. This would make it possible to feel the materials when shopping online for example. It would also be possible to feel contours and to be able to guide oneself on the surface. This would be particularly useful for the visually impaired people, who could finally "feel" the information on their digital graphical display. Yet, adding such localised multitouch vibrotactile feedback to a touchscreen is not straightforward, due to issues of vibration propagation, reverberation and attenuation. Therefore, the research question tackled by this thesis is how to physically localise these vibrations to achieve a multitouch rendering on a touch surface, for future integration into commonly used devices. There exist different technologies allowing a localised vibratory feedback. However, they have drawbacks such as the high electrical power to be supplied, the lack of choice of parameters to tune the feedback or the difficulty of implementation. Therefore, this thesis has investigated and developed a new method for localised multitouch vibratory feedback to solve these issues. This approach is based on the active control of the vibrations that propagate in the surface. Indeed, as mentioned previously, when the finger touches the surface, it will receive a vibratory feedback. However, this vibration will not remain concentrated at the point of contact but instead, will propagate throughout the surface, reverberate and eventually fade out. Indeed, the wavelength in a glass surface of 1 mm thickness at a frequency of 250 Hz is about 15 cm, thus it is not possible to make a localised rendering below this wavelength. The goal of this thesis was to beat this limit in order to obtain a finer resolution of the order of the centimetre, i.e. the fingertip size. The approach described in this thesis, called the Inverse Filter method, allowed to overcome this limit and to localise the vibrations with a resolution of 1 cm, well below the wavelength. This was demonstrated with a first prototype that applied the Inverse Filter method on a glass surface by knowing beforehand the position of the fingers. Measurements were performed to determine the physical characteristics of the prototype: resolution, maximum amplitude and impact of the finger on the surface. Then, a second prototype was implemented with, this time, a touchscreen allowing the recovery in realtime of the positions of the fingers. This prototype enabled a haptic feedback in realtime, where

Introduction

the user could choose the position of their fingers on the surface. To achieve realtime feedback, it was necessary to implement a Fourier interpolation method in Python in order to optimise the required input data and the calculations of the Inverse Filter method to produce a feedback with the shortest latency. Measurements were also performed to obtain the physical characteristics of the prototype: resolution and maximum amplitude. These data were compared to the first prototype to assess which prototype was the most efficient. These technical contributions led to two publications, one patent and a demonstration:

Pantera L. and Hudin C. Sparse actuator array combined with Inverse Filter for multitouch vibrotactile stimulation. In : 2019 IEEE World Haptics Conference (WHC). IEEE, 2019.

Pantera L. and Hudin C. Multitouch vibrotactile feedback on a tactile screen by the Inverse Filter technique: Vibration amplitude and spatial resolution. IEEE transactions on haptics, 2020.

Pantera L., Hudin C. and Panëels S. Dispositif haptique de lecture mettant en œuvre la méthode Braille-Perkins. Brevet 2021.

Dispositif LOTUS, Enrichir l'interaction tactile grâce à un rendu hyper-localisé. CES Las Vegas 2019 [32].

This kind of technology is at the heart of research to improve user interaction with tactile surfaces. In addition, it is particularly relevant in the field of accessibility and particularly for visually impaired people. In fact, they still face difficulties to access digital content, in particular in mobile contexts. They have two main options available today: text-to-speech or Braille. Text-to-speech enables to translate the content of the screen into speech. This method is widely used as it is simple and does not require learning an alphabet. Yet, its main drawback is that it can affect the literacy, in particular speech omits grammar, spelling, gender and it also does not apply voice intonations to distinguish questions from statements for instance. An alternative is to use Braille, which is an alphabet that can be felt through six indented dots under the fingertip. The dynamic reading and writing of Braille is achieved with a refreshable Braille display, which includes a Braille bar for reading Braille and a Perkins keyboard for writing Braille. A Braille letter in reading consists of six dots (two columns of three dots) and each dot is spaced 2 mm apart. The user reads Braille with his/her index fingers. Concerning Perkins Braille, it consists of six keys, each mapped to a dot, and

Introduction

the user uses his/her index, middle and ring fingers of both hands to write it. Many researchers have been working on rendering Braille on a touchscreen, but it is difficult to achieve a resolution in mm. Researchers have therefore developed methods to circumvent this limitation, such as through learning a new language [10] or by using additional external devices such as wearables [11, 12]. The prototypes developed in this thesis do not allow a resolution of 2 mm for classic Braille rendering but it is possible to reach a resolution of 1 cm to make a Braille Perkins rendering. The user can put their six fingers (index, middle and ring fingers) of both hands on the screen and can feel independent vibrations in the different fingers that they can then translate into letters. Moreover, the presented technology has the potential for integration into current common touchscreen devices, without requiring additional peripherals or the learning of a new language. Several user studies with both sighted and visually impaired people were carried out to evaluate the effectiveness of the Inverse Filter method in conveying localised multitouch feedback and its feasibility for conveying words to the visually impaired. Five experiments were conducted overall grouped into two main studies. The first study was conducted with sighted people to verify that users could feel localised multitouch feedback, with vibrations sent simultaneously or with delays between each vibration. Then a second study, divided into four successive experiments and validated by the Paris Saclay ethics committee, was conducted with visually impaired people. The overarching goal was to evaluate the transmission of letters to eventually read words. A first experiment evaluated three methods of presentation in order to find out which method was the most effective to convey Braille letters. The second experiment was conducted with sighted people to test whether providing a different feedback on the different fingers, by changing the frequency, would improve the recognition rate. The third experiment was a continuation of the second study with visually impaired users by changing the presentation time parameters and testing a new presentation method to evaluate whether it could improve the recognition rate. Finally, the last experiment presented five-letter words to visually impaired participants. The results of these studies and contributions on the perception of localised feedback and its application to an accessibility use case led to two publications:

Pantera L., Hudin C. and Panëels S. Two-Point Haptic Pattern Recognition with the Inverse Filter Method. In : International Conference on Human Haptic Sensing and Touch Enabled Computer Applications. Springer, Cham, 2020.

Introduction

Panter L., Hudin C. and Panëels S. LotusBraille: Localised Multifinger Feedback on a Surface for Reading Braille Letters. In : 2021 IEEE World Haptics Conference (WHC). IEEE, 2021. (finalist for the best presentation at the World Haptics Conference 2021)

This thesis describes these contributions in more details through five chapters, including this introduction, structured as follows. The second chapter reviews the different methods for multitouch and localised haptic feedback. The third chapter focuses on the Inverse Filter method. First, a theoretical explanation of the Inverse Filter method is presented. Then, two prototypes that were developed are presented in order to apply the Inverse Filter method on a glass surface. The measurements realised on the two prototypes are presented in order to exhibit their physical characteristics. The fourth chapter is focused on the human evaluation of the prototype, and in particular on a use case focused on accessibility. Five studies are presented. The first study described aimed to validate the Inverse Filter method and the perception of localised multitouch feedback. The other four studies focused on the transmission of the Braille alphabet, the improvement of presentation methods and finally the transmission of five letter words to visually impaired users. The fifth chapter concludes the thesis by summarising the results and with suggestions for future work.

1. Methods for localised and multitouch haptic feedback on a surface

According to Georges-Louis Leclerc Buffon [33]: “The sensations would only produce false judgments, if they were not, at any time, rectified by the testimony of touch; this is the solid sense, it is the touchstone and the measure of all the others”.

Indeed, touch is an integral communication channel and a powerful vehicle for emotions. There are different types of haptic feedback, but in everyday commercial devices, the most used haptic feedback for communication is in the form of vibrations that could be applied to any part of the body. These haptic feedback have been used successfully in several fields, for example in virtual reality to convey emotions and increase immersion [34, 35, 36, 37, 38, 39, 40, 41], including for maintenance training [37, 34, 38], in medical training, rehabilitation [42, 43, 44, 45] and tele-surgery [43], to help visually impaired people in their daily lives [46], or simply in everyday life with smart surfaces [47, 48]. In this thesis, we are particularly interested in vibrotactile feedback at the hand level and more particularly at the finger level. The goal is to be able to make a multitouch haptic feedback on a surface. Multitouch is controversial but useful to improve haptic performance [49]. Morash et al. [49] conducted a user study that proved that tasks were best performed with two hands and several fingers. However, it all depended on the task at hand. When it was a line drawing, the task was faster when the user used two hands and one finger per hand. For local and global target search, the task was faster when the user used several fingers but with one hand. In addition, multitouch has the potential to create more complex and precise interactions [50, 51, 52] by leveraging sensory illusions, such as generating apparent motion [50] or additional static phantom sensations thanks to the funneling illusion [51, 52]. As the goal of this thesis was to make a non-invasive haptic feedback, through a device not cumbersome for the human and easy to use, we focused on a device that does not directly equip the hand, such as a wearable, but on a surface instead, such as touchscreens. Therefore, the remainder of this chapter reviews existing techniques for localised multitouch vibrotactile feedback

1. *Methods for localised and multitouch haptic feedback on a surface*

on a surface. These can be divided mainly into techniques relying on feedback outside the surface, on deformable surfaces, and on non-deformable surfaces.

1.1. **Multitouch feedback technology outside the surface**

Part of research on multitouch haptic feedback has focused on hands-free haptic feedback, by providing feedback in the air, as this can enable to deliver feedback in 3D space without equipping the user. Examples of applications are for virtual and augmented reality, interaction with public displays or future holograms [53]. For example, some researchers have worked on a toroidal flow of air [54], which is a vortex ring. It can be formed by pushing air with a piston through a circular aperture or hole. The characteristics depend on the volume of air pushed, the velocity of the piston and the diameter of the circular aperture/hole. The technology developed based on this principle was robust because the vortex ring created kept its characteristics, i.e. shape, size and momentum as it travelled. The prototype allowed obtaining a resolution of 100 mm with a distance between the user and the prototype of 2.5 m. The distance of 2.5 m was reasonable, it was roughly the distance a user is from their TV when they played a video game and this kind of feedback could make their game more immersive. Unfortunately, the resolution was not small enough for feedback on the finger and the haptic feedback touched not only the desired location but also its closest neighbours. Moreover, the prototype was quite bulky ($28 \times 28 \times 15$ cm). This kind of haptic feedback in the air is also used by the ultrasonic technology [55, 13, 56], see Fig. 1.1. The devices have about 240 actuators organised in a matrix form. In this case, the haptic feedback is not based on a vortex ring but rather on the creation of an acoustic field, which allows to focus in the space a breath of air. Indeed, when a haptic feedback is required, a phase delay and amplitude is calculated for each transducer to create an acoustic field forming the desired focal points. These technologies have achieved a resolution of 1cm, which is very appropriate for hand feedback as it corresponds to the size of the fingertip. However, the actuators work at a high frequency, i.e. 40 kHz, well beyond the tactile sensitivity band that ranges from a frequency of 30 to 1000 Hz [57]. For the human to perceive it, it is necessary to modulate the emitted ultrasound signal with frequencies of the tactile sensitivity range. It adds a computational step but allows the user to choose any excitation frequency and it can render a multitude of haptic feedbacks: more or less strong vibrations, vibration with tunable frequency, with tunable shape etc. Yet, this technology relies on an actuator matrix that is very

1. Methods for localised and multitouch haptic feedback on a surface

large and very energy consuming. Consequently, the device is not easily transportable and is more suitable when the user is sedentary, and thus at home or in a store but it cannot be implemented yet in a smartphone for example.



Figure 1.1.: The UltraHaptics system: Left: the setup. Centre: an example of two focal points in the air. Right: user receiving two independent stimulation. Source: images from [13].

1.2. Multitouch feedback technology on a deformable surface

The technologies presented until now allowed a multitouch feedback outside a surface, but it is also possible to realise such a haptic feedback on a surface. It can be achieved either by locally deforming the surface, by localising vibrations in the surface or by directly acting on the finger. Regarding technologies with local deformation, researchers have investigated mechanical deformation of the surface [14, 15]. Iwata et al. [14] produced a surface with a size of 24×24 cm, named FEELEX (see Fig. 1.2), with a linear actuator array of 6×6 attached under it. The actuators were driven individually by a DC motor and deformed the shape of the surface. This technology enabled to explore a surface completely and to feel the hollows and the bumps. The authors envisioned that it could enable the visually impaired to feel the relief of maps, for example the mountains through bumps and the plains through hollows, and locate themselves. The major disadvantage of the FEELEX technology is the difficulty in its implementation. It required a large number of actuators that had to be controlled simultaneously, which required a perfect synchronisation of the control electronics and therefore a high-performance computer equipment. Moreover, another limitation highlighted by participants in their study was the shape of objects that could be displayed. Indeed, only the front or the back side of the objects could be seen and felt, not both at the same time.

Another rather atypical way is to use water jets [15]. For instance, Reusser et al.

1. Methods for localised and multitouch haptic feedback on a surface

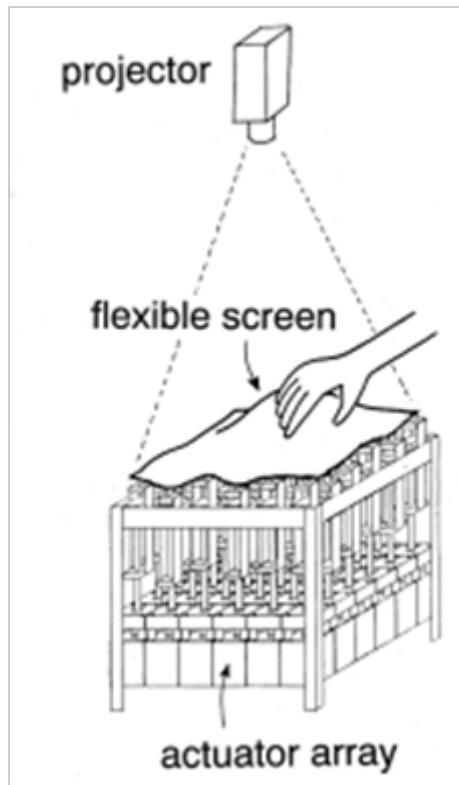

Figure 1.2.: Idea of the setup with mechanical feedback (Source: image from [14])

[15] used a flexible screen, backed by five pan-tilt nozzles that deliver water jets, with different nozzles to generate different feedback effects on the surface (see Fig. 1.3). The surface is also interactive, using a Kinect to detect screen finger presses. This technology could produce a “rocket feedback” (i.e. a feedback to a specific point on the surface) with a 6 mm diameter, which is very thin. This technology was developed to allow the visually impaired to feel fireworks. The main disadvantage of this technology is that it must be used in a vertical position and it is not suited for smaller surfaces and smaller devices such as handhelds or wearables. It is, however, limited in terms of feedback. Although it is possible to adjust the water pressure, it remains difficult to produce a wide variety of feedbacks compared to vibrotactile feedback, which allows one to choose the shape of the signal, the amplitude, the frequency etc.

The deformation of the surface can be achieved in a more classical way with the help of electricity. For example, TableHop [58] is a tablet or table-sized shape-changing surface. The prototype had a 30×40 cm surface area. The surface of TableHop was made of

1. Methods for localised and multitouch haptic feedback on a surface

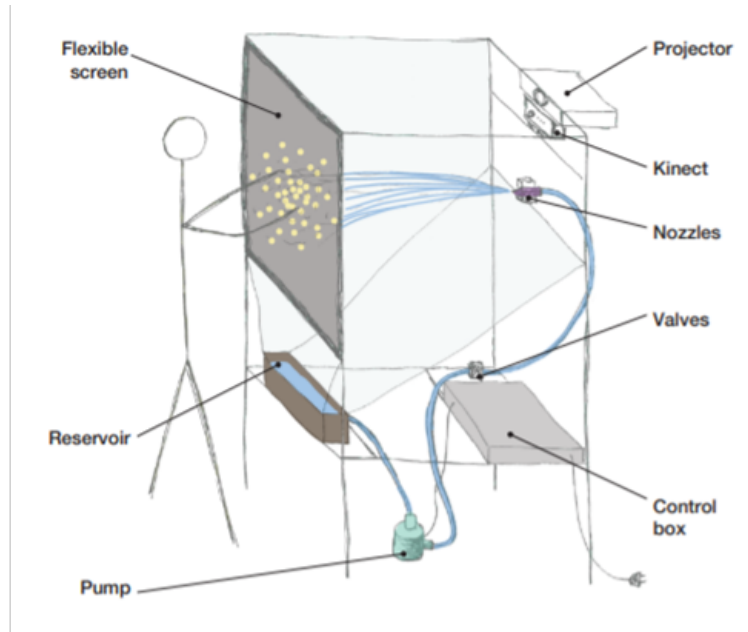

Figure 1.3.: Localised feedback based on water jets and a flexible screen (Source: image from [15])

a fabric that is elastically deformable through user manipulation and self-actuation. It included an array of thin transparent film indium tin oxide (ITO) electrodes arranged as a grid of 3×3 . A second set of electrodes on a transparent substrate was placed below the fabric. Thus, the fabric was actuated using electrostatic force by applying a high voltage between the electrodes to the desired position. TableHop worked in the tactile sensitivity range. It achieved a deformation of ± 5 mm, which is a very fine resolution. Unfortunately, authors mentioned that electrostatically deflected elastic systems suffer from pull-in or snap-down instability, which led to a degradation of the haptic feedback. It occurs when the applied voltage is increased beyond a certain critical voltage. Moreover, TableHop does not enable very sharp deformable physical features, similarly to other elastic and malleable displays. The deformation can also be produced thanks to magnetorheological fluids [16, 59]. Jansen et al. [16, 59] developed MudPad (see Fig. 1.4). Below the surface was a layer of magnetorheological (MR) fluid and below the layer there was an array of electromagnets. The viscosity of the MR fluid can be altered linearly by applying a magnetic field of variable strength. The stronger the magnetic field, the more the haptic feedback would be felt. The rendering thus enables to vary the amplitude of the feeling. Unfortunately, it is not possible to choose

1. Methods for localised and multitouch haptic feedback on a surface

the frequency of the feeling. It would be interesting to have different frequencies in order to be able to transfer a multitude of different stimulations. Moreover, the feedback is only provided above the coils; outside the coils, the user is not able to feel anything. Hence, the user does not have access to the whole surface and can actually touch some locations without getting any haptic feedback.

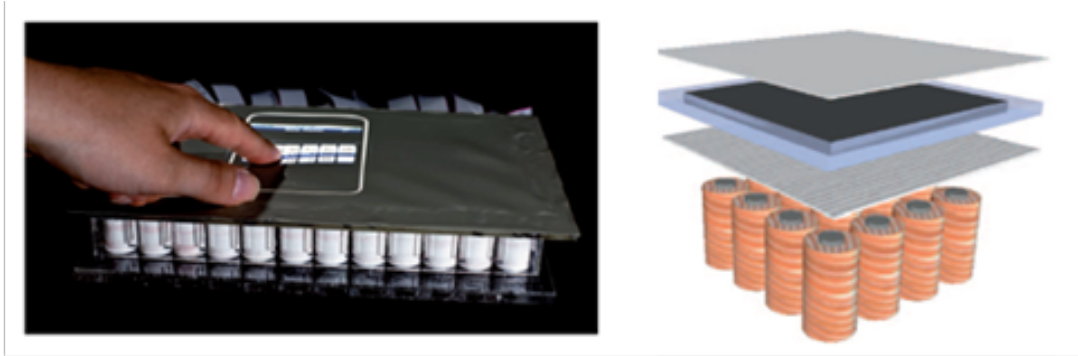

Figure 1.4.: On the left: the setup of the MudPad. On the right: the technological composition of the setup. Source: images from [16]

Aside from mechanical and electric stimulation, it is possible to generate a localised haptic feedback in a soft surface thanks to vibrations. Reardon et al. [60] have developed Elastowave. It is a soft tactile interface that provides localised tactile feedback via a soft, compliant surface. The localisation of the haptic feedback is done by focusing elastic wave fields generated by a compact array of remote actuators, which are placed on the soft surface. Their method is based on variations of Time-Reversal focusing techniques for elastodynamic waves. They are able to produce single or multi-point localised feedback with a centimeter resolution. This technology is very effective and must be well felt because they manage to obtain $100 \mu\text{m}$ of amplitude at the focused point but it has not been tested with users. Unfortunately, for the moment, this technique is applied on a soft surface and cannot be applied to a screen because the mathematical model it relies upon depends on flexible surfaces and the behaviour of elastic waves in those. Finally, it is also possible to produce a feedback by suction of the finger. The VacuumTouch prototype [61] consists of an air vacuum pump, an air tank and an array of electric magnetic air valves connected to holes on the surface. When a finger is detected, the valve opens and the pump starts to aspire the finger. The feedback is frank and surely well felt: 21 out of 24 participants felt the suction force all the time or frequently. However, the prototype produces a finger suction only

1. *Methods for localised and multitouch haptic feedback on a surface*

where the pumps are located. Moreover, it is very cumbersome and as it is, i.e. based on a pump, a tank and valves, it cannot be combined with a screen for mobile devices. These various technologies reviewed so far enable to render a multitouch haptic feedback either outside the surface, or by locally deforming a surface. In this thesis, however, we decided to focus on multitouch feedback directly on a surface and more precisely on an unmodified surface, such as a touchscreen for wider application with the prospect of future integration into common commercial devices.

1.3. Multitouch localised feedback on non-deformable surfaces

1.3.1. Different types of feedback on touch surfaces

On tactile surfaces, traditionally there are two main types of interaction: either by moving your finger on the surface, to render a texture for example, aka dynamic feedback, or by staying static on the surface, to render pressing a button for example, aka static feedback. Concerning dynamic feedback, texture rendering can be achieved in high frequency with a force modulation in the tangential plane when the finger is sliding on the surface [62, 63]. One method for this is to use ultrasonic waves. When a finger slides over a high frequency vibrating plate, the friction that this motion produces decreases as the vibration amplitude increases. This kind of phenomenon is called active lubrication. Two different mechanisms have been suggested to explain this phenomenon. The first is the squeeze film effect [64], where air is trapped between the finger and the surface. The second mechanism is based on the intermittent contact between the finger and the surface [65]. It is also possible to combine two modes of vibration controlled in amplitude and phase [66]. This allows for a multi-point haptic feedback. Phononic crystals [67] could be used to localise the modulation of friction in specific portions of the surface of a thin plate. Another way is to use electrostatic forces [68]. These different methods of producing texture feedback have been implemented in tablets (e.g. [69]). More details about friction-based technologies for the rendering of textures can be found in Basdogan et al.'s review [70].

Concerning static feedback [71, 4], the finger is stationary and usually receives a vibration in the normal direction. This vibration is often created by an actuator that is placed on the surface at the center or periphery and allows the propagation of the vibration in the material before reaching the finger. This type of haptic feedback is directly detectable by the human tactile system if the frequency is within the tactile sensitivity band, i.e. below 1000 Hz. Yet, there are also examples of static feedback for button

1. *Methods for localised and multitouch haptic feedback on a surface*

clicks in the high frequency range using ultrasonic stimulation [72, 73]. It is possible to go beyond the simple static feedback. Indeed, vibrations combined with force sensing and synthesis algorithms can raise the illusion of compliant surfaces, such as pressing a button [74, 75, 76], thus engaging users into more immersive interactions. Kildal et al. [74] and Kim et al. [75] used an actuator coupled with a sequence of different vibrations to render a button with depth. The user presses on a rigid surface and yet feels the sensation of sinking into the material as if they were really pressing a push button. This effect is achievable thanks to a frequency modulation as a function of time.

In this thesis, we are interested in static localised feedback in the low frequency range, but rendering dynamic feedback in either the low or high frequency range could be a lead for a continuation of the thesis. In fact, vibrotactile feedback in low frequency range is already present in our smartphones. However, these tactile feedbacks are very basic and have limitations. Indeed, when the vibration is generated, it will propagate and reverberate in the material and when two fingers will touch the surface, they will receive the same vibratory information. It is therefore difficult to produce a localised feedback to a part of the surface. Yet, it could be beneficial for multi-user interaction, exploration tasks and more generally for more natural user interaction. Research has investigated techniques to circumvent these phenomena of propagation and reverberation of vibrations in a surface and they are detailed in the following section.

1.3.2. **Localisation methods for static feedback on surfaces**

This section presents the different existing methods to localise multitouch static haptic feedback on surfaces.

1.3.2.1. **Control of vibrations in the surface**

One of the ways to make a multitouch rendering is to know how the plate behaves according to the frequencies of the vibration to then control it. One of the methods is the Time-Reversal approach [77, 78, 17, 79, 80]. It is a physical phenomenon that allows concentrating all the energy at a defined point on the surface. The prototype of Hudin et al. [17], for example, is composed of a glass plate with piezoelectric actuators glued on the contour of the plate (see Fig. 1.5). The Time-Reversal focusing is achieved thanks to a set of actuators that record the out-of-plane displacements. This displacement is produced by an impulse source located at a point that has been chosen on the surface. The signal recorded by each actuator is the impulse response between the point and one

1. Methods for localised and multitouch haptic feedback on a surface

actuator. Then, these impulse responses are time-reversed and used as driving voltage for all actuators. The re-emission leads to the re-focusing of the waves at the point. This method offers several benefits because the actuators are at the periphery of the plate, which allows to use a common transparent screen and thus to have a haptic feedback collocated with a visual feedback. Moreover, the focusing of the energy allows one to choose the location of the impulse on the surface and to extend it to several fingers. However, this phenomenon occurs in high frequency, beyond the tactile sensitivity range. The perception of the stimulation is thus based on the lift-off of the pulp of the finger, which is a phenomenon difficult to control. In addition, working in the high frequency domain requires a lot of energy to control all these actuators.

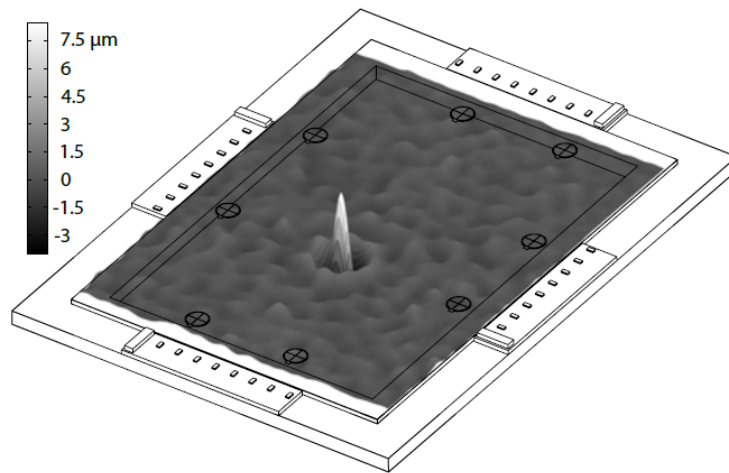

Figure 1.5.: The Time-Reversal approach [17]. Source: Image reproduced with the permission of Dr. Hudin.

Other researchers proposed another method to achieve multitouch localised haptic feedback but still based on exploiting the deformation of the plate as a function of frequency. One of these researchers has developed Haptable [18], depicted in Fig. 1.6. This table has three modules: gesture detection, visual display and haptic feedback. For the haptic feedback, four piezoelectric patches are glued on all four sides of the surface. The surface is divided into 84 grid points (7 rows by 12 columns). The technique is based on several steps. First, a vibratory learning of the plate is conducted, i.e. the displacement of each point of the grid is recorded when the actuators vibrate individually and then all at the same time. Then, a frequency response functions (FRF) is obtained for all the points of the grid. In order to produce a localised haptic feedback, the

1. Methods for localised and multitouch haptic feedback on a surface

5 FRFs (4 FRFs actuators and 1 FRFs all actuators together) of each selected point on the surface are plotted, and the frequency where the amplitude is maximum for the activated point and minimum for the inactivated point is identified as well as which actuator is used (one of the four or the four together). This method allows for the rendering of localised feedback with an amplitude of up to $14\ \mu\text{m}$ of displacement. The actuators are glued on the periphery, which allows a transparent interface. However, the technology, involving a screen, but also a camera, mirror and lens, is limited to a specific setup and thus not easily integrated into typical touchscreen devices such as smartphones or computers. Moreover, it is not possible to choose the frequency, the amplitude and the location of the vibration. Either the location is chosen and therefore the amplitude and frequency are imposed, or it is possible to choose the frequency but not the location of the vibration. Yet, controlling these parameters is important because they allow a wider range of haptic feedbacks and thus more realistic feedback.

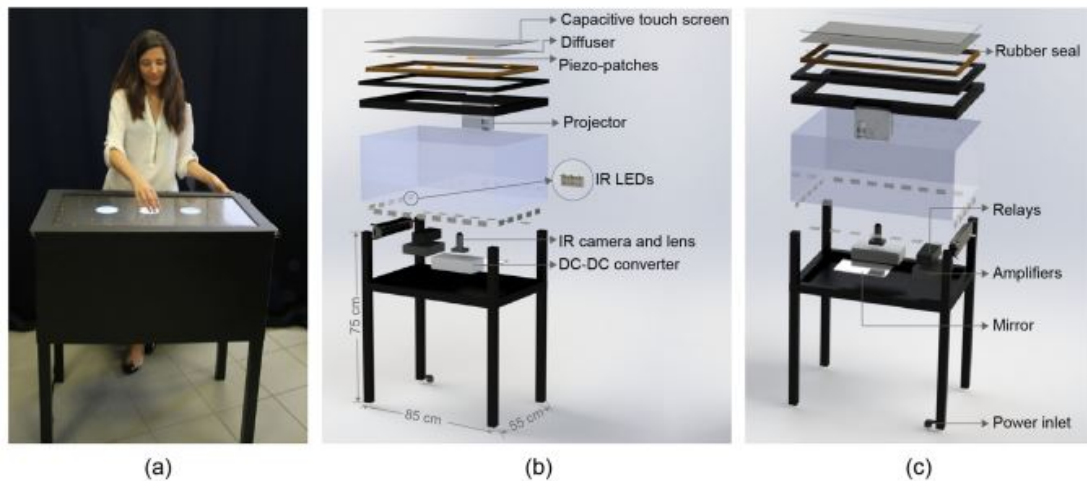

Figure 1.6.: Illustration of Haptable (a), (b) rear and (c) front views. Source: images from [18]

1.3.2.2. Combination of the vibration modes of a plate

Plate modes can be used to achieve multitouch localised haptic feedback. They allow the activation of specific areas of the plate according to the chosen frequency. Woo [19] has developed a prototype composed of a glass plate with 34 actuators glued at the periphery of the surface (see in Fig. 1.7). In order to make a multitouch haptic rendering, the author uses two functions: an eigen function superposition or a traveling wave control, which

1. Methods for localised and multitouch haptic feedback on a surface

are used to establish the contribution of each mode on the plate. Then, general inverse methods are used to obtain the actuator weightings for achieving the target pattern. This method places its actuators on the contour, which permits a transparent surface, and the actuators are driven at a frequency of 300 Hz in the tactile sensitivity range. However, it is not possible to choose the shape of the vibration and the activation is performed only by zones ranging from 35 cm^2 ($7 \times 5 \text{ cm}$) to 99 cm^2 ($11 \times 9 \text{ cm}$), called hot for an activated zone and cold for a non-activated zone. Thus, it is not possible to deliver feedback at the finger scale (i.e. several fingers side-by-side can receive the same feedback).



Figure 1.7.: Illustration of the prototype for vibration rendering on a thin plate. Source: image from [19]

Enferad et al. [81] have been working on the development of modal superimposition. Their prototype consists of a staple shaped aluminium beam where piezoelectric patches are glued to the underside of the surface. This method is based on the velocity field. Indeed, depending on the voltage applied to the different actuators, some modes will be excited and not others, which enables to make a localised rendering. The localisation does not depend on the actuators and can be performed at any point on the surface. On the other hand, the surface is not transparent and therefore does not allow a visual feedback. The characteristics of the vibration such as the frequency of the feedback haptic cannot be chosen either, it depends on the activated mode.

1.3.2.3. Non-propagative approach

Another method of localisation is based on the geometry of the plate. Indeed, Ben-Dhiab et al. [8] have taken an aluminium plate with a width of 25 mm. Piezoelectric actuators were glued under the plate at a regular distance from each other on the same line. The plate must be narrow because below a certain frequency called cut-off frequency, no plate mode exists and therefore no vibration is propagated. When a vibration is sent to an actuator, it remains localised above it, as shown in Fig. 1.8. This method does not require any signal processing as it relies only on the geometry of the plate. It works in the tactile sensitivity range because the cut-off frequency is well above 1000 Hz. It is possible to choose the form and frequency of the signal for haptic feedback. This method can even be extended to a 2D surface [20] by dividing a plate into several narrow plates. However, this method does not allow rendering feedback at any point of the surface; the haptic feedback can only occur above a piezoelectric actuator. This can be an issue because if the user touches the screen at a location between two actuators, they will not receive any haptic feedback. Furthermore, as in this method the actuators are glued directly below the interactive surface, this feedback cannot be integrated into current transparent touchscreens and thus coupled with a visual feedback. This also applies to our method, yet, researchers are working on transparent piezo-actuation [82], amongst other leads.

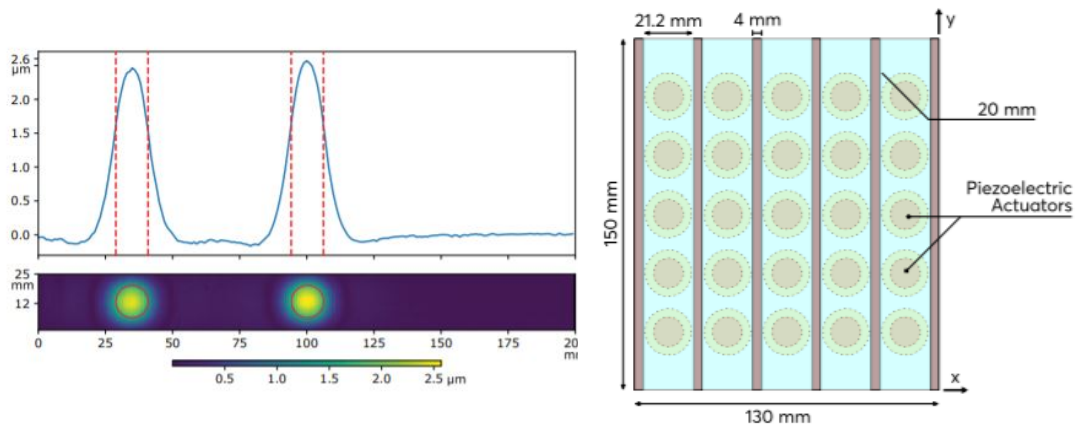

Figure 1.8.: Illustration of the prototype of wave confinement. Source: image reproduced with the permission of Ben-Dhiab et al. [8, 20]

1.3.2.4. Electroviibration

A last method is to use the electric field to make a multi-finger rendering. This method is based on a relaxor ferroelectric polymer (RFP) film [21]. Indeed, the film is inserted between two electrodes both subjected to a certain voltage as shown in Fig. 1.9. In order to have a distance with the bottom electrode, dot spacers are placed between the film and the bottom electrode. Above the top electrode is the touch sensors and the cover film where the finger will interact. When the finger applies a force to the film cover, the two electrodes come closer together and an electric field is created, thus inducing a localised vibration at the fingertip. The intensity of the induced vibration depends on the voltage applied across the electrodes: it can go up to 200 V for an amplitude of 3.5 μm . This method enables to produce a haptic feedback at any point of a screen. It can be coupled with a visual feedback and it works in the tactile sensitivity range. Unfortunately, it does not allow to choose the shape of the vibration as well as the frequency.

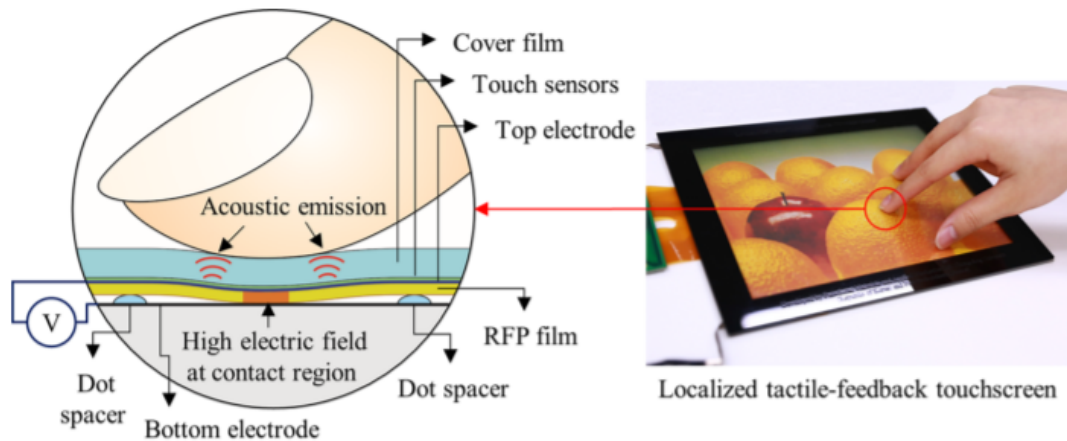

Figure 1.9.: Illustration of the electrovibration method. Source: image from [21]

1.4. Conclusion

Haptic feedback is a vast research field with applications in several sectors such as virtual reality [34, 35, 36, 37, 38] or the medical [42, 43]. Haptic feedback can be applied to any part of the body, but in this thesis, we are interested in feedback at the hand level and more particularly at the finger level. To stimulate the fingers, it is possible to perform

1. Methods for localised and multitouch haptic feedback on a surface

it in the air, on deformable surfaces by [54, 55, 13] or it is possible to make a haptic feedback on deformable surfaces by locally deforming the surface [14, 15, 58, 16, 59, 60] or by intervening directly on the finger by suction [61]. In this thesis, we are interested in haptic feedback on non-deformable surfaces such as touchscreens. On this kind of surface, there are two types of feedback depending on finger interaction: a stationary haptic feedback [71, 4] and a dynamic haptic feedback by sliding the finger on the surface in order to render texture [70]. This thesis focuses on the static feedback. Several methods exist to realise localised haptic feedback on tactile surfaces. They either rely on controlling the vibrations in the surface [17, 18], on using the modes of the plates [19], on the geometry of the plate [8, 20] or on electrovibration [21]. The proposed methods either work beyond the tactile sensitivity band so the feeling is not very pleasant [17], and do not allow to choose all the parameters of the vibrotactile feedback [18, 19, 21], namely amplitude, frequency, shape and position, or provide feedback only above the actuators [8, 20]. Therefore, there is a need for a method that not only enables to tune the different characteristics of the vibration, with vibrations generated anywhere on a surface and in the tactile sensitivity range. This thesis describes the principle and implementation of such a method, which can be included in the category of methods that control the vibrations of the surface. Indeed, thanks to a matrix of piezoelectric actuators glued under the surface, it is possible to control the vibrations at any point of the surface and to send a vibration by choosing all its characteristics, namely amplitude, frequency and shape. This method is described in detail in the next chapter.

2. Localisation of the vibrations by the Inverse Filter method

2.1. Introduction

The Inverse Filter method is a technique of vibration control that finds applications in medical imaging [83] and spatial audio rendering [84, 85] to control the acoustic field value at chosen positions. The Inverse Filter method is based on a set of actuators and control points, i.e the location where the Inverse Filter method will be applied. It enables to calculate the signals to send to each of the actuators in order to achieve a given space-time profile on a set of control points. In this thesis, this method was adapted and applied to a tactile surface for a novel usage, i.e. to achieve localised haptic feedback at a specific point(s) on the surface.

2.2. Mathematical principle

Consider a system subject to Q actuators and F control points where a spatiotemporal profile is desired. An actuator q is driven with an electrical signal $s_q(t)$ and the displacement above a control point f is noted $u_f(t)$ (see Fig. 2.1).

The relation between the electrical signal $s_q(t)$ and the displacement $u_f(t)$ is:

$$u_f(t) = h_{fq}(t) \otimes s_q(t) \quad (2.1)$$

where \otimes is the convolution operator and $h_{fq}(t)$ the impulse response between actuator q and control point f . The impulse response is obtained experimentally because it depends on each system studied. In the frequency domain, this equation can be rewritten as:

2. Localisation of the vibrations by the Inverse Filter method

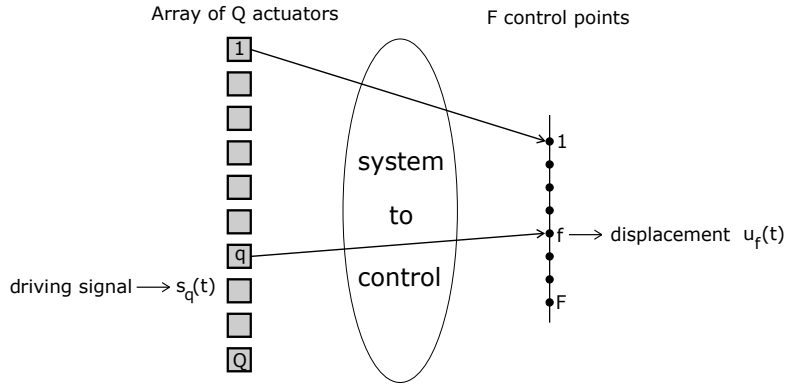

Figure 2.1.: Illustration of the Inverse Filter method: Q actuators allowing to control F control points.

$$U_f(\omega) = H_{fq}(\omega) \cdot S_q(\omega) \quad (2.2)$$

where ω is the circular frequency and H_{fq} the transfer function. The system is considered as linear, that is why the displacement at each control point is the addition of all actuators' contribution, thus leading to a matrix relation between the sets of displacements and the driving signals:

$$\begin{pmatrix} U_1 \\ U_2 \\ \vdots \\ U_F \end{pmatrix} = \begin{pmatrix} H_{11} & H_{12} & \dots & H_{1Q} \\ H_{21} & H_{22} & \dots & H_{2Q} \\ \vdots & \vdots & \ddots & \vdots \\ H_{F1} & H_{F2} & \dots & H_{FQ} \end{pmatrix} \begin{pmatrix} S_1 \\ S_2 \\ \vdots \\ S_Q \end{pmatrix} \quad (2.3)$$

In condensed form, this matrix equation can be summarised as:

$$\mathbf{U}(\omega) = \mathbf{H}(\omega)\mathbf{S}(\omega) \quad (2.4)$$

The idea of inverse filtering is to inverse, for each frequency components, the matrix $\mathbf{H}(\omega)$ in order to calculate the driving signals $\mathbf{S}(\omega)$ that will produce the target displacements $\mathbf{U}(\omega)$ at the set of control points. Since in the general case, the number of control points and actuators are different, the inverse operation is achieved by a pseudo-inverse based on a singular-value decomposition instead of a classical matrix

2. Localisation of the vibrations by the Inverse Filter method

inversion. The driving signal $\mathbf{S}(\omega)$ is therefore calculated as follows:

$$\mathbf{S} = \mathbf{H}^+ \mathbf{U} \quad (2.5)$$

where \mathbf{H}^+ is the pseudo-inverse.

Finally, the signal S is calculated thanks to the equation (2.5). An Inverse Fourier Transform is applied to obtain the signal in the time domain and to drive the different actuators.

2.3. Inverse Filter method to localise haptic feedbacks at calibration points

Before the start of the thesis, a first prototype [86] had been made in the laboratory in order to verify that the Inverse Filter principle worked. The prototype consisted of a plate with four aligned piezoelectric actuators glued, see in Fig. 2.2.



Figure 2.2.: First prototype to validate the Inverse Filter method.

In this prototype, the Inverse Filter method was applied only above the piezoelectric actuators and therefore to only four positions. A user study [86] was conducted to assess whether participants could perceive the feedback as localised, by comparing the vibrations generated with the Inverse Filter method and without. Participants positioned their four fingers (index and middle fingers of both hands) above the

2. Localisation of the vibrations by the Inverse Filter method

actuators and a vibration was sent to one of the participant's fingers. Then, they had to identify and verbalise which finger was activated. Results showed that participants could identify the localised stimulus significantly better with the Inverse Filter method, vs the standard method, i.e. without any compensations for localisation (75 % vs 64 %). This indicates that users were more successful in locating the vibration with the Inverse Filter method. However, the localisation of the vibrations was limited to above the position of the actuators. Therefore, the first investigations of this PhD consisted in demonstrating that it was possible to localise vibrations at any point of a glass surface. Indeed, the control of vibrations above a piezoelectric actuator is easier there because this is where the energy provided by the piezoelectric element is at its maximum, thus it is the location where there is the most vibratory information for effective localisation.

Indeed, the more we move away from the piezo, the less the vibration will be strong and therefore, the matrix inversion becomes more unstable, so it is more difficult to cancel the crosstalk. However, outside of this location, and thus with fewer vibratory information, a question that arose is whether it is possible to control vibrations in a field close to an actuator and thus, to be able to locate vibrations at any point of a surface.

2.3.1. Description of the prototype 1

The first prototype of the thesis was designed to achieve haptic feedback at any point on a glass surface. In order to achieve this, it was necessary to cover a maximum of a given surface with piezoelectric elements assuming that it is possible to control points in close field of the actuators. Different configurations have been considered, as can be seen on Fig. 2.3, before the design of the final prototype with actuators of diameter 20 mm.

The configurations number 1 and 3 had only 8 actuators in order to use only one electronic board and thus facilitate the control of the electronics. Unfortunately, these configurations do not cover enough area on the screen and it might not be possible to localise vibrations in the corners of the surface where the control points are far from the actuators. An evolution has been to propose configuration 2 with a smaller spacing between each actuator than configuration 1. In configuration 2, it is possible to have 20 actuators and to cover the whole plate with them. This configuration respected the 5 mm tape that will allow to stick the screen to its plastic support. However, this would require three electronic boards to drive all the actuators and therefore, too much driving electronics that makes the development of the prototype more difficult with more wires and more complicated maintenance. Configuration 4 was an evolution of

2. Localisation of the vibrations by the Inverse Filter method

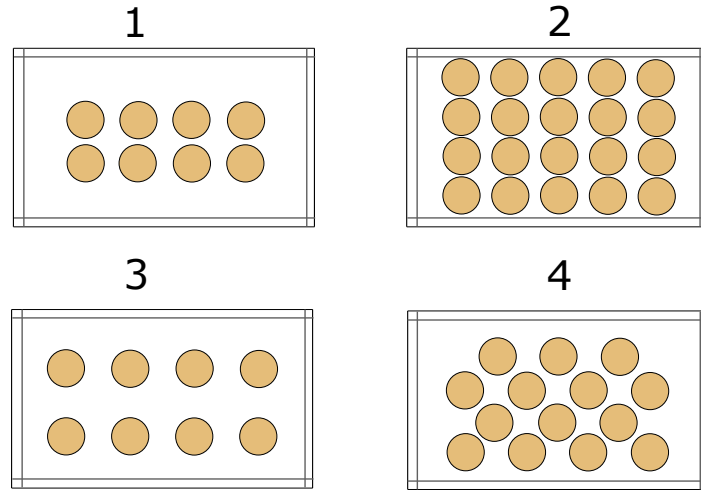

Figure 2.3.: Different configurations of the piezoelectric elements.

configuration 3, by inserting both actuators between the two lines of the matrix of configuration 3 and actuators above and below this matrix to cover more surface with less actuators than in configuration 2. In this configuration, 14 actuators can be driven with only two electronic boards and most of the surface is covered. It is therefore this last configuration that was chosen.

To realise this prototype, 14 piezoelectric actuators were used with a diameter of 20 mm (piezoelectric diaphragms 7BB Murata) and they were glued on the bottom of a $96 \times 162 \times 1$ mm touchscreen (7" pingbo PB70DR8272-R1) with epoxy, see Fig. 2.4.

This screen was glued itself on a 3D printed plastic frame with the same external dimensions. Both were screwed on a rigid plastic plate in order to have a fixed support. Each actuator was driven independently of the others. This could be achieved using the commercial electronic board DRV8662 of Texas Instrument. This board enables to convert an analog signal into a voltage signal between -100 V and 100 V, which can be directly sent to the actuators. Unfortunately, this board can drive only a single actuator, thus to drive 14 actuators, 14 boards would be needed. Not only is this board expensive (100 euros), but stacking 14 boards would also take a lot of space. Therefore, a custom-made board designed by researchers in our laboratory was used instead, in order to drive eight actuators with a single board. To measure the surface displacements, a commercial laser vibrometer (Polytec OFV-534/2570) was used. It was mounted on a motorised three-axis platform. Finally, for the acquisition, the NI-9264 module was used for sending signals to the actuators while the NI-9205 module was used to measure

2. Localisation of the vibrations by the Inverse Filter method

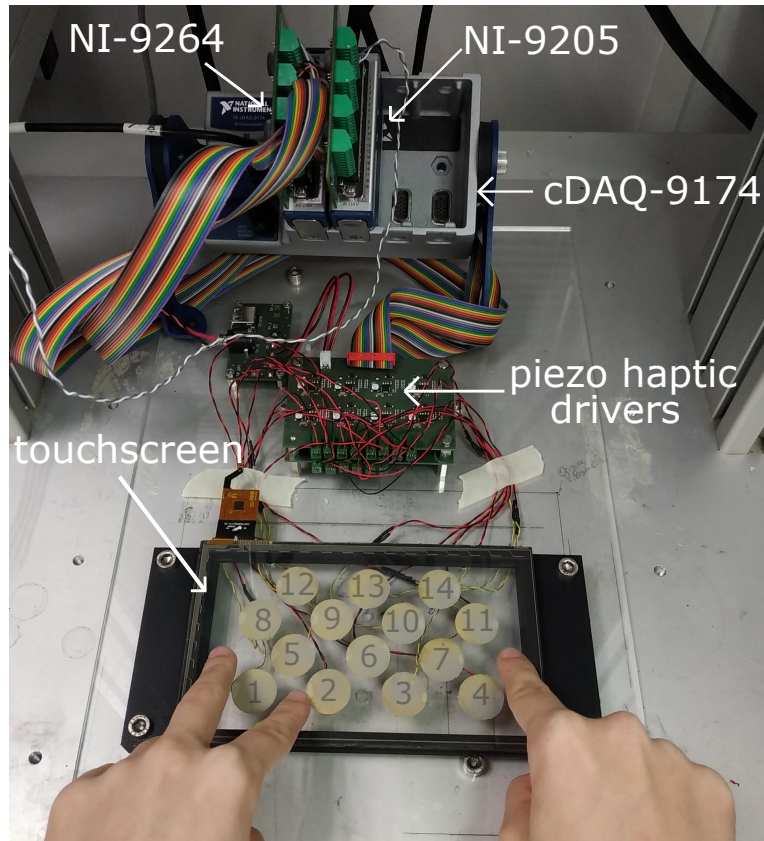

Figure 2.4.: The touchscreen where the 14 piezoelectric actuators are glued, and the electronic interface of the prototype, with the acquisition device NI-9264 and NI-9205, the electronic support cDAQ-9174, and the piezo haptic drivers that drive the piezoelectric actuators.

the displacement of the surface. These boards were mounted on the cDAQ-9174, which allows communication with the computer via a USB port. All signals were sampled at $F_s = 10$ kHz.

2.3.2. Calibration of the prototype 1

In order to apply the Inverse Filter method to the prototype, the first step is to measure the matrix $h_{fq}(t)$, i.e. the transfer function between each actuator q and each control point f (as described in section 2.2). This matrix captures the mechanical transduction of the actuators as well as the propagation, reverberation and attenuation of waves into the touch surface. Each entry $h_{fq}(t)$ was measured for all frequencies at once with the following method: a swept sine signal of duration $T = 200$ ms is sent to the actuator

2. Localisation of the vibrations by the Inverse Filter method

q . A swept sine is a sinus whose frequency varies linearly from 0 to $F_s/2 = 5$ kHz. The displacement above a control point f is synchronously measured, it contains $N_{sample} = F_s \times T$ samples. Then, a Fourier Transform was performed on the displacement and on the sweep signal in order to have these two signals in the frequency domain. The transfer function H_{fq} was calculated as the ratio, in the frequency domain, of the displacement by the sweep signal. The same procedure was repeated for all actuators and for all control points desired on the plate. Fig. 2.5 summarises this procedure.

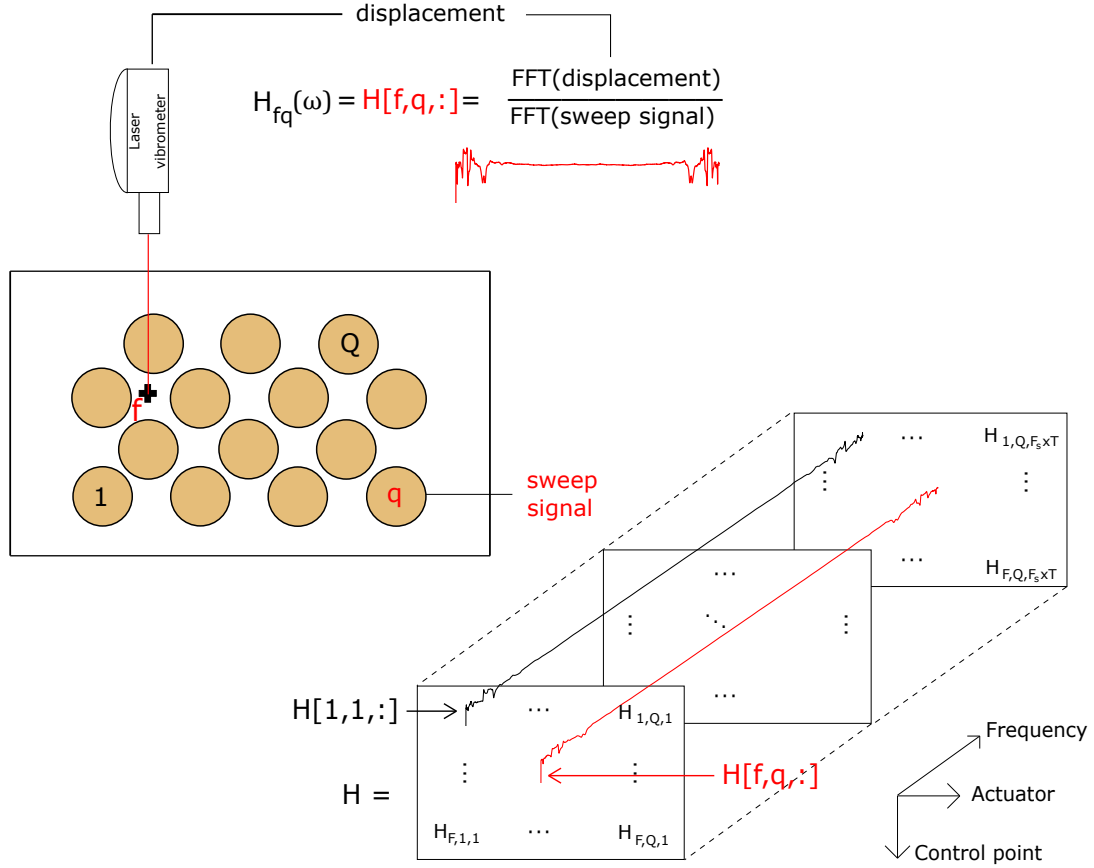

Figure 2.5.: Recording of the displacement and creation of the impulse response matrix.

2.3.3. Validation of the Inverse Filter method for two control points

When the positions of the two control points on the surface are chosen, the transfer function $H_{fq}(w)$ is recorded, as seen in section 2.3.2. A matrix of size equal to the number of control points, number of actuators and number of frequencies is obtained

2. Localisation of the vibrations by the Inverse Filter method

$H[F, Q, N_{sample}]$. Then, a target signal $u_f(t)$ is chosen for a control point. Usually the target signal is a burst that is a cosine at a chosen frequency, with a chosen duration t multiplied by a Hann window (equation (2.6)) with as width: $L = t \times F_s$. The burst frequency should be between 10 and 1000 Hz in the touch sensitivity bandwidth. Finally, a burst at 250 Hz was chosen, as the sensation was demonstrated as being optimal at this frequency [87]. The first control point is therefore activated with a burst at 250 Hz, while the second control point is activated with a burst at 350 Hz and a delay of 100 ms (see Fig. 2.6).

$$w(n) = \begin{cases} \frac{1}{2}(1 - \cos(\frac{2\pi n}{N_s-1})) & \text{if } n \in [0, N_s - 1] \\ 0 & \text{otherwise.} \end{cases} \quad (2.6)$$

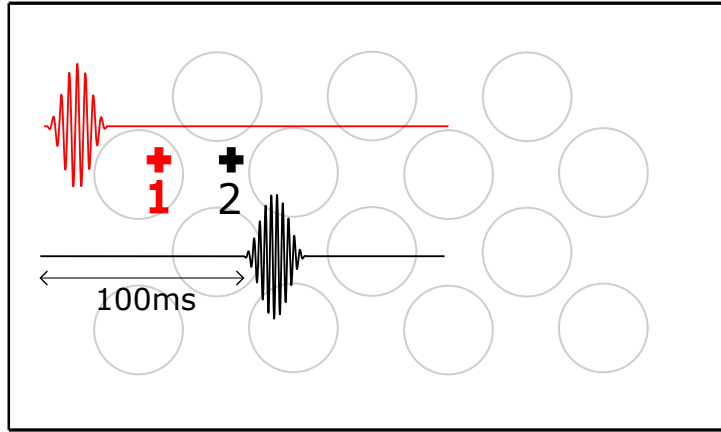

Figure 2.6.: Target displacement: the first control point activated with a 250 Hz burst and the second control point activated with a 350 Hz burst and a delay of 100 ms.

This behaviour was chosen to show that it is possible to locate two vibrations with different frequencies at two different locations. Moreover, this example allows showing that when a vibration is played on a control point, nothing happens on the second one and vice versa. This example also shows that we keep the temporality between the signals. This example is a summary of all possible examples.

Once the $H[F, Q, N_{sample}]$ matrix is recorded and the target displacements for the control points are chosen, the Inverse Filter method can be applied. Thus, the signal S is calculated thanks to the equation (2.5). The signal S is calculated in the frequency domain, thus it is imperative to apply an inverse Fourier Transform in order to place it

2. Localisation of the vibrations by the Inverse Filter method

in the time domain. A signal $s(t)$ is then obtained between -100 V and 100 V which can be sent to the different actuators (see in Fig. 2.7).

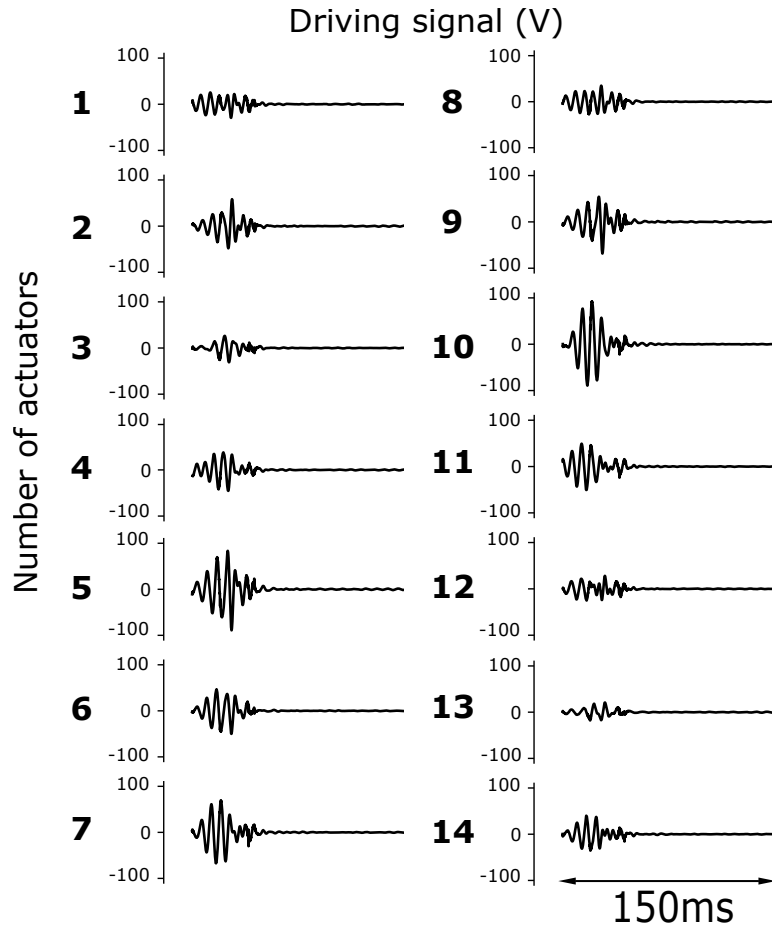

Figure 2.7.: Calculated signal $s(t)$ using the Inverse Filter method: these signals will be sent to the actuators to create the target displacements chosen in Fig. 2.6.

Finally, the signal $s(t)$ is sent to the different actuators and the displacement over each control point is measured to verify that the target displacement desired, as depicted in Fig 2.6, is correctly obtained. Fig. 2.8 shows the displacement obtained over the control points.

For all the measured displacements, no processing (i.e. filtering, smoothing or averaging) was done. The displacements in Fig. 2.8 show a good agreement with the displacements depicted in Fig. 2.6. A correlation coefficient was calculated in order to verify the accuracy of the result. This coefficient is defined as follows:

2. Localisation of the vibrations by the Inverse Filter method

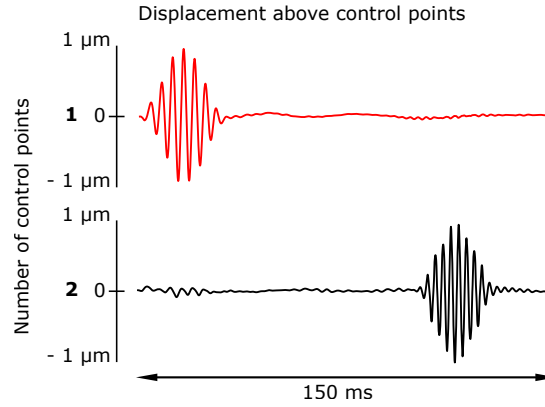

Figure 2.8.: Measurement of the displacement of the two control points obtained thanks to the control signal $s(t)$ in Fig. 2.5

$$c_{u,v} = \frac{\sum_t u.v}{\sqrt{\sum_t u^2 \cdot \sum_t v^2}} \quad (2.7)$$

where u is the target signal and v is the obtained signal. To have a good accuracy, the coefficient must be close to one.

The displacement of the first control point has a correlation coefficient of 0.99 and the second control point has a correlation coefficient of 0.97. Both coefficients are close to one, which proves the good accuracy. Although small amplitude ripples are visible before and after the stimuli, the waveform, amplitude and time location of the target signal are very well preserved. This demonstrates the ability to control accurately the vibration by cancelling crosstalk and reverberation effects in the surface. It also illustrates the wideband aspect of this Inverse Filter approach: it is capable of producing complex vibrotactile signals. There is an infinite number of possible configurations: frequency ranging from 100 to 1000 Hz, the shape of the signal that can be a burst, square, triangular etc., the selected time of the stimulation, the selected time between each stimulation, etc. This capability is especially important in the perspective of multi-user interactions with a touchscreen, where the stimuli delivered to one user should not be felt by another and it should be possible to provide two distinct signals with different vibrations.

2.3.4. Characteristics of the prototype

The feasibility of localising a haptic feedback with the Inverse Filter method at any point of the surface has been demonstrated in section 2.3.3. However, some questions remain: how many control points can be controlled on a plate, what the resolution is, and the maximum achievable amplitude. This part of the section tackles these questions and provides all the characteristics of the prototype.

2.3.4.1. Spatial resolution of the prototype 1

The resolution is the smallest distance between two points that can be effectively controlled. Far from actuators, this distance should be about half the wavelength, owing to the diffraction limit. At a frequency $f = 250$ Hz in a 1 mm thick glass plate, this wavelength is $\lambda = 20$ cm. Operating in the near field of actuators enables to beat this diffraction limit and control points at a smaller scale. It can localise vibrations at the centimeter scale. To find the actual resolution of the prototype, two control points were first chosen on the plate, then the Inverse Filter method was applied and finally output displacements were measured. The distances between the two points were chosen amongst the values 2, 1.5, 1.0 and 0.5 cm, to assess the minimal distance between two control points for which the method still enables to localise stimuli. This choice of distance is arbitrary. Initial tests were carried out to see how far the method could go, which resulted in the lower limit of 0.5 cm. For the high limit, 2 cm was chosen to have four examples but it is possible to go higher in distance, however, all examples could not be tested. The goal being to show that the smaller the distance between two points, the more difficult it is to localise correctly the vibrations. The results obtained are presented in Fig. 2.9.

The Fig. 2.20 shows that the Inverse Filter method is globally well respected. The shorter the distance, the smaller the signal amplitude and the amplitude on the inactive point increased. Between the distances 2 and 0.5 cm, the amplitude is reduced by a factor two: for 2 cm and for 0.5 cm, the amplitude was $7 \mu\text{m}$ and $3.4 \mu\text{m}$ respectively. To obtain the perceptual resolution, it is important to compute the attenuation in dB between the activated signal and the non-activated signal, as presented in the article of Kim et al. [88]. Indeed, thanks to the equation (2.8) below, it is possible to calculate the attenuation between two signals. Kim et al. concluded that at least 18 dB of difference between the amplitude of the two points is needed to be able to feel them as two distinct points and avoid masking effects that could lead the user to misinterpret the vibrations

2. Localisation of the vibrations by the Inverse Filter method

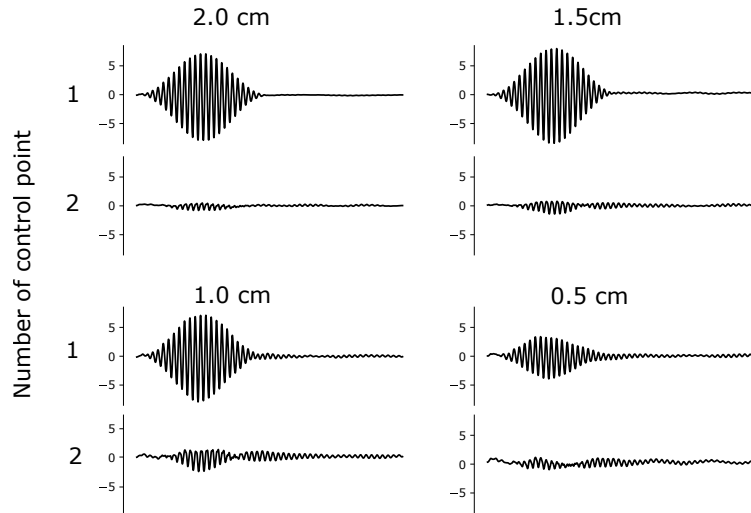

Figure 2.9.: Displacement in micrometer of two control points where the Inverse Filter method is applied according to the distance between these two points: 2, 1.5, 1.0 and 0.5 cm.

received. The equation can be depicted as:

$$\text{Attenuation} = 20 \times \log_{10}\left(\frac{A_{\text{active}}}{A_{\text{passive}}}\right) \quad (2.8)$$

Where A_{active} is the maximum amplitude of the activated control point and A_{passive} is the maximum amplitude of the non-activated control point. In our case, using the equation (2.8), the attenuation for 2, 1.5, 1 and 0.5 cm is respectively 53, 46, 32 and 21 dB, thus well above 18 dB. The resolution can thus go up to 0.5 cm, but the amplitude is less strong and it is not currently known if two vibrations would be felt under the same finger at a distance of 0.5 cm. Research has been conducted to identify at what distance a human feels two distinct points under the sole finger. Dean et al. [89] showed that humans could discriminate two points up to 3 mm apart on the index finger, with a skin indentation stimulation, which is completely different from a stimulation by vibration and therefore, these results cannot be simply transposed to our case. A finely machined industrial caliper was used for this testing. The study was conducted with a mechanical instrument; it would be interesting to reproduce this study to evaluate from what distance a user can feel two distinct vibrations under the same finger with our new technology. The study was not carried out during the thesis because the research focused rather on an evolution and improvement of the prototype and on user studies to check the functionality of the prototypes. Given our resolution results with the prototype, we

2. Localisation of the vibrations by the Inverse Filter method

chose 1 cm of minimal distance between two points as it is the diameter of a finger.

2.3.4.2. Achievable vibration amplitude with the Prototype 1

A study was conducted on the amplitudes of the stimuli that were possible to achieve with the prototype. The study was conducted with two to five control points with each time from one to five control points activated, i.e. with a non zero target displacement. This study is experimental hence all the results obtained are measurements made with a vibrometer. For each case studied, a position for each control point was randomly chosen (executed by a python program developed during the thesis) on the prototype so that each control point was separated by 1 cm to respect the resolution of the prototype. Then, the transfer function of the control points were recorded. The target signal above the control points was then chosen. It was a burst at 250 Hz. The number of the activated control point(s) was also randomly selected by the same python program. The actuator control signal was then calculated and sent to the different actuators. The displacement over the control point was measured and the maximum amplitude of the activated control point(s) was kept. These different steps were carried out 50 times, for each case studied, to scan the entire surface of the prototype. The cases included:

- Two control points: only one or two activated,
- Three control points: one, two or three activated,
- Four control points: one, two, three or four activated,
- Five control points: one, two, three, four or five activated.

The results are depicted in Fig. 2.10.

The figure shows that the maximum amplitudes are obtained when only one control point is activated at a time, regardless of the number of total control points. We can also see that as the number of activated points increases, the amplitude decreases from 7.8 μm for one activated control point to 3.5 μm for five activated control points. Table 2.1 summarises the minimum and maximum amplitudes obtained according to the case studied.

2. Localisation of the vibrations by the Inverse Filter method

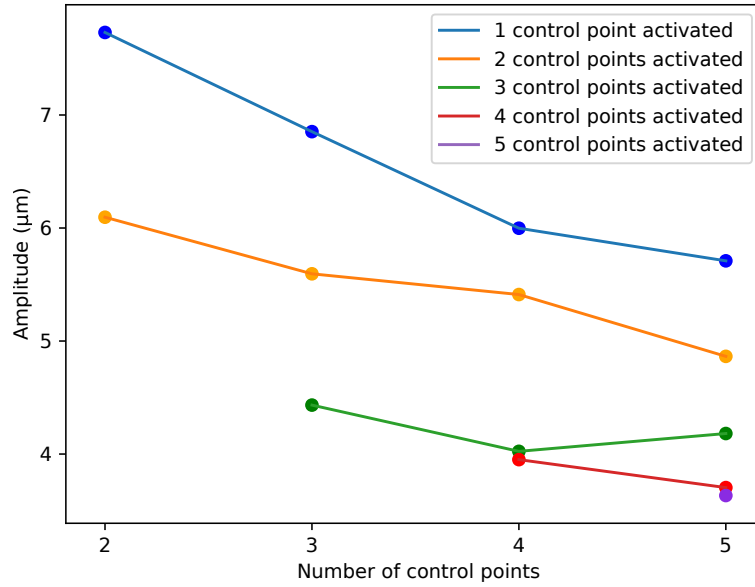

Figure 2.10.: Average amplitude over 50 random positions for each number of control points activated as a function of the total number of control points.

Number of control points	Number of activated control points	Min and Max amplitude (μm)
2	1	[3.62, 12.25]
	2	[2.36, 12.25]
3	1	[3.12, 12.24]
	2	[2.43, 10.92]
	3	[1.87, 10.84]
4	1	[3.82, 8.85]
	2	[1.92, 11.48]
	3	[1.48, 8.03]
	4	[1.25, 8.79]
5	1	[1.30, 9.54]
	2	[2.37, 9.32]
	3	[1.06, 9.11]
	4	[1.00, 12.24]
	5	[1.00, 12.24]

Table 2.1.: Maximum amplitude measured as a function of the total number of control points and the number of activated control points.

This table shows that it is possible to reach amplitudes well beyond $7.8 \mu\text{m}$. We

2. Localisation of the vibrations by the Inverse Filter method

can go up to 12 μm of displacement. This amplitude cannot be chosen in advance. Indeed, it is possible to ask set the prototype to provide the maximum amplitude it can at a given set of positions but the user does not know in advance the amplitude it will have. They just know that it is the maximum amplitude that the prototype can provide at this location. The user can choose the amplitude themselves but they may choose an amplitude that is too high for the position and thus saturates the electronics, which leads to a degradation of the localisation. Not all locations provide the same amplitude. These are experimental observations from the various trials and usage of the prototype. A theoretical or systematic study would need to be conducted to explain this phenomenon, to provide some time to study the application of the Inverse Filter method in a user scenario.

2.3.5. Conclusion

These first investigations highlighted that the Inverse Filter method could be applied not only above the actuators but also at any point of a surface, without any degradation of the signal/amplitude. This was achieved with a first prototype, relying on an actuator matrix glued below a glass surface with an evenly spaced actuator layout. The experimental evaluations demonstrated that this first prototype could achieve a resolution of 1 cm, which is well below the wavelength at 250 Hz, and can produce a vibration with an amplitude ranging from 1 to 12 μm . Nonetheless, this kind of vibration feedback requires knowing in advance where the control points are. A possibility to obtain these control points positions is to simply fix them. Yet, this limits the interaction to a predefined set of points. To overcome this, another possibility is to use the detection from a touchscreen to have the flexibility of choice for the control points. This would also enable realtime rendering of localised haptic feedbacks, delivering certain feedbacks at only the contact points received. Consequently, this was the next step in this work and is described in the next section.

2.4. Realtime rendering at any points with a touchscreen

After demonstrating that it was possible to achieve a haptic feedback at any point on a surface with predefined positions, the aim was to achieve the same feedback but in realtime. That is, the user can put their fingers anywhere on a surface and can feel a haptic feedback in realtime. The challenge was that in this case, the positions were not predefined, it was thus necessary to be able to recover in realtime the position of the

2. Localisation of the vibrations by the Inverse Filter method

fingers thanks to a touchscreen. It was also necessary to be able to have all the impulse responses of each point of the plate in order to apply the Inverse Filter method, which accounts to thousands of possibilities that represent all possible locations on the plate. Therefore, we investigated a solution to reduce this number of possibilities and thus the calculation complexity, which can negatively impact the realtime rendering.

2.4.1. Description of the prototype 2

In order to convey localised haptic feedback in realtime, a second prototype was designed, this time using a touchscreen. The touchscreen 7" pingbo PB70DR8272-R1 was used, with a capacitive detection that enables to recover the position of up to five fingers. For this prototype, 11 piezoelectric actuators (Murata 7BB-35-3, 35 mm diameter, 0.51 mm thickness) were glued on the bottom of the screen. Only 11 actuators were used, instead of the 14 as described in section 2.3.1, because the actuators have a larger diameter than the ones used for the previous prototype. Larger actuators have been chosen to reach a higher amplitude than the first prototype and to have less electronics to manage. However, the actuators are arranged with the same layout. This new prototype is depicted in Fig. 2.11.

The driving electronics was the same as the prototype depicted in Fig. 2.4. For this prototype, it was necessary to add an Arduino board that was connected to the capacitive screen. This Arduino board enabled getting the position on the screen through an I2C protocol and communicated them to the computer through a serial communication. The capacitive screen sent the information in the form of a frame (see Fig. 2.12) to the Arduino board. This frame was then decoded with python: it must necessarily begin with "0XAA 0XAA" and end with "0XAA 0XAA". Then, a request was sent to the screen so that it could start sending data: it started with the number of control points and then the positions X,Y of the different control points.

2.4.2. Calibration of the prototype 2 with the multiple sweep method

Once the position of the fingers are known, it is necessary to obtain the transfer function matrix. The number of control points can be from zero to five, due to the detection capacity of the used touchscreen, and their positions are not known in advance. It is therefore necessary to create an exhaustive database of all transfer functions on the surface. To achieve this, a mapping of the plate needs to be conducted first. The screen had a dimension of 96×162 mm, which maps to 15552 points spaced 1 mm apart that

2. Localisation of the vibrations by the Inverse Filter method

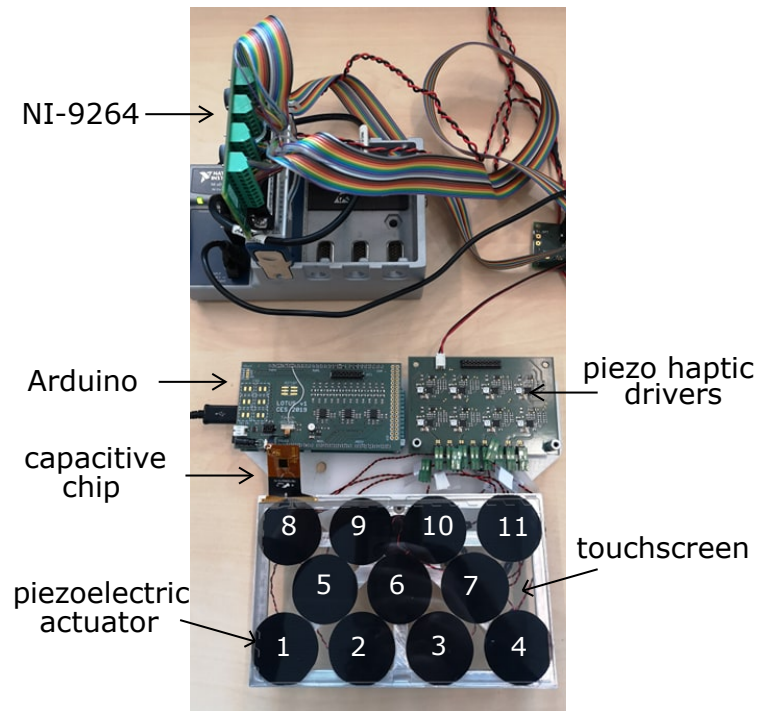

Figure 2.11.: Electronic interface of the prototype: an acquisition device NI-9264 and NI-9205, an electronic support cDAQ-9174, piezo haptic drivers that drive the piezoelectric actuators and the touchscreen where are glued the eleven piezoelectric actuators and the capacitive screen.

1	2	3	4	4+N	5+N	6+N
Start of the frame	Get position	Lenght N of data	N data	End of the frame		
0XAA	0XAA	↑		↑	0X0D	0X0A
		request		position 16-bit coded		

Figure 2.12.: Frame that enables to recover the number of control points as well as their respective positions.

need to be recorded. This represents a very large number of points. In order to reduce by two the number of points, impulse responses are recorded every 2 mm and 79 points are taken along the x-axis and 45 points along the y-axis. It is possible to further reduce the database, by factors other than two, but here the choice was made to divide only by two in order to keep a better accuracy. The recorded points amount to 3555 points that

2. Localisation of the vibrations by the Inverse Filter method

are called calibration points (see Fig. 2.13). The matrix corresponding to the transfer functions of these calibration points is referred to \hat{H}_c .

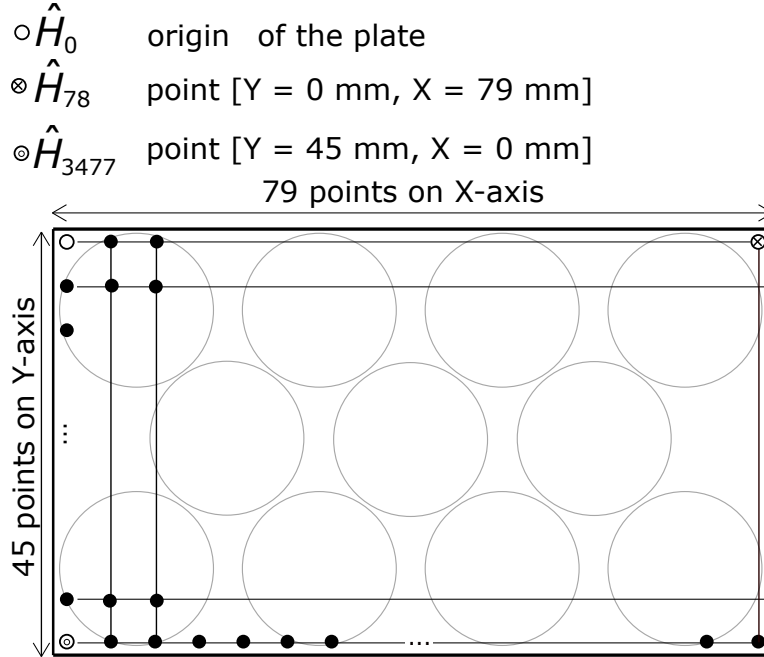

Figure 2.13.: Dot grid for the calibration of the plate: 3555 control points and the corresponding \hat{H}_c .

These entries of the matrix \hat{H} are calculated as the ratio between the displacement above a calibration point (point on the plate spaced at 2 mm in X and Y-axis) and the driving signal sent to an actuator, in the frequency domain. The calibration matrix \hat{h} is the time domain representation of the calibration transfer function matrix \hat{H} . The previous method sent a linear sweep in each actuator and simultaneously recorded the displacement above the control point. For this calibration, the multiple sweep method [90] was used. All actuators were driven simultaneously with a time shifted version of the same exponential sweep from 0 to $F_s/2 = 5$ kHz, while measuring synchronously the resulting displacement at calibration point c (see in Fig. 2.14).

Each entry of the \hat{h} matrix is then calculated. A Fourier Transform is then performed on the displacement and on the sweep signal. The \hat{H} matrix is the ratio of the displacement by the corresponding sweep. The same procedure was repeated for all actuators and all calibration points. A matrix of size $[C, Q, N_h]$ is thus obtained knowing that a calibration point c has coordinates in X and Y-axis. This calibration

2. Localisation of the vibrations by the Inverse Filter method

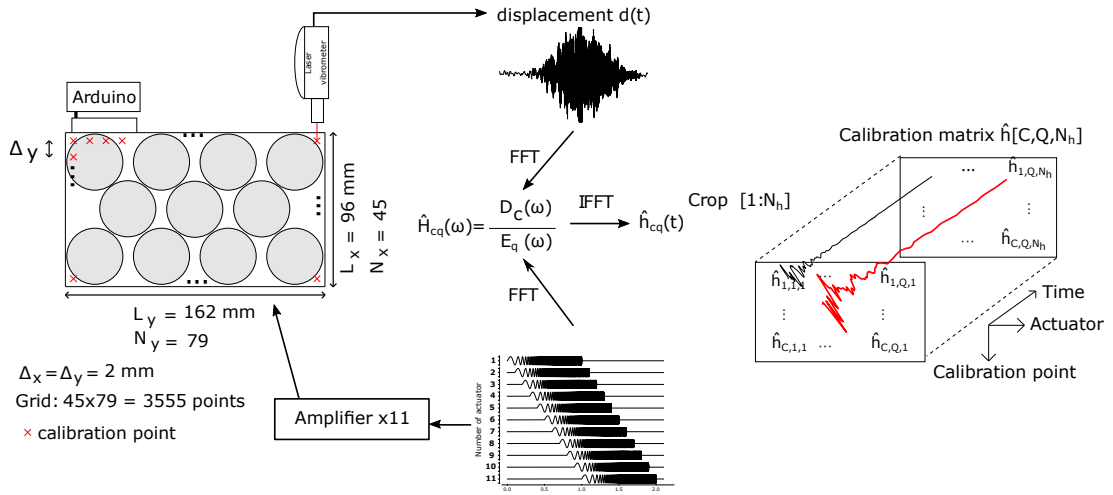

Figure 2.14.: Explanation of the construction of the matrix $\hat{h}_{cq}(t)$ thanks to the multiple sweep method.

technique is much faster than the method of sending one actuator sweep per actuator.

2.4.3. Fourier interpolation method

Once the calibration of the plate is finished, the Inverse Filter method cannot be directly applied. In fact, only the impulse responses of the calibration points have been recorded. Thus, when a finger touches the surface, it is very unlikely that its location corresponds precisely to a position where the impulse response has been recorded. Therefore, the transfer function H needs to be calculated for this specific position (see in Fig. 2.15). For this purpose, a 2D Fourier Interpolation (equation (2.9)) is used.

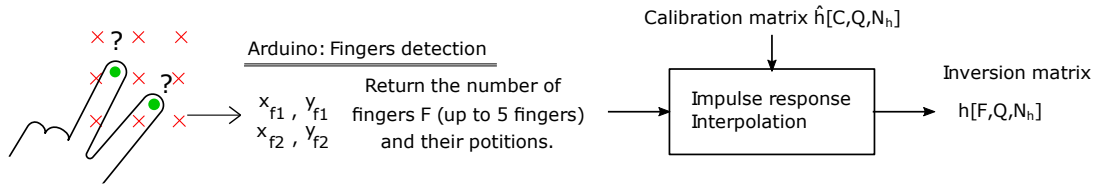

Figure 2.15.: Calculation of the impulse response matrix using the Fourier interpolation method for a given finger position.

$$H_{fq}(\omega) = \sum_{c=1}^C \hat{H}_{cq}(\omega) \cdot \text{sinc}\left(\frac{\pi(x_f - x_c)}{dx}\right) \cdot \text{sinc}\left(\frac{\pi(y_f - y_c)}{dy}\right) \quad (2.9)$$

2. Localisation of the vibrations by the Inverse Filter method

- $\text{sinc}(x) = \sin(x)/x$: The cardinal sine function,
- x_f : The coordinates of the control point on the X-axis,
- y_f : The coordinates of the control point on the Y-axis,
- x_c : The coordinates of the calibration point on the X-axis,
- y_c : The coordinates of the calibration point on the Y-axis,
- $\hat{H}_{cq}(\omega)$: The transfer function measured at the calibration point.

For each control point, a product is achieved between the \hat{H}_{cq} transfer function at a calibration point and two cardinal sinuses on X-axis and Y-axis between the control point and a calibration point. This product is repeated for all the 3555 calibration points and all these products are summed to obtain the transfer function H_{fq} at the control point.

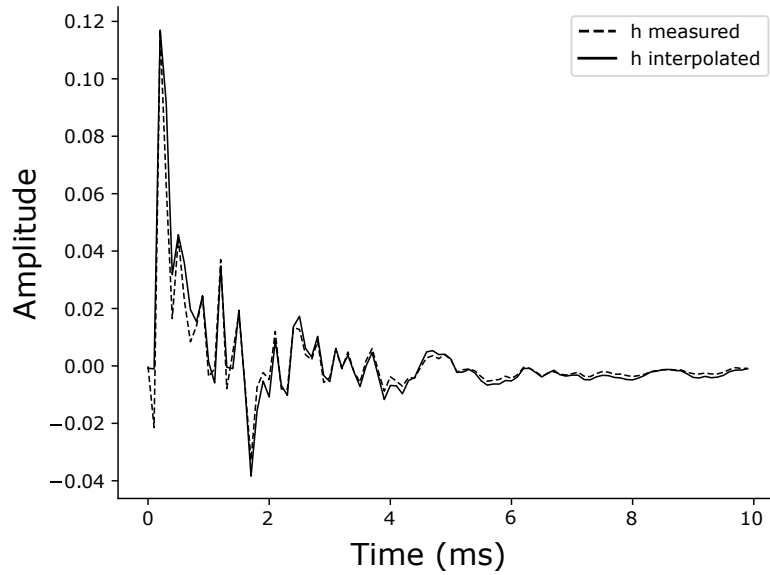

Figure 2.16.: The figure shows the difference between the impulse response h measured above a control point and the impulse response h interpolated at that same control point.

This interpolation procedure was validated by comparing the actual and the interpolated impulse responses at positions that were not on the original calibration grid. We can see in Fig. 2.16 that the impulse response interpolated h_{fq} is very close to

2. Localisation of the vibrations by the Inverse Filter method

the measured h_{fq} with a correlation coefficient of 0.97, calculated thanks to the equation (2.7). The Inverse Filter method was then applied to validate the method. Three control points were chosen randomly on the plate at three control positions that were not on the calibration grid. At this set of control points, the $H_{fq}(t)$ transfer function are unknown and were calculated with the interpolation method. In the experiment depicted in Fig. 2.17, the target displacement at the first control point was a burst at 250 Hz with 25 cycles and an amplitude of 1 μm , while the second and third control points were set with a zero displacement, i.e. no vibrations. The frequency was chosen with a value in the range of tactile perception and for which the sensation was demonstrated as being optimal [91].

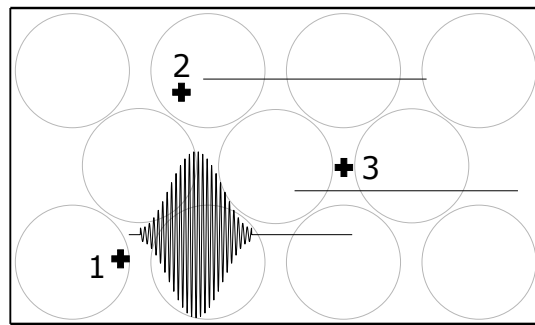

Figure 2.17.: Control output: the first control point is activated with a 250 Hz burst, the second and third control points are not activated.

The inverse filtering operation was then performed and the actual displacements above the control points were measured. Fig. 2.18 shows a very good agreement between the target and the actual displacements. The Inverse Filter method based on the interpolated impulse responses is therefore effective.

Furthermore, Fig. 2.18 highlights that the interpolation was correctly performed because the displacement above the different control points is the same as the selected target displacements of Fig. 2.17; the waveform and time location of the signals are very well preserved. Yet, there are some small differences. First, the amplitude of the measured signal above the first control point is slightly lower than the chosen target signal (0.99 μm vs 1 μm). Second, small amplitude ripples are present above the muted control points, but they have an amplitude nine times smaller than the activated control point. These amplitudes are about three times lower than the detection threshold at the fingertip as measured by Verillo [87]. They are therefore negligible.

2. Localisation of the vibrations by the Inverse Filter method

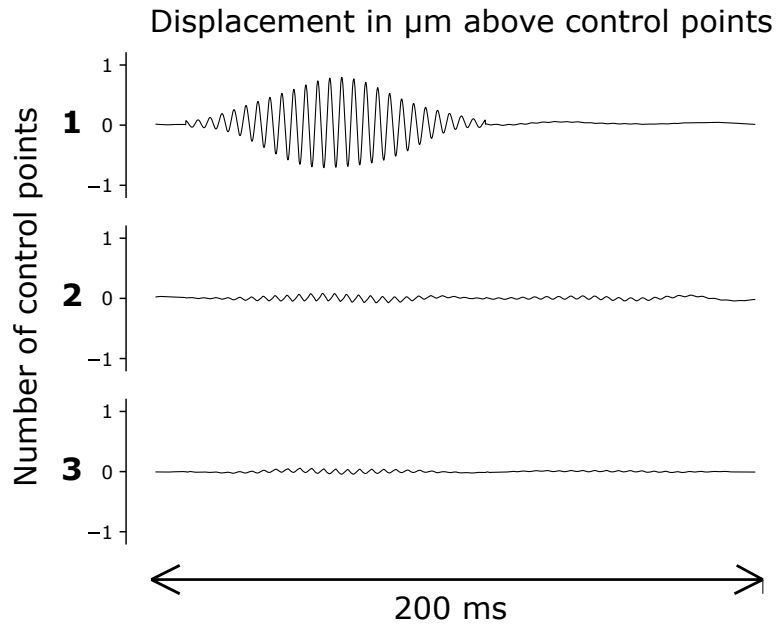

Figure 2.18.: Measurement of the displacement at the three control points with a correlation coefficient of 0.99.

This different steps of calculation, in order to have a multitouch localised haptic feedback in realtime, are done with a main program that calls the different functions under python 3.7. The pseudo-inversion is done with the “pinv” function in the NumPy library. The computer is a laptop Dell with an Intel(R) core(TM) i7-8650 U CPU@1.90 GHz 2.11 GHz for the processor and 16 Go of RAM. The Fig. 2.19 shows that it takes 40 ms of calculation for a signal time of 100 ms, i.e. half the time. The calculation time of the Inverse Filter method is short enough to perform realtime localised haptic rendering.

2.4.4. Characteristics of the prototype 2

2.4.4.1. Spatial resolution of the prototype

To find the resolution of the prototype, two control points were chosen on the plate and the Inverse Filter method was applied. The two points were separated by 2.5, 2.0, 1.5 and 1.0 cm to evaluate the limit of the prototype. The lowest value chosen is 1 cm because below this value, the location is no longer acceptable as the attenuation between the displacements of the two control points is not high enough for the user to feel two

2. Localisation of the vibrations by the Inverse Filter method

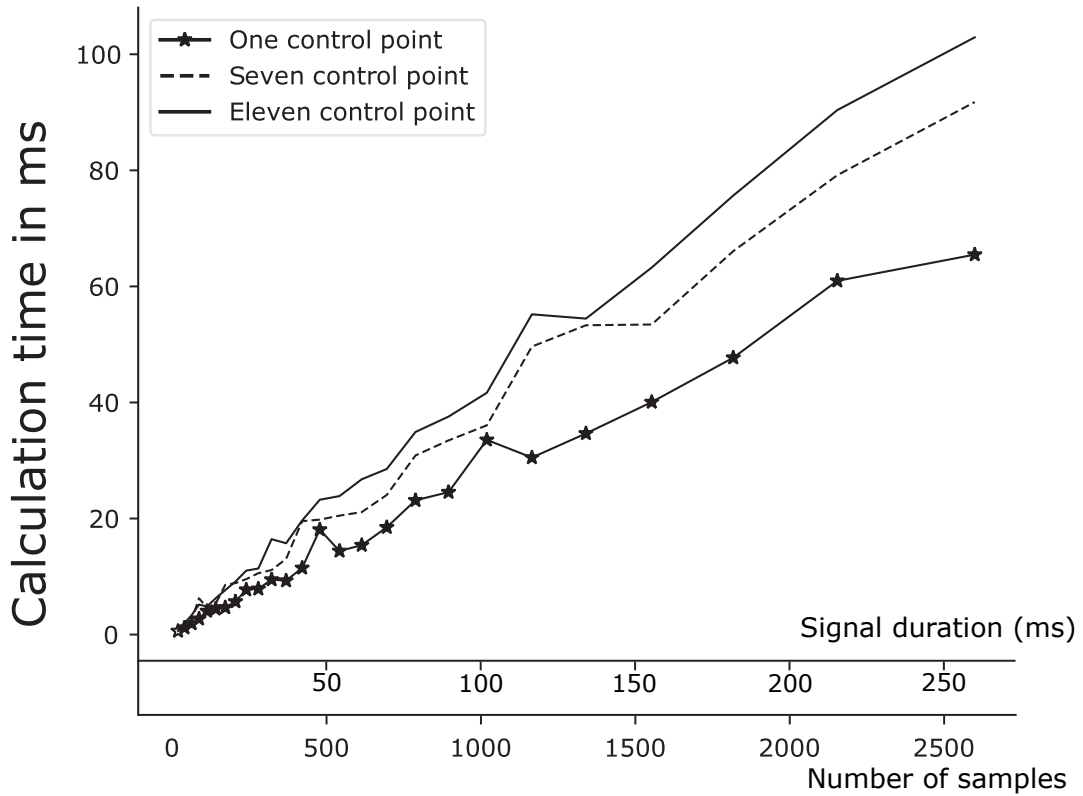

Figure 2.19.: Time calculation of the Inverse Filter method in function of the number of control points and the number of samples with $F_s = 10$ kHz. 20 samples correspond to a burst with 1 cycle at 500 Hz and 2600 samples correspond to a burst with 26 cycles at 100 Hz.

distinct vibrations. This is why the measurements below this value are not presented. The results obtained are presented in Fig. 2.20.

Fig. 2.20 shows that the shorter the distance, the smaller the signal amplitude. The amplitude of the last case is three times smaller than the amplitude of the first case (5 vs 1.4 μm). The attenuation in dB is calculated using the equation (2.8). The attenuations for 2.5, 2.0 and 1.5 cm are respectively 68, 46 and 31 dB, thus well above 18 dB, the limit below which a user no longer feels a single distinct point but feels the two vibrations. On the other hand, for 1.0 cm the attenuation is 15 dB, thus below the minimum threshold. In this case, the user will not feel only one vibrated finger but both, so the localisation no longer works. The resolution of the prototype is therefore of the order of 1.5 cm, which means that the distance between two points needs to be at least 1.5 cm so that the user can feel localised feedback. This resolution is lower than the resolution of the

2. Localisation of the vibrations by the Inverse Filter method

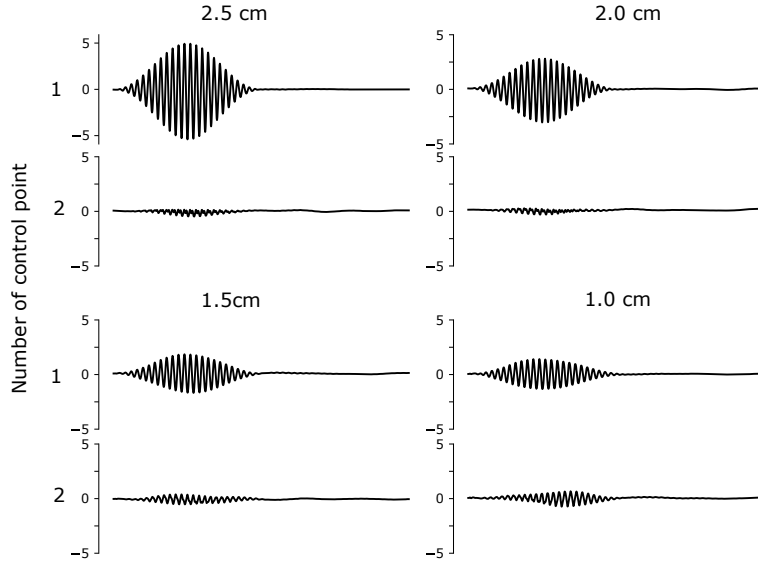

Figure 2.20.: Displacement in micrometer of two control points where the Inverse Filter method is applied according to the distance between these two points: 2.5, 2.0, 1.5 and 1.0 cm.

prototype 1, which could go up to 0.5 cm. This difference may be due to the size of the actuators. Indeed, the smaller the size of the actuators, the finer the resolution will be because the surface covered by each actuator is smaller than with large actuators. It is therefore easier to constrain the displacement to small distances.

2.4.4.2. Global displacement of the plate submitted to the Inverse Filter method

The displacement above the control points after application of the Inverse Filter method is known and measured. However, the global behaviour of the plate is unknown, this is why the displacement is unknown outside these points. The global behaviour of the plate means the behaviour outside of the control points. Since the calibration matrix $\hat{H}_{cq}(t)$ captures the response of all actuators at all the calibration points, it is possible to calculate theoretically the displacement at any point on the plate outside of the control points. Recall that in the frequency domain, the signal $S_q(\omega)$ is calculated using the equation (2.10).

$$S_q(\omega) = \sum_{f=1}^F H_{qf}^{-1}(\omega) \cdot U_f(\omega) \quad (2.10)$$

With S_q the driving signal of actuator q and U_f the target displacement at control

2. Localisation of the vibrations by the Inverse Filter method

points f . Then, to calculate the displacement for all the calibration points, it is necessary to return to the basic expression of the Inverse Filter method (equation (2.11)) and multiply the impulse response matrix of the desired calibration point $\hat{H}_{cq}(\omega)$ by the previously calculated signal $S_q(\omega)$.

$$U_c(\omega) = \sum_{q=1}^Q \hat{H}_{cq}(\omega) \cdot S_q(\omega) \quad (2.11)$$

In order to observe the behaviour of the plate, two control points have been randomly chosen on the plate with the constraint that their minimal distance from each other was 1.5 cm, i.e. the previously computed resolution. The target displacements U_f were chosen as a 250 Hz burst with 25 cycles for the first control point and a zero displacement at the second control point. The equation (2.11) gives the displacement above all the calibration points of the plate.

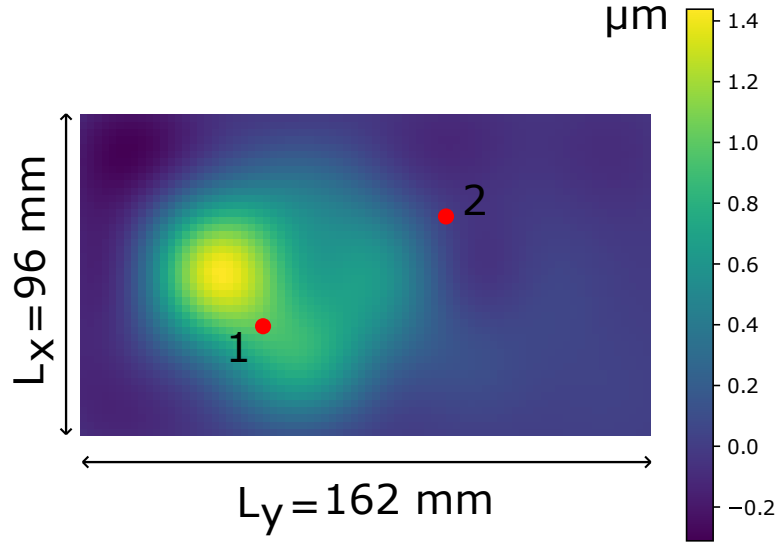

Figure 2.21.: Calculated peak displacement in μm above all the calibration points of the screen when the displacement is maximum. The first control point is activated with a 250 Hz burst and the second control point is not activated, i.e. set to zero.

Fig. 2.21 shows the displacement of the plate when the maximum displacement is reached above the first control point. It shows a displacement of 1 μm above the first control point and zero above the second. Interestingly, in order to reach a displacement of 1 μm above the control point, we need a displacement of 1.4 μm at a distance of

2. Localisation of the vibrations by the Inverse Filter method

1.5 cm of the activated control point (yellow area on Fig. 2.21). Otherwise, the plate is not subject to a strong enough displacement. To quantify the displacement over the whole plate and the difference between displacements at control points and elsewhere, a metric was defined as:

$$\sigma_f(x_c, y_c) = \sqrt{\frac{1}{T} \int_0^T [u_c(x_c, y_c, t) - u_f(x_f, y_f, t)]^2 dt} \quad (2.12)$$

where $u_c(x_c, y_c, t)$ is the displacement at the calibration point c and $u_f(x_f, y_f, t)$ is the displacement at the control point f . It represents the root mean square difference in micrometer between the displacements above control points and the displacements at all calibration points. A metric of the difference between the displacement reached at this control point and the displacement at any other point on the plate is thus obtained for each control point. The deviation values obtained for each control point are plotted in Fig. 2.22.

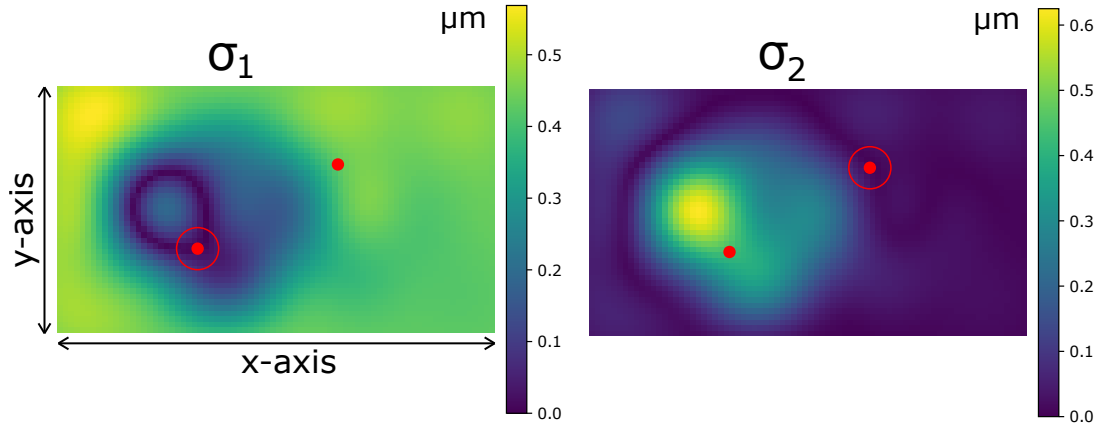

Figure 2.22.: σ_1 is the deviation of the first control point and σ_2 is the deviation of the second control point. The red circle has a diameter of 7.5 mm, it represents the surface of a finger.

The first control point deviation σ_1 , see Fig. 2.22, shows that the deviation near the first control point activated is close to zero. It means that points around this control point exhibit very similar displacements in both phase and amplitude to the displacement at the control point. It is worth noting that when a finger will be in contact with the plate, a large part of its surface will be exposed to the same surface displacement. For the second control point deviation σ_2 , see Fig. 2.22, the figure shows that when we require a zero displacement, the area of zero displacement is very large.

2. Localisation of the vibrations by the Inverse Filter method

Nevertheless, it is interesting to measure the evolution of the deviation with the distance from the control point in order to see how the plate displacement evolves when moving away from the control point. The distance is computed, in meter, between the considered control point f and the calibration point c : $r_{f,c} = \sqrt{(x_c - x_f)^2 + (y_c - y_f)^2}$. This distance is exemplified in Fig. 2.23. The calculation of the equation was then repeated for 100 random trials in order to see if this behaviour can be generalised to all the couple of points of the plate. The deviation is an average of 100 values of deviation by $r_{f,c}$.

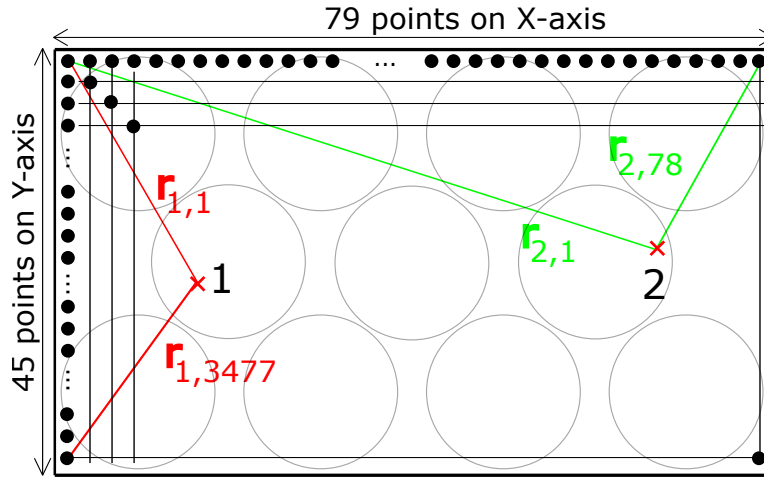

Figure 2.23.: Explanation of the $r_{f,c}$ distance which enables us to calculate the evolution of the deviation criterion.

Fig. 2.24 shows that when $r_{f,c}$ is greater than 30 mm, the deviation is roughly constant with a value of 0.35 μm . The difference function decreases down to zero as the distance $r_{f,c}$ decreases, thus confirming that points nearby the control points exhibit the same waveform and thus behaviour. Fig. 2.22 shows that below 20 mm, the deviation grows linearly with the distance from the control point. It is therefore crucial to minimise this distance by interpolating a transfer function to control as much as possible the centre point of the finger contact area.

2.4.4.3. Study on the peak amplitude obtainable with the prototype 2

A study was conducted on the amplitudes of the stimuli that were possible with the prototype. The study was conducted with two control points up to five control points with each time from one to five control points activated. This study is not theoretical but experimental so all the results obtained are measurements made with a vibrometer. For

2. Localisation of the vibrations by the Inverse Filter method

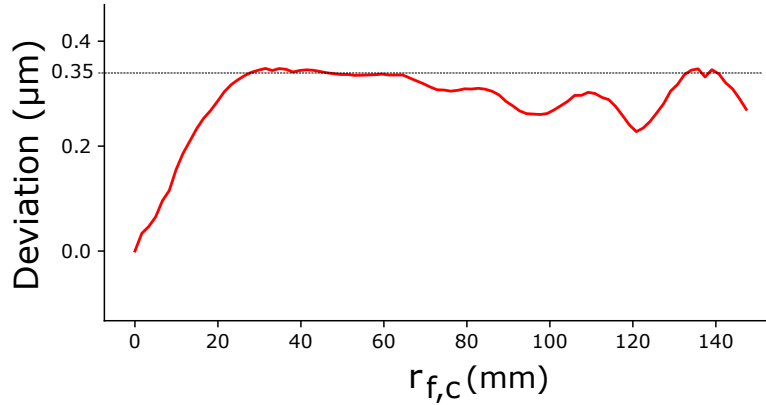

Figure 2.24.: Evolution of the deviation on 100 random draws for two control points.

each case studied, the position of each control point was randomly drawn, thanks to a python program developed during the thesis, so that each control point on the prototype was separated by 1.5 cm to respect the resolution of the prototype. Then, the transfer function matrix of the control points was recorded. The target signal above the control points was then chosen. It was a burst at 250 Hz. The number of the activated control point(s) was also randomly selected. The actuator control signal was then calculated and sent to the different actuators. The displacement over the control point was measured and the maximum amplitude of the activated control point(s) was kept. These different steps were carried out 50 times, for each case studied, to scan the entire surface of the prototype. The cases included:

- Two control points: one and two activated,
- Three control points: one, two and three activated,
- Four control points: one, two, three and four activated,
- Five control points: one, two, three, four and five activated,
- Six control points: one, two, three, four and five activated.

The results are depicted in Fig. 2.25. The figure shows that the maximum amplitudes are obtained when only one control point is activated at a time, regardless of the number of total control points. We can also observe that as the number of activated points increases, the amplitude decreases from 4.5 μm for one activated control point to 1.5 μm for five activated control points. This graph shows the average amplitude over 50 trials.

2. Localisation of the vibrations by the Inverse Filter method

The Table 2.2 summarises the minimum and maximum amplitudes obtained according to the case studied.

Number of control points	Number of activated control points	Min and Max amplitude (μm)
2	1	[1.49, 8.53]
	2	[1.48, 7.07]
3	1	[1.07, 8.17]
	2	[1.11, 6.95]
	3	[1.04, 7.73]
4	1	[1.41, 8.66]
	2	[1.06, 7.61]
	3	[1.00, 11.86]
	4	[1.02, 5.81]
5	1	[1.19, 7.50]
	2	[1.12, 6.39]
	3	[1.02, 6.04]
	4	[1.01, 5.94]
	5	[1.00, 5.10]

Table 2.2.: Maximum amplitude measured as a function of the total number of control points and the number of activated control points.

This table shows that it is possible to reach amplitudes well beyond 4 μm . We can go up to 11 μm of displacement. Like the first prototype, this amplitude cannot be chosen in advance. Indeed, either the user sets the prototype to provide the maximum amplitude at the chosen location but without knowledge of the resulting amplitude, or the user chooses a specific output amplitude value with the risk of too high a value. This can lead to a saturation of the electronics and thus, a poor localisation of the signals. Consequently, not all locations provide the same amplitude. No theoretical or practical was conducted study during the thesis to explain this phenomenon, which can be a lead for future work. This table also enables to highlight that overall the amplitudes of this prototype are much lower than those of prototype 1. For the curve depicting one control point, it is between 4.5 and 3.5 μm for this prototype against 7.6 and 6 μm for the prototype 1, i.e. practically twice as less. Same for the curve obtained for the two-control points, it is between 3.5 and 2.5 μm for this prototype against 6 μm for the prototype 1. The prototype 2 is thus less powerful in amplitude than the prototype

2. Localisation of the vibrations by the Inverse Filter method

1. The large actuators were chosen because we hypothesised that they would provide a higher amplitude. After the frequency study carried out on the two prototypes, we can observe it is not the case. We conclude that the choice of actuators depends on the application.

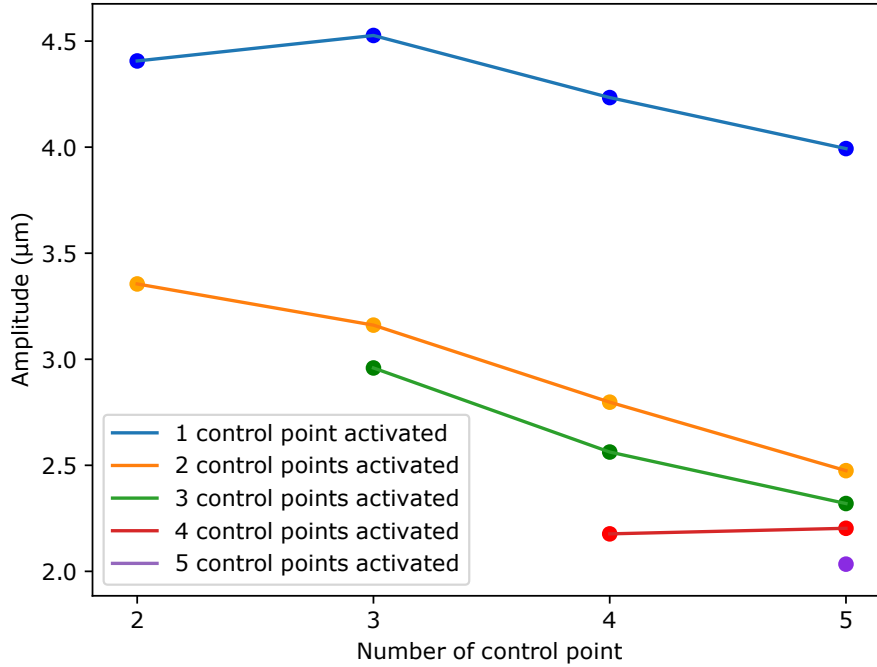

Figure 2.25.: Average amplitude over 50 random position draws for each number of control points activated as a function of the total number of control points.

2.4.4.4. Finger damping effect

We have demonstrated this far that a localised multitouch feedback can be achieved in realtime. However, the impact of the finger pressure on the plate is unknown. Therefore, we conducted preliminary observations to assess the impact of the finger's force on the haptic feedback. A 25-year-old man was selected to participate in this pilot observation. The target displacement was a sine burst at 250 Hz. The surface displacement was measured under the control point on the bottom side of the plate by reflecting a laser beam on two consecutive mirrors, as depicted on the left of Fig. 2.26.

Two measurements were carried out: without a finger and with a finger applying a force with the same intensity as for pressing a button. The force was not measured, a simple instruction was given to the user by asking him to press as if it were a keyboard

2. Localisation of the vibrations by the Inverse Filter method

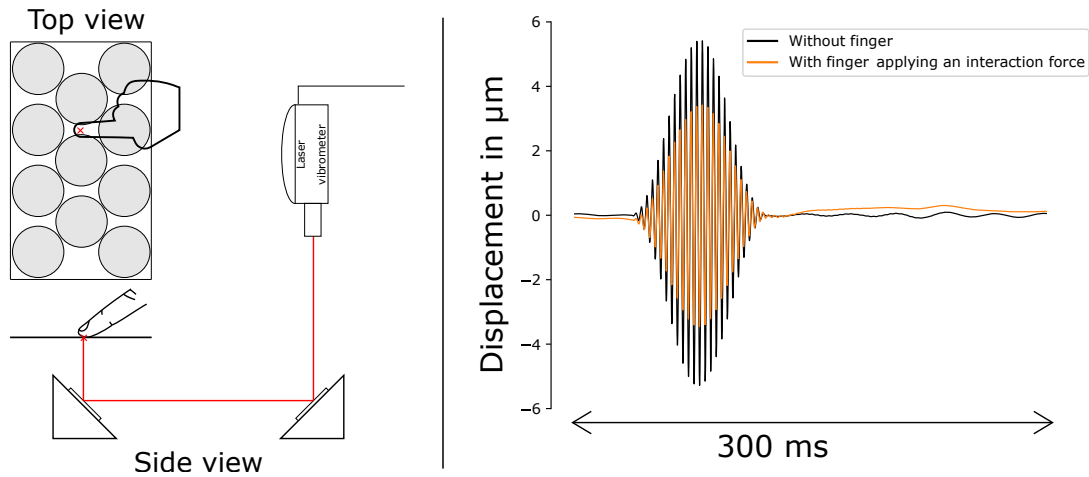

Figure 2.26.: On the left: Setup measuring the displacement under the control point. On the right: Difference between the haptic feedback signals when a finger applied an interaction force on the plate and without the finger on the plate.

key. The right of Fig. 2.26 shows that when a finger applied a force, the vibration waveform was preserved but attenuated by about 40%. This preliminary result shows a potential impact of the force applied on the feedback, and thus the related interactions. A more in-depth study is needed, especially to evaluate the impact on user's perception and to measure the distortion of the vibration as a function of the applied force. However, in this thesis, we chose to focus the efforts on evaluating the technology and feedback with users, and as in the studies participants laid their fingers on the plate passively, we assume this phenomenon has not impact the feedback and interactions much.

2.4.5. Conclusion

The addition of a capacitive screen allowed for realtime haptic feedback as it enabled to retrieve the finger positions in realtime. The implementation of the interpolation method enabled us to reduce the vibration database and thus, to have faster calculations for a realtime vibrotactile feedback. Moreover, larger actuators of diameter 35 mm were tested and glued under the surface to cover as possible but with less actuators, thus reducing the control electronics. This change did not affect the application of the Inverse Filter method. However, it did lower the resolution of the prototype from 0.5 cm with actuators of 20 mm diameter to 1.5 cm for the larger actuators (i.e. diameter of 35 mm). Regarding

2. Localisation of the vibrations by the Inverse Filter method

the amplitude, it is lower on prototype 2 than on prototype 1. It is possible to obtain 8 μm displacements for a single control point activated in the case of two control points chosen with prototype 1, whereas with prototype 2, it is possible to reach only 4 μm for the same case. Indeed, having larger actuators enables to reduce the control electronics but degrades the resolution as well as the amplitude. The choice of actuators must be made according to the application. Amplitudes of 4 μm are already well perceived amplitudes and it may not be necessary sometimes to have a very fine resolution. Finally, the study on the impact of the finger highlighted that even if the finger applies a force on the plate, the shape of the signal remains unchanged but the amplitude clearly decreases. Before choosing the amplitude of the signal to be sent, it is therefore necessary to think about the interaction that the user will have with the touch surface.

2.5. Conclusion

To conclude, the results described in this chapter demonstrate that the Inverse Filter method can be applied to a glass plate using an actuator matrix, which covers as much as possible the plate, and can produce a localised haptic feedback not only above the actuators but also at any point of the plate. This feedback is only possible if the positions of the control points are predefined in advance. In order to render a localised haptic feedback in realtime without knowing in advance the position of the fingers, a touchscreen can be used with the Inverse Filter method to retrieve the localisation of the fingers on the surface in realtime (or any similar method providing the positions). This realtime aspect was achieved thanks to the implementation of an interpolation method that reduces the vibratory database and thus, decreases the calculation time. This calculation time can take from a few millisecond up to 90 ms. We tested the Inverse Filter method with two types of actuators (diameter 20 mm and 35 mm). Using a matrix with larger actuators enables to reduce the driving electronics but it decreases the resolution (1 cm to 1.5 cm) as well as the amplitude of the haptic feedback (8 μm to 4 μm). For future work, it would be interesting to be able to move the actuators to the periphery, such as for the Time-Reversal approach [17], to obtain a transparent surface and allow a visual feedback collocated with the tactile feedback. The control electronics would also need to be miniaturised so that it can be embedded in a smartphone.

These haptic technologies are developed to enrich the interaction of the user, it is therefore necessary to study the feeling of the user. Indeed, questions related to

2. Localisation of the vibrations by the Inverse Filter method

whether the amplitude of the stimulus is strong enough, if it is pleasant or if the user can discriminate two vibrations, etc. remain. Therefore, these are tackled in the next chapters, through the chosen case study of Braille reading on a tactile surface.

3. Braille: a challenging case study

3.1. History of the Braille

“Hearing, sight, touch, taste and smell... Our five senses open the doors to feelings and sensations...” Le Club 5 Sens [92].

When we are deprived of one of these senses, we can no longer perceive everything and we must learn to live without it. Since the dawn of time, people are born or become visually impaired in the course of their lives. Deprived of this sense and without resources at their disposal, daily life can become complicated, such as for travelling, exercising, searching for items or for accessing graphical and scientific content. This is why for decades, people have worked on inventing techniques to enable the visually impaired to participate in the activities of society and improve their quality of life, in particular by enabling them to read and write. In the XIXth century, Charles Barbier de La Serres [93] invented a system called “night writing” or “sonography”, see Fig. 3.1.

This method enabled to transcribe 36 sounds in the form of points on a rectangle of 2×6 . Charles Barbier de la Serres introduced this writing and reading system to the National Institution for Young Blind People. Louis Braille deemed this technique promising, however, the sonography had no spelling, no grammar, no punctuation and no numbers. He decided to improve this method by reusing the method of raised dots and by creating an alphabet, and thus, Braille was born in 1821. It is composed of two columns with three dots (see Fig. 3.2). Louis Braille defined precise rules for the Braille notation so that it could become universal (see Fig. 3.3). Two points of a Braille cell are spaced by 2.3 mm while two Braille cells are spaced 6 mm apart and two lines of Braille are spaced by 10 mm. A dot in a braille cell is only 0.5 mm high and 1.4 mm wide.

Today, this technique remains the standard for reading and writing text as well as the best way to develop literacy for the visually impaired people and ensure their integration in the work life [94]. With the arrival of computers, the Braille cell evolved into an eight dots cell with a 7th dot below the dot 3 and an 8th dot below the dot 6.

This allowed to make 2^8 combinations thus 256 combinations as for the ASCII table.

3. Braille: a challenging case study

	1	2	3	4	5	6
1	•• •• •• •• •• a	•• •• •• •• •• i	•• •• •• •• •• o	•• •• •• •• •• u	•• •• •• •• •• é	•• •• •• •• •• è
2	•• •• •• •• •• an	•• •• •• •• •• in	•• •• •• •• •• on	•• •• •• •• •• un	•• •• •• •• •• eu	•• •• •• •• •• ou
3	•• •• •• •• •• b	•• •• •• •• •• d	•• •• •• •• •• g	•• •• •• •• •• j	•• •• •• •• •• v	•• •• •• •• •• z
4	•• •• •• •• •• p	•• •• •• •• •• t	•• •• •• •• •• q	•• •• •• •• •• ch	•• •• •• •• •• f	•• •• •• •• •• s
5	•• •• •• •• •• l	•• •• •• •• •• m	•• •• •• •• •• n	•• •• •• •• •• r	•• •• •• •• •• gn	•• •• •• •• •• ll
6	•• •• •• •• •• oi	•• •• •• •• •• oin	•• •• •• •• •• ian	•• •• •• •• •• ien	•• •• •• •• •• ion	•• •• •• •• •• ieui

Figure 3.1.: Night writing invented by Charles Barbier de La Serres. Source: image from ligue Braille [22]

A	B	C	D	E	F	G
•• •• ••	•• •• ••	•• •• ••	•• •• ••	•• •• ••	•• •• ••	•• •• ••
H	I	J	K	L	M	N
•• •• ••	•• •• ••	•• •• ••	•• •• ••	•• •• ••	•• •• ••	•• •• ••
O	P	Q	R	S	T	U
•• •• ••	•• •• ••	•• •• ••	•• •• ••	•• •• ••	•• •• ••	•• •• ••
V	W	X	Y	Z		
•• •• ••	•• •• ••	•• •• ••	•• •• ••	•• •• ••		

Figure 3.2.: Braille alphabet created by Louis Braille. Source: image from Musée des sciences et de la technologie du Canada [23]

3. Braille: a challenging case study

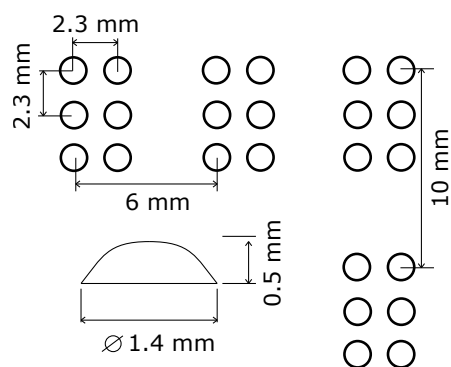
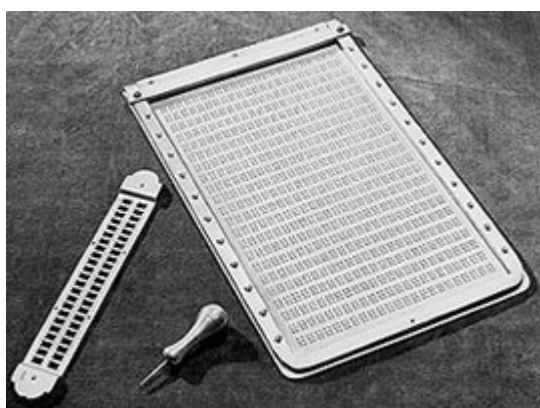
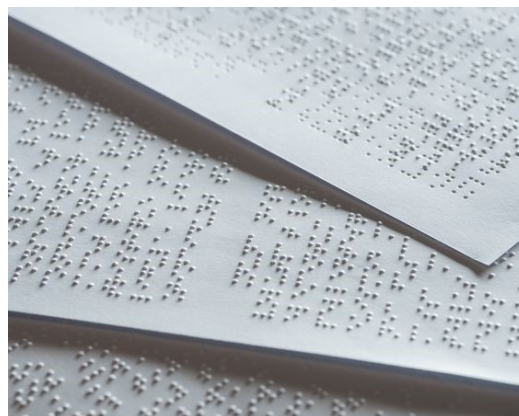

Figure 3.3.: Rules of Braille.



(a) Tablet and punch. Source: image from *ligue Braille* [96]



(b) The result. Source: image from *Accès Sensoriel* [97]

Figure 3.4.: The first way to write Braille.

However, this Braille code is only used in computer science. Indeed, it is more difficult to read because it is difficult to perceive the entire eight points under the fingertip.

3.2. Tools for reading and writing Braille

When Braille was invented, the only way to write it was to use a mechanical tablet [95], which was covered with grooves arranged in 2×3 and a punch (see Fig. 3.4a).

A sheet of paper was placed on the tablet and guided by a ruler; the paper was perforated by the user by entering into the grooves of the tablet. After writing the text, the sheet was removed from the tablet and had bumps representing Braille letters (see Fig. 3.4b). This technique required to write backwards in order to have the roughness

3. Braille: a challenging case study

on the outside. Soon after, the first Braille typewriters were created. A first prototype was built in 1929 and was called the Perkins machine (see Fig. 3.5) [98].



Figure 3.5.: Perkins machine. Source: image from Catawiki [24]

It was composed of six keys representing the six dots of a Braille letter and a central space key. These machines enabled to increase the writing speed but were noisy and frequently broke [99]. Unfortunately, the Perkins machine had its drawbacks. Indeed, the transcription time was long and these machines were difficult to produce because of their complexity [100]. It was difficult with a Perkins machine to press the keys or to go back to correct an error because there is no pointer to position itself on the sheet, hence the importance of going digital. In the 1950's, audio tapes and compact discs came to the market and made information more accessible through audio recordings. Unfortunately, sometimes this mode of reading made it difficult for the reader to imagine the structure of a book and to easily browse it, even when the user progresses in the book citeLivreAudio. It showed that audio alone is not enough [101]. Given these limitations of audio, the innovations for reading and writing are thus usually focused on the Braille notation. One such first innovation was the Digicassette [102] from Pierre Schneider-Maunoury created in 1976 (see Fig. 3.6).

Digicassette allowed to type Braille with a keyboard and to read Braille with 12 refreshable Braille cells. It could record and store Braille characters on a magnetic tape cassette. This tool is the ancestor of the Braille displays used nowadays (see in Fig. 3.6). Indeed, with the advent of computer technologies, refreshable Braille displays [103] have been developed, with refreshable cells for reading and a keyboard for writing Braille. These cells are actuated mechanically with piezo actuation, which

3. Braille: a challenging case study



Figure 3.6.: The Digicassette invented by Pierre Schneider-Maunoury. Source: image from Museum of the American Printing House for the Blind [25]

updates the Braille cells dynamically to provide access to digital content. To date, it remains the most commonly used tool to display textual content into Braille [103]. Available in different sizes (typically 14, 24, 40 or 80 cells) and prices (1 445 to 10 000 €) for mobility or home uses. These refreshable Braille displays enable an easy reading, give an idea of the representation of the screen and can convey a multitude of information, including highlighting, bold, etc. [104]. However, refreshable Braille displays remain rather expensive and impose an additional peripheral that can be cumbersome to carry or impractical to use, in crowded spaces for instance. Thus, visually impaired people also use Text-To-Speech (TTS). It is a synthetic voice that gives access to the digital world without relying on Braille. It indicates, for example, the location of the cursor or reads text, etc. There is VoiceOver on Iphone and TalkBack on Android [105]. Braille and sound complement each other to provide the user with the information he/she needs. Unfortunately, this TTS technology cannot replace Braille exclusively as it is ill-suited in noisy environments, for collaborative work, for conveying graphics or for deafblind people and it affects literacy [94].

Research has been carried out to find alternative solutions. For instance, the Pantobraille [26] combined the Pantograph, a force-feedback finger device, for pointing, feeling shapes and hand guidance, and two 8-dot cells to provide tactile feedback, for textures and Braille output. The visually impaired users simply put their index finger onto the device and explored the content on the 2D page associated with the content (see Fig. 3.7). However, when users used the Pantobraille for the first time, it required to develop new reading habits. This technology was not so easy to use based on user

3. Braille: a challenging case study

feedback.

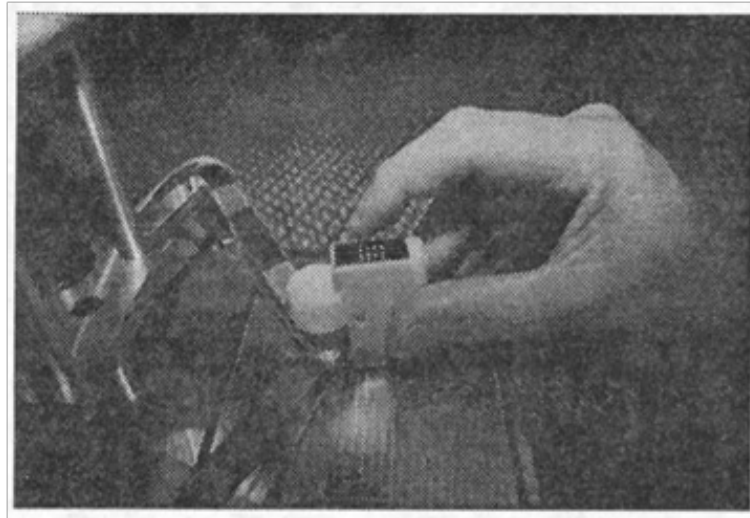

Figure 3.7.: Pantobrilie. Source: image from [26]

Other researchers have investigated novel actuation mechanisms to replace the traditional piezoelectric Braille modules, which are expensive, while still displaying content using the conventional Braille dots. For example, the VITAL [27] aimed at providing a setup with a simple assembly procedure and a competitive price, using an electromagnetic actuator arranged in a 8×8 pin matrix (see Fig. 3.8).

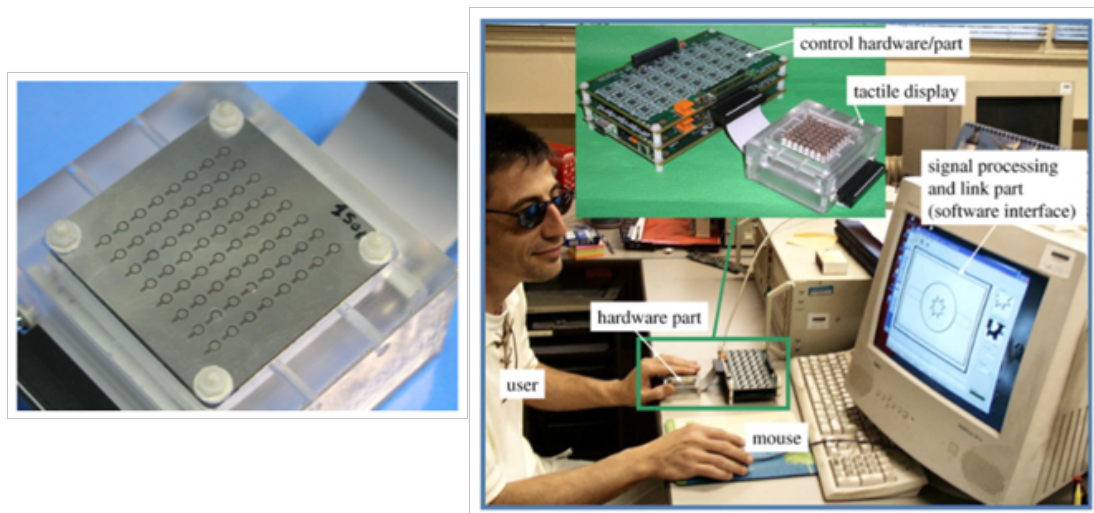

Figure 3.8.: Vital. Source: image from [27]

3. Braille: a challenging case study

It was developed to provide access to maps and graphics, both static and dynamic. This technology was not developed to read Braille but instead to communicate shapes to the user. A user study conducted with 10 visually impaired people demonstrated that it was effective for conveying dynamic shapes (78% recognition rate). This technology enables to indicate the direction; however, it requires a higher resolution to be able to display shapes and fine surface roughness and textures. Moreover, at the time of the publication, it was not integrated within a computer or a smartphone. It is an additional peripheral, relying on a computer or smartphone for inputs. Russomanno et al. [28] used pneumatic actuation to raise the Braille dots to display graphics and maps as well (see Fig. 3.9). This technology made it possible to respect the rules of Braille and a Braille user was able to read words correctly. Future work will focus on improving the strength supported by the setup, which is quite weak at the moment.

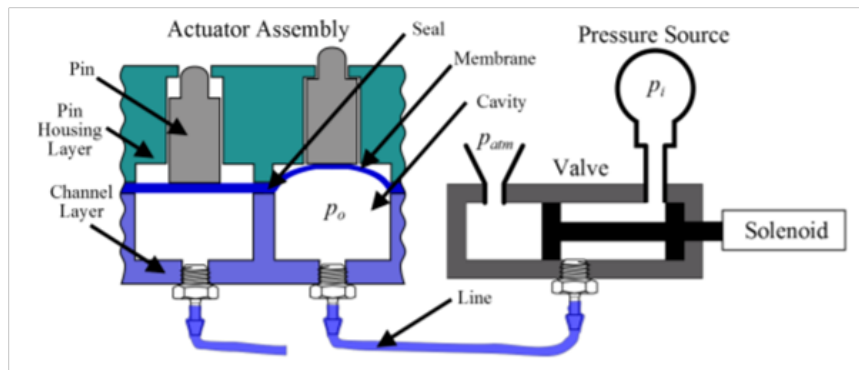

Figure 3.9.: Pneumatic. Source: image from [28]

These methods provide interesting alternatives to the typical and expensive piezo-actuated Braille cells. However, similarly to refreshable Braille displays, all of these technologies consist of dedicated displays, requiring an additional peripheral, and cannot or are not mature yet to be integrated into common touchscreen device.

3.3. Other ways of rendering Braille

Despite the various methods developed and efforts commercially and in academia, as illustrated in section 3.2, access to digital content by the visually impaired remains challenging, even for content as simple as text. In order to get rid of the pins of the classical Braille, which is difficult to realise, there are other technologies relying on

3. Braille: a challenging case study

Ultrasound and wearables that can render Braille through actuators on the fingers or through tactile surfaces.

3.3.1. Braille directly on the hand

3.3.1.1. Ultrasound technology

Some researchers have investigated the possibility to render a tactile feedback without direct contact with a device. The ultrasound technology can be used to do this. The HaptiRead device [29] used this technology to focus the six dots of a Braille letter on the palm of the hand (see Fig. 3.10).



Figure 3.10.: Haptiread device. Source: image from [29]

The prototype is based on a matrix of $16 \times 16 = 256$ transducers. It could produce up to eight points located at a maximum distance of 70 cm. The resolution of the dots was 8.6 mm; it was fine but not enough to make Braille under the finger. This type of technology worked in ultrasound at a frequency of 40 kHz well beyond the sensitivity range so the skin could not receive a sensation, it was necessary to modulate the signal with a frequency detectable by the receptors in the human skin. The actuator worked well between 100 and 200 Hz, hence the authors had chosen to modulate with six different frequencies in this frequency range with a step of 20 Hz. They conducted a user study to assess whether visually impaired people could discriminate the numbers from 0 to 9.

3. Braille: a challenging case study

Up to 4 points were activated at the same time unlike Braille letters that can have up to 5 dots activated at the same time. In order to present these patterns, they have used different methods of presentation:

- Constant: all points vibrated at the same time;
- Point-by-point: the points vibrated one after the other with a stimulation duration of 200 ms and a pause between each vibration of 300 ms;
- Row-by-row: the points vibrated at the same time on the same line with a duration of 300 ms followed by the second line without a pause between them.

The results were very encouraging. They achieved a recognition rate of 81% for the Constant method, 88% for the Point-by-Point and 75% for the Row-by-Row. Participants reported that the Point-by-Point method required them slightly lower mental demand and that the Row-by-Row method had the lowest reading comfort. The majority of the errors (61%) were due to misperception of a single point and 8% of the errors were due to the omission of two or more points. Feedback from the 11 visually impaired people was positive; participants reported they felt comfortable with reading the Braille numbers (up to 4 dots). The Constant method felt closest to regular Braille and some participants found the Point-by-Point too slow. They found that using the palm of the hand was comfortable. They gave use cases for the technology: read door signs in public, at the self-checkout register in the supermarket, at a ticket machine, as a small portable clock, to read relief maps and so on. Other benefits are that it was a non-invasive setup and the user did not need to learn a new language. However, the authors tested only a small subset of Braille characters limited to four cells, and rendering letters (up to 6 dots) is another challenge. Moreover, this technology requires a lot of energy and is cumbersome, so it is difficult to use it for personal use in public transportation for example.

3.3.1.2. Actuators on the hand

An alternative method of actuation is to transfer information by direct actuation on the fingers rather than the fingertip. Nicolau et al. [11] attached rings directly to the fingers. The middle of the fingers yielded best results in stimuli discrimination, to transmit the Braille letters through vibrations (see Fig. 3.11).

The aluminium ring was actuated using a lily pad vibrate board, which included a small vibration motor. It could produce 0.8 G of amplitude and operate under low voltage of

3. Braille: a challenging case study

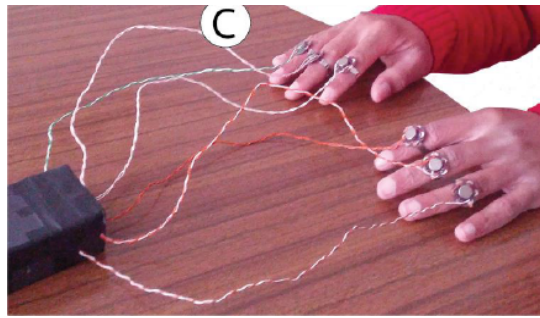

Figure 3.11.: Prototype Ubibraille: six vibrotactile actuators directly to the fingers.
Source: image from [11]

3.8 Volts when it was activated. They were inspired by the standard writing system of the Perkins Braille by using the index, middle and ring fingers of both hands associated each to a Braille dot, typically for typing, to receive the stimuli for reading instead. The fingers were activated at the same time and received a vibration of 2 s. They conducted a user study with 11 visually impaired people to evaluate their method called UbiBraille and obtained good recognition rates of 82 %. They found higher error rates on characters that required several stimuli on both hands, for example Y (two vibrations on the left hand and three vibrations on the right hand), Z (two vibrations on the left hand and two vibrations on the right hand) or V (three vibrations on the left hand and one vibration on the right hand). Sometimes, errors occurred when one single dot was inaccurately identified, either one point more or one point less was sensed. Some participants reported that UbiBraille demanded some attention. To further validate the principle, based on the positive recognition of letters, the authors conducted another study to convey five letter words. They tested four configurations:

- 4 s: 2 s stimulus duration and 2 s interval duration;
- 2 s: 1 s stimulus duration and 1 s interval duration;
- 1 s: 0.5 s stimulus duration and 0.5 s interval duration;
- 0.5 s: 0.25 s stimulus duration and 0.25 s interval duration.

The results showed that the recognition rates of 4 and 2 s were very close to about 90 %, hence longer times were not needed. The 2 s condition seemed ideal because with shorter times the recognition rate went down to 64 % for the 1 s case and 32 % for the 0.5 s case. Participants reported that the context might play an important role. Indeed,

3. Braille: a challenging case study

if a user was alone and fully concentrated on the reading, then a faster setting could, and should, be employed; on the other hand, if in a more demanding situation, only the longest settings would be feasible. The learning plays a significant role too. Participants found that the more they used UbiBraille, the more they improved their recognition rate. This technology enables to read 12 words per minute, which is much less than the 115 words per minute of a refreshable Braille display with 32 cells [106]. However, this technology is portable and can be used in the bus or the subway. Nonetheless, it is necessary to rethink the design to make it more functional. The authors planned to do future work with miniaturised, wireless, and easy to attach actuators. The actuators can also be put inside a glove as in the work of Luzhnica et al. [12]. The actuators were positioned at the back of the hand and fingers. They were placed on the middle phalanx leaving the fingertips free (see Fig. 3.12). The vibrotactile actuators used had an amplitude of 0.8 G. Thanks to this glove, they could produce the 26 letters of the alphabet. They created their own vibratory alphabet by actuating a single actuator for the letters most used for example A, E or I, by going up to activate three actuators at most for the less used such as Z, Q or K. A training round was conducted with three means of stimulation in parallel: hearing (via computer speakers), touch (via actuators) and sight (on the screen of the computer). Four hours later, four sighted participants had a recognition rate of 94 %. This technology assigned a vibrotactile pattern to a letter of the alphabet so the participant had to familiarise himself/herself with this new method and learn 26 patterns. This kind of technology would be interesting to test with visually impaired people. Unfortunately, these two technologies cannot be directly embedded into a screen, it is necessary to add an external element.

3.3.2. Braille on a tactile surface

Both these solutions have demonstrated that other feedback technologies, i.e. ultrasound and vibrotactile, can be efficient to render Braille instead of indented pins, with various presentation methods. However, both also require the addition of an external peripheral to render Braille. Nowadays, tactile surfaces are omnipresent in our daily life. For instance, we interact with tactile cash registers for self-check-out when shopping, with tactile ATMs to withdraw cash, with interactive tables in commercial centres or museums for additional information, and at home with home appliances or more commonly with the smartphones or tablets. They have become the new standard of interaction, as touch interaction is more direct and natural. In order to avoid the problem of an additional external peripheral, some researchers have therefore tried to render Braille directly onto

3. Braille: a challenging case study

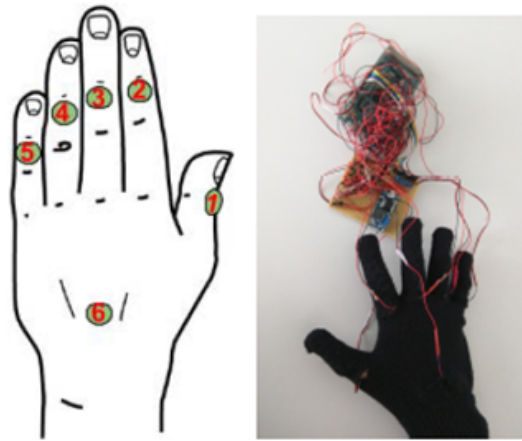

Figure 3.12.: Wearable setup of the glove. Source: image from [12]

touchscreens to enable visually impaired people to read Braille on their smartphones.

3.3.2.1. One finger stimulated at a time

Rendering Braille on a surface requires a resolution of 2 mm, which is currently not feasible on tactile surfaces because this requires many actuators, complex control electronics to set up and complex calculations. Methods have been developed to overcome this problem and the lack of feasible localised haptics. Al-Qudah et al. [10] have rewritten the Braille alphabet into Morse code. The Braille is composed of two columns with three points each so eight different possible combinations of lowered and raised points per column exist. In their article, one column was considered as a single unit and encoded with a single vibration. A column was a combination of dots with a short duration period of vibration 20 ms and dashed with a longer duration period of vibration 100 ms. In order to optimise the presentation time of the Braille characters, they looked at which combination came up the most to assign them the least amount of vibration pattern. The summary is depicted in Fig. 3.13.

The Braille character is composed of a rhythm of two vibrations patterns, one per column, with a period of silence between the two columns of 500 ms. The silence between dot and dash varied between 100 and 220 ms. For the user study, they used a Nokia 5800 Xpress-Music smartphone, which had a vibration motor that allowed controlling the vibration period. The participant held the phone in one hand and placed a finger of his/her other hand on the screen to start the presentation of the vibration. The participant felt the vibrations as they went through the hand holding

3. Braille: a challenging case study

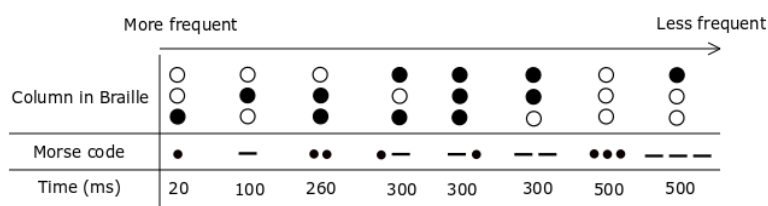

Figure 3.13.: Morse code in order to render Braille characters. Source: image from [10]

the phone. The authors obtained a recognition rate of 73 % with 4 visually impaired participants and 95 % of the errors arrived on the first column. They also tried two other time combinations, one by setting the time between the two columns at 400 ms instead of 500 ms and another by changing the dash duration to 80 ms instead of 100 ms. This reduced the overall presentation time of Braille characters. They obtained a recognition rate of 62 and 61 % respectively with the same participants. They found that the recognition rate improved significantly as the usage time of the system increased. The participants reported that the system required the user to concentrate to complete the reading task. Some participants reported that when the column started with a dot, it was difficult to recognise the pattern. They suggested that a small silence period before the dot may improve the recognition rate. This approach uses only eight different vibration patterns and only two vibrations (dot and dash). Moreover, it requires a relatively low presentation time. However, the users need to learn a new language that is not directly based on Braille, which some people can be reluctant about given all the things they already need to learn. In addition, it needs high concentration from users [107]. Thus, other researchers have investigated alternative methods of delivering Braille dots on a surface, to avoid the need of a new language. For instance, Rantala et al. [30] designed three novel interaction methods involving the use of a stylus for reading Braille characters on a tablet (see Fig. 3.14), either in a static position or by moving the stylus, where points are delivered successively through vibrations. The methods included: scan (by scanning the dots laid out in the standard 2×3 matrix representation from top to bottom and by column), sweep (by moving the stylus horizontally with dots laid out in the Perkins Braille configuration) and rhythm (where the dots are delivered successively at the stylus position). The three methods were evaluated with six blind participants; they obtained a percentage of accuracy of 97 % for the scan, 91 % for the sweep and 92 % for the rhythm. The differences were not statistically significant but the participants

3. Braille: a challenging case study

indicated that the scan and the rhythm methods were more pleasant than the sweep method. Four out of five participants would have chosen the rhythm method for their personal use. This technology is fast and can deliver one character per second. Yet, all participants reported that these methods of presentation required intensive concentration on the reading task.



Figure 3.14.: Nokia 770 internet tablet, which allows presenting the vibrations thanks to a stylus. Source: image from [30]

3.3.2.2. Several fingers stimulated at a time

The authors of UbiBraille [11] pursued their efforts with HoliBraille [31] that permitted a multi-finger feedback on a screen. The actuators were not integrated in the screen but rather attached to the back of the phone. They consisted in six vibrotactile motors mounted onto springs, which enabled to isolate the vibrations for localised feedback, see Fig. 3.15. A user study was conducted with 12 visually impaired participants and the entire Braille alphabet was presented to them twice. A simultaneous vibration was sent to each activated finger. Results show that participants could identify Braille letters with an accuracy of 73 %, with a lower recognition rate when four or more points were activated at the same time. This technology enables to activate at the same time the six fingers, which is the closest to the typical way of reading Braille. However, the technology is not directly integrated into the screen and requires the addition of vibrotactile motors.

3.4. Conclusion

Various technologies have been developed to enable the visually impaired to read and write Braille. The most used tool remains to date the refreshable Braille display [103], which allows to read Braille and to write Braille Perkins. This kind of technology

3. Braille: a challenging case study



Figure 3.15.: Prototype of HoliBraille. Source: image from [31]

works thanks to cells activated by piezoelectric actuators, which are, however, very expensive. Researchers have conducted research to keep a typical pin display but relying on another technology to reduce the cost to the user [26, 27, 28]. However, pin methods require an additional device [26, 27, 108, 12], ultrasound technologies [29] require a lot of energy and pneumatic actuators techniques are not mature enough to be used in everyday life [28]. Other technologies can convey a Braille feedback on a screen but the vibration is encoded [109, 110] to transmit it on a single finger.

To summarise, despite interesting alternative technologies or methods to render Braille, few of them have the potential to be simply or soon integrated into a typical smartphone or tablet. The main issue is being able to render Braille dots at the mm scale, currently not achievable in standard touchscreen devices. Our technology for localised haptic feedback using the Inverse Filter method (called LotusBraille and described in Chapter 4), enables to render localised and multipoint feedback at the cm scale and can potentially be integrated into touchscreen devices, particularly those using the recent OLED screen technologies. Therefore, we have investigated conveying Braille dots using the rendering method introduced by Nicolau et al. [11, 31], i.e. by using the Perkins Braille input method for output onto six fingers. Indeed, we chose this method because we did not want the user to learn a new language. Moreover, this method allows activating six fingers at the same time, which is possible to achieve on a surface with our Inverse Filter method. For the presentation methods, we were inspired by HaptiRead [29]: with the simultaneous method where all fingers vibrate at the same time, row by row where the fingers vibrate two by two and sequential where the fingers vibrate one after the other. This investigation was warranted as the feedback provided by our technology on a single surface is different from wearables attached to fingers [11] or at the back of a device [31], with its own perceptual challenges in terms of

3. Braille: a challenging case study

discrimination. Furthermore, as the method for localised feedback is novel and rather recent, this remains an uncharted territory. The following sections describe the evaluation of LotusBraille with the different presentation methods.

4. Evaluation of LotusBraille as a method for reading Braille on a screen

As described in the previous chapter, accessibility to digital content, as elementary as text, is still difficult on a touchscreen device, even though it is currently one of the most used devices. Visually impaired people either require additional peripherals, such as expensive Braille refreshable displays or rely on embedded TTS, which poses its own issues. Researchers have investigated alternative solutions, relying either also on additional components or wearables, or on presentation techniques requiring a new learning (see previous chapter). Thanks to our novel technique for localising vibrations on a surface (detailed in Chapter 2), using the Perkins Braille layout, we can convey letters and ultimately words on a touchscreen. However, as this type of feedback on a surface is novel, it requires user studies to evaluate the perception and modalities of delivery. In this chapter and in the following subsections, we will describe the various studies conducted and their results. They include:

- A preliminary perceptual study to validate the multitouch discrimination with 10 sighted users;
- A study on Braille letter discrimination with different presentation methods with 6 visually impaired participants;
- A study on the impact of different frequencies on different fingers to improve the discrimination with 10 sighted users;
- A study on Braille letter discrimination with different timings and a new presentation method with 6 visually impaired participants and,
- A final study on reading words with 4 visually impaired individuals.

The last four studies were conducted following the ethics approval from the ethics

committee from Paris-Saclay. All the studies were conducted following the GDPR principles.

4.1. Two-point haptic pattern recognition

The purpose of this user study was to conduct preliminary investigations of multitouch feedback recognition on a tactile surface using the Inverse Filter method. Specifically, this study investigated whether users could discriminate vibrotactile stimuli on two different fingers and in particular simultaneous stimuli. To that effect, four different timing differences were chosen, i.e. 0 ms, 100 ms, 200 ms and 300 ms. The stimuli have an amplitude of 1 μm and a frequency of 250 Hz and a duration of 100 ms.

4.1.1. Participants

The study was conducted with 12 sighted participants (4f-8m), aged between 14 and 45 ($M = 28.25$, $SD = 7.5$). 11 participants were aged between 25 and 45 and only one minor participated. All but two participants were right-handed. Half of the participants were very familiar with haptic technologies (researchers recruited within the laboratory), while the rest had limited or no knowledge about haptics (a college student, a security coordinator, a project manager in construction project management and three researchers from the vision laboratory). None reported any issues with their fingers or sensitivity aside from two participants who reported having moist hands. The device was placed on a table, in front of the participant (see Fig. 4.1). The participants were instructed to place their fingers onto the tactile screen for the trials, at the positions that were comfortable to them, as displayed in Fig. 4.1, with their wrists on resting supports to minimise the fatigue. They wore noise-cancelling headphones during the trials with pink noise to cancel any bias due to the noise generated by the setup. We used a standard Windows laptop both for running the python application controlling the feedback and for logging the verbal answers.

4.1.2. Description of the experimental setup

The user study carried was conducted on the setup depicted on the left of Fig. 4.1 (and described in section 2.4.1). Despite lower performance, this prototype was chosen due to its integration with a touchscreen to retrieve finger positions in realtime. It is for this reason that this prototype was chosen. Eleven piezoelectric actuators (Murata

4. Evaluation of LotusBraille as a method for reading Braille on a screen

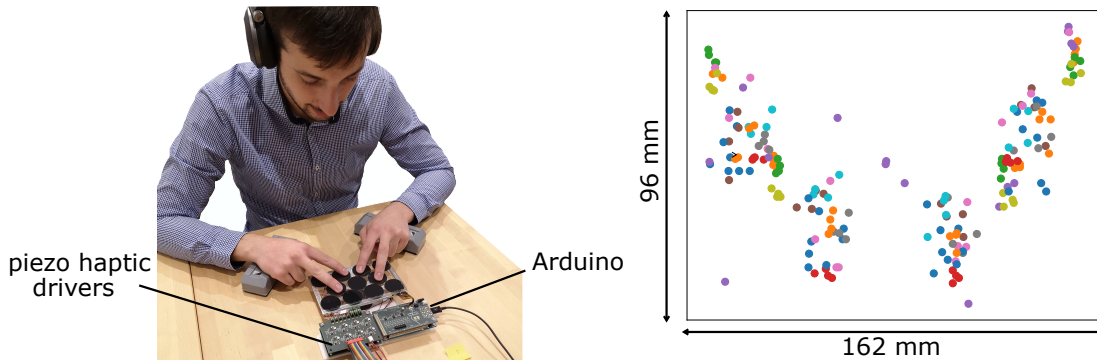

Figure 4.1.: Left: experimental setup. Right: finger positions of the participants. (the photo was reproduced with the authorisation of the participant)

7BB-35-3, 35 mm diameter, 0.51 mm thickness) were glued on the bottom of a $96 \times 162 \times 1$ mm touchscreen (7" pingbo PB70DR8272R1), which can detect up to five fingers. An Arduino receives the finger localisation data through an I2C protocol. After decoding the data with python, the number of control points can be obtained as well as their X, Y coordinates. Actuators were driven individually with piezo haptic drivers (DRV8662-Texas Instrument) delivering up to 200 Vpp. Surface displacements were measured by a laser vibrometer (Polytec OFV5000/MLV-100) mounted on a motorised three axis platform. The acquisition device (NI-9264, NI-9205 and cDAQ-9174) allowed for a synchronous emission and acquisition of actuators and vibrometer signals. All signals were sampled at $F_s = 10$ kHz.

4.1.3. Protocol

The experiment was a within-subject repeated measures design with four conditions (0, 100, 200, 300 ms), tested in different sessions. The order of the sessions was counterbalanced between participants as well as the direction of the stimuli within a session (i.e. playing either from left-to-right, or from right-to-left). There were 10 trials per stimuli/finger combination (depicted on Fig. 4.2) with half from each direction, accounting for 60 trials per session. In total, each participant performed 240 trials. The experiment lasted one hour on average.

In each trial, the task was to identify the positions/finger combination that received the haptic stimuli with the fingers numbered from 1 to 4 (e.g. stimuli on the index fingers of each hand corresponded to “2-3”, see Fig. 4.2). The participants were instructed to provide the answer verbally as soon as they recognised the stimuli, which was provided

4. Evaluation of LotusBraille as a method for reading Braille on a screen

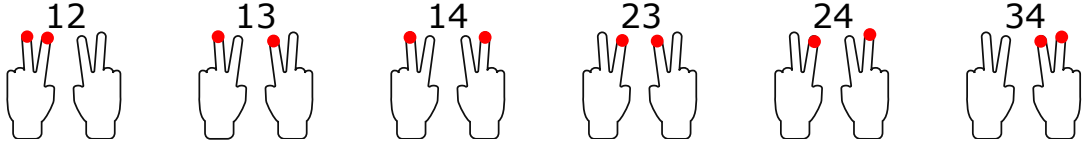

Figure 4.2.: Stimulation number corresponding to the stimulated fingers.

only once, whilst their hands remained on the device. The experimenter logged the answer by first, pressing a button to measure the response time and then, typing the given answer. This was a forced-choice experiment: if participants had doubts, they were asked to answer the most likely option. To accustom participants and reduce the impact of learning effects, prior to each condition, participants were presented with each of the stimuli twice per direction and performed a blind test before the trials. After each session, the participants were asked whether they perceived a difference with the previous condition and to describe it. They were also asked to rate the difficulty of discrimination on a continuous numeric scale from 0 to 10 (10: very difficult). At the end of the last session, the participants were asked which timing difference they preferred and general comments about the perception. Throughout the study, the experimenter also noted relevant participant behaviour, comments and any external factors that might affect the results. As for quantitative measures, the interface collected the responses and the response times. The response time was collected to provide trends, as the experimenter logging the responses induced a bias, in particular in terms of longer hesitations to answer for a condition.

4.1.4. Results

4.1.4.1. Recognition Rates

The average recognition rates are displayed in Fig. 4.3. The distribution was normal for all the conditions except for 0 ms. Therefore, a Friedman’s ANOVA was conducted and revealed that the recognition rates were significantly different between the timing conditions, $\chi^2(3) = 13.07$, $p < .05$ ($M_0 = 49.58$ or 82.64%, $SE_0 = 6.1$, $M_{100} = 51.83$ or 86.39 %, $SE_{100} = 4.78$, $M_{200} = 54.75$ or 91.25%, $SE_{200} = 3.52$, $M_{300} = 55$ or 91.67%, $SE_{300} = 4.59$). Post hoc tests were conducted based on the following inequality:

$$|\overline{R}_u - \overline{R}_v| \geq z_{\alpha/k(k-1)} \sqrt{k(k+1)/6N} \quad (4.1)$$

with $R_{u,v}$ the mean rank of a group, z the statistic from the table of the standard

4. Evaluation of LotusBraille as a method for reading Braille on a screen

normal distribution, k the number of conditions and N the total sample size.

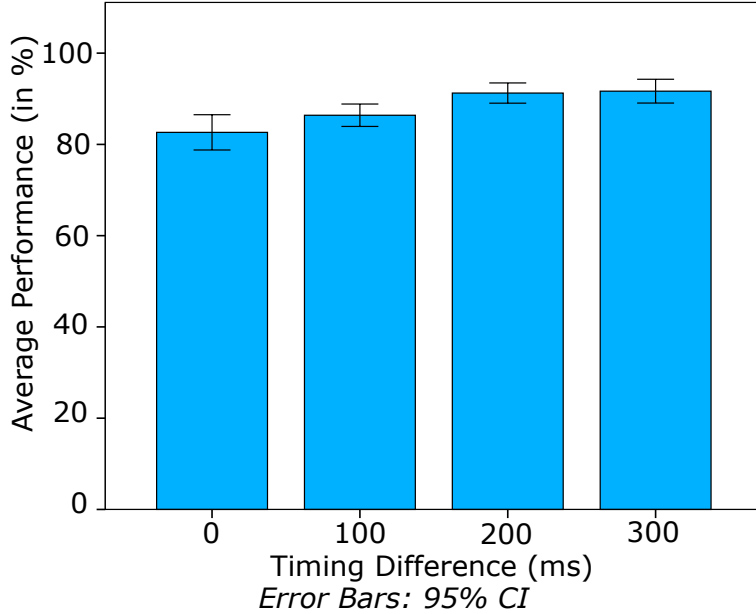

Figure 4.3.: Average performance (in %).

We computed the critical difference (right side of equation (4.1)) as being equal to 1.39 with a z value of 2.64. We then calculated the differences between the mean ranks of the groups with the most likely significant differences, i.e. 0-200, 0-300, 100-200 and 100-300. The inequality of equation (4.1) indicates that if the differences between mean ranks is greater than or equal to the critical difference, then that difference is significant (summary in Table 4.1). In this case, the pairs 0-200 ($|1.67 - 3.13|$) and 0-300 ($|1.67 - 3.17|$) have values of 1.46 and 1.5, greater than 1.39, thus their difference is significant. Overall, the results indicate that participants recognised well patterns made of two distinct stimuli on the surface using the Inverse Filter method, even simultaneous ones (82.64 % recognition, chance level at 17 %). However, to further confirm this hypothesis, studies involving mixed stimuli on one to several fingers need to be conducted as the knowledge of having only two stimuli could have biased the conditions with a lower temporal difference by guessing.

There were no major differences between participants judged as haptic experts and non-experts, if anything, non-experts had higher scores than experts. As expected, participants performed better at longer timing differences with a significant difference between 0 and 200 ms onwards. For further analysis of the participants' performance, we

4. Evaluation of LotusBraille as a method for reading Braille on a screen

Table 4.1.: Differences between mean ranks

Comparison (u-v)	\overline{R}_u	\overline{R}_v	$ \overline{R}_u - \overline{R}_v $
0 - 200	1.67	3.13	1.46
0 - 300	1.67	3.17	1.5
100 - 200	2.04	3.13	1.09
100 - 300	2.04	3.17	1.13

computed confusion matrices for each of the conditions (see Fig. 4.4). They show that the pairs “12” and “34” are nearly always recognised, no matter the timing difference between stimuli. Most of the confusion happened when involving pairs of fingers from different hands. In particular, for 0 and 100 ms, the pairs with the lowest scores were “13”, “14” and “24” and the confusion most often happened with one adjacent finger. For instance, for patterns “14” and “24” for 0 and 100 ms, the most important confusion happened with “24” and “34” respectively (with values $> 10\%$) while for “13” for 0 and 100 ms, it was mostly confused with “12” and “23” respectively. Preliminary analysis of the results of amplitude differences between patterns did not indicate any notable impact on the perception. For 0 ms, the amplitude varied on average between 2.95 (patterns “13” and “24”) and 4.16 μm (pattern “23”), for 100 ms between 2.75 (pattern “24”) and 3.72 (pattern “23”), for 200 ms between 2.69 (patterns “13” and “14”) and 3.75 (pattern “23”) and for 30 ms between 2.78 (patterns “12” and “13”) and 3.8 (pattern “23”). There was no clear correlation between this difference in amplitude and the recognition rates, as for instance “23” always had the highest amplitudes, but not the highest recognition rates. For 100 ms the lowest recognition was for “13” and yet had an amplitude of 3.06 μm .

4.1.4.2. Response Times

The average response times are displayed right of Fig. 4.5. The distribution was normal for all the conditions except for the 300 ms condition. Therefore, a Friedman’s ANOVA was conducted and revealed that the response times did not significantly change between the different timing conditions, $\chi^2(3) = 3.6$, $p > .05$ ($M_0 = 2.06$, $SE_0 = 0.57$, $M_{100} = 2.05$, $SE_{100} = 0.37$, $M_{200} = 2.03$, $SE_{200} = 0.41$, $M_{300} = 2.07$, $SE_{300} = 0.37$). This shows that participants had no particular difficulty according to the timing difference, even with simultaneous stimuli, which is confirmed by the relatively high recognition rates.

4. Evaluation of LotusBraille as a method for reading Braille on a screen

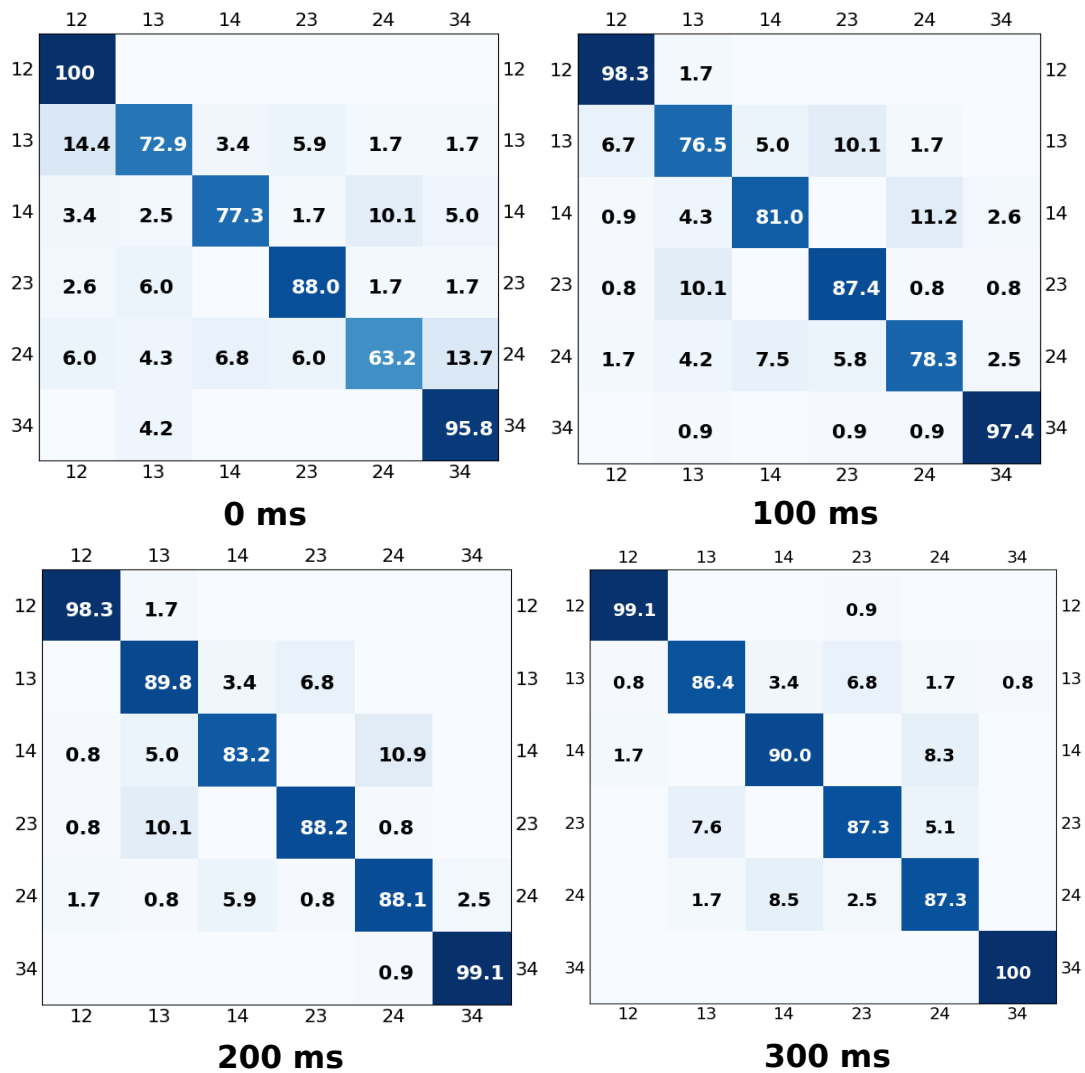

Figure 4.4.: Confusion matrices. From left to right: 0 ms, 100 ms, 200 ms and 300 ms.

4.1.4.3. Qualitative Feedback

During the study, after each session, participants were asked to rate the difficulty of discrimination for each condition on a scale of 0 to 10, with 10 being “very difficult”. 0 ms obtained an average score of 6.42 out of 10, 100 ms a score of 3.63, 200 ms a score of 3.36 and 300 ms an average score of 2.33. This shows that despite good recognition rates for the 0 ms condition, participants felt less confident, some participants reported feeling a movement rather than two distinct points. This echoes the work on “out of the body” phantom sensations on a surface [111, 52] and warrants further exploration.

4. Evaluation of LotusBraille as a method for reading Braille on a screen

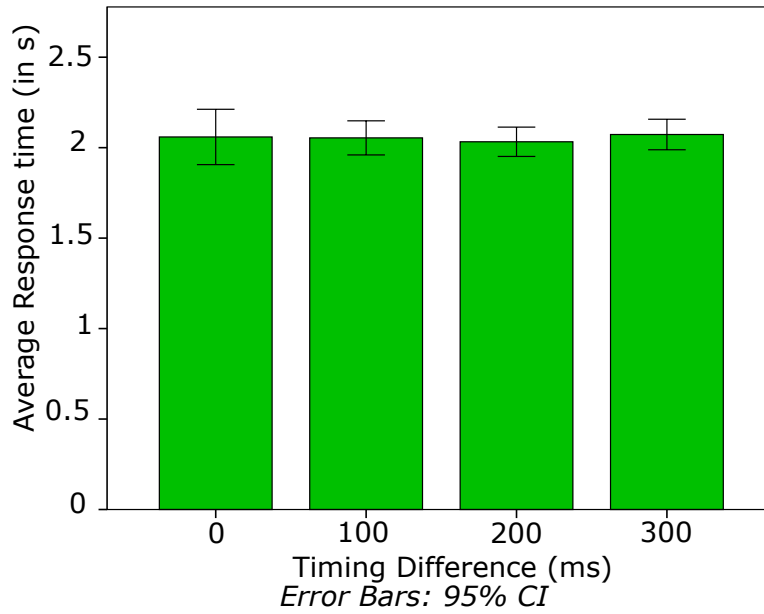

Figure 4.5.: Average response time (in s).

On the contrary, the 300 ms condition was deemed the less difficult as participants could clearly feel and distinguish the two stimuli. From a pattern recognition point of view, this is an interesting result as the 0 ms could produce patterns or textures that need to be perceived as continuous movements, whereas timing delays above 200 ms could be used to ensure the discrimination of several points. In concordance with the perceived difficulty ratings, 7 participants preferred the 300 ms condition as they were more confident about the perception, with stimuli well separated, whereas 5 participants preferred the 100 ms where the stimuli were still well perceived and the rhythm was faster. Only one participant preferred the 200 ms judging it as the best compromise between speed and confident discrimination, though that participant commented that 100 ms was also a good option but could necessitate more training. Some participants reported perceiving different intensities on their fingers in a trial, though not consistently. This could be explained by the uncontrolled amplitude of the setup, though the difference in amplitude of the stimuli were constant for a given finger in a trial, which contradicts user perceptions.

4.1.5. Discussion

This first study validated the fact that it is possible to stimulate two fingers of the same hand or of two different hands using the Inverse Filter method and that participants could discriminate the different stimuli. Different temporalities were tested between two stimulations ranging from simultaneous to 300 ms. The study showed that the recognition rates for two stimuli were rather constant ranging from 80 % for the simultaneous condition to 88 % for the 300 ms condition. The 200 ms time delta allows having a good balance between good recognition rate and information transmission speed. Indeed, the 0 and 100 ms time delta were deemed too fast or necessitating training and the 300 ms, even though it was the preferred timing for recognition, is too slow for conveying words ultimately. After validating the discrimination of vibrations on the fingers thanks to the Inverse Filter method, the next step consisted in transferring letters of the Braille alphabet to visually impaired people.

4.2. Perkins Braille alphabet rendering on a glass surface

The purpose of this user study was to conduct preliminary investigations into LotusBraille, i.e. rendering Braille letters as efficiently as possible using the principle of the Perkins Braille, for reading, with the novel localised and multipoint haptic feedback on a glass surface (Lotus [32]). The Perkins Braille principle, for writing, is integrated into Braille displays [103] and even smartphones [112]. It consists in mobilising six fingers: the index, middle and ring fingers of both hands to write Braille, as described in section 3.1. Traditionally used for Braille input, we applied it for output of Braille letters and thus for reading. The primary objective was to evaluate the feasibility of this principle with localised feedback for reading (compared to [31]). The secondary objective was to evaluate three different presentation methods, from sequential to simultaneous stimuli, to assess the best compromise between performance and efficiency (similarly to Paneva et al. [29]). Indeed, we hypothesised that the sequential method would provide the most accurate results, but would be judged rather inefficient for reading words. On the contrary, a hybrid or simultaneous method would be more difficult but more promising for reading efficiency.

4. Evaluation of LotusBraille as a method for reading Braille on a screen

4.2.1. Participants

A total of 10 visually impaired participants (4f-6m) were recruited for this study. Out of the 10 participants, one decided to stop at the very beginning, because he/she could not feel the vibrations, and three after the familiarisation of the second method, because they found the feedback unusual and they were uncomfortable. Thus, the analysis was conducted with the six participants who completed all the trials. The six participants (1f-5m) were aged between 33 and 62 years old ($M = 43$, $SD = 12.8$). Four participants were right handed, one left handed and one ambidextrous. Except for one, all participants were blind from birth. Amongst them, four could still perceive light. They all learnt Braille at the age of five and were proficient in using it. None reported any issues with their fingers or sensitivity.

4.2.2. Setup and Conditions

The device was placed on a table in front of the participant (see Fig. 4.6). The participants were instructed to place their fingers inside circles that were glued on the surface, with their wrists on resting supports to minimise fatigue. They wore noise cancelling headphones during the trials with pink noise to cancel any bias due to the noise generated by the setup. Sanitary measures were respected, i.e. with frequent cleaning of the apparatus and disposable covers for headphones. The experimenters used a Windows laptop for running the python application for controlling the feedback and for logging the verbal answers.



Figure 4.6.: Prototype of the experimental study

The Braille letters were presented according to three methods as illustrated in Fig. 4.7:

4. Evaluation of LotusBraille as a method for reading Braille on a screen

- *Sequential*: the fingers vibrate one after the other for 100 ms with a pause of 200 ms between two vibrations (total duration up to 1300ms, for the letter “y”);
- *Hybrid* (line by line): the vibrations are sent first to the indexes simultaneously for 100 ms, then to the middle fingers, and finally to the ring fingers, with a pause of 200 ms between each vibration (total duration up to 700 ms, for the letter “y”);
- *Simultaneous*: all fingers jointly vibrate for 100 ms.

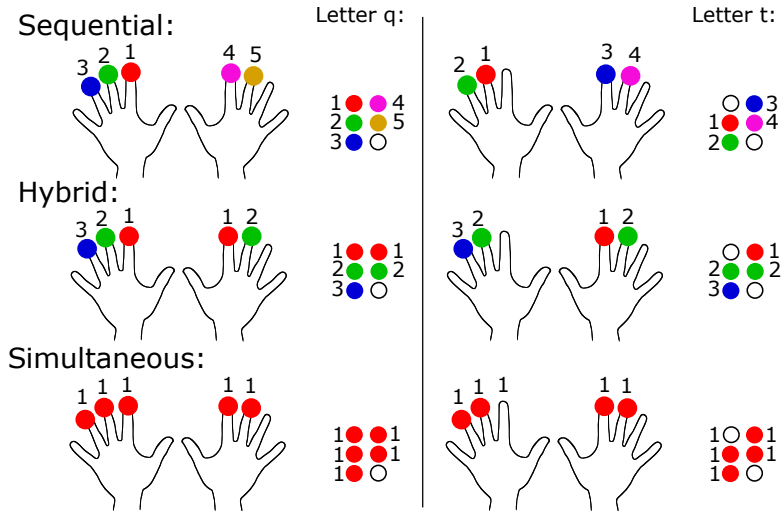

Figure 4.7.: Illustration of the three methods of presentation.

In order to respect the Braille convention, the index, middle and ring fingers of the left hand were associated to positions 1, 2, and 3 respectively while on the right hand, they were associated to positions 4, 5 and 6. The timing between the stimuli was chosen following a two-point discrimination study (refer to section 4.1), which highlighted that 200 ms was the best compromise between recognition and speed. The stimuli duration was chosen according to Gescheider et al. [113], which demonstrated that the detection threshold decreases as stimulus duration increases after 100ms. We also evaluated the timings and techniques with a blind colleague to help us fine-tune the setup and methods. The user study was carried out on the setup depicted in Fig. 4.6. A third prototype was created on a glass plate, this time with larger dimensions so that the participants could have room to put their six fingers. Thirty-two piezoelectric actuators (piezoelectric PIC255, 20 mm diameter, 0.5 mm thickness) were glued underneath an 80 mm × 200 mm × 0.95 mm glass surface in

4. Evaluation of LotusBraille as a method for reading Braille on a screen

order to have a better resolution. This surface was glued on a 3D printed plastic frame with the same external dimensions. Both were screwed on a rigid plastic plate. Actuators were driven individually with piezo haptic drivers (DRV8662-Texas Instrument) delivering up to 200 Vpp. Surface displacements were measured by a laser vibrometer (Polytec OFV-5000/MLV-100) mounted on a motorised three axis platform. The acquisition device (NI- 9264, NI-9205 and cDAQ-9174) enabled a synchronous emission and acquisition of actuators and vibrometer signals. All signals were sampled at $F_s = 20$ kHz and consisted of bursts at 250 Hz (chosen as it is the tactile sensitivity peak) with an amplitude of 4 μm . In this setup, we used six predefined positions as we used a simple glass, devoid of finger tracking capabilities. Stimuli were delivered locally at the activated fingers using the Inverse Filter method, which cancels vibrations at other positions thanks to pre-calculated signals sent to all actuators.

4.2.3. Protocol

Before starting the study, a consent form was read to the participant and signed. The participant was then asked questions about his/her background and the expertise with Braille and the Perkins Braille method, tools used to access digital content and experience with haptic technologies. After this, the evaluation of the three presentation methods started. The order of the methods was not counterbalanced and they were administered in the order of increasing difficulty, namely sequential, hybrid and simultaneous. We deemed that this would not introduce any major bias (besides fatigue) as the presentations rely on instantaneous feeling and are sufficiently different in perception from dynamic to static presentations to avoid a significant learning effect between them. In fact, results showed that within a method, there were no learning effects. Before each of the three presentation methods, the participants were first presented successively with all the 26 letters of the French alphabet (A to Z without the special characters) twice in a familiarisation phase. This was followed by a small recognition test on 10 randomly chosen letters with varied difficulty and the possibility to repeat the letters if needed at the end (lasted ~ 5 min). Once ready, they started the trials and were presented four times with the 26 letters, i.e. 104 trials per presentation method, in a counterbalanced manner. For each method, the trials were divided into two blocks of 52 trials to enable frequent breaks (see Fig. 4.8).

In total, each participant performed 312 trials. In each trial, the task was to identify the letter, which was provided only once, whilst the participants' hands remained on the device. The participants were instructed to provide the answer verbally. They were

4. Evaluation of LotusBraille as a method for reading Braille on a screen

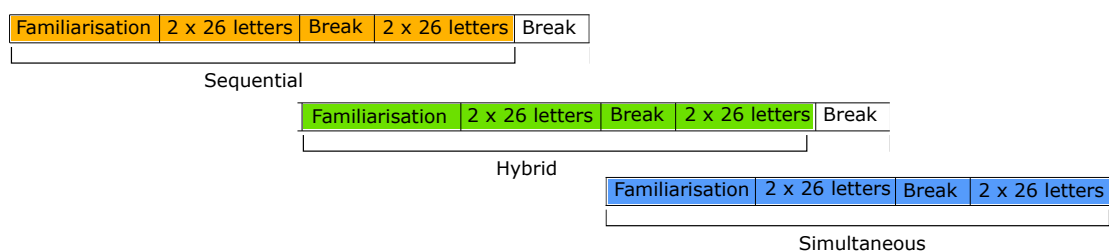

Figure 4.8.: Progress of the user study.

instructed to answer the letter they recognised, if they did not, they were instructed to reply “I don’t know”, in order to assess the letters they thought they were sure or most likely sure of. In between the presentation methods, participants were asked about their experience and perception and had to answer a Likert scale questionnaire, see Appendice A (from 1 “not at all” to 6 “completely”) in order to evaluate the presentation method. It included questions on the ease of perceiving letters, the effort of concentration, the feeling of the stimuli, and if the participants had any suggestions for improvement. At the very end, they were asked questions about the preferred method and open questions about interest in using the technology for reading Braille, or in other contexts in daily life. On average, the experiment lasted one hour and a half.

4.2.4. Results

4.2.4.1. Sequential method

Overall, participants were able to discriminate all Braille letters with a mean recognition rate of 59 %, with 35 % error and 6 % where the participant answered that they did not know (see Fig. 4.9). The letter “a” was always correctly recognised, which was expected as it contains only one point of stimulation. Letters with two points had a recognition rate of 74 % [min 50, max 95] $_{N=5letters}$ for example “b” or “c”. Letters with three points had a recognition rate of 62 % [37,83] $_{N=9}$ for example “h” or “i”. Letters with four points had a recognition rate of 44 % [16,79] $_{N=9}$, for example “r” or “x”. Lastly, letters with five points had a recognition rate of 63 % [45,79] $_{N=2}$, i.e. “q” and “y”. In general, the more points there were, the more difficult it was to recognise the letter. In 26 % of the cases, the errors came from the misperception of the position of one or more points. In 53 % of the cases, a single point was misplaced (e.g., “c” was confused with “e” and “o” with “h”) and in 22 % of the cases, two points were incorrectly felt (e.g.,

4. Evaluation of LotusBraille as a method for reading Braille on a screen

twice the time to feel the vibrations with HaptiRead. Moreover, the participant felt different vibrations for each point, which could have played a role in improving point discrimination. Rantala et al. [110] obtained an average recognition rate of 88 % for the rhythm method (i.e. a series of static vibrations delivered to the finger) with the Finnish alphabet (i.e. with three additional letters) vs our 59 %. This difference could be explained by the fact that in their study the participant used a stylus, thus excluding any error on the finger activated as in our study. The raised dots had a vibration of 19 ms, much less than in our study (100 ms), but they also displayed lowered dots with a vibration of 130 ms, absent in our setup. In our study, points that are not displayed (i.e. lowered dots) were never activated, not even temporally with a longer break. Raised dots were conveyed with a 341 ms break before the next dot [110], whilst the break lasted 230 ms for lowered dots, with a longer break between columns. Thus, the average duration of a letter was 2.45 s while we used a presentation of maximum 1.3 s. This longer exposure, and possibly the separation between two columns, could explain the better recognition rates. Interestingly, when they reduced their presentation time to 1.25 s, which is closer to our overall duration, their recognition rate dropped to 70 %, only 10 % more than in our study. This comparison with similar techniques exhibits promising results for the LotusBraille technology. The main known modifiable differences (besides amplitude and choice of actuator technology), as described above, concern the duration of the stimuli and duration of the breaks between stimuli, which were much shorter in this study, sometimes by half. In fact, two participants reported that the stimuli were too “quick” to perceive them. These durations were chosen based on the initial 2-point discrimination study and as one of the objective is to provide a “quick” technique to enable reading words. However, as it is a novel presentation technique, there is likely a learning curve. An emerging hypothesis was that longer presentation durations would lead to better recognition rates. This was later validated in a follow-up study in section 4.4. Qualitative feedback from participants was collected using a 6-point Likert scale (from 1 “not at all” to 6 “completely”). They are presented in Fig. 4.21.

The majority of participants (4 out of 6) found that the sequential method is a useful method for recognising letters (see Fig. 4.10). All the participants (6/6) found the stimuli to be pleasant. They generally said that the letters were difficult to recognise (4/6) and that it required much concentration effort (4/6). Indeed, during the interview, the participants mentioned that it was difficult to perceive the vibrations, to retain them and to transcribe them into Braille letters. Moreover, this type of Braille rendering

4. Evaluation of LotusBraille as a method for reading Braille on a screen

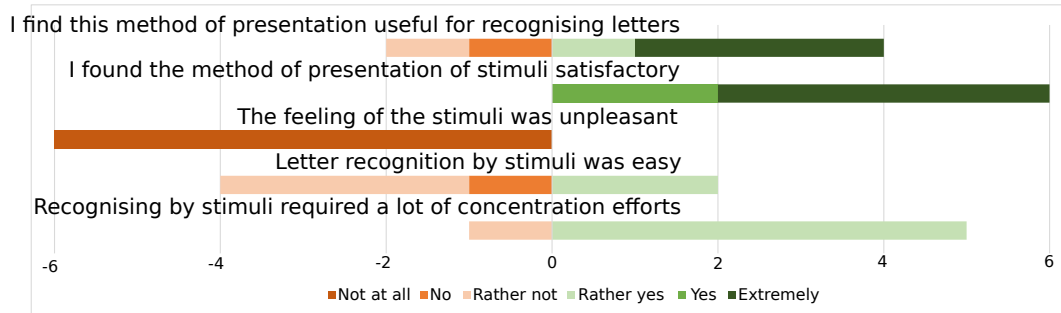

Figure 4.10.: Qualitative feedback from participants for the sequential method using a Likert scale. The negative answers were grouped on the left side of the pictures (gradient of orange colours for the level) and similarly the positive answers were grouped on the right side (gradient of green colours). The x-axis represents the total number of answers for a given type.

requires the mobilisation of six fingers as opposed to classical Braille that requires the use of only one or two fingers. Thus, one participant reported that the method was not as effective as traditional Braille because they could not read the letter at once. Participants said globally that when few fingers were activated for example letter “a” or “c”, it was rather easy but when there was more than one vibration on the same hand, it was more difficult. They would feel more comfortable if they had had a longer training and with a longer stimulus time. They thought that with these changes they could get better recognition rates. Finally, one participant suggested another method of presentation that would consist of vibrating the fingers of the left hand first and then those of the right hand, a method between the hybrid and simultaneous.

4.2.4.2. Hybrid method

This method obtained an average recognition rate of 54 % (with 41 % error and 4 % missed stimuli, see Fig. 4.11), which is a little less than the sequential method (59 %) but remains a promising result for an alternative and more optimised technique for Braille delivery.

Letters with a single line of presentation such as “a” and “c” had a recognition rate of 92 %. Letters with two lines of presentation, e.g. “h” or “e”, had a recognition rate of 63 % while letters with three lines of presentation, for example “s” or “w” had a recognition rate of 41 %. We can draw the same conclusion as for the sequential method: the more points there were, the more difficult it was to recognise the letter. Errors occurred in 18 % of cases on the omission of a point. Interestingly, in 34 % of

4. Evaluation of LotusBraille as a method for reading Braille on a screen

of correct answers compared to 75 % for HaptiRead [29], for the same letters used (“a”, “j”, “c”, “d”, “e”, “f”, “g”, “h”, “i”). The difference could be explained again by the fact that their stimuli were much longer, of 300 ms unlike 100 ms in our study. Qualitative feedback from participants was collected using a Likert scale. They are displayed in Fig. 4.12.

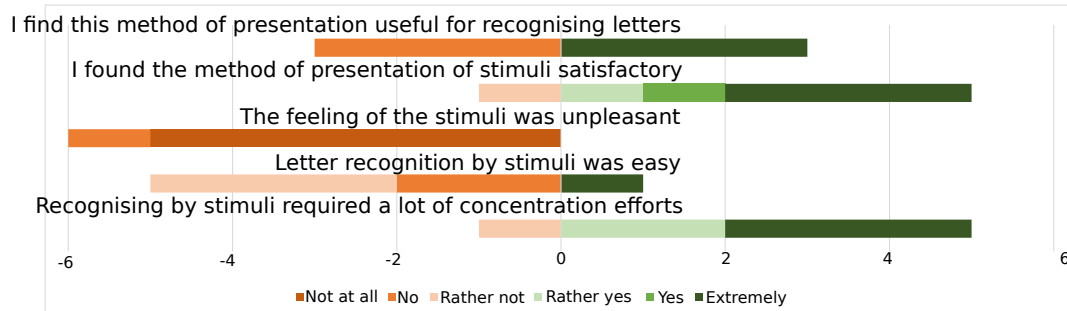

Figure 4.12.: Qualitative feedback from participants for the hybrid method using a Likert scale. The negative answers were grouped on the left side of the pictures and similarly the positive answers were grouped on the right side. The x-axis represents the total number of answers for a given type.

For the hybrid method, the participants were divided into two about its usefulness, with half finding the method extremely useful for recognising letters while the other half did not. This is due to the fact that this method is perceived as “unnatural” by the visually impaired as the order of point perception is altered, for example the point four can vibrate before point two, for the letter “i”. However, despite the unnatural aspect of the presentation method, 5 out of 6 participants said that the presentation method was satisfactory. Similarly to the sequential method, all the participants (6/6) found the feeling of the stimuli very pleasant. They found the method difficult (5/6) to recognise letters and it required much concentration effort (5/6) due to the speed and task difficulty. One participant commented: “the sequential method is good for reading letters: precision, but the hybrid method is good for reading words: efficiency”. This highlights the need for an acceptable and effective compromise between precision and efficiency, in this case between the difficulties and durations of the presentation methods.

4.2.4.3. Simultaneous method

This method obtained an average recognition rate of 23 % (see Fig. 4.13), which is much lower than the recognition rates of the first two methods (59 % for sequential and 54 % for hybrid). Unsurprisingly, the letter “a” obtained 100 % of correct answers. Letters

4. Evaluation of LotusBraille as a method for reading Braille on a screen

with two points, e.g. “c” and “e”, had a recognition rate of 42 %. Letters with three points, e.g. “o” and “m”, had a recognition rate of 19 % while it reached 12 % for four points such as “p” and “r”. Lastly, letters with five points, i.e. “q” and “y”, had a recognition rate of 10 %. The rates are significantly lower than the previous methods but the same tendency remains where the more the number of dots increases, the more difficult it is to recognise the letter.

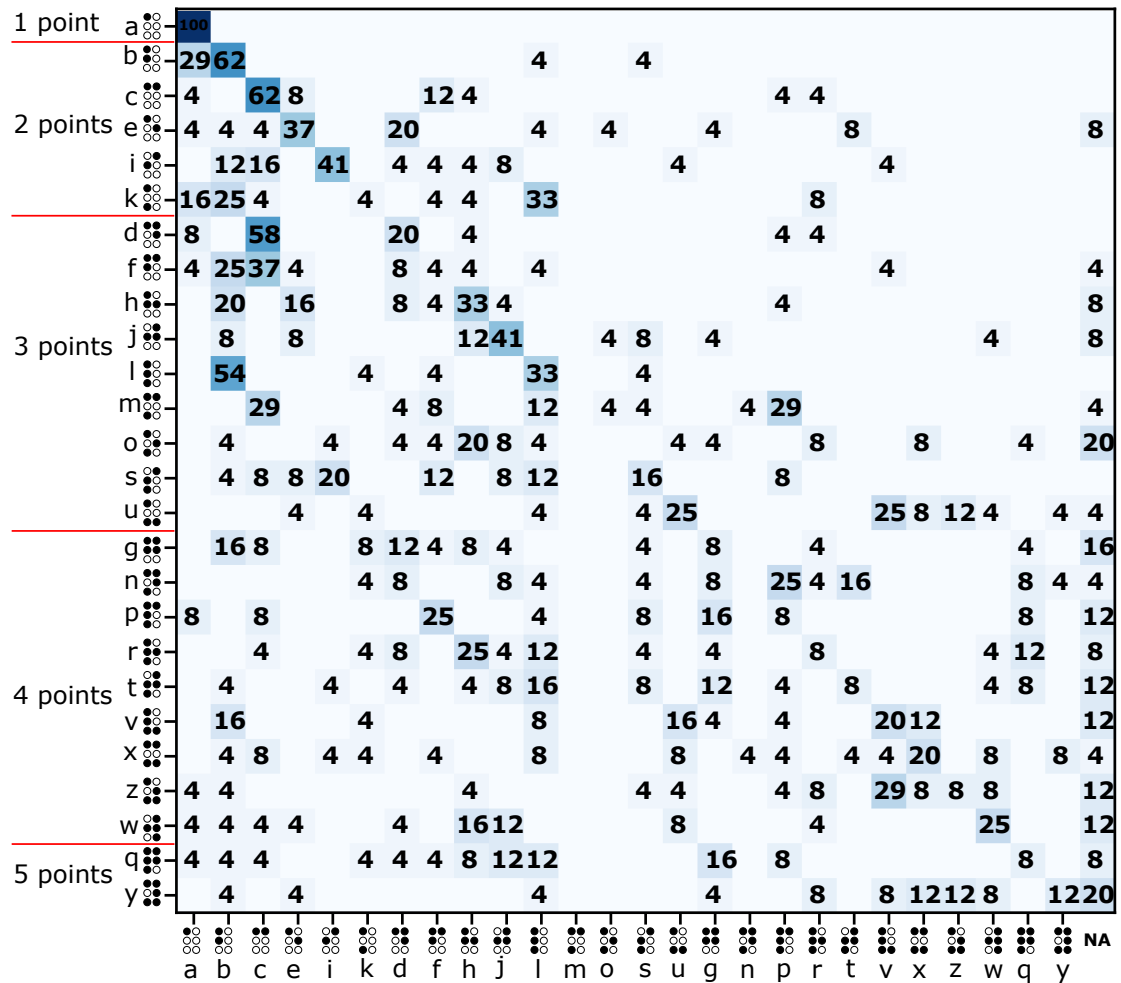

Figure 4.13.: Confusion matrix for the simultaneous method averaged across participants. The darker the color, the higher the recognition rate. Confusions are indicated outside of the diagonal.

When comparing to the literature, HaptiRead and HoliBraille had similar representations, either with ultrasounds focused on the palm of the hand or actuators at the back of the phone. Compared to HaptiRead [29], the method obtained an

4. Evaluation of LotusBraille as a method for reading Braille on a screen

average of 41 % correct answers against 81 % for the letters used (“a”, “j”, “c”, “d”, “e”, “f”, “g”, “h”, “i”). This discrepancy could be explained by the fact that the vibrations sent by HaptiRead did not have a predefined duration as in our setup but only stopped once the participant provided an answer. HoliBraille and UbiBraille had a recognition rate of 72 % and 81 % respectively. HoliBraille and UbiBraille had a presentation time of 2 s, which is 20 times greater than in this study (100 ms). Similarly, to the previous methods, this could indicate that our presentation times were too short. However, fatigue could also have played a role as well as the higher cognitive load with the increasing number of simultaneous stimuli and a higher concentration. Given the novelty of such a representation and such feedback for Braille reading, longer stimuli could most likely benefit the recognition, at least in a first step for familiarisation (similarly to text-to-speech that can be progressively accelerated). The duration of 100 ms was kept across methods to keep a common duration for comparison. Qualitative feedback from participants was collected again with the same questionnaire as for previous methods using a 6-point Likert scale. They are presented in Fig 4.14.

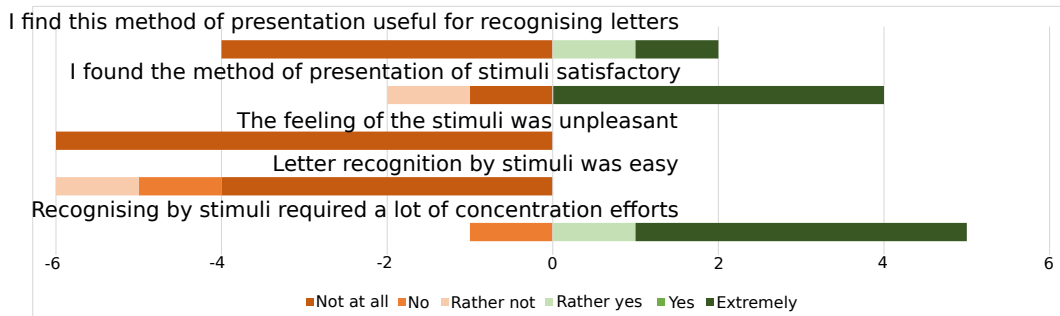

Figure 4.14.: Qualitative feedback from participants for the simultaneous method using a Likert scale. The negative answers were grouped on the left side of the pictures (gradient of orange colours for the level) and similarly the positive answers were grouped on the right side (gradient of green colours). The x-axis represents the total number of answers for a given type.

The results are very different from the sequential and hybrid methods ones. The majority of the participants (4/6) found that the simultaneous method is not a useful method for recognising letters. One participant commented “it’s messy”, that he could not distinguish the vibrations and that everything was mixed. Participants generally (6/6) said that the letters were difficult to recognise and that it required a lot of concentration (5/6). Indeed, they all said that for this method, it would be necessary to

4. Evaluation of LotusBraille as a method for reading Braille on a screen

have a long learning time in order to use it as a reading technique. They all admitted that despite the difficulty of the method, it is the closest to classic Braille reading. They suggested keeping the vibration on until they skipped to the next letter. One participant explained that he used an aid that consisted in feeling if there was more vibration on the left or on the right hand. For example, if most of the vibration is focused on the left hand, by deduction the letter will be more of a “v” or a “p” whereas if it is concentrated on the right hand, it will be more of a “w” or a “y”. In order to improve the perception and recognition rate, one participant suggested changing the vibration mode for each finger, i.e. this could be achieved with a different frequency under each finger. This type of improvement was foreseen in the initial complete study protocol validated by the Ethics committee and was investigated shortly after. The results are presented in section 4.3.

4.2.5. Overall feedback from participants

In summary, across conditions, participants reported that the feeling of the stimuli was not at all unpleasant. They commented that the effort to concentrate increased from method to method. For the sequential method, the participants found that the letters were rather easy to recognise and that it was slightly harder with the hybrid method and very difficult with the simultaneous method. Indeed, their recognition rate decreased according to the method as shown in Fig. 4.15.

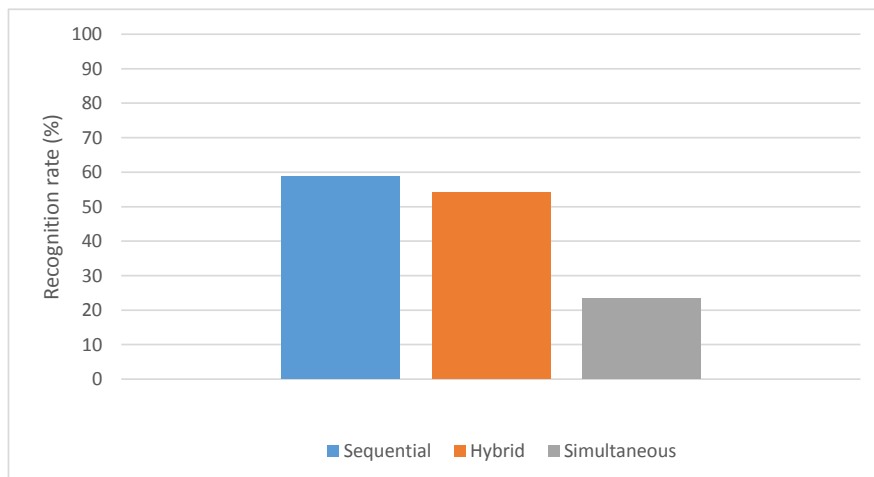

Figure 4.15.: Recognition rate per participant according to the different methods: sequential, hybrid and simultaneous.

4. *Evaluation of LotusBraille as a method for reading Braille on a screen*

Thus, when asked about the preferred method, four (out of 6) preferred the sequential method. A participant commented that it was the easiest method. Interestingly, one participant mentioned that ideally, the simultaneous method would be the most appropriate but it was currently too difficult and he was confident that with more training he would perform better. If he had a prototype at home and could train, it could become the best method. In this spirit, despite the poor results, two participants preferred the simultaneous method. One of them explained that it required less thinking because all the stimuli were felt at the same time, compared to the other methods. The other said that the simultaneous method had the most potential because it was the closest to Braille. In general, all the participants reported that they needed time to adapt to this new type of Braille stimulation and they thought that after a long-term repetitive training they would perform better. In fact, our learning phase was short and lasted 5 min at most for all conditions, as we wanted to assess our technology with little training. These results highlight the necessity to provide a longer familiarisation, repeated over time, with the technology and the presentation method(s). Overall, when comparing the techniques, the sequential method was appreciated but was foreseen to be inefficient for reading words due to the length of presentation and the concentration and fatigue it may entail. For the simultaneous method, some participants suggested increasing the presentation time and even keeping the stimuli activated until they recognised the letter. For all methods, the user feedback that stood out was the unusual use of six fingers, as visually impaired people can read a letter with a single finger. In addition, our methods are static while Braille is read dynamically. One participant suggested another method of presentation that would consist of vibrating the fingers of the left hand first and then those of the right hand, a method between the hybrid and simultaneous. In fact, this suggestion echoes previous work [110], where there was a break between the Braille columns to provide an additional cue for recognition. It is also worth noting that the two participants with the highest scores were regular users of the Perkins input method on the smartphone and thus familiar with using the respective fingers on a surface. It is anecdotic at this stage but it may be worth investigating with a larger pool of participants, especially as many users complained about the unusual use of the six fingers. When asked about potential use cases, they thought LotusBraille could be used to read quick information such as time or notifications, for instance on displays at railway stations or at bus stops. They added it could also be used for the tactile interfaces of home appliances, for example the

4. Evaluation of LotusBraille as a method for reading Braille on a screen

cooking plates or the washing machine. Participants were quite positive about the different presentation methods. Indeed, the sequential method was the best for the moment in terms of recognition; the simultaneous method was not to be abandoned but required more time to learn it. Given the various results and user feedback, the sequential method was chosen as the technique for the follow-up study for reading words, even if it was judged too slow to read letters. The hybrid and sequential methods were put aside for that next study because they were judged too difficult and would thus impede the evaluation of the feasibility of using LotusBraille for reading words. With the feasibility demonstrated, however, these methods could be used, if judged satisfactorily, with more training. It could also be a user setting, as users have different abilities and preferences.

4.3. Different vibration frequencies for the fingers of the same hand

After conducting the study on different methods for presenting Perkins Braille with the visually impaired people, the next goal of the thesis was to investigate how to improve the recognition rate. One of the solutions was suggested by a participant and also presented by Paneva et al. [29]. It consists in using different frequencies for each finger to provide different feedbacks on the fingers and hence, to help the user better discriminate the activated fingers. Haptiread [29] decided to put 200 Hz for cell 1, 140 Hz for cell 2, 120 Hz for cell 3, 160 Hz for cell 4, 180 Hz for cell 5 and 100 Hz for cell 6. In our case, after having carried out preliminary tests on few sighted people in our laboratory, we chose to apply 500 Hz for cell 1 and 4, 400 Hz for cell 2 and 5, and 300 Hz for cell 3 and 6. The choice of frequencies was made internally by testing informally different frequencies with three people. Following this pilot study, a total of 10 sighted participants were recruited for the frequency study in the laboratory. The participants (4f-6m) were aged between 22 and 56 years old ($M = 31.9$, $SD = 10.5$). 9 out of 10 participants were familiar with haptic technologies and 1 was a novice.

4.3.1. Description of the experimental study

The experiment was conducted on the same setup as for the study on Perkins Braille, see previous section 4.2, with a glass surface equipped with 32 piezo actuators and predefined positions for the Inverse Filter localisation method. This study was divided

4. Evaluation of LotusBraille as a method for reading Braille on a screen

into two sessions: one session where the stimuli were presented with the same frequency at 250 Hz (original setup for LotusBraille), and a second session where the stimuli were presented with the three different chosen frequencies for each finger on the same hand (i.e. 500 Hz, 400 Hz and 300 Hz). The order of the sessions was counterbalanced between participants. The stimuli, depicted on Fig. 4.16, were chosen as letters with two to four fingers activated (i.e. 3 categories in total) with four stimuli/letter per category. There are only two letters with five points activated so as four letters were chosen for each category no five points letter was presented. There were four trials per stimuli/letter accounting for 48 trials ($4 \times 4 \times 3$) per session. In total, each participant performed 96 trials. The experiment lasted thirty minutes on average. The stimuli were presented with the sequential method with a stimulus time of 200 ms and an inter-stimuli duration of 100 ms.

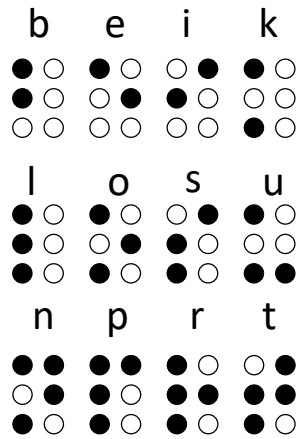

Figure 4.16.: Letters used for the frequency study

In each trial, the task was to identify the fingers that received the haptic stimuli with the fingers numbered from 1 to 6. The index fingers of both hands were numbered 1 and 4, the middle fingers of both hands were 2 and 5 and the ring fingers of both hands were 3 and 6 like in the Braille notation. The participants were instructed to provide the answer verbally, which was provided only once, whilst their hands remained on the device. The experimenter logged the answer by typing the given answer. This was a forced-choice experiment: if participants had doubts, they were asked to answer the most likely option. To accustom participants and reduce the impact of learning effects, prior to each condition, participants were presented with each of the stimuli twice and performed a blind test before the trials. At the end of the study, the participants were

4. Evaluation of LotusBraille as a method for reading Braille on a screen

asked which session they preferred and general comments about the perception.

4.3.2. Results

The average recognition rate without different frequencies was 75 % versus 78 % with different frequencies (see in Fig. 4.17). First, a Shapiro Wilk test was performed to verify the normal distribution of the data. The test resulted in $w = 0.98 > w_{0.05} = 0.842$, thus indicating that the data follow a normal distribution. A t-test was applied to verify whether there was a significant difference between the discrimination results with and without different frequencies.

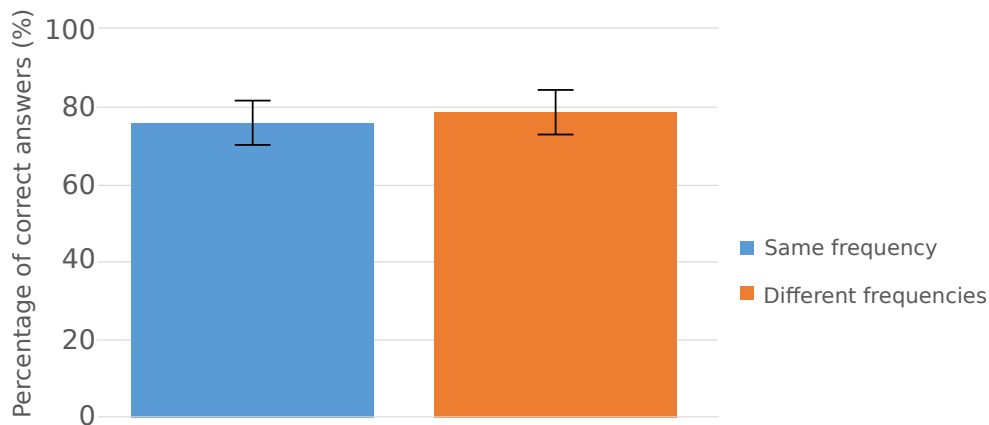

Figure 4.17.: Differences in recognition rates with and without different frequencies among participants.

On average, participants experienced better recognition with different frequencies ($M = 78, SE = 18.96$) than without different frequencies ($M = 76, SE = 19.07$). This difference was not significant $|t(9)| = 0.86, p < 0.05$. However, the qualitative feedback from participants highlighted that 9 out of 10 participants preferred the different frequencies; they reported that they had the sensation of better differentiating the vibrations and had a better localisation perception. This study allowed us to highlight the fact that putting different frequencies under the fingers makes the participants more confident, they have the impression to feel the stimuli better. For the next studies, we decided to keep the same frequency for each finger. Indeed, despite the user preference for different frequencies, the difference between the two conditions was not significant and as it was not tested with the visually impaired, due to lack of time and availabilities, we decided not to include a novel variable with unknown outcomes.

4. Evaluation of LotusBraille as a method for reading Braille on a screen

Moreover, we wanted to keep the same design to compare the results from the presentation methods in section 4.2.4.1 with the results of the sequential method using different timings. Moreover, another method, described in the following section 4.4, will be tested. However, this parameter should be considered in future work.

4.4. Perkins Braille rendering on a glass surface with longer presentation times

This study is a continuation of the study on the Perkins Braille alphabet presented in section 4.2. Indeed, the main conclusion that emerged from the first study was that the presentation times were probably too short and the learning time was not enough to be able to read correctly. Therefore, before continuing with the reading of words, it was important to verify this by renewing the study with longer presentation times. However, it was conducted with some other changes. In fact, the hybrid and simultaneous methods were left aside for this study, as the hybrid method was deemed rather unnatural by the participants while the simultaneous method was promising, as the closest to typical Braille reading, but too difficult at this stage with a limited training. Thus, for direct comparison with the study in section 4.2.4.1, solely the sequential method was kept, albeit with longer presentation times, and the same protocol and training duration. A new method was also introduced, following a suggestion from one of the participants. In this semi-simultaneous method, the left hand vibrates first with the fingers activated simultaneously, followed by the right hand.

4.4.1. Participants and setup

A total of six visually impaired participants were recruited for this study. Among these, four participants had already participated in the previous study and two were novices to LotusBraille. The six participants (2f-4m) were aged between 33 and 42 years old ($M = 40$, $SD = 7.76$). All participants were blind from birth. Amongst them, four could still perceive light. They all learnt Braille at the age of five and were proficient in using it. None reported any issues with their fingers or sensitivity. Half were technophiles and another half used a smartphone but had never tested haptic technology besides global vibrations in mobile devices. Their professions were quite varied: receptionist, sales consultant, administrative assistant, teacher of office automation and unemployed. The same device as in the first study was placed on a table in front of the participants.

4. Evaluation of LotusBraille as a method for reading Braille on a screen

The participants were instructed to place their fingers inside circles that were glued on the surface, with their wrists on resting supports to minimise fatigue. They wore noise-cancelling headphones during the trials with pink noise to cancel any bias due to the noise generated by the setup. Sanitary measures were respected, i.e. with frequent cleaning of the apparatus and disposable covers for headphones. The experimenters used a Windows laptop for running the python application for controlling the feedback and for logging the verbal answers. The pause time between vibrations was extended to 300 ms vs 200 ms initially and the vibration duration was extended to 300 ms vs 100 ms to give the participant more time to feel the stimuli. The Braille letters were presented according to two methods as follows (see. Fig. 4.18):

- Sequential: the fingers vibrate one after the other for 300 ms with a pause of 300 ms between two vibrations;
- Semi-Simultaneous: all fingers jointly vibrate on the left hand for 300 ms, and then a pause of 300 ms and all fingers jointly vibrate on the right hand for 300 ms.

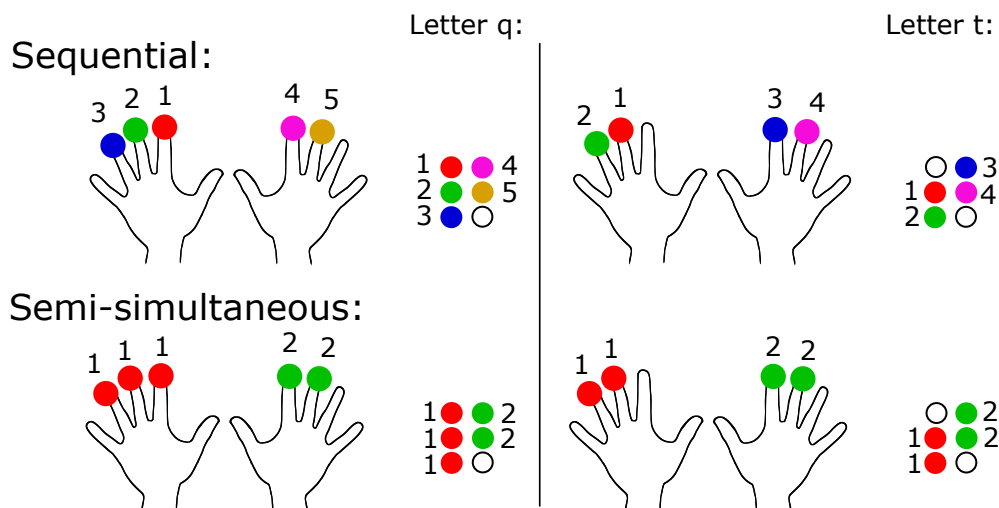

Figure 4.18.: Illustration of the two methods: sequential and semi-simultaneous.

4.4.2. Protocol

Before starting the study, a consent form was read to the participant and signed for participants who did not participate in the previous study. The participant was then asked questions about his/her background and the expertise with Braille and the

4. Evaluation of LotusBraille as a method for reading Braille on a screen

Perkins Braille method, tools used to access digital content and experience with haptic technologies. After this, the evaluation of the two presentation methods started. The order of the methods was not counterbalanced and they were administered in the order of increasing difficulty, namely sequential first followed by the semi-simultaneous method. We deemed that this would not introduce any major bias similarly to the previous study based on the same protocol. Before each of the two presentation methods, the participants were first presented successively with all the 26 letters of the French alphabet (A to Z without the special characters) twice in a familiarisation phase, followed by a small recognition test on 10 randomly chosen letters with varied difficulty and the possibility to repeat the letters if needed at the end. This familiarisation phase lasted ~5min, it is the same as in the first study. Once ready, they started the trials and were presented four times with the 26 letters, i.e. 104 trials per presentation method, in a counterbalanced manner, same as for the first study. For each method, the trials were divided into two blocks of 52 trials to enable frequent breaks. In total, each participant performed 208 trials. In each trial, the task was to identify the letter, which was provided only once, whilst the participants' hands remained on the device. The participants were instructed to provide the answer verbally. They were instructed to answer the letter they recognised, if they did not, they were instructed to reply "I don't know", in order to assess the letters they thought they were sure or most likely sure of. At the very end, they were asked questions about the preferred method. On average, the experiment lasted 30 minutes.

4.4.3. Results

4.4.3.1. Sequential method

The sequential method was retested with longer presentation times to evaluate whether it improved the recognition rate. The new presentation times were about three times those of the initial study in section 4.2.4.1. The sequential method obtained a global recognition rate of 88 % with a 10 % error rate and 1.6 % of "I don't know" replies. The letter "a" was always correctly recognised, which was expected as it contains only one point of stimulation. Letters with two points had a recognition rate of 87 % for example "b" or "c". Letters with three points had a recognition rate of 86 % for example "h" or "l". Letters with four points had a recognition rate of 89 %, for example "r" or "x". Lastly, letters with five points had a recognition rate of 90 %, i.e. "q" and "w". These results are much higher than those obtained in the previous study (i.e. 59 %), thus

4. Evaluation of LotusBraille as a method for reading Braille on a screen

further validating the approach for reading letters but highlighting the required suitable presentation timings, which could evolve with training. In the first study, the more dots the letter had, the more difficult it was to recognise it. Interestingly in this study, the trend is inverted. In fact, the more dots the letter has, the better the recognition rate is increasing from 87 - 86 % for two and three points to 90 % for five dots. This can be explained by the fact that the time was longer, so they had more time to distinguish them. Another reason can be that there are only two letters with five points compared to letters with three and four points, which each have 9 letters (so more possibilities for mistakes).

Four participants had already participated in the first study. On average, they had a 35 % increase (68 vs 91 %) in recognition (see Fig. 4.19). For the other two participants who were novices, they obtained an average recognition rate of 82 %, thus with an increase of 39 % (59 vs 82 %) compared to the averaged rate obtained by the participants during the first study. Although the pool of participants is too small for statistical analysis, this trend shows that increasing the presentation times allowed users to obtain a better recognition rate, which highlights that the recognition issues are not due to the type of stimuli (i.e. localised vibrations on a surface) but rather the right combination of parameters to perceive them. Participants who had previously participated in the first study were unanimously positive. They all felt more confident and felt that there has been an evolution in the prototype. They felt that they could distinguish the vibrations better, even though they were no changes in the prototype. However, they reported that this method is too slow with these timing settings. These results highlight the importance of training and its impact on the presentation times. Indeed, in addition to improved perception and speed requirements for efficiency, participants commented that by having a prototype at home, they would be able to use it every day and consequently to decrease gradually the presentation times to reach an optimal efficiency. All users rated this method as the preferred method.

4.4.3.2. Semi-simultaneous method

The semi-simultaneous method obtained a global recognition rate of 43 % with a 54 % error rate and 3 % of “I don’t know”. It obtained a better recognition rate than the simultaneous method in the study from section 4.2.4.3, which obtained 23 %, but it has a worse recognition rate than the hybrid, which obtained 54 %. The letter “a” had a recognition rate of 75 %. Despite the fact that it has only one point it has not been always correctly recognised. Letters with two points had a recognition rate of 57 %,

4. Evaluation of LotusBraille as a method for reading Braille on a screen

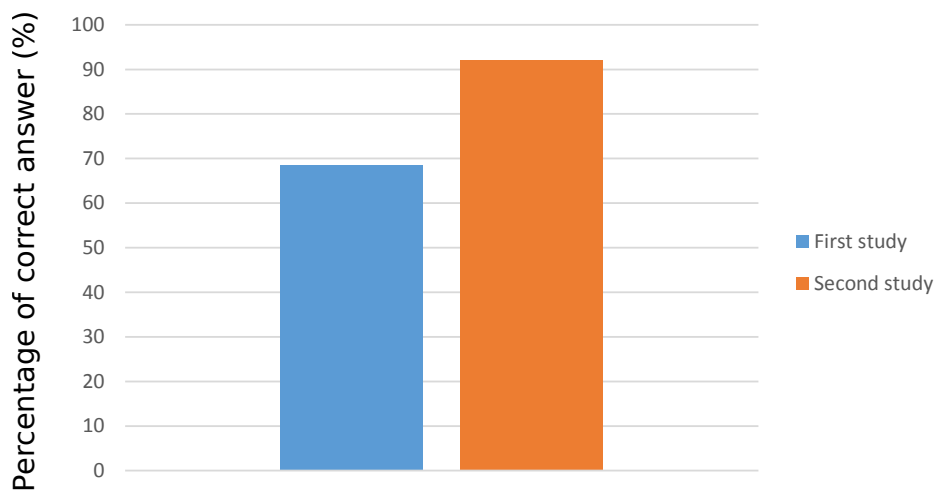

Figure 4.19.: Results of the study with longer presentation times.

for example “b” or “c”. Letters with three points had a recognition rate of 45 %, for example “h” or “l”. Letters with four points had a recognition rate of 35 %, for example “r” or “x”. Lastly, letters with five points had a recognition rate of 18 %. Similarly to the initial study in 4.2, the more points the letter has, the lower the recognition rate is. It is therefore harder to recognise letters with more dots. The confusion matrix (see Fig. 4.20) shows that the letter “l” was 58 % of the times confused with the letter “b” and the letter “k” was 37 % of the times confused with the letter “l”. The largest confusion occurs when a point was added or forgotten. For example, “m” was confused 37 % with the letter “p”, where the user perceived an additional point. The “p” was confused at 75 % of the times with the letter “f” and the “t” at 66 % of the times by the letter “m”, where the participant would omit a point. Participants reported they could not feel whether they received two or three vibrations on one hand. It is possible that the human capacity is limited for detecting simultaneous vibrations on different fingers and the human cannot perceive the distinction of so many stimulations simultaneously. In the study of section 4.1, the participants were able to distinguish between two vibrations, but beyond that, it may be more difficult as shown by the results of this study. Cohen et al. [114] stimulated from 2 to 5 fingers on the same hand. The stimulations were transmitted by vibrotactile actuators directly placed on the fingers. They found that stimuli applied to neighboring fingers gave more accurate response than to non-neighboring fingers. This goes against our results and the results of Gallace et al. [115], which suggested that simultaneous tactile inputs across neighboring

4. Evaluation of LotusBraille as a method for reading Braille on a screen

perception more difficult. It would be interesting to be able to put sensors on the hands, such as Shao et al. [116] to see how the fingers and the hand react to our vibrotactile stimulations. This would allow us to better understand the perception of the participants.

Fig. 4.21 shows the distribution of answers for the Likert Scale questionnaires. It highlights that the users (4 out of 6) globally found the method interesting for recognising letters. However, they (5 out of 6) found the method difficult and that it required a lot of concentration (5 out of 6). The participants all said that it would take a learning period to become comfortable with the method, but it could still be a viable option as it has the potential to improve reading speed.

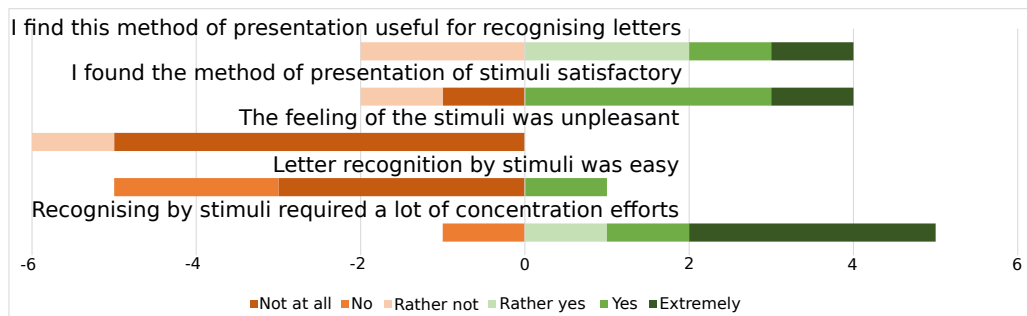

Figure 4.21.: Qualitative feedback from participants for the semi simultaneous method using a Likert scale.

4.4.4. Conclusion

This study showed that with longer times the sequential method could obtain a better recognition rate (88 % vs 59 %). Indeed, the participants have more time and can therefore better assimilate the information. A new semi-simultaneous method was tested. It obtained a score of 43 %, which is much better than the 23 % of the simultaneous method of the first study but lower than the 54 % of the hybrid method. However, participants found the differentiation of the vibrations too difficult, thus this method was set aside until future work can assess the phenomena that affect the localisation on the same hand and hence possible solutions. For the following study, we kept the sequential method, which obtained the best recognition rates and kept the longer presentation times where the participants were more comfortable and obtained better recognition rates.

4.5. Reading of words

After validating the communication of Braille letters by the sequential method with longer presentation times, it was important to try to transmit words, as it is the ultimate goal of LotusBraille. This section therefore describes the user study that tested the transmission of five-letter words to visually impaired people. Studies of sections 4.2 and 4.4 showed that the most effective method to convey letters, with limited training, was the sequential method. Hence, to test the transmission of words, the sequential method was chosen as the method of presentation. Concerning the timings of stimuli delivery, study of section 4.4 highlighted that 300 ms of vibration and 300 ms of pause was effective. Finally, despite study in section 4.3 showing that different frequencies provide better results and preferences, the same frequencies were chosen for consistency between the previous study protocols.

4.5.1. Participants and setup

Four visually impaired people were recruited for this study. The four participants (2f-2m) were aged between 37 and 43 years old ($M = 40.5$, $SD = 2.29$). The participants had very different professional situations: research engineer, switchboard operator, receptionist and unemployed. Three of them were technophiles and had already tested haptic technologies such as vibrating bracelets or canes. One participant was a novice but used his smartphone daily. Three of the participants had already participated in at least one of the previous studies. One participant had never tested the technology and participated in the word study directly. The same device than for the other two studies (sections 4.2 and 4.4) was placed on a table in front of the participant. Similarly to the previous setups and protocols, the participants were instructed to place their fingers inside the designated positions on the surface, with their wrists on resting supports to minimise fatigue. They wore again noise cancelling headphones during the trials with pink noise to cancel any bias due to the noise generated by the setup. Sanitary measures were again applied, i.e. with frequent cleaning of the apparatus and disposable covers for headphones. The experimenters used a Windows laptop for running the python application for controlling the feedback and for logging the verbal answers.

4.5.2. Protocol

Forty five-letter words in French (see Appendix C), drawn at random from a list, were conveyed to the participants. We have chosen five letter words for comparison with UbiBraille [11] because the average word length in French is 4.8 [117]. The list was established by searching for five-letter French words and choosing commonly known words, such as flower (fleur), book (livre), etc. During the test, 20 words were presented, followed by a pause and then the other 20 words. Before starting, the entire alphabet was presented once to the participant then a learning phase where five words were presented to him/her to become familiar with them (lasted \sim 5min). The task of the study was to identify the word and not each letter, which was provided only once, whilst the participants' hands remained on the device. The participants were instructed to provide the answer verbally. They were instructed to answer the word they recognised, if they did not, they were instructed to reply "Je ne sais pas" (I don't know), in order to assess the word they thought they were sure or most likely sure of. At the end, participants were asked questions about the usability of LotusBraille using the System Usability Scale (SUS), see Appendix B. It evaluates agreement on a scale of 1- "not at all" to 5- "totally agree" with affirmations about the daily use of the device, the complexity of the device, the ease of use of the device, the need for help in using it, the system integration, the ease of learning for other people, the confidence in using the device and the things to learn in order to use the device. On average, the experiment lasted thirty minutes.

4.5.3. Results

The participants obtained an overall recognition rate of 74 %. They had individual rates of 95 %, 83 %, 60 % and 56 %. The two participants with the best scores in the other studies also participated in this one. One participant had participated in the first two letter reading studies and scored 91 % and 100 %. The second participant had only participated in the second letter reading study and scored 100 %. These two participants obtained the scores of 83 % and 95 % respectively in this word study, exhibiting high scores, well above the remaining two participants. These participants use Perkins input on their phone on a daily basis. The third participant had also previously participated in the other studies and scored 56 % in the first study and 90 % in the second study. In this study, he scored 60 %. This time, it is not asked to detect letter by a letter but it is a sequence of letters to form a word so the task is a little more complex than the previous studies and we think that it will surely require a

4. Evaluation of LotusBraille as a method for reading Braille on a screen

training time for some people. The novice participant obtained a score of 56 %, which is practically equal to the score of the participant who participated in the first two studies (60 %). This is an encourage result as word reading is a more difficult task than letter recognition and as the participant was fully novice to the stimuli and presentation method. The participant said that with practice, they could get a better recognition rate.

The errors in recognising the words were mainly due to either a misinterpretation of a letter or the missing of the first letter, which disturbed the participants and led them to answer “I don’t know”. For example, the word “train” (train in English) was confused by two (out of 4) participants with “trait” (line in English). In this case, the letter “n” was confused with “t”, the vibration was felt on the middle finger instead of the index finger, the vibration was shifted by one finger. The word “porte” (door in English) was confused by two (out of 4) participants with “poste” (post office in English). Here, the letter “r” was confused with “s”, i.e. one vibration was felt on the wrong finger and another was not felt. One participant confused the word “chose” (thing in English) with “chote” (actually not an existing word). The letter “s” was confused with the letter “t”, as the participant had the impression of feeling an extra vibration. Participants who had scores of 56 % and 60 % often answered “I don’t know” because they missed a letter, which confused them for the next letter, but 80 % of the time, they gave a correct answer on the words answered. The other errors originated from several letter misinterpretation: e.g. “salut” (hello) recognised as “sable” (sand), “place” (place) as “plait” (like), “jeune” (young) as “jeudi” (Thursday) or “appel” (call) as “appli” (application). We can notice that the participants had the beginning of the word right but ended up saying a completely different word. This may be due to fatigue and loss of concentration because a word took on average 7.23 s to be sent. Regarding the response time, they took on average 1.24 s to answer. The two participants with the best scores had a response time of 0.83 s, the other two had a response time of 1.66 s, i.e. twice as long. We can infer that those with the best scores were more confident and had a shorter response time while those with the lowest scores were less confident and took longer to recognise the words.

This word study drew inspiration from the word study of UbiBraille [11], which also involved 5 letter words and a sequential delivery of letters, though each letter was presented simultaneously by activating all the necessary fingers. They tested various durations of the stimuli/letters, namely 4, 2, 1 and 0.5 s, and thus durations of 20, 10, 5 and 2.5 s per word. They obtained recognition rates ranging from 92 % to 32 % for

4. Evaluation of LotusBraille as a method for reading Braille on a screen

the durations ranging respectively from 20 s to 2.5 s per word. Our results are not directly comparable as the letters were delivered sequentially in our case, which could have played a role in improving the recognition, and consequently our letter and word duration is variable [letter 0.6 to 2.1 s; words 5.7 to 8.7 s]. However, our recognition rate of 74 % is within the range of their recognition rates for similar word durations [5/10 s; 64/88 % vs 5.7 s to 8.7 s; median: 6.9 s; 74 %]. This is an encouraging result for using this technology as an alternative to mid-air approaches. However, as we only tested with four participants (vs 7 for UbiBraille), this warrants further testing with more participants to fully validate the approach.

According to the SUS (see appendix B), participants tended to agree that the system was rather simple to use because it did not require learning much before use, thus that it was easy to get familiar with, and that users did not need an assistant to use it. At the level of their personal experience, half of the participants had confidence in using the system and would use it in their daily life. The other half were unsure about the system and did not envision using it in their daily life “only if the system remains in the current state”, i.e. if the duration of presentation could not be faster and if the prototype is not more embedded. However, the purpose of this system is that each user can enter his/her own parameters and evolve at his/her own pace to be able to tend towards the simultaneous method. Regarding the System Usability Scale (see appendix B), the prototype obtained a SUS score of 71, which is between “correct” and “good”, which is very encouraging for the future.

4.5.4. Conclusion

This final study enabled to assess the reading of words with the targeted users and hence, to obtain a preliminary validation that it is feasible with the LotusBraille prototype. The four participants had an average recognition rate of 74 %, which is rather promising, particularly given that the words were provided without context. Despite the sample of participants being small, it points towards the fact that the localised haptic feedback, the Lotus technology, is a viable option for delivering short messages, in mobile contexts for instance (bus stops, train stations, etc.). Further testing should be conducted with reading of short sentences or messages. Participants were generally positive about the methods and did not find the stimuli unpleasant. However, they nearly all highlighted that it was a rather novel method for reading, which needed training and concentration. For usage in ecological conditions, longer training times should be provided with the possibility to tune the presentation time and intervals durations and possibly change

4. Evaluation of LotusBraille as a method for reading Braille on a screen

the presentation method from sequential to simultaneous. It would also be relevant to investigate with the target users the combination of other parameters to improve the recognition by, e.g. rendering different stimuli on the fingers (e.g. with the frequency).

5. Conclusion

5.1. Summary of contributions

5.1.1. Implementation and evaluation of localised haptics surface technology

Tactile surfaces are omnipresent in daily life; they are part of nearly all our interactions with digital interfaces, whether in cars, when shopping or with appliances. In fact, most smartphones are now nearly entirely tactile. Unfortunately, current tactile surfaces are devoid of rich and dynamic touch feedback. Yet, rich haptic feedback on mobile devices, such as localised feedback, with textures or compliance effects, present several advantages. These include, for example, reducing typing errors with digital keyboards, improving exploration of lists, icons/buttons or targets, improving pleasantness of the interaction, rapidity of task completion and reducing cognitive load. Furthermore, it can benefit users with sensory impairments such as the visually impaired or people with motor issues, such as the elderly. Currently, smartphones generally provide feedback in the form of a global vibration, that is to say that the vibration will propagate in the entire surface and two fingers in contact simultaneously on the surface will receive the same vibratory information. This can be explained in part by the fact that adding localised multitouch vibrotactile feedback to a touchscreen is not straightforward, due to issues of vibration propagation, reverberation and attenuation. Therefore, in this thesis, we explored a method to enable such localised multitouch feedback on a surface, based on the novel Inverse Filter method, which can be potentially integrated into current commercially available consumer tactile devices. A first prototype was developed with 14 piezo actuators of diameter 20 mm, glued under the surface to apply the Inverse Filter method, well known in the medical field for example, to the field of haptics. The Inverse Filter method is a technique of vibration control, which enables controlling the acoustic field value at chosen positions. Through this thesis work, the Inverse Filter method has been applied for the first time in the field of haptics to localise the vibrations at any point on a plate and not only

5. Conclusion

above the piezo actuators, as previously achieved [8, 9]. The results demonstrated that it was indeed possible to render independent vibrotactile feedback at several simultaneous predefined locations, other than above the actuators. The first experiments on the prototype showed that it was also possible to choose the characteristics of the vibrotactile feedback, as opposed to existing work where only some parameters are variable. These characteristics include the location of the stimuli anywhere on the surface, the amplitude [0 to 8 μm], the frequency [250 to 1000 Hz], the shape of the signal [Square, Hanning window, etc.] and the duration [1 ms to any duration].

A second prototype was developed to apply the Inverse Filter method at any point of a plate and not only at predefined points. Indeed, in the first prototype, the position of the points was predefined whereas in this second prototype, the fingers can be placed anywhere on the surface and the calculation of the vibratory signal can be performed in realtime thanks to a vibratory database. A touchscreen was used to retrieve the position of the user's fingers on the screen in realtime, with 11 larger actuators [diameter = 35 mm] glued under the surface. The vibratory database was coupled with a Fourier interpolation to reduce the calculation time and enable multitouch realtime haptic feedback. This database includes the impulse responses of each calibrated point of the plate and allows calculating the signals to be sent to the different actuators to obtain the desired vibratory feedback. An experiment was carried out to find out the maximum amplitude that the prototype could provide by taking random points on the plate and measuring the maximum amplitude that can be obtained according to the number of points chosen. Moreover, its resolution was measured by taking the minimum distance between each point of control in order to apply the Inverse Filter method. When comparing the two prototypes, the results showed that the second prototype with larger actuators was less efficient in amplitude (4 μm vs 8 μm) and resolution (1.5 cm vs 1 cm) than the first prototype.

Once the second prototype was characterised, it was applied to a use case to help people with visual impairment access digital text. In fact, the visually impaired people use vocal synthesis or a Braille display to have access to digital content. Unfortunately, these solutions are either tiring and noisy or too expensive and cumbersome (e.g. with prices up to 10000 euros and weights up to 0.5 kg). These solutions are therefore difficult to use in a quiet place or in mobility, e.g. when visually impaired people are in the metro. Our goal was to find an alternative to the Braille display, for these use cases, and which could be integrated into already available and used consumer devices

5. Conclusion

for reasons of cost and transportability. Thus, we used our prototype solution based on the Inverse Filter method to transfer letters and then words to visually impaired people via localised feedback. Before conveying letters to the visually impaired person, an initial study was carried out to verify that a user could correctly distinguish two simultaneous vibrations on different fingers. A discrimination study was conducted with 10 sighted participants and four randomised conditions (0, 100, 200 and 300 ms) where participants had to report the two fingers stimulated amongst the four fingers as well as their preferred condition. The study showed that users could correctly distinguish between two vibrations, whether they were played simultaneously (82 % of recognition rate) on two different fingers or sequentially (91 % of recognition rate), but with an optimal interval duration of 200 ms.

A second experiment, divided into several studies and approved by the Ethics Committee of Paris Saclay, was carried out to assess whether our localised feedback on a surface could be used to transmit the Braille alphabet and eventually words to visually impaired people. To achieve that, the Perkins layout was used. Initially used as a keyboard involving three fingers from each hand each mapped to a Braille dot to type a character, the layout was kept but this time to “receive” tactually the letter for reading. Three presentation methods were tested: simultaneous (all fingers vibrate at the same time), sequential (the fingers vibrate one after the other) and hybrid (the symmetric fingers from each hand vibrate two by two). Six visually impaired participants tested the sequential method first, followed by the hybrid and finally the simultaneous with all the 26 letters of the Latin alphabet. The results showed that the simultaneous method (23 % recognition rate) was too complicated because all the fingers were vibrating at the same time and the participants could not distinguish them. Yet, this method is closest to the traditional way of reading Braille and participants did not reject it, on the basis it could be learnt but would probably require a lot of training. The hybrid method (54 % recognition rate) was considered unnatural by participants, as sometimes the index finger of the right hand vibrated before the middle finger of the left hand, which does not respect the Braille code. The sequential method had the best recognition rate of 58 % and was considered the easiest. After this study, the results highlighted it was possible to transfer the Braille alphabet, but the recognition rate was rather low, in particular in comparison to the literature with other technologies. In the literature, in addition to the presentation methods, other strategies were employed to improve the recognition, such as using different vibration characteristics under each finger or longer durations, which we

5. Conclusion

evaluated in subsequent studies.

A study assessing longer presentation times for letter recognition was conducted with the sequential method. The overall duration of the stimuli increased from 300 ms in the study of section 4.2 (with 100 ms of stimulus duration and 200 ms of inter-stimuli duration) to 600 ms (with 300 ms of stimulus duration and 300 ms of inter-stimuli duration). This study was conducted with six visually impaired participants and their results highlighted that it did not significantly improve the recognition rate (75 % with and 78% without), but that people felt more confident.

A new study assessing longer presentation times (increased from 300 ms: 200 ms of stimuli and 100 ms of break to 600 ms: 300 ms of stimuli and 300 ms of break) with the sequential method, conducted with six visually impaired participants, highlighted that longer presentation times significantly improved the recognition rate (88 % vs 58 %). Participants found that the longer timings made reading easier and that they had more time to feel the vibrations and locate them properly.

The last study conducted aimed to transfer words, with four visually impaired participants. Participants had to recognise 5-letter words, amongst a list of 40 words delivered randomly. Participants obtained an average score of 74 % correct response. Participants reported that the task required a lot of concentration and that the pace was slow to read an entire word, but with practice the word transfer could be faster.

Overall, the technology was fairly well accepted by the participants and demonstrated that not only it was important to find the suitable combination of parameters (i.e. stimuli and inter-stimuli duration, frequency, etc.) but also that users have different preferences and learning curves. Thus, it will be important to provide various presentation methods and tuning of durations so that the users can become familiar with them and tune them according to their needs.

5.1.2. Lessons and guidelines for localised haptics on tactile surfaces

Throughout the thesis and various experiments, some lessons have been learnt. For the implementation of the prototypes, we realised that using larger actuators did not necessarily enable to increase the output amplitude. Indeed, with smaller actuators, the prototype amplitude could go up to 8 μm , whereas the second prototype with larger actuators could reach only 4.5 μm , i.e. nearly half as much. As far as resolution is concerned, it is of the same order of magnitude for both prototypes, with 1 cm for the first prototype against 1.5 cm for the second. Therefore, we recommend using small actuators if fine resolution is desired, however, the size of the electronics will be

5. Conclusion

increased with the necessity of driving more actuators, as well power consumption and more calculations. Concerning LotusBraille technology, for novices, long presentation times are necessary at the beginning to get familiar with the technology and the reading method, with at least stimuli duration of 300 ms and a break time between stimuli of 300 ms. Different frequencies could be used to increase users' confidence. The most efficient presentation method, according to the participants, was the simultaneous method, but it was deemed too difficult when being a novice and would require longer learning. The method that allowed the visually impaired to feel the most comfortable and to have the best performance is the sequential method, but it was deemed slow by the participants. The semi-simultaneous method (i.e. all the fingers of the left hand vibrate at the same time then all the fingers of the right hand vibrate at the same time) could be a compromise between the sequential and the simultaneous methods. However, it required a longer learning time according to the participants. Indeed, they complained that it was difficult to distinguish the fingers activated on the same hand, when more than a single finger received a vibration. Finally, the hybrid method should be discarded as participants were not comfortable with a method too far from the Braille standard.

5.2. Leads for future work

5.2.1. Typology of actuators under the surface

In this thesis, the position of the actuators was considered empirically, but not evaluated. It would be beneficial to model the plate and compare different actuator shapes (e.g. square, round, triangle), location configurations and number of actuators to verify the impact of these factors on the rendered signal. Moreover, assessing how many actuators need to be activated to achieve an optimal signal would enable to reduce the number of calculations to be performed while remaining with a solution as efficient as possible. Indeed, the further away from the finger that needs to be vibrated the actuator is, the less it contributes. Hence, depending on the position of the finger, not all actuators may need to be activated. Only those close to the finger could be operated. A path of research would be to compare the signals with all the actuators used and with only those around the finger to verify whether the signal is degraded. This optimisation should take into account the impact of the fingers on the surface. Indeed, we have observed from preliminary tests described in the thesis that the finger has an impact on the amplitude of the signal, with an amplitude divided by two with pressure equivalent to a button

5. Conclusion

press. Further studies should be conducted to measure experimentally the impact of several fingers on the amplitude and whether the fingers impact the optimisation of the actuators, i.e. using all the actuators or only those in the vicinity of the fingers.

5.2.2. Integration into touchscreen devices such as smartphones

The main goal of the technology is to be eventually embedded into current tactile surfaces, such as smartphones. However, as the technology relies on piezo actuators glued under the screen, in its current state, it cannot be easily integrated into touchscreens as the actuators are not transparent and would thus interfere with the visual display. One solution overcoming the transparency issue would consist in being able to move the actuators to the periphery, similarly to the Time-Reversal approach [17]. This would enable the use of a transparent surface and thus, a visual feedback collocated with the tactile feedback. A numerical model should be made in order to be able to vary the number of actuators at the periphery and according to the number, assess whether the Inverse Filter method is correctly applied. It would be considered well applied if two different vibrations (or one vibration and none on the other) can be sent at two distinct points and felt as such [88]. Yet the further the actuators are from the point with desired localised feedback, the more difficult it will be to localise the vibrations. Indeed, when the learning phase is carried out, no information at the center of the plate can be recovered, only the vibratory information of the plate contour, and hence less comprehensive data for applying the Inverse Filter method. It will therefore be necessary to work on the stability of the inversion of the H matrix.

Another solution to deal with the transparency issue consist in using OLED displays, i.e. opaque screens use the same principle as an LCD (liquid crystal display), but simplified since each pixel produces its own light. Nowadays, such OLED screens are appearing on the display market and are very thin. Indeed, they are so thin that it would be possible to glue our actuator matrix directly under the surface and have both vibratory and visual feedback collocated. Initial tests in the laboratory, yet unpublished, have shown that it was possible to reach amplitudes of the order of a few microns, which is sufficient to feel a tactile stimulation. A prototype should be developed and user studies conducted to test the device in real conditions.

5.2.3. LotusBraille as a Braille display

Initial results demonstrated that LotusBraille could be used to read letters and words, but needed some improvements on the choice of the stimuli characteristics (i.e. duration, etc.). This is a promising first step. Yet, the LotusBraille prototype needs more evaluation to fully validate the technology as an alternative to a Braille display in some use cases, e.g. in mobility or for short messages such as bus stops. For that purpose, several laboratory studies still need to be conducted, including reading longer words and sentences, with and without distractions/concurring tasks, with and without different postures (such as standing to simulate mobility), and with and without use case context (i.e. either random sentences or sentences related to a predefined scenario such as expecting bus information at a bus stop). After that, ecological and long-term studies should be conducted where the visually impaired could use the prototype on a daily basis. This would enable to assess familiarisation with the technology and presentation method(s) and learning effects, as well as evolving preferences with learning of the presentation methods. For example, such a study would enable observing whether visually impaired people would eventually tend towards a simultaneous presentation instead of a sequential one, similarly to the speed of Text-To-Speech gradually increasing with familiarisation. Allowing visually impaired people to choose the different parameters of the signal, such as durations, different frequencies on fingers, shape, etc., would also enable to assess which parameters and their combinations are most optimal, or whether it is user specific. Finally, it would enable to test sentence reading in real conditions. Other complementary studies should also be conducted to better understand the perception of the vibrations and their localisations. Indeed, sometimes, some users reported feeling vibrations traveling in the hand, or in the middle such as with the funnelling illusion [52], and thus interfering with the localisation. Thus, it would be valuable to conduct studies on the propagation of vibrations in the hand whilst using our device and map them when receiving vibrations, with and without pressure applied by the fingers. Three sensors could be placed equidistantly per finger and 10 (or more) on the top of the hand to cover most of the hand surface (see in Fig. 5.1), similarly to the work by Yitian et al. [116] who used a similar device to measure the vibration propagation in the hand. These 24 points would be the references and all other unmeasured points on the hand would be interpolated in order to reconstitute a cartography. The results could explain some of the feedback collected from participants and would also assess which frequency is

5. Conclusion

optimal and propagates the least in the rest of the hand. A hypothesis is that the results will vary according to the size of the hand, and the length and thickness of the fingers. Perhaps, the bone density of the hand also plays a role on the propagation of the vibrations.

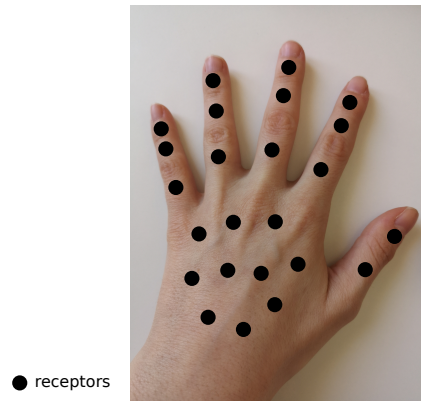

Figure 5.1.: Possible layout of the sensors on the hand to measure vibration propagation.

In summary, the Inverse Filter method is a promising tool that can change the way we interact with tactile surfaces. In this thesis, we proposed the LotusBraille prototype to eventually enable visually impaired people to read digital content on touchscreens. The work of this thesis coupled with the future research outlined above could take inclusion and tactile interactions a step further. Moreover, it would be interesting to consider a coupling of the Inverse Filter method with the texture rendering of Ben Dhiab [118] so that on a single smartphone, it would be possible to feel both localised vibrations and texture. This coupling is challenging because these two technologies do not use the same electronics. Indeed, the Inverse Filter method relies on electronics operating in low frequency whereas the texture rendering operates in the high frequency range to render the squeeze film effect. It would thus be necessary to manage to couple principles, the corresponding driving algorithms and electronics in a single prototype. We would then have to create an architecture that would allow us to switch from one technology to the other quickly enough so as not to create latency for realtime rendering. User studies should be conducted to verify that users can feel the textures and vibratory feedback on the prototype. This texture rendering would be interesting, for example to feel clothes before ordering them online or to feel the materials of a sofa. It could also have pedagogical applications such as letting children feel things not easily accessible, such as dangerous or exotic animals. In general, this type of surface feedback technologies

5. Conclusion

could be useful in accessibility, including for the elderly or people with motor issues, for educations as ICT technologies are frequently used, in HCI for remote interactions, including social touch (e.g. for distant communication) or mobile interactions (e.g. in cars, in pedestrian mobility), in marketing, gaming and augmented reality amongst many possible domains. Overall, it would open up many new avenues for natural human-computer interaction with a surface and *design for all* opportunities.

Appendices

A. Likert Scale Questionnaire



B – COMPREHENSION AND RECOGNITION OF STIMULI

Check the box corresponding to the participant's choice
After each presentation method:

Acceptability/usability of the technology:

Rate on a scale from not at all (1) to completely (6) the following statements :

	1	2	3	4	5	6
The recognition of the letters by stimuli required a lot of effort of concentration	<input type="checkbox"/>	<input type="checkbox"/>	<input type="checkbox"/>	<input type="checkbox"/>	<input type="checkbox"/>	<input type="checkbox"/>
Letter recognition by stimuli was easy	<input type="checkbox"/>	<input type="checkbox"/>	<input type="checkbox"/>	<input type="checkbox"/>	<input type="checkbox"/>	<input type="checkbox"/>
The feeling of the stimuli was unpleasant	<input type="checkbox"/>	<input type="checkbox"/>	<input type="checkbox"/>	<input type="checkbox"/>	<input type="checkbox"/>	<input type="checkbox"/>
I found the method of presenting the stimuli satisfactory	<input type="checkbox"/>	<input type="checkbox"/>	<input type="checkbox"/>	<input type="checkbox"/>	<input type="checkbox"/>	<input type="checkbox"/>
I find this method inefficient for reading Braille compared to traditional methods	<input type="checkbox"/>	<input type="checkbox"/>	<input type="checkbox"/>	<input type="checkbox"/>	<input type="checkbox"/>	<input type="checkbox"/>
I find this presentation method useful for recognizing letters	<input type="checkbox"/>	<input type="checkbox"/>	<input type="checkbox"/>	<input type="checkbox"/>	<input type="checkbox"/>	<input type="checkbox"/>

Do you have any suggestions for improving the feedback or the presentation method ? (r.g. changing some parameters such as time between stimuli or duration of stimuli, new strategy, finger positioning, etc.)

Do you have any other comments or suggestions ?

B. System Usability Scale (SUS)



System usability scale⁶

	Not at all agree				Totally agree
1. I think that I would like to use this system frequently.	<input type="checkbox"/>	<input type="checkbox"/>	<input type="checkbox"/>	<input type="checkbox"/>	<input type="checkbox"/>
	1	2	3	4	5
2. I found the system unnecessarily complex.	<input type="checkbox"/>	<input type="checkbox"/>	<input type="checkbox"/>	<input type="checkbox"/>	<input type="checkbox"/>
	1	2	3	4	5
3. I thought the system was easy to use.	<input type="checkbox"/>	<input type="checkbox"/>	<input type="checkbox"/>	<input type="checkbox"/>	<input type="checkbox"/>
	1	2	3	4	5
4. I think that I would need the support of a technical person to be able to use this system	<input type="checkbox"/>	<input type="checkbox"/>	<input type="checkbox"/>	<input type="checkbox"/>	<input type="checkbox"/>
	1	2	3	4	5
5. I found the various functions in this system were well integrated.	<input type="checkbox"/>	<input type="checkbox"/>	<input type="checkbox"/>	<input type="checkbox"/>	<input type="checkbox"/>
	1	2	3	4	5
6. I thought there was too much inconsistency in this system.	<input type="checkbox"/>	<input type="checkbox"/>	<input type="checkbox"/>	<input type="checkbox"/>	<input type="checkbox"/>
	1	2	3	4	5
7. I would imagine that most people would learn to use this system very quickly.	<input type="checkbox"/>	<input type="checkbox"/>	<input type="checkbox"/>	<input type="checkbox"/>	<input type="checkbox"/>
	1	2	3	4	5
8. I found the system very cumbersome to use.	<input type="checkbox"/>	<input type="checkbox"/>	<input type="checkbox"/>	<input type="checkbox"/>	<input type="checkbox"/>
	1	2	3	4	5
9. I felt very confident using the system.	<input type="checkbox"/>	<input type="checkbox"/>	<input type="checkbox"/>	<input type="checkbox"/>	<input type="checkbox"/>
	1	2	3	4	5
10. I needed to learn a lot of things before I could get going with this system.	<input type="checkbox"/>	<input type="checkbox"/>	<input type="checkbox"/>	<input type="checkbox"/>	<input type="checkbox"/>
	1	2	3	4	5

C. List of words

Jeune	Vieux	Livre	Poche	Boite
Carte	Fleur	Fille	Forme	Heure
Image	Ligne	Odeur	Place	Porte
Route	Soeur	Suite	Tapis	Ville
Choix	Coeur	Temps	Amour	Appel
Arbre	Bruit	Doigt	Monde	Oncle
Point	Salut	Liste	Train	Verre
Stylo	Avion	Envie	Chose	Geste

Bibliography

- [1] Markus Egert, Kerstin Späth, Karoline Weik, Heike Kunzelmann, Christian Horn, Matthias Kohl, and Frithjof Blessing. Bacteria on smartphone touchscreens in a german university setting and evaluation of two popular cleaning methods using commercially available cleaning products. *Folia microbiologica*, 60(2):159–164, 2015.
- [2] Zhaoyuan Ma, Darren Edge, Leah Findlater, and Hong Z. Tan. Haptic keyclick feedback improves typing speed and reduces typing errors on a flat keyboard. In *2015 IEEE World Haptics Conference (WHC)*, pages 220–227, Evanston, IL, June 2015. IEEE.
- [3] Byung-kil Han, Kwangtaek Kim, Koji Yatani, and Hong Z. Tan. *Text Entry Performance Evaluation of Haptic Soft QWERTY Keyboard on a Tablet Device*.
- [4] Masaaki Fukumoto and Toshiaki Sugimura. Active click: tactile feedback for touch panels. In *CHI '01 extended abstracts on Human factors in computing systems - CHI '01*, page 121, Seattle, Washington, 2001. ACM Press.
- [5] Rock Leung, Karon MacLean, Martin Bue Bertelsen, and Mayukh Saubhasik. Evaluation of haptically augmented touchscreen gui elements under cognitive load. In *Proc. of the ninth int. conf. on Multimodal interfaces - ICMI '07*, page 374, Nagoya, Aichi, Japan, 2007. ACM Press.
- [6] Matthew J. Pitts, Skrypchuk Lee, Tom Wellings, Alex Attridge, and Mark A. Williams. Evaluating user response to in-car haptic feedback touchscreens using the lane change test. *Advances in Human-Computer Interaction*, 2012.
- [7] Tomer Moscovich. Principles and applications of multi-touch interaction. 2007.
- [8] Ayoub Ben Dhiab and Charles Hudin. Confinement of Vibrotactile Stimuli in Narrow Plates. In *2019 IEEE World Haptics Conference (WHC)*, pages 431–436, Tokyo, Japan, July 2019. IEEE.

Bibliography

- [9] Charles Hudin and Sabrina Panëels. Localisation of Vibrotactile Stimuli with Spatio-Temporal Inverse Filtering. In Domenico Prattichizzo, Hiroyuki Shinoda, Hong Z. Tan, Emanuele Ruffaldi, and Antonio Frisoli, editors, *Haptics: Science, Technology, and Applications*, Lecture Notes in Computer Science, pages 338–350, Cham, 2018. Springer International Publishing.
- [10] Z. Al-Qudah, I. A. Doush, F. Alkhateeb, E. A. Maghayreh, and O. Al-Khaleel. Reading Braille on mobile phones: A fast method with low battery power consumption. In *2011 International Conference on User Science and Engineering (i-USEr)*, pages 118–123, November 2011.
- [11] Hugo Nicolau, João Guerreiro, Tiago Guerreiro, and Luís Carriço. UbiBraille: designing and evaluating a vibrotactile Braille-reading device. In *Proceedings of the 15th International ACM SIGACCESS Conference on Computers and Accessibility - ASSETS '13*, pages 1–8, Bellevue, Washington, 2013. ACM Press.
- [12] Granit Luzhnica, Eduardo Veas, and Viktoria Pammer. Skin reading: Encoding text in a 6-channel haptic display. In *Proceedings of the 2016 ACM International Symposium on Wearable Computers*, pages 148–155, 2016.
- [13] Tom Carter, Sue Ann Seah, Benjamin Long, Bruce Drinkwater, and Sriram Subramanian. UltraHaptics: multi-point mid-air haptic feedback for touch surfaces. In *Proceedings of the 26th annual ACM symposium on User interface software and technology - UIST '13*, pages 505–514, St. Andrews, Scotland, United Kingdom, 2013. ACM Press.
- [14] Hiroo Iwata, Hiroaki Yano, Fumitaka Nakaizumi, and Ryo Kawamura. Project feelex: adding haptic surface to graphics. In *Proceedings of the 28th annual conference on Computer graphics and interactive techniques*, pages 469–476, 2001.
- [15] Dorothea Reusser, Espen Knoop, Roland Siegwart, and Paul Beardsley. Feeling fireworks: An inclusive tactile firework display. In *Proceedings of the 2019 CHI Conference on Human Factors in Computing Systems*, pages 1–11, 2019.
- [16] Yvonne Jansen, Thorsten Karrer, and Jan Borchers. MudPad: localized tactile feedback on touch surfaces. In *Adjunct proceedings of the 23rd annual ACM symposium on User interface software and technology - UIST '10*, page 385, New York, New York, USA, 2010. ACM Press.

Bibliography

- [17] Charles Hudin, Jose Lozada, and Vincent Hayward. Localized Tactile Feedback on a Transparent Surface through Time-Reversal Wave Focusing. *IEEE Transactions on Haptics*, 8(2):188–198, April 2015.
- [18] Senem Ezgi Emgin, Amirreza Aghakhani, T. Metin Sezgin, and Cagatay Basdogan. HapTable: An Interactive Tabletop Providing Online Haptic Feedback for Touch Gestures. *IEEE Transactions on Visualization and Computer Graphics*, 25(9):2749–2762, September 2019.
- [19] Jung-Han Woo and Jeong-Guon Ih. Vibration rendering on a thin plate with actuator array at the periphery. *Journal of Sound and Vibration*, 349:150–162, 2015.
- [20] Ayoub Ben Dhiab and Charles Hudin. Confinement of vibrotactile stimuli in periodically supported plates. In *International Conference on Human Haptic Sensing and Touch Enabled Computer Applications*, pages 334–342. Springer, 2020.
- [21] Quang Van Duong, Vinh Phu Nguyen, Fabrice Domingues Dos Santos, and Seung Tae Choi. Localized fretting-vibrotactile sensations for large-area displays. *ACS applied materials & interfaces*, 11(36):33292–33301, 2019.
- [22] Night writing. <https://www.braille.be/fr/documentation/louis-braille-et-son-invention/louis-braille>. Accessed 05/04/2022.
- [23] Braille alphabet. <https://ingeniumcanada.org/fr/scitech/educatif/mets-a-lessai/braille>. Accessed 05/04/2022.
- [24] Perkins machine image. <https://www.catawiki.com/fr/1/21508107-david-abraham-perkins-brailleur-machine-a-ecrire-braille-howe-press>. Accessed 05/04/2022.
- [25] Digicassette image. <https://sites.aph.org/museum-virtual-exhibit/vex4/DA3EB197-D332-45BB-AE4F-351762353470.htm>. Accessed 05/04/2022.
- [26] Christophe Ramstein. Combining Haptic and Braille Technologies: Design Issues and Pilot Study. page 8.
- [27] Mohamed Benali-Khoudja, Moustapha Hafez, and Abderrahmane Kheddar. VITAL: An electromagnetic integrated tactile display. *Displays*, 28(3):133–144, July 2007.

Bibliography

- [28] Alexander Russomanno, R Brent Gillespie, Sile O'Modhrain, and James Barber. Modeling pneumatic actuators for a refreshable tactile display. In *International Conference on Human Haptic Sensing and Touch Enabled Computer Applications*, pages 385–393. Springer, 2014.
- [29] V. Paneva, S. Seinfeld, M. Kraiczi, and J. Müller. HaptiRead: Reading Braille as Mid-Air Haptic Information. In *DIS '20*, pages 13–20, 2020.
- [30] J. Rantala, R. Raisamo, J. Lylykangas, V. Surakka, J. Raisamo, K. Salminen, T. Pakkanen, and A. Hippula. Methods for Presenting Braille Characters on a Mobile Device with a Touchscreen and Tactile Feedback. *IEEE Transactions on Haptics*, 2(1):28–39, January 2009.
- [31] Hugo Nicolau, Kyle Montague, Tiago Guerreiro, André Rodrigues, and Vicki L. Hanson. HoliBraille: multipoint vibrotactile feedback on mobile devices. In *Proceedings of the 12th Web for All Conference on - W4A '15*, pages 1–4, Florence, Italy, 2015. ACM Press.
- [32] Technologie lotus ou comment enrichir l'interaction tactile. https://www.youtube.com/watch?v=7MTbCPuH_sg&ab_channel=CEARcherche. Accessed 02/04/2022.
- [33] Georges Louis Leclerc. Comte de bouffon - hist. nat. hom. oeuv. t. iv, p. 181. <http://littre.reverso.net/dictionnaire-francais/auteur/buffon/18/citations/page79>, Accessed 27/11/2021.
- [34] Bukun Son and Jaeyoung Park. Haptic feedback to the palm and fingers for improved tactile perception of large objects. In *Proceedings of the 31st Annual ACM Symposium on User Interface Software and Technology*, pages 757–763, 2018.
- [35] Alexandra Delazio, Ken Nakagaki, Roberta L Klatzky, Scott E Hudson, Jill Fain Lehman, and Alanson P Sample. Force jacket: Pneumatically-actuated jacket for embodied haptic experiences. In *Proceedings of the 2018 CHI Conference on Human Factors in Computing Systems*, pages 1–12, 2018.
- [36] SK Alamgir Hossain, Abu Saleh Md Mahfujur Rahman, and Abdulmotaieb El Saddik. Interpersonal haptic communication in second life. In *2010 IEEE International Symposium on Haptic Audio Visual Environments and Games*, pages 1–4. IEEE, 2010.

Bibliography

- [37] Jonathan Blake and Hakan B Gurocak. Haptic glove with mr brakes for virtual reality. *IEEE/ASME Transactions On Mechatronics*, 14(5):606–615, 2009.
- [38] M Waleed Uddin, Xiaohan Zhang, and Dangxiao Wang. A pneumatic-driven haptic glove with force and tactile feedback. In *2016 International Conference on Virtual Reality and Visualization (ICVRV)*, pages 304–311. IEEE, 2016.
- [39] Jérôme Perret and Emmanuel Vander Poorten. Touching virtual reality: a review of haptic gloves. In *ACTUATOR 2018; 16th International Conference on New Actuators*, pages 1–5. VDE, 2018.
- [40] Ryoko Ueoka, Shuhei Yamamoto, and Mami Yamaguchi. Facial tactile display using vortex air cannon. *IEICE Technical Report; IEICE Tech. Rep.*
- [41] Mohamed Yacine Tsalamlal, Will Rizer, Jean-Claude Martin, Mehdi Ammi, and Mounia Ziat. Affective communication through air jet stimulation: Evidence from event-related potentials. *International Journal of Human–Computer Interaction*, 34(12):1157–1168, 2018.
- [42] Aaron Plauché, Dario Villarreal, and Robert D Gregg. A haptic feedback system for phase-based sensory restoration in above-knee prosthetic leg users. *IEEE transactions on haptics*, 9(3):421–426, 2016.
- [43] Jessica D’Abbraccio, Luca Massari, Sahana Prasanna, Laura Baldini, Francesca Sorgini, Giuseppe Airò Farulla, Andrea Bulletti, Marina Mazzoni, Lorenzo Capineri, Arianna Menciassi, et al. Haptic glove and platform with gestural control for neuromorphic tactile sensory feedback in medical telepresence. *Sensors*, 19(3):641, 2019.
- [44] David Escobar-Castillejos, Julieta Noguez, Luis Neri, Alejandra Magana, and Bedrich Benes. A review of simulators with haptic devices for medical training. *Journal of medical systems*, 40(4):1–22, 2016.
- [45] Xiaojun Chen and Junlei Hu. A review of haptic simulator for oral and maxillofacial surgery based on virtual reality. *Expert Review of Medical Devices*, 15(6):435–444, 2018.
- [46] Slim Kammoun, Christophe Jouffrais, Tiago Guerreiro, Hugo Nicolau, and Joaquim Jorge. Guiding blind people with haptic feedback. *Frontiers in Accessibility for Pervasive Computing (Pervasive 2012)*, 3, 2012.

Bibliography

- [47] Yon Visell, Jeremy R Cooperstock, Bruno L Giordano, Karmen Franinovic, Alvin Law, Stephen McAdams, Kunal Jathal, and Federico Fontana. A vibrotactile device for display of virtual ground materials in walking. In *International Conference on Human Haptic Sensing and Touch Enabled Computer Applications*, pages 420–426. Springer, 2008.
- [48] Yon Visell, Alvin Law, and Jeremy R Cooperstock. Touch is everywhere: Floor surfaces as ambient haptic interfaces. *IEEE Transactions on Haptics*, 2(3):148–159, 2009.
- [49] Valerie S Morash, Allison E Connell Pensky, and Joshua A Miele. Effects of using multiple hands and fingers on haptic performance. *Perception*, 42(7):759–777, 2013.
- [50] Carl E Sherrick and Ronald Rogers. Apparent haptic movement. *Perception & Psychophysics*, 1(3):175–180, 1966.
- [51] Payal Patel, Rahul Kumar Ray, and Muniyandi Manivannan. Power law based “out of body” tactile funneling for mobile haptics. *IEEE transactions on haptics*, 12(3):307–318, 2019.
- [52] Mathilde Jeannin, Ayoub Ben Dhiab, Lucie Pantera, Charles Hudin, and Sabrina Panëels. The funneling illusion using the confinement of vibrotactile stimuli in narrow plates. In *2021 IEEE World Haptics Conference (WHC)*, pages 1147–1147. IEEE, 2021.
- [53] Levitation with localised tactile and audio feedback for mid-air interactions. <https://cordis.europa.eu/project/id/737087>. Accessed 27/11/2021.
- [54] Sidhant Gupta, Dan Morris, Shwetak N Patel, and Desney Tan. Airwave: Non-contact haptic feedback using air vortex rings. In *Proceedings of the 2013 ACM international joint conference on Pervasive and ubiquitous computing*, pages 419–428, 2013.
- [55] Takayuki Hoshi, Masafumi Takahashi, Takayuki Iwamoto, and Hiroyuki Shinoda. Noncontact Tactile Display Based on Radiation Pressure of Airborne Ultrasound. *IEEE Transactions on Haptics*, 3(3):155–165, July 2010.

Bibliography

- [56] Ismo Rakkolainen, Euan Freeman, Antti Sand, Roope Raisamo, and Stephen Brewster. A survey of mid-air ultrasound haptics and its applications. *IEEE Transactions on Haptics*, 14(1):2–19, 2020.
- [57] Jonathan Bell, Stanley Bolanowski, and Mark H Holmes. The structure and function of pacinian corpuscles: a review. *Progress in neurobiology*, 42(1):79–128, 1994.
- [58] Deepak Ranjan Sahoo, Kasper Hornbæk, and Sriram Subramanian. Tablehop: An actuated fabric display using transparent electrodes. In *Proceedings of the 2016 CHI Conference on Human Factors in Computing Systems*, pages 3767–3780, 2016.
- [59] Yvonne Jansen, Thorsten Karrer, and Jan Borchers. Mudpad: tactile feedback for touch surfaces. In *CHI'11 Extended Abstracts on Human Factors in Computing Systems*, pages 323–328. 2011.
- [60] Gregory Reardon, Nikolas Kastor, Yitian Shao, and Yon Visell. Elastowave: Localized tactile feedback in a soft haptic interface via focused elastic waves. In *2020 IEEE Haptics Symposium (HAPTICS)*, pages 7–14. IEEE, 2020.
- [61] Taku Hachisu and Masaaki Fukumoto. Vacuumtouch: attractive force feedback interface for haptic interactive surface using air suction. In *Proceedings of the SIGCHI Conference on Human Factors in Computing Systems*, pages 411–420, 2014.
- [62] Joe Mullenbach, Dan Johnson, J Edward Colgate, and Michael A Peshkin. Activepad surface haptic device. In *2012 IEEE Haptics Symposium (HAPTICS)*, pages 407–414. IEEE, 2012.
- [63] Michel Amberg, Frédéric Giraud, Betty Semail, Paolo Olivo, Géry Casiez, and Nicolas Roussel. Stimtac: a tactile input device with programmable friction. In *Proceedings of the 24th annual ACM symposium adjunct on User interface software and technology*, pages 7–8, 2011.
- [64] Mélisande Biet, Frédéric Giraud, and Betty Lemaire-Semail. Squeeze film effect for the design of an ultrasonic tactile plate. *IEEE transactions on ultrasonics, ferroelectrics, and frequency control*, 54(12):2678–2688, 2007.
- [65] Eric Vezzoli, Zlatko Vidrih, Vincenzo Giamundo, Betty Lemaire-Semail, Frédéric Giraud, Tomaz Rodic, Djordje Peric, and Michael Adams. Friction reduction

Bibliography

- through ultrasonic vibration part 1: Modelling intermittent contact. *IEEE transactions on haptics*, 10(2):196–207, 2017.
- [66] Sofiane Ghenna, Christophe Giraud-Audine, Frédéric Giraud, Michel Amberg, and Betty Lemaire-Semail. Control and evaluation of a 2-d multimodal controlled-friction display. In *2017 IEEE World Haptics Conference (WHC)*, pages 593–598. IEEE, 2017.
- [67] Thomas Daunizeau, David Gueorguiev, Sinan Haliyo, and Vincent Hayward. Phononic crystals applied to localised surface haptics. *IEEE Transactions on Haptics*, 14(3):668–674, 2021.
- [68] Olivier Bau, Ivan Poupyrev, Ali Israr, and Chris Harrison. TeslaTouch: electrovibration for touch surfaces. In *Proceedings of the 23rd annual ACM symposium on User interface software and technology - UIST '10*, page 283, New York, New York, USA, 2010. ACM Press.
- [69] Hap2u. <https://www.hap2u.net/>. Accessed 27/03/2022.
- [70] Cagatay Basdogan, Frederic Giraud, Vincent Levesque, and Seungmoon Choi. A review of surface haptics: enabling tactile effects on touch surfaces. *IEEE transactions on haptics*, 13(3):450–470, 2020.
- [71] Hsiang-Yu Chen, Jaeyoung Park, Steve Dai, and Hong Z. Tan. Design and Evaluation of Identifiable Key-Click Signals for Mobile Devices. *IEEE Transactions on Haptics*, 4(4):229–241, October 2011.
- [72] Pierre Garcia, Frédéric Giraud, Betty Lemaire-Semail, Matthieu Rupin, and Michel Amberg. 2motac: Simulation of button click by superposition of two ultrasonic plate waves. In *International Conference on Human Haptic Sensing and Touch Enabled Computer Applications*, pages 343–352. Springer, 2020.
- [73] Jocelyn Monnoyer, Emmanuelle Diaz, Christophe Bourdin, and Michaël Wiertelwski. Ultrasonic friction modulation while pressing induces a tactile feedback. In *International Conference on Human Haptic Sensing and Touch Enabled Computer Applications*, pages 171–179. Springer, 2016.
- [74] Johan Kildal. 3D-press: haptic illusion of compliance when pressing on a rigid surface. In *International Conference on Multimodal Interfaces and the Workshop*

Bibliography

- on Machine Learning for Multimodal Interaction on - ICMI-MLMI '10*, page 1, Beijing, China, 2010. ACM Press.
- [75] Sunjun Kim and Geehyuk Lee. *Haptic Feedback Design for a Virtual Button Along Force-Displacement Curves*.
- [76] Yon Visell and Jeremy R. Cooperstock. Design of a vibrotactile display via a rigid surface. In *2010 IEEE Haptics Symposium*, pages 133–140, Waltham, MA, USA, March 2010. IEEE.
- [77] Mingsian R Bai and Yao Kun Tsai. Impact localization combined with haptic feedback for touch panel applications based on the time-reversal approach. *The Journal of the Acoustical Society of America*, 129(3):1297–1305, 2011.
- [78] S Wöckel, U Steinmann, and H Arndt. Modelling of time reversal for localized tactile feedback on displays. *Procedia engineering*, 120:302–305, 2015.
- [79] Charles Hudin, Jose Lozada, and Vincent Hayward. Localized tactile stimulation by time-reversal of flexural waves: Case study with a thin sheet of glass. In *2013 World Haptics Conference (WHC)*, pages 67–72. IEEE, 2013.
- [80] Charles Hudin, José Lozada, Michael Wiertlewski, and Vincent Hayward. Tradeoffs in the application of time-reversed acoustics to tactile stimulation. In *International Conference on Human Haptic Sensing and Touch Enabled Computer Applications*, pages 218–226. Springer, 2012.
- [81] Ehsan Enferad, Christophe Giraud-Audine, Frédéric Giraud, Michel Amberg, and Betty Lemaire Semail. Generating controlled localized stimulations on haptic displays by modal superimposition. *Journal of Sound and Vibration*, 449:196–213, 2019.
- [82] Gwenael Le Rhun, Christel Dieppedale, Baba Wagué, Corentin Querne, Grégory Enyedi, Pierre Perreau, Pierre Montméat, Christophe Licitra, and Stéphane Fanget. Transparent pzt mim capacitors on glass for piezoelectric transducer applications. In *2019 20th International Conference on Solid-State Sensors, Actuators and Microsystems & Eurosensors XXXIII (TRANSDUCERS & EUROSENSORS XXXIII)*, pages 1800–1802. IEEE, 2019.

Bibliography

- [83] M. Tanter, J.-F. Aubry, J. Gerber, J.-L. Thomas, and M. Fink. Optimal focusing by spatio-temporal inverse filter. I. Basic principles. *The Journal of the Acoustical Society of America*, 110(1):37–47, July 2001.
- [84] Steven L Gay and Jacob Benesty. *Acoustic signal processing for telecommunication*, volume 551. Springer Science & Business Media, 2012.
- [85] Bruno Masiero, Janina Fels, and Michael Vorlander. Review of the crosstalk cancellation filter technique. page 6, 2011.
- [86] Charles Hudin and Sabrina Panëels. Localisation of vibrotactile stimuli with spatio-temporal inverse filtering. In *International Conference on Human Haptic Sensing and Touch Enabled Computer Applications*, pages 338–350. Springer, 2018.
- [87] Ronald T. Verrillo. Vibrotactile thresholds measured at the finger. *Perception & Psychophysics*, 9(4):329–330, July 1971.
- [88] Jin Ryong Kim, Xiaowei Dai, Xiang Cao, Carl Picciotto, Desney Tan, and Hong Z. Tan. A Masking Study of Key-Click Feedback Signals on a Virtual Keyboard. In David Hutchison, Takeo Kanade, Josef Kittler, Jon M. Kleinberg, Friedemann Mattern, John C. Mitchell, Moni Naor, Oscar Nierstrasz, C. Pandu Rangan, Bernhard Steffen, Madhu Sudan, Demetri Terzopoulos, Doug Tygar, Moshe Y. Vardi, Gerhard Weikum, Poika Isokoski, and Jukka Springare, editors, *Haptics: Perception, Devices, Mobility, and Communication*, volume 7282, pages 247–257. Springer Berlin Heidelberg, Berlin, Heidelberg, 2012.
- [89] Dean S Louis, Thomas L Greene, Kurt E Jacobson, Christian Rasmussen, Patricia Kolowich, and Steven A Goldstein. Evaluation of normal values for stationary and moving two-point discrimination in the hand. *The Journal of hand surgery*, 9(4):552–555, 1984.
- [90] Piotr Majdak. Multiple Exponential Sweep Method for Fast Measurement of Head-Related Transfer Functions. *J. Audio Eng. Soc.*, 55(7):15, 2007.
- [91] Ronald T Verrillo. Psychophysics of vibrotactile stimulation. *The Journal of the Acoustical Society of America*, 77(1):225–232, 1985.
- [92] Le club 5 sens. <https://www.leclub5sens.fr>, Accessed 27/11/2021.
- [93] Sonography. <https://museelouisbraille.com/en/barbier-l-intuitif>, Accessed 27/11/2021.

Bibliography

- [94] F.K. Schroeder. Perceptions of Braille Usage by Legally Blind Adults, 1996.
- [95] Slate and stylus. https://en.wikipedia.org/wiki/Slate_and_stylus, Accessed 27/11/2021.
- [96] Tablet and punch. <https://www.braille.be/fr/documentation>. Accessed 05/04/2022.
- [97] Rendering braille on a sheet. <https://www.accesensoriel.com/services>. Accessed 05/04/2022.
- [98] Perkins Brailler. Wikipedia presentation. https://en.wikipedia.org/wiki/Perkins_Brailler#:~:text=7%20External%20links-,History,problems%20of%20the%20existing%20technology., Accessed 27/11/2021.
- [99] Pourquoi la machine à écrire braille est toujours populaire auprès des aveugles. <https://www.visiole.fr/bassevision/imprimante-braille/machine-a-ecrire-braille/>. Accessed 27/11/2021.
- [100] Histoire de la machine perkins. <https://abracadabraille.org/perkins/histoire-de-la-machine-perkins/>. Accessed 27/11/2021.
- [101] Yayoi Shimomura, Ebba Thora Hvannberg, and Hjalmtyr Hafsteinsson. Accessibility of audio and tactile interfaces for young blind people performing everyday tasks. *Universal Access in the Information Society*, 9(4):297–310, 2010.
- [102] Digicassette. <https://sites.aph.org/museum-virtual-exhibit/vex4/DA3EB197-D332-45BB-AE4F-351762353470.htm>. Accessed 02/04/2022.
- [103] Refreshable Braille display. https://en.wikipedia.org/wiki/Refreshable_braille_display, Accessed 27/11/2021.
- [104] Afficheurs et bloc-notes braille. <https://www.ceciaa.com/technologie-braille-relief/terminal-braille.html>, Accessed 27/11/2021.
- [105] Talback et voiceover: comment les lecteurs d'écran. <https://www.pucker-up.net/talkback-et-voiceover-comment-fonctionnent-les-lecteurs-decran/>, Accessed 27/11/2021.
- [106] Braille numérique contre braille papier. https://www.aqpehv.qc.ca/textes-interessants-complet?id_texte=47. Accessed 27/11/2021.

Bibliography

- [107] Vincent Lévesque, Jérôme Pasquero, and Vincent Hayward. Braille display by lateral skin deformation with the stress2 tactile transducer. In *Second Joint EuroHaptics Conference and Symposium on Haptic Interfaces for Virtual Environment and Teleoperator Systems (WHC'07)*, pages 115–120. IEEE, 2007.
- [108] H. Nicolau, J. Guerreiro, T. Guerreiro, and L. Carriço. UbiBraille: designing and evaluating a vibrotactile braille-reading device. In *ASSETS '13*, pages 1–8, 2013.
- [109] Z. Al-Qudah, I.A. Doush, F. Alkhateeb, E. Al Maghayreh, and O. Al-Khaleel. Reading braille on mobile phones: A fast method with low battery power consumption. In *i-USEr '11*, pages 118–123, 2011.
- [110] J. Rantala, R. Raisamo, J. Lylykangas, V. Surakka, J. Raisamo, K. Salminen, T. Pakkanen, and A. Hippula. Methods for Presenting Braille Characters on a Mobile Device with a Touchscreen and Tactile Feedback. *IEEE Trans. Haptics*, 2(1):28–39, 2009.
- [111] Youngsun Kim, Jaedong Lee, and Gerard J. Kim. Extending "Out of the Body" Tactile Phantom Sensations to 2D and Applying It to Mobile Interaction. *Personal and Ubiquitous Computing*, 19(8):1295–1311, 2015.
- [112] Shiri Azenkot, Jacob O Wobbrock, Sanjana Prasain, and Richard E Ladner. Input Finger Detection for Nonvisual Touch Screen. page 9, 2012.
- [113] G.A. Gescheider, S.J. Bolanowski, and R.T. Verrillo. Some characteristics of tactile channels. *Behav. Brain Res.*, 148(1-2):35–40, 2004.
- [114] Zahira Z Cohen, Sharon Naparstek, and Avishai Henik. Tactile enumeration of small quantities using one hand. *Acta psychologica*, 150:26–34, 2014.
- [115] Alberto Gallace, Hong Z Tan, and Charles Spence. Can tactile stimuli be subitised? an unresolved controversy within the literature on numerosity judgments. *Perception*, 37(5):782–800, 2008.
- [116] Yitian Shao, Hui Hu, and Yon Visell. A wearable tactile sensor array for large area remote vibration sensing in the hand. *IEEE Sensors Journal*, 20(12):6612–6623, 2020.
- [117] Utilise-t-on plutôt des mots courts ou longs ? <https://zestedesavoir.com/billets/2393/utilise-t-on-plutot-des-mots-courts-ou-longs/>. Accessed 27/11/2021.

Bibliography

- [118] Ayoub Ben Dhiab. *Confinement of vibrations for localised surface haptics*. PhD thesis, Sorbonne Université Paris VI, 2022.