



HAL
open science

Life cycle inventory and environmental assessment of biobased materials

Alejandra Gomez Campos

► **To cite this version:**

Alejandra Gomez Campos. Life cycle inventory and environmental assessment of biobased materials. Material chemistry. Institut National Polytechnique de Toulouse - INPT, 2021. English. NNT : 2021INPT0087 . tel-04164770

HAL Id: tel-04164770

<https://theses.hal.science/tel-04164770v1>

Submitted on 18 Jul 2023

HAL is a multi-disciplinary open access archive for the deposit and dissemination of scientific research documents, whether they are published or not. The documents may come from teaching and research institutions in France or abroad, or from public or private research centers.

L'archive ouverte pluridisciplinaire **HAL**, est destinée au dépôt et à la diffusion de documents scientifiques de niveau recherche, publiés ou non, émanant des établissements d'enseignement et de recherche français ou étrangers, des laboratoires publics ou privés.



Université
de Toulouse

THÈSE

En vue de l'obtention du

DOCTORAT DE L'UNIVERSITÉ DE TOULOUSE

Délivré par :

Institut National Polytechnique de Toulouse (Toulouse INP)

Discipline ou spécialité :

Sciences des Agroressources

Présentée et soutenue par :

Mme ALEJANDRA GOMEZ CAMPOS

le mardi 28 septembre 2021

Titre :

Life cycle inventory and environmental assessment of biobased materials

Ecole doctorale :

Sciences de la Matière (SDM)

Unité de recherche :

Laboratoire de Chimie Agro-Industrielle (LCA)

Directeur(s) de Thèse :

MME CAROLINE SABLAYROLLES

MME CLAIRE VIALLE

Rapporteurs :

MME ANNE TREMIER, INRA RENNES

M. THIBAUT LECOMPTE, UNIVERSITE DE BRETAGNE SUD

Membre(s) du jury :

M. FRÉDÉRIC LACHAUD, ISAE-SUPAERO, Président

M. ANTOINE ROUILLY, TOULOUSE INP, Invité(e)

MME CAROLINE SABLAYROLLES, TOULOUSE INP, Membre

MME CLAIRE VIALLE, TOULOUSE INP, Invité(e)

MME JOANA BEIGBEDER, ECOLE DES MINES D'ALES, Membre

M. PIERRE OUAGNE, ECOLE NATIONALE D'INGENIEUR DE TARBES, Membre

VALORIZATION OF THE RESEARCH WORK

Published articles

Gomez-Campos, A., Vialle, C., Rouilly, A., Hamelin, L., Rogeon, A., Hardy, D., and Sablayrolles, C. (2021). Natural Fiber Polymer Composites—A game changer for the aviation sector? *Journal of Cleaner Production*, 286, 124986. <https://doi.org/10.1016/j.jclepro.2020.124986>

Gomez-Campos, A., Vialle, C., Rouilly, A., Sablayrolles, C., and Hamelin, L. (2021). Flax fiber for technical textile: A life cycle inventory. *Journal of Cleaner Production*, 281, 125177. <https://doi.org/10.1016/j.jclepro.2020.125177>

Articles waiting for submission

Gomez-Campos, A., Sablayrolles, C., Hamelin, L., Rouilly, A., Evon, P., Vialle, C. Environmental and technical performance of innovative sound absorbing panels made from sunflower straw.

Posters in international congress

RRB-15 (15th International Conference on Renewable Resources and Biorefineries) at Toulouse, France du 3 au 5 Juin 2019. *Towards lighter, bio-based materials for the aeronautics a cradle-to-gate life cycle assessment of flax fiber reinforcement in composite materials.*

Alejandra Gomez-Campos, Claire Vialle, Antoine Rouilly, Lorie Hamelin, Caroline Sablayrolles

Oral presentation in international congress

ISBBB 2018 (International Symposium on Bioplastics, Biocomposites and Biorefining) at Guelph, ON, Canada (24-27 July 2018)

Flax as an alternative fiber source in composites: an LCA uncovering aspects of circularity including the fate of co-products and their counterfactuals.

Alejandra Gomez-Campos, Claire Vialle, Antoine Rouilly, Lorie Hamelin, Caroline Sablayrolles

5th CIGR International Conference 2021 (virtual conference) held at Quebec City, QC, Canada (11-14 May 2021)

Acoustic insulation panels based on by-products derived from the cultivation of oleaginous sunflower.

Alejandra Gomez-Campos, Caroline Sablayrolles, Antoine Rouilly, Philippe Evon, Lorie Hamelin, Claire Vialle

5th CIGR International Conference 2021 (virtual conference) held at Quebec City, QC, Canada (11-14 May 2021)

Biobased materials - A promising option for reducing environmental impacts on the aviation sector?

Alejandra Gomez-Campos, Claire Vialle, Antoine Rouilly, Caroline Sablayrolles, Lorie Hamelin

TABLE OF CONTENTS

GENERAL INTRODUCTION	1
CHAPTER I. STATE OF THE ART	4
I.1. INTRODUCTION	5
I.2. BIO-BASED MATERIALS	6
I.2.1. BIOMASS AS A SOURCE OF MATERIALS	7
I.2.2. CLASSIFICATION OF MATERIALS	9
I.2.2.1. Organic materials	10
I.2.2.2. Fossil-based materials	10
I.2.2.3. Plastics	10
I.2.2.4. Bio-based materials	11
I.2.2.5. Bioplastics	11
I.2.2.6. Biocomposites	12
I.2.2.7. Agro-materials	12
I.2.3. END-OF-LIFE OF MATERIALS	12
I.2.3.1. Biodegradability	14
I.2.3.2. Compostability	15
I.2.3.3. Home-compostable	16
I.3. ENVIRONMENTAL ASSESSMENT	18
I.3.1. SUSTAINABLE DEVELOPMENT	19
I.3.2. LIFE CYCLE THINKING	20
I.3.3. ENVIRONMENTAL INDICATORS	21
I.3.4. ENVIRONMENTAL ASSESSMENT METHODS	23
I.4. THE LIFE CYCLE ASSESSMENT (LCA) METHOD	26
I.4.1. DEFINITION	26
I.4.2. METHODOLOGICAL FRAMEWORK	27
I.4.3. TWO APPROACHES FOR PERFORMING A LCA	31
I.5. LCA FOR BIO-BASED PRODUCTS	33
I.5.1. CLIMATE CHANGE MITIGATION POTENTIAL OF BIOMASS	33
I.5.2. METHODOLOGICAL CONSTRAINTS	34
I.5.2.1. Life Cycle Inventory data quality	34
I.5.2.2. End-of-life management techniques	34
I.5.2.3. Indirect Land Use Change (iLUC)	35
I.5.2.4. Carbon accounting	35
I.6. CONCLUSION & PERSPECTIVES	37
CHAPTER II. ECO-DESIGN & ENVIRONMENTAL ASSESSMENT OF AN INNOVATIVE BIOCOSPOSITE PANEL FOR AVIATION	39

II.1. INTRODUCTION	40
II.1.1. NATURAL FIBER-REINFORCED POLYMER COMPOSITES (NFPC)	40
II.1.1.1. Composite materials	41
II.1.2. FLAX FIBER AS A TECHNICAL TEXTILE	42
II.1.2.1. Agricultural phase	43
II.1.2.2. Retting	44
II.1.2.3. Scutching	44
II.1.2.4. Combing	44
II.1.2.5. Spinning & Weaving	44
II.1.3. LCA OF NFPCs AND THEIR APPLICATION IN AERONAUTICS	45
II.2. DESCRIPTION OF THE CASE STUDY	47
II.3. FLAX FIBER FOR TECHNICAL TEXTILE: A LIFE CYCLE INVENTORY	48
II.3.1. INTRODUCTION	49
II.3.2. MATERIALS AND METHODS	50
II.3.2.1. LCA approach	50
II.3.2.2. Goal	50
II.3.2.3. Functional Unit	51
II.3.2.4. Scope	51
II.3.3. LIFE CYCLE INVENTORY	51
II.3.3.1. Overview	51
II.3.3.2. System boundaries	54
II.3.3.3. Flax cultivation	54
II.3.3.4. Retting	55
II.3.3.5. Scutching	56
II.3.3.6. Combing	58
II.3.3.7. Spinning	58
II.3.3.8. Weaving	58
II.3.4. SENSITIVITY ANALYSIS	59
II.3.5. RESULTS	59
II.3.5.1. LCA Results	59
II.3.5.2. Sensitivity Analysis	63
II.3.6. DISCUSSION	64
II.3.7. CONCLUSION	67
II.4. NATURAL FIBER POLYMER COMPOSITES – A GAME CHANGER FOR THE AVIATION SECTOR?	69
II.4.1. INTRODUCTION	70
II.4.2. MATERIALS AND METHODS	71
II.4.2.1. Environmental assessment method	71
II.4.2.2. Goal and scope definition	71
II.4.3. LIFE CYCLE INVENTORY ANALYSIS	72
II.4.3.1. Raw materials	72
II.4.3.2. Production	75
II.4.3.3. Use	76
II.4.3.4. End-of-life	77
II.4.4. LIFE CYCLE IMPACT ASSESSMENT	77
II.4.5. RESULTS	78

II.4.6.	DISCUSSION	82
II.4.6.1.	From a cradle-to-grave's perspective	82
II.4.6.2.	From a cradle-to-gate's perspective	82
II.4.6.3.	A consequential approach	83
II.4.6.4.	Carbon sequestration	83
II.4.6.5.	Future work	84
II.4.7.	CONCLUSION	84
II.5.	CONCLUSION & PERSPECTIVES	86
II.6.	ADDENDUMS	87
II.6.1.	ADDENDUM 1 – FLAX FIBER FOR TECHNICAL TEXTILE: A LIFE CYCLE INVENTORY	87
II.6.2.	ADDENDUM 2 – NATURAL FIBER POLYMER COMPOSITES – A GAME CHANGER FOR THE AVIATION SECTOR?	90
CHAPTER III. PRODUCTION & ENVIRONMENTAL ASSESSMENT OF AN AGRO-MATERIAL AS A SOUND-ABSORBING PANEL		88
III.1.	INTRODUCTION	89
III.2.	DESCRIPTION OF THE CASE STUDY	92
III.3.	PRODUCTION OF SUNFLOWER PITH PANELS	93
III.3.1.	SUNFLOWER PITH PRODUCTION	93
III.3.2.	PRODUCTION OF THE SOUND-ABSORPTION SUNFLOWER BASED PANELS	97
III.4.	EVALUATION OF ACOUSTIC PROPERTIES	101
III.4.1.	ACOUSTIC PROPERTIES MEASUREMENTS	101
III.4.2.	RESULTS	102
III.4.3.	INCORPORATION TO THE LIFE CYCLE ASSESSMENT	105
III.5.	MODELLING OF SOIL ORGANIC CARBON DYNAMICS	106
III.5.1.	C-TOOL PRESENTATION	106
III.5.2.	INPUTS FOR THE C-TOOL SIMULATION	107
III.5.2.1.	Mean monthly temperatures	107
III.5.2.2.	Soil initial conditions	107
III.5.2.3.	Carbon input in the form of biomass	108
III.5.3.	RESULTS OF SOIL ORGANIC CARBON DYNAMICS	111
III.5.4.	INCORPORATION TO THE LIFE CYCLE ASSESSMENT	113
III.6.	LIFE CYCLE ASSESSMENT	114
III.6.1.	MATERIALS AND METHODS	114
III.6.2.	RESULTS & DISCUSSION	116
III.6.2.1.	Life Cycle Assessment of the sunflower acoustic panels	116
III.6.2.2.	Sensitivity analysis - Impact of the valorization of bark	118
III.6.2.3.	Sensitivity analysis - Impact of the evaluation method	119
III.6.2.4.	Optimization of the harvesting process	121
III.7.	LIMITATIONS & PERSPECTIVES	123

III.8. CONCLUSION	124
GENERAL CONCLUSION	130
BIBLIOGRAPHY	137
ANNEXES	151
VI.1. ANNEXES CHAPTER II	151
VI.1.1. SI – FLAX FIBER FOR TECHNICAL TEXTILE: A LIFE CYCLE INVENTORY	151
VI.1.2. SI – NFPCS: A GAME CHANGER FOR THE AVIATION SECTOR?	157
VI.2. ANNEXES CHAPTER III	160
VI.2.1. AGRICULTURAL OPERATION	160
VI.2.2. SUNFLOWER PITH PRODUCTION	162
VI.2.3. PANELS PRODUCTION AND EOL	164
VI.2.4. ACOUSTIC TESTS RESULTS	165
VI.2.5. SOUND ABSORPTION COEFFICIENT VALUES (EXTENDED)	165
VI.2.1. SOUND ABSORPTION COEFFICIENT VALUES (CONDENSED)	169
VI.2.2. C-TOOL INPUT VALUES	170
VI.2.3. LCA MODELING	171
EXTENDED SUMMARY (IN FRENCH)	173

LIST OF FIGURES

FIGURE I-1. WORLD OIL RESERVES AND CONSUMPTION IN 2016 (BP GLOBAL 2017).....	7
FIGURE I-2. NUMBER OF PUBLICATIONS CONTAINING THE WORDS BIOFUELS, BIOPLASTICS AND BIO-BASED MATERIALS.....	9
FIGURE I-3. ORGANIC MATERIALS CLASSIFICATION GIVEN ITS PROPERTIES AND OBTAINMENT METHOD.	10
FIGURE I-4. ESTIMATED GROWTH OF THE GLOBAL PRODUCTION CAPACITIES OF BIOPLASTICS.	18
FIGURE I-5. GRAPHIC REPRESENTATION OF SUSTAINABLE DEVELOPMENT. INSPIRED FROM (MANCEBO, 2010).....	20
FIGURE I-6. DEVELOPMENT FROM A STRONG SUSTAINABILITY POINT OF VIEW*	20
FIGURE I-7. GENERAL VIEW OF A PRODUCT'S (OR SERVICE) LIFE CYCLE FROM "CRADLE TO GRAVE". IMAGE INSPIRED BY (ASHBY, 2013).	21
FIGURE I-8. THE DPSIR FRAMEWORK FOR REPORTING ON ENVIRONMENTAL ISSUES (EEA, 1999).	22
FIGURE I-9. ENVIRONMENTAL ASSESSMENT METHODS SCOPE'S GRAPHICAL VIEW AND EXAMPLES.....	25
FIGURE I-10. LIFE CYCLE POSSIBLE SYSTEM APPROACHES.	27
FIGURE I-11. STAGES OF A LIFE CYCLE ASSESSMENT FOLLOWING ISO 14040 GUIDELINES.	28
FIGURE I-12. GENERAL VIEW OF A LIFE CYCLE'S INVENTORY PHASE.....	29
FIGURE I-13. REPRESENTATION OF THE ILCD 2011 MIDPOINT+ EVALUATION METHOD	30
FIGURE II-1. MAP OF FLAX FIBER PRODUCTION AND TRANSFORMATION INSTALLED CAPACITIES. IMAGE FROM (C.E.L.C. 2019A).....	42
FIGURE II-2. PROCESS TREE INCLUDING INPUT AND OUTPUT FLOWS AND THE FATE OF CO-PRODUCTS.....	52
FIGURE II-3. PROCESS FLOW DIAGRAM ILLUSTRATING THE FATE OF THE CO-PRODUCTS FROM THE PRODUCTION OF A FLAX FIBER TECHNICAL TEXTILE. BOXES REPRESENT INDUCED PROCESSES WHILE DOTTED LINES REPRESENT AVOIDED PROCESSES.	54
FIGURE II-4. PROCESSES CONTRIBUTION TO GENERATED (POSITIVE VALUES) AND AVOIDED (NEGATIVE VALUES) ENVIRONMENTAL IMPACTS IN THE PRODUCTION OF A FLAX FIBER TECHNICAL TEXTILE FROM 1 HA OF CULTIVATED LAND	59
FIGURE II-5. FLAX CULTIVATION - INDIVIDUAL ANALYSIS OF THE MAIN INDUCED AND AVOIDED ENVIRONMENTAL IMPACTS AND THE SUBSTANCES RESPONSIBLE.....	60
FIGURE II-6. ILUC - INDIVIDUAL ANALYSIS OF THE MAIN ENVIRONMENTAL IMPACTS AND THE SUBSTANCES RESPONSIBLE.....	61
FIGURE II-7. SPINNING - INDIVIDUAL ANALYSIS OF THE MAIN INDUCED ENVIRONMENTAL IMPACTS AND THE SUBSTANCES RESPONSIBLE	61
FIGURE II-8. WEAVING - INDIVIDUAL ANALYSIS OF THE MAIN ENVIRONMENTAL IMPACTS AND THE SUBSTANCES RESPONSIBLE	61
FIGURE II-9. AVOIDED PRODUCTION OF GLASS FIBER - INDIVIDUAL ANALYSIS OF THE MAIN AVOIDED ENVIRONMENTAL IMPACTS AND THE SUBSTANCES RESPONSIBLE	62
FIGURE II-10. AVOIDED HEAT PRODUCTION FROM NATURAL GAS - INDIVIDUAL ANALYSIS OF THE MAIN AVOIDED ENVIRONMENTAL IMPACT AND THE SUBSTANCES RESPONSIBLE.....	62
FIGURE II-11. AVOIDED ANIMAL FEED PRODUCTION - INDIVIDUAL ANALYSIS OF THE MAIN AVOIDED ENVIRONMENTAL IMPACT AND THE SUBSTANCES RESPONSIBLE.....	62
FIGURE II-12. SENSITIVITY ANALYSIS FOR PRODUCTION CONSIDERING DIFFERENT ELECTRICITY MIXES.....	64
FIGURE II-13. OMEGA CORE SANDWICH PANEL STRUCTURE. IMAGE FROM CORDIS WEBSITE (EC 2018c).	71
FIGURE II-14. BIOCOMPOSITE PANEL MANUFACTURING PROCESS.....	75
FIGURE II-15. CONVENTIONAL PANEL MANUFACTURING PROCESS	75
FIGURE II-16. REPRESENTATION OF THE ILCD 2011 MIDPOINT+ EVALUATION METHOD	78
FIGURE II-17. COMPARISON OF THE ENVIRONMENTAL PERFORMANCE OF A BIOCOMPOSITE AND A CONVENTIONAL PANEL FROM A CRADLE-TO-GRAVE PERSPECTIVE	79
FIGURE II-18. CONTRIBUTION OF THE RAW MATERIALS TO THE POTENTIAL ENVIRONMENTAL IMPACT OF THE BIOCOMPOSITE PANEL .	80
FIGURE II-19. CONTRIBUTION OF THE RAW MATERIALS TO THE POTENTIAL ENVIRONMENTAL IMPACT OF THE CONVENTIONAL PANEL	80
FIGURE II-20. COMPARISON OF THE ENVIRONMENTAL PERFORMANCE OF A BIOCOMPOSITE AND A CONVENTIONAL PANEL FROM A CRADLE-TO-GATE PERSPECTIVE	80
FIGURE II-21. LCA RESULTS OF A FLAX FIBER TECHNICAL TEXTILE INCLUDING IMPACT CATEGORIES OF LAND-USE, TOXICITY, ECOTOXICITY, AND WATER CONSUMPTION	87
FIGURE II-22. NORMALIZED RESULTS OF THE ENVIRONMENTAL PERFORMANCE OF A FLAX FIBER TECHNICAL TEXTILE.....	88
FIGURE II-23. LCA RESULTS OF A FLAX FIBER TECHNICAL TEXTILE USING THE ReCiPe 2016 MIDPOINT (H) ENVIRONMENTAL ASSESSMENT METHOD	89
FIGURE II-24. ANALYSIS OF THE RAW MATERIALS STAGE OF THE BIOCOMPOSITE PANEL, INCLUDING THE IMPACT CATEGORIES OF LAND- USE, TOXICITY, ECOTOXICITY, AND WATER CONSUMPTION.....	90

FIGURE II-25. LCA RESULTS OF THE RAW MATERIALS STAGE OF A BIOCOMPOSITE PANEL USING THE ReCiPe 2016 Midpoint (H) ENVIRONMENTAL ASSESSMENT METHOD	91
FIGURE III-1. SUNFLOWER PRODUCTION IN FRANCE (SOURCE: AGRESTE – SSP). IMAGE FROM (TERRES OLÉOPro, 2016)	89
FIGURE III-2. PARTS OF A SUNFLOWER	89
FIGURE III-3. FORAGE HARVESTER USED FOR HARVESTING THE SUNFLOWER STEMS	93
FIGURE III-4. HARVESTED STEMS AS STORED	93
FIGURE III-5. HAMER MILL USED FOR THE CRUSHING OF THE SUNFLOWER STEMS.....	94
FIGURE III-6. CRUSHED STEMS AFTER PASSAGE BY THE HAMMER MILL	94
FIGURE III-7. SIEVE AND ASPIRATION SYSTEM USED IN THE SEPARATION PROCESS	95
FIGURE III-8. BARK AFTER SIEVING	95
FIGURE III-9. PITH RECOVERED AFTER SIEVING	95
FIGURE III-10. CONVEYOR BELT AND ASPIRATION SYSTEM PUT TOGETHER FOR THE PURIFICATION PROCESS.....	96
FIGURE III-11. PURIFIED PITH.....	96
FIGURE III-12. BARK RECOVERED AFTER THE PURIFICATION PROCESS.....	96
FIGURE III-13. MOLD USED FOR THE PRODUCTION OF THE ACOUSTIC PANELS	97
FIGURE III-14. HEAT PRESS USED FOR THE PRODUCTION OF THE WATER VAPOR ACOUSTIC PANEL.....	97
FIGURE III-15. WALLPAPER GLUE USED AND PRODUCTION PROCESS OF A STARCH SUNFLOWER INSULATING PANEL	98
FIGURE III-16. CHITOSAN USED AND PRODUCTION PROCESS OF A CHITOSAN SUNFLOWER INSULATING PANEL	98
FIGURE III-17. PROTEIN ISOLATE USED AND PRODUCTION PROCESS OF A PROTEIN ISOLATE SUNFLOWER INSULATING PANEL.....	99
FIGURE III-18. PRODUCTION PROCESS OF A WATER VAPOR SUNFLOWER INSULATING PANEL	100
FIGURE III-19. INSULATING PANELS IN THE OVEN FOR DRYING.....	100
FIGURE III-20. FINISHED PRODUCTS AS STOCKED IN THE CONTROLLED TEMPERATURE AND HUMIDITY CHAMBER. S = STARCH; IP1 = PROTEIN ISOLATE FIRST BATCH; CH = CHITOSAN; IP2 = PROTEIN ISOLATE SECOND BATCH; VdE = WATER VAPOR.	100
FIGURE III-21. PLANE-WAVE ABSORPTION COEFFICIENT (45 MM DIAMETER), SUNFLOWER STARCH FORMULATION (TH. 50 MM) ..	102
FIGURE III-22. PLANE-WAVE ABSORPTION COEFFICIENT (45 MM DIAMETER), SUNFLOWER CHITOSAN FORMULATION (TH. 50 MM) 103	103
FIGURE III-23. PLANE-WAVE ABSORPTION COEFFICIENT (45 MM DIAMETER), CORK (TH. 50 MM)	103
FIGURE III-24. PLANE-WAVE ABSORPTION COEFFICIENT (45 MM DIAMETER), MELAMINE FOAM (TH. 14 MM).....	104
FIGURE III-25. SOUND ABSORPTION COEFFICIENTS AT DIFFERENT FREQUENCIES	105
FIGURE III-26. STRUCTURE OF THE C-TOOL MODEL. IMAGE TAKEN FROM TAGHIZADEH-TOOSI ET AL. (2014)	107
FIGURE III-27. CARBON CONTENT OF FRENCH SOILS (INRAE 2020b).	108
FIGURE III-28. CLAY CONTENT IN THE CAMARGUE AGRICULTURAL REGION (INRAE 2020a). VALUES ARE EXPRESSED IN G/KG.	108
FIGURE III-29. IDENTIFICATION OF THE ABOVE AND BELOW GROUND COMPONENTS OF SUNFLOWER AND THE CUT POINTS FOR HARVESTING.	109
FIGURE III-30. CARBON DYNAMICS IN SUNFLOWER FIELD ON A 100-YEAR TIME PERIOD.....	111
FIGURE III-31. CARBON DYNAMICS IN SUNFLOWER FIELD ON A 20-YEAR PERIOD	111
FIGURE III-32. CO ₂ EMISSIONS FROM A SUNFLOWER FIELD IN A 100-YEAR TIME PERIOD.....	112
FIGURE III-33. CO ₂ EMISSIONS FROM A SUNFLOWER FIELD IN A 3-YEAR TIME PERIOD.....	113
FIGURE III-34. PROCESS FLOW DIAGRAM AND SYSTEM BOUNDARY CONSIDERED FOR THE PRODUCTION OF A SUNFLOWER PITH SOUND ABSORPTION PANEL. DOTTED LINES REPRESENT AVOIDED PROCESSES.	114
FIGURE III-35. PROCESS BREAKDOWN OF THE ENVIRONMENTAL PERFORMANCE OF THE STARCH-BASED SUNFLOWER PITH PANEL (EF LCIA METHOD); MF: MELAMINE FOAM.....	117
FIGURE III-36. PROCESS BREAKDOWN OF THE ENVIRONMENTAL PERFORMANCE OF THE CHITOSAN-BASED SUNFLOWER PITH PANEL.118	118
FIGURE III-37. ENVIRONMENTAL PERFORMANCE OF SUNFLOWER PITH SOUND-ABSORBING PANELS CONSIDERING BARK VALORIZATION AS PARTICLEBOARD (EF LCIA METHOD); S: STARCH; CH: CHITOSAN; -BARK VAL: WITH VALORIZATION OF THE BARK AS PARTICLE BOARD	119
FIGURE III-38. SENSITIVITY ANALYSIS OF THE IMPACT ASSESSMENT METHOD FOR THE STARCH-BASED SUNFLOWER PANEL	120
FIGURE III-39. SENSITIVITY ANALYSIS OF THE IMPACT ASSESSMENT METHOD FOR THE CHITOSAN-BASED SUNFLOWER PANEL.....	121
FIGURE IV-1. GRAPHICAL ABSTRACT DESCRIBING THE LCA OF A FLAX FIBER TECHNICAL TEXTILE. IMAGE FROM (GOMEZ-CAMPOS ET AL., 2021)	132
FIGURE IV-2. GRAPHICAL ABSTRACT DESCRIBING THE WORK ON THE LCA OF A BIOCOMPOSITE SANDWICH PANEL WITH AN APPLICATION IN THE AVIATION SECTOR. IMAGE FROM (GOMEZ-CAMPOS ET AL., 2021)	133
FIGURE IV-3. PROCESS FOR THE EXTRACTION OF SUNFLOWER PITH.	134

LIST OF TABLES

TABLE I-1. REFERENCE STANDARDS FOR DEFINING BIODEGRADABLE, COMPOSTABLE AND HOME-COMPOSTABLE.	14
TABLE I-2. PARAMETERS FOR VALIDATING BIODEGRADABILITY ACCORDING TO STANDARD EN 13432.	15
TABLE I-3. MAXIMUM ELEMENT CONTENT FOR DECLARING COMPOSTABLE AS STATED IN EN 13432.....	16
TABLE I-4. CONDITIONS FOR DECLARING COMPOSTABLE FOLLOWING STANDARD EN 13432.	16
TABLE I-5. CONDITIONS FOR DECLARING HOME-COMPOSTABLE FOLLOWING STANDARD NF T51-800.	17
TABLE I-6. TYPOLOGY OF INDICATOR ACCORDING TO THE EEA (1999).	22
TABLE I-7. INDICATORS USED WITHIN THE DPSIR FRAMEWORK (EEA, 1999).	23
TABLE I-8. ENVIRONMENTAL ASSESSMENT METHODS (GENERIC VS SPECIFIC).....	24
TABLE I-9. LIST OF ISO STANDARDS IN RELATION TO LIFE CYCLE ASSESSMENT.	27
TABLE I-10. DIFFERENT APPROACHES DEVELOPED FOR CARBON ACCOUNTING IN BIO-BASED PRODUCTS	36
TABLE II-1. VALUES OF INPUT AND OUTPUT FLOWS FROM THE TECHNICAL TEXTILE SUPPLY CHAIN. ALL UNITS ARE PER HECTARE OF CULTIVATED LAND PER YEAR.	53
TABLE II-2. MARGINAL ELECTRICITY MIX FOR FRANCE AND CHINA (SOURCE: ECOINVENT V3.4 PROCESSES)	59
TABLE II-3. RESULTS OF THE ENVIRONMENTAL IMPACT OF PRODUCING FLAX FIBER TECHNICAL TEXTILE ISSUED FROM ONE HA OF CULTIVATED LAND.....	60
TABLE II-4. MATERIAL COMPOSITION OF 1 M ² OF AIRCRAFT PANEL.....	72
TABLE II-5. LCI DATA FOR THE RAW MATERIALS LIFE CYCLE STAGE	74
TABLE II-6. MANUFACTURING PROCESS OF 1M ² OF THE BIOCOMPOSITE PANEL	75
TABLE II-7. LCI DATA FOR THE PRODUCTION LIFE CYCLE STAGE	76
TABLE II-8. AIRCRAFT SPECIFICATIONS CONSIDERED IN THIS STUDY.....	76
TABLE II-9. CONTRIBUTION OF EACH LIFE CYCLE STAGE OF BOTH PANELS TO THE ENVIRONMENTAL IMPACT CATEGORIES. RM: RAW MATERIALS; P: PRODUCTION; U: USE; EOL: END-OF-LIFE; REN. : RENEWABLE. N: NEGLIGIBLE.	78
TABLE II-10. CONTRIBUTION OF EACH LIFE CYCLE STAGE (IN %) OF BOTH PANELS TO THE ENVIRONMENTAL IMPACT CATEGORIES FROM A CRADLE-TO-GATE PERSPECTIVE. RM: RAW MATERIALS; P: PRODUCTION; REN. : RENEWABLE.	79
TABLE II-11. BIOCOMPOSITE PANEL'S ENVIRONMENTAL PERFORMANCE RELATIVE TO THE CONVENTIONAL PANEL, CRADLE-TO-GATE.	81
TABLE III-1. STATE-OF-THE-ART FOR THE VALORIZATION OF SUNFLOWER STALKS.....	90
TABLE III-2. STATE-OF-THE-ART FOR THE VALORIZATION OF SUNFLOWER HEADS	91
TABLE III-3. PRODUCTION OF 1 KG PURIFIED SUNFLOWER PITH: PROCESS STAGES AND MASS BALANCE.....	96
TABLE III-4. FORMULATION FOR THE PRODUCTION OF A PANEL MADE FROM 1 KG OF SUNFLOWER PITH, FROM PURIFIED PITH UP TO THE MOLDING STAGE.....	101
TABLE III-9. CALCULATED MEAN ABSORPTION COEFFICIENTS FOR THE DIFFERENT PANELS	105
TABLE III-10. PANELS CHARACTERISTICS AND AMOUNT IN KG OF PANEL REQUIRED TO PROVIDE 1 M ² SABIN OF SOUND ABSORPTION FOR ALL AND LOW FREQUENCY RANGES.....	106
TABLE III-5. MEAN TEMPERATURES REPRESENTATIVE OF ARLES AND THE CAMARGUE REGION.....	107
TABLE III-6. MEAN VALUES FOR THE COMPOSITION IN DRY MATTER (DM) OF THE SUNFLOWER PLANT (EVON 2008).....	109
TABLE III-7. SCENARIOS IDENTIFIED FOR THE QUANTIFICATION OF C INPUT FROM BIOMASS.	109
TABLE III-8. C INPUT VALUES USED IN C-TOOL	110
TABLE III-11. VALUES OF CARBON IN SOIL FOR YEARS 0 & 19 AND DELTA C.....	113
TABLE III-12. CREATED PROCESSES AND THEIR VALUES FOR CO ₂ EMISSIONS FROM THE FIELD.....	113
TABLE III-13. RESULTS OF THE ENVIRONMENTAL PERFORMANCE OF SUNFLOWER PANELS, IN ABSOLUTE VALUES.....	118
TABLE III-14. SENSITIVITY ANALYSIS RESULTS FOR THE OPTIMIZATION OF THE HARVESTING OPERATION CONSIDERING A NET REDUCTION OF DIESEL CONSUMPTION BY 10%, 25%, 50%, 75%, AND 100%, FOR THE STARCH-BASED SUNFLOWER PANEL.....	122
TABLE III-15. SENSITIVITY ANALYSIS RESULTS FOR THE OPTIMIZATION OF THE HARVESTING OPERATION AND CONSIDERING A REDUCTION OF DIESEL CONSUMPTION BY 10%, 25%, 50%, 75%, AND 100% FOR THE CHITOSAN-BASED SUNFLOWER PANEL	122
TABLE VI-1. PROPORTION OF THE COMPONENTS PER M ² OF CONVENTIONAL PANEL (INSPIRED FROM VIDAL ET AL., 2018).....	157

ABBREVIATIONS

Bio-PE	–	Biopolyethylene
CTP	–	Climate Tipping Point
dLUC	–	Direct Land Use Change
EOL	–	End of Life
GHG	–	Green House Gases
GWP	–	Global Warming Potential
iLUC	–	Indirect Land Use Change
LCA	–	Life Cycle Assessment
LCI	–	Life Cycle Inventory
LUC	–	Land Use Change
NFPCs	–	Natural Fiber-Reinforced Polymer Composites
PBS	–	Polybutylene succinate
PCL	–	Polycaprolactone
PE	–	Polyethylene
PET	–	Polyethylene-terephthalate
PHA	–	Polyhydroxyalkanoates
PLA	–	Polyactic acid
PP	–	Polypropylene
PS	–	Polystyrene
PVC	–	Polyvinyl chloride

GENERAL INTRODUCTION

General Introduction

Human activities and industrialization practices have modified the way societies interact with their surroundings, in particular with their natural resources. Consequently, negative impacts are visible in the form of air, soil, and water pollution, resource depletion, and ozone layer destruction, among others; all contributing to accelerating the effects of climate change.

To this day, as the industrial sector attempts to fulfill an ever-growing demand for products and services, the pressure exerted on natural resources intensifies. In the search of relieving some of this pressure and slowing down climate change, countries and scientists have engaged in discussions to develop projects, methods, and procedures that would allow for better decision-making practices that integrate an environmental approach.

As a result, through policies such as the Biomass Action Plan and the Renewable Energy and Fuel Quality Directives, the European Commission promotes and encourages the transition from a fossil-based to a bio-based economy (bioeconomy).

The European Commission defines a bioeconomy as an economic system that “uses renewable biological resources from land and sea, such as crops, forests, fish, animals, and micro-organisms, to produce food, materials and energy” (EU, 2020), and considers it a strong contributor to the development of a circular, low-carbon economy. Moreover, the implementation of a bioeconomy would favor the creation of greener industrial processes and has been estimated to have a climate change mitigation potential of 2.5 billion tonnes of CO₂ equivalent per year (by 2030) (EBCD, 2015).

Biomass large availability has already made it a target resource for turning production and consumption habits towards a bioeconomy system. Specifically, biomass has been used as a source of energy (i.e., biofuels) and materials through the production of bio-based materials. Out of the two, the valorization of biomass as bio-based products, contributes to the delay of carbon emissions by keeping it in the technosphere for as long as the lifespan of the products allows.

However, bio-based products have long been restrained to the substitution of existing materials (i.e., plastics) for applications with a short lifespan or to give products with an otherwise low environmental performance, a greener aspect. Furthermore, there is still not complete clarity on the amount of biomass a product should contain to be considered as a bio-based material, and regulation is still vague in this matter. Hence, their environmental advantages can greatly vary from one product to another, as well as the approaches taken on the management of their end-of-life.

Nonetheless, in order to boost a bioeconomy, bio-based materials must become full-fledged, well-identified materials that actually contribute to a better management of natural resources and the deployment of sustainable consumption practices. Among bio-based products, many subdivisions (i.e., biomaterials, bioplastics, biocomposites, etc.) co-exist and should be clearly defined. One specific category can be highlighted, agro-materials. They represent products made 100% of biological molecules (biopolymers), and that maintain their natural chemical structure throughout their whole life cycle. This kind of products are, therefore, inherently biodegradable but might, in some cases, lack the performance properties of their fossil-based counterparts.

As the European Union targets to become climate neutral by the year 2050, not only the deployment of a bioeconomy is necessary, but also a strong decision-making strategy to invest in the right environmentally friendly technologies.

In this perspective, the environmental assessment of bio-based products is essential to validate the overall impression that they are more environmentally friendly than their synthetic, mineral, or even massive counterparts (in the case of wood). Assessing the environmental impacts of bio-based products through a Life Cycle perspective is particularly relevant as environmental burdens may shift from one environmental impact category to another. However, the evaluation of the environmental performance of bio-based materials raises several methodological challenges yet to be overcome.

The description of the work carried out, begins with a bibliographic review presented in Chapter I. In said chapter, a thorough description of the classification of materials is presented in the aim of clarifying the definition of bio-based materials and their properties. Moreover, the concepts of sustainability, environmental assessment, and Life Cycle Thinking are detailed. Finally, the Life Cycle Assessment methodology is described, as well as the specifics that apply for the evaluation of the environmental performance of bio-based products, and the methodological constraints linked to it.

Moving forward, in Chapter II, a first case study is presented and the LCA of a bio-based composite sandwich panel with an application in the aviation sector is carried out. Through this case study, the impact of using flax fiber as feedstock is evaluated and the first scientific question is addressed by considering the diversion from a textile to an industrial material application. By following a consequential approach, the effects of land use change and the potential valorization of co-products in the environmental performance of the final product, were addressed.

Next, in Chapter III, the work carried out in the frame of a second case study is described. In this chapter, the specific end-of-life of agro-materials (natural recycling) and their carbon storage potential is highlighted by carrying out an LCA of a sunflower-based sound-absorbing panel with an application in the building sector.

Finally, the main findings along with prospects for the work herein presented are summarized in the form of a general conclusion.

CHAPTER I

STATE OF THE ART

CHAPTER I. STATE OF THE ART

This first chapter is a bibliographic review of the different terms and concepts used throughout the thesis work. Firstly, an introduction to the chapter is presented, followed by a description of the characteristics of the materials addressed by this work, where efforts focused on procuring a clear classification system regarding the origin and end-of-life of the different materials.

Moving forward, the concepts of sustainability, and life cycle thinking are presented; followed by a description of environmental indicators and the different environmental assessment methods available for evaluating the environmental performance of a product.

Afterwards, the Life Cycle Assessment (LCA) method is presented. This section includes a definition of the method, the methodological framework it follows and two different approaches that can be taken for performing an LCA.

Next, the particularities and methodological constraints of the LCA method applied for bio-based products is explored. Topics such as climate change mitigation potential; land use change, and carbon accounting, are discussed.

Chapter I closes with a conclusion summing up the main concepts discussed throughout it.

I.1. Introduction

The impact of human activities on the environment has long been rippling a series of discussions among countries and scientists concerning the development of methods and tools for a better assessment of possible consequences and how to prevent them. From this need, different concepts, methods and procedures have been developed in the search of better decision-making practices that integrate an environmental approach.

Additionally, securing resource availability is a main axe on the *sustainable* line of thought as development should be able to “meet the needs of the present without compromising the ability of future generations to meet their own needs” (WCED 1987). Furthermore, the sustainability concept exposes the need for economic, social and environmental aspects to entwine; making them dependable on one another. From this dependency, two concepts are distinguished as *weak* and *strong* sustainability; both recognize a human (economic and social) and a natural (environment) capital and consider them to be complementary with one another. The distinction between both concepts is that weak sustainability considers the different capitals to be substitutable and allows the detriment of one in benefit of the others. Contrary to this, strong sustainability ensures that capitals are indeed complementary but in no way interchangeable.

Materials being the elementary components of every final product, they play crucial role for assessing the environmental impact of a product or system. Their extraction for industrial purposes induces a depletion of natural resources that will perforce have to be managed in a sustainable way to avoid scarcity and the environmental negative impacts related to it. Moreover, the tardy degradation rate of most of the more frequently used materials (i.e., plastics) has led to waste accumulation and pollution problems.

It is for this reason that a focus on where materials come from and how products are disposed of has become a big part of environmental assessment practices. This emphasis on, not only the impact of the manufacturing phase of a product, but also on the beginning and the end of its useful life has propitiated a concept known as Life Cycle Thinking.

1.2. Bio-based Materials

First materials distinction to be made is concerning the chemical composition of the materials into organic and inorganic. The interest of this report concerns the first ones, those which structures contain carbon, nitrogen, hydrogen and oxygen.

Furthermore, materials can be distinguished as natural or synthetic, their procurement methods being by biosynthesis or chemical synthesis, respectively. The first one refers to compounds and chemical structures naturally present in nature as a result of the metabolic processes of living organisms. Meanwhile, the second one corresponds to compounds or structures chemically produced by man.

These characteristics can be attributed to pretty much every material disregarding their origin, use or the way they are disposed of. It is the amplest distinction we can make, and it is important to keep in mind that a natural structure can be chemically modified into a synthetic one and vice versa, a synthetic one could be designed to exactly mimic natural structures. This distinction is of particular interest in this study as the chemical structure of a material used for product manufacture will have important repercussions on the waste treatment techniques used in the end of its useful life.

Narrowing the more general categories discussed above, organic materials can have either a biomass or a fossil origin and this characteristic distinguishes them as bio-based or fossil-based, respectively. Both type of materials have a biomass origin, but fossil raw materials result from biomass degradation on a time scale that is too long for them to be considered as renewable.

This origin should not be confused with the before mentioned procurement methods as a natural structure could be reproduced by chemical synthesis methods, if the resulting “natural structure” is then used as a material in manufacturing, the final product would be considered as bio-based but having chemical synthesis as a procurement method. The reverse case becomes less probable as it would need for living organisms to metabolize chemical no-natural structures and converting them into biomolecules. This could be possible but would require the use of genetically modified organisms (GMO) for living organisms to be able to perform such a task.

First materials available to mankind where those procured directly by nature and since the earliest beginnings of human history, they have enabled the development of civilizations as they were a source of everyday tools, shelter and weapons (Ashby 2013). As natural materials are mainly composed of biopolymers, carbohydrates, proteins, and some other components constituted the basis of human tools. However, as civilizations developed, given the increasing need for resources and the rapid development of technologies, plastic became the to-go choice for the manufacturing of a wide variety of products. Historical conditions as well as technological advances during the 20th and 21st centuries have been the cause for the swift rise of synthetic polymers; so much that this period might as well be known as the plastic era (Marais 2005).

Plastic production is comparable with that of steel and might have even already surpassed it. Considering that consumption is thought to fourfold by the end of this century, energy supply and other applications given to crude oil might be jeopardized. It is then possible to expect that crude oil prices would rise, creating a market change that would affect society in more than one of its basic needs (Philp et al. 2013a).

On the other hand, economies are largely influenced by fossil resources. Crude oil reserves are not distributed equally among countries and neither are the world’s oil consumption habits (Figure I-1); this situation creates a gap that might cause for some countries to have, at some extent, a higher

economic and political power. In order to avoid this from happening, a de-centralized system of resourcing where petrol doesn't monopolize the market is visibly necessary; meaning that alternative sources of energy and materials should be encouraged in order to switch off from a fossil-based economy.

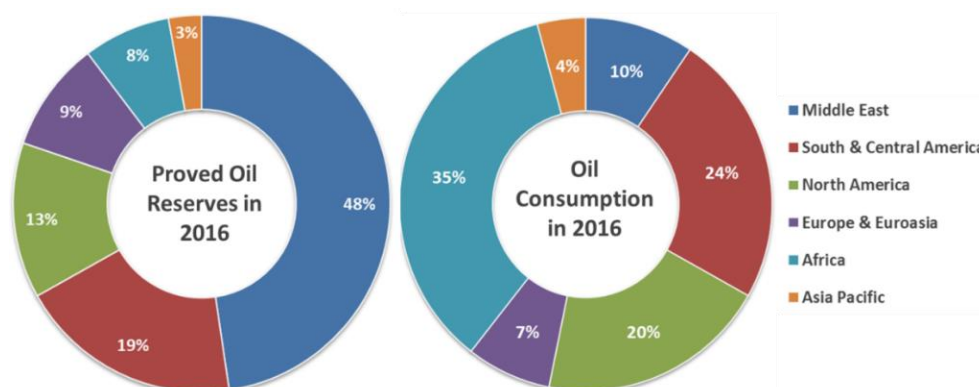

Figure I-1. World Oil Reserves and Consumption in 2016 (BP Global 2017).

Although plastic production represents only about 4% of the total oil consumption, the latter remains its main source of raw material, which makes the process dependent on oil availability and prices. Considering that plastic use does not seem to decrease, the expectancy of higher oil prices and volatile oil supply becomes a concerning threat to society's current lifestyle (Philp et al. 2013b).

For these reasons, bio-based plastics represent an alternative form of plastic and they englobe a very ample category of materials with properties said to be less harmful for the environment than those of their petrochemical counterparts. Research on more environmentally efficient materials has gone as far as obtaining products issued 100% from vegetal and/or animal biopolymers, respecting their original structures; that is to say, completely biosynthesized. These materials are, in this work, to be referred to as *agro-materials*. An example of a natural biopolymer valorized as a bio-based material is lignin extracted from wood, which properties are of interest in a large number of sectors (i.e. cosmetics, textiles, animal feed, agrochemicals) (Tribot et al., 2019).

Examples of bio-based and agro-materials are, however, not limited to plastics and have applications in a wide variety of sectors (i.e., buildings, transportation, leisure products, furniture, among others). Crop and wood residues represent an important source of materials available for further valorization. Straw issued from the culture of cereals and fiber crops (i.e. rice, wheat, flax, hemp, wood flour) have been subject of research for their use as insulation materials used in buildings and or as construction materials (Ahmadi et al., 2020; Heidari et al., 2019; Liu et al., 2019; Moussa et al., 2018; Rahim et al., 2016). Another commonly given application of these materials, are their use as fillers in composite materials (Di Landro & Janszen, 2014; Fernandes et al., 2004; Halvarsson et al., 2009; Yasin et al., 2018).

I.2.1. Biomass as a source of materials

Biomass large availability has made it a target resource for changing production and consumption habits. As a response to current environmental conditions (fossil resources depletion, climate change, etc.), a switch from a fossil-based economy to a bio-based one (bioeconomy) has already been promoted in European policies such as the Biomass Action Plan and the Renewable Energy and Fuel Quality Directives (Crenna et al. 2017).

Either by direct combustion processes or by its biofuel potential, biomass represents an alternate option to fossil-based energy production. Direct combustion has long been used by mankind as a source of heat and light, even before fossil fuels. However, direct use of biomass as a source of energy fails to meet the current environmental concerns. It is for this reason that special attention has been given to the production of biofuels.

Nonetheless, biofuels fail to exploit the carbon storage potential of biomass used as a source of raw material for product manufacture and are, therefore, maybe not the best approach for assessing climate change objectives such as stabilizing Green-House Gases (GHG) concentrations and the increase of global temperature values. Moreover, food-competition is a major drawback for biofuels as ensuring food availability is a more relevant concern, especially as other alternative energy sources have been already developed.

Equivalent to oil-refinery, biorefineries have been a current subject of study (Philp et al. 2013a; Fahd et al. 2012), the idea behind this being for biomass to serve as a source of energy and materials (chemicals) at the same time. Still, production costs of biofuels are not competitive with those of their fossil counterparts, which may lead to bioplastics becoming the main interest of the biorefinery system (Philp et al. 2013a). Considering that second generation biofuels (produced from crop residues/by-products) are even less competitive than first-generation ones, the previous conjecture becomes crucial for exalting food crop residues as a more effective source of materials rather than energy.

Added to this, CO₂ sequestration occurs naturally in vegetal matter by photosynthesis processes, a characteristic that allows for bio-based products to serve also as carbon storage units. This *climate mitigation potential* of bio-based products is further developed in Section I.5.1.

Altogether, the environmental qualities of biomass make it an appealing source of materials and have catapulted the research on bio-based products, as about 70% of the publications containing the words bioplastics/bio-plastics and biobased/bio-based materials have been done from the year 2012 to 2017.

However, energy security has been a more pressing issue for the last decade; and research has almost neglected the potential use of biomass as a source of materials. A quick internet search of the *Web of Science Core Collection* (through the *Web of Knowledge* website) shows that publications having *biofuels/bio-fuels* as a topic are about 10 times higher than those containing the words *bioplastics/bio-plastics* and *biobased/bio-based materials* together (Figure I-2). The latter meaning that even if a higher interest has been given to bio-based materials, there's still a large gap to be covered in order to understand biomass as a source of materials as much as of biofuels. However, a remark should be made on the fact that recently, publications on biofuels have decreased while biomass as a source of materials has gained attention and publications rising.

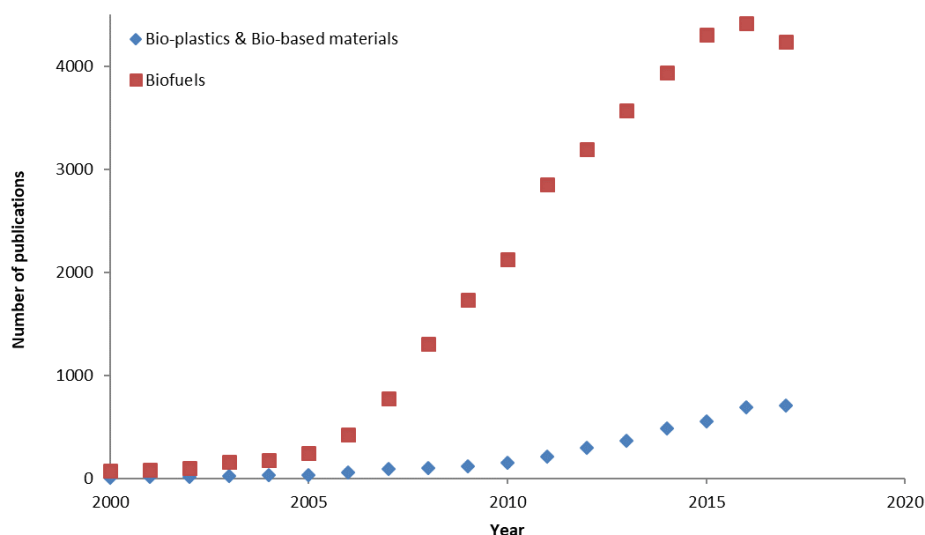

Figure I-2. Number of publications containing the words biofuels, bioplastics and bio-based materials.

On the downside, food supply and land allocation remain two big discussion topics holding back a faster development of biomass as a source of energy and materials. Nonetheless, agriculture is a source of a wide set of co-products that are usually of no specific use. By implementing sustainable practices, crop residues and side-streams of agroindustry could become products with an added value that make agricultural mitigation a cost competitive option (Smith and Olesen 2010) to assess climate change challenges. Co-products such as wheat straw, sugar beet pulp, old paper waste and coconut fiber powder, to name a few; have been researched for their contribution to the bioplastics sector (Rouilly and Rigal 2002).

The former information underscores the fact that for biomass to gain competitiveness in the market, products issued from it need to overrule petroleum-based products not only on a sustainable level but also on functionalities such as lower weight, toughness, heat and water resistance, durability, and flame retardancy (Graichen et al. 2017).

1.2.2. Classification of materials

Many definitions concerning the environmental qualities of materials are used within the scientific community and it becomes difficult to distinguish within one another and have clarity over their real meaning. As part of this study, an attempt to better define and constraint such terms will be done as established by current regulations and international standards. As a result, Figure I-3 aims to be used as a tool for understanding the relationship between the different properties that can be attributed to a material regarding their origin and end of life. Examples of materials belonging to the different categories are given in the round cases as a way of helping the reader place some of the currently commonly used materials and their classification.

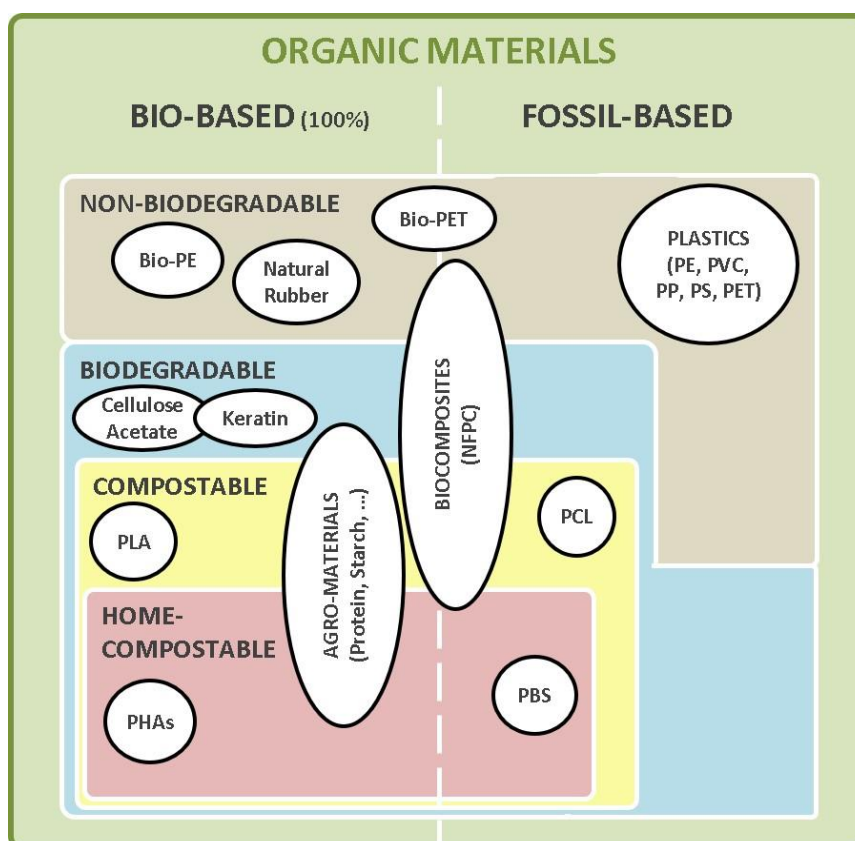

Figure I-3. Organic materials classification given its properties and obtainment method.

1.2.2.1. Organic materials

To start with, the amplest category unto which the subjects of this study fall into is that of *organic materials* as it refers to the carbon-based composition of a product, meaning that a product can have either a biomass or a petrochemical origin. They are materials in which the main component is carbon (C) but those containing nitrogen (N), oxygen (O) and hydrogen (H) can also fall into this category as well.

1.2.2.2. Fossil-based materials

Crude oil or natural gases, and the different compounds obtained from it when refined are constituted by hydrocarbon chains, which make it an organic compound. Fossil resources have been largely used for the synthesis of structures that are not naturally present in the environment; materials known as *fossil-based*. Given the availability and cost-effectiveness of the resource, it has been widely used for a broad set of applications, one of the most representatives being plastic production. Howbeit, important environmental impacts are related to it and are therefore of great concern.

1.2.2.3. Plastics

This catch-all term is herein used to define polymer-based materials shaped through heat (thermoplastic) or chemical (thermosets) processes. While biopolymers share some plastic properties, it is commonly used exclusively for synthetic polymers. The top five polymers currently used for product manufacture are Polyethylene (PE), Polyvinyl chloride (PVC), Polypropylene (PP), Polystyrene (PS) and Polyethylene-terephthalate (PET) (Ashby 2013).

The so-long praised durability and disposable nature of plastic have now become their biggest reason of rejection as they have led to concerning levels of plastic accumulation and pollution of water bodies and land. Additionally, its fossil origin makes them a target of concern when it comes to climate change given the GHG emissions related to their production.

1.2.2.4. Bio-based materials

In search of products with a lower environmental impact, bio-based materials have been developed. For a product to be considered as bio-based it must be derived from natural feedstock (biomass), either animal or vegetable. Congruently with this definition Karamanlioglu et al. (2017) describes these materials (referring to them as bioplastics or biopolymers) as polymers produced or synthesized from renewable natural sources. However, a precise figure of the biomass content that a material must have in order to be considered as bio-based remains undefined and therefore, not regulated by current standards.

The USDA has a certification program in which product categories have been accorded biomass content percentages. A product has to meet or exceed these percentages for it to be considered as bio-based (BioPreferred 2017). Therefore, the 25% proposed by the USDA for materials not belonging to a specific category could be used as a reference point for declaring a product to be bio-based or not. However, this percentage may be very low for environmental gains to be reflected on the final product.

A crucial condition of bio-based materials to be understood is that they are indeed fully or partially originated from natural sources, but their final chemical structure may not resemble the original natural one. Natural structures can be reconstructed in order to resemble petrochemical ones, once modified they will no longer have their inherent qualities but those of the new structure, both positive and negative; an example of this is bio-polyethylene (Bio-PE). Bio-PE ethylene monomer is obtained by dehydration of ethanol, itself obtained from the natural fermentation of sugar.

Bio-based materials have already been widely used in the food packaging industry, for pharmaceutical uses, and as construction materials, to cite some examples; and their applications continue to expand. The increase in interest for these materials, other than the alleged reduction of environmental impacts, can be explained by the fact that they can be sourced from processes in which they are co-products, resulting in a possible reduction of expenditure in raw materials.

1.2.2.5. Bioplastics

Given the growing concern of plastic pollution, important research on bio-based materials has been dedicated to the creation of plastics out of renewable, biomass sources, or that can be degraded by microorganisms, at the least. This kind of materials are referred to as **bioplastics** and have been continuously gaining interest from industries all over as environmental concerns become more and more relevant. Their main application concerns the packaging sector as it represented over 58% of global bioplastics production capacities in 2017 (European Bioplastics and nova-Institute 2017).

Bio-PE (for the bio-based ones), PCL or PBS (for the fossil-based), Polylactic acid (PLA), Polyhydroxyalkanoates (PHA), and Starch-based plastics are some of the currently produced bioplastics (European Bioplastics and nova-Institute 2017). Work has already been done in the assessment of their environmental impacts compared to their fossil-based counterparts (Hottle et al. 2017, 2013; Yates and Barlow 2013; Álvarez-Chávez et al. 2012) following a Life Cycle approach.

Generally speaking, a bioplastic is the same as a bio-based material but one that specifically aims to mimic plastic properties. Therefore, it shares every aspect described before for bio-based materials. This means that depending on their chemical structures a bio-based plastic can be either degradable or non-degradable, disregarding the source of its raw materials. In this category, materials containing biodegradable fossil-based polymers can also be found.

1.2.2.6. Biocomposites

Composites are multiphase materials resulting from the gathering of two or more different components. Such components are usually a fiber used as reinforcement and a polymer matrix used to bind said fibers together. Composites and their components are described in Section II.1.1.1.

Biocomposites are therefore composites in which the fibers and/or the polymer matrix are bio-based, but in most cases the term refers to composite materials reinforced by natural fibers (NFPCs). The classification of such materials should be done considering the final product, when the different components are bound together, as one they are, they are considered as a whole, different and new material.

1.2.2.7. Agro-materials

The need for finding more sustainable choices when it comes to materials has opened a path for what has been referred to as **agro-materials**. As the name states, they represent materials created from agricultural sources. Product manufacture directly from biomass constituents has been possible thanks to the research and knowledge on the structure of vegetable and animal tissues, and biopolymers (Rouilly and Rigal 2002). The term remains relatively new, and it is scarcely used as the terms *bio-sourced* or *bio-based* are preferred and used interchangeably; however, there is an underlying distinction between the concepts bio-based and agro-material. The main difference between one another relies in a notion of destruction and reconstruction of natural structures.

For a material to be bio-based the requirement is for one or more of its constituents to come from natural sources and for it to be present in a certain amount. Even if the natural polymers underwent a set of physical and chemical treatments (sometimes completely changing their original natural structure) or were combined with petrochemical polymers to achieve its final form, the material would still be considered as bio-based. Therefore, the final product might result in synthetic chemical structures that no longer make it nor biodegradable nor compostable. In this type of materials, the main interest lies in the avoidance of non-renewable resources depletion and not so much in the end of life of the final product.

Whereas the main characteristic of an agro-material is the persistence of the biopolymer natural structure as it remains unchanged from the beginning to the end of the material's life cycle (ex. Paper, wood or TPS); a characteristic that renders it to be completely and irrevocably biodegradable and compostable. The end-of-life process of such material will be the same as the one that the biomass from which is made of, would naturally have. Moreover, products coming from agro-materials are a 100% made out of biomass, which is not the case for all of the products claiming to be bio-based.

Finally, agro-materials could be considered as an extension of **biomaterials**. They are of natural structure and are compatible with the natural carbon cycle, and offer advantages such as increased soil fertility and low waste accumulation if biodegradable, which may also translate to a reduction of waste management (Tokiwa et al. 2009). However, biomaterials are still unfortunately limited to medical applications and can be of a mineral origin.

1.2.3. End-of-life of materials

The terms referred to throughout Section 1.2.2 refer to the characteristic of a material depending on their origin (organic/inorganic, bio-based/fossil-based, bioplastic or agro-material). This section aims to describe the properties of a material/final product regarding their disposal stage or end of life phase.

Different waste treatment approaches are taken based on the type of material being disposed of depending on their biologic and chemical compositions. According to Ashby (2013), waste destination can be summed up in five words: “landfill, combustion, recycling, re-engineering and reuse”. Congruently, in his work Damien (2016) describes techniques such as incineration, co-incineration, disposal/storage and recycling as waste management practices carried out today as well as which one to apply depending on the waste nature; added to this he also refers to the biological waste treatment of composting. Something compostable is inherently biodegradable but not everything biodegradable can be compostable; for this reason, this work will make a distinction between these two terms.

Biological waste treatments are among the most attractive approaches from an environmental point of view. Along with recycling, they allow reduction of waste volumes and for waste to have an added value when used as a product for other processes. A product or material can be considered as biodegradable, compostable and/or home-compostable depending on its degradation properties. As an effort to define clear guidelines that establishes these properties, standards and regulations have been made available.

Table I-1 shows the standards this work takes as reference for defining the terms biodegradable, compostable and home-compostable. Nonetheless, standards are used to define a frame in the end-of-life of man-made objects but do not really make a difference between **bio-assimilable** materials (i.e., of natural chemical structure) and potentially **bio-cumulative** substances. For example, bark and leaves containing a high level of lignin may not degrade within the time-frame limits stipulated by standards.

Table I-1. Reference standards for defining biodegradable, compostable and home-compostable.

Reference standard	Year	Name
FD CEN/TR 15351	2007	Plastics - Guide for vocabulary in the field of degradable and biodegradable polymers and plastic items.
EN 13432	2000	Requirements for packaging recoverable through composting and biodegradation - test scheme and evaluation criteria for the final acceptance of packaging.
FD CEN/TR 15822	2010	Plastics - Biodegradable plastics in or on soil - Recovery, disposal and related environmental issues
NF U52-001	2005	Biodegradable materials for use in agriculture and horticulture - Mulching products - Requirements and test methods.
NF EN 14995	2007	Plastics - Evaluation of compostability - Test scheme and specifications.
NF T51-800	2015	Plastics - Specifications for plastics suitable for home composting.

1.2.3.1. Biodegradability

Given the growing accumulation of plastic in the environment caused by its lack of assimilation by nature, efforts have been made on creating **biodegradable plastics**. For a plastic to be considered as biodegradable, macromolecules must be broken down into gases and micro-molecules that will be then assimilated by microorganisms that can be found in natural environments (Duval 2009).

French standardization FD CEN/TR 15351:2000 (Guide for vocabulary in the field of degradable and biodegradable polymers and plastic items) defines the term **biodegradation** as “*the alteration of macromolecules with chain cleavage caused by cells regardless of their type [...]. The biodegradation of a polymeric item has to be related to a measurable phenomenon. The production of CO₂ and CH₄, for anaerobic process, or the consumption of O₂ are usually considered [...]*”.

Following this description, many plastics nowadays can be considered as biodegradable even if they come from petrochemical sources, such as Polycaprolactone (PCL) and Polybutylene succinate (PBS) (Tokiwa et al. 2009), as they can be degraded by microorganisms’ activities. Nonetheless, this process may lead to a “partial degradation” where the material is only broken down into smaller pieces and, if no proof is available on whether they can effectively be degraded too, only visual pollution will be avoided but the particles persist (Duval 2009). In fact, when determining the biodegradability of a product/material absolute and relative percentages are considered valid.

For these reasons, standards have also established conditions for materials to fulfill in order to be given the quality of biodegradability. In a general manner, plastics can be qualified as biodegradable if they decompose up to 60% in six months for simple polymers or to 90% in case of more complex ones (Damien 2016). These values depend on the test conditions on the level of biodegradability expected to be attained (absolute or relative).

Table I-2 sums up the different conditions to be fulfilled by a product in order to be considered as biodegradable by standards; it should be noted that the standard taken as reference focus on packaging materials as this is the main use given to bioplastics. However, more particular cases have been regulated, such as materials used in agriculture that do not normally end up in waste treatment

facilities but remain in the crop area and are to be degraded in or on soil at regular atmospheric conditions (French Standard NF U52-001).

Table I-2. Parameters for validating biodegradability according to Standard EN 13432.

Conditions	Products	Time period	Biodegradability
Aerobic	CO ₂ , H ₂ O, mineral salts, biomass	6 months	90%
Anaerobic	CO ₂ , CH ₄ , mineral salts, biomass	2 months	>50% of theoretical value of biogas production

Moreover, materials and products can be constituted by more than one compound. For determining their biodegradability as a whole, *Significant Organic Constituents* (“any organic constituent present in more than 1% of dry weight of that material” (EN 13432 2000)) are identified and each tested for biodegradability. Materials or products where organic constituents without proven biodegradability exceed 5% will not be considered as biodegradable.

One of the main advantages of bio-based and agro-materials is their biodegradable condition. This is especially true for agro-materials given that bio-based materials are not always biodegradable. Additionally, materials of natural origin that remain chemically unmodified are accepted as biodegradable without further testing. For being declared as compostable and/or home-compostable, only chemical characterization and fulfillment of the disintegration criteria and compost quality is required (EN 13432 2000; NF T51-800 2015).

This inherent biodegradability renders agro-materials interesting from an environmental point of view but not so much from a mechanical/functional one; as biomass is sensitive to humidity, the durability of bio-based and agro-materials is weakened and so does its appeal for industrial long-lasting applications. Research efforts have been dedicated to improving the durability of this type of materials by surface treatment, formulation or modification of its internal structure (Rouilly and Rigal 2002). In example, Yan et al. (2014) discuss physical treatments of natural fibers and the effects they have on their tensile properties and Bachmann et al. (2017) make reference to the need of treating natural fibers with flame retardants for them to have a broader application in the aviation sector. As natural structures are treated and/or modified to meet industrial requirement, their biodegradable advantages might change.

1.2.3.2. Compostability

Alike bio-based and agro-material, the terms biodegradable and **compostable** are largely used interchangeably in scientific literature. Both are systematically referred to as processes where matter is degraded by the action of enzymes produced by microorganisms such as bacteria, fungi and algae (Karamanlioglu et al. 2017; Gross and Kalra 2002; Harding et al. 2017a), without making a clear distinction between the two of them.

Yadav et al. (2017) define composting as a “microbiological process that transforms various organic wastes into bio-fertilizers and soil conditioners”. Additionally, for a product to be considered as compostable, its eco-toxicity must be evaluated (Rizzarelli et al. 2016). The former definitions make reference to the utility of compost as an additive for soil nutrition, giving compostable products an added value over the just biodegradable ones.

Compostable material ought to contain “a minimum of 50% of volatile solids which exclude largely inert materials” (EN 13432 2000) and elements contained in Table I-3 shall not surpass the established limits. The volatile solids indicate the amount of organic matter present in the material (NF T51-800

2015); meaning that materials should be made up of at least 50% of organic compounds for compostability to be considered as an option.

Table I-3. Maximum element content for declaring compostable as stated in EN 13432.

Element	mg/kg*	Element	mg/kg*
Zn	150	Cr	50
Cu	50	Mo	1
Ni	25	Se	0.75
Cd	0.5	As	5
Pb	50	F	100
Hg	0.5	*of dry matter	

For something to be compostable, its biodegradability has to be evaluated (NF EN 14995, 2007). But although also aimed to prove a product's capacity of being degraded by the action of microorganisms; tests differ from those to proving biodegradability in test periods, temperatures and validation thresholds. In addition to information given in Table I-4 regarding the validation results for compostability, standards require no remaining plastic residue to be distinguishable at 500 μ m.

Table I-4. Conditions for declaring compostable following Standard EN 13432.

Conditions	Time period	Biodegradability	Particle's size	Temperature
Aerobic composting	12 weeks	90%	<2mm	(58 \pm 2) °C
Anaerobic bio-gasification	5 weeks	90%	<2 mm	(58 \pm 2) °C

Once biodegradability is proven, compost quality ought to be tested and no component shall have a negative effect for the material to be designated as organically recovered (EN 13432, 2000). This is achieved by proving a germination rate higher than 90% compared to results issued from a test with blank compost.

Altogether, the term **biodegradable** reflects a characteristic of a material, meaning that it can be broken down and assimilated by microorganisms but that it isn't either inherently good for the environment (toxic substances might be present and absorbed by the soil) nor serves a specific purpose other than reduce the volumetric mass of pollution. Meanwhile, composting corresponds to a relatively controlled process that aims to nourish the soil through the decomposition of materials. For something to be **compostable**, it has therefore to have a nutritional value with which to contribute to soil enrichment and be proven to be non-toxic.

1.2.3.3. Home-compostable

When it comes to the compostable nature of a product, a distinction can be made between being **compostable** and **home-compostable**. Compostability is something that can be achieved by somehow "forcing" the adequate conditions for a material to biodegrade and become compost; this is achievable by, for example, using compost reactors with high temperatures. Reactors and processes required for industrial composting require energy inputs that reduce the potential environmental benefits from composting over other waste treatment methods. Consequently, for such materials an adequate sorting of waste is necessary to direct them towards industrial composting units.

Home-composting, on the other hand, is a "composting process performed by a private individual with the aim of producing compost for his own use" as described by NF T51-800, which is the French Standard that establishes the guidelines for declaring a product as home-compostable. This requires

for matter to degrade at ambient conditions of temperature and pressure, and no extra energy inputs should be required for the composting process to take place.

Conditions for home-composting are the same as those described in the previous section (controlled composting) regarding: the volatile solids content (>50%), elements contained in Table I-3 shall not exceed the established limits (plus Co levels lower than 38 mg/kg of dry matter), the absolute biodegradation rate (90%), the particle size's conditions (no more than 10% of the original dry mass is greater than 2 mm), and plastic residues being indistinguishable to the naked eye at a distance of 500 mm. However, composting conditions do change for a product to be considered as home-compostable; such conditions are reported in Table I-5.

Table I-5. Conditions for declaring home-compostable following Standard NF T51-800.

Conditions	Time period	Biodegradability	Particle's size	Temperature
Aerobic composting	< 365 days	90%	<2mm	(25 ± 5) °C

Moreover, every component of the final product shall comply with the above-mentioned specifications and not include any endocrine disruptor or CMR substance (NF T51-800, 2015).

One major drawback of home-composting products is that consumers might not always achieve adequate composting conditions. Which puts home-composting behind industrial composting in terms of environmental performance as bad composting techniques involve higher methane production (due to anaerobic conditions). Methane has a global warming potential that is about 34 times higher than carbon dioxide (EC, 2017).

1.3. Environmental assessment

Current conditions and environmental changes have raised society awareness of the possible impacts that industrial processes can have in the environment. As a result, industrial processes have become more interested in improving their environmental performances in order to not only comply with the growing environmental-focused regulations but also to approach market trends towards a more environmental responsible consumption.

As already addressed in the previous section, plastic is the most representative material of the modern era and one of the most important issues concerning waste accumulation and pollution in water bodies and land. For this reason, its replacement with “greener” options have been gaining interest from different industry sectors. From 2.05 million tonnes in 2017, European Bioplastics along with Nova-Institute estimate a growth of bioplastics’ production capacity of almost 20% in the next five years (Figure I-4).

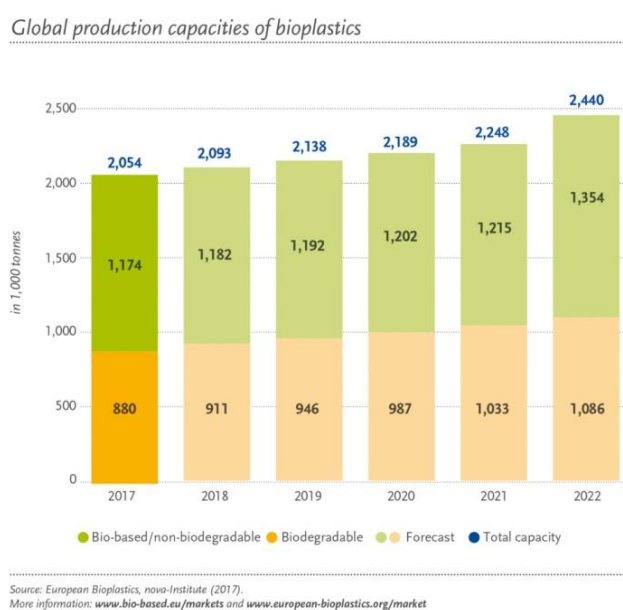

Figure I-4. Estimated growth of the global production capacities of bioplastics. (European Bioplastics and nova-Institute, 2017)

As this demand increases, so does the demand for feedstock consecrated to material production, thus possibly reducing those dedicated to food supply, which is a particular concern when it comes to bio-based materials. Dedicating only crop by-products to material production while the main products left untouched for food supply could assess this dilemma. However, there is also a competition between the use of biomass as a source of materials and energy (Gerssen-Gondelach et al., 2014).

Other than its use as an alternative resource to petrochemical materials, biomass is interesting from an environmental point of view given its potential of delaying down climate change consequences. From this point of view, it is then of utter importance to assess and understand the real positive effects that it can have, and which are the most promising applications that it can have. In order to do so, studies that evaluate the environmental impact of such applications are to be conducted; these studies are known as environmental assessment methods and vary depending on the scope of the study to be carried out, the environmental impact to be assessed, the system in question as well as the product’s life stage taken into consideration.

Environmental assessment practices have developed along with those of sustainability and more than one method is available as a result of the different scenarios to which it can be applied. For the results

to be valid and pertinent, it is of particular importance to correctly define the boundaries of the system to be analyzed. That is to say, to have a clear view of which stages of the life of a product are to be taken into consideration as this will define the method's approach and evaluation type. For this, the life cycle of a product becomes a crucial concept to be known, understood and applied.

Once the system is defined and the assessment correctly done, results will be obtained in the form of environmental indicators. This information (numbers) can be interpreted and serve as a base for comparing products, systems or scenarios, and their respective possible impacts. The European Environmental Agency (EEA) proposes a framework for analyzing a system, the different relations between the environment and human activities and how these two are linked with one another; it is known as the DPSIR framework.

Environmental indicators can be grouped up in three main categories, which represent the protection areas that would be affected and are identified as Ecosystem, Human Health and Resources. Some methods may address only one of these areas while others approach them at the same time.

As the plastics and materials procurement remains a point of interest in order to make front to current environmental concerns, it is proposed for this work to take the most robust and complete environmental assessment method in order to be able to evaluate the current situation and, at the same time, the impacts linked to possible solutions. One that procures a global vision of the state of things and serves as an aide for defying the best way of action not only for the needs of today but for possible repercussions on the near or far future to be evaluated; the latter in order to encourage a development that follows a sustainable line of action.

1.3.1. Sustainable Development

The need for reducing pollution levels and securing resources availability are some of the reasons behind the propulsion of environmental assessment as an important part of any business plan. The challenge of achieving the former while at the same time keeping productivity and profit rates to fulfill current demand, led to the introduction of a sustainability concept. A *sustainable development* exposes the need for the economic, social and environmental ambits to entwine, making them dependable on one another (Figure I-5).

As already approached in the introductory section, the sustainability concept can follow two different lines of thought, referred to as *weak* and *strong sustainability*. While both ideologies recognize a human (economic and social) and a natural (environment) capital and consider them to be complementary with one another; the first one considers the different ambits to be substitutable and allows the detriment of one in benefit of the others, giving the natural capital a value that takes only into consideration the service they provide and not based on their availability (Mancebo, 2010). This approach makes way for development to lean more towards one of the three axes and still be considered as sustainable by being *bearable*, *equitable* or *viable* (as shown in Figure I-5).

Opposed to weak sustainability, *strong sustainability* sustains that capitals are indeed complimentary but in no way interchangeable, therefore for development to be truly sustainable all three aspects shall be respected and approached with equivalent importance and urgency, no sustainability can be achieved without one another and thus Figure I-5 becomes Figure I-6. In this case, environmental resources are given the importance they have regarding their existence as their depletion has consequences in both the societal and economical spheres. This is a notion that better approaches

reality as the environment is the ultimate source of humankind's existence and therefore of society and the economy.



Figure I-5. Graphic representation of sustainable development. Inspired from (Mancebo, 2010).

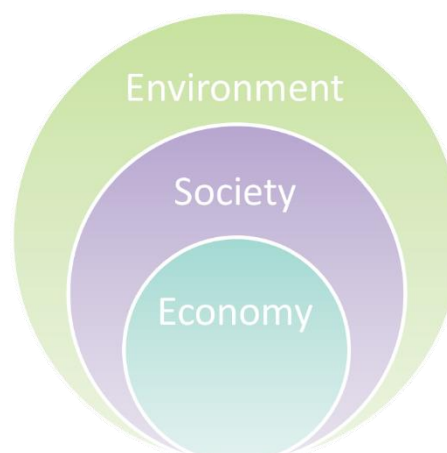

Figure I-6. Development from a strong sustainability point of view*.

In any case, to develop in a sustainable fashion requires for systems and processes to be understood, analyzed and inputs/outputs quantified. It is important to understand where they come from and where they will end up, so resources are used as efficiently as possible, waste is reduced to a maximum. The latter at the same time taking into consideration the welfare of society and the growth and nourishment of economic systems. Therefore, as the sustainability concept gains force, so does the need for better and more powerful environmental methodologies and tools.

It becomes clear then that in order to move in the right direction well informed intelligent decisions are to be made, but sometimes system's complexity toughens this task. When it comes to this, a Life Cycle Thinking (LCT) approach allows for decision-makers to understand the environmental, social and economic impacts of a policy or system over its entire life cycle thus incorporating a sustainability approach to the development of products and/or policies (UN Environment, 2017).

I.3.2. Life Cycle Thinking

Having its roots in the biological cycles of living organisms, the idea of *life cycle* has been broadly applied in different study fields. It goes from studying the progress of an innovation project in the business ambit to the interaction of a product with the environment and natural resources (Ashby, 2013); the latter being the one of interest for this work.

Much as a living organism, a material is born, it develops and dies; only the same terminology does not apply, and these stages are named more accordingly to the actual processes in the life cycle of a product. However, the analogy is used for approaching materials in a "cradle-to-grave" fashion, meaning that the different stages of its life are identified and assessed starting from the supply of raw materials (from cradle) to its end of life when it is disposed as waste (to grave). Figure I-7 generally illustrates the main stages of a product's life cycle. Different variants of this strategy may be used, such as "cradle-to-gate" (no use or end-of-life stages are considered), "cradle-to-cradle" and "gate-to-gate", depending on the stages taken into consideration as part of the analysis. These concepts are defined in Section I.4.1.

This concept allows for materials to be “tracked down” throughout the whole life cycle of the product they’re a part of (as one of the constituents or as the main one) and thus the environmental impacts are more accurately evaluated. The attractiveness of the Life Cycle Thinking concept relies in the fact that every life cycle stage represents an opportunity and has the potential of reducing environmental impacts; opposed to the more traditional approach where environmental assessment is focused on production sites or the manufacturing process itself (UN Environment, 2017).

From a more “industrial” point of view rather than an environmental one, this concept opens opportunities for companies to improve their processes without necessarily changing or investing in new technologies. By, for example, improving the use of resources or recycling part of their wastes, factories could reduce their need for raw materials and energy consumption, thus reducing production costs that could translate to higher profit margins. The whole process in a real system is more complex than the example given, but it aims to illustrate the possible benefits of introducing Life Cycle Thinking to business strategies, other than the environmental ones.

Moreover, even if the environmental assessment is not done considering the whole life of a product, the model is useful when it comes to delimiting boundaries of the system to be evaluated as it allows a better understanding of it and its relationships with natural and human resources as well as other stages. This is of particular interest as not all environmental assessment methods have been developed for the same reasons or with the same objectives, resulting in different approaches for different stages that may also focus on distinctive environmental impacts.

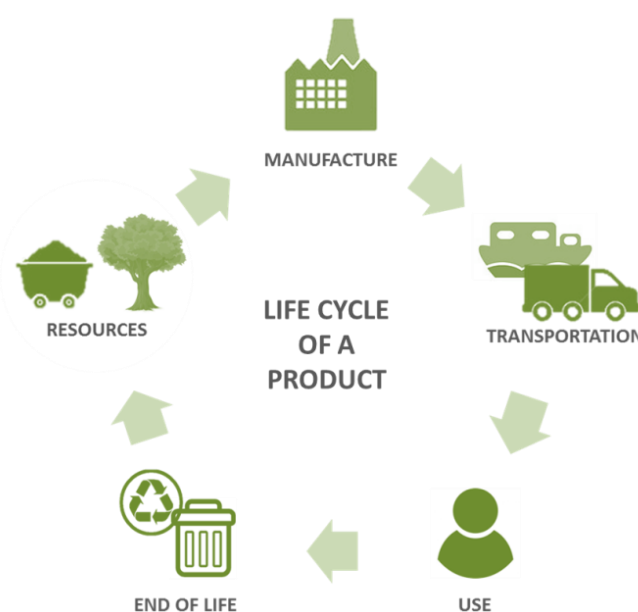

Figure I-7. General view of a product's (or service) life cycle from “cradle to grave”. Image inspired by (Ashby, 2013).

I.3.3. Environmental Indicators

Important aspects of an environmental assessment are the environmental indicators that are used to quantify and compare the impacts of a product or process over another one. Therefore, it is crucial for them to be well defined and regulated in order for policymakers and environmental practitioners to clearly understand their relevance and meaning (EEA, 1999). Moreover, indicators allow for more grounded understandable results that can be exploited and presented to policymakers, process developers and even customers.

The European Environmental Agency (EEA) in its technical report “*Environmental indicators; typology and overview*”, describes different types of indicators and classifies them in four groups (as shown in Table I-6) accordingly to the **DPSIR impact pathway framework**.

Table I-6. Typology of indicator according to the EEA (1999).

Type	Indicator	Questions addressed
A	Descriptive	What is happening to the environment and humans?
B	Performance	Does it matter?
C	Efficiency	Are we improving?
D	Total Welfare	Are we on the whole better of?

Descriptive indicators (Type A) are the most currently used and assessed by following a DPSIR framework also described by the EEA in their technical report. Indicators result from a system analysis and the DPSIR framework reflects the relations between the environmental and the human system as shown in Figure I-8.

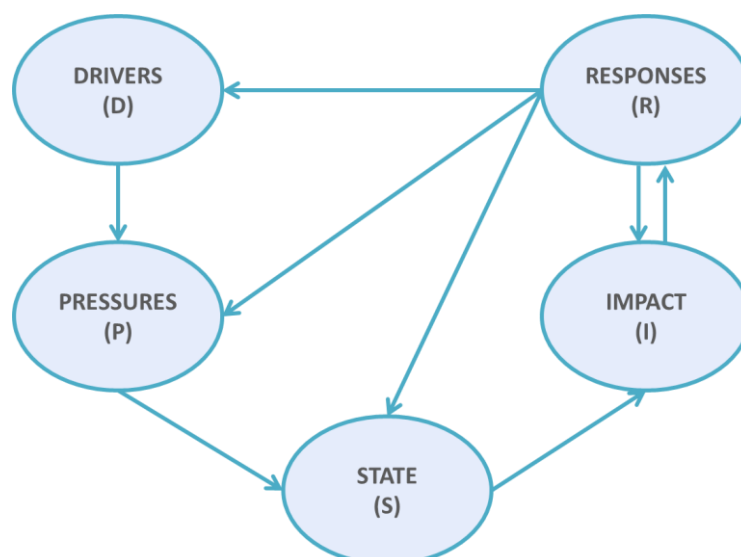

Figure I-8. The DPSIR Framework for Reporting on Environmental Issues (EEA, 1999).

Generally explained, systems exert pressure on the environment and consequently changes occur; these changes will have an impact that may provoke a response from society in order to address and hopefully of avoiding it. An ampler description of the descriptive indicators used to follow this framework is given in Table I-7. These indicators represent an important support in order to understand the consequences of processes or activities in the form of environmental impacts.

It should be noted that Descriptive indicators only reflect a situation as it is, no reference is made as to how it should be. Other type of indicators may be used for monitoring progress (Performance indicators) and to express the actual improvement of products and services concerning their environmental efficiency (Efficiency indicators).

Table I-7. Indicators used within the DPSIR framework (EEA, 1999).

Type A indicators	Description	Example
Drivers	Social, demographic and economic developments that induce a change in consumption and production patterns.	Increase in the use of vehicles
Pressure	Release of substances, physical and biological agents into the environment, use of resources and land that manifest in changes in environmental conditions.	CO ₂ emissions
State	Quantity and quality of physical, biological and chemical phenomena in a certain area.	Atmospheric CO ₂ concentrations
Impact	Changes in the state of the environment as a consequence of an exerted pressure have an impact on a societal and economical level. Impact may occur in a sequence and are assessed as primary, secondary and tertiary effects.	- Primary effect: CO ₂ air pollution. - Secondary effect: increase in global temperature. - Tertiary effect: rise of sea level resulting in loss of biodiversity.
Response	Society's attempts to "prevent, compensate, ameliorate or adapt to changes"	Promote the use of electric vehicles.

In its technical report, the EEA also states that throughout Europe, descriptive indicators are the more commonly used ones for environmental reporting; driving (D), pressure (P) and state (S) indicators being the most often mentioned. Impact (I) indicators are the least used ones and are only referred to situations and for specific issues.

Different environmental assessment methods aim for different indicators as the scope and limitations that each may present will delimit the system being analyzed and, therefore, the information that can be obtained from it. Consequently, the aim of this next section is to introduce the different environmental assessment methods available, their reach, advantages and disadvantages; as well as to introduce the Life Thinking Concept and the assessment methodologies that best go with it.

1.3.4. Environmental Assessment Methods

Different needs have favored the development of more than one way of assessing the environmental impact of a product, process or system. These same needs have also defined the way methods approach a system, the impacts they take into consideration and the life stage(s) being evaluated. Furthermore, the multiple fields to which an environmental assessment can be applied allow for methods to be generic or specific to the impacts or stages being evaluated. Some of the currently available methodologies for assessing environmental impacts can be found in Table I-8; distinguishing between generic and specific.

Table I-8. Environmental assessment methods (generic vs specific).

Generic methods	Specific methods
<ul style="list-style-type: none"> • Material/Substance Flow Analysis (MFA/SFA), • Cost-Benefit Analysis (CBA), • Environmental Impact Analysis (EIA), • Environmental Risk Assessment and Management, • Carbon Footprint, • Water Footprint, • Life Cycle Analysis (LCA). 	<ul style="list-style-type: none"> • INDIGO (for Agriculture sector), • IDEA (for Agriculture sector), • BREEAM (for Building sector), <p>among others.</p>

Even if all methods aim to assess environmental impacts, not all of them have the same approach, use the same indicators or have the same scope. As much as they may share some basic characteristics, the information they provide will be as extensive as the system it takes into consideration, which represents a very important condition to take into consideration when making the choice between one another.

In order to identify the characteristics and relevance of the generic methods found in Table I-8, this work puts forward five main categories:

Sustainable Development pillars concerned.

According to the information discussed in Section I.3.1, this would exhibit whether the method assesses the system from an economic, societal or environmental point of view.

Approach and Evaluation type.

When it comes to the approach that an environmental assessment can take, there are two possible lines of thought: one where the object of study is a precise site or project and a second one where the interest relies on the product or the service itself.

A Site/Project approach is restrained by the specific location where it takes place, so only the impacts directly linked to it will be exposed. Therefore, this kind of approach might assess the contribution of more than one product or service as one site/project offers more than one product/service. The possible environmental impacts are assessed from a *local* point of view.

On the other hand, the Product/Service approach “follows” its possible environmental impacts throughout the different locations that might be linked to its life cycle. As a product/service goes through the different stages of its life, it is possible that it will go through assessing more than one location. Therefore, this point of view takes a more *global* approach.

By situating the methods in the schema shown in Figure I-9, it is possible to better understand their scope and relevancy depending on the system to be assessed.

Another distinction can be made concerning the type of evaluation a methodology is able to perform as *relative* or *absolute*. A relative evaluation is useful for comparative purposes where the environmental performance of one system/product is put into perspective with another one. This allows for a choice to be made when deciding which system/product would be the best environmental choice. The second one, refers to whether a system/product is, for example, environmentally sustainable or not; no comparison is done whatsoever with another system/product. This type of evaluation is better used when the purpose of an analysis is only to identify one system/product’s environmental performance and/or to evaluate if it respects regulated values.

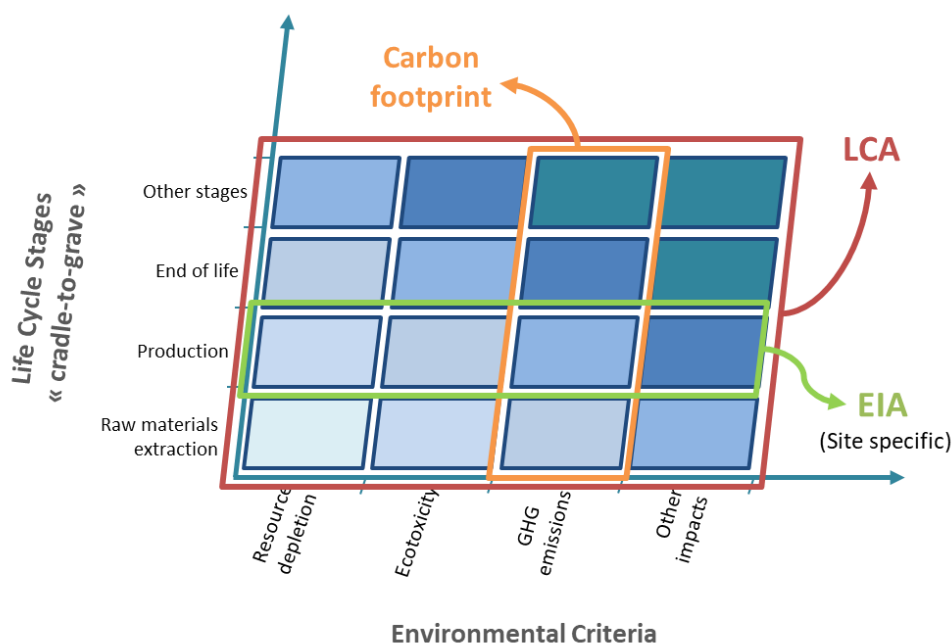

Figure I-9. Environmental assessment methods scope's graphical view and examples.

Environmental Axes taken into consideration.

As shortly discussed in sections above, different methods might address different possible impacted areas. These environmental axes comprise the Ecosystem, Human Health and Natural Resources.

The choice of applying one method over the other ones should take into consideration, which is the highest concern or objective of the analysis that is taking place.

Indicators characteristics.

Some environmental methods take a *monocriterion* approach while some others include more than environmental criteria into consideration and assess them at the same time; the latter refers to a multicriterion approach. Figure I-9 gives a graphical representation of methods taking into consideration one indicator (carbon footprint, i.e.) and those having a more multicriterial approach (such as LCA – Life Cycle Assessment and EIA – Environmental Impact Assessment).

Moreover, indicators can also be differentiated as *qualitative* or *quantitative*; both approaches may give information on the impact level of the assessed situation but while the first ones refer to a state being good or bad (simply put), the second ones provide numerical values that give a more exact, and sometimes pertinent, information; allowing for more concrete solutions to be implemented.

Method type.

Methods can also be distinguished as Analytical methods or Procedural tools. Analytical methods aim to assess a situation and analyze its current state. Procedural tools allow for the assessment of different situations by comparing scenarios.

1.4. The Life Cycle Assessment (LCA) method

The environmental and economic attractiveness of biotic resources as a source of materials has propitiated for projects to focus on creating circular economy models of bio-based products. In the case of plastics, the European Commission recently published a document entitled “A European Strategy for Plastics in a Circular Economy” in which they expose the need but also the challenge of changing the current plastic’s habitudes into more sustainable / bio-based ones. The concerns raised by the so mentioned document regarding plastic management as well as the information discussed in the previous sections of this work, require for holistic methodologies to evaluate the real benefits of bio-based materials. This need comes from the fact that a product that has a renewable source (such as biomass) does not necessarily mean that it is sustainable as “burden shifting” (the transfer of environmental impacts) could occur, which requires for the actual environmental gains to be identified and their relevancy evaluated.

The Life Cycle Assessment methodology being the robust method that it is, does not lack on complexity and will, therefore, be discussed in the subsequent sections for a deeper and more complete understanding of it.

1.4.1. Definition

A LCA is a management and environmental method that evaluates the potential impact of a system, a product, service or process. It takes into consideration a particular functionality and goes through every stage of its life cycle (Jolliet et al., 2017).

It is then a method that allows the identification of critical points or stages that represent opportunity areas for improvement or development of new products. It gives a more wholesome and global understanding of a process, thus allowing better-based decisions taking into consideration not only the more obvious (economical, technical) but also the long-term consequences (environmental, social), both positive and/or negative.

Most commonly, its application aims for the identification and comparison of the environmental impacts of different products, services, systems or processes. It can also be helpful when identifying the impacts of the different stages of the same product, therefore making possible to improve one specific constraint of a whole process (hotspot analysis).

When trying to improve a process, it is not always evident the consequences that certain changes may induce. By following the LCA method we are able identify the transfer of impacts that may occur among life cycle stages or even from one environmental impact category to another one; by quantifying them and comparing different possible scenarios it is possible to find the better route of improvement to be followed.

LCA follows a “cradle-to-grave” methodology, based on the Life Cycle Thinking concept, in which every aspect of a product’s life cycle is considered to determine the overall impact of its production. However, more restricted approaches exist and are sometimes applied depending on the scope of the evaluation to be carried out, as shown in Figure I-10.

The “gate-to-gate” approach evaluates the environmental impacts linked to the product/service since it enters the manufacture life stage and until it leaves it; no impacts related to resource acquisition or its use and end of life stages are taken into consideration. This approach could be compared to the

Environmental Impact Assessment method in which is location specific as it only considers potential impacts in the manufacture site and does not go further than that.

The next approach, “cradle-to-gate”, in addition to the manufacture stage, it also includes impacts linked to the procurement of resources as well as the Transport stages that might occur between these two stages.

Ultimately, the goal would be to achieve a fully closed loop in which is known as a “cradle-to-cradle” approach. Where products are not disposed of at their end-of-life but rather reintegrated into the loop as raw materials.

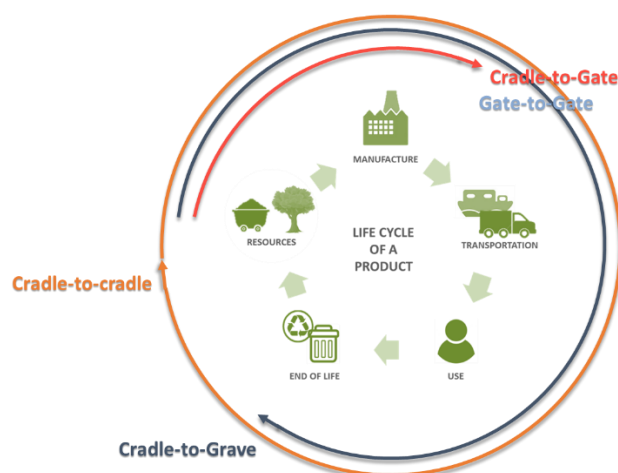

Figure I-10. Life Cycle possible system approaches.

Most importantly, LCA is a standardized method with a clear way of action that needs to be respected and followed for results to be accepted and considered valid and relevant, a topic that is to be explored in the next section.

I.4.2. Methodological framework

LCA method has been developed and standardized by three organizations: the International Organization for Standardization (ISO), the Society of Environmental Toxicology and Chemistry (SETAC) and the United Nations Environment Programme (UNEP or UN Environment) (Jolliet et al., 2017). Among them, probably the most representative regarding current methodology are the norms developed by ISO. The norm ISO 14040 establishes the general guidelines for executing a LCA. Moreover ISO 14044, ISO 14046 - 14049, detail the different steps and analysis carried out throughout the assessment (Jolliet et al., 2017), as shown in Table I-9.

Table I-9. List of ISO standards in relation to Life Cycle Assessment.

Standard	Year	Topic
ISO 14040	2006	Principles and framework (reviewed in 2016)
ISO 14044 ¹	2006	Requirements and guidelines (reviewed in 2016)
ISO 14047	2012	Illustrative examples on how to apply ISO 14044 to impact assessment situations
ISO 14048	2002	Data documentation format (reviewed in 2020)

¹ Standard subject to a revision project. The first Draft Standard dates from January 2017.

ISO 14049	2012	Illustrative examples on how to apply ISO 14044 to goal and scope definition and inventory analysis
ISO 14072	2014	Requirements and guidelines for organizational life cycle assessment (reviewed in 2019)

In order to follow an LCA, as suggested by ISO and SETAC, and based on the methodological framework established by the standard ISO 14040, four main steps should be implemented. These steps are represented in Figure I-11 and will be further developed.

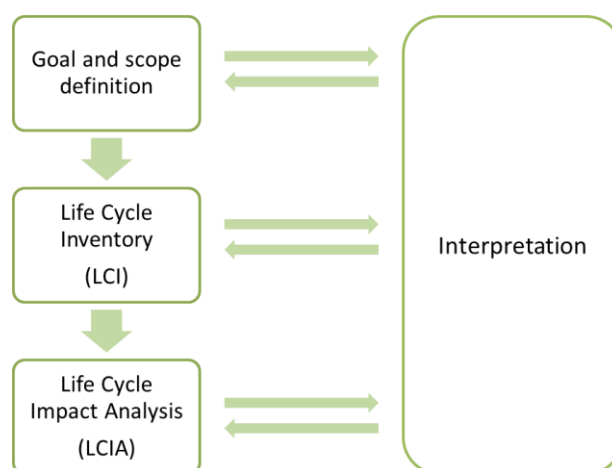

Figure I-11. Stages of a Life Cycle Assessment following ISO 14040 guidelines.

First step is the “*Goal and scope definition*” in which, the main goal of the assessment has to be established (what is the purpose of the study?). This is achieved by defining a *functional unit*, which represents the function that the system being studied is bound to deliver. In other words, it is a well-defined value that illustrates the ultimate purpose of the product/service in question; and it serves as the base of comparison among the different scenarios to be evaluated.

The scope definition corresponds to the system boundaries or delimitations that will be considered. It outlines the extent of the analysis, what will be taken into consideration and what will not.

The next step is the “*Inventory analysis*”; this is a stage where *elementary flows*² going in (extraction) or out (emissions) every life stage comprised in the system boundaries are identified and accounted for; Figure I-12 shows a graphical example of this step. The stages of the cycle can be further developed depending on the process it follows or the detail with which the assessment is to be carried out with.

² Transfers between the technosphere (human activities) and the ecosphere (environment).

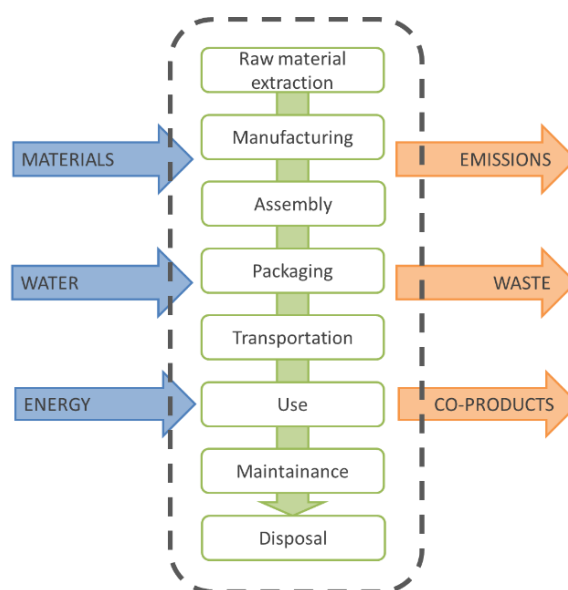

Figure I-12. General view of a Life Cycle's Inventory phase³.

Data acquisition represents a key point as the quality of the results of a LCA is “largely limited by the quality and completeness of the data on which is built” (Grabowski et al., 2015). When it comes to data collection, environmental databases already exist for many materials and are, in most of the cases very useful, some examples include: Ecoinvent, LCA Commons, LCA Food DK, Agri-footprint, European Reference Life Cycle Database (ELCD), etc. As recommended by Jolliet et al. (2017), the reader is referred to Curran and Notten (2006)⁴ for a broader vision of the different databases available worldwide.

Databases can be specific for certain industry sectors or geographic zones. It is thus key to use the one that better represents the scenario being evaluated as data can be, as discussed by Grabowski et al. (2015), technological, geographical and age sensitive.

Moreover, the distinction between foreground and background data is an important concept to understand for correctly choosing the best one, situation accordingly, for results to be accurate. As defined by a widely used LCA tool, SimaPro software, *Foreground data* is that which describes a product or system and it specifically relates to them. Opposite to this, *Background data* refers to generic processes for producing energy, providing transportation, procuring materials and some waste management practices. Background data is more easily found on databases or from literature. However, as foreground data is specific for each system being assessed, it usually involves a laborious data collection work.

Once the flows are quantified, an “*Environmental impact analysis*” is to be performed; a step in which the inventory data is linked to specific environmental impacts.

Impacts are first *classified* and then *characterized*; the latter can be addressed through a *midpoint* or *endpoint approach*. The first one is seen as “a point in the cause-effect chain of a particular impact

³ The dotted line represents the systems boundaries, blue arrows represent the inputs to be considered for each of the steps inside the system boundary; and the orange arrows represent the outputs to the environment.

⁴ Information given is regularly updated as part of the UNEP Life Cycle Initiative program. Therefore, this reference is the updated version of the originally referred to by Jolliet et al. (2017); which is the 2002 version of the report.

category” (Bare et al., 2000), it is the problem that leads to an actual damage. Damages are represented by the endpoint categories.

By using characterization techniques, different models have been developed to quantify environmental impacts. While some of them are specific for each category, many others combine both approaches (midpoint and endpoint), such as: ILCD 2011 Midpoint+, ReCiPe, IMPACT 2002+, IMPACT World+, LIME, EU-LCA, etc. As both techniques have strengths and limitations related to them (one might have more certainty but be less relevant than the other and vice versa), it is recommended for an impact analysis method to use them as complementary techniques (Bare et al., 2000). Thus, allowing for decision-making processes to be better based and more complete. Moreover, not every method assesses the same environmental impacts and some of them are specific to a determined impact. Figure I-13 shows the midpoint and endpoint categories, and how they relate, taken into consideration by the ILCD 2011 Midpoint+ evaluation method.

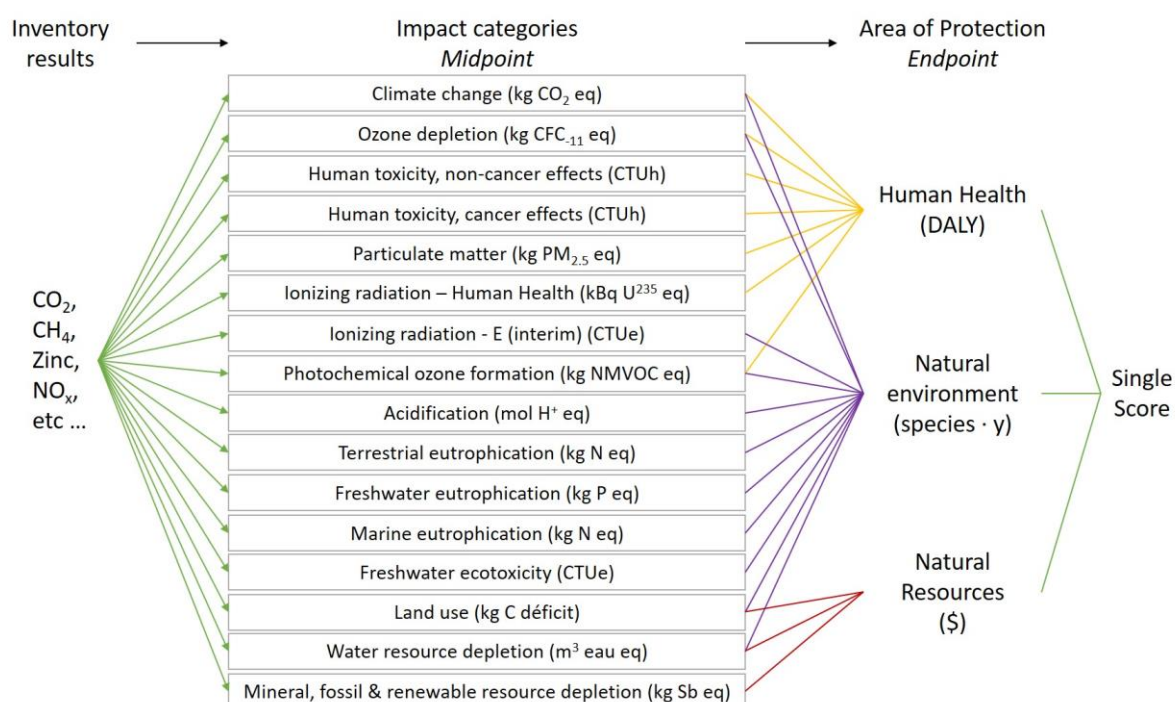

Figure I-13. Representation of the ILCD 2011 Midpoint+ evaluation method

When following ISO standards, only the classification and characterization steps are mandatory when conducting an environmental impact analysis. To go further in the analysis, it is also possible to follow *normalization* and *weighting* steps. The first aims to compare the corresponding contribution of each product/service to the overall impact regarding a specific category; while the second one intends to define the importance (weight) of one option over the other based on the social value attributed to each category (Jolliet et al., 2017).

While these optional steps may provide more tangible/approachable results (the yearly impact of one person for every functional unit, financial factors, etc.), the consistency and relevance of their inclusion in LCA studies is still debated. Further information on the current debates and recommendations for their application is discussed in the paper of Pizzol et al. (2017).

After the analysis is completed, the “*Interpretation*” phase takes place. This step does not only consist on identifying the different areas of opportunity to improve the process, but it also allows evaluating the uncertainties linked to the analysis; meaning that the quality and relevancy of the results is evaluated. The main purpose of this step is to identify the areas in which it is more relevant to act upon

as they're the ones causing a greater damage to the environment; they're known as *priority areas* (Jolliet et al., 2017).

The evaluation of uncertainties is an activity that is not limited to the end of the analysis; on the contrary, it should be applied throughout the whole process in order to ensure the veracity of the results. A *quality control* is applied to the system modeling, the units used, the calculations including mass and CO₂ balance; this is achievable by meticulously choosing the data to be used and by comparing the results obtained, as far as possible, with those documented in the concerned literature. As well as the data, the methodology chosen for the analysis should be consistent and coherent with the scenario in question.

Moreover, even if the data has been carefully selected, there is always a place for inaccuracies. Either because of its inherent random nature or simply due to the lack of complete knowledge of some processes (Qin and Suh, 2017), uncertainty is bound to be present in any set of data. In order to assess this issue statistical methods are used, the most applied being the Monte Carlo simulation. This simulation allows for the degree of uncertainty of the analysis' results to be addressed. At the same time, it can show how two scenarios differ from one another (Jolliet et al., 2017).

Finally, a complete analysis is done taking into consideration all the results, the opportunity areas, the positive and negative impacts of the process, the possible improvements, etc. It is essential for all the assumptions done and the choice of methodologies to be well explained. The more solid the arguments, the more significant the results of the LCA will be.

When carrying out a LCA, delimiting the system boundaries becomes complex as the making of many products includes the formation of co-products that may or may not have a useful purpose. This complicates the assessment because the environmental impacts linked to these co-products are also to be evaluated. Two approaches can be taken to assess the co-product situation, one known as allocation and the other one as system expansion; both are further discussed in the section to come.

I.4.3. Two approaches for performing a LCA

Allocation happens when co-products are present on the system being studied and, in order to address the environmental impacts related to them, different environmental weights are "allocated" to each one. In this way, environmental burdens are distributed but depending on how the **allocation** is done, results may differ from one study to another even if the system being evaluated is the same. For this reason, ISO standards recommend avoiding allocation whenever possible.

This first manner of dealing with co-products follows a traditional or **attributorial LCA** approach. Attributorial LCA remains a method that bases its results purely on physical relationships (Earles and Halog, 2011) (the use of x kg of raw material will produce a total of y GHG emissions). It therefore assumes that avoiding one activity has a direct effect on the environmental impact it causes (if we reduce the consumption of a raw material by half, the GHG emissions will be cut by half too); in other words, it offers a static view of a current situation. This quality of the LCA does not represent a problem when the evaluation aims to compare the environmental efficiency of one product/process over another one. However, it can be a major limitation not only when allocation is required but also when it comes to policy and decision-making.

If allocation is to be avoided, it is possible to rather follow a **system expansion approach**, by expanding the system boundaries, the fate of these co-products is considered and thus the problem avoided

(Brandão et al., 2017). The guidelines for such an approach follow a LCA technique known as **consequential LCA**, which purpose is to show the environmental consequences of decision-making and thus takes into consideration not only the fate of the system in question but also the effects that systems that are coupled or linked to the main one may have.

Moreover, when a policy is made it targets to create a change in the current state of things and as the purpose of a LCA is to avoid the transfer of environmental impacts from one activity to another; averting them from one period to another one, should also be taken into consideration and a consequential approach would be the most fitting methodology for doing it.

Introduced in the 1990's and strongly developed in the last 4 years (Zamagni et al., 2012), consequential LCA emerges as a methodology concerned with "predicting the environmental impacts of a technology (or policy) shock taking into consideration how markets will adjust to such a shock" (Rajagopal, 2017). Through basic laws of supply and demand, cause-effect relationships can be introduced to the system, consequently presenting what the scenario will possibly be once a decision is taken.

In lesser words, consequential LCA can be described as a combination of an attributional LCA and economical modeling techniques (Earles and Halog, 2011). Which economic methods to use has been a subject of discussion (Earles and Halog, 2011; Rajagopal, 2017) and recommendations include PE models, CGE models and learning curves (Brandão et al., 2017).

One of the strengths of consequential LCA regards what is known as "rebound effects". They represent the consequences of a decision taken; how a change in the product may affect the market dynamic, affect the consumption and therefore, its environmental impact as production adjusts. In their review on consequential LCA, Earles and Halog, (2011) differentiate two types of rebound effects: direct and indirect.

The first one occurs when prices lower, given an increase of efficiency in production, leading to an increase in the consumption of the product/service. In this case, to cover the new demand production may have to be also increased, possibly counteracting the already avoided environmental impacts.

The indirect effect occurs when the price drop of one good leads to "freed income" to be spent somewhere else. This may lead to a higher production yield in other products, thus triggering a possible displacement of environmental impacts from one system to another.

Given the information presented before, it may seem for the consequential approach to be more complete or better than the traditional one. However, the complexity of the first also gives way for information to be more speculative. Hence, this work aims to present both techniques as complementary rather than opposed as Rajagopal (2017) stipulates in his work. In fact, Yang, (2016) proposes a consequential LCA methodology following the attributional framework. His method consists of a two-step approach where a LCA is carried out considering the present situation. Then, the consequences of a decision are analyzed and the original LCI (Life Cycle Inventory) modified accordingly and a new LCA is launched. By repeating this process, LCIs representing different time scenarios will be obtained, giving a dynamic view of the environmental impacts caused by policy and decision-making.

1.5. LCA for bio-based products

Assessing the environmental impacts of bio-based products through a Life Cycle perspective is particularly relevant as their “green” nature makes it seem as they were inherently better for the environment, which might not always be the case. As discussed before, burden shifting may occur and while CO₂ emissions might be avoided, some other environmental constraints such as water depletion, pollution and eutrophication (to name a few) might increase because of more intensive agricultural practices. However, there are also some environmental benefits characteristic to the use of biomass that should also be evaluated and taken into consideration.

Furthermore, when performing LCA for bio-based products, specific methodological constraints linked to the agricultural phase are to be considered.

1.5.1. Climate change mitigation potential of biomass

Other than their Global Warming Potential (GWP), GHG emissions contribute to Climate Tipping Potential (CTP) values. These values represent a threshold for an abrupt change in climate conditions and they show a time related information on when it would happen. The atmosphere has a finite capacity of absorbing GHG; hence, the higher the emissions, the lower its absorbing capacity and the faster we approach to an irreversible damage (Jørgensen et al. 2014).

Biomass represents both a source and a sink for GHG emissions as agriculture releases significant amounts of GHG but at the same time contribute mitigation as soil carbon sinks (Smith and Olesen, 2010). Moreover, biomass used as material for replacing fossil-based products also serves as storage basins for the CO₂ it sequesters during its growth. According to Debaeke et al. (2017) “agriculture can improve the net GHG emissions balance via three levers: less N₂O, CH₄ and CO₂ emissions, more carbon storage, and green energy production”.

Given the information above, two main factors can be identified when assessing the potential influence of bio-based materials in climate change mitigation: sustainable agriculture practices and carbon storage; by sequestering carbon and not releasing it right away back into the atmosphere.

Even though little information is currently available on the actual carbon storage potential of bio-based materials, Jørgensen et al. (2015) report that, based on their analysis, “temporary carbon storage in biomaterials has the potential for playing a noteworthy role in mitigating climate change” based on the CTP values obtained by the methodology proposed in their study. Moreover, they present CTP characterization values that can be directly included in LCA scenarios to better assess the environmental impacts of bio-based materials.

Mostly, research in alternative uses of biomass has been focused on producing energy from it as a form of climate change mitigation technique. However, biomass potential for reducing GHG emissions is higher when it works as a basin for storing carbon for over 50 years or longer ideally; giving time for lasting, adapted solutions to be implemented before surpassing the target level of the atmosphere’s capacity for absorbing GHG (Jørgensen et al. 2015). By using bio-based materials in long-lasting products and/or structures may therefore, help prevent reaching CTP values or at least delaying them and giving time for cleaner technologies and policies to be developed and implemented. This argument is particularly relevant when assessing the application given to biomass (during its use phase). For example, Gustavsson et al. (2006) showed in their study that using wood as construction material (to substitute concrete) is a more efficient for carbon mitigation than its use as a biofuel.

1.5.2. Methodological constraints

1.5.2.1. Life Cycle Inventory data quality

A particular challenge of LCA for bio-based materials is understanding the impact of growing the feedstock as LCA databases content on crops is limited. This represents an important issue as data quality limits the accuracy and usefulness of LCA results.

Data quality can be evaluated through their “pedigree matrix” which takes into consideration its reliability, completeness, temporal correlation, geographical correlation and the technical correlation. Grabowski et al. (2015) identified wood, corn, wheat, rapeseed and soy to be the crops with the largest number of datasets, in that order, after an analysis of the Ecoinvent, GaBi-PE, USLCI, LCA Food DK, and LCA Commons databases. It should, however, be noted that agricultural specific databases such as Agri-footprint and Agribalyse are not part of their analysis. In their work, authors also acknowledge that most of the available data is representative of North America (mostly the USA) and Europe, from which over half of it is representative of Switzerland.

Other than the limited geographical representativeness of data, the temporal factor is also particularly relevant as a variation on crop yields has the effect of diluting or enhancing (depending on whether yields increases or decreases) the environmental impacts of a crop-based system. Moreover, an increase in crop production also entails higher land use impacts. In this matter, the larger problem in data quality is the limited completeness of, specifically, indirect land use changes. Current available datasets lack clear information on how this impact, or if it is at all, accounted for, which highly affects the quality of crop datasets given that an increased demand on bio-based products translates into further expansion of cultivated land.

Moreover, agricultural techniques and transport requirements are usually national averages that already fail to represent correctly specific regions and/or processes, let alone other countries.

1.5.2.2. End-of-life management techniques

An important misconception of bio-based products is that they are inherently better for the environment because they are biodegradable. However, not all bio-based materials can be considered biodegradable or suitable treatment by biological techniques and sometimes techniques such as incineration or industrial composting could be more beneficial if energy is recovered, and emissions are controlled.

Moreover, available EOL management techniques might not be technologically ready for new materials and this can significantly influence their environmental impacts. Hottle et al. (2017), for example, identify recycling as the best option for PE and PET but the same is not true for materials such as PLA, even if it is considered as recyclable, given current infrastructure. The authors also state that PLA and TPS could improve their overall environmental performance if “they can scale adequately to warrant recycling”.

Additionally, the EOL of bio-based materials becomes more challenging when carbon stored in the material is accounted for. Techniques allowing for carbon to be kept in the technosphere for a longer period (i.e., mechanical recycling) can perform better than biological techniques. In this matter, out of different waste management techniques Piemonte (2011) identified mechanical recycling to be more performant than incineration, composting and anaerobic digestion; for materials such as PLA and Mater-Bi. On another study, Hermann et al. (2011) pinpoint anaerobic digestion as the better EOL technique and home composting to have roughly the same impact as waste incineration with energy recovery.

All of the above-mentioned situations make clear that difficulties for accounting stored carbon and the technological readiness of waste management techniques limit the possible environmental advantages of bio-based materials.

1.5.2.3. Indirect Land Use Change (iLUC)

Land Use Change (LUC) impacts refer to the effects of diverting the current use of land to the cultivation of biomass to be used as bio-based materials feedstock. Consequently, and counterintuitively, bio-based options could be responsible for greater quantities of net GHG emissions than their fossil-based counterparts could (Fargione et al., 2008). This is due to the release of carbon, previously stored in plants and soil, through the decomposition or combustion of vegetation.

LUC impacts are differentiated into **Direct (dLUC)** and **Indirect (iLUC)**. The former accounts for impacts related to the intentional transition of land use, and according to the PAS 2050 methodology (BSI, 2011), it must be included as part of the Life Cycle Assessment of bio-based materials (Pawelzik et al., 2013). The latter refers to the unintentional change of land use as additional land is taken into agricultural production elsewhere (i.e., forests); induced by the rededication of land being used to produce food into biomass feedstock. This land transformation leads to indirect GHG emissions and foregone sequestration caused by the deforestation or removal of vegetation.

Out of the two, iLUC is the one that presents the most challenges when accounting for the environmental impacts related to them and are less frequently assessed. Some of the main limitations are due to uncertainties related to “projections on the location and type of land use changes, production and trade patterns of biomass, price effects and related-price elasticity” as well as accounting for co-products (Pawelzik et al., 2013).

Impacts related to land use change may limit the attractiveness of bio-based materials and accountings for carbon may not represent their full environmental impact. For this reason, LUC impacts, both direct and indirect, are to be included in LCAs dealing with bio-based materials. Otherwise, an important contributor to climate change could be overlooked.

1.5.2.4. Carbon accounting

Specific to LCA studies dealing with bio-based materials, carbon sequestration is usually taken into consideration as negative emissions, but the duration of the carbon in the technosphere (carbon storage) is usually not accounted for. Not assign benefits to carbon temporarily removed but rather to use a constant GWP characterization factor, is the current LCA practice. The disadvantages of this approach are not significant when long periods of time are considered, but for shorter ones they are.

In their work, Brandão et al. (2013) review and discuss five other methods to include the impacts of carbon sequestration and storage of carbon in LCA, the methods being the Moura-Costa method, the Lashof method, the PAS 2050 method, the dynamic LCA method, and the ILCD handbook method. Furthermore, new and developing approaches to address the matter are discussed and bring forward the importance of timing emissions in relation to climate tipping points.

Furthermore, the environmental gains of carbon storage in bio-based materials vary according to the agricultural and production processes, the potential carbon sequestration of the biomass, and the end-of-life treatment of the final product (Miller et al., 2007). In bio-based materials, carbon makes up for almost 50% of the mass, and the biogenic carbon is generally considered as neutral (Pittau et al., 2018), however, for some products net carbon sequestration does not occur as it might be released at the end of life of the product.

The carbon footprint of a bio-based product depends on whether its waste management consists of reusing, burning, recycling, landfilling, or biodegradation. Moreover, carbon gains or neutrality depend on the time it remains trapped in a stable solid form. Meaning that the longer the lifespan of the bio-based commodity, the higher the carbon benefit (Miller et al., 2007).

For products where biogenic carbon storage is temporary, the question on whether it should be accounted for in environmental assessments has been debated. Overall, two main approaches can be taken:

- Carbon storage is considered in the account of biogenic carbon. Meaning that CO₂ is captured from the atmosphere and retained within the bio-based product, thus delaying the effect of GHG emissions on climate change, or
- Biogenic carbon is considered as CO₂ neutral and thus not considered as part of the inventory analysis.

Different approaches have been developed on how to deal with carbon accounting for the biogenic carbon stored in bio-based materials. Pawelzik et al. (2013) identified seven of these approaches, which are summed up in Table I-10.

Table I-10. Different approaches developed for carbon accounting in bio-based products

Approach	Framework
ADEME ⁵ 's methodology	<ul style="list-style-type: none"> • Biogenic carbon should be considered carbon neutral • Lifespan of bio-based products rarely exceeds 10-20 years • Delay in radiative forcing due to carbon storage is negligible
EC ⁶ 's Lead Market Initiative	<ul style="list-style-type: none"> • Biogenic carbon shall be deducted from the total carbon emissions for a "cradle-to-gate" system • No further guidance is given for a "cradle-to-grave" system
GHG Protocol Initiative	<ul style="list-style-type: none"> • Carbon credits are given for a "cradle-to-gate" system • Carbon released in the use and EOL phases of a "cradle-to-grave" system must be accounted for, and embedded carbon that is not released is excluded • Biogenic carbon of intermediate bio-based materials (e.g., inputs for other processes) should be reported
ISO 14067	<ul style="list-style-type: none"> • All emissions and removals of carbon (both fossil and biogenic) must be taken into account, regardless of the lifespan of the bio-based product
ILCD Handbook	<ul style="list-style-type: none"> • Accounts for time distinguishing between carbon released within a 100-year period and more than 100 years after production • Credit for carbon storage is calculated by multiplying the mass of embodied carbon within the bio-based product by its lifespan, and then dividing by the timeframe of 100 years
PAS 2050	<ul style="list-style-type: none"> • Considers a timeframe of 100 years • All emissions and removals within the timeframe are quantified • Effects of the delay in emissions may be taken into account after one year from production • Delayed emissions are quantified following the approach of ILCD Handbook • For the case when all emissions are released between the 2nd and 25th year, in a single event, a correction factor is incorporated (a multiplicative factor to represent the removal rate of CO₂ from the atmosphere resulting from the absorption of CO₂ in oceans)

⁵ French Environment and Energy Management Agency

⁶ European Commission

I.6. Conclusion & Perspectives

Today's shift in market and society trends are shifting forward materials with higher environmental performances. Focus has been particularly given to plastic as they have become one of the main environmental problems of recent years. Added to the fact that plastic has a fossil-origin, its durability and lower production prices, make it a difficult material to be treated in its end-of-life as not all plastic can be recycled, and important quantities of plastic waste ends up in the ocean. Bio-based materials offer thus an attractive solution and efforts should be focused on their further improvement to boost their environmental performance and attractiveness. Equally important, is the need to not only see them as replacement for petroleum-based products but rather as new materials to which applications remain to be discovered and implemented.

The terms bio-based and agro-materials are used interchangeably but are inherently different. The main distinction relies their chemical structures. For the first one, they can be synthetic chemical structures created from natural sources. While for the second one, the natural structures of biomass are maintained thus also preserving its completely biodegradable/compostable characteristic. Furthermore, agro-materials are 100% made of biomass, which is not the case for materials that can be labelled as bio-based.

It should be highlighted that the environmental impacts and advantages of bio-based and agro-materials, as well as those from petrochemical sources, reflect only the current state of things. If indeed biomaterials' production increases, so will the environmental impacts related to them (GHG emissions, land use, eutrophication/acidification, etc.) and the advantages they represent may or may not increase proportionally. Moreover, before starting to turn to a fully bio-based economic system in the aim of counteracting climate change and pollution problems; it is of utter importance to perform a deep analysis of the actual environmental impacts such change could have taking into consideration not only the environmental aspect but also the economic and social factor that will be certainly affected. In order to do so, different methodologies have been implemented and regulated.

To correctly assess the environmental impact of turning to a bioeconomy system, it is important to perform an analysis of the consequences of such decision. For this, different methodologies have been developed, implemented and regulated. Among said methodologies, Life Cycle Assessment background on the Life Cycle Concept and multicriterion approach, is the one that better fits the complexity of systems with a global approach, and multiple potential environmental impacts. The evaluation of the environmental performance of a system or product through LCA, following a consequential approach aims to aid decision-making processes to move towards a use of biomass that considers a strong sustainability approach.

From the approaches that can be followed when performing an LCA, the two of them should be understood as different techniques to be applied depending on the system and the ultimate goal of the environmental evaluation rather than two opposite or conflicting lines of thought. It should, however, always be indicated the approach taken and the specifications of the study made available for the results to be better understood, reproducible and compared.

The carbon storage potential of biomass increases the attractiveness of a bioeconomy in the aim of improving current environmental practices. Moreover, it means that the main application of bio-based materials should be focused on sectors where products have a lifespan sufficiently long to delay the release of carbon.

However, and despite the climate mitigation potential of biomass, the complexity of the systems and natural cycles, make some methodological challenges to be yet fully standardized. Given the novelty of bio-based products, data remains geographically and temporally limited, and some of their end-of-life management techniques remain to be fully developed. At the same time, agricultural practices also induce environmental damages that have yet to be successfully integrated into the LCA methodology, such as the effects of land use change (both direct and indirect), as well as how to credit materials for the storage of biogenic carbon and delay in GHG emissions, remain subjects of debate among LCA practitioners. Nonetheless, LCA remains a relevant methodology for the development of better products with higher environmental performances through their comparison with current available products in the market.

Overall, the complexity of LCAs as well as of biomass, translates into some methodological challenges linked to the specificities of bio-based materials. Namely, the availability of life cycle inventory data, the handling multi-functionality of a product whenever there are co-products present as part of the system boundaries, the impacts of indirect land use change, carbon accounting (i.e., CO₂ sequestration, carbon storage), and the end-of-life management techniques available for bio-based products.

In this context, to address the relevance of introducing bio-based products as a strategy for climate change mitigation, this thesis aims to shed light on the specifics of performing a Life Cycle Assessment (LCA) on bio-based products by answering the scientific questions of:

- How does the diversion of resources affect the environmental impact of a bio-sourced product? And
- How to apply the LCA methodology to agro-materials?

While these scientific questions seem to be quite generic, responses tend to be very sector and case specific. Therefore, through a collaboration of the Laboratoire de Chimie Agro-industrielle with external companies, two case studies were developed to address and answer these scientific questions. Case studies are presented from a partially bio-based material to a 100% one (referred to as an agro-material).

Moreover, to address the methodological challenges as well as the scientific questions presented beforehand, challenges were approached by applying system expansion techniques and a counterfactual analysis by prioritizing the use of marginal data instead of average, as the former represents technologies able to respond to a change in demand.

All of this was addressed and applied through two case studies. The first case study, referred to as the “BOPA project”, resulted from an ADEME project an industrial collaboration with the SME VESO Concept® and an academic collaboration of the Institut Clément Ader and CIRIMAT. It was part of an ADEME project and concerns the environmental evaluation of a prototype of biocomposite sandwich panel for an application in aeronautics, using flax fiber as reinforcement material.

The second case study, the LUMA project, stems from the collaboration with an association of designers by the name of Atelier LUMA, the Agromat lab, and associations Ovalie Innovation and CRITT. In this case, the collaboration allowed for work to be carried out on the production and environmental evaluation of a sound-absorbing panel made from sunflower pith extracted from unharvested sunflower stalks.

CHAPTER II

ECO-DESIGN & ENVIRONMENTAL ASSESSMENT OF AN INNOVATIVE BIOCOMPOSITE PANEL FOR AVIATION

CHAPTER II. ECO-DESIGN & ENVIRONMENTAL ASSESSMENT OF AN INNOVATIVE BIOCOMPOSITE PANEL FOR AVIATION

Chapter II is dedicated to the Life Cycle Assessment of a biocomposite material, developed as part of the BOPA project, to produce a sandwich panel with an innovative omega core structure. The panel is aimed to be used in the interior fitting of an aircraft, and the evaluation of its environmental performance addresses the first scientific question “How does the diversion of resources affect the environmental impact of a bio-based product?” To do so, a consequential approach was followed by incorporating the environmental impact of the co-products’ fate to the overall environmental performance of the sandwich panel. Moreover, the effects of land use change (iLUC, in particular) were addressed to evaluate the potential impacts of an increase in demand for natural fibers for a technical application.

Firstly, an introduction addressing the concepts of Natural Fiber-reinforced Polymer Composites (NFPCs) is presented, along with the use of flax fiber as a technical textile, and a state-of-the-art of current LCAs carried out for NFPCs with different applications.

Preceded by a general description of the case study, a detailed Life Cycle Inventory (LCI) on the production of a flax fiber technical textile, and the LCA of a flax fiber-reinforced sandwich panel with an application in the aviation sector are presented in the form of scientific articles. The elements of the scientific articles taken from the thesis manuscript are presented in *italics*, as to avoid reading repetition.

Moreover, a conclusion of the work described in Chapter II is presented, followed by annexes relevant to the chapter.

Finally, supplementary analysis of the LCI on flax fiber and the LCA of the sandwich panel, are presented in the form of addendums at the end of this chapter.

II.1. Introduction

Current environmental problems concerning pollution levels and climate change have forced industry sectors to shift towards more sustainable and environmentally friendly practices. The aeronautics sector is not the exception and in 2011 the European Commission, through the Advisory Council for Aviation Research and Innovation in Europe (ACARE), published their five goals to be achieved in the Flightpath 2050 report. One of these goals concerns the protection of the environment and the energy supply which targets for a 75% and 90% reduction in CO₂ emissions per passenger kilometer and NO_x emissions, respectively. Moreover, it also aims for aircrafts to be recyclable (ACARE 2011).

Natural fiber reinforced composites have been demonstrated to have higher environmental performance when used in the automotive industry (Joshi et al. 2004; Le Duigou and Baley 2014; Deng and Tian 2015). Bachmann et al. (2017) discuss the potential use of these type of composites in the aviation sector even if “no published LCA on bio-fibers specifically for aviation applications has been identified” to date. The environmental benefits of this type of composites are a result of the less energy-intensive production processes of fibers, as well as their lower density values, the latter translates into fuel savings as less mass is being transported.

However, an increase in the implementation of natural fiber reinforced composites represents the need for higher yields in natural fiber production, which at the same time, may result in the shifting of environmental burdens from (in this case) the use phase of the aircraft to the fabrication of its components. Moreover, most co-products generated through the process of fiber transformation are re-circulated into the economy and valorized as new products (C.E.L.C. 2019a) and their influence in the overall environmental impact of natural fiber textiles should not be overlooked.

Among the various natural fibers that have been used as reinforcement in composite materials (i.e., hemp, flax, jute), flax represented 50% of the market share in 2012 (Barth and Carus 2015) and is the fourth most produced, commercially available fiber (Faruk et al. 2012).

The environmental performance of flax fiber reinforced composites has been assessed in previous Life Cycle Assessment (LCA) studies (Bachmann et al. 2017; Le Duigou et al. 2012; van der Werf and Turunen 2008; Bensadoun et al. 2016). However, these studies do not focus on the production of the flax fiber technical textile itself and, therefore, lack detailed information on the LCI. Additionally, co-products are handled by using economic allocation techniques and their fate is little discussed or specified.

Flax thus appears as a potentially important feedstock to a Europe aiming to deploy a sustainable bioeconomy. However, the full consequences induced using flax as a source of fiber to replace glass fibers has been little studied. For this reason, a complete Life Cycle Assessment should be carried out in order to confirm the environmental relevance or level of “greenness” of natural fiber reinforced composites, compared to their current market competitors, in the aeronautics sector.

II.1.1. Natural Fiber-reinforced Polymer Composites (NFPC)

Environmental and resource conservation concerns have boosted the research on the use of more environmentally performant materials. As a consequence, currently used synthetic/man-made fibers (i.e., glass and carbon fibers) are being substituted by natural fibers as reinforcement in composites. This type of material is known as Natural Fiber-reinforced Polymer Composites (NFPCs) and the application given to them vary depending on the fiber type, origin and structure.

NFPCs have attracted different industry sectors given the properties of natural fibers and their advantage over synthetic ones in term of their environmental, processing, mechanical and physical properties. In fact, natural-fiber reinforced materials are increasingly being used as a substitute for glass fiber reinforced composites, particularly in the automotive sector (Deng and Tian 2015; Yan et al. 2014), since it allows a weight reduction of parts of ca. 5% (Le Duigou and Baley 2014), among other benefits. For this reason, different authors have extensively reviewed the use of natural fibers as reinforcement on composite materials (Ticoalu et al. 2010; Faruk et al. 2012; Mohammed et al. 2015; Hristian et al. 2016; Peças et al. 2018; Sanjay et al. 2018).

Natural fibers can either have a vegetal or animal origin; however, for composite materials the term “natural fibers” refers to vegetal fibers. Vegetal fibers are classified into bast fibers (i.e., flax), seed fibers (i.e., cotton), leaf fibers (i.e., pineapple), grass and reed fibers (i.e., corn, wheat), core fibers (i.e., hemp shives), and all other not having a particular classification such as wood and roots (Faruk et al. 2012; Peças et al. 2018). Binders used for NFPCs can be thermoplastic (i.e., polyethylene, polyvinyl chloride (PVC), and polypropylene) or thermosetting matrices; phenolic, polyester, and epoxy resins are among the most commonly used thermosetting matrices (Mohammed et al. 2015).

Properties of NFPCs are highly dependent on the quality of the fibers, which are affected by geographical aspects, the conditions on which they are cultivated, the quality/type of the retting, the extracting processes, among others (Ticoalu, Aravinthan, and Cardona 2010). Moreover, the lignocellulosic nature of fibers affects their adhesion to the polymeric matrices (Spiridon 2014) and therefore different techniques for its improvement have been studied to chemically alter the fiber’s structure (Mohammed et al. 2015).

II.1.1.1. Composite materials

Chung (2010) defines composite materials as “multiphase materials obtained through the artificial combination of different materials in order to attain properties that the individual components by themselves could not attain”. Composites are differentiated from alloys as the latter are formed through natural processes, whereas the former require the use of artificial processes.

By correctly choosing the components, composite materials can be tailored to meet specific properties. In this case, not only the nature of the components can alter the properties, but also their proportions, structure, crystallinity, and morphologies, among others. Due to the liberty in design that this represents, composite materials can be adapted to satisfy the requirements of any industry (i.e., aeronautics, automobile, construction, energy).

The general structure of composite materials consists of one component being the *matrix* (also commonly known as the *binder*) and one or more components being the *fillers*. The nature of the matrix classifies composite materials, they can therefore be identified as polymer, metal, ceramic or cement composite materials.

For the different matrices that can be used for composite materials, polymer matrices are commonly the most preferred. The relatively low processing temperatures required for the manufacturing process, make them the easiest to produce. Polymer-Matrix Composites are differentiated in thermoset or thermoplastic depending on the type of polymer matrix being used. Between the two of them, Thermoset-matrix (such as epoxy, and phenolic resins) composites have the lower processing temperatures (ca. 200°C) (Chung 2010) and are extensively used.

Another classification can also be given depending on the shape of the filler, composites with particles as filler are known as particulate composites, while fibrous composites have fibers as fillers. From the

latter classification, the arrangement of the fibers has an important role on the performance of the composite.

Fibrous composites involving continuous fibers (known as Continuous Fiber Composites) make very good structural materials given the strength and modulus of the fibers. Moreover, the orientation of the fibers has an impact on the properties of the composite material, and different layers with different orientation of the fibers can be stacked one over another. This further increases the tailorability and versatility of the materials. In fact, according to Chung (2010), “continuous fibers have much more effect than short fibers on the composite’s mechanical properties, electrical resistivity, thermal conductivity, and on other properties” and can be used in “unidirectionally aligned tape or woven fabric form”.

II.1.2. Flax fiber as a technical textile

Flax (*Linum usitatissimum*) is an annual herbaceous plant grown for its fiber and, to a lower extent, for its oilseeds. Nearly 100 varieties of flax are cultivated; textile flax varieties are little branched, have small seeds and grow up to 80-120 cm. Additionally to the production of clothing and high-quality household textiles, flax fibers are used for more technical applications such as reinforcement for composite materials. In fact, 10% of long fibers produced are destined to the production of technical textile.

Worldwide, Europe accounts for 70% of the world’s flax production, with the French Normandy region responsible for up to 85% of the European production (C.E.L.C. 2019b; FAOSTAT 2017), making France the world leader of flax fiber production. This reflects the suitable agronomic conditions provided in the North of France (humid climate and nutrient rich soils) for the cultivation of flax, combined with a long-established know-how for cultivating and supplying this crop for the flax seed and fiber market. At the European level, there are about 140 flax fiber-processing plants and France has the installed capacity to carry out all stages of the supply chain (C.E.L.C. 2019b) i.e., the cultivation stage up to the final weaving into technical or textile fabric. Figure II-1 shows the installed capacities on production of flax fibers and their transformation into textile.

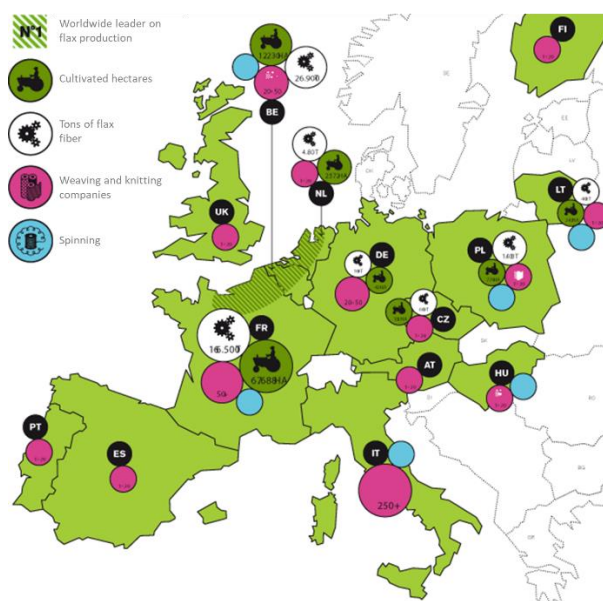

Figure II-1. Map of flax fiber production and transformation installed capacities. Image from (C.E.L.C. 2019a).

Flax seeds are sowed between the months of March and April and in little more than 3 months flax achieves sufficient height for it to be used as a textile fiber. Flax stalks begin a green color to then turn from yellow to a dark green once maturity is achieved. The stem ends give rise to flowers, whose life is only of a few hours, which in turn forms capsules, each one of them containing about 8-10 seeds. Depending on the variety, the color of the flower varies from blue to a purple/pink white. The duration of a flower goes from a few hours to a whole day if climate allows (cool and cloudy weather favor the petals) (USRTL 2019a).

The outer part of the stalks contains the bast fibers from which the textiles are made. Flax fiber's composition is ca. 70% cellulose and the remaining 30% is shared among hemicellulose, lignin, pectin and wax (Yan et al. 2014). Examination of the cross-section of flax fibers show that pectin holds together bundles of 10 to 40 fibers and exhibit a polygonal shape (Baley 2002).

Since the chemical composition of flax fibers is highly dependent on a set of parameters (species, variety, soil quality, weather, level of plant maturity) (Yan et al. 2014); values reported by different authors show a variability of proportions on the different components. Cellulose content values, for example, go from 60-70% (Lilholt et al. 1999; Tröger et al. 1998; Dittenber and GangaRao 2012) up to 70-80% (Fuqua et al. 2012; Gurunathan et al. 2015; Sisti et al. 2018). However, cellulose percentage is consistently high (over 60%); which, according to Yan et al. (2014), is what enables flax fibers to be considered as the reinforcement component in composite materials.

A set of steps are to be followed in order to extract the fibers from the stems and transform them into the desired product. After the agricultural phase, stems are retted to latter be scutched for the fibers to be accessible. Fibers are then combed, spun and woven into the technical textile. Stages are detailed in the following sections.

II.1.2.1. Agricultural phase

Flax is an annual crop with low nitrogen requirements (Fernando et al. 2015) and a high sensitivity to the soil's quality (ADEME and ITCF 1998). Flax growth is a delicate and fast process; in about 4 months stems must achieve enough height for long fiber yields to be sufficient but not so much for them to become thin and fragile. Ideal conditions for its growth involve a deep silt and fertile soil with a slightly acidic pH, and a mild, humid weather with at least 700 mm of rainfall.

Input of nitrogen, phosphate and potassium fertilizers is relatively low as flax is sensitive to a surplus in nitrogen and phosphate and potassium are mostly restored to the soil during retting. Phytosanitary treatments are also lower than other textile crops, i.e., flax requires 10 times less treatment than cotton (USRTL 2019b).

Flax, as other bast fiber and cereal crops, is susceptible to "lodging", which refers to the bending of the stems near ground level. Lodging may occur because of a nitrogen surplus in the soil or adverse weather conditions such as heavy rainfall and storms. For textile flax it is a very sensitive matter for flax growers as the taller the plant grows, the more vulnerable it becomes. Moreover, lodging highly affects the yield and quality of the fiber as harvesting is done by pulling the whole stem out (roots included), and not by reaping, to ensure for fibers to be as long as possible.

Textile flax is considered mature five weeks after blooming and it is characterized by a complete yellowing of the stem, the fall of leaves and the slight browning of the capsules containing the seeds. At this stage, flax stems are pulled out and laid down in the ground in thin-layered windrows.

II.1.2.2. Retting

Flax is then left out at the field for the stems to be broken down by the action of microorganisms and rain. This corresponds to the first phase of transformation of the plant into textile fiber and is known as Retting. The retting process happens as a natural process where, by the enzymatic action of microorganisms present in the ground, the pectose binding together the fibers to the outer, woody-like layer of the stems is broken down.

The process can take from 2 weeks to up to 3 months depending on weather conditions. Stems are turned over at least twice during the retting period to ensure a homogenous result and an optimal breaking down, otherwise fibers cannot be extracted, and flax becomes unusable.

At the end of the retting process, stems need to be sufficiently dry (moisture content lower than 15%) for them to be rolled up into round or rectangular bales and stored.

II.1.2.3. Scutching

When required, bales are transported to scutching facilities where the fibers will be extracted. In order to do so, flax is mechanically broken down in scutching machines where stems are beat for recovering the seeds and passed through a set of metal toothed rollers for crushing. Consequently, fibers are beaten and scrapped (combed) to remove the broken woody-like inner part of the stems and the surface pectin. The obtained fibers are then passed through drum carders spinning at 200 rpm, where long fibers are separated from shorter ones, as the desired output is fibers that go from 60 to 90 cm long (GNIS 2018a). Long fibers are then packed in bales or rolls of about 100 kg.

Throughout the scutching process, different co-products are issued and are extracted by an aspiration system embedded in the machine. All the co-products are separated by a shaker, collected and further valorized.

First co-product is the linseeds, which are sold to the vegetable oil market to produce linseed oil (Deng and Tian 2015). When linseeds are recovered, parts of the fibrous tissue covering them detaches from them and fall, this is known as flakes. Flakes are valorized as animal feed (BIOIntelligence Service 2007) as a source of fiber and protein. When the stems are crushed, the wood-like inner part that falls is known as shives. Shives are the most largely produced co-product and are valorized as gardening mulch, animal litter and/or as eco-building materials (C.E.L.C. 2019b). Short fibers separated from the longer ones are of no use to the flax textile industry, so they are rather used as reinforcement in thermoplastic composite materials with applications that go from leisure products (e.g., rackets, boards, helmets) and furniture, to eco-building materials, and automotive parts (e.g. door panels, dashboards) (C.E.L.C. 2019b). Throughout the whole scutching process, inert residues are also produced and include small plant residues, dust and the eventual soil carried out from the field along with the flax stems. The few centimeters of produced residues are not valorized but taken back to the fields of nearby farmers to be mixed with the amendments conventionally applied to the soil.

II.1.2.4. Combing

Rolls of flax fibers have to be completely untangled and homogenized before being spun into yarn. For this, fibers are combed and stretched in the form of soft, glossy ribbons. These ribbons are known as flax sliver. During this process, flax tow and dust is produced as co-product and regarded as inert residues, which follow the same fate as residues issued from the scutching stage.

II.1.2.5. Spinning & Weaving

More and more, the combing of flax fibers takes place directly at the scutching facilities and from there is taken to spinning facilities. Firstly, ribbons become wick as they are regularized and stretched. Afterwards, by twisting it, the wick is spun and transformed into yarn.

Spinning techniques vary depending on the type of yarn to be produced. Wet spinning (fibers are soaked in water at 60°C) results in fine threads suited for the weaving of clothing and linens. Dry spinning gives more rustic and thicker threads used to produce mats, ropes, technical textile, among others.

Threads are finally woven into fabric. For the clothing/linen sector, fibers undergo an extra set of treatment stages for fabrics to have the desired color and quality (i.e., bleaching, dyeing). In this work, however, the product of interest is a technical textile and therefore there is no need for threads to undergo further treatment.

II.1.3. LCA of NFPCs and their application in aeronautics

Currently, NFPCs main application is in the automotive sector. In fact, in the EU only, 95% of this type of composites are used as automotive components (Deng and Tian 2015). Joshi et al. (2004), for example, review the use of a hemp fiber composite with an epoxy resin in an Audi A3 and with an EPDM/PP resin in a Ford car. This kind of application is also brought forward by Le Duigou and Baley (2014); Yan et al. (2014), and Fernando et al. (2015).

Authors have evaluated the environmental performance of NFPCs through Life Cycle Assessment (LCA), and report results that are favorable for the natural fiber reinforced alternatives. In their work, Deng et al. (2016) state that the substitution of glass fibers with natural fibers can lead to 10-20% of impact reduction from the production and use phases of printed circuit boards.

Different authors have also evaluated the environmental performance of fibers such as jute, kenaf, cotton, and china reed as fillers in NFPCs; as well as the influence of the different factors affecting their performance. Lately, research has also focused on ramie fiber, but information is still limited (Dong et al. 2018).

Korol et al. (2016) compared the environmental performance of NFPCs using cotton, jute and kenaf fibers to composites reinforced with glass fibers. Authors conceive possible applications in packaging, automotive industry, construction materials, furniture and consumer goods. The LCA was carried out with ReCiPe Endpoint as method and data retrieved from Ecoinvent v3.1. From the different composite materials, the cotton fiber reinforced composite had the worst environmental performance, followed by glass fibers.

Yan et al. (2014) review the research done on flax fiber reinforced composites, and the evaluation of the mechanical properties of the fiber and the composite itself. Research focuses on flax fiber reinforced composites and comprises the factors affecting the tensile properties of fibers (i.e., structure, chemical composition, tensile deformation, tensile failure mechanism, and the configuration in which fibers are used (i.e., mat, fabric, roving, monofilament, yarn). Moreover, it presents a view of the different LCAs carried out on flax fiber (i.e., van der Werf and Turunen 2008; Deng et al. 2016; Dissanayake et al. 2009; Le Duigou et al. 2012).

Most of the LCAs on NFPCs use the ReCiPe Midpoint evaluation method and Ecoinvent as data source and apply allocation techniques to deal with the different co-products issued from the different stages of transforming the fibers (i.e., Duflou et al. (2014); Deng et al. (2016)).

LCA results show that the main processes contributing to the environmental impact of flax fibers are related to yarn production. Fernando et al. (2015) report this process is responsible for about 69-78% of the overall impact of flax fibers. Nonetheless, woven fabric offers superior mechanical properties

than the rest of the possible fiber configurations (Deng et al. 2016), which makes the spinning process a must. Therefore, even though natural fiber production has a lower impact than glass fiber production (Joshi et al. 2004), the validity of this affirmation is dependent on the natural fiber transformation processes (Dissanayake et al. 2009). Additionally, typical environmental drawbacks for natural fibers composites are related to agricultural activities. Eutrophication, freshwater ecotoxicity and land use are among the reported impacts in which synthetic fibers outperform natural ones (Duflou et al. 2014; Le Duigou and Baley 2014; Deng et al. 2016).

One of the main environmental advantages that NFPCs possess is the delay of greenhouse effects as the use of fiber crops for biocomposites allows for carbon sequestration (Fernando et al. 2015). This, however, depends on the lifespan of the materials as benefits from the storage of carbon are null if carbon is released too soon. Deng et al. (2016), for example, do not account for carbon sequestration in their study as the lifespan of the final product is no longer than 7 years. Because of this, an application in sectors where materials have a longer use phase would increase the environmental advantage of NFPCs over conventional composites. Another advantage is that fiber crops present the possibility of using them to treat wastewater (reducing the nutrient load), desertification and/or land degradation by phytoremediation (Fernando et al. 2015).

Concerning the management at the end of life of NFPCs, the relevance of the different techniques has been addressed. In the work of Bensadoun et al. (2016), the advantages and disadvantages of chemical recycling, mechanical recycling and incineration are discussed. Flax fiber being a combustible resource leaving no slag after incineration (Duflou et al. 2014) and the possibility of recovering the energy produced from the combustion of NFPCs, make incineration an attractive option. In any case, the correct End-of-Life (EoL) management technique can provide extra incentive for natural fibers to replace synthetic ones.

Particularly in the aeronautics sector, the use of NFPCs for main and secondary aircraft structures has been recently discussed, as well as their influence on the environmental performance of an aircraft. Natural fiber composites are of particular interest as they are lighter than synthetic ones and the weight reduction translates into less GHG emissions. Which is particularly relevant in this sector since air transport emissions can be more environmentally damaging compared to those at ground (due to an increased interaction with gases at high altitudes). Moreover, it has been demonstrated that the use phase is the most critical for aviation, the GHG indicator being responsible for more than 75% of the emissions in the whole life cycle (Bachmann et al. 2017).

In their work, Vieira and Bravo (2016), perform a Life Cycle Carbon Emissions Assessment (LCCEA) of a jute fiber reinforced PLA composite to be used for main aircraft structures such as the wings, and conclude that NFPCs could be promising if the level of control/mastery over these novel materials reaches that of conventional ones. Secondary structures thus offer more viable and immediate areas of application in airplanes (i.e., fairings, landing gear doors, cabin ceiling panels, sidewalls, and floor panels). Vidal et al. (2018), for example, perform a LCA of NFPCs to be used as interior panels in a Boeing 747-400.

Most LCAs confirm that the use of natural fibers in composites can reduce the global environmental impacts of a composite. There is, however, still room for improvement and key considerations in creating more environmentally performant NFPCs include: to “produce aligned fiber reinforcement without the need for the energy-intensive spinning operation” and accounting for co-products issued from the different transformation steps (Dissanayake et al. 2009), as well as developing more sustainable bio-based resins (Bachmann et al. 2017).

II.2. Description of the case study

In the context of an ADEME project, the SME VESO-Concept developed a bio-based composite (biocomposite) sandwich panel that incorporates flax fibers as reinforcement material. Moreover, the sandwich panel was designed with a novel core structure and was aimed to replace the current panels used in the interior fittings of commercial airplanes (i.e., baggage compartments).

To assess the environmental pertinence of substituting current materials with the proposed novel structure, a Life Cycle Assessment was carried out.

As part of the LCA, a thorough work of data collection on the production and transformation process of flax fibers into a technical textile was carried out and a Life Cycle Inventory was produced. The complete work is presented in Section II.3 in the form of a scientific article. Along with the LCI produced, the environmental performance of the final product (the technical textile) was assessed. Supporting Information referred to throughout the article, can be found in Annex VI.1. The functional unit for the evaluation of the environmental performance of the flax fiber technical textile was defined as the cultivation of 1 ha of flax fiber per year, corresponding to the annual production of 2330m² of flax fiber technical textile.

Once the LCI on the flax fiber technical textile was completed, the LCA of the biocomposite sandwich panel was performed. The complete assessment, along with its results and their interpretation, is detailed in Section II.4 in the form of a scientific article. The work presented follows the production, use, and end-of-life management of a sandwich panel made out from a biocomposite material using flax fiber as reinforcement. The panel is aimed to be used for the interior fittings of a commercial airplane. Through Life Cycle Assessment, the environmental performance of the biocomposite panel was evaluated and compared to the commercial counterpart. Supporting Information referred to throughout the article, is available in Annex VI.1 and VI.1.2. For this evaluation, the functional unit was defined as the use of 1m² of sandwich panel made of a flax fiber reinforced composite material, for an application as secondary structures of an airplane with a lifespan of 30 years.

By taking a consequential approach, this case study brings forward the effect of the diversion of resources on the overall environmental impact of a bio-based product.

The research leading to the results presented in both scientific articles, received funding from the ADEME under the grant agreement n°1501C0050. Moreover, the time used by L. Hamelin during this research was funded by the Cambioscop project, supported by the French National Research Agency, Programme Investissement d'Avenir (ANR-17-MGPA-0006) and Region Occitanie (18015981).

II.3. Flax fiber for technical textile: A life cycle inventory

Alejandra Gomez-Campos^{1*}, Claire Vialle^{1*}, Antoine Rouilly¹, Caroline Sablayrolles¹, Lorie Hamelin²

¹Laboratoire de Chimie Agro-industrielle, LCA, Université de Toulouse, INRAE, Toulouse, France

²Toulouse Biotechnology Institute (TBI), INSA, INRAE UMR792 and CNRS UMR5504, Federal University of Toulouse, 135 Avenue de Rangueil, F-31077, Toulouse, France

*Corresponding authors (alejandra.gomezcampos@ensiacet.fr / claire.vialle@ensiacet.fr)

Published in Journal of Cleaner Production. January 2021. DOI: 10.1016/j.jclepro.2020.125177

Alejandra Gomez-Campos: Methodology, Investigation, Writing - original draft, Visualization.

Claire Vialle: Validation, Writing - review & editing, Supervision.

Antoine Rouilly: Writing - review & editing, Supervision, Funding.

Caroline Sablayrolles: Validation, Writing - review & editing, Supervision.

Lorie Hamelin: Validation, Writing - review & editing, Supervision.

KEYWORDS

Consequential LCA; System expansion; Life Cycle Assessment; flax fiber biobased materials; bioeconomy

ABSTRACT

Flax fiber appears as a suitable feedstock in the endeavor of deploying a sustainable biobased economy. Its environmental performance as reinforcement in composite materials has been studied in previous Life Cycle Assessments (LCAs). However, these studies only present a coarse Life cycle Inventory (LCI) and often fail to detail all processes of the supply chain or to represent the co-products. This paper aims to bridge this gap and provide data for future LCAs on flax fiber production and transformation.

The study focuses on the impacts of producing a bio-based reinforcement material (a fabric product for non-aesthetic purposes) with a system expansion perspective. The functional unit is defined as the production of 2400 m² flax-based technical textile per year, this corresponds to 1 ha of cultivated land. The geographical scope considers that the production occurs in France and that some manufacturing processes are outsourced in China. A Sensitivity Analysis was carried out to assess the influence of the electricity mix in the various countries involved in the manufacturing cycle.

A detailed life cycle inventory for flax fiber production and transformation was built and the environmental performance of a flax technical textile was assessed as a cradle-to-gate LCA. The fate of coproducts was documented and was shown to contribute to the reduction of the generated environmental impacts.

Through a cradle-to-gate LCA, a broader understanding of the environmental performance of a flax-based technical textile was presented by including the valorization of co-products and a wider set of analyzed impact categories, going therefore beyond the existing state-of-the-art. Results show agricultural activities and electricity production to be the biggest contributors to the environmental impacts of flax technical textile; contributions due to land use changes were minor in comparison. Very specifically for this case study, a sensibility analysis showed the influence of an all-French production to be more efficient from an environmental point of view

II.3.1. Introduction

The latest update of the European Commission's (EC) Bioeconomy Strategy (EC, 2018b) sheds light on the strategic role of bio-based products and services in the transition towards a post-fossil carbon economy, bringing both innovative and sustainable solutions to global challenges such as climate change, land- and ecosystem degradation. Because it allows decoupling the material and in particular, the chemical sector from the use of fossil carbon, bio-based materials is a growing and encouraged market throughout Europe (EC, 2018b). In France, for example, the national Bioeconomy Action Plan suggests using bio-based materials for the construction of the Olympic Village 2024 (Embassy of France in Washington, 2018), among others.

Flax (*Linum usitatissimum*) has been long used as a source of textile fibers. Lately, it has also been used to meet technical applications such as reinforcement for composite materials. *In fact, natural-fiber reinforced materials are increasingly being used as a substitute for glass fiber reinforced composites, particularly in the automotive sector (Deng and Tian 2015; Yan et al., 2014), since it allows a weight reduction of parts of ca. 5% (Le Duigou and Baley, 2014), among other benefits. Amongst the different natural fibers being used, flax represented 50% of the market share for composites in 2012 (Barth and Carus 2015).*

Worldwide, Europe accounts for 70% of the world's flax production, with the French Normandy region responsible for ca. 85% of the European production (C.E.L.C., 2019b; FAOSTAT 2017), making France the world leader of flax fiber production. This reflects the suitable agronomic conditions provided in the North of France (humid climate and nutrient rich soils) for the cultivation of flax, combined with a long-established know-how for cultivating and supplying this crop for the flax seed and fiber market. At the European level, there are about 140 flax fiber-processing plants and France has the installed capacity to carry out all stages of the supply chain (C.E.L.C., 2019b) i.e., the cultivation stage up to the final weaving into technical or textile fabric.

C.E.L.C. (2010) states that the cultivation of 1 ha of flax fiber contributes to stock 3.7 tonnes of CO₂ (below-ground carbon). Moreover, most co-products generated through the flax fiber transformation stages are re-circulated into the economy and valorized as new products (C.E.L.C., 2019a). *The environmental performance of flax fiber reinforced composites has been assessed in previous Life Cycle Assessment (LCA) studies (Bachmann et al., 2017; Le Duigou et al., 2011; Van der Werf and Turunen, 2008; Bensadoun et al., 2016). However, these studies do not focus on the production of the flax fiber technical textile per se and, therefore, lack detailed information on the LCI. Additionally, co-products are handled by using economic allocation techniques and their fate is little discussed or specified.*

Flax thus appears as a potentially important feedstock to a Europe aiming to deploy a sustainable bioeconomy. However, the full consequences induced by the use of flax as a source of fiber to replace glass fibers has been little studied.

To the authors' knowledge, current work on LCAs assessing the environmental impact of flax fibers as reinforcement on composite materials is limited and what is available either does not address the whole supply chain of flax fiber transformation (from cultivation to weaving into a technical textile) or lacks transparent information on the LCI used. Le Duigou et al. (2011) presented LCI data up until the combing process and used mass allocation to artificially attribute parts of the impacts to the studied product only. On the other hand, Deng and Tian (2015) did follow a consequential approach, but accounted only for seeds, short fibers, shives and flax tow as co-products; whereas in this work every co-product emerging in the supply chain were accounted for, along with consequences of demanding constrained resources (e.g., land use changes).

In an endeavor to bridge this gap, the purpose of this study is to assess the environmental performance associated to transforming flax fibers into a technical fabric used as reinforcement in a composite material, in the short-term horizon. It also aims to provide transparent, clear and precise inventory data for future LCAs to be carried out for flax fiber intended for the technical textile sector.

II.3.2. Materials and Methods

II.3.2.1. LCA approach

The Life Cycle Assessment was carried out with the SimaPro LCA software, version 8.5.2. The impact assessment method ILCD 2001 Midpoint+ was used but slightly adapted based on the recommendations from the European Commission (EC) “product environmental footprint category rules” (PEFCR; EC 2017), themselves based upon the IPCC update published in their Fifth Assessment Report (AR5; IPCC 2013). This affects the GWP100 of i) biogenic methane (34 kg CO₂ eq); ii) non-biogenic methane (36.75 kg CO₂ eq) and iii) carbon monoxide, fossil and from land use changes (1.57 kg CO₂ eq).

From the 16 impact categories proposed by ILCD 2001 Midpoint+, the following were selected to be part of the assessment, being explicitly mentioned in the European Commission policy recommendation (EC 2013) for the methods to use for LCA, namely: Climate change, Ozone depletion, Particulate matter, Photochemical ozone formation, Acidification, Freshwater eutrophication, Marine eutrophication and Mineral, fossil & renewable resource depletion. Moreover, to include impacts related to the use of nuclear energy, the impact category Ionizing radiation (Human Health) was included as well.

Although no official guidelines exist about this specific issue, LCAs are often labeled as “attributorial” or “consequential” (e.g. (Ekvall et al., 2016; Finnveden et al., 2009; Hamelin 2013; Weidema et al., 2018)), though other (e.g., advanced attributorial) or additional (e.g., prospective, hybrid, etc.), labels are also used. The LCA performed herein could be referred as “consequential” (Brandão et al., 2017; Earles and Halog 2011), i.e., no co-products are left out from the system boundaries and all their exchanges from and to the environment, in terms of material and substance flows, are fully taken into account. This approach allows to gain insights of the environmental burdens associated to changes in demand and ultimately to foresee the environmental consequences of a decision being made (Sonnemann and Vigon 2011).

Accordingly, a system expansion approach was taken, and allocation techniques were avoided, as recommended in ISO 14040 and 14044 (ISO 14040. 2006, 2019); (ISO 14044. 2006, 2019). Background data were extracted from two life cycle inventory databases, namely Ecoinvent v3.4 and Agribalyse v1.3 (a French specific agricultural database) from which “consequential processes” (Weidema et al., 2013; Wernet et al., 2016) or identified marginal processes were selected.

II.3.2.2. Goal

This study focuses on the impacts of producing a bio-based reinforcement material; from this point onwards, to be referred to as “technical textile”, i.e., a fabric product manufactured for non-aesthetic purposes. In subsequent steps, this technical fabric is impregnated with a thermoplastic or thermosetting all-polymeric matrix (e.g., epoxy, polyester, vinyl-ester resins, among others) to form a composite material. It is the long-term vision of the authors to address the consequences of the use of such bio-based technical textile for the aviation sector, though this full assessment is beyond the scope of the present study. The present study follows therefore a cradle-to-gate approach; it encompasses all steps of flax fiber production and transformation, from the fields up until (and including) the

production stage, i.e., just prior to blend the fabric with the polymeric resin. The work carried out aims to provide a complete LCI for future LCA studies to be performed.

II.3.2.3. Functional Unit

The functional unit is defined as the production of 2330m² flax-based technical textile per year, having the required properties for an eventual use in the aviation sector. This corresponds to 1 ha of cultivated land, from which about 7000 kg of flax green stems (wet weight; ww) are harvested per year (mean yield value of the last ten years according to data from FAOSTAT, 2017). For tractability reasons, the results will be here expressed per ha of land used for the cultivation of flax.

II.3.2.4. Scope

Geographical scope. The geographical scope considers that the production stems from a company located in France; parts of the manufacturing process are however outsourced in China. In other words, the cultivation and initial stages of the flax fibers' conversion takes place in France (the inventory data reflects the French biophysical and legislative conditions), while the last steps of the process chain take place in China (under the applying Chinese context for the use of electricity and other inputs). Background systems affected outside these two countries (e.g., the production of fertilizers) are also included, in accordance with state-of-the-art LCA principles (ISO 14040 2006; ISO 14044 2006).

According to C.E.L.C (2010) the European flax fiber production market is represented by over 10 000 companies distributed in 14 European countries. Europe is responsible for 80% of the world's flax fibers (scutched fibers) production and over 60% of the registered suppliers of technical fabric are located in France. However, China is considered the world leader of textile-clothing production (IFM 2004) as it makes up for 22 and 24% of the world's installed capacities for spinning and weaving, respectively (BIOIntelligence Service 2007). Hence, these last steps of the production are considered to take place in China.

Temporal Scope. The temporal scope of the study considers the short-term horizon, i.e., data from "current" production practices were collected, assuming they can be representative of future production conditions. In other words, our data represent "today's" production and are judged valid to represent the production taking place within the next five to ten years.

II.3.3. Life Cycle Inventory

II.3.3.1. Overview

The identified supply chain stages to obtain a flax fibers technical fabric are presented in Figure II-2 along with the various coproducts emerging from these, and their fate. As per experts in the area, specifically of the French production chain of flax fibers in the textile sector, the possible fate of the co-products presented in Figure II-2 represent their main valorization. However, co-products could also be found to serve other, in this case less common, purposes.

The overall input and output flows to and from the system's boundaries in terms of materials and emissions are summarized in Table II-1 (foreground data). These are represented per ha of cultivated land; values above 1 ha in Table II-1 mean that more than one passage of the agricultural machinery is required. For plowing, for example, machinery passes three times, each time covering the totality of the one-hectare field. This is the same for the application of fertilizers and plant protection products.

As it can be seen from Table II-1, the foreground inventory data considered for the flax cultivation, scutching, combing, spinning and weaving processes were essentially drawn from the work of Bensadoun et al. (2016), BIOIntelligence Service (2007) and Le Duigou et al. (2011); the only existing inventories documenting French flax production. The work behind these inventories was based on data from the industry, albeit indirectly (namely from the “Institute Technique du Lin”, a French organization that manages the production and transformation of flax fiber) and the C.E.L.C.

The life cycle inventory for the retting stage as well as for the use of the co-products have not been documented before and are a novelty of this study. The hypothesis, calculations and data source behind these inventories are detailed in the Supporting Information (SI) Word document. All background processes (e.g. agricultural activities, production of fertilizers) involved were retrieved from the Ecoinvent v 3.4 database; the exact processes used are documented in the SI Excel document.

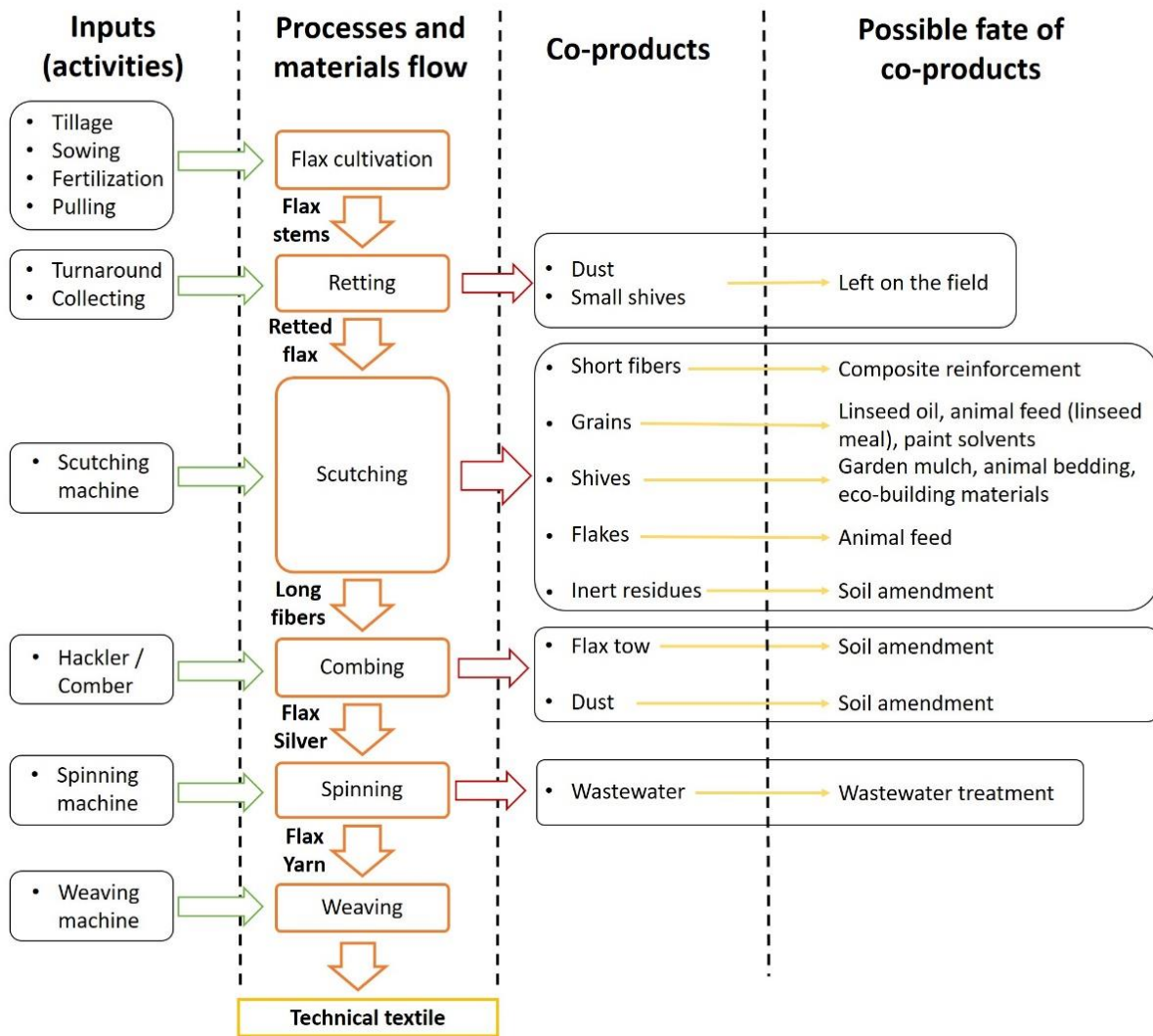

Figure II-2. Process tree including input and output flows and the fate of co-products.

Table II-1. Values of input and output flows from the technical textile supply chain. All units are per hectare of cultivated land per year.

FLAX CULTIVATION				RETTING			
Input		Value	Units	Input		Value	Units
Tillage	Plowing	3	ha	Flax stems		7000	kg
	Rotary cultivator	1	ha	Land Use		1	ha
	Harrowing	1	ha	Agricultural Machinery	Turnover	2	ha
Sowing		1	ha	Collecting		4.67	m ³
Fertilizing & zinc application by broadcaster		3	ha	Output*			
Plant protection (Herbicides&Pesticides) by field sprayer		5.5	ha	Retted flax		6230	kg
Pulling		1	ha	CO ₂ emissions		545	kg
Seeds		115	kg	CH ₄ emissions		4.55	kg
Land Use		1	ha*a	CO emissions		1.21	kg
Fertilizers	Potassium chloride	117	kg	NH ₃ emissions		0.42	kg
	Ammonium nitrate phosphate	86	kg	N ₂ O direct emissions		0.098	kg
	Triple superphosphate	146	kg	N ₂ O indirect emissions		5.4E-05	kg
Pesticides	Carbendazime / Benzimidazole	150	g	SCUTCHING			
	Prochloraze	38	g	Input			
	Flusilazole	300	g	Retted flax		6230	kg
	Thirame	73	g	Electricity		723	kWh
Herbicides	Triallate	144	g	Transport from field		249	tkm
	Linuron	90	g	Output			
	Bentazone	1584	g	Long fibers		1470	kg
Insecticides	Deltamethrin / Pyrethroid	15	g	Short fibres		770	kg
Zinc	For seed's treatment	414	g	Grains		350	kg
	For soil treatment after sowing	1000	g	Shives		2520	kg
Copper		9.53	g	Flakes		490	kg
Iron		3.48	kg	Inert residues		630	kg
Calcium		30.24	kg	Co-products fate*			
Carbon dioxide (captured from air)		10395	kg	Production of glass fibre composites (Short fibres)		-693	kg DM
Output				Marginal oil production (Grains)		-99	kg
Flax stems		7000	kg	Marginal animal feed production (Linseed meal)	Marginal protein (soybean)	-177	kg FM
Induced Land Use Change		0.05	ha	Marginal carbohydrate (maize)		-149	kg
Emissions to air	Ammonia	0.73	kg	Marginal fats (palm oil)		-3.83	kg
	Dinitrogen monoxide	0.49	kg	Avoided Land Use Change		-0.013	ha
	Nitrogen dioxide	0.1	kg	Combustion of woody residues		41	MJ
	Carbendazim	7.5	g	Heat production from natural gas (Shives)		-33	GJ
	Triallate	136.8	g	Marginal animal feed production (Flakes)	Marginal protein (soybean)	-81	kg
	Linuron	45	g	Marginal fibre (hay)		-666	kg
	Bentazone	237.6	g	Use of inert residues as amendment		630	kg
	Deltamethrin (pyrethroid)	0.15	g	COMBING			
Emissions to water	Carbendazim	0.75	g	Input			
	Triallate (groundwater)	1.57	g	Long fibers		1470	kg
	Triallate (river)	0.86	g	Electricity		809	kWh
	Linuron	0.45	g	Output			
	Bentazone	7.9	g	Flax Silver		980	kg
	Deltamethrin (pyrethroid)	0.075	g	Flax tow		420	kg
	Nitrate	25	kg	Dust		70	kg
	Phosphate	0.93	kg	Co-products fate*			
	Nickel (river)	1.51	g	Use of inert residues as amendment		490	kg
	Phosphorus (groundwater)	0.07	kg	SPINNING			
	Phosphorus (river)	0.276	kg	Input			
	Cadmium (groundwater)	42.24	mg	Flax Silver		980	kg
	Cadmium (river)	18.68	mg	Electricity		4414	KWh
	Chromium (groundwater)	20.87	g	Gas		24024	MJ
	Chromium (river)	2.18	g	Water		12.74	m ³
	Lead (groundwater)	102.7	mg	Lubricating oil		49000	g
	Lead (river)	307.3	mg	Transport from Combing facility to port		147	tkm
	Mercury (groundwater)	0.17	mg	Transport from port to port		19110	tkm
	Mercury (river)	0.44	mg	Transport from port to factory		196	tkm
	Zinc (groundwater)	10.4	g	Output			
	Zinc (river)	1.44	g	Flax Yarn		910	kg
Copper (groundwater)	2.73	g	Wastewater		12.74	m ³	
Copper (river)	1.4	g	WEAVING				
Emissions to soil	Arsenic (As)	0.56	g	Input			
	Cadmium (Cd)	18	g	Flax Yarn		910	kg
	Cobalt (Co)	1.5	g	Electricity		11830	kWh
	Chromium (Cr)	92	g	Starch		159	kg
	Copper (Cu)	17	g	Transport from factory to port		168	tkm
	Iron (Fe)	5965	g	Transport from port to port		16380	tkm
	Mercury (Hg)	0.011	g	Transport from port to distribution place		168	tkm
	Molybdenum (Mo)	1.2	g	Output			
	Nickel (Ni)	17	g	Technical textile		840	kg
	Lead (Pb)	2.2	g				
	Selenium (Se)	1	g				
	Zinc (Zn)	116	g				

II.3.3.2. System boundaries

As previously discussed, system expansion was used to quantify the environmental impacts stemming from the co-products. Their inclusion into the system boundaries was done by identifying their most common use in the market, along with identifying the marginal (avoided) processes that would most likely be reacting to the demand change induced by their introduction to the market (Figure II-3). These choices were validated by experts and professionals of the sector.

Other than agricultural machinery, infrastructure of foreground data is not taken into consideration. On the other hand, infrastructure related to background data is included in the already existing Ecoinvent processes. Transportation requirements and corresponding transport distances are documented in the BioIntelligence Service report (2007) and these were considered herein. A 40 km distance between the cultivation location and the scutching/combing facilities is considered to be covered by a 32-t truck. The same transport goes for the distance between the scutching facility and the French port (150 km) from which flax fibers will be shipped by a transoceanic freight ship to the Nanjing port in China (19500 km). Fibers are then transported by land to a facility at 200 km where they will be spun and woven. The technical textile is afterwards sent back to France considering the same transportation route, except that once in France, a 200 km distance from the port to a selling point is covered by truck. In the model, transport processes are taken into consideration as part of the spinning and weaving processes; their influence is addressed in the discussion section.

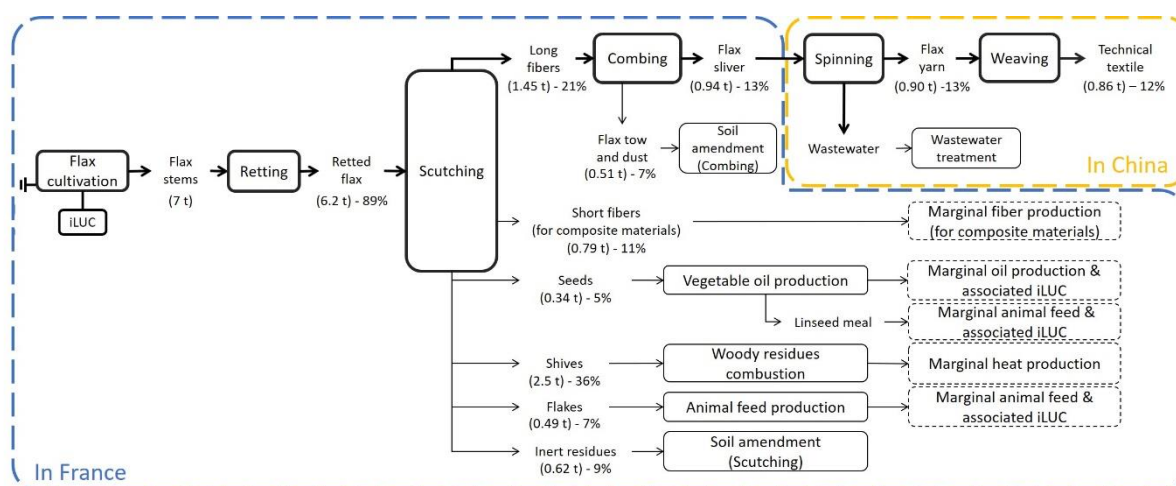

Figure II-3. Process flow diagram illustrating the fate of the co-products from the production of a flax fiber technical textile. Boxes represent induced processes while dotted lines represent avoided processes.

II.3.3.3. Flax cultivation

For the cultivation of 1 ha of flax fiber, about 115 kg of flax seeds are sowed. Sowing takes place between the months of March and April. After 100 days (blooming stage), the stems reach a height of 1 m. As a result, by the month of July 7000 kg ha⁻¹ of flax stems (ww) are harvested by pulling (not reaping). This is done particularly for flax grown to be used as a fiber source for textile production; by pulling the whole stem, along with the roots, farmers ensure that fibers will be as long as possible.

Data for the planting and harvesting stages were collected from BIOIntelligence Service (2007) and Le Duigou et al. (2011), as documented in the SI.

The impact of displacing land as additional arable land is demanded for flax cultivation, i.e., the so-called land use changes, was taken into account based on the approach described in a recently release study from the European Commission (EC 2019), itself updating the deterministic approach presented in Tonini et al. (2016). In a nutshell, this approach is based on an analysis of the global deforestation that occurred between 2000 and 2010 and considers two key reactions to an increased demand for

arable land, namely arable land expansion (85% of the response) and agricultural intensification (15% of the response; here translated as an additional fertilizer demand only). All carbon (carbon dioxide; CO₂, methane; CH₄ and carbon monoxide; CO), nitrogen (ammonia; NH₃, dinitrogen monoxide; N₂O, nitrogen oxides; NO_x and nitrates; NO⁻³) and phosphorus flows occurring as a result of these two responses were considered. When translated into CO₂ eq, it results in an emission factor of 4.0 t CO₂ eq ha⁻¹ y⁻¹. Which is in the same order of magnitude as the factor derived by Tonini et al. (2016) (4.1 t CO₂ eq ha⁻¹ y⁻¹), but slightly above the factors derived by Schmidt and Muños (2014) (1.7 t CO₂ eq ha⁻¹ y⁻¹); value for “world average arable land”).

The iLUC value is obtained by considering the annualization of the use of 1 ha of land over 20 years, based on EU methods. More specifically, the iLUC factor used was retrieved from EC (2019), itself an update of the deterministic method presented in Tonini et al. (2016). To derive this factor, the 20-y annualization method was followed based on the recommendations of the Product Environmental Footprint Category Rules Guidance (PEFCR, version 6.3) of the European Commission (EC, 2017).

Removals of calcium, copper and iron from the ground were accounted for. The starting point for this was the composition of the flax plant (Heuzé et al. 2015). Here, it was considered that no external application of these micro-nutrients take place; therefore, the whole quantities of these in the flax plant is assumed to stem from soil withdrawals. Biogenic CO₂ captured by the plant was calculated through Equation II-1 (Boutin et al. 2005). In this equation, Q_{CO₂} represents the amount of CO₂ required by the plant to make up its weight in dry matter (Q_{DM}); %_C corresponds to the carbon content of flax fibers (here 45%; (Sharma and van Sumere 1992)) and M_{CO₂} and M_C represent the molar mass of CO₂ and C, respectively.

$$\text{Equation II-1} - Q_{CO_2} = (Q_{DM} * \%_C) * \left(\frac{M_{CO_2}}{M_C}\right)$$

Flax's nitrogen requirements are low and sensitive to the quality of the soil. According to ADEME and ITCF (1998), an input of 10-20 kg ha⁻¹ suffices for a high-quality soil, while 40 kg ha⁻¹ are needed for soils with less humus content. Independently of the soil quality, potassium (K₂O) and phosphate (P₂O₅) requirements amount each to 70 kg ha⁻¹. For this study an average of 30 kg ha⁻¹ was considered as nitrogen input. The specific fertilizers considered are based on the BioIntelligence Report (2007) and correspond to the marginal fertilizers identified by Hamelin (2013) for Europe, namely: ammonium nitrate (35% N content), potassium chloride (60% K₂O content) and triple superphosphate (48% P₂O₅ content). Similarly, the application of pesticides and herbicides was modelled based on the data from the BioIntelligence report (2007).

II.3.3.4. Retting

The first transformation step from plant to fiber is the *retting* process. Once the stems are pulled, they are laid over the field in windrows of approximately 1 meter long and left to “rot” by the enzymatic action of the microorganisms present in the soil, being exposed to rain and other climate conditions particular to the region. Stems must be well aligned and not too tight to avoid mold (GNIS 2018b). *To optimize the retting process, farmers will turn over the stems to obtain a homogeneous result. The quality of the fibers depends greatly on how well the retting was carried out by the farmers.*

During the process, the pectins that bind the fibers to the woody part of the plant are depolymerized. *This step can take from two to 12 weeks depending on the climate conditions and the industrial requirements for the fiber. At the end of the retting process, when the flax stems are sufficiently dry (less than 15% moisture content) they are stored rolled up in round or rectangular bales.*

As confirmed by experts from the French organization “Union Syndicale des Rouisseurs-Teilleurs de Lin” (USRTL), no biomass is left on the field after collection of the retted stems. Possible dust and small shives produced from the retting process and their contribution to adverse health or as an input of carbon and macronutrients to soil are considered as negligible. Therefore, the mass loss is assumed to be emissions to air.

Consequently, carbon (CO_2 , CO , CH_4) and nitrogen (N_2O , NO_x , NH_3) emission flows from the decomposition of biomass were estimated in order to model the overall environmental impact of the retting process. Carbon losses were calculated considering that 22% of the total mass loss happens in the form of carbon. This proxy is based upon ongoing research (Bleuze 2019) on the retting of hemp under industrial condition as no quantified data characterizing the degradation of flax during the retting process was available. By considering an overall mass loss of 11% (Table 1; specifications in SI) and a dry matter content of 90% for flax (Heuzé et al. 2015), the total carbon losses amount to about $150 \text{ kg C}_{\text{loss}} \text{ ha}^{-1}$, being lost as of CO_2 , CO and CH_4 , as further detailed in the SI. Regarding nitrogen emissions, it was considered that losses correspond to 0.06% of the dry matter (DM), based on Hamelin et al. (2014); which translates into $0.42 \text{ kg N}_{\text{loss}} \text{ ha}^{-1}$. These were considered to occur as N_2O and NH_3 ; details of the calculations can be found in the SI.

II.3.3.5. Scutching

Retted stems are baled and transferred to scutching facilities where the wood-like part of the stem is broken up for the fibers to be accessible. This is the first mechanical transformation of the fibers and a process in which numerous co-products are generated, namely long fibers that go from 60 to 90 cm (GNIS 2018a) (desired output), short fibers below 60 cm, grains, shives, flakes and plant residues that may include some dust and soil (Figure II-2). The energy input related to this process was modelled according to BIOIntelligence Service (2007) and Le Duigou et al. (2011), as well as the mass percentages of the different co-products resulting from this step.

Bales are unrolled on carpets and, after having recovered the seeds by beating them, flax stems are spread out parallel as they pass through a machine composed of a set of metal toothed rollers that crush, beat and then comb them to eliminate the inside wood-like core. Drum carders spinning at 200 rpm, where long and short fibers are separated, then clean the fibers. Long fibers are kept while the different co-products fall to the floor of the machine. Small components such as flakes and plant residues in the form of dust, are extracted by an aspiration system.

Short fibers. As their name suggests, this co-product represent fibers of a reduced length. This co-product, also known as scutched tow, is essentially valorized as reinforcement in thermoplastic composite materials for leisure products (such as rackets, boards, skis, helmets, among others), automotive parts (e.g. dashboard, door panels), eco-building or composite furniture (C.E.L.C. 2021). This application, i.e. reinforcement in composite materials, was therefore considered herein.

In some cases, short fibers undergo another cleaning process where high and low quality short fibers are distinguished. Low quality fibers are then used as insulation material for housing. Whether this additional step does take place or not is plant-dependent and was not considered in this life cycle assessment.

Although, the nature of the reinforcement material might result in a change of performance, here the production of fiber-reinforced composites was considered to replace glass fiber reinforced composites in a 1 to 1 ratio. This assumption implies that markets are unconstrained, that supply is fully elastic (Weidema et al. 2013), and that both fibers deliver the same functionality per unit of mass. It was further considered that the type of fibers used (glass or flax) does not affect the quantity of resin needed to produce the composite material (resin was therefore left out of the system boundary). This

assumption was taken as a way to simplify the studied system and as a consequence of a lack of information specific to this case study. However, were the information to be available it should be included in future studies in order to further improve the pertinence of the results.

It was then considered that the 770 kg of short fibers produced per functional unit, avoid the production of 693 kg of glass fibers (considering a 90% DM content for the short fibers). To represent the displaced glass fibers production (from the 770 kg of short fibers produced per functional unit), the process *avoided glass fiber production* was modelled, adapted from an existing process of the Ecoinvent v3.4 database, as further detailed in the SI Excel document.

Seeds. Linseeds are flat-shaped and have a bright, brown color. They are small and light, 2000 seeds weight around 10 g; which corresponds to the dose required to sow one m² of land (GNIS 2018a). They come inside a structure known as a capsule; each capsule is made up of two lobes that can contain 1-2 seeds. In total, 8-10 seeds can be obtained from one capsule.

Seeds are collected right at the beginning of the *scutching* process and are typically used to extract oil (Deng and Tian 2015), to be sold on the vegetable oil market, thereby replacing the production of marginal oil. This is here considered to be palm oil, as identified by Schmidt and Weidema (2007). In the linseed oil extraction process, linseed meal is generated as a co-product. Linseed meal is considered to be further valorized as animal feed. It has a higher protein quality than other commonly used sources of protein (Newkirk 2015) and there is no other real economic market for it (Chandrasekaran 2013). The LCA model considers that the carbohydrate, lipid and protein content of the meal replaces marginal carbohydrate, lipid and protein sources in animal feed, respectively. The marginal carbohydrate was taken to be maize, as identified by Tonini et al. (2016), the marginal protein to be soybean meal (Dalgaard et al. 2008), and the marginal lipid as palm oil (Schmidt and Weidema 2007).

Substitution factors were derived based on the nutritional valued of linseed meal and those of the marginal displaced feed ingredients (detailed in Table II-1 and the SI), an approach similar to that taken by e.g. Tonini et al. (2016). The life cycle inventory of the displaced ingredients was retrieved from the Ecoinvent v3.4 database (consequential processes; exact processes documented in the SI). The so-called “oil loop” documented in Dalgaard et al. (2008), i.e. reflecting that the substituted palm oil is produced along with palm meal, whose displacement in turns affect other commodities, is taken into account through the use of these consequential processes of the Ecoinvent database.

Shives. Shives represent the inner core of the stem, a wood-like layer typically valorized as gardening mulch, animal litter and/or as eco-building materials in the form of chipboard panels (C.E.L.C. 2019b). For these three uses, an increased availability of shives involves a decrease in the use of wood residues. Wood waste (as wood chips for the case of gardening mulch and animal litter; and as a variety of streams for eco-building materials) is here considered as the marginal supplier for these uses. In other words, it is considered to be the least competitive supplier of these services, and thus the one to be displaced as a new alternative (here shives) becomes available. The fate considered for this increased availability of wood waste (no longer needed where shives are now used) is combustion in a 300 kW furnace with silo, supplying heat for district heating. This is based upon the findings of Projet AF Filières (2018), presenting a detailed material flow analysis of woody resources for the whole of France. The heat produced by these wood residues would then induce a decrease on the use of natural gas, the latter representing the marginal heat source for France.

The composition of flax shives and wood chips, in terms of DM, C and N, is very similar (C – 51% vs 50%; N – 0.6% vs 0.4%; expressed as % of the DM and retrieved from the Phyllis database). This involves

that the emissions and impacts linked to their respective management (prior to their use) can be expected to be very similar to one another; these were thus neglected herein.

In a nutshell, the overall management of shives implies two key processes, namely:

- Induced *woody residues combustion*, to represent the emissions from generating district heating heat from the displaced wood residues and,
- *Avoided heat production from natural gas*, which would have otherwise been used to generate that heat.

Detailed information on the processes used as proxys to model this can be found in the SI Excel document.

Flakes. Flakes represent the fibrous tissue covering the flax grains and can be further valorized as animal feed (BIOIntelligence Service 2007). The mechanical force applied to the fibers during the *scutching* process, causes the outer tissue of the grains to detach and fall. The nutritional content of flakes is high on fiber, but also contains protein (SI). Just like the calculations done for the valorization of linseed meal as animal feed, the fiber content of hay (marginal fiber) and soybean meal (marginal protein) were compared to the nutritional composition of flakes in order to derive the displacement ratios. The processes *avoided soybean meal production (Flakes)* and *avoided hay production (Flakes)* were created, as detailed in the SI.

Inert residues. Inert residues include the dust from the plant itself, small plant residues and soil carried out from the field with the flax stems. Based on personal communications with the stakeholders of the flax supply chain, these few centimeters of dusty residues are typically returned to nearby farmers and mixed with the amendments conventionally applied to soils. They are thus not used instead of fertilizers (or other amendments), but on top of these. Therefore, they do not replace marginal fertilizers. To model the emissions due to the application of this material on land (AoL), the algorithms detailed in Hamelin et al. (2014) for AoL were used, as further elaborated in Section 3 of the SI Word document.

II.3.3.6. *Combing*

Long fibers are combed for untangling and homogenization as well as removing small debris that may be left from the *scutching* process. *Fibers are transformed into ribbons (flax sliver)* and are ready to be spun into yarn. During this process, flax tow and plant residues are produced as inert materials. Similar to the inert residues produced during the *scutching* process, they are generally re-incorporated to nearby fields as amendment. The flows from and to the environment due to this were modelled using the same algorithms applied for the AoL of inert residues from the *scutching* process, as further detailed in the SI Excel document.

II.3.3.7. *Spinning*

Flax sliver is transported to China and spun into yarn by a process of untangling, regularizing, stretching and threating of the fibers. Wet spinning is a common practice to this end, and wastewater is generated as a result. This was represented in the model as *Wastewater treatment (from spinning)* as detailed in the SI.

II.3.3.8. *Weaving*

The last step is the *weaving* of the fabric. During this process, starch is usually used as a gluing agent. The result is a flax technical textile of 360 g/m². Detailed information on the input and exact processes used can be found in the SI Excel document.

II.3.4. Sensitivity Analysis

The production process of flax-based technical textile takes place in different countries, namely France and China. Table II-2 highlights that China's marginal electricity mix mainly consists of coal (77%) and hydropower (20%), while France mainly relies on wind (84%) and solar power (44%) for their marginal electricity production (as modelled by the Ecoinvent v3.4 consequential processes for each country's electricity mix). Marginal sources of electricity represent the technologies that will be able to react to a surplus in demand.

Table II-2. Marginal electricity mix for France and China (Source: Ecoinvent v3.4 processes)

Electricity mix (2016)	France	China
Coal	-	77%
Gas	-	<1%
Waste	13%	-
Nuclear	-	2%
Hydro	<1%	20%
Solar PV	44%	<1%
Wind	84%	<1%
Geothermal	2%	-

It has been shown several times (Ewertowska et al. 2016; Santoyo-Castelazo et al. 2011; Pehme et al. 2017) that electricity mixes involving less fossil supply (coal, natural gas, shale oil or gas) will yield an overall greater environmental performance, especially when it comes to climate change. To quantify the importance of the electricity mix for the present flax-based technical textile case, a virtual sensitivity analysis was made considering that all uses of electricity stems from the French electricity mix. This sensitivity analysis will thus reflect the impact of a hypothetical future wind and solar energy system.

II.3.5. Results

II.3.5.1. LCA Results

The main contributors to the overall environmental impact of the production of 2330 m² (considering a grammage of 360 g/m²) of technical textile issued from 1 ha of cultivated flax, are the processes of weaving, spinning, flax cultivation, retting, the avoided glass fiber production, the woody residues combustion and, to a lower extent, the induced land use change (iLUC) (Figure II-4).

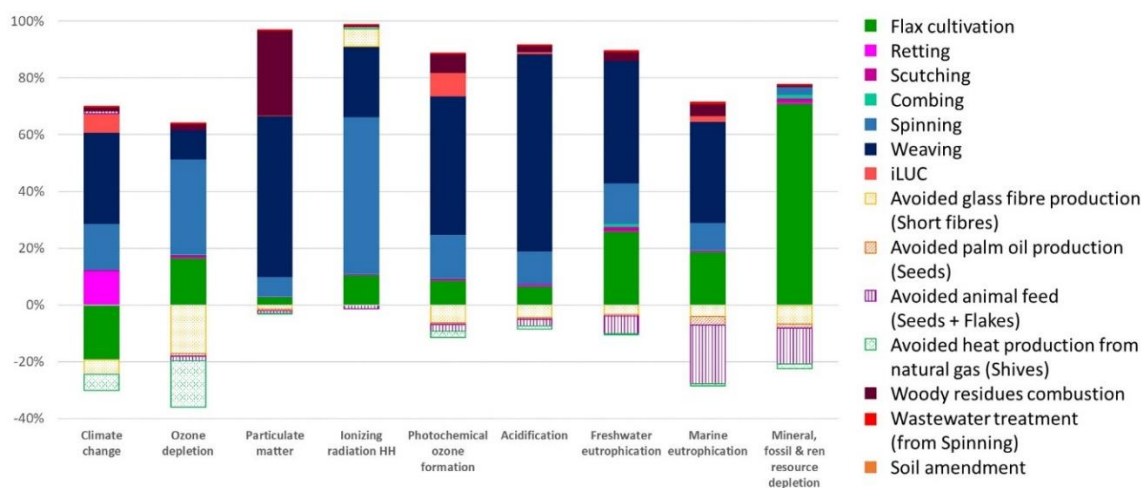

Figure II-4. Processes contribution to generated (positive values) and avoided (negative values) environmental impacts in the production of a flax fiber technical textile from 1 ha of cultivated land

Moreover, Figure II-4 illustrates the generated (positive values) as well as avoided (negative values) impacts, broken down at the process level. The absolute values behind Figure II-4 are presented in Table II-3.

Table II-3. Results of the environmental impact of producing flax fiber technical textile issued from one ha of cultivated land

Impact category	Total/ha	Total/m ² of technical textile	Unit
Climate change	18162	7.79	kg CO2 eq
Ozone depletion	3.6x10 ⁻⁴	1.55x10 ⁻⁷	kg CFC-11 eq
Particulate matter	52	0.02	kg PM2.5 eq
Ionizing radiation	1048	0.45	kBq U235 eq
Photochemical ozone formation	87	0.04	kg NMVOC eq
Acidification	194	0.08	molc H+ eq
Freshwater eutrophication	4.5	1.2x10 ⁻³	kg P eq
Marine eutrophication	23	9.8x10 ⁻³	kg N eq
Mineral, fossil & renewable resource depletion	0.48	2.1x10 ⁻⁴	kg Sb eq

To better understand the causes and substances behind the environmental impacts (generated or avoided), each of the processes identified as main contributors were analyzed individually, as shown in Figure II-5 to Figure II-11.

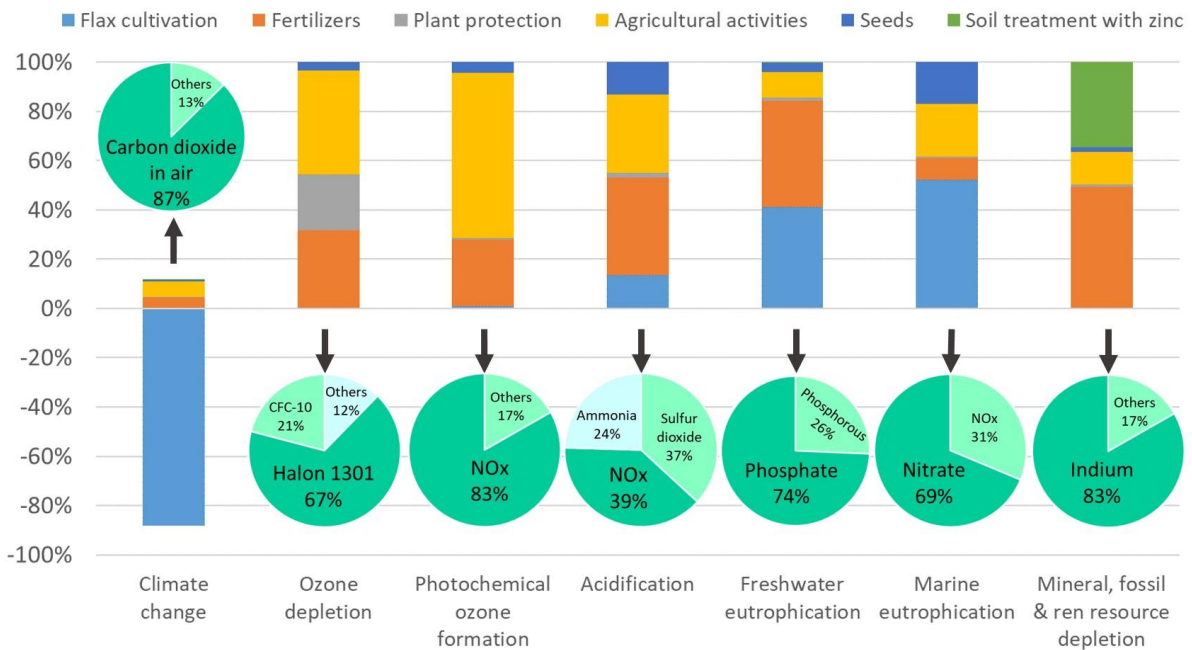

Figure II-5. Flax cultivation - Individual analysis of the main induced and avoided environmental impacts and the substances responsible

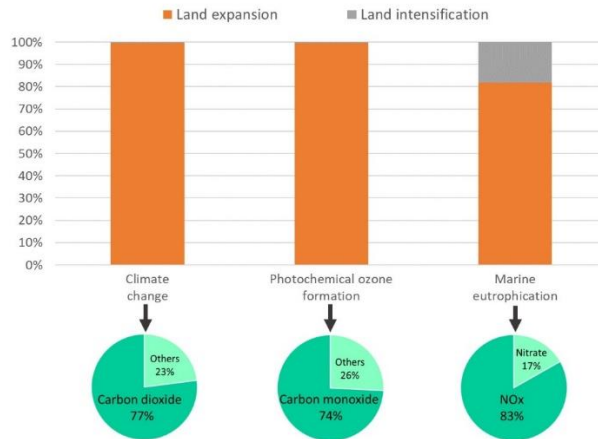

Figure II-6. iLUC - Individual analysis of the main environmental impacts and the substances responsible

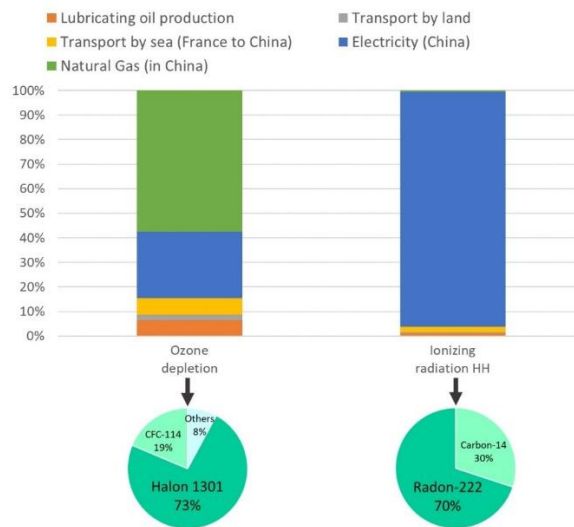

Figure II-7. Spinning - Individual analysis of the main induced environmental impacts and the substances responsible

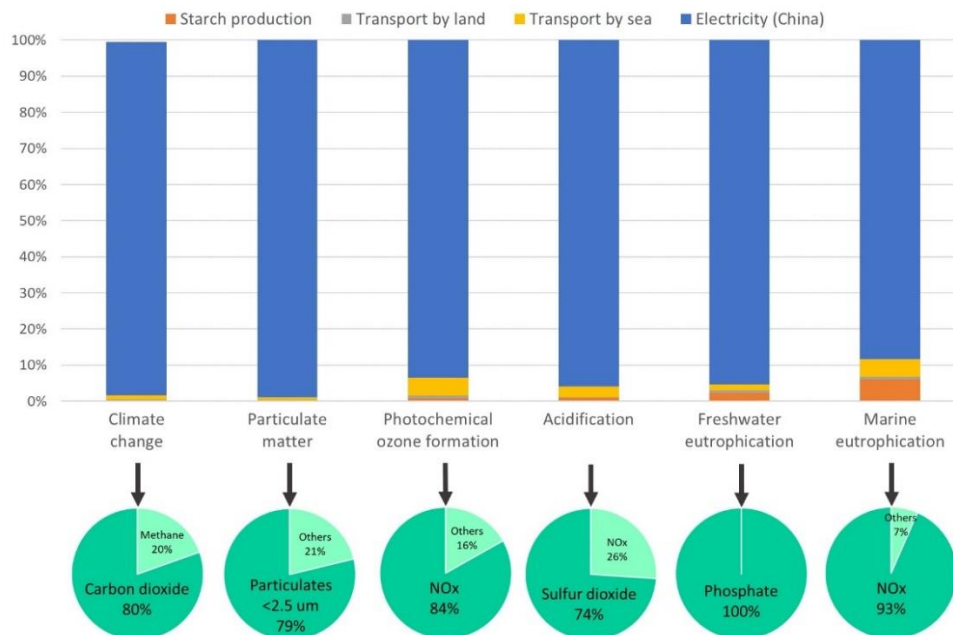

Figure II-8. Weaving - Individual analysis of the main environmental impacts and the substances responsible

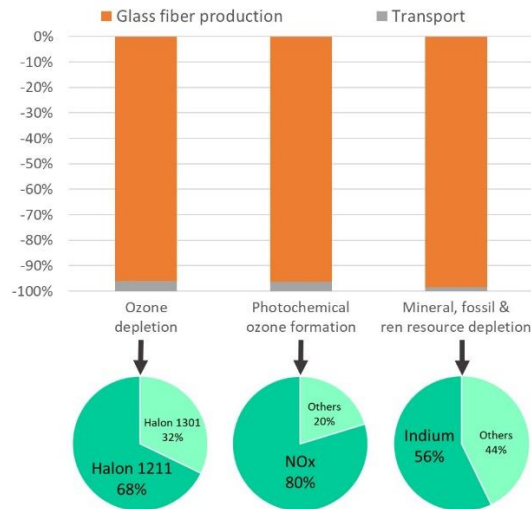

Figure II-9. Avoided production of glass fiber - Individual analysis of the main avoided environmental impacts and the substances responsible

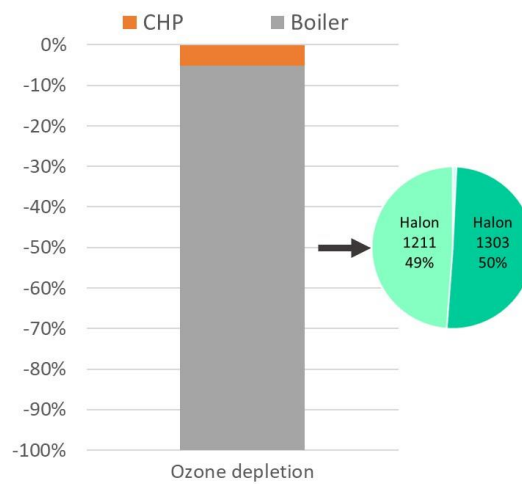

Figure II-10. Avoided heat production from natural gas - Individual analysis of the main avoided environmental impact and the substances responsible

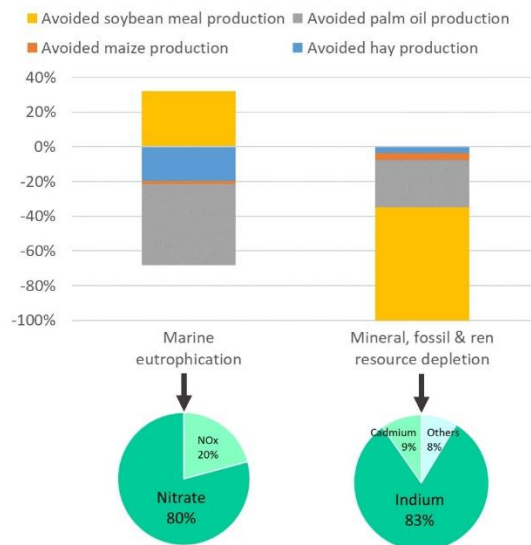

Figure II-11. Avoided animal feed production - Individual analysis of the main avoided environmental impact and the substances responsible

In general, results show that:

- The spinning and weaving processes represent between 45% and 95% of the generated environmental impact in all of the categories except for Mineral, fossil & renewable resources depletion.
- The combustion of woody residues has higher or almost equivalent environmental impact than the benefits generated by the fossil-based heat it avoids (avoided heat production from natural gas). This is particularly true for the impact category Particulate matter. However, wood-based heat (rather than natural gas heat) contributes to the reduction of Ozone depletion and Climate change, as well as Photochemical ozone formation and Acidification, to a lower extent.
- A contribution of the induced land use change (iLUC) to the impact category Climate change is visible and, to a lower extent, to the impacts Photochemical ozone formation, Acidification and Marine eutrophication.
- The avoided glass fiber production (due to the generation of short fibers as a co-product in the scutching process) translates into avoiding impacts (i.e. negative values), even if small, in all the environmental categories assessed, except for Ionizing radiation HH where a generated (or positive) impact is clearly visible.
- The avoided animal feed resulting from the valorization of seeds and flakes (scutching process), results in avoided impacts for Freshwater and Marine eutrophication as well as Acidification and Mineral, fossil & renewable resource depletion. A contribution to a reduction in the impacts Ionizing radiation and Photochemical ozone formation is also visible, even if lower.
- In the totality of the system, ten substances were identified as the main cause of the generated environmental impacts. These substances (and their cause) being: Carbon dioxide (iLUC, Chinese electricity), Halon 1301 (flax cultivation; Chinese electricity), Particulate matter <2.5 mm (Electricity in China), Radon-222 (Electricity in China), Carbon monoxide (iLUC), Nitrogen oxides (flax cultivation; Chinese electricity; iLUC), Sulphur dioxide (Chinese electricity), Nitrate (flax cultivation), Phosphate (flax cultivation; Chinese electricity) and Indium depletion (flax cultivation).

Finally, the avoided environmental impacts were mainly due to the avoidance of using or generating the following substances: Halon 1211 & 1301, Indium, Nitrates and Carbon dioxide uptake during flax cultivation (the LCI being cradle-to-gate).

II.3.5.2. Sensitivity Analysis

Figure II-12 shows the impacts of an all-French electricity production and use (i.e. no use of the Chinese electricity mix). It highlights that using 100% French electricity rather than a mix of the French and Chinese electricity would be beneficial for every impact category, except for Ozone depletion and Mineral, fossil & renewable resources depletion.

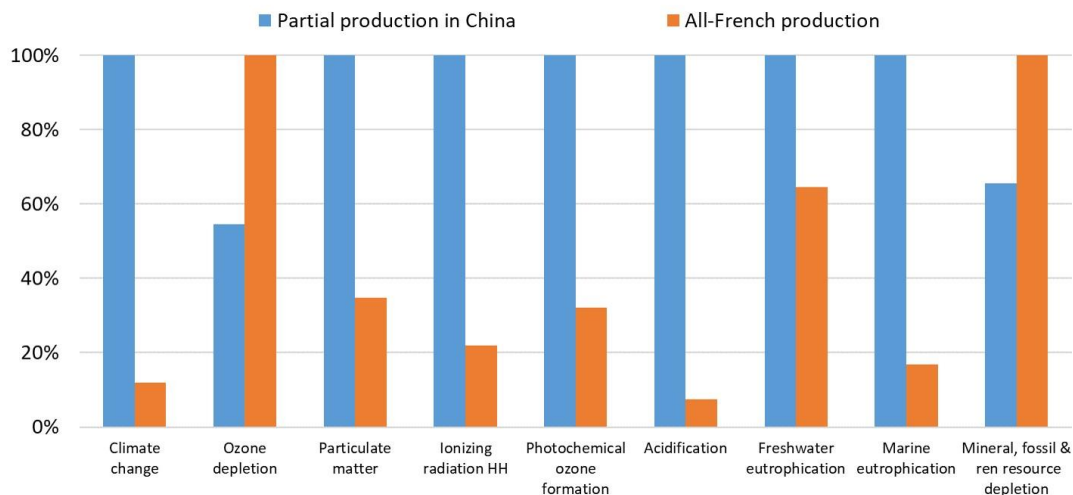

Figure II-12. Sensitivity Analysis for production considering different electricity mixes

Nowadays, given its installed capacities and production prices, the production of textile products is most likely to be outsourced to China. However, France counts with the technology to locally produce a flax fiber technical textile. Through Figure II-12, it is visible that an all-French supply chain would result in a more performant product, from an environmental point of view.

II.3.6. Discussion

Flax cultivation is a process that both generates and avoids environmental impacts (Figure II-5). Generated impacts are significant for *Freshwater* and *Marine eutrophication*, *Ozone depletion* and for *Mineral, fossil & renewable resources depletion*; mainly due to fertilizers and zinc for soil treatment. For instance, the production of triple superphosphate fertilizer (35%; essentially due to discharges to water compartments) and its application on the field (40%; process detailed in the SI) induces freshwater eutrophication due to leakage of phosphates and phosphorous to water sources. Moreover, the production of the same fertilizer along with zinc used for soil treatment after sowing, causes a depletion of resources as the infrastructure for mines induces an exhaustion of substances such as indium and cadmium. Over 60% of the impact on *Mineral, fossil & renewable resources depletion* is in fact due to flax cultivation, and of this almost 50% is due to triple superphosphate and 35% to zinc.

Results show a high relation between zinc procurement and the depletion of indium, which is the main responsible for the impact on *Mineral, fossil & renewable resources depletion*. This is due to the fact that indium is a by-product of zinc extraction, along with other substances such as cadmium (Classen et al. 2009).

Ozone depletion is caused mainly by Halons and CFCs, these substances are linked to the distribution of fossil-based fuels and the production of plant protection products (bentazone, specifically). Halon gases are used as fire retardant agents in pipelines; the Ecoinvent processes for fossil-based fuels (i.e. diesel and natural gas) consider emissions of halon gases to air to be caused by accidents and values were estimated from corporative environmental reports (Faist Emmenegger et al. 2007).

The NO_x emissions responsible for the *Photochemical ozone formation* and *Acidification* impacts are as well consequences of the use fossil-based energy sources in the production of fertilizers (namely, nitrogen and phosphate fertilizers) and used in agricultural activities (i.e. plowing).

Marine eutrophication is essentially due to the procurement of seeds. The impact originates from the use of nitrogen fertilizers and NO_x emissions issued from the agricultural machines required for their production.

Because this analysis is cradle-to-gate, *flax cultivation* is here shown as a process reducing the *Climate Change* impact. This happens as a result of the CO₂ captured by the plant during its growth; the relevance of this benefit depends upon the time the captured carbon will reside in the technosphere (e.g. as flax-based panels). A short-time period between the sequestration of carbon and its re-emission to the atmosphere at the end-of-life phase of the panel has very little benefit and makes almost no difference in terms of long-term climate change impact (Jorgensen et al., 2015). A lifetime as long as possible as well as end-of-life solutions allowing to recycle (or maintain) the technical textile carbon within the technosphere are thus of tremendous importance to reduce the climate change impact, when the full life cycle will be considered. However, as highlighted in Figure II-4, the induced demand for new arable land caused by the additional flax cultivation in France (i.e. iLUC process) reduces the global warming benefits from flax cultivation. In this study, the induced land use change represents slightly less than 10% of the impact on Climate change; which is coherent with results obtained by different authors where iLUC represents 5-20% of the impact (Pehme et al. 2017; EC 2019; though with some outliers at almost 70%). Figure II-6 shows that the main cause of the impacts generated by the induced land use change are the effects of land expansion. Land expansion itself consists, based on the model used herein, of two processes: land clearing and foregone sequestration. Biomass burning occurring during land clearing produces CO₂, CO and NO_x emissions responsible for over 80% of the Climate change, Photochemical ozone formation and Marine eutrophication impacts. For climate change, CO₂ produced during biomass burning (which alone represents over 99% of the impact) is the main contributor to the generated impact. It should be highlighted that previous studies on flax fiber as a bio-based feedstock did not include the effects of land use changes.

Deng and Tian (2015), for example, justified this omission on the premise that *flax cultivation* areas are currently decreasing; a premise that is obviously inconsistent with the starting point of this study, where flax is investigated as a resource to produce a new bio-based material to be introduced in the economy. The vision is thus to produce more of this material, if it is found to be a sustainable alternative to materials based on fossil-carbon. This implicitly suggests an increased demand for it and its source feedstock. In fact, flax represented about 50% of the market share in natural fibers used in the European automotive industry in 2012, and is foreseen to play a dominant role in future composite materials production (Barth and Carus 2015).

The main impact affected by the retting of flax stems was *Climate change*. This was caused by a background process, namely the use of agricultural machinery (i.e. rotary tedder) used for turning the stems over. Specifically, the impact is generated given the use of fossil-based fuels (i.e. diesel) as energy sources by the machinery.

As earlier stated, the *spinning* and *weaving* processes are responsible for more than 60% of the contribution to all impact categories but *Mineral, fossil & renewable resources depletion* (where they represent slightly less than 3% of the impact). Electricity and heat (natural gas used in spinning) production and use are responsible for over 85% of the generated impacts by the spinning (Figure II-7) and weaving (Figure II-8) processes. These two processes take place in China, where almost 70% of the electricity mix comes from coal burning (hard coal) according to data from the IEA (2016a). Both the burning of coal and the activities related to its procurement have an important contribution to the overall generated impacts from Chinese electricity, in all categories. Impacts are, however, exacerbated by the fact that the Ecoinvent process considers hard coal to be about 75% of China's source of electricity.

Moreover, Dissanayake et al. (2009) also identified *spinning* as a hot spot. These authors pointed out that avoiding that process, if possible, is an opportunity for reducing energy consumption. In fact, on the basis that the *spinning* process might diminish the mechanical properties of fibers, Le Duigou et al. (2011) did not take it into consideration in their LCA. However, their final composite material products consider as reinforcement a flax mat where fibers are randomly dispersed, so there is no need for them to be spun or woven. Bachmann et al. (2018), whom studied the impact of various “novel sustainable panels” for the aviation sector, did consider spinning in their LCI of flax yarn production. Impacts to *Ozone depletion* are a consequence of the procurement (on-shore extraction) of fossil-based energy sources (i.e. natural gas) used during the *spinning* process. This is due to the use of substances such as Halon 1301 and 1211; used as fire suppression agents in oil pipelines (UNEP HTOC 2014). Figure II-7 and Figure II-8 as well show that impacts from transportation are negligible when compared to those issued from electricity procurement. This means that the degree of the impact of outsourcing production depends more on the way countries produce electricity than the distances between them or the energy source used by the transportation vessels.

Furthermore, the valorization of the co-produced short fibers as a reinforcement component in composite materials results in a diminishment of the production of glass fiber. This, in turn, translates in avoided impacts *Ozone depletion*, *Photochemical ozone formation* and *Mineral, fossil & renewable resources depletion*, predominantly. This is mainly due to the avoided consumption of Halon 1211 and Indium as well as a reduction of NO_x emissions (Figure II-9); the impact of Halon 1211 is due to the use of fossil-based energy use in the production of glass fibers as it is used as a fire suppression agent (as previously stated). Moreover, the use of Indium is related to the mining of zinc (as for the *flax cultivation* process), which is used for the coating of steel coils required for the construction of glass fiber factories. NO_x emissions come from electricity production in the Asian markets. The advantages of using natural fibers as reinforcement materials instead of glass fibers have also been proven on various occasions by different authors (Akhshik et al. 2017; Corbiere-Nicollier et al. 2001).

The most visible benefit of *avoiding heat production from natural gas* is the decrease on the use of Halon 1211 and Halon 1303 (Figure II-10); which, as previously mentioned, are used in pipelines as fire suppressant agents and contribute to the depletion of the ozone layer. These are directly related to the transportation of natural gas in pipelines.

On the other hand, the *avoided heat production from natural gas* generates impact on *Ionizing radiation*. This is due to the fact that the process used to model the avoided heat production from natural gas (consequential process from Ecoinvent v3.4) considers that producing heat from natural gas through a co-generation plant in Europe reduces the use of current European marginal electricity. By no longer using natural gas, that marginal European electricity is no longer avoided (by the no longer co-generated electricity). Further analysis led to the identification of Radon-22 to be the main cause of the impact. As Radon-22 is a gas resulting from the radioactive decay of Uranium, it leads to the conclusion that no longer producing heat from natural gas increases the use of nuclear power. This was corroborated by an analysis of the Ecoinvent v3.4 process for heat production from natural gas, which considers that electricity produced from co-generation, reduces the use of nuclear power. The same analysis applies for the *avoided glass fiber production* where the generated impact on *Ionizing radiation* is much more visible. In fact, the Ecoinvent process used to model glass fiber production considers an important use of co-generated natural gas heat.

The most visible impact generated by the *woody residues combustion* is the generation of particulate matter, a well-documented issue of biomass combustion (Keller and Burtscher 2017; Nyström et al. 2017; Dasch 1982), which displays a much more complex chemical composition than natural gas.

The major impacts affected by the *avoided animal feed production* are *Marine eutrophication* and *Mineral, fossil & renewable resources depletion* (Figure II-11). The impact on the former is essentially explained by the avoidance of nitrate emissions from the avoided hay and palm oil production. Agricultural activities are linked to the procurement of zinc; it being closely tied to indium mining, leads to the decrease of the *Mineral, fossil & renewable resources depletion* impact. Figure II-11 further highlights that the avoided soybean meal production increases the *Marine eutrophication* impact. This is explained by the work of Dalgaard et al. (2008) where it is demonstrated that an increase in demand for soybean meal affects the production of palm oil, thus creating what they refer to as a soybean loop. In other words, the avoidance of soybean meal implies less oil production; palm oil production will thus react to this oil shortage. Therefore, nitrates emitted from the cultivation of palm are the substances responsible for the *Marine eutrophication* caused by the *avoided soybean meal production*. It should also be noted that the avoided soybean meal may have been slightly overestimated. In fact, the substitution considered here was made on the basis of crude protein content. Yet, in terms of protein, it is rather the quality that counts, and more precisely the quantity of essential amino acids.

When comparing scenarios for a production with the *spinning* and *weaving* processes carried out with different electricity mixes, results favored a production with the French electricity mix (Figure II-12). This result is coherent with the results obtained by Deng and Tian (2015) when comparing different electricity supply mixes for producing a composite material with flax as reinforcement. Nonetheless, a partial production in China appears more favorable for two impacts, namely for *Ozone* and *Mineral, fossil & renewable resources depletion*. For the former, this is due to an increased use of Halon 1211, as the French electricity induces the use of natural gas as source of energy. Meanwhile, the higher impact on *Mineral, fossil & renewable resources depletion* reflects the higher solar power used in the French electricity mix (making ca. 45% of the mix against <1% in China) and thus resources for photovoltaic panels. A higher impact in *Ionizing radiation* could have been expected for the French electricity mix, given the high percentage of nuclear energy in France (72% of all electricity demand in 2016; IEA 2016). However, this study is consequential and considers the processes that can react as a result of a demand change. Nuclear energy can hardly react to an increased demand for electricity, among others because of the long lag between the decision to establish a new capacity and the moment where the plant is fully operational (Moora and Lahtvee 2009), and because of a legal ceiling on installed nuclear capacity in the specific case of France (EC 2018a). In fact, the low voltage French electricity mix processes used herein (consequential process retrieved from Ecoinvent v3.4) does not include nuclear energy (but rather a high percentage of solar power, as earlier mentioned).

II.3.7. Conclusion

Through a cradle-to-gate LCA, the environmental performance of a flax-based technical textile was assessed. The presented consequential life cycle inventory aims to (but not limited to) be used by LCA practitioners and interested parties for performing LCA for comparing the environmental impact of products with one of their components being flax fiber. The proposed LCI allows for future assessments to be carried out considering either the whole supply chain of production and transformation of flax or with focus on specific processes, depending on specific system boundaries and the product of interest (i.e. short fibers). Efforts focused on presenting information in a clear and concise fashion for modifications to be easily made, allowing a better representation of a broad spectrum of scenarios as agricultural practices and market trends might evolve.

The herein presented work improved existing LCAs on flax fiber production by the inclusion of the emissions issued from the *retting* process, the valorization of co-products (through system expansion),

and the analysis of more impact categories than the regularly addressed in other studies (namely, climate change, ozone layer and abiotic depletion). Presenting a broader picture of the potential environmental impacts of using flax fiber as a source of materials.

Results show agricultural activities and electricity production (from the *flax cultivation, spinning and weaving* processes) to be the biggest contributors to the negative environmental performance of a flax technical textile. Very specifically for this case study, the sensibility analysis proved an all-French production to be more efficient from an environmental point of view; however China's installed capacities for fabric production and low manufacturing prices make partial production in China more attractive from a technical and economical perspective. Thus a change in production patterns (change to an all-French production) might not be completely viable. It remains, nonetheless an important factor to take into consideration and further develop as countries' relationship with renewable and fossil energies evolve.

Additionally, the impact generated by land use change from flax culture is diminished (in almost a 25%) by the avoided land use change as a result of the valorization as animal feed of some of the co-products. Consequently, impacts being relatively small compared to those issued from electricity production and use, land use change does not represent a disadvantage for bio-based products.

The larger number of impact categories included/analyzed, contributes to a larger understanding of how co-products might affect the environmental impact of a product. It also makes room for further analysis on different ways in which co-products can be valorized and the options that have a lower environmental impact. With this study, for example, it was made visible that the valorization of shives has a high influence on the formation of particulate matter and is, therefore, an important contributor to the overall generated impact. Through this analysis, areas for improvement can be identified concerning not only the main processes but also those related to co-products. In this case, for example, the implementation of better technologies for combustion could be studied in the view of improving the environmental performance.

Moreover, the inclusion of the fate of the co-products by system expansion contributes to a more accurate assessment of the potential environmental impacts. Otherwise, the impact on categories such as *Ozone depletion* and *Marine eutrophication* would have been largely overestimated; while impacts concerning *Particulate matter* and *Ionizing radiation*, underestimated. Given that a consequential approach was taken for this study, decisions aiming to improve the environmental performance of a flax fiber technical textile can be made having a clearer, more close to reality point of view.

Overall, this study shows the relevance of taking into consideration a country's energy mix and the geographical scope of a product's life cycle as it has important impact on its environmental performance. Moreover, when considering the fate of co-products, the valorization they are given plays as well a very important role as they will not forcibly generate a benefit but it was proven that they can contribute to an increase of the impact on different categories. Therefore, correctly defining the former becomes as crucial a factor as having a complete and precise life cycle inventory.

II.4. Natural Fiber Polymer Composites – A game changer for the aviation sector?

Alejandra Gomez-Campos^{1*}, Claire Vialle^{1*}, Antoine Rouilly¹, Lorie Hamelin², Aline Rogeon³, David Hardy³, Caroline Sablayrolles¹

¹Laboratoire de Chimie Agro-industrielle, LCA, Université de Toulouse, INRAE, Toulouse, France

²Toulouse Biotechnology Institute (TBI), INSA, INRAE UMR792 and CNRS UMR5504, Federal University of Toulouse, 135 Avenue de Rangueil, F-31077, Toulouse, France

³VESO Concept, 1620 Route de Bellevue, F-31530, Merenvielle, France

*Corresponding authors (alejandra.gomezcampos@ensiacet.fr / claire.vialle@toulouse-inp.fr)

Published in Journal of Cleaner Production. March 2021. DOI: 10.1016/j.jclepro.2020.124986

Alejandra Gomez-Campos: Methodology, Investigation, Writing - original draft, Visualization.

Claire Vialle: Validation, Writing - review & editing.

Antoine Rouilly: Writing - review & editing.

Lorie Hamelin: Validation, Writing - review & editing.

Aline Rogeon: Project administration.

David Hardy: Project administration.

Caroline Sablayrolles: Validation, Writing – review & editing.

KEY WORDS

Life Cycle Assessment; Bio-based materials; Flax fiber; Climate change; Aviation; Interior fittings

ABSTRACT

As part of the efforts to reduce the environmental impacts caused by the aviation sector, the use of bio-based instead of fossil-based materials has been proposed as one possible mitigation option. Natural Fiber Polymer Composites have proven to have a higher environmental performance in the automotive sector and are emerging as an option for weight reduction in aircrafts. This study quantifies, through Life Cycle Assessment, the environmental performance of specific flax-based composite panels intended for an application in aircrafts as interior fitting elements (i.e. partition panels, tray tables, baggage compartments) compared to a glass fiber/epoxy composite with a honeycomb core. Through system expansion, the fate of co-products issued from the production of the flax fiber technical textile used as reinforcement in the biocomposite material was considered in the assessment.

Results showed that for an application in the aeronautics sector, the weight of the panels is the upmost critical parameter shaping the overall environmental performance of panels. Focusing on the panel production only, the biocomposite panel showed a higher environmental performance in the categories of climate change and marine eutrophication compared to the conventional panel, and the flame retardant agent was identified as the main contributor to the environmental impacts of the bio-based panel. Yet these gains were negligible when considering the full life cycle of the panels, due to the higher weight (14%) of the bio-based panels; which is linked to it being still at a prototype stage.

In order to improve the environmental performance of the biocomposite panel and thus reduce its weight, it was shown relevant to optimize the geometry of the panel itself, especially its core, so less resin could be used.

II.4.1. Introduction

Though it only represents a little over 2% of global greenhouse gas (GHG) emissions (Graver et al., 2019), aviation is becoming a growing public concern in the light of the current climate urgency (IPCC 2018). Because fuel represents ca. 25% of operating expenses for the global air transport industry (IATA 2019), efforts to reduce fuel consumption have already been undertaken by the sector. *In 2011, the European Commission, through the Advisory Council for Aviation Research and Innovation in Europe (ACARE), published five goals to be achieved in the Flightpath 2050 report. One of these goals targets a 75% reduction in CO₂ emissions and a 90% reduction in NO_x emissions per passenger kilometre, while another goal aims for aircrafts to be recyclable (ACARE 2011).*

In an attempt to achieve these goals, lighter materials have been researched to replace those currently used, this allowing for lower fuel use. Indeed, jet fuel used during an aircraft lifetime is in fact responsible for more than 75% of the GHG emissions in the whole life cycle (Bachmann et al., 2017). Moreover, these GHG emissions are more environmentally damaging compared to those emitted at ground level due to the increased interaction of gases at higher altitudes (IPCC 1999).

Given the lower density of natural fibers compared to glass fibers, different authors have extensively reviewed the use of natural fibers as reinforcement in composite materials (Ticoalu et al., 2010; Faruk et al., 2012; Mohammed et al., 2015; Hristian et al., 2016; Peças et al., 2018; Sanjay et al., 2018). Among the various natural fibers that have been used as reinforcement, flax represented 50% of the market share for composites in 2012 (Barth and Carus 2015) and comes fourth in production out of the different commercially major fiber sources available (Faruk et al., 2012). To date, the main industrial application for natural fiber reinforced composites remains the automotive sector (Deng and Tian 2015; Joshi et al., 2004; Le Duigou and Baley 2014; Yan et al., 2014; Fernando et al., 2015) as well as their use as construction materials or leisure products/consumer goods (C.E.L.C., 2020).

Through Life Cycle Assessment (LCA), Natural Fiber Polymer Composites (NFPCs) have been demonstrated to have higher environmental performance when used in the automotive industry (Joshi et al., 2004; Le Duigou and Baley 2014), mainly due to the lighter weight of natural fibers; which translates into lower emissions resulting from fuel combustion. The potential application of these type of composites in the aviation sector has been addressed in the work of Bachmann et al. (2017), Vieira and Bravo (2016) and Vidal et al. (2018).

While these studies are valuable contributions in understanding the overall environmental performance and drawbacks of these materials, they suffer from limitations. Among others, these studies do not detail how the various co-products generated through the production of the flax fiber (i.e. short fibers, seeds, shives, flakes and waste) are used and traded on the market. At best, simple allocation techniques are applied where past (or hypothetical) economical values (e.g. Vidal et al., 2018) or weights (e.g. Le Duigou and Baley 2014) are used to divide the overall environmental impacts between the desired product (composite material) and its various coproducts.

Other studies do not even document if co-products are generated nor the exact inventory data that are considered (e.g. Vieira and Bravo 2016). The study of Deng and Tian (2015) is a notable exception where an effort to document the actual coproducts fate was made, but it suffers from a major misunderstanding of the agricultural phase of the feedstock. In fact, the authors considered flax in the same way as when it is cultivated for seed production. Yet, when flax is intended for the composite material sectors, it is harvested at a much later stage where the stem has reached full maturity but the seeds remaining are of lower quality and quantity. In the specific case of applications for the aviation sector, detailed life cycle inventories are scarce as pointed out in the review of Bachmann et al. (2017).

Moreover, existing life cycle results are given for a rather limited number of impact categories, essentially focusing on cumulative energy demand and greenhouse gas emissions (e.g. Vieira and Brave 2016; Vidal et al., 2018).

In an endeavour to bridge these gaps, this study presents a complete Life Cycle Assessment to confirm or infirm the overall environmental relevance of flax fiber reinforced composites, compared to their current market competitors, in the aeronautics sector. The vision is to uncover the potential trade-offs among the various environmental impacts, on the basis of a full consideration of the co-products fate and interactions with the market.

II.4.2. Materials and Methods

II.4.2.1. Environmental assessment method

The full environmental impact of the panels was quantified through a LCA following a consequential approach (Brandão et al., 2017; Earles and Halog 2011; Weidema et al., 2018).

The LCA carried out herein is considered consequential in the sense that no co-product is left outside the system boundaries and their fate is taken into consideration as part of the environmental performance of the final product. This approach follows ISO 14040:2006 and ISO 14044:2006 recommendations and aims to reflect the intended and non-intended environmental consequences of decision-making, here relating to investments into biobased composites for use in aircrafts. Furthermore, it strives to only take into account marginal processes and suppliers, i.e. those reacting to a demand change (Hamelin 2013; Brandão et al., 2017).

II.4.2.2. Goal and scope definition

This study takes its point of departure from a real-case where a SME (small and medium enterprise) is developing a sandwich panel with a novel core structure that aims to substitute the current materials used in the interior design of airplanes (i.e. partition panels, tray tables, baggage compartments).

The specific prototype panel developed by this SME represents the biocomposite panel studied herein. The prototype is an omega core sandwich panel (Figure II-13), made entirely out of a flax fiber reinforced composite with an epoxy matrix. This includes both the skins and the core. The goal of the LCA is two-fold: (1) to compare the environmental performance of this biocomposite panel with the performance of a conventional panel with skins made out of glass fiber reinforced composite (with an epoxy resin) and a honeycomb core in aramid fiber paper, and (2) to identify, in a perspective of design enhancement, the key areas for opportunity for overall environmental improvement associated with this prototype. From this point onwards, this particular prototype will be referred to as biocomposite panel.

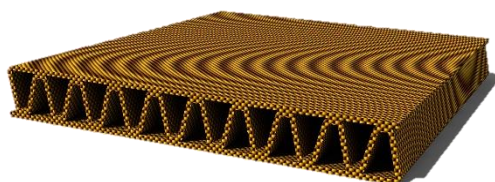

Figure II-13. Omega core sandwich panel structure. Image from CORDIS website (EC 2018c).

The production and transformation process of flax fiber into the technical textile is carried out in France. For both panels, all other raw materials were considered to be purchased from the global market. As specific distances between production sites is unknown, “market for” data was used as it

incorporates transportation values. Moreover, the production of the biocomposite panel was considered to be carried out in France.

The conventional panel used as reference is based on the technical characteristics of the panel currently commercialized under the name NORBOND®. Technical characteristics of the NORBOND® panel were used as reference for values and production was considered to be carried out in France. Therefore, a French electricity mix was used.

The functional unit was defined as the use of 1 m² of sandwich panel as secondary structures (interior fitting elements) in the interior of an airplane A320 NEO with a lifespan of 30 years.

The evaluation was carried out with SimaPro 8.5.2 software.

II.4.3. Life Cycle Inventory analysis

The life cycle inventory (LCI) data related to the inputs and outputs from the different life cycle stages of the panels (foreground data) were obtained directly from the SME producing the panel. When the needed LCI data could not be obtained from the company, data were collected from scientific literature. Background data (e.g. electricity production, raw materials, transport processes) were obtained from the LCI database Ecoinvent v3.4. The exact LCI data considered are here detailed and grouped per life cycle stage, namely (i) raw material, (ii) production; (iii) use and (iv) end-of-life.

II.4.3.1. Raw materials

Materials from the sandwich panels are classified into two main components: skins and core. The skins and core of the biocomposite panel are made from the same materials: flax fiber technical textile as reinforcement, an epoxy resin as the binding agent, methylamine as the hardening agent and ammonium polyphosphate as the flame retardant agent.

In contrast, the skins and core of the conventional panel are made from different materials. The skins are made from glass fiber, epoxy resin, methylamine and decaBDE (Decabromodiphenyl ether) as the flame retardant agent. The core of the conventional panel is a commonly used structure known as honeycomb, made of aramid fiber paper dipped in a phenolic resin. Table II-4 details the composition of 1 m² of each of the panels assessed. A detailed description of how these values were calculated can be found in the Supporting Information.

Table II-4. Material composition of 1 m² of aircraft panel

Structure	Material	Biocomposite panel	Conventional panel
		kg/m ²	
Skins	Epoxy resin	0.55	0.55
	Methylamine (hardener)	0.19	0.12
	APP (flame retardant)	0.34	
	decaBDE (flame retardant)		0.10
	Flax fiber technical textile	0.72	
	Glass fiber		1.16
Core	Epoxy resin	0.41	
	Methylamine (hardener)	0.15	
	APP (flame retardant)	0.25	
	Flax fiber technical textile	0.54	

	Aramid fiber		0.55
	Phenolic resin		0.10
	TOTAL	3.15	2.58

For the production of the biocomposite panel, a commercial polymeric matrix was used. The chemical composition of the polymeric matrix (which comprises the epoxy resin, the hardening agent and the flame retardant agent) was experimentally determined to better identify the major components and their proportions, as described in the SI. Mass quantities were obtained through calculations described in the SI and sum up to a total mass of 3.15 kg/m².

Components of the conventional panel were based on the technical datasheet provided by the manufacturer, where an average weight of the NORBOND® panel of 2.58 kg/m² is presented.

The individual constituents were identified and scaled on the basis of the work of Vidal et al. (2018), as further detailed in the SI. However, the conventional panel considered in the work of Vidal et al. (2018) uses a phenolic resin as the polymeric matrix, while NORBOND® technical datasheet specifies epoxy resin as the polymeric matrix. For consistency, the proportions of Vidal et al. (2018) were not modified and an epoxy resin was nevertheless considered.

The life cycle inventory (LCI) for each of the materials presented in Table II-4 is summarized in Table II-5. The LCI of the flax fiber technical textile encompasses the agricultural stage and the production of the technical textile itself. Every process part of the production chain is detailed in the SI.

Table II-5. LCI data for the Raw Materials life cycle stage

Material	LCI source data	Ecoinvent process used	Comments
Epoxy resin	Ecoinvent v3.4	Epoxy resin {GLO} market for epoxy resin Conseq, U	The commercial polymeric resin used for the production of the biocomposite panel contains the flame retardant agent. From the chemical analysis carried out for the commercial resin (detailed in the SI), a 1.63 epoxy/flame retardant ratio was determined.
Ammonium Polyphosphate (APP)	Ecoinvent v3.4	Nitrogen fertiliser, as N {RER} monoammonium phosphate production APOS, U (Used as proxy with modifications)	Since no consequential process were available, the one mentioned herein was used as starting point and adjusted with consequential data. A detailed description of the modifications is available in the SI.
Decabromodiphenyl ether (decaBDE)	Ecoinvent v3.4	Decabromodiphenyl ether {GLO} market for decabromodiphenyl ether Conseq, U	From Vidal et al. (2018), the flame retardant agent used in the conventional panel is identified as decaBDE.
Methylamine	Ecoinvent 3.4	Methylamine {GLO} market for Conseq, U (Used as proxy)	From the chemical analysis of the commercial hardener used for the biocomposite panel (detailed in the SI), three main substances were identified: isophorone diamine, alkylether polyamine and methylamine. Only the production of methylamine is present in the Ecoinvent database. As the toxicity of the three molecules is highly similar, this process was used as proxy.
Flax fiber technical textile	Gomez-Campos et al. 2020	Flax fiber technical textile {FR} Conseq	This dataset comprises all activities from the agricultural phase to the weaving of the textile, and includes land use changes. The complete LCI used for the creation of the flax fiber technical textile production process is available in the SI.
Glass fiber	Ecoinvent v3.4	Glass fiber {GLO} market for Conseq, U	
Aramid fiber	Ecoinvent v3.4	Nylon 6-6 {GLO} market for Conseq, U (Used as proxy)	The most commonly used material in honeycomb core structures is known as NOMEX (Morton-Jones and Ellis 1986) and is described as a type of nylon. Based on this and on literature work involving the production of aramid fiber (Wilhelm 2018), the production process of nylon was used as a proxy for aramid fiber production.
Phenolic resin	Ecoinvent v3.4	Phenolic resin {GLO} market for Conseq, U	

II.4.3.2. Production

The production stages of manufacturing of 1m² of biocomposite panel are shown in Figure II-14.

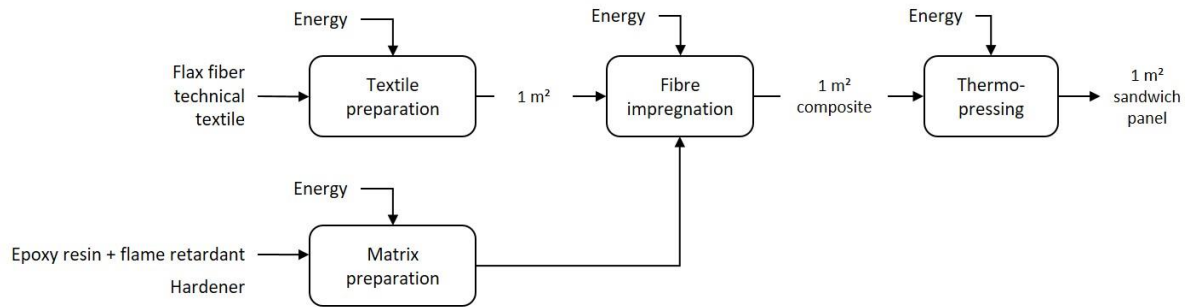

Figure II-14. Biocomposite panel manufacturing process

Data on electricity consumption were estimated directly from the prototype’s production process by the manufacturer and are presented in Table II-6. Based on the information given by the manufacturer, an optimized process was considered, therefore no losses are considered and no waste is produced.

Table II-6. Manufacturing process of 1m² of the biocomposite panel

Production stage	Energy consumption (Wh/m ²)
Textile preparation	Considered negligible
Matrix preparation	15
Fiber impregnation	160
Thermo-pressing	525
TOTAL	700

The manufacture of the conventional panel was based on the production process described by Vidal et al. (2018). In their work, the authors take into consideration the application of a decorative film at the end of the process. To ensure comparability with the biocomposite panel, this step was not included in the system boundaries of this study nor waste issued during production. Figure II-15 shows the manufacturing process of 1m² of conventional panel.

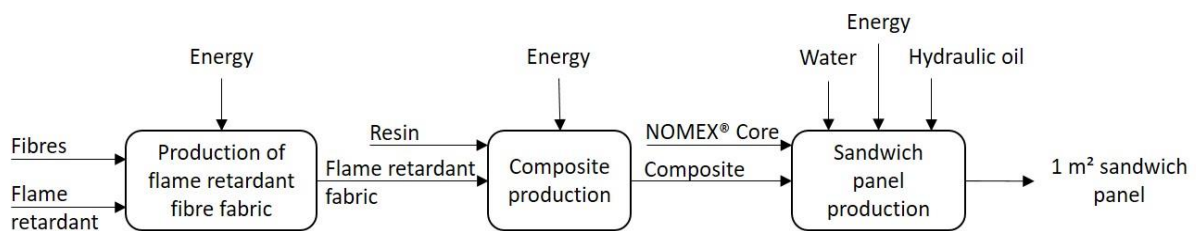

Figure II-15. Conventional panel manufacturing process

Data for the inputs for the production stage of the conventional were obtained from the work of Vidal et al. (2018). In total, the production of 1m² of conventional panel requires 16 kWh (≈57.6 MJ as defined in the original source) of electricity, 0.0082 kg of hydraulic oil and 0.9 kg of water. From the work of Vidal et al. (2018), it is understood that the energy consumption value comprises the production of the honeycomb core and the moulding of the conventional panel itself.

The life cycle inventory for the processes considered in the production of both panels is summarized in Table II-7.

Table II-7. LCI data for the Production life cycle stage

Process	LCI source data	Ecoinvent process used	Comments
Electricity production (biocomposite panel)	Ecoinvent v3.4	Electricity, medium voltage {FR} market for Conseq, U	The production of the biocomposite panel is carried out in France.
Electricity production (conventional panel)	Ecoinvent v3.4	Electricity, medium voltage {FR} market for Conseq, U	The conventional panel is considered to be carried out in France.
Hydraulic oil (conventional panel)	Ecoinvent v3.4	Lubricating oil {RoW} market for lubricating oil Conseq, U	
Water (conventional panel)	Substances	Water, process, unspecified natural origin/kg	

II.4.3.3. Use

The use of the panels is related to the operation of the aircraft and more specifically, to fuel consumption as it is directly linked to the total mass of the aircraft. To evaluate the environmental performance of the panel, an aircraft A320neo was modelled. Technical data from the aircraft (Table II-8) was recovered from the SME producing the biocomposite panel as well as from the specifications given by Scandinavian Airlines about their air fleet (SAS 2019), which includes A320neo aircrafts. The lifespan of the interior fitting elements (i.e. partition panels, toilet doors/walls, baggage compartments, service tables, etc.) for which the panels will be used is the same as the airplane itself as there is typically no replacement of these elements over the plane lifespan. Throughout their lifetime, aircrafts are considered to have a kilometric performance of 5.59×10^7 km (Maibach et al., 1999).

Table II-8. Aircraft specifications considered in this study

Specification	Value	Source
Aircraft	A320neo	Project partner
Aircraft lifespan	30 years	Project partner
Aircraft max. take-off weight	77 t	Project partner / SAS 2019
Interior design elements' weight	10 t	Project partner
Range	4600 km	SAS 2019
Seats	174	SAS 2019
Fuel (kerosene) consumption	0.025 l/seat km	SAS 2019

The range of the aircraft makes it possible to assume that it will be used for intracontinental flights within Europe. The "Transport, passenger, aircraft {RER}| intracontinental | Conseq, U" process from the Ecoinvent v3.4 database was therefore taken as reference for the estimation of direct emissions linked to the kerosene consumption on a medium haul aircraft. The kilograms of kerosene consumed per m² of panel per the lifetime of the aircraft (KCP) were calculated through Equation II-2. Where FC is the aircraft fuel consumption, kmP represents the kilometric performance, Mp is the mass of the panel, ρ_{kerosene} is kerosene's density, and W is the interior design elements' weight.

$$\text{Equation II-2} - \text{KCP} = \frac{\text{FC} \cdot \text{Seats} \cdot \text{kmP} \cdot \text{Mp} \cdot \rho_{\text{kerosene}}}{W}$$

II.4.3.4. End-of-life

Following the French Environment & Energy Management (ADEME) legislation on waste (article R547-8 of the environmental code) (ADEME 2018), a product is considered as dangerous waste if they present one or more of the following characteristics: Explosive (H1), Oxidizer (H2), Highly flammable (H3-A), Flammable (H3eB), Irritating (H4), Harmful (H5), Toxic (H6), Carcinogenic (H7), Corrosive (H8), Infectious (H9), Toxic for reproduction (H10), Mutagenic (H11), Substances and preparations which, in contact with water, air or acid, release a toxic or very toxic gas (H12), Sensitizing agent (H13), Ecotoxic (H14), Substances and preparations which, after elimination, may make way by any means to another substance to form, for example a leachate, that has any of the characteristics previously listed (H15).

Based on this, and because of the presence of substances such as methylamine in the hardener (H14), both panels were treated as dangerous waste. The Ecoinvent v3.4 process used for the modelling of the end-of-life phase was then chosen as “Hazardous waste, for incineration {Europe without Switzerland} | market for hazardous waste, for incineration | Conseq, U”.

Currently, some recycling facilities exist for recycling specific recyclable parts of the aircraft. However, as there is too little of these recyclable parts reaching the recycling facilities to ensure a sufficient revenue from such businesses, the innovation and improvement in this field is rather slow. For this reason, the recycling industry for aircraft panels was judged insufficiently mature to consider recycling as a feasible option for end-of-life management technique.

II.4.4. Life Cycle Impact Assessment

The European Commission established the Product Environmental Footprint (PEF) as the way to evaluate the life cycle environmental performance of a product (EC 2020). As at the time that this study was carried out, the method was still not available, the ILCD 2011 Midpoint β method (Figure II-16) was chosen to evaluate the environmental impacts of the panels. This method was chosen as it is the most recently developed and similar to the methodology followed by the PEF. In order to be as close to the PEF method as possible, the ILCD Midpoint β method was slightly adapted to meet recent recommendations from the European Commission (PEFCR; EC 2017) based on the latest IPCC update (AR5; IPCC 2013). This affects the GWP100 of i) biogenic methane (34 kg CO₂ eq); ii) non-biogenic methane (36.75 kg CO₂ eq) and iii) carbon monoxide, fossil and from land use changes (1.57 kg CO₂ eq).

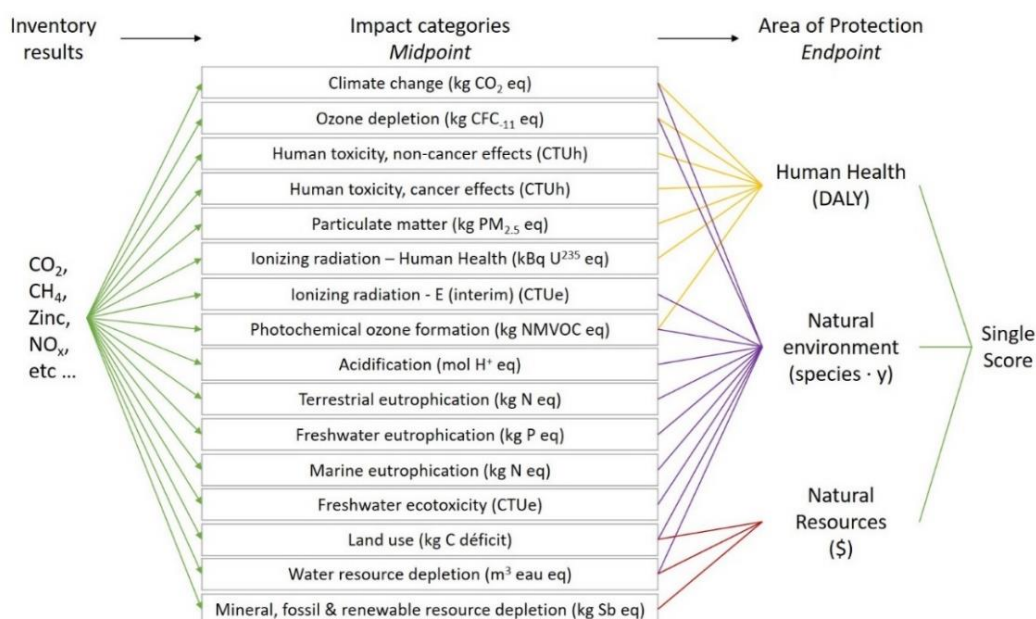

Figure II-16. Representation of the ILCD 2011 Midpoint+ evaluation method

Through the environmental analysis method, the inputs and outputs of the elementary flows identified during the life cycle inventory analysis (collected data) are translated into impact indicator results. Results can be presented at midpoint, endpoint and single score levels.

As recommended by the European Commission on the use of common methods for LCAs (EC 2013), out of the 16 impact categories evaluated in the ILCD 2011 Midpoint+ method, the following impacts were chosen to be assessed: Climate change, Ozone depletion, Particulate matter formation, Ionizing radiation, Photochemical ozone formation, Acidification, Freshwater eutrophication, Marine eutrophication and Mineral, fossil & renewable resources depletion. More precisely, only impacts labelled as “category I” (i.e. the highest recommendation level) and as “category II” were considered (JRC 2011). The only exception is terrestrial eutrophication, since marine and freshwater eutrophication are already considered.

II.4.5. Results

Results highlight that for each environmental impact studied, the environmental performance of both panels is essentially shaped by the use phase (Table II-9).

Table II-9. Contribution of each life cycle stage of both panels to the environmental impact categories. RM: Raw Materials; P: Production; U: Use; EOL: End-of-Life; ren. : renewable. N: Negligible.

Impact category	Biocomposite Panel				Conventional Panel			
	RM	P	U	EOL	RM	P	U	EOL
Climate change (kg CO ₂ eq)	7.76	0.03	23x10 ⁵	7.07	12.57	0.60	19x10 ⁵	6.08
Ozone depletion (kg CFC ₋₁₁ eq)	N	N	0.40	N	N	N	0.33	N
Particulate matter (kg PM _{2.5} eq)	0.03	N	338	0.01	N	N	277	N
Ionizing radiation HH (kBq U ₂₃₅ eq)	0.56	N	14x10 ⁴	-0.07	0.09	0.01	11x10 ⁴	-0.06
Photochemical ozone formation (kg NMVOC eq)	0.06	N	11x10 ³	0.01	0.03	N	9.3x10 ³	0.01
Acidification (molc H+ eq)	0.06	N	11x10 ³	0.02	0.04	0.01	8.5x10 ³	0.02
Freshwater eutrophication (kg P eq)	N	N	47.51	N	N	N	39	N
Marine eutrophication (kg N eq)	0.01	N	4x10 ³	N	0.01	N	3.1x10 ³	N
Mineral, fossil & ren. resource depletion (kg Sb eq)	N	N	10.50	N	N	N	8.60	N

Moreover, results show that the conventional panel outperforms the biocomposite panel by 14% in all impact categories (Figure II-17). This difference corresponds precisely to the mass gap between the two panels, the biocomposite panel having a higher mass than the conventional panel. This correlation is due to the fact that emissions are linked to the combustion of fuel. At the same time, fuel consumption is linked to the weight of the aircraft. The higher the mass of the aircraft, the higher the fuel consumption level and, therefore, the amount of emissions produced. As in this case the Use Phase is the main contributor for both the panels, the mass difference translates directly into the difference of impact between them.

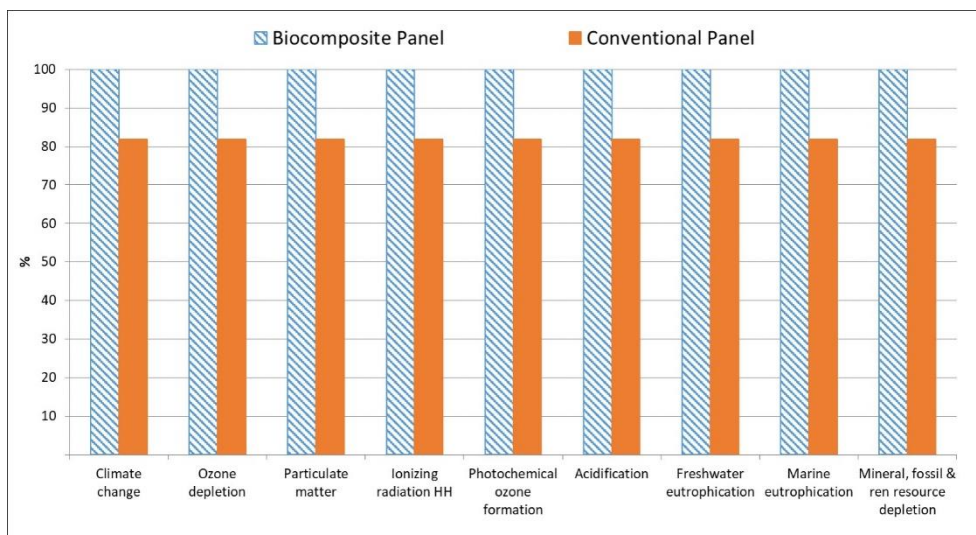

Figure II-17. Comparison of the environmental performance of a biocomposite and a conventional panel from a cradle-to-grave perspective

Figure II-17 shows the performance of panels over their whole life cycle (i.e. cradle-to-grave). By following a cradle-to-gate approach, the environmental performance of both panels was evaluated without taking into consideration the Use and End-of-Life stages of their life cycle. From this analysis, and considering all studied impact categories, the Raw Materials stage was identified to be responsible for up to 99% of the environmental impact of the biocomposite panel and over 65% for all categories for the conventional panel (Table II-10).

Table II-10. Contribution of each life cycle stage (in %) of both panels to the environmental impact categories from a cradle-to-gate perspective. RM: Raw Materials; P: Production; ren. : renewable.

Impact category	Biocomposite Panel		Conventional Panel	
	RM	P	RM	P
Climate change	99.71	0.29	95.76	4.24
Ozone depletion	99.90	0.10	95.78	4.22
Particulate matter	99.87	0.13	83.25	16.75
Ionizing radiation HH	99.89	0.11	84.71	15.29
Photochemical ozone formation	99.71	0.29	90.23	9.77
Acidification	99.67	0.33	91.76	8.24
Freshwater eutrophication	99.50	0.50	55.21	44.79
Marine eutrophication	99.41	0.59	91.94	8.06
Mineral, fossil & ren. resource depletion	100.07	-0.07	106	-6.00

Further analysis of the raw materials of both panels showed that for the biocomposite panel, the flame retardant agent and the production of the flax fiber technical textile are the main contributors to the studied environmental impacts (Figure II-18). On the other hand, glass fiber and aramid fiber production are the main contributors to the environmental impacts of the conventional panel, followed by the flame retardant agent and the epoxy resin production (Figure II-19).

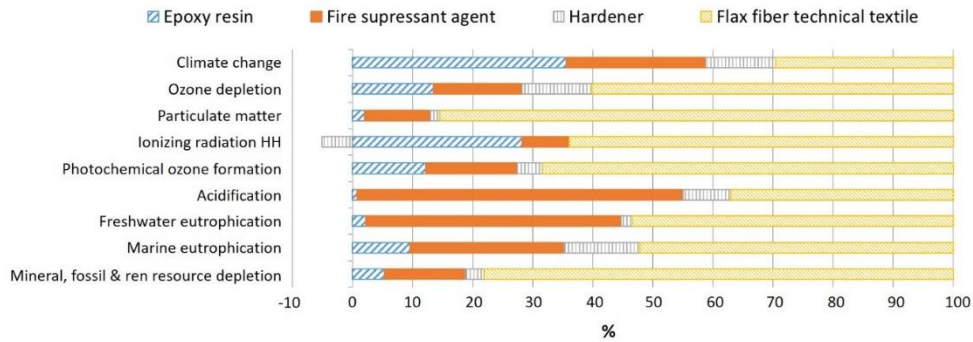

Figure II-18. Contribution of the raw materials to the potential environmental impact of the biocomposite panel

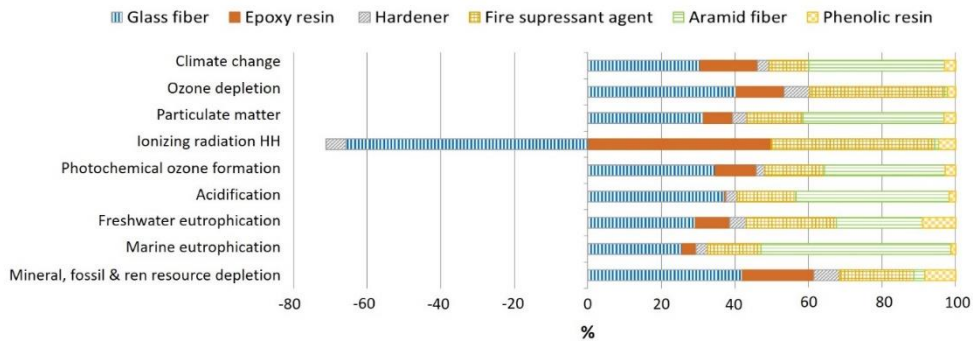

Figure II-19. Contribution of the raw materials to the potential environmental impact of the conventional panel

From comparing the performance of both panels, results showed (Figure II-20) that the biocomposite panel has a better performance in the environmental impact categories of Climate change and Marine eutrophication than the conventional panel. However, the conventional panel outperforms the biocomposite panel in all the other categories (Ozone depletion, Particulate matter, Ionizing radiation, Photochemical ozone formation, Acidification, Freshwater eutrophication and Mineral, fossil & renewable resources depletion).

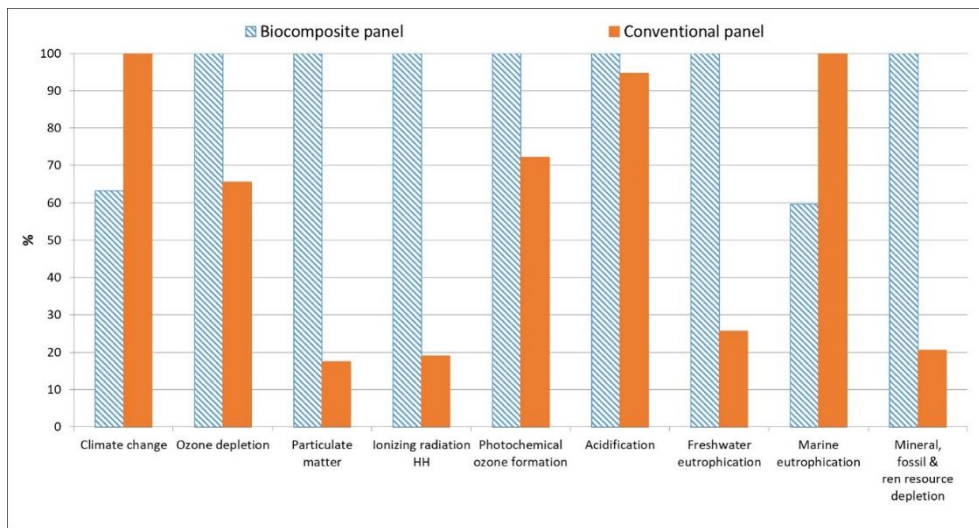











Figure II-20. Comparison of the environmental performance of a biocomposite and a conventional panel from a cradle-to-gate perspective

To identify the strengths and weaknesses of the biocomposite panel, the main contributors to each of the impact categories were identified. Findings are summarized in Table II-11, which presents the performance of the biocomposite panel compared to the conventional panel and the process/main contributors responsible for the potential environmental impacts for each category.

Table II-11. Biocomposite panel's environmental performance relative to the conventional panel, cradle-to-gate

Impact category	Performance*	Main contributors (biocomposite panel)
Climate change	 34%	Flax fiber technical textile: Flax cultivation (-167%)** Gains are directly linked to flax culture, specifically to the CO ₂ captured by the plant.
Ozone depletion	 27%	Flax fiber technical textile: Spinning (58%) Halons used in the coating of pipelines distributing natural gas used as energy source for the spinning process of the flax fibers are responsible for the impacts on ozone depletion.
Particulate matter	 84%	Flax fiber technical textile: Wood residues combustion (80%) The valorisation of flax shives (issued from the scutching step of flax fiber transformation) induces the displacement of wood residues to waste (details in Gomez-Campos et al., 2020), which are then burnt. The combustion of these wood residues contribute to particulate matter formation.
Ionizing radiation HH	 93%	Flax fiber technical textile: Flax cultivation (62%) Epoxy resin production (35%) Electricity consumption linked to the production of the epoxy resin's components as well as fertilizers used in the flax cultivation stage.
Photochemical ozone formation	 36%	Flax fiber technical textile: Flax cultivation (68%) CO emissions linked to land clearing as a result of additional arable land demand.
Acidification	 5%	Flame retardant (51%) Flax fiber technical textile: Flax cultivation (41%) The production of phosphoric acid used for the production of MAP (used as flame retardant agent and fertilizer in the case of flax cultivation) is responsible for the acidification impact.
Freshwater eutrophication	 80%	Flame retardant (49%) Flax fiber technical textile: Flax cultivation (47%) Impact results from the phosphate emissions into water linked to the production of phosphoric acid used for MAP synthesis (used as flame retardant agent and fertilizer in the case of flax cultivation).
Marine eutrophication	 30%	Flax fiber technical textile: Hay production (-141%) The valorisation of flax flakes (issued from the scutching step of flax fiber transformation) as animal feed reduces the amount of hay production and the impacts associated to it (details in Gomez-Campos et al., 2020).
Mineral, fossil & renewable resource depletion	 85%	Flax fiber technical textile: Flax cultivation (95%) Zinc used for treatment of seeds and soils for flax cultivation induces resource depletion.

*Difference on the environmental impact between the biocomposite panel and the conventional panel.

** Contribution of the mentioned process to the environmental impact.

II.4.6. Discussion

II.4.6.1. *From a cradle-to-grave's perspective*

For an application in aeronautics, the critical element of the panel is its mass as it has a direct influence on fuel consumption and therefore on the level of air emissions. This is revealed in Table II-9 where the use phase is shown to represent more than 99% of the contribution to all impact categories considered in this study. This is acknowledged by previous studies; Vidal et al. (2018), for instance, estimated that the use phase represents over 98% of the contribution, although they do not present the results of this phase in their study.

This implies that for any material with an application in aeronautics, the nature of the raw materials, the efficiency of their supply chains and/or its management in end-of-life has negligible influence over their environmental performance. This means that as long as the biocomposite panel has a higher mass value than its non-bio-based counterpart, the conventional panel will always be more competitive from an environmental point of view.

Our study found that the biocomposite panel had a 14% higher mass than its counterpart. This was in part due to the fact that aviation industry imposes stringent requirements with very little manoeuvre for changes, making it challenging for the biocomposite panel to keep its expected lower weight advantage. In the present case, due to the high porosity of the flax fiber absorbing the resin, a fiber: resin:ratio of 40:60 was required instead of the originally 50:50 ratio stipulated by the resin manufacturer; which contributed to render the biocomposite material heavier.

One way to minimize the overall amount of material being used could have been through changes in the geometrical shape (defining and limiting the total height of the panel; Figure II-13). Yet, this is in turn limited by the moulding technology available to attain the desired structure as well as the high mechanical exigencies of the sector.

II.4.6.2. *From a cradle-to-gate's perspective*

Focusing on the raw materials phase only, the procurement of flame retardants proved to be one of the main contributors to the panels' environmental impacts (Figure II-18 and Figure II-19). However, the exigencies on fireproofing are as well very high and allow for little flexibility for environmental improvements.

Specifically referring to the raw materials of the biocomposite panel, the production of the flax fiber technical textile proved to be an important contributor to its environmental impact (Figure II-18). This is due mainly to the agricultural activities linked to flax production and the fiber transformation step of spinning (Gomez-Campos et al., 2020).

This result is consistent with recent LCA studies showing that the main processes contributing to the environmental impact of flax fibers are related to yarn production (spinning). Fernando et al. (2015), for example, report this process to be responsible for about 69-78% of the overall impact of flax fibers. The spinning step may be omitted, as e.g. in the automotive sector where randomly distributed fibers pose no problems to meet technical specifications for some components. Yet spinning is not an optional step when the fibers are intended for aviation applications as woven fibers offer superior mechanical properties (Deng et al., 2016). Therefore, once again, it is really important to look beyond the fiber itself; as even though natural fiber production has a lower impact than glass fiber production (Joshi et al., 2004), this affirmation is dependent on the natural fiber transformation processes used (Dissanayake et al., 2009) and the type of energy mix used.

Moreover, typical environmental drawbacks for natural fibers composites have been related to agricultural activities. Eutrophication, freshwater ecotoxicity and land use, for example, are among the reported impacts in which synthetic fibers outperform natural ones (Duflou et al., 2014; Le Duigou and Baley 2014; Deng et al., 2016). In this case, the production of nitrogen fertilizers and zinc amendments to soil are the main causes of the environmental impacts caused by the cultivation of flax.

II.4.6.3. A consequential approach

An important aspect covered by this study, is the consequential approach with which the LCA was carried out. By taking into consideration the fate of co-products and the land use change induced by an increased demand for flax stems, the environmental performance of the flax fiber technical textile was affected both positively through induced processes (marine eutrophication) and negatively through avoided impacts (particulate matter and photochemical ozone formation) (Gomez-Campos et al., 2020).

The cradle to-gate assessment of the biocomposite (Figure II-18) and the conventional (Figure II-19) panels reveal net negative impacts (avoided impacts) only in the Ionizing radiation HH (Human Health) category. In both cases, the production of the hardener (methylamine) is responsible for the avoided impact; for the conventional panel, the production of the glass fibers also contributes. The methylamine and glass fiber consequential processes used for the LCA, were withdrawn from the Ecoinvent database and consider natural gas burned in co-generation power plants as the marginal source of energy. Meaning that in case of an increase in the production of methylamine and glass fiber, the consumption of natural gas will increase. This, in turn, causes a reduction in the electricity supplied from nuclear power and therefore the environmental impacts related to it, namely ionizing radiation.

II.4.6.4. Carbon sequestration

Climate-wise, another expected advantage of biocomposite panels is the long-term sequestration of carbon. Carbon dioxide is taken from air by flax fibers during its growing stage (cultivation of flax) and remains “sequestered” by it until its end-of-life. According to Le Duigou et al. (2011), 1.65 kg of CO₂ are taken by flax for growing 1 kg of flax fibers (FM). This translates into almost 1250 kg of CO₂ stored per m² of flax fiber technical textile (considering a humidity content of flax of 90%, a flax fiber yield of 7 t/ha and, a technical textile yield of 12%).

Carbon sequestration is particularly relevant in the aeronautics sector as the aircrafts’ materials aim to have a lifespan of 20-30 years (same as the aircraft itself). By storing carbon in such lengthy periods of time, impacts on climate change can be mitigated by delaying carbon emissions into the technosphere and giving more time for other technologies (such as direct air capture) to improve and be used as scale. This advantage, however, could not be quantified with the static LCA approach used in this study.

If the prototype biocomposite panel could be improved to attain the same mass value as the conventional one, the environmental performances of both panels would be exactly the same, over the full cradle-to-grave life cycle of the panel. However, by using the biocomposite panel, about 17 kt of CO₂ eq could be stored by airplane (by taking into consideration the characteristics of the A320neo aircraft presented in Table II-8).

Considering that the worldwide commercial aviation fleet is expected to double in the next 20 years (AIRBUS 2019), the use of bio-based materials could contribute to delay the emission of over 675 Mt of CO₂ eq. This number is a rough estimation based on the work herein presented and assuming that the interior design elements of the aircraft are entirely made from the biocomposite materials. Moreover, supply would have to be assured and an evaluation should be made on whether or not flax fiber alone could cover the demand of such market, including the environmental burdens

related to it. Nonetheless, it represents a real opportunity for bio-based materials, conditional to achieving weight reductions by using the biocomposite panels.

II.4.6.5. Future work

The work herein presented is based upon the development of one specific prototype, and uncovered many of the technical challenges to be solved in order to ensure a real weight reduction of biobased panels in the aeronautic sector, which in turns governs the overall environmental performance of these panels in comparison to their conventional counterparts. The conventional panels benefited from years of optimization and refinement; while the bio-based panels are relatively newcomers. This also explains why there is a limited amount of studies to compare our results with.

The most notable attempt to document the environmental impacts of bio-based materials in the aeronautics sector is the work of (Vidal et al., 2018) where different panels are evaluated, including one bio-based alternative. However, the bio-based panel presented only uses flax fiber reinforced composite as the core structure, while the skins remain a thermoplastic material; which differs from the biocomposite panel presented in this work and therefore a direct comparison between the environmental performance of the two of them is not possible. At the same time, results given by Vidal et al. (2018) are presented as Endpoint categories, while in this work results are given at a Midpoint level.

Our work also highlighted the stringent technical requirements of the aeronautics sector. Though beyond the scope of the present work, these strict technical requirements could eventually be questioned when it comes to panels destined as interior fittings. More moderate requirements for panels could be key in achieving additional weight reductions.

II.4.7. Conclusion

The work presented in this study uncovered that for an application of bio-based materials in aeronautics, weight is an utmost critical parameter defining the overall environmental performance.

From a cradle-to-grave approach, there is no other parameter more important than this; the nature of raw materials has, in comparison, no incidence on the environmental performance. In this matter, future work should be aimed towards the improvement of the fiber/resin ratio and the geometry of the biocomposite panel prototype in order to reduce its mass. Concerning the fiber/resin ratio, the use of different resins could be tested to evaluate their interaction with the flax fibers. Another possibility would involve the chemical treatment of flax fibers to improve their interaction with the resin. However, this would alter their composition and the environmental advantages of using natural fibers could be affected or lost. Further work should also focus on the improvement of the prototype, specifically on its geometry, in order to attain lower mass values, which would translate in a reduction of the environmental impact of the biocomposite panel. This would also imply a verification of the presented LCA in order to effectively represent the production process, if any changes were to have place.

Overall, from a cradle-to-gate approach, the biocomposite panel was shown to be more environmentally competitive than the conventional panel in the impact categories of climate change and marine eutrophication, by 34% and 30%, respectively. Yet climate change gains are fictitious if the lifespan of the panel is short, as the stored carbon will be released into the atmosphere at the end of the panel's life. The processes identified as responsible for the overall environmental impacts of the panels are essentially linked to the procurement of raw materials. Agricultural activities (such as zinc

amendments to soil treatment and fertilizer production) are the main processes responsible for the higher environmental impact of the biocomposite panel when compared to the conventional one.

The valorization of co-products, on the other hand, affects both positively and negatively the environmental performance of the bio-based panels and must not be neglected from the system boundary.

Given that materials in the aviation sector have a lifespan of 30 years and over, a biocomposite panel represents a relevant option when it comes to climate change mitigation. It was calculated that through the use of bio-based panels as elements in interior fittings in airplanes for the next 20 years, the emission of over 75 megatonnes of CO₂ could be delayed. However, production processes and regulations are yet to be optimized and adjusted for biocomposite materials to have a place in the aviation sector.

II.5. Conclusion & Perspectives

Several studies have proven natural fibers to be an interesting material to be used as replacement of the fossil-based currently used fibers as reinforcement in composite materials. Flax fiber has been widely researched and appears to be an interesting option for reducing weight and, therefore, fuel consumption and the GHG emissions related to the combustion of fossil fuels.

The use of NFPCs in aircrafts has emerged as a plausible contributor to achieving the sustainability goals set by the aviation sector. However, the availability of a Life Cycle Inventory data for flax fiber as technical textile was found to be limited to a reduced number of studies. For this reason, efforts focused on presenting information in a clear and concise fashion for modifications to be easily made, allowing a better representation of a broad spectrum of scenarios as agricultural practices and market trends might evolve.

Moving forward, the work carried out uncovered that for an application of bio-based materials in aeronautics, weight is an utmost critical parameter defining the overall environmental performance. From a cradle-to-grave approach, the nature of raw materials has, in comparison, no incidence on the environmental performance. However, from a cradle-to-gate perspective, the consequential approach taken allowed for the influence of coproduct's valorisation to be addressed. In this way, the effect of diverting resources was evaluated and allowed for a more accurate understanding of the main product's environmental impact. It was found out that while some potential environmental impacts could be underestimated, some other could be greatly overestimated. Results brought forward the importance of applying system expansion instead of allocation techniques when dealing with co-products.

The effects of diverting land resources originally allocated to the culture of different products, was addressed by incorporating the notion of indirect land use change (iLUC). It was found out that impacts generated by iLUC can be overthrown or balanced out by the valorisation of co-products as animal feed.

Additionally, it was shown that the strict requirements and regulations from the aviation sector, limit the green aspect of a bio-based material. Nonetheless, the long lifespan of aircrafts (ca. 30 years) represents an opportunity for storing the CO₂ captured by the plant through the process of photosynthesis, thus contributing to the delay of the effects of climate change.

Overall, it was found out that the valorization of co-products, issued from the transformation of flax fibers into a technical textile, contributes to the diminishment of the land use change impact generated as a consequence of increasing flax culture. Consequently, land use change impacts do not represent a disadvantage for bio-based products when co-products are valorized, particularly as animal feed. Additionally, it was shown that the environmental advantages of a bio-based products greatly rely on the geographical scope (i.e., a country's energy mix), how co-products are handled, as well as the application they are given.

In the aim of continuing to boost the incorporation of bio-based materials to favor the implementation of a bioeconomy, future work should focus on the optimization of production processes of bio-based materials to increase their competitiveness in the market. Supply chains should also focus on production practices that prioritize an efficient use of resources by taking advantage of as much of the biomass available as possible (valorization of co-products). Moreover, for a bioeconomy to be successfully deployed, current regulations and materials' requirements should be revised and rethought from a bio-based perspective, taking into consideration the qualities and specificities of products with a bio-based origin.

II.6. Addendums

II.6.1. Addendum 1 – Flax fiber for technical textile: A life cycle inventory

Figure II-21 presents the results from the LCA performed for the flax fiber technical textile with the additional environmental impact categories of land-use, toxicity, ecotoxicity, and water consumption.

Impacts on land use are a consequence of the flax cultivation and retting processes, mainly. This comes because of diesel consumption from flax cultivation and land use dedicated to the construction of sheds required to storage the bales of retted stems.

Flax cultivation appears as the main contributor to the impacts on human toxicity, both cancer and non-cancer effects. Processes responsible are the production of nitrogen and phosphate fertilizers, respectively.

Effects on ecotoxicity are a result of emissions resulting from the mining of copper; copper is used to produce wind turbines. Electricity requirements from the weaving and spinning processes induce the use of wind power, thus contributing to the generated impacts on ecotoxicity.

Impacts on water depletion are caused in its majority by the weaving process and avoided glass fiber production. For the former, the impact stems from water used in the production of potatoes from where starch is obtained. For the latter, the displacement of glass fiber induces the avoided production of heat and energy from natural gas. This avoided process; is the responsible for the generated impacts on water depletion. On the other hand, avoided impacts on water depletion are a result of the avoided palm oil production, namely the refinery process.

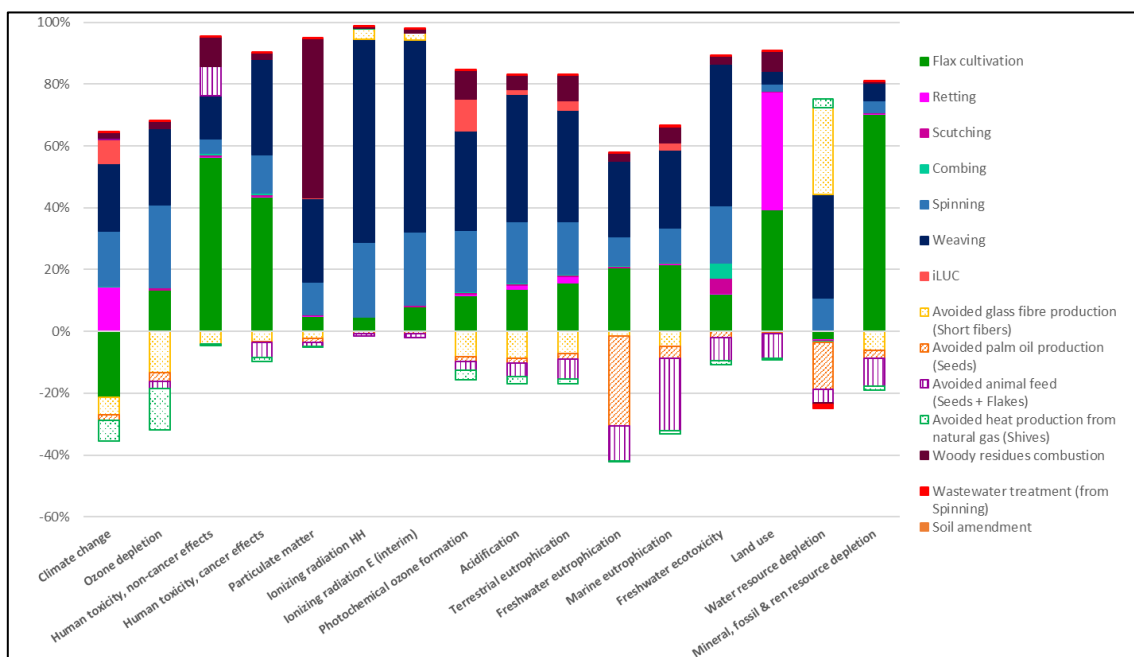

Figure II-21. LCA results of a flax fiber technical textile including impact categories of land-use, toxicity, ecotoxicity, and water consumption

A normalization of the results obtained for the environmental performance of the flax fiber technical textile is presented in Figure II-22. By normalizing the results, the most important impact categories are highlighted. In this case in particular, said categories are human toxicity (non-cancer and cancer effects), and freshwater ecotoxicity.

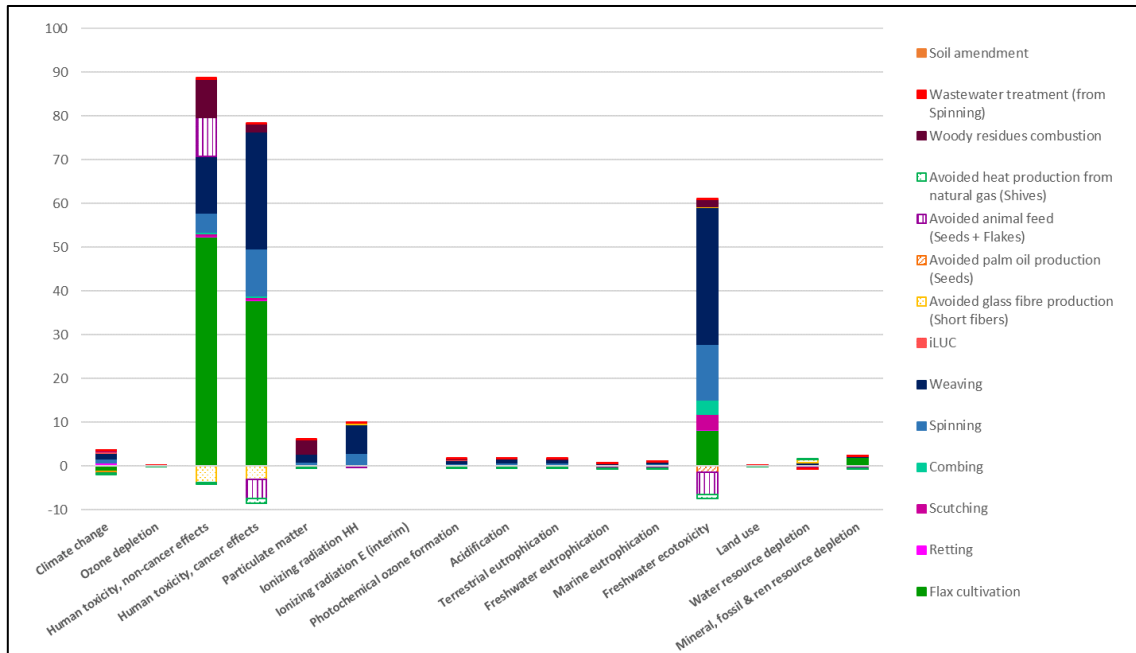

Figure II-22. Normalized results of the environmental performance of a flax fiber technical textile

Moving forward, the validity of the conclusions drawn from the results obtained from the LCA of the flax fiber technical textile was evaluated through a sensitivity analysis. This was done by comparing the results from the assessment method of choice (ILCD 2011 Midpoint+ with modifications) (Figure II-21) to those obtained by using a different one, in this case, to ReCiPe 2016 Midpoint (H) (Figure II-23).

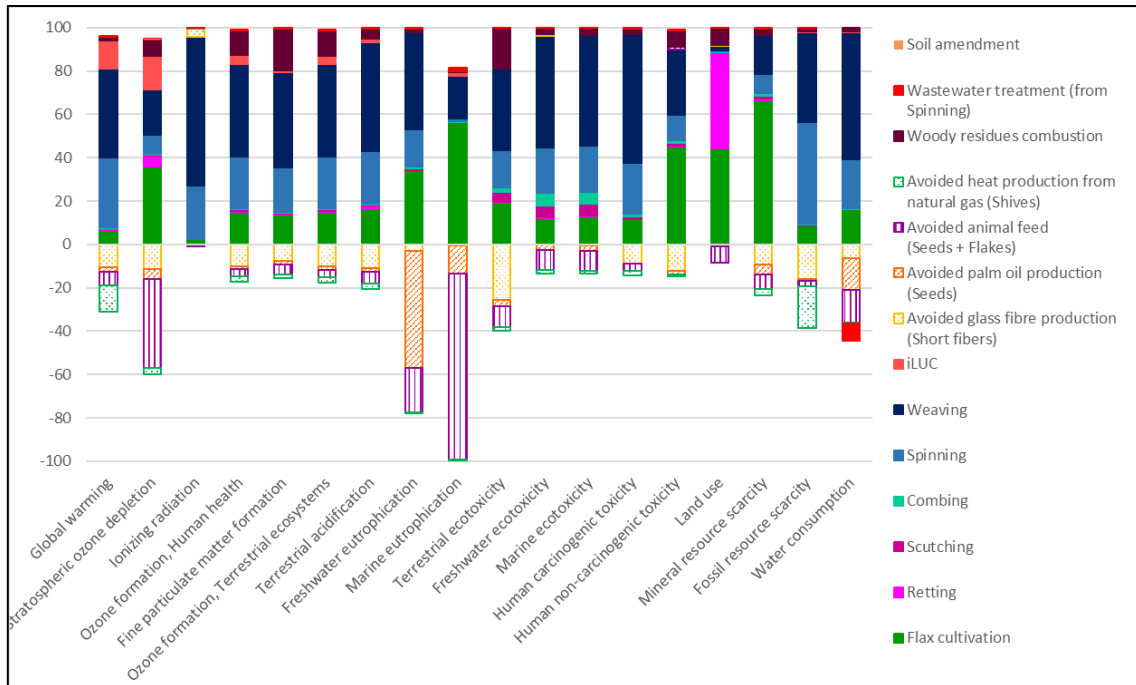

Figure II-23. LCA results of a flax fiber technical textile using the ReCiPe 2016 Midpoint (H) environmental assessment method

The Sensitivity Analysis carried out to compare environmental assessment methods; shows that it has little to none influence on the results as the conclusions that can be drawn from either of the assessments are the same. Namely, the weaving and spinning processes are the main contributors in all impact categories, and the avoided production of animal feed and palm oil the main reasons behind the avoided (negative) impacts observed.

II.6.2. Addendum 2 – Natural Fiber Polymer Composites – A game changer for the aviation sector?

The additional analysis of the raw materials from the biocomposite panel (Figure II-24), show that for the impact categories of toxicity; land use, ecotoxicity and water depletion, the main contributors are the production of the flax fiber technical textile and the fire suppressant agent. For the water depletion category, the production of the epoxy resin and the hardener appear as avoided impacts, which is linked to the avoided production of heat by natural gas considered by the consequential Ecoinvent processes.

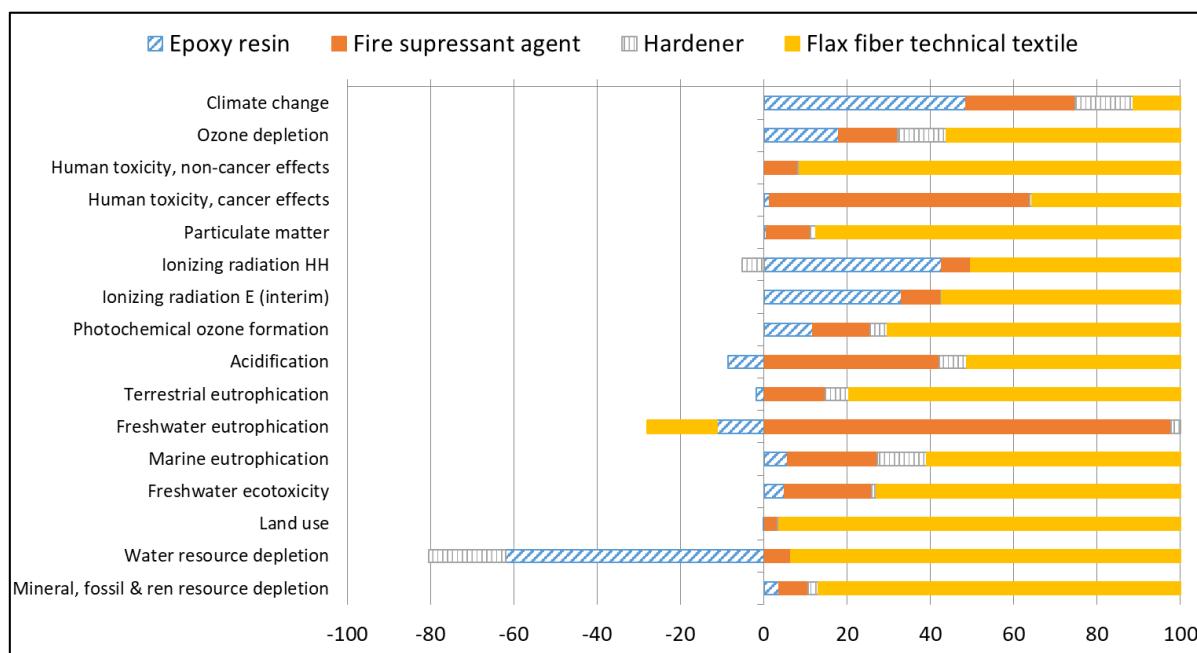

Figure II-24. Analysis of the raw materials stage of the biocomposite panel, including the impact categories of land-use, toxicity, ecotoxicity, and water consumption.

Afterwards, a sensitivity analysis was carried out for evaluating the influence of the environmental assessment method on the results. For this, results from Figure II-24 (using ILCD 2011 Midpoint+ with modifications) were compared to results obtained by using the ReCiPe 2016 Midpoint (H) assessment method.

Results from the sensitivity analysis (Figure II-25), show the fire suppressant agent and the flax fiber technical textile production to be the two main contributors to the generated impact for all the evaluated categories.

One of the main differences lays on the influence of the flax fiber technical textile production on the category of marine eutrophication. Using the ReCiPe evaluation method results in a negative (avoided) impact. This may be since both methods have different characterization factors as well as substances considered for the evaluation of this impact.

Moreover, the environmental advantages of the production of the epoxy resin and the hardener on the water depletion category (using the ILCD 2011 Midpoint+) are nullified when the ReCiPe method is applied. This is a consequence of the ReCiPe method using characterization factors of either 1, -1 or 0 for all water considered in the evaluation, while ILCD 2011 Midpoint+ has different characterization factors for water use. These factors are dependent on the geographical source of the water, as well as the intended use.

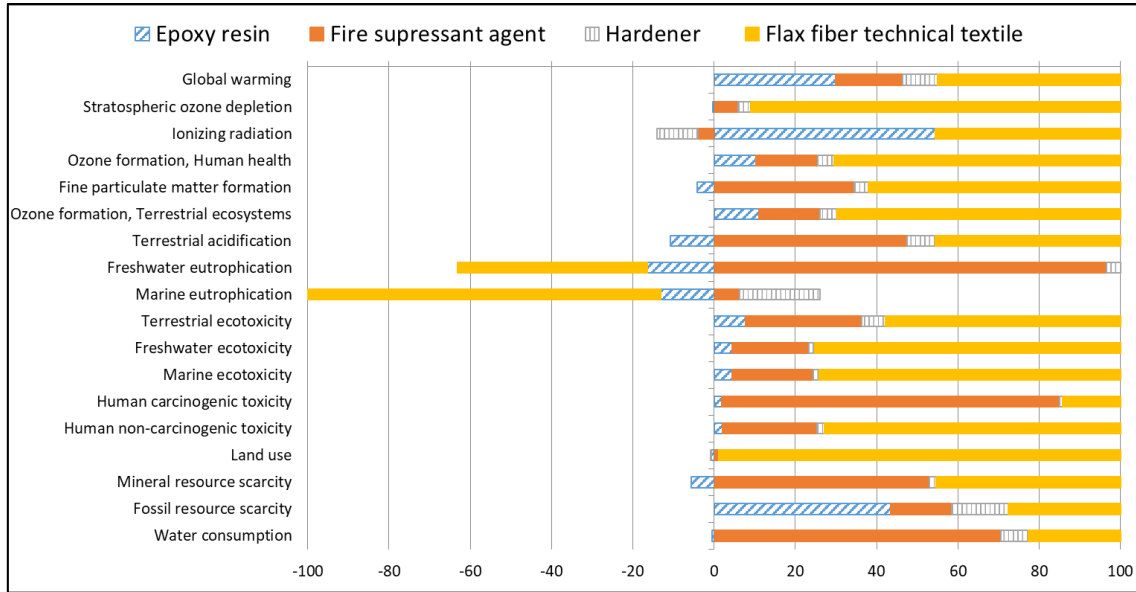

Figure II-25. LCA results of the raw materials stage of a biocomposite panel using the ReCiPe 2016 Midpoint (H) environmental assessment method

CHAPTER III

PRODUCTION & ENVIRONMENTAL ASSESSMENT OF AN AGRO-MATERIAL AS A SOUND-ABSORBING PANEL

CHAPTER III. PRODUCTION & ENVIRONMENTAL ASSESSMENT OF AN AGRO-MATERIAL AS A SOUND-ABSORBING PANEL

Chapter III explores the specificities of a 100% bio-based, and naturally synthesized material, hereafter referred as an agro-material, both on a technical and an environmental ambit. Through one case study, a sound-absorbing panel was produced using sunflower pith. By taking into consideration the dynamic aspect of carbon and the natural recycling aspects of agro-materials, the second scientific question “How to apply the LCA methodology to agro-materials?” is addressed in this chapter. Like the one taken in chapter II, a consequential approach was taken by including the fate of the co-products in the overall environmental performance of the main product, through the application of system expansion and the use of marginal data.

The chapter begins with an introduction where current valorization practices of the different parts of sunflower are described as well as a summary on the current LCAs available in the literature concerning the valorization of the sunflower plant and its different components. Next, a detailed description of the case study is presented.

Overall, the work herein presented aims to describe the production process of the sunflower pith panels, starting from the agricultural operation of harvesting the stalks, as well as the evaluation of the sound absorption properties of the panels. Moreover, the dynamic aspect of carbon is evaluated by quantifying the amount of CO₂ emissions that are avoided as a result of the stalks’ valorization. Moving forward, an LCA is carried out to evaluate the pertinence of valorizing sunflower pith as sound absorption panels and compare its environmental performance to a fossil-based (melamine foam) sound absorption alternative.

Finally, limitations and perspectives for future work, followed by a conclusion of the chapter are presented.

III.1. Introduction

The need to sustainably replace fossil carbon and to maintain the current temperature-rise below 2°C has made agricultural co-products a subject of interest to the scientific community. The valorization of crop residues as a source of materials represents a carbon source without the environmental burdens linked to the use of additional arable land. Moreover, bio-based products act as carbon storage units, contributing to the delay of greenhouse gas (GHG) emissions.

Albeit cereal straw is commonly exploited (Thorenz et al., 2018), the use of oilseed straw, and in particular sunflower straw (also commonly referred to as sunflower stalks), has received less attention in terms of their use as a carbon feedstock in the future bioeconomy. Yet, the cultivation of sunflower has steadily increased over the last 20 years, and European production is responsible for more than half the global supply (FAOSTAT, 2020).

Worldwide, France ranks at the 5th place in sunflower production, and in 2015, with about 615 000 hectares of cultivated land (Figure III-1), was responsible for almost 17% of the European production (Terres OléoPro 2016).

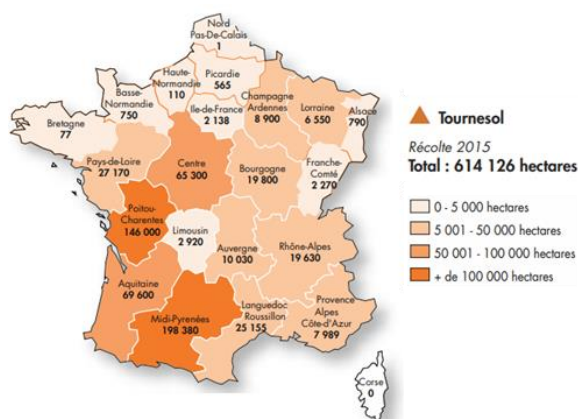

Figure III-1. Sunflower production in France (Source: AGRESTE – SSP). Image from (Terres OléoPro, 2016)

From the different parts of the sunflower plant (Figure III-2), the current main product of interest is the seeds, which are used as a source of oil for the food sector. From the oil extraction process, sunflower meal is obtained and valorized as animal feed. The harvesting process takes place at a maturity stage of the plant at which the petals and leaves have already dried out and fallen to the ground. Only the heads are harvested and threshed on the spot. Once the seeds are collected, they are left in the field along with the stalk as a source of nutrients to the soil. Together, the heads and stalks left at the field represent around 7 tonnes of dry matter (per hectare), equivalent to 1.2 – 1.5 tonnes of hummus (Evon 2008).

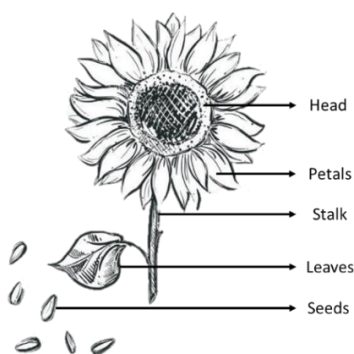

Figure III-2. Parts of a sunflower

As common practice is to leave the co-products at the field, there is not specific agricultural machinery to harvest them. However, commonly used machinery has been adapted to carry out the job. Evon (2008) for example, describes three different collection methods, their advantages and disadvantages.

Different authors have addressed the valorization of the different co-products issued from sunflower's culture, from which stalks are the preferred given their composition and availability, as they represent about 25% (in dry mass) of the total mass of the plant (Evon 2008).

Applications go from the production of particleboards (Khristova et al., 1996; Evon et al., 2012) used for furniture manufacture (Bektas et al. 2005; Klímek et al. 2016) to materials to be used for packaging (Klímek et al. 2016; Marechal and Rigal 1999) or for thermal insulation (Mati-Baouche et al. 2014; da Rosa et al. 2015; Mathias et al. 2015; Mati-Baouche et al. 2016). Other applications include its use to produce low-weight components for vehicles (Mathias et al. 2015) and materials used in the construction sector (Oancea et al. 2018). Table III-1 summarizes current work on the valorization of sunflower stalks.

Table III-1. State-of-the-Art for the valorization of sunflower stalks

Author	Country	Product of interest	Valorized as:
Khristova et al. (1996)	Sudan & Spain	Sunflower stalks (whole and depithed)	Particleboard
Marechal and Rigal (1999)	France	Paper pulp from stalks	Corrugated cardboard
Bektas et al. (2005)	Turkey	Milled sunflower stalks (pure or combined with poplar wood chips)	Furniture manufacture or other indoor applications
Mati-Baouche et al. (2014)	France	Shredded sunflower stalks mixed with chitosan	Biocomposites with thermal insulation properties
da Rosa et al. (2015)	Brazil	Chopped and peeled sunflower stalk mixed with rice husk, gypsum and jute fiber	Thermal insulation of solar collectors to heat water
Mathias et al. (2015)	France	Pith from stalks	Thermal insulation material
		Bark from stalks	Low weight components for vehicles
Klímek et al. (2016)	Germany	Milled stalks	Particleboards for furniture production
		Pith from stalks	Low-density packaging material
Mati-Baouche et al. (2016)	France	Shredded sunflower stalks mixed with chitosan	Biocomposites with thermal insulation properties
Oancea et al. (2018)	Romania	Shredded sunflower stalks mixed with concrete	Construction materials with higher sound absorption coefficients

From the sunflower stalks, two components can be distinguished: the bark and the pith. The first one is the outer wood-like layer of the stalk while the latter is the inner foam-like component with insulating properties (both thermal and acoustic).

To a lower extent, the valorization of the sunflower heads has also been researched for applications mainly as a source of pectin (Kang et al. 2015; Y. Zhang et al. 2016) for use as an essential oil (Marechal and Rigal 1999) and potential use in commercial food (Miyamoto and Chang 1992). Moreover, applications as filler in composite materials (Weiguo Liu et al. 2017) and as roughage for animal feed (Mohan, Reddy, and Reddy 1997) have also been reported. A state of the art of the valorization of sunflower heads is presented in Table III-2.

Table III-2. State-of-the-Art for the valorization of sunflower heads

Author	Country	Product of interest	Valorized as:
Miyamoto and Chang (1992)	USA	Pectin extracted from heads	Potential use in commercial food applications
Mohan et al. (1997)	India	Heads	Roughage
Marechal and Rigal (1999)	France	Pectin extracted from heads	Source of essential oil
Kang et al. (2015)	China	Pectin extracted from heads	No specific application
Nagalakshmi et al. (2016)	India	Extruded heads	Complement in animal feed
Zhang et al. (2017)	China	Pectin extracted from heads	No specific application
Liu et al. (2017)	Tajikistan	Extruded heads	Filler in composites

To the authors knowledge, most environmental assessments on sunflower have focused on biofuel production (Sanz Requena et al. 2011; Iriarte et al. 2010; Spinelli et al. 2012, 2013; Iglesias et al. 2012; Spugnoli et al. 2012; Ragolini et al. 2011; Tsoutsos et al. 2010). Some other studies focus mostly on the cultivation challenges of sunflower crops intended for biodiesel production (Figueiredo et al. 2012, 2017; Harris et al. 2016).

LCAs on sunflower production as a source of materials have been reported by Volpe et al. (2018), who studied the benefits of using sunflower seed fried oil as a filler for PLA, and by the study of Mathias et al. (2015), in which the properties of sunflower stalks to be used as a source of materials for biocomposites are evaluated. However, the work of Mathias et al. (2015) is limited to the agricultural stage of sunflower production.

Overall, there are no LCA studies on the valorization of sunflower as a source of materials nor studies on how materials made from sunflower perform, environmentally speaking, compared to their conventional counterparts.

III.2. Description of the case study

Through the “Atelier LUMA” program, the LUMA Foundation (an experimental cultural center based in the city of Arles, France) seeks to create an interdisciplinary center where local resources, materials, knowledge and talent co-exist and thrive. Specifically, Atelier LUMA imagines innovative and sustainable ways to valorize the natural and cultural resources of its region. The center of its activities focuses on practices that respect the environment and that promote a circular economy.

As part of its projects, the Atelier LUMA wishes to valorize agricultural waste, in particular stems issued from the culture of sunflower grown for the production of oil. The objective of the project is to separate the pith from the rest of the stem and to take advantage of its insulation properties to produce acoustic insulation panels to be used for improving the acoustics of the cafeteria area of the LUMA Foundation building. Furthermore, their environmental performance will be assessed and compared with commonly used materials to evaluate the advantages of using sunflower pith.

As current common practice is for sunflower stalks to be left on soil, they contribute to the natural nutrient supply of the soil. For this reason, the harvesting of stalks for their valorization as materials generate concerns, among others, of depleting soil carbon stocks (Hansen et al. 2020). To address this concern, through Life Cycle Assessment (LCA) it is possible to evaluate if the environmental gains of valorizing biomass as materials outweigh the depletion of the soil.

The sunflower-based panels represent an example of an agro-material as the natural structures of the pith are maintained. To produce the panels, the use of a gluing agent is required to keep the pith fragments together. In order to keep the final product an agro-material, the gluing agents are to be non-synthetic compounds, and four different formulations were tested in order to evaluate the best one from a functional and environmental point of view.

Overall, the present study investigates a real-life demonstration case of a 4-ha sunflower field in the Camargue region of France, where sunflower stalks were harvested and used for producing bio-based sound-absorbing panels. The vision is to determine whether and under which conditions it is environmentally relevant to harvest sunflower stalks for this application instead of leaving them on the field as a source of carbon for the soil.

Chapter III thus describes the production process of the sunflower pith panels, starting from the agricultural operation of harvesting the stalks, as well as the evaluation of the sound absorption properties of the panels. Moreover, the dynamic carbon balance as the stalk-carbon is temporally sequestered in the panel is studied, including the quantification of the yearly changes in soil organic carbon resulting from the harvest of stalks. Finally, an LCA is carried out to evaluate the relevance of valorizing sunflower stalks as sound absorption panels.

III.3. Production of sunflower pith panels

The demonstration site is located in the Camargue area of France, on a 4-ha sunflower plot, where pith from sunflower stalks is used to produce sound-absorbing panels. The production of the panels then takes place at the Atelier LUMA's facilities, located nearby the cultivation fields.

The production of the panels encompasses four main processes: the harvest of the stalks, the separation of the pith particles from the stalks, the purification of the piths, and the production of the panels themselves. The vision is to use a minimum of petrochemical and chemical additives, in order to return the panel to agricultural fields at the end of its life (EoL).

The following sub-sections present the harvest of the sunflower stalks and the pith recovery process, as well as the steps for the production of the sound-absorbing panels following four different formulations.

III.3.1. Sunflower pith production

For the production of the sunflower pith, a forage harvester (Figure III-3) typically used for harvesting maize, harvests the remaining sunflower stems after seeds were collected. However, not the totality of the stem is harvested, as the cut is done at about 10 cm above the ground, leaving this part of the sunflower stem in the field. By passing through the forage harvester, stems are crushed, and a first separation of pith and bark is visible.



Figure III-3. Forage harvester used for harvesting the sunflower stems

As a result of the harvesting by forage harvester, about 1500 kg FM of “pre-crushed” stems (Figure III-4) are transported to a shed (dimensions: 9.6 x 5.6 m) nearby Atelier LUMA's facilities, located at about 22 km from the field, where they are stored until required.



Figure III-4. Harvested stems as stored

As over 60% of the pith is still attached to the bark, the next step is to further crush the harvested stems in order to recover as much pith as possible. For this, harvested stems are fed into a hammer mill (Figure III-5) to which a comb is attached to improve the breaking down of big pieces into smaller ones.



Figure III-5. Hamer mill used for the crushing of the sunflower stems

During the grinding process, mass losses occur in the form of dust and particles falling out of the hammer mill due to the outlet not being fully closed. However, said losses represent less than 1% and are considered negligible. Therefore, for every 1 kg FM of stems entering the hammer mill, 1 kg FM of crushed stems are produced. Figure III-6 shows the resulting stems after passing through the hammer mill.



Figure III-6. Crushed stems after passage by the hammer mill

The crushed stems are then passed through a sieve where the bark is separated from the pith. An aspiration system is placed over the sieve (Figure III-7) and is used to recover the pith by aspiration due to its very low density in comparison with that of bark particles ($20\text{-}30\text{ kg/m}^3$ instead of ca. 250 kg/m^3). The crushed stems are separated into 63% of bark (Figure III-8), 25% of pith (Figure III-9) and 11% of fines (fine particles of $<1\text{ mm}$), on a weight basis. Fines are coming from bark and, in a lesser extent, from pith as well. The process results in a mass loss of 1% as some small components are not recovered during the process.



Figure III-7. Sieve and aspiration system used in the separation process



Figure III-8. Bark after sieving



Figure III-9. Pith recovered after sieving

After being sifted, the pith undergoes another separation process in order to separate it from the remaining small bark pieces. Depending on the application, the purification process might be done twice in order to increase the quality of the pith.

The purification process is carried out by passing the sifted stems through a conveyor belt, the configuration of the purification system is shown in Figure III-10. The sifted stems are blown in the opposite direction of the moving belt. The corrugated surface of the belt holds back the bark fragments while the pith moves forward and is sucked in by the aspiration system thanks to its lower density. The bark fragments are removed at the top of the conveyor belt, and the quite spherical particles of pith roll down on the belt to be sucked at the bottom by the aspiration system.



Figure III-10. Conveyor belt and aspiration system put together for the purification process

The pith resulting from the purification process (Figure III-11) is the final product used for the sound-absorbing panels. Along with the pith, some more bark (Figure III-12) is obtained and some losses are observable.



Figure III-11. Purified pith



Figure III-12. Bark recovered after the purification process

Table III-3 shows the stages and quantities of product required to generate 1 kg of sunflower pith from the stalks in the field. Energy consumption values, machinery requirements, and other specifications for each of the production stages are detailed in the SI.

Table III-3. Production of 1 kg purified sunflower pith: Process Stages and mass balance

Process	Product entering the process	Mass (w/w) at the process output (kg)
Harvesting	On-field stalks	13.50
Crushing	Harvested (pre-crushed) stalks	13.50
Separation (sieving)	Crushed stalks	3.38
Purification (1 st passage)	Fraction made of pith particles	1.75
Purification (2 nd passage)	Partly purified pith	1.00

III.3.2. Production of the sound-absorption sunflower based panels

To produce the panels, four formulations were tested by using different gluing agents: (i) starch, (ii) chitosan, (iii) sunflower protein isolate, and (iv) water vapor. For each formulation, three samples of the same panel were produced with a density of 50 kg/m^3 and dimensions of $15 \times 15 \times 5 \text{ cm}^3$.

Calculations were made in order to obtain the required amounts of pith and adhesive agent for each of the panels. The panels were processed all following the same procedure. The adhesive agent was prepared (i.e., water-dissolved) and mixed with the sunflower pith at a concentration of 3.4% w/w. The mixture was then put into a $15 \times 15 \text{ cm}$ mold (Figure III-13) to which a weight was added (in the form of a lid) in order to facilitate the compression of the panel. To obtain a thickness of 5 cm, two shims (or spacers) were placed.



Figure III-13. Mold used for the production of the acoustic panels

For the water vapor panels, the mold was then placed in a heat press (Figure III-14) where the mold was heated at 150°C for 30 minutes; no pressure was applied to the lid as its weight itself was sufficient. For the rest, no heat or pressure was applied, only the weight of the lid applied for about 3 minutes.



Figure III-14. Heat press used for the production of the water vapor acoustic panel

Panels were dried in a furnace at 60°C for 48 hours. After this time was passed and panels were ready, they were stored in a controlled temperature and humidity chamber at 23.3°C and 46% in humidity.

The specifics of the production of each of the panels are described here after.

Starch panel (S)

The starch was obtained in the form of wallpaper glue (distributed by BOSTIK SA and sold by Mr. Bricolage as the B RESIST brand). The glue was prepared by manually mixing 6.67 g of glue powder to 186.67 ml of water. Once ready, the glue was then added to 56.25 g of sunflower pith and mixed by hand.

The final mixture was put into the mold and covered with the lid to add weight for about 3 minutes. Passed this time, the panel was removed from the mold and put into an oven for drying at 60°C for 48 h. The panels were then taken out of the oven and put into the controlled temperature and humidity chamber for stocking.

Figure III-15 shows the wallpaper glue used and the process for the production of the starch panel.

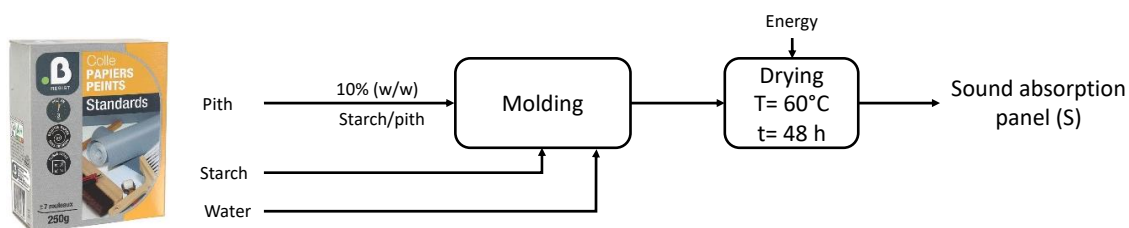

Figure III-15. Wallpaper glue used and Production process of a starch sunflower insulating panel

The resulting panels held together, seemed robust and were resistant to manipulation. No pith particles detached from the panels during demolding or transportation to and from the oven and controlled conditions chamber. The resulting panels' dimensions were 15x15x15 cm³.

Chitosan panel (Ch)

For the chitosan formulation, 1% (v/v) acetic acid solution was prepared to obtain a pH \approx 3 (186 ml of water + 1.867 ml of acetic acid). Afterwards, 6.67 g of chitosan powder (Chitosan 90+ KALYS Lot: 3320-3327) were added to 187 ml of the acetic acid 1% solution and mixed manually. Acetic acid was used for complete dissolution of chitosan in water. Once ready, the chitosan and the pith (56.25 g) were mixed by hand and put into the mold and covered with the lid. After about 3 minutes, the panel was demolded and put into an oven at 60°C for 48 h. The panels were then taken out of the oven and put into the controlled temperature and humidity chamber for storage.

Figure III-16 shows the chitosan used and the process for the production of the chitosan panel.

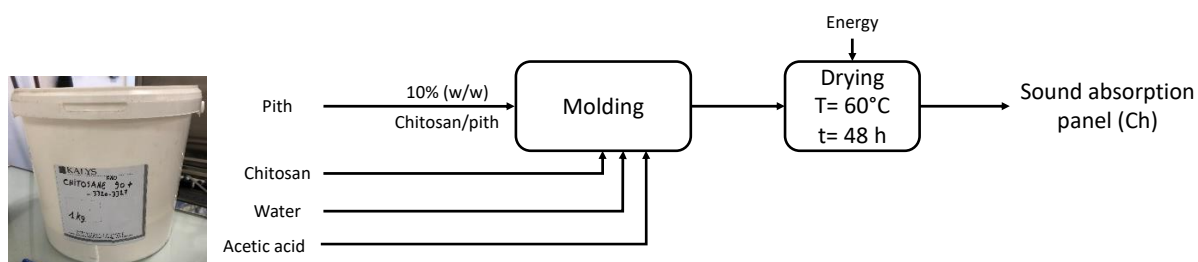

Figure III-16. Chitosan used and Production process of a chitosan sunflower insulating panel

First batch of Ch panels that were produced did not hold together and fell apart during the demolding process. Following the work of Mati-Baouche et al. (2014) it was noticed that for chitosan powder was to be dissolved in an acidic solution (pH \approx 3). Once this was done, the mixture worked perfectly, and the new panels held together just as well as the A panels. The resulting panels' dimensions were 15x15x15 cm³.

Protein isolate panel (iP)

For this formulation, 0.10 g of NaOH were added to 186.67 ml of water to obtain a solution with a pH \approx 12. Then, 6.67 g of the sunflower protein isolate were added and mixed by hand. NaOH was used for complete dissolution of proteins in water.

The protein isolate mixture was then mixed with 56.25 g of pith and put into the mold and covered with the lid. After 3 minutes the panel was demolded and put into an oven at 60°C for 48 h.

As the resulting panels were very fragile, three more panels were produced. The procedure followed was the same except that the protein isolate solution was left to rest for two hours before mixing it with the pith and about 500 ml of protein isolate solution were mixed with the 56.25 g of pith. This means that the binder-to-pith ratio was increased, for better cohesion, from 0.12 (w/w) to 0.32 (w/w).

The panels were then taken out of the oven and put into the controlled temperature and humidity chamber for stocking.

Figure III-17 shows the sunflower protein isolate (extracted from industrial cake in the lab following the Leyris procedure) in powder and solution state used in the production of the isolate panel production. In the same figure, the production process of said panel is also presented.

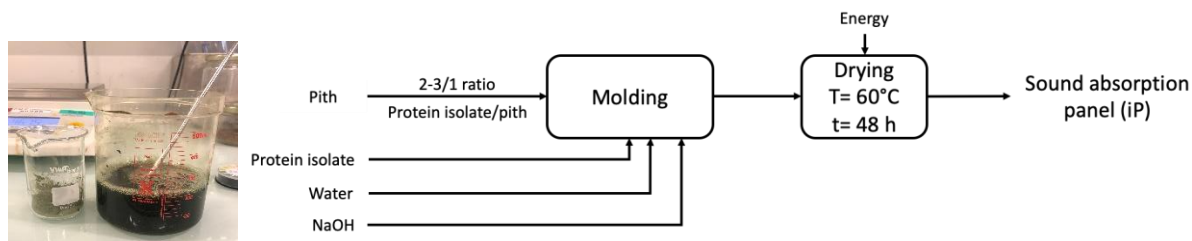

Figure III-17. Protein isolate used and Production process of a protein isolate sunflower insulating panel

As a result, both attempts lead to panels that held together when wet, but that had to be displaced carefully. As the panels dried, they became more fragile and prone to breaking if not handled very cautiously. The resulting panels' dimensions were 15x15x15 cm³.

The difference in the binder-to-pith ratio had little incidence in the final product. The panel with the higher ratio (second attempt) had a darker color and held together better than the other one. Nonetheless, it did not hold together well enough and was still very fragile.

Water vapor panel (VdE)

To 56.25 g of sunflower pith 168.75 g of water (1:3 ratio) were added. The mixture was put into the mold and the lid was placed. In order to improve the cohesion of the pith and to facilitate the handling of the panels, the spacers were not used so the thickness of the VdE panel was reduced as the weight of the lid pressed further down the pith. The thickness of the panels went then from 5 cm to, on average, 3 cm. The mold was placed into the heat press and was heated with the lid for 30 minutes.

To allow the vapor to come out, the lid was removed, and the mold was heated for another 15-20 minutes. Passed this time, the panel was removed from the mold and directly put into the controlled temperature and humidity chamber.

Figure III-18 shows the production process of the water vapor panel.

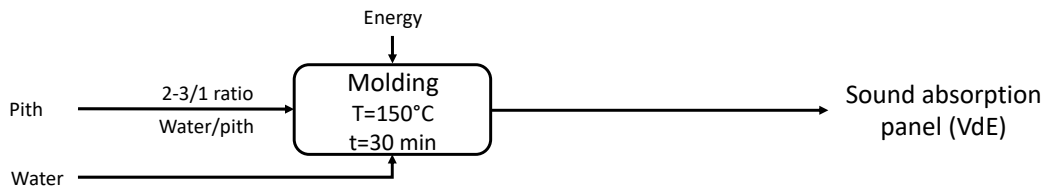

Figure III-18. Production process of a water vapor sunflower insulating panel

First batch of VdE panels were too fragile and did not hold together. Therefore, the spacers had to be removed for them to increase the compression of the pith particles. This resulted in a lower thickness than the rest, and thus in higher density (84 kg/m^3 instead of the 50 kg/m^3 as originally stipulated).

The final panels had a thickness value of $\approx 3 \text{ cm}$ and, while still more fragile than the A and Ch panels, held together in place and did not break as easily as the first batch. The resulting panels' dimensions were $15 \times 15 \times 3 \text{ cm}^3$.

Finished panels are shown in the drying oven in Figure III-19, and stored on the controlled temperature and humidity chamber in Figure III-20. Samples are identified as S=starch-based panel, Ch=chitosan-based panel, iP1=protein isolate-based panel (first batch), iP2=protein isolate-based panel (second batch), and VdE= water vapor-based panel.



Figure III-19. Insulating panels in the oven for drying

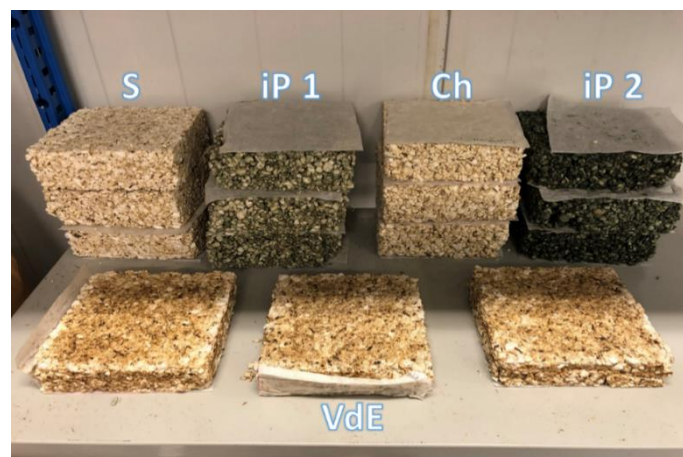

Figure III-20. Finished products as stocked in the controlled temperature and humidity chamber. S = Starch; iP1 = protein isolate first batch; Ch = Chitosan; iP2 = protein isolate second batch; VdE = water vapor.

Given the first results on the production of the panels, S and Ch panels seem to be the ones better suited for an application as acoustic insulation materials given their thickness and hold. This is since starch and chitosan are polysaccharide-based adhesives like pectins, which are largely present in the pith. Consequently, this results in a much better affinity of these two adhesive agents with the pith particles in comparison with water vapor and proteins.

For this reason, only the panels resulting from the starch and chitosan formulation were kept as final products to be included as scenarios for the Life Cycle Assessment.

The overall formulation of the panels is summarized in Table III-4.

Table III-4. Formulation for the production of a panel made from 1 kg of sunflower pith, from purified pith up to the molding stage

Component	Starch-based	Chitosan based
	S	Ch
Sunflower pith	1.00 kg	
Water	3.32 L	
Energy (drying)	1.82 kWh	
Binding agent	0.12 kg	
Acetic acid	-	0.035 kg

III.4. Evaluation of acoustic properties

III.4.1. Acoustic properties measurements

Acoustic insulation materials are distinguished as sound absorbing or soundproofing. While soundproofing materials are used for blocking sound from getting in or out from a determined space, sound absorbing materials are used to reduce echo and improve the acoustics of a room. Out of the two, sound absorption is preferred as acoustic insulation in open-space offices. For construction purposes, ideal materials are both soundproofing and absorbing.

The unit for measuring sound absorption is the sabin. Sabins are used for calculating the reverberation time of spaces such as concert halls and recording studios. In metric units, one square meter of a 100% absorbing material equals to 1 m² Sabin. By knowing the sound-absorption coefficient of a material (α_w) it is possible to calculate the surface of a sound absorbing panel (S) needed to attain 1 m² Sabin (A) (Equation III-1).

Equation III-1 – $A = S * \alpha_w$

Schiavoni et al. (2016) analyze a wide set of conventional commercial insulation materials along with commercialized alternatives and more advanced materials. From the different materials addressed, glasswool and polymer foams (i.e., melamine foam commercialized as Basotect® by BASF) are the ones mostly used as acoustic panels for open spaces.

The acoustic properties of sunflower pith have been studied by different authors and is a good bio-based alternative to fossil-based materials. According to Chabriac et al. (2016), along with other agricultural by-products, sunflower pith present sound absorption coefficient values that can be equivalent to those obtained from materials such as fiberglass. Moreover, Oancea et al. (2018) found that concrete mixed with agricultural by-products (i.e., sunflower pith) to have higher sound absorption coefficients than conventional concrete used as a building material.

The acoustic performance of the sunflower pith panels, as well as the fossil-based (melamine foam; MF) and bio-based (cork; C) alternatives, was evaluated by measuring the absorption coefficient values of each one. The measurements were carried out by the Acoustics & Vibrations Department of the Le Mans Technology Transfer Center (Centre de Transfert de Technologie du Mans).

The coefficient values were measured in a Kundt's tube at one-third octave bands for a frequency range from 80 to 4000 Hz. The sunflower pith panels had a 50 mm thickness, same as the cork panel. The melamine foam, on the other hand, was 14 mm thick. Three samples of 45 mm were tested (on both sides, named *a* and *b*) for the sunflower pith panels, two for the cork panel, and one for the melamine foam. To have the same number of tested samples, one cork panel was measured twice, and the melamine foam panel was tested three times.

III.4.2. Results

Data obtained from the Transfer Center is presented in Figure III-21 to Figure III-24, the numerical values are available in Annex VI.2. According to the expert, currently commercialized sound-absorbing materials do not have high absorption coefficients between 500 and 1500 Hz, which is visibly the case for the melamine foam panel (Figure III-24). However, both formulations of the sunflower pith panels (starch and chitosan) have very interesting properties because the coefficient values go up to 0.5 since the beginning (Figure III-21 and Figure III-22). This property makes them an interesting option for sound absorption applications at low frequency values, in particular the starch formulation.

The curve for the melamine foam panel represents a typical curve for a sound-absorbing panel (Figure III-24). Meanwhile, the cork panel presents a profile and characteristics for sound insulation rather than sound-absorption. From Figure III-23, the coefficient values are the lowest of the other three alternatives and remain under 0.2 throughout almost the totality of the frequency range.

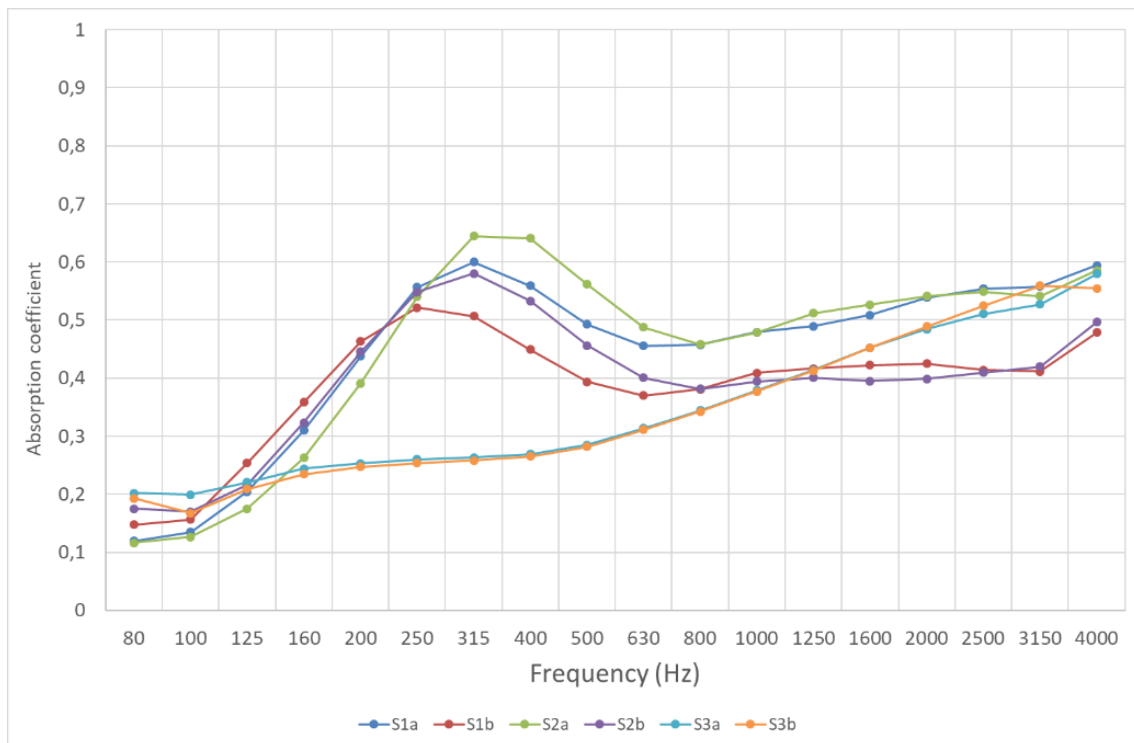

Figure III-21. Plane-wave absorption coefficient (45 mm diameter), sunflower starch formulation (th. 50 mm)

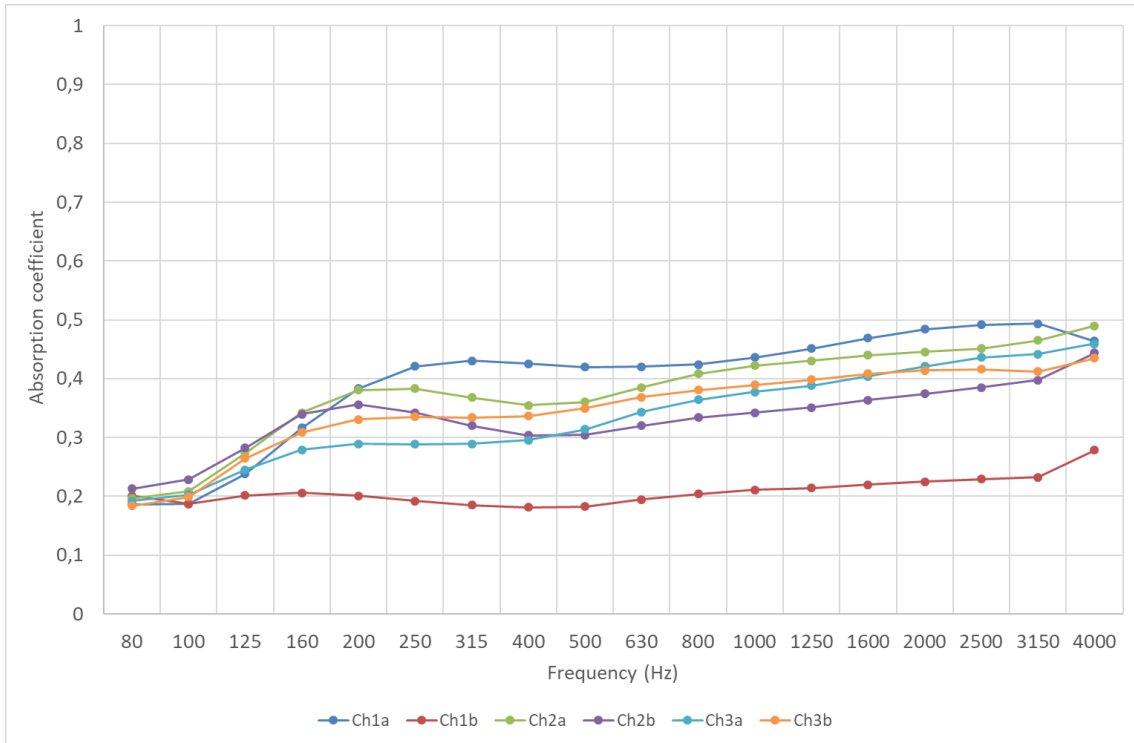

Figure III-22. Plane-wave absorption coefficient (45 mm diameter), sunflower chitosan formulation (th. 50 mm)

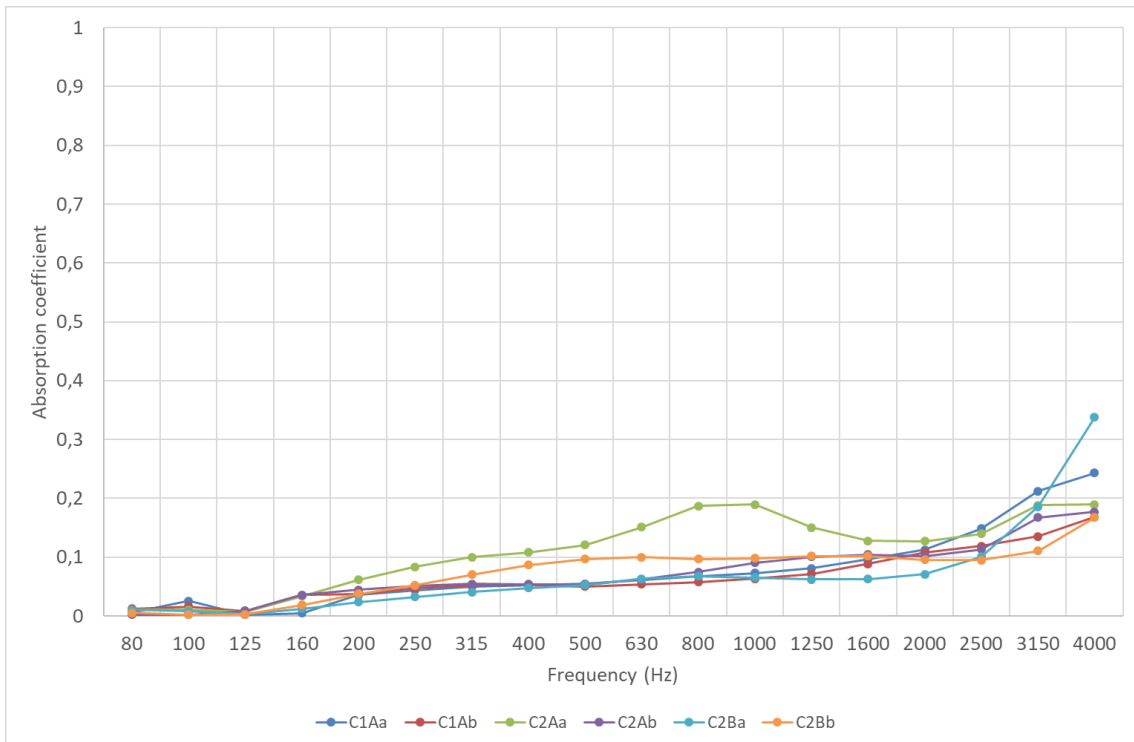

Figure III-23. Plane-wave absorption coefficient (45 mm diameter), cork (th. 50 mm)

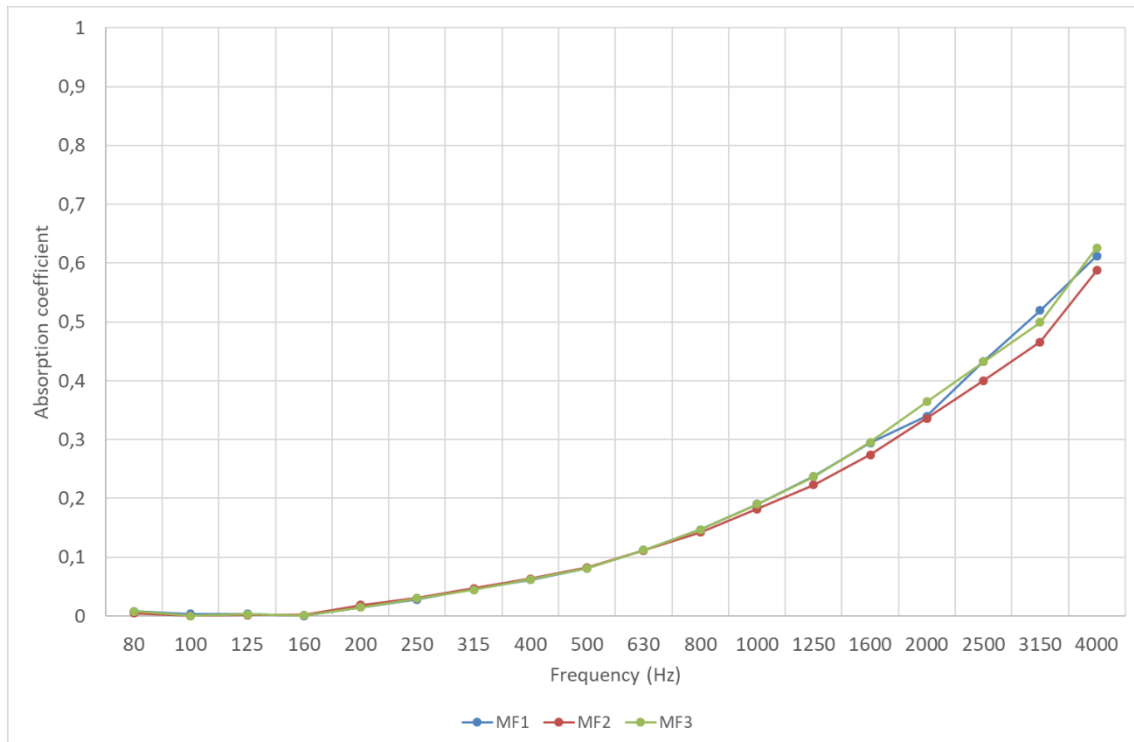

Figure III-24. Plane-wave absorption coefficient (45 mm diameter), melamine foam (th. 14 mm)

Figure III-25 present a condensed version of the absorption coefficients measured for each panel and allows comparison among them. From these results, it is visible that the starch and chitosan-based sunflower pith panels displayed sound absorption properties comparable and competitive to a melamine foam panel, reaching the same sound absorption coefficient values at frequencies of 3000 Hz and 2500 Hz, respectively. Unlike the reference melamine foam, their sound absorption coefficient is relatively stable throughout the whole frequency range, besides being higher at most frequencies (a coefficient of 1 representing a perfect sound absorption). Throughout the whole frequency range, the starch sunflower pith panel reached higher coefficients than the chitosan pith panel. Cork panels, which were tested for comparison only, reached much lower sound absorption coefficients for the whole range of frequencies tested than their counterparts. This was expected, since the overall sound-absorption profile of the cork panel, along with its physical properties (i.e., volumetric mass of 115 kg/m^3 , and low porosity) make it a material more fitting for acoustic insulation rather than absorption. By not having comparable functional units, the cork panel was not considered as part of the environmental assessment.

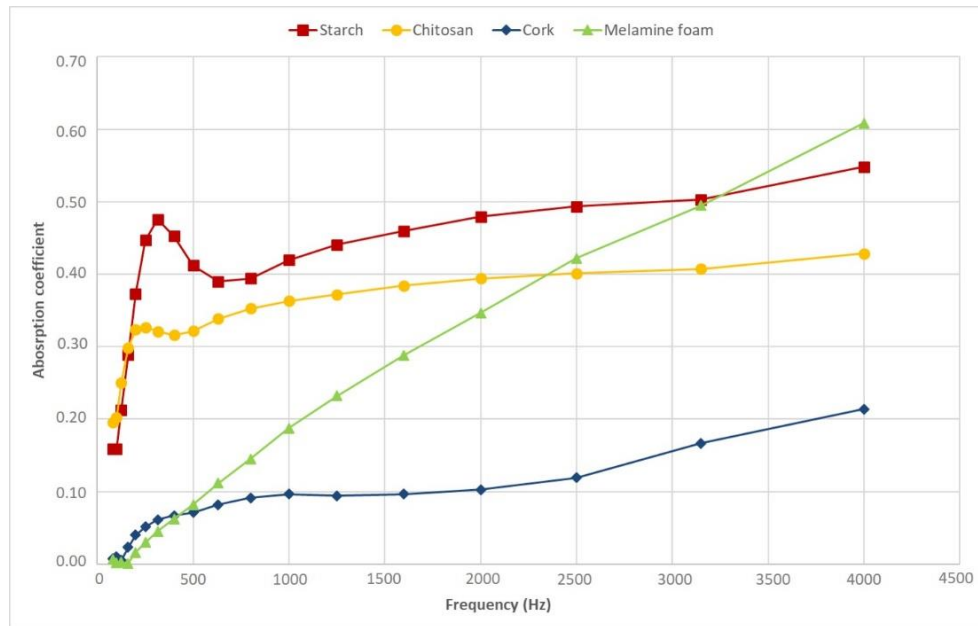

Figure III-25. Sound absorption coefficients at different frequencies

In order to obtain a coefficient value representative of each panel, independent from the frequency value, the procedure described in the standardized norm ISO 11654 was followed. The process described is to “perform a translation of a reference curve in 0.05 steps to the measured values until the sum of the unfavorable deviations is less than or equal to 0.10 [...]. The weighted sound absorption index α_w is defined as the value at 500 Hz of the displaced curve.” (ISO 11654, 1997). In this way, results of Figure III-25 are translated into mean absorption coefficients in Table III-5. To obtain an average value for the complete frequency range (from 80 to 4000 Hz), the guideline described in the ISO 11654 standard was followed. For the frequency range between 250-400 Hz, a simple average calculation was carried out (i.e., coefficient values from the frequencies 250, 315, and 400 Hz were added up and divided by three). Table III-5 validates the conclusions from Figure III-25: the pith panels displayed higher sound absorption coefficient for the two frequency ranges considered in this study than their industrial counterparts.

Table III-5. Calculated mean absorption coefficients for the different panels

Panel	Frequency range 80-4000 Hz	Frequency range 250-400 Hz
	α_w	α_w
S (n = 3)	0.45	0.46
Ch (n = 3)	0.35	0.32
C (n = 2)	0.10	0.06
MF (n = 1)	0.15	0.05

S = starch-based pith panel, Ch = chitosan-based pith panel, C = Cork, MF = melamine foam, n= number of samples.

III.4.3. Incorporation to the life cycle assessment

The results of Table III-5 were used to calculate, through Equation III-1, the amount (in kg) required to provide 1m² Sabin of sound absorption for each of the panels considered to be part of the environmental assessment (namely, the starch and chitosan-based panels as well as the melamine foam panel). Results are shown in Table III-6, also taking into consideration the panels' thickness and volumetric mass. It can be seen that the chitosan-based panel requires a higher amount of material given that its sound-absorbing coefficient has a lower value than the starch-based one, which in turn

requires less material. By comparing frequency ranges, the amount of kg required to provide 1m² Sabin of sound absorption is affected as the coefficient values vary.

Table III-6. Panels characteristics and amount in kg of panel required to provide 1 m² Sabin of sound absorption for all and low frequency ranges

Panel	Thickness (mm)	Volumetric mass (kg/m ³)	Frequency range 80-4000 Hz	Frequency range 250-400 Hz
			kg	kg
S	50	50	5.55	5.42
Ch	50	50	7.15	7.80
MF	14	9	0.84	2.52

S = starch-based pith panel, Ch = chitosan-based pith panel, MF = melamine foam

III.5. Modelling of soil organic carbon dynamics

Sunflower pith panels are expected to have a lifespan of at least 20 years. By the end of this period, panels were considered to be taken back to the field, as an input of carbon to soils. This is compared to the situation where the stalks are left unharvested. These dynamics, in terms of overall soil organic carbon changes, were simulated using the C-TOOL model. Outputs from the C-TOOL simulation, in the form of CO₂ emissions, were incorporated to the LCA as a way of including carbon dynamics as part of the environmental assessment of the sunflower pith panels.

III.5.1. C-Tool presentation

C-TOOL simulates the effects of agricultural management on Soil Organic Carbon (SOC) storage on a medium- to long-term time period. The structure and equations of the C-TOOL model are described and detailed in the work of Taghizadeh-Toosi et al. (2014). It is similar to other carbon turnover models such as CENTURY, RothC, and Daisy, but requires fewer input parameters. The driving variables of the C-TOOL model are (i) the mean monthly temperatures of the region, (ii) the soil initial conditions (total carbon and clay content), and (iii) the biomass left on the field in terms of carbon.

Generally speaking, C-TOOL quantifies the transformation, through decomposition, of carbon (C) represented in three conceptual pools:

- C in Fresh Organic Matter (FOM; carbon above ground in the form of plant residues, roots, animal manure),
- C in Humified Organic Matter (HUM; organic matter stabilized in the soil through microbial transformation), and
- C in Resistant Organic Matter (ROM; organic matter considered biologically resistant assumed to have a very slow turnover).

The model follows the degradation of C as it moves between the different pools of the soil profile. C-TOOL recognizes two soil layers: topsoil (from 0 – 0.25 cm) and subsoil (0.25 – 1 m). The degradation of carbon follows a first-order reaction kinetics, is dependent on temperature and clay content, and emits CO₂ into the atmosphere. After simulating its turnover, a fraction of the C present on the initial FOM is allocated to the subsoil, while the more resistant organic matter is transferred to other pools (undergoes humification).

The proportion of C transferred to the HUM pool is influenced by the clay content of the soil, while the partition between HUM and ROM is dependent on the soil's C/N ratio (carbon/nitrogen ratio). However, ROM turnover is considered negligible in simulations where time periods are of 100 years or higher. A graphical representation of the C-TOOL model structure is shown in Figure III-26.

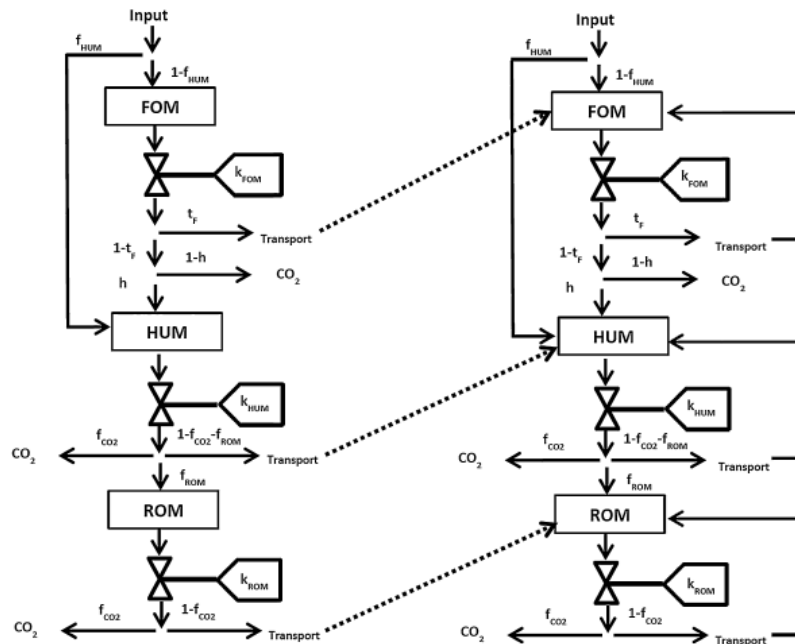

Figure III-26. Structure of the C-TOOL model. Image taken from Taghizadeh-Toosi et al. (2014)

III.5.2. Inputs for the C-Tool simulation

The input parameters specific to the case study for the modeling of the carbon dynamics occurring as a result of the harvest of the sunflower stems and the return of the organic matter at the end-of-life of the panels are detailed in the following sub-sections.

III.5.2.1. Mean monthly temperatures

From Météo-France (Météo-France 2020) the maximal and minimal monthly temperatures were obtained. The mean monthly temperature was obtained by calculating the average of the two of them. Data is representative of the Nîmes weather station (closest station to the city of Arles and the Camargue region where the sunflower is grown) recovered from 1981 to 2010. Values are shown in Table III-7.

Table III-7. Mean temperatures representative of Arles and the Camargue region

(T in °C)	T min	T max	Mean T
January	2.7	11.0	6.9
February	3.2	12.4	7.8
March	5.8	16.0	10.9
April	8.3	18.6	13.5
May	12.1	23.0	17.6
June	15.8	27.5	21.7
July	18.7	31.0	24.9
August	18.4	30.5	24.5
September	14.9	25.7	20.3
October	11.5	20.4	16.0
November	6.5	14.5	10.5
December	3.6	11.3	7.5

III.5.2.2. Soil initial conditions

The total initial carbon on the soil was obtained from the *Gis Sol* website from the « *Carte nationale des stocks de carbone des sols intégrée dans la carte mondiale de la FAO (0-30 cm)* » created by the

French National Research Institute for Agriculture, Food and Environment (INRAe - Institut National de Recherche pour l'Agriculture, l'Alimentation et l'Environnement). This chart shows the carbon content of soils in the French territory. Figure III-27 shows the area where the sunflower is grown, which has a carbon content of 40-50 tonnes ha⁻¹. The total initial carbon on the soil was thus considered to be 45 tonnes ha⁻¹.

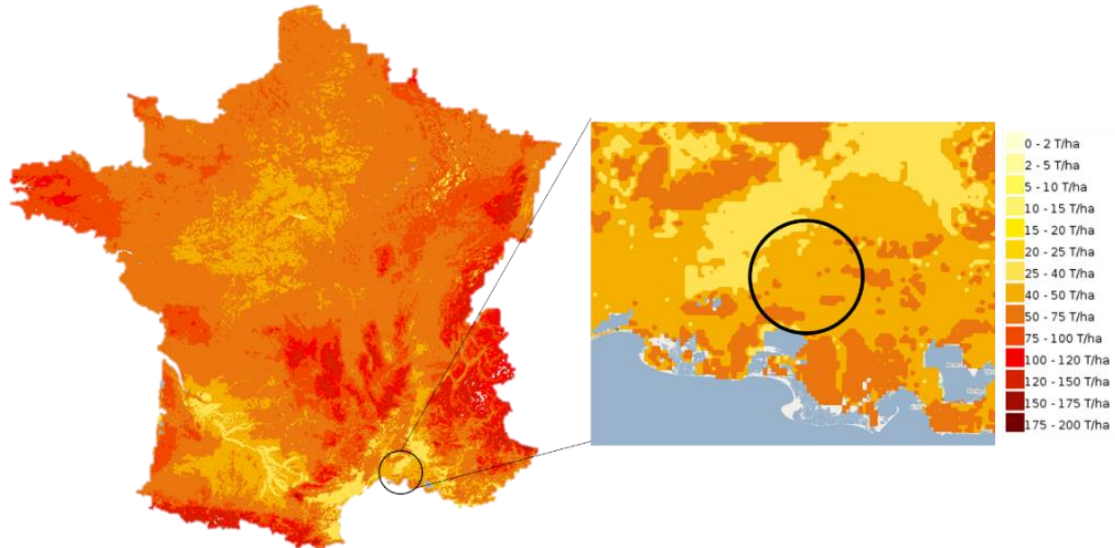

Figure III-27. Carbon content of French soils (INRAe 2020b).

From the same source, the average value of clay content on the agricultural region of Camargue, was obtained. As represented in Figure III-28, the clay content of said region is of about 230 g/kg, which corresponds to a clay content of 23%.



Figure III-28. Clay content in the Camargue agricultural region (INRAe 2020a). Values are expressed in g/kg.

III.5.2.3. Carbon input in the form of biomass

The biomass left at the field can be identified as Above Ground (AG) and Below Ground (BG). Figure III-29 identifies the AG and BG components of the plant as well as the different cutting point for harvesting and the approximate measurements of the different plant sections. The biomass from the plant structure left at the field is identified and its contribution as carbon input to the soil quantified.

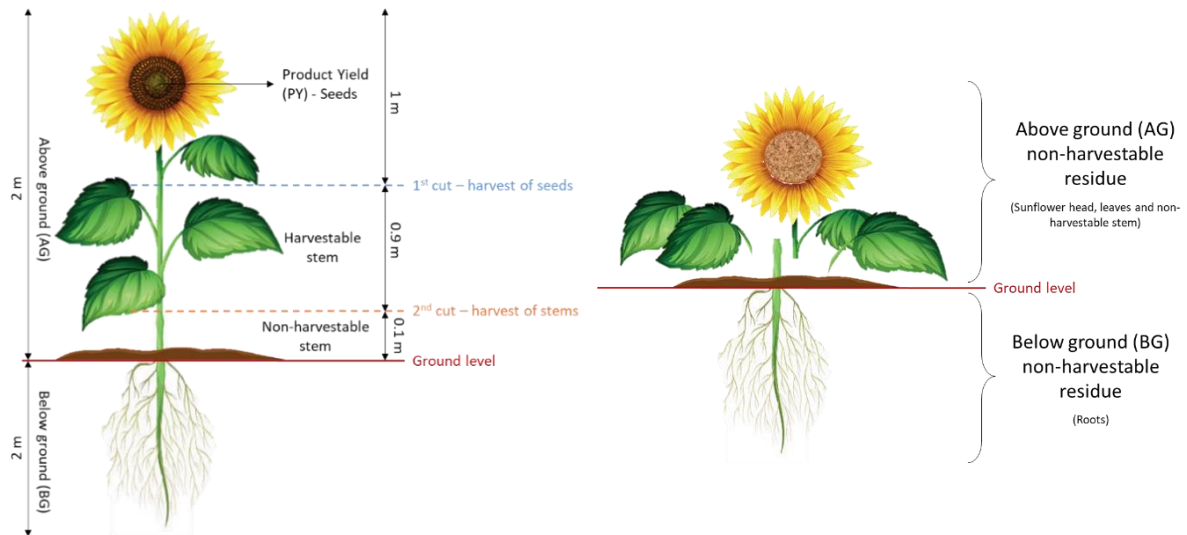

Figure III-29. Identification of the Above and Below Ground components of sunflower and the cut points for harvesting.

Parting from the Product Yield, the different parts of the plant were quantified following the percentages shown in Table III-8. The Product Yield (PY) value was obtained from data retrieved from the Agreste website on French agricultural statistics. The mean value of the last five available years (from 2014 to 2018) was calculated, resulting in 1.7 Mg DM (DM = Dry Matter) of seeds produced per hectare per year in the Bouches-du-Rhône department (to which the Camargue region belongs to).

Table III-8. Mean values for the composition in dry matter (DM) of the sunflower plant (Evon 2008).

Component	Composition (% DM)
Seeds	30
Sunflower head	19
Stem	25
Leaves	18
Roots	8

Three possible scenarios were identified to quantify the carbon (C) input coming from biomass (as described in Table III-9). By considering a carbon content of 50% in the biomass, the Mg DM of each component are translated into Mg of C.

Harvest of stems is considered to be a one-time event as the quantity collected could fulfill a demand of about 40-56 m² of panels with a volumetric mass of 50 kg/m³.

Table III-9. Scenarios identified for the quantification of C input from biomass.

Scenario	Description
Sunflower1	<ul style="list-style-type: none"> • Case with harvest of sunflower stems and WITH bark valorized. • Harvest of stems is considered to happen only during year 1. • The rest of the years no harvest of stems is considered and therefore the C input corresponds to the totality of the AG biomass except the seeds. • In year 1, C input corresponds to the AG biomass without the harvested stem (non-harvestable AG biomass). • In year 2, C input corresponds to the totality of the AG biomass (harvestable and non-harvestable) plus the C input from the non-valorized co-products of the pith procurement process (fines).

	<ul style="list-style-type: none"> • In year 20, C input corresponds to the totality of the AG biomass (harvestable and non-harvestable) plus the C input from the panels taken back to the field at their end-of-life.
Sunflower2	<ul style="list-style-type: none"> • Case with harvest of sunflower stems and WITHOUT bark valorized. • Harvest of stems is considered to happen only during year 1. • The rest of the years no harvest of stems is considered and therefore the C input corresponds to the totality of the AG biomass except the seeds. • In year 1, C input corresponds to the AG biomass without the harvested stem (non-harvestable AG biomass). • In year 2, C input corresponds to the totality of the AG biomass (harvestable and non-harvestable) plus the C input from the non-valorized co-products of the pith procurement process (bark and fines). • In year 20, C input corresponds to the totality of the AG biomass (harvestable and non-harvestable) plus the C input from the panels taken back to the field at their end-of-life.
Sunflower3	<ul style="list-style-type: none"> • Case with no harvest of sunflower stems. All of the biomass is left at the field and is considered as C input.

Values used for the calculation of the carbon available to the soil from the biomass left at the field are presented in Table III-10.

Table III-10. C input values used in C-TOOL

	Harvesting	W/O Harvesting
Crop parameters		
Product yield (Mg DM/ha*y)	1.7	1.7
Harvestable stems (Mg DM/ha*y)	1.35	NA
Non-harvestable		
Leaves	1.02	1.02
Sunflower head	1.077	1.077
Non-harvestable stems or W/O Harvesting	0.071	1.417
Non-harvestable residue AG (Mg DM/ha*y)	2.168	3.513
Non-harvestable residue BG (Mg DM/ha*y)	0.45	0.45
Residues from the pith's procurement process		
Bark (Mg C/ha*y)	1.077	NA
Fines (Mg C/ha*y)	0.148	NA
Content of residues		
C content of biomass DM (kg C/kg DM)	0.5	0.5
C input		
From AG residues (Mg C/ha*y)	1.084	1.757
From BG residues (Mg C/ha*y)	0.225	0.225
Total (AG+BG) (Mg C/ha*y)	1.309	1.982
Total (AG+BG) (Mg C/ha*y) - Bark valorization	NA	2.056
Total (AG+BG) (Mg C/ha*y) - W/O bark valorization	NA	2.594
C input at year 20		
Pith from the panels (Mg C/ha*y)	2.029	NA

III.5.3. Results of soil organic carbon dynamics

Results show that in a 100-year period (Figure III-30), the dynamics of carbon for the three scenarios follow the same behavior. Meaning that, on the long run, taking the sunflower stems to produce acoustic panels does not disturb the natural dynamics of carbon in soil. However, this is true in the case where the harvest of panels is done only in one year and the rest of the time, organic matter is left at the field.

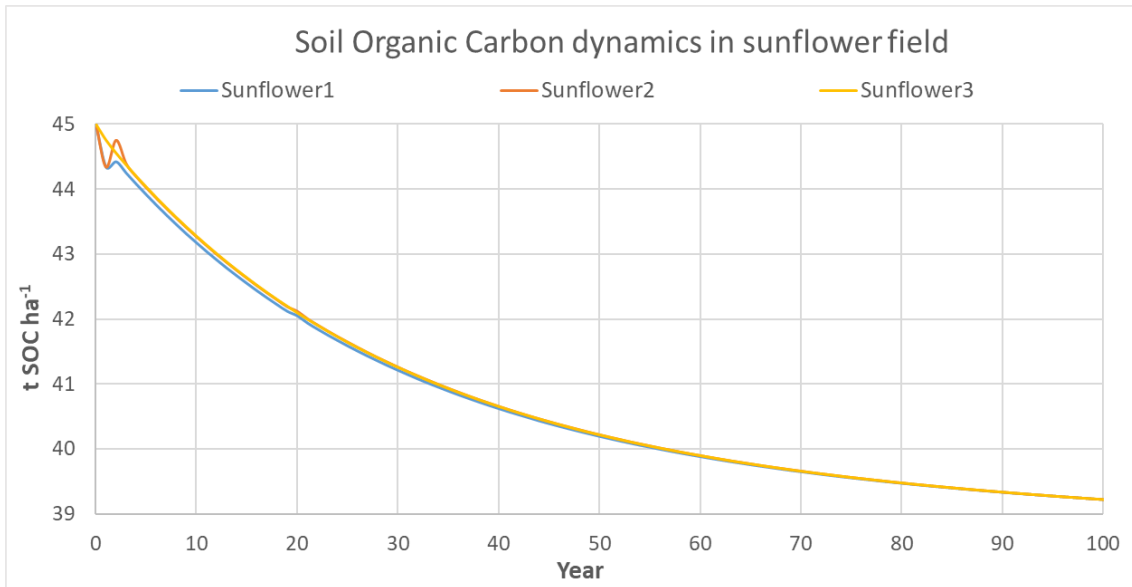

Figure III-30. Carbon dynamics in sunflower field on a 100-year time period

In the 20-year lifespan period shown in Figure III-31, it is visible that the scenario where the bark is not valorized and restituted to the soil in year 2 (Sunflower2), carbon content reaches the same level as the no harvest scenario (Sunflower3) by year three. Moreover, a slight increase in carbon content is visible by year 20, which corresponds to the return of the panels to the field.

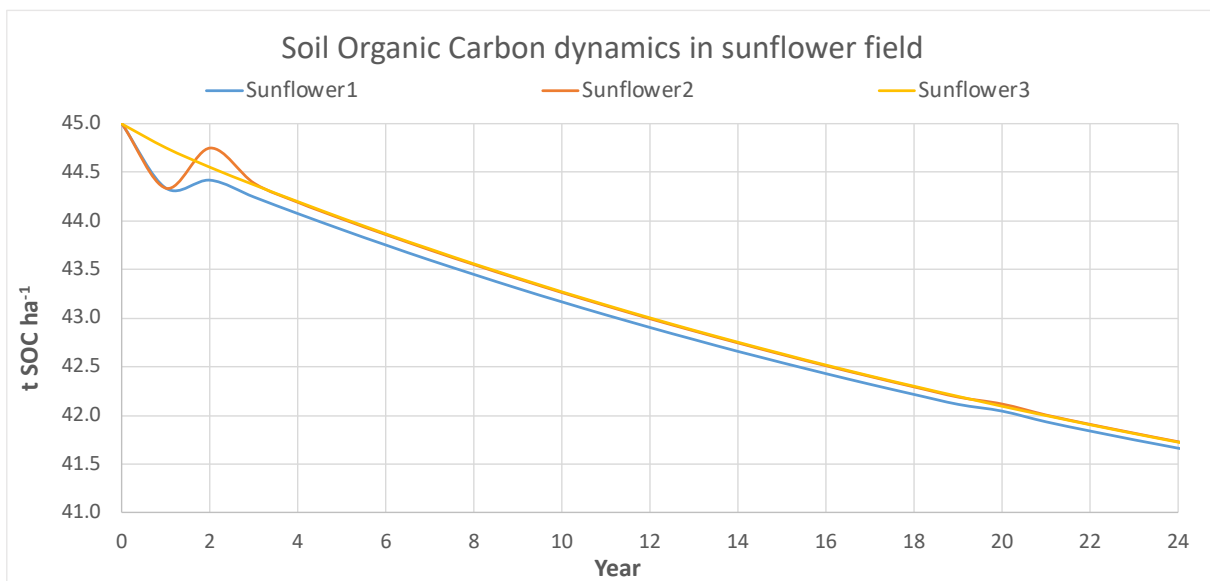

Figure III-31. Carbon dynamics in sunflower field on a 20-year period

Between the years zero and one the decrease in carbon content corresponds to the harvest of the stems. At year two, carbon levels increase as a result of the return of some organic matter issued from

the pith production process (bark). From year 3 onwards, no notable difference between the SOC level of the systems is observed. The situation to avoid is when the full or partial harvest of crop residues leads to a loss of native soil carbon, and therefore to the generation of additional biogenic CO₂ emissions that would have otherwise not happen (over the time period). Here, this situation appears to be the case (loss of native SOC) even if no harvest occurs (Sunflower3 scenario). This reflects that the soil of the demonstration site is prone to SOC losses, which is partly explained by the high monthly annual temperature of the region (SI), and the specificities of the soil in terms of clay content (23%) and C/N ratio.

This situation implies that none of the stalk-C here ends up in the SOC pool, but completely degrades to CO₂. This field system thus implies two biogenic emissions, namely from the crop residues and from the native SOC. Results show that although the panel system leads to more losses of native SOC at year 1, the overall CO₂ emissions are still more important for the no-harvest system, due to the degradation of the crop residues. In fact, the portion of the residues that is harvested to produce the panels is therefore not degraded as CO₂. The carbon harvested, of course, will also be emitted when returned to soil, whether as bark (year 2) or shredded panel (year 20), but with the advantage of inducing a delay in comparison to the situation where all carbon is emitted at year one. Although this matters in the perspective of the climate urgency, this temporal advantage has not been quantified herein.

As the difference in carbon levels in the three scenarios is small, CO₂ emissions seem to be almost the same in a 100-year time period (Figure III-32). However, by taking a closer look (i.e., a 3-years period) as shown in Figure III-33, it is visible that the Sunflower1 scenario is more advantageous (lower CO₂ emissions) as stems are harvested and bark is valorized. By doing so, carbon is stored in the materials made from the pith and bark, thus avoiding the corresponding carbon dioxide emissions.

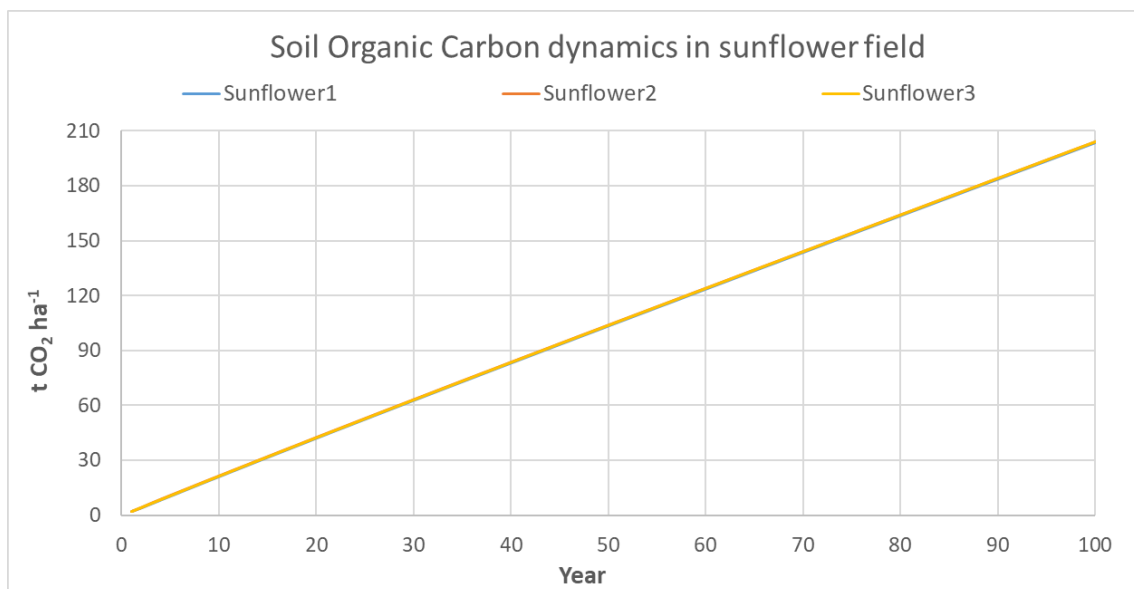

Figure III-32. CO₂ emissions from a sunflower field in a 100-year time period

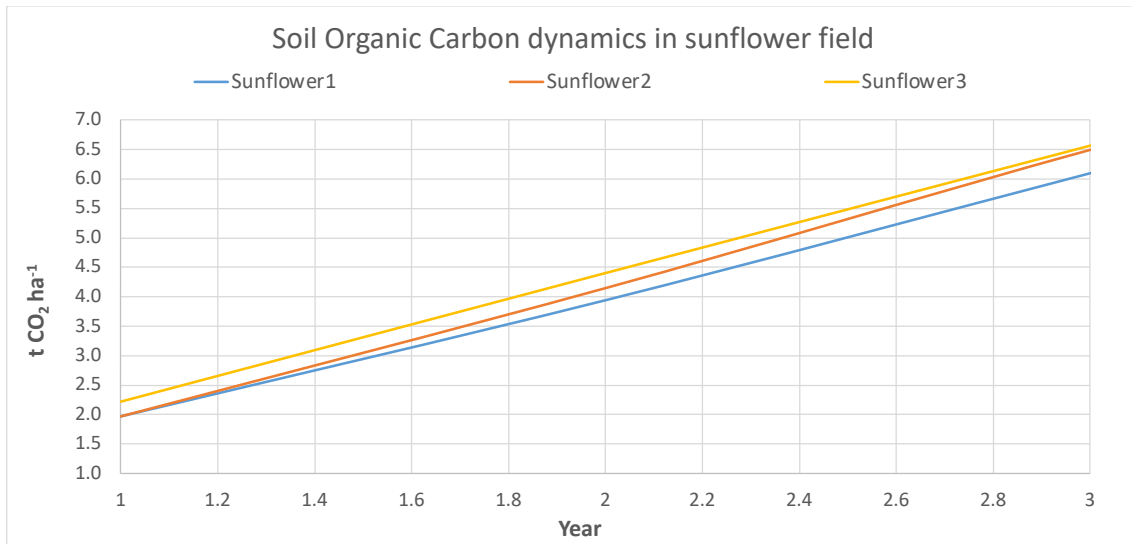

Figure III-33. CO₂ emissions from a sunflower field in a 3-year time period

Because of the return of the bark and panel to soil, the only difference among the systems, over the 20-y period considered to supply the FU of this LCA, is the difference in native SOC losses. The dynamic aspect of carbon was included in the LCA model by annualizing the loss of carbon happening because of harvesting the stems. This value was obtained by calculating the ΔC of each scenario between years 0 and 19 (a 20-year time period) and dividing it by 20. The ΔC value shows the amount of carbon lost from the field per year. The 20 years correspond to the lifespan of the panels. Resulting values are shown in Table III-11.

Table III-11. Values of carbon in soil for years 0 & 19 and delta C.

Scenario	C year 0 (t C ha ⁻¹)	C year 19 (t C ha ⁻¹)	ΔC per year ^a
Sunflower1	45.0000	42.1170	-0.1442
Sunflower2	45.0000	42.1910	-0.1405
Sunflower3	45.0000	42.1970	-0.1402

^a Applying an annualization technique evenly dividing the releases over the period considered

III.5.4. Incorporation to the life cycle assessment

To obtain the amount of avoided carbon dioxide emissions linked to the lost carbon from the soil, the difference of ΔC between the scenarios where harvest occurs (Sunflower1 and Sunflower2) and the one where stems are left at the field (Sunflower3) was calculated. To transform the obtained value from carbon to carbon dioxide, it was multiplied by 44 and then divided by 12. Created processes and the values of CO₂ emissions are shown in Table III-12.

Table III-12. Created processes and their values for CO₂ emissions from the field

Process	Avoided CO ₂ emissions (t CO ₂ ha ⁻¹)
Carbon emissions from field Sunflower 1 WITH bark valorization	-0.0147
Carbon emissions from field Sunflower 2 WITHOUT bark valorization	-0.0011

III.6. Life Cycle Assessment

III.6.1. Materials and methods

The Life Cycle Assessment was facilitated with the SimaPro LCA software (version 9.1). Co-products issued from the different production stages were dealt with considering system expansion, as recommended by ISO 14040 and 14044 (ISO 14040, 2006; ISO 14044, 2006). The life cycle impact assessment (LCIA) used is the Environmental Footprint (EF 3.0) methodology, as prescribed by the European Commission (EC, 2020). Only the mid-point impact categories considered robust (category I/II; (Fazio et al., 2018)) were assessed.

Foreground data were, to the extent possible, obtained directly from own measurements, or from suppliers manufacturing the inputs required (or avoided); when this was not possible, data were obtained or estimated from scientific literature. Background life cycle inventory (LCI) data (e.g., electricity production, transport processes) were obtained from the LCI database Ecoinvent v3.6 (from which “consequential” processes were selected).

The functional unit (FU) of the study is defined as the mass of panel required to provide 1 m² Sabin of sound absorption for a time period of 20 years. These panels are considered for applications where the following two frequencies range applies: (i) a wide frequency range from 80 to 4000 Hz, and (ii) for an application at low frequencies (ranging from 250 to 400 Hz). Two panel variants are considered, based on the binding agent used at the molding stage (namely chitosan and starch). The amount (in kg) required to fulfill the FU was calculated in Table III-6.

The geographical scope is tied to the demonstration case considered, namely the French Camargue region, where the cultivation of sunflower and subsequent production of panel from sunflower pith is considered to happen.

The system boundary considered for the LCA is presented in Figure III-34.

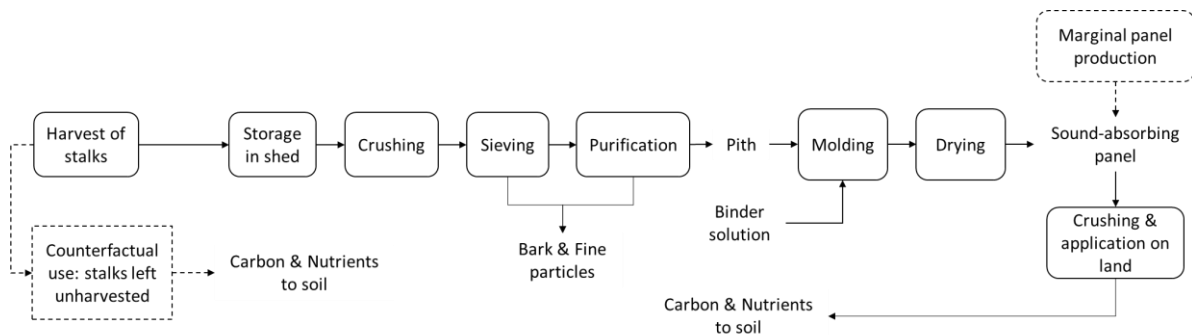

Figure III-34. Process flow diagram and system boundary considered for the production of a sunflower pith sound absorption panel. Dotted lines represent avoided processes.

The harvesting operation was created following the equations used in Nemecek & Kägi (2007) for the modeling of agricultural activities. Required inputs were obtained considering the specifications of a forage harvester *Jaguar CLAAS 830* (used at the demonstration site) as reference values for calculating machinery requirements and emissions to air and soil issued as a result of the agricultural operation. Values and specifications are detailed in Annex VI.2.1. Based on the yield considered for stalks (425 kg ha⁻¹), and a cultivated area of 4 ha, about 1700 kg FM (FM = Fresh Matter) of “pre-crushed” stems were transported to a storage shed located at about 22 km from the field.

The processes for the production of purified sunflower pith (from crushing to molding) were modeled from the data presented in Table III-3 and Table III-4. To successfully compare the environmental

performance of the panels, the data from the demonstration site were scaled-up to an industrial level. This was done by considering the use of machinery for 255 days per year and for 7.5 hours a day. In the production chain, the sieving process is the limiting factor by only being able to process 300 kg h⁻¹ of crushed stalks (as detailed in the machine specifications available in the SI). Over a year, a total of 557 t of harvested stems can thus be processed for the production of almost 40 t of sunflower pith. The value of 557 t of processed stalks was used for the calculation of the machinery requirements for each of the production stages.

Chitosan production was modeled using the life cycle inventory presented in Munoz et al. (2018), where chitosan is produced in India. Their study follows the transformation of waste shrimp shells into chitin as a first production step. During this step, the process involves the use of dilute hydrochloric acid for demineralization, and dilute sodium hydroxide for protein removal. The protein obtained from this step (in a sludge form) is locally recycled as fertilizer. Chitosan is then obtained through the deacetylation of chitin using highly concentrated solutions of sodium hydroxide. Outputs from the chitosan production process include CO₂, N fertilizer, wastewater, and calcium salts. Their study also considers the counterfactual (or foregone) use of waste shrimp shells, being its use as animal feed. Deriving waste shrimp shells towards chitosan production thus implies the need to compensate for the animal feed service no longer supplied, which is included in the dataset of Munoz et al. (2018) used herein.

The starch needed as binding agent was considered to be produced from maize and was modelled with the Ecoinvent process “Maize starch {GLO}| market for | Conseq, U”.

All processes presented in Figure III-34, except for the avoided processes and EoL, were grouped under the umbrella “Sunflower pith panel production”. As illustrated in Figure III-34, the EoL of the panels considers the crushing of the panels and their transportation and application back to the field, a process happening only once after 20 years of use.

Avoided carbon emissions from the valorization of the sunflower stalks were quantified by using the output of the simulations of the SOC changes as described in section III.5.4.

The overall sunflower production is considered to remain unaffected by the changed management of the stalks. This, however, could be challenged by arguing that the stalks do contain nutrients that are no longer returned to soil, and hence a deficit should be compensated (or a yield decrease observed). Based on ADEME (2015), it is here considered that such compensation would not happen in practice and that yields would remain unaffected, especially since there is still a return of organic matter through the seedless heads left on soil.

The “avoided marginal panel” production process was created considering a melamine foam sound absorption panel, which corresponds to one of the most widely used material for acoustic insulation. The amount of melamine foam panels (in kg) that could be avoided as a result of using the sunflower pith panels (1 Sabine m² of sound absorption) was calculated by applying Equation III-1 and using the sound absorption coefficient measured from the measurements (section III.4.3). The melamine foam was modelled considering the Ecoinvent process “Polystyrene foam slab for perimeter insulation {CH}| processing | Conseq, U”, adapted by changing the raw material polystyrene by melamine resin.

The baseline assessment was carried out by considering that all co-products of sunflower pith panels are taken back to the field. However, recent projects are discussing the valorization of bark in the form of particleboards (ADEME, 2015). A sensitivity analysis (SA) was therefore carried out considering the valorization of the bark produced as co-product from the sunflower pith procurement process as particleboard. This was modelled based on Gomez-Campos et al. (2020), as further detailed in the SI.

Moreover, a second sensitivity analysis was carried out for evaluating the influence of the chosen assessment method on the overall results. This was done by comparing the LCIA results obtained with the EF method with those obtained using the ReCiPe 2016 Midpoint (H) method.

An analysis considering cork instead of melamine foam as the marginal panel was initially considered, but this was not done given the poor sound absorption performance measured for these panels.

Finally, the influence of the level of optimization of the harvesting process on the environmental performance of the panels was evaluated through a third sensitivity analysis.

III.6.2. Results & Discussion

III.6.2.1. *Life Cycle Assessment of the sunflower acoustic panels*

From Figure III-35 and Figure III-36 it is visible that the main process responsible for the positive environmental impact (i.e. induced emissions) of the sunflower pith panels, considering all assessed impact categories, is the harvesting of the sunflower stalks (responsible for up to 80-95% of the generated impacts in some of the categories evaluated). By individually analyzing the harvesting process, emissions linked to the combustion of diesel by the agricultural machinery were found to be the responsible of 50-90% of the generated impacts. Moreover, it should be highlighted that these results consider that current machinery can collect only about 55% of the stalks. Here, this would not influence the service (1m² Sabin of sound insulation supplied) studied. In a broader perspective, however, it does influence the overall amount of available resource (sunflower stalks) that can be used for producing such panels.

One notable additional process contributing to the positive impact of freshwater eutrophication is the use of electricity for the production of the panels (drying process) and the avoided production of the marginal panel (melamine foam). This, however, applies only for the starch-based panel, as for the chitosan-based panel it is overshadowed by the production of chitosan, which has a greater impact. The impact of electricity production on freshwater eutrophication is essentially linked to the use of photovoltaic panels. Solar energy represents about 40% of the marginal French electricity mix (low voltage), according to the Ecoinvent consequential process used, which is in good agreement with the mix derived from French predictive studies (e.g., Fournie et al., 2018). Spoils from lignite and copper mining are responsible for the phosphate emissions contributing to the impacts on freshwater eutrophication, both used in the production of inverters (a component of the photovoltaic panels).

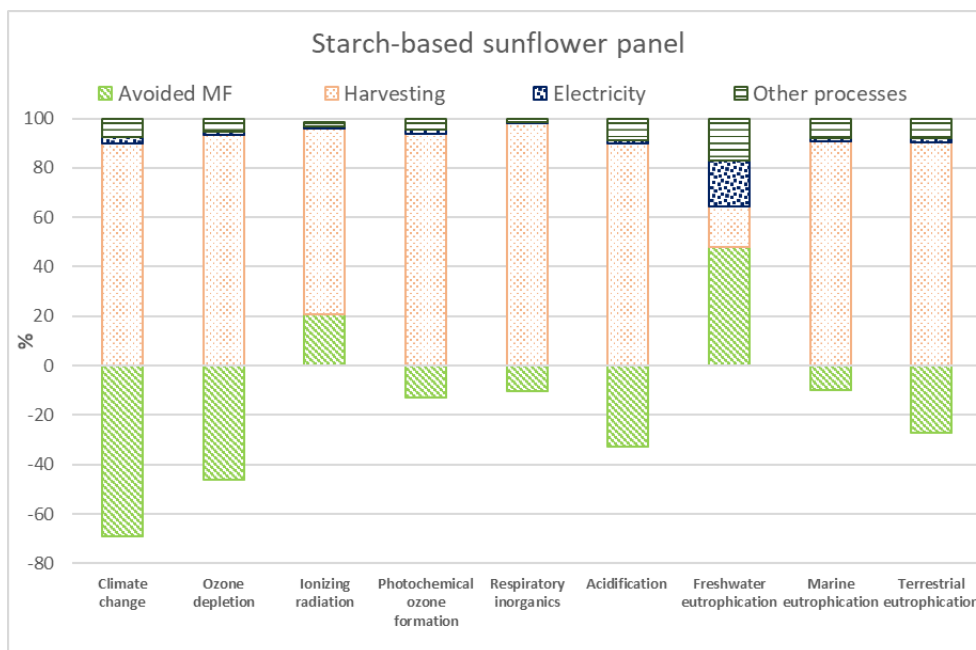

Figure III-35. Process breakdown of the environmental performance of the starch-based sunflower pith panel (EF LCIA method); MF: melamine foam

The main difference of the environmental performance between the two formulations (starch and chitosan) is linked to the procurement process of chitosan. As shown in Figure III-36, chitosan procurement has an important incidence on the impact categories of ozone depletion, photochemical ozone formation, respiratory inorganics, acidification, and freshwater and terrestrial eutrophication. The valorization of protein sludge (issued from the chitin production process) as nitrogen fertilizer is responsible for the impacts on photochemical ozone formation, respiratory inorganics, acidification, and terrestrial eutrophication. Impacts on ozone depletion, and freshwater eutrophication are linked to the procurement of raw materials for chitin production, in particular chlorine required for the production of hydrochloric acid, and the lignite used to produce heat and energy.

On the other hand, the additional animal feed produced to compensate the feed value of the waste shrimp shells that are now used to produce chitosan contributes to reducing the impacts on ionizing radiation and marine eutrophication. This is because this induced production of animal feed involves the production of soybean meal as marginal protein source. However, the production of soybean meal results in the production of soy oil as co-product, which substitutes the production of marginal oil, namely palm oil (Dalgaard et al. (2008); Schmidt (2015); Tonini et al. (2016)). Here, the impacts linked to the palm oil production activity are thus avoided (Munoz et al., 2018). Gains on Ionizing radiation are due to the use of heat issued from heat and power co-generation during the chitin procurement process, involving that marginal electricity production is avoided (in India) from the co-produced electricity. In this case, the marginal electricity mix (modelled following Munoz et al. (2018), with the “rest of the world (RoW)” consequential process including a variety of countries mixes), considers nuclear power to be the source of a significant amount of the mix, namely 14%. For this reason, a reduction in the use of nuclear power for electricity production and, therefore, the ionizing radiation impacts linked to it, is observed.

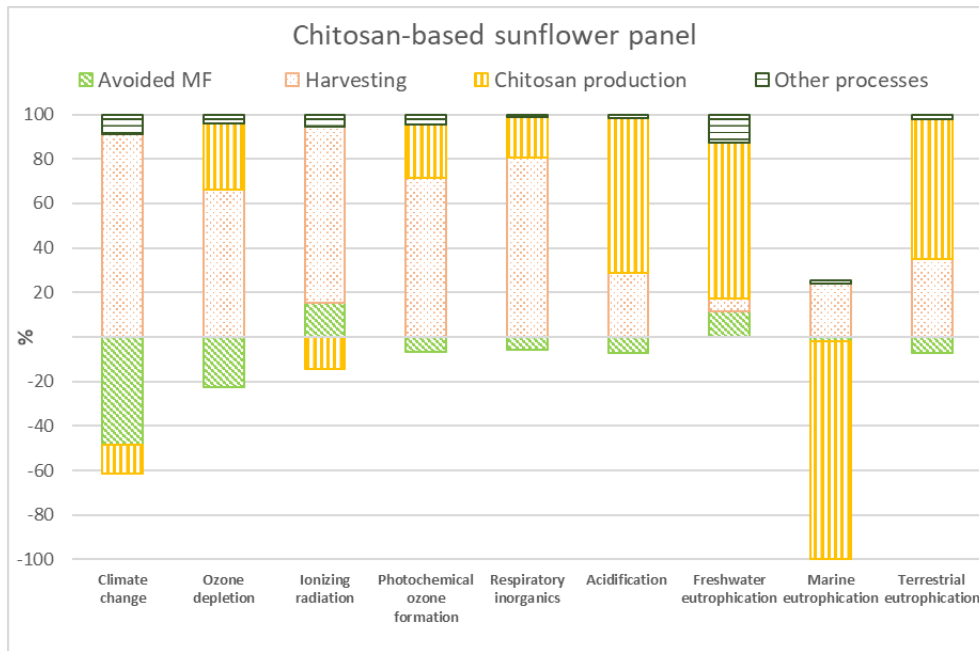

Figure III-36. Process breakdown of the environmental performance of the chitosan-based sunflower pith panel.

Absolute net values presented in Table III-13 show the production of sound absorbing panel from sunflower pith as a replacement of melamine foam panels as an environmental disadvantage. This is true for both formulations (starch and chitosan) for all impact categories except for marine eutrophication (chitosan-based panel) and ozone depletion (starch-based panel).

Table III-13. Results of the environmental performance of sunflower panels, in absolute values

Impact category	Unit	Starch-based sunflower panel	Chitosan-based sunflower panel
Climate change	kg CO ₂ eq	1.11	3.88
Ozone depletion	kg CFC ₁₁ eq	-3.40x10 ⁻⁷	1.84 x10 ⁻⁷
Ionising radiation	kBq ²³⁵ U eq	8.44 x10 ⁻²	2.94 x10 ⁻²
Photochemical ozone formation	kg NMVOC eq	3.06 x10 ⁻²	4.50 x10 ⁻²
Particulate matter	disease inc.	1.86 x10 ⁻⁶	2.38 x10 ⁻⁶
Acidification	mol H ⁺ eq	1.73 x10 ⁻²	9.19 x10 ⁻²
Freshwater eutrophication	kg P eq	6.31 x10 ⁻⁴	1.99 x10 ⁻³
Marine eutrophication	kg N eq	1.20 x10 ⁻²	-4.12 x10 ⁻²
Terrestrial eutrophication	mol N eq	1.05 x10 ⁻¹	3.65 x10 ⁻¹

III.6.2.2. Sensitivity analysis - Impact of the valorization of bark

Results from the sensitivity analysis showed that the valorization of bark as particleboard reduces the environmental impact of the sunflower pith panels for all the impact categories (Figure III-37).

As seen in Figure III-37, every biomass element returned to the field directly translated into CO₂ emissions. By valorizing bark as particleboard instead of taking it back to the field, carbon that would otherwise be emitted here contributes to the avoided production of the marginal particleboard (made from wood chips).

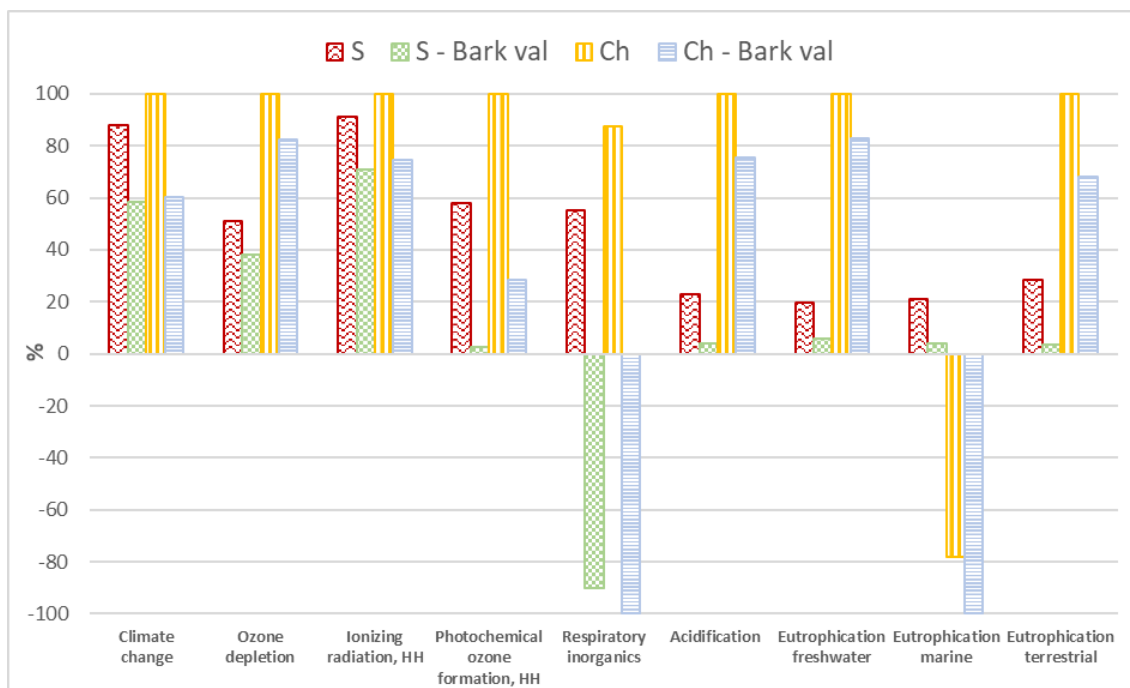

Figure III-37. Environmental performance of sunflower pith sound-absorbing panels considering bark valorization as particleboard (EF LCIA method); S: Starch; CH: Chitosan; -Bark val: with valorization of the bark as particle board

III.6.2.3. Sensitivity analysis - Impact of the evaluation method

Results from the Sensitivity Analysis on the LCIA method for the starch-based sunflower panel are presented in Figure III-38, while the results for the chitosan panel are presented in Figure III-39. These figures show that the assessment method has little influence on the main conclusions. For most of the impact categories, the key processes contributing to the generated impact are the same for both cases in almost the same proportion. For the starch panel, the impact categories in which a visible difference is identified are: (i) ionizing radiation, in which the avoided production of melamine foam outweighs the impacts linked to the harvesting process with the Recipe LCIA method; and (ii) marine eutrophication, where the generated impact is mainly due to starch production with Recipe (as opposed to harvesting with EF). The former can be explained as both methods use different reference substances for quantification (Uranium-235 for EF method, and Cobalt-60 for ReCiPe), while the latter is a consequence of the different values of the characterization factors used by both methods in all substances. Moreover, the starch production process is more visible with the Recipe method, for marine eutrophication and ozone depletion. This can be explained by the fact that both methods use different characterization factors for most of the substances. Additionally, not all the same substances are considered for evaluation (i.e., ReCiPe includes dinitrogen monoxide and excludes halothane, while the contrary is true for EF).

It can also be highlighted that the overall advantages of avoided melamine foam production reach different proportions according to the method, although in different direction according to the impact category.

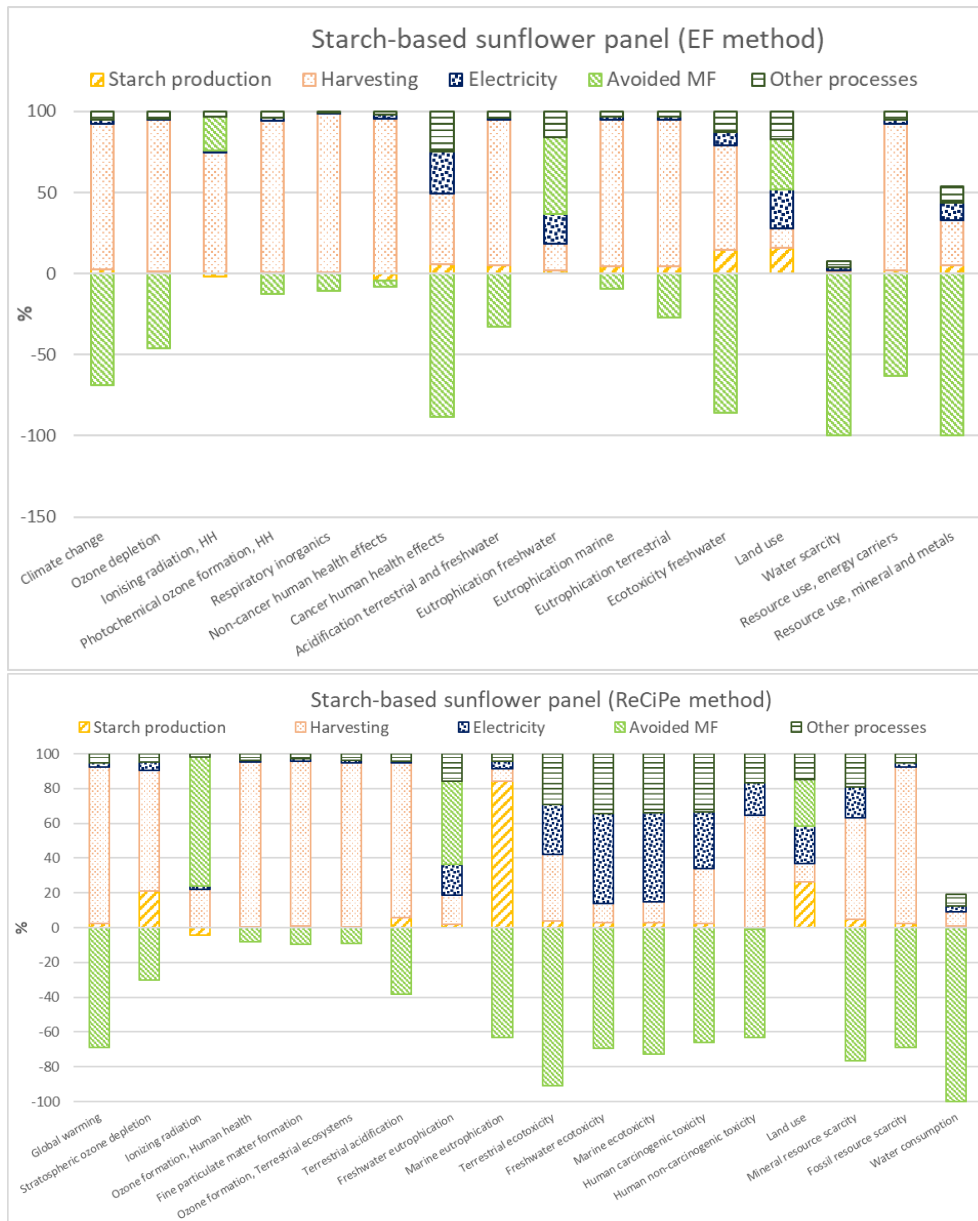

Figure III-38. Sensitivity analysis of the impact assessment method for the starch-based sunflower panel

For the chitosan-based sunflower panel, one major visible difference applies to the impact category of ozone depletion. For this impact, chitosan production whether appears as a net contributor (EF method) or as a net saving (Recipe method). This is because the ReCiPe method has a characterization factor for dinitrogen monoxide (N₂O), while the EF method does not include this substance in the evaluation of the ozone depletion impact category. Specifically, the production process of chitosan considers avoided emissions of N₂O as a result of the valorization of some of the co-products as fertilizers, which explains results from the ReCiPe method.

Moreover, electricity production has a more visible impact in the categories of freshwater ecotoxicity when using the ReCiPe assessment method. In this case, both methods differ from one another on the reference units used. The EF method uses Comparative Toxic Unit for ecosystems (CTUe) while the ReCiPe method expresses results in terms of 1,4-Dichlorobenzene (1,4-DCB).

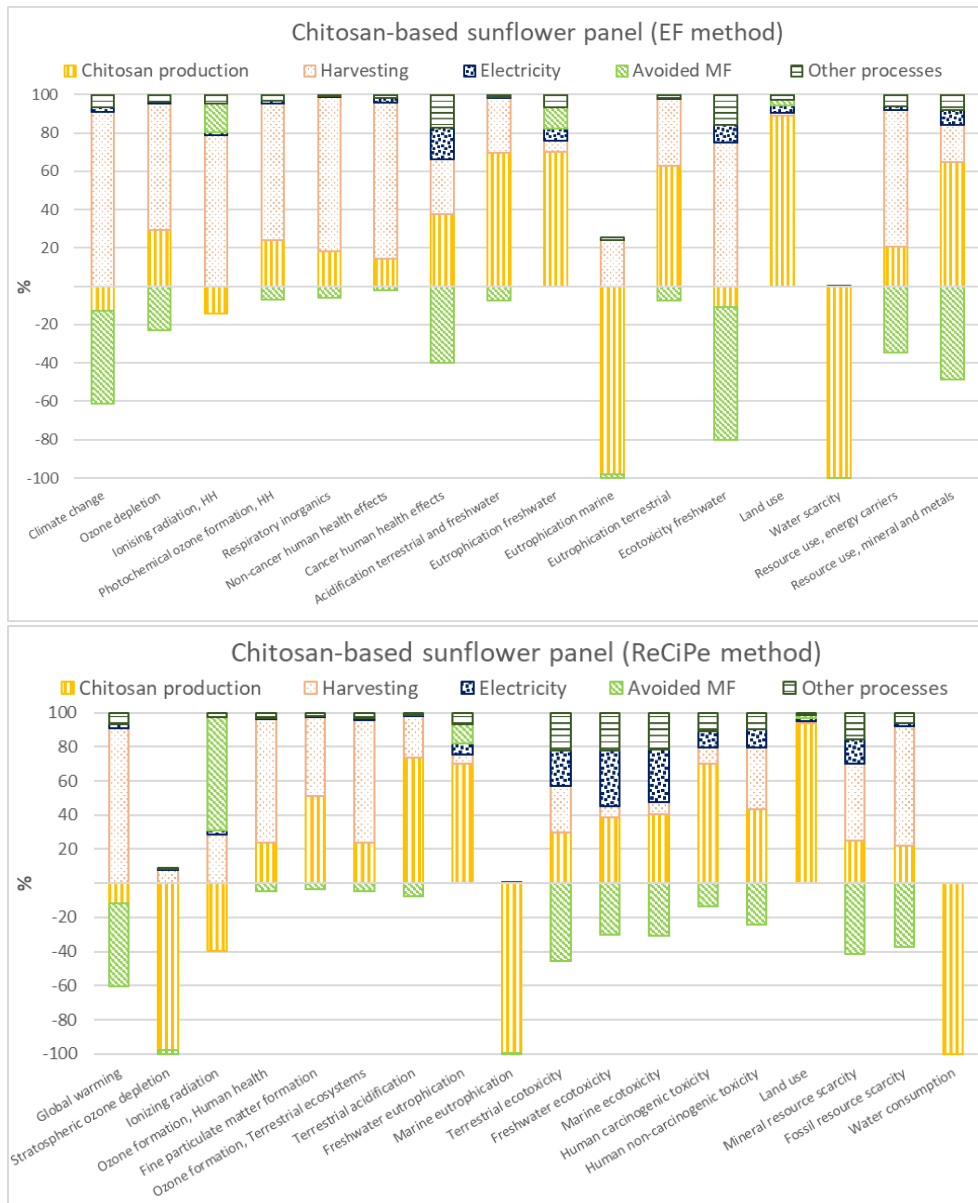

Figure III-39. Sensitivity analysis of the impact assessment method for the chitosan-based sunflower panel

III.6.2.4. Optimization of the harvesting process

The SA was carried out considering a coupled harvest of sunflower seeds and stalks, thereby preventing the need for additional agricultural machinery as considered in the baseline case. This was modelled as an additional diesel consumption during sunflower seeds harvest (sunflower seed harvest itself being excluded from the system boundary, being part of both the panel system and the reference). This additional consumption, coupled with the removal of the stand-alone stalk harvesting process, was translated as five scenarios of net diesel consumption decrease (in comparison to baseline), namely: 10%- 25%, 50%, 75%, and 100%.

Results from Table III-14 show that just a 10% net decrease in diesel consumption during harvest would be enough to make the starch-based panel more environmentally performant than the reference for four of the assessed impacts, namely: climate change, particulate matter, acidification, and terrestrial eutrophication. Moreover, reducing diesel consumption to at least 75% could represent net savings on the additional impact categories of ozone depletion and photochemical ozone formation.

Table III-14. Sensitivity analysis results for the optimization of the harvesting operation considering a net reduction of diesel consumption by 10%, 25%, 50%, 75%, and 100%, for the starch-based sunflower panel

Impact category (EF)	Unit	Net diesel consumption reduction scenarios				
		10%	25%	50%	75%	100%
Climate change	kg CO ₂ eq	-2.00	-2.06	-2.15	-2.25	-2.34
Ozone depletion	kg CFC ₁₁ eq	4.20x10 ⁻⁷	2.93x10 ⁻⁷	8.22 x10 ⁻⁸	-1.29 x10 ⁻⁷	-3.40 x10 ⁻⁷
Ionising radiation	kBq ²³⁵ U eq	2.92 x10 ⁻¹	2.57x10 ⁻¹	2.00x10 ⁻¹	1.42x10 ⁻¹	8.44x10 ⁻²
Photochemical ozone formation	kg NMVOC eq	1.29x10 ⁻³	8.31x10 ⁻⁴	7.45x10 ⁻⁵	-6.82x10 ⁻⁴	-1.44x10 ⁻³
Particulate matter	disease inc.	-1.53x10 ⁻⁷	-1.55x10 ⁻⁷	-1.59x10 ⁻⁷	-1.63x10 ⁻⁷	-1.66x10 ⁻⁷
Acidification	mol H ⁺ eq	-2.62x10 ⁻³	-3.26x10 ⁻³	-4.32x10 ⁻³	-5.38x10 ⁻³	-6.45x10 ⁻³
Freshwater eutrophication	kg P eq	6.27x10 ⁻⁴	6.28x10 ⁻⁴	6.29x10 ⁻⁴	6.30x10 ⁻⁴	6.31x10 ⁻⁴
Marine eutrophication	kg N eq	9.32x10 ⁻⁴	8.34x10 ⁻⁴	6.70x10 ⁻⁴	5.06x10 ⁻⁴	3.42x10 ⁻⁴
Terrestrial eutrophication	mol N eq	-1.69x10 ⁻²	-1.79x10 ⁻²	-1.97x10 ⁻²	-2.15x10 ⁻²	-2.33x10 ⁻²

For the chitosan-based sunflower panel (Table III-15), even when considering a scenario without diesel consumption (100% diesel consumption reduction), the only impact category where net savings are visible remains marine eutrophication. This reflects that without the agricultural operation, chitosan production becomes the process with a higher contribution to the environmental impact of the panel.

Table III-15. Sensitivity analysis results for the optimization of the harvesting operation and considering a reduction of diesel consumption by 10%, 25%, 50%, 75%, and 100% for the chitosan-based sunflower panel

Impact category	Unit	Diesel consumption reduction scenarios				
		10%	25%	50%	75%	100%
Climate change	kg CO ₂ eq	7.75X10 ⁻¹	7.19X10 ⁻¹	6.25X10 ⁻¹	5.31X10 ⁻¹	4.37X10 ⁻¹
Ozone depletion	kg CFC ₁₁ eq	9.43X10 ⁻⁷	8.17X10 ⁻⁷	6.06X10 ⁻⁷	3.95X10 ⁻⁷	1.84X10 ⁻⁷
Ionising radiation	kBq ²³⁵ U eq	2.37X10 ⁻¹	2.02X10 ⁻¹	1.45X10 ⁻¹	8.71X10 ⁻²	2.94X10 ⁻²
Photochemical ozone formation	kg NMVOC eq	1.57X10 ⁻²	1.52X10 ⁻²	1.44X10 ⁻²	1.37X10 ⁻²	1.29X10 ⁻²
Particulate matter	disease inc.	3.64X10 ⁻⁷	3.62X10 ⁻⁷	3.58X10 ⁻⁷	3.54X10 ⁻⁷	3.51X10 ⁻⁷
Acidification	mol H ⁺ eq	7.19X10 ⁻²	7.13X10 ⁻²	7.02X10 ⁻²	6.92X10 ⁻²	6.81X10 ⁻²
Freshwater eutrophication	kg P eq	1.98X10 ⁻³	1.99X10 ⁻³	1.99X10 ⁻³	1.99X10 ⁻³	1.99X10 ⁻³
Marine eutrophication	kg N eq	-5.23X10 ⁻²	-5.24X10 ⁻²	-5.25X10 ⁻²	-5.27X10 ⁻²	-5.29X10 ⁻²
Terrestrial eutrophication	mol N eq	2.43X10 ⁻¹	2.42X10 ⁻¹	2.40X10 ⁻¹	2.38X10 ⁻¹	2.37X10 ⁻¹

III.7. Limitations & Perspectives

Our case study results showed that harvesting sunflower stalks or not had little impact on the carbon content of the soil. This could have been different on another type of soil. However, such loss does not necessarily need to translate in a reduced biomass potential for the bioeconomy, as suggested in e.g., Hansen et al. (2020). For instance, it can instead be compensated using cover crops (e.g., radish, rapeseed, rye, oats, phacelia) established before the sunflower crop.

The analysis also highlighted that one clear hotspot to improve the overall environmental performance of such bio-based panels is the fuel consumption during harvest. In the long-term, it can be envisaged that the harvesting operations could be electrified, albeit also not free of impacts, as shown by the relatively important contribution of electricity in some of the impact categories. In the shorter-term, to reduce the fuel consumption, the development of a collection belt coupled to and therefore towed by the combine harvester itself could allow the harvesting of the stalks (and heads) at the same time as the seeds. As shown in our sensitivity analysis, a net diesel consumption reduction of 10% from the one considered herein (108 L ha^{-1}) would render the starch panel more environmentally performant than the reference for some of the impact categories assessed, including climate change. This improvement, however, would not render the chitosan-based panel more environmentally performant, due to important emissions during the chitosan production process. These emissions are related to the use of sodium hydroxide (categories of climate change, freshwater eutrophication, and ecotoxicity), hydrochloric acid (ozone depletion, ionizing radiation), as well as emissions linked to the use of protein sludge as fertilizer.

However, one aspect not explored and quantified herein is chitosan's antimicrobial properties and the eventual effects of this. In fact, different authors have addressed the effects of chitosan in microorganisms (i.e., *gram-negative*, *gram-positive* bacteria and fungi) (Goy et al., 2009) as well as its use in combination with various materials for a broad spectrum of applications in the medical, food and textile sectors (Kong et al., 2010). This antimicrobial property is expected to render chitosan-based panels less prone to degradation by fungi and small insects, giving it an advantage over the starch-based formulation. The influence of chitosan in the use phase (i.e., eventual longer lifespan) of the panels could be addressed by performing accelerated aging studies on both the starch- and chitosan-based panels.

The French Environment and Energy Management Agency (ADEME; ADEME 2015) estimated that from the almost 2800 million tonnes (DM) of oilseed stalks (including sunflower) produced per year, 1400 million tonnes should be left on the field to maintain its fertility. If this is followed and 50% of the sunflower stalks produced per year at a national level (ca. 500 000 tonnes; ADEME 2015) were harvested, about 20 000 tonnes y^{-1} of pith could be extracted. This translates into 800 000 m^2 of sunflower pith panels, and the avoided production of 650-930 tonnes of melamine foam per year. If the agricultural process of harvesting of the stalks is optimized (10% net reduction), this could result in the net avoidance of 1600 tonnes $\text{CO}_2 \text{ eq y}^{-1}$, with respect to the base case scenario. This represents the level of annual emissions of ca. 300 French citizen (based on 2017 data: Ritchie & Roser, 2020), reflecting the potential importance of developing such valorization pathways.

III.8. Conclusion

Sunflower is grown almost exclusively for the production of oil seeds for the food sector. Being so, current practice is for the rest of the sunflower parts to be left in the field where they contribute to the composition of the soil as nutrient supply. Nonetheless, the properties some of these co-products make them an interesting option for their valorization as materials, thus contributing to the development of a bioeconomy. For this reason, scientific research has been carried out concerning the potential valorization of the different parts of the sunflower plant for applications as insulation materials, biocomposites, and furniture, among others.

From the different co-products issued from the culture of sunflower plant, stalks are the preferred component for valorization, given its large availability and characteristics. Different authors have studied the valorization of pith from inside the stalks for applications as thermal insulation materials, as well as a low-density packaging alternative.

This work explored the valorization of sunflower pith as an acoustic insulation material in the form of sound-absorbing panels aimed to reduce noise reverberation in open spaces inside buildings. As a result, sunflower pith panels were successfully produced with two different formulations, using starch and chitosan as binding agents. The sound absorption properties of the produced panels along with those of cork and melamine foam panels were assessed by measuring their sound absorption coefficient. Sunflower pith panels were identified as performant at low frequencies (250-400 Hz), presenting absorption coefficient values 6-9 times higher than existing industrial panels.

The LCA showed that overall, sunflower pith panels could allow a net environmental mitigation in comparison to leaving the pith-containing stalks unharvested and using conventional melamine foam for sound absorption, but this is conditioned to the use of starch as binder, and to the optimization of the agricultural activity of harvesting the stalks (by simultaneously harvesting seeds and stalks and limiting any extra diesel consumption to maximum 108 L ha⁻¹). It further only applies to the environmental impact categories of climate change, particulate matter, acidification and terrestrial eutrophication. For climate change, we showed that using half the annual amount of sunflower stalks produced in France could lead to avoiding CO₂ eq emissions equivalent to the annual emissions of 300 average French citizens. Moreover, the consequential approach taken allow the evaluation of scenarios in which co-products from the pith procurement process are further valorized. The valorization of co-products contributed to gains from 20% to 260% for all impact categories.

Out of the two formulations assessed, the starch-based panel outperformed, in terms of environmental performance, the chitosan-based one. This due to the impacts generated by the production of chitosan (the use of chemicals such as sodium hydroxide and hydrochloric acid) and the valorization of co-products issued from it.

Overall, the harvest of the sunflower stalks was found to have negligible impact on the carbon content of the soil, as the studied soil naturally loses carbon.

The specificities of applying the LCA methodology to agro-materials was addressed through the incorporation of carbon dynamics to the assessment. In this way, aspects such as carbon uptake from soil, its storage in the final product, and the natural recycling end-of-life quality of agro-materials, were considered in the overall environmental performance of the sunflower pith-based sound-absorbing panels. This positively reflected on the panels in the environmental impact category of Climate change, in which the starch formulation of the sunflower pith panel outperformed the commercial alternatives.

General Conclusion

General Conclusion

The incorporation of practices to the current economic system to successfully deploy a bioeconomy, must come accompanied by decision-making processes that follow the guidelines of strong sustainability. Novel, greener materials, and their end-of-life properties should be clearly classified and regulated for them to effectively contribute to said deployment.

The large availability of biomass, in particular in the form of agricultural waste, represents an important asset for switching production and consumption habits towards more sustainable practices. The valorization of biomass as a source of materials has the potential of contributing to the mitigation of climate change, as well as of reducing pollution levels. Nonetheless, bio-based materials are not always inherently better from an environmental perspective, nor biodegradable/compostable. Additionally, terminology has been used interchangeably to define materials with different characteristics, which leads to confusion.

Presented in Chapter I, a classification system considering the origin and end-of-life properties of materials aims to be of use for improving the understanding of bio-based materials, and their advantages as well as their limitations. This system aims as well to clearly identify the possible end-of-life properties of bio-based materials, and therefore, the possible waste management techniques. This becomes particularly relevant for the evaluation of the environmental performance of bio-based materials.

Out of the different environmental assessment methods presented in this thesis work, the holistic quality of Life Cycle Assessment (LCA), makes of it the most fitting option to evaluate the environmental relevance of incorporating bio-based materials into the market. An LCA allows the comparison of different materials, the identification of areas of improvement, and by following a consequential approach, the pertinence of valorizing co-products and their effect on the environmental performance of a product, can be evaluated.

Methodological challenges linked to the evaluation of the environmental performance of bio-based materials through LCA that were identified in this thesis work were addressed through the application of the two case studies presented.

The methodological challenge of life cycle inventory data was approached by producing LCIs from own measurements and direct contact with field experts. In this way, a complete and detailed LCI for flax fiber was built, as well as a LCI for the procurement of sunflower pith and the production of sound-absorbing panels.

For the multi-functionality challenge, co-products were handled through system expansion and by using marginal data. This allowed for demonstration that the valorization of co-products influence the environmental performance of a product. In this study, the inclusion of co-products showed to contribute to the reduction of impacts on most of the environmental categories evaluated.

The specificities of indirect land use change (iLUC) and its influence on the addressed impact categories, was tackled through the creation of an iLUC process considering the effects of increasing land requirements were it to be an increase in demand for crop products. Its influence was visible in the impact categories of climate change, ozone formation and marine eutrophication. This was illustrated through the first study (presented in Chapter II) at the flax fiber technical textile section.

Challenges related to carbon accounting in bio-based materials were addressed through the modelling of soil organic carbon dynamics and its incorporation as part of the LCA evaluation. Specific to the case study assessed in this work, the harvest of sunflower stalks for their valorization as sound-absorbing panels proved to have little influence on the environmental performance of the panels.

Lastly, the approach taken to address the particularities of the end-of-life management of bio-based materials, was to adapt existing EOL processes according to the specific emissions of biomass. In this case, this concerned the emissions linked to the combustion of natural fibers (in the case of the biocomposite material) as well as from the decomposition of the sunflower panels when returned to the field for a natural recycling process.

In this context, the first scientific question of *How does the diversion of resources affect the environmental impact of a bio-sourced product?* was answered through the incorporation of the fate of the co-products to the environmental performance of the main product, by system expansion, and the inclusion of the effects of land use change occurring because of increasing flax fiber yield for the production of technical textiles.

Moreover, the second scientific question of *How to apply the LCA methodology to agro-materials?* was addressed by incorporating the specificities of agro-materials such as of carbon uptake from soil, carbon storage, and natural recycling as part of the LCA. This was possible through the evaluation and inclusion of carbon dynamics in the evaluation.

Main results and conclusions obtained from the two case studies evaluated in this work are presented hereafter.

Main results – Chapter II: Eco-design & Environmental Assessment of an innovative biocomposite panel for aviation

Stemmed from the environmental objectives set by the aviation sector on the Flightpath 2050 report by ACARE, research for new materials with higher environmental performances than the currently used ones has been carried out. In this light, biocomposite materials have become a subject of interest given the low density of natural fibers, their bio-based nature, as well as their carbon storage potential.

The BOPA project emerges from this need and aimed to produce a biocomposite sandwich panel with a novel core structure to be used for the interior fitting elements of an aircraft.

First work consisted in the production of a consequential life cycle inventory for the production of a flax fiber technical textile. As presented in Figure IV-1, through a cradle-to-gate LCA, the stages from the supply chain of the technical textile were identified, as well as the different elements contributing to a diversion of resources (i.e., land use change, avoided production of marginal suppliers). As a result, an extensive and detailed LCI was produced. This work was published as an original scientific article in the Journal of Cleaner Production.

The LCI presented includes the potential valorization of the different co-products produced and allows for future assessments to be carried out. Furthermore, the LCA performed improved existing LCAs on flax fiber production by estimating and considering the emissions issued from the retting process as part of the environmental assessment. Moreover, the analysis of several impact categories presented a broader picture of the potential environmental impacts of using flax fiber as a technical textile.

Results from the LCA of the flax fiber technical textile showed agricultural production and electricity production to be the main contributors to the environmental impact of the final product. The inclusion of the fate of the co-products inside the system boundaries revealed that the impact of diverting resources can be influenced by the fate given to them. Specifically, LCA results showed that the impacts of land use change induced by an increase in agricultural production were reduced in almost 25% as a result of the valorization of co-products as animal feed. Moreover, without the inclusion of the fate of co-product in the assessment, impacts could have been over or underestimated.

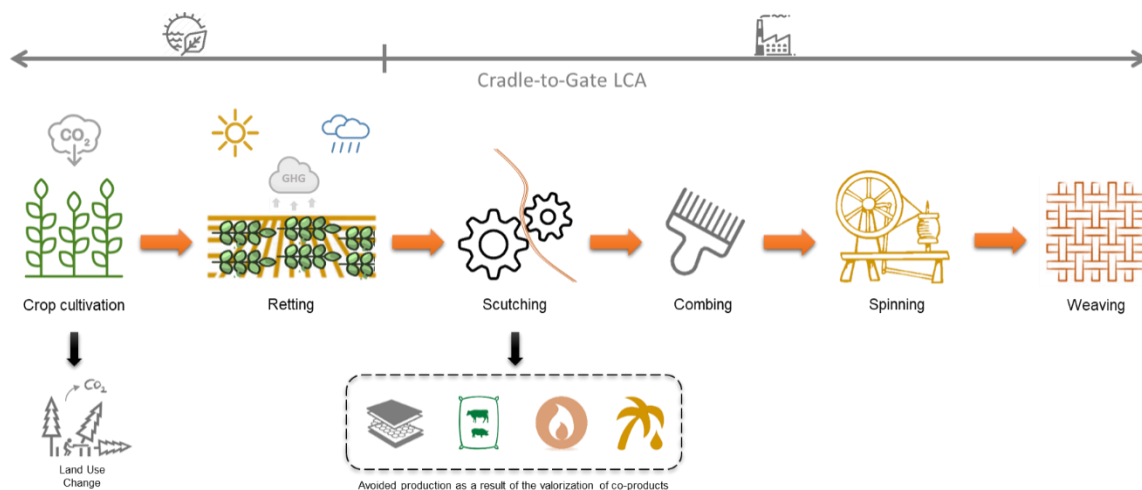

Figure IV-1. Graphical abstract describing the LCA of a flax fiber technical textile. Image from (Gomez-Campos et al., 2021)

The biocomposite sandwich panel prototype developed within the BOPA project consisted of a flax fiber technical textile embedded with a commercial fire-suppressing epoxy resin. The biocomposite panel was aimed to replace current glass fiber-reinforced composite panels used in aircrafts. The evaluation of the environmental relevance of said replacement, was assessed through an LCA for which

the produced LCI for flax fiber as a technical textile was used to represent the procurement process of one of the raw materials of the biocomposite panel.

Firstly, the different life cycle stages of the biocomposite panel (Figure IV-2) were identified and properly documented. As far as possible, foreground data was obtained directly from the prototype developer. When not available, data was obtained from literature and existing databases (i.e., Ecoinvent) when relevant.

In general, results from the LCA carried out confirmed that for an application in aeronautics, the upmost critical parameter of an aircraft component is its weight. Additionally, this case study brought forward the need for industrial sectors to re-evaluate requirements and regulations as well as working around the properties of bio-based products. Moreover, it also shed some light on the fact that the novelty and development stage of bio-based products limits their environmental performance. This since end-of-life management techniques (such as recycling) for bio-based products are sometimes limited by technology. However, the advantages of carbon storage in bio-based products were proven relevant, in particular for applications where products have a long lifespan, as in the aviation sector.

It was estimated that about 17 kt of CO₂ eq could be stored in an airplane (with the characteristics of the A320neo aircraft) by producing all interior fitting elements with the biocomposite panel. Moreover, commercial aviation fleet is expected to double in the next 20 years, meaning that the implementation of bio-based materials could contribute to the delay of over 675 Mt of CO₂ eq (for the duration of the use life of the aircrafts). This, given that conventional panels are fully replaced by the flax fiber-reinforced biocomposite sandwich panel herein presented.

The work done concerning the LCA of the herein presented biocomposite sandwich panel, was published as an original scientific article in the Journal of Cleaner Production.

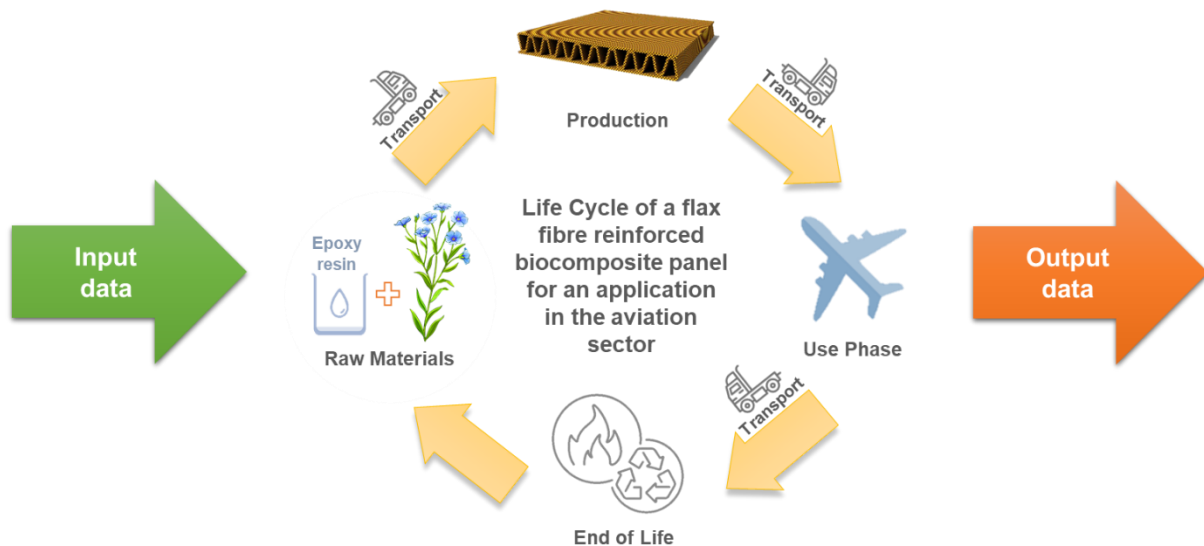

Figure IV-2. Graphical abstract describing the work on the LCA of a biocomposite sandwich panel with an application in the aviation sector. Image from (Gomez-Campos et al., 2021)

Overall, the presented case study contributed to the understanding of how the diversion of resources affect the environmental impact of a bio-sourced product. This was done through the incorporation of the fate of the co-products to the environmental performance of the main product, by system expansion, and the inclusion of the effects of land use change occurring as a consequence of increasing flax fiber yield for the production of technical textiles.

Main results – Chapter III: Production & Environmental Assessment of an agro-material as a sound-absorbing panel

Global environmental objectives for mitigating the effects of climate change and the action plans set by the European Commission for the deployment of a bioeconomy, has made agricultural co-products (otherwise regarded as waste) an interesting alternative to successfully attain the goals set. In fact, agricultural co-products have the advantage of the possibility of producing bio-based products without the environmental burdens commonly linked to them, such as the need of additional arable land.

Through the LUMA case study, the environmental specificities of an agro-material (a 100% bio-based material, in which the natural structure of its constituents is preserved) were explored. The case study consisted on the production and evaluation (technical and environmental) of a sound-absorbing panel made from sunflower stalks (more specifically, from the pith component) for an application in the building sector.

First, the extraction process of the sunflower pith was defined Figure IV-3. For this, experiments were carried out at a semi-industrial scale after which the production of the panels was carried out following four different formulations. Out of the four formulations, only two of them (those with chitosan and starch as binding agents) resulted in robust enough panels that could be used for the desired application.

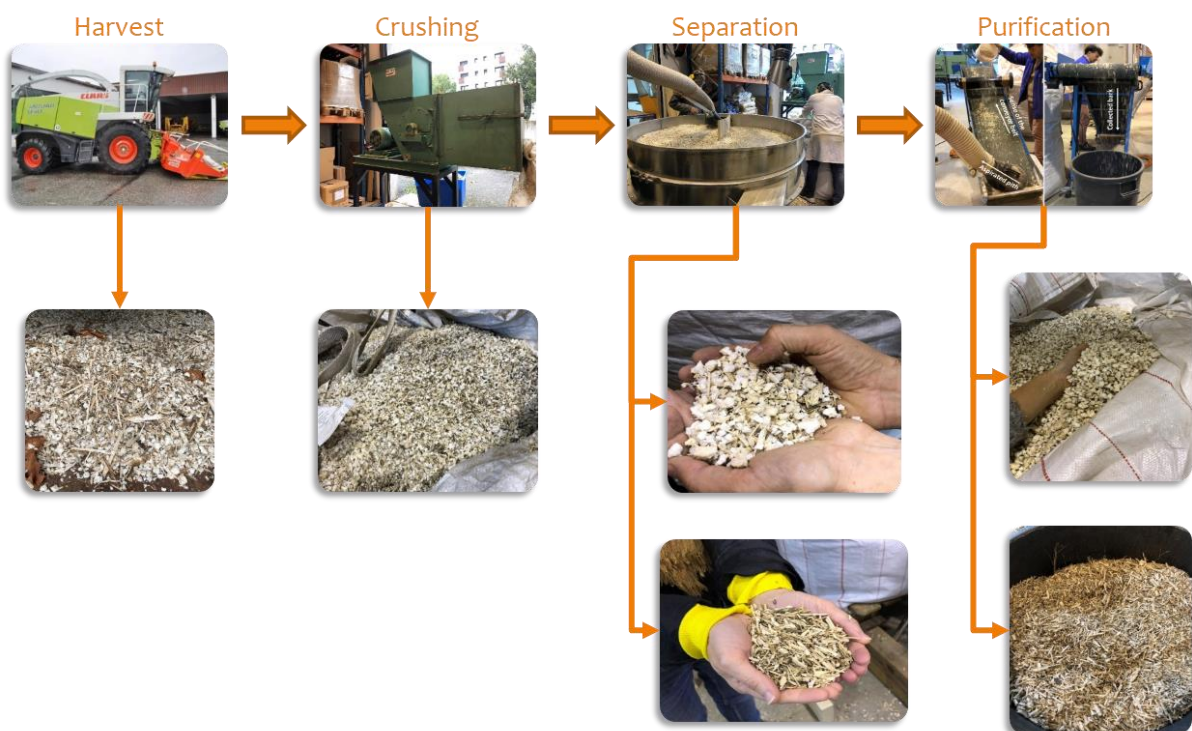

Figure IV-3. Process for the extraction of sunflower pith.

Afterwards, the sound-absorption properties of the panels were evaluated and compared to those of a fossil-based alternative (melamine foam panels), as well as another agro-material (cork panels). Measurements were carried out by the *Centre de Transfert de Technologie du Mans*. The mean absorption coefficients of the different panels were obtained following the ISO 11654 standard. Results showed that the sunflower pith panels, in particular the starch-based formulation, present interesting properties for an application at low and mid-range frequency values. The curve for the melamine foam panel represents a typical curve for a sound-absorbing panel. Meanwhile, the cork panel presents a profile and characteristics for sound insulation rather than sound-absorption.

To address the specificities of agro-materials (such as natural recycling at their end-of-life), as well as the impact on the C content of the soil resulting from the harvest of the stalks, the dynamic aspect of carbon was evaluated through the C-TOOL model. C-TOOL simulates the effects of agricultural management on Soil Organic Carbon (SOC) storage on a medium- to long-term time period and follows the degradation of C as it moves between the different pools of the soil profile. As a result, it was determined that the harvest of the sunflower stalks has little impact on the C content of the soil and therefore, does not affect its quality. Moreover, it was confirmed that the valorization of agricultural by-products has the possibility of contributing to the delay of climate change through the storage of carbon, as CO₂ emissions from the degradation of biomass are avoided.

Finally, the environmental performance of the sunflower pith panels was evaluated through an LCA. Results showed that the difference in carbon content in the soil with or without harvest of stalks has no influence on the environmental impact of the final product. Moreover, the consequential approach taken revealed that it is more environmentally advantageous to valorize the bark issued as co-product, as particle board rather than taken back to the field.

In general, the specificities of carbon uptake from soil, carbon storage, and natural recycling of agro-materials were incorporated to the LCA through the evaluation and inclusion of carbon dynamics to the assessment. This allowed for a better understanding of the environmental impact of agro-materials and their potential as agents on climate change mitigation.

Perspectives

Moving on onto the perspectives of this thesis work, we can identify those linked to the improvement of the case studies themselves and the LCA methodology. Starting with the former, perspectives include:

(i) The environmental and technical pertinence of using flax short fibers instead of a technical textile, which could prove interesting in the aim of improving the environmental performance of the biocomposite material by avoiding the energy-intensive stages of spinning and weaving. Moreover, an LCA comparing both of materials (long vs short fibers) could be used to evaluate the influence of the avoided impacts on land use change as consequence of using an agricultural co-product for biocomposite production, instead of a product originally destined for the textile industry.

(ii) Regarding the production and evaluation of the sunflower pith panels in the context of the LUMA case study (Chapter III), further work could be focused on the improvement of the water vapor and protein isolate formulations. If functional panels are achieved, their environmental and technical performances could then be compared to those of the starch and chitosan-based panels. Added to this, the influence of the thickness of the panels on their sound-absorbing performance could be assessed. By varying the thickness of the sunflower pith panels, the product characteristics for obtaining the optimal environmental performance could be defined and exploited.

(iii) For the case study, the sunflower panels were estimated to have a lifespan of 20 years. To demonstrate the validity of this assumption, aging studies should be carried out. This would also be pertinent for addressing the antimicrobial properties of chitosan and their influence on the environmental impact of the panels.

(iv) In the aim of continuing to boost the incorporation of bio-based materials to favor the implementation of a bioeconomy, future work should focus on the optimization of production processes of bio-based materials to increase their competitiveness in the market. Supply chains should

also focus on production practices that prioritize an efficient use of resources by taking advantage of as much of the biomass available as possible (valorization of co-products). Moreover, for a bioeconomy to be successfully deployed, current regulations and materials' requirements should be revised and rethought from a bio-based perspective, taking into consideration the qualities and specificities of products with a bio-based origin.

From a more methodological point of view:

(i) Given the less mature level of development of bio-based products, compared to their industrially produced fossil-based counterparts, it appears necessary to focus on the scale-up of collected data. This would lead for production processes to be compared following same TRL levels, thus allowing a more accurate evaluation and interpretation of results.

(ii) From an eco-design standpoint, further work on the BOPA project should focus on the optimization of the biocomposite panel (i.e., its geometry) to improve its environmental performance and thus the relevance of its introduction to the market. In this context, the coupling of the SimaPro model to a simulation software allowing to test different configurations of the prototype could be advantageous. This way, the optimal geometry of the biocomposite sandwich panel having the best environmental performance could be assessed. This simultaneous analysis of mechanical and environmental performances could be extended to any new products/materials with a bio-based origin.

(iii) Finally, in the aim of having a more wholesome evaluation of not only the environmental performance but also the sustainability aspect of bio-based products, the incorporation of a social and economic perspective into the LCA would prove advantageous.

In conclusion, bio-based products were demonstrated to be a valuable option for the successful development of a bioeconomy. Through LCA, the potential improvement areas for the production of bio-based materials were identified, and their climate change mitigation potential addressed.

Furthermore, this thesis work shone light on the need for rethinking and adjusting production practices, as well as regulations, to the specificities of bio-based products. In this way, their incorporation into the current economic system would improve, they would become more competitive and, therefore, more relevant in their role as key actors on the deployment of a bioeconomy.

BIBLIOGRAPHY

Bibliography

- ACARE (2011) *Flightpath 2050 - Europe's Vision for Aviation*. European Commission.
- ADEME (2015) *Panorama des coproduits et résidus biomasse à usage des filières chimie et matériaux biosourcés en France*.
- ADEME (2018) *Les déchets dangereux - Généralités et réglementation, Agence de l'Environnement et de la Maîtrise de l'Energie*. Available at: <https://www.ademe.fr/expertises/dechets/quoi-parle-t/types-dechets/dossier/dechets-dangereux/generalites-reglementation> (Accessed: 1 April 2019).
- ADEME and ITCF (1998) 'Etude agricole - Lin fibre'. Available at: <https://www.doc-developpement-durable.org/file/Culture-plantes-a-fibres/lin/lin%20fibre.pdf> (Accessed: 28 November 2018).
- AIRBUS (2019) 'Airbus forecasts need for over 39,000 new aircraft in the next 20 years'. Available at: <https://www.airbus.com/aircraft/market/global-market-forecast.html>.
- Akhshik, M. *et al.* (2017) 'Life cycle assessment and cost analysis of hybrid fiber-reinforced engine beauty cover in comparison with glass fiber-reinforced counterpart', *Environmental Impact Assessment Review*, 65, pp. 111–117.
- Álvarez-Chávez, C. R. *et al.* (2012) 'Sustainability of bio-based plastics: general comparative analysis and recommendations for improvement', *Journal of Cleaner Production*, 23(1), pp. 47–56.
- Ashby, M. F. (2013) *Materials and the Environment: eco-informed material choice*. Second Edition. Elsevier Inc.
- Bachmann, J., Hidalgo, C. and Bricout, S. (2017) 'Environmental analysis of innovative sustainable composites with potential use in aviation sector—A life cycle assessment review', *Science China Technological Sciences*, 60(9), pp. 1301–1317.
- Baley, C. (2002) 'Analysis of the flax fibres tensile behaviour and analysis of the tensile stiffness increase', *Composites Part A: Applied Science and Manufacturing*, 33(7), pp. 939–948.
- Bare, J. C. *et al.* (2000) 'Midpoints versus endpoints: The sacrifices and benefits', *The International Journal of Life Cycle Assessment*, 5(6), p. 319.
- Barth, M. and Carus, M. (2015) *Carbon Footprint and Sustainability of Different Natural Fibres for Biocomposites and Insulation Material*. nova-Institut GmbH.
- Bektas, I. *et al.* (2005) 'The Manufacture of Particleboards using Sunflower Stalks (*helianthus annuus* L.) And Poplar Wood (*populus alba* L.)', *Journal of Composite Materials*, 39(5), pp. 467–473.
- Bensadoun, F. *et al.* (2016) 'Environmental impact assessment of end of life options for flax-MAPP composites', *Industrial Crops and Products*, 94, pp. 327–341.
- BIOIntelligence Service (2007) *Analyse de Cycle de Vie comparée d'une chemise en lin et d'une chemise en coton*. Organisations professionnelles du lin.
- BioPreferred (2017) *USDA, Voluntary Labeling Initiative*. Available at: <https://www.biopreferred.gov/BioPreferred/faces/pages/AboutBioPreferred.xhtml> (Accessed: 13 November 2017).

- Bleuze, L. (2019) *Rouissage au sol du chanvre industriel (Cannabis sativa L): dynamique sous environnement contrôlé et modélisation*.
- Boutin, M.-P. et al. (2005) 'Étude des caractéristiques environnementales du chanvre par l'analyse de son cycle de vie'. Ministère de l'agriculture et de la pêche.
- BP Global (2017) *BP Statistical Review of World Energy*, bp.com. Available at: <https://www.bp.com/en/global/corporate/energy-economics/statistical-review-of-world-energy/oil/oil-reserves.html> (Accessed: 10 November 2017).
- Brandão, M. et al. (2017) *Consequential Life Cycle Assessment: What, How, and Why?*
- BSI (2011) 'PAS 2050 - Specification for the assessment of the life cycle greenhouse gas emissions of goods and services'.
- CEC (2003) *Integrated Product Policy - Building on Environmental Life-Cycle Thinking*. Communication from the Commission to the Council and the European Parliament – COM. Available at: <https://eur-lex.europa.eu/LexUriServ/LexUriServ.do?uri=COM:2003:0302:FIN:en:PDF> (Accessed: 5 March 2021).
- C.E.L.C. (2019a) *Le lin et le chanvre européen, Scéma du lin*. Available at: http://mastersoflinen.com/eng/lin/7-schema-du-lin__ (Accessed: 29 October 2018).
- C.E.L.C. (2019b) *Le lin et le chanvre européen, Masters of Linen*. Available at: http://mastersoflinen.com/fre/lin/19-la-carte-du-lin__ (Accessed: 26 November 2018).
- C.E.L.C. (2020) *Le lin et le chanvre européen, Secteurs d'application*. Available at: <http://europeanflax.com/eng/technique/19-secteurs-d-application> (Accessed: 7 April 2020).
- C.E.L.C. (2021) *Le lin et le chanvre européen, Linen Life Cycle*. Available at: <http://news.europeanflax.com/lin/7-schema-du-li/> (Accessed: 26 November 2018).
- Chabriac, P. A. et al. (2016) 'Agricultural by-products for building insulation: Acoustical characterization and modeling to predict micro-structural parameters', *Construction and Building Materials*, 112, pp. 158–167.
- Chandrasekaran, M. (2013) *Valorization of food processing by-products*. Boca Raton, Fla.: CRC Press (Fermented foods and beverages series).
- Chung, D. D. L. (2010) *Composite materials: science and applications*. 2nd ed. London ; New York: Springer (Engineering materials and processes).
- Classen, M. et al. (2009) *Life Cycle Inventories of Metals*. 10. Dübendorf, CH: Swiss Centre for Life Cycle Inventories.
- Corbiere-Nicollier, T. et al. (2001) 'Life cycle assessment of biofibres replacing glass fibres as reinforcement in plastics', *Resources Conservation and Recycling*, 33(4), pp. 267–287.
- Crenna, E., Sozzo, S. and Sala, S. (2017) 'Natural biotic resources in LCA: Towards an impact assessment model for sustainable supply chain management', *Journal of Cleaner Production*.
- Curran, M. A. and Notten, P. (2006) *Summary of Global Life Cycle Inventory Data resources*. Task Force 1: Database Registry. SETAC/UNEP Life Cycle Initiative.
- Dalgaard, R. et al. (2008) 'LCA of soybean meal', *The International Journal of Life Cycle Assessment*, 13(3), pp. 240–254.

- Damien, A. (2016) *Guide du traitement des déchets - Réglementation et choix des procédés*. 7e edn. Dunod.
- Dasch, J. M. (1982) 'Particulate and gaseous emissions from wood-burning fireplaces', *Environmental Science & Technology*, 16(10), pp. 639–645.
- Debaeke, P., Pellerin, S. and Scopel, E. (2017) 'Climate-smart cropping systems for temperate and tropical agriculture: mitigation, adaptation and trade-offs', *Cahiers Agricultures*, 26(3), p. 34002.
- Deng, Y. *et al.* (2016) 'Life cycle assessment of flax-fibre reinforced epoxidized linseed oil composite with a flame retardant for electronic applications', *Journal of Cleaner Production*, 133, pp. 427–438.
- Deng, Y. and Tian, Y. (2015) 'Assessing the Environmental Impact of Flax Fibre Reinforced Polymer Composite from a Consequential Life Cycle Assessment Perspective', *Sustainability*, 7(9), pp. 11462–11483.
- Dissanayake, N. P. J. *et al.* (2009) 'Energy Use in the Production of Flax Fiber for the Reinforcement of Composites', *Journal of Natural Fibers*, 6(4), pp. 331–346.
- Dittenber, D. B. and GangaRao, H. V. S. (2012) 'Critical review of recent publications on use of natural composites in infrastructure', *Composites Part A: Applied Science and Manufacturing*, 43(8), pp. 1419–1429.
- Dong, S., Xian, G. and Yi, X. (2018) 'Life Cycle Assessment of Ramie Fiber Used for FRPs', *Aerospace*, 5(3), p. 81.
- Duflou, J. R. *et al.* (2014) 'Comparative impact assessment for flax fibre versus conventional glass fibre reinforced composites: Are bio-based reinforcement materials the way to go?', *CIRP Annals*, 63(1), pp. 45–48.
- Duval, C. (2009) *Matières plastiques et environnement : Recyclage, Valorisation, Biodégradabilité, Ecoconception Ed. 2*. Dunod.
- Earles, J. M. and Halog, A. (2011) 'Consequential life cycle assessment: a review', *The International Journal of Life Cycle Assessment*, 16(5), pp. 445–453.
- EBCD (2015) *The Role of Bioeconomy in Climate Change Mitigation*, EBCD. Available at: <https://ebcd.org/the-role-of-bioeconomy-in-climate-change-mitigation/> (Accessed: 9 February 2021).
- EC (2013) 'Commission Recommendation of 9 April 2013 on the use of common methods to measure and communicate the life cycle environmental performance of products and organisations'.
- EC (2017) *PEFCR Guidance document - Guidance for the development of Product Environmental Footprint Category Rules (PEFCRs), version 6.3*.
- EC (2018a) *A Clean Planet for all - A European strategic long-term vision for a prosperous, modern, competitive and climate neutral economy*. Available at: https://ec.europa.eu/clima/sites/clima/files/docs/pages/com_2018_733_en.pdf (Accessed: 12 March 2019).
- EC (2018b) *Bio-based products*. Available at: http://ec.europa.eu/growth/sectors/biotechnology/bio-based-products_en (Accessed: 26 November 2018).

- EC (2018c) *Periodic Reporting for period 1 - BIOPANELS (Biocomposite panels for transportation) - Report Summary*. Available at: <https://cordis.europa.eu/project/id/782890/reporting> (Accessed: 23 January 2020).
- EC (2019) *Environmental impact assessments of innovative bio-based product . Task 1 of “Study on Support to R&I Policy in the Area of Bio-based Products and Services”*. Website. Available at: <https://publications.europa.eu/en/publication-detail/-/publication/15bb40e3-3979-11e9-8d04-01aa75ed71a1/language-en> (Accessed: 18 March 2019).
- EC (2020) *European Platform on Life Cycle Assessment, European Commission Service Site*. Available at: <https://eplca.jrc.ec.europa.eu/EnvironmentalFootprint.html> (Accessed: 10 April 2020).
- EEA, (European Environment Agency) (1999) *Environmental indicators: Typology and overview. Technical report No 25*. Copenhagen.
- Embassy of France in Washington (2018) *National action plan for bioeconomy announced, French food in the US - The Agriculture Department*. Available at: <https://frenchfoodintheus.org/3809> (Accessed: 26 November 2018).
- EN 13432 (2000) ‘Requirements for packaging recoverable through composting and biodegradation – test scheme and evaluation criteria for the final acceptance of packaging.’
- Engineering ToolBox (2003) *Room Sound Absorption - Sound Absorption Coefficient*. Available at: https://www.engineeringtoolbox.com/acoustic-sound-absorption-d_68.html (Accessed: 15 October 2020).
- EU (2020) *Bioeconomy - Why the EU supports bioeconomy research and innovation, European Commission - European Commission*. Available at: https://ec.europa.eu/info/research-and-innovation/research-area/bioeconomy_en (Accessed: 8 February 2021).
- European Bioplastics and nova-Institute (2017) *Bioplastics market data 2017*. Berlin: European Bioplastics e.V. Available at: <http://www.european-bioplastics.org/market/> (Accessed: 4 December 2017).
- Evon, P. (2008) *Nouveau procédé de bioraffinage du tournesol plante entière par fractionnement thermo-mécano-chimique en extrudeur bi-vis: Etude de l’extraction aqueuse des lipides et de la mise en forme du raffinat en agromatériaux par thermomoulage*. Université de Toulouse - Institut National Polytechnique de Toulouse.
- Evon, P. *et al.* (2014) ‘New thermal insulation fiberboards from cake generated during biorefinery of sunflower whole plant in a twin-screw extruder’, *Industrial Crops and Products*, 52, pp. 354–362.
- Evon, P. *et al.* (2015) ‘Influence of thermo-pressing conditions on the mechanical properties of biodegradable fiberboards made from a deoiled sunflower cake’, *Industrial Crops and Products*, 65, pp. 117–126.
- Evon, P., Vandenbossche, V. and Rigal, L. (2012) ‘Manufacturing of renewable and biodegradable fiberboards from cake generated during biorefinery of sunflower whole plant in twin-screw extruder: Influence of thermo-pressing conditions’, *Polymer Degradation and Stability*, 97(10), pp. 1940–1947.

- Ewertowska, A. *et al.* (2016) 'Assessment of the environmental efficiency of the electricity mix of the top European economies via data envelopment analysis', *Journal of Cleaner Production*, 116(C), pp. 13–22.
- Fahd, S. *et al.* (2012) 'Cropping bioenergy and biomaterials in marginal land: The added value of the biorefinery concept', *Energy*, 37(1), pp. 79–93.
- Faist Emmenegger, M., Heck, T. and Jungbluth, N. (2007) *Erdgas*. Dübendorf, CH: Swiss Centre for Life Cycle Inventories.
- FAOSTAT (2017) *Crops*. Available at: <http://www.fao.org/faostat/en/?#data/QC> (Accessed: 26 November 2018).
- FAOSTAT (2020) *Sunflower seed, Crops*. Available at: <http://www.fao.org/faostat/en/#data/QC/visualize> (Accessed: 8 October 2020).
- Fargione, J. *et al.* (2008) 'Land Clearing and the Biofuel Carbon Debt', *Science*, 319(5867), pp. 1235–1238.
- Faruk, O. *et al.* (2012) 'Biocomposites reinforced with natural fibers: 2000–2010', *Progress in Polymer Science*, 37(11), pp. 1552–1596.
- Fazio, S. *et al.* (2018) *Supporting information to the characterisation factors of recommended EF Life Cycle Impact Assessment methods*. EUR 28888, European Commission. Ispra: JRC109369.
- Fernando, A. L. *et al.* (2015) 'Environmental aspects of fiber crops cultivation and use', *Industrial Crops and Products*, 68, pp. 105–115.
- Finnveden, G. *et al.* (2009) 'Recent developments in Life Cycle Assessment', *Journal of Environmental Management*, 91(1), pp. 1–21.
- Fuqua, M. A., Huo, S. and Ulven, C. A. (2012) 'Natural Fiber Reinforced Composites', *Polymer Reviews*, 52(3), pp. 259–320.
- Gerssen-Gondelach, S. J. *et al.* (2014) 'Competing uses of biomass: Assessment and comparison of the performance of bio-based heat, power, fuels and materials', *Renewable and Sustainable Energy Reviews*, 40(Supplement C), pp. 964–998.
- GNIS (2018a) *Glossaire du lin | Le lin côté nature*. Available at: https://www.lin-cotenature.fr/ajax_getDefinition.php?id_definition=2 (Accessed: 30 January 2019).
- GNIS (2018b) *Le rouissage de lin, une opération délicate, Le lin côté nature*. Available at: <https://www.lin-cotenature.fr/FR/Le-rouissage-du-lin-une-operation-delicate-166.html> (Accessed: 30 January 2019).
- Gomez-Campos, A., Vialle, C., Rouilly, A., Sablayrolles, C., *et al.* (2021) 'Flax fiber for technical textile: A life cycle inventory', *Journal of Cleaner Production*, 281, p. 125177.
- Gomez-Campos, A., Vialle, C., Rouilly, A., Hamelin, L., *et al.* (2021) 'Natural Fibre Polymer Composites - A game changer for the aviation sector?', *Journal of Cleaner Production*, 286, p. 124986.
- Grabowski, A. *et al.* (2015) 'Life cycle inventory data quality issues for bioplastics feedstocks', *The International Journal of Life Cycle Assessment*, 20(5), pp. 584–596.
- Graichen, F. H. M. *et al.* (2017) 'Yes, we can make money out of lignin and other bio-based resources', *Industrial Crops and Products*, 106(Supplement C), pp. 74–85.

- Graver, B., Zhang, K. and Rutherford, D. (2019) *CO2 emissions from commercial aviation, 2018*. ICCT, p. 13.
- Gross, R. A. and Kalra, b; (2002) 'Biodegradable Polymers for the Environment', *Science*, 297(5582), pp. 803–807.
- Gurunathan, T., Mohanty, S. and Nayak, S. K. (2015) 'A review of the recent developments in biocomposites based on natural fibres and their application perspectives', *Composites Part A: Applied Science and Manufacturing*, 77, pp. 1–25.
- Gustavsson, L., Pingoud, K. and Sathre, R. (2006) 'Carbon Dioxide Balance of Wood Substitution: Comparing Concrete- and Wood-Framed Buildings', *Mitigation and Adaptation Strategies for Global Change*, 11(3), pp. 667–691.
- Hamelin, L. (2013) *Carbon management and environmental consequences of agricultural biomass in a danish renewable energy strategy*. PhD Thesis. University of Southern Denmark.
- Hamelin, L., Naroznova, I. and Wenzel, H. (2014) 'Environmental consequences of different carbon alternatives for increased manure-based biogas', *Applied Energy*, 114, pp. 774–782.
- Hansen, J. H. *et al.* (2020) 'Agricultural residues bioenergy potential that sustain soil carbon depends on energy conversion pathways', *GCB Bioenergy*, 12(11), pp. 1002–1013.
- Harding, K. G., Gounden, T. and Pretorius, S. (2017) "'Biodegradable" Plastics: A Myth of Marketing?', *Procedia Manufacturing*, 7(Supplement C), pp. 106–110.
- Hermann, B. G. *et al.* (2011) 'To compost or not to compost: Carbon and energy footprints of biodegradable materials' waste treatment', *Polymer Degradation and Stability*, 96(6), pp. 1159–1171.
- Heuzé V., Tran G., and Lebas F. (2015) *Flax straw and flax crop by-products*, *Feedipedia, a programme by INRA, CIRAD, AFZ and FAO*. Available at: <https://www.feedipedia.org/node/132> (Accessed: 28 October 2018).
- Hottle, T. A., Bilec, M. M. and Landis, A. E. (2013) 'Sustainability assessments of bio-based polymers', *Polymer Degradation and Stability*, 98(9), pp. 1898–1907.
- Hottle, T. A., Bilec, M. M. and Landis, A. E. (2017) 'Biopolymer production and end of life comparisons using life cycle assessment', *Resources, Conservation and Recycling*, 122(Supplement C), pp. 295–306.
- Hristian, L. *et al.* (2016) 'The study about the use of the natural fibres in composite materials', *IOP Conference Series: Materials Science and Engineering*, 145, p. 032004.
- IATA (2019) *Fuel*. Available at: <https://www.iata.org/whatwedo/ops-infra/fuel/pages/index.aspx> (Accessed: 10 December 2019).
- IEA (2016) *Statistics | France - Total Primary Energy Supply (TPES) by source (chart)*. Available at: <https://www.iea.org/statistics/?country=FRANCE&year=2016&category=Key%20indicators&iindicator=TPESbySource&mode=chart&categoryBrowse=false&dataTable=ELECTRICITYANDHEAT&showDataTable=true> (Accessed: 27 November 2018).
- IFM (2004) *Les données clés du textile-habillement chinois - [menaces et opportunités]*. Clichy: IFM-Ctoe. Available at:

- https://data.bnf.fr/fr/12007583/centre_textile_de_conjoncture_et_d_observation_economique_france/ (Accessed: 27 November 2018).
- INRAe (2020a) *BDAT - Moyenne des teneurs en Argile pour la période début 1990 à fin 2014, découpage par petite région agricole - Outil cartographique Geosol*. Available at: <https://webapps.gissol.fr/geosol/> (Accessed: 18 March 2020).
- INRAe (2020b) *La carte nationale des stocks de carbone des sols intégrée dans la carte mondiale de la FAO*. Available at: <https://agroenvgeo.data.inra.fr/geonetwork/srv/fre/catalog.search?uuid=f858525a-9fea-5ae3-93ab-43afab78483f#/metadata/f858525a-9fea-5ae3-93ab-43afab78483f> (Accessed: 18 March 2020).
- IPCC (1999) *Aviation and the Global Atmosphere - Summary for Policymakers*. San Jose, Costa Rica. Available at: <https://www.ipcc.ch/site/assets/uploads/2018/03/av-en-1.pdf> (Accessed: 10 December 2019).
- IPCC (2013) *Climate Change 2013 The Physical Science Basis - Working Group I Contribution to the Fifth Assessment Report of the Intergovernmental Panel on Climate Change*. Available at: https://www.ipcc.ch/site/assets/uploads/2018/02/WG1AR5_all_final.pdf (Accessed: 25 March 2019).
- IPCC (2018) *Global Warming of 1.5 °C — An IPCC Special Report on the impacts of global warming of 1.5°C above pre-industrial levels and related global greenhouse gas emission pathways, in the context of strengthening the global response to the threat of climate change, sustainable development, and efforts to eradicate poverty*. [Masson-Delmotte, V., P. Zhai, H.-O. Pörtner, D. Roberts, J. Skea, P.R. Shukla, A. Pirani, W. Moufouma-Okia, C. Péan, R. Pidcock, S. Connors, J.B.R. Matthews, Y. Chen, X. Zhou, M.I. Gomis, E. Lonnoy, T. Maycock, M. Tignor, and T. Waterfield (eds.)]. *In Press*. Available at: <https://www.ipcc.ch/sr15/> (Accessed: 10 December 2019).
- ISO 11654 (1997) 'Acoustique - Absorbants pour l'utilisation dans les bâtiments - Évaluation de l'absorption acoustique'.
- ISO 14040 (2006) 'Environmental management - Life cycle assessment - Principles and framework'.
- ISO 14044 (2006) 'Environmental management - Life cycle assessment - Requirements and guidelines'.
- Jolliet, O. *et al.* (2017) *Analyse du cycle de vie Comprendre et réaliser un écobilan*. 3e edn. Lausanne: Presses polytechniques et universitaires romandes.
- Jørgensen, S. V., Hauschild, M. Z. and Nielsen, P. H. (2014) 'Assessment of urgent impacts of greenhouse gas emissions—the climate tipping potential (CTP)', *The International Journal of Life Cycle Assessment*, 19(4), pp. 919–930.
- Jørgensen, S. V., Hauschild, M. Z. and Nielsen, P. H. (2015) 'The potential contribution to climate change mitigation from temporary carbon storage in biomaterials', *The International Journal of Life Cycle Assessment*, 20(4), pp. 451–462.
- Joshi, S. V. *et al.* (2004) 'Are natural fiber composites environmentally superior to glass fiber reinforced composites?', *Composites Part A: Applied Science and Manufacturing*, 35(3), pp. 371–376.
- JRC (2011) *ILCD Handbook: Recommendations for Life Cycle Impact Assessment in the European context*. Luxembourg: Publications Office.

- Kang, J. *et al.* (2015) 'Characterization of natural low-methoxyl pectin from sunflower head extracted by sodium citrate and purified by ultrafiltration', *Food Chemistry*, 180, pp. 98–105.
- Karamanlioglu, M., Preziosi, R. and Robson, G. D. (2017) 'Abiotic and biotic environmental degradation of the bioplastic polymer poly(lactic acid): A review', *Polymer Degradation and Stability*, 137 (Supplement C), pp. 122–130.
- Karan, S. K. and Hamelin, L. (2021) 'Crop residues may be a key feedstock to bioeconomy but how reliable are current estimation methods?', *Resources, Conservation and Recycling*, 164, p. 105211.
- Keller, A. and Burtscher, H. (2017) 'Characterizing particulate emissions from wood burning appliances including secondary organic aerosol formation potential', *Journal of Aerosol Science*, 114, pp. 21–30.
- Khristova, P., Yossifov, N. and Gabir, S. (1996) 'Particle board from sunflower stalks: Preliminary trials', *Bioresource Technology*, 58(3), pp. 319–321.
- Klímek, P. *et al.* (2016) 'Using sunflower (*Helianthus annuus* L.), topinambour (*Helianthus tuberosus* L.) and cup-plant (*Silphium perfoliatum* L.) stalks as alternative raw materials for particleboards', *Industrial Crops and Products*, 92, pp. 157–164.
- Kong, M. *et al.* (2010) 'Antimicrobial properties of chitosan and mode of action: A state of the art review', *International Journal of Food Microbiology*, 144(1), pp. 51–63.
- Korol, J., Burchart-Korol, D. and Pichlak, M. (2016) 'Expansion of environmental impact assessment for eco-efficiency evaluation of biocomposites for industrial application', *Journal of Cleaner Production*, 113, pp. 144–152.
- Le Duigou, A. *et al.* (2012) 'PLLA/Flax Mat/Balsa Bio-Sandwich—Environmental Impact and Simplified Life Cycle Analysis', *Applied Composite Materials*, 19(3), pp. 363–378.
- Le Duigou, A. and Baley, C. (2014) 'Coupled micromechanical analysis and life cycle assessment as an integrated tool for natural fibre composites development', *Journal of Cleaner Production*, 83, pp. 61–69.
- Le Duigou, A., Davies, P. and Baley, C. (2011) 'Environmental Impact Analysis of the Production of Flax to be Used as Composite Material Reinforcement', *Journal of Biobased Materials and Bioenergy*, 5, pp. 1–13.
- Lilholt, H. *et al.* (1999) 'Natural Composites Based on Cellulosic Fibres and Polypropylene Matrix. Their Processing and Characterisation', *Proceedings of ICCM 12, Paris*, p. 9.
- Liu, W. *et al.* (2017) 'Economic and life cycle assessments of biomass utilization for bioenergy products', *Biofuels, Bioproducts and Biorefining*, 11(4), pp. 633–647.
- Maibach, M., Peter, D. and Seiler, B. (1999) *Ökoinventar Transporte : Grundlagen für den ökologischen Vergleich von Transportsystemen und den Einbezug von Transportsystemen in Ökobilanzen*. 2nd edn. Zürich: Infrac.
- Mancebo, F. (2010) *Le développement durable*. 2ème. Paris: Armand Colin.
- Marais, C. (2005) *L'âge du plastique: Découvertes et Utilisations*. Editions L'Harmattan.

- Marechal, V. and Rigal, L. (1999) 'Characterization of by-products of sunflower culture – commercial applications for stalks and heads', *Industrial Crops and Products*, 10(3), pp. 185–200.
- Mathias, J.-D. *et al.* (2015) 'Upcycling Sunflower Stems as Natural Fibers for Biocomposite Applications', *BioResources*, 10(4), pp. 8076–8088–8088.
- Mati-Baouche, N. *et al.* (2014) 'Mechanical, thermal and acoustical characterizations of an insulating bio-based composite made from sunflower stalks particles and chitosan', *Industrial Crops and Products*, 58, pp. 244–250.
- Mati-Baouche, N. *et al.* (2016) 'Sound absorption properties of a sunflower composite made from crushed stem particles and from chitosan bio-binder', *Applied Acoustics*, 111, pp. 179–187.
- Météo-France (2020) *Normales et relevés sur la station de NÎMES*. Available at: <http://www.meteofrance.com/climat/france/nimes/30189001/normales> (Accessed: 18 March 2020).
- Miller, S. A., Landis, A. E. and Theis, T. L. (2007) 'Feature: Environmental Trade-offs of Biobased Production', *Environmental Science & Technology*, 41(15), pp. 5176–5182.
- Miyamoto, A. and Chang, K. C. (1992) 'Extraction and Physicochemical Characterization of Pectin from Sunflower Head Residues', *Journal of Food Science*, 57(6), pp. 1439–1443.
- Mohan, A. M., Reddy, G. V. N. and Reddy, M. R. (1997) 'Utilization of sunflower (*Helianthus annuus*) heads as roughage source in complete diets', *Indian Journal of Animal Sciences*, 67(12), pp. 1098–1100.
- Moora, H. and Lahtvee, V. (2009) 'Electricity Scenarios for the Baltic States and Marginal Energy Technology in Life Cycle Assessments – a Case Study of Energy Production from Municipal Waste Incineration', *Oil Shale*, 26, pp. 331–346.
- Morton-Jones, D. H. and Ellis, J. W. (1986) "'Fiberlam" Aircraft Flooring', in Morton-Jones, D. H. and Ellis, J. W. (eds) *Polymer Products: Design, Materials and Processing*. Dordrecht: Springer Netherlands, pp. 211–220.
- Munoz, I. *et al.* (2018) 'Life cycle assessment of chitosan production in India and Europe', *International Journal of Life Cycle Assessment*, 23(5), pp. 1151–1160.
- Nagalakshmi, D., Reddy, D. N. and Prasad, M. R. (2016) 'Effect of feeding expander extruder processed sunflower heads based complete diets on performance, nutrient digestibility and carcass characteristics of lambs', *Indian Journal of Animal Research*, (OF).
- Nemecek, T. and Kägi, T. (2007) 'Life Cycle Inventories of Agricultural Production Systems - Ecoinvent Report No. 15', (15), p. 360.
- Newkirk, R. (2015) *Flax Feed Industry Guide*. Winnipeg, Manitoba: Flax Canada. Available at: <https://flaxcouncil.ca/wp-content/uploads/2015/02/Flax-Feed-Industry-Guide-Final.pdf> (Accessed: 3 December 2018).
- NF EN 14995 (2007) 'Plastics - Evaluation of compostability - Test scheme and specifications'.
- NF T51-800 (2015) 'Plastics - Specifications for plastics suitable for home composting'.
- Nyström, R. *et al.* (2017) 'Influence of Wood Species and Burning Conditions on Particle Emission Characteristics in a Residential Wood Stove', *Energy & Fuels*, 31(5), pp. 5514–5524.

- Oancea, I. *et al.* (2018) 'Considerations on sound absorption coefficient of sustainable concrete with different waste replacements', *Journal of Cleaner Production*, 203, pp. 301–312.
- Pawelzik, P. *et al.* (2013) 'Critical aspects in the life cycle assessment (LCA) of bio-based materials – Reviewing methodologies and deriving recommendations', *Resources, Conservation and Recycling*, 73(Supplement C), pp. 211–228.
- Peças, P. *et al.* (2018) 'Natural Fibre Composites and Their Applications: A Review', *Journal of Composites Science*, 2(4), p. 66.
- Pehme, S., Veromann, E. and Hamelin, L. (2017) 'Environmental performance of manure co-digestion with natural and cultivated grass – A consequential life cycle assessment', *Journal of Cleaner Production*, 162, pp. 1135–1143.
- Philp, J. C., Ritchie, R. J. and Guy, K. (2013) 'Biobased plastics in a bioeconomy', *Trends in Biotechnology*, 31(2), pp. 65–67.
- Piemonte, V. (2011) 'Bioplastic Wastes: The Best Final Disposition for Energy Saving', *Journal of Polymers and the Environment*, 19(4), pp. 988–994.
- Pittau, F. *et al.* (2018) 'Fast-growing bio-based materials as an opportunity for storing carbon in exterior walls', *Building and Environment*, 129, pp. 117–129.
- Pizzol, M. *et al.* (2017) 'Normalisation and weighting in life cycle assessment: quo vadis?', *The International Journal of Life Cycle Assessment*, 22(6), pp. 853–866.
- Projet AF Filières (2018) *Analyse des flux des filières biomasse pour des stratégies régionales de bioéconomie., Modèle forêt-bois 1.1 - France et Régions*. Available at: https://www.flux-biomasse.fr/resultats/sankey_bois/France (Accessed: 3 December 2018).
- Qin, Y. and Suh, S. (2017) 'What distribution function do life cycle inventories follow?', *The International Journal of Life Cycle Assessment*, 22(7), pp. 1138–1145.
- Rajagopal, D. (2017) 'A Step Towards a General Framework for Consequential Life Cycle Assessment', *Journal of Industrial Ecology*, 21(2), pp. 261–271.
- Rizzarelli, P. *et al.* (2016) 'Determination of polyethylene in biodegradable polymer blends and in compostable carrier bags by Py-GC/MS and TGA', *Journal of Analytical and Applied Pyrolysis*, 117(Supplement C), pp. 72–81.
- da Rosa, L. C. *et al.* (2015) 'Use of rice husk and sunflower stalk as a substitute for glass wool in thermal insulation of solar collector', *Journal of Cleaner Production*, 104, pp. 90–97.
- Rouilly, A. and Rigal, L. (2002) 'Agro-Materials: A Bibliographic Review', *Journal of Macromolecular Science, Part C*, 42(4), pp. 441–479.
- Sanjay, M. R. *et al.* (2018) 'Characterization and properties of natural fiber polymer composites: A comprehensive review', *Journal of Cleaner Production*, 172, pp. 566–581.
- Santoyo-Castelazo, E., Gujba, H. and Azapagic, A. (2011) 'Life cycle assessment of electricity generation in Mexico', *Energy*, 36(3), pp. 1488–1499.
- SAS (2019) *New aircraft and fleet | SAS*. Available at: <https://www.sasgroup.net/about-sas/the-fleet/airbus-a319-a320-a320neo-a321/> (Accessed: 27 February 2019).

- Schiavoni, S. *et al.* (2016) 'Insulation materials for the building sector: A review and comparative analysis', *Renewable and Sustainable Energy Reviews*, 62, pp. 988–1011.
- Schmidt, J. H. and Muños, I. (2014) *The carbon footprint of Danish production and consumption: Literature review and model calculations*. Copenhagen: Danish Energy Agency. Available at: http://vbn.aau.dk/files/196725552/_dk_carbon_footprint_20140305final.pdf (Accessed: 19 February 2019).
- Schmidt, J. H. and Weidema, B. P. (2007) 'Shift in the marginal supply of vegetable oil', *The International Journal of Life Cycle Assessment*, 13(3), p. 235.
- Sharma, H. S. S. and van Sumere, C. F. (1992) *The Biology and processing of flax*. M Publications.
- Sisti, L. *et al.* (2018) 'Retting Process as a Pretreatment of Natural Fibers for the Development of Polymer Composites', in *Lignocellulosic Composite Materials*. Springer, Cham (Springer Series on Polymer and Composite Materials), pp. 97–135.
- Smith, P. and Olesen, J. E. (2010) 'Synergies between the mitigation of, and adaptation to, climate change in agriculture', *The Journal of Agricultural Science*, 148(5), pp. 543–552.
- Sonnemann, G. and Vigon, B. (2011) *Global guidance principles for life cycle assessment LCA databases: a basis for greener processes and products*. Paris: United Nations Environment Programme (UNEP).
- Spiridon, I. (2014) 'Natural fiber-polyolefin composites. Mini-review', *Cellulose Chemistry and Technology*.
- StarchEurope (2020) *The European starch industry, EU Starch Market Data*. Available at: <https://starch.eu/the-european-starch-industry/> (Accessed: 10 March 2021).
- Taghizadeh-Toosi, A. *et al.* (2014) 'C-TOOL: A simple model for simulating whole-profile carbon storage in temperate agricultural soils', *Ecological Modelling*, 292, pp. 11–25.
- Terres OléoPro (2016) 'Statistiques des oléagineux et plantes riches en protéines 2014 - 2015'. Available at: <https://www.terresoleopro.com/sites/default/files/mediabox/files/statistiques-terres-oleopro-2013-2014.pdf> (Accessed: 5 February 2019).
- Thorenz, A. *et al.* (2018) 'Assessment of agroforestry residue potentials for the bioeconomy in the European Union', *Journal of Cleaner Production*, 176, pp. 348–359.
- Ticoalu, A., Aravinthan, T. and Cardona, F. (2010) 'A review of current development in natural fiber composites for structural and infrastructure applications', in *Southern Region Engineering Conference*, Toowoomba, Australia, p. 5.
- Tokiwa, Y. *et al.* (2009) 'Biodegradability of Plastics', *International Journal of Molecular Sciences*, 10(9), pp. 3722–3742.
- Tonini, D., Hamelin, L. and Astrup, T. F. (2016) 'Environmental implications of the use of agro-industrial residues for biorefineries: application of a deterministic model for indirect land-use changes', *GCB Bioenergy*, 8(4), pp. 690–706.
- Tröger, F., Wegener, G. and Seemann, C. (1998) 'Miscanthus and flax as raw material for reinforced particleboards', *Industrial Crops and Products*, 8(2), pp. 113–121.

- UN Environment (2017) *What is Life Cycle Thinking?, The Life Cycle Initiative*. Available at: <https://www.lifecycleinitiative.org/starting-life-cycle-thinking/> (Accessed: 14 December 2017).
- UNEP HTOC (2014) 'Montreal Protocol on Substances that Deplete the Ozone Layer', *2014 Assessment Report*, 1(2), pp. 231–246.
- USRTL - Industrie Française du Lin (2019a) *Le Lin textile en 10 étapes*. Available at: <http://www.usrtl-ifl.fr/spip.php?article34> (Accessed: 19 June 2019).
- USRTL - Industrie Française du Lin (2019b) *Présentation de la fibre de lin*. Available at: <http://www.usrtl-ifl.fr/spip.php?article2> (Accessed: 18 June 2019).
- Vidal, R. *et al.* (2018) 'Life Cycle Assessment of Novel Aircraft Interior Panels Made from Renewable or Recyclable Polymers with Natural Fiber Reinforcements and Non-Halogenated Flame Retardants: LCA of Novel Aircraft Interior Panels', *Journal of Industrial Ecology*, 22(1), pp. 132–144.
- Vieira, D. R. and Bravo, A. (2016) 'Life cycle carbon emissions assessment using an eco-demonstrator aircraft: the case of an ecological wing design', *Journal of Cleaner Production*, 124, pp. 246–257.
- WCED, (World Commission on Environment and Development) (1987) *Our Common Future (Brundtland Report)*. United Nations.
- Weidema, B. *et al.* (2013) 'The ecoinvent database: Overview and methodology, Data quality guideline for the ecoinvent database version 3', p. 169.
- Weidema, B. P. *et al.* (2018) 'Attributional or consequential Life Cycle Assessment: A matter of social responsibility', *Journal of Cleaner Production*, 174, pp. 305–314.
- van der Werf, H. M. G. and Turunen, L. (2008) 'The environmental impacts of the production of hemp and flax textile yarn', *Industrial Crops and Products*, 27(1), pp. 1–10.
- Wernet, G. *et al.* (2016) 'The ecoinvent database version 3 (part I): overview and methodology', *The International Journal of Life Cycle Assessment*, 21(9), pp. 1218–1230.
- Wilhelm, S. (2018) 'Life Cycle Assessment of Electricity Production from Airborne Wind Energy', in Schmehl, R. (ed.) *Airborne Wind Energy*. Singapore: Springer Singapore, pp. 727–750.
- Yadav, H. *et al.* (2017) 'Enhancement of applicability of rock phosphate in alkaline soils by organic compost', *Applied Soil Ecology*, 113(Supplement C), pp. 80–85.
- Yan, L., Chouw, N. and Jayaraman, K. (2014) 'Flax fibre and its composites – A review', *Composites Part B: Engineering*, 56, pp. 296–317.
- Yang, Y. (2016) 'Two sides of the same coin: consequential life cycle assessment based on the attributional framework', *Journal of Cleaner Production*, 127(Supplement C), pp. 274–281.
- Yates, M. R. and Barlow, C. Y. (2013) 'Life cycle assessments of biodegradable, commercial biopolymers—A critical review', *Resources, Conservation and Recycling*, 78(Supplement C), pp. 54–66.
- Zamagni, A. *et al.* (2012) 'Lights and shadows in consequential LCA', *The International Journal of Life Cycle Assessment*, 17(7), pp. 904–918.

- Zhang, F. *et al.* (2017) 'Life cycle assessment of diammonium- and monoammonium-phosphate fertilizer production in China', *Journal of Cleaner Production*, 141, pp. 1087–1094.
- Zhang, Y. *et al.* (2016) 'Isolation and structural characterization of a low-molecular-weight pectic polysaccharide SHPPB-1 isolated from sunflower heads', *Journal of Carbohydrate Chemistry*, 35(5), pp. 273–285.

ANNEXES

ANNEXES

VI.1. Annexes Chapter II

VI.1.1. SI – Flax fiber for technical textile: A Life Cycle Inventory

LCI - Technical textile

CROP CULTIVATION		Value	Units	Process	Database	Process used by:	Value reference	Comments
Input								
Tillage	Plowing	3	ha	Tillage, ploughing (CH) processing Conseq, U	Ecoinvent 3	1 & 2	2	No data sheet for Market for / Only European country / 3 passages
	Rotary cultivator	1	ha	Tillage, rotary cultivator (CH) processing Conseq, U	Ecoinvent 3	1 & 2	1 & 2	No data sheet for Market for / Only European country / 1 passage
	Harrowing	1	ha	Tillage, harrowing, by rotary harrow (CH) processing Conseq, U	Ecoinvent 3	1 & 2	1 & 2	No data sheet for Market for / Only European country / 1 passage
Sowing		1	ha	Sowing (CH) processing Conseq, U	Ecoinvent 3	1 & 2	1 & 2	No data sheet for Market for / Only European country / 1 passage
Fertilizing & zinc application by broadcaster		3	ha	Fertilising, by broadcaster (CH) processing Conseq, U	Ecoinvent 3	1 & 2	1 & 2	No data sheet for Market for / Only European country / 3 passages
Plant protection (Herbicides&Pesticides) by field sprayer		5.5	ha	Application of plant protection product, by field sprayer (CH) processing Conseq, U	Ecoinvent 3	1 & 2	1 & 2	Market for Data sheet available / Only European country / 5.5 passages
Pulling		1	ha	Swath, by rotary windrower (CH) processing Conseq, U	Ecoinvent 3	1 & 2	1 & 2	Market for Data sheet available / Only European country / 1 passages
Seeds		115	kg	Flaxseed, national average, animal feed, at farm gate/FR U	Agribalyse	1	-	
Land Use		1	ha*a	Occupation, annual crop	Substance	-	-	
Fertilizers	Potassium chloride	117	kg	Potassium chloride, as K2O/FR U	Agribalyse	-	1 & 2	Data includes transport.
	Ammonium nitrate phosphate	86	kg	Ammonium nitrate phosphate, as N/FR U	Agribalyse	-	1 & 2 & 4	Uses RER and RoW data from Ecoinvent based on Imports data.
	Triple superphosphate	146	kg	Triple superphosphate, as P2O5/FR U	Agribalyse	-	1 & 2	Data from Ecoinvent is Alloc Rec 5
Pesticides	Carbendazim / Benimidazole	150	g	Benimidazole-compound (GLO) market for Conseq, U	Ecoinvent 3	1	1 & 2	
	Prochloraze	38	g	Cyclic N-compound (GLO) market for Conseq, U	Ecoinvent 3	1	1 & 2	For seed treatment (prochloraze)
	Flusilazole	300	g	Cyclic N-compound (GLO) market for Conseq, U	Ecoinvent 3	1	1 & 2	During flax cultivation (flusilazole)
	Thirame	73	g	Dithiocarbamate-compound (GLO) market for Conseq, U	Ecoinvent 3	1	1 & 2	
Herbicides	Triallate	144	g	[thio]carbamate-compound (GLO) market for Conseq, U	Ecoinvent 3	1	1 & 2	
	Linuron	90	g	[sulfony]urea-compound (GLO) market for Conseq, U	Ecoinvent 3	1	1 & 2	
	Bentazone	1584	g	Benzo[thia]diazole-compound (GLO) market for Conseq, U	Ecoinvent 3	1	1 & 2	
Insecticides		15	g	Pyrethroid-compound (GLO) market for Conseq, U	Ecoinvent 3	1	1 & 2	
Zinc	For seed's treatment	414	g	Zinc concentrate (GLO) market for Conseq, U	Ecoinvent 3	1	1	Not considered in the model as Agribalyse process for flax seed production already considers their treatment with zinc.
	For soil treatment after sowing	1000	g	Zinc concentrate (GLO) market for Conseq, U	Ecoinvent 3	1	1	
Copper		9.53	g	Copper	Substance	-	3	Copper is taken out of the soil by the plant. 8.4 g of Copper taken by the 6170 kg of flax yield from 1 ha as considered by the reference (0.001361 kg Cu/kg FM of flax)
Iron		3.48	kg	Iron	Substance	-	-	553 mg/kg DM - Value from Feedipedia "Flax straw" data (https://www.feedipedia.org/node/12103)
Calcium		30.24	kg	Calcium	Substance	-	-	4.8 g/kg DM - Value from Feedipedia "Flax straw" data (https://www.feedipedia.org/node/12103)
Carbon dioxide (captured from air)		10395	kg	Carbon dioxide, in air	Substance	-	2	Le Duigou et al. 2011 report 1,65 kg of CO ₂ sequestered to produce one kg of dry flax fibers.
Output								
Flax stems		7000	kg	"Crop cultivation" process created	-	-	1 & 2	
Induced Land Use Change		0.05	ha	"iLUC" process created	-	-	-	Detailed information on the creation of the process on the iLUC tab
Emissions to air	Ammonia	0.73	kg	Ammonia	Substance	-	1	
	Dinitrogen monoxide	0.49	kg	Dinitrogen monoxide	Substance	-	1	
	Nitrogen dioxide	0.1	kg	Nitrogen dioxide	Substance	-	1	
	Carbendazim	7.5	g	Carbendazim	Substance	-	1	
	Triallate	136.8	g	Triallate	Substance	-	1	
	Linuron	45	g	Linuron	Substance	-	1	
	Bentazone	237.6	g	Bentazone	Substance	-	1	
	Deltamethrin (pyrethroid)	0.15	g	Deltamethrin	Substance	-	1	

Emissions to water	Carbendazim	0.75	g	Carbendazim	Substance	-	1	
	Triallate (groundwater)	1.57	g	Triallate (Sub-compartment: groundwater)	Substance	-	1	
	Triallate (river)	0.86	g	Triallate (Sub-compartment: river)	Substance	-	1	
	Linuron	0.45	g	Linuron	Substance	-	1	
	Bentazone	7.9	g	Bentazone	Substance	-	1	
	Deltamethrin (pyrethroid)	0.075	g	Deltamethrin (pyrethroid)	Substance	-	1	
	Nitrate	25	kg	Nitrate	Substance	-	1	
	Phosphate	0.93	kg	Phosphate	Substance	-	1	
	Nickel (river)	1.51	g	Nickel (Sub-compartment: river)	Substance	-	3	
	Phosphorus (groundwater)	0.07	kg	Phosphorus (Sub-compartment: groundwater)	Substance	-	3	
	Phosphorus (river)	0.276	kg	Phosphorus (Sub-compartment: river)	Substance	-	3	
	Cadmium (groundwater)	42.24	mg	Cadmium (Sub-compartment: groundwater)	Substance	-	3	
	Cadmium (river)	18.68	mg	Cadmium (Sub-compartment: river)	Substance	-	3	
	Chromium (groundwater)	20.87	g	Chromium (Sub-compartment: groundwater)	Substance	-	3	
	Chromium (river)	2.18	g	Chromium (Sub-compartment: river)	Substance	-	3	
	Lead (groundwater)	102.7	mg	Lead (Sub-compartment: groundwater)	Substance	-	3	
	Lead (river)	307.3	mg	Lead (Sub-compartment: river)	Substance	-	3	
	Mercury (groundwater)	0.17	mg	Mercury (Sub-compartment: groundwater)	Substance	-	3	
	Mercury (river)	0.44	mg	Mercury (Sub-compartment: river)	Substance	-	3	
	Zinc (groundwater)	10.4	g	Zinc (Sub-compartment: groundwater)	Substance	-	3	
Zinc (river)	1.44	g	Zinc (Sub-compartment: river)	Substance	-	3		
Copper (groundwater)	2.73	g	Copper (Sub-compartment: groundwater)	Substance	-	3		
Copper (river)	1.4	g	Copper (Sub-compartment: river)	Substance	-	3		
Emissions to soil	Arsenic (As)	0.56	g	Arsenic	Substance	-	1	
	Cadmium (Cd)	18	g	Cadmium	Substance	-	1	
	Cobalt (Co)	1.5	g	cobalt	Substance	-	1	
	Chromium (Cr)	92	g	Chromium	Substance	-	1	
	Copper (Cu)	17	g	copper	Substance	-	1	
	Iron (Fe)	5965	g	Iron	Substance	-	1	
	Mercury (Hg)	0.011	g	Mercury	Substance	-	1	
	Molybdenum (Mo)	1.2	g	Molybdenum	Substance	-	1	
	Nickel (Ni)	17	g	Nickel (Sub-compartment: river)	Substance	-	1	
	Lead (Pb)	2.2	g	Lead	Substance	-	1	
	Selenium (Se)	1	g	Selenium	Substance	-	1	
	Zinc (Zn)	116	g	Zinc	Substance	-	1	

RETTING		Value	Units	Datasheet	Database	As used by:	Reference	Comments
Input								
Flax stems		7000	kg	-	-	-	-	
Land Use		1	ha	Occupation, annual crop	Substance	-	1 & 2	
Agricultural Machinery	Turnover	2	ha	Haying, by rotary tedder (CH) processing Conseq, U	Agribalyse	-	1 & 2	Ecoinvent datasheet selected (Agribalyse datasheet units are in hr) / 2 passages
	Collecting	4.67	m ³	Fodder loading, by self-loading trailer (CH) processing Conseq, U	Ecoinvent 3	1 & 2	1 & 2	Value based on flax density=1,5g/cm3 (Amiri et al., 2017)
Output*								
Retted flax		6230	kg	"Retting" process created	Substance	-	1 & 2	89% of flax stems yield
CO ₂ emissions		545	kg	Carbon dioxide, biogenic	Substance	-	-	
CH ₄ emissions		4.55	kg	Methane, biogenic	Substance	-	-	
CO emissions		1.21	kg	Carbon monoxide, biogenic	Substance	-	-	
NH ₃ emissions		0.42	kg	Ammonia	Substance	-	-	
N ₂ O direct emissions		0.098	kg	Dinitrogen monoxide	Substance	-	-	
N ₂ O indirect emissions		5.4E-05	kg	Dinitrogen monoxide	Substance	-	-	

SCUTCHING		Value	Units	Datasheet	Database	As used by:	Reference	Comments
Input								
Retted flax		6230	kg	-	-	-	-	
Electricity		723	kWh	Electricity, low voltage (FR) market for Conseq, U	Ecoinvent 3	1	1 & 2	0.116 kWh per kg of retted flax to go throught the scutching machine
Transport from field		249	tkm	Transport, freight, lorry 16-32 metric ton, EURO3 (GLO) market for Conseq, U	Ecoinvent 3	1	1	Considers a 40 km distance as scutching facilities are located close to the cultivation fields.

Output							
Long fibers	1470	kg	"Scutching" process created	-	-	1 & 2	21% of flax stems yield
Short fibres	770	kg	"Scutching" process created	-	-	1 & 2	11% of flax stems yield
Seeds	350	kg	"Scutching" process created	-	-	1 & 2	5% of flax stems yield
Shives	2520	kg	"Scutching" process created	-	-	1 & 2	36% of flax stems yield
Flakes	490	kg	"Scutching" process created	-	-	1 & 2	7% of flax stems yield
Inert residues	630	kg	"Scutching" process created	-	-	1 & 2	9% of flax stems yield
Co-products fate*							
Production of glass fibre composites (Short fibres)	-693	kg	"Avoided glass fibre production (Short fibres)" process created	Ecoinvent 3	-	-	Copied from "Glass fibre (GLO) market for Conseq, U" / 1 to 1 fiber substitution is considered.
Marginal oil production (Seeds)	-99	kg	"Avoided palm oil production (Seeds)" process created	Ecoinvent 3	-	-	Copied from "Palm oil, refined (GLO) market for Conseq, U"
Marginal animal feed production (Linseed meal)	Marginal protein (soybean)	-177	kg	"Avoided soybean meal production (Linseed meal)" process created	Ecoinvent 3	-	Copied from "Soybean meal (GLO) market for Conseq, U"
	Marginal carbohydrate (maize)	-149	kg	"Avoided maize grain production (Linseed meal)" process created	Ecoinvent 3	-	Copied from "Maize grain (GLO) market for Conseq, U"
	Marginal fats (palm oil)	-3.83	kg	"Avoided palm oil production (Linseed meal)" process created	Ecoinvent 3	-	Copied from "Palm oil, refined (GLO) market for Conseq, U"
Avoided Land Use Change	-0.013	ha	ILUC	-	-	-	
Combustion of woody residues	41	GJ	"Wood residues combustion" process created from proxy	Ecoinvent 3	-	-	Copied from "Heat, district or industrial, other than natural gas (CH) heat production, softwood chips from forest, at furnace 300kW Conseq, U"
Heat production from natural gas (Shives)	-33	GJ	"Avoided heat production from natural gas (Shives)" process created	Ecoinvent 3	-	-	Copied from "Heat, central or small-scale, natural gas (Europe without Switzerland) market for heat, central or small-scale, natural gas Conseq, U"
Marginal animal feed production (Flakes)	Marginal protein (soybean)	-81	kg	"Avoided soybean meal production (Flakes)" process created	Ecoinvent 3	-	Copied from "Soybean meal (GLO) market for Conseq, U"
	Marginal fibre (hay)	-666	kg	"Avoided hay production (Flakes)" process created	Ecoinvent 3	-	Copied from "Hay (GLO) market for Conseq, U"
Use of inert residues as amendment	630	kg	"Soil amendment (Scutching)" process created	Ecoinvent 3	-	-	
COMBING							
Value	Units	Datasheet		Database	As used by:	Reference	Comments
Input							
Long fibers	1470	kg	-	-	-	-	
Electricity	809	kWh	Electricity, low voltage (FR) market for Conseq, U	Ecoinvent 3	-	1 & 2	0.55 kWh per kg of scutched flax
Output							
Flax Silver	980	kg	"Combing" process created	Ecoinvent 3	-	1 & 2	14% of flax stem yield
Flax tow	420	kg	"Combing" process created	Ecoinvent 3	-	1 & 2	6% of flax stem yield
Dust	70	kg	"Combing" process created	Ecoinvent 3	-	1 & 2	1% of flax stem yield
Co-products fate*							
Use of inert residues as amendment	490	kg	"Soil amendment (Combing)" process created	Ecoinvent 3	-	-	Flax tow and Dust mass are considered as a whole for the composting process
SPINNING							
Value	Units	Datasheet		Database	As used by:	Reference	Comments
Input							
Flax Silver	980	kg	-	-	-	1 & 2	
Electricity	4414	kWh	Electricity, low voltage (CN) market for Conseq, U	Ecoinvent 3	-	1	4.85 kWh/kg of yarn produced (Includes energy intake for washing, bleaching and spinning; might be lower for technical fabric as some of these steps might not be required).
Gas	24024	MJ	Electricity, high voltage (CN-JS) electricity production, natural gas, conventional power plant Conseq, U	Ecoinvent 3	-	1	26.4 MJ/ kg of yarn produced (Includes energy intake for washing, bleaching and spinning; might be lower for technical fabric as some of these steps might not be required).
Water	12.74	m ³	Water, unspecified natural origin, CN	Substances	-	1	13 L/kg of silver spun into yarn (as wet-spinning is considered by the reference).
Lubricating oil	49000	g	Lubricating oil (GLO) market for Conseq, U	Ecoinvent 3	-	1	50 g/kg of silver spun into yarn.
Transport from Combing facility to port	147	tkm	Transport, freight, lorry 16-32 metric ton, EURO3 (GLO) market for Conseq, U	Ecoinvent 3	1	1	150 kms are considered between the Combing facility and Le Havre port.
Transport from port to port	19110	tkm	Transport, freight, sea, transoceanic ship (GLO) market for Conseq, U	Ecoinvent 3	1	1	19500 kms are considered between the Le Havre port in France and the Nanjing port in china (Jiangsu province).
Transport from port to factory	196	tkm	Transport, freight, lorry 16-32 metric ton, EURO3 (GLO) market for Conseq, U	Ecoinvent 3	1	1	200 km are considered between the Nanjing port and the factory where the combing, spinning and weaving stages will take place.
Input data for Sensitivity Analysis (production in France rather than China)							
Electricity	4414	kWh	Electricity, low voltage (FR) market for Conseq, U	Ecoinvent 3	-	-	
Gas	24024	MJ	Electricity, high voltage (FR) electricity production, natural gas, conventional power plant Conseq, U	Ecoinvent 3	-	-	
Water	12.74	m ³	Water, unspecified natural origin, FR	Substances	-	-	
Transport from Combing to Spinning facility	98	tkm	Transport, freight, lorry 16-32 metric ton, EURO3 (GLO) market for Conseq, U	Ecoinvent 3	-	-	100 km are considered between Combing and Spinning facilities as they're based in the Normandy area in France (from CELC-annuaries webpage data).
Output							
Flax Yarn	910	kg	"Spinning" process created	-	-	1	4% mass loss according to BioIntelligence (2007), not specified why.
Wastewater	12.74	m ³	"Wastewater treatment (from Spinning)" process created	Ecoinvent 3	-	1	Copied from "Wastewater, average (RoW) treatment of, capacity 1E9l/year Conseq, U"

WEAVING	Value	Units	Datasheet	Database	As used by:	Reference	Comments
Input							
Flax Yarn	910	kg	-	-	-	1	
Electricity	11830	kWh	Electricity, low voltage [CN] market for Conseq, U	Ecoinvent 3	-	1	13 kWh/kg of yarn woven.
Starch	159	kg	Potato starch [GLO] market for Conseq, U	Ecoinvent 3	-	1	175 g of starch/kg of yarn processed. There is no potato starch datasheet for China so we take the Global information available.
Transport from factory to port	168	tkm	Transport, freight, lorry 16-32 metric ton, EURO3 [GLO] market for Conseq, U	Ecoinvent 3	1	1	200 km are considered between the Nanjing port and the factory where the combing, spinning and weaving stages will take place.
Transport from port to port	16380	tkm	Transport, freight, sea, transoceanic ship [GLO] market for Conseq, U	Ecoinvent 3	1	1	19500 kms are considered between the Le Havre port in France and the Nanjing port in china (Jiangsu province).
Transport from port to distribution place	168	tkm	Transport, freight, lorry 16-32 metric ton, EURO3 [GLO] market for Conseq, U	Ecoinvent 3	1	1	200 km are considered from porto to distribution facilities (reference considers Paris as distribution place)
Input data for Sensitivity Analysis (production in France rather than China)							
Electricity	11830	kWh	Electricity, low voltage [FR] market for Conseq, U	Ecoinvent 3	-	-	
Transport from Spinning to Weaving facility	182	tkm	Transport, freight, lorry 16-32 metric ton, EURO3 [GLO] market for Conseq, U	Ecoinvent 3	-	-	200 kms are considered between the Spinning and Weaving facilities (from CELC-annuaries webpage data). Transport of flax yarn.
Transport from Weaving facility to Distributors	168	tkm	Transport, freight, lorry 16-32 metric ton, EURO3 [GLO] market for Conseq, U	Ecoinvent 3	-	-	200 kms are considered between the Weaving facilities and Distributors (from CELC-annuaries webpage data). Transport of finished product (technical textile).
Output							
Technical textile	840	kg	"Weaving" process created	-	-	1	

Units are expressed per hectare used per year

References

¹ BioIntelligence (2007)

² Le Duigou et al., 2011

³ Besandoun et al., 2016

⁴ Flaxseed Datasheet (Agribalyse)

LCI - Land Use Change

ILUC	1	ha	Process	Database	Comments
Input					
Land expansion	1	ha	Land expansion process created	-	
Land intensification	1	ha	Land intensification process created	-	
Land expansion					
Input					
Land expansion_clearing	1	ha	Land expansion_clearing process created	-	
Land expansion_foregone sequestration	1	ha	Land expansion_foregone sequestration process created	-	
Land expansion_clearing					
Output					
Carbon dioxide emissions to air	71.59	ton	Carbon dioxide, land transformation	Substance	Land clearing, AG biomass
Carbon monoxide emissions to air	4.708	ton	Carbon monoxide, land transformation	Substance	Land clearing, AG biomass
Methane emissions to air	0.3068	ton	Methane, land transformation	Substance	Land clearing, AG biomass
Dinitrogen monoxide emissions to air	0.00908	ton	Dinitrogen monoxide	Substance	Land clearing, AG biomass
Nitrogen oxides emissions to air	0.07329	ton	Nitrogen oxides	Substance	NOx as NO2. Land clearing, biomass
Land expansion_foregone sequestration					
Output					
Carbon dioxide emissions to air	0.74	ton	Carbon dioxide, land transformation	Substance	
Land intensification					
Input					
Nitrogen (N) fertilizer	166	kg	Urea, as N {GLO} market for Conseq, U	Ecoinvent v3.4	Additional fertilizer used in intensified production
Phosphate (P) fertilizer	68	kg	Phosphate fertiliser, as P2O5 {RER} diammonium phosphate production Conseq, U	Ecoinvent v3.4	Additional fertilizer used in intensified production. No GLO so RER selected.
Potassium (K) fertiliser	47	kg	Potassium chloride, as K2O {GLO} market for Conseq, U	Ecoinvent v3.4	Additional fertilizer used in intensified production
Output					
Carbon dioxide emissions to air	261	kg	Carbon dioxide	Substance	From urea CO2. IPCC (2006) Chap 11
Dinitrogen monoxide emissions to air	4.4	kg	Dinitrogen monoxide	Substance	
Ammonia emissions to air	4	kg	Ammonia	Substance	
Nitrogen oxides emissions to air	6	kg	Nitrogen oxides	Substance	
Nitrate emissions to water	146	kg	Nitrate	Substance	

LCI – Emissions from inert residues

Soil amendment (Scutching)		Value	Units	Datasheet	Database	Reference	Comments
Output*							
Emissions to air	CO ₂ emissions	0.31	kg	Carbon dioxide, biogenic	Substance	Hamelin et al. (2014)	CO ₂ = 71% of total C
	NH ₃ emissions	2.0E-05	kg	Ammonia	Substance		NH ₃ -N = 0,5% of TAN TAN = 92% of total N
	N ₂ O direct emissions	5.5E-05	kg	Dinitrogen monoxide	Substance		N ₂ O-N direct = 0,01 kg / kg of total N
	N ₂ O indirect emissions	2.6E-07	kg	Dinitrogen monoxide	Substance		N ₂ O-N indirect = 0,01 kg / kg (NH ₃ -N NO _x -N)
	N ₂ O indirect emissions (from N leaching)	1.4E-05	kg	Dinitrogen monoxide	Substance		N ₂ O-N indirect = 0,0075 kg / kg of N leaching
	NO _x emissions	1.6E-06	kg	Nitrate compounds	Substance		NO _x -N= 0,01*N ₂ O-N direct
Emissions to water	Nitrate leaching	1.2E-03	kg	Nitrate	Substance		N leaching = 33% of total N
	P leaching	2.3E-05	kg	Phosphate	Substance		P leaching = 5% of total P

Soil amendment (Combing)		Value	Units	Datasheet	Database	Reference	Comments
Output*							
Emissions to air	CO ₂ emissions	0.31	kg	Carbon dioxide, biogenic	Substance	Hamelin et al. (2014)	CO ₂ = 71% of total C
	NH ₃ emissions	2.0E-05	kg	Ammonia	Substance		NH ₃ -N = 0,5% of TAN TAN = 92% of total N
	N ₂ O direct emissions	5.5E-05	kg	Dinitrogen monoxide	Substance		N ₂ O-N direct = 0,01 kg / kg of total N
	N ₂ O indirect emissions	2.6E-07	kg	Dinitrogen monoxide	Substance		N ₂ O-N indirect = 0,01 kg / kg (NH ₃ -N NO _x -N)
	N ₂ O indirect emissions (from N leaching)	1.4E-05	kg	Dinitrogen monoxide	Substance		N ₂ O-N indirect = 0,0075 kg / kg of N leaching
	NO _x emissions	1.6E-06	kg	Nitrate compounds	Substance		NO _x -N= 0,01*N ₂ O-N direct
Emissions to water	Nitrate leaching	1.2E-03	kg	Nitrate	Substance		N leaching = 33% of total N
	P leaching	2.3E-05	kg	Phosphate	Substance		P leaching = 5% of total P

*Units per kg of inert residue

VI.1.2. SI – NFPCs: A game changer for the aviation sector?

Calculations concerning the biocomposite panel's proportions

For the production of 1m² of biocomposite panel, 3.5 m² of natural fiber polymer composite is required (1m² per skin and 1.5 m² for the omega core). The fibers are impregnated with the polymer matrix on a 60/40 ratio. Meaning that for every kg of fiber, 1.5 kg of matrix will be added. The technical textile has a grammage of 360 g/m², this results into 1.26 kg of flax fiber technical textile per m² of biocomposite panel to which 1.89 kg of matrix will be added.

The resin is 62% epoxy and 38% flame retardant agent. The resin is mixed with the hardener in an 82/12 ratio. Therefore, the 1.89 kg of matrix required for the NFPC production result from the mixture of 1.55 kg of resin (from where 0.96 kg are epoxy and 0.59 kg are the flame retardant agent) and 0.34 kg of hardener.

Calculations concerning the conventional panel's proportions

From the work of Vidal et al. (2018) the characteristics and raw materials' proportions from a conventional panel used in the aviation sector were identified. In their work, the authors consider a PVC finishing for the panel. As this finishing step is not taken into consideration in the work herein presented, the mass of the PVC film was subtracted from the total mass of the reference panel. Afterwards, the percentage that each of the components represent regarding the total mass was calculated. This percentage was used as reference for determining the proportion of the raw materials used for the production of the conventional panel.

The proportion of the hardener is not specified for the reference panel. For this reason, it was considered that the same proportions as those for the biocomposite panel applied (an 82/12 resin/hardener ratio). Results from the calculations are shown in Table VI-1.

Table VI-1. Proportion of the components per m² of conventional panel (inspired from Vidal et al., 2018)

Component	Material	Reference panel (Vidal et al., 2018)		Conventional panel
		Quantity (kg)	%	Quantity (kg)
Skins	Glass fiber	0.73	45	1.16
	Epoxy	0.42	26	0.55
	Hardener	-	-	0.12
	Flame retardant	0.07	4	0.10
Core (honeycomb)	Aramid fiber	0.41	25	0.55
	Phenolic resin	-	-	0.10
TOTAL		1.63		2.58

Chemical analysis of the resin and the hardener

The objective of the chemical analysis was to identify the type and structures of epoxides and amines present in the commercial resin and hardener used in the production of the biocomposite panel, as well as their proportions and the nature and number of additives present in the resin; specifically, the flame-retardant agent.

Firstly, the glass transition temperature of the resin was determined and compared to the DER 332 compound in order to corroborate the presence of DEGBA (Bisphenol A diglycidyl ether) which is a known constituent of epoxy resins. The transition temperature of the commercial resin was found to

be the same as that of DER 332 ($T_g = -41^\circ\text{C}$), which is a high purity DEGBA epoxy resin, thus confirming its presence in the mixture.

Furthermore, the spectrum of the resin was obtained through IR and ^1H NMR spectrometry. Results were compared to literature values and corroborated the presence of DEGBA, 1,6-Bis(2,3-epoxypropoxy)hexane and oxirane, 2-phenoxyethyl, the latter being a reaction product.

Through an XRD analysis, the flame-retardant agent was identified as ammonium phosphate. Additionally, a TGA analysis was carried out and results showed that the mineral charges constitute 38.4% of the resin mixture.

As done for the resin, IR and ^1H NMR spectrometry led to identification of 3-aminoethyl-3,5,5-trimethylcyclohexylamine, alkylether polyamine, and methylamine as the constituents of the commercial hardener. A pH-metric dosage of amine functions proved the molarity of the primary amine functions of the commercial hardener to be 8.1 mol/L.

Creation of an APP production process

APP is the fire suppressant agent found in the polymeric resin used in the production of the biocomposite panel, which corresponds to 38% (w/w) of the mixture. MAP synthesis follows the same process as APP synthesis.

MAP main application is as a nitrogen fertilizer, followed by their use as fire suppressant agents. It is therefore possible to use the MAP production process as a proxy to evaluate the impacts of APP production. The Ecoinvent process for MAP synthesis is available as “Nitrogen fertiliser, as N {RER}| monoammonium phosphate production | APOS, U”. Here an effort was made to make this process consequential. First, the “APOS” processes it contains were substituted by “Conseq” processes in order to keep the consequential approach taken by this study.

However, the process considers the production of MAP by the synthesis of ammonia and phosphoric acid in 70% solution state, which corresponds to a fertilizer grade. For the production of an industrial grade MAP, phosphoric acid is used in 85% solution state. Therefore, the Ecoinvent process was modified by replacing the phosphoric acid in 70% solution state to one with an 85% solution state, as an industrial grade is required for the synthesis of APP.

As the new solution is more concentrated, the value for phosphoric acid was adjusted from 1.9096 kg to 1.5726 kg per 0.3467 kg ammonia to produce 1 kg of MAP. In order to not over or underestimate the impact of MAP production with an application as a fire suppressant agent, the validity of the adjustment was proven by the comparison of three different MAP production processes: 1) MAP production with phosphoric acid 70% solution, 2) MAP production with phosphoric acid 85% solution with adjustment of value, and 3) MAP production with phosphoric acid 85% solution without value adjustment.

Flow chart of the production of a biocomposite sandwich panel

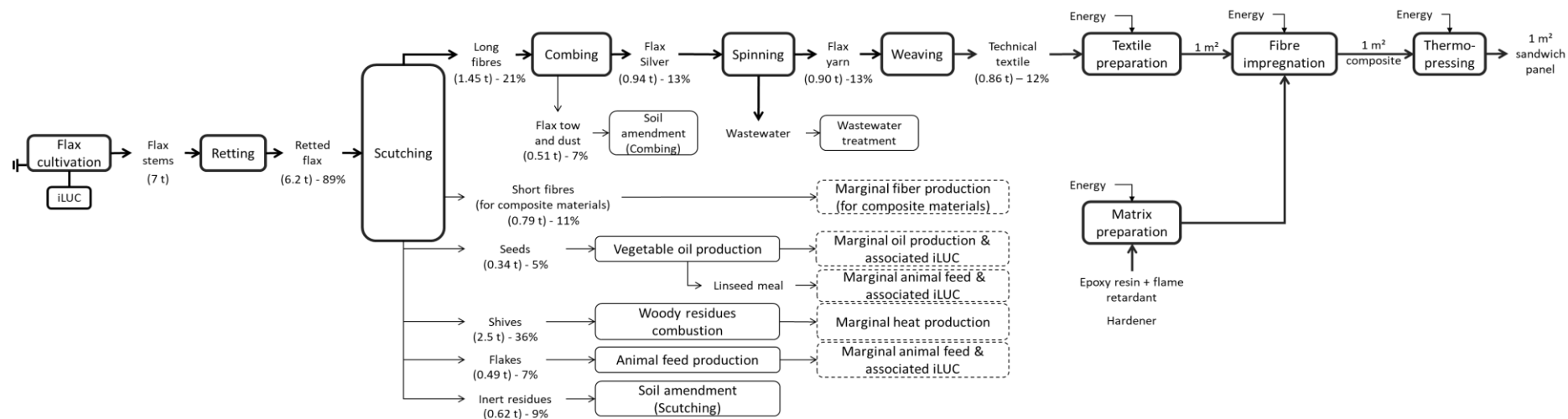

VI.2. Annexes Chapter III

VI.2.1. Agricultural Operation

Harvesting (by forage harvester)		Value	Units	Process	Database	Value reference	Comments
Input							
Forage harvester		4	kg/ha	Agricultural machinery, unspecified {CH} production Conseq, U	Ecoinvent 3.6	Ecoinvent report No. 15	Ecoinvent process was chosen following the "maize chopping" process as a forage harvester is used for this activity.
Shed (for storage of the forage harvester)		0.0024	m ² /ha	Shed {CH} construction Conseq, U	Ecoinvent 3.6	Ecoinvent report No. 15	
Diesel consumption		120.8	kg/ha	Diesel {CH} market for Conseq, U	Ecoinvent 3.6	Ecoinvent report No. 15	
Output							
Air emissions	HC	0.184	kg/ha	NMVOC, non-methane volatile organic compounds, unspecified origin	Substances	Ecoinvent report No. 15	
	NOx	3.34	kg/ha	Nitrogen oxides	Substances	Ecoinvent report No. 15	
	Carbon monoxide	0.556	kg/ha	Carbon monoxide, fossil	Substances	Ecoinvent report No. 15	
	Carbon dioxide	377	kg/ha	Carbon dioxide, fossil	Substances	Ecoinvent report No. 15	
	Sulfur dioxide	122	g/ha	Sulfur dioxide	Substances	Ecoinvent report No. 15	
	Lead	0	g/ha	Lead	Substances	Ecoinvent report No. 15	
	Methane	15.6	g/ha	Methane, fossil	Substances	Ecoinvent report No. 15	
	Benzene	0.88	g/ha	Benzene	Substances	Ecoinvent report No. 15	
	Particulate Matter	0.916	kg/ha	Particulates, < 2.5 um	Substances	Ecoinvent report No. 15	
	Cadmium	0.0012	g/ha	Cadmium	Substances	Ecoinvent report No. 15	
	Chromium	0.006	g/ha	Chromium	Substances	Ecoinvent report No. 15	
	Copper	0.205	g/ha	Copper	Substances	Ecoinvent report No. 15	
	Dinitrogen monoxide	14.5	g/ha	Dinitrogen monoxide	Substances	Ecoinvent report No. 15	
	Nickel	0.0084	g/ha	Nickel	Substances	Ecoinvent report No. 15	
	Zinc	0.12	g/ha	Zinc	Substances	Ecoinvent report No. 15	
	Benzo(a)pyrene	0.0036	g/ha	Benzo(a)pyrene	Substances	Ecoinvent report No. 15	
	Ammonia	2.42	g/ha	Ammonia	Substances	Ecoinvent report No. 15	
	Selenium	0.0012	g/ha	Selenium	Substances	Ecoinvent report No. 15	
	Polycyclic aromatic	0.397	g/ha	PAH, polycyclic aromatic hydrocarbons	Substances	Ecoinvent report No. 15	Sum of the different PAHs listed below.
		Benzo(a)-Anthracene	0.0096	g/ha	-	-	Ecoinvent report No. 15
	Benzo(b)-Fluoranthracene	0.006	g/ha	-	-	Ecoinvent report No. 15	
	Chrysene	0.024	g/ha	-	-	Ecoinvent report No. 15	
	Dibenzo(a,h)-Anthracene	0.0012	g/ha	-	-	Ecoinvent report No. 15	
	Fluoranthene	0.0544	g/ha	-	-	Ecoinvent report No. 15	
	Phenanthrene	0.302	g/ha	-	-	Ecoinvent report No. 15	
Soil emissions	Zinc	7.88	g/ha	Zinc	Substances	Ecoinvent report No. 15	
	Lead	1.28	g/ha	Lead	Substances	Ecoinvent report No. 15	
	Cadmium	0.30	g/ha	Cadmium	Substances	Ecoinvent report No. 15	

Machine Specifications

Forage harvester	
<i>Jaguar CLAAS 830</i>	
Weight of the machinery	10 000 kg
Operation time	4 h/ha
Lifetime of the machinery	10 000 h
Repair factor (initial materials replaced)	15%
Surface of the machine (without cutter bar)	15 m ²
Annual employment of the machinery	500 h
Lifespan of the storage unit	50 ans
Specific weight of diesel	0.755 kg/l
Energy input (diesel consumption per hour)	40 l/h
Nominal power of the machinery	367 CV
Number of tires	4 tires: - 2 front (680/75 R32) - 2 back (540/65 R24)

Conveyor belt	
Frequency	50 Hz
Motor power	0.22 kW
Power factor	0.61 cos ϕ
Electric current	1.56 A
Flow rate (1)	32.1 kg/h
Flow rate (2)	17.2 kg/h

Aspiration system	
Frequency	
Motor power	4 kW
Power factor	0.85 cos ϕ
Electric current	7.9 A
Weight	125 kg

Hammer Mill	
<i>Electra GOULU N 3212 2006</i>	
Frequency	50 Hz
Motor power	15 kW
Power factor	0.86 cos ϕ
Electric current	28 A
Flow rate	857 kg/h
Weight	350 kg

Sieve	
<i>Ritec 1800 (1800 mm diameter)</i>	
Frequency	50 Hz
Motor power	2 kW
Power factor	0.84 cos ϕ
Electric current	3.6 A
Flow rate	240 kg/h
Weight	

Drying furnace	
Frequency	50 Hz
Power (calculated)	5.7 kW
Electric current	15 A
Voltage	380 V

VI.2.2. Sunflower pith production

Stems' harvesting		Value	Units	Process	Database	Value reference	Comments
Input							
Harvest		6.67x10 ⁻⁴	ha	Harvest (by forage harvester)	Ecoinvent 3.6	Atelier LUMA	Considering a national average yield of 1.5 t FM/ha of harvestable sunflower stalks for France
Stem's storage		1.87x10 ⁻⁶	m ²	Shed (CH) construction Conseq, U	Ecoinvent 3.6	Atelier LUMA	Size of the shed used for the stock of sunflower stems is 9.6 x 5.6 m. A lifespan of 50 years was considered. 575 t of harvestable stems available per year.
Transport		0.022	tkm	Transport, freight, lorry 3.5-7.5 metric ton, euro3 {RER} market for transport, freight, lorry 3.5-7.5 metric ton, EURO3 Conseq, U	Ecoinvent 3.6	Atelier LUMA	Value was obtained considering a 22km distance between the field and the storage unit in Arles.
Output							
Sunflower stems		1	kg	Main product	-	Ovalie Innovation	Yield = 350-500 kg/ha according to Stéphane Ballas (Ovalie Innovation).
Crushing (by hammer mill)		Value	Units	Process	Database	Reference	Comments
Input							
Energy		0.0175	kWh	Electricity, low voltage (FR) market for Conseq, U	Ecoinvent 3.6	Agromat	Per kg of crushed stem.
Hammer mill		0.206	kg	Industrial machine, heavy, unspecified {GLO} market for Conseq, U	Ecoinvent 3.6	Agromat	Per kg of crushed stem.
Output							
Crushed stems		1	kg	Main product	-	Agromat	No mass loss, for every kg of stems passed through the hammer mill, 1 kg of crushed stems is produced.
Sieving		Value	Units	Process	Database	Reference	Comments
Input							
Energy		0.0333	kWh	Electricity, low voltage (FR) market for Conseq, U	Ecoinvent 3.6	Agromat	Per kg of sifted stem.
Sieve		1.588	kg	Industrial machine, heavy, unspecified {GLO} market for Conseq, U	Ecoinvent 3.6	Agromat	
Aspiration system	Energy	0.0167	kWh	Electricity, low voltage (FR) market for Conseq, U	Ecoinvent 3.6	Agromat	Per kg of sifted stem.
	Machinery	0.294	kg	Industrial machine, heavy, unspecified {GLO} market for Conseq, U	Ecoinvent 3.6	Agromat	
Output							
Sifted pith		1	kg	Main product	-	Agromat	
Bark		2.52	kg	Return to the field	Copied from Ecoinvent 3.6	Agromat	The transport of the co-product back to the field is considered in the process. The "Return to field" process was built considering 0,022 tkm of the "Transport, freight, lorry 3.5-7.5 metric ton, euro3 {RER} market for transport, freight, lorry 3.5-7.5 metric ton, EURO3 Conseq, U" Ecoinvent v3.6 process
Fines		0.44	kg	Return to the field	Copied from Ecoinvent 3.6	Agromat	The transport of the co-product back to the field is considered in the process. The "Return to field" process was built considering 0,022 tkm of the "Transport, freight, lorry 3.5-7.5 metric ton, euro3 {RER} market for transport, freight, lorry 3.5-7.5 metric ton, EURO3 Conseq, U" Ecoinvent v3.6 process
Losses		0.04	kg	Inert waste treatment Conseq	Copied from Ecoinvent 3.6	Agromat	

Purification (1st passage)		Value	Units	Process	Database	Reference	Comments		
Input									
Energy		0.0037	kWh	Electricity, low voltage {FR} market for Conseq, U	Ecoinvent 3.6	Agromat	Per kg of purified pith		
Conveyor belt		0.0092	m	Conveyor belt {GLO} market for Conseq, U	Ecoinvent 3.6	Agromat	Per kg of purified pith		
Aspiration system	Energy	0.1333	kWh	Electricity, low voltage {FR} market for Conseq, U	Ecoinvent 3.6	Agromat	Per kg of purified pith		
	Machinery	0.577	kg	Industrial machine, heavy, unspecified {GLO} market for Conseq, U	Ecoinvent 3.6	Agromat	Per kg of purified pith		
Output									
Purified pith		1	kg	Main product	-	Agromat			
Bark		0.9217	kg	Return to the field	Copied from Ecoinvent 3.6	Agromat	The transport of the co-product back to the field is considered in the process. The "Return to field" process was built considering 0,022 tkm of the "Transport, freight, lorry 3.5-7.5 metric ton, euro3 {RER} market for transport, freight, lorry 3.5-7.5 metric ton, EURO3 Conseq, U" Ecoinvent v3.6 process		
Losses		0.0392	kg	Inert waste treatment Conseq	-	Agromat			
Purification (2nd passage)		Value	Units	Process	Database	Reference	Comments		
Input									
Energy		0.0126	kWh	Electricity, low voltage {FR} market for Conseq, U	Ecoinvent 3.6	Agromat	Per kg of purified pith		
Conveyor belt		0.0159	m	Conveyor belt {GLO} market for Conseq, U	Ecoinvent 3.6	Agromat	Per kg of purified pith		
Aspiration system	Energy	0.406	kWh	Electricity, low voltage {FR} market for Conseq, U	Ecoinvent 3.6	Agromat	Per kg of purified pith		
	Machinery	0.994	kg	Industrial machine, heavy, unspecified {GLO} market for Conseq, U	Ecoinvent 3.6	Agromat	Per kg of purified pith		
Output									
Purified pith		1	kg	Main product	-	Agromat			
Bark		0.6896	kg	Return to the field	Copied from Ecoinvent 3.6	Agromat	The transport of the co-product back to the field is considered in the process. The "Return to field" process was built considering 0,022 tkm of the "Transport, freight, lorry 3.5-7.5 metric ton, euro3 {RER} market for transport, freight, lorry 3.5-7.5 metric ton, EURO3 Conseq, U" Ecoinvent v3.6 process		
Losses		0.0345	kg	Inert waste treatment Conseq	-	Agromat			
Crushing (by hammer mill) Panels E		Value	Units	Process	Database	Reference	Comments		
Input									
Energy		0.0175	kWh	Electricity, low voltage {FR} market for Conseq, U	Ecoinvent 3.6	Agromat	Motor power = 15kW & Flow rate = 857 kg/h		
Hammer mill		3.48x10 ⁻⁴	kg	Industrial machine, heavy, unspecified {RER} market for industrial machine, heavy, unspecified Conseq, U	Ecoinvent 3.6	Agromat	350 kg machine/(575000*,07) kg of panel /25 years lifespan of the machine = 0,000348		
Output									
Crushed panels		1	kg	Main product	-	Agromat			
Waste treatment sunflower pith panel		1	kg	Activity	Value	Units	Process	Reference	Comments
Crushing of the panels		1	kg	Stem's harvesting				Agromat	
Transportation to the field		0.022	tkm	Transport, freight, lorry 3.5-7.5 metric ton, euro3 {RER} market for transport, freight, lorry 3.5-7.5 metric ton, EURO3 Conseq, U				Agromat	

Sunflower pith production {FR} Conseq		1 kg				
Activity	Value	Units	Process	Reference	Comments	
Harvesting	13.5	kg	Stem's harvesting	Agromat	Harvested stems	
Crushing	13.5	kg	Crushing (by hammer mill)	Agromat	Crushed stems. No losses from harvested stems	
Separation	3.38	kg	Sieving	Agromat	Sifted stems - 25% of crushed stems	
Purification	1.75	kg	Purification (1st passage)	Agromat	Purified stems - 51% of sifted stems	
Purification	1	kg	Purification (2nd passage)	Agromat	Final product - 58% of purified stems	
EOL	1	kg	Waste treatment sunflower pith panel			

VI.2.3. Panels production and EOL

Sunflower pith panel production Starch Conseq		1 m ³					
Activity	Value	Units	Process	Database	Reference	Comments	
Sunflower pith	1	kg	Sunflower pith production {FR} Conseq	-			
Water	3.32	l	Water, unspecified natural origin, FR	Substance			
Starch	0.119	kg	Maize starch {GLO} market for Conseq, U	Ecoinvent 3.6			
Energy	1.82	kWh	Electricity, low voltage {FR} market for Conseq, U	Ecoinvent 3.6		48 hours of use of the drying furnace 50 kg/m3. Considering a capacity of aprox 3 m3 of panel per furnace	

Sunflower pith panel production Chitosan Conseq		1 m ³					
Activity	Value	Units	Process	Database	Reference	Comments	
Sunflower pith	1	kg	Sunflower pith production {FR} Conseq	-			
Water	3.32	l	Water, unspecified natural origin, FR	Substance			
Acetic acid	0.0348	kg	Acetic acid, without water, in 98% solution state {GLO} market for Conseq, U	Ecoinvent 3.6			
Chitosan	0.119	kg	Chitosan {IN} Chitosan production Conseq	-			
Energy	1.82	kWh	Electricity, low voltage {FR} market for Conseq, U	Ecoinvent 3.6		48 hours of use of the drying furnace 50 kg/m3. Considering a capacity of aprox 3 m3 of panel per furnace	

Crushing (by hammer mill) Panels EOL		Value	Units	Process	Database	Reference	Comments
Input							
Energy	0.0175	kWh	Electricity, low voltage {FR} market for Conseq, U	Ecoinvent 3.6	Agromat	Per kg of crushed panel	
Hammer mill	0.118	kg	Industrial machine, heavy, unspecified {GLO} market for Conseq, U	Ecoinvent 3.6	Agromat	Per kg of crushed panel	
Output							
Crushed panels	1	kg	Main product	-	Agromat		

VI.2.4. Acoustic tests results

VI.2.5. Sound absorption coefficient values (extended)

Sunflower panel (starch formulation)

Frequency (Hz)	S1a	S1b	S2a	S2b	S3a	S3b
80	1.20×10^{-1}	1.48×10^{-1}	1.16×10^{-1}	1.75×10^{-1}	2.02×10^{-1}	1.93×10^{-1}
100	1.35×10^{-1}	1.56×10^{-1}	1.26×10^{-1}	1.70×10^{-1}	1.99×10^{-1}	1.68×10^{-1}
125	2.04×10^{-1}	2.54×10^{-1}	1.75×10^{-1}	2.16×10^{-1}	2.21×10^{-1}	2.09×10^{-1}
160	3.10×10^{-1}	3.59×10^{-1}	2.62×10^{-1}	3.23×10^{-1}	2.44×10^{-1}	2.34×10^{-1}
200	4.38×10^{-1}	4.63×10^{-1}	3.91×10^{-1}	4.45×10^{-1}	2.53×10^{-1}	2.47×10^{-1}
250	5.56×10^{-1}	5.21×10^{-1}	5.40×10^{-1}	5.48×10^{-1}	2.60×10^{-1}	2.54×10^{-1}
315	6.00×10^{-1}	5.07×10^{-1}	6.45×10^{-1}	5.80×10^{-1}	2.63×10^{-1}	2.58×10^{-1}
400	5.59×10^{-1}	4.49×10^{-1}	6.41×10^{-1}	5.33×10^{-1}	2.69×10^{-1}	2.65×10^{-1}
500	4.92×10^{-1}	3.94×10^{-1}	5.62×10^{-1}	4.56×10^{-1}	2.85×10^{-1}	2.82×10^{-1}
630	4.56×10^{-1}	3.70×10^{-1}	4.88×10^{-1}	4.00×10^{-1}	3.14×10^{-1}	3.11×10^{-1}
800	4.58×10^{-1}	3.81×10^{-1}	4.58×10^{-1}	3.81×10^{-1}	3.45×10^{-1}	3.43×10^{-1}
1000	4.79×10^{-1}	4.09×10^{-1}	4.78×10^{-1}	3.94×10^{-1}	3.79×10^{-1}	3.77×10^{-1}
1250	4.89×10^{-1}	4.17×10^{-1}	5.12×10^{-1}	4.01×10^{-1}	4.14×10^{-1}	4.13×10^{-1}
1600	5.08×10^{-1}	4.22×10^{-1}	5.27×10^{-1}	3.95×10^{-1}	4.52×10^{-1}	4.52×10^{-1}
2000	5.39×10^{-1}	4.25×10^{-1}	5.41×10^{-1}	3.99×10^{-1}	4.85×10^{-1}	4.89×10^{-1}
2500	5.54×10^{-1}	4.14×10^{-1}	5.49×10^{-1}	4.10×10^{-1}	5.10×10^{-1}	5.25×10^{-1}
3150	5.58×10^{-1}	4.12×10^{-1}	5.41×10^{-1}	4.20×10^{-1}	5.27×10^{-1}	5.59×10^{-1}
4000	5.94×10^{-1}	4.79×10^{-1}	5.85×10^{-1}	4.97×10^{-1}	5.79×10^{-1}	5.55×10^{-1}

Sunflower panel (chitosan formulation)

Frequency (Hz)	Ch1a	Ch1b	Ch2a	Ch2b	Ch3a	Ch3b
80	1.86×10^{-1}	2.01×10^{-1}	1.96×10^{-1}	2.13×10^{-1}	1.92×10^{-1}	1.84×10^{-1}
100	1.88×10^{-1}	1.87×10^{-1}	2.08×10^{-1}	2.28×10^{-1}	2.03×10^{-1}	1.99×10^{-1}
125	2.38×10^{-1}	2.02×10^{-1}	2.74×10^{-1}	2.82×10^{-1}	2.45×10^{-1}	2.64×10^{-1}
160	3.17×10^{-1}	2.06×10^{-1}	3.42×10^{-1}	3.40×10^{-1}	2.79×10^{-1}	3.09×10^{-1}
200	3.83×10^{-1}	2.01×10^{-1}	3.81×10^{-1}	3.56×10^{-1}	2.89×10^{-1}	3.31×10^{-1}
250	4.21×10^{-1}	1.92×10^{-1}	3.83×10^{-1}	3.42×10^{-1}	2.89×10^{-1}	3.35×10^{-1}
315	4.30×10^{-1}	1.85×10^{-1}	3.68×10^{-1}	3.20×10^{-1}	2.89×10^{-1}	3.34×10^{-1}
400	4.25×10^{-1}	1.81×10^{-1}	3.55×10^{-1}	3.04×10^{-1}	2.95×10^{-1}	3.37×10^{-1}
500	4.19×10^{-1}	1.83×10^{-1}	3.60×10^{-1}	3.04×10^{-1}	3.14×10^{-1}	3.50×10^{-1}
630	4.20×10^{-1}	1.95×10^{-1}	3.85×10^{-1}	3.20×10^{-1}	3.43×10^{-1}	3.69×10^{-1}
800	4.24×10^{-1}	2.04×10^{-1}	4.08×10^{-1}	3.34×10^{-1}	3.64×10^{-1}	3.81×10^{-1}
1000	4.36×10^{-1}	2.11×10^{-1}	4.22×10^{-1}	3.42×10^{-1}	3.77×10^{-1}	3.89×10^{-1}
1250	4.51×10^{-1}	2.14×10^{-1}	4.30×10^{-1}	3.51×10^{-1}	3.88×10^{-1}	3.98×10^{-1}
1600	4.69×10^{-1}	2.20×10^{-1}	4.40×10^{-1}	3.64×10^{-1}	4.04×10^{-1}	4.09×10^{-1}
2000	4.84×10^{-1}	2.25×10^{-1}	4.45×10^{-1}	3.74×10^{-1}	4.21×10^{-1}	4.14×10^{-1}
2500	4.92×10^{-1}	2.29×10^{-1}	4.51×10^{-1}	3.85×10^{-1}	4.36×10^{-1}	4.16×10^{-1}
3150	4.93×10^{-1}	2.33×10^{-1}	4.65×10^{-1}	3.98×10^{-1}	4.41×10^{-1}	4.12×10^{-1}
4000	4.64×10^{-1}	2.78×10^{-1}	4.90×10^{-1}	4.44×10^{-1}	4.59×10^{-1}	4.35×10^{-1}

Cork panel

Frequency (Hz)	C1Aa	C1Ab	C2Aa	C2Ab	C2Ba	C2Bb
80	5.24×10^{-3}	1.22×10^{-2}	1.00×10^{-2}	1.92×10^{-3}	1.02×10^{-2}	5.10×10^{-3}
100	2.52×10^{-2}	1.58×10^{-2}	1.02×10^{-2}	2.10×10^{-3}	7.98×10^{-3}	2.11×10^{-3}
125	2.24×10^{-3}	8.49×10^{-3}	6.84×10^{-3}	8.19×10^{-3}	2.86×10^{-3}	2.68×10^{-3}
160	4.56×10^{-3}	3.54×10^{-2}	3.38×10^{-2}	3.54×10^{-2}	1.19×10^{-2}	1.86×10^{-2}
200	3.57×10^{-2}	3.77×10^{-2}	6.11×10^{-2}	4.45×10^{-2}	2.38×10^{-2}	3.72×10^{-2}
250	4.35×10^{-2}	4.70×10^{-2}	8.32×10^{-2}	5.14×10^{-2}	3.25×10^{-2}	5.19×10^{-2}
315	5.00×10^{-2}	5.17×10^{-2}	9.98×10^{-2}	5.43×10^{-2}	4.06×10^{-2}	7.02×10^{-2}
400	5.25×10^{-2}	5.22×10^{-2}	1.08×10^{-1}	5.41×10^{-2}	4.73×10^{-2}	8.66×10^{-2}
500	5.42×10^{-2}	4.98×10^{-2}	1.21×10^{-1}	5.38×10^{-2}	5.28×10^{-2}	9.65×10^{-2}
630	6.15×10^{-2}	5.41×10^{-2}	1.51×10^{-1}	6.22×10^{-2}	6.32×10^{-2}	9.99×10^{-2}
800	6.70×10^{-2}	5.74×10^{-2}	1.87×10^{-1}	7.44×10^{-2}	6.76×10^{-2}	9.69×10^{-2}
1000	7.28×10^{-2}	6.32×10^{-2}	1.89×10^{-1}	9.04×10^{-2}	6.54×10^{-2}	9.81×10^{-2}
1250	8.10×10^{-2}	7.13×10^{-2}	1.50×10^{-1}	1.00×10^{-1}	6.18×10^{-2}	1.02×10^{-1}
1600	9.59×10^{-2}	8.88×10^{-2}	1.28×10^{-1}	1.04×10^{-1}	6.26×10^{-2}	1.02×10^{-1}
2000	1.13×10^{-1}	1.08×10^{-1}	1.27×10^{-1}	1.02×10^{-1}	7.09×10^{-2}	9.54×10^{-2}
2500	1.49×10^{-1}	1.19×10^{-1}	1.39×10^{-1}	1.13×10^{-1}	1.01×10^{-1}	9.47×10^{-2}
3150	2.12×10^{-1}	1.35×10^{-1}	1.88×10^{-1}	1.67×10^{-1}	1.86×10^{-1}	1.11×10^{-1}
4000	2.43×10^{-1}	1.68×10^{-1}	1.89×10^{-1}	1.77×10^{-1}	3.38×10^{-1}	1.67×10^{-1}

Melamine foam panel

Frequency (Hz)	MF1	MF2	MF3
80	7.72×10^{-3}	4.96×10^{-3}	7.98×10^{-3}
100	3.32×10^{-3}	5.41×10^{-4}	5.50×10^{-4}
125	3.31×10^{-3}	1.57×10^{-3}	3.14×10^{-3}
160	4.75×10^{-4}	1.91×10^{-3}	8.42×10^{-4}
200	1.48×10^{-2}	1.89×10^{-2}	1.48×10^{-2}
250	2.80×10^{-2}	3.08×10^{-2}	3.01×10^{-2}
315	4.55×10^{-2}	4.68×10^{-2}	4.43×10^{-2}
400	6.17×10^{-2}	6.32×10^{-2}	6.19×10^{-2}
500	8.19×10^{-2}	8.25×10^{-2}	8.13×10^{-2}
630	1.12×10^{-1}	1.11×10^{-1}	1.12×10^{-1}
800	1.47×10^{-1}	1.43×10^{-1}	1.46×10^{-1}
1000	1.90×10^{-1}	1.82×10^{-1}	1.90×10^{-1}
1250	2.37×10^{-1}	2.23×10^{-1}	2.37×10^{-1}
1600	2.94×10^{-1}	2.74×10^{-1}	2.96×10^{-1}
2000	3.40×10^{-1}	3.36×10^{-1}	3.64×10^{-1}
2500	4.33×10^{-1}	4.00×10^{-1}	4.33×10^{-1}
3150	5.19×10^{-1}	4.66×10^{-1}	4.99×10^{-1}
4000	6.12×10^{-1}	5.87×10^{-1}	6.26×10^{-1}

VI.2.1. Sound absorption coefficient values (condensed)

Frequency (Hz)	Measured absorption coefficient values			
	Starch-based sunflower pith panel	Chitosan-based sunflower pith panel	Cork panel	Melamine foam panel
80	0.16	0.20	0.01	0.01
100	0.16	0.20	0.01	0.00
125	0.21	0.25	0.01	0.00
160	0.29	0.30	0.02	0.00
200	0.37	0.32	0.04	0.02
250	0.45	0.33	0.05	0.03
315	0.48	0.32	0.06	0.05
400	0.45	0.32	0.07	0.06
500	0.41	0.32	0.07	0.08
630	0.39	0.34	0.08	0.11
800	0.39	0.35	0.09	0.19
1000	0.42	0.36	0.10	0.19
1250	0.44	0.37	0.09	0.23
1600	0.46	0.38	0.10	0.29
2000	0.48	0.39	0.10	0.35
2500	0.49	0.40	0.12	0.42
3150	0.50	0.41	0.17	0.49
4000	0.55	0.43	0.21	0.61

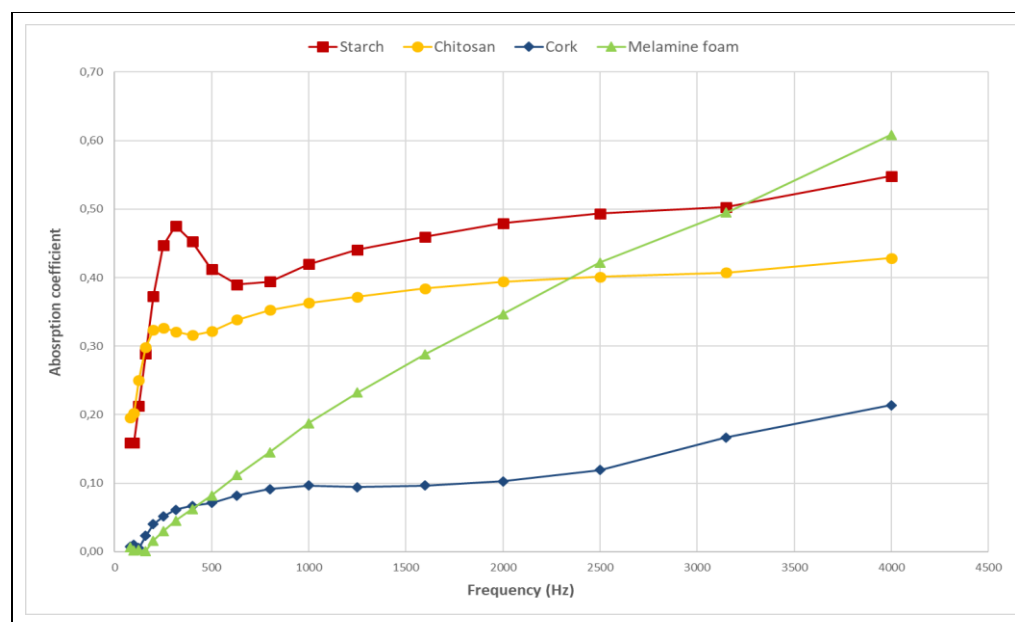

VI.2.2. C-TOOL input values

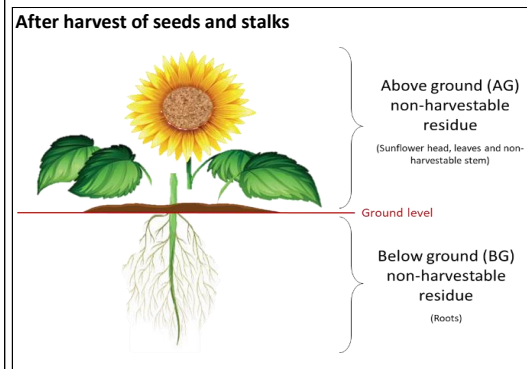
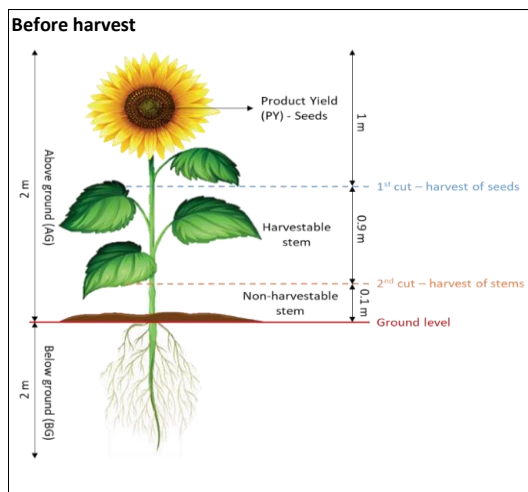

Monthly mean temperatures (Nimes station)			
(T in °C)	T min	T max	Mean T
January	2.7	11.0	6.9
February	3.2	12.4	7.8
March	5.8	16.0	10.9
April	8.3	18.6	13.5
May	12.1	23.0	17.6
June	15.8	27.5	21.7
July	18.7	31.0	24.9
August	18.4	30.5	24.5
September	14.9	25.7	20.3
October	11.5	20.4	16.0
November	6.5	14.5	10.5
December	3.6	11.3	7.5

	Harvesting	W/O Harvesting
Crop parameters		
Product yield (Mg DM/ha*y)	1.7	1.7
Harvestable stems (Mg DM/ha*y)	1.35	NA
Non-harvestable		
Leaves	1.02	1.02
Sunflower head	1.077	1.077
Non-harvestable stems or W/O Harvesting	0.071	1.417
Non-harvestable residue AG (Mg DM/ha*y)	2.168	3.513
Non-harvestable residue BG (Mg DM/h*y)	0.45	0.45
Residues from the pith's procurement process		
Bark (Mg C/ha*y)	1.077	NA
Fines (Mg C/ha*y)	0.148	NA
Content of residues		
C content of biomass DM (kg C/kg DM)	0.5	0.5
C input		
From AG residues (Mg C/ha*y)	1.084	1.757
From BG residues (Mg C/ha*y)	0.225	0.225
Total (AG+BG) (Mg C/ha*y)	1.309	1.982
C input at year 20		
Pith from the panels (Mg C/ha*y)	2.029	NA

Composition in DM of the sunflower plant*	
Component	Composition (% DM)
Seeds	30
Sunflower head	19
Stem	25
Leaves	18
Roots	8

*Evon, P. (2008). Nouveau procédé de bioraffinage du tournesol plante entière par fractionnement thermo-mécano-chimique en extrudeur bi-vis: Etude de l'extraction aqueuse des lipides et de la mise en forme du raffinat en agromatériaux par thermomoulage. Université de Toulouse - Insitut National Polytechnique de Toulouse.

Product yield of harvested sunflower stems		
Product	Yield percentage	Yield percentage without losses
Bark	80%	81.3%
Pith	70%	7.5%
Losses	2%	-
Fine particles	11%	11.2%

Results			
Scenario	C year 0 (Mg C/ha)	C year 19 (Mg C/ha)	ΔC per year
Harvesting	45	42.191	-0.1405
W/O Harvesting	45	42.197	-0.1402

VI.2.3. LCA Modeling

LCA Sunflower panel Starch		1 kg				
Activity	Value	Units	Process	Reference	Comments	
Production of the sunflower pith panel	1	kg	Sunflower pith panel Starch Conseq			
Avoided marginal panel production	- 0.1513	kg	Melamine foam panel production {CH} Conseq, U	Agromat	From the UF --> 5,55 kg of starch pith panel = 0,84 kg of melamine foam panel (1 kg = 0,1513)	
Avoided CO ₂ emissions	0.0095	kg	Carbon emissions from field	Agromat	1ha/(1,5*,07)t = 0,0095 ha needed per kg of pith	
LCA Sunflower panel Chitosan		1 kg				
Activity	Value	Units	Process	Reference	Comments	
Production of the sunflower pith panel	1	kg	Sunflower pith panel Chitosan Conseq			
Avoided marginal panel production	- 0.0839	kg	Melamine foam panel production {CH} Conseq, U	Agromat	From the UF --> 7,15 kg of chitosan pith panel is equivalent to 0,6 kg of melamine foam panel (1kg ch panel = 0,0839 kg mel foam panel)	
Avoided CO ₂ emissions	0.0095	kg	Carbon emissions from field	Agromat	1ha/(1,5*,07)t = 0,0095 ha needed per kg of pith	
LCA Sunflower panel Starch Low Freq		1 kg				
Activity	Value	Units	Process	Reference	Comments	
Production of the sunflower pith panel	1	kg	Sunflower pith panel Starch Conseq			
Avoided marginal panel production	- 0.4650	kg	Melamine foam panel production {CH} Conseq, U	Agromat	From the UF --> 5,42 kg of starch pith panel = 2,52 kg of melamine foam panel (1 kg = 0,4650)	
Avoided CO ₂ emissions	0.0095	kg	Carbon emissions from field	Agromat	1ha/(1,5*,07)t = 0,0095 ha needed per kg of pith	
LCA Sunflower panel Chitosan Low Freq		1 kg				
Activity	Value	Units	Process	Reference	Comments	
Production of the sunflower pith panel	1	kg	Sunflower pith panel Chitosan Conseq			
Avoided marginal panel production	- 0.3231	kg	Melamine foam panel production {CH} Conseq, U	Agromat	From the UF --> 7,8 kg of chitosan pith panel is equivalent to 2,52 kg of melamine foam panel (1kg ch panel = 0,3231 kg mel foam panel)	
Avoided CO ₂ emissions	0.0095	kg	Carbon emissions from field	Agromat	1ha/(1,5*,07)t = 0,0095 ha needed per kg of pith	

EXTENDED SUMMARY (IN FRENCH)

Extended Summary (in French)

Inventaire du cycle de vie et évaluation environnementale de matériaux biosourcés :

Cas d'un panneau biocomposite d'aménagement intérieur pour l'aéronautique & d'un agromatériau pour l'isolation phonique dans le bâtiment

Introduction

Les activités humaines et leur industrialisation ont modifié la manière dont les sociétés interagissent avec leur environnement, en particulier avec leurs ressources naturelles. Des impacts négatifs sont visibles sous la forme de pollution de l'air, du sol et de l'eau, d'épuisement des ressources et de destruction de la couche d'ozone, entre autres; tout cela contribue à accélérer les effets du changement climatique.

Aujourd'hui encore, alors que le secteur industriel tente de répondre à une demande toujours croissante de produits et de services, la pression exercée sur les ressources naturelles s'intensifie. Dans le but d'alléger cette pression et de ralentir le changement climatique, les pays et les scientifiques ont entamé des discussions pour développer des projets, des méthodes et des procédures qui permettraient de prendre de meilleures décisions en intégrant une approche environnementale.

Par conséquent, par le biais de politiques telles que le plan d'action dans le domaine de la biomasse et les directives sur les énergies renouvelables et la qualité des carburants, la Commission européenne favorise et encourage la transition d'une économie fondée sur les ressources fossiles à une économie fondée sur les ressources biologiques (bioéconomie).

La Commission européenne définit la bioéconomie comme un système économique qui "utilise des ressources biologiques renouvelables provenant de la terre et de la mer, telles que les cultures, les forêts, les poissons, les animaux et les micro-organismes, pour produire des aliments, des matériaux et de l'énergie" (UE, 2020), et considère qu'elle contribue fortement au développement d'une économie circulaire à faible émission de carbone. En outre, la mise en œuvre d'une bioéconomie favoriserait la création de processus industriels plus écologiques et a été estimée à un potentiel d'atténuation du changement climatique de 2,5 milliards de tonnes de CO₂ équivalent par an (d'ici 2030) (EBCD, 2015).

La grande disponibilité de la biomasse fait d'elle une ressource cible pour faire évoluer les habitudes de production et de consommation vers une bioéconomie. Plus précisément, la biomasse a été utilisée comme source d'énergie (i.e. biocarburants) et comme matière première pour la fabrication de produits biosourcés. La valorisation de la biomasse sous forme de produits biosourcés contribue à retarder les émissions de carbone en les gardant dans la technosphère aussi longtemps que la durée de vie des produits le permet.

Cependant, les produits biosourcés ont longtemps été limités à la substitution de matériaux existants (i.e. les plastiques) pour des applications à courte durée de vie ou pour donner un aspect plus écologique à des produits dont la performance environnementale est par ailleurs faible. En outre, la quantité de biomasse qu'un produit doit contenir pour être considéré comme un matériau biosourcé

n'est pas encore tout à fait claire, et la réglementation reste vague à ce sujet. Par conséquent, leurs avantages environnementaux peuvent varier considérablement d'un produit à l'autre, de même que les approches adoptées pour sa gestion de sa fin de vie.

Néanmoins, afin de favoriser le déploiement d'une bioéconomie, les matériaux biosourcés doivent devenir des matériaux à part entière, bien identifiés, qui contribuent réellement à une meilleure gestion des ressources naturelles et au déploiement de pratiques de consommation durables. Parmi les produits biosourcés, on peut identifier une catégorie spécifique, celle des agromatériaux. Elle représente des produits issus à 100% de la biomasse, et dans lesquels la structure chimique naturelle de leurs constituants est conservée tout au long de leur cycle de vie. Ce type de produits est donc intrinsèquement biodégradable, mais peut, dans certains cas, ne pas avoir les propriétés de performance de leurs homologues d'origine fossile.

L'Union européenne s'étant fixé pour objectif de devenir neutre sur le plan climatique d'ici à 2050, il est nécessaire non seulement de déployer une bioéconomie, mais aussi de mettre en place une stratégie décisionnelle solide pour investir dans les bonnes technologies respectueuses de l'environnement.

Dans cette perspective, l'évaluation environnementale des produits biosourcés est essentielle pour valider l'impression générale qu'ils sont plus respectueux de l'environnement que leurs homologues synthétiques, minéraux ou parfois simplement massifs (dans le cas du bois). L'évaluation des impacts environnementaux des produits biosourcés dans une perspective de cycle de vie est particulièrement pertinente afin de prendre conscience d'un éventuel transfert des impacts environnementaux d'une étape du cycle de vie à une autre. Cependant, l'évaluation de la performance environnementale des matériaux biosourcés soulève un certain nombre de défis méthodologiques qui doivent encore être relevés.

Dans ce contexte général, afin d'aborder la pertinence de l'introduction des produits biosourcés comme stratégie d'atténuation du changement climatique, cette thèse vise à éclaircir les spécificités de la réalisation d'une analyse du cycle de vie (ACV) des produits biosourcés en répondant aux questions scientifiques suivantes :

(i) Comment le détournement des ressources affecte-t-il l'impact environnemental d'un produit biosourcé ?

(ii) Comment appliquer la méthodologie ACV aux matériaux biosourcés dont les agromatériaux ?

Grâce à des collaborations du Laboratoire de Chimie Agro-industrielle avec des entreprises externes, deux cas d'études ont été développées pour aborder et répondre aux questions scientifiques.

Le premier cas d'étude, appelé " projet BOPA ", est le résultat d'une collaboration industrielle avec la PME VESO Concept® sur un projet ADEME dans le cadre de la convention de subvention n°1501C0050. Le travail réalisé dans cette thèse, concerne les activités du "Lot 6" du projet original ; qui consiste en l'évaluation de la performance environnementale, par ACV, d'un prototype de panneau sandwich en biocomposite lin/époxy.

La deuxième cas d'étude découle de la collaboration avec l'association de designers *Atelier LUMA*, ce cas d'étude est désigné sous le nom de "projet LUMA". Dans ce cas, l'objet d'étude est un panneau acoustique à base de moelle de tournesol et d'une colle naturelle. La collaboration a permis de travailler sur le processus d'approvisionnement de la matière première principale, sur le développement du prototype lui-même ainsi que sur l'évaluation de ses performances, et enfin, sur l'évaluation environnementale du produit final en appliquant la méthode ACV.

La description du travail réalisé commence par une revue bibliographique présentée au chapitre I. Dans ce chapitre, une description approfondie de la classification des matériaux est présentée dans le but de clarifier la définition des matériaux biosourcés et de leurs propriétés. En outre, les concepts de durabilité, d'évaluation environnementale et de réflexion sur le cycle de vie sont détaillés. Enfin, la méthodologie de l'Analyse du Cycle de Vie est décrite, ainsi que les spécificités qui s'appliquent à l'évaluation de la performance environnementale des produits biosourcés, et les contraintes méthodologiques qui y sont liées.

Dans le chapitre II, le cas d'étude BOPA est présenté et l'ACV d'un panneau sandwich composite biosourcé avec une application dans le secteur de l'aviation est réalisée. Grâce à ce cas d'étude, l'impact de l'utilisation de la fibre de lin comme matière première est évalué et la première question scientifique est abordée en considérant le détournement d'un textile vers une application industrielle. Les effets du changement d'affectation des sols et la valorisation potentielle des coproduits dans la performance environnementale du produit final, ont été abordés au travers d'une approche conséquente.

Ensuite, dans le chapitre III, les travaux réalisés dans le cadre du projet LUMA sont décrits, et la deuxième question scientifique est abordée. Dans ce chapitre, la fin de vie spécifique des agromatériaux (i.e. recyclage naturel) et leur potentiel de stockage du carbone sont mis en évidence par la réalisation d'une ACV d'un panneau d'isolation acoustique à base de tournesol ayant une application dans le secteur du bâtiment.

Enfin, les principaux résultats ainsi que les perspectives d'avenir du travail présenté ici sont résumés sous la forme d'une conclusion générale.

Chapitre I - État-de-l'art

L'impact des activités humaines sur l'environnement suscite depuis longtemps une série de discussions entre les pays et les scientifiques concernant le développement de méthodes et d'outils permettant de mieux évaluer leurs conséquences possibles et de les prévenir. À partir de ce besoin, différents concepts, méthodes et procédures ont été développés dans la recherche de meilleures pratiques décisionnelles intégrant une approche environnementale.

En outre, la garantie de la disponibilité des ressources est un axe principal de la ligne de pensée *durable*, car le développement doit pouvoir "répondre aux besoins du présent sans compromettre la capacité des générations futures à répondre aux leurs" (CMEC 1987). En outre, le concept de durabilité met en évidence la nécessité d'imbriquer les aspects économiques, sociaux et environnementaux, en les rendant dépendants les uns des autres. À partir de cette dépendance, deux concepts sont distingués : la durabilité *faible* et la durabilité *forte* ; tous deux reconnaissent un capital humain (économique et social) et un capital naturel (environnement) et les considèrent comme complémentaires l'un de l'autre. La distinction entre les deux concepts est que la durabilité faible considère les différents domaines comme substituables et permet le détriment de l'un au profit des autres. Contrairement à cela, la durabilité forte garantit que les capitaux sont effectivement complémentaires mais en aucun cas interchangeables.

La grande disponibilité de la biomasse en a fait une ressource cible pour le changement des habitudes de production et de consommation. En réponse aux conditions environnementales actuelles (épouement des ressources fossiles, changement climatique, etc.), le passage d'une économie fondée sur les ressources fossiles à une économie fondée sur les ressources biologiques (bioéconomie) a déjà

été encouragé dans des politiques européennes telles que le plan d'action en faveur de la biomasse et les directives sur les énergies renouvelables et la qualité des carburants (Crenna et al. 2017).

Équivalentes aux raffineries de pétrole, les bioraffineries sont un sujet d'étude actuel (Philp et al. 2013a; Fahd et al. 2012), l'idée étant que la biomasse serve à la fois de source d'énergie et de matériaux. Pourtant, les coûts de production des biocarburants ne sont pas compétitifs par rapport à ceux de leurs équivalents fossiles, ce qui peut conduire à ce que les matériaux biosourcés deviennent le principal intérêt de la bioraffinerie (Philp et al. 2013a). Si l'on considère que les biocarburants de deuxième génération (produits à partir de résidus/sous-produits de cultures) sont encore moins compétitifs que ceux de première génération, la conjecture précédente devient cruciale pour présenter les résidus de cultures alimentaires comme une source plus efficace de matériaux que d'énergie. En outre, le CO₂ est naturellement piégé dans la matière végétale par les processus de photosynthèse, une caractéristique qui permet aux produits biosourcés de participer au stockage du carbone.

Dans l'ensemble, les qualités environnementales de la biomasse en font une source de matériaux attrayante et ont entraîné une explosion de la recherche sur les produits biosourcés, puisqu'environ 70 % des publications contenant les mots *bioplastics/bio-plastics* et matériaux *biobased/bio-based* ont été réalisées entre 2012 et 2017.

De nombreuses définitions concernant les qualités environnementales des matériaux sont utilisées au sein de la communauté scientifique et il devient difficile de les distinguer les unes des autres et d'avoir une idée claire de leur signification réelle. Dans le cadre de cette étude, on tentera de mieux définir et de contraindre ces termes, comme le prévoient les réglementations et les normes internationales en vigueur. En conséquence, la Figure 1 a pour but d'être utilisée comme un outil permettant de comprendre la relation entre les différentes propriétés qui peuvent être attribuées à un matériau en fonction de son origine et de sa fin de vie. Des exemples de matériaux appartenant aux différentes catégories sont présentés afin d'aider le lecteur à situer certains des matériaux couramment utilisés et leur classification.

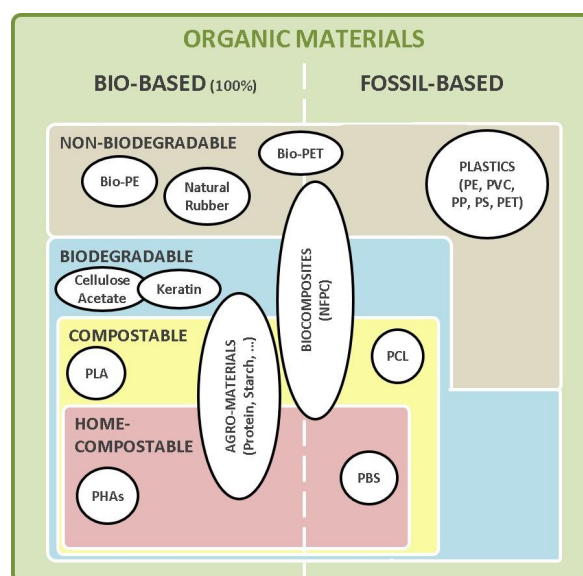

Figure 1. Classification des matières organiques en fonction de leurs propriétés et de leur mode d'obtention.

Les termes « biosourcés », « bioplastiques », « biomatériaux » et « agromatériaux » sont parfois utilisés de manière interchangeable, mais sont fondamentalement différents. La principale distinction repose finalement sur leurs structures chimiques. Dans les deux premiers cas, il peut s'agir de structures chimiques synthétiques nouvelles créées à partir de sources naturelles. Le cas des biomatériaux est réservé aux applications médicales et cette catégorie englobe de nombreux matériaux différents. Pour les agromatériaux, les structures naturelles de la biomasse sont préservées, ce qui permet de conserver les caractéristiques de biodégradabilité et de compostage de la matière première. En outre, les agromatériaux sont composés à 100% de biomasse, ce qui n'est pas le cas des matériaux pouvant être qualifiés de biosourcés.

La nécessité de réduire les niveaux de pollution et de garantir la disponibilité des ressources sont quelques-unes des raisons qui expliquent la propulsion de l'évaluation environnementale en tant que partie importante de tout *business plan*. Le défi d'atteindre le premier objectif tout en maintenant la productivité et les taux de profit pour répondre à la demande actuelle, a conduit à l'introduction d'un concept de durabilité. Le *développement durable* met en évidence la nécessité de lier les milieux économiques, sociaux et environnementaux, en les rendant dépendants les uns des autres.

Pour avancer dans la bonne direction, des décisions intelligentes et bien informées doivent être prises, mais parfois la complexité des systèmes rend cette tâche plus difficile. Dans ce contexte, l'approche de la réflexion sur le cycle de vie (*Life Cycle Thinking, LCT*) permet aux décideurs de comprendre les impacts environnementaux, sociaux et économiques d'une politique ou d'un système sur l'ensemble de son cycle de vie, ce qui permet d'intégrer une approche de durabilité dans le développement des produits et/ou des politiques (ONU Environnement, 2017). Le concept de *cycle de vie* a été largement appliqué dans différents domaines d'étude. Il va de l'étude de l'évolution d'un projet d'innovation dans le cadre de l'entreprise à l'interaction d'un produit avec l'environnement et les ressources naturelles (Ashby, 2013). D'un point de vue industriel, ce concept ouvre des opportunités aux entreprises pour améliorer leurs processus sans nécessairement changer ou investir dans de nouvelles technologies.

Des besoins différents ont favorisé le développement de plusieurs méthodes d'évaluation de l'impact environnemental d'un produit, d'un processus ou d'un système. Ces mêmes besoins ont également défini la manière dont les méthodes abordent un système, les impacts qu'elles prennent en considération et la ou les étapes de vie évaluées. En outre, les multiples domaines auxquels une évaluation environnementale peut être appliquée permettent aux méthodes d'être génériques ou spécifiques aux impacts ou aux étapes évalués. Certaines des méthodes actuellement disponibles pour évaluer les impacts environnementaux sont présentées dans le Tableau 1; en distinguant les méthodes génériques et spécifiques.

Tableau 1. Méthodes d'évaluation environnementale (génériques ou spécifiques).

Méthodes génériques	Méthodes spécifiques
<ul style="list-style-type: none"> • Analyse des flux de matières/substances (MFA/SFA), • Analyse coûts-avantages (ACA), • Analyse des incidences sur l'environnement (EIE), • Évaluation et gestion des risques environnementaux, • Empreinte carbone, • Empreinte de l'eau, • Analyse de cycle de vie (ACV). 	<ul style="list-style-type: none"> • INDIGO (pour le secteur de l'agriculture), • IDEA (pour le secteur de l'agriculture), • BREEAM (pour le secteur du bâtiment), • parmi d'autres.

L'attrait environnemental et économique des ressources biotiques comme source de matériaux a incité les projets à se concentrer sur la création de modèles d'économie circulaire pour les produits biosourcés. Dans le cas des plastiques, la Commission Européenne a récemment publié un document intitulé « *A European Strategy for Plastics in a Circular Economy* » dans lequel elle expose la nécessité mais aussi le défi de changer les habitudes actuelles liées à l'utilisation des plastiques en des habitudes plus durables en incluant des produits biosourcés. Les préoccupations soulevées par le document susmentionné concernant la gestion des plastiques, ainsi que les informations discutées dans les sections précédentes de ce travail, nécessitent des méthodologies holistiques pour évaluer les avantages réels des matériaux biosourcés. Ce besoin vient du fait qu'un produit qui a une source renouvelable (comme la biomasse) ne signifie pas nécessairement qu'il est durable, car un "transfert de pollution" (le transfert des impacts environnementaux) pourrait se produire ; ce qui exige que les gains environnementaux réels soient identifiés et leur pertinence évaluée.

Une ACV est une méthode qui évalue l'impact potentiel d'un système, un produit, un service ou un processus. Elle prend en compte une fonctionnalité particulière et passe par toutes les étapes de son cycle de vie (Jolliet et al., 2017). C'est alors une méthode qui permet d'identifier les points ou étapes critiques qui représentent des zones d'opportunité pour l'amélioration ou le développement de nouveaux produits. Elle donne une compréhension globale d'un processus, permettant ainsi de prendre des décisions mieux fondées en prenant en compte non seulement les plus évidentes (économiques, techniques) mais aussi les conséquences à long terme (environnementales, sociales), positives et/ou négatives. Le plus souvent, son application vise l'identification et la comparaison des impacts environnementaux de différents produits, services, systèmes ou processus. Elle peut également être utile pour identifier les impacts des différentes étapes d'un même produit, permettant ainsi d'améliorer une étape spécifique d'un processus entier (*hotspot analysis*).

La méthode d'ACV a été développée et normalisée par trois organisations : l'Organisation internationale de normalisation (ISO), la *Society of Environmental Toxicology and Chemistry* (SETAC) et le Programme des Nations unies pour l'environnement (PNUE ou ONU Environnement) (Jolliet et al., 2017). Parmi elles, les normes développées par l'ISO sont probablement les plus représentatives de la méthodologie actuelle. La norme ISO 14040 établit les lignes directrices générales pour la réalisation d'une ACV. De plus, les normes ISO 14044, ISO 14046 - 14049, détaillent les différentes étapes et analyses réalisées tout au long de l'évaluation (Jolliet et al., 2017).

Néanmoins, lors de la réalisation d'une ACV pour des produits biosourcés, des contraintes méthodologiques spécifiques liées à la phase agricole doivent être prises en compte. Un défi particulier de l'ACV pour les matériaux biosourcés est de comprendre l'impact de la culture de la matière première, car le contenu des bases de données ACV sur les cultures est limité. Cela représente un problème important car la qualité des données limite la précision et l'utilité des résultats de l'ACV. En outre, une idée fautive concernant les produits biosourcés est qu'ils seraient intrinsèquement meilleurs pour l'environnement parce qu'ils seraient biodégradables. Cependant, tous les matériaux biosourcés ne peuvent pas être considérés comme biodégradables ou adaptés à un traitement par des techniques biologiques. Parfois des techniques telles que l'incinération ou le compostage industriel pourraient être plus bénéfiques si l'énergie est récupérée et les émissions contrôlées.

En outre, les impacts liés au changement d'affectation des sols peuvent limiter l'attrait des matériaux biosourcés et la comptabilisation du carbone peut ne pas représenter l'intégralité de leur impact environnemental. C'est pourquoi les impacts de l'utilisation des sols, tant directs qu'indirects, doivent être inclus dans les ACV portant sur les matériaux biosourcés. Sinon, un facteur important du changement climatique pourrait être négligé.

En résumé, les tendances actuelles du marché et de la société font évoluer les matériaux vers des performances environnementales plus élevées. L'accent a été mis en particulier sur le plastique, qui est devenu l'un des principaux problèmes environnementaux de ces dernières années. Outre le fait que le plastique est d'origine fossile, sa durabilité et ses faibles prix de production en font un matériau difficile à traiter en fin de vie, car tout le plastique ne peut pas être recyclé et d'importantes quantités de déchets plastiques finissent dans l'océan. Les matériaux biosourcés offrent donc une solution attrayante et il convient de concentrer les efforts sur leur amélioration afin de renforcer leurs performances environnementales et leur attrait. Il est tout aussi important de ne pas les considérer uniquement comme des produits de remplacement des produits pétrochimiques, mais plutôt comme de nouveaux matériaux dont les applications restent à découvrir et à mettre en œuvre.

Il convient de souligner que les impacts et avantages environnementaux des matériaux biosourcés, comme ceux des matériaux d'origine fossile, ne reflètent que l'état actuel des choses. En effet, si la production de matériaux biosourcés augmente, les impacts environnementaux qui y sont liés (émissions de GES, utilisation des sols, eutrophisation/acidification, etc.) et les avantages qu'ils représentent peuvent ou non augmenter proportionnellement. En outre, avant de commencer à se tourner vers un système économique entièrement basé sur des ressources renouvelables dans le but de contrer le changement climatique et les problèmes de pollution, il est de la plus haute importance d'effectuer une analyse approfondie des impacts environnementaux réels qu'un tel changement pourrait avoir en prenant en considération non seulement l'aspect environnemental mais aussi le facteur économique et social qui sera certainement affecté.

Pour évaluer correctement l'impact environnemental du passage à un système de bioéconomie, il est important d'effectuer une analyse des conséquences d'une telle décision. Pour cela, différentes méthodologies ont été développées, mises en œuvre et réglementées. Parmi ces méthodologies, l'analyse du cycle de vie, fondée sur le concept de cycle de vie et sur une approche multicritère, est celle qui s'adapte le mieux à la complexité des systèmes avec une approche globale et de multiples impacts environnementaux potentiels. L'évaluation de la performance environnementale d'un système ou d'un produit par le biais de l'analyse du cycle de vie, en suivant une approche conséquentielle, vise à faciliter les processus de prise de décision en vue d'une utilisation de la biomasse qui tienne compte d'une approche solide de la durabilité.

Les approches qui peuvent être suivies lors de la réalisation d'une ACV (attributionnelle et conséquentielle) ne doivent pas être considérées comme deux lignes de pensée opposées ou conflictuelles. Le choix de l'une ou l'autre doit se faire en fonction du système et de l'objectif final de l'évaluation environnementale. Il convient toutefois de toujours indiquer l'approche adoptée et de mettre à disposition les spécifications de l'étude pour que les résultats soient mieux compris, reproductibles et comparés.

Dans l'ensemble, il y a encore du travail à faire pour améliorer les pratiques d'ACV afin de mieux évaluer et comprendre les impacts environnementaux des produits biosourcés. Néanmoins, l'ACV reste une méthodologie pertinente pour le développement de produits plus performants sur le plan environnemental en les comparant aux produits actuellement disponibles sur le marché.

[Chapitre II - Éco-conception et évaluation environnementale d'un panneau biocomposite innovant pour l'aviation](#)

Les problèmes environnementaux actuels concernant les niveaux de pollution et le changement climatique ont forcé les secteurs industriels à s'orienter vers des pratiques plus durables et

respectueuses de l'environnement. Le secteur aéronautique ne fait pas exception et en 2011, la Commission Européenne, par l'intermédiaire du Conseil consultatif pour la recherche et l'innovation dans l'aviation en Europe (ACARE), a publié ses cinq objectifs à atteindre dans le rapport *Flightpath 2050*. L'un de ces objectifs concerne la protection de l'environnement et de l'approvisionnement énergétique et vise une réduction de 75 % et 90 % des émissions de CO₂ par passager-kilomètre et des émissions de NO_x, respectivement. En outre, il vise également à ce que les avions soient recyclables (ACARE 2011).

Les composites polymères renforcés par des fibres naturelles (NFPCs) ont attiré différents secteurs industriels étant donné les propriétés des fibres naturelles et leur avantage par rapport aux fibres synthétiques en termes de propriétés environnementales, de traitement, mécaniques et physiques. En fait, les matériaux renforcés par des fibres naturelles sont de plus en plus utilisés comme substitut aux composites renforcés par des fibres de verre, notamment dans le secteur automobile (Deng et Tian 2015; Yan et al. 2014), car ils permettent une réduction du poids des pièces d'environ 5% (Le Duigou et Baley 2014), entre autres avantages. Pour cette raison, différents auteurs ont largement étudié l'utilisation des fibres naturelles comme renfort de matériaux composites (Ticoalu et al. 2011; Faruk et al. 2012; Mohammed et al. 2015; Hristian et al. 2016; Peças et al. 2018; Sanjay et al. 2018). Les avantages environnementaux de ce type de composites résultent des processus de production moins énergivores des fibres, ainsi que de leurs valeurs de densité plus faibles, ces dernières se traduisant par des économies de carburant puisque moins de masse est transportée.

Les fibres naturelles peuvent être d'origine végétale ou animale; toutefois, pour les matériaux composites, le terme "fibres naturelles" fait référence aux fibres végétales. Les fibres végétales sont classées en fibres libériennes (i.e. le lin), fibres de graine (i.e. le coton), fibres de feuille (i.e. l'ananas), fibres d'herbe et de roseau (i.e. le maïs, le blé), fibres de noyau (i.e. le chanvre), et toutes les autres n'ayant pas de classification particulière comme le bois et les racines (Faruk et al. 2012; Peças et al. 2018). Les liants utilisés pour les NFPCs peuvent être des matrices thermoplastiques (i.e. polyéthylène, polychlorure de vinyle (PVC) et polypropylène) ou thermodurcissables ; les résines phénoliques, polyester et époxy sont parmi les matrices thermodurcissables les plus couramment utilisées (Mohammed et al. 2015).

Les propriétés des NFPCs dépendent fortement de la qualité des fibres, qui sont affectées par les aspects géographiques, les conditions de culture, la qualité/le type de rouissage, les procédés d'extraction, entre autres (Ticoalu, Aravinthan, et Cardona 2010). De plus, la nature lignocellulosique des fibres affecte leur adhésion aux matrices polymériques (Spiridon 2014) et donc différentes techniques pour son amélioration ont été étudiées pour modifier chimiquement la structure de la fibre (Mohammed et al. 2015).

Cependant, une augmentation de l'utilisation de composites renforcés de fibres naturelles conditionne un besoin de rendements plus élevés dans la production de fibres naturelles, ce qui, en même temps, peut entraîner le déplacement des charges environnementales de (dans ce cas) la phase d'utilisation de l'avion vers la fabrication de ses composants. En outre, la plupart des coproduits générés par le processus de transformation des fibres sont remis en circulation dans l'économie et valorisés comme de nouveaux produits (C.E.L.C. 2019a) et leur influence dans l'impact environnemental global des textiles en fibres naturelles ne doit pas être négligée.

Parmi les différentes fibres naturelles qui ont été utilisées comme renfort dans les matériaux composites (i.e. le chanvre, le lin, le jute), le lin représentait 50% de la part de marché en 2012 (Barth et Carus 2015) et est la quatrième fibre la plus produite (Faruk et al. 2012). Le lin apparaît donc comme une matière première potentiellement importante pour une Europe visant à déployer une

bioéconomie durable. Cependant, l'ensemble des conséquences induites par l'utilisation du lin comme source de fibres pour remplacer les fibres de verre a été peu étudié. Pour cette raison, une ACV complète est nécessaire afin de confirmer la pertinence environnementale des composites renforcés de fibres naturelles, par rapport à leurs concurrents actuels du marché, dans le secteur aéronautique.

La performance environnementale des composites renforcés de fibres de lin a été évaluée dans des études ACV précédentes (Bachmann et al. 2017; Le Duigou et al. 2012; van der Werf et Turunen 2008; Bensadoun et al. 2016). Cependant, ces études ne se concentrent pas sur la production du textile technique en fibre de lin lui-même et, par conséquent, manquent d'informations détaillées sur l'inventaire du cycle de vie. De plus, les coproduits sont traités en utilisant des techniques d'allocation économique et leur devenir est peu discuté ou précisé.

Description du cas d'étude

Dans le cadre d'un projet de l'ADEME, la PME VESO-Concept a développé un panneau sandwich en composite biosourcé (biocomposite) qui intègre des fibres de lin comme matériau de renforcement. En outre, le panneau sandwich a été conçu avec une nouvelle structure centrale et vise à remplacer les panneaux actuels utilisés dans l'aménagement intérieur des avions commerciaux (i.e. les compartiments à bagages). Afin d'évaluer la pertinence environnementale du remplacement des matériaux actuels par la nouvelle structure proposée, une analyse du cycle de vie a été réalisée.

Dans le cadre de l'ACV, un travail approfondi de collecte de données sur le processus de production et de transformation des fibres de lin en un textile technique a été réalisé et un inventaire du cycle de vie (ICV) a été produit. Parallèlement à l'ICV, la performance environnementale du produit final (le textile technique) a été évaluée. Une fois l'ICV du textile technique en fibres de lin terminé, l'ACV du panneau sandwich biocomposite a été réalisée. Le travail présenté suit la production, l'utilisation et la gestion de la fin de vie d'un panneau sandwich fabriqué à partir d'un matériau biocomposite utilisant un tissu de lin comme renfort et une matrice époxy anti-feu adaptée aux normes aéronautiques.

En adoptant une approche conséquentielle, ce cas d'étude met en avant l'effet du détournement des ressources sur l'impact environnemental global d'un produit biosourcé.

L'évaluation des deux ACV réalisée pour ce cas d'étude a été réalisée avec le logiciel SimaPro (version 8.5.2). La méthode d'analyse d'impact ILCD 2001 Midpoint+ a été utilisée mais légèrement adaptée, sur la base des recommandations de la Commission européenne (CE) « *Product environmental footprint category rules* » (PEFCR ; EC, 2017).

ICV d'un textile technique en fibres de lin

La performance environnementale d'un textile technique à base de lin a été évaluée par une ACV du berceau à la porte. L'inventaire conséquentiel du cycle de vie présenté a pour but (mais pas seulement) d'être utilisé par les praticiens de l'ACV et les parties intéressées pour réaliser des ACV afin de comparer l'impact environnemental de produits dont l'un des composants est la fibre de lin. L'ICV proposé permet de réaliser des évaluations futures en considérant soit l'ensemble de la chaîne d'approvisionnement de la production et de la transformation du lin, soit des processus spécifiques, en fonction des limites spécifiques du système et du produit concerné (i.e. les fibres courtes). Les efforts se sont concentrés sur la présentation des informations de manière claire et concise afin que des modifications puissent être facilement apportées, permettant ainsi une meilleure représentation

d'un large spectre de scénarios en fonction de l'évolution des pratiques agricoles et des tendances du marché.

Ce travail permettra d'améliorer les ACV existantes sur la production de fibres de lin par l'inclusion des émissions issues du processus de *rouissage*, la valorisation des coproduits (expansion du système), et l'analyse de plus de catégories d'impact que celles régulièrement abordées dans d'autres études (à savoir, le changement climatique, la couche d'ozone et l'épuisement abiotique). Donc ce travail présente une image plus large des impacts environnementaux potentiels de l'utilisation de la fibre de lin comme source de matériaux.

Les résultats montrent que les activités agricoles et la production d'électricité (provenant de la *culture du lin* et des processus de *filature* et de *tissage*) sont les principaux responsables de la performance environnementale négative d'un textile technique en lin (Figure 2).

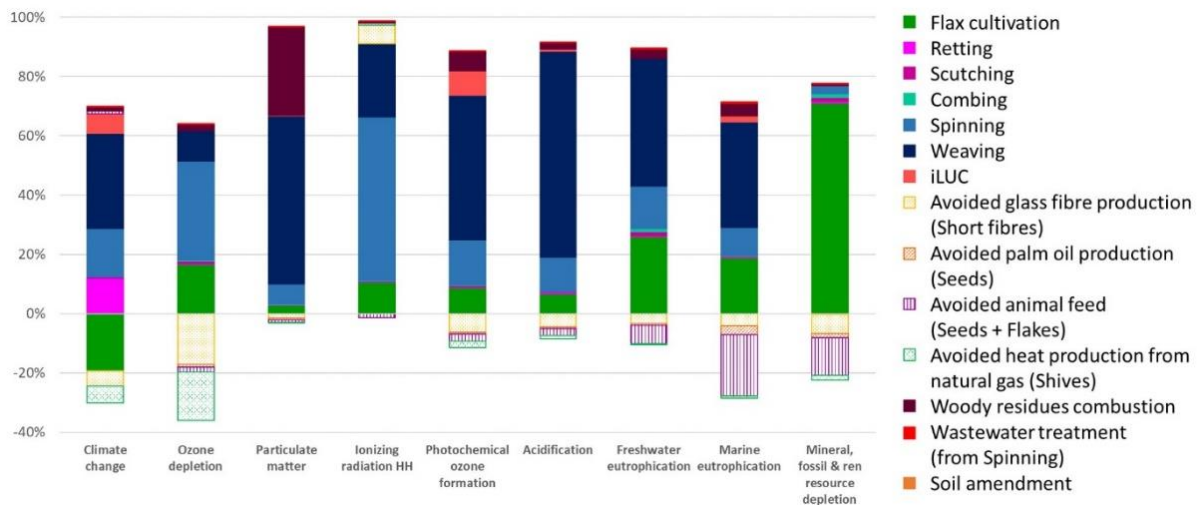

Figure 2. Contribution des processus aux impacts environnementaux générés (valeurs positives) et évités (valeurs négatives) dans la production d'un textile technique en fibre de lin à partir d'un hectare de terre cultivée.

De manière très spécifique à ce cas d'étude, l'analyse de sensibilité a prouvé qu'une production entièrement française était préférable d'un point de vue environnemental. Cependant, les capacités industrielles pour la production de tissus et les faibles prix de fabrication rendent la production partielle en Chine plus intéressante d'un point de vue technique et économique. Ainsi, un changement dans les modèles de production (passage à une production entièrement française) pourrait ne pas être totalement viable. Cela reste néanmoins un facteur important à prendre en considération et à développer au fur et à mesure que les relations des pays avec les énergies renouvelables et fossiles évoluent.

En outre, l'impact généré par le changement d'affectation des sols lié à la culture du lin est diminué (de près de 25 %) par le changement d'affectation des sols évité grâce à la valorisation de certains des coproduits dans l'alimentation animale. Par conséquent, les impacts étant relativement faibles par rapport à ceux de la production et de l'utilisation d'électricité, le changement d'affectation des sols ne représente pas un réel désavantage pour les produits biosourcés.

Le plus grand nombre de catégories d'impact incluses/analysées contribue à une meilleure compréhension de la manière dont les coproduits peuvent affecter l'impact environnemental d'un produit. Il permet également d'approfondir l'analyse des différentes manières dont les coproduits peuvent être valorisés et des options qui ont un impact environnemental plus faible. Grâce à cette étude, par exemple, il est apparu que la valorisation des anas a une grande influence sur la formation de particules et contribue donc de manière importante à l'impact global généré. Grâce à cette analyse,

il est possible d'identifier des domaines d'amélioration concernant non seulement les processus principaux mais aussi ceux liés aux coproduits. Dans ce cas, par exemple, la mise en œuvre de meilleures technologies de combustion pourrait être étudiée en vue d'améliorer la performance environnementale globale de l'utilisation des fibres de lin.

De plus, l'inclusion du devenir des coproduits par l'expansion du système contribue à une évaluation plus précise des impacts environnementaux potentiels. Sinon, l'impact sur des catégories telles que l'appauvrissement de la couche d'ozone et l'eutrophisation marine aurait été largement surestimé, tandis que les impacts concernant la formation de particules et le rayonnement ionisant auraient été sous-estimés. Étant donné qu'une approche conséquentielle a été adoptée pour cette étude, les décisions visant à améliorer la performance environnementale d'un textile technique en fibre de lin peuvent être prises en ayant un point de vue plus clair et plus proche de la réalité.

Globalement, cette étude montre la pertinence de prendre en considération le mix énergétique d'un pays et la portée géographique du cycle de vie d'un produit car cela a un impact important sur sa performance environnementale. De plus, lorsque l'on considère le devenir des coproduits, leur valorisation joue également un rôle très important car ils ne génèrent pas forcément un bénéfice mais il a été prouvé qu'ils peuvent contribuer à une augmentation de l'impact sur différentes catégories. Par conséquent, définir correctement les co-produits et leur devenir devient un facteur aussi crucial que de disposer d'un inventaire complet et précis du cycle de vie.

ACV d'un panneau sandwich biocomposite pour une application dans le secteur de l'aviation

Cette étude présente une analyse complète du cycle de vie pour confirmer ou infirmer la pertinence environnementale globale des composites renforcés de fibres de lin, par rapport à leurs concurrents actuels, dans le secteur de l'aéronautique. L'objectif est de découvrir les compromis potentiels entre les différents impacts environnementaux, sur la base d'un examen complet du devenir des coproduits et des interactions avec le marché.

L'ACV réalisée est considérée comme conséquentielle en ce sens qu'aucun coproduit n'est laissé en dehors des limites du système et que leur devenir est pris en considération dans le cadre de la performance environnementale du produit final. Cette approche suit les recommandations des normes ISO 14040:2006 et ISO 14044:2006 et vise à refléter les conséquences environnementales intentionnelles et non intentionnelles de la prise de décision.

L'unité fonctionnelle a été définie comme l'utilisation de 1 m² de panneau sandwich comme structures secondaires (éléments d'aménagement intérieur) à l'intérieur d'un avion A320 NEO d'une durée de vie de 30 ans.

L'objectif de l'ACV est double : (1) comparer les performances environnementales de ce panneau biocomposite avec celles d'un panneau conventionnel, et (2) identifier, dans une perspective d'écoconception, les principaux domaines d'opportunité d'amélioration environnementale globale associés à ce prototype. À partir de ce point, ce prototype particulier sera désigné « panneaux biocomposite ».

Le biocomposite est un panneau sandwich avec un cœur en oméga, entièrement constitué d'un composite renforcé de fibres de lin avec une matrice époxy. Cela comprend à la fois les peaux et le cœur. En revanche, les peaux et le cœur du panneau conventionnel sont faites de matériaux différents. Les peaux sont constituées de fibres de verre, de résine époxy, de méthylamine et de décabromodiphényléther (decaBDE) comme agent anti-feu. Le cœur du panneau conventionnel est

une structure couramment utilisée, connue sous le nom de nid d'abeille, composée de papier en fibre d'aramide trempé dans une résine phénolique.

Les résultats soulignent que pour chaque impact environnemental étudié, la performance environnementale des deux panneaux est essentiellement déterminée par la phase d'utilisation. En outre, ils montrent que le panneau conventionnel surpasse le panneau biocomposite de 14% dans toutes les catégories d'impact. Cette différence correspond précisément à l'écart de masse entre les deux panneaux, le panneau biocomposite ayant une masse plus élevée que le panneau conventionnel. Cette corrélation est due au fait que les émissions sont liées à la combustion du carburant. Dans le même temps, la consommation de carburant est liée à la masse de l'avion. Plus la masse de l'avion est élevée, plus le niveau de consommation de carburant est élevé et, par conséquent, la quantité d'émissions produites. Comme dans ce cas la phase d'utilisation est le principal contributeur pour les deux panneaux, la différence de masse se traduit directement par la différence d'impact entre eux.

En comparant les performances des deux panneaux, les résultats montrent que le panneau biocomposite est plus performant que le panneau conventionnel dans les catégories d'impact environnemental du changement climatique et d'eutrophisation marine. Cependant, le panneau conventionnel est plus performant que le panneau biocomposite dans toutes les autres catégories (appauvrissement de la couche d'ozone, formation de particules, rayonnement ionisant, formation d'ozone photochimique, acidification, eutrophisation de l'eau douce et épuisement des ressources minérales, fossiles et renouvelables).

Dans la catégorie Changement climatique, les gains sont directement liés à la culture du lin, notamment à la capture du CO₂ par la plante, qui permet une réduction des impacts de près de 35%. De plus, la réduction de 30% de l'impact sur l'eutrophisation marine, est une conséquence de la valorisation des anas (issus de l'étape de teillage de la transformation de la fibre de lin) en alimentation animale, ce qui réduit la production de paille et les impacts associés.

Les hydrocarbures halogénés utilisés dans le revêtement des oléoducs distribuant le gaz naturel utilisé comme source d'énergie pour le processus de filature des fibres de lin sont responsables des impacts sur l'appauvrissement de la couche d'ozone. L'impact sur la formation de particules provient de la valorisation des anas de lin (issus de l'étape de teillage de la transformation des fibres de lin) en panneaux de particules, ce qui induit le déplacement des résidus de bois vers les déchets, qui sont ensuite brûlés. En outre, la consommation d'électricité liée à la production des composants de la résine époxy et des engrais utilisés dans la phase de culture du lin, ainsi que les émissions de CO liées au défrichage des terres en raison de la demande supplémentaire de terres arables pour la culture du lin contribuent aux catégories d'impact des rayonnements ionisants et de la formation d'ozone photochimique, respectivement. Les impacts sur l'acidification sont liés à la production d'acide phosphorique utilisé pour la fabrication de l'agent retardateur de flamme, tandis que les émissions de phosphate issues de ce processus de fabrication provoquent l'eutrophisation des eaux douces. Enfin, le zinc utilisé pour le traitement des graines de lin et des sols pour la culture du lin induit des impacts sur la catégorie Épuisement des ressources minérales, fossiles et renouvelables.

Globalement, du point de vue de l'approche « du berceau à la tombe », il n'y a pas d'autre phase plus importante que l'étape d'utilisation; la nature des matières premières n'a, en comparaison, aucune incidence sur la performance environnementale. À cet égard, les travaux futurs devraient viser à améliorer le rapport fibre/résine et la géométrie du prototype de panneau biocomposite afin d'en réduire la masse. En ce qui concerne le rapport fibre/résine, l'utilisation de différentes résines pourrait être testée pour évaluer leur interaction avec les fibres de lin. Une autre possibilité consisterait à traiter chimiquement les fibres de lin pour améliorer leur interaction avec la résine. Cependant, cela

modifierait leur composition et les avantages environnementaux de l'utilisation de fibres naturelles pourraient être affectés ou perdus. Les travaux futurs devraient également se concentrer sur l'amélioration du prototype, en particulier sur sa géométrie, afin d'atteindre des valeurs de masse plus faibles, ce qui se traduirait par une réduction de l'impact environnemental du panneau biocomposite. Cela impliquerait également une vérification de l'ACV présentée afin de représenter efficacement le processus de production, si des changements devaient avoir lieu.

En outre, du début à la fin, le panneau biocomposite s'est révélé plus compétitif sur le plan environnemental que le panneau conventionnel dans les catégories d'impact du changement climatique et de l'eutrophisation marine, de 34% et 30% respectivement. Cependant, les gains liés au changement climatique sont fictifs si la durée de vie du panneau est courte, car le carbone stocké sera libéré dans l'atmosphère à la fin de la vie du panneau. Les processus identifiés comme responsables de l'impact environnemental global des panneaux sont essentiellement liés à l'approvisionnement en matières premières. Les activités agricoles (telles que les amendements en zinc pour le traitement des sols et la production d'engrais) sont les principaux responsables de l'impact environnemental plus élevé du panneau biocomposite par rapport au panneau conventionnel.

La valorisation des coproduits, d'autre part, affecte positivement et négativement la performance environnementale des panneaux biosourcés et ne doit pas être négligée dans les limites du système.

Enfin, étant donné que les matériaux utilisés dans le secteur de l'aviation ont une durée de vie de 30 ans et plus, un panneau biocomposite représente une option pertinente en matière d'atténuation du changement climatique. Il a été calculé que l'utilisation de panneaux biosourcés comme éléments de l'aménagement intérieur des avions au cours des 20 prochaines années permettrait de retarder l'émission de plus de 75 mégatonnes de CO₂. Toutefois, les processus de production et les réglementations doivent encore être optimisés et ajustés pour que les matériaux biocomposites aient leur place dans le secteur de l'aviation.

En conclusion, grâce à ce cas d'étude, l'effet du détournement des ressources a été évalué et a permis une compréhension plus précise de l'impact environnemental du produit principal. Il a été constaté que si certains impacts environnementaux potentiels pouvaient être sous-estimés, d'autres pouvaient être largement surestimés. Les résultats ont mis en évidence l'importance d'appliquer l'expansion du système plutôt que les techniques d'allocation lorsqu'il s'agit de coproduits. Les effets du détournement des ressources foncières initialement allouées à la culture de différents produits ont été abordés en incorporant la notion de changement indirect d'affectation des terres (iLUC). Il a été constaté que les impacts générés par le changement indirect d'utilisation des terres peuvent être renversés ou équilibrés par la valorisation des coproduits par exemple en alimentation animale.

En outre, il a été démontré que les exigences et réglementations strictes du secteur de l'aviation limitent la performance environnementale d'un matériau biosourcé. Néanmoins, la longue durée de vie des avions (environ 30 ans) représente une opportunité de stocker dans le matériau biosourcé le CO₂ capturé par la plante à travers le processus de photosynthèse, contribuant ainsi à retarder les effets du changement climatique.

Globalement, il a été constaté que la valorisation des coproduits, issus de la transformation des fibres de lin en textile technique, contribue à diminuer l'impact sur le changement d'affectation des sols généré par l'augmentation de la culture du lin. Par conséquent, l'impact du changement d'affectation des sols ne représente pas un inconvénient pour les produits biosourcés lorsque les coproduits sont valorisés, notamment en alimentation animale. En outre, il a été démontré que les avantages environnementaux des produits biosourcés dépendent largement de la portée géographique (i.e. du

mix énergétique d'un pays), de la manière dont les coproduits sont traités, ainsi que de l'application qui leur est donnée.

Dans le but de continuer à stimuler l'incorporation de matériaux biosourcés pour favoriser la mise en place d'une bioéconomie, les travaux futurs devraient se concentrer sur l'optimisation des processus de production des matériaux biosourcés afin d'accroître leur performance et finalement leur compétitivité sur le marché. Les chaînes d'approvisionnement devraient également se concentrer sur des pratiques de production qui privilégient une utilisation efficace des ressources en tirant parti de la plus grande partie possible de la biomasse disponible (valorisation des coproduits). En outre, pour qu'une bioéconomie puisse être déployée avec succès, les réglementations actuelles et les exigences relatives aux matériaux devraient être révisées et repensées dans une perspective biosourcée, en tenant compte des qualités et des spécificités des produits d'origine biosourcée.

Chapitre III - Production et évaluation environnementale d'un agromatériau utilisé comme panneau insonorisant

La nécessité de remplacer durablement le carbone fossile et de maintenir l'augmentation actuelle de la température en dessous de 2°C a fait des coproduits agricoles un sujet d'intérêt pour la communauté scientifique. La valorisation des résidus de culture comme source de matériaux représente une source de carbone sans les charges environnementales liées à l'utilisation de terres arables supplémentaires. De plus, les produits biosourcés agissent comme des unités de stockage du carbone, contribuant ainsi à retarder les émissions de gaz à effet de serre (GES).

Bien que la paille de céréales soit couramment exploitée (Thorenz et al., 2018), l'utilisation de la paille d'oléagineux, et en particulier de la paille de tournesol, a reçu moins d'attention en ce qui concerne leur utilisation comme matière première carbonée dans la future bioéconomie. Pourtant, la culture du tournesol n'a cessé d'augmenter au cours des 20 dernières années, et la production européenne est responsable de plus de la moitié de l'offre mondiale (FAOSTAT, 2020). Au niveau mondial, la France se place au 5e rang de la production de tournesol, et en 2015, avec environ 615 000 hectares de terres cultivées soit près de 17% de la production européenne (Terres OléoPro 2016).

Le principal produit d'intérêt actuel de la culture du tournesol est la graine, qui est utilisée comme source d'huile pour le secteur alimentaire. À partir du processus d'extraction de l'huile, on obtient la farine de tournesol qui est valorisée dans l'alimentation animale. La récolte a lieu à un stade de maturité de la plante où les pétales et les feuilles ont déjà séché et sont tombés au sol. Seules les têtes sont récoltées et battues sur place. Une fois les graines récoltées, elles sont laissées dans le champ avec la tige comme source de nutriments pour le sol.

Différents auteurs se sont penchés sur la valorisation des différents coproduits issus de la culture du tournesol, dont les tiges sont les préférées compte tenu de leur composition et de leur disponibilité, puisqu'elles représentent environ 25% (en masse sèche) de la masse totale de la plante (Evon 2008). Dans les tiges de tournesol, on peut distinguer deux composants : l'écorce et la moelle. La première est la couche externe de la tige, semblable à du bois, tandis que la seconde est le composant interne, semblable à de la mousse, qui possède des propriétés isolantes (thermiques et acoustiques).

Les propriétés acoustiques de la moelle de tournesol ont été étudiées par différents auteurs et constituent une bonne alternative biosourcée aux matériaux d'origine fossile. Selon Chabriac et al. (2016), avec d'autres sous-produits agricoles, la moelle de tournesol présente des valeurs de coefficient d'absorption acoustique qui peuvent être équivalentes à celles obtenues avec des

matériaux tels que la fibre de verre. En outre, Oancea et al. (2018) ont constaté que le béton mélangé à des sous-produits agricoles (i.e. la moelle de tournesol) présente des coefficients d'absorption acoustique plus élevés que le béton conventionnel utilisé comme matériau de construction.

Les matériaux d'isolation acoustique sont classés en deux catégories : celle des matériaux d'absorption et celle des matériaux d'insonorisation. Alors que les matériaux d'insonorisation sont utilisés pour empêcher le son d'entrer ou de sortir d'un espace déterminé, les matériaux d'absorption du son sont utilisés pour réduire l'écho et améliorer l'acoustique d'une pièce. Des deux, l'absorption acoustique est préférée en tant qu'isolation acoustique dans les bureaux en espace ouvert. En matière de construction, les matériaux idéaux sont à la fois insonorisants et absorbants.

L'unité de mesure de l'absorption acoustique est le Sabin. Les Sabins sont utilisés pour calculer le temps de réverbération d'espaces tels que les salles de concert et les studios d'enregistrement. En unités métriques, un mètre carré d'un matériau absorbant à 100% équivaut à 1 m² Sabin.

Des ACV sur la production de tournesol comme source de matériaux ont été rapportées par Volpe et al. (2018), qui ont étudié les avantages de l'utilisation de l'huile frite de tournesol comme charge pour le PLA, et par l'étude de Mathias et al. (2015), dans laquelle les propriétés des tiges de tournesol utilisées comme source de matériaux pour les biocomposites sont évaluées. Cependant, le travail de Mathias et al. (2015) se limite au stade agricole de la production de tournesol.

Dans l'ensemble, il n'existe pas d'études ACV sur la valorisation du tournesol en tant que source de matériaux ni d'études sur les performances environnementales des matériaux fabriqués à partir de tournesol par rapport à leurs homologues conventionnels.

Description du cas d'étude

Grâce au programme "Atelier LUMA", la Fondation LUMA (un centre culturel expérimental basé dans la ville d'Arles, en France) cherche à créer un centre interdisciplinaire où les ressources, les matériaux, les connaissances et les talents locaux coexistent et s'épanouissent. Plus précisément, l'Atelier LUMA imagine des moyens innovants et durables de valoriser les ressources naturelles et culturelles de sa région. Le centre de ses activités se concentre sur les pratiques respectueuses de l'environnement et la promotion d'une économie circulaire.

Dans le cadre de ses projets, l'Atelier LUMA souhaite valoriser les déchets agricoles, en particulier les tiges issues de la culture du tournesol destinée à la production d'huile. L'objectif du projet est de séparer la moelle du reste de la tige et de profiter de ses propriétés isolantes pour produire des panneaux d'isolation acoustique qui seront utilisés pour améliorer l'acoustique de la cafétéria du bâtiment de la Fondation LUMA. En outre, leur performance environnementale sera évaluée et comparée à celle des matériaux couramment utilisés afin d'évaluer les avantages de l'utilisation de la moelle de tournesol.

Comme la pratique courante actuelle est de laisser les tiges de tournesol au champs, elles contribuent à l'approvisionnement naturel en nutriments au sol. Pour cette raison, la récolte des tiges pour leur valorisation en tant que matériaux suscite des inquiétudes, notamment quant à l'épuisement des stocks de carbone du sol (Hansen et al. 2020). Pour répondre à cette préoccupation, l'analyse du cycle de vie (ACV) permet d'évaluer si les gains environnementaux liés à la valorisation de la biomasse en tant que matériau sont supérieurs aux pertes liées à l'épuisement des sols.

Les panneaux à base de tournesol représentent un exemple d'agromatériau car les structures naturelles de la moelle sont maintenues. Pour la production des panneaux, l'utilisation d'un agent de collage est nécessaire pour maintenir les fragments de moelle ensemble. Afin de préserver le produit

final et l'agromatériau, les agents de collage doivent être naturels, et quatre formulations différentes ont été testées afin d'évaluer la meilleure d'un point de vue fonctionnel et environnemental.

Les performances environnementales des panneaux à base de tournesol seront évaluées et comparées à celles de deux panneaux commerciaux équivalents (l'un synthétique et d'origine fossile et l'autre naturel, issu d'une culture dédiée) par le biais de l'analyse du cycle de vie.

Panneaux de moelle de tournesol

Pour la production de la moelle de tournesol, les tiges de tournesol restantes après la récolte des graines sont collectées. Suite à la récolte par l'ensileuse, les tiges "pré-broyées" sont transportées dans un hangar, où elles sont stockées jusqu'à leur utilisation. Comme plus de 60 % de la moelle est encore attachée à l'écorce, l'étape suivante consiste à broyer davantage les tiges récoltées afin de récupérer autant de moelle que possible. Pour cela, les tiges récoltées sont introduites dans un broyeur à marteaux auquel est fixé un peigne pour améliorer le broyage des gros morceaux en plus petits. Les tiges broyées passent ensuite dans un tamis où l'écorce est séparée de la moelle. En raison de sa très faible densité par rapport à celle des particules d'écorce (20-30 kg/m³ au lieu d'environ 250 kg/m³), la moelle est récupérée par un système d'aspiration. En conséquence, les tiges broyées sont séparées en 63% d'écorce, 25% de moelle et 11% de fines (particules fines de <1 mm), sur une base pondérale.

Après avoir été tamisée, la moelle subit un processus de purification. Ce processus est réalisé en faisant passer les tiges criblées à travers un tapis roulant, où les elles sont soufflées dans le sens inverse du tapis roulant. La surface ondulée de la bande retient les fragments d'écorce et ceux-ci sont retirés en haut du tapis roulant. Pendant ce temps, la moelle est soufflée vers l'avant et aspirée sur le côté opposé du tapis. La forme sphérique des particules de moelle permet à celles-ci de rouler vers le bas du tapis roulant et facilite leur collecte par le système d'aspiration. Le processus est effectué deux fois, afin de garantir une moelle de haute qualité. La moelle purifiée résultant du processus de purification est le produit final utilisé pour les panneaux d'absorption sonore.

Pour la production des panneaux, quatre formulations ont été testées en utilisant différents agents de collage : (i) amidon, (ii) chitosan, (iii) isolat de protéines de tournesol, et (iv) vapeur d'eau. Pour chaque formulation, trois échantillons du même panneau ont été produits avec une densité de 50 kg/m³ et des dimensions de 15 x 15 x 5 cm³.

Des calculs ont été effectués afin d'obtenir les quantités requises de moelle et d'agent adhésif pour chacun des panneaux. Les panneaux ont tous été traités en suivant la même procédure. L'agent adhésif a été préparé (dissous dans l'eau) et mélangé à la moelle de tournesol à une concentration de 3,4 % (w/w). Le mélange a ensuite été placé dans un moule de 15 x 15 cm auquel on a ajouté un poids afin de faciliter la compression du panneau. Pour obtenir une épaisseur de 5 cm et la masse volumique ciblée, deux cales (ou entretoises) ont été utilisées.

Pour les panneaux de vapeur d'eau, le moule a ensuite été placé dans une thermopresse où le moule a été chauffé à 150°C pendant 30 minutes; aucune pression n'a été appliquée sur le couvercle, son propre poids étant suffisant. Pour le reste, aucune chaleur ou pression n'a été appliquée, seul le poids du couvercle a été appliqué pendant environ 3 minutes.

Les panneaux ont été séchés dans une étuve à 60°C pendant 48 heures. Une fois ce temps écoulé et les panneaux prêts, ils ont été stockés dans une chambre à température et humidité contrôlées à 23,3°C et 46% d'humidité.

Les formulations à base d'amidon et de chitosan se sont avérées être les plus adaptées à une application en tant que matériaux d'absorption acoustique compte tenu de leur épaisseur et de leur

tenue. Ceci est dû au fait que l'amidon et le chitosan sont des adhésifs à base de polysaccharides comme les pectines, qui sont largement présents dans la moelle. Par conséquent, il en résulte une bien meilleure affinité de ces deux agents adhésifs avec les particules de moelle. Pour cette raison, seuls les panneaux résultant de la formulation d'amidon et de chitosan ont été conservés comme produits finaux à inclure dans les scénarios de l'analyse du cycle de vie. et, par conséquent, pour l'évaluation de leurs propriétés acoustiques.

La performance acoustique des panneaux de moelle de tournesol, ainsi que des alternatives fossiles (mousse de mélamine) et biosourcées (liège), a été évaluée en mesurant les valeurs du coefficient d'absorption de chacun d'entre eux. Les mesures ont été réalisées par le département Acoustique & Vibrations du Centre de Transfert de Technologie du Mans.

Les valeurs du coefficient ont été mesurées dans un tube de Kundt à des bandes d'un tiers d'octave pour une gamme de fréquences allant de 80 à 4000 Hz. Les panneaux de moelle de tournesol avaient une épaisseur de 50 mm, identique à celle du panneau de liège. La mousse de mélamine, quant à elle, avait une épaisseur de 14 mm. Trois échantillons de 45 mm de diamètre ont été testés (sur les deux faces, nommés *a* et *b*) pour les panneaux de moelle de tournesol, deux pour le panneau de liège et un pour la mousse de mélamine.

Les matériaux d'absorption acoustique actuellement commercialisés ne présentent pas de coefficients d'absorption élevés entre 500 et 1500 Hz. Cependant, les deux formulations des panneaux de moelle de tournesol (amidon et chitosan) ont des propriétés très intéressantes car les valeurs du coefficient sont de l'ordre de 0,5 dès le début de la gamme de fréquence. Cette propriété en fait une option intéressante pour les applications d'absorption acoustique à basse fréquence, en particulier la formulation à base d'amidon.

Afin d'obtenir une valeur de coefficient représentative de chaque panneau, indépendante de la valeur de la fréquence, la procédure décrite dans la norme standardisée ISO 11654 a été suivie. En conséquence, une valeur de coefficient de $\alpha_w=0,45$ a été obtenue pour le panneau de formulation d'amidon de tournesol, $\alpha_w=0,35$ pour la formulation de chitosan, $\alpha_w=0,10$ pour le panneau de liège et $\alpha_w=0,15$ pour l'alternative de mousse de mélamine.

La modélisation de la modification de la teneur en carbone du sol résultant de la récolte des tiges a été réalisée à l'aide du modèle C-TOOL. Ce modèle simule les effets de la gestion agricole sur le stockage du carbone organique du sol (SOC) sur une période de temps de moyen à long terme. La structure et les équations du modèle C-TOOL sont décrites et détaillées dans le travail de Taghizadeh-Toosi et al. (2014). Il est similaire à d'autres modèles de renouvellement du carbone tels que CENTURY, RothC et Daisy, mais nécessite moins de paramètres d'entrée. Les variables motrices du modèle C-TOOL sont (i) les températures mensuelles moyennes de la région, (ii) les conditions initiales du sol (teneur en carbone total et en argile), et (iii) la biomasse laissée sur le terrain en termes de carbone.

Pour la définition du scénario, il a été considéré que les panneaux devaient avoir une durée de vie d'au moins 20 ans pour que le carbone séquestré ait un impact positif sur le ralentissement du changement climatique. À la fin de cette période, les panneaux doivent être ramenés sur le terrain pour contribuer à l'apport de carbone dans les sols. Cela compenserait la perte de carbone qui s'est produite à l'origine en raison de l'enlèvement des tiges de tournesol du champ pour produire les panneaux.

Les résultats montrent que sur une période de 100 ans, la dynamique du carbone pour les trois scénarios suit le même comportement. Cela signifie que, sur le long terme, le prélèvement des tiges de tournesol pour la production de panneaux acoustiques ne perturbe pas la dynamique naturelle du

carbone dans le sol. Dans la période de vie de 20 ans, lorsque l'écorce n'est pas valorisée, la teneur en carbone atteint le même niveau que dans le scénario sans récolte dès la troisième année.

D'autre part, en réduisant la quantité de carbone disponible dans le sol, les émissions de CO₂ sont également évitées. Sur une période de 3 ans, il est visible que le scénario le plus avantageux (moins d'émissions de CO₂) se produit lorsque les tiges sont récoltées et que l'écorce est également valorisée. Ce faisant, le carbone est stocké dans les matériaux fabriqués à partir de la moelle et de l'écorce, ce qui évite les émissions de CO₂ correspondantes.

L'aspect dynamique du carbone a été inclus dans le modèle d'ACV en annualisant la perte de carbone résultant de la récolte des tiges. Cette valeur a été obtenue en calculant le ΔC de chaque scénario entre les années 0 et 19 (une période de 20 ans) et en le divisant par 20. La valeur ΔC indique la quantité de carbone perdue par le champ par an. Les 20 ans correspondent à la durée de vie des panneaux. On a estimé qu'un total de 0,0147 t CO₂/ha et 0,0011 t CO₂/ha pourrait être évité grâce à l'utilisation de la moelle de tournesol comme matériau insonorisant, avec et sans valorisation supplémentaire de l'écorce émise comme coproduit du processus d'obtention de la moelle, respectivement.

L'analyse du cycle de vie a été facilitée par le logiciel SimaPro LCA (version 9.1). Les coproduits issus des différentes étapes de production ont été traités par l'expansion du système, comme le recommandent les normes ISO 14040 et 14044 (ISO 14040, 2006 ; ISO 14044, 2006). L'évaluation de l'impact du cycle de vie utilisée est la méthodologie de l'empreinte environnementale des produits (PEF), telle que prescrite par la Commission Européenne (CE, 2020). La mise en œuvre est basée sur la méthode EF 2.0. Seules les catégories d'impact du point médian considérées comme robustes (catégorie I/II; (Fazio et al., 2018)) ont été évaluées.

Les données de premier plan ont été, dans la mesure du possible, obtenues directement à partir de mesures propres, ou auprès de fournisseurs et de producteurs ; lorsqu'elles n'étaient pas disponibles, les données ont été tirées de la littérature scientifique. Les données de base (par exemple, la production d'électricité, les processus de transport) ont été obtenues à partir de la base de données ICV Ecoinvent v3.6 (dans laquelle les processus « Conseq » ont été sélectionnés).

L'unité fonctionnelle (UF) de l'étude est définie comme la masse de panneau nécessaire pour fournir 1 m² Sabin d'absorption acoustique pendant une période de 20 ans. Ces panneaux sont considérés pour des applications où les deux gammes de fréquences suivantes s'appliquent : (i) une large gamme de fréquences allant de 80 à 4000 Hz, et (ii) pour une application à basses fréquences (allant de 250 à 400 Hz). Deux variantes de panneaux sont envisagées, en fonction du liant utilisé au stade du moulage (le chitosan et l'amidon). La portée géographique est liée au cas de démonstration considéré, à savoir la région française de Camargue, où la culture du tournesol et la production ultérieure de panneaux à partir de moelle de tournesol sont considérées comme possibles.

L'évaluation a été réalisée en considérant que tous les coproduits des panneaux de moelle de tournesol sont ramenés au champ car c'est le sort que ces éléments subissent actuellement. Cependant, des projets récents ont été réalisés pour valoriser les tiges de tournesol laissées au champ. Dans ces projets, la valorisation des écorces sous forme de panneaux de particules est abordée (ADEME, 2015). Une analyse de sensibilité a donc été réalisée en considérant la valorisation des écorces produites comme coproduit de la filière d'approvisionnement en moelle de tournesol sous forme de panneaux de particules.

Les résultats montrent que la valorisation des tiges de tournesol comme panneaux d'absorption acoustique présente un avantage environnemental pour sept des neuf catégories d'impact évaluées (Figure 3). Le remplacement des panneaux en mousse de mélamine par l'une ou l'autre des

formulations de panneaux à base de tige de tournesol a le potentiel de réduire les impacts sur le changement climatique (50-70%), l'appauvrissement de la couche d'ozone (20-45%), la formation d'ozone photochimique (jusqu'à 10%), les substances inorganiques respiratoires (environ 10%), l'acidification (jusqu'à 30%), l'eutrophisation marine (environ 10%) et l'eutrophisation terrestre (10-25%).

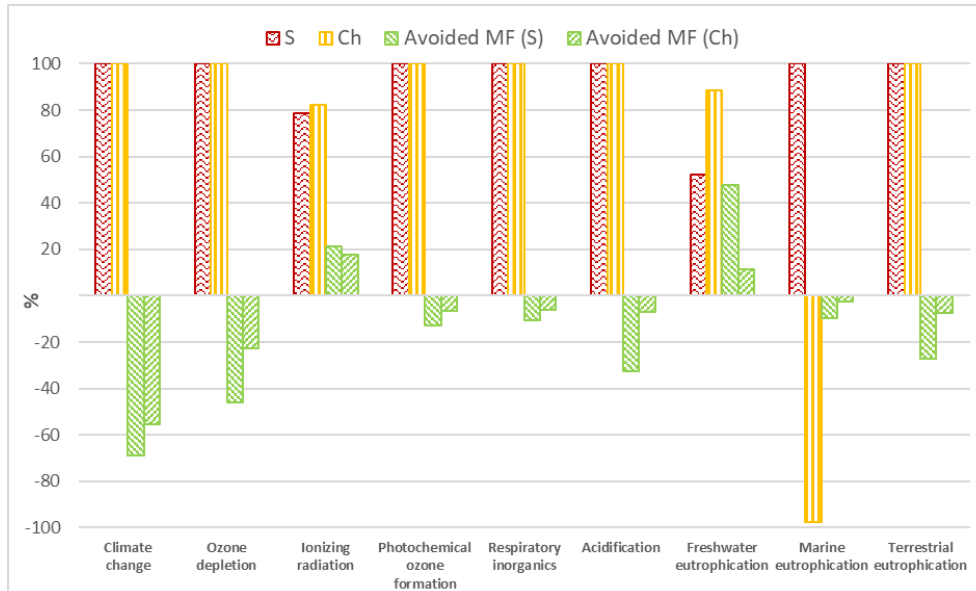

Figure 3. Impact environnemental des panneaux d'absorption acoustique à base de tournesol pour une application à basse fréquence (250 - 400 Hz). S = amidon, Ch = chitosan, MF = mousse de mélamine.

Entre les deux formulations, le panneau à base d'amidon semble avoir une meilleure performance environnementale que celui à base de chitosan pour toutes les catégories environnementales, à l'exception de l'eutrophisation marine, où la production du panneau à base de chitosan a elle-même induit un impact négatif (évité).

Une analyse plus poussée du processus de récolte a montré que les émissions liées à la combustion du diesel par les machines agricoles étaient à l'origine des impacts générés. L'efficacité environnementale des panneaux pourrait alors être améliorée en augmentant la quantité de tiges récoltées, car les machines actuelles ne sont capables de récolter qu'environ 55% de la tige. Cependant, une augmentation de la quantité de tiges récoltées entraînerait un éventuel épuisement des nutriments dans le sol et les impacts environnementaux qui y sont liés devraient être abordés. Spécifiquement pour le panneau de tournesol à base d'amidon, l'électricité utilisée pour la production des panneaux (processus de séchage), apparaît comme un contributeur à l'impact sur l'eutrophisation des eaux douces en raison des émissions de phosphates liées à la production de panneaux photovoltaïques (l'énergie solaire est considérée comme la source d'énergie marginale pour le mix électrique français par la fiche de procédé Ecoinvent).

La principale différence de performance environnementale entre les deux formulations (amidon et chitosan) est liée au processus de production du chitosan. L'approvisionnement en chitosan a une incidence sur les catégories d'impact suivantes : appauvrissement de la couche d'ozone, formation d'ozone photochimique, substances inorganiques respiratoires, acidification et eutrophisation des eaux douces et terrestres. La valorisation des boues protéiques, issues du processus de production de la chitine, comme engrais azoté, est responsable des impacts sur la formation d'ozone photochimique, les substances inorganiques respiratoires, l'acidification et l'eutrophisation terrestre. Les impacts sur l'appauvrissement de la couche d'ozone et l'eutrophisation des eaux douces sont liés à l'approvisionnement en matières premières pour la production de chitine. Plus précisément,

l'approvisionnement en chlore et le lignite utilisé pour la production de chaleur et d'énergie, respectivement.

D'autre part, la valorisation des coproduits issus du processus d'approvisionnement en chitosan contribue à réduire les impacts sur le changement climatique et l'eutrophisation marine. Plus précisément, cela est dû à la valorisation des déchets de crevettes en tant qu'alimentation animale, car elle réduit les impacts liés à la production de farine de soja. De plus, les gains sur les radiations ionisantes proviennent de l'énergie utilisée dans le processus d'obtention de la chitine, car la fiche de procédé conséquentielle Ecoinvent pour la cogénération de chaleur et d'électricité considère que cela réduit l'utilisation de l'énergie nucléaire pour la production d'électricité.

Les résultats de l'analyse de sensibilité ont montré que la valorisation de l'écorce comme panneau de particules, réduit l'impact environnemental des panneaux de moelle de tournesol pour toutes les catégories d'impact, le Tableau 2 montre la réduction d'impact (en %).

Tableau 2. Gains environnementaux pour toutes les catégories d'impact en considérant la valorisation de l'écorce comme panneau de particules.

Catégorie d'impact	Formulation à base d'amidon	Formulation à base de chitosane
Changement climatique	-33%	-40%
Appauvrissement de la couche d'ozone	-26%	-18%
Rayonnement ionisant	-22%	-25%
Formation d'ozone photochimique	-96%	-72%
Matières inorganiques respiratoires	-263%	-214%
Acidification	-83%	-24%
Eutrophisation en eau douce	-69%	-17%
Eutrophisation marine	-81%	28%
Eutrophisation terrestre	-87%	-32%

En conclusion, ce travail a exploré la valorisation de la moelle de tournesol comme matériau d'isolation acoustique sous forme de panneaux d'absorption acoustique visant à réduire la réverbération du bruit dans les espaces ouverts à l'intérieur des bâtiments. Les panneaux de moelle de tournesol ont été produits avec succès avec deux formulations différentes, utilisant l'amidon et le chitosan comme agents liants. Les propriétés d'absorption acoustique des panneaux finis ainsi que celles des panneaux en liège et en mousse de mélamine ont été évaluées en mesurant leur coefficient d'absorption acoustique.

Dans l'ensemble, les panneaux de moelle de tournesol constituent une option compétitive en tant que matériaux d'absorption acoustique en termes de performances environnementales et acoustiques. Les meilleures performances environnementales des panneaux sont obtenues lorsqu'une application pour les basses fréquences est visée. Parmi les deux formulations, le panneau à base d'amidon est plus performant que celui à base de chitosan. Cependant, les propriétés antimicrobiennes du chitosan confèrent aux panneaux à base de moelle de tournesol un avantage qui devrait être évalué de manière plus approfondie, car il serait moins sujet à la dégradation par les champignons et les petits insectes. L'influence du chitosan dans la phase d'utilisation (c'est-à-dire dans la durée de vie) des panneaux

pourrait être étudiée en réalisant des études de vieillissement accéléré sur les panneaux à base d'amidon et de chitosan.

En outre, l'approche conséquentielle adoptée permet d'évaluer des scénarios dans lesquels les coproduits issus du processus d'approvisionnement en moelle sont davantage valorisés. La valorisation des coproduits a contribué à des gains de 20% à 260% pour toutes les catégories d'impact.

Grâce à l'analyse de la dynamique du carbone de l'agromatériau, le problème majeur de l'absorption du carbone du sol, résultant de la récolte des tiges de tournesol, a été abordé et s'est avéré avoir peu d'influence sur la qualité du sol sur une période de 20 à 100 ans. De plus, le retour des panneaux dans le champ de culture à la fin de leur vie utile a eu un effet négligeable sur les caractéristiques du carbone du sol, mais a permis d'éviter l'émission de 14 kg de CO₂ par hectare de terre cultivée (en considérant une valorisation des coproduits), provenant de la décomposition de la biomasse.

Les spécificités de l'application de la méthodologie ACV aux agromatériaux ont été abordées par l'incorporation de la dynamique du carbone dans l'évaluation. Ainsi, des aspects tels que l'absorption du carbone par le sol, son stockage dans le produit final et la qualité du recyclage naturel des agromatériaux en fin de vie ont été pris en compte dans la performance environnementale globale des panneaux d'absorption acoustique à base de moelle de tournesol. Cela s'est reflété positivement sur les panneaux dans la catégorie d'impact environnemental du changement climatique, dans laquelle la formulation d'amidon du panneau à base de moelle de tournesol a surpassé les alternatives commerciales.

Conclusion et perspectives

L'incorporation de pratiques au système économique actuel pour déployer avec succès une bioéconomie doit s'accompagner de processus décisionnels qui suivent les lignes directrices d'une forte durabilité. Les matériaux nouveaux et plus écologiques, ainsi que leurs propriétés en fin de vie, doivent être clairement classés et réglementés pour qu'ils puissent contribuer efficacement à ce déploiement.

La grande disponibilité de la biomasse, en particulier sous la forme de déchets agricoles, représente un atout important pour faire évoluer les habitudes de production et de consommation vers des pratiques plus durables. La valorisation de la biomasse comme source de matériaux a le potentiel de contribuer à l'atténuation du changement climatique, ainsi qu'à la réduction des niveaux de pollution. Néanmoins, les matériaux biosourcés ne sont pas toujours intrinsèquement meilleurs d'un point de vue environnemental, ni biodégradables/compostables. En outre, la terminologie a été utilisée de manière interchangeable pour définir des matériaux présentant des caractéristiques différentes, ce qui est source de confusion.

Présenté au chapitre I, un système de classification tenant compte de l'origine et des propriétés de fin de vie des matériaux vise à améliorer la compréhension des matériaux biosourcés, de leurs avantages et de leurs limites. Ce système vise également à identifier clairement les propriétés de fin de vie possibles des matériaux biosourcés et, par conséquent, les techniques de gestion des déchets possibles. Cela devient particulièrement pertinent pour l'évaluation de la performance environnementale des matériaux biosourcés.

Parmi les différentes méthodes d'évaluation environnementale présentées dans ce travail de thèse, la qualité holistique de l'analyse du cycle de vie (ACV) en fait l'option la plus appropriée pour évaluer la pertinence environnementale de l'intégration des matériaux biosourcés sur le marché. L'ACV permet

de comparer différents matériaux, d'identifier les points à améliorer et, en suivant une approche conséquentielle, d'évaluer la pertinence de la valorisation des coproduits et leur effet sur la performance environnementale d'un produit.

Les défis méthodologiques liés à l'évaluation de la performance environnementale des matériaux biosourcés par l'ACV qui ont été identifiés dans ce travail de thèse ont été abordés à travers l'application des deux études de cas présentées.

Le défi méthodologique des données d'inventaire du cycle de vie a été abordé en produisant des ICV à partir de mesures propres et de contacts directs avec des experts de terrain. De cette façon, un ICV complet et détaillé pour la fibre de lin a été construit, ainsi qu'un ICV pour l'approvisionnement en moelle de tournesol et la production de panneaux insonorisants.

Pour le défi de la multifonctionnalité, les coproduits ont été traités par l'expansion du système et par l'utilisation de données marginales. Cela a permis de démontrer que la valorisation des coproduits influence la performance environnementale d'un produit. Dans cette étude, l'inclusion des coproduits a contribué à la réduction des impacts sur la plupart des catégories environnementales évaluées.

Les spécificités du changement indirect d'affectation des terres (iLUC) et son influence sur les catégories d'impact abordées, ont été abordées par la création d'un processus iLUC prenant en compte les effets de l'augmentation des besoins en terres si la demande en produits agricoles augmente. Son influence était visible dans les catégories d'impact du changement climatique, de la formation d'ozone et de l'eutrophisation marine. Ceci a été illustré par la première étude (présentée au chapitre II) au niveau de la section textile technique de la fibre de lin.

Les défis liés à la comptabilisation du carbone dans les matériaux biosourcés ont été abordés par la modélisation de la dynamique du carbone organique du sol et son incorporation dans le cadre de l'évaluation ACV. Spécifiquement pour l'étude de cas évaluée dans ce travail, la récolte des tiges de tournesol pour leur valorisation en tant que panneaux insonorisants s'est avérée avoir peu d'influence sur la performance environnementale des panneaux.

Enfin, l'approche adoptée pour répondre aux particularités de la gestion de la fin de vie des matériaux biosourcés, a été d'adapter les processus EOL existants en fonction des émissions spécifiques de la biomasse. Dans le cas présent, il s'agissait des émissions liées à la combustion des fibres naturelles (dans le cas du matériau biocomposite) ainsi qu'à la décomposition des panneaux de tournesol lors de leur retour au champ pour un processus de recyclage naturel.

Dans ce contexte, la première question scientifique, à savoir comment le détournement des ressources affecte-t-il l'impact environnemental d'un produit biosourcé, a été résolue par l'incorporation du sort des coproduits dans la performance environnementale du produit principal, par l'expansion du système, et par l'inclusion des effets du changement d'utilisation des terres résultant de l'augmentation du rendement de la fibre de lin pour la production de textiles techniques.

En outre, la deuxième question scientifique, à savoir comment appliquer la méthodologie de l'ACV aux agro-matériaux, a été abordée en intégrant les spécificités des agro-matériaux, telles que l'absorption du carbone par le sol, le stockage du carbone et le recyclage naturel, dans le cadre de l'ACV. Cela a été possible grâce à l'évaluation et à l'inclusion de la dynamique du carbone dans l'évaluation.

En ce qui concerne les perspectives de ce travail de thèse, nous pouvons identifier celles liées à l'amélioration des études de cas elles-mêmes et de la méthodologie ACV. En commençant par les premières, les perspectives comprennent :

(i) La pertinence environnementale et technique de l'utilisation de fibres courtes de lin au lieu d'un textile technique, ce qui pourrait s'avérer intéressant dans le but d'améliorer la performance environnementale du matériau biocomposite en évitant les étapes énergivores de filage et de tissage. En outre, une ACV comparant les deux matériaux (fibres longues et fibres courtes) pourrait être utilisée pour évaluer l'influence des impacts évités sur le changement d'affectation des sols du fait de l'utilisation d'un coproduit agricole pour la production de biocomposites, au lieu d'un produit initialement destiné à l'industrie textile.

(ii) En ce qui concerne la production et l'évaluation des panneaux de moelle de tournesol dans le contexte de l'étude de cas LUMA (chapitre III), les travaux ultérieurs pourraient être axés sur l'amélioration des formulations de vapeur d'eau et d'isolat de protéines. Si des panneaux fonctionnels sont obtenus, leurs performances environnementales et techniques pourraient alors être comparées à celles des panneaux à base d'amidon et de chitosan. En outre, l'influence de l'épaisseur des panneaux sur leurs performances d'absorption acoustique pourrait être évaluée. En faisant varier l'épaisseur des panneaux de moelle de tournesol, les caractéristiques du produit permettant d'obtenir une performance environnementale optimale pourraient être définies et exploitées.

(iii) Pour l'étude de cas, les panneaux de tournesol ont été estimés avoir une durée de vie de 20 ans. Pour démontrer la validité de cette hypothèse, des études de vieillissement devraient être réalisées. Cela serait également pertinent pour aborder les propriétés antimicrobiennes du chitosan et leur influence sur l'impact environnemental des panneaux.

(iv) Dans le but de continuer à stimuler l'incorporation de matériaux biosourcés pour favoriser la mise en œuvre d'une bioéconomie, les travaux futurs devraient se concentrer sur l'optimisation des processus de production des matériaux biosourcés afin d'accroître leur compétitivité sur le marché. Les chaînes d'approvisionnement devraient également se concentrer sur des pratiques de production qui privilégient une utilisation efficace des ressources en tirant parti de la plus grande partie possible de la biomasse disponible (valorisation des coproduits). En outre, pour qu'une bioéconomie puisse être déployée avec succès, les réglementations actuelles et les exigences relatives aux matériaux devraient être révisées et repensées dans une perspective biosourcée, en tenant compte des qualités et des spécificités des produits d'origine biosourcée.

D'un point de vue plus méthodologique :

(i) Étant donné que le niveau de développement des produits biosourcés est moins avancé que celui de leurs équivalents fossiles produits industriellement, il semble nécessaire de se concentrer sur la mise à l'échelle des données collectées. Cela permettrait de comparer les processus de production en suivant les mêmes niveaux de TRL, ce qui permettrait une évaluation et une interprétation plus précises des résultats.

(ii) Du point de vue de l'éco-conception, les travaux futurs du projet BOPA devraient se concentrer sur l'optimisation du panneau biocomposite (c'est-à-dire sa géométrie) afin d'améliorer ses performances environnementales et donc la pertinence de son introduction sur le marché. Dans ce contexte, le couplage du modèle SimaPro à un logiciel de simulation permettant de tester différentes configurations du prototype pourrait être avantageux. Ainsi, la géométrie optimale du panneau sandwich biocomposite présentant les meilleures performances environnementales pourrait être évaluée. Cette analyse simultanée des performances mécaniques et environnementales pourrait être étendue à tout nouveau produit/matériau d'origine biosourcée.

(iii) Enfin, dans le but d'avoir une évaluation plus complète non seulement de la performance environnementale mais aussi de l'aspect durable des produits biosourcés, l'incorporation d'une perspective sociale et économique dans l'ACV s'avérerait avantageuse.

En conclusion, les produits biosourcés se sont avérés être une option valable pour le développement réussi d'une bioéconomie. Grâce à l'ACV, les domaines d'amélioration potentiels pour la production de matériaux biosourcés ont été identifiés, et leur potentiel d'atténuation du changement climatique a été abordé.

En outre, ce travail de thèse a mis en lumière la nécessité de repenser et d'adapter les pratiques de production, ainsi que les réglementations, aux spécificités des produits biosourcés. De cette manière, leur intégration dans le système économique actuel serait améliorée, ils deviendraient plus compétitifs et, par conséquent, plus pertinents dans leur rôle d'acteurs clés du déploiement d'une bioéconomie.