



HAL
open science

Geometric techniques for the study of maximal operators

Anthony Gauvan

► **To cite this version:**

Anthony Gauvan. Geometric techniques for the study of maximal operators. Functional Analysis [math.FA]. Université Paris-Saclay, 2023. English. NNT : 2023UPASM016 . tel-04191328

HAL Id: tel-04191328

<https://theses.hal.science/tel-04191328>

Submitted on 30 Aug 2023

HAL is a multi-disciplinary open access archive for the deposit and dissemination of scientific research documents, whether they are published or not. The documents may come from teaching and research institutions in France or abroad, or from public or private research centers.

L'archive ouverte pluridisciplinaire **HAL**, est destinée au dépôt et à la diffusion de documents scientifiques de niveau recherche, publiés ou non, émanant des établissements d'enseignement et de recherche français ou étrangers, des laboratoires publics ou privés.

Techniques géométriques pour l'étude
des opérateurs maximaux
*Geometric techniques for the study of maximal
operators*

Thèse de doctorat de l'université Paris-Saclay

École doctorale de Mathématiques Hadamard n°574 (EDMH)
Spécialité de doctorat : Mathématiques Fondamentales
Graduate School : Mathématiques. Référent : Faculté des sciences d'Orsay

Thèse préparée dans le **Laboratoire de Mathématiques d'Orsay** (Université Paris-Saclay, CNRS), sous la direction de **Laurent MOONENS**, Maître de conférence à l'Université Paris-Saclay, et la co-direction de **Emmanuel RUSS**, Professeur à l'Université Grenoble-Alpes

Thèse soutenue à Paris-Saclay, le 10 Juillet 2023, par

Anthony GAUVAN

Composition du jury

Membres du jury avec voix délibérative

Sandrine GRELLIER Professeure, Université d'Orléans	Présidente
Pascal AUSCHER Professeur, Université Paris-Saclay	Examineur
Frédéric BERNICOT Directeur de recherche, Université de Nantes	Rapporteur & Examineur
Galia DAFNI Professeure, Concordia University	Rapporteuse & Examinatrice
Ioannis PARISSIS Professeur associé, University of the Basque Country	Examineur
Séverine RIGOT Professeure, Université Côte d'Azur	Examinatrice

Titre: Techniques géométriques pour l'étude des opérateurs maximaux

Mots clés: Opérateur maximal, analyse harmonique

Résumé: Si les propriétés de l'opérateur maximal de Hardy-Littlewood sont bien connues, la situation est plus complexe lorsque l'opérateur maximal est défini sur une famille de rectangles ayant moins de symétrie ou de régularité que la famille des cubes de l'espace Euclidien. Cette thèse est dédiée à l'étude d'opérateurs maximaux définis sur de telles

familles : nous développons et utilisons des techniques géométriques pour obtenir des propriétés de bornitudes optimales pour différents types d'opérateurs maximaux. En particulier, nous utilisons des variantes de construction d'arbre de Perron, la technologie de Bateman-Katz et la technique de cristallisation de Stokolos.

Title: Geometric techniques for the study of maximal operators

Keywords: Maximal operator, harmonic analysis

Abstract: It is well known that the Hardy-Littlewood maximal operator defined on cubes is bounded on the scale of Lebesgue spaces, the situation is more complex for a maximal operator defined on a family of rectangles with prescribed angles, eccentricities or volumes. This thesis is dedicated to the study of such geometric

maximal operators: we develop and use geometric techniques in order to obtain sharp boundedness properties for different kinds of maximal operators. In particular, we use variants of the so-called Perron trees, Bateman-Katz's technology and crystallisation technique *à la* Stokolos.

A mes parents.

Remerciements

En premier, je souhaite remercier mes directeurs de thèse Laurent et Emmanuel : merci de m'avoir initié à la pratique des mathématiques et d'avoir partagé avec moi votre vaste culture mais surtout, merci pour votre bienveillance et votre patience. Laurent, j'aimerais aussi te remercier pour tes mots d'encouragements qui ont, je crois bien, grandement joué sur certains chemins.

Je suis très reconnaissant envers Galia Dafni et Frédéric Bernicot d'avoir relu et rapporté cette thèse avec gentillesse et soin. J'exprime toute ma gratitude envers Pascal Auscher, Frédéric Bernicot, Galia Dafni, Séverine Rigot, Sandrine Grellier et Ioannis Parissis d'avoir accepté de faire partie de mon jury, c'est un grand honneur qu'ils me font. C'est aussi Cyril Imbert que je remercie d'être présent aujourd'hui aux côtés des membres du jury.

Ce manuscrit contient des résultats obtenus en collaboration avec Emma et Laurent ainsi que Romain et Samuel. Aux premiers comme aux seconds, merci d'avoir pris du temps pour réfléchir ensemble : une part de ce texte vous revient naturellement.

J'ai eu la chance de rencontrer des mathématiciens et mathématiciennes pour qui j'ai énormément d'estime et qui m'ont donné l'occasion de voyager ces dernières années : je remercie donc très chaleureusement Ioannis Parissis, Luz Roncal, Neal Bez, Diogo Oliveira e Silva et Shobu Shiraki pour leur générosité.

Le voyage n'aurait pas été si agréable, entre Orsay et Paris, sans la présence de nombreuses personnes. Que ce soit pour prendre un café, déjeuner ou rire, discuter des q -adiques, parler de rectangles et dessiner aux murs, flâner dans les bars et les couloirs, surveiller des examens, chamberer et se faire chamberer ou encore travailler, j'aimerais exprimer mes sincères remerciements à Olivier Hénard, Vadim Lebovici, Antoine Prouff, Jérémie Capitao, Arnaud Durand, Ayman Moussa, Jean-Christophe Barbelet, Lucas Vacossin, Arnaud Vanhaecke, Lino Benedetto, Samuel Bronstein, Ariane Mézard, Romain Branchereau, Coline Emprin et Spyridon Filippas. J'ai une pensée particulière pour mon camarade et ami Alex, qui m'a vu navigué depuis Châtenay-Malabry jusqu'ici.

Enfin et évidemment, à mes proches, merci de m'avoir accompagné jusqu'à aujourd'hui, sans vous rien n'aurait été possible.

Bibliographie de l'auteur

Ce manuscrit est dédié à l'étude des opérateurs maximaux dit *géométriques* sous la condition de *Buseman-Feller*. Pour garder une certaine unité dans la présentation, j'ai décidé d'omettre deux travaux rédigés durant ma thèse.

Publications et pré-publications présentées

- Le troisième chapitre est contenu dans [11] *(Un)boundedness of directional maximal operators through a notion of "Perron capacity" and an application*. Il s'agit d'un travail en collaboration avec Emma D'Aniello et Laurent Moonens qui a été accepté pour publication aux *Proceedings of the American Mathematical Society*.
- Le quatrième chapitre est contenu dans [24] *Perron capacity of random sets*. Ce travail a été accepté pour publication aux *Proceedings of the Edinburgh Mathematical Society*.
- Le cinquième chapitre est contenu dans [20] *Application of Perron Trees to Geometric Maximal Operators*. Ce travail a été accepté pour publication à *Colloquium Mathematicum*.
- Le sixième chapitre est contenu dans [21] *Keakeya-type sets and Maximal Operators*. Ce travail est actuellement en soumission.
- Le septième chapitre est contenu dans [22] *Sharp weak-type estimate for maximal operators under an arithmetic condition*. Ce travail est actuellement en soumission.
- Le huitième chapitre est contenu dans [7] *Maximal operators on hyperbolic triangles*. Il s'agit d'un travail en collaboration avec Romain Branchereau et Samuel Bronstein, actuellement en soumission.

Publications non présentées

- L'article [12] *Almost everywhere convergence for Lebesgue differentiation processes along rectangles* accepté pour publication au *Journal of Fourier Analysis and Applications* est un travail en collaboration avec Emma D'Aniello, Laurent Moonens et Joseph Rosenblatt.
- L'article [23] *Norm estimates for the Keakeya Maximal function in high dimensions with respect to general measures* est quant à lui accepté pour publication au *Real Analysis Exchange*.

Contents

1	Introduction en français	11
1.1	L'opérateur maximal de Hardy-Littlewood	12
1.2	La théorie de Cordoba et Fefferman	14
1.3	Compression de Keakeya dans l'espace euclidien	15
1.4	Le Théorème maximal fort	18
1.5	Opérateurs maximaux directionnels	19
1.6	Ensembles de direction linéaire et de type Cantor	20
1.7	Le théorème de Bateman	21
1.8	La conjecture de Zygmund	23
1.9	Sur des espaces non euclidiens	25
1.10	Contributions	26
2	Introduction	31
2.1	The Hardy-Littlewood maximal operator	32
2.2	The theory of Cordoba and Fefferman	34
2.3	Keakeya blow in the Euclidean space	34
2.4	The strong maximal Theorem	38
2.5	Directional maximal operators	39
2.6	The linear set and the Cantor set of directions	40
2.7	Bateman's Theorem	41
2.8	Zygmund's conjecture	43
2.9	On non-Euclidean spaces	44
2.10	Contributions	46
3	Perron capacity I	51
3.1	Results	52
3.2	Proof of Theorem 3.1.2	53
3.3	Homogeneous sets	53
3.4	Proof of Theorem 3.1.1	55
4	Perron capacity II	57
4.1	Proof of Theorem 4.0.2	58
4.2	Proof of Theorem 4.0.3	60
5	Application of Perron Trees to maximal operators	63
5.1	Results	64
5.2	Proof of Theorem 5.1.2	65
5.3	Geometric estimates and generalized Perron tree	65
5.4	Proof of Theorem 5.1.3	69

5.5	Proof of Theorem 5.1.1	71
6	Keakeya-type sets for maximal operators	73
6.1	Result	73
6.2	Definition of \mathcal{T}	74
6.3	Structure of \mathcal{T}	75
6.4	Analytic split	76
6.5	Keakeya-type sets	77
6.6	Bateman's construction	78
6.7	Geometric estimates	80
6.8	Proof of Theorem 6.1.1	85
7	Sharp weak-type estimate under an arithmetic condition	89
7.1	Result	91
7.2	Cartesian families	92
7.3	Crystal	94
7.4	Proof of Theorem 7.1.1	95
8	Maximal operators on hyperbolic triangles	97
8.1	Result	97
8.2	Thick triangles	99
8.3	Partly ideal triangles	101
8.4	Thin and small triangles	103

1 - Introduction en français

Une problématique classique en analyse est de déterminer si un opérateur donné est borné d'un espace fonctionnel à un autre. On s'intéresse plus précisément aux opérateurs dits maximaux parmi lesquels se distinguent l'opérateur maximal de *Hardy-Littlewood*, l'opérateur de *Carleson* et l'opérateur maximal sphérique de *Stein*. Ces opérateurs ont été intensivement étudiés car chacun d'entre eux est naturellement lié à la convergence presque partout de *processus* spécifiques, par exemple, à la moyenne sur des ensembles géométriques, à la formule de reconstruction de Fourier ou à des équations aux dérivées partielles.

Dans cette thèse, nous nous intéressons principalement aux opérateurs maximaux apparentés à l'opérateur maximal de Hardy-Littlewood : étant donnée une famille \mathcal{B} composée de rectangles de mesure positive finie, nous définissons l'opérateur maximal $M_{\mathcal{B}}$ pour $f \in L^\infty$ et $x \in \mathbb{R}^n$ comme

$$M_{\mathcal{B}}f(x) := \sup_{R \in \mathcal{B}} \frac{1}{|R|} \int_R |f|.$$

Nous supposons toujours que la famille \mathcal{B} qui définit l'opérateur maximal $M_{\mathcal{B}}$ est invariante par translations *i.e.* pour tout rectangle $R \in \mathcal{B}$ et tout $t \in \mathbb{R}^n$, nous avons

$$t + R \in \mathcal{B}.$$

Nous appellerons une telle famille \mathcal{B} une *famille invariante par translations* et, naturellement, nous dirons que $M_{\mathcal{B}}$ est un *opérateur maximal invariant par translations*.

Dans les premiers chapitres, nous supposons que la famille invariante par translations \mathcal{B} est également invariante par dilatations centrales *i.e.* pour tout rectangle $R \in \mathcal{B}$ et tout $\lambda > 0$, nous avons

$$\lambda R \in \mathcal{B}.$$

Ici, le rectangle λR est le rectangle qui a le même centre que le rectangle R mais dont les longueurs des côtés sont dilatées par le facteur $\lambda > 0$. On dira qu'une famille \mathcal{B} invariante par ces deux symétries est une *famille géométrique* et on dira dans ce cas que $M_{\mathcal{B}}$ est un *opérateur maximal géométrique*.

Tout opérateur maximal est évidemment borné de L^∞ à L^∞ *i.e.* pour tout $f \in L^\infty$, nous avons l'estimation suivante

$$\|M_{\mathcal{B}}f\|_\infty \leq \|f\|_\infty.$$

Comment la géométrie de la famille \mathcal{B} influence-t-elle les propriétés de bornitude de l'opérateur $M_{\mathcal{B}}$ sur des espaces L^p pour $p \in [1, \infty)$? Et si possible,

peut-on déterminer les propriétés de bornitude *optimales* de l'opérateur maximal $M_{\mathcal{B}}$? C'est le problème général qui est considéré dans cette thèse.

Cette introduction est organisée de la façon suivante : nous commençons par rappeler des faits classiques sur l'opérateur maximal de Hardy-Littlewood et sa relation avec la différentiation d'intégrale. Ensuite, nous détaillerons la relation entre les propriétés de bornitude de $M_{\mathcal{B}}$ et les propriétés de recouvrement de la famille \mathcal{B} telles qu'expliquées par Cordoba et Fefferman dans [8]. Par la suite, nous rappellerons les propriétés de deux opérateurs maximaux bien connus, à savoir l'opérateur maximal *strong* et l'opérateur maximal *grand*. Cela nous amènera à considérer les opérateurs maximaux *directionnels* et le théorème de Bateman. Enfin, nous rappellerons l'énoncé de la *conjecture de Zygmund* et sa reformulation par Stokolos. Finalement, nous décrirons brièvement nos contributions à ces problèmes.

1.1 . L'opérateur maximal de Hardy-Littlewood

L'opérateur maximal de *Hardy-Littlewood* est l'un des opérateurs maximaux les plus classiques : il apparaît naturellement lorsque l'on cherche à comprendre la convergence presque partout des processus de moyennisation sur des cubes ou des boules. En 1910, Lebesgue a prouvé qu'étant donné une fonction localement intégrable f définie sur \mathbb{R}^n , on a presque partout

$$f(x) = \lim_{r \rightarrow 0} A_r f(x).$$

Ici la notation $A_r f(x)$ représente la moyenne de la fonction f sur le cube centré au point x et de longueur de côté r . Cette identité peut être formulée de manière quantitative grâce à l'opérateur maximal de Hardy-Littlewood M (voir [29]) qui est défini comme suit : pour $f \in L^\infty$ et $x \in \mathbb{R}^n$, nous définissons

$$Mf(x) := \sup_{x \in Q \in \mathcal{Q}_n} \frac{1}{|Q|} \int_Q |f|.$$

Ici, nous avons désigné par \mathcal{Q}_n la famille contenant tous les cubes parallèles à l'axe de \mathbb{R}^n . Des arguments classiques montrent que le théorème de différentiation de Lebesgue tient dès que l'on prouve que pour toute fonction f et $t > 0$, on a l'*estimation de type faible* suivante au voisinage de L^1

$$|\{Mf > t\}| \lesssim_n \int_{\mathbb{R}^n} \frac{|f|}{t}.$$

Dans la littérature, on dit que l'opérateur M est borné de L^1 à l'espace de Lorentz $L^{1,\infty}$ traditionnellement appelé L^1 faible. Il s'avère que cette propriété est une conséquence facile du théorème de recouvrement de Vitali.

Théorème 1.1 (Théorème de recouvrement de Vitali). *Pour n'importe quelle famille finie composée de cubes $\{Q_i : i \in I\}$, il est possible de trouver une sous-famille $J \subset I$ telle que les cubes $\{Q_j : j \in J\}$ soient deux à deux disjoints et telle qu'on ait l'inclusion suivante*

$$\bigcup_{i \in I} Q_i \subset \bigcup_{j \in J} 4^n Q_j.$$

La preuve du théorème de différentiation de Lebesgue se résume donc à un argument géométrique *modulo* des détails techniques. Remarquons aussi que puisque l'opérateur M est naturellement borné de L^∞ à L^∞ , il s'ensuit par interpolation que M est borné de L^p à L^p pour tout $p > 1$: cet argument est général et vaut pour tous les opérateurs maximaux que nous considérerons.

Une généralisation naturelle de l'opérateur maximal de Hardy-Littlewood consiste à calculer la moyenne sur des ensembles géométriques plus complexes. Comme nous l'avons dit précédemment, nous sommes particulièrement intéressés par les familles composées de *rectangles* : un rectangle n -dimensionnel est simplement un produit de n intervalles finis qui est éventuellement tourné. Voici différents types de familles que l'on peut considérer :

- La famille \mathcal{I}_n qui contient tous les rectangles parallèles aux axes de l'espace euclidien *i.e.* la famille

$$\mathcal{I}_n = \{J_1 \times \cdots \times J_n : \forall i \leq n, \exists -\infty < a_i < b_i < \infty, J_i = [a_i, b_i]\}.$$

L'opérateur maximal associé à \mathcal{I}_n est appelé l'opérateur maximal *fort* et sera noté M_n dans ce qui suit.

- La famille \mathcal{R}_n qui contient tous les rectangles de l'espace euclidien *i.e.* la famille

$$\mathcal{R}_n = \{\phi(R) : R \in \mathcal{I}_n, \phi \in Iso(\mathbb{R}^n)\}.$$

Ici, bien sûr, $Iso(\mathbb{R}^n)$ représente les mouvements rigides de l'espace euclidien. L'opérateur maximal associé à \mathcal{R}_n est appelé le *grand* opérateur maximal.

- Si on nous donne une famille F incluse dans \mathcal{R}_n , la *famille géométrique* engendrée par F est définie comme

$$\mathcal{B}_F = \{t + \lambda R : t \in \mathbb{R}^n, \lambda > 0, R \in F\}.$$

Évidemment, la famille \mathcal{B}_F est la plus petite famille stable par translations et dilatations centrales et qui contient F .

- Dans le plan euclidien, une classe importante de familles géométriques qui nous intéressera est celle des familles dites *directionnelles*. Étant

donné un ensemble arbitraire $\Omega \subset \mathbb{S}^1$, nous désignons par \mathcal{R}_Ω la famille directionnelle définie comme

$$\mathcal{R}_\Omega = \{R \in \mathcal{R}_2 : \omega_R \in \Omega\}$$

où $\omega_R \in \mathbb{S}^1$ représente l'angle que fait le plus grand côté de R avec l'axe horizontal. L'opérateur maximal associé à la famille \mathcal{R}_Ω sera noté M_Ω .

1.2 . La théorie de Cordoba et Fefferman

Les propriétés de bornitude d'un opérateur maximal $M_\mathcal{B}$ sont profondément liées aux propriétés de *recouvrement* de la famille \mathcal{B} et une partie importante du travail présenté dans l'article fondateur [8] concerne cette dualité. Précisément, Cordoba et Fefferman disent qu'une famille \mathcal{B} (non nécessairement géométrique) satisfait la propriété de recouvrement V_q pour $q \in (1, \infty)$ si, étant donnée toute famille finie $\{R_i : i \in I\}$ incluse dans \mathcal{B} , il existe une sous-famille $J \subset I$ telle qu'on ait

$$\left| \bigcup_{i \in I} R_i \right| \lesssim \left| \bigcup_{j \in J} R_j \right|$$

et aussi

$$\left\| \sum_{j \in J} \mathbb{1}_{R_j} \right\|_q \lesssim \left| \bigcup_{j \in J} R_j \right|^{\frac{1}{q}}.$$

L'intérêt principal de ces propriétés de recouvrement réside dans le théorème suivant.

Théorème 1.2 (Cordoba et Fefferman). *Une famille \mathcal{B} satisfait la propriété de recouvrement V_q si et seulement si l'opérateur maximal associé $M_\mathcal{B}$ est de type faible (p, p) i.e. si pour tout f et $t > 0$, on a*

$$|\{M_\mathcal{B}f > t\}|^{\frac{1}{p}} \lesssim \frac{\|f\|_p}{t}.$$

Ici, on a supposé $\frac{1}{p} + \frac{1}{q} = 1$.

L'élégance et la simplicité de cette relation sont évidentes, mais est-elle efficace? Et peut-elle donner des résultats optimaux? Bien sûr, si nous considérons une famille arbitraire \mathcal{B} , on ne peut pas dire grand chose de l'opérateur $M_\mathcal{B}$, puisque la famille \mathcal{B} elle-même n'est pas facilement descriptible, mais si nous restreignons notre attention aux familles géométriques, nous verrons qu'il devient possible de déduire les propriétés de bornitude de $M_\mathcal{B}$ *via* les propriétés géométriques de la famille \mathcal{B} .

1.3 . Compression de Kakeya dans l'espace euclidien

Nous allons maintenant détailler les propriétés de bornitude de du *grand* opérateur maximal $M_{\mathcal{R}_n}$ associé à la famille \mathcal{R}_n qui contient tous les rectangles de l'espace euclidien. Cela nous permettra de rappeler un obstacle géométrique important de l'espace euclidien que nous appellerons *compression de Kakeya*. Que peut-on dire du grand opérateur maximal

$$M_{\mathcal{R}_n} : L^\infty \rightarrow L^\infty$$

associé à la famille \mathcal{R}_n qui contient tous les rectangles de \mathbb{R}^n ? Peut-on prouver qu'il est borné sur un certain espace L^p ? Nous discutons cette question dans le plan euclidien \mathbb{R}^2 puisque la situation y est déjà complexe : dans la suite du mémoire, nous désignons par

$$\mathcal{R} := \mathcal{R}_2 = \{ \phi(R) : R \in \mathcal{I}_2, \phi \in Iso(\mathbb{R}^2) \}$$

la famille qui contient tous les rectangles du plan. Il n'est pas difficile de voir que cet opérateur ne peut pas être borné sur L^p lorsque $p \leq 2$ puisque la fonction $M_{\mathcal{R}}\phi$ ne décroît pas assez vite à l'infini pour toute fonction test ϕ .

La situation est en fait bien pire que cela puisque l'opérateur $M_{\mathcal{R}}$ n'est pas borné sur L^p pour tout $p < \infty$: ce mauvais comportement trouve sa racine dans un phénomène géométrique de l'espace euclidien à savoir la possibilité de faire un *compression de Kakeya* avec la famille \mathcal{R} .

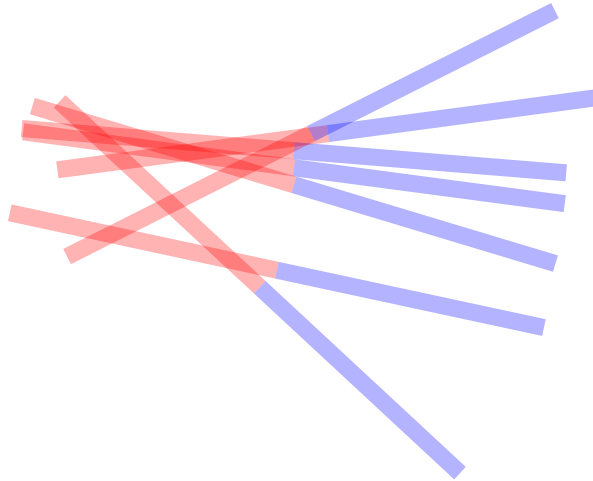

FIGURE 1.1 : Une illustration du théorème 2.3.1 : étant donné toute grande constante $A \gg 1$, il est possible de trouver une configuration de rectangles telle que l'aire rouge est A fois plus petite que l'aire bleue. Il existe deux méthodes pour le prouver (1) la construction déterministe d'un arbre de Perron (2) la construction aléatoire de Bateman.

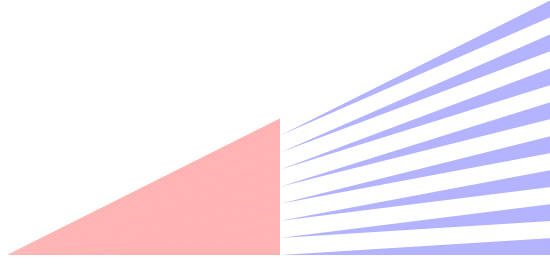

FIGURE 1.2 : La construction déterministe d'un arbre de Perron est détaillée dans [14]. En gros, étant donné un grand entier $N \gg 1$, on découpe un grand triangle rouge en 2^N triangles plus petits de même surface : les triangles bleus représentent le décalage des triangles rouges.

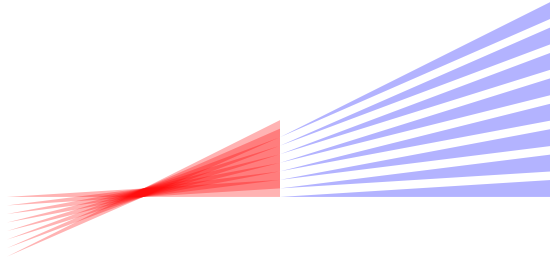

FIGURE 1.3 : Par la suite, la construction d'un arbre de Perron consiste à décaler verticalement les triangles rouges (ainsi que les bleus) par paires et de manière récursive. Ce faisant, on peut s'assurer que (1) les triangles rouges sont compressés *i*. l'aire a diminué d'un facteur $\log(N)^{-1}$ (2) les triangles bleus sont disjoints et donc l'aire bleue est $\simeq 1$.

Théorème 1.3 (Compression de Kakeya avec \mathcal{R}). *Pour n'importe quelle constante $A \gg 1$, il existe une famille finie de rectangles*

$$\{R_i : i \in I\} \subset \mathcal{R}$$

telle qu'on ait

$$\left| \bigcup_{i \in I} TR_i \right| \geq A \left| \bigcup_{i \in I} R_i \right|.$$

Ici, on a noté TR le rectangle R translaté dans le sens de son orientation et de la longueur de son plus grand côté.

Cette obstruction géométrique est un outil fondamental pour le reste de la thèse. Dans un certain sens, l'un de nos principaux problèmes peut être formulé comme suit : étant donné une famille géométrique \mathcal{B} , peut-on faire une compression de Kakeya avec cette famille ? Et si ce n'est pas le cas, que peut-on dire des propriétés de bornitude de $M_{\mathcal{B}}$? Nous faisons trois remarques concernant la compression de Kakeya :

- La possibilité de réaliser une compression de Kakeya a été découverte à l'origine dans l'étude du problème historique de l'aiguille de Kakeya. Elle exploite le fait que la famille \mathcal{R} contient des objets géométriques arbitrairement fins et orientés dans de nombreuses directions.
- Nous invitons le lecteur à consulter [18] où Fefferman a utilisé cette construction pour réfuter la célèbre conjecture du multiplicateur sphérique. En outre, le travail de Fefferman fournit une preuve du théorème 2.3.1.
- Il n'y a pas de moyen simple de prouver qu'il est possible de faire une compression de Kakeya, mais il existe au moins deux méthodes. La première consiste à construire un arbre de Perron (voir [18] par exemple) et la seconde est une construction aléatoire développée par Bateman et Katz dans [6] et développée plus encore par Bateman dans [5].

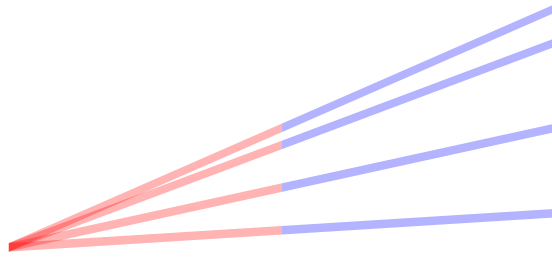

FIGURE 1.4 : La construction de Bateman est une réalisation d'une compression de Kakeya plus complexe que la construction d'un arbre de Perron. Supposons que l'on veuille réaliser une compression de Kakeya avec la restriction que les rectangles utilisés doivent être orientés dans un ensemble prescrit de directions $\Omega \subset \mathbb{S}^1$: si l'ensemble Ω est trop *irrégulier*, la construction de l'arbre de Perron ne fonctionnera pas. C'est le cas si Ω est un ensemble de Cantor ternaire classique par exemple.

Grâce à la possibilité de faire une compression de Kakeya avec \mathcal{R} , il s'ensuit qu'étant donné toute grande constante $A \gg 1$, il existe un ensemble borné E satisfaisant l'estimation suivante

$$\left| \left\{ M_{\mathcal{R}} \mathbb{1}_E \geq \frac{1}{2} \right\} \right| \geq A |E|.$$

Il suffit de fixer $E = \cup_{i \in I} R_i$ et d'observer que nous avons l'inclusion suivante

$$\bigcup_{i \in I} TR_i \subset \left\{ M_{\mathcal{R}} \mathbb{1}_E \geq \frac{1}{2} \right\}.$$

L'estimation précédente implique facilement que $M_{\mathcal{R}}$ n'est pas borné sur L^p pour tout $p < \infty$. En dimension supérieure, on peut utiliser la même procédure pour prouver que l'opérateur $M_{\mathcal{R}_n}$ n'est pas borné sur L^p pour tout $p < \infty$.

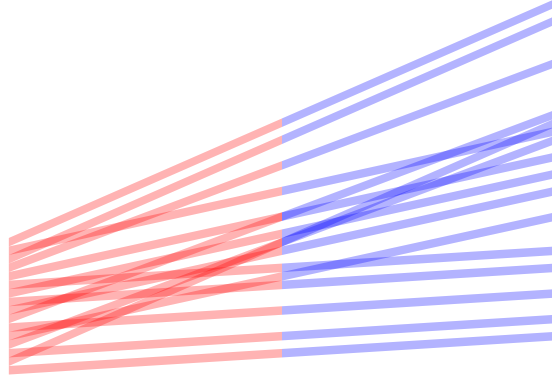

FIGURE 1.5 : Dans le cas où l'on souhaite réaliser une compression de Keakeya uniquement avec des rectangles orientés en Ω , l'idée de Bateman et Katz est d'arranger *aléatoirement* les rectangles à disposition et d'exploiter la structure arborescente dyadique de la situation pour prouver que, avec une probabilité positive, certaines réalisations de cette construction satisferont la condition *compressée-décompressée* de la compression de Keakeya.

1.4 . Le Théorème maximal fort

Dans l'espace euclidien \mathbb{R}^n , l'opérateur maximal *fort* M_n est associé à la famille \mathcal{I}_n contenant tous les rectangles dans \mathbb{R}^n dont les côtés sont parallèles à l'axe : cet opérateur a été intensivement étudié dans la littérature, notamment parce qu'il est lié à la théorie multilinéaire des opérateurs singuliers.

Il n'est pas difficile de voir que l'opérateur fort M_n ne peut pas être borné de L^1 à $L^{1,\infty}$ comme l'opérateur de Hardy-Littlewood M . En effet, pour tout petit $t > 0$, nous avons l'estimation suivante

$$\frac{1}{t} \left(1 + \log^+ \frac{1}{t}\right)^{n-1} |Q| \lesssim_n |\{M_n \mathbb{1}_Q \geq t\}|$$

où Q est un cube quelconque dans \mathbb{R}^n . La perte logarithmique vient du fait que la famille \mathcal{I}_n contient des rectangles qui peuvent devenir arbitrairement fins. Pourtant, l'opérateur M_n est toujours borné au voisinage de L^1 , ce qui est précisé par le théorème suivant.

Théorème 1.4 (Théorème maximal fort). *Pour toute fonction f et $t > 0$, on a*

$$|\{M_n f > t\}| \lesssim_n \int_{\mathbb{R}^n} \frac{|f|}{t} \left(1 + \log^+ \frac{|f|}{t}\right)^{n-1}.$$

En d'autres termes, le théorème maximal fort stipule que M_n est borné de l'espace d'Orlicz $L^1(1 + \log^+ L^1)^{n-1}$ à $L^{1,\infty}$. Cette estimation est due à l'origine à Jessen, Marcinkiewicz et Zygmund dans [32] et leur preuve repose sur

le fait qu'il est possible de dominer l'opérateur M_n par la composition de n -un opérateur maximal de Hardy-Littlewood unidimensionnel associé à chaque axe. Cependant, comme l'expliquent Cordoba et Fefferman dans [8], même si cette preuve est fondamentale, elle n'apporte pas une compréhension plus profonde de la géométrie des rectangles précisément parce qu'elle ne détaille pas les propriétés de recouvrement de la famille \mathcal{I}_n . Pour résoudre ce problème, Cordoba et Fefferman ont introduit dans [8] la propriété de recouvrement *exponentiel* $V_{\text{exp},n}$ qui est définie comme suit : par définition, une famille \mathcal{B} possède la propriété de recouvrement $V_{\text{exp},n}$ lorsque, étant donné toute famille finie $\{R_i : i \in I\}$ incluse dans \mathcal{B} , il existe une sous-famille $J \subset I$ telle que nous avons

$$\left| \bigcup_{i \in I} R_i \right| \lesssim \left| \bigcup_{j \in J} R_j \right|$$

et aussi

$$\int_{\mathbb{R}^n} \exp \left(\sum_{j \in J} \mathbb{1}_{R_j}(x) \right)^{\frac{1}{n-1}} dx \lesssim \left| \bigcup_{j \in J} R_j \right|.$$

Bien sûr, l'intérêt de cette propriété de recouvrement vient du fait suivant.

Théorème 1.5 (Cordoba et Fefferman). *Une famille \mathcal{B} satisfait la propriété $V_{\text{exp},n}$ si et seulement si l'opérateur maximal associé $M_{\mathcal{B}}$ est borné de $L(\log L)^{n-1}$ à $L^{1,\infty}$. Par ailleurs, la famille \mathcal{I}_n satisfait la propriété de recouvrement $V_{\text{exp},n}$.*

Par conséquent, le théorème maximal fort peut être prouvé par des moyens *analytiques* comme dans [32] ou par des arguments *géométriques* comme dans [8]. Comme pour l'opérateur maximal de Hardy-Littlewood, des arguments d'interpolation montrent que l'opérateur M_n est borné de L^p à L^p pour tout $p > 1$.

1.5 . Opérateurs maximaux directionnels

Les opérateurs maximaux directionnels forment un intermédiaire naturel entre l'opérateur maximal fort M_2 et le grand opérateur maximal $M_{\mathcal{R}}$. Rappelons que dans le plan euclidien \mathbb{R}^2 , nous disons qu'une famille incluse dans \mathcal{R} est une *famille directionnelle* lorsqu'elle est de la forme

$$\mathcal{R}_{\Omega} = \{R \in \mathcal{R} : \omega_R \in \Omega\}$$

où nous avons désigné par ω_R l'angle que fait le plus grand côté du rectangle R avec l'axe horizontal et par Ω un sous-ensemble de \mathbb{S}^1 et naturellement, nous désignons par M_{Ω} l'opérateur maximal associé à la famille \mathcal{R}_{Ω} . Etant donné un ensemble spécifique de directions Ω , est-il possible de trouver un exposant p' tel que M_{Ω} soit borné sur L^p pour $p' < p$ et non borné sur L^p pour $p < p'$?

A la fin des années 70, des analystes (voir [41], [38] ou [10]) ont considéré la famille directionnelle associée à l'ensemble des directions Ω_{lac} défini comme

$$\Omega_{\text{lac}} = \left\{ \frac{\pi}{2^k} : k \geq 1 \right\}.$$

La méthode de recouvrement introduite par Cordoba et Fefferman leur a permis d'étudier l'opérateur maximal $M_{\Omega_{\text{lac}}}$: dans [10], ils ont prouvé que la famille $\mathcal{R}_{\Omega_{\text{lac}}}$ possède la propriété de recouvrement V_2 et, en corollaire, l'opérateur $M_{\Omega_{\text{lac}}}$ est de type faible $(2, 2)$. Cependant, que se passe-t-il près de l'extrémité L^1 ? Un an plus tard, Nagel, Stein et Wainger ont prouvé dans [38] que l'opérateur $M_{\Omega_{\text{lac}}}$ est borné sur L^p pour tout $p > 1$.

Étonnamment, leur méthode ne repose pas sur des arguments géométriques mais sur des techniques d'analyse de Fourier. D'une certaine manière, l'idée sous-jacente à [38] est que deux rectangles peuvent se comporter comme s'ils étaient *orthogonaux* lorsque certaines conditions sont remplies. Ce principe a été développé dans les travaux ultérieurs d'Alfonseca, Soria et Vargas dans [2] et [3] et un dernier principe de *presque-orthogonalité* a été détaillé dans [1] par Alfonseca. Plus précisément, Alfonseca a prouvé qu'il est toujours possible d'effectuer une division géométrique de tout ensemble de directions Ω en un nombre dénombrable de parties

$$\Omega = \bigcup_{k \geq 1} \Omega_k$$

et d'obtenir, pour tout $p > 1$, l'estimation suivante

$$\|M_{\Omega}\|_p \lesssim \left(\sup_{k \geq 1} \|M_{\Omega_k}\|_p \right) + E_p$$

où E_p est un terme d'erreur qui dépend de la partition $\{\Omega_k : k \geq 1\}$ de l'ensemble Ω . Suivant la terminologie de Bateman dans [5], ce principe montre que tout ensemble de directions Ω qui est *finiment lacunaire* produit un opérateur maximal M_{Ω} qui est borné sur L^p pour tout $p > 1$.

1.6 . Ensembles de direction linéaire et de type Cantor

En revanche, un examen attentif de la construction d'un arbre de Perron montre qu'il est possible de faire une compression de Kakeya avec la famille $\mathcal{R}_{\Omega_{\text{lin}}}$ où l'ensemble Ω_{lin} est défini comme

$$\Omega_{\text{lin}} = \left\{ \frac{\pi}{k} : k \geq 1 \right\}.$$

Comme nous l'avons dit plus haut, une conséquence de ce fait est que l'opérateur maximal $M_{\Omega_{\text{lin}}}$ n'est pas borné sur L^p pour tout $p < \infty$. Bien sûr il est possible de construire d'autres grands ensembles de directions modélées

sur l'ensemble Ω_{lin} qui ont la même propriété mais il apparaît que pour faire un compression de Keakeya *via* la construction de l'arbre de Perron n'est pas suffisante pour traiter le cas le plus général.

En effet, le cas d'un ensemble de directions très irrégulier a posé problème pendant un certain temps. Le cas le plus emblématique est le suivant : dénotant par Ω_{Cantor} un ensemble de Cantor ternaire normalisé dans \mathbb{S}^1 ou $(0, \pi)$, que peut-on dire de l'opérateur $M_{\Omega_{\text{Cantor}}}$? Différents auteurs ont étudié les opérateurs maximaux associés à ce type d'ensemble irrégulier mais c'est grâce aux travaux de Bateman et Katz que les propriétés géométriques de la famille $\mathcal{R}_{\Omega_{\text{Cantor}}}$ ont été totalement comprises. Dans leur travail [6], les auteurs ont prouvé le théorème suivant.

Théorème 1.6 (Bateman et Katz). *Il est possible de faire une compression de Keakeya avec la famille directionnelle $\mathcal{R}_{\Omega_{\text{Cantor}}}$.*

Contrairement à la construction déterministe de l'arbre de Perron, Bateman et Katz ont fait d'un compression de Keakeya *via* une procédure aléatoire. Cette randomisation n'est pas la seule idée nouvelle qu'ils ont utilisée : les techniques déployées dans [6] tirent également parti (1) d'une discrétisation de la famille des rectangles qui démêle la *structure arborescente* du problème (2) de la notion d'*adhérence* qui provient de l'approche moderne du problème de Keakeya et enfin (3) d'arguments tirés de la théorie de la percolation. En d'autres termes, le résultat présenté dans [6] est assez difficile mais il conduit au corollaire suivant : l'opérateur maximal $M_{\Omega_{\text{Cantor}}}$ n'est pas borné sur L^p pour tout $p < \infty$.

1.7 . Le théorème de Bateman

La stratégie et le mécanisme développés dans [6] sont si efficaces que Bateman a réussi à classifier le comportement des opérateurs maximaux directionnels dans son travail [5]. Précisément, Bateman a prouvé que si un ensemble de direction Ω n'est pas finiment lacunaire, alors il est possible de faire un compression de Keakeya avec la famille \mathcal{R}_{Ω} et donc, l'opérateur maximal M_{Ω} n'est pas borné sur L^p pour n'importe quel $p < \infty$. Au regard du résultat d'Alfonseca, ceci complète l'étude *a priori* de l'opérateur maximal directionnel. En effet, le théorème de Bateman montre que la notion correcte de structure concernant Ω est de savoir si elle est *finiment lacunaire* ou non. Définissons cette notion en suivant une belle présentation faite par Kroc et Pramanik [34] : nous commençons par définir la notion de *séquence lacunaire* et ensuite la notion de *ensemble lacunaire d'ordre fini*. Nous disons qu'une suite de nombres réels $L = \{\ell_k : k \geq 1\}$ est une suite lacunaire convergeant vers $\ell \in \mathbb{R}$ lorsqu'il existe

$$|\ell - \ell_{k+1}| \leq \frac{1}{2}|\ell - \ell_k|$$

pour tout k . Par exemple les séquences $\{\frac{1}{2^k} : k \geq 2\}$ et $\{\frac{1}{k!} : k \geq 4\}$ sont lacunaires. Nous définissons maintenant par induction la notion d'ensemble lacunaire d'ordre fini.

Definition 1.7.1 (Ensemble lacunaire d'ordre fini). *Un ensemble lacunaire d'ordre 0 dans \mathbb{R} est un soit un singleton soit l'ensemble vide. Récursivement, pour tout $N \in \mathbb{N}^*$, on dit qu'un ensemble Ω dans \mathbb{R} est un ensemble lacunaire d'ordre au plus $N+1$ - et on écrit $\Omega \in \Lambda(N+1)$ - si il existe une suite lacunaire L avec les propriétés suivantes : pour tout $a, b \in L$ consécutifs, l'ensemble $\Omega \cap (a, b)$ est un ensemble lacunaire d'ordre au plus N i.e. $\Omega \cap (a, b) \in \Lambda(N)$.*

Par exemple, l'ensemble

$$\Omega := \left\{ \frac{\pi}{2^k} + \frac{\pi}{4^l} : k, l \in \mathbb{N}, l \leq k \right\}$$

est un ensemble lacunaire d'ordre 2. Dans ce cas, observons que l'ensemble Ω ne peut pas être réécrit comme une suite monotone, puisqu'il possède plusieurs points d'accumulation. On peut enfin donner une définition d'un ensemble finiment lacunaire.

Definition 1.7.2 (Ensemble finiment lacunaire). *Un ensemble Ω dans $[0, \pi)$ est dit finiment lacunaire si il existe un nombre fini d'ensembles $\{\Omega_k : k \leq M\}$ d'ordre lacunaire fini tels qu'on ait*

$$\Omega \subset \bigcup_{k \leq M} \Omega_k.$$

Insistons sur le point suivant : la notion de finitude lacunaire est purement géométrique, elle ne dépend que de la structure de l'ensemble Ω et non d'un indice p ou de propriétés de recouvrement. En ce qui concerne notre problématique, le théorème de Bateman est typiquement la forme de résultat que l'on souhaite obtenir contrairement au résultat de Cordoba et Fefferman.

Théorème 1.7 (Bateman). *On a l'alternative suivante :*

- *si Ω est finiment lacunaire alors M_Ω est borné sur L^p pour tout $p > 1$.*
- *si Ω n'est pas finiment lacunaire alors il est possible de faire une compression de Keakeya avec la famille directionnelle \mathcal{R}_Ω .*

En dimensions supérieures, la situation est plus complexe et certaines subtilités restent à détailler : nous invitons le lecteur à se pencher par exemple sur les travaux de Parcet et Roger [39], Kroc et Pramanik [35] et [34], Di Plinio et Parissis [16] et [15].

1.8 . La conjecture de Zygmund

Dans l'espace euclidien \mathbb{R}^n , il est possible de dépasser le théorème maximal fort : dans [47], Zygmund a considéré pour $1 \leq k \leq n$, la famille $\mathcal{I}_n(k)$ qui est composée de tous les rectangles $R \in \mathcal{I}_n$ qui n'ont pas plus de k de longueurs de côté différentes. Il a prouvé que l'opérateur maximal $M_{n,k}$ associé à la famille $\mathcal{I}_n(k)$ satisfait

$$M_{n,k} : L^1 (1 + \log^+ L^1)^{k-1} \rightarrow L^{1,\infty}.$$

Rappelons que cela signifie que pour toute fonction f et tout $t > 0$, nous avons

$$|\{M_{n,k}f > t\}| \lesssim_n \int_{\mathbb{R}^n} \frac{|f|}{t} \left(1 + \log^+ \frac{|f|}{t}\right)^{k-1}.$$

En outre, il n'est pas difficile de voir que cette estimation est *optimale* dans le sens suivant : étant donné tout entier $m \gg 1$, il existe un ensemble E (prendre $E = [0, 1]^n$ par exemple) tel que

$$|\{M_{n,k}\mathbb{1}_E > 2^{-m}\}| \gtrsim_n m^{k-1} 2^m |E|.$$

Nous dirons qu'un tel opérateur maximal est *borné de manière optimale de $L^1 \log^{k-1} L^1$ à $L^{1,\infty}$* .

Par la suite, motivé par des problèmes soulevés dans la théorie des intégrales singulières, Zygmund a considéré des opérateurs maximaux définis sur des familles présentant un niveau de symétrie inférieur. Par exemple, il a posé la question suivante : en désignant par \mathcal{B}_Z la famille composée de rectangles parallèles aux axes dans \mathbb{R}^3 dont les longueurs des côtés sont de la forme

$$t \times s \times \sqrt{ts},$$

peut-on prouver que nous avons la propriété de délimitation suivante

$$M_{\mathcal{B}_Z} : L^1 (1 + \log^+ L^1) \rightarrow L^{1,\infty}.$$

Comme précédemment, Zygmund s'attendait à un tel résultat car un rectangle dans \mathcal{B}_Z , en tant que rectangle plan, n'est défini que par deux paramètres (jusqu'aux translations) et donc $M_{\mathcal{B}_Z}$ devrait se comporter comme M_2 . Comme annoncé dans [9], Cordoba a répondu positivement à la question de Zygmund en prouvant le Théorème suivant : fixez une fonction arbitraire $\phi : \mathbb{R}^2 \rightarrow \mathbb{R}^+$ croissante dans chaque variable et considérer la famille invariante par translations \mathcal{B}_ϕ composée de tous les rectangles parallèles aux axes dont les longueurs des côtés sont de la forme

$$s \times t \times \phi(s, t).$$

Théorème 1.8 (Cordoba). *Avec les notations précédentes, l'opérateur maximal $M_{\mathcal{B}_\phi}$ associé à la famille \mathcal{B}_ϕ est borné de $L^1 (1 + \log^+ L^1)$ à $L^{1,\infty}$.*

En ce qui concerne ce théorème, la conjecture suivante a été proposée : soyons $\{\phi_i : i \leq n\}$ soient n fonctions réelles positives dépendant de k variables, augmentant dans chaque variable séparément et prenant des valeurs arbitrairement petites et considérons la famille \mathcal{B}_ϕ de tous les rectangles parallèles à l'axe dans \mathbb{R}^n dont les longueurs de côté sont de la forme

$$\phi_1(t_1, \dots, t_k) \times \dots \times \phi_n(t_1, \dots, t_k).$$

La conjecture stipule à l'origine que dans cette situation, nous avons la propriété de bornitude suivante pour l'opérateur $M_{\mathcal{B}_\phi}$

$$M_{\mathcal{B}_\phi} : L^1 (1 + \log^+ L^1)^{k-1} \rightarrow L^{1,\infty}.$$

Il apparaît qu'énoncée sous cette forme, la conjecture de Zygmund est fautive et cela a été prouvé par Soria dans le cas le plus simple $n = 3$ et $k = 2$. Plus récemment, Rey a exposé une nouvelle classe de contre-exemples à cette conjecture dans [40]. Cependant, les résultats de Soria et Rey n'indiquent pas que l'idée derrière la conjecture de Zygmund est fautive mais plutôt qu'elle n'est pas correctement formulée.

En effet, dans son ouvrage fondateur [45], Stokolos a prouvé le théorème suivant (par souci de clarté, nous omettons la description géométrique de ce théorème) grâce à l'idée clé de *crystallisation* qu'il a développée.

Théorème 1.9 (Stokolos). *Pour toute famille invariante par translations \mathcal{B} composée de rectangles parallèles aux axes dans \mathbb{R}^2 , il existe un entier $i \in \{0, 1\}$ tel que l'opérateur maximal associé $M_{\mathcal{B}}$ est borné de manière optimale de $L^1 (1 + \log^+ L^1)^i$ à $L^{1,\infty}$.*

En ce qui concerne le théorème 2.8.2, Stokolos a proposé la reformulation suivante de la conjecture de Zygmund dans [43] et au cours des dernières années, plusieurs auteurs (parmi lesquels D'Aniello et Moonens [13], Dmitrishin, Hagelstein et Stokolos [17], Fefferman et Pipher [19], Hagelstein, Oniani et Stokolos [25], Hagelstein et Stokolos [28], [27] et Stokolos [45], [43], [44]) ont présenté des résultats qui donnent du poids à sa possible véracité.

Conjecture 1.8.1. *Pour toute famille invariante par translations \mathcal{B} composée de rectangles parallèles aux axes dans \mathbb{R}^n , il existe un entier $1 \leq i \leq n$ tel que l'opérateur maximal associé $M_{\mathcal{B}}$ est borné de manière optimale de $L^1 (1 + \log^+ L^1)^{i-1}$ à $L^{1,\infty}$.*

Jusqu'à présent, cette conjecture n'a pas été réfutée : nous donnerons d'autres exemples dans le sixième chapitre. Disons aussi que même pour les familles géométriques \mathcal{B} (c'est-à-dire même si l'on suppose la stabilité par dilatations centrales), on sait très peu de choses sur le problème de Zygmund en dimension $n \geq 3$.

1.9 . Sur des espaces non euclidiens

Les opérateurs maximaux ont également fait l'objet d'études intensives au-delà du domaine euclidien : sur les graphes [42], sur les espaces de dimension infinie [33] ou sur les espaces hyperboliques [37], [31] ou [46], pour n'en citer que quelques-uns. Dans ces espaces, la théorie s'est principalement concentrée sur l'étude de l'opérateur de Hardy-Littlewood : précisément, étant donné un espace métrique mesuré (X, d, μ) dénotons par \mathcal{Q} la famille contenant toutes les boules de l'espace *i.e.* Dans ce cadre, il est naturel de considérer l'opérateur maximal apparenté à l'opérateur maximal de Hardy-Littlewood (ou sa version centrée) et défini comme

$$Mf(x) = \sup_{x \in B \in \mathcal{Q}} \frac{1}{\mu(B)} \int_B |f|$$

et sa version centrée

$$M^c f(x) = \sup_{r>0} \frac{1}{\mu(B(x, r))} \int_{B(x, r)} |f|.$$

La régularité de l'opérateur M est bien comprise dès que l'on a des informations sur la mesure et la métrique, en particulier lorsque l'on suppose que la métrique est double. Cela vient en partie du fait que les arguments couvrants à la Vitali sont assez flexibles et peuvent être utilisés dans des espaces métriques mesurés généraux : voir aussi [36] par exemple.

Il s'avère que ces techniques de recouvrement ne peuvent pas être appliquées directement à l'opérateur maximal de Hardy-Littlewood défini sur une surface négativement incurvée, car le volume des boules y croît de manière exponentielle. Cependant, il est possible d'étudier les opérateurs maximaux sur ces espaces, par exemple Stromberg a fait une étude importante de cette situation dans [46] pour les espaces symétriques non compacts. Une application particulière de son résultat concerne le plan hyperbolique \mathbb{H}^2 doté de sa métrique naturelle d et de sa mesure μ .

Théorème 1.10 (Stromberg). *L'opérateur de Hardy-Littlewood (centré) M^c défini sur (\mathbb{H}^2, d, μ) est de type faible $(1, 1)$.*

Contrairement à l'espace métrique mesuré avec la propriété de doublement, l'opérateur maximal de Hardy-Littlewood non centré a un comportement tout à fait différent : dans [31], Ionescu a prouvé le théorème suivant (également pour un espace symétrique non compact, mais nous l'énonçons dans \mathbb{H}^2 pour des raisons de simplicité).

Théorème 1.11 (Ionescu). *L'opérateur de Hardy-Littlewood (non centré) M défini sur (\mathbb{H}^2, d, μ) est borné de L^p à L^p uniquement pour $p \in (2, \infty]$.*

En ce qui concerne la théorie dans l'espace euclidien, nous ne sommes pas spécifiquement intéressés par l'opérateur de Hardy-Littlewood mais plutôt par l'interaction des objets géométriques de \mathbb{H}^2 qui possèdent, en quelque sorte, une géométrie plus riche que les boules habituelles et cette question fera l'objet de la dernière partie de ce texte.

1.10 . Contributions

Pour conclure cette introduction, détaillons brièvement les contributions apportées.

Perturbations d'ensembles de direction

La première partie de la thèse est consacrée aux opérateurs maximaux associés à des ensembles de directions *concrete*. Il est important de comprendre les exemples classiques d'ensembles de directions Ω_{lin} et Ω_{lac} puisque, dans un certain sens, ce sont les plus petits ensembles qui sont infinis et respectivement *non finiment lacunaire* et *finiment lacunaire*.

Stokolos a remarqué qu'il peut être difficile d'appliquer le théorème de Bateman *i.e.* il est difficile de décider si un ensemble donné de directions Ω est finiment lacunaire ou non. Il a demandé ce que l'on pouvait dire des ensembles classiques Ω_{lac} et Ω_{lin} lorsqu'ils sont perturbés dans le sens suivant : considérons les ensembles

$$\Omega_{cos,lin} = \left\{ \frac{\pi \cos(k)}{k} : k \geq 1 \right\}$$

et

$$\Omega_{cos,lac} = \left\{ \frac{\pi \cos(k)}{2^k} : k \geq 1 \right\}.$$

Nous résolvons le cas de $\Omega_{cos,lin}$ dans le deuxième chapitre sans utiliser la technologie de Bateman.

Théorème 1.12 (D'Aniello, G. et Moonens). *Il est possible de faire une compression de Kakeya avec la famille directionnelle $\mathcal{R}_{\Omega_{cos,lin}}$.*

La preuve de ce théorème repose sur la présentation de grandes séquences arbitraires dans $\Omega_{cos,lin}^{-1}$ qui sont presque homogènes. Avec ces grandes séquences à disposition, nous sommes alors capables de construire un arbre de Perron avec les éléments de $\mathcal{R}_{\Omega_{cos,lin}}$ *i.e.* nous réalisons une compression de Kakeya avec cette famille. Afin de comprendre comment les ensembles Ω_{lac} et Ω_{lin} se comportent lorsqu'ils sont perturbés, nous étudions alors les ensembles aléatoires de direction

$$\Omega_{rand,lin} = \left\{ \frac{\pi X_k}{k} : k \geq 1 \right\}$$

et

$$\Omega_{rand,lac} = \left\{ \frac{\pi X_k}{2^k} : k \geq 1 \right\}$$

où les variables $\{X_k : k \geq 1\}$ sont indépendantes et uniformément distribuées dans $(0, 1)$. Dans le troisième chapitre, nous prouvons le théorème suivant.

Théorème 1.13 (G.). *Presque sûrement, il est possible de faire une compression de Keakeya avec les familles directionnelles $\mathcal{R}_{\Omega_{\text{rand},\text{lin}}}$ et $\mathcal{R}_{\Omega_{\text{rand},\text{lac}}}$.*

De la même manière que précédemment, la preuve repose sur la présence de grandes séquences dans $\Omega_{\text{rand},\text{lin}}^{-1}$ et $\Omega_{\text{rand},\text{lac}}^{-1}$ qui sont bien distribuées. Notons que le cas de l'ensemble des directions $\Omega_{\text{cos},\text{lac}}$ reste ouvert.

Opérateur maximal géométrique

La deuxième partie de la thèse est consacrée à l'étude des opérateurs maximaux *géométriques* dans le plan associés à une famille géométrique : nous nous intéressons plus particulièrement aux familles qui ne sont pas directionnelles. En effet, au-delà du théorème de Bateman, il semble souhaitable d'étudier les familles \mathcal{B} incluses dans \mathcal{R} qui sont uniquement supposées invariantes par translations et dilatations.

Dans le quatrième chapitre, nous considérons l'opérateur maximal $M_{a,b}$ associé à la famille de rectangles $\mathcal{B}_{a,b}$ définie comme

$$\mathcal{B}_{a,b} = \left\{ R \in \mathcal{R} : \exists n \in \mathbb{N}, e_R = \frac{1}{n^a}, \omega_R = \frac{\pi}{n^b} \right\}.$$

Ici e_R représente l'excentricité de R *i.e.* le rapport entre la longueur du plus petit côté de R par la longueur de son plus grand côté. Nous prouvons le théorème suivant.

Théorème 1.14 (G.). *On a l'alternative suivante :*

- si $a > b$ alors $M_{a,b}$ est borné sur L^p pour tout $p > 1$.
- si $a \leq b$ alors il est possible de faire une compression de Keakeya avec la famille $\mathcal{B}_{a,b}$.

Afin de traiter le problème général, nous introduisons dans le cinquième chapitre une quantité géométrique

$$\lambda_{\mathcal{B}} \in \mathbb{N}^* \cup \{\infty\}$$

associée à toute famille géométrique \mathcal{B} que nous appelons *division analytique*. Contrairement à la propriété de recouvrement, la division analytique d'une famille géométrique \mathcal{B} est *calculable* en principe et ne dépend d'aucun indice p . Nous prouvons alors le théorème suivant.

Théorème 1.15 (G.). *Pour tout $1 < p < \infty$, on a*

$$\|M_{\mathcal{B}}\|_p^p \gtrsim_p \log(\lambda_{\mathcal{B}}).$$

De plus, si on a $\lambda_{\mathcal{B}} = \infty$ alors il est possible de faire une compression de Keakeya avec la famille \mathcal{B} .

La preuve de ce théorème repose sur l'exploitation de Bateman mais avec des familles de rectangles qui ne sont pas directionnels. En se basant sur la technique développée pour le théorème 2.10.4, Hagelstein et Stokolos ont prouvé le théorème suivant dans [26] qui conclut l'étude des opérateurs géométriques maximaux dans le plan.

Théorème 1.16 (Hagelstein et Stokolos). *Pour toute famille géométrique \mathcal{B} incluse dans \mathcal{R} , on a l'alternative suivante :*

- soit l'opérateur $M_{\mathcal{B}}$ est borné sur L^p pour tout $p > 1$.
- soit l'opérateur $M_{\mathcal{B}}$ n'est pas borné L^p pour tout $p < \infty$.

Il semble donc intéressant d'étudier maintenant les opérateurs maximaux invariants par translations dans le plan.

Famille cartésienne pour le problème de Zygmund

Dans la troisième partie de cette thèse, nous nous intéressons à un cas particulier de la conjecture de Zygmund. En particulier, nous nous intéressons aux familles \mathcal{B} incluses dans \mathcal{I}_n invariantes par translations et qui présentent une *structure cartésienne*. Sans perte de généralité, on peut toujours supposer qu'un rectangle parallèle à l'axe est - jusqu'aux translations - un rectangle dyadique de la forme

$$R_{\hat{\mathbf{a}}} := I_{a_1} \times \cdots \times I_{a_n}$$

pour $\hat{\mathbf{a}}$ dans \mathbb{Z}^n et où, étant donné un entier $\ell \in \mathbb{Z}$, nous laissons I_{ℓ} être l'intervalle dyadique $[0, 2^{\ell}]$. Il serait intéressant d'étudier la conjecture de Zygmund pour le type de familles suivant.

Definition 1.10.1 (Famille cartésienne). *Etant donnés $(n - 1)$ familles d'entiers*

$$\{A_i \subset \mathbb{Z} : 1 \leq i \leq n - 1\},$$

on dit que la famille invariante par translations qui contient pour tout $\mathbf{a} \in A_1 \times \cdots \times A_{n-1}$ le rectangle dyadique de volume 1

$$R_{\mathbf{a}} = I_{a_1} \times \cdots \times I_{a_{n-1}} \times I_{-(a_1 + \cdots + a_{n-1})}$$

est une famille cartésienne. On notera cette famille $\mathcal{B}_{A_1 \times \cdots \times A_{n-1}}$ et l'opérateur maximal associé $M_{A_1 \times \cdots \times A_{n-1}}$.

Insistons sur le fait que nous avons supposé que la famille $\mathcal{B}_{A_1 \times \cdots \times A_{n-1}}$ est juste invariante par translations. Nous discuterons de la variante du problème plus tard. Dans le sixième chapitre, étant donné un ensemble d'entiers $A \subset \mathbb{Z}$, nous considérons la famille cartésienne $\mathcal{B}_{A^{n-1}}$ qui contient tous les rectangles de la forme

$$[0, 2^{a_1}] \times \cdots \times [0, 2^{a_{n-1}}] \times [0, 2^{-(a_1 + \cdots + a_{n-1})}]$$

pour tout $a_1, \dots, a_{n-1} \in A$. Nous prouvons le théorème suivant dans \mathbb{R}^n .

Théorème 1.17 (G.). *Si l'ensemble A contient des progressions arithmétiques arbitrairement longues alors l'opérateur maximal $M_{A^{n-1}}$ est borné de manière optimale de $L^1 \log^{n-1} L^1$ à $L^{1,\infty}$.*

La preuve repose sur la construction de fonctions tests spécifiques adaptées à l'opérateur $M_{A^{n-1}}$ et basées sur la technique de cristallisation. Pour l'instant, il semble difficile d'aller au-delà de la condition arithmétique faite sur l'ensemble A pour traiter des familles cartésiennes générales mais nous espérons développer ces méthodes dans le futur. Nous ferons d'autres commentaires plus tard.

Opérateur maximal dans le plan hyperbolique

Dans la dernière partie de cette thèse, nous nous intéressons au plan hyperbolique \mathbb{H}^2 doté de sa métrique naturelle et de sa mesure μ et dénotons par G son groupe d'isométries. Au regard des théorèmes de Stromberg et Ionescu, il semble intéressant d'étudier les opérateurs maximaux définis sur des ensembles géométriques plus généraux : nous mènerons cette problématique avec *triangles hyperboliques*. Précisément, nous laissons \mathcal{X} être une famille composée de triangles hyperboliques dans \mathbb{H}^2 stables par des isométries *i.e.* telles que pour tout $T \in \mathcal{X}$ et $g \in G$, on a

$$g(T) \in \mathcal{X}.$$

Nous prouvons le Théorème suivant dans lequel nous avons omis la description géométrique de chaque situation.

Théorème 1.18 (Branchereau, Bronstein et G.). *On a l'alternative suivante :*

- *il existe une constante $C_{\mathcal{X}} < \infty$ telle que pour toute fonction f on a*

$$\|M_{\mathcal{X}}f\|_1 \leq C_{\mathcal{X}}\|f\|_1.$$

- *il existe une constante $C_{\mathcal{X}} < \infty$ telle que pour toute fonction f et $t > 0$, on a*

$$\mu(\{M_{\mathcal{X}}f > t\}) \leq C_{\mathcal{X}} \frac{\|f\|_1}{t}.$$

- *pour toute fonction non nulle f , il existe une constante $c > 0$ telle qu'on a*

$$M_{\mathcal{X}}f > c.$$

- *pour tout $C \gg 1$, il existe un ensemble borné mesurable E in \mathbb{H}^2 tel qu'on ait*

$$\mu\left(\left\{M_{\mathcal{X}}\mathbb{1}_E \geq \frac{1}{4}\right\}\right) \geq C\mu(E).$$

Nous verrons que la preuve repose exclusivement sur des méthodes géométriques. Pour les deux premières situations, nous utiliserons des méthodes valables dans les espaces métriques mesurés généraux, en particulier les arguments des techniques de recouvrement *à la Vitali*. La deuxième situation est spécifique à la géométrie du plan hyperbolique et de ses triangles géodésiques. Enfin, la dernière situation exploite le compression de *Takeya* du plan euclidien *via* le plan tangent et la carte exponentielle. Notons également qu'un résultat similaire est valable pour les familles de k -polygones géodésiques invariants par le groupe d'isométries G . Ainsi, il est maintenant possible de considérer des familles géométriques moins régulières de triangles définis sur le plan hyperbolique.

L'exemple suivant semble intéressant : étant donné un point $\omega \in \mathbb{H}^2$, dénotons par \mathcal{G}_ω la famille contenant toute géodésique infinie qui atteint ω à l'infini et dénotons également par \mathcal{H}_ω la famille contenant tous les horocycles tangents à ω sur la frontière de \mathbb{H}^2 . Étant donné deux géodésiques distinctes $g, g' \in \mathcal{G}_\omega$ et deux horocycles distincts $h, h' \in \mathcal{H}_\omega$, considérons le plus grand ensemble borné

$$P := P(g, g', h, h') \subset \mathbb{H}^2$$

dont la frontière est délimitée par les courbes g, g', h et h' . Considérons alors la famille \mathcal{P}_ω définie comme

$$\mathcal{P}_\omega := \{P(g, g', h, h') : g \neq g' \in \mathcal{G}_\omega, h \neq h' \in \mathcal{H}_\omega\}.$$

Les éléments de \mathcal{P}_ω *ne sont pas* des 4-gons géodésiques mais ce sont des objets géométriques qui sont - dans un certain sens - *orientés* dans la direction ω , qui ont une certaine *épaisseur* et dont le diamètre peut être arbitrairement petit ou grand et, enfin, dont le volume peut devenir arbitrairement grand ou petit. Que peut-on dire de l'opérateur maximal $M_{\mathcal{P}_\omega} : L^\infty \rightarrow L^\infty$? Si l'on prouve des propriétés de bornitude pour cet opérateur, alors, étant donné un ensemble arbitraire de points $\Omega \subset \partial\mathbb{H}^2$, on peut considérer la famille

$$\mathcal{P}_\Omega = \bigcup_{\omega \in \Omega} \mathcal{P}_\omega.$$

Que peut-on dire de l'opérateur $M_{\mathcal{P}_\Omega} : L^\infty \rightarrow L^\infty$? Ses propriétés de bornitude dépendent-elles de l'ensemble Ω comme dans le cas euclidien ?

2 - Introduction

A central question in analysis is to determine if a given maximal operator is bounded from a functional space to another one. Those operators, among which stand out the *Hardy-Littlewood* maximal operator, the *Carleson's* operator and *Stein's* spherical maximal operator, have been intensively studied since each of them is naturally connected to almost everywhere convergence of specific *processes* related, for example, to averaging on geometric sets, Fourier's reconstruction formula or partial differential equations.

In this dissertation, we are mostly concerned by maximal operators akin to the Hardy-Littlewood maximal operator : given a family \mathcal{B} composed of *rectangles* with finite positive measure, we define the maximal operator $M_{\mathcal{B}}$ for $f \in L^\infty$ and $x \in \mathbb{R}^n$ as

$$M_{\mathcal{B}}f(x) := \sup_{x \in R \in \mathcal{B}} \frac{1}{|R|} \int_R |f|.$$

We always assume that the family \mathcal{B} which defines the maximal operator $M_{\mathcal{B}}$ is invariant by translations *i.e.* for any rectangle $R \in \mathcal{B}$ and any $t \in \mathbb{R}^n$, we have

$$t + R \in \mathcal{B}.$$

We will call such a family \mathcal{B} a *translation invariant family* and, naturally, we will say that $M_{\mathcal{B}}$ is a *translation invariant maximal operator*.

In the first chapters, we will assume that the translation invariant family \mathcal{B} is also invariant by *central dilations i.e.* for any rectangle $R \in \mathcal{B}$ and any $\lambda > 0$, we have

$$\lambda R \in \mathcal{B}.$$

Here, the rectangle λR is the rectangle which has same center as the rectangle R but whose side lengths are dilated by the factor $\lambda > 0$. We will say that a family \mathcal{B} which is invariant by those two symmetries is a *geometric family* and we will say in this case that $M_{\mathcal{B}}$ is a *geometric maximal operator*.

Any maximal operator is obviously bounded from L^∞ to L^∞ *i.e.* for any $f \in L^\infty$, we have the following sharp estimate

$$\|M_{\mathcal{B}}f\|_\infty \leq \|f\|_\infty.$$

How does the geometry exhibited by the family \mathcal{B} influence the boundedness properties of the operator $M_{\mathcal{B}}$ on non trivial spaces such as L^p for $p \in [1, \infty)$? And if possible, can we determine the *optimal* boundedness properties of the maximal operator $M_{\mathcal{B}}$? This is the general problema that is considered in this dissertation.

This introduction is organized as follow : we start by recalling classic facts about the Hardy-Littlewood maximal operator and its relation to differentiation of integrals. Secondly, we will detail the relation between the boundedness properties of $M_{\mathcal{B}}$ and the covering properties of the family \mathcal{B} as explained by Cordoba and Fefferman in [8]. Thereafter, we will recall the properties of two well known maximal operators, namely the *strong* maximal operator and the *grand* maximal operator. This will lead us to consider *directional* maximal operators and the theorem of Bateman, and finally *Zygmund's conjecture* and its reformulation by Stokolos. Finally, we will briefly describe our contributions in regards of those problems.

2.1 . The Hardy-Littlewood maximal operator

The *Hardy-Littlewood* maximal operator is one of the most classic maximal operators : it arises naturally when one tries to understand the convergence almost everywhere of averaging processes over cubes or balls. In 1910, Lebesgue proved that given any locally integrable function f defined on \mathbb{R}^n , we have almost everywhere

$$f(x) = \lim_{r \rightarrow 0} A_r f(x).$$

Here the notation $A_r f(x)$ stands for the average of the function f on the cube centered at the point x and of side length r . This identity can be formulated in a quantitative way thanks to the Hardy-Littlewood maximal operator M (see [29]) which is defined as follow : for $f \in L^\infty$ and $x \in \mathbb{R}^n$, we define

$$Mf(x) := \sup_{x \in Q \in \mathcal{Q}_n} \frac{1}{|Q|} \int_Q |f|.$$

Here, we have denoted by \mathcal{Q}_n the family containing every axis-parallel cubes of \mathbb{R}^n . Classic arguments show that the theorem of differentiation of Lebesgue holds as soon as we prove that for any function f and $t > 0$, we have the following *weak-type estimate* near L^1

$$|\{Mf > t\}| \lesssim_n \int_{\mathbb{R}^n} \frac{|f|}{t}.$$

In the literature, we say that the operator M is bounded from L^1 to the Lorentz space $L^{1,\infty}$ traditionally called weak L^1 . It turns out that this boundedness property is an easy consequence of the so-called Vitali covering theorem.

Theorem 2.1.1 (Vitali covering theorem). *Given any finite family $\{Q_i : i \in I\}$ of cubes, it is possible to find a subfamily $J \subset I$ such that the cubes $\{Q_j : j \in J\}$ are pairwise disjoint and such that the following inclusion holds*

$$\bigcup_{i \in I} Q_i \subset \bigcup_{j \in J} 4^n Q_j.$$

Hence the proof of Lebesgue's differentiation theorem boils down to a geometric argument *modulo* technical details. Let us also observe that since the operator M is naturally bounded from L^∞ to L^∞ , it follows by interpolation that M is bounded from L^p to L^p for any $p > 1$: this argument is general and holds for all maximal operators that we will consider.

A natural generalisation of the Hardy-Littlewood maximal operator consists in averaging on more complex geometric sets. As said earlier, we are particularly interested by families which are composed of *rectangles* : an n -dimensional rectangle is simply a product of n finite intervals which is eventually rotated. Here are different types of families that could be considered :

- The family \mathcal{I}_n which contains all axis-parallel rectangles of the Euclidean space *i.e.* the family

$$\mathcal{I}_n = \{J_1 \times \cdots \times J_n : \forall i \leq n, \exists -\infty < a_i < b_i < \infty, J_i = [a_i, b_i]\}.$$

The maximal operator associated to \mathcal{I}_n is called the *strong* maximal operator and will be denoted M_n in the following.

- The family \mathcal{R}_n which contains all rectangles of the Euclidean space *i.e.* the family

$$\mathcal{R}_n = \{\phi(R) : R \in \mathcal{I}_n, \phi \in Iso(\mathbb{R}^n)\}.$$

Here of course, $Iso(\mathbb{R}^n)$ stands for the rigid motions of the Euclidean space. The maximal operator associated to \mathcal{R}_n is called the *grand* maximal operator.

- If we are given a family F included in \mathcal{R}_n , the *geometric family* generated by F is defined as

$$\mathcal{B}_F = \{t + \lambda R : t \in \mathbb{R}^n, \lambda > 0, R \in F\}.$$

Obviously, the family \mathcal{B}_F is the smallest family which is stable by translations and central dilations and which contains F .

- In the Euclidean plane, an important class of geometric families that will interest us are the so-called *directional families*. Given an arbitrary set $\Omega \subset \mathbb{S}^1$, we denote by \mathcal{R}_Ω the directional family defined as

$$\mathcal{R}_\Omega = \{R \in \mathcal{R}_2 : \omega_R \in \Omega\}$$

where $\omega_R \in \mathbb{S}^1$ stands for the angle that the longest side of R makes with the horizontal axis. The maximal operator associated to the family \mathcal{R}_Ω will be denoted M_Ω .

2.2 . The theory of Cordoba and Fefferman

The boundedness properties of a maximal operator $M_{\mathcal{B}}$ are deeply related to the *covering* properties of the family \mathcal{B} and an important part of the work presented by Cordoba and Fefferman in their seminal paper [8] concerns this duality. Precisely, Cordoba and Fefferman say that a family \mathcal{B} (not necessarily a geometric one) satisfies the covering property V_q for $q \in (1, \infty)$ if given any finite family $\{R_i : i \in I\}$ included in \mathcal{B} , there exists a subfamily $J \subset I$ such that we have

$$\left| \bigcup_{i \in I} R_i \right| \lesssim \left| \bigcup_{j \in J} R_j \right|$$

and also

$$\left\| \sum_{j \in J} \mathbb{1}_{R_j} \right\|_q \lesssim \left| \bigcup_{j \in J} R_j \right|^{\frac{1}{q}}.$$

The main interest of those covering properties lies in the following theorem.

Theorem 2.2.1 (Cordoba and Fefferman). *A family \mathcal{B} satisfies the covering property V_q if and only if the associated maximal operator $M_{\mathcal{B}}$ is of weak-type (p, p) i.e. if for any f and $t > 0$, one has*

$$|\{M_{\mathcal{B}}f > t\}|^{\frac{1}{p}} \lesssim \frac{\|f\|_p}{t}.$$

Here we have supposed that $\frac{1}{p} + \frac{1}{q} = 1$.

The elegance and simplicity of this relation are obvious, however is it effective? And can it give optimal results? Of course, if we consider an arbitrary family \mathcal{B} , not much can be said about the operator $M_{\mathcal{B}}$, since the family \mathcal{B} itself is not easily describable, but if we restrict our attention to geometric families, we will see that it becomes possible to deduce the boundedness properties of $M_{\mathcal{B}}$ via the geometric properties of the family \mathcal{B} .

2.3 . Kakeya blow in the Euclidean space

We are going to detail now the boundedness properties of the *grand* maximal operator $M_{\mathcal{R}_n}$ associated to the family \mathcal{R}_n which contains all rectangles of the Euclidean space. This will allow us to recall an important *geometric obstruction* of the Euclidean space that we call *Kakeya blow* in this dissertation. What can be said about the grand maximal operator

$$M_{\mathcal{R}_n} : L^\infty \rightarrow L^\infty$$

associated to the family \mathcal{R}_n which contains every rectangles of \mathbb{R}^n ? Can we prove that it is bounded on a certain L^p space? We discuss this question in

the Euclidean plane \mathbb{R}^2 since the situation is already complex there : for the rest of the dissertation, we denote by

$$\mathcal{R} := \mathcal{R}_2 = \{ \phi(R) : R \in \mathcal{I}_2, \phi \in Iso(\mathbb{R}^2) \}$$

the family that contains every rectangle of the plane. It is not difficult to see that this operator cannot be bounded on L^p when $p \leq 2$ since the function $M_{\mathcal{R}}\phi$ does not decay fast enough at infinity for any test function ϕ and so by opposition, we cannot have a Vitali's covering Theorem for the family \mathcal{R} .

The situation is actually much worse than that since the operator $M_{\mathcal{R}}$ is not bounded on L^p for any $p < \infty$: this poor behavior has its root in a geometric phenomenon of the Euclidean space namely the possibility to make a *Keakeya blow* with the family \mathcal{R} .

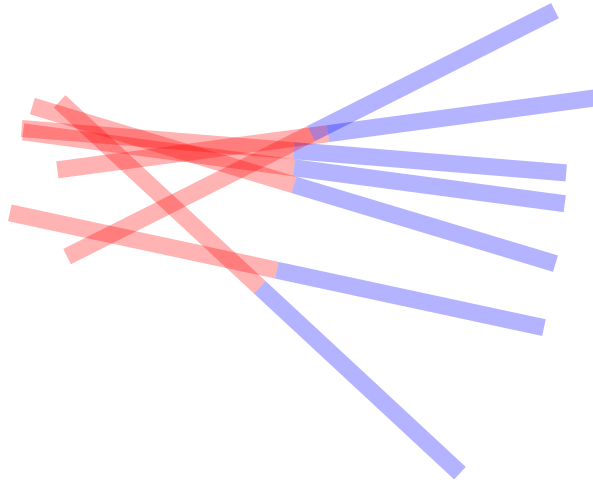

FIGURE 2.1 : An illustration of Theorem 2.3.1 : given any large constant $A \gg 1$, it is possible to find a configuration of rectangles such that the red area is A times smaller than the blue area. There exists two methods to prove this (1) the deterministic construction of a Perron tree (2) the random construction of Bateman.

Theorem 2.3.1 (Keakeya blow with \mathcal{R}). *Given any large constant $A \gg 1$, there exists a finite family of rectangles*

$$\{R_i : i \in I\} \subset \mathcal{R}$$

such that we have

$$\left| \bigcup_{i \in I} TR_i \right| \geq A \left| \bigcup_{i \in I} R_i \right|.$$

Here, we have denoted by TR the rectangle R translated along its longest side by its own length

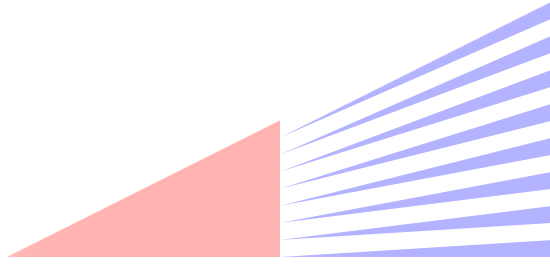

FIGURE 2.2 : The deterministic construction of a Perron tree is detailed in [14]. Loosely speaking, given a large integer $N \gg 1$, one slices a large red triangle in 2^N smaller triangles of same area : the blue triangles represent the shift of the red triangles.

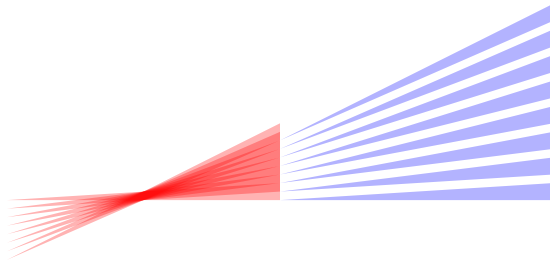

FIGURE 2.3 : Thereafter, the construction of a Perron tree consists in shifting vertically the red triangles (along with the blue ones) by pairs and recursively. By doing so, one can assure that (1) the red triangles are compressed *i.e.* the area has decreased by a factor $\log(N)^{-1}$ (2) the blue triangles are disjoint and so the blue area is $\simeq 1$.

This geometric obstruction is a fundamental tool for the rest of the dissertation. In some sense, one of our main problematic can be formulated as follow : given a geometric family \mathcal{B} , can we make a Kakeya blow with this family? And if not, what can be said about the boundedness properties of $M_{\mathcal{B}}$? We make three remarks concerning Kakeya blow :

- The possibility to make a Kakeya blow was discovered originally in the study of the historical Kakeya needle problem. It exploits the fact that the family \mathcal{R} contains geometric objects which are arbitrarily thin and oriented in many directions.
- We invite the reader to look at [18] where Fefferman used this construction to disprove the famous Ball multiplier conjecture. In addition, Fefferman's work provides a proof of Theorem 2.3.1.
- There is no *easy* way to prove that it is possible to make a Kakeya blow but at least two methods exist. The first consists in the construction

of a *Perron tree* (see [18] for example) and the second one is a random construction developed by Bateman and Katz in [6] and developed further by Bateman in [5].

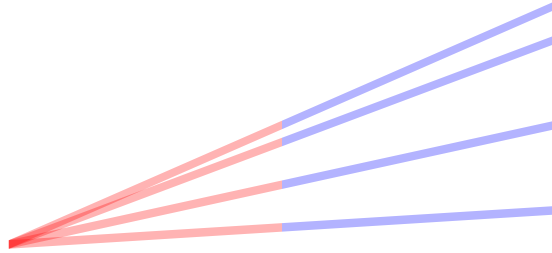

FIGURE 2.4 : Bateman's construction is a realization of a Keakeya blow is more complex than the construction of a Perron tree. Suppose that one wants to realize a Keakeya blow with the restriction that the rectangles used must be oriented in a prescribed set of directions $\Omega \subset \mathbb{S}^1$: if the set Ω is too *rough*, the Perron tree construction won't work. This is the case if Ω is a classic ternary Cantor set for example.

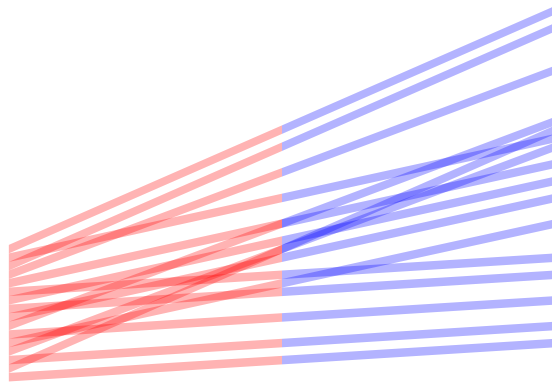

FIGURE 2.5 : In the case where one wants to make a Keakeya blow only with rectangles oriented in Ω , the idea of Bateman and Katz is to arrange *randomly* the rectangles at disposition and to exploit the dyadic tree structure of the situation to prove that, with positive probability, some realizations of this construction will satisfy the *compressed-decompressed* condition of the Keakeya blow.

Thanks to the possibility to make a Keakeya blow with \mathcal{R} , it follows that given any large constant $A \gg 1$, there exists a bounded set E satisfying the following estimate

$$\left| \left\{ M_{\mathcal{R}} \mathbb{1}_E \geq \frac{1}{2} \right\} \right| \geq A |E|.$$

It suffices to set $E = \cup_{i \in I} R_i$ and to observe that we have the following inclusion

$$\bigcup_{i \in I} TR_i \subset \left\{ M_{\mathcal{R}} \mathbb{1}_E \geq \frac{1}{2} \right\}.$$

The previous estimate easily implies that $M_{\mathcal{R}}$ is not bounded on L^p for any $p < \infty$. In higher dimensions, one can use the same procedure to prove that the operator $M_{\mathcal{R}_n}$ is not bounded on L^p for any $p < \infty$.

2.4 . The strong maximal Theorem

In the Euclidean space \mathbb{R}^n , the *strong* maximal operator M_n is associated to the family \mathcal{I}_n containing all the rectangles in \mathbb{R}^n whose sides are parallel to the axis : this operator has been intensively studied in the literature notably because it is connected to the multilinear theory of singular operators.

It is not difficult to see that the strong operator M_n cannot be bounded from L^1 to $L^{1,\infty}$ as the Hardy-Littlewood operator M . Indeed, for any small $t > 0$, we have the following estimate

$$\frac{1}{t} \left(1 + \log^+ \frac{1}{t} \right)^{n-1} |Q| \lesssim_n |\{M_n \mathbb{1}_Q \geq t\}|$$

where Q is any cube in \mathbb{R}^n . The logarithmic loss comes from the fact that the family \mathcal{I}_n contains rectangles that can become arbitrarily thin. Yet, the operator M_n is still bounded near L^1 and this is precised by the following Theorem.

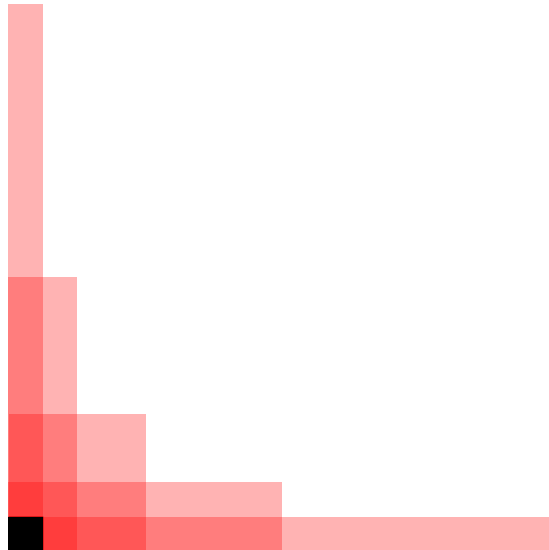

FIGURE 2.6 : The red area represents approximately a quarter of the level set $\{M_2 \mathbb{1}_Q \geq \frac{1}{16}\}$ where Q is the black square.

Theorem 2.4.1 (Strong maximal Theorem). *For any f and any $t > 0$, we have*

$$|\{M_n f > t\}| \lesssim_n \int_{\mathbb{R}^n} \frac{|f|}{t} \left(1 + \log^+ \frac{|f|}{t}\right)^{n-1}.$$

In other words, the strong maximal Theorem states that M_n is bounded from the Orlicz space $L^1(1 + \log^+ L^1)^{n-1}$ to $L^{1,\infty}$. This estimate is originally due to Jessen, Marcinkiewicz, and Zygmund in [32] and their proof relies on the fact that it is possible to dominate the operator M_n by the composition of n -fold one dimensional Hardy-Littlewood maximal operator associated to each axis. However, as explained by Cordoba and Fefferman in [8], even if this proof is fundamental, it does not bring a deeper comprehension of the geometry of rectangles precisely because it does not detail the covering properties of the family \mathcal{I}_n . To overcome this issue, Cordoba and Fefferman introduced in [8] the *exponential* covering property $V_{\text{exp},n}$ which is defined as follow : by definition, a family \mathcal{B} has the covering property $V_{\text{exp},n}$ when, given any finite family $\{R_i : i \in I\}$ included in \mathcal{B} , there exists a subfamily $J \subset I$ such that we have

$$\left| \bigcup_{i \in I} R_i \right| \lesssim \left| \bigcup_{j \in J} R_j \right|$$

and also

$$\int_{\mathbb{R}^n} \exp \left(\sum_{j \in J} \mathbb{1}_{R_j}(x) \right)^{\frac{1}{n-1}} dx \lesssim \left| \bigcup_{j \in J} R_j \right|.$$

Of course, the interest of this covering property comes from the fact

Theorem 2.4.2 (Cordoba and Fefferman). *A family \mathcal{B} satisfies the property $V_{\text{exp},n}$ if and only if the associated maximal operator $M_{\mathcal{B}}$ is bounded from $L^1(1 + \log^+ L^1)^{n-1}$ to $L^{1,\infty}$. In addition, the family \mathcal{I}_n satisfies the property $V_{\text{exp},n}$.*

Hence, the strong maximal Theorem can be proved by *analytic* means as in [32] or by *geometric* arguments as in [8]. As for the Hardy-Littlewood maximal operator, interpolation arguments show that the operator M_n is bounded from L^p to L^p for any $p > 1$.

2.5 . Directional maximal operators

Directional maximal operators form a natural intermediate between the strong maximal operator M_2 and the grand maximal operator $M_{\mathcal{R}}$. Recall that in the Euclidean plane \mathbb{R}^2 , we say that a family included in \mathcal{R} is a *directional family* when it is of the form

$$\mathcal{R}_{\Omega} = \{R \in \mathcal{R} : \omega_R \in \Omega\}$$

where we have denoted by ω_R the angle that the longest side of the rectangle R makes with the horizontal axis and by Ω a subset of \mathbb{S}^1 and naturally, we denote by M_Ω the maximal operator associated to the family \mathcal{R}_Ω . Given a specific set of directions Ω , is it possible to find an exponent p' such that M_Ω is bounded on L^p for $p' < p$ and unbounded on L^p for $p < p'$? In the late seventies, analysts (see [41], [38] or [10]) considered the directional family associated to the set of directions Ω_{lac} defined as

$$\Omega_{\text{lac}} = \left\{ \frac{\pi}{2^k} : k \geq 1 \right\}.$$

The covering method introduced by Cordoba and Fefferman allowed them to study the maximal operator $M_{\Omega_{\text{lac}}}$: in [10], they proved that the family $\mathcal{R}_{\Omega_{\text{lac}}}$ has the covering property V_2 and as a corollary, the operator $M_{\Omega_{\text{lac}}}$ has weak-type $(2, 2)$. Yet, what happens near the endpoint L^1 ? A year later Nagel, Stein and Wainger proved in [38] that the operator $M_{\Omega_{\text{lac}}}$ is bounded on L^p for any $p > 1$. Surprisingly, their method does not rely on geometric arguments but rather on Fourier analysis techniques. In some sense, the underlying idea in [38] is that two rectangles can behave as if they were *orthogonal* when some conditions are met. This principle has been developed in the subsequent work of Alfonseca, Soria and Vargas in [2] and [3] and a final *almost-orthogonality* principle was detailed in [1] by Alfonseca. More precisely, Alfonseca proved that it is always possible to make a geometric split of any set of directions Ω into countably many parts

$$\Omega = \bigcup_{k \geq 1} \Omega_k$$

and then to obtain, for any $p > 1$, the following estimate

$$\|M_\Omega\|_p \lesssim \left(\sup_{k \geq 1} \|M_{\Omega_k}\|_p \right) + E_p$$

where E_p is an error term which depends on the partition $\{\Omega_k : k \geq 1\}$ of the set Ω . Following the terminology of Bateman in [5], this principle shows that any set of directions Ω which is *finitely lacunary* yields a maximal operator M_Ω which is bounded on L^p for any $p > 1$.

2.6 . The linear set and the Cantor set of directions

On the other hand, a close inspection to the construction of a classic Perron tree shows that it is actually possible to make a Kakeya blow only with the family $\mathcal{R}_{\Omega_{\text{lin}}}$ where the set Ω_{lin} is defined as

$$\Omega_{\text{lin}} = \left\{ \frac{\pi}{k} : k \geq 1 \right\}.$$

As said earlier, a consequence of this fact is that the maximal operator $M_{\Omega_{\text{lin}}}$ is not bounded on L^p for any $p < \infty$. Of course it is possible to construct other

large set of directions modeled on the set Ω_{lin} which have the same property but it appears that to make a *Keakeya blow* *via* the Perron tree construction is not enough to treat more general case.

Indeed, the case of very irregular set of directions posed trouble for some times. The most emblematic case is the following one : denoting by Ω_{Cantor} a ternary Cantor set normalized in \mathbb{S}^1 or $(0, \pi)$, what can be said about the operator $M_{\Omega_{\text{Cantor}}}$? Different authors studied maximal operators associated to this kind of irregular set but it is thanks to the work of Bateman and Katz that the geometric properties of the family $\mathcal{R}_{\Omega_{\text{Cantor}}}$ were totally understood. In their work [6], the authors proved the following Theorem.

Theorem 2.6.1 (Bateman and Katz). *It is possible to make a Keakeya blow with the directional family $\mathcal{R}_{\Omega_{\text{Cantor}}}$.*

In contrast with the Perron tree deterministic construction, Bateman and Katz made a *Keakeya blow* *via* a random procedure. This randomization is not the only new idea they used : the techniques deployed in [6] also take advantages of (1) a discretization of the family of rectangles which unravels the *tree structure* of the problem (2) the notion of *stickiness* which comes from the modern approach to the *Keakeya* problem and finally (3) arguments from percolation theory. In other words, the result presented in [6] is quite difficult but it lead to the following corollary : the maximal operator $M_{\Omega_{\text{Cantor}}}$ is not bounded on L^p for any $p < \infty$.

2.7 . Bateman's Theorem

The strategy and mechanism developed in [6] are so efficient that Bateman successfully classified the behavior of directional maximal operators in his work [5]. Precisely, Bateman proved that if a set of direction Ω is not finitely lacunary, then it is possible to make a *Keakeya blow* with the family \mathcal{R}_{Ω} and hence, the maximal operator M_{Ω} is not bounded on L^p for any $p < \infty$. In regards of Alfonseca's result, this complete the *a priori* study of directional maximal operator. Indeed, Bateman's Theorem shows that the correct notion of structure concerning Ω is whether it is *finitely lacunary* or not. Let us define this notion following a nice presentation made by Kroc and Pramanik [34] : we start by defining the notion of *lacunary sequence* and then the notion of *lacunary set of finite order*. We say that a sequence of real numbers $L = \{\ell_k : k \geq 1\}$ is a lacunary sequence converging to $\ell \in \mathbb{R}$ when there holds

$$|\ell - \ell_{k+1}| \leq \frac{1}{2} |\ell - \ell_k|$$

for any k . For example the sequences $\{\frac{1}{2^k} : k \geq 2\}$ and $\{\frac{1}{k!} : k \geq 4\}$ are lacunary. We define now by induction the notion of lacunary set of finite order.

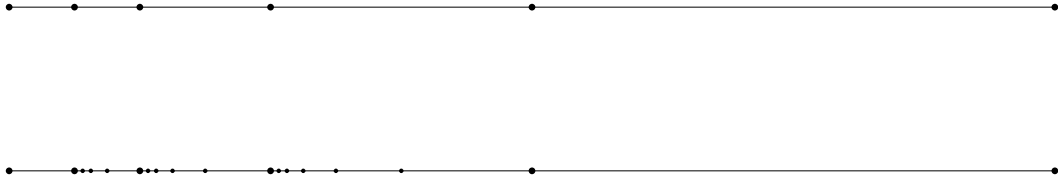

FIGURE 2.7 : Une représentation d'un ensemble lacunaire de niveau 1 et 2.

Definition 2.7.1 (Lacunary set of finite order). *A lacunary set of order 0 in \mathbb{R} is a set which is either empty or a singleton. Recursively, for $N \in \mathbb{N}^*$, we say that a set Ω included in \mathbb{R} is a lacunary set of order at most $N + 1$ — and write $\Omega \in \Lambda(N + 1)$ — if there exists a lacunary sequence L with the following properties : for any $a, b \in L$ such that $a < b$ and $(a, b) \cap L = \emptyset$, the set $\Omega \cap (a, b)$ is a lacunary set of order at most N i.e. $\Omega \cap (a, b) \in \Lambda(N)$.*

For example the set

$$\Omega := \left\{ \frac{\pi}{2^k} + \frac{\pi}{4^l} : k, l \in \mathbb{N}, l \leq k \right\}$$

is a lacunary set of order 2. In this case, observe that the set Ω cannot be re-written as a monotone sequence, since it has several points of accumulation. We can finally give a definition of a finitely lacunary set.

Definition 2.7.2 (Finitely lacunary set). *A set Ω in $[0, \pi)$ is said to be finitely lacunary if there exists a finite number of set $\Omega_1, \dots, \Omega_M$ which are lacunary of finite order such that*

$$\Omega \subset \bigcup_{k \leq M} \Omega_k.$$

Let us insist on the following point : the notion of lacunary finiteness is purely geometric, it only depends on structure of the set Ω and not on an index p or some covering properties. In regards of our problematic, Bateman's Theorem is typically the form of result that we wish to obtain in contrast with Cordoba and Fefferman's result.

Theorem 2.7.1 (Bateman). *We have the following alternative :*

- if Ω is finitely lacunary then M_Ω is bounded on L^p for any $p > 1$.
- if Ω is not finitely lacunary then it is possible to make a *Keakeya blow* with the family \mathcal{R}_Ω .

In higher dimensions, the situation is more complex and some subtleties remain to be detailed : we invite the reader to look for example at the work of Parcet and Roger [39], Kroc and Pramanik [35] and [34], Di Plinio and Parissis [16] and [15].

2.8 . Zygmund's conjecture

In the Euclidean space \mathbb{R}^n , it is possible to go beyond the strong maximal : in [47], Zygmund considered for $1 \leq k \leq n$, the family $\mathcal{I}_n(k)$ which is composed of all the rectangles $R \in \mathcal{I}_n$ who do not have more than k different side lengths. He proved that the maximal operator $M_{n,k}$ associated to the family $\mathcal{I}_n(k)$ satisfies

$$M_{n,k} : L^1 (1 + \log^+ L^1)^{k-1} \rightarrow L^{1,\infty}.$$

Let us recall this means that for any function f and any $t > 0$, we have

$$|\{M_{n,k}f > t\}| \lesssim_n \int_{\mathbb{R}^n} \frac{|f|}{t} \left(1 + \log^+ \frac{|f|}{t}\right)^{k-1}.$$

In addition, it is not difficult to see that this estimate is *sharp* in the following sense : given any integer $m \gg 1$, there exists a set E (take $E = [0,1]^n$ for example) such that

$$|\{M_{n,k}\mathbb{1}_E > 2^{-m}\}| \gtrsim_n m^{k-1} 2^m |E|.$$

We will say that such a maximal operator is *sharply bounded from $L^1 \log^{k-1} L^1$ to $L^{1,\infty}$* .

Thereafter, motivated by problematics arising in the theory of singular integrals, Zygmund considered maximal operators defined on families exhibiting a lower level of symmetry. For example, he asked the following question : denoting by \mathcal{B}_Z the family composed of axis parallel rectangles in \mathbb{R}^3 whose side lengths are of the form

$$t \times s \times \sqrt{ts},$$

can one prove that we have the following boundedness property

$$M_{\mathcal{B}_Z} : L^1 (1 + \log^+ L^1) \rightarrow L^{1,\infty}.$$

As before, Zygmund expected such result because a rectangle in \mathcal{B}_Z , as a plane rectangle, is only defined by two parameters (up to translations) and so $M_{\mathcal{B}_Z}$ should behave like M_2 . As announced in [9], Cordoba answered positively to the question of Zygmund by proving the following Theorem : fix an arbitrary function $\phi : \mathbb{R}^2 \rightarrow \mathbb{R}^+$ increasing in each variable and consider the translation invariant family \mathcal{B}_ϕ composed of every axis-parallel rectangles whose side lengths are of the form

$$s \times t \times \phi(s, t).$$

Theorem 2.8.1 (Cordoba). *With the previous notations, the maximal operator $M_{\mathcal{B}_\phi}$ associated to the translation invariant family \mathcal{B}_ϕ is bounded from $L^1 (1 + \log^+ L^1)$ to $L^{1,\infty}$.*

In regards of this Theorem, the following conjecture was proposed : let $\{\phi_i : i \leq n\}$ be n positive real functions depending on k variables, increasing in each variable separately and assuming arbitrarily small values and consider the family \mathcal{B}_ϕ of all axis parallel rectangles in \mathbb{R}^n whose side lengths are of the form

$$\phi_1(t_1, \dots, t_k) \times \cdots \times \phi_n(t_1, \dots, t_k).$$

The conjecture originally states that in this situation, we have the following boundedness property for the operator $M_{\mathcal{B}_\phi}$

$$M_{\mathcal{B}_\phi} : L^1 (1 + \log^+ L^1)^{k-1} \rightarrow L^{1,\infty}.$$

It appears that stated in this form, Zygmund's conjecture is false and this was proved by Soria in the simplest case $n = 3$ and $k = 2$. More recently, Rey exhibited a whole new class of counter examples to this conjecture in [40]. However, Soria and Rey results do not indicate that the idea behind Zygmund's conjecture is false but rather that it is not correctly formulated.

Indeed, in his seminal work [45], Stokolos proved the following Theorem (for the sake of clarity, we omit the *geometric description* of this Theorem) thanks to the key idea of *crystallisation* he developed.

Theorem 2.8.2 (Stokolos). *Given any translation invariant family \mathcal{B} of axis parallel rectangles in \mathbb{R}^2 there exists an integer $i \in \{0, 1\}$ such that the maximal operator $M_{\mathcal{B}}$ is sharply bounded from $L^1 (1 + \log^+ L^1)^i$ to $L^{1,\infty}$.*

In regards of Theorem 2.8.2, Stokolos proposed the following reformulation of Zygmund's conjecture in [43] and in the past years, several authors (among which D'Aniello and Moonens [13], Dmitrishin, Hagelstein and Stokolos [17], Fefferman and Pipher [19], Hagelstein, Oniani and Stokolos [25], Hagelstein and Stokolos [28], [27] and Stokolos [45], [43], [44]) exhibited results which lend weight to its possible veracity.

Conjecture 2.8.1 (Zygmund's conjecture II). *Given any family \mathcal{B} invariant by translations included in \mathcal{I}^n , there exists an integer $1 \leq k \leq n$ such that the maximal operator $M_{\mathcal{B}}$ is sharply bounded from $L^1 (1 + \log^+ L^1)^{k-1}$ to $L^{1,\infty}$.*

So far, this conjecture has not been refuted : we will give more examples in the sixth chapter. Let us also say that even for geometric families \mathcal{B} (that is to say even if we assume the stability by central dilations) very little is known concerning Zygmund's problem in dimension $n \geq 3$.

2.9 . On non-Euclidean spaces

Maximal operator have also been intensively studied beyond the Euclidean realm : on graphs [42], on infinite dimensional space [33] or on hyperbolic

spaces [37], [31] or [46] to cite a few. In those spaces, the theory has mainly been focused on the study of the Hardy-Littlewood operator : precisely, given a measured metric space (X, d, μ) let us denote by \mathcal{Q} the family containing all the balls of the space *i.e.*

$$\mathcal{Q} = \{B(y, r) : y \in X, r > 0\}.$$

In this setting, it is natural to consider the maximal operator akin to the Hardy-Littlewood maximal (or its centered version) operator and defined as

$$Mf(x) = \sup_{x \in B \in \mathcal{Q}} \frac{1}{\mu(B)} \int_B |f|$$

and its centered version

$$M^c f(x) = \sup_{r > 0} \frac{1}{\mu(B(x, r))} \int_{B(x, r)} |f|$$

The regularity of the operator M is well understood as soon as we have some information on the measure and the metric, in particular when we suppose that the metric is doubling. This comes partly from the fact that covering arguments *à la* Vitali are quite flexible and can be used in general measured metric spaces : see also [36] for example.

It turns out that those covering techniques cannot directly applied to the Hardy-Littlewood maximal operator defined on negatively curved surface since the volume of balls grows exponentially there. Yet, it is possible to study maximal operators on those spaces, for example Stromberg made an important study of this situation in [46] for non-compact symmetric space. A particular application of his result concerns the hyperbolic plane \mathbb{H}^2 endowed with its natural metric d and measure μ .

Theorem 2.9.1 (Stromberg). *The (centered) Hardy-Littlewood maximal operator M^c defined on (\mathbb{H}^2, d, μ) satisfies a weak-type estimate *i.e.* for any f and $t > 0$ one has*

$$\mu(\{M^c f > t\}) \lesssim \int_{\mathbb{H}^2} \frac{|f|}{t} d\mu.$$

In contrast with measured metric space with the doubling property, the non-centered Hardy-Littlewood maximal operator has a behavior quite different : in [31], Ionescu proved the following Theorem (also for non-compact symmetric space but we state it in \mathbb{H}^2 for simplicity).

Theorem 2.9.2 (Ionescu). *The (uncentered) Hardy-Littlewood maximal operator M defined on (\mathbb{H}^2, d, μ) is bounded from L^p to L^p in the sharp range of exponents $p \in (2, \infty]$.*

In regards of the theory in the Euclidean space, we are not specifically interested by the Hardy-Littlewood operator but rather by the interaction of geometric objects of \mathbb{H}^2 which possess, in some sense, a richer geometry than the usual balls and this question will be the object of the last part of this text.

2.10 . Contributions

To conclude this introduction, let us briefly detail the contributions made.

Perturbations of concrete set of directions

The first part of the dissertation is dedicated to maximal operators associated to *concrete* set of directions. It is important to understand the classic examples of sets of directions Ω_{lin} and Ω_{lac} since, in some sense, they are the smallest sets which are infinite and respectively *non finitely lacunary* and *finitely lacunary*.

Stokolos observed that it could be difficult to apply Bateman's Theorem *i.e.* it is difficult to decide if a given set of directions Ω is finitely lacunary or not. He asked what could be said about the classic sets Ω_{lac} and Ω_{lin} when they are perturbed in the following sense : consider the sets

$$\Omega_{cos,lin} = \left\{ \frac{\pi \cos(k)}{k} : k \geq 1 \right\}$$

and

$$\Omega_{cos,lac} = \left\{ \frac{\pi \cos(k)}{2^k} : k \geq 1 \right\}.$$

We settle the case of $\Omega_{cos,lin}$ in the second chapter without using Bateman's technology.

Theorem 2.10.1 (D'Aniello, G. and Moonens). *It is possible to make a Kakeya blow with the directional family $\mathcal{R}_{\Omega_{cos,lin}}$.*

The proof of this Theorem relies on exhibiting arbitrary large sequences in $\Omega_{cos,lin}^{-1}$ which are almost homogeneous. With those large sequences at hands, we are then able to construct a Perron tree with the elements of $\mathcal{R}_{\Omega_{cos,lin}}$ *i.e.* we realize a Kakeya blow with this family. In order to understand how the set Ω_{lac} and Ω_{lin} behaves when they are *generically* perturbed, we study then the random sets of direction

$$\Omega_{rand,lin} = \left\{ \frac{\pi X_k}{k} : k \geq 1 \right\}$$

and

$$\Omega_{rand,lac} = \left\{ \frac{\pi X_k}{2^k} : k \geq 1 \right\}$$

where the variables $\{X_k : k \geq 1\}$ are independent and uniformly distributed in $(0, 1)$. In the third chapter, we prove the following Theorem.

Theorem 2.10.2 (G.). *Almost surely, it is possible to make a Kakeya blow with the directional families $\mathcal{R}_{\Omega_{rand,lin}}$ and $\mathcal{R}_{\Omega_{rand,lac}}$.*

In the same fashion than before, the proof relies on exhibiting large sequences in $\Omega_{rand,lin}^{-1}$ and $\Omega_{rand,lac}^{-1}$ which are well distributed and conclude using Borel-Cantelli like arguments. Let us note that the case of the set of directions $\Omega_{cos,lac}$ remains open.

Geometric maximal operators which are not directional

The second part of the dissertation is dedicated to the study of *geometric* maximal operators in the plane associated to geometric family : we specifically focus on families which are not directional. Indeed, beyond Bateman's Theorem, it seems desirable to study families \mathcal{B} included in \mathcal{R} which are solely supposed invariant by translations and dilations.

In the fourth chapter, we consider the maximal operator $M_{a,b}$ associated to the family of rectangles $\mathcal{B}_{a,b}$ defined as

$$\mathcal{B}_{a,b} = \left\{ R \in \mathcal{R} : \exists n \in \mathbb{N}, e_R = \frac{1}{n^a}, \omega_R = \frac{\pi}{n^b} \right\}.$$

Here e_R stands the eccentricity of R *i.e.* the ratio between the length of the smallest side of R by the length of its longest side. We prove the following Theorem.

Theorem 2.10.3 (G.). *We have the following alternative :*

- *If $a > b$ then $M_{a,b}$ is bounded on L^p for any $p > 1$.*
- *If $a \leq b$ then it is possible to make a *Keakeya blow* with the family $\mathcal{B}_{a,b}$.*

In order to treat the general problem, we introduce in the fifth chapter a geometric quantity

$$\lambda_{\mathcal{B}} \in \mathbb{N}^* \cup \{\infty\}$$

associated to any geometric family \mathcal{B} that we call *analytic split*. In contrast to the covering property, the analytic split of a geometric family \mathcal{B} is *computable* in principle and does not depend on any index p . We prove then the following Theorem

Theorem 2.10.4 (G.). *For any $1 < p < \infty$, the following estimate holds*

$$\|M_{\mathcal{B}}\|_p^p \gtrsim_p \log(\lambda_{\mathcal{B}}).$$

*In addition, if $\log(\lambda_{\mathcal{B}}) = \infty$ then it is possible to make a *Keakeya blow* with the family \mathcal{B} .*

The proof of this Theorem relies on the exploitation of Bateman's but with families of rectangles which are not directional. Based on the technique developed for the sake of Theorem 2.10.4, Hagelstein and Stokolos proved the following Theorem in [26] which conclude the study of geometric maximal operators in the plane.

Theorem 2.10.5 (Hagelstein and Stokolos). *Given a geometric family \mathcal{B} in \mathcal{R} , we have the following alternative :*

- *either the operator $M_{\mathcal{B}}$ is bounded on L^p for any $p > 1$.*
- *either the operator $M_{\mathcal{B}}$ is not bounded on L^p for any $p < \infty$.*

Hence, it seems interesting to study now translation invariant maximal operators in the plane.

Cartesian families for Zygmund's conjecture

In the third part of this dissertation, we turn our attention to a specific case of Zygmund's conjecture. In particular, we are interested by families \mathcal{B} included in \mathcal{I}_n invariant by translations and which exhibit a *Cartesian structure*. Without loss of generality, we can always suppose that an axis parallel rectangle is - up to translations - a dyadic rectangle of the form

$$R_{\hat{\mathbf{a}}} := I_{a_1} \times \cdots \times I_{a_n}$$

for $\hat{\mathbf{a}}$ in \mathbb{Z}^n and where given an integer $\ell \in \mathbb{Z}$, we let I_ℓ be the dyadic interval $[0, 2^\ell]$. It would be interesting to study Zygmund's conjecture for the following type of families.

Definition 2.10.1 (Cartesian family). *Given $(n-1)$ arbitrary sets of integers*

$$\{A_i \subset \mathbb{Z} : 1 \leq i \leq n-1\},$$

we say that the smallest family invariant by translations that contains for any $\mathbf{a} \in A_1 \times \cdots \times A_{n-1}$ the dyadic rectangles of unit volume

$$R_{\mathbf{a}} = I_{a_1} \times \cdots \times I_{a_{n-1}} \times I_{-(a_1+\cdots+a_{n-1})}$$

is a Cartesian family. We denote this family $\mathcal{B}_{A_1 \times \cdots \times A_{n-1}}$ and the maximal operator associated by $M_{A_1 \times \cdots \times A_{n-1}}$.

Let us insist that we have supposed that the family $\mathcal{B}_{A_1 \times \cdots \times A_{n-1}}$ is just invariant by translations. We will discuss variant of the problem later. In the sixth chapter, given a set of integer $A \subset \mathbb{Z}$, we consider the Cartesian family $\mathcal{B}_{A^{n-1}}$ which contains every rectangles of the form

$$[0, 2^{a_1}] \times \cdots \times [0, 2^{a_{n-1}}] \times [0, 2^{-(a_1+\cdots+a_{n-1})}]$$

for any $a_1, \dots, a_{n-1} \in A$. We prove the following Theorem in \mathbb{R}^n .

Theorem 2.10.6 (G.). *If the set A contains arbitrarily large arithmetic progression then the maximal operator $M_{A^{n-1}}$ is sharply bounded from $L^1 \log^{n-1} L^1$ to $L^{1,\infty}$.*

The proof relies on the construction of specific test functions adapted to the operator $M_{A^{n-1}}$ and based on the technique of crystallisation. For the moment, it seems difficult to goes beyond the arithmetic condition made on the set A in order to treat general Cartesian families but we hope to develop those methods in the future. We make further comments later.

Maximal operator on the hyperbolic plane

In the last part of this dissertation, we turn our attention to the hyperbolic plane \mathbb{H}^2 endowed with its natural metric and measure μ and denote by G its group of isometries. In regards of Stromberg and Ionescu's Theorems, it seems interesting to study maximal operators defined on more general geometric sets : we will lead this problematic with *hyperbolic triangles*. Precisely, we let \mathcal{X} be a family composed of hyperbolic triangles in \mathbb{H}^2 stable by isometries *i.e.* such that for any $T \in \mathcal{X}$ and $g \in G$, we have

$$g(T) \in \mathcal{X}.$$

We prove the following Theorem in which we have omitted the geometric description of each situation.

Theorem 2.10.7 (Branchereau, Bronstein and G.). *We have the following alternative :*

- (I) *there exists a constant $C_{\mathcal{X}} < \infty$ such that for any function f we have*

$$\|M_{\mathcal{X}}f\|_1 \leq C_{\mathcal{X}}\|f\|_1$$

- (II) *there exists a constant $C_{\mathcal{X}} < \infty$ such that for any function f and $t > 0$, the following estimate holds*

$$\mu(\{M_{\mathcal{X}}f > t\}) \leq C_{\mathcal{X}}\frac{\|f\|_1}{t}.$$

- (III) *for any non zero function f , there exists a positive constant $c > 0$ such that for any $y \in \mathbb{H}^2$, one has*

$$M_{\mathcal{X}}f(y) > c.$$

- (IV) *for any large constant $C \gg 1$, there exists a bounded set E in \mathbb{H}^2 satisfying*

$$\mu\left(\left\{M_{\mathcal{X}}\mathbb{1}_E \geq \frac{1}{4}\right\}\right) \geq C\mu(E).$$

We will see that the proof relies exclusively on geometric methods. For the first two situations, we will use methods which are valid in general measured metric spaces, in particular covering techniques arguments *à la* Vitali. The second situation is specific to the geometry of the hyperbolic plane and its geodesic triangles. Finally, the last situation exploits the Kakeya blow of the Euclidean plane *via* the tangent plane and the exponential map. Let us also note that a similar result holds for family of geodesic k -polygons invariant by the group of isometries G . Hence, it is now possible to consider less regular geometric families of triangles defined on the hyperbolic plane.

The following example seems interesting : given a point $\omega \in \partial\mathbb{H}^2$, let us denote by \mathcal{G}_ω the family containing every infinite geodesic that reaches ω at infinity and denote also by \mathcal{H}_ω the family containing every horocycles tangent at ω on the boundary of \mathbb{H}^2 . Given two distinct geodesic $g, g' \in \mathcal{G}_\omega$ and two distinct horocycles $h, h' \in \mathcal{H}_\omega$, consider the biggest bounded set

$$P := P(g, g', h, h') \subset \mathbb{H}^2$$

whose boundary is delimited by the curves g, g', h and h' . Consider then the family \mathcal{P}_ω defined as

$$\mathcal{P}_\omega := \{P(g, g', h, h') : g \neq g' \in \mathcal{G}_\omega, h \neq h' \in \mathcal{H}_\omega\}.$$

The elements of \mathcal{P}_ω are *not* geodesic 4-gons but they are geometric objects that are - in some sense - *oriented* in the direction ω , which have a certain *thickness* and which whose diameter can be arbitrarily small or large and finally, their volume can become arbitrarily large and small. What can be said about the maximal operator $M_{\mathcal{P}_\omega} : L^\infty \rightarrow L^\infty$? If one proves some boundedness properties for this operator then, given an arbitrary sets of points $\Omega \subset \partial\mathbb{H}^2$, one can consider the family

$$\mathcal{P}_\Omega = \bigcup_{\omega \in \Omega} \mathcal{P}_\omega.$$

What can be said about the operator $M_{\mathcal{P}_\Omega} : L^\infty \rightarrow L^\infty$? Does its boundedness properties depend on the set Ω as in the Euclidean case?

3 - Perron capacity I

The content of this chapter is contained in *(Un)boundedness of directional maximal operators through a notion of "perron capacity" and an application* [11]. It is a joint work with Emma D'Aniello and Laurent Moonens.

As said earlier, in the Euclidean plane \mathbb{R}^2 , *directional* maximal operators form a natural intermediate between the strong maximal operator M_2 and the grand maximal operator $M_{\mathcal{R}}$. Recall that we say that a family included in \mathcal{R} is a *directional family* when it is of the form

$$\mathcal{R}_\Omega = \{R \in \mathcal{R} : \omega_R \in \Omega\}$$

where we have denoted by ω_R the angle that the longest side of the rectangle R makes with the horizontal axis and by Ω a subset of \mathbb{S}^1 and naturally, we denote by M_Ω the maximal operator associated to the family \mathcal{R}_Ω .

Bateman's Theorem in [5] is an explicit classification of directional maximal operator depending on the geometric structure of the set of directions Ω .

Theorem 3.0.1 (Bateman). *Given a set of directions $\Omega \subset \mathbb{S}^1$, we have the following alternative :*

- if Ω is finitely lacunary then M_Ω is bounded on L^p for any $p > 1$.
- if Ω is not finitely lacunary then it is possible to make a *Keakeya blow* with the family \mathcal{R}_Ω .

Concretely, can we use Bateman's Theorem on specific set of directions? Stokolos raised the questions for the two classical sets Ω_{lac} and Ω_{lin} when they are perturbed by a certain phase. Precisely, what can be said about the following sets of directions

$$\Omega_{\text{cos,lin}} = \left\{ \frac{\pi \cos(k)}{k} : k \geq 1 \right\}$$

and

$$\Omega_{\text{cos,lac}} = \left\{ \frac{\pi \cos(k)}{2^k} : k \geq 1 \right\}.$$

Are they finitely lacunary or not? We are going to show that the set $\Omega_{\text{cos,lin}}$ is not finitely lacunary.

3.1 . Results

Given an infinite set of directions $\Omega \subset \mathbb{S}^1$ whose only point of accumulation is 0, we write

$$\Omega = \left\{ \frac{\pi}{u} : u \in \Omega^{-1} \right\}$$

and we order Ω^{-1} as a strictly increasing sequence $\{v_k : k \in \mathbb{N}^*\}$. With those notations, we define the *Perron factor* of Ω as

$$PF(\Omega) := \sup_{\substack{k \geq 1 \\ l \leq k}} \left(\frac{v_{k+2l} - v_{k+l}}{v_{k+l} - v_k} + \frac{v_{k+l} - v_k}{v_{k+2l} - v_{k+l}} \right).$$

In [30], Hare and Ronning proved the following Theorem.

Theorem 3.1.1 (Hare and Ronning). *If we have $PF(\Omega) < \infty$ then it is possible to make a Keakeya blow with the family \mathcal{R}_Ω*

It turns out that it is difficult to compute the Perron factor of the set

$$\Omega_{\text{cos,lin}} = \left\{ \frac{\pi \cos(k)}{k} : k \geq 1 \right\}$$

since the oscillation of the cosinus prevent us to obtain a good description of the sequence $\{v_k : k \in \mathbb{N}^*\}$ associated to $\Omega_{\text{cos,lin}}$. Based on a careful read of the proof of Theorem 3.1.1, for an arbitrary set of directions Ω included in \mathbb{S}^1 , we define its *Perron capacity* as

$$PC(\Omega) := \liminf_{N \rightarrow \infty} \inf_{\substack{U \subset \Omega^{-1} \\ \#U=2^N}} PF(\Omega) \in [2, \infty]$$

where as before

$$PF(\Omega) = \sup_{\substack{k, l \geq 1 \\ k+2l \leq 2^N}} \left(\frac{u_{k+2l} - u_{k+l}}{u_{k+l} - u_k} + \frac{u_{k+l} - u_k}{u_{k+2l} - u_{k+l}} \right)$$

if $U = \{u_1 < \dots < u_{2^N}\}$. Our first result reads as follow : in contrast with Hare and Ronning Theorem, we do not assume that the set Ω is ordered.

Theorem 3.1.2 (D’Aniello, G. and Moonens). *For any set of directions Ω , if we have*

$$PC(\Omega) < \infty$$

then it is possible to make a Keakeya blow with the family \mathcal{R}_Ω

Loosely speaking, the fact that $PC(\Omega) < \infty$ indicates whether the set Ω^{-1} contains arbitrary large subsets which are (more or less) uniformly distributed in \mathbb{R} . Our second result is an application of Theorem 3.1.2 and deals with the set of $\Omega_{\text{cos,lin}}$.

Theorem 3.1.3 (D’Aniello, G. and Moonens). *The Perron capacity of the set $\Omega_{\text{cos,lin}}$ is finite i.e. we have*

$$PC(\Omega_{\text{cos,lin}}) < \infty.$$

3.2 . Proof of Theorem 3.1.2

Recall that for any set $U := \{u_1, \dots, u_{2^N}\} \subset \mathbb{R}_+$ with $u_1 < u_2 < \dots < u_{2^N}$ (so that U has 2^N elements), its *Perron factor* is defined as

$$PF(\Omega) := \sup_{\substack{k,l \geq 1 \\ k+2l \leq 2^N}} \left(\frac{u_{k+2l} - u_{k+l}}{u_{k+l} - u_k} + \frac{u_{k+l} - u_k}{u_{k+2l} - u_{k+l}} \right) \in (0, \infty).$$

The following proposition is a careful reading of Hare and Ronning's work [30].

Proposition 3.2.1. *There exists $\epsilon_0 \in (0, 1)$ such that for any $\alpha \in [1 - \epsilon_0, 1)$ there exists a set $X \subseteq \mathbb{R}^2$ for which one has :*

$$|X| \leq [\alpha^{2^N} + PF(\Omega)(1 - \alpha)^2] \left| \left\{ M_U \mathbb{1}_X > \frac{1}{4} \right\} \right|.$$

Hence for any $0 < \alpha < 1$ close enough to 1, this gives us the following lower bound for any $p \in (1, \infty)$:

$$\|M_U\|_p^p \gtrsim_p \frac{1}{\alpha^{2^N} + PF(\Omega)(1 - \alpha)^2},$$

where \gtrsim_p means that the inequality holds up to a multiplicative constant that does only depend on p . Indeed, we have

$$\|M_U \mathbb{1}_X\|_p^p \geq \frac{1}{4^p} \left| \left\{ M_U \mathbb{1}_X > \frac{1}{4} \right\} \right| \gtrsim_p \frac{|X|}{\alpha^{2^N} + PF(\Omega)(1 - \alpha)^2}.$$

This allows us now to easily conclude the proof of Theorem 3.1.2. Indeed, fix an arbitrary set $\Omega \subset \mathbb{R}$ and suppose that its Perron capacity is finite *i.e.* assume that one has :

$$PC(\Omega) < \infty.$$

By definition of $PC(\Omega)$, there thus exists a strictly increasing sequence of integers $\{N_k : k \in \mathbb{N}^*\}$ such that for any k there is a set $U_k \subset \Omega$ such that $G(U_k) < 2PC(\Omega)$ and $\#U_k = 2^{N_k}$. Since there holds $U_k \subset \Omega$, we obtain, for any $0 < \alpha < 1$ sufficiently close to 1 and any $k \geq 1$:

$$\|M_\Omega\|_p^p \geq \|M_{U_k}\|_p^p \gtrsim \frac{1}{\alpha^{2^{N_k}} + 2PC(\Omega)(1 - \alpha)^2}.$$

Since this holds for any $k \geq 1$ and any α close to 1, this implies that we have $\|M_\Omega\|_p = \infty$.

3.3 . Homogeneous sets

We fix an arbitrary set U in \mathbb{R}_+^* whose cardinal is 2^N for some $N \in \mathbb{N}^*$. The following proposition shows that it is equivalent for U to be uniformly distributed or that its Perron factor equals 2.

Proposition 3.3.1. *We have $PF(U) = 2$ if and only if the elements of U are in arithmetic progression i.e. U is of the form*

$$U = \{a + k\delta : 1 \leq k \leq 2^N\}$$

for some $a \in \mathbb{R}$ and $\delta > 0$.

Démonstration. If U is in arithmetic progression we have easily $PF(U) = 2$. On the other hand if we have $PF(U) = 2$ since $x + \frac{1}{x} = 2$ if and only if $x = 1$ we have for any k (taking $\ell = 1$)

$$u_{k+2} - u_{k+1} = u_{k+1} - u_k$$

which concludes the proof. \square

We will be particularly interested by *homogeneous sets* that is to say sets H of the form

$$H := H_{a,N} = \{ka : 1 \leq k \leq 2^N\}$$

for some integers $a \in \mathbb{N}^*$ and $N \in \mathbb{N}$. In particular, we wish to perturb a little bit an homogeneous set $H_{a,N}$ into a set H' such that the Perron constant of H' is still bounded. More precisely, fix any $a, N \in \mathbb{N}^*$ and let ϵ be an arbitrary function

$$\epsilon : H_{a,N} \rightarrow [0, \infty).$$

Define then the set $H_{a,N}(\epsilon)$ as

$$H_{a,N}(\epsilon) := \{(1 + \epsilon(x))x : x \in H_{a,N}\}.$$

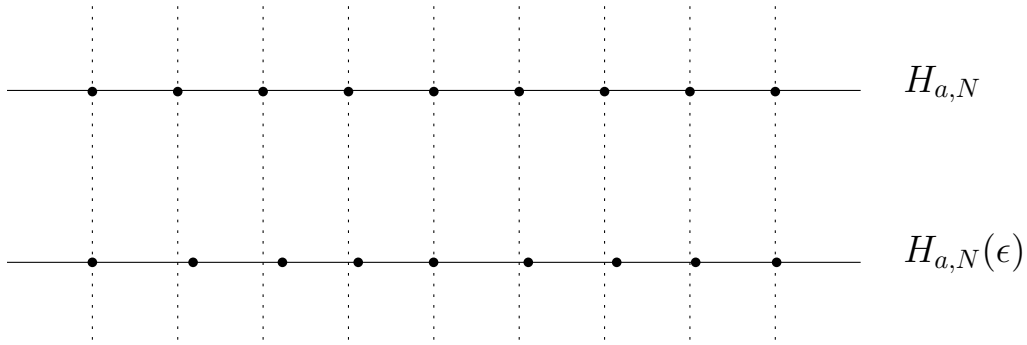

FIGURE 3.1 : A representation of a uniformly distributed set and its perturbation.

Proposition 3.3.2. *Assume that $a \in \mathbb{R}_+^*$, $N \in \mathbb{N}^*$ and $\epsilon : H_{a,N} \rightarrow [0, \infty)$ are given. If one has*

$$2^N \|\epsilon\|_\infty \leq \frac{1}{2},$$

then we have $PF(H_{a,N}) \leq 6$.

Démonstration. To simplify the notations, let for $1 \leq k \leq 2^N$, $h_k := [1 + \epsilon(ka)]ka$. First, observe that for $1 \leq k \leq 2^N - 1$, one has :

$$\begin{aligned} h_{k+1} - h_k &= \{1 + \epsilon[(k+1)a]\}(k+1)a - [1 + \epsilon(ka)]ka \\ &\geq a - ak\epsilon(ka) = a[1 - k\epsilon(ka)] \geq a[1 - (2^N - 1)\|\epsilon\|_\infty] > 0, \end{aligned}$$

so that there holds $h_1 < h_2 < \dots < h_{2^N}$.

Now compute, for $1 \leq l \leq k$ such that $k + 2l \leq 2^N$ (implying in particular that one has $\frac{k}{l} \leq 2^N - 2$) :

$$\frac{h_{k+2l} - h_{k+l}}{h_{k+l} - h_k} \leq \frac{la + 2^N a \|\epsilon\|_\infty}{la - \|\epsilon\|_\infty ka} = \frac{1 + \frac{2^N}{l} \|\epsilon\|_\infty}{1 - \frac{k}{l} \|\epsilon\|_\infty} \leq \frac{1 + 2^N \|\epsilon\|_\infty}{1 - (2^N - 2) \|\epsilon\|_\infty} \leq 3.$$

One obtains a similar inequality for the symmetric ratio. \square

3.4 . Proof of Theorem 3.1.1

Recall that we have defined

$$\Omega_{\cos, \text{lin}}^{-1} := \left\{ \frac{n}{\cos n} : n \in \mathbb{N}^* \right\}$$

and that we wish to prove that the Perron capacity of $\Omega_{\cos, \text{lin}}$ is finite *i.e.* that we have

$$PC(\Omega_{\cos, \text{lin}}) < \infty.$$

To do so, we are simply going to prove that the set $\Omega_{\cos, \text{lin}}$ contains “small perturbations” of *arbitrarily long homogeneous sets*. Specifically, for any $N \in \mathbb{N}$, we consider the set

$$E(N) := \{n \in \mathbb{N}^* : \exists m \in \mathbb{Z}, |n + 2\pi m| < 2^{-N}\}.$$

To begin with, it is not difficult to observe that for any $N \in \mathbb{N}$ we have

$$\#E(N) = \infty.$$

We claim then the following.

Claim 3.4.1. *For any $N \in \mathbb{N}$ and any $n \in E(N)$, one has :*

$$1 < \frac{1}{\cos n} \leq 1 + 2^{-2N}.$$

Proof of the claim. Choosing $m \in \mathbb{Z}$ such that one has $|n + 2\pi m| < 2^{-N}$ (which exists by definition since one has $n \in E(N)$), one obtains, using the inequality $1 - \cos x \leq \frac{1}{2}x^2$ valid for any $x \in \mathbb{R}$:

$$1 - \cos n = 1 - \cos(n + 2\pi m) \leq \frac{1}{2}(n + 2\pi m)^2 \leq \frac{1}{2}2^{-2N}.$$

Note that, in particular, this yields $0 < \cos n < 1$.

Using the fact that one has $\frac{1}{1-x} \leq 1 + 2x$ for any $0 \leq x \leq \frac{1}{2}$, one finally computes :

$$\frac{1}{\cos n} = \frac{1}{1 - (1 - \cos n)} \leq 1 + 2(1 - \cos n) \leq 1 + 2^{-2N},$$

as was announced. \square

Fix an arbitrary large $N \in \mathbb{N}$ and any integer $a \in E(2N)$. We claim the following.

Claim 3.4.2. *For any $a \in E(2N)$, we have*

$$H_{a,N} \subset E(N).$$

Démonstration. Fix $a \in E(2N)$; by definition we have $m \in \mathbb{Z}$ such that

$$|a + 2\pi m| < 2^{-2N}.$$

Hence for any $1 \leq k \leq 2^N$ we have

$$|ka + 2\pi km| < k2^{-2N} \leq 2^{-N}$$

i.e. for any $1 \leq k \leq 2^N$ we have $ka \in E(N)$. \square

Fix now $N \in \mathbb{N}^*$ and $a \in E(2N)$ and define $\epsilon : H_{a,N} \rightarrow [0, \infty)$ by the formula

$$1 + \epsilon(n) = \frac{1}{\cos n}$$

for $n \in H_{a,N}$ that is to say we see the set

$$\left\{ \frac{n}{\cos n} : n \in H_{a,N} \right\} = \{(1 + \epsilon(n))n : n \in H_{a,N}\},$$

as a perturbation of the above type of the set $H_{a,N}$. We compute, using Claim 3.4.1 :

$$2^N \|\epsilon\|_\infty \leq \frac{1}{2},$$

so that Proposition 3.3.2 yields $PF(H_{a,N}(\epsilon)) \leq 6$. Finally, observe that we have by construction the inclusion

$$H_{a,N}(\epsilon) \subset \Omega_{\cos, \text{lin}}.$$

Since this holds for any $N \in \mathbb{N}^*$, it follows that we have $PC(\Omega_{\cos, \text{lin}}) \leq 6$ as desired.

4 - Perron capacity II

The content of this chapter is contained in *Perron capacity of random sets* [24].

It turns out to be difficult to use Bateman's Theorem in order to treat the case of the directional maximal operator associated to the set of directions

$$\Omega_{\cos, \text{lac}} = \left\{ \frac{\pi \cos(k)}{2^k} : k \geq 1 \right\}.$$

The main problem of this set of directions is that we have a very poor control on the deterministic sequence $\{\cos(k) : k \geq 1\}$ and that initially, the set Ω_{lac} is finitely lacunary : hence, the perturbations are quite difficult to handle.

Yet, we are going to show that a generic perturbation of the classic examples Ω_{lac} and Ω_{lin} gives sets that are not finitely lacunary. Precisely we consider the following random sets of directions

$$\Omega_{\text{rand, lin}} := \left\{ \frac{\pi X_k}{k} : k \geq 1 \right\}$$

and

$$\Omega_{\text{rand, lac}} := \left\{ \frac{\pi X_k}{2^k} : k \geq 1 \right\}$$

where $\{X_k : k \geq 1\}$ are random variables uniformly distributed in $(0, 1)$ and independent. We are going to prove that almost surely, both sets are not finitely lacunary.

Theorem 4.0.1. *Almost surely, the sets $\Omega_{\text{rand, lin}}$ and $\Omega_{\text{rand, lac}}$ are not finitely lacunary.*

Our technique relies, as in the previous chapter, on the possibility to compute effectively the Perron capacity of the random sets $\Omega_{\text{rand, lin}}$ and $\Omega_{\text{rand, lac}}$. Indeed, in regards of the previous chapter, it suffices to study the Perron capacity of both set of directions. We start by proving the following Theorem.

Theorem 4.0.2. *The Perron capacity of $\Omega_{\text{rand, lin}}$ is finite almost surely i.e. almost surely we have*

$$PC(\Omega_{\text{rand, lin}}) < \infty.$$

Morally, Theorem 4.0.2 means that if a set Ω presents structured patterns - like large uniformly distributed sequence - then a small perturbation of Ω will still exhibit those patterns. The second result we prove is the following.

Theorem 4.0.3. *The Perron capacity of $\Omega_{\text{rand},\text{lac}}$ is finite almost surely i.e. almost surely we have*

$$PC(\Omega_{\text{rand},\text{lac}}) < \infty.$$

Loosely speaking, we prove Theorem 4.0.3 using the self-similarity of the set $L = \{2^k : k \geq 1\}$ with respect to dilation : taking any $N \gg 1$ consecutive points $\{2^{d+k} : 1 \leq k \leq N\}$, we show that the probability of the event "*the set $\{\frac{2^{d+k}}{X_{d+k}} : 1 \leq k \leq N\}$ is uniformly distributed*" is only dependent on N . We conclude using Borel-Cantelli technique to prove that the entire set $\Omega_{\text{rand},\text{lac}}$ contains, almost surely, arbitrary large uniformly distributed patterns.

4.1 . Proof of Theorem 4.0.2

We wish to prove that the Perron capacity of $\Omega_{\text{rand},\text{lin}}$ is finite almost surely. We are going to prove that *the set $\Omega_{\text{rand},\text{lin}}$ contains small perturbation of arbitrarily long homogeneous sets*. We say that a set H of the form

$$H := H_{a,N} = \{ka : 1 \leq k \leq 2^N\}$$

for some integer $a \in \mathbb{N}^*$ is an *homogeneous set*. The following claim is easy and were already discussed in the previous chapter.

Claim 4.1.1. *For any $a, N \in \mathbb{N}$, one has $PF(H_{a,N}) = 2$.*

We wish to perturb a little an homogeneous set H into a set H' such that the Perron constant of H' is still controlled. Precisely, fix any $a, N \in \mathbb{N}^*$ and let ϵ be an arbitrary function

$$\epsilon : H_{a,N} \rightarrow [0, \infty).$$

Define then the set $H_{a,N}(\epsilon)$ as

$$H' := H_{a,N}(\epsilon) := \{(1 + \epsilon(l))l : l \in H_{a,N}\}.$$

If the perturbation ϵ is small enough compared to the integer N , one can control uniformly $PF(H')$.

Proposition 4.1.1. *With the previous notations, if we have*

$$2^N \|\epsilon\|_\infty \leq \frac{1}{2}$$

then we have $PF(H_{a,N}(\epsilon)) < 6$.

We are now ready to prove Theorem 4.0.2. We fix a large integer $N \in \mathbb{N}$ and consider the following set of indices

$$E_N := \{k \in \mathbb{N} : |X_k - 1| \leq 2^{-N}\}.$$

In other words, an integer k belongs to E_N when X_k is close to 1 with precision 2^{-N} . We claim that this random set E_N contains almost surely large (with at least 2^N points) homogeneous sequences.

Claim 4.1.2. For any $N \geq 1$, the set E_N contains an homogeneous set of cardinal 2^N almost surely.

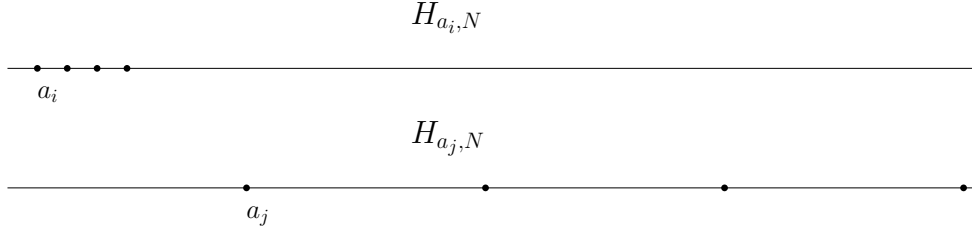

FIGURE 4.1 : We choose the sequence $\{a_i : i \geq 1\}$ such that $H_{a_i, N} \cap H_{a_j, N} = \emptyset$ for any $i \neq j$.

Démonstration. Observe that for any $a \in \mathbb{N}^*$, the following probability $\mathbb{P}(H_{a, N} \subset E_N) := c_N$ is independant of a . Hence we fix a sequence $\{a_i\}_{i \geq 1}$ satisfying for any $i \neq j$

$$H_{a_i, N} \cap H_{a_j, N} = \emptyset.$$

For example, setting $a_i = 2^{2N(i+1)}$ works since we have $a_i 2^N < a_{i+1}$ for any $i \geq 1$. In particular this means that the events

$$\{(H_{a_i, N} \subset E_N) : i \geq 1\}$$

are independant and since we have

$$\sum_{i \geq 1} \mathbb{P}(H_{a_i, N} \subset E_N) = \infty$$

an application of Borel-Cantelli lemma yields the conclusion. \square

We can now conclude the proof : we define a perturbation ϵ for any $n \geq 1$ as

$$1 + \epsilon(n) = X_n^{-1}.$$

We fix a large integer $N \gg 1$ and we know that almost surely there exists an integer $a \in \mathbb{N}^*$ such that $H_{a, N} \subset E_N$. Observe now that by definition one has the following inclusion

$$H_{a, N}(\epsilon) \subset \Omega_{\text{rand, lin}}^{-1}.$$

However since $H_{a, N} \subset E_N$ and that it is not difficult to see that we have

$$\|\epsilon|_{H_{a, N}}\|_{\infty} \lesssim 2^{-N},$$

it follows that we have $PC(\Omega_{\text{rand, lin}}) < 6$ almost surely applying Proposition 4.1.1.

4.2 . Proof of Theorem 4.0.3

We wish to prove that the Perron capacity of $\Omega_{\text{rand,lac}}$ is finite almost surely. Observe that if U is a set in \mathbb{R} who is well distributed then one can control its Perron capacity.

Claim 4.2.1. *If we have $\delta > 0$ and a set*

$$U = \{u_1 < \dots < u_{2^N}\}$$

such that for any $1 \leq i \leq 2^N - 1$ we have

$$\delta \leq u_{i+1} - u_i \leq 3\delta$$

then one has $PF(U) \lesssim 1$.

Démonstration. The fact that

$$PF(U) \lesssim 1$$

is a simple consequence of the fact that, by hypothesis, for any i, j such that $i + j \leq 2^N - 1$, one has $u_{i+j} - u_i \simeq j\delta$. \square

We are going to prove the following proposition.

Proposition 4.2.1. *For any $N \geq 1$, there exists almost surely a scale $\delta > 0$ and a set $U \subset \Omega_{\text{rand,lac}}$ such that*

$$U := \{u_1 < \dots < u_{2^{N-1}}\}$$

and for any $i \leq 2^{N-1}$ one has

$$\delta < u_{i+1} - u_i < 3\delta.$$

Theorem 4.0.3 is a consequence of Claim 4.2.1 and Proposition 4.2.1 and the rest of the section is devoted to the proof of Proposition 4.2.1.

Proof of Proposition 4.2.1

We consider the following dyadic intervals for $d \in \mathbb{N}$

$$I_d := \left[2^d, 2^{d+1}\right].$$

We wish to obtain information on the distribution of the points of the set $\Omega_{\text{rand,lac}}$ that may be in the interval I_d . We fix a large integer $N \gg 1$ and we divide each dyadic interval I_d into 2^N intervals of same length *i.e.* for any $1 \leq l \leq 2^N$ we set

$$I_{d,l} = \left[2^d \left(1 + \frac{l-1}{2^N}\right), 2^d \left(1 + \frac{l}{2^N}\right)\right].$$

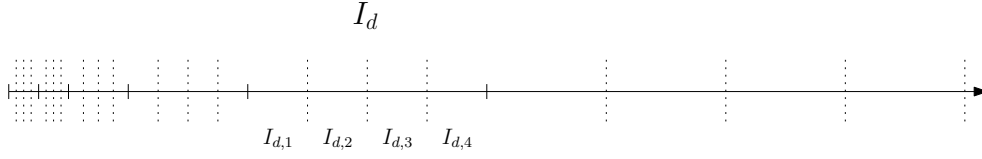

FIGURE 4.2 : For $N = 2$, each intervals I_d is divided in $2^N = 4$ equal parts.

Claim 4.2.2. *For any $d \geq 2^N + 1$ and any $1 \leq l \leq 2^N$, the following probability is independant of d*

$$\mathbb{P} \left(\frac{2^{d-l}}{X_{d-l}} \in I_{d,l} \right) = p_{l,N}$$

where $p_{l,N} = 2^{-l} \left(\left(1 + \frac{l-1}{2^N}\right)^{-1} - \left(1 + \frac{l}{2^N}\right)^{-1} \right)$.

Démonstration. By definition of $I_{d,l}$, one has $2^{d-l}X_{d-l}^{-1} \in I_{d,l}$ if and only if

$$2^{-l} \left(1 + \frac{l}{2^N} \right)^{-1} \leq X_{d-l} \leq 2^{-l} \left(1 + \frac{l-1}{2^N} \right)^{-1}.$$

One has $\mathbb{P} \left(2^{d-l}X_{d-l}^{-1} \in I_{d,l} \right) = p_{l,N}$ since the variable X_{d-l} is uniformly distributed in $(0, 1)$. \square

We fix an extraction $\{d_s : s \geq 1\}$ satisfying the following property

$$d_{s+1} - d_s > 2^N + 1$$

for any $s \geq 1$; this growth condition will assure that the events we will consider are independant and we will be able to apply Borel-Cantelli lemma when needed. The following claim is left to the reader.

Claim 4.2.3. *For any $s \geq 1$, the following probability is independant of s*

$$\mathbb{P} \left(\bigcap_{l \leq 2^N} \left(\frac{2^{d_s-l}}{X_{d_s-l}} \in I_{d_s,l} \right) \right) = \eta_N > 0.$$

Démonstration. By independence, we have

$$\mathbb{P} \left(\bigcap_{l \leq 2^N} \left(\frac{2^{d_s-l}}{X_{d_s-l}} \in I_{d_s,l} \right) \right) = \prod_{l \leq 2^N} p_{l,N} := \eta_N.$$

\square

Now for any $d \geq 1$, we consider the following event $A_{d,N}$ defined as

$$A_{d,N} := \bigcap_{l \leq 2^N} \{ \Omega_{\text{rand,lac}} \cap I_{d,l} \neq \emptyset \}.$$

In other words, the event $A_{d,N}$ occurs when the random set $\Omega_{\text{rand,lac}}$ fills each sub-intervals $\{I_{d,l} : 1 \leq l \leq 2^N\}$ with at least one point. In particular, observe that we have

$$\bigcap_{l \leq 2^N} \left(\frac{2^{d-l}}{X_{d-l}} \in I_{d,l} \right) \subset A_{d,N}.$$

We claim that the union of those events

$$B_N := \bigcup_{d \geq 1} A_{d,N}$$

occurs almost surely.

Claim 4.2.4. *One has $\mathbb{P}(B_N) = 1$.*

Démonstration. Indeed we have

$$\sum_s \mathbb{P} \left(\bigcap_{l \leq 2^N} \left(\frac{2^{d_s-l}}{X_{d_s-l}} \in I_{d_s,l} \right) \right) = \sum_s \eta_N = \infty.$$

Using Borel-Cantelli lemma, one obtains

$$\mathbb{P} \left(\bigcup_{s \geq 1} A_{N,d_s} \right) = 1.$$

In particular, one has $\mathbb{P}(B_N) = 1$. □



FIGURE 4.3 : The random set $\Omega_{\text{rand,lac}}$ contains almost surely uniformly distributed subsets of arbitrarily large cardinal.

Proposition 4.2.1 comes now easily by observing that one has

$$\mathbb{P} \left(\bigcap_{N \geq 1} B_N \right) = 1.$$

Precisely, for any $N \geq 1$, the event B_N occurs almost surely. This means that there exists a (for each N , we just need one) dyadic interval I_d such that

$$\Omega_{\text{rand,lac}} \cap I_{d,l} \neq \emptyset$$

for any $1 \leq l \leq 2^N$. We let v_l be one point in $\Omega_{\text{rand,lac}} \cap I_{d,l}$ and we claim that the set

$$U := \{v_{2^l} : 1 \leq l \leq 2^{N-1}\}$$

satisfies the condition of Proposition 4.2.1 with $\delta \simeq 2^{d-N}$.

5 - Application of Perron Trees to maximal operators

The content of this chapter is contained in *Application of Perron Trees to Geometric Maximal Operators* [20].

In the Euclidean plane \mathbb{R}^2 , can we obtain a Theorem *à la* Bateman for a larger class of family of rectangles? That is to say for families of rectangles which are not necessarily directional families? In this regards, the natural type of family we would like to study are families which are invariant by translations and dilations of the plane. Given a family \mathcal{B} included in \mathcal{R} , recall that we say it is a geometric family when for any $R \in \mathcal{B}$, $t \in \mathbb{R}^2$ and $\lambda > 0$, we have

$$t + \lambda R \in \mathcal{B}.$$

We are going to study a concrete geometric family of rectangles : fix two real positive numbers $a, b > 0$ and denote by $\mathcal{B}_{a,b}$ the family of rectangles R whose eccentricity and orientation are of the form

$$(e_R, \omega_R) = \left(\frac{1}{n^a}, \frac{\pi}{4n^b} \right)$$

for some integer $n \in \mathbb{N}^*$. Let us recall that e_R stands for the eccentricity of the rectangle R and that ω_R stands for the angle that its longest side make with the horizontal axis. Naturally, we denote by $M_{a,b}$ the geometric maximal operator associated to the geometric family $\mathcal{B}_{a,b}$. Let us recall this precisely means that for any $f \in L^\infty$ and $x \in \mathbb{R}^2$, we have

$$M_{a,b}f(x) = \sup_{R \in \mathcal{B}_{a,b}} \frac{1}{|R|} \int_R |f|.$$

In addition, if Δ (or T) is a subset of the Euclidean space \mathbb{R}^2 (typically a rectangle or a triangle) then we denote by M_Δ the maximal operator associated to the smallest family \mathcal{B} invariant by translations and dilations that contains Δ that is to say for any $f \in L^\infty$ and $x \in \mathbb{R}^2$, we have

$$M_\Delta f(x) = \sup_{R \in \mathcal{B}} \frac{1}{|R|} \int_R |f|.$$

and we prove a Theorem analogue to Bateman's Theorem for this specific class of geometric families. **Let us remark now that for any $b > 0$, the set of directions**

$$\Omega(b) := \left\{ \frac{\pi}{4n^b} : n \geq 1 \right\}$$

is not finitely lacunary and so the case of $\mathcal{B}_{a,b}$ cannot be immediately treated *via* Bateman's Theorem.

5.1 . Results

We prove the following Theorem concerning the maximal operator $M_{a,b}$.

Theorem 5.1.1. *We have the following alternative :*

- *If $a > b$ then $M_{a,b}$ is bounded on L^p for any $p > 1$.*
- *If $a \leq b$ then it is possible to make a Keakeya blow with the family $\mathcal{B}_{a,b}$. In particular, the maximal operator $M_{a,b}$ is not bounded on L^p for any $p < \infty$.*

We shall prove Theorem 5.1.1 thanks to Theorems 5.1.2 and 5.1.3. In the following, we denote by

$$\boldsymbol{\omega} = \{\omega_k\}_{k \geq 1} \subset [0, \frac{\pi}{4}]$$

a sequence of angles decreasing to 0 and by $\mathbf{e} = \{e_k\}_{k \geq 1} \subset (0, 1]$ a positive sequence. With those notations, for $k \geq 1$, we consider a rectangle $R_k := R_k(\mathbf{e}, \boldsymbol{\omega})$ whose orientation and eccentricity are defined by $(e_{R_k}, \omega_{R_k}) = (e_k, \omega_k)$. Define then the geometric family

$$\mathcal{B} = \mathcal{B}(\mathbf{e}, \boldsymbol{\omega})$$

as the one generated by the rectangles $\{R_k : k \geq 1\}$. Our first result reads as follow.

Theorem 5.1.2. *Suppose there is a constant $C > 0$ such that for any $k \geq 1$, we have*

$$\omega_k \leq C e_k.$$

In this case the operator $M_{\mathcal{B}}$ is bounded on L^p for any $p > 1$.

Our second result concerns a situation where the set of directions $\boldsymbol{\omega}$ is not finitely lacunary, and more precisely when its Perron factor is infinite.

Theorem 5.1.3. *Suppose that $PF(\boldsymbol{\omega}) < \infty$ and also that there is a constant $\mu_0 > 0$ such that for any $k \geq 1$, we have*

$$e_k < \mu_0 |\omega_k - \omega_{k+1}|.$$

In this case, it is possible to make a Keakeya blow with the geometric family $\mathcal{B}(\mathbf{e}, \boldsymbol{\omega})$.

Before going into the proofs, let us expose general remarks about geometric maximal operators that will be useful. Without loss of generality, we will work at some point with triangles instead of rectangles. For any $k \geq 1$ define the triangle T_k as

$$T_k := T_k(\mathbf{e}, \boldsymbol{\omega}) = OA_k E_k$$

where $O = (0, 0)$, $A_k = (1, \omega_k)$ and $E_k = (1, \omega_k + e_k)$. Loosely speaking, the triangle T_k is a triangle which is oriented along the direction ω_k and of whose eccentricity is e_k . Denoting by \mathcal{B}' the geometric family generated by the triangles T_k one can observe that we have the following property. For any $R \in \mathcal{B}$ there exists $T \in \mathcal{B}'$ satisfying for some vector $\vec{t} \in \mathbb{R}^2$

$$\vec{t} + \frac{1}{16}T \subset R \subset T$$

and conversely for any $T \in \mathcal{B}'$ there exists $R \in \mathcal{B}$ satisfying for some vector $\vec{t} \in \mathbb{R}^2$

$$\vec{t} + \frac{1}{16}R \subset T \subset R.$$

This implies that for any $f \in L^1_{\text{loc}}(\mathbb{R}^2)$ and $x \in \mathbb{R}^2$ we have

$$M_{\mathcal{B}}f(x) \simeq M_{\mathcal{B}'}f(x).$$

Hence it is equivalent to work with \mathcal{B} or with \mathcal{B}' and we will denote both family by \mathcal{B} .

5.2 . Proof of Theorem 5.1.2

By an easy geometric observation and using the property that $\omega_k < Ce_k$, one can prove that for any $R \in \mathcal{B}$ there exists a rectangle P whose sides are parallel to the axis which satisfies $R \subset P$ and

$$|P| \leq 8(1 + C)|R|.$$

This property allows us to use the strong maximal operator M_2 in order to make a pointwise domination of the operator $M_{\mathcal{B}}$. Fix any $f \in L^1_{\text{loc}}(\mathbb{R}^2)$ and any $R \in \mathcal{B}$ and the associated rectangle P , we have

$$\frac{1}{|R|} \int_R |f| \leq \frac{8(1 + C)}{|P|} \int_P |f|$$

which shows that for any $x \in \mathbb{R}^2$ we have

$$M_{\mathcal{B}}f(x) \leq 8(1 + C)M_2f(x).$$

The conclusion comes from the fact that the strong maximal operator M_2 is bounded on L^p for any $p > 1$ as usual.

5.3 . Geometric estimates and generalized Perron tree

The proof of Theorem 5.1.3 relies on geometric estimates and the construction of generalized Perron trees. Fix an arbitrary open triangle $\Delta = ABC$ and consider the triangle Δ_2 defined as $\Delta_2 := \vec{B} + \frac{1}{2}(\Delta - \vec{A})$.

Lemma 5.3.1 (Geometric estimate I). *The following inclusion holds*

$$\Delta_2 \subset \left\{ M_{\Delta} \mathbb{1}_{\Delta} \geq \frac{1}{4} \right\}.$$

In other words, the level set $\{M_{\Delta} \mathbb{1}_{\Delta} \geq \frac{1}{4}\}$ contains Δ_2 .

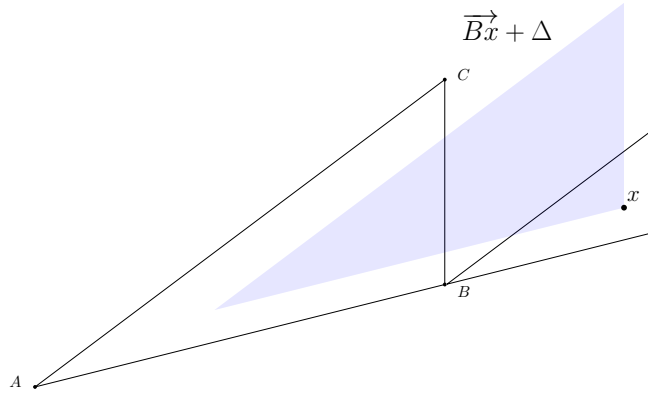

FIGURE 5.1 : The proof of lemma 5.3.1 relies on the fact that $|\Delta \cap (\vec{Bx} + \Delta)| \geq \frac{1}{4}|\Delta|$.

Démonstration. Fix $x \in \vec{B} + \frac{1}{2}(\Delta - \vec{A})$. It suffices to observe that we have $x \in \vec{Bx} + \Delta$ and that $|\Delta \cap (\vec{Bx} + \Delta)| \geq \frac{1}{4}|\vec{Bx} + \Delta|$. Hence $x \in \{M_{\Delta} \mathbb{1}_{\Delta} \geq \frac{1}{4}\}$. \square

Actually we need a more general version of the previous estimate. For $e \in \mathbb{R}_+$ and $\Delta = ABC$ as before, define the triangle T as

$$T := T(\Delta, e) = AB(B + e\vec{BC}).$$

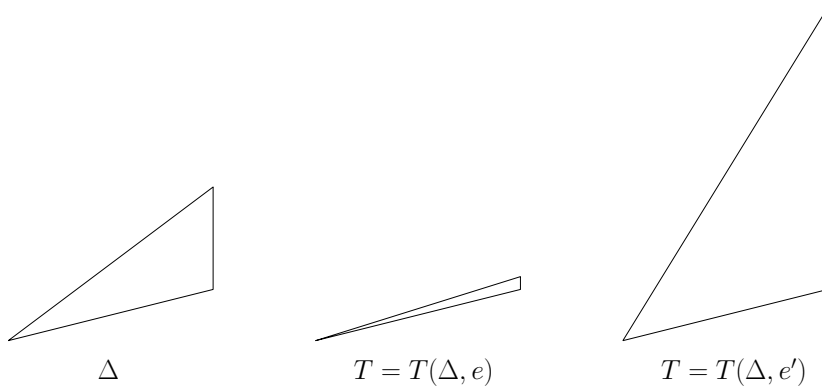

FIGURE 5.2 : A representation of Δ and $T = T(\Delta, e)$ for $e \ll 1$ and $e' > 1$.

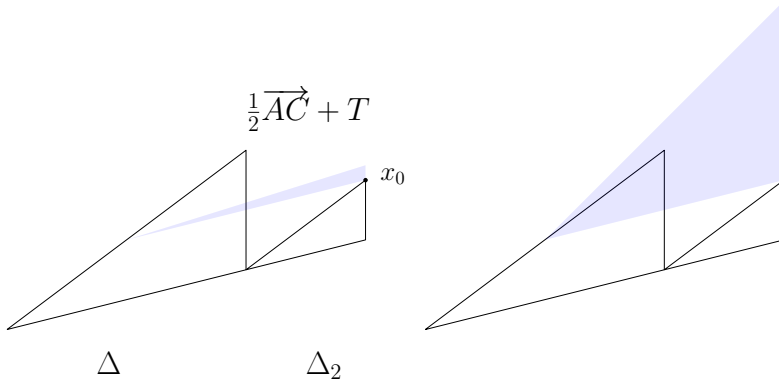

FIGURE 5.3 : An illustration of the argument of lemma 5.3.2; the left side represents the case $0 < e \leq 1$ and the right side the case $e > 1$; the triangle in shaded blue represents $\frac{1}{2}\overrightarrow{AC} + T$.

Lemma 5.3.2 (Geometric estimate II). *For any pair (Δ, T) as defined above, the following inclusion holds $\Delta_2 \subset \{M_T \mathbb{1}_\Delta \geq \eta(e)\}$ where $\eta(e) = \min \{\frac{1}{4}, \frac{1}{4e}\}$.*

Démonstration. The proof is akin to the proof of lemma 5.3.1 and we invite the reader to look at figure 5.3 for a geometric representation. It is enough to check

$$x_0 \in \{M_T \mathbb{1}_\Delta > \eta(e)\}$$

where $x_0 = B + \frac{1}{2}\overrightarrow{AC}$ because this is the worst case. To begin with, observe that we have $x_0 \in \frac{1}{2}\overrightarrow{AC} + T$. We distinguish then two situations; if we have

$$0 < e \leq 1$$

we claim that we are in the situation corresponding to the left situation in figure 5.3, that is to say we have

$$\left| \Delta \cap \left(\frac{1}{2}\overrightarrow{AC} + T \right) \right| = \frac{1}{4}|T|$$

and hence also

$$x_0 \in \left\{ M_T \mathbb{1}_\Delta \geq \frac{1}{4} \right\}.$$

The second situation corresponds to the case where $1 < e$; in this case, we have (see figure 5.3 again)

$$\left| \Delta \cap \left(\frac{1}{2}\overrightarrow{AC} + T \right) \right| \geq \frac{1}{4}|\Delta| \geq \frac{1}{4e}|T|.$$

This shows that we have $x_0 \in \{M_T \mathbb{1}_\Delta > \frac{1}{4e}\}$ and concludes the proof. \square

We now turn our attention to the construction of generalized Perron tree. Denote by Δ_k the triangle whose vertices are the points $O, A_k = (1, \omega_k)$ and $A_{k+1} = (1, \omega_{k+1})$. Recall that we have supposed $PF(\boldsymbol{\omega}) < \infty$. We now give a slightly improved version of the construction of generalized Perron trees as defined in [30]

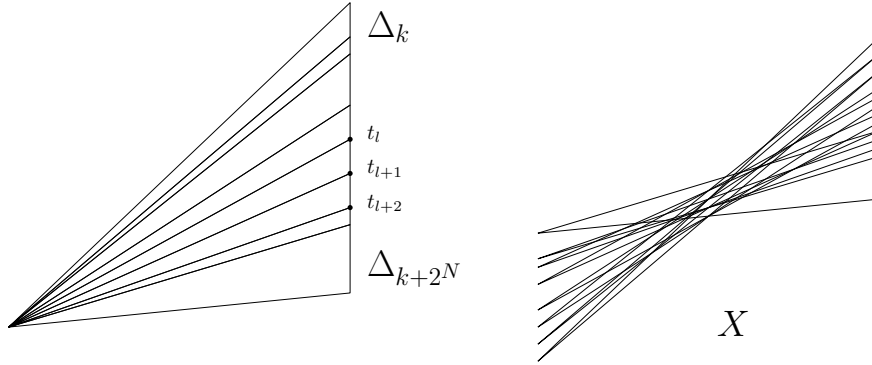

FIGURE 5.4 : A representation of some Δ_k and on the left side a Perron tree X generated with those triangles. The idea is that for large n one has $|X| \ll |\Delta_k \sqcup \cdots \sqcup \Delta_{k+2N}|$; plus the second property of proposition 5.3.1.

Proposition 5.3.1 (Generalized Perron Tree). *For any positive ratio α close to 1 and any integer $n \geq 1$, there exists an integer $N \gg 1$ and 2^n vectors $\vec{s}_k := (0, s_k)$ such that defining the set*

$$X = \bigcup_{N+1 \leq k \leq N+2^n} (\vec{s}_k + \Delta_k)$$

we have the following properties

- $|X| \leq (\alpha^{2^n} + PF(\boldsymbol{\omega})(1 - \alpha)) |\Delta_{N+1} \sqcup \cdots \sqcup \Delta_{N+2^n}|$;
- *for any $k \neq l$ the triangles $(\vec{A}_k + \vec{s}_k) + \frac{1}{2}\Delta_k$ and $(\vec{A}_l + \vec{s}_l) + \frac{1}{2}\Delta_l$ are disjoint.*

We say that the set X is a generalized Perron tree of scale (α, n) and we denote it by $X_{\alpha, n}(\boldsymbol{\omega})$.

Note that the fact that the triangles $(\vec{A}_k + \vec{s}_k) + \frac{1}{2}\Delta_k$ and $(\vec{A}_l + \vec{s}_l) + \frac{1}{2}\Delta_l$ are disjoint is not proven in [30] yet it is a simple observation. Observe that for any $\epsilon > 0$, one can first choose α close to one and then n large enough in order to have

$$|X_{\alpha, n}(\boldsymbol{\omega})| \leq \epsilon |\Delta_{N+1} \sqcup \cdots \sqcup \Delta_{N+2^n}|$$

for some large N . To obtain such an inequality, we need a sufficient condition on the thin triangles Δ_k that ensures in some sense that they are comparable. Indeed, suppose that we had defined for any $k \geq 1$ the triangle Δ_k as the one whose vertices are the points $O, G_k = (1, \frac{1}{2^k})$ and $G_{k+1} = (1, \frac{1}{2^{k+1}})$. In this situation, for any $I \subset \mathbb{N}$ and any sequence of vectors $\{\vec{s}_i\}_{i \in I} \subset \mathbb{R}^2$ the set X_I defined as

$$X_I = \bigcup_{i \in I} (\vec{s}_i + \Delta_i)$$

satisfies the following inequality

$$|X_I| \geq |\Delta_{i_0}| \geq \frac{1}{2} \left| \bigcup_{i \in I} \Delta_i \right|$$

where $i_0 := \min I$. Hence we cannot hope to stack up the triangles Δ_k into a set X that has a small area compared to the sum of the areas of the Δ_k . Hopefully this example shed light on the condition imposed on ω which is

$$PF(\omega) := \sup_{k \geq 0, l \leq k} \left(\frac{\omega_{k+2l} - \omega_{k+l}}{\omega_{k+l} - \omega_k} + \frac{\omega_{k+l} - \omega_k}{\omega_{k+2l} - \omega_{k+l}} \right) < \infty.$$

This ensure that the triangles Δ_k are comparable in some sense and that we can construct *generalized Perron trees* with them.

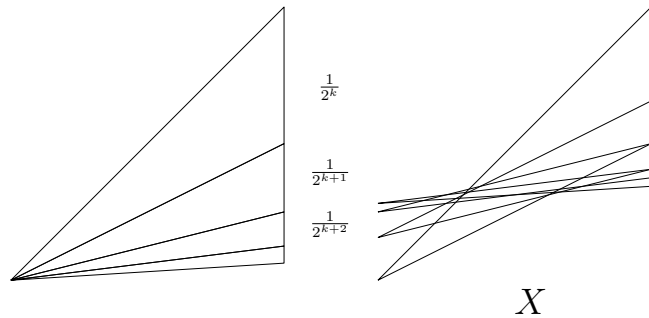

FIGURE 5.5 : It quite difficult to construct a Perron tree; one needs a condition to ensure that the triangles Δ_k are *comparable* in some sense. On this figure, the Δ_k differs too much in volume and one will always have $|X| \simeq |\cup \Delta_i|$ as explained.

5.4 . Proof of Theorem 5.1.3

Recall that we suppose there is a constant $\mu_0 > 0$ such that for any $k \geq 1$, $e_k < \mu_0 |\omega_k - \omega_{k+1}|$. To begin with, we are going to construct a Perron tree $X_{\alpha, n}(\omega)$ with the triangles $\{\Delta_k\}_{k \geq 1}$. Then we will exploit this Perron tree $X_{\alpha, n}(\omega)$ with the triangles $\mathcal{B} = \{T_k\}_{k \geq 1}$ to show that $M_{\mathcal{B}}$ is not bounded on L^p for any $p < \infty$. Precisely we prove the following claim.

Claim 5.4.1. For any α close to 1 and any $n \in \mathbb{N}$, the Perron tree $X := X_{\alpha,n}(\omega)$ satisfies the following inequality

$$|X| \leq \epsilon |\{M_{\mathcal{B}}\mathbb{1}_X > \eta(\mu_0)\}|$$

where $\epsilon = \alpha^{2n} + PF(\omega)(1 - \alpha)$.

Démonstration. Fix α close to 1 and $n \in \mathbb{N}$ and consider a Perron tree of scale (α, n)

$$X := X_{\alpha,n}(\omega) = \bigcup_{N+1 \leq k \leq N+2^n} (\vec{s}_k + \Delta_k)$$

where N is given by proposition 5.3.1. Fix any $k \in \{N+1, \dots, N+2^n\}$ and consider the pair of triangles

$$(\vec{s}_k + \Delta_k, \vec{s}_k + T_k)$$

or more simply the pair (Δ_k, T_k) which is the same up to a translation. We can apply lemma 5.3.2 to this pair which yields the following inclusion

$$\left(\vec{A}_{k+1} + \vec{s}_k\right) + \frac{1}{2}\Delta_k \subset \{M_{\{T_k\}}\mathbb{1}_{\vec{s}_k + \Delta_k} > \eta(\mu_0)\}.$$

Since we have $M_{T_k} \leq M_{\mathcal{B}}$ we also have

$$\left(\vec{A}_{k+1} + \vec{s}_k\right) + \frac{1}{2}\Delta_k \subset \{M_{\mathcal{B}}\mathbb{1}_{\vec{s}_k + \Delta_k} > \eta(\mu_0)\}.$$

The previous inclusion then yields

$$\bigsqcup_{k=N}^{N+2^n} \left(\vec{A}_{k+1} + \vec{s}_k\right) + \frac{1}{2}\Delta_k \subset \{M_{\mathcal{B}}\mathbb{1}_X > \eta(\mu_0)\}.$$

In the latter inclusion, the fact that the union is disjoint comes from our statement of Proposition 5.3.1. Hence this gives in terms of Lebesgue measure

$$\sum_{N+1 \leq k \leq N+2^n} \frac{1}{4}|\Delta_k| \leq |\{M_{\mathcal{B}}\mathbb{1}_X > \eta(\mu_0)\}|.$$

Using the fact that X is a Perron tree constructed with the triangles Δ_k we have

$$|X| \leq (\alpha^{2n} + PF(\omega)(1 - \alpha)) |\Delta_{N+1} \sqcup \dots \sqcup \Delta_{N+2^n}|.$$

In other words we have

$$|X| \leq 4(\alpha^{2n} + PF(\omega)(1 - \alpha)) |\{M_{\mathcal{B}}\mathbb{1}_X > \eta(\mu_0)\}|.$$

□

Observe finally that the claim implies that for any $p > 1$ we have

$$\|M_{\mathcal{B}}\|_p \geq \eta(\mu_0)(4\alpha^{2n} + 4PF(\omega)(1 - \alpha))^{-\frac{1}{p}}$$

for any α close to 1 and any $n \in \mathbb{N}$. The fact that constant $\eta(\mu_0)$ is independent of the scale (α, n) concludes : we have $\|M_{\mathcal{B}}\|_p = \infty$ for any $p < \infty$ as expected and thus Theorem 5.1.3 is proved.

5.5 . Proof of Theorem 5.1.1

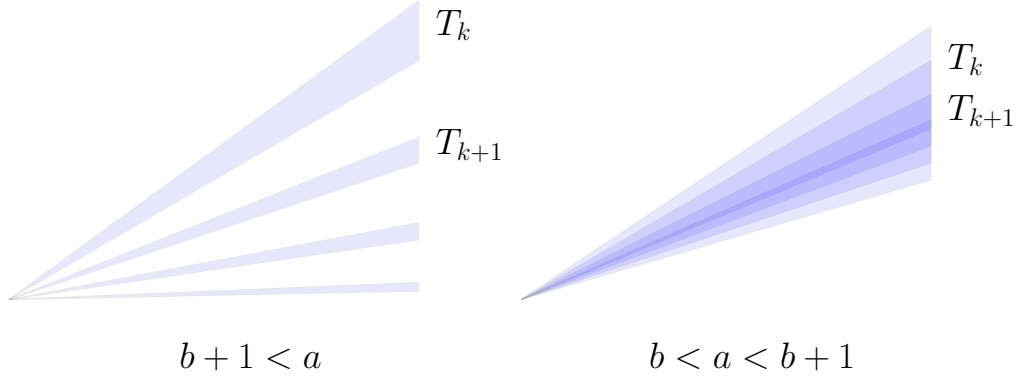

FIGURE 5.6 : On the left side a representation of the regime $a > b + 1$. In this situation, the triangles T_k do not overlap at all for large k (actually the gap gets bigger with k). On the right side a representation of the regime $b + 1 > a > b$. In this situation, the triangles T_k tend to completely overlap each other.

We are now ready to prove Theorem 5.1.1 ; we fix $a, b > 0$ and recall that we define the basis $\mathcal{B}_{a,b}$ as the one generated by a sequence of rectangles $\{R_n\}_{n \geq 1}$ satisfying

$$(e_{R_n}, \omega_{R_n}) = \left(\frac{1}{n^a}, \frac{\pi}{4n^b} \right).$$

Recall also that for any $b > 0$ letting $\omega = \{\frac{\pi}{4n^b}\}$ we have $P(\omega) < \infty$.

Case $a \leq b$

In the case $a \leq b$, observe that we have for $n \geq 1$

$$\frac{4}{\pi n^b} \lesssim \frac{1}{n^a}$$

and so applying Theorem 5.1.2 we obtain that $M_{\mathcal{B}}$ is bounded on L^p for any $p > 1$.

Case $a \geq b + 1$

In the case $a \geq b + 1$, observe that we have for $n \geq 1$

$$\left| \frac{\pi}{n^b} - \frac{\pi}{(n+1)^b} \right| \simeq \frac{1}{n^{b+1}}$$

and so we have

$$\frac{1}{n^a} \lesssim \left| \frac{\pi}{n^b} - \frac{\pi}{(n+1)^b} \right|.$$

We can apply Theorem 5.1.3 which implies that $M_{\mathcal{B}}$ is not bounded on L^p for any $p < \infty$.

Case $b < a < b + 1$

Observe that for any $\ell \in \mathbb{N}^*$, we have $\mathcal{B}_{\ell a, \ell b} \subset \mathcal{B}_{a, b}$. Hence we trivially have

$$M_{\ell a, \ell b} \leq M_{a, b}.$$

Since $a > b$, for $\ell_0 \gg 1$ we have $a > b + \frac{1}{\ell_0}$ that is to say

$$\ell_0 a > \ell_0 b + 1.$$

Applying the previous case, it appears that $M_{\ell_0 a, \ell_0 b}$ is a bad operator and so is $M_{a, b}$.

6 - Kakeya-type sets for maximal operators

The content of this chapter is contained in *Kakeya-type sets for Geometric Maximal Operators* [21].

In order to get a Theorem *à la* Bateman but for geometric family of rectangles, we need to develop the ideas introduced by Bateman in [5] and in particular its vocabulary of binary tree which will allows us to encode any geometric family by a subtree. With this setting, we are able to associate to any geometric family \mathcal{B} contained in \mathcal{R} , a geometric quantity $\lambda_{[\mathcal{B}]} \in \mathbb{N} \cup \{\infty\}$ that we call *analytic split* of \mathcal{B} . Loosely speaking, the analytic split $\lambda_{[\mathcal{B}]}$ quantifies if \mathcal{B} contains a lot of rectangles in terms of *orientation* and *eccentricity*. We are going prove then that for any $1 < p < \infty$ we have

$$\log(\lambda_{[\mathcal{B}]}) \lesssim_p \|M_{\mathcal{B}}\|_p^p.$$

In addition, if $\log(\lambda_{\mathcal{B}}) = \infty$ then this means that it is possible to make a Kakeya blow with the family \mathcal{B} . An important feature of this inequality is that we do not make any assumption on the family \mathcal{B} and we insist on the fact that this estimate is concrete since the analytic split is a geometric quantity associated to \mathcal{B} which is independent of any index p .

6.1 . Result

Given any geometric family \mathcal{B} included in \mathcal{R} , we define a geometric quantity called *analytic split* of the family \mathcal{B}

$$\lambda_{[\mathcal{B}]} \in \mathbb{N} \cup \{\infty\}$$

and we prove the following estimate.

Theorem 6.1.1. *For any $1 < p < \infty$ we have*

$$\log(\lambda_{[\mathcal{B}]}) \lesssim_p \|M_{\mathcal{B}}\|_p^p.$$

In addition, if $\log(\lambda_{\mathcal{B}}) = \infty$ then it is possible to make a Kakeya blow with the family \mathcal{B}

In order to define precisely the analytic split of a geometric family \mathcal{B} , we need to discretize the family \mathcal{R} , see sections 6.2, 6.3 and 6.4. Then in sections 6.5 and 6.6, we introduce the notion of *Kakeya-type sets* and recall how Bateman constructed them in [5]. Finally we develop important geometric estimates in section 6.7 and we finally prove Theorem 6.1.1 in section 6.8.

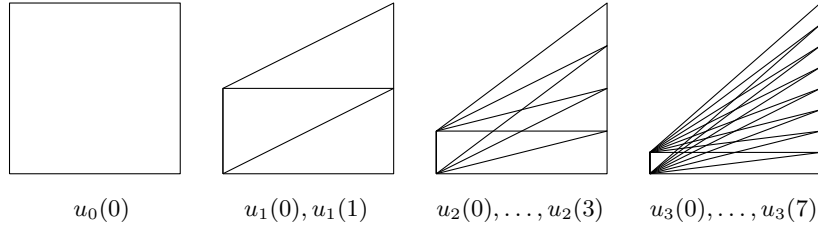

FIGURE 6.1 : A representation of the first element of \mathcal{T} .

6.2 . Definition of \mathcal{T}

Instead of working with rectangles, we will consider that our family \mathcal{B} is included in the geometric family \mathcal{T} which is defined as follow. For $n \geq 0$ and $0 \leq k \leq 2^n - 1$ consider the parallelogram $u_n(k)$ whose vertices are the points $(0, 0)$, $(0, \frac{1}{2^n})$, $(1, \frac{k-1}{2^n})$ and $(1, \frac{k}{2^n})$. We say that $u_n(k)$ is a *pulled-out parallelogram of scale n* and we define the family \mathcal{T} as the smallest geometric family which contains

$$T = \{u_n(k) : n \geq 0, 0 \leq k \leq 2^n - 1\}.$$

The parallelogram $u_n(k)$ should be thought as a rectangle whose eccentricity and orientation are

$$(e_{u_n(k)}, \omega_{u_n(k)}) = \left(\frac{1}{2^n}, \frac{k}{2^n} \frac{\pi}{4} \right).$$

The following proposition precises that we do not lose information if we consider that our geometric family \mathcal{B} is generated by elements of \mathcal{T} . We won't prove it since this kind of reduction is well known in the literature, see Bateman [5] or Alfonseca [1] for examples.

Proposition 6.2.1. *Fix an arbitrary geometric family \mathcal{B} in \mathcal{R} , without loss of generality, we can suppose that we have $\{\omega_r : r \in \mathcal{B}\} \subset [0, \frac{\pi}{4}]$. There exists a geometric family \mathcal{B}' contained in \mathcal{T} satisfying the following inequality*

$$M_{\mathcal{B}} \simeq M_{\mathcal{B}'}$$

In regards of the $L^p(\mathbb{R}^2)$ norm, the maximal operator $M_{\mathcal{B}}$ and $M_{\mathcal{B}'}$ have the same behavior and so in the following, we will work with family

$$\mathcal{B} \subset \mathcal{T}.$$

In addition, we identify the geometric family \mathcal{B} with the family $B := \mathcal{B} \cap T$ and also \mathcal{T} with T .

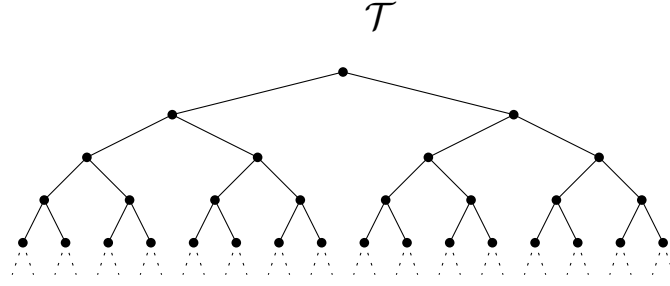

FIGURE 6.2 : A representation of the first element of \mathcal{T} .

6.3 . Structure of \mathcal{T}

The collection of \mathcal{T} has a natural structure of binary tree and we develop a vocabulary adapted to this structure.

Parent and children

For any $u \in \mathcal{T}$ of scale $n \geq 1$, there exist a unique $u_f \in \mathcal{T}$ of scale $n - 1$ such that $u \subset u_f$. We say that u_f is the *parent* of u . In the same fashion, observe that there are only two elements $u_h, u_l \in \mathcal{T}$ of scale $n + 1$ such that $u_h, u_l \subset u$. We say that u_h and u_l are the *children* of u . Observe that $u \in \mathcal{T}$ is the child of $v \in \mathcal{T}$ if and only if $u \subset v$ and $2|u| = |v|$: we will often use those two conditions.

Path

We say that a sequence (finite or infinite) $\{u_i\}_{i \in \mathbb{N}} \subset \mathcal{T}$ is a *path* if it satisfies $u_{i+1} \subset u_i$ and $2|u_{i+1}| = |u_i|$ for any i i.e. if u_i is the parent of u_{i+1} for any i . Different situations can occur. A finite path \mathcal{P} has a first element u and a last element v (defined in a obvious fashion) and we will write $\mathcal{P}_{u,v} := \mathcal{P}$. On the other hand, an infinite path \mathcal{P} has no endpoint.

Tree

For any family \mathcal{B} contained in \mathcal{T} , there is a unique parallelogram $r \in \mathcal{T}$ such that any $u \in \mathcal{B}$ is included in r and $|r|$ is minimal. We say that this element $r_{\mathcal{B}} := r$ is the *root* of \mathcal{B} and we define the set $[\mathcal{B}]$ as

$$[\mathcal{B}] := \{u \in \mathcal{T} : \exists v \in \mathcal{B}, v \subset u \subset r_{\mathcal{B}}\}.$$

A subset of \mathcal{T} of the form $[\mathcal{B}]$ is called a *tree* generated by \mathcal{B} .

Leaf

We define the set $\mathcal{L}_{\mathcal{B}}$ as

$$\mathcal{L}_{\mathcal{B}} = \{u \in \mathcal{B} : \forall v \in \mathcal{B}, v \subset u \Rightarrow v = u\}.$$

An element of $\mathcal{L}_{\mathcal{B}}$ is called a *leaf* of \mathcal{B} . Observe that for any \mathcal{B} in \mathcal{T} we have $[\mathcal{B}] = [\mathcal{L}_{\mathcal{B}}]$ and also $\mathcal{L}_{\mathcal{B}} = \mathcal{L}_{[\mathcal{B}]}$. The first identity says that the leaves of a

tree $[\mathcal{B}]$ can be seen as the minimal set that generates $[\mathcal{B}]$. The second identity states that $[\mathcal{B}]$ is not bigger than \mathcal{B} in the sense that it does not have more leaves. If \mathcal{P} is an infinite path, we have by definition $\mathcal{L}_{\mathcal{P}} = \emptyset$.

Structural disposition

Let \mathcal{B} be an arbitrary family in \mathcal{T} and let r be the root of $[\mathcal{B}]$. We fix an arbitrary element \tilde{r} in \mathcal{T} and we consider the family $\tilde{\mathcal{B}}$ defined as follow : the family $\tilde{\mathcal{B}}$ has the exact same tree structure as \mathcal{B} in \mathcal{T} but $[\tilde{\mathcal{B}}]$ is rooted at \tilde{r} . In order to formulate it precisely consider the unique bijective linear map with positive determinant $L : \mathbb{R}^2 \rightarrow \mathbb{R}^2$ such that $L(r) = \tilde{r}$ and define the family $\tilde{\mathcal{B}}$ as

$$\tilde{\mathcal{B}} := \{L(u) : u \in \mathcal{B}\} \subset \mathcal{T}.$$

Now, it is routine to show that we have for any $f \in L^1_{\text{loc}}(\mathbb{R}^2)$

$$M_{\tilde{\mathcal{B}}}f = \frac{1}{|\det(L)|} \times M_{\mathcal{B}}(f \circ L)$$

and so we have $\|M_{\tilde{\mathcal{B}}}\|_p = \|M_{\mathcal{B}}\|_p$ for any $1 < p < \infty$. Hence, what truly matters when considering a family \mathcal{B} contained in \mathcal{T} is not its *absolute position* in the tree \mathcal{T} but its *structural disposition* in the binary tree.

6.4 . Analytic split

We associate to any family \mathcal{B} included in \mathcal{T} a natural number $\lambda_{[\mathcal{B}]} \in \mathbb{N} \cup \{\infty\}$ that we call *analytic split*; its definition relies on specific trees in \mathcal{T} , namely *fig trees*.

Boundary of $[\mathcal{B}]$ and splitting number

For any tree $[\mathcal{B}]$, we define its *boundary* $\partial[\mathcal{B}]$ as the set of path in $[\mathcal{B}]$ that are maximal for the inclusion *i.e.* $\mathcal{P} \in \partial[\mathcal{B}]$ if and only if \mathcal{P} is a path included in $[\mathcal{B}]$ such that if $\mathcal{P}' \subset [\mathcal{B}]$ is a path that contains \mathcal{P} then $\mathcal{P} = \mathcal{P}'$. For any tree $[\mathcal{B}]$ and path $\mathcal{P} \in \partial[\mathcal{B}]$ we define the *splitting number of \mathcal{P} relatively to $[\mathcal{B}]$* as

$$s_{\mathcal{P},[\mathcal{B}]} := \# \{u \in [\mathcal{B}] \setminus \mathcal{P} : \exists v \in \mathcal{P}, u \subset v, 2|u| = |v|\}.$$

Observe that the splitting number of a path \mathcal{P} is defined relatively to a tree $[\mathcal{B}]$ *i.e.* we might have $s_{\mathcal{P},[\mathcal{B}]} \neq s_{\mathcal{P},[\mathcal{C}]}$ for different trees \mathcal{B} and \mathcal{C} .

Fig trees $[\mathcal{F}]$

We say that a tree $[\mathcal{F}]$ is a *fig tree of scale n and height h* when

- $[\mathcal{F}]$ is finite and $\#\partial[\mathcal{F}] = 2^n$
- for any $\mathcal{P} \in \partial[\mathcal{F}]$ we have $s_{\mathcal{P},[\mathcal{F}]} = n$ and $\#\mathcal{P} = h$.

Observe that by construction we always have $h \geq n$. A basic example of fig tree of scale n is the tree $[\mathcal{T}_n]$ defined as $[\mathcal{T}_n] = \{u \in \mathcal{T} : |u| \geq \frac{1}{2^n}\}$. In this case, the height of $[\mathcal{T}_n]$ is n ; however this is the only fig tree satisfying this. One may see a fig tree $[\mathcal{F}]$ of scale n as a uniformly stretched version of $[\mathcal{T}_n]$.

Analytic split of \mathcal{B}

We define the *analytic split* $\lambda_{[\mathcal{B}]}$ of a tree $[\mathcal{B}]$ as the integer n such that $[\mathcal{B}]$ contains a fig tree $[\mathcal{F}]$ of scale n and does not contains any fig tree of scale $n + 1$. In the case where $[\mathcal{B}]$ contains fig trees of arbitrary high scale, we set $\lambda_{[\mathcal{B}]} = \infty$. More generally for any family \mathcal{B} contained in \mathcal{T} (*i.e.* when \mathcal{B} is not necessarily a tree), we define its analytic split as

$$\lambda_{\mathcal{B}} := \lambda_{[\mathcal{B}]}.$$

Hence by definition, the analytic split of a family \mathcal{B} is the same as the analytic split of the tree $[\mathcal{B}]$. Observe that thanks to Theorem 6.1.1 this definition is pertinent.

6.5 . Kakeya-type sets

We detail how we can construct a set A with elements of \mathcal{B}^* that gives non trivial lower bound on $\|M_{\mathcal{B}}\|_p$ for any $1 < p < \infty$. We say that a maximal operator $M_{\mathcal{B}}$ admits a *Kakeya-type set* $A \subset \mathbb{R}^2$ of level (η, ϵ) with $\epsilon, \eta > 0$ when we have

$$|A| \leq \epsilon \times |\{M_{\mathcal{B}}\mathbb{1}_A > \eta\}|.$$

In this case, for any $p > 1$ we have

$$\|M_{\mathcal{B}}\|_p \geq \eta \epsilon^{-\frac{1}{p}}.$$

Indeed, we have $\int (M_{\mathcal{B}}\mathbb{1}_A)^p \geq \eta^p \epsilon^{-1} |A|$; since $|A| = \|\mathbb{1}_A\|_p^p$.

Proposition 6.5.1. *If $M_{\mathcal{B}}$ admits a Kakeya-type set of level (η, ϵ) then for any $1 < p < \infty$ we have*

$$\|M_{\mathcal{B}}\|_p \geq \eta \epsilon^{-\frac{1}{p}}.$$

Formally one can construct interesting Kakeya-type sets for $M_{\mathcal{B}}$ with elements of \mathcal{B}^* as follow. Suppose there is a collection $\{p_i\}_{i \in I} \subset \mathcal{B}^*$ such that for each $i \in I$ there is a subset $s_i \subset p_i$ satisfying $|s_i| \geq \eta |p_i|$ and

$$\left| \bigcup_{i \in I} s_i \right| < \epsilon \left| \bigcup_{i \in I} p_i \right|.$$

In this case, the set $A := \bigcup_{i \in I} s_i$ is a Kakeya-type set of level (η, ϵ) . Indeed, we have the following inclusion

$$\bigcup_{i \in I} p_i \subset \{M_{\mathcal{B}}\mathbb{1}_A > \eta\}$$

because $p_i \in \mathcal{B}^*$ for any $i \in I$ and so $|A| \leq \epsilon |\{M_{\mathcal{B}}\mathbb{1}_A > \eta\}|$.

6.6 . Bateman's construction

In [5], Bateman proves the following Theorem 6.6.1 by making an explicit construction of a Kakeya-type set of the desired level. We will recall how he achieves the construction of this set since we will use it in order to prove Theorem 6.1.1.

Theorem 6.6.1 (Bateman's construction [5]). *Suppose that $[\mathcal{F}]$ is a fig tree of scale n and height h . In this case the maximal operator $M_{[\mathcal{F}]}$ admits a Kakeya-type set of level*

$$\left(\frac{1}{4}, C \log(n)^{-1}\right) \simeq \left(\frac{1}{4}, \log(n)^{-1}\right).$$

We fix an arbitrary fig tree $[\mathcal{F}]$ of scale n and height h rooted at $u_0(0)$; we are looking for a Kakeya-type set - that we will denote A_1 - of level

$$\left(\frac{1}{4}, C \log(n)^{-1}\right).$$

Bateman constructs this Kakeya-type set A_1 as a realisation of a random set that we denote - in the same fashion, $A_1(\omega)$ - this is done in three steps.

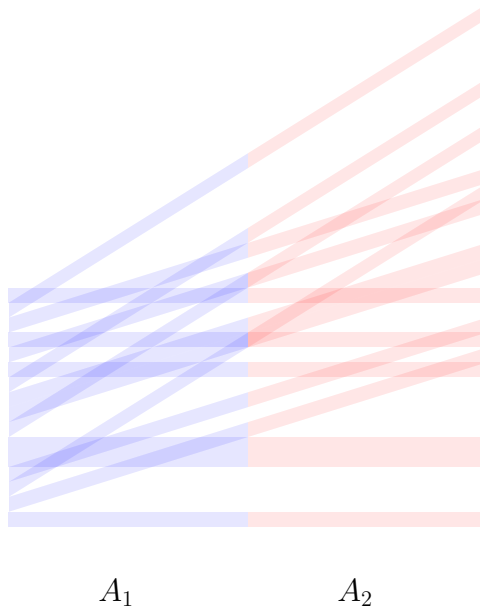

FIGURE 6.3 : With positive probability, the random sets A_1 and A_2 satisfies $|A_2| \gtrsim \log(n)|A_1|$.

Step 1 : construction of $A_2(\omega)$

For $u \in \mathcal{T}^*$, we will denote by u' the parallelogram u but shifted of one unit length on the right along its orientation. We fix a 2^h mutually independent

random variables

$$r_k : (\Omega, \mathbb{P}) \rightarrow \mathcal{L}_{[\mathcal{F}]}$$

who are uniformly distributed in the set $\mathcal{L}_{[\mathcal{F}]}$ i.e. for any $k \leq 2^h$ and any $u \in \mathcal{L}_{[\mathcal{F}]}$ we have

$$\mathbb{P}(r_k = u) = 2^{-n}.$$

We define then the random set A as

$$A = \bigcup_{k \leq 2^h} \vec{t}_k + (r_k \cup r'_k)$$

where $\vec{t}_k = (0, \frac{k-1}{2^h})$ is a deterministic vector. Define also the first and second halves of A as

$$A_1 = \bigcup_{k \leq 2^h} (\vec{t}_k + r_k)$$

and

$$A_2 = \bigcup_{k \leq 2^h} (\vec{t}_k + r'_k).$$

Step 2 : Bateman's estimate

We state Bateman's main result in [5] which quantifies to which point $|A_2|$ is bigger than $|A_1|$.

Theorem 6.6.2. *We have $\mathbb{P}(|A_2| \geq \frac{\log(n)}{C}|A_1|) > 0$. Here C is an absolute constant.*

The proof of this Theorem is difficult. It involves fine geometric estimates, percolation theory and the use of the so-called notion of *stickiness* of thin tubes of the euclidean plane. We refer to [5] for its proof and for more information but we would suggest to take a look at [6] first. Indeed, in [6], Bateman and Katz built a scheme of proof that is similar to the one in [5] but in a simpler setting.

Step 3 : the set A_1 is a Kakeya-type set of level $\simeq (\frac{1}{4}, \log(n)^{-1})$

With positive probability the set A_1 is a Kakeya-type set of level $(\frac{1}{4}, C^2 \log(n)^{-1})$ for $M_{[\mathcal{F}]}$. Indeed, pick any realisation $\omega \in \left\{ |A_2| \geq \frac{\log(n)}{C}|A_1| \right\}$ and we show that $A_1 := A_1(\omega)$ is a Kakeya-type set of the desired level. Observe that by construction, for any $x \in \vec{t}_k + r_k(\omega)' := \vec{t}_k + r'_k$, we have

$$\frac{1}{|\vec{t}_k + 2r'_k|} \int_{\vec{t}_k + 2r'_k} \mathbb{1}_{A_1}(y) dy > \frac{|\{\vec{t}_k + 2r'_k\} \cap \{\vec{t}_k + r_k\}|}{4|r_k|} = \frac{1}{4}$$

and so

$$A_2 \subset \left\{ M_{[\mathcal{F}]} \mathbb{1}_{A_1} > \frac{1}{4} \right\}.$$

Since we also have $|A_2| \geq \frac{\log(n)}{C}|A_1|$ this shows that A_1 is a Kakeya-type set of level $(\frac{1}{4}, C \log(n)^{-1})$.

6.7 . Geometric estimates

We need different geometric estimates in order to prove Theorem 6.1.1. We start with geometric estimates on \mathbb{R} which will help us to prove geometric estimates on \mathbb{R}^2 . Finally we prove a geometric estimate on \mathbb{R}^2 involving geometric maximal operators that is crucial.

Geometric estimates on \mathbb{R}

If I is a bounded interval on \mathbb{R} and $\tau > 0$ we denote by τI the interval that has the same center as I and τ times its length *i.e.* $|\tau I| = \tau |I|$. The following lemma can be found in [4] for example.

Lemma 6.7.1 (Intervals covering lemma). *Let $\{I_\alpha\}_{\alpha \in A}$ a finite family of bounded intervals on \mathbb{R} . There is a disjoint subfamily*

$$\{I_{\alpha_k}\}_{k \leq N}$$

such that

$$\bigcup_{\alpha \in A} I_\alpha \subset \bigcup_{k \leq N} 3I_{\alpha_k}$$

We apply the previous covering lemma to prove two geometric estimates on intervals of the real line. The first one concerns union of dilated intervals.

Lemma 6.7.2. *Fix $\tau > 0$ and let $\{I_\alpha\}_{\alpha \in A}$ a finite family of bounded intervals on \mathbb{R} . We have*

$$B_\tau \times \left| \bigcup_{\alpha \in A} \tau I_\alpha \right| \leq \left| \bigcup_{\alpha \in A} I_\alpha \right| \leq C_\tau \times \left| \bigcup_{\alpha \in A} \tau I_\alpha \right|$$

where $C_\tau = \sup\{\tau, \frac{1}{\tau}\}$ and $B_\tau = \inf\{\tau, \frac{1}{\tau}\}$. In other words we have

$$\left| \bigcup_{\alpha \in A} I_\alpha \right| \simeq_\tau \left| \bigcup_{\alpha \in A} \tau I_\alpha \right|.$$

Démonstration. Suppose that $\tau > 1$. We just need to prove that

$$\left| \bigcup_{\alpha \in A} \tau I_\alpha \right| \leq \tau \left| \bigcup_{\alpha \in A} I_\alpha \right|.$$

Simply observe that we have

$$\bigcup_{\alpha \in A} \tau I_\alpha \subset \left\{ M \mathbb{1}_{\bigcup_{\alpha \in A} I_\alpha} > \frac{1}{\tau} \right\}$$

and apply the one dimensional maximal Theorem. □

Now that we have dealt with union of dilated intervals we consider union of translated intervals.

Lemma 6.7.3. *Let $\mu > 0$ be a positive constant. For any finite family of intervals $\{I_\alpha\}_{\alpha \in A}$ on \mathbb{R} and any finite family of scalars $\{t_\alpha\}_{\alpha \in A} \subset \mathbb{R}$ such that, for all $\alpha \in A$*

$$|t_\alpha| < \mu \times |I_\alpha|$$

we have

$$\left| \bigcup_{\alpha \in A} I_\alpha \right| \simeq_\mu \left| \bigcup_{\alpha \in A} (t_\alpha + I_\alpha) \right|.$$

Démonstration. We apply Austin's covering lemma to the family $\{I_\alpha\}_{\alpha \in A}$ which gives a disjoint subfamily $\{I_{\alpha_k}\}_{k \leq N}$ such that

$$\bigcup_{\alpha \in A} I_\alpha \subset \bigcup_{k \leq N} 3I_{\alpha_k}.$$

In particular we have

$$\left| \bigsqcup_{k \leq N} I_{\alpha_k} \right| \simeq \left| \bigcup_{\alpha \in A} I_\alpha \right|.$$

We consider now the family

$$\{(1 + \mu)I_{\alpha_k}\}_{k \leq N}$$

which is *a priori* not disjoint. We apply again Austin's covering lemma which gives a disjoint subfamily that we will denote $\{(1 + \mu)I_{\alpha_{k_l}}\}_{l \leq M}$ who satisfies

$$\bigcup_{k \leq N} (1 + \mu)I_{\alpha_k} \subset \bigcup_{l \leq M} 3(1 + \mu)I_{\alpha_{k_l}}.$$

In particular we have

$$\left| \bigsqcup_{l \leq M} (1 + \mu)I_{\alpha_{k_l}} \right| \simeq \left| \bigcup_{k \leq N} (1 + \mu)I_{\alpha_k} \right|.$$

To conclude, it suffices to observe that for any $\alpha \in A$ we have

$$t_\alpha + I_\alpha \subset (1 + \mu)I_\alpha$$

because $|t_\alpha| \leq \mu \times |I_\alpha|$. Hence the family

$$\{t_{\alpha_{k_l}} + I_{\alpha_{k_l}}\}_{l \leq M}$$

is disjoint and so finally

$$\left| \bigsqcup_{l \leq M} (t_{\alpha_{k_l}} + I_{\alpha_{k_l}}) \right| = \sum_{l \leq M} |I_{\alpha_{k_l}}| \geq \frac{1}{3(1 + \mu)} \left| \bigcup_{l \leq M} 3(1 + \mu)I_{\alpha_{k_l}} \right| \simeq_\mu \left| \bigcup_{\alpha \in A} I_\alpha \right|$$

where we have used lemma 6.7.2 in the last step. \square

Geometric estimates on \mathbb{R}^2

We denote by \mathcal{S} the set containing *all* parallelograms $u \subset \mathbb{R}^2$ whose vertices are of the form $(p, a), (p, b), (q, c)$ and (q, d) where $p - q > 0$ and $b - a = d - c > 0$. We say that $l_u := p - q$ is the *length* of u and that $w_u := b - a$ is the *width* of u ; we do not have necessarily $l_u \geq w_u$. For $u \in \mathcal{S}$ and a positive ratio $0 < \tau < 1$ we denote by $\mathcal{S}_{u,\tau}$ the collection defined as

$$\mathcal{S}_{u,\tau} := \{s \in \mathcal{S} : s \subset u, l_s = l_u, |s| \geq \tau|u|\}.$$

We won't use directly the following proposition but its proof is instructive.

Proposition 6.7.1 (geometric estimate I). *Fix $\tau > 1$ and any finite family of parallelograms $\{u_i\}_{i \in I} \subset \mathcal{S}$. For each $i \in I$, select an element $s_i \in \mathcal{S}_{u_i,\tau}$. The following holds*

$$\left| \bigcup_{i \in I} s_i \right| \geq \frac{\tau}{3} \left| \bigcup_{i \in I} u_i \right|.$$

Démonstration. We let $U = \bigcup_{i \in I} u_i$ and $V = \bigcup_{i \in I} s_i$. Fix $x \in \mathbb{R}$ and for $i \in I$, denote by u_i^x and s_i^x the segments $u_i \cap \{x \times \mathbb{R}\}$ and $s_i \cap \{x \times \mathbb{R}\}$. Observe that we have by hypothesis $|s_i^x| \geq \tau|u_i^x|$. By definition, we have the following equality

$$\left| \bigcup_{i \in I} u_i^x \right| = \int \mathbb{1}_U(x, y) dy$$

and as well as

$$\left| \bigcup_{i \in I} s_i^x \right| = \int \mathbb{1}_V(x, y) dy.$$

We apply Austin's covering lemma to the family $\{u_i^x\}_{i \in I}$ which gives a subfamily $J \subset I$ such that the segments $\{u_j^x\}_{j \in J}$ are disjoint intervals satisfying

$$\bigcup_{i \in I} u_i^x \subset \bigcup_{j \in J} 3u_j^x.$$

This yields

$$\left| \bigcup_{i \in I} s_i^x \right| \geq \sum_{j \in J} |s_j^x| \geq \frac{\tau}{3} \left| \bigcup_{i \in I} u_i^x \right|.$$

An integration over $x \in \mathbb{R}$ concludes the proof. \square

We aim to give a more general version of proposition 6.7.1 using lemma 6.7.2 and 6.7.3. For $u \in \mathcal{S}$ define the parallelogram $h_u \in \mathcal{S}$ as *the parallelogram who has same length, orientation and center than u but is 5 times wider i.e. $w_{h_u} = 5w_u$.*

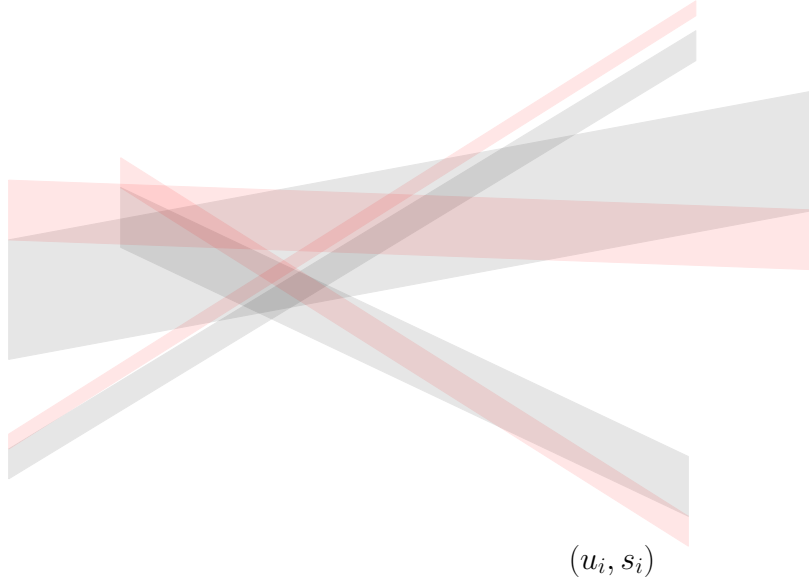

FIGURE 6.4 : An illustration of Proposition 6.7.2 with parameter $\tau = \frac{1}{4}$. The red area is bigger than $\simeq \tau$ times the grey area.

Proposition 6.7.2 (geometric estimate II). *Fix $0 < \tau < 1$ and any finite family of parallelograms $\{u_i\}_{i \in I} \subset \mathcal{S}$. For each $i \in I$, select an element $s_i \in \mathcal{S}_{h_{u_i}, \tau}$. The following estimate holds*

$$\left| \bigcup_{i \in I} s_i \right| \geq \frac{\tau}{54} \left| \bigcup_{i \in I} u_i \right|.$$

Démonstration. As in the proof of lemma 6.7.1, denote $U = \bigcup_{i \in I} u_i$ and $V = \bigcup_{i \in I} s_i$. Fix $x \in \mathbb{R}$ and for $i \in I$, denote by u_i^x and s_i^x the segments $u_i \cap \{x \times \mathbb{R}\}$ and $s_i \cap \{x \times \mathbb{R}\}$. For any $i \in I$, observe that there is a scalar t_i satisfying $|t_i| \leq \mu \times |u_i|$ with

$$\mu = 5$$

such that

$$t_i + \tau u_i^x \subset s_i^x.$$

Applying lemma 6.7.3, we then have (since $9 \times (1 + \mu) = 54$)

$$\left| \bigcup_{i \in I} s_i^x \right| \geq \left| \bigcup_{i \in I} (t_i + \tau u_i^x) \right| \geq \frac{1}{54} \left| \bigcup_{i \in I} \tau u_i^x \right|.$$

We conclude using lemma 6.7.2

$$\frac{1}{54} \left| \bigcup_{i \in I} \tau u_i^x \right| \geq \frac{\tau}{54} \left| \bigcup_{i \in I} u_i^x \right|$$

by integrating on x as before. □

Geometric estimate involving a maximal operator

We state a last geometric estimate involving maximal operator that will turn out to be crucial and we begin by a specific case. Consider $u := [0, 1]^2$, $u' := \overrightarrow{(1, 0)} + u$ and any element $v \in \mathcal{S}$ included in u such that $l_v = l_u$ and $|v| \leq \frac{1}{2}|u|$.

Proposition 6.7.3. *There is a parallelogram $s \in \mathcal{S}_{h_u, \frac{1}{4}}$ depending on v such that the following inclusion holds*

$$s \subset \left\{ M_v \mathbb{1}_{u'} > \frac{1}{16} \right\}.$$

Démonstration. Without loss of generality, we can suppose that the lower left corner of v is O . The upper left corner of v is the point $(0, w_v)$ and we denote by $(d, 1)$ and $(d + w_v, 1)$ its lower right and upper right corners. Since $v \subset u$ we have

$$d + w_v \leq 1.$$

The upper right corner of $\frac{1}{2}v$ is the point $(\frac{1}{2}(d + w_v), \frac{1}{2})$ and so for any $0 \leq y \leq 1 - \frac{1}{2}(d + w_v)$ we have

$$(0, y) + \frac{1}{2}v \subset u.$$

This yields our inclusion as follow. Let $\vec{t} \in \mathbb{R}^2$ be a vector such that the center of the parallelogram $\tilde{v} = \vec{t} + 2v$ is the point $(1, 0)$. By construction we directly have

$$|\tilde{v} \cap u'| \geq \frac{1}{16}$$

but moreover for any $0 \leq y \leq \frac{1}{2}$ we have

$$|\{(0, y) + \tilde{v}\} \cap u'| \geq \frac{1}{16}$$

since the upper right quarter of \tilde{v} is relatively to u' in the same position than v relatively to u . Finally, denoting by v^* the parallelogram $\tilde{v} \cap [0, 1] \times \mathbb{R}$, the parallelogram s defined as

$$s := \bigcup_{0 \leq y \leq \frac{1}{2}} ((0, y) + v^*)$$

satisfies the condition claimed. This concludes the proof. \square

We state now the previous proposition in its general form. We fix an arbitrary element $u \in \mathcal{P}$ and an element $v \in \mathcal{S}$ included in u such that $l_v = l_u$ and $|v| \leq \frac{1}{2}|u|$. Recall that we denote by u' the parallelogram u translated of one unit length in its direction.

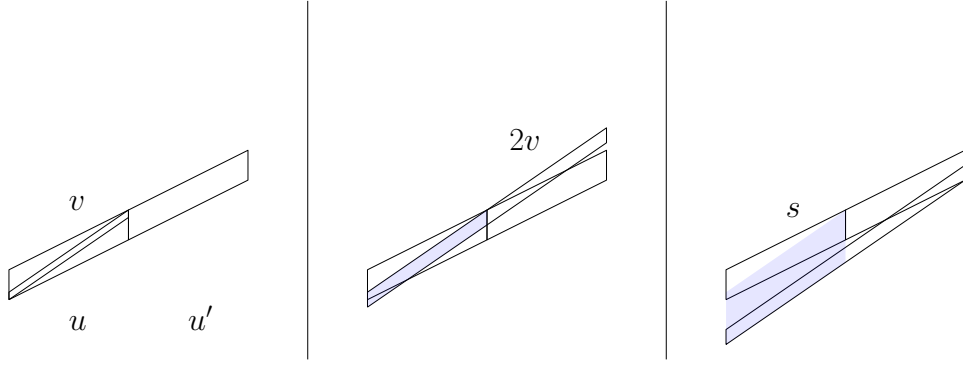

FIGURE 6.5 : An illustration of Proposition 6.7.4.

Proposition 6.7.4. *There is parallelogram $s \in \mathcal{S}_{h_u, \frac{1}{4}}$ depending on v such that the following inclusion holds*

$$s \subset \left\{ M_v \mathbb{1}_{u'} > \frac{1}{4} \right\}.$$

Démonstration. There is a unique linear function $f : \mathbb{R}^2 \rightarrow \mathbb{R}^2$ with positive determinant such that $f(u) = [0, 1]^2$. Using this function and the previous lemma, the conclusion comes. \square

6.8 . Proof of Theorem 6.1.1

We fix an arbitrary family \mathcal{B} contained in \mathcal{T} and $1 < p < \infty$. We are going to prove that one has

$$B_p \times \log(\lambda_{[\mathcal{B}]}) \leq \|M_{\mathcal{B}}\|_p^p.$$

To do so, we will prove that $M_{\mathcal{B}}$ admits a Kakeya-type set of level

$$\left(\frac{1}{16}, C \log(n)^{-1} \right) \simeq \left(\frac{1}{2}, \log(n)^{-1} \right).$$

Strategy

The family \mathcal{B} generates a tree $[\mathcal{B}]$; we fix a fig tree $[\mathcal{F}] \subset [\mathcal{B}]$ of scale $\lambda_{[\mathcal{B}]}$ and we denote by $h \in \mathbb{N}$ its height. Consider as before the random set A associated to $[\mathcal{F}]$

$$A := \bigcup_{k \leq 2^h} \vec{t}_k + (r_k \cup r'_k).$$

We fix a realisation $\omega \in \Omega$ such that $|A_2(\omega)| \geq \frac{\log(n)}{C} |A_1(\omega)|$. We take advantage of $A_1 := A_1(\omega)$ but this time using elements of \mathcal{B} and not elements of $[\mathcal{F}]$.

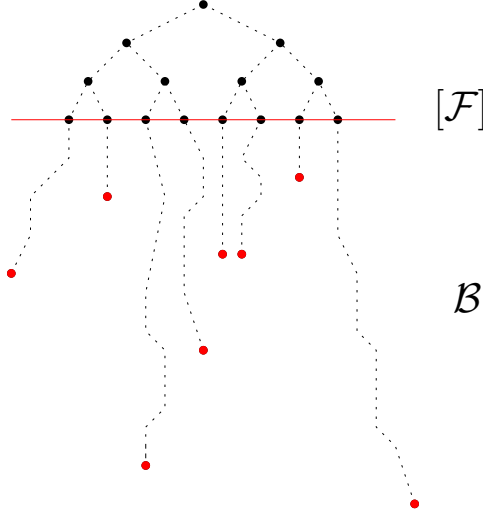

FIGURE 6.6 : Theorem 6.1.1 shows that we can virtually use the tree $[\mathcal{F}]$ for the operator $M_{\mathcal{B}}$ even if \mathcal{B} has no structure. On the illustration, \mathcal{B} is composed of the red dots which represent rectangles who have very different scale and yet they *interact* at the level of $[\mathcal{F}]$.

Applying Proposition 6.7.4

For any $u \in \mathcal{L}_{[\mathcal{F}]}$ we fix an element v_u of \mathcal{B} such that $v_u \subset u$. To each pair (u, v_u) we apply Proposition 6.7.4 and this gives a parallelogram $s_u \in \mathcal{S}_{h_u, \frac{1}{4}}$ such that $s_u \subset \{M_{v_u} \mathbb{1}_{u'} > \frac{1}{16}\}$. We define then the set B_2 as

$$B_2 := \bigcup_{k \leq 2^h} \vec{t}_k + s'_{r_k}$$

Because $v_u \in \mathcal{B}$ we obviously have $M_{v_u} \leq M_{\mathcal{B}}$ and so $s_u \subset \{M_{\mathcal{B}} \mathbb{1}_{u'} > \frac{1}{16}\}$. Considering the union over $k \leq 2^h$ we obtain

$$B_2 := \bigcup_{k \leq 2^h} \vec{t}_k + s'_{r_k} \subset \left\{ M_{\mathcal{B}} \mathbb{1}_{A_1} > \frac{1}{16} \right\}$$

and so finally $|B_2| \leq \left| \left\{ M_{\mathcal{B}} \mathbb{1}_{A_1} > \frac{1}{16} \right\} \right|$.

Applying Proposition 6.7.2

It remains to compute $|B_2|$; to do so we observe that we can use proposition 6.7.2 with the families $\{\vec{t}_k + r'_k\}_{k \leq 2^h}$ and $\{\vec{t}_k + s'_{r_k}\}_{k \leq 2^h}$. This yields

$$|B_2| \geq \frac{1}{21 \times 4} |A_2|$$

and so we finally have

$$|A_1| \lesssim \frac{1}{\log(n)} \left| \left\{ M_{\mathcal{B}} \mathbb{1}_{A_1} > \frac{1}{16} \right\} \right|.$$

In other words, the set A_1 is a Kakeya-type set of level $\simeq (\frac{1}{2}, \log(n)^{-1})$ for the maximal operator $M_{\mathcal{B}}$ and this concludes the proof of Theorem 6.1.1.

7 - Sharp weak-type estimate under an arithmetic condition

The content of this chapter is contained in *Sharp weak-type estimate for maximal operators under an arithmetic condition* [22].

In this chapter, we work in the Euclidean space \mathbb{R}^n and for $U \subset \mathbb{R}^n$ we denote by $|U|$ its n -dimensional Lebesgue measure. **In this chapter, the families of rectangle considered will solely be supposed invariant by translations and not by central dilations i.e. we only consider translations invariant families.**

Let us recall that the *strong maximal operator* M_n is defined for $f \in L^\infty$ and $x \in \mathbb{R}^n$ as

$$M_n f(x) := \sup_{x \in R \in \mathcal{I}^n} \frac{1}{|R|} \int_R |f|.$$

Here, the notation \mathcal{I} stands for the family containing every bounded intervals of the real line so that the family \mathcal{I}^n defined as

$$\mathcal{I}^n := \mathcal{I} \times \cdots \times \mathcal{I}$$

stands for the family containing every axis parallel rectangles in \mathbb{R}^n . In their seminal work [32], Jessen, Marcinkiewicz, and Zygmund proved the so-called *strong maximal Theorem* which specifies the sharp boundedness property of M_n near L^1 .

Theorem 7.0.1 (Strong maximal Theorem). *For any function f and any $t > 0$, the following estimate holds*

$$|\{M_n f > t\}| \lesssim_n \int_{\mathbb{R}^n} \frac{|f|}{t} \left(1 + \log^+ \frac{|f|}{t}\right)^{n-1}.$$

As explained in the second chapter in the case $n = 2$, it is not difficult to see that Theorem 7.0.1 is optimal in the following sense : given any convex increasing function $\phi : [0, \infty) \rightarrow [0, \infty)$ such that

$$\lim_{x \rightarrow \infty} \frac{\phi(x)}{x(1 + \log^+ x)^{n-1}} = 0,$$

the operator M_n cannot be bounded from the Orlicz space L^ϕ to $L^{1,\infty}$ that is to say we cannot have for any f and t

$$|\{M_n f > t\}| \lesssim_n \int_{\mathbb{R}^n} \phi\left(\frac{|f|}{t}\right).$$

Indeed, it is simple to check that given any integer $m \geq 1$, the following estimate holds

$$|\{M_n \mathbb{1}_Q \geq 2^{-m}\}| \gtrsim_n m^{n-1} 2^m |Q|$$

where Q is any axis parallel cube in \mathbb{R}^n .

Obviously more general maximal operators associated to geometric sets can be considered : given a family \mathcal{B} included in \mathcal{I}^n and invariant by translations, one can form in the same fashion the maximal operator $M_{\mathcal{B}}$ defined as

$$M_{\mathcal{B}}f(x) := \sup_{x \in R \in \mathcal{B}} \frac{1}{|R|} \int_R |f|.$$

What can be said about the boundedness properties of the operator $M_{\mathcal{B}}$ near L^1 ? Let us recall that Stokolos proposed the following reformulation of Zygmund's conjecture in [43].

Conjecture 7.0.1 (Zygmund's conjecture II). *Given any family \mathcal{B} invariant by translations included in \mathcal{I}^n , there exists an integer $1 \leq k \leq n$ such that the maximal operator $M_{\mathcal{B}}$ is sharply bounded from $L^1 (1 + \log^+ L^1)^{k-1}$ to $L^{1,\infty}$.*

As we have said in the introduction, this conjecture is true in dimension $n = 2$ (due to Stokolos, see [45]) and has not been refuted in higher dimension. Let us give non trivial examples :

- In \mathbb{R}^n , given an integer $1 \leq k \leq n$, consider the family $\mathcal{I}^n(k)$ defined as

$$\mathcal{I}^n(k) := \{J_1 \times \cdots \times J_n \in \mathcal{I}^n : \#\{|J_j| : 1 \leq j \leq n\} \leq k\}.$$

In [47], Zygmund proved that the maximal operator $M_{n,k}$ associated to the family $\mathcal{I}^n(k)$ is bounded from $L^1 (1 + \log^+ L^1)^{k-1}$ to $L^{1,\infty}$ and easy computations show that those bounds are actually sharp.

- In \mathbb{R}^n , fix n arbitrary infinite sets of integers $\{A_i : 1 \leq i \leq n\}$ and denote by \mathcal{B} the smallest family invariant by translations which contains the dyadic rectangles

$$R_{\mathbf{a}} = I_{a_1} \times \cdots \times I_{a_n}$$

for any $\mathbf{a} = (a_1, \dots, a_n) \in A_1 \times \cdots \times A_n$. In [44], Stokolos proved the maximal operator $M_{\mathcal{B}}$ associated to the family \mathcal{B} is sharply bounded from $L^1 (1 + \log^+ L^1)^{n-1}$ to $L^{1,\infty}$. As explained by Stokolos, this classical result illustrates the fact that a simple *rarefaction* of the family \mathcal{I}^n into a family of the form \mathcal{B} does not improve the boundedness property of the maximal operator $M_{\mathcal{B}}$ associated.

- In \mathbb{R}^3 , given an infinite set of integers $S \subset \mathbb{N}$, consider the family \mathcal{B} composed of every axis parallel rectangles whose side lengths are of the form

$$t \times s \times 2^j st$$

for any $t, s > 0$ and $j \in S$. In [27], Hagelstein and Stokolos proved that the maximal operator $M_{\mathcal{B}}$ is sharply bounded sharply bounded from $L^1 (1 + \log^+ L^1)^2$ to $L^{1,\infty}$.

- In \mathbb{R}^3 , given an infinite set of integers $S \subset \mathbb{N}$, consider the family \mathcal{B} composed of every axis parallel rectangles whose side lengths are of the form

$$s \times \frac{2^j}{s} \times t$$

for any $t, s > 0$ and $j \in S$. In [17], Dmitrishin, Hagelstein and Stokolos proved that the maximal operator $M_{\mathcal{B}}$ is sharply bounded sharply bounded from $L^1 (1 + \log^+ L^1)^2$ to $L^{1,\infty}$.

7.1 . Result

Given an integer $\ell \in \mathbb{Z}$, we let I_ℓ be the dyadic interval $[0, 2^\ell]$ and we use the following notations :

- For $\hat{\mathbf{a}}$ in \mathbb{Z}^n , we consider the n -dimensional dyadic rectangle $R_{\hat{\mathbf{a}}}$ defined as

$$R_{\hat{\mathbf{a}}} := I_{a_1} \times \cdots \times I_{a_n}.$$

- For \mathbf{a} in \mathbb{Z}^{n-1} , we consider the n -dimensional dyadic rectangle of unit volume $R_{\mathbf{a}}$ defined as

$$R_{\mathbf{a}} := I_{a_1} \times \cdots \times I_{a_{n-1}} \times I_{-(a_1 + \cdots + a_{n-1})}.$$

When studying maximal operators of the above type, a classic argument shows that given an arbitrary family \mathcal{B} included in \mathcal{I}^n and invariant by translations, one can suppose that any rectangle $R \in \mathcal{B}$ is - up to translations - of the form

$$R_{\hat{\mathbf{a}}} = I_{a_1} \times \cdots \times I_{a_n},$$

for some $\hat{\mathbf{a}} \in \mathbb{Z}^n$. Hence, given an arbitrary infinite set of integer $A \subset \mathbb{Z}$, let us denote by $\mathcal{B}_{A^{n-1}}$ the smallest family invariant by translations which contains the dyadic rectangle of unit volume

$$R_{\mathbf{a}} = I_{a_1} \times \cdots \times I_{a_{n-1}} \times I_{-(a_1 + \cdots + a_{n-1})}$$

for any $\mathbf{a} = (a_1, \dots, a_{n-1}) \in A^{n-1}$. We will detail thereafter why it seems interesting to study families of the form $\mathcal{B}_{A^{n-1}}$ for infinite $A \subset \mathbb{Z}$. We prove the following Theorem.

Theorem 7.1.1. *If the set $A \subset \mathbb{Z}$ contains arbitrarily large arithmetic progressions then for any integer $m \geq 1$, there exists a set E such that*

$$|\{M_{\mathcal{B}_{A^{n-1}}} \mathbb{1}_E \geq 2^{-m}\}| \gtrsim_n m^{n-1} 2^m |E|.$$

In particular, the maximal operator $M_{\mathcal{B}_{A^{n-1}}}$ associated to the family $\mathcal{B}_{A^{n-1}}$ is sharply bounded from $L^1 (1 + \log^+ L^1)^{n-1}$ to $L^{1,\infty}$.

Thanks to the inclusion $\mathcal{B}_{A^{n-1}} \subset \mathcal{I}^n$ and the strong maximal Theorem 7.0.1, it suffices to focus on the *sharpness* of this bound. Let us discuss about the arithmetic condition : given any integer m , we suppose that A contains a set $\{u_0 < \dots < u_{m-1}\}$ such that for any $0 \leq k \leq m-1$

$$u_k = u_0 + k(u_1 - u_0).$$

Let us insist that without this arithmetic condition on the set A , it is for the moment difficult to study the sharp boundedness property of the operator $M_{\mathcal{B}_{A^{n-1}}}$. We will exploit the additive structure of A in order to create a resonance on n -th axis : given an arbitrary $m \geq 1$, the set E will be constructed as the Cartesian product of one dimensional *crystals* *i.e.* we will set

$$E = C_1 \times \dots \times C_n.$$

A one dimensional crystal is a Cantor-like set whose structure is adapted to the specific scales ; we make this precise in the following. If it is clear that the first crystals $\{C_i : i \leq n-1\}$ should be defined according to the set A , the last crystal C_n must be defined with great care since we do not have freedom on this axis. Finally, the fact that A contains arbitrarily large arithmetic progression is assured if, for example, it has a strictly positive asymptotic upper density thanks to Szemerédi's Theorem.

7.2 . Cartesian families

The family $\mathcal{B}_{A^{n-1}}$ defined above is a specific type of *Cartesian families* of rectangles and it would be desirable to obtain more informations on maximal operators associated to such families in order to progress on Zygmund's problem. More precisely, one could try to tackle Zygmund's problem with the *additional hypothesis* that the family \mathcal{B} is invariant by *central dilations* *i.e.* if for any $R \in \mathcal{B}$ and any $\lambda > 0$, we suppose that we have

$$\lambda R \in \mathcal{B}.$$

In the same spirit than the dyadic reduction made above, one can show that such a family \mathcal{B} is always generated by a family of dyadic rectangles of unit volume

$$\{R_{\hat{\mathbf{a}}} : \hat{\mathbf{a}} \in F\}$$

and so where the set $F \subset \mathbb{Z}^n$ is included in

$$F \subset \{x_1 + \dots + x_n = 0\}.$$

In the following, let us denote by $D^{n,1}(0)$ the family $\{x_1 + \dots + x_n = 0\}$ that we identify with dyadic rectangles of unit volume anchored at 0. One can easily inject \mathbb{Z}^{n-1} into $D^{n,1}(0)$ as follow : given $\mathbf{a} \in \mathbb{Z}^{n-1}$, it suffices to define the rectangle $R_{\mathbf{a}} \in D^{n,1}(0)$ defined as

$$R_{\mathbf{a}} := I_{a_1} \times \dots \times I_{a_{n-1}} \times I_{-(a_1 + \dots + a_{n-1})}.$$

The fact that we have normalized along the n -th axis is not canonical but this is irrelevant for our problem. It would be interesting to give the sharp boundedness properties of maximal operators associated to *Cartesian families* and *homogeneous Cartesian families*.

Definition 7.2.1 (Cartesian family and homogeneous Cartesian family). *Given $(n - 1)$ arbitrary sets of integers*

$$\{A_i \subset \mathbb{Z} : 1 \leq i \leq n - 1\},$$

we say that :

- *the smallest translation invariant family that contains the family of dyadic rectangles of unit volume*

$$\{R_{\mathbf{a}} : \forall \mathbf{a} \in A_1 \times \dots \times A_{n-1}\} \subset D^{n,1}(0)$$

is a Cartesian family. We denote this family $\mathcal{B}_{A_1 \times \dots \times A_{n-1}}$ and the maximal operator associated by $M_{A_1 \times \dots \times A_{n-1}}$.

- *the smallest geometric family that contains the family $\mathcal{B}_{A_1 \times \dots \times A_{n-1}}$ is a homogeneous Cartesian family.*

Let us insist that in this chapter, we deal with translations invariant families *i.e.* we do not have stability by central dilations. It turns out that even in dimension $n = 3$, it is difficult to handle Cartesian families or homogeneous Cartesian families. Shall we understand if Zygmund's problem is purely geometric or requires arithmetic tools, the following problems should be addressed :

- Can one specify the sharp boundedness property of the operator $M_{L \times \mathbb{Z}}$ where the set L is defined as

$$L = \{2^k : k \geq 1\}.$$

The set L is a typical example of set of integers which do not have additive structure.

- Can one specify the sharp boundedness property of the operator $M_{L \times L}$ associated to the family $L \times L$?
- Generally, can one specify the sharp boundedness property of the operator $M_{A \times B}$ where A and B are arbitrary (infinite) sets of integers?

7.3 . Crystal

The concept of *crystallisation* was developed by Stokolos in [45] and is fundamental for our purpose : we introduce the notion of *crystal* in dimension 1 and n and we detail then different geometric properties of those sets that will be useful in the following. These definitions and properties were already described in the second chapter but solely for the case $n = 1, 2$.

Given an integer $a \in \mathbb{Z}$, we denote by I_a the dyadic interval $[0, 2^a]$ and by O_a the *oscillation at scale a* which is a subset of \mathbb{R} defined as

$$O_a := \bigcup_{k \in \mathbb{Z}} (k2^{a+1} + I_a).$$

A one dimensional *crystal* is defined as follow.

Definition 7.3.1 (Crystal). *Fix a finite set A in \mathbb{Z} that we denote*

$$A = \{a_1 < \dots < a_m\}.$$

We define the crystal $C(A)$ as

$$C(A) := I_{a_m} \cap \bigcap_{1 \leq i < m} O_{a_i}.$$

An n -dimensional crystal is simply by definition the Cartesian product of n one dimensional crystals *i.e.* a set E of the form

$$E := C_1 \times \dots \times C_n.$$

We will usually denote a n -dimensional crystal by the letter E or Y and one dimensional crystal by C . We define the notion of *primitive* rectangle associated to a n -dimensional crystal.

Definition 7.3.2 (Primitive rectangle). *Given an n -dimensional crystal E , there exists a biggest dyadic rectangle R anchored at 0 included in E : we say that it is the primitive rectangle of associated to the crystal E .*

We have the following disjointness property and we omit its proof since it is well known in the literature, see [44] for example.

Proposition 7.3.1 (Disjointness property). *Fix a finite number of n -dimensional crystals $\{E_i : i \leq N\}$ and suppose that the primitive rectangles associated*

$$\{R_i : i \leq N\}$$

are independent i.e. for any $i \leq N$ we have

$$\left| R_i - \bigcup_{j \neq i} R_j \right| \geq c_n |R_i|.$$

In this situation, we have the following estimate

$$\left| \bigcup_{i \leq N} E_i \right| \simeq_n \sum_{i \leq N} |E_i|.$$

In order to exploit n -dimensional crystals with a given maximal operator, we need to detail a specific property of those sets which indicate that, in some sense, they are well distributed at specific scales. The following notation will be useful : given a set of integer $A = \{a_1 < \dots < a_m\}$ and $1 \leq i \leq m$, we denote by $A[i]$ the set

$$A[i] := \{a_i < \dots < a_m\}.$$

Consider an n -dimensional crystal E defined by n sets of integers $\{A_k : k \leq n\}$ *i.e.* the crystal

$$E = C(A_1) \times \dots \times C(A_n).$$

Fix then a multi-indices $\hat{\mathbf{i}} \in \mathbb{N}^n$ and consider the crystal

$$Y(\hat{\mathbf{i}}) := C(A_1[i_1]) \times \dots \times C(A_n[i_n]).$$

Of course we have supposed that $i_k \leq \#A_k$. It is clear that we have $E \subset Y(\hat{\mathbf{i}})$ and denote then by m the integer satisfying

$$\left| Y(\hat{\mathbf{i}}) \right| = 2^m \left| Y(\hat{\mathbf{i}}) \cap E \right|.$$

We claim the following.

Proposition 7.3.2 (Homogeneity property). *If we denote by R the primitive rectangle associated to $Y(\hat{\mathbf{i}})$, we have*

$$Y(\hat{\mathbf{i}}) \subset \{M_R \mathbb{1}_E \geq 2^{-m}\}.$$

Here, M_R stands for the maximal operator associated to the smallest family invariant by translations and which contains the dyadic rectangle R .

The proof of this Proposition is not difficult and so we omit it.

7.4 . Proof of Theorem 7.1.1

With Propositions 7.3.1 and 7.3.2 at hands, we are ready to prove Theorem 7.1.1. Given an arbitrary large integer $m \gg 1$, we construct an n -dimensional crystal $E \subset \mathbb{R}^n$ such that

$$\left| \{M_{\mathcal{B}_{A^{n-1}}} \mathbb{1}_E > 2^{-m}\} \right| \gtrsim_n m^{n-1} 2^m |E|.$$

By hypothesis, A contains an arithmetic progression of length m that we denote

$$\{u_0 < \dots < u_{m-1}\}.$$

For $s \in \{0, 1, \dots, m-1\}$, define

$$h_s := (n-1)u_0 + (u_1 - u_0)s$$

and consider then the one dimensional crystals $X := C(u_0 < u_1 < \dots < u_{m-1})$ and $Z = C(-h_{m-1} < \dots < -h_0)$. Thanks to the crystal X and Z , we define the n -dimensional crystal E as

$$E := X^{n-1} \times Z \subset \mathbb{R}^n.$$

Let us prove as claimed that we have

$$|\{M_{\mathcal{B}_{A^{n-1}}} \mathbb{1}_E > 2^{-m}\}| \gtrsim m^{n-1} 2^m |E|.$$

Given a positive multi-indices $\mathbf{i} = (i_1, \dots, i_{n-1})$ such that

$$i_1 + \dots + i_{n-1} = s \leq m-1$$

consider the crystal $Y(\mathbf{i})$ defined as

$$Y(\mathbf{i}) = C(u_{i_1} < \dots < u_{m-1}) \times \dots \times C(u_{i_{n-1}} < \dots < u_{m-1}) \times C(-h_s < \dots < -h_0).$$

First observe that we have $E \subset Y(\mathbf{i})$ and also

$$|Y(\mathbf{i})| \simeq 2^{-i_1} \dots 2^{-i_{n-1}} 2^{-(m-1-s)} |E| \simeq 2^{-m} |E|.$$

Observe now that the primitive rectangle associated to $Y(\mathbf{i})$ is the rectangle

$$R(\mathbf{i}) = I_{u_{i_1}} \times \dots \times I_{u_{i_{n-1}}} \times I_{-h_s}.$$

The crux of the argument lies in the fact that we have

$$h_s = u_{i_1} + \dots + u_{i_{n-1}}$$

since $i_1 + \dots + i_{n-1} = s$ and that $\{u_k : 1 \leq k \leq m\}$ is an arithmetic progression. Hence the primitive rectangle $R(\mathbf{i})$ satisfies

$$R(\mathbf{i}) \in \mathcal{B}_{A^{n-1}}$$

We apply now Proposition 7.3.2 which yields

$$Y(\mathbf{i}) \subset \{M_{R(\mathbf{i})} \mathbb{1}_E > 2^{-m}\} \subset \{M_{\mathcal{B}_{A^{n-1}}} \mathbb{1}_E > 2^{-m}\}.$$

To conclude, it is not difficult to see that the family of rectangles

$$\{R(\mathbf{i}) : \mathbf{i} \geq 0, i_1 + \dots + i_{n-1} \leq m-1\}$$

is independent and so applying Proposition 7.3.1 we obtain

$$\left| \bigcup_{\mathbf{i}} Y(\mathbf{i}) \right| \simeq \sum_{\mathbf{i}} |Y(\mathbf{i})| \simeq m^{n-1} 2^m |E|.$$

This concludes the proof of Theorem 7.1.1.

8 - Maximal operators on hyperbolic triangles

The content of this chapter is contained in *Maximal operators on hyperbolic triangles* [7]. It is a joint work with Romain Branchereau and Samuel Bronstein.

On the hyperbolic plane (\mathbb{H}^2, d, μ) , the behavior of the centered Hardy-Littlewood maximal operator M^c defined as

$$M^c f(x) := \sup_{r>0} \frac{1}{\mu(B(x, r))} \int_{B(x, r)} |f|$$

is well understood : as in the Euclidean case, this operator is bounded from L^1 to $L^{1, \infty}$ and this was proved by Stromberg in [46]. However, due to the exponential growth of the volume of balls, this boundedness property does not come from a Vitali's covering Theorem in \mathbb{H}^2 . As said in the introduction, the behavior of the non-centered Hardy-Littlewood maximal operator M defined as

$$Mf(x) := \sup_{x \in B \in \mathcal{Q}} \frac{1}{\mu(B)} \int_B |f|$$

is quite different : Ionescu proved in [31] that the operator M is bounded from L^p to L^p only for $p > 2$, this range being sharp. Here, let us recall that we have denoted by \mathcal{Q} the family containing every balls of the hyperbolic plane *i.e.* we have

$$\mathcal{Q} := \{B(y, r) : y \in \mathbb{H}^2, r > 0\}.$$

In regards of the Euclidean theory, it seems desirable to understand how different family of geometric objects of the hyperbolic plane interact through a maximal operator. The natural analogue of Euclidean rectangles are geodesic triangles because they are geometric objects that are *orientated* and more or less *thick* or *thin*. In this chapter, given an arbitrary family \mathcal{B} composed of geodesic triangles and stable by G , the group of isometries of \mathbb{H}^2 , we characterize the regularity of the maximal operator $M_{\mathcal{B}}$ on the L^p scale according to the geometry exhibited by the family \mathcal{B} .

8.1 . Result

We are interested by families composed of geodesic triangles which are invariant under the action of isometries. In the following, we denote by G the group of isometries of \mathbb{H}^2 and by \mathcal{T} the family containing all geodesic triangles in \mathbb{H}^2 . A family $\mathcal{B} \subset \mathcal{T}$ and invariant under G is parameterized by the angles exhibited by the triangles it contains : if we denote by $\alpha_{\mathcal{T}}$ the set of angles of

the triangle T and that we let $A_{\mathcal{B}} := \{\alpha_T : T \in \mathcal{B}\}$ then, because \mathcal{B} is invariant under G , we precisely have

$$\mathcal{B} = \{T \in \mathcal{T} : \alpha_T \in A_{\mathcal{B}}\}.$$

We consider the simplex S of admissible angles which is defined as

$$S := \left\{ \alpha \in (\mathbb{R}_+)^3 : s(\alpha) \leq \pi \right\}$$

where $s(\alpha) := \alpha_1 + \alpha_2 + \alpha_3$. We are going to decompose the simplex S in three disjoint parts S_1, S_2 and S_3 according to the *eccentricity* function p defined as

$$p(\alpha) := \alpha_1 \alpha_2 \alpha_3.$$

Precisely we define :

- $S_0 := \{\alpha \in S : s(\alpha) < \pi, p(\alpha) > 0\}$
- $S_1 := \{\alpha \in S : s(\alpha) = \pi, p(\alpha) > 0\}$,
- $S_2 := \{\alpha \in S : s(\alpha) < \pi, p(\alpha) = 0\}$,
- and $S_3 := \{\alpha \in S : s(\alpha) = \pi, p(\alpha) = 0\}$

The functions s and p have simple geometric interpretations : on the one hand, for any triangle T , one has

$$\mu(T) = \pi - s(\alpha_T)$$

and on the other hand, $p(\alpha_T)$ represents the eccentricity of the triangle T , its *thickness*. We can now state our main result.

Theorem 8.1.1 (Branchereau, Bronstein and G.). *Let \mathcal{B} be a family of hyperbolic triangles stable by isometries and recall its set of angle is defined as $A := \{\alpha_T : T \in \mathcal{B}\}$. We have the following alternatives :*

- (I) *if $\bar{A} \subset S_0$, then the operator $M_{\mathcal{B}}$ is bounded from L^1 to L^1 i.e. there exists a constant $C_{\mathcal{B}} < \infty$ such that for any function f we have*

$$\|M_{\mathcal{B}}f\|_1 \leq C_{\mathcal{B}}\|f\|_1.$$

- (II) *if $\bar{A} \subset S_1$ and $\bar{A} \cap S_1 \neq \emptyset$, then the operator $M_{\mathcal{B}}$ has weak-type $(1,1)$ i.e. there exists a constant $C_{\mathcal{B}} < \infty$ such that for any function f and $t > 0$, the following estimate holds*

$$|\{M_{\mathcal{B}}f > t\}| \leq C_{\mathcal{B}} \frac{\|f\|_1}{t}.$$

- (III) if $\bar{A} \cap S_2 \neq \emptyset$, then for any non zero function f , there exists a positive constant $c > 0$ depending on f and \mathcal{B} such that for any $y \in \mathbb{H}^2$, one has

$$M_{\mathcal{B}}f(y) > c.$$

- (IV) if $\bar{A} \cap S_3 \neq \emptyset$, then for any large constant $C \gg 1$, there exists a bounded set E in \mathbb{H}^2 satisfying

$$\left| \left\{ M_{\mathcal{B}}\mathbb{1}_E \geq \frac{1}{4} \right\} \right| \geq C|E|.$$

The proof of Theorem 8.1.1 will be done in different parts and relies on different ideas : in contrast with the work of Stromberg [46], we exclusively use geometric techniques. To begin with, if $\bar{A} \subset S_0$, then the operator $M_{\mathcal{B}}$ is controlled by

$$\mathcal{A}_r : f(x) \rightarrow \frac{1}{B(x,r)} \int_{B(x,r)} |f|$$

where the radius r is independent of x . Such an averaging operator \mathcal{A}_r is bounded from L^1 to L^1 and since $M_{\mathcal{B}} \leq T$, the conclusion comes. If $\bar{A} \subset S_1$ and $\bar{A} \cap S_1 \neq \emptyset$, this means that the triangles in the family \mathcal{B} cannot become arbitrarily thin. Hence, one can compare each of them to ball whose radius is uniformly bounded and this will allow us to prove the desired weak-type estimate thanks to a covering argument *à la* Vitali. In the case where $\bar{A} \cap S_2 \neq \emptyset$, the family \mathcal{B} contains triangles that tend to become *partly ideal* (an hyperbolic triangle is said to be partly ideal when at least one of its angle is 0). We prove that given any pair of point (x_0, y) one can always catch the point y and a small ball centered at x_0 with partly ideal triangles and this will allow us to prove that the maximal function $M_{\mathcal{B}}f$ of any non zero function is uniformly bounded by below. This effect is specific to the hyperbolic plane \mathbb{H}^2 and cannot be observed in the Euclidean space. Finally, if $\bar{A} \cap S_3 \neq \emptyset$ then the family \mathcal{B} contains arbitrarily thin triangles that tend to become Euclidean. We will be able to construct the desired set E by considering local families of triangles : we will prove that their images by the exponential map contain enough Euclidean triangles in an arbitrary tangent space $T_{x_0}\mathbb{H}^2$ which will allow us to exploit a Kakeya-type set of the Euclidean plane.

8.2 . Thick triangles

We suppose that we have $\bar{A} \subset S_0$. For any $x \in \mathbb{H}^2$, consider the family $\mathcal{B}(x)$ defined as

$$\mathcal{B}(x) := \{T \in \mathcal{B} : x \in T\}.$$

In other words, $\mathcal{B}(x)$ is composed of all triangles T in \mathcal{B} which contains the point x . We claim the following.

Claim 8.2.1. *If $\bar{A} \subset S_0$ then there exists $r = r(\mathcal{B}) > 0$ such that for any $T \in \mathcal{B}(x)$, one has $T \subset B(x, r)$ and also $\mu(T) \simeq_{\mathcal{B}} \mu(B(x, r))$.*

With this proposition at hands, the conclusion comes easily : for any f , we have

$$\int_{\mathbb{H}^2} M_{\mathcal{B}}f(x)d\mu(x) \lesssim_{\mathcal{B}} \int_{\mathbb{H}^2 \times \mathbb{H}^2} |f|(y)\mathbb{1}_{d(x,y) \leq r}d\mu(y)d\mu(x).$$

Indeed for any $x \in \mathbb{H}^2$, there exists $T \in \mathcal{B}(x)$ such that

$$M_{\mathcal{B}}f(x) \leq \frac{2}{\mu(T)} \int_T |f| \lesssim_{\mathcal{B}} \frac{1}{\mu(B(x, r))} \int_{B(x, r)} |f|$$

since we have $T \subset B(x, r)$ and that both sets have comparable volume. Using Fubini we obtain as expected

$$\int_{\mathbb{H}^2} M_{\mathcal{B}}f(x)d\mu(x) \lesssim_{\mathcal{B}} \|f\|_1.$$

We suppose now that the family \mathcal{B} satisfies $\bar{A} \subset S_1$ and $\bar{A} \cap S_1 \neq \emptyset$. This condition means that the eccentricity of a triangle in \mathcal{B} is uniformly bounded by below but we do not have control on its volume now. The following Claim holds.

Claim 8.2.2. *For any triangle $T \in \mathcal{B}$, there exists a ball $B(T)$ containing T and satisfying*

$$\mu(B(T)) \simeq_{\mathcal{B}} \mu(T).$$

In particular, there exists a constant $R < \infty$ only depending on \mathcal{B} such that

$$\sup_{T \in \mathcal{B}} \text{diam}(B(T)) < R.$$

We recall now the Vitali covering Theorem which is valid in metric space.

Theorem 8.2.1 (Vitali covering Theorem). *Given any family \mathcal{F} of balls whose radius is uniformly bounded by a constant $R < \infty$, there exists a sub-family $\mathcal{F}' \subset \mathcal{F}$ satisfying the following properties : on one hand the balls of \mathcal{F}' are pairwise disjoint and on the other hand, one has*

$$\bigcup_{B \in \mathcal{F}} B \subset \bigcup_{B' \in \mathcal{F}'} 5B'.$$

Here $5B$ stands for the ball $B(x, 5r)$ if $B = B(x, r)$.

With Claim 8.2.2 and Theorem 8.2.1 at hands, we can prove that $M_{\mathcal{B}}$ has weak-type $(1, 1)$. We fix f a function on \mathbb{H}^2 and $t > 0$: by definition the level set $\{M_{\mathcal{B}}f > t\}$ is the union of the triangles T belonging to \mathcal{B} satisfying

$$\int_T |f| > \mu(T)t.$$

We denote by \mathcal{F} this family of triangles and we apply Claim 8.2.2 for each T in \mathcal{F} and then we apply Theorem 8.2.1 to the family of balls $\{B(T) : T \in \mathcal{F}\}$. This gives us a subfamily \mathcal{F}' of \mathcal{F} satisfying the following inclusion

$$\{M_{\mathcal{B}}f > t\} \subset \bigcup_{T' \in \mathcal{F}'} 5B(T')$$

and moreover, the balls $B(T')$ for $T' \in \mathcal{F}'$ are pairwise disjoint. Since all the balls considered have a radius uniformly bounded, we have

$$\mu(5B(T')) \simeq_{\mathcal{B}} \mu(B(T'))$$

and so the following estimate holds

$$\mu\left(\bigcup_{T' \in \mathcal{F}'} 5B(T')\right) \leq \sum_{T' \in \mathcal{F}'} \mu(5B(T')) \lesssim_{\mathcal{B}} \sum_{T' \in \mathcal{F}'} \mu(B(T')).$$

Now we also have $\mu(B(T')) \simeq_{\mathcal{B}} \mu(T')$ and so we obtain

$$\sum_{T' \in \mathcal{F}'} \mu(B(T')) \lesssim_{\mathcal{B}} \sum_{T' \in \mathcal{F}'} \frac{1}{t} \int_{B(T')} |f|.$$

Since the balls $B(T')$ are pairwise disjoint we obtain as expected

$$\mu(\{M_{\mathcal{B}}f > t\}) \lesssim_{\mathcal{B}} \frac{1}{t} \int |f|.$$

8.3 . Partly ideal triangles

We suppose now that the family \mathcal{B} satisfies $\bar{A} \cap S_2 \neq \emptyset$. We fix an element $\alpha \in \bar{A} \cap S_2$ and without loss of generality we suppose that it is of the form $\alpha = (0, \alpha_2, \alpha_3)$. We prove the following Proposition.

Proposition 8.3.1. *For any $x_0 \in \mathbb{H}^2$, there exists $r > 0$ such that for any $y \in \mathbb{H}^2$, there is a triangle T satisfying $\alpha_T = (0, \alpha_2, \alpha_3)$, $y \in T$ and $B(x_0, r) \subset T$.*

Démonstration. Let $x_0 \in \mathbb{H}^2$ and consider a triangle T_0 of angles $(0, \alpha_2, \alpha_3)$. As the action of G on \mathbb{H}^2 is transitive, we may assume that T_0 contains x_0 in its interior : fix then $r > 0$ such that T_0 contains the ball $B(x_0, r)$. Given any point $y \in \mathbb{H}^2$, its orbit under the stabilizer of x_0 is exactly the circle $C(x_0, d(x_0, y))$. As T_0 has at least one angle equal to 0 by hypothesis, it is noncompact and intersect nontrivially $C(x_0, d(x_0, y))$. Hence there is $g \in G$ such that $g(x_0) = x_0$ and $g(y) \in T_0$ i.e. $y \in T := g^{-1}T_0$ and we have

$$B(x_0, r) \subset T.$$

□

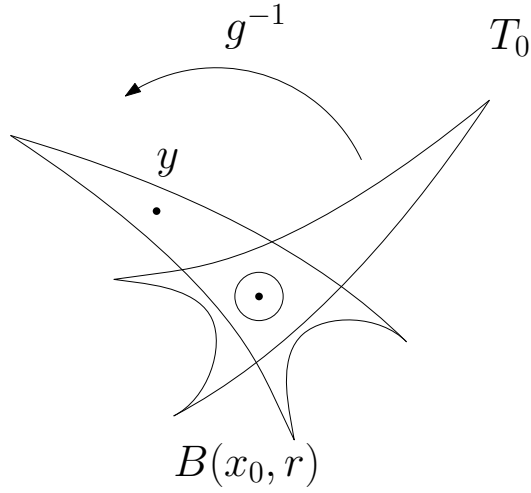

FIGURE 8.1 : An illustration of the proof of Theorem 8.3.1.

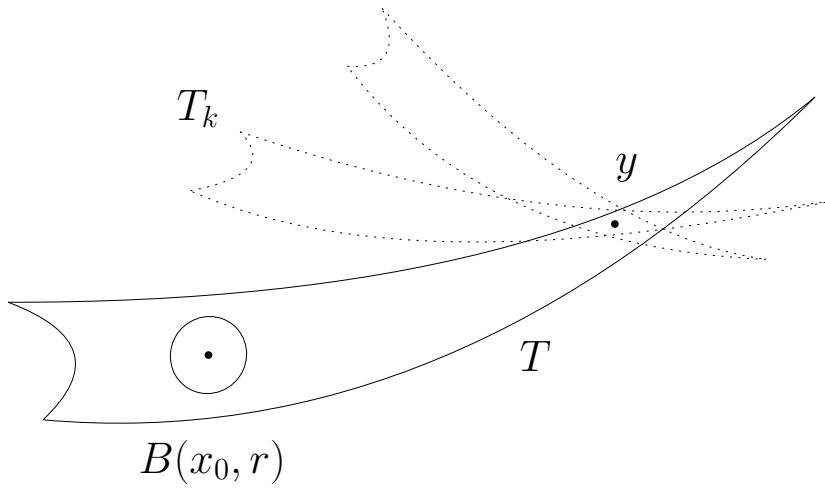

FIGURE 8.2 : The existence of the sequence $\{T_k : k \geq 1\}$ comes from the fact that α belongs to \bar{A} .

Proposition 8.3.1 yields the conclusion as follow. Consider a non zero function f on \mathbb{H}^2 : there exists a ball $B(x_0, r)$ such that $\int_{B(x_0, r)} |f| > 0$ and by a standard compactness argument, we can choose r to be arbitrarily small. We fix any point y in \mathbb{H}^2 and we apply Proposition 8.3.1 which gives us a triangle T satisfying $\alpha_T = (0, \alpha_2, \alpha_3)$, $y \in T$ and $B(x_0, r) \subset T$. To conclude, it suffices to observe that since $\alpha \in \bar{A} \cap S_2$, there exists a sequence of triangles $\{T_k : k \geq 1\} \subset \mathcal{B}$ such that each of them contain y and satisfying

$$\int_{T_k} |f| \rightarrow \int_T |f|.$$

In particular we have

$$M_{\mathcal{B}}f(y) \geq \frac{1}{|T|} \int_T |f| \geq \frac{1}{\pi} \int_{B(x_0, r)} |f|.$$

This yields the desired conclusion since the integral $\int_{B(x_0, r)} |f|$ is independent of the point y (it only depends on f and \mathcal{B}).

8.4 . Thin and small triangles

We suppose now that the family \mathcal{B} satisfies $\bar{A} \cap S_3 \neq \emptyset$. We are going to prove that for any constant $C \gg 1$, there exists a bounded set E in \mathbb{H}^2 satisfying

$$\mu \left(\left\{ M_{\mathcal{B}} \mathbb{1}_E \geq \frac{1}{4} \right\} \right) \geq C \mu(E).$$

In particular, this property implies that the operator $M_{\mathcal{B}}$ is not bounded on the space $L^p(\mathbb{H}^2)$ for any $p < \infty$. To construct the set E , the idea is to make a Kakeya blow with the triangles of the family \mathcal{B} : this is possible precisely because the family \mathcal{B} contains triangles which are arbitrarily thin and almost Euclidean. To make this argument rigorous, we need to work in a tangent space $T_{x_0}\mathbb{H}^2$ and to precisely describe the image of small triangles in a neighborhood of x_0 by the exponential map.

We introduce the following notation : given two triangles T and T' (Euclidean or hyperbolic), we note

$$T \sim T'$$

if there is an isometry g such that $T = g(T')$. In the following, we fix any point $x_0 \in \mathbb{H}^2$ and let \exp_{x_0} be the exponential map between \mathbb{H}^2 and $T_{x_0}\mathbb{H}^2$. We also suppose that we work in a neighborhood $B(x_0, r)$ of x_0 so small that we have the following estimate for any open set $U \subset B(x_0, r)$ and with $h = \frac{1}{1000}$

$$(1 - h) |\exp_{x_0}(U)| \leq |U| \leq (1 + h) |\exp_{x_0}(U)|.$$

We consider *local* families of triangles : given any $r > 0$ and a triangle T , we consider the following family of triangles

$$\mathcal{L}_r(T) := \{T' \in \mathcal{T} : T' \sim T, T' \subset B(x_0, r)\}.$$

Because we want to be able to *move* our triangle T in the ball $B(x_0, r)$, we assume that we have

$$\frac{r}{10} > \text{diam}(T).$$

The following proposition states that in the Euclidean plane, a maximal operator defined on a local family of thin triangles can exploit a Kakeya-type set.

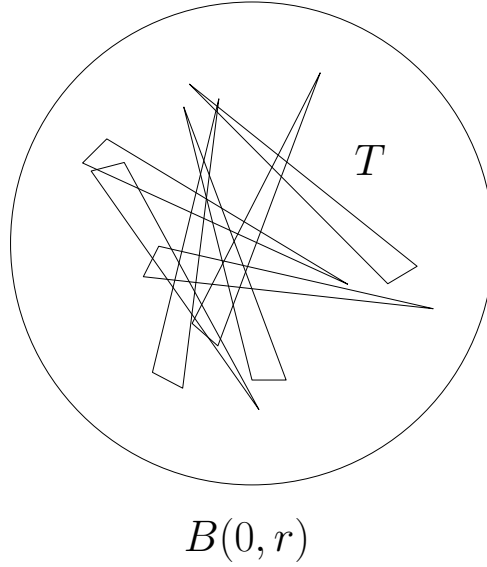

FIGURE 8.3 : Representation of a local family $\mathcal{L}_r(T)$ in the Euclidean plane.

Proposition 8.4.1. *For any large constant $C \gg 1$, there exists $0 < \epsilon \ll 1$ such that if T_i is an Euclidean triangle thin enough (i.e. satisfying $p(\alpha_{T_i}) < \epsilon$) then any maximal operator $M_{\mathcal{L}_r(T_i)}$ defined on a non empty local family*

$$\mathcal{L}_r(T_i) := \{T' \in \mathcal{T} : T' \sim T, T' \subset B(0, r)\}$$

admits a Kakeya-type set F included in $B(x_0, r)$ satisfying

$$\left| \left\{ M_{\mathcal{L}_r(T_i)} \mathbb{1}_F \geq \frac{1}{4} \right\} \right| \geq C |F|.$$

Proposition 8.4.1 is a well-known fact in the literature and we omit its proof. To conclude the proof of Theorem 8.1.1, we need the following proposition which simply states that given a local family generated by a small triangle T in \mathbb{H}^2 , its image under the exponential maps is compatible with a local family generated by a triangle T_i which is close of T according to their sets of angles.

Proposition 8.4.2. *Fix an arbitrary precision $\delta > 0$: there exists $0 < r, \epsilon \ll 1$ (which can be taken arbitrarily small) such that for any set of angles $\alpha_0 \in \mathcal{S}$ satisfying $|\pi - s(\alpha_0)| \leq \epsilon$, there exists a set of Euclidean angles α_1 satisfying $\|\alpha_0 - \alpha_1\|_1 \leq \delta$ and such that for any triangle T included in $B(x_0, r)$ and satisfying*

$$\alpha_T = \alpha_0,$$

there exists an Euclidean triangle $\varphi(T)$ which depends on T satisfying

$$\varphi(T) \subset \exp_{x_0}(T) \tag{8.1}$$

$$|\varphi(T)| = \frac{1}{10}|T| \tag{8.2}$$

$$\alpha_{\varphi(T)} = \alpha_1. \tag{8.3}$$

Finally, there exists $0 < r' \ll 1$ such that the following inclusion holds

$$\emptyset \neq \mathcal{L}_{r'}(\varphi(T)) \subset \varphi(\mathcal{L}_r(T)).$$

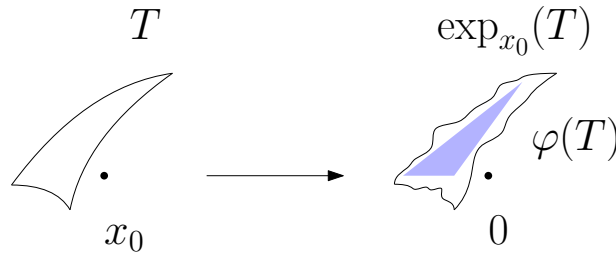

FIGURE 8.4 : Given a triangle T close to x_0 , we claim that its image $\exp_{x_0}(T)$ contains a triangle $\varphi(T)$ which is not too small compared to T and which is also thin enough.

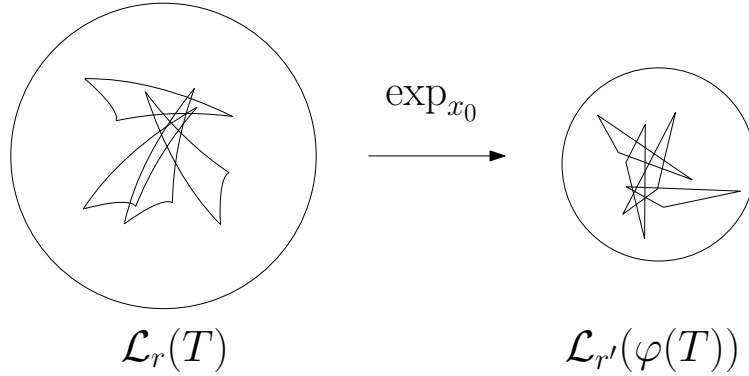

FIGURE 8.5 : We also claim that the image of the local family $\mathcal{L}_r(T)$ under the exponential will contain a local family $\mathcal{L}_{r'}(\varphi(T))$: this second family is now contained in the Euclidean plane and so we can use Proposition 8.4.1.

With Propositions 8.4.1 and 8.4.2 at hands, we can conclude the proof of Theorem 8.1.1. Fix a large constant $C \gg 1$ and let $\epsilon \ll 1$ as in Proposition 8.4.1. Because we suppose that $\bar{A} \cap S_3 \neq \emptyset$, we can choose an set of angles $\alpha_0 \in A$ such that if α_1 is the set of Euclidean angles as described in Proposition 8.4.2, then

$$p(\alpha_1) < \epsilon.$$

In this situation, the local family $\mathcal{L}_{r'}(\varphi(T))$ given by Proposition 8.4.2 satisfies the condition of Proposition 8.4.1 : hence there exists a Kakeya-type set F satisfying

$$\left| \left\{ M_{\mathcal{L}_{r'}(\varphi(T))} \mathbb{1}_F \geq \frac{1}{4} \right\} \right| \geq C |F|.$$

Define now the set E in \mathbb{H}^2 as the pre-image of F by the exponential map

$$E := \exp_{x_0}^{-1}(F)$$

and let us see why we can exploit the set E with the maximal operator $M_{\mathcal{B}}$. Fix $\varphi(T')$ in $\mathcal{L}_{r'}(\varphi(T))$ such that

$$|\varphi(T') \cap F| \geq \frac{1}{4} |\varphi(T')|$$

and observe that in \mathbb{H}^2 we have

$$\mu(T' \cap E) \simeq |\exp_{x_0}(T' \cap E)| \geq |\varphi(T') \cap F| \geq \frac{1}{4} |\varphi(T')| \simeq \frac{1}{40} \mu(T').$$

Finally, the following estimate follows by inclusion

$$\mu \left(\left\{ M_{\mathcal{B}} \mathbb{1}_E \geq \frac{1}{40} \right\} \right) = \mu \left(\bigcup_{T'} T' \right) \simeq \left| \bigcup_{T'} \varphi(T') \right| \geq C |F| \simeq C \mu(E).$$

Bibliographie

- [1] A. Alfonseca. Strong type inequalities and an almost-orthogonality principle for families of maximal operators along directions in \mathbb{R}^2 . *J. Lond. Math. Soc., II. Ser.*, 67(1) :208–218, 2003.
- [2] A. Alfonseca, F. Soria, and A. Vargas. An almost-orthogonality principle in L^2 for directional maximal functions. In *Harmonic analysis at Mount Holyoke. Proceedings of an AMS-IMS-SIAM*, pages 1–7. 2003.
- [3] A. Alfonseca, F. Soria, and A. Vargas. A remark on maximal operators along directions in \mathbb{R}^2 . *Math. Res. Lett.*, 10(1) :41–49, 2003.
- [4] D. Austin. A geometric proof of the Lebesgue differentiation theorem. *Proc. Am. Math. Soc.*, 16 :220–221, 1965.
- [5] M. Bateman. Kakeya sets and directional maximal operators in the plane. *Duke Math. J.*, 147(1) :55–77, 2009.
- [6] M. Bateman and N. H. Katz. Kakeya sets in Cantor directions. *Math. Res. Lett.*, 15(1) :73–81, 2008.
- [7] R. Branchereau, S. Bronstein, and A. Gauvan. Maximal operators on hyperbolic triangles. *submitted*, 2023.
- [8] A. Corboda and R. Fefferman. A geometric proof of the strong maximal theorem. *Ann. Math. (2)*, 102 :95–100, 1975.
- [9] A. Cordoba. Maximal functions : A proof of a conjecture of A. Zygmund. *Bull. Am. Math. Soc., New Ser.*, 1 :255–257, 1979.
- [10] A. Cordoba and R. Fefferman. On differentiation of integrals. *Proc. Natl. Acad. Sci. USA*, 74 :2211–2213, 1977.
- [11] E. D’Aniello, A. Gauvan, and L. Moonens. (Un)boundedness of directional maximal operators through a notion of “Perron capacity” and an application. *Proc. Am. Math. Soc.*, 151(6) :2517–2526, 2023.
- [12] E. D’Aniello, A. Gauvan, L. Moonens, and J. Rosenblatt. Almost everywhere convergence for Lebesgue differentiation processes along rectangles. *J. Fourier Anal. Appl.*, 29(3) :31, 2023.
- [13] E. D’Aniello and L. Moonens. Averaging on n -dimensional rectangles. *Ann. Acad. Sci. Fenn., Math.*, 42(1) :119–133, 2017.

- [14] M. de Guzman. *Differentiation of integrals in \mathbb{R}^n* , volume 481 of *Lect. Notes Math.* Springer, 1975.
- [15] F. Di Plinio and I. Parissis. Maximal directional operators along algebraic varieties. *Am. J. Math.*, 143(5) :1463–1503, 2021.
- [16] F. Di Plinio and I. Parissis. Maximal subspace averages. *Adv. Math.*, 410B :51, 2022.
- [17] D. Dmitrishin, P. Hagelstein, and A. Stokolos. Sharp weak type estimates for a family of Soria bases. *J. Geom. Anal.*, 32(5) :11, 2022. Id/No 169.
- [18] C. Fefferman. The multiplier problem for the ball. *Ann. Math. (2)*, 94 :330–336, 1971.
- [19] R. Fefferman and J. Pipher. A covering lemma for rectangles in \mathbb{R}^n . *Proc. Am. Math. Soc.*, 133(11) :3235–3241, 2005.
- [20] A. Gauvan. Application of Perron Trees to Geometric Maximal Operators. *Colloquium Math.*, 172 :1–13, 2021.
- [21] A. Gauvan. Keakeya-type sets and Maximal Operators. *submitted*, 2021.
- [22] A. Gauvan. Sharp weak-type estimate for maximal operators under an arithmetic condition. *submitted*, 2023.
- [23] A. Gauvan. Norm estimates for the Keakeya Maximal function in high dimensions with respect to general measures. *Real Anal. Exchange*, 48 :1–13, 2023.
- [24] A. Gauvan. Perron capacity of random sets. *in revision*, 2023.
- [25] P. Hagelstein, G. Oniani, and A. Stokolos. Sharp Weak Type Estimates for Maximal Operators associated to Rare Bases. *arxiv*, 2022.
- [26] P. Hagelstein and A. Stokolos. $L^p(\mathbb{R}^2)$ bounds for geometric maximal operators associated to homothety invariant convex bases. *Indiana Mathematics Journal*, 2022.
- [27] P. Hagelstein and A. Stokolos. Sharp weak type estimates for a family of Córdoba bases. *Collectanea Mathematica*, 2022.
- [28] P. Hagelstein and A. Stokolos. Sharp weak type estimates for a family of Zygmund bases. *Proc. Am. Math. Soc.*, 150(5) :2049–2057, 2022.
- [29] G. H. Hardy and J. E. Littlewood. A maximal theorem with function-theoretic applications. *Acta Math.*, 54 :81–116, 1930.

- [30] K. E. Hare and J.-O. Rönning. Applications of generalized Perron trees to maximal functions and density bases. *J. Fourier Anal. Appl.*, 4(2) :215–227, 1998.
- [31] A. D. Ionescu. A maximal operator and a covering lemma on non-compact symmetric spaces. *Math. Res. Lett.*, 7(1) :83–93, 2000.
- [32] B. Jessen, J. Marcinkiewicz, and A. Zygmund. Note on the differentiability of multiple integrals. *Fundam. Math.*, 25 :217–234, 1935.
- [33] D. Kosz, J. C. Martínez-Perales, V. Paternostro, E. Rela, and L. Roncal. Maximal operators on the infinite-dimensional torus. *Math. Ann.*, 385(3-4) :1–39, 2023.
- [34] E. Kroc and M. Pramanik. Lacunarity, Kakeya-type sets and directional maximal operators. *arXiv preprint arXiv :1404.6241.*, 2014.
- [35] E. Kroc and M. Pramanik. Kakeya-type sets over Cantor sets of directions in \mathbb{R}^{d+1} . *J. Fourier Anal. Appl.*, 22(3) :623–674, 2016.
- [36] E. Le Donne and S. Rigot. Besicovitch covering property on graded groups and applications to measure differentiation. *J. Reine Angew. Math.*, 750 :241–297, 2019.
- [37] H. Q. Li. Centered Hardy-Littlewood maximal function on hyperbolic spaces, $p > 1$. *preprint*, <https://arxiv.org/abs/1304.3261>, 2013.
- [38] A. Nagel, E. M. Stein, and S. Wainger. Differentiation in lacunary directions. *Proc. Natl. Acad. Sci. USA*, 75 :1060–1062, 1978.
- [39] J. Parcet and K. M. Rogers. Directional maximal operators and lacunarity in higher dimensions. *Am. J. Math.*, 137(6) :1535–1557, 2015.
- [40] G. Rey. Another counterexample to Zygmund’s conjecture. *Proc. Am. Math. Soc.*, 148(12) :5269–5275, 2020.
- [41] P. Sjögren and P. Sjölin. Littlewood-Paley decompositions and Fourier multipliers with singularities on certain sets. *Ann. Inst. Fourier*, 31(1) :157–175, 1981.
- [42] J. Soria and P. Tradacete. Best constants for the Hardy-Littlewood maximal operator on finite graphs. *J. Math. Anal. Appl.*, 436(2) :661–682, 2016.
- [43] A. Stokolos. Zygmund’s program : some partial solutions. *Ann. Inst. Fourier*, 55(5) :1439–1453, 2005.

- [44] A. Stokolos. On weak type inequalities for rare maximal functions in \mathbb{R}^n . *Colloq. Math.*, 104(2) :311–315, 2006.
- [45] A. M. Stokolos. On the differentiation of integrals of functions from $L\phi(L)$. *Stud. Math.*, 88(2) :103–120, 1988.
- [46] J.-O. Strömberg. Weak type L^1 estimates for maximal functions on non-compact symmetric spaces. *Ann. Math. (2)*, 114 :115–126, 1981.
- [47] A. Zygmund. A note on the differentiability of integrals. *Colloq. Math.*, 16 :199–204, 1967.