



HAL
open science

Multilingual study of chemistry lexicon at the interface of terminology and general language

Polina Mikhel

► **To cite this version:**

Polina Mikhel. Multilingual study of chemistry lexicon at the interface of terminology and general language. Linguistics. Université de Lorraine, 2022. English. NNT : 2022LORR0338 . tel-04198394

HAL Id: tel-04198394

<https://theses.hal.science/tel-04198394>

Submitted on 7 Sep 2023

HAL is a multi-disciplinary open access archive for the deposit and dissemination of scientific research documents, whether they are published or not. The documents may come from teaching and research institutions in France or abroad, or from public or private research centers.

L'archive ouverte pluridisciplinaire **HAL**, est destinée au dépôt et à la diffusion de documents scientifiques de niveau recherche, publiés ou non, émanant des établissements d'enseignement et de recherche français ou étrangers, des laboratoires publics ou privés.



**UNIVERSITÉ
DE LORRAINE**

**BIBLIOTHÈQUES
UNIVERSITAIRES**

AVERTISSEMENT

Ce document est le fruit d'un long travail approuvé par le jury de soutenance et mis à disposition de l'ensemble de la communauté universitaire élargie.

Il est soumis à la propriété intellectuelle de l'auteur. Ceci implique une obligation de citation et de référencement lors de l'utilisation de ce document.

D'autre part, toute contrefaçon, plagiat, reproduction illicite encourt une poursuite pénale.

Contact bibliothèque : ddoc-theses-contact@univ-lorraine.fr
(Cette adresse ne permet pas de contacter les auteurs)

LIENS

Code de la Propriété Intellectuelle. articles L 122. 4

Code de la Propriété Intellectuelle. articles L 335.2- L 335.10

http://www.cfcopies.com/V2/leg/leg_droi.php

<http://www.culture.gouv.fr/culture/infos-pratiques/droits/protection.htm>

MULTILINGUAL STUDY OF CHEMISTRY LEXICON
AT THE INTERFACE OF TERMINOLOGY
AND GENERAL LANGUAGE

Thesis

submitted and publicly defended on December 16, 2022

for the award of

Doctor of Philosophy of Université de Lorraine
Language sciences (*Sciences du langage*)

by

Polina MIKHEL

Committee:

Éva BUCHI – Chair, examiner

John HUMBLEY – Reporting examiner

Maria Teresa ZANOLA – Reporting examiner

Béatrice DAILLE – Examiner

Svetlana KRYLOSOVA – Examiner

Alain POLGUÈRE – Supervisor

Francesca INGROSSO – Co-supervisor

ÉCOLE DOCTORALE SOCIÉTÉS, LANGAGES, TEMPS, CONNAISSANCES (SLTC)

To my mother Svetlana and my stepfather Nikolay.

Stalker:

“Let everything that’s been planned come true.

Let them believe.

And let them have a laugh at their passions. <...>

When a man is just born, he is weak and flexible.

When he dies, he is hard and insensitive.

When a tree is growing, it’s tender and pliant.

But when it’s dry and hard, it dies.

Hardness and strength are death’s companions.

Pliancy and weakness are expressions of the freshness of being. Because what has hardened will never win.”

Stalker, 1979

Andrei Tarkovsky

Table of contents

	Page
Table of contents	vii
List of figures	xi
List of tables	xiii
Abstract	1
Résumé	3
Acknowledgements	5
Abbreviations, symbols and writing conventions	7
Chapter 1 General introduction to the research	9
1.1 The strong bond between chemistry and terminology	10
1.2 Context	12
1.3 Object of study	13
1.4 Theoretical and descriptive framework	14
1.5 Objectives	18
1.6 Methodology	19
1.6.1 Stages of the research	19
1.6.2 Building specialised corpora: design and compilation process policy	21
1.6.2.1 Preliminary work	21
1.6.2.2 Data storage	22
1.6.2.3 Text selection criteria	23
1.6.2.4 Adjustments made in the course of the study	26
1.6.3 Establishing nomenclatures of core chemical terms	27
1.6.4 Lexical Networks for terminological modeling	28
1.7 Organisation of the thesis	29
PART I: LEXICOLOGICAL STUDY	31
Chapter 2 State of the question	33
2.1 Introduction	34
2.2 Overview of terminological resources on chemistry	34

Chapter	Page
2.3	Detected issues 37
2.3.1	Minimal linguistic information approach 37
2.3.2	Definitions 39
2.3.3	Polysemy 41
2.3.4	Phraseology 45
2.3.4.1	Idioms 45
2.3.4.2	Combinatorics 46
2.4	Recapitulation 48
Chapter 3	Chemistry and its language 49
3.1	Introduction 51
3.2	Conceptual characterization of chemistry 51
3.2.1	Chemistry as a science 51
3.2.2	Defining chemistry 53
3.2.3	Chemical industry 55
3.3	Vocabulary of chemistry 57
3.3.1	Chemical nomenclatures 58
3.3.2	Scientific vocabulary as one of the challenging factors in teaching the discipline 59
3.3.3	Issues of teaching vocabulary of chemistry 60
3.3.3.1	Symbolic representation of chemical names 61
3.3.3.2	Use of anthropomorphic language 62
3.3.3.3	Use of polysemous terms and general language lex- ical units in scientific context 62
3.4	Different senses of En. CHEMISTRY, Fr. CHIMIE, Ru. ХИМИЯ ¹ and ХИ- МИЯ ² 65
3.4.1	En. CHEMISTRY 65
3.4.2	Fr. CHIMIE 67
3.4.3	Ru. ХИМИЯ ¹ and ХИМИЯ ² 69
3.4.3.1	Polysemy of Ru. ХИМИЯ ¹ 69
3.4.3.2	Homonymy of Ru. ХИМИЯ ¹ and ХИМИЯ ² 73
3.4.4	Focus on chemistry-related senses 75
3.5	Recapitulation 77

Chapter	Page
Chapter 4 Lexicographic modeling of terminology: a Lexical System approach	79
4.1 Introduction	81
4.2 Lexicographic article structure in the Lexical Systems	81
4.2.1 Grammatical characteristics	82
4.2.2 Definition	86
4.2.2.1 <i>Equivalence, or Adequacy, Principle</i>	86
4.2.2.2 <i>Hierarchical Structure Principle</i>	87
4.2.2.3 <i>Semantic Decomposition Principle</i>	88
4.2.2.4 <i>Minimal Decomposition [= Maximal Block] Principle</i>	89
4.2.2.5 <i>Univocity Principle</i>	90
4.2.2.6 <i>Semantic Network Principle</i>	91
4.2.3 Paradigmatic and syntagmatic connections	92
4.2.4 Copolysemy relations	93
4.2.5 Illustrative examples	94
4.2.6 The case of spec REACT 1.1d	95
4.3 Recapitulation	96
Chapter 5 Three terminological building blocks: <i>matter</i> , <i>substance</i> , and <i>atom</i>	97
5.1 Introduction	98
5.2 Polysemous vocables En. MATTER, Fr. MATIÈRE, and Ru. МАТЕРИЯ	98
5.2.1 En. MATTER	98
5.2.2 Fr. MATIÈRE	102
5.2.3 Ru. МАТЕРИЯ	104
5.3 Polysemous vocables En. SUBSTANCE, Fr. SUBSTANCE, and Ru. ВЕ-	
ЩЕСТВО	106
5.3.1 En. SUBSTANCE	106
5.3.2 Fr. SUBSTANCE	109
5.3.3 Ru. ВЕЩЕСТВО	110
5.4 Polysemous vocables En. ATOM, Fr. ATOME, and Ru. АТОМ	112
5.4.1 En. ATOM	112
5.4.2 Fr. ATOME	114
5.4.3 Ru. АТОМ	116

Chapter	Page
5.5	Recapitulation 117
Chapter 6	The notion of <i>element</i> 119
6.1	Introduction 121
6.2	Historical development of the notion of <i>element</i> 122
6.3	Definitions of <i>chemical element</i> in the IUPAC <i>Gold Book</i> 126
6.4	Misconceptions associated with the notion of <i>element</i> 130
6.5	Lexicographic modeling of the polysemous vocables En. ELEMENT, Fr. ÉLÉMENT, and Ru. ЭЛЕМЕНТ 136
6.5.1	En. ELEMENT 136
6.5.2	Fr. ÉLÉMENT 140
6.5.3	Ru. ЭЛЕМЕНТ 141
6.5.4	Focus on chemistry-related senses 144
6.5.4.1	spec ELEMENT III.3a 144
6.5.4.2	spec critic ELEMENT III.3b 145
6.6	Recapitulation 146
Chapter 7	General conclusion 149
7.1	Concluding remarks 150
7.1.1	Interactions of specialized and non-specialized lexical units . 150
7.1.2	Discrepancies in terminological modeling in the three lan- guages 153
7.2	Solutions to the issues detected in terminological resources on chem- istry 154
7.3	Prospects 157
PART II:	TERMINOGRAPHIC DESCRIPTIONS 159
Chapter 8	Three systems of core chemical notions 161
8.1	Introduction 162
8.2	Fundamental lexicon of chemistry 163
8.3	System of English chemical notions 167
8.4	System of French chemical notions 193
8.5	System of Russian chemical notions 219
Bibliography 247
Index of notions 259

List of figures

Figure	Page
1.1 Insertion of specialized lexical units in polysemous vocables	15
1.2 Editing and storing process in a DMS	22
2.1 Extracts from three editions of the IUPAC <i>Compendium of Chemical Terminology</i> : entries En. ION, Fr. ION, and Ru. ИОН	35
2.2 Entry En. ION in the Oxford <i>Dictionary of Chemistry</i>	37
2.3 “Interactive Link Map”, a former feature on the IUPAC <i>Gold Book</i> website	38
2.4 Extracts from Richer (2012) on the left and from Gazizov (2010) on the right	39
2.5 Entries En. ATOM, CHEMICAL ELEMENT and NUCLEUS on the IUPAC <i>Gold Book</i> website	40
2.6 Extracts from the Oxford <i>Dictionary of Chemistry</i> (2008)	40
2.7 Entries for Fr. RÉACTIF _(N) in the <i>Dictionnaire de chimie</i> by Menten and in the <i>Vocabulaire de la chimie et des matériaux</i> (<i>FranceTerme</i>)	42
2.8 French terms denoting types of chemical substances	46
3.1 Extract from the <i>Bulletin de la Société chimique de Paris</i> , 1864	61
3.2 Polysemy structure of the vocable En. CHEMISTRY	65
3.3 Polysemy structure of the vocable Fr. CHIMIE	67
3.4 Polysemy structure of the vocable Ru. ХИМИЯ ¹	69
3.5 The case of homonymy: Ru. ХИМИЯ ¹ vs. ХИМИЯ ²	75
3.6 Copolysemy relations between specialized senses of En. CHEMISTRY, Fr. CHIMIE and Ru. ХИМИЯ ¹	75
4.1 Assigning grammatical characteristics to a lexical unit in <i>Dicet</i> editor	83
4.2 Lexical network around спец RÉACTEUR 1.2	83
4.3 Lexical network around (спец) MATIÈRE 1.a	85
4.4 Formal encoding of the definition of спец RÉACTEUR 1.2 in <i>Dicet</i> editor	91
4.5 Lexical network around спец REACT 1.1d in <i>Spiderlex</i>	92
4.6 Copolysemy relations in the vocable En. REACT in <i>Dicet</i> editor	93
4.7 Associating examples with several senses in <i>Dicet</i> editor	95

Figure	Page
4.8 “Article view” of spec REACT I.1d in <i>Dicet</i> editor	95
5.1 Polysemy structure of the vocable En. MATTER	99
5.2 Lexical network around (spec) MATTER I.a in <i>Spiderlex</i>	100
5.3 Polysemy structure of the vocable Fr. MATIÈRE	102
5.4 Polysemy structure of the vocable Ru. МАТЕРИЯ	104
5.5 Polysemy structure of the vocable En. SUBSTANCE	106
5.6 Lexical network around spec SUBSTANCE I.1b in <i>Spiderlex</i>	108
5.7 Polysemy structure of the vocable Fr. SUBSTANCE	109
5.8 Polysemy structure of the vocable Ru. ВЕЩЕСТВО	111
5.9 Polysemy structure of the vocable En. АТОМ	112
5.10 Lexical network around spec АТОМ I.2 in <i>Spiderlex</i>	114
5.11 Polysemy structure of the vocable Fr. ATOME	115
5.12 Polysemy structure of the vocable Ru. АТОМ	116
5.13 Building blocks of the core chemical notions system	117
6.1 Entry En. <i>chemical element</i> in the IUPAC <i>Gold Book</i>	126
6.2 Schema “Classification of matter” taken from the textbook <i>Chemistry:</i> <i>The Central Science</i> (Brown, LeMay, <i>et al.</i> 2018: 55)	134
6.3 Polysemy structure of the vocable En. ELEMENT	137
6.4 Polysemy structure of the vocable Fr. ÉLÉMENT	140
6.5 Polysemy structure of the vocable Ru. ЭЛЕМЕНТ	141
6.6 Lexical network around spec ELEMENT III.3a	145
7.1 Types of insertion of specialized lexical units in polysemous vocables	152
7.2 Lexical network around spec BOND _(V) I.2a in <i>Spiderlex</i>	152
7.3 The bottom (most basic) level of the <i>defined-by</i> hierarchy of the French chemical notions	155
7.4 Automatic checking of sense inclusions	155
7.5 “Article view” of the idiom spec \lceil CORPS COMPOSÉ \rceil in <i>Dicet</i> editor	156
7.6 Lexical network around the idiom spec \lceil CORPS COMPOSÉ \rceil in <i>Spiderlex</i>	157
8.1 The <i>defined-by</i> hierarchy of English chemical notions	167
8.2 The <i>defined-by</i> hierarchy of French chemical notions	193
8.3 The <i>defined-by</i> hierarchy of Russian chemical notions	219

List of tables

Table	Page
1.1 Outline of the external – non-linguistic – criteria	24
1.2 Outline of the internal – linguistic – criteria	25
1.3 Some of the most frequently occurring chemical terms (PEPS STRÉTCH project)	27
2.1 Example of some specialized idioms missing in chemical dictionaries . .	46
2.2 En. REACT I.1d , Fr. RÉAGIR I.1d , Ru. РЕАГИРОВАТЬ I.1d , and their col- locates in the three languages	47
3.1 Formal definition of En. CHEMISTRY I	55
3.2 Formal definition of En. PHYSICS I	55
3.3 Formal definition of spec CHEMISTRY II.1	76
3.4 Formal definition of spec CHEMISTRY II.2	76
4.1 Formal definition of spec ALLOTROPES	87
4.2 Formal definition of spec ANION	87
4.3 Formal definition of spec CATION	88
4.4 Formal definition of spec ION	88
4.5 Formal definition of spec PARTICLE I.2	89
4.6 Formal definition of (spec) MATTER I.a	89
4.7 Formal definition of (spec) INTERACT I	89
4.8 Formal definition of spec COMPOUND _(N) I.2	90
4.9 Formal definition of spec LIQUID _(Adj) I.2	91
4.10 Formal definition of spec SOLID _(Adj) I.2	91
5.1 Formal definition of (spec) MATTER I.a	99
5.2 Formal definition of (spec) MATIÈRE I.a	103
5.3 Formal definition of (спец) МАТЕРИЯ I.a	105
5.4 Formal definition of spec SUBSTANCE I.1b	107
5.5 Formal definition of spec АТОМ I.2	113
6.1 Two terms proposed by Paneth in 1931	125
6.2 Names and defining characteristics of elements <i>vs.</i> simple substances . .	132

Table	Page
6.3 Formal definition of spec ELEMENT III.3a	144
6.4 Formal definition of spec critic ELEMENT III.3b	146

Abstract

Our interdisciplinary research is based on the hypothesis that scientific terminologies, since they function in texts interacting with the general language lexicon, have a similar structure as that of the general lexicon. The vast majority of terminological models treat terminologies in isolation and are unable to account for the kinds of connections they have with the general language and the practical consequences of these connections for the evolution of terminologies as well as for teaching and learning of terminologies. We study this problem from both theoretical (lexicological) and descriptive (lexicographic) perspectives, focusing on the case of chemistry terminology.

On the theoretical level, the research aims, on the one hand, to provide a solution to the problem of formal and rigorous modeling of the multidimensionality inherent in the organization of terminologies, i.e. the fact that terms can be apprehended and terminologies can be navigated following multiple axes. On the other hand, and in a related way, the research aims to account for the interdependence between the general language lexicon and the terminological lexicon.

On the practical level, we elaborate the multilingual terminological models of chemistry for three typologically distinct languages: English, French and Russian. These models, designed to evolve and be enriched in the long term, can serve as practical tools for scientists as well as for teachers and students of chemistry. The research is thus intended to have an impact not only in the field of lexicology and terminology research, but also on the chemistry community.

Key-words: contrastive lexicology, computational formal lexicography, chemistry terminology, lexical networks.

Résumé

Notre recherche interdisciplinaire repose sur l'hypothèse que les terminologies scientifiques, puisqu'elles fonctionnent dans les textes en interaction avec le lexique de langue générale, doivent posséder une structure identique ou similaire avec celle du lexique général. Les modèles terminologiques, dans leur immense majorité, traitent les terminologies de façon isolationniste et ne sont pas en mesure de rendre compte des types de connexions qu'elle entretiennent avec la langue générale et des conséquences pratiques de ces connexions sur l'évolution des terminologies, ainsi que sur l'enseignement et l'apprentissage des terminologies. Nous étudions ce problème dans une perspective à la fois théorique (lexicologique) et descriptive (lexicographique) en nous consacrant au cas de la terminologie de la chimie.

Sur le plan théorique, la recherche vise, d'une part, à apporter une solution au problème de la modélisation formelle et rigoureuse de la multidimensionnalité inhérente à l'organisation des terminologies, c'est-à-dire le fait que les termes peuvent être appréhendés et les terminologies parcourues selon de multiples axes. D'autre part, et de façon liée, la recherche vise à rendre compte de l'interdépendance entre lexique de langue générale et lexique terminologique.

Sur le plan pratique, nous élaborons les modèles terminologiques multilingues de la chimie pour trois langues typologiquement distinctes : l'anglais, le français et le russe. Ces modèles, conçus pour évoluer et être enrichis sur le long terme, peuvent servir d'outils pratiques pour les scientifiques ainsi que pour les enseignants et les étudiants en chimie. La recherche est de ce fait destinée à avoir une résonance non seulement dans le domaine de la recherche en lexicologie et terminologie, mais aussi auprès de la communauté des chimistes.

Mots clés : lexicologie contrastive, lexicographie formelle informatisée, terminologie de la chimie, réseaux lexicaux.

Acknowledgements

I would like to express my deepest gratitude to everyone who contributed to this research:

to my supervisor, Alain POLGUÈRE, for having invited me to this challenging journey, for the encouragement, for believing in me and being my guiding star;

to my co-supervisor, Francesca INGROSSO, for the precious time invested in our interdisciplinary collaboration, for this enriching experience, for being kind and supportive;

to Éva BUCHI, Béatrice DAILLE, John HUMBLEY, Svetlana KRYLOSOVA, and Maria Teresa ZANOLA, for having kindly accepted to examine the thesis and be the members of my jury;

to the University of Lorraine and ATILF laboratory, to the Région Grand Est and CNRS, for the financial and technical support of this research;

to Yan GREUB and Maxime AMBLARD, for being members of my follow-up committee;

to all my colleagues at the ATILF laboratory; to Sandrine OLLINGER, Nabil GADER, Étienne PETITJEAN, Isabelle CLÉMENT, Jessika PERIGNON, Laurent TAMBURINI, for your technical support and advice; to Éva BUCHI, Veronika LUX-POGODALLA, Olivier SERVAS, Laurent GOBERT, for our inspiring conversations;

to members of the OLST laboratory, to Patrick DROUIN, Francois LAREAU, and Marie-Claude L'HOMME, for the warm welcome during my internship at the University of Montreal;

to Igor Aleksandrovich MEL'ČUK and Lidija Nikolaevna IORDANSKAJA, for being our lifetime linguistic inspirations, for your kindness and your sense of humor;

to the LEC-ru team, to Svetlana KRYLOSOVA, Lidia KOLZUN, Elena AK-

BORISOVA, Tomara GOTKOVA, Nikolay CHERPURNYKH, *спасибо, дорогие коллеги, за бесценную поддержку и за вдохновение все эти годы;*

to my colleagues and my students at INaLCO, for encouraging me at the very last stage of this journey;

to my dear friends, Toma, Lou, Lioudmila, for sharing these years, for our gatherings and laughs;

to my mother, my stepfather and my little brother, for always believing in me, for your enthusiasm and optimism;

to my dearest Kolya, for your endless support and kindness.

Abbreviations, symbols and writing conventions

Abbreviations

critic, критик	:	criticizable (usage notes)
En., Fr., Ger., Ru.	:	English, French, German, Russian languages
IUPAC	:	International Union of Pure and Applied Chemistry
lit.	:	literally
LN	:	Lexical Network, e.g. <i>en-LN, fr-LN, ru-LN</i>
спец / spéc / спец	:	specialized (usage notes)
(спец) / (spéc) / (спец)	:	runaway term (usage notes)

Symbols

'...'	:	signified, e.g. 'positively charged ion'
「...」	:	idiom, e.g. 「ATOMIC NUMBER」
X, Y, etc.	:	actant slots, e.g. <i>X interacts with Y</i>
Ω	:	actant slot of a lexical unit mentioned in the definition of another lexical unit
{...}	:	set, e.g. 'type of matter that has constant chemical properties {Ω}'

Writing conventions

note	:	usage note, e.g. Fr., спец
notion	:	important notion, e.g. <i>element</i>
VOCABLE_(gram. feat.)^{no.}	:	e.g. BOND_(V), ХИМИЯ¹
LEXICAL UNIT_(gram. feat.)^{no. no.}	:	e.g. BOND_(V) 1.2a, ХИМИЯ¹ 1.1
signifier	:	e.g. <i>bond, химия</i>
wordform_(gram. feat.)^{no. no.}	:	e.g. bonds_(V) 1.2a, химией¹ 1.1
Lexical function	:	e.g. S₀, Redun
Lexical function(<i>argument</i>)	:	
[i.e. lexical function application]	:	e.g. S₀(<i>bond_(V) 1.2a</i>), Redun(<i>bond_(V) 1.2a</i>)

Chapter 1

General introduction to the research

SUMMARY

1.1	The strong bond between chemistry and terminology	10
1.2	Context	12
1.3	Object of study	13
1.4	Theoretical and descriptive framework	14
1.5	Objectives	18
1.6	Methodology	19
1.6.1	Stages of the research	19
1.6.2	Building specialised corpora: design and compilation process policy	21
1.6.3	Establishing nomenclatures of core chemical terms	27
1.6.4	Lexical Networks for terminological modeling	28
1.7	Organisation of the thesis	29

1.1 The strong bond between chemistry and terminology

The reflection on the language of chemistry has a long and rich history, yet most of the efforts to standardize chemical terminology have been devoted to the naming of chemical compounds, since chemistry, by the very nature of this science, continually generates new molecules and needs new names to designate them.

Already in the eighteenth century, it was suggested by A. Lavoisier and L.-B. Guyton de Morveau to apply a systematic approach to the naming of compounds (Zanola 2014: 113–128), so that the morphological structure of the names themselves could reflect the molecular structure of the designated substances as well as the order of combination of the elements. For instance, the term *carbon tetrahydride* reflects the structure of the compound CH_4 with one atom of the element carbon (C) bonded to four atoms of the element hydrogen (H_4). In a paper published in 1989, R. Hoffman (Nobel Prize in Chemistry in 1981) and P. Laszlo pointed out that knowing the name of a chemical compound gives a chemist enormous “power” over the molecule, since its name is closely related to its structure, its properties and behavior (Hoffmann and Laszlo 1989). The importance of the correct usage of terminology in chemistry led to the creation of the international organization IUPAC (International Union of Pure and Applied Chemistry), one of its purposes being the development of rules for the nomenclature of compounds in order to avoid ambiguity and to harmonize names of newly discovered molecules.

In the book *La parole des choses : ou le langage de la chimie*¹ (Laszlo 1993), P. Laszlo continues to reflect on the link between language and chemistry establishing correspondences between linguistic categories and their counterparts in chemistry. For instance, the fact that a molecule can behave as an acid or as a base depending on another participant involved in the reaction is in some way analogous to the manifestation of the linguistic category “polysemy”. More recently, an international team of chemical engineers has demonstrated, using statistical analysis, that computational methods of applied linguistics can be exploited to study complex structural and reactivity patterns within organic molecules (Cadeddu *et al.* 2014). The experiment has shown that natural languages and organic chem-

¹The language of things: or the language of chemistry

istry have the same structure in terms of the frequency of “text fragments” (words, sentences) and “molecular fragments” (atoms, molecules, sets of molecules). This discovery has formally validated the famous quote of J.-M. Lehn (Nobel Prize in Chemistry in 1987):

Atoms are letters, molecules are the words, supramolecular entities are the sentences and the chapters. (Lehn 1995)

Despite the obvious interest of chemists in the language of their discipline, examples of systematic studies of the lexicon of chemistry, especially multilingual ones, remain surprisingly rare. One of the few examples is the dissertation of S. Peraldi (Peraldi 2011) who analyzed the language of organic chemistry, highlighting its indeterminate nature and multidimensional character of certain key concepts. Through the elaboration of a specialized corpus in English, Peraldi proposed solutions for the construction of a terminological model that could assist organic chemists in their scientific communication.

Indeed, while writing articles and in oral speech, many scientist are confronted with difficulties related to the communication of concepts that are often highly technical and specific to their subfield (e.g. organic chemistry, physical chemistry, analytical chemistry, etc.). Yet, other challenges arise in the pedagogical context: the need to use clear expressions, to avoid ambiguous definitions, to favor illustrations of simple concepts by well-chosen terms. According to I. Kermen (2016), teacher’s choice of words is the key point in helping students to understand the concepts and signs that are specific to the discipline of chemistry.

Studies actually show that students’ misinterpretations are often the result of a teaching approach that relies on non-perceptible species and entities (Taber 2001), and thus, most likely on wrong connections between terms and concepts. On top of it, there is a tendency to attribute “behaviors” to chemical entities (Taber 1998), which is a very common problem in chemistry teaching linked to formulations used in class and in textbooks. For instance, it is often explained that an atom *prefers* to be surrounded by eight electrons, or that it *seeks to get rid of* a valence electron to *achieve* electronic stability, and then, many students tend to say that atoms *want, need, like, are eager, greedy, happy* or *have no wish*

for certain outcomes (see Chapter 3, 3.3.3.2). This excessive usage of anthropomorphic language and metaphorization is in part caused by a lack of large-scale linguistic resources that would be truly adapted to the teaching of chemistry and in particular of its terminology.

1.2 Context

The present study is the result of an interdisciplinary collaboration undertaken in the framework of the project FRONTERME.² Our project in lexicology applied to chemical terminology was launched in coincidence with “2018-2019 Année de la chimie, de l’école à l’université”,³ the initiative of the French Ministry of Education, Ministry of Higher Education, Research and Innovation in partnership with the CNRS (Centre national de la recherche scientifique⁴).

The collaboration between chemists of LPCT (Laboratoire de Physique et Chimie Théoriques⁵) and linguists of the laboratory ATILF (Analyse et Traitement Informatique de la Langue Française⁶) has been possible thanks to the efforts of Professor Francesca Ingrosso and Professor Alain Polguère, who started their first investigations on chemical terminology back in 2015 with a project PEPS STRÉTCH.⁷ This testing project resulted in the creation of a corpus of chemical journal abstracts and the retrieval of two lists of the most frequently occurring chemical terms in English and French (see 1.6.3).

The preliminary research has also shown that:

- most scientific journals, authoritative textbooks and dictionaries on chemistry are written in English;
- there is a lack of multilingual perspective on chemical terminology which leads to serious issues in the context of teaching the discipline in schools and universities (Ingrosso and Polguère 2015);

²Financed by the Région Grand Est

³Year of Chemistry, from school to university

⁴National Center for Scientific Research

⁵Laboratory of Theoretical Physics and Chemistry

⁶Analysis and Computer Processing of the French Language

⁷Financed by the PEPS Mirabelle 2015, CNRS & University of Lorraine

- there is a need for systematic and fundamental studies of the lexicon of chemistry using the tools of computational lexicography in order to provide a system of rigorous definitions and a complete description of fundamental chemical terms.

The author of the present thesis joined the team for the project FRONTERME when it was decided to start solving the above listed problems by modeling the terminology of chemistry for English, French and Russian.

1.3 Object of study

The object of our study is the fundamental terms of chemistry. In what follows, we specify what we understand by *terms* as well as by *fundamental terms*.

There are various viewpoints and extensive literature on the notion of *term*, see, for instance, Cabré (2003), Danilenko (1977), Desmet (2007), Golovin and Kobrin (1987), Grinev-Grinevič (2008), Felber (1984), Humbley (2004), Kageura (2002), Reformatskij (1968), Rey (1979), Temmerman (2000), and Wüster (1981, 1991); a summary of different viewpoints can be found in L’Homme (2005). In our study, we adopt the approach proposed by L’Homme and Polguère (2008).

We understand by *notion* an association of a concept (i.e. a unit of thought or inference) and a term. In other words, a notion is a concept that is lexicalized by means of a term (Polguère 2016b: 1–2). By *terms* we understand *specialized* lexical units that are distinguished from general language, or *non-specialized*, lexical units only by the fact that mastering of terms is associated with mastering of a given field of knowledge (scientific, technical, etc.). Apart from that, there is no fundamental difference between the two types of lexical units – specialized and non-specialized ones – **as regards their central structural properties** (L’Homme and Polguère 2008: 193–194), namely

- a. their semantics (= signified),
- b. their form (= signifier),
- c. their combinatorial properties.

We assume that terms can be studied and described on the basis of the same lexicographic approach that we use for the description of the general language lexical units (see 1.4). This implies, among other considerations, that we aim for the description of specialized lexical units belonging to each of the four major parts of speech: nouns, verbs, adjectives and adverbs. Hereinafter, we refer to the practice of the lexicographic description applied to terms as to *terminography*.

By *fundamental terms*, we understand a set of terms that forms the notional core of the discipline in question. Fundamental, or *core*, terms of chemistry are those that are learned in the course of the so-called general chemistry, an introductory chemistry course taught at school and university levels. Core terms of chemistry can also be characterized as being shared by most subdomains of chemistry (Chapter 3, 3.2) and not belonging to one specific branch. Examples of core chemical terms are *atom*, *bond_(N)*, *bond_(V)*, *element*, *molecule*, *reactive* (see 1.6.3).

1.4 Theoretical and descriptive framework

Our research is motivated by two observations: 1) traditional approaches to the study and representation of scientific terminology systems rely essentially on taxonomic models – cf. computer ontologies based on hierarchies of conceptual classes (Hirst 2009); 2) contemporary studies on the organization of the general language lexicon (lexicology, psycholinguistics, etc.) tend to agree on a mode of structuring lexicons in multidimensional and non-taxonomic lexical networks (Aitchison 2012; Motter *et al.* 2002; Polguère 2016a).

Our research is based on the hypothesis that scientific terminologies, since they function in texts in interaction with the general language lexicon, must possess a structure homomorphic with that of the general lexicon, with which they merge within the language (L’Homme and Polguère 2008). In this context, we focus in our research on the relationship between specialized and non-specialized lexical units, both on paradigmatic and syntagmatic levels, and on modeling of this relationship.

On the paradigmatic level, chemical terms are often inserted into the polysemous structure of vocables, some of whose meanings are not related to the terminological system and belong to the general language lexicon.

A *vocable* is a grouping of lexical units that have the following two properties:

1. they possess the same signifier (graphic and acoustic form), 2. they have a clear semantic connection. Lexical units of a vocable are called *senses* of that vocable.

We distinguish between two types of lexical units: lexemes and idioms.

Lexeme is a grouping of word-forms only distinguished by flexion.

Idiom is a semantically non-compositional phraseological expression.⁸

(Polguère 2016a: 70)

Now, to illustrate the interconnection between specialized and non-specialized senses within a polysemous vocable, let us consider the case of ATOM, as we propose to model it (for the detailed analysis see Chapter 5, 5.4.1). A sense ATOM I.1 ‘particle believed by laypersons to be the smallest indivisible constituent of matter’ belongs at this stage of the language and science evolution to the general language. This sense is linked to the specialized sense ATOM I.2, as in *atoms form chemical bonds* (see Part II, p. 168), which makes part of the fundamental chemical lexicon. In turn, ATOM I.2 is a source of metaphor for the derived non-specialized lexeme ATOM II, as in *the era of the atom*. Finally, ATOM I.1 controls not only the specialized sense ATOM I.2 but also a metaphorical derivative ATOM III ‘a very small degree or amount of something’, as in *every rumour has an atom of truth in it*. In such a way, our specialized lexeme related to the lexicon of chemistry is inserted in the polysemous vocable ATOM with three non-specialized senses around it (see Figure 1.1).

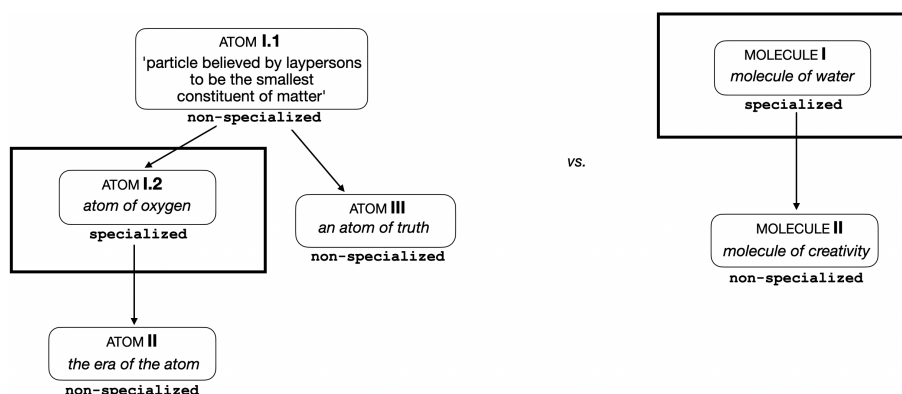

Figure 1.1 – Insertion of specialized lexical units in polysemous vocables.

⁸Our translation.

Another example would be the case of the vocable MOLECULE with a specialized lexeme MOLECULE **I**, as in *five **molecules** of water* (see Part II, p. 184), controlling a metaphorical non-specialized derivative MOLECULE **II**, as in *every **single molecule** of creativity is wide awake in me*.

Figure 1.1 illustrates two possible ways of insertion of a specialized sense in a polysemous vocable. For now, we limit ourselves to these two cases and will discuss other examples, including vocables with specialized senses linked to other specialized senses, in Chapter 4.

Since terms do not exist on their own but function in texts, they inevitably interact with the general language lexicon at the syntagmatic level as well. In order to characterize the combinatorial properties of terms, we need to describe the connections they have both with specialized and non-specialized lexical units, i.e. the collocations they form.

Collocation is a semantically compositional expression made up of at least two components:

A. the *base* of the collocation, a full lexical unit which is “freely” chosen by the speaker;

B. the *collocate*, a lexical unit or a multi-lexical expression which is selected according to combinatorial constraints imposed by the base.⁹

(Polguère 2016b: 65)

For instance, to master a specialized verb *react* **I.1d** (see more in Chapter 2, 2.3.4.2; for its definition, see Part II, p. 188), as in *calcium **reacts** with oxygen*, and to use it correctly in a sentence, it is important to know that it can be intensified by means of the non-specialized adverbs *strongly*, *violently*, *vigorously* or *actively*, as in (1a). In French, in order to intensify *réagir* **I.1d** ‘react’ (see Part II, p. 216), we use adverbs *fortement* ‘strongly’, *violemment* ‘violently’, *vigoureusement* ‘vigorously’ and *vivement* ‘vividly’. Finally, in Russian, not only we use *сильно* ‘strongly’ and *активно* ‘actively’ to intensify *реагировать* **I.1d** ‘react’ (see Part II, p. 232), but also *бурно* ‘widely, roughly’ and *энергично* ‘energetically, vigorously’, see (1b).

⁹Our translation.

- (1) a. *Calcium reacts strongly with oxygen and water creating various forms of calcium oxides or hydroxides that have insulating properties.*
- b. *При нагревании железо бурно реагирует с серой с образованием феррум сульфида..*
- lit. ‘When heated, iron **widely reacts** with sulfur with the formation of ferrum sulfide.’

The vast majority of terminological models treat terminologies in isolation and are unable to account for the kinds of connections they have with the general language and the practical consequences of these connections for the evolution of terminologies as well as for teaching and learning of terminologies.

We study this problem from the lexicographic perspective using the **theoretical and descriptive** approach of the Explanatory and Combinatorial Lexicology (Mel’čuk, Clas and Polguère 1995; Mel’čuk 2006). This approach has been previously tested by the research group Observatoire de linguistique Sens-Texte¹⁰ (OLST) at the University of Montreal to study computer science and environment terminologies (L’Homme 2002, 2007).¹¹

In order to model fundamental chemical terminology, we explore a new approach to the structuring of lexicons based on non-taxonomic multidimensional graph structures called *Lexical Systems* (Polguère 2009, 2014). A Lexical System is a “disambiguated” graph where each node represents one well-specified meaning, i.e. one lexical unit, be it a lexeme or an idiom. Edges of a Lexical System are semantic and combinatorial lexical relations that are modeled by means of lexical functions borrowed from the Meaning-Text theory (an exhaustive presentation of the notion of lexical functions can be found in Mel’čuk and Polguère (2021); see also Chapter 4, 4.2.3).

Lexical functions are a formal tool conceived on the basis of mathematical function models to describe lexical relations.

¹⁰Meaning-Text Linguistics Observatory

¹¹<http://olst.ling.umontreal.ca/cgi-bin/dicoinfo/search.cgi>, <http://olst.ling.umontreal.ca/cgi-bin/dicoenviro/search.cgi>

Paradigmatic lexical functions model paradigmatic relations between lexical units of the language; they deal with semantic derivations (Polguère and Mel'čuk 2006), such as **Syn**, **Anti**, **S₀**, **V₀**, e.g. $S_0(\text{react } \mathbf{1.1d}) = \text{reaction } \mathbf{1.1d}$, $V_0(\text{reaction } \mathbf{1.1d}) = \text{react } \mathbf{1.1d}$.¹²

Syntagmatic lexical functions model syntagmatic relations between collocates and bases of collocations, e.g. $\text{Magn}(\text{react } \mathbf{1.1d}) = \text{strongly , violently , vigorously , actively}$.¹³

Lexical Systems are essentially structured by means of lexical functions, although there are other types of relations being implemented, such as semantic embeddings encoded through lexicographic definitions, copolysemy links between senses of the same vocable, grammatical characteristics, citations from corpora and other types of information attributed to each lexical unit under study (see Chapter 4).

The lexicographic work in the framework of the Lexical Systems approach consists in graph weaving rather than text writing. For the purposes of our study, we are weaving the fundamental terminological network of chemistry embedded in the general language networks, namely the *English*, *French* and *Russian Lexical Networks* (*en-LN*, *fr-LN*, *ru-LN*). We perform the lexicographic work using a graph editor *Dicet* (Gader, Lux-Pogodalla and Polguère 2012) and a tool for lexical data visualization and navigation called *Spiderlex* (Gader, Ollinger and Polguère 2014; Ollinger *et al.* 2020).

1.5 Objectives

On the theoretical, or lexicological, level (Part I of the thesis), the research aims to provide a solution to the problem of formal and rigorous modeling of the multidimensionality inherent in the organization of terminologies (Bowker 1997), i.e. the fact that terms can be apprehended and terminologies can be navigated fol-

¹²**Syn** and **Anti** are lexical functions that link synonyms and antonyms of a language respectively. **S₀** is a lexical function that links a verbal, adjectival or adverbial lexical unit to its nominal counterpart. Conversely, **V₀** is a lexical function that links a nominal, adjectival or adverbial lexical unit to its verbal counterpart (Polguère 2016b).

¹³**Magn** is a lexical function that links a lexical unit to its syntactic modifiers expressing the general meaning ‘intense’, ‘very’, etc.

lowing multiple axes. In a related way, the research aims to account for the interdependence between the general language lexicon and the terminological lexicon.

On the descriptive, or lexicographic, level (Part II of the thesis), we aim to model the fundamental terminology of chemistry for the three typologically distinct languages: English, French and Russian. In particular, we focus on the elaboration of a rigorous system of definitions (Chapter 4, 4.2.2) of chemical terms. Our lexical models, designed to evolve and be enriched in the long term, can serve as practical tools for scientists as well as for teachers and students of chemistry.

The research is intended to have an impact not only in the field of lexicology and terminology, but also on the chemistry community. The possibility to access a multilingual resource on the lexicon of chemistry, navigating through this lexicon thanks to the various connections between terms, the information on their behaviour in texts and examples of their usage in scientific publications, will allow the implementation of new pedagogical tools for chemistry teachers and may stimulate the development of new strategies on teaching the discipline and the elaboration of innovative methodologies.

1.6 Methodology

Our interdisciplinary research adopts a multilingual perspective and is based on the formal lexicographic approach of Lexical Systems, following the principles of Explanatory and Combinatorial Lexicology (1.4).

The stages of our research are listed in 1.6.1. In 1.6.2 we describe the methodology elaborated for building our linguistic corpora. In 1.6.3 we deal with establishing nomenclatures of the fundamental terms related to the lexicon of chemistry in the three languages. In 1.6.4 we touch on the descriptive work performed using lexical networks.

1.6.1 Stages of the research

Previously trained in linguistics and lexicography, we were not experienced in chemistry. Therefore, the very first stage of our research was dedicated to gaining knowledge in the field of chemistry through reading introductory textbooks and

scientific publications, studying encyclopaedic and dictionary articles in Russian, English and French, but also through the meetings with the co-supervisor of the project, Professor Ingrosso, who is a theoretical chemist at the laboratory LPCT of the University of Lorraine (1.2).

The goal was to immerse in the discipline in order to get a deeper understanding of the fundamental notions of chemistry and to be able to recognise issues related to the use of chemical terminology. It was at this stage that we noticed numerous problems in existing resources on chemistry, among which were vicious circles in definitions, ambiguous, contradictory or outdated definitions, lack of description of specialized idioms and collocations, and other issues that we will present in Chapter 2.

Along with it, we started elaborating the methodology and principles of building specialized corpora that would meet the goals of our study. In 1.6.2 we present the results of our five-day long internship at the OLST laboratory of the University of Montreal, which was specifically dedicated to elaboration of the specialized corpora design and compilation process policy.

The stage of collecting the linguistic data and building our corpora was followed by the identification of the fundamental terminology of chemistry (1.6.3), which was a precondition for any further descriptive and theoretical study.

As soon as our list of terms was ready, we proceeded with the actual lexicographic work in the three Lexical Networks (1.6.4). Chapter 4 is dedicated to the detailed presentation of the methodology of our practical descriptive work.

At the final stage of the research, we reviewed the results of the lexicographic work done (whose semantic component is given in Part II), analysed and described the identified divergences in terminological structuring between the three languages as well as the existing interactions between specialized and non-specialized lexical units.

1.6.2 Building specialised corpora: design and compilation process policy

1.6.2.1 Preliminary work

A preliminary work was done by the two supervisors of the thesis in the framework of the PEPS STRÉTCH project (Ingrosso and Polguère 2015) in collaboration with two members of the former chemistry laboratory SRSMC. The project led to the construction of the French and English corpora, whose size was significant enough to allow a first estimation of the terminological nomenclatures to be considered and to carry out experiments on the terminographic description of the vocabulary of chemistry.

The STRÉTCH team has chosen the specialized journals that publish scientific articles in all fields of chemistry. *The Journal of the American Chemical Society* and *Chemistry, a European Journal* were the two English journal selected as the most popular ones among chemists. Both journals were accessed and downloaded through the subscriptions of the University of Lorraine. As for the selected French journal, *L'Actualité Chimique*, agreements were made directly with the editorial management.¹⁴ The set of articles – 750 in English and 1,400 in French – provided the STRÉTCH team with two corpora, each of them containing three million word-occurrences.

For the purposes of our study, we needed to extend these corpora, so we started to develop a design and compilation process policy for building corpora in collaboration with Patrick Drouin, the then head of the OLST laboratory.

Following the classification of Pearson (1998), we were seeking for *special purpose, comparable, full text* corpora, the specific purpose being, in our case, the linguistic analysis of the core terminology of chemistry and of its interaction with the general language lexicon.

As opposed to *parallel* corpora, *comparable* means that corpora can be made of different languages (English, French and Russian), but the compilation process and the general composition must be shared.

As opposed to *sample* corpora, *full text* corpora means that we wanted them

¹⁴The STRÉTCH team is grateful to Mrs. S. Bléneau.

to consist not of short extracts but of complete unabridged texts, such as scientific articles, journals, textbooks, etc.

1.6.2.2 Data storage

It was decided to exploit the Document Management Systems (DMS) such as *OpenKM*,¹⁵ instead of storing hundreds of files in simple folders. One of the advantages of *OpenKM* is that it is freely accessible and web-based allowing to store, retrieve and update the data from remote locations. Its other advantage is that the metadata and reference can be stored and changed in the DMS according to our needs, so that we can unite and retrieve any type of data, e.g. for building subcorpora. It also has the Document Versioning feature that allows us to eliminate duplications of our files, since the creation of multiple revised versions of a document is done automatically and in a systematic way.

The elaborated process of storing and editing documents in a DMS is illustrated by Figure 1.2. In general, we planned to store three types of files:

- originals;
- converted DOC files;
- converted TXT files.

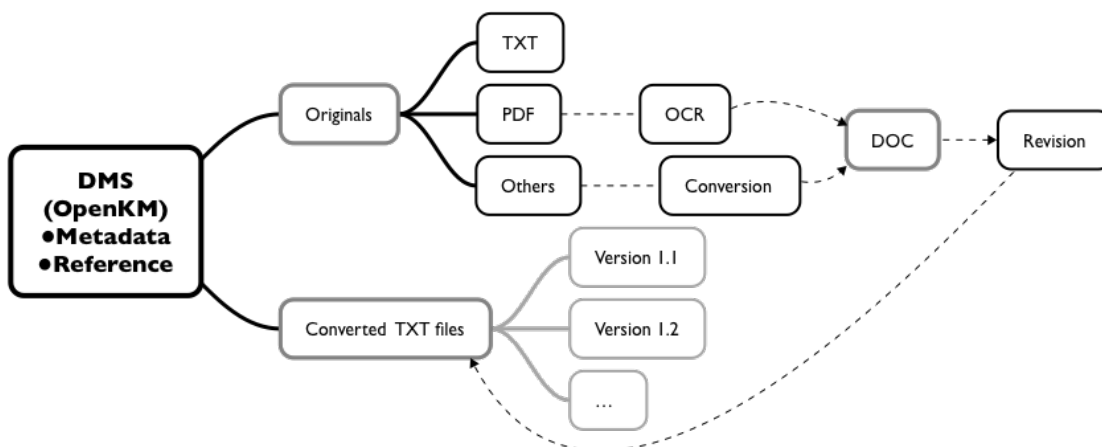

Figure 1.2 – Editing and storing process in a DMS.

¹⁵<https://www.openkm.ca>

If our original is already a TXT file, we store it as well as its revised versions, if needed. If our original is a scanned PDF file, we first extract the text using Optical Character Recognition (OCR). There are several OCR professional software tools such as, for instance, *Tesseract*, *Readiris Pro* or *ABBYY FineReader*. The former one is a free software but, unlike *Readiris Pro* and *ABBYY Finereader*, it only allows the conversion of scanned PDFs directly to TXTs, but not to DOCs. This transitional DOC version might be important for examining tables, pictures or graphics after the conversion of PDF files.

As soon as the OCR is done, all the files are revised manually and/or by means of grammar and spelling checkers, so that all probable mistakes or broken lines are detected and corrected.

If our original file does not require the OCR, we use a free software *Apache Tika* to extract text and convert any type of text files first to DOC and then to TXT formats.

Bibliographic references are stored as metadata in BibTex generic citation style, e.g.:

```
@book{BowkerPearson_2002,  
  Author={Bowker, L. and Pearson, J.},  
  Title={Working with Specialized Language. A Practical Guide to Using Cor-  
  pora},  
  Publisher={Routledge},  
  Place={London},  
  Year={2002}}.
```

1.6.2.3 Text selection criteria

The very first decisions to be made concerned the corpus size and the period of time that our corpus should cover.

Since there is no complete agreement on how big a special purpose corpus should be (Morin *et al.* 2007: 664), the size is something to be decided on by the team of lexicographers at the outset. Taking into account the needs of our project, availability of data and amount of time we had, we wanted our special purpose

corpus to contain between one and five million words for each language. The representativeness of the corpus should be constantly revised by its actual users in the course of linguistic analysis, and the corpus should grow on a continuing basis.

As regards the period of time, we aimed for the material being less than twenty years old, which means we were only looking for the texts written and published after 2000. This is due to our intention to study chemistry lexicon in its current state both at conceptual and linguistic level.

In order to make our corpus calibrated and representative of the subject in question, we have devised a set of criteria presented below. Following the recommendation in Pearson (1998) and Bowker and Pearson (2002), we combined two categories of criteria for text selection: the external and internal criteria.

Audience	Semi-experts and experts
Author	Subject-field experts
Mode	Published written texts
Genre	Textbooks 35%, research papers 35%, standards and reports 20%, instructional texts 10%

Table 1.1 – Outline of the external – non-linguistic – criteria.

Table 1.1 represents the external – non-linguistic – criteria. The target audience was a starting point of our reflection, since the choices made at this level affect most of the other criteria. In our case, the target audience of the texts should consist of

- semi-experts, i.e. chemistry students at universities or colleges; pupils studying chemistry at school; trainees;
- experts, i.e. professionals working in the field of chemistry.

We looked for the texts written by experts, namely chemistry researchers, professors and teachers at universities and schools.

We were only concerned with written published texts (including online publications) and did not include any spoken transcriptions in our corpus. We expected

the purpose of the texts to be either information, or recommendation, or recreation, or discussion, therefore, it has been decided to include four different types of texts in our corpus, namely research papers (e.g. articles in scientific journals), textbooks and manuals, international standards and reports, and instructional texts (e.g. to conduct chemistry experiments). We decided to calibrate our corpus according to the target audience and the goal of the project. The needed percentage of each text genre is indicated in Table 1.1.

Further, we also relied on the three internal, or linguistic, criteria shown in Table 1.2.

Topics	General, or introductory, chemistry; main subdomains of chemistry (analytical, biological, inorganic, organic, physical, polymer chemistry)
Style	Formal
Language	Written by native speakers 85%, by non-native speakers 15%

Table 1.2 – Outline of the internal – linguistic – criteria.

Since the goal of our research was the linguistic analysis of the fundamental chemical terminology, we needed to have a collection of texts on the so-called general, or introductory, chemistry and/or from different subdomains of chemistry listed in Table 1.2.

At the first stage, texts written in informal style for general public had to be avoided. We were looking for texts written in formal style to be included in our corpus. At the same time, we had to avoid extremely technical texts and privilege those where chemistry terms merge with the general language lexicon.

The preference was given to the texts written by native speakers. We expected though to find a significant amount of texts written in English by non-native speakers, since English is the international language of scientific publication. We proposed to limit the number of such texts in our corpus to 15% and, ideally, ensure proofreading them by native speakers.

1.6.2.4 Adjustments made in the course of the study

Due to the constraints imposed by the pandemic Covid-19,¹⁶ which started halfway through our research and affected the flow of the study, we were not able to fully implement the developed methodology in collaboration with the OLST team. A scheduled two-month long internship at the OLST laboratory, which was supposed to be dedicated to the actual building of corpora, has been postponed several times and then canceled due to travel restrictions.¹⁷

The schedule of the research and the workflow had to be adjusted to the constantly changing conditions. The design and compilation policy described in 1.6.2 underwent some changes as well. We tried several different solutions, namely, we tested first the integration of the part of our English specialized corpora into *Frantext*,¹⁸ a general language database developed at the ATILF laboratory. We appreciated the support of the ATILF research engineers who helped us construct our sub-corpus on the basis of six textbooks on introductory and general chemistry, using a software *Allegro*, developed at the laboratory first as a simple concordancer and then transformed into a platform for building up corpora and exploiting textual data (Petitjean *et al.* 2019). Our texts were integrated and labeled with the tool *TreeTagger*; our metadata adopted to the *Frantext* format included:

<Author>, *<Title>*, *<Date of the file generation>*, *<Number of pages>*,
<Type of the document>, *<Language>*, *<Level of studies>*, *<Editor>*, *<Type
of license>*, *<Link to the source>*, *<Key words>*.

In parallel with that, for the three corpora in English, French and Russian, we have been using a freeware *AntConc*, which is a corpus analysis toolkit for concordancing and text analysis.¹⁹

¹⁶Including restricted access to research laboratories in France and closure of research laboratories at the University of Montreal for months, inability to meet with experts in chemistry for consultations, closed borders causing the cancelation of internships, etc.

¹⁷We are grateful to the University of Lorraine and the LUE initiative (DrEAM) for having awarded us a scholarship in case the internship could take place.

¹⁸<https://www.frantext.fr/>

¹⁹<https://www.laurenceanthony.net/software/antconc/>

Finally, we have been regularly consulting and exploiting the data of the following corpora:

- *Corpus of Contemporary American English (COCA)*;²⁰
- *Frantext*'s integral corpus;
- *Russian National Corpus*;²¹
- *SketchEngine* (for the three languages).²²

1.6.3 Establishing nomenclatures of core chemical terms

We followed three steps for establishing our nomenclatures of the fundamental terms related to the lexicon of chemistry.

First, we examined the results of the preliminary research project PEPS STRÉTCH (1.2), namely the list of the retrieved English terms based on their frequency of occurrence in the corpora built in the framework of this project. Among the most frequently occurring terms, there were the following basic chemical terms (Table 1.3).

lemma	frequency
reaction	5560
bond	2866
molecule	2500
compound	2422
product	2055
interaction	1974
mixture	1719
atom	1671
electron	1552

Table 1.3 – Some of the most frequently occurring chemical terms (PEPS STRÉTCH project).

Second, we processed the textual data of our own corpora using *TermoStat*, a software tool for term extraction (Drouin 2003) developed by P. Drouin at the University of Montreal.²³ We compared our results with the results of the

²⁰<https://www.english-corpora.org/coca/>

²¹<https://ruscorpora.ru/>

²²<https://www.sketchengine.eu/>

²³<http://termostat.ling.umontreal.ca/>

PEPS STRÉTCH project and created a list of about twenty terms that were shared on all frequency lists.

Finally, in the course of the actual lexicographic description of chemistry terms, we expanded our nomenclatures up to 102-107 units in each language, 312 lexical units in total. Following the *Semantic Decomposition Principle* while writing lexicographic definitions (see Chapter 4, 4.2.2.3), we inevitably encountered new terms that needed to be treated. The list also expanded through lexical connections established between terms. For instance, the very first term that we analyzed was *reaction I.1d*, apparently one of the most frequently used chemical terms. After we did the semantic decomposition of its meaning, we had to add on our list and describe the following terms: *substance I.1b*, *chemical change*, *transformation II.1*. Then, through establishing lexical connections with *reaction I.1d*, we enriched our list with *react I.1d*, *reactant*, *reagent*, *reactive I.1d*, *reactor I.2*, *product I.3*, *elementary reaction*, etc. In such a way, taking as a starting point one term, we expanded our list with at least ten additional terms.

In Part II (Chapter 8, 8.2), we present a list of vocables where at least one of the senses belongs to the fundamental lexicon of chemistry. The set of such senses forms our chemical nomenclature. As it will be shown in Chapters 3-6, our nomenclatures mostly include chemical terms, but also certain terms originating from the field of physics, e.g. *electric charge*, *matter I.a*, as well as some general language lexical units, e.g. *macroscopic I*, *microscopic II.a*, etc.

1.6.4 Lexical Networks for terminological modeling

In compliance with the theoretical and **descriptive** lexicology approach, the lexicographic component is an integral part of our research.

We carried out the practical descriptive work in a comparative manner – for the three languages taken into account – in order to identify 1) the divergences in terminological structuring between English, French and Russian, and 2) the divergences in the interconnection between terminology and general language.

Intensive exploitation has been made of the *English* and *French Lexical Networks* developed at the ATILF laboratory as well as of the *Russian Lexical Network*

developed in collaboration with the CREE laboratory of INaLCO (Krylosova 2016).

In the course of our study, we enriched these resources with data on English, French, and Russian chemistry terminologies. Lexicographic treatment of our specialized lexical units included the description of the following properties:

- grammatical characteristics;
- semantics (= definition);
- paradigmatic and syntagmatic connections;
- relations with other lexical units within the same vocable;
- examples of use.

The methodology of the lexicographic modeling of terms performed within the *Lexical Networks* will be discussed in detail in Chapter 4. The semantic (the central) component of our terminographic descriptions will be presented in Part II.

1.7 Organisation of the thesis

The thesis consists of eight chapters, including the general introduction to the research. The following chapters are divided into two main parts. Part I is dedicated to the lexicological study; Part II presents the central part of the terminographic descriptions performed for the three languages.

In Part I, Chapter 2, we start with an introduction to the current state of terminological resources on chemistry for the English, French and Russian languages. We give a brief overview of already existing chemical dictionaries and vocabularies and the most significant issues detected in these resources.

In Chapter 3, we characterize the discipline of chemistry and the chemical industry. We take a look at the evolution of the chemical nomenclatures and identify some challenging factors in teaching the discipline and its language. Further, we analyze what is understood by *chemistry*, *chimie* and *химия* in English, French and Russian respectively.

Chapter 4 presents the methodology of the lexicographic descriptions of chemical terms performed in the framework of the theoretical and descriptive approach of the Explanatory and Combinatorial Lexicology and that of the Lexical Systems.

We describe types of linguistic information encoded in the Lexical Systems and our principles of writing lexicographic definitions which represent the central part of our descriptive work.

In Chapter 5, we propose and discuss an extensive example of such lexicographic modeling of three core terms related to the lexicon of chemistry, namely *matter 1.a*, *substance 1.1b* and *atom 1.2* as well as their counterparts in French and Russian.

Chapter 6 demonstrates how we dealt with complex cases like *element*, the central and yet probably the most debated term of the chemical lexicon that needed to be studied in depth, with special attention to the historical development of the notion and all the issues and misconceptions associated with it.

In Chapter 7 we summarize on the solutions that we propose to the issues detected in Chapter 2 and draw our conclusions on the observed interactions between specialized and non-specialized lexical units both on paradigmatic and syntagmatic levels as well as on the discrepancies between English, French and Russian chemical terminologies, discovered in the course of the lexicographic modeling in the three *Lexical Networks*.

In Part II, Chapter 8, we provide the list of English, French and Russian vocables with at least one of the senses belonging to the fundamental lexicon of chemistry. The set of such senses forms our chemical nomenclature. Further, we present the centerpiece of our study, i.e. the system of formal definitions elaborated for the lexical units belonging to the core lexicon of chemistry. Each definition is followed by a short illustrative example for an easier perception of the analysed meanings.

In the end, we propose an index of important notions discussed or mentioned in the thesis.

PART I: LEXICOLOGICAL STUDY

Chapter 2

State of the question

SUMMARY

2.1	Introduction	34
2.2	Overview of terminological resources on chemistry	34
2.3	Detected issues	37
2.3.1	Minimal linguistic information approach	37
2.3.2	Definitions	39
2.3.3	Polysemy	41
2.3.4	Phraseology	45
2.4	Recapitulation	48

2.1 Introduction

This chapter provides an introduction to the current state of terminological resources on chemistry for the English, French and Russian languages.

In Section 2.2 we start with a brief overview of existing chemical dictionaries, vocabularies and online databases in our three target languages.

In Section 2.3 we present the most interesting and significant problems which we have detected in these resources and for which we will propose solutions in the following chapters (3–6).

We would like to point out that we are not seeking a complete review of all chemistry resources; we will only name the most relevant and authoritative ones, leaving aside, for instance, numerous editions by universities that tend to publish their own vocabularies as a support for their chemistry courses.

We also leave aside general language dictionaries which include a limited number of terms from different specialized domains, such as biology, chemistry, mathematics, music, psychology, etc. Terminological entries in general language dictionaries are usually prepared in collaboration with consultants, specialists of the domains, but not in a systematic and exhaustive way. All of the problems stated in Section 2.3 concern terminological entries in general language dictionaries as well.

2.2 Overview of terminological resources on chemistry

The most authoritative resource on terminology of chemistry is the *Compendium of Chemical Terminology* also known as the *Gold Book* published by the International Union of Pure and Applied Chemistry (McNaught 1997). The IUPAC *Gold Book* website¹ relaunched in July 2019 represents an expanded collection of 7,000 definitions taken from the IUPAC recommendations previously published in the journal *Pure and Applied Chemistry* and in the IUPAC “Colour” Books.

The IUPAC *Compendium* has been translated into French by Jean-Claude Richer and published in the form of a printed dictionary *Compendium de terminologie chimique. Recommandations IUPAC* (Richer 1999). All entries include

¹<https://goldbook.iupac.org/pages/about>

indications on corresponding English terms and definitions in French which are translations of the original English definitions.

For its part, the Russian edition called *Номенклатурные правила ИЮПАК по химии*² (Golubkova 1993) keeps the original definitions in English accompanied by corresponding Russian terms.

Figure 2.1 illustrates differences in the three IUPAC editions based on the example of **En.** ION, **Fr.** ION and **Ru.** ИОН.

IUPAC <i>Compendium of Chemical Terminology</i>	<p>ion An atomic or molecular particle having a net electric charge.</p> <p>Source: PAC, 1982, 54, 1533 (<i>Glossary of terms used in nuclear analytical chemistry (Provisional)</i>) on page 1545</p>
French edition <i>Compendium de terminologie chimique. Recommandations IUPAC</i>	<p>ion n. m. ion <i>Particule atomique ou moléculaire porteuse d'une charge électrique totale non nulle.</i> 1982, 54, 1645 CTC 1993</p>
Russian edition <i>Номенклатурные правила ИЮПАК по химии</i>	<p>ИОН. Ион. An atomic or molecular particle having a net electric charge. 1982, 54, (1545)</p>

Figure 2.1 – Extracts from three editions of the IUPAC *Compendium of Chemical Terminology*: entries **En.** ION, **Fr.** ION, and **Ru.** ИОН.

The Oxford *Dictionary of Chemistry*³ is another authoritative resource aimed at teachers and students of chemistry. The eighth edition of the dictionary, with over 5,000 English terms and their definitions, is claimed to cover all aspects of chemistry from physical chemistry to biochemistry (Law and Rennie 2020).

As for the French chemical terminology, one of the main references along with the IUPAC *Compendium* is the *Vocabulaire de la chimie et des matériaux*⁴ published in 2018 by Délégation générale à la langue française et aux langues de France⁵. The *Vocabulaire* is a compilation of 582 chemical terms and their definitions validated by the Académie française and the Commission d'enrichissement

²IUPAC nomenclature rules for chemistry

³<https://www.oxfordreference.com/view/10.1093/acref/9780199204632.001.0001/acref-9780199204632>

⁴Vocabulary of chemistry and materials, https://www.academie-francaise.fr/sites/academie-francaise.fr/files/chimie_2018.pdf

⁵General delegation for the French language and languages of France.

de la langue française.⁶ The *Vocabulaire* has been previously published in parts in the *Journal officiel* of the French republic and is accessible online through the website *FranceTerme*⁷ of the French Ministry of Culture.

Another important and widely used French dictionary on chemistry is the *Dictionnaire de chimie* edited by Pierre de Menten (de Menten de Horne 2013). The dictionary is intended to provide scientists, teachers and students with the linguistic and historical information on 1,560 chemistry terms.

*Lexique de terminologie chimique français-anglais/anglais-français*⁸ is a bilingual vocabulary by Jean-Claude Richer which covers 160,000 chemical terms in two languages (Richer 2012).

Along with the English-Russian IUPAC nomenclature, *Химия. Большой энциклопедический словарь*⁹ (Knunjanec 1998) edited by Ivan Knunyants is one of the reference sources on Russian chemical terminology. This edition is an updated dictionary version of the famous *Химическая энциклопедия*¹⁰ by Ivan Knunyants and Nikolay Zefirov which covers 5,524 chemical terms (Knunjanec and Zefirov 1988–1998).

A bilingual vocabulary *Англо-русский химический словарь*¹¹ by Mukattis Gazizov provides a list of 45,000 terms and phrases translated from English to Russian (Gazizov 2010). *Словарь химических терминов*¹² by Evdoščenko *et al.* covers 20,000 Russian terms and their definitions with short indications on English corresponding terms (Evdoščenko, Dubchinskij and Gajvoronskaja 2006).

⁶French academy and Committee for the enrichment of the French language

⁷<http://www.culture.fr/franceterme>

⁸French-English/English-French lexicon of chemical terminology

⁹Chemistry. The Great Encyclopedic Dictionary

¹⁰Chemical encyclopaedia, <http://www.cnsnb.ru/AKDiL/0048/default.shtm>

¹¹English-Russian chemical dictionary

¹²Dictionary of chemical terms

2.3 Detected issues

In this section we discuss the most significant and interesting issues detected in the terminological resources on chemistry mentioned in Section 2.2. Overall, we have identified four main areas of concern:

- minimal linguistic information approach (2.3.1);
- definitions (2.3.2);
- polysemy (2.3.3);
- phraseology (idioms and collocations) (2.3.4).

In what follows we state problems and give illustrative examples from the terminological resources in the three languages. Our solutions to these problems will be discussed in detail in Chapter 4 and Chapter 7, Section 7.2.

2.3.1 Minimal linguistic information approach

The main reference resources such as IUPAC *Compendium* or Oxford *Dictionary of Chemistry* are monolingual being devoted to the English chemical terminology. The information on linguistic properties of terms is minimal in their entries with the main focus on definitions.

Figure 2.2 shows an entry ION taken from the Oxford *Dictionary of Chemistry*. The definition is given in the form of a short encyclopaedic summary mentioning two types of ions (CATION and ANION). At the end of the entry we find a cross-reference to the derivative IONIZATION. The kinds of relations between ION, IONIZATION, CATION and ANION are not named explicitly.

ion An atom or group of atoms that has either lost one or more electrons, making it positively charged (a cation), or gained one or more electrons, making it negatively charged (an anion).
See *also* IONIZATION

Figure 2.2 – Entry **En.** ION in the Oxford *Dictionary of Chemistry*.

As we have seen on Figure 2.1 in Section 2.2, the IUPAC *Compendium* provides its users with even less information. IUPAC entry for ION in English only

includes a definition and a references source. Until 2019 when the IUPAC *Gold Book* website was updated and relaunched, most entries used to have a feature called “Interactive Link Map”. Users got access to a hierarchy of terms like the one shown on Figure 2.3.¹³

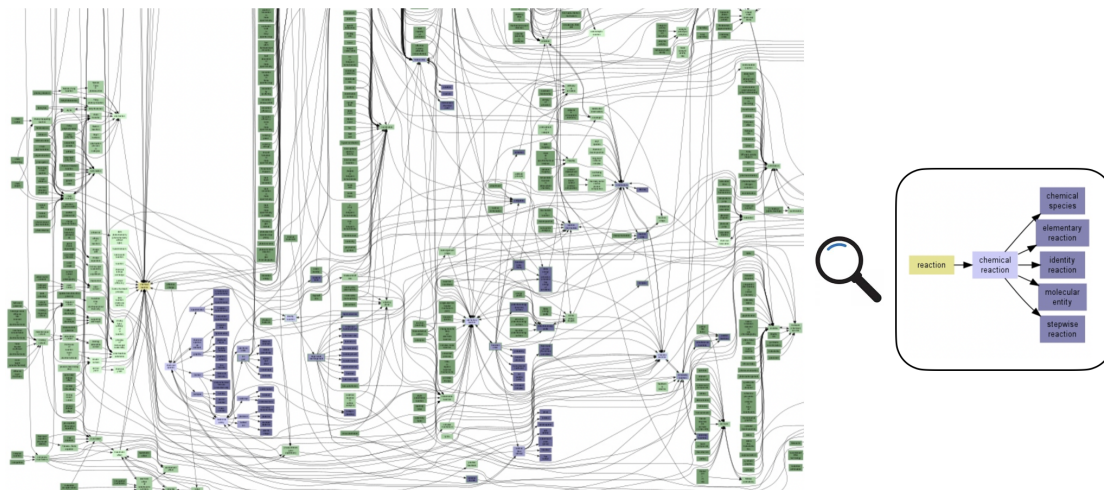

Figure 2.3 – “Interactive Link Map”, a former feature on the IUPAC *Gold Book* website.

Unfortunately, it was hardly possible to navigate through the “Interactive Link Maps” without any user guide. Looking at connections around the term CHEMICAL REACTION we see terms such as ELEMENTARY REACTION, STEPWISE REACTION, CHEMICAL SPECIES and MOLECULAR ENTITY. No explanation was given to the users on the kind of relations between these terms. Comparing the map to the actual definitions – or rather encyclopaedic summaries – we assume that the map used to represent a media-structure of the *Gold Book* resource showing all cross-references within its entries. At the present time, this feature is no longer available on the website.

The French and Russian editions of the IUPAC *Compendium* as well as dictionaries such as *Vocabulaire de la chimie et des matériaux* (FranceTerme), *Dictionnaire de chimie* by Menten and *Словарь химических терминов* by Evdoščenko *et al.* also have their main focus on definitions and are dedicated to chemical terminology in one particular language, but almost all their entries are provided with indications on corresponding terms in other languages (English, German, or Russian).

¹³The screenshot was made in July 2018. We apologize for its poor quality that cannot be improved, since the “Interactive Link Map” feature is no more available on the IUPAC website.

As for bilingual vocabularies, most of them propose lists of term-to-term translations with no definitions, no description of the linguistic behavior of terms, no indications on relations between terms, see extracts in Figure 2.4. In the case of *Lexique de terminologie chimique français-anglais/anglais-français* by Richer, French terms are followed by indications on part of speech, gender and corresponding terms in English. A bilingual vocabulary *Англо-русский химический словарь* by Gazizov has a similar structure with English terms followed by Russian equivalents.

Fr. : En.	En. : Ru.
liage n. m. : mixing	rarefaction разрежение; разведение
liais n. m. : liais	rarefiable разрежаемый
liaison n. f. : bond	rarefied разреженный
	rarefy разрежать
	rate скорость

Figure 2.4 – Extracts from Richer (2012) on the left and from Gazizov (2010) on the right.

From what we can observe, specialized dictionaries give minimal linguistic information on chemical terms. The linguistic behaviour of terms is not outlined; the description of relations between terms is limited to occasional indications on synonyms and antonyms. **Neither of the resources previously mentioned propose any examples of use of chemical terms in scientific contexts.**

2.3.2 Definitions

A problem common both to specialized and general language dictionaries is vicious circles in definitions. Figure 2.5 shows three extracts from the IUPAC *Gold Book* website where ATOM is defined through CHEMICAL ELEMENT and NUCLEUS while CHEMICAL ELEMENT and NUCLEUS are defined through ATOM.

Erroneous and misleading definitions is another problem detected in lexicographic resources on chemistry. In the IUPAC definition of ATOM (Figure 2.5), it is not specified to which sense of CHEMICAL ELEMENT it is pointing. Taking a closer look at this definition we realize that it is referring to the second sense – ‘a pure chemical substance’, so the definition of ATOM should read ‘smallest particle still characterizing a substance’. The reference to this obsolete sense of

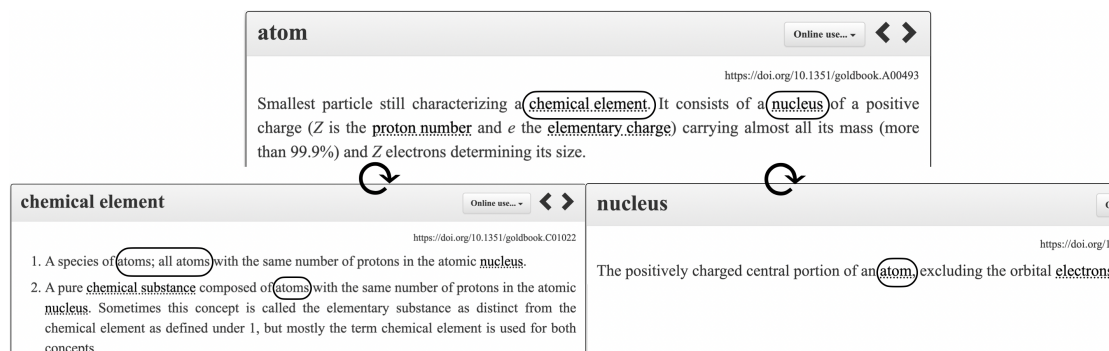

Figure 2.5 – Entries **En.** ATOM, CHEMICAL ELEMENT and NUCLEUS on the IUPAC *Gold Book* website.

CHEMICAL ELEMENT is misleading because elements should not be regarded as entities; ELEMENT denotes something much more abstract: **type** of atoms, the ones we find in the Periodic Table of Elements (see Chapter 6).

Oxford *Dictionary of Chemistry* also provides their users with similar misleading definitions. Again, looking at the definitions of ATOM and of ELEMENT in Figure 2.6, one might conclude that elements are simple substances and atoms are their smallest parts. Following the logic of such definitions, it turns out that the Periodic Table is a table of simple substances which would be a completely wrong understanding. The Periodic Table does not list tangible entities like simple substances but is a systematic representation of different **types** of atoms. See a detailed discussion on the notion of *element* in Chapter 6.

atom The smallest part of an element that can exist chemically. Atoms consist of a small dense nucleus of protons and neutrons surrounded by moving electrons. The number of electrons equals the number of protons so the overall charge is zero. The electrons are considered to move in circular or elliptical orbits (see BOHR THEORY) or, more accurately, in regions of space around the nucleus (see ORBITAL).

element A substance that cannot be decomposed into simpler substances. In an element, all the atoms have the same number of protons or electrons, although the number of neutrons may vary. There are 92 naturally occurring elements. See also PERIODIC TABLE; TRANSURANIC ELEMENTS; TRANSACTINIDE ELEMENTS.

periodic table A table of elements arranged in order of increasing proton number to show the similarities of chemical elements with related electronic configurations.

Figure 2.6 – Extracts from the Oxford *Dictionary of Chemistry* (2008).

Definitions of some basic chemical terms are missing in specialized dictionaries, e.g. the Oxford *Dictionary of Chemistry* has no entry for SUBSTANCE which is one of the fundamental chemical terms and which is in the core of many definitions

in this dictionary. The IUPAC *Gold Book* does not define basic terms like COMPOUND, GAS, LIQUID, PARTICLE, SOLID, several specialized senses of CHEMISTRY (see Chapter 3, Section 3.4), etc. An important number of fundamental French terms is missing in the *Vocabulaire de la chimie* (FranceTerme), e.g. ALLOTROPES, ATOME, COMPOSÉ ‘compound’, ÉLECTRON, ÉLÉMENT, ION, ISOTOPES, LIAISON ‘bond’, MÉLANGE ‘mixture’, MOLÉCULE, RÉACTION, SUBSTANCE and many others. We will see more examples in Subsection 2.3.4.

Finally, specialized dictionaries tend to define nominal lexical units but not verbs, adjectives or adverbs. For instance, it is not clear from the Oxford definition of ATOM (Figure 2.6) what is meant by “can exist **chemically**”, and the polysemous adverb CHEMICALLY has no entry within this dictionary. Or, we can find nominal lexical units like ION and IONIZATION in the IUPAC and Oxford dictionaries, but the description of the derivative verbal and adjectival lexical units is missing in both dictionaries, namely at least two specialized senses of IONIZE, two specialized senses of IONIC and the adjective IONIZED; see more on this case in Subsection 2.3.3.

2.3.3 Polysemy

In most specialized dictionaries, polysemous vocables with several specialized senses are either described as if they were monosemous or they are not treated at all. Let us consider some examples.

As mentioned in Subsection 2.3.2, IONIZE should be represented as a polysemous vocable (see Part II, p. 179) with at least two specialized verbal lexical units, namely IONIZE **a** which means ‘particle X undergoes a transformation to become an ion’, as in (1a), and the causative IONIZE **b** which means ‘fact Y causes that a particle X ionizes **a**’, as in (1b).

- (1) a. *Calcium atom **ionizes a** by losing two electrons.*
 Post-JAMB Exam Guidelines, <https://www.academia.edu/>, 24/07/2022
- b. *In the atmosphere above about 70 km, ultraviolet radiation from the sun **ionizes b** molecules generating free electrons, which remain unattached for considerable time because of the low density of the atoms.*
 BERTONI Henry L., Radio Propagation, 2003

The same applies to IONIC which should be represented as a polysemous vocable (see Part II. p. 179) with two specialized adjectival lexical units, IONIC 1 ‘X relating to ions’ and IONIC 2 ‘X such that it is made of ions’, see (2a-c).

- (2) a. *The negative **ionic 1** charge of OH^- is 1.*
Sincero A. P., Sincero G. A., Physical-Chemical Treatment of Water and Wastewater, 2022
- b. *Although they consist of positively and negatively charged ions, **ionic 2** compounds are electrically neutral, because the charges are always equal and opposite.*
Web, <https://www.chemicool.com/>, 24/07/2022
- c. *There is a strong correlation between **ionic 1** size and the melting point of an **ionic 2** compound.*
Moore et al., ChemPRIME, <https://chem.libretexts.org/>

IONIZE and IONIC are examples of polysemous vocables that are not treated at all in specialized resources on chemistry such as the IUPAC or Oxford dictionaries. Now let us consider the case when a lexicographic entry is present in a dictionary but the polysemy is not taken into account.

Figure 2.7 shows two entries for **Fr.** RÉACTIF_(N) ‘reactant; reagent’ taken from the *Dictionnaire de chimie* by Menten (on the left) and from the *Vocabulaire de la chimie et des matériaux* (*FranceTerme*) (on the right).

RÉACTIF n. m.
 ⚗ Substance qui réagit; avec éventuellement l'idée que la réaction soit indicatrice de la présence d'un autre réactif (démarche analytique).
Angl. reagent

459. réactif, n.m.
 ♦ **Domaine** : CHIMIE. ♦ **Définition** : Substance introduite pour prendre part à une réaction chimique. ♦ **Note** : **1.** Le réactif n'est pas obligatoirement l'entité réagissante ; ainsi, dans la nitration du benzène, HNO_3 est le réactif et le cation NO_2^+ l'entité réagissante. **2.** Le terme « réactif » s'emploie également comme adjectif pour indiquer une plus ou moins grande aptitude à participer à une réaction. ♦ **Voir aussi** : entité réagissante. ♦ **Équivalent étranger** : reactive (adj.), reagent.
 Source : *Journal officiel* du 18 avril 2001.

Figure 2.7 – Entries for **Fr.** RÉACTIF_(N) in the *Dictionnaire de chimie* by Menten and in the *Vocabulaire de la chimie et des matériaux* (*FranceTerme*).

It is worth noting that the two dictionaries have relatively rich microstructures. The *Dictionnaire de chimie* describes history of terms and concepts, gives definitions, French synonyms (when relevant), German and English corresponding terms. Since we would like to focus on the definition and an English equivalent

of RÉACTIF_(N), we only present in Figure 2.7 an extract of its long entry and skip the historical and etymological overview.

A typical entry of the *Vocabulaire de la chimie et des matériaux* usually includes an indication on chemistry subdomain, a definition, a note, an English equivalent and a reference source; some entries have cross-references to antonyms, synonyms and other paradigmatically-related terms.

That being said, let us consider the case of RÉACTIF_(N). Examples (3a) and (4a-b) illustrate two different senses of RÉACTIF_(N). In (3a) RÉACTIF_(N) **1** roughly means ‘substance that reacts and that is consumed at the end of a chemical reaction’. As the example (3a) shows, *réactif* in this sense is contrasted to the term *produit* ‘substance that is formed at the end of a chemical reaction’. RÉACTIF_(N) **1** has a less frequently used synonym attested since 1980 – RÉACTANT_(N), see (3b). A corresponding English term of RÉACTIF_(N) **1** and RÉACTANT_(N) is REACTANT.

- (3) a. *En système fermé, lors d’une réaction chimique, la masse des **réactifs 1** est égale à la masse des produits. Le nombre d’atomes à l’entrée (dans les **réactifs 1**) est aussi égal au nombre d’atomes à la sortie (dans les produits).*

‘In a closed system, during a chemical reaction, the mass of the **reactants** is equal to the mass of the products. The number of atoms at the beginning (in the **reactants**) is also equal to the number of atoms at the end (in the products).’

Web, <https://www.superprof.fr>, 21/07/2022

- b. *L’objectif principal de ce projet est de détecter les **réactants** et produits de réactions à de très basses températures jamais atteintes précédemment pour de telles mesures <...>.*

‘The main objective of this project is to detect **reactants** and reaction products at very low temperatures never previously reached for such measurements.’

Agence National de la Recherche, <https://anr.fr/Projet-ANR-11-BS04-0024>

In (4a-b) RÉACTIF_(N) **2** roughly means ‘substance used by a chemist in order to test another substance’. Such test substances are prepared in chemical laboratories and usually have proper names, e.g. *réactif de Collins* ‘Collins reagent’, *Réactif de Grignard* ‘Grignard reagent’, etc. A corresponding English term of RÉACTIF_(N) **2** is REAGENT.

- (4) a. *Tous les flacons de **réactifs 2** doivent être conservés au froid et n'être sortis qu'au moment du test.*

All **reagent** bottles should be kept cold and only taken out at the time of testing.

LAVEISSIÈRE C., PENCHENIER C., Manuel de lutte contre la maladie du sommeil, 2005

- b. *Je me trompais sans cesse dans mes mesures, et finalement, j'ai cassé un flacon de **réactif 2** Rhésus.*

'I kept getting my measurements wrong, and finally, I broke a vial of Rhesus **reagent**.'

Frantext, TOURNIER Michel, Le Roi des Aulnes, 1970, p. 407

RÉACTIF_(N) should be described as a polysemous vocable (see Part II, p. 214) with two specialized senses, RÉACTIF_(N) **1** 'reactant' and RÉACTIF_(N) **2** 'reagent'. However, it is not the case in the dictionaries known to us.

As shown on Figure 2.7, RÉACTIF_(N) in the *Dictionnaire de chimie* is not treated as a polysemous vocable, and an indication on the English equivalent REAGENT presupposes that authors of the entry are only referring to the second sense of RÉACTIF_(N), i.e. RÉACTIF_(N) **2** 'reagent'. The *Vocabulaire de la chimie et des matériaux* provides us with two definitions, but in fact the numbering **1** and **2** is not an indication on polysemy of RÉACTIF_(N). The first definition refers again to the sense 'reagent' and is followed by an indication on the English equivalent REAGENT. The second definition should be put out to a separate entry, because it concerns an adjective RÉACTIF_(Adj) and is not supposed to be treated in the entry of a noun RÉACTIF_(N).

From what we can observe, polysemous vocables are either treated as monosemous, as in the case of **Fr.** RÉACTIF_(N) 'reactant; reagent', or they are not present in some dictionaries at all, as in the case of **En.** IONIZE and IONIC.

2.3.4 Phraseology

Another issue detected in specialized dictionaries on chemistry is the lack of description of phrasemes, namely of idioms and collocations.

2.3.4.1 Idioms

The fundamental chemical vocabulary contains numerous idioms, e.g. 「ATOMIC NUMBER」, 「CHEMICAL CHANGE」, 「MASS NUMBER」, 「PURE SUBSTANCE」, etc. Let us take a closer look at the latter one.

One of the difficulties that a beginner in chemistry encounters is understanding the difference between types of *substances*, especially between 「*pure substance*」, 「*simple substance*」, *compound* and *mixture*.

Basically, there are two big groups of *substances*:

- 「*pure substances*」 that are individual substances made of one type of atoms or one type of molecules, and whose composition and properties are constant throughout any sample of the substance, e.g. Dioxygen (O₂), Dihydrogen monoxide (H₂O);
- *mixtures* that are combinations of non-bonded substances, each substance keeping its individual chemical properties, e.g. mixture of oil and water.

Then, 「*pure substances*」 can be divided into two subtypes:

- 「*simple substances*」 that are pure substances made of atoms of the same element, e.g. Diamond (C);
- *compounds* that are pure substances made of different elements, e.g. Carbon dioxide (CO₂).

On Figure 2.8 you can find French terms denoting these four types of substances and relations between them which can be described as follows: **Fr.** SUBSTANCE ‘substance’ is a generic term for 「CORPS PUR」 ‘pure substance’ and MÉLANGE ‘mixture’, the latter two being contrastive terms. The two other contrastive terms – 「CORPS SIMPLE」 ‘simple substance’ and 「CORPS COMPOSÉ」 ‘compound’ – are richer synonyms of 「CORPS PUR」 ‘pure substance’.

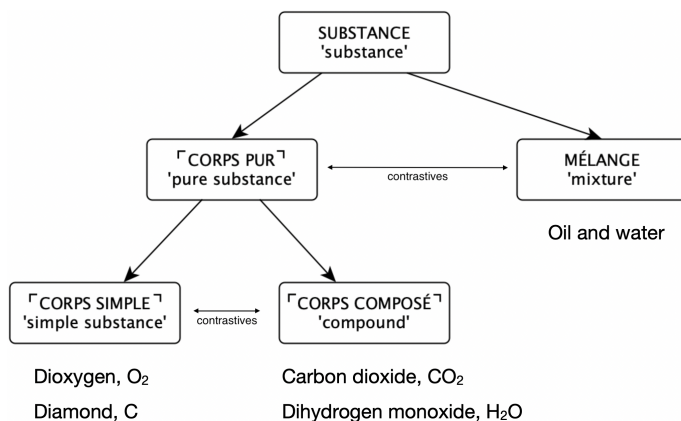

Figure 2.8 – French terms denoting types of chemical substances.

As discussed in Subsection 2.3.2, entries of the fundamental chemical lexemes **En.** SUBSTANCE and **Fr.** SUBSTANCE are missing in certain chemical dictionaries. Now, the idioms **Fr.** 「CORPS PUR」, 「CORPS SIMPLE」, 「CORPS COMPOSÉ」 as well as **En.** 「PURE SUBSTANCE」, 「SIMPLE SUBSTANCE」, 「ELEMENTARY SUBSTANCE」 also are part of the fundamental chemical vocabulary but their entries are missing in most of our reference dictionaries, see Table 2.1.

	<i>IUPAC Compendium of Chemical Terminology (Gold Book)</i>	<i>Oxford Dictionary of Chemistry</i>
En. 「PURE SUBSTANCE」	–	–
En. 「SIMPLE SUBSTANCE」; 「ELEMENTARY SUBSTANCE」	–	–
	<i>Vocabulaire de la chimie et des matériaux (FranceTerme)</i>	<i>Dictionnaire de Chimie (by P. Menten)</i>
Fr. 「CORPS PUR」	–	–
Fr. 「CORPS SIMPLE」	–	+
Fr. 「CORPS COMPOSÉ」	–	–

Table 2.1 – Example of some specialized idioms missing in chemical dictionaries.

2.3.4.2 Combinatorics

Not only the meaning of specialized lexical units (be they idioms or lexemes) is crucial but also information on how to use terms in scientific context. If we take, for instance, a specialized verb REACT **1.1d**, we would want to know its meaning, which is roughly ‘substance(s) X undergo(es) a chemical change, which results in

the transformation of X into one or more substances Y '. In order to be able to use REACT **1.1d** in a sentence, we would also need to know its combinatorial properties.

If we compare several senses of the polysemous vocable REACT, we can see that the government patterns (Mel'čuk 2004a,b) of general language lexemes are X_1 reacts **to** X_2 <...> or X_1 reacts **against** X_2 <...>, while the government pattern of the specialized chemical lexeme is X_1 reacts **with** X_2 to form Y .

- *his pupils reacted to light*
 - *my stomach badly reacts to milk*
 - *people react strongly to criticism*
 - *markets reacted negatively to Brexit*
 - *workers reacted against unfair treatment*
- vs.
- *calcium reacts with oxygen to form calcium oxide*

Talking about X_1 reacting with X_2 , we would need adverbs that take REACT **1.1d** as a base of collocations to express, for instance, the meaning of a strong chemical reaction taking place. Thus, it would be important to know that in English such adverbs are *strongly, violently, vigorously*; in French we can say X_1 réagit fortement/violemment/vigoureusement/vivement avec X_2 pour produire Y , but in Russian we say X_1 реагирует с X_2 сильно/активно/бурно/энергично, превращаясь в Y , see Table 2.2. To our knowledge, there is no such lexicographic resource on chemistry that would provide its users with this kind of information.

En.	Fr.	Ru.
REACT 1.1d	RÉAGIR 1.1d	РЕАГИРОВАТЬ 1.1d
X_1 reacts with X_2 to produce Y	X_1 réagit avec X_2 pour produire Y	X_1 реагирует с X_2 -ом, об- разуя Y
Intensifiers <i>strongly</i> <i>violently</i> <i>vigorously</i>	Intensifiers <i>fortement</i> 'strongly' <i>violemment</i> 'violently' <i>vigoureusement</i> 'vigorously' <i>vivement</i> 'vividly'	Intensifiers <i>сильно</i> 'strongly' <i>активно</i> 'actively' <i>бурно</i> 'widly, roughly' <i>энергично</i> 'energetically'

Table 2.2 – **En.** REACT **1.1d**, **Fr.** RÉAGIR **1.1d**, **Ru.** РЕАГИРОВАТЬ **1.1d**, and their collocates in the three languages.

2.4 Recapitulation

This chapter gave a critical overview of existing terminological resources on chemistry, among which the most authoritative one is the IUPAC *Compendium of Chemical Terminology*.

Most of the analyzed resources provide their users with minimal information on chemical terms. Monolingual dictionaries such as the IUPAC or Oxford dictionaries put the emphasis on definitions in the form of short encyclopaedic entries. Bilingual vocabularies such as *Lexique de terminologie chimique français-anglais/anglais-français* by Richer propose simple lists of term-to-term translations with no definitions, usage notes, nor indications on relations between terms. Both monolingual and bilingual resources do not describe the linguistic behaviour of terms. Examples of use in scientific contexts are not provided. The description of relations between terms is limited to occasional indications on synonyms and antonyms.

A number of issues concerns definitions, among which vicious circles and erroneous or outdated definitions. Specialized dictionaries on chemistry tend to define nominal lexical units but not verbs, adjectives or adverbs. Polysemous vocables are either not present or described as being monosemous. Some of the observed resources are lacking fundamental chemical terms such as **En.** *atom*, **Fr.** *molécule*, *substance*. The description of chemical idioms and collocations is also missing.

Our solutions to identified problems will be discussed in detail in Chapter 4 and Chapter 7, Section 7.2.

Chapter 3

Chemistry and its language

SUMMARY

3.1	Introduction	51
3.2	Conceptual characterization of chemistry	51
3.2.1	Chemistry as a science	51
3.2.2	Defining chemistry	53
3.2.3	Chemical industry	55
3.3	Vocabulary of chemistry	57
3.3.1	Chemical nomenclatures	58
3.3.2	Scientific vocabulary as one of the challenging factors in teaching the discipline	59
3.3.3	Issues of teaching vocabulary of chemistry	60
3.4	Different senses of En. CHEMISTRY, Fr. CHIMIE, Ru. ХИ- МИЯ ¹ and ХИМИЯ ²	65
3.4.1	En. CHEMISTRY	65
3.4.2	Fr. CHIMIE	67
3.4.3	Ru. ХИМИЯ ¹ and ХИМИЯ ²	69
3.4.4	Focus on chemistry-related senses	75
3.5	Recapitulation	77

Language is a major barrier (if not the major barrier)
to most students in learning science.

Wellington J. and Osborne J., *How to deal with
linguistic issues in the chemistry classroom*, 2001, p. 2

To be discussed.

3.1 Introduction

The aim of this chapter is to propose both conceptual and linguistic analyses of chemistry and its language.

We characterize chemistry as a science and the chemical industry in 3.2. Moving to the vocabulary of chemistry in 3.3, we focus on the evolution of chemical nomenclatures and identify challenging factors in teaching the discipline and its vocabulary.

In 3.4 we propose a linguistic analysis of what is understood by **En.** *chemistry*, **Fr.** *chimie* and **Ru.** *химия* in our three target languages. We identify different senses and relations between them for each language separately and then conclude on the discrepancies between the languages.

3.2 Conceptual characterization of chemistry

In 3.2.1 we characterize chemistry as a science and in 3.2.2 we propose our definition of lexical units denoting it. In 3.2.3 we touch on the issue of the chemical industry and its role in the social perception of chemistry.

3.2.1 Chemistry as a science

Modern *chemistry* began in the seventeenth century with the first attempts to apply exact measurements to chemical changes in substances. According to Greenberg (2006: 10), the roots of modern chemistry

[...] included practical chemistry (the mining and purification of metals, the creation of jewelry, pottery, and weaponry), medicinal chemistry (the use of herbs and various preparations made from them), and mystical beliefs (the search for the Philosopher's Stone or the Universal Elixir).

The latter practice is known as *alchemy*, the medieval forerunner of chemistry, concerned with the transmutation of matter¹ (Morris 2003; Haeffner 2004; Kahn 2007; Cobb and Goldwhite 2013).

¹ *Oxford Dictionaries*, <https://www.lexico.com/definition/alchemy>

The transition from alchemy to chemistry was marked by the publication of the book *The Sceptical Chymist: or Chymico-Physical Doubts & Paradoxes* by Robert Boyle in 1661 (Boyle 1661). Boyle brought an experimental scientific method to chemistry, which led, among others, to the new approach in defining elements and compounds (see Chapter 6).

Being grounded in disciplines like physics and mathematics, modern chemistry and the language of chemistry have been in turn involved in sciences like biology, medicine, engineering, geology, and many others. The interconnectedness of chemistry and other sciences led to the emergence of new disciplines, such as nuclear chemistry, geochemistry or cheminformatics. Due to its role in fundamental understanding of related disciplines, chemistry is sometimes called *the central science*, especially after the publication of the introduction textbook to the discipline *Chemistry: The Central Science* by Theodore L. Brown and Eugene LeMay in 1977 (Brown and LeMay 1977).

The main branches of modern chemistry are known to be analytical, biological, inorganic, organic, physical and polymer chemistry.² Although a number of chemical terms is shared by most chemists, chemistry branching resulted in a domain-specific usage of certain terms, as illustrated in (1) and (2). The following definitions are borrowed from the IUPAC *Gold Book*.³

- (1) a. *transformation* in physical organic chemistry:
The conversion of a substrate into a particular product, irrespective of reagents or mechanisms involved.
- b. *transformation* in biotechnology:
A process for genetic alteration of a cell following incorporation of foreign DNA.
- (2) a. *promoter* in physical chemistry:
A relatively small quantity of one or more substances, which when added to a catalyst improves the activity, the selectivity, or the useful lifetime of the catalyst.

²<https://www.acs.org/content/acs/en/careers/college-to-career/areas-of-chemistry.html>

³<https://goldbook.iupac.org>

b. *promoter* in biotechnology:

The DNA region, usually upstream to the coding sequence of a gene or operon, which binds and directs RNA polymerase to the correct transcriptional start site and thus permits the initiation of transcription.

As discussed in Chapter 1, 1.3, we will focus in our study on the analysis and terminological description of the fundamental chemical terms used in the so-called general chemistry, which is taught as an introductory course at the high school and university levels.⁴

3.2.2 Defining chemistry

Introductory textbooks on chemistry tend to define the discipline in the very first chapters, but the definitions are sometimes confusing, as, for example, in the case of the textbooks *Chemistry 2* and *Beginning chemistry*:

[...] you will be learning **chemistry**, the study of the composition, properties, and interactions of matter.⁵

The definition of **chemistry** – the study of the interactions of matter with other matter and with energy – uses some terms that should also be defined.⁶

[bold added]

Chemistry defined this way does not seem to be distinct from *physics*, which is also a science of matter and energy and of interactions between the two; see, for instance, a definition taken from the *Merriam-Webster* dictionary:

physics

a science that deals with matter and energy and their interactions⁷

This confusion often arises from the physical basis of many chemical concepts (Taber 2001: 125). It should be clear from the definitions though that the

⁴https://chem.libretexts.org/Bookshelves/General_Chemistry

⁵<https://openstax.org/books/chemistry-2e/pages/1-1-chemistry-in-context>

⁶https://chem.libretexts.org/Courses/Los_Angeles_Trade_Technical_College/DMA_Chem_51

⁷<https://www.merriam-webster.com/dictionary>

key difference between physics and chemistry is that the latter one deals with **transformations** of matter at the **submicroscopic** level. An indication on it is missing or veiled not only in some textbooks' definitions, but also in certain specialized dictionaries of chemistry; see an entry taken from the Oxford *Dictionary of Chemistry*:

chemistry

The study of the elements and the compounds they form.

Chemistry is mainly concerned with effects that depend on the outer electrons in atoms.⁸

In the worst case, entries for the lexical units denoting chemistry as a science are not present at all on the wordlist of some specialized dictionaries, e.g. we find neither *chemistry* in the IUPAC *GoldBook* nor *chimie* in the *Vocabulaire de la chimie et des matériaux*, which are among the leading terminological resources on chemistry for English and French (see discussion above in Section 2).

One might argue that such lexical units are not specialized units, and as they belong to the general lexicon, there is no interest to include them in terminological dictionaries. At first glance it seems to be reasonable. However, to us it does not seem possible to avoid using specialized lexical units in the definition of *chemistry* / *chimie* / *химия* 'science...', which then makes these lexemes specialized as well. And then, there are at least two specialized senses semantically connected with the basic sense 'science...' (see Subsection 3.4), which are also missing in numerous chemical dictionaries.

Based on the considerations above, we propose the following formal definition of the lexical unit denoting chemistry as a science. In Table 3.1 we take as an example the English lexeme CHEMISTRY I; for the corresponding definitions of **Fr.** CHIMIE I.1 and **Ru.** ХИМИЯ¹ I.1, see Part II, p. 197 and p. 241.

You can compare it now with our formal definition of PHYSICS I (Table 3.2).

⁸<https://www.oxfordreference.com>

<p><i>chemistry</i> I practiced by <i>X</i> : science practiced by the human <i>X</i></p> <ul style="list-style-type: none"> • whose object is the study of the matter I.a and its transformations II.1 at the submicroscopic level

Table 3.1 – Formal definition of **En.** CHEMISTRY **I**.

<p><i>physics</i> I practiced by <i>X</i> : science practiced by the human <i>X</i></p> <ul style="list-style-type: none"> • whose object is the study of the matter I.a, the energy II.1 and their interactions I

Table 3.2 – Formal definition of **En.** PHYSICS **I**.

3.2.3 Chemical industry

The field of chemistry is remarkable for the close cooperation of science and industry. *Chemical industry* is crucial for the development of new materials and technologies which influence our everyday life. However, according to numerous public opinion surveys, chemical industry steadily has a more negative image in comparison to most of other industries, such as the electronic or car industries. Thus, for instance, in 2004 chemical industry received 67% and 75% of negative opinions in France and Sweden respectively, which was the second worst result after the nuclear industry (Chastrette and Dumon 2007: 142).

There is a popular belief that chemical industry is only interested in maximizing its immediate profit, hence the quality and harmlessness of produced goods – from food to medicines and vaccines – are constantly doubted. The industry is often claimed to bear responsibility for environmental pollution and subsequent development of certain types of cancer (Chastrette and Dumon 2007: 143).

Bataille and Bram (2004) assert that the origins of the negative attitude to chemistry can be traced back to the twentieth century with the first usage of chemical weapons in World War I. Numerous infamous events contributed significantly to the negative image of chemistry and its industry: the use of Zyklon B by Nazi Germany at extermination camps, the use of Agent Orange by British Armed Forces in Malaysia during the Malayan Emergency and by the United States Armed Forces in Vietnam during the Vietnam War, the Halabja chemical attack as a part of the Al-Anfal Campaign in Iraq (led by Ali Hassan al-Majid

who was dubbed *Chemical Ali* for his use of chemical weapons in attacks against the Kurds), the use of sarin, mustard agent and chlorine gas in numerous chemical attacks during the Syrian Civil War, industrial disasters, such as in Bhopal, and the invention of harmful drugs, such as thalidomide or diamorphine, etc.

The term *chemophobia* was included in IUPAC's *Glossary of terms used in Toxicology*⁹ and defined as 'irrational fear of chemicals' (Duffus, Nordberg and Templeton 2007). The birth of chemophobia occurred in the twentieth century, and in 2013 an American chemist Michelle M. Francl concluded:

We are a chemophobic culture. *Chemical* has become a synonym for something artificial, adulterated, hazardous, or toxic. Chemicals are bad – for you, for your children, for the environment. But whatever chemophobics would like to think, there is no avoiding chemicals, no way to create chemical-free zones. Absolutely everything is made of atoms and molecules; it's all chemistry.¹⁰

A widely spread fear of chemicals and the opposition of chemistry to nature by laypersons is linguistically expressed in our three languages through the opposition of adjectival lexical units denoting 'chemical' *vs.* 'natural' (see Subsection 3.4.3.1).

In Russian, the idea of artificiality and potential dangerousness of chemical substances can be found in two additional non-specialized senses of ХИМИЯ¹: ХИМИЯ¹ III.a 'substance of artificial origin, potentially dangerous for living creatures and/or environment' and ХИМИЯ¹ III.b 'product containing a lot of химия¹ III.a'. The harmfulness of chemical industry has been expressed in Russian through an idiom «БОЛЬШАЯ ХИМИЯ» II (lit. big chemistry) 'penal labor at chemical factory': building a chemical factory or working at one was an actual criminal penalty in the twentieth century in the USSR (see Subsection 3.4.3.2).

Because of this image of a useful but at the same time potentially dangerous science, chemistry has a conceptual *connotation* 'dangerousness', 'unnaturalness'.¹¹

⁹<https://media.iupac.org/publications/pac/2007/pdf/7907x1153.pdf>

¹⁰<https://slate.com/technology/2013/02/curing-chemophobia-dont-buy-the-alternative-medicine-in-the-boy-with-a-thorn-in-his-joints.html>

¹¹An indication on the conceptual connotation should be added to the semantic zone of the entries of the derived lexical units meaning 'chemical'. For more on two types of connotations,

There are constant attempts though to change public opinion on chemistry and its industry. For instance, a famous advertising slogan “Better Things for Better Living...Through Chemistry” was adopted by one of the world’s largest chemical companies DuPont in 1935 for the next 47 years (Do and Pavlath 2017). Even though one of the intentions was to dispel fears of chemical industry, the slogan was very often ironically reused in media referring to recreational drug use or a widespread practice of treating kids’ ADD (Attention Deficit Disorder) with chemical medication.

The year 2019 was marked by the 47th IUPAC World Chemistry Congress in Paris, which celebrated the centenary of the creation of IUPAC. For the first time in its history, IUPAC organized a symposium “Chemistry and Society” in the framework of this international congress, providing an opportunity to chemists and scientists from both industry and academia to debate about the perception of their discipline by the citizens and the ways of improving its image.¹²

3.3 Vocabulary of chemistry

In this section, we move to the vocabulary of chemistry as a scientific discipline. To start with, we suggest the following classification¹³ of scientific terminology:

1. Terms and symbols that are entities, e.g. *iron* , Fe, H₂O;
2. Terms and symbols that are processes, e.g. *reaction* , *interact* , +, → (as in $2\text{H}_2 + \text{O}_2 \rightarrow 2\text{H}_2\text{O}$);
3. Terms and symbols that are properties, e.g. *heat* , *charged* , + (as in Fe⁺⁺).

As regards to the chemistry vocabulary, the first group is represented by rich and constantly growing nomenclatures of substance names and traditionally is best described and unified (see 3.3.1). The two other groups of terms pose particular challenges for teaching and learning chemistry (see 3.3.2 and 3.3.3).

see Iordanskaja and Mel’čuk (2009).

¹²At the symposium “Chemistry and Society”, we had a chance to present the preliminary results of our research on chemical terminology to members of the chemistry community, see Mikhel, Ingrosso and Polguère (2019).

¹³Based on the taxonomy of scientific terms at four levels of abstraction proposed by Wellington and Ireson (2002: 168–169)

3.3.1 Chemical nomenclatures

Although modern chemistry began in the second half of the seventeenth century (3.2.1), a language inherited from alchemy had been still widely used for more than a century. The year 1787 was marked by the publication of the famous *Méthode de nomenclature chimique* by four French chemists: L.-B. Guyton de Morveau, A.-L. Lavoisier, C.-L. Berthollet and A.-F. de Fourcroy (Lavoisier, Fourcroy, *et al.* 1787). In this collaborative work, the scientists expressed the necessity to replace the obscure and symbolic language of alchemists with a homogeneous, scientific nomenclature.

The language of alchemy was full of mysteries, metaphors, double senses and multiple names for the same substances, e.g. *oxygen* was referred to as *oxigine*, *base de l'air vital*, *principe acidifiant*, *empyrée*, *principe sorbible* (Lavoisier, Fourcroy, *et al.* 1787: 203). The initial aim of alchemists was to hide knowledge from laypersons and make their mysterious texts hard to decode, but as a result, it retarded the scientific progress and kept in ignorance many scientists themselves.

The new nomenclature proposed by Lavoisier and his colleagues was aimed at uniformity and standardization.

[...] il en résulte qu'il seroit impossible de perfectionner la science, si on n'en perfectionnoit le langage, & que quelque vrais que fussent les faits, quelque justes que fussent les idées qu'ils auroient fait naître, ils ne transmettroient encore que des impressions fausses, si on n'avoit pas des expressions exactes pour les rendre.¹⁴ (Lavoisier, Fourcroy, *et al.* 1787: 13–14)

They reformed names of elementary substances and compounds, proposed general principles for the further naming and classification of substances based on their structure. The new naming of substances reflecting their characteristic properties was meant to help scientists and beginners in the field to comprehend and memorize chemical nomenclature more easily. This was a remarkable example of

¹⁴[...] it results in that it is impossible to improve the science without improving the language, & that no matter how true the facts may be, no matter how true the ideas that arise from them may be, they would still be transmitted as false impressions, if we do not have exact expressions to convey them.

how the appearance and development of new scientific concepts should be followed by the reformation of the whole lexicon of the domain (Zanola 2014: 114).

By that time, French was the international language, and as soon as the *Méthode de Nomenclature chimique* was accepted, the new nomenclature was translated and adapted in other languages. The first adaptations for English were done by J. St. John in 1788 and by J. Pearson in 1794 (Leicester and Klickstein 1952); the first translation for Russian was done by B. Severgine in 1815 (Sokolov 2013).

However, Lavoisier's nomenclature covered only inorganic compounds. The need for standardization of organic compounds arose with an active development of organic chemistry and biochemistry already in the nineteenth century (Kersaint 1968: 205). On occasion of the Geneva Congress on Organic Nomenclature in 1892, sixty rules of naming organic compounds were elaborated by the International Chemistry Committee. The rules had to be clarified and completed later on, which happened after the creation of the International Union of Pure and Applied Chemistry in 1919 (Jaussaud 2006). Since then, IUPAC has published a significant collection of the so-called *Color Books*,¹⁵ which contain standardized and internationally accepted nomenclatures (see Chapter 2).

From the Lavoisier's nomenclature to most of the current editions of the IUPAC *Color Books*, the focus of attention has been on establishing principles of naming new chemical substances and rules for selecting unique names among the alternatives. However, the actual vocabulary of chemistry commonly used by scientists, teachers and students does not only consist of substance names but is large and heterogenous.

3.3.2 Scientific vocabulary as one of the challenging factors in teaching the discipline

Understanding the challenges of chemistry brings insight on how useful terminological support might be in teaching the discipline.

Chemistry is known to be a very complex subject due to many factors, such as the abstract nature of many chemical concepts, the threefold representation of

¹⁵<https://iupac.org/what-we-do/books/color-books/>

matter (on the macroscopic, submicroscopic and symbolic levels), the structure of the discipline and the needed background in physics and mathematics, a need for laboratory activities, and much memorization involved in learning. Besides all that, the complexity of the chemistry language is among the most challenging factors in learning and teaching the subject (Rees, Kind and Newton 2018).

The importance of a deep understanding of scientific language has been recognized in educational research literature since the last decades of the twentieth century (Johnstone and Cassels 1985; Lemke 1990; Herron 1996; Gabel 1999; Johnstone and Selepeng 2001; Lee 2001; Gee 2004; Wellington and Osborne 2001; Fang 2005; Fraser, Tobin and McRobbie 2012; Gunstone 2015; Childs, Markic and Ryan 2015).

According to Childs, Markic and Ryan (2015: 422), the scientific language became a bigger obstacle in teaching sciences today than it was thirty years ago. They suggested the following reasons of the reduced overall literacy in relation to sciences:

- the “science for all” trend and, as a consequence, the mixed ability context of teaching and learning;
- linguistic heterogeneity in classrooms with students learning sciences in their second, non-native language;
- decline of Latin and Greek studies, which makes students unfamiliar with roots and prefixes of terms drawn from classical languages;
- changes in science assessment procedures with less emphasis on writing and speaking on scientific topics using appropriate terminology.

These factors are all relevant to teaching the multifaceted chemistry language, known in some research as *chemish* (Markic and Childs 2016).

3.3.3 Issues of teaching vocabulary of chemistry

We discuss in what follows several particularly challenging factors in teaching and mastering the language of chemistry (some of them might be transposed to many other sciences as well).

3.3.3.1 Symbolic representation of chemical names

In chemistry, matter can be observed on a macroscopic level, but also studied and described on a submicroscopic level with terms like *electron* and *atom* as well as with chemical symbols, formulas and equations (Gabel 1999: 548). Although the symbolic language of chemistry is universal, different languages have their own names for elements and compounds.

For instance, a symbolic representation of the seventh element of the Periodic table is **N**, from the Latin *nitrogenium* ‘forming niter’. However, Antoine Lavoisier proposed to name it in French *azote*, meaning ‘no life’ from Greek, and in the nineteenth century, the symbol **Az** coexisted with **N** (Nicolardot 1910); see an extract from the *Bulletin de la Société chimique de Paris* on Figure 3.1 (Barreswil 1864).¹⁶

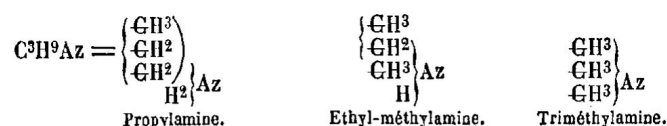

Mais il y a aussi une autre espèce d'isomérisie pour ainsi dire moins grossière : tous les atomes de carbone de deux molécules isomères sont alors, dans l'un comme dans l'autre cas, unis directement entre eux. Ainsi, les deux atomes de carbone forment le groupe $\left\{ \begin{array}{l} \text{C} \\ \text{C} \end{array} \right\}$ dans le glycol comme dans la glycolamide ; ce groupe, dans l'une comme dans l'autre de ces deux substances, est uni à (AzH²)' à (HΘ)' à H² et à Θ, et cependant les deux substances ne sont pas identiques.

Figure 3.1 – Extract from the *Bulletin de la Société chimique de Paris*, 1864.

Although the symbol **N** is internationally accepted today and used in French and Russian as well, the element itself is still called *azote* in French and *азот* /azot/ in Russian, while in English its name is *nitrogen*. This might be confusing for chemistry learners, since the root *nitr-* is nevertheless used in all three languages in derived names of chemical compounds, e.g. *sodium nitrate* (NaNO₃) is *nitrate de sodium* in French and *нитрат натрия* /nitrát natrija/ in Russian.

Another difficulty for learners consists in that symbols might be interpreted in several ways, e.g. **Fe** can be understood either as the **element** iron, or as one atom of such element, or as a pure substance iron (Gabel 1999: 549).

¹⁶<https://gallica.bnf.fr/ark:/12148/bpt6k2819503/f115.item>

Finally, in spite of the universal naming system, chemical substances might still have several names, as in the case of CH_3COOH , which is called *vinegar* by laypersons, *acetic acid* – in industry, and *ethanoic acid* – in class and research laboratories (Childs, Markic and Ryan 2015: 428).

3.3.3.2 Use of anthropomorphic language

Lacking for scientific terminology and correct understanding of chemical processes, learners tend to use anthropomorphic explanations. They might talk of atoms *wanting* or *needing to share* or *donate* electrons, *preferring*, *liking*, *being eager* to be stable, or *having no wish* for certain outcomes (Taber 2001; Kermen 2016).

Analyzing how college students appropriate scientific vocabulary in chemistry laboratories, Cink and Song (2016) noticed that college students often use lexical items such as *that*, *thing*, *stuff* instead of naming chemical substances, or they use colloquial expressions while performing experiments and describing their observations. Such explanations by description very often lead to misconceptions. Chemistry teachers, if using metaphorical explanations themselves, should make sure that they are not taken literally and always proceed with reiterations in formal scientific terms. For instance, talking about a covalent bond and using a metaphor of *shared* pair of electrons, it would be appropriate to reexplain it in more scientific language of physical forces, stating that by *shared* we mean that electrons are “positioned between, and attracted to and by two atomic cores” (Taber 2001: 153).

There is also a need for learners to practice in using the scientific language and incorporating chemical terms in their oral and written explanations (Rees, Kind and Newton 2018). Laboratory work is one of the opportunities to make students not only perform experiments and observations, but keep detailed records of chemical procedures (Laszlo 1999) using the appropriate scientific terminology.

3.3.3.3 Use of polysemous terms and general language lexical units in scientific context

Chemistry teachers often regard highly technical terms as being the most complex for learners, not realizing that polysemous items might be even more challenging. Unfortunately, some science teachers do not see their role in teaching language,

or they assume that students have already mastered the language of chemistry and, therefore, do not even make sure that students share with them the same understanding of the material (Markic 2015; Markic and Childs 2016).

The polysemous nature of scientific vocabulary has received special attention in science educational literature (Eiss 1961; Gardner 1972a,b; Johnstone and Cas-sels 1985; Herron 1996; Donovan 1997; Johnstone and Selepeng 2001; Snow 2008; Jasien and Oberem 2008; Jasien 2009, 2011; D. J. Short, Vogt and Echevarria 2010; Song and Carheden 2014; Childs, Markic and Ryan 2015; Cink and Song 2016; Kermen 2016; Canac and Kermen 2016; Rees, Kind and Newton 2018).

It has been widely recognized that lexical items used in both general language and scientific contexts might pose greater problems in understanding scientific texts than highly technical vocabulary (Markic and Childs 2016).

In the studies mentioned above, authors focus on distinct aspects of this problem, but sometimes several challenging factors seem to be mixed up. For instance, following the categorization of Snow (2008), Cink and Song (2016: 607) refer to the lexical items that have both “academic” (used across disciplines) and “technical” meanings as to *Cross Meaning Vocabulary*, and then to the lexical items that have different meanings in scientific and everyday context – as to *Dual Meaning Vocabulary*. They provide a list of lexical items appropriated by participants in the course of their study, each of them being marked as belonging either to *Dual Meaning Vocabulary* or to *Cross Meaning Vocabulary*, if applicable.

This division turns to be inconsistent, as there are lexical items on the list, which have in fact different meanings in all three tiers (“everyday”, “academic”, and “discipline-specific”). For instance, *indicator* belongs, according to Cink and Song (2016: 610), to *Cross Meaning Vocabulary*, although it is widely used in general language as well; *react* and *reaction* are marked as *Dual Meaning Vocabulary*, although these terms are used across disciplines, such as physics, chemistry, or psychology, having different meanings.

Based on the studies mentioned above, we would suggest to unite challenging polysemous lexical items as follows:

- lexical items with different terminological senses in scientific disciplines, e.g.:

(3) REAGENT in chemistry *vs.* in biology

- lexical items with both different terminological senses in scientific disciplines and non-terminological senses in general language, e.g.:

(4) a. WEIGHT in physics *vs.* in biology *vs.* in general language

b. BASE in chemistry *vs.* in mathematics *vs.* in linguistics *vs.* in general language

- lexical items with non-terminological but different senses in scientific and in general language contexts, e.g.:

(5) a. STRONG as in *strong coffee*, *strong chemical bond* *vs.* *strong acid* (meaning that the acid completely dissociates in water (Jasien 2011))

b. NEUTRAL as in *neutral territory* *vs.* *neutral molecule* ‘uncharged’ *vs.* *neutral solution* ‘neither acidic nor basic’

Chemistry learners are often unaware of polysemous nature of terms and general language lexical units that they encounter in scientific contexts, which consequently leads to ubiquitous misconceptions. Song and Carheden (2014) came to a conclusion that general language meanings were dominating over the specialized meanings of selected lexical items both before and after the terminological meanings were introduced to students in their chemistry class. As a result, learners continued to rely on the incorrect – general language – meanings in scientific contexts, not even realizing or admitting their misunderstanding of chemical concepts.

One of the reasons might be the fact that students learn general language meanings at a younger age and associate them with their personal experiences (Song and Carheden 2014: 137). Among other factors are the passive learning of scientific vocabulary in chemistry class with rare use of challenging lexical units in scientific context, use of rote memorization technique in learning chemistry vocabulary as well as circularity and incompleteness of terminological definitions, which impedes students’ understanding (Wong, Chu and Yap 2014).

As suggested by Childs, Markic and Ryan (2015: 434):

[...] the first step is for science teachers to become aware of the most problematic words used in their national language (as this problem is language-specific). When they first occur in a lesson or textbook, the teacher must deliberately address the issue and try to ensure that the teacher and students share a common understanding. This will need to be continually reinforced, so that students become familiar with the idea that the meaning depends on the context.

3.4 Different senses of **En.** CHEMISTRY, **Fr.** CHIMIE, **Ru.** ХИМИЯ¹ and ХИМИЯ²

Now we move to the analysis of the polysemy of **En.** CHEMISTRY, **Fr.** CHIMIE, **Ru.** ХИМИЯ¹ (and of its homonym ХИМИЯ²) in each language separately. We identify their polysemy structures and copolysemy relations (see Chapter 4, 4.2.4) and conclude on discrepancies between the three languages.

3.4.1 **En.** CHEMISTRY

We have identified four senses of CHEMISTRY in English, whose polysemy structure is visualized on Figure 3.2.¹⁷

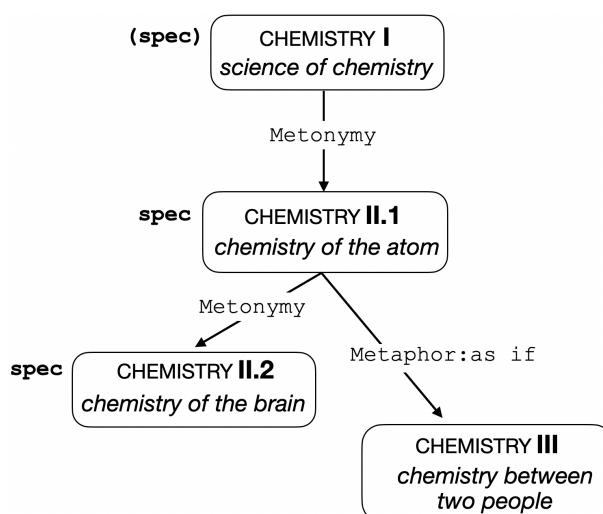

Figure 3.2 – Polysemy structure of the vocable **En.** CHEMISTRY.

¹⁷Hereinafter we use short phrases in italics to illustrate the sense of a given lexical unit.

The *basic lexical unit* (Polguère 2018) – CHEMISTRY I ‘science’, as in (6) – belongs both to the general language and specialized lexicons. A detailed discussion on this sense as well as its formal definition can be found in Section 3.2.1 above.

- (6) *She received a Ph.D. in **chemistry** from the University of Illinois in 1939 with a study of the derivatives of sulfuric acid.*
COCA, DONOHUE John W., *Three sisters*, January 1999, MAG: America, Vol. 180, Iss. 3, p. 20

While analyzing examples in our corpus, we further identified two specialized senses of CHEMISTRY.

CHEMISTRY II.1 ‘properties of matter X that determine its transformations at the submicroscopic level’, as in (7), is a metonymic sense derived from CHEMISTRY I.

- (7) *Since the **chemistry** of an atom is determined by how it combines with other atoms, which in turn depends only on the number of electrons in its outer shell, all atoms with the same number of protons will be chemically identical.*
LAWSON R. S., *Basic Discussion on Electromagnetic Radiation: Gamma Radiation in Relation to SPECT Imaging*, 2013, Practical SPECT/CT in Nuclear Medicine, Springer, p. 23

CHEMISTRY II.2, as in (8), is linked to CHEMISTRY II.1 by the relation of metonymy and denotes transformations that occur in matter X due to its chemistry II.1.

- (8) *Biochemical individuality simply tells us that body **chemistries** are not the same. Two people of about the same hight and weight have about the same total metabolism, but the details of chemical reactions taking place in their bodies may be different.*
GITTLEMAN Ann Louise, *Your Body Knows Best*, 1997, p. 5

CHEMISTRY III is a metaphorical sense semantically derived from CHEMISTRY II.1; it denotes human affinity, as in (9).

- (9) *In Friends, David Schwimmer and Jennifer Aniston had the **chemistry** as*

actors to make the pairing captivating for 10 seasons.

Web, 5 February 2020, <https://www.cheatsheet.com/entertainment/what-friends-fans-think-of-ross-and-rachel-today.html/>

The case of CHEMISTRY II.1 and CHEMISTRY III is an example of how a specialized lexeme can be a source of a metaphor for a general language lexeme. Interestingly, a quasi-synonym of CHEMISTRY III – ATTRACTION I.1b – is a general language lexeme, from which, the other way round, a specialized lexeme ATTRACTION III ‘force exerted between bodies’ is derived.

3.4.2 Fr. CHIMIE

In French, we have identified five senses of CHIMIE, whose polysemy structure is visualized on Figure 3.3.

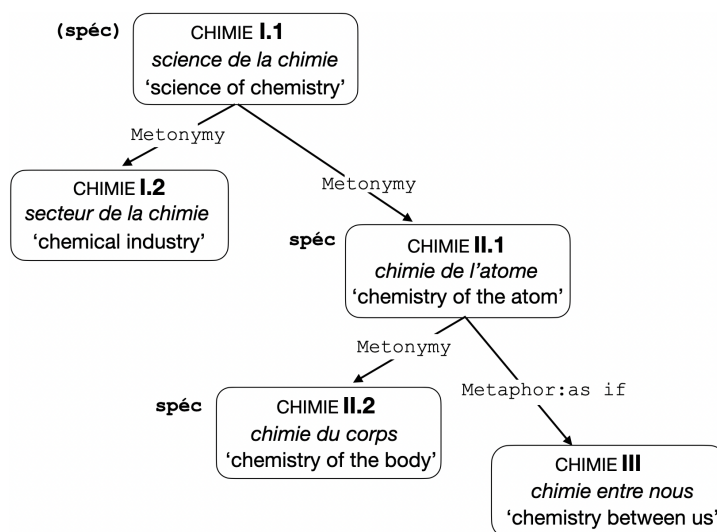

Figure 3.3 – Polysemy structure of the vocable Fr. CHIMIE.

The basic lexical unit is CHIMIE I.1 ‘science’, as in (10).

- (10) *Il travaille au laboratoire de **chimie** du Collège de France !*
 ‘He works at the **chemistry** laboratory of the Collège de France!’
 Frantext, SCHREIBER Boris, *Un silence d’environ une demi-heure*, 1996, p. 161

In French, there is an additional metonymic sense CHIMIE I.2, semantically derived from the basic lexeme. CHIMIE I.2 means ‘chimie I.1 applied to the industry’, as in (11).

- (11) *La modification des attentes et du comportement des consommateurs impacte le secteur de la **chimie**.*

‘Changes in consumer expectations and behaviour are impacting the sector of **chemistry**.’

Web, 29 May 2020, https://www.alsace-eurometropole.cci.fr/sites/default/files/lindustrie_de_la_chimie_en_alsace.pdf

Then, there are also two specialized senses, CHIMIE II.1 ‘properties’, as in (12), and CHIMIE II.2 ‘transformations’, as in (13).

- (12) *La **chimie** de l’atome de soufre dans l’atmosphère est moins bien connue que celle du carbone.*

‘The **chemistry** of the sulphur atom in the atmosphere is less well known than that of carbon.’

Web, 4 May 2020, http://www.uqac.ca/chimie_ens/Cinetique_chimique/CHAP_6.html

- (13) *La **chimie** du corps et du cerveau lors de grands états de peur entraîne une chute dramatique du QI tant que l’enfant ou l’adulte se sent menacé.*

‘The **chemistry** of the body and the brain during great states of fear leads to a dramatic drop in IQ as long as the child or adult feels threatened.’

SUNDERLAND Margot, *Aider les enfants qui ont peur: Tout petit dans un monde trop grand*, 2016, p. 21

Concerning the metaphorical sense CHIMIE III ‘human affinity’, the French *chimie entre X et Y* initially was a calque from the English *chemistry between X and Y*.¹⁸ There is a French quasi-synonymous idiom ‘ATOMES CROCHUS’, which can be used in some contexts instead, as in (14a-b).

- (14) a. *J’ai parlé du premier ministre avec le président. Je les ai vus ensemble. Il existe une bonne **chimie** entre les deux.*

‘I talked about the Prime Minister with the President. I’ve seen them together. There is good **chemistry** between the two.’

Web, 25 August 2022, <https://www.noscommunes.ca/DocumentViewer/fr/37-1/chambre/seance-198/debats>

- b. *D’autre part, il n’aimait pas Roosevelt ; il n’y avait pas d’**atomes***

¹⁸<https://www.btb.termiumplus.gc.ca/tpv2guides/guides/clefsfp/index-fra.html?lang=fra>

crochus entre les deux hommes et leurs relations étaient plus que méfiantes.

‘On the other hand, he didn’t like Roosevelt; there was no **chemistry** between the two men, and their relationships were more than wary.’

Frantext, MENDÈS-FRANCE Pierre, *Œuvres complètes. 6. Une vision du monde. 1974-1982*, 1990, p. 41

3.4.3 Ru. ХИМИЯ¹ and ХИМИЯ²

We have identified **ten** senses of the Russian vocable ХИМИЯ¹, whose polysemy structure is analyzed in 3.4.3.1 and visualized on Figure 3.4. The case of Russian is particularly notable for the fact that ХИМИЯ¹ has a homonym ХИМИЯ², which will be explained in 3.4.3.2.

3.4.3.1 Polysemy of Ru. ХИМИЯ¹

Figure 3.4 illustrates the polysemy structure of the Russian vocable ХИМИЯ¹ with seven non-specialized and three specialized senses.¹⁹

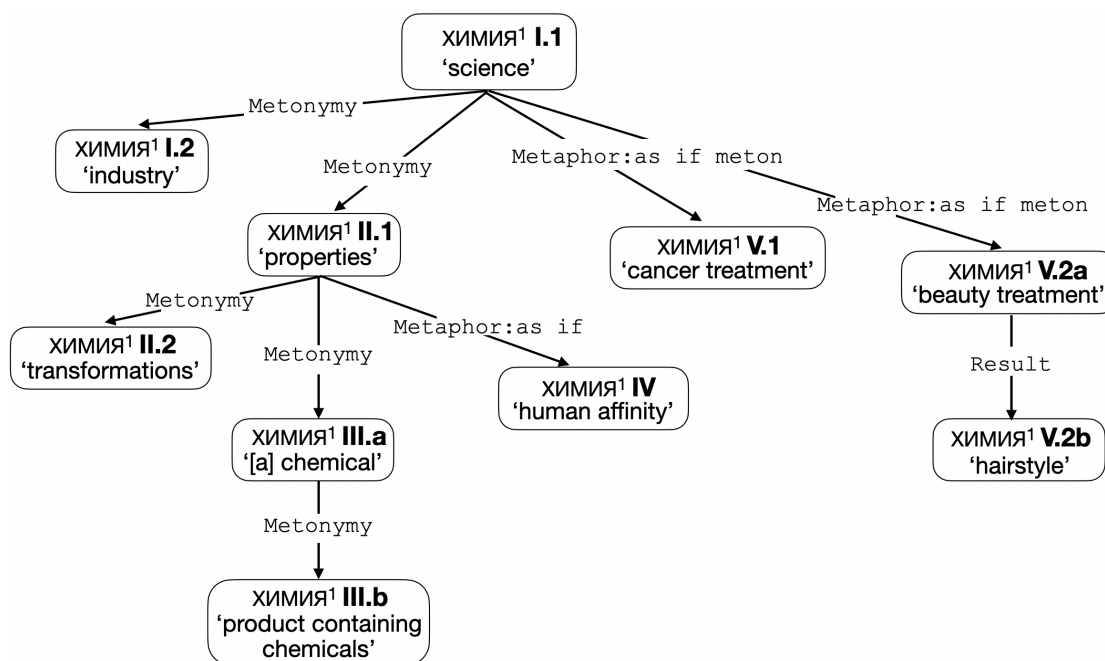

Figure 3.4 – Polysemy structure of the vocable Ru. ХИМИЯ¹.

¹⁹For the sake of space and readability of the figure, we put short glosses for each sense; illustrative examples can be found in the text below.

Similar to the French, ХИМИЯ¹**I.1** ‘science’ is the basic lexical unit, from which derives ХИМИЯ¹**I.2** ‘химия¹**I.1** applied to the industry’, see (15) and (16).

- (15) *Но даже при этих обстоятельствах я не мог заставить себя сколько-нибудь серьезно подготовиться к уроку, потому что **химию** не любил и не понимал.*

‘But even under these circumstances, I could not bring myself to prepare for class in any serious way, because I did not like and did not understand **chemistry**.’

Ruscopora, ЛЕВИН Борис, *Блуждающие огни*, 1995

- (16) *В производственном секторе, например, в металлургии и **химии**, бюджеты снизились до минимума, который нужен лишь для поддержания производства.*

‘In the manufacturing sector, such as metallurgy and **chemistry**, budgets have been reduced to the minimum needed only to sustain production.’

Ruscopora, ХАНФЕРЯН Варган, *Эксперт*, Надежда на государство, 2014

Like in English and French, we observe in Russian two metonymic specialized lexemes ХИМИЯ¹**II.1** ‘properties’, as in (17), and ХИМИЯ¹**II.2** ‘transformations’, as in (18), as well as a metaphorical lexeme ХИМИЯ¹**IV** ‘human affinity’, as in (19).

- (17) *Итак, **химия** атома зависит от числа электронов, а число электронов в изолированном атоме напрямую зависит от количества протонов.*

‘So, the **chemistry** of an atom depends on the number of electrons, and the number of electrons in an isolated atom depends directly on the number of protons.’

Web, 27 April 2020, <https://education.ru>

- (18) *Так впервые было продемонстрировано, что пробиотики оказывают непосредственное влияние на **химию** мозга.*

‘In this way, it was demonstrated for the first time that probiotics have a direct impact on brain **chemistry**.’

Ruscopora, *Знание–сила*, «Будьте здоровы», 2014

- (19) ***Химия** между влюбленными является важной частью романтических отношений.*

‘**Chemistry** between lovers is an important part of romantic relation-

ships.’

Web, 27 April 2020, <https://news.myseldon.com/ru/news/index/216526161>

We have identified another sense, ХИМИЯ¹ III.a, which is linked to ХИМИЯ¹ II.1 by the relation of metonymy. ХИМИЯ¹ III.a, as in (20), denotes a substance contained in food or household goods, this substance being of artificial origin and potentially dangerous for living creatures and/or environment (cf. Fr. «PRODUIT CHIMIQUE» II). Its synonyms are ХИМИКАТ ‘[a] chemical’ and ХИМИКАЛИИ ‘chemicals’ (mostly in plural).

(20) *На самом деле никакой химии в майонезе нет. Только растительное масло, желтки, горчица и соль.*

‘Actually, there is no **chemistry** [= chemicals] in mayonnaise. Only vegetable oil, yolks, mustard and salt.’

Web, 27 April 2020, <https://echo.msk.ru/programs/medinfo/1921496-echo/>

A metonymic sense derived from ХИМИЯ¹ III.a is ХИМИЯ¹ III.b, as in (21). It denotes food or household goods as a whole containing a significant amount of ХИМИЯ¹ III.a.

(21) а. *Не ешь ты эту химию!*

‘Don’t eat this **chemistry** [= food containing many non-natural ingredients]!’.

Web, 27 April 2020, <https://teletype.in/@biggie/tb67kpwlu>

б. — *Он не будет эту гадость есть. — Тогда таблетки купи.*

— *Не верю я в эту химию. Только желудок портить.*

‘— He will not eat that crap. — Then get some pills. — I do not believe in that **chemistry** [= non-natural medicines containing many chemicals]. It will just ruin the stomach.’

Ruscorpora, ТРАУБ Маша, *Нам выходит на следующей*, 2011

As mentioned in 3.2.3, ХИМИЯ¹ III.a and ХИМИЯ¹ III.b clearly demonstrate that chemistry is opposed by laypersons to “natural” things, even though everything that surrounds us is made of chemicals. A derived adjective ХИМИЧЕСКИЙ II.2 ‘chemical’ is actually used in Russian as a synonym to ИСКУССТВЕННЫЙ II ‘artificial’ and as an antonym to НАТУРАЛЬНЫЙ I ‘natural’. The same

opposition of chemical *vs.* natural is linguistically expressed in English and French through the derogatory adjectives **En.** CHEMICAL II.2 and **Fr.** CHIMIQUE II.2.

Another metaphorical sense derived from ХИМИЯ¹ I is ХИМИЯ¹ V.1, as in (22). ХИМИЯ¹ V.1 denotes a type of cancer treatment using chemical medications. Its exact synonym in Russian is ХИМИОТЕРАПИЯ ‘chemotherapy’.

- (22) *Девочке провели операцию по удалению новообразования, а затем назначили несколько курсов **химии** и лучевой терапии.*

‘The girl underwent surgery to remove the neoplasm, then she was prescribed several sessions of **chemistry** [= chemotherapy] and radiotherapy.’

Web, 27 April 2020, <https://bfkh.ru/children/2666/>

The last metaphorical sense derived from ХИМИЯ¹ I is ХИМИЯ¹ V.2a, as in (23). ХИМИЯ¹ V.2a denotes a beauty treatment done with chemicals to create a long-lasting curly hairstyle. Its exact synonym is a weak idiom «ХИМИЧЕСКАЯ ЗАВИВКА»¹ lit. ‘chemical waving’.

- (23) *Мастер сообщила, что на **химию** надо времени – 2 часа.*

‘The hairdresser said that a **chemistry** [= chemical waving] takes two hours.’

Web, 27 April 2020, https://spb.zoon.ru/beauty/salon_krasoty_donna_na_leninskom_prospekte/reviews/

The result of ХИМИЯ¹ V.1a is ХИМИЯ¹ V.2b ‘hairstyle’, as in (24). Its exact synonym is «ХИМИЧЕСКАЯ ЗАВИВКА»² ‘permanent hairstyle’.

- (24) ***Химия** держится от 1 месяца до 3-х, а иногда и значительно дольше. Это зависит от индивидуальных особенностей волос: их структуры и здоровья.*

‘**Chemistry** [= permanent hairstyle] lasts one to three months, but sometimes much longer. It depends on the individual characteristics of the hair: its structure and health.’

Web, 16 May 2020, <http://strigkipricheskifoto.ru>

3.4.3.2 Homonymy of **Ру.** ХИМИЯ¹ and ХИМИЯ²

We explain now why ХИМИЯ¹ and ХИМИЯ² should be considered as homonyms, although it is not a coincidence that they are morphologically related.

ХИМИЯ² is mostly used in media and in colloquial Russian; it denotes penal labor, as in (25).

(25) *Миша получил год **химии**, и говорили, что ему повезло – с его статъей обычно дают зону.*

‘Misha was sentenced to one year of **chemistry** [= penal labour], and they said he was lucky – for his type of crime they usually send you to jail.’

Ruscorpora, КАРАЛИС Дмитрий, *Автопортрет*, 1999.

The term appeared in the twentieth century in the USSR and related to penal labor, prototypically at chemical factories. Instead of being sent to prisons, criminals were sentenced to work at factories in order to boost the chemical industry of the country.

In modern Russian, the meaning of ХИМИЯ² has changed since the reinstated law in 2009.²⁰ It denotes now any kind of penal labor, such as cleaning or construction. ХИМИЯ² produced in its turn an idiom *«ДОМАШНЯЯ ХИМИЯ»* lit. ‘home chemistry’, which denotes penal labor without sending a convicted person to any correctional facility.

In such a way, if we want to describe the meaning of ХИМИЯ² nowadays, chemical industry will not be mentioned in its definition anymore, which makes ХИМИЯ² a homonym of ХИМИЯ¹.

It is worth noting that *химия*² is used with the preposition *на* ‘at’ instead of *в* ‘in’, as in the example (26). Compare *он работает в химии*¹ ‘he works in chemistry’ (it can both mean ‘in science’ or ‘in industry’) *vs.* *он работает на химии*² lit. ‘he works at chemistry [= at labor]’. A person sentenced to such labor might be called *химик*² ‘chemist’, usually put in quotes though.

²⁰<https://rg.ru/2009/07/23/minust.html>

- (26) *На **химии** работают оппозиционные политики. [...] Представьте, каково к ним отношение администрации, если такой «**химик**» получает почту со всего мира от иностранных президентов и послов?»*
 ‘Opposition politicians work at **chemistry**. [...] Imagine what the administration’s attitude is, if such “**chemist**” receives mail from foreign presidents and ambassadors from all around the world?’
 Web, 4 December 2019, <https://dic.academic.ru>

Finally, it is interesting to note that even in the history of the term, ХИМИЯ² was not directly derived from any sense of ХИМИЯ¹. Initially, there was a semi-idiom «БОЛЬШАЯ ХИМИЯ»^I ‘chemical industry’, as in (27). The expression originated from *Большая Химия СССР* ‘Big Chemistry of the USSR’, which was a semi-official name for the USSR’s national economic project aimed at chemical industrialization of the country.

- (27) *Дальше на северо-запад лежал отравленный Новомосковск, город **большой химии**, где каждый пятый ребенок был от рождения болен, а каждый третий заболел потом. . .*
 ‘Further to the north-west lay the poisoned Novomoskovsk, a city of the **big chemistry** [= chemical industry], where every fifth child was sick from birth and every third one got sick later...’
 Ruscorpora, Дивов Олег, *Молодые и сильные выживут*, 1998

Then, it produced a metonymic sense «БОЛЬШАЯ ХИМИЯ»^{II} – penal labor at «БОЛЬШАЯ ХИМИЯ»^I.²¹ ХИМИЯ² derived in its turn from «БОЛЬШАЯ ХИМИЯ»^{II} and was used as its quasi-synonym.

Figure 3.5 summarizes our discussion on homonymy of ХИМИЯ¹ and ХИМИЯ².

²¹<https://dic.academic.ru/dic.nsf/proverbs/47458>

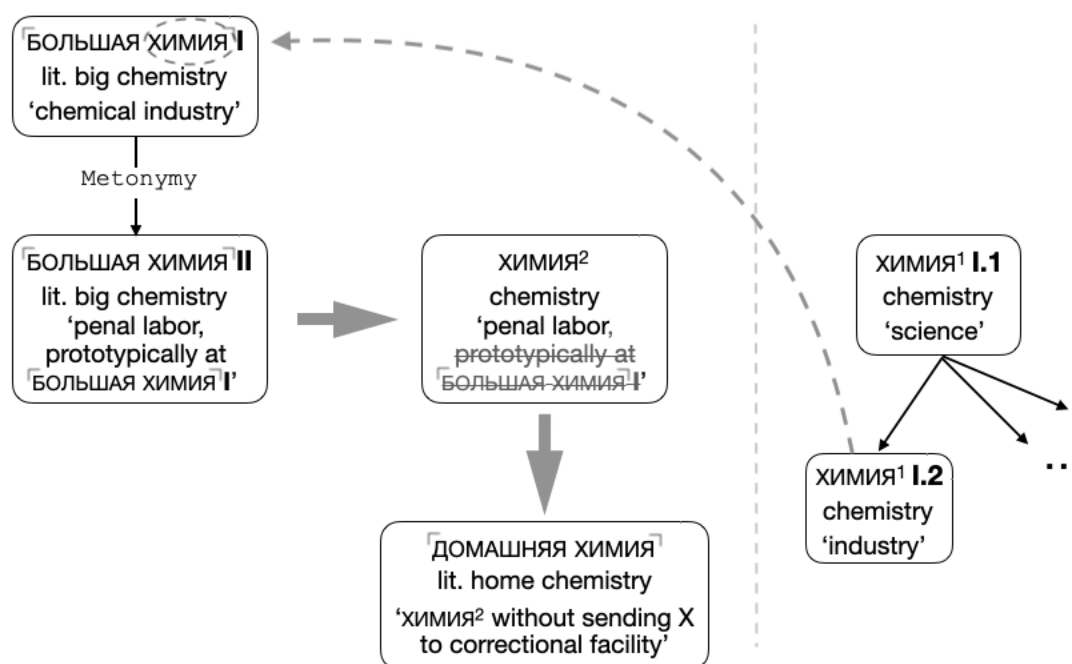

Figure 3.5 – The case of homonymy: **Ру.** ХИМИЯ¹ vs. ХИМИЯ².

3.4.4 Focus on chemistry-related senses

Although the number of senses of **En.** CHEMISTRY, **Fr.** CHIMIE and **Ру.** ХИМИЯ¹ varies from one language to another (four in English, five in French and ten in Russian), Figure 3.6 shows that there are no discrepancies in their polysemy structures as regards to the level of specialized lexemes (for *specialized* vs. *non-specialized* see Chapter 1, 1.3).

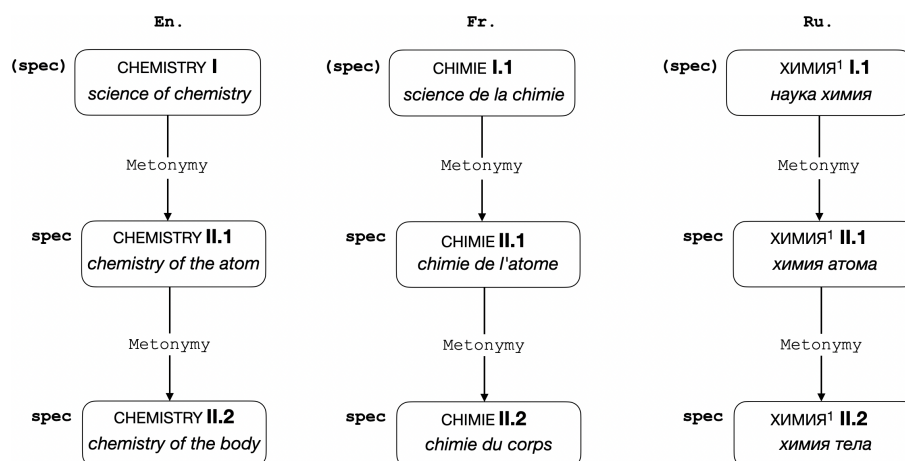

Figure 3.6 – Copolysemy relations between specialized senses of **En.** CHEMISTRY, **Fr.** CHIMIE and **Ру.** ХИМИЯ¹.

We propose the following formal definition of **En. CHEMISTRY II.1**, see Table 3.3. For the definitions of the corresponding lexemes **Fr. CHIMIE II.1** and **Ru. ХИМИЯ¹ II.1**, see Part II, p. 197 and p. 242.

<i>chemistry II.1 of X</i> : properties of the matter I.a X <ul style="list-style-type: none"> • that determine the transformations II.1 of X at the submicroscopic level
--

Table 3.3 – Formal definition of **spec CHEMISTRY II.1**.

As for **En. CHEMISTRY II.2**, we came up with the following formal definition presented in Table 3.4. For the definitions of the corresponding lexemes **Fr. CHIMIE II.2** and **Ru. ХИМИЯ¹ II.2** see Part II, p. 198 and p. 242.

<i>chemistry II.2 of X</i> : transformations II.1 in the matter I.a X <ul style="list-style-type: none"> • that occur due to the chemistry II.1 of X
--

Table 3.4 – Formal definition of **spec CHEMISTRY II.2**.

It is worth mentioning that the lexeme denoting transformations can be used in plural in English only. For instance, *body chemistries II.2* would be expressed in singular as *chimie II.2 du corps* ‘chemistry of the body’ in French and as *химия¹ II.2 тела* ‘chemistry of the body’ in Russian. In French and Russian, we also observe the frequent usage of synonymous phrases instead, such as *procédés chimiques/химические процессы* ‘chemical processes’, *transformations chimiques/химические превращения* ‘chemical transformations’ and *réactions chimiques/химические реакции* ‘chemical reactions’.

In Russian, **ХИМИЯ¹ II.2** can also be replaced in some contexts by a less frequently used term **ХИМИЗМ** ‘chemical nature of processes/substances’, as in (28).

(28) *Благодаря крупным успехам биохимии к настоящему времени в основном раскрыт химизм таких кардинальных звеньев обмена веществ, как дыхание и брожение, фотосинтез, обмен азотистых соединений, жиров, углеводов и органических кислот и многие другие процессы.*

‘Thanks to the major successes of biochemistry, it was possible to discover the **chemistry** of the key elements of metabolism, such as respiration and fermentation, photosynthesis, exchange of nitrogen compounds, fats, car-

bohydrates and organic acids, and many other processes.’

Web, 11 december 2019, <https://chem21.info/info/1757864>

As mentioned in Chapter 2, Section 2.3.2, the specialized senses of **En.** CHEMISTRY, **Fr.** CHIMIE and **Ru.** ХИМИЯ¹ are yet another example of chemical terms missing in most terminological resources on chemistry, such as IUPAC *Gold-Book*, Oxford *Dictionary of Chemistry* (Law and Rennie 2020), *Dictionnaire de chimie* (de Menten de Horne 2013), *Vocabulaire de la chimie et des matériaux* (*FranceTerme*), *Словарь химических терминов* (Evdoščenko, Dubchinskij and Gajvoronskaja 2006) or *Англо-русский химический словарь* (Gazizov 2010).

3.5 Recapitulation

Chemistry is the science that studies matter and its natural and caused transformations at the submicroscopic level. Chemistry plays a fundamental role in understanding numerous related disciplines like biology, medicine, geology, and is grounded itself in disciplines like mathematics and physics.

The field of chemistry is remarkable for the close cooperation of science and industry. The negative image of the chemical industry caused by numerous infamous events in the course of the last two centuries resulted in the negative attitude to chemistry in general. Chemistry is often perceived by laypersons as dangerous and artificial, which is linguistically expressed in our three languages by the opposition of adjectival lexical units meaning ‘chemical’ *vs.* ‘natural’.

As for the language of chemistry, there have been constant attempts to normalize and standardize it with the main focus on nomenclatures of chemical substances. The main linguistic focus in chemistry class also stays on learning chemical nomenclatures using rote memorization techniques (Fang 2005) with little or no attention to fundamental terminology and polysemous items. Consequently, students tend to rely on general language meaning of words they use, which leads to the wrong understanding of scientific concepts.

According to Gabel (1999), chemistry educational research had little influence on the way chemistry was taught in the twentieth century. The situation has not changed much in the twenty-first century (Ryan and Childs 2013), in spite of

numerous studies in the field. Misconceptions are still widespread among learners of chemistry, which is caused by a lack of the deep understanding of chemical terminology.

New strategies and techniques have to be adopted by teachers to integrate chemistry language learning with the content of the subject (Yuriev, Capuano and J. Short 2016). Teachers should privilege the usage of rigorous terms and explanations, make students stay active in class and master the language of chemistry by applying scientific terminology in oral and written contexts, since mastering the scientific language is an integral part of mastering the discipline.

Our linguistic analysis of different senses of **En.** CHEMISTRY, **Fr.** CHIMIE and **Ru.** ХИМИЯ¹ has shown that the number of senses varies from one language to another (four senses in English, five – in French, and ten – in Russian), but on the level of specialized lexemes, we do not observe any discrepancies in polysemy structures of the three vocables. The case of Russian is notable for the fact that ХИМИЯ¹ has a homonym ХИМИЯ² which denotes penal labor, historically at chemical factories. The idea of dangerousness of chemistry is expressed by two non-specialized senses of ХИМИЯ¹ which denote artificial and potentially dangerous chemicals (ХИМИЯ¹ III.a) and products containing many such (ХИМИЯ¹ III.b).

Finally, we have proposed formal definitions of the specialized lexical units **En.** CHEMISTRY I, CHEMISTRY II.1 and CHEMISTRY II.2; our definitions of the corresponding French and Russian lexical units can be found in Part II, Sections 8.4 and 8.5.

Chapter 4

Lexicographic modeling of terminology: a Lexical System approach

SUMMARY

4.1	Introduction	81
4.2	Lexicographic article structure in the Lexical Systems	81
4.2.1	Grammatical characteristics	82
4.2.2	Definition	86
4.2.3	Paradigmatic and syntagmatic connections	92
4.2.4	Copolysemy relations	93
4.2.5	Illustrative examples	94
4.2.6	The case of spec REACT 1.1d	95
4.3	Recapitulation	96

Only fools do not change their mind.

Alain Polguère, 2021

Comment on numerous changes in our definitions.

4.1 Introduction

This chapter presents the methodology and some of the results of the terminographic descriptions done in the framework of the theoretical and descriptive approach of the Explanatory and Combinatorial Lexicology and that of the Lexical Systems.

The Lexical System approach to the structuring of lexicons is based on multidimensional non-taxonomic disambiguated graphs. Each node of the graph represents one well-specified meaning, and the edges of the graph are semantic and combinatorial lexical relations (Chapter 1, 1.4). In the course of our study, we have been building the terminological networks of chemistry on top of the *English*, *French* and *Russian Lexical Networks* (*en-LN*, *fr-LN*, *ru-LN*), general language resources developed at the ATILF laboratory. The weaving of the networks is performed with *Dicet* (Gader, Lux-Pogodalla and Polguère 2012), the lexicographic editor specially designed for this purpose. The encoded data for the English and French languages can be accessed through the visualization and navigation tool *Spiderlex*.¹

In what follows (4.2) we describe the types of linguistic data encapsulated in our lexical models. The work discussed in this chapter resulted in the terminographic descriptions, whose semantic (definitional) component for the three languages in question will be presented in Part II, Chapter 8. Extended examples of lexicographic modeling of the core chemical terms will be given in Chapter 5 and Chapter 6.

4.2 Lexicographic article structure in the Lexical Systems

Lexical Systems (Chapter 1, 1.4) are fundamentally relational by nature, and the process of building them consists in weaving the graphs rather than in text writing. A lexicographer working within this approach is provided with the graph editor *Dicet* with the access to an “article-view” of lexical units under description. For the purposes of our study, we have been assigning the following properties to our lexical units:

¹<https://spiderlex.atilf.fr>

- grammatical characteristics;
- definition;
- paradigmatic and syntagmatic connections;
- connections with other lexical units within the same vocable, i.e. copolysemy relations;
- examples of use.

In 4.2.1–4.2.4 we review each property in detail showing concrete examples of the encoding process done on the fundamental terminology of chemistry.

4.2.1 Grammatical characteristics

The minimal information on grammatical properties that we assign to a lexical unit is its part of speech and its gender as for the French and Russian lexical units. In case there is a certain constraint on the usage of a lexical unit, we assign it a usage note.

Usage note is a label assigned to lexical units in order to indicate constraints on their use.

In our system, the usage notes are divided into three groups (Polguère 2020):

- *linguistic usage notes* indicating constraints related to the properties of the linguistic code (historical, geographical, etc.), e.g. **arch**, **BritE**;
- *stylistic usage notes* indicating the socio-cultural context associated with the use of the labeled lexical unit, e.g. **formal**, **child**;
- *rhetorical usage notes* indicating the speakers attitude (affectionate, derogatory, ironic, etc.), e.g. **affectionate**, **derog**, **iron**.

Figure 4.1 shows a part of the article-view in the lexicographic editor *Dicet*, where all the properties, including the part of speech, gender and usage note, are not manually written but attributed as labels to each lexical unit under lexicographic description.

At the beginning of our research, we were making use of one particular linguistic usage note which is **spec** to label lexical units belonging to the specialized

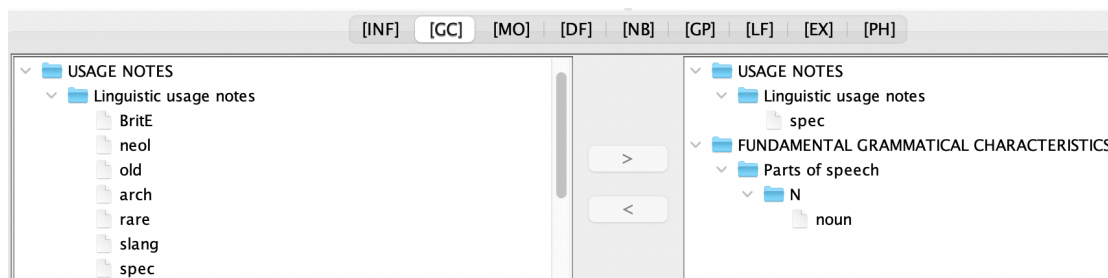

Figure 4.1 – Assigning grammatical characteristics to a lexical unit in *Dicet* editor.

language. As we progressed with the study of the fundamental chemical terminology, we observed four different cases and proposed to expand the list of our linguistic usage notes as follows.

The usage note **spec** is assigned to the so-called *full terms*, i.e. lexical units belonging to the specialized language of a given domain, e.g. $\text{BOND}_{(V)}$ **I.2a**, **CATIONIC**, **ATOMICALLY**, **Fr. RÉACTEUR I.2** ‘reactor’. We would like to emphasize the fact that in our approach, there are no usage notes for any particular specialized domain like chemistry, biology, psychology or any other. We presuppose that domains associated with a term can automatically be deduced from the rest of the lexicographic description and the system of connections between the term in question and other lexical units of the language (Polguère 2020: 15-16). Figure 4.2 demonstrates the lexical connections around **Fr. RÉACTEUR I.2** ‘reactor’, from which it can be deduced that chemistry is the specialized domain to which belongs **RÉACTEUR I.2**, since it is linked to the lexemes such as **CHIMIE I.1** ‘chemistry’, **CHIMIQUE II.1** ‘chemical’, **RÉACTION I.1d** ‘reaction’, **RÉACTANT** ‘reactant’, and many other chemical terms.

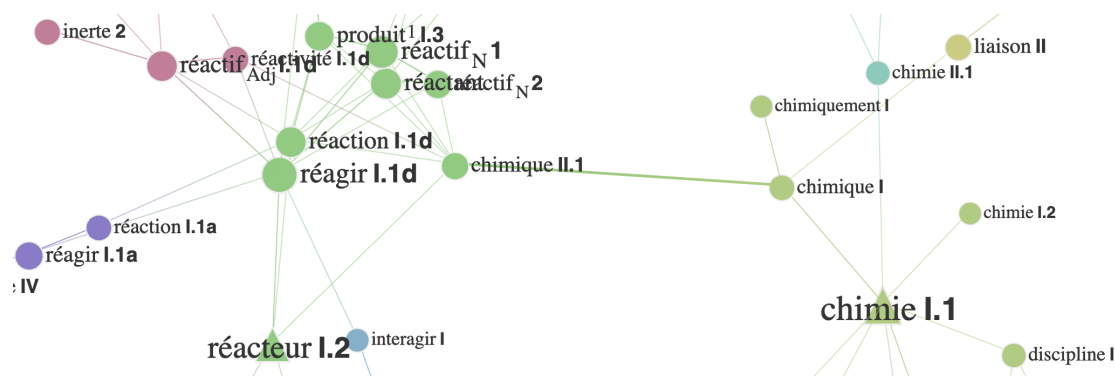

Figure 4.2 – Lexical network around **spec** **RÉACTEUR I.2**.

The usage note (**spec**) is assigned to the so-called *runaway terms*² that can be of two types:

- lexical units belonging to a specialized domain and at the same time being widely present in non-specialized contexts, provided that there is no linguistic evidence for dividing one lexical unit into two different senses, e.g. **Fr. MATIÈRE I.a** ‘matter’ (see Chapter 5, 5.2), **POIDS I.2** ‘weight’ (see Part II, p. 212);
- lexical units that at first sight seem to belong to the general language but whose lexicographic definition includes the full or other runaway terms, e.g. **CHEMISTRY I** (see Chapter 3, 3.2.2), **CHEMICAL_(Adj) I**, **PHYSICS I**, **PHYSICAL III.1** (see Part II, p. 172, 187, 186).

The case of **MATIÈRE I.a** ‘matter’ is particularly interesting for the fact that this lexeme belongs at the same time to the two specialized domains – of physics and chemistry – as well as to the general language lexicon, which can be traced through the connections linking this lexeme to the other lexical units of the language, e.g. **PHYSIQUE_(Adj) III.2** ‘physical’, **CHIMIQUE II.1** ‘chemical’, **ATOME I.2** ‘atom’, **MASSE I.1** ‘mass’, **MATÉRIAU** ‘material’, **ESPRIT I.1** ‘spirit’, etc., see Figure 4.3.

The usage note **spec critic** is assigned to the lexical units whose definition seems to be highly technical but the usage of these lexical units is criticized by the specialists of the domain. It is recommended to avoid using such term in specialized texts because of their misleading or erroneous meaning producing distortion of the truly specialized sense. One of the examples of such terms is **spec critic ELEMENT III.3b** as compared to **spec ELEMENT III.3a**, which we will discuss in detail in Chapter 6 (see also Part II, p. 175). Another example is **spec critic ISOTOPE 2** as compared to **spec ISOTOPES 1**. According to IUPAC, the term *isotopes* should be used in plural and refer to a set of nuclides of the same element, thus having the same atomic number, but having different mass numbers.

²See also the thesis “The Lexicon of the Environment and Its Chemistry-Related Terms in Ordinary Discourse. Using Social Networks as Corpora” by T. Gotkova, in progress.

Finally, **Quasi-spec** is assigned to the so-called *quasi-terms* that are used by non-specialists, or laypersons, who do not master the terminology of the domain and refer to a sense that is obsolete and does not reflect the current state of science, e.g. **ATOM I.1** which is still used in the sense of the smallest indivisible particle of matter (see Chapter 5, 5.4).

4.2.2 Definition

In the framework of the Explanatory Combinatorial Lexicology, lexicographic definition is the representation of the meaning of a lexical unit which plays the central role in a lexical entry accounting for its semantic, syntactic and lexically restricted cooccurrences. We adopt the definition-writing methodology developed by I. Mel'čuk and A. Polguère (Mel'čuk and Polguère 2018).

In 4.2.2.1–4.2.2.6 we summarize the six lexicographic principles of writing definitions concerning the informational content and the form of a definition that we follow in our lexicographic practice. To illustrate each principle, we propose examples of our actual definitions elaborated for the fundamental chemical terms.

4.2.2.1 *Equivalence, or Adequacy, Principle*

We establish the semantic equivalence between the *Definiendum*, a name of the headword, and *Definiens*, a linguistic paraphrase. Names of predicative lexical units (Polguère 2016b: 162-166) are accompanied by *semantic actant slots* that they control expressed by variables X, Y, Z, etc., e.g. *chemical II.1 X*. We call such short expressions *propositional form* of a lexical unit.

Predicative lexical units are “binding” senses that are either semantic predicates or quasi-predicates.

Semantic predicates denote facts like actions, states, events, characteristics, e.g. *allotropic I X*, *chemically II X*, *X bonds_(V) I.2a with Y forming Z*.

Quasi-predicates denote entities like substances, individuals, objects, e.g. *nucleus I.2 of X*, *electron I of X interacting with Y*, *reactor I.2 used by X for Y*.

On the contrary, *semantic names* are non-“binding” senses that denote entities, e.g. *ion*, *anion*, *cation*, \lceil *pure substance* \rceil .

By establishing the equivalence between the definiendum and the definiens we ensure that the definiens can be manipulated as a paraphrase of our headword. Table 4.1 presents the definition we propose for ALLOTROPES (Part II, p. 167) which is a bi-actantial quasi-predicate. Now taking the example (2a) below, we can verify and see that the replacing of *allotropes* in (2a) with its definiens from Table 4.1 gives a perfectly correct outcome in (2b).

*Y that are **allotropes** of X :* Y that are structurally different forms of the element **III.3a** X

Table 4.1 – Formal definition of **spec** ALLOTROPES.

- (2) a. *Diamond, graphite, graphene and various fullerenes are **allotropes** of carbon.*
- b. *Diamond, graphite, graphene and various fullerenes are **structurally different forms of the element** carbon.*

4.2.2.2 Hierarchical Structure Principle

We distinguish between the *central component* of the definiens, i.e. the minimal paraphrase of the headword, and a set of *peripheral components* that serve to distinguish between semantically related lexical units. Each peripheral component is marked with a bullet and starts on a new line. Tables 4.2 and 4.3 show our definitions of ANION and CATION (Part II, p. 168 and 171), where the central component of both definiens is ‘ion’, but then, one peripheral component in each definiens helps to distinguish one meaning from another one.

anion : ion
 • that is negatively charged **II**

Table 4.2 – Formal definition of **spec** ANION.

<i>cation</i> : ion <ul style="list-style-type: none"> • that is positively charged II

Table 4.3 – Formal definition of **spec** CATION.

4.2.2.3 *Semantic Decomposition Principle*

A definition should be the result of the semantic analysis, i.e. decomposition of the meaning. In the definiens, we only include the meanings that are semantically simpler than the analysed meaning itself. To illustrate this idea, we propose to consider one of the definitions presented above, namely in Table 4.2, and the one of ION in Table 4.4 (see also Part II, p. 178).

<i>ion</i> : particle I.2 <ul style="list-style-type: none"> • that is atomic I.2 or molecular I.2 • that is charged II

Table 4.4 – Formal definition of **spec** ION.

As we can see, the definiens of *anion* includes the meaning ‘ion’ as a simpler and poorer one: *ion* is any charged particle, while *anion* is a particular type of ion, a negatively charged one. Once having included ‘ion’ in the definiens of *anion*, we do not include ‘anion’ in the definiens of *ion*, alike it is done in numerous dictionaries, which results in vicious circles in such definitions (e.g. in the Oxford *Dictionary of chemistry*, see Chapter 2, 2.3.1). Doing it this way, not only avoid we the vicious circles in our system of definitions, but also prioritize the linguistic analysis of lexical units over the encyclopaedic or pragmatic knowledge. The information on that ions can be of two types – anions and cations – does not belong to the linguistic knowledge about *ion* and therefore, should not be reflected in its lexicographic definition. In our system, this information will easily be deduced from the lexical connections that we establish between ION, ANION and CATION on paradigmatic level through the system of lexical functions (4.2.3).

Finally, following the *Semantic Decomposition Principle*, we also inevitably reach the level where the semantic decomposition of meanings is no more possible in terms of simpler specialized meanings; in this case, we can claim that we have reached what we call a *terminological semantic prime* (cf. the notion introduced by

Wierzbicka (1972, 1985) and Goddard (2012)). For instance, if we decompose the meaning of *anion* into ‘ion’ and then *ion* into ‘particle’, we get to the definition of *particle* **1.2**, which is presented in Table 4.5 (see also Part II, p. 185). If we continue to decompose the meaning of *particle* **1.2**, we get to the definitions of *matter* **1.a** and *interact* **1**, which are non-decomposable any further in terms of specialized meanings, see Tables 4.6-4.7 (Part II, p. 182 and 178). Thus, we claim *matter* **1.a** and *interact* **1** to be our terminological semantic primes, i.e. the simplest specialized meanings in the system of our definitions of the terms related to the chemistry lexicon.

<p><i>particle</i> 1.2 of <i>X interacting with Y</i> : constituent of the <i>matter</i> 1.a X</p> <ul style="list-style-type: none"> • that <i>interacts</i> 1 with the other entities Y

Table 4.5 – Formal definition of **(spec) PARTICLE 1.2**.

<p><i>matter</i> 1.a that <i>X is made of</i> : entity of the ‘physical world’</p> <ul style="list-style-type: none"> • that things X are made of

Table 4.6 – Formal definition of **(spec) MATTER 1.a**.

<p><i>X and Y interact</i> 1 : The entities X and Y have a mutual effect on each other</p>

Table 4.7 – Formal definition of **(spec) INTERACT 1**.

4.2.2.4 Minimal Decomposition [= Maximal Block] Principle

We decompose the meaning of the headword to a minimal degree to keep the definition simple and easy to understand.

Looking back at the definitions in Tables 4.3 and 4.2, one can notice that we did not define *anion* as ‘an atomic or molecular particle that is charged’ but rather shortened it directly to the corresponding meaning ‘ion’ reducing the central component of the definiens to just one element.

Another example is the definition of **COMPOUND_(N) 1.2** presented in Table 4.8 (see also Part II, p. 174). The peripheral component in the definiens of *compound_(N) 1.2* could have been ‘that is made of different types of atoms **1.2** which are

identified by the number **X** corresponding to the quantity of protons in the nucleus **1.2** of these atoms **1.2**'. Fortunately, we were able to reformulate and shorten it by referring to the meaning 'element **III.3a**'.

<i>compound</i> _(N) 1.2 made of <i>X</i> : 「pure substance」 • that is made of different elements III.3a <i>X</i>
--

Table 4.8 – Formal definition of **spec COMPOUND**_(N) **1.2**.

4.2.2.5 Univocity Principle

We ensure that elements of our definitions are non ambiguous and that configurations of given meanings are always the same.

For instance, we always express in the same way the meaning of adjectival pure semantic derivatives (Polguère and Mel'čuk 2006):

- *chemical* **II.1** *X* : 'X relating to chemistry **II.1**' (e.g. *chemical bond*);
- *molecular* **I.1a** *X* : 'X relating to molecules **I**' (e.g. *molecular structure*)

In the same harmonized way, we express the meaning of adverbial pure semantic derivatives:

- *chemically* **II.1** *X* : 'X as regards to chemistry **II.1**' (e.g. *chemically identical atoms*);
- *molecularly* *X* : 'X as regards to molecules **I**' (e.g. *molecularly different substances*)

The corresponding formulas were implemented and normalized for French and Russian as well, e.g. 'X relatif à...', 'X, относящийся к ...' for adjectival meanings, and 'X relativement à ...', 'X относительно ...' for adverbial meanings.

We also ensure that the definitions reflect the semantic closeness of certain lexical units by having similar inner organization of their definitions and similar configuration of meanings, like in definitions presented in Tables 4.9-4.10 (see also Part II, p. 181 and 191).

<p><i>liquid</i>_(Adj) I.2 X : matter I.a X that is in a physical III.2 state such that</p> <ul style="list-style-type: none"> • X has indefinite shape • X has definite volume • X's particles I.2 are mobile and interact I

Table 4.9 – Formal definition of **spec LIQUID**_(Adj) **I.2**.

<p><i>solid</i>_(Adj) I.2 X : matter I.a X that is in a physical III.2 state such that</p> <ul style="list-style-type: none"> • X has definite shape • X has definite volume • X's particles I.2 are non mobile
--

Table 4.10 – Formal definition of **spec SOLID**_(Adj) **I.2**.

4.2.2.6 Semantic Network Principle

The *Semantic Network Principle* presupposes that the definitions can be formally encoded by building semantic networks, where the nodes of the graph are senses and the arcs are the semantic dependencies. In the course of our research, we have learned the process of the formal encoding of lexicographic definitions using the lexicographic tool *Dicet*, which allows for building such semantic networks (see Figure 4.4).³

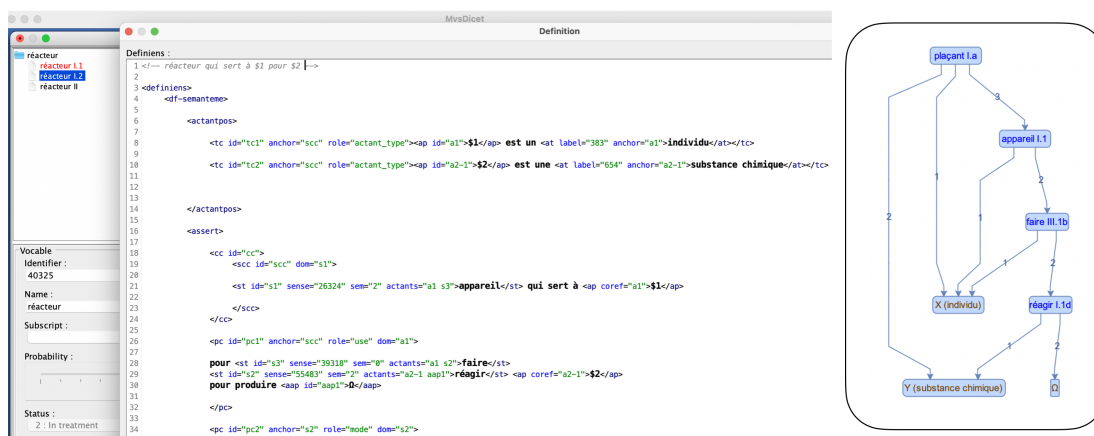
Figure 4.4 – Formal encoding of the definition of **spec RÉACTEUR I.2** in *Dicet* editor.

³The formal encoding of all our definitions presented in Part II has been scheduled for the post-doctoral research project Cythère aimed at valorization of the outcomes of the research and the creation of the special website for teachers and students of chemistry (see Prospects in Chapter 7, 7.3).

4.2.3 Paradigmatic and syntagmatic connections

As discussed in Chapter 1, 1.4, our main structuring tool for modeling semantic and combinatorial lexical relations is *lexical functions* borrowed from the Meaning-Text Theory. The notion of lexical functions is exhaustively presented in the recent work Mel'čuk and Polguère (2021).

Figure 4.5 shows a lexical network around our specialized verb REACT **I.1d** (*Xs react producing Y*; see Part II, p. 188), which is linked by means of paradigmatic and syntagmatic lexical functions to numerous lexical units, e.g.:

- CHEMICALLY **II.1** (redundant modifier);
- REACTION **I.1d** (pure semantic derivative);
- REACTANT (typical name of the first actant);
- PRODUCT **I.3** (typical name of the second actant);
- REACTOR **I.2** (typical place where a reaction takes place);
- REACTIVE **I.1d** (typical characteristic of the first actant);
- STRONGLY **II**, VIOLENTLY **II**, VIGOROUSLY (intensifiers);
- REACT **I.1e** (causative).

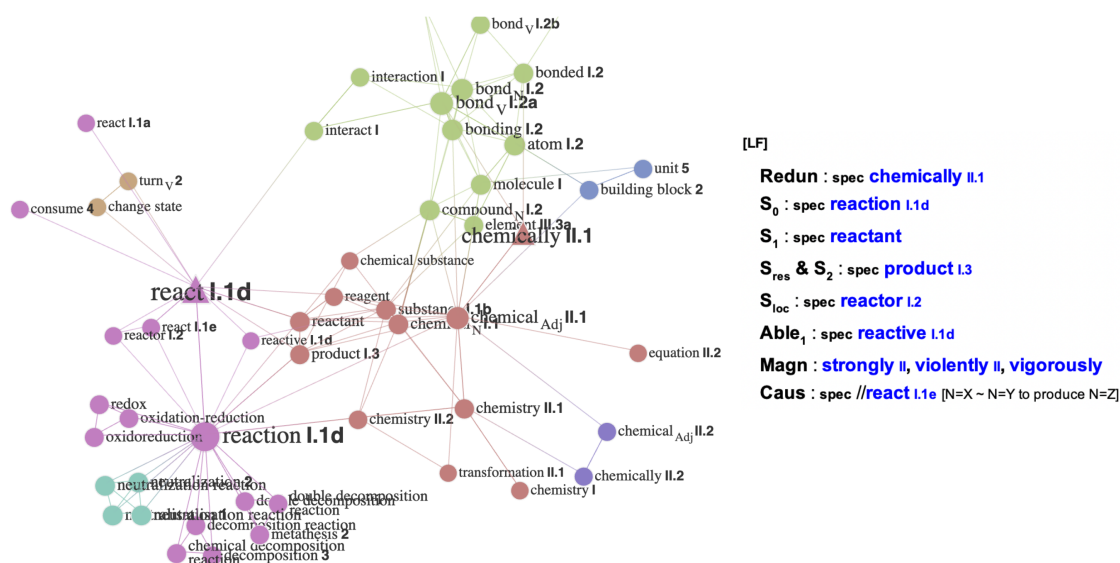

Figure 4.5 – Lexical network around spec REACT **I.1d** in *Spiderlex*.

4.2.4 Copolysemy relations

In Part II (Chapter 8, Section 8.2), we present a list of vocables where at least one of the senses belongs to the fundamental lexicon of chemistry. Most of the vocables on this list are polysemous, and some are highly polysemous, as in the case of **ELEMENT** (14 senses according to our analysis, see Chapter 6, 6.5.1), **REACT** (10 senses, see below), or **Ру. ХИМИЯ**¹ (10 senses, see Chapter 3, 3.4.3.1). For the purposes of our study, we analysed the structure of such vocables and hypothesized on the copolysemy relations existing between different senses, see, for instance, Figure 4.6.

Copolysemy between two lexical units L_1 and L_2 – symbolized as $L_1 \rightarrow L_2$ – is the formal and semantic relation linking L_2 to L_1 which conditions their grouping within the same polysemous vocable.

Copolysemes are lexical units that belong to the same vocable – they are connected either directly or indirectly by a copolysemy relation within this vocable. (Polguère 2018: 794-795)

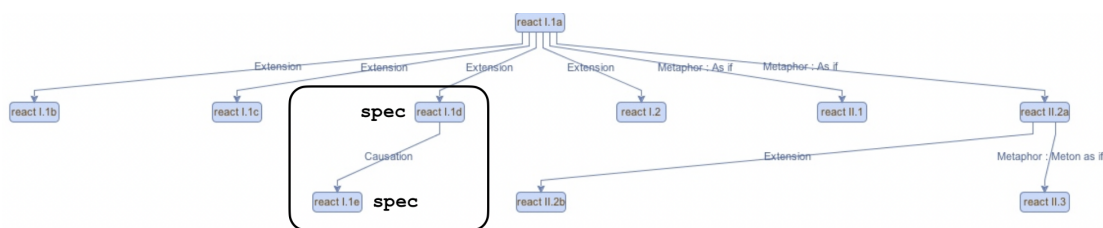

Figure 4.6 – Copolysemy relations in the vocable **En. REACT** in *Dicet* editor.

In the course of our lexicographic descriptions, we have encountered and encoded in our systems the following copolysemy relations between different senses of the vocables with at least one chemistry-related sense:

- *Causation*, where L_2 means ‘to cause L_1 ’, e.g.:
REACT I.1d \rightarrow **REACT I.1e** (see Part II, p. 188),
BOND I.2a \rightarrow **BOND I.2b** (Part II, p. 170),
IONIZE a \rightarrow **IONIZE b** (Part II, p. 179);
- *Specialization*, where L_2 is a richer synonym of L_1 , or at least L_2 contains L_1 in the central component of its definition (Polguère 2018), e.g.:

ELEMENT **I.1** ‘part of something’, as in *important element of the story*, →

ELEMENT **I.2** ‘element **I.1** of a physical entity’, as in *battery pack is the heaviest element of the car* (see Chapter 6, 6.5.1),

SUBSTANCE **I.1b**, as in *chemical substance*, → SUBSTANCE **I.2**, as in *to abuse substances* (see Chapter 5, 5.3.1);

- *Extension*, where L_2 and L_1 are relatively close, but there is no relation of synonymy between the two, e.g.:

REACT **I.1a** ‘to respond to a stimulus’, as in *robot’s sensors react to touch and sound*, → REACT **I.2** ‘to have an allergic or other negative response’, as in *my body reacted to the allergens/to milk*;

- *Metaphor*, where L_2 relates to L_1 through analogy, e.g.:

MOLECULE **I**, as in *molecule of water*, → MOLECULE **II**, as in *molecule of creativity* (see Chapter 1, 1.4);

- *Metonymy*, where L_2 relates to L_1 through contiguity, e.g.:

CHEMISTRY **II.1**, as in *chemistry of the atom*, → CHEMISTRY **II.2**, as in *chemistry of the brain* (see Chapter 3, 3.4.1);

- *Result*, where L_2 is the result of L_1 , e.g.:

ХИМИЯ¹ **V.2a** ‘hair beauty treatment done with chemicals’ → ХИМИЯ¹ **V.2b** ‘long-lasting curly hairstyle, the result of химия **V.2a**’ (see Chapter 3, 3.4.3.1).

The detailed analysis of polysemy structures of МАТТЕР, SUBSTANCE, АТОМ, ELEMENT and their counterparts in French and Russian will be presented in Chapters 5 and 6; see also Chapter 3 for CHEMISTRY, СНІМІЕ, ХИМИЯ¹ and ХИМИЯ².

4.2.5 Illustrative examples

We exemplify each sense of a vocable under description, including senses that are not related to the lexicon of chemistry, to illustrate and distinguish between different meanings. Each sense is normally illustrated with at least two examples; chemical lexical units are exemplified with three to twelve citations taken from different types of sources (scientific articles, manuals, Web), e.g. our vocable REACT contains 43 citations. In the course of our research, we have created a considerable database of examples in our systems. Each example is formally encoded by means of the lexicographic editor *Dicet* and gets the following metadata: *Identifier of*

the citation, Source of citation, Author, Title, Date of publication. To be noted that examples can be associated with different senses at once, creating additional connections between the senses in our lexical networks, see Figure 4.7.

Associations :		
Senses	Occurrences before example modification	Occurrences after example modification
<input checked="" type="checkbox"/> react I.1d	Calcium reacts strongly with oxygen and water creating various forms of calcium oxides or hydroxides that have insulating properties.	Calcium reacts strongly with oxygen and water creating various forms of calcium oxides or hydroxides that have insulating properties.
<input checked="" type="checkbox"/> strongly II	Calcium reacts strongly with oxygen and water creating various forms of calcium oxides or hydroxides that have insulating properties.	Calcium reacts strongly with oxygen and water creating various forms of calcium oxides or hydroxides that have insulating properties.

Created by pomik on October 26, 2018 at 1:14:13 PM Updated by pomik on October 26, 2018 at 1:14:13 PM

Figure 4.7 – Associating examples with several senses in *Dicet* editor.

4.2.6 The case of spec REACT I.1d

- react
- react I.1a
- react I.1b
- react I.1c
- react I.1d**
- react I.1e
- react I.2
- react II.1
- react II.2a
- react II.2b
- react II.3

[GC]

spec
verb

[DF]

to be involved in a physical process

$X_{=1}$ **react** producing $Y_{=2}$

=

X is a substance I.1b

Y is a substance I.1b

The **substances I.1b** X **undergo** a **chemical change**

that **results_v 1a** in the **transformation II.1** of X into one or several **substances I.1b** Y

[LF]

Redun : spec **chemically II.1**

S₀ : spec **reaction I.1d**

S₁ : spec **reactant**

S_{res} & S₂ : spec **product I.3**

S_{loc} : spec **reactor I.2**

Able₁ : spec **reactive I.1d**

Magn : **strongly II, violently II, vigorously**

Caus : spec // **react I.1e** [N=X - N=Y to produce N=#3]

[EX]

Calcium **reacts** strongly with oxygen and water creating various forms of calcium oxides or hydroxides that have insulating properties.

Off databases: Web 26 october 2018, <http://theses.whiterose.ac.uk/16009/1/Christogiannis%20PhD%20Thesis.pdf>

Figure 4.8 – “Article view” of spec REACT I.1d in *Dicet* editor.

Figure 4.8 presents an example of our terminographic description proposed for the lexical unit REACT I.1d. According to it, the specialized lexical unit REACT I.1d makes part of the polysemous vocable REACT with ten senses. The copolysemy relations between different senses of this vocable can be found on Figure 4.6. On Figure 4.8, we can see a formally encoded definition resulting in a small semantic network where nodes are well-defined senses and arcs are the semantic dependencies. Then, we see a list of the paradigmatic and syntagmatic relations encoded by

means of lexical functions, which resulted in a lexical network around REACT **1.1d** presented above on Figure 4.5. The list of illustrative examples associated to the lexeme is not fully presented on Figure 4.8 due to space limitations.

4.3 Recapitulation

This chapter presented the methodology of lexicographic descriptions performed in the framework of the theoretical and descriptive approach of the Explanatory and Combinatorial Lexicology and that of the Lexical Systems. Each specialized lexical unit, be it a lexeme or an idiom, is assigned the following properties: grammatical characteristics, definition, paradigmatic and syntagmatic links, copolysemy relations, examples of use.

As for grammatical characteristics, we assign each lexical unit its part of speech, gender (for French and Russian), and a usage note, if applicable. In the course of our study, we observed four types of lexical units that needed to be attributed four different usage notes. Thus, we proposed to extend the list of usage notes in our lexicographic editor *Dicet* as follows: **spec** for full terms, **(spec)** for runaway terms, **spec critic** for specialized but criticizable lexical units, and **quasi-spec** for quasi-terms.

Further, we presented six principles of writing lexicographic definitions that we followed in our lexicographic practice. These principles concern both the content and the form of definitions. We illustrated each principle with concrete examples taken from our terminographic descriptions performed for the core chemical terms.

We have shown some results of modeling our chemical networks by means of paradigmatic and syntagmatic lexical relations (lexical functions). Since we have been working mostly with polysemous and highly polysemous vocables, establishing copolysemy relations between different senses of such vocables was another integral part of our lexicographic descriptions. We have given examples of copolysemy relations that we encountered and encoded based on our analysis of the polysemy structure of our chemistry-related vocables. Finally, another important part of our lexicographic work was creation of a considerable database of citations taken from corpora that were formally encoded and associated with senses of the vocables under study.

Chapter 5

Focus on three terminological building blocks:

matter, substance, and atom

SUMMARY

5.1	Introduction	98
5.2	Polysemous vocables En. MATTER, Fr. MATIÈRE, and Ru. МАТЕРИЯ	98
5.2.1	En. MATTER	98
5.2.2	Fr. MATIÈRE	102
5.2.3	Ru. МАТЕРИЯ	104
5.3	Polysemous vocables En. SUBSTANCE, Fr. SUBSTANCE, and Ru. ВЕЩЕСТВО	106
5.3.1	En. SUBSTANCE	106
5.3.2	Fr. SUBSTANCE	109
5.3.3	Ru. ВЕЩЕСТВО	110
5.4	Polysemous vocables En. АТОМ, Fr. АТОМЕ, and Ru. АТОМ	112
5.4.1	En. АТОМ	112
5.4.2	Fr. АТОМЕ	114
5.4.3	Ru. АТОМ	116
5.5	Recapitulation	117

5.1 Introduction

This chapter demonstrates the lexicographic modeling of the building blocks – the most fundamental terms – of our system of the core chemical notions. As discussed in Chapter 4, 4.2.2.3, *matter* is one of the so-called *terminological semantic primes*, since the semantic decomposition of its meanings is no more possible in terms of simpler specialized meanings. Even though *substance* and *atom* are not terminological semantic primes, they are also at the most basic level of our system of notions (see Chapter 7, 7.2, as well as a *defined-by* hierarchy of English notions in Part II, p. 167). The distinction between *matter* and *substance* poses particular problems in the context of chemistry teaching, therefore, it is important to analyse both of them in detail.

In 5.2 we start with the lexicographic description of **En.** MATTER, a term originating from the field of physics widely used in chemistry. We analyze in what follows its French and Russian equivalents, **Fr.** MATIÈRE and **Ru.** МАТЕРИЯ.

In 5.3 we proceed with the terminographic modeling of **En.** SUBSTANCE, the central chemical term, as well as of its French and Russian counterparts **Fr.** SUBSTANCE and **Ru.** ВЕЩЕСТВО.

In 5.5 we conclude on the lexicographic modeling of these core terms in the three languages.

5.2 Polysemous vocables **En.** MATTER, **Fr.** MATIÈRE, and **Ru.** МАТЕРИЯ

5.2.1 **En.** MATTER

Our English vocable MATTER comprises five senses. Its polysemy structure is visualized in Figure 5.1.

The basic lexeme of the vocable is, according to our analysis, MATTER **1.a**, as in *solid matter of wood*. We are particularly interested in this lexeme in the context of chemistry and will therefore discuss it in more detail.

MATTER **1.a** is an uncountable noun. We have marked it with a usage note

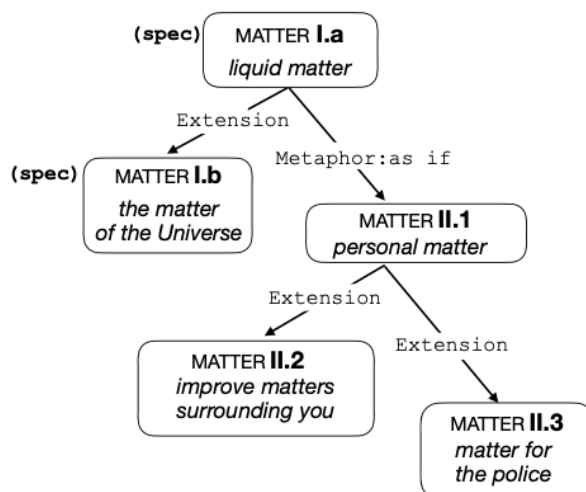

Figure 5.1 – Polysemy structure of the vocable **En.** MATTER.

(**spec**)¹ since it frequently occurs both in specialized and non-specialized contexts, see, for instance, (1a-b).

- (1) a. *As **matter** moves through its cycles, it changes state repeatedly. For example, in the water cycle, water repeatedly changes from a gas to a liquid or solid and back to a gas again.*
 Web, 27 February 2021, <https://chem.libretexts.org/Courses>
- b. *The goal of the mission was to study the gas content and solid **matter** of the comet in order to understand its composition more fully.*
 Web, 04 September 2021, <http://www.digifind-it.com/westfield>

Table 5.1 shows the formal definition that we propose for MATTER **I.a**, see also Part II, p. 182.

<p><i>matter I.a</i> that <i>X</i> is made of : entity of the 「physical world」</p> <ul style="list-style-type: none"> • that things <i>X</i> are made of

Table 5.1 – Formal definition of (**spec**) MATTER **I.a**.

The central component of our definition is meant to reflect the fact that 1) MATTER **I.a** is an entity and 2) it has physical existence. The importance of these semantic components becomes evident in the contexts where *matter* is contrasted

¹On usage notes see Section 4, Subsection 4.2.1.

with *form* (which is not an entity but a fact) or with *spirit* (which has no physical existence), see (2a-b).

(2) a. *In Metaphysics, Aristotle introduces the distinction between **matter and form** synchronically, applying it to an individual substance at a particular time. The **matter** of a substance is the stuff it is composed of; the **form** is the way that stuff is put together so that the whole it constitutes can perform its characteristic functions.*

COCA, *Aristotle's Metaphysics* (Stanford Encyclopedia of Philosophy), 2012

b. *Natural philosophy (as science was then called) had declared an absolute separation between **matter and spirit**, and limited its attentions to the material world.*

COCA, CARREL Jennifer Lee, *Newton's Vice*, December 2000, MAG: Smithsonian, Vol. 31, Issue 9, p. 130

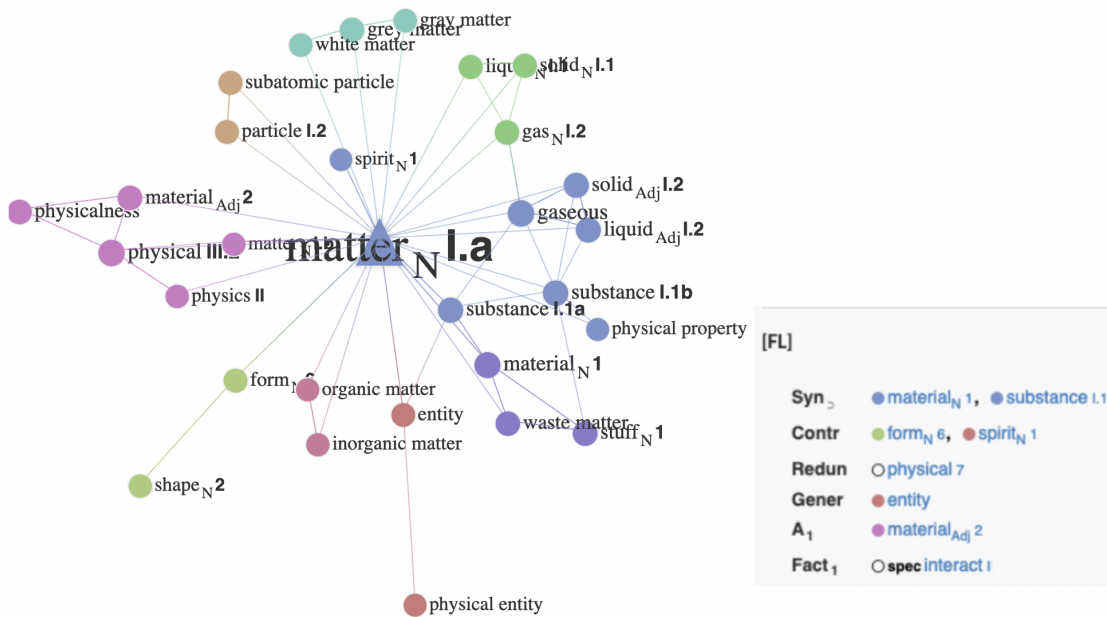

Figure 5.2 – Lexical network around (spec) MATTER 1.a in *Spiderlex*.

Figure 5.2 demonstrates the lexical network around MATTER 1.a which includes both specialized and general language lexical units:

- a richer synonym (spec) SUBSTANCE 1.1a (see Subsection 5.3.1);
- an intersecting synonym MATERIAL_(N) 1;
- contrastive lexemes FORM 6 and SPIRIT 1;

- a redundant modifier PHYSICAL **7**;
- a qualifying adjective of the first actant MATERIAL_(Adj) **2**;
- a verb of realization INTERACT **1**;
- numerous idioms for which MATTER **1.a** is a generic term, e.g. 「WASTE MATTER」, **spec** 「INORGANIC MATTER」, **spec** 「ORGANIC MATTER」, **spec** 「GREY MATTER」, **spec** 「WHITE MATTER」, see (3).

(3) *The **white matter** and **grey matter** are similar as they are both essential sections of both the brain as well as the spinal cord. The **grey matter** gets its grey tone from a high concentration of neuronal cell bodies.*

MERCADANTE Anthony A., TADI Prasanna, *Neuroanatomy, Gray Matter*, <https://www.ncbi.nlm.nih.gov/books/NBK553239/>

The sense extension of the basic lexeme is (**spec**) MATTER **1.b** ‘matter **1.a** as a physical constituent of the Universe’. The hyponyms of MATTER **1.b** are the specialized lexical units such as **spec** 「NORMAL MATTER」, **spec** 「ORDINARY MATTER」, **spec** 「BARYONIC MATTER」, **spec** 「DARK MATTER」, **spec** 「DEGENERATE MATTER」 as well as **spec** ANTIMATTER, see (4a-b).

(4) a. *Unlike **normal matter**, **dark matter** does not interact with the electromagnetic force. This means it does not absorb, reflect or emit light, making it extremely hard to spot.*

Web, 01 March 2021, <https://home.cern/science/physics/dark-matter>

b. *The Big Bang started out from pure energy that produced as much **matter** as **antimatter**. Both of them should have mutually annihilated one another, yet we exist today thanks to an excess of **matter**.*

Web, 01 March 2021, <https://news.cnrs.fr/articles/the-enigma-of-antimatter>

In (4b) *antimatter* is opposed to *matter 1.b* as if the two were antonyms. However, *antimatter* is usually defined through *matter 1.b*, e.g. the dictionary of *Antidote 10*² defines *antimatter* as ‘matter that is made up of antiparticles’; *Collins dictionary*³ defines it as ‘a form of matter whose particles have characteristics and properties opposite to those of ordinary matter’. The real antonym of ANTIMAT-

²<https://www.antidote.info/fr>, visited on 30/08/2022

³<https://www.collinsdictionary.com/dictionary/english/antimatter>, visited on 30/08/2022

TER is not MATTER **I.b** but 「ORDINARY MATTER」 or 「NORMAL MATTER」. In the examples such as (4b), the confusion arises from the fact that authors often use *matter* as a shortcut omitting its modifiers *ordinary* or *normal*.

The second grouping of lexemes unites three senses which belong to general language lexicon:

- MATTER **II.1** ‘subject that requires consideration’, as in *he was concerned with social and economic matters*;
- MATTERS **II.2** ‘situation or circumstances’ (in plural), as in *your boss had the chance to improve matters*;
- MATTER **II.3** ‘someone’s responsibility or concern’, as in *if there are death threats being made, that’s a matter for the police*.

We limit our description to this number of frequently occurring lexemes of MATTER and do not analyze for now any specialized lexemes belonging to domains other than physics and chemistry.

5.2.2 Fr. MATIÈRE

The French vocable MATIÈRE comprises five senses. Its polysemy structure is visualized in Figure 5.3.

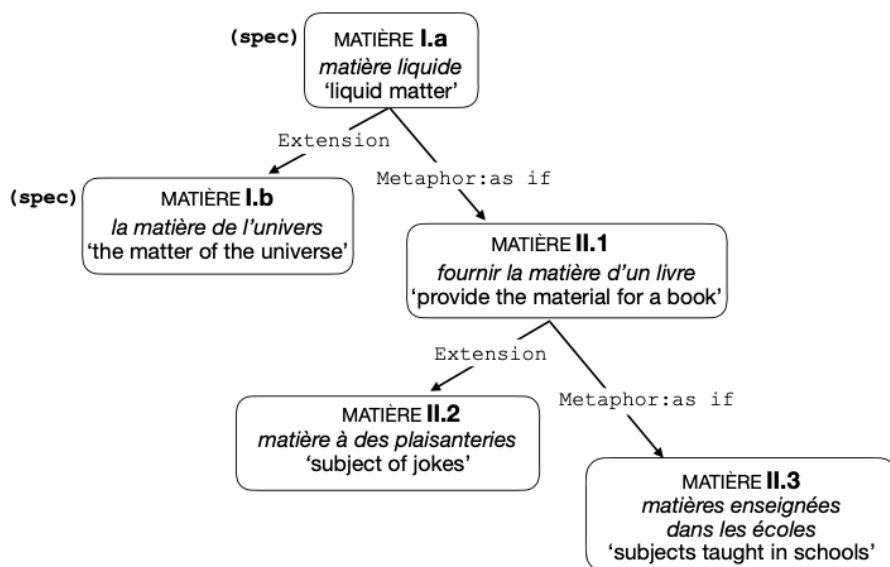

Figure 5.3 – Polysemy structure of the vocable Fr. MATIÈRE.

The first two lexemes correspond to the first two senses discussed in 5.2:

- (spec) MATIÈRE **1.a** ‘matter’, as in *matière liquide du gel de cactus* ‘liquid **matter** of the cactus gel’ and as in (5);
- (spec) MATIÈRE **1.b** ‘matter’, as in *la matière noire représente plus de 80% de la matière de l’univers* ‘black matter represents 80% of the **matter** of the universe’.

(5) *Le contact de matière réactive à la surface d’un catalyseur est souvent le facteur limitant pour la vitesse d’une réaction catalytique et le taux de conversion des réactifs.*

‘The contact of reactive **matter** on the surface of a catalyst is often the limiting factor for the rate of a catalytic reaction and the conversion rate of the reactants.’

Web, 4 December 2018, https://www.cnrs.fr/inc/communication/direct_labos/lafon.htm

The formal definition of MATIÈRE **1.a** can be found in Table 5.2, see also Part II, p. 207.

<i>matière 1.a dont X est constitué</i> : entité du 「monde physique」 • dont les choses X sont constituées
--

Table 5.2 – Formal definition of (spec) MATIÈRE **1.a**.

The lexical network around MATIÈRE **1.a** unites both specialized and non-specialized lexical units, e.g. its richer synonym (spec) SUBSTANCE **1.1a** ‘substance’, its intersecting synonym MATÉRIAU ‘material’, its redundant modifier PHYSIQUE_{Adj} **1.2** ‘physical’, its verb of realization INTERAGIR **1** ‘interact’.

MATIÈRE **1.a** is a generic term for specialized lexical units, such as 「MATIÈRE ORGANIQUE」 ‘organic matter’, 「MATIÈRE GRISE」 ‘grey matter’, 「MATIÈRE ÉPURANTE」 ‘cleansing substance’. MATIÈRE **1.a** is a generic term for non-specialized lexical units as well, e.g. 「MATIÈRE GRASSE」 ‘fat’, 「MATIÈRE FÉCALE」 ‘fecal matter; waste’, 「MATIÈRE NOBLE」 ‘noble material’, 「MATIÈRE PREMIÈRE」 ‘raw material’, and others.

The second grouping of lexemes unites three senses:

- MATIÈRE II.1 ‘informational content, material’, as in *ce sujet-là fournit la matière d’un livre* ‘this subject provides the **material** for a book’. It makes part of the nominal idiom ‘TABLE DES MATIÈRES’ ‘table of contents’;
- MATIÈRE II.2 ‘reason’, as in *les lois de la morale et de la piété ne sont pas matière à plaisanter pour lui* ‘for him the laws of morality and piety are not something to laugh about [= not a **reason** to laugh]’;
- MATIÈRE II.3 ‘subject’, as in *j’aimerais savoir quelles sont les matières enseignées en fac de lettres* ‘I would like to know what **subjects** are taught at the humanities faculty’.

These three senses are peculiar to French and are found neither within the corresponding vocable **En.** MATTER nor **Ru.** МАТЕРИЯ.

5.2.3 **Ru.** МАТЕРИЯ

The Russian vocable МАТЕРИЯ comprises only four senses. Its polysemy structure is visualized in Figure 5.4.

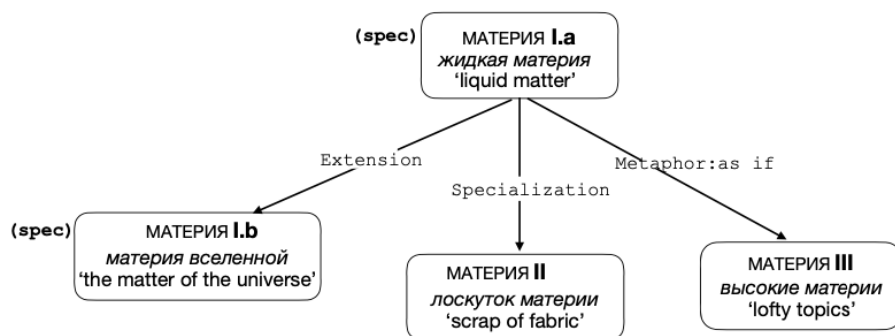

Figure 5.4 – Polysemy structure of the vocable **Ru.** МАТЕРИЯ.

The first two lexemes correspond to the first two senses discussed in 5.2.1 and 5.2.2:

- (спец) МАТЕРИЯ I.a ‘matter’, as in *раскалённая жидкая материя лавы* ‘red-hot liquid **matter** of lava’;

- (спец) МАТЕРИЯ I.b ‘matter’, as in *если бы исчезла материя, вместе с ней исчезли бы пространство и время* ‘if the **matter** disappeared, the space and the time would disappear with it’.

The formal definition of МАТЕРИЯ I.a can be found in Table 5.3, see also Part II, p. 227.

<p><i>материя I.a, из которой состоит X</i> : сущность \lceilфизического мира\rceil,</p> <ul style="list-style-type: none"> • из которой состоят вещи X
--

Table 5.3 – Formal definition of (спец) МАТЕРИЯ I.a.

It has to be noted that МАТЕРИЯ I.a is less present in modern Russian. We can observe in the *National Corpus of Russian language* that collocations such as *твёрдая материя* ‘solid matter’ or *жидкая материя* ‘liquid matter’ mostly occur in the texts that date back to the eighteenth and nineteenth centuries. Instead of МАТЕРИЯ I.a, we tend to use nowadays its richer synonym ВЕЩЕСТВО I.1a, e.g. in collocations such as *твёрдое вещество* ‘solid substance’, *жидкое вещество* ‘liquid substance’ and in idioms such as спец \lceil ОРГАНИЧЕСКОЕ ВЕЩЕСТВО \rceil ‘organic substance’, спец \lceil СЕРОЕ ВЕЩЕСТВО \rceil ‘grey substance’, etc.

МАТЕРИЯ I.a is nonetheless a source of metaphor for two other senses in Russian: МАТЕРИЯ II ‘fabric, material’, as in (6a), and МАТЕРИЯ III ‘topic, subject of speech or thought’, as in (6b).

- (6) a. *Некоторые, желая придать мёду вкус и запах пряностей, вешают в бочку завернутые в лоскутах материи гвоздику, кардамон и корицу.*

lit. ‘Some people, wanting to give the taste and the smell of spices to the honey, hang cloves, cardamom, and cinnamon wrapped in a scrap of **fabric** in the barrel.’

Ruscorpora, КИРИЧЕНКО А., *Зеркало мира*, «И я там был, мёд-пиво пил», 2012

- b. *Мой старший внук Антон с раннего детства проявлял интерес к высоким материям — философии, эзотерике, оккультизму.*

‘My eldest grandson Anton was interested from an early age in lofty **topics** [matters] - philosophy, esotericism, occultism.’

Ruscorpora, РЕКЕМЧУК А. Е., *Мамонты*, 2006

5.3 Polysemous vocables **En.** SUBSTANCE, **Fr.** SUBSTANCE, and**Ru.** ВЕЩЕСТВО5.3.1 **En.** SUBSTANCE

We have identified five senses in the English vocable SUBSTANCE. Its polysemy structure is visualized in Figure 5.5.

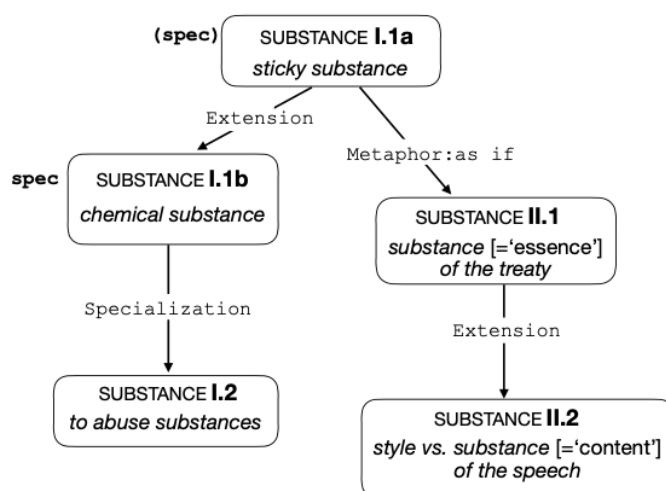

Figure 5.5 – Polysemy structure of the vocable **En.** SUBSTANCE.

The basic lexeme of the vocable is (spec) SUBSTANCE I.1a ‘type of matter I.a which can be sensed’. Just like its poorer synonym MATTER I.a, SUBSTANCE I.1a is commonly used both in specialized and non-specialized contexts, see (7a-c).

- (7) a. *Male koalas communicate through scent, smearing a smelly **substance** on trees to mark their home boundaries. Their large noses help the animals pick up other koalas’ scent warnings that say “Go away, this tree is taken.”*

COCA, BOYER Crispin, 10 Cool Things about Koalas, September 2011, MAG: National Geographic Kids

- b. *Sebum is the waxy, oily **substance** that protects and hydrates the skin.*

Web, 6 February 2020, <https://www.medicalnewstoday.com/articles/321090.php>

- c. *The **substance** of the star during a fall into a black hole heats up to several million degrees, resulting in an outbreak of x-ray radiation, which scientists were able to record using telescopes Chandra, Swift and XMM-Newton.*

Web 25 February 2020, <https://www.forumdaily.com/en>

SUBSTANCE **1.1b** derived from the basic lexeme through sense extension, see (8). SUBSTANCE **1.1b** is one of the fundamental chemical terms, so we propose to take a closer look at it.

- (8) *A chemical reaction is a process that leads to the transformation of one set of chemical **substances** to another.*

Introductory chemistry, 9 August 2019, <https://chem.libretexts.org>

We propose the following definition of SUBSTANCE **1.1b** presented in Table 5.4, see also Part II, p. 192.

<p><i>substance 1.1b</i> : type of matter 1.a</p> <ul style="list-style-type: none"> • that has a constant composition • that has constant characteristic properties $\{\Omega\}$

Table 5.4 – Formal definition of **spec** SUBSTANCE **1.1b**.

Figure 5.6 shows the semantic network around **spec** SUBSTANCE **1.1b** which includes both specialized and general language lexical units, e.g.:

- a richer synonym **spec** \lceil PURE SUBSTANCE \rceil ;
- an intersecting synonym **spec** CHEMICAL_(N) **1.1**;
- a redundant modifier CHEMICAL_(Adj) **11.1**;
- a verb of realization **spec** REACT **1.1d**;
- numerous specialized lexical units for which SUBSTANCE **1.1b** is a generic term, such as **spec** REAGENT , **spec** REACTANT , **spec** COMPOUND **1.2**, (**spec**) SOLID_(N) **1.1**, (**spec**) LIQUID_(N) **1.1**, (**spec**) GAS **1.1**, **spec** \lceil ELEMENTRAY SUBSTANCE \rceil , **spec** \lceil SIMPLE SUBSTANCE \rceil , etc.

The specialization (Chapter 4, 4.2.4) of the sense SUBSTANCE **1.1b** is SUBSTANCE **1.2** ‘substance **1.1b** which someone can get addicted to (and which is illegal)’, see (9). SUBSTANCE **1.2** makes part of the idioms \lceil SUBSTANCE ABUSE \rceil and \lceil SUBSTANCE ABUSER \rceil .

- (9) *Important gains have been made in understanding the reinforcing properties of alcohol and drugs on the brain, to be sure, yet no one seems to know why*

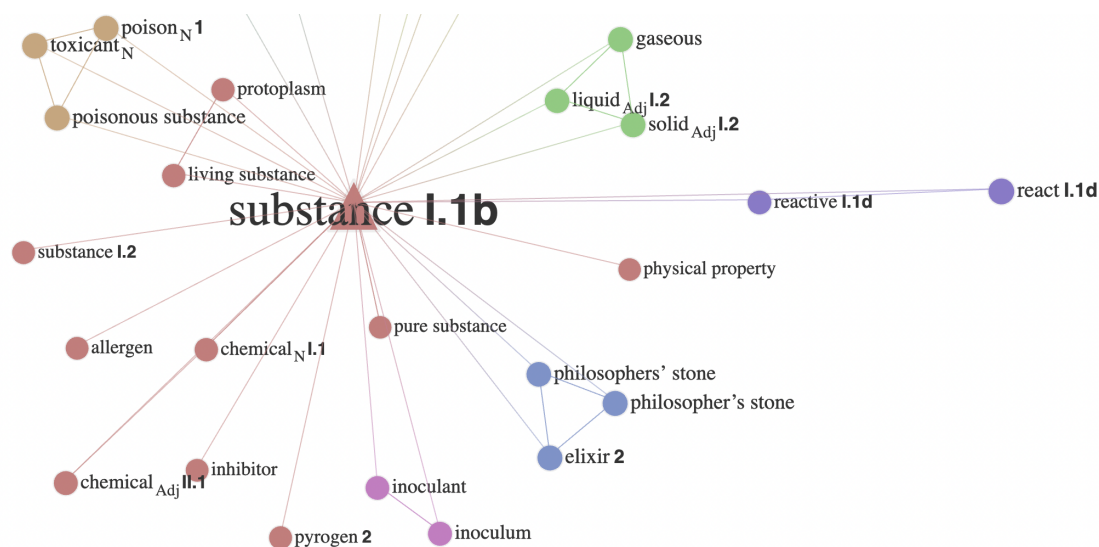

Figure 5.6 – Lexical network around **spec SUBSTANCE I.1b** in *Spiderlex*.

*some people tend to abuse **substances** more heavily than others, despite similar genetic makeups and social backgrounds.*

COCA, MEACHAM Andrew, Selling Serenity, 2000, ACAD: Humanist, Vol. 60, Issue 4, p. 15

SUBSTANCE II.1 is a metaphorical sense derived from SUBSTANCE I.1a. It denotes ‘the most essential part of something’, as in (10). SUBSTANCE II.1 makes part of the idiom ‘THE SUM AND SUBSTANCE’, as in *tell me quickly **the sum and substance** of your proposal*.

- (10) [...] *the meeting records that were available lacked detail or did not reflect the **substance** of the discussions.*

Web, 6 February 2020, <https://www.ombudsman.on.ca/digest>

The sense extension of SUBSTANCE II.1 is SUBSTANCE II.2 ‘content’ as opposed to *form* or *style*, see (11). SUBSTANCE II.2 makes part of the idioms ‘OF SUBSTANCE’ I ‘important, significant’, as in *he lacked ambition to get anything **of substance** done*, and ‘OF SUBSTANCE’ II ‘wealthy’, as in *he is a man **of substance***.

- (11) *Post notes that the distinction between the style and **substance** of speech is what underlies British law on blasphemous libel, which permits anything to be said so long as the “decencies of controversy are observed.”*

DACHIN Peter G., Defaming Muhammad: Dignity, Harm, and Incitement to Religious Hatred, Duke Forum for Law & Social Change, Vol. 2, pp. 5-38, 2010, <https://core.ac.uk/download/pdf/62560315.pdf>

5.3.2 Fr. SUBSTANCE

We have identified five senses in the French vocable SUBSTANCE, see Figure 5.7. There are two senses in the first grouping of lexemes. One sense is missing, namely *substance* ‘drug’ which is an anglicism used rather in Canadian French.

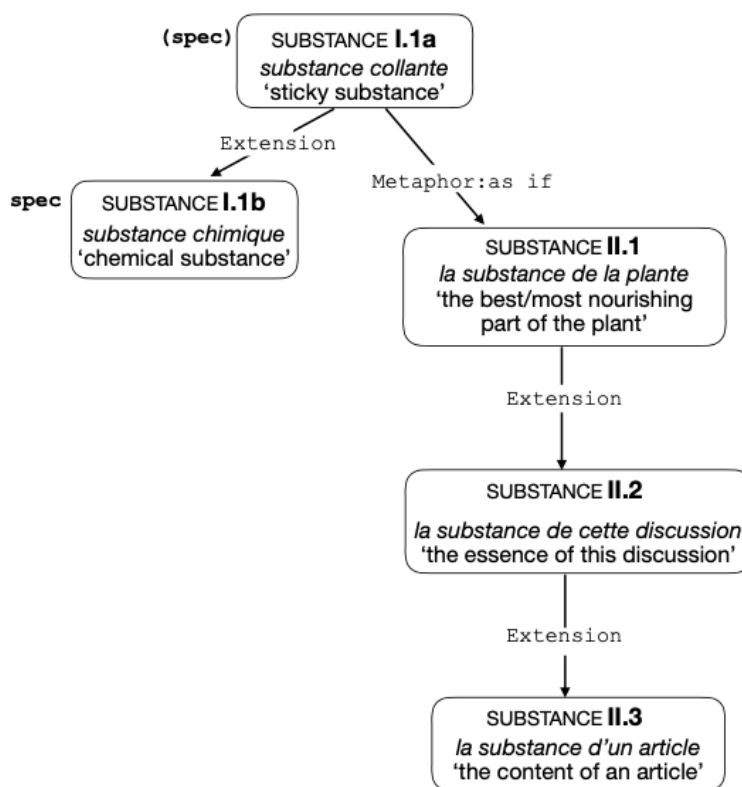

Figure 5.7 – Polysemy structure of the vocable Fr. SUBSTANCE.

- (spec) SUBSTANCE I.1a ‘type of matter which can be sensed’, as in *les abeilles fabriquent une **substance** collante, la propolis pour solidifier et protéger leur ruche* ‘bees produce a sticky **substance**, propolis, to solidify and protect their hive’;
- spec SUBSTANCE I.1b ‘type of matter which is characterized by its constant composition and its constant properties’, as in (12).

(12) *En effet, pour connaître la composition d'une **substance** inconnue, on peut la faire réagir avec différents composés chimiques connus et observer les produits obtenus après la réaction*

‘In fact, to find out the composition of an unknown **substance**, one can react it with different known chemical compounds and observe the products obtained after the reaction.’

Web, 4 December 2018, <http://cesifs.emse.fr>

The semantic network around **spec SUBSTANCE 1.1b** includes specialized and non-specialized lexical units, e.g. an intersecting synonym **spec CORPS III** ‘[chemical] body’, a richer synonym **spec** \lceil CORPS PUR \rceil ‘pure substance’, a redundant modifier CHIMIQUE **II.1** ‘chemical’, a verb of realization **spec RÉAGIR 1.1d** ‘react’. **SUBSTANCE 1.1b** is a generic term for **spec RÉACTIF 1** ‘reagent’ et **spec RÉACTIF 2** ‘reactant’, **spec** \lceil CORPS SIMPLE \rceil ‘simple substance’, **spec** \lceil CORPS ÉLÉMENTAIRE \rceil ‘elementary substance’, **spec** \lceil CORPS COMPOSÉ \rceil ‘compound’, and others.

The second grouping of lexemes unites three senses:

- **SUBSTANCE II.1** ‘the best, most nourishing part of something’, as in *les baies immaculées paraissent avoir capté toute la **substance** de la plante qui les porte* ‘the immaculate berries seem to have captured all the **substance** [= the most nourishing parts] of the plant that bears them’;
- **SUBSTANCE II.2** ‘most essential part of something’, as in *voici, en quelques lignes, la **substance** de cette discussion* ‘here, in a few lines, is the **substance** [= essence] of this discussion’;
- **SUBSTANCE II.3** ‘content of something’, as in *les mot-clés correspondent exactement à la **substance** d’un article* ‘the keywords correspond exactly to the **substance** [= content] of an article’.

5.3.3 Ru. БЕЩЕКТБО

The polysemy structure of the Russian vocable БЕЩЕКТБО is visualized in Figure 5.8.

In comparison to its English and French counterparts, БЕЩЕКТБО is the least polysemous vocable as it only comprises three senses:

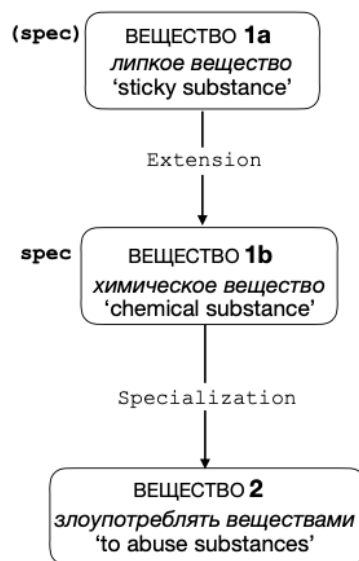
Figure 5.8 – Polysemy structure of the vocable **Ru.** ВЕЩЕСТВО.

- **(spec)** ВЕЩЕСТВО **1a** as in *он вляпался рукой в липкое **вещество*** ‘he got his hand in a sticky **substance**’;
- **spec** ВЕЩЕСТВО **1b** as in *натрий имеет высокую активность и способен бурно реагировать со многими другими **веществами*** ‘sodium is highly active and can react violently with many other **substances**’;
- ВЕЩЕСТВО **2** as in *во всем мире, наиболее часто злоупотребляют **веществами** такими как: алкоголь, марихуана, опиаты и кокаин* ‘globally, the most commonly abused **substances** are: alcohol, marijuana, opiates, and cocaine’.

The following lexical units are part of the semantic network around **spec** ВЕЩЕСТВО **1b**: ХИМИЧЕСКИЙ ‘chemical’, **spec** РЕАГЕНТ ‘reagent’, **spec** РЕАКТИВ ‘reactant’, **spec** РЕАКТАНТ ‘reactant’, **spec** ЧИСТОЕ ВЕЩЕСТВО ‘pure substance’, **spec** ПРОСТОЕ ВЕЩЕСТВО ‘simple substance’, **spec** СЛОЖНОЕ ВЕЩЕСТВО ‘complex substance’, and others.

Apart from *вещество*, we also have in Russian *субстанция* /*substancija*/ which originated from the Latin *substantia* and which might look at first glance like a real counterpart of **En.** *substance* and **Fr.** *substance*.

Indeed, one of the lexemes of the vocable СУБСТАНЦИЯ is a richer synonym of ВЕЩЕСТВО **1a** denoting ‘substance, rather unidentified or strange one’, as in

чёрная липкая субстанция ‘black sticky substance’. СУБСТАНЦИЯ also includes several specialized senses, such as ‘active pharmaceutical ingredient’ and ‘substratum; thing-in-itself’. Unlike ВЕЩЕСТВО, СУБСТАНЦИЯ does not have any specialized sense relevant to the core terminology of chemistry. Thus, there is no interest for us in analyzing this vocable in detail.

5.4 Polysemous vocables **En.** ATOM, **Fr.** ATOME, and **Ru.** АТОМ

5.4.1 **En.** ATOM

We have identified four senses in the English vocable ATOM, whose polysemy structure is visualized in Figure 5.9.

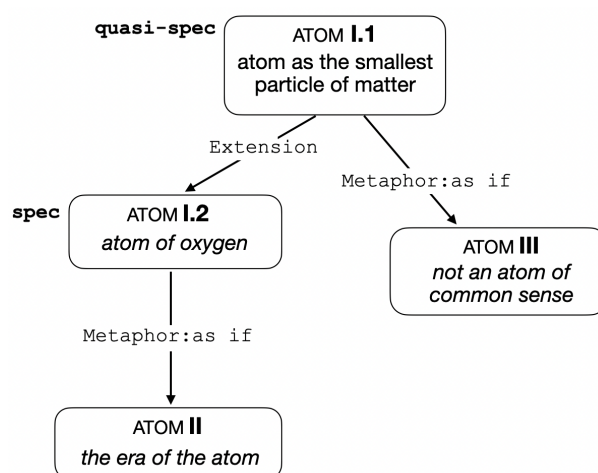

Figure 5.9 – Polysemy structure of the vocable **En.** ATOM.

The basic lexeme is a quasi-specialized sense **quasi-spec**⁴ ATOM I.1 ‘particle believed to be the smallest indivisible constituent of matter I.a’, see (13).

(13) *Atoms are the smallest particles of matter.*

Web, 14 December 2020, <http://lcwu.edu.pk/ocd/>

ATOM I.2 is a sense extension of ATOM I.1, see (14a-b). Table 5.5 demonstrates the definition that we propose for this fundamental chemical term, see also Part II, p. 168.

⁴See the discussion on usage notes in Subsection 4.2.1.

<p><i>atom</i> 1.2 of <i>X</i> combining with <i>Y</i> : particle 1.2</p> <ul style="list-style-type: none"> • that interacts 1 with similar particles 1.2 <i>Y</i> to form the smallest unit of substance 1.1b <i>X</i>
--

Table 5.5 – Formal definition of **spec** ATOM **1.2**.

- (14) a. *A water molecule is formed when two **atoms** of hydrogen bond covalently with an **atom** of oxygen. In a covalent bond electrons are shared between **atoms**.*
- COCA, Why is water such a good solvent?, 2012, http://www.edinformatics.com/interactive_molecules/water.htm
- b. *In areas where temperatures hover just above absolute zero, hydrogen **atoms** combine into molecules and form vast molecular clouds.*
- COCA, SHUBINSKI Raymond, All about the Horsehead Nebula, December 2006, Astronomy, Vol. 34, Issue 12, p. 66

The semantic network around **spec** ATOM **1.2** (see Figure 5.10) includes mostly specialized lexical units, e.g.:

- an intersecting synonym **spec** 「BUILDING BLOCK」**2**;
- the generic term **spec** PARTICLE **1.2**;
- an adjectival lexeme with the same sense as ATOM **1.2** – **spec** ATOMIC **1.1**;
- a lexeme naming the first actant **spec** MOLECULE **1**;
- modifiers of the first actant **spec** MONATOMIC , **spec** MONOATOMIC , **spec** DI-ATOMIC , **spec** POLYATOMIC ;
- verbs of realization (**spec**) INTERACT **1**, **spec** BOND_(V) **1.2a**;
- ATOM **1.2** is itself the first actant of **spec** ELECTRON , **spec** PROTON , **spec** NEUTRON , **spec** NUCLEUS **1.2**.

ATOM **11** ‘source of nuclear energy’ is a metaphorical sense derived from ATOM **1.2**, see (15).

- (15) *The Federation of American Scientists - originally the Federation of Atomic Scientists - takes the lead in lobbying to remove domestic control of the **atom** from military departments of government and in promoting the idea of international control.*
- SQUIRES Arthur M., The Tender Ship: Governmental Management of Technological Change, 14 March 2013, Springer Science & Business Media

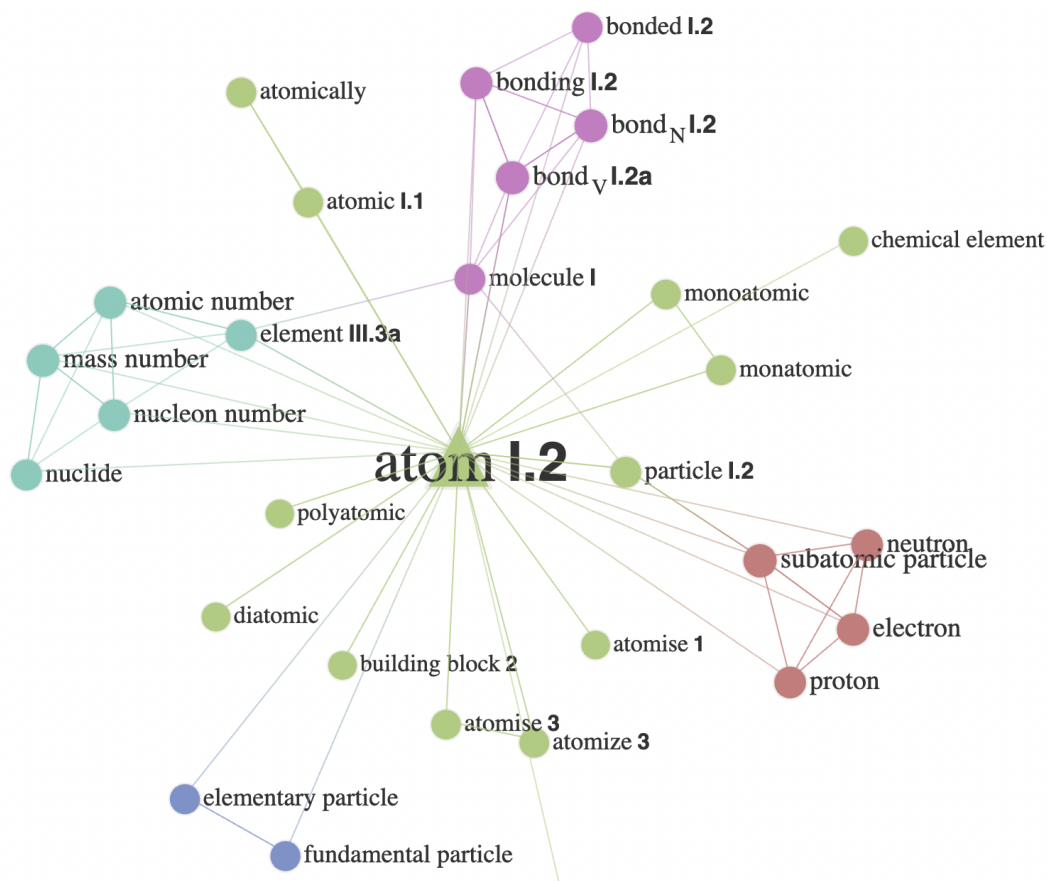

Figure 5.10 – Lexical network around **spec ATOM I.2** in *Spiderlex*.

ATOM III ‘a very small degree or amount of something’ is a metaphorical sense derived from ATOM I.1, see (16).

(16) *For you must know that there is not even an **atom** of reproach or bitterness in me about what has befallen the two of us.*

BONHOEFFER Dietrich, *Letters Papers from Prison*, 2011, <https://books.google.fr/books?isbn=1451650531>

5.4.2 Fr. ATOME

The polysemy structure of the French vocable ATOME is identical to its corresponding English one described above, see Figure 5.11.

It comprises the same four senses:

- **quasi-spec ATOM I.1**, as in *les **atomes** sont les plus petites particules de matière qui soient* ‘**atoms** are the smallest particles of matter that exist’;

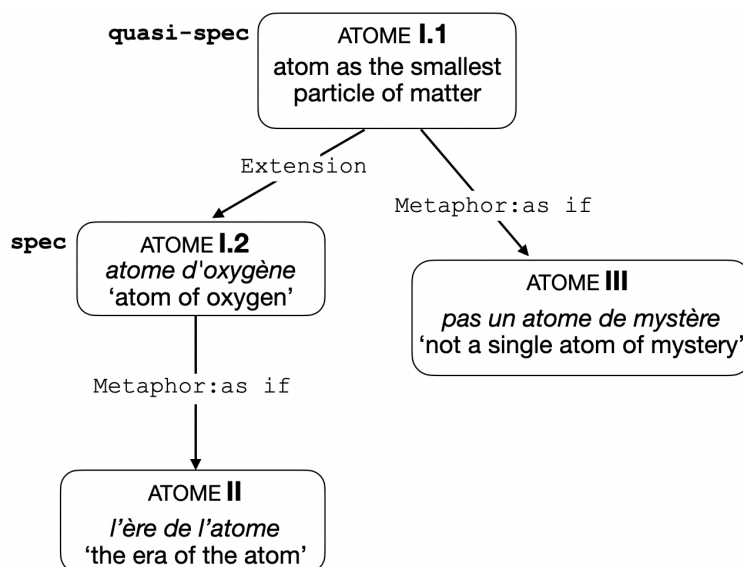
Figure 5.11 – Polysemy structure of the vocable **Fr.** ATOME.

- **spec** ATOME I.2, as in *lors des transformations chimiques les **atomes** se combinent pour former des molécules nouvelles* ‘during chemical transformations, **atoms** combine to form new molecules’;
- ATOME II, as in *des sous-marins naviguaient déjà à l'**atome*** ‘submarines were already sailing with the **atomic energy**’;
- ATOME III, as in *ceci n'est qu'un **atome** de vérité dans un océan de mensonges et de propagande* ‘this is just an **atom** of truth in an ocean of lies and propaganda’.

The semantic network around **spec** ATOME I.2 unites specialized lexical units, such as its generic term **spec** PARTICULE I.2 ‘particle’, an adjectival lexeme with the same sense as ATOME I.2 – **spec** ATOMIQUE I.1 ‘atomic’, a lexeme naming the first actant **spec** MOLECULE ‘molecule’, and others. ATOME I.2 is itself the first actant of **spec** ÉLECTRON ‘electron’, **spec** PROTON ‘proton’, **spec** NEUTRON ‘neutron’, **spec** NOYAU I.2 ‘nucleus’.

5.4.3 Ru. АТОМ

There are three senses in the Russian vocable АТОМ, see Figure 5.12.

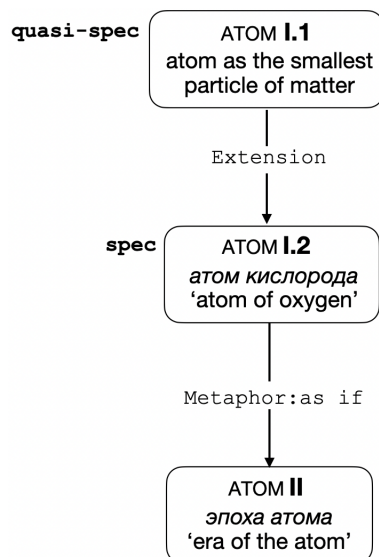

Figure 5.12 – Polysemy structure of the vocable **Ru.** АТОМ.

- **quasi-spec** АТОМ I.1, as in *атом* – мельчайшая частица материи – формируется электромагнитными волнами [...] ‘**atom**, the smallest particle of matter, is formed by electromagnetic waves’;
- **spec** АТОМ I.2, as in *в кристалле атомы взаимодействуют между собой, образуя химическую связь* ‘in a crystal, **atoms** interact with each other forming a chemical bond’;
- АТОМ II, as in *с открытием первой АЭС человечество официально вступило в новую эпоху – эпоху атома* ‘with the opening of the first nuclear power plant, mankind officially entered a new era – the era of the **atom**’.

The following lexical units are part of the semantic network around **spec** АТОМ I.2: **spec** ЧАСТИЦА I.2 ‘particle’, **spec** АТОМНЫЙ I.1 ‘atomic’, **spec** МОЛЕКУЛА ‘molecule’, **spec** ЭЛЕКТРОН ‘electron’, **spec** ПРОТОН ‘proton’, **spec** НЕЙТРОН ‘neutron’, **spec** ЯДРО I.2 ‘nucleus’, etc.

5.5 Recapitulation

This chapter presented a detailed example of the lexicographic modeling of the fundamental terms related to the lexicon of chemistry.

We decided to focus on *matter*, *substance* and *atom*, because in the course of our study, they turned out to be the building blocks of our system of the core chemical notions, see Figure 5.13. In other words, the rest of the system is built on top of them in terms of sense inclusion in the definitions of other core terms (see Chapter 7, 7.2; see also the full version of the *defined-by* hierarchy of English notions in Part II, p. 167). According to our descriptions, *matter* is one of the terminological semantic primes, since the semantic decomposition of its meaning is impossible in terms of simpler specialized meanings.

Finally, the specialized senses of *matter* and *substance* are not clearly distinguishable and pose particular problems in the context of teaching chemistry, therefore, we found it important to analyse them, perform lexicographic descriptions and propose the formal definitions for each of them.

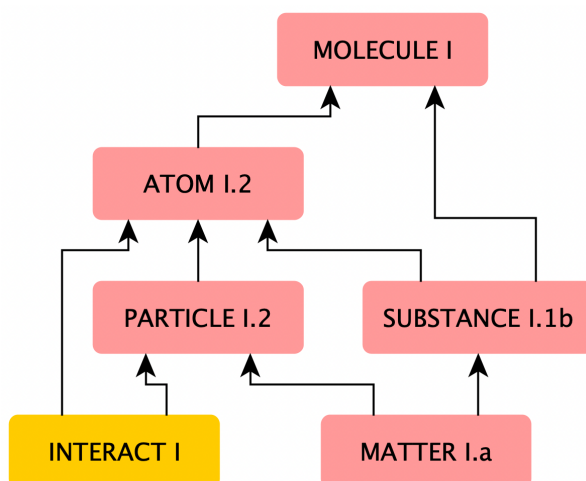

Figure 5.13 – Building blocks of the core chemical notions system.

Chapter 6

The notion of *element*

SUMMARY

6.1	Introduction	121
6.2	Historical development of the notion of <i>element</i>	122
6.3	Definitions of <i>chemical element</i> in the IUPAC <i>Gold Book</i>	126
6.4	Misconceptions associated with the notion of <i>element</i>	130
6.5	Lexicographic modeling of the polysemous vocables En. ELEM- MENT, Fr. ÉLÉMENT, and Ru. ЭЛЕМЕНТ	136
6.5.1	En. ELEMENT	136
6.5.2	Fr. ÉLÉMENT	140
6.5.3	Ru. ЭЛЕМЕНТ	141
6.5.4	Focus on chemistry-related senses	144
6.6	Recapitulation	146

The most interesting aspects of chemistry are at the advancing frontiers of the science; most chemists assume that the basic terms of their field have been clarified long ago. The lack of felt importance in clarifying meanings for fundamental chemical concepts [...] is one possible reason for long-term survival of an obsolete definition of *element*. [italics added]

Joseph Emmet Earley (Scerri and Ghibaudi 2020: 118)

6.1 Introduction

Element is one of the most important fundamental terms of the chemical lexicon. At the same time, it is probably the most debated chemical term when it comes to defining it.

Many scientists agree in that *element* is an abstract notion which refers to different types of atoms. Some still think and talk of elements as of *simple substances*, although this view is an obsolete and misleading one. As early as in 1918, a radiochemist and a future Nobel Prize laureate Frederick Soddy said:

I am not much concerned with definitions, but I think the Chemical Society might safely offer a prize of a million pounds to any one of its members who will shortly and satisfactorily define the element and the atom for the benefit of and within the understanding of a first-year student of chemistry at the present time (Soddy 1919: 5).

More than a hundred years after, a consensus on the definition of *element* still has not been reached. IUPAC still proposes two distinct definitions of *chemical element*, although both of them have been criticized by numerous chemists, including epistemologists, educators, historians and philosophers of chemistry (see, for instance, Scerri and Ghibaudi 2020).

Not that we aspire to a million pounds prize suggested by Soddy, but the aim of this chapter is to propose a formal definition of *element* based on our conceptual and linguistic analysis and to demonstrate how we deal with such complex cases that need to be studied in depth.

In order to do so, we begin with the historical development of the notion of *element* in 6.2. In 6.3 we examine the two current definitions of *chemical element* of the IUPAC *Gold Book*. In 6.4 we move to the misconceptions that arise from the definitions of *element* found in numerous modern dictionaries, textbooks and other resources on chemistry. Finally, in 6.5 we analyze the polysemy of the vocables **En.** ELEMENT, **Fr.** ÉLÉMENT and **Ru.** ЭЛЕМЕНТ, focusing on the specialized senses related to the chemical lexicon.

6.2 Historical development of the notion of *element*

The notion of *element* was first introduced by the Greek philosophers in the fifth century B.C.E. and related to a limited number of elementary principles of the Universe. Empedocles referred to the air, earth, fire and water as to *panton rhizōmata* ‘roots of all things’; Plato is claimed to be the first to call elements *stoicheia*. The original sense of the term *stoicheion* was ‘letter of the alphabet’, but Plato used it metaphorically, drawing an analogy between letters of the alphabet and elements of the Universe (Simone 2020: 3–4). By Aristotle’s time elements were assumed to be quality bearers, i.e. entities responsible for the main sensible qualities of the bodies (cold, hot, dry, wet). The idea of a limited number of elements of the Universe which are somehow preserved within transformations of matter was however a philosophical hypothesis with no empirical evidence.

The philosophical character of the concept of elements was completely changed in the eighteenth century with the chemical revolution brought by Antoine Lavoisier who proposed a very different understanding of the concept in his book *Traité Élémentaire de Chimie*¹ (Lavoisier and Cuchet 1789). The distinction between **Fr. élément** ‘element’ and *corps simple* ‘simple body’ was almost abolished, since elements were no longer perceived as abstract entities that caused certain behavior of bodies but as tangible substances with well-defined physico-chemical properties. Lavoisier related to elements as to substances which cannot be further decomposed by any currently available chemical means and which can only be identified on experimental basis:

[...] si au contraire nous attachons au nom d'**éléments**² ou de principes des corps l'idée du dernier terme auquel parvient l'analyse, toutes les substances que nous n'avons encore pu décomposer par aucun moyen, sont pour nous des **éléments** ; non pas que nous puissions assurer que ces **corps** que nous regardons comme **simple**, ne soient pas eux-mêmes composés de deux ou même d'un plus grand nombre de principes, mais puisque ces principes ne se séparent jamais, ou plutôt puisque nous n'avons aucun moyen de les séparer, ils agissent à notre égard à la manière des **corps simples**, & nous ne

¹Elementary Treatise on Chemistry

²Spelling before 1835.

devons les supposer composés qu'au moment où l'expérience & l'observation nous en auront fourni la preuve.³ (Lavoisier and Cuchet 1789: xvii–xviii)

The new concept of elements as simple substances proposed by Lavoisier was widely accepted, but the paradox of the fundamental principle of chemistry – that elements persist in their compounds – had yet to be solved. In order to illustrate this paradox, we can take as an example sulphur dioxide (SO₂) which is a gaseous colorless pungently smelling substance, while sulphur as a simple substance (S₈) is a solid yellow odorless and tasteless substance. It is obvious that the element (in the Lavoisier's sense of a simple substance) sulphur with all its properties is not preserved in the compound sulphur dioxide (Paneth 1962b: 149).

The solution of this paradox was proposed by Dmitri Mendeleev who, on the contrary, insisted on the necessity of distinguishing between the notions **Ру. элемент** 'element' and *простое тело* 'simple body'. According to Mendeleev, the term *элемент* 'element' should only be used in reference to the components of simple substances and compounds; it is elements as such components that are able to survive the transformations of matter and that are identified by the atomic weight:

В этом-то смысле и должно различать понятия о **простом теле** и об **элементе**. **Простым**, как мы уже знаем, называется вещество, которое, в отдельности взятое, никакими до сих пор произведенными способами не может быть изменено химически и составлено из преобразования каких-либо других тел. **Элемент** же есть отвлеченное понятие, материя, содержащаяся в простом теле и могущая без изменения в весе переходить во все тела, получающиеся из этого тела.⁴ (Mendeleev 1949: 381–382)

³[...] if, on the contrary, we attach to the name of **elements** or principles of bodies the idea of the last point which analysis is capable of reaching, all substances that we have not yet been able to decompose by any means are for us **elements**; not that we can guarantee that these **bodies** which we consider as **simple**, are not themselves composed of two or even of a greater number of principles, but since these principles never break up, or rather since we have no means of breaking them up, they seem to act as **simple bodies**, and we should not assume them to be compounds until experience and observation have given us proofs of that. (Our translation, bold added.)

⁴In this sense, one should distinguish between the notions of **simple body** and **element**. As we already know, we call a substance **simple**, when, taken individually, it cannot be chemically altered by any means produced up until now or be formed through the transformation of any other bodies. An **element**, on the other hand, is an **abstract** notion – matter contained in a simple body that can be transferred without change in weight to all bodies obtained from this body. (Our translation, bold added.)

The distinction between *простое тело* ‘simple body’ and *элемент* ‘element’ made it possible to overcome the paradox of the conservation of elements within their compounds. According to Mendeleev, it is not simple substances with their physico-chemical properties but elements as immutable components of simple and complex substances which maintain their identity within a chemical transformation.

В красной ртутной окиси содержится не два **простых тела** – металл и газ, а два **элемента**: ртуть и кислород, дающих в отдельности металл и кислородный газ. Не ртуть, как металл, и не кислород в своем газообразном виде содержатся в красной ртутной окиси [...] Притом многие **простые тела** существуют в различных видоизменениях, а **элемент** есть нечто, изменению не подлежащее. Так, углерод является в виде угля, графита и алмаза, которые суть различные **тела**, притом **простые**, а **элемент** их один. Тот же углерод содержится и в углекислом газе, но в нем нет ни угля, ни графита, ни алмаза.⁵ (Mendeleev 1934: 38)

In comparison to Lavoisier’s concept of elements which had a limited explanatory potential and no predictive power, Mendeleev’s understanding of the concept “proved extremely powerful for explaining and ordering chemical phenomena, as well as predicting unknown elements” (Scerri and Ghibaudi 2020: 49). The absolute distinction between the two notions – *элемент* ‘element’ and *простое тело* ‘simple body’ – allowed Mendeleev to elaborate the *Periodic Table* (Scerri 2003; Ghibaudi, Regis and Roletto 2013), which is a classification of elements, and not of simple substances, as it is often mistakenly stated even in modern textbooks on chemistry (see Section 6.4).

Unfortunately, Mendeleev’s proposal to distinguish between elements and simple substances did not get much attention in later chemical textbooks outside the Russian Empire. According to Paneth (1962b: 155), one of the reasons

⁵Red mercury oxide does not contain two **simple bodies** – metal and gas, but two **elements**: mercury and oxygen, which separately produce metal and oxygen gas. It is not mercury as a metal and not oxygen in its gaseous state that constitute red mercury oxide [...]. Moreover, many **simple bodies** exist in various modifications, but the **element** is something that cannot be changed. So, carbon exists in the form of coal, graphite and diamond, which are essentially different **bodies**, **simple** in fact, but their **element** is one and the same. The same carbon is contained in carbon dioxide, but it contains neither coal, nor graphite, nor diamond. (Our translation, bold added.)

for that was a bad choice of terminology. The two terms already introduced by Lavoisier – *élément* ‘element’ and *corps simple* ‘simple body’ – were commonly used as synonyms, so it was hardly possible to start using the synonymous terms to designate two distinct things.

In 1931 Friedrich Paneth presented a historical analysis of the notion of *element* and criticized the fact that the definition proposed by Lavoisier in 1789 was still commonly adopted in chemistry teaching (Paneth 1962a,b). Paneth maintained that **Ger.** *Element* ‘element’ was used in two different senses, and in order to keep them apart he proposed to refer to them in German as to *Grundstoff* lit. ‘basic matter’ and *einfacher Stoff* lit. ‘simple matter/substance’. Following Mendeleev, he emphasized once again that “the fundamental principle of chemistry that elements persist in their compounds refers to the quality-less basic substances⁶ only” (Paneth 1962b: 151). We summarize the discussion on the two terms proposed by Paneth and the difference between them in Table 6.1

Term	Ger. <i>Grundstoff</i> ‘basic matter/substance’ equivalent to Mendeleev’s Ru. <i>элемент</i> ‘element’	Ger. <i>einfacher Stoff</i> ‘simple substance’ equivalent to Lavoisier’s Fr. <i>élément</i> ‘element’ and <i>corps simple</i> ‘simple body’ and to Mendeleev’s Ru. <i>простое тело</i> ‘simple body’
Rough definition	Class of all atoms of equal nuclear charge, indestructible matter present in compounds and simple substances.	Stable material, substance that cannot be decomposed by chemical means.
Defining characteristics	Atomic number No sensible properties	Physico-chemical properties, such as color, odor, state, etc.
Example	Chlorine Cl – as it exists, for instance, in carbon tetrachloride CCl ₄ – has atomic number 17. Chlorine is not associated to any color, odor, etc.	Chlorine Cl ₂ (also called <i>dichlorine</i>) is a yellow-green gaseous pungent substance.

Table 6.1 – Two terms proposed by Paneth in 1931.

⁶The original lecture by Friedrich Paneth was translated from German into English by his son Heinz Post, a physicist and philosopher of science. Post translated *Grundstoff* as *basic substance* and *einfacher Stoff* as *simple substance*. The translation of *Grundstoff* as *basic substance* has been heavily criticized, because Paneth’s key point was exactly that an element as a component of simple and complex substances is not an independent substance itself (Earley 2009: 69).

By the mid-twentieth century several factors contributed to the shift in the understanding of the concept of elements. Earley (2009: 74) names, among other factors: the discovery of *isotopes*, of the nuclear nature of the atom and the identification of the *neutron* as an uncharged particle of the same mass as the positively-charged *proton*. It resulted in the adoption of a new definition of *element* by the IUPAC. According to the new definition, it is no more the *atomic weight* (the number of protons and neutrons in the atomic nucleus) but the *atomic number* (the number of protons in the atomic nucleus) that is the defining characteristic of elements.

Up until now, the terminological units denoting elements are commonly but often mistakenly used in two distinct senses in our three languages. Lavoisier's understanding of elements as simple substances is still present in numerous dictionaries as well as in modern textbooks and other resources on chemistry, which we will discuss in 6.3 and 6.4.

6.3 Definitions of *chemical element* in the IUPAC *Gold Book*

IUPAC acknowledges the fact that the term *chemical element*⁷ is used in two distinct senses (see Figure 6.1). It is not specified though, whether the usage of *chemical element* in the sense of a simple substance is correct.

The screenshot shows the IUPAC Gold Book entry for "chemical element". At the top left is the title "chemical element" in bold. To the right is a button "Online use..." with left and right arrow icons. Below the title is the DOI link: "https://doi.org/10.1351/goldbook.C01022". The main content consists of two numbered definitions:

1. A species of atoms; all atoms with the same number of protons in the atomic **nucleus**.
2. A pure **chemical substance** composed of atoms with the same number of protons in the atomic **nucleus**. Sometimes this concept is called the elementary substance as distinct from the chemical element as defined under 1, but mostly the term chemical element is used for both concepts.

 Below the definitions is the "Source:" section, which reads: "Red Book, 3rd ed., p. 35 [Terms] [Book]". At the bottom, there is a "Cite as:" section with the full citation: "IUPAC. Compendium of Chemical Terminology, 2nd ed. (the "Gold Book"). Compiled by A. D. McNaught and A. Wilkinson. Blackwell Scientific Publications, Oxford (1997). Online version (2019-) created by S. J. Chalk. ISBN 0-9678550-9-8. https://doi.org/10.1351/goldbook." At the very bottom, there are navigation buttons for "Div. VIII", "PDF", "Text", "JSON", and "History", along with the text "Last revised: February 24, 2014".

Figure 6.1 – Entry **En.** *chemical element* in the IUPAC *Gold Book*.

⁷For us, *chemical* is a redundant modifier. The actual term is a simple one: *element*.

The two current definitions found in the IUPAC *Gold Book* have been debated by numerous chemists, including epistemologists, educators, historians and philosophers of chemistry (Scerri and Ghibaudi 2020).

In the first place, the very duality of the proposed definitions raises concerns among some scientists: are there really two separate senses, or should they somehow be united? Even though it is well known that specialized lexicon – just as general language lexicon – allows for polysemy, many chemists are seeking for a unique precise definition of *element*.

What strikes me first is the strange allowance for polysemy. Scientists are supposed, by philosophers and laypeople alike, to maintain tightly controlled, nearly literal technical definitions of their foundational terms, aren't they? Isn't the ideal a precise, unambiguous single meaning, not a pair of range of possible meanings? After all, this isn't poetry, it's science! (Scerri and Ghibaudi 2020: 144)

If we take a closer look at each of the IUPAC definitions, the first one is mostly criticized for the fact that it feeds the conceptual confusion between the notions *atom* and *element*. It might lead to a false idea that the Periodic Table lists atoms, which is not the case since there are no atoms with the atomic weight (except for monoisotopic elements) indicated for each element of the Table. Moreover, the first definition does not account for the formal character of the notion of *element* underlined by Mendeleev and Paneth, i.e. it is elements that are preserved in the course of chemical reaction, but neither atoms nor simple substances.

In fact, isolated atoms (intended as individual entities defined by a nucleus and a cloud of electrons) do not survive as such within simple substances and compounds, as their electronic clouds interact with each other. [...] the properties of hydrogen atoms within methane, benzene, or water are clearly different, although they keep some features that allow identification of them as hydrogen and to designate them with the same symbol, H. The symbol expresses the formal character of the element already underlined by Mendeleev. (Ghibaudi, Regis and Roletto 2013: 1629)

Concerning the second IUPAC definition, in theory, it should have been abandoned long time ago because it contradicts the law of element conservation in a chemical reaction (as discussed above in 6.2). Earley claims:

More than ten generations after Lavoisier identified that concept as a residue of erroneous ancient ideas, the definition of element as indecomposable substance *should now be abandoned*. [...] The *benefit* of the second part of the IUPAC definition of an element is that it allows old folks to keep talking as they are used to doing, even though their concepts are obsolete (Scerri and Ghibaudi 2020: 117–118).

One can also notice that in the second definition of *chemical element* proposed by IUPAC the term *elementary substance* is used instead of *simple substance*. Both terms are indeed widely used in the modern chemical literature; surprisingly, no definition for any of the two terms can be found in the IUPAC *Gold Book*.

We came across an interesting discussion on this issue in the section “Up for discussion”⁸ of the official IUPAC forum of *Chemistry International*, where its members share their ideas and concerns. Giomini, Cardinali and Cardellini, – the authors of the publication “Simples and Compounds: A Proposal”⁹ – touch on a problem of mixing-up the terms *elementary substance* and *element*. They point out that in speech as well as in the scientific literature the term *elementary substance* is often mistakenly shortened to *element*, e.g. elementary substances such as diatomic oxygen (O₂) or crystalline silicon (Si) are often called elements. It is rarely the case for elementary substances such as diamond (C) or ozone (O₃) though.

In order to avoid the confusion, Giomini, Cardinali and Cardellini suggest replacing the term *elementary substance* with *simple substance*, which would be, as they believe, a revival of the original term used by Mendeleev. For the sake of precision, we would like to remind the reader of that both Lavoisier and Mendeleev used a bit different terms, namely **Fr.** *corps simple* and **Ru.** *простое тело* ‘simple body’. What is more, if we take a closer look at Mendeleev’s textbook (Mendeleev

⁸<http://publications.iupac.org/publications/ci/dpt/forum.html>

⁹<http://publications.iupac.org/publications/ci/2005/2701/ud.html>

1934: 35), we find out that he used terms *простое тело* ‘simple body’ and *элементарное вещество* ‘elementary substance’ as synonyms himself, only making a clear-cut distinction between *элемент* ‘element’ and these two terms:

Итак, воздух не есть **простое тело**, а состоит из двух газов – кислорода и азота, следовательно, мнение о том, что воздух есть **элементарное вещество**, несправедливо.¹⁰

In response to the proposal of Giomini, Cardinali and Cardellini, it was suggested by Scerri¹¹ to simply accept the fact that the term *element* is used in two distinct senses. However, if we accepted that the second meaning of *element* is synonymous to *elementary substance*, then it should have been correct to say both (1a) and (1b), while it is not, according to what we have observed in the vocabulary of chemists.

- (1) a. *Ozone (O₃), diamond (C), graphite (C), white phosphorus (P₄) and sulphur (S₈) are elementary substances.*
- b. **Ozone (O₃), diamond (C), graphite (C), white phosphorus (P₄) and sulphur (S₈) are elements.*

Hammond, the second opponent of the Proposal “Simples and Compounds”, claims that chemists use *element* as a shorthand for *elementary substance* but they themselves understand well what they mean in each particular case. Thus, Hammond acknowledges the fact that *element* can be used in two senses but finds it unnecessary to linguistically separate one from another by using two distinct terms: *element* and *simple substance*. He believes it might be even more confusing for non-chemists who would hardly understand the difference anyway.

¹⁰So, the air is not a **simple body**, but consists of two gases – oxygen and nitrogen, thus, the belief that the air is an **elementary substance** is wrong. (Our translation, bold added.) It is important to note though that by saying that the air consists of two **gases** – and not of two **elements** – Mendeleev contradicts his own words found in the same textbook. The original text was already cited on the pages 53–54, so we only remind the reader of the English translation: “Red mercury oxide does not contain two simple bodies – metal and **gas**, but two **elements**: mercury and oxygen, which separately produce metal and oxygen gas. It is not mercury as a metal and not oxygen in its gaseous state that constitute red mercury oxide [...]”

¹¹http://publications.iupac.org/ci/2005/2703/ud2_scerri.html

I believe the change suggested by Giomini *et al.* (Jan-Feb 2005 *CI*, p.18) is not necessary. Chemists generally understand the difference between elements and elementary substances and use the term “element” as a shorthand descriptor. I do not know any chemist who would not understand that diamond, graphite, or fullerenes are all different forms of the element carbon—the common names take care of differentiation. Non-chemists are unlikely to understand the distinction and could become further confused by having “two types of elements.”

It is hard to agree with Hammond in that “the common names take care of differentiation”. As we will show it in Section 6.4, the common names usually do not take care of differentiation, and the case of *diamond*, *graphite*, *fullerenes* and *carbon* is a rare exception.

Concerning the mentioned non-chemists, it is, on the contrary, extremely important to use unambiguous terms when teaching chemistry or talking to non-specialists of the domain, otherwise their misunderstanding of basic notions will result in further confusion. We could not agree more with Philip Ball in that “it is always a little dangerous in science to overconfidently assume that because you can use a word or concept without being challenged, you and others know what it means and agree on that” (Scerri and Ghibaudi 2020: viii).

6.4 Misconceptions associated with the notion of *element*

The separation of the two meanings of *element* is rarely and inconsistently reflected in the chemical nomenclature (Paneth 1962b; Earley 2009; Ghibaudi, Regis and Roletto 2013).

The term *oxygen* is used by chemists to refer both to the element O and to the gaseous simple substance O₂, although there is a separate term – *ozone* – used for the simple substance O₃. In the case of diamond C, graphite C, fullerenes (such as C₆₀) and the element carbon C, the names of simple substances are completely different from the name of their element.

Most of other simple substances have the same name as their corresponding element, e.g. the term *sulfur* is used both for the element S and for the solid S₈,

the term *argon* – for the element Ar and the noble gas Ar, the term *cobalt* – for the element Co and the metal Co, etc. In order to linguistically separate one from another, we can call some simple substances by their alternative name which reflects their molecular structure, e.g. *dichlorine* Cl₂, *dioxygen* O₂, *tetraphosphorus* P₄, *cyclo-octasulfur* S₈.

According to what we have observed in the chemical literature, the replacement of the terms *elementary substance*/*simple substance* by *element* usually happens in those cases when the name of a simple substance, such as *argon* or *copper*, is identical with the name of the element that the substance is made of. If the name of a simple substance is different from the name of its element, it is very rare that the term *element* is applied; e.g. chemists would hardly refer to ozone, diamond, graphite or fullerenes as to *elements*.

Such inconsistency and frequent overlaps in the naming of simple substances and their elements brings much confusion. We often encounter the misleading statements in encyclopedias, textbooks and online resources from which one might conclude that the Periodic Table of Elements is the table of simple substances. Here are some examples:

Argon is colorless, tasteless and odorless noble gas that is located in Group 18 on the Periodic Table.¹²

Le manganèse (symbole Mn, n° atomique 25) est un métal gris clair, brillant comme l'acier, avec des reflets rougeâtres. Il se situe en tête de la colonne VII A de la classification périodique [...].¹³

Un élément est une substance pure qui ne peut être décomposée en substances plus simples. Le tableau périodique, inspiré par Mendeleïev, en donne la liste complète.¹⁴

¹²https://chem.libretexts.org/Bookshelves/Inorganic_Chemistry

¹³Manganese (symbol Mn, atomic no. 25) is a light grey metal, shiny like steel, with reddish reflections. It is located at the top of column VII A of the periodic classification [...]. | <https://www.universalis.fr/classification/chimie>

¹⁴An element is a pure substance that cannot be broken down into simpler substances. The periodic table, inspired by Mendeleïev, gives the complete list of them. | <http://www.geocities.ws/profmokeur/chimie/elecomp.htm>

Каждый период Периодической таблицы начинается активным металлом и заканчивается инертным газом.¹⁵

It is clear from Table 6.2 though that, unlike simple substances, elements are devoid of any observable qualities, such as color, odor, taste, etc.

Element	Simple substance(s)
Carbon, C atomic number 6	Diamond, C transparent colorless hardest solid, a poor conductor of heat and electricity Graphite, C black silky soft solid, a good conductor of heat and electricity
Oxygen, O atomic number 8	Oxygen = Dioxygen, O₂ colorless and odorless gas Ozone = Trioxygen, O₃ pale blue gas with a pungent smell
Phosphorus, P atomic number 15	White phosphorus = Yellow phosphorus = Tetraphosphorus, P₄ translucent soft waxy toxic solid Red phosphorus, P dark red amorphous solid (powder) Black phosphorus, P black flaky solid
Sulfur, S atomic number 16	Sulfur = (Cyclo-)octasulfur, S₈ bright-yellow odorless solid
Argon, Ar atomic number 18	Argon, Ar colorless and odorless gas
Cobalt, Co atomic number 27	Cobalt, Co hard lustrous silver-gray metal

Table 6.2 – Names and defining characteristics of elements *vs.* simple substances.

The Periodic Table is not a table of elements in the sense of simple substances, otherwise, in the cell, for instance, of the sixth element carbon we would have had diamond, graphite or fullerenes. What is more, even in the case of the element carbon, whose name is different from the names of the simple substances it forms, one can encounter numerous misleading statements, such as the following:

Chaque élément est constitué d'un nombre gigantesque d'entités minuscules mais identiques qu'on appelle des atomes. Ainsi, un élément tel que le

¹⁵Each period of the Periodic Table begins with an active metal and ends with an inert gas. | <http://www.hemi.nsu.ru/ucheb142.htm>

carbone est entièrement composé d'atomes de carbone. L'oxygène ne contient que des atomes d'oxygène.¹⁶

The first and the third sentences would only makes sense if by *élément* we understand simple substance and by *oxygène* we understand the substance O₂. Following this logic, one might conclude from the second sentence that carbon is also a simple substance which does not make any sense.

Another misleading statement found in chemical literature is the opposition “elements *vs.* compounds” that we often encounter on schematic classifications of matter and throughout the text of numerous textbooks and online resources on chemistry. To illustrate this, we take as an example two definitions and the schema “Classification of matter”¹⁷ on Figure 6.2 from the fourteenth edition of the famous textbook *Chemistry: The Central Science* (Brown, LeMay, *et al.* 2018: 51–55):

All substances are either elements or compounds.

- Elements are substances that cannot be decomposed into simpler substances. On the molecular level, each element is composed of only one kind of atom.
- Compounds are substances composed of two or more elements; they contain two or more kinds of atoms. Water, for example, is a compound composed of two elements: hydrogen and oxygen.

The authors of the textbook mix-up the notions of *atom*, *molecule*, *simple substance* as well as two senses of *element*.

They claim first that elements are simple substances, without any indication on another sense of *element* which they later refer to in the definition of *compounds*.

From their definition of *elements* one can also assume that elements are molecules composed of one kind of atoms, but again, elements as we find them on the Periodic Table are not molecules and are not composed of atoms, as many students believe because of such definitions in their manuals.

¹⁶Each element consists of a gigantic number of tiny but identical entities called atoms. Thus, an element such as carbon is composed entirely of carbon atoms. Oxygen contains only oxygen atoms. | <https://books.google.ru/books?id=rlwpAwAAQBAJ&dq>

¹⁷We highlighted problem areas with exclamation marks.

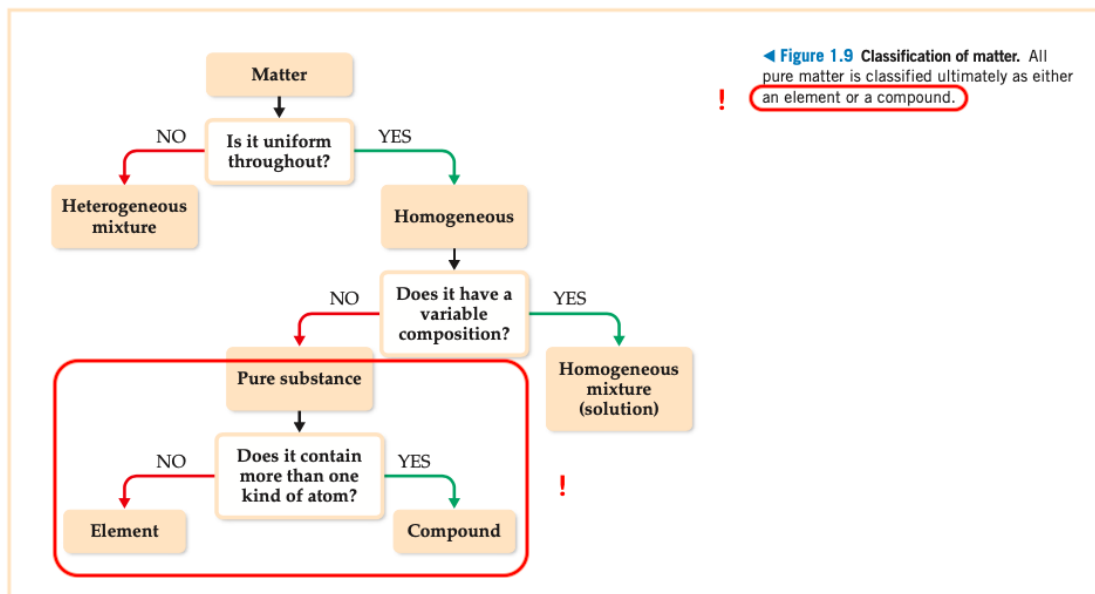

Figure 6.2 – Schema “Classification of matter” taken from the textbook *Chemistry: The Central Science* (Brown, LeMay, *et al.* 2018: 55).

Moving to the definition of *compounds*, we can see that it contradicts the definition of *elements* proposed just above. The phrase “compounds are substances composed of two or more **elements**” is followed by the reformulation “they contain two or more **kinds of atoms**”. In this case, the authors are referring to *elements* not as to simple substances but kinds of atoms. The phrase “water is a compound composed of two elements: hydrogen and oxygen” would only make sense, if by *element* they mean ‘kinds of atoms’ and by *hydrogen* and *oxygen* they mean the elements of the Periodic Table hydrogen H and oxygen O, but not the simple substances hydrogen H₂ and oxygen O₂. In such a way, in the definition of *compounds* the authors of the textbook switched from one meaning of *element* to another one, without making it clear to the student, which is very confusing.

Similar to this example taken from *Chemistry: The Central Science*, many authors of other chemical textbooks and online resources still follow Lavoisier’s definition and refer to elements as to substances:

Elements and compounds are both examples of pure substances. A substance that cannot be broken down into chemically simpler components is an **element**.¹⁸

¹⁸https://chem.libretexts.org/Courses/El_Paso_Community_College

Chaque élément est une substance pure, simple, qu'il est impossible de décomposer par des méthodes chimiques.¹⁹

ЭЛЕМЕНТ – вещество, состоящее из атомов одного вида (из атомов с одинаковым зарядом ядра).²⁰

The definition of *element* found in Oxford *Dictionary of Chemistry* (Daintith 2008: 202) is also confusing because its authors are switching from one meaning of *element* to another one without stating it explicitly:

element

A substance that cannot be decomposed into simpler substances.

In an element, all the atoms have the same number of protons or electrons, although the number of neutrons may vary.

There are 92 naturally occurring elements.

See also PERIODIC TABLE; TRANSURANIC ELEMENTS; TRANSACTINIDE ELEMENTS.

First, *element* is defined as a simple substance, but then it is claimed that there are only ninety-two naturally occurring elements, i.e. authors of the definition are not talking anymore of elementary substances (because there are obviously many more than ninety-two) but of the first ninety-two elements of the Periodic Table.

As we can observe, the authors of such definitions overlook the formal character of the notion of elements evoked by Mendeleev, Paneth and many other chemists (Ghibaudi, Regis and Roletto 2013: 1628). They bring much confusion by defining *element* as a simple substance and contradict the fundamental principle of chemistry that elements persist in compounds, while simple substances do not.

We would like to conclude this section with the citation of Elena Ghibaudi who underlines the importance of unambiguous definitions in the teaching context:

¹⁹Each element is a pure, simple substance that cannot be broken down by chemical methods. | <https://books.google.ru/books?id=rlwpAwAAQBAJ&dq>

²⁰ELEMENT – substance consisting of one kind of atoms (atoms with equal nuclear charge). | <http://www.hemi.nsu.ru/slovar.htm>

Chemistry classes are the places where chemical knowledge is primarily conveyed and inherited by new generations of chemists; chemical education assures the continuity and the dissemination of chemical knowledge. It has a pivotal role in “building up” the epistemic community of chemists. In this respect, the unambiguous definition of foundational chemistry notions is not an irrelevant issue (Scerri and Ghibaudi 2020: 260).

6.5 Lexicographic modeling of the polysemous vocables

En. ELEMENT, Fr. ÉLÉMENT, and Ru. ЭЛЕМЕНТ

In 6.5.1 we begin with the analysis of the polysemy structure of the English vocable ELEMENT, which comprises, among other senses, one specialized (see 6.5.4.1) and one semi-specialized (see 6.5.4.2) lexemes related to the lexicon of chemistry.

Since the corresponding French and Russian vocables ÉLÉMENT and ЭЛЕМЕНТ are very similar in structure to the English one, in 6.5.2 and 6.5.3, we do not focus on their polysemy but only point out the discrepancies found in the three languages.

6.5.1 En. ELEMENT

We have identified fourteen senses in the vocable ELEMENT; its polysemy structure is visualized on Figure 6.3.

The basic lexeme ELEMENT **1.1** belongs to the general language lexicon and means ‘part of something’, as in (2).

- (2) *Focus on a key **element** of the story and write down words or phrases associated with it.*

COCA, How to Come Up with a Book Title. A New Fiction Writers Forum, 2012

A specialization of the basic lexeme and at the same time its richer synonym is ELEMENT **1.2** ‘element **1.1** of a physical entity’, as in (3).

- (3) *The 85-kwh battery pack is the heaviest **element** of the car at roughly 1000 pounds.* COCA, *Technical Innovation*, December 2012, MAG: Popular Mechanics, Vol. 189, Issue 12, p. 60

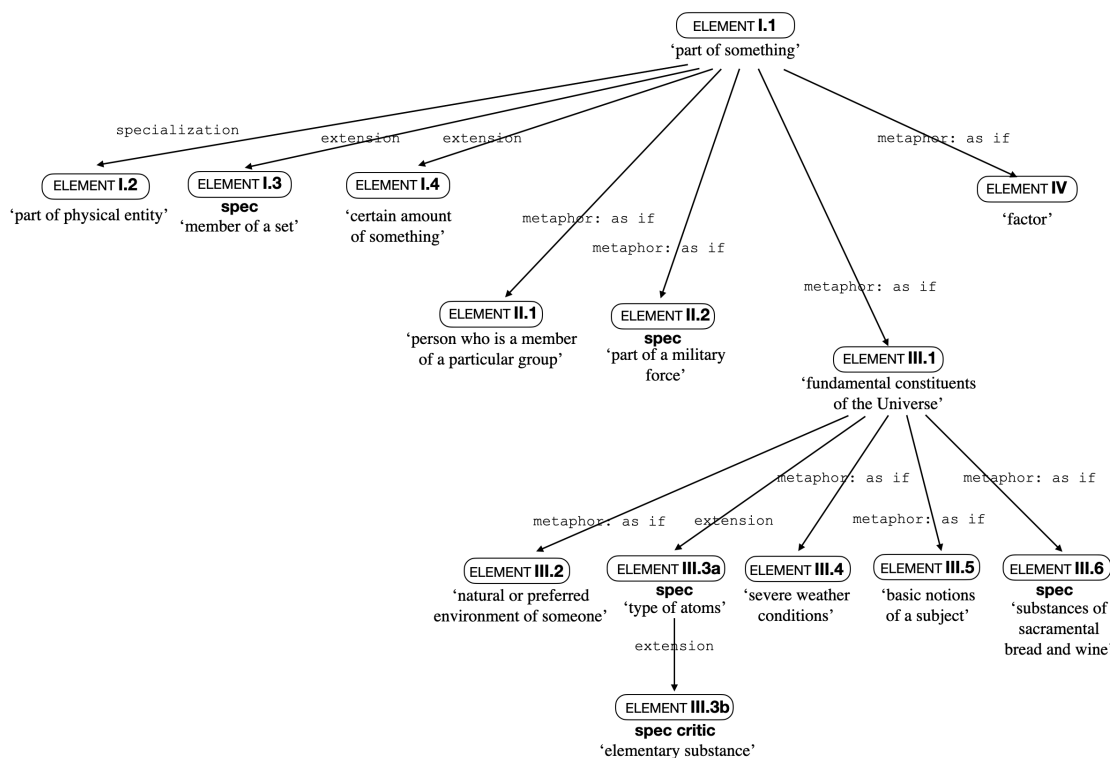
Figure 6.3 – Polysemy structure of the vocable **En.** ELEMENT.

ELEMENT I.3 and ELEMENT I.4 are both sense extensions of ELEMENT I.1. ELEMENT I.3 is a specialized lexeme denoting ‘member of a set’, as in (4a). ELEMENT I.4 means ‘certain amount of something’, as in (4b).

- (4) a. *The **elements** of a set can be numbers, mathematical functions, or even sets themselves.*
 COCA, KLARREICH Erica, *Science News*, Infinite wisdom, 30 August 2003, Vol. 164, Issue 9, p. 139-141
- b. *As with most hackneyed phrases, there is an **element** of truth in the saying “Variety is the spice of life”.*
 COCA, WILSON John R. U. *et al*, *Bioscience*, Plant Diversity in the Human Diet, February 2008, Vol. 58, Issue 2, p. 151-159

The second grouping of lexemes comprises two metaphorical senses derived from ELEMENT I.1, namely ELEMENT II.1 ‘person who is a member of a particular group’, see (5a), and a specialized sense ELEMENT II.2 ‘part of a military force’, see (5b).

- (5) a. *The holiday season is a time for sharing, spreading peace, and promoting goodwill. . . but it's also a time when tempers fray, people over-indulge and the outright criminal **elements** of society take advantage of spirit of the season to wreak havoc.*

Web, 12 February 2021, <https://blog.oup.com/2015/12/top-5-holiday-crimes/>

- b. *Frontline **elements** lost all contact with their artillery.*

COCA, FLEMING Thomas, *Military History*, Argonne: Paying the price, 2002, p. 42

Now we move to the third grouping of seven closely related lexemes. ELEMENT III.1 is a metaphorical sense derived from ELEMENT I.1. ELEMENT III.1 means ‘substance formerly believed to be one of the fundamental constituents of the matter’ and is mostly used in plural, see (6).

- (6) *As a philosopher, Empedocles is best known for his theory that the world is composed of four **elements** or, more precisely, ‘roots’ – fire, air, earth, and water.*

Web, 29 December 2020, <https://www.ancient-origins.net>

ELEMENT III.2 ‘natural or preferred environment of someone’ is a metaphorical sense derived from ELEMENT III.1, see (7a); it makes part of idioms ‘TO BE OUT OF ONE’S ELEMENT’ and ‘TO BE IN ONE’S ELEMENT’, see (7b).

- (7) a. *I am always surprised to rediscover what a water person I am: how directly and specifically the water is my **element**, what a familiar and reassuring embrace it has for me.*

JEROME John, *Stone Work: Reflections on Serious Play and Other Aspects of Country Life*, 1990

- b. *Under the stagelights, surrounded by those who loved him, Clemons was in his **element**.*

COCA, Clarence Clemons dies of complications from stroke, 2012, Web, http://www.nj.com/news/index.ssf/2011/06/clarence_clemons_dies.html

The specialized lexemes ELEMENT III.3a ‘type of atoms’ and ELEMENT III.3b

‘pure substance composed of the same elements **III.3a**’ relate to the lexicon of chemistry and will be discussed in detail in 6.5.4.1 and 6.5.4.2.

The next three lexemes are metaphors derived from ELEMENT **III.1**. ELEMENT **III.4** denotes ‘severe weather conditions’ and is mostly used in plural, as in (8).

- (8) *Nighttime temperatures dropped to as low as minus 25, ensuring that many men left exposed to the **elements** would not survive until morning.*

COCA, *Weider Reader*, November 2014, MAG: Military History, Vol. 31, Issue 4

ELEMENT **III.5** means ‘basic notions of a subject’ and is also used in plural, as in (9).

- (9) *Its multidisciplinary nature is what makes it interesting; we study **elements** of maths, physics, mechanics, some elementary programming and different branches of chemistry.*

Web, 1 December 2020, <https://www.soci.org/blog/2019-10-01-3-reasons-why-i-chose-chemeng>

ELEMENT **III.6** is a specialized lexeme; it denotes ‘substances of bread and wine consecrated and consumed during the Eucharist’, see (10). The sacramental elements are perceived by some Christians as symbolic representations of the Christ’s body and blood.²¹ It is also believed that the substances of bread and wine are changed into the actual body and blood of the Christ during the Eucharist; the term *transubstantiation* is used to denote this transformation. Interestingly, we use *espèces* ‘species; appearances’ in French and *вещества* ‘substances’ in Russian to refer to the sacramental bread and wine of the Eucharist (see 6.5.2 and 6.5.3).

- (10) *A widely accepted practice is for all to receive and hold the **elements** until everyone is served, then consume the bread and cup in unison. Usually, music is performed and Scripture is read during the receiving of the **elements**.*

Web, *Abrahamic Religions*, 1 December 2020, <https://books.google.ru/>

²¹“But the kind and mode of this presence are not yet particularly defined, and admit very different views: Christ may be conceived as really present either in and with the elements (consubstantiation, impanation), or under the illusive appearance of the changed elements (transubstantiation), or only dynamically and spiritually.” | https://www.ccel.org/s/schaff/history/3_ch07.htm

Finally, we have at least one additional metaphorical sense derived from the basic lexeme **ELEMENT I.1**. **ELEMENT IV** is synonymous to **FACTOR I** and denotes ‘something that affects an event’, as in (11).

- (11) *Advocates worry that the new system won't take the human **element** into account, ignoring the long-term relationships some mentally ill patients have formed with case managers and caregivers.*

COCA, *Big changes are coming in the way the...*, Fayetteville Observer, 2012

6.5.2 Fr. ÉLÉMENT

As Figure 6.4 shows, the French vocable ÉLÉMENT comprises thirteen senses.

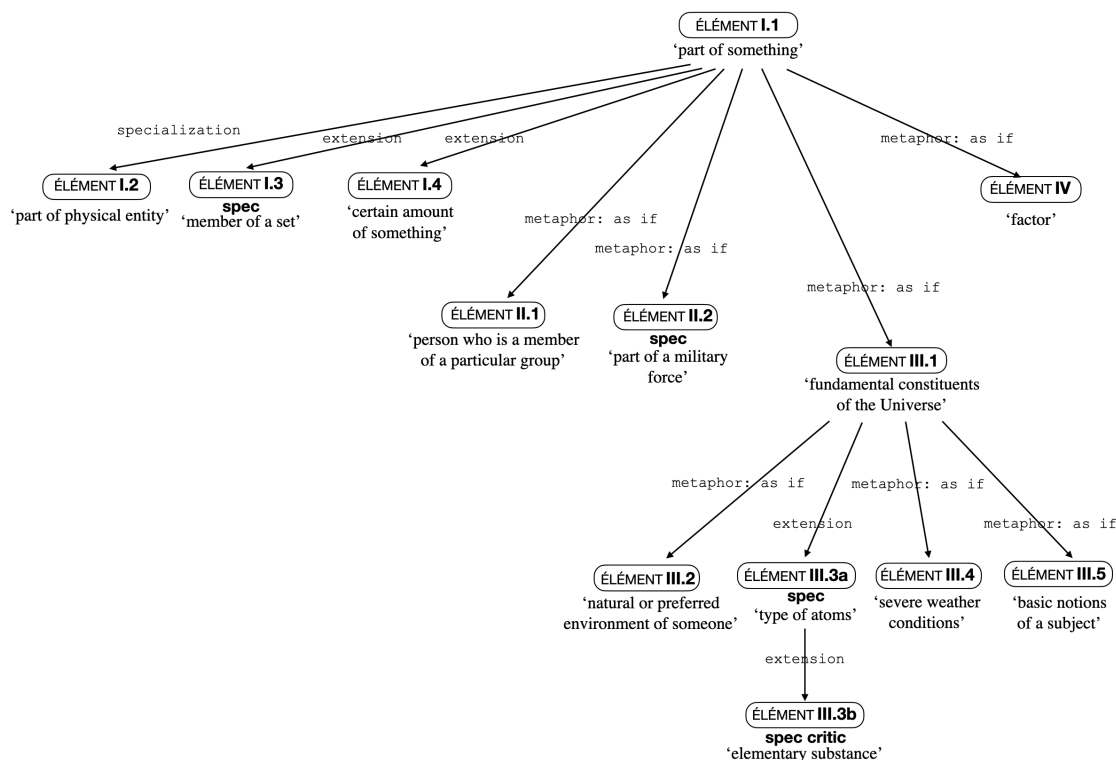

Figure 6.4 – Polysemy structure of the vocable **Fr.** ÉLÉMENT.

In contrast to the English vocable **ELEMENT**, there is no lexeme denoting ‘substances of bread and wine consecrated during the Eucharist’ within the vocable **ÉLÉMENT**. The French term used to refer to the sacramental elements is *espèce* ‘species; appearances’, see (12), which conveys the idea that only the appearances of bread and wine stay the same after the consecration, while their substances are changed into the Christ’s body and blood.

- (12) *Nous savons grâce à la foi de l'Église que le Christ tout entier est présent sous chacune des deux espèces, du pain et du vin consacrés, et dans chacune de leurs parties.*

‘We know from the faith of the Church that the Christ is entirely present under each of the two **species** [= elements], the consecrated bread and wine, and in each of their parts.’

Web, 11 December 2020, <https://www.catholique-nancy.fr/>

Apart from that, we have not identified any other discrepancies in polysemy structure of the French vocable **ÉLÉMENT**: all other senses described in 6.5.1 are present there as well.

6.5.3 Ru. ЭЛЕМЕНТ

The Russian vocable **ЭЛЕМЕНТ** comprises only nine senses, see Figure 6.5.

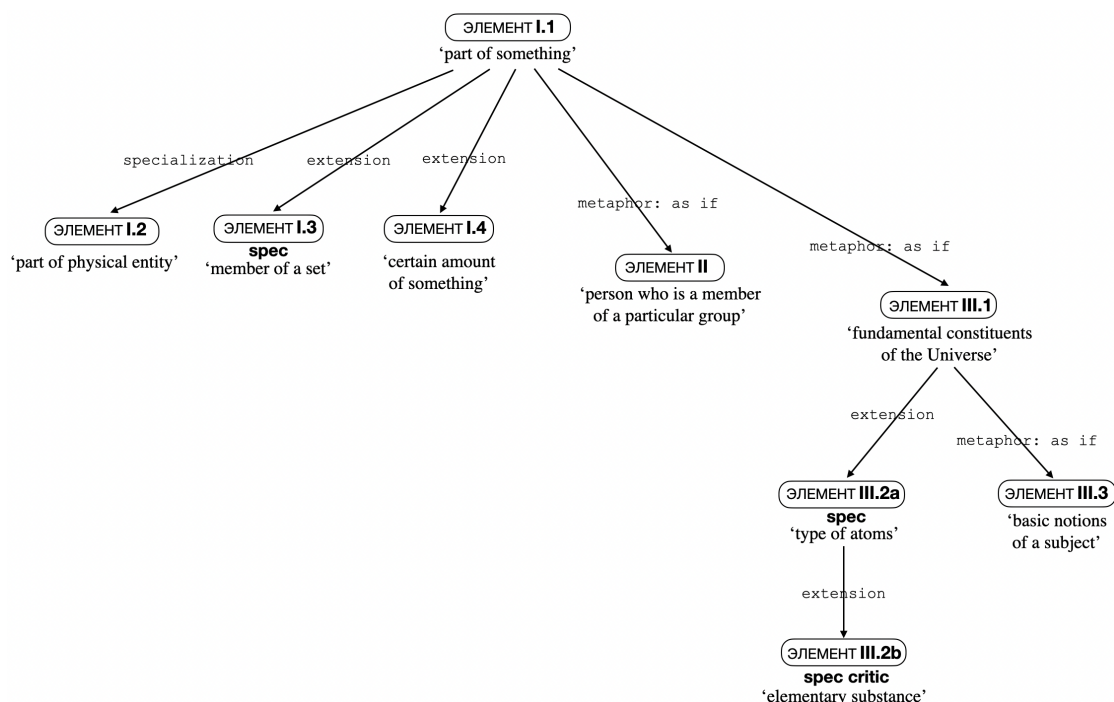

Figure 6.5 – Polysemy structure of the vocable **Ru. ЭЛЕМЕНТ**.

The sense ‘part of a military force’ is one of the missing senses in **ЭЛЕМЕНТ**, if we compare it to the corresponding English and French vocables. In order to express this meaning in Russian, we would use the specialized lexemes such as **ЧАСТЬ II** ‘part; unit’ or **ПОДРАЗДЕЛЕНИЕ III** ‘subdivision’, see (13).

- (13) *Проезжая запретную зону, Иоганн видел войсковые пехотные и моторизованные **части** второго эшелона: они стояли на исходных позициях.*

‘Driving through the exclusion zone, Johann saw military infantry and motorized **units** [= elements] of the second echelon: they were in their initial positions.’

Ruscopora, КОЖЕВНИКОВ Вадим, *Щит и меч. Книга первая*, 1968

Moving further, we would like to point out that in Russian there are two synonymous lexemes which denote ‘substance formerly believed to be one of the fundamental constituents of the matter’:

- ЭЛЕМЕНТ **II.1** /element/, which etymologically derived from the Latin *elementum*;
- СТИХИЯ **I.1** /stichija/, which derived from the original Ancient Greek term *stoicheion* (*stoicheia* in plural; see 6.2).

Both terms can only be translated into English as *elements*, see (14).

- (14) *По определению Платона, **стихии**, или **элементы**, – это то, из чего состоят и на что распадаются сложные тела.*

‘According to Plato’s definition, **elements** are what complex bodies consist of and break down into.’

КАРЕЛИН В., *Чего не знает современная наука*, 2018

Interestingly, the Russian vocable ЭЛЕМЕНТ neither includes the sense ‘natural or preferred environment of someone’ nor the sense ‘severe weather conditions’. These metaphorical senses are to be found in the polysemous vocable СТИХИЯ under СТИХИЯ **I.2** and СТИХИЯ **I.3** respectively, see (15a-b).

- (15) a. *Нет, ребята, — говорит Юрка, — море не моя **стихия**.*

‘No, guys, — Jurka says, — the sea is not my **element**.’

Ruscopora, АКСЁНОВ Василий, *Звёздный билет*, “Юность”, 1961

- b. *Люди пытались спастись всеми доступными средствами, но все же многие оказались бессильны перед бушующей **стихией**.*

‘People tried to save themselves by all available means, but still many

were powerless in the face of the raging **natural force** [= elements].’

ГОРОДНИЦКИЙ А. М., *Тайны и мифы науки. В поисках истины*, 2014

The sense ‘substances of bread and wine consecrated during the Eucharist’ is also missing in ЭЛЕМЕНТ. In order to refer to the sacramental elements, we either use the term ВЕЩЕСТВО II ‘substance’ in plural, as in (16a), or an idiom «СВЯТЫЕ ДАРЫ» lit. ‘sacred gifts’, as in (16b).

- (16) a. *Веществами для совершения литургии служат чистый пшеничный квасной хлеб и чистое виноградное вино, смешанное с водой.*

‘The **substances** used for the liturgy are pure wheat leavened bread and pure grape wine mixed with water.

Web, 13 December 2020, <https://www.pravenc.ru/text/348067.html>

- b. *Те, кто имел счастье служить вместе с отцом Николаем, навсегда запомнили, с каким благоговением отец Николай относился к Таинству Евхаристии: почти всегда, принимая **Святые Дары**, он плакал.*

‘Those who were fortunate enough to serve with Father Nikolay remembered forever the reverence with which Father Nikolay treated the Sacrament of the Eucharist: when receiving the **Sacred Gifts**, he almost always wept.’

Ruscorpora, Протоиерей ХМЫЛОВ Николай, *Журнал Московской патриархии*, 2004

Finally, the sense ‘something that affects an event’ is not present in the Russian vocable ЭЛЕМЕНТ. In order to express this meaning, we use a lexeme ФАКТОР I, as in (17).

- (17) *В управлении подчеркнули, что “в большинстве случаев не сложные погодные условия, а именно человеческий **фактор** является основной причиной ДТП”.*

‘The department stressed that “in most cases, it is not the difficult weather conditions, but the human **factor** [= element] which is the main cause of car accidents”.’

Web, 13 December 2020, <https://www.interfax.ru/russia/167133>

6.5.4 Focus on chemistry-related senses

Now we take a closer look at the senses belonging to the lexicon of chemistry. We focus on the case of English and present our lexicographic description for the specialized lexemes ELEMENT **III.3a** (6.5.4.1) and ELEMENT **III.3b** (6.5.4.2).

6.5.4.1 *spec* ELEMENT **III.3a**

ELEMENT **III.3a** is a sense extension of ELEMENT **III.1**; it is a specialized lexeme related to the fundamental lexicon of chemistry, see (18a-b).

- (18) a. *The **element** hydrogen, at the upper left of the table, has an atomic number of 1, so every hydrogen atom has one proton in its nucleus.*
- b. *How is an atom of the **element** 54 (Xe) likely to act during a chemical reaction? It is likely to be unreactive.*

After having studied the notion of element from historical as well as pedagogical perspectives, we came up with the following definition of ELEMENT **III.3a** presented in Table 6.3. For the definitions of the corresponding lexemes **Fr.** ÉLÉMENT **III.3a** and **Ru.** ЭЛЕМЕНТ **III.2a** see Part II, p. 200 and p. 244.

<p><i>element</i> III.3a <i>X</i> : type of atoms I.2</p> <ul style="list-style-type: none"> • that is identified by the number X corresponding to the quantity of protons in the nucleus I.2 of the atoms I.2

Table 6.3 – Formal definition of *spec* ELEMENT **III.3a**.

Figure 6.6 shows a lexicographic article of the lexeme ELEMENT **III.3a** as well as its lexical network in the en-LN (for Lexical Networks see Chapter 4).

The propositional form *element X* shows that ELEMENT **III.3a** is a uniactantial quasi-predicate, i.e. it controls one semantic actant slot. The actant X can be expressed by lexical units which denote an atomic number or a name of a particular element, e.g. *element 96*, *element curium*.

The semantic label *type of physical matter* as well as the central component of the paraphrase – ‘type of atom’ – make it clear that ELEMENT **III.3a** is not

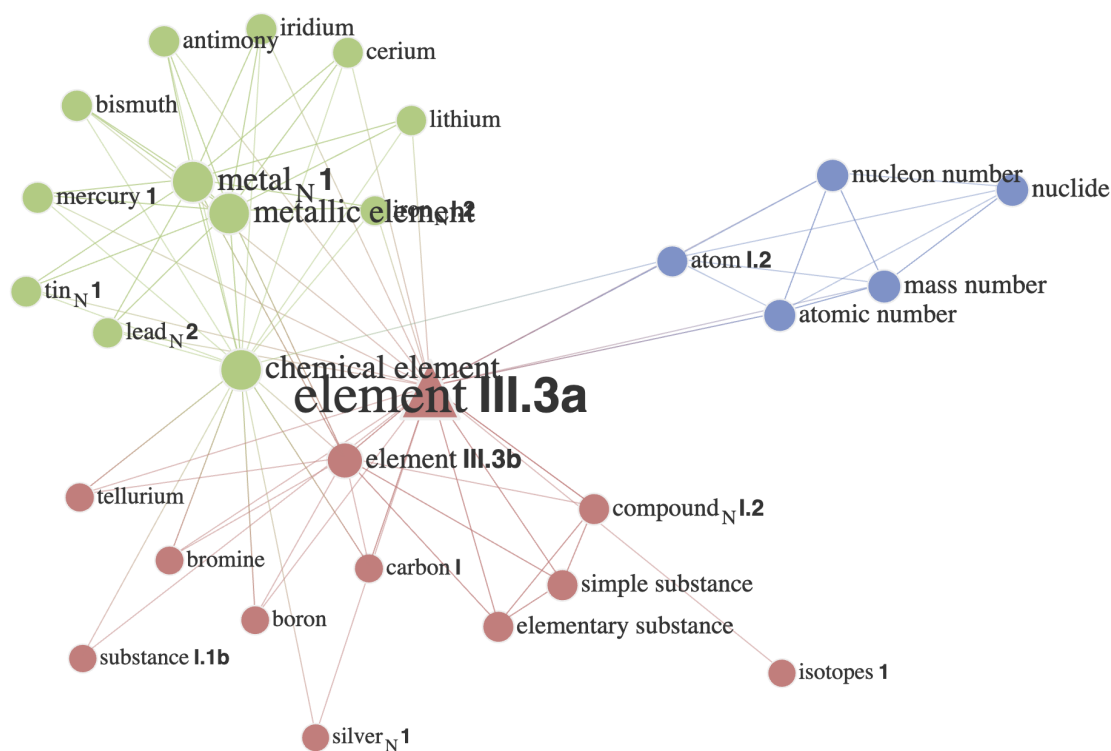
Figure 6.6 – Lexical network around *spec* ELEMENT III.3a.

a physical thing itself (which is a common false belief, see 6.4) but a **type** of the matter, and this reflects an abstract nature of the notion.

The peripheral component – ‘that is identified by the number X’ – underlines the defining characteristic of an element which is the atomic number, and reflects the formal character of the notion.

Such definition of ELEMENT III.3a seems to be concise, comprehensible and devoid of any misleading statements. It is clear from our definition that *element III.3a* is a type of chemical entity, but neither is it an atom, nor a simple substance.

6.5.4.2 *spec critic* ELEMENT III.3b

We cannot ignore the fact that *element* in the sense of a simple substance is still present in numerous textbooks and articles on chemistry. Since we use a descriptive approach to the language and not a prescriptive one, we have no choice but to describe this sense, too.

Our formal definition of ELEMENT II.3b is shown in Table 6.4. In contrast to ELEMENT III.3a, ELEMENT III.3b is not a full-fledged specialized lexeme, since

its meaning is an obsolete and a misleading one. For this lexeme we put an additional usage note “criticisable” in order to draw learners’ attention to the fact that the usage of this lexeme is criticized by specialists of the domain.

element **III.3b** : 「pure substance」
 • that is made of a single element **III.3a**

Table 6.4 – Formal definition of **spec critic ELEMENT III.3b**.

6.6 Recapitulation

This chapter was dedicated to *element*, one of the most important fundamental notions of the chemical lexicon. Its meaning has been inevitably changing in accordance with development of the concept of elements.

The initial hypothesis of the ancient Greek philosophers was that there is a very limited number of elements – substances, such as air, earth, fire and water, that constitute everything in the Universe.

The philosophical character of the concept was completely changed in the eighteenth century by Antoine Lavoisier who proposed to identify elements on experimental basis only. By **Fr.** *éléments* ‘elements’ Lavoisier understood simple substances which cannot be further decomposed by any available chemical means.

Almost a century later, Dmitri Mendeleev made a clearcut distinction between **Ru.** *простое тело* ‘simple body’ and *элемент* ‘element’ stating that elements, as opposed to simple substances, are able to survive transformations of matter and that only elements persist in simple substances and compounds. This absolute distinction between the two notions allowed Mendeleev to elaborate the Periodic Table based on the formal criterion which was the atomic weight.

Several discoveries of the twentieth century (such as the discovery of isotopes, of the nuclear nature of the atom, and the identification of the neutron as an uncharged particle of the same weight as protons) resulted in the adoption of a slightly different definition of *element*. According to the new understanding of the concept, it is the atomic number that is the main defining characteristic of elements.

Up until today though, the Lavoisier’s definition of *elements* as simple sub-

stances is still present in numerous modern dictionaries and textbooks on chemistry. Authors of such definitions overlook the formal character of the concept of elements evoked by Mendeleev, Paneth and many other chemists. Defining *element* as a simple substance contradicts the fundamental principle of chemistry that elements persist in their compounds, while simple substances do not. Moreover, such definitions result in further misconceptions of other chemical terms.

As we have observed, proper nouns rarely reflect the distinction between simple substances and the elements they are made of, e.g. *sulfur* as a bright-yellow odorless solid *vs.* *sulfur* as the element 16. It also contributes to further confusion, such as that the Periodic Table is often perceived as a Table of simple substances with certain physico-chemical properties and not of elements devoid of any tangible qualities.

This led us to the conclusion that, when teaching chemistry, it is crucial to use precise terminology and to not switch from one meaning to another one without stating it explicitly to students.

As we moved further to the lexicographic analysis of **En.** ELEMENT, **Fr.** ÉLÉMENT and **Ru.** ЭЛЕМЕНТ, we realized that the specialized lexical units denoting chemical element are part of extremely polysemous vocables in the three languages, i.e. seventeen senses in English, fifteen senses in French, and thirteen senses in Russian.

We have seen that the original meaning of *element* ‘substance believed to be one of the fundamental constituents of the matter’ evoked by the Greek philosophers is still present in our three languages. It is exactly this sense that became a source of metaphor for many other lexemes, and our specialized lexeme related to the lexicon of chemistry is a sense extension of this original sense. *Element* in the sense of a simple substance is also still present in the language, but it should not be regarded as a full-fledged specialized lexeme, since its meaning is an obsolete and a misleading one, so for this lexeme we decided to put an additional usage note “criticisable”.

Finally, based on our conceptual and linguistic analysis, we came up with definitions for the specialized chemical lexemes **En.** ELEMENT III.3a, **Fr.** ÉLÉMENT III.3a

and **Ru.** ЭЛЕМЕНТ **III.2a**, and in English it reads as ‘type of atoms **I.2** that is identified by the number X corresponding to the quantity of protons in the nucleus **I.2** of the atoms’. In such a way, we made it clear with our definition that *element III.3a* is a **type** of chemical entities but neither is it an atom, nor a substance itself. This definition reflects the abstract and formal character of the notion of elements and is aligned with the system of other definitions avoiding vicious circles and misconceptions.

Chapter 7

General conclusion

SUMMARY

7.1	Concluding remarks	150
7.1.1	Interactions of specialized and non-specialized lexical units	150
7.1.2	Discrepancies in terminological modeling in the three languages	153
7.2	Solutions to the issues detected in terminological resources on chemistry	154
7.3	Prospects	157

7.1 Concluding remarks

We studied the question of interconnections between terminologies and the general language lexicon from both theoretical (lexicological) and descriptive (lexicographic) perspectives, focusing on the case of chemistry terminology.

The results of our research confirm our initial hypothesis that scientific terminologies possess a structure homomorphic with that of the general lexicon, with which they merge within the language. We have also proved that terms can be studied and described on the basis of the same lexicographic approach that we use for the description of the general language lexical units, namely the theoretical and descriptive approach of the Explanatory and Combinatorial Lexicology and that of the Lexical Systems.

On the theoretical level, we accounted for the interdependence between the general language and the terminological lexicons and proposed the solution to the problem of the formal and rigorous modeling of the multidimensionality inherent in the organization of terminologies, i.e. the fact that terms can be apprehended and terminologies can be navigated following multiple axes.

On the practical level, we elaborated the terminological models of chemistry for three typologically distinct languages: English, French and Russian. These models, designed to evolve and be enriched in the long term, can serve as practical tools for scientists as well as for teachers and students of chemistry.

7.1.1 Interactions of specialized and non-specialized lexical units

We analysed the relationship between specialized and non-specialized lexical units both on paradigmatic and syntagmatic levels. On paradigmatic level, fundamental chemical terms are often inserted into the polysemous structure of vocables, some of whose meanings are not related to the terminological system and belong to the general language lexicon.

In the course of our study, we have observed three types of insertion of the specialized chemistry-related lexical units into polysemous vocables.

1. Specialized lexical units semantically derived from general language lexical units, e.g.:

PARTICLE **I.1**, as in *particles of dust in the room*, → **spec** PARTICLE **I.2**, as in *positively charged particle of an atom* (see Part II, p. 185),

REACT **I.1a**, as in *pupils react to light*, → **spec** REACT **I.1d**, as in *calcium reacts with oxygen* (Chapter 4, 4.2.4 and Part II, p. 188).

2. Specialized lexical units semantically derived from other specialized lexical units, e.g.:

spec ISOTOPES **1** ‘nuclides of the same element...’ → **spec** **critic** ISOTOPE **2** ‘any type of atom...’ (Chapter 4, 4.2.1 and Part II, p. 180),

spec RÉACTIF_(N) **1** ‘substance that reacts...’ → **spec** RÉACTIF_(N) **2** ‘substance used by the human X to test another substance...’ (Chapter 2, 2.3.3 and Part II, p. 214); verbs of causation, such as:

spec BOND **I.2a** → **spec** BOND **I.2b** (Part II, p. 170),

spec IONIZE **a** → **spec** IONIZE **b** (Part II, p. 179)

spec REACT **I.1d** → **spec** REACT **I.1e** (Part II, p. 188).

3. Specialized lexical units being a source of semantic derivation for general language units, e.g.:

spec CHEMISTRY **II.1**, as in *chemistry of the atom*, → CHEMISTRY **III**, as in *chemistry between two people* (Chapter 3, 3.4.1),

(**spec**) MATIÈRE **I.a**, as in *matière liquide* ‘liquid matter’, → MATIÈRE **II.1**, as in *fournir la matière d’un livre* ‘provide the material of a book’ (Chapter 5, 5.2.2),

(**spec**) ХИМИЯ¹ **I.1** ‘science...’ → ХИМИЯ¹ **I.2** ‘industry...’ (Chapter 3, 3.4.3.1).

Figure 7.1 summarizes the three types of insertion of specialized lexical units into polysemous vocables that we observed in the course of our study of the fundamental chemical terminology.

As for the lexical connections at the syntagmatic level, terms inevitably interact with the general language lexicon, since they do not exist in isolation but function in texts. In order to characterize the combinatorial properties of the core chemical terms, we described the connections that they have both with specialized and non-specialized lexical units, i.e. the collocations they form, e.g.:

7.1.2 Discrepancies in terminological modeling in the three languages

While modeling our terminological networks, we aimed at normalization and standardization of our descriptions in order to highlight the correspondences between specialized lexical units in the three languages. However, we have encountered some discrepancies, albeit a fairly limited number of them. Here are some examples of the differences observed.

The English language allows for systematic creation of causative verbs, such as in the case of REACT **1.1d** ‘Xs react forming Y...’ → REACT **1.1e** ‘human X causes² that Ys react **1.1d**...’. On the contrary, the French and Russian languages do not allow for such systematic creation of causative senses within the same vocable. Thus, we have no corresponding lexical units to REACT **1.1e** in French nor in Russian. In order to express this meaning in Russian, one can use different collocations, such as **Ru.** *вызвать реакцию* ‘cause/provoke a reaction’ or *провести реакцию* ‘perform a reaction’; in French, a causative construction *faire*+Inf. is commonly used, which results in **Fr.** *faire réagir* ‘make react’.

We have also observed that certain one-word lexical units (lexemes) in English correspond to specialized idioms in French and/or Russian, and vice versa, e.g. **En.** SOLID_(N) **1.2** corresponds to **Ru.** «ТВЁРДОЕ ТЕЛО» lit. ‘solid body’; on the contrary, specialized idioms such as **En.** «CHEMICAL ENTITY» and **Fr.** «ENTITÉ CHIMIQUE» have no corresponding idiom in Russian.

In Russian terminologies, there are many coexisting borrowings with Latin and Greek roots, which, on top of it, sometimes coexist with terms that are internal creations (Buchi 2016: 339) having Slavic roots. This results in that we might have several synonymous terms corresponding to one single term in English or French, e.g. **Ru.** *субстанция* and *вещество* cf. **En./Fr.** *substance* (see Chapter 5, 5.3.3); **Ru.** *элемент* and *стихия* cf. **En.** *element* (see Chapter 6, 6.5.3).

Finally, we observed significant discrepancies in polysemy structures of certain vocables, for instance, in the case of **En.** CHEMISTRY with four senses, **Fr.** CHIMIE with five senses, and **Ru.** ХИМИЯ¹ with ten senses (according to our analysis; see Chapter 3, 3.4).

7.2 Solutions to the issues detected in terminological resources on chemistry

At the beginning of our research (Chapter 2, 2.3), we have analysed and described some of the most significant issues detected in existing terminological resources on chemistry:

1. minimal linguistic information approach;
2. misleading definitions, vicious circles in definitions;
3. polysemy not taken into account;
4. lack of descriptions of specialized idioms and collocations.

After having identified these four main areas of concern, we aimed at finding and proposing solutions to them.

1. We applied the theoretical and descriptive approach of the Explanatory and Combinatorial Lexicology in order to provide rigorous lexicographic descriptions of the core chemical terms, which included the description of the following properties: grammatical characteristics, semantics (definition), paradigmatic and syntagmatic connections, copolysemy relations, examples of use taken from corpora. Taking a multilingual perspective and following the methodological principles described in Chapter 4, we have performed terminographic descriptions of 107 English, 103 French and 102 Russian lexical units, i.e. of 312 chemistry-related lexical units.

2. The central part of our terminographic descriptions is the system of formal definitions (presented in Part II). In order to ensure the absence of vicious circles in our definitions, first, we followed six lexicographic principles of writing definitions presented and illustrated in Chapter 4, 4.2.2. Further, we have created the so-called *defined-by* hierarchies of English, French and Russian notions; see the bottom part, i.e. the most basic level of the hierarchy of our French notions on Figure 7.3 (the full hierarchy will be presented in Part II, p. 193). In our defined-by hierarchies, the edges represent the inclusion of more simple senses in the definitions of the more complex senses. Moreover, we have used a Python script¹ in order to automatically check the absence of vicious circles in our definitions at all levels, see Figure 7.4.

¹We express our gratitude to Nikolay Chepurnykh for having created this script for us.

Both the manual (by means of the defined-by hierarchies) as well as the automatic (by means of the Python script) checking resulted in **zero** vicious circles in our English, French and Russian systems.

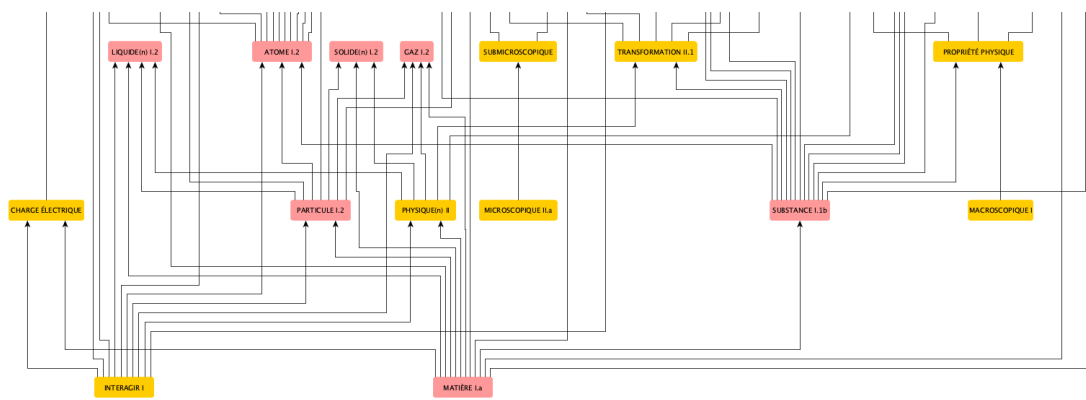

Figure 7.3 – The bottom (most basic) level of the *defined-by* hierarchy of the French chemical notions.

	A	B	C	D	E
1	allotropes	élément III.3a			
2	allotropique 1	allotropes			
3	allotropique 2	élément III.3a	allotropes		
4	allotropie	élément III.3a	allotropique 2		
5	anion	ion	chargé IV.2		
6	anionique	anion			
7	atome I.2	particule I.2	interagir I	substance I.1b	
8	atomique 1	atome I.2			
9	atomique 2	atome I.2	élément III.3a	lié(Adj) II	
10	atomiquement	atome I.2			
11	cation	ion	chargé IV.2		
12	cationique	cation			
13	changement chimique	propriété chimique	substance I.1b	transformation II.1	
14	changement physique	propriété physique	substance I.1b		
15	charge électrique	matière I.a	interaction I		
16	chargé IV.2	charge électrique			
17	chimie I.1	matière I.a	transformation II.1	submicroscopique	
18	chimie II.1	matière I.a	transformation II.1	submicroscopique	
19	chimie II.2	transformation II.1	matière I.a	chimie II.1	
20	chimique I	chimie I.1			
21	chimique II.1	chimie II.1			
22	chimiquement I	chimie I.1			
23	chimiquement II	chimie II.1			
24	composé(n) I.2	corps pur	élément III.3a		
25	corps composé	corps pur	élément III.3a		
26	corps pur	substance I.1b	atome I.2	molécule I	
27	corps simple	corps pur	élément III.3a		
28	électron	particule subatomique	atome I.2	interagir I	
29	électronique I	électron			
30	élément III.3a	atome I.2	proton	noyau I.2	

```

13 def check_circular_dependencies(dictionary):
14     # create a copy of the dictionary to modify
15     dependencies = {(k: set(v) for k, v in dictionary.items())}
16     counter = 0
17
18     for key in dependencies.keys():
19         # initialize set to store nodes to visit
20         visiting = set()
21
22         # initialize set to store nodes that have already been visited
23         visited = set()
24
25         visiting.update(dependencies[key])
26
27         # visiting the nodes from all levels inside the definitions
28         while len(visiting) > 0:
29             visiting2 = set()

```

Figure 7.4 – Automatic checking of sense inclusions.

3. As demonstrated in Chapters 3–6, our approach to modeling the lexicon of chemistry accounts for polysemy inherent in general language as well as terminological vocables containing chemistry-related senses. See, for instance, **spec ALLOTROPIC 1** and **spec ALLOTROPIC 2**, **spec ATOMIC I.1** and **spec ATOMIC I.2**, **spec IONIZE 1** and **spec IONIZE 2**, **MICROSCOPIC I**, **MICROSCOPIC II.a** and **spec MICROSCOPIC II.b**, etc. (see Part II).

4. Last but not least, our descriptive approach accounts for phraseology in specialized lexicons. For collocations, see Section 7.1.1 and Figure 7.2 above. As for specialized idioms, we provide them with similar lexicographic descriptions as specialized lexemes. Figure 7.5 shows the case of **spec** 「CORPS COMPOSÉ」 ‘compound’ that received a detailed description of its properties, including grammatical characteristics, semantics (formal definition), paradigmatic and syntagmatic connections, and examples of use. Figure 7.6 shows the resulting lexical network around **spec** 「CORPS COMPOSÉ」 ‘compound’.

corps composé	<p>[GC]</p> <p>spéc locution nominale [corps III + composé_{Adj} I] masc locution faible</p>
<p>[DF]</p> <p>substance</p> <p>corps composé = corps pur</p> <p>tel qu'il est constitué d'éléments III.3a différents 1</p>	
<p>[LF]</p> <p>Syn : spéc composé_N 2</p> <p>Anti : spéc corps simple</p> <p>Anti_s : spéc critic élément III.3b</p> <p>Gener : spéc corps pur</p>	
<p>[EX]</p> <p>L'élément est ce qui est commun au corps simple et à tous les corps composés qu'il peut former (ex. : l'élément oxygène est commun au dioxygène (gaz oxygène), à l'ozone et à tous les composés oxygénés). Hors bases : publication VIOVY R., <i>La notion d'élément chimique</i>, 1984, Bulletin de l'Union des Physiciens, http://materiel-physique.ens-lyon.fr</p> <p>Dans un corps composé, les éléments sont liés par des liaisons chimiques. Ainsi l'eau (H₂O), le dioxyde de carbone (CO₂), le sel de table ou chlorure de sodium (NaCl) sont des corps composés.</p>	

Figure 7.5 – “Article view” of the idiom **spec** 「CORPS COMPOSÉ」 in *Dicet* editor.

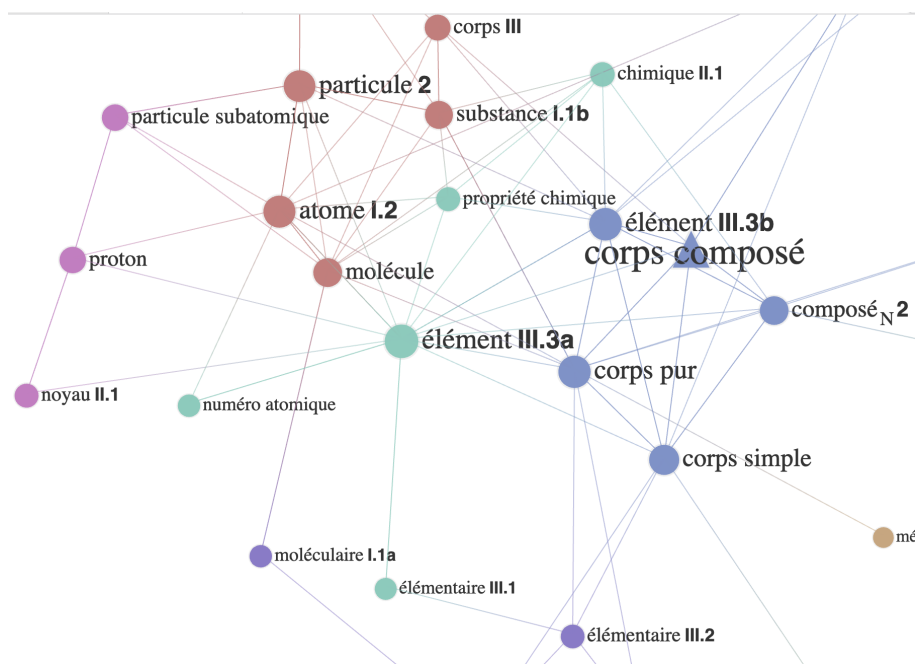

Figure 7.6 – Lexical network around the idiom **spec** \lceil CORPS COMPOSÉ \rceil in *Spi-derlex*.

7.3 Prospects

The present research is the result of a collaboration between the linguistic laboratory ATILF and the chemical laboratory LPCT of the University of Lorraine. The preliminary results of our research have been disseminated via conference talks and publications, which allowed us to expand our network for the future interdisciplinary collaborations.

As a result, we have launched a *Cythère* project,² which aims at valorisation of the results of the present study in the context of chemistry teaching. We target the creation of an online platform with an access to our multilingual terminological system and the dissemination of our definitions of core chemical terms among secondary school teachers and students.

Finally, we would be interested in testing and applying the elaborated methodology to modeling lexicons of scientific disciplines other than chemistry.

²In the framework of the Université de Lorraine’s initiative “Valorisation non économique de la recherche” (Non-economic valorization of research).

PART II: TERMINOGRAPHIC DESCRIPTIONS

Chapter 8

Three systems of core chemical notions

SUMMARY

8.1	Introduction	162
8.2	Fundamental lexicon of chemistry	163
8.3	System of English chemical notions	167
8.4	System of French chemical notions	193
8.5	System of Russian chemical notions	219

8.1 Introduction

This chapter presents the semantic – the central – component of our terminographic descriptions, namely the systems of formal definitions elaborated for the lexical units belonging to the core lexicon of chemistry.

In 8.2 we start with the list of English, French and Russian vocables which have at least one chemistry-related sense. The set of such senses forms our chemical nomenclature.

In 8.3–8.5 we present the three systems of fundamental chemical notions for the English, French and Russian languages. As discussed in Chapter 7, 7.2, we created the so-called *defined-by* hierarchies of the chemical notions, first, to avoid vicious circles in our definitions. It is important to note though that these hierarchies account for the way the core chemical notions should actually be studied.

We attach a hierarchy to each of the three tables and suggest to study them by starting with the most basic notions at the bottom and gradually proceeding with the more and more complex ones at the top.

In the tables themselves, the elaborated formal definitions are presented in the alphabetical order for easier search. Each definition is followed by a shortened example to illustrate the analysed sense.

All in all, we propose in what follows the formal definitions for 312 lexical units in total: 107 for the English language, 103 for French and 102 for Russian.

8.2 Fundamental lexicon of chemistry:
vocables containing core chemical terms

English	French	Russian
ALLOTROPES	ALLOTROPES	АЛЛОТРОПЫ
ALLOTROPIC	ALLOTROPIQUE	АЛЛОТРОПНЫЙ
ALLOTROPY	ALLOTROPIE	АЛЛОТРОПИЯ
ANION	ANION	АНИОН
ANIONIC	ANIONIQUE	АНИОННЫЙ
ATOM	ATOME	АТОМ
ATOMIC	ATOMIQUE	АТОМНЫЙ ; АТОМАРНЫЙ
ATOMICALLY	ATOMIQUEMENT	АТОМАРНО
「ATOMIC NUMBER」	「NUMÉRO ATOMIQUE」	「АТОМНЫЙ НОМЕР」
BOND _(N)	LIAISON	СВЯЗЬ
BOND _(V)	SE LIER	СОЕДИНЯТЬСЯ
BOND _(V)	LIER	СОЕДИНЯТЬ
BONDED _(Adj)	LIÉ _(Adj)	СВЯЗАННЫЙ
BONDING _(N)	LIAISON	СВЯЗЬ
「BUILDING BLOCK」	–	–
CATION	CATION	КАТИОН
CATIONIC	CATIONIQUE	КАТИОННЫЙ
CHARGED _(Adj)	CHARGÉ _(Adj)	ЗАРЯЖЕННЫЙ
CHEMICAL _(Adj)	CHIMIQUE	ХИМИЧЕСКИЙ
CHEMICAL _(N)	「PRODUIT CHIMIQUE」	ХИМИКАТ
「CHEMICAL CHANGE」	「CHANGEMENT CHIMIQUE」	「ХИМИЧЕСКОЕ ИЗМЕНЕНИЕ」
「CHEMICAL ENTITY」	「ENTITÉ CHIMIQUE」	–
CHEMICALLY	CHIMIQUEMENT	ХИМИЧЕСКИ

English	French	Russian
「CHEMICAL PROPERTY」	「PROPRIÉTÉ CHIMIQUE」	「ХИМИЧЕСКОЕ СВОЙСТВО」
「CHEMICAL SPECIES」	「ESPÈCE CHIMIQUE」	–
CHEMISTRY	CHIMIE	ХИМИЯ
COMPOUND _(N)	「CORPS COMPOSÉ」 ; COMPOSÉ _(N)	СОЕДИНЕНИЕ
「ELECTRIC CHARGE」	「CHARGE ÉLECTRIQUE」	「ЭЛЕКТРИЧЕСКИЙ ЗАРЯД」
ELECTRON	ÉLECTRON	ЭЛЕКТРОН
ELECTRONIC	ÉLECTRONIQUE	ЭЛЕКТРОННЫЙ
ELEMENT	ÉLÉMENT	ЭЛЕМЕНТ
ELEMENTAL	ÉLÉMENTAIRE	ЭЛЕМЕНТАРНЫЙ
「ELEMENTARY REACTION」	「RÉACTION ÉLÉMENTAIRE」	「ЭЛЕМЕНТАРНАЯ РЕАКЦИЯ」
「ELEMENTARY SUBSTANCE」	「CORPS SIMPLE」	「ПРОСТОЕ ВЕЩЕСТВО」
EQUATION	ÉQUATION	УРАВНЕНИЕ
GAS	GAZ	ГАЗ
GASEOUS	GAZEUX	ГАЗООБРАЗНЫЙ
INTERACT	INTERAGIR	ВЗАИМОДЕЙСТВОВАТЬ
INTERACTION	INTERACTION	ВЗАИМОДЕЙСТВИЕ
ION	ION	ИОН
IONIC	IONIQUE	ИОННЫЙ
IONIZATION	IONISATION	ИОНИЗАЦИЯ
IONIZE	S'IONISER	ИОНИЗИРОВАТЬСЯ
IONIZE	IONISER	ИОНИЗИРОВАТЬ
IONIZED _(Adj)	IONISÉ _(Adj)	ИОНИЗИРОВАННЫЙ
ISOTOPES	ISOTOPES	ИЗОТОПЫ

English	French	Russian
ISOTOPIC	ISOTOPIQUE	ИЗОТОПНЫЙ
LIQUID _(Adj)	LIQUIDE _(Adj)	ЖИДКИЙ
LIQUID _(N)	LIQUIDE _(N)	ЖИДКОСТЬ
MACROSCOPIC	MACROSCOPIQUE	МАКРОСКОПИЧЕСКИЙ
MASS	MASSE	МАССА
「MASS NUMBER」	「NOMBRE DE MASSE」	「МАССОВОЕ ЧИСЛО」
MATTER	MATIÈRE	МАТЕРИЯ
MICROSCOPIC	MICROSCOPIQUE	МИКРОСКОПИЧЕСКИЙ
MIXTURE	MÉLANGE	СМЕСЬ
MOLECULAR	MOLÉCULAIRE	МОЛЕКУЛЯРНЫЙ
MOLECULARITY	MOLÉCULARITÉ	МОЛЕКУЛЯРНОСТЬ
MOLECULARLY	MOLÉCULAIREMENT	МОЛЕКУЛЯРНО
MOLECULE	MOLÉCULE	МОЛЕКУЛА
NEUTRON	NEUTRON	НЕЙТРОН
NUCLEAR	NUCLÉAIRE	ЯДЕРНЫЙ
NUCLEON	NUCLÉON	НУКЛОН
「NUCLEON NUMBER」	<i>(nombre de nucléons)</i>	「НУКЛОННОЕ ЧИСЛО」
NUCLEUS	NOYAU	ЯДРО
NUCLIDE	NUCLÉIDE	НУКЛИД
PARTICLE	PARTICULE	ЧАСТИЦА
PHYSICAL	PHYSIQUE _(Adj)	ФИЗИЧЕСКИЙ
「PHYSICAL CHANGE」	「CHANGEMENT PHYSIQUE」	「ФИЗИЧЕСКОЕ ИЗМЕНЕНИЕ」
「PHYSICAL PROPERTY」	「PROPRIÉTÉ PHYSIQUE」	「ФИЗИЧЕСКОЕ СВОЙСТВО」
PHYSICS	PHYSIQUE _(N)	ФИЗИКА
PRODUCT	PRODUIT	ПРОДУКТ

English	French	Russian
PROTON	PROTON	ПРОТОН
PROTONIC	–	–
「PURE SUBSTANCE」	「CORPS PUR」	「ЧИСТОЕ ВЕЩЕСТВО」
REACT	RÉAGIR	РЕАГИРОВАТЬ
REACTANT	RÉACTIF _(N)	РЕАКТИВ ; РЕАГЕНТ
REACTION	RÉACTION	РЕАКЦИЯ
REACTIVE	RÉACTIF _(Adj)	РЕАКТИВНЫЙ
REACTIVITY	RÉACTIVITÉ	РЕАКТИВНОСТЬ
REACTOR	RÉACTEUR	РЕАКТОР
REAGENT	RÉACTIF _(N)	РЕАГЕНТ ; РЕАКТИВ
「SIMPLE SUBSTANCE」	「CORPS SIMPLE」	「ПРОСТОЕ ВЕЩЕСТВО」
SOLID _(Adj)	SOLIDE _(Adj)	ТВЕРДЫЙ
SOLID _(N)	SOLIDE _(N)	「ТВЁРДОЕ ТЕЛО」
SUBATOMIC	SUBATOMIQUE	СУБАТОМНЫЙ
「SUBATOMIC PARTICLE」	「PARTICULE SUBATOMIQUE」	「СУБАТОМНАЯ ЧАСТИЦА」
SUBMICROSCOPIC	SUBMICROSCOPIQUE	СУБМИКРОСКОПИЧЕСКИЙ
SUBSTANCE	SUBSTANCE	ВЕЩЕСТВО
TRANSFORMATION	TRANSFORMATION	ПРЕВРАЩЕНИЕ ; ТРАНСФОРМАЦИЯ
WEIGHT	POIDS	ВЕС

8.3 System of English chemical notions

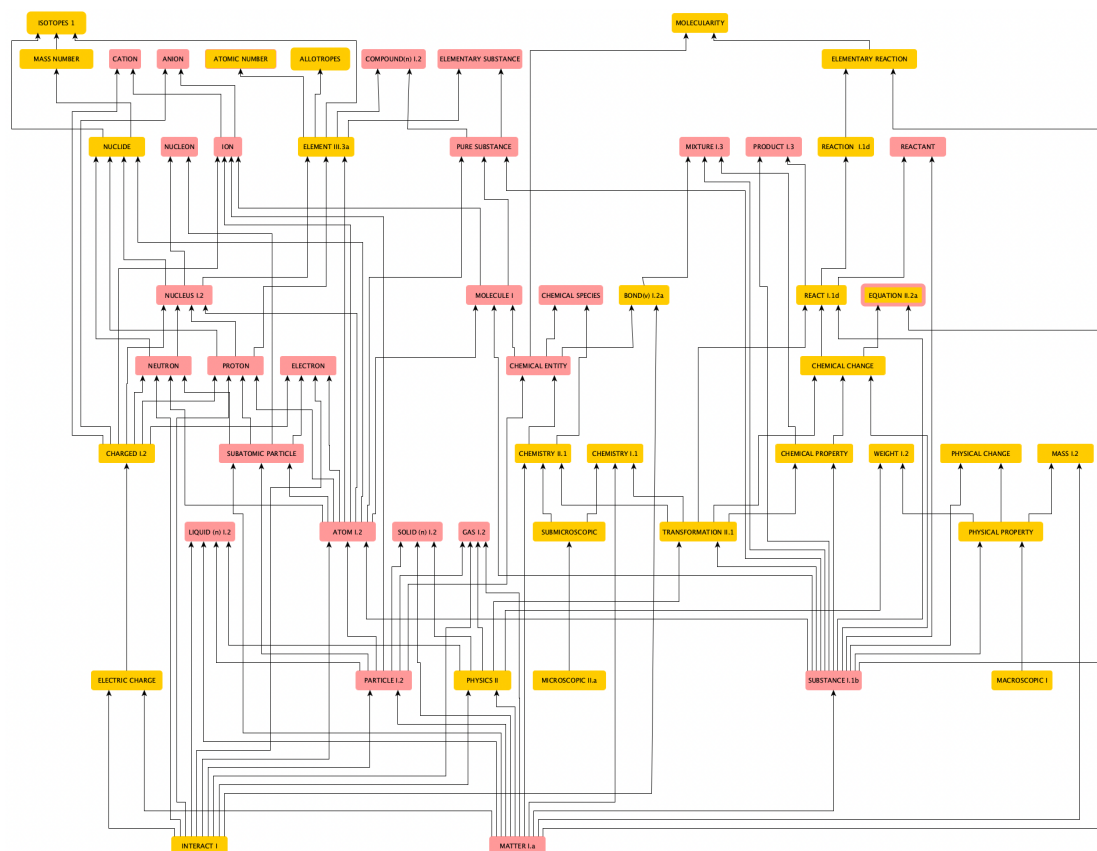
Figure 8.1 – The *defined-by* hierarchy of English chemical notions.

Lexical unit	Definition [<i>Propositional form</i> : Paraphrase]	Example
ALLOTROPES spec	<i>Y that are allotropes of X :</i> Y that are structurally different forms of the element III.3a X A₀ : ALLOTROPIC 1	<i>Diamond is one of the naturally occurring forms of C; the other allotropes of carbon are graphite, graphene, and various fullerenes.</i>
ALLOTROPIC 1 spec	<i>allotropic 1 X :</i> X relating to allotropes	<i>Sulfur exists in several allotropic forms, the most common stable allotrope is the yellow solid S₈.</i>

Lexical unit	Definition	Example
ALLOTROPIC 2 spec	allotropic 2 X : element III.3a X such that it has allotropes S ₀ Pred : ALLOTROPY	<i>Group 16 contains only three allotropic elements: oxygen, sulphur, and selenium.</i>
ALLOTROPY spec	allotropy of X : characteristic of the element III.3a X being allotropic 2 A ₁ : ALLOTROPIC 2	<i>Allotropy is not common amongst metals and the allotropy exhibited by iron confers on it some of its most useful properties.</i>
ANION spec	anion : ion • that is negatively charged _(Adj) II A ₀ : ANIONIC	<i>Most nonmetallic atoms attract electrons more strongly than metallic atoms, and so gain electrons to form anions.</i>
ANIONIC spec	anionic X : X relating to anions	<i>The resulting copolymers are water-soluble and have a net anionic charge.</i>
ATOM 1.2 spec	atom 1.2 of X combining with Y : particle 1.2 • that interacts I with similar particles 1.2 Y to form the smallest unit of substance 1.1b X A ₀ : ATOMIC 1	<i>A water molecule is formed when two atoms of hydrogen bond covalently with an atom of oxygen.</i>
ATOMIC 1.1 spec	atomic 1 X : X relating to atoms 1.2 Adv ₀ : ATOMICALLY	<i>Radioactivity is an atomic property caused by reactions taking place in the atomic nucleus.</i>

Lexical unit	Definition	Example
ATOMIC 1.2 spec	<p>atomic 2 X :</p> <p>X such that it is made</p> <ul style="list-style-type: none"> of atoms1.2 of the same element III.3a Ω not bonded1.2 with each other 	<p>Molecular hydrogen (H_2) is a much poorer coolant than atomic hydrogen (H).</p>
ATOMICALLY spec	<p>atomically X :</p> <p>X as regards to atoms1.2</p> <p>A_0 : ATOMIC 1.1</p>	<p>Carbon-14 has six protons and eight neutrons in its nucleus, a configuration that makes it atomically unstable. As a result, the atom undergoes a process called radioactive decay.</p>
「ATOMIC NUMBER」 spec	<p>Y is the 「atomic number」 of X :</p> <p>Y is the number</p> <ul style="list-style-type: none"> that characterizes the element III.3a X 	<p>Atomic number of the element nitrogen is 7. The periodic table displays all of the known elements and is arranged in order of increasing atomic number.</p>
BOND _(N) 1.2 spec	<p>bond_(N) 1.2 between X and Y forming Z :</p> <p>fact of the 「chemical entities」 X and Y bonding_(V) 1.2a to form a 「chemical entity」 Z</p> <p>Syn : BONDING_(N) 1.2</p> <p>V_0 : BOND_(V) 1.2a</p> <p>$A_{1/2}$Perf : BONDED_(Adj) 1.2</p>	<p>Hydrogen atoms form a strong bond with an oxygen atom from another water molecule: we call this a hydrogen bond.</p>

Lexical unit	Definition	Example
BOND _(V) 1.2a spec	<p><i>X bonds 1.2a with Y to form Z :</i></p> <p>The 「chemical entity」 X interacts₁ with the 「chemical entity」 Y</p> <ul style="list-style-type: none"> • that results in the formation of a 「chemical entity」 Z that is more stable than separate X and Y <p>S₀ : BOND_(N) 1.2 A_{1/2}Perf : BONDED_(Adj) 1.2 Caus : //BOND_(V) 1.2b</p>	<p><i>In explosives nitrates contain nitrogen atoms weakly bonded to oxygen. When this bond is broken, the nitrogen atoms bond strongly to other nitrogen atoms, forming very strong bonds and releasing a lot of energy.</i></p>
BOND _(V) 1.2b spec	<p><i>X bonds 1.2b Y with Z to form W :</i></p> <p>The human X causes₂ that the 「chemical entities」 Y and Z bond 1.2a to form a 「chemical entity」 W</p>	<p><i>How do chemists bond atoms to make the molecules? What is usually seen when you bond the two atoms together?</i></p>
BONDED _(Adj) 1.2 spec	<p><i>X bonded_(Adj) 1.2 with Y :</i></p> <p>「chemical entity」 X that bonds_(V) 1.2a with the 「chemical entity」 Y forming a 「chemical entity」 Ω</p>	<p><i>In a diamond, the carbon atoms are strongly bonded in all directions and create an extremely hard material with extraordinary electrical, thermal, optical and chemical properties.</i></p>
BONDING _(N) 1.2 spec	<p><i>bonding_(N) 1.2 between X and Y forming Z :</i></p> <p>fact of the 「chemical entities」 X and Y bonding_(V) 1.2a to form a 「chemical entity」 Z</p> <p>Syn : BOND_(N) 1.2 V₀ : BOND_(V) 1.2a A_{1/2}Perf : BONDED_(Adj) 1.2</p>	<p><i>This chemical interaction of electrons creates a strong bonding between the atoms as compared to other types of bonds.</i></p>

Lexical unit	Definition	Example
「BUILDING BLOCK」 ² spec	<p><i>Y that is a 「building block」² of X :</i></p> <p><i>Y that is a 「chemical entity」</i></p> <ul style="list-style-type: none"> • that a more complex 「chemical entity」 X is made of 	<p><i>Atom is the basic building block of chemicals.</i></p> <p><i>Libraries of fluorine-containing building blocks are typical examples of building block collections for medicinal chemistry.</i></p>
CATION spec	<p><i>cation :</i></p> <p>ion</p> <ul style="list-style-type: none"> • that is positively charged_(Adj) <p>A₀ : CATIONIC</p>	<p><i>Metallic atoms hold some of their electrons relatively loosely. Consequently, they tend to lose electrons and form cations.</i></p>
CATIONIC spec	<p><i>cationic X :</i></p> <p>X relating to cations</p>	<p><i>Aluminum and iron salts are powerful sources of cationic charge and tend to coagulate colloidal and particulate matter and natural organic matter.</i></p>
CHARGED _(Adj) spec	<p><i>charged</i>_(Adj) X :</p> <p>X that has an 「electric charge」 Ω</p>	<p><i>Atom consists of a nucleus, containing positively charged protons and electrically neutral neutrons, surrounded by negatively charged electrons.</i></p>
CHEMICAL _(Adj) (spec)	<p><i>chemical</i>_(Adj) X :</p> <p>X relating to chemistry </p> <p>Adv₀ : CHEMICALLY </p>	<p><i>Our task is to teach robots to execute almost completely independently many experiments in chemical laboratories.</i></p>

Lexical unit	Definition	Example
CHEMICAL _(Adj) II.1 spec	<i>chemical</i> _(Adj) II.1 X : X relating to chemistry II.1 of Ω Adv ₀ : CHEMICALLY II	<i>Silver undergoes a chemical reaction, classified as an oxidation reaction, with sulfur containing substances.</i>
CHEMICAL _(N) I.1 spec	X is a <i>chemical</i> _(N) I.1 : X is a substance I.1b <ul style="list-style-type: none"> such that it can be identified by its 「chemical properties」 Ω 	<i>A catalytic chain is a series of two or more chemical reactions in which one chemical (the catalyst) destroys another chemical without itself being destroyed.</i>
「CHEMICAL CHANGE」 spec	「 <i>chemical change</i> 」 of X into Y : change of 「 chemical properties 」 Ω of the substance I.1b X <ul style="list-style-type: none"> that affects the composition of X that results in the transformation II.1 of X into a different substance I.1b Y 	<i>When the reactants are mixed, the temperature change caused by the reaction is an indicator of a chemical change.</i>
「CHEMICAL ENTITY」 spec	「 <i>chemical entity</i> 」 : particle I.2 <ul style="list-style-type: none"> that can be identified by its 「chemical properties」 $\{\Omega\}$ 	<i>The hydrogen molecule is the smallest neutral chemical entity and a benchmark system of molecular spectroscopy.</i>
CHEMICALLY I (spec)	<i>chemically</i> I X : X as regards to chemistry I A ₀ : CHEMICAL I	<i>It is a chemically proven fact that fluorocarbons provide the highest measurable level of water repellency.</i>

Lexical unit	Definition	Example
CHEMICALLY II spec	<i>chemically</i> II X : X as regards to chemistry II.1 of Ω A_0 : CHEMICAL II.1	<i>All atoms with the same number of protons will be chemically identical.</i> <i>The addition of molecular CO_2 to water makes the water less chemically reactive.</i>
「CHEMICAL PROPERTY」 spec	Y is a 「 <i>chemical property</i> 」 of X : Y is a property of the substance I.1b X <ul style="list-style-type: none"> relating to possible transformations II of X into different substances I.1b Ω 	<i>Examples of chemical properties include flammability, toxicity, acidity, reactivity, and heat of combustion.</i>
「CHEMICAL SPECIES」 spec	「 <i>chemical species</i> 」 : set of 「 chemical entities 」 <ul style="list-style-type: none"> that are chemically II identical 	<i>Reactive chemical species with an unpaired electron in the outer valence orbitals are called free radicals.</i>
CHEMISTRY I (spec)	<i>chemistry</i> I practiced by X : science practiced by the human X <ul style="list-style-type: none"> whose object is the study of the matter I.a and its transformations II.1 at the submicroscopic level A_0 : CHEMICAL I	<i>In chemistry, it is impossible to deal with a single atom or molecule because we cannot see them or count them or weigh them.</i>
CHEMISTRY II.1 spec	<i>chemistry</i> II.1 of X : properties of the matter I.a X <ul style="list-style-type: none"> that determine the transformations II.1 of X at the submicroscopic level A_0 : CHEMICAL II.1	<i>The chemistry of an atom determines how it combines with other atoms, which in turn depends on the number of electrons in its outer shell.</i>

Lexical unit	Definition	Example
CHEMISTRY II.2 spec	<p><i>chemistry</i> II.2 of X : transformations II.1 in the matter I.a X</p> <ul style="list-style-type: none"> that occur due to the <i>chemistry</i> II.1 of X 	<p><i>Electroconvulsive therapy changes the chemistry of the brain. Biochemical individuality tells us that body chemistries are not the same. Certain reactions will take place ten times as fast in one individual as in another.</i></p>
COMPOUND _(N) I.2 spec	<p><i>compound</i>_(N) I.2 made of X : 「pure substance」</p> <ul style="list-style-type: none"> that it is made of different elements III.3a X 	<p><i>The deposits comprise essentially inorganic compounds present in the fuel as well as minor amounts of carbon and carboniferous compounds, sulfur compounds, such as ferrous sulfide, sulfide trioxide, etc.</i></p>
「ELECTRIC CHARGE」 spec	<p>「<i>electric charge</i>」 of X of value Y : property of the matter I.a X</p> <ul style="list-style-type: none"> that allows it to have electric interactions I with the other entities Ω that is measured by the numerical value Y <p>A₁ : CHARGED_(Adj) II</p>	<p><i>Electrons have an electric charge of -1, which is equal but opposite to the electric charge of a proton, which is $+1$.</i></p>

Lexical unit	Definition	Example
ELECTRON spec	<p><i>electron</i> of X interacting with Y :</p> <p>「subatomic particle」 of the atom 1.2 X</p> <ul style="list-style-type: none"> that interacts I with the 「subatomic particles」 Y of X that is negatively charged_(Adj) II <p>A_0 : ELECTRONIC I</p>	<p>We will deal with the physics of events that occur when photons and electrons interact with matter.</p>
ELECTRONIC I spec	<p><i>electronic</i> I X :</p> <p>X relating to electrons</p>	<p>With a combination of analytical methods and computer calculations, the scientists were able to determine the electronic structure of gold atoms.</p>
ELEMENT III.3a spec	<p><i>element</i> III.3a X :</p> <p>type of atoms 1.2</p> <ul style="list-style-type: none"> that is identified by the number X corresponding to the quantity of protons in the nucleus 1.2 of the atoms 1.2 <p>A_0 : ELEMENTAL II.1</p>	<p>The element hydrogen, at the upper left of the table, has an atomic number of 1, so every hydrogen atom has one proton in its nucleus.</p> <p>How is an atom of the element 54 (Xe) likely to act during a chemical reaction?</p>
ELEMENT III.3b spec critic	<p><i>element</i> III.3b :</p> <p>「pure substance」</p> <ul style="list-style-type: none"> that is made of a single element III.3a Ω <p>Syn : 「ELEMENTARY SUBSTANCE」, 「SIMPLE SUBSTANCE」</p>	<p>Any substance that contains only one kind of atoms is known as an element. Most elements are metals, which are shiny and conduct electricity well.</p>

Lexical unit	Definition	Example
ELEMENTAL II.1 spec	<i>elemental</i> II.1 X : X relating to elements III.3a	<i>Periodic trends, arising from the arrangement of the Periodic Table, provide chemists with an invaluable tool to quickly predict elemental properties.</i>
ELEMENTAL II.2 spec	<i>elemental</i> II.2 X : substance I.1b X such that it is made of a single element III.3a Ω	<i>In agriculture, elemental sulfur and sulfur compounds are applied to adjust the pH of basic soils by acidification and to supply plant.</i>
「ELEMENTARY REACTION」 spec	<i>elementary reaction</i> between X producing Y : reaction I.1d between the substances I.1b X producing a substance I.1b Y • in one single step	<i>The sum of the individual steps, or elementary reactions, in the reaction mechanism must give the balanced chemical equation for the overall reaction.</i>
「ELEMENTARY SUBSTANCE」 spec	「 <i>elementary substance</i> 」 : 「 pure substance 」 • that is made of a single element III.3a Ω Syn : 「SIMPLE SUBSTANCE」 ; ELEMENT III.3b	<i>If the atoms which compose the molecules of a pure substance are all of the same kind, the substance is an elementary substance. Dioxygen (O_2) is an elementary substance made of identical atoms.</i>

Lexical unit	Definition	Example
EQUATION II.2a spec	<p>equation II.2a between <i>X</i> and <i>Y</i> :</p> <p>symbolic representation</p> <ul style="list-style-type: none"> of the equivalence of the matter I.a in the context of the 'chemical change' of the substances I.1b <i>X</i> into the substances I.1b <i>Y</i> that has a form of an equation II.1 with <i>X</i> on the left and <i>Y</i> on the right 	<p>Balanced chemical equations have the same number and type of each atom on both sides of the equation, e.g.</p> $4Al + 3O_2 = 2Al_2O_3.$
EQUATION II.2b spec	<p>equation II.2b between <i>X</i> and <i>Y</i> :</p> <p>symbolic representation</p> <ul style="list-style-type: none"> of a reaction I.1d between the substances I.1b <i>X</i> producing the substance I.1b <i>Y</i> that has a form of expression similar to an equation II.1 with <i>X</i> on the left and <i>Y</i> on the right 	<p>The equation of a complete combustion of methane is</p> $1CH_4 + 2O_2 \rightarrow 1CO_2 + 2H_2O.$
GAS I.2 spec	<p><i>X</i> is a gas I.2 :</p> <p><i>X</i> is matter I.a in a physical III.2 state such that</p> <ul style="list-style-type: none"> <i>X</i> has indefinite shape <i>X</i> has indefinite volume <i>X</i>'s particles I.2 are very mobile and interact I weakly <p>Anti_□ : LIQUID_(N) I.2 ; SOLID_(N) I.2 A₁ : GASEOUS I.2</p>	<p>The formation of carbon dioxide, sulfur oxide and ammonia gases is the result of the breakdown of an intermediate product of a double displacement reaction of an acid with a base.</p>

Lexical unit	Definition	Example
GASEUS I.2 spec	<i>gaseus</i> I.2 X : X such that it has the characteristics of a gas I.2 Anti _∩ : LIQUID _(Adj) I.2 ; SOLID _(Adj) I.2 S ₁ Pred : GAS I.2	<i>Nitrogen (N₂) and oxygen (O₂) are referred to as gases, but gaseous water in the atmosphere is called water vapor.</i>
INTERACT I (spec)	X and Y interact I : The entities X and Y have a mutual effect on each other S ₀ : INTERACTION I	<i>The rules of quantum mechanics tell us how atoms interact to form molecules, and how molecules interact with each other to produce supramolecular entities.</i>
INTERACTION I (spec)	<i>interaction</i> I between X and Y : fact of entities X and Y interacting I V ₀ : INTERACT I	<i>Molecules with hydrogen atoms bonded to electronegative atoms such as O, N, and F tend to exhibit unusually strong intermolecular interactions due to a particularly strong type of dipole-dipole attraction called hydrogen bonding.</i>
ION spec	<i>ion</i> : particle I.2 • that is atomic I.2 or molecular I.2 • that is charged _(Adj) II A ₀ : IONIC I	<i>More reactive metals have a greater tendency to loose electrons and form positive ions.</i>
IONIC I spec	<i>ionic</i> I X : X relating to ions	<i>There is a strong correlation between ionic size and the melting point of an ionic compound.</i>

Lexical unit	Definition	Example
IONIC 2 spec	<i>ionic</i> 2 X : X such that it is made of ions	<i>There is a strong correlation between ionic size and the melting point of an ionic compound.</i>
IONIZATION 1 spec	<i>ionisation</i> of X : process in which the particle 1.2 X ionizes a V_0 : IONIZE a	<i>The ionization of sodium can be chemically illustrated as follows: $Na \rightarrow Na^+ + e^-$.</i>
IONIZE a spec	X <i>ionizes</i> : The particle 1.2 X undergoes a transformation 11.1 <ul style="list-style-type: none">• to become an ion S_0 : IONIZATION 1 Caus : //IONIZE b	<i>Calcium atom ionizes by losing two electrons.</i>
IONIZE b spec	X <i>ionizes</i> Y : The fact X causes 1 that the particle 1.2 Y ionizes a	<i>The Sun's ultraviolet radiation ionizes the gas molecules by stripping electrons from them.</i>
IONIZED(Adj) spec	<i>ionized</i> X : X such that it ionized a S_1 Pred : ION	<i>It has been hypothesized that photons from young, massive star clusters are responsible for maintaining the ionization of diffuse warm ionized gas seen in both the Milky Way and other disk galaxies.</i>

Lexical unit	Definition	Example
ISOTOPES 1 spec	<p><i>isotopes 1 of X :</i></p> <p>nuclides</p> <ul style="list-style-type: none"> that belong to the same element III.3a X that have different 「mass numbers」 Ω <p>A₀ : ISOTOPIC</p>	<p><i>Carbon-12, carbon-13, and carbon-14 are three isotopes of the element carbon with mass numbers 12, 13, and 14, respectively.</i></p>
ISOTOPE 2 spec critic	<p><i>isotope 2 :</i></p> <p>type of atoms I.2</p> <ul style="list-style-type: none"> that is characterized by the number of protons and neutrons in the nucleus I.2 of the atoms I.2 <p>Syn : NUCLIDE</p>	<p><i>$\delta^{13}C$ and $\delta^{15}N$ are the two most common stable isotopes commonly used for assessing nutritional interactions. $\delta^{18}O$ and $\delta^{34}S$ are less used stable isotopes.</i></p>
ISOTOPIC spec	<p><i>isotopic X :</i></p> <p>X relating to isotopes 1</p>	<p><i>Factors controlling the Li isotopic composition (δ^7Li) of river water have not yet been fully resolved.</i></p>
LIQUID _(Adj) I.2 spec	<p><i>liquid_(Adj) I.2 X :</i></p> <p>matter I.a X that is in a physical III.2 state such that</p> <ul style="list-style-type: none"> X has indefinite shape X has definite volume X's particles I.2 are mobile and interact I <p>Anti_□ : GASEOUS I.2 ; SOLID_(Adj) I.2</p> <p>S₁Pred : LIQUID_(N) I.2</p>	<p><i>Unlike most substances, the solid form of water is less dense than its liquid form, which allows ice to float on water.</i></p>

Lexical unit	Definition	Example
LIQUID _(N) 1.2 spec	<p><i>X is liquid_(N) 1.2 :</i></p> <p><i>X is matter 1.a</i></p> <ul style="list-style-type: none"> • that is liquid_(Adj) 1.2 <p>Anti_□ : GAS 1.2 ; SOLID_(N) 1.2</p> <p>A₁ : LIQUID_(Adj) 1.2</p>	<p><i>Substances with weak intermolecular interactions are likely to be liquids at lower temperatures. Their attractive forces are more easily broken hence they melt more readily.</i></p>
MACROSCOPIC 1	<p><i>macroscopic 1 X :</i></p> <p><i>X whose size is such</i></p> <ul style="list-style-type: none"> • that one can see it with the 'naked eye' 	<p><i>On the macroscopic level a silvery liquid, mercury, is mixed with a red-brown liquid, bromine, and white crystals are produced.</i></p>
MASS 1.2 spec	<p><i>mass 1.2 of X of value Y :</i></p> <p><i>'physical property' of the physical_(Adj) 1.2 thing X</i></p> <ul style="list-style-type: none"> • that is a quantity Y of matter 1.a that X contains • that determines the inertia of X 	<p><i>Convert the mass of AlCl₃ to moles and then use the balanced chemical equation to find the number of moles of HCl formed. A liter of water has a mass of 1.0 kg. How many moles of water are 1.0 kg?</i></p>
'MASS NUMBER' spec	<p><i>Y is the 'mass number' of X :</i></p> <p><i>Y is the number</i></p> <ul style="list-style-type: none"> • that characterizes the nuclide X 	<p><i>The mass number of oxygen-16 is 16. This means there are eight protons and eight neutrons in the nucleus of an oxygen-16 atom.</i></p>
MATTER 1.a (spec)	<p><i>matter 1.a that X is made of :</i></p> <p><i>entity of the 'physical world'</i></p> <ul style="list-style-type: none"> • that things X are made of 	<p><i>The condition of transparency is dependent on the state of matter and how such matter interacts with light. If matter does not absorb light, it will not emit it.</i></p>

Lexical unit	Definition	Example
MICROSCOPIC I	<p>microscopic I X :</p> <p>X relating to the use of a microscope</p>	<p><i>At the end of the experiment microscopic analysis showed that those who had consumed alcohol sustained heart muscle deterioration.</i></p>
MICROSCOPIC II.a	<p>microscopic II.a X :</p> <p>X whose size is such</p> <ul style="list-style-type: none"> • that one can only see it under an optical microscope <p>Anti_n : MICROSCOPIC II.b</p>	<p><i>Microscopic dust particles found in meteoritic material on Earth were likely formed in stellar explosions that occurred long before the creation of the Sun.</i></p>
MICROSCOPIC II.b spec	<p>microscopic II.b X :</p> <p>X whose size is such</p> <ul style="list-style-type: none"> • that it is smaller than the microscopic II.a entities • that it is therefore not visible under an optical microscope <p>Syn : SUBMICROSCOPIC</p> <p>Anti_n : MICROSCOPIC II.a</p>	<p><i>Atoms and molecules are microscopic particles; their structure, properties and motions can be described by the laws of quantum mechanics.</i></p>
MIXTURE I.3 spec	<p>mixture I.3 of X :</p> <p>combinaton of substances I.1b $\{X\}$</p> <ul style="list-style-type: none"> • such that X are not bonded I.2 • such that each X keeps its individual 「chemical properties」 $\{\Omega\}$ 	<p><i>Mixtures can always be separated again into component pure substances, because bonding among the atoms of the constituent substances does not occur in a mixture.</i></p>

Lexical unit	Definition	Example
MOLECULAR 1.1a spec	molecular 1.1a X : X relating to molecules Adv ₀ : MOLECULARLY	<i>You can skate on a lake during a harsh winter while the fish underneath you continue to swim. This unusual property is caused by the molecular structure of water.</i>
MOLECULAR 1.2 spec	molecular 1.2 X : X such that it is made of molecules	<i>Molecular oxygen (O_2) and molecular nitrogen (N_2) are not compounds because each is composed of a single element. Covalent bonds within molecular substances are very strong.</i>
MOLECULARITY spec	<i>molecularity of X of value Y</i> : property of the elementary reaction X • that corresponds to the number Y of chemical entities involved in X	<i>A single-step chemical reaction is said to have a molecularity of 1 if just one molecule transforms into products. We call this a unimolecular reaction. An example is the decomposition of N_2O_4.</i>
MOLECULARLY spec	molecularly X : X as regards to molecules A ₀ : MOLECULAR 1.1a	<i>Two molecularly different ice crystals may look nearly identical, even under a microscope, making the question of whether every snowflake is unique more complicated.</i>

Lexical unit	Definition	Example
MOLECULE I spec	<p><i>molecule</i> I of Y made of X :</p> <p>「chemical entity」</p> <ul style="list-style-type: none"> • that is made of atoms I.2 {X} • that is the smallest unit of substance I.1b Y <p>A₀ : MOLECULAR I.1a</p>	<p>A water molecule consists of one oxygen atom with two hydrogen atoms. Molecules can be as simple as two atoms or very elaborate, relatively large structures. A molecule of glucose, a common form of sugar, is about 0.9 nanometer.</p>
NEUTRON spec	<p><i>neutron</i> of X interacting with Y :</p> <p>「subatomic particle」 of the atom I.2 X</p> <ul style="list-style-type: none"> • that interacts I with the 「subatomic particles」 Y of X • that is not charged (Adj) II 	<p>The atom is not the smallest particle in nature. It consists of a nucleus, containing positively charged protons and electrically neutral neutrons, surrounded by negatively charged electrons.</p>
NUCLEAR I.2 spec	<p><i>nuclear</i> I.2 X :</p> <p>X relating to nuclei I.2</p>	<p>Nuclear reactions involve changes in nuclear structure. The basic idea of nuclear structure is that the nucleus of an atom is composed of protons and, with the exception of ${}^1_1\text{H}$, neutrons.</p>
NUCLEON spec	<p><i>nucleon</i> of X :</p> <p>「subatomic particle」</p> <ul style="list-style-type: none"> • that is a constituent of the nucleus I.2 X 	<p>The total number of protons and neutrons, collectively called nucleons, in the nucleus of an atom is called the mass number of that atom.</p>

Lexical unit	Definition	Example
NUCLEUS 1.2 spec	<p><i>nucleus</i> 1.2 of <i>X</i> :</p> <p>central part of the atom 1.2 <i>X</i></p> <ul style="list-style-type: none"> • that is made of protons and neutrons • that is positively charged_(Adj) II <p>A₀ : NUCLEAR 1.2</p>	<p>An unstable nucleus that decays spontaneously is radioactive, and its emissions are collectively called radioactivity.</p>
NUCLIDE spec	<p><i>nuclide</i> :</p> <p>type of atoms 1.2</p> <ul style="list-style-type: none"> • that is characterized by the number of protons and neutrons in the nucleus 1.2 of the atoms 1.2 <p>Syn : ISOTOPE 2</p>	<p>The number that is sometimes given with the name of the nuclide is called its mass number. For example, carbon-14 is a nuclide of carbon with 6 protons and 8 neutrons.</p>
PARTICLE 1.2 spec	<p><i>particle</i> 1.2 of <i>X</i> (interacting with <i>Y</i>) :</p> <p>constituent of the matter 1.a <i>X</i></p> <ul style="list-style-type: none"> • (that interactsI with the other entities <i>Y</i>) 	<p>Positive and negative charges can neutralize each other, or neutral particles can split to form positively and negatively charged pairs of particles, but the net amount of charge always remains the same.</p>
PHYSICAL III.1 (spec)	<p><i>physical</i> III.1 <i>X</i> :</p> <p><i>X</i> relating to the physicsI</p>	<p>The instructor should explain a step-by-step procedure for performing the physical laboratory experiment to the group.</p>

Lexical unit	Definition	Example
PHYSICAL III.2 spec	<i>physical</i> III.2 X : X relating to the physics II of Ω	<i>Because of its physical structure, a water molecule is bipolar, which means that it is slightly charged, with a positive charge on one side and a negative charge on the opposite side.</i>
「PHYSICAL CHANGE」 spec	「 <i>physical change</i> 」 of X : change of 「 physical properties 」 Ω of the substance I.1b X	<i>Physical change involves a change in properties such as smell, shape, size, color, volume or density of matter without a change in its composition.</i>
「PHYSICAL PROPERTY」 spec	Y is a 「 <i>physical property</i> 」 of X : Y is a property of the substance I.1b X <ul style="list-style-type: none"> • that is inherent in X • that can be measured or observed at the macroscopic I level 	<i>Physical properties that will change if the amount of matter changes are mass, volume and length. Density, color, conductivity and luster are physical properties that will be the same regardless of the amount of matter.</i>
PHYSICS I (spec)	<i>physics</i> I practiced by X : science practiced by the human X <ul style="list-style-type: none"> • whose object is the study of the matter I.a, the energy II.1 and their interactions I 	<i>Quantum electrodynamics, a subfield of physics, explains the interactions of charged particles and light.</i>
A ₀ : PHYSICAL III.1		

Lexical unit	Definition	Example
PHYSICS II spec	<p><i>physics</i> II of X :</p> <p>properties of the matter I.a or the energy II.1 X</p> <ul style="list-style-type: none"> that determine the interactions I of X with the matter I.a or the energy II.1 Ω <p>A₀ : PHYSICAL III.2</p>	<p><i>Insights into medical imaging and its progress necessitate an understanding of the physics of radiation and matter.</i></p>
PRODUCT I.3 spec	<p><i>product</i> I.3 of X :</p> <p>substance I.1b</p> <ul style="list-style-type: none"> that is formed at the end of the reaction I.1d X between the substances I.1b Ω <p>S₁ : REACTION I.1d</p>	<p><i>A truly irreversible chemical reaction is usually achieved when one of the products exits the reacting system, for example, as does carbon dioxide (volatile) in the reaction $\text{CaCO}_3 + 2\text{HCl} \rightarrow \text{CaCl}_2 + \text{H}_2\text{O} + \text{CO}_2\uparrow$.</i></p>
PROTON spec	<p><i>proton</i> of X interacting with Y :</p> <p>「subatomic particle」 of the atom I.2 X</p> <ul style="list-style-type: none"> that interacts I with the 「subatomic particle」 Y of X that is positively charged_(Adj) II 	<p><i>In a hydrogen atom, a negative electron orbits a positive proton because of the electromagnetic, not the gravitational, force between the two particles.</i></p>
PROTONIC spec	<p><i>protonic</i> X :</p> <p>X relating to protons</p>	<p><i>New methods were applied to the research of protonic structure of oxalic acid dihydrate $(\text{COOH})_2 \cdot 2 \text{H}_2\text{O}$.</i></p>

Lexical unit	Definition	Example
「PURE SUBSTANCE」 spec	<p>「<i>pure substance</i>」 :</p> <p>distinct substance1.1b</p> <ul style="list-style-type: none"> that is made of one type of atoms1.2 or one type of molecules1 whose composition and properties are constant throughout any sample of this substance1.1b 	<p><i>Oxygen at room temperature is a pure substance that is an odorless colorless gas.</i></p>
REACT 1.1d spec	<p><i>X react1.1d producing Y :</i></p> <p>The substances1.1b X undergo a 「chemical change」</p> <ul style="list-style-type: none"> that results in the transformation11.1 of X into one or several substances1.1b Y <p>S₀ : REACTION 1.1d S₁ : REACTANT S_{res} & S₂ : PRODUCT 1.3 Able₁ : REACTIVE 1.1d S_{loc} : REACTOR 1.2 Caus : //REACT 1.1e</p>	<p><i>Calcium reacts strongly with oxygen and water creating various forms of calcium oxides or hydroxides that have insulating properties.</i></p> <p><i>Hydrogen atoms react with oxygen, releasing reactive oxygen species, such as hydroxyl radicals, which in turn react with the benzene to form phenol.</i></p>
REACT 1.1e spec	<p><i>X reacts1.1e Y to produce Z :</i></p> <p>The human X causes² that the substances1.1b Y react1.1d to produce one or several substances1.1b Z</p> <p>S_{instr} : REACTOR 1.2</p>	<p><i>Our conclusion is that to get 20 grams of Fe(OH)₃, we need to react 30.3 grams of FeCL₃ with 22.4 grams of NaOH.</i></p>

Lexical unit	Definition	Example
<p>REACTANT spec</p>	<p><i>X is a reactant :</i></p> <p>X is a substance 1.1b</p> <ul style="list-style-type: none"> • that reacts 1.1d with a substance 1.1b Ω_1 producing a different substance 1.1b Ω_2 • that is consumed (partially) at the end of this reaction 1.1d 	<p><i>The reactants are placed in a test-tube, flask or beaker. They are mixed together, often heated for the reaction to take place and are then cooled. The products are poured out and, if necessary, purified.</i></p>
<p>REACTION 1.1d spec</p>	<p><i>reaction 1.1d between X producing Y :</i></p> <p>fact of the substances 1.1b X reacting 1.1d to produce one or several substances 1.1b Y</p> <p>V_0 : REACT 1.1d</p> <p>S_1 : REACTANT</p> <p>S_{res} & S_2 : PRODUCT 1.3</p> <p>$Able_1$: REACTIVE 1.1d</p> <p>S_{loc} : REACTOR 1.2</p>	<p><i>The candle will not burn if one of the reactants (wax or oxygen) is no longer available because both reactants are required for the chemical reaction to continue.</i></p>
<p>REACTIVE 1.1d spec</p>	<p><i>X reactive 1.1d with Y :</i></p> <p>substance 1.1b X such that it reacts 1.1d with the substance 1.1b Y to produce a substance 1.1b Ω</p> <p>S_0Pred : REACTIVITY 1.1d</p>	<p><i>Metals like potassium, sodium, calcium and aluminium are known as highly reactive metals.</i></p>
<p>REACTIVITY 1.1d spec</p>	<p><i>reactivity 1.1d of X :</i></p> <p>fact of the substance 1.1b X being reactive 1.1d with Ω</p> <p>A_1 : REACTIVE 1.1d</p>	<p><i>The high reactivity of fluorine is due to its high electronegativity.</i></p>

Lexical unit	Definition	Example
REACTOR 1.2 spec	<p>reactor 1.2 used by X for Y :</p> <p>device used by the human X</p> <ul style="list-style-type: none"> to react 1.1e the substances 1.1b Y in order to produce a substance 1.1b Ω by placing Y in this device 	<p>With a continuous-flow reactor the problem can be confined to the small volume of the reactor and the process can be shutdown immediately by stopping the inflow of the reactants.</p>
REAGENT spec	<p>reagent used by X :</p> <p>substance 1.1b used by the human X</p> <ul style="list-style-type: none"> to react 1.1e it with a substance 1.1b Ω_1 in order to analyse it or produce a substance 1.1b Ω_2 	<p>The company was allowed to sell its own reagents, or test chemicals, for the cell counters. Lithium aminoborohydride (LAB) reagents are a new class of powerful and selective reagents developed at the University of California. These reagents have reactivity comparable to lithium aluminum hydride ($LiAlH_4$).</p>
「SIMPLE SUBSTANCE」 spec	<p>「simple substance」 :</p> <p>「pure substance」</p> <ul style="list-style-type: none"> such that it is made of a single element III.3a Ω <p>Syn : 「ELEMENTARY SUBSTANCE」 ; ELEMENT III.3b</p>	<p>By studying combustion of coal and other compounds, A. Lavoisier was the first to show that carbon is a simple substance.</p>

Lexical unit	Definition	Example
SOLID _(Adj) 1.2 spec	<p>solid_(Adj) 1.2 <i>X</i> :</p> <p>matter 1.a <i>X</i> that is in a physical_(Adj) 111.2 state such that</p> <ul style="list-style-type: none"> • <i>X</i> has definite shape • <i>X</i> has definite volume • <i>X</i>'s particles 1.2 are non mobile <p>Anti_∩ : GASEOUS 1.2 ;</p> <p>LIQUID_(Adj) 1.2</p> <p>S₁Pred : SOLID_(N) 1.2</p>	<p>The volume of solid helium, ³He and ⁴He, can be decreased by more than 30% by applying pressure.</p>
SOLID _(N) 1.2 spec	<p><i>X</i> is a solid_(N) 1.2 :</p> <p><i>X</i> is matter 1.a</p> <ul style="list-style-type: none"> • that is solid_(Adj) 1.2 <p>Anti_∩ : GAS 1.2 ; LIQUID_(N) 1.2</p> <p>A₁ : SOLID_(Adj) 1.2</p>	<p>In the water cycle, water repeatedly changes from a gas to a liquid or solid and back to a gas again.</p>
SUBATOMIC 1.1 spec	<p>subatomic 1.1 <i>X</i> :</p> <p><i>X</i> relating to the inner structure of atoms 1.2</p>	<p>Quantum theory explains the nature and behavior of matter and energy on the atomic and subatomic level.</p>
SUBATOMIC 1.2 spec	<p>subatomic 1.2 <i>X</i> :</p> <p><i>X</i> such that it is found within atoms 1.2</p>	<p>The atomic nucleus contains all of the heavy subatomic protons and neutrons. The rest of the atom is made up of incredibly light electrons.</p>
⌈SUBATOMIC PARTICLE⌋ spec	<p>⌈subatomic particle⌋ of <i>X</i> :</p> <p>particle 1.2 of the matter 1.a <i>X</i></p> <ul style="list-style-type: none"> • that is a constituent of an atom 1.2 	<p>Atoms can be broken apart into smaller subunits, or subatomic particles, such as protons, neutrons and electrons.</p>

Lexical unit	Definition	Example
SUBMICROSCOPIC spec	<p>submicroscopic X :</p> <p>X whose size is such</p> <ul style="list-style-type: none"> • that it is smaller than the microscopic II.a entities • that it is therefore not visible under an optical microscope <p>Syn : MICROSCOPIC II.b</p> <p>Anti_n : MICROSCOPIC II.a</p>	<p><i>An atom is a submicroscopic particle that serves as the building block for ordinary matter.</i></p>
SUBSTANCE I.1b spec	<p>substance I.1b :</p> <p>type of matter I.a</p> <ul style="list-style-type: none"> • that has a constant composition • that has constant characteristic properties $\{\Omega\}$ 	<p><i>A chemical reaction leads to the transformation of one set of chemical substances to another.</i></p>
TRANSFOR- MATION II.1 spec	<p>transformation II.1 of X into Y :</p> <p>transformation I.1a of the substance I.1b X into Y</p> <ul style="list-style-type: none"> • that is either X in another physical III.2 state, or a substance I.1b other than X 	<p><i>A substance changes phase without undergoing any chemical transformation: the evaporation of water or the melting of ice occur without decomposition or modification of the water molecules.</i></p>
WEIGHT I.2 spec	<p>weight I.2 of X of value Y :</p> <p>「physical property」 of the physical I.2 thing X</p> <ul style="list-style-type: none"> • relative to the intensity of the gravity force acting on X • that is measured by the numerical value Y 	<p><i>The weight of an object is dependent on its location. If your weight is 82 kilograms (180 pounds) on Earth, your weight on the moon will be 14 kilograms (30 pounds).</i></p>

8.4 System of French chemical notions

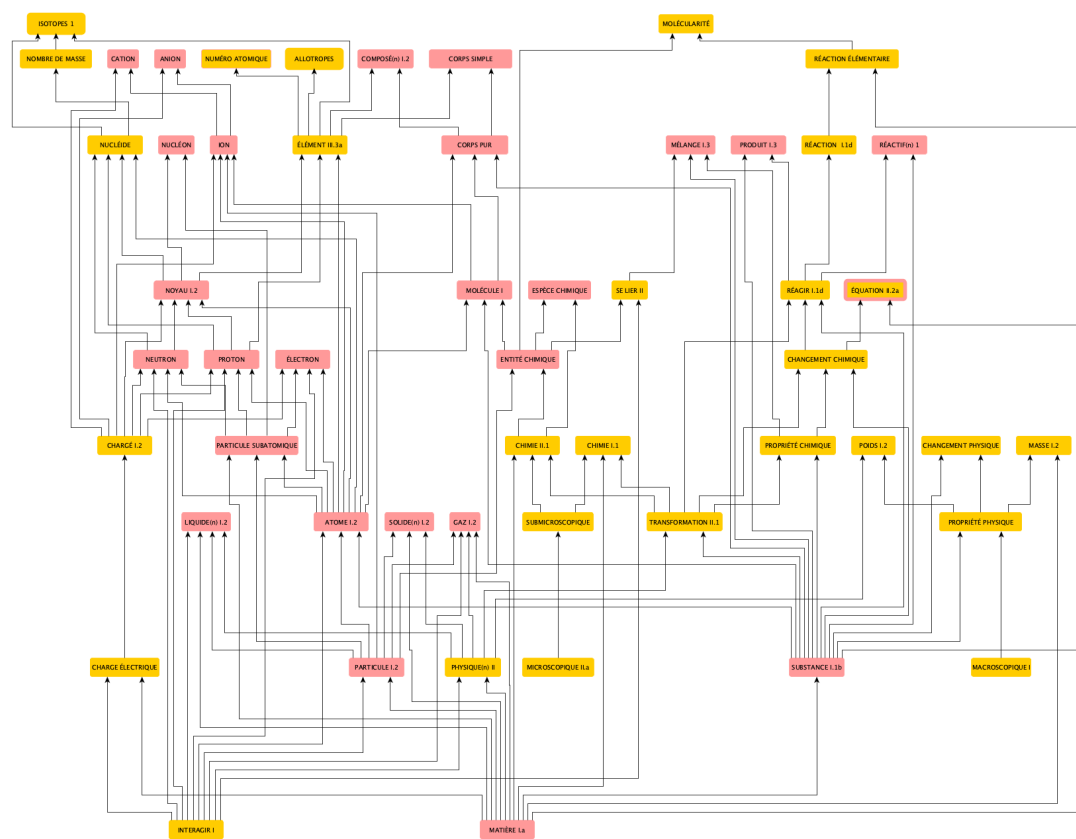
Figure 8.2 – The *defined-by* hierarchy of French chemical notions.

Lexical unit	Definition [Propositional form : Paraphrase]	Example
ALLOTROPES spéc	<i>Y qui sont des allotropes de X :</i> <i>Y qui sont des formes de l'élément III.3a X structurellement différentes</i> A_0 : ALLOTROPIQUE 1	<i>Certains allotropes de carbone, tels que le graphite et le diamant, sont naturels ; d'autres, comme les nanotubes, doivent être fabriqués en laboratoire.</i>
ALLOTROPIQUE 1 spéc	<i>X allotropique 1 :</i> <i>X relatif aux allotropes</i>	<i>Les deux formes allotropiques de l'oxygène, le dioxygène et l'ozone peuvent exister dans les phases solide, liquide et gazeuse.</i>

Lexical unit	Definition	Example
ALLOTROPIQUE 2 spéc	<i>X</i> allotropique 2 : élément III.3a <i>X</i> tel qu'il a des allotropes S ₀ Pred : ALLOTROPIE	<i>Les éléments allotropiques les plus connus sont carbone, soufre, phosphore, oxygène.</i>
ALLOTROPIE spéc	allotropie de X : caractéristique de l'élément III.3a <i>X</i> d'être allotropique 2 A ₁ : ALLOTROPIQUE 2	<i>Les non-métaux sont plus enclins à l'allotropie que les métaux. L'allotropie du fer est de grande importance industrielle.</i>
ANION spéc	anion : ion • qui est chargé _(Adj) IV.2 négativement A ₀ : ANIONIQUE	<i>La formule chimique d'un solide ionique exprime les proportions de cations et d'anions qu'il contient. Cette proportion respecte toujours la neutralité électrique globale.</i>
ANIONIQUE spéc	<i>X</i> anionique : <i>X</i> relatif aux anions	<i>Les dérivés cationiques sont trop réactifs avec les composés anioniques et sont trop sensibles à la présence des ions Ca⁺⁺ et Mg⁺⁺.</i>
ATOME I.2 spéc	atome I.2 de <i>X</i> qui se combine avec <i>Y</i> : particule I.2 • qui interagit I avec des particules I.2 <i>Y</i> similaires pour former la plus petite unité de substance I.1b X A ₀ : ATOMIQUE 1	<i>Les atomes ayant la même électronégativité partagent des électrons dans des liaisons covalentes, parce qu'aucun des deux atomes n'attire ou ne répulse de préférence les électrons qu'il partage.</i>

Lexical unit	Definition	Example
ATOMIQUE 1 spéc	<p><i>X</i> atomique 1 :</p> <p><i>X</i> relatif aux atomes I.2</p> <p>Adv₀ : ATOMIQUEMENT</p>	<p><i>La stabilité d'un noyau atomique dépend de la nature et du nombre de nucléons qui le composent.</i></p>
ATOMIQUE 2 spéc	<p><i>X</i> atomique 2 :</p> <p><i>X</i> tel qu'il est constitué</p> <ul style="list-style-type: none"> • d'atomes I.2 du même élément III.3a et non liés II entre eux 	<p><i>Les réactions de l'ozone avec l'oxygène atomique ou l'oxygène moléculaire pour créer deux molécules d'oxygène sont fortement dépendantes de la température.</i></p>
ATOMIQUEMENT spéc	<p><i>X</i> atomiquement :</p> <p><i>X</i> relativement aux atomes I.2</p> <p>A₀ : ATOMIQUE 1</p>	<p><i>Une unité BN et deux atomes de carbone (CC) ont le même nombre d'électrons et des structures similaires, mais leur interaction avec les molécules de gaz est différente en raison de la nature atomiquement hétérogène du BN.</i></p>
CATION spéc	<p>cation :</p> <p>ion</p> <ul style="list-style-type: none"> • qui est chargé_(Adj) IV.2 positivement <p>A₀ : CATIONIQUE</p>	<p><i>Dans les liaisons ioniques, le métal perd des électrons pour devenir un cation chargé positivement, alors que le non-métal les accepte pour devenir un anion chargé négativement.</i></p>

Lexical unit	Definition	Example
CATIONIQUE spéc	X <i>cationique</i> : X relatif aux cations	<i>La charge cationique permet d'associer les acides nucléiques avec les vecteurs pour former des assemblages cohésifs.</i>
「CHANGEMENT CHIMIQUE」 spéc	「 <i>changement chimique</i> 」 de X en Y : changement de 「 propriétés chimiques 」 Ω de la substance I.1b X <ul style="list-style-type: none"> • qui affecte la composition de X • qui a pour résultat la transformation II.1 de X en une substance I.1b Y différente 	<i>Le dégagement d'énergie sous forme de chaleur indique qu'un changement chimique se produit.</i>
「CHANGEMENT PHYSIQUE」 spéc	「 <i>changement physique</i> 」 de X : changement de 「 propriétés physiques 」 Ω de la substance I.1b X	<i>La dissolution du sucre dans l'eau est un exemple de changement physique. Les molécules impliquées dans le changement physique demeurent intactes.</i>
「CHARGE ÉLECTRIQUE」 spéc	「 <i>charge électrique</i> 」 de X de valeur Y : propriété de la matière I.a X <ul style="list-style-type: none"> • qui lui permet d'avoir des interactions I électriques avec d'autres entités Ω • qui est mesurée par la valeur numérique Y 	<i>Il faut que l'air, électriquement neutre, s'ionise, c'est-à-dire qu'il devienne porteur d'une charge électrique. Un électron est chargé négativement et possède une charge électrique de $1,6 \cdot 10^{-19}$ C.</i>
	A ₁ : CHARGÉ _(Adj) IV.2	

Lexical unit	Definition	Example
CHARGÉ _(Adj) IV.2 spéc	X chargé _(Adj) IV.2 : X qui a une \lceil charge électrique $\rceil \Omega$	<i>Dans le noyau de l'atome se trouvent les protons (chargés positivement) et les neutrons (non chargés), tandis que les électrons (chargés négativement) sont localisés autour du noyau.</i>
CHIMIE I.1 (spéc)	chimie I.1 pratiquée par X : science pratiquée par l'individu X <ul style="list-style-type: none"> dont l'objet est l'étude de la matière I.a et de ses transformations II.1 au niveau submicroscopique A_0 : CHIMIQUE I	<i>La chimie théorique est l'étude de la chimie à travers un raisonnement théorique fondamental, habituellement à l'aide des mathématiques et de la physique.</i>
CHIMIE II.1 spéc	chimie II.1 de X : propriétés de la matière I.a X <ul style="list-style-type: none"> qui déterminent les transformations II.1 de X au niveau submicroscopique A_0 : CHIMIQUE II.1	<i>La chimie de l'atome de soufre dans l'atmosphère est moins bien connue que celle du carbone.</i>
CHIMIE II.2 spéc	chimie II.2 de X : transformations II.1 dans la matière I.a X <ul style="list-style-type: none"> qui se produisent du fait de la chimie II.1 de X 	<i>La chimie du corps et du cerveau lors de grands états de peur entraîne une chute dramatique du QI tant que l'enfant ou l'adulte se sent menacé.</i>

Lexical unit	Definition	Example
CHIMIQUE I (spéc)	<p>X <i>chimique I</i> :</p> <p>X relatif à la chimie I.1</p> <p>Adv_0 : CHIMIQUEMENT I</p>	<p><i>L'utilisation d'une expérience</i></p> <p>chimique dans</p> <p><i>l'enseignement est l'un des problèmes les plus développés dans la méthodologie de l'enseignement de la chimie.</i></p>
CHIMIQUE II.1 spéc	<p>X <i>chimique II.1</i> :</p> <p>X relatif à la chimie II.1 de Ω</p> <p>Adv_0 : CHIMIQUEMENT II</p>	<p><i>Un autre type de liaison</i></p> <p>chimique forte entre deux atomes ou plus est une liaison covalente.</p>
CHIMIQUEMENT I (spéc)	<p>X <i>chimiquement I</i> :</p> <p>X relativement à la chimie I.1</p> <p>A_0 : CHIMIQUE I</p>	<p><i>Il est chimiquement prouvé que la température affecte l'état de conservation des œuvres puisque les changements brusques de température peuvent affecter les conditions des pigments et les toiles.</i></p>
CHIMIQUEMENT II spéc	<p>X <i>chimiquement II</i> :</p> <p>X relativement à la chimie II.1 de Ω</p> <p>A_0 : CHIMIQUE II.1</p>	<p><i>Enfin un dernier stade de scission sépare les deux constituants différents</i></p> <p>chimiquement et laisse une protéine, isolée de l'acide nucléique, d'un poids moléculaire de 12 0000.</p>

Lexical unit	Definition	Example
COMPOSÉ _(N) 1.2 spéc	<p>composé_(N) 1.2 de <i>X</i> :</p> <p>「corps pur」</p> <ul style="list-style-type: none"> tel qu'il est constitué d'éléments III.3a <i>X</i> différents <p>Syn_□ : 「CORPS COMPOSÉ」</p>	<p>Une formule chimique énumère les différents éléments présents dans un composé donné ainsi que le nombre relatif de chacun des éléments.</p> <p>La houille de mauvaise qualité et le pétrole contiennent des composés de soufre et génèrent du SO₂ lors de leur combustion</p>
「CORPS COMPOSÉ」 spéc	<p>「corps composé」 :</p> <p>「corps pur」</p> <ul style="list-style-type: none"> tel qu'il est constitué d'éléments III.3a <i>Ω</i> différents <p>Syn_□ : COMPOSÉ_(N) 1.2</p>	<p>L'eau (H₂O), le dioxyde de carbone (CO₂) ou chlorure de sodium (NaCl) sont des corps composés.</p>
「CORPS PUR」 spéc	<p>「corps pur」 :</p> <p>substance I.1b distincte</p> <ul style="list-style-type: none"> qui est constituée d'un seul type d'atomes I.2 ou d'un seul type de molécules I dont la composition et les propriétés sont constantes dans tout l'échantillon de cette substance I.1b 	<p>Le diazote N₂ qui constitue la grande majorité de l'air est bien un corps pur, de même que le dioxygène O₂, l'argon Ar, le dioxyde de carbone CO₂, etc.</p>
「CORPS SIMPLE」 spéc	<p>「corps simple」 :</p> <p>「corps pur」</p> <ul style="list-style-type: none"> tel qu'il est constitué d'un unique élément III.3a <i>Ω</i> <p>Syn : ÉLÉMENT III.3b</p>	<p>Le dioxygène O₂, composé uniquement d'Oxygène, est un corps simple alors que l'eau H₂O est un corps composé.</p>

Lexical unit	Definition	Example
ÉLECTRON spéc	<p><i>électron</i> de <i>X</i> qui interagit avec <i>Y</i> :</p> <p>「particule subatomique」 de l'atome I.2 <i>X</i></p> <ul style="list-style-type: none"> • qui interagit I avec les 「particules subatomiques」 <i>Y</i> de <i>X</i> • qui est chargée_(Adj) IV.2 négativement <p>A₀ : ÉLECTRONIQUE I</p>	<p>Selon la théorie orbitale moléculaire de Hückel, un composé est particulièrement stable si toutes ses orbitales moléculaires de liaison sont remplies d'électrons apparés.</p>
ÉLECTRONIQUE I spéc	<p><i>X électronique</i> I :</p> <p><i>X</i> relatif aux électrons</p>	<p>L'énergie d'ionisation de l'atome est trop grande et l'affinité électronique de l'atome est trop faible pour que la liaison ionique se produise.</p>
ÉLÉMENT III.3a spéc	<p><i>élément</i> III.3a <i>X</i> :</p> <p>type d'atomes I.2</p> <ul style="list-style-type: none"> • qui est identifié par le numéro <i>X</i> correspondant à la quantité de protons dans noyau I.2 de ces atomes I.2 <p>A₀ : ÉLÉMENTAIRE III.1</p>	<p>L'élément 6 (carbone) forme divers composés inorganiques comme le dioxyde de carbone CO₂ et une grande variété de composés organiques et de polymères.</p>
ÉLÉMENT III.3b spéc critic	<p><i>élément</i> III.3b :</p> <p>「corps pur」</p> <ul style="list-style-type: none"> • tel qu'il est constitué d'un unique élément III.3a Ω <p>Syn : 「CORPS SIMPLE」</p>	<p>Un élément est une substance formée d'une seule sorte d'atomes.</p> <p>Cet élément est un métal dense, gris argenté, qui réagit avec l'oxygène.</p>

Lexical unit	Definition	Example
ÉLÉMENTAIRE III.1 spéc	<i>X élémentaire</i> III.1 : X relatif aux éléments III.3a	<i>L'analyse élémentaire</i> consiste à déterminer les proportions d'atomes de chaque élément chimique dans la composition d'une substance.
ÉLÉMENTAIRE III.2 spéc	<i>X élémentaire</i> III.2 : substance I.1b X tel qu'elle est constituée d'un unique élément III.3a Ω	<i>Le dioxyde de carbone (CO₂)</i> de l'air et l'eau sont transformés en glucose et en fructose, tandis que l'oxygène élémentaire (O ₂) est libéré.
「ENTITÉ CHIMIQUE」 spéc	「 <i>entité chimique</i> 」 : particule I.2 • telle qu'elle peut être identifiée par ses propriétés chimique II.1 { Ω }	À l'échelle microscopique, une entité chimique peut être un atome, une molécule ou un ion.
ÉQUATION II.2a spéc	<i>équation</i> II.2a entre X et Y : représentation symbolique • de l'équivalence de la matière I.a dans le cadre du 「 changement chimique 」 de la substance I.1b X en substance I.1b Y • qui a la forme d'une équation II.1 avec X à gauche et Y à droite	Pour qu'une équation chimique soit équilibrée, le nombre d'atomes du côté gauche d'une équation doit être égal au nombre d'atomes du côté droit de l' équation , par ex. $2H_2 + O_2 = 2H_2O$.
ÉQUATION II.2b spéc	<i>équation</i> II.2b entre X et Y : représentation symbolique • d'une réaction I.1d entre les substances I.1b X qui produit Y • qui a la forme d'une expression similaire à une équation II.1 avec X à gauche et Y à droite	L' équation chimique de la combustion complète du méthane dans le dioxygène est $CH_4 + 2O_2 \rightarrow CO_2 + 2H_2O$.

Lexical unit	Definition	Example
「ESPÈCE CHIMIQUE」 spéc	「 <i>espèce chimique</i> 」 : ensemble d'「entités chimiques」 • chimiquement II identiques	<i>L'espèce chimique eau désigne un ensemble de molécules d'eau.</i>
GAZ I.2 spéc	<i>X est un gaz I.2 :</i> <i>X est une matière I.a dans un état physique</i> _{(Adj) III.2} • tel que X a une forme indéfinie • tel que X a un volume indéfini • tel que les particules I.2 de X sont très mobiles et interagissent I peu <i>Anti</i> _∩ : LIQUIDE _(N) I.2 ; SOLIDE _(N) I.2 <i>A</i> ₁ : GAZEUX I.2	<i>À haute pression, les molécules de gaz sont très proches les unes des autres et l'espace libre entre chaque molécule se réduit.</i>
GAZEUX I.2 spéc	<i>X gazeux</i> I.2 : X tel qu'il possède les caractéristiques d'un gaz I.2 <i>Anti</i> _∩ : LIQUIDE _(Adj) I.2 ; SOLIDE _(Adj) I.2 <i>S</i> ₁ Pred : GAZ I.2	<i>Pour déterminer la masse volumique d'une substance gazeuse, il faut calculer le rapport entre la masse et le volume du gaz.</i>
INTERACTION I (spéc)	<i>interaction</i> I entre X et Y : fait que les entités X et Y interagissent I <i>V</i> ₀ : INTERAGIR I	<i>On peut distinguer deux types d'hydrolyses : celles qui se font par transfert de protons, rapides, et celles qui se font par interaction de l'atome d'oxygène de l'eau avec un atome du substrat, beaucoup plus lentes.</i>

Lexical unit	Definition	Example
INTERAGIR I (spéc)	<i>X et Y interagissent</i> I : Les entités X et Y ont un effet l'une sur l'autre S ₀ : INTERACTION I	<i>Cette particule qui était créée dans les interactions nucléaires de grande énergie interagissait très faiblement avec la matière.</i>
ION spéc	<i>ion</i> : particule 1.2 • atomique 2 ou moléculaire 1.2 • qui est chargée (Adj) IV.2 A ₀ : IONIQUE 1	<i>Pour respecter la règle du duet ou de l'octet, un atome, autre qu'un gaz noble, peut perdre ou gagner des électrons et se transformer en ions.</i>
IONISATION 1 spéc	<i>ionisation</i> de X : processus par lequel la particule 1.2 X s' ionise V ₀ : S'IONISER	<i>L'énergie d'ionisation d'un atome est l'énergie qu'il faut fournir à un atome neutre pour arracher un électron (le moins lié) à l'état gazeux et former un ion positif.</i>
IONISÉ(Adj) spéc	X <i>ionisé</i> : X tel qu'il s'est ionisé S ₁ Pred : ION	<i>En effet un atome ionisé peut se combiner avec un électron pour donner un atome neutre.</i>
IONISER spéc	X <i>ionise</i> Y : Le fait X cause ¹ que la particule 1.2 Y s' ionise	<i>Les rayonnements alpha, bêta et gamma ionisent les atomes de matière avec lesquels ils interagissent.</i>

Lexical unit	Definition	Example
S'IONISER spéc	<p>X <i>s'ionise</i> :</p> <p>La particule1.2 X subit une transformation II.1</p> <ul style="list-style-type: none"> • pour devenir un ion <p>S₀ : IONISATION 1 Caus : //IONISER</p>	<p><i>Il faut que l'air, électriquement neutre, s'ionise, c'est-à-dire qu'il devienne porteur d'une charge électrique. L'ionisation est favorisée par certains facteurs atmosphériques : température et humidité notamment.</i></p>
IONIQUE 1 spéc	<p>X <i>ionique</i> 1 :</p> <p>X relatif aux ions</p>	<p><i>Les scientifiques peuvent manipuler les propriétés ioniques et ces interactions afin de former les produits désirés.</i></p>
IONIQUE 2 spéc	<p>X <i>ionique</i> 2 :</p> <p>X tel qu'il est constitué d'ions</p>	<p><i>La formule chimique d'un solide ionique exprime les proportions de cations et d'anions qu'il contient.</i></p>
ISOTOPES 1 spéc	<p><i>isotopes</i> 1 de X :</p> <p>nucléides</p> <ul style="list-style-type: none"> • qui appartiennent au même élément III.3a X • qui ont des nombres de masse Ω différents <p>A₀ : ISOTOPIQUE</p>	<p><i>Les isotopes d'hydrogène protium ${}^1_1\text{H}$, deutérium ${}^2_1\text{H}$ et tritium ${}^3_1\text{H}$ peuvent également être appelés hydrogène-1, hydrogène-2 et hydrogène-3, respectivement.</i></p>
ISOTOPE 2 spéc critic	<p><i>isotope</i> 2 :</p> <p>type d'atomes I.2</p> <ul style="list-style-type: none"> • qui est caractérisé par le nombre de protons et de neutrons dans le noyau I.2 de ces atomes I.2 <p>Syn : NUCLÉIDE</p>	<p><i>On connaît actuellement environ 325 isotopes naturels et 1200 isotopes créés artificiellement.</i></p>

Lexical unit	Definition	Example
ISOTOPIQUE spéc	X <i>isotopique</i> : X relatif aux isotopes 1	<i>L'analyse isotopique des éléments présents dans les météorites fournit des indices essentiels pour comprendre la formation et l'évolution de notre système solaire.</i>
LIAISON II spéc	<i>liaison II</i> entre X et Y qui forme Z : fait que les «entités chimiques» X et Y se lient II pour former une «entité chimique» Z V_0 : SE LIER II $A_{1/2}$ Perf : LIÉ _(Adj) II	<i>Dans une réaction endothermique, l'énergie requise pour briser les liaisons dans les réactifs est supérieur à l'énergie dégagée par la formation de liaisons dans les produits.</i>
LIÉ _(Adj) II spéc	X <i>lié</i> _(Adj) II à Y : «entité chimique» X qui s'est liée II à l'«entité chimique» Y en formant une «entité chimique» Ω	<i>En plus de la nature des éléments liés, la différence d'électronégativité entre les éléments que l'on veut lier contribue à déterminer le type de liaison chimique.</i>
LIER II spéc	X <i>lie II</i> Y à Z pour former W : L'individu X cause 2 que les «entités chimiques» Y et Z se lient II pour former une «entité chimique» W	<i>Pour établir la structure moléculaire d'un édifice polyatomique, il faut lier les atomes entre eux sachant que ceux-ci ne se lient pas de façon aléatoire.</i>

Lexical unit	Definition	Example
SE LIER II spéc	<p>X <i>se lie</i> II à Y pour former Z :</p> <p>L^{\lceil}entité chimique\lrcorner X interagit I avec L^{\lceil}entité chimique\lrcorner Y</p> <ul style="list-style-type: none"> ce qui a pour résultat la formation d'une \lceilentité chimique\lrcorner Z qui est plus stable que X et Y séparées <p>S_0 : LIAISON II $A_{1/2}$Perf : LIÉ_(Adj) II Caus : //LIER II</p>	<p>Les cétones sont des composés où un atome d'oxygène <i>se lie</i> à un atome de carbone pour former une unité qui se rattache à un composé hydrocarboné.</p>
LIQUIDE _(Adj) I.2 spéc	<p>X <i>liquide</i>_(Adj) I.2 :</p> <p>matière I.a X qui est dans un état physique_(Adj) III.2</p> <ul style="list-style-type: none"> tel que X a une forme indéfinie tel que X a un volume défini tel que les particules I.2 de X sont mobiles et interagissent I <p>Anti\lrcorner : GAZEUX I.2 ; SOLIDE_(Adj) I.2 S_1Pred : LIQUIDE_(N) I.2</p>	<p>Pour déterminer la masse volumique d'une substance <i>liquide</i>, il faut calculer le rapport entre la masse et le volume du liquide.</p>
LIQUIDE _(N) I.2 spéc	<p>X est un <i>liquide</i>_(N) I.2 :</p> <p>X est une matière I.a</p> <ul style="list-style-type: none"> qui est <i>liquide</i>_(Adj) I.2 <p>Anti\lrcorner : GAZ I.2 ; SOLIDE_(N) I.2 A_1 : LIQUIDE_(Adj) I.2</p>	<p>La proximité entre les atomes de <i>liquide</i> fait également que, comme pour les solides, celui-ci reste difficilement compressible.</p>

Lexical unit	Definition	Example
MACROSCOPIQUE I	<p>X macroscopique I :</p> <p>X dont la taille est telle</p> <ul style="list-style-type: none"> • qu'on peut le voir «à l'œil nu» 	<p><i>Le rôle de la chimie est de faire ce lien entre ces deux mondes : les modèles microscopiques sont utilisés pour expliquer les propriétés macroscopiques de la matière.</i></p>
MASSE I.2 spéc	<p>masse I.2 de X de valeur Y :</p> <p>«propriété physique» de la chose physique_(Adj) I.2 X</p> <ul style="list-style-type: none"> • qui est la quantité Y de matière I.a que X contient • qui détermine l'inertie de X 	<p><i>La masse d'une de ces boites de mouchoirs est de 175 g. Le gramme (g) est l'unité de base de la masse, mais il existe d'autres unités pour l'exprimer.</i></p>
MATIÈRE I.a (spéc)	<p>matière I.a dont X est constitué :</p> <p>entité du «monde physique»</p> <ul style="list-style-type: none"> • dont les choses X sont constituées 	<p><i>Des particules subatomiques interagissent et produisent des atomes et des molécules, lesquels interagissent à leur tour et produisent de la matière organique et inorganique.</i></p>
MÉLANGE I.3 spéc	<p>mélange I.3 de X :</p> <p>combinaison de substances I.1b $\{X\}$</p> <ul style="list-style-type: none"> • telle que les X ne sont pas liées_(Adj) II • telle que chaque X garde ses «propriétés chimiques» $\{\Omega\}$ individuelles 	<p><i>On peut dire qu'un composé se dissout dans un liquide si ce composé n'est plus observable dans le mélange après agitation : le mélange obtenu est donc homogène.</i></p>

Lexical unit	Definition	Example
MICROSCOPIQUE I	<p>X microscopique I :</p> <p>X relatif à l'usage du microscope</p>	<p><i>Les méthodes d'analyse microscopiques sont les méthodes de référence pour la caractérisation de l'amiante, notamment dans une matrice solide.</i></p>
MICRO-SCOPIQUE II.a	<p>X microscopique II.a :</p> <p>X dont la taille est telle</p> <ul style="list-style-type: none"> • qu'on ne peut le voir qu'au microscope optique <p>Anti_∩ : MICROSCOPIQUE II.b</p>	<p><i>La poussière respirable est constituée de particules de poussière microscopiques qui sont invisibles à l'œil nu et pénètrent profondément dans les poumons.</i></p>
MICRO-SCOPIQUE II.b spec	<p>X microscopique II.b :</p> <p>X dont la taille est telle</p> <ul style="list-style-type: none"> • qu'il est plus petit que les entités microscopiques II.a • qu'il est par conséquent non visible au microscope optique <p>Syn : SUBMICROSCOPIQUE</p> <p>Anti_∩ : MICROSCOPIQUE II.a</p>	<p><i>Dans un gaz parfait les particules microscopiques – atomes ou molécules – n'interagissent pas entre elles à distance.</i></p>
MOLÉCULAIRE I.1a spec	<p>X moléculaire I.1a :</p> <p>X relatif aux molécules I</p> <p>Adv₀ : MOLÉCULAIREMENT</p>	<p><i>Choisis parmi les représentations moléculaires suivantes celle qui modélise la dissolution totale du sucre dans l'eau. Justifie ta réponse.</i></p>
MOLÉCULAIRE I.2 spec	<p>X moléculaire I.2 :</p> <p>X tel qu'il est constitué de molécules I</p>	<p><i>L'azote moléculaire est également présent dans les atmosphères et les surfaces de Pluton et de Triton, le satellite de Neptune.</i></p>

Lexical unit	Definition	Example
MOLÉCULAIRE- MENT spéc	<p>X moléculairement :</p> <p>X relativement aux molécules I</p> <p>A_0 : MOLÉCULAIRE I.1a</p>	<p><i>Il faut construire des architectures</i></p> <p>moléculairement précises basées sur les récentes avancées de la chimie supramoléculaire : explorer ce qui n'a pas été construit par la Nature.</p>
MOLÉCULARITÉ spéc	<p><i>molécularité de X de valeur Y :</i></p> <p>propriété de la réaction élémentaire $\lceil X$</p> <ul style="list-style-type: none"> • qui correspond au nombre Y d'entités chimiques \lceil impliquées dans X 	<p><i>La molécule H_2 se forme en une seule étape ; la molécularité de cette réaction est de 2.</i></p>
MOLÉCULE I spéc	<p>molécule I de Y composée de X :</p> <p>entité chimique \lceil</p> <ul style="list-style-type: none"> • qui est constituée des atomes I.2 $\{X\}$ • qui est la plus petite unité de substance I.1b Y <p>A_0 : MOLÉCULAIRE I.1a</p>	<p><i>La formule chimique d'une molécule renseigne sur sa composition chimique. La molécule d'eau, de formule H_2O, par exemple, est constituée de deux atomes d'hydrogène, H, et d'un atome d'oxygène, O.</i></p>
NEUTRON spéc	<p>neutron de X qui interagit avec Y :</p> <p>particule subatomique \lceil de l'atome I.2 X</p> <ul style="list-style-type: none"> • qui interagit I avec les particules subatomiques $\lceil Y$ de X • qui n'est pas chargée (Adj) IV.2 	<p><i>Avec les protons, les neutrons forment le noyau d'un atome, celui-ci étant entouré d'électrons.</i></p>

Lexical unit	Definition	Example
「NOMBRE DE MASSE」 spéc	<p>Y est le 「nombre de masse」 de X :</p> <p>Y est le nombre</p> <ul style="list-style-type: none"> • qui caractérise le nucléide X 	<p>Un atome de calcium a un nombre de masse de 42 et un numéro atomique de 20.</p> <p>Combien y a-t-il de neutrons dans son noyau ?</p>
NOYAU 1.2 spéc	<p>noyau 1.2 de X :</p> <p>partie centrale de l'atome 1.2 X</p> <ul style="list-style-type: none"> • qui est constituée de protons et de neutrons • qui est chargée_(Adj) IV.2 positivement <p>A_0 : NUCLÉAIRE 1.2</p>	<p>Lorsque l'énergie de liaison d'un noyau atomique est suffisamment importante, le noyau est dit stable. Un noyau atomique instable est qualifié de noyau radioactif.</p>
NUCLÉAIRE 1.2 spéc	<p>X nucléaire 1.2 :</p> <p>X relatif aux noyaux 1.2</p>	<p>L'examen de la composition nucléaire des atomes qui constituent ces pierres permet de déterminer leur âge.</p>
NUCLÉIDE spéc	<p>nucléide :</p> <p>type d'atomes 1.2</p> <ul style="list-style-type: none"> • qui est caractérisé par le nombre de protons et de neutrons dans le noyau 1.2 de ces atomes 1.2 <p>Syn : ISOTOPE 2</p>	<p>Le carbone 14 est un nucléide avec 6 protons et 8 neutrons.</p> <p>Dans la nature, il y a 252 nucléides stables et à peu près 85 nucléides instables. Par ailleurs, environ 3000 nucléides instables ont été produits par des méthodes artificielles.</p>
NUCLÉON spéc	<p>nucléon de X :</p> <p>「particule subatomique」</p> <ul style="list-style-type: none"> • qui est un constituant du noyau 1.2 X 	<p>Le noyau de l'atome d'aluminium possède 13 protons et 14 neutrons, soit 27 nucléons.</p>

Lexical unit	Definition	Example
「NUMÉRO ATOMIQUE」 spéc	<p><i>Y est le 「numéro atomique」 de X :</i></p> <p>Y est le nombre</p> <ul style="list-style-type: none"> • qui caractérise l'élément III.3a X 	<p>À l'aide du tableau périodique, on repère que le symbole de l'azote est N et que son numéro atomique est 7.</p>
PARTICULE I.2 spéc	<p>particule I.2 de X (qui interagit avec Y) :</p> <p>constituant de la matière I.a X</p> <ul style="list-style-type: none"> • (qui interagit I avec d'autres entités Y) 	<p>A l'échelle microscopique, il existe des particules neutres (neutron, neutrino, photon) ainsi que des particules électriquement chargées (électron, proton, quarks, ions...).</p>
「PARTICULE SUBATOMIQUE」 spéc	<p>「particule subatomique」 de X :</p> <p>particule I.2 de la matière I.a X</p> <ul style="list-style-type: none"> • qui est un constituant d'un atome I.2 	<p>Chaque atome est composé de particules plus petites (électrons, protons, neutrons), appelées particules subatomiques.</p>
PHYSIQUE _(Adj) III.1 (spéc)	<p>X physique_(Adj) III.1 :</p> <p>X relatif à la physique_(N) I</p>	<p>Une théorie physique a pour objet l'explication d'un ensemble de lois expérimentalement établies.</p>
PHYSIQUE _(Adj) III.2 spéc	<p>X physique_(Adj) III.2 :</p> <p>X relatif à la physique_(N) II de Ω</p>	<p>On considère qu'il existe un quatrième état physique de la matière, appelé plasma, constitué de gaz ionisé.</p>

Lexical unit	Definition	Example
PHYSIQUE _(N) I (spéc)	<p>physique_(N) I pratiquée par X :</p> <p>science pratiquée par l'individu X</p> <ul style="list-style-type: none"> dont l'objet est l'étude de la matière I.a, de l'énergie II.1 et de leurs interactions I <p>A₀ : PHYSIQUE_(Adj) III.1</p>	<p>La physique se divise en plusieurs branches ; par exemple, la physique fondamentale est la physique des particules qui repose sur les principes de la mécanique quantique.</p>
PHYSIQUE _(N) II spéc	<p>physique_(N) II de X :</p> <p>propriétés de la matière I.a ou de l'énergie II.1 X</p> <ul style="list-style-type: none"> qui déterminent les interactions I de X avec la matière I.a ou l'énergie II.1 Ω <p>A₀ : PHYSIQUE_(Adj) III.2</p>	<p>L'ouvrage décrit en détail les mécanismes, essentiels pour comprendre la physique de l'atmosphère et ses implications dans le climat.</p>
POIDS I.2 spéc	<p>poids I.2 de X de valeur Y :</p> <p>「propriété physique」 de la chose physique_(Adj) I.2 X</p> <ul style="list-style-type: none"> relative à l'intensité de la force de gravité agissant sur X qui est mesurée par la valeur numérique Y 	<p>Le poids de la balle de tennis sur la Terre est de 0,441 N.</p> <p>Le poids de la balle de tennis est plus petit sur la Lune, soit 0,0729 N.</p>
PRODUIT I.3 spéc	<p>produit I.3 de X :</p> <p>substance I.1b</p> <ul style="list-style-type: none"> qui est formée suite à la réaction I.1d X entre les substances I.1b Ω <p>S₁ : RÉACTION I.1d</p>	<p>Après une réaction chimique, les produits que l'on obtient n'ont pas les mêmes propriétés chimiques que les réactifs que l'on avait au début.</p>

Lexical unit	Definition	Example
「PRODUIT CHIMIQUE」 spéc	<p><i>X est un 「produit chimique」^I :</i></p> <p><i>X est une substance I.1b</i></p> <ul style="list-style-type: none"> • telle qu'elle peut être identifiée par ses 「propriétés chimiques」^Ω 	<p><i>Les produits chimiques peuvent être d'origine naturelle (eau, sucre, plomb...) ou fabriqués à partir du pétrole (plastique, colorant alimentaire synthétique, parfum synthétique).</i></p>
「PROPRIÉTÉ CHIMIQUE」 spéc	<p><i>Y est une 「propriété chimique」^Γ de X :</i></p> <p><i>Y est une propriété de la substance I.1b X</i></p> <ul style="list-style-type: none"> • relative aux transformations II.1 possibles de X en d'autres substances I.1b Ω 	<p><i>Les propriétés chimiques d'une substance peuvent être utilisées pour prédire comment la substances va réagir. Voici quelques exemples de propriétés chimiques : combustibilité, radioactivité, réactivité.</i></p>
「PROPRIÉTÉ PHYSIQUE」 spéc	<p><i>Y est une 「propriété physique」^Γ de X :</i></p> <p><i>Y est une propriété de la substance I.1b X</i></p> <ul style="list-style-type: none"> • qui est inhérente à X • qui peut être mesurée ou observée au niveau macroscopique I 	<p><i>Exemples de propriétés physiques : masse, densité, couleur, volume, etc. La couleur bleue du sulfate de cuivre est l'une de ses propriétés physiques.</i></p>
PROTON spéc	<p><i>proton de X qui interagit avec Y :</i></p> <p>「particule subatomique」^Γ de l'atome I.2 X</p> <ul style="list-style-type: none"> • qui interagit I avec les 「particules subatomiques」^Γ Y de X • qui est chargée_(Adj) IV.2 positivement 	<p><i>Le nombre de protons d'un noyau détermine les propriétés chimiques de l'atome et donc quel élément chimique il représente.</i></p>

Lexical unit	Definition	Example
RÉACTEUR 1.2 spéc	<p>réacteur 1.2 utilisé par X pour les Y :</p> <p>appareil utilisé par l'individu X</p> <ul style="list-style-type: none"> pour faire réagir 1.1d les substances 1.1b Y afin de produire une substance 1.1b Ω dans lequel X place Y 	<p>Ils ont notamment développé un réacteur chimique agité qui permet l'obtention de réactions entre un gaz et un liquide, en présence d'un catalyseur solide à haute température et pression.</p>
RÉACTIF _(Adj) 1.1d spéc	<p>X réactif_(Adj) 1.1d avec Y :</p> <p>substance 1.1b X telle qu'elle réagit 1.1d avec la substance 1.1b Y pour produire une substance 1.1b Ω</p> <p>S₀Pred : RÉACTIVITÉ 1.1d</p>	<p>Le baryum est très réactif avec d'autres éléments et n'est donc présent dans la nature pratiquement que sous une forme liée.</p>
RÉACTIF _(N) 1 spéc	<p>X est un réactif_(N) 1 :</p> <p>X est une substance 1.1b</p> <ul style="list-style-type: none"> qui réagit 1.1d avec une substance 1.1b Ω_1 pour produire une substance 1.1b Ω_2 qui est consommée (partiellement) à la fin de cette réaction 1.1d 	<p>Pendant la réaction, les atomes des réactifs se réorganisent afin de former les produits.</p>
RÉACTIF _(N) 2 spéc	<p>réactif_(N) 2 utilisé par X :</p> <p>substance 1.1b utilisée par l'individu X</p> <ul style="list-style-type: none"> pour la faire réagir 1.1d avec une substance 1.1b Ω_1 afin de l'analyser ou de produire une substance 1.1b Ω_2 	<p>Tous les flacons de réactifs doivent être conservés au froid et n'être sortis qu'au moment du test.</p> <p>Je me trompais sans cesse dans mes mesures, et finalement, j'ai cassé un flacon de réactif Rhésus.</p>

Lexical unit	Definition	Example
RÉACTION 1.1d spéc	<p>réaction 1.1d entre les X qui produit Y :</p> <p>fait que les substances 1.1b X réagissent 1.1d pour produire une ou plusieurs substances 1.1b Y</p> <p>V_0 : RÉAGIR 1.1d S_1 : RÉACTIF_(N) 1 S_{res} & S_2 : PRODUIT_(N) 1.3 $Able_1$: RÉACTIF_(Adj) 1.1d S_{loc} : RÉACTEUR 1.2</p>	<p>Après la réaction chimique entre le dihydrogène et le dioxygène, on obtient de l'eau qui n'a pas les mêmes caractéristiques que le dihydrogène et le dioxygène. À température et pression ambiantes, le produit de la réaction est liquide alors que les réactifs sont gazeux.</p>
「RÉACTION ÉLÉMENTAIRE」 spéc	<p>réaction élémentaire entre les X qui produit Y :</p> <p>réaction 1.1d entre les substances 1.1b X qui produit la substance 1.1b Z</p> <ul style="list-style-type: none"> • en une étape unique 	<p>Il y a participation de deux molécules dans la réaction élémentaire $NO + O_3 \rightarrow NO_2 + O_2$. On dira que la molécularité de cette réaction élémentaire est égale à deux.</p>
RÉACTIVITÉ 1.1d spéc	<p>réactivité 1.1d de X :</p> <p>fait que la substance 1.1b X est réactive 1.1d avec Ω</p> <p>A_1 : RÉACTIF_(Adj) 1.1d</p>	<p>Ces intermédiaires sont appelés espèces réactives de l'oxygène (ERO), car ils ont une réactivité beaucoup plus importante que l'oxygène qui leur a donné naissance.</p>

Lexical unit	Definition	Example
RÉAGIR I.1d spéc	<p>X réagissent I.1d pour produire Y :</p> <p>Les substances I.1b X subissent un «changement chimique»</p> <ul style="list-style-type: none"> avec pour résultat la transformation II.1 de X en une ou plusieurs substances I.1b Y <p>S_0 : RÉACTION I.1d S_1 : RÉACTIF_(N) 1 S_{res} & S_2 : PRODUIT_(N) I.3 $Able_1$: RÉACTIF_(Adj) I.1d S_{loc} : RÉACTEUR I.2</p>	<p>Le carbure de calcium est un solide (en poudre ou en morceaux) qui réagit fortement avec l'eau en produisant de l'acétylène, gaz hautement inflammable et détonant.</p> <p>Le césium réagit violemment avec l'eau, avec formation d'hydrogène.</p>
SOLIDE _(Adj) I.2 spéc	<p>X solide_(Adj) I.2 :</p> <p>matière I.a X qui est dans un état physique_(Adj) III.2</p> <ul style="list-style-type: none"> tel que X a une forme définie tel que X a un volume défini tel que les particules I.2 de X sont immobiles <p>$Anti_{\cap}$: GAZEUX I.2 ; LIQUIDE_(Adj) I.2 S_1Pred : SOLIDE_(N) I.2</p>	<p>Lorsque la température atteint 0 °C, l'eau solide commence à devenir liquide.</p> <p>Ayant fait une solution de nitrocellulose et de camphre, il obtint une substance solide, élastique, peu altérable, facile à travailler à chaud.</p>
SOLIDE _(N) I.2 spéc	<p>X est un solide_(N) I.2 :</p> <p>X est une matière I.a</p> <ul style="list-style-type: none"> qui est solide_(Adj) I.2 <p>$Anti_{\cap}$: GAZ I.2 ; LIQUIDE_(N) I.2 A_1 : SOLIDE_(Adj) I.2</p>	<p>Parmi les liaisons qui maintiennent les atomes d'un solide ensemble, on peut citer les liaisons covalentes. Généralement, l'existence de ce type de liaison conduit à des solides particulièrement durs, comme le diamant.</p>

Lexical unit	Definition	Example
SUBATOMIQUE I.1 spéc	X <i>subatomique</i> I.1 : X relatif à la structure interne des atomes I.2	<i>La physique subatomique étudie la matière organisée à des échelles de grandeurs plus petites que l'atome.</i>
SUBATOMIQUE I.2 spéc	X <i>subatomique</i> I.2 : X tel qu'il se trouve dans les atomes I.2	<i>Elle a fourni la première preuve expérimentale que le principe de conservation de la parité ne tient pas dans les interactions subatomiques faibles.</i>
SUBMICRO- SCOPIQUE spéc	X <i>submicroscopique</i> : X dont la taille est telle <ul style="list-style-type: none"> • qu'il est plus petit que les entités microscopiques II.a • qu'il est par conséquent non visible au microscope optique Syn : MICROSCOPIQUE II.b Anti _n : MICROSCOPIQUE II.a	<i>Les savoirs en chimie sont considérés comme relevant d'un niveau macroscopique (celui du tangible, du perceptible), d'un niveau submicroscopique (les molécules, les atomes, les modèles) et d'un niveau symbolique regroupant toutes les représentations utilisées en classe de chimie (graphiques, formules, équations, etc.).</i>
SUBSTANCE I.1b spéc	substance I.1b : type de matière I.a <ul style="list-style-type: none"> • qui a une composition constante • qui a des propriétés caractéristiques $\{\Omega\}$ constantes 	<i>L'analyse élémentaire consiste à déterminer les proportions d'atomes de chaque élément chimique dans la composition d'une substance.</i>

Lexical unit	Definition	Example
TRANSFOR- MATION II.1 spéc	<p><i>transformation</i> II.1 de <i>X</i> en <i>Y</i> :</p> <p>transformation I.1a d'une substance I.1b <i>X</i> en <i>Y</i></p> <ul style="list-style-type: none"> • qui est soit <i>X</i> dans un autre état physique_(Adj) III.2, soit une substance I.1b autre que <i>X</i> 	<p>La <i>transformation</i> de <i>réactifs</i> en <i>produits</i> s'effectue généralement en plusieurs <i>étapes</i>.</p> <p>Les <i>méthodes chimiques</i> <i>permettent</i> la <i>transformation</i> de <i>corps</i> <i>composés</i> en <i>corps simples</i>.</p>

8.5 System of Russian chemical notions

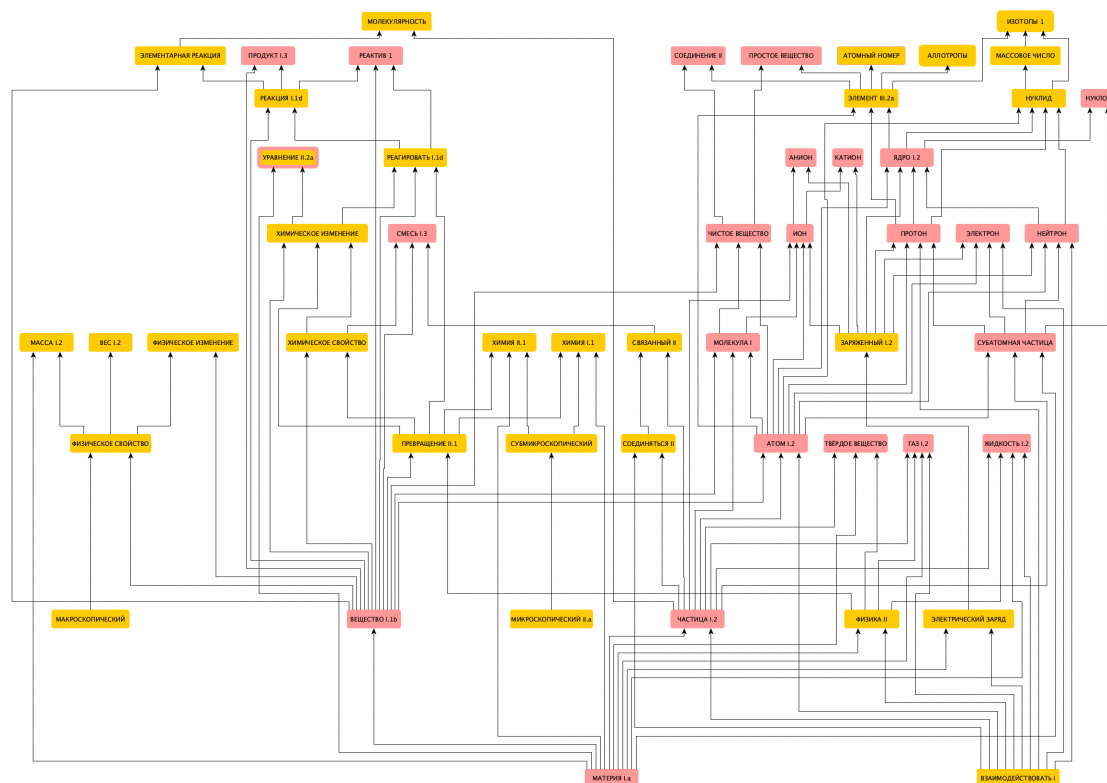
Figure 8.3 – The *defined-by* hierarchy of Russian chemical notions.

Lexical unit	Definition [<i>Propositional form</i> : Paraphrase]	Example
АЛЛОТРОПИЯ спец	<i>аллотропия</i> X -а : характеристика элемента III.2a X , являющегося аллотропным 2 A_1 : АЛЛОТРОПНЫЙ 2	<i>Аллотропия</i> железа хорошо изучена и имеет большое значение в процессах механической и термической обработки чугуна и стали.
АЛЛОТРОПНЫЙ 1 спец	<i>аллотропный 1</i> X : X , относящийся к аллотропам	<i>Аллотропные</i> формы серы включают в себя ромбическую и моноклинную формы.

Lexical unit	Definition	Example
АЛЛОТРОПНЫЙ 2 спец	<i>аллотропный</i> 2 X : элемент III.2a X , имеющий аллотропы S_0Pred : АЛЛОТРОПИЯ	<i>Углерод и сера являются наиболее известными аллотропными элементами.</i>
АЛЛОТРОПЫ спец	Y , <i>аллотропы</i> X -а : Y , формы элемента III.2a X , отличающиеся по структуре A_0 : АЛЛОТРОПНЫЙ 1	<i>Аллотропы углерода включают алмаз, графит, графен и фуллерены.</i>
АНИОН спец	<i>анион</i> : ион, • заряженный 1.2 отрицательно A_0 : АНИОННЫЙ	<i>В результате взаимодействия катионов Fe^{3+} и анионов OH^- образуется красновато-коричневый осадок нерастворимого основания – гидроксида железа(III) $Fe(OH)_3$.</i>
АНИОННЫЙ спец	<i>анионный</i> X : X , относящийся к анионам	<i>Анионная форма угольной кислоты образуется при избытке в системе CO_2.</i>
АТОМ 1.2 спец	<i>атом</i> 1.2 X -а, соединяющийся с Y -ом : частица 1.2, • взаимодействующая 1 с аналогичными частицами 1.2 Y , формируя наименьшую единицу вещества 1.1b X A_0 : АТОМНЫЙ 1	<i>Все атомы водорода в молекуле серной кислоты связаны с атомами кислорода.</i>

Lexical unit	Definition	Example
АТОМАРНО спец	<i>атомарно</i> X : X относительно атомов I.2 A_0 : АТОМНЫЙ 1	Эти <i>атомарно</i> тонкие нанопроволоки обладают свойствами, уникальными для их одномерной структуры.
АТОМНЫЙ 1 спец	<i>атомный 1</i> X : X , относящийся к атомам I.2 Adv_0 : АТОМАРНО	Число протонов определяет электрический заряд атомного ядра и порядковый номер атома в Периодической системе элементов.
АТОМАРНЫЙ 1 спец	<i>атомарный 2</i> X : X , состоящий из атомов I.2 одного элемента III.2a Ω , не связанных II между собой	Атомарный водород можно получить путём диссоциации молекулярного водорода.
«АТОМНЫЙ НОМЕР» спец	Y , « <i>атомный номер</i> » X -а : Y является номером, • характеризующим элемент III.2a X	Атомный номер кислорода (O) равен 8.
ВЕС I.2 спец	<i>вес I.2</i> X -а, выраженный Y -ом : « <i>физическое свойство</i> » физического I.2 тела X • относительно интенсивности силы тяжести, действующей на X , • выраженное числовым значением Y	При погружении в воду вес железного якоря становится меньше на 150Н.

Lexical unit	Definition	Example
ВЕЩЕСТВО I.1b спец	вещество I.1b : тип материи I.a , <ul style="list-style-type: none"> • имеющий постоянный состав, • обладающий постоянными характерными свойствами $\{\Omega\}$ 	<i>Химическая реакция приводит к превращению одних химических веществ в другие.</i>
ВЗАИМО-ДЕЙСТВИЕ I (спец)	взаимодействие I между X-ом и Y-ом : факт того, что сущности X и Y взаимодействуют I V ₀ : ВЗАИМОДЕЙСТВОВАТЬ I	<i>Химическая связь определяется взаимодействием между заряженными частицами.</i>
ВЗАИМО-ДЕЙСТВОВАТЬ I (спец)	X и Y взаимодействуют I : Сущности X и Y оказывают влияние друг на друга S ₀ : ВЗАИМОДЕЙСТВИЕ I	<i>Правила квантовой механики говорят нам о том, как атомы взаимодействуют, образуя молекулы, и как молекулы взаимодействуют друг с другом, образуя супрамолекулярные структуры.</i>
ГАЗ I.2 спец	X является газом I.2 : X является материей I.a в таком физическом III.2 состоянии, что <ul style="list-style-type: none"> • X имеет неопределенную форму, • X имеет неопределенный объем, • частицы I.2 X-а очень подвижны и мало взаимодействуют I 	<i>Образование углекислого газа, оксида серы и аммиака является результатом распада промежуточного продукта реакции двойного замещения кислоты с основанием.</i>
	Anti ₀ : ЖИДКОСТЬ I.2 ; ТВЕРДОЕ ТЕЛО ¹ A ₁ : ГАЗООБРАЗНЫЙ I.2	

Lexical unit	Definition	Example
ГАЗООБРАЗНЫЙ I.2 спец	газообразный I.2 X : материя I.a X , обладающая свойствами газа I.2 Anti _∩ : ЖИДКИЙ I.2 ; ТВЁРДЫЙ I.2 S ₁ Pred : ГАЗ I.2	<i>Азот (N_2) и кислород (O_2) называются газами, а газообразная вода в атмосфере называется водяным паром.</i>
ЖИДКИЙ I.2 спец	жидкий I.2 X : материя I.a X в таком физическом III.2 состоянии, что <ul style="list-style-type: none"> • X имеет неопределенную форму, • X имеет определенный объем, • частицы I.2 X-а подвижны и взаимодействуют I Anti _∩ : ГАЗООБРАЗНЫЙ I.2 ; ТВЁРДЫЙ I.2 S ₁ Pred : ЖИДКОСТЬ I.2	<i>В отличие от большинства веществ, твердая форма воды имеет меньшую плотность, чем её жидкая форма, что позволяет льду держаться на воде.</i>
ЖИДКОСТЬ I.2 спец	X является жидкостью I.2 : материя I.a X , <ul style="list-style-type: none"> • являющаяся жидкой I.2 Anti _∩ : ГАЗ I.2 ; «ТВЁРДОЕ ТЕЛО» A ₁ : ЖИДКИЙ I.2	<i>Вещества со слабыми межмолекулярными взаимодействиями, скорее всего, будут жидкостями при более низких температурах.</i>
ЗАРЯЖЕННЫЙ I.2 спец	заряженный I.2 X : X , имеющий « электрический заряд » Ω	<i>Атом состоит из ядра, содержащего нейтроны и положительно заряженные протоны, окруженного отрицательно заряженными электронами.</i>

Lexical unit	Definition	Example
ИЗОТОП 2 спец критик	изотоп 2 : тип атомов I.2, • характеризующийся числом протонов и нейтронов в ядре I.2 таких атомов I.2 Syn : НУКЛИД	$\delta^{13}C$ и $\delta^{15}N$ – два наиболее распространенных стабильных изотопа , обычно используемых для оценки взаимодействий...
ИЗОТОПНЫЙ спец	изотопный X : X, относящийся к изотопам 1	Факторы, контролирующие изотопный состав Li (δ^7Li) речной воды, еще не полностью изучены.
ИЗОТОПЫ 1 спец	изотопы 1 X-а : нуклиды, • относящиеся к одному элементу III.2a X, • имеющие разные Γ массовые числа Γ A ₀ : ИЗОТОПНЫЙ	Углерод-12, углерод-13 и углерод-14 – это три изотопа элемента углерода с массовыми числами 12, 13 и 14 соответственно.
ИОН спец	ион : частица I.2 • атомарная I или молекулярная I.2, • заряженная I.2 A ₀ : ИОННЫЙ 1	Более активные металлы имеют большую склонность к потере электронов и образованию положительных ионов .
ИОНИЗАЦИЯ 1 спец	ионизация X-а : процесс, в результате которого частица I.2 X ионизируется V ₀ : ИОНИЗИРОВАТЬСЯ	Ионизация натрия может быть проиллюстрирована следующим образом: $Na \rightarrow Na^+ + e^-$.

Lexical unit	Definition	Example
ИОНИЗИРОВА- ННЫЙ спец	<i>ионизированный</i> X : X , который ионизировался S_1 Pred : ИОН	<i>Диффузный теплый</i> ионизированный газ наблюдается как в Млечном Пути, так и в других дисковых галактиках.
ИОНИЗИРОВАТЬ спец	X <i>ионизирует</i> Y : Факт X каузирует 1 то, что частица 1.2 Y ионизируется	<i>Ультрафиолетовое</i> <i>излучение Солнца</i> ионизирует молекулы газа.
ИОНИЗИРОВАТЬСЯ спец	X <i>ионизируется</i> : Частица 1.2 X проходит превращение 11.1 , <ul style="list-style-type: none">• становясь ионом S_0 : ИОНИЗАЦИЯ 1 S_{aus} : //ИОНИЗИРОВАТЬ	<i>Атом кальция</i> ионизируется , теряя два электрона.
ИОННЫЙ 1 спец	<i>ионный 1</i> X : X , относящийся к ионам	<i>Вещество было получено</i> <i>путём добавления</i> <i>реагентов с ярко</i> <i>выраженными</i> ионными свойствами в структуру полимерной матрицы.
ИОННЫЙ 2 спец	<i>ионный 2</i> X : X , состоящий из ионов	<i>Существует сильная</i> <i>зависимость между</i> <i>размером иона и</i> <i>температурой</i> <i>плавления ионного</i> <i>соединения.</i>

Lexical unit	Definition	Example
КАТИОН спец	<p>катион :</p> <p>ион,</p> <ul style="list-style-type: none"> • заряженный 1.2 положительно <p>A_0 : КАТИОННЫЙ</p>	<p><i>Поверхностная активность катионов на положительно заряженной поверхности такая же, что и на незаряженной.</i></p>
КАТИОННЫЙ спец	<p>катионный X :</p> <p>X, относящийся к катионам</p>	<p><i>При добавлении в бумажную массу крахмала с катионным зарядом его молекулы притягиваются к отрицательно заряженным волокнам и наполнителям.</i></p>
МАКРО- СКОПИЧЕСКИЙ 1	<p>макроскопический 1 X :</p> <p>X такой, что</p> <ul style="list-style-type: none"> • его можно увидеть «невооружённым глазом»¹ 	<p><i>Микроскопические модели используются для объяснения макроскопических свойств материи.</i></p>
МАССА 1.2 спец	<p>масса 1.2 X-а, выраженная Y-ом :</p> <p>«физическое свойство»¹ физического 1.2 тела X,</p> <ul style="list-style-type: none"> • выражающее количество Y материи 1.a, содержащейся в X-е, • определяющее инерцию X-а 	<p><i>Масса литра воды составляет 1,0 кг. Сколько молей воды составляет 1,0 кг?</i></p>

Lexical unit	Definition	Example
ГМАССОВОЕ ЧИСЛО ^Г спец	<p>Y, Г<i>массовое число</i>^Г X-a :</p> <p>Y является числом,</p> <ul style="list-style-type: none"> • характеризующим нуклид X 	<p><i>Массовое число</i> кислорода-16 равно 16. Это означает, что в ядре атома кислорода-16 восемь протонов и восемь нейтронов.</p>
МАТЕРИЯ I.a (спец)	<p><i>материя I.a</i>, из которой состоит X :</p> <p>сущность Гфизического мира^Г,</p> <ul style="list-style-type: none"> • из которой состоят вещи X 	<p>Состояние прозрачности зависит от состояния <i>материи</i> и от того, как эта <i>материя</i> взаимодействует со светом. Если <i>материя</i> не поглощает свет, она не будет его излучать.</p>
МИКРОСКО- ПИЧЕСКИЙ I	<p><i>микроскопический I</i> X :</p> <p>X, относящийся к использованию микроскопа</p>	<p>В конце эксперимента <i>микроскопический</i> анализ показал, что у тех, кто употреблял алкоголь, наблюдалось ухудшение состояния сердечной мышцы.</p>
МИКРОСКО- ПИЧЕСКИЙ II.a	<p><i>микроскопический II.a</i> X :</p> <p>X такой, что</p> <ul style="list-style-type: none"> • его можно увидеть только с помощью оптического микроскопа <p>Anti_Г : МИКРОСКОПИЧЕСКИЙ II.b</p>	<p><i>Микроскопические</i> частицы пыли, обнаруженные в метеоритном материале, вероятно, образовались в результате звездных взрывов.</p>

Lexical unit	Definition	Example
МИКРОСКО- ПИЧЕСКИЙ II.b спец	<p>микроскопический II.b X :</p> <p>X такой, что</p> <ul style="list-style-type: none"> • он меньше, чем микроскопические II.a сущности, • вследствие чего он не виден под оптическим микроскопом <p>Syn : СУБМИКРОСКОПИЧЕСКИЙ</p> <p>Anti_Г : МИКРОСКОПИЧЕСКИЙ II.a</p>	<p><i>Атомы и молекулы являются микроскопическими частицами; их структура, свойства и движение могут быть описаны законами квантовой механики.</i></p>
МОЛЕКУЛА I спец	<p>молекула I Y-а, состоящая из X-ов :</p> <p>частица I.2,</p> <ul style="list-style-type: none"> • состоящая из атомов I.2 $\{X\}$, • являющаяся наименьшей единицей вещества I.1b Y <p>A_0 : МОЛЕКУЛЯРНЫЙ I.1a</p>	<p><i>Молекула воды состоит из одного атома кислорода и двух атомов водорода.</i></p>
МОЛЕКУЛЯРНО спец	<p>молекулярно X :</p> <p>X относительно молекул I</p> <p>A_0 : МОЛЕКУЛЯРНЫЙ I.1a</p>	<p><i>Два молекулярно различных кристалла льда могут выглядеть почти одинаково даже под микроскопом.</i></p>
МОЛЕКУЛЯР- НОСТЬ спец	<p>молекулярность X-а, выраженная Y-ом :</p> <p>свойство Γ элементарной реакции ΓX,</p> <ul style="list-style-type: none"> • соответствующее числу Y частиц I.2, задействованных в X-е 	<p><i>Молекулярность химической реакции может быть равна 1, 2 или 3.</i></p>

Lexical unit	Definition	Example
МОЛЕКУЛЯР- НЫЙ 1.1a спец	<i>молекулярный</i> 1.1a X : X , относящийся к молекулам 1 Adv_0 : МОЛЕКУЛЯРНО	<i>Это необычная характеристика обусловлена молекулярными свойствами вещества.</i>
МОЛЕКУЛЯР- НЫЙ 1.2 спец	<i>молекулярный</i> 1.2 X : X , состоящий из молекул 1	<i>Молекулярный кислород (O_2) и молекулярный азот (N_2) не являются соединениями, поскольку каждый из них состоит из одного элемента. Ковалентные связи внутри молекулярных веществ очень прочны.</i>
НЕЙТРОН спец	<i>нейтрон</i> X -а, взаимодействующий с Y -ом : «субатомная частица» атома 1.2 X , • взаимодействующая 1 с «субатомными частицами» Y X -а, • не заряженная 1.2	<i>Ядро атома состоит из нейтронов и положительно заряженных протонов.</i>
НУКЛИД спец	<i>нуклид</i> : тип атомов 1.2, • характеризующийся числом протонов и нейтронов в ядре 1.2 таких атомов 1.2 Syn : ИЗОТОП 2	<i>Число, которое иногда указывается вместе с названием нуклида, называется его массовым числом. Например, углерод-14 – это нуклид углерода с 6 протонами и 8 нейтронами.</i>

Lexical unit	Definition	Example
<p>НУКЛОН</p> <p>спец</p>	<p><i>нуклон</i> X-а :</p> <p>«субатомная частица»,</p> <ul style="list-style-type: none"> составляющая ядра I.2 X 	<p>Общее число протонов и нейтронов, называемых нуклонами, в ядре атома называется <i>массовым числом</i> этого атома.</p>
<p>ПРЕВРАЩЕНИЕ II.1</p> <p>спец</p>	<p><i>превращение</i> II.1 X-а в Y :</p> <p>превращение I.1a вещества I.1b X в Y,</p> <ul style="list-style-type: none"> где Y является или X-ом в другом физическом III.2 состоянии, или веществом I.1b, отличным от X-а <p>Syn : ТРАНСФОРМАЦИЯ II.1</p>	<p><i>Вещество</i> меняет агрегатное состояние без каких-либо <i>химических превращений</i>: испарение воды или таяние льда происходит без разложения или изменения молекул воды.</p>
<p>ПРОДУКТ I.3</p> <p>спец</p>	<p><i>продукт</i> I.3 X-а :</p> <p>вещество I.1b,</p> <ul style="list-style-type: none"> образованное в результате реакции I.1d X между веществами I.1b Ω <p>S₁ : РЕАКЦИЯ I.1d</p>	<p>По-настоящему <i>необратимая химическая реакция</i> обычно происходит, когда один из продуктов выходит из <i>реагирующей системы</i>, например, как <i>углекислый газ (летучий)</i> в реакции</p> $\text{CaCO}_3 + 2\text{HCl} \rightarrow \text{CaCl}_2 + \text{H}_2\text{O} + \text{CO}_2\uparrow.$
<p>«ПРОСТОЕ ВЕЩЕСТВО»</p> <p>спец</p>	<p>«<i>простое вещество</i>» :</p> <p>«<i>чистое вещество</i>»,</p> <ul style="list-style-type: none"> состоящее из одного элемента III.2a Ω <p>Syn : ЭЛЕМЕНТ III.2b</p>	<p>Изучая горение угля и других соединений, А. Лавуазье первым показал, что <i>углерод</i> является простым веществом.</p>

Lexical unit	Definition	Example
ПРОТОН спец	<p><i>протон</i> X-а, <i>взаимодействующий с</i> Y-ом : «субатомная частица» атома I.2 X,</p> <ul style="list-style-type: none"> • <i>взаимодействующая</i> I с «субатомными частицами» Y X-а, • <i>заряженная</i> I.2 положительно 	<p><i>В атоме водорода отрицательный электрон вращается вокруг положительного протона из-за электромагнитной, а не гравитационной силы между этими двумя частицами.</i></p>
РЕАГЕНТ 1 спец	<p>X является <i>реагентом 1</i> : X является <i>веществом</i> I.1b, <ul style="list-style-type: none"> • которое <i>реагирует</i> I.1d с веществом I.1b Ω_1, образуя вещество I.1b Ω_2, • которое расходуется в конце такой <i>реакции</i> I.1d Syn : РЕАКТИВ 1</p>	<p><i>Реагенты помещают в пробирку, колбу или стакан. Их смешивают вместе, часто нагревают для проведения реакции и затем охлаждают. Продукты выливают и, если необходимо, очищают.</i></p>
РЕАГЕНТ 2 спец	<p><i>реагент 2</i>, используемый X-ом : <i>вещество</i> I.1b, используемое человеком X с целью <ul style="list-style-type: none"> • вызвать <i>реакцию</i> I.1d между веществами I.1b Ω_1, • проанализировать или произвести <i>вещество</i> I.1b Ω_2 Syn : РЕАКТИВ 2</p>	<p><i>Реагенты на основе аминокорогидрида лития (LAV) – это новый класс мощных и селективных реагентов, разработанных в Калифорнийском университете.</i></p>

Lexical unit	Definition	Example
РЕАГИРОВАТЬ I.1d спец	<p><i>X</i>-ы реагируют I.1d, образуя <i>Y</i> :</p> <p>Вещества I.1b <i>X</i> претерпевают «химическое изменение», • что в результате приводит к превращению II.1 <i>X</i>-ов в одно или несколько других веществ I.1b <i>Y</i></p> <p>S₀ : РЕАКЦИЯ I.1d S₁ : РЕАГЕНТ 1 ; РЕАКТИВ 1 S_{res} & S₂ : ПРОДУКТ I.3 Able₁ : РЕАКТИВНЫЙ I.1d S_{loc} : РЕАКТОР I.2</p>	<p><i>Кальций</i> сильно реагирует с кислородом и водой, образуя различные формы оксидов или гидроксидов кальция, которые обладают изоляционными свойствами.</p>
РЕАКТИВ 1 спец	<p><i>X</i> является реактивом 1 :</p> <p><i>X</i> является веществом I.1b, • которое реагирует I.1d с веществом I.1b Ω₁, образуя вещество I.1b Ω₂, • которое расходуется в конце такой реакции I.1d</p> <p>S_{up} : РЕАГЕНТ 1</p>	<p>Реактивы помещают в пробирку, колбу или стакан. Их смешивают вместе, часто нагревают для проведения реакции и затем охлаждают. Продукты выливают и, если необходимо, очищают.</p>
РЕАКТИВ 2 спец	<p>реактив 2, используемый <i>X</i>-ом :</p> <p>вещество I.1b, используемое человеком <i>X</i> с целью • вызвать реакцию I.1d между веществами I.1b Ω₁, • проанализировать или произвести вещество I.1b Ω₂</p> <p>S_{up} : РЕАГЕНТ 2</p>	<p><i>Компании</i> было разрешено продавать свои собственные реактивы, химикаты для тестирования.</p>

Lexical unit	Definition	Example
РЕАКТИВ- НОСТЬ I.1d спец	<i>реактивность</i> I.1d <i>X-а</i> : факт того, что вещество I.1b <i>X</i> является реактивным I.1d A_1 : РЕАКТИВНЫЙ I.1d	<i>Высокая реактивность</i> <i>фтора обусловлена его</i> <i>высокой электроотрица-</i> <i>тельностью.</i>
РЕАКТИВ- НЫЙ I.1d спец	<i>X реактивный</i> I.1d <i>с Y-ом</i> : вещество I.1b <i>X</i> , реагирующее I.1d <i>с</i> веществом I.1b <i>Y</i> , образуя вещество I.1b Ω S_0 Pred : РЕАКТИВНОСТЬ I.1d	<i>Калий, натрий, кальций</i> <i>и алюминий являются</i> <i>очень реактивными</i> <i>металлами.</i>
РЕАКТОР I.2 спец	<i>реактор</i> I.2, используемый <i>X-ом</i> <i>для Y-ов</i> : устройство, используемое человеком <i>X</i> , <ul style="list-style-type: none"> • в которое <i>X</i> помещает <i>Y</i>, • чтобы вызвать реакцию I.1d между веществами I.1b <i>Y</i> с целью произвести вещество I.1b Ω 	<i>Процессы в химическом</i> <i>реакторе протекают</i> <i>непрерывно.</i>
РЕАКЦИЯ I.1d спец	<i>реакция</i> I.1d <i>между X-ами,</i> <i>образующая Y</i> : факт того, что вещества I.1b <i>X</i> реагируют I.1d, образуя одно или несколько веществ I.1b <i>Y</i> V_0 : РЕАГИРОВАТЬ I.1d S_1 : РЕАГЕНТ 1 ; РЕАКТИВ 1 S_{res} & S_2 : ПРОДУКТ I.3 $Able_1$: РЕАКТИВНЫЙ I.1d S_{loc} : РЕАКТОР I.2	<i>Свеча не будет гореть,</i> <i>если один из реактивов</i> <i>(воск или кислород)</i> <i>перестанет быть</i> <i>доступным, потому что</i> <i>для продолжения</i> <i>химической реакции</i> <i>необходимы оба</i> <i>реактива.</i>

Lexical unit	Definition	Example
СВЯЗАННЫЙ II спец	X , связанный II с Y -ом : частица I.2 X , соединяющаяся II с частицей I.2 Y и формирующая частицу I.2 Ω	В живой материи чрезвычайно редки органические вещества, которые содержат связанные атомы азота или кислорода.
СВЯЗЬ II спец	связь II между X -ом и Y -ом, формирующая Z : факт того, что частицы I.2 X и Y соединяются II , формируя частицу I.2 Z V_0 : СОЕДИНЯТЬСЯ II $A_{1/2}Perf$: СВЯЗАННЫЙ II	Для альдегидов характерно присутствие в молекуле кислорода, связанного двойной связью с атомом углерода.
СОЕДИНЕНИЕ II спец	соединение II , состоящее из X -ов : «чистое вещество», • состоящее из разных элементов III.2a X	Отложения состоят в основном из неорганических соединений , содержащихся в топливе.
СМЕСЬ I.3 спец	смесь I.3 , состоящая из X -ов : совокупность разных веществ I.1b $\{X\}$, где • X -ы не являются связанными II , • каждый X сохраняет свои «химические свойства» $\{\Omega\}$	Смесь всегда можно снова разделить на составляющие чистые вещества, поскольку в смеси атомы составляющих веществ не связаны друг с другом.

Lexical unit	Definition	Example
СОЕДИНЯТЬ II спец	<i>X соединяет II Y с Z-ом, чтобы сформировать W :</i> Человек X каузирует 2 факт того, что частицы I.2 Y и Z соединяются II , чтобы сформировать W	<i>Для создания этих сложных химических веществ ученые должны соединять атомы углерода вместе.</i>
СОЕДИНЯТЬСЯ II спец	<i>X соединяется II с Y-ом, чтобы сформировать Z :</i> частица I.2 X взаимодействует I с частицей I.2 Y, • формируя частицу I.2 Z , являющуюся более стабильной, чем X и Y по отдельности S ₀ : СВЯЗЬ II A _{1/2} Perf : СВЯЗАННЫЙ II Caus : //СОЕДИНЯТЬ II	<i>По химическому составу углеводные вещества весьма просты: углерод соединяется с атомами кислорода и водорода.</i>
「СУБАТОМНАЯ ЧАСТИЦА」 спец	<i>「субатомная частица」 X :</i> частица I.2 материи I.a X, • составляющая атома I.2	<i>Атомы можно разделить на более мелкие, субатомные частицы, такие как протоны, нейтроны и электроны.</i>
СУБАТОМНЫЙ I.1 спец	<i>субатомный I.1 X :</i> X, относящийся к внутренней структуре атомов I.2	<i>Квантовая теория объясняет природу и поведение материи и энергии на атомном и субатомном уровнях.</i>

Lexical unit	Definition	Example
СУБАТОМНЫЙ I.2 спец	<i>субатомный</i> I.2 X : X , находящийся в атомах I.2	<i>Атомное ядро содержит все тяжелые субатомные протоны и нейтроны. Остальная часть атома состоит из невероятно легких электронов.</i>
СУБМИКРО- СКОПИЧЕСКИЙ спец	<i>субмикроскопический</i> X : X такой, что <ul style="list-style-type: none"> • он меньше, чем микроскопический II.a, • вследствие чего он не виден под оптическим микроскопом <p>Syn : МИКРОСКОПИЧЕСКИЙ II.b Anti_∩ : МИКРОСКОПИЧЕСКИЙ II.a</p>	<i>Атом – это субмикроскопическая частица, которая служит строительным блоком для обычной материи.</i>
Г ТВЁРДОЕ ТЕЛО ^Г спец	X является Г <i>твёрдым телом</i> ^Г : материя I.a X , <ul style="list-style-type: none"> • являющаяся твёрдой I.2 <p>Anti_∩ : ГАЗ I.2 ; ЖИДКОСТЬ II.2 A₁ : ТВЁРДЫЙ I.2</p>	<i>Химия твёрдого тела – наука о превращениях, в которых принимают участие (в качестве исходных реагентов или продуктов реакции) вещества, хотя бы одно из которых находится в твердом состоянии.</i>

Lexical unit	Definition	Example
ТВЁРДЫЙ I.2 спец	<p><i>твёрдый</i> I.2 X :</p> <p>материя I.a X в таком физическом III.2 состоянии, что</p> <ul style="list-style-type: none"> • X имеет определенную форму, • X имеет определенный объём, • частицы I.2 X-а неподвижны <p>Anti_Г : ГАЗООБРАЗНЫЙ I.2 ; жидкий I.2 S₁Pred : «ТВЁРДОЕ ТЕЛО»</p>	<p>Объем твёрдого гелия, ${}^3\text{He}$ и ${}^4\text{He}$, может быть уменьшен на 30% путем повышения давления.</p>
ТРАНСФОРМАЦИЯ II.1 спец	<p><i>трансформация</i> II.1 X-а в Y :</p> <p>трансформация I.1a вещества I.1b X в Y,</p> <ul style="list-style-type: none"> • где Y является или X-ом в другом физическом III.2 состоянии, или веществом I.1b, отличным от X-а <p>Syn : ПРЕВРАЩЕНИЕ II.1</p>	<p>Вещество меняет агрегатное состояние без каких-либо химических трансформаций: испарение воды или таяние льда происходит без разложения или изменения молекул воды.</p>
УРАВНЕНИЕ II.2a спец	<p><i>уравнение</i> II.2a между X-ом и Y-ом :</p> <p>символическая репрезентация</p> <ul style="list-style-type: none"> • эквивалентности материи I.a в контексте «химического изменения» X-а, • имеющая форму уравнения II.1 с X-ом слева и Y-ом справа 	<p>В сбалансированных химических уравнениях число и тип каждого атома с обеих сторон уравнения одинаковы, например, $4\text{Al} + 3\text{O}_2 = 2\text{Al}_2\text{O}_3$.</p>

Lexical unit	Definition	Example
УРАВНЕНИЕ II.2b спец	<p><i>уравнение II.2b</i> между X-ом и Y-ом :</p> <p>символическая репрезентация</p> <ul style="list-style-type: none"> • реакции I.1d между X-ами, образующей Y, • имеющая форму выражения, похожую на уравнение II.1 с X-ом слева и Y-ом справа 	<p>Уравнение полного сгорания метана:</p> $1\text{CH}_4 + 2\text{O}_2 \rightarrow 1\text{CO}_2 + 2\text{H}_2\text{O}.$
ФИЗИКА I (спец)	<p>физика I, которой занимается X :</p> <p>наука, которой занимается человек X,</p> <ul style="list-style-type: none"> • объектом которой является исследование материи I.a, энергии II.1 и их взаимодействий I <p>A₀ : ФИЗИЧЕСКИЙ III.1</p>	<p>Квантовая электродинамика, подраздел физики, объясняет взаимодействие заряженных частиц и света.</p>
ФИЗИКА II спец	<p>физика II X-а :</p> <p>свойства материи I.a или энергии II.1 X,</p> <ul style="list-style-type: none"> • которые определяют взаимодействия I X-а с материей I.a или энергией II.1 Ω <p>A₀ : ФИЗИЧЕСКИЙ III.2</p>	<p>Понимание медицинской визуализации и ее прогресса требует понимания физики излучения и материи.</p>
ФИЗИЧЕСКИЙ III.1 (спец)	<p>физический III.1 X :</p> <p>X, относящийся к физике I</p>	<p>Преподаватель должен объяснить группе пошаговую процедуру выполнения физического лабораторного эксперимента.</p>

Lexical unit	Definition	Example
ФИЗИЧЕСКИЙ III.2 спец	<i>физический</i> III.2 X : X, относящийся к физике II Ω-и	<i>Из-за своей физической структуры молекула воды является биполярной, что означает, что она слегка заряжена, с положительным зарядом на одной стороне и отрицательным зарядом на противоположной стороне.</i>
「ФИЗИЧЕСКОЕ ИЗМЕНЕНИЕ」 спец	「 <i>физическое изменение</i> 」 X-а : изменение 「 физических свойств 」 Ω вещества I.1b X	<i>Физическое изменение подразумевает изменение свойств, таких как запах, форма, размер, цвет, объем или плотность материи без изменения ее состава.</i>
「ФИЗИЧЕСКОЕ СВОЙСТВО」 спец	Y является 「 <i>физическим свойством</i> 」 X-а : Y является свойством материи I.1b X, которое <ul style="list-style-type: none"> • присуще X-у, • может быть измерено или замечено на макроскопическом I уровне 	<i>Физические свойства, которые изменяются при изменении количества вещества, – это масса, объем и длина. Плотность, цвет, проводимость и блеск – это физические свойства, которые остаются неизменными независимо от количества вещества.</i>

Lexical unit	Definition	Example
ХИМИКАТ I.1 спец	<p>X является химикатом I.1 :</p> <p>X является веществом I.1b,</p> <ul style="list-style-type: none"> • которое может быть идентифицировано по его «химическим свойствам» Ω 	<p>Каталитическая цепь – это серия из двух или более химических реакций, в которых один из химикатов (катализатор) разрушает другой химикат, не разрушаясь при этом сам.</p>
ХИМИЧЕСКИ I (спец)	<p>химически I X :</p> <p>X относительно химии I.1</p> <p>A_0 : ХИМИЧЕСКИЙ I</p>	<p>Химически доказано, что фторуглероды обеспечивают самый высокий уровень водоотталкивающих свойств.</p>
ХИМИЧЕСКИ II спец	<p>химически II X :</p> <p>X относительно химии II.1 Ω-и</p> <p>A_0 : ХИМИЧЕСКИЙ II.1</p>	<p>Все атомы с одинаковым количеством протонов будут химически идентичны.</p>
ХИМИЧЕСКИЙ I (спец)	<p>химический I X :</p> <p>X, относящийся к химии I.1</p> <p>Adv_0 : ХИМИЧЕСКИ I</p>	<p>Наша задача - научить роботов практически полностью самостоятельно выполнять множество экспериментов в химических лабораториях.</p>

Lexical unit	Definition	Example
ХИМИЧЕСКИЙ II.1 спец	<i>химический</i> II.1 X : X , относящийся к химии II.1 Ω -и Adv_0 : ХИМИЧЕСКИ II	<i>При химической реакции происходит разрыв одних и образование других химических связей.</i>
ГХИМИЧЕСКОЕ ИЗМЕНЕНИЕ ^Г спец	Г <i>химическое изменение</i> ^Г X -а : изменение Г химических свойств ^Г Ω_1 вещества I.1b X , которое <ul style="list-style-type: none"> • влияет на состав X-а, • имеет результатом превращение II.1 X-а в другое вещество I.1b Ω_2 	<i>Когда реактивы смешиваются, изменение температуры, вызванное реакцией, является показателем химического изменения.</i>
ГХИМИЧЕСКОЕ СВОЙСТВО ^Г спец	Y является Г <i>химическим</i> <i>свойством</i> ^Г X -а : Y является свойством вещества I.1b X , <ul style="list-style-type: none"> • относительно возможных превращений II.1 X-а в другие вещества I.1b Ω 	<i>Примеры химических свойств включают горючесть, токсичность, кислотность и реактивность.</i>
ХИМИЯ I.1 (спец)	<i>химия</i> I.1, которой занимается X : наука, которой занимается человек X , <ul style="list-style-type: none"> • объектом которой является исследование материи I.a и её превращений II.1 на субмикроскопическом уровне A_0 : ХИМИЧЕСКИЙ I	<i>В химии невозможно иметь дело с отдельным атомом или молекулой, потому что мы не можем ни увидеть их, ни сосчитать, ни взвесить.</i>

Lexical unit	Definition	Example
ХИМИЯ II.1 спец	<i>химия</i> II.1 X-а : свойства материи I.a X, <ul style="list-style-type: none"> определяющие превращения II.1 X-а на субмикроскопическом уровне A ₀ : ХИМИЧЕСКИЙ II.1	Химия атома определяет, как он соединяется с другими атомами, что, в свою очередь, зависит от количества электронов в его внешней оболочке.
ХИМИЯ II.2 спец	<i>химия</i> II.2 X-а : превращения II.1 в материи I.a X, <ul style="list-style-type: none"> связанные с химией II.1 X-а 	Электросудорожная терапия изменяет химию мозга.
ЧАСТИЦА I.2 спец	<i>частица</i> I.2 X, (взаимодействующая с Y-ом) : составляющая материи I.a X, <ul style="list-style-type: none"> (взаимодействующая I с другими сущностями Y) 	Нейтральные частицы могут разделяться, образуя положительно и отрицательно заряженные пары частиц , но абсолютная величина заряда всегда остается неизменной.
ГЧИСТОЕ ВЕЩЕСТВО ^Г спец	Г <i>чистое вещество</i> ^Г : отдельное вещество I.1b , <ul style="list-style-type: none"> состоящее из одного типа атомов I.2 или одного типа молекул I, чей состав и свойства постоянны в любом образце такого вещества I.1b 	Кислород при комнатной температуре – это чистое вещество , представляющее собой бесцветный газ без запаха.

Lexical unit	Definition	Example
«ЭЛЕКТРИЧЕСКИЙ ЗАРЯД» спец	« <i>электрический заряд</i> » X -а, выраженный Y -ом : свойство материи Ω X , которое <ul style="list-style-type: none"> • позволяет ей электрически взаимодействовать с другими сущностями Ω, • измеряется числовой величиной Y A_1 : ЗАРЯЖЕННЫЙ Ω	<i>Электрический заряд</i> протона равен $+1$.
ЭЛЕКТРОН спец	<i>электрон</i> X -а, взаимодействующий с Y -ом : «субатомная частица» атома Ω X , <ul style="list-style-type: none"> • взаимодействующая с «субатомными частицами» Y X-а • заряженная Ω негативно A_0 : ЭЛЕКТРОННЫЙ Ω	<i>Электроны</i> имеют электрический заряд -1 .
ЭЛЕКТРОННЫЙ Ω спец	<i>электронный</i> Ω X : X , относящийся к электронам	С помощью комбинации аналитических методов и компьютерных расчетов ученые смогли определить <i>электронную</i> структуру атомов золота.

Lexical unit	Definition	Example
ЭЛЕМЕНТ III.2a спец	<p><i>элемент III.2a X</i> :</p> <p>тип атомов I.2,</p> <ul style="list-style-type: none"> • который идентифицируется номером X, который соответствует количеству протонов в ядре I.2 таких атомов I.2 <p>A_0 : ЭЛЕМЕНТАРНЫЙ III.1</p>	<p><i>Элемент</i> водород, расположенный в верхней левой части таблицы, имеет атомный номер 1. Как может повести себя атом <i>элемента</i> 54 (Xe) во время химической реакции?</p>
ЭЛЕМЕНТ III.2b спец критик	<p><i>элемент III.2b</i> :</p> <p>«чистое вещество»,</p> <ul style="list-style-type: none"> • состоящее из одного элемента III.2a Ω <p>Суп : «ПРОСТОЕ ВЕЩЕСТВО»</p>	<p><i>Любое вещество, содержащее только один вид атомов, называется элементом.</i></p> <p><i>Большинство элементов – это металлы, которые блестят и хорошо проводят электричество.</i></p>
«ЭЛЕМЕНТАРНАЯ РЕАКЦИЯ» спец	<p><i>элементарная реакция между X-ами, образующая Y</i> :</p> <p>реакция I.1d между веществами I.1b X, образующая вещество I.1b Z</p> <ul style="list-style-type: none"> • в одну стадию 	<p><i>Сумма отдельных этапов, или элементарных реакций, в механизме реакции должна дать сбалансированное химическое уравнение для всей реакции.</i></p>

Lexical unit	Definition	Example
ЭЛЕМЕНТАР- НЫЙ III.1 спец	<i>элементарный</i> III.1 X : X , относящийся к элементам III.2а	<i>Периодические закономерности, вытекающие из расположения элементов в Периодической таблице, дают химикам бесценный инструмент для быстрого прогнозирования элементарных свойств.</i>
ЭЛЕМЕНТАР- НЫЙ III.2 спец	<i>элементарный</i> III.2 X : X , состоящий из одного элемента III.2а Ω	<i>В сельском хозяйстве элементарная сера и соединения серы применяются для корректировки pH почвы путем подкисления.</i>
ЯДЕРНЫЙ I.2 спец	<i>ядерный</i> I.2 X : X , относящийся к ядру I.2	<i>Ядерные реакции связаны с изменениями в ядерной структуре.</i>
ЯДРО I.2 спец	<i>ядро</i> I.2 X -а : центральная часть атома I.2 X , <ul style="list-style-type: none"> • состоящая из протонов и нейтронов, • заряженная I.2 положительно A_0 : ЯДЕРНЫЙ I.2	<i>Нестабильное ядро, которое спонтанно распадается, является радиоактивным, а его выбросы в совокупности называются радиоактивностью.</i>

Bibliography

- AITCHISON Jean (2012). *Words in the Mind: An Introduction to the Mental Lexicon*. 4th edition. Oxford, UK, Wiley-Blackwell.
- BARRESWIL Charles-Louis (1864). *Bulletin de la Société chimique de Paris, janvier 1864*. Paris.
- BATAILLE Xavier and BRAM Georges (2004). Une petite histoire de la vulgarisation de la chimie. In: *L'Actualité Chimique*. Paris, pp. 12–16.
- BOWKER Lynne (1997). Multidimensional Classification of Concepts and Terms. In S. E. Wright and G. Budin (eds.): *Handbook of Terminology Management. Volume 1: Basic Aspects of Terminology Management*. Amsterdam/Philadelphia, John Benjamins, pp. 133–143.
- BOWKER Lynne and PEARSON Jennifer (2002). *Working with specialized language: a practical guide to using corpora*. London, Routledge, p. 256.
- BOYLE Robert (1661). *The Sceptical Chymist: Or, Chymico-physical Doubts & Paradoxes, Touching the Spagyrist's Principles Commonly Call'd Hypostat-ical, as They are Wont to be Propos'd and Defended by the Generality of Alchymists. Whereunto is Praemis'd Part of Another Discourse Relating to the Same Subject*. London, Dawsons of Pall Mall. URL: <https://books.google.fr/books?id=pxhKAQAAMAAJ>.
- BROWN Theodore L. and LEMAY H. Eugene (1977). *Chemistry: The Central Science*. New Jersey, Prentice-Hall. URL: <https://books.google.fr/books?id=cqhSzQEACAAJ>.
- BROWN Theodore L., LEMAY H. Eugene, BURSTEN Bruce E., MURPHY Catherine J., WOODWARD Patrick M. and STOLTZFUS Matthew W. (2018). *Chemistry: the central science*. Harlow, UK, Pearson.
- BUCHI Eva (2016). Etymological dictionaries. In P. Durkin (ed.): *The Oxford Handbook of Lexicography*. Oxford, Oxford University Press, pp. 338–349.

- CABRÉ M. Teresa (2003). Theories of terminology: Their description, prescription and explanation. *Terminology. International Journal of Theoretical and Applied Issues in Specialized Communication*, 9:2, pp. 163–199.
- CADEDDU Andrea, WYLIE Elizabeth K., JURCZAK Janusz, WAMPLER-DOTY Matthew and GRZYBOWSKI Bartosz A. (2014). Organic Chemistry as a Language and the Implications of Chemical Linguistics for Structural and Retrosynthetic Analyses. *Angewandte Chemie (International ed.)*, 53:31, pp. 8108–8112.
- CANAC Sophie and KERMEN Isabelle (2016). Exploring the mastery of French students in using basic notions of the language of chemistry. *Chemistry Education Research and Practice*, 17:3, pp. 452–473.
- CHASTRETTE Maurice and DUMON Alain (2007). L'image de la chimie est mauvaise. Pourquoi ? Que faire ? *Didaskalia*.
- CHILDS Peter E., MARKIC Silvija and RYAN Marie C. (2015). The role of language in the teaching and learning of chemistry. In G.-M. J. and S.-T. E. (eds.). Weinheim, Germany, Wiley-VCH Verlag GmbH & Co.KGaA, pp. 421–445.
- CINK Ruth B. and SONG Youngjin (2016). Appropriating scientific vocabulary in chemistry laboratories: a multiple case study of four community college students with diverse ethno-linguistic backgrounds. *Chemistry Education Research and Practice*, 17:3, pp. 604–617.
- COBB Cathy. and GOLDWHITE Harold (2013). *Creations of Fire: Chemistry's Lively History from Alchemy to the Atomic Age*. US, Springer Science & Business Media. URL: <https://books.google.fr/books?id=jU35BwAAQBAJ>.
- DAINTITH John (ed.) (2008). *A Dictionary of Chemistry*. Oxford, Oxford University Press.
- DANILENKO Valerija P. (1977). *Russkaja terminologija*. Moscow, Nauka, p. 246.
- DE MENTEN DE HORNE Pierre (2013). *Dictionnaire de chimie: Une approche étymologique et historique*. Bruxelles, De Boeck Supérieur.
- DESMET Isabel (2007). Terminologie, culture et société. Éléments pour une théorie variationniste de la terminologie et des langues de spécialité. In: *Cahier du Rifal*. 26, pp. 3–13.

- DO Choon H. and PAVLATH Attila E. (2017). *Chemistry: Our Past, Present, and Future*. Singapore, Jenny Stanford Publishing. URL: <https://books.google.fr/books?id=36QzDwAAQBAJ>.
- DONOVAN Michael P. (1997). The vocabulary of biology and the problem of semantics. *Journal of College Science Teaching*, 26:6, p. 381.
- DROUIN Patrick (2003). Term extraction using non-technical corpora as a point of leverage. *Terminology*, 9:1, pp. 99–115.
- DUFFUS John, NORDBERG Monica and TEMPLETON Douglas M. (Jan. 2007). Glossary of terms used in toxicology, 2nd edition (IUPAC Recommendations 2007). *Pure and Applied Chemistry*, 79, pp. 1153–1344.
- EARLEY Joseph E. (2009). How chemistry shifts horizons: element, substance, and the essential. *Foundations of Chemistry*, 11:2, pp. 65–77.
- EISS Albert F. (1961). Problems in semantics of importance in science teaching. *Science Education*, 45:4, pp. 343–347.
- EVDOŠČENKO S. I., DUBCHINSKIJ V. V. and GAJVORONSKAJA V. V. (eds.) (2006). *Slovar' khimicheskikh terminov*. Rostov-na-Donu, Feniks.
- FANG Zhihui (2005). Scientific literacy: A systemic functional linguistics perspective. *Science education*, 89:2, pp. 335–347.
- FELBER Helmut (1984). *Terminology Manual*. Paris, Unesco.
- FRASER Barry, TOBIN Kenneth and MCROBBIE Campbell J. (2012). *Second international handbook of science education*. vol. 24. Dordrecht, Heidelberg, New York, London, Springer Science & Business Media.
- GABEL Dorothy (1999). Improving teaching and learning through chemistry education research: A look to the future. *Journal of Chemical education*, 76:4, p. 548.
- GADER Nabil, LUX-POGODALLA Veronika and POLGUÈRE Alain (2012). Hand-Crafting a Lexical Network With a Knowledge-Based Graph Editor. In: *Proceedings of the 3rd Workshop on Cognitive Aspects of the Lexicon*. Mumbai, India, The COLING 2012 Organizing Committee, pp. 109–126.
- GADER Nabil, OLLINGER Sandrine and POLGUÈRE Alain (2014). One Lexicon, Two Structures: So What Gives? In: *Proceedings of the Seventh Global WordNet Conference (GWC2014)*. Tartu, Estonie, Global WordNet Association, pp. 163–171.

- GARDNER Paul L. (1972a). Difficulties with non-technical vocabulary amongst junior secondary school students: the words in science project. In. vol. 2. 1. Springer, pp. 58–81.
- GARDNER Paul L. (1972b). Words in Science. In. Melbourne.
- GAZIZOV Mukattis B. (2010). *Anglo-russky khimichesky slovar'*. Moscow, Alfa-M.
- GEE James P. (2004). Language in the science classroom: Academic social languages as the heart of school-based literacy. In: *Establishing scientific classroom discourse communities*. New York, Routledge, pp. 28–52.
- GHIBAUDI Elena, REGIS Alberto and ROLETTO Ezio (2013). What Do Chemists Mean When They Talk about Elements? *Journal of chemical education*, 90:12, pp. 1626–1631.
- GODDARD Cliff (2012). Semantic primes, semantic molecules, semantic templates: Key concepts in the NSM approach to lexical typology. In. vol. 50. 3. Berlin, New York, De Gruyter, pp. 711–743.
- GOLOVIN Boris N. and KOBRIN R. U. (1987). *Lingvističeskie osnovy učeniya o terminax*. Moscow, Vysšaja škola, p. 104.
- GOLUBKOVA N. A. (1993). *Nomenklaturnye pravila IUPAC po ximii: slovar' terminov, ispol'zuemyx v ximii*. vol. T. 7. Moscow, Viniti.
- GREENBERG Arthur (2006). *From Alchemy to Chemistry in Picture and Story*. Hoboken, New Jersey, John Wiley & Sons, Inc. URL: <https://books.google.fr/books?id=dG5ReuR4GqoC>.
- GRINEV-GRINEVIČ Sergej V. (2008). *Vvedenie v terminovedenie*. Moscow, Akademija, p. 304.
- GUNSTONE Richard (2015). *Encyclopedia of Science Education; With 88 Figures and 32 Tables*. Dordrecht, Heidelberg, New York, London, Springer.
- HAEFFNER M. (2004). *Dictionary of Alchemy: From Maria Prophetessa to Isaac Newton*. Great Britain, Aeon Books Limited. URL: <https://books.google.fr/books?id=zB-8OTIBErAC>.
- HERRON J. Dudley (1996). The role of language in teaching of chemistry. In. Washington, DC, pp. 161–182.
- HIRST Graeme (2009). Ontology and the Lexicon. In S. Staab and R. Studer (eds.): *Handbook on Ontologies. International Handbooks on Information Systems*. 2nd edition. Berlin Heidelberg, Springer, pp. 269–292.

- HOFFMANN Roald and LASZLO Pierre (1989). Representation in Chemistry. In: *Angewandte Chemie*. vol. 30. 1, pp. 1–16.
- HUMBLEY John (2004). La réception de l'œuvre d'Eugen Wüster dans les pays de langue française. *Les Cahiers du CIEL*, pp. 33–51.
- INGROSSO Francesca and POLGUÈRE Alain (2015). How Terms Meet in Small-World Lexical Networks: The Case of Chemistry Terminology. In: *Proceedings of the conference Terminology and Artificial Intelligence*. Granada, Spain, pp. 167–171.
- IORDANSKAJA Lidia and MEL'ČUK Igor (2009). Connotation (in Linguistic Semantics). In T. B. S. Kempgen P. K. and K. Gutschmidt (eds.). Berlin, New York, Walter de Gruyter, pp. 875–882.
- JASIEN Paul G. (2009). You said “neutral”, but what do you mean? *Journal of Chemical Education*, 87:1, pp. 33–34.
- JASIEN Paul G. (2011). What Do You Mean That “Strong” Doesn't Mean “Powerful”? *Journal of Chemical Education*, 88:9, pp. 1247–1249.
- JASIEN Paul G. and OBEREM Graham E. (2008). Student contextual understanding of the terms sense and energy: A qualitative study. *The Chemical Educator*, 13:2, pp. 46–53.
- JAUSSAUD Philippe (2006). Les pharmaciens français et la nomenclature des composés organiques. *L'Actualité chimique*, pp. 41–46.
- JOHNSTONE Alexander H. and CASSELS J. R. T. (1985). Words that matter in science. In. London, UK, Royal Society of Chemistry.
- JOHNSTONE Alexander H. and SELEPENG Ditshupo (2001). A language problem revisited. *Chemistry Education Research and Practice*, 2:1, pp. 19–29.
- KAGEURA Kyo (2002). *The Dynamics of Terminology: A descriptive theory of term formation and terminological growth*. vol. 5. Amsterdam/Philadelphia, John Benjamins.
- KAHN Didier (2007). *Alchimie et Paracelsisme en France à la fin de la Renaissance (1567-1625)*. Cahiers d'humanisme et Renaissance. Genève, Droz. URL: <https://books.google.fr/books?id=Hhty9y6WnTMC>.
- KERMEN Isabelle (2016). Usage et apprentissage des mots en chimie. *L'Actualité chimique*, pp. 34–36.

- KERSAINT Georges (1968). Aperçu sur les nomenclatures en chimie. *Revue d'Histoire de la Pharmacie*, 56:199, pp. 203–206.
- KNUNJANC I. L. (1998). *Ximija: bol'soj ènciklopedičeskij slovar'*. Moscow, AST, Bol'saja Rossijskaja Ènciklopedija.
- KNUNJANC I. L. and ZEFIROV N. S. (1988–1998). *Ximičeskaja ènciklopedija*. Moscow, Bol'saja Rossijskaja Ènciklopedija.
- KRYLOSOVA Svetlana (2016). *Présentation du projet Lexicologie Explicative et Combinatoire du Russe selon l'approche des Réseaux lexicaux (LEC-ru)*. Tech. rep. CREE, INaLCO.
- L'HOMME Marie-Claude (2002). Fonctions lexicales pour représenter les relations sémantiques entre termes. *TAL. Traitement automatique des langues*, 43:1, pp. 19–41.
- L'HOMME Marie-Claude (2005). Sur la notion de «terme». *Meta : journal des traducteurs / Meta: Translators' Journal*, 50:4, pp. 1112–1132.
- L'HOMME Marie-Claude (2007). Using explanatory and combinatorial lexicology to describe terms. *Selected Lexical and Grammatical Topics in the Meaning-Text Theory. In Honour of Igor Mel'čuk*, pp. 167–202.
- L'HOMME Marie-Claude and POLGUÈRE Alain (2008). Mettre en bons termes les dictionnaires spécialisés et les dictionnaires de langue générale. In F. Maniez and P. Dury (eds.): *Lexicologie et terminologie : histoire de mots. Hommage à Henri Béjoint*. Travaux du CRTT. Lyon, pp. 191–206.
- LASZLO Pierre (1993). *La parole des choses : ou le langage de la chimie*. Collection Savoir Sciences. Paris, Hermann.
- LASZLO Pierre (1999). Circulation of Concepts. *Foundations of Chemistry*, 1:3, pp. 225–238.
- LAVOISIER Antoine-Laurent and CUCHET Gaspard-Joseph (1789). *Traité élémentaire de chimie: présenté dans un ordre nouveau et d'après les découvertes modernes ...* Paris, Cuchet.
- LAVOISIER Antoine-Laurent, FOURCROY Antoine-François, BERTHOLLET Claude-Louis and GUYTON-MORVEAU Louis-Bernard (1787). *Méthode de nomenclature chimique*. Paris, Cuchet.
- LAW Jonathan and RENNIE Richard (2020). *A Dictionary of Chemistry*. Oxford, Oxford University Press.

- LEE Okhee (2001). Culture and language in science education: What do we know and what do we need to know? *Journal of Research in Science Teaching: The Official Journal of the National Association for Research in Science Teaching*, 38:5, pp. 499–501.
- LEHN Jean-Marie (1995). *Supramolecular Chemistry: Concepts and Perspectives*. Weinheim, Wiley VCH.
- LEICESTER Henry M. and KLINKSTEIN Herbert S. (1952). *A Source Book in Chemistry, 1400-1900*. Source books in the history of the sciences. Cambridge, Massachusetts, McGraw-Hill. URL: <https://books.google.fr/books?id=zXZKfpRHLCcC>.
- LEMKE Jay L. (1990). *Talking science: Language, learning, and values*. Norwood, New Jersey, ERIC.
- MARKIC Silvija (Dec. 2015). Chemistry Teachers' Attitudes and Needs When Dealing with Linguistic Heterogeneity in the Classroom. In. Berlin, Heidelberg, Springer, pp. 279–295.
- MARKIC Silvija and CHILDS Peter E. (2016). Language and the teaching and learning of chemistry. In. vol. 17. 3. Weinheim, Germany, Wiley-VCH Verlag GmbH & Co.KGaA, pp. 434, 438.
- MCNAUGHT Alan D. (1997). *Compendium of chemical terminology [Texte imprimé] : IUPAC recommendations / International Union of Pure and Applied Chemistry ; comp. by Alan D. McNaught and Andrew Wilkinson*. 2nd ed. UK, Blackwell Science.
- MEL'ČUK Igor (2004a). Actants in semantics and syntax I: Actants in semantics. *Linguistics*, 42:1, pp. 1–66.
- MEL'ČUK Igor (2004b). Actants in semantics and syntax II: actants in syntax. *Linguistics*, 42:2, pp. 247–291.
- MEL'ČUK Igor (2006). Explanatory combinatorial dictionary. In G. Sica (ed.): *Open problems in linguistics and lexicography*. Monza, Polimetrica, pp. 225–355.
- MEL'ČUK Igor, CLAS André and POLGUÈRE Alain (1995). *Introduction à la lexicologie explicative et combinatoire*. Louvain-la-Neuve, Duculot.
- MEL'ČUK Igor and POLGUÈRE Alain (2018). Theory and Practice of Lexicographic Definition. *Journal of Cognitive Science*, pp. 417–470.

- MEL'ČUK Igor and POLGUÈRE Alain (2021). Les fonctions lexicales dernier cri. In S. Marengo (ed.): *La Théorie Sens-Texte. Concepts-clés et applications*. Dixit Grammatica. Paris, L'Harmattan, pp. 75–155.
- MENDELEEV Dmitri Ivanovich (1934). *Osnovy ximii*. Moscow, Leningrad, ONTI, Goshimtehizdat.
- MENDELEEV Dmitri Ivanovich (1949). *Sochineniya*. vol. T. 15. Izdatel'stvo Akademii Nauk SSSR.
- MIKHEL Polina, INGROSSO Francesca and POLGUÈRE Alain (2019). Towards a multilingual resource on the language of chemistry: A Lexical Network approach. In: *Abstract book IUPAC, 50th General Assembly & 47th IUPAC World Chemistry Congress, Chemistry and Society, Oral communications*. Paris, IUPAC.
- MORIN Emmanuel, DAILLE Béatrice, TAKEUCHI Koichi and KAGEURA Kyo (2007). Bilingual Terminology Mining – Using Brain, not brawn comparable corpora. In: *Proceedings of the 45th Annual Meeting of the Association of Computational Linguistics*. Prague, Czech Republic, Association for Computational Linguistics, pp. 664–671.
- MORRIS Richard (2003). *The Last Sorcerers: The Path from Alchemy to the Periodic Table*. Washington D.C., Joseph Henry Press. URL: <https://books.google.fr/books?id=IGU4XBIWHVoC>.
- MOTTER Adilson E., DE MOURA Alessandro P. S., LAI Ying-Cheng and DASGUPTA Partha (2002). Topology of the conceptual network of language. In. vol. 65. United States of America.
- NICOLARDOT Paul (1910). Le Symbole de l'azote : Az ou N. In. 11, pp. 325–330.
- OLLINGER Sandrine, POLGUÈRE Alain, CHUDY Yannick and GAUME Bruno (2020). Spiderlex et compagnie. In: *6e conférence conjointe Journées d'Études sur la Parole (JEP, 33e édition), Traitement Automatique des Langues Naturelles (TALN, 27e édition), Rencontre des Étudiants Chercheurs en Informatique pour le Traitement Automatique des Langues (RÉCITAL, 22e édition)*. Volume 4 : Démonstrations et résumés d'articles internationaux. Nancy, France, pp. 60–63.

- PANETH F. A. (1962a). The Epistemological Status of the Chemical Concept of Element (I). *The British Journal for the Philosophy of Science*, XIII:49, pp. 1–14.
- PANETH F. A. (1962b). The Epistemological Status of the Chemical Concept of Element (II). *The British Journal for the Philosophy of Science*, 13:50, pp. 144–160.
- PEARSON Jennifer (1998). *Terms in context*. Amsterdam ; Philadelphia, John Benjamins, p. 258.
- PERALDI Sandrine (2011). *Indétermination terminologique et multidimensionnalité dans le domaine de la chimie organique*. PhD thesis. Paris, Université Paris Diderot (Paris 7).
- PETITJEAN Étienne, BENZITOUN Christophe, HUSSON Benjamin and OLLINGER Sandrine (2019). *Allegro: une plateforme «couteau suisse» pour l'exploitation des ressources textuelles*.
- POLGUÈRE Alain (2009). Lexical systems: graph models of natural language lexicons. *Language Resources and Evaluation*, 43:1, pp. 41–55.
- POLGUÈRE Alain (2014). From Writing Dictionaries to Weaving Lexical Networks. *International Journal of Lexicography*, 27:4, pp. 396–418.
- POLGUÈRE Alain (2016a). La question de la géométrie du lexique. In: *SHS Web of Conferences. Actes du « 5e Congrès Mondial de Linguistique Française (CMLF 2016) »*.
- POLGUÈRE Alain (2016b). *Lexicologie et sémantique lexicale : notions fondamentales*. Troisième édition. Montréal, Les Presses de l'Université de Montréal.
- POLGUÈRE Alain (2018). A lexicographic approach to the study of copolysemy relations. *Russian Journal of Linguistics*, 22:4, pp. 788–820.
- POLGUÈRE Alain (2020). Vers une approche systémique des marques d'usage. In G. Armianov (ed.): *Marques de registre dans les dictionnaires bilingues. Europe(s)*. Paris, Presses de l'Inalco, p. 7–26.
- POLGUÈRE Alain and MEL'ČUK Igor (2006). Dérivations sémantiques et collocations dans le DiCo/LAF. *Langue française*, 2, pp. 66–83.
- REES Simon, KIND Vanessa and NEWTON Douglas (2018). Meeting the Challenge of Chemical Language Barriers in University Level Chemistry Education. In.

- REFORMATSKIJ Aleksandr A. (1968). Termin kak člen leksičeskoj sistemy jazyka. In: *Problema strukturnoj lingvistiki*. Moscow, Nauka, pp. 103–125.
- REY Alain (1979). *La terminologie: noms et notions*. Paris, Presses Universitaires.
- RICHER Jean-Claude (1999). *Compendium de terminologie chimique, recommandations IUPAC : avec lexique anglais/français*. 2e édition. Paris, Edition TecDoc.
- RICHER Jean-Claude (2012). *Lexique de terminologie chimique / Lexicon of chemical terminology : français-anglais, anglais-français, 160 000 traductions French-English, English-French, 160 000 translations*. Paris, TecDoc Lavoisier.
- RYAN Marie C. and CHILDS Peter E. (2013). Irish science teacher's views on linguistic diversity. In P. N. Constantinou C. P. and H. A. (eds.). Nicosia, Cyprus, Nicosia, Cyprus: ESERA, pp. 47–54.
- SCERRI Eric (2003). Response to Vollmer's Review of Minds and Molecules. *Philosophy of Science*, 70:2, pp. 391–398.
- SCERRI Eric and GHIBAUDI Elena (2020). *What Is a Chemical Element?: A Collection of Essays by Chemists, Philosophers, Historians, and Educators*. Oxford, Oxford University Press, Incorporated.
- SHORT Deborah J., VOGT MaryEllen and ECHEVARRIA Jana (2010). The academic language of science. In D. J. Short, M. Vogt and J. Echevarria (eds.). Boston, MA, Pearson Education, Inc., pp. 1–20.
- SIMONE Pia De (2020). Plato's use of the term stoicheion. *Archai (Brasília, Distrito Federal, Brazil)*, 30. URL: <https://doaj.org/article/a0050825f50e4e06a390aac5e425b04e>.
- SNOW Catherine (2008). What is the vocabulary of science? In R. A. S. and W. B. (eds.). Arlington, VA, National Science Teachers Association, pp. 71–83.
- SODDY Frederick (1919). The conception of the chemical element as enlarged by the study of radioactive change. *Journal of the Chemical Society, Transactions*, 115, pp. 1–26.
- SOKOLOV Aleksandr I. (2013). Russkie perevody novoy ximičeskoj nomenclatury načala XIX veka. *Acta Linguistica Petropolitana*, IX:2, pp. 495–510.
- SONG Youngjin and CARHEDEN Shannon (2014). Dual meaning vocabulary (DMV) words in learning chemistry. *Chemistry Education Research and Practice*, 15:2, pp. 128–141.

- TABER Keith S. (1998). An alternative conceptual framework from chemistry education. *International journal of science education*, 20:5, pp. 597–608.
- TABER Keith S. (2001). Building the structural concepts of chemistry: some considerations from educational research. *Chemistry Education Research and Practice*, 2:2, pp. 123–158.
- TEMMERMAN Rita (2000). *Towards new ways of terminology description: The sociocognitive approach*. Amsterdam/Philadelphia, John Benjamins, p. 274.
- WELLINGTON Jerry and IRESON Gren (2002). *Teaching and learning secondary science*. London, New York, Routledge.
- WELLINGTON Jerry and OSBORNE Jonathan (2001). *Language and literacy in science education*. Buckingham, Philadelphia, Open University Press.
- WIERZBICKA Anna (1972). Semantic primitives. In: *Linguistische Forschungen*. vol. 22. Frankfurt, Athenäum.
- WIERZBICKA Anna (1985). *Lexicography and conceptual analysis*. Karoma.
- WONG Chee Leong, CHU Hye-Eun and YAP Kueh Chin (2014). Developing a framework for analyzing definitions: a study of the Feynman Lectures. *International Journal of Science Education*, 36:15, pp. 2481–2513.
- WÜSTER Eugen (1981). L'étude scientifique générale de la terminologie, zone frontalière entre la linguistique, la logique, l'ontologie, l'informatique et les sciences des choses. In G. R. e. H. Felber (ed.): *Textes choisis de terminologie. I. Fondements théoriques de la terminologie*. vol. 1. Québec, Girsterm, pp. 55–114.
- WÜSTER Eugen (1991). *Einführung in die Allgemeine Terminologielehre und terminologische Lexikographie / Eugen Wüster ; mit einem Vorwort von Richard Baum*. 3. Aufl. Abhandlungen zur Sprache und Literatur. Bonn, Romanistischer Verlag.
- YURIEV Elizabeth, CAPUANO Ben and SHORT Jennifer (2016). Crossword puzzles for chemistry education: learning goals beyond vocabulary. *Chemistry Education Research and Practice*, 17:3, pp. 532–554.
- ZANOLA Maria T. (2014). *Arts et métiers au XVIIIe siècle: études de terminologie diachronique*. Collection "Rose des vents". Paris, L'Harmattan.

Index of notions

- alchemy, 51, 58
- argon, 131
- atom, 126, 127, 133
- atomic number, 126
- atomic weight, 126
- base [of collocation], 16
- basic lexical unit [of a vocable], 66
- carbon, 130
- central component, 87
- chemical, 56
 - ~ industry, 55
 - ~ nomenclature, 58
 - ~ weapons, 55
- cheminformatics, 52
- chemish, 60
- chemistry, 51, 53
 - analytical ~, 52
 - biological ~, 52, 59
 - general ~, 53
 - geo~, 52
 - inorganic ~, 52
 - nuclear ~, 52
 - organic ~, 52, 59
 - physical ~, 52
 - polymer ~, 52
- chemophobia, 56
- cobalt, 131
- collocate, 16
- collocation, 16, 45
- combinatorial properties, 13, 16
- compound, 10, 45, 133
- connotation, 56
- copolysemes, 93
- copolysemy, 18
- copolysemy relation, 93
 - ~ causation, 93
 - ~ extension, 94
 - ~ metaphor, 94
 - ~ metonymy, 94
 - ~ result, 94
 - ~ specialization, 93, 107
- core terms, 14
- corpus, 12, 19, 21
 - comparable ~, 21
 - full text ~, 21
 - parallel ~, 21
 - sample ~, 21
 - special purpose ~, 21
- defined-by hierarchy, 98, 117, 154
- definiendum, 86
- definiens, 86
- definition, 18

- element, 40, 121
Fr. *élément*, 122, 134
Ger. *Element*, 125
Ger. *Grundstoff*, 125
Ru. *элемент*, 123, 134
- elementary substance, 128
Ru. *элементарное вещество*, 129
- full term, 83
- fundamental terms, 14
- government pattern, 47
- idiom, 15, 45
- isotope, 126
- IUPAC, 34, 59
- lexeme, 15
- lexical function, 17, 92
~ paradigmatic, 18
~ syntagmatic, 18
- lexical network, 14
- lexical system, 17
- linguistic usage note, 82
- mixture, 45
- molecule, 133
- neutron, 126
- nomenclature, 27
- non-specialized LU, 13
- paradigmatic, 14
- Periodic Table, 124, 131
- peripheral components, 87
- phraseme, 45
- physics, 53, 54
- polysemy, 15
- predicative lexical unit, 86
- propositional form, 86
- proton, 126
- pure substance, 45
- quasi-predicate, 86
- quasi-term, 86
- rhetorical usage note, 82
- runaway term, 84
- semantic actant slot, 86
- semantic name, 87
- semantic predicate, 86
- sense, 15
- signified, 13
- signifier, 13
- simple substance, 45, 121, 133
Fr. *corps simple*, 122, 128
Ger. *einfacher Stoff*, 125
Ru. *простое тело*, 123, 129
- specialized LU, 13
- stylistic usage note, 82
- submicroscopic, 54
- substance, 45
- syntagmatic, 16
- taxonomy, 14
- term, 13
- terminography, 14
- terminological semantic prime, 88, 98
- transformation, 54
- usage note, 82
- vocable, 15

Résumé de la thèse de Polina MIKHEL

Étude multilingue du lexique de la chimie à l'interface entre terminologie et langue générale

Directeur de thèse : Alain POLGUÈRE (Université de Lorraine, CNRS, ATILF)

Codirectrice de thèse : Francesca INGROSSO (Université de Lorraine, CNRS, LPCT)

Notre recherche interdisciplinaire repose sur l'hypothèse que les terminologies scientifiques, puisqu'elles fonctionnent dans les textes en interaction avec le lexique de langue générale, doivent posséder une structure identique ou similaire avec celle du lexique général. Les modèles terminologiques, dans leur immense majorité, traitent les terminologies de façon isolationniste et ne sont pas en mesure de rendre compte des types de connexions qu'elle entretiennent avec la langue générale et des conséquences pratiques de ces connexions sur l'évolution des terminologies, ainsi que sur l'enseignement et l'apprentissage des terminologies. Nous étudions ce problème dans une perspective à la fois théorique (lexicologique) et descriptive (lexicographique) en nous consacrant au cas de la terminologie de la chimie.

Sur le plan théorique, la recherche vise, d'une part, à apporter une solution au problème de la modélisation formelle et rigoureuse de la multidimensionnalité inhérente à l'organisation des terminologies, c'est-à-dire le fait que les termes peuvent être appréhendés et les terminologies parcourues selon de multiples axes. D'autre part, et de façon liée, la recherche vise à rendre compte de l'interdépendance entre lexique de langue générale et lexique terminologique.

Sur le plan pratique, nous élaborons les modèles terminologiques multilingues de la chimie pour trois langues typologiquement distinctes : l'anglais, le français et le russe. Ces modèles, conçus pour évoluer et être enrichis sur le long terme, peuvent servir d'outils pratiques pour les scientifiques ainsi que pour les enseignants et les étudiants en chimie. La recherche est de ce fait destinée à avoir une résonance non seulement dans le domaine de la recherche en lexicologie et terminologie, mais aussi auprès de la communauté des chimistes.

Mots clés : lexicologie contrastive, lexicographie formelle informatisée, terminologie de la chimie, réseaux lexicaux.

Contexte

Notre recherche s'appuie sur un double constat : d'une part, les approches traditionnelles de représentation des *terminologies scientifiques* reposent essentiellement sur le recours à des modèles taxinomiques – cf. les ontologies informatiques fondées sur des hiérarchies de classes conceptuelles (Hirst, 2009) ; d'autre part, les études contemporaines sur l'organisation du lexique de langue générale (lexicologie, psycholinguistique, etc.) tendent à s'accorder sur un mode de structuration en *réseaux lexicaux* non hiérarchiques et non taxinomiques (Aitchison, 2012; Polguère, 2016). La recherche fait l'hypothèse que les terminologies scientifiques, puisqu'elles fonctionnent dans les textes en interaction avec le lexique de langue générale, doivent posséder une structure homomorphe avec celle du lexique général, avec lequel elles fusionnent au sein de la langue (L'Homme et Polguère, 2008).

Les modèles terminologiques, dans leur immense majorité, traitent les terminologies de façon isolationniste et ne sont pas en mesure de rendre compte des types de connexions qu'elle entretiennent avec la langue générale et des conséquences pratiques de ces connexions sur la dynamique lexicale (évolution des terminologies), ainsi que sur l'enseignement et l'apprentissage des terminologies. La recherche doctorale étudie ce problème dans une perspective à la fois théorique (lexicologique) et descriptive (lexicographique/terminographique) en se consacrant au cas de la *terminologie de la chimie*.

La réflexion sur le langage de la chimie a une longue et riche histoire (Zanola, 2014, pp. 113–128). Pourtant, l'essentiel des efforts de normalisation et rationalisation de cette terminologie s'est concentré sur le nommage des composés chimiques, puisque la chimie, de par la nature même de la discipline, engendre de façon continue de nouvelles molécules et, donc, de nouveaux noms pour les désigner. Le domaine de la chimie est remarquable en ce sens que, à la suite de Lavoisier, une logique de nommage des composés chimiques a été adoptée afin que la structure morphologique même des termes reflète la structure moléculaire de la substance désignée, ainsi que l'ordre de combinaison des éléments.

Dans un article publié en 1991, R. Hoffman (Prix Nobel de Chimie 1981) et P. Lazlo ont souligné que la connaissance du nom d'un composé chimique, qui est strictement lié à sa structure, donne au chimiste un énorme « pouvoir » sur la molécule (Hoffman & Lazlo 1991). Le nom est en relation étroite avec le comportement, les propriétés de la substance. L'importance d'une utilisation

correcte de la terminologie en chimie a mené, à partir de 1919, à la création d'un organisme international – *IUPAC : International Union for Pure and Applied Chemistry* –, dont une des activités consiste à développer des règles pour la nomenclature des molécules, afin d'éviter des ambiguïtés dans les définitions et harmoniser les nouvelles propositions lors de la découverte d'une molécule.

Dans l'ouvrage *La parole des choses* (Lazlo 1993), P. Lazlo continue la réflexion sur le lien entre la chimie et la langue jusqu'à établir un tableau de correspondances entre des catégories linguistiques et leurs répondants en chimie (par exemple, le fait qu'une molécule peut se comporter comme un acide ou comme une base suivant le partenaire de la réaction, peut s'interpréter comme une instanciation de la catégorie « polysémie »).

Plus récemment, une équipe internationale fait la démonstration du fait que les méthodes computationnelles de la linguistique appliquée au Traitement Automatique de la Langue peuvent être employées pour l'étude de la réactivité de molécules organiques (Cadeddu *et al.* 2014). Il est en fait possible de montrer que les relations entre les « fragments » qui constituent la langue et celles qui existent entre les « fragments moléculaires », utilisés dans l'approche rétrosynthétique, ont la même structure, qui se base sur le concept de « fréquence » d'apparition. Cette découverte récente concrétise et formalise la phrase du prix Nobel de Chimie, J.-M. Lehn :

« Atoms are letters, molecules are the words, supramolecular entities are the sentences and the chapters » (Lehn 1995).

Malgré l'intérêt évident que les chimistes portent aux questions d'utilisation des termes dans la pratique de leur discipline, les exemples d'études systématiques du lexique de la chimie restent étonnamment rares. Dans ses travaux de thèse (Peraldi 2011), S. Peraldi analyse le langage de la chimie organique, en mettant en évidence son caractère indéterminé et multidimensionnel. Par l'élaboration d'un corpus spécialisé (en anglais), Peraldi propose des pistes pour la construction d'un modèle terminologique qui pourrait assister les chimistes organiciens dans leurs efforts de communication scientifique. Or, dans la rédaction d'articles comme dans l'expression orale, tout(e) scientifique est confronté(e) aux difficultés liées à la communication de concepts qui sont souvent très techniques et spécifiques d'un sous-domaine (par ex., chimie organique, chimie des matériaux, chimie physique).

D'autres difficultés ressortent dans un contexte pédagogique : nécessité d'utiliser une expression claire, d'éviter des définitions ambiguës, de privilégier l'illustration de concepts simples par des termes bien choisis. Comme I. Kermen l'a remarqué (Kermen 2016), le choix des mots par un enseignant est un point clé pour aider à la compréhension de concepts comme des signes spécifiques de la chimie. Des études montrent en fait que des interprétations erronées des élèves sont souvent générées par une pédagogie qui repose sur des espèces et des entités non perceptibles (Taber, 2001), et donc très probablement sur un mauvais lien entre termes et concepts, et par une tendance à attribuer aux entités chimiques des « comportements », des « significations ontologiques » (Taber 1998). Dans ce dernier cas, il s'agit d'un problème très courant dans la pédagogie de la chimie, lié à des formulations utilisées en cours comme dans les ouvrages. Par exemple, il est souvent dit qu'un atome qui suit la règle de l'octet « préfère » être entouré par huit électrons, et que le sodium « cherche à se débarrasser » d'un électron de valence pour aboutir à une stabilité électronique. Ces abus de métaphorisation sont en partie la conséquence d'une absence de ressources linguistiques d'envergure véritablement adaptées à l'enseignement de la chimie, et notamment de sa terminologie.

En regard de tous les challenges posés par la question terminologique dans le domaine de la chimie, les efforts de l'IUPAC sont principalement orientés vers la normalisation de la terminologie très prolifique des composés chimiques. En comparaison, peu d'attention a été portée sur une meilleure normalisation de ce que l'on appellera la *terminologie fondamentale de la chimie*, c'est-à-dire la terminologie qui forme le noyau notionnel de la discipline. La terminologie fondamentale de la chimie représente, de plus, le socle sur lequel s'appuie toute la terminologie dénomminative des substances.

En effet, cette terminologie est celle qui pose le plus de problèmes quant à l'interaction avec la langue générale, par exemple, dans les contextes pédagogiques. De plus, les chimistes sont aujourd'hui fréquemment amenés à faire face à des thématiques d'intérêt public, comme le développement de matériaux et procédés respectueux de l'environnement, le développement industriel, le risque chimique. Ils sont ainsi de plus en plus conscients de l'importance d'une approche non isolationniste de la terminologie de leur domaine et de la nécessité d'une amélioration des stratégies d'enseignement de celui-ci.

Un autre point important à mentionner est que les principales ressources terminologiques existants sur la chimie sont monolingues, comme le *Gold Book* de l'IUPAC, qui traite uniquement

du lexique anglais. Pour ce qui est des ressources prenant en charge les correspondances interlangues en chimie, les efforts sont très souvent limités à l'élaboration d'index, qui présentent des traductions terme à terme. Il s'agit de simples tables de correspondances, sans information sur le sens et le comportement linguistique des termes traités.

Objectifs

Sur le plan théorique, la recherche vise, d'une part, à apporter une solution au problème de la modélisation formelle et rigoureuse de la multidimensionnalité inhérente à l'organisation des terminologies (Bowker, 1997), c'est-à-dire le fait que les termes peuvent être appréhendés et les terminologies parcourues selon de multiples axes. D'autre part, et de façon liée, la recherche vise à rendre compte de l'interdépendance entre lexique de langue générale et lexique terminologique.

La recherche porte spécifiquement sur la nomenclature fondamentale de la chimie (par exemple, des termes comme *atome*, *liaison*, *réaction*, etc.)

Une des problématiques centrales de la description des terminologies étant celle de leur traduction, la recherche adopte une perspective multilingue, en s'appuyant sur les travaux de lexicologie théorique et descriptive menés à l'ATILF sur le français, l'anglais et le russe. Sur le plan pratique, la thèse débouche sur des modèles terminologiques multilingues de la chimie pour les trois langues typologiquement distinctes considérées. Ces modèles sont des outils destinés aux scientifiques aussi bien qu'aux enseignants en chimie. La recherche est donc de ce fait destinée à avoir une résonance non seulement dans le domaine de la recherche en lexicologie et terminologie, mais aussi auprès de la communauté des chimistes.

Le projet se situe dans la thématique des études lexicales, qui sont au cœur du projet scientifique du laboratoire ATILF. Il présente l'originalité d'aborder le sujet du *rapport entre terme et non-terme* dans le cadre des travaux menés à l'ATILF par A. Polguère sur les grands réseaux lexicaux. Une exploitation intensive a été faite des modèles lexicaux développés au laboratoire depuis plusieurs années : les réseaux lexicaux du français et de l'anglais (Gader et al., 2014) et, dans le cadre d'une collaboration avec le laboratoire CREE de l'INaLCO Paris (Projet *LEC-ru*), le réseau du russe. En retour, la recherche doctorale a alimenté ces ressources en données sur les terminologies anglaise, française et russe de la chimie.

Méthodologie

Notre approche théorique et descriptive est celle de la *Lexicologie Explicative et Combinatoire* (Mel'čuk et al., 1995), qui a été amplement appliquée à l'étude de vocabulaires terminologiques, tels que ceux de l'informatique et de l'environnement (L'Homme, 2012). Le travail lexicographique a été mené de façon comparative – pour les trois langues prises en compte – afin d'identifier

1) les divergences de structuration terminologiques entre langues et 2) les divergences quant à l'interconnexion entre terminologie et langue générale.

La détermination d'une terminologie fondamentale de la chimie est un préalable à toute étude descriptive et théorique. Un travail préparatoire a été effectué par A. Polguère dans le cadre du projet PEPS Mirabelle STRÉTCH de F. Ingrosso – codirectrice de la thèse –, en collaboration avec deux autres membres l'ancien laboratoire de chimie SRSMC. Ce projet a mené notamment à la construction de deux corpus anglais et français, dont la taille est suffisamment significative (3 millions de mots-occurrences pour chacun des corpus) pour permettre une première estimation des nomenclatures terminologiques à considérer et pour effectuer des expérimentations sur la description terminographique du vocabulaire de la chimie – pour une présentation de l'approche adoptée et des travaux réalisés, voir Ingrosso & Polguère (2015).

Après avoir identifié une terminologie fondamentale de la chimie, nous avons modélisé la terminologie identifiée selon l'approche des Systèmes Lexicaux (Polguère, 2014). Les propriétés formelles des Systèmes Lexicaux permettent d'étudier la façon dont une terminologie donnée pénètre la langue générale et, réciproquement, est pénétrée par elle. La méthodologie a été ancrée dans la modélisation lexicographique des termes (sens, caractéristiques grammaticales, connexions lexicales sémantiques et phraséologie) avec un recours systématique aux corpus textuels de chimie et à l'interaction avec les spécialistes du domaine du laboratoire de chimie LPCT.

Au cours de notre étude, nous avons réalisé des descriptions terminographiques pour 312 unités lexicales (107 unités lexicales anglaises, 103 unités lexicales française, 102 unités lexicales russes) qui constituent le noyau de la nomenclature de la terminologie chimique. Notre ressource multilingue sur le lexique de la chimie avec les connexions riches entre termes, ainsi que les informations sur leur comportement dans les textes, permettra la mise en place de nouveaux outils pédagogiques pour les enseignants et les scientifiques et pourra susciter de nouvelles stratégies sur la pédagogie de la discipline et stimuler la conception de méthodologies innovantes.