



HAL
open science

Contribution to the measurement and improvement of the performance of organizations toward an Industry 4.0 context

Diana Cardenas-Cristancho

► To cite this version:

Diana Cardenas-Cristancho. Contribution to the measurement and improvement of the performance of organizations toward an Industry 4.0 context. Operations Research [math.OC]. Université de Lorraine, 2023. English. NNT: 2023LORR0002 . tel-04210636

HAL Id: tel-04210636

<https://theses.hal.science/tel-04210636v1>

Submitted on 19 Sep 2023

HAL is a multi-disciplinary open access archive for the deposit and dissemination of scientific research documents, whether they are published or not. The documents may come from teaching and research institutions in France or abroad, or from public or private research centers.

L'archive ouverte pluridisciplinaire **HAL**, est destinée au dépôt et à la diffusion de documents scientifiques de niveau recherche, publiés ou non, émanant des établissements d'enseignement et de recherche français ou étrangers, des laboratoires publics ou privés.



**UNIVERSITÉ
DE LORRAINE**

**BIBLIOTHÈQUES
UNIVERSITAIRES**

AVERTISSEMENT

Ce document est le fruit d'un long travail approuvé par le jury de soutenance et mis à disposition de l'ensemble de la communauté universitaire élargie.

Il est soumis à la propriété intellectuelle de l'auteur. Ceci implique une obligation de citation et de référencement lors de l'utilisation de ce document.

D'autre part, toute contrefaçon, plagiat, reproduction illicite encourt une poursuite pénale.

Contact bibliothèque : ddoc-theses-contact@univ-lorraine.fr
(Cette adresse ne permet pas de contacter les auteurs)

LIENS

Code de la Propriété Intellectuelle. articles L 122. 4

Code de la Propriété Intellectuelle. articles L 335.2- L 335.10

http://www.cfcopies.com/V2/leg/leg_droi.php

<http://www.culture.gouv.fr/culture/infos-pratiques/droits/protection.htm>



**UNIVERSITÉ
DE LORRAINE**

SIMPPÉ



École Doctorale SIMPPÉ -Sciences et Ingénierie des Molécules des Produits des
Procédés et de l'Énergie

Laboratoire ERPI -Equipe de Recherche sur les Processus Innovatifs

Thèse

Thèse présentée et soutenue publiquement pour l'obtention du titre de :

DOCTEUR DE L'UNIVERSITÉ DE LORRAINE

Mentions : **Génie des Systèmes Industriels**

Par **Diana Marcela CARDENAS CRISTANCHO**

Sous la direction de **Davy MONTICOLO et Laurent MULLER**

Contribution à la mesure et à l'amélioration de la performance des entreprises vers un contexte d'Industrie 4.0

Soutenue publiquement le 4 janvier 2023 à Nancy

Membres du jury :

Directeur :	Pr. Davy MONTICOLO	Université de Lorraine
Co-directeur :	Dr. Laurent MULLER	Université de Lorraine
Rapporteurs :	Dr. HDR Virginie GOEPP	Université Strasbourg
	Dr. HDR Florent LAROCHE	Ecole Centrale de Nantes
Examineurs :	Pr. Benoit IUNG (Président du Jury)	Université de Lorraine
	Pr. Mickael GARDONI	ETS Montreal
Invité :	Dr. Bertrand MARCONNET	ECAM Lyon

*In an economy where the only certainty is
uncertainty, the one sure source of lasting
competitive advantage is knowledge*

Ikujiro Nonaka

Acknowledgements

Without any doubt this thesis has been a great adventure, which would not have been possible without the support of different people throughout these years. First of all, I would like to thank my thesis directors Davy Monticolo and Laurent Muller for coaching me during these years. Thank you for your valuable contributions, for the discussions, meetings, and for motivating me to go further. I would also like to thank Pascal Lhoste for his valuable advice, ideas and availability throughout this thesis.

Also, a special thanks to Mauricio Camargo, Laure Morel, Valerie Rault and Vincent Boly for their always relevant comments and dynamism in the discussions at the doctoral seminars in the ERPI laboratory, which I consider key for the development of the thesis. I also extend my gratitude to Barthelemy Zoz, thank you for the discussions and allowing me to participate openly in your courses. Thanks to all the ERPI, ENSGSI and LF2L teams, thank you for all your support and cooperation in the different activities I have undertaken.

Thanks to all my doctoral and postdoctoral colleagues for all the discussions and every smile shared: Jose, Benjamin, Juliana, Marie, Anaëlle, Fedoua, Fatima, Nicolas, Maksym, Fangkai, Tu, Neal, and everyone. A special thanks to Alex for your valuable help and for the Ontology working group you gathered. And also, to Fanny, Catalina and Guillaume for embarking with me in the adventure of organizing the NITIM PhD summer school.

What would life be without friends? Thanks, from the bottom of my heart to Natalia and Maxence, thanks for all your friendship, support, positivism and adventures...really looking forward to the next ones. Thanks also to Carlos, for his support and good energy despite the distance. Also, to Linda, Alex, Gio, Diana, Fabio, Tamara, Laurent, thank you for all the beautiful moments we have shared.

Infinite thanks to my family and especially to my parents, Esperanza and Hector, without you none of this would have been possible. Thank you for always believing in me, thank you for helping me grow every day and for reminding me that everything is possible. Thank you to all my family, to those who are here and to those who are no longer with me but will always be in my heart. Thanks also to my in-laws for all your support through the distance.

And closing, the most special thanks, thanks to my husband Ferney. Thank you for filling me with motivation and conviction day after day. Thank you for always being there, thank you for your patience and your unconditional support. Thank you for always pushing me to give the best of me.

Abstract

In the context of Industry 4.0, organizations are constantly confronted with the need to keep on improving their performance in a continuous basis while rationalizing their resources in order to remain competitive in the complex market. For which the Continuous Improvement of Performance (CIP) has been widely recognized by academics and practitioners as a key approach. Nevertheless, recent studies are highlighting a high rate of failed implementations, which raises concerns on the need of clarifying the process of the CIP, and more specifically in how to improve the decision-making within it. Organizations seeking to improve and adapt to increasingly uncertain conditions need to move away from relying on intuitive and satisficing approaches, and instead embrace complexity in their decision-making to become more assertive in improving their performance and sustaining it over time. Therefore, this thesis seeks to assist CIP managers and engineers in better establishing a performance strategy and thus improving the performance under a systemic approach. Consequently, throughout this thesis (1) the CIP process is clarified and formalized through a MASK-KROM approach; (2) based on a literature review and DEMATEL method, an approach for identifying and analyzing the influence interrelationships of performance indicators is developed; and (3) a Decision Support System architecture including an ontology that integrates the complexity of the performance indicator-practice-tool interrelationships is proposed and evaluated. Altogether, it constitutes a methodological approach that helps in eliciting the most relevant performance indicators, and in prioritizing the improvement practices and tools to implement for improving the performance.

Keywords: Performance indicator, continuous improvement, knowledge management, decision making, decision support system, ontology, operational excellence, lean manufacturing.

Résumé

Dans le contexte de l'industrie 4.0, les organisations sont constamment confrontées à la nécessité de continuer à améliorer leur performance de manière continue tout en rationalisant leurs ressources afin de rester compétitives sur un marché complexe. Pour cela, l'amélioration continue de la performance (CIP) est largement reconnue par les académiciens et les praticiens comme une approche clé. Néanmoins, des études récentes mettent en évidence un taux élevé d'échecs de mise en œuvre, ce qui soulève des inquiétudes concernant la nécessité de clarifier le processus de CIP, et plus particulièrement la manière d'améliorer la prise de décision dans ce processus. Les organisations qui cherchent à s'améliorer et à s'adapter à des conditions de plus en plus incertaines ne doivent plus s'appuyer sur des approches intuitives et satisfaisantes, mais plutôt intégrer la complexité dans leur processus décisionnel afin d'améliorer leur performance et de la maintenir dans le temps. Cette thèse a donc pour but d'aider les managers et les ingénieurs du CIP à mieux établir une stratégie de performance et ainsi améliorer la performance dans le cadre d'une approche systémique. Par conséquent, dans cette thèse, (1) le processus de CIP est clarifié et formalisé à travers une approche basée sur MASK-KROM ; (2) sur la base d'une revue de littérature et de la méthode DEMATEL, une approche pour identifier et analyser les interrelations d'influence entre les indicateurs de performance est développée ; et (3) un architecture de Système d'Aide à la Décision comprenant une ontologie qui intègre la complexité des interrelations entre les indicateurs de performance, les pratiques et les outils d'amélioration est proposé et évaluée. Tous ces éléments articulés constituent une approche méthodologique qui permet d'obtenir les indicateurs de performance les plus pertinents et de prioriser les pratiques et outils d'amélioration à mettre en œuvre pour améliorer la performance.

Mots-clés : Indicateurs de performance, amélioration continue, gestion des connaissances, prise de décision, système d'aide à la décision, ontologie, excellence opérationnelle, lean manufacturing.

Table of contents

	Page
Abstract	VII
Résumé	VIII
Table of contents	IX
List of figures	XII
List of tables	XIV
1. Introduction	1
1.1 Context and Motivation	1
1.2 Research positioning.....	3
1.3 Scientific objectives and Research questions	5
1.3.1 Modeling of the Continuous Improvement of performance (CIP) process ...	6
1.3.2 Identification of performance indicators and its interrelationship model.....	7
1.3.3 Design of a Decision Support System for improving the performance	8
1.4 Thesis structure	9
2. Performance: the concept, its continuous improvement, and the decision-making within it	11
2.1 The notion of Performance.....	12
2.2 Challenges in Continuous Improvement of Performance	14
2.3 CIP and organizational decision-making support.....	16
2.4 CIP Decision-Making and the need for a Knowledge Management approach and decision support.....	19
2.4.1 Knowledge Management.....	21
2.4.2 Decision Support Systems	23
2.5 Conclusion	25
3. Unfolding the process of the Continuous Improvement of the Performance 27	
3.1 Knowledge Capitalization: MASK method for structuring and modeling CIP process.....	28
3.2 The conjunction of MASK and KROM for knowledge capitalization.....	30
3.2.1 MASK steps and KROM metamodel for knowledge capitalization	32
3.2.2 Methodology implementation.....	33
3.3 The process of CIP: model proposition	37
3.3.1 Organizational structure model	37
3.3.2 Process model	39

3.4	Conclusion.....	47
4.	Developing a systemic understanding of performance indicators in CIP based on their influence interrelationships	49
4.1	Diving into one of CIP's most representative methodologies: Lean Manufacturing	50
4.2	A combined literature review and DEMATEL method approach.....	51
4.2.1	Performance indicator identification	53
4.2.2	Performance Indicator Cause-Effect Analysis Supported by DEMATEL.....	54
4.2.3	Validation of robustness of analysis.....	59
4.3	Identifying and structuring performance indicators based on their influence interrelationships	60
4.3.1	Performance Indicator Identification.....	60
4.3.2	Performance Indicator Cause-Effect Analysis Supported by DEMATEL.....	68
4.3.3	Validation of robustness of analysis.....	76
4.4	Making sense of performance indicator systemic view	78
4.5	Conclusion.....	80
5.	A Decision Support System for the decision-making process in Continuous Improvement of the Performance	83
5.1	Toward the conception of the CIP-DSS	84
5.2	Positioning the CIP-DSS into CIP process.....	86
5.3	CIP-DSS model proposition	89
5.3.1	General CIP-DSS architecture.....	90
5.3.2	CIP-DSS components.....	91
5.4	Knowledge container: Performance System Ontology	94
5.5	Reasoning logic.....	100
5.5.1	Performance indicators interrelations module	100
5.5.2	Prioritization of practices and tools module.....	104
5.6	Conclusion.....	116
6.	Evaluation and application of the CIP-DSS methodological approach	117
6.1	The methodological approach CIP-DSS	117
6.2	Stage 1: Setup data for performance strategy.....	118
6.3	Stage 2: Performance indicator interrelationships & PSOnto population	122
6.4	Stage 3: Decision support process	123
6.5	CIP-DSS prototype practical application.....	132
6.5.1	Context of application	132
6.5.2	CIP-DSS prototype development.....	133
6.5.3	Practical application	134
6.6	Conclusion.....	138
7.	Conclusion.....	141
7.1	Contributions.....	141
7.2	Implications.....	145
7.3	Limitations and perspectives	146
Appendix A.	Dates and Protocol of interview for CIP experts.....	151
Appendix B.	Activity models of CIP process under KROM metamodel ...	157
Appendix C.	Characterization of interviewed CIP experts.....	163
Appendix D.	Performance Indicators in the literature.....	165

Appendix E.	Performance Indicator definition and objective	171
Appendix F.	Complete matrices obtained from DEMATEL method	175
Appendix G.	Kendall's coefficients sample influence evaluation.....	183
Appendix H.	DEMATEL sensitivity analysis	185
Appendix I.	Performance System Ontology tables	195
Appendix J.	Improvement practices and tools relationships	199
Appendix K.	CIP-DSS decision process: additional use cases	207
Appendix L.	CIP-DSS prototype: questionnaire and screenshots.....	215
Appendix M.	Scientific dissemination and publications	219
Appendix N.	Summary in French	221
Bibliography	231

List of figures

	Page
Figure 1-1: Structure of the document.....	10
Figure 2-1. Simplified Decision-Making process. Taken from (Power, 2002)	20
Figure 2-2. SECI model. Taken from (Nonaka et al., 2000).....	23
Figure 3-1. Knowledge Capitalization: externalizing tacit into explicit knowledge (adapted from (Nonaka et al., 2000)).....	28
Figure 3-2. Knowledge Capitalization.....	31
Figure 3-3. KROM meta-model (taken from (Monticolo, 2015)).....	31
Figure 3-4. Methodology for knowledge capitalization from experts.....	32
Figure 3-5. CIP Organizational structure model	38
Figure 3-6. CIP Process model: Diagram A-0	40
Figure 3-7. CIP Process model: Diagram A0.....	41
Figure 3-8. CIP Process model: Diagram A1 - To support performance strategy	43
Figure 3-9. CIP Process model: Diagram A2 - To support problem resolution.....	44
Figure 3-10. CIP Process model: Diagram A4 - To measure performance indicators.....	45
Figure 3-11. CIP Process model: Diagram A5 - To follow-up & report performance indicators	46
Figure 4-1. Methodological approach	52
Figure 4-2. <i>Example of direct influence among indicators</i>	57
Figure 4-3. Normalized direct influences with 7 criteria: (a) Matrix N; (b) Graphical influence representation.....	70
Figure 4-4. <i>Direct influences for Customer Satisfaction: (a) Matrix N; (b) Graphical influence representation</i>	71
Figure 4-5. <i>First level of Indirect Influences for Customer Satisfaction: (a) Matrix N2; (b) Graphical influence representation</i>	71
Figure 4-6. <i>Second level of Indirect Influences for Customer Satisfaction: (a) Matrix N3; (b) Graphical influence representation</i>	72
Figure 4-7. <i>Sum of direct and first two level of indirect influences: (a) $N + N2 + N3$; (b) Graphical representation</i>	73
Figure 4-8. DEMATEL Influence map.....	75
Figure 4-9. Result of the attribute agreement analysis with Minitab software.....	77
Figure 4-10. Sensitivity analysis - 4 scenarios	79
Figure 5-1. CIP-DSS approach.....	86
Figure 5-2. CIP-DSS interaction in A1 - To support performance strategy	87
Figure 5-3. CIP-DSS interaction in A2 - To support problem resolution.....	89
Figure 5-4. CIP-DSS general architecture.....	90

Figure 5-5. CIP-DSS architecture	92
Figure 5-6. Performance System Ontology - PSOnto.....	98
Figure 5-7. SPARQL queries results Ontotext-GraphDB.....	99
Figure 5-8. PSOnto Knowledge Graph.....	101
Figure 5-9. Total prioritization logic	105
Figure 5-10. Direct analysis	106
Figure 5-11. Indirect analysis.....	108
Figure 5-12. Direct/indirect effect weight allocation.....	109
Figure 5-13. Example of improvement practices and tools.....	111
Figure 6-1. Methodological approach CIP-DSS.....	119
Figure 6-2. SPARQL query for obtaining (1) definition, family and influence direction index for <i>Cost Reduction</i> , and query result	124
Figure 6-3. SPARQL query for obtaining (2) the performance indicators influencing <i>Cost Reduction</i> (with their total influence values), and query result.....	124
Figure 6-4. SPARQL query for obtaining (3) the performance indicators being influenced by <i>Cost Reduction</i> (with their total influence values), and query result	124
Figure 6-5. SPARQL query for obtaining (3) improvement practices and tools having an improvement effect on <i>Cost Reduction</i> (with their improvement values), and query result.....	126
Figure 6-6. SPARQL query for obtaining (4) improvement practices and tools having an improvement effect on <i>Efficiency</i> (with their improvement values), and query result	126
Figure 6-7. CIP-DSS module 1: performance indicator influence map	135
Figure 6-8. CIP-DSS module 1: analysis of performance indicator.....	135
Figure 6-9. CIP-DSS module 2: direct analysis.....	136
Figure 6-10. CIP-DSS module 2: indirect analysis.....	137
Figure 6-11. CIP-DSS module 2: recommended prioritization of practices and tools	137

List of tables

	Page
Table 3-1: Framing of Knowledge Capitalization project	33
Table 3-2: Characterization of interviewed experts	35
Table 4-1: Literature review protocol.....	53
Table 4-2: Performance Indicator families per scientific publications.....	61
Table 4-3: Performance indicators retrieved from literature	63
Table 4-4: Excerpt from the performance indicator direct influence matrix assessment by experts.....	69
Table 4-5: Intensity and direction of the influence indexes for influenced and causal performance indicators.....	73
Table 4-6: Sensitivity analysis scenarios	78
Table 5-1: Domain and scope of PSOnto.....	95
Table 5-2: Excerpt from PSOnto classes	96
Table 5-3: Excerpt from PSOnto class properties	96
Table 5-4: Excerpt from PSOnto object properties	96
Table 5-5: Example of competency questions and SPARQL queries.....	99
Table 5-6: Example: improvement practices - Direct analysis	112
Table 5-7: Example: improvement tools - Direct analysis	112
Table 5-8: Example: improvement practices - Indirect analysis.....	113
Table 5-9: Example: improvement tools - Indirect analysis	113
Table 5-10: Example: prioritized improvement practices	115
Table 5-11: Example: prioritized improvement tools	115
Table 6-1: Example of direct influences among performance indicators	120
Table 6-2: Example of operationalization relationship of practices and tools	121
Table 6-3: Improvement effect of practices on performance indicators.....	122
Table 6-4: Extract of Improvement tools directly impacting Cost reduction	127
Table 6-5: Extract of Improvement practices indirectly impacting <i>Cost reduction</i>	128
Table 6-6: Extract of Improvement tools indirectly impacting <i>Cost reduction</i>	129
Table 6-7: Extract of normalized-weighted direct improvement effect of practices on <i>Cost reduction</i>	130
Table 6-8: Extract of weighted indirect improvement effect of practices on <i>Cost</i> <i>reduction</i>	131
Table 6-9: Total prioritization of improvement practices for <i>Cost reduction</i>	131
Table 6-10: Total prioritization of improvement tools for <i>Cost reduction</i>	131
Table 6-11: Performance indicator improvement	138

1. Introduction

1.1 Context and Motivation

In recent times, society has been facing constant changing and turbulent times, which leads to the industry being confronted with increased complexity, variability, and competition. Changes like the fast-paced technological one that we are facing, brings organizations to be constantly confronted with the need to develop technological, product or organizational innovations in order to cope with the highly dynamic context (Boly et al., 2016). This context with its disruptions and transformations is what is known today as the Industry 4.0 (Ghobakhloo et al., 2021), also known as Fourth Industrial Revolution or Industry of the Future. It comes with new challenges that have the ability to shape how we live and how we work (Schwab & Davis, 2018). It has been receiving an increasing interest from the industry (Liao et al., 2017), driven by the construct that it will have the potential to impact and improve the performance in organizations (Albers et al., 2016). Nevertheless, there does not yet seem to be a clear understanding of how it is intended to happen (Hofmann & Rüscher, 2017).

Therefore, changing contexts like the current one, come with challenges for the industry, pushing organizations to improve on a continuous basis their level of performance in order to remain competitive (S. A. Khan et al., 2019) and to be more effective and flexible while improving their cost, quality and delivery to customers (Psomas & Antony, 2019). Thus, performance is a qualitatively or quantitatively measurable result (ISO, 2015), that represents an organization's strategy outcomes (Defee & Stank, 2005). Hence, Continuous Improvement of Performance plays a fundamental role in organizations, as it has been known over the years, as an approach whose main purpose is to enhance the performance in an organization and in their processes (Hyland et al., 2007).

The relevance of the Continuous Improvement of Performance remains even stronger, especially in the manufacturing sector, as it is expected to be key for making the most out of the current context of Industry 4.0 (Maginnis et al., 2019; Rossini et al., 2019). It has been stated in the literature that its implementation also contributes to the organization's innovation and establishment of a shared culture for facing challenges in the context and thus enduring its sustainability (Hyland et al., 2007). By the implementation of a Continuous Improvement approach, organizations are expected to have an improved performance, seeing impacts in quality, delivery, lead time, inventory levels, employee satisfaction, among others (Ferdousi & Ahmed, 2009), for which an adequate and constant management and measurement of the performance indicators is a must (Liker, 2004).

In spite of the great prominence, essential and strategic role of Continuous Improvement of Performance, it has been evidenced in recent studies that there is a high rate of unsuccessful or non-sustained implementations over time (Mirdad & Eseonu, 2015) and implementations that are unable to sustain or even achieve the expected levels of performance (Lameijer et al., 2022). Some of the reasons for these failures seem to be related to the vagueness on the concept of Continuous Improvement (Bessant et al., 2001), an inadequate organizational culture in the organization (McLean et al., 2015), lack of clarity on performance measurement, prioritization of improvement actions and formalization of its process (Sanchez-Ruiz et al., 2020). Therefore, it becomes clear that there is a lot of work to be done, literature on the subject remains still underdeveloped and fuzzy which urges for deepening further development. A better understanding of performance and the continuous improvement process is needed. In this sense, the motivation for this thesis focusses on contributing to the literature by giving a systemic view and thus aiding in the decision process of improving the performance in organizations. This becomes even more crucial in today's context of Industry 4.0, where there is a continuous increase in the amount of data generated, making the decision-making process further challenging (Nudurupati et al., 2022).

1.2 Research positioning

The Continuous Improvement of Performance (from now on, referred as CIP) is a concept that has been popularized as an umbrella term worldwide implemented through various methodologies (Gutierrez-Gutierrez & Antony, 2019), being Lean Manufacturing, Six Sigma and Lean Six Sigma among the most important and well-knowns (McLean et al., 2015). Research in this field keeps on raising a growing interest among academics and practitioners, but it is leaving aside the discussion on the process of CIP itself (Sanchez & Blanco, 2014). This can be seen in the fact that recent studies on CIP in the current context are only limited to analyzing its relationship with new technologies (Rosin et al., 2020), as catalyzer or moderator (Bittencourt et al., 2021), or its expected benefits (Antony, McDermott, et al., 2022) and challenges within the new context (Núñez-Merino et al., 2020), but do not define, explore or discuss the CIP process. Thus, reaffirming the importance of this subject.

Moreover, despite the widespread adoption of CIP and its strategic role within organizations, multiple studies are highlighting the high rate of failed implementations leading to significant amounts of resources being wasted (Sanchez-Ruiz et al., 2020). This shows that there are several gaps to be filled in the literature, but also suggest that we are starting to see a paradox, the organizations begin their journey for improving their performance, but due to the lack of success on its implementation, they might end up harming its performance and wasting resources on the way.

We observe a lack of a shared understanding of CIP, which begins with the confusion or blurry use of the term. It is indiscriminately used to refer to the entire process, but at the same time also to just the outputs (impacts or improvements) of the said process (Bessant et al., 2001). Recent studies, like the one from Unzueta *et al.* (2020), focus mainly on presenting the expected impacts (process outputs), but leaving aside the how to do it, how to reach that performance improvement. Or studies showing reasons of failed implementations, like high variety of unstructured performance indicators (Belekoukias et al., 2014; Bhamu & Sangwan, 2014), and therefore an inappropriate follow-up strategy (Sanchez-Ruiz et al., 2020).

Literature lacks in analyzing and clarifying the complete CIP process, in formalizing it, and in providing means to improve the decision-making process for identifying the most critical performance indicators (Bhamu & Sangwan, 2014) and for supporting the selection of suitable improvement strategies (Antony & Gupta, 2019). Indeed, today it is possible to observe a significant quantity and diversity of performance indicators, which represent different dimensions or families of the performance besides the traditional financial one (Issor, 2017). However, despite this multidimensional perspective, they remain unstructured, therefore leading organizations to measure a vast amount and variety of performance indicators, but not necessarily relevant for decision-making (Taouab & Issor, 2019).

Moreover, this lack of clarity on CIP performance indicators represents, as a consequence, a considerable consumption and waste of organizational resources (Radnor & Barnes, 2007). This stresses the need to center on the performance indicators towards an improvement in the decision-making in CIP. For being able to focus on the right and most crucial indicators and therefore, approach the fundamental causes instead of the apparent ones (Smeds, 2022).

Subsequently, besides understanding CIP process and identifying the most relevant performance indicators, another issue within CIP that becomes of crucial matter is to have the means to effectively determine how to address the actual improvement of the performance indicators, how to better select improvement strategies (Antony, Lizarelli, et al., 2022). In fact, the identification of the most suitable improvement tools and practices to implement for maximizing performance is recognized as of great importance, but also quite time demanding for organizations (Thomas et al., 2016).

Furthermore, although we are at the dawn of the Industry 4.0, where decision-making should rely on data, in the field for performance improvement it is mostly naturalistic, meaning that most of the times it is based on tacit knowledge and intuition, while at the same time being affected by time pressure and uncertainty (Alaskari et al., 2016; Saurin et al., 2021). Thereby, evidencing a current need for developing a system focused on improving the decision-making in this matter, one that integrates the complexity of interactions among CIP elements.

The aforementioned, leave us with unattached bricks that need to be assembled for improving the decision-making, and thus, move away from the current unstructured and intuition-driven approach in order to achieve better performance results. Therefore, the above discussion leads us to identify the following Scientific Gaps (SG) in the literature, which are going to be addressed throughout this thesis:

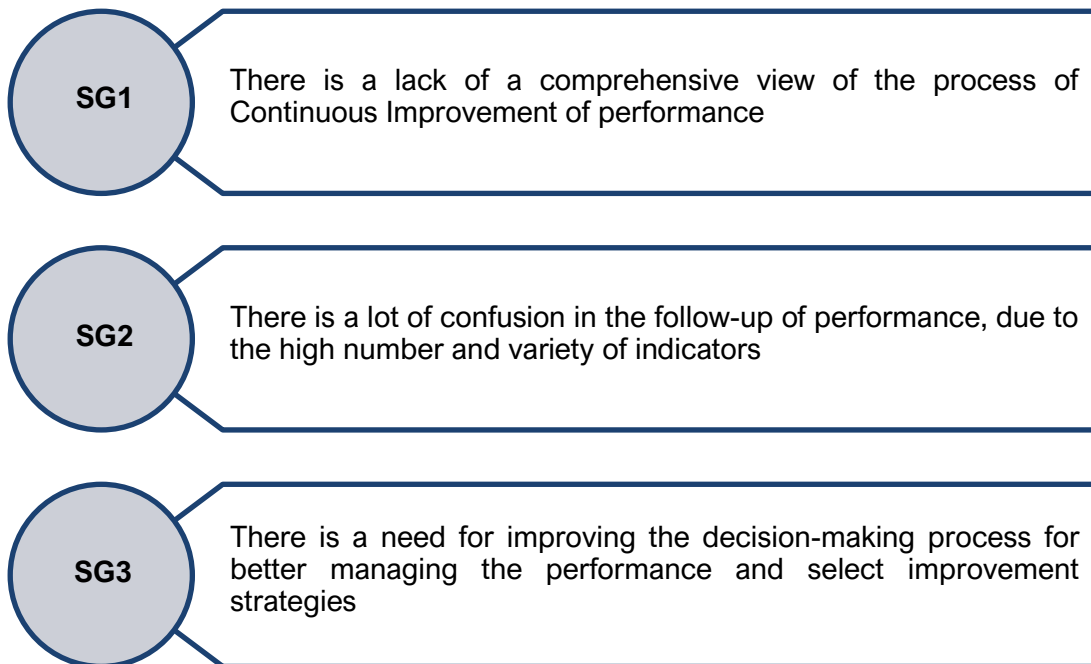

1.3 Scientific objectives and Research questions

Thus, considering the motivation and the aforementioned scientific gaps identified in the literature, the main objective of this thesis is the following:

To propose a knowledge-based approach for the support of decision-making in the Continuous Improvement of Performance integrating the performance indicator-practice-tool interrelationships.

In order to achieve the main objective, it is subsequently expressed by the following specific objectives:

- ➔ To model the process of CIP, by capitalizing the knowledge from experts in order to make it more comprehensible and to highlight the activities and importance of use of performance indicators. Answering in this way to the scientific gap SG1.
- ➔ To identify in the scientific literature the performance indicators and elicit the most relevant ones based on their influence interrelationships. This answers to the scientific gap SG2.
- ➔ To design a Decision Support System for helping in the decision-making process of performance improvement based on the performance indicators and improvement practices and tools. Thus, answering to scientific gap SG3.

With the aim of providing a clear overview of the contributions of this thesis to the readers, the following subsections are developed for introducing each of them.

1.3.1 Modeling of the Continuous Improvement of performance (CIP) process

The process of CIP, as seen before, regardless of its prominence for organizations, has not yet been clarified nor formalized. Moreover, incipient efforts in the literature focus mainly on only the outcomes. Thus, generating major confusions and ending up in unsuccessful implementations. Hence, it becomes crucial, in order to bring forward the research, to focus on understanding, analyzing and then proposing a modeling of the process for the current context we are in (SG1). Therefore, the first contribution of this thesis, which is in line with the first specific objective, aims to answer to the following research question (RQ1).

RQ1: How to clarify and model the process of Continuous Improvement of the performance in the organizations?

With the aim of answering to research question RQ1, we follow a Knowledge Management approach focused on knowledge capitalization from expert interviews, due to the richness of knowledge generated through practice and experience (Kamsu

Foguem et al., 2008) and precisely, the great potential of Knowledge Management in translating this tacit knowledge into something tangible (Ermine, 2003, 2013). Under this approach, industrial experts in the subject will be interviewed with the purpose of understanding the CIP process and subsequently formalizing their knowledge through the process modeling by means of the Method for Analysis and Structuring Knowledge (MASK) (Husain & Ermine, 2021) and Knowledge Reuse Organizational Meta-model (KROM) (Girodon et al., 2012).

By doing so, with this first contribution, we seek to clarify CIP process in organizations by understanding the complexity and identifying the different stages involved in this process, while at the same time emphasizing the importance of decision making for performance improvement. Addressing in this way the need to understand CIP as a complete process that is key to organizations (Antony et al., 2017; Snee, 2010). This CIP process modeling represents the foundation of this thesis, as it allows to better understand the process and to elicit the cruciality of the decision-making process for CIP, and the pivotal importance of the performance indicators in it.

1.3.2 Identification of performance indicators and its interrelationship model

Given the strategic nature of the performance indicators in the decision-making in CIP, but paradoxically, at the same time, their lack of structure, which does not allow to make assertive decisions. There is indeed a need for developing a systemic view of the performance with its continuously increasing number of indicators, for better structuring it for responding to the needs of the field (SG2). Consequently, in order to respond to the second specific objective, this contribution of the thesis is centered to answer the research question (RQ2).

RQ2: How to identify and define the most relevant indicators that will allow to measure and follow-up the performance?

For answering this research question, we seek to offer a new lens to the vision on performance indicators. To integrate a systemic perspective, no longer assuming that performance indicators are independent of each other, but rather embracing the complexity by analyzing and including in the decision-making process the interrelationships of influence that may exist between them. For doing so, a scientific approach will be adopted, comprising the identification of performance indicators in the literature and the subsequent analysis of influence interrelationships among them.

Firstly, for identifying the performance indicators, a literature review will be performed for gathering the information from studies in a synthetic way (Rowe, 2014; Snyder, 2019). Secondly, Decision-Making Trial and Evaluation Laboratory (DEMATEL) (Fontela & Gabus, 1976) will be applied to the identified performance indicators. Applying DEMATEL will allow us to elicit a clear representation of the total interrelationships of influence among performance indicator, as well as to class them into causal or influenced (Si et al., 2018). Allowing us in this way to identify the most relevant ones for better improving performance.

1.3.3 Design of a Decision Support System for improving the performance

The problematic of CIP process as currently managed, relies in the fact that it considers the performance indicators as independent and isolated parts, it is shortsighted by not integrating the complexity of their interrelationships in the decision-making process. Moreover, the strategies for improving the performance are basically established or chosen based on intuition alone, but without proper analysis of the complete performance improvement system as a whole (SG3). A system comprising performance indicators, their interrelationships, and the links with improvement practices and tools. Thus, this thesis contribution, corresponding to the third specific objective, aims at answering the following research question (RQ3).

RQ3: How to assist experts in Continuous Improvement in the decision-making process to improve the performance?

Hence, seeking to answer this third research question, we will propose a support for decision makers (engineers and managers in CIP) in order to assist them in better selecting performance indicators and determining the improvement strategies (practices and tools) to implement for improving a performance indicator, a selection of multiple ones, or even different performance families at the same time. Comprising in it, the performance indicators along with their influence interrelationships and the performance improvement tools and practices with their improvement effect over the performance indicators.

In order to achieve this, as we are undoubtedly talking about complex decisions, for this final contribution of the thesis, a Decision-Support System (DSS) (Power, 2000) is proposed, since DSS are interactive computer-based systems focused on helping in making effective decisions in complex environments (Kasie et al., 2017; Power, 2002). Therefore, a detailed architecture of the system will be presented and explained, as well as an ontology specification including performance indicators, practices, and tools, and a functional prototype of the system.

1.4 Thesis structure

The structure of this thesis is represented in **Figure 1-1**. This document is composed of 7 chapters as follows: this introductory first chapter positions the context and identifies the scientific gaps in the literature regarding our research subject. Following, chapter 2 is centered on giving the lector a clarity on the principal concepts on which this thesis is founded on. Then, chapters 3, 4 and 5 are centered in presenting the contributions of this thesis. Next, chapter 6 describes the implementation of the prototype of the proposed Decision Support System. And finally, in chapter 7, the conclusions, implications, limitations and perspectives are presented.

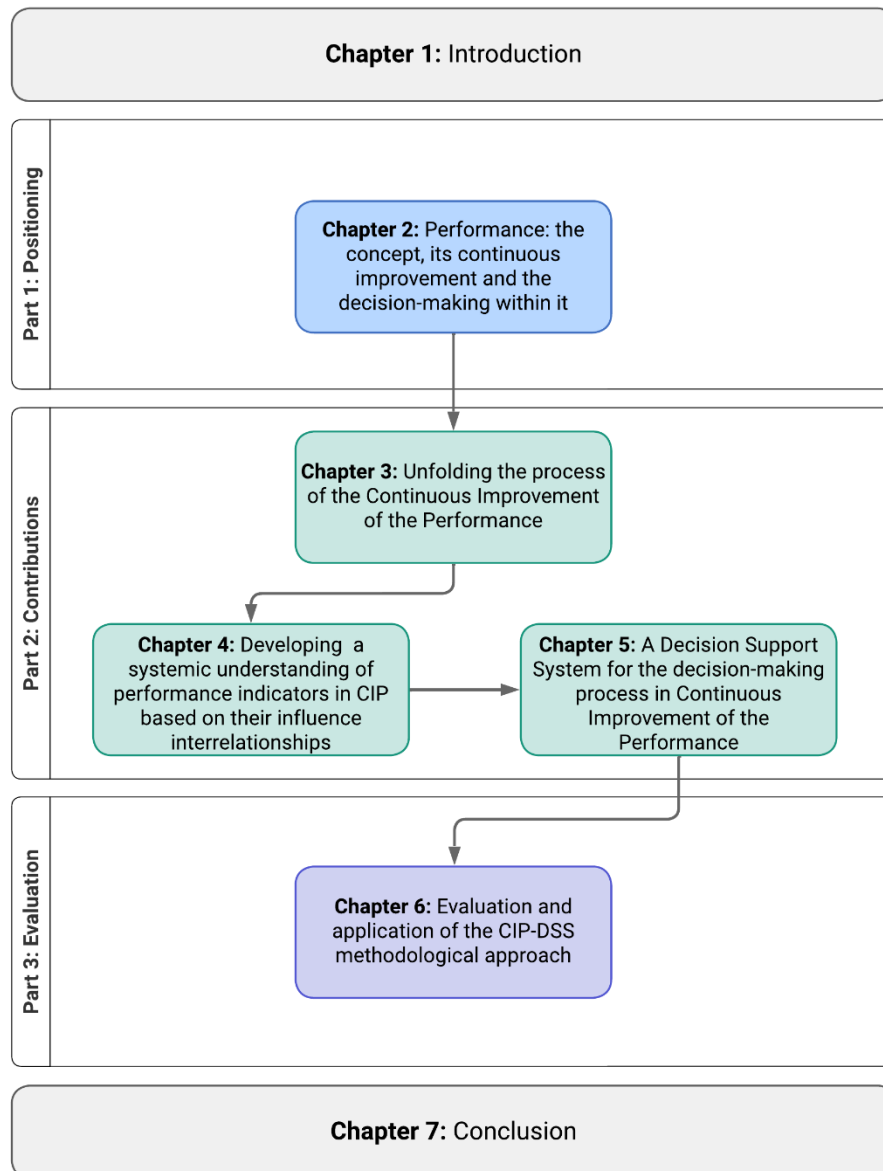

Figure 1-1: Structure of the document

2. Performance: the concept, its continuous improvement, and the decision-making within it

From its beginnings, the Continuous Improvement of Performance, CIP, has been recognized as a key approach for the performance improvement (Gonzalez Aleu & Van Aken, 2016), whose adoption rate is constantly increasing worldwide (Hyland et al., 2007). According to the literature, CIP was originated in Japan after the Second World War, it was started to be used as an approach and philosophy for performance improvement rather than only as isolated initiatives. Becoming in this way, one of the foundations of the success of the Japanese manufacturing, emerging since then as a competitive approach for organizations (J. Singh & Singh, 2015).

As described in the literature review developed by (Sanchez & Blanco, 2014), the firsts definition and references of CIP in the literature date from the 1980's. Since which and until today, it is highlighted that CIP is not a one-time effort, but rather a process to sustain on doing over time. A process seeking to contribute to the performance of the organization (Gutierrez-Gutierrez & Antony, 2019). In which some key factors for its success include the knowledge development and involvement of the organization (McLean et al., 2015), the alignment of CIP and organizational objectives and a management commitment (Paipa-Galeano et al., 2020).

This umbrella term to which we refer as CIP, encompasses numerous methodologies, such as, Lean Manufacturing, Six Sigma, Lean Six Sigma, Total Productive Maintenance, Total Quality Management, among others (Patel & Patel, 2020). This concept has been evolving along with the changes in the environment, it has been constantly ratifying its great importance, given the need and constant quest of organizations for improving their performance (Soltan and Mostafa, 2015), for remaining

competitive in the market (J. Singh & Singh, 2013) and for having the ability to adapt to the new context (S. A. Khan et al., 2019).

As has been mentioned, CIP is fundamental for improving performance, but it has not yet been defined what is understood by performance, what are the challenges of CIP to achieve this performance improvement, and by means of which approaches we can achieve this objective of performance management and improvement. Therefore, the remaining of this chapter is structured as follows: first, a focus is made on clarifying the notion of performance; then we will go into detail on the challenges identified in the literature concerning CIP; and then finally we will delve into approaches that could help us cope with them.

2.1 The notion of Performance

Performance is understood in the literature as a result that shows the comparison of how the processes are actually being carried out against a given standard in an organization (Rosman et al., 2017). This measurable result could be either quantitative or qualitative (ISO, 2015). It should contribute to the strategic objectives of the organization and to the creation of value. Therefore, the analysis of performance should cover the short, medium and long term (Issor, 2017), suggesting that nowadays, performance has a particularly strategic scope, which should at the same time consider the expectations of various stakeholders (Marche, 2018).

However, the notion of performance has undergone an evolution over the years, from being analyzed under a purely financial focus lens (Nudurupati et al., 2011); to having a broader, multifaceted (Lakri et al., 2015) or multidimensional view (Staedele et al., 2019). This evolution goes hand in hand with the various changes and challenges in today's complex environment (Issor, 2017), driving more interest than before on other aspects, such as flexibility and human and social dimensions. This is also emphasized by Beelaerts van Blokland et al. (2019), who highlight that by keeping a purely financial view of performance, the real current and future situation of company performance might be neglected.

Based on the above, we could summarize by saying that:

Performance is a qualitative or quantitative outcome of an organization. It has a strategic nature, and it is multifaceted, comprising different groups of criteria (quality, time, cost, human factors, etc.)

Once clarifying the notion of performance and its strategic nature, in order to attain a better performance and support the decision-making process, it becomes then of high importance to be able to measure the performance (Taouab & Issor, 2019). It has been noted that performance measurement plays a key role in the organization, but especially for managers when it comes to identifying the potential areas in a company for making improvements and further enhancing the levels of performance (Mirdad & Eseonu, 2015).

Performance measurement is understood as the use of a set of indicators reflecting the multidimensional nature of the performance, which are then used for the planning and management within an organization (Bourne et al., 2003). It is the process of quantifying its different indicators, reporting them, analyzing them, and taking actions, which should result in improvements, better control and innovations (Radnor & Barnes, 2007). Performance measurement has an essential function, it is based on the organization strategies and should be intended not only to monitor the performance, but to improve it on an ongoing basis, in order to achieve continuous improvement.

Then, in order to improve performance, its measurement is critical, in which there are two main factors: what to measure (i.e., performance indicators) and how to measure (i.e., methods, technologies for data collection and calculation). In this sense, the selection of the appropriate performance indicators is with no doubt recognized as a key and highly valuable process (Neely et al., 2000). Its measurement contributes to value creation, it is strategic to assess the current state of an organization and help in the decision-making process for analyzing future improvements.

Nevertheless, some authors have remarked that this is still a subject that generates a lot of confusion among researchers and practitioners (Bourne et al., 2018). There is indeed

a lot of misunderstanding, resulting in the measurement of an increasing amount of performance indicators, but without knowing or understanding which ones are truly relevant (Taouab & Issor, 2019). Therefore, even if performance measurement is essential for organizations, it is being perceived as highly time and resource consuming (Radnor & Barnes, 2007).

Thus, the real challenge that arises from literature is to be able to determine the right indicators to measure. To be able to develop a set of performance indicators that are coherent and connected in order to measure performance as a system, rather than multiple indicators measuring only specific parts or activities in an isolated manner. Generating in this way a motivation for exploring the interrelations among performance indicators to achieve a more comprehensive view of performance in CIP and thus impact the decision-making process.

2.2 Challenges in Continuous Improvement of Performance

Literature often shows that the implementation of CIP in organizations brings substantial improvements in performance levels (Ni & Sun, 2009). These improvement can be of qualitative or quantitative nature (Bhamu & Sangwan, 2014), like better quality, delivery and employee satisfaction (Ferdousi & Ahmed, 2009). However, on the other side of the coin, there are also studies showing the not so ideal side of CIP implementations, evidencing cases that do not achieve the goals (Mosadeghrad, 2014) or these fade in the short term (Soliman, 2013).

Mostly in recent years, we have been noticing a concern in the literature regarding the failed implementations of CIP. Some of which refer to a project level, relating to the failed improvement strategies (performance improvement practices and tools implementation) for specific identified needs, not delivering the expected benefits; and others even referring to an upper level, the organizational one, denoting the discontinuation and termination of the adoption of CIP methodologies in general by the organizations (Lameijer et al., 2022).

Some authors have tried to delve into the reasons for these failures, in order to give hints towards the sustainability of CIP implementations. Among the identified reasons for failure, there is the lack of engagement (Antony et al., 2019) and support from top management (Mosadeghrad, 2014). Which goes hand in hand with the lack of clarification the CIP process (Bhamu & Sangwan, 2014) and how it fits into the organization strategy and goals. Since while not having a clear understanding of the CIP process and how it contributes to the organization, its added value may be underestimated, and therefore, its impact may be prone to be minimized by the top management and therefore be left aside.

Furthermore, it is noted that in fact, the reported unattained or non-sustained performance improvements lies highly in a faulty selection of CIP practices and tools to implement (Asif, 2021). In which play a fundamental role the large and unstructured quantity of practices, tools (Sony et al., 2019) and performance indicators through which follow its improvement (Bhamu & Sangwan, 2014). Then, the decision-making process for selecting the adequate improvement practices and tools that best correspond to the analyzed problem should be properly handled, even if it is high time demanding (Antony & Gupta, 2019). Otherwise, if the most suitable CIP practices and tools are not selected, its implementation is doomed to fail either on the short or medium term (Sony et al., 2019).

Despite the importance and relevance of CIP, it is still a subject that needs to be further developed in order to reduce the unsuccessful implementation rate in CIP, and with that the resources that are being wasted with every attempt (McLean et al., 2015). Therefore, there is a need to have an overarching vision of the CIP process in the industry, for allowing to understand it in a comprehensive manner and better identify how to strengthen the critical decision-making process for better achieving the expected improvements (Mumani et al., 2021).

There is a recent effort in the literature for taken a holistic view on CIP. This is the case of the study form Lameijer et al. (2021), in which they look to identify the readiness and sustainable factors that could help the deployment of CIP in an organization toward a higher maturity level. Studies like this one are very valuable, as they evidence the need

to move forward in the study of CIP, nevertheless, they still do not address CIP as an organizational process, how to operationalize and manage CIP.

2.3 CIP and organizational decision-making support

As discussed, CIP is a key process for organizations, making its main methodologies increasingly popular and implemented all over the world. But at the same time, there is a high incidence of unsuccessful implementations, in which, besides the lack of clarity of CIP process itself, and an unstructured view of its performance indicators, a poor choice and prioritization of improvement practices and tools plays an important role, becoming a significant challenge for organizations (Elkhairi et al., 2019; Naeemah & Wong, 2021).

There is a need for better selection of practices and tools to improve performance (Amin & Karim, 2013), as organizations are currently struggling to do so in an effective way (Reda & Dvivedi, 2022). At the same time, in recent years it is seen that the literature is quite scarce in studies making efforts to address this issue (Naeemah & Wong, 2021), even if it has been strongly suggested (Yahya et al., 2016). In the existing literature, most of the studies do not rely yet on computer aided systems, nevertheless, there is a high use of multi-criteria decision-making methods (MCDM).

This is the case of the studies such as the one of Nowotarski et al. (2021) with the application of Analytic Hierarchy Process (AHP) in the construction sector for the prioritization of pre-selected tools. Other examples are those of Shukla et al. (2021) and K. Singh et al. (2021), both use the Best Worst Method (BMW) as a means to determine weights to criteria for prioritizing improvement projects in the automotive sector. Lastly, there is the study of Ortíz et al. (2015) with the application of DEMATEL and Analytic Network Process (ANP) for evaluating project alternatives in healthcare sector.

The aforementioned studies begin to focus on the problematic of selecting the right improvement strategies, but they fall into applying MCDM for prioritizing already pre-selected improvement alternatives with not so much detail on it. But in doing so, they do

not consider CIP as a complex system, and thus neglect the interaction between the elements by overlooking the improvement effects of practices and tools upon performance indicators and the influence interrelationships among the latter ones. In consequence these studies do not address the problem in decision-making in CIP, instead there is a high reliance on intuition and tacit knowledge without a clear structure (Saurin et al., 2021) and the insufficient importance given to the interactions or impacts as a system (Mumani et al., 2021).

However, there are other studies in recent years that go further by already proposing more detailed methodologies that begin to incorporate the relationship between some tools or practices with performance indicators or with wastes. Among these are the works of Reda & Dvivedi (2022) and Bhuvanesh Kumar et al. (2022), they start by the implementation of the Value Stream Mapping (VSM) for identifying the wastes in the process. Next, on the one hand, the former conducts an identification of the critical resources in the process by a fuzzy Quality function Deployment (QFD), followed by the identification of improvement tools for the prioritized failure modes by implementing fuzzy Failure Mode and Effect Analysis (FMEA).

On the other hand, the latter, after the waste identification, does a selection of improvement tools and techniques upon expert opinion and literature, for consequently prioritize them by using fuzzy Technique for Order Preference by Similarity to Ideal Solution (TOPSIS) and Complex Proportional Assessment (COPRAS). Neither of these two studies proposes a system that eases the decision-making process, they do not allow the analysis of different scenario without having to apply the complete methodology over again, making their proposals too time-consuming to be applied on a day-to-day basis (Naeemah & Wong, 2021).

From their side, Mendes et al. (2021) propose a Decision Support System (DSS) that begins with a yes/no questionnaire to the users, with which identifies the wastes present in the organization and then, based on the organization economic activity, the DSS filters and shows the improvement tools or practices that can be applied. However, there are three important points to consider: first, they do not differentiate between tools and practices, and they do not prioritize them, but only filter them by industry sector. Therefore, do not give the user a vision of which practices or tools to first focus on.

Second, although the practices are filtered based on their alleged applicability to each specific industrial sector, there is no explanation of how this was done. And third, the architecture of the DSS is not shown nor detailed.

Finally, Alaskari et al. (2016) propose a methodology based on performance indicators, critical factors affecting the performance indicators and improvement tools. Their study is very valuable, as they begin to question and integrate the level of importance and impact of the relationships between the indicators (through critical factors) and the tools, for the prioritization of the latter ones. However, they also present some limitations: they are reductionist by only taking into account 4 improvement tools and 5 performance indicators, where their relationships are always considered positive. Furthermore, they also assume that performance indicators are independent without considering the interrelationships between them.

The reviewed studies start to give us some perspective on the challenges (in terms of difficulty and resource-consuming) and importance of an adequate selection and prioritization of improvement strategies (Reda & Dvivedi, 2022), as well as the relevance of applying MCDM methods for this means (Naeemah & Wong, 2021). But we believe that for effectively supporting CIP experts on their decision-making process, just the application of MCDM methods is not enough, but rather an integrative methodology and a system easy to use by CIP engineers and managers without computer or mathematical technical backgrounds. Furthermore, none of the reviewed studies seem to position their proposed methodologies or approaches within a clearly defined CIP process, thus, making it difficult to really understand how they would impact such process (Mumani et al., 2021).

On top of that, even if in the literature there are studies acknowledging that CIP is indeed a complex system (Elkhairi et al., 2019), in which the interactions between the elements of the system must be considered for a better analysis (Saurin et al., 2021), the previously discussed studies still lack in further integrating this complexity into the selection and prioritization of improvement strategies. In most of the cases these approaches go in line with what Mintzberg et al. (1976) referred as a “satisficing” decision-making by reducing the complexity, meaning that most of the authors seem to disregard influence interrelationships among performance indicators, or opt for a

reductionist view, by analyzing only just a handful of tools or practices. While few others have attempted to consider the complexity but end up in proposing highly complicated and time-demanding approaches, making them unpractical to be used in a daily basis by CIP experts.

Therefore, it is more relevant than ever the need for addressing the decision-making process by including the complexity of the performance system (relationships of performance indicators and improvement strategies), while at the same time ensuring simplicity and convenience in their use (Naeemah & Wong, 2021). Improving a company's decision-making capacity requires a change of paradigm, setting in the first place the prioritization of improvement strategies based on performance indicators rather than on wastes, as they clearly represent the improvement of the organizations (Alaskari et al., 2016).

2.4 CIP Decision-Making and the need for a Knowledge Management approach and decision support

There is a growing need to assist CIP experts as decision-making processes become increasingly complex and, at the same time, unstructured and highly reliant on intuition (Saurin et al., 2021). Ultimately, this has a strong impact on performance results, which in turn may affect the adoption and sustainability of CIP in organizations (Mumani et al., 2021).

Therefore, it becomes relevant to discuss about decision-making itself. The study of decision-making is something that have intrigued humanity for quite long time starting in the ancient Greece, and being its apogee since 1950s (Peterson, 2017). Where decision is defined as a "specific commitment to action (usually a commitment of resources) and a decision process as a set of actions and dynamic factors that begins with the identification of a stimulus for action and ends with the specific commitment to action" (Mintzberg et al., 1976, p. 246).

Then, a decision-making process constitute the different analyses that have to be done in order to arrive to a decision. **Figure 2-1**, illustrates a simplified process proposed by (Power, 2002), in which it can be appreciated that decision-making is not just about deciding. The decision-making process comprises a series of steps that begin with the definition of the problem, deciding who is responsible for deciding, collecting the needed information, identifying, and evaluating alternatives, deciding upon those alternatives, implementing, and following up.

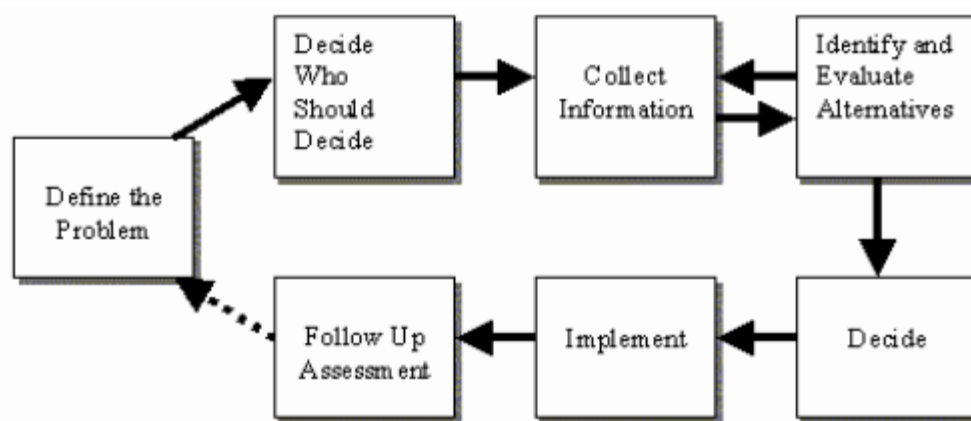

Figure 2-1. Simplified Decision-Making process. Taken from (Power, 2002)

Notwithstanding, making effective decisions, decisions that are able to achieve the desired initial objectives (Power et al., 2019) is not easy to accomplish. It is in fact a complex and high knowledge-intensive process, for which a high amount of information should be needed, but due to business constraints, more decisions are needed to be taken in less time, leading to lower levels of effectiveness and quality in them (Jones, 2006).

Furthermore, decision makers are confronted with decision problems that often surpass their intellectual capacities (Molloy & Schwenk, 1995). Most of the times, humans are only able to effectively handle around seven facts (Saaty, 1990). Thus, in complex scenarios, effective decision-making represents a heavy mental load for decision makers. Consequently, by nature, they tend to cope with this complexity, by doing an oversimplification of the complex environment (Gras et al., 2020), or just opting for barely acceptable solutions, instead of more suitable ones (Hosack et al., 2012).

Nevertheless, regardless of the human limits to process information, we find in the literature, that it is indeed difficult to assure that the decision makers could have all the needed information that they should for making effective decisions, which at the same time brings uncertainty to the process (Apolo-Vivanco et al., 2021). However, we are stepping into a new context where thanks to new technologies, organizations are having large amount of data at disposal, which paradoxically complexifies even more the decision-making, as organizations are not ready to handle such volume of information (Nudurupati et al., 2022).

Additionally, as decision makers are often facing with very varied and fragmented activities and conditions (Mintzberg et al., 1976), this makes it difficult to maintain an integrated view of the decision-making process and the business process of which it is part. Then, it becomes relevant and needed to support and enhance the decision-making, for which a departing point is the context of the decision and how they are made and how they should be made (Power, 2002).

2.4.1 Knowledge Management

Knowledge is something intrinsic to every organization and when well-managed, it can represent a real leverage for innovation, sustainability (Mårtensson, 2000) and for increasing an organization competitiveness (Meski et al., 2021). According to the literature, knowledge can be defined as something that constitutes a belief, the truth of which is founded on the interactions of individuals with the world (Nonaka et al., 2006). Knowledge is the complex set of various elements, such as experiences, information, values, norms and perceptions that originates within people (Arfi et al., 2019; Davenport & Prusak, 1998). It is what can allow people and organizations to prepare, decide and perform a particular task or a problem (Nonaka & von Krogh, 2009).

In fact, knowledge constitutes a fundamental part in CIP methodologies (L. Zhang & Chen, 2016). Among other factors, the knowledge of people and how it is used and shaped, is considered to strongly impact the implementations of CIP methodologies (Dombrowski et al., 2012). Indeed, its management is seen as an asset that can really

contribute to enhance performance improvement in CIP implementations (Ni & Sun, 2009). The amount of knowledge generated in people through practice, experience and continuous implementations is certainly something that is not to be neglected, it is worth analyzing, even if challenging (Kamsu Foguem et al., 2008).

Knowledge Management is not only relevant in CIP, it has been widely studied, with a remarkable increase of interest from academic researchers as well as practitioners over the last decades (M. R. Lee & Chen, 2012), in part thanks to the advancements in technology which enables data accessibility (Sarka et al., 2019). It is a management approach that encompasses the mechanisms and processes through which the creation, sharing and re-utilization of knowledge is enabled (Mårtensson, 2000), in line with the achievement of organization goals (Bolis et al., 2012) and the sustainability of its competitive advantage (Grimsdottir & Edvardsson, 2018). Being thus considered as strategic in the era of the knowledge economy, while aiming at creating value, developing intangible resources, and improving the competitiveness in organizations (Patil & Kant, 2014).

Knowledge management is grounded on the organizational knowledge creation theory by Nonaka and Takeuchi (1995). It acknowledges that there is a difference on how knowledge was being seen and appreciated in the west and in the east. While in the former one, mostly what was appreciated as knowledge was the one already documented and represented by words and numbers (explicit). Instead, in the latter one, explicit knowledge, what is visible, only represents a small portion. It recognizes that the most valuable part is in fact not visible and not easy to understand, the tacit knowledge (Nonaka, 1991). Hence, there are two complementary types of knowledge, the tacit and the explicit. And is therefore through its interaction that the process of knowledge creation is enabled (Nonaka et al., 2000).

In the theory it is stated that the creation of knowledge process is done through a four stages model: socialization, externalization, combination, and internalization. Which is known as the SECI model (see **Figure 2-2**). It expresses the knowledge creation or crystallization as a never-ending spiral that starts with the individual tacit knowledge (it represents the know-how, expertise and perceptions of people) that is subsequently transformed into explicit knowledge through conceptualization (Konno et al., 2014). This

knowledge is then shared among and across organizations, for ultimately being internalized by individuals, providing a greater understanding and then generating more tacit knowledge (Nonaka & von Krogh, 2009).

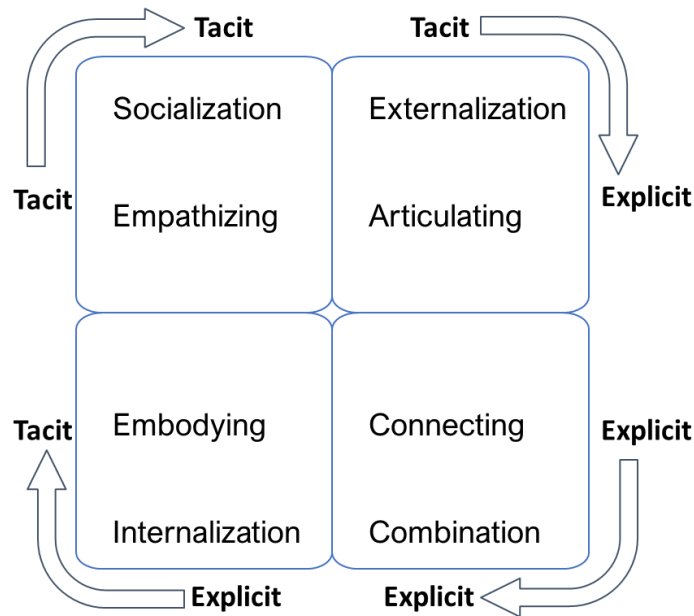

Figure 2-2. SECI model. Taken from (Nonaka et al., 2000)

Knowledge management builds up on this theory, it is a strategic approach that is centered in supporting the knowledge creation process (Matta et al., 2001). It is focused on analyzing the organization knowledge as a resource, with the main objectives of knowledge capitalization (valorize the knowledge and preserve it), sharing (not only related to the knowledge circulation, but to reaching a collective intelligence) and creation (linked to the permanent innovation of organizations) (Ermine, 2003; Kamsu Foguem et al., 2008). Therefore, within Knowledge Management, we will be particularly interested in knowledge capitalization, or in other words, the externalization of tacit knowledge into explicit.

2.4.2 Decision Support Systems

Knowledge Management is considered, among others (e.g., computer science, management science with MCDM, etc.), as a reference discipline on which the decision

support is grounded (Eom, 2008). Knowledge Management has in fact a twofold impact on decision support, as on one hand, this approach, through the capitalization of knowledge, could help us understand the context on which our decisions will be taken and how they flow through the CIP process.

And also, on the other hand, it can help us for structuring, managing and reusing the knowledge needed for the effective decisions (Burstein & Carlsson, 2008). For which, ontologies are widely recognized (Abecker & van Elst, 2009), especially in complex decision-making (Delir Haghighi et al., 2013). As they are defined as explicit specification and representation of knowledge of a particular domain, containing classes, relationships, axioms and instances (Meski et al., 2021).

Decision support is known as a continuous effort to support or help decision makers in making rational decisions (Power et al., 2019), where Decision Support Systems (DSS) surged since 1970's as a conjunction between decision-making and computer-based technology areas of research for ensuring decision-making (Shim et al., 2002). DSS research has kept on evolving ever since, and with it our understanding and research dept on decision-making, which has been further complexified by the speed at which decision must be made in the current context (Hosack et al., 2012).

DSS are defined as computer-based systems created for aiding users in an interactive way in making effective decisions in dynamic and unstructured or semi-structured situations (Kasie et al., 2017). With the characteristic of simplifying the decision-making process for the decision makers while reducing the negative consequences of their information processing limitations, without the aim to replace but to enhance them (Power, 2002). DSS are seen as an approach for supporting decision-making with the use of various techniques, among which are optimization models, case-based reasoning (CBR), (G. Zhang et al., 2015), MCDM, ontologies (Ben Souissi et al., 2019), etc. Whose usefulness keeps on increasing hand in hand with technology evolution (Meski et al., 2021).

Therefore, for this thesis it is through the knowledge capitalization in Knowledge Management, by clarifying and formalizing the CIP process, that we will be able to comprehend the decision-making in CIP and what it implies. In order to understand and

identify the key areas where to support CIP managers and engineers through the proposal of a DSS. This with the objective of improving performance in organizations and thus contribute to reduce failed CIP implementations.

2.5 Conclusion

This chapter was focused on presenting and discussing the central concepts for this thesis, the Continuous Improvement of Performance (CIP) and the Performance. It has shown the importance and strategic nature of CIP in organizations for their performance improvement, since its origins dating from 1980's, until today through the various methodologies comprised within this umbrella term. Also, it was discussed how the understanding of performance has evolved from a single financial perspective towards a multifaceted one, and the importance of it for having a clearer picture of present and future organization's situation.

Moreover, throughout this chapter it was discussed how despite the great advances and widespread adoption of CIP in organizations, mostly in recent years, there are studies questioning its ability to sustain performance improvements over time, or even attain the promised goals. Thus, it was possible to discern the current issues that arise from the literature concerning CIP, starting with the absence of clarity on the process of CIP within organizations, following with an unstructured view of its performance indicators, and an urgent need to improve the decision-making for a more effective prioritization of improvement practices and tools, that would better impact on the desired performance indicators.

It was as well discussed what decision-making is and the different efforts made by scholars in order to support the decision-making in CIP for selecting improvement practices and tools, and also why they still fall short. Finally, there were presented two promising approaches, Knowledge Management and Decision Support System, that will help us in answering to the research questions of this thesis.

3. Unfolding the process of the Continuous Improvement of the Performance

As argued in the precedent sections of this thesis, CIP has a fundamental importance within organizations, it is at the heart of transformations seeking to improve the performance. Yet, CIP process is still quite enigmatic, despite its strategic role, with no overarching vision, heading organizations into a state of confusion, which might end up in non-sustained performance improvements or CIP implementations that do not achieve their promised improvement goals.

Therefore, this thesis chapter seeks to answer to our first research question (RQ1: How to clarify and model the process of Continuous Improvement of the performance in the organizations?), by proposing a comprehensive model of the process of CIP. As seen on Chapter 2, the aim of doing so is to provide practitioners and researchers with a better understanding and clarification of what the process of CIP is. But also, to identify where the decision-making occurs throughout the CIP process and what its critical points are, in order to be able to better propose a decision support through subsequent chapters of this thesis.

On this basis, the next section of this chapter introduces the interest on knowledge capitalization for knowledge externalization. Then, we dive into the description and implementation of our approach for knowledge capitalization. Next, the proposition of models of CIP process is presented and discussed.

3.1 Knowledge Capitalization: MASK method for structuring and modeling CIP process

Given the lack of formalization of the CIP process in the literature, and since the richness of knowledge is tacit in the experts' minds (Dombrowski et al., 2012), and it is precisely the direct experience which is the most important and powerful source of knowledge (Nonaka & Takeuchi, 1995). Then, our objective is to explore and access experts' knowledge of CIP practitioners. In order to understand what CIP represents today in organizations, its strategic role, and to begin to see and analyze it for what it really is, a complete process and not just separate and disconnected pieces of it (Antony et al., 2017).

For this reason, we seek to transform the unstructured tacit knowledge of CIP into something tangible and explicit. We therefore center ourselves for this chapter's contribution on Knowledge Capitalization, which in the knowledge creation process, is the process of externalizing the tacit knowledge into explicit one (Fradi et al., 2022), as shown in blue in **Figure 3-1**.

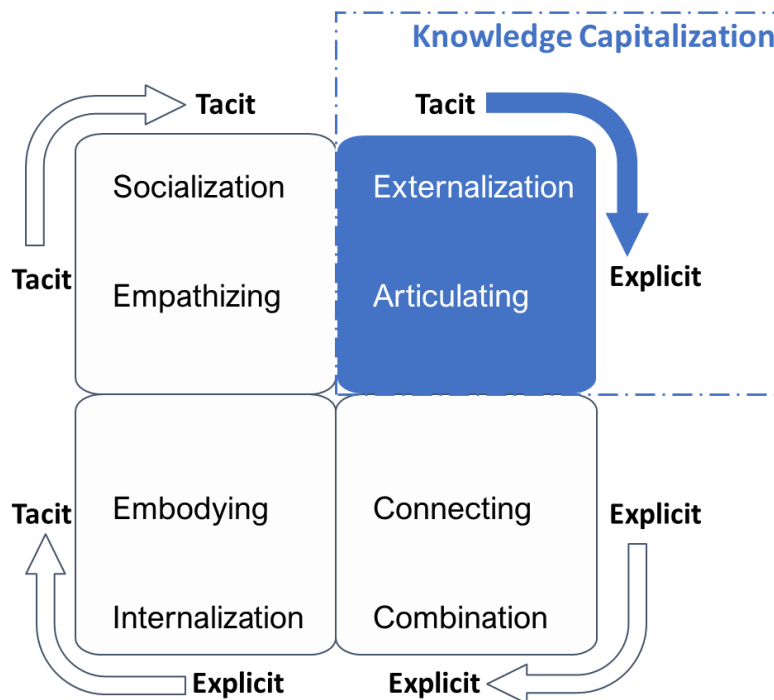

Figure 3-1. Knowledge Capitalization: externalizing tacit into explicit knowledge (adapted from (Nonaka et al., 2000))

From an engineering perspective, there are two techniques for transforming tacit knowledge into explicit. The first, direct knowledge extraction, is focused on extracting knowledge from the activity of the organization (e.g., data mining). And the second, knowledge capitalization, for extracting knowledge from experts by interviews and then modelling it (Matta et al., 2002). Considering the current absence of formalization of CIP process and the fact that the first technique requires a large amount of data (Ermine, 2003), we are interested in the valuable source of knowledge of the CIP domain experts. Therefore, we opt for the second technique in order to capitalize or externalize the tacit knowledge from the experts into comprehensive models.

When referring to the methods for the capitalization of knowledge there are several ones established in the literature, namely, REX, MASK, CommonKADS, KOD (El Amrani et al., 2021), CYGMA, workshop FX, MEREX, and Componential framework (Dieng et al., 2001). These methods in general seek to provide multiple ways to capture and formalize the sources of knowledge within an organization, a process, or a job. However, they all differ in terms of the way knowledge is represented and organized, the tools that are used and where they are applied (Dieng et al., 2001).

Perhaps some of the most known methods oriented to knowledge modeling are MASK, CommonKADS and KOD (El Amrani et al., 2021); they can be characterized in either bottom-up (starts with obtaining verbal data, and based on it builds a knowledge model) or top-down (it is a model-driven approach, it starts with the definition of models, then based on these models guides the knowledge acquisition) (Chergui & Chakir, 2020), being the top-down (CommonKADS and MASK) more generalizable and reusable (Rasovska et al., 2008).

Particularly, MASK method allows for the knowledge acquisition and modelling to be developed at the same time, opposite to CommonKADS. For this reason, MASK is recognized to be more flexible than CommonKADS, and thus, to be more time efficient (Guaglianone & Matta, 2012). Therefore, from the different knowledge capitalization methods, and for the purpose of this chapter, MASK method is followed.

3.2 The conjunction of MASK and KROM for knowledge capitalization

MASK (Method for Analysis and Structuring Knowledge) is a well-recognized method that has been developed with the aim of capitalizing the knowledge and subsequently sharing it (Husain & Ermine, 2021). It was born from the evolution of a line of methods, first MOISE (organizational method for expert systems engineering), and then, MKSM (Method for knowledge management) (Ermine et al., 1996). It has been constantly improved through its multiple applications for now almost 30 years (Aries et al., 2008).

MASK is based on interviews to experts (Matta et al., 2002), where experts are understood as people who have accumulated a relevant amount of knowledge in a specific domain (Oble, 1992). MASK extracts their knowledge and interactively transforms this tacit knowledge into explicit with the help of formalization and expert validation by means of models (Aries et al., 2008). Thus, MASK is both, a method for knowledge capitalization, and an ensemble of models that are proposed to be used.

Hence, given our motivation, we follow MASK method for developing the interview protocol. And as for the models to be used for formalizing the knowledge, as shown in **Figure 3-2**, we opted for Knowledge Reuse Organizational Meta-model (KROM), as KROM focuses on organizational modelling based on expert knowledge (Girodon et al., 2012). By combining MASK and KROM we can clarify the knowledge on CIP in terms of its organizational structure, goals, missions and subprocesses. Further, also it allows us to zoom down to the level of activities and elicit the used and shared data that is needed for developing each of them (Barrios et al., 2017).

Thus, KROM allow us not only to better understand the strategic nature of CIP in the organizations, and also to formalize how this process is managed through the clarification of the subprocess and how they and its activities are connected. As depicted in **Figure 3-3**, KROM meta-model is composed of 4 models: organizational structure model, from which by iterative zooming into the elements, there are the process model and the activity model, and finally, the role model (Monticolo, 2015). For the scope of

this thesis, we will be centered on the three first models, which are outlined in blue in **Figure 3-3**.

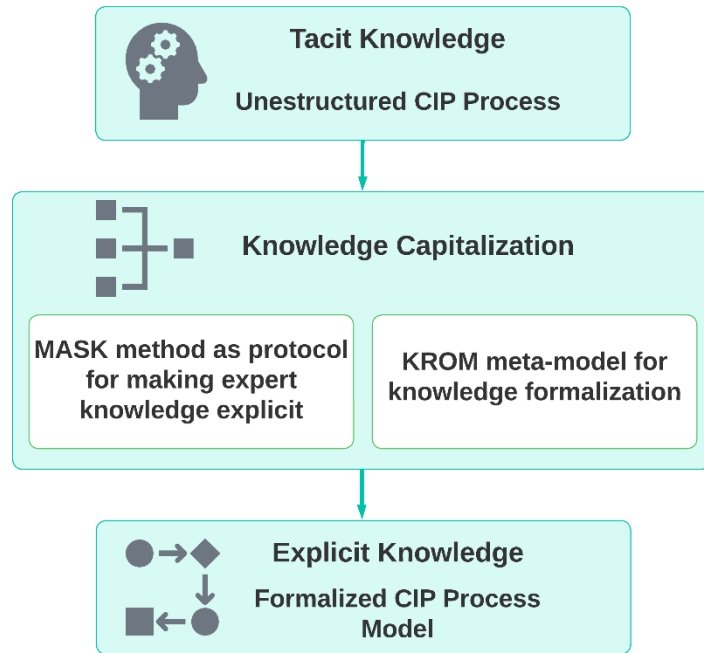

Figure 3-2. Knowledge Capitalization

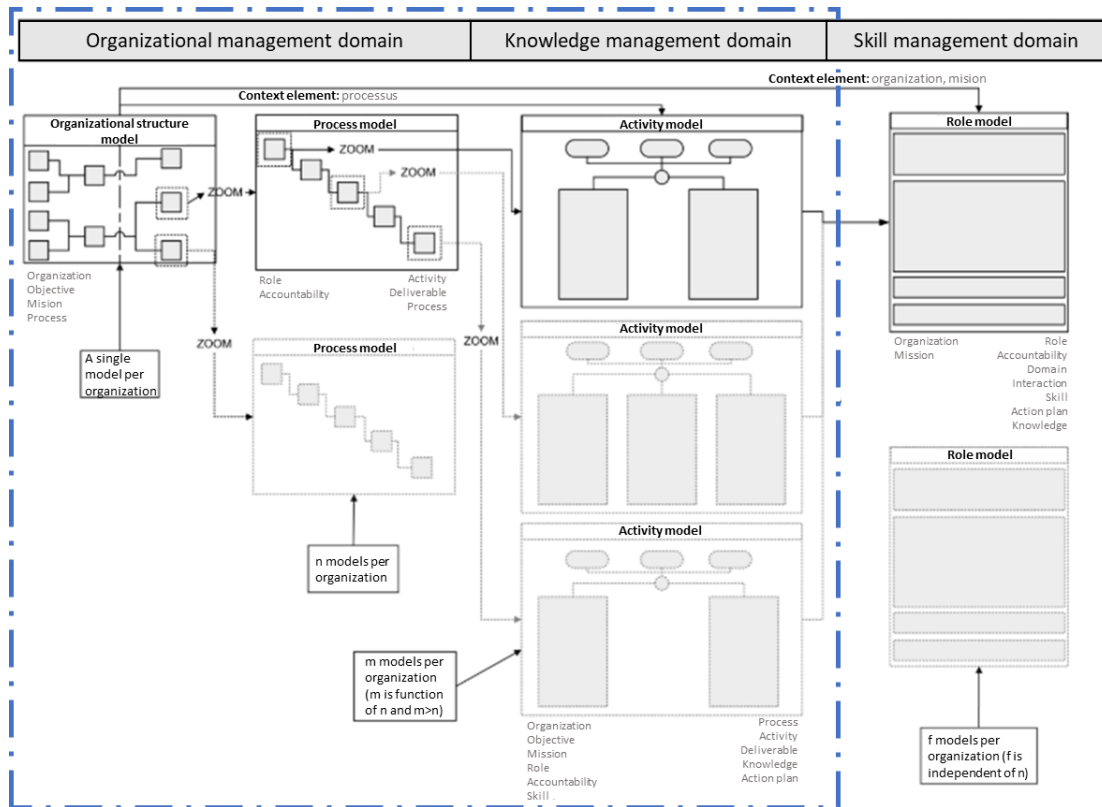

Figure 3-3. KROM meta-model (taken from (Monticolo, 2015))

3.2.1 MASK steps and KROM metamodel for knowledge capitalization

Therefore, with the purpose of answering to the thesis first research question and providing a clearer understanding and modelling the process of CIP, the following methodology is proposed (see **Figure 3-4**).



Figure 3-4. Methodology for knowledge capitalization from experts

The steps of MASK method as described in (Ermine, 2013) are followed: starting with the framing of the knowledge capitalization project by establishing the objectives and scope and clarifying what is needed for externalizing the knowledge. Followed by the identification of the profiles of the experts to be interviewed, for which, the selected experts come from the industry and specifically in the CIP domain. Also, different organizations and locations are privileged, as experts' diversity represents an important factor for taking into account different practices (Nonaka & von Krogh, 2009). Then, the

planning of the interviews is done, for which, a series of questions and a protocol of interview is established and subsequently tested for further improvement.

Afterwards, following our methodology, the actual interviews to the selected experts are developed by explaining the objective of the study and following the interview protocol. For the next step, based on the collected experts' knowledge from the interviews, the knowledge modelling is done by means of KROM meta-model. Through it, the organizational, process and activity models are developed, for making it possible to clarify the CIP process, showing its goals, missions, subprocesses and the activities within them.

Subsequently, after developing the models, an important step to follow is to develop a second interview with the experts. In which the models are presented to the experts in order to have a discussion about the knowledge gathered in them and consequently have their validation on its accuracy or feedback for further improvement. Finally, the last stage of the methodology consists of making improvements to the models according to the feedback received from the experts. These two stages must be repeated as needed until there is no more knowledge to be added.

3.2.2 Methodology implementation

This subsection describes the implementation of the aforementioned methodology for knowledge capitalization as following:

1. Framing of the project:

In this first stage, which is decisive for the subsequent stages, the objective of the knowledge capitalization project was established. It was also clarified how this objective was to be achieved, as shown in **Table 3-1**.

Table 3-1: Framing of Knowledge Capitalization project

Objective	To access and capitalize the knowledge of experts in CIP, with the goal to understand and clarify its processes, activities, and key aspects.
Five W's and How	

What	The domain of study is the process of CIP in the industry.
Who	The group of experts to interview are industry professionals with vast experience on CIP.
Where	The interviews are developed by videoconference due to the pandemic situation and for having access to a diverse group of experts.
When	Each interview is designed to last 1 hour. The total length of the process, including modeling and second round of interviews (experts' feedback on built models) is about 4 to 5 months.
How	A first interview with a defined protocol is done with the experts for gathering information. Following, after analyzing and structuring the information, a second round of interviews with experts is developed to validate the structured models and receive feedback for further improvement.
Why	Because there is a need for a clarification on CIP process, to externalize the tacit knowledge from leading experts into explicit, and therefore sharable knowledge. And through this to elucidate how to help experts in the decision making.

Through this clarification, it was possible to determine the scope and the models that are useful to achieve the objective of the knowledge capitalization project. We are interested in knowing which are the sub-processes and activities as well as the necessary information within them in order to correctly develop the CIP process. Likewise, we are interested in being able to provide clarity on how these sub-processes are connected and contribute to the missions and objectives of CIP.

II. Identification of the profile of the experts:

Next, based on the framing of the project, the profile of the CIP experts to be interviewed for this knowledge capitalization was determined. In order to access adequate and high-quality knowledge, it was decided that the profile of the experts to be interviewed should be the following: experts from the industry with a large amount of experience in CIP, working in high level positions in CIP in their organizations, and additionally those organizations to which the experts belong should have an important maturity in CIP methodologies.

Once the profile of the experts to be interviewed was defined, the selection process was carried out. For this purpose, the social network LinkedIn was used, in which a communication campaign was carried out, along with a screening of people's profiles, which were subsequently contacted by mail. For which, the person's position, their

experience in CIP and the company's profile (large companies with a mature CIP mind-set) were considered.

In total, from the effective responses, the pool of CIP experts to be interviewed was composed of 5 people, all from manufacturing sector and most from different contexts. Then, a characterization of the 5 experts was done, see **Table 3-2** for the summarized information (the detailed description is accessible in Appendix C).

Table 3-2. Characterization of interviewed experts

Expert	Job position	Company	Country	CIP experience	Certification
#1	Sr. Process Excellence Specialist	Ball Corporation	Mexico, USA	8 years	LSS BB
#2	Operational Excellence Regional Director	Safran	France	18 years	LSS BB
#3	Lean Expert	Siemens	Switzerland	12 years	Lean expert
#4	Production and Lean Manager	Henkel	France	6 years	-
#5	Continuous Improvement Manager	Ball Corporation	Mexico, USA	15 years	LSS BB

III. Planning the first interviews with experts:

In the third stage, based on the framing of the knowledge capitalization project, as well as the chosen models, the interview protocol was designed with its respective questions. For this, an iterative approach was followed, in which, each question was defined along with its objective (to understand CIP's importance and identify its missions and goals, as well as to understand the expert role and identify its missions, processes and details of the activities). The complete set of questions and objectives (see Appendix A) was reviewed with the supervisors of this thesis and subsequently improved according to the received feedback.

Once this iterative process was completed, we proceeded to test the protocol in two stages. The first consisted of a mock interview with one of the supervisors, who has more than 20 years of experience in the field and also has an LSS BB certification. And finally, as a second stage, the complete interview protocol was explained and discussed with an external researcher for evaluating the understanding of the questions. The

objective of these tests was to further improve the interview protocol. The final version consisted of a set of 8 questions in three languages, English, Spanish and French (see Appendix A). Also, a consent for participation in the research interview was done and sent to the interviewees before the interview.

IV. Interviews with experts:

Subsequently, interviews were conducted with the 5 CIP experts via Microsoft Teams. Before proceeding with the interview questions of the protocol, a brief description of the study's objective was given. These interviews were conducted in the 3 languages and, with the consent of the experts, were recorded. In addition to the recordings, notes were taken throughout the interviews. Each interview lasted approximately 1 hour, except for the interview with expert #3, which was completed at a later date (see Appendix A).

V. Knowledge modelling:

After each interview, transcriptions of the interview recordings were made. Each of the interview transcripts were coded in Microsoft Word using different colors to identify the different parts of the models to which they corresponded. After this, the analysis and grouping of the coding of the interviews together with the notes taken during the interviews was done in Google Sheets. Based on this, the development of the knowledge modeling began; this was a process of iterative improvement, in which the knowledge in the tables was reanalyzed and the models were continuously adjusted until a stable version for the organizational and process models was obtained. The models begun to be developed from the first interview and were improved with the knowledge of subsequent experts.

VI. Second interview with experts - feedback:

The two last stages of this methodology are intended for validating with the experts that all the relevant knowledge is being capitalized and that we are not omitting any important part. For this means, a second round of interviews with the experts was conducted, in which the models were presented and explained to the experts. In these, as suggested by MASK method, the aim is to obtain feedback and validation of the models by the experts, which process is considered sufficient when there is nothing more to add to the models, in our case, two experts were needed for this means. The first of these second interviews was at the beginning of the process with the first expert, in order to validate

the early stages of the models; and the other one was at the end of the process with the fourth expert, after capitalizing the knowledge from all of the experts and consolidating them into one set of unified and comprehensive models.

VII. Improvement of models based on received feedback:

It was evidenced through the second interviews with experts 1 and 4 that there was no further knowledge to be added or corrected. It was possible to observe that besides the particularities of the context of each expert, their knowledge on the subject of study was consistent. It was observed that the experts shared the same vision on CIP, and through the process even some of their answers were very similar, meaning in this way that good quality and pertinent knowledge was captured and externalized by this knowledge capitalization approach.

3.3 The process of CIP: model proposition

As a result of the implementation of the previously described methodology, the formalization of knowledge was carried out with its modeling from the point of view of the experts in CIP. After the validation of the formalized knowledge by the experts, the developed models were further refined in order to make them easier to read and understand. Through these models, which will be presented and described in this section, the goals, the missions as well as the five sub-processes of the general process of CIP are proposed. Additionally, based on the process models, the activity models were developed (available in Appendix B), which helped us to further understand the decision-making through the CIP process.

3.3.1 Organizational structure model

The organizational structure model in **Figure 3-5** shows the missions of CIP, and how they contribute to the goals, as well as how each of the missions rely on the different subprocesses of CIP (whose numbers refer to their order in the process model). By means of this model it can be seen and understood how the CIP process contributes

through its subprocesses, missions, and objectives to the organization's strategy. With this model it can be explicitly seen the key role of CIP in organizations for adapting to customer demands, excelling competition, and sustaining the organization over time, and therefore highlights the need to address it in its entirety as a complete and comprehensive process.

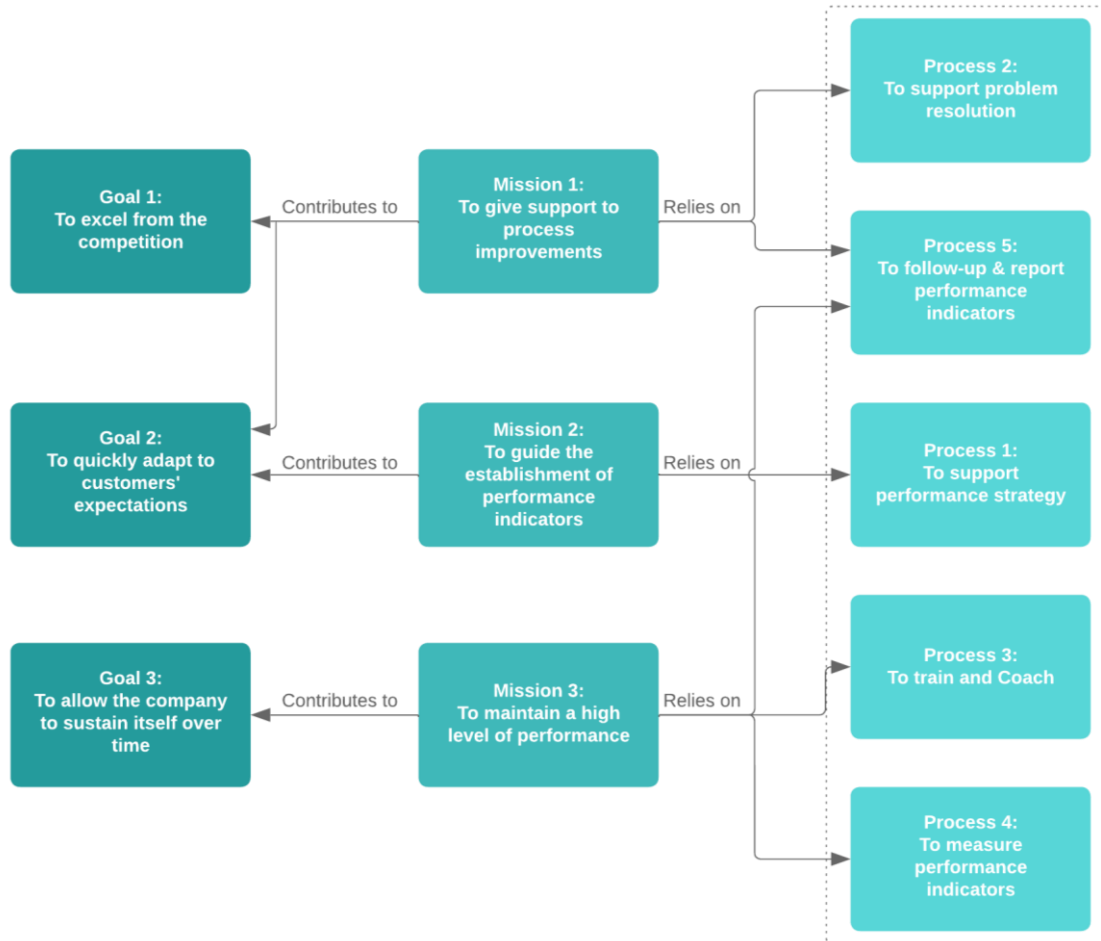

Figure 3-5. CIP Organizational structure model

The CIP organizational structure model is designed for showing the three principal missions of CIP: 1. To give support to process improvements, 2. To guide the establishment of performance indicators, and 3. To maintain a high level of performance. Among which, the first mission contributes to both, the first goal (to excel from the competition) as well as to the second goal (to quickly adapt to customers' expectations). For doing so, this first mission relies on two subprocesses of CIP: subprocess number 2, to support problem resolution; and subprocess number 5, to follow-up and report performance indicators.

Furthermore, the second mission of CIP contributes to the second goal (to quickly adapt to customers' expectations) and relies at the same time on subprocess number 1 (to support performance strategy). And last but not least, CIP third mission is contributing to the third goal (to allow the company to sustain itself over time). For which, this mission relies on the following 3 subprocesses: subprocess 5 (to follow-up and report performance indicators), subprocess 3 (to train and coach) and subprocess 4 (to measure performance indicators). All these five subprocesses, enclosed by the dotted rectangle, constitute the complete CIP process.

Thanks to the previous proposed model, it becomes possible to see the extent of CIP within the organizations, showing in this way how it is fully connected to the organization's strategy. This is particularly important as it has been noted before, the lack of alignment with the organization strategy represents one of the failure reasons in CIP implementations.

3.3.2 Process model

Based on the knowledge from the interviews, the formalization of the complete process of CIP with its subprocesses and activities is done by means of the process model proposed by KROM meta-model, which is based on SADT/IDEF0 modeling language (ISO, 2012; Jaulent & IGL Technology, 1989). It is a hierarchical representation of diagrams representing the process, which starts with the A-0 diagram. Diagram A-0 (see **Figure 3-6**) represents the context of study, thus containing only one box, the process being modeled. Each diagram, starting with A0, contains from 3 to 6 boxes, each of these indicating the name of the activities and their respective data.

This data can be input (arrow entering from the left), output (arrows exiting on the right), control (arrows entering at the top) or mechanism (arrows entering at the bottom). Being the inputs what enters to a box to be transformed into outputs. Control is the data that enters a box but is not modified, it acts as the conditions required to produce the outputs.

And finally, mechanism is what supports the activities, it represents the how or by whom the activity is developed.

To manage the Continuous Improvement of the performance

A-0

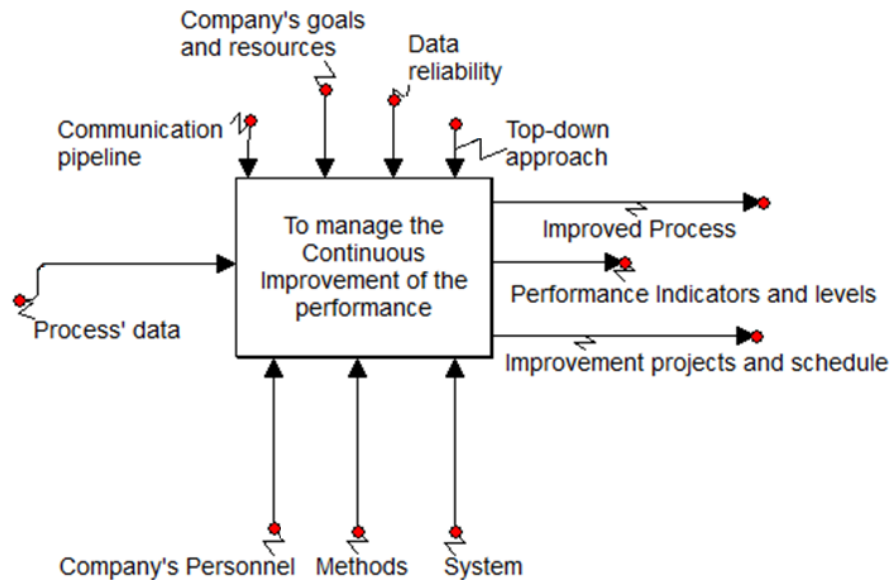

Figure 3-6. CIP Process model: Diagram A-0

Consistent with the modelling language,

Figure 3-6 shows the top-level diagram A-0 of the CIP process. It can be clearly seen the external entry of the process (process' data), the 4 controls (communication pipeline; company's goals and resources; data reliability; top-down approach), the 3 outputs (improved process; performance indicators and levels; improvement projects and schedule), and the 3 mechanisms (company's personnel; methods; system).

Next, **Figure 3-7** provides the diagram A0, showing how all five subprocesses mentioned in the organizational structure model are connected. It shows how this is indeed a complete organizational process. With this diagram is also possible to see to which subprocesses the external entry, controls and mechanism arrive, and also, from which subprocesses the general outputs of the system are generated. From this model, as our intention is to focus on analyzing how to assist in the decision-making, we chose to focus specifically on A1, A2, A4 and A5. Considering that A3 does not contain a high level of decision-making and depending on the organization it can be mostly managed by human resources, or between human resources and CIP.

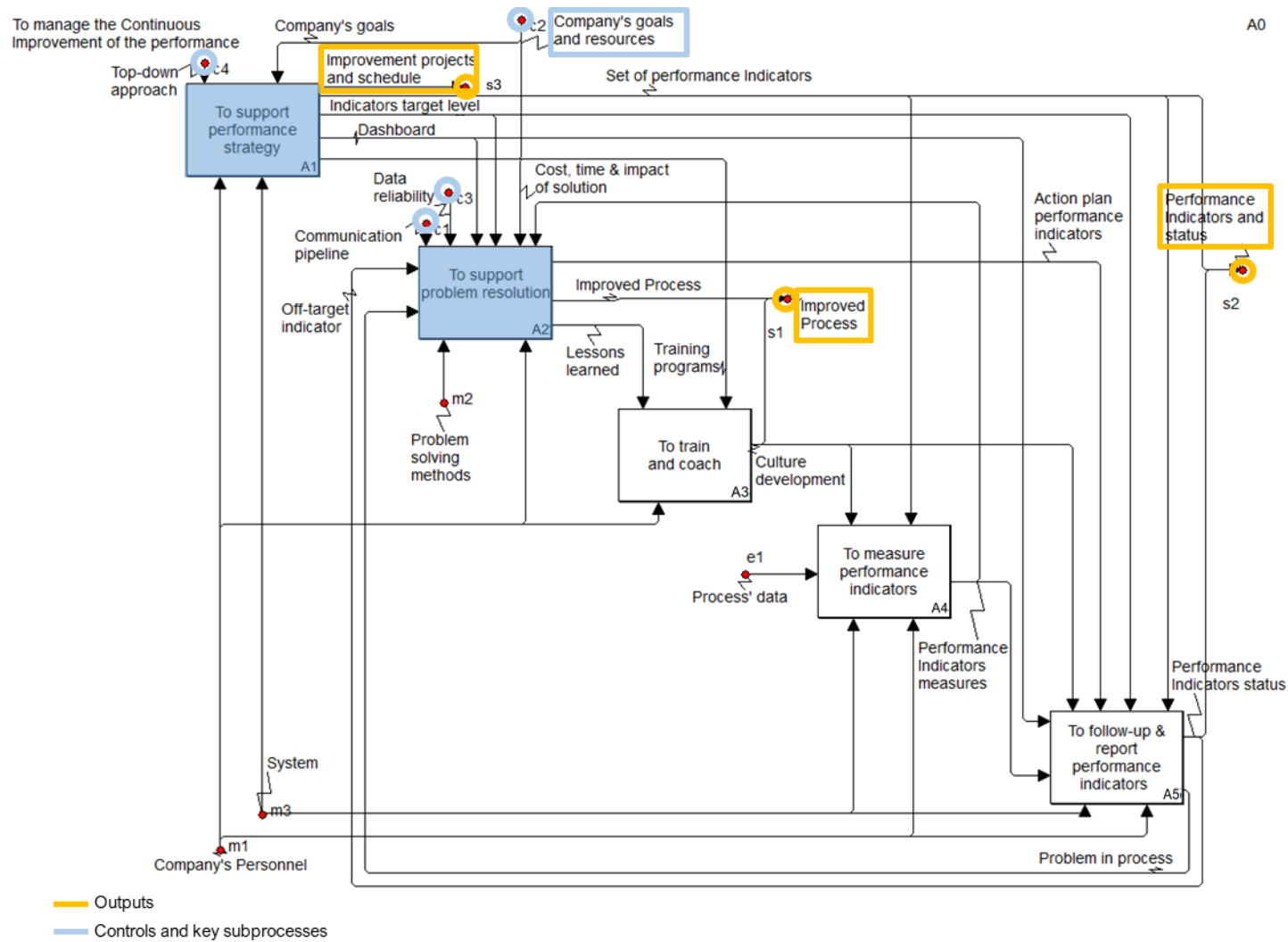

Figure 3-7. CIP Process model: Diagram A0

From the three outputs in diagram A-0 (see in **Figure 3-7** highlighted in yellow), it can be observed the paramount importance of the performance indicators and the assertive selection of improvement actions (improvement practices, improvement tools to implement). The performance indicators are present in the output s2. And as for the improvement actions, these are contained in the output s3, since improvement projects, among others, are composed of improvement actions. Hence, the importance of having an adequate prioritization of improvement practices and tools, in order to maximize improvement impact and used resources. And finally, in output s1 as well, as the improved process depends on the assertiveness of the implemented improvement actions, which is measured by the results of performance indicators.

From the models it is also worth highlight the great relevance of A1 (to support performance strategy) and A2 (to support problem resolution), as they both have an important role in contributing to all the three outputs of the process. These two also receive all the external controls of the process, from which it is worth noting that the control c2 arrives to both A1 and A2. Showing in this way the impact of these 2 subprocesses in the transformation of the organization's goals and resources into performance improvements (see **Figure 3-7** highlighted in blue).

Subprocess A1: To support performance strategy

The first subprocess, to support performance strategy, is further detailed in **Figure 3-8**. This subprocess supports the fulfillment of the mission 2, to guide the establishment of performance indicators. In this diagram, A1, we can observe that this subprocess is composed of 4 activities and generates 5 outputs. For achieving so, it starts by supporting the definition of the vision and mission of the organization based on its general goals. Afterwards, based on them, it supports the identification of the performance indicators and the corresponding target levels, by following a top-down approach. Then, the dashboard in which these performance indicators are going to be reported is structured, and also it is determined the CIP yearly strategy, comprising the training programs and improvement projects and their schedule.

To support performance strategy

A1

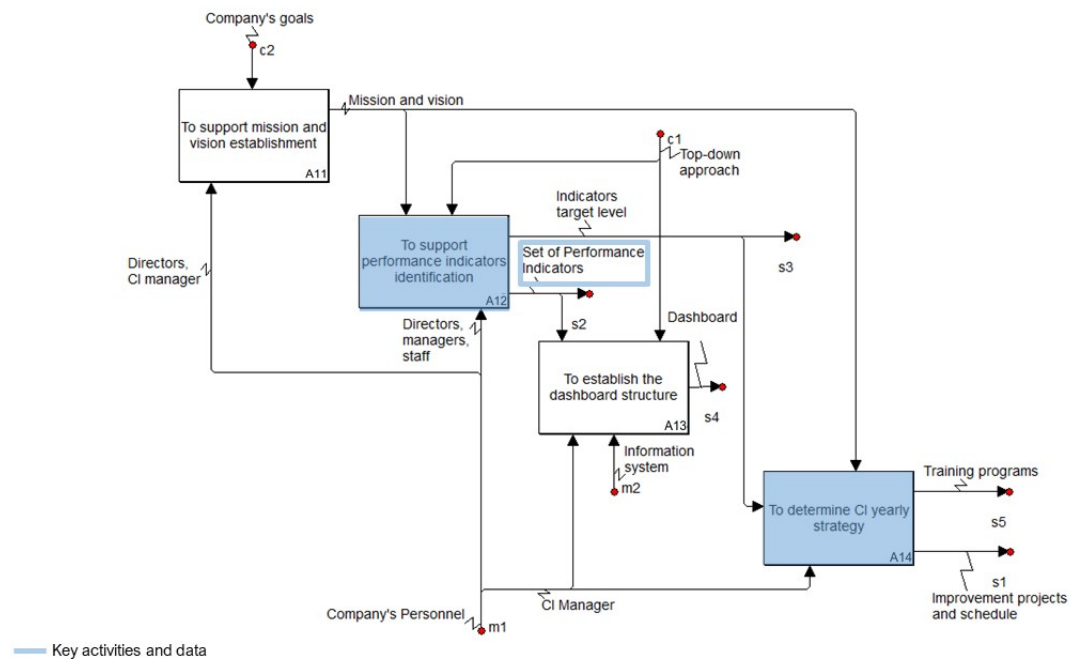

Figure 3-8. CIP Process model: Diagram A1 - To support performance strategy

Through the interviews with the experts, it was appreciated that although the identification of performance indicators plays a major role in the process, this is mainly done by instincts. This in fact, represents one of the major decisions that have to be taken in the CIP process, to determine the performance indicators to measure and follow (activity A12, see **Figure 3-8** highlighted in blue). Their identification and the interrelationship of dependence between the different indicators undoubtedly represent an important opportunity for improvement. This, which is in line with the second research question of this thesis (RQ2: How to identify and define the most relevant indicators that will allow to measure and follow-up the performance?), will be indeed addressed in the Chapter 4.

Subprocess A2: To support problem resolution

In **Figure 3-9** is depicted subprocess A2, to support problem resolution. It is composed of 5 activities, generating in total 3 outputs, namely: lessons learned, the action plan for improving performance indicators, and the improved process. Through which, A2 contributes to fulfilling mission 1, to give support to process improvements. This diagram starts with the contact from the plant with an off-target performance indicator or a process problem. Based on the process information, the data and causes are analyzed

for selecting the main causes. Then, based on intuition and experience, possible solutions are proposed and subsequently evaluated for choosing the most suitable ones (practices and tools) for improving the analyzed performance indicators. Based on that, the action plan is defined, which is consequently followed-up.

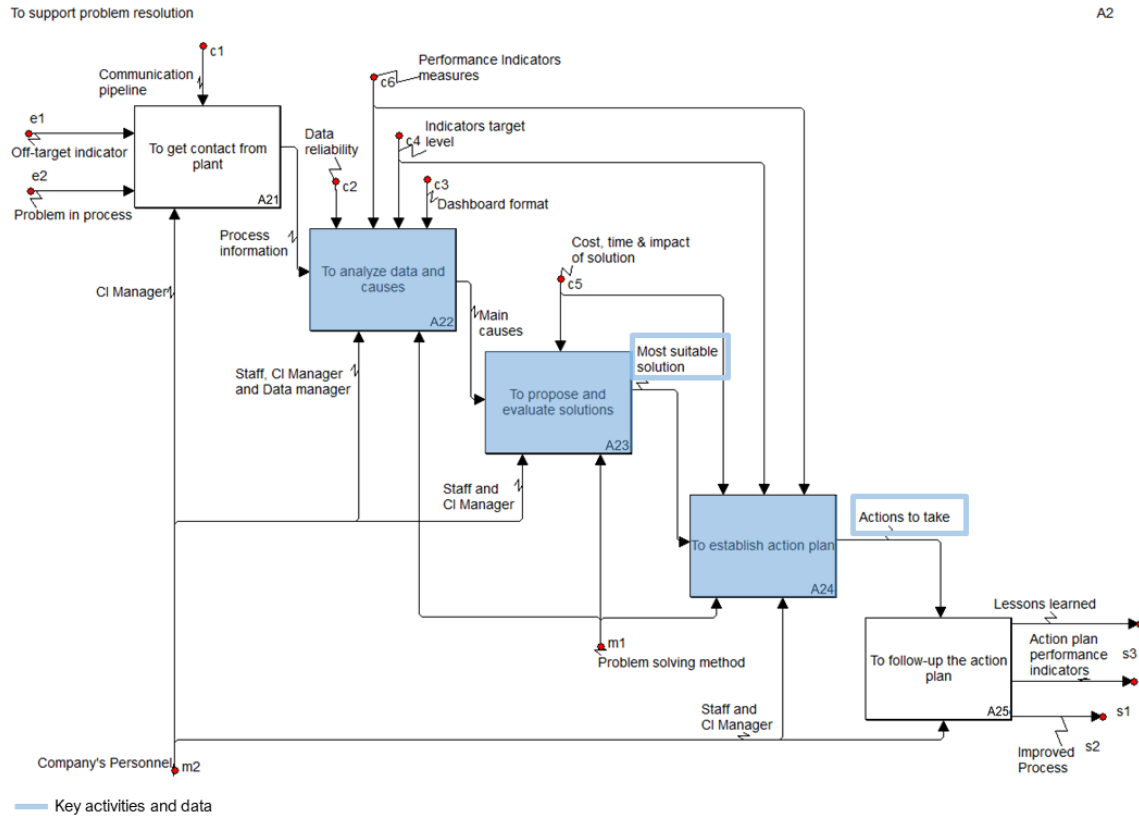

Figure 3-9. CIP Process model: Diagram A2 - To support problem resolution

Another major decision of the CIP process is made in subprocess A2. Based on the analysis of the data and performance indicators, the most suitable improvement strategies are chosen (see **Figure 3-9** highlighted in blue). Which as the previous decision, it is done by feelings and tacit experience. Therefore, it arises a need for better and faster decisions, in order to improve the reaction time and effectiveness to the problems. This is actually in line with our third research question of the thesis (RQ3: How to assist experts in Continuous Improvement in the decision-making process to improve the performance?) and will be addressed in Chapter 5.

Subprocess A4: To measure performance indicators

The fourth subprocess (to measure performance indicators), along with subprocesses A3 and A5, support the achievement of mission 3 (to maintain a high level of performance). Subprocess A4 is depicted in **Figure 3-10**. In this diagram it can be observed the 3 activities constituting this subprocess, as well as its output. This subprocess depends on the defined set of performance indicators, the culture and process data. First, it gathers the process data, then the data is entered to the system (manually or automatically). Finally, it calculates the performance indicator measures.

To measure performance indicators

A4

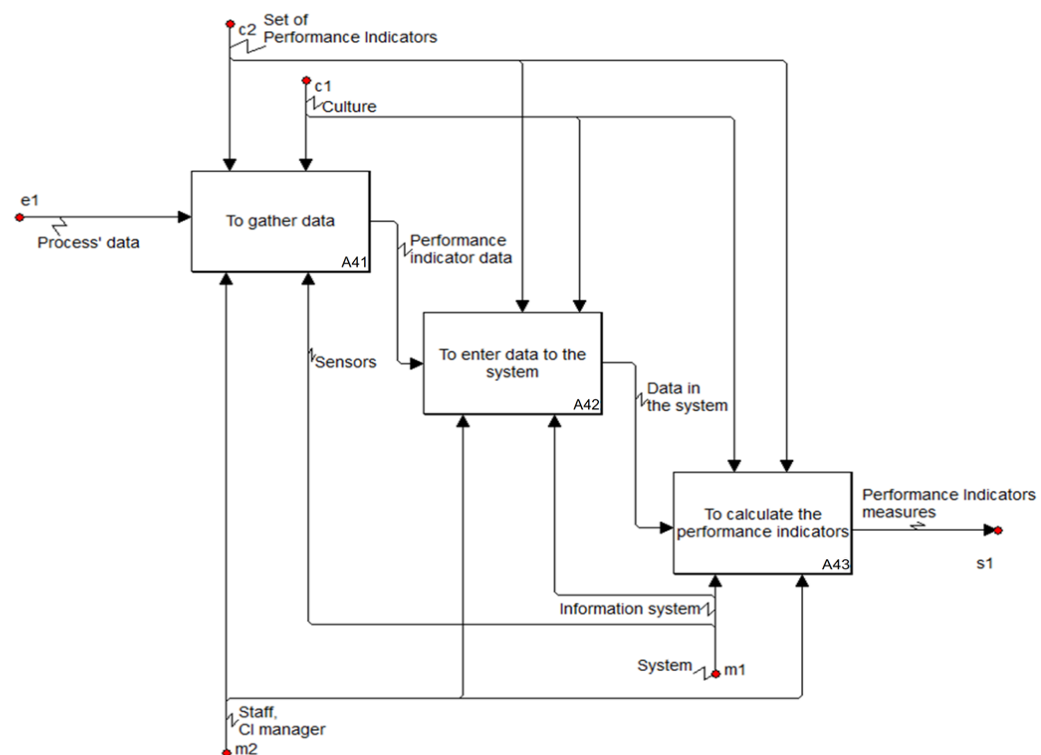

Figure 3-10. CIP Process model: Diagram A4 - To measure performance indicators

Subprocess A5: To follow-up and report performance indicators

Lastly, **Figure 3-11**, shows the subprocess 5, to follow-up and report performance indicators. It supports the fulfillment of both, mission 1 (to give support to process improvement) and mission 3 (to maintain a high level of performance). It comprises 3 activities, with which generates 2 outputs, namely, performance indicator status and process problems. It starts with the development of the daily stand-up meeting for checking up the performance indicators. Thus, it has as entry the daily measures, and

as control the defined set of performance indicators (the ones defined in A1, as well as in A2) along with their target levels, and the culture. After that, the performance indicators are aggregated accordingly in medium and strategic level. They are checked and compared to the target levels in order to determine its compliance.

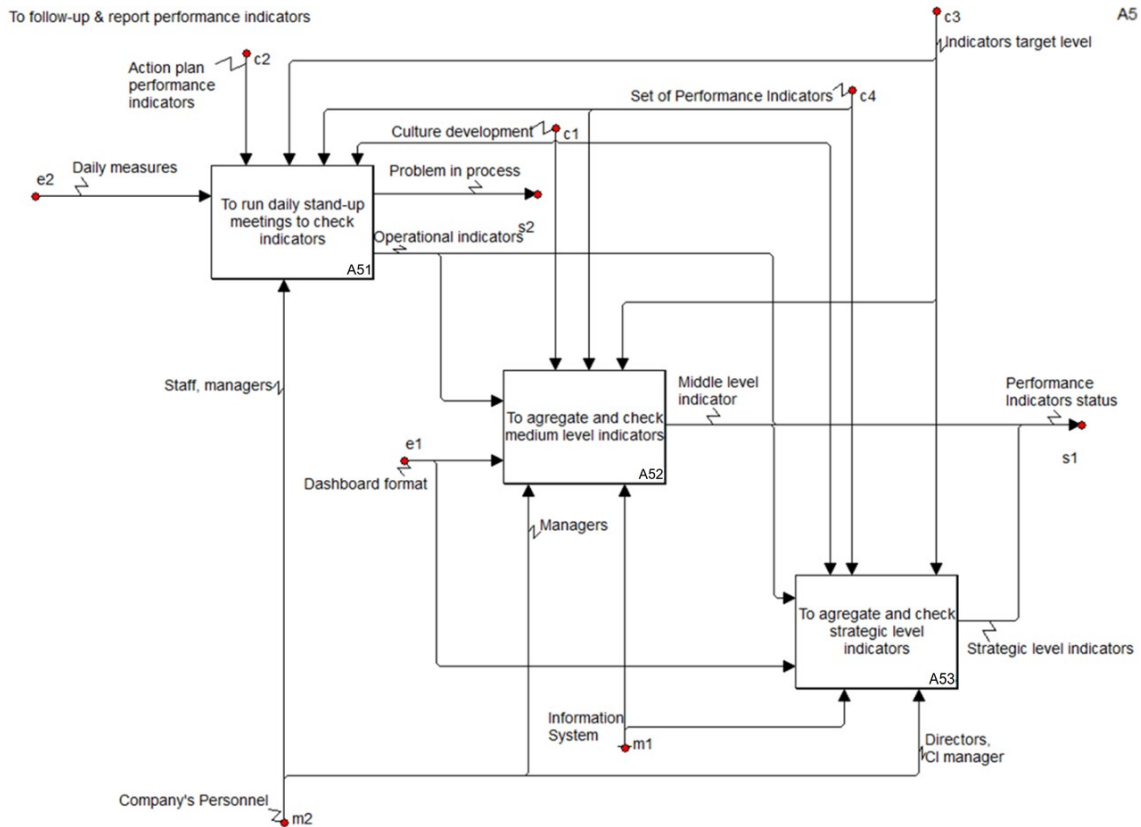

Figure 3-11. CIP Process model: Diagram A5 - To follow-up & report performance indicators

Finally, a shared opinion among the interviewed experts is that CIP is fundamental for organizations seeking to be adaptable and competitive, which is key in this highly changing current environment. It is an essential part, no matter under which specific methodology it is implemented (e.g.: Lean, Six Sigma, Lean Six Sigma, Total Quality Management, etc.), or the way it is represented in the companies (a whole department, a group of experts, a shared philosophy with each process owner empowered), but it should be always present, and with no doubt it is worth studying and analyzing how to improve it.

3.4 Conclusion

This chapter sought to answer to the first research question of this thesis (RQ1: How to clarify and model the process of Continuous Improvement of the performance in the organizations?). To this end and given that the knowledge in this domain is still quite tacit and informal, we opted for a Knowledge Capitalization approach, by following the MASK method, and thus formalizing the knowledge from the experts through the models proposed by KROM meta-model.

This chapter provided as contributions, the organizational structure model and process model for CIP. The former shows the goals, missions and subprocesses that constitute the process of CIP. And the latter provides a comprehensive view of how these subprocesses and the activities within them are connected to each other. Highlighting the need for and importance of looking at CIP as a complete and complex process, instead of isolated activities. With the proposed models, we seek to provide more clarity on the CIP process. These could help academics and practitioners to have a better understanding and management of CIP, as they could serve as a guide for CIP implementations.

Furthermore, the development of the process models and subsequently the activity models (Appendix B) helped us to understand and formalize the CIP process. In doing so, it was possible to identify where the key decision-making occurs: subprocess A1 (to support performance strategy) and A2 (to support problem resolution), with the corresponding activities. On top of that, the identification of performance indicators, and the assertive selection of improvement practices and tools for maximizing its impact on the performance have been identified as critical points that seem to rely significantly on the experience and intuition of CIP experts.

Consequently, Chapter 4 will focus precisely on analyzing and offering a comprehensive view of performance indicators. And in Chapter 5, based on the subprocess, activities and critical points for decision-making identified in CIP process in this chapter, along with the contribution of Chapter 4, a decision support will be proposed to help managers and CIP engineers to make better decisions to improve performance more effectively.

The contributions of this chapter were in part presented and published at CIGI-Qualita International Conference on Industrial Engineering and Quality, whose conference paper had a peer-reviewed process: Cardenas-Cristancho, D., Monticolo, D., Muller, L. and Lhoste, P. (2021), "Continuous Improvement process model: A Knowledge Management approach", CIGI-QUALITA2021 - Conférence Internationale de Génie Industriel - QUALITA, Grenoble, France. DOI: HAL-03288224, available at: <https://doi.org/hal-03288224>.

4. Developing a systemic understanding of performance indicators in CIP based on their influence interrelationships

Throughout the chapters of this thesis, it has been argued the importance of the performance indicators, and thus the relevance on analyzing them. How they become instrumental in the previously modeled process of CIP and therefore, in the pursuit of improving the decision making within it. Nevertheless, beyond measuring, what is really pivotal, is how we can make sense of the performance indicators. It is worth nothing having a large quantity of measures, if we cannot see the importance of what is being measured, and far beyond that, understand what the most relevant indicators are for doing so. When talking about the measurement of performance, we have different pieces of important things: there are the performance indicators, what is being measured; there is also the data from these indicators; and how we gather the data, by what means or systems. Thus, the starting point is the performance indicators, and that is the reason of our focus on them with this thesis.

Consequently, this chapter focuses on identifying what are the performance indicators from the literature and then provides a comprehensive understanding built on the analysis of the influence interrelationships among them. Here it is proposed a novel approach to select and prioritize performance indicators depending on whether they are influencing or being influenced by others, thereby assisting in the decision-making process for improving overall performance. Thus, answering in this way to our second research question (RQ2: How to identify and define the most relevant indicators that will allow to measure and follow-up the performance?).

For this means and given that CIP works as an umbrella term encompassing different methodologies, each of them having their own principles that may delimit their specific

performance indicators. Thus, it becomes important to focus on one CIP methodology. Lean Manufacturing was selected as it is recognized as the most widely adopted one. This CIP methodology is introduced in the first section of this chapter. Next, an approach combining literature review and multi-criteria analysis is proposed and applied. Then, for validating the robustness of the analysis, a concordance assessment and a sensitivity analysis are performed. Finally, the contributions of this chapter are discussed.

4.1 Diving into one of CIP's most representative methodologies: Lean Manufacturing

We focused on Lean Manufacturing since it stands out among the most recognized, studied and widely adopted around the world (Dieste et al., 2019). This in no case with the intention to restrict the results, but to be able to exemplify, as the proposed approach in this chapter can be applicable to any of the CIP methodologies and in diverse sectors. Lean Manufacturing (initially known as Toyota Production System) originated at Toyota Motor Company (Ohno, 1988). It started to be worldwide known as Lean (Lean Manufacturing or Lean Production) after the influential publication of Krafcik (1988), in which he referred to it as a lean production capable of having high flexibility and low inventories while maintaining high quality levels.

Lean is a methodology that is based on a series of principles, practices and tools for achieving a continuous improvement to performance (Čiarnienė & Vienažindienė, 2014). Among the diverse publications on Lean, the ones from Liker stand out (Stone, 2012) by providing an integrative understanding (Bhasin & Burcher, 2006). In his book *The Toyota Way*, Liker (2004) captured the nature of Lean as a result of 20 years of studying Toyota by denoting not only its principles, but also the practices and tools constituting it. He states that most efforts to implement Lean remain superficial because it is often seen exclusively as a goal, and not as a process in which it is necessary to change the way of thinking (in line with the importance of the contribution of Chapter 3).

The main purpose of Lean is to improve the time to provide products and services to customers, while at the same time lowering costs for the organization (Bhamu &

Sangwan, 2014) by analyzing the value in the process and eliminating the waste (all non-value-added activities that are not essential) in it (Antony et al., 2017). The expected benefits after its implementation range from qualitative to quantitative, including: lower costs, improved quality, reductions in lead time, processing time and cycle time, lower inventory levels, better morale among workers, better safety levels in the production, and empowerment of teams (Bhamu & Sangwan, 2014; Liker & Morgan, 2006).

But despite the various studies mentioning the expected benefits of Lean, there are still issues not sufficiently addressed, which leads to numerous failed implementations (as discussed in Chapter 2). Authors, like Psomas and Antony (2019), state that research on Lean is fragmented, and elucidate that research on performance is among its most important research gaps. There is currently a need for studies focused on performance measurement and its indicators (Bhamu & Sangwan, 2014). Although there are studies such as those of Gonçalves et al. (2019) and Saini and Singh (2020), which focus on analyzing the possible impact on organization performance after implementing Lean practices, they still fail to analyze the importance of performance indicators nor take into account their possible interrelationships and influences.

4.2 A combined literature review and DEMATEL method approach

Nowadays, organizations operate in a complex and uncertain environment, but in spite of this, the analysis of their performance indicators does not correspond to this reality. Notwithstanding the great interest among practitioners and researchers in CIP and particularly in Lean, there is still a lack of a shared view and understanding of its performance indicators, which is in fact paradoxical as the main motivation for its implementation is a promised improvement in performance.

Thus, we have in one hand, an absence of a comprehensive view of performance, without which, it becomes uncertain to measure the right indicators, and therefore to make assertive decisions. And, on the other hand, a need to rationalize time and

resources, for which, it is important to be able to analyze the indicators that might exert the most influence, and thereby determine which indicators warrant action implementation in order to have the greatest impact on improving the system. Therefore, it becomes important and necessary to move from the unstructured and isolated view in which we analyze performance indicators, to a systemic one, in which we understand the performance indicators as a complete system with influence interrelations among them. And hence, have a better understanding and analysis that will further contribute to the decision making.

Consequently, this chapter seeks to contribute to helping academics and practitioners by identifying the performance indicators and exploring the interrelationships of influence between, in order to identify the most relevant ones for performance improvement. Therefore, a methodology comprising three stages is proposed, as shown in **Figure 4-1**. Each of the stages are described as follows:

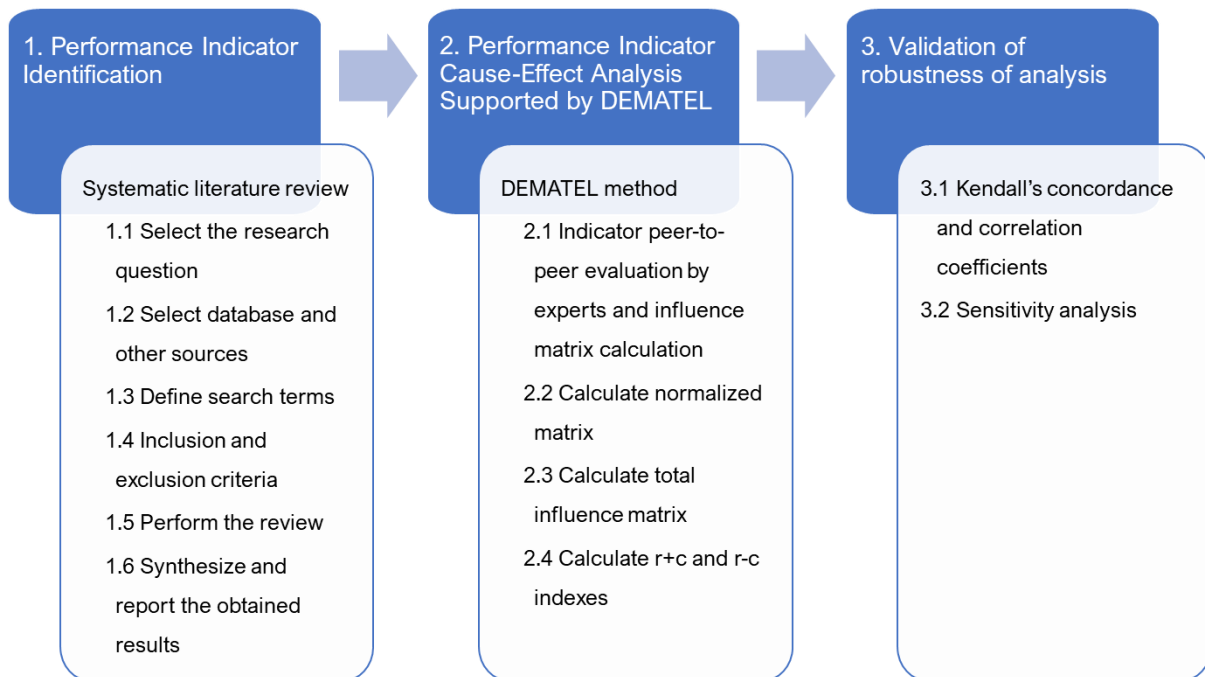

Figure 4-1. Methodological approach

4.2.1 Performance indicator identification

For this stage, a literature review was performed in order to gather the performance indicators used in Lean. Through the development of a literature review it is possible to gather the relevant studies in the analyzed topic, in a transparent, reproducible and effective process that aims to synthesize the information shown in the studies regarding a specific question (Snyder, 2019). In addition, by means of the expert interviews conducted in Chapter 3, it was observed that the indicators used by them were globally within the set of indicators collected from the literature

By following the steps proposed in Gutierrez-Gutierrez & Antony (2019), first, the research question is defined as follows: what are the performance indicators considered in Lean?. Second, the sources are defined as being the Scopus database, the Web of Science database and two very prominent references in studies of Lean, which were added based on their determining role in the history of Lean, while capturing its essence: the article of Krafcik (1988), and the book of Liker (2004).

As a third step, the search strategy is defined by delimitating the search terms used in Scopus and Web of Science. As we are interested in having studies that are centered on Lean and that show performance measurement indicators for the manufacturing sector. Four complementary parts are therefore considered: 1. overall performance, operational performance, or manufacturing performance; 2. manufacturing (to restrict the results to this sector); 3. Lean (to get scientific publications on the different variants of Lean, e.g., Lean Manufacturing, Lean Production); 4. measure, measurement, or indicators. These were applied to the title, keywords, and abstract fields. The search is limited to journal articles or reviews written in English and dated between 2008 and 2019. Then, the inclusion and exclusion criteria are applied on the gathered studies. The detail of the literature review protocol is presented in **Table 4-1**. Based on it, the final selection of the studies for review is determined.

Table 4-1: Literature review protocol

Stage	Description
Research question	What are the performance indicators considered in Lean?
Sources	Scopus database

		Web of Science database Additional prominent references: (Krafcik, 1988; Liker, 2004)
Search strategy	Type of studies	Journal articles
	Search equation	("overall performance" OR "Operational performance" OR "Manufacturing performance") AND manufacturing AND lean AND (measure OR measurement OR indicators)
	Search fields	Title, abstract, keywords
	Language	English
	Period of time	2008-2019
Exclusion/inclusion criteria & title and abstract review		Articles focused on manufacturing Articles making reference to performance indicators Articles on Lean Manufacturing

4.2.2 Performance Indicator Cause-Effect Analysis Supported by DEMATEL

In this second stage of the proposed methodology, the analysis of the cause and effect of the set of performance indicators is done through the analysis of the influence interrelations among them. Thus, we propose to base the assessment of these interrelations on the Decision-Making Trial and Evaluation Laboratory (DEMATEL), an MCDM method developed in the 1970s by Fontela and Gabus (1976), as this is a method that evidences the direction and level of influence among criteria.

DEMATEL, widely adopted in decision-making, is a method based on graph theory (Huang et al., 2007), it allows to identify and understand causal relationship among criteria by categorizing them into cause and effect groups and by bringing out the direct and indirect interrelationships within the system (Seyed-Hosseini et al., 2006; W.-W. Wu, 2008). DEMATEL through its simple application identifies cause-effect interrelationships and influence level of components in a system (Y. C. Lee et al., 2010) while providing a visualization through an influence map that can help in solving real complex problems by eliciting its most important factors (Susanty et al., 2020). Making it, as Si et al. (2018) point out, a promising method that provides insights for decision-making in complex systems.

For the purpose of this study, DEMATEL stands out as the most suitable MCDM method to be used. Other commonly-utilized MCDM methods, such as MAUT (multi-attribute utility theory) and AHP (analytics hierarchy process) (Velasquez & Hester, 2013) make the assumption that the analyzed criteria are mutually independent neglecting any possible interrelations between them (Tan et al., 2012; Tzeng et al., 2007), something that is the core of the DEMATEL method.

In addition, DEMATEL differs from other methods that explore criteria interactions, as explained by Gölcük and Baykasoğlu (2016), these methods are grouped in two main families, one focused on studying criteria dependency, and the other on exploring their interaction. In the first one we find the Analytical Network Process (ANP) (Saaty, 1996), which is a well-known method that seeks for structural dependency but not for causal dependency; moreover, it requires an a priori hierarchical structure of criteria.

Regarding the second family, it analyzes the interactivity of criteria, which, in methodological and philosophical terms, differs from criteria dependence (here the word interactive is associated with the concept of togetherness). The Choquet (Choquet, 1954) and Sugeno integrals (Sugeno, 1974) belong to this family (Grabisch & Labreuche, 2010). Lastly, an important feature of the fuzzy measures is that they assign degrees of importance not only to criteria but also to the coalition of criteria, making these methods insightful and more sophisticated, but its diffusion is limited due to their complexity of application.

Literature concerning DEMATEL applications in Lean includes studies like the one by Azadeh et al. (2015), whose focus was on assessing leanness degree in an Iranian packing and printing enterprise. They established different criteria of Leanness and, among other steps, evaluated the degree of impact among them based on the DEMATEL method. Also, there is the study by Seleem et al. (2016), in which, by means of DEMATEL, the Theory of Constraints and the Balanced scorecard, they proposed an approach for prioritizing improvement initiatives or projects to be implemented (previously proposed based on a root cause analysis).

There is also the study of Sharma et al. (2016), which proposes the use of DEMATEL in a case study of an Indian manufacturing company. They sought to prioritize a defined

group of tools for implementing Lean Manufacturing. Lastly, Wu and Tsai (2011) implemented DEMATEL in order to determine the causal relationships between dimensions and criteria for supplier selection. The criteria were gathered from a non-exhaustive literature review and the opinions of experts from Taiwan. They only analyzed influence between the 7 major dimensions and among the criteria inside each dimension and did not analyze the possible interrelationships between the criteria across dimensions. All these studies are very valuable and interesting and through them it is possible to see the applicability of DEMATEL. As yet, however, none of them has addressed performance indicators and the influences among them and across different dimensions or facets of performance.

Therefore, we propose to apply the DEMATEL method in order to analyze the possible interrelations of influence and dependency between the performance indicators previously identified in the first stage. DEMATEL is a method that is based on the evaluation from experts and comprises a series of steps, which are described as follows:

- **Step 1: Calculate direct influence matrix**

The first step of DEMATEL method is to calculate the direct influence matrix D . This is done by making a peer-to-peer influence evaluation of each of the criteria (performance indicators in our case) on the others by experts on the analyzed subject. This evaluation has to be done in both directions, meaning that the influence (on a scale from 0 to 4, with 0 representing no influence and 4 representing a very high influence (Chiu et al., 2006)) of performance indicator Ind_1 on performance indicator Ind_2 , and the influence of performance indicator Ind_2 on performance indicator Ind_1 have to be assessed. The influence is understood as the fact that a change in a performance indicator causes a change in another one (Cardenas-Cristancho et al., 2022). This is represented in a $n \times n$ matrix D with the performance indicators on the rows influencing the ones on the columns, in which its diagonal elements are equal to zero.

- **Step 2: Normalize direct influence matrix**

In this step, matrix N is obtained by normalizing previously obtained matrix D . As shown in (1), this is done by finding the maximum value between the sum of columns and the

sum of rows by indicator d_{ij} (elements of matrix D), and multiplying its inverse by matrix D (Huang et al., 2007).

$$N = \frac{1}{\text{Max}_{i,j} \sum_{j=1}^n d_{ij} \sum_{i=1}^n d_{ij}} * D \quad (1)$$

Thus, matrix N represents the normalized direct influence among the performance indicators. This matrix can give powerful insights, it can be interpreted as in Li and Tzeng (2009), from rows to columns, to see and represent the performance indicators influencing the others. Or it can as well be interpreted from columns to rows, showing the influences received by the performance indicators, as depicted in **Figure 4-2**. Where for example, Ind_0 (performance indicator 0) is being **directly influenced** by Ind_1 and Ind_2 , and at the same time, Ind_1 is being directly influenced by Ind_3 and Ind_4 . This is only the direct influence among performance indicators, which is precisely what is obtained from the matrix N .

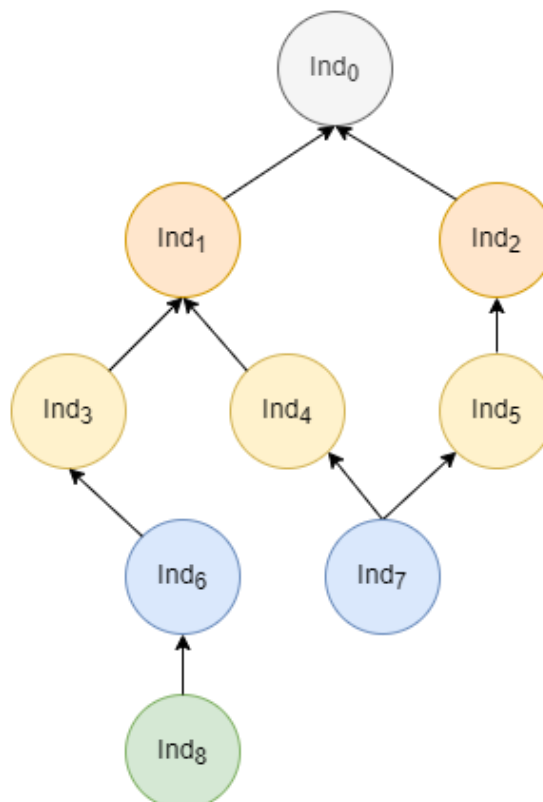

Figure 4-2. Example of direct influence among indicators

- **Step 3: Obtain the total influence matrix**

In **Figure 4-2** it can however also be observed the **different levels of influence** that a given indicator is receiving. Meaning that going back to the example of Ind_0 , in total, it is directly influenced by only Ind_1 and Ind_2 . But at the same time, it is being **indirectly influenced**, in a first level by Ind_3 , Ind_4 and Ind_5 . In a second level by Ind_6 and Ind_7 . And finally, in a third level by Ind_8 . This is precisely what is represented in the total influence matrix T , the direct and all the different levels of indirect influence. Therefore, matrix T is obtained, as seen in equation (2), by doing the sum of the k powers of matrix N , each power representing each of the levels of indirect influence.

$$T = \sum_{k=1}^{\infty} N^k = N + N^2 + N^3 + \dots + N^k \quad (2)$$

As matrix N is a normalized matrix, a continuous decrease on the values in matrix N along with its powers is observed, and then $\lim_{k \rightarrow \infty} N^k = [0]$. And since the resultant of multiplying a matrix by its identity I , is itself. Then, we can have the following development of equation (2) for obtaining equation (3) as follows (Azadeh et al., 2015; Tan et al., 2012):

$$\begin{aligned} T &= N + N^2 + N^3 + \dots + N^k \\ &= N(I + N + N^2 + N^3 + \dots + N^{k-1}) \\ &= N(I - N)^{-1}(I - N)(I + N + N^2 + N^3 + \dots + N^{k-1}) \\ &= N(I - N)^{-1}(I - N^k) \quad ; \quad \lim_{k \rightarrow \infty} N^k = [0] \\ &= N(I - N)^{-1} \end{aligned} \quad (3)$$

Therefore, the elements (i, j) of the matrix T , total influence matrix, denote the totality of the direct and indirect influences (Li & Tzeng, 2009) received or given by an element, depending on whether the matrix is being read from columns to rows, or from rows to columns.

A direct influence refers to the influences initially assessed by experts. Whereas a total influence comprises the direct influence as well as the different levels of indirect influence obtained by computing matrix T .

- **Step 4: Calculate degree and direction of influence**

As the last step of DEMATEL method, for each one of the elements in matrix T , the sum of the row r_i and the sum of the column c_i is calculated. Where r_i denotes the direct and indirect influences given by element i to all the other elements in the system, and c_i is the sum of influences received from all the other element i (Huang et al., 2007). With this, the degree of the influence per indicator $r_i + c_i$ and the direction of the influence $r_i - c_i$ are computed. $r_i + c_i$ represents the importance of element i regarding the links (number and value) of influence relationships with the other elements of the system. And $r_i - c_i$ determines whether element i is categorized as a causal or influenced element: if positive, i is predominantly a causal element; if negative, it is mainly an influenced one (Azadeh et al., 2015).

4.2.3 Validation of robustness of analysis

As DEMATEL is a method based on the assessment of criteria done by experts, one important limitation is the degree of consistency of their evaluations (Kumar & Dixit, 2018; C. Singh et al., 2021). Therefore, to seek to overcome this limitation, it is proposed as a third phase of the methodology, to perform the validation of the robustness of the DEMATEL analysis. This is done by two steps, the first is the application of the Kendall's concordance and correlation coefficients, following by a sensitivity analysis.

Kendall's concordance and correlation coefficients (Kendall & Smith, 1939) are statistical coefficients used for determining the conformity or reliability of experts' evaluations by evaluating the relative differences between experts' ratings (Sheskin, 2020; Silvério et al., 2020). Through these, we seek to validate the direct influence evaluation carried out in the first step of DEMATEL method by taking an aleatory sample of the evaluations and assessing them with four external experts. As denoted by Duleba & Moslem (2018), the results of the coefficients range from 0 (no agreement) to 100% (perfect agreement), where a strong agreement is defined by a result over 60%. Besides the aforementioned study, there are other examples found in the literature, in which an approach combining MCDM and Kendall's coefficient is applied in diverse case

scenarios, such as plants in the supply chain (Susanty et al., 2020) and industrial robot (Athawale & Chakraborty, 2011) and medical device selection (Ivlev et al., 2015).

There are various indices or coefficients to evaluate the interrater agreement and reliability, namely, Cohen's kappa, Fleiss kappa, weighted kappa, Kendall's coefficient of concordance, intraclass correlation coefficient (ICC) and Bland-Altman plots. Given that we are precisely interested in evaluating the concordance among raters with an ordinal level of measurement, then the only adequate ones are weighted kappa, ICC and Kendall's coefficients. Among those, only Kendall's coefficients and ICC are adapted for more than 2 raters (Gisev et al., 2013). Additionally, as we are interested in analyzing the relative difference between the influences, we found pertinent to apply Kendall's coefficients as this is its purpose, opposite to ICC, which is focused on the absolute difference (Sheskin, 2020).

Finally, this stage ends with a sensitivity analysis that is performed in order to validate the robustness of the results from DEMATEL (S. Khan et al., 2019). This can be done by changing some of the values given to the peer-to-peer evaluations of some criteria, while keeping the others constant, as it is shown in Govindan et al. (2015) and Seyed-Hosseini et al. (2006). The sensitivity analysis thus is developed in order to appreciate the changes in the cause and effect relationships, and thus in the indexes of intensity and direction of influence (Kumar & Dixit, 2018).

4.3 Identifying and structuring performance indicators based on their influence interrelationships

4.3.1 Performance Indicator Identification

By following the steps of the first stage described in the methodology section, with the established literature review protocol (**Table 4-1**) an initial set of 88 journal articles were found. After doing a screening for eliminating the repeated studies from the two databases, a total of 68 journal articles was preselected. Following the methodology, an exclusion and inclusion criteria was applied, all articles that did not make reference to

Reference	Quality	Productivity	Inventory level	Total cost plant	Flexibility	Worktime	Lead Time	Human factor	Travel distance	Profitability	Reliability	Speed	Pull ratio	Waste	Effectiveness	Mura	market share	Production rate	Transfers
(Fullerton & Wempe, 2009)	x	x		x		x	x												
(Hallgren & Olhager, 2009)	x			x	x														
(Taj, 2008)	x	x	x		x	x		x											
(Liker, 2004)	x	x		x			x		x										
(Krafcik, 1988)	x	x																	
TOTAL	27	22	14	13	11	11	9	7	5	4	4	2	2	2	2	1	1	1	1

It is worth noting in **Table 4-2** that the families of performance indicators that are most frequently found in the literature are those related to quality and productivity, followed by inventory levels, with a marked difference in number of references when compared with the other families. It is also important to note that, although there are 19 different families of performance indicators, the maximum occurrence among the studies is 8 families. Lastly, it can also be observed that in the last 5 years, the presence of different families of performance has diversified. This goes in hand with what was discussed in Chapter 2, the transformation over time of the multiple facets of performance, which might be indicating a change in the context, and the need to study it.

Table 4-3 shows the final set of the 50 performance indicators gathered from the literature review and analysis. For which, based on the reviewed scientific publications and this author and the codirector’s knowledge, the definition of each of them is provided below. These definitions, along with their objectives (to be maximized, to be minimized or to maintain at a target), are presented grouped according to their families. information is summarized and presented in Appendix E.

Table 4-3. Performance indicators retrieved from literature

Performance indicators	
Effectiveness	Labor downtime
Manufacturing lot size	# Of NVA motions
Employee training & team building	Cost reduction
Ergonomic risk	Pull ratio

absenteeism rate	AOQL
Employee compensation	Defect rate
Job security	FYP
Labor turnover rate	#Andon per dept per cause
Safety risk factor	Scrap rate
knowledge disconnection	delivery
Inventory turnover ratio	customer satisfaction
WIP inventory	MTBF
Quantity of finished goods inv	MTTR
Lead time	Speed
New product launch	Rework costs
Supplier LT	Unit cost of manufacturing
market share	Number of transfer lots
Inappropriate processing	Transfer lot size
Overproduction	People travel distance
Mura	Product travel distance
Production rate	Setup time
equipment downtime	Cycle time
Uptime	Overtime
Efficiency	Capacity utilization
Value-added ratio	Process capability index

The first performance indicator, “*effectiveness*,” can be defined as the comparison of the output of a production process against a target (Karim & Arif-Uz-Zaman, 2013; Zammori, 2015) and thus, its objective is to be maximized for attaining the target level. Following, there are seven indicators related to productivity. The first, “*efficiency*,” compares the output of a process or a machine, against the utilized resources in a given period (Karim & Arif-Uz-Zaman, 2013; Zammori, 2015), the greater its value, the better. Then, “*labor downtime*” and “*equipment downtime*,” for both of which the objective is to be minimized. They refer to the idle time of the resources (employees, machines, etc.) during working hours (Cortes et al., 2016). Next, the “*number of NVA motions*” is an indicator to be minimized, as it represents all the movements that do not add value to the product or the production process. Additionally, a performance indicator that we seek to maximize, the “*value-added ratio*,” represents the comparison between the sum of the total value-added time and the lead time (Liker, 2004). For “*capacity utilization*” and “*uptime*,” the objective is also to be maximized. They represent the utilization rate of manpower and machines and the ratio between the real effective working hours and the planned working hours, respectively (Maasouman & Demirli, 2016).

Next, there are two performance indicators relating to the cost of the plant and their objective is to be minimized. They are “*unit cost of manufacturing*,” which refers to the

cost of manufacturing one good unit of final product, and “*rework cost*,” which is the cost in material and in labor for reworking defective products. Following, there are eight indicators related to quality, for four of which the objective is to be minimized. They are *AOQL*, *number of Andon per department per cause*, *defect rate* and *scrap rate*. “*AOQL*” stands for the average outgoing quality limit of the production process. The “*number of Andons per department per cause*” refers to the number of Andon (quality or process problem notification) pulls to stop the production line due to quality problems. This indicator must be monitored by each department and per specific cause (Liker, 2004). “*Defect rate*” represents the percentage of quality problems that occur throughout the production process and “*scrap rate*” is the ratio between the scrap in the process (considering all the products that are not acceptable for the customer, and defects in handling and transformation) and the total units produced (Cortes et al., 2016). Next, four performance indicators were identified that are to be maximized: *FPY*, *customer satisfaction*, *delivery* and *process capability index*. “*FPY*”, the first pass yield, represents the percentage of products that go through the production process the first time with no defects (Liker, 2004). Then, “*customer satisfaction*,” refers to the service level of the degree of fulfilling the customer expectation by providing good-quality products at the needed time. “*Delivery*” represents the percentage of on-time delivery of good-quality products. Lastly, “*process capability index*” measures the ability of the production process to meet determined product characteristics (Pearn et al., 1998; Perakis & Xekalaki, 2002).

One performance indicator denoting flexibility is “*manufacturing lot size*.” It is the quantity of products constituting a manufacturing batch and the lower it is, the more flexible the process becomes. Also, six performance indicators were identified related to lead and working times. For the performance indicators of “*lead time*,” “*setup time*” and “*overtime*,” whose objective is to be minimized, we adapted the definitions from (Santos Bento & Tontini, 2018) as follows: “*lead time*” is the total time from the moment the customer orders a good until its delivery. They define “*setup time*” as the time during which production is stopped for a switch-over to a different product. And “*overtime*” is described as the time worked outside the established working hours. Also, for the next two indicators in this group, the objective is to be minimized. They are “*supplier LT*,” referring to the total time that passes from the moment an order is placed to the supplier until it is received. “*New product launch*” is the time employed for launching a new

product onto the market. Finally, for this part, the “*cycle time*” is the time between the exit from production of one unit and the exit of the following one. Then, there are two indicators denoting travel distance: “*people travel distance*” and “*product travel distance*.” The first refers to the total distance that the logistics operator travels during a shift, while the second is the total distance the product travels into the production chain.

Next is a performance indicator to be maximized, “*pull ratio*,” expressing the proportion of the working stations that use pull (Mirdad & Eseonu, 2015). Then, three indicators to be minimized, the first is “*mura*,” representing the unevenness in production (Cortes et al., 2016). The other two relate to waste: “*overproduction*,” is the quantity of production that is ahead of the demand of the client (Cortes et al., 2016), and “*inappropriate processing*,” which is the unnecessary or incorrect processing, or having a more complex process than needed. Next, three indicators concerning inventory, the two first of which are to be minimized and the last, maximized: “*Quantity of finished goods*” is the total inventory quantity of the finished products; “*WIP inventory*” is the quantity of work in process inventory; and “*inventory turnover ratio*” represents the replacement rate of a company’s inventory over a given period of time (Santos Bento & Tontini, 2018). Then there are three indicators to be maximized: “*cost reduction*,” an indicator associated with profitability, quantifies the reduction of the production costs; “*market share*” representing the portion of the market that a given company has; and “*production rate*,” referring to the quantity of finished products that are produced in a given time period. There are two indicators related to reliability: “*MTBF*,” the mean time between failures, which is to be maximized; and “*MTTR*” to be minimized, which is the mean time to repair when a failure occurs.

Following this, there are two performance indicators referring to transfers, the first one, the “*transfer lot size*,” to be minimized, is the quantity produced per transfer batch (Cuatrecasas-Arbós et al., 2015); and the second one, the “*number of transfer lots*,” to be maximized, is the number of lots or batches that are transferred. In addition, eight performance indicators related to human factors were also found, three to be maximized, and five to be minimized. The ones to be maximized are: “*employee training & team building*,” which represents the level of training given to the employees and the team building developed for problem resolution; “*employee compensation*” is the

economic or non-economic incentive given to employees for their commitment and performance; and “*job security*,” which refers to the stability of the job for workers. Then come the definitions of the last 5 performance indicators, all to be minimized. “*Knowledge disconnection*” represents the lack of shared objectives and culture within the different levels of an organization. “*Labor turnover*” is the ratio of employees entering and leaving an organization (Cortes et al., 2016). Lastly, as defined by (Maasouman & Demirli, 2016), “*safety risk factor*” is the ratio between high and medium safety-risk workstations and the total number of workstations; “*absenteeism rate*,” denotes the ratio between the number of man-days lost due to absenteeism and the total of working man-days available; and “*ergonomic risk*” refers to the ratio between the high and medium ergonomic risk workstations and the total number of workstations.

On the basis of this literature review, on the one hand we have a definition of each of the performance indicators found and, on the other hand, a multifaceted view of performance, thus obtaining a more comprehensive set of performance indicators and their families than in previous studies. Since this literature review covers a variety of relevant articles, such as case studies or surveys to practitioners, it gives an overview of the most relevant indicators in practice, as well as articles that identify the most recurrent indicators from the literature.

From this literature review, we were able to identify a large number of, but it was also possible to note the absence of any holistic view or any way of classifying or prioritizing them, resulting in the lack of an established and shared framework of reference on performance indicators in Lean, meaning that the performance indicators are not well structured enough to help make decisions to improve performance. The reviewed studies stressed the importance of studying performance indicators in Lean, as performance measurement is crucial for continuous improvement (as noted in Chapter 3 of this document) and helps organizations move from a decision-making approach of intuition to one based on facts (Soltan & Mostafa, 2015). Some authors, such as Olivella and Gregorio (2015), even said that performance measurement should be performed frequently, even on a weekly or daily basis. Paradoxically, when this is done there can be some drawbacks, like taking up people’s time and distracting them for doing their jobs (Liker, 2004).

It is also observed that although Lean aims to improve performance, there is a lack of understanding and uniformity regarding its performance indicators, making further studies in this area needed (Bhamu & Sangwan, 2014) in order to tackle failures of Lean implementations (Karim & Arif-Uz-Zaman, 2013). It is therefore necessary to analyze how performance is being measured in Lean. Some valuable studies, like the one by Mirdad and Eseonu (2015) and, more recently Kovács et al. (2020), have begun to address the issue. The former extracted some of the principles, practices, and performance measures of Lean through a literature survey, and then confronted them with experts in the field, while the latter explored the relationship between the implementation of Lean practices and performance through a longitudinal case study, identifying some categories of performance indicators. In the end, however, they fall short in providing a more understandable view and did not analyze the possible relationships among indicators. In the different studies, performance indicators have been shown in an isolated way, dependent only on the actions implemented, but the influence that they might have on one another is currently neglected in the literature.

4.3.2 Performance Indicator Cause-Effect Analysis Supported by DEMATEL

Therefore, once having a clear definition and objective for the performance indicators, we seek to analyze the influence interrelationships among the identified performance indicators. By following the proposed methodological approach, the first step of DEMATEL method is developed and with it, the assessment of the influence of each performance indicator over the others. With 50 performance indicators, this meant 2,500 influence evaluations. Due to the large number of evaluations, the process was divided into different sessions over four days to avoid any bias or misevaluation due to mental workload of experts (this author and the codirector of this thesis, with 5 and 20 years on experience in Lean, respectively). For these evaluations, in addition to having a clear definition of the performance indicators, it was important to only consider direct influences and assume that the other indicators (besides the two being analyzed at a given moment) were not affected. From the peer-to-peer comparison of the influence of the performance indicators, the 50×50 direct influence matrix (matrix D) was obtained,

an excerpt of which is shown in **Table 4-4** (the complete matrix is presented in Appendix F). This matrix shows the direct influences of the indicators in the rows over the ones in the columns. In it we can see for example that *Effectiveness* has an influence of 4 on *Efficiency*; an influence of 2 on *value-added ratio*, *capacity utilization*, *rework cost* and *unit cost of manufacturing*; an influence of 1 on *uptime*; and no influence at all on *Labor downtime*, *number of non-value-added motions* and *equipment downtime*.

Table 4-4. Excerpt from the performance indicator direct influence matrix assessment by experts

	Effectiveness	Efficiency	Labor downtime	Number of NVA motions	Value-added ratio	Equipment downtime	Uptime	Capacity utilization	Rework cost	Unit cost of manufacturing
Effectiveness	0	4	0	0	2	0	1	2	2	2
Efficiency	0	0	0	0	0	0	0	3	2	4
Labor downtime	0	4	0	0	3	1	1	2	0	2
Number of NVA motions	0	4	0	0	3	0	0	0	0	1
Value-added ratio	0	4	0	0	0	0	2	2	0	3

After this, the normalization of matrix D was done by following the second step of DEMATEL, and thus obtaining matrix N , which can be found in Appendix F of this thesis. Subsequently, matrix T was as well calculated (see Equation 3 in Section 4.2.2), containing in it the total influences among performance indicators. As it was explained in section 4.2.2, matrix T comprises the direct influences and all the different indirect influence levels for all of the 50 performance indicators. Thus, for having a better illustration on the different levels of influence included in matrix T , Figures 4-3 to 4-6 are presented. These figures not only show a vis-à-vis of the powers of matrix N (N, N^2, N^3) and the graphical representation of the influences per level k , but also the decreasing effect of the indirect influences along with the power of the matrix. For the easiness of explanation, from the 50×50 matrix N of the performance indicators, this example takes an excerpt of a 7×7 sub matrix N with the following performance indicators: *Capacity utilization*, *rework costs*, *unit cost of manufacturing*, *AOQL*, *FYP*, *customer satisfaction*, and *delivery*.

In **Figure 4-3a**, the 7×7 matrix N with normalized direct influences among the 7 performance indicators is shown, in which, the greater the value, the higher the influence. Likewise, **Figure 4-3b** gives a graphical representation of these influences' links. In total, there are 13 direct influences among these 7 performance indicators. These influences, in the matrix and in the graph, can be read in both ways, the influences given to other performance indicators, or the influences received from the others. Being *AOQL* the performance indicator with the highest number of influences being given (influencing 5 performance indicators), and *unit cost of manufacturing*, the one receiving the most influences (influenced by 4 performance indicators).

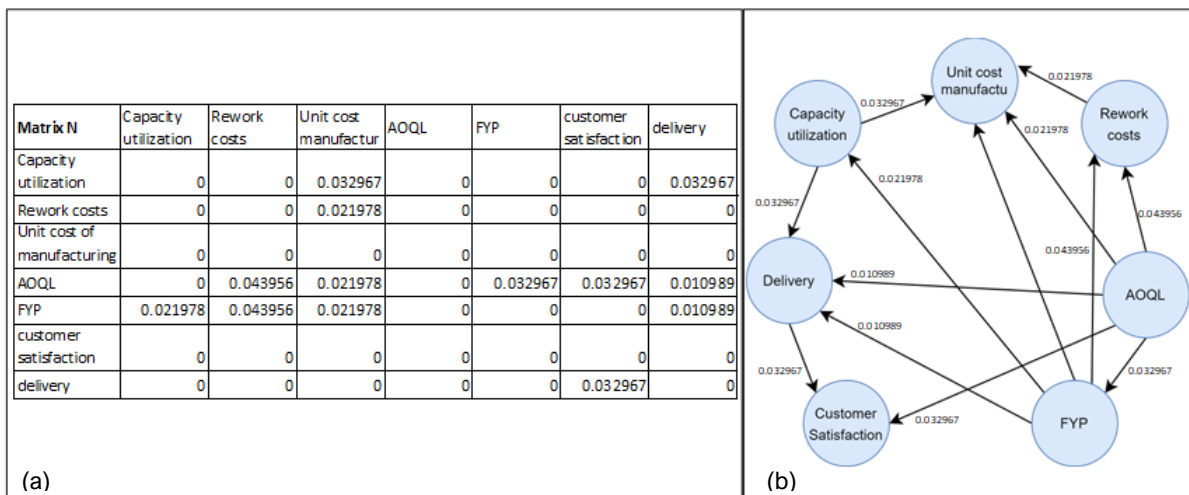

Figure 4-3. Normalized direct influences with 7 criteria: (a) Matrix N ; (b) Graphical influence representation

In this example, the performance indicator *customer satisfaction* is analyzed, and a focus is made on the influences received by it. In **Figure 4-4a**, highlighted in orange is the column of the matrix N denoting the 2 direct influences that *customer satisfaction* is receiving, one from *AOQL* and the other one from *delivery*. This is graphically represented as well in **Figure 4-4b**, in which the performance indicator being analyzed, *customer satisfaction*, is colored in gray, and the performance indicators directly influencing it along with the arrows representing this interaction are colored in orange, all the other performance indicators from the system that do not represent a direct influence to *customer satisfaction* are colored in blue.

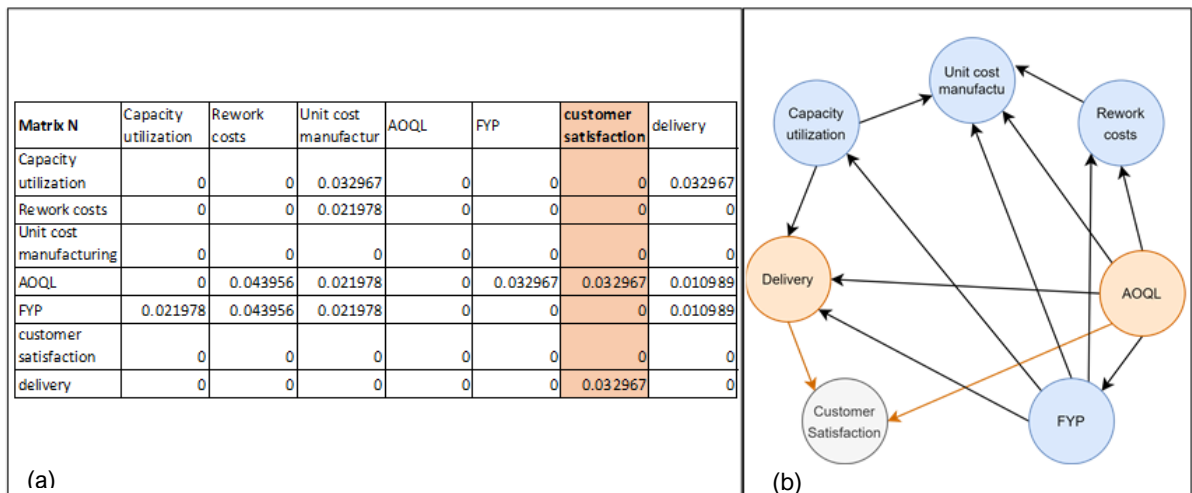

Figure 4-4. Direct influences for Customer Satisfaction: (a) Matrix N; (b) Graphical influence representation

Next, we proceed to multiply matrix N by itself to obtain N^2 . The elements in Matrix N^2 contain the first level of indirect influences received and given by the performance indicators. By looking at the column of *customer satisfaction* in **Figure 4-5a** (in yellow), it is possible to see the three links of influence received from *capacity utilization*, *AOQL* and *FYP*. These influences, as can be seen in yellow (the performance indicators and the connecting arrows) in **Figure 4-5b**, correspond to the performance indicators influencing the ones that were directly influencing *customer satisfaction*.

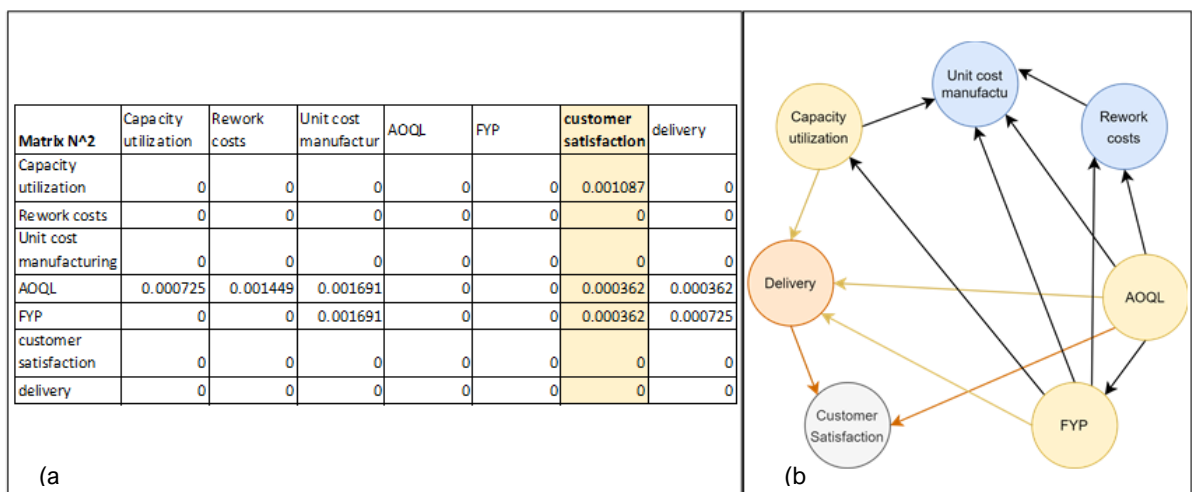

Figure 4-5. First level of Indirect Influences for Customer Satisfaction: (a) Matrix N^2 ; (b) Graphical influence representation

Following, in **Figure 4-6**, it is observed the third power of matrix N , which means, the second level of indirect influences. Thus, in **Figure 4-6a** *customer satisfaction* column

(green) has the two indirect influences in second level for this performance indicator, being, *AOQL* and *FYP*. Which are the performance indicators directly influencing the ones in yellow in precedent **Figure 4-5**. Thus, **Figure 4-6b** shows in green these performance indicators and their connecting arrows.

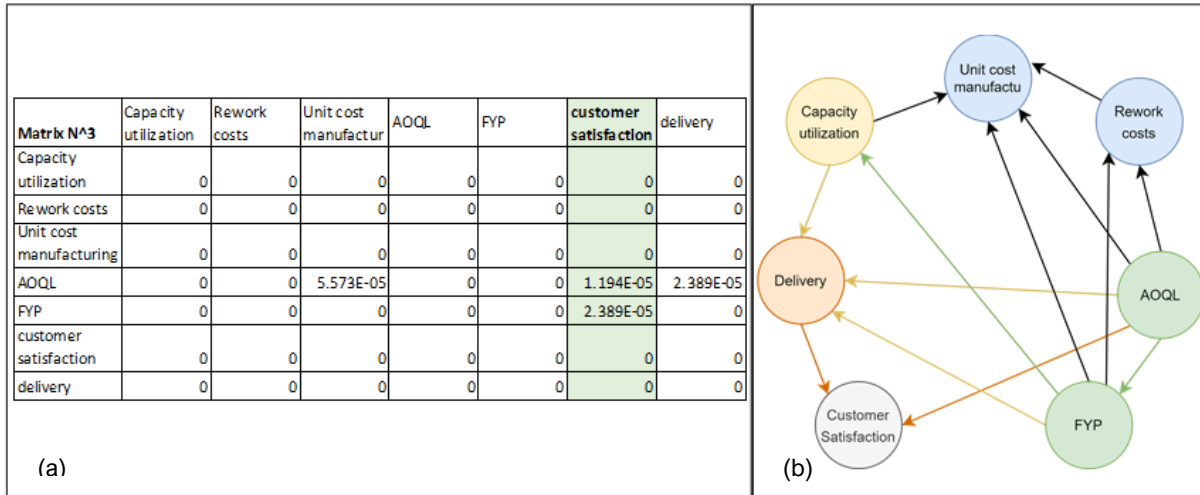

Figure 4-6. Second level of Indirect Influences for Customer Satisfaction: (a) Matrix N^3 ; (b) Graphical influence representation

By keep on doing this procedure an infinite number of times and summing up the powers of Matrix N ($N + N^2 + N^3 + \dots + N^k$), the resulting matrix T (Equation (3)) will consider the direct influences and all the indirect influences which will be gradually decreasing in magnitude along with the increase in the power k of matrix N . To illustrate this, **Figure 4-7a** represents the sum of matrices N , N^2 and N^3 , in which the gray column has total of direct influence and two first levels of indirect influence given to *customer satisfaction* by *capacity utilization*, *AOQL*, *FYP* and *delivery*. Note that numeric results of this example, due to the properties of matrix, do not necessarily match with results from the complete analysis of the 50×50 matrix T (see Appendix F for the complete matrix), as this example only takes 7 performance indicators instead of all the 50 in the complete system.

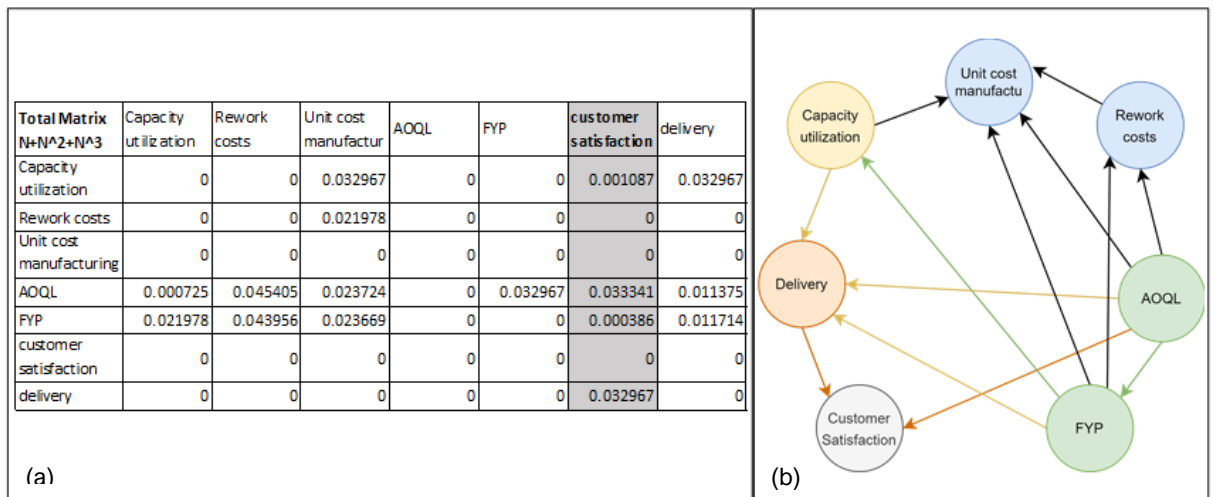

Figure 4-7. Sum of direct and first two level of indirect influences: (a) $N + N^2 + N^3$; (b) Graphical representation

After obtaining matrix T , and with it the total influences (including direct and all levels of indirect influences) among performance indicators. Then the fourth and last step of DEMATEL method is performed in order to obtain two indexes for each performance indicator (see **Table 4-5**). The first index, $r_i + c_i$, measures the degree of the influence, meaning that the performance indicators for which this index is closer to zero are the ones that have the lowest degree of influence relations (influence links with other performance indicators), and the ones with a higher value have a greater degree of influence, which in this case were: *efficiency*, *capacity utilization* and *value-added ratio*.

The second index, $r_i - c_i$, measures the direction of the influence, thus when positive, it means that it is a “causal” indicator, it has a predominant influence over other indicators. But if on the contrary $r_i - c_i$ index is negative, this indicator is “influenced,” the quantity of indicators that influence it is greater than those it is influencing. In total, from the 50 performance indicators, there were 29 that are causal and 21 that are influenced.

Table 4-5. Intensity and direction of the influence indexes for influenced and causal performance indicators

Causal Performance Indicator	R+C	R-C	Influenced Performance Indicator	R+C	R-C
#andon per dept per cause	0.98	0.17	Efficiency	1.69	-0.83
equipment downtime	0.93	0.24	Capacity utilization	1.24	-0.35
Defect rate	0.89	0.17	Value-added ratio	1.14	-0.31

Causal Performance Indicator	R+C	R-C	Influenced Performance Indicator	R+C	R-C
AOQL	0.86	0.19	Cost reduction	1.09	-0.58
Process capability index	0.82	0.28	Lead time	0.88	-0.71
Effectiveness	0.80	0.36	Production rate	0.85	-0.25
FYP	0.75	0.08	Unit cost of manufacturing	0.83	-0.77
Ergonomic risk	0.62	0.10	Mura	0.79	-0.03
Employee training & team building	0.62	0.58	WIP inventory	0.78	-0.34
Labor downtime	0.60	0.07	Inventory turnover ratio	0.76	-0.39
absenteeism rate	0.53	0.25	Uptime	0.73	-0.06
MTBF	0.50	0.46	Speed	0.68	-0.03
Cycle time	0.49	0.12	delivery	0.65	-0.40
Setup time	0.47	0.42	Scrap rate	0.62	-0.22
MTTR	0.45	0.32	Q. finished goods inv	0.52	-0.24
Employee compensation	0.43	0.29	Labor turnover rate	0.50	-0.03
Manufacturing lot size	0.41	0.32	Rework costs	0.43	-0.33
# of NVA motions	0.39	0.11	customer satisfaction	0.42	-0.25
Product travel distance	0.38	0.33	market share	0.33	-0.28
People travel distance	0.37	0.20	Overtime	0.20	-0.06
Pull ratio	0.36	0.36	New product launch	0.18	-0.06
Number of transfer lots	0.32	0.08			
Transfer lot size	0.29	0.11			
Overproduction	0.29	0.18			
Inappropriate processing	0.28	0.23			
Job security	0.26	0.20			
Supplier LT	0.17	0.14			
knowledge disconnection	0.13	0.11			
Safety risk factor	0.13	0.08			

Finally, with the data from the previous table, the DEMATEL influence map was obtained (**Figure 4-8**). In this, the color and form of the markers (dot or triangle) denote the family of the performance to which each indicator belongs. Here, the X axis represents the degree of the influence ($r_i + c_i$), and the Y axis the direction of this influence ($r_i - c_i$). In this way, it is possible to have a clearer view of which performance indicators are causal (the ones above the x axis), and which are the ones being influenced (below the x axis). Also, the indicators that are further to the right are the ones that have the greater number and value of (causal or influenced) interrelations with other indicators.

Looking at the causal performance indicators in the DEMATEL influence map (the ones in the upper part, $(r_i - c_i) > 0$), it is worth highlighting that the most recurrent family is the *Human Factor* (its indicators are denoted in the map by the blue dot), accounting for

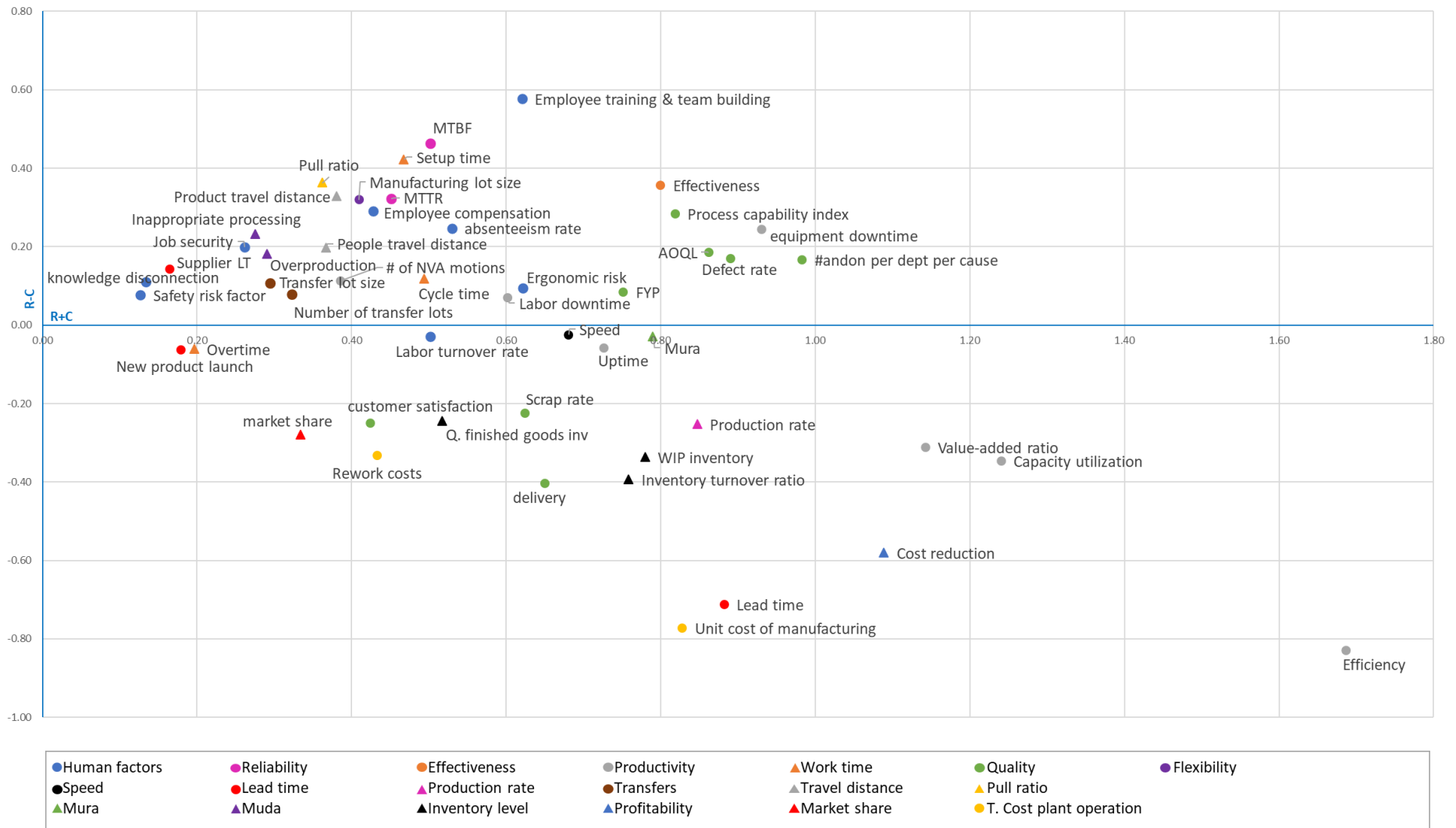

Figure 4-8. DEMATEL Influence map

24% of the total causal performance indicators, or 7 out of 29. Those indicators are *Employee training & team building*, *Employee compensation*, *Absenteeism rate*, *Job security*, *Knowledge disconnection*, *Ergonomic risk*, and *Safety risk factor*. Which leads us to see and stress the critical influencing role that human factors play in the performance of a company.

Also, it is possible to observe in this figure the distribution of the different families of indicators. It is worth noting that families of *productivity*, *quality*, *inventory levels* and *cost plant operation*, which are among most commonly used or discussed in the literature (**Table 4-2**), are not in the majority among the most influencing ones. For the *Quality family*, even though some of its indicators are considered causal, still nearly 38% of them are among influenced indicators, as is the case for *delivery*, with a $r - c$ value of -0.4 (**Table 4-5**).

Regarding the performance indicators in the families of *inventory levels* and *cost plant*, they are entirely in the lower part of the map. And as for *productivity*, this family is strongly distributed in the lower and right part, indicating that even though it is one of the most discussed in literature, it does not have a high influence over the other indicators and its results are in fact highly influenced by other indicators. For example, taking *Efficiency*, a performance indicator in this family, it is influenced by 37 indicators and influences 19, which suggests that if a better performance level is being targeted, those may not be the indicators to start making improvements upon, being the ones in the upper part of the map a better option.

4.3.3 Validation of robustness of analysis

As explained in Section 4.2.3, in order to overcome the potential limitation of DEMATEL analysis (reliance on expert's evaluation), this last stage of our methodological approach shows the results of the validation analysis for complementing the aforementioned DEMATEL results. Therefore, this section first presents the results from the Kendall coefficients, and then concludes with those of the Sensitivity analysis.

For Kendall's concordance and correlation coefficients, the interest was to evaluate the degree of consistency and accuracy of the evaluations made by the two initial experts, for which, a random sample of 20 comparisons (20 pairs of indicators) was selected from matrix *D*. Then, 4 Black Belt-certified experts in Lean Six Sigma were asked to evaluate, from 0 to 4, the peer-to-peer influence for this sample (shown in Appendix G). Their evaluations, along with those of the initial experts, were used to calculate the Kendall's coefficients. Using Minitab software, a 69% was obtained for the Kendall's Coefficient of Concordance between appraisers, and a 66% for the Kendall's Correlation Coefficient with the reference (**Figure 4-9**). These results, while being greater than 60% (Duleba & Moslem, 2018), suggest strong agreement among experts. Therefore, it can be said that the external experts generally agree with the initial influences entered into the matrix *D*.

Between Appraisers				All Appraisers vs Standard			
Kendall's Coefficient of Concordance				Kendall's Correlation Coefficient			
Coef	Chi - Sq	DF	P	Coef	SE Coef	Z	P
0,694584	52,7884	19	0,00005	0,658213	0,0811107	8,09877	0,0000000000000006

Figure 4-9. Result of the attribute agreement analysis with Minitab software

Following this, as a last stage for validating the robustness of DEMATEL results, the sensitivity analysis was done, this is commonly developed under different scenarios for comparing the stability of their results (Bhuvanesh Kumar et al., 2022). For this, from the total of the influence links established matrix *D*, an aleatory sample of the 10% was selected, representing a total of 61 peer-to-peer influence evaluations (see Appendix H). Then, the influence value of each of them was modified for creating the 4 scenarios for testing, they are shown in **Table 4-6** (since our evaluation scale is set from 0 to 4, therefore, in any case the calculated values must exceed these values).

Next, for each of the scenarios, all the DEMATEL steps were correspondingly recalculated, in order to obtain the new $r_i + c_i$ and $r_i - c_i$ indexes in each case, with which the influence maps shown in **Figure 4-10** are generated. Thus, with this sensitivity analysis, we are assessing how an error or variation in the 10% of the influence evaluations made by the experts could have affected the final results of DEMATEL analysis.

Table 4-6. Sensitivity analysis scenarios

Tested Scenario	Characteristics
Scenario 1	Adding 1 to each of the 61 values
Scenario 2	Adding 2 to each of the 61 values
Scenario 3	Subtracting 1 to each of the 61 values
Scenario 4	Subtracting 2 to each of the 61 values

From the analysis of the overall results of each of the 4 scenarios, there do not seem to be significant changes. The analysis shows that even if a slight change in the order in the cause-effect ranking is observed, it is not representative, the ranking remains almost the same in all the 4 scenarios compared with the base one. This can be observed in **Figure 4-10**, as well as in Appendix H, in which a table for each scenario containing the new calculated $r_i + c_i$ and $r_i - c_i$ is given. In both, it is highlighted in blue and red, the top 10 most causal and the top 10 most influenced performance indicators from the base scenario, respectively. This suggests that with a difference in 10% of the evaluations of influence, the results remain generally stable, and thus the methodology seems to be stable and robust.

4.4 Making sense of performance indicator systemic view

Both, the influence map with indexes $r_i + c_i$ and $r_i - c_i$, along with the total influences (received and given by each performance indicator) comprised in matrix T constitute a great insight into improving the decision-making process in CIP. Their use can provide decision makers with valuable information with which it would be possible to identify the most relevant performance indicators. The influence map provides a more comprehensive and graphical view of the performance indicators and makes it easier to distinguish the causal performance indicators from the influenced ones. While matrix T provides a numerical representation of the level of total influence among each of the indicators.

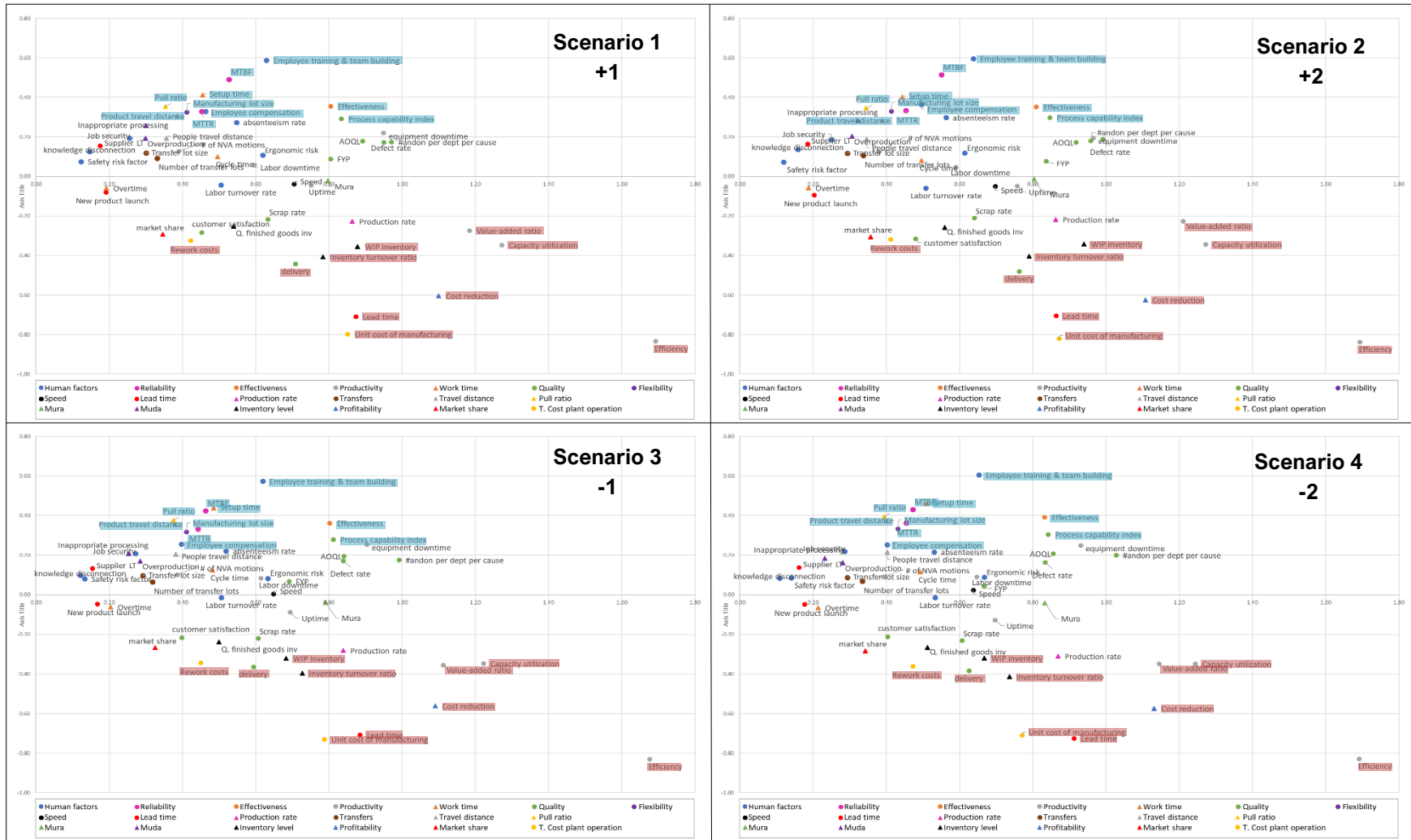

Figure 4-10. Sensitivity analysis - 4 scenarios

The aforementioned (influence map with causal/influenced indicators, and their total influence interrelationships) is instrumental to prioritize the analysis of the performance indicators that are mostly causal, rather than to focus only on the influenced ones (mainly among the most cited ones in the literature. See **Table 4-3**. Performance indicators retrieved from literature). Thus, in this way, when looking to improve a given performance indicator, this proposed approach also makes it possible to include the other performance indicators that might be affecting its result (as will be shown in Chapter 5). Aiding to have a better resource allocation and maximization of the effects of the improvement actions to be implemented.

With this, we propose a shift in the way performance improvement implementations is approached. As it usually starts by selecting a performance indicator for a given problem, identifying the root causes of that problem, and then acting on these causes to improve the chosen indicator (as depicted in Chapter 3). What is proposed here, implies that this approach may be incomplete if the selected performance indicator is mostly being influenced by others. Seeking to have a more effective analysis, it is therefore suggested to look for the performance indicators influencing the ones we are interested in improving prior to analyzing root causes. Thus, in this way, prevent failed implementations, by being able to identify and propose improvements directly on the root causes (causal indicators), instead on the apparent ones (Smeds, 2022).

With the approach proposed in this chapter, we argue not to analyze performance indicators under an isolated basis, as it has been done so far. But instead, with a systemic view of the performance indicators for establishing an approach that allows to identify the most relevant performance indicators by analyzing their influence interrelationships.

4.5 Conclusion

The contributions of this chapter aimed to answer to the second research question of the thesis (RQ2: How to identify and define the most relevant indicators that will allow to

measure and follow-up the performance?). This study contributes to the research on CIP by proposing an approach for analyzing performance in a more comprehensive and systemic way by analyzing the influence interrelationships among its indicators. For this purpose, the performance indicators in Lean manufacturing were gathered from the literature, resulting in a final set of 50 indicators. This provided a more integrated and updated set of indicators than previous studies, while covering 19 different families of performance. Then, an analysis for identifying most relevant performance indicators was performed based on the elicitation of the interrelationships among them, resulting in 29 causal and 21 influenced performance indicators along with the matrix containing the total influences.

The relevance of these contributions lies in the following points. First, results from DEMATEL analysis suggest the importance of reevaluating the pertinence of classic performance indicators, and of emphasizing the use of the causal indicators to improve performance more effectively by acting on the causes (causal indicators) and not on the consequences (influenced indicators) (Cardenas-Cristancho et al., 2022). Moreover, the complex relationships among the indicators suggest the importance of analyzing performance indicators as part of a complete system, instead of as isolated and independent factors.

Finally, the proposed approach and results of this chapter have the potential to serve as a foundation to support CIP experts through their decision-making process for improving the performance in a more holistic way. One that better represents the complex environment where organizations operate by including the influence interrelationships among indicators, and through which experts may take more assertive decisions, and therefore have an impact for reducing CIP implementation failures.

The contributions on this chapter were originally published in the *International Journal of Lean Six Sigma* (Q1 in Industrial and Manufacturing Engineering): Cardenas-Cristancho, D., Muller, L., Monticolo, D. and Camargo, M. (2021), "Toward a holistic understanding of performance in Lean Manufacturing: a discussion on the relevance of its indicators", *International Journal of Lean Six Sigma*, Vol. ahead-of-print, No. ahead-of-print. DOI:10.1108/IJLSS-10-2020-0163, available at: <https://doi.org/10.1108/IJLSS-10-2020-0163>.

5.A Decision Support System for the decision-making process in Continuous Improvement of the Performance

Throughout this thesis, it has been shown the relevance of the CIP process within organizations for performance improvement and thus for remaining competitive in the current environment, as well as the paramount importance that a systemic analysis of performance indicators plays in it. An organizational and process model of CIP, along with a systemic view of performance indicators for eliciting the most relevant ones have been proposed. However, as earlier discussed, decision-making for improving organizational performance is complex and requires support and guidance. To continue proposing improvement strategies (practices, tools) without acknowledging the influence interrelationships among performance indicators and improvement effects from practices and tools, will certainly continue to lead to failed CIP implementations.

Therefore, aiming to answer to our third research question (RQ3: How to assist experts in Continuous Improvement in the decision-making process to improve the performance?), this chapter focuses on the proposition of a Decision Support System (DSS) for performance improvement. Our purpose is to design a DSS architecture contingent to the systemic nature of the CIP process and its key decisional points so as to assist in the selection of performance indicators and the prioritization of performance improvement strategies. Building on the previously modeled CIP process and the casual-influenced relationships of performance indicators presented in the previous chapters, an ontology will be structured for being used by the logical reasoning of the DSS architecture.

In the remainder of this chapter, the structure of the DSS along with its positioning in the CIP process is described. Then, the general architecture of the proposed DSS is

introduced. And lastly, knowledge container and the reasoning logic of the DSS are discussed.

5.1 Toward the conception of the CIP-DSS

As for developing a Decision Support System (DSS) it is important to firstly clarify and understand the decision making context to which it is intended to aid (Power, 2002). Then it becomes fundamental the analysis and formalization of the process of CIP developed in Chapter 3. Through the contribution presented in that chapter, it is possible not only to understand how the process of CIP is executed, but also, it allows to identify the decisional moments in the process, where are the critical moments in which decisions are being made (the activities), and which are the key elements for doing so. The analysis of the CIP process model developed in Chapter 3 (and breakdown shown in Appendix B with the activity diagrams from KROM), allowed us to identify the importance of subprocesses A1 (to support performance strategy) and A2 (to support problem resolution) for the decision-making throughout the CIP process. The decisional moments within these are focused on the identification of the performance indicators to measure and follow, and on the selection of the most suitable improvement practices and tools. The CIP process model reveals the isolated and simplistic way in which improvement strategies are implemented in real environments, ignoring the interrelationships and influences that performance indicators can have on each other.

In this sense, the contributions of Chapter 4 offer a comprehensive view of performance indicators by analyzing and capturing the interrelationships of influences among them, something that has not been explored in depth in theory or practice so far. This approach to generate influence maps of performance indicators is instrumental for decision making in order to identify key indicators and ultimately define clearer and more effective strategies. The possibility to elicit the total influences between performance indicators then becomes the cornerstone in the prioritization of practices and tools (to improve performance indicators) closer to the complex reality.

Therefore, a decision support system for continuous performance improvement (CIP-

DSS) should focus precisely on emphasizing the analysis of the influence interrelationships between performance indicators, establishing the indicator-practice-tool influence interrelationship, and integrating this interrelation into the final prioritization of improvement tools and practices. In this way, decision-makers could have a comprehensive view of their performance system, as well as a suggestion of priority actions to be implemented according to the need to improve a given indicator. A decision support system following this approach could then contribute to incorporate the complexity and being instrumental in identifying effective improvement strategies, while reducing the mental load and time consumption for the user.

With the aforementioned in mind, **Figure 5-1** illustrates how the CIP-DSS proposition is situated and connected to the previous contributions in this thesis. This proposal seeks not only to assist in the actual decision-making process, but also to improve how these decisions are made. For this purpose, performance is approached as a complete system including (1) the performance indicators and the influence interrelationships among them, (2) the performance improvement practices and their improvement effects on the performance indicators, and (3) the links between the improvement practices and the tools through which these can be implemented.

The CIP-DSS does not seek in any way to take the place of the decision makers, but instead, it is intended to be an aid for them in decision-making, by:

(a) giving them information for better selecting performance indicators based on their causal or influenced nature, the influence they might exert on other indicators or that they might be receiving, as well as the definition of the indicator and the family to which it belongs.

And,

(b) by showing for the selected performance indicators by the user, which prioritized practices and consequently which tools, should be considered to implement in order to improve the given performance indicators.

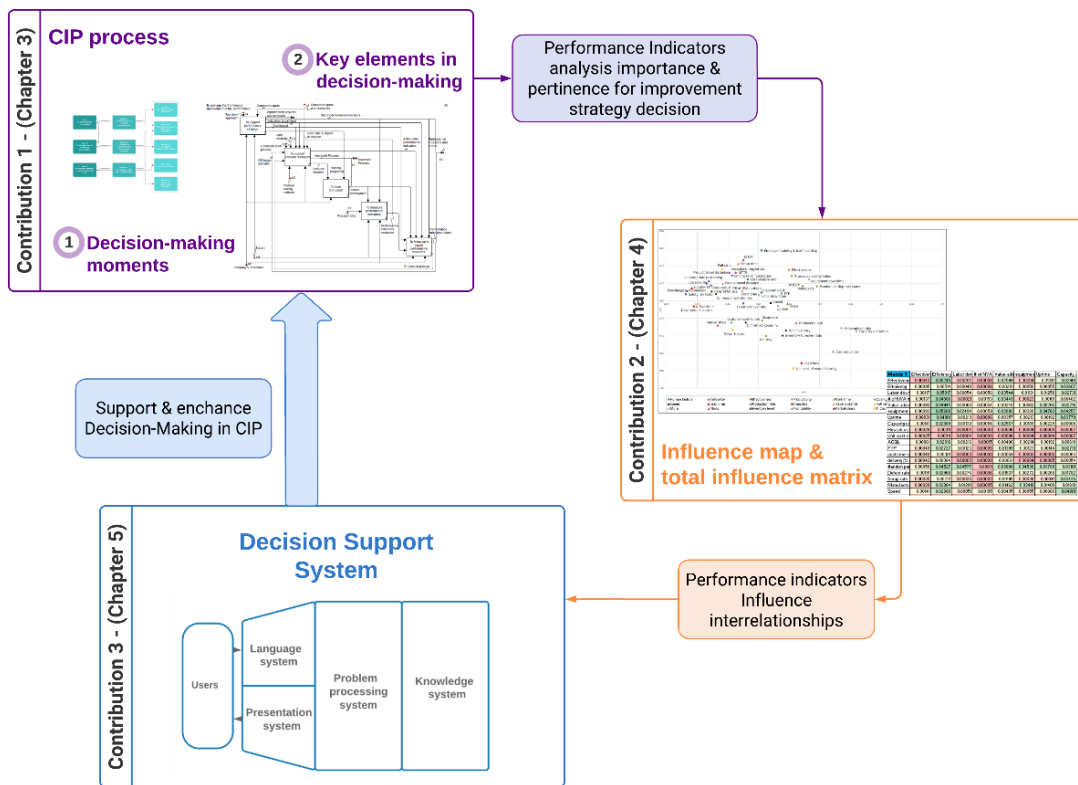

Figure 5-1. CIP-DSS approach

5.2 Positioning the CIP-DSS into CIP process

Since, as previously mentioned, sub-processes A1 (to support performance strategy) and A2 (to support problem resolution) are the most relevant in decision making, it is precisely on them that we are going to focus to provide support with our system. The proposed CIP-DSS will include the different elements of the performance system, along with a reasoning logic (to be explained in Section 5.5), in order to improve the decision-making in the CIP process. Therefore, for having a better clarity regarding the activities in the CIP process where the CIP-DSS will have an impact on, the following paragraphs will be focused on explaining the CIP-DSS interactions with A1 and A2 subprocesses. Impacted activities are denoted in *blue*, along with the new activities and data interactions in *purple* in **Figure 5-2** and **Figure 5-3** respectively.

- **A1: Performance Indicator Identification**

In subprocess A1, the impact of the CIP-DSS will be seen as affecting some of existing activities in CIP process (described in Chapter 3) and it will also represent new data, interactions, and activities in the process, as seen in **Figure 5-2**. The CIP-DSS is intended to impact activity **A12** “to support performance indicator identification”, as this is where the performance indicators are today determined (selected) intuitively following a top-down approach and with no interaction among them. The aim of this activity is to change that by providing a systemic view in the subprocess.

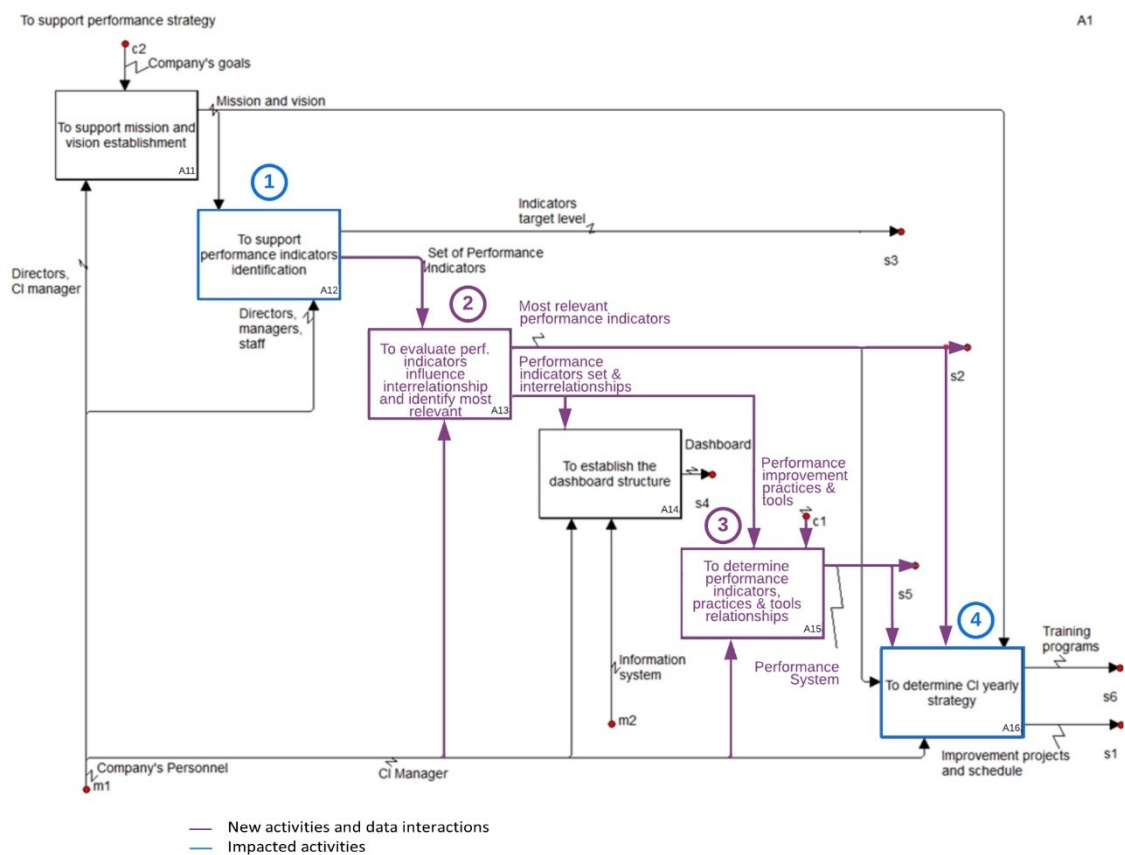

Figure 5-2. CIP-DSS interaction in A1 - To support performance strategy

- **A1: Evaluation of performance indicator influence interrelationships**

Once the identification or listing of all the performance indicators is done, there will be an additional activity (see circle number 2 in **Figure 5-2**), **A13** “to evaluate performance indicators influence interrelationships and identify most relevant ones”. Here, the influences among the identified performance indicators will be evaluated and analyzed

for having the most relevant performance indicators, which will constitute the subprocess output **S2** (using the first functionality of CIP-DSS). Also, a second output of **A13** will use the set of performance indicators and their influences interrelationships as a control for activity **A14** and the new **A15** (circle number 3 in **Figure 5-2**).

- **A1: Evaluation of indicator-practice-tool improvement interrelationships**

In activity **A15** the improvement relationships among performance indicators, practices and tools are elicited, establishing in this way the full performance system. This will be the output **S5** of the subprocess, as well as a control for activity **A16** (circle number 4 in **Figure 5-2**), providing comprehensive insights to feed into the definition of the yearly strategy and the subsequent definition of the respective improvement projects.

As for subprocess A2, the CIP-DSS, will impact the existing activities **A22** (to analyze data and causes), **A23** (to propose and evaluate solutions), **A24** (to establish action plan) and **A25** (to follow-up the action plan) of the CIP process. The Performance System defined in subprocess A1 will be of paramount importance for subprocess A2, as it will act as control for activities **A22**, **A23**, **A24** and **A25** as depicted in **Figure 5-3**.

- **A2: Performance system supporting problem cause analysis**

Now in activity **A22** (circle 1 in **Figure 5-3**), instead of just analyzing a plain and narrow set of performance indicators, the CIP-DSS will allow to integrate the whole performance system into the analysis of the causes. It will allow to visualize for the off-target performance indicator (entry **e1**) which are the performance indicator that might be exerting an influence on it, and thus, that are relevant to consider.

- **A2: Performance system supporting prioritization of improvement practices and tools**

Next, the identification and evaluation of possible improvement solutions in activity **A23** can now rely on the knowledge contained within the performance system (indicator-practice-tool improvement interrelationships) to propose a prioritization of improvement practices and tools to be applied on a case-by-case basis. This prioritization should feed decision-makers with specific information for defining an action plan in activity **A24** (circle 3 in **Figure 5-3**). Finally, the CIP-DSS could also impact activity **A25** (circle 4 in

Figure 5-3) by assisting decision-makers in a better selection of the performance indicators (causal ones) to follow the action plan.

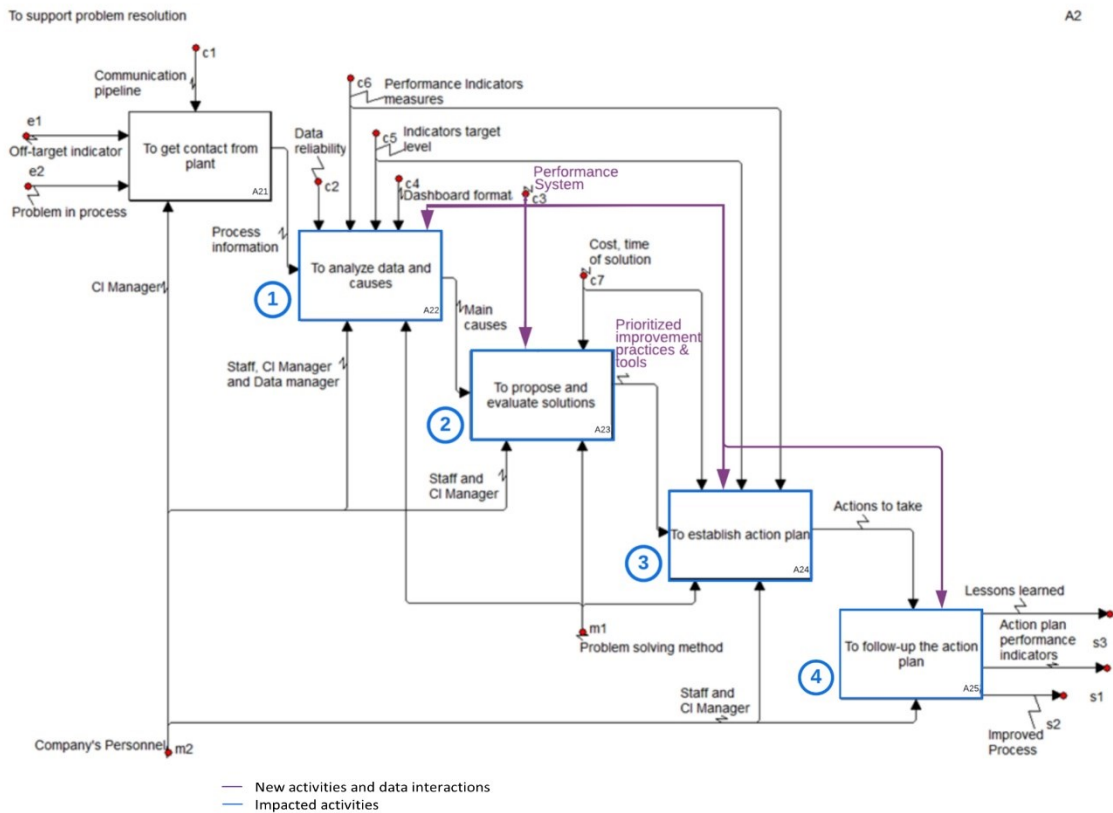

Figure 5-3. CIP-DSS interaction in A2 - To support problem resolution

5.3 CIP-DSS model proposition

This chapter section focuses on describing the model proposition of our CIP-DSS. Which will enable it to fulfill its objectives. For this means, it will start by presenting the architecture of the system, and then, it will focus on showing its components.

5.3.1 General CIP-DSS architecture

According to Holsapple (2008), a generic DSS architecture is composed of the following essential elements: a language system, a presentation system and knowledge system, all at the same time coordinated by a fourth one, the problem-processing system. Based on this, we propose a general architecture for our CIP-DSS, as shown in **Figure 5-4**. On the left side there are the system users, the CIP managers and engineers (decision-makers), who will interact with CIP-DSS and for who the system is developed.

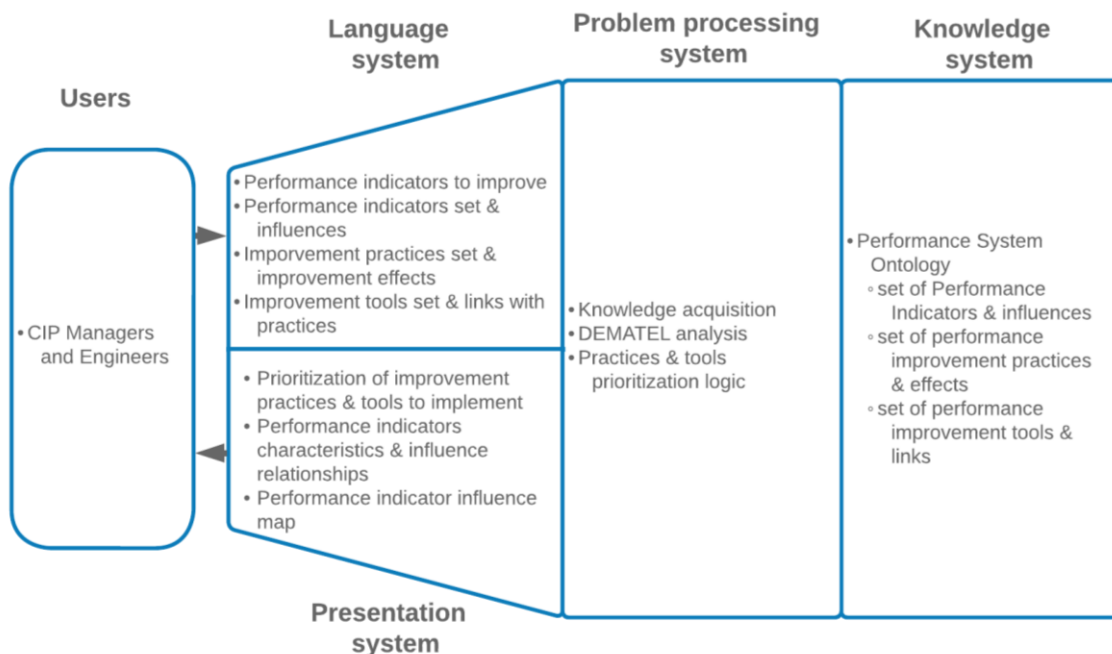

Figure 5-4. CIP-DSS general architecture

In the language system are all the possible inputs that the CIP-DSS can receive from users: the performance indicators the user seeks to improve, performance indicators set and peer-to-peer direct influences, as well as the set of improvement practices and their improvement effect towards indicators, and the improvement tools with their respective links with the defined practices. Then, the presentation system includes the messages or information that the CIP-DSS can give to the user: the prioritization of improvement practices and tools to implement for a given (set of) performance indicator(s), the characteristics and influence relationships for selected performance indicators, their influence map.

As for the knowledge system, this includes our Performance System Ontology, PSOnto (to be developed in detail in Section 5.4), which contains all the identified set of performance indicators, improvement practices and tools along with their influence, improvement, and operationalization relationships. And finally, the problem-processing system that is the element in charge of articulating the others, by making it possible to choose what elements the DSS will present to the user. It includes: the knowledge acquisition, the DEMATEL analysis (refer to Chapter 4), and the practices and tools prioritization logic.

5.3.2 CIP-DSS components

Based on the general architecture, a detailed architecture for CIP-DSS can be specified. A detailed architecture should specify how the different elements of the system are integrated and connected. As it can be seen in **Figure 5-5**, the core high-level components of the proposed CIP-DSS are the following:

- **The user interface.** It allows users to interact with the DSS, enter the inputs (the performance strategy setup and the performance indicators to improve) to the system and visualize its outputs (including the prioritization of improvement practices and tools, and influence map and characterization of performance indicators).
- **The performance indicator interrelations module.** This module, based on influence interrelation analysis, helps users to identify the most relevant performance indicators by giving a visual representation and categorization of the performance indicators, along with a characterization of selected performance indicator, showing its exerting and receiving influences.

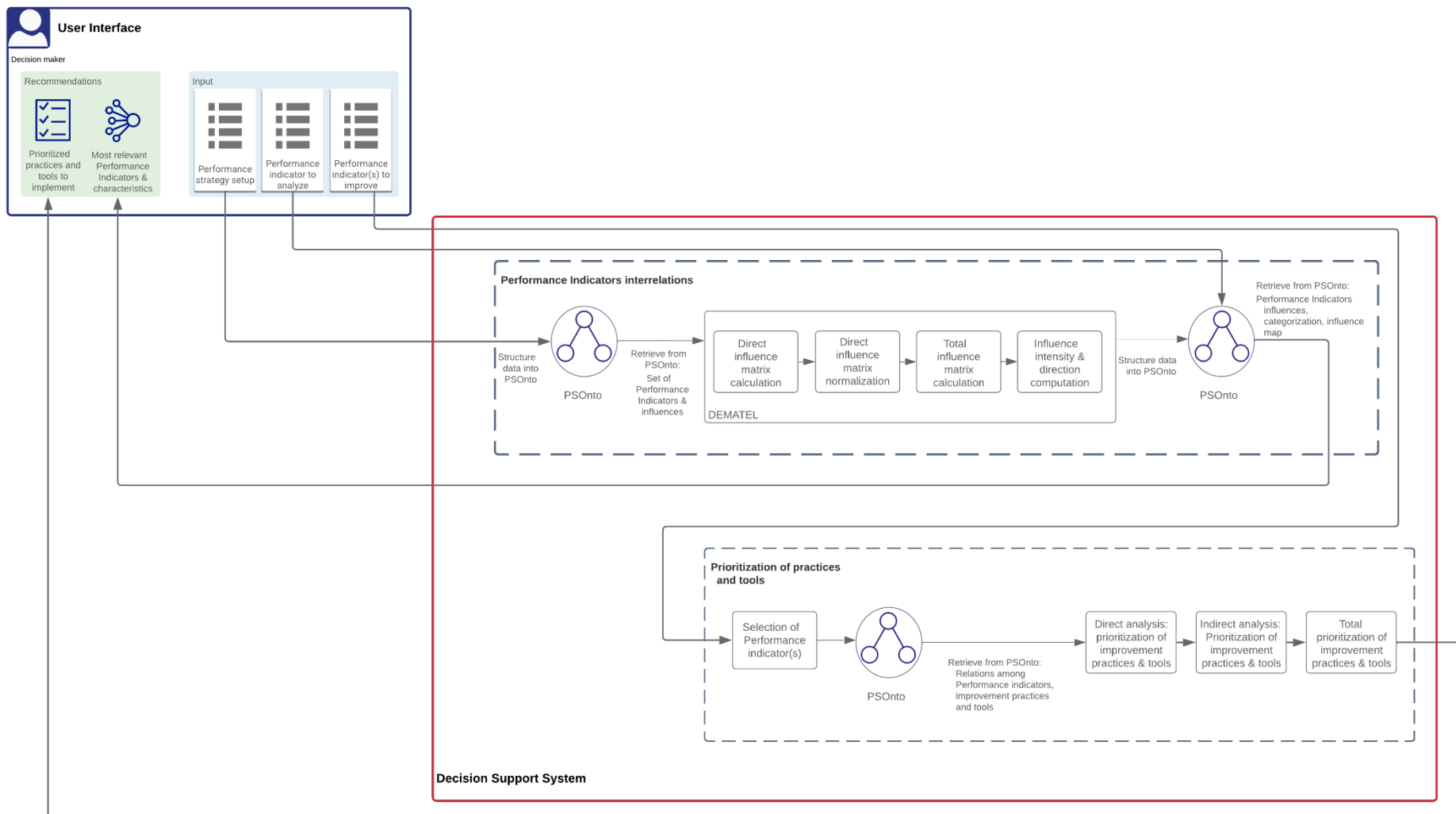

Figure 5-5. CIP-DSS architecture

- **The prioritization of practices and tools module.** Based on a selected performance indicator or set of them, it is capable of analyzing the received influences from other performance indicators and consequently the module gives the user a prioritization of the most adequate practices and tools to implement in order to improve the selected performance indicators.

By the means of the aforementioned components and the architecture shown in **Figure 5-5**, the following are the steps in the CIP-DSS parametrizing and decision support process:

I. Parametrizing steps:

Step 1: The CIP-DSS populates the PSOnto (to be detailed in Section 5.4), with the data entered by the user (CIP managers and engineers) in the performance strategy setup: performance indicators, improvement practices and tools, and relationships (impacts activities A12, A13, A15 from **Figure 5-2**).

Step 2: The CIP-DSS first module sends queries to the PSOnto for getting the set of performance indicators along with its peer-to-peer direct influence relationships (activity A13 from **Figure 5-2**).

Step 3: Next, the CIP-DSS applies the steps of DEMATEL method, and thus produces the total influences, influence indexes and map (activity A13 from **Figure 5-2**).

Step 4: Then, the obtained data from DEMATEL analysis is stored in the PSOnto (activity A15 from **Figure 5-2**).

II. Decision support process steps:

Step 1: Upon selection from the user, the first module by retrieving the data from the PSOnto, provides them with the required information to identify the most relevant performance indicators: influence map, performance indicators characteristics and influences (activities A13 from **Figure 5-2** and A25 from **Figure 5-3**).

Step 2: The user selects an individual performance indicator or a set of them that wishes to improve (activities A16 from **Figure 5-2** and A22 from **Figure 5-3**).

Step 3: The CIP-DSS second module retrieves the needed data (performance indicators, total influences and indexes, practices, and tools with improvement links) from the PSOnto.

Step 4: Following this, the CIP-DSS compute the direct analysis of the prioritization of practices and tools for selected performance indicators.

Step 5: Then the CIP-DSS proceeds to compute the indirect analysis of the prioritization of practices and tools for selected performance indicators.

Step 6: Based on the performed direct and indirect analysis, the CIP-DSS calculates the final total prioritization of practices and tools.

Step 7: Finally, the CIP-DSS provides the user the total prioritization of practices and tools to implement for improving the previously selected performance indicators (activities A16 from **Figure 5-2**, and A23 and A24 from **Figure 5-3**).

5.4 Knowledge container: Performance System Ontology

The Performance System Ontology (PSOnto) constitutes a cornerstone for the proposed CIP-DSS, since it is within it that the knowledge will be stored and retrieved to be used in the reasoning logic of the system (to be explained in Section 5.5). Thus, this section is focused on the development of the ontology, which instances are created, constituting our knowledge base. We opted to develop an ontology for the knowledge container of the CIP-DSS, because it allows to specify a common vocabulary of a domain, including its definitions and relations, while enabling the reuse of knowledge and interoperability among people and machines (Noy & McGuinness, 2001).

Thus, this section is focused on the development of the PSOnto, by which we not only integrate the performance indicator's interrelationships resulting from DEMATEL analysis, but also, to incorporate the relationships among performance indicators and improvement practices and tools. For structuring our PSOnto, we adapted the stages described in (Gabriel et al., 2017; Noy & McGuinness, 2001), which includes the definition of domain and scope of the ontology, its conceptualization, development and finally its validation.

Table 5-1 specifies the domain in which the ontology will be used, for what it will be used and by whom, as well, as all the different competency questions to which the

PSOnto should provide answers to. These competency questions will be later verified in the validation stage, for which, SPARQL¹ queries language will be used in order to retrieve the data stored in the ontology.

Table 5-1. Domain and scope of PSOnto

Domain and Scope of the Ontology	
Question	Answer
What is the domain that the ontology will cover?	The process of continuous improvement of the performance
For what will the ontology be used?	For storing and retrieving knowledge within CIP-DSS, for helping the decision maker to make better decision to improve the performance
Who will use the ontology?	Performance improvement Managers / Engineers through the CIP-DSS
Competency questions: For what type of questions the information in the ontology should provide answers?	
Which are the performance indicators per performance family?	
To which performance family does a given indicator belong?	
What is the definition of a performance indicator?	
What is the objective of a performance indicator?	
What is the type (causal/influenced) of a performance indicator?	
What is the influence direction index for a performance indicator?	
What are the performance indicators giving a direct influence (with its influence value) to a given performance indicator?	
Which performance indicators are receiving a direct influence (with its influence value) by a given performance indicator?	
What are the performance indicators giving a total influence (with its influence value) to a given performance indicator?	
Which performance indicators are receiving a total influence (with its influence value) by a given performance indicator?	
What are the performance indicators improved by an improvement practice (with its improvement value)?	
Which are the improvement tools to operationalize an improvement practice?	

After this, the vocabulary of PSOnto is determined, for which **Table 5-2**, **Table 5-3** and **Table 5-4**, respectively show an excerpt of (see Appendix I for the complete tables): the classes, along with their super class and definition; the class properties; and the object properties. Thus, PSOnto is composed of 10 classes, in which there are the performance

1. <https://www.w3.org/TR/rdf-sparql-query/>

indicator and family, performance improvement method, practice and tool, and the different relationships (influence, total influence, direct influence, improvement).

Table 5-2. Excerpt from PSOnto classes

Class	Super Class	Natural language definition
Performance Family	Thing	The various facets or dimensions of the performance in an organization
Performance Indicator	Performance Family	A type of measurement through which the different performance dimensions can be assessed
Performance Improvement Method	Thing	Applied method with the main purpose of enhancing the performance in an organization or their processes

Table 5-3. Excerpt from PSOnto class properties

Relation	Domain	Range	Natural language definition
hasDefinition	Performance Indicator	String	The definition of a performance indicator
hasType	Performance Indicator	String	Describes the type (causal or influenced) of a performance indicator, resulting from DEMATEL analysis
hasTotalInfluenceValue	Total Influence	Decimal	The value of the total influence between 2 performance indicators, resulting from DEMATEL analysis

Table 5-4. Excerpt from PSOnto object properties

Relation	Domain	Range	Natural language definition
hasTotalInfluence	Performance Indicator	Total Influence	Property indicating that a performance indicator is receiving a total influence
isTotalInfluencing	Total Influence	Performance Indicator	Property indicating that a total influence is influencing a performance indicator
hasImpactOn	Performance Improvement Practice	Improvement Relationship	Property indicating that a performance improvement practice has an improvement impact on an improvement relationship

Based on the formalization made with the previous tables, the PSOnto was structured in Web Ontology Language (OWL) by using Protégé², as it is a widely known software by the scientific community. **Figure 5-6** shows the PSOnto graph, in which it can be appreciated the classes and the relations among them that constitute our ontology. Denoting, for example, that a performance improvement practice contributes to the implementation of a performance improvement method. And that a performance improvement practice has an impact on an improvement relationship with a given value, which improves a performance indicator that has a performance family.

In order to be able to verify our PSOnto, it was subsequently instantiated, for which with no aim to reduce generality, but to illustrate, we centered on Lean (CIP methodology). Resulting in this way in the following quantities of instances: 50 performance indicators (with their corresponding characteristics), 19 performance families, 41 performance improvement practices, 23 performance improvement tools, along with the more than 1600 total influence, direct influence, and improvement relationships. The data used as instances for performance indicators, performance families and total and direct influences can be consulted in Appendixes E and F (resulting from Chapter 4). As for performance improvement practices and tools (taken from (Liker, 2004) as previously mentioned in Chapter 4), and improvement relationships (assessed by the same experts as for DEMATEL analysis), are shown in Appendix J. In the use of the CIP-DSS (as mentioned in Section 5.3.2 and further explained in Section 5.5), the instances will correspond to the data entered by the user and the results from DEMATEL analysis.

Afterwards, based on the developed PSOnto and their instances, a knowledge graph was developed with Ontotext-GraphDB³ software. With it, we verified our PSOnto by transforming the competency questions into SPARQL queries. **Table 5-5** shows 3 of these queries. Being the first one to obtain the performance family and definition of the performance indicator *Cycle time*. The second one to get the performance indicators directly influencing (with the influence values) the performance indicator *Cost reduction*. And the third one to retrieve the performance indicators improved by (with the improvement values) the practice of *Create a strong and stable culture*. The results of these 3 queries are consequently shown in **Figure 5-7**.

2. <https://protege.stanford.edu/>

3. <https://www.ontotext.com/products/graphdb/?ref=menu>

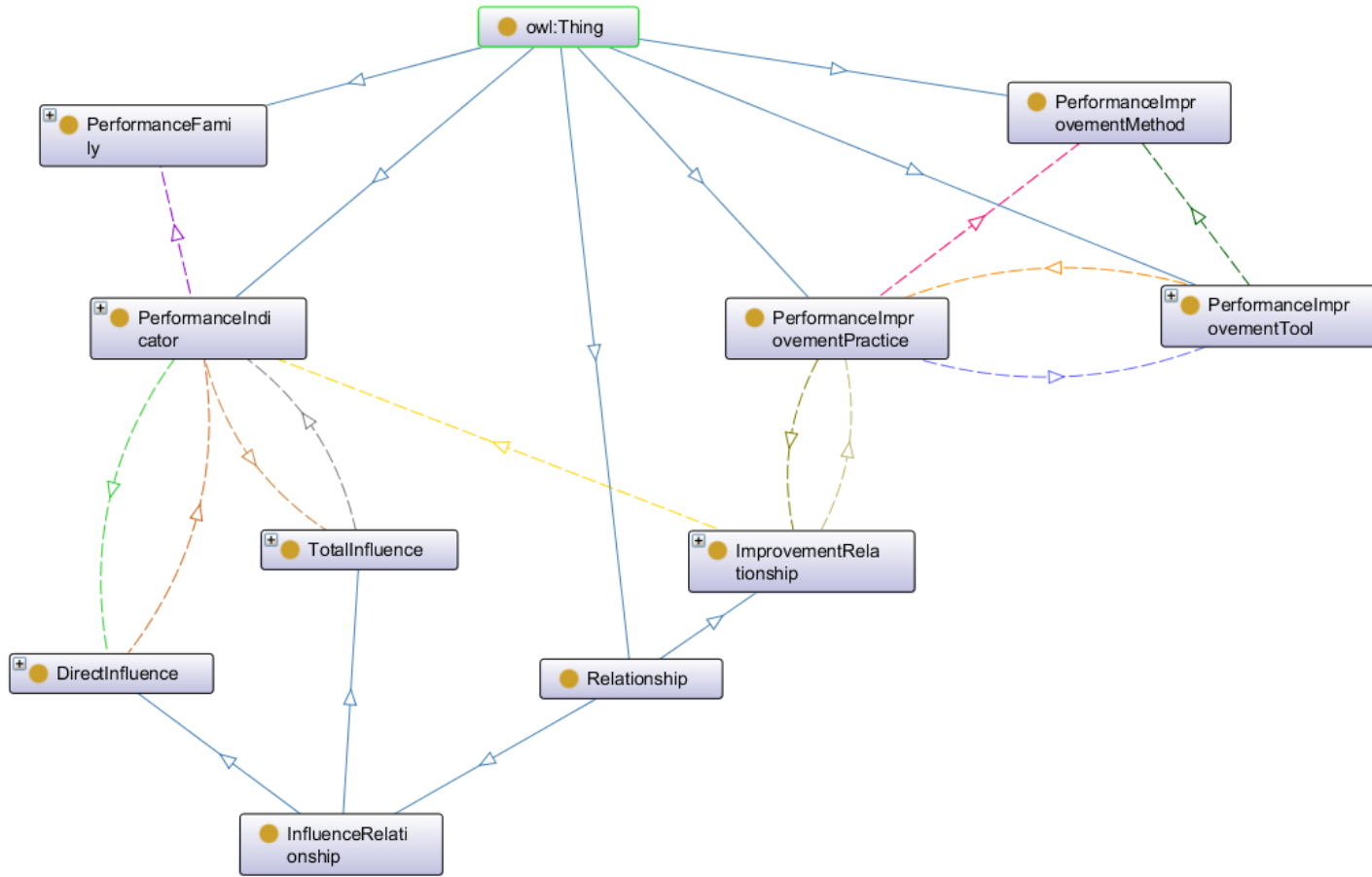

Arc Types

type filter text

- has individual
- has subclass
- hasDirectInfluence (Domain>Range)
- hasFamily (Domain>Range)
- hasImpactOn (Domain>Range)
- hasTotalInfluence (Domain>Range)
- isAssisting (Domain>Range)
- isContributingTo (Domain>Range)
- isDirectlyInfluencing (Domain>Range)
- isImpactedBy (Domain>Range)
- isImproving (Domain>Range)
- isOperationalizedBy (Domain>Range)
- isOperationalizing (Domain>Range)
- isTotallyInfluencing (Domain>Range)

Figure 5-6. Performance System Ontology - PSOnto

Table 5-5. Example of competency questions and SPARQL queries

Competency question	SPARQL query
*To which performance family does a given indicator belong? *What is the definition of a performance indicator?	select * where { :CycleTime :hasFamily ?Family; :hasDefinition ?def. }
*What are the performance indicators giving a direct influence (with its influence value) to a given performance indicator?	select ?InfluencingIndicator ?value where { ?DirInfluence :isDirectlyInfluencing :CapacityUtilization ; :hasDirectInfluenceValue ?value. ?InfluencingIndicator :hasDirectInfluence ?DirInfluence. }
*What are the performance indicators improved by an improvement practice (with its improvement value)?	select * where { :CreateAStrongAndStableCulture :hasImpactOn ?ImprovRelation. ?ImprovRelation :isImproving ?Indicator; :hasImprovementValue ?value. }

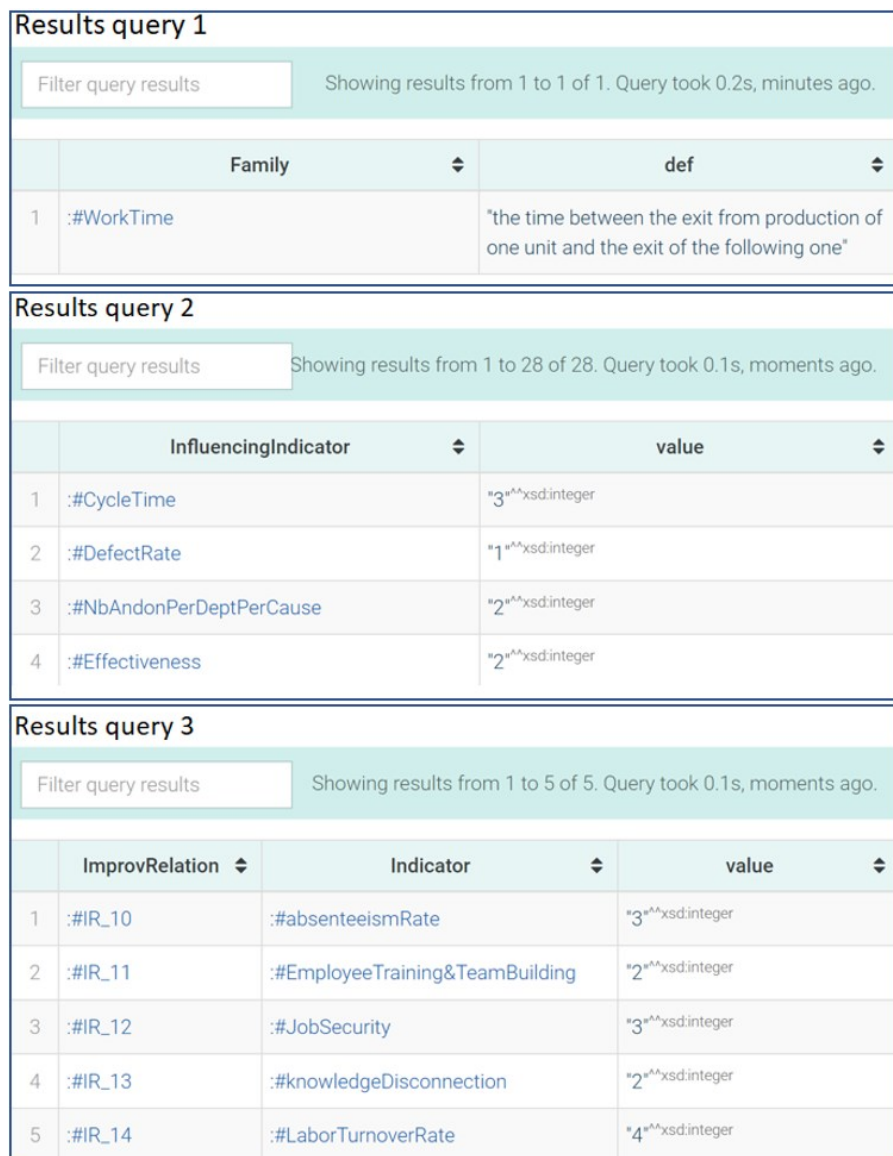

Figure 5-7. SPARQL queries results Ontotext-GraphDB

Finally, **Figure 5-8** shows a knowledge graph of our PSOnto generated with Ontotext-GraphDB for the performance indicator of *Lead time*. There, it is possible to see a fraction of the total influence (TI), direct influence (DI) and improvement (IR) relationships (for better visibility, the graph was restricted to a maximum of 40 relationships). And by expanding an improvement relationship (IR_52), we observe that this performance indicator is being improved, among others, by the improvement practice of *Design visual systems to support flow and pull*. Which at the same time is being operationalized by the improvement tools *one-piece flow cell* and *Kanban*.

Therefore, the developed ontology, PSOnto, constitutes the knowledge container of our proposed CIP-DSS. The PSOnto will allow our CIP-DSS to store the knowledge entered by the user and resulting from DEMATEL analysis, and subsequently it will allow its reuse by the reasoning logic in order to fulfill the CIP-DSS objective.

5.5 Reasoning logic

After describing the architecture of CIP-DSS with its corresponding components and explaining its knowledge container, the following section, will explain the reasoning logic of our proposed CIP-DSS. This will be done in terms of its two modules.

5.5.1 Performance indicators interrelations module

This first module (see **Figure 5-5**) aims at helping the decision-makers in the development of the performance strategy (Subprocess A1) by structuring the PSOnto and eliciting the most relevant performance indicators. Therefore, this module has two main objectives, firstly, to obtain the needed knowledge that will be stored into the PSOnto (to be done once, for parametrizing the system), which will be access throughout each use of the CIP-DSS by the user.

GraphDB

Import

Explore

Graphs overview

Class hierarchy

Class relationships

Visual graph

Similarity

SPARQL

Monitor

Setup

Help

Visual graph

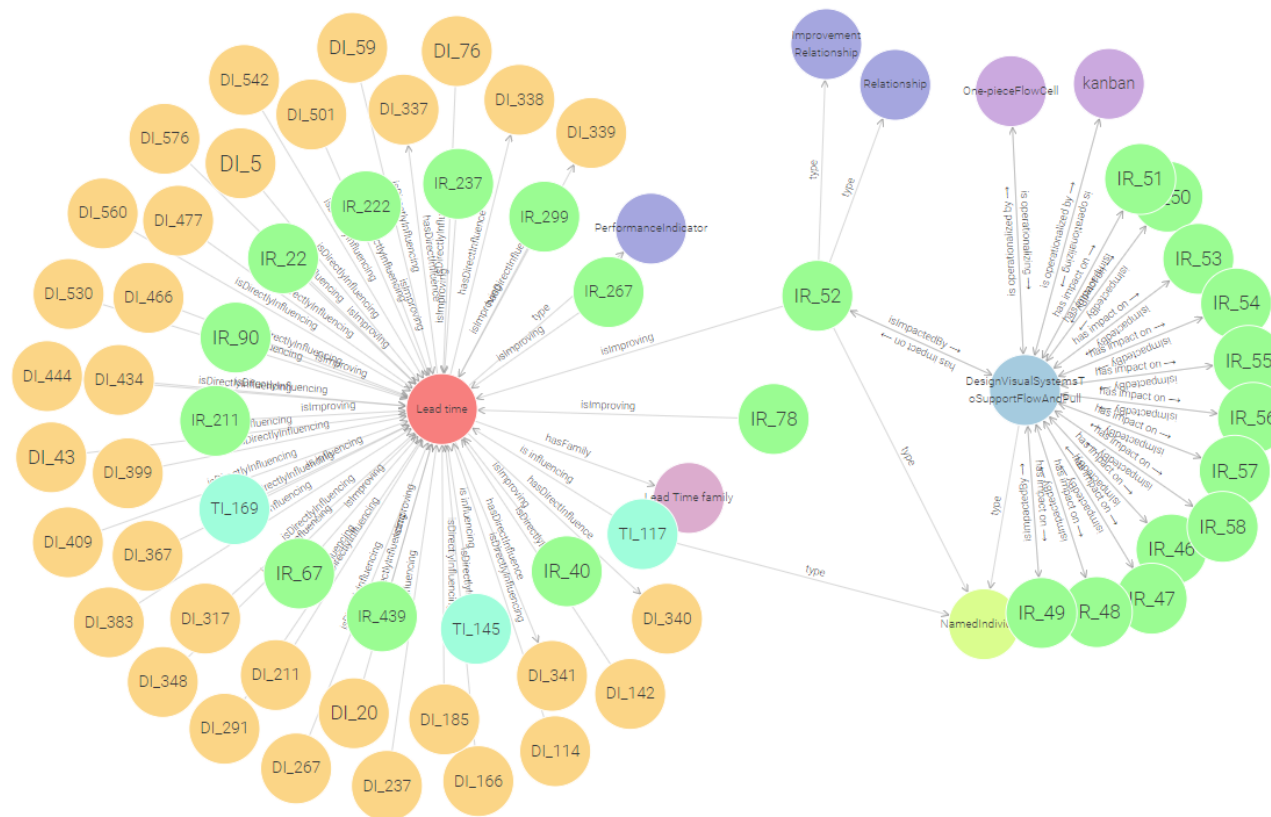

Figure 5-8. PSONto Knowledge Graph



And, secondly, to provide the user with the needed information for better analyzing the performance indicators and thus identify the most relevant ones among all the defined set. Therefore, the logic of the first module is structured as follows:

I. Structure performance strategy data into the PSOnto

This first module of our CIP-DSS provides the users with the functionality to setup the performance strategy data specific for their organization, which will be stored in the PSOnto, the knowledge system of the CIP-DSS (see **Figure 5-4**). It is important to note that this setup is to be done once (as a parametrization), to constitute the knowledge upon which the CIP-DSS will rely on for giving the recommendations to the user. The stored knowledge, given by the user, should be updated if needed (see Chapter 3), when the strategy of performance within the organization presents changes (i.e., when organization's global objectives change or when the need to include new performance indicators is evidenced).

Therefore, the stored knowledge in the PSOnto in this step is the following:

1. The complete set of performance indicators, along with their definition, and performance family to which each belong.
2. The peer-to-peer direct influences among performance indicators, which is done from 0 to 4 (as described in Chapter 4).
3. The set of improvement practices with their corresponding improvement effect to each of the performance indicators, which is assessed from 0 to 4 (following a five-point Likert scale as in (Alaskari et al., 2016)), and denoting when it is a positive or a negative effect.
4. The set of improvement tools along with their corresponding operationalization links to each of the improvement practices. Having in mind that a practice can be operationalized by multiple tools, and a tool can operationalize multiple practices.

II. Send queries to PSOnto and application of DEMATEL

The reasoning logic for this module heavily resides in the DEMATEL analysis application, which, as the previous step is to be done only once, for parametrizing the system. The CIP-DSS builds upon DEMATEL analysis as this is a powerful method widely used on

the analysis and simplification of complex problems by the deduction of a clear structure on the criteria relationships of the analyzed system (see Chapter 4). Thus, the power of DEMATEL does not only rely on eliciting the most important factors on a set, but beyond that, on the measure of the influence among criteria, the knowledge from the network of interrelationship of influence, which could help us better understand the analyzed problems and make strategic decisions on them.

Since this section is by no means intended to be redundant, then for details of the steps and equations comprised in DEMATEL analysis, readers are invited to refer to Chapter 4 of this document. With the application of DEMATEL steps in our CIP-DSS, we search to include into the analysis the intensity and direction of influence indexes per performance indicator ($r_i + c_i$ and $r_i - c_i$), as well as the total influence interrelationships expressed within matrix T . Thus, to embrace the complexity and include it within the analysis in a transparent way to the users.

III. Store total influences within the PSOnto

The added value of this module lies not only in the fact of applying DEMATEL, but also in the importance of being able to store this knowledge (user parameters in step 1 and DEMATEL results) in an ontology so that this knowledge can be accessed and reused for decision making. In this way, the users do not have to go through all the steps and calculations every time they want to make a decision, allowing in this way the decision-making in the CIP process to be much more effective and faster. Thus, ensuring a comprehensive analysis by integrating all interrelationships, regardless of their quantity, in every day-to-day decision making.

Consequently, the results from DEMATEL to be stored in the PSOnto are the total influences from Matrix T (includes direct and all indirect level of influences among criteria, as explained in Chapter 4), the influence direction index ($r_i - c_i$) per performance indicator as well as their type (causal or influenced).

IV. Visualization of influence map and performance indicator characteristics

Upon the parametrization of the CIP-DSS, this module retrieves from the PSOnto the intensity and direction of influence indexes per performance indicator ($r_i + c_i$ and $r_i - c_i$), for showing the user an influence map with the possibility to visualize all the performance indicators or a selection of them (individually selected or by family). Lastly, based on the selection of a performance indicator by the user, it provides, by querying the PSOnto, a view of the performance indicators that influence and are influenced by the selected one (sorted by magnitude of influence).

5.5.2 Prioritization of practices and tools module

Given the paramount importance performance indicators play in decision-making in CIP process, in which they should be considered as part of a whole system, thus, improvement actions should be then proposed by integrating the interrelationships within it. Then, when looking for improving a given performance indicator, one should consider the influences received from others depending on whether it is mainly causal or influenced. Assuring in this way that improvement actions are not limited to the isolated analysis of just the given indicator, but instead include the influence interrelationships from other indicators within the system.

Therefore, the reasoning logic for this second module of our CIP-DSS is based on three paramount elements: the results obtained from DEMATEL analysis (module 1), the improvement effects of the practices over the performance indicators, and the operationalization links among practices and tools. All of which are structured and stored in the PSOnto (Section 5.4). It integrates the complexity of the performance indicator system interactions by incorporating them into the analysis of the recommendation of improvement practices and tools.

I. Selection of performance indicators and queries to the PSOnto

Accordingly, in this second module (see **Figure 5-5**), the CIP-DSS allows the user to select as many performance indicators as needed (from the same or from different performance families) for improvement. For each of the selected performance indicators, the CIP-DSS obtains from the PSOnto their definition, influence direction index, the total influences received from the other performance indicators in the system (the performance indicators as well as the influence level), the improvement relations of the practices to each of the performance indicators (the ones being analyzed and the ones influencing them), along with its improvement level, and the related improvement tools for implementing those practices.

All of the aforementioned is retrieved from the PSOnto in order to have the needed knowledge for performing the steps for the prioritization logic of improvement practices and tools. To this end, the CIP-DSS develops two complementary analyses: a *direct* one and an *indirect* one, which are illustrated in **Figure 5-9**. For a performance indicator (Ind_a) in blue, there are: the performance indicators exerting an influence over it are colored in yellow, the improvement practices in pink, the improvement tools in gray, and the arrows denote the respective received improvement or influence effects. These two analyses and the computation of the total prioritization will be further explained below.

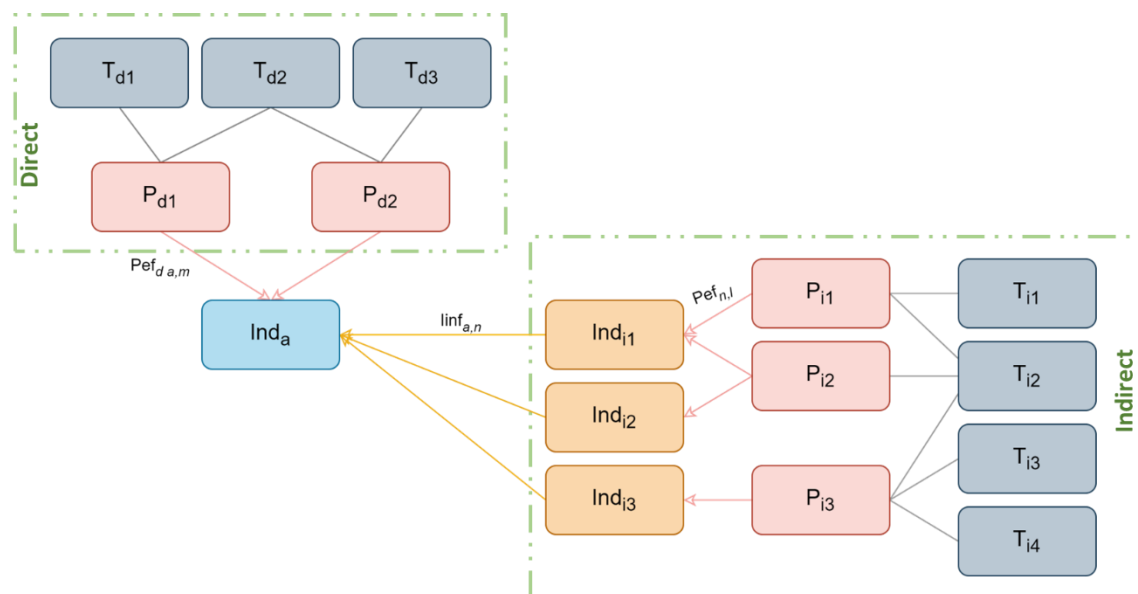

Figure 5-9. Total prioritization logic

II. Prioritization of improvement practices and tools: Direct analysis

The *direct analysis* starts by looking for the improvement practices (Pd_m) that have an improvement effect ($Pefd_{a,m}$) on a performance indicator (Ind_a), then sorts the m practices from the ones with the highest improvement effect to the lowest and selects the top ones. Subsequently, as the improvement practices are linked to the practices (Td_o) in the PSOnto, in which a practice can be operationalized by multiple tools, and a tool at the same time can operationalized multiple practices, then the tools (Td_o) inherit the improvement effect from the practices they are linked to, and thus they are as well prioritized based on the improvement effect, and the top ones are selected.

This *direct analysis* is depicted in **Figure 5-10**, in which for a performance indicator Ind_a , there are two practices Pd_1 and Pd_2 that are exerting an improvement effect $Pefd_{a,1}$ and $Pefd_{a,2}$ respectively. These practices are going to be sorted based on whether $Pefd_{a,1}$ is greater or smaller than $Pefd_{a,2}$. As for the improvement tools, Td_1 is linked to Pd_1 , thus it will take $Pefd_{a,1}$ improvement effect; Td_2 is linked to both, Pd_1 and Pd_2 , thus its improvement effect will be given by $Pefd_{a,1} + Pefd_{a,2}$; and finally, as Td_3 is linked to Pd_2 , its improvement effect will be $Pefd_{a,2}$. These tools will likewise be sorted according to the final improvement level.

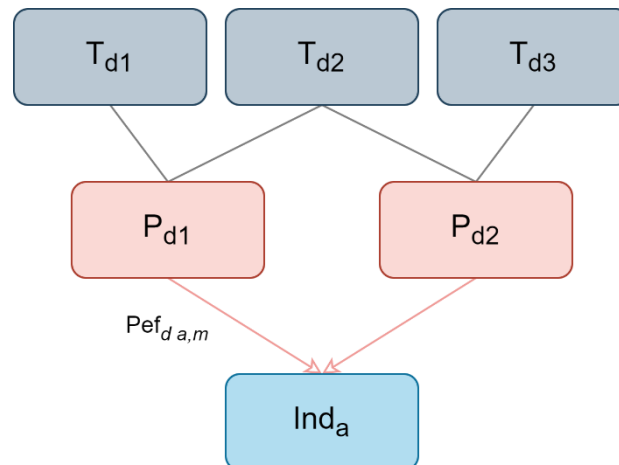

Figure 5-10. Direct analysis

III. Prioritization of improvement practices and tools: Indirect analysis

Following this, the *indirect analysis* integrates the total influence interrelations among the performance indicators (DEMATEL analysis results from Matrix T). Accordingly, the

CIP-DSS begins by looking for the performance indicators ($Indi_n$) exerting an influence ($Iinf_{a,n}$) on the performance indicator(s) (Ind_a) that the user wants to improve. Then, for each of those influencing performance indicators ($Indi_n$), the CIP-DSS identifies the practices (Pi_l) that have an improvement effect ($Pef_{n,l}$) on them. These practices will indirectly have an improvement effect ($Pefi_{a,l}$) on the performance indicator (Ind_a), therefore, it will be expressed as the multiplication of the effect of practice l on performance indicator n with the influence of performance indicator n on performance indicator a , as it is shown in equation (4). Then, the prioritization of the l practices is done from the highest to the lowest improvement effect ($Pefi_{a,l}$). As for the tools (Ti_p), as in the previous analysis, they will inherit the improvement effect from the practices. Only the top improvement practices and tools will be selected to be presented to the user.

$$Pefi_{a,l} = Pef_{n,l} \times Iinf_{a,n} \quad (4)$$

This *indirect analysis* is represented in **Figure 5-11**, where performance indicator Ind_a receives influences $Iinf_{a,1}$, $Iinf_{a,2}$ and $Iinf_{a,3}$, by correspondingly 3 performance indicators, $Indi_1$, $Indi_2$ and $Indi_3$. In which practice Pi_1 has an improvement effect $Pef_{1,1}$ on $Indi_1$, Pi_2 has an improvement effect $Pef_{1,2}$ on $Indi_1$ and $Pef_{2,2}$ on $Indi_2$, and Pi_3 has an improvement effect $Pef_{3,3}$. Therefore, Ind_a receives the following indirect effects: $Pef_{1,1} \times Iinf_{a,1}$ from practice Pi_1 ; $Pef_{1,2} \times Iinf_{a,1} + Pef_{2,2} \times Iinf_{a,2}$ from practice Pi_2 ; and finally $Pef_{3,3} \times Iinf_{a,3}$ from practice Pi_3 . And consequently, the effects of the tools on Ind_a will be as follows: $Pef_{1,1} \times Iinf_{a,1}$ from tool Ti_1 ; $Pef_{1,1} \times Iinf_{a,1} + Pef_{1,2} \times Iinf_{a,1} + Pef_{2,2} \times Iinf_{a,2} + Pef_{3,3} \times Iinf_{a,3}$ from tool Ti_2 ; $Pef_{3,3} \times Iinf_{a,3}$ from tool Ti_3 ; and $Pef_{3,3} \times Iinf_{a,3}$ from tool Ti_4 .

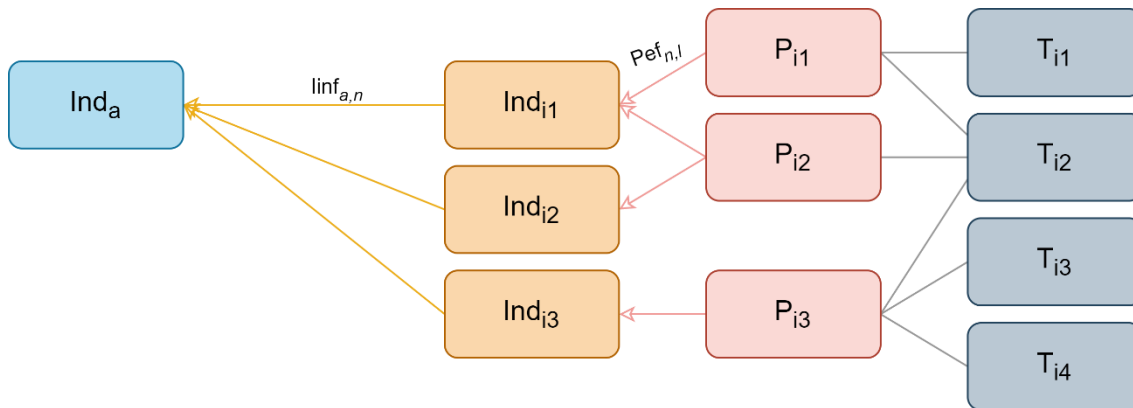

Figure 5-11. Indirect analysis

IV. Total prioritization of improvement practices and tools

Once the *direct* and the *indirect analysis* are developed, the CIP-DSS compounds the total improvement effects of the practices and tools for the performance indicator(s) to improve (see **Figure 5-9**). This is done by taking into account that the computation of the *direct* and *indirect* analysis is not exactly the same for the influenced and the causal performance indicators. Since the result of the causal ones is mostly affected by the results of the indicators that influence them, while for the influenced ones, their result depends mostly on themselves. Thus, the following principles for the total prioritization are defined:

1. For recommending the improvement practices and tools, the allocated weight for *direct* and *indirect* analysis for the prioritization is based upon the influence direction index $r_i - c_i$ of the analyzed performance indicator.
2. The more causal ($r_i - c_i > 0$) the analyzed performance indicator is, the more weight the prioritization will allocate to the *direct* effects ($Pefd_{a,m}$).
3. On the contrary, the more influenced ($r_i - c_i < 0$) the performance indicator is, the more weight the prioritization will allocate to the *indirect* effects ($Pefi_{a,l}$).

Following, in order to compute the final improvement effect of the practices and the tools, the following two prior steps must be developed:

- a) To normalize $r - c$ index for all performance indicators:

As $r - c$ is an index for each performance indicator, whose value can range from positive to negative, it should be normalized for being able to easily implement it in the equation for the final computation of the improvement effect of practices. Thus, by using equation (5), $(r - c)'$ is calculated, where $(r - c)_{min}$ is the minimum value among all the performance indicators, and $(r - c)_{max}$ is the maximum one

$$(r - c)' = \frac{(r - c) - (r - c)_{min}}{(r - c)_{max} - (r - c)_{min}} \quad (5)$$

As a result, $(r - c)'$ becomes an index from 0 to 1, by which the weight to the *direct* and *indirect* effects for the performance indicators is allocated, as represented in **Figure 5-12**. When $(r - c)'$ is closer to 0, as it is an influenced performance indicator, the *indirect* effects will have more weight than the *direct* ones. In this way, as previously explained, when analyzing an influenced performance indicator, the CIP-DSS integrates the analysis of the causes (the performance indicators influencing it). And thus, when $(r - c)'$ is closer to 1, it is a causal performance indicator, the *direct* effects will have more weight than the *indirect* ones. This will be given by multiplying the *direct* effects by $(r - c)'$, and the *indirect* effects by $1 - (r - c)'$, as will be shown later in this section.

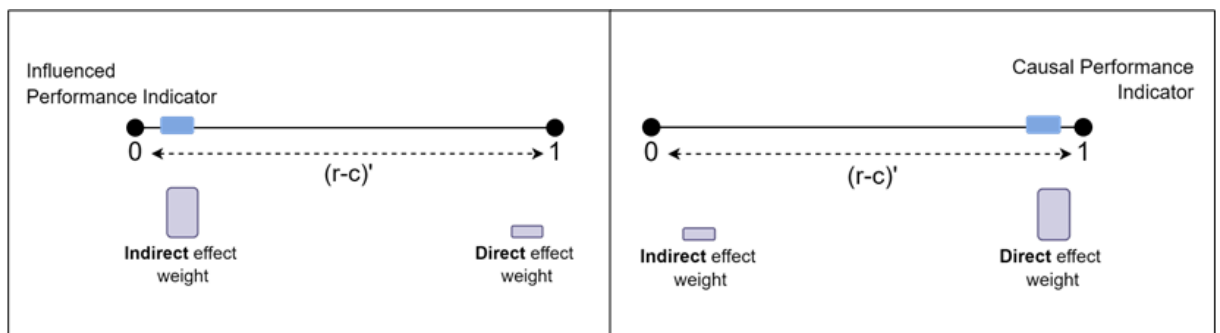

Figure 5-12. Direct/indirect effect weight allocation

b) To normalize the improvement effect of the practices from the *direct* analysis: In order to be able to effectively integrate the *indirect* and the *direct* effects in the same final equation, they should have the same order of magnitude. Considering that *indirect* effect, Pe_{fi} , results from the multiplication of an integer (Pe_f) and a decimal number smaller than 1 (I_{inf}), then we need to scale *direct* effect, Pe_{fd} , value to the same order

of magnitude as $Pefi$. Hence, a normalization to a given range, which in this case are the minimum and maximum values of the *indirect* effects [$Pefi_{min}, Pefi_{max}$], is done by using equation (6).

$$Pefd' = Pefi_{min} + \frac{(Pefd - Pefd_{min}) \times (Pefi_{max} - Pefi_{min})}{Pefd_{max} - Pefd_{min}} \quad (6)$$

Therefore, the total effect of improvement by the practices will be given by equation (7). In which, the improvement effect for each practice will be calculated by adding their *direct* and *indirect* effects on the analyzed performance indicator(s), while accordingly affecting them by an index that allocates complementary weight depending on whether the analyzed performance indicator(s) are more causal or influenced. Consequently, the effect of the tools will be given by the sum of the total effects of the practices to which they are linked to in the PSOnto. And lastly, the final prioritization of the practices and tools will be done based on their total effect (from higher to lower) on the selected performance indicator(s).

$$Pef_{TOTAL} = Pefi \times (1 - (r - c)') + Pefd' \times (r - c)' \quad (7)$$

As the practices and tools prioritization logic of the CIP-DSS is applicable to a single performance indicator, to an entire family of performance indicators, as well as to a group of multiple performance indicators and/or families. Then, the final effect of practices and tools will be the sum of their total effects for each of the selected performance indicators, as shown in equation (8).

$$Pef_{FINAL} = \sum_{i=1}^n Pef_{TOTAL} = \sum_{i=1}^n (Pefi_i \times (1 - (r_i - c_i)') + Pefd'_i \times (r_i - c_i)') \quad (8)$$

Therefore, the improvement practices and tools will be prioritized from the highest improvement level to the lowest. Being their improvement level Pef_{TOTAL} or Pef_{FINAL} , whether we are respectively analyzing a single performance indicator or group of them. In this way, our CIP-DSS is able to furnish comprehensive recommendations results to the decision-makers, by integrating into its logic, as many and as diverse performance

indicators as needed by the managers and engineers of CIP, accessible to them in just few seconds, transforming in this way the decision-making in CIP, into something more agile, reliable, and less time-consuming.

Illustration of improvement practices and tools prioritization:

For giving more clarity on the prioritization of improvement practices and tools, it is going to be illustrated with a simplified case. For it, we will analyze the performance indicator of *Value-added ratio*. For which, from all its relations with improvement practices, we will only consider 2 (out of 18) improvement practices for the *direct* analysis. And as for the *indirect* analysis, only 1 (out of 28) influencing performance indicator will be considered, along with only 2 (out of 18) improvement practices (improving the influencing performance indicator). With all of the selected improvement practices (*direct* and *indirect*) being only linked to 1 unique tool. This is depicted in **Figure 5-13**.

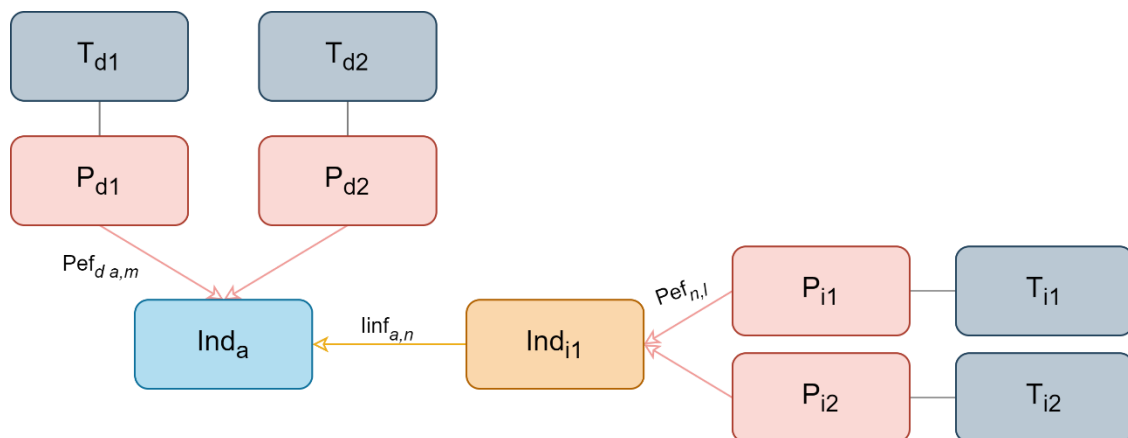

Figure 5-13. Example of improvement practices and tools

Where:

Ind_a = Value – added ratio

Pd_1 = Identify root causes and apply countermeasures

Td_1 = 5 – why

Pd_2 = Reduce / eliminate non – value added

Td_2 = 7 mudas

Ind_{i1} = Effectiveness

Pi_1 = Standardize best practices

Ti_1 = Standard work

Pi_2 = Use quality assurance methods

Ti_2 = Poka – yoke

Direct analysis:

As in this example we are only considering 2 improvement practices, each with only 1 (not in common) tool. From where, the first practice (Pd_1) exerts an improvement effect of 2, and the second practice (Pd_2) an improvement effect of 4 on Ind_a . Therefore, the results from the direct analysis are the following:

Table 5-6. Example: improvement practices - Direct analysis

Improvement practice	Direct improvement effect
Reduce / eliminate non-value added	4
Identify root causes and apply countermeasures	2

Table 5-7. Example: improvement tools - Direct analysis

Improvement tool	Direct improvement effect
7 mudas	4
5-why	2

Indirect analysis:

Regarding the *indirect* analysis, Ind_{i1} has a total influence effect ($Iinf_1$) of 0.02599 over Ind_a . Also, Ind_{i1} receives an improvement effect of 4 from practice Pi_1 , and an improvement effect of 2 from practice Pi_2 . Which are respectively operationalized by tools Ti_1 and Ti_2 . Therefore, by applying Equation (4), we obtain the *indirect* improvement effect $Pefi_{a,1}$ of Pi_1 and *indirect* improvement effect $Pefi_{a,2}$ of Pi_2 over Ind_a , as follows:

$$Pefi_{a,l} = Pef_{n,l} \times Iinf_{a,n} \quad (4)$$

Where:

$$Pefi_{a,1} = Pef_{1,1} \times Iinf_{a,1}$$

$$Pefi_{a,1} = 4 \times 0.02599 = 0.10396$$

And

$$Pefi_{a,2} = Pef_{1,2} \times Iinf_{a,1}$$

$$Pefi_{a,2} = 2 \times 0.02599 = 0.05198$$

Hence, the results from this indirect analysis are the following:

Table 5-8. Example: improvement practices - Indirect analysis

Improvement practice	Indirect improvement effect
Standardize best practices	0.10396
Use quality assurance methods	0.05198

Table 5-9. Example: improvement tools - Indirect analysis

Improvement tool	Indirect improvement effect
Standard work	0.10396
Poka-yoke	0.05198

Total prioritization of improvement practices and tools:

Next, once having the results from the *direct* and *indirect* analysis. By following with the steps, we proceed to apply Equation (5) for normalizing $r - c$ index for Ind_a .

$$(r - c)' = \frac{(r - c) - (r - c)_{min}}{(r - c)_{max} - (r - c)_{min}} \quad (5)$$

Where:

$$\begin{aligned} (r - c) &= -0.3123 \\ (r - c)_{min} &= -0.829 \\ (r - c)_{max} &= 0.5766 \end{aligned}$$

Therefore:

$$(r - c)' = \frac{(-0.3123) - (-0.829)}{0.5766 - (-0.829)} = 0.367583$$

After that, we proceed then to normalize the improvement effects from the *direct* analysis by applying Equation (6) for each of the 2 improvement practices Pd_1 and Pd_2 .

$$Pefd' = Pefi_{min} + \frac{(Pefd - Pefd_{min}) \times (Pefi_{max} - Pefi_{min})}{Pefd_{max} - Pefd_{min}} \quad (6)$$

Where:

$$Pefi_{min} = -0.14879$$

$$Pefi_{max} = 0.20979$$

$$Pefd_{min} = -3$$

$$Pefd_{max} = 4$$

Thus, we have for Pd_1 , the following:

$$\begin{aligned} Pefd'_1 &= -0.14879 + \frac{(2 - (-3)) \times (0.20979 - (-0.14879))}{4 - (-3)} = \\ &= -0.14879 + \frac{(5) \times (0.35858)}{7} = 0.107339 \end{aligned}$$

And for Pd_2 :

$$\begin{aligned} Pefd'_2 &= -0.14879 + \frac{(4 - (-3)) \times (0.20979 - (-0.14879))}{4 - (-3)} = \\ &= -0.14879 + \frac{(7) \times (0.35858)}{7} = 0.20979 \end{aligned}$$

Next,

$$Pef_{TOTAL} = Pefi \times (1 - (r - c)') + Pefd' \times (r - c)' \quad (7)$$

As for this example, we chose improvement practices that were not in common between *direct* and *indirect* analysis, and the improvement tools were linked to only one improvement practice, then by applying Equation (7), we have the following:

$$Pef_{TOTAL} = Pefi \times (1 - (r - c)') + Pefd' \times (r - c)' \quad (7)$$

For Pd_1 (Identify root causes and apply countermeasures):

$$Pef_{T1} = 0 \times (1 - (0.367583)) + 0.107339 \times 0.367583 = 0.039456$$

Then, the improvement effect of Td_1 , as it is only linked to Pd_1 , it is equal to 0.039456.

For Pd_2 (Reduce / eliminate non-value added)

$$Pef_{T2} = 0 \times (1 - (0.367583)) + 0.20979 \times 0.367583 = 0.077115$$

Being the improvement effect of Td_2 equal to 0.077115.

For Pi_1 (Standardize best practices)

$$Pef_{T3} = 0.10396 \times (1 - (0.367583)) + 0 \times 0.367583 = 0.065746$$

Where the improvement effect of Ti_1 is equal to 0.065746.

For Pi_2 (Use quality assurance methods)

$$Pef_{T4} = 0.05198 \times (1 - (0.367583)) + 0 \times 0.367583 = 0.032873$$

And finally, the improvement effect of Ti_2 being equal to 0.032873.

Which prioritized by the improvement effect values, results in the following:

Table 5-10. Example: prioritized improvement practices

	Prioritized improvement practice	Improvement effect value
1	Reduce / eliminate non-value added (Pd_2)	0.077115
2	Standardize best practices (Pi_1)	0.065746
3	Identify root causes and apply countermeasures (Pd_1)	0.039456
4	Use quality assurance methods (Pi_2)	0.032873

And consequently, for the improvement tools:

Table 5-11. Example: prioritized improvement tools

	Prioritized improvement tool	Improvement effect value
1	7 mudas (Td_2)	0.077115
2	Standard work (Ti_1)	0.065746
3	5-why (Td_1)	0.039456
4	Poka-yoke (Ti_2)	0.032873

Through this short example, it is possible to observe not only the application of the different equations involved in the logic. But also, that with this analysis a new prioritization of improvement practices and tools is proposed, compared to the one that could be obtained by only considering the *direct* analysis. Where (taking the improvement practices as example) instead of only proposing to apply *Reduce / eliminate non-value added* and *Identify root causes and apply countermeasures*, it proposed to apply in a prioritized way: first, *Reduce / eliminate non-value added*; second, *standardize best practices*; third, *identify root causes and apply countermeasures*; and

fourth, *use quality assurance methods*. This change in the prioritization by including the system complexity, can be observed even if in the analysis only 1 of the 28 performance indicators that is giving an influence on the analyzed one is being included. Meaning that the *indirect* analysis effect could be even bigger if all the 28 influencing performance indicators alongside their improvement practices were considered.

5.6 Conclusion

This chapter was focused on answering to the third and last research question of this thesis (RQ3: How to assist experts in Continuous Improvement in the decision-making process to improve the performance?). The main contribution of this chapter is the proposal of a decision support system for the continuous improvement of performance, CIP-DSS. This chapter articulates the formalized CIP process and the systemic analysis of performance indicators presented in prior chapters, together with the integration of interrelationships of practices and improvement tools with the performance indicators. This knowledge has been structured in a performance system ontology PSOnto (to facilitate its acquisition, retrieval, and reuse), and a specified reasoning logic as the key components of the CIP-DSS.

Through the proposition of a CIP-DSS we seek to provide CIP managers and engineers a knowledge-based assistance to navigate the decision-making process to improve performance in a more structured, objective, and efficient way. By shedding light on the indicator-practice-tool interrelationships, our approach enables decision-makers to address organizational performance improvement as a complex system while at the same time facilitating the identification of key performance indicators and improvement actions.

This chapter provides to practitioners and academics an approach for maximizing the improvement impact of practices and tools in the performance indicators, and thus, expecting to help in maintaining successful improvement implementation. Further, in this chapter it has been shown how the CIP-DSS impacts and could be incorporated into the activities within the CIP process.

6. Evaluation and application of the CIP-DSS methodological approach

In the previous chapter it was shown in general how the different contributions of the thesis are assembled, and we proposed a decision support system for the process of continuous improvement of performance, called CIP-DSS. Therefore, with Chapters 3, 4 and 5, we have respectively answered to our Research questions 1, 2 and 3. Then, in this Chapter, we go through the different proposals made throughout this thesis, showing how, by articulating them, they constitute a methodological approach to assist decision-making throughout the CIP process.

Accordingly, this chapter focuses on showing its evaluation and application. To this end, the chapter is structured as follows: first, the complete CIP-DSS methodological approach is presented. Next, a focus is made on the evaluation of the performance strategy setup and the analysis of the performance indicators interrelations. This is followed by a use-case evaluation of the decision support process proposed in the CIP-DSS modules for analyzing the most relevant performance indicators and prioritizing improvement practices and tools. Finally, the application of our approach shown through the implementation of a CIP-DSS prototype in a practical case.

6.1 The methodological approach CIP-DSS

The methodological approach CIP-DSS, presented in **Figure 6-1**, seeks to support the key subprocesses identified on the CIP process. Through it, the identification and structuring of the data conforming the performance strategy, the analysis of the

interrelationships among performance indicators, and the decision support process proposed within the CIP-DSS are articulated.

Our proposal is then structured on the following three essential stages:

1. Stage 1: The setup data for the performance strategy: Here, the identification of the performance indicators, improvement practices and tools, along with their respective relationships is developed.
2. Stage 2: Performance indicators interrelations and PSOnto population: In this stage, DEMATEL analysis is done. Also, the knowledge is stored for reusing.
3. Stage 3: Decision process for analyzing performance indicators and prioritizing improvement practices and tools: This last stage comprises the analysis of performance indicators influences and the prioritization of improvement practices and tools.

These stages will be evaluated in the following sections, for which we will focus on the CIP methodology of Lean Manufacturing (building up on the work developed on Chapters 4 and 5).

6.2 Stage 1: Setup data for performance strategy

The identification of the data to parametrize in performance strategy setup constitutes the departing point of our methodological approach, denoted with the purple circle number 1 in **Figure 6-1**. As mentioned throughout this document, something that is essential for improving the decision-making in the CIP process (Chapter 3) are the performance indicators. Identifying them, and subsequently structuring them, is of paramount importance for better articulating the performance improvement practices and tools. The steps within this stage are described as follows:

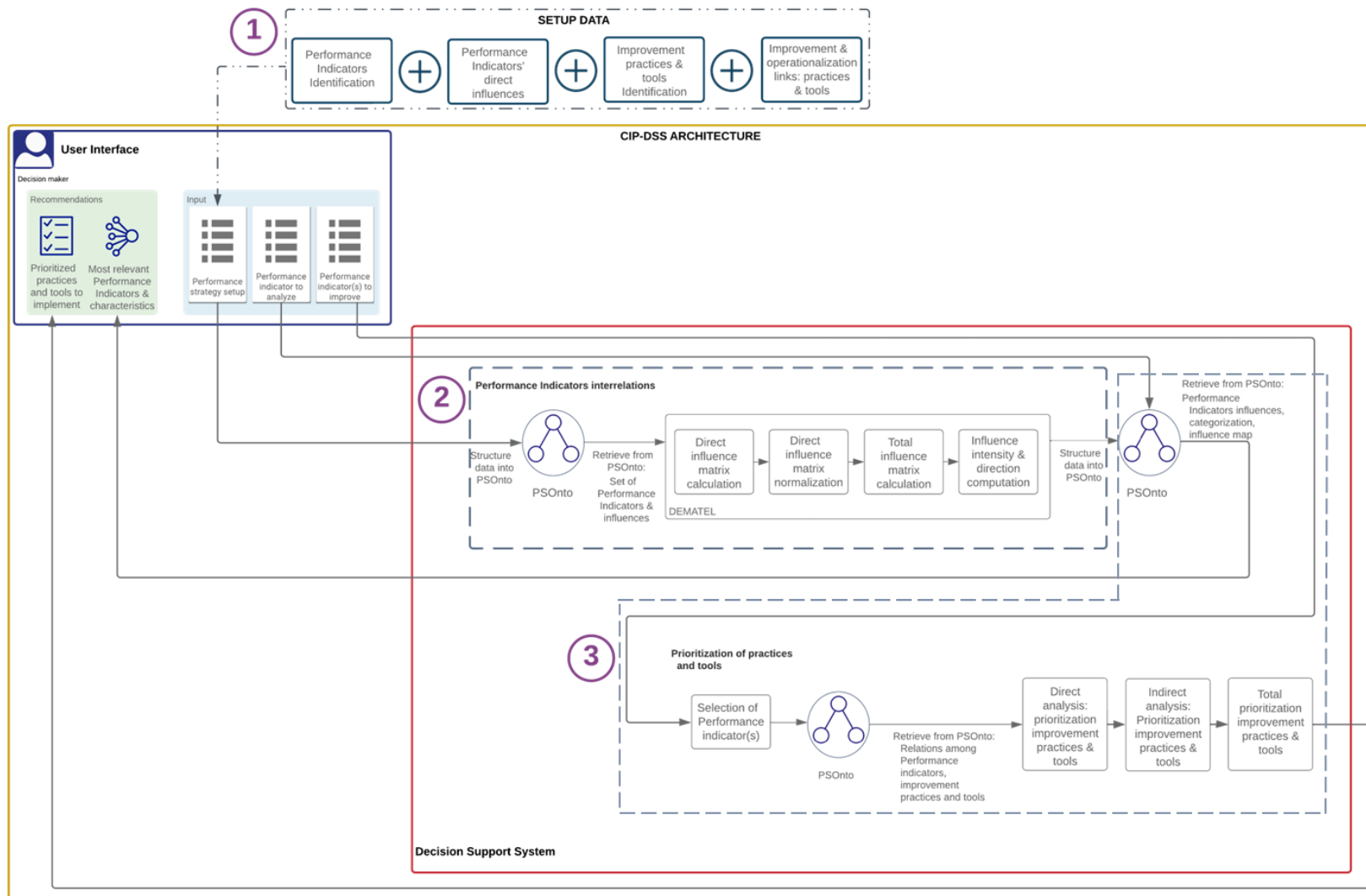

Figure 6-1. Methodological approach CIP-DSS

I. Identification of performance indicators

For this first step, the identification of the performance indicators, we have developed a literature review (as detailed on Section 4.2.1) for identifying the complete set of performance indicators centered on Lean Manufacturing CIP methodology. Allowing in this way the identification of a wide range of performance indicators from different perspectives and not only the most frequently used. A total of 50 performance indicators within 19 performance families were identified.

II. Assessment of direct influences among performance indicators

The next step is the assessment of the direct influences among the performance indicators by CIP experts. This is made by analyzing the indicators in pairs and evaluating whether or not there is an influence between them. When there is no influence, we denote it with a 0; and when there is, we denote its level between 1 and 4, with 1 being a low influence and 4 a very high influence (see Section 4.2.2). As the influences assessment has to be done in both ways, in our case, with a total of 50 performance indicators, it represents 50X50 assessments. An example is given in **Table 6-1**, illustrating two influence evaluations from performance indicators *value-added ratio* and *equipment downtime* (as mentioned on Section 4.3.2, the complete assessment on the 50 performance indicators can be found in Appendix F in form of matrix).

Table 6-1. Example of direct influences among performance indicators

Performance Indicator	Influences on	Performance Indicator	
Value-added ratio	0	Equipment downtime	There is no influence
Value-added ratio	2	Uptime	Medium influence
Equipment downtime	3	Value-added ratio	High influence
Equipment downtime	4	Uptime	Very high influence

As it is key for the CIP process to contribute and to be aligned with the organization's strategy, thus, here it is suggested to identify key stakeholders in the organization (i.e.: key areas as quality or production) with whom perform a concordance analysis (see Section 4.2.3) of a sample of the direct influence evaluations among the performance indicators. With this, obtaining a result higher than 60% confirms a strong agreement between CIP experts and the identified key stakeholders, and therefore, when it is lower,

it invites to review the evaluations. For our case while doing the analysis with 4 external experts (see Section 4.3.3), a result greater than 60% was obtained.

The importance of carrying out this analysis is due to the fact that, as can be seen in the A1 process model of CIP, the identification of performance indicators is an activity that within an organization is not only done by the CIP expert, but also in conjunction with other key people in the organization. It is therefore important to confirm the concordance of the assessment with them.

III. Identification of performance practices and tools and assessment of improvement and operationalization relationships

Next, the identification of the improvement practices and tools within the selected CIP methodology is done. Then, the improvement relationship of the practices on the performance indicators is assessed from 1 to 4 (being 1 a low level, and 4 a high level. While denoting whether is a positive or a negative improvement effect). And the operationalization relationships between practices and tools are established. This is done by the CIP experts, as they are the ones with the required knowledge of CIP within the organizations.

Thus, for evaluating, we propose to use the 41 improvement practices and 23 tools described in the work from Liker (2004). Then, the relationships are established by the same CIP experts of Chapter 4. **Table 6-2** shows an example of the operationalization relationships (see Appendix J for the complete table), which indicates that *reduce/eliminate non-value added* is being operationalized by *7mudas* and *spaghetti diagram*, while *solve problems quick and put in place countermeasures* is operationalized by *in-station quality control*.

Table 6-2. Example of operationalization relationship of practices and tools

Improvement Practice	Operationalized by Tools
Reduce/eliminate non-value added	7 mudas
Reduce/eliminate non-value added	Spaghetti diagram
Solve problems quick and put in place countermeasures	In-station quality control

Table 6-3 shows an example of the assessment of the improvement relationships from the practices towards the performance indicators (see Appendix J for the complete table), where *minimize WIP and warehouse inventory* has an improvement effect of 4 (very high positive) on *inventory turnover ratio*, and an effect of -1 on *delivery* (low negative). And *learn by standardizing best practices* has an improvement effect of 2 (medium positive) on *rework cost*.

Table 6-3. Improvement effect of practices on performance indicators

Improvement Practice	Improvement	Performance Indicator	
Minimize WIP (work in progress) and warehouse inventory	4	Inventory turnover ratio	Very high positive improvement effect
Minimize WIP (work in progress) and warehouse inventory	-1	Delivery	Low negative improvement effect
Learn by standardizing best practices	2	Rework costs	Medium positive improvement effect

With this, all the interrelations among the key elements for the decision-making in CIP are set. Since this information is stored in the PSOnto ontology (described in Section 5.4).

6.3 Stage 2: Performance indicator interrelationships & PSOnto population

This second stage, denoted with purple circle number 2 in **Figure 6-1**, is supported by the first module (Performance indicators interrelations) of the CIP-DSS. In this stage two main steps are done: (i) the development of DEMATEL analysis, and (ii) the storage of the knowledge into the ontology PSOnto (structured in Section 5.4). DEMATEL analysis is developed on the performance indicators (based on the direct influences assessed by the CIP experts on Stage 1) for obtaining the total influence interrelationships among them, as well as their influence indexes (influence direction: $r_i - c_i$ and influence degree: $r_i + c_i$). With these, their classification into causal or influenced, and corresponding representation through an influence map (refer to Chapter 4 for a detailed explanation of the steps and results) is done.

Regarding the ontology PSOnto, it is populated in two steps, the first one with the data supplied by the CIP expert in the first stage, and then, it is complemented with the results obtained from DEMATEL analysis (total influences, influence indexes). In this way, the knowledge is structured and stored (therefore stages 1 and 2 are only required to be done once and should be updated when the need to add an additional indicator appears), for enabling its subsequent use in the decision process in the following stage.

6.4 Stage 3: Decision support process

This last stage (denoted by the purple circle number 3 in **Figure 6-1**) will be focused on the decision process proposed in the CIP-DSS (shown in Section 5.3.2), which, by integrating its two modules, seeks to support the decision-making in analyzing the most relevant performance indicators, and prioritizing the improvement practices and tools. The evaluation of the decision process is done by following the steps through a use case based on *Cost reduction*, a performance indicator among the most influenced ones (two additional use cases, one with a causal and the other with a mostly neutral performance indicator are developed in Appendix K).

I. Interrelation analysis information retrieval from PSOnto

This step focusses on obtaining the performance indicator interrelation information in order to assist the user in the analysis of the most relevant performance indicators (module 1), by providing the influence map, and the characteristics and influences for a selected performance indicator. Therefore, based on the selected performance indicator of our use case, *Cost Reduction*, we proceed to question our PSOnto by means of the SPARQL queries shown below. Obtaining with them: (1) the performance family, influence index, definition; (2) the performance indicators that influence it; and (3) the performance indicators it is influencing. **Figures 6-2, 6-3** and **6-4** show the SPARQL queries along with their respective results obtained with Ontotext-GraphDB.

```

PREFIX :
<http://www.semanticweb.org/cardenas2/ontologies/2022/PerformanceSystemOnto#>
select ?Definition ?Family ?
InfDirection where { :CostReduction
:hasDefinition ?Definition;
:hasFamily ?Family;
:hasInfluenceDirectionIndex
?InfDirection. }

```

	Definition	Family	InfDirection
1	"seeks the lowest cost of production"	:#Profitability	"-0.5808317991470192" ^{xsd:decimal}

Figure 6-2. SPARQL query for obtaining (1) definition, family and influence direction index for *Cost Reduction*, and query result

```

PREFIX :
<http://www.semanticweb.org/cardenas2/ontologies/2022/PerformanceSystemOnto#>
select ?InfluencingIndicator ?
InfluenceValue where {
?TotInfluence :isTotallyInfluencing
:CostReduction ;
:hasTotalInfluenceValue ?
InfluenceValue.
?InfluencingIndicator
:hasTotalInfluence ?TotInfluence.}

```

	InfluencingIndicator	InfluenceValue
1	:#Efficiency	"0.04959734647299699" ^{xsd:decimal}
2	:#Value-addedRatio	"0.03919389112126098" ^{xsd:decimal}
3	:#FYP	"0.029526999581032304" ^{xsd:decimal}
4	:#CapacityUtilization	"0.0283434799579186" ^{xsd:decimal}

Figure 6-3. SPARQL query for obtaining (2) the performance indicators influencing *Cost Reduction* (with their total influence values), and query result

```

PREFIX :
<http://www.semanticweb.org/cardenas2/ontologies/2022/PerformanceSystemOnto#>
select ?InfluencedIndicator ?
InfluenceValue where {
:CostReduction :hasTotalInfluence ?
totInf.
?totInf
?totInf
:hasTotalInfluenceValue ?
InfluenceValue; :isTotallyInfluencing ?
InfluencedIndicator}

```

	InfluencedIndicator	InfluenceValue
1	:#FYP	"0.02538683228431729" ^{xsd:decimal}
2	:#customerSatisfaction	"0.013613047233289035" ^{xsd:decimal}
3	:#delivery	"0.013051340735028392" ^{xsd:decimal}
4	:#Effectiveness	"0.011598168865645323" ^{xsd:decimal}

Figure 6-4. SPARQL query for obtaining (3) the performance indicators being influenced by *Cost Reduction* (with their total influence values), and query result

II. Performance indicator strategy

Once retrieving the information from the PSOnto, the CIP-DSS is able to provide the visualization of the influence map with the performance indicators (based on the influence indexes), in which it is possible to distinguish the causal and the influenced ones, and also to provide for a specific performance indicator its characteristics and the

performance indicators giving an influence and the ones receiving it. Thus, with the development of this stage, the CIP experts have at their disposal the needed knowledge to be able to make the decision regarding the selection of the most relevant indicators to measure and follow up.

Accordingly, for *Cost reduction*, it shows its definition and that it belongs to the *Profitability* performance family. Also, that *Cost reduction* has an influence direction index of -0.58, indicating that it is an influenced performance indicator. Which implies that its result highly depends on the results from the performance indicators influencing it. Finally, it also provides the ordered list of performance indicators that influence *Cost reduction*, where *Efficiency* is the exerting the biggest influence value (0.0496), followed by *value-added ratio* (0.0392). And the list of performance indicators that receive an influence from *Cost reduction*, where *FYP* receives the highest influence (0.0259), followed by *Customer satisfaction* (0.0136). In this way, the CIP-DSS contributes in providing a better understanding of which performance indicators are more critical to follow.

III. Selection of performance indicator and information retrieval from PSOnto

Next, by positioning ourselves in the second module of CIP-DSS, in this step we retrieve the needed information from PSOnto for developing the prioritization of improvement practices and tools to implement for improving a performance indicator or a group of them. Thus, proceeding with our use case, we question the ontology through SPARQL queries for retrieving: (1) the influence direction index ($r - c$) for *Cost reduction*; (2) the performance indicators exerting an influence on it; (3) the improvement practices and tools that have an improvement effect (and its value) on it; (4) the improvement practices and tools that have an improvement effect (and its value) on each on the performance indicators that are influencing the selected one.

Since (1) and (2) were also obtained for *Cost reduction* at the first step with queries 1 and 2 (for module 1), they are not shown in this step. Then, **Figure 6-5** shows the SPARQL query (and some of the results) for obtaining the improvement practices and tools for *Cost reduction*. And **Figure 6-6** shows, as example (this information has to be retrieved for all the influencing performance indicators), the improvement practices and

tools for the *Efficiency*, which (as seen in step 1) is first performance indicator influencing Cost reductions.

The screenshot shows a SPARQL query editor with the following query:

```

PREFIX :
<http://www.semanticweb.org/cardenas2/ontologies/2022/PerformanceSystemOnto#>
select ?ImpRel ?ImprPractice ?Value ?
ImprTool where {
  ?ImpRel :isImproving :CostReduction ;
          :hasImprovementValue ?Value.
  ?ImprPractice :hasImpactOn ?ImpRel.
  ?ImprTool :isOperationalizing ?
ImprPractice. }

```

The results table shows 4 rows:

ImpRel	ImprPractice	Value	ImprTool
1 :#IR_61	:#DetectProblemsAndStop	*3**xsd:integer	:#Andon
2 :#IR_61	:#DetectProblemsAndStop	*3**xsd:integer	:#AutomaticStops
3 :#IR_287	:#Reduce/eliminatenon-valueAdded	*3**xsd:integer	:#SpaghettiDiagram
4 :#IR_287	:#Reduce/eliminatenon-valueAdded	*3**xsd:integer	:#7Mudas

Figure 6-5. SPARQL query for obtaining (3) improvement practices and tools having an improvement effect on *Cost Reduction* (with their improvement values), and query result

The screenshot shows a SPARQL query editor with the following query:

```

PREFIX :
<http://www.semanticweb.org/cardenas2/ontologies/2022/PerformanceSystemOnto#>
select ?ImpRel ?ImprPractice ?Value ?ImprTool
where {
  ?ImpRel :isImproving :Efficiency ;
          :hasImprovementValue ?Value.
  ?ImprPractice :hasImpactOn ?ImpRel.
  ?ImprTool :isOperationalizing ?
ImprPractice. }

```

The results table shows 4 rows:

ImpRel	ImprPractice	Value	ImprTool
1 :#IR_152	:#IdentifyRootCausesAndApplyC	*4**xsd:integer	:#ParetoDiagram
2 :#IR_152	:#IdentifyRootCausesAndApplyC	*4**xsd:integer	:#5-Why
3 :#IR_152	:#IdentifyRootCausesAndApplyC	*4**xsd:integer	:#PDCA(plan-do-check-act)
4 :#IR_18	:#CreateMaterial&InformationFlo	*4**xsd:integer	:#VSM

Figure 6-6. SPARQL query for obtaining (4) improvement practices and tools having an improvement effect on *Efficiency* (with their improvement values), and query result

IV. Development of prioritization logic of improvement practices and tools

After retrieving the information from the PSOnto, then, this step focuses on the prioritization of improvement practices and tools, which comprises the computation of the direct and indirect analysis and total prioritization. These are going to be subsequently evaluated for *Cost reduction*.

Direct analysis:

The direct analysis presents the improvement practices and tools that have an improvement effect on *Cost reduction*. For the improvement practices, it corresponds

directly with the results from the query in the previous step (see **Figure 6-5**), where *detect problems and stop* and *reduce/eliminate non-value added* are among the ones that have a high improvement impact (with a value of 3) on this performance indicator.

For the improvement tools, given that one improvement tool can operationalize multiple improvement practices, then (as explained in Section 5.5.2), their improvement value will be given by the sum of the improvement values of each practice they are linked to. **Table 6-4** shows an extract of the top improvement tools directly impacting *Cost reduction*. Where for example, the first tool (*in-station quality control*), has an improvement value of 4 on *Cost reduction*. Whose value is obtained by summing the improvement values given by the two improvement practices it is linked to: *quality drives value proposition*, with a value of 2; and *solve problem quick and put in place countermeasures* with a value of 2 as well.

Table 6-4. Extract of Improvement tools directly impacting Cost reduction

Improvement Tool	Value
In-station quality control	4
Kaizen workshops	3
PDCA (plan-do-check-act)	3
7 Mudas	3
Andon	3
Automatic stops	3
Spaghetti diagram	3
5S's	1

Indirect analysis:

Based on the retrieved information from the PSOnto on step 3 (the performance indicators having a total influence on *Cost reduction* and the improvement practices and tools that have an improvement effect on those influencing performance indicators), the indirect improvement effects of those improvement practices and tools on *Cost reduction* are calculated by applying the Equation (4) shown in Section 5.5.2. An extract with the top 7 improvement practices is shown in **Table 6-5** and of the top 7 improvement tools in **Table 6-6**.

An example showing the computing (with Equation (4)) of the indirect improvement value of *make employees use kaizen to eliminate waste* practice is shown as follows:

$$Pefi_{a,l} = Pef_{n,l} \times Inf_{a,n} \quad (4)$$

Where:

For influencing performance indicator of *Efficiency*:

$$Inf_{a,1} = 0.0496 \quad ;\text{and} \quad Pef_{1,1} = 4$$

For influencing performance indicator of *Value-added ratio*:

$$Inf_{a,2} = 0.0392 \quad ;\text{and} \quad Pef_{1,2} = 2$$

For influencing performance indicator of *FYP*:

$$Inf_{a,3} = 0.0295 \quad ;\text{and} \quad Pef_{1,3} = 3$$

For influencing performance indicator of *Capacity utilization*:

$$Inf_{a,4} = 0.0283 \quad ;\text{and} \quad Pef_{1,4} = 2$$

For influencing performance indicator of *Effectiveness*:

$$Inf_{a,5} = 0.0212 \quad ;\text{and} \quad Pef_{1,5} = 3$$

For influencing performance indicator of *Employee training & team building*:

$$Inf_{a,6} = 0.0202 \quad ;\text{and} \quad Pef_{1,6} = 3$$

For influencing performance indicator of *MTBF*:

$$Inf_{a,7} = 0.0197 \quad ;\text{and} \quad Pef_{1,7} = 1$$

For influencing performance indicator of *Uptime*:

$$Inf_{a,8} = 0.0173 \quad ;\text{and} \quad Pef_{1,8} = 2$$

Then:

$$Pefi_{a,1} = 4 \times 0.0496 + 2 \times 0.0392 + 3 \times 0.0295 + 2 \times 0.0283 + 3 \times 0.0212 + 3 \times 0.0202 + 1 \times 0.0197 + 2 \times 0.0173 = 0.600$$

Table 6-5. Extract of Improvement practices indirectly impacting *Cost reduction*

Improvement practice	Value
Make employees use Kaizen to eliminate waste	0.600
Reduce/eliminate non-value added	0.567
Create material & information flow	0.535
Redesign work processes - high value-added, continuous flow	0.535
Identify root causes and apply countermeasures	0.519
Use Hansei (reflection) at key milestones to identify shortcomings and develop countermeasures	0.519
Standardize best practices	0.369

Whereas for the improvement tools, their improvement value is given by the sum of the improvement values of each practice they are linked to. Where for *VSM*, they are: *Create material & information flow* ($P_{efi} = 0.5351$), *redesign work process – high value-added continuous flow* ($P_{efi} = 0.5351$) and *minimize WIP and warehouse inventory* ($P_{efi} = 0.0574$). Therefore, the improvement value of *VSM* is equal to 1.128.

Table 6-6. Extract of Improvement tools indirectly impacting *Cost reduction*

Improvement tool	Value
VSM	1.128
Kaizen workshops	0.921
Standard work (takt time, sequence, standardized stock on hand)	0.900
PDCA (plan-do-check-act)	0.842
7 Mudas	0.567
Spaghetti diagram	0.567
Takt time	0.535

Total prioritization:

Next, we proceed with the calculation of the total prioritization of the improvement practices and tools for *Cost reduction*. By using the Equation (5) shown in Section 5.5.2, we normalize the influence direction index for the analyzed performance indicator, as following:

$$(r - c)' = \frac{(r - c) - (r - c)_{min}}{(r - c)_{max} - (r - c)_{min}} \quad (5)$$

Where:

$$\begin{aligned} (r - c) &= -0.5808 \\ (r - c)_{min} &= -0.829 \\ (r - c)_{max} &= 0.5766 \end{aligned}$$

Therefore:

$$(r - c)' = \frac{(-0.5808) - (-0.829)}{0.5766 - (-0.829)} = 0.1765$$

Following this, the normalized direct improvement effect of the practices is calculated by applying Equation (6), which is then multiplied by $(r - c)'$ (from Equation (7)) for obtaining the weighted direct effects, as shown in **Table 6-7**. This is developed for the first improvement practice (*detect problems and stop*):

$$Pefd' = Pefi_{min} + \frac{(Pefd - Pefd_{min}) \times (Pefi_{max} - Pefi_{min})}{Pefd_{max} - Pefd_{min}} \quad (6)$$

Where:

$$Pefi_{min} = -0.14879$$

$$Pefi_{max} = 0.20979$$

$$Pefd_{min} = -3$$

$$Pefd_{max} = 4$$

Thus, we have for Pd_1 , the following:

$$\begin{aligned} Pefd' &= -0.14879 + \frac{(3 - (-3)) \times (0.20979 - (-0.14879))}{4 - (-3)} = \\ &= -0.14879 + \frac{(6) \times (0.35858)}{7} = 0.1586 \end{aligned}$$

Then:

$$Pefd' \times (r - c)' = 0.1586 \times 0.1765 = 0.028$$

Table 6-7. Extract of normalized-weighted direct improvement effect of practices on *Cost reduction*

Improvement Practice	Normalized-weighted direct value
Detect problems and stop	0.028
Help partners to grow and develop	0.028
Reduce/eliminate non-value added	0.028
Empower people. Use cross-functional teams to improve quality and productivity	0.019
Generate value for the customer	0.019
Quality drives value proposition	0.019
Solve problems quick and put in place countermeasures	0.019
Get consensus on problems and potential solutions with all stakeholders	0.010

By continuing applying Equation (7), the indirect improvement effect of the practices (**Table 6-5**) is multiplied by $1 - (r - c)'$, obtaining in this way the values shown in **Table 6-8**. An example is given for the computation of the weighted indirect value *for make employees use kaizen to eliminate waste*.

$$Pefi \times (1 - (r - c)') = 0.600 \times (1 - 0.1765) = 0.494$$

Table 6-8. Extract of weighted indirect improvement effect of practices on *Cost reduction*

Improvement Practice	Weighted indirect value
Make employees use Kaizen to eliminate waste	0.494
Reduce/eliminate non-value added	0.467
Create material & information flow	0.441
Redesign work processes - high value-added, continuous flow	0.441
Identify root causes and apply countermeasures	0.427
Use Hansei (reflection) at key milestones to identify shortcomings and develop countermeasures	0.427
Standardize best practices	0.304
Use visual indicators for determining standard conditions	0.283

Finally, the indirect and direct improvement values are added for obtaining the total improvement effects (Equation (7) in Section 5.5.2) of improvement practices and tools.

I. Presentation of total prioritization of improvement practices and tools

Based on the total prioritization effect obtained in the previous step, the improvement practices and tools are ordered from the highest to the lower value, and the top 7 (seen in **Table 6-9** and **Table 6-10**) are presented to the user.

Table 6-9. Total prioritization of improvement practices for *Cost reduction*

Practice	Total improvement factor
Make employees use Kaizen to eliminate waste	0.504
Reduce/eliminate non-value added	0.495
Create material & information flow	0.441
Redesign work processes - high value-added, continuous flow	0.441
Identify root causes and apply countermeasures	0.437
Use Hansei (reflection) at key milestones to identify shortcomings and develop countermeasures	0.437
Standardize best practices	0.314

Table 6-10. Total prioritization of improvement tools for *Cost reduction*

Tool	Total improvement factor
VSM	0.938
Kaizen workshops	0.787
Standard work (takt time, sequence, standardized stock on hand)	0.751

PDCA (plan-do-check-act)	0.722
7 Mudas	0.495
Spaghetti diagram	0.495
In-station quality control	0.460

From this, we observe that as *Cost reduction* is an influenced performance indicator, in the prioritization of improvement practices and tools, the indirect analysis part has more weight than the direct one. Having a significant different result that the one we would obtain by just analyzing the direct part.

This section showed, through a use case, the evaluation of the prioritization of practices and tools to implement for improving a given performance indicator based on its influence direction index (which indicates its degree of causality or influence). Therefore, while in this use case in the final result predominates the indirect analysis, it is the opposite for the second case (shown in Appendix K), which being one of the most causal performance indicators, the prioritization is mostly given by the direct analysis.

6.5 CIP-DSS prototype practical application

After discussing the methodological approach proposed in this thesis and its subsequent evaluation through the use cases. In this section, it will be partially implemented through a prototype developed in Microsoft Power BI, and its use will be exemplified by means of an application to a practical case. Accordingly, this section will be structured as follows: first the context of the practical application will be presented. Then, the development of the prototype will be explained. And finally, the application will be shown and discussed.

6.5.1 Context of application

The context of application in which we will develop is based on an educational simulation of a production process (*Festo simulation*). The *Festo simulation* is a practical

application of a production process under controlled conditions. It is part of a training module offered by the ENSGSI school (Ecole Nationale Supérieure en Génie des Systèmes de l'innovation) of the University of Lorraine and takes place at the regional center of educational resource AIP-PRIMECA, located in Nancy, France. The *Festo simulation* has the objective to train future engineers and to introduce them to the Lean practices and tools, giving the opportunity to the students to apply for the Green Belt LSS certification.

This module comprises a first simulation of discovery and familiarization with the process and the roles, followed by a theoretical training of 20 hours, after which the implementation simulation is carried out. We are particularly interested in intervening in the latter. This is carried out during half a day, which allows the simulation of the logistics chain of a company that manufactures, assembles, and sells pneumatic cylinders (final product). During the simulation, the working group (composed of 14 participants) must replicate the production process to meet the customer's demand, afterwards analyze the points for improvement and then propose and implement improvement actions to carry out a final simulation. In this process there are 3 different references of final product, each one composed of 8 different components. The roles to be assumed by the participants are: customer, supplier, manufacturing (manufacturing, assembly 1, assembly 2, control station, rework, packaging and final inspection), support functions: production management, logistics, sales.

6.5.2 CIP-DSS prototype development

Since the *Festo simulation* is an environment in which the participants work on a manufacturing process, which they seek to improve through the implementation of improvement practices and tools of Lean, this makes it a good starting point for the practical application of our approach. As *Festo simulation* is a simplified and controlled environment, this allows to implement improvements and observe the changes in the process in a shorter time than if the application was directly in an enterprise, since the latter could take much more time to be done, making it not feasible for this thesis, but it should be the subject of further work.

Thus, our objective in carrying out an application on Festo simulation is to have a first confrontation with potential future users in order to be able to test the usefulness and understanding of our approach. For doing so, based on the architecture and reasoning logic described in Chapter 5, the CIP-DSS prototype was developed. It was developed in an iterative way over a period of more than a year, comprising 5 versions, whose development started with a simple mockup, moving to simplistic implementation through dynamic tables in Excel and ending up on a functional and interactive prototype developed in Power BI. For improving the prototype, we relied on the feedback given by Festo simulation participants through a questionnaire adapted from the work of Borenstein (1998) (the questionnaire and some screenshots of versions are shown in Appendix L). The results of this questionnaire allowed us to appreciate the strengths and the points to be improved in the prototype (from the point of view of potential users) in order to achieve a better comprehension.

Through the CIP-DSS prototype our methodological approach is partially implemented for giving the user the functionalities to: (1) see the distribution of the performance indicators in the influence map, analyze the characteristics of a specific performance indicator; and (2) based on the selection of a set of performance indicators, to see the recommendation of the prioritized improvement practices and tools to implement.

Through this link the prototype can be accessed: <https://tinyurl.com/47w9sk56>

And in this, a video shows how a user could interact with it: <https://youtu.be/ilqdVYQ56k8>

6.5.3 Practical application

The participants were introduced to the CIP-DSS prototype. For which a brief explanation of the general logic and importance of including the relationship among performance indicators, improvement practices and improvement tools. Then, the prototype in Power BI was shown, starting with the first module. It was shown to the participants how, as seen in **Figure 6-7**. CIP-DSS module 1: performance indicator influence map, it can be accessed to see the distribution of the performance indicators in the influence map and how to interpret it (according to the influence direction and the influence degree, as explained in Chapter 4) and how to visualize only specific performance indicators or families.

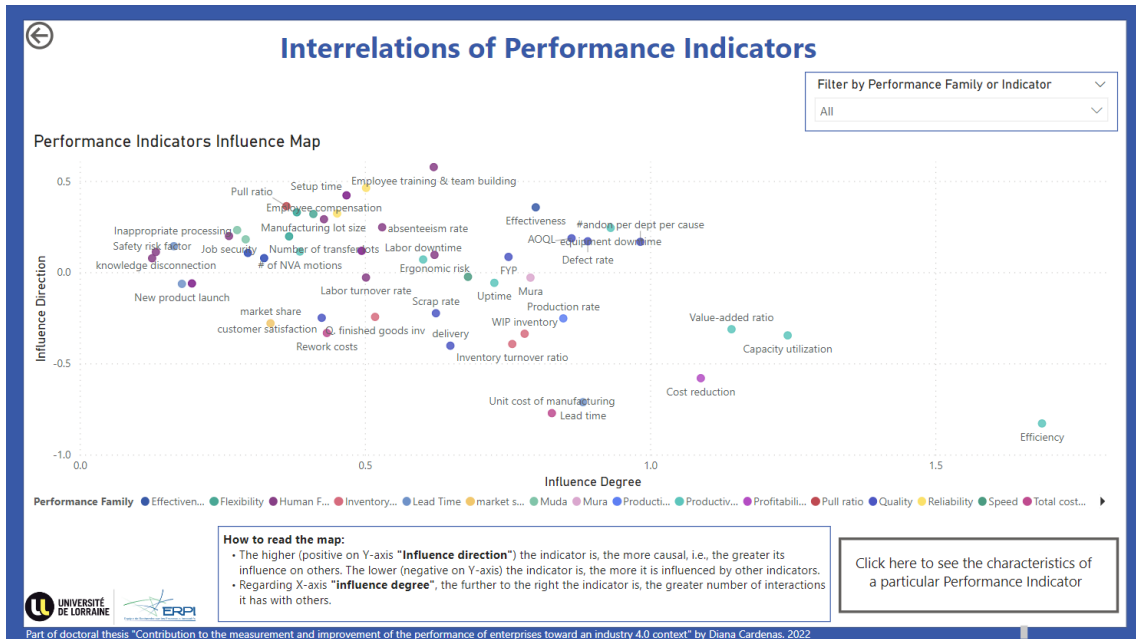

Figure 6-7. CIP-DSS module 1: performance indicator influence map

Then, it was further explained through the importance of integrating the influence interrelationships among performance indicators for the selection of the most relevant ones. In addition, an emphasis was made on explaining how the CIP-DSS prototype (as seen in Figure 6-8) allows the user to select a specific performance indicator and visualize its definition, whether it is causal or influenced, and also the other performance indicators exerting an influence on it, and the ones it is influencing.

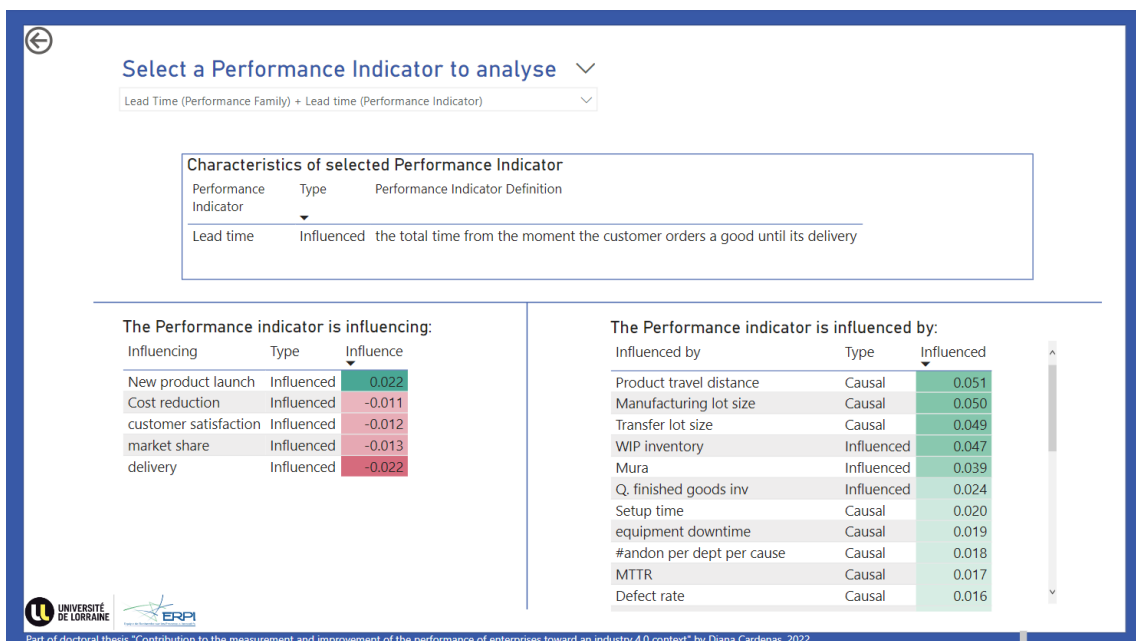

Figure 6-8. CIP-DSS module 1: analysis of performance indicator

Afterwards, the second module of the prototype was presented as well, it was explained in a general manner the objective of the module (to give the user a prioritized selection of practices and tools to implement for improving a set of performance indicators), and how it is done (direct and indirect analysis). For this, the participants selected the performance indicators of *defect rate*, *lead time* and *delivery* as the ones they wanted to improve.

As our intention with the proposed CIP-DSS is not to give a black box to the user, but instead, to show to the user the intermediary results, so in this way they can better understand from where the recommendation comes and would therefore better trust it for their daily use in decision-making. This second module shows first the direct analysis, then the indirect one, and finally it presents the users with the recommendation of the prioritized improvement practices and tools. Accordingly, by selecting the aforementioned set of performance indicators in the prototype, the results of the direct and indirect analysis are obtained as shown respectively in **Figure 6-9** and **Figure 6-10**.

Prioritization of performance improvement Practices & Tools

Select the Performance Indicator(s) or Performance Family you wish to improve

- Effectiveness
- Effectiveness
- Flexibility
- Human Factors
- Inventory level
- Lead Time
- Lead time

Select whether you want to see the "Direct Analysis" to see the prioritization based only on the performance indicator(s) you are analyzing, or whether you want to see the "Indirect Analysis" to see the analysis considering the performance indicators that influence the one(s) you want to improve.

Note: For visualizing the total recommendation of practices and tools to implement, you can directly click on "Go to recommendation summary". This comprises both direct and indirect analysis.

Direct Analysis Indirect Analysis

Prioritization of performance improvement Practices		
Practice	Factor	RC_Factor
Reduce/eliminate non-value added	0.322	0.086
Day-by-day shifts instead of computer schedules	0.266	0.046
Identify root causes and apply countermeasures	0.266	0.145
Make employees use Kaizen to eliminate waste	0.266	0.145
Quality drives value proposition	0.266	0.166
Use Hansel (reflection) at key milestones to identify shortcomings and develop countermeasures	0.266	0.145

Prioritization of performance improvement Tools		
Tool	Factor	RC_Factor
kanban	0.864	0.167
VSM	0.532	0.034
In-station quality control	0.476	0.315
PDCA(plan-do-check-act)	0.476	0.294
Standard work (takt time, sequence, standardized stock on hand)	0.434	0.250

Go to recommendation summary

Figure 6-9. CIP-DSS module 2: direct analysis

Prioritization of performance improvement Practices & Tools

Select the Performance Indicator(s) or Performance Family you wish to improve

- Effectiveness
- Flexibility
- Human Factors
 - absenteeism rate
 - Employee compensation
 - Employee training & team building
 - Ergonomic risk

Select whether you want to see the "Direct Analysis" to see the prioritization based only on the performance indicator(s) you are analyzing, or whether you want to see the "Indirect Analysis" to see the analysis considering the performance indicators that influence the one(s) you want to improve.

Note: For visualizing the total recommendation of practices and tools to implement, you can directly click on "Go to recommendation summary". This comprises both direct and indirect analysis

Direct Analysis Indirect Analysis

Practice	Factor	RC_Factor
Reduce/eliminate non-value added	1.301	0.999
Create material & information flow	1.222	1.001
Redesign work processes - high value-added, continuous flow	1.222	1.001
Make employees use Kaizen to eliminate waste	0.955	0.607
Identify root causes and apply countermeasures	0.860	0.552
Use Hansei (reflection) at key milestones to identify shortcomings and develop countermeasures	0.860	0.552

Tool	Factor	RC_Factor
VSM	2.781	2.337
PDCA(plan-do-check-act)	1.689	1.080
Standard work (takt time, sequence, standardized stock on hand)	1.544	1.058
Kaizen workshops	1.542	0.963
In-station quality control	1.371	0.844

Go to recommendation summary

Part of doctoral thesis "Contribution to the measurement and improvement of the performance of enterprises toward an industry 4.0 context" by Diana Cardenas, 2022.

Figure 6-10. CIP-DSS module 2: indirect analysis

Then, by clicking on “go to recommendation summary” button, the CIP-DSS provides the user with the top 7 prioritized practices and tools that are recommended to implement for improving the three selected performance indicators (*defect rate, lead time, delivery*), along with some additional information (performance indicator definitions, type and list of the performance indicators influencing the ones that the user seeks to improve) as seen in Figure 6-11.

Prioritization of performance improvement Practices & Tools

Performance Indicator(s)/Family selected

- #andon per dept per cause
- AOQL
- customer satisfaction
- Defect rate
- delivery
- FYP
- Scrap rate

Performance Indicators influencing selected indicator(s)

Influenced by	Influenced
Manufacturing lot size	0.050
Transfer lot size	0.049
AOQL	0.048
WIP inventory	0.047
Product travel distance	0.035
#andon per dept per cause	0.025
Mura	0.023
Efficiency	0.022

Characteristics of selected Performance Indicator

Performance Indicator	Type	Performance Indicator Definition
delivery	Influenced	the percentage of on-time delivery of good-quality products
Lead time	Influenced	the total time from the moment the customer orders a good until its delivery
Defect rate	Causal	the percentage of quality problems that occur throughout the production process

Recommended Improvement Practices & Tools to implement

Practice	Factor
Reduce/eliminate non-value added	1.084
Create material & information flow	1.018
Redesign work processes - high value-added, continuous flow	1.018
Make employees use Kaizen to eliminate waste	0.752
Identify root causes and apply countermeasures	0.697
Use Hansei (reflection) at key milestones to identify shortcomings and develop countermeasures	0.697
Solve problems quick and put in place countermeasures	0.677

Tool	Factor
VSM	2.370
PDCA(plan-do-check-act)	1.374
Standard work (takt time, sequence, standardized stock on hand)	1.309
Kaizen workshops	1.201
In-station quality control	1.159
7 Mudas	1.084
Spaghetti diagram	1.084

Part of doctoral thesis "Contribution to the measurement and improvement of the performance of enterprises toward an industry 4.0 context" by Diana Cardenas, 2022.

Figure 6-11. CIP-DSS module 2: recommended prioritization of practices and tools

The participants then were able to apply the recommended improvement practices, and regarding the improvement tools, due to time constraints, the participants were not able to implement the following ones, even if their pertinence was acknowledged: *VSM*, *standard work* and *spaghetti diagram*. According to the participants feedback, they considered that the recommendations provided by the CIP-DSS prototype seemed relevant and guided them to reach agreements on the improvement actions to be implemented. The improvement on the analyzed performance indicators is shown in **Table 6-11**.

Table 6-11. Performance indicator improvement

Performance indicator	Simulation 1	Simulation 2
Defect rate	25%	3.3%
Lead time	12.89 mins	2.75 mins
Delivery	17%	30%

From the above results, a significant improvement in *Defect rate* and *Lead time* can be observed. However, for *Delivery*, although it improved considerably with respect to the first simulation, it seems that although the group delivered all the orders required by the client, its result is being diminished by an accumulated delay in deliveries. After further analysis, a constant delay in the supply of raw materials by the supplier was identified. Thus, this suggests that our proposal could be further improved by including performance indicators encompassing the entire supply chain, since these are currently limited to inside the organization.

6.6 Conclusion

This chapter articulates the contributions presented so far in a series of logical stages to constitute a methodological approach to assist CIP experts (managers, engineers) in the decision-making for the continuous improvement of performance. It comprises the respective steps within each of its three major stages, namely the setup data for performance strategy, the performance indicators interrelations, and decision support process.

Subsequently, in this chapter, the evaluation and application of the proposed methodological approach was carried out. Its evaluation was performed based on Lean Manufacturing as a specific CIP methodology, where a use case was developed. Finally, our approach was applied through the development of a prototype in a practical case in an educational environment. This allowed us to appreciate the relevance and potential of our approach in improving decision making in the CIP process.

With this methodological approach, we seek to enhance the decision-making within the CIP process, by leaving behind the commonly used satisficing approach of simplifying complex systems through reductionist representations, which leads to an apparent gain in decision-making time, but while arriving to non-appropriate or inaccurate solutions.

7. Conclusion

Through this thesis we have sought to clarify the understanding of the CIP process in organizations and to assist in decision making for performance improvement. In this process, several contributions have been developed in order to manage and improve performance in a more effective way, including the complexity of the interrelationships and serving as an aid and basis to navigate the current complex context in which organizations operate. Therefore, this thesis has focused on (1) clarifying and formalizing the CIP process, (2) identifying and analyzing the interrelationships of influence between performance indicators, and (3) proposing a decision support system that integrates the complexity of the indicator-practice-tool interrelationships. All of which articulated, form a methodological approach to support the critical activities of the CIP process, seeking to contribute to reduce the failed implementations of CIP in organizations.

This final chapter is structured as following, first the contributions of this thesis are summarized. Then, the implications are discussed. For finally building up on the limitations and perspectives of this thesis.

7.1 Contributions

By answering to our first research question (RQ1: How to clarify and model the process of Continuous Improvement of the performance in the organizations?), we positioned ourselves under a knowledge management approach and focused on knowledge capitalization from expert interviews, in order to transform the tacit knowledge regarding the CIP process into explicit. This was particularly important since the knowledge on the

CIP has relied mostly on the expertise and experience of industrial experts, we sought therefore to transform the existent unstructured knowledge into a formalized CIP process. Then, the knowledge from 5 interviewed CIP experts was accessed and formalized by following the MASK method combined with KROM meta-model. Thus, we proposed our first thesis contribution:

The proposal of a model of the Continuous Improvement of performance (CIP) process

The interviews from the CIP experts, due to their vast experience in CIP and maturity on the adoption of CIP in their organizations, allowed to access very valuable knowledge. Upon which, it was able to formalize the objectives, missions, subprocesses and activities within CIP. This allowed us not only to clarify the process itself and the importance of analyzing it as a complete process but also, to comprehend the critical aspects for the decision-making within the process for improving the performance: an assertive selection of (1) performance indicators and (2) improvement practices and tools to implement.

This led us to the importance of the second research question of this thesis (RQ2: How to identify and define the most relevant indicators that will allow to measure and follow-up the performance?). The assertive selection of performance indicators remains an important scientific issue given the absence of a comprehensive view of performance, the increasing number of possible indicators available to measure, and the need to rationalize time and resources. This makes the identification of how performance indicators interrelate, and which ones can exert the most influence on each other of paramount importance in guiding performance measurement and monitoring. Consequently, it is necessary to move from an unstructured and isolated view of performance indicators to a systemic one. For this means, an approach comprising a literature review and an analysis of influence interrelationships based on DEMATEL method was followed in order to identify the performance indicators and structure them. Accordingly, the following contributions were proposed:

The identification of performance indicators in the scientific literature, and the elicitation of the most relevant ones based on their influence interrelationships

Therefore, in a first instance, a literature review was developed. It allowed (by positioning on a specific CIP methodology, Lean Manufacturing) to identify from the literature, 50 performance indicators within 19 performance families. Then, through the use of DEMATEL, we provided a systemic and comprehensive view of the performance indicators by analyzing their influence interrelationships and categorizing them into either causal or influenced. This allowed us to analyze the influence relationships of each performance indicator and, through an influence map, to identify the most causals and hence, the most relevant ones.

The contributions discussed so far allowed to understand the CIP process, the decision-making in it (for better identifying where to support CIP experts) and provided a new approach for analyzing performance indicators. Building on this and in order to answer to our third research question (RQ3: How to assist experts in Continuous Improvement in the decision-making process to improve the performance?), the contribution below was developed:

The proposal of a Decision Support System (CIP-DSS) for assisting in the decision-making within the CIP process, by integrating the complexity of the indicator-practice-tool interrelationships

Accordingly, the architecture of the CIP-DSS was specified including an ontology (PSOnto) for enabling the storage and reuse of the knowledge by the reasoning logic for assisting in the decision-making. The CIP-DSS integrates and structures the complexity for easing the mental burden on CIP managers and engineers, while improving decision-making for performance improvement. Thus, the CIP-DSS helps them in, first, the analysis and the identification of the most relevant performance indicators based on the influence interrelationship among them. And second, in the prioritization of improvement practices and tools for improving the performance

indicators of interest, while analyzing the performance as a complex and complete system.

It was also explained how the CIP-DSS would intervene in the activities of the CIP process, bringing in this way more clarity on its impact and where it could be incorporated. Specifically, we argue that our CIP-DSS proposition can assist in the CIP process in (1) the identification of performance indicators, (2) the evaluation of performance indicator influence interrelationships, (3) the evaluation of the indicator-practice-tool improvement interrelationships, (4) problem cause analysis and (5) the prioritization of improvement practices and tools. A prototype of the CIP-DSS was as well developed, including a selection of 50 performance indicators drawn of the literature, along with a set of 41 improvement practices and 23 improvement tools as proposed by Liker (2004), along with the interrelationships among them.

Altogether, the contributions of this thesis provide both theoretical and practical knowledge to support CIP experts in (1) the decision-making through the activities within the performance strategy and problem resolution subprocess, (2) by better representing the complex interrelationships within performance, and thus (3) contributing to make assertive decisions and reduce failures in CIP implementations.

We argue that these contributions can guide the CIP experts through identification and setting up of the data constituting the performance strategy (performance indicators, improvement practices and tools, and their respective relationships), followed by performance indicators total interrelationships analysis and the population of all the knowledge in the PSOnto. For lastly, supporting in the decision process for analyzing the performance indicators influences and prioritizing improvement practices and tools. Through this, we are enabling the structuring and translation of tacit knowledge into explicit (as the influence and improvement assessment is to be done by the CIP experts) and therefore allowing it to be reused for the decision-making in a daily basis.

7.2 Implications

The proposed methodological approach and contributions represent a step forward in improving the decision-making in CIP process. We consider the work developed in this thesis to be a starting point for better understanding the CIP process, what performance means, how it is represented. Also, in showing how this understanding is critical for proposing decision-making support for improving the prioritization of improvement practices and tools. The formalized CIP process, besides clarifying the process and allowing us to understand the decision-making for improving the performance, it has also the potential to become the basis for guiding practitioners through its implementation and management. Furthermore, the developed models represent how CIP is currently being managed and developed, and it was shown how this can be assisted by a DSS for improving the decision-making.

Moreover, with the influence interrelationship analysis of performance indicators, a more holistic view of the performance indicators was proposed and with it the relevance of analyzing them as a part of a system with complex interactions, rather than in isolation, as it is commonly done. Thus, this provides a new perspective in the study of performance indicators. The resulting influence map from this analysis highlight the importance of reevaluating the relevance of classic performance indicators (mostly among influenced ones) and emphasizes in the use of causal indicators over the influenced ones for improving the performance more effectively.

Additionally, we believe this analysis and its results could serve practitioners for monitoring performance and analyze CIP implementations more effectively. Given the constant need of organizations to rationalize resources and time, then, it is highly relevant that they have the means to identify the most relevant performance indicators. By having a clearer view of which performance indicators to focus on, it could help managers better determine which key performance indicators should be displayed on a dashboard, and which indicators are key for making more accurate decisions. It may also help improve the process of identifying areas in which to develop transformation or improvement strategies for enhancing the organization's performance. It may also allow for better follow-up of improvement initiatives and prevent potential unsuccessful implementations in time.

Furthermore, the developed CIP-DSS takes the DEMATEL analysis further and integrates into its reasoning logic not only the resultant influence indexes, but also the richness of the total influence interrelationships among performance indicators. These along with the relationships with improvement practices and tools, by being structured into the PSOnto, allows not only the transformation of tacit knowledge (expert's assessments) into explicit, but also its reuse. Contributing to both, the knowledge creation process in CIP, and the interoperability of the system.

The reasoning logic described in our CIP-DSS and evaluated and applied through use cases and a practical experimentation environment, implies a major change in the analysis for prioritization of the improvement practices and tools to be implemented. We are proposing to take into account the complexity of the indicator-practice-tools interrelationships for the analysis. This, therefore, changes the way improvement practices and tools had been commonly prioritized, as (1) we are formalizing these interrelationships and allowing its reuse for future decision-making. And (2) with this reasoning logic, the prioritization varies according to the influence degree of each of the analyzed performance indicators to improve, implying that the more influenced a performance indicator is, the more the prioritization will give importance to the influences received by them (the so-called indirect analysis). This has a significant impact on the analysis of the most commonly used performance indicators, which, as we have seen earlier, are among the most influenced.

7.3 Limitations and perspectives

We are aware that the work developed in this thesis has some limitations, but which at the same time open the possibilities to new perspectives and future work. The first of which relates to the formalized CIP process. The quantity of interviewed experts (they were 5), even if according to MASK method was enough as no more new knowledge was being evidenced, could represent a limitation for generalizability. Therefore, we suggest enriching this work by accessing the knowledge of more experts and from diverse sectors.

The interviewed experts were all from large multinational organizations with a mature view of CIP methodologies, which gave us a robust view on the process of CIP and on the room for improvement and assistance for decision-making. This enabled us to develop and evaluate our methodological approach and reasoning logic of the CIP-DSS. However, we consider that, besides to continuing developing further applications at an experimentation level (Festo simulation or similar), it should be as well confronted with CIP experts in the industry, not only from big companies but also from smaller ones. This in order to evaluate its applicability regardless the size of the organization and appreciate different points of view and different scale of needs.

With the aim of exemplifying the proposed methodological approach, as mentioned earlier, we centered on Lean Manufacturing. Based on which, the identification of performance indicators, the establishment and assessment of the indicators-practices-tools interrelationships, and their subsequent instantiation in the PSOnto were done. Nevertheless, even if they were applied to a specific CIP methodology, we argue that the CIP-DSS methodological approach and the contributions have the potential to be applied to other sectors and other CIP methodologies, with their distinct set of performance indicators and improvement practices and tools. We thus suggest exploring this in further studies.

Additionally, as the evaluation of influence among performance indicators for DEMATEL analysis and also for the relationships with improvement practices and tools rely significantly on the assessment by experts, it is important for researchers and practitioners to expand the pool of experts and confirm the concordance among appraisers, while assuring an adequate experience and knowledge in CIP. Furthermore, the analyzed performance indicators corresponded to the internal processes of the organizations. This should be complemented by including performance indicators of the external supply chain and also, performance indicators related to sustainability and environmental awareness, linked with the societal challenges of today's context (e.g., energy consumption, carbon footprint, reusable and recycled resources). On top of that, future research efforts could explore the potential of the performance indicator interrelationship approach as a new input to strategic planning methods and contrast it to more traditional ones that do not yet consider it (e.g., balanced scorecard).

We believe that the CIP-DSS can serve as a useful means to delve deeper into the indicator-practice-tool interrelationships and explore in more detail the effects and impacts it has on the CIP. Accordingly, future steps in this research should be focused on further exploring the interrelationship analysis of influence among performance indicators by applying it to different organizations so that multiple representations can be obtained. The systematic collecting of this data could be processed to establish correlations and deduce causalities between performance indicators and thus enrich our analysis. Data mining approaches can be very useful in this regard.

Similarly, another research path may focus on refining and validating the improvement effects of practices and tools on performance indicators. This could be pursued through deeper theoretical studies (e.g., meta-analysis of literature) complemented by broader expert panels in order to corroborate the improvement effects proposed here or to unveil new ones. In addition, even if functional and promising, we acknowledge that the CIP-DSS needs to be further improved for better assisting experts in CIP. To this end, we propose to conduct a multiple case-study by developing a feedback protocol, through which the impact of the implemented improvement practices and tools can be studied. Understanding how the CIP-DSS performs and how users interact with it in practical scenarios could be useful for further validating its reasoning logic for the prioritization of improvement practices and tools.

Lastly, we consider that it is of high importance to address “how” to measure performance. Throughout this thesis we have focused on “what” to measure and its implications for decision making. Yet, exploring what other performance measurement possibilities there may be and how they can be better measured is equally necessary. Organizations in general have an increasing drive to implement digital transformation processes and adopt new technologies of the Industry 4.0 (e.g., internet of things, artificial intelligence, blockchain and others) which entails potential changes not only in the way they execute processes or activities but also in how they are monitored. The proliferation of these new technologies means that the possibilities in terms of performance indicators are constantly evolving, so it is necessary to study their real impact on the CIP.

In this sense, we propose to work on two main perspectives. First, on the identification of the various possibilities in which new technologies could allow the inclusion of new indicators regarding human-machine interactions. For instance, the implementation of cobots widely spread in the industrial sector has been associated mainly in relation to the indicators of the specific activities in which they have been implemented such as cycle time and efficiency. But the introduction of such technologies also involves considering their impact throughout the organization's processes, by measuring indicators such as data quality and reliability, impact on the efficiency of adjacent activities, mental workload on collaborators or technology acceptability. This could be further examined through mixed-method studies to assess how these technologies can be sources of new indicators and how they can be integrated into the performance strategy.

Secondly, we believe it is essential to deepen the understanding of how new technologies may allow to better measure and manage large volumes of data. The increase in the amount of available data and, therefore, the availability of performance indicators could make CIP management even more difficult. It is then necessary to understand how the availability of more robust data can impact the continuous improvement process, leading even to the automation of some activities (e.g., periodic manual measurement by operators) or enhanced data analysis. Ultimately, this may lead in the future to a rethinking of CIP management from a reactive logic (act to correct) to a proactive logic (act to anticipate). In this sense, it is intended as future work, to continue on exploring in the Festo simulation, the implementation of technologies like indoor position systems and sensors, and how through the data obtained, further statistical analysis can be developed to identify trends or patterns in performance indicators, allowing more reliable insights for decision making.

Appendix A. Dates and Protocol of interview for CIP experts

In the following two tables, the interview dates for each of the experts are specified:

Expert	1 st Interview date
#1	7 th July 2020
#2	10 th July 2020
#3	15 th & 21 st July 2020
#4	17 th August 2020
#5	28 th August 2020

Expert	2 nd Interview date
#1	17 th July 2020
#4	23 rd October 2020

Following, questions from 1 to 8 were used for the process modelling.

English version:

Protocol of Interview – Interview Questions	
Profile: Expert in Continuous Improvement of Performance	
The following questions are to be done in the first interview with the experts after a brief explanation of the study	
Question	Question objective
Part 1	
1. Could you please explain to me the importance of the continuous improvement of the performance in an organization?	To understand through the importance of continuous improvement, which are its missions and the goals
2. What is your role as responsible of Performance improvement in your organization?	To understand the expert's role and identify missions
3. Could you please tell me how a day as a responsible of Performance improvement is? what are the different activities that you develop?	To identify the different processes
4. Could you please describe more [x]? what are the different steps you follow? [to adapt to the interviewee precedent answer]	To have more information on the processes and identify the different activities

5. Could you please describe how you measure the performance indicators and collect the data? What are the different steps you follow?	To deep into the activities of collecting and measuring the performance indicators
6. Could you tell me which are the indicators that you follow in a daily basis?	To identify performance indicators
7. Are there any other indicators that even if not followed in a daily basis you consider important?	To identify performance indicators
8. For gathering the data of the performance indicators do you rely on or interact with other areas or roles? Which ones?	To identify interactions with other areas in gathering the performance indicators
Part 2	
9. How would you define the industry 4.0?	To understand the interviewee's notion of Industry 4.0
10. Has your organization implemented any technologies of the industry 4.0? If "no": Ask questions 11 to 19 If "yes": Ask questions 20 to 28	To determine whether or not they have implemented an Industry 4.0 technology
11. In your opinion what are the main characteristics of performance improvement processes today?	To understand how companies are currently managing the performance improvement
12. And which could it be in the context of the industry 4.0?	To understand which would be the new characteristics in the performance improvement in the industry 4.0 (target system)
13. How could a company be able to make this transition towards the industry 4.0?	To understand what the needed things or actions are for attaining the target system
14. Why would a company be interested in making this transition? what could trigger it?	To understand which are the trigger elements
15. what do you think are the different factors that may have an influence in this change?	To understand the environment of influence
16. Which do you believe are the barriers or obstacles that could prevent a company to make the transition into the industry 4.0?	To understand the possible barriers
17. Once a company is in the new context of the industry 4.0, which could be the consequences in term of improvement of performance?	To understand the consequences of the transition to the new context
18. How could the industry 4.0 change the process of improvement of the performance?	To understand the consequences of the transition to the new context

19. Which activities could change? are there activities that will disappear or that will appear as new?	To understand the consequences of the transition to the new context
20. Which are those technologies?	To identify the implemented technologies
21. In which activities has this technology been implemented? What are the applications of this technology in your organization?	To understand the different uses of the implemented technology
22. Into what extent do you think the implementation of this technology has affected the performance improvement processes?	To understand the changes (before-after) on the performance improvement, due to the implementation of the technology
23. Has the implementation of this technology changed the measurement of any performance indicators?	To understand the impact of the technology on the measurement of performance indicators
24. What triggers the implementation of this technology?	To understand which were the trigger elements
25. What are the key factor that made it possible?	To understand what the needed things or actions were for attaining the target system
26. What were the external factors that influenced this implementation?	To understand the environment of influence
27. Were there any barriers or obstacles that your organization had to overcome?	To understand the barriers faced
28. Overall, what are the gains and changes in the performance improvement after the implementation?	To understand the consequences of the transition to the new context

Spanish version of the questions:

1. Puede por favor explicar cuál es la importancia de la mejora continua del rendimiento en una organización?
2.Cuál es su rol como responsable de la mejora del rendimiento en su organización?
3. Puede decirme cómo es un día como un responsable de la mejora del rendimiento? ¿cuáles son las diferentes actividades que usted desarrolla?
4. Puede darme un poco más de detalle en [x]? cuáles son las diferentes actividades que usted desarrolla? [a adapta acorde a la respuesta de la pregunta anterior]
5. Puede por favor describir como realiza la medición de los indicadores de rendimiento y como recolecta los datos?
6. Puede por favor decirme cuales son los indicadores a los que le hace seguimiento diariamente?
7. ¿Qué otros indicadores considera usted importantes, aunque no les haga un seguimiento diario?
8. ¿Para recolectar la información o los datos de los indicadores de rendimiento, usted interactúa con otras áreas o roles? cuáles?

9. Cómo definiría usted la industria 4.0?
10. En su organización han implementado alguna de las tecnologías de la industria 4.0? "NO": Preguntas 11 a 19. "SI": Preguntas 20 a 28
11. En su opinión, ¿cuáles son las características principales del proceso de mejora del rendimiento actualmente?
12. Cómo cree usted que podría ser en un contexto de la industria 4.0?
13. Cómo podría una compañía hacer esa transición o transformación hacia la industria 4.0?
14. Por qué una compañía podría estar interesada en hacer esta transición? ¿que podría motivarla?
15. Cuáles cree que podrían ser los diferentes factores (internos/externos -depende de la respuesta anterior) que influenciarían este cambio?
16. Cuáles piensa que serían las barreras u obstáculos que podrían impedir que una compañía haga esa transición hacia la industria 4.0?
17. Situándonos ya en el contexto de la industria 4.0, ¿cuáles cree que pueden ser las consecuencias en la mejora del rendimiento?
18. Cómo la industria 4.0 cambiaría los procesos de mejora del rendimiento?
19. Cuáles actividades cambiarían? ¿cree usted que habrá actividades que desaparecerían o que aparecerían?
20. Cuáles son esas tecnologías?
21. En qué actividades se ha implementado esta tecnología? ¿Cuáles son las aplicaciones de esta tecnología en su organización?
22. En qué medida cree usted que la implementación de esta tecnología ha afecto los procesos de la mejora del rendimiento?
23. La implementación de esta tecnología ha cambiado la medición de algún indicador de rendimiento?
24. Que motivó la implementación de esta tecnología?
25. Cuáles son los factores clave que hicieron posible esta implementación?
26. Cuáles son los factores externos que influenciaron la implementación?
27. Cuáles fueron las barreras u obstáculos que su organización tuvo que superar?
28. En general, ¿cuáles son las ganancias y cambios en la mejora del rendimiento después de la implementación?

French version of the questions:

1. Pouvez-vous m'expliquer l'importance de l'amélioration continue de la performance dans une organisation ?
2. Quel est votre rôle en tant que responsable de l'amélioration de la performance dans votre organisation ?
3. Pourriez-vous me dire comment se déroule une journée en tant que responsable de l'amélioration de la performance ? Quelles sont les différentes activités que vous réalisez ?

4. Pourriez-vous décrire plus en détail [x] ? quelles sont les différentes étapes que vous suivez ? [Adapter en fonction de la réponse précédente]
5. Pourriez-vous décrire comment vous mesurez et collectez les données des indicateurs de performance ? Quelles sont les différentes étapes que vous suivez ?
6. Pouvez-vous me dire quels sont les indicateurs que vous suivez au quotidien ?
7. Y a-t-il d'autres indicateurs qui, même s'ils ne sont pas suivis au quotidien, sont à votre avis importants ?
8. Pour collecter les données des indicateurs de performance, vous interagissez avec d'autres départements ou rôles ? Lesquels ?
9. Comment définiriez-vous l'industrie 4.0 ?
10. votre organisation a-t-elle mis en œuvre des technologies de l'industrie 4.0 ? Si "non" : Posez les questions 11 à 19. Si "oui" : Posez les questions 20 à 28
11. À votre avis, quelles sont les principales caractéristiques des processus d'amélioration de la performance aujourd'hui ?
12. Comment pensez-vous que cela pourrait être dans un contexte d'industrie 4.0 ?
13. Comment une entreprise devrait-elle s'y prendre pour gérer cette transition ou cette transformation vers l'industrie 4.0 ?
14. Pourquoi une entreprise serait-elle intéressée à faire cette transition ? Qu'est-ce qui pourrait la motiver ?
15. Selon vous, quels pourraient être les différents facteurs (internes/externes - selon la réponse ci-dessus) qui influenceraient cette transformation ?
16. Quels seraient, à votre avis, les barrières ou obstacles qui pourraient empêcher une entreprise de faire cette transformation vers l'industrie 4.0 ?
17. En considérant une entreprise ayant réussi sa transition vers l'industrie 4.0, quelles pourraient être, selon vous, les conséquences sur l'amélioration de la performance ?
18. Comment l'industrie 4.0 changerait-elle les processus d'amélioration de la performance ?
19. Quelles activités changeraient ? Pensez-vous qu'il y aurait des activités qui disparaîtraient ou qui apparaîtraient ?
20. Quelles sont ces technologies ?
21. Dans quelles activités ces technologies ont-elles été mises en œuvre ? Quelles sont les applications de ces technologies dans votre organisation ?
22. Dans quelle mesure pensez-vous que la mise en œuvre de cette technologie a impacté les processus d'amélioration de la performance ?
23. La mise en œuvre de cette technologie a changé la façon dont certains indicateurs de performance sont mesurés ?
24. Qu'est-ce qui a motivé la mise en œuvre de cette technologie ?
25. Quels sont les facteurs clés qui ont rendu cette mise en œuvre possible ?
26. Quels sont les facteurs externes qui ont influencé la mise en œuvre ?
27. Quels ont été les obstacles ou barrières que votre organisation a dû surmonter ?
28. En général, à votre avis, quels sont les gains et les changements dans l'amélioration de la performance après la mise en œuvre ?

Appendix B. Activity models of CIP process under KROM metamodel

Following, for each of the activities presented in Chapter 3 for the CIP process, an activity model is presented

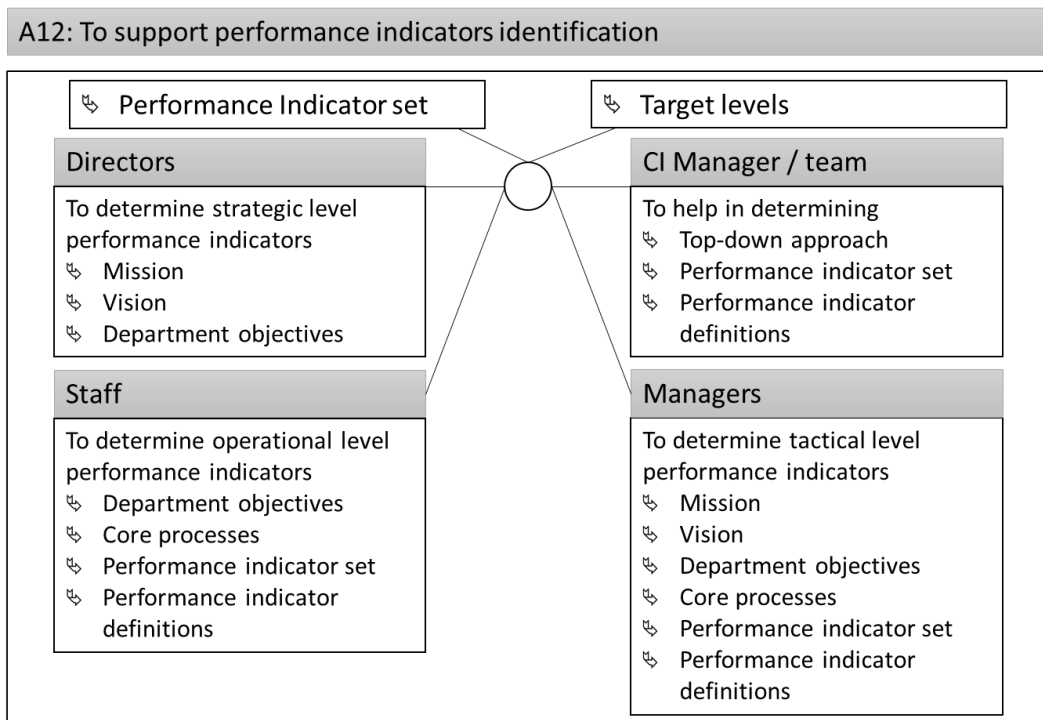
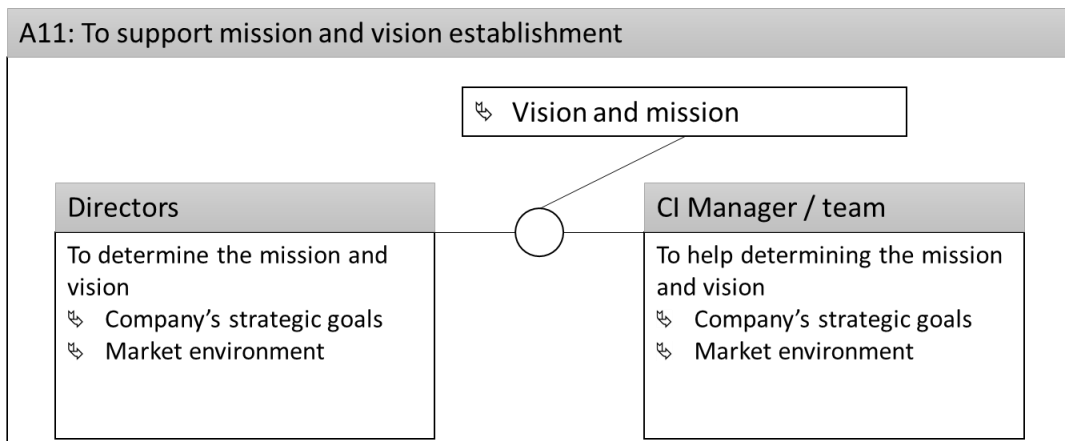

A13: To establish the dashboard structure

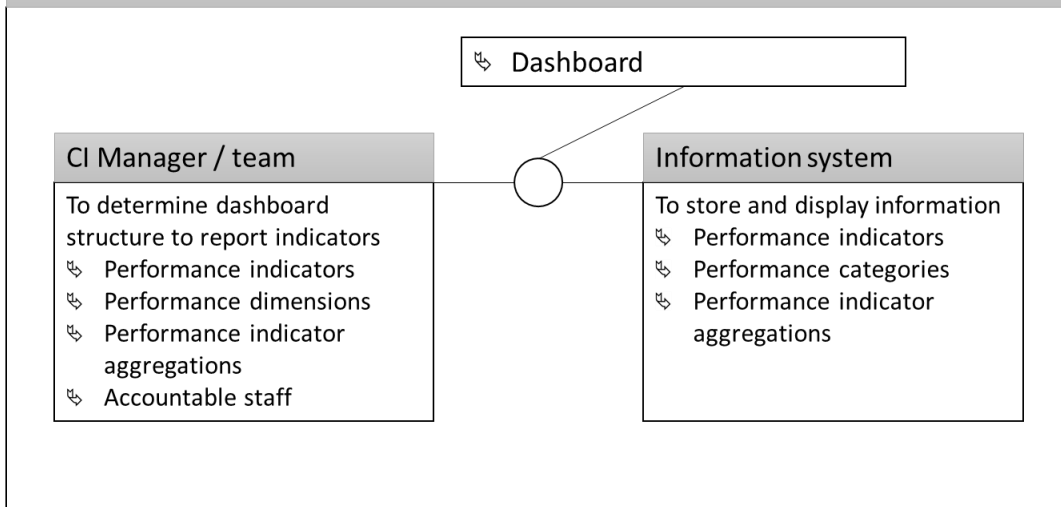

A14: To determine CI yearly strategy

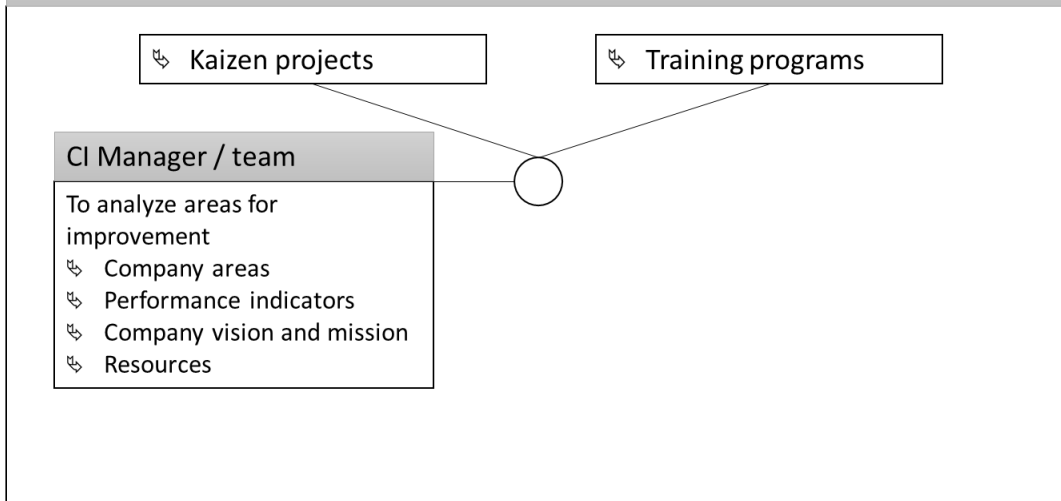

A21: To get contact from plant

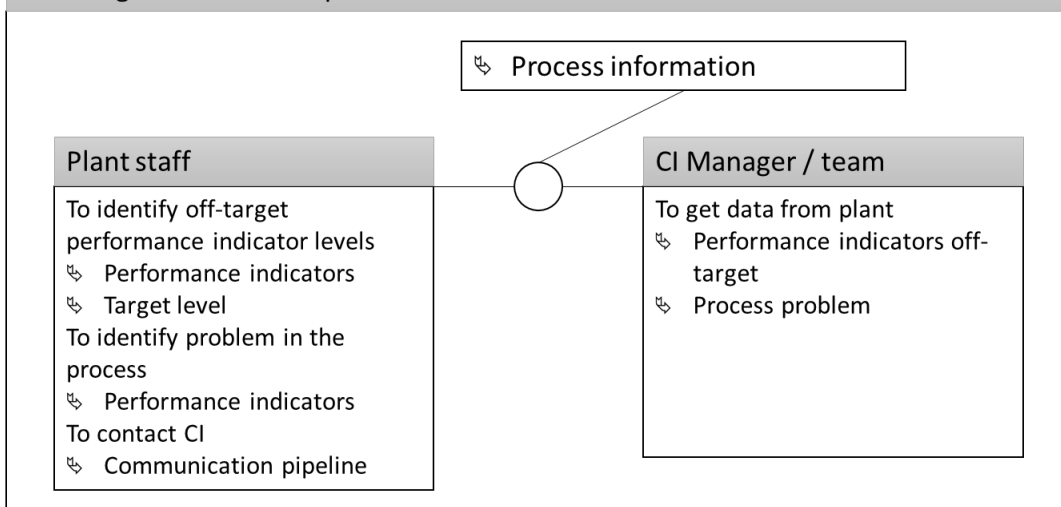

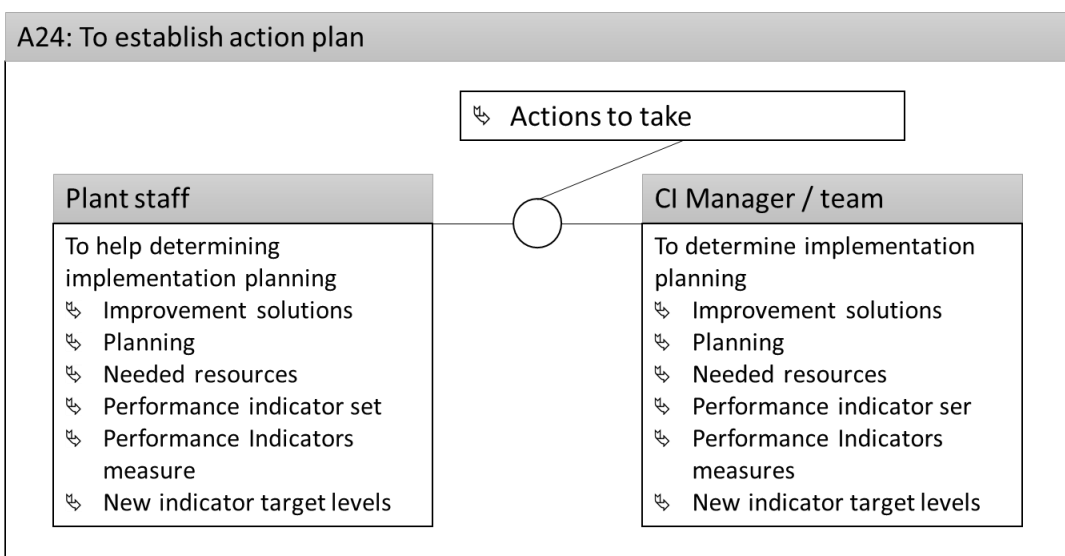
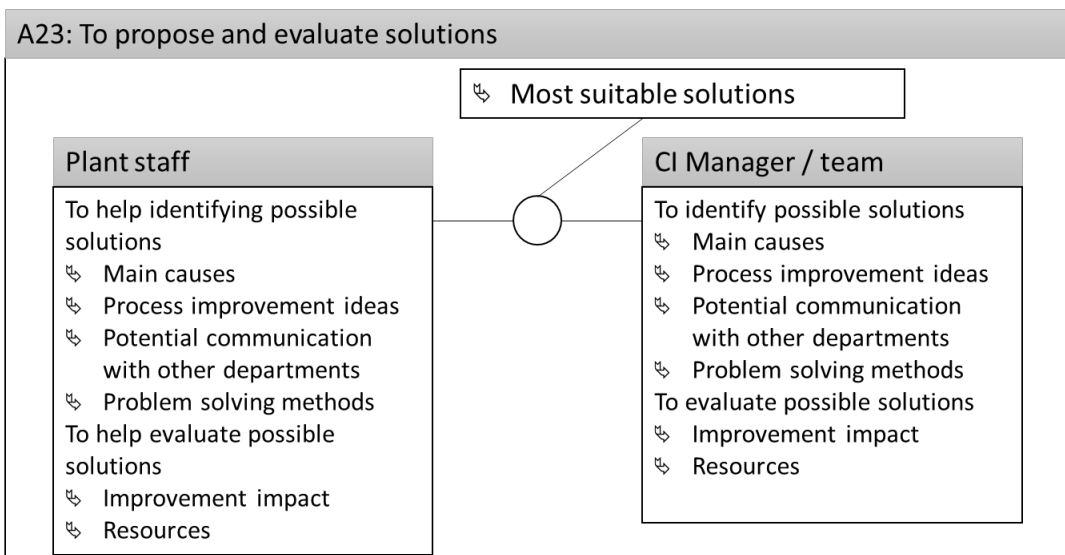
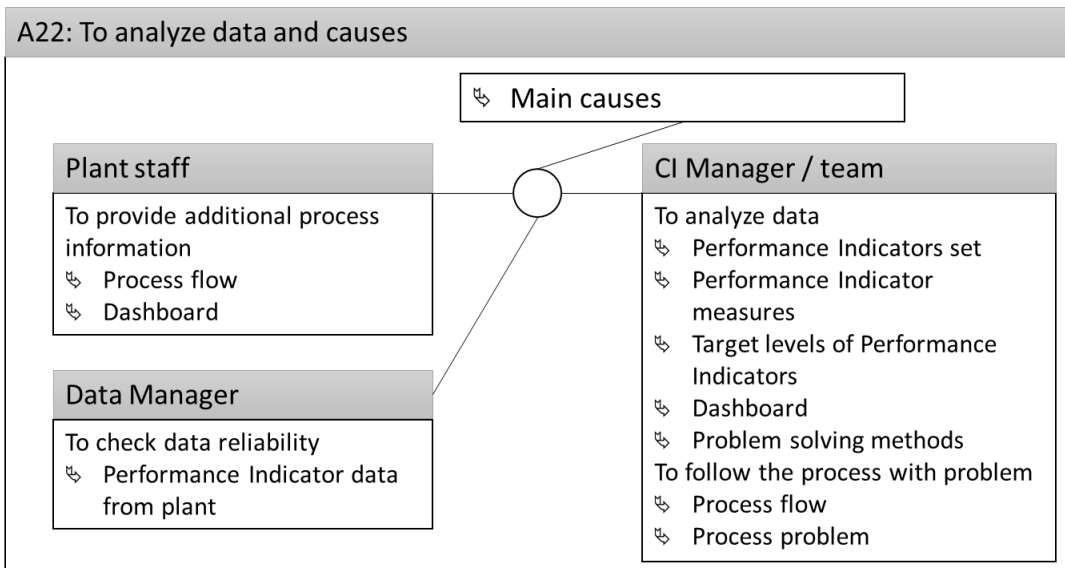

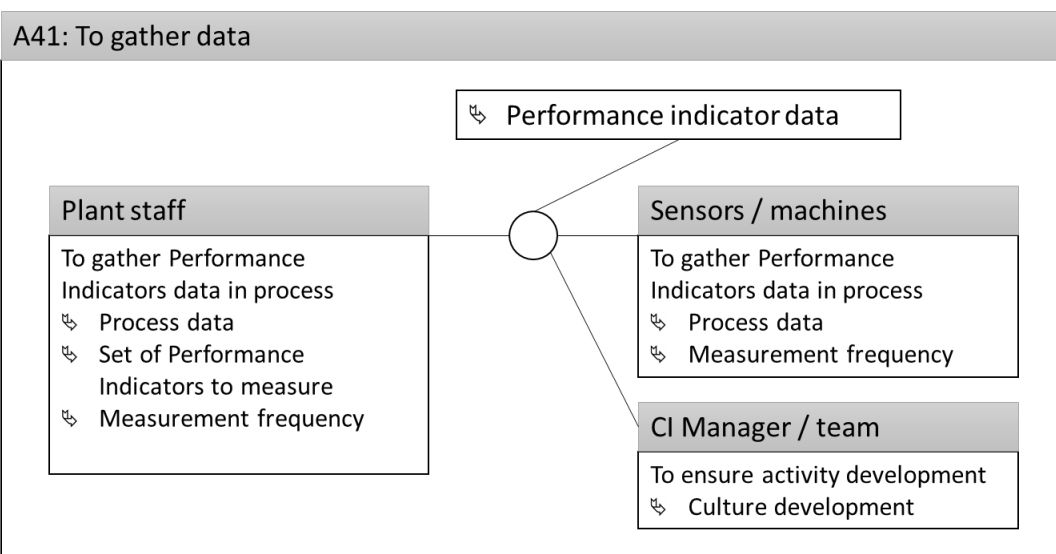
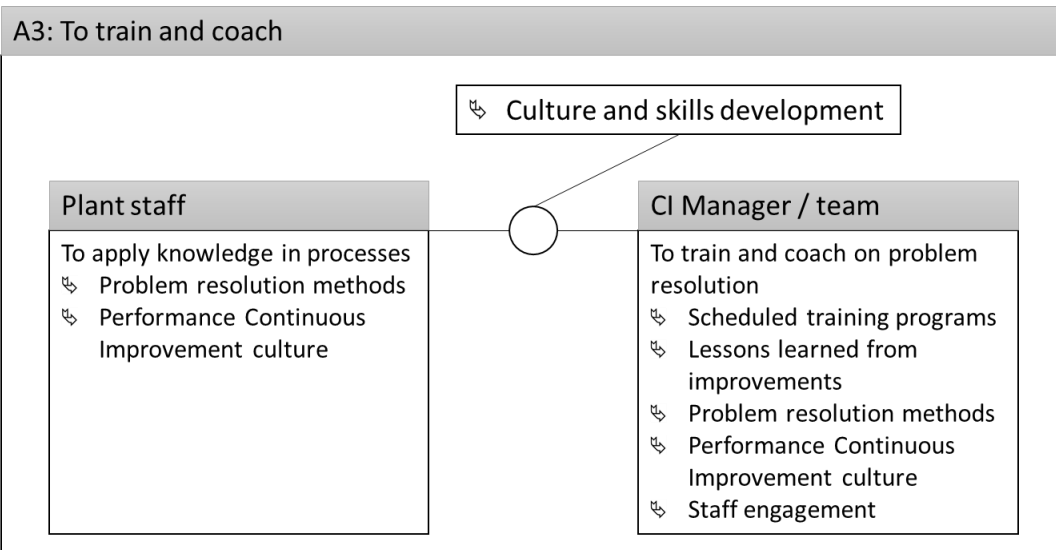
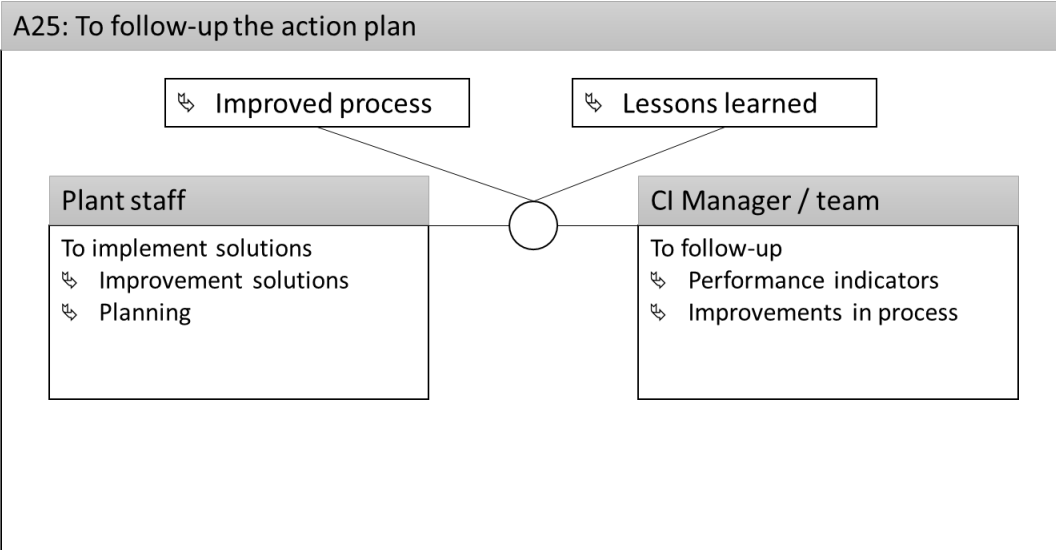

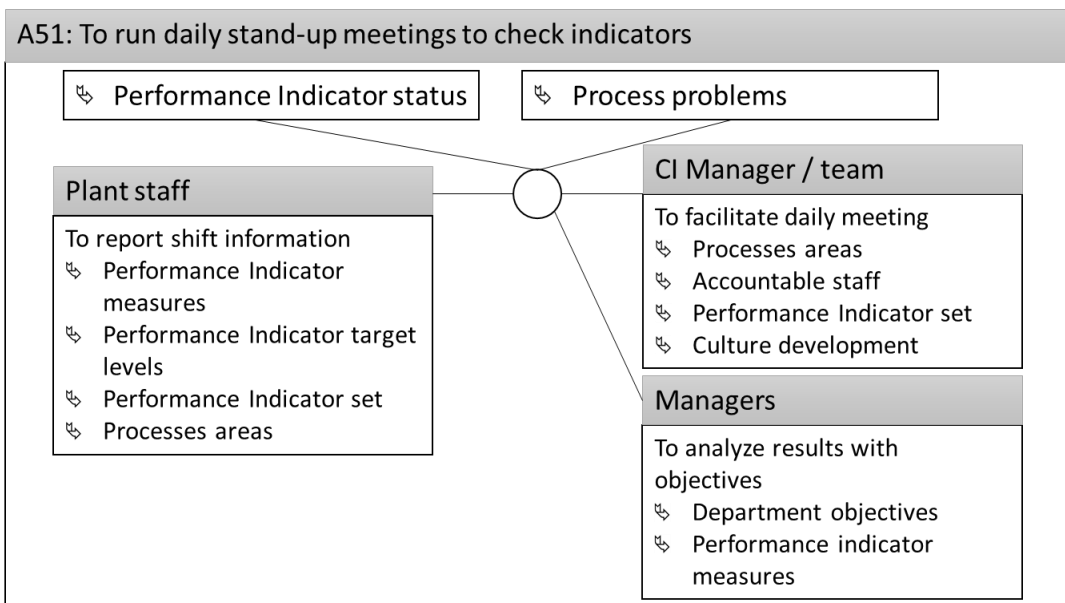
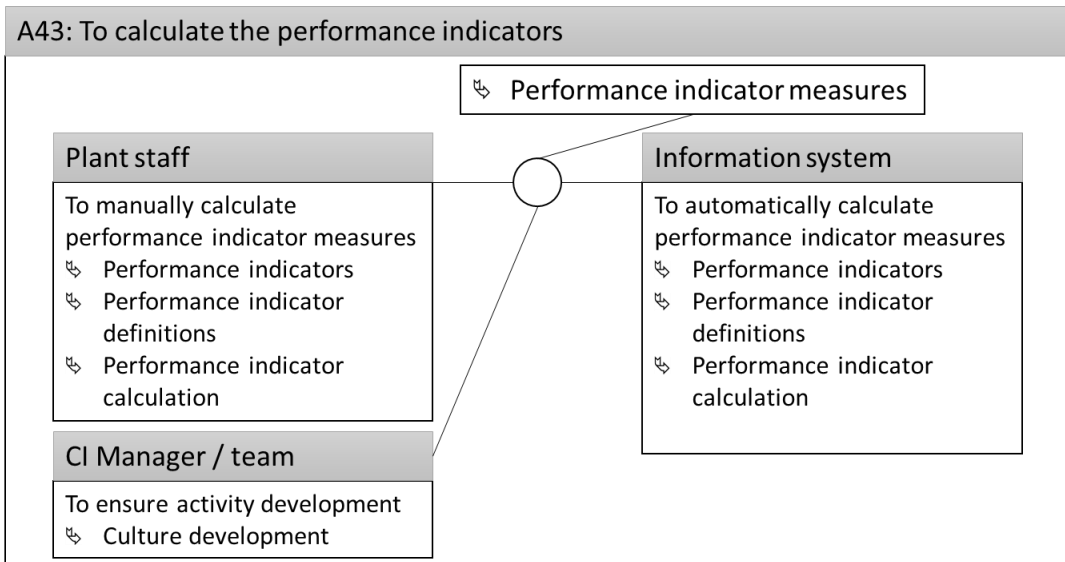
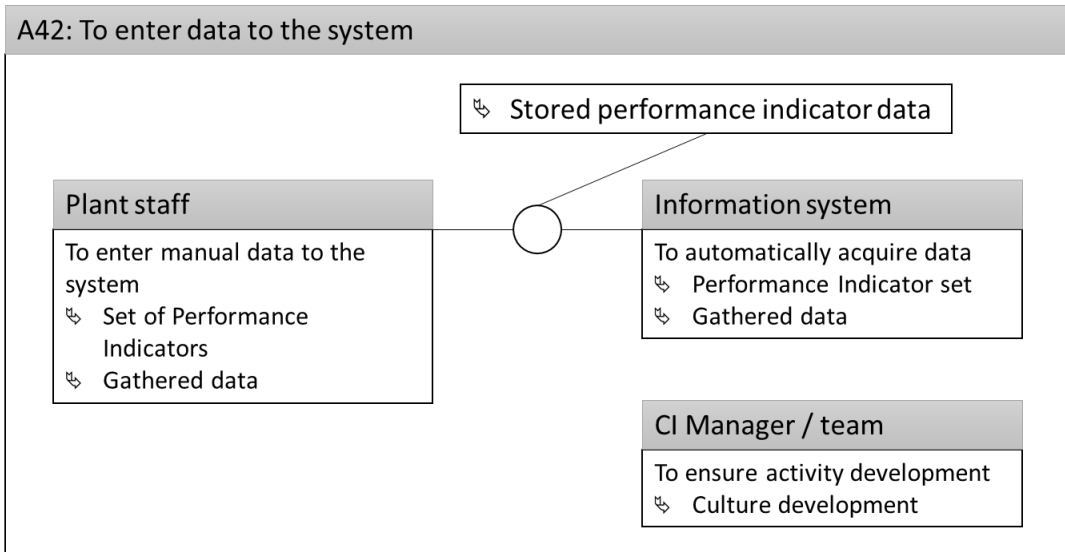

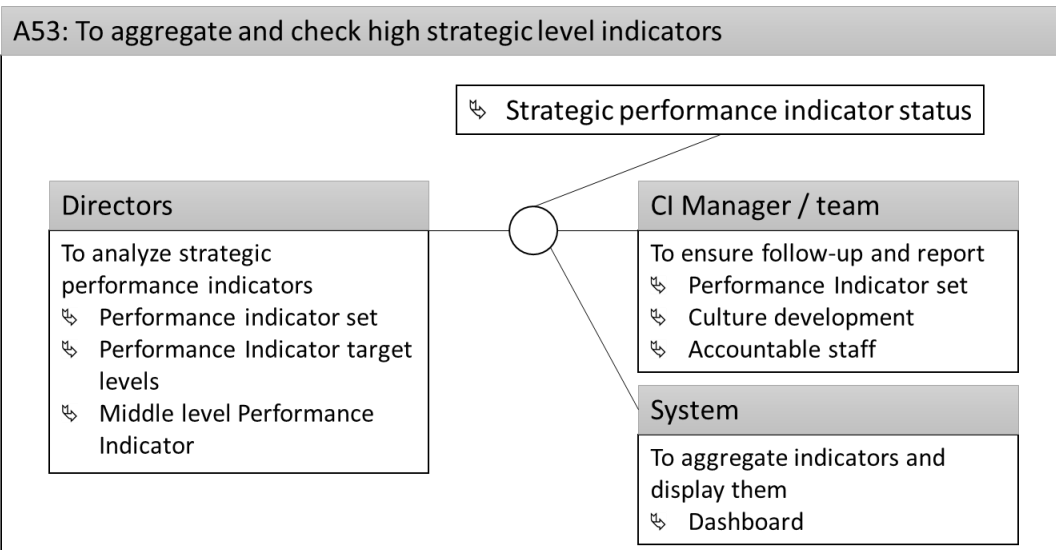
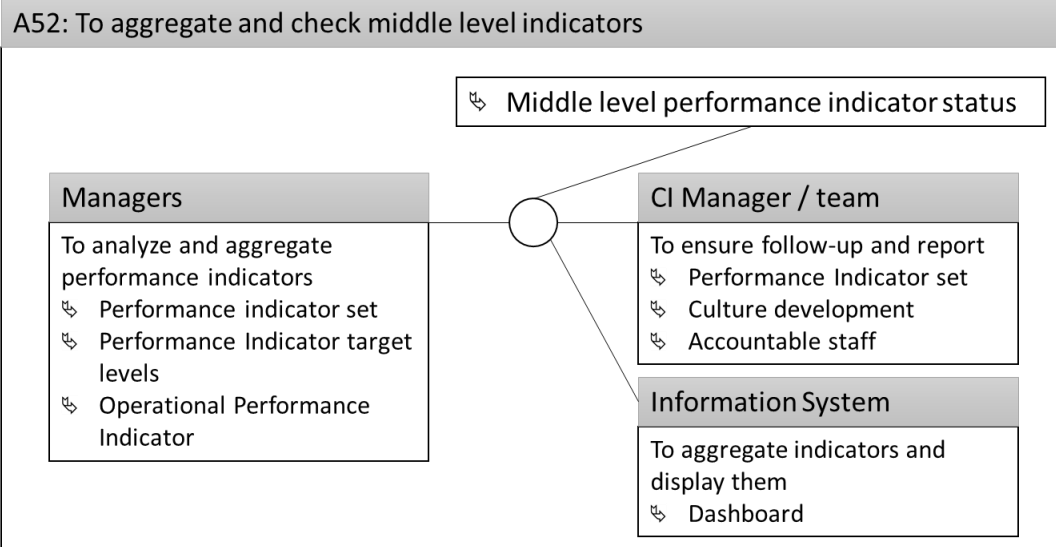

Appendix C. Characterization of interviewed CIP experts

- Expert #1: The first expert has over 8 years of experience in CIP and holds a Lean Six Sigma Black Belt (LSS BB) certification. The expert works as a Senior Process Excellence Specialist at Ball Corporation. The expert is located in Mexico and gives support to both, Mexico, and the United States of America. Ball Corporation is an American multinational company in the industry of packaging and aerospace. It was founded in 1880 and currently has more than 20,000 workers in its 100 different locations. Its net sales are US\$11.8 billion.
- Expert #2: The second expert has 18 years of experience in CIP and also holds a LSS BB certification. The expert is located in France and works as an Operational Excellence Regional Director at Safran. Safran is a French multinational company in the industry of aerospace and defense. It was founded in 2005, it has 76,000 workers in its more than 300 locations worldwide. Its net sales are US\$24 billion.
- Expert #3: Our third expert has 12 years of experience in CIP, holds a Lean Expert certification. This expert is located in Switzerland and works as a Lean Expert at Siemens. Siemens is a German multinational company in multiple industries (digital, financial, mobility, smart infrastructure...). It was founded in 1847 and has 303,000 workers in its 200 locations worldwide. Its net sales are US\$60.5 billion.
- Expert #4: Our fourth expert has 6 years of experience in CIP and is currently located in France. This expert works as a Production and Lean Manager at Henkel. Henkel is a German multinational company in the industry of fast-moving consumer

goods. It was founded in 1876 and has more than 52,000 workers in its 124 locations worldwide. Its net sales are US\$19.5 billion.

- Expert #5: The fifth and last expert has 15 years of experience in CIP and holds a LSS BB certification. The expert works as a Continuous Improvement Manager at Ball Corporation, the same company as the first expert.

Appendix E. Performance Indicator definition and objective

Performance family	Performance indicator	Objective	Definition
Effectiveness	Effectiveness	Maximize	Compares the output of a production process against a target (Karim & Arif-Uz-Zaman, 2013; Zammori, 2015)
Productivity	Efficiency	Maximize	Compares the output of a process or a machine, against the utilized resources in a given period (Karim & Arif-Uz-Zaman, 2013; Zammori, 2015)
	Labor downtime	Minimize	The idle time of the employees during working hours (Cortes et al., 2016)
	# of NVA motions	Minimize	All the movements that do not add value to the product or the production process
	Value-added ratio	Maximize	Compares the sum of the total value-added time and the lead time (Liker, 2004)
	equipment downtime	Minimize	The idle time of the machines during working hours (Cortes et al., 2016)
	Uptime	Maximize	The utilization rate of manpower and machines (Maasouman & Demirli, 2016)
	Capacity utilization	Maximize	Ratio between the real effective working hours and the planned working hours (Maasouman & Demirli, 2016)
Total cost plant operation	Rework costs	Minimize	The cost in material and in labor for reworking defective products
	Unit cost of manufacturing	Minimize	The cost of manufacturing one good unit of final product
Quality	AOQL	Minimize	Average outgoing quality limit of the production process
	FYP	Maximize	The percentage of products that go through the production process the first time with no defects (Liker, 2004)

Performance family	Performance indicator	Objective	Definition
	customer satisfaction	Maximize	The service level of the degree of fulfilling the customer expectation by providing good-quality products at the needed time
	delivery	Maximize	The percentage of on-time delivery of good-quality products. Lastly
	#andon per dept per cause	Minimize	The number of Andon pulls to stop the production line due to quality problems
	Defect rate	Minimize	Percentage of quality problems that occur throughout the production process (Cortes et al., 2016)
	Scrap rate	Minimize	Ratio between the scrap in the process and the total units produced (Cortes et al., 2016)
	Process capability index	Maximize	Represents the ability of the production process to meet determined product characteristics (Pearn et al., 1998; Perakis & Xekalaki, 2002)
Flexibility	Manufacturing lot size	Minimize	Quantity of products constituting a manufacturing batch
Speed	Speed	Maximize	Represents the rate at which the production is operating
Lead time	Lead time	Minimize	Total time from the moment the customer orders a good until its delivery (Santos Bento & Tontini, 2018)
	New product launch	Minimize	The time employed for launching a new product onto the market
	Supplier LT	Minimize	Total time that passes from the moment an order is placed to the supplier until it is received
Work time	Cycle time	Maintain to a target	The time between the exit from production of one unit and the exit of the following one
	Setup time	Minimize	The time during which production is stopped for a switch-over to a different product (Santos Bento & Tontini, 2018)
	Overtime	Minimize	The time worked outside the established working hours (Santos Bento & Tontini, 2018)
Travel distance	People travel distance	Minimize	The total distance that the logistics operator travels during a shift
	Product travel distance	Minimize	The total distance the product travels into the production chain.

Performance family	Performance indicator	Objective	Definition
Pull ratio	Pull ratio	Maximize	The proportion of the working stations that use pull (Mirdad & Eseonu, 2015)
Mura	Mura	Minimize	Represents the unevenness in production (Cortes et al., 2016)
Muda	Overproduction	Minimize	The quantity of production that is ahead of the demand of the client (Cortes et al., 2016)
	Inappropriate processing	Minimize	Represents the unnecessary or incorrect processing, or having a more complex process than needed
Inventory level	Quantity of finished goods	Minimize	The total inventory quantity of the finished products
	Inventory turnover ratio	Maximize	The replacement rate of a company's inventory over a given period of time (Santos Bento & Tontini, 2018)
	WIP inventory	Minimize	The quantity of work in process inventory
Profitability	Cost reduction	Maximize	Quantifies the reduction of the production costs
Market share	Market share	Maximize	Representing the portion of the market that a given company has
Human Factors	Knowledge disconnection	Minimize	Represents the lack of shared objectives and culture within the different levels of an organization
	Employee training & team building	Maximize	Represents the level of training given to the employees and the team building developed for problem resolution
	Employee compensation	Maximize	Represents the economic or non-economic incentive given to employees for their commitment and performance
	Safety risk factor	Minimize	The ratio between high and medium safety-risk workstations and the total number of workstations (Maasouman & Demirli, 2016)
	Job security	Maximize	Refers to the stability of the job for workers
	absenteeism rate	Minimize	The ratio between the number of man-days lost due to absenteeism and the total of working man-days available (Maasouman & Demirli, 2016)
	Ergonomic risk	Minimize	The ratio between the high and medium ergonomic risk workstations and the total number of workstations (Maasouman & Demirli, 2016)

Performance family	Performance indicator	Objective	Definition
	Labor turnover	Minimize	the ratio of employees entering and leaving an organization (Cortes et al., 2016)
Reliability	MTBF	Maximize	The mean time between failures
	MTTR	Minimize	The mean time to repair when a failure occurs
Production rate	Production rate	Maximize	The quantity of finished products that are produced in a given time period
Transfers	Transfer lot size	Minimize	The quantity produced per transfer batch (Cuatrecasas-Arbós et al., 2015)
	Number of transfer lots	Maximize	The number of lots or batches that are transferred

Appendix F. Complete matrices obtained from DEMATEL method

For the sake of easiness of representation, the following matrix D, N and T do not show the complete name of the performance indicators, but instead the following abbreviations

Abbreviation	Performance indicator	Abbreviation	Performance indicator
PI1	Effectiveness	PI26	People travel distance
PI2	Efficiency	PI27	Product travel distance
PI3	Labor downtime	PI28	Pull ratio
PI4	# of NVA motions	PI29	Mura
PI5	Value-added ratio	PI30	Overproduction
PI6	equipment downtime	PI31	Inappropriate processing
PI7	Uptime	PI32	Q. finished goods inv
PI8	Capacity utilization	PI33	Inventory turnover ratio
PI9	Rework costs	PI34	WIP inventory
PI10	Unit cost of manufacturing	PI35	Cost reduction
PI11	AOQL	PI36	market share

PI12	FYP	PI37	knowledge disconnection
PI13	customer satisfaction	PI38	Employee training & team building
PI14	delivery	PI39	Employee compensation
PI15	#andon per dept per cause	PI40	Safety risk factor
PI16	Defect rate	PI41	Job security
PI17	Scrap rate	PI42	absenteeism rate
PI18	Manufacturing lot size	PI43	Ergonomic risk
PI19	Speed	PI44	Labor turnover rate
PI20	Lead time	PI45	MTBF
PI21	New product launch	PI46	MTTR
PI22	Supplier LT	PI47	Production rate
PI23	Cycle time	PI48	Transfer lot size
PI24	Setup time	PI49	Number of transfer lots
PI25	Overtime	PI50	Process capability index

Matrix D

	PI1	PI2	PI3	PI4	PI5	PI6	PI7	PI8	PI9	PI10	PI11	PI12	PI13	PI14	PI15	PI16	PI17	PI18	PI19	PI20	PI21	PI22	PI23	PI24	PI25	PI26	PI27	PI28	PI29	PI30	PI31	PI32	PI33	PI34	PI35	PI36	PI37	PI38	PI39	PI40	PI41	PI42	PI43	PI44	PI45	PI46	PI47	PI48	PI49	PI50	
PI1	0	4	0	0	2	0	1	2	2	2	1	1	1	1	2	3	2	0	1	2	1	0	1	0	1	0	0	0	2	0	0	2	2	2	1	1	0	0	0	0	0	0	0	0	0	1	0	0	0		
PI2	0	0	0	0	0	0	0	3	2	4	2	1	1	3	0	0	0	0	1	1	0	0	1	0	1	0	0	0	0	0	0	1	1	1	4	1	0	0	1	0	0	0	0	0	1	0	0	2	0	0	0
PI3	0	4	0	0	3	1	1	2	0	2	0	0	0	1	0	0	0	0	1	1	1	0	1	0	0	0	0	0	1	0	0	0	0	0	1	0	0	0	0	0	0	0	0	0	0	0	0	1	0	0	1
PI4	0	4	0	0	3	0	0	0	0	1	0	0	0	0	0	0	0	0	1	1	0	0	2	0	0	0	0	0	1	0	0	0	0	0	1	0	0	0	0	0	0	0	3	0	0	0	0	0	0	0	
PI5	0	4	0	0	0	0	2	2	0	3	1	1	1	2	0	0	0	0	1	1	1	0	1	0	0	0	0	0	0	1	0	0	1	1	1	3	1	0	0	0	0	0	0	0	1	0	0	0	0		

0.0004	0.0004	0.0004	0.0006	0.0003	0.0003	0.0014	0.0003	0.0009	0.0009	0.0014	0.0012	0.0009	0.0009	0.0014	0.0012	0.0009
0.0008	0.0008	0.0273	0.0282	0.0001	0.0001	0.0289	0.0490	0.0560	0.0494	0.0489	0.0502	0.0502	0.0494	0.0489	0.0502	0.0501
0.0000	0.0000	0.0012	0.0022	0.0000	0.0000	0.0013	0.0021	0.0249	0.0006	0.0002	0.0005	0.0005	0.0006	0.0002	0.0005	0.0005
0.0000	0.0000	0.0001	0.0002	0.0000	0.0000	0.0005	0.0001	0.0006	0.0005	0.0015	0.0006	0.0006	0.0005	0.0015	0.0006	0.0001
0.0006	0.0006	0.0140	0.0040	0.0001	0.0001	0.0257	0.0036	0.0389	0.0024	0.0345	0.0354	0.0354	0.0024	0.0345	0.0354	0.0028
0.0000	0.0000	0.0012	0.0021	0.0000	0.0000	0.0019	0.0021	0.0032	0.0006	0.0002	0.0113	0.0006	0.0006	0.0002	0.0113	0.0005
0.0001	0.0000	0.0014	0.0019	0.0000	0.0000	0.0023	0.0019	0.0476	0.0226	0.0010	0.0126	0.0006	0.0226	0.0010	0.0126	0.0006
0.0005	0.0006	0.0273	0.0061	0.0001	0.0001	0.0050	0.0378	0.0426	0.0272	0.0046	0.0273	0.0361	0.0272	0.0046	0.0273	0.0361
0.0001	0.0001	0.0481	0.0502	0.0001	0.0001	0.0016	0.0022	0.0041	0.0025	0.0014	0.0020	0.0241	0.0025	0.0014	0.0020	0.0241
0.0006	0.0007	0.0291	0.0297	0.0001	0.0221	0.0377	0.0280	0.0436	0.0390	0.0157	0.0285	0.0488	0.0390	0.0157	0.0285	0.0488
0.0005	0.0005	0.0028	0.0036	0.0008	0.0008	0.0028	0.0022	0.0037	0.0136	0.0021	0.0027	0.0242	0.0136	0.0021	0.0027	0.0242
0.0005	0.0005	0.0024	0.0364	0.0006	0.0006	0.0023	0.0019	0.0144	0.0131	0.0015	0.0022	0.0135	0.0131	0.0015	0.0022	0.0135
0.0331	0.0001	0.0023	0.0355	0.0003	0.0003	0.0033	0.0019	0.0029	0.0141	0.0015	0.0026	0.0142	0.0029	0.0141	0.0026	0.0142
0.0004	0.0001	0.0148	0.0146	0.0003	0.0003	0.0376	0.0157	0.0185	0.0267	0.0037	0.0158	0.0366	0.0185	0.0037	0.0158	0.0366
0.0005	0.0004	0.0138	0.0371	0.0008	0.0008	0.0020	0.0339	0.0477	0.0028	0.0008	0.0019	0.0031	0.0477	0.0008	0.0019	0.0031
0.0005	0.0005	0.0344	0.0472	0.0006	0.0006	0.0018	0.0015	0.0138	0.0022	0.0008	0.0015	0.0032	0.0138	0.0022	0.0008	0.0032
0.0005	0.0005	0.0465	0.0382	0.0004	0.0004	0.0015	0.0123	0.0255	0.0020	0.0005	0.0015	0.0026	0.0255	0.0020	0.0005	0.0026
0.0000	0.0000	0.0000	0.0000	0.0000	0.0000	0.0000	0.0000	0.0000	0.0000	0.0000	0.0000	0.0000	0.0000	0.0000	0.0000	0.0000
0.0003	0.0003	0.0129	0.0024	0.0000	0.0000	0.0025	0.0129	0.0150	0.0134	0.0137	0.0136	0.0130	0.0150	0.0134	0.0137	0.0130
0.0002	0.0002	0.0157	0.0157	0.0001	0.0001	0.0481	0.0161	0.0187	0.0154	0.0129	0.0144	0.0149	0.0187	0.0154	0.0129	0.0144
0.0001	0.0001	0.0005	0.0004	0.0000	0.0000	0.0015	0.0004	0.0011	0.0114	0.0007	0.0117	0.0005	0.0011	0.0007	0.0117	0.0005
0.0000	0.0000	0.0000	0.0000	0.0000	0.0000	0.0000	0.0000	0.0000	0.0000	0.0000	0.0000	0.0000	0.0000	0.0000	0.0000	0.0000
0.0003	0.0003	0.0007	0.0006	0.0000	0.0000	0.0014	0.0008	0.0017	0.0119	0.0234	0.0123	0.0117	0.0017	0.0119	0.0234	0.0117
0.0001	0.0001	0.0000	0.0000	0.0000	0.0000	0.0000	0.0000	0.0000	0.0000	0.0000	0.0000	0.0001	0.0000	0.0000	0.0000	0.0001
0.0110	0.0000	0.0015	0.0007	0.0000	0.0000	0.0339	0.0021	0.0024	0.0019	0.0009	0.0018	0.0128	0.0024	0.0019	0.0009	0.0128
0.0000	0.0000	0.0000	0.0001	0.0000	0.0000	0.0001	0.0000	0.0002	0.0001	0.0004	0.0001	0.0000	0.0002	0.0001	0.0004	0.0000
0.0000	0.0000	0.0000	0.0110	0.0000	0.0000	0.0000	0.0000	0.0000	0.0001	0.0000	0.0000	0.0003	0.0000	0.0001	0.0000	0.0003
0.0000	0.0000	0.0000	0.0000	0.0000	0.0000	0.0000	0.0000	0.0000	0.0000	0.0000	0.0000	0.0000	0.0000	0.0000	0.0000	0.0000
0.0002	0.0002	0.0239	0.0140	0.0003	0.0003	0.0127	0.0233	0.0371	0.0130	0.0122	0.0129	0.0019	0.0371	0.0130	0.0122	0.0129
0.0000	0.0000	0.0000	0.0000	0.0000	0.0000	0.0000	0.0000	0.0000	0.0000	0.0000	0.0000	0.0000	0.0000	0.0000	0.0000	0.0000
0.0000	0.0000	0.0000	0.0000	0.0000	0.0000	0.0000	0.0000	0.0000	0.0000	0.0000	0.0000	0.0000	0.0000	0.0000	0.0000	0.0000
0.0001	0.0001	0.0134	0.0139	0.0001	0.0001	0.0015	0.0130	0.0150	0.0126	0.0014	0.0018	0.0117	0.0150	0.0126	0.0014	0.0117
0.0001	0.0001	0.0150	0.0150	0.0001	0.0001	0.0138	0.0147	0.0170	0.0142	0.0020	0.0027	0.0133	0.0170	0.0142	0.0020	0.0133
0.0001	0.0001	0.0143	0.0140	0.0001	0.0001	0.0346	0.0142	0.0164	0.0135	0.0016	0.0027	0.0129	0.0164	0.0135	0.0016	0.0129
0.0004	0.0003	0.0295	0.0412	0.0221	0.0226	0.0283	0.0173	0.0326	0.0392	0.0157	0.0173	0.0496	0.0326	0.0392	0.0157	0.0496
0.0345	0.0440	0.0017	0.0362	0.0001	0.0001	0.0028	0.0015	0.0023	0.0141	0.0014	0.0024	0.0140	0.0023	0.0141	0.0014	0.0140
0.0000	0.0000	0.0000	0.0000	0.0000	0.0000	0.0000	0.0000	0.0000	0.0000	0.0000	0.0000	0.0000	0.0000	0.0000	0.0000	0.0000
0.0000	0.0000	0.0000	0.0000	0.0000	0.0000	0.0000	0.0000	0.0000	0.0000	0.0000	0.0000	0.0000	0.0000	0.0000	0.0000	0.0000
0.0115	0.0110	0.0005	0.0009	0.0000	0.0000	0.0011	0.0008	0.0009	0.0010	0.0006	0.0008	0.0117	0.0009	0.0010	0.0006	0.0117
0.0000	0.0000	0.0000	0.0000	0.0000	0.0000	0.0001	0.0000	0.0001	0.0001	0.0004	0.0001	0.0000	0.0001	0.0001	0.0004	0.0000
0.0114	0.0110	0.0002	0.0006	0.0000	0.0000	0.0004	0.0002	0.0002	0.0004	0.0001	0.0002	0.0006	0.0002	0.0004	0.0001	0.0006
0.0006	0.0006	0.0004	0.0001	0.0000	0.0000	0.0115	0.0005	0.0009	0.0007	0.0012	0.0008	0.0008	0.0009	0.0007	0.0012	0.0008
0.0000	0.0000	0.0012	0.0005	0.0000	0.0000	0.0121	0.0012	0.0132	0.0122	0.0345	0.0127	0.0013	0.0132	0.0122	0.0345	0.0127
0.0123	0.0119	0.0008	0.0010	0.0000	0.0000	0.0124	0.0012	0.0017	0.0016	0.0015	0.0014	0.0125	0.0017	0.0016	0.0015	0.0125
0.0000	0.0000	0.0003	0.0001	0.0000	0.0000	0.0110	0.0004	0.0005	0.0003	0.0001	0.0003	0.0004	0.0005	0.0003	0.0001	0.0004
0.0000	0.0000	0.0003	0.0001	0.0000	0.0000	0.0115	0.0004	0.0005	0.0003	0.0001	0.0003	0.0004	0.0005	0.0003	0.0001	0.0004
0.0005	0.0004	0.0152	0.0145	0.0001	0.0001	0.0357	0.0151	0.0177	0.0151	0.0039	0.0154	0.0254	0.0177	0.0151	0.0039	0.0254
0.0000	0.0000	0.0000	0.0004	0.0000	0.0000	0.0000	0.0000	0.0000	0.0000	0.0000	0.0000	0.0000	0.0000	0.0000	0.0000	0.0000
0.0000	0.0000	0.0003	0.0004	0.0000	0.0000	0.0001	0.0003	0.0003	0.0003	0.0003	0.0003	0.0003	0.0003	0.0003	0.0003	0.0003
0.0006	0.0005	0.0024	0.0025	0.0003	0.0003	0.0124	0.0013	0.0024	0.0015	0.0009	0.0122	0.0020	0.0024	0.0015	0.0009	0.0122

PI50	PI49	PI48	PI47	PI46	PI45	PI44	PI43	PI42	PI41
0.0443	0.0001	0.0001	0.0013	0.0003	0.0004	0.0121	0.0335	0.0015	0.0121
0.0299	0.0027	0.0027	0.0490	0.0420	0.0448	0.0270	0.0423	0.0300	0.0158
0.0009	0.0004	0.0004	0.0002	0.0236	0.0257	0.0008	0.0003	0.0013	0.0007
0.0000	0.0008	0.0008	0.0006	0.0001	0.0001	0.0000	0.0445	0.0006	0.0000
0.0146	0.0131	0.0131	0.0347	0.0266	0.0286	0.0132	0.0271	0.0257	0.0135
0.0009	0.0007	0.0007	0.0002	0.0449	0.0479	0.0008	0.0008	0.0120	0.0009
0.0016	0.0010	0.0010	0.0009	0.0364	0.0389	0.0011	0.0018	0.0130	0.0012
0.0071	0.0125	0.0125	0.0380	0.0396	0.0420	0.0044	0.0166	0.0278	0.0032
0.0540	0.0001	0.0001	0.0020	0.0013	0.0017	0.0043	0.0021	0.0037	0.0036
0.0318	0.0015	0.0015	0.0284	0.0190	0.0206	0.0052	0.0060	0.0068	0.0037
0.0474	0.0003	0.0003	0.0030	0.0020	0.0024	0.0135	0.0026	0.0138	0.0135
0.0486	0.0003	0.0003	0.0023	0.0019	0.0026	0.0137	0.0022	0.0141	0.0139
0.0371	0.0008	0.0008	0.0020	0.0021	0.0023	0.0022	0.0016	0.0029	0.0017
0.0151	0.0020	0.0020	0.0049	0.0166	0.0178	0.0028	0.0041	0.0156	0.0021
0.0171	0.0002	0.0002	0.0014	0.0040	0.0263	0.0130	0.0019	0.0142	0.0136
0.0501	0.0001	0.0001	0.0019	0.0013	0.0019	0.0140	0.0023	0.0139	0.0142
0.0516	0.0001	0.0001	0.0012	0.0020	0.0026	0.0143	0.0019	0.0145	0.0146
0.0000	0.0000	0.0000	0.0000	0.0000	0.0000	0.0000	0.0000	0.0000	0.0000
0.0029	0.0005	0.0005	0.0349	0.0028	0.0032	0.0132	0.0148	0.0141	0.0019
0.0153	0.0486	0.0486	0.0032	0.0168	0.0180	0.0025	0.0041	0.0151	0.0020
0.0010	0.0012	0.0012	0.0005	0.0009	0.0010	0.0003	0.0011	0.0116	0.0006
0.0000	0.0000	0.0000	0.0000	0.0000	0.0000	0.0000	0.0000	0.0000	0.0000
0.0012	0.0005	0.0005	0.0122	0.0012	0.0013	0.0118	0.0141	0.0122	0.0012
0.0000	0.0000	0.0000	0.0000	0.0000	0.0000	0.0000	0.0000	0.0000	0.0000
0.0012	0.0005	0.0005	0.0022	0.0020	0.0021	0.0008	0.0016	0.0016	0.0005
0.0000	0.0230	0.0230	0.0002	0.0000	0.0000	0.0000	0.0110	0.0001	0.0000
0.0005	0.0000	0.0000	0.0000	0.0000	0.0000	0.0001	0.0000	0.0002	0.0001
0.0000	0.0000	0.0000	0.0000	0.0000	0.0000	0.0000	0.0000	0.0000	0.0000
0.0044	0.0009	0.0009	0.0015	0.0147	0.0157	0.0125	0.0143	0.0248	0.0025
0.0000	0.0000	0.0000	0.0000	0.0000	0.0000	0.0000	0.0000	0.0000	0.0000
0.0000	0.0000	0.0000	0.0000	0.0000	0.0000	0.0000	0.0000	0.0000	0.0000
0.0040	0.0002	0.0002	0.0011	0.0133	0.0142	0.0019	0.0021	0.0025	0.0015
0.0045	0.0016	0.0016	0.0028	0.0147	0.0157	0.0025	0.0030	0.0035	0.0017
0.0042	0.0351	0.0351	0.0024	0.0146	0.0155	0.0021	0.0027	0.0034	0.0016
0.0214	0.0022	0.0022	0.0276	0.0182	0.0197	0.0047	0.0059	0.0174	0.0038
0.0164	0.0009	0.0009	0.0015	0.0017	0.0018	0.0017	0.0016	0.0026	0.0014
0.0000	0.0000	0.0000	0.0000	0.0000	0.0000	0.0000	0.0000	0.0000	0.0000
0.0000	0.0000	0.0000	0.0000	0.0000	0.0000	0.0000	0.0000	0.0000	0.0000
0.0009	0.0001	0.0001	0.0006	0.0007	0.0007	0.0004	0.0005	0.0005	0.0002
0.0000	0.0000	0.0000	0.0001	0.0000	0.0000	0.0000	0.0110	0.0001	0.0000
0.0006	0.0000	0.0000	0.0001	0.0002	0.0002	0.0001	0.0001	0.0002	0.0000
0.0001	0.0002	0.0002	0.0009	0.0005	0.0006	0.0001	0.0334	0.0008	0.0220
0.0006	0.0009	0.0009	0.0129	0.0019	0.0020	0.0011	0.0038	0.0128	0.0006
0.0011	0.0002	0.0002	0.0014	0.0012	0.0013	0.0004	0.0238	0.0231	0.0447
0.0001	0.0001	0.0001	0.0004	0.0004	0.0005	0.0000	0.0002	0.0003	0.0000
0.0001	0.0001	0.0001	0.0004	0.0005	0.0444	0.0001	0.0002	0.0003	0.0000
0.0158	0.0007	0.0007	0.0053	0.0152	0.0163	0.0145	0.0154	0.0161	0.0027
0.0000	0.0440	0.0440	0.0000	0.0000	0.0000	0.0000	0.0000	0.0000	0.0000
0.0001	0.0019	0.0441	0.0008	0.0001	0.0001	0.0003	0.0003	0.0003	0.0000
0.0023	0.0002	0.0002	0.0124	0.0014	0.0015	0.0015	0.0019	0.0132	0.0129

Appendix G. Kendall's coefficients sample influence evaluation

Performance indicator A	Performance indicator B	Evaluation of the influence from performance indicator A towards performance indicator B				
		Base scenario	Expert 1	Expert 2	Expert 3	Expert 4
customer satisfaction	Overproduction	0	0	0	1	1
Safety risk factor	absenteeism rate	1	2	3	1	2
Product travel distance	Lead time	4	4	3	4	1
Capacity utilization	Overproduction	0	0	0	2	0
market share	Setup time	0	0	0	0	0
Uptime	Safety risk factor	0	0	0	1	0
Cost reduction	Scrap rate	1	1	0	1	2
Employee compensation	market share	0	1	0	2	1
knowledge disconnection	Effectiveness	0	1	0	3	2
#andon per dept per cause	market share	0	1	0	1	0
New product launch	Labor turnover rate	0	0	0	1	1
Uptime	Employee training & team building	0	0	0	0	0
People travel distance	MTBF	0	1	0	0	1
Overproduction	Labor turnover rate	0	0	0	3	1
Scrap rate	Mura	0	0	0	0	2
knowledge disconnection	Overtime	0	0	1	2	1
Cycle time	Production rate	4	4	3	4	3
AOQL	FYP	3	4	4	4	4
equipment downtime	Capacity utilization	3	4	3	4	3
Manufacturing lot size	Labor downtime	1	0	2	2	2

Appendix H. DEMATEL sensitivity analysis

The above table shows the 61 peer-to-peer influence evaluations random sample from matrix D.

Performance indicator A	Performance indicator B	Influence of A towards B
FYP	Defect rate	3
Capacity utilization	WIP inventory	3
AOQL	Product travel distance	1
Employee compensation	Cost reduction	1
Efficiency	customer satisfaction	1
Uptime	Q. finished goods inv	1
equipment downtime	delivery	1
Value-added ratio	market share	1
WIP inventory	Uptime	1
WIP inventory	Efficiency	2
Number of transfer lots	Capacity utilization	1
MTBF	Mura	1
Process capability index	Cost reduction	1
Supplier LT	Labor downtime	1
FYP	Lead time	1
FYP	Scrap rate	4
Capacity utilization	Inventory turnover ratio	1
Employee training & team building	delivery	1
# of NVA motions	Value-added ratio	3
Inappropriate processing	Efficiency	2
Q. finished goods inv	customer satisfaction	2
Inventory turnover ratio	Unit cost of manufacturing	1
Manufacturing lot size	Scrap rate	1
Mura	equipment downtime	1
Overproduction	Capacity utilization	2
knowledge disconnection	Effectiveness	2
Process capability index	delivery	1
Effectiveness	AOQL	1

MTTR	WIP inventory	1
Uptime	Capacity utilization	3
absenteeism rate	Defect rate	1
Defect rate	FYP	2
MTBF	delivery	1
Transfer lot size	WIP inventory	3
MTBF	Q. finished goods inv	1
Value-added ratio	New product launch	1
AOQL	Unit cost of manufacturing	2
Speed	Inventory turnover ratio	3
Employee training & team building	Production rate	1
MTBF	MTTR	4
#andon per dept per cause	delivery	1
WIP inventory	equipment downtime	1
Ergonomic risk	Speed	1
Cycle time	Speed	4
Defect rate	WIP inventory	1
absenteeism rate	Efficiency	2
Inappropriate processing	Process Capability index	2
Production rate	Cycle time	1
Scrap rate	Cost reduction	2
Defect rate	AOQL	2
Uptime	Efficiency	4
Employee compensation	Defect rate	1
FYP	Unit cost of manufacturing	2
delivery	Labor turnover rate	1
equipment downtime	#andon per dept per cause	4
Production rate	Speed	3
Inventory turnover ratio	Lead time	4
Employee compensation	Value-added ratio	2
Value-added ratio	WIP inventory	1
Efficiency	Unit cost of manufacturing	4
Value-added ratio	FYP	1

Following it is presented a table for each of the 4 scenarios, containing the new calculated $r_i + c_i$ and $r_i - c_i$. In each table it is highlighted in blue the top 10 most causal performance indicators from the base scenario. In red, the top 10 most influenced ones. And in green it is highlighted when a performance indicator changed type compared to the base scenario.

	Scenario 1: After +1				
INDICATOR	R+C After+1	R-C After+1	Type	r+c rank After+1	r-c rank After+1
Employee training & team building	0.6299	0.5873	Causal	22	1
MTBF	0.5277	0.4892	Causal	27	2
Setup time	0.4559	0.4114	Causal	31	3
Pull ratio	0.3537	0.3537	Causal	39	5
Effectiveness	0.8054	0.3544	Causal	14	4
Product travel distance	0.3856	0.3061	Causal	37	9
MTTR	0.4529	0.3277	Causal	33	7
Manufacturing lot size	0.4121	0.3251	Causal	35	8
Employee compensation	0.4630	0.3282	Causal	30	6
Process capability index	0.8342	0.2913	Causal	13	10
absenteeism rate	0.5475	0.2733	Causal	25	11
equipment downtime	0.9496	0.2194	Causal	7	13
Inappropriate processing	0.3003	0.2571	Causal	43	12
Job security	0.2557	0.1931	Causal	45	14
People travel distance	0.3571	0.1924	Causal	38	15
AOQL	0.8921	0.1790	Causal	8	17
Overproduction	0.2992	0.1923	Causal	44	16
Defect rate	0.9505	0.1718	Causal	6	19
#andon per dept per cause	0.9715	0.1738	Causal	5	18
Supplier LT	0.1756	0.1543	Causal	48	20
Cycle time	0.4966	0.0991	Causal	29	25
# of NVA motions	0.3901	0.1269	Causal	36	21
knowledge disconnection	0.1462	0.1245	Causal	49	22
Transfer lot size	0.3012	0.1177	Causal	42	23
Ergonomic risk	0.6192	0.1077	Causal	23	24
FYP	0.8047	0.0883	Causal	15	27
Number of transfer lots	0.3312	0.0918	Causal	41	26
Safety risk factor	0.1229	0.0745	Causal	50	28
Labor downtime	0.5965	0.0583	Causal	24	29
Speed	0.7050	-0.0400	Influenced	20	31

Labor turnover rate	0.5051	-0.0438	Influenced	28	32
Mura	0.7981	-0.0217	Influenced	16	30
Uptime	0.7514	-0.0456	Influenced	18	33
Overtime	0.1925	-0.0600	Influenced	46	34
New product launch	0.1916	-0.0799	Influenced	47	35
Scrap rate	0.6338	-0.2176	Influenced	21	36
Q. finished goods inv	0.5400	-0.2523	Influenced	26	38
customer satisfaction	0.4533	-0.2840	Influenced	32	40
Production rate	0.8642	-0.2287	Influenced	11	37
market share	0.3467	-0.2938	Influenced	40	41
Value-added ratio	1.1846	-0.2750	Influenced	3	39
Rework costs	0.4226	-0.3258	Influenced	34	42
WIP inventory	0.8789	-0.3561	Influenced	9	44
Capacity utilization	1.2727	-0.3472	Influenced	2	43
Inventory turnover ratio	0.7837	-0.4078	Influenced	17	45
delivery	0.7091	-0.4435	Influenced	19	46
Cost reduction	1.1001	-0.6044	Influenced	4	47
Lead time	0.8743	-0.7097	Influenced	10	48
Unit cost of manufacturing	0.8516	-0.7985	Influenced	12	49
Efficiency	1.6925	-0.8344	Influenced	1	50

Scenario 2: After +2					
INDICATOR	R+C After+2	R-C After+2	Type	r+c rank After+2	r-c rank After+2
Employee training & team building	0.6374	0.5962	Causal	22	1
MTBF	0.5507	0.5134	Causal	27	2
Setup time	0.4434	0.4004	Causal	33	3
Pull ratio	0.3450	0.3450	Causal	40	6
Effectiveness	0.8097	0.3517	Causal	15	5
Product travel distance	0.3898	0.2838	Causal	36	11
MTTR	0.4537	0.3324	Causal	32	7
Manufacturing lot size	0.4138	0.3295	Causal	34	8
Employee compensation	0.4961	0.3639	Causal	30	4

Process capability index	0.8467	0.2981	Causal	13	9
absenteeism rate	0.5628	0.2978	Causal	25	10
equipment downtime	0.9654	0.1951	Causal	6	14
Inappropriate processing	0.3230	0.2811	Causal	42	12
Job security	0.2498	0.1875	Causal	45	16
People travel distance	0.3468	0.1873	Causal	39	17
AOQL	0.9185	0.1715	Causal	9	19
Overproduction	0.3064	0.2028	Causal	43	13
Defect rate	0.9923	0.1881	Causal	5	15
#andon per dept per cause	0.9582	0.1795	Causal	7	18
Supplier LT	0.1849	0.1643	Causal	48	20
Cycle time	0.4968	0.0804	Causal	29	26
# of NVA motions	0.3790	0.1245	Causal	37	22
knowledge disconnection	0.1582	0.1371	Causal	49	21
Transfer lot size	0.2942	0.1159	Causal	44	24
Ergonomic risk	0.6144	0.1187	Causal	23	23
FYP	0.8371	0.0761	Causal	14	27
Number of transfer lots	0.3375	0.1048	Causal	41	25
Safety risk factor	0.1191	0.0723	Causal	50	28
Labor downtime	0.5898	0.0470	Causal	24	29
Speed	0.6976	-0.0509	Influenced	20	32
Labor turnover rate	0.5081	-0.0591	Influenced	28	34
Mura	0.8037	-0.0146	Influenced	16	30
Uptime	0.7582	-0.0494	Influenced	19	31
Overtime	0.1876	-0.0582	Influenced	47	33
New product launch	0.2029	-0.0949	Influenced	46	35
Scrap rate	0.6406	-0.2111	Influenced	21	36
Q. finished goods inv	0.5604	-0.2590	Influenced	26	39
customer satisfaction	0.4802	-0.3158	Influenced	31	41
Production rate	0.8628	-0.2193	Influenced	12	37
market share	0.3572	-0.3059	Influenced	38	40
Value-added ratio	1.2104	-0.2273	Influenced	3	38
Rework costs	0.4117	-0.3182	Influenced	35	42

WIP inventory	0.9404	-0.3434	Influenced	8	43
Capacity utilization	1.2724	-0.3448	Influenced	2	44
Inventory turnover ratio	0.7908	-0.4052	Influenced	17	45
delivery	0.7635	-0.4808	Influenced	18	46
Cost reduction	1.1080	-0.6251	Influenced	4	47
Lead time	0.8639	-0.7043	Influenced	11	48
Unit cost of manufacturing	0.8723	-0.8211	Influenced	10	49
Efficiency	1.6936	-0.8381	Influenced	1	50

Scenario 3: After -1					
INDICATOR	R+C After-1	R-C After-1	Type	r+c rank After-1	r-c rank After-1
Employee training & team building	0.6190	0.5730	Causal	21	1
MTBF	0.4641	0.4231	Causal	30	3
Setup time	0.4852	0.4370	Causal	28	2
Pull ratio	0.3756	0.3756	Causal	39	4
Effectiveness	0.8028	0.3617	Causal	12	5
Product travel distance	0.3798	0.3563	Causal	38	6
MTTR	0.4431	0.3317	Causal	32	7
Manufacturing lot size	0.4111	0.3169	Causal	33	8
Employee compensation	0.3973	0.2554	Causal	35	10
Process capability index	0.8121	0.2788	Causal	11	9
absenteeism rate	0.5187	0.2213	Causal	25	12
equipment downtime	0.9037	0.2535	Causal	6	11
Inappropriate processing	0.2535	0.2068	Causal	45	14
Job security	0.2715	0.2074	Causal	44	13
People travel distance	0.3819	0.2035	Causal	37	15
AOQL	0.8413	0.1945	Causal	8	16
Overproduction	0.2852	0.1697	Causal	43	19
Defect rate	0.8395	0.1710	Causal	10	18
#andon per dept per cause	0.9918	0.1750	Causal	5	17
Supplier LT	0.1547	0.1317	Causal	48	20

Cycle time	0.4828	0.1235	Causal	29	21
# of NVA motions	0.3869	0.1007	Causal	36	22
knowledge disconnection	0.1212	0.0977	Causal	50	23
Transfer lot size	0.2926	0.0956	Causal	42	24
Ergonomic risk	0.6329	0.0830	Causal	20	26
FYP	0.6915	0.0668	Causal	17	28
Number of transfer lots	0.3188	0.0637	Causal	41	29
Safety risk factor	0.1329	0.0801	Causal	49	27
Labor downtime	0.6143	0.0835	Causal	22	25
Speed	0.6493	0.0043	Causal	19	30
Labor turnover rate	0.5057	-0.0146	Influenced	26	31
Mura	0.7911	-0.0394	Influenced	13	32
Uptime	0.6942	-0.0892	Influenced	16	35
Overtime	0.2038	-0.0636	Influenced	46	34
New product launch	0.1677	-0.0466	Influenced	47	33
Scrap rate	0.6072	-0.2203	Influenced	23	37
Q. finished goods inv	0.4997	-0.2402	Influenced	27	38
customer satisfaction	0.3988	-0.2167	Influenced	34	36
Production rate	0.8399	-0.2817	Influenced	9	40
market share	0.3255	-0.2688	Influenced	40	39
Value-added ratio	1.1124	-0.3558	Influenced	3	44
Rework costs	0.4500	-0.3446	Influenced	31	42
WIP inventory	0.6836	-0.3219	Influenced	18	41
Capacity utilization	1.2226	-0.3479	Influenced	2	43
Inventory turnover ratio	0.7278	-0.3963	Influenced	15	46
delivery	0.5941	-0.3644	Influenced	24	45
Cost reduction	1.0905	-0.5623	Influenced	4	47
Lead time	0.8853	-0.7074	Influenced	7	48
Unit cost of manufacturing	0.7879	-0.7297	Influenced	14	49
Efficiency	1.6759	-0.8312	Influenced	1	50

	Scenario 4: After -2				
INDICATOR	R+C After-2	R-C After-2	Type	r+c rank After-2	r-c rank After-2
Employee training & team building	0.6528	0.6046	Causal	20	1
MTBF	0.4728	0.4295	Causal	31	3
Setup time	0.5103	0.4598	Causal	28	2
Pull ratio	0.3945	0.3945	Causal	38	4
Effectiveness	0.8323	0.3918	Causal	13	5
Product travel distance	0.3998	0.3752	Causal	37	6
MTRR	0.4543	0.3618	Causal	32	7
Manufacturing lot size	0.4320	0.3332	Causal	33	8
Employee compensation	0.4025	0.2527	Causal	36	10
Process capability index	0.8423	0.3044	Causal	10	9
absenteeism rate	0.5300	0.2165	Causal	26	13
equipment downtime	0.9313	0.2486	Causal	6	11
Inappropriate processing	0.2321	0.1830	Causal	45	17
Job security	0.2867	0.2189	Causal	43	12
People travel distance	0.4029	0.2149	Causal	35	14
AOQL	0.8562	0.2067	Causal	9	15
Overproduction	0.2817	0.1606	Causal	44	19
Defect rate	0.8343	0.1628	Causal	11	18
#andon per dept per cause	1.0282	0.1987	Causal	5	16
Supplier LT	0.1618	0.1377	Causal	48	20
Cycle time	0.4931	0.1142	Causal	29	21
# of NVA motions	0.3919	0.0900	Causal	39	22
knowledge disconnection	0.1085	0.0839	Causal	50	27
Transfer lot size	0.2941	0.0870	Causal	42	25
Ergonomic risk	0.6680	0.0881	Causal	17	24
FYP	0.6672	0.0413	Causal	19	29
Number of transfer lots	0.3345	0.0672	Causal	41	28
Safety risk factor	0.1406	0.0849	Causal	49	26
Labor downtime	0.6475	0.0891	Causal	21	23

Speed	0.6376	0.0230	Causal	22	30
Labor turnover rate	0.5330	-0.0146	Influenced	25	31
Mura	0.8332	-0.0427	Influenced	12	32
Uptime	0.6971	-0.1278	Influenced	16	35
Overtime	0.2146	-0.0670	Influenced	46	34
New product launch	0.1768	-0.0496	Influenced	47	33
Scrap rate	0.6074	-0.2318	Influenced	24	37
Q. finished goods inv	0.5125	-0.2661	Influenced	27	38
customer satisfaction	0.4040	-0.2122	Influenced	34	36
Production rate	0.8691	-0.3109	Influenced	8	40
market share	0.3430	-0.2833	Influenced	40	39
Value-added ratio	1.1454	-0.3489	Influenced	3	42
Rework costs	0.4729	-0.3616	Influenced	30	44
WIP inventory	0.6678	-0.3212	Influenced	18	41
Capacity utilization	1.2443	-0.3499	Influenced	2	43
Inventory turnover ratio	0.7369	-0.4135	Influenced	15	46
delivery	0.6263	-0.3846	Influenced	23	45
Cost reduction	1.1320	-0.5748	Influenced	4	47
Lead time	0.9132	-0.7259	Influenced	7	49
Unit cost of manufacturing	0.7716	-0.7100	Influenced	14	48
Efficiency	1.6920	-0.8283	Influenced	1	50

Appendix I. Performance System Ontology tables

Performance System Ontology classes

Class	Super Class	Natural language definition
Performance Family	Thing	The various facets or dimensions of the performance in an organization
Performance Indicator	Performance Family	A type of measurement through which the different performance dimensions can be assessed
Performance Improvement Method	Thing	Applied method with the main purpose of enhancing the performance in an organization or their processes
Performance Improvement Practice	Performance Improvement Method	The practices constituting the performance improvement method adopted by the organization
Performance Improvement Tool	Performance Improvement	The instruments through which practices can be operationalized
Relationship	Thing	Class representing the effects of influence among performance indicators and improvement from practices to indicators
Improvement Relationship	Relationship	Represents the value of the improvement relationship from improvement practices to performance indicators
Influence Relationship	Relationship	The direct and total influences relationships among performance indicators
Direct Influence	Influence Relationship	The value of the direct influence between two performance indicators given by the user
Total Influence	Influence Relationship	The value of the total influence relationship between two performance indicators, resulting from DEMATEL analysis

Performance System Ontology class properties

Relation	Domain	Range	Natural language definition
hasName	Performance Indicator Performance Improvement Practice Performance Improvement Tool Performance Improvement Method Performance Family	String	Describes the name of a performance indicator, performance improvement practice, performance improvement tool, performance improvement method, performance family
hasDefinition	Performance Indicator	String	The definition of a performance indicator
hasType	Performance Indicator	String	Describes the type (causal or influenced) of a performance indicator, resulting from DEMATEL analysis
hasObjective	Performance Indicator	String	Denotes the objective (to be maximized, to be minimized) of a performance indicator
hasInfluence Direction Index	Performance Indicator	Decimal	The value of influence direction index of a performance indicator, resulting from DEMATEL analysis
hasImprovementValue	Improvement Relationship	Integer	The value (from -4 to -1 and 1 to 4) of an improvement relationship from an improvement practice to a performance indicator
hasDirectInfluenceValue	Direct Influence	Integer	The value (from to 4) of the direct influence between 2 performance indicators
hasTotalInfluenceValue	Total Influence	Decimal	The value of the total influence between 2 performance indicators, resulting from DEMATEL analysis

Performance System Ontology object properties

Relation	Domain	Range	Natural language definition
hasTotalInfluence	Performance Indicator	Total Influence	Property indicating that a performance indicator is receiving a total influence

isTotallyInfluencing	Total Influence	Performance Indicator	Property indicating that a total influence is influencing a performance indicator
hasImpactOn	Performance Improvement Practice	Improvement Relationship	Property indicating that a performance improvement practice has an improvement impact on an improvement relationship
isImpactedBy	Improvement Relationship	Performance Improvement Practice	Property indicating that an improvement relationship receives and improvement impact from a performance improvement practice
hasDirectInfluence	Performance Indicator	Direct Influence	Property indicating that a performance indicator is receiving a direct influence
isDirectlyInfluencing	Direct Influence	Performance Indicator	Property indicating that a direct influence is influencing a performance indicator
isImproving	Improvement Relationship	Performance Indicator	Property indicating that an improvement relationship is improving a performance indicator
isOperationalizedBy	Performance Improvement Practice	Performance Improvement Tool	Property indicating that a performance improvement practice is implemented by a performance improvement tool
isOperationalizing	Performance Improvement Tool	Performance Improvement Practice	Property indicating that a performance improvement tool is implementing a performance practice
hasFamily	Performance Indicator	Performance Family	Property indicating that a performance indicator belongs to a performance family
isContributingTo	Performance Improvement Practice	Performance Improvement Method	Property indicating that through a performance improvement practice
isAssisting	Performance Improvement Tool	Performance Improvement Method	Property indicating

Appendix J. Improvement practices and tools relationships

Improvement tool	Operationalizes Improvement practice
5S's	Use visual indicators for determining standard conditions
5-Why	Identify root causes and apply countermeasures
7 Mudas	Reduce/eliminate non-value added
A3 report	Get consensus on problems and potential solutions with all stakeholders
Andon	Detect problems and stop
Automatic stops	Detect problems and stop
Eliminate Mura (Unevenness)	Eliminate unevenness in the production schedule
Eliminate Muri (overburdening people or equipment)	Eliminate overburden to people and equipment
Hansei events	Use Hansei (reflection) at key milestones to identify shortcomings and develop countermeasures
In-station quality control	Quality drives value proposition
In-station quality control	Solve problems quick and put in place countermeasures
Kaizen workshops	Empower people. Use cross-functional teams to improve quality and productivity
Kaizen workshops	Make employees use Kaizen to eliminate waste
kanban	Day-by-day shifts instead of computer schedules
kanban	Design visual systems to support flow and pull
kanban	Material replenishment initiated by consumption
kanban	Minimize WIP and warehouse inventory
kanban	To provide the customer what they want in the right amount and time
One-piece flow cell	Design visual systems to support flow and pull
One-piece flow cell	one-piece flow
Pareto diagram	Identify root causes and apply countermeasures
PDCA(plan-do-check-act)	Identify root causes and apply countermeasures
PDCA(plan-do-check-act)	Solve problems quick and put in place countermeasures

Poka-yoke	Use quality assurance methods
Policy deployment (hoshin kanri)	Create a strong and stable culture
quick changeover - SMED	Minimize WIP and warehouse inventory
Spaghetti diagram	Reduce/eliminate non-value added
Standard work (takt time, sequence, standardized stock on hand)	Learn by standardizing best practices
Standard work (takt time, sequence, standardized stock on hand)	Standardize best practices
Standard work (takt time, sequence, standardized stock on hand)	Use stable, repeatable methods to maintain predictability, regular timing, regular output
Takt time	Redesign work processes - high value-added, continuous flow
VSM	Create material & information flow
VSM	Minimize WIP and warehouse inventory
VSM	Redesign work processes - high value-added, continuous flow
Work standard	Avoid moving worker's focus with computer screens
Work standard	Use visual indicators for determining standard conditions

For facilitating the display of the improvement relationships, the following abbreviation of the improvement practices, along with the ones for performance indicators done in Appendix E are used:

Abbreviation	Improvement practice
PR1	Create material & information flow
PR2	Identify root causes and apply countermeasures
PR3	Make employees use Kaizen to eliminate waste
PR4	Redesign work processes - high value-added, continuous flow
PR5	Reduce/eliminate non-value added
PR6	Standardize best practices
PR7	Use Hansei (reflection) at key milestones to identify shortcomings and develop countermeasures
PR8	Use technology to support people, not to replace them
PR9	Use visual indicators for determining standard conditions
PR10	Detect problems and stop
PR11	Empower people. Use cross-functional teams to improve quality and productivity
PR12	Quality drives value proposition
PR13	Solve and improve process by observing and verifying data in the source

PR14	Solve problems quick and put in place countermeasures
PR15	Use quality assurance methods
PR16	Use stable, repeatable methods to maintain predictability, regular timing, regular output
PR17	Be responsible. Decisions based on LT philosophy
PR18	Create a strong and stable culture
PR19	Grow leaders within the organization
PR20	Leaders are role models and must understand the daily work
PR21	Teach teamwork
PR22	Train individuals and teams
PR23	Get consensus on problems and potential solutions with all stakeholders
PR24	Learn by standardizing best practices
PR25	Minimize WIP and warehouse inventory
PR26	Think and speak based on personally verified data
PR27	To provide the customer what they want in the right amount and time
PR28	Use proven technology. Test it before adopting it
PR29	Day-by-day shifts instead of computer schedules
PR30	Design visual systems to support flow and pull
PR31	Eliminate overburden to people and equipment
PR32	Eliminate unevenness in the production schedule
PR33	one-piece flow
PR34	Generate value for the customer
PR35	Have respect for partners and suppliers
PR36	Help partners to grow and develop
PR37	Material replenishment initiated by consumption
PR38	Avoid moving worker's focus with computer screens
PR39	Maintain and improve skills-added value
PR40	Reduce reports length
PR41	Work, grow and align the organization toward a common purpose

Practice	Improves	Indicator	Practice	Improves	Indicator	Practice	Improves	Indicator
PR1	4	PI4	PR21	4	PI37	PR35	1	PI35
PR1	3	PI8	PR21	1	PI44	PR35	1	PI16
PR1	3	PI23	PR22	2	PI42	PR35	1	PI33
PR1	4	PI2	PR22	1	PI39	PR35	1	PI17
PR1	3	PI6	PR22	4	PI38	PR35	1	PI22
PR1	3	PI33	PR22	2	PI41	PR36	3	PI35
PR1	2	PI3	PR22	3	PI37	PR36	2	PI16
PR1	4	PI20	PR22	2	PI44	PR36	2	PI33
PR1	4	PI18	PR23	1	PI11	PR36	2	PI17
PR1	3	PI49	PR23	1	PI35	PR36	3	PI22
PR1	1	PI25	PR23	1	PI1	PR36	2	PI10
PR1	3	PI32	PR23	2	PI2	PR37	2	PI14

PR1	3	PI24	PR23	2	PI38	PR37	-2	PI2
PR1	1	PI19	PR23	1	PI12	PR37	-1	PI6
PR1	2	PI22	PR23	3	PI37	PR37	3	PI33
PR1	3	PI48	PR23	1	PI44	PR37	1	PI20
PR1	3	PI7	PR23	1	PI5	PR37	4	PI30
PR1	4	PI5	PR24	1	PI11	PR37	4	PI28
PR1	3	PI34	PR24	1	PI16	PR37	3	PI32
PR10	4	PI15	PR24	2	PI1	PR37	3	PI34
PR10	4	PI11	PR24	1	PI2	PR38	1	PI2
PR10	3	PI35	PR24	4	PI38	PR38	1	PI43
PR10	3	PI13	PR24	1	PI12	PR38	1	PI29
PR10	1	PI1	PR24	1	PI31	PR38	-1	PI5
PR10	-1	PI2	PR24	3	PI37	PR39	1	PI2
PR10	-1	PI6	PR24	2	PI9	PR39	4	PI38
PR10	-2	PI3	PR24	1	PI17	PR39	1	PI41
PR10	-1	PI20	PR24	1	PI10	PR39	1	PI44
PR10	1	PI36	PR25	-1	PI11	PR39	1	PI5
PR10	-1	PI29	PR25	1	PI35	PR4	4	PI4
PR10	2	PI9	PR25	-1	PI13	PR4	3	PI8
PR10	-1	PI17	PR25	-1	PI14	PR4	3	PI23
PR11	2	PI15	PR25	1	PI43	PR4	4	PI2
PR11	2	PI42	PR25	4	PI33	PR4	3	PI6
PR11	2	PI11	PR25	3	PI20	PR4	3	PI33
PR11	2	PI35	PR25	1	PI29	PR4	2	PI3
PR11	1	PI13	PR25	1	PI26	PR4	4	PI20
PR11	2	PI16	PR25	1	PI27	PR4	4	PI18
PR11	1	PI14	PR25	4	PI32	PR4	3	PI49
PR11	2	PI1	PR25	-1	PI17	PR4	1	PI25
PR11	2	PI2	PR25	1	PI10	PR4	3	PI32
PR11	4	PI38	PR25	4	PI34	PR4	3	PI24
PR11	2	PI12	PR26	1	PI11	PR4	1	PI19
PR11	2	PI41	PR26	1	PI14	PR4	2	PI22
PR11	4	PI37	PR26	1	PI1	PR4	3	PI48
PR11	2	PI44	PR26	1	PI2	PR4	3	PI7
PR11	2	PI9	PR26	1	PI12	PR4	4	PI5
PR11	1	PI17	PR26	2	PI31	PR4	3	PI34
PR11	1	PI5	PR26	3	PI37	PR40	1	PI2
PR12	2	PI15	PR26	1	PI5	PR40	2	PI38
PR12	4	PI11	PR27	4	PI11	PR40	3	PI37
PR12	2	PI35	PR27	4	PI13	PR40	1	PI5
PR12	3	PI13	PR27	4	PI14	PR41	1	PI38
PR12	4	PI16	PR27	4	PI1	PR41	3	PI37
PR12	1	PI14	PR27	4	PI36	PR5	4	PI4

PR12	1	PI1	PR27	3	PI21	PR5	1	PI42
PR12	1	PI2	PR28	1	PI11	PR5	1	PI11
PR12	4	PI12	PR28	1	PI35	PR5	3	PI8
PR12	2	PI36	PR28	1	PI16	PR5	3	PI35
PR12	2	PI9	PR28	1	PI1	PR5	1	PI13
PR12	2	PI17	PR28	1	PI2	PR5	1	PI23
PR13	1	PI15	PR28	1	PI6	PR5	1	PI16
PR13	2	PI11	PR28	1	PI12	PR5	2	PI14
PR13	1	PI35	PR28	2	PI45	PR5	4	PI2
PR13	1	PI16	PR28	2	PI46	PR5	4	PI6
PR13	2	PI14	PR28	1	PI9	PR5	2	PI43
PR13	2	PI1	PR28	1	PI17	PR5	1	PI12
PR13	2	PI2	PR29	-2	PI8	PR5	3	PI31
PR13	1	PI43	PR29	2	PI14	PR5	3	PI3
PR13	2	PI12	PR29	-2	PI2	PR5	1	PI44
PR13	3	PI31	PR29	-2	PI6	PR5	3	PI20
PR13	4	PI37	PR29	3	PI33	PR5	2	PI29
PR13	2	PI5	PR29	-2	PI3	PR5	3	PI21
PR14	4	PI15	PR29	3	PI20	PR5	-2	PI49
PR14	4	PI11	PR29	-1	PI29	PR5	1	PI30
PR14	2	PI35	PR29	3	PI30	PR5	4	PI26
PR14	3	PI13	PR29	-2	PI25	PR5	4	PI27
PR14	4	PI16	PR29	3	PI32	PR5	1	PI47
PR14	2	PI1	PR29	3	PI34	PR5	2	PI9
PR14	3	PI2	PR3	1	PI4	PR5	2	PI40
PR14	4	PI12	PR3	3	PI15	PR5	2	PI17
PR14	1	PI33	PR3	3	PI11	PR5	3	PI24
PR14	1	PI36	PR3	2	PI8	PR5	2	PI19
PR14	1	PI29	PR3	1	PI35	PR5	2	PI10
PR14	1	PI32	PR3	1	PI13	PR5	4	PI7
PR14	3	PI9	PR3	3	PI16	PR5	4	PI5
PR14	3	PI17	PR3	2	PI14	PR5	1	PI34
PR14	1	PI10	PR3	3	PI1	PR6	1	PI4
PR14	1	PI34	PR3	4	PI2	PR6	1	PI15
PR15	2	PI15	PR3	3	PI38	PR6	3	PI11
PR15	4	PI11	PR3	1	PI6	PR6	1	PI35
PR15	1	PI35	PR3	1	PI43	PR6	1	PI13
PR15	3	PI13	PR3	3	PI12	PR6	3	PI16
PR15	3	PI16	PR3	1	PI37	PR6	4	PI1
PR15	2	PI1	PR3	1	PI3	PR6	2	PI2
PR15	2	PI2	PR3	2	PI44	PR6	2	PI38
PR15	4	PI12	PR3	1	PI45	PR6	3	PI12
PR15	4	PI36	PR3	1	PI46	PR6	3	PI31
PR15	3	PI9	PR3	1	PI9	PR6	1	PI36

PR15	3	PI17	PR3	1	PI17	PR6	4	PI9
PR15	1	PI10	PR3	1	PI10	PR6	3	PI17
PR16	1	PI15	PR3	2	PI7	PR6	2	PI10
PR16	2	PI11	PR3	2	PI5	PR6	1	PI7
PR16	1	PI8	PR30	1	PI8	PR6	1	PI5
PR16	2	PI16	PR30	1	PI14	PR7	1	PI4
PR16	1	PI14	PR30	1	PI2	PR7	3	PI15
PR16	3	PI1	PR30	1	PI6	PR7	3	PI11
PR16	3	PI2	PR30	1	PI33	PR7	2	PI8
PR16	-3	PI43	PR30	1	PI3	PR7	1	PI35
PR16	2	PI12	PR30	1	PI20	PR7	1	PI13
PR16	2	PI33	PR30	1	PI29	PR7	3	PI16
PR16	1	PI20	PR30	1	PI30	PR7	2	PI14
PR16	4	PI29	PR30	1	PI32	PR7	2	PI1
PR16	2	PI32	PR30	1	PI19	PR7	4	PI2
PR16	2	PI9	PR30	1	PI7	PR7	1	PI6
PR16	1	PI17	PR30	1	PI34	PR7	3	PI12
PR16	1	PI19	PR31	1	PI8	PR7	1	PI3
PR16	1	PI10	PR31	1	PI2	PR7	1	PI45
PR16	2	PI34	PR31	1	PI6	PR7	1	PI46
PR17	3	PI42	PR31	3	PI43	PR7	1	PI9
PR17	2	PI38	PR31	1	PI3	PR7	1	PI17
PR17	1	PI41	PR31	2	PI44	PR7	1	PI10
PR17	1	PI37	PR31	1	PI20	PR7	2	PI7
PR17	1	PI44	PR31	1	PI25	PR7	2	PI5
PR18	3	PI42	PR31	1	PI7	PR8	2	PI4
PR18	2	PI38	PR31	1	PI5	PR8	1	PI42
PR18	3	PI41	PR31	2	PI34	PR8	1	PI11
PR18	2	PI37	PR32	3	PI8	PR8	1	PI16
PR18	4	PI44	PR32	1	PI2	PR8	2	PI1
PR19	2	PI42	PR32	2	PI6	PR8	2	PI2
PR19	2	PI39	PR32	2	PI43	PR8	4	PI43
PR19	3	PI38	PR32	3	PI33	PR8	1	PI12
PR19	1	PI41	PR32	2	PI3	PR8	2	PI44
PR19	4	PI37	PR32	3	PI44	PR8	2	PI26
PR19	2	PI44	PR32	-3	PI20	PR8	1	PI40
PR2	1	PI4	PR32	4	PI29	PR8	1	PI17
PR2	3	PI15	PR32	2	PI30	PR8	2	PI5
PR2	3	PI11	PR32	2	PI25	PR9	2	PI4
PR2	2	PI8	PR32	3	PI32	PR9	1	PI15
PR2	1	PI35	PR32	3	PI34	PR9	1	PI42
PR2	1	PI13	PR33	-1	PI8	PR9	1	PI11
PR2	3	PI16	PR33	-3	PI35	PR9	1	PI35

PR2	2	PI14	PR33	3	PI23	PR9	2	PI23
PR2	2	PI1	PR33	-3	PI2	PR9	1	PI16
PR2	4	PI2	PR33	-3	PI6	PR9	2	PI1
PR2	1	PI6	PR33	4	PI33	PR9	2	PI2
PR2	3	PI12	PR33	-1	PI3	PR9	2	PI38
PR2	1	PI3	PR33	4	PI20	PR9	3	PI43
PR2	1	PI45	PR33	4	PI18	PR9	1	PI12
PR2	1	PI46	PR33	1	PI29	PR9	2	PI37
PR2	1	PI9	PR33	4	PI49	PR9	2	PI3
PR2	1	PI17	PR33	-3	PI26	PR9	1	PI44
PR2	1	PI10	PR33	-1	PI47	PR9	1	PI45
PR2	2	PI7	PR33	4	PI32	PR9	1	PI46
PR2	2	PI5	PR33	-1	PI17	PR9	4	PI29
PR20	1	PI42	PR33	4	PI48	PR9	2	PI26
PR20	2	PI38	PR33	-2	PI10	PR9	2	PI9
PR20	4	PI37	PR33	4	PI34	PR9	1	PI17
PR20	1	PI44	PR34	2	PI35	PR9	1	PI10
PR21	1	PI42	PR34	4	PI13	PR9	2	PI7
PR21	4	PI38	PR34	2	PI36	PR9	2	PI5
PR21	1	PI41	PR34	2	PI5			

Appendix K. CIP-DSS decision process: additional use cases

I. Second use case: Effectiveness

For this second use case, we focus on the performance indicator of *Effectiveness*. Which, in contrast to the use case shown in Chapter 6, is among the most causal performance indicators. This in order to appreciate the difference in the weight allocation for the improvement practices and tools in the total prioritization.

Direct analysis:

By following the same steps as in the previous use case, we proceed to develop the direct analysis by identifying the practices directly improving *Effectiveness* performance indicator. An extract is shown in **Table K-1** with some of the practices and their direct influence value (see second column). Correspondingly, **Table K-2** presents an extract of the tools improving this performance indicator with its direct influence value (second column).

Table K-1. Extract of Improvement practices directly impacting Effectiveness: direct & normalized-weighted direct values

Improvement Practice	Direct value	Normalized-weighted direct value
Standardize best practices	4	0.177
To provide the customer what they want in the right amount and time	4	0.177
Make employees use Kaizen to eliminate waste	3	0.134
Use stable, repeatable methods to maintain predictability, regular timing, regular output	3	0.134
Empower people. Use cross-functional teams to improve quality and productivity	2	0.090

Identify root causes and apply countermeasures	2	0.090
Learn by standardizing best practices	2	0.090
Solve and improve process by observing and verifying data in the source	2	0.090

Table K-2. Extract of Improvement tools directly impacting Effectiveness: direct & normalized-weighted direct values

Improvement Tool	Direct value	Normalized-weighted direct value
Standard work (takt time, sequence, standardized stock on hand)	9	0.401
Kaizen workshops	5	0.224
PDCA (plan-do-check-act)	4	0.181
kanban	4	0.177
In-station quality control	3	0.138
5S's	2	0.090
5-Why	2	0.090
Hansei events	2	0.090

Indirect analysis:

Next, an extract of the performance indicators that exert a total influence on Effectiveness are shown in **Table K-3**. And therefore, by using Equation (4), the improvement practices and tools having an indirect impact on Effectiveness, with their improvement values are calculated (see, respectively, the second columns of **Table K-4** and **Table K-5**).

Table K-3. Extract of performance indicators influencing Effectiveness

Influenced by	Influence
Employee training & team building	0.024
Employee compensation	0.012
Job security	0.012
Cost reduction	0.012

Table K-4. Extract of improvement practices indirectly impacting Effectiveness

Improvement Practice	Indirect value	Weighted indirect value
Empower people. Use cross-functional teams to improve quality and productivity	0.145	0.023
Train individuals and teams	0.134	0.021

Grow leaders within the organization	0.110	0.017
Maintaining and improve skills-added value	0.110	0.017
Teach teamwork	0.110	0.017
Learn by standardizing best practices	0.097	0.015
Create a strong and stable culture	0.085	0.013
Make employees use Kaizen to eliminate waste	0.085	0.013

Table K-5. Extract of improvement tools indirectly impacting Effectiveness

Improvement Tool	Indirect value	Weighted indirect value
Kaizen workshops	0.230	0.036
Standard work (takt time, sequence, standardized stock on hand)	0.158	0.025
Policy deployment (hoshin kanri)	0.085	0.013
5S's	0.060	0.009
A3 report	0.060	0.009
Work standard	0.060	0.009
In-station quality control	0.046	0.007
7 Mudras	0.035	0.005

Total prioritization:

For proceeding with the computing of the total prioritization of the improvement practices and tools. With Equation (5) we calculate the $(r - c)'$ for Effectiveness, being it equal to 0.8431. Then, with Equation (6) and Equation (7), the normalized and weighted direct improvement value for practices and tools are calculated (see third column of **Table K-1** and **Table K-2**). Likewise, the weighted indirect improvement value of the practices and tools is obtained (third column of **Table K-4** and **Table K-5**).

Given Equation (7) we can obtain the total improvement effect of practices and tools on *Effectiveness*, **Table K-6** and **Table K-7** present their prioritization of the top 7 ones, based on their improvement value (from highest to lowest). As *Effectiveness* is among the most causal performance indicators (with the highest influence direction index), therefore, the final recommendation is mostly driven by the direct part of the analysis.

Table K-6. Total prioritization of improvement practices for Effectiveness

Improvement Practice	Total improvement factor
Standardize best practices	0.186

To provide the customer what they want in the right amount and time	0.177
Make employees use Kaizen to eliminate waste	0.147
Use stable, repeatable methods to maintain predictability, regular timing, regular output	0.134
Empower people. Use cross-functional teams to improve quality and productivity	0.113
Learn by standardizing best practices	0.106
Use visual indicators for determining standard conditions	0.100

Table K-7. Total prioritization of improvement tools for Effectiveness

Improvement Tool	Total improvement factor
Standard work (takt time, sequence, standardized stock on hand)	0.426
Kaizen workshops	0.260
PDCA (plan-do-check-act)	0.186
kanban	0.179
In-station quality control	0.145
5S's	0.100
Work standard	0.100

II. Third use case: Labor turnover rate

For the third use case, we will base the evaluation of the different steps on *Labor turnover rate*, a performance indicator whose direction influence is close to 0.

Direct analysis:

Like in the last two use cases, the practices and tools that are directly improving the analyzed performance indicator were identified. **Table K-8** and **Table K-9** show an extract of these practices and tools, along with its direct influence value in the second column.

Table K-8. Extract of Improvement practices directly impacting Labor turnover rate: direct & normalized-weighted direct values

Improvement Practice	Direct value	Normalized -weighted direct value

Create a strong and stable culture	4	0.119
Eliminate unevenness in the production schedule	3	0.090
Eliminate overburden to people and equipment	2	0.061
Empower people. Use cross-functional teams to improve quality and productivity	2	0.061
Grow leaders within the organization	2	0.061
Make employees use Kaizen to eliminate waste	2	0.061
Train individuals and teams	2	0.061
Use technology to support people, not to replace them	2	0.061

Table K-9. Extract of Improvement tools directly impacting Labor turnover rate: direct & normalized-weighted direct values

Improvement Tool	Direct value	Normalized-weighted direct value
Kaizen workshops	4	0.122
Policy deployment (hoshin kanri)	4	0.119
Eliminate Mura (Unevenness)	3	0.09
Eliminate Muri (overburdening people or equipment)	2	0.061
5S's	1	0.032
7 Mudras	1	0.032
A3 report	1	0.032
Spaghetti diagram	1	0.032
Work standard	1	0.032

Indirect analysis:

Proceeding with the indirect analysis, **Table K-10** show some of the performance indicators that exert the most influence on *Labor turnover rate*. Subsequently, in **Table K-11** and **Table K-12** are shown some of the practices and tools that have an indirect improvement effect on *Labor turnover rate*, whose value (second column) is calculated by using Equation (4).

Table K-10. Extract of performance indicators influencing Labor turnover rate

Influenced by	Influence
Ergonomic risk	0.024
absenteeism rate	0.023
Safety risk factor	0.023
knowledge disconnection	0.022

Table K-11. Extract of improvement practices indirectly impacting Labor turnover rate

Improvement Practice	Indirect value	Weighted indirect value
Use technology to support people, not to replace them	0.141	0.061
Use visual indicators for determining standard conditions	0.139	0.060
Empower people. Use cross-functional teams to improve quality and productivity	0.136	0.058
Grow leaders within the organization	0.136	0.058
Reduce/eliminate non-value added	0.116	0.050
Create a strong and stable culture	0.114	0.049
Train individuals and teams	0.113	0.049
Solve and improve process by observing and verifying data in the source	0.113	0.049

Table K-12. Extract of improvement tools indirectly impacting Labor turnover rate

Improvement Tool	Indirect value	Weighted indirect value
Kaizen workshops	0.182	0.078
Work standard	0.163	0.070
5S's	0.139	0.060
7 Mudass	0.116	0.050
Spaghetti diagram	0.116	0.050
Policy deployment (hoshin kanri)	0.114	0.049
Eliminate Muri (overburdening people or equipment)	0.071	0.031
A3 report	0.067	0.029

Total prioritization:

Then, by using Equation (5), we obtain that the $(r - c)'$ for Labor turnover rate is 0.569. Following with Equations (6) and (7), we calculate the normalized and weighted direct improvement from the practices and tools (third columns on **Table K-8** and **Table K-9**). Also, the weighted indirect improvement values of the practices and tools is obtained (see third columns on **Table K-11** and **Table K-12**). Finally, **Table K-13** and **Table K-14** show the prioritization of the top 7 practices and tools that have the bigger improvement impact on *Labor turnover rate*. in this case as *Labor turnover rate* is a performance indicator that is almost as causal as influenced (an influence direction index close to zero), the prioritization is not mostly given by either the direct or the indirect analysis, but by a combination of both (given the $(r - c)'$ value).

Table K-13. Total prioritization of improvement practices for Labor turnover rate

Improvement Practice	Total improvement factor
Create a strong and stable culture	0.169
Use technology to support people, not to replace them	0.122
Empower people. Use cross-functional teams to improve quality and productivity	0.119
Grow leaders within the organization	0.119
Eliminate unevenness in the production schedule	0.111
Train individuals and teams	0.110
Use visual indicators for determining standard conditions	0.092

Table K-14. Total prioritization of improvement tools for Labor turnover rate

Improvement Tool	Total improvement factor
Kaizen workshops	0.200
Policy deployment (hoshin kanri)	0.169
Eliminate Mura (Unevenness)	0.111
Work standard	0.102
5S's	0.092
Eliminate Muri (overburdening people or equipment)	0.092
7 Mudas	0.082

Appendix L. CIP-DSS prototype: questionnaire and screenshots

Questionnaire:

1. Form 1 (very little) to 4 (a lot), How do you think this system facilitates the decision-making process in your Festo simulation? Why?
2. From 1 (not likely) to 4 (highly possible), Would you use this decision support system to solve future improvement problems? Why?
3. What do you think are the advantages of using this system for selecting improvement actions in your Festo simulation?
4. What do you think are the disadvantages of this system?
5. From 1 (poor) to 4 (very good), How do you like the presentation of the graphs and tables? Why?
6. From 1 (poor) to 4 (very good), How do you find the clarity of the recommendations given for the system? Why?
7. Could you specify possible improvements?
8. Overall, on a scale from 1 to 4 (4 being very good), how do you evaluate DSS use? Why?

November 2021: Microsoft Power BI



Select a Performance Indicator to analyse ▼

Human Factors (Performance Family) + Employee training & team building (Performa... ▼

Characteristics of selected Performance Indicator

Type Performance Indicator Definition

Causal Represents the level of training given to the employees and the team building developed for proble resolution

The Performance indicator is influencing

Influencing	Type	Influence
Effectiveness	Causal	2
Efficiency	Influenced	2
Value-added ratio	Influenced	2
Capacity utilization	Influenced	1
Cost reduction	Influenced	1
customer satisfaction	Influenced	1
delivery	Influenced	1
FYP	Causal	1
market share	Influenced	1
Production rate	Influenced	1
Total		-9

The Performance indicator is influenced by

Influenced by	Type	Influenced
Pull ratio	Causal	2
Total		2

Prioritization of performance improvement Practices & Tools

Select the Performance Indicator(s) or Performance Family you wish to improve ▼

- Effectiveness
- Flexibility
- Human Factors
 - absenteeism rate
 - Employee compensation
 - Employee training & team building
 - Ergonomic risk
 - Job security
 - knowledge disconnection
 - Labour turnover rate

Prioritization of performance improvement Practices

Practice	Influence practice
Reduce/eliminate non-value added	10
Quality drives value proposition	8
Solve problems quick and put in place countermeasures	8
Identify root causes and apply countermeasures	7
Make employees use Kaizen to eliminate waste	7
Standardize best practices	7
Use Hansei (reflection) at key milestones to identify shortcomings and develop countermeasures	7
Use quality assurance methods	7
Use technology to support people, not to replace them	6
Use visual indicators for determining standard conditions	6
Create material & information flow	4
Total	99

Prioritization of performance improvement Tools

Tool	Tool factor
In-station quality control	16
PDCA(plan-do-check-act)	15
Standard work (takt time, sequence, standardized stock on hand)	13
Kaizen workshops	11
7 Mudas	10
Spaghetti diagram	10
VSM	9
5-Why	7
Hansei events	7
Pareto diagram	7
Poka-yoke	7
5S's	6
Total	128

Appendix M. Scientific dissemination and publications

Journal article

Cardenas-Cristancho, D., Muller, L., Monticolo, D., & Camargo, M. (2022). Toward a holistic understanding of performance in Lean Manufacturing: a discussion on the relevance of its indicators. *International Journal of Lean Six Sigma*, 13(5), 1025–1057. <https://doi.org/10.1108/IJLSS-10-2020-0163>

Conference proceeding

Cardenas-Cristancho, D., Monticolo, D., Muller, L., & Lhoste, P. (2021). Continuous Improvement process model: A Knowledge Management approach. CIGI-QUALITA2021 - Conférence Internationale de Génie Industriel - QUALITA. <https://doi.org/hal-03288224>

Teaching

2019-2020. ENSGSI, Université de Lorraine. 48HETD

2020-2021. ENSGSI, Université de Lorraine. 32HETD

Collective responsibility activities

PhD member of the board of the Doctoral School SIMPPÉ
NITIM Summer School 2022 – (Organizing team)

Journée scientifique de l'école doctorale SIMPPÉ 2021 – (Organizing team)

Journée scientifique de l'école doctorale SIMPPÉ 2022 – (Organizing team)

72heures Agiles 2020 & 2021 – (Organizing team)

Training courses followed

AT 1. HC-SIMPPÉ: NITIM Summer School 2020 - 11 juin 2020

AT1. SIMPPÉ 18 - Ecole d'été : Industry 4.0 - 23 juin 2020

AT 1. SIMPPÉ 08 – Modélisation des systèmes

AT2. MDD 22 - Formation à la culture de prévention Nancy

AT2. MDD 01 Conducting your doctoral project

AT2. MDD 15 Open Science & Data Management

AT2. MDD 42 - Public Speaking Workshop

AT3. MDD 11 - Culture de l'intégrité scientifique

PA1.3 MDD 37 - 48 heures pour faire vivre des idées

PA1.3 MDD 38 – 48 heures pour réveiller les brevets dormants

PA1.2 MDD 23 - Insertion professionnelle et techniques de recherche d'emploi

AT4. MDD 27 - Français Langues étrangère : Renforcer ses compétences communicatives en français à propos de son domaine de recherche

AT4. MDD 24 - Interact in French in your professional environment (intermediate)

Appendix N. Summary in French

A travers cette thèse, nous avons cherché à clarifier la compréhension du processus de CIP dans les organisations et à aider dans la prise de décision pour l'amélioration de la performance. Dans ce processus, plusieurs contributions ont été développées afin de gérer et d'améliorer la performance de manière plus efficace, en incluant la complexité des interrelations et en servant d'aide et de base pour naviguer dans le contexte complexe actuel dans lequel les organisations opèrent. Par conséquent, cette thèse s'est concentrée sur (1) la clarification et la formalisation du processus de CIP, (2) l'identification et l'analyse des interrelations d'influence entre les indicateurs de performance, et (3) la proposition d'un système d'aide à la décision qui intègre la complexité des interrelations indicateur-pratique-outil. Tous ces éléments articulés constituent une approche méthodologique pour soutenir les activités critiques du processus de CIP, en cherchant à contribuer à réduire les échecs de mise en œuvre de CIP dans les organisations.

Ce chapitre final est structuré de la manière suivante, d'abord les contributions de cette thèse sont résumées. Ensuite, les implications sont discutées. Pour enfin construire sur les limites et les perspectives de cette thèse.

Contributions

En répondant à notre première question de recherche (RQ1 : Comment clarifier et modéliser le processus d'Amélioration Continue de la performance dans les organisations ?), nous nous sommes positionnés dans une approche de gestion des connaissances et nous nous sommes concentrés sur la capitalisation des

connaissances à partir d'entretiens avec des experts, afin de transformer les connaissances tacites concernant le processus d'amélioration continue en connaissances explicites. Ceci était particulièrement important puisque les connaissances sur CIP reposent principalement sur l'expertise et l'expérience d'experts industriels, nous avons donc cherché à transformer les connaissances non structurées existantes en un processus de CIP formalisé. Ensuite, nous avons accédé aux connaissances de 5 experts de CIP interviewés et les avons formalisées en suivant la méthode MASK combinée avec le méta-modèle KROM. Ainsi, nous avons proposé notre première contribution à la thèse :

La proposition d'un modèle de processus de l'amélioration continue de la performance (CIP)

Les entretiens avec les experts CIP, en raison de leur grande expérience dans le domaine de CIP et de leur maturité quant à l'adoption de CIP dans leurs organisations, ont permis d'accéder à des connaissances très riches. Sur lesquelles, il a été possible de formaliser les objectifs, les missions, les sous-processus et les activités au sein de CIP. Cela nous a permis non seulement de clarifier le processus lui-même et l'importance de l'analyser comme un processus complet, mais aussi de comprendre les aspects critiques pour la prise de décision dans le processus d'amélioration de la performance : une sélection assertive (1) des indicateurs de performance et (2) des pratiques et outils d'amélioration à mettre en œuvre.

Cela nous a conduit à l'importance de la deuxième question de recherche de cette thèse (RQ2 : Comment identifier et définir les indicateurs les plus pertinents qui permettront de mesurer et de suivre la performance ?). La sélection assertive des indicateurs de performance reste une question scientifique importante étant donné l'absence d'une vision globale de la performance, le nombre croissant d'indicateurs possibles à mesurer et la nécessité de rationaliser le temps et les ressources. Il est donc primordial de déterminer comment les indicateurs de performance sont liés entre eux et lesquels peuvent exercer le plus d'influence les uns sur les autres pour guider la mesure et le suivi de la performance. Par conséquent, il est nécessaire de passer d'une vision non structurée et isolée des indicateurs de performance à une vision systémique. Pour cela,

une approche comprenant une revue de la littérature et une analyse des interrelations d'influence basée sur la méthode DEMATEL a été suivie afin d'identifier les indicateurs de performance et de les structurer. En conséquence, les contributions suivantes ont été proposées :

L'identification des indicateurs de performance dans la littérature scientifique, et l'élicitation des plus pertinents en fonction de leurs interrelations d'influence.

C'est pourquoi, dans un premier temps, une revue de la littérature a été développée. Elle a permis (en se positionnant sur une méthodologie spécifique de CIP, le Lean Manufacturing) d'identifier dans la littérature, 50 indicateurs de performance au sein de 19 familles de performance. Ensuite, grâce à l'utilisation de DEMATEL, nous avons fourni une vue systémique et complète des indicateurs de performance en analysant leurs interrelations d'influence et en les classant en catégories causales ou influencées. Cela nous a permis d'analyser les relations d'influence de chaque indicateur de performance et, par le biais d'une carte d'influence, d'identifier les plus causales et donc les plus pertinentes.

Les contributions discutées jusqu'à présent ont permis de comprendre le processus de CIP, la prise de décision dans ce processus (pour mieux identifier où aider les experts de CIP) et ont fourni une nouvelle approche pour analyser les indicateurs de performance. Sur cette base et afin de répondre à notre troisième question de recherche (RQ3 : Comment aider les experts en Amélioration Continue dans le processus de prise de décision pour améliorer la performance ?), la contribution ci-dessous a été développée :

La proposition d'un système d'aide à la décision (CIP-DSS) pour aider à la prise de décision dans le cadre du processus de CIP, en intégrant la complexité des interrelations indicateurs-pratiques-outils.

En conséquence, l'architecture du CIP-DSS a été spécifiée en incluant une ontologie (PSOnto) pour permettre le stockage et la réutilisation des connaissances par la logique de raisonnement pour aider à la prise de décision. Le CIP-DSS intègre et structure la complexité pour alléger la charge mentale des responsables et des ingénieurs du CIP, tout en améliorant la prise de décision pour l'amélioration de la performance. Ainsi, le CIP-DSS les aide, premièrement, à analyser et à identifier les indicateurs de performance les plus pertinents en fonction des relations d'influence entre eux. Ensuite, dans la priorisation des pratiques d'amélioration et des outils pour améliorer les indicateurs de performance d'intérêt, tout en analysant la performance comme un système complexe et complet.

Il a également été expliqué comment le CIP-DSS interviendrait dans les activités du processus CIP, apportant de cette manière plus de clarté sur son impact et où il pourrait être incorporé. Plus précisément, nous affirmons que notre proposition de CIP-DSS peut aider le processus CIP dans (1) l'identification des indicateurs de performance, (2) l'évaluation des interrelations d'influence des indicateurs de performance, (3) l'évaluation des interrelations indicateur-pratique-outil d'amélioration, (4) l'analyse des causes des problèmes et (5) la hiérarchisation des pratiques et outils d'amélioration. Un prototype du CIP-DSS a également été développé, comprenant une sélection de 50 indicateurs de performance tirés de la littérature, ainsi qu'un ensemble de 41 pratiques d'amélioration et 23 outils d'amélioration tels que proposés par Liker (2004), avec les interrelations entre eux.

Dans l'ensemble, les contributions de cette thèse fournissent des connaissances théoriques et pratiques pour aider les experts en CIP à (1) prendre des décisions dans les activités du sous-processus de stratégie de performance et de résolution de problèmes, (2) en représentant mieux les interrelations complexes au sein de la performance, et donc (3) en contribuant à prendre des décisions assertives et à réduire les échecs dans les mises en œuvre de CIP.

Nous affirmons que ces contributions peuvent guider les experts du CIP dans l'identification et la mise en place des données constituant la stratégie de performance (indicateurs de performance, pratiques et outils d'amélioration, et leurs relations respectives), suivies de l'analyse des interrelations totales des indicateurs de

performance et de la population de toutes les connaissances dans la PSOnto. Enfin, l'aide au processus de décision pour l'analyse des influences des indicateurs de performance et la priorisation des pratiques et outils d'amélioration. Grâce à cela, nous permettons la structuration et la traduction des connaissances tacites en connaissances explicites (puisque l'évaluation de l'influence et de l'amélioration doit être effectuée par les experts du CIP) et donc leur réutilisation pour la prise de décision au quotidien.

Implications

L'approche méthodologique et les contributions proposées représentent un pas en avant dans l'amélioration de la prise de décision dans le processus CIP. Nous considérons le travail développé dans cette thèse comme un point de départ pour mieux comprendre le processus CIP, ce que signifie la performance, comment elle est représentée. De même, en montrant comment cette compréhension est essentielle pour proposer une aide à la décision afin d'améliorer la priorisation des pratiques et outils d'amélioration. Le processus formalisé de CIP, en plus de clarifier le processus et de nous permettre de comprendre la prise de décision pour améliorer la performance, a également le potentiel de devenir la base pour guider les praticiens à travers sa mise en œuvre et sa gestion. En outre, les modèles développés représentent la façon dont CIP est actuellement gérée et développée, et il a été montré comment cela peut être assisté par un DSS pour améliorer la prise de décision.

De plus, avec l'analyse des interrelations d'influence des indicateurs de performance, une vision plus holistique des indicateurs de performance a été proposée et avec elle la pertinence de les analyser en tant que partie d'un système avec des interactions complexes, plutôt qu'isolément, comme c'est généralement le cas. Cela offre donc une nouvelle perspective dans l'étude des indicateurs de performance. La carte d'influence résultant de cette analyse souligne l'importance de réévaluer la pertinence des indicateurs de performance classiques (principalement parmi les indicateurs influencés) et met l'accent sur l'utilisation d'indicateurs causaux plutôt que d'indicateurs influencés pour améliorer la performance plus efficacement.

En outre, nous pensons que cette analyse et ses résultats pourraient servir aux praticiens pour suivre la performance et analyser plus efficacement les mises en œuvre de CIP. Étant donné le besoin constant des organisations de rationaliser les ressources et le temps, il est donc très pertinent qu'elles aient les moyens d'identifier les indicateurs de performance les plus pertinents. En ayant une vision plus claire des indicateurs de performance sur lesquels se concentrer, cela pourrait aider les gestionnaires à mieux déterminer quels indicateurs de performance clés devraient être affichés sur un tableau de bord, et quels indicateurs sont essentiels pour prendre des décisions plus précises. Cela pourrait également contribuer à améliorer le processus d'identification des points dans lesquels développer des stratégies de transformation ou d'amélioration pour accroître la performance de l'organisation. Il peut également permettre un meilleur suivi des initiatives d'amélioration et prévenir à temps les éventuelles mises en œuvre infructueuses.

De plus, le CIP-DSS développé va plus loin dans l'analyse DEMATEL et intègre dans sa logique de raisonnement non seulement les indices d'influence résultants, mais aussi la richesse des interrelations d'influence totale entre les indicateurs de performance. Ces relations, ainsi que celles avec les pratiques et les outils d'amélioration, en étant structurées dans le PSOnto, permettent non seulement la transformation des connaissances tacites (évaluations d'experts) en connaissances explicites, mais aussi leur réutilisation. Cela contribue à la fois au processus de création de connaissances dans CIP et à l'interopérabilité du système.

La logique de raisonnement décrite dans notre CIP-DSS et évaluée et appliquée à travers des cas d'utilisation et un environnement d'expérimentation pratique, implique un changement majeur dans l'analyse de la priorisation des pratiques et outils d'amélioration à mettre en œuvre. Nous proposons de prendre en compte la complexité des interrelations indicateur-pratique-outil pour l'analyse. Cela change donc la façon dont les pratiques et outils d'amélioration étaient généralement hiérarchisés, car (1) nous formalisons ces interrelations et permettons leur réutilisation pour de futures prises de décision. Et (2) avec cette logique de raisonnement, la priorisation varie en fonction du degré d'influence de chacun des indicateurs de performance à améliorer analysés, ce qui implique que plus un indicateur de performance est influencé, plus la priorisation donnera de l'importance aux influences qu'il reçoit (l'analyse dite indirecte). Ceci a un

impact significatif sur l'analyse des indicateurs de performance les plus utilisés, qui, comme nous l'avons vu précédemment, sont parmi les plus influencés.

Limites et perspectives

Nous sommes conscients que le travail développé dans cette thèse présente certaines limites, mais qui ouvrent en même temps les possibilités de nouvelles perspectives et de travaux futurs. La première d'entre elles concerne le processus de CIP formalisé. Le nombre d'experts interrogés (ils étaient 5), même si selon la méthode MASK il était suffisant car aucune nouvelle connaissance n'était mise en évidence, pourrait représenter une limite pour sa généralisation. Par conséquent, nous suggérons d'enrichir ce travail en accédant aux connaissances de plus d'experts et de secteurs divers.

Les experts interrogés provenaient tous de grandes organisations multinationales ayant une vision mature des méthodologies de la CIP, ce qui nous a permis d'avoir une vision solide du processus de CIP et des possibilités d'amélioration et d'aide à la décision. Cela nous a permis de développer et d'évaluer notre approche méthodologique et la logique de raisonnement du CIP-DSS. Cependant, nous considérons que, en plus de continuer à développer d'autres applications à un niveau expérimental (simulation Festo ou similaire), il devrait être confronté à des experts en CIP dans l'industrie, non seulement de grandes entreprises mais aussi de plus petites. Ceci afin d'évaluer son applicabilité indépendamment de la taille de l'organisation et d'apprécier différents points de vue et différentes échelles de besoins.

Dans le but d'exemplifier l'approche méthodologique proposée, comme mentionné précédemment, nous nous sommes concentrés sur le Lean Manufacturing. Sur cette base, l'identification des indicateurs de performance, l'établissement et l'évaluation des interrelations indicateurs-pratiques-outils, et leur instanciation ultérieure dans le PSOnto ont été réalisés. Néanmoins, même s'ils ont été appliqués à une méthodologie CIP spécifique, nous soutenons que l'approche méthodologique CIP-DSS et les contributions ont le potentiel d'être appliquées à d'autres secteurs et d'autres

méthodologies de CIP, avec leur ensemble distinct d'indicateurs de performance et de pratiques et outils d'amélioration. Nous suggérons donc d'explorer ce point dans des études ultérieures.

De plus, comme l'évaluation de l'influence entre les indicateurs de performance pour l'analyse DEMATEL et également pour les relations avec les pratiques et les outils d'amélioration repose de manière significative sur l'évaluation par des experts, il est important pour les chercheurs et les praticiens d'élargir le groupe d'experts et de confirmer la concordance entre les évaluateurs, tout en assurant une expérience et des connaissances adéquates dans CIP. En outre, les indicateurs de performance analysés correspondaient aux processus internes des organisations. Ils devraient être complétés par des indicateurs de performance de la chaîne d'approvisionnement externe ainsi que par des indicateurs de performance liés à la durabilité et à la sensibilisation à l'environnement, en rapport avec les défis sociétaux du contexte actuel (par exemple, la consommation d'énergie, l'empreinte carbone, les ressources réutilisables et recyclées). Aussi, les efforts de recherche futurs pourraient explorer le potentiel de l'approche de l'interrelation des indicateurs de performance en tant que nouvel apport aux méthodes de planification stratégique et la comparer aux méthodes plus traditionnelles qui ne la prennent pas encore en compte (e.g., le *balanced scorecard*).

Nous pensons que le CIP-DSS peut servir de moyen utile pour approfondir les interrelations indicateur-pratique-outil et explorer plus en détail les effets et impacts qu'il a sur CIP. Par conséquent, les étapes futures de cette recherche devraient être axées sur l'approfondissement de l'analyse des interrelations d'influence entre les indicateurs de performance en l'appliquant à différentes organisations afin d'obtenir des représentations multiples. La collecte systématique de ces données pourrait être traitée pour établir des corrélations et déduire des causalités entre les indicateurs de performance et ainsi enrichir notre analyse. Les approches de data mining peuvent être très utiles à cet égard.

De même, une autre voie de recherche pourrait se concentrer sur le raffinement et la validation des effets d'amélioration des pratiques et des outils sur les indicateurs de performance. Cela pourrait se faire par le biais d'études théoriques plus approfondies (e.g., des méta-analyses de la littérature) complétées par des panels d'experts plus

larges afin de corroborer les effets d'amélioration proposés ici ou d'en dévoiler de nouveaux. En outre, même s'il est fonctionnel et prometteur, nous reconnaissons que le CIP-DSS doit être encore amélioré pour mieux aider les experts en CIP. À cette fin, nous proposons de mener une étude de cas multiple en développant un protocole de retour d'information, grâce auquel l'impact des pratiques et outils d'amélioration mis en œuvre peut être étudié. Comprendre comment le CIP-DSS fonctionne et comment les utilisateurs interagissent avec lui dans des scénarios pratiques pourrait être utile pour valider davantage sa logique de raisonnement pour la priorisation des pratiques et outils d'amélioration.

Enfin, nous considérons qu'il est très important de se concentrer sur le "comment" mesurer la performance. Tout au long de cette thèse, nous nous sommes concentrés sur "quoi" mesurer et ses implications pour la prise de décision. Pourtant, il est tout aussi nécessaire d'explorer les autres possibilités de mesure de la performance et la façon dont elles peuvent être mieux mesurées. Les organisations en général ont de plus en plus tendance à mettre en œuvre des processus de transformation numérique et à adopter les nouvelles technologies de l'industrie 4.0 (e.g., l'internet des objets, l'intelligence artificielle, la blockchain et autres), ce qui implique des changements potentiels non seulement dans la façon dont elles exécutent les processus ou les activités, mais aussi dans la façon dont elles sont suivies. La prolifération de ces nouvelles technologies signifie que les possibilités en termes d'indicateurs de performance sont en constante évolution, il est donc nécessaire d'étudier leur impact réel sur CIP.

Dans ce sens, nous proposons de travailler sur deux perspectives principales. Premièrement, sur l'identification des différentes possibilités dans lesquelles les nouvelles technologies pourraient permettre l'inclusion de nouveaux indicateurs concernant les interactions homme-machine. Par exemple, la mise en œuvre de cobots largement répandus dans le secteur industriel a été associée principalement aux indicateurs des activités spécifiques dans lesquelles ils ont été mis en œuvre, tels que le temps de cycle et l'efficacité. Mais l'introduction de ces technologies implique également de considérer leur impact sur l'ensemble des processus de l'organisation, en mesurant des indicateurs tels que la qualité et la fiabilité des données, l'impact sur

l'efficacité des activités adjacentes, la charge mentale des collaborateurs ou l'acceptabilité de la technologie. Cet aspect pourrait être approfondi par des études à méthodes mixtes afin d'évaluer comment ces technologies peuvent être sources de nouveaux indicateurs et comment elles peuvent être intégrées dans la stratégie de performance.

Deuxièmement, nous pensons qu'il est essentiel d'approfondir la compréhension de la manière dont les nouvelles technologies peuvent permettre de mieux mesurer et gérer de grands volumes de données. L'augmentation de la quantité de données disponibles et, par conséquent, de la disponibilité des indicateurs de performance pourrait rendre la gestion de CIP encore plus difficile. Il est alors nécessaire de comprendre comment la disponibilité de données plus robustes peut avoir un impact sur le processus d'amélioration continue, conduisant même à l'automatisation de certaines activités (par exemple, la mesure manuelle périodique par les opérateurs) ou à une meilleure analyse des données. Finalement, cela pourrait conduire à repenser la gestion de CIP en passant d'une logique réactive (agir pour corriger) à une logique proactive (agir pour anticiper). En ce sens, il est prévu, dans le cadre de travaux futurs, de continuer à explorer, dans la simulation Festo, la mise en œuvre de technologies telles que des systèmes de positionnement en intérieur et des capteurs, et la manière dont, grâce aux données obtenues, une analyse statistique plus robuste peut être développée afin d'identifier des tendances ou des modèles dans les indicateurs de performance, permettant ainsi d'obtenir des informations plus fiables pour la prise de décision.

Bibliography

- Abecker, A., & van Elst, L. (2009). Ontologies for Knowledge Management. In *Handbook on Ontologies. International Handbooks on Information Systems*. (pp. 713–734). Springer. https://doi.org/10.1007/978-3-540-92673-3_32
- Alaskari, O., Ahmad, M. M., & Pinedo-Cuenca, R. (2016). Development of a methodology to assist manufacturing SMEs in the selection of appropriate lean tools. *International Journal of Lean Six Sigma*, 7(1), 62–84. <https://doi.org/10.1108/IJLSS-02-2015-0005>
- Albers, A., Gladysz, B., Pinner, T., Butenko, V., & Stürmlinger, T. (2016). Procedure for defining the system of objectives in the initial phase of an industry 4.0 project focusing on intelligent quality control systems. *6th International Conference on Changeable, Agile, Reconfigurable and Virtual Production, CARV 2016*, 262 – 267. <https://doi.org/10.1016/j.procir.2016.07.067>
- Ali, R., & Deif, A. (2016). Assessing leanness level with demand dynamics in a multi-stage production system. *Journal of Manufacturing Technology Management*, 27(5), 614–639. <https://doi.org/10.1108/JMTM-08-2015-0064>
- Álvarez, R., Calvo, R., Peña, M. M., & Domingo, R. (2009). Redesigning an assembly line through lean manufacturing tools. *International Journal of Advanced Manufacturing Technology*, 43(9–10), 949–958. <https://doi.org/10.1007/s00170-008-1772-2>
- Amin, M. Al, & Karim, M. A. (2013). A time-based quantitative approach for selecting lean strategies for manufacturing organisations. *International Journal of Production Research*, 51(4), 1146–1167. <https://doi.org/10.1080/00207543.2012.693639>
- Antony, J., & Gupta, S. (2019). Top ten reasons for process improvement project failures. *International Journal of Lean Six Sigma*, 10(1), 367–374. <https://doi.org/10.1108/IJLSS-11-2017-0130>
- Antony, J., Lizarelli, F. L., Fernandes, M. M., Dempsey, M., Brennan, A., & McFarlane, J. (2019). A study into the reasons for process improvement project failures: results from a pilot survey. *International Journal of Quality and Reliability Management*, 36(10), 1699–1720. <https://doi.org/10.1108/IJQRM-03-2019-0093>
- Antony, J., Lizarelli, F. L., & Machado Fernandes, M. (2022). A Global Study Into the Reasons for Lean Six Sigma Project Failures: Key Findings and Directions for Further Research. *IEEE Transactions on Engineering Management*, 69(5), 2399–2414. <https://doi.org/10.1109/TEM.2020.3009935>
- Antony, J., McDermott, O., Powell, D., & Sony, M. (2022). The evolution and future of lean Six Sigma 4.0. *The TQM Journal, ahead-of-p*(ahead-of-print). <https://doi.org/10.1108/TQM-04-2022-0135>
- Antony, J., Snee, R., & Hoerl, R. (2017). Lean Six Sigma: yesterday, today and tomorrow. *International Journal of Quality & Reliability Management*, 34(7), 598–625. <https://doi.org/10.1108/IJQRM-03-2016-0035>
- Apolo-Vivanco, N. J., López-Rodríguez, J., & Sotomayor-Pereira, J. G. (2021). Theoretical Aspects of the Strategic Management Decision-Making of

- Companies. In E. Nermend, K., Łatuszyńska, M., Thalassinos (Ed.), *Decision-Making in Management. CME 2019. Contributions to Management Science* (pp. 3–22). Springer, Cham. https://doi.org/10.1007/978-3-030-67020-7_1
- Arfi, W. Ben, Enström, R., Sahut, J. M., & Hikkerova, L. (2019). The significance of knowledge sharing platforms for open innovation success: A tale of two companies in the dairy industry. *Journal of Organizational Change Management*, 32(5), 496–516. <https://doi.org/10.1108/JOCM-09-2018-0256>
- Aries, S., Le Blanc, B., & Ermine, J.-L. (2008). MASK : une méthode d'ingénierie des connaissances pour l'analyse et la structuration des connaissances. In *Management et ingénierie des connaissances : modèles et méthodes*. Hermes Science Publications-Lavoisier.
- Asif, M. (2021). Lean Six Sigma institutionalization and knowledge creation: towards developing theory. *Total Quality Management & Business Excellence*, 32(7–8), 811–828. <https://doi.org/10.1080/14783363.2019.1640598>
- Athawale, V. M., & Chakraborty, S. (2011). A comparative study on the ranking performance of some multi-criteria decision-making methods for industrial robot selection. *International Journal of Industrial Engineering Computations*, 2(4), 831–850. <https://doi.org/10.5267/j.ijiec.2011.05.002>
- Azadeh, A., Zarrin, M., Abdollahi, M., Noury, S., & Farahmand, S. (2015). Leanness assessment and optimization by fuzzy cognitive map and multivariate analysis. *Expert Systems with Applications*, 42(15–16), 6050–6064. <https://doi.org/10.1016/j.eswa.2015.04.007>
- Barrios, P. C., Monticolo, D., Sidhom, S., & Gabriel, A. (2017). An organizational model to understand the creativity workshop. *2017 13th International Conference on Signal-Image Technology & Internet-Based Systems (SITIS)*, 496–502. <https://doi.org/10.1109/SITIS.2017.87>
- Beelaerts van Blokland, W., van de Koppel, S., Lodewijks, G., Wales, S., & Breen, W. (2019). Method for performance measurement of car companies from a stability-value leverage perspective. The balancing act between investment in R&D, supply chain configuration and value creation. *International Journal of Lean Six Sigma*, 10(1), 411–434. <https://doi.org/10.1108/IJLSS-03-2017-0024>
- Belekoukias, I., Garza-Reyes, J. A., & Kumar, V. (2014). The impact of lean methods and tools on the operational performance of manufacturing organisations. *International Journal of Production Research*, 52(18), 5346–5366. <https://doi.org/10.1080/00207543.2014.903348>
- Ben Souissi, S., Abed, M., El Hiki, L., Fortemps, P., & Pirlot, M. (2019). PARS, a system combining semantic technologies with multiple criteria decision aiding for supporting antibiotic prescriptions. *Journal of Biomedical Informatics*, 99, 103304. <https://doi.org/10.1016/j.jbi.2019.103304>
- Bessant, J., Caffyn, S., & Gallagher, M. (2001). An evolutionary model of continuous improvement behaviour. *Technovation*, 21(2), 67–77. [https://doi.org/https://doi.org/10.1016/S0166-4972\(00\)00023-7](https://doi.org/https://doi.org/10.1016/S0166-4972(00)00023-7)
- Bhamu, J., & Sangwan, K. S. (2014). Lean manufacturing: Literature review and research issues. *International Journal of Operations and Production Management*, 34(7), 876–940. <https://doi.org/10.1108/IJOPM-08-2012-0315>
- Bhasin, S., & Burcher, P. (2006). Lean viewed as a philosophy. *Journal of Manufacturing Technology Management*, 17(1), 56–72. <https://doi.org/10.1108/17410380610639506>
- Bhuvanesh Kumar, M., Antony, J., Cudney, E., Furterer, S. L., Garza-Reyes, J. A., & Senthil, S. M. (2022). Decision-making through fuzzy TOPSIS and COPRAS approaches for lean tools selection: A case study of automotive accessories

- manufacturing industry. *International Journal of Management Science and Engineering Management, ahead-of-p*(ahead-of-print), 1–10.
<https://doi.org/10.1080/17509653.2022.2064356/FORMAT/EPUB>
- Binti Aminuddin, N. A., Garza-Reyes, J. A., Kumar, V., Antony, J., & Rocha-Lona, L. (2016). An analysis of managerial factors affecting the implementation and use of overall equipment effectiveness. *International Journal of Production Research*, 54(15), 4430–4447. <https://doi.org/10.1080/00207543.2015.1055849>
- Bittencourt, V. L., Alves, A. C., & Leão, C. P. (2021). Industry 4.0 triggered by Lean Thinking: insights from a systematic literature review. *International Journal of Production Research*, 59(5), 1496–1510.
<https://doi.org/10.1080/00207543.2020.1832274>
- Bolis, I., Brunoro, C., & Sznclwar, L. I. (2012). The workers role in knowledge management and sustainability policies. *Work*, 41, 2713–2720.
<https://doi.org/10.3233/WOR-2012-0515-2713>
- Boly, V., Camargo, M., & Morel, L. (2016). *Ingénierie de l'innovation*. Lavoisier-Hermès.
<https://hal.univ-lorraine.fr/hal-01960108>
- Borenstein, D. (1998). Towards a practical method to validate decision support systems. *Decision Support Systems*, 23(3), 227–239.
[https://doi.org/10.1016/S0167-9236\(98\)00046-3](https://doi.org/10.1016/S0167-9236(98)00046-3)
- Bourne, M., Melnyk, S., & Bititci, U. S. (2018). Performance measurement and management: theory and practice. *International Journal of Operations and Production Management*, 38(11), 2010–2021. <https://doi.org/10.1108/IJOPM-11-2018-784>
- Bourne, M., Neely, A., Mills, J., & Platts, K. (2003). Implementing performance measurement systems: a literature review. *Int. J. Business Performance Management*, 5(1), 1–24. <https://doi.org/10.1504/IJBPM.2003.002097>
- Burstein, F., & Carlsson, S. A. (2008). Decision Support Through Knowledge Management. In F. Burstein & C. W. Holsapple (Eds.), *Handbook on Decision Support Systems 1. International Handbooks Information System* (pp. 103–120). Springer, Berlin, Heidelberg. https://doi.org/10.1007/978-3-540-48713-5_6
- Cardenas-Cristancho, D., Monticolo, D., Muller, L., & Lhoste, P. (2021). Continuous Improvement process model: A Knowledge Management approach. *CIGI-QUALITA2021 - Conférence Internationale de Génie Industriel - QUALITA*.
<https://doi.org/hal-03288224>
- Cardenas-Cristancho, D., Muller, L., Monticolo, D., & Camargo, M. (2022). Toward a holistic understanding of performance in Lean Manufacturing: a discussion on the relevance of its indicators. *International Journal of Lean Six Sigma*, 13(5), 1025–1057. <https://doi.org/10.1108/IJLSS-10-2020-0163>
- Chergui, M., & Chakir, A. (2020). IT Governance Knowledge: From Repositories to Artificial Intelligence Solutions. *Journal of Engineering Science and Technology Review*, 13(5), 67–76. <https://doi.org/10.25103/jestr.135.09>
- Chiu, Y. J., Chen, H. C., Tzeng, G. H., & Shyu, J. Z. (2006). Marketing strategy based on customer behaviour for the LCD-TV. *International Journal of Management and Decision Making*, 7(2/3), 143–165. <https://doi.org/10.1504/IJMDM.2006.009140>
- Choquet, G. (1954). Theory of capacities. *Annales de l'institut Fourier*, 5, 131–295.
<https://doi.org/10.5802/aif.53>
- Čiarnienė, R., & Vienažindienė, M. (2014). How to Facilitate Implementation of Lean Concept? *Mediterranean Journal of Social Sciences*, 5(13), 177–183.
<https://doi.org/10.5901/mjss.2014.v5n13p177>
- Cortes, H., Daaboul, J., Le Duigou, J., & Eynard, B. (2016). Strategic Lean

- Management: Integration of operational Performance Indicators for strategic Lean management. *IFAC-PapersOnLine*, 49(12), 65–70.
<https://doi.org/10.1016/J.IFACOL.2016.07.551>
- Cuatrecasas-Arbós, L., Fortuny-Santos, J., Ruiz-de-Arbulo-López, P., & Vintró-Sanchez, C. (2015). Monitoring processes through inventory and manufacturing lead time. *Industrial Management & Data Systems*, 115(5), 951–970.
<https://doi.org/10.1108/IMDS-12-2014-0375>
- Davenport, T. H., & Prusak, L. (1998). *How Organizations Manage What They Know*. Harvard Business Review Press.
- Defee, C. C., & Stank, T. P. (2005). Applying the strategy-structure-performance paradigm to the supply chain environment. *The International Journal of Logistics Management*, 16(1), 28–50. <https://doi.org/10.1108/09574090510617349>
- Delir Haghighi, P., Burstein, F., Zaslavsky, A., & Arbon, P. (2013). Development and evaluation of ontology for intelligent decision support in medical emergency management for mass gatherings. *Decision Support Systems*, 54(2), 1192–1204.
<https://doi.org/10.1016/j.dss.2012.11.013>
- Dieng, R., Corby, O., Gandon, F., Giboin, A., Golebiowska, J., Matta, N., & Ribière, M. (2001). *Méthodes et outils pour la gestion des connaissances: une approche pluridisciplinaire du knowledge management*. Dunod.
- Dieste, M., Panizzolo, R., Garza-Reyes, J. A., & Anosike, A. (2019). The relationship between lean and environmental performance: Practices and measures. *Journal of Cleaner Production*, 224, 120–131.
<https://doi.org/10.1016/j.jclepro.2019.03.243>
- Dombrowski, U., Mielke, T., & Engel, C. (2012). Knowledge management in lean production systems. *Procedia CIRP*, 3(1), 436–441.
<https://doi.org/10.1016/j.procir.2012.07.075>
- Dora, M., & Gellynck, X. (2015). Lean Six Sigma Implementation in a Food Processing SME: A Case Study. *Quality and Reliability Engineering International*, 31(7), 1151–1159. <https://doi.org/10.1002/qre.1852>
- Duleba, S., & Moslem, S. (2018). Sustainable urban transport development with stakeholder participation, an AHP-Kendall model: a case study for Mersin. *Sustainability*, 10(10), 3647. <https://doi.org/10.3390/su10103647>
- El Amrani, I., Saka, A., Matta, N., & Ouazzani Chahdi, T. (2021). Experimentation of MASK applied to formalize the design technique of ornamental patterns. *CPI 2019. Lecture Notes in Mechanical Engineering*, 620–632.
https://doi.org/10.1007/978-3-030-62199-5_55
- Elkhairi, A., Fedouaki, F., & El Alami, S. (2019). Barriers and critical success factors for implementing lean manufacturing in SMEs. *IFAC-PapersOnLine*, 52(13), 565–570.
<https://doi.org/10.1016/j.ifacol.2019.11.303>
- Eom, S. B. (2008). Reference Disciplines of Decision Support Systems. In F. Burstein & C. W. Holsapple (Eds.), *Handbook on Decision Support Systems 1. International Handbooks Information System* (pp. 141–159). Springer, Berlin, Heidelberg.
https://doi.org/10.1007/978-3-540-48713-5_8
- Ermine, J.-L. (2003). *La gestion des connaissances* (Vol. 2). Hermes Sciences Publications. <https://hal.archives-ouvertes.fr/hal-00997696>
- Ermine, J.-L. (2013). Knowledge Management with the MASK method. In Scientific International (Ed.), *Knowledge Management for Sustainable Development* (p. hal-02080443). <https://hal.archives-ouvertes.fr/hal-02080443>
- Ermine, J.-L., Chaillot, M., Bigeon, P., Charreton, B., & Malavieille, D. (1996). MKSM, Méthode pour la gestion des connaissances. In *Ingénierie des systèmes d'information* (Vol. 4, pp. 541–575). AFCET-Hermès.

- Ferdousi, F., & Ahmed, A. (2009). An investigation of manufacturing performance improvement through lean production: a study on Bangladeshi garment firms. *International Journal of Business and Management*, 25(2), 106–116.
- Fontela, E., & Gabus, A. (1976). *The DEMATEL observer, DEMATEL 1976 report*.
- Fradi, M., Gaha, R., Mhenni, F., Mlika, A., & Choley, J.-Y. (2022). Knowledge capitalization in mechatronic collaborative design. *Concurrent Engineering*, 30(1), 32–45. <https://doi.org/10.1177/1063293X211050438>
- Fullerton, R. R., & Wempe, W. F. (2009). Lean manufacturing, non-financial performance measures, and financial performance. *International Journal of Operations & Production Management*, 29(3), 214–240. <https://doi.org/10.1108/01443570910938970>
- Gabriel, A., Monticolo, D., Camargo, M., & Bourgault, M. (2017). Ontology to Represent the Knowledge Domain of a Creative Workshop. *12th International Conference on Signal Image Technology and Internet-Based Systems, SITIS 2016*, 618–623. <https://doi.org/10.1109/SITIS.2016.102>
- Ghobakhloo, M., Fathi, M., Iranmanesh, M., Maroufkhani, P., & Morales, M. E. (2021). Industry 4.0 ten years on: A bibliometric and systematic review of concepts, sustainability value drivers, and success determinants. *Journal of Cleaner Production*, 302(127052). <https://doi.org/10.1016/j.jclepro.2021.127052>
- Girodon, J., Monticolo, D., Bonjour, E., & Perrier, M. (2012). KROM: An organizational Meta-Model oriented to knowledge: A case from Ophthalmic industry. *Eighth International Conference on Signal Image Technology and Internet Based Systems, SITIS*, 845–851. <https://doi.org/10.1109/SITIS.2012.127>
- Gisev, N., Bell, J. S., & Chen, T. F. (2013). Interrater agreement and interrater reliability: Key concepts, approaches, and applications. *Research in Social and Administrative Pharmacy*, 9(3), 330–338. <https://doi.org/10.1016/J.SAPHARM.2012.04.004>
- Gölcük, I., & Baykasoğlu, A. (2016). An analysis of DEMATEL approaches for criteria interaction handling within ANP. *Expert Systems with Applications*, 46(15), 346–366. <https://doi.org/10.1016/j.eswa.2015.10.041>
- Gonçalves, T. I. G., Sousa, P. S. A., & Moreira, M. R. A. (2019). Does lean practices implementation impact on company performance? A meta-analytical research. *Management and Production Engineering Review*, 10(4), 11–24. <https://doi.org/10.24425/mper.2019.131441>
- Gonzalez Aleu, F., & Van Aken, E. M. (2016). Systematic literature review of critical success factors for continuous improvement projects. *International Journal of Lean Six Sigma*, 7(3), 214–232. <https://doi.org/10.1108/IJLSS-06-2015-0025>
- Govindan, K., Khodaverdi, R., & Vafadarnikjoo, A. (2015). Intuitionistic fuzzy based DEMATEL method for developing green practices and performances in a green supply chain. *Expert Systems with Applications*, 42(20), 7207–7220. <https://doi.org/10.1016/j.eswa.2015.04.030>
- Grabisch, M., & Labreuche, C. (2010). A decade of application of the Choquet and Sugeno integrals in multi-criteria decision aid. *Annals of Operations Research*, 175(1), 247–290. <https://doi.org/10.1007/s10479-009-0655-8>
- Gras, D., Conger, M., Jenkins, A., & Gras, M. (2020). Wicked problems, reductive tendency, and the formation of (non-)opportunity beliefs. *Journal of Business Venturing*, 35(3). <https://doi.org/10.1016/j.jbusvent.2019.105966>
- Grimsdottir, E., & Edvardsson, I. R. (2018). Knowledge Management, Knowledge Creation, and Open Innovation in Icelandic SMEs. *SAGE Open*, 8(4). <https://doi.org/10.1177/2158244018807320>

- Guaglianone, M. T., & Matta, N. (2012). MNEMO (Methodology for Knowledge Acquisition and Modelling): Definition of a Global Knowledge Management Approach Combining Knowledge Modelling Techniques. *International Journal on Advances in Information Sciences and Service Sciences (AISS)*, 4(12), 160–169. <https://doi.org/10.4156/AISS.vol4.issue12.19>
- Gutierrez-Gutierrez, L., & Antony, J. (2019). Continuous improvement initiatives for dynamic capabilities development: A systematic literature review. *International Journal of Lean Six Sigma*, 11(1), 125–149. <https://doi.org/10.1108/IJLSS-07-2018-0071>
- Hallgren, M., & Olhager, J. (2009). Lean and agile manufacturing: External and internal drivers and performance outcomes. *International Journal of Operations and Production Management*, 29(10), 976–999. <https://doi.org/10.1108/01443570910993456>
- Henao, R., Sarache, W., & Gómez, I. (2019). Lean manufacturing and sustainable performance: trends and future challenges. *Journal of Cleaner Production*, 208, 99–116. <https://doi.org/10.1016/j.jclepro.2018.10.116>
- Hofmann, E., & Rüsçh, M. (2017). Industry 4.0 and the current status as well as future prospects on logistics. *Computers in Industry*, 89, 23–34. <https://doi.org/10.1016/j.compind.2017.04.002>
- Holsapple, C. w. (2008). DSS Architecture and Types. In *Handbook on Decision Support Systems 1* (pp. 163–189). Springer, Berlin, Heidelberg. https://doi.org/10.1007/978-3-540-48713-5_9
- Hosack, B., Hall, D., Paradise, D., & Courtney, J. F. (2012). A look toward the future: Decision support systems research is alive and well. *Journal of the Association for Information Systems*, 13(5), 315–340. <https://doi.org/10.17705/1jais.00297>
- Huang, C.-Y., Shyu, J. Z., & Tzeng, G.-H. (2007). Reconfiguring the innovation policy portfolios for Taiwan's SIP Mall industry. *Technovation*, 27(12), 744–765. <https://doi.org/10.1016/j.technovation.2007.04.002>
- Husain, S., & Ermine, J.-L. (2021). *Knowledge Management Systems : concepts, technologies and practices*. Emerald Publishing Limited. <https://doi.org/10.1108/9781801173483>
- Hyland, P. W., Mellor, R., & Sloan, T. (2007). Performance measurement and continuous improvement: Are they linked to manufacturing strategy? *International Journal of Technology Management*, 37(3–4), 237–246. <https://doi.org/10.1504/IJTM.2007.012260>
- ISO. (2012). *Information technology — Modeling Languages — Part 1: Syntax and Semantics for IDEF0 (ISO/IEC/IEEE 31320-1:2012)*. <https://www.iso.org/standard/60615.html>
- ISO. (2015). *Quality management systems - fundamentals and vocabulary (ISO Standard No. 9000:2015)*.
- Issor, Z. (2017). La performance de l'entreprise : un concept complexe aux multiples dimensions. *Projectics / Proy ctica / Projectique*, 17(2), 93–103. <https://doi.org/10.3917/proj.017.0093>
- Ivlev, I., Vacek, J., & Kneppo, P. (2015). Multi-criteria decision analysis for supporting the selection of medical devices under uncertainty. *European Journal of Operational Research*, 247(1), 216–228. <https://doi.org/10.1016/j.ejor.2015.05.075>
- Jasti, N. V. K., & Kodali, R. (2015). Lean production: literature review and trends. *International Journal of Production Research*, 53(3), 867–885. <https://doi.org/10.1080/00207543.2014.937508>
- Jalient, P., & IGL Technology. (1989). *SADT: Un langage pour communiquer* (Eyrolles).

- Jayaram, J., Das, A., & Nicolae, M. (2010). Looking beyond the obvious: Unraveling the Toyota production system. *Intern. Journal of Production Economics*, 128, 280–291. <https://doi.org/10.1016/j.ijpe.2010.07.024>
- Jones, K. (2006). Knowledge Management as a Foundation for Decision Support Systems. *Journal of Computer Information Systems*, 46(4), 116–124. <https://doi.org/10.1080/08874417.2006.11645918>
- Kamsu Fogue, B., Coudert, T., Bé, C., & Geneste, L. (2008). Knowledge formalization in experience feedback processes: An ontology-based approach. *Computers in Industry*, 59, 694–710. <https://doi.org/10.1016/j.compind.2007.12.014>
- Karim, A., & Arif-Uz-Zaman, K. (2013). A methodology for effective implementation of lean strategies and its performance evaluation in manufacturing organizations. *Business Process Management Journal*, 19(1), 169–196. <https://doi.org/10.1108/14637151311294912>
- Kasie, F. M., Bright, G., & Walker, A. (2017). Decision support systems in manufacturing: a survey and future trends. *Journal of Modelling in Management*, 12(3), 432–454. <https://doi.org/10.1108/JM2-02-2016-0015>
- Kaur, P., Marriya, K., & Kashyap, R. (2016). Assessment of lean in apparel export industry of national capital region (India). *Journal of Textile and Apparel, Technology and Management*, 10(1), 17.
- Kendall, M. G., & Smith, B. B. (1939). The Problem of m Rankings. *The Annals of Mathematical Statistics*, 10(3), 275–287. <http://www.jstor.org/stable/2235668>
- Khan, S. A., Kaviani, M. A., Galli, B. J., & Pharma, A. (2019). Application of continuous improvement techniques to improve organization performance A case study. *International Journal of Lean Six Sigma*, 10(2), 542–565. <https://doi.org/10.1108/IJLSS-05-2017-0048>
- Khan, S., Khan, M. I., & Haleem, A. (2019). Evaluation of barriers in the adoption of halal certification: a fuzzy DEMATEL approach. *Journal of Modelling in Management*, 14(1), 153–174. <https://doi.org/10.1108/JM2-03-2018-0031>
- Konno, N., Nonaka, I., & Ogilvy, J. (2014). The mind of the scenario thinker. *World Futures: Journal of General Evolution*, 70(1), 44–51. <https://doi.org/10.1080/02604027.2014.875723>
- Kovács, T., Kő, A., & Demeter, K. (2020). Measuring the impact of lean practices on manufacturing performance – case study from the process industry. *International Journal of Lean Six Sigma*, 26. <https://doi.org/10.1108/IJLSS-01-2019-0004>
- Krafcik, J. F. (1988). Triumph of the lean production system. *MIT Sloan Management Review*, 30(1), 41–52.
- Kumar, A., & Dixit, G. (2018). An analysis of barriers affecting the implementation of e-waste management practices in India: a novel ISM-DEMATEL approach. *Sustainable Production and Consumption*, 14, 36–52. <https://doi.org/10.1016/j.spc.2018.01.002>
- Kumar Sharma, R., & Gopal Sharma, R. (2014). Integrating Six Sigma Culture and TPM Framework to Improve Manufacturing Performance in SMEs. *Quality and Reliability Engineering International*, 30(5), 745–765. <https://doi.org/10.1002/qre.1525>
- Lakri, S., Bocquet, J.-C., Grégoire, L., Dallery, Y., & Jemai, Z. (2015). Designing supply chain performance measurement and management systems: a systemic perspective. In Inc. Institute of Electrical and Electronics Engineers (Ed.), *4th IEEE International Conference on Advanced Logistics and Transport, IEEE ICALT* (pp. 211–216). Inc. Institute of Electrical and Electronics Engineers. <https://doi.org/10.1109/ICAdLT.2015.7136625>

- Lameijer, B. A., Antony, J., Borgman, H. P., & Linderman, K. (2022). Process improvement project failure: a systematic literature review and future research agenda. *International Journal of Lean Six Sigma*, 13(1), 8–32. <https://doi.org/10.1108/IJLSS-02-2020-0022>
- Lameijer, B. A., Boer, H., Antony, J., & Does, R. J. M. M. (2021). Continuous improvement implementation models: a reconciliation and holistic metamodel. *Production Planning and Control, ahead-of-p*(ahead-of-print), 1–20. <https://doi.org/10.1080/09537287.2021.1974114>
- Lee, M. R., & Chen, T. T. (2012). Revealing research themes and trends in knowledge management: From 1995 to 2010. *Knowledge-Based Systems*, 28, 47–58. <https://doi.org/10.1016/j.knosys.2011.11.016>
- Lee, Y. C., Li, M. L., Yen, T. M., & Huang, T. H. (2010). Analysis of adopting an integrated decision making trial and evaluation laboratory on a technology acceptance model. *Expert Systems with Applications*, 37(2), 1745–1754. <https://doi.org/10.1016/J.ESWA.2009.07.034>
- Li, C. W., & Tzeng, G. H. (2009). Identification of a threshold value for the DEMATEL method using the maximum mean de-entropy algorithm to find critical services provided by a semiconductor intellectual property mall. *Expert Systems with Applications*, 36(6), 9891–9898. <https://doi.org/10.1016/j.eswa.2009.01.073>
- Liao, Y., Deschamps, F., Rocha Loures, E., Felipe Ramos, L., de Freitas Rocha Loures, E., & Felipe Pierin Ramos, L. (2017). Past, present and future of Industry 4.0 - a systematic literature review and research agenda proposal. *International Journal of Production Research*, 55(12), 3609–3629. <https://doi.org/10.1080/00207543.2017.1308576>
- Liker, J. K. (2004). *The Toyota way: 14 management principles from the world's greatest manufacturer*. McGraw-Hill Education.
- Liker, J. K., & Morgan, J. M. (2006). The Toyota way in services: the case of Lean product development. *Academy of Management Perspectives*, 20(2), 5–20. <https://doi.org/10.5465/amp.2006.20591002>
- Lotfi, M., & Saghiri, S. (2018). Disentangling resilience, agility and leanness Conceptual development and empirical analysis. *Journal of Manufacturing Technology Management*, 29(1), 168–197. <https://doi.org/10.1108/JMTM-01-2017-0014>
- Maasouman, M. A., & Demirli, K. (2016). Development of a lean maturity model for operational level planning. *The International Journal of Advanced Manufacturing Technology*, 83, 1171–1188. <https://doi.org/10.1007/s00170-015-7513-4>
- Maginnis, M. A., Hapuwatte, B. M., & Keown, D. (2019). The Integration of True Lean and Industry 4.0 to Sustain a Culture of Continuous Improvement. In *IFIP Advances in Information and Communication Technology: Vol. 565 IFIP*. Springer International Publishing. https://doi.org/10.1007/978-3-030-42250-9_32
- Marche, B. (2018). *From product design to supply chain design: Which methodologies for the upstream stages of innovation?* Université de Lorraine. NNT:2018LORR0155. tel-01946850.
- Mårtensson, M. (2000). A critical review of knowledge management as a management tool. *Journal of Knowledge Management*, 4(3), 204–216. <https://doi.org/10.1108/13673270010350002>
- Matta, N., Ermine, J.-L., Aubertin, G., & Trivin, J.-Y. (2001). How to capitalize knowledge with the MASK method ? *IJCAI 2001 Workshop on Knowledge Management and Organizational Memories, Seattle, Washington USA, August, 6*, 1–13.
- Matta, N., Ermine, J. L., Aubertin, G., & Trivin, J.-Y. (2002). Knowledge Capitalization with a Knowledge Engineering Approach: The Mask Method. In *Knowledge*

- Management and Organizational Memories* (pp. 17–28). Springer US.
https://doi.org/10.1007/978-1-4615-0947-9_2
- Maware, C., & Adetunji, O. (2019). Lean manufacturing implementation in Zimbabwean industries: Impact on operational performance. *International Journal of Engineering Business Management*, 11, 1–12.
<https://doi.org/10.1177/1847979019859790>
- McLean, R. S., Antony, J., & Dahlgaard, J. J. (2015). Failure of Continuous Improvement initiatives in manufacturing environments: a systematic review of the evidence. *Total Quality Management & Business Excellence*, 28(3–4), 219–237.
<https://doi.org/10.1080/14783363.2015.1063414>
- Mendes, A., Lima, T. M., & Gaspar, P. D. (2021). Lean Tools Selector - A Decision Support System. *2021 International Conference on Decision Aid Sciences and Application (DASA)*, 45–50. <https://doi.org/10.1109/DASA53625.2021.9682227>
- Meski, O., Belkadi, F., Laroche, F., Ritou, M., & Furet, B. (2021). A generic knowledge management approach towards the development of a decision support system. *International Journal of Production Research*, 59(22), 6659–6676.
<https://doi.org/10.1080/00207543.2020.1821930>
- Minovski, R., Jovanoski, B., & Galevski, P. (2021). Lean implementation and implications: experiences from Macedonia. *International Journal of Lean Six Sigma*, 12(1), 78–97. <https://doi.org/10.1108/IJLSS-10-2016-0057>
- Mintzberg, H., Raisinghani, D., & Theoret, A. (1976). The Structure of “Unstructured” Decision Processes. *Administrative Science Quarterly*, 21(2), 246–275.
<https://doi.org/10.2307/2392045>
- Mirdad, W. K., & Eseonu, C. I. (2015). A conceptual map of the Lean nomenclature: comparing expert classification to the Lean literature. *Engineering Management Journal*, 27(4), 188–202. <https://doi.org/10.1080/10429247.2015.1082068>
- Molloy, S., & Schwenk, C. R. (1995). The effects of information technology on strategic decision making. *Journal of Management Studies*, 32(3), 283–311.
<https://doi.org/10.1111/J.1467-6486.1995.TB00777.X>
- Monticolo, D. (2015). *Approches organisationnelles pour la conception de systèmes multi-agents dédiés à la gestion des connaissances ; Application aux projets d ’ ingénierie et d ’ innovation Composition du jury*. Université de Lorraine.
- Mosadeghrad, A. M. (2014). Why TQM programmes fail? A pathology approach. *The TQM Journal*, 26(2), 160–187. <https://doi.org/10.1108/TQM-12-2010-0041>
- Mumani, A. A., Magableh, G. M., & Mistarihi, M. Z. (2021). Decision making process in lean assessment and implementation: a review. *Management Review Quarterly*, 1–40. <https://doi.org/10.1007/s11301-021-00222-z>
- Naeemah, A. J., & Wong, K. Y. (2021). Selection methods of lean management tools: a review. *International Journal of Productivity and Performance Management, ahead-of-p*(ahead-of-print). <https://doi.org/10.1108/IJPPM-04-2021-0198>
- Neely, A., Mills, J., Platts, K., Richards, H., Gregory, M., Bourne, M., & Kennerley, M. (2000). Performance measurement system design: Developing and testing a process-based approach. *International Journal of Operations and Production Management*, 20(10), 1119–1145. <https://doi.org/10.1108/01443570010343708>
- Netland, T. H., Schloetzer, J. D., & Ferdows, K. (2015). Implementing corporate lean programs: The effect of management control practices. *Journal of Operations Management*, 36, 90–102. <https://doi.org/10.1016/j.jom.2015.03.005>
- Ni, W., & Sun, H. (2009). The relationship among organisational learning, continuous improvement and performance improvement: An evolutionary perspective. *Total Quality Management and Business Excellence*, 20(10), 1041–1054.

- <https://doi.org/10.1080/14783360903247312>
- Nonaka, I. (1991). The knowledge-creating company. *Harvard Business Review*, 69(11/12), 96–104.
- Nonaka, I., & Takeuchi, H. (1995). *The Knowledge-creating company: How japanese companies create the dynamics of innovation*. Oxford university press.
https://books.google.fr/books?id=B-qxrPaU1-MC&printsec=frontcover&source=gbs_ge_summary_r&cad=0#v=onepage&q&f=false
- Nonaka, I., Toyama, R., & Konno, N. (2000). SECI, Ba and Leadership: A Unified Model of Dynamic Knowledge Creation. *Long Range Planning*, 33(1), 5–34.
[https://doi.org/10.1016/S0024-6301\(99\)00115-6](https://doi.org/10.1016/S0024-6301(99)00115-6)
- Nonaka, I., & von Krogh, G. (2009). Tacit knowledge and knowledge conversion: Controversy and advancement in organizational knowledge creation theory. *Organization Science*, 20(3), 635–652. <https://doi.org/10.1287/orsc.1080.0412>
- Nonaka, I., Von Krogh, G., & Voelpel, S. (2006). Organizational knowledge creation theory: Evolutionary paths and future advances. *Organization Studies*, 27(8), 1179–1208. <https://doi.org/10.1177/0170840606066312>
- Nowotarski, P., Pasławski, J., & Dallasega, P. (2021). Multi-criteria assessment of lean management tools selection in construction. *Archives of Civil Engineering*, 67(1), 711–726. <https://doi.org/10.24425/ace.2021.136498>
- Noy, N. F., & Mcguinness, D. L. (2001). Ontology Development 101: A Guide to Creating Your First Ontology. *Stanford Knowledge Systems Laboratory Technical Report KSL-01-05 and Stanford Medical Informatics Technical Report SMI-2001-0880*.
- Nudurupati, S. S., Bititci, U. S., Kumar, V., & Chan, F. T. S. (2011). State of the art literature review on performance measurement. *Computers and Industrial Engineering*, 60(2), 279–290. <https://doi.org/10.1016/j.cie.2010.11.010>
- Nudurupati, S. S., Tebboune, S., Garengo, P., Daley, R., & Hardman, J. (2022). Performance measurement in data intensive organisations: resources and capabilities for decision-making process. *Production Planning and Control*. <https://doi.org/10.1080/09537287.2022.2084468>
- Núñez-Merino, M., Maqueira-Marín, J. M., Moyano-Fuentes, J., & Martínez-Jurado, P. J. (2020). Information and digital technologies of Industry 4.0 and Lean supply chain management: a systematic literature review. *International Journal of Production Research*, 58(16), 5034–5061. <https://doi.org/10.1080/00207543.2020.1743896>
- Oble, F. (1992). *Intérêts et limites de l'analyse structurelle et de la méthode Delphi appliquées à l'étude de l'évolution des marchés alimentaires* [Gestion et management. Institut National Polytechnique de Lorraine]. <https://doi.org/NNT:1992INPL113N>
- Ohno, T. (1988). *Toyota production system: beyond large-scale production*. Productivity Press.
- Olivella, J., & Gregorio, R. (2015). A case study of an integrated manufacturing performance measurement and meeting system. *Journal of Manufacturing Technology Management*, 26(4), 515–535. <https://doi.org/10.1108/JMTM-09-2012-0089>
- Ortiz, M. A., Felizzola, H. A., & Isaza, S. N. (2015). A contrast between DEMATEL-ANP and ANP methods for six sigma project selection: A case study in healthcare industry. *BMC Medical Informatics and Decision Making*, 15(S3), 1–12. <https://doi.org/10.1186/1472-6947-15-S3-S3>
- Paipa-Galeano, L., Bernal-Torres, C. A., Agudelo-Otalora, L. M., Jarrah-Nezhad, Y., & González-Blanco, H. A. (2020). Key lessons to sustain continuous improvement: A

- case study of four companies. *Journal of Industrial Engineering and Management*, 13(1), 195–211. <https://doi.org/10.3926/jiem.2973>
- Patel, A. S., & Patel, K. M. (2020). Critical review of literature on Lean Six Sigma methodology. *International Journal of Lean Six Sigma*, 12(3), 627–674. <https://doi.org/10.1108/IJLSS-04-2020-0043>
- Patil, S. K., & Kant, R. (2014). Methodological literature review of knowledge management research. *Tékhne*, 12(1–2), 3–14. <https://doi.org/10.1016/j.tekhne.2014.07.001>
- Pearn, W. L., Pea Rn, W. L., & Hen, & K. S. C. (1998). New generalization of process capability index Cpk New generalization of process capability index Cpk. *Journal of Applied Statistics*, 25(6), 801–810. <https://doi.org/10.1080/02664769822783>
- Perakis, M., & Xekalaki, E. (2002). A process capability index that is based on the proportion of conformance. *Journal of Statistical Computation and Simulation*, 72(9), 707–718. <https://doi.org/10.1080/00949650214270>
- Peterson, M. (2017). *An Introduction to Decision Theory (2nd ed., Cambridge Introductions to Philosophy)*. Cambridge University Press. <https://doi.org/10.1017/9781316585061>
- Power, D. J. (2000). Web-based and model-driven decision support systems: concepts and issues. *Americas Conference on Information Systems*. <http://www.internetivity.com/>
- Power, D. J. (2002). *Decision Support Systems: Concepts and Resources for Managers*. Greenwood Publishing Group. <https://scholarworks.uni.edu/facbook/67>
- Power, D. J., Cyphert, D., & Roth, R. M. (2019). Analytics, bias, and evidence: the quest for rational decision making. *Journal of Decision Systems*, 28(2), 120–137. <https://doi.org/10.1080/12460125.2019.1623534>
- Psomas, E., & Antony, J. (2019). Research gaps in Lean manufacturing: a systematic literature review. *International Journal of Quality and Reliability Management*, 36(5), 815–839. <https://doi.org/10.1108/IJQRM-12-2017-0260>
- Radnor, Z. J., & Barnes, D. (2007). Historical analysis of performance measurement and management in operations management. *International Journal of Productivity and Performance Management*, 56(5–6), 384–396. <https://doi.org/10.1108/17410400710757105>
- Rasovska, I., Chebel-Morello, B., & Zerhouni, N. (2008). A mix method of knowledge capitalization in maintenance. *Journal of Intelligent Manufacturing*, 19(3), 347–359. <https://doi.org/10.1007/s10845-008-0087-3>
- Reda, H., & Dvivedi, A. (2022). Decision-making on the selection of lean tools using fuzzy QFD and FMEA approach in the manufacturing industry. *Expert Systems With Applications*, 192, 11641, 12. <https://doi.org/10.1016/j.eswa.2021.116416>
- Rosin, F., Forget, P., Lamouri, S., & Pellerin, R. (2020). Impacts of Industry 4.0 technologies on Lean principles. *International Journal of Production Research*, 58(6), 1644–1661. <https://doi.org/10.1080/00207543.2019.1672902>
- Rosman, I., Mohd Kamarul Irwan, A. R., & Mohd Akhir, A. (2017). Lean production and business performance in Malaysian manufacturing industries. *International Journal of Supply Chain Management*, 6(2), 250–255.
- Rossini, M., Costa, F., Tortorella, G. L., & Portioli-Staudacher, A. (2019). The interrelation between Industry 4.0 and lean production: an empirical study on European manufacturers. *International Journal of Advanced Manufacturing Technology*, 102(9–12), 3963–3976. <https://doi.org/10.1007/s00170-019-03441-7>
- Rowe, F. (2014). What literature review is not: diversity, boundaries and recommendations. *European Journal of Information Systems*, 23(3), 241–255.

- <https://doi.org/10.1057/ejis.2014.7>
- Saaty, T. L. (1990). How to make a decision: The analytic hierarchy process. *European Journal of Operational Research*, 48(1), 9–26. [https://doi.org/10.1016/0377-2217\(90\)90057-I](https://doi.org/10.1016/0377-2217(90)90057-I)
- Saaty, T. L. (1996). *NoDecision making with dependence and feed back, The analytic network process*. Pittsburgh:RWS Publications.
- Sahoo, S., & Yadav, S. (2018). Lean implementation in small- and medium-sized enterprises. *Benchmarking: An International Journal*, 25(4), 1121–1147. <https://doi.org/10.1108/BIJ-02-2017-0033>
- Saini, S., & Singh, D. (2020). Impact of implementing lean practices on firm performance: a study of Northern India SMEs. *International Journal of Lean Six Sigma*, 11(6), 1019–1048. <https://doi.org/10.1108/IJLSS-06-2019-0069>
- Sanchez-Ruiz, L., Gomez-Lopez, R., & Blanco, B. (2020). Barriers to effectively implementing continuous improvement in Spanish firms. *Total Quality Management and Business Excellence*, 31(13), 1409–1426. <https://doi.org/10.1080/14783363.2019.1699783>
- Sanchez, L., & Blanco, B. (2014). Three decades of continuous improvement. *Total Quality Management & Business Excellence*, 25(9–10), 986–1001. <https://doi.org/10.1080/14783363.2013.856547>
- Sangwa, N. R., & Sangwan, K. S. (2018). Development of an integrated performance measurement framework for lean organizations. *Journal of Manufacturing Technology Management*, 29(1), 41–84. <https://doi.org/10.1108/JMTM-06-2017-0098>
- Santos Bento, G. dos, & Tontini, G. (2018). Developing an instrument to measure lean manufacturing maturity and its relationship with operational performance. *Total Quality Management & Business Excellence*, 29(9–10), 977–995. <https://doi.org/10.1080/14783363.2018.1486537>
- Sarka, P., Heisig, P., Caldwell, N. H. M., Maier, A. M., & Ipsen, C. (2019). Future research on information technology in knowledge management. *Knowledge and Process Management*, 26(3), 277–296. <https://doi.org/10.1002/kpm.1601>
- Saurin, T. A., Luz Tortorella, G., Soliman, M., & Garza-Reyes, J. A. (2021). Lean production myths: an exploratory study. *Journal of Manufacturing Technology Management*, 32(1), 1–19. <https://doi.org/10.1108/JMTM-08-2020-0302>
- Schwab, K., & Davis, N. (2018). *Shaping the Fourth Industrial Revolution*. World Economic Forum.
- Seleem, S. N., Attia, E.-A., & El-Assal, A. (2016). Managing performance improvement initiatives using DEMATEL method with application case study. *Production Planning & Control*, 27(7–8), 637–649. <https://doi.org/10.1080/09537287.2016.1165301>
- Seyed-Hosseini, S. M., Safaei, N., & Asgharpour, M. J. (2006). Reprioritization of failures in a system failure mode and effects analysis by decision making trial and evaluation laboratory technique. *Reliability Engineering and System Safety*, 91(8), 872–881. <https://doi.org/10.1016/j.res.2005.09.005>
- Sezen, B., Karakadilar, I. S., & Buyukozkan, G. (2012). Proposition of a model for measuring adherence to lean practices: Applied to Turkish automotive part suppliers. *International Journal of Production Research*, 50(14), 3878–3894. <https://doi.org/10.1080/00207543.2011.603372>
- Sharma, V., Dixit, A. R., & Qadri, M. A. (2016). Empirical assessment of the causal relationships among lean criteria using DEMATEL method. *Benchmarking: An International Journal*, 23(7), 1834–1859. <https://doi.org/10.1108/BIJ-08-2014-0078>
- Sheskin, D. J. (2020). *Handbook of Parametric and Nonparametric Statistical*

- Procedures* (5th ed.). Chapman and Hall/CRC.
<https://doi.org/10.1201/9780429186196>
- Shim, J. P., Warkentin, M., Courtney, J. F., Power, D. J., Sharda, R., & Carlsson, C. (2002). Past, present, and future of decision support technology. *Decision Support Systems*, 33(2), 111–126. [https://doi.org/10.1016/S0167-9236\(01\)00139-7](https://doi.org/10.1016/S0167-9236(01)00139-7)
- Shrafat, F. D., & Ismail, M. (2019). Structural equation modeling of lean manufacturing practices in a developing country context. *Journal of Manufacturing Technology Management*, 30(1), 122–145. <https://doi.org/10.1108/JMTM-08-2017-0159>
- Shukla, V., Swarnakar, V., & Singh, A. R. (2021). Prioritization of Lean Six Sigma project selection criteria using Best Worst Method. *Materials Today: Proceedings*, 47(17), 5749–5754. <https://doi.org/10.1016/J.MATPR.2021.04.038>
- Si, S.-L., You, X.-Y., Liu, H.-C., & Zhang, P. (2018). DEMATEL Technique: A Systematic Review of the State-of-the-Art Literature on Methodologies and Applications. *Mathematical Problems in Engineering*, 2018, 1–33. <https://doi.org/10.1155/2018/3696457>
- Silvério, L., Trabasso, L. G., & Pereira Pessôa, M. V. (2020). A roadmap for a leanness company to emerge as a true lean organization. *Concurrent Engineering: Research and Applications*, 28(1), 3–19. <https://doi.org/10.1177/1063293X19888259>
- Singh, C., Singh, D., & Khamba, J. S. (2021). Analyzing barriers of Green Lean practices in manufacturing industries by DEMATEL approach. *Journal of Manufacturing Technology Management*, 32(1), 176–198. <https://doi.org/10.1108/JMTM-02-2020-0053>
- Singh, J., & Singh, H. (2013). Continuous Improvement Strategies: An Overview. *IUP Journal of Operations Management*, 12(1), 32–57. <https://doi.org/10.4324/9781315154237>
- Singh, J., & Singh, H. (2015). Continuous improvement philosophy – literature review and directions. *Benchmarking*, 22(1), 75–119. <https://doi.org/10.1108/BIJ-06-2012-0038>
- Singh, K., Swarnakar, V., & Singh, A. R. (2021). Lean Six Sigma project selection using Best Worst Method. *Materials Today: Proceedings Journal*, 47, 5766–5770 Contents. <https://doi.org/10.1016/j.matpr.2021.04.094>
- Smeds, M. (2022). Deming's tampering revisited: definition and future research agenda. *International Journal of Quality and Service Sciences*, 14(5), 37–51. <https://doi.org/10.1108/IJQSS-03-2021-0041>
- Snee, R. D. (2010). Lean Six Sigma – getting better all the time. *International Journal of Lean Six Sigma*, 1(1), 9–29. <https://doi.org/10.1108/20401461011033130>
- Snyder, H. (2019). Literature review as a research methodology: An overview and guidelines. *Journal of Business Research*, 104, 333–339. <https://doi.org/10.1016/J.JBUSRES.2019.07.039>
- Soliman, M. (2013). Lean Transformation Guidance: Why Organizations Fail To Achieve and Sustain Excellence Through Lean Improvement. *International Journal of Lean Thinking*, 4(1). <https://www.researchgate.net/publication/271965111>
- Soltan, H., & Mostafa, S. (2015). Lean and agile performance framework for manufacturing enterprises. In D. Kurniawan & F. M. Nor (Eds.), *2nd International Materials, Industrial, and Manufacturing Engineering Conference, MIMEC2015, 4-6 February 2015* (Vol. 2, pp. 476–484). <https://doi.org/10.1016/J.PROMFG.2015.07.082>

- Sony, M., Naik, S., & Therisa, K. K. (2019). Why do organizations discontinue Lean Six Sigma initiatives? *International Journal of Quality & Reliability Management*, 36(3), 420–436. <https://doi.org/10.1108/IJQRM-03-2018-0066>
- Staedele, A. E., Ensslin, S. R., & Forcellini, F. A. (2019). Knowledge building about performance evaluation in lean production: An investigation on international scientific research. *Journal of Manufacturing Technology Management*, 30(5), 798–820. <https://doi.org/10.1108/JMTM-12-2017-0277>
- Stone, K. B. (2012). Four decades of lean: a systematic literature review. *International Journal of Lean Six Sigma*, 3(2), 112–132. <https://doi.org/10.1108/20401461211243702>
- Sugeno, M. (1974). Theory of fuzzy integrals and its applications. *Unpublished PhD. Tokyo, Japan: Tokyo Institute of Technology.*
- Susanty, A., Puspitasari, N. B., Prastawa, H., & Renaldi, S. V. (2020). Exploring the best policy scenario plan for the dairy supply chain: a DEMATEL approach. *Journal of Modelling in Management*, 16(1), 240–266. <https://doi.org/10.1108/JM2-08-2019-0185>
- Taggart, P., & Kienhöfer, F. (2013). The effectiveness of Lean Manufacturing audits in measuring operational performance improvements. *The South African Journal of Industrial Engineering*, 24(2), 140. <https://doi.org/10.7166/24-2-749>
- Taj, S. (2008). Lean manufacturing performance in China: assessment of 65 manufacturing plants. *Journal of Manufacturing Technology Management*, 19(2), 217–234. <https://doi.org/10.1108/17410380810847927>
- Tan, W., Yeh, Y., Chen, S., Lin, Y., & Kuo, C. (2012). Using DEMATEL and the smartphone as a case study to investigate how consumers evaluate many features of a product collectively. *International Journal of Applied Mathematics and Informatics*, 6(3), 117–125. <http://naun.org/main/UPress/ami/16-215.pdf>
- Taouab, O., & Issor, Z. (2019). Firm performance: definition and measurement models. *European Scientific Journal ESJ*, 15(1), 93–106. <https://doi.org/10.19044/esj.2019.v15n1p93>
- Thomas, A. J., Francis, M., Fisher, R., & Byard, P. (2016). Implementing Lean Six Sigma to overcome the production challenges in an aerospace company. *Production Planning & Control*, 27(8), 591–603. <https://doi.org/10.1080/09537287.2016.1165300>
- Tortorella, G., & Fettermann, D. (2018). Help chain in companies undergoing a lean implementation: The impact of critical success factors on quality and efficiency performance. *International Journal of Lean Six Sigma*, 9(1), 113–132. <https://doi.org/10.1108/IJLSS-08-2016-0039>
- Tortorella, G. L., Giglio, R., & van Dun, D. H. (2019). Industry 4.0 adoption as a moderator of the impact of lean production practices on operational performance improvement. *International Journal of Operations and Production Management*, 39, 860–886. <https://doi.org/10.1108/IJOPM-01-2019-0005>
- Tzeng, G. H., Chiang, C. H., & Li, C. W. (2007). Evaluating intertwined effects in e-learning programs: a novel hybrid MCDM model based on factor analysis and DEMATEL. *Expert Systems with Applications*, 32(4), 1028–1044. <https://doi.org/10.1016/j.eswa.2006.02.004>
- Unzueta, G., Esnaola, A., & Eguren, J. A. (2020). Continuous improvement framework to develop cultural change: case study, capital goods company. *TQM Journal*, 32(6), 1327–1348. <https://doi.org/10.1108/TQM-02-2019-0051>
- Velasquez, M., & Hester, P. T. (2013). An analysis of multi-criteria decision making methods. *International Journal of Operations Research*, 10(2), 56–66.
- Wu, H. H., & Tsai, Y. N. (2011). A DEMATEL method to evaluate the causal relations

- among the criteria in auto spare parts industry. *Applied Mathematics and Computation*, 218(5), 2334–2342. <https://doi.org/10.1016/j.amc.2011.07.055>
- Wu, W.-W. (2008). Choosing knowledge management strategies by using a combined ANP and DEMATEL approach. *Expert Systems with Applications*, 35(3), 828–835. <https://doi.org/10.1016/j.eswa.2007.07.025>
- Yahya, M. S., Mohammad, M., Omar, B., & Ramly, E. F. (2016). A review on the selection of lean production tools and techniques. *ARPN Journal of Engineering and Applied Sciences*, 11(12), 7721–7727.
- Zammori, F. (2015). Fuzzy Overall Equipment Effectiveness (FOEE): capturing performance fluctuations through LR Fuzzy numbers. *Production Planning & Control*, 26(6), 451–466. <https://doi.org/10.1080/09537287.2014.920545>
- Zhang, G., Jie, L., & Ya, G. (2015). Decision Making and Decision Support Systems. In *Multi-Level Decision Making. Intelligent Systems Reference Library* (Vol. 82, pp. 3–24). Springer. https://doi.org/10.1007/978-3-662-46059-7_1
- Zhang, L., & Chen, X. (2016). Role of Lean Tools in Supporting Knowledge Creation and Performance in Lean Construction. *Procedia Engineering*, 145, 1267–1274. <https://doi.org/10.1016/j.proeng.2016.04.163>