



**HAL**  
open science

# Evaluation of innovative platinum compounds as antitumor agents combining chemotherapy and immunotherapy

May Wantz

► **To cite this version:**

May Wantz. Evaluation of innovative platinum compounds as antitumor agents combining chemotherapy and immunotherapy. Medicinal Chemistry. Université de Strasbourg, 2019. English. NNT : 2019STRAJ053 . tel-04213424

**HAL Id: tel-04213424**

**<https://theses.hal.science/tel-04213424>**

Submitted on 21 Sep 2023

**HAL** is a multi-disciplinary open access archive for the deposit and dissemination of scientific research documents, whether they are published or not. The documents may come from teaching and research institutions in France or abroad, or from public or private research centers.

L'archive ouverte pluridisciplinaire **HAL**, est destinée au dépôt et à la diffusion de documents scientifiques de niveau recherche, publiés ou non, émanant des établissements d'enseignement et de recherche français ou étrangers, des laboratoires publics ou privés.

**ÉCOLE DOCTORALE SCIENCES DE LA VIE ET DE LA SANTE**

**Laboratoire CAMB – UMR7199 CNRS/Unistra**

**THÈSE** présentée par :

**May WANTZ**

soutenue le : **20 septembre 2019**

pour obtenir le grade de : **Docteur de l'Université de Strasbourg**

Discipline : Sciences du Vivant - Aspects moléculaires et cellulaires de la biologie

Spécialité : Immunologie

**Evaluation of innovative platinum  
compounds as antitumor agents  
combining chemotherapy and  
immunotherapy**

**THÈSE dirigée par :**

**Mme FOURNEL Sylvie**

Professeur, Université de Strasbourg

**RAPPORTEURS :**

**M MICHEAU Olivier**

Directeur de recherche, Université de Bourgogne

**Mme VALLADEAU Jenny**

Chargée de recherche, Centre de recherche en cancérologie de  
Lyon – Centre Léon Bérard

**AUTRES MEMBRES DU JURY :**

**M GROS Frédéric**

Maître de conférences, Université de Strasbourg

**MEMBRE INVITE DU JURY :**

**M BELLEMIN Stéphane**

Directeur de recherche, Institut de Physique et de Chimie des  
Matériaux de Strasbourg



*A ma chère Mimi*





## Remerciements

---

Une page de ma vie se termine...

Au cours de cette aventure, j'ai pu croiser le chemin de nombreuses personnes qui ont contribué, chacune à sa façon, à rendre cette expérience inoubliable et qui m'ont permis d'arriver jusqu'au bout.

Tout d'abord, je tiens à remercier les membres de mon jury de thèse, le Dr. Jenny Valladeau, le Dr. Olivier Micheau et le Dr. Frédéric Gros sans oublier le Dr. Stéphane Bellemin-Laponnaz en tant que membre invité, de m'avoir fait l'honneur de juger ce travail de thèse.

Cette thèse a été réalisée au sein de l'équipe 3Bio du Laboratoire de Conception et Application de Molécules Bioactives à la Faculté de Pharmacie à Illkirch-Graffenstaden sous la direction du Pr. Sylvie Fournel. Je tiens à exprimer ma plus grande gratitude à ma directrice de thèse pour m'avoir fait confiance à mener à bien ce projet intéressant, pour sa patience, pour son temps qu'elle m'a consacré, ses conseils et son soutien pendant les quatre ans passés au labo. Merci beaucoup pour la relecture de ce manuscrit et les nombreux conseils.

Je me rappelle encore quand notre chemin s'est croisé pour la première fois en 2014, lors des travaux pratiques d'immunologie en L3. Ensuite, tu m'as permis d'intégrer le *Master Immunologie et Inflammation* et de faire mes deux stages de Master dans l'équipe 3Bio. Tu m'as encouragée et motivée pour passer le concours de l'Ecole Doctorale, ce qui m'a permis de réaliser mon rêve et de faire une thèse dans le but de devenir enseignant-chercheur. Pendant la thèse, tu m'as initiée à l'enseignement en me permettant de faire du monitorat en immunologie ce qui était une expérience très enrichissante pour moi et ce qui a renforcé mon idée de devenir enseignant-chercheur.

Je tiens également à remercier les directeurs de l'équipe le Dr. Benoit Frisch et le Dr. Antoine Kichler de m'avoir accueillie au sein de l'équipe anciennement *Biovectorologie* et maintenant *3Bio*. Un grand merci à Benoit pour ses conseils et d'avoir répondu à mes questions naïves de biologiste sur les biomatériaux et sur les modifications chimiques possibles de mon composé de platine dans le but d'augmenter son potentiel immunothérapeutique. Un grand merci également à Antoine pour ses conseils et surtout pour m'avoir initié à la formation des complexes avec le polyI:C.

Je tiens à remercier le Dr. Jean-Serge Remy, directeur du Laboratoire de Conception et Application de Molécules Bioactives pour avoir accepté d'intégrer son unité de recherche UMR7199.

Un très grand merci à Cendrine, qui m'a initiée aux bonnes pratiques de laboratoire lors de mon stage de Master 1 et qui a toujours été très patiente lors de mes questions très nombreuses (et parfois répétitives). Merci de m'avoir formée à la cytométrie en flux, de m'avoir donné de multiples conseils et de m'avoir aidée lors des expériences *in vivo*. Merci de m'avoir encouragée et d'avoir essayé d'augmenter ma confiance en moi, ce qui n'était pas toujours très facile.

Merci beaucoup à Béatrice de m'avoir accompagnée lors de la formulation de mes premiers liposomes, d'avoir pris le temps de m'expliquer les calculs et de m'avoir donné de nombreux conseils.

Un très grand merci à Anais pour ses conseils et de m'avoir aidée lors des expériences *in vivo*. Tu as toujours essayé d'augmenter ma confiance en moi lors des manip à l'animalerie.

Merci beaucoup à Marcella et Maria pour leurs conseils, leurs réponses à mes questions naïves de chimie et leurs explications détaillées. Vous m'avez permis de mieux comprendre certains aspects chimiques. Merci aussi à Line pour ses conseils. Merci à Patrick, l'autre Luxembourgeois du labo, pour ses conseils lors des mesures de tailles de mes complexes au Nanosizer.

Merci beaucoup aussi à Guillaume pour ses conseils, ses explications sur les biomatériaux et surtout sa bonne humeur.

Un énorme merci à toutes les personnes qui ont partagé le même bureau que moi au cours de ces quatre ans pour des périodes plus ou moins longues. Un très grand merci à Célia, ma voisine de bureau pendant trois ans. Tu as toujours été à mon écoute et m'as toujours encouragée. Je ne vais jamais oublier nos longues journées passées à l'animalerie et ensuite en salle de culture pour récupérer les cellules immunitaires. Tu m'as motivée pour me lancer dans les expériences *in vivo*.

Merci beaucoup au rayon de soleil du bureau, Hanadi. Même si tu n'étais pas toujours physiquement présente, tu m'as quand même toujours encouragée et motivée. Merci aussi pour tes nombreux conseils au labo et lors de la finalisation de ce manuscrit et surtout pour ta bonne humeur.

Merci beaucoup à Eya et à Claire pour votre bonne humeur, nos discussions intéressantes et surtout nos pauses « café » devant le distributeur.

Merci beaucoup aussi à Florence, ma « sœur » de thèse. Tu as embarqué dans cette aventure au même moment que moi et nous avons partagé beaucoup d'expériences. Merci de m'avoir soutenue lors de mes formulations de liposomes.

Merci à Alexandre, mon binôme d'azote, pour tes conseils en chimie et pour les discussions lors des nombreux tours pour remplir les containers d'azote.

Merci aussi aux stagiaires qui ont permis de faire avancer le projet : Mathias et Alisa. Et surtout un très grand merci à Candice qui a fait une grande partie des travaux sur les cellules souches. Merci aux autres stagiaires du labo, surtout Pauline et Romaisaa, qui m'ont soutenue lors de la rédaction.

Merci beaucoup à Neila de m'avoir confié le projet sur la platine, son bébé, lors de son départ du labo et de m'avoir formée pendant mes deux premiers mois de mon stage de Mater 2.

Un très grand merci au Dr. Stéphane Bellemin-Lapponnaz sans qui je n'aurais pas pu travailler, faute de molécules. Merci pour les réponses à mes multiples questions lors de l'évaluation de nouveaux dérivés de platine et pour les conseils. Merci aussi à Mathilde d'avoir synthétisé toutes molécules et d'avoir réapprovisionné mes stocks de manière super rapide.

Merci à toute l'équipe enseignante en immunologie d'avoir fait de cette expérience une aventure inoubliable : merci à Sylvie, Fred, Samuel, Fanny, Hélène et bien sûr aux autres moniteurs Simone, Antoine et Sophia.

Merci à tous les membres de l'équipe LFCS (anciens et actuels): Alain, Guilhem, Sylvain, Fabien, David, Sébastien, Igor, Manon, Elisabetta, Charlotte, Tony, Victor, Julien, Linda, Eric, Marc et Isabelle. Merci pour les repas au RU à midi et pour les nombreux goûters, ainsi que pour les parties de «Président» et ensuite de tarot (Charlotte a enfin réussi à me convaincre ☺). Merci aussi à Sacha et à Sergii pour les intéressantes discussions philosophiques au RU.

Un très grand merci à Chloé pour ses multiples conseils en microscopie et cytométrie en flux.

Merci à toutes les autres personnes qui ont croisé mon chemin au laboratoire : Françoise, Anne, Carole, Fanny, Thomas, Yasmine.

Un très grand merci aux gestionnaires : Nathalie et ensuite Frédérique. Merci d'avoir géré toutes les commandes et surtout les commandes de souris de dernière minute.

Merci au personnel de l'animalerie de la Faculté de Pharmacie Jean-François, Lionel et Feyzi pour leur disponibilité et leurs coups de mains.

Merci à Romain de la plateforme de microscopie de m'avoir formée à l'utilisation du microscope confocal.

### Les amis et la famille

Un grand merci à mes amis Jackie, Lynn, Manon, Alain, Yves, Frank, Kenzo, Marc, Eric, Séba. Merci de m'avoir changé les idées lors de nos soirées « jeux ».

Un très grand merci à Margot de m'avoir soutenue et encouragée pendant de longues années.

Cependant, je n'aurais jamais pu arriver au bout de cette aventure sans le soutien de mes parents qui m'ont permis de réaliser mes rêves et de poursuivre mon parcours universitaire.

Un énorme MERCI à ma mère qui m'a encouragée et soutenue du début jusqu'à la fin. Même si certains moments ont été difficiles, tu as toujours été à mon écoute. Je t'en remercie très sincèrement. Sans toi, je n'aurais pas pu arriver au bout de cette aventure.

Un énorme MERCI aussi à ma grand-mère, à qui je dédie cette thèse. Tu m'as encouragée et épaulée tout au long de ma vie et de mes études et tu voulais absolument assister à ma soutenance, mais malheureusement tu as dû nous quitter il y a deux mois, laissant un très grand vide.

C'est avec une larme aux yeux que je termine ces pages de remerciements, mais la page du livre se tourne et un nouveau chapitre de la vie commence maintenant...

## Contents

List of Figures .....	5
List of Tables .....	7
List of abbreviations .....	9
<b>Introduction</b> .....	15
<b>Part A: Generalities on cancer</b> .....	17
1. What is at the origin of cancer development? .....	17
2. What are the hallmarks of cancer? .....	18
3. How can cancer progression be explained? .....	19
4. What are the different treatments against cancer? .....	20
4.1. Conventional therapies .....	20
4.1.1. Surgery .....	20
4.1.2. Radiation therapy or radiotherapy .....	20
4.1.3. Chemotherapy .....	20
4.2. Other therapies .....	20
4.2.1. Hormonotherapy .....	20
4.2.2. Stem cell transplant .....	21
4.2.3. Immunotherapy .....	21
5. Towards the development of a new therapy: precision medicine .....	21
6. The need of new anticancer agents .....	21
<b>Part B: Chemotherapy</b> .....	23
1. Different chemotherapeutic agents .....	23
1.1. Alkylating agents and related compounds .....	23
1.2. Mitotic inhibitors .....	24
1.3. Antimetabolites .....	24
1.4. Topoisomerase inhibitors .....	24
2. Platinum compounds, the most common chemotherapeutic agents .....	25
2.1. Cisplatin, a surprising discovery .....	25
2.1.1. Cisplatin and its mechanism of action .....	26
a) <i>Interaction with nucleic acids</i> .....	28
b) <i>Effect on mitochondrial activity</i> .....	29
c) <i>Interaction with cell membrane phospholipids</i> .....	30
d) <i>Interaction with proteins</i> .....	30

2.2.	Towards new platinum (II)-based compounds.....	30
2.2.1.	Second-generation platinum(II) compounds.....	31
2.2.2.	Third-generation platinum (II) compounds.....	32
2.2.3.	Attempts to vectorise cisplatin.....	33
2.2.4.	The emergence of N-heterocyclic carbene-metal complexes .....	34
2.2.5.	Platinum (IV) compounds.....	38
2.3.	The drawbacks of platinum(II)-based compounds.....	39
2.3.1.	Resistances against platinum (II) compounds.....	39
2.3.2.	Resistance due to cancer stem cells .....	42
2.3.2.1.	Features of CSCs.....	42
2.3.2.2.	Metabolic deregulations of CSCs.....	43

### **Part C: Cancer and the immune system** 45

1.	The concept of immunosurveillance.....	47
2.	How can the immune system distinguish cancer cells from healthy cells?.....	48
2.1.	The danger model.....	48
2.2.	The recognition of cancer cells by immune cells.....	49
2.2.1.	The recognition of tumor-associated antigens (TAAs) by the immune system .....	49
3.	The cancer-immunity cycle .....	51
4.	The different actors of the antitumor immune response and their role .....	52
4.1.	The dendritic cell (DC) – key initiator of an antitumor immune response .....	52
4.1.1.	Maturation of the dendritic cells.....	52
4.1.2.	Processing of antigens by DCs .....	54
4.2.	Activation of T lymphocytes.....	55
4.2.1.	Activation of CD4 <sup>+</sup> T cells.....	55
4.2.2.	Activation of CD8 <sup>+</sup> T cells.....	57
4.3.	Other immune cells implicated in the antitumor immune response.....	58
4.3.1.	NK cells .....	58
4.3.2.	iNKT cells.....	60
4.3.3.	B lymphocytes .....	60
4.3.4.	Regulatory T cells .....	61
4.3.5.	$\gamma\delta$ T cells .....	61
4.3.6.	Other cells: macrophages, neutrophils, myeloid-derived suppressor cells .	62
5.	The concept of immunediting.....	63

5.1. Elimination .....	65
5.2. Equilibrium.....	65
5.3. Escape.....	65
5.3.1. The immune checkpoints .....	66
6. Platinum compounds and their effect on the immune system .....	67
6.1. Deleterious effects.....	67
6.2. Beneficial effect: induction of immunogenic cell death (ICD).....	67
6.2.1. Exposure of calreticulin .....	68
6.2.2. Release of ATP .....	69
6.2.3. Release of HMGB1 .....	70
7. Targeting the immune system to fight against cancer: the use of immunotherapy ...	71
7.1. Non-specific immunotherapy .....	72
7.2. Passive specific immunotherapy .....	72
7.3. Active specific immunotherapy .....	72
<b>Thesis objectives</b> .....	73
<b>Results</b> .....	79
<b>Chapter 1 Optimization of innovative platinum-based compounds</b> .....	79
Context and objectives .....	81
Results.....	81
Conclusions.....	82
N-Heterocyclic Carbene-Polyethyleneimine (PEI) Platinum Complexes Inducing Human Cancer Cell Death: Polymer Carrier Impact.....	83
<b>Chapter 2 Targeting glioblastoma-derived cancer stem cells</b> .....	95
Context and objectives .....	97
Results.....	97
Conclusions.....	98
Targeting glioblastoma-derived cancer stem cells with N-heterocyclic carbene platinum complexes .....	99
<b>Chapter 3 Activation of the antitumor immune response by innovative platinum (II) compounds</b> .....	119
Context and objectives .....	121
Results.....	121
Conclusions.....	122



Development and evaluation of innovative platinum compounds able to activate the antitumor immune response .....	123
--	-----

## **Discussion and Perspectives** .....

155

1. Context	157
2. Getting insight in the mechanism of action of NHC-Pt(II)-PEI30	157
3. How can platinum-based conjugates selectively target cancer cells?	159
3.1. Previous attempts .....	159
3.2. Other possible targeting strategies .....	160
3.2.1. Targeting estrogen receptors .....	160
3.2.2. Targeting nucleolin .....	160
3.2.3. Targeting integrins .....	161
3.2.4. Targeting prostate-specific membrane antigen (PSMA) .....	162
3.2.5. Targeting cancer stem cells .....	162
3.2.6. Creation of antibody drug conjugates (ADCs) .....	163
4. What is the implication of ROS production in the efficacy of anticancer therapies?	163
5. What is the role of autophagy?	164
6. Do not forget the intestinal microbiome in the efficacy of cancer therapies!	165
7. Towards the development of a combotherapy	166
7.1. Targeting TLRs .....	166
7.2. Combination with other immunotherapies .....	166
7.3. The use of liposomal constructs .....	167

## **Bibliography** .....

169

## **Appendix** .....

189

Publications	191
Communications	192
Résumé français	195
Article: Platinum(IV) N-heterocyclic carbene complexes: their synthesis, characterisation and cytotoxic activity	201

## List of Figures

---

<b>Figure 1:</b> Tumorigenesis	17
<b>Figure 2:</b> Hallmarks of cancer	18
<b>Figure 3:</b> The different cancer models	19
<b>Figure 4:</b> Classification of chemotherapeutic agents	23
<b>Figure 5:</b> Summary of chemotherapeutic agents and their mechanism of action	25
<b>Figure 6:</b> Structure of Cisplatin and Transplatin	26
<b>Figure 7:</b> The mechanism of action of cisplatin	27
<b>Figure 8:</b> Different types of DNA adducts formed by cisplatin	28
<b>Figure 9:</b> Summary of the proteins and complexes involved in the recognition of Pt-DNA adducts	29
<b>Figure 10:</b> Effect of cisplatin on mitochondrial activity	29
<b>Figure 11:</b> Structures of second-generation platinum compounds	31
<b>Figure 12:</b> Structures of third-generation platinum compounds	33
<b>Figure 13:</b> Structural representation of carbene-metal bond in N-heterocyclic carbenes	35
<b>Figure 14:</b> Structure of the platinum(IV)-based compound Satraplatin	38
<b>Figure 15:</b> Induction of apoptosis by tumor suppressor p53	40
<b>Figure 16:</b> Mechanisms of resistance after cisplatin treatment	41
<b>Figure 17:</b> Presence of cancer stem cells (CSC) within a tumor leads to treatment resistance	42
<b>Figure 18:</b> Summary of metabolic adaptations of cancer stem cells leading to cancer therapy resistance	44

<b>Figure 19:</b> Overview of the barriers and the effector cells of the immune system	45
<b>Figure 20:</b> Different functions of DAMPs	48
<b>Figure 21:</b> The cancer-immunity cycle	51
<b>Figure 22:</b> The antitumor immune response	53
<b>Figure 23:</b> Antigen presentation by dendritic cells	55
<b>Figure 24:</b> Activation of CD4+ T cells by dendritic cells	56
<b>Figure 25:</b> Activation of CD8+ T cells	57
<b>Figure 26:</b> The functions NK cells	59
<b>Figure 27:</b> Summary of immune cells implicated in the antitumor immune response	63
<b>Figure 28:</b> The three E's of immunoediting: elimination, equilibrium, escape	64
<b>Figure 29:</b> The escape mechanisms developed by cancer cells to avoid immune recognition	66
<b>Figure 30:</b> Induction of immunogenic cell death	68
<b>Figure 31:</b> Structure of NHC-Pt(II)-PEI	73
<b>Figure 32:</b> In vivo antitumor effect of NHC-Pt(II)-PEI30 in immunodeficient mouse model	74
<b>Figure 33:</b> Cellular localization of oxaliplatin and NHC-Pt(II)-PEI30	74
<b>Figure 34:</b> Different NHC-Pt(II)-PEI compounds	82
<b>Figure 35:</b> Cytotoxicity of platinum(II) compound targeting nucleolin	161
<b>Figure 36:</b> Structure of an antibody-drug conjugate (ADC)	163
<b>Figure 37:</b> Process of autophagy	165
<b>Figure 38:</b> Examples of possible liposomal constructs as immunotherapeutic agents	168

## List of Tables

---

<b>Table 1:</b> Worldwide approved platinum compounds	33
<b>Table 2:</b> Different platinum-based conjugates	34
<b>Table 3:</b> N-heterocyclic carbene-metal complexes evaluated for their antitumor activities	36
<b>Table 4:</b> Summary of the differences between innate and adaptive immunity	46
<b>Table 5:</b> Different tumor-associated antigens (TAAs)	50
<b>Table 6:</b> DAMPs involved in immunogenic cell death	71



## List of abbreviations

---

ACK	ammonium-chloride-potassium
ADC	antibody-drug conjugate
ADCC	antibody-dependent cell-mediated cytotoxicity
ADP	adenosine diphosphate
APC	antigen-presenting cell
Atox	Antioxidant protein
ATP	adenosine triphosphate
BBB	blood-brain-barrier
BCIP/NBT	5-bromo-4-chloro-3-indolyl phosphate / nitro blue tetrazolium
BCR	B cell receptor
BIT	bovine serum albumin-insulin-transferrin
CALR	calreticulin
CAR	chimeric antigen receptor
cDC	conventional dendritic cell
CDK	cyclin-dependent kinase
CEA	carcinoembryonic antigen
CLIP	class II-associated invariant-chain peptide
CSC	cancer stem cell
CTL	cytotoxic T lymphocyte
CTR1	copper transporter
DACH	diaminocyclohexane
DAMP	damage-associated molecular pattern
DC	dendritic cell
DMEM	Dulbecco's modified Eagle's medium
DMSO	dimethyl sulfoxide
DNA	deoxyribonucleic acid

EBV	Epstein-Barr virus
EDTA	ethylenediaminetetraacetic acid
EEA1	early endosome antigen 1
EGF	epidermal growth factor
EGFR	epidermal growth factor receptor
EPR	permeability and retention effect
ER	endoplasmic reticulum
FCS	fetal calf serum
FDA	Food and Drug Administration
FGF	fibroblast growth factor
FITC	fluorescein isothiocyanate
GBM	glioblastoma multiform
HA	hyaluronic acid
HEPES	4-(2-hydroxyethyl)-1-piperazineethanesulfonic acid
HIF	hypoxia-inducible factor
HLA	human leukocyte antigen
HMG	high mobility group
HMGB1	high mobility group box 1
HMW	high molecular weight
HPV	human papilloma virus
HSA	human serum albumin
HSP	heat-shock protein
hTERT	human telomerase reverse transcription
ICAM	intercellular adhesion molecule
ICD	immunogenic cell death
IFN	interferon
IL	interleukin

INCa	Institut National du Cancer
iNKT	invariant Natural Killer T
iNOS	inducible nitric oxide synthase
IPCMS	Institut de physique et de chimie des Matériaux de Strasbourg
KIR	killer cell immunoglobulin-like receptor
LAG	lymphocyte activation gene
LPS	lipopolysaccharide
MAMP	microbe-associated molecular pattern
MCA	methylcholanthrene
MDSC	myeloid-derived suppressor cell
MEM	Minimum Essential Medium
MGMT	O6-Methylguanine DNA methyltransferase
MHC	major histocompatibility complex
MMR	mismatch repair
MPLA	monophosphoryl lipid A
NCI	National Cancer Institute
NER	nucleotide excision repair
NET	neutrophil extracellular trap
NHC	N-heterocyclic carbene
NK	Natural Killer
NKT	Natural Killer T cell
NSCLC	non-small cell lung cancer
OCT	organic cation transporter
Pam <sub>2</sub> CAG	S-[2,3-bispalmitoyloxy-(2R)-propyl]-R-cysteinyl-alanyl-glycine
PARP	poly(ADP-ribosyl)ated protein
PBS	phosphate buffered saline
pDC	plasmacytoid dendritic cell



PEI	polyethylenimine
PI	propidium iodide
PIGF	placental growth factor
polyI:C	polyinosinic:polycytidylic acid
PRR	Pattern Recognition Receptor
PSA	prostate-specific antigen
PSMA	prostate-specific membrane antigen
RAGE	receptor for advanced glycation endproducts
RGD	arginine-glycine-aspartic acid
RNA	ribonucleic acid
ROS	reactive oxygen species
RPMI	Roswell Park Memorial Institute
RT	room temperature
SCID	severe combined immunodeficient
SEM	standard error of the mean
TAA	tumor-associated antigen
TAP	transporters associated with antigen processing
TCR	T cell receptor
TGF	tumor growth factor
Th	T helper
TIM	T-cell immunoglobulin
TLR	Toll-like receptor
TMZ	temozolomide
TNF	tumor necrosis factor
TRAIL	TNF-related apoptosis inducing ligand
Treg	regulatory T cell
TrxR	thioredoxin reductase

UV	ultraviolet
VEGF	vascular-endothelial growth factor
WHO	World Health Organization



# **Introduction**

Dans la vie, rien n'est à craindre, tout est à comprendre.

*Marie Curie*

## Part A: Generalities on cancer

Cancer is a major health problem and can be considered among the leading causes of death worldwide. In France, it is estimated that 382000 patients were diagnosed with cancer in 2018 and that 157400 patients died from the consequences of cancer (source Institut National du Cancer, INCa).

### 1. What is at the origin of cancer development?

The human body is composed of trillions of cells that persist in an equilibrium state. Cells are steadily renewed; they divide and give rise to “new” cells able to replace the “old” ones which in turn undergo cell death. However, unfortunately, this tightly regulated homeostasis can be disrupted by genetic modifications leading to an uncontrolled cell growth. These genetic changes may have numerous origins. First, some of these mutations can be inherited from parents. Nevertheless, various alterations can also appear throughout a person’s lifetime when errors are incorporated in the genome during cell division as a consequence of different environmental factors (National Cancer Institute, NCI). The rate of spontaneous mutations during cell generation is usually low, due to numerous genome maintenance systems (Hanahan and Weinberg, 2011). However, our genetic information is very sensitive to environmental factors like radiation (UV rays, X rays,...) or chemical substances contained for example in tobacco smoke. Prolonged exposures to these compounds can induce mutations that affect cell division leading to the accumulation of new mutations and the development of a tumor (National Cancer Institute, NCI) (**Figure 1**).

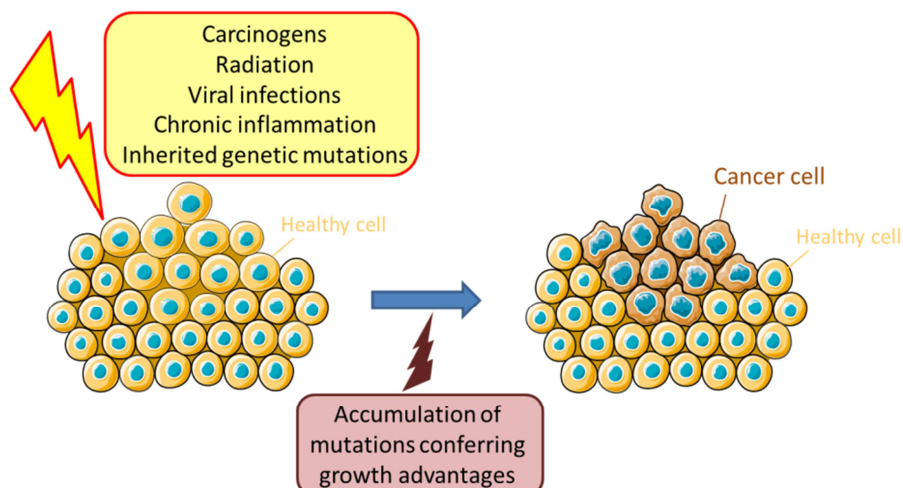
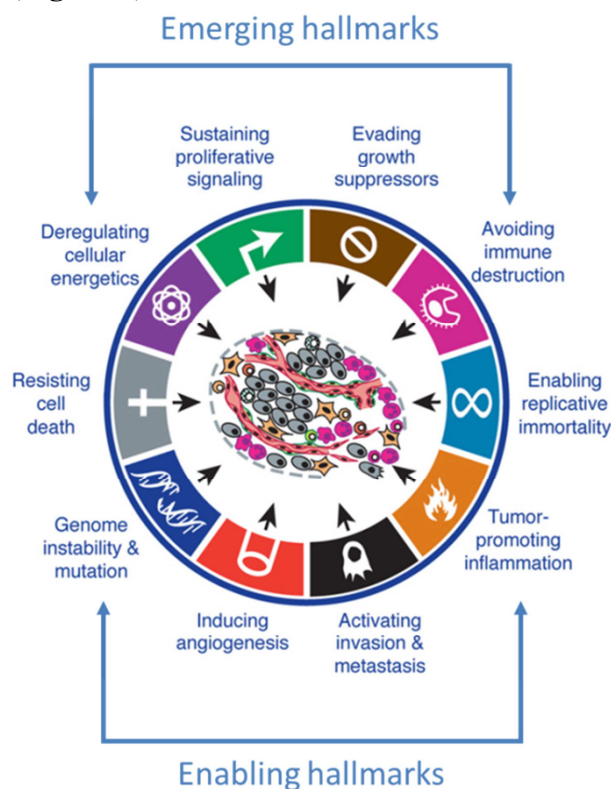

**Figure 1: Tumorigenesis**

Healthy cells are subjected to various environmental stress situations, as carcinogens, radiations, viruses or chronic inflammation, resulting in the modification of their genome in addition to inherited genetic alterations. Throughout time, these cells accumulate mutations, which confer them growth advantages resulting in an uncontrolled proliferation and the development of a tumor.

## 2. What are the hallmarks of cancer?

Tumor cells need to exhibit different features allowing them to further progress and invade healthy organs. In 2000, Hanahan and Weinberg have listed six hallmarks of cancer which enable the cells to become tumorigenic and ultimately malignant. They have to i) present an unlimited proliferative potential, ii) sustain proliferative signaling, iii) evade growth suppressors, iv) escape apoptosis, v) induce angiogenesis and vi) activate tissue invasion and metastasis (Blandin et al., 2015; Hanahan and Weinberg, 2000). However, the research in cancer has much progressed over the last years. That is why, in 2011, Hanahan and Weinberg published an updated version of the hallmarks of cancer. They added two enabling characteristics as well as two emerging features. I) Cancer cells possess a genomic instability which can be at the origin of metabolic deregulations leading to defects in signaling pathways and so, uncontrolled cell proliferation. II) As many tumors are infiltrated by immune cells, the importance of the immune system in cancer progression has become more evident. Nevertheless, its effect varies throughout tumor progression. At the beginning, the immune system tries to protect the organism and to eradicate the tumor cells. However, tumor cells continue accumulating mutations which confer them advantages and thus lead to the development of various mechanisms to circumvent the detection by the immune system. This evasion of the immune surveillance as well as the reprogramming of cellular energetics were revealed as new hallmarks of cancer (Blandin et al., 2015; Hanahan and Weinberg, 2011) (Figure 2).



**Figure 2: Hallmarks of cancer**

(adapted from Hanahan and Weinberg, 2011)

Cancer cells present physiological modifications which enable them to grow and progress in an uncontrolled manner and to form a tumor. This figure summarizes the main hallmarks of tumor cells.

### 3. How can cancer progression be explained?

Recent studies have shown that a tumor cannot be depicted as a homogenous mass of cells, but consists of a complex ecosystem composed of tumor cells as well as several other infiltrating cell types like endothelial, hematopoietic, stromal and immune cells that shape the tumor microenvironment (Kreso and Dick, 2014).

Several models explaining the tumor progression and heterogeneity were proposed (Konrad et al., 2017). On one side, the “**clonal evolution model**” postulates that tumors originate from a single cell which underwent mutations giving them growth advantages over normal cells. The proliferation of this cell results in the development of a bulk of tumor cells that acquire supplementary mutations during divisions. This leads to the generation of new subpopulations which present a selective advantage over healthy cells as well as the initial neoplastic cell and prevent their elimination (Nowell, 1976) (**Figure 3A**). On the other side, the “**cancer stem cell model**” hypothesizes that a tumor is constituted of different types of cancer cell subpopulations (tumorigenic and nontumorigenic) which are hierarchically organized according to their tumorigenic potential (Konrad et al., 2017; Shackleton et al., 2009). Pluripotent and self-renewing cancer stem cells (CSCs) seem to be at the origin of tumor development. These CSCs can undergo asymmetrical division which leads to the generation of i) progenitor cells able to differentiate into non-tumorigenic cancer cells forming the tumor bulk and ii) of additional CSCs which engender new tumors (Bradshaw et al., 2016) (**Figure 3B**).

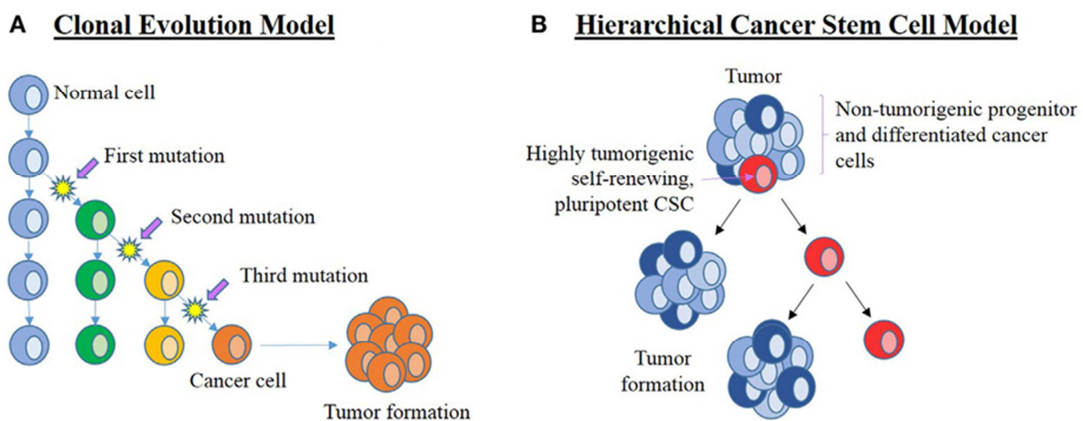

**Figure 3: The different cancer models** (Bradshaw et al., 2016)

**A.** The clonal evolution model postulates that a tumor arises from a normal cell which has undergone several mutations conferring growth advantages over healthy cells. **B.** The cancer stem cell model hypothesizes that a tumor is formed of different subpopulations of cancer cells which are organized hierarchically. Cancer stem cells which are pluripotent and experience asymmetrical cell divisions can engender new tumors.



## **4. What are the different treatments against cancer?**

### **4.1. Conventional therapies**

Different therapies can be considered to treat cancer, depending on the cancer type, the localization and the progression state.

#### **4.1.1. Surgery**

Surgery consists in the removal of a solid tumor that is contained in one area (Damyanov et al., 2018). However, this therapy is only local and cannot be applied for targeting metastasis. It is often associated with chemotherapy, radiotherapy and recently immunotherapy to ensure the eradication of circulating tumor cells (NCI).

#### **4.1.2. Radiation therapy or radiotherapy**

Radiotherapy uses high doses of ionizing radiations to damage the DNA of cancer cells (Damyanov et al., 2018). The radiations induce mutations which cannot be repaired by the cell repair machinery and thus lead to apoptosis. This treatment is mainly regional and applied for solid tumors. It can be associated with other therapies, like surgery, chemotherapy or immunotherapy. Unfortunately, the radiations can be harmful for healthy cells surrounding the irradiated area (NCI).

#### **4.1.3. Chemotherapy**

Chemotherapy consists in the administration of drugs in order to kill or inhibit proliferation of the cancer cells (Damyanov et al., 2018). Several classes of chemotherapeutic agents exist (cf Introduction §B.1.); even if they do not present exactly the same mechanism of action, they mainly affect dividing cells and induce their cell death by interfering with DNA replication. Chemotherapy can be applied alone or in association with other treatments, like surgery, radiation or immunotherapy. It does not only target tumor cells (as part of a tumor bulk or circulating tumor cells), but can also have deleterious effects on quickly dividing healthy cells (cells of the bone marrow, hair follicles) (NCI).

### **4.2. Other therapies**

#### **4.2.1. Hormonotherapy**

This therapy is applied to treat cancers whose development is dependent on hormones (e.g. breast cancer or prostate cancer). It can act by two different mechanisms: i) by blocking the hormonal production of the patient or ii) by interfering with hormones already secreted and thus limiting their effect in order to slow down the progression of the tumor cells dependent on these hormones (NCI).

#### 4.2.2. Stem cell transplant

Various malignancies implicating blood cells (leukemia, lymphoma, myeloma) need high doses of chemotherapy and radiotherapy to efficiently kill the cancer cells. In order to restore the blood cells, stem cells are injected to the patients. These pluripotent cells will translocate to the bone marrow and develop into blood cells (erythrocytes, leukocytes, thrombocytes) (NCI; Canadian Cancer Society).

#### 4.2.3. Immunotherapy

Immunotherapy implicates the immune system of the patient to fight against the tumor cells and to kill them. This can be achieved by various strategies like for example i) the administration of tumor-specific antibodies targeting antigens expressed by the cancer cells in order to induce their lysis by the immune system, ii) modulation of the immune landscape to favor an effector immune response by inhibiting immune checkpoints or iii) injection of cancer vaccines priming the antitumor immune response (cf Introduction §C.7.). At the beginning, immunotherapy was principally proposed as supplementary treatment to conventional therapies, like surgery, chemotherapy or radiotherapy. However, over the last years, much progress has been done in the development of immunotherapy, so that nowadays, immunotherapy can also be administered as monotherapy (NCI).

### 5. Towards the development of a new therapy: precision medicine

Everybody knows that patients suffering from the same type of cancer respond in a different manner to the applied treatment. So, the goal of precision medicine is to develop a personalized therapy adapted to each patient. For this, a sample of the patient's tumor, called biopsy, is removed and its genome is sequenced in order to identify the genetic alterations at the origin of neoplasia. This way, a treatment specifically targeting the patient's tumor cells can be developed. This can for example be achieved by the administration of antibodies targeting antigens expressed at the cells' surface (immunotherapy).

### 6. The need of new anticancer agents

Chemotherapy is one of the most common therapies used to treat cancer: it accounts for 40.8% of oncological hospital activity in France (InCa).

Nonetheless, despite its high efficacy, it presents various side effects. The major drawback of the chemotherapeutic agents consists in their lack of specificity. Most of the compounds do not target specifically the cancer cells, but affect all the fast-growing healthy cells with high

nutrition requirements, like for example cells of bone marrow, hair follicles, and mucous membranes (Ma et al., 2019). However, the action of the anticancer drugs can be limited by resistance mechanisms of the tumor cells. In fact, some cancer cells are able to adapt their metabolism in order to circumvent the effect of the chemotherapeutic agents and prevent cell death (cf Introduction §B.2.3.1.). Furthermore, a tumor is a heterogenous mass, composed of numerous cell types. A subpopulation of chemo-resistant cells has gained increasing attention over the last years: the **cancer stem cells**. These cells are very perfidious, as they seem to be invulnerable and responsible for tumor relapse.

Taken together, these considerations highlight that, despite numerous efforts and progress over the last years, the development of new antitumor treatments remains still a big challenge.

That is why, during my thesis, I focused on the development of new compounds able to circumvent all these difficulties and to eradicate efficiently the cancer cells without any side effects on healthy cells. For this, I first evaluated the cytotoxic effect of several candidate compounds in order to identify a promising agent showing a high efficacy, but with few adverse effects. Then, I assessed the impact of this agent on the cancer stem cells, which are resistant to a numerous therapies. Finally, I was wondering if this compound was able to boost the immune system to fight against the cancer cells and if this effect could even be enhanced.

## Part B: Chemotherapy

In 2018, chemotherapy accounted for 40.8% of oncology hospital activity in France (INCa). This treatment consists in the use of cytotoxic drugs to kill cancer cells by stopping or slowing down their growth (NCI). That is why these compounds mainly target cells in division. According to *Vidal*, these antineoplastic agents can be classified in different categories (**Figure 4**).

### 1. Different chemotherapeutic agents

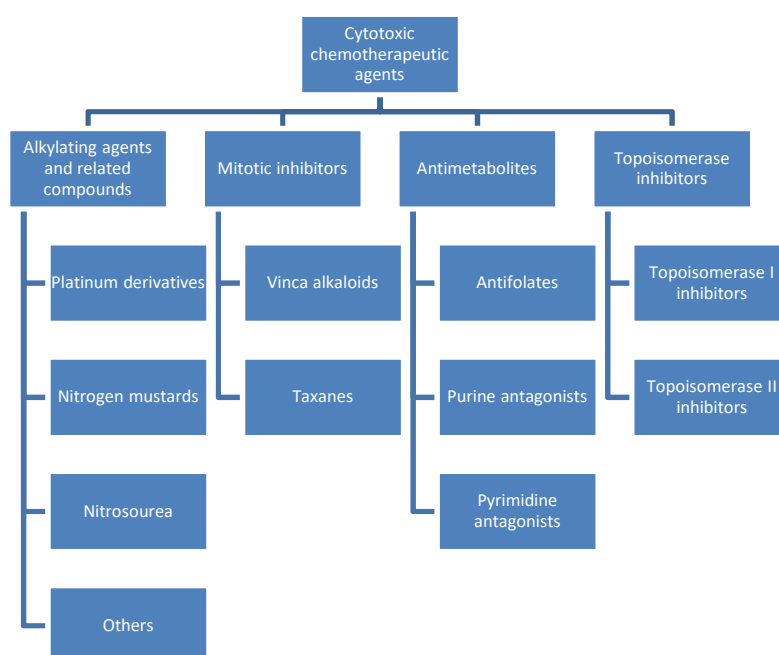

**Figure 4: Classification of chemotherapeutic agents** (according to Vidal)

#### 1.1. Alkylating agents and related compounds

These very reactive compounds represent the oldest class of anticancer agents (Puyo et al., 2014). They are able to interfere with the cell replication machinery. For this, they react with the nucleophilic moieties of DNA or proteins which results in the covalent transfer of an alkyl group (Puyo et al., 2014). However, their action is not specific, as the DNA modifications affect all the cells, especially the cells with a high division rate. This class is not only constituted of alkylating agents like Trabectedin, Temozolomide and mitomycins, but also comprises platinum derivatives, nitrogen mustards and nitrosourea. The alkylating agents, nitrogen mustards and nitrosourea damage DNA by targeting the N7 atom of the purine ring of guanine by attaching an alkyl group, while platinum derivatives create cross-links, called adducts, between DNA strands (Espinosa et al., 2003) (**Figure 5**). Alkylating agents mainly induce apoptosis, but some compounds also favour other types of cell death, like necrosis, autophagy or senescence (temozolomide) (Pawlowska et al., 2018; Ricci, 2006).

### 1.2. Mitotic inhibitors

The uncontrolled cell proliferation is considered as one of the hallmarks of cancer (Hanahan and Weinberg, 2000, 2011). That is why, drugs targeting the mitosis have been developed. They can be divided in two main categories with different mechanisms of action: the vinca alkaloids and the taxanes (for example Paclitaxel). The vinca alkaloids bind tubulin and prevent polymerization of microtubules, thus acting as microtubule destabilizers, while taxanes are microtubule stabilizers and stop their depolymerization (Penna et al., 2017) (**Figure 5**).

### 1.3. Antimetabolites

This category of chemotherapeutic agents regroups molecules resembling nucleotide metabolites which impede the activity of enzymes involved in nucleotide base synthesis thus affecting the DNA replication (Luengo et al., 2017). One can for example distinguish between antifolates, pyrimidine and purine antagonists, pyrimidine and purine analogues and ribonucleotide reductase inhibitors (**Figure 5**).

### 1.4. Topoisomerase inhibitors

The topoisomerase inhibitors block the topoisomerases, the enzymes implicated in the winding of DNA. This blockade results in the formation of single- or double-stranded DNA breaks and thus the induction of apoptosis (Liang et al., 2019). They do not directly interact with DNA, but target protein-DNA complexes (Espinosa et al., 2003). One can distinguish between topoisomerase I inhibitors (camptothecine derivatives, introducing double-strand breaks) and topoisomerase II inhibitors (anthracyclines and derivatives, intercalating DNA) (Dezhenkova et al., 2014) (**Figure 5**).

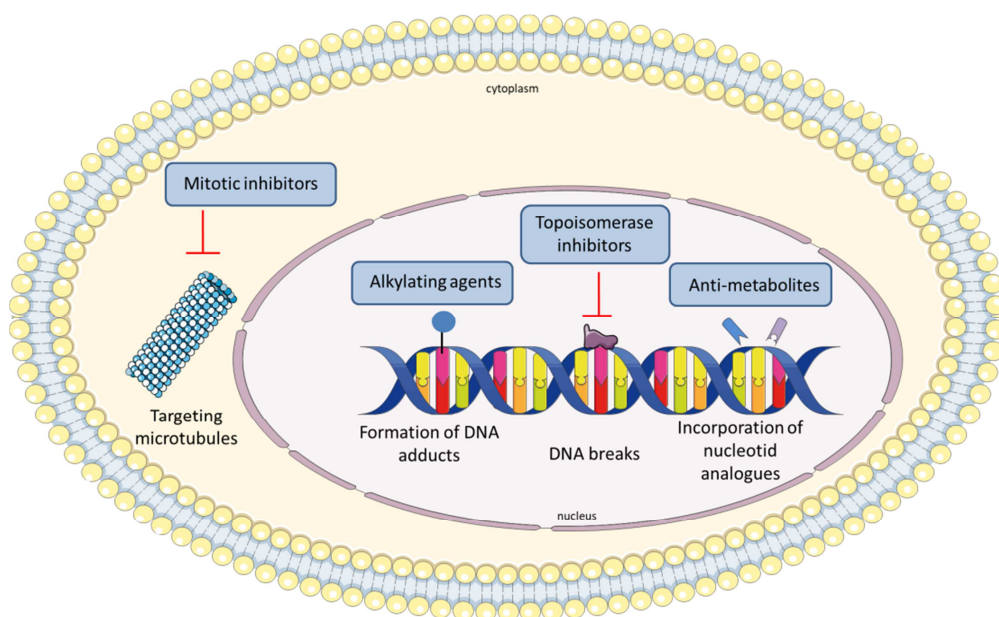

**Figure 5: Summary of chemotherapeutic agents and their mechanism of action.**

## 2. Platinum compounds, the most common chemotherapeutic agents

In more than 50% of the chemotherapeutic treatments, a platinum-based compound is administered (Gibson, 2019). Platinum exists in two different oxidation states: platinum(II) and platinum(IV). The platinum-based compounds approved by the Food and Drug Administration (FDA) are platinum(II) derivatives.

### 2.1. Cisplatin, a surprising discovery

In 1844, the Italian chemist Michele Peyrone synthesized for the first time a platinum compound, called Peyrone's chloride (Kauffman et al., 2010; Peyrone, 1844), whose structure was elucidated by the Swiss Alfred Werner in the 1893 (Dasari and Bernard Tchounwou, 2014; Kauffman et al., 2010; Werner, 1893). The anti-cancer effect of this platinum coordination complex, known nowadays as cis-diamminedichloroplatinum (II) or as cisplatin (**Figure 6**), was discovered by serendipity in 1965. In fact, Barnett Rosenberg wanted to study the effect of an electric field on the growth processes in the bacteria *Escherichia coli*. It appeared that the platinum electrodes used for the experiment underwent corrosion and released a platinum compound responsible for the inhibition of the bacteria: cisplatin (Rosenberg et al., 1965). After this observation, Rosenberg also showed that cisplatin had an antitumor activity in various mouse models, for example in mice suffering from sarcoma or leukemia (Rosenberg et al., 1969). In 1978, the FDA approved cisplatin as the first platinum-based anticancer treatment for testicular, ovarian, bladder, melanoma, non-small cell lung cancer, lymphomas and myelomas cancer (Ghosh, 2019; Kelland, 2007). However, transplatin

(**Figure 6**), the isomer of cisplatin, lacks antitumor activity (Dilruba and Kalayda, 2016). This is mainly due to i) the deactivation of transplatin because of a kinetic instability and ii) the formation of DNA adducts with a regioselectivity and stereochemistry different from those of its cis analogue (Coluccia and Natile, 2007).

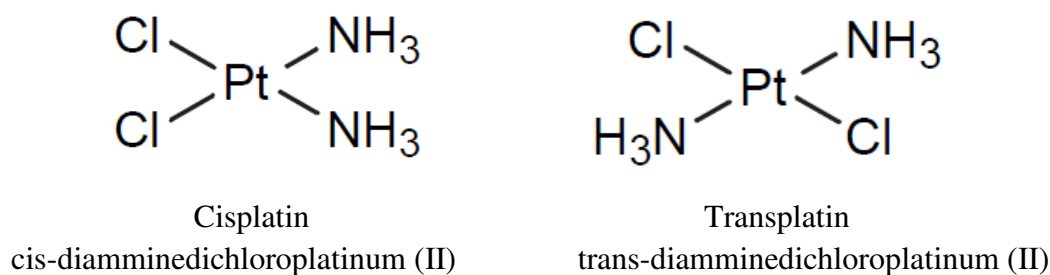

**Figure 6: Structure of Cisplatin and Transplatin** (Alderden et al., 2006)

### 2.1.1. Cisplatin and its mechanism of action

Many studies were interested in elucidating the mechanism of action of cisplatin (**Figure 7**). However, there still remain some dark sides. It seems that cisplatin, constituted of a central platinum atom coordinated with two chlorides and two ammonia molecules in a cis configuration, is prone to interactions with other chemical compounds (nucleophilic substitutions). That is why, once in solution, different neutral and positively charged “aquated” species of cisplatin co-exist in equilibrium, a process dependent on the pH, temperature and especially chloride concentration (Martinho et al., 2019). When cisplatin is injected intravenously in the patients, it remains neutral, as the chloride concentration of the blood is relatively high (approximately 100 mM) (Ghosh, 2019). This platinum compound will then be transported by the bloodstream to the cancer cells where it can enter the cells either *via* passive diffusion or *via* an active mechanism of entry through particular organic transporters, like copper transporters (CTR1) (Ghosh, 2019; Martinho et al., 2019). The decrease of the chloride concentration within the cell (approximately 4-20 mM in the cytoplasm), leads to hydrolysis of cisplatin resulting in a very active platinum compound able to interact with different components and to enter the nucleus to bind to DNA (Dilruba and Kalayda, 2016; Ghosh, 2019).

Even if cisplatin mainly targets nucleic acids, it can also interact with other cell components.



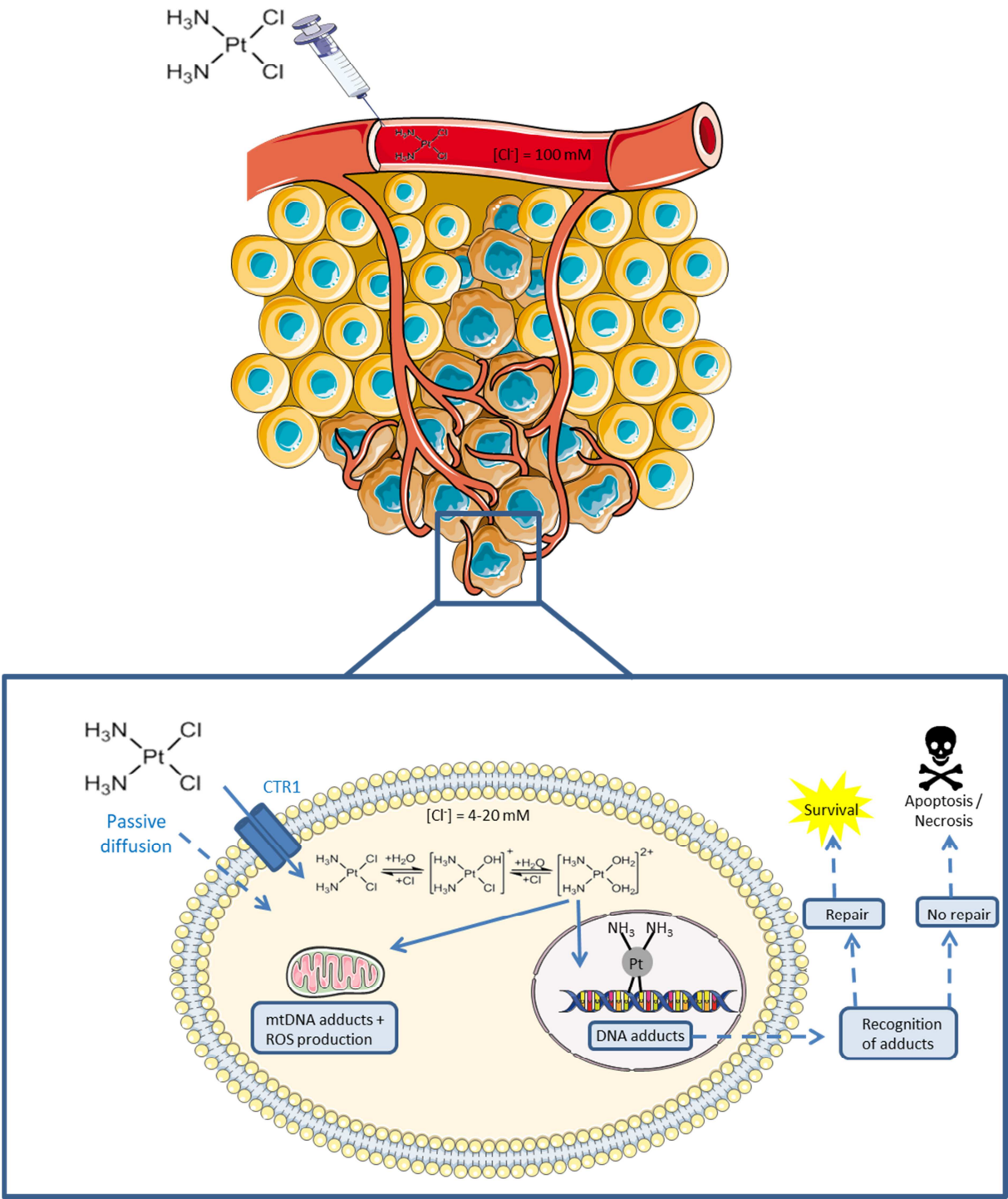

**Figure 7: The mechanism of action of cisplatin**

After an intravenous injection, cisplatin remains neutral in the blood and travels through the bloodstream towards the tumor cells. It can enter these cells either *via* passive diffusion or *via* active transport using the copper transporter CTR1. In the cytoplasm, cisplatin undergoes “aquation” process to become a highly reactive compound that can enter the nucleus and form DNA adducts leading to a distortion of the double helix and thus interfering with replication and inducing cell death. However, it can also target the mitochondria by inducing the production of reactive oxygen species (ROS) (Brozovic et al., 2010).



### a) Interaction with nucleic acids

This activated form of cisplatin preferentially attacks the N7 position of the imidazole ring of guanine bases creating inter- or intrastrand crosslinks between two adjacent guanines (**Figure 8**) (Dilruba and Kalayda, 2016; Ghosh, 2019). However, at a lower extent, it can eventually target the N7 position of adenines, but not the cytosines or thymines (Ghosh, 2019).

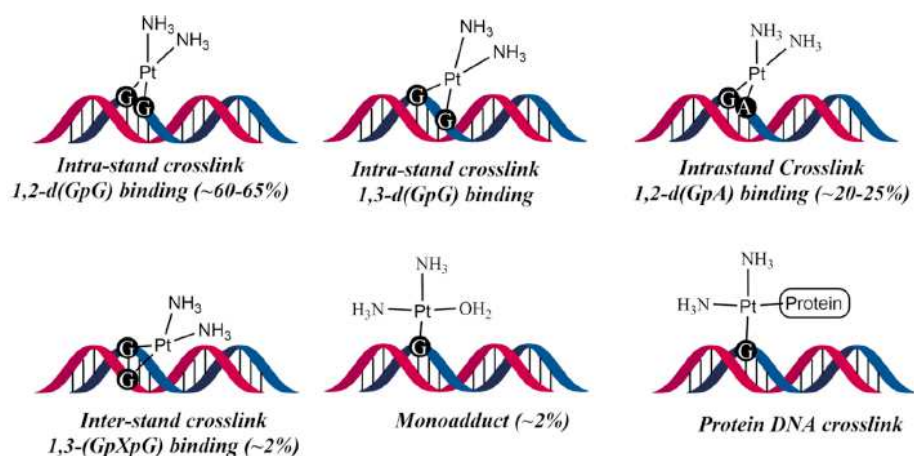
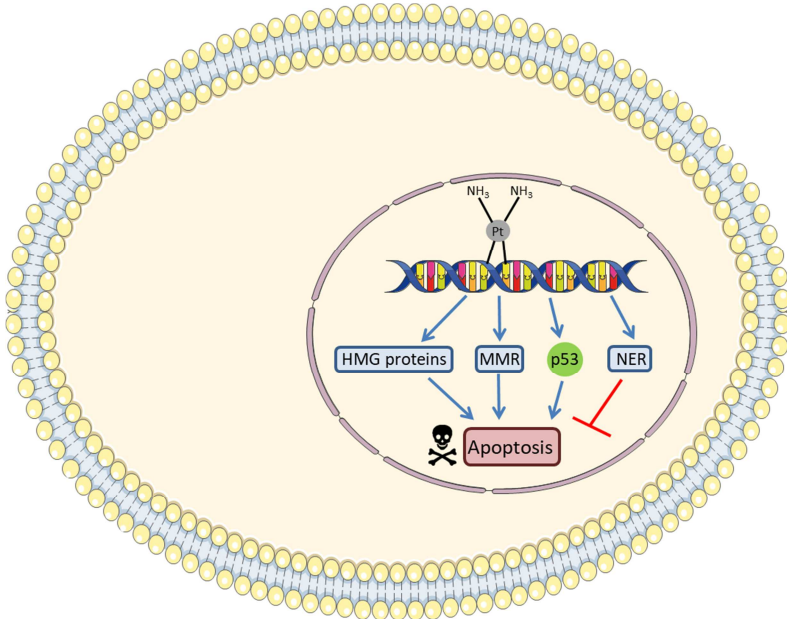

**Figure 8: Different types of DNA adducts formed by cisplatin** (Ghosh, 2019)

Cisplatin mainly targets the N7 position of guanine bases leading to the formation of either inter- or intrastrand DNA crosslinks.

The resulting distortion of DNA will be considered as a lesion and recognized by some proteins inducing cell cycle arrest mainly in the G2/M checkpoint before repairing, replication bypass or apoptosis (Dilruba and Kalayda, 2016; Ferreira et al., 2016). This involves the non-histone chromosomal high-mobility group proteins 1 and 2 (HMG1 and HMG2) as well as the proteins of the nucleotide excision (NER) and the mismatch repair (MMR) (**Figure 9**) (Dilruba and Kalayda, 2016). Intrastrand crosslinks between adjacent guanines can be recognized by HMG1 and HMG2 which prevent the Pt-DNA adducts from repair and this way induce apoptosis of the cell (Brown et al., 1993; Dilruba and Kalayda, 2016). Furthermore, the mispairings caused by the platinum adducts can be bound by the mismatch repair protein complex. This mechanism tries to input correct nucleotides on the non-damaged DNA strand. However, as the initial lesion is not removed, this results in futile replication/repair cycles leading to cell death (Dilruba and Kalayda, 2016; Ghosh, 2019; Vaisman et al., 1998). Furthermore, the tumor suppressor protein p53 can also detect Pt-DNA adducts and induce apoptosis (Ghosh, 2019). Finally, the NER consisting in the removal of

the damaged nucleotides on both strands followed by the reconstitution of the nucleotide sequence prevents apoptosis and thus leads to resistances (Ghosh, 2019). Over the last years, a possible implication of another protein family, the poly(ADP-ribosyl)ated proteins (PARP), was suggested (Michels et al., 2013). In fact, it was proposed that the co-administration of cisplatin and PARP inhibitors might improve the activity of cisplatin and limit some side effects of cisplatin, like for example neurotoxicity (McQuade et al., 2018; Michels et al., 2013).

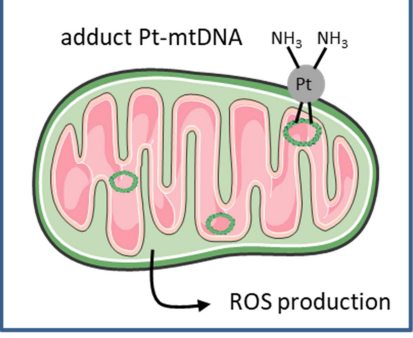

**Figure 9: Summary of the proteins and complexes involved in the recognition of Pt-DNA adducts** (reproduced from Dilruba and Kalayda, 2016)

Pt-DNA adducts can be recognized by HMG proteins, by the proteins from the mismatch repair complex (MMR) or by the tumor suppressor p53. These proteins lead to cell cycle arrest and then to the induction of apoptosis. However, when the Pt-DNA adduct is recognized by proteins of the nucleotide excision repair (NER), the damaged nucleotide is removed and replaced by a new one which prevents apoptosis of the cancer cells.

*b) Effect on mitochondrial activity* (Figure 10)

Cisplatin could also affect the mitochondrial functioning. Besides binding to genomic DNA, this platinum compound could target mitochondrial DNA (mtDNA) and form Pt-mtDNA adducts (Yang et al., 2006). Moreover, the induction of oxidative stress and thus the formation of reactive oxygen species (ROS) by cisplatin has been suggested, leading to an alteration of the mitochondrial respiratory activity and this way to cell death (Brozovic et al., 2010).



**Figure 10: Effect of cisplatin on mitochondrial activity**

*c) Interaction with cell membrane phospholipids*

It has appeared that cisplatin is also able to bind to cell membrane lipids, but at a lower magnitude compared to the interaction with proteins (Martinho et al., 2019; Wang et al., 1996). Even if the data found in literature are quite controversial, it seems that the binding of cisplatin to phospholipids could modify the biophysical properties of the cell membrane and increase its fluidity, which in turn might influence the clustering of death receptors and the induction of apoptosis (Martinho et al., 2019).

*d) Interaction with proteins*

Some research works describe the interaction of cisplatin with proteins. This already happens in the bloodstream where the compound encounters proteins before reaching the tumor cells. Thus, cisplatin interacts with thiol-containing proteins, like albumin and transferrin, or with the amino acid cysteine leading to a partial deactivation of the drug (Alderden et al., 2006; Ghosh, 2019). This process does not induce apoptosis, but limits the cytotoxic effect of platinum by reducing the concentration of the platinum compound entering the cancer cells and thus leading to resistances as described below in § B.2.3.1. (Dilruba and Kalayda, 2016; Ghosh, 2019).

**2.2. Towards new platinum (II)-based compounds**

However, even if the discovery of cisplatin as chemotherapeutic agent was a milestone in the development of cancer treatments, it appeared that this drug had numerous side effects. In fact, the compound does not specifically target cancer cells, but affects most of the cells that undergo division. Furthermore, platinum-based treatments are often associated with intrinsic or acquired cell resistances (for more details on platinum-induced resistances, see below §B.2.3.1).

That is why many research groups have accepted the challenge to develop thousands of platinum (II) complexes during the last years and to screen them for their antitumor activity (Gibson, 2019).

### 2.2.1. Second-generation platinum(II) compounds

In order to overcome the resistance of some cancer cells towards cisplatin, to broaden the types of cancer targeted and to reduce the dose-limiting toxicity, researchers have developed hundreds of new platinum compounds since the approval of cisplatin as anticancer agent (Boulikas et al., 2007; Dilruba and Kalayda, 2016). A new platinum derivative with a cyclobutane moiety arose from their efforts: cis-diammine(1,1-cyclobutane dicarboxylato)platinum(II), known as carboplatin (**Figure 11**). This compound, approved worldwide in 1989, contains a bidentate dicarboxylate ligand instead of the two chloride ligands resulting in a reduced aquation rate and this way also a decreased toxicity profile (Dasari and Bernard Tchounwou, 2014; Dilruba and Kalayda, 2016). A slower reaction with glutathione and metallothioneins helps to circumvent some resistances observed for cisplatin and enables a higher platinum concentration in the cell nucleus (Boulikas et al., 2007). Its mechanism of action is similar to that of cisplatin. Even if its efficacy is diminished compared to cisplatin for the treatment of germ cell cancers, head and neck cancers and bladder and esophageal carcinomas, carboplatin is often prescribed in combination with paclitaxel, a mitotic agent interacting with the microtubules and thus inhibiting cell division, for the treatment of ovarian cancer (Boulikas et al., 2007; Dasari and Bernard Tchounwou, 2014; Dilruba and Kalayda, 2016). Myelosuppression remains an important side effect of carboplatin, limiting the dose administered (Dilruba and Kalayda, 2016).

Nedaplatin (cis-diammineglycolatoplatinum(II)) (**Figure 11**) is another second-generation platinum drug which has been locally approved in Japan in 1995 for the treatment of small cell lung cancer, non-small cell lung cancer, head and neck and esophageal cancer (Dilruba and Kalayda, 2016; Ghosh, 2019).

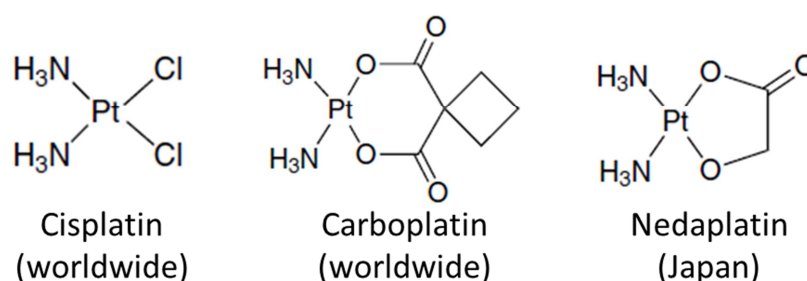
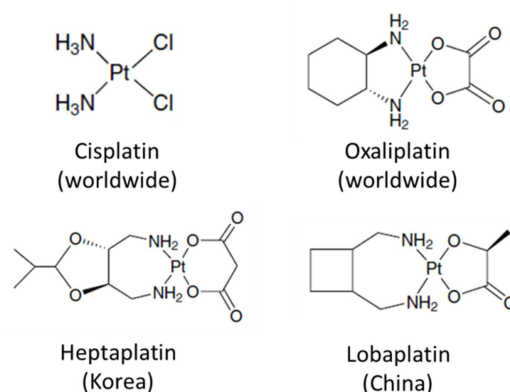

**Figure 11: Structures of second-generation platinum compounds**  
 (adapted from Dilruba and Kalayda, 2016)

### 2.2.2. Third-generation platinum (II) compounds

The researchers continued the development of platinum-based compounds in order to circumvent the resistances against cisplatin and carboplatin. These efforts lead in 2002 to the worldwide approval of the third-generation platinum drug trans-R,R-1,2-diaminocyclohexane oxalate platinum(II), known as oxaliplatin for the treatment of colon cancer (**Figure 12**) (Boulikas et al., 2007; Dilruba and Kalayda, 2016). Compared to cisplatin, the chloride leaving group is replaced by dicarboxylate and the ammonia carrier ligand by 1,2-diamminocyclohexane (Ghosh, 2019). This leaving group significantly reduces the reactivity of the compound, limiting this way the side effects, while the carrier ligand enables a higher penetration of the compound through the cell membrane due to an increased lipophilicity (Dilruba and Kalayda, 2016; Ghosh, 2019). However, in addition to passive diffusion, transmembrane transporters might also be involved in the mechanism of entry of oxaliplatin in the cell: the organic cation transporters OCT1 and OCT2. In fact, it has been shown that their overexpression correlates with an increased accumulation of oxaliplatin within the cells (Dilruba and Kalayda, 2016). The copper transporter CTR1, implicated in the mechanism of entry of cisplatin, does not seem to transport oxaliplatin (Lai et al., 2018). Oxaliplatin, like cisplatin and carboplatin, interacts with guanine and adenine creating intra- and interstrand crosslinks (Boulikas et al., 2007). However, it seems that the antitumor activity of oxaliplatin is MMR-independent. The Pt-DNA adducts generated by oxaliplatin are bulkier than those formed by cisplatin and carboplatin, which makes their recognition by MMR proteins more difficult, but does not decrease their cytotoxicity (Dilruba and Kalayda, 2016).

Two other third-generation platinum drugs have been approved regionally. In Korea, Heptaplatin (**Figure 12**) is used since 1999 for the treatment of advanced gastric cancer, while Lobaplatin (**Figure 12**) is used in China since 2010 for the treatment of chronic myelogenous leukemia, small cell lung cancer and inoperable metastatic breast cancer (Ghosh, 2019).



**Figure 12: Structures of third-generation platinum compounds**

(adapted from Dilruba and Kalayda, 2016)

**Table 1: Worldwide approved platinum compounds**

This table summarizes the worldwide available platinum-based chemotherapeutic agents and their applications.

Platinum derivative	Cancer
Cisplatin	Endometrial cancer, esophageal cancer, ovarian cancer, bladder cancer, cervical cancer, testicular cancer, squamous cell carcinoma, head and neck cancer
Carboplatin	Small cell lung cancer, ovarian cancer, head and neck cancer
Oxaliplatin	Colorectal cancer

### 2.2.3. Attempts to vectorise cisplatin

The commercially available platinum drugs present some limitations: side effects on healthy cells, resistances (described below §2.3.1.), low bioavailability and low water solubility. One of the main problems consists in their passive diffusion through the membranes due to their low molecular weight affecting this way not only tumor, but also healthy cells. However, it seems that malignant tissues display an increased permeability and poor lymphatic clearance, known as increased permeability and retention effect (EPR). That is why, several research groups have focused on the carrier-delivery of platinum compounds by creating macromolecules that will preferentially accumulate in malignant tissues (Dilruba and Kalayda, 2016). So, different conjugates have been synthesized: liposomal formulations of platinum drugs, platinum-polymer conjugates, platinum coupled to dendrimers, platinum in nanotubes or in polymer micelles (Dilruba and Kalayda, 2016). Some of them already started clinical trials. The results obtained with these compounds are summarized in **Table 2**.

**Table 2: Different platinum-based conjugates**

This table summarizes various platinum conjugates, their name, the platinum drug contained within the compound as well as the phase of clinical trial.

Formulation	Name	Pt drug	Human clinical trial	Cancer types	References
Liposomal formulations	Lipoplatin	cisplatin	Phase III finished	NSCLC, Pancreatic cancer	Dilruba and Kalayda, 2016; Hang et al., 2016
	SPI-077	cisplatin	Phase II but discontinued due to low therapeutic efficacy	Ovarian cancer, lung cancer	Dilruba and Kalayda, 2016; Hang et al., 2016
	Aroplatin	structural analog of oxaliplatin	Phase II completed	Colorectal cancer, Esophageal cancer	Dilruba and Kalayda, 2016; Hang et al., 2016
	Lipoxal	oxaliplatin	Phase II	Gastrointestinal cancer	Dilruba and Kalayda, 2016; Hang et al., 2016
	LiPlaCis	cisplatin	Phase I but stopped, because of severe renal toxicity	Breast cancer, melanoma	Bulbake et al., 2017; Hang et al., 2016
	MBP-426	oxaliplatin	Phase II ongoing	Esophageal cancer	Hang et al., 2016
Platinum complexes in polymer micelles	Nanoplatin or NC-6004	cisplatin	Phase I ongoing	Pancreatic cancer, Head and neck cancer	Dilruba and Kalayda, 2016; Hang et al., 2016
	NC-4016	DACH-Pt	Phase I ongoing	Lymphoma, Solid tumors	Hang et al., 2016
Platinum-polymer conjugates	ProLindac or AP5346	DACH-Pt	Phase II discontinued	Head and neck cancer	Dilruba and Kalayda, 2016
	AP5280	cisplatin	Phase I/II discontinued	Solid tumors	Dilruba and Kalayda, 2016

DACH: diaminocyclohexane; NSCLC: non-small cell lung cancer

#### 2.2.4. The emergence of N-heterocyclic carbene-metal complexes

At the end of the 20<sup>th</sup> century, a special class of carbon-containing compounds gained attention: the N-heterocyclic carbenes (**Figure 13**). These compounds, first described in the 1960s by Wanzlick, are defined as a divalent carbon atom with a six-electron valence shell included in a ring structure containing at least one nitrogen atom (César and Bellemin-Laponnaz, 2009; Hopkinson et al., 2014; Wanzlick, 1962). In 1968, the German scientists Wanzlick and Öfele reported independently the synthesis of stable N-heterocyclic-metal



complexes (César and Bellemin-Lapponnaz, 2009; Öfele, 1968; Wanzlick and Schönherr, 1968). Since then, the interest in these complexes has grown and they have found many applications in organometallic chemistry (Gautier and Cisnetti, 2012). Recently, it appeared that these highly  $\sigma$ -donating ligands forming stable transition metal complexes could be of interest for biological applications (Merces and Albrecht, 2010). In fact, it has been shown that some NHC-metal complexes present anti-infective, antimicrobial or antitumor activities (Merces and Albrecht, 2010; Oehninger et al., 2013). In this work, I will only focus on the antitumor properties of NHC-metal compounds that have been developed during the last years. The team of Berners-Price was one of the first groups investigating the antitumor effects of NHC-gold complexes (Barnard et al., 2004; Zou et al., 2018). Their promising results encouraged numerous other teams to develop NHC-metal complexes containing for example platinum, palladium, silver or copper (**Table 3**). It appears that coinage metals, like gold and silver, are widely explored, as they seem to be less harmful to the human body compared to other transition metals (Mora et al., 2019). The mechanism of action and the cytotoxicity profile of the different compounds are dependent on the nature of the metal as well as on the chemical groups contained in the complexes (Teyssot et al., 2009).

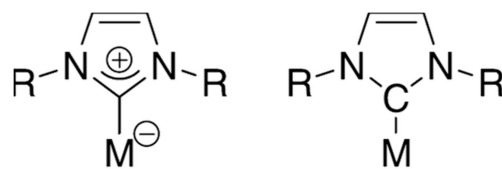

**Figure 13: Structural representation of carbene-metal bond in N-heterocyclic carbenes.**

The representation on the left is only rarely used, even if it contains the most information. The structure on the right is often used for simplicity. (adapted from César and Bellemin, 2009)



**Table 3: N-heterocyclic carbene-metal complexes evaluated for their antitumor activities**

This table summarizes various NHC-metal complexes and their mechanism of action (this list is not exhaustive).

Metal	Compound	Mechanism of action	References
Platinum	NHC-Pt(II)	more stable against reduction by glutathione; some complexes locate preferentially in the mitochondria and promote cell death while others cause endoplasmic reticulum (ER)-stress or target DNA and induce cell cycle arrest	Chekkat et al., 2016; Liu and Gust, 2016; Oehninger et al., 2013; Zou et al., 2018
	NHC-Pt(IV)	induction of oxidative stress in mitochondria; induction of apoptosis by activation of the mitochondrial pathway	Bouché et al., 2018
Silver	NHC-Ag(I)	some compounds seem to induce cell death by targeting thioredoxin reductase (TrxR); various complexes are described to interact with DNA, while others promote apoptotic cell death or cell cycle arrest by targeting the mitochondria and interfering with cellular respiration and metabolism	Johnson et al., 2017; Liu and Gust, 2016; Oehninger et al., 2013
Gold	NHC-Au(I)	several hypotheses for mechanism of action, but inhibition of enzymes containing thiols (TrxR, glutathione reductase, glutathione-S-transferase, poly[ADP-ribose]polymerase I, aquaglyceroporin-3 and cysteine protease) plays an important role; some compounds show a selectivity towards mitochondrial selenoproteins, affecting the mitochondrial activity	Liu and Gust, 2016; Mora et al., 2019; Oehninger et al., 2013; Porchia et al., 2018; Zou et al., 2018
	NHC-Au(III)	intercalation into DNA; inhibition of DNA relaxation activity of DNA topoisomerase I	Zou et al., 2018

Palladium	NHC-Pd(II)	inhibition of EGFR signalling pathway and promotion of apoptosis some complexes can be found in the ER and cause ER-stress several compounds can induce cell cycle arrest while others promote immunogenic cell death	Oehninger et al., 2013; Zou et al., 2018
Copper	NHC-Cu(I)	some compounds target the ubiquitin-proteasome degradation pathway possible induction of ROS formation, cell cycle arrest and apoptosis	Liu and Gust, 2016; Oehninger et al., 2013
Ruthenium	NHC-Ru(II)	several complexes interact with DNA and induce cell cycle arrest, while others target enzymes containing thiols (for example TrxR) or various non-enzymatic biomolecules	Aher et al., 2014; Liu and Gust, 2016
Rhodium	NHC-Rh(I)	inhibition of DNA replication, alteration of cell migration and promotion of DNA condensation	Liu and Gust, 2016
Nickel	NHC-Ni	only some compounds with low cytotoxic activity were developed and the mechanism of action was not studied in detail	Liu and Gust, 2013
Mercury	NHC-Hg	some complexes promote the inhibition of tubulin polymerization	Liu and Gust, 2016
Iridium	NHC-Ir(III)	mitochondrial dysfunction (induction of ROS production, cytochrome c release, caspase activation, apoptosis)	Liu and Gust, 2016

ER: endoplasmic reticulum; EGFR: epidermal growth factor receptor; TrxR: thioredoxin reductase

### 2.2.5. Platinum (IV) compounds

Recently, conjugates with a platinum (IV) atom in the center have gained attention to improve the pharmacological properties of platinum (II) compounds (Dilruba and Kalayda, 2016). These derivatives appear to be more resistant and inert to substitution, which seems to prevent the occurrence of some side effects and resistances. Their bioavailability is increased due to a limited interaction with proteins in the bloodstream (Dilruba and Kalayda, 2016). They act as prodrugs, because they are metabolized once they enter the cell leading to their activation (Lazarević et al., 2017). This process, likely to implicate glutathione and ascorbate, is believed to happen by reduction of the platinum (IV) complexes to active square planar platinum (II) drugs (Ghosh, 2019; Gibson, 2019). Platinum (II)-based drugs are commonly injected intravenously. However, due to their increased stability, the platinum (IV) prodrugs could even be administered orally (Dilruba and Kalayda, 2016; Gibson, 2019). Several Pt(IV) prodrugs have entered clinical trials and Satraplatin is the first lipophilic platinum (IV) drug that completed phase III clinical trials by oral administration for the treatment of hormone-refractory prostate cancer (**Figure 14**) (Dilruba and Kalayda, 2016; Ghosh, 2019; Sternberg et al., 2005).

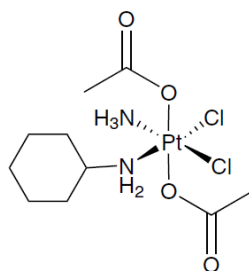

**Figure 14: Structure of the platinum(IV)-based compound Satraplatin**

(adapted from Dilruba and Kalayda, 2016)

As NHC-Pt(II) compounds showed an increased stability against oxidizing and acidic media, some research teams (Belyaev, Beck, Steinborn, Puddephatt) have reported NHC-Pt(IV) derivatives (Meyer et al., 2010). However, the biological activities and especially the antitumor potential of these conjugates have barely been investigated. So, Stéphane Bellemin-Laponnaz' team, in collaboration with my host laboratory, developed different NHC-Pt(IV) complexes that showed promising cytotoxic activities *in vitro* against several cancer cell lines (Bouché et al., 2016, 2018). Furthermore, during my Master 2 internship, I demonstrated that these compounds altered the mitochondrial function by inducing the accumulation superoxide ions and decreasing the mitochondrial respiratory activity (Bouché et al., 2016). The paper showing these results can be found as appendix of the thesis.

### 2.3. The drawbacks of platinum(II)-based compounds

Even if the three platinum-based drugs that are currently used in clinics in Europe, namely cisplatin, carboplatin and oxaliplatin, show an important efficacy against several cancer types, their use is limited. First, these compounds do not specifically target cancer cells, but also affect healthy cells with high nutrition requirements: cells of bone marrow, hair follicles and mucous membranes (Ma et al., 2019). This leads to side effects, like myelosuppression, hair loss, emesis and diarrhea. Some platinum compounds can even induce ototoxicity, nephrotoxicity and neurotoxicity (Kelland, 2007). The efficacy of platinum-based drugs is also limited by resistances.

Some cancer cells can be resistant towards platinum from the beginning of the treatment (intrinsic resistance), while other cancer cells become resistant after an extended exposure during the treatment (acquired resistance) (Gottesman et al., 2016).

#### 2.3.1. Resistances against platinum (II) compounds

Several research groups have tried to elucidate the mechanism of action behind these resistances. It appeared that the resistances can occur at different levels.

The platinum-based drugs are administered intravenously to the patients. So, the first level of resistance is due to an **interaction** of the platinum compounds **with proteins** encountered in the bloodstream before reaching the target cells (**Figure 16 ①**). Among these proteins, one should mention human serum albumin (HSA), as Ivanov et al (1999) have reported that 65-95% of cisplatin could be bound to HSA after 24 hours of administration (Ghosh, 2019; Ivanov et al., 1998). This results in a small amount of platinum reaching the tumor cells.

Once arrived at the cancer cells, the platinum compound can still face several difficulties leading to resistances at intracellular level. First, a **reduced drug accumulation** can happen either as a result of decreased drug uptake (**Figure 16 ②**) or an increased efflux (**Figure 16 ③**) of the compound. Several reports mention, besides passive transport, the importance of copper transporter CTR1 in the cellular uptake of platinum (Dilruba and Kalayda, 2016; Ghosh, 2019; Gottesman et al., 2016). It seems that these transmembrane transporters enable the entry of cisplatin, carboplatin, but not oxaliplatin in the tumor cells (Ghosh, 2019; Lai et al., 2018). However, some studies showed that cisplatin causes degradation of CTR1, resulting in a decrease of the cellular uptake of the platinum compound and thus resistance (Dasari and Bernard Tchounwou, 2014). When cisplatin has entered the cell, it is carried away by the copper chaperon Antioxidant protein 1 (Atox1) and delivered to

ATP7A and ATP7B (Ghosh, 2019; Lai et al., 2018). These ATPases (ATP7A and ATP7B) are involved in the efflux of copper and of cisplatin, limiting thus the accumulation of platinum within the cell. However, at the moment, the exact mechanism of export is not well understood (Lai et al., 2018).

Another level of resistance can arise in the cytoplasm when cisplatin binds to **glutathione and metallothioneins**, which are involved in the **detoxification** process of heavy metals, leading to its inactivation and its export (**Figure 16 ④**) (Ghosh, 2019). Ishikawa and Ali-Osman (1993) have reported that up to 60% of intracellular platinum can bind to glutathione (Ishikawa and Ali-Osman, 1993; Wexselblatt et al., 2012).

The **DNA repair** machinery also constitutes a level of resistance in the nucleus (**Figure 16 ⑤**). The distortion of the double helix due to platinum-DNA adducts is recognized by proteins inducing DNA repair. This results in the removal of the damaged nucleotide followed by the synthesis of DNA (nucleotide excision repair, NER) (Ghosh, 2019).

Finally, in some cancer cells the resistance can develop due to a **dysfunction of the apoptosis pathway** (**Figure 16 ⑥**). For example, in 50% of the human cancers, a missense mutation of the transcription factor p53 can be detected (Raguz and Yagüe, 2008). p53 plays various roles within the cell: it is implicated in the induction of apoptosis and of senescence, in cell cycle arrest, in autophagy, in the detection of DNA lesions and DNA repair (Moulder et al., 2018). The mutation of p53 confers platinum resistance to the tumor cells by preventing them to undergo apoptosis (Gottesman et al., 2016). The mechanism of apoptosis induction by p53 is depicted in **Figure 15**.

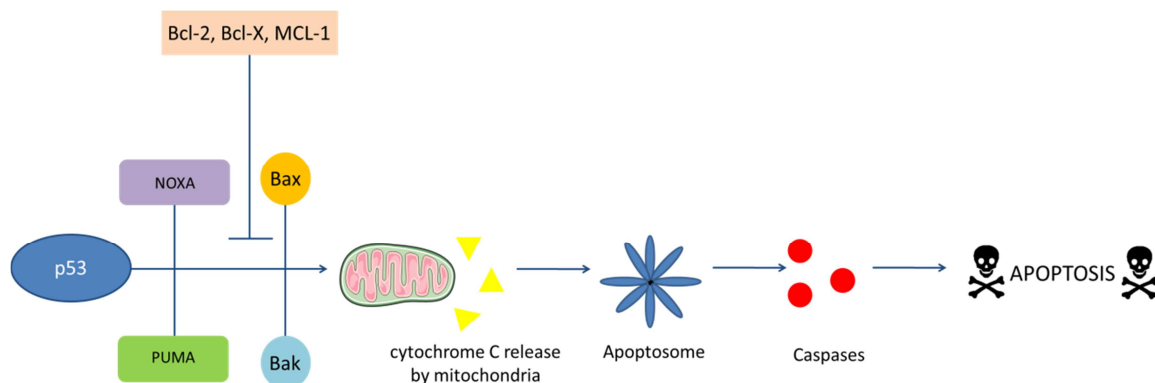

**Figure 15: Induction of apoptosis by tumor suppressor p53** (adapted from Yu et al., 2014)

P53 can activate apoptosis by favoring the release of cytochrome C by mitochondria and thus the activation of apoptosome and various caspases.

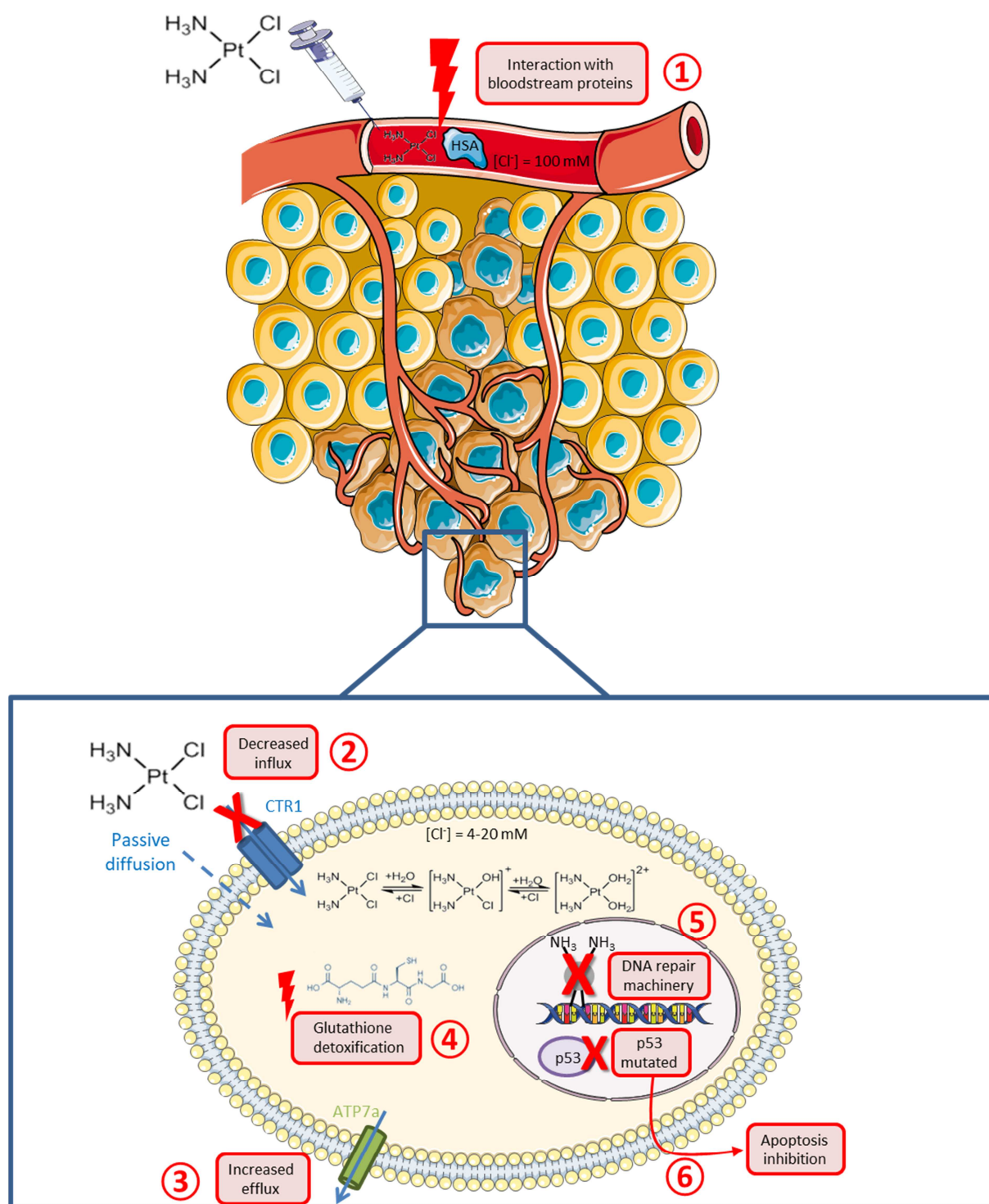

**Figure 16: Mechanisms of resistance after cisplatin treatment**

Resistance can happen at different levels after intravenous injection of cisplatin. First, it can interact with proteins contained in the bloodstream (1), for example human serum albumin (HSA). However, the resistance can also be due to a decreased influx (2) or an increased efflux (3) of the platinum compound resulting in a low accumulation within the cancer cell. Furthermore, different intracellular actions, like glutathione detoxification (4) or DNA repair (5), can prevent the effect of the chemotherapeutic agent. After all, the cancer cell may also present a default in signaling pathways implicated in apoptosis (6).



### 2.3.2. Resistance due to cancer stem cells

Cancer drug resistance can also partly be linked to the presence of a sub-population of chemo-resistant cells: the **cancer-stem cells (CSCs)** (**Figure 17**) (Ferreira et al., 2016; Freitas et al., 2014).

#### 2.3.2.1. Features of CSCs

The existence of CSCs was already suspected in the 19<sup>th</sup> century, when microscopic observations revealed similarities between embryonic and cancer tissues (Sell, 2004). In fact, the CSCs share properties with normal stem cells: the ability of self-renewal and of differentiation and express similar cell surface markers (Dawood et al., 2014). However, CSCs differ from normal stem cells, as they do not have the possibility to regulate their development by maintaining a balance between self-renewal and differentiation (Dawood et al., 2014).

The CSCs can be found within numerous cancer types, like for example melanoma, breast, brain, ovary, prostate, lung and colon cancer (Dawood et al., 2014; Freitas et al., 2014; Konrad et al., 2017). They are believed to be a major cause of cancer relapse, because they present an indefinite proliferative potential and can this way drive the growth of tumors (Konrad et al., 2017; Reya et al., 2001). Furthermore, they are often described as having a tumorigenic potential, as they enable the development of tumors after transplantation in animal models (Dawood et al., 2014). In 1994, Lapidot et al. published data highlighting the presence of a subset of leukemic cells expressing the normal stem cell surface marker CD34 (Konrad et al., 2017). These particular cells were able to induce tumor development after transplantation in severe combined immunodeficient (SCID) mice (Konrad et al., 2017; Lapidot et al., 1994).

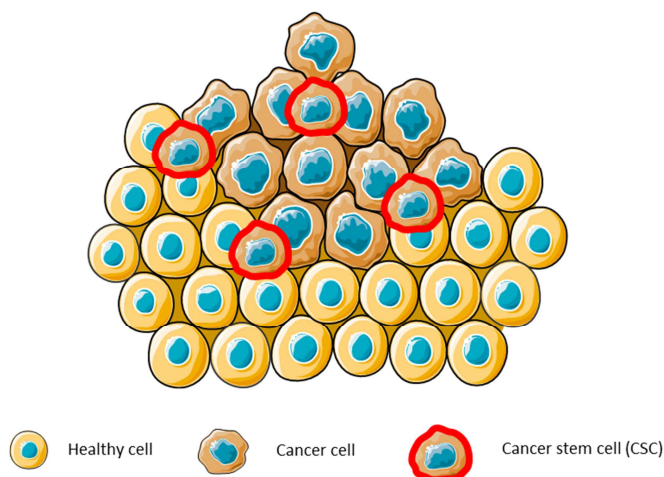

**Figure 17: Presence of cancer stem cells (CSC) within a tumor leads to treatment resistance.**

Tumors develop from healthy cells that have acquired some mutations resulting in an uncontrolled proliferation. This feature can be stopped by several cancer therapies (for example radiation therapy, chemotherapy). However, often cancer relapses due to the presence of a sub-type of cancer cells resistant to the conventional treatments: the cancer stem cells (CSCs).

### 2.3.2.2. Metabolic deregulations of CSCs

It seems that these cells are resistant to chemotherapy and radiation preventing the complete eradication of the tumor. The conventional therapies target the tumor bulk, leading to tumor regression, but, unfortunately, they often fail to eliminate the CSCs which continue proliferating and thus contribute to cancer relapse and even to the formation of distant metastases (Dawood et al., 2014; Konrad et al., 2017).

Their exact mechanism of resistance has not clearly been elucidated for the moment. Nonetheless, it has been hypothesized that various factors might be involved (**Figure 18**). First, a **deregulation of signaling pathways** implicated in the self-renewal, like for example the Hedgehog or the Notch signaling pathway, could lead to sustained proliferation and survival of the CSCs (Dawood et al., 2014; Lei et al., 2017). Secondly, CSCs might also benefit from an **increased expression of membrane-transporters** implicated in the efflux of the chemotherapeutic agents and thus leading to chemoresistance (Dawood et al., 2014; Lei et al., 2017). Thirdly, conventional cancer therapies often target cancer cells by inducing DNA damages. An increased activity of the **DNA repair machinery** might prevent apoptosis in CSCs (Dawood et al., 2014; Lei et al., 2017). Fourthly, **hypoxia** might also be essential for CSC development, as CSCs are often found in hypoxic niches (Tong et al., 2018). It has been shown, that CSCs present an increased activity of hypoxia-inducible factors (HIFs), proteins involved in the metabolism of cells in hypoxic environment, suggesting the implication of hypoxia in the survival and progression of CSCs (Lei et al., 2017; Tong et al., 2018).

Some research teams tried to better understand the metabolism of these cells and found that the **mitochondria** played an important role (Farnie et al., 2015; Lamb et al., 2014, 2015). In fact, it appeared that CSCs possessed an increased mitochondrial mass and an upregulation of mitochondrial enzymes which could be associated with an increased mitochondrial biogenesis and a decreased mitochondrial degradation (Farnie et al., 2015; Lamb et al., 2014).

**Autophagy**, a cellular process, consisting in the self-digestion of proteins or damaged organelles, could also be involved (Lei et al., 2017). However, the exact role remains controversial: some studies suggest a stemness maintenance by autophagy, while others reveal a stemness loss (Lei et al., 2017). So, on one hand, it has been hypothesized that autophagy might be a source of energy and nutrients for CSCs while, on the other hand, researchers observed a decrease of autophagy-related proteins in CSCs after chemotherapy (Jun et al., 2009; Lei et al., 2017).



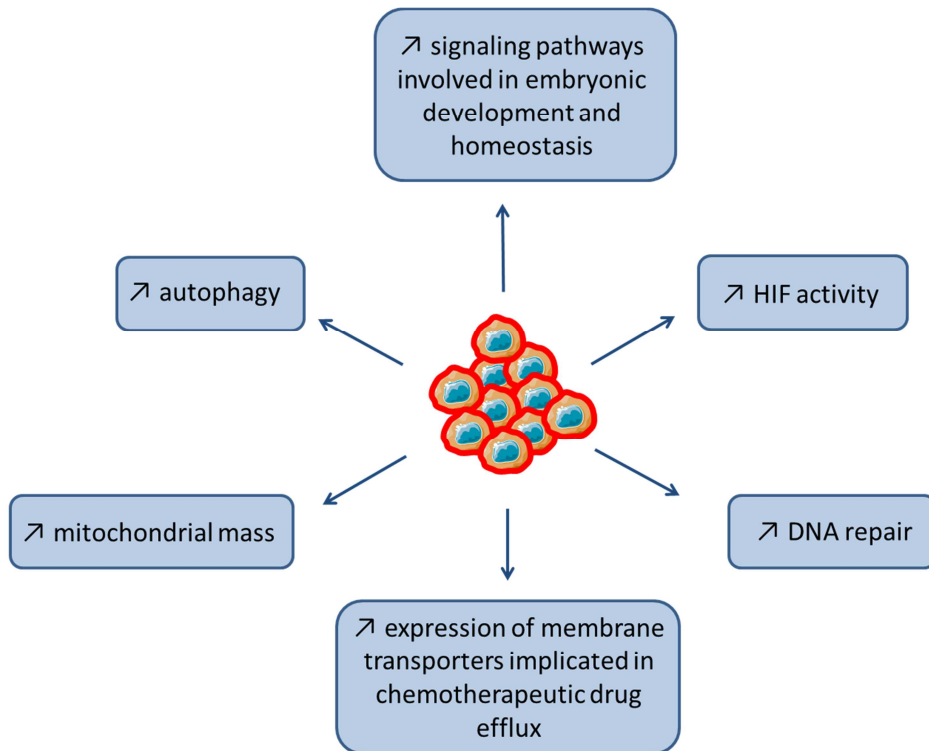

**Figure 18: Summary of metabolic adaptations of cancer stem cells leading to cancer therapy resistance** (adapted from Lei et al., 2017).

CSCs have a metabolism that is different from differentiated cancer cells and allows them to resistant to conventional cancer therapies.

# Part C: Cancer and the immune system

Tumors do not only consist of cancer cells, but they are often infiltrated by various immune cells, suggesting that the immune system is involved in cancer development.

A brief description of the immune system, its main features and its effector cells will be provided below, before explaining in detail the role of the immune system in cancer.

## General overview of the immune system

The immune system can be considered as defence system of organism, as it is supposed to protect it as well against pathogens and disease as against alterations of its own components (for example cancer cells resulting from modified healthy cells).

The immune system can be divided into two branches with different features: the innate immunity and the adaptive immunity.

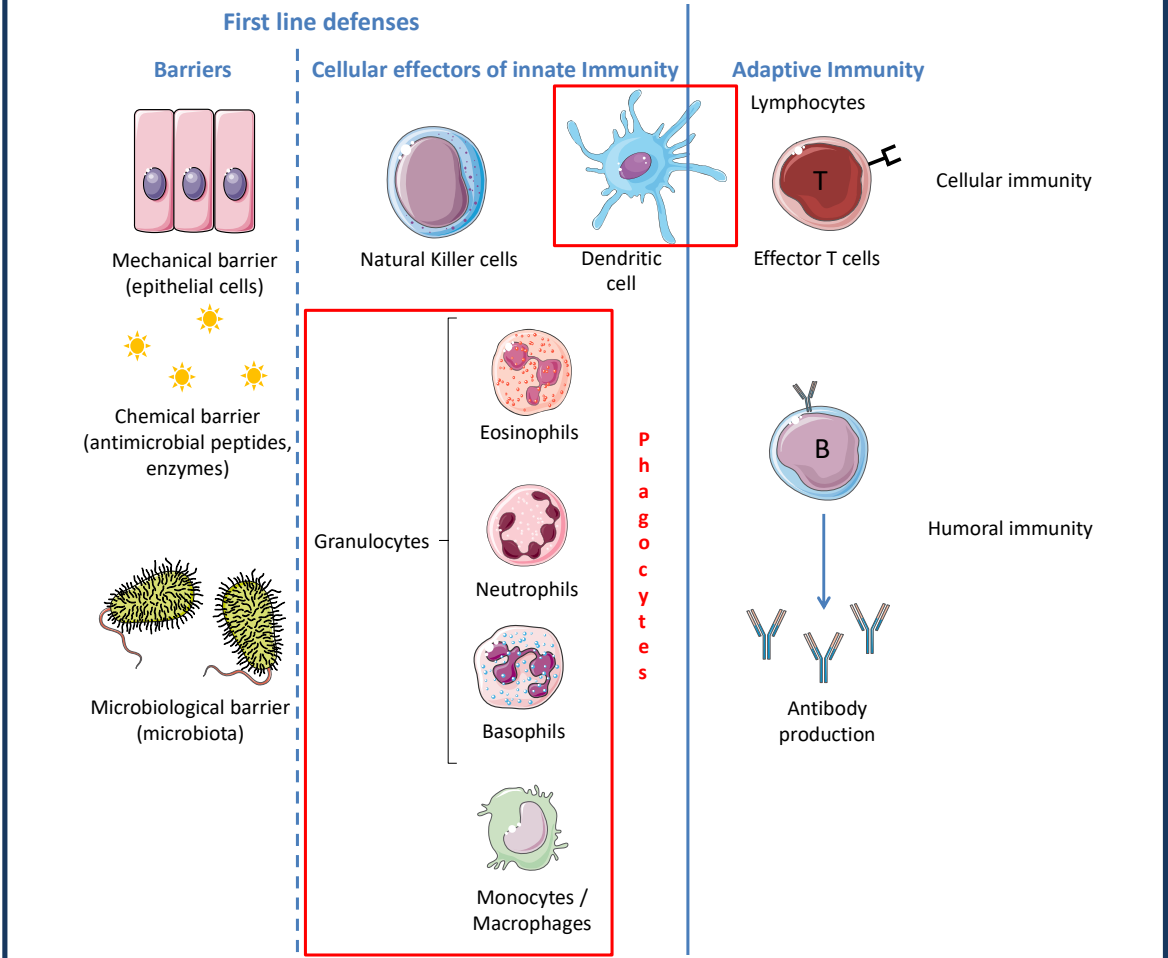

**Figure 19: Overview of the barriers and the effector cells of the immune system.**

The innate branch of the immune system consists of the first line defenses and regroups the different barriers as well as numerous effector cells, mainly phagocytes (red frame). The dendritic cells are part of the innate immunity, but are able to create a link between the two branches of the immune system, as they act as antigen-presenting cells for the T lymphocytes and are thus essential for their activation.

## Main differences between innate and adaptive immune system

Table 4: Summary of the differences between innate and adaptive immunity.

	<b>Innate immunity</b>	<b>Adaptive immunity</b>
<b>What is recognized?</b>	Microbe-associated molecular patterns (MAMPs) or damage-associated molecular patterns (DAMPs)	Antigens derived from self or foreign molecules
<b>Receptors</b>	Limited number of Pattern Recognition Receptors (PRR), Receptors of NK cells (KIR, NKG2D,...)	B-cell receptor (BCR) and T-cell receptor (TCR) present at the surface of B and T lymphocytes, unlimited diversity of BCR and TCR
<b>Effector mechanisms</b>	Phagocytosis, inflammation, lysis of damaged or modified cells	Production of antibodies by B cells and generation of effector T helper cells and cytotoxic T cells
<b>Role of the effector mechanisms</b>	<u>Phagocytosis</u> : engulfment and digestion of particles in order to eliminate them; <u>Inflammation</u> : production of proteins and cells to combat infection <u>Cell lysis by NK cells</u> : release of cytotoxic proteins or interaction with death receptors to induce cell death	<u>Antibodies</u> : increase of phagocytosis, activation of NK cells, activation of complement system, neutralization; <u>Cell lysis by cytotoxic T cells</u> : release of cytotoxic proteins or interaction with death receptors to induce cell death

The innate and the adaptive immune system are involved in the defense of the organism against cancer cells.

However, this thesis work is mainly interested in the activation of the adaptive immunity.

That is why, more attention is given to the induction of adaptive immune responses.

Nevertheless, the role of the innate immune cells is mentioned in §C.4.3.

### 1. The concept of immunosurveillance

In 1909, Paul Ehrlich was one of the first scientists suggesting that the immune system could play an important role in cancer by repressing the tumor growth, leading to the hypothesis of immunosurveillance (Dunn et al., 2002; Ehrlich, 1909). This postulate gained attention in the 1950s, when Burnet and Thomas also assumed an implication of the immune system in tumor development (Dunn et al., 2002). So, Burnet enounced in 1957: *“It is by no means inconceivable that small accumulations of tumor cells may develop and because of their possession of new antigenic potentialities provoke an effective immunological reaction with regression of the tumor and no clinical hint of its existence.”* (Burnet, 1957; Dunn et al., 2002) A few years later, he stated: *“In large, long-lived animals, like most of the warm-blooded vertebrates, inheritable genetic changes must be common in somatic cells and a proportion of these changes will represent a step toward malignancy. It is an evolutionary necessity that there should be some mechanism for eliminating or inactivating such potentially dangerous mutant cells and it is postulated that this mechanism is of immunological character.”* (Burnet, 1970, 1964; Dunn et al., 2002). But, unfortunately, due to missing evidence, this statement was left behind until the 1990s, when it appeared that the growth of transplanted tumors and the generation of chemically-induced as well as spontaneous tumors seemed to be prevented by endogenous IFN- $\gamma$  (Dighe et al., 1994; Dunn et al., 2002) Moreover, Street et al (2001) demonstrated that C57BL/6 mice lacking perforin, a protein contained in the cytolytic granules of cytotoxic T cells and NK cells, were more susceptible to methylcholanthrene (MCA)-induced tumor generation (Dunn et al., 2002; Street et al., 2001). This was the origin of the theory of immunosurveillance postulating that the immune system does not only play an important role in the protection of the organism against pathogens, but is also involved in cancer prevention, development and progression. Furthermore, several studies have demonstrated that immunodeficient patients are more prone to cancer progression compared to immunocompetent individuals (Dunn et al., 2002; Zitvogel et al., 2008).

## 2. How can the immune system distinguish cancer cells from healthy cells?

Cancer cells may not be detected by the immune system, as they derive from normal cells.

### 2.1. The danger model

For a long time, it has been believed that the immune system distinguishes between “self” and “foreign (non-self)” antigens (Garg and Agostinis, 2017; Matzinger, 1994, 2002). However, in 1994, Polly Matzinger proposed another model hypothesizing that the immune system might rather differentiate “dangerous” and “safe” entities, regardless of their source: the danger model (Garg and Agostinis, 2017; Matzinger, 1994, 2002). So, the immune response might be activated by danger molecules, called alarmins, which can be recognized by Pattern Recognition Receptors (PRRs) expressed mainly by antigen-presenting cells (APCs) (Garg and Agostinis, 2017; Matzinger, 1994, 2002). These alarmins regroup molecules derived from pathogens, from infected, diseased, injured or necrotic tissues and from cells undergoing non-physiological cell death processes (Garg and Agostinis, 2017). They are referred to as damage-associated molecular patterns (DAMPs) and their functions are summarized in

**Figure 20.**

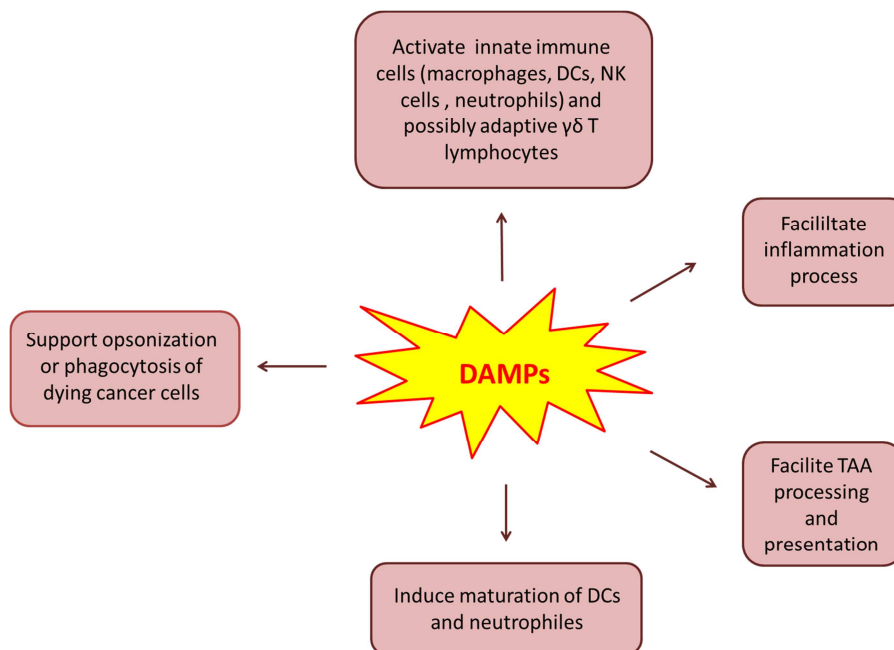

**Figure 20: Different functions of DAMPs.**

DAMPs can have various functions on the immune system: i) activation of mainly innate immune cells, ii) facilitation of the inflammatory process, iii) facilitation of tumor-associated antigen (TAA) processing and presentation, induction of DC neutrophil maturation or iv) support of opsonization and phagocytosis (Garg and Agostinis, 2017).

## 2.2. The recognition of cancer cells by immune cells

Cancer development can be compared to Darwinian evolution: normal cells undergo successive mutations conferring them growth advantages and leading this way to a conversion from normal cells to cancer cells (Hanahan and Weinberg, 2000). These cells then present regulatory defects in homeostasis resulting in an uncontrolled proliferation (Hanahan and Weinberg, 2000). It has appeared that an increased number of mutations, mainly point mutations, facilitates the recognition of the tumor cells by the immune system (Chen and Mellman, 2017). Nonetheless, cancer cells also emit danger molecules (DAMPs) which are perceived by APCs and thus lead to the activation of the immune system (Garg et al., 2013).

### 2.2.1. The recognition of tumor-associated antigens (TAAs) by the immune system

In 1988, Barnd et al published a study where they were able to isolate cytotoxic T lymphocytes (CTLs) that could specifically lyse pancreatic cancer cells (Barnd et al., 1988; Boon et al., 1994) by recognizing antigens expressed by these cells (Barnd et al., 1988; Boon et al., 1994). For this, lymph node cells of pancreatic cancer patients were stimulated with an allogeneic pancreatic tumor cell line (Barnd et al., 1988; Boon et al., 1994). Further investigations revealed that these CTLs could also lyse cells derived from breast cancer, but not from colon carcinoma. That is why, the researchers were looking for an antigen specifically expressed by these pancreatic and breast cancer cells and detected a mutated form of mucins, which was then described as one of the first tumor-associated antigens (TAAs) (Barnd et al., 1988; Boon et al., 1994). It appeared that mucins expressed at the surface of cancer cells present another glycosylation state than mucins found in healthy cells triggering this way the activation of the immune system (Boon et al., 1994). Peptides derived from these hypoglycosylated mucins can be presented on the major histocompatibility complex I (MHC I) of cancer cells and thus be recognized by CTLs (Lakshminarayanan et al., 2012; Roulois et al., 2013; Stepensky et al., 2006).

TAAs can be classified in various categories depending on their origin or expression: neoantigens, viral antigens, cancer testis antigens, differentiation antigens and overexpressed antigens (Chen and Mellman, 2017; Ilyas and Yang, 2015; Melero et al., 2014; Vigneron, 2015) (**Table 5**).

**Table 5: Different tumor-associated antigens (TAAs)**

Summary of the different classes of tumor-associated antigens, their expression and examples

Specificity	Antigen class	Expression / Description	Examples	References
Unique / specific tumor-associated antigens	<b>neoantigens</b>	antigens encoded by point mutations in ubiquitously expressed genes	KRAS CDK4 β-catenin	Ilyas and Yang, 2015; Melero et al., 2014; Vigneron, 2015
	<b>viral antigens</b>	some viruses can induce cancer; the tumor cells produce viral proteins that can be detected by the immune system	HPV EBV MCC	Ilyas and Yang, 2015; Vigneron, 2015
Shared antigens	<b>cancer-testis antigens</b>	antigens expressed by germline cells and by cancer cells	NY-ESO-1 MAGE-A3 GAGE BAGE	Chen and Mellman, 2017; Ilyas and Yang, 2015; Melero et al., 2014; Vigneron, 2015
	<b>differentiation antigens</b>	antigens derived from proteins that are specifically expressed by a healthy tissue and the tumor cells of this tissue	gp100 tyrosinase PSA MelanA (=MART1) CEA	Chen and Mellman, 2017; Ilyas and Yang, 2015; Melero et al., 2014; Vigneron, 2015
	<b>overexpressed antigens</b>	antigens that are silent or expressed at low levels in normal tissue, but transcriptionally activated in certain tumors	HER2 Surviving hTERT	Ilyas and Yang, 2015; Melero et al., 2014

CDK: cyclin-dependent kinase; CEA: carcinoembryonic antigen; EBV: Epstein-Barr virus; HPV: human papilloma virus; hTERT: human telomerase reverse transcription; PSA: prostate-specific antigen

### 3. The cancer-immunity cycle

The antitumor immune response (implicating the adaptive immune system) can be described as a cyclic process according to Chen and Mellman (2013) (Figure 18). Briefly, dendritic cells (DC), which play a key role in the initiation of adaptive immune response, are maturing after recognition of DAMPs expressed by cells damaged from cancer or released from dying cancer cells in the tumor microenvironment. These fragments are also captured by endocytosis or phagocytosis by the DCs. TAAs expressed by these fragments are then processed and presented to T lymphocytes *via* specific proteins at their cell surface: the molecules of the major histocompatibility complex (MHC). After this contact with mature DCs, T cells differentiate towards effector T cells:  $CD4^+$  T cells become T helper 1 (Th1) lymphocytes which then participate, with the DCs, in the differentiation of  $CD8^+$  T cells towards CTLs. The latter are able to specifically recognize the tumor cells and to lyse them, which then completes the cycle by releasing fragments that are again captured by DCs.

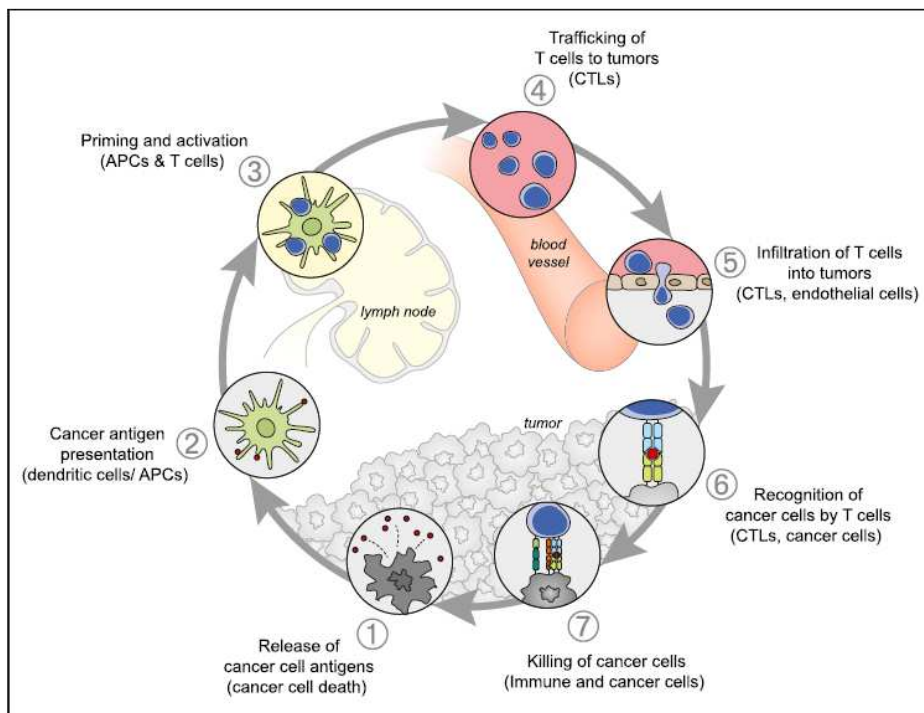

**Figure 21: The cancer-immunity cycle** (Chen and Mellman, 2013)

Tumor-associated antigens expressed by fragments released from dying cancer cells (1) are captured by antigen-presenting cells, mainly dendritic cells, which process them and present peptides originating from these antigens on their major histocompatibility complex (2). In the same way, DAMPs expressed by the same fragments induce DC maturation. TAA presentation takes place while the DCs migrate from the tumor site to the lymph node where they activate  $CD4^+$  and  $CD8^+$  T cells leading to their differentiation towards T helper cells and cytotoxic T lymphocytes (CTLs) respectively (3). The latter leave the lymph node and travel via the bloodstream to the tumor (4), where they exit the blood vessels by extravasation and infiltrate the tumor (5). The CTLs specifically recognize the cancer cells (6) and induce their apoptosis (7) releasing this way fragments/antigens which can be captured by the DCs (1).



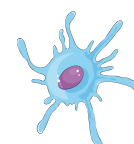

#### 4. The different actors of the antitumor immune response and their role

##### 4.1. The dendritic cell (DC) – key initiator of an antitumor immune response

Dendritic cells can be considered as sentinel cells, as they alert the organism against pathogens and damage (Garg and Agostinis, 2017). These professional antigen-presenting cells derive from a bone marrow progenitor common to monocytes, macrophages and granulocyte (Markov et al., 2016). They are located in the tissues and screen them for the presence of “dangers” in order to activate the adaptive immune system (Markov et al., 2016). DCs can be divided into two main categories with distinct functions: conventional DCs (cDCs) or plasmacytoid DC (pDCs). Both groups derive from a committed DC precursor in the bone marrow, but evolve separately. cDCs leave the bone marrow and migrate towards peripheral organs while pDCs undergo *in situ* development in the bone marrow (Macri et al., 2018). Furthermore, both cell types play different roles in the immune response. pDCs are mainly implicated in the antiviral response by secreting type I and type III interferons. However, they can also infiltrate tumors, which is often associated with a poor prognosis, because they remain immature and are unable to secrete IFN- $\alpha$  (Lombardi et al., 2015; Sisirak et al., 2013). On the other hand, cDCs essentially recognize damaged tissues, capture structures expressing foreign or self-antigens and process them in order to present them to T cells and activate this way the adaptive immune response (Collin and Bigley, 2018; Markov et al., 2016). So, the DCs implicated in the establishment of the antitumor immune response are the cDCs. The establishment of the immune response is depicted in **Figure 22**.

##### 4.1.1. Maturation of the dendritic cells

The DCs are the most potent professional antigen-presenting cells. Immature DCs can be found either as tissue-resident DCs in the periphery or as lymph-node-resident DCs. They engulf structures containing antigens, for example TAAs in the case of cancer, by endocytosis, mainly macropinocytosis and phagocytosis (Mellman, 2013). However, at that time, they are unable to present these antigens efficiently to T cells. It has suggested that tissue-resident DCs might capture structures expressing antigens at the tumor sites and that soluble antigens might be transported to the lymph nodes *via* lymphatic vessels and become engulfed by lymph-node resident DCs (Palucka and Coussens, 2016). In order to acquire the ability of antigen presentation within 12 to 24 hours, DCs need some supplementary signals. These can result from stimulation by DAMPs of various pattern recognition receptors (PRRs),

like cell-surface bound or endosomal Toll-like receptors (TLRs) or intracellular receptors (Kepp et al., 2014). Then, the DCs upregulate chemokine receptors, like CCR7 and start migrating to lymphoid organs and processing captured antigens in order to load them on the proteins of the MHC. They also produce co-stimulatory molecules and cytokines important for the establishment of an immune response (Mellman, 2013).

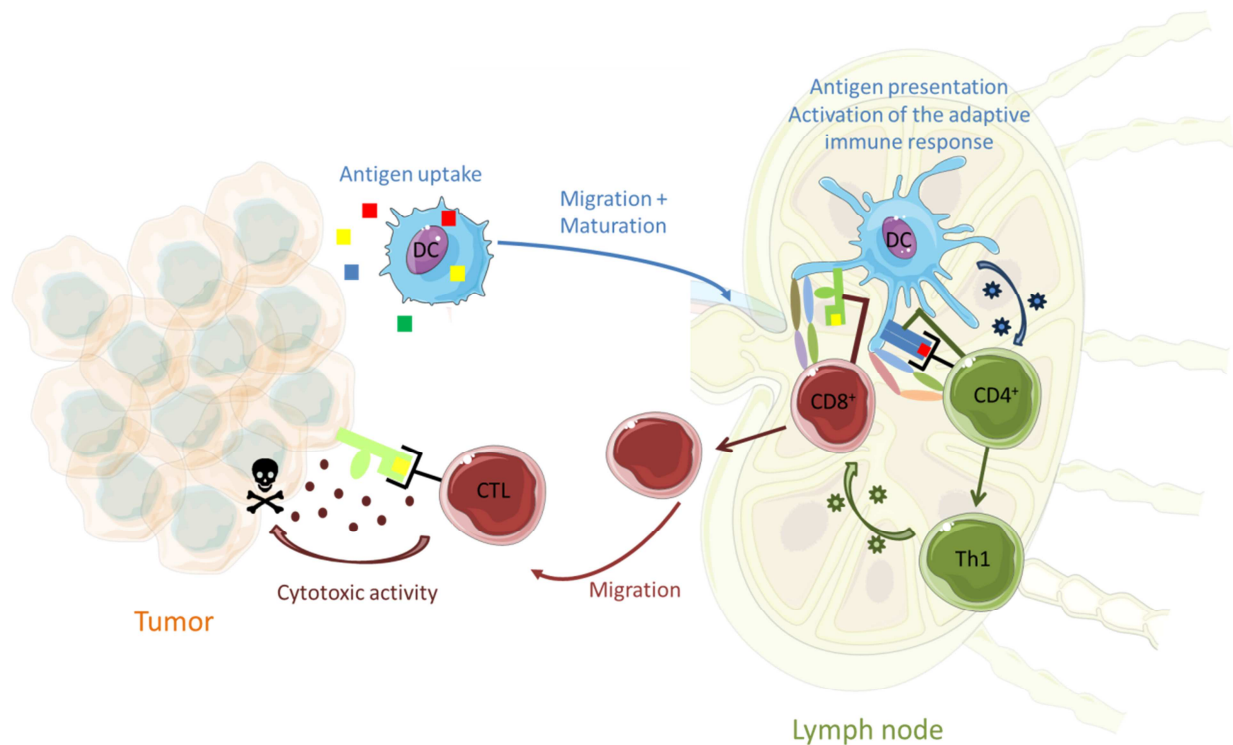

**Figure 22: The antitumor immune response** (adapted from Melero et al., 2014).

The immature DCs engulf structures expressing tumor-associated antigens and detect DAMPs released by the cancer cells at the tumor site. They migrate towards the lymph nodes and undergo maturation. During this time, they process the antigens in order to present them on their MHC. In the lymph nodes, the mature DCs encounter naïve CD4<sup>+</sup> and CD8<sup>+</sup> T cells and induce their differentiation into T helper (Th) cells and CTLs respectively. The latter leave the lymph node via the bloodstream and join the tumor where they specifically recognize the cancer cells and induce their apoptosis by releasing cytotoxic proteins.

#### 4.1.2. Processing of antigens by DCs

MHC I molecules have a ubiquitous expression profile while MHC II molecules are restricted to immune cells, namely antigen-presenting cells (DCs, macrophages, B cells). Antigens which have been phagocytosed by DCs progress through several vesicular compartments from endosomes to phagosomes and lysosomes with increasing acidity and hydrolytic activity resulting in their unfolding, their denaturation and their cleavage into small peptides. These amino acid sequences are then loaded onto MHC II molecules translocated from the endoplasmic reticulum (ER) towards the endocytic vesicle. The complex peptide:MHC II becomes expressed at the cell surface, where it can be recognized by CD4<sup>+</sup> T cells (**Figure 23 right part**).

Endogenous antigens, for example viral fragments present in the cytoplasm of infected cells, are loaded on MHC I. For this, the antigens are cleaved in the cytosol by the immunoproteasome before their transport into the ER where they are charged on MHC I molecules. However, DCs possess the special ability of charging exogenous antigens, which have evaded from the endosomes, onto MHC I, a process known as cross-presentation (**Figure 23 left part**). The exact escape mechanism is not clearly elucidated, but several hypothesis have been proposed (Mellman, 2013). The transfer of the exogenous antigens in the cytoplasm could be due to a destabilization of the endosomal membrane (Cruz et al., 2017). Furthermore, the presence of ER proteins, involved in the transport of abnormal proteins from the ER lumen to the cytosol, has been reported in the endosomes. That is why, these proteins could also be responsible for the transfer of exogenous antigens in the cytoplasm (Cruz et al., 2017).

Cross-dressing is another presentation mechanism which has been described recently for the DCs: they collect peptide:MHC I complexes from dying tumor cells and present them immediately to CD8<sup>+</sup> T cells without processing the antigens (Markov et al., 2016).

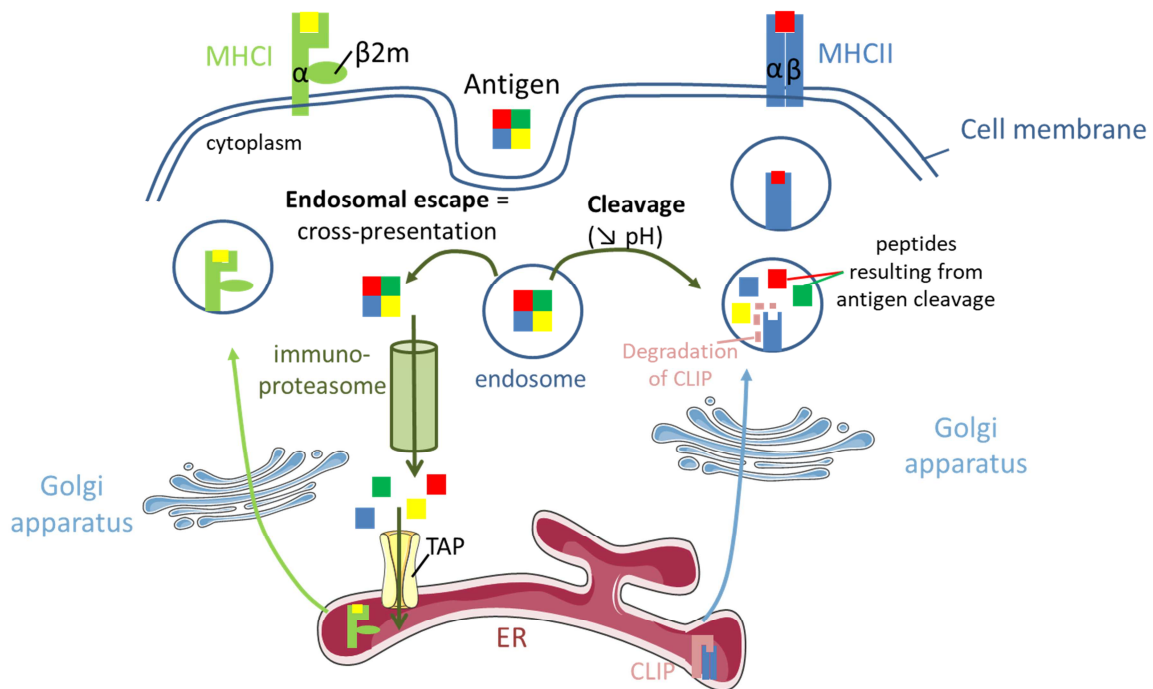

**Figure 23: Antigen presentation by dendritic cells** (adapted from Mellman, 2013)

The MHC II molecules travel from the endoplasmic reticulum (ER) where they are associated with a peptide, called class II-associated invariant-chain peptide (CLIP) which prevents the binding of a another peptide, through the Golgi apparatus towards the endosomal vesicles. DCs engulf structures expressing exogenous antigens by endocytosis. The antigens then pass through several endosomal vesicles with decreasing pH and increasing hydrolytic activity resulting in its cleavage into small peptides. The vesicle with the MHC II molecule and the endosome merge in order to enable the peptide to bind to the MHC II. The peptide:MHC II complex then becomes expressed at the cell surface (right part of the figure).

Sometimes, the antigens can escape from the endosome and locate in the cytoplasm, where they are degraded by the immunoproteasome into small peptides which enter the ER through a protein called transporters associated with antigen processing (TAP). They are then charged in the ER lumen on the MHC I and the complex peptide:MHC I travels through the Golgi apparatus in order to become expressed at the cell surface.

## 4.2. Activation of T lymphocytes



### 4.2.1. Activation of CD4<sup>+</sup> T cells

Mature DCs migrate in the paracortical region and more precisely the T cell-rich zones in the lymphoid organs where they activate at first CD4<sup>+</sup> and then CD8<sup>+</sup> T cells. Naïve T cells are continuously circulating between the bloodstream and the lymphoid organs and mature DCs try to recruit T cells by secreting the chemokines CCL19 and CCL18. Once a T cell encounters via the TCR its specific antigen exposed at the surface of a DC on the MHCII complex, it stops migrating. However, a preliminary association of the co-receptor CD4 with the TCR is necessary to ensure effective antigen recognition by the T cell. For this, CD4 binds

to an invariant site of the MHC II molecule which increases the sensitivity of the TCR-peptide:MHC II interaction without any disturbance. In order to guarantee a stable interaction between the DC and the T cells, both also interact through adhesion molecules (for example LFA-1 and CD2 on T cells and ICAM-1, ICAM-2 and CD58 on DCs). The T cell then undergoes massive proliferation, known as clonal expansion and finally differentiates in T helper 1 (Th1) cells under the influence of cytokines, like for example interleukin-12 (IL-12), released by the DC.

Three signals are required for an efficient T cell activation (**Figure 24**).

1. An interaction between the TCR and the peptide:MHC II complex as well as between the co-receptor CD4 and MHC II is needed.
2. Co-stimulatory signals are also necessary for the T cell activation. These involve the B7 molecules (B7.1 (also known as CD80) and B7.2 (also known as CD86)) on the DCs and CD28 on the T cells to guarantee survival and expansion of the T lymphocytes.
3. Finally, the release of cytokines also serves as co-stimulatory signal by directing the T cell differentiation.

The activated  $CD4^+$  T cells also secrete interleukin-2 (IL-2) which acts as survival factor for both the  $CD4^+$  and the  $CD8^+$  T cells.

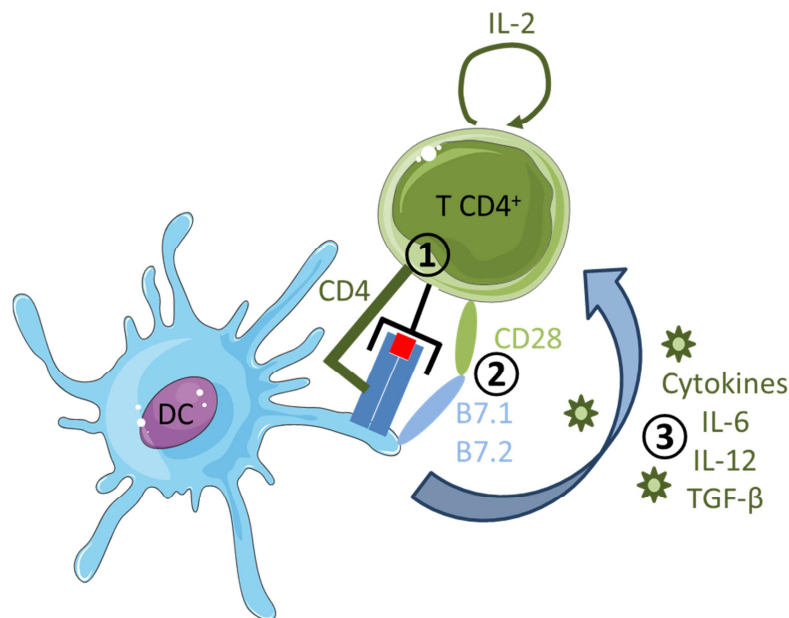

**Figure 24: Activation of  $CD4^+$  T cells by dendritic cells**

In the lymphoid organs, mature DCs encounter naïve  $CD4^+$  T cells specific of the antigen expressed on the MHC II of the DCs. The differentiation of the  $CD4^+$  T cells towards a T helper (Th) cell needs three signals: ① the recognition of the peptide:MHC II complex by the TCR, ② the interaction of the co-stimulatory molecules (B7.1, B7.2 and CD28) and ③ the release of cytokines (IL-6, IL-12, TGF-β) by the DC. The activated  $CD4^+$  T cells also produce IL-2 which acts as survival factor.

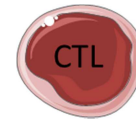

#### 4.2.2. Activation of CD8<sup>+</sup> T cells (Figure 25)

The activation of the CD8<sup>+</sup> T cells happens via the recognition of the peptide:MHC I complex by the TCR. This process also involves the interaction between the co-receptor CD8 with the MHC, as well as the interaction TCR-peptide:MHC I complex, co-stimulatory molecules B7.1, B7.2 and CD28 as well as cytokines. Furthermore, the presence of Th1 cells is important, as the interaction between their CD40L and CD40 expressed by the DC enables the transformation of naïve CD8<sup>+</sup> T cells into cytotoxic lymphocytes (CTLs). These CTLs are then able to leave the lymphoid organs and to circulate in the bloodstream towards the tumor bed. There, they exit the blood vessels by diapedesis and recognize the peptide:MHC I complexes at the surface of the cancer cells and stick to them via the TCR. This binding induces the apoptosis of the tumor cell by two distinct mechanisms: a) the delivery of cytotoxic effector proteins (perforin, granzymes and granulysin) initially contained in granules within the CTLs or b) the activation of signalling pathways involving receptors from the tumor-necrosis factor (TNF) family (Fas-L or TRAIL on T cells and their receptors Fas and TRAIL-R on tumor cells).

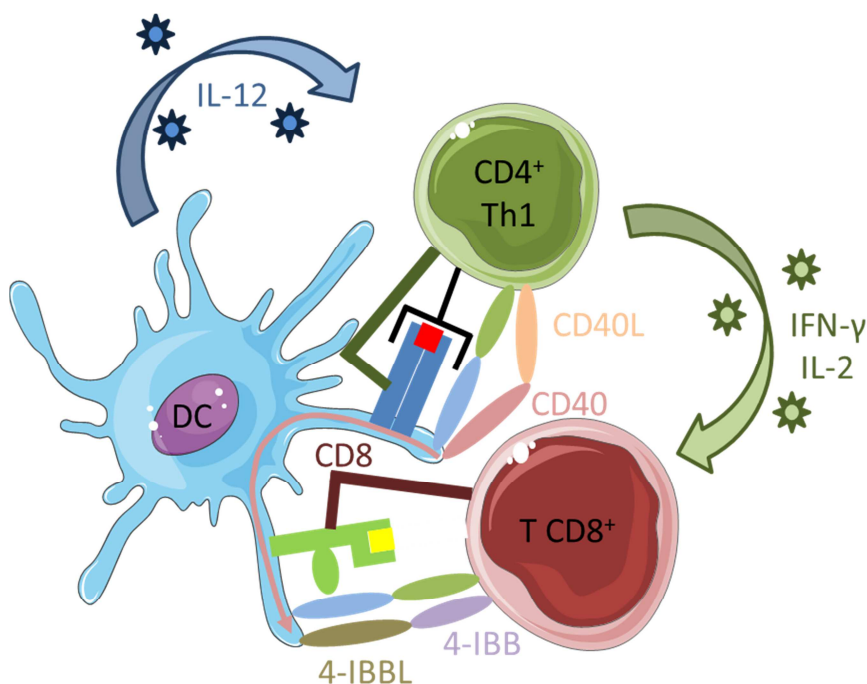

**Figure 25: Activation of CD8<sup>+</sup> T cells**

CD8<sup>+</sup> T cells recognize a peptide:MHC I complex expressed at the surface of DCs via their TCR. This interaction is reinforced by binding of CD8 to the MHC I and co-stimulatory molecules: B7.1., B7.2. (light blue), CD28 (light green), 4-IBBL and 4-IBB. Furthermore, cytokines (IFN- $\gamma$ , IL-2) provided by Th cells complete the differentiation of naïve CD8<sup>+</sup> T cells towards CTLs.



### 4.3. Other immune cells implicated in the antitumor immune response

Even if the cytotoxic response provided by CTLs accounts for one of the most important processes in the antitumor immune response, other immune cells, as well from the innate as from the adaptive arm of the immune system, are implicated.



#### 4.3.1. NK cells

58

The innate immunity includes a cell type which plays an important role in the defense against infections and cancer without being specific of an antigen: the natural killer (NK) cells (Vallentin et al., 2015). Their activation is promoted by cytokines produced by DCs and Th lymphocytes: IL-2, IL-12, IL-15, IL-18 and IFN- $\alpha$ . These cells, like CTLs, release cytotoxic proteins in order to induce apoptosis of the cancer cells (Pahl and Cerwenka, 2017). However, in contrast to CTLs, the NK cells are able to kill cancer cells immediately without prior sensitization (Morvan and Lanier, 2016). For this, they recognize various ligands expressed at the surface of their target cells. Stressed, transformed and infected cells can be distinguished from healthy cells based on the expression of inhibitory (HLA-A/B/C interacting with killer cell immunoglobulin-like receptor (KIR) at the surface of NK cells), activating (MHC class I chain-related genes MICA and MICB or UL-binding proteins ULBP1–6 binding to NKG2D expressed by NK cells) and adhesion ligands (CD112 or CD155 binding to the co-stimulatory adhesion receptor DNAM-1) at their cell surface (Pahl and Cerwenka, 2017). In physiological conditions, a net balance between inhibitory and activating signals persists, preventing cell lysis (**Figure 26 A**). However, cancer cells can undergo mutations and selective pressure exerted by CTLs resulting in a down-regulation of MHC I molecules at their cell surface (Morvan and Lanier, 2016). This process, known as “missing-self”, leads to the activation of NK cells due to a lack of inhibitory signals and thus a takeover of activating signals (**Figure 26 B**) (Morvan and Lanier 2016). Nonetheless, some cancer cells do not experience this modification, but overexpress stress-induced activating signals (MICA, MICB, H60 and MUT1) perceived by NK receptors (NKG2D, NCR, DNAM1) and resulting this way in the activation of these innate immune cells (**Figure 26 C**) (Morvan and Lanier, 2016). Finally, tumor cells can also be targeted by various therapeutic antibodies binding to TAAs. The Fc portion of these antibodies can then be recognized by the receptor Fc $\gamma$ RIIIA (CD16) borne on NK cells and contributing this way to their activation (Morvan and Lanier, 2016). This mechanism is referred to as antibody-dependent cell-mediated cytotoxicity (ADCC)

(Figure 26 D) (Morvan and Lanier, 2016). Once triggered, the NK cells, like CTLs, can induce apoptosis of tumor cells either by releasing cytotoxic proteins (perforin, granzymes, granulysin) within the immunological synapse or by an interaction between members of the TNF family implicating Fas and Fas-L (Morvan and Lanier, 2016). Furthermore, they secrete IFN- $\gamma$  in order to enhance the expression of MHC I on tumor cells and of MHC II on APCs (Pahl and Cerwenka, 2017).

Some studies have hypothesized that NK cells may be implicated in the prevention of metastasis, as they are predominant in the bloodstream and only present in a limited number in solid tumors (López-Soto et al., 2017; Malmberg et al., 2017; Morvan and Lanier, 2016).

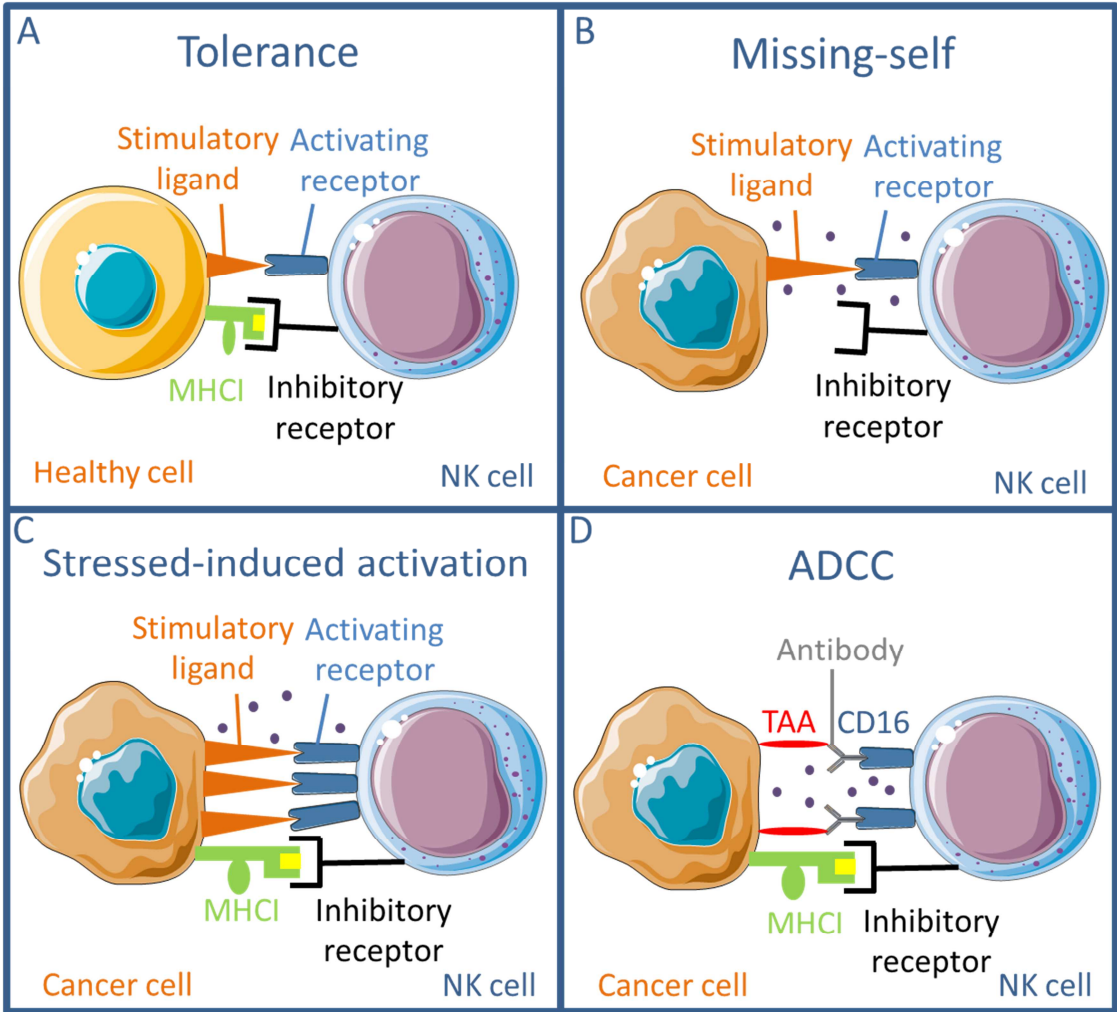

**Figure 26: The functions NK cells** (adapted from Morvan and Lanier, 2016)  
**A.** In physiological conditions, there is a balance between activating and inhibitory signals which prevents lysis of healthy cells. **B.** Cancer cells can lack the expression of MHC I molecules, leading to an activation of NK cells. This process is called “missing-self”. **C.** Cancer cells can express stress-induced activating signals resulting in their lysis by NK cells. **D.** TAAs can be bound by therapeutic antibodies which in their turn are recognized by NK cells. This favors the release of cytotoxic proteins by the NK cells.





### 4.3.2. iNKT cells

A particular class of innate-like lymphocytes which share features both with NK cells and with T lymphocytes has been shown to be implicated in the antitumor immune response: the invariant natural killer T (iNKT) cells. These cells recognize lipid moieties presented on the conserved and non-polymorphic MHC I-like molecule CD1d (expressed by APCs) (Altman et al., 2015). These unconventional T cells display an anticancer effect via three different mechanisms (Altman et al., 2015; Gonzalez et al., 2018):

- a) Indirect cytotoxicity: iNKT via their TCR recognize the lipid displayed by DCs on CD1d. This process is accompanied by a release of cytokines (for example IFN- $\gamma$ , IL-4, IL-17) which are able to stimulate effector cells
- b) Alteration of the tumor microenvironment: iNKT cells can prevent the effect of pro-tumorigenic cells, like macrophages involved in angiogenesis
- c) Direct cytotoxicity: the receptor NKG2D binds to stress ligands expressed by tumor cells which results in the liberation of cytotoxic proteins (granzymes, perforin) killing the targeted cancer cells

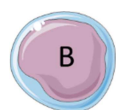

### 4.3.3. B lymphocytes

The precise role of B cells in cancer progression is quite controversial and less understood than that of T cells (Gonzalez et al., 2018). They can either have a positive or a negative effect on the antitumor immune response (Yuen et al., 2016). On one side, B lymphocytes can have harmful effects and correlate with a bad clinical outcome. In fact, B cells can suppress antitumor immune responses by forming circulating immune complexes which can promote tissue remodeling and this way tumor progression (Yuen et al., 2016). Furthermore, tumor-infiltrating B lymphocytes are able to boost angiogenesis and inhibit the effect of CTLs and NK cells by releasing cytokines, like lymphotoxin or IL-10 respectively (Yuen et al., 2016). On the other side, B lymphocytes are able to facilitate the development of ectopic tertiary lymphoid structures which are associated with a good prognosis (Yuen et al., 2016). They can also take over the role of DCs as APCs even if they are less efficient (Yuen et al., 2016).

#### 4.3.4. Regulatory T cells



In addition to CD4<sup>+</sup> T helper cells and to CTLs, the presence of another group of T lymphocytes is important in order to maintain the homeostasis of the immune system, to modulate immune responses and to prevent the recognition of self-antigens and so auto-immunity: the regulatory T cells (Tregs) (Rakebrandt et al., 2016). However, their role in cancer progression is not clearly defined and remains controversial. On one side, they can have a beneficial effect for the patients. In fact, some cancers are initiated or accompanied by an inflammation (for example gastric cancer). In this case, Tregs try to prevent tissue degradation by stopping the inflammatory process and to contain this way tumor growth (Walsh and Mills, 2013; Whiteside, 2012; Wolf et al., 2015). On the other side, they can promote cancer progression by releasing cytokines (IL-10, TGF- $\beta$ ) and dampening effector T cell responses which thus results in a down-regulation of the antitumor immunity (Schreiber et al., 2011; Walsh and Mills, 2013).

#### 4.3.5. $\gamma\delta$ T cells



This subset of T lymphocytes was first associated with an antitumor effect. It has been shown that they prevent tumor development by various mechanisms similar to CTLs or NK cells: a) lysis of tumor cells via granzyme and perforin release, b) induction of apoptosis through TRAIL and FasL, c) interaction of CD16 present at the surface of  $\gamma\delta$  T cells with Fc fragment of antibodies bound to a TAA, resulting in ADCC or d) production of various cytokines (IFN- $\gamma$ , TNF- $\alpha$ ) preventing angiogenesis (Zhao et al., 2018).

However, recently, the  $\gamma\delta$  T lymphocytes have been depicted as having a pro-tumorigenic role in cancer progression. It appears that these cells can also adopt a Treg/Th2-like profile and release cytokines (IL-10, TGF- $\beta$ , IL-4) which limit the action of effector T cells. Moreover, in presence of  $\gamma\delta$  T cells, one of the main actors of an antitumor immune response, namely the DCs, show a decreased maturation and enter a senescence state. They also produce important quantities of the cytokine IL-17, which has been correlated with angiogenesis and recruitment of immunosuppressive cells (Treg, MDSC) to the tumor microenvironment (Fleming et al., 2017; Zhao et al., 2018).



#### 4.3.6. Other cells: macrophages, neutrophils, myeloid-derived suppressor cells

(Figure 27)

Macrophages are phagocytes which belong to the innate immune system and are considered as the most abundant immune cells in the microenvironment of solid tumors (Nielsen and Schmid, 2017). They can play a pro- and anti-tumorigenic role, depending on their polarization phenotype. Anti-tumor macrophages display a M1-like phenotype (pro-inflammatory, driven by lipopolysaccharide (LPS) and IFN- $\gamma$ ) and seem to be implicated in the elimination of cancer cells. However, during cancer progression, pro-tumorigenic macrophages with a M2-like profile (anti-inflammatory, driven by IL-4, IL-10, IL-13 or tumor-derived lactic acid) take over and promote tumor progression (Nielsen and Schmid, 2017). They can release immunosuppressive cytokines resulting in reduced activities of effector T cells and impaired maturation of DCs (Gonzalez et al., 2018). They also provide different factors important for angiogenesis in hypoxic areas of solid tumors: vascular-endothelial growth factor A (VEGF-A) and placental growth factor (PlGF) (Gonzalez et al., 2018; Nielsen and Schmid, 2017).

Neutrophils are the first innate immune cells recruited during the inflammatory process. Their function consists in eliminating pathogens in the damaged tissues by various mechanisms (for example phagocytosis or synthesis of web-like structures formed of decondensed chromatin and cytosolic and granule proteins: the neutrophil extracellular traps (NETs)). However, in cancer, several studies have shown that they seem to play principally a pro-tumorigenic role. First, the NETs, initially meant to catch pathogens, also immobilize circulating cancer cells facilitating this way their extravasation and the formation of metastasis. Tumor associated neutrophils, in the manner of macrophages, release cytokines implicated in angiogenesis, like vascular-endothelial growth factor (VEGF) (Gonzalez et al., 2018; Ocana et al., 2017). Furthermore, they can release enzymes (nitric oxide synthase (iNOS) or arginase 1(ARG1)) which inhibit the function of CTLs and NK cells (Ocana et al., 2017).

Myeloid derived-suppressor cells (MDSCs) are part of another population of immune cells generated in the bone marrow and implicated in cancer progression (Ocana et al., 2017). They group myeloid progenitor cells and immature myeloid cells which are attracted by the chemokines CCL2 and CCL5 to the tumor site (Ocana et al., 2017; Vesely et al., 2011). They impede effector T cells by expressing TGF- $\beta$ , iNOS or ARG1, by nitrating the TCR, by depleting amino acids which are essential for the function T cells or by inducing Tregs (Mittal et al., 2014; Schreiber et al., 2011; Vesely et al., 2011).

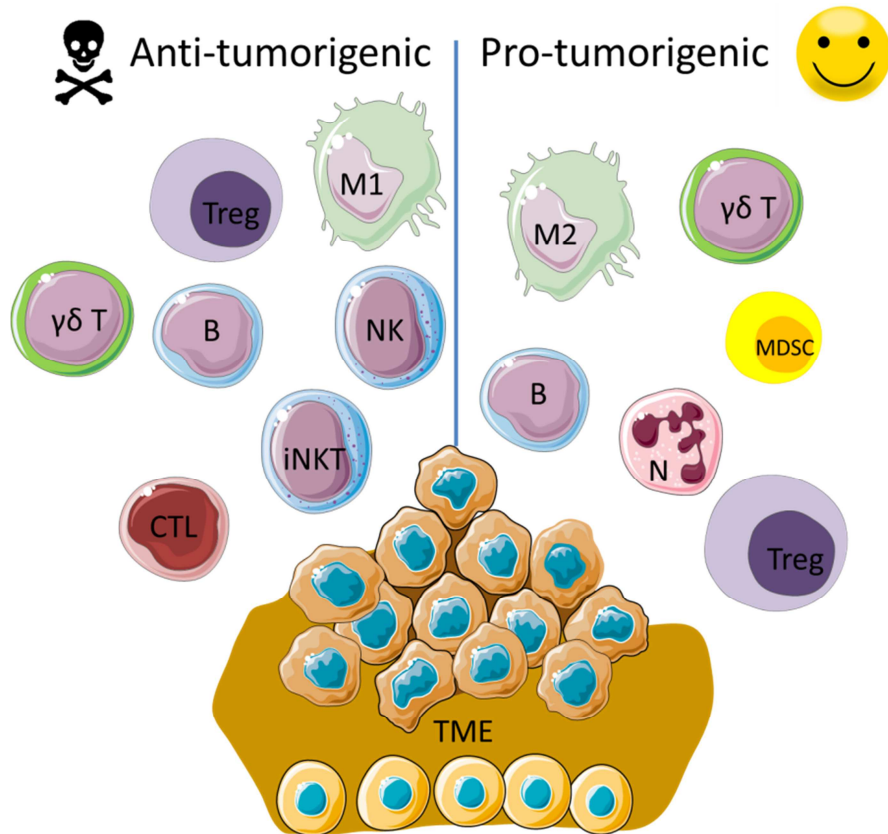

**Figure 27: Summary of immune cells implicated in the antitumor immune response**

Immune cells can have a pro -or anti-tumorigenic effect. CTLs, iNKT and NK cells have an anti-tumorigenic effect, while neutrophils and MDSCs have a pro-tumorigenic effect. B lymphocytes,  $\gamma\delta$  T cells, macrophages and Tregs can have both effects, depending on the situation.

### 5. The concept of immunediting (Figure 28)

During their development, cancer cells undergo mutations leading to the expression of TAAs at their cell surface which enable the immune cells to identify and to eliminate them. Unfortunately, tumor cells manage to hijack the immune cells and to evade their alertness, resulting in uncontrolled tumor progression. But how is this possible?

Over the last two decades, the hypothesis of immunosurveillance has evolved towards a new concept: the immunoediting (Mittal et al., 2014). This approach suggests that the interaction of the immune system and the tumor cells can be divided into three phases: elimination, equilibrium and escape.

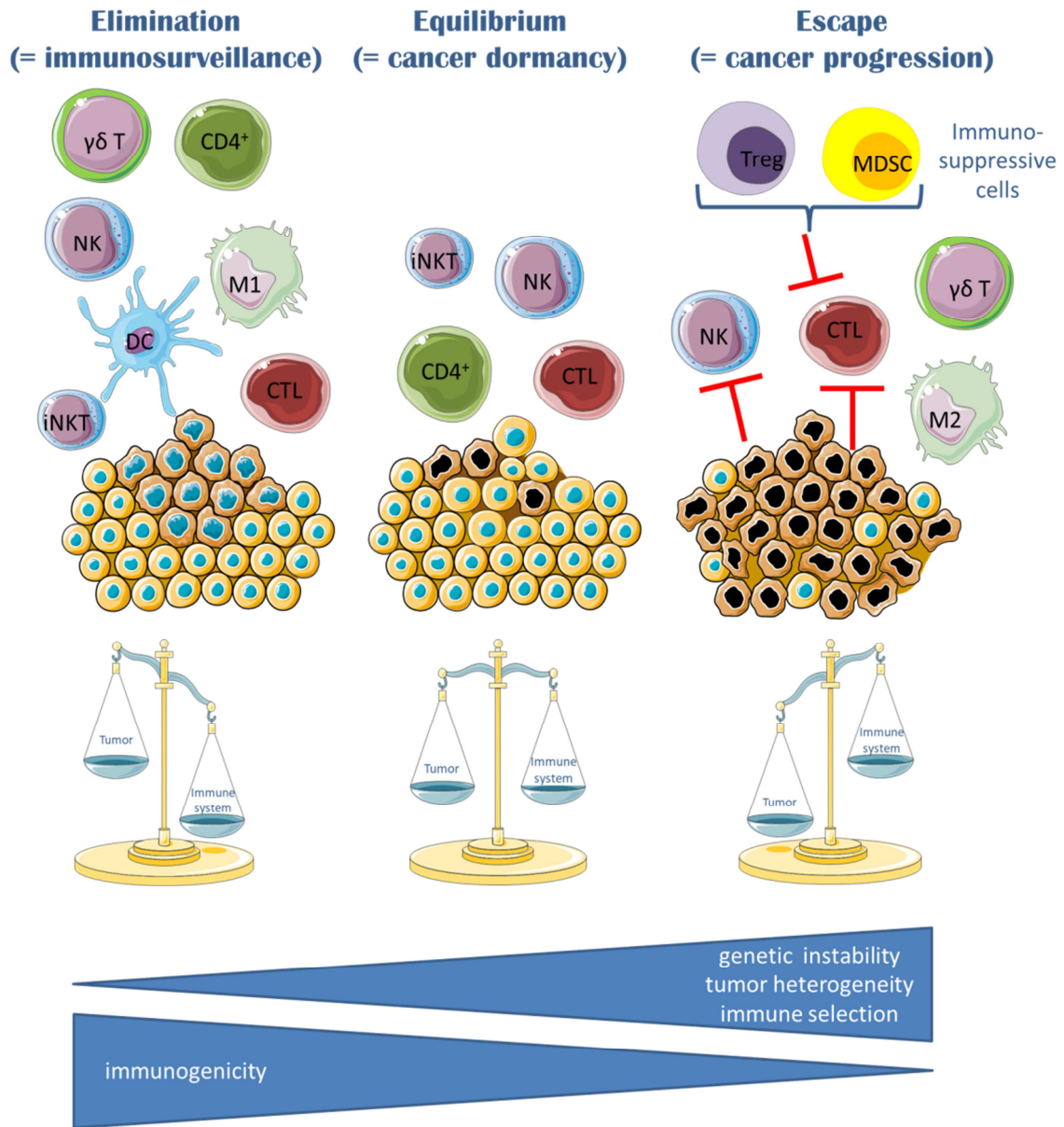

**Figure 28: The three E's of immunoediting: elimination, equilibrium, escape** (adapted from (Dunn et al., 2002; Mittal et al., 2014; Schreiber et al., 2011; Vesely et al., 2011))

Overview of the three phases of cancer progression and the different immune cells implicated. During the phase of elimination, cancer cells can be recognized and eliminated by various immune cells. However, some cancer cell variants (depicted as cancer cells with black nucleus) resist to the immune cells. During the phase of equilibrium, these cancer cells undergo Darwinian pressure and accumulate more and more mutations which allow them to proliferate continuously and to escape the control of the immune cells leading to the third phase: the escape. In this phase, the cancer cells progresses and the immune system is unable to constrain it.

### 5.1. Elimination

This phase consists in the detection of the cancer cells by the immune cells patrolling the tissues and thus the activation of the innate and the adaptive branch of the immune system to stop tumor development. The immune cells identify the tumor cells via differences at their cell surface. NK cells detect for example a modified expression of MHC I molecules (“missing-self”), while TAAs are essential for the expansion and differentiation of CD4<sup>+</sup> and CD8<sup>+</sup> T lymphocytes (Schreiber et al., 2011). The immune cells are recruited by various cytokines and chemokines to the tumor sites where they try to eradicate all the tumor cells and constrain this way their progression.

### 5.2. Equilibrium

However, some cancer cell variants can withstand this process and remain undetected in the tissue (Schreiber et al., 2011). This results in a dynamic equilibrium where neoplasia is prevented, although the tumor mass is not completely destroyed (Dunn et al., 2002). During this latency period, which can last for several years, immune cells and tumor cells co-exist, but the immune system performs a selection pressure on the cancer cells while trying to eliminate them (Dunn et al., 2002). The remaining tumor cells undergo Darwinian pressure, leading to the accumulation of more mutations (Dunn et al., 2002). Thus, these cells compile genetic and epigenetic alterations compared to the initial cells which confer them resistance to the attack of immune cells (Dunn et al., 2002, 2004; Schreiber et al., 2011).

### 5.3. Escape

The phenotype of the cancer cells progressively changes and so, they become “invisible” to the immune system. The tumor cells circumvent the action of innate and adaptive immune cells by various escape mechanisms (**Figure 29**) (Dunn et al., 2004). Their resistance can for example be due to a reduced immunogenicity characterized by a loss of TAAs. However, they can also induce the activation of anti-apoptotic pathways in order to endure the cytotoxic effects of immunity (Schreiber et al., 2011). Furthermore, they can either recruit regulatory immune cells (Tregs and MDSCs) or release different cytokines, such as VEGF, TGF- $\beta$ , galectin, indoleamine 2,3-dioxygenase, in order to set up an immunosuppressive tumor microenvironment (Schreiber et al., 2011). It is at this stage that neoplasia becomes clinically detectable (Dunn et al., 2002).



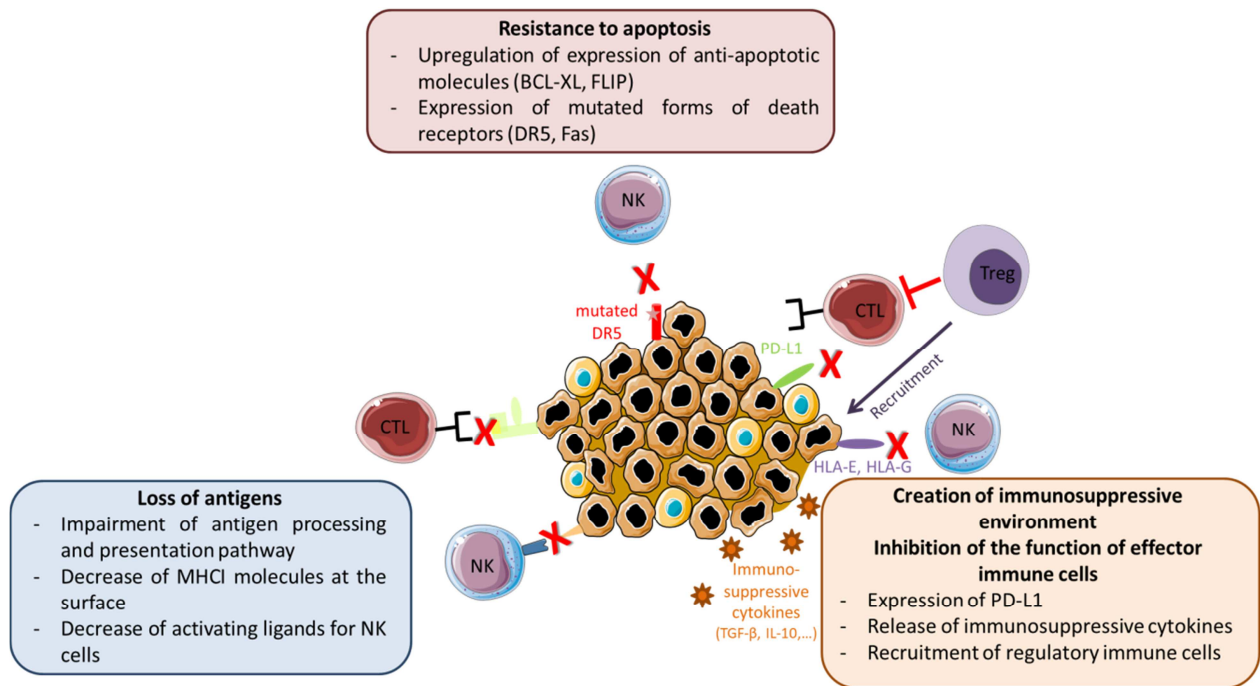

**Figure 29: The escape mechanisms developed by cancer cells to avoid immune recognition** (adapted from Vesely et al., 2011)

Cancer cells develop various mechanisms to prevent recognition by immune cells. They try to resist to apoptosis by upregulating the expression of anti-apoptotic molecules or by expressing mutated death receptors. Moreover, they can also limit the recognition of TAAs by immune cells by decreasing the expression of MHC I molecules or activating ligands for NK cells. Finally, cancer cells can create an immunosuppressive tumor microenvironment by releasing various cytokines, recruiting regulatory immune cells (Tregs and MDSCs) or expressing specific molecules at their surface (e.g. PD-L1).

### 5.3.1. The immune checkpoints

In physiological conditions, the immune responses are tightly regulated by Tregs and MDSCs in order to prevent excessive responses leading to damage. This implicates the interaction of inhibitory molecules, like PD-1 or CTLA-4, at the surface of T cells, known as immune checkpoints (Dyck and Mills, 2017). However, in the escape phase of cancer, the immune response is deregulated and becomes unable to fight against the cancer cells. After some time, the T cell response becomes limited due to the interaction of these inhibitory receptors with their ligands. However, the tumor is still present and will continue growing, as the immune cells are unable to eradicate it (Dyck and Mills, 2017). Furthermore, cancer cells can also overexpress PD-L1, which interacts with effector T cells and thus limits the antitumor immune response (Lim et al., 2017). Recently, other immune checkpoints have been evoked, like lymphocyte activation gene-3 (LAG-3) and T-cell immunoglobulin-3 (TIM-3) (Dyck and Mills, 2017). Over the last years, numerous investigations have been done to further understand these inhibitory mechanisms and to target them in order to limit cancer progression (Darvin et al., 2018).

## **6. Platinum compounds and their effect on the immune system**

### **6.1. Deleterious effects**

As already mentioned (§B.2.3.), platinum compounds have many side effects and also affect the bone marrow and thus the blood cell production. So, patients undergoing chemotherapy often present a reduced number of white and red blood cells as well as platelets due to myelosuppression (Oun et al., 2018). The patients can suffer from anaemia because of a decreased level of red blood cells and from thrombocytopenia, a low level of platelets leading to blood clotting problems. However, they also have to deal with a weakening of the immune system. In fact, all the immune cells, the lymphoid-derived ones and myeloid-derived ones, develop from the bone marrow. That is why, neutropenia is also described as a common side effect of chemotherapy since the neutrophils, a class of phagocytes, constitute the most abundant type of white blood cells. These immune cells are implicated in the inflammation process and in the defence against pathogens. Hence, a neutropenia leads to an impairment of the immune system.

### **6.2. Beneficial effect: induction of immunogenic cell death (ICD)**

The immune system is continuously in contact with dying cells, because of cell renewal, injury or disease, but becomes only activated under certain conditions. For a long time, it was believed that two categories of cell death existed with distinct effects on the immune system: apoptosis, which was considered as tolerogenic and did not activate the immune system, and necrosis, considered as immunogenic and thus eliciting an immune response (Green et al., 2009). This classification was mainly based on morphological alterations. Apoptosis was characterized by a decreased cellular volume, fragmentation of the nucleus, condensation of chromatin and the formation of apoptotic bodies, while the features of necrosis consisted in an increase of the cellular volume due to organelle swelling followed by a destruction of the cellular membrane (Krysko et al., 2012). However, over the last years, this categorization has been reviewed. In fact, it has appeared that, under particular conditions, cells can show apoptotic morphology and induce the activation of an adaptive immune response: this type of cell death was called immunogenic cell death (ICD) (Galluzzi et al., 2017; Wang et al., 2013).

ICD consists in the release of immuno-stimulatory DAMPs in a definite spatiotemporal configuration which can be triggered by various anticancer therapies including platinum-based chemotherapeutic agents (Dudek et al., 2013; Garg et al., 2015; Kepp et al., 2014; Tesniere et al., 2010; Zhou et al., 2019). These treatments induce ER stress and the production



of reactive-oxygen species which then help in the release of DAMPs (Kepp et al., 2013; Krysko et al., 2012). The main DAMPs involved in ICD are the exposure at the cell surface of the ER chaperone calreticulin (CALR), as well as the emission of adenosine triphosphate (ATP) and non-histone chromatin-binding protein high mobility group box 1 (HMGB1) (Kepp et al., 2014) (**Figure 30**).

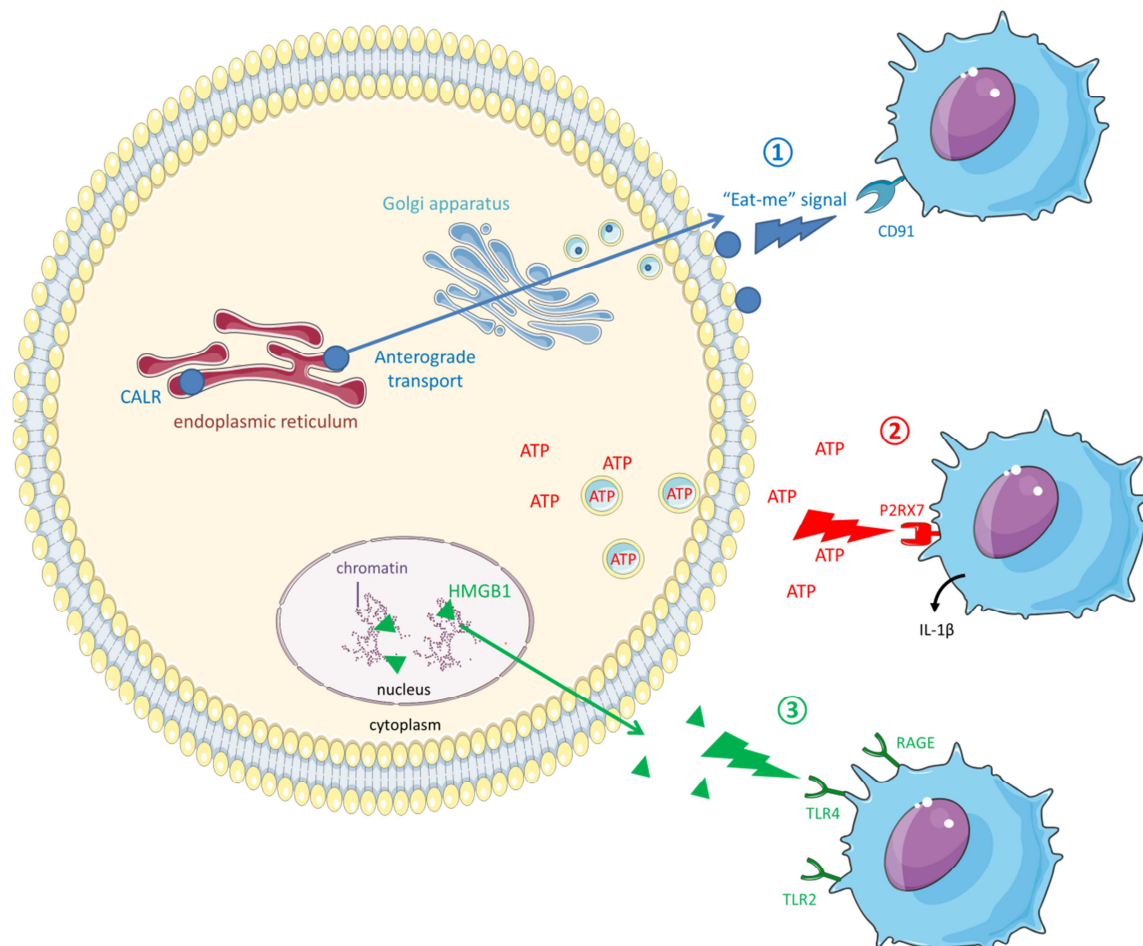

**Figure 30: Induction of immunogenic cell death.**

Some cancer treatments induce immunogenic cell death (ICD), an apoptosis able to activate the immune system. ICD is characterized by three features: ① the exposure of the protein calreticulin at the cell surface which serves as phagocytic signal, ② the release of ATP which triggers the activation of the inflammasome NLRP3 and thus the production of IL-1β and ③ the emission of the protein HMGB1 acting as immuno-stimulatory molecule by facilitating the antigen presentation and processing.

### 6.2.1. Exposure of calreticulin (Figure 30 ①)

In physiological conditions, ER-located CALR acts as chaperone by ensuring the proper folding of proteins and is also involved in maintaining the homeostasis of cytosolic and ER calcium concentrations (Fucikova et al., 2018; Gold et al., 2010). In cells undergoing ICD, the translocation of calreticulin from ER to the cell surface *via* anterograde transport is an early

process: it appears before the shuffling of phosphatidylserines from the inner to the outer membrane leaflet, a feature of early apoptosis (Fucikova et al., 2018; Kepp et al., 2014; Panaretakis et al., 2009). The ER stress induced by the anticancer treatment leads to the activation of the ER kinase PERK, which then phosphorylates the eukaryotic translation initiation factor EIF2 $\alpha$ . This results in partial activation of the caspase 8 which cleaves the ER protein BAF and activates the pro-apoptotic proteins BAX and BAK. CRT is then translocated *via* anterograde transport from the ER to the Golgi apparatus followed by exocytosis towards the cell membrane (Fucikova et al., 2018; Kepp et al., 2014; Panaretakis et al., 2009).

Once exposed at the cell surface, CALR interacts with various receptors expressed on immune cells, like TLRs and phagocytosis and scavenger receptors (e.g. CD91) and serves as “eat-me signal” for phagocytes, which improves the engulfment of apoptotic cells (Fucikova et al., 2018; Kepp et al., 2014; Lu et al., 2015; Obeid et al., 2007). However, an antitumor immune response cannot be triggered by ecto-CALR alone; other signals are required (Fucikova et al., 2018).

### 6.2.2. Release of ATP (Figure 30 ②)

The release of ATP occurs later than the exposure of CALR, but it requires an intact premortem autophagy machinery (Kepp et al., 2014; Wang et al., 2013). The mechanism of ATP release is quite complex. It has appeared that ATP can be found in the cytoplasm and within LAMP1<sup>+</sup> lysosomal vesicles in the cells (Ainscow et al., 2002; Li et al., 2011; Martins et al., 2014). When cancer cells undergo ICD, ATP relocates towards autophagolysosomes, resulting from the fusion of lysosomes and autophagosomes (Gebremeskel and Johnston, 2015; Martins et al., 2014). The exposure of LAMP1 at the cell surface indicates the fusion of the autophagolysosomes with the cell membrane, a process dependent on caspase activation and known as lysosomal exocytosis (Martins et al., 2014). The caspases also activate the transmembrane Pannexin 1 channel, which enables the diffusion of small hydrophilic molecules and ATP from the cytoplasm to the extracellular space (Kepp et al., 2014; Wang et al., 2013).

The extracellular ATP has two roles: i) it acts as chemoattractant by recruiting myeloid immune cells to the dying cancer cells and ii) it interacts with the purinergic receptor P2RX7, thus leading to the activation of the caspase-1-dependent NLRP3 inflammasome in APCs and in the production of IL-1 $\beta$  (Gebremeskel and Johnston, 2015; Kepp et al., 2014; Serrano-del Valle et al., 2019).

### 6.2.3. Release of HMGB1 (Figure 30 ③)

HMGB1 is a non-histone chromatin binding protein which mainly locates in the cell nucleus, where it is involved in various processes, like telomere maintenance, DNA repair and genome stability (He et al., 2017). During ICD, HMGB1 is released in the extracellular space following the postmortem loss of nucleus and cell membrane integrity (Kepp et al., 2014). The exact mechanism involved in the emission of HMGB1 in case of ICD is not clearly elucidated, but several hypotheses were emitted. It seems that HMGB1 might not be able to be directly translocated from the Golgi apparatus towards the cell membrane. In this case, HMGB1 is acetylated in order to prevent it from being transporting in the nucleus and it then accumulates in lysosomal vesicles which fuse with the cell membrane and this way release HMGB1 (He et al., 2017). However, it has also be proposed that the emission of HMGB1 could be due to passive diffusion, after the loss of the cell membrane integrity of dying cells, a process more likely to happen in the case of ICD (He et al., 2017; Serrano-del Valle et al., 2019).

Extracellular HMGB1 binds to various PRRs on immune cells, like TLR4, TLR2 or Receptor for advanced glycation endproducts (RAGE), thus acting as immuno-stimulatory molecule and facilitating the processing of antigens and their presentation by APCs (Kepp et al., 2014; Serrano-del Valle et al., 2019).

**Table 6: DAMPs involved in immunogenic cell death.**

This table gives a non exhaustive overview of some DAMPs implicated in immunogenic cell death and their receptors.

DAMPs	Receptors	References
<b>Calreticulin</b>	CD91	Galluzzi et al., 2017; Garg and Agostinis, 2017; Hernandez et al., 2016
<b>ATP</b>	P2RX7, P2RY2	Galluzzi et al., 2017; Garg and Agostinis, 2017; Hernandez et al., 2016
<b>HMGB1</b>	TLR2, TLR4, RAGE	Galluzzi et al., 2017; Garg and Agostinis, 2017; Hernandez et al., 2016
<b>Annexin A1 (ANXA1)</b>	FPR1	Galluzzi et al., 2017; Garg and Agostinis, 2017; Hernandez et al., 2016
<b>Nucleic acids</b> (double-stranded DNA, double-stranded RNA)	TLR3, TLR7/8, TLR9	Galluzzi et al., 2017; Garg and Agostinis, 2017
<b>Heat-shock proteins</b> (HSP60, HSP70, HSP72, HSP90)	CD91, TLR2, TLR4	Galluzzi et al., 2017; Garg and Agostinis, 2017

### 7. Targeting the immune system to fight against cancer: the use of immunotherapy

In the 1890s, Dr. William Coley, an American surgeon, was intrigued by the remission of a case of round cell sarcoma. In fact, the patient had a very poor prognosis and underwent several surgeries. After a skin graft, he was infected with erysipelas, an infection believed to be caused by *Streptococcus pyogenes*, which resulted in the disappearance of the tumors, thus suggesting that the infection might have had a beneficial effect on tumor regression (Brassil and Ginex, 2018; Decker et al., 2017).

In the 1960s, the implication of the immune system in cancer development has gained increasing attention. This led to the emergence of a new anticancer therapy: **immunotherapy**, which consists in a modulation of the immune system to efficiently fight against the cancer (Milling et al., 2017).

At the beginning, immunotherapy was divided in two categories: passive and active immunotherapy (Galluzzi et al., 2014). Compounds inducing the activation of the patient's immune system, like for example cancer vaccines or checkpoint inhibitors, were classified as active immunotherapeutic agents. However, the administration of tumor-targeting monoclonal antibodies or adoptively transferred T cells targeting directly the cancer cells was described as passive immunotherapy (Galluzzi et al., 2014). Nevertheless, over the years, this classification was reviewed, resulting in a classification based on antigen-specificity (Galluzzi et al., 2014).

### 7.1. Non-specific immunotherapy

**Non-specific immunotherapy** consists in the administration of agents able to activate the immune system and to enhance this way the antitumor immune response. The injection of immunostimulatory cytokines (IFN- $\alpha$ 2b, IL-2) or monoclonal antibodies acting as checkpoint inhibitors (anti-CTLA4, anti-PD-1) or as angiogenesis inhibitors (anti-VEGF) account in this category (Galluzzi et al., 2014; Granier et al., 2016).

### 7.2. Passive specific immunotherapy

The replacement or *ex vivo* modification of effectors of the immune system can be considered as **passive specific immunotherapy**. Among this category, one can cite the injection of **antibodies specifically recognizing the tumor cells**. These antibodies are able to bind to receptors or TAAs expressed at the surface of cancer cells, resulting in the lysis of the cancer cell by antibody-dependent cell-mediated cytotoxicity (Galluzzi et al., 2014). Furthermore, autologous T cells can be manipulated *ex vivo* to generate T cells recognizing a specific peptide:MHC complex before being re-injected to the patient: a technique called **adoptive T cell transfer** (Dudley et al., 2003). Another strategy has evolved during the last years: the introduction of a **chimeric antigen receptor (CAR) in T cells** (Khalil et al., 2016). The CAR is composed of the fusion of a single-chain variable fragment (scFv) of an antibody specific of TAAs with a TCR signaling complex and can thus specifically recognize TAAs which are not presented on MHC molecules and induce the activation of the T cell *via* the TCR signaling complex (Khalil et al., 2016).

### 7.3. Active specific immunotherapy

This strategy consists in the *in vivo* stimulation of the immune system. This can be done by injection of **vaccines containing TAAs** and thus priming the immune system to specifically recognize these TAAs (Galluzzi et al., 2014).

## Thesis objectives

### Context

Platinum(II)-based drugs are commonly used chemotherapeutic agents to treat various cancer types. However, they present numerous drawbacks as described in the §B.2.3. of the introduction. Their use is either limited by intrinsic or acquired resistances or by various severe side effects (Gottesman et al., 2016; Kelland, 2007; Ma et al., 2019).

That is why, the development of innovative platinum(II)-based compounds targeting specifically the malignant cells and thus inducing less side effects, has become a major challenge in research.

### Preliminary results

In this context, my host laboratory in collaboration with the chemistry team of Dr. Stéphane Bellemin-Lapponnaz (UMR 7504, IPCMS, Strasbourg, France) decided in 2009 to develop innovative platinum-based compounds. For this, they took advantage of ligands forming stable complexes with transition metals, like platinum, and thus being of interest for the development of metal-based drugs: the N-heterocyclic carbenes (NHC). These ligands allow a fine-tuning of both the physicochemical properties and the reactivity in biological medium. This way, they perfectly fit prerequisites for efficient antineoplastic drug design (Merces and Albrecht, 2010). Several research groups, including my host laboratory, demonstrated *in vitro* cytotoxicity of NHC-Pt compounds against cancer cells (Chardon et al., 2012a, 2012b; Chtchigrovsky et al., 2013; Muenzner et al., 2015; Skander et al., 2010; Wai-Yin Sun et al., 2011). However, as their *in vivo* use was limited due to weak solubility under biological conditions, my host laboratory in collaboration with the chemists created innovative compounds starting from linear 25 kDa polyethyleneimine (PEI), a cationic polymer commonly used as transfection agent. They generated 3 compounds containing one NHC-platinum complex every 10, 20 or 30 units of ethylenediamine (**Figure 31**).

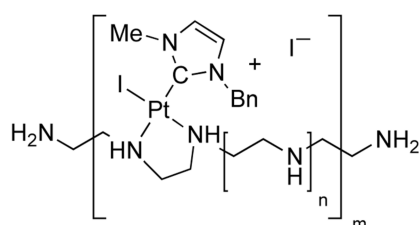

**Figure 31: Structure of NHC-Pt(II)-PEI.** (Chekkat et al., 2016)

For NHC-Pt(II)-PEI10 n=9 and m=60;  
for NHC-Pt(II)-PEI20 n=19 and m=30;  
for NHC-Pt(II)-PEI30 n=29 and m=20.

It appeared that the conjugate with one NHC-Pt complex every 30 units of ethylenediamine (NHC-Pt(II)-PEI30) showed the best cytotoxic activity against several human and murine cancer cell lines *in vitro*. Furthermore, this compound was able to limit tumor growth *in vivo* in an immunodeficient mouse model xenografted with human adenocarcinoma cell line HCT116 and displayed less side effects than the clinically used platinum(II) derivative oxaliplatin (Figure 32) (Chekkat et al., 2016).

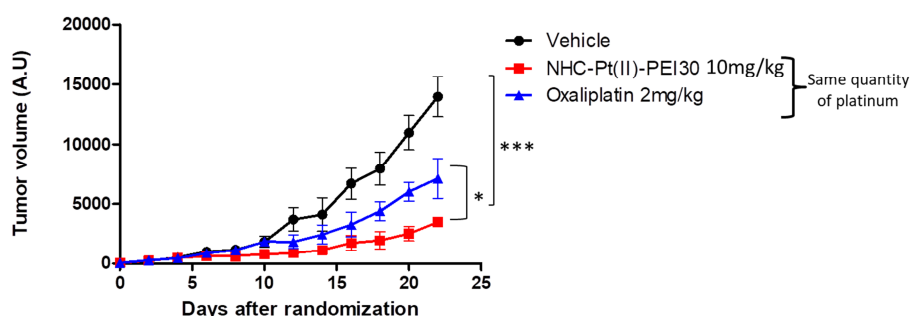
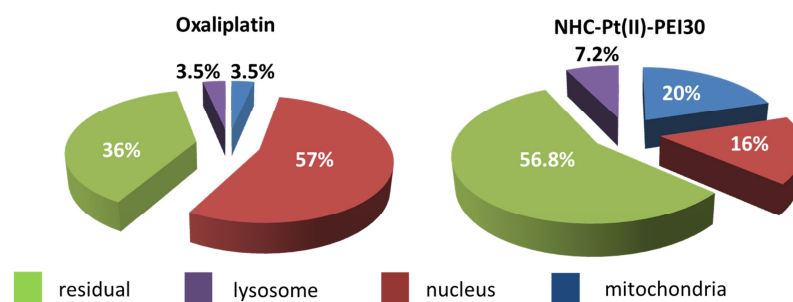

**Figure 32: *In vivo* antitumor effect of NHC-Pt(II)-PEI30 in immunodeficient mouse model.** (Chekkat et al., 2016)

Human adenocarcinoma cells HCT116 were injected subcutaneously in immunodeficient mice to generate tumors. After tumor apparition, the mice were treated with 10mg/kg of NHC-Pt(II)-PEI30, 2 mg/kg of oxaliplatin or vehicle every 48 hours during 22 days and the tumor size was measured throughout the experiment to evaluate the tumor volume. \* p-value =0.5; \*\*\* p-value < 0.001

Moreover, it appeared that NHC-Pt(II)-PEI30 was able to kill *in vitro* cancer cells mutated for the tumor suppressor p53. These cells were resistant to conventionally used platinum(II)-based derivatives oxaliplatin and cisplatin, which suggested that NHC-Pt(II)-PEI30 might have a different mechanism of action (Chekkat et al., 2016).

In order to gain better understanding of the mechanism of action of NHC-Pt(II)-PEI30, its cellular localization was evaluated and it appeared that NHC-Pt(II)-PEI30 was mainly found in the mitochondria and to lesser extent in the nucleus, which was in contrast with oxaliplatin targeting primarily the nucleus (Figure 33) (Chekkat et al., 2016).



**Figure 33: Cellular localization of oxaliplatin and NHC-Pt(II)-PEI30.** (Chekkat et al., 2016)

Human adenocarcinoma cells HCT116 were treated during 6 hours with 5  $\mu$ M of platinum before assessing its cellular localization by ICP-MS.



That is why, during my Master 2 internship, I analyzed the effect of NHC-Pt(II)-PEI30 on mitochondria. I demonstrated that the compound impaired mitochondrial function by inducing the accumulation of superoxide ions as well as the decrease of their respiratory activity (Chekkat et al., 2016).

Based on these promising results, I started my PhD work, which consisted in the **evaluation of innovative platinum compounds as antitumoral agents combining chemotherapy and immunotherapy**. This work was divided into three parts which will be further detailed below.

### Objective 1: Optimization of innovative platinum-based compounds

As already previously mentioned, three different NHC-Pt(II)-PEI compounds had been developed with one NHC-Pt(II) complex every 10, 20 or 30 units of ethylenediamine and it appeared that NHC-Pt(II)-PEI30 displayed the best cytotoxic profile. However, we considered if the cytotoxic activity could be ameliorated by increasing the NHC-Pt(II)/PEI ratio.

So, the first goal of my PhD thesis consisted in the **evaluation of the cytotoxicity of these new conjugates**. Moreover, to gain better understanding of the mechanism of action of NHC-Pt(II)-PEI30, I analyzed **different exposure times** of NHC-Pt(II)-PEI30 and of oxaliplatin, a commercially available platinum(II) derivative used as control in our experiments, on human cancer cells in order to assess the exposure time which was sufficient to induce efficient cytotoxicity. Finally, to track the platinum conjugates within the cell and thus further elucidate their mechanism of action, the chemists synthesized various **fluorescent derivatives of NHC-Pt(II)-PEI30**. I checked if the **cytotoxicity** of the conjugate was maintained after addition of the fluorophore and performed preliminary **microscopy experiments**.

The results of this part were **published in 2018** (Wantz et al., 2018) and this paper is presented in **Chapter 1**.

Over the last years, platinum(IV)-based conjugates have gained increasing attention as potential anticancer drugs. That is why, I evaluated the **cytotoxic activity of NHC-Pt(IV)** compounds on various cancer cell lines. I also assessed their **effect on mitochondrial function** in order to compare their mechanism of action to that of NHC-Pt(II) conjugates. The results of these investigations were **published in 2016** (Bouché et al., 2016) and this paper can be found as **appendix** of the thesis.



## Objective 2: Targeting glioblastoma-derived cancer stem cells

Some cancer types, especially glioblastomas are resistant to numerous therapies, thus leading to a poor prognosis. These resistances can partly be associated with the presence of a particular sub-population of cancer cells within the tumor bulk: the cancer stem cells (Bradshaw et al., 2016; Konrad et al., 2017). These cells, like embryonic stem cells, are able to self-renew and are pluripotent, enabling them to differentiate into all lineages of progeny found in glioma, leading this way to tumor relapse (Deshmukh et al., 2016). These cells are resistant to radio-and chemotherapy which makes their eradication difficult (Venere et al., 2011). However, several years ago, it has appeared that the mitochondrial biogenesis is important for their survival.

Based on these results and having demonstrated that our conjugate NHC-Pt(II)-PEI30 affected the mitochondrial function (cf preliminary results), we emitted the hypothesis that our innovative compound might be able to kill the cancer stem cells. So, I evaluated the **cytotoxic activity** of NHC-Pt(II)-PEI30 **on cancer stem cells** derived from patients suffering from glioblastoma and analyzed its **effect of the mitochondrial function**. This part of my thesis was realized in collaboration with a Master 2 student and the results are presented in the **Chapter 2** in the form of an **article in preparation**.

## Objective 3: Activation of the antitumor immune response by innovative platinum(II) compounds

Over the last years, it has been observed the chemotherapy is more efficient in immunocompetent patients compared to immunodeficient individuals (Vesely et al., 2011; Zitvogel et al., 2013). Furthermore, it has been proven that the clinically used platinum(II) derivative oxaliplatin is able to induce a special type of apoptosis leading to the activation of an antitumor immune response: the immunogenic cell death (ICD) (Dudek et al., 2013; Tesniere et al., 2010; Zhou et al., 2019). This cell death is characterized by the release of damage-associated molecular patterns (DAMPs) which are considered as danger signals by innate immune cells and therefore implicated in their activation process (Garg et al., 2013; Krysko et al., 2012).

That is why, the third aim of my thesis work consisted in **evaluating the immunotherapeutic potential of** our platinum(II) conjugate **NHC-Pt(II)-PEI30**. I first investigated the antitumor and the immuno-stimulatory effect of NHC-Pt(II)-PEI30 in **immunocompetent mouse model**. Then, I assessed its **ability to induce ICD** i) directly by analyzing the presence

DAMPs and ii) indirectly by measuring the activation of immune cells after treatment of cancer cells. Furthermore, I generated complexes of NHC-Pt(II)-PEI30 with an agonist of receptors present in immune cells in order to stimulate their activation and thus **enhance the immunotherapeutic potential of NHC-Pt(II)-PEI30**. The effect of these complexes was evaluated *in vitro* and *in vivo* in immunocompetent mouse model.

The results of this part are presented in **Chapter 3** in form of an **article in preparation**.



# **Chapter 1**

Optimization of innovative platinum-based  
compounds

La science consiste à passer d'un étonnement à un autre.

*Aristote*

## Context and objectives

Platinum(II)-based compounds are the most commonly used chemotherapeutic agents (Gibson, 2019). However, they present various drawbacks as described in the introduction (§B.2.3.). That is why thousands of platinum derivatives have been synthesized and investigated for their cytotoxic activity against cancer cells (Liu et al., 2017). Nevertheless, only three compounds obtained a worldwide approval by the FDA: cisplatin, carboplatin and oxaliplatin.

My host laboratory, in collaboration with the team of Stéphane Bellemin-Laponnaz (IPCMS, Strasbourg) focused on the development of innovative conjugates formed of N-heterocyclic carbene-platinum complexes attached to the transfection agent polyethylenimine (PEI). Previous studies revealed a good cytotoxic activity *in vitro* and *in vivo* of a conjugate containing one platinum complex every 30 units of ethylenediamine: NHC-Pt(II)-PEI30 (Chekkat et al., 2016).

**The goal of this study was to optimize this compound in order to develop an innovative conjugate with good cytotoxic activity against cancer cells and to gain further insight in its mechanism of action.**

## Results

First, the **cytotoxic activity** of several NHC-Pt(II)-PEI compounds with **various platinum complex/polymer ratios (Figure 34)** was evaluated *in vitro* confirming that NHC-Pt(II)-PEI30 was the best candidate to continue investigations. To gain further insight in its mechanism of action, the **exposure time** necessary to induce *in vitro* cytotoxicity was assessed and appeared to be shorter than that of commercially available platinum(II) derivative oxaliplatin. NHC-Pt(II)-PEI30 was able to induce high cytotoxicity after only 45 minutes of exposure, which was not the case for oxaliplatin. Moreover, in order to track the conjugate within the cell by microscopy, **two fluorescent derivatives** were synthesized: one with a fluorophore attached to the platinum complex and one with a fluorophore attached to the PEI moiety. I could prove that the cytotoxic activity of these fluorescent compounds was maintained before starting observations by confocal microscopy. First observations suggest that NHC-Pt(II)-PEI30 is able to enter the cancer cells and that this might happen by endocytosis.

## Conclusions

These studies allowed to clearly delineate an innovative platinum(II)-based compound with an important cytotoxic activity *in vitro* against cancer cells. It displayed a shorter exposure time necessary for the induction of cytotoxicity efficacy than oxaliplatin, which is actually used in clinics. Finally, preliminary microscopic observations with the fluorescent derivatives were performed to further elucidate the mechanism of action of the conjugate. Altogether these results highlighted several advantages of our compound compared to commercially available oxaliplatin. Furthermore, the fluorescent derivatives would allow a tracking of the compounds within the cell using confocal microscopy. The attachment of the fluorophore on the platinum complex and on the PEI moiety would be of interest to observe a possible dissociation of the compound within the cell.

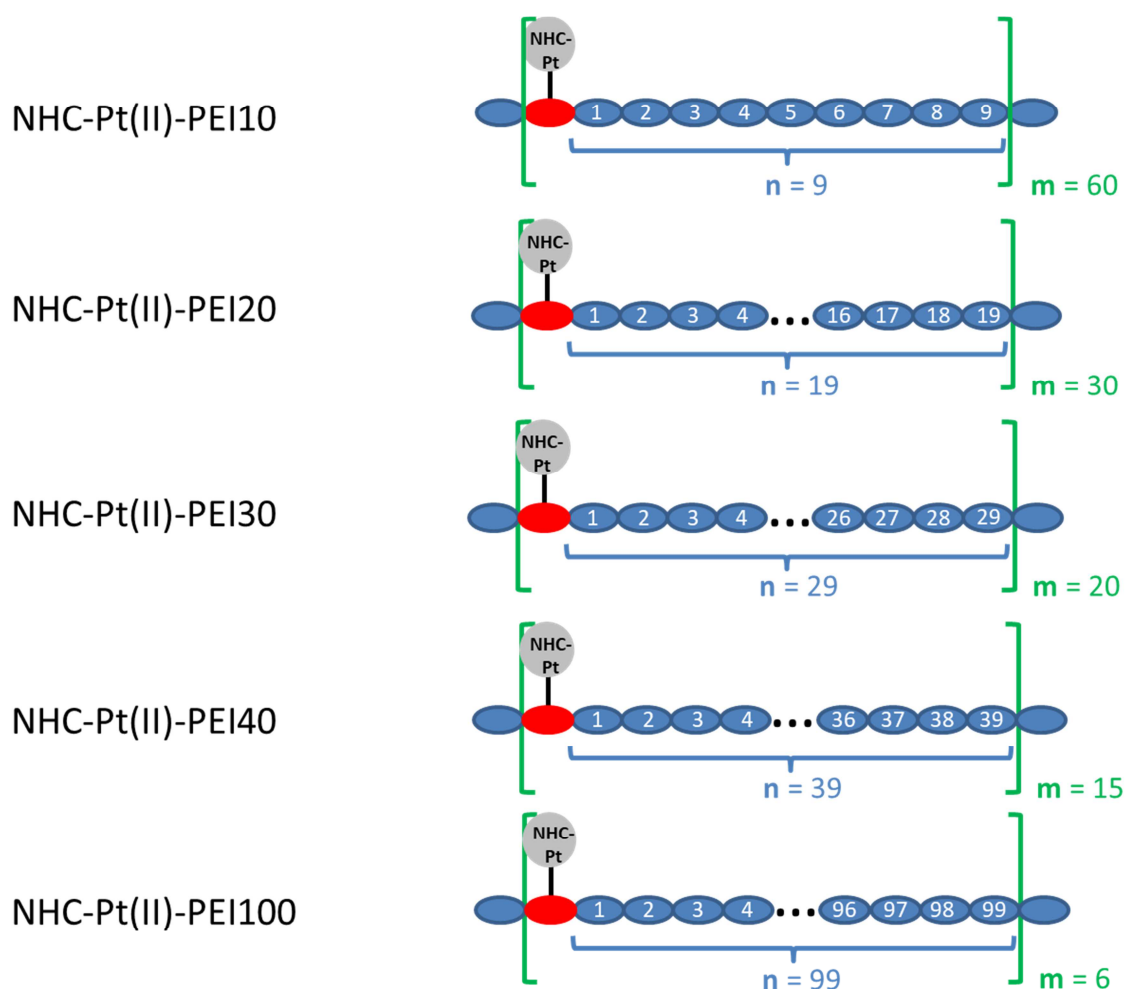

**Figure 34: Different NHC-Pt(II)-PEI compounds.**

Schematic representation of NHC-Pt(II)-PEI compounds with various complex/polymer ratios.



Article

# *N*-Heterocyclic Carbene-Polyethyleneimine (PEI) Platinum Complexes Inducing Human Cancer Cell Death: Polymer Carrier Impact

May Wantz <sup>1,†</sup>, Mathilde Bouché <sup>2,†</sup> , Georges Dahm <sup>2</sup>, Neïla Chekkat <sup>1</sup>, Sylvie Fournel <sup>1,\*</sup> and Stéphane Bellemin-Laponnaz <sup>2,\*</sup>

<sup>1</sup> UMR 7199, Faculté de Pharmacie, Université de Strasbourg-CNRS, 74 Route du Rhin, BP 60024, 67401 Illkirch CEDEX, France; may.wantz@etu.unistra.fr (M.W.); Neila.Chekkat@sanofi.com (N.C.)

<sup>2</sup> Institut de Physique et Chimie des Matériaux de Strasbourg, UMR 7504 CNRS-Université de Strasbourg, 23 rue du Loess, 67000 Strasbourg, France; mathilde.bouche9@gmail.com (M.B.); georges.dahm@etu.unistra.fr (G.D.)

\* Correspondence: s.fournel@unistra.fr (S.F.); bellemin@unistra.fr (S.B.-L.); Tel.: +33-368-854-173 (S.F.); +33-388-107-166 (S.B.-L.)

† These authors contributed equally to this work.

Received: 8 October 2018; Accepted: 2 November 2018; Published: 5 November 2018



**Abstract:** The high interest in *N*-Heterocyclic platinum carbene complexes in cancer research stems from their high cytotoxicity to human cancer cells, their stability, as well as their ease of functionalization. However, the development of these new molecules as anticancer agents still faces multiple challenges, in particular solubility in aqueous media. Here, we synthesized platinum-NHC bioconjugates that combine water-solubility and cytotoxicity by using polyethyleneimine as polymer carrier. We showed on 8 different types of cells that the activity of these conjugates is modulated by the size of the polymer and the overall density of metal ions onto polymer chains. Using HCT116 cells, the conjugates displayed an effective activity after only 45 min of exposure in vitro correlated with a quick uptake by the cells as shown by the use of various fluorescent-tagged derivatives.

**Keywords:** antitumoral activity; platinum; *N*-Heterocyclic carbene; polyethyleneimine

## 1. Introduction

Due to their unique properties, metal ions are the subject of intensive research for the development of drugs against acute illness [1]. The interest in metal-based drugs has essentially started with the discovery of the antiproliferative activity of cisplatin by Rosenberg, which is still now the most widely used anticancer drug (Figure 1) [2]. However, cancer treatment with cisplatin (and its derivatives such as oxaliplatin) is accompanied by various severe toxic side effects and in addition tumour resistance is a real concern that pushes chemists and biologists to develop alternative molecules [3]. Nevertheless, the success of cisplatin remains a motivation for the development of new platinum complexes displaying lower side effects [4,5].

Transition metal complexes featuring *N*-Heterocyclic carbene (NHC) ligands have received much interest in recent years in the context of cancer therapy [6]. Positive preliminary results motivated research and development in this direction and recently many NHC-containing platinum compounds have shown high activity in vitro against various cancer cell lines with cytotoxicity significantly higher than cisplatin (Figure 1) [7–9]. However, the (pre)clinical development of these new molecules as anticancer agents still faces multiple challenges, including the clarification of their mode of action. Moreover, a major barrier of these promising candidates remains their poor solubility in physiologic



medium. Thus, the development of innovative strategies to bring solubility in water while maintaining the biological activity is a topical subject for these systems.

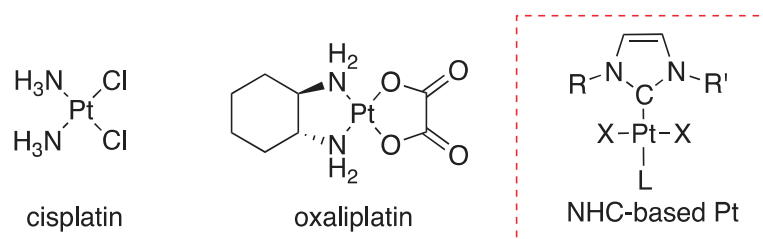

**Figure 1.** Chemical structures of platinum complexes cisplatin, oxaliplatin and *N*-Heterocyclic carbene platinum (II) complexes that showed high cytotoxic activities against cancer cells.

We recently highlighted that polyethyleneimine (PEI), a polymer widely used as transfection agent, can be used as ligand for *N*-Heterocyclic carbene platinum complexes to generate NHC-Pt-PEI conjugates that induce human cancer cell death *in vitro* and *in vivo* [10]. Interestingly, we showed that a part of the cytotoxicity induced by our compounds was not affecting the nucleus and seemed related to mitochondrial dysfunction. Herein, we wish to report the synthesis and *in vitro* activities of such conjugates where the polymer type (linear or branched) and size (low Mw to high Mw) were varied. We also studied the local platinum concentration effect onto the biological activity and concluded that an optimal balance between all these parameters is required for an efficient anticancer activity. To go further in the understanding of the conjugate's mode of action, we evaluated their cellular uptake using fluorescent derivatives and showed that a short exposure is sufficient to induce tumour cell cytotoxicity.

## 2. Results

### 2.1. Synthetic Procedure and Characterization

#### 2.1.1. NHC-Pt-PEI Conjugate

Ligand substitution on a preformed NHC-platinum pyridine complex is a direct and practical method for the synthesis of conjugates [11,12]. This strategy allowed us to easily generate libraries of functionalized Pt(II)-NHC complexes [13]. Using the same strategy, NHC-platinum-PEI conjugates were synthesized by reacting *trans* [(NHC)PtI<sub>2</sub>(pyridine)] (1) (NHC = 3-benzyl-1-imidazolilydene) and the desired PEI polymer chain (Figure 2). In very mild condition (EtOH, 55 °C), the complete grafting of the NHC platinum complexes on polyethyleneimine (PEI) was observed after 48 h of reaction. The conversion was quantitative and variation in the nature (linear or branched) and in the molecular weight of the PEI as well as the ratio between the number of platinum centres and the number of nitrogen atoms gave access to a large variety of polycationic NHC-Pt-PEI conjugates with different metal-loadings. The grafting of the NHC-Pt moiety was easily evidenced by NMR spectroscopy thanks to the characteristic peaks of the NHC ligand and to the disappearance of the pyridine signals. Moreover, integration of the characteristic signals of the NHC ligand by <sup>1</sup>H NMR spectroscopy allowed us to determine the Pt:NH ratio of the NHC-Pt-PEI conjugates that were found to be in accordance with the Pt- and N-quantification obtained by elementary analyses.

Four different polyethylenimines were used: a branched polymer of 1.8 kDa and three linear polymers of 2.5, 25 and 250 kDa. The ratio between the number of platinum centres and the number of nitrogen atoms was also varied, thus affording NHC-Pt-PEI conjugates with various metal-loadings. Interestingly, all NHC-Pt complexes showed an improved water-solubility. Whereas stock solutions in DMSO are generally required to solubilize NHC-metal complexes, NHC-Pt-PEI conjugates are easily solubilized in ethanol and then could be diluted in aqueous solutions such as cell culture medium.



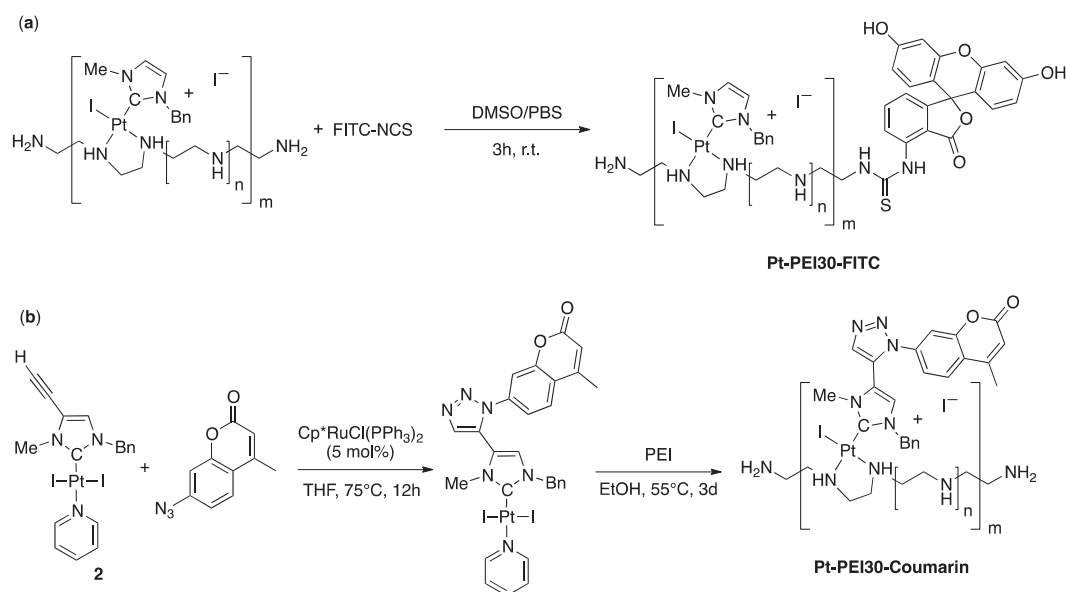
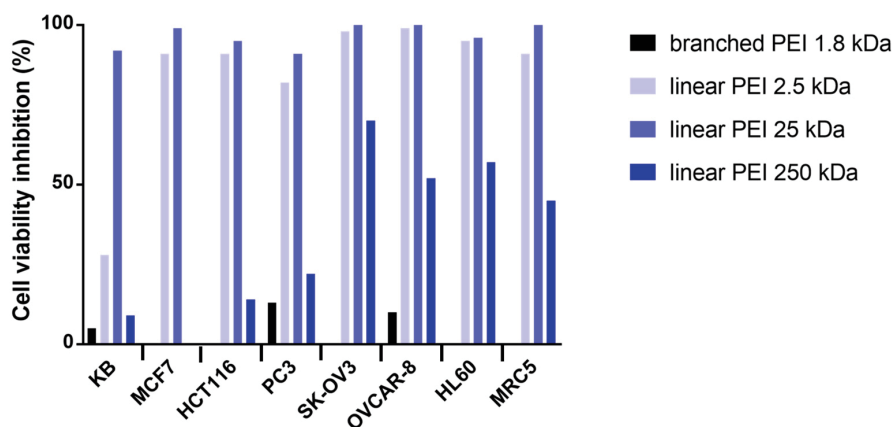

**Figure 3.** Synthesis of FITC-labelled Pt-PEI30 Pt-PEI30-FITC (a) and direct functionalization of the NHC platinum complex **2** prior to synthesis of the NHC-Pt-PEI conjugate Pt-PEI30-Coumarin (b).

## 2.2. In Vitro Study

### 2.2.1. Polymer Size Effect

The cytotoxicity of the NHC-Pt-PEI conjugates was investigated on a panel of 7 cancer cell lines, namely, KB (epidermal carcinoma), MCF7 (breast adenocarcinoma), HCT116 (human colorectal adenocarcinoma), PC3 (human prostate adenocarcinoma), SK-OV3 (ovarian adenocarcinoma), OVCAR-8 (human ovarian carcinoma), HL60 (acute promyelocytic leukaemia) and one cell line derived from normal lung tissue (MRC5). The aim of the study was first to evaluate the polymer size effect while keeping the same platinum/polymer unit ratio. Thus, four NHC-Pt-PEI conjugates that contain one Pt complex per 20 ethylene diamine units were investigated, one with a branched PEI 1.8 kDa and 3 with linear PEI (2.5, 25 et 250 kDa). The toxic effects were evaluated by measuring cell metabolic activity using 3-(4,5-dimethylthiazol-2-yl)-5-(3-carboxymethoxy-phenyl)-2-(4-sulfophenyl)-2H-tetrazolium (MTS). The results are shown in Figure 4.

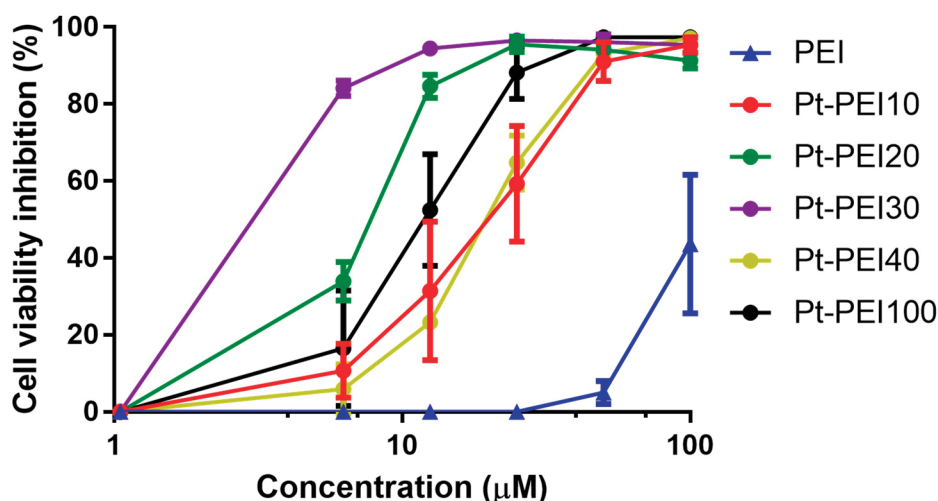

**Figure 4.** Effects on different cell lines of NHC-Pt-PEI conjugates at concentration of  $10^{-5}$  M (platinum concentration) with branched PEI 1.8 kDa (black), linear PEI 2.5 kDa (light blue), linear PEI 25 kDa (blue) and linear PEI 250 kDa (dark blue). A fixed ratio of 20 was used between Pt and monomeric PEI units.

As shown in Figure 4, NHC-Pt-PEI conjugate containing branched PEI gave essentially no cytotoxic activity whereas the conjugates with linear PEI displayed a promising cytotoxicity against all cell lines at a concentration of 100  $\mu\text{M}$  (platinum concentration). While looking at the linear macromolecule size effect, at a concentration of 100  $\mu\text{M}$ , the best activity was observed with 2.5 and 25 kDa PEI (92–100% cell viability inhibition). However, the conjugate with the largest PEI (250 kDa) showed poor cell viability inhibition at this concentration. To continue the studies, we decided to focus on 25 kDa PEI as it displayed a good cytotoxic activity and as it is close to 22 kDa PEI, which is well known for its transfection ability [16].

### 2.2.2. Platinum Concentration Effect

The metal complex/polymer ratio was varied in order to obtain NHC-Pt-PEI conjugates that contain one platinum complex per 10, 20, 30, 40 or 100 ethylenediamine units (referred to as Pt-PEI10, Pt-PEI20, etc.). These ratios correspond to ca. 60, 30, 20, 15 and 6 platinum atoms per PEI chain of 25 kDa, respectively. The cytotoxicity of these conjugates was then investigated on human colorectal adenocarcinoma cells (HCT116) as shown in Figure 5 (all concentrations are expressed as function of platinum concentration and not polymer concentration) [17]. The toxic effects were evaluated by measuring cell metabolic activity using MTS after 24 h of treatment. Activity was dependent on the density of metal ions on the polymer chain.



**Figure 5.** Effects on HCT116 cell metabolic activity of NHC-Pt-PEI conjugates with various metal ions density onto polymer chains. The numbers refer to the ratio between monomeric PEI units and platinum ions (Pt/NH). Results are expressed as mean  $\pm$  SEM of at least three independent experiments. All concentrations (in  $\mu\text{M}$ ) are expressed as platinum concentration except for PEI.

As shown in Figure 5, all the NHC-Pt-PEI conjugates display a strong cytotoxic activity against HCT116 cells. Nevertheless, the NHC-Pt-PEI compound containing one platinum complex per 30 ethylenediamine units, namely Pt-PEI30, has the smallest  $\text{IC}_{50}$  value. That is why we decided to continue our studies with this compound. The stability in solution of Pt-PEI30 has been investigated and no change of the activity (in vitro) was observed while keeping the conjugate Pt-PEI30 in ethanol solution for more than 2 months at 4  $^{\circ}\text{C}$ .

### 2.3. Short Time Exposure with NHC-Pt-PEI30 is Enough to Induce High Cytotoxicity Activity

To go further in NHC-Pt-PEI conjugate mode of action, we evaluated the time exposure sufficient to promote in vitro cell cytotoxicity. For this, HCT116 cells were incubated with Pt-PEI30 for 45 min and 2 h, then the cytotoxic platinum compound was removed and replaced by cell culture medium. Cell cytotoxicity was evaluated 24 h after exposure by measuring cell metabolic activity using MTS.

Incubation of cells with Pt-PEI30 during the whole 24 h was used as control assay. As shown in Figure 6, a 45 min exposure is sufficient to induce a high cytotoxic activity in the same range as the one induced after 24 h of incubation. These results suggest a quick uptake of the NHC-Pt-PEI conjugate by the cells. Oxaliplatin was used as a reference in our experiment (Figure 6) and the data showed that it required longer time exposure for efficacy.

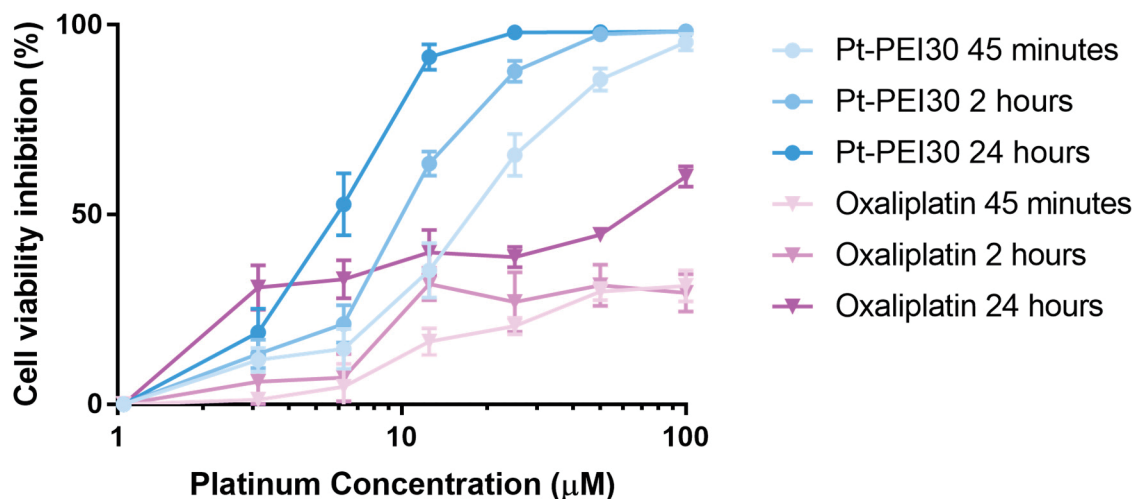

**Figure 6.** Effects on HCT116 cell metabolic activity of various exposure times of Pt-PEI30 conjugate and oxaliplatin as a reference. Results are expressed as mean  $\pm$  SEM of at least four independent experiments. All concentrations (in  $\mu\text{M}$ ) are expressed as platinum concentration.

#### 2.4. Cellular Uptake of Pt-PEI30

To follow cellular uptake of NHC-Pt-PEI30 conjugate, two fluorescent derivatives were used. The fluorophore was either attached onto the polymer chain (i.e., Pt-PEI30-FITC) or directly onto the *N*-Heterocyclic carbene (i.e., Pt-PEI30-Coumarin). The impact of the fluorescent probe on the cytotoxic activity of the conjugate was first investigated by measuring cell metabolic activity of HCT116 cells after 24 h of exposure. As depicted in Figure 7, both displayed a slight and non-significant decrease of activity which is negligible compared to the overall activity.

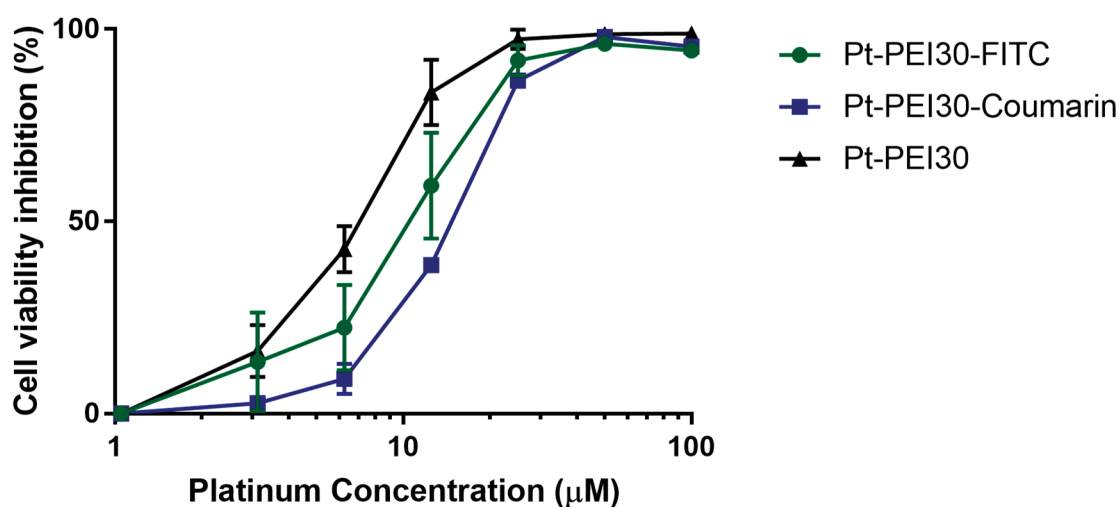

**Figure 7.** Effects on HCT116 cell metabolic activity of fluorescent Pt-PEI30 conjugates and non-fluorescent Pt-PEI30 compound as a reference. Results are expressed as mean  $\pm$  SEM of at least two independent experiments. All concentrations (in  $\mu\text{M}$ ) are expressed as platinum concentration.

Using confocal microscopy, we showed efficient cell uptake of the fluorescent Pt-PEI30 conjugates. We observed the fluorescence with the two conjugates showing that attachment of the fluorophore directly onto the *N*-Heterocyclic carbene complex (i.e., Pt-PEI30-Coumarin, a) or onto the PEI polymer chain (i.e., Pt-PEI30-FITC, b) has no effect on their activity. The additional staining of the cell nucleus either with DRAQ5 for the Pt-PEI30-Coumarin compound (Figure 8a) or with Hoechst 33342 for the Pt-PEI30-FITC compound (Figure 8b) showed that fluorescent Pt-PEI30 conjugates were essentially found in the cytosol and only at a very low extent in the nucleus. These observations suggest that the conjugates enter the cell through endocytosis. Moreover, the localization in the cytosol and not in the nucleus correlated with a cytotoxicity independent of nucleus events.

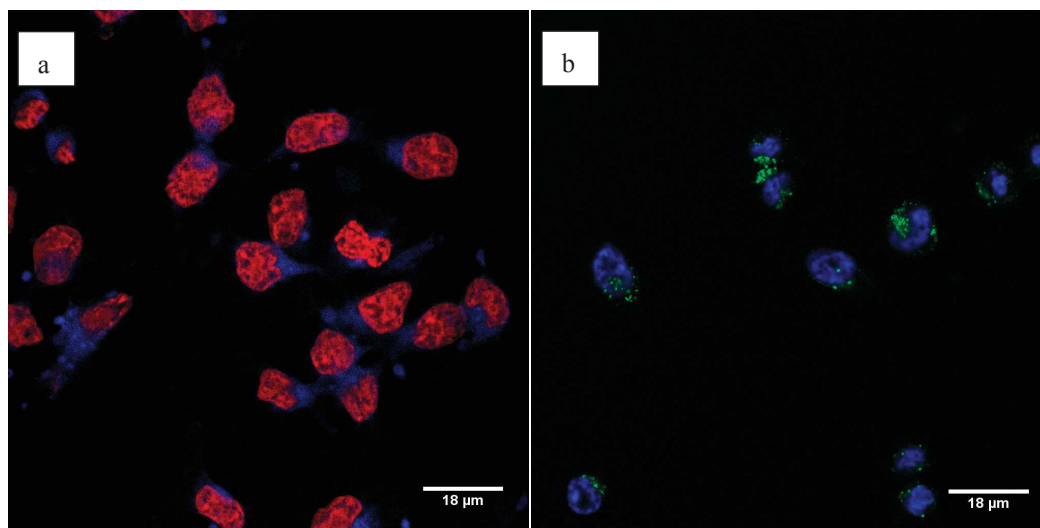

**Figure 8.** Cellular uptake of fluorescent Pt-PEI30 compounds was visualized by confocal microscopy after 3h30 treatment on HCT116 cells. (a) Cells were treated with Pt-PEI30-Coumarin conjugate (in blue) and cell nucleus was stained using DRAQ5 (in red), (b) cells were treated with Pt-PEI30-FITC conjugate (in green) and cell nucleus was stained with Hoechst 33342 (in blue).

### 3. Discussion

Numerous strategies have been studied in order to circumvent side effects associated with cisplatin-based chemotherapy. In particular, drug delivery based on polymeric assemblies has raised massive interest to protect the platinum centre from side reactions and to promote selective Pt accumulation into the cancer cells [18]. Polyethyleneimine (PEI) is well established as polycationic, water-soluble and biocompatible carrier, especially for transfection purpose [19,20]. In vivo, such polycationic macromolecules are expected to target cells thanks to electrostatic interactions with the negatively charged phospholipid cellular membrane. Drug delivery is believed to occur through cell endocytosis of the drug-PEI assembly. Endosomal escape is favoured by the action of enzymes (ATPase) which acidify the media within the particle thus promoting PEI protonation and elongation. Subsequent osmotic swelling provokes a rupture of the endosomal membrane and drug release into the cytoplasm [21].

We synthesized platinum *N*-Heterocyclic carbene bioconjugates by using polyethyleneimine as polymer carrier. In these systems, branched and linear PEI polymers with various sizes were used as ligand to stabilize the *N*-Heterocyclic platinum carbene complexes. Interestingly, the introduction of PEI ligand to the Pt-NHC fragment induced good water-solubility of the overall system. Whereas stock solutions in DMSO are generally required to solubilize classical NHC-metal complexes, these NHC-Pt-PEI conjugates are solubilized in ethanol at a concentration of 5 mM and then diluted in aqueous solutions for further biological studies (final concentration of EtOH at 10 µM = 0.2%).



Investigation of the biological activities on several cancer cell lines showed that Pt-PEI with branched polymer were ineffective whereas Pt-PEI with linear polymer of 2.5 or 25 kDa displayed very good activities at concentration of platinum metal down to  $10^{-5}$  M. Since the cell viability inhibitions were slightly higher with a PEI of 25 kDa, we selected this size of polymer for further investigations. Interestingly, the highest efficiencies for gene delivery both in vitro and in vivo are also obtained with PEI of 25 kDa [22,23]. Next, biological activity as function of the overall density of metal ions onto 25 kDa PEI polymer chain revealed an optimal ratio Pt/PEI unit of 30 ( $IC_{50}$  of  $\sim 3$   $\mu$ M). We conclude that the conjugate Pt-PEI30 with linear PEI of 25 kDa is the best candidate for further development as anticancer agent.

Pt-PEI30 exhibits a higher cytotoxic activity than oxaliplatin at the same platinum concentration. Moreover, its cytotoxic activity is induced after very short exposures of the cells suggesting a rapid uptake of the conjugate by the cells, sufficient to induce pathways leading to death. In a previous study, we showed that Pt-PEI30, in contrast to oxaliplatin, induced cell apoptosis by a mechanism, at least partly, independent of the nucleus [10]. As mitochondria dysfunctions were induced by the compound, we suggest that apoptosis was induced by the mitochondrial pathway [24].

To go further in the Pt-PEI30 mode of action, we tracked the fate of Pt-PEI30 in the cells. For this, we synthesized two types of fluorescent-tagged conjugates: one carrying the fluorophore on the polymer and the other directly on the *N*-Heterocyclic carbene. The two fluorescent conjugates displayed a high cytotoxic activity and strong fluorescence capacity. Interestingly, pictures with the two fluorescent conjugates showed the same features: multiple dots in the cytosol and very few in the nucleus. These features are totally in accordance with the hypothesis of the cell death induction through a mitochondrial pathway. Moreover, as the pictures of cells incubated with the two fluorescent Pt-PEI30 derivatives are similar, we can hypothesize that PEI and NHC remains tethered after cell uptake at least during the 3 first hours of the experiment. The next step will consist of a kinetic analysis of the localization of the two moieties (PEI and NHC) in the cell and more particularly in the different organelles like the mitochondria. This precise analysis will permit to better understand the Pt-PEI30 mode of action and then, to optimize the design of conjugates for a better anticancer activity.

## 4. Materials and Methods

### 4.1. General Remarks

All manipulations of air and moisture sensitive compounds were carried out using standard Schlenk techniques under an inert atmosphere of argon and solvents were purified and degassed following standard procedures. All reagents were purchased from commercial chemical suppliers (Acros Organics, Illkirch, France; Alfa Aesar, Karlsruhe, Germany and TCI Europe, Paris, France) and used without further purification.  $^1H$  and  $^{13}C$  Nuclear Magnetic Resonance (NMR) spectra were recorded on a Bruker Avance 300 or a Bruker Avance 500 spectrometer using the residual solvent peak as a reference ( $CDCl_3$ :  $\delta H = 7.26$  ppm;  $\delta C = 77.16$  ppm) at 295 K. The two [(NHC)PtI<sub>2</sub>(pyridine)] precursors (1 and 2) used for the synthesis of Pt-PEI, Pt-PEI30-FITC or Pt-PEI30-coumarin were synthesized according to reported procedures [10,15].

### 4.2. Synthesis of NHC-Pt-PEI Complexes

NHC-Pt-PEI: Pt-PEI30. Under argon, a solution of *trans* [(NHC)PtI<sub>2</sub>(pyridine)] 1 (NHC = 3-benzyl-1-imidazolilydene) (20 mg, 28.6  $\mu$ mol) and PEI (36.9 mg, 25 kDa) in ethanol (10 mL) was stirred 2 days at 55 °C. The colour of the solution is turning from yellow to colourless. The solution was concentrated under reduced pressure, precipitated by addition of excess diethyl ether and subsequently washed to afford the Pt-PEI30 as a white solid (55 mg, quant.). The Pt/ethylenediamine unit ratio was confirmed by elemental analysis and  $^1H$  NMR. Anal. Calcd for [(PEI 25 kDa)(C<sub>11</sub>H<sub>12</sub>N<sub>2</sub>PtI<sub>2</sub>)<sub>20</sub>]: C, 44.3; H, 8.4; N, 23.2; Pt, 10.4; Found: C, 43.6; H, 8.1; N, 22.7; Pt, 9.8.  $^1H$ -NMR ( $CD_3OD/CD_3CN$ ,

300 MHz, 20 °C):  $\delta$  2.2–3.1 (m, CH<sub>2</sub>), 3.1–3.6 (m, NH<sub>2</sub> and NH), 4.0–4.5 (m, N-CH<sub>3</sub>), 5.9 (m, N-CH<sub>2</sub>), 7.1–8.0 (m, H<sub>ar</sub> and 2 C-H). The same experimental procedure was used for all NHC-Pt-PEI conjugates.

**Pt-PEI30-FITC:** To a solution of Pt-PEI30 (20 mg, 0.54  $\mu$ mol) in DMSO (1 mL) and PBS (2 mL) was added a solution of fluorescein isothiocyanate (0.026 mg, 0.054  $\mu$ mol) in DMSO (100  $\mu$ L) and stirred in the dark at 20 °C, for 3 h. The solution was concentrated under reduced pressure, diluted in ethanol (0.3 mL) and subsequently dialyzed toward PBS (500 mL) at 20 °C for 24 h. The mixture was then recovered and lyophilized under reduced pressure to afford the NHC-Pt-PEI conjugate as a deep orange muggy solid. Orange oil, quant. <sup>1</sup>H NMR (MeOD, 500 MHz, 20 °C):  $\delta$  0.81–1.19 (m, CH<sub>2</sub>,PEI), 2.87 (bs, CH<sub>2</sub>,PEI), 3.22 (bs, CH<sub>2</sub>,PEI), 3.25–3.55 (m, CH<sub>2</sub>,PEI), 3.87–4.12 (m, CH<sub>2</sub>,PEI + N-CH<sub>3</sub>), 4.75 (bs, CH<sub>2</sub>,PEI + NHPEI), 5.41–5.90 (m, N-CH<sub>2</sub>), 6.41–6.42 (m, H<sub>ar</sub>), 7.01–8.46 (m, H<sub>ar</sub>); UV-vis (EtOH)  $\lambda_{\max}$  (nm): 508; Fluorescence:  $\lambda_{\text{ex}}$  = 508 nm,  $\lambda_{\text{em}}$  = 525 nm.

**Pt-PEI30-coumarin:** By adaptation of a reported synthesis [15], a solution of alkyne-functionalized [(NHC)PtH<sub>2</sub>(pyridine)] 2 (6.5 mg, 7.5  $\times$  10<sup>-6</sup> mol) in THF (1.5 mL) and a solution of 7-azido-4-methylcoumarin (3 mg, 1.49  $\times$  10<sup>-5</sup> mol) in THF (1 mL) were added to a solution of [RuClCp\*(PPh<sub>3</sub>)<sub>2</sub>] (0.6 mg, 7.45  $\times$  10<sup>-7</sup> mol) in THF (1 mL). The mixture was then heated overnight at 75 °C. The solvent was then removed under vacuum. The residue was purified by means of silica gel chromatography using a mixture of CH<sub>2</sub>Cl<sub>2</sub>/pentane 3:1 followed by CH<sub>2</sub>Cl<sub>2</sub> and then ethyl acetate to afford the compound as a yellow-brown oil. Under argon, a solution of coumarin functionalized [(NHC)PtH<sub>2</sub>(pyridine)] complex (20 mg, 28.6  $\mu$ mol) and linear poly(ethyleneimine) of 25 kDa (36.9 mg, 1.47  $\mu$ mol) in ethanol (10 mL) was stirred for three days at 55 °C. The resulting solution was then concentrated under reduced pressure, precipitated by addition of excess diethyl ether and further centrifuged for 10 min at 10,000 rpm to afford the NHC-Pt-PEI conjugate as a yellow muggy solid. Light yellow muggy solid, quant. <sup>1</sup>H NMR (MeOD, 500 MHz, 20 °C):  $\delta$  0.91 (t,  $J$  = 6.7 Hz, CH<sub>2</sub>,PEI), 1.12 (t,  $J$  = 6.7 Hz, CH<sub>2</sub>,PEI), 1.26–1.41 (m, CH<sub>2</sub>,PEI), 2.22 (s, CH<sub>3</sub>), 2.77 (m, CH<sub>2</sub>,PEI), 3.32–3.65 (m, CH<sub>2</sub>,PEI), 3.92 (m, N-CH<sub>3</sub>), 5.08–5.37 (m, CH<sub>2</sub>,PEI + N-CH<sub>2</sub>), 5.50 (bs, CH<sub>2</sub>,PEI + NHPEI), 6.51 (m, CH<sub>im</sub>), 6.62 (m, H<sub>ar</sub>), 6.91 (m, H<sub>ar</sub>), 6.93–7.47 (m, H<sub>ar</sub>), 8.07 (m, H<sub>ar</sub>), 8.56 (s, H<sub>ar</sub>). UV-vis (EtOH)  $\lambda_{\max}$  (nm): 370; Fluorescence:  $\lambda_{\text{ex}}$  = 370 nm,  $\lambda_{\text{em}}$  = 455 nm.

#### 4.3. Preparation of Platinum Derivatives for in Vitro Assays

Oxaliplatin was purchased from Sigma Aldrich, (Saint-Louis, MO, USA) and was prepared by dissolution in H<sub>2</sub>O at 5 mM (metal concentration). NHC-Pt-PEI conjugates PEI10, PEI20, PEI30, PEI40, PEI100, PEI30-FITC and PEI30-coumarin stock solutions were prepared by dissolution in absolute ethanol at 5 mM (metal concentration). Samples were then diluted in cell culture medium (RPMI 1640 supplemented with 10% (v/v) of heat-decomplemented foetal calf serum and Penicillin-Streptomycin (10U–0.1 mg/mL)) referred as complete medium.

#### 4.4. Cell Exposure to the Different Platinum Compounds for Cell Viability Assays

Human cancer cell line HCT116 (colorectal adenocarcinoma) was cultured in complete medium at 37 °C with 5% CO<sub>2</sub>, 80% humidity. For the cell viability experiments, cells were seeded in 96-well plates at 3  $\times$  10<sup>4</sup> cells per well in 50  $\mu$ L of complete medium. After they had adhered to the culture plate, the cells were exposed to the different platinum compounds (NHC-Pt-PEI or oxaliplatin as control) during 45 min, 2 or 24 h at 37 °C (5% CO<sub>2</sub>). For the treatments of 45 min and 2 h, cells were exposed to the platinum derivatives for these times and then the treatment was replaced by new complete culture medium until 24 h.

#### 4.5. Evaluation of Cell Viability by MTS Assays

After 24 h, 20  $\mu$ L of the tetrazolium compound 3-(4,5-dimethylthiazol-2-yl)-5-(3-carboxymethoxyphenyl)-2-(4-sulfophenyl)-2H-tetrazolium (MTS) (Promega Corporation, Madison, WI, USA) were added in each well. After 2 h of incubation at 37 °C, absorbance was measured at 490 nm (SP200, Safas, Monaco), which is directly proportional to the number of



metabolically active living cells in culture. The absorbance of the blank (RPMI + MTS) was subtracted from the values of each well and the optical density (OD) of non-treated cells was considered as 100% of viability. The percentage of cell viability inhibition was calculated using the following formula: % cell viability inhibition =  $100 - [\text{OD}(\text{treatment})/\text{OD}(100\% \text{ viability}) \times 100]$ .

#### 4.6. Cell Exposure to the Fluorescent Platinum Compounds and Confocal Microscopic Analysis

Cells were seeded on coverslips disposed in a 24-well plate at  $7.5 \times 10^4$  cells per well in 500  $\mu\text{L}$  of complete medium and maintained at 37 °C (5%  $\text{CO}_2$ ) overnight for adherence. Then, the culture medium was removed and replaced by the platinum conjugates (6.25  $\mu\text{M}$  platinum concentration) for 3 h 30. After several washing steps, the cells were fixed in paraformaldehyde 1%. The nucleus was stained either with Hoechst 33342 (1  $\mu\text{g}/\text{mL}$ , Sigma-Aldrich, Saint-Quentin Fallavier, France) or with DRAQ5 (5  $\mu\text{M}$ , Abcam, Cambridge, UK) and coverslips were mounted on slides using ProLong Gold Antifade Reagent (Life Technologies, Waltham, MA, USA) and visualized by confocal microscopy (Leica TSC SPE, Wetzlar, Germany).

**Author Contributions:** S.B.-L. and S.F. designed research. M.B., G.D. and S.B.-L. conceived, designed and performed the chemical experiments. M.W., N.C. and S.F. performed the biological experiments. S.B.-L. wrote the paper and M.B., M.W. and S.F. participated in manuscript writing.

**Funding:** This research was funded by La Ligue Contre le Cancer—Grand-Est and by the University of Strasbourg/CNRS—Program IDEX Interdisciplinaire. M.W. and M.B. were granted by the French “Ministère de la Recherche”.

**Acknowledgments:** The authors thank the Plateforme d’Imagerie Quantitative at the Faculty of Pharmacy at the University of Strasbourg for the availability and the help for confocal microscopy.

**Conflicts of Interest:** The authors declare no conflict of interest.

#### References and Note

1. Sessler, J.L.; Doctrow, S.R.; McMurry, T.J.; Lippard, T.J. *Medicinal Inorganic Chemistry*; ACS Symposium Series; ACS: Washington, DC, USA, 2005.
2. Rosenberg, B.; Van Camp, L.; Krigas, T. Inhibition of cell division in *Escherichia coli* by electrolysis products from a platinum electrode. *Nature* **1965**, *205*, 698–699. [[CrossRef](#)] [[PubMed](#)]
3. Fuertes, M.A.; Alonso, C.; Pérez, J.M. Biochemical modulation of Cisplatin mechanisms of action: Enhancement of antitumor activity and circumvention of drug resistance. *Chem. Rev.* **2003**, *103*, 645–662. [[CrossRef](#)] [[PubMed](#)]
4. Gasser, G.; Metzler-Nolte, N. The potential of organometallic complexes in medicinal chemistry. *Curr. Opin. Chem. Biol.* **2012**, *16*, 84–91. [[CrossRef](#)] [[PubMed](#)]
5. Gasser, G.; Ott, I.; Metzler-Nolte, N. Organometallic anticancer compounds. *J. Med. Chem.* **2011**, *54*, 3–25. [[CrossRef](#)] [[PubMed](#)]
6. Mercks, L.; Albrecht, M. Beyond catalysis: *N*-Heterocyclic carbene complexes as components for medicinal, luminescent, and functional materials applications. *Chem. Soc. Rev.* **2010**, *39*, 1903–1912. [[CrossRef](#)] [[PubMed](#)]
7. Gautier, A.; Cisnetti, F. Advances in metal-carbene complexes as potential anti-cancer agents. *Metallomics* **2012**, *4*, 23–32. [[CrossRef](#)] [[PubMed](#)]
8. Hindi, K.M.; Panzner, M.J.; Tessier, C.A.; Cannon, C.L.; Youngs, W.J. The medicinal applications of imidazolium carbene-metal complexes. *Chem. Rev.* **2009**, *109*, 3859–3884. [[CrossRef](#)] [[PubMed](#)]
9. Liu, W.; Gust, R. Metal *N*-Heterocyclic carbene complexes as potential antitumor metallodrugs. *Chem. Soc. Rev.* **2013**, *42*, 755–773. [[CrossRef](#)] [[PubMed](#)]
10. Chekkat, N.; Dahm, G.; Chardon, E.; Wantz, M.; Sirz, J.; Decossas, M.; Lambert, O.; Frisch, B.; Rubbiani, R.; Gasser, G.; et al. *N*-Heterocyclic Carbene-Polyethyleneimine Platinum Complexes with Potent in vitro and in vivo Antitumor Efficacy. *Bioconjugate Chem.* **2016**, *27*, 1942–1948. [[CrossRef](#)] [[PubMed](#)]
11. Chardon, E.; Dahm, G.; Guichard, G.; Bellemin-Laponnaz, S. Derivatization of preformed platinum *N*-Heterocyclic carbene complexes with amino acid and peptide ligands, and cytotoxic activities towards human cancer cells. *Organometallics* **2012**, *31*, 7618–7621. [[CrossRef](#)]

12. Chardon, E.; Dahm, G.; Guichard, G.; Bellemin-Lapponnaz, S. Exploring nitrogen ligand diversity in trans-*N*-Heterocyclic carbene-amine platinum complexes: Synthesis, characterization and application to fluorescence. *Chem. Asian J.* **2013**, *8*, 1232–1242. [[CrossRef](#)] [[PubMed](#)]
13. Dahm, G.; Borré, E.; Guichard, G.; Bellemin-Lapponnaz, S. A chemoselective and modular post-synthetic multi-functionalization of platinum-NHC complexes. *Eur. J. Inorg. Chem.* **2015**, *10*, 1665–1668. [[CrossRef](#)]
14. Chardon, E.; Puleo, G.L.; Dahm, G.; Guichard, G.; Bellemin-Lapponnaz, S. Direct functionalization of group 10 *N*-Heterocyclic carbene complexes for diversity enhancement. *Chem. Commun.* **2011**, *47*, 5864–5866. [[CrossRef](#)] [[PubMed](#)]
15. Chardon, E.; Puleo, G.L.; Dahm, G.; Fournel, S.; Guichard, G.; Bellemin-Lapponnaz, S. Easy derivatisation of group 10 *N*-Heterocyclic carbene complexes and in vitro evaluation of an anticancer oestradiol-conjugate. *Chem. Plus Chem.* **2012**, *77*, 1028–1038.
16. Breunig, M.; Lungwitz, U.; Liebl, R.; Fontanari, C.; Klar, J.; Kurtz, A.; Blunk, T.; Goepferich, A. Gene delivery with low molecular weight linear polyethylenimines. *J. Gene Med.* **2005**, *7*, 1287–1298. [[CrossRef](#)] [[PubMed](#)]
17. The complex *trans* [(NHC)PtI<sub>2</sub>(pyridine)] **1** (NHC = 3-benzyl-1-imidazolilydene) displays poor solubility in EtOH/H<sub>2</sub>O so that its biological activity could not be determined under those conditions.
18. Maeda, H. Toward a full understanding of the EPR effect in primary and metastatic tumors as well as issues related to its heterogeneity. *Adv. Drug Deliv. Rev.* **2015**, *91*, 3–6. [[CrossRef](#)] [[PubMed](#)]
19. Boussif, O.; Lezoualc'h, F.; Zanta, M.A.; Mergny, M.D.; Scherman, D.; Demeneix, B.; Behr, J.-P. A versatile vector for gene and oligonucleotide transfer into cells in culture and in vivo: Polyethylenimine. *Proc. Natl. Acad. Sci. USA* **1995**, *92*, 7297–7301. [[CrossRef](#)] [[PubMed](#)]
20. Neuberger, P.; Kichler, A. Recent developments in nucleic acid delivery with polyethylenimines. *Adv. Genet.* **2014**, *88*, 263–288. [[PubMed](#)]
21. Sonawane, N.D.; Szoka, F.C.; Verkman, A.S. Chloride accumulation and swelling in endosomes enhances DNA transfer by polyamine-DNA polyplexes. *J. Biol. Chem.* **2003**, *278*, 44826–44831. [[CrossRef](#)] [[PubMed](#)]
22. Remy, J.-S.; Goula, D.; Steffan, A.M.; Zanta, M.A.; Boussif, O.; Behr, J.P.; Demeneix, B. *Self-Assembling Complexes for Gene Delivery*; Kabanov, A.V., Felgner, P.L., Seymour, L.W., Eds.; Wiley: Chichester, UK, 1998.
23. Kichler, A.; Behr, J.P.; Erbacher, P. *Nonviral Vectors for Gene Therapy*; Huang, L., Hung, M.C., Wagner, E., Eds.; Academic Press: San Diego, CA, USA, 1999.
24. Ichim, G.; Tait, S.W.G. A fate worse than death: Apoptosis as an oncogenic process. *Nat. Rev. Cancer* **2016**, *16*, 539–548. [[CrossRef](#)] [[PubMed](#)]



© 2018 by the authors. Licensee MDPI, Basel, Switzerland. This article is an open access article distributed under the terms and conditions of the Creative Commons Attribution (CC BY) license (<http://creativecommons.org/licenses/by/4.0/>).



# **Chapter 2**

Targeting glioblastoma-derived cancer  
stem cells

La vérité scientifique sera toujours plus belle que les créations de notre imagination et que les illusions de notre ignorance.

*Claude Bernard*

## Context and objectives

Glioblastomas are aggressive brain tumors which are often resistant to conventional chemo- and radiotherapy and thus are associated with poor prognosis (Anjum et al., 2017; Tivnan et al., 2017). It has appeared that the resistance could partly be explained by the presence of a population of self-renewing and pluripotent cells: the cancer stem cells (CSCs) (Deshmukh et al., 2016; Konrad et al., 2017). A few years ago, some research teams highlighted the importance of the mitochondria for the survival of these CSCs (Farnie et al., 2015; Lamb et al., 2014, 2015). My host laboratory, in collaboration with the team of Stéphane Bellemin-Laponnaz (IPCMS; Strasbourg) had previously developed an innovative platinum(II)-based compound composed of an N-heterocyclic carbene-platinum complex associated to the transfection agent polyethylenimine (NHC-Pt(II)-PEI30) (Chekkat et al., 2016). Previous investigations had revealed that this conjugate impaired mitochondrial function by inducing superoxide ion accumulation and altering the respiratory activity (Chekkat et al., 2016). Furthermore, NHC-Pt(II)-PEI30 was able to kill *in vitro* cancer cells mutated for the tumor suppressor p53 and thus resistant to conventional platinum drugs (Chekkat et al., 2016). Based on these data, we emitted the hypothesis that NHC-Pt(II)-PEI30 might be able to kill CSCs by targeting their most important organelle: the mitochondria.

**In collaboration with Monique Dontenwill's team (UMR7213), we proposed to specifically target the chemo- and radiotherapy-resistant cancer stem cells using an innovative platinum-based compounds affecting mitochondrial function.**

## Results

Two CSC-like cell lines derived from patient with human glioblastomas were used to evaluate the cytotoxic activity of NHC-Pt(II)-PEI30 *in vitro* by microscopic observation and flow cytometry. As previous results had shown that NHC-Pt(II)-PEI30 was able to trigger apoptosis in human colon adenocarcinoma cells HCT116 (Chekkat et al., 2016), I first analyzed the mechanism of cell death induced in a well-established glioma cell line by flow cytometry using propidium iodide and Annexin-V staining and found that NHC-Pt(II)-PEI30 induced apoptosis. Then, this experiment was also performed on two patient-derived CSC-like cell lines revealing that the compound was also able to induce their apoptosis. Furthermore, the effect of NHC-Pt(II)-PEI30 on the mitochondria of the CSCs was assessed by flow cytometry. An accumulation of superoxide ions as well as an alteration of the mitochondrial respiratory activity were observed *in vitro*.

### Conclusions

Altogether these results suggest that NHC-Pt(II)-PEI30 might be an interesting candidate for the eradication of chemo- and radioresistant CSCs, as it was able to induce apoptosis their apoptosis. Furthermore, the mitochondrial function of CSCs was altered after treatment with NHC-Pt(II)-PEI30, indicating that our platinum compound might be able to target one of the most important organelles of CSCs, thus leading to their cell death. In the future, NHC-Pt(II)-PEI30 could be associated with targeting agents specific of markers expressed by these self-renewing, pluripotent cells, like for example CD44 or transferrin receptor.

# Targeting glioblastoma-derived cancer stem cells with N-heterocyclic carbene platinum complexes

May Wantz<sup>a</sup>, Candice Dussouillez<sup>a</sup>, Marie-Cécile Mercier<sup>b</sup>, Mathilde Bouché<sup>c</sup>, Monique Dontenwill<sup>b</sup>, Stéphane Bellemin-Laponnaz<sup>c</sup>, Antoine Kichler<sup>✉a</sup>, Sylvie Fournel<sup>✉a</sup>

<sup>a</sup> UMR7199 – Laboratory of Conception and Application of Bioactive Molecules – Team 3Bio, Faculty of Pharmacy, University of Strasbourg – CNRS, 74 route du Rhin, BP 60024, F-67401 Illkirch Cédex

<sup>b</sup> UMR7213 – Laboratory of Bioimaging and Pathologies – Team Tumoral signalling, Faculty of Pharmacy, University of Strasbourg – CNRS, 74 route du Rhin, BP 60024, F-67401 Illkirch Cédex

<sup>c</sup> UMR 7504 – Organic Materials – Team Conception and Synthesis – Institut de Physique et de Chimie des Matériaux Strasbourg (IPCMS), University of Strasbourg – CNRS, 23 rue du Loess, F-67000 Strasbourg

✉ Corresponding author: Sylvie Fournel, s.fournel@unistra.fr and Antoine Kichler, kichler@unistra.fr

## Keywords

Cancer stem cells, glioblastoma, mitochondria, chemotherapy, platinum(II) conjugate

## Abbreviations

APC: **A**llo**p**hycocyanin; BIT: **b**ovine serum albumin-**i**nsulin-**t**ransferrin; CSC: **c**ancer stem cell; DMEM: **D**ulbecco's **M**odified **E**agle's **M**edium; DMSO: **d**imethyl sulfoxide; EDTA: **e**thylenedi**a**minetetr**a**acetic acid; EGF: **e**pidermal **g**rowth **f**actor; FDA: **F**ood and **D**rug Administration; FGF: **f**ibroblast **g**rowth **f**actor; GBM: **g**lioblastoma **m**ultiform; HA: **h**yaluronic **a**cid; HEPES: 4-(2-**h**ydroxyethyl)-1-**p**iperazineethanesulfonic acid; MEM: **M**inimum **E**ssential **M**edium; MGMT: O6-**M**ethylguanine DNA **m**ethyltransferase; PEI: **p**olyethylenimine; PI: **p**ropidium **i**odide; RT: **r**oom **t**emperature; SEM: **s**tandard **e**rror of the **m**ean; TMZ: **t**emozolomide; WHO: **W**orld **H**ealth **O**rganization

## Disclosure of interest

The authors report no conflict of interest.



### Abstract

Glioblastoma are aggressive brain cancers with a poor prognosis. They are often resistant to conventional treatments like radio- and chemotherapy. It has appeared that this resistance can partly be explained by the presence of a particular subpopulation of cancer cells within the tumor bulk: the cancer stem cells (CSCs). These cells, similar to embryonic stem cells, are able to self-renew and to differentiate into all lineages of glial cancer cells being this way responsible for cancer relapse. Recently, it has been revealed that the CSCs possess a high mitochondrial mass and show an overexpression of mitochondrial-related proteins, suggesting the importance of this organelle in the metabolism of CSCs and its possible implication in resistance. That is why the development of mitochondria-targeting agents has gained growing attention over the last years. In this paper, we propose an innovative platinum (II)-based compound in order to kill the CSCs by targeting mitochondria. We demonstrate that our conjugate displays a cytotoxic activity against several cancer stem cell-like cell lines and is able to impair mitochondrial function.

## Introduction

Gliomas are the most common group of brain tumors and include all forms of malignant cells with a glial cell origin, like astrocytomas, oligodendrogliomas and ependymomas (Alifieris and Trafalis, 2015; Anjum et al., 2017). According to the World Health Organization (WHO), they can be classified into four categories based on their malignancy which is tightly linked to the clinical outcome (Louis et al., 2007; Wesseling and Capper, 2018). Glioblastoma multiform (GBM) is ranked as grade IV glioma which means that it is considered as the most aggressive glioma (Crespo et al., 2015; Nicolaidis, 2015). One can distinguish between primary glioblastomas arising *de novo* (60% cases) and secondary glioblastomas derived from lower-grade gliomas (40% cases) (Anjum et al., 2017; Crespo et al., 2015; Ohgaki et al., 2004). Glioblastomas are generally associated with poor prognosis, with a mean survival rate ranging from 8 to 15 months after diagnosis and a 5-year survival rate <5% (Anjum et al., 2017; Tivnan et al., 2017). This brain cancer is nearly incurable, despite many efforts in the development of new therapies. The conventional treatments for GBM, namely surgery, radiotherapy and chemotherapy using the alkylating agent temozolomide (TMZ) only show limited efficacy (Alifieris and Trafalis, 2015; Anjum et al., 2017; Lee, 2016). Glioblastomas present an important inter- and intratumor cellular heterogeneity, which seems to be implicated in therapy resistances (Bradshaw et al., 2016). A subpopulation of cells with particular features was identified in numerous cancer types including glioblastomas: the cancer stem cells (CSCs) (Konrad et al., 2017). These pluripotent cells, similar to embryonic stem cells, are able to self-renew and to differentiate into all lineages of progeny found in glioma, leading this way to tumor relapse (Deshmukh et al., 2016). Moreover, these CSCs appear to be resistant to radio- and chemotherapy (Venere et al., 2011). The exact mechanism of resistance is not clearly elucidated, but several research groups have suggested a possible implication of mitochondria (Farnie et al., 2015; Lamb et al., 2014). These organelles play an important role in cell metabolism, because they are involved as well in the energy metabolism as in the apoptosis pathway (Farnie et al., 2015). It has been shown that CSCs possess a high mitochondrial mass and overexpress numerous mitochondria-related proteins (Farnie et al., 2015; Lamb et al., 2014). These observations seem to be consistent with the hypothesis that enhanced mitochondrial biogenesis is needed for survival and clonal expansion of CSCs (Lamb et al., 2015). Furthermore, studies using several FDA-approved antibiotics affecting mitochondrial function were able to efficiently eradicate CSCs *in vitro* (Lamb et al., 2015).

These considerations highlight the importance of the development of new therapies targeting mitochondria to cure glioblastomas and efficiently destroy CSCs.

Recently, our team has developed innovative platinum(II)-based compounds, named NHC-Pt(II) that display high cytotoxicity against various human and murine tumor cells (Chardon et al., 2012a, 2012b). In order to increase its bioavailability, we decided to associate it with linear 25 kDa polyethylenimine, a polymer widely used as transfection agent (Chekkat et al., 2016; Wantz et al., 2018). This conjugate containing one platinum atom every 30 units of ethylenediamine, called NHC-Pt(II)-PEI30 (**Supplementary Figure 1**), displayed an important cytotoxic activity against numerous murine and human cancer cell lines *in vitro* and *in vivo* (Chekkat et al., 2016). Its effect seemed to be higher than that of cisplatin and in the same range than that of oxaliplatin, two clinically used platinum(II) derivatives (Chekkat et al., 2016). Furthermore, it was able to kill cancer cells mutant for the tumor suppressor p53 molecule and thus resistant to conventional platinum(II)-based chemotherapeutic agents (Chekkat et al., 2016). Interestingly, further *in vitro* studies demonstrated that NHC-Pt(II)-PEI30 localized in the mitochondria and affected its function by inducing superoxide ion accumulation and impairment of mitochondrial respiration (Chekkat et al., 2016). Taken together, these considerations lead to the hypothesis that our compound could be a promising candidate for the eradication of CSCs by targeting their most important organelle, namely the mitochondria.

## Material and methods

### 1. Preparation of compounds

The platinum conjugate NHC-Pt(II)-PEI30 was synthesized by the team of Stéphane Bellemin-Laponnaz (IPMS, Strasbourg, France) as previously reported (Chekkat et al., 2016) and was prepared by dissolution in absolute ethanol at 5 mM (platinum concentration) and stored at 4°C. Oxaliplatin was purchased from Sigma (St. Louis, MO), prepared by dissolution in water at 5 mM (platinum concentration) and stored at room temperature (RT). Temozolomide (TMZ) (Sigma) was dissolved in dimethyl sulfoxide (DMSO, Eurobio, Courtaboeuf, France) at 100 mM and stored at -20°C. The compounds were diluted in the culture medium of the cells used for the experiment.

### 2. Cell culture

#### 2.1. Cancer stem cells

Human glioblastoma stem-like cell lines NCH421K and NCH644 were established in 2008 by Christel Herold-Mende and provided by Dr. Monique Dontenwill (Faculty of Pharmacy, UMR7213, Strasbourg). Both cell lines are derived from human glioblastomas: NCH421K cells originate from a 66 year old Caucasian male, while NCH644 cells come from a 66 year old Caucasian female (Campos et al., 2010; Podergajs et al., 2013). Briefly, glioblastoma samples were obtained from patients undergoing surgery and tissues were enzymatically dissociated to isolate the cells (Campos et al., 2010). They were cultured in DMEM/F12 medium (PanBiotech, Aidenbach, Germany) supplemented with 10% BIT-100 (Provitro, Berlin, Germany), 4 mM ultraglutamine (Sigma), 20 ng/mL fibroblast growth factor (FGF, Reliatech, Wolfenbüttel, Germany), 20 ng/mL epidermal growth factor (EGF, Reliatech), 100 U/mL penicillin and 0.1 mg/mL streptomycin (Sigma). This medium will be referred to as “cancer stem-cell medium”.  $7.5 \times 10^5$  cells were seeded in a 75 cm<sup>2</sup> culture flask (Greiner Bio-One, Frickenhausen, Germany). These cells self-organize into spheres. After 7 days of culture, they were harvested in order to be used for experiment or for continuing cell culture. For this, they were centrifuged at 350g for 5 minutes at RT and the cell pellet was resuspended in accutase solution (according to manufacturer’s instructions, Sigma) for dissociating the spheres for 5 minutes at RT.

## **2.2. Differentiated cancer cells**

The adherent human glioblastoma cell line U87-MG (ATCC<sup>®</sup> HTB-14<sup>™</sup>) was cultured in Minimum Essential Medium (MEM, Gibco, Waltham, MA) supplemented with 10% fetal bovine serum (FBS, Gibco), 10 mM sodium pyruvate (Lonza, Basel, Switzerland), 1% of non-essential amino acids (Dutscher, Brumath, France), 100 U/mL penicillin and 0.1 mg/mL streptomycin (Sigma) at 37°C, 5% CO<sub>2</sub> and 80% humidity. When the cells reached 80% of confluence, they were detached from the cell culture flask using trypsin-EDTA solution (Sigma, 0.5 g/L trypsin and 0.2 g/L EDTA) centrifuged at 350g for 5 minutes at RT before being seeded in a new culture flask for continuing cell culture or in a cell culture plate for experiment.

## **3. Evaluation of cell cytotoxicity**

U87-MG cells were seeded in 96-well plates (Greiner Bio-One) at  $3.5 \times 10^4$  cells per well in 50  $\mu$ L of cell culture medium. When the cells had adhered (at least 3 hours), they were treated with the different compounds diluted in cell culture medium for 24 hours before measurement of cytotoxicity.

NCH421K and NCH644 cells were seeded in 96-well plates (Greiner Bio-One) at  $7.5 \times 10^3$  cells per well in 100  $\mu$ L of cancer stem cell medium and cultivated during 4 days at 37°C, 5% CO<sub>2</sub> and 80% humidity to enable them to form spheres. The cells were treated with the different compounds once the spheres were formed in order to simulate more physiological tumor conditions. After 24 or 48 hours, the cells were harvested and the spheres were dissociated using Accutase solution as described above.

### **3.1. Microscopy observation**

After 72 hours of treatment, the cells were removed from the incubator, their morphology was observed by an inverted microscope and pictures were taken (Zeiss Axio Vert A1, Oberkochen, Germany).

### **3.2. Viability analysis after propidium iodide labeling**

After 24 or 48 hours of treatment, the cells were harvested and the spheres were dissociated with Accutase solution as described above. They were stained with propidium iodide (0.01 mg/mL, Sigma) and immediately analyzed by flow cytometry.

### 3.3. Apoptosis analysis by Annexin V and Propidium Iodide labelling

In order to evaluate the induction of apoptosis, the cells were stained after 24 hours of treatment with Annexin V-APC (eBioscience, Waltham, Massachusetts,) and Propidium Iodide (Sigma). Briefly, the NCH421K and NCH644 cells were harvested and the spheres were dissociated with accutase solution as described above. After a washing step with Annexin V Buffer (10 mM HEPES, 140 mM NaCl, 2.5 mM CaCl<sub>2</sub>, pH 7.4), the cells were incubated with Annexin V-APC (diluted 1/200, according to manufacturer's instructions) during 15 minutes at RT before being stained with PI (0.01 mg/mL) and immediately analyzed by flow cytometry. The percentage of specific apoptosis was calculated according to the following formula:

$$\% \text{ specific apoptosis} = \frac{\% \text{ apoptosis (sample)} - \% \text{ apoptosis (untreated)}}{100 - \% \text{ apoptosis (untreated)}} * 100$$

### 4. Analysis of the mitochondrial activity

The effect of the different compounds on the production of reactive oxygen species, mainly superoxide ions, as well as the mitochondrial respiratory activity was evaluated. For this, CSCs were harvested after 24 hours of treatment and dissociated as described above. The cells were then incubated either with MitoSox Red (Invitrogen, Carlsbad, CA, 1 μM) or MitoTracker Deep Red and Green (Invitrogen, 0.2 μM) at 37°C for 30 minutes in the dark and immediately analyzed by flow cytometry.

MitoSox enters the cells and targets specifically mitochondria where it becomes oxidized by superoxide ions which results in a highly fluorescent compound. MitoTracker Green and Deep Red passively diffuse across the cell membrane and accumulate within the mitochondria. They allow to distinguish between respiring and non-respiring mitochondria: Mitotracker Green stains all mitochondria regardless of their respiratory state, while MitoTracker Deep Red only marks respiring mitochondria (Zhou et al., 2011).

### 5. Flow cytometry analysis

After staining, 5000 or 10000 cells were analyzed using a FacsCalibur flow cytometer (Becton Dickinson, Franklin Lakes, NJ) and CellQuest software and the results were processed with FlowJo V10 Data Analysis software.

## Results

### Evaluation of cytotoxicity and analysis of the type of cell death

Our platinum(II) compound NHC-Pt(II)-PEI30 has already proven to be efficient against several human and murine cancer cell lines *in vitro* and in immunodeficient mouse model *in vivo* (Chekkat et al., 2016). That is why, we wanted to evaluate its effect on CSCs. For this, we started our investigations on the glioblastoma stem cell-like cell line NCH421K. This cell line was isolated from a patient suffering from glioblastoma (Campos et al., 2010; Podergajs et al., 2013) These cells self-organize into spheres. In order to simulate physiological conditions and to enable them to form spheres, the cells were cultured during four days before adding our compound. We first analyzed by microscopy if the spheres formed by the cells underwent morphological changes after a treatment with NHC-Pt(II)-PEI30. We observed a decrease of their size as well as an alteration of the refringence already after one day of treatment, indicating a dissociation of the spheres induced by our compound (**Figure 1**).

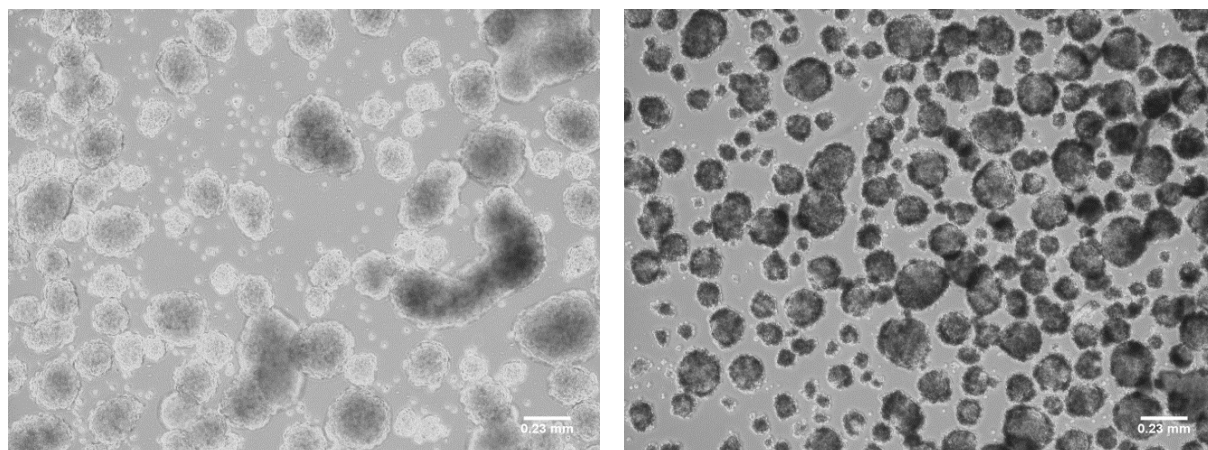

**Figure 1: Microscopic observation of NCH421K cells treated with NHC-Pt(II)-PEI30.**

NCH421K cells were cultured during 4 days to enable formation of spheres. They were then treated with NHC-Pt(II)-PEI30 at different concentrations for 72 hours before microscopy observation. Untreated cells (A) and cells treated with 6.25  $\mu\text{M}$  of NHC-Pt(II)-PEI30 (platinum concentration) (B) are depicted.

To gain better understanding of the process, we evaluated the cytotoxicity of NHC-Pt(II)-PEI30 on CSCs at different time points (24, 48 and 72 hours). For this, the cells were analyzed by flow cytometry using propidium iodide staining, a fluorescent stain of nucleic acids unable to enter live cells. Oxaliplatin, a third-generation platinum(II) derivative used in clinics since its approval by the FDA in 1996, served as control. The results revealed that NHC-Pt(II)-PEI30 was able to inhibit viability of CSCs NCH421K with an effector concentration that induced 50% of cell death (EC50) of approximately 5  $\mu\text{M}$  after 24 hours



(**Figure 2A**) or 48 hours (**Figure 2B**) of treatment. Moreover, oxaliplatin did not have any considerable cytotoxic effect on the CSCs neither after 24 hours (**Figure 2A**) nor after 48 hours (**Figure 2B**) of treatment. These observations suggest that our platinum(II) compound NHC-Pt(II)-PEI30 was able to kill CSCs.

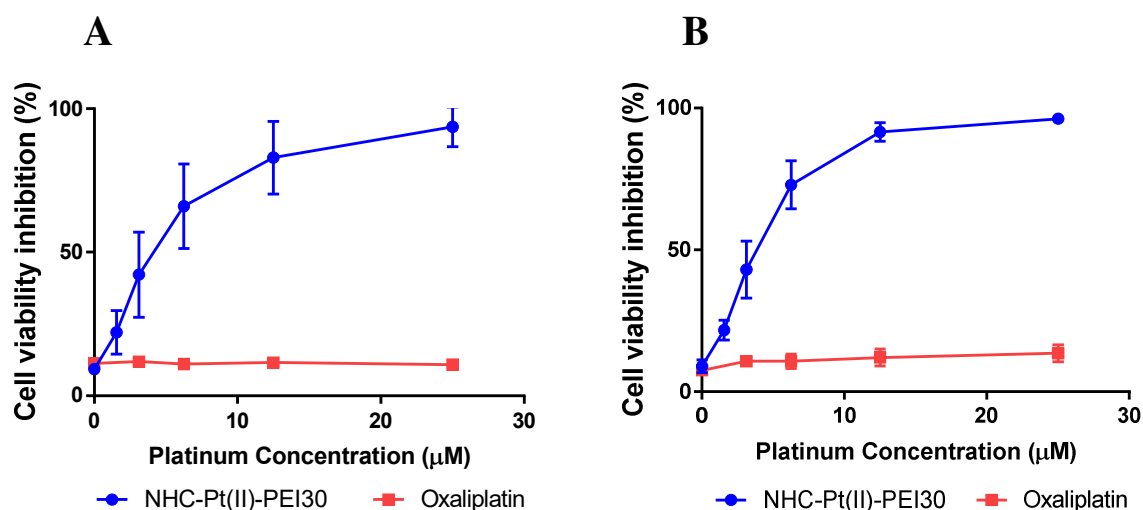
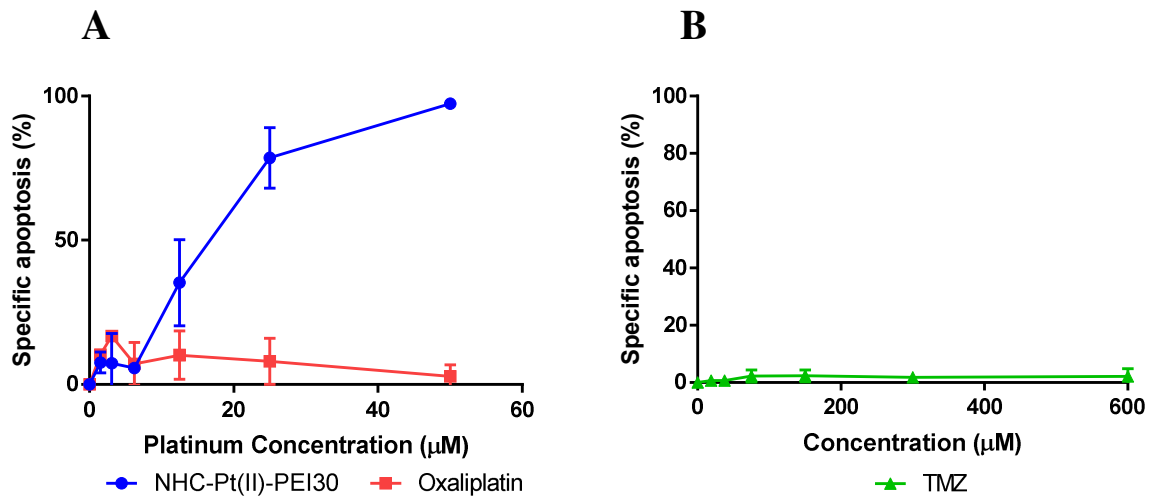

**Figure 2: Evaluation of cytotoxicity in NCH421K cells.**

NCH421K were cultured during 4 days to enable sphere formation. Then, they were treated with NHC-Pt(II)-PEI30 or oxaliplatin during 24 (A) or 48 (B) hours, before being stained with propidium iodide and analyzed by flow cytometry in order to evaluate the cytotoxicity of the platinum(II) compounds. The results are expressed as mean  $\pm$  SEM of at least two independent experiments.

Based on these data, we wanted to further investigate the cell death mechanism. That is why, we evaluated if NHC-Pt(II)-PEI30 was able to induce apoptosis of CSCs. We had already proven that NHC-Pt(II)-PEI30 could generate apoptosis in human colorectal cancer cell line HCT116 (Chekkat et al., 2016). Before using CSCs from patients, we wanted to check if our conjugate NHC-Pt(II)-PEI30 was able to induce apoptosis of a well-established glioma cell line. For this, U87 cells were treated with our compound or with oxaliplatin and TMZ as control during 24 hours. As shown in figure 3, NHC-Pt(II)-PEI30 induced apoptosis of U87 cells from 10  $\mu$ M with a EC50 of approximately 20  $\mu$ M of platinum. By contrast, no apoptosis was observed when the cells were treated with oxaliplatin (**Figure 3A**) or TMZ (**Figure 3B**).

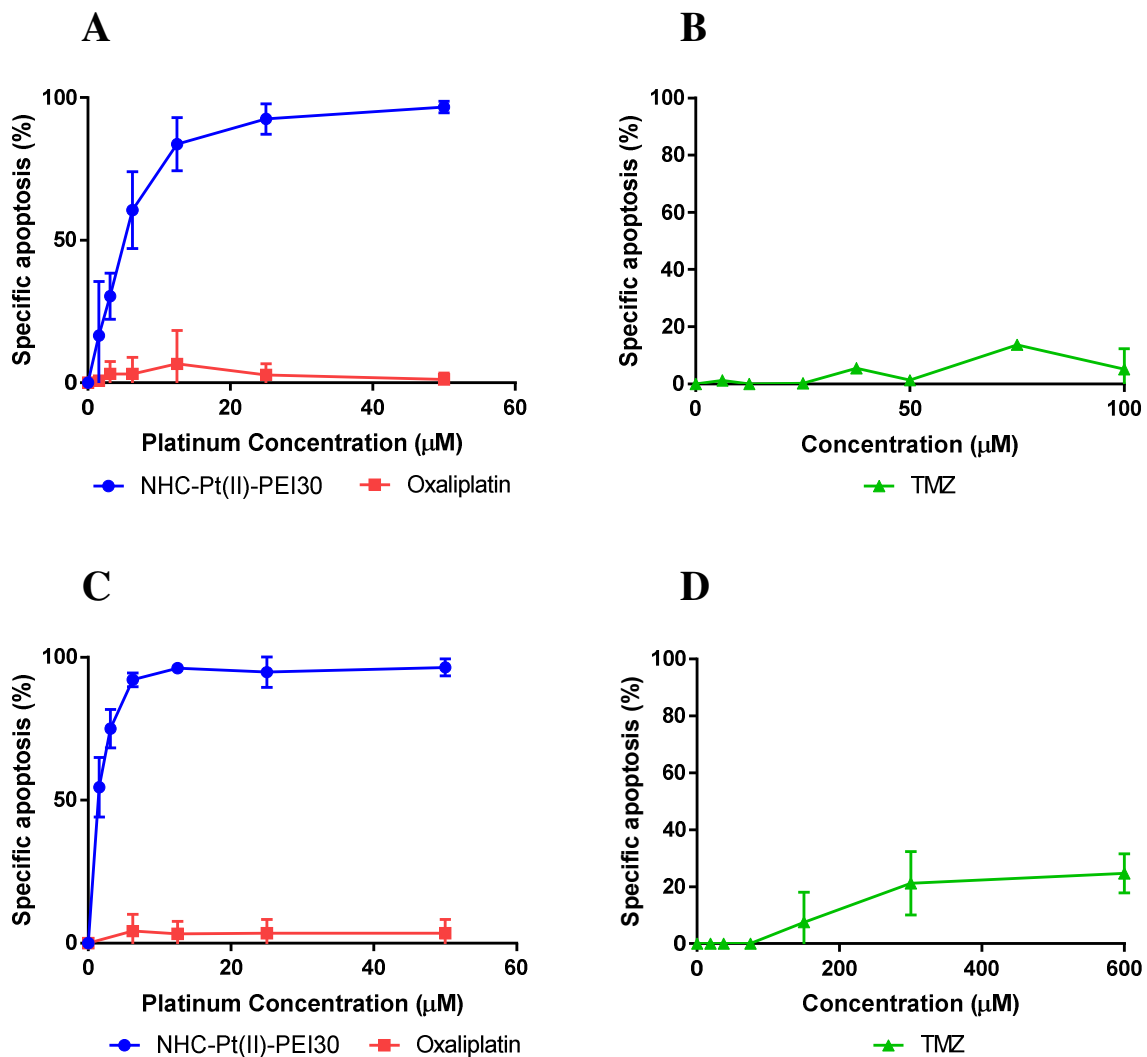



**Figure 3: Evaluation of apoptosis in differentiated glioma cancer cells U87.**

U87 cancer cells were seeded and once they had adhered (2-3 hours), they were treated with the different platinum(II) compounds (A) or with TMZ (B) for 24 hours, before being analyzed by flow cytometry using Annexin V-APC and propidium iodide labelling. The results represent the mean  $\pm$  SEM of three independent experiments.

We then analyzed the induction of apoptosis on two patient-derived CSC-like cell lines NHC421K and NCH644 by flow cytometry using Annexin V-APC and Propidium Iodide staining. Both CSC-like cell lines NCH421K (**Figure 4A and 4B, Supplementary Figure 2**) and NCH644 (**Figure 4C and D**) underwent apoptosis when they were treated during 24 hours with NHC-Pt(II)-PEI30 from a platinum concentration of 1.5625  $\mu$ M and with an EC50 of approximately 5  $\mu$ M. At a concentration of 25 $\mu$ M, almost all the cells underwent apoptosis. Nonetheless, oxaliplatin and TMZ, the chemotherapeutic agent currently used for glioblastoma therapy, did not have any effect on the CSCs. These results showed that NHC-Pt(II)-PEI30 could induce apoptosis of CSCs contrary to oxaliplatin and TMZ.



**Figure 4: Evaluation of apoptosis in NCH421K (A+B) and NCH644 (C+D) cells.**

NCH421K (A+B) and NCH644 (C+D) cells were cultured during 4 days to enable sphere formation, before being treated either with the platinum (II) conjugates NHC-Pt(II)-PEI30 and oxaliplatin (A+C) or with TMZ (B+D) for 24 hours. The induction of apoptosis was then evaluated by flow cytometry using Annexin V-APC and propidium iodide staining. The results are expressed as mean  $\pm$  SEM of two (B,C,D) or three (A) independent experiments.

All these results suggest that NHC-Pt(II)-PEI30 induces apoptosis not only of differentiated glioblastoma cancer cells, but also of CSCs, whereas another platinum(II)-based compound (oxaliplatin) or the first line treatment of glioblastoma TMZ do not.

### Evaluation of the mitochondrial effect

Mitochondria play an important role in CSCs as it has been demonstrated that CSCs possess a high mitochondrial mass which correlates with chemoresistance towards various compounds (Farnie et al., 2015). Simultaneously, it has been proposed that mitochondria could be considered as an Achille's heel in CSCs and this way be an excellent target for new anticancer

agents (Lamb et al., 2014, 2015). As our conjugate NHC-Pt(II)-PEI30 had already revealed a harmful effect on mitochondrial activity of human colorectal cancer cells HCT116 (Chekkat et al., 2016), we wanted to know if this was also the case on CSCs. For this, NCH421K cells were cultured in presence of our conjugate, oxaliplatin or TMZ as reference during 24 hours before analyzing the mitochondrial function by flow cytometry. First, we evaluated by MitoSox staining the accumulation of superoxide ions, a reactive oxygen species associated with mitochondrial dysfunction (Storz, 2007). Upon interaction with superoxide ions, MitoSox emits red fluorescence. **Figure 5A** depicts an increased number of MitoSox positive cells after a treatment of 24 hours with NHC-Pt(II)-PEI30 at a platinum concentration above 3.25  $\mu\text{M}$  and with an EC50 of approximately 5  $\mu\text{M}$ , which points out an impairment of mitochondrial function. At a platinum concentration of 25  $\mu\text{M}$ , nearly all the cells accumulate superoxide ions. Nonetheless, oxaliplatin and TMZ (**Figure 5B, Supplementary Figure 3**) did not have any effect.

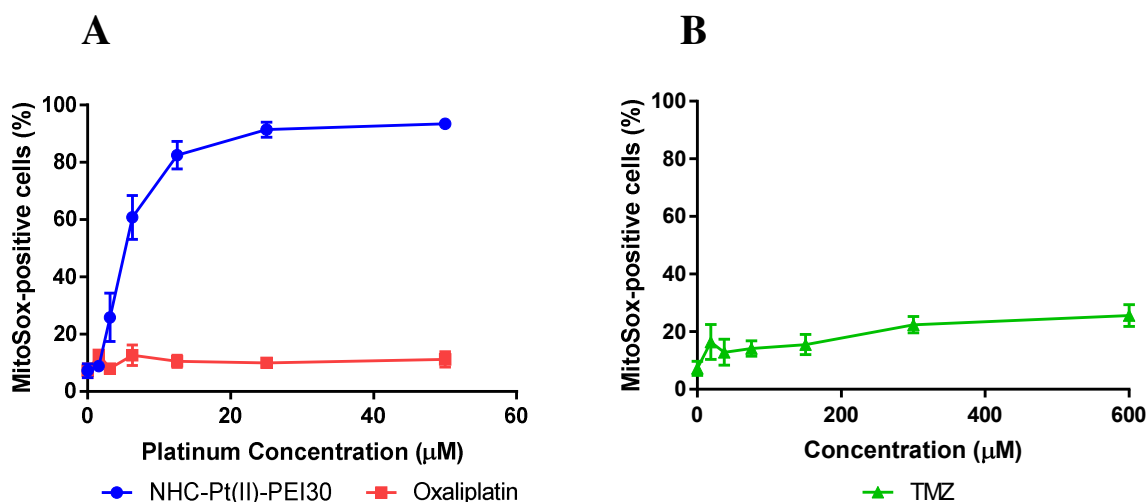
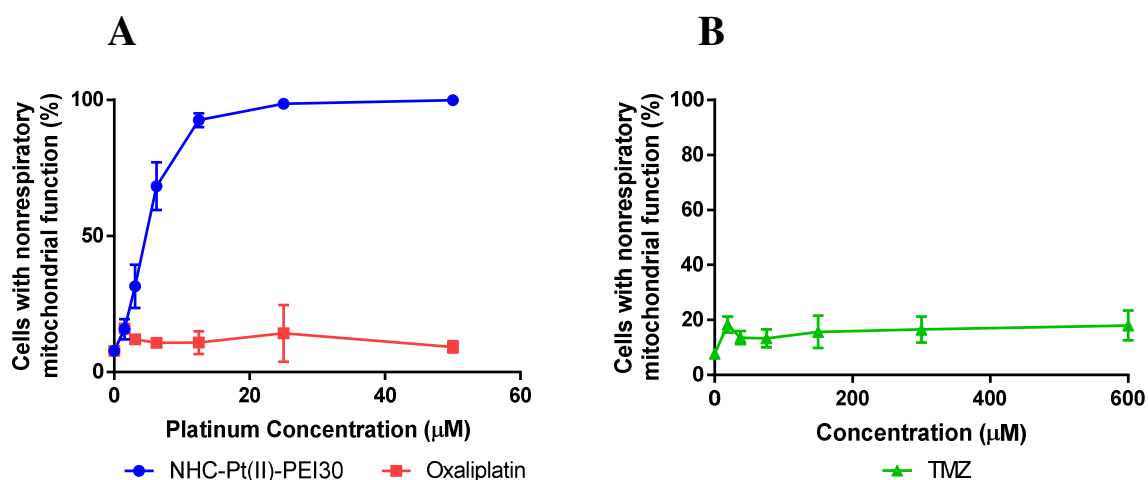

**Figure 5: Evaluation of the accumulation of superoxide ions in NCH421K cells.**

NCH421K cells were cultured during 4 days to enable sphere formation. They were then treated with the platinum(II) conjugates NHC-Pt(II)-PEI30 and oxaliplatin (A) or with TMZ (B) for 24 hours before being stained with MitoSox and analyzed by flow cytometry to evaluate the accumulation of superoxide ions, indicator of mitochondrial dysfunction. The results represent the mean  $\pm$  SEM of three independent experiments.

Following these results, we also studied the respiratory activity of mitochondria by flow cytometry using MitoTracker Green and Deep Red staining. Both markers passively diffuse through the cell membrane and accumulate within the mitochondria. MitoTracker Green stains all mitochondria regardless of their respiratory state, while MitoTracker Deep Red

preferentially marks respiring mitochondria (Zhou et al., 2011). NCH421K cells were treated as described above before staining with the two dyes. **Figure 6A** reveals that NHC-Pt(II)-PEI30 led to an increased number of cells with an impaired mitochondrial respiratory function at a platinum concentration higher than 3.125  $\mu\text{M}$  and with an EC50 of approximately 5  $\mu\text{M}$ . This could not be observed when cells were cultured with oxaliplatin and TMZ (**Figure 6B and Supplementary Figure 4**). Altogether, our results demonstrate that NHC-Pt(II)-PEI30 influenced the mitochondrial function which was reflected by an accumulation of superoxide ions as well as a decrease of the mitochondrial respiratory capacity.



**Figure 6: Evaluation of the mitochondrial respiratory activity NCH421K cells.**

NCH421K cells were cultured during 4 days to enable sphere formation before being treated with platinum(II) compounds NHC-Pt(II)-PEI30 and oxaliplatin (A) and TMZ (B). Then, they were stained with MitoTracker Deep Red and Green and analyzed by flow cytometry in order to evaluate the respiratory activity of mitochondria. The results represent the mean  $\pm$  SEM of three independent experiments.

## Discussion

Platinum(II) drugs are commonly used chemotherapeutic agents to treat numerous cancer cell types. However, they display a limited efficacy in the treatment of GBM (Roberts et al., 2016). Recently, we developed an innovative platinum(II)-based conjugate NHC-Pt(II)-PEI30 able to kill several cancer cell lines *in vitro* and with potent *in vivo* effect in immunodeficient mice (Chekkat et al., 2016; Wantz et al., 2018). We also demonstrated that NHC-Pt(II)-PEI30 did not only act as conventionally platinum(II) derivatives by targeting nucleic acids, but altered the mitochondrial function by favoring superoxide ion accumulation and decreasing the mitochondrial respiratory activity in human colon adenocarcinoma cells HCT116 (Chekkat et al., 2016). GBM is a cancer with poor prognosis due to intrinsic and acquired resistances to numerous cancer therapies and also to the first line treatment TMZ (Persano et al., 2013). TMZ is a prodrug that is either injected or administered orally and that can cross the blood-brain-barrier due to its lipophilic nature (Lee, 2016). It is considered as alkylating agent, as it adds methyl groups to N7 and O6 positions on guanines and O3 position on adenines in DNA (Lee, 2016). These modifications then lead to the incorporation of false bases in DNA, for example of thymine instead of cytosine opposite to O6-methylguanine resulting in cell cycle arrest and induction of apoptosis (Lee, 2016). However, some studies have suggested an overexpression of the enzyme O6-Methylguanine DNA methyltransferase (MGMT) in glioblastomas resulting in an inhibition of the induction of cell death by TMZ (Li et al., 2017). Furthermore, GBM displays an inter- and intratumor cellular heterogeneity (Bradshaw et al., 2016; Persano et al., 2013). Over the last years, a pluripotent self-renewing subpopulation of radio- and chemoresistant tumor cells gained rising attention: the CSCs (Venere et al., 2011). Various research teams proved that the mitochondrial biogenesis was important for the survival of these cells that are responsible for tumor relapse (Farnie et al., 2015; Lamb et al., 2014, 2015). Based on these results, we evaluated if NHC-Pt(II)-PEI30 was able to kill CSCs by impairing the mitochondrial function. Our data showed that our conjugate induced apoptosis of CSCs and mitochondrial dysfunction. Nevertheless, the controls TMZ and oxaliplatin, a clinically used platinum(II) derivative, did not have any effect on the CSCs. The absence of apoptosis induction by TMZ is not surprising, because some studies have revealed that TMZ induces preferentially senescence and rarely apoptosis of cancer cells (Hirose et al., 2001). The efficacy of NHC-Pt(II)-PEI30 might be due to its capacity of targeting the core organelle of CSCs, the mitochondria. Altogether we propose

that our compound could be considered as promising candidate for the development of anticancer treatments targeting CSCs. The next step consists now in the *in vivo* evaluation of our conjugate. Nonetheless, further experiments must be performed to analyze the ability of our conjugate NHC-Pt(II)-PEI30 to cross the blood-brain-barrier. Finally, the CSCs specifically express some receptors, like for example CD44, enabling this way a targeting. For this, we are thinking of modifying our conjugate by attaching hyaluronic acid (HA), the ligand of CD44, to the PEI moiety (Zhou et al., 2009).

### Acknowledgements

This work was supported by “Initiative d’Excellence” (IdEx), Centre National de la Recherche Scientifique (CNRS) and University of Strasbourg. May Wantz is a recipient of a PhD grant from the French Ministère de l’Education Nationale, de la Recherche et de la Technologie.

## References

Alifieris, C., and Trafalis, D.T. (2015). Glioblastoma multiforme: Pathogenesis and treatment. *Pharmacology & Therapeutics* 152, 63–82.

Anjum, K., Shagufta, B.I., Abbas, S.Q., Patel, S., Khan, I., Shah, S.A.A., Akhter, N., and Hassan, S.S. ul (2017). Current status and future therapeutic perspectives of glioblastoma multiforme (GBM) therapy: A review. *Biomedicine & Pharmacotherapy* 92, 681–689.

Bradshaw, A., Wickremsekera, A., Tan, S.T., Peng, L., Davis, P.F., and Itinteang, T. (2016). Cancer Stem Cell Hierarchy in Glioblastoma Multiforme. *Frontiers in Surgery* 3.

Campos, B., Wan, F., Farhadi, M., Ernst, A., Zeppernick, F., Tagscherer, K.E., Ahmadi, R., Lohr, J., Dictus, C., Gdynia, G., et al. (2010). Differentiation Therapy Exerts Antitumor Effects on Stem-like Glioma Cells. *Clinical Cancer Research* 16, 2715–2728.

Chardon, E., Dahm, G., Guichard, G., and Bellemin-Lapponnaz, S. (2012a). Derivatization of Preformed Platinum N-Heterocyclic Carbene Complexes with Amino Acid and Peptide Ligands and Cytotoxic Activities toward Human Cancer Cells. *Organometallics* 31, 7618–7621.

Chardon, E., Puleo, G.L., Dahm, G., Fournel, S., Guichard, G., and Bellemin-Lapponnaz, S. (2012b). Easy Derivatization of Group 10 N-Heterocyclic Carbene Complexes and In Vitro Evaluation of an Anticancer Oestradiol Conjugate. *ChemPlusChem* 77, 1028–1038.

Chekkat, N., Dahm, G., Chardon, E., Wantz, M., Sitz, J., Decossas, M., Lambert, O., Frisch, B., Rubbiani, R., Gasser, G., et al. (2016). N-Heterocyclic Carbene–Polyethylenimine Platinum Complexes with Potent in Vitro and in Vivo Antitumor Efficacy. *Bioconjugate Chemistry* 27, 1942–1948.

Crespo, I., Vital, A.L., Gonzalez-Tablas, M., Patino, M. del C., Otero, A., Lopes, M.C., de Oliveira, C., Domingues, P., Orfao, A., and Tabernero, M.D. (2015). Molecular and Genomic Alterations in Glioblastoma Multiforme. *The American Journal of Pathology* 185, 1820–1833.

Deshmukh, A., Deshpande, K., Arfuso, F., Newsholme, P., and Dharmarajan, A. (2016). Cancer stem cell metabolism: a potential target for cancer therapy. *Molecular Cancer* 15.

Farnie, G., Sotgia, F., and Lisanti, M.P. (2015). High mitochondrial mass identifies a sub-population of stem-like cancer cells that are chemo-resistant. *Oncotarget* 6.

Hirose, Y., Berger, M.S., and Pieper, R.O. (2001). p53 Effects Both the Duration of G2/M Arrest and the Fate of Temozolomide-treated Human Glioblastoma Cells. *Cancer Research* 61, 1957–1963.

Konrad, C.V., Murali, R., Varghese, B.A., and Nair, R. (2017). The role of cancer stem cells in tumor heterogeneity and resistance to therapy. *Canadian Journal of Physiology and Pharmacology* 95, 1–15.

- Lamb, R., Harrison, H., Hult, J., Smith, D.L., Lisanti, M.P., and Sotgia, F. (2014). Mitochondria as new therapeutic targets for eradicating cancer stem cells: Quantitative proteomics and functional validation via MCT1/2 inhibition. *Oncotarget* 5.
- Lamb, R., Ozsvari, B., Lisanti, C.L., Tanowitz, H.B., Howell, A., Martinez-Outschoorn, U.E., Sotgia, F., and Lisanti, P. (2015). Antibiotics that target mitochondria effectively eradicate cancer stem cells, across multiple tumor types: Treating cancer like an infectious disease. *Oncotarget* 6, 16.
- Lee, S.Y. (2016). Temozolomide resistance in glioblastoma multiforme. *Genes & Diseases* 3, 198–210.
- Li, Q., Guo, J., Wang, W., and Wang, D. (2017). Relationship between MGMT gene expression and treatment effectiveness and prognosis in glioma. *Oncology Letters* 14, 229–233.
- Louis, D.N., Ohgaki, H., Wiestler, O.D., Cavenee, W.K., Burger, P.C., Jouvet, A., Scheithauer, B.W., and Kleihues, P. (2007). The 2007 WHO Classification of Tumours of the Central Nervous System. *Acta Neuropathologica* 114, 97–109.
- Nicolaidis, S. (2015). Biomarkers of glioblastoma multiforme. *Metabolism* 64, S22–S27.
- Ohgaki, H., Dessen, P., Jourde, B., Horstmann, S., Nishikawa, T., Patre, P.-L.D., Burkhard, C., Pisani, P., Yonekawa, Y., and Yasargil, M.G. (2004). Genetic Pathways to Glioblastoma: A Population-Based Study. *Cancer Research* 64, 9.
- Persano, L., Rampazzo, E., Basso, G., and Viola, G. (2013). Glioblastoma cancer stem cells: Role of the microenvironment and therapeutic targeting. *Biochemical Pharmacology* 85, 612–622.
- Podergajs, N., Brekka, N., Radlwimmer, B., Herold-Mende, C., Talasila, K.M., Tiemann, K., Rajcevic, U., Lah, T.T., Bjerkgvig, R., and Miletic, H. (2013). Expansive growth of two glioblastoma stem-like cell lines is mediated by bFGF and not by EGF. *Radiology and Oncology* 47, 330–337.
- Roberts, N.B., Wadajkar, A.S., Winkles, J.A., Davila, E., Kim, A.J., and Woodworth, G.F. (2016). Repurposing platinum-based chemotherapies for multi-modal treatment of glioblastoma. *OncoImmunology* 5, e1208876.
- Storz, P. (2007). Mitochondrial ROS – radical detoxification, mediated by protein kinase D. *Trends in Cell Biology* 17, 13–18.
- Tivnan, A., Heilinger, T., Lavelle, E.C., and Prehn, J.H.M. (2017). Advances in immunotherapy for the treatment of glioblastoma. *Journal of Neuro-Oncology* 131, 1–9.
- Venere, M., Fine, H.A., Dirks, P.B., and Rich, J.N. (2011). Cancer stem cells in gliomas: Identifying and understanding the apex cell in cancer's hierarchy. *Glia* 59, 1148–1154.
- Wantz, M., Bouché, M., Dahm, G., Chekkat, N., Fournel, S., and Bellemin-Laponnaz, S. (2018). N-Heterocyclic Carbene-Polyethyleneimine (PEI) Platinum Complexes Inducing Human Cancer Cell Death: Polymer Carrier Impact. *International Journal of Molecular Sciences* 19, 3472.



Wesseling, P., and Capper, D. (2018). WHO 2016 Classification of gliomas. *Neuropathology and Applied Neurobiology* 44, 139–150.

Zhou, B.-B.S., Zhang, H., Damelin, M., Geles, K.G., Grindley, J.C., and Dirks, P.B. (2009). Tumour-initiating cells: challenges and opportunities for anticancer drug discovery. *Nature Reviews Drug Discovery* 8, 806–823.

Zhou, R., Yazdi, A.S., Menu, P., and Tschopp, J. (2011). A role for mitochondria in NLRP3 inflammasome activation. *Nature* 469, 221–225.

Supplementary Data

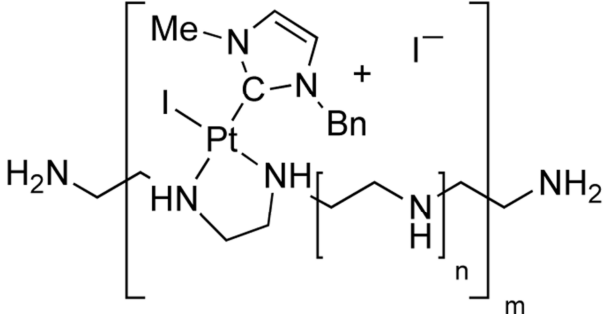

**Supplementary Figure 1: Structure of NHC-Pt(II)-PEI30**  
 n = 29 and m = 200

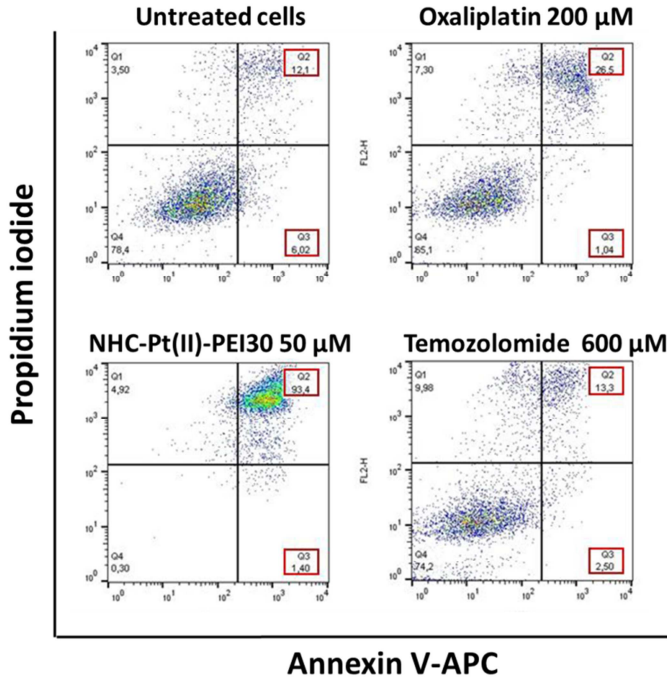

**Supplementary Figure 2: Example of flow cytometry dotplot of apoptosis evaluation NCH421K cells.**

Cells were treated as described in Figure 4. Percentage of apoptotic cells is indicated.

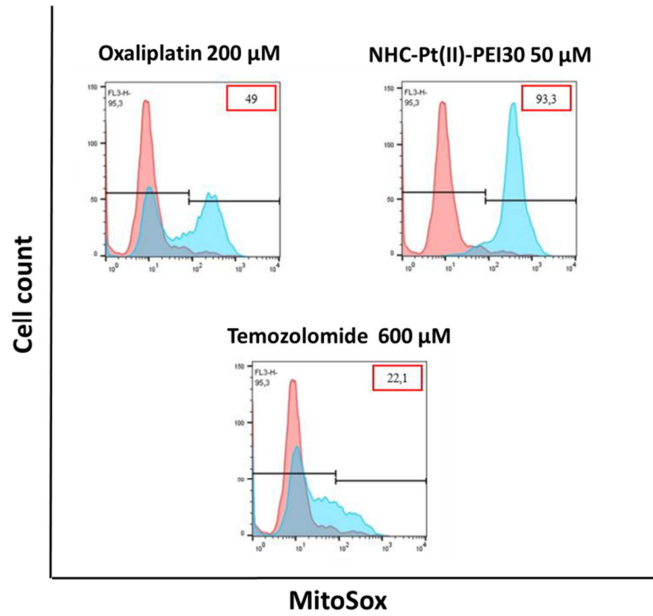

**Supplementary Figure 3: Examples of histograms obtained by flow cytometry after MitoSox staining of NCH421K cells.**

Cells were treated as described in Figure 5. Percentage of MitoSox-positive cells is indicated.

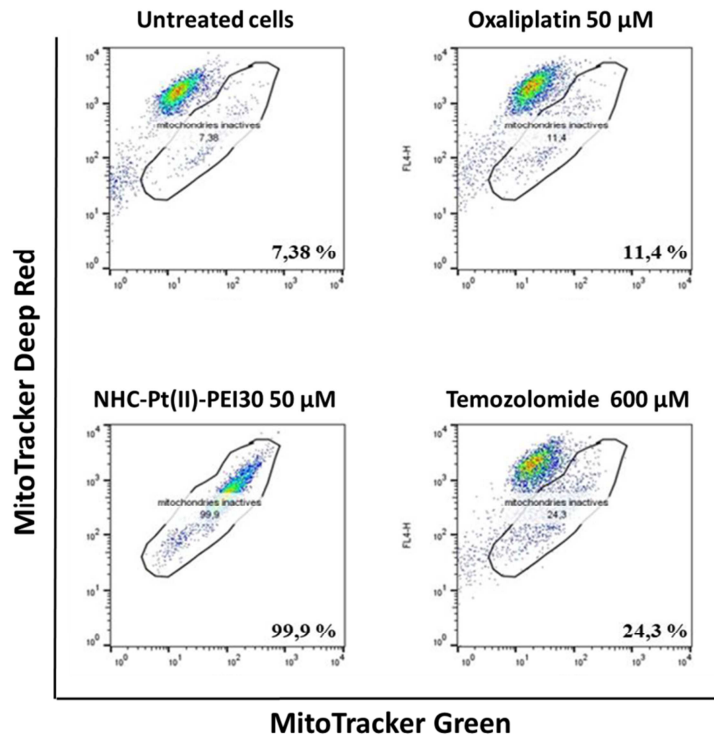

**Supplementary Figure 4: Examples of dotplots obtained by flow cytometry after MitoTracker staining of NCH421K cells.**

Cells were treated as described in Figure 6. Percentage of cells with non-respiratory mitochondria is indicated.

# **Chapter 3**

Activation of the antitumor immune  
response by innovative platinum (II)  
compounds

C'est par l'expérience que la science et l'art font leur progrès chez les hommes.

*Aristote*

## Context and objectives

Over the last years, it has appeared that chemotherapy was more efficient in immunocompetent patients than in immunosuppressed individuals, suggesting an implication of the immune system in the effect of chemotherapeutic agents (Vesely et al., 2011; Zitvogel et al., 2013). In fact, some anticancer drugs induce a particular apoptosis of cancer cells, able to activate the immune system: immunogenic cell death (ICD). This cell death is characterized by the release of danger molecules (DAMPs) by the cancer cells in a definite spatiotemporal configuration. These DAMPs regroup the exposure of the endoplasmic reticulum chaperone calreticulin at the cell surface as well as the emission of ATP and non-histone chromatin-binding protein HMGB1 and result in the activation of an adaptive immune response (Galluzzi et al., 2017; Zhou et al., 2019). As oxaliplatin, a commercially available platinum drug, is able to trigger ICD (Dudek et al., 2013; Tesniere et al., 2010; Zhou et al., 2019), the hypothesis was emitted that NHC-Pt(II)-PEI30 might do the same.

**That is why, the aim of this study was to analyze the ability of NHC-Pt(II)-PEI30 to favor ICD and to associate it with supplementary danger signals to enhance the induced immune response.**

## Results

First, I analyzed the antitumor effect of our compound NHC-Pt(II)-PEI30 in an immunocompetent mouse model bearing lung tumors. At the same time, I evaluated the immune response in these mice to consolidate our hypothesis that the compound might induce an antitumor immune response. I also assessed *in vitro* the induction of ICD using two strategies: i) direct measurement of the presence of DAMPs, e.g. the exposure of calreticulin at the cell surface of cancer cells treated with NHC-Pt(II)-PEI30 and ii) indirect assessment of the DAMPs release by transferring the medium of treated cancer cells onto immune cells and evaluating their activation. As these experiments only revealed a weak activation of the immune response, I tried to enhance this effect by creating complexes composed of NHC-Pt(II)-PEI30 and a danger signal. *In vitro* data showed that the cytotoxic and immunostimulatory activities of these complexes were maintained after complex formation. Furthermore, their activity was analyzed *in vivo* in immunocompetent mouse model and it appeared that the complexes displayed an important antitumoral effect.

### Conclusions

First, these studies allowed me to demonstrate that the NHC-Pt(II)-PEI30 conjugate did not only show a cytotoxic activity in immunodeficient mice xenografted with human cancer cells, but also in an immunocompetent mouse model bearing lung tumors. At the same time, the observation of an increased local antitumor immune response strengthened the hypothesis that NHC-Pt(II)-PEI30 might trigger ICD. I assessed *in vitro* the release of DAMPs by the cancer cells and generated complexes composed of NHC-Pt(II)-PEI30 and a danger signal in order to enhance the antitumor immune response. I proved that the cytotoxicity of the platinum compound and the immunostimulatory activity of the danger signal was maintained after complex formation. Finally, preliminary *in vivo* results indicated a good cytotoxic activity in immunocompetent mice bearing lung tumors.

# Development and evaluation of innovative platinum compounds able to activate the antitumor immune response

May Wantz<sup>a</sup>, Mathilde Bouché<sup>b</sup>, Cendrine Seguin<sup>a</sup>, Célia Jacobberger-Foissac<sup>a</sup>, Anais Brion<sup>a</sup>, Antoine Kichler<sup>a</sup>, Stéphane Bellemin-Laponnaz<sup>b</sup>, Sylvie Fournel<sup>✉a</sup>

<sup>a</sup> UMR7199 – Laboratory of Conception and Application of Bioactive Molecules – Team 3Bio, Faculty of Pharmacy, University of Strasbourg – CNRS, 74 route du Rhin, BP 60024, F-67401 Illkirch Cédex

<sup>b</sup> UMR7213 – Laboratory of Bioimaging and Pathologies – Team Tumoral signalling, Faculty of Pharmacy, University of Strasbourg – CNRS, 74 route du Rhin, BP 60024, F-67401 Illkirch Cédex

<sup>c</sup> UMR 7504 – Organic Materials – Team Conception and Synthesis – Institut de Physique et de Chimie des Matériaux Strasbourg (IPCMS), University of Strasbourg – CNRS, 23 rue du Loess, F-67000 Strasbourg

✉ Corresponding author: Sylvie Fournel, s.fournel@unistra.fr

## Keywords

Antitumor immune response, immunogenic cell death, calreticulin, orthotopic pulmonary mouse model, polyI:C

## Abbreviations

ATP: adenosine triphosphate; BCIP/NBT: 5-bromo-4-chloro-3-indolyl phosphate / nitro blue tetrazolium; CALR: calreticulin; DAMP: damage-associated molecular pattern; DMEM: Dulbecco's Modified Eagle's Medium; EDTA: ethylenediaminetetraacetic acid; ER: endoplasmic reticulum; FCS: fetal calf serum; FDA: Food and Drug Administration; FITC: fluorescein isothiocyanate; HMGB1: high mobility group box 1; HMW: high molecular weight; HSP70: heat shock protein 70; ICD: immunogenic cell death; IFN: interferon; NHC: N-heterocyclic carbene; NO: nitric oxide; NO<sub>2</sub><sup>-</sup>: nitrite; PBS: phosphate buffered saline; PEI: polyethylenimine; polyI:C: polyinosinic:polycytidylic acid; PRR: Pattern Recognition Receptor; RNA: ribonucleic acid; RPMI: Roswell Park Memorial Institute; RT: room temperature; SEM: standard error of the mean; TLR: Toll-like receptor

## Disclosure of interests

The authors report no conflict of interest.



## Abstract

Over the last years, the enhanced efficacy of chemotherapy in patients with a strong immune system has gained increasing attention. Several chemotherapeutic agents, including platinum(II) derivatives, have been shown to induce immunogenic cell death (ICD), an apoptosis able to activate the antitumor immune response. We recently developed NHC-Pt(II)-PEI30, an innovative platinum(II)-based compound, with an important cytotoxic activity *in vitro* against numerous cancer cell lines as well as *in vivo* in immunodeficient mouse model. Here, we evaluated *in vitro* and *in vivo* if this compound was able to promote or enhance an antitumor immune response. NHC-Pt(II)-PEI30 showed a cytotoxic activity *in vivo* in an immunocompetent orthotopic mouse model and could activate a local antitumor immune response. That is why, we investigated if this effect was due to immunogenic cell death (ICD). We measured the exposure of calreticulin at the cell surface, first feature of ICD and only detected a weak increase. We therefore decided to enhance the immuno-stimulatory effect of NHC-Pt(II)-PEI30 by associating it with danger signals able to activate the antitumor immune response. The ability of PEI to compact nucleic acids allowed us to generate complexes with NHC-Pt(II)-PEI30 and the synthetic double-stranded RNA polyinosinic:polycytidylic acid (polyI:C), which is a TLR3 agonist. We demonstrated that the compaction did neither affect the cytotoxic potential of the NHC-Pt(II)-PEI30 nor the immuno-stimulatory capacity of polyI:C. Moreover, NHC-Pt(II)-PEI30-polyI:C complexes displayed an anti-tumoral effect and induced a tumor-specific immune response *in vivo* in an immunocompetent mouse model. These results highlight the possibility of developing anticancer therapies acting as chemotherapeutic agents by killing the cancer cells and as immunotherapeutic agents by strengthening the antitumor immune response.

## Introduction

In more than 50% of the chemotherapeutic treatments of cancer, a platinum compound is administered (Gibson, 2019). For the moment, only three platinum(II)-based conjugates got a worldwide approval from the Food and Drug Administration (FDA): cisplatin in 1978, carboplatin in 1989 and oxaliplatin in 2002 (Kelland, 2007). However, these conventional platinum(II) compounds face many limitations: they have severe side effect, like ototoxicity, neurotoxicity and nephrotoxicity (Kelland, 2007). Furthermore, it appears that cancer cells can acquire resistance mechanisms towards these chemotherapeutic drugs, thus preventing their effect (Gottesman et al., 2016). That is why over the last years, many efforts have been done to synthesize new platinum-based conjugates. For this, we decided to focus on N-heterocyclic carbenes (NHC), because these ligands are able to form stable transition metal complexes which could be of interest for numerous biological applications (Merces and Albrecht, 2010). Several groups, including us, showed that the NHC-Pt(II) compounds showed a cytotoxic activity against numerous cancer cells lines *in vitro* (Chardon et al., 2012a, 2012b; Muenzner et al., 2015; Wai-Yin Sun et al., 2011). Nonetheless, due to a weak solubility under biological conditions, their use for *in vivo* experiments was restricted. That is why we created multivalent cationic platinum complexes starting from a polymer widely used as transfection agent, linear polyethylenimine (PEI). We generated different compounds by varying the platinum complex/polymer ratio and found that the conjugate containing one platinum complex every 30 units of ethylenediamine presented the best cytotoxic activity *in vitro* against several cancer cell lines (Wantz et al., 2018). Moreover, *in vivo* studies in an immunodeficient mouse model xenografted with human colon carcinoma cells HCT116 revealed that NHC-Pt(II)-PIE30 was able to limit tumor development with less side effects than oxaliplatin (Chekkat et al., 2016). Further investigations exposed that NHC-Pt(II)-PEI30 localized mainly in the mitochondria and only to a smaller extent in the nucleus (Chekkat et al., 2016). These observations are in contrast with the conventional platinum conjugates which target primarily the nucleus by forming DNA adducts, suggesting that NHC-Pt(II)-PEI30 may have a different mechanism of action (Boulikas et al., 2007).

Additionally, during the last years, it has been proven that chemotherapy was more efficient in healthy patients with a strong immune system compared to immunosuppressed individuals (Vesely et al., 2011; Zitvogel et al., 2013). Furthermore, radiotherapy and some chemotherapeutic agents can induce a specific type of cell death able to activate the immune system: immunogenic cell death (Galluzzi et al., 2017; Zhou et al., 2019). Oxaliplatin, but not cisplatin, displayed the ability to induce ICD (Dudek et al., 2013; Tesniere et al., 2010; Zhou

et al., 2019). ICD is characterized by the emission of damage-associated molecular patterns (DAMPs) by the dying cancer cells (Krysko et al., 2012). The DAMPs are endogenous molecules that are concealed within the cell in physiological conditions and are released as a consequence of stress, injury or cell death (Garg et al., 2015). Most of them act as danger signals upon diffusion and can be perceived by innate immune cells *via* their pattern recognition receptors (PRRs) leading to their activation (Garg et al., 2013; Krysko et al., 2012). PRRs group several families of receptors, like for example Toll-like receptors (TLRs) which are expressed at the cell membrane or within the endosomes (Brubaker et al., 2015). The main features of ICD are the exposure of the endoplasmic reticulum (ER) chaperone calreticulin (CALR) at the cell surface, as well as the release of adenosine triphosphate (ATP) and of non-histone chromatin-binding protein high mobility group box 1 (HMGB1) (Tesniere et al., 2008).

According to these observations, we hypothesized that our innovative NHC-Pt(II)-PEI30 conjugate may also have an effect on the immune system. We first investigated the antitumor effect and the activation of the immune response *in vivo* in immunocompetent orthotopic pulmonary mouse model. We then analyzed, *in vitro*, the induction of ICD directly by evaluating the exposure of CALR at the cell surface and indirectly by determining the activation of immune cells stimulated by DAMPs possibly contained in the supernatant of cancer cells treated with various chemotherapeutic agents. Furthermore, we took advantage of the ability of PEI to compact nucleic acids in order to enhance the antitumor immune response. For this, we generated complexes formed of NHC-Pt(II)-PEI30 with an agonist of TLR3, polyinosinic:polycytidylic acid (polyI:C). The endosomal TLR3 is a PRR implicated in the sensing of double-stranded RNA (Shekarian et al., 2017). Considering the fact that PEI is a commonly used transfection agent to transport nucleic acids and entering by endocytosis, we emitted the hypothesis that our NHC-Pt(II)-PEI30 conjugate might also enter the cells by endocytosis (Köping-Höggård et al., 2001; Lungwitz et al., 2005; Mansouri et al., 2006). That is why targeting this endosomal receptor could be of interest for the activation of immune responses. Previous studies of other research teams had already reported the compaction of PEI with the synthetic double-stranded RNA polyI:C (Rajendrakumar et al., 2018; Schaffert et al., 2011; Shir et al., 2005). We investigated if NHC-Pt(II)-PEI30 was able to efficiently compact polyI:C, before verifying that the compaction did not alter the cytotoxic activity of NHC-Pt(II)-PEI30 and the immune activation induced by polyI:C. Finally, we analyzed *in*

*in vivo* the antitumor effect of these NHC-Pt(II)-PEI30-polyI:C complexes as well as the activation of the antitumor immune response.

## Material and Methods

### 1. Preparation of products

The platinum compound NHC-Pt(II)-PEI30 (**Supplementary Figure 1**) was synthesized by the team of Stéphane Bellemin-Lapponnaz as previously reported (Chekkat et al., 2016; Wantz et al., 2018). Oxaliplatin was purchased from Sigma (St. Louis, MO).

NHC-Pt(II)-PEI30 was prepared by dissolution in absolute ethanol at a platinum concentration of 5 mM for *in vitro* experiments or at 10 mg/mL for *in vivo* experiments and then stored at 4°C.

Oxaliplatin was dissolved in water at a platinum concentration of 5 mM for *in vitro* experiments or at a concentration of 5 mg/mL for *in vivo* experiments and then stored at room temperature (RT).

Before use, NHC-Pt(II)-PEI30 and oxaliplatin were diluted in the cell culture medium for *in vitro* experiments and in physiological saline solution (NaCl 0.9% (p/v)) for *in vivo* experiments.

Polyinosinic:polycytidylic acid (poly(I:C)) HMW VacciGrade™ was purchased from Invivogen (San Diego, CA) and prepared by dissolution in endotoxin-free physiological saline solution (NaCl 0.9% (p/v)) at a concentration of 4 mg/mL and heated at 65°C for 10 minutes and then cooled down for 1 hour at RT to ensure annealing. The aliquots were stored at -20°C for long-term storage.

### 2. Formation of NHC-Pt(II)-PEI30-polyI:C complexes and verification of compaction by agarose gel shift

Complexes with various N/P ratios were generated. For this NHC-Pt(II)-PEI30 and polyI:C were mixed in physiological saline solution (NaCl 0.9% (p/v)) and left at RT for 40 minutes to enable complex formation. Then, the complexes were added on the cancer cells *in vitro*. For *in vivo* experiments, the complexes were administered to the mice immediately upon mixing to prevent the formation of large complexes.

The compaction was verified by agarose gel shift using conventional 1% agarose gel containing SYBR Safe (following manufacturer's instructions, Invitrogen, Carlsbad, CA) to visualize the nucleic acids in the gels. The migration of the complexes was performed for

30 minutes at 80V. In case of compaction of PEI with polyI:C, a delayed or no migration at all is observed compared to polyI:C alone.

### 3. Cell culture

The human colorectal adenocarcinoma cells HCT116 (ATCC<sup>®</sup> CCL-247<sup>TM</sup>) and the murine pulmonary cancer cells TC-1 (ATCC<sup>®</sup> CRL-2785<sup>TM</sup>) were cultured in RPMI medium (Sigma) supplemented with 10% heat-inactivated fetal calf serum (FCS, Gibco, Watham, MA), 100 U/mL penicillin and 0.1 mg/mL streptomycin (Sigma) and the murine macrophages RAW 264.7 (ATCC<sup>®</sup> TIB-71<sup>TM</sup>) were cultured in Dulbecco's Modified Eagle's Medium (DMEM) – high glucose (Sigma) supplemented with 5% FCS (Gibco), 100 U/mL penicillin and 0.1 mg/mL streptomycin (Sigma) at 37°C, 5% CO<sub>2</sub> and 80% humidity. When these adherent cells reached 80% of confluence, they were detached from the cell culture flask using trypsin-EDTA (0.5 g/L trypsin and 0.2 g/L EDTA, Sigma) for 5-10 minutes at 37°C and centrifuged at 200g for 5 minutes at RT before being seeded in a new culture flask or used for experiment.

### 4. *In vitro* evaluation of the effect of the different platinum compounds

Human colon adenocarcinoma cells HCT116 were seeded in 96-well plates (Greiner Bio-One, Frickenhausen, Germany) in 50 µL of cell culture medium at  $7.5 \times 10^4$  cells per well for assessment of cytotoxicity,  $5 \times 10^4$  cells per well for analysis of calreticulin exposure at the cell surface in flow cytometry or at  $3 \times 10^4$  cells per well for evaluation of DAMP release in cell culture supernatants. When the cells had adhered (at least 2 hours), they were treated with different compounds and incubated at 37°C, 5% CO<sub>2</sub> and 80% humidity. The cells were then detached by trypsin-EDTA and used for experiments.

#### 4.1. Assessment of cytotoxicity

After 20 hours of treatment with the different compounds, the cells were stained with propidium iodide (PI, 0.01 mg/mL, Sigma) and immediately analyzed using FACS Calibur (Becton Dickinson, Franklin Lakes, NJ) flow cytometer. 5000 cells were acquired with CellQuest software and the results were further processed with FlowJo V10 Data Analysis software.

#### **4.2. Analysis of calreticulin exposure at the cell surface**

The exposure of calreticulin at the cell surface was determined by two distinct techniques: flow cytometry and confocal microscopy.

For flow cytometry experiments, HCT116 cells were cultured with the various compounds in 96-well plates (Greiner Bio-One) for 5 or 12 hours, before being detached and washed in PBS supplemented with 2% FCS (Gibco).

For microscopic observations, HCT116 cells were seeded on microscope cover slides disposed in 24-well plates (Greiner Bio-One) at  $8 \times 10^4$  cells per slide in 500  $\mu$ L of cell culture medium. The cells were incubated during 24 hours at 37°C, 5% CO<sub>2</sub> and 80% humidity to enable adhesion before being treated with the different compounds during 4 hours. The cells were then washed in PBS 2% FCS solution.

For both experiments, cells were incubated during 30 minutes on ice with anti-calreticulin antibody (clone FMC75, 10  $\mu$ g/mL, GeneTex, Irvine, CA) and washed in PBS 2% FCS before being stained with secondary antibody anti-mouse IgG heavy and light chain conjugated to DyLight 488 (5  $\mu$ g/mL, Bethyl Laboratories, Montgomery, TX). Then, the cells were washed again in PBS 2% FCS.

For flow cytometry, the cells were additionally stained with propidium iodide and immediately analyzed as described in 4.1.

For microscopic observations, cells were fixed with 1% formaldehyde (Sigma) for 10 minutes at RT and washed in PBS 2% FCS before staining of the nucleus with Hoechst 33342 (1  $\mu$ g/mL, Sigma). After a final washing step, the cells were mounted on a microscope slide using ProLong Gold Antifade Mountant (Thermo Fisher, Waltham, MA) and observed by confocal microscope (Leica SPE, Wetzlar, Germany).

#### **4.3. Evaluation of DAMP release in cell culture supernatants**

HCT116 cells were treated with the different compounds and incubated for 48 hours. Then, supernatants were collected and put in contact with murine macrophages RAW 264.7. For this, RAW 264.7 cells were seeded in a 96-well plate (Greiner Bio-One) at  $1 \times 10^5$  cells per well in 50  $\mu$ L of culture medium. When the cells had adhered (at least 2 hours), the medium was removed and replaced by the supernatant of the previously treated cancer cells. The activation of macrophages was measured by evaluating nitric oxide (NO) production.

#### 4.4. Measurement of nitric oxide (NO) production

Nitric oxide is a very short-lived free radical which is rapidly oxidized to a more stable product: nitrite ( $\text{NO}_2^-$ ) (Bryan and Grisham, 2007; Grisham et al., 1996; Yang et al., 2009).  $\text{NO}_2^-$ , and so indirectly NO, can be quantified by Griess assay. Briefly, 60  $\mu\text{L}$  of Griess reagent (v/v mixture of 58.1 mM p-aminobenzene sulfonamide in 30% acetic acid and 3.9 mM N-1-naphthylethylenediamine dihydrochloride in 60% acetic acid) were added to 40  $\mu\text{L}$  of cell culture supernatant and the absorbance was measured at 543 nm using SAFAS FLX-Xenius spectrophotometer (Safas, Monaco). The  $\text{NO}_2^-$  concentrations of the samples were determined according to a sodium nitrite standard curve. In this assay,  $\text{NO}_2^-$  reacts with sulfanilamide to form a diazonium salt intermediate which then reacts with N-1-naphthylethylenediamine to form an azo dye absorbing at 543 nm (Coneski and Schoenfisch, 2012).

### 5. Evaluation of the *in vivo* effect of the different compounds

#### 5.1. Animals

Specific pathogen-free C57BL/6J mice aged 5-6 weeks were purchased from Janvier Labs (Le Genest-Saint-Isle, France). *In vivo* experiments were performed in full compliance with the CEE directive 2010/63/EU adopted on 22 September 2010, relating to the protection of animals used for experimental purposes and were done in compliance with the French law (décret n° 2013-118, 1 February 2013). Experiments were performed with the approval of the local Animal Care and Use Committee of Alsace (authorization number: AL/107/114/02/13).

#### 5.2. Injection of cancer cells and treatment of mice

TC-1 murine pulmonary cancer cells were harvested as previously described (§3) and washed in physiological saline solution NaCl 0.9% (p/v).  $1 \times 10^5$  cells were injected intravenously in the tail vein of C57BL/6J mice in 100  $\mu\text{L}$  of NaCl 0.9% (p/v).

Treatments were diluted in NaCl 0.9% (p/v) and administered by intraperitoneal injection in the mice 10, 14 and 18 days after injection of the cancer cells. At day 24, the mice were euthanized and the lungs, the spleen and the tumor draining axillary and inguinal lymph nodes were harvested for the evaluation of the antitumor effect and the analysis of the immune response.



### **5.3. Evaluation of the antitumor effect *in vivo***

In order to evaluate the antitumor effect of the different treatments, the lungs of the mice were collected after euthanasia and stained with 15% Indian ink solution by intratracheal injection before being bleached in Fekete's solution. This way, the nodules became white while the lung tissue remained black, facilitating the counting. For each mouse, the nodules were counted using a magnifier lamp.

### **5.4. Evaluation of the immune response**

#### **5.4.1. Harvesting of immune cells**

After euthanasia of the mice, the spleen and the tumor-draining axillary and inguinal lymph nodes were collected, the cells were harvested after dissociation of the organs and filtration on a 70  $\mu\text{m}$  nylon mesh cell strainer (Miltenyi Biotec, Bergisch Gladbach, Germany) and pooled per condition to analyze the antitumor immune response *ex vivo*. The cell suspensions were centrifuged at 200g for 5 minutes at RT. The pellet of lymph node cells was resuspended in RPMI supplemented with 2% normal mouse serum (Dutscher, Brumath, France) while the pellet of splenocytes was resuspended in ammonium-chloride-potassium (ACK) lysis buffer (150 mM  $\text{NH}_4\text{Cl}$ , 1 mM  $\text{KHCO}_3$ , 0.1 mM EDTA, pH 7.4) for 30 seconds at RT to destroy the red blood cells. The reaction was stopped by dilution in RPMI and the cells were centrifuged at 200g for 5 minutes at RT before being resuspended in RPMI 2% normal mouse serum. The cells were seeded at a concentration of  $4 \times 10^6$  cells/mL for ELISpot assay.

#### **5.4.2. ELISpot assay**

The number of tumor-specific interferon- $\gamma$  (IFN- $\gamma$ )-producing T cells was evaluated using ELISpot assay. For this, 96-well plates containing a PVDF membrane (MultiScreen Filter Plate, Merck Millipore, Burlington, MA) were used. The membrane was activated during 10 minutes with 35% ethanol and coated with purified anti-mouse IFN- $\gamma$  antibody (clone AN-18, 15  $\mu\text{g}/\text{mL}$ , eBiosciences, San Diego, CA) in PBS overnight at 4°C. After three washes in PBS, the membrane was blocked by RPMI supplemented with 10% heat-inactivated FCS (Sigma) for at least 2 hours at 37°C. After three washes with RPMI without FCS,  $4 \times 10^5$  spleen or lymph node cells were cultured as triplicates in 100  $\mu\text{L}$  of RPMI supplemented with 2% of normal mouse serum in presence of recombinant human interleukin-2 (IL-2, 30U/mL, ImmunoTools, Friesoythe, Germany) and i)  $2.5 \times 10^4$  tumor cells TC-1, ii) control peptide (10  $\mu\text{g}/\text{mL}$ ), iii) RPMI without FCS as negative control or iv) concanavaline A (Sigma, 1.25  $\mu\text{g}/\text{mL}$ ) as positive control. The plate was incubated during 20 hours at 37°C, 5%  $\text{CO}_2$  and



80% humidity. The wells were then washed with PBS 0.01% Tween20 (Sigma) and consecutively incubated with biotinylated anti-mouse IFN- $\gamma$  antibody (clone R4-6A2, 1  $\mu$ g/mL, eBiosciences) for 2 hours at 37°C, alkaline phosphatase conjugated to extravidin (dilution 1/5000, Sigma) for 45 minutes at 37°C and BCIP/NBT liquid substrate solution (Sigma) for 20 minutes at RT protected from light. Spots were then counted using a Bioreader 4000 PRO-S plate reader (Byosis, Karben, Germany). The number of spots obtained with the negative control (RPMI alone) was subtracted from all the conditions and the spots numbers were reported for 10<sup>6</sup> cells. The results were displayed as the mean of the triplicates.

### 6. Statistical analysis

All data are presented as mean  $\pm$  SEM. Statistical differences between results obtained in the counting of lung nodules were determined by an ANOVA followed by a Tukey post-hoc test, carried out with the GraphPad Prism 7.0 software. Difference between groups was considered statistically significant for  $p < 0.05$ .

## Results

### Cytotoxicity and immune response induced by NHC-Pt(II)-PEI30 in immunocompetent orthotopic mouse model

We recently reported that our innovative platinum(II) conjugate NHC-Pt(II)-PEI30 displayed a good cytotoxic activity *in vitro* against several murine and human cancer cell lines as well as *in vivo* in immunodeficient xenograft mouse model (Chekkat et al., 2016). Over the last years, the implication of the immune system in the efficacy of anticancer therapies has gained rising attention (Zitvogel et al., 2013). It has appeared that the platinum(II)-based compound oxaliplatin could increase the antitumor immune response (Dudek et al., 2013; Tesniere et al., 2010; Zhou et al., 2019). That is why, we were wondering if our conjugate NHC-Pt(II)-PEI30 was also able to affect the immune response.

#### Analysis of the antitumor effect

We first evaluated the antitumor effect of NHC-Pt(II)-PEI30 in immunocompetent orthotopic pulmonary mouse model. Briefly, 6-week old immunocompetent C57BL/6J mice were injected intravenously with murine pulmonary cancer cells TC-1 in the tail vein, resulting in the formation of lung nodules appearing 8 days after injection (**Supplementary figure 2**). The mice were then treated three times 10, 14 and 18 days post-injection with 10 mg/kg of

NHC-Pt(II)-PEI30, with 10 mg/kg of oxaliplatin or vehicle (NaCl 0.9% (p/v)) before being euthanized 24 days after the injection of cancer cells. At this time, the lungs were collected and the tumors were counted in order to evaluate the antitumor effect of NHC-Pt(II)-PEI30. For this first experiment in immunocompetent mouse model, oxaliplatin was used as a positive control, but at a platinum concentration five times higher compared to NHC-Pt(II)-PEI30. As shown in figure 1, mice treated with NHC-Pt(II)-PEI30 had less pulmonary tumors compared to mice treated with vehicle (**Figure 1**). This number was in the same range than mice treated with oxaliplatin, but at a platinum concentration which was five times higher, suggesting that NHC-Pt(II)-PEI30 was able to limit the development of cancer cells in immunocompetent mouse model.

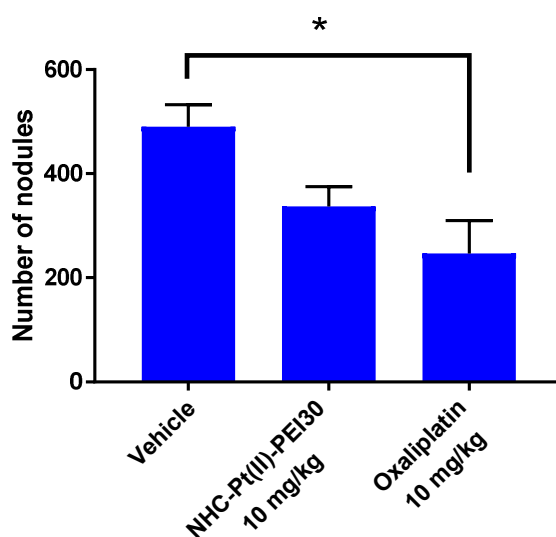

**Figure 1: Number of pulmonary nodules in orthotopic pulmonary mouse model.**

Murine pulmonary cancer cells TC-1 were injected intravenously in the tail vein of 6-week old immunocompetent C57BL/6J mice in order to induce the formation of lung nodules. The mice were treated 10, 14 and 18 days later with 10 mg/kg of NHC-Pt(II)-PEI30, 10 mg/kg of oxaliplatin or vehicle alone. At day 24, the mice were euthanized, the lungs were collected and colored by intratracheal injection of 15% Indian ink solution followed by a bleaching in Fekete’s solution to contrast the white nodules and the black tissue. The lung tumors were then counted for each mouse and the results are represented as mean ± SEM of 5 mice per group. \* p-value = 0.01

### Analysis of the immune response

At the same time of euthanasia, the tumor-draining axillary and inguinal lymph nodes were collected in order to evaluate the immune response of the mice by ELISpot assay. This *ex vivo* procedure enables the detection of tumor-specific interferon- $\gamma$ -producing T cells (Cole, 2005; Jacobberger-Foissac et al., 2019). An increased number of tumor-specific IFN- $\gamma$ -producing T cells was observed in the tumor-draining lymph nodes of the mice treated with NHC-Pt(II)-

PEI30 and oxaliplatin compared to control mice (**Figure 2**). The high number of tumor-specific IFN- $\gamma$  producing T cells in mice treated with the clinically used platinum(II) derivative is not surprising, as this compound is already known to positively affect the antitumor immune response (Bloy et al., 2017; Hato et al., 2014; Tesniere et al., 2010). NHC-Pt(II)-PEI30 induced less numbers of tumor-specific T cells than oxaliplatin, but at a concentration of five times less platinum suggesting that NHC-Pt(II)-PEI30 compound was able to activate a tumor specific immune response.

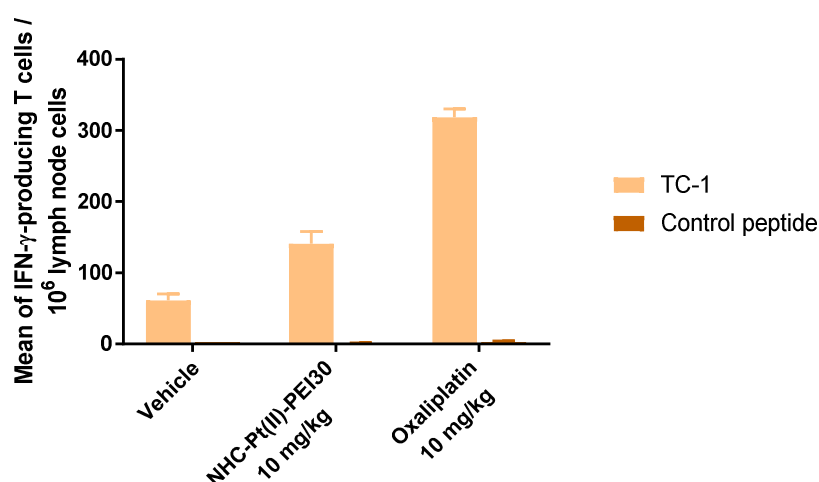

**Figure 2: Evaluation of the local antitumor immune response.**

Mice were treated as described in figure 1. At day 24, the mice were euthanized, the tumor-draining axillary and inguinal lymph nodes were collected from 5 mice per group and pooled. The number of IFN- $\gamma$ -producing cells was determined by ELISpot assay after incubation in presence of  $2.5 \times 10^4$  tumor cells TC-1 or  $10 \mu\text{g/mL}$  control peptide during 20 hours at  $37^\circ\text{C}$ , 5%  $\text{CO}_2$  and 80% humidity. Results are expressed as mean  $\pm$  SEM of IFN- $\gamma$ -producing cells per  $10^6$  lymph node cells (triplicates per condition).

### Induction of immunogenic cell death

Over the last years, it appeared that some anticancer therapies are able to induce *de novo* or reactivate antitumor immune responses by favoring ICD (Dudek et al., 2013; Zhou et al., 2019; Zitvogel et al., 2013). Some studies revealed that the clinically used platinum compound oxaliplatin is able to induce this particular type of apoptosis (Dudek et al., 2013; Tesniere et al., 2010; Zhou et al., 2019). Based on these observations, we evaluated if our platinum compound NHC-Pt(II)-PEI30 was also able to induce ICD.

That is why, the first feature of ICD, namely the exposure of calreticulin (CALR) at the cell surface, was measured. Briefly, human colon carcinoma cells HCT116 were treated with our platinum compound for different time periods before being stained with an antibody specific

of calreticulin and analyzed by flow cytometry. We could observe a slight increase of the percentage of cells expressing calreticulin after a treatment of 5 hours (**Figure 3A**) or 12 hours (**Figure 3B**) with NHC-Pt(II)-PEI30. However, in our hands, we did not detect any increase of the exposure of CALR after a treatment with oxaliplatin, which is in contradiction with previously published observations by other groups (Tesniere et al., 2010). Even if these results seemed to suggest the exposure of CALR at the cell surface and thus the induction of ICD by NHC-Pt(II)-PEI30, we wanted to confirm that we actually measured the level of CALR exposed at the cell surface. Indeed, as consequence of a loss of the cell membrane integrity, the chaperones found within the cell could be accessible to the anti-calreticulin antibody. That is why, we repeated the same flow cytometry experiments by staining CALR, but additionally used a counterstaining with propidium iodide that only enters in cells having lost their cell membrane integrity. Using this strategy, we exclusively analyzed cells with an intact cell membrane and thus evaluate the exposure of CALR at the cell surface. Using the double staining, we did not detect a substantial increase of the exposure of CALR at the cell surface compared to untreated cells (**Figure 3C**) questioning our previous observations on the induction of ICD by NHC-Pt(II)-PEI30. In order to obtain further information, we also observed by confocal microscopy the presence of CALR in human adenocarcinoma cells HCT116 treated with NHC-Pt(II)-PEI30 (**Supplementary figure 3**). It seemed that the cells treated during 4 hours with NHC-Pt(II)-PEI30 showed an ubiquitous expression of CALR evoking a possible exposure at the cell membrane. Altogether, these data did not allow to draw a definite conclusion on exposure of CALR at the cell surface.

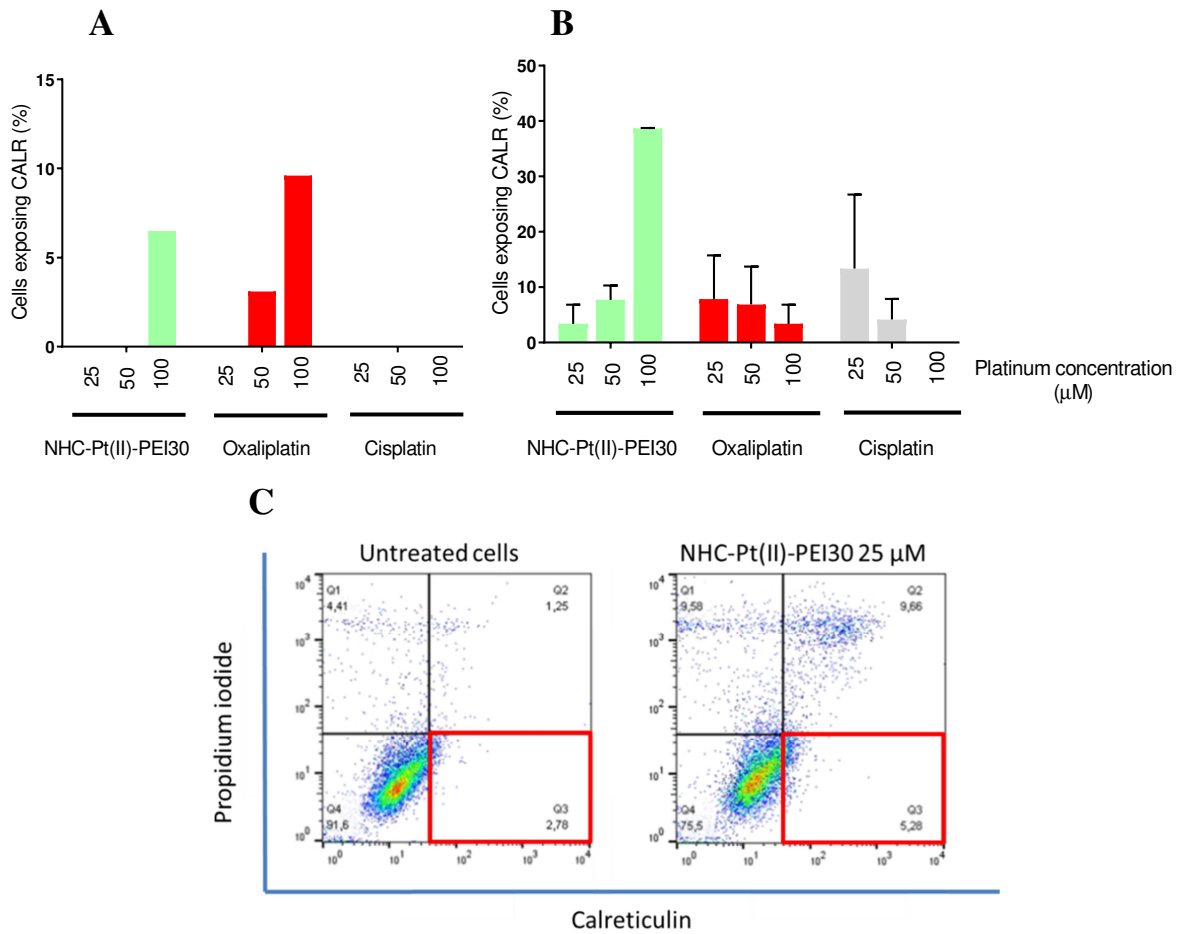

**Figure 3: Determination of the exposure of calreticulin at the cell surface, first feature of immunogenic cell death**

Human colon adenocarcinoma cells HCT116 were treated during 5 hours (A) or 12 hours (B) with NHC-Pt(II)-PEI, oxaliplatin or cisplatin and stained with anti-calreticulin antibody. The percentage of cells exposing calreticulin was assessed. The results show the data obtained after subtraction of the values obtained for untreated cells (only culture medium). The experiment with a treatment of 5 hours was performed once while the results for a treatment of 12 hours are expressed as mean  $\pm$  SEM of 2 independent experiments.

(C) Dot plots obtained by flow cytometry analysis of human adenocarcinoma cells HCT116 treated during 4 hours with NHC-Pt(II)-PEI30 or with culture medium (untreated cells) and stained with anti-calreticulin antibody and propidium iodide. The percentage of cells exposing calreticulin at their cell surface without having lost their membrane integrity (CALR<sup>+</sup>PI) was assessed (red frame). One experiment representative of 3.

We also investigated the induction of ICD indirectly by treating HCT116 cancer cells with the different compounds during 48 hours and then transferring their supernatant onto RAW 264.7 macrophages. If the cancer cells underwent ICD, they released DAMPs, like ATP, HMGB1, HSP70, in their supernatant (Garg et al., 2013). These molecules could then stimulate the macrophages whose activation was assessed by nitrite quantification, because the production

of nitric oxide which becomes oxidized to nitrite is considered as indication of macrophage activation. In **Figure 4**, a slight increase of nitrite production by the macrophages was observed when they were incubated with supernatant of cancer cells treated with NHC-Pt(II)-PEI30, suggesting a weak activation and thus a weak induction of ICD. However, in our hands, oxaliplatin, was unable to efficiently induce ICD.

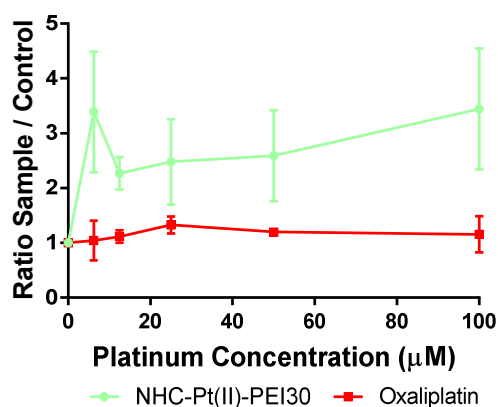

**Figure 4: Indirect evaluation of ICD induction.**

HCT116 cancer cells were treated during 48 hours with NHC-Pt(II)-PEI30 or with oxaliplatin. Their supernatant, potentially containing DAMPs in case of ICD, was transferred onto macrophages RAW 264.7. Their activation was then assessed by measuring the nitrite production using Griess assay. The results are represented as ratio between the sample and the untreated cells (only incubated with cell culture medium). The results are expressed as mean ± SEM of 2 independent experiments.

### Enhancement of the antitumor immune response

We therefore proposed to enhance the antitumor immune response by associating our NHC-Pt(II)-PEI30 conjugate with danger signals able to activate immune cells by triggering their PRRs. For this, we took advantage of the ability of PEI to compact nucleic acids (Shen et al., 2017). We emitted the hypothesis that our NHC-Pt(II)-PEI30 might enter *via* endocytosis in the cells due to the presence of the commonly used transfection agent PEI (Wantz et al., 2018). That is why, we first targeted endosomal TLRs and created complexes formed of NHC-Pt(II)-PEI30 and the TLR3 agonist polyI:C. This synthetic double-stranded RNA is a mimic of viral double-stranded RNA and its successful compaction with PEI has already been reported by several research teams (Hafner et al., 2013; Rajendrakumar et al., 2018; Schaffert et al., 2011; Shir et al., 2005). The compaction consists in the interaction of the amine groups contained in the PEI of NHC-Pt(II)-PEI30 and the negatively charged phosphate groups of polyI:C. This enables the calculation of a N/P ratio which consists in the ratio of moles of amine groups of the cationic polymer PEI to those of the phosphate ones in polyI:C (Zhao et al., 2009).

### PolyI:C compaction with NHC-Pt(II)-PEI30

In order to prove that the NHC-Pt(II) moiety did not influence the compaction of PEI and polyI:C, we first verified the compaction by agarose gel electrophoresis. For this, NHC-Pt(II)-PEI30 and polyI:C were mixed at different N/P ratios. The migration was observed using staining of the nucleic acid polyI:C. In case of compaction of NHC-Pt(II)-PEI30 with polyI:C, a delayed or no migration at all is visualized compared to polyI:C alone. The results revealed that NHC-Pt(II)-PEI30 was able to form complexes at a ratio  $N/P \geq 4$  (**Figure 5**). At a ratio  $N/P=1$ , no shift and thus no complex formation could be observed, while, at the ratio  $N/P=2$ , complexes were partly formed, but isolated polyI:C could still be detected (faint band). For the complexes at a ratio  $N/P \geq 4$ , polyI:C might not be accessible for nucleic acid stain, explaining the lack of detection of a band in the wells.

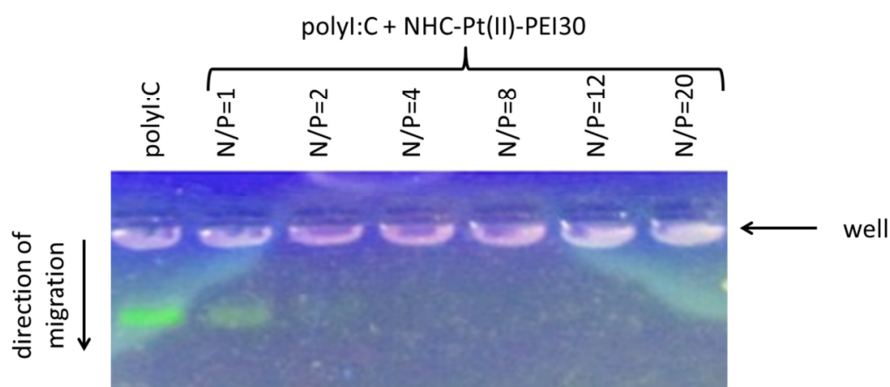
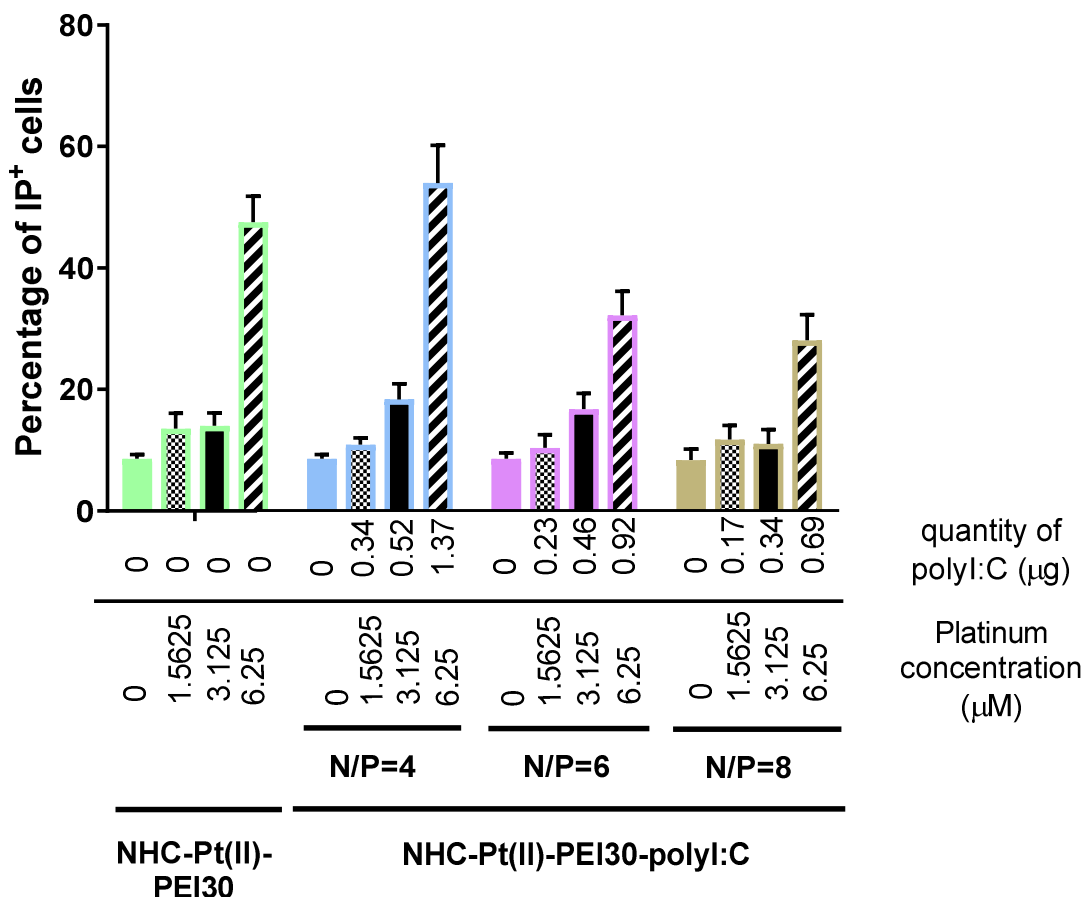

**Figure 5: Evaluation of NHC-Pt(II)-PEI30-polyI:C compaction by agarose gel shift.**

NHC-Pt(II)-PEI30 and polyI:C were mixed at different ratios in order to verify complex formation. The migration of polyI:C was followed using SYBRSafe nucleic acid stain.

### Evaluation of cytotoxic activity

Furthermore, the maintenance of the cytotoxic activity of NHC-Pt(II)-PEI30 was evaluated after complex formation with polyI:C. For this, human colon adenocarcinoma cells HCT116 were treated with NHC-Pt(II)-PEI30 alone or with NHC-Pt(II)-PEI30-polyI:C at different N/P ratios for 20 hours before flow cytometry analysis using propidium iodide staining. According to **Figure 6**, NHC-Pt(II)-PEI30-polyI:C complexes displayed a cytotoxic activity that was in the same range than that observed for NHC-Pt(II)-PEI30 alone. The TLR3 agonist polyI:C alone did not show any negative effect on the cell viability (**Supplementary figure 4**). These results suggest that the compaction of NHC-Pt(II)-PEI30 with the double-stranded RNA polyI:C did not alter the activity of the platinum(II) derivative.



**Figure 6: Analysis of the cytotoxic activity.**

Human colon adenocarcinoma cells HCT116 were treated with NHC-Pt(II)-PEI30-polyI:C complexes at different N/P ratios or with NHC-Pt(II)-PEI30 alone for 20 hours. They were then stained with propidium iodide and analyzed by flow cytometry. The results are expressed as mean  $\pm$  SEM of at least 3 independent experiments.

### Assessment of immune-stimulatory activity

The double-stranded RNA polyI:C is an agonist of the endosomal TLR3 present in immune cells and thus serving as danger signal for their activation (Gupta et al., 2016; Hafner et al., 2013). We checked if the ability of polyI:C to activate the immune cells was conserved after compaction with NHC-Pt(II)-PEI30. So, we treated murine macrophages RAW 264.7 with the complex NHC-Pt(II)-PEI30-polyI:C at various N/P ratios or with polyI:C alone at the same concentration than in the complexes during 24 hours before analyzing their activation by assessment of the nitrite concentration. We observed a slight activation of the macrophages incubated with polyI:C alone compared to control macrophages (incubated with culture medium) (**Figure 7**). Interestingly, the formation of the complexes NHC-Pt(II)-PEI30-polyI:C at N/P ratios of 4, 6, and 8 did not alter this activation, indicating that the compaction did not interfere with the immuno-stimulatory effect of polyI:C.



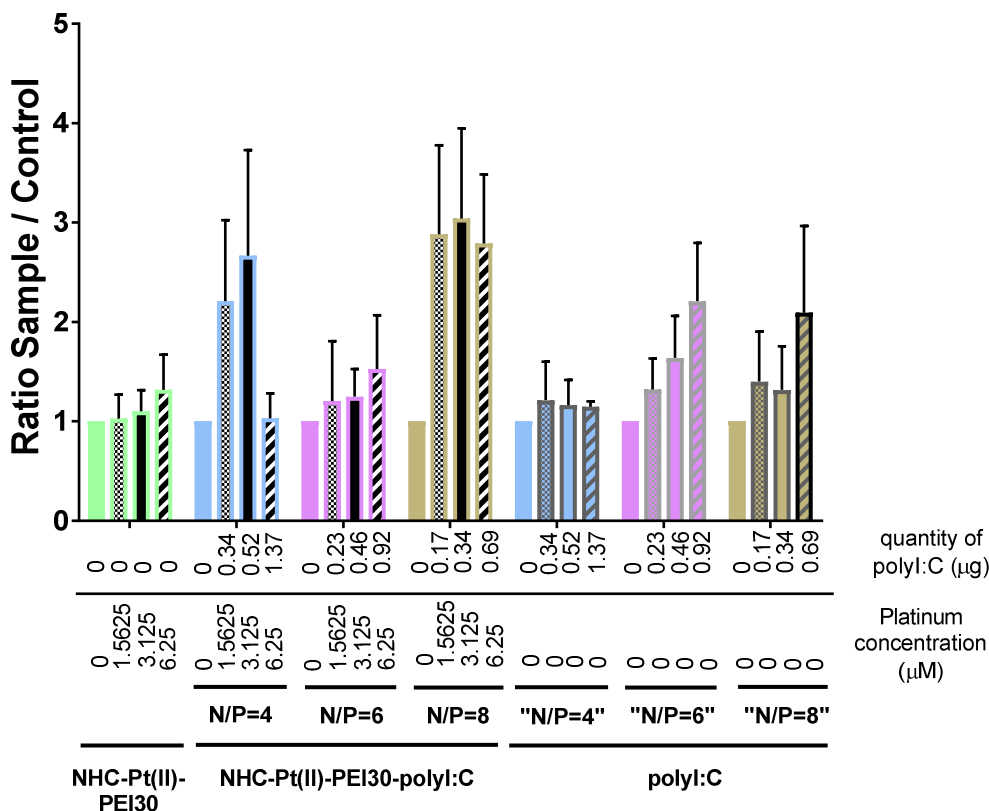
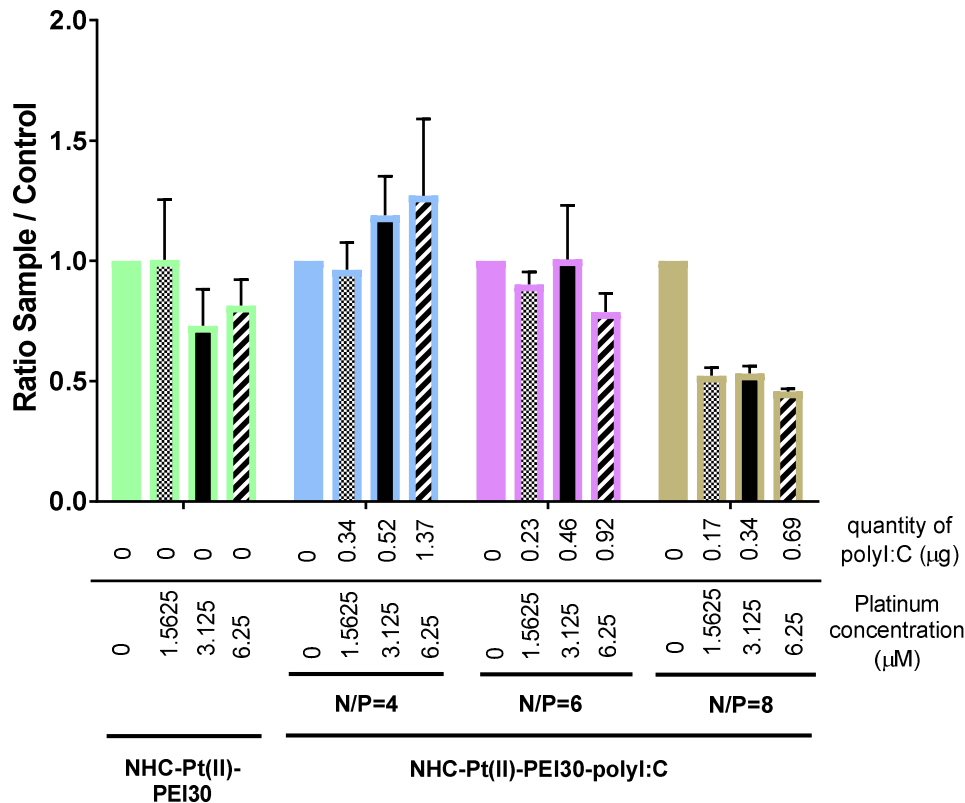

**Figure 7: Assessment of macrophage activation by Griess assay**

Murine macrophages RAW 264.7 were treated with NHC-Pt(II)-PEI30-polyI:C complexes at the ratios N/P=4, N/P=6 and N/P=8, with polyI:C alone at the same concentrations as in the complexes or with NHC-Pt(II)-PEI30 alone for 24 hours. Their activation was then assessed by colorimetric Griess assay by quantifying the production of nitrite, representative of nitric oxide. The results are represented as ratio between the sample and the untreated cells (only incubated with cell culture medium). The results are expressed as mean ± SEM of at least 4 independent experiments.

### Analysis of the induction of ICD

According to these results, we investigated the induction of ICD after a treatment with the complexes NHC-Pt(II)-PEI30-polyI:C. For this, we realized the same experiment than previously by treating HCT116 cancer cells with the different compounds, transferring their supernatant onto RAW 264.7 macrophages and measuring their activation by assessing the nitrite production. Nonetheless, no significant increase of the nitrite production and thus no considerable activation of the macrophages could be detected after the transfer of the supernatant of cancer cells treated with the complexes onto the immune cells (**Figure 8 and Supplementary Figure 5**). These results suggest that the complex NHC-Pt(II)-PEI30-polyI:C did not induce ICD.



**Figure 8: Indirect evaluation of the induction of ICD.**

HCT116 cancer cells were treated during 48 hours with NHC-Pt(II)-PEI30 alone or the complexes NHC-Pt(II)-PEI30-polyI:C. Their supernatant, potentially containing DAMPs in case of ICD, was transferred onto macrophages RAW 264.7. Their activation was then assessed by measuring the nitrite production using Griess assay. The results represented as ratio between the sample and the untreated cells (only incubated with cell culture medium). The results are expressed as mean  $\pm$  SEM of at least 4 independent experiments.

### Cytotoxicity and immune response induced by NHC-Pt(II)-PEI30-polyI:C complexes in immunocompetent orthotopic mouse model

As shown in **Figures 1 and 2**, NHC-Pt(II)-PEI30 induces an effective anti-tumor immune response. Moreover, previous *in vivo* studies had already revealed the potential of polyI:C to enhance antitumor immune responses when associated with various proteins inducing apoptosis (Gupta et al., 2016; Rajendrakumar et al., 2018).

#### Evaluation of the antitumor effect

We therefore investigated the effect of our NHC-Pt(II)-PEI30-polyI:C complexes in an immunocompetent orthotopic mouse model as described above (**Figure 1**). Pulmonary tumor-bearing mice were treated at days 10, 14 and 18 after tumor cells injection with the NHC-Pt(II)-PEI30-polyI:C complex at a ratio of N/P=6 (corresponding to 10 mg/kg of NHC-Pt(II)-

PEI30 and 153  $\mu\text{g}$  of polyI:C), 10 mg/kg of NHC-Pt(II)-PEI30 alone, polyI:C alone (153  $\mu\text{g}$ ), 2 mg/kg of oxaliplatin (equivalent quantity of platinum than contained in NHC-Pt(II)-PEI30) or vehicle alone as control. At day 24, the number of lung nodules was evaluated. **Figure 9** shows a number of lung nodules that was three times decreased in the mice treated with the complex NHC-Pt(II)-PEI30-polyI:C compared to control mice. Furthermore, the tumor progression was also reduced in mice treated with NHC-Pt(II)-PEI30 alone and oxaliplatin at the same platinum concentration. Mice treated with polyI:C alone had less tumors, too, which is in concordance with the results obtained by other groups, where the TLR3 agonist already displayed an antitumor effect (Cho et al., 2013; Nagato et al., 2014). Altogether, these results illustrate a potent cytotoxic activity of our NHC-Pt(II)-PEI30-polyI:C complexes in immunocompetent mouse model.

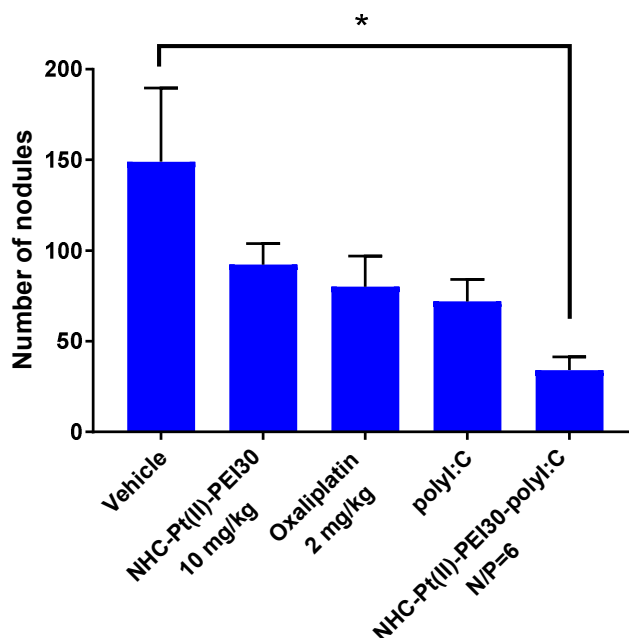
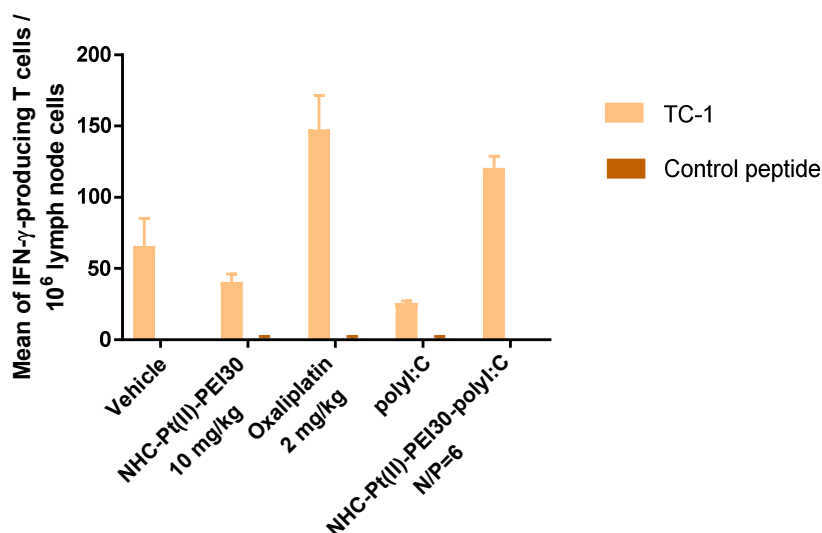

**Figure 9: Number of pulmonary nodules in orthotopic pulmonary mouse model.**

Murine pulmonary cancer cells TC-1 were injected intravenously in the tail vein of 6-week old immunocompetent C57BL/6J mice in order to induce the formation of lung nodules. The mice were treated 10, 14 and 18 days later with 10 mg/kg of NHC-Pt(II)-PEI30, 2 mg/kg of oxaliplatin, complex NHC-Pt(II)-PEI30-polyI:C at N/P=6 (10 mg/kg NHC-Pt(II)-PEI30 and 153  $\mu\text{g}$  of polyI:C), polyI:C alone (153  $\mu\text{g}$ ) or vehicle. At day 24, the mice were euthanized, the lungs were collected and colored as described in Figure 1. The results are represented as mean  $\pm$  SEM of 3-5 mice per group. \* p-value = 0.0035

### Analysis of the antitumor immune response

At the same time of euthanasia, the tumor-draining axillary and inguinal lymph nodes were collected to analyze the antitumor immune response by ELISpot assay. The lymph nodes of mice treated with NHC-Pt(II)-PEI30-polyI:C complexes incorporated an increased number of tumor-specific IFN- $\gamma$ -producing T cells compared to control mice (**Figure 10**). This number was in the same range than that obtained for mice treated with oxaliplatin at the same quantity of platinum. Surprisingly, we did not observe the same results for NHC-Pt(II)-PEI30 alone for this experiment than for the previous one (**Figure 1**). Furthermore, polyI:C alone was not able to induce a potent local antitumor immune response in our model. Taken together, our data reveal the activation of a tumor-specific immune response following a treatment with NHC-Pt(II)-PEI30-polyI:C.



**Figure 10: Evaluation of the local antitumor immune response.**

The mice were treated as described in Figure 9. At day 24, the mice were euthanized, the tumor-draining axillary and inguinal lymph nodes were collected from 5 mice per group and pooled. The number of IFN- $\gamma$ -producing cells was determined by ELISpot assay after incubation in presence of  $2.5 \times 10^4$  tumor cells TC-1 or 10  $\mu\text{g/mL}$  control peptide during 20 hours at 37°C, 5% CO<sub>2</sub> and 80% humidity. Results are expressed as mean  $\pm$  SEM of IFN- $\gamma$ -producing cells per  $10^6$  lymph node cells (triplicates per condition).

## Discussion

Recently, we developed an innovative platinum(II)-based NHC-Pt(II)-PEI30 conjugate with a potent cytotoxic activity *in vitro* against several cancer cell lines and *in vivo* in immunodeficient mouse model (Chekkat et al., 2016; Wantz et al., 2018). We were now able to prove that this effect was also detected in an immunocompetent orthotopic pulmonary mouse model and could additionally activate a local antitumor immune response. Based on these data, we were wondering if these observations were due to ICD. The characteristics of this apoptosis include the exposure of the ER chaperone calreticulin at the cell surface, as well as the release of ATP and non-histone chromatin-binding protein HMGB1 (Kroemer et al., 2013). In fact, ICD induction had already been analyzed for various platinum(II) derivatives, including the two clinically used drugs oxaliplatin and cisplatin (Dudek et al., 2013; Tesniere et al., 2010; Zhou et al., 2019). Oxaliplatin was able to promote efficiently ICD, characterized by the three previously cited features, while cisplatin could not induce the exposure of CALR at the cell surface (Tesniere et al., 2010). Several years ago, a research team synthesized a NHC-Pt(II) compound displaying the features of ICD, which strengthened our hypothesis that NHC-Pt(II)-PEI30 could promote ICD (Wong et al., 2015). That is why we started evaluating the first feature, namely the exposure of calreticulin, by flow cytometry. We found an increased number of cells expressing CALR after treatment with NHC-Pt(II)-PEI30; nevertheless, oxaliplatin did not favor CALR exposure in our hands, which was in contradiction with results obtained by other research groups (Tesniere et al., 2010). However, the exposure of CALR is an early event of ICD and takes place before the loss of integrity of the cell membrane (Kepp et al., 2014). In order to ensure the observation of membrane-bound CALR, we co-stained the cancer cells with the nucleic acid dye propidium iodide which particularly enters cells having lost their membrane integrity. After exclusion of the PI<sup>+</sup> cells from the analysis, we only detected a weak exposure of CALR questioning our hypothesis. Nonetheless, the use of PI to differ between live and late apoptotic / necrotic cells is quite controversial, as some studies showed that this dye was able to enter live cells through ionotropic receptor P2X7, thus leading to false positives (Virginio et al., 1997). To definitely confirm ICD, it would be essential to monitor the release of ATP and HMGB1. The most common method to measure ATP is the direct quantification of the extracellular ATP in cell culture supernatant. For this, eukaryotic luciferase transforms the exogenously added D-luciferin in an ATP-dependent manner to light which can be detected at 560 nm (Kepp et al., 2014). However, first attempts, in our hands, revealed that this was quite challenging, as the

reaction is inhibited by FCS contained in the cell culture medium. The release of ATP could also be analyzed indirectly by a fluorescence resonance energy-transfer (FRET)-based assay. Imamura et al (2009) linked a cyan fluorescent protein and a yellow fluorescent protein to the  $\epsilon$  subunit of ATP synthase derived from *Bacillus subtilis*. Upon ATP binding to the  $\epsilon$  subunit, the structure experiences a conformational change leading to FRET and enabling this way the measurement of intracellular ATP (Imamura et al., 2009; Kepp et al., 2014). The release of HMGB1 could be assessed in culture supernatants using a commercially available ELISA kit specific for human HMGB1 (Kepp et al., 2014). Furthermore, it would be possible to visualize *via* microscopy the absence of HMGB1 in the cell nucleus and thus observe indirectly the induction of ICD.

In this paper, we assessed ICD indirectly by transferring the supernatant of treated cancer cells onto macrophages to determine their activation and thus the presence of DAMPs in the supernatant of the cancer cells. However, we only observed a slight activation of the macrophages as well with the complexes NHC-Pt(II)-PEI30-polyI:C and polyI:C alone. This could partly be due to the small quantities of polyI:C applied on the macrophages which might be unable to efficiently induce their activation. Furthermore, the macrophages are not the key cells involved in the establishment of an antitumor immune response: it would be of interest to monitor the activation of the dendritic cells. For this, human dendritic cells could be derived *ex vivo* from elutriated human monocytes using GM-CSF and IL-4. They could then be incubated with the supernatant of the treated cancer cells and their activation could be monitored either by assessment of activation markers, like CD80, CD86, MHCII by flow cytometry or by quantification of the cytokine release, like TNF- $\alpha$ , IL-6, IL-12 by ELISA.

We then wanted to enhance the activation of the antitumor immune response by associating NHC-Pt(II)-PEI30 with immuno-stimulatory molecules. For this, we thought of targeting the endosomal TLRs of immune cells. Indeed, PEI is a commonly used transfection agent entering the cells by endocytosis and able to compact nucleic acids in order to deliver them within the cells (Köping-Höggård et al., 2001; Lungwitz et al., 2005; Mansouri et al., 2006). Previous observations using fluorescent NHC-Pt(II)-PEI30 compounds suggested that the conjugate might also be endocytosed (Wantz et al., 2018). We thought that it might be able form complexes with nucleic acids, too. In fact, the endosomal TLR3, sensing double-stranded viral RNA, can also be activated by its agonist polyI:C which is able to induce potent immune responses. Furthermore, some studies already revealed the increase of an antitumor immune response in mice models when treated with polyI:C-containing conjugates (Gupta et al., 2016; Rajendrakumar et al., 2018). We demonstrated *in vitro* that the cytotoxic activity of

NHC-Pt(II)-PEI30 and the immuno-stimulatory effect of polyI:C were maintained after compaction with polyI:C. Nonetheless, the weak immune response induced by polyI:C alone and the complexes could be explained by the small quantity of polyI:C applied on the cells. The quantity of polyI:C could be increased by diminishing the N/P ratio. However, below a ratio  $N/P = 3$ , the compaction is not complete. To enhance the immuno-stimulatory effect of NHC-Pt(II)-PEI30, we could also target other endosomal receptors, like TLR9 by complexing NHC-Pt(II)-PEI30 with CpG moieties, as we did for polyI:C, or like TLR7/8 by attaching its agonist resiquimod by chemical modification onto the PEI.

Finally, the complexes NHC-Pt(II)-PEI30 displayed a cytotoxic activity in immunocompetent mouse model and promoted a local antitumor immune response that was in the same range than that obtained with the clinically used drug oxaliplatin at the same quantity of platinum. Surprisingly, NHC-Pt(II)-PEI30 could not promote a potent local antitumor immune response in the second experiment, which might be due to technical problems during the experiment. Nonetheless, less side effects were observed in mice treated with the complexes NHC-Pt(II)-PEI30-polyI:C compared to mice treated with oxaliplatin. To validate the results, the experiment should be repeated accompanied by a toxicological analysis.

Altogether, based on our data, we propose that NHC-Pt(II)-PEI30 could be an interesting candidate for the development of an innovative cancer therapy. This conjugate could act as well as chemotherapeutic agent by killing the cancer cells and as immunotherapeutic agent by inducing a strong antitumor immune response.

### Acknowledgements

This work was supported by “La Ligue Contre le Cancer”, Centre National de la Recherche Scientifique (CNRS) and University of Strasbourg. May Wantz is a recipient of a PhD grant from the French Ministère de l'Éducation Nationale, de la Recherche et de la Technologie.

We thank the Plateforme d'Imagerie Quantitative at the Faculty of Pharmacy at the University of Strasbourg for the availability and the help for confocal microscopy

## References

- Bloy, N., Garcia, P., Laumont, C.M., Pitt, J.M., Sistigu, A., Stoll, G., Yamazaki, T., Bonneil, E., Buqué, A., Humeau, J., et al. (2017). Immunogenic stress and death of cancer cells: Contribution of antigenicity vs adjuvanticity to immunosurveillance. *Immunological Reviews* 280, 165–174.
- Boulikas, T., Pantos, A., Bellis, E., and Christofis, P. (2007). Designing platinum compounds in cancer: structures and mechanisms. 48.
- Brubaker, S.W., Bonham, K.S., Zanoni, I., and Kagan, J.C. (2015). Innate Immune Pattern Recognition: A Cell Biological Perspective. *Annual Review of Immunology* 33, 257–290.
- Bryan, N.S., and Grisham, M.B. (2007). Methods to detect nitric oxide and its metabolites in biological samples. *Free Radical Biology and Medicine* 43, 645–657.
- Chardon, E., Dahm, G., Guichard, G., and Bellemin-Laponnaz, S. (2012a). Derivatization of Preformed Platinum N-Heterocyclic Carbene Complexes with Amino Acid and Peptide Ligands and Cytotoxic Activities toward Human Cancer Cells. *Organometallics* 31, 7618–7621.
- Chardon, E., Puleo, G.L., Dahm, G., Fournel, S., Guichard, G., and Bellemin-Laponnaz, S. (2012b). Easy Derivatisation of Group 10 N-Heterocyclic Carbene Complexes and In Vitro Evaluation of an Anticancer Oestradiol Conjugate. *ChemPlusChem* 77, 1028–1038.
- Chekkat, N., Dahm, G., Chardon, E., Wantz, M., Sitz, J., Decossas, M., Lambert, O., Frisch, B., Rubbiani, R., Gasser, G., et al. (2016). N-Heterocyclic Carbene–Polyethylenimine Platinum Complexes with Potent in Vitro and in Vivo Antitumor Efficacy. *Bioconjugate Chemistry* 27, 1942–1948.
- Cho, H.-I., Barrios, K., Lee, Y.-R., Linowski, A.K., and Celis, E. (2013). BiVax: a peptide/poly-IC subunit vaccine that mimics an acute infection elicits vast and effective anti-tumor CD8 T-cell responses. *Cancer Immunology, Immunotherapy* 62, 787–799.
- Cole, G.A. (2005). Interferon- $\gamma$  ELISPOT Assay for the Quantitative Measurement of Antigen-Specific Murine CD8<sup>+</sup> T-Cells. In *Handbook of ELISPOT*, (New Jersey: Humana Press), pp. 191–204.
- Coneski, P.N., and Schoenfisch, M.H. (2012). Nitric oxide release: Part III. Measurement and reporting. *Chemical Society Reviews* 41, 3753.
- Dudek, A.M., Garg, A.D., Krysko, D.V., De Ruyscher, D., and Agostinis, P. (2013). Inducers of immunogenic cancer cell death. *Cytokine & Growth Factor Reviews* 24, 319–333.
- Galluzzi, L., Buqué, A., Kepp, O., Zitvogel, L., and Kroemer, G. (2017). Immunogenic cell death in cancer and infectious disease. *Nature Reviews Immunology* 17, 97–111.
- Garg, A.D., Dudek, A.M., and Agostinis, P. (2013). Cancer immunogenicity, danger signals, and DAMPs: What, when, and how?: Danger signaling, DAMPs, and Cancer. *BioFactors* 39, 355–367.



Garg, A.D., Galluzzi, L., Apetoh, L., Baert, T., Birge, R.B., Bravo-San Pedro, J.M., Breckpot, K., Brough, D., Chaurio, R., Cirone, M., et al. (2015). Molecular and Translational Classifications of DAMPs in Immunogenic Cell Death. *Frontiers in Immunology* 6.

Gibson, D. (2019). Multi-action Pt(IV) anticancer agents; do we understand how they work? *Journal of Inorganic Biochemistry* 191, 77–84.

Gottesman, M.M., Lavi, O., Hall, M.D., and Gillet, J.-P. (2016). Toward a Better Understanding of the Complexity of Cancer Drug Resistance. *Annual Review of Pharmacology and Toxicology* 56, 85–102.

Grisham, M.B., Johnson, G.G., and Lancaster, J.R. (1996). Quantitation of nitrate and nitrite in extracellular fluids. In *Methods in Enzymology*, (Elsevier), pp. 237–246.

Gupta, S.K., Yadav, P.K., Tiwari, A.K., Gandham, R.K., and Sahoo, A.P. (2016). Poly (I:C) enhances the anti-tumor activity of canine parvovirus NS1 protein by inducing a potent anti-tumor immune response. *Tumor Biology* 37, 12089–12102.

Hafner, A.M., Corthésy, B., and Merkle, H.P. (2013). Particulate formulations for the delivery of poly(I:C) as vaccine adjuvant. *Advanced Drug Delivery Reviews* 65, 1386–1399.

Hato, S.V., Khong, A., de Vries, I.J.M., and Lesterhuis, W.J. (2014). Molecular Pathways: The Immunogenic Effects of Platinum-Based Chemotherapeutics. *Clinical Cancer Research* 20, 2831–2837.

Imamura, H., Huynh Nhat, K.P., Togawa, H., Saito, K., Iino, R., Kato-Yamada, Y., Nagai, T., and Noji, H. (2009). Visualization of ATP levels inside single living cells with fluorescence resonance energy transfer-based genetically encoded indicators. *Proceedings of the National Academy of Sciences* 106, 15651–15656.

Jacobberger-Foissac, C., Saliba, H., Seguin, C., Brion, A., Kakhi, Z., Frisch, B., Fournel, S., and Heurtault, B. (2019). Optimization of peptide-based cancer vaccine compositions, by sequential screening, using versatile liposomal platform. *International Journal of Pharmaceutics* 562, 342–350.

Kelland, L. (2007). The resurgence of platinum-based cancer chemotherapy. *Nature Reviews Cancer* 7, 573–584.

Kepp, O., Senovilla, L., Vitale, I., Vacchelli, E., Adjemian, S., Agostinis, P., Apetoh, L., Aranda, F., Barnaba, V., Bloy, N., et al. (2014). Consensus guidelines for the detection of immunogenic cell death. *OncoImmunology* 3, e955691.

Köping-Höggård, M., Tubulekas, I., Guan, H., Edwards, K., Nilsson, M., Vårum, K., and Artursson, P. (2001). Chitosan as a nonviral gene delivery system. Structure–property relationships and characteristics compared with polyethylenimine in vitro and after lung administration in vivo. *Gene Therapy* 8, 1108–1121.

Kroemer, G., Galluzzi, L., Kepp, O., and Zitvogel, L. (2013). Immunogenic Cell Death in Cancer Therapy. *Annual Review of Immunology* 31, 51–72.

Krysko, D.V., Garg, A.D., Kaczmarek, A., Krysko, O., Agostinis, P., and Vandenabeele, P. (2012). Immunogenic cell death and DAMPs in cancer therapy. *Nature Reviews Cancer* 12, 860–875.

Lungwitz, U., Breunig, M., Blunk, T., and Göpferich, A. (2005). Polyethylenimine-based non-viral gene delivery systems. *European Journal of Pharmaceutics and Biopharmaceutics* 60, 247–266.

Mansouri, S., Cuie, Y., Winnik, F., Shi, Q., Lavigne, P., Benderdour, M., Beaumont, E., and Fernandes, J.C. (2006). Characterization of folate-chitosan-DNA nanoparticles for gene therapy. *Biomaterials* 27, 2060–2065.

Mercs, L., and Albrecht, M. (2010). Beyond catalysis: N-heterocyclic carbene complexes as components for medicinal, luminescent, and functional materials applications. *Chemical Society Reviews* 39, 1903.

Muenzner, J.K., Rehm, T., Biersack, B., Casini, A., de Graaf, I.A.M., Worawutputtpong, P., Noor, A., Kempe, R., Brabec, V., Kasparkova, J., et al. (2015). Adjusting the DNA Interaction and Anticancer Activity of Pt(II) N-Heterocyclic Carbene Complexes by Steric Shielding of the Trans Leaving Group. *Journal of Medicinal Chemistry* 58, 6283–6292.

Nagato, T., Lee, Y.-R., Harabuchi, Y., and Celis, E. (2014). Combinatorial Immunotherapy of Polyinosinic–Polycytidylic Acid and Blockade of Programmed Death-Ligand 1 Induce Effective CD8 T-cell Responses against Established Tumors. *Clinical Cancer Research* 20, 1223–1234.

Rajendrakumar, S., Mohapatra, A., Singh, B., Revuri, V., Lee, Y.-K., Kim, C., Cho, C.-S., and Park, I.-K. (2018). Self-Assembled, Adjuvant/Antigen-Based Nanovaccine Mediates Anti-Tumor Immune Response against Melanoma Tumor. *Polymers* 10, 1063.

Schaffert, D., Kiss, M., Rödl, W., Shir, A., Levitzki, A., Ogris, M., and Wagner, E. (2011). Poly(I:C)-Mediated Tumor Growth Suppression in EGF-Receptor Overexpressing Tumors Using EGF-Polyethylene Glycol-Linear Polyethylenimine as Carrier. *Pharmaceutical Research* 28, 731–741.

Shekarian, T., Valsesia-Wittmann, S., Brody, J., Michallet, M.C., Depil, S., Caux, C., and Marabelle, A. (2017). Pattern recognition receptors: immune targets to enhance cancer immunotherapy. *Annals of Oncology* 28, 1756–1766.

Shen, C., Li, J., Zhang, Y., Li, Y., Shen, G., Zhu, J., and Tao, J. (2017). Polyethylenimine-based micro/nanoparticles as vaccine adjuvants. *International Journal of Nanomedicine Volume* 12, 5443–5460.

Shir, A., Ogris, M., Wagner, E., and Levitzki, A. (2005). EGF Receptor-Targeted Synthetic Double-Stranded RNA Eliminates Glioblastoma, Breast Cancer, and Adenocarcinoma Tumors in Mice. *PLoS Medicine* 3, e6.

Tesniere, A., Panaretakis, T., Kepp, O., Apetoh, L., Ghiringhelli, F., Zitvogel, L., and Kroemer, G. (2008). Molecular characteristics of immunogenic cancer cell death. *Cell Death & Differentiation* 15, 3–12.

### Chapter 3: Activation of the antitumor immune response by innovative platinum (II) compounds

Tesniere, A., Schlemmer, F., Boige, V., Kepp, O., Martins, I., Ghiringhelli, F., Aymeric, L., Michaud, M., Apetoh, L., Barault, L., et al. (2010). Immunogenic death of colon cancer cells treated with oxaliplatin. *Oncogene* 29, 482–491.

Vesely, M.D., Kershaw, M.H., Schreiber, R.D., and Smyth, M.J. (2011). Natural Innate and Adaptive Immunity to Cancer. *Annual Review of Immunology* 29, 235–271.

Virginio, C., Church, D., North, R.A., and Surprenant, A. (1997). Effects of divalent cations, protons and calmidazolium at the rat P2X7 receptor. *Neuropharmacology* 36, 1285–1294.

Wai-Yin Sun, R., Lok-Fung Chow, A., Li, X.-H., Yan, J.J., Sin-Yin Chui, S., and Che, C.-M. (2011). Luminescent cyclometalated platinum(ii) complexes containing N-heterocyclic carbene ligands with potent in vitro and in vivo anti-cancer properties accumulate in cytoplasmic structures of cancer cells. *Chemical Science* 2, 728.

Wantz, M., Bouché, M., Dahm, G., Chekkat, N., Fournel, S., and Bellemin-Laponnaz, S. (2018). N-Heterocyclic Carbene-Polyethyleneimine (PEI) Platinum Complexes Inducing Human Cancer Cell Death: Polymer Carrier Impact. *International Journal of Molecular Sciences* 19, 3472.

Wong, D.Y.Q., Ong, W.W.F., and Ang, W.H. (2015). Induction of Immunogenic Cell Death by Chemotherapeutic Platinum Complexes. *Angewandte Chemie International Edition* 54, 6483–6487.

Yang, E.-J., Yim, E.-Y., Song, G., Kim, G.-O., and Hyun, C.-G. (2009). Inhibition of nitric oxide production in lipopolysaccharide-activated RAW 264.7 macrophages by Jeju plant extracts. *Interdisciplinary Toxicology* 2, 245–249.

Zhao, Q.-Q., Chen, J.-L., Lv, T.-F., He, C.-X., Tang, G.-P., Liang, W.-Q., Tabata, Y., and Gao, J.-Q. (2009). N/P Ratio Significantly Influences the Transfection Efficiency and Cytotoxicity of a Polyethylenimine/Chitosan/DNA Complex. *Biological & Pharmaceutical Bulletin* 32, 706–710.

Zhou, J., Wang, G., Chen, Y., Wang, H., Hua, Y., and Cai, Z. (2019). Immunogenic cell death in cancer therapy: Present and emerging inducers. *Journal of Cellular and Molecular Medicine* 23, 4854–4865.

Zitvogel, L., Galluzzi, L., Smyth, M.J., and Kroemer, G. (2013). Mechanism of Action of Conventional and Targeted Anticancer Therapies: Reinstating Immunosurveillance. *Immunity* 39, 74–88.

## Supplementary Data

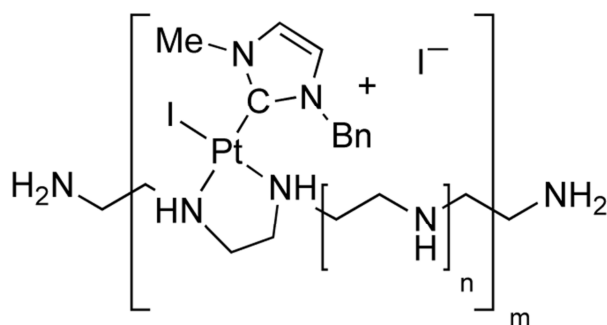

151

**Supplementary Figure 1: Structure of NHC-Pt(II)-PEI30**  
n = 29 and m = 200

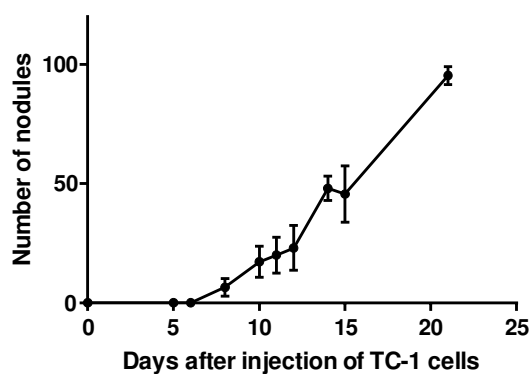

### Supplementary figure 2: Apparition of lung nodules

Murine pulmonary cancer cells TC-1 were injected intravenously in the tail vein of 6-week old immunocompetent C57BL/6J mice in order to induce the formation of lung nodules. The mice were euthanized after 5, 6, 8, 10, 11, 12, 14, 15 or 21 days and the lungs were collected and colored by intratracheal injection of 15% Indian ink solution followed by a bleaching in Fekete's solution to contrast the white nodules and the black tissue. The lung tumors were then counted for each mouse and the results are represented as mean  $\pm$  SEM of at least 3 mice per group.

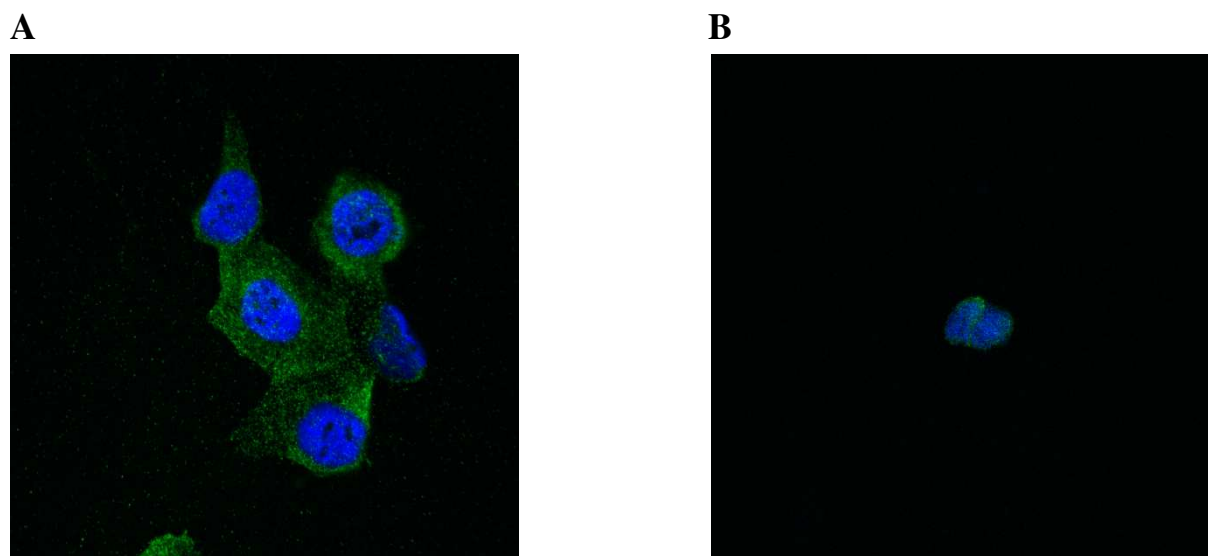

**Supplementary figure 3: Confocal microscopy observation of the exposure of CALR.**

Human colon adenocarcinoma cells HCT116 were incubated during 4 hours with 25  $\mu$ M (platinum concentration) NHC-Pt(II)-PEI30 (A) or with culture medium (untreated cells) (B) before being stained with anti-calreticulin antibody (green) and Hoechst 33342 (blue). The cells were then observed by confocal microscopy.

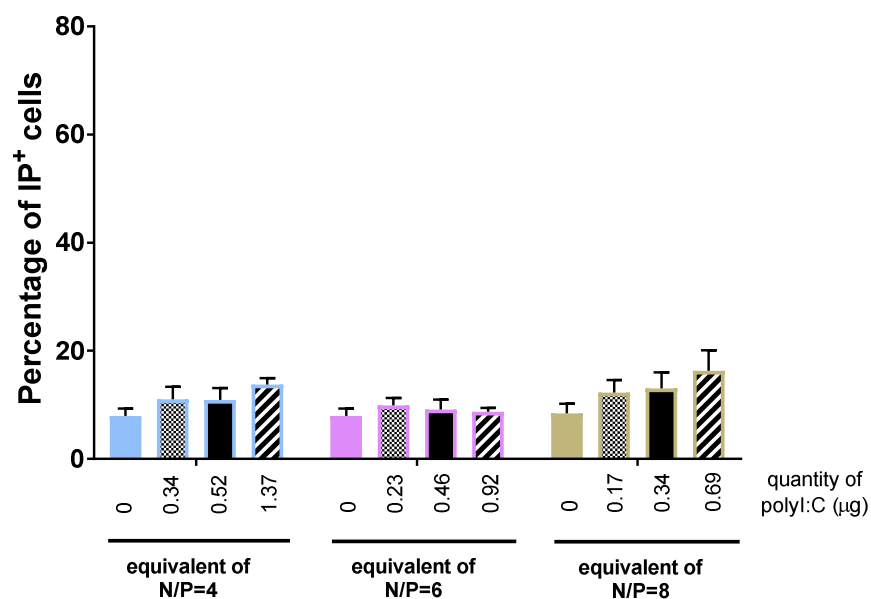

**Supplementary figure 4: Analysis of the cytotoxic activity.**

Human colon adenocarcinoma cells HCT116 were treated with polyI:C alone or cell culture medium (untreated cells) for 18 hours. They were then stained with propidium iodide and analyzed by flow cytometry. The results are expressed as mean  $\pm$  SEM of at least 3 independent experiments.

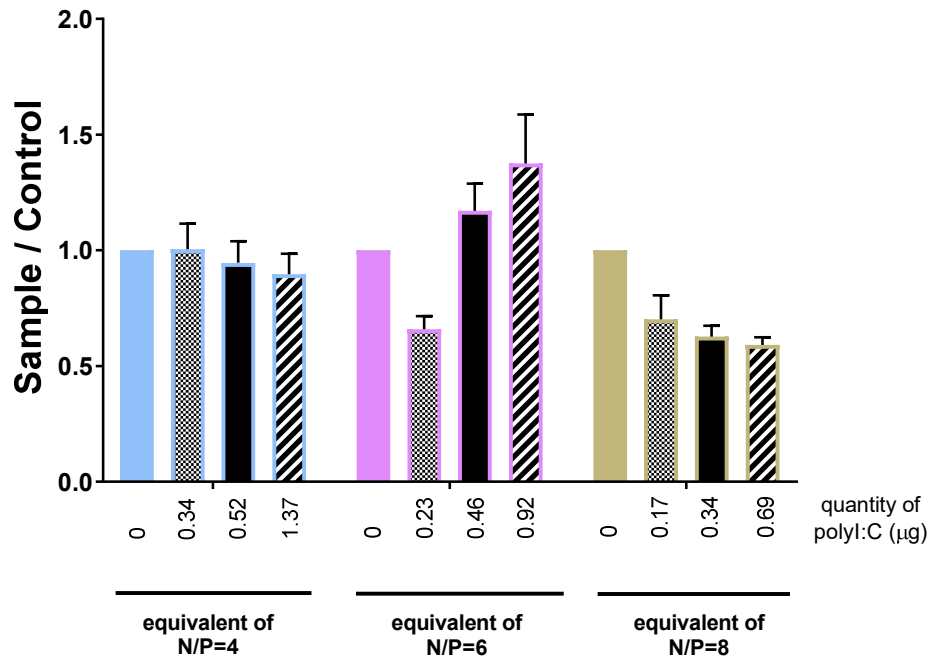

**Supplementary figure 5: Indirect evaluation of the induction of ICD by polyI:C.**

HCT116 cancer cells were treated during 48 hours with polyI:C alone or with culture medium (untreated cells). Their supernatant, potentially containing DAMPs in case of ICD, was transferred onto macrophages RAW 264.7. Their activation was then assessed by measuring the production of nitrogen dioxide using Griess assay. The results are represented as ratio between the sample and the untreated cells. The results are expressed as mean  $\pm$  SEM of at least 4 independent experiments.



**Discussion  
and  
Perspectives**



L'imagination est plus importante que le savoir.

*Albert Einstein*

## 1. Context

Platinum(II)-based compounds account for the most common used chemotherapeutic agents. The anticancer activity of the first platinum(II)-based conjugate cisplatin was discovered by serendipity, but can be considered as an important step in the development of anticancer drugs (Rosenberg et al., 1965). However, it appeared that cisplatin did not only target the cancer, but also affected healthy cells, leading to severe side effects (Ma et al., 2019). Furthermore, some cancer cells were not sensitive to cisplatin action, due to intrinsic or acquired resistances (Gottesman et al., 2016). In order to overcome these problems, thousands of platinum derivatives were synthesized and evaluated *in vitro* and *in vivo* (Liu et al., 2017). Nevertheless, for the moment, the Food and Drug Administration only delivered a worldwide approval for three compounds: cisplatin, carboplatin and oxaliplatin. Even if carboplatin and oxaliplatin display some improvements compared to cisplatin, like for example decreased toxicity on healthy cells or increased stability, several side effects remain. Numerous efforts are still needed to develop new platinum-based compounds. That is why, my host laboratory in collaboration with Stéphane Bellemin-Laponnaz' team decided to focus on innovative platinum(II) derivatives based on N-heterocyclic carbene ligands able to form stable complexes with the transition metal platinum (Chardon et al., 2012a, 2012b). They associated these conjugates to the commonly used transfection agent polyethylenimine in order to increase the bioavailability and the solubility in biological medium (Chekkat et al., 2016). After evaluation of the cytotoxic activity of several candidates, one compound has shown very promising *in vitro* and *in vivo* results: NHC-Pt(II)-PEI30. In fact, the antitumor activity of NHC-Pt(II)-PEI30 was in the same range than that observed with oxaliplatin at the same platinum concentration. However, mice treated with oxaliplatin suffered from hemorrhagic event at the injection site, which was not the case for mice treated with NHC-Pt(II)-PEI30, suggesting that the innovative platinum compound induced less side effects (Chekkat et al., 2016).

## 2. Getting insight in the mechanism of action of NHC-Pt(II)-PEI30

As described in **Chapter 1**, some other compounds were evaluated. First, **different PEI polymer sizes** were tested: NHC-Pt(II) was attached to linear PEI of 2.5, 25 and 250 kDa and branched PEI of 1.8 kDa at a ratio of one platinum complex every 20 units of ethylenediamine (Wantz et al., 2018). We found that the conjugate with the linear PEI of 25 kDa, which is close to the PEI commonly used in transfection experiments (22 kDa) displayed the best cytotoxic activity and continued the studies with this compound. Furthermore, other PEI

derivatives developed in our laboratory were tested (Kichler et al., 2002), but none was more efficient than PEI 25kDa (data not shown). We then tested conjugates with **various platinum/complex ratios**, but it appeared that the conjugate with one platinum complex every 30 units of ethylenediamine displayed the best cytotoxic activity (Wantz et al., 2018). That is why, the studies were continued with NHC-Pt(II)-PEI30. The **cellular localization** of platinum was different in cells treated with oxaliplatin compared to cells treated with NHC-Pt(II)-PEI30 at the same platinum concentration: oxaliplatin mainly localized in the nucleus while NHC-Pt(II)-PEI30 was found in mitochondria (Chekkat et al., 2016). These observations suggested that NHC-Pt(II)-PEI30 might have a different mechanism of action compared to conventional platinum(II) derivatives which target the cell nucleus by forming DNA adducts (Dilruba and Kalayda, 2016; Ghosh, 2019). In order to further elucidate the mechanism of action of our innovative compound, the chemists generated **fluorescent derivatives**. After verification that the addition of the fluorophore did not alter the cytotoxicity of the compound, preliminary **microscopic observations** were realized (Wantz et al., 2018). First, the mechanism of entry of NHC-Pt(II)-PEI30 in the cancer cells has to be explored. PEI is a commonly used transfection agent and various studies showed that PEI/DNA polyplexes were able to enter the cells via **endocytosis** (Lungwitz et al., 2005; Zhao et al., 2009). Based on preliminary confocal microscopy observations (Wantz et al., 2018), we emitted the hypothesis that NHC-Pt(II)-PEI30 might also be endocytosed by the cancer cells. So, **colocalization** with antibodies targeting early endosome antigen 1 (**EEA1**) might give us an indication on the entry of the platinum derivative. Moreover, we are wondering if the **conjugate is dissociated** within the cells and if the two moieties experience different fates. That is why, on one compound, the fluorophore was attached on the NHC-Pt complex and on the other one the fluorophore was attached on the polymer PEI. Tracking the two conjugates within the cells, might give us information on dissociation and the final localization of the two moieties. Furthermore, the **staining of various organelles** could give us an indication on the mechanism of action of NHC-Pt(II)-PEI30. For this, mitochondria and lysosomes could for example be labelled within the cells using MitoTracker and LysoTracker respectively to detect **colocalization with the fluorescent compounds**. As previous results have revealed that NHC-Pt(II)-PEI30 affects mitochondrial function, it would be interesting to further investigate its action on this organelle. It was shown that cisplatin can form mitochondrial DNA adducts and induce cytochrome c release (Yang et al., 2006). Based on these observations, we could suppose that this might be the case for NHC-Pt(II)-PEI30, too. We could for example isolate mitochondria and treat incubate them in presence of NHC-Pt(II)-

PEI30, before assessing the release of cytochrome c by Western Blot. Furthermore, the mitochondrial DNA could be isolated from cells treated with our platinum conjugate in order to determine the formation of adducts using flameless atomic absorption spectroscopy (Yang et al., 2000, 2006).

### 3. How can platinum-based conjugates selectively target cancer cells?

An important drawback of platinum(II)-based chemotherapeutic agents is their **lack of selectivity**. Their mechanism of action consists in inducing apoptosis of cells by creating DNA adducts, which mainly affects quickly dividing cells. Actually, uncontrolled cell proliferation is one of the hallmarks of cancer (Hanahan and Weinberg, 2011). Unfortunately, there are also other cells with high nutrition requirements (cells of bone marrow, hair follicles or mucous membranes) which are touched, resulting in **severe side effects** (Ma et al., 2019). That is why, there is a need in developing new conjugates, which specifically target the cancer cells. The **targeted delivery** of the chemotherapeutic agent to the cancer cells would i) lower the side effects, ii) enable to decrease the administered concentration, as all the compound would be taken up by the cancer cells and iii) thus, increase the intracellular concentration of the conjugate within the cancer cells (Chardon et al., 2012b). However, targeting cancer cells has revealed to be quite tricky, as this implicates to use a **marker or receptor** which is **overexpressed or preferably exclusively expressed by the cancer cells**.

#### 3.1. Previous attempts

Several attempts to synthesize platinum derivatives bearing a targeting agent were undertaken. In 2012, Graf et al. reported experiments with of a **platinum(IV)-chlorotoxin conjugate** which displayed cytotoxic activity *in vitro* against several cancer cell lines (Graf et al., 2012). Chlorotoxin, a peptide initially derived from a scorpion, but which can be synthesized in the laboratory, binds to various cell-surface proteins like metalloproteinase 2 and chloride ion channels. These **proteins are overexpressed in various cancer types**, thus allowing specific targeting of the tumor tissue (Graf et al., 2012).

Furthermore, in 2016, a **glycoconjugate containing cisplatin and fluorine** was proposed by Liu et al. to target the glucose receptor **GLUT1, overexpressed in the majority of human cancers** due to an increased glucose consumption (Liu et al., 2017). They were able to develop a compound which showed promising cytotoxic activity *in vitro* against six human carcinoma cell lines as well as *in vivo* in immunodeficient mice xenografted with the human colon carcinoma cell line HT29 (Liu et al., 2017).

### 3.2. Other possible targeting strategies

#### 3.2.1. Targeting estrogen receptors

Previously, my host laboratory in collaboration with the team of Stéphane Bellemin-Laponnaz had also developed an N-heterocyclic platinum compound bearing an estradiol moiety and thus targeting the **estrogen receptor** which is **overexpressed in** numerous **hormone-dependent cancers**, like breast, uterus, ovarian and colon cancer. First *in vitro* experiments, had revealed a good cytotoxic activity of this compound against several human cancer cell lines (Chardon et al., 2012b). Nevertheless, this compound would only be effective against a limited number of cancer types, overexpressing the estrogen receptor.

#### 3.2.2. Targeting nucleolin

That is why, we were looking for another potential target and thought of **nucleolin**, an ubiquitously expressed DNA-, RNA- and protein-binding protein in eukaryotic cells (Krust et al., 2011). This protein is mainly expressed in the cell nucleus and in the cytoplasm, but can also be found at the cell surface of numerous cancer cell (Krust et al., 2011). The surface-bound nucleolin is glycosylated compared to the intracellular form and can be recognized by an antagonist, the **pseudopeptide HB-19** generating irreversible complexes. That is why, in collaboration with Gilles Guichard from the University of Bordeaux, as well as Stéphane Bellemin-Laponnaz, we developed an innovative NHC-Pt(II)-PEI conjugate carrying two pseudopeptides HB-19 at each side of the polymer. First *in vitro* experiments on human adenocarcinoma cells HCT116 displayed that the initial cytotoxic effect of the NHC-Pt(II)-PEI30 compound was maintained after addition of the two pseudopeptides (**Figure 35**). In order to confirm the selective targeting of cancer cells overexpressing nucleolin at their cell surface, animal experiments need to be planned. In fact, it is challenging to monitor the targeting *in vitro*, as it is difficult to reproduce the complex interactions happening between the cancer cells and the healthy cells *in vivo*.

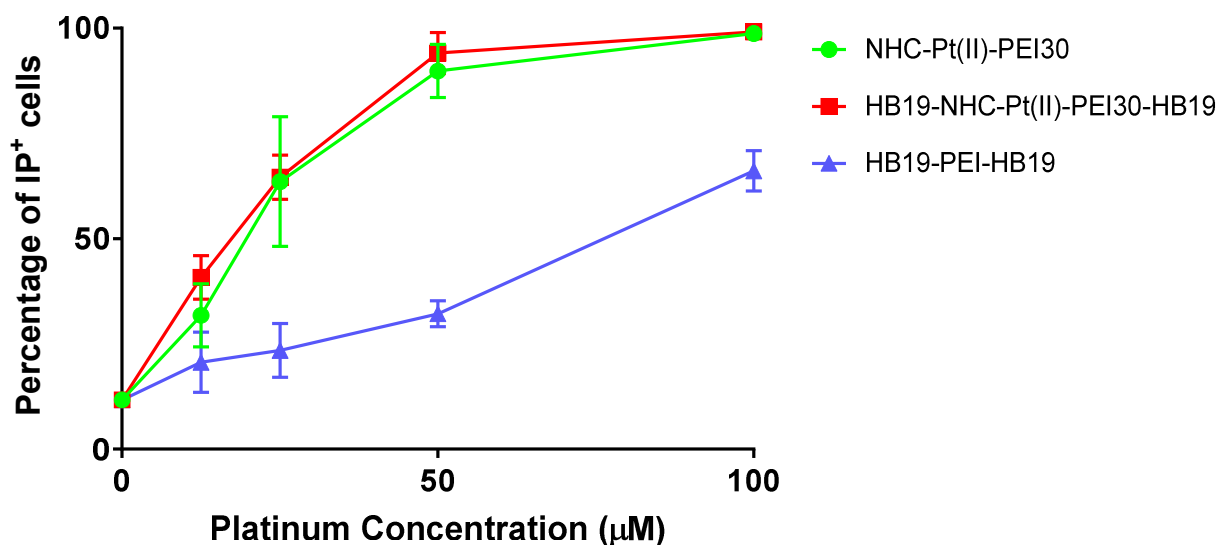

**Figure 35: Cytotoxicity of platinum(II) compound targeting nucleolin**

Human adenocarcinoma cells HCT116 were treated during 24 hours with a platinum derivative containing two HB19 peptides (HB19-NHC-Pt(II)-PEI30-HB19), with a compound without platinum complex (HB19-PEI-HB19) or with NHC-Pt(II)-PEI30 as a control. In order to evaluate the cytotoxicity, the cells were then stained with propidium iodide and analyzed by flow cytometry. The results are represented as mean  $\pm$  SEM of two independent experiments.

### 3.2.3. Targeting integrins

Several studies have revealed that a heterodimeric cell surface receptor overexpressed on tumor neovessels and solid tumors, like breasts cancer or glioblastoma, might be an interesting therapeutic target: the  $\alpha 5 \beta 1$  integrin (Fechter et al., 2019). Previous studies showed that  $\alpha 5 \beta 1$  integrin interacts with an arginine-glycine-aspartic acid (RGD) peptide sequence contained in fibronectin. In 2017, Wu et al. developed nanoparticles bound to RGD sequence in order to target breast cancer cells expressing  $\alpha 5 \beta 1$  (Wu et al., 2017). That is why, we thought of conjugating our platinum compound to RGD in order to specifically target cancer cells overexpressing  $\alpha 5 \beta 1$ . Furthermore, over the last years, single-stranded DNA or RNA molecules have emerged as therapeutic tools: the aptamers (Fechter et al., 2019; Mercier et al., 2017). This led to the recent development of an aptamer targeting the integrin  $\alpha 5 \beta 1$  by Fechter et al. (2019). In collaboration with Laurence Choulier in Monique Dontenwill's team (UMR7213), we could take advantage of the ability of PEI to complex with nucleic acids in order to generate a complex formed of this aptamer and NHC-Pt(II)-PEI30 to specifically target cancer cells overexpressing the integrin  $\alpha 5 \beta 1$ .

### 3.2.4. Targeting prostate-specific membrane antigen (PSMA)

Most prostate cancer cells overexpress the transmembrane glycosylated protein prostate-specific membrane antigen (PSMA). Jin et al have identified GTI, a peptide specifically binding with high affinity and specificity to PSMA. Moreover, they showed that this peptide was able to deliver a cargo inducing apoptosis of the cancer cells expressing PSMA (Jin et al., 2016). That is why, attaching the GTI peptide on the PEI moiety of our compound NHC-Pt(II)-PEI30 might be an option to specifically target prostate cancer cells.

### 3.2.5. Targeting cancer stem cells

Additionally, we would like to target cancer stem cells, a subpopulation of self-renewing, pluripotent and chemoresistant cells within the tumor bulk, which lead to tumor relapse (Deshmukh et al., 2016; Venere et al., 2011). As described in **Chapter 2**, we showed that NHC-Pt(II)-PEI30 was able to efficiently kill the CSCs *in vitro* and to impact the mitochondrial function by inducing superoxide ion accumulation and altering the respiratory activity. However, we would like to target specifically the CSCs in order to limit any side effects. It has been described that glioblastoma-derived CSCs express **CD44**, a marker which correlates with the stemness phenotype and tumor aggressiveness and seems to be involved in radioresistance (Han et al., 2017; Zhou et al., 2009). **Hyaluronic acid** (HA) is known to bind to CD44. That is why, we thought about two strategies: either creating complexes based on electrostatic interactions between HA and NHC-Pt(II)-PEI30 or attaching HA by chemical bonding to the PEI moiety.

Furthermore, an **upregulation of the transferrin receptor** able to bind the iron transporter transferrin has been observed in glioblastoma-derived CSCs suggesting an important iron demand (Schonberg et al., 2015). We could consider developing conjugates where the transferrin protein or specific peptide sequences binding to the transferrin receptor are attached on PEI in order to specifically target the CSCs (Lee et al., 2001).

Nevertheless, in order to target glioblastoma-derived CSCs, it would be essential to develop a compound able to cross the **blood-brain-barrier** (BBB). A few years ago, researchers emitted the hypothesis that antibodies directed against the transferrin receptor might cross the BBB, because iron is important for the brain function and is delivered using transferrin from the blood through the BBB towards the brain (Paterson and Webster, 2016). That is why, they thought that transferrin might also be able to deliver drugs through the BBB. However, some compounds showed side effects, as the transferrin receptor was not exclusively expressed by the brain cells (Paterson and Webster, 2016).

### 3.2.6. Creation of antibody drug conjugates (ADCs)

Another therapeutic strategy has gained increasing attention during the last years: the antibody drug conjugates (ADCs). These compounds consist of a recombinant monoclonal antibody which is covalently linked to a cytotoxic agent using synthetic linkers (**Figure 36**) (Beck et al., 2017). That is why, it would be interesting to create an antibody specifically targeting one of the afore mentioned cancer cell markers and link it to our cytotoxic platinum compound NHC-Pt(II)-PEI30.

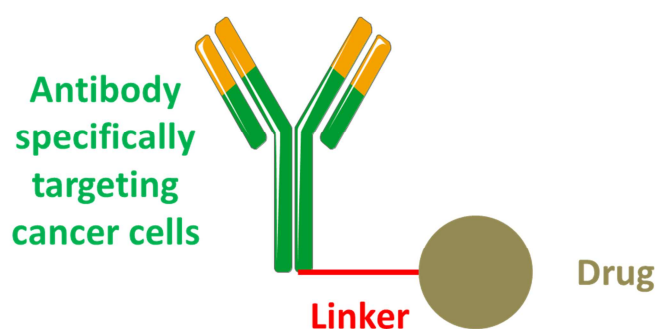

**Figure 36: Structure of an antibody-drug conjugate (ADC)**

ADCs are composed of an antibody targeting specifically a marker expressed by the cancer cells linked to a drug using a synthetic linker. We could replace the drug by our NHC-Pt(II)-PEI30 compound.

## 4. What is the implication of ROS production in the efficacy of anticancer therapies?

We previously demonstrated that our NHC-Pt(II)-PEI30 conjugate affected mitochondrial function by inducing accumulation of superoxide ions, a reactive oxygen species (ROS), and by impairing mitochondrial respiratory function (Chekkat et al., 2016). That is why, attention should be paid to the effect of ROS production in cancer progression. Various cellular organelles, like mitochondria, endoplasmic reticulum or peroxisomes, can produce ROS, very reactive oxygen metabolites, as byproducts of metabolic reactions (Yuan et al., 2018). However, the main source of ROS is the mitochondria, resulting from a leakage of electrons from the electron transport chain during oxidative phosphorylation (Poillet-Perez et al., 2015). In physiological conditions, ROS are involved in several signaling pathways which regulate cell growth, proliferation and differentiation (Yuan et al., 2018). However, high concentrations of ROS can have deleterious effects on the cell. That is why, in order to maintain redox homeostasis and prevent oxidative stress, the cells possess an inherent detoxification machinery consisting of endogenous antioxidant enzymes, like superoxide dismutase, catalase and glutathione peroxidase (He et al., 2017; Yuan et al., 2018).



Actually, the role of ROS in cancer is not clearly elucidated and seems to be dependent on various factors. So, modifications in tumor microenvironment (hypoxia) or exogenous factors (UV, smoking) can increase **ROS production** and favor **tumor progression** (Yang et al., 2018). However, some studies have shown that ROS removal by antioxidant therapies decreased the survival of individuals, suggesting an **antitumoral effect** (Yang et al., 2018). Based on our results, we emitted the hypothesis that the mitochondrial targeting of NHC-Pt(II)-PEI30 might induce a ROS accumulation and ultimately lead to cell death. Nonetheless, the exact mechanism remains to be explored.

### 5. What is the role of autophagy?

The **ROS production** is often **associated with** a cellular mechanism involved in the maintenance of metabolic homeostasis: **autophagy** (Li et al., 2017). This process consists in the clearance of damaged organelles and in the removal of long-lived, aggregated and misfolded proteins (Ravanan et al., 2017). It is initiated by the formation of an isolation membrane, called phagophore, in the cytoplasm which engulfs the elements that should be degraded in order to form a closed, double-membrane structure, the autophagosome (Li et al., 2017). The latter then fuses with the lysosomes to generate an autolysosome, leading to the degradation of the enveloped elements by lysosomal enzymes, like for example cathepsins, and the release of the recycled biomolecules in the cytoplasm for reuse (**Figure 37**) (Li et al., 2017; Singh et al., 2018). Several models explaining the interplay of ROS and autophagy in cancer have been proposed (Poillet-Perez et al., 2015). It has appeared that autophagy can often be associated with **resistance to cancer therapies**, as organelles damaged by ROS accumulation could be degraded by autophagy, thus preventing the induction of apoptosis and favoring cell survival (Poillet-Perez et al., 2015).

Nevertheless, it has been hypothesized that in case of excessive organelle damage due to ROS accumulation, the **autophagic process** might be **ineffective**, thus leading to apoptosis induction (Al Dhaheri et al., 2014; Poillet-Perez et al., 2015).

Furthermore, Michaud et al. indicated that **autophagy and** the induction of **ICD might be associated**. In fact, it appeared that, following chemotherapeutic treatment, DCs were recruited in tumors with intact autophagy machinery rather than in tumors with defective autophagy machinery. Moreover, the inhibition of autophagy prevented the release of the danger molecule ATP and thus the induction of ICD (Kroemer et al., 2013; Michaud et al., 2011). To gain further insight in the mechanism of action of NHC-Pt(II)-PEI30, the evaluation of autophagy would be of interest. At the moment, a question still remains

unanswered: does NHC-Pt(II)-PEI30 induce an excessive oxidative stress resulting in the inhibition of autophagy? An answer can only be obtained by evaluating the autophagic activity in cancer cells treated with NHC-Pt(II)-PEI30.

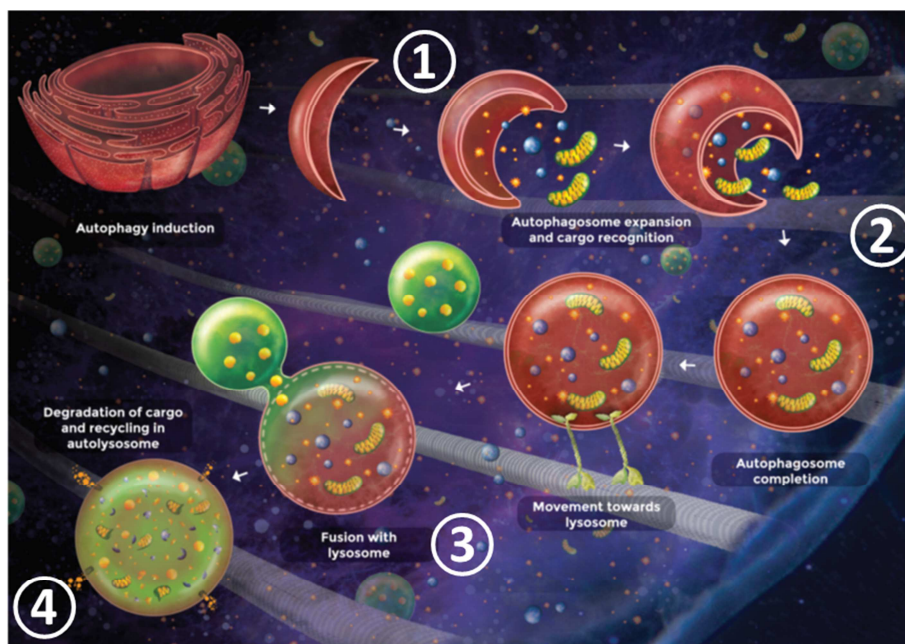

**Figure 37: Process of autophagy** (Singh et al., 2018).

Autophagy consists in the formation of an isolation membrane, called phagophore, in the cytoplasm which engulfs the elements that should be degraded (organelles, proteins) ① in order to form a closed, double-membrane structure, the autophagosome ②. The latter then fuses with lysosomes to generate an autolysosome ③ which leads to the degradation of the enveloped elements by lysosomal enzymes and the release of the recycled biomolecules in the cytoplasm for reuse ④.

## 6. Do not forget the intestinal microbiome in the efficacy of cancer therapies!

It has appeared that the effect of the **gut microbiota** might be involved in the efficacy of anticancer therapies, like for example oxaliplatin (Perez-Chanona and Trinchieri, 2016). The human gut is colonized by trillions of commensal microorganisms, which have coevolved with the host, leading to an optimal mutualism (Viaud et al., 2014). Antibiotics can disturb the bacterial balance in the gut (Perez-Chanona and Trinchieri, 2016). It has been demonstrated that an antibiotic treatment in mice resulted in a modified intestinal microbiome and that this reduced the efficacy of some chemotherapeutic agents (Perez-Chanona and Trinchieri, 2016). In 2013, Iida et al showed that antibiotic treatment decreased the DNA adducts created by oxaliplatin and cisplatin and thus the apoptosis (Iida et al., 2013). Based on these observations, it would be interesting to evaluate the implication of the intestinal microbiome on the cytotoxic effect of NHC-Pt(II)-PEI30. Nevertheless, it is difficult to control the composition of the microbiome in mice. One possibility would be to use germ-free mice

housed in sterile conditions in order to prevent contact with any microorganisms and then induce colonization with definite bacteria to study the role of the different bacterial classes (Kennedy et al., 2018).

### 7. Towards the development of a combotherapy

For a long time, immunotherapy was considered as marginal therapeutic option, despite strong evidence that the immune system was implicated in tumor development (Granier et al., 2016). However, over the last years, it has appeared that chemotherapy was more efficient in patients with a strong immune system compared to immunosuppressed individuals, thus increasing the interest in immunotherapy (Vesely et al., 2011; Zitvogel et al., 2013). That is why, **the aim of our project was to develop innovative platinum-based compounds which could act as chemotherapeutic agents by killing the cancer cells and as immunotherapeutic agents by activating the antitumor immune response.**

#### 7.1. Targeting TLRs

As shown in **Chapter 3**, we only observed a weak inherent ability of the NHC-Pt(II)-PEI30 to induce ICD. That is why, we tried to enhance the antitumor immune response. For this, we took advantage of the ability of PEI to complex nucleic acids. We mixed NHC-Pt(II)-PEI30 with the TLR3 agonist polyI:C and produced NHC-Pt(II)-PEI30-polyI:C complexes. We also demonstrated that the latter maintained the cytotoxic as well as the immunostimulatory capacity of the platinum compound and the TLR3 agonist respectively. We could proceed in the same manner and form complexes between our conjugate and CpG-containing oligodeoxynucleotides targeting endosomal TLR9 (Pohar et al., 2017). Furthermore, we could also modify the PEI moiety of our compound by attaching the immunostimulatory compound resiquimod on our conjugate to target endosomal TLR7/8 (Engel et al., 2011).

#### 7.2. Combination with other immunotherapies

Nevertheless, other strategies to combine chemotherapy and immunotherapy could be explored. In fact, at the beginning of tumor development, the immune system fights against the cancer cells. However, the latter elaborate mechanisms which allow them to escape the surveillance of immune cells, like for example by creating an immunosuppressive tumoral microenvironment or by inhibiting the functions of immune effector cells, like CTLs. Tumor cells recruit regulatory immune cells, like MDSCs or Tregs, which then interact with effector cells. At this stage of tumor progression, the immune checkpoints play an important role. Tregs express for example CTLA-4 which interacts with B7.1 and B7.2 on APCs, mainly

DCs. The latter become this way unable to induce differentiation of naïve T cells to effector T cells, as B7.1 and B7.2 are essential co-stimulatory molecules for this process (Dyck and Mills, 2017). This leads to a decrease of the immune response and allows the tumor to progress in an uncontrolled manner (Vesely et al., 2011). Furthermore, the cancer cells themselves can express the inhibitory molecule PD-L1 at their cell surface which binds to PD-1 expressed on CTLs and induces their inactivation (Lim et al., 2017). Over the last years, numerous monoclonal antibodies were developed to target these immune checkpoints and prevent the interaction between the receptor and its ligand (Darvin et al., 2018). Some of these antibodies showed promising results and are already approved by the FDA, like for example ipilimumab targeting CTLA-4 (Dyck and Mills, 2017). That is why, it might be interesting to combine our chemotherapeutic agent NHC-Pt(II)-PEI30 with **checkpoint inhibitors**. This might prevent the immunosuppressive tumoral microenvironment and favor the establishment of an antitumor immune response.

### 7.3. The use of liposomal constructs

In my host laboratory, **liposomes** are commonly used as vectors in the development of cancer vaccines to deliver adjuvants and tumor-specific peptides in order to activate the antitumor immune response (Jacobberger-Foissac et al., 2019). In fact, these phospholipid vesicles composed of an aqueous core surrounded by a phospholipid bilayer are of great interest, as they are biocompatible and display a low proinflammatory activity and cytotoxicity (Jacobberger-Foissac et al., 2019). As we had observed a weak activation of the antitumor immune response after treatment with NHC-Pt(II)-PEI30, we could emit the hypothesis that the compound was able to trigger the release of tumor-associated antigens or fragments derived from cancer cells while inducing their cell death. So, it would be of interest to add danger molecules to the equation to enhance the antitumor immune. Two strategies would be possible: i) creating one liposomal construction by **incorporating the platinum compound and the immunostimulatory molecules within the phospholipid membrane (Figure 38A)** or ii) **administrating simultaneously** the NHC-Pt(II)-PEI30 conjugate **with liposomes containing the immunostimulatory molecules (Figure 38B)**. For this, we could consider adding agonists of TLRs expressed at the cell surface of immune cells, like for example S-[2,3-bispalmitoyloxy-(2R)-propyl]-R-cysteinyl-alanyl-glycine (Pam<sub>2</sub>CAG), an agonist of TLR2/6, or the lipopolysaccharide derivative monophosphoryl lipid A (MPLA), an agonist of TLR4. These adjuvants have already been successfully incorporated in liposomes and tested *in vivo* (Jacobberger-Foissac et al., 2019). However, the insertion of the NHC-Pt(II)-PEI30

complex in the liposome has revealed to be more challenging. In fact, only molecules with a lipophilic part can be included in the phospholipid membrane. So, the NHC-Pt(II) derivative was modified in order to bear a lipophilic chain, which unfortunately resulted in a loss of its cytotoxic activity (unpublished data). Another strategy might be to use a hydrophilic platinum compound as well as an hydrophilic adjuvant and to **incorporate them within the aqueous core of the liposome (Figure 38C)**. It would also be possible to **insert targeting agents within the liposome** to specifically target the cancer cells, like for example ligands of receptors overexpressed by cancer cells or antibodies targeting markers expressed by the cancer cells. Recently, our laboratory developed innovative cancer vaccines composed of three elements to efficiently trigger an antitumor immune response: i) a peptide able to activate CD4<sup>+</sup> T cells, ii) a tumor-specific peptide able to activate CD8<sup>+</sup> T cells and iii) a danger signal targeting PRRs expressed by the immune cells (Jacobberger-Foissac et al., 2019). The simultaneous administration of these liposomes with NHC-Pt(II)-PEI30 might trigger an efficient antitumor immune response (**Figure 38D**).

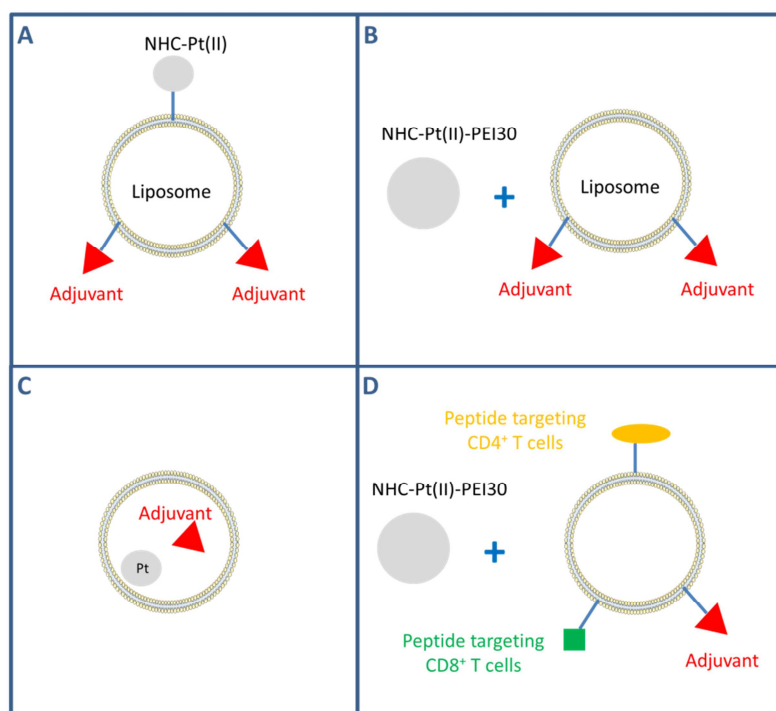

**Figure 38: Examples of possible liposomal constructs as immunotherapeutic agents.**

A. The platinum compound and the adjuvant can be inserted in the liposomal phospholipid bilayer. B. NHC-Pt(II)-PEI30 can be administered simultaneously with a liposome containing an adjuvant. C. A hydrophilic platinum derivative and adjuvant can be incorporated in the aqueous core of the liposome. D. NHC-Pt(II)-PEI30 can be administered simultaneously with an innovative cancer vaccine developed in our laboratory and bearing a peptide targeting CD4<sup>+</sup> cells, a tumor-specific peptide targeting CD8<sup>+</sup> cells and an adjuvant.

# **Bibliography**



## A

Aher, S.B., Muskawar, P.N., Thenmozhi, K., and Bhagat, P.R. (2014). Recent developments of metal N-heterocyclic carbenes as anticancer agents. *European Journal of Medicinal Chemistry* 81, 408–419.

Ainscow, E.K., Mirshamsi, S., Tang, T., Ashford, M.L.J., and Rutter, G.A. (2002). Dynamic imaging of free cytosolic ATP concentration during fuel sensing by rat hypothalamic neurones: evidence for ATP-independent control of ATP-sensitive K<sup>+</sup> channels. *The Journal of Physiology* 544, 429–445.

Al Dhaheri, Y., Attoub, S., Ramadan, G., Arafat, K., Bajbouj, K., Karuvantevida, N., AbuQamar, S., Eid, A., and Iratni, R. (2014). Carnosol Induces ROS-Mediated Beclin1-Independent Autophagy and Apoptosis in Triple Negative Breast Cancer. *PLoS ONE* 9, e109630.

Alderden, R.A., Hall, M.D., and Hambley, T.W. (2006). The Discovery and Development of Cisplatin. *Journal of Chemical Education* 83, 728.

Altman, J.B., Benavides, A.D., Das, R., and Bassiri, H. (2015). Antitumor Responses of Invariant Natural Killer T Cells. *Journal of Immunology Research* 2015, 1–10.

Anjum, K., Shagufta, B.I., Abbas, S.Q., Patel, S., Khan, I., Shah, S.A.A., Akhter, N., and Hassan, S.S.U. (2017). Current status and future therapeutic perspectives of glioblastoma multiforme (GBM) therapy: A review. *Biomedicine & Pharmacotherapy* 92, 681–689.

## B

Barnard, P.J., Baker, M.V., Berners-Price, S.J., and Day, D.A. (2004). Mitochondrial permeability transition induced by dinuclear gold(I)–carbene complexes: potential new antimitochondrial antitumour agents. *Journal of Inorganic Biochemistry* 98, 1642–1647.

Barnd, D., Kerr, L., Metzgar, M., and Finn, O. (1988). Human tumor-specific cytotoxic T cell lines generated from tumor-draining lymph node infiltrate. *Transplantation Proceedings* 20, 339–341.

Beck, A., Goetsch, L., Dumontet, C., and Corvaia, N. (2017). Strategies and challenges for the next generation of antibody–drug conjugates. *Nature Reviews Drug Discovery* 16, 315–337.

Blandin, A.-F., Renner, G., Lehmann, M., Lelong-Rebel, I., Martin, S., and Dontenwill, M. (2015).  $\beta$ 1 Integrins as Therapeutic Targets to Disrupt Hallmarks of Cancer. *Frontiers in Pharmacology* 6, 279–288.

Boon, T., Cerottini, J.-C., Van den Eynde, B., van der Bruggen, P., and Van Pel, A. (1994). Tumor Antigens Recognized by T Lymphocytes. *Annual Review of Immunology* 12, 337–365.



Bouché, M., Dahm, G., Wantz, M., Fournel, S., Achard, T., and Bellemin-Laponnaz, S. (2016). Platinum(IV) N-heterocyclic carbene complexes: their synthesis, characterisation and cytotoxic activity. *Dalton Transactions* 45, 11362–11368.

Bouché, M., Bonnefont, A., Achard, T., and Bellemin-Laponnaz, S. (2018). Exploring diversity in platinum(IV) N-heterocyclic carbene complexes: synthesis, characterization, reactivity and biological evaluation. *Dalton Transactions* 47, 11491–11502.

Boulikas, T., Pantos, A., Bellis, E., and Christofis, P. (2007). Designing platinum compounds in cancer: structures and mechanisms. *Cancer Therapy* 5, 537–583.

Bradshaw, A., Wickremsekera, A., Tan, S.T., Peng, L., Davis, P.F., and Itinteang, T. (2016). Cancer Stem Cell Hierarchy in Glioblastoma Multiforme. *Frontiers in Surgery* 3, 21–35.

Brassil, K.J., and Ginex, P.K. (2018). History of Immunotherapy. In *Guide to Cancer Immunotherapy*, (Oncology Nursing Society), pp. 1–18.

Brown, S.J., Kellett, P.J., and Lippard, S.J. (1993). Ixrl, a Yeast Protein That Binds to Platinated DNA and Confers Sensitivity to Cisplatin. *261*, 603–605.

Brozovic, A., Ambriović-Ristov, A., and Osmak, M. (2010). The relationship between cisplatin-induced reactive oxygen species, glutathione, and BCL-2 and resistance to cisplatin. *Critical Reviews in Toxicology* 40, 347–359.

Bulbake, U., Doppalapudi, S., Kommineni, N., and Khan, W. (2017). Liposomal Formulations in Clinical Use: An Updated Review. *Pharmaceutics* 9, 1–33.

Burnet, F.M. (1970). The Concept of Immunological Surveillance. In *Progress in Tumor Research*, R.S. Schwartz, ed. (S. Karger AG), pp. 1–27.

Burnet, M. (1957). Cancer - a biological approach. *British Medical Journal* 1, 841–847.

Burnet, M. (1964). Immunological factors in the process of carcinogenesis. *British Medical Bulletin* 20, 154–158.

## C

César, V., and Bellemin-Laponnaz, S. (2009). Les carbènes N-hétérocycliques. *L'actualité Chimique* 326, 8–14.

Chardon, E., Dahm, G., Guichard, G., and Bellemin-Laponnaz, S. (2012a). Derivatization of Preformed Platinum N-Heterocyclic Carbene Complexes with Amino Acid and Peptide Ligands and Cytotoxic Activities toward Human Cancer Cells. *Organometallics* 31, 7618–7621.

Chardon, E., Puleo, G.L., Dahm, G., Fournel, S., Guichard, G., and Bellemin-Laponnaz, S. (2012b). Easy Derivatization of Group 10 N-Heterocyclic Carbene Complexes and In Vitro Evaluation of an Anticancer Oestradiol Conjugate. *ChemPlusChem* 77, 1028–1038.

Chekkat, N., Dahm, G., Chardon, E., Wantz, M., Sitz, J., Decossas, M., Lambert, O., Frisch, B., Rubbiani, R., Gasser, G., et al. (2016). N-Heterocyclic Carbene–Polyethylenimine

Platinum Complexes with Potent in Vitro and in Vivo Antitumor Efficacy. *Bioconjugate Chemistry* 27, 1942–1948.

Chen, D.S., and Mellman, I. (2013). Oncology Meets Immunology: The Cancer-Immunity Cycle. *Immunity* 39, 1–10.

Chen, D.S., and Mellman, I. (2017). Elements of cancer immunity and the cancer-immune set point. *Nature* 541, 321–330.

Chtchigrovsky, M., Eloy, L., Jullien, H., Saker, L., Ségal-Bendirdjian, E., Poupon, J., Bombard, S., Cresteil, T., Retailleau, P., and Marinetti, A. (2013). Antitumor trans-N-Heterocyclic Carbene–Amine–Pt(II) Complexes: Synthesis of Dinuclear Species and Exploratory Investigations of DNA Binding and Cytotoxicity Mechanisms. *Journal of Medicinal Chemistry* 56, 2074–2086.

Collin, M., and Bigley, V. (2018). Human dendritic cell subsets: an update. *Immunology* 154, 3–20.

Coluccia, M., and Natile, G. (2007). Trans-platinum complexes in cancer therapy. *Anticancer Agents in Medicinal Chemistry* 7, 111–123.

Cruz, F.M., Colbert, J.D., Merino, E., Kriegsman, B.A., and Rock, K.L. (2017). The Biology and Underlying Mechanisms of Cross-Presentation of Exogenous Antigens on MHC-I Molecules. *Annual Review of Immunology* 35, 149–176.

## D

Damyanov, C.A., Maslev, I.K., Pavlov, V.S., and Avramov, L. (2018). Conventional Treatment of Cancer Realities and Problems. *Annals of Complementary and Alternative Medicine* 1, 1002–1010.

Darvin, P., Toor, S.M., Sasidharan Nair, V., and Elkord, E. (2018). Immune checkpoint inhibitors: recent progress and potential biomarkers. *Experimental & Molecular Medicine* 50, 165–175.

Dasari, S., and Bernard Tchounwou, P. (2014). Cisplatin in cancer therapy: Molecular mechanisms of action. *European Journal of Pharmacology* 740, 364–378.

Dawood, S., Austin, L., and Cristofanilli, M. (2014). Cancer Stem Cells: Implications for Cancer Therapy. *Oncology Journal* 28, 1101–1107.

Decker, W.K., da Silva, R.F., Sanabria, M.H., Angelo, L.S., Guimarães, F., Burt, B.M., Kheradmand, F., and Paust, S. (2017). Cancer Immunotherapy: Historical Perspective of a Clinical Revolution and Emerging Preclinical Animal Models. *Frontiers in Immunology* 8, 829–841.

Deshmukh, A., Deshpande, K., Arfuso, F., Newsholme, P., and Dharmarajan, A. (2016). Cancer stem cell metabolism: a potential target for cancer therapy. *Molecular Cancer* 15, 69–78.

Dezhenkova, L.G., Tsvetkov, V.B., and Shtil, A.A. (2014). Topoisomerase I and II inhibitors: chemical structure, mechanisms of action and role in cancer chemotherapy. *Russian Chemical Reviews* 83, 82–94.

Dighe, S., Richards, E., Old, L.J., and Schreiber, R.D. (1994). Enhanced In Vivo Growth and Resistance to Rejection of Tumor Cells Expressing Dominant Negative IFN $\gamma$  Receptors. *Immunity* 1, 447–456.

Dilruba, S., and Kalayda, G.V. (2016). Platinum-based drugs: past, present and future. *Cancer Chemotherapy and Pharmacology* 77, 1103–1124.

Dudek, A.M., Garg, A.D., Krysko, D.V., De Ruyscher, D., and Agostinis, P. (2013). Inducers of immunogenic cancer cell death. *Cytokine & Growth Factor Reviews* 24, 319–333.

Dudley, M.E., Wunderlich, J.R., Shelton, T.E., Even, J., and Rosenberg, S.A. (2003). Generation of Tumor-Infiltrating Lymphocyte Cultures for Use in Adoptive Transfer Therapy for Melanoma Patients: *Journal of Immunotherapy* 26, 332–342.

Dunn, G.P., Bruce, A.T., Ikeda, H., Old, L.J., and Schreiber, R.D. (2002). Cancer immunoediting: from immunosurveillance to tumor escape. *Nature Immunology* 3, 991–998.

Dunn, G.P., Old, L.J., and Schreiber, R.D. (2004). The Immunobiology of Cancer Immunosurveillance and Immunoediting. *Immunity* 21, 137–148.

Dyck, L., and Mills, K.H.G. (2017). Immune checkpoints and their inhibition in cancer and infectious diseases. *European Journal of Immunology* 47, 765–779.

## E

Ehrlich, P. (1909). Über den jetzigen Stand der Karzinomforschung. *Ned. Tijdschr. Geneesk.* 120–164.

Engel, A.L., Holt, G.E., and Lu, H. (2011). The pharmacokinetics of Toll-like receptor agonists and the impact on the immune system. *Expert Review of Clinical Pharmacology* 4, 275–289.

Espinosa, E., Zamora, P., Feliu, J., and González Barón, M. (2003). Classification of anticancer drugs—a new system based on therapeutic targets. *Cancer Treatment Reviews* 29, 515–523.

## F

Farnie, G., Sotgia, F., and Lisanti, M.P. (2015). High mitochondrial mass identifies a subpopulation of stem-like cancer cells that are chemo-resistant. *Oncotarget* 6, 30472–30486.

Fechter, P., Cruz Da Silva, E., Mercier, M.-C., Noulet, F., Etienne-Seloum, N., Guenot, D., Lehmann, M., Vauchelles, R., Martin, S., Lelong-Rebel, I., et al. (2019). RNA Aptamers Targeting Integrin  $\alpha 5\beta 1$  as Probes for Cyto- and Histofluorescence in Glioblastoma. *Molecular Therapy - Nucleic Acids* 17, 63–77.

Ferreira, J.A., Peixoto, A., Neves, M., Gaiteiro, C., Reis, C.A., Assaraf, Y.G., and Santos, L.L. (2016). Mechanisms of cisplatin resistance and targeting of cancer stem cells: Adding glycosylation to the equation. *Drug Resistance Updates* 24, 34–54.

Fleming, C., Morrissey, S., Cai, Y., and Yan, J. (2017).  $\gamma\delta$  T Cells: Unexpected Regulators of Cancer Development and Progression. *Trends in Cancer* 3, 561–570.

Freitas, D.P., Teixeira, C.A., Santos-Silva, F., Vasconcelos, M.H., and Almeida, G.M. (2014). Therapy-induced enrichment of putative lung cancer stem-like cells: Therapy-induced enrichment of putative lung CSLCs. *International Journal of Cancer* 134, 1270–1278.

Fucikova, J., Kasikova, L., Truxova, I., Laco, J., Skapa, P., Ryska, A., and Spisek, R. (2018). Relevance of the chaperone-like protein calreticulin for the biological behavior and clinical outcome of cancer. *Immunology Letters* 193, 25–34.

## G

Galluzzi, L., Vacchelli, E., Pedro, J.-M.B.-S., Buqué, A., Senovilla, L., Baracco, E.E., Bloy, N., Castoldi, F., Abastado, J.-P., Agostinis, P., et al. (2014). Classification of current anticancer immunotherapies. *Oncotarget* 5, 12472–12508.

Galluzzi, L., Buqué, A., Kepp, O., Zitvogel, L., and Kroemer, G. (2017). Immunogenic cell death in cancer and infectious disease. *Nature Reviews Immunology* 17, 97–111.

Garg, A.D., and Agostinis, P. (2017). Cell death and immunity in cancer: From danger signals to mimicry of pathogen defense responses. *Immunological Reviews* 280, 126–148.

Garg, A.D., Dudek, A.M., and Agostinis, P. (2013). Cancer immunogenicity, danger signals, and DAMPs: What, when, and how?: Danger signaling, DAMPs, and Cancer. *BioFactors* 39, 355–367.

Garg, A.D., Galluzzi, L., Apetoh, L., Baert, T., Birge, R.B., Bravo-San Pedro, J.M., Breckpot, K., Brough, D., Chaurio, R., Cirone, M., et al. (2015). Molecular and Translational Classifications of DAMPs in Immunogenic Cell Death. *Frontiers in Immunology* 6, 588–611.

Gautier, A., and Cisnetti, F. (2012). Advances in metal–carbene complexes as potent anti-cancer agents. *Metallomics* 4, 23–32.

Gebremeskel, S., and Johnston, B. (2015). Concepts and mechanisms underlying chemotherapy induced immunogenic cell death: impact on clinical studies and considerations for combined therapies. *Oncotarget* 6, 41600–41619.

Ghosh, S. (2019). Cisplatin: The first metal based anticancer drug. *Bioorganic Chemistry* 88, 102925–102944.

Gibson, D. (2019). Multi-action Pt(IV) anticancer agents; do we understand how they work? *Journal of Inorganic Biochemistry* 191, 77–84.

Gold, L.I., Eggleton, P., Sweetwyne, M.T., Van Duyn, L.B., Greives, M.R., Naylor, S.-M., Michalak, M., and Murphy-Ullrich, J.E. (2010). Calreticulin: non-endoplasmic reticulum functions in physiology and disease. *The FASEB Journal* 24, 665–683.

Gonzalez, H., Hagerling, C., and Werb, Z. (2018). Roles of the immune system in cancer: from tumor initiation to metastatic progression. *Genes & Development* 32, 1267–1284.

Gottesman, M.M., Lavi, O., Hall, M.D., and Gillet, J.-P. (2016). Toward a Better Understanding of the Complexity of Cancer Drug Resistance. *Annual Review of Pharmacology and Toxicology* 56, 85–102.

Graf, N., Mokhtari, T.E., Papayannopoulos, I.A., and Lippard, S.J. (2012). Platinum(IV)-chlorotoxin (CTX) conjugates for targeting cancer cells. *Journal of Inorganic Biochemistry* 110, 58–63.

Granier, C., Karaki, S., Roussel, H., Badoual, C., Tran, T., Anson, M., Fabre, E., Oudard, S., and Tartour, E. (2016). Immunothérapie des cancers: rationnel et avancées récentes. *La Revue de Médecine Interne* 37, 694–700.

Green, D.R., Ferguson, T., Zitvogel, L., and Kroemer, G. (2009). Immunogenic and tolerogenic cell death. *Nature Reviews Immunology* 9, 353–363.

## H

Han, X., Xue, X., Zhou, H., and Zhang, G. (2017). A molecular view of the radioresistance of gliomas. *Oncotarget* 8, 100931–100941.

Hanahan, D., and Weinberg, R.A. (2000). The Hallmarks of Cancer. *Cell* 100, 57–70.

Hanahan, D., and Weinberg, R.A. (2011). Hallmarks of Cancer: The Next Generation. *Cell* 144, 646–674.

Hang, Z., Cooper, M.A., and Ziora, Z.M. (2016). Platinum-based anticancer drugs encapsulated liposome and polymeric micelle formulation in clinical trials. *Biochemical Compounds* 4, 1–10.

He, S.-J., Cheng, J., Feng, X., Yu, Y., Tian, L., and Huang, Q. (2017). The dual role and therapeutic potential of high-mobility group box 1 in cancer. *Oncotarget* 8, 64534–64550.

Hernandez, C., Huebener, P., and Schwabe, R.F. (2016). Damage-associated molecular patterns in cancer: a double-edged sword. *Oncogene* 35, 5931–5941.

Hopkinson, M.N., Richter, C., Schedler, M., and Glorius, F. (2014). An overview of N-heterocyclic carbenes. *Nature* 510, 485–496.

## I

Iida, N., Dzutsev, A., Stewart, C.A., Smith, L., Bouladoux, N., Weingarten, R.A., Molina, D.A., Salcedo, R., Back, T., Cramer, S., et al. (2013). Commensal Bacteria Control Cancer Response to Therapy by Modulating the Tumor Microenvironment. *Science* 342, 967–970.

Ilyas, S., and Yang, J.C. (2015). Landscape of Tumor Antigens in T Cell Immunotherapy. *The Journal of Immunology* 195, 5117–5122.

Ishikawa, T., and Ali-Osman, F. (1993). Glutathione-associated cis-Diamminedichloroplatinum(II) Metabolism and ATP-dependent Efflux from Leukemia Cells. *The Journal of Biological Chemistry* 268, 20116–20125.

Ivanov, A.I., Christodoulou, J., Parkinson, J.A., Barnham, K.J., Tucker, A., Woodrow, J., and Sadler, P.J. (1998). Cisplatin Binding Sites on Human Albumin. *Journal of Biological Chemistry* 273, 14721–14730.

## J

Jacoberger-Foissac, C., Saliba, H., Seguin, C., Brion, A., Kakhi, Z., Frisch, B., Fournel, S., and Heurtault, B. (2019). Optimization of peptide-based cancer vaccine compositions, by sequential screening, using versatile liposomal platform. *International Journal of Pharmaceutics* 562, 342–350.

Jin, W., Qin, B., Chen, Z., Liu, H., Barve, A., and Cheng, K. (2016). Discovery of PSMA-specific peptide ligands for targeted drug delivery. *International Journal of Pharmaceutics* 513, 138–147.

Johnson, N.A., Southerland, M.R., and Youngs, W.J. (2017). Recent Developments in the Medicinal Applications of Silver-NHC Complexes and Imidazolium Salts. *Molecules* 22, 1263–1282.

Jun, F., Zhi-gang, L., Xiao-mei, L., Fu-rong, C., Hong-liu, S., Chung-sean, P.J., Ho-keung, N., and Zhong-ping, C. (2009). Glioblastoma stem cells resistant to temozolomide-induced autophagy. *Chinese Medical Journal* 122, 1255–1259.

## K

Kauffman, G.B., Pentimalli, R., Doldi, S., and Hall, M.D. (2010). Michele Peyrone (1813-1883), Discoverer of Cisplatin. *Platinum Metals Review* 54, 250–256.

Kelland, L. (2007). The resurgence of platinum-based cancer chemotherapy. *Nature Reviews Cancer* 7, 573–584.

Kennedy, E.A., King, K.Y., and Baldrige, M.T. (2018). Mouse Microbiota Models: Comparing Germ-Free Mice and Antibiotics Treatment as Tools for Modifying Gut Bacteria. *Frontiers in Physiology* 9, 1534–1549.

Kepp, O., Menger, L., Vacchelli, E., Locher, C., Adjemian, S., Yamazaki, T., Martins, I., Sukkurwala, A.Q., Michaud, M., Senovilla, L., et al. (2013). Crosstalk between ER stress and immunogenic cell death. *Cytokine & Growth Factor Reviews* 24, 311–318.

Kepp, O., Senovilla, L., Vitale, I., Vacchelli, E., Adjemian, S., Agostinis, P., Apetoh, L., Aranda, F., Barnaba, V., Bloy, N., et al. (2014). Consensus guidelines for the detection of immunogenic cell death. *OncoImmunology* 3, e955691-1-e955691-19.

Khalil, D.N., Smith, E.L., Brentjens, R.J., and Wolchok, J.D. (2016). The future of cancer treatment: immunomodulation, CARs and combination immunotherapy. *Nature Reviews Clinical Oncology* 13, 273–290.

Kichler, A., Chillon, M., Leborgne, C., Danos, O., and Frisch, B. (2002). Intranasal gene delivery with a polyethylenimine–PEG conjugate. *Journal of Controlled Release* *81*, 379–388.

Konrad, C.V., Murali, R., Varghese, B.A., and Nair, R. (2017). The role of cancer stem cells in tumor heterogeneity and resistance to therapy. *Canadian Journal of Physiology and Pharmacology* *95*, 1–15.

Kreso, A., and Dick, J.E. (2014). Evolution of the Cancer Stem Cell Model. *Cell Stem Cell* *14*, 275–291.

Kroemer, G., Galluzzi, L., Kepp, O., and Zitvogel, L. (2013). Immunogenic Cell Death in Cancer Therapy. *Annual Review of Immunology* *31*, 51–72.

Krust, B., El Khoury, D., Nondier, I., Soundaramourty, C., and Hovanessian, A.G. (2011). Targeting surface nucleolin with multivalent HB-19 and related Nucant pseudopeptides results in distinct inhibitory mechanisms depending on the malignant tumor cell type. *BMC Cancer* *11*, 333–354.

Krysko, D.V., Garg, A.D., Kaczmarek, A., Krysko, O., Agostinis, P., and Vandenabeele, P. (2012). Immunogenic cell death and DAMPs in cancer therapy. *Nature Reviews Cancer* *12*, 860–875.

## L

Lai, Y.-H., Kuo, C., Kuo, M., and Chen, H. (2018). Modulating Chemosensitivity of Tumors to Platinum-Based Antitumor Drugs by Transcriptional Regulation of Copper Homeostasis. *International Journal of Molecular Sciences* *19*, 1486–1503.

Lakshminarayanan, V., Thompson, P., Wolfert, M.A., Buskas, T., Bradley, J.M., Pathangey, L.B., Madsen, C.S., Cohen, P.A., Gendler, S.J., and Boons, G.-J. (2012). Immune recognition of tumor-associated mucin MUC1 is achieved by a fully synthetic aberrantly glycosylated MUC1 tripartite vaccine. *Proceedings of the National Academy of Sciences* *109*, 261–266.

Lamb, R., Harrison, H., Hult, J., Smith, D.L., Lisanti, M.P., and Sotgia, F. (2014). Mitochondria as new therapeutic targets for eradicating cancer stem cells: Quantitative proteomics and functional validation via MCT1/2 inhibition. *Oncotarget* *5*, 11029–11037.

Lamb, R., Ozsvari, B., Lisanti, C.L., Tanowitz, H.B., Howell, A., Martinez-Outschoorn, U.E., Sotgia, F., and Lisanti, P. (2015). Antibiotics that target mitochondria effectively eradicate cancer stem cells, across multiple tumor types: Treating cancer like an infectious disease. *Oncotarget* *6*, 4569–4584.

Lapidot, T., Sirard, C., Vormoor, J., Murdoch, B., Hoang, T., Caceres-Cortes, J., Minden, M., Paterson, B., Caligiuri, M.A., and Dick, J.E. (1994). A cell initiating human acute myeloid leukaemia after transplantation into SCID mice. *Nature* *367*, 645–648.

Lazarević, T., Rilak, A., and Bugarčić, Ž.D. (2017). Platinum, palladium, gold and ruthenium complexes as anticancer agents: Current clinical uses, cytotoxicity studies and future perspectives. *European Journal of Medicinal Chemistry* *142*, 8–31.



- Lee, J.H., Engler, J.A., Collawn, J.F., and Moore, B.A. (2001). Receptor mediated uptake of peptides that bind the human transferrin receptor: Peptide endocytosis by the transferrin receptor. *European Journal of Biochemistry* 268, 2004–2012.
- Lei, Y., Zhang, D., Yu, J., Dong, H., Zhang, J., and Yang, S. (2017). Targeting autophagy in cancer stem cells as an anticancer therapy. *Cancer Letters* 393, 33–39.
- Li, A., Banerjee, J., Leung, C.T., Peterson-Yantorno, K., Stamer, W.D., and Civan, M.M. (2011). Mechanisms of ATP Release, the Enabling Step in Purinergic Dynamics. *Cellular Physiology and Biochemistry* 28, 1135–1144.
- Li, Y.-J., Lei, Y.-H., Yao, N., Wang, C.-R., Hu, N., Ye, W.-C., Zhang, D.-M., and Chen, Z.-S. (2017). Autophagy and multidrug resistance in cancer. *Chinese Journal of Cancer* 36, 52–61.
- Liang, X., Wu, Q., Luan, S., Yin, Z., He, C., Yin, L., Zou, Y., Yuan, Z., Li, L., Song, X., et al. (2019). A comprehensive review of topoisomerase inhibitors as anticancer agents in the past decade. *European Journal of Medicinal Chemistry* 171, 129–168.
- Lim, S., Phillips, J.B., Madeira da Silva, L., Zhou, M., Fodstad, O., Owen, L.B., and Tan, M. (2017). Interplay between Immune Checkpoint Proteins and Cellular Metabolism. *Cancer Research* 77, 1245–1249.
- Liu, W., and Gust, R. (2013). Metal N-heterocyclic carbene complexes as potential antitumor metallodrugs. *Chem. Soc. Rev.* 42, 755–773.
- Liu, W., and Gust, R. (2016). Update on metal N-heterocyclic carbene complexes as potential anti-tumor metallodrugs. *Coordination Chemistry Reviews* 329, 191–213.
- Liu, R., Fu, Z., Zhao, M., Gao, X., Li, H., Mi, Q., Liu, P., Yang, J., Yao, Z., and Gao, Q. (2017). GLUT1-mediated selective tumor targeting with fluorine containing platinum(II) glycoconjugates. *Oncotarget* 8.
- Lombardi, V.C., Khaiboullina, S.F., and Rizvanov, A.A. (2015). Plasmacytoid dendritic cells, a role in neoplastic prevention and progression. *European Journal of Clinical Investigation* 45, 1–8.
- López-Soto, A., Gonzalez, S., Smyth, M.J., and Galluzzi, L. (2017). Control of Metastasis by NK Cells. *Cancer Cell* 32, 135–154.
- Lu, Y.-C., Weng, W.-C., and Lee, H. (2015). Functional Roles of Calreticulin in Cancer Biology. *BioMed Research International* 2015, 1–9.
- Luengo, A., Gui, D.Y., and Vander Heiden, M.G. (2017). Targeting Metabolism for Cancer Therapy. *Cell Chemical Biology* 24, 1161–1180.
- Lungwitz, U., Breunig, M., Blunk, T., and Göpferich, A. (2005). Polyethylenimine-based non-viral gene delivery systems. *European Journal of Pharmaceutics and Biopharmaceutics* 60, 247–266.



## M

Ma, D.-L., Wu, C., Cheng, S.-S., Lee, F.-W., Han, Q.-B., and Leung, C.-H. (2019). Development of Natural Product-Conjugated Metal Complexes as Cancer Therapies. *International Journal of Molecular Sciences* 20, 341–355.

Macri, C., Pang, E.S., Patton, T., and O’Keeffe, M. (2018). Dendritic cell subsets. *Seminars in Cell & Developmental Biology* 84, 11–21.

Malmberg, K.-J., Carlsten, M., Björklund, A., Sohlberg, E., Bryceson, Y.T., and Ljunggren, H.-G. (2017). Natural killer cell-mediated immunosurveillance of human cancer. *Seminars in Immunology* 31, 20–29.

Markov, O.V., Mironova, N.L., Vlasov, V.V., and Zenkova, M.A. (2016). Molecular and Cellular Mechanisms of Antitumor Immune Response Activation by Dendritic Cells. *Acta Naturae* 8, 17–30.

Martinho, N., Santos, T.C.B., Florindo, H.F., and Silva, L.C. (2019). Cisplatin-Membrane Interactions and Their Influence on Platinum Complexes Activity and Toxicity. *Frontiers in Physiology* 9, 1898–1912.

Martins, I., Wang, Y., Michaud, M., Ma, Y., Sukkurwala, A.Q., Shen, S., Kepp, O., Métivier, D., Galluzzi, L., Perfettini, J.-L., et al. (2014). Molecular mechanisms of ATP secretion during immunogenic cell death. *Cell Death & Differentiation* 21, 79–91.

Matzinger, P. (1994). Tolerance, Danger, and the Extended Family. *Annual Review of Immunology* 12, 991–1045.

Matzinger, P. (2002). The Danger Model: A Renewed Sense of Self. *Science* 296, 301–305.

McQuade, R.M., Stojanovska, V., Bornstein, J.C., and Nurgali, K. (2018). PARP inhibition in platinum-based chemotherapy: Chemopotentiation and neuroprotection. *Pharmacological Research* 137, 104–113.

Melero, I., Gaudernack, G., Gerritsen, W., Huber, C., Parmiani, G., Scholl, S., Thatcher, N., Wagstaff, J., Zielinski, C., Faulkner, I., et al. (2014). Therapeutic vaccines for cancer: an overview of clinical trials. *Nature Reviews Clinical Oncology* 11, 509–524.

Mellman, I. (2013). Dendritic Cells: Master Regulators of the Immune Response. *Cancer Immunology Research* 1, 145–149.

Mercier, M.-C., Dontenwill, M., and Choulier, L. (2017). Selection of Nucleic Acid Aptamers Targeting Tumor Cell-Surface Protein Biomarkers. *Cancers* 9, 69–102.

Mercs, L., and Albrecht, M. (2010). Beyond catalysis: N-heterocyclic carbene complexes as components for medicinal, luminescent, and functional materials applications. *Chemical Society Reviews* 39, 1903–1912.

Meyer, D., Ahrens, S., and Strassner, T. (2010). Platinum(IV) Complexes with Chelating N-Heterocyclic Carbene Ligands. *Organometallics* 29, 3392–3396.

Michaud, M., Martins, I., Sukkurwala, A.Q., Adjemian, S., Ma, Y., Pellegatti, P., Shen, S., Kepp, O., Scoazec, M., Mignot, G., et al. (2011). Autophagy-Dependent Anticancer Immune Responses Induced by Chemotherapeutic Agents in Mice. *Science* *334*, 1573–1577.

Michels, J., Vitale, I., Senovilla, L., Enot, D.P., Garcia, P., Lissa, D., Olaussen, K.A., Brenner, C., Soria, J.-C., Castedo, M., et al. (2013). Synergistic interaction between cisplatin and PARP inhibitors in non-small cell lung cancer. *Cell Cycle* *12*, 877–883.

Milling, L., Zhang, Y., and Irvine, D.J. (2017). Delivering safer immunotherapies for cancer. *Advanced Drug Delivery Reviews* *114*, 79–101.

Mittal, D., Gubin, M.M., Schreiber, R.D., and Smyth, M.J. (2014). New insights into cancer immunoediting and its three component phases—elimination, equilibrium and escape. *Current Opinion in Immunology* *27*, 16–25.

Mora, M., Gimeno, M.C., and Visbal, R. (2019). Recent advances in gold–NHC complexes with biological properties. *Chemical Society Reviews* *48*, 447–462.

Morvan, M.G., and Lanier, L.L. (2016). NK cells and cancer: you can teach innate cells new tricks. *Nature Reviews Cancer* *16*, 7–19.

Moulder, D., Hatoum, D., Tay, E., Lin, Y., and McGowan, E. (2018). The Roles of p53 in Mitochondrial Dynamics and Cancer Metabolism: The Pendulum between Survival and Death in Breast Cancer? *Cancers* *10*, 189–210.

Muenzner, J.K., Rehm, T., Biersack, B., Casini, A., de Graaf, I.A.M., Worawutputtpong, P., Noor, A., Kempe, R., Brabec, V., Kasparkova, J., et al. (2015). Adjusting the DNA Interaction and Anticancer Activity of Pt(II) N-Heterocyclic Carbene Complexes by Steric Shielding of the Trans Leaving Group. *Journal of Medicinal Chemistry* *58*, 6283–6292.

## N

Nielsen, S.R., and Schmid, M.C. (2017). Macrophages as Key Drivers of Cancer Progression and Metastasis. *Mediators of Inflammation* *2017*, 1–11.

Nowell, P. (1976). The clonal evolution of tumor cell populations. *Science* *194*, 23–28.

## O

Obeid, M., Tesniere, A., Panaretakis, T., Tufi, R., Joza, N., van Endert, P., Ghiringhelli, F., Apetoh, L., Chaput, N., Flament, C., et al. (2007). Ecto-calreticulin in immunogenic chemotherapy. *Immunological Reviews* *220*, 22–34.

Ocana, A., Nieto-Jiménez, C., Pandiella, A., and Templeton, A.J. (2017). Neutrophils in cancer: prognostic role and therapeutic strategies. *Molecular Cancer* *16*, 137–143.

Oehninger, L., Rubbiani, R., and Ott, I. (2013). N-Heterocyclic carbene metal complexes in medicinal chemistry. *Dalton Trans.* *42*, 3269–3284.

Öfele, K. (1968). 1,3-Dimethyl-4-Imidazolinylliden-(2)-Pentacarbonylchrom ein neuer Übergangsmetall-Carben-Komplex. *Journal of Organometallic Chemistry* *12*, 42–43.

Oun, R., Moussa, Y.E., and Wheate, N.J. (2018). The side effects of platinum-based chemotherapy drugs: a review for chemists. *Dalton Transactions* 47, 6645–6653.

### P

Pahl, J., and Cerwenka, A. (2017). Tricking the balance: NK cells in anti-cancer immunity. *Immunobiology* 222, 11–20.

Palucka, A.K., and Coussens, L.M. (2016). The Basis of Oncoimmunology. *Cell* 164, 1233–1247.

Panaretakis, T., Kepp, O., Brockmeier, U., Tesniere, A., Bjorklund, A.-C., Chapman, D.C., Durchschlag, M., Joza, N., Pierron, G., van Endert, P., et al. (2009). Mechanisms of pre-apoptotic calreticulin exposure in immunogenic cell death. *The EMBO Journal* 28, 578–590.

Paterson, J., and Webster, C.I. (2016). Exploiting transferrin receptor for delivering drugs across the blood-brain barrier. *Drug Discovery Today: Technologies* 20, 49–52.

Pawlowska, E., Szczepanska, J., Szatkowska, M., and Blasiak, J. (2018). An Interplay between Senescence, Apoptosis and Autophagy in Glioblastoma Multiforme—Role in Pathogenesis and Therapeutic Perspective. *International Journal of Molecular Sciences* 19, 889.

Penna, L.S., Henriques, J.A.P., and Bonatto, D. (2017). Anti-mitotic agents: Are they emerging molecules for cancer treatment? *Pharmacology & Therapeutics* 173, 67–82.

Perez-Chanona, E., and Trinchieri, G. (2016). The role of microbiota in cancer therapy. *Current Opinion in Immunology* 39, 75–81.

Peyrone, M. (1844). Ueber die Einwirkung des Ammoniaks auf Platinchlorür. *Annalen der Chemie und Pharmacie* 51, 1–29.

Pohar, J., Lainšček, D., Kunšek, A., Cajnko, M.-M., Jerala, R., and Benčina, M. (2017). Phosphodiester backbone of the CpG motif within immunostimulatory oligodeoxynucleotides augments activation of Toll-like receptor 9. *Scientific Reports* 7, 14598–14608.

Poillet-Perez, L., Despouy, G., Delage-Mourroux, R., and Boyer-Guittaut, M. (2015). Interplay between ROS and autophagy in cancer cells, from tumor initiation to cancer therapy. *Redox Biology* 4, 184–192.

Porchia, M., Pellei, M., Marinelli, M., Tisato, F., Del Bello, F., and Santini, C. (2018). New insights in Au-NHCs complexes as anticancer agents. *European Journal of Medicinal Chemistry* 146, 709–746.

Puyo, S., Montaudon, D., and Pourquier, P. (2014). From old alkylating agents to new minor groove binders. *Critical Reviews in Oncology/Hematology* 89, 43–61.

### R

Raguz, S., and Yagiue, E. (2008). Resistance to chemotherapy: new treatments and novel insights into an old problem. *British Journal of Cancer* 99, 387–391.

Rakebrandt, N., Littringer, K., and Joller, N. (2016). Regulatory T cells: balancing protection versus pathology. *Swiss Medical Weekly* 146, w14343.

Ravanan, P., Srikumar, I.F., and Talwar, P. (2017). Autophagy: The spotlight for cellular stress responses. *Life Sciences* 188, 53–67.

Reya, T., Morrison, S.J., Clarke, M.F., and Weissman, I.L. (2001). Stem cells, cancer, and cancer stem cells. *Nature* 414, 105–111.

Ricci, M.S. (2006). Chemotherapeutic Approaches for Targeting Cell Death Pathways. *The Oncologist* 11, 342–357.

Rosenberg, B., Van Camp, L., and Krigas, T. (1965). Inhibition of Cell Division in *Escherichia coli* by Electrolysis Products from a Platinum Electrode. *Nature* 205, 698–699.

Rosenberg, B., Vancamp, L., Trosko, J.E., and Mansour, V.H. (1969). Platinum Compounds: a New Class of Potent Antitumour Agents. *Nature* 222, 385–386.

Roulois, D., Grégoire, M., and Fonteneau, J.-F. (2013). MUC1-Specific Cytotoxic T Lymphocytes in Cancer Therapy: Induction and Challenge. *BioMed Research International* 2013, 1–10.

## S

Schonberg, D.L., Miller, T.E., Wu, Q., Flavahan, W.A., Das, N.K., Hale, J.S., Hubert, C.G., Mack, S.C., Jarrar, A.M., Karl, R.T., et al. (2015). Preferential Iron Trafficking Characterizes Glioblastoma Stem-like Cells. *Cancer Cell* 28, 441–455.

Schreiber, R.D., Old, L.J., and Smyth, M.J. (2011). Cancer Immunoediting: Integrating Immunity's Roles in Cancer Suppression and Promotion. *Science* 331, 1565–1570.

Sell, S. (2004). Stem cell origin of cancer and differentiation therapy. *Critical Reviews in Oncology/Hematology* 51, 1–28.

Serrano-del Valle, A., Anel, A., Naval, J., and Marzo, I. (2019). Immunogenic Cell Death and Immunotherapy of Multiple Myeloma. *Frontiers in Cell and Developmental Biology* 7, 50–71.

Shackleton, M., Quintana, E., Fearon, E.R., and Morrison, S.J. (2009). Heterogeneity in Cancer: Cancer Stem Cells versus Clonal Evolution. *Cell* 138, 822–829.

Singh, S.S., Vats, S., Chia, A.Y.-Q., Tan, T.Z., Deng, S., Ong, M.S., Arfuso, F., Yap, C.T., Goh, B.C., Sethi, G., et al. (2018). Dual role of autophagy in hallmarks of cancer. *Oncogene* 37, 1142–1158.

Sisirak, V., Faget, J., Vey, N., Blay, J.-Y., Ménétrier-Caux, C., Caux, C., and Bendriss-Vermare, N. (2013). Plasmacytoid dendritic cells deficient in IFN $\alpha$  production promote the amplification of FOXP3<sup>+</sup> regulatory T cells and are associated with poor prognosis in breast cancer patients. *OncoImmunology* 2, e22338.

Skander, M., Retailleau, P., Bourrié, B., Schio, L., Mailliet, P., and Marinetti, A. (2010). N-Heterocyclic Carbene-Amine Pt(II) Complexes, a New Chemical Space for the Development of Platinum-Based Anticancer Drugs. *Journal of Medicinal Chemistry* 53, 2146–2154.

Stepensky, D., Tzehoval, E., Vadai, E., and Eisenbach, L. (2006). O-glycosylated versus non-glycosylated MUC1-derived peptides as potential targets for cytotoxic immunotherapy of carcinoma. *Clinical and Experimental Immunology* 143, 139–149.

Sternberg, C., Whelan, P., Hetherington, J., Paluchowska, B., Slee, P., Vekemans, K., Van Erps, P., Theodore, C., Koriakine, O., Oliver, T., et al. (2005). Phase III trial of satraplatin, an oral platinum plus prednisone vs. prednisone alone in patients with hormone-refractory prostate cancer. *Oncology* 68, 2–9.

Street, S.E.A., Cretney, E., and Smyth, M.J. (2001). Perforin and interferon-gamma activities independently control tumor initiation, growth, and metastasis. *Blood* 97, 192–197.

## T

Tesniere, A., Schlemmer, F., Boige, V., Kepp, O., Martins, I., Ghiringhelli, F., Aymeric, L., Michaud, M., Apetoh, L., Barault, L., et al. (2010). Immunogenic death of colon cancer cells treated with oxaliplatin. *Oncogene* 29, 482–491.

Teyssot, M.-L., Jarrousse, A.-S., Manin, M., Chevy, A., Roche, S., Norre, F., Beaudoin, C., Morel, L., Boyer, D., Mahiou, R., et al. (2009). Metal-NHC complexes: a survey of anti-cancer properties. *Dalton Transactions* 35, 6894–6902.

Tivnan, A., Heilinger, T., Lavelle, E.C., and Prehn, J.H.M. (2017). Advances in immunotherapy for the treatment of glioblastoma. *Journal of Neuro-Oncology* 131, 1–9.

Tong, W.-W., Tong, G.-H., and Liu, Y. (2018). Cancer stem cells and hypoxia-inducible factors (Review). *International Journal of Oncology* 53, 469–476.

## V

Vaisman, A., Varchenko, M., and Umar, A. (1998). The Role of hMLH1, hMSH3, and hMSH6 Defects in Cisplatin and Oxaliplatin Resistance: Correlation with Replicative Bypass of Platinum-DNA Adducts. *Cancer Research* 58, 3579–3585.

Vallentin, B., Barlogis, V., Piperoglou, C., Cypowyj, S., Zucchini, N., Chene, M., Navarro, F., Farnarier, C., Vivier, E., and Vely, F. (2015). Innate Lymphoid Cells in Cancer. *Cancer Immunology Research* 3, 1109–1114.

Venere, M., Fine, H.A., Dirks, P.B., and Rich, J.N. (2011). Cancer stem cells in gliomas: Identifying and understanding the apex cell in cancer's hierarchy. *Glia* 59, 1148–1154.

Vesely, M.D., Kershaw, M.H., Schreiber, R.D., and Smyth, M.J. (2011). Natural Innate and Adaptive Immunity to Cancer. *Annual Review of Immunology* 29, 235–271.

Viaud, S., Daillere, R., Boneca, I.G., Lepage, P., Pittet, M.J., Ghiringhelli, F., Trinchieri, G., Goldszmid, R., and Zitvogel, L. (2014). Harnessing the Intestinal Microbiome for Optimal Therapeutic Immunomodulation. *Cancer Research* 74, 4217–4221.

Vigneron, N. (2015). Human Tumor Antigens and Cancer Immunotherapy. *BioMed Research International* 2015, 1–17.

## W

Wai-Yin Sun, R., Lok-Fung Chow, A., Li, X.-H., Yan, J.J., Sin-Yin Chui, S., and Che, C.-M. (2011). Luminescent cyclometalated platinum(II) complexes containing N-heterocyclic carbene ligands with potent in vitro and in vivo anti-cancer properties accumulate in cytoplasmic structures of cancer cells. *Chemical Science* 2, 728–736.

Walsh, K.P., and Mills, K.H.G. (2013). Dendritic cells and other innate determinants of T helper cell polarisation. *Trends in Immunology* 34, 521–530.

Wang, K., Lu, J., and Li, R. (1996). The events that occur when cisplatin encounters cells. *Coordination Chemistry Reviews* 151, 53–88.

Wang, Y., Martins, I., Ma, Y., Kepp, O., Galluzzi, L., and Kroemer, G. (2013). Autophagy-dependent ATP release from dying cells via lysosomal exocytosis. *Autophagy* 9, 1624–1625.

Wantz, M., Bouché, M., Dahm, G., Chekkat, N., Fournel, S., and Bellemin-Lapponnaz, S. (2018). N-Heterocyclic Carbene-Polyethyleneimine (PEI) Platinum Complexes Inducing Human Cancer Cell Death: Polymer Carrier Impact. *International Journal of Molecular Sciences* 19, 3472–3482.

Wanzlick, H.W. (1962). Aspects of Nucleophilic Carbene Chemistry. *Angewandte Chemie International Edition in English* 1, 75–80.

Wanzlick, H.-W., and Schönherr, H.-J. (1968). Direct Synthesis of a Mercury Salt-Carbene Complex. *Angewandte Chemie International Edition in English* 7, 141–142.

Werner, A. (1893). Beitrag zur Konstitution anorganischer Verbindungen. *Zeitschrift für anorganische Chemie* 3, 267–330.

Wexselblatt, E., Yavin, E., and Gibson, D. (2012). Cellular interactions of platinum drugs. *Inorganica Chimica Acta* 393, 75–83.

Whiteside, T.L. (2012). What are regulatory T cells (Treg) regulating in cancer and why? *Seminars in Cancer Biology* 22, 327–334.

Wolf, D., Sopper, S., Pircher, A., Gastl, G., and Wolf, A.M. (2015). Treg(s) in Cancer: Friends or Foe?: The ambiguous role of Treg in cancer. *Journal of Cellular Physiology* 230, 2598–2605.

Wu, P.-H., Onodera, Y., Ichikawa, Y., Rankin, E., Giaccia, A., Watanabe, Y., Qian, W., Hashimoto, T., Shirato, H., and Nam, J.-M. (2017). Targeting integrins with RGD-conjugated gold nanoparticles in radiotherapy decreases the invasive activity of breast cancer cells. *International Journal of Nanomedicine* 12, 5069–5085.

## Y

Yang, H., Villani, R.M., Wang, H., Simpson, M.J., Roberts, M.S., Tang, M., and Liang, X. (2018). The role of cellular reactive oxygen species in cancer chemotherapy. *Journal of Experimental & Clinical Cancer Research* 37, 266–275.

Yang, Z., Faustino, P.J., Andrews, P.A., Monastra, R., Rasmussen, A.A., Ellison, C.D., and Cullen, K.J. (2000). Decreased cisplatin/DNA adduct formation is associated with cisplatin resistance in human head and neck cancer cell lines. *Cancer Chemotherapy and Pharmacology* 46, 255–262.

Yang, Z., Schumaker, L.M., Egorin, M.J., Zuhowski, E.G., Guo, Z., and Cullen, K.J. (2006). Cisplatin Preferentially Binds Mitochondrial DNA and Voltage-Dependent Anion Channel Protein in the Mitochondrial Membrane of Head and Neck Squamous Cell Carcinoma: Possible Role in Apoptosis. *Clinical Cancer Research* 12, 5817–5825.

Yu, Z., Xu, Z., DiSante, G., Wright, J., Wang, M., Li, Y., Zhao, Q., Ren, T., Ju, X., Gutman, E., et al. (2014). miR-17/20 sensitization of breast cancer cells to chemotherapy-induced apoptosis requires *Akt1*. *Oncotarget* 5, 1083–1090.

Yuan, X., Wang, B., Yang, L., and Zhang, Y. (2018). The role of ROS-induced autophagy in hepatocellular carcinoma. *Clinics and Research in Hepatology and Gastroenterology* 42, 306–312.

Yuen, G.J., Demissie, E., and Pillai, S. (2016). B Lymphocytes and Cancer: A Love–Hate Relationship. *Trends in Cancer* 2, 747–757.

## Z

Zhao, Q.-Q., Chen, J.-L., Lv, T.-F., He, C.-X., Tang, G.-P., Liang, W.-Q., Tabata, Y., and Gao, J.-Q. (2009). N/P Ratio Significantly Influences the Transfection Efficiency and Cytotoxicity of a Polyethylenimine/Chitosan/DNA Complex. *Biological & Pharmaceutical Bulletin* 32, 706–710.

Zhao, Y., Niu, C., and Cui, J. (2018). Gamma-delta ( $\gamma\delta$ ) T cells: friend or foe in cancer development? *Journal of Translational Medicine* 16, 3–15.

Zhou, B.-B.S., Zhang, H., Damelin, M., Geles, K.G., Grindley, J.C., and Dirks, P.B. (2009). Tumour-initiating cells: challenges and opportunities for anticancer drug discovery. *Nature Reviews Drug Discovery* 8, 806–823.

Zhou, J., Wang, G., Chen, Y., Wang, H., Hua, Y., and Cai, Z. (2019). Immunogenic cell death in cancer therapy: Present and emerging inducers. *Journal of Cellular and Molecular Medicine* 23, 4854–4865.

Zitvogel, L., Apetoh, L., Ghiringhelli, F., André, F., Tesniere, A., and Kroemer, G. (2008). The anticancer immune response: indispensable for therapeutic success? *Journal of Clinical Investigation* 118, 1991–2001.



Zitvogel, L., Galluzzi, L., Smyth, M.J., and Kroemer, G. (2013). Mechanism of Action of Conventional and Targeted Anticancer Therapies: Reinstating Immunosurveillance. *Immunity* 39, 74–88.

Zou, T., Lok, C.-N., Wan, P.-K., Zhang, Z.-F., Fung, S.-K., and Che, C.-M. (2018). Anticancer metal-N-heterocyclic carbene complexes of gold, platinum and palladium. *Current Opinion in Chemical Biology* 43, 30–36.





# Appendix



## Publications

---

**Wantz, M.**, Bouché, M., Dahm, G., Chekkat, N., Fournel, S., and Bellemin-Lapponnaz, S. (2018). N-heterocyclic carbene-polyethyleneimine (PEI) platinum complexes inducing human cancer cell death: polymer carrier impact. *Int J Mol Sci.* 19 (11), 3472

Chekkat, N., Dahm, G., Chardon, E., **Wantz, M.**, Sitz, J., Decossas, M., Lambert, O., Frisch, B., Rubbiani, R., Gasser, G., Guichard, G., Fournel, S., and Bellemin-Lapponnaz, S. (2016). N-heterocyclic carbene-polyethylenimine platinum complexes with potent in vitro and in vivo antitumor efficacy. *Bioconjug Chem* 27 (8), 1942-1948

Bouché, M., Dahm, G., **Wantz, M.**, Fournel, S., Achard, T., Bellemin-Lapponnaz, S. (2016). Platinum(IV) N-heterocyclic carbene complexes: their synthesis, characterisation and cytotoxic activity. *Dalton Trans* 45 (28), 11362-11368

### Abstract

**Wantz, M.**, Chekkat, N., Bouché, M., Dahm, G., Kichler, A., Frisch, B., Bellemin-Lapponnaz, S., and Fournel, S. (2019). Innovative antitumoral platinum (II) compounds as chemotherapeutic and immunotherapeutic agents. The 6<sup>th</sup> Leading International Cancer Immunotherapy Conference in Europe, *Eur J Cancer* 110, S31-S32

### In preparation

**Wantz, M.**, Dussouillez, C., Mercier, M.-C., Bouché, M., Dontenwill, M., Bellemin-Lapponnaz, S., Kichler, A., and Fournel, S. Targeting glioblastoma-derived cancer stem cells with N-heterocyclic carbene platinum complexes.

**Wantz, M.**, Bouché, M., Seguin, C., Jacobberger-Foissac, C., Brion, A., Kichler, A., Bellemin-Lapponnaz, S., and Fournel, S. Development and evaluation of innovative platinum compounds able to activate the antitumor immune response

## Communications

---

### Oral communications

**M. Wantz**, N. Chekkat, M. Bouché, G. Dahm, B. Frisch, S. Bellemin-Laponnaz, S. Fournel  
Development and evaluation of innovative platinum derivatives as new anticancer agents  
*UMR7199 Symposium, 18-19 December 2017, Goersdorf (France)*

**M. Wantz**, N. Chekkat, M. Bouché, G. Dahm, B. Frisch, S. Bellemin-Laponnaz, S. Fournel  
Innovative antitumoral platinum (II) compounds able to induce immunogenic cell death?  
*Doctoral School Days, 8-9 March 2018, Strasbourg (France)*

**M. Wantz**, N. Chekkat, M. Bouché, G. Dahm, B. Frisch, S. Bellemin-Laponnaz, S. Fournel  
Development of innovative antitumoral platinum (II) compounds to induce immunogenic cell death  
*Journées du Campus d'Illkirch, 15-16 May 2018, Illkirch (France)*

**M. Wantz**, N. Chekkat, M. Bouché, G. Dahm, B. Frisch, S. Bellemin-Laponnaz, S. Fournel  
Development of innovative antitumoral platinum (II) compounds able to activate the antitumor immune response  
*Forum BioChem, 7-8 June 2018, Strasbourg (France)* (Award for the best oral communication)

### Poster communications

**M. Wantz**, N. Chekkat, M. Bouché, G. Dahm, B. Frisch, S. Bellemin-Laponnaz, S. Fournel  
Induction of immunogenic cell death by innovative antitumoral platinum(II) compounds  
*Journées du Campus d'Illkirch, 27-28 March 2017, Illkirch (France)*

**M. Wantz**, N. Chekkat, M. Bouché, G. Dahm, B. Frisch, S. Bellemin-Laponnaz, S. Fournel  
Innovative antitumoral platinum (II) compounds able to induce immunogenic cell death?  
*Meeting of the Upper Rhine Immunology Group, 1<sup>st</sup> December 2017, Illkirch (France)*

**M. Wantz**, N. Chekkat, M. Bouché, G. Dahm, B. Frisch, S. Bellemin-Laponnaz, S. Fournel  
Induction of immunogenic cell death by innovative antitumoral platinum (II) compounds  
*5<sup>th</sup> European Congress of Immunology, 2-5 September 2018, Amsterdam (Netherlands)*

**M. Wantz**, N. Chekkat, M. Bouché, G. Dahm, B. Frisch, S. Bellemin-Laponnaz, S. Fournel  
Development of innovative platinum (II) compounds for the activation of the antitumor immune response

*Meeting of the Upper Rhine Immunology Group, 19 October 2018, Freiburg (Germany)*

**M. Wantz**, N. Chekkat, M. Bouché, G. Dahm, B. Frisch, S. Bellemin-Laponnaz, S. Fournel  
Association of innovative platinum (II) compounds with polyI:C to activate the antitumor immune response

*Journées du Campus d'Illkirch, 1-2 April 2019, Illkirch (France)*

**M. Wantz**, N. Chekkat, M. Bouché, G. Dahm, B. Frisch, S. Bellemin-Laponnaz, S. Fournel  
Innovative antitumoral platinum (II) compounds as chemotherapeutic and immunotherapeutic agents

*6<sup>th</sup> Immunotherapy of Cancer Conference, 11-13 April 2019, Vienne (Austria)*



## Résumé français

### Evaluation de composés innovants à base de platine pour un traitement antitumoral combinant la chimiothérapie et l'immunothérapie

---

Cette thèse a été réalisée sous la direction du Professeur Sylvie Fournel à l'UMR7199 – Laboratoire de Conception et Application de Molécules Bioactives – Equipe 3Bio à l'Université de Strasbourg.

#### Contexte et objectifs

Les médicaments à base de platine (II), appelés «dérivés de platine», tels que l'oxaliplatine, le cisplatine ou le carboplatine, font partie des agents de chimiothérapie les plus utilisés. Cependant, malgré leur capacité importante à tuer les cellules tumorales, ces molécules présentent de nombreux effets secondaires touchant par exemple le système nerveux (neurotoxicité), le système auditif (ototoxicité) ou encore le système rénal (néphrotoxicité) (McWhinney et al., 2009). En outre, des résistances aux traitements à base de dérivés de platine ont été observées, limitant ainsi leur efficacité (Gottesman et al., 2016). Voilà pourquoi, mon laboratoire d'accueil en collaboration avec l'équipe de Stéphane Bellemin-Laponnaz de l'Institut de Physique et de Chimie des Matériaux de Strasbourg (IPCMS) s'est intéressé au développement de molécules innovantes à base de Pt(II) ayant la même efficacité cytotoxique, mais moins d'effets secondaires : les carbènes N-hétérocycliques liés au Pt(II) (Chekkat et al., 2016). Parmi les molécules que les membres de l'équipe de Stéphane Bellemin-Laponnaz ont synthétisées, plusieurs présentent *in vitro* une activité cytotoxique significative sur des lignées tumorales humaines de différentes origines. Afin de faciliter leur utilisation *in vivo*, ils ont décidé d'associer ces complexes à un agent de transfection, le polyéthylèneimine (PEI), dans le but d'augmenter leur solubilité et leur biodisponibilité. Ainsi, ils ont développé des molécules comportant un PEI linéaire de 25 kDa portant un résidu de Pt(II) tous les 30 monomères de PEI (Chekkat et al., 2016).

Des premières études ont montré que ces complexes NHC-Pt(II)-PEI30 peuvent s'organiser en nanoparticules présentant une cytotoxicité *in vitro* contre plusieurs lignées de cellules tumorales ainsi qu'*in vivo* dans des souris immunodéficientes xénotransplantées avec un carcinome du colon humain, la lignée HCT116 (Chekkat et al., 2016). Des analyses réalisées en partie pendant mon stage de M2 ont révélé que le NHC-Pt(II)-PEI30, contrairement à l'oxaliplatine, induisait des modifications mitochondriales conduisant à la production d'espèces réactives de l'oxygène, suggérant ainsi un mécanisme d'action différent (Chekkat et al., 2016).



**L'objectif principal de ma thèse consiste à développer et évaluer des composés de platine innovants pour une utilisation non seulement comme agents de chimiothérapie, mais aussi comme agents d'immunothérapie.**

Tout d'abord, la **première partie** de la thèse a eu pour but de **tester plusieurs dérivés de platine**, synthétisés par les chimistes de l'équipe de Stéphane Bellemin-Laponnaz, afin de trouver le meilleur candidat présentant un profil cytotoxique similaire voire amélioré comparé aux dérivés déjà utilisés en clinique tout en provoquant moins d'effets secondaires.

Certains types de cancers étant résistants à la chimiothérapie à base de composés de platine, le **deuxième objectif** de la thèse a été de déterminer la capacité du NHC-Pt(II)-PEI30, le dérivé le plus prometteur, à **tuer** des cellules tumorales résistantes à de nombreux traitements : **les cellules souches cancéreuses (CSC)**.

L'immunothérapie antitumorale est un traitement qui consiste en l'induction ou l'augmentation de la réponse immunitaire contre les cellules tumorales afin de les détruire. Au cours des dernières années, des études ont montré que les agents chimiothérapeutiques étaient plus efficaces dans des individus immunocompétents et que certains dérivés de platine étaient capables d'activer le système immunitaire ([Zitvogel et al, 2013](#), [Tesniere et al, 2010](#)). Voilà pourquoi, **l'analyse et l'amélioration du potentiel immunothérapeutique** du NHC-Pt(II)-PEI30 a constitué mon **troisième objectif** de la thèse.

### **Optimisation de composés innovants à base de platine**

Les dérivés de platine qui sont actuellement utilisés en clinique ont de nombreux effets secondaires limitant ainsi leur utilisation. Voilà pourquoi, mon laboratoire d'accueil en collaboration avec l'équipe de Stéphane Bellemin-Laponnaz a décidé de développer de nouveaux composés antitumoraux à base de platine : les carbènes N-hétérocycliques liés au platine et associés au polyéthylèneimine. Des études précédentes avaient montré que le composé portant un atome de platine toutes les 30 répétitions d'éthylènediamine présentait une importante efficacité cytotoxique *in vitro* contre plusieurs lignées de cellules cancéreuses ([Chekkat et al, 2016](#)). Dans un premier temps, nous avons voulu savoir si la modification du nombre de monomères de PEI entre les atomes de platine pouvait augmenter l'effet antitumoral de ce composé. Ainsi, les chimistes ont synthétisé des dérivés portant un atome de platine toutes les 40 et toutes les 100 répétitions d'éthylènediamine. Cependant, les résultats ont démontré que le composé le plus efficace restait le NHC-Pt(II)-PEI30 ([Wantz et al, 2018](#)). Voilà pourquoi, nous avons continué toutes nos études avec ce dérivé.

En parallèle, j'ai été amenée à travailler sur des molécules de type NHC-Pt(IV) dans lesquelles le platine (II) est remplacé par un platine (IV) plus stable *in vivo*. Nous avons montré *in vitro* que le NHC-Pt(IV) tout comme le NHC-Pt(II) pouvait induire l'apoptose des cellules tumorales et modifier l'activité mitochondriale (Bouché et al, 2016). Cependant, il n'a pas été possible de l'associer à du PEI pour des études *in vivo*.

Le mode d'action du cisplatine, du carboplatine et de l'oxaliplatine repose sur la formation d'adduits à l'ADN conduisant à l'apoptose de la cellule tumorale. Jusqu'à présent, le mécanisme d'action du NHC-Pt(II)-PEI30 n'est pas encore élucidé. Pourtant, la sensibilité de cellules cancéreuses résistantes aux médicaments de platine conventionnels, ainsi que des modifications au niveau du fonctionnement mitochondrial semblent indiquer un mécanisme différent pour le NHC-Pt(II)-PEI30. Ainsi, pour pouvoir suivre le devenir des complexes dans la cellule cancéreuse, les chimistes ont modifié le NHC-Pt(II)-PEI30 en y accrochant des fluorochromes. Ils ont ainsi marqué soit le PEI soit le carbène N-hétérocyclique. Des analyses réalisées sur les cellules cancéreuses HCT116, issues d'un carcinome colorectal humain, ont montré que la cytotoxicité de ces complexes n'est pas modifiée par l'ajout des fluorochromes et qu'ils entrent dans la cellule sans doute par endocytose (Wantz et al, 2018). Des observations par microscopie confocale sont en cours pour déterminer la localisation exacte des complexes à l'intérieur de la cellule cancéreuse dans le but de mieux comprendre le devenir du NHC-Pt(II)-PEI30 et ainsi appréhender plus précisément son mode d'action.

### **Evaluation de l'effet du NHC-Pt(II)-PEI30 sur des cellules souches de glioblastome**

L'efficacité de la chimiothérapie à base de composés de platine est limitée due à des résistances des cellules tumorales. En effet, certains types de cancers ne sont pas sensibles à un traitement au platine (résistance intrinsèque), tandis que d'autres cellules cancéreuses développent une résistance suite à une exposition prolongée aux composés de platine (résistance acquise) (Gottesman et al, 2016). Plusieurs mécanismes cellulaires peuvent être à l'origine de ces résistances. Par exemple, il s'est également avéré qu'un type cellulaire particulier au sein de la tumeur affectait la sensibilité de certains traitements anticancéreux : les cellules souches cancéreuses (CSC). Ces cellules présentent des caractéristiques communes avec les cellules souches, à savoir la capacité d'auto-renouvellement et de différenciation multipotente (Konrad et al, 2017). De plus, la biogenèse mitochondriale est essentielle pour la survie et la prolifération des CSC (Lamb et al, 2015). Précédemment, notre équipe a déjà montré que le NHC-Pt(II)-PEI30 semblait avoir un mécanisme d'action

différent des dérivés de platine conventionnels, car il était capable de tuer des cellules cancéreuses mutées pour la protéine p53 et de ce fait résistantes à l'oxaliplatine et au cisplatine. Des expériences réalisées en partie pendant mon stage de M2 ont montré que le NHC-Pt(II)-PEI30 avait un impact sur le fonctionnement mitochondrial en favorisant l'accumulation d'espèces réactives de l'oxygène (Chekkat et al, 2016). Au vu de ces observations, nous avons émis l'hypothèse que notre composé de platine pourrait induire la mort cellulaire des CSC en affectant la mitochondrie, organe cellulaire important pour la survie des CSC. Nous avons commencé par l'étude de la cytotoxicité du NHC-Pt(II)-PEI30 sur des cellules souches de glioblastomes. Les expériences ont montré une sensibilité de ces cellules à notre composé de platine, ce qui n'a pas été le cas pour un traitement à l'oxaliplatine ou même au témozolomide, le traitement de référence du glioblastome en clinique. Des analyses plus détaillées ont révélé que le NHC-Pt(II)-PEI30 pouvait favoriser l'apoptose des CSC et modifier le fonctionnement mitochondrial. Ceci s'est traduit par une diminution du nombre de mitochondries fonctionnelles ainsi qu'une accumulation d'ions superoxydes dans les cellules. Ces résultats semblent souligner un effet cytotoxique de notre composé de platine sur ces cellules résistantes à de nombreux traitements anticancéreux (article en préparation).

### **Analyse et amélioration du potentiel immunothérapeutique du NHC-Pt(II)-PEI30**

Des études ont montré que certains dérivés de platine, comme l'oxaliplatine, peuvent favoriser un type de mort cellulaire capable d'induire une réponse immunitaire antitumorale : la mort immunogène (Dudek et al, 2013). Nous avons donc émis l'hypothèse que le NHC-Pt(II)-PEI30 pourrait augmenter la réponse immunitaire antitumorale en induisant une mort immunogène, qui est caractérisée par la sécrétion ou l'expression à la surface des cellules tumorales apoptotiques de molécules de dommages cellulaires (DAMP). Trois DAMP jouent un rôle prépondérant dans la réponse immunitaire antitumorale : la calréticuline, l'ATP et la protéine HMGB1. Ainsi, le premier signe d'une mort immunogène, à savoir l'exposition de la chaperone calréticuline à la surface de cellules HCT116 issues d'un carcinome colorectal humain a été déterminée après traitement avec le NHC-Pt(II)-PEI30. De plus, le surnageant de culture de ces cellules traitées avec le NHC-Pt(II)-PEI30 et renfermant potentiellement les DAMP dans le cas d'une mort immunogène a été transféré sur des macrophages afin d'évaluer sa capacité à activer ces cellules immunitaires. Les résultats ont montré une légère exposition de la calréticuline à la surface des cellules HCT116 ainsi qu'une faible activation des macrophages, suggérant une faible induction de la mort immunogène.

Dans le but d'améliorer le potentiel immunothérapeutique de notre composé, nous avons décidé de l'associer à des signaux de danger pouvant cibler des récepteurs des cellules immunitaires. Pour cela, nous avons profité de la capacité du PEI à compacter des acides nucléiques. Ainsi, nous avons complexé le NHC-Pt(II)-PEI30 avec l'acide polyinosinique:polycytidylique (polyI:C), un analogue synthétique d'un ARN double brin connu comme agoniste du TLR3. Les résultats ont indiqué que la formation du complexe NHC-Pt(II)-PEI30-polyI:C ne modifie pas l'activité cytotoxique de notre composé de platine *in vitro*. Des analyses plus profondes semblent suggérer une légère capacité des complexes à activer les cellules immunitaires sans augmenter l'induction de la mort immunogène des cellules cancéreuses (article en préparation). Des études *in vivo* dans des modèles précliniques murins sont en cours.

## Conclusion

L'ensemble de ces résultats ont été réalisés dans le but de développer un traitement antitumoral à base de platine en combinant la chimiothérapie et l'immunothérapie.

Dans un premier temps, nous avons sélectionné un candidat qui présente un profil cytotoxique important *in vitro* et *in vivo*, tout en limitant les effets secondaires : le NHC-Pt(II)-PEI30.

Ensuite, nous avons pu montrer que ce complexe était également capable de favoriser l'apoptose de cellules souches cancéreuses de glioblastome, des cellules responsables de la réapparition de plusieurs cancers et résistantes à de nombreux traitements anticancéreux.

Finalement, nous avons constaté que le NHC-Pt(II)-PEI30 seul ne pouvait pas induire une mort immunogène des cellules cancéreuses et ainsi activer le système immunitaire. Voilà pourquoi, nous avons associé notre composé de platine à un agoniste de TLR3, le polyI:C, pour augmenter la réponse immunitaire antitumorale.

## Références

---

Bouché, M., Dahm, G., **Wantz, M.**, Fournel, S., Achard, T., and Bellemin-Lapponnaz, S. (2016). Platinum(IV) N-heterocyclic carbene complexes: their synthesis, characterisation and cytotoxic activity. *Dalton Trans* 45, 11362-11368

Chekkat, N., Dahm, G., Chardon, E., **Wantz, M.**, Sitz, J., Decossas, M., Lambert, O., Frisch, B., Rubbiani, R., Gasser, G., Guichard, G., Fournel, S., and Bellemin-Lapponnaz, S. (2016). N-Heterocyclic Carbene-Polyethyleneimine Platinum Complexes with Potent *in vitro* and *in vivo* Antitumor Efficacy. *Bioconjugate Chem.* 27, 1942-1948

Dudek, A.M., Garg, A.D., Krysko, D.V., De Ruyscher, D., and Agostinis, P. (2013). Inducers of immunogenic cancer cell death. *Cytokine Growth Factor Rev.* 24, 319-333

- Gottesman, M.M., Lavi, O., Hall, M.D., and Gillet, J. (2016). Toward a better understanding of the complexity of cancer drug resistance. *Annu. Rev. Pharmacol. Toxicol.* 56, 85-102
- Konrad, C.V., Murali, R., Varghese, B.A., and Nair, R. (2017). The role of cancer stem cells in tumor heterogeneity and resistance to therapy. *Can. J. Physiol. Pharmacol.* 95, 1-15
- Lamb, R., Ozsvari, B., Lisanti, C.L., Tanowitz, H.B., Howell, A., Martinez-Outschoorn, U.E., Sotgia, F., and Lisanti M.P. (2016). Antibiotics that target mitochondria effectively eradicate cancer stem cells, across multiple tumor types: Treating cancer like an infectious disease. *Oncotarget* 6, 4569-4584
- McWhinney, S., Goldberg, R.M., and McLeod, H.L. (2009). Platinum neurotoxicity pharmacogenetics. *Mol. Cancer Ther.* 8, 10-16
- Tesniere, A., Schlemmer, F., Boige, V., Kepp, O., Martins, I., Ghiringhelli, F., Aymeric, L., Michaud, M., Apetoh, L., Barault, L., Mendibourne, J., Pignon, J., Jooste, V., van Endert, P., Ducreux, M., Zitvogel, L., Piard, F., and Kroemer, G. (2010). Immunogenic death of colon cancer cells treated with oxaliplatin. *Oncogene* 29, 482-491
- Wantz, M.**, Bouché, M., Dahm, G., Chekkat, N., Fournel, S., and Bellemin-Laponnaz, S. (2018). N-heterocyclic carbene-polyethyleneimine (PEI) platinum complexes inducing human cancer cell death: polymer carrier impact. *Int J Mol Sci.* 19, 3472
- Zitvogel, L., Galluzzi, L., Smyth, M.J., and Kroemer, G. (2013). Mechanism of action of conventional and targeted anticancer therapies: reinstating immunosurveillance. *Immunity* 39, 74-88

Cite this: *Dalton Trans.*, 2016, **45**,  
11362

## Platinum(IV) N-heterocyclic carbene complexes: their synthesis, characterisation and cytotoxic activity†

M. Bouché,<sup>a</sup> G. Dahm,<sup>a</sup> M. Wantz,<sup>b</sup> S. Fournel,<sup>b</sup> T. Achard<sup>a</sup> and  
S. Bellemin-Laponnaz<sup>\*a,c</sup>

Platinum(II) N-heterocyclic carbene complexes have been oxidized by bromine or iodobenzene dichloride to provide the fully characterised corresponding platinum(IV) NHC complexes. Antiproliferative activities of Pt(IV) NHC complexes were assayed against several cancer cell lines and the results were correlated with respect to their stability. Mechanistic investigations revealed that mitochondrial dysfunction and ROS production were associated with the cytotoxic process induced by these compounds.

Received 10th May 2016,  
Accepted 10th June 2016

DOI: 10.1039/c6dt01846g

www.rsc.org/dalton

### Introduction

Cisplatin and its platinum(II) derivatives such as oxaliplatin play a key role as anticancer agents despite their dose-dependent toxicity and acquired – or intrinsic – drug resistances. These severe side effects are important factors motivating scientists to design new drugs that can overcome the stated limitations of clinically used Pt compounds.<sup>1</sup>

It is generally accepted that the mechanism of action of cisplatin involves adduct formation with DNA, which causes DNA damage and subsequently induces cell death.<sup>2,3</sup> Undoubtedly, these Pt(II) complexes can also interact with other cellular macromolecules and induce a parallel mode of action, which is different from DNA damage.<sup>2,4</sup> These mechanisms could modify other intracellular signalling pathways that regulate cancer cell survival. A current strategy to circumvent the drawbacks of cisplatin derivatives is by the exploration of these parallel mechanisms.<sup>5</sup>

In this direction, platinum(II) N-heterocyclic carbene (NHC) complexes have shown very promising results for the development of anticancer drugs.<sup>6</sup> NHCs have emerged as a privileged class of ligands in part due to their strong binding to transition metals and their modularity.<sup>7</sup> Several Pt(II) NHC complexes have been successfully considered as drug candidates with higher

activities than that of cisplatin.<sup>8</sup> Recent mechanistic investigations suggest that these compounds most likely interact with not only DNA but also target mitochondria, thus providing a basis for the development of new drugs against cancer.<sup>8,9</sup>

In another way, encouraging results were reached by oxidation of diamine Pt(II) derivatives into platinum(IV) species.<sup>10</sup> These Pt(IV) complexes usually are converted *in vivo* into active Pt(II) species under an intracellular reducing environment.<sup>11</sup> They were found to be more stable with fewer side effects and could even be administered orally rather than intravenously. Altogether, they offer the potential for achieving a significantly improved therapy of many cancer types.

Encouraged by these results, the synthesis of Pt(IV) NHC complexes by the direct oxidation of Pt(II) NHC precursors was investigated. Herein, we describe the synthesis, characterization, reactivity and stability of related Pt(IV) NHC complexes. We also report their cytotoxic activities against various cancer cell lines together with preliminary biological studies.

### Results and discussion

#### Synthetic procedure and characterization

Based on previous reports on forming platinum(IV) complexes, our strategy was to oxidize the [(NHC)PtX<sub>2</sub>(pyridine)] scaffold with a suitable reagent.<sup>12</sup> Indeed, complete conversion of the [(IMeBn)Pt<sub>2</sub>(pyridine)] (IMeBn = 1-methyl-3-benzylimidazol-2-ylidene) precursor can be achieved by rapid exposure to a slight excess of bromine reagent. The resulting *trans* Pt(IV) complex [(NHC)PtBr<sub>4</sub>(pyridine)] **1<sub>Br</sub>** was isolated in quantitative yield by a simple precipitation with pentane. This procedure was extended to a larger range of complexes as shown in Scheme 1. Excellent yields were obtained in all cases.

<sup>a</sup>Institut de Physique et Chimie des Matériaux de Strasbourg, Université de Strasbourg-CNRS UMR7504, 23 rue du Loess, BP 43, 67034 Strasbourg Cedex 2, France. E-mail: bellemin@unistra.fr; Fax: +33 388107246; Tel: +33 388107166

<sup>b</sup>Faculté de Pharmacie, Université de Strasbourg-CNRS UMR 7199, 74 Route du Rhin, BP 60024, 67401 Illkirch Cedex, France

<sup>c</sup>University of Strasbourg Institute for Advanced Study (USIAS), 5 allée du Général Rouvillois, 67083 Strasbourg, France

†Electronic supplementary information (ESI) available: Additional crystallographic data and biological studies. CCDC 1452899 (1<sub>Cl</sub>). For ESI and crystallographic data in CIF or other electronic format see DOI: 10.1039/c6dt01846g



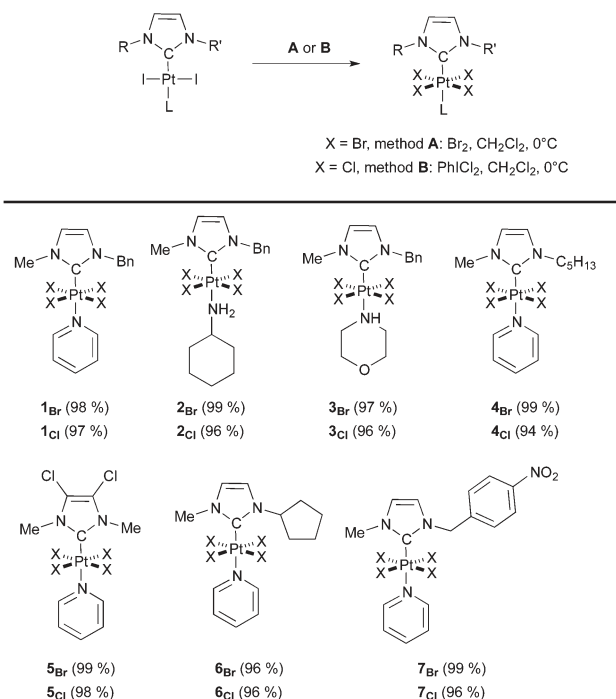

**Scheme 1** Synthesis of [(NHC)PtX<sub>4</sub>(L)] complexes 1–7 by the direct oxidation of Pt(II) NHC complexes (isolated yields in parentheses).

The majority of platinum complexes that entered clinical trials are functionalized with chloride ligands. Thus, the chloride-Pt(IV) counterparts were also obtained by oxidation with the hypervalent iodine reagent PhICl<sub>2</sub> again with excellent yields (Scheme 1). These complexes are stable under air in the solid state or in chlorinated solvents (CHCl<sub>3</sub>, CH<sub>2</sub>Cl<sub>2</sub>). Pyridine-containing complexes usually displayed a low solubility in all organic solvents.

Akin to Pt(II) NHC complexes, we found that the labile character of pyridine induced by the *trans* effect of the carbene ligand makes the [(NHC)PtX<sub>4</sub>(pyridine)] complexes valuable precursors to access functionalised Pt(IV) NHC complexes.<sup>13</sup> For example, complexes 2 and 3 were alternatively quantitatively obtained by ligand exchange as shown in Scheme 2. This strategy allows generating diversity easily in metallodrug candidates by varying the ligand located *trans* to the carbene.

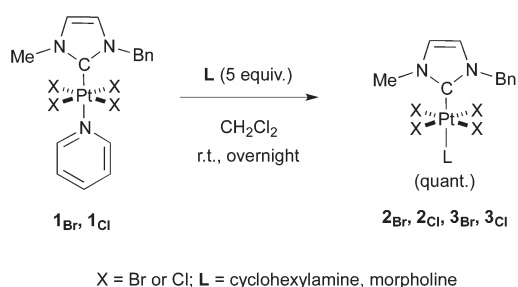

**Scheme 2** Pyridine substitution with cyclohexylamine or morpholine.

The <sup>1</sup>H NMR spectra in CDCl<sub>3</sub> display signals shifted to lower field by up to 0.7 ppm compared to their Pt(II) counterparts. Typical features were also noticed leading to more complex signal splitting patterns due to coupling to <sup>195</sup>Pt and the carbenic center. As expected, chemical shifts to higher field were also noticed by <sup>13</sup>C NMR spectroscopy while carbenic signals were observed at *ca.* δ 109–120 ppm.<sup>14</sup>

<sup>195</sup>Pt NMR spectra of bromide-containing Pt(IV) NHC derivatives display a single resonance in the range –2040 to –2167 ppm. The nature of the amine has a relatively moderate influence on the chemical shift, whereas the NHC has a low influence. However, the magnetic environment of the platinum nucleus is strongly affected by the halides: chloride-containing Pt(IV) NHC complexes exhibit resonance in the range –810 to –825 ppm, which follows the same trend as the position of these ligands in the nephelauxetic series.<sup>12c</sup>

To unambiguously establish the atom connectivity, single crystals of several Pt(IV) NHC complexes were grown by slow diffusion in pentane/dichloromethane. Fig. 1 displays the molecular structure of the Pt(IV) complex 1<sub>Cl</sub> which was selected as a representative example. The geometry at the platinum centre is close to octahedral with halide ligands located at equatorial positions. Both NHC and the pyridine ring lie in the same plane and the carbene–Pt and Pt–N bond distances are 2.034(11) Å and 2.127(9) Å respectively.

### Investigations of cytotoxic activity

Antiproliferative activities of representative Pt(IV) complexes, namely 2<sub>Br</sub>, 2<sub>Cl</sub>, 3<sub>Br</sub>, 4<sub>Br</sub>, and 4<sub>Cl</sub>, were measured on a panel of three different human tumor cell lines (MCF7, HCT116 and

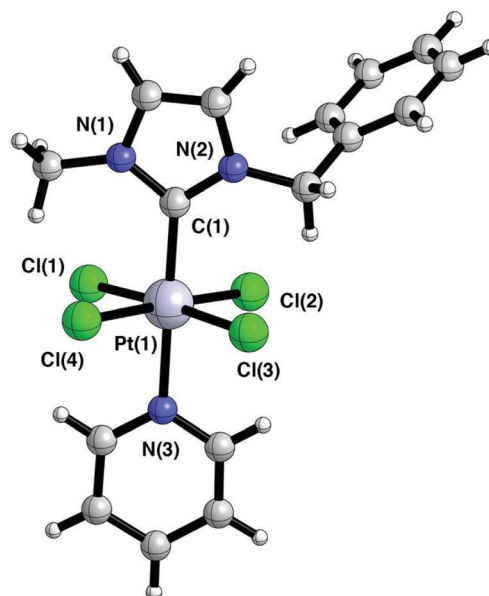

**Fig. 1** Molecular structure of Pt(IV) NHC complex 1<sub>Cl</sub>.† Selected bond distances (Å) and angles (°): C(1)–Pt(1), 2.034(11); Cl(1)–Pt(1), 2.329(3); Cl(2)–Pt(1), 2.327(3); Cl(3)–Pt(1), 2.336(3); Cl(4)–Pt, 2.330(3); N(3)–Pt(1), 2.127(9); C(1)–Pt(1)–N(3), 178.4(4); C(1)–Pt(1)–Cl(2), 91.6(4); N(3)–Pt(1)–Cl(2), 89.2(3); Cl(2)–Pt(1)–Cl(4), 177.34(12); Cl(1)–Pt(1)–Cl(4), 91.85(12).

**Table 1** Half inhibitory concentrations  $IC_{50}$  (in  $\mu\text{M}$ ) of the selected compounds against human cancer cell lines<sup>a</sup>

Entry	Compound	HCT116	MCF7	PC3
1	<b>Cisplatin</b>	$3.7 \pm 0.1$	$4.2 \pm 0.7$	$3.1 \pm 0.2$
2	<b>2<sub>Br</sub></b>	$14 \pm 2$	$5 \pm 1$	$5 \pm 1$
3	<b>2<sub>Cl</sub></b>	$0.50 \pm 0.03$	$0.50 \pm 0.09$	$1.0 \pm 0.1$
4	<b>3<sub>Br</sub></b>	$11.0 \pm 0.3$	$3.0 \pm 0.7$	$2.1 \pm 0.5$
5	<b>4<sub>Br</sub></b>	$5.0 \pm 1.0$	$4.0 \pm 0.2$	$5.0 \pm 1.0$
6	<b>4<sub>Cl</sub></b>	$1.4 \pm 0.2$	$1.7 \pm 0.6$	$1.3 \pm 0.2$
7	<b>(NHC)PtBr<sub>2</sub>(Py)</b>	$5.4 \pm 1.0$	$7.7 \pm 1.0$	$5.3 \pm 1.6$
8	<b>(NHC)PtCl<sub>2</sub>(Py)</b>	$3.8 \pm 0.1$	$3.5 \pm 1.0$	$4.4 \pm 0.9$
9	<b>(NHC)PtBr<sub>2</sub>(DMSO)</b>	>100	>100	>100
10	<b>(NHC)PtCl<sub>2</sub>(DMSO)</b>	$63 \pm 5$	$80 \pm 13$	$65 \pm 6$

<sup>a</sup> After 72 h of incubation; stock solutions in DMSO for all the complexes; stock solution in H<sub>2</sub>O for cisplatin. NHC = IMeBn.

PC3) ( $IC_{50}$ , entries 2–6, Table 1).<sup>15</sup> Cisplatin was used as a reference for our studies (entry 1) and four pertinent Pt(II) NHC complexes were also tested for comparison purpose: [(IMeBn)PtX<sub>2</sub>(pyridine)] and [(IMeBn)PtX<sub>2</sub>(DMSO)] (X = Br, Cl and IMeBn = 1-methyl-3-benzylimidazol-2-ylidene) (entries 7–10). All Pt(IV) complexes demonstrated good activities. A noticeable difference in activity as a function of the halide ligand was observed, both chloride complexes being more effective than their bromide counterparts. The  $IC_{50}$  values range from 0.5  $\mu\text{M}$  to 1.7  $\mu\text{M}$  for chloride complexes whereas those for bromide compounds range from 2.1 to 14  $\mu\text{M}$  (compare entries 2 with 3 or 5 with 6).

In an independent experiment, we also evaluated the apoptosis induced by **4<sub>Cl</sub>** and **4<sub>Br</sub>** on HCT116 cells deficient in p53, revealing that p53 mutations are involved in tumor cell resistance of platinum drugs.<sup>3b</sup> As expected the HCT166 p53 KO cells were oxaliplatin-resistant. On the other hand, complexes **4<sub>Cl</sub>** and **4<sub>Br</sub>** induced a significant increase of apoptosis suggesting a different pathway to induce cell death (Fig. S6†).

Because solutions were prepared in DMSO/water, these results should be correlated with the stability of the platinum(IV) complexes in solution, which could be easily monitored by <sup>1</sup>H NMR or UV-vis spectroscopy.<sup>16</sup> No significant change was observed at the concentrations used for *in vitro* studies. On the other hand, in pure DMSO and at high concentration ( $10^{-3}$  M), the platinum complexes containing bromide ligands quickly transform into platinum(II) species within half a day at room temperature (Scheme 3 and ESI†). An analogous reduction process required a much longer time for complexes containing chloride ligands (*ca.* one month for complete conversion).<sup>17</sup> In all cases, the reduction led to the selective and exclusive formation of *cis* (NHC)PtX<sub>2</sub>(DMSO) species.<sup>18</sup> We also found that addition of glutathione (GSH) greatly accelerates the kinetics of reduction of Pt(IV)<sup>19</sup> (see ESI† for experimental details).

Investigation of the antiproliferative activities of Pt(II) NHC complexes *cis* (IMeBn)PtX<sub>2</sub>(DMSO) (X = Br, Cl) revealed that they were much less active ( $IC_{50} > 100$   $\mu\text{M}$ , X = Br and  $> 63$   $\mu\text{M}$ , X = Cl; entries 9 & 10) than related Pt(IV) complexes, suggesting that the Pt(II) DMSO adduct is not a relevant biological intermediate.<sup>18</sup> All in all, these results suggest that Pt(IV) NHC com-

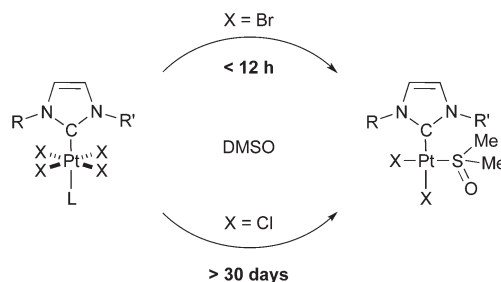
**Scheme 3** Reactivity of Pt(IV) NHC complexes in DMSO ( $C = 10^{-3}$  M, 25 °C).

plexes display sufficient stability for *in vitro* studies and that they are prompted to be reduced to Pt(II), in particular by bio-reductive activation, which is thought to be essential to afford compounds highly cytotoxic towards cancer cell lines.<sup>10</sup>

### Effects on mitochondria

Metal NHC complexes as drugs can potentially perturb various organelles in the cell.<sup>6b</sup> Indeed, it is important to understand whether alternative targets – besides nuclear DNA – can increase the activity of Pt-based drugs, thus offering the possibility of treating resistant tumors. Several groups recently

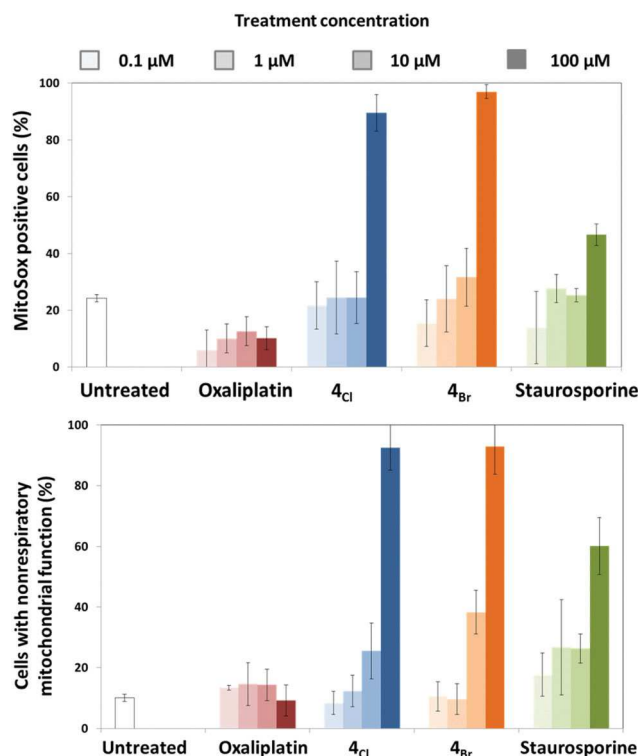
**Fig. 2** ROS production in mitochondria (top) and mitochondrial respiratory activity (bottom) on the HCT116 cell line after treatment with **4<sub>Cl</sub>**, **4<sub>Br</sub>**, oxaliplatin or staurosporine at indicated concentrations (12 h of incubation). ROS production and cells with nonrespiratory mitochondrial function were evaluated by flow cytometry using mitoSox and mitoTracker dye respectively.



showed that gold(III) or platinum(II) NHC complexes are targeting mitochondria and then inducing cell apoptosis through various mechanisms.<sup>6a-d,9,20</sup> In an attempt to study whether the cytotoxic activity of Pt(IV) compounds is associated with mitochondrial dysfunctions, we performed experiments with Pt(IV) NHC complexes **4<sub>Br</sub>** and **4<sub>Cl</sub>** to evaluate the production of Reactive Oxygen Species (ROS) in mitochondria.<sup>21</sup> Thus both ROS production and the decrease of the normal respiratory activity of mitochondria have been investigated. Fig. 2 displays the effects on human colorectal carcinoma cells HCT116, which is a cancer usually treated using Pt(II) oxaliplatin. Pt(IV) NHC complexes showed a higher ROS production than oxaliplatin and were similar to staurosporine, a compound known to induce ROS production and is used here as a reference (Fig. 2, top).<sup>22</sup> The ROS production dramatically increased at a higher concentration of 100  $\mu$ M, whereas oxaliplatin had no effect.

These results are associated with an increased number of cells containing inactive mitochondria as shown in Fig. 2, bottom. Again, oxaliplatin did not induce mitochondrial dysfunction and Pt(IV) NHC complexes displayed activities comparable to staurosporine. These results highlight the potential of Pt(IV) NHC complexes and as such are worthy of further investigations.

## Conclusions

In conclusion, we have synthesised novel platinum(IV) N-heterocyclic carbene complexes by the direct oxidation of the corresponding platinum(II) NHC complexes. Bromide and chloride complexes were obtained quantitatively using either bromine or iodobenzene dichloride, respectively. Antiproliferative activities of Pt(IV) NHC complexes were assayed against several cancer cell lines and the results were correlated with respect to their stability. Preliminary mechanistic investigations revealed that mitochondrial dysfunction and ROS production were associated with the cytotoxic process induced by these compounds.

## Experimental

All manipulations of air and moisture sensitive compounds were carried out using standard Schlenk techniques under an argon atmosphere and solvents were purified and degassed following standard procedures. All reagents were purchased from commercial chemical suppliers (Acros, Alfa Aesar, and TCI Europe) and used without further purification. <sup>1</sup>H and <sup>13</sup>C Nuclear Magnetic Resonance (NMR) spectra were recorded on a Bruker Avance 300 or a Bruker Avance 500 spectrometer using the residual solvent peak as a reference (CDCl<sub>3</sub>:  $\delta$ H = 7.26 ppm;  $\delta$ C = 77.16 ppm) at 295 K. HMQC <sup>1</sup>H-<sup>195</sup>Pt spectra were recorded on a Bruker Avance 600 spectrometer using the residual solvent peak as a reference (H<sub>2</sub>PtCl<sub>6</sub> in D<sub>2</sub>O:  $\delta$ Pt = 0 ppm) at the Institut de Chimie NMR Facility of the University

of Strasbourg. Positive mode electrospray ionization mass spectra (ESI-HRMS) analyses have been carried out using microTOF (Bruker Daltonics). X-Ray diffraction studies were carried out at the Institut de Chimie X-ray Facility of the University of Strasbourg. Crystal data were collected at 173 K using MoK $\alpha$  graphite monochromated ( $\lambda$  = 0.71073 Å) radiation on a Nonius KappaCCD diffractometer. The structures were solved using direct methods with SHELXS97552 and refined against  $F^2$  using the SHELXL97 software. Non-hydrogen atoms were refined anisotropically. Hydrogen atoms were generated according to stereochemistry and refined using a riding model in SHELXL97.

### General procedure for the synthesis of (NHC)PtBr<sub>4</sub>(amine) complexes

In a 10 mL round bottom flask, the precursor [(NHC)PtL<sub>2</sub>]<sup>8c</sup> (10 mg, 1 equiv.) was dissolved in CH<sub>2</sub>Cl<sub>2</sub> (5 mL) and cooled at 0 °C and Br<sub>2</sub> (2 equiv.) was slowly added under nitrogen. After 30 min, pentane (10 mL) was added and the resulting red precipitate (**1<sub>Br</sub>**-**7<sub>Br</sub>**) was filtered off, washed and dried.

**1<sub>Br</sub>**. Red solid, 10.7 mg, yield 98%. <sup>1</sup>H NMR (CD<sub>2</sub>Cl<sub>2</sub>, 500 MHz, 20 °C):  $\delta$  = 4.45 (s, 3H, N-CH<sub>3</sub>), 6.09 (s, 2H, N-CH<sub>2</sub>), 6.78 (d,  $J$  = 2.1 Hz, 1H, CH<sub>im</sub>), 7.01 (d,  $J$  = 2.1 Hz, 1H, CH<sub>im</sub>), 7.32–7.37 (m, 7H, H<sub>ar</sub>), 7.46 (m, 2H, H<sub>pyr</sub>), 7.94 (m, 1H, H<sub>pyr</sub>), 9.64 (m, 2H, H<sub>pyr</sub>); <sup>13</sup>C NMR (CD<sub>2</sub>Cl<sub>2</sub>, 125 MHz, 20 °C):  $\delta$  = 44.1 (N-CH<sub>3</sub>), 59.1 (N-CH<sub>2</sub>), 109.3 (C-Pt), 124.4 (s + d,  $J$  = 10.8 Hz, CH<sub>im</sub>), 124.8 (CH<sub>ar</sub>), 125.7 (s + d,  $J$  = 10.8 Hz, CH<sub>im</sub>), 128.7 (CH<sub>ar</sub>), 128.8 (CH<sub>ar</sub>), 136.7 (C<sub>pyr</sub>), 139.8 (C<sub>pyr</sub>), 154.3 (C<sub>pyr</sub>); HMQC <sup>1</sup>H-<sup>195</sup>Pt NMR (CDCl<sub>3</sub>, 64.2 MHz, 20 °C):  $\delta$  = -2048 (m); MS (positive ESI) [M - 3Br]: C<sub>16</sub>H<sub>16</sub>Br<sub>1</sub>N<sub>3</sub>Pt<sub>1</sub>: 523.01, found 524.01; elemental anal. calc. for C<sub>16</sub>H<sub>17</sub>Br<sub>4</sub>N<sub>3</sub>Pt<sub>1</sub>: C 25.09, H 2.24, N 5.49, found: C 24.74, H 2.23, N 5.40.

**2<sub>Br</sub>**. Red solid, 11.3 mg, yield 99%. <sup>1</sup>H NMR (CDCl<sub>3</sub>, 300 MHz, 20 °C):  $\delta$  = 1.22–1.47 (m, 6H, CH<sub>2</sub>), 1.72–1.79 (m, 2H, CH<sub>2</sub>), 2.33 (m, 2H, CH<sub>2</sub>), 3.59 (m, 1H, N-CH), 3.9–4.2 (bs, 2H, NH<sub>2</sub>), 4.36 (s, 3H, N-CH<sub>3</sub>), 5.97 (s, 2H, N-CH<sub>2</sub>), 6.73 (d,  $J$  = 2.1 Hz, 1H, CH<sub>im</sub>), 6.94 (d,  $J$  = 2.1 Hz, 1H, CH<sub>im</sub>), 7.35 (m, 5H, H<sub>ar</sub>); <sup>13</sup>C NMR (CDCl<sub>3</sub>, 125 MHz, 20 °C):  $\delta$  = 24.4 (CH<sub>2</sub>), 25.2 (CH<sub>2</sub>), 35.4 (CH<sub>2</sub>), 43.6 (CH), 54.6 (N-CH<sub>3</sub>), 58.9 (N-CH<sub>2</sub>), 115.2 (C-Pt), 124.0 (s + d,  $J$  = 11.1 Hz, CH<sub>im</sub>), 125.2 (s + d,  $J$  = 11.1 Hz, CH<sub>im</sub>), 128.3 (C<sub>ar</sub>), 128.8 (C<sub>ar</sub>), 136.1 (C<sub>ar</sub>); HMQC <sup>1</sup>H-<sup>195</sup>Pt NMR (CDCl<sub>3</sub>, 64.2 MHz, 20 °C):  $\delta$  = -2167 (m); MS (positive ESI) [M - 3Br]: C<sub>17</sub>H<sub>25</sub>N<sub>3</sub>Pt<sub>1</sub>Br<sub>1</sub> 546.08, found 546.09; elemental anal. calc. for C<sub>17</sub>H<sub>25</sub>Br<sub>4</sub>N<sub>3</sub>Pt<sub>1</sub>: C 25.97, H 3.21, N 5.35, found: C 26.00, H 3.28, N 5.27.

**3<sub>Br</sub>**. Red solid, 11.2 mg, yield 97%. <sup>1</sup>H NMR (CDCl<sub>3</sub>, 300 MHz, 20 °C):  $\delta$  = 3.46–3.52 (m, 2H, CH<sub>2</sub>), 3.65–3.82 (m, 4H, CH<sub>2</sub>), 4.01–4.06 (m, 2H, CH<sub>2</sub>), 4.36 (s + d,  $J$  = 1.9 Hz, 3H, N-CH<sub>3</sub>), 5.98 (s + d,  $J$  = 2.1 Hz, 2H, N-CH<sub>2</sub>), 6.73 (d,  $J$  = 2.1 Hz, 1H, CH<sub>im</sub>), 6.93 (d,  $J$  = 2.1 Hz, 1H, CH<sub>im</sub>), 7.34–7.38 (m, 5H, H<sub>ar</sub>); <sup>13</sup>C NMR (75 MHz, CDCl<sub>3</sub>):  $\delta$  = 44.2 (N-CH<sub>3</sub>), 52.0 (O-CH<sub>2</sub>), 59.4 (N-CH<sub>2</sub>), 69.2 (s + d,  $J$  = 9.8 Hz, N-CH<sub>2</sub>), 112.7 (C-Pt), 124.4 (s + d,  $J$  = 11.4 Hz, CH<sub>im</sub>), 125.6 (s + d,  $J$  = 11.4 Hz, CH<sub>im</sub>), 128.5 (C<sub>ar</sub>), 128.9 (C<sub>ar</sub>); HMQC <sup>1</sup>H-<sup>195</sup>Pt NMR (CDCl<sub>3</sub>, 64.2 MHz, 20 °C):  $\delta$  = -2080 ppm (m); MS (positive ESI) [M - 3Br]: C<sub>15</sub>H<sub>21</sub>N<sub>3</sub>O<sub>1</sub>Pt<sub>1</sub>Br<sub>1</sub> 534.05, found 534.04;

elemental anal. calc. for  $C_{15}H_{20}Br_4N_3O_1Pt_1$ : C 23.28, H 2.73, N 5.43, found: C 22.92, H 2.82, N 5.43.

**4<sub>Br</sub>**. Red solid, 11.6 mg, yield 99%.  $^1H$  NMR ( $CDCl_3$ , 300 MHz, 20 °C):  $\delta$  = 0.93 (t,  $J$  = 7.0 Hz, 3H,  $CH_3$ ), 1.43 (m, 4H,  $CH_2$ ), 1.92 (m, 2H,  $CH_2$ ), 4.44 (s, 3H, N- $CH_3$ ), 4.78 (m, 2H, N- $CH_2$ ), 7.03 (d,  $J$  = 2.1 Hz, 1H,  $CH_{im}$ ), 7.12 (d,  $J$  = 2.1 Hz, 1H,  $CH_{im}$ ), 7.44 (m, 2H,  $H_{pyr}$ ), 7.89 (m, 1H,  $H_{pyr}$ ), 9.71 (m, 2H,  $H_{pyr}$ );  $^{13}C$  NMR (75 MHz,  $CDCl_3$ ):  $\delta$  = 14.2 ( $CH_3$ ), 22.6 ( $CH_2$ ), 28.8 ( $CH_2$ ), 44.2 (N- $CH_3$ ), 55.4 (N- $CH_2$ ), 109.2 (C-Pt), 123.5 (s + d,  $J$  = 11.1 Hz,  $CH_{im}$ ), 124.7 (s + d,  $J$  = 9.9 Hz,  $C_{pyr}$ ), 125.8 (s + d,  $J$  = 11.1 Hz,  $CH_{im}$ ), 139.5 ( $C_{pyr}$ ), 154.6 ( $C_{pyr}$ ); HMQC  $^1H$ - $^{195}Pt$  NMR ( $CDCl_3$ , 64.2 MHz, 20 °C):  $\delta$  = -2040 ppm (m); HRMS (positive ESI) [ $M$  + Na]:  $C_{14}H_{21}Br_4N_3Pt_1Na_1$  764.8010, found 764.8009; elemental anal. calc. for  $C_{14}H_{21}Br_4N_3Pt_1$ : C 23.54, H 2.84, N 5.63, found: C 23.61, H 2.99, N 5.81.

**5<sub>Br</sub>**. Red solid, 11.5 mg, yield 99%.  $^1H$  NMR ( $CDCl_3$ , 300 MHz, 20 °C):  $\delta$  = 4.45 (m, 6H, N- $CH_3$ ), 7.46 (m, 2H,  $H_{pyr}$ ), 7.93 (m, 1H,  $H_{pyr}$ ), 9.65 (m, 2H,  $H_{pyr}$ );  $^{13}C$  NMR (75 MHz,  $CDCl_3$ ):  $\delta$  = 29.8 (N- $CH_3$ ), 43.1 (N- $CH_2$ ), 120.7 (C-Pt), 124.9 (s + d,  $J$  = 10.4 Hz,  $2C_{im}$ ), 139.8 ( $C_{pyr}$ ), 154.7 (s + d,  $J$  = 4.6 Hz,  $C_{pyr}$ ); HMQC  $^1H$ - $^{195}Pt$  NMR ( $CDCl_3$ , 64.2 MHz, 20 °C):  $\delta$  = -2058 ppm (m); MS (positive ESI) [ $M$  + Na]:  $C_{10}H_{11}Br_4Cl_2N_3Pt_1Na_1$  776.6609, found 776.6604.

**6<sub>Br</sub>**. Red solid, 11.2 mg, yield 96%.  $^1H$  NMR ( $CDCl_3$ , 300 MHz, 20 °C):  $\delta$  = 1.85 (m, 6H,  $CH_2$ ), 2.57 (m, 2H,  $CH_2$ ), 4.41 (s, 3H, N- $CH_3$ ), 6.17 (m, 1H, N-CH), 7.05 (d,  $J$  = 2.1 Hz, 1H,  $CH_{im}$ ), 7.07 (d,  $J$  = 2.1 Hz, 1H,  $CH_{im}$ ), 7.47 (m, 2H,  $H_{pyr}$ ), 7.92 (m, 1H,  $H_{pyr}$ ), 9.64 (m, 2H,  $H_{pyr}$ ); no  $^{13}C$  NMR spectrum could be recorded due to very low solubility; HMQC  $^1H$ - $^{195}Pt$  NMR ( $CDCl_3$ , 64.2 MHz, 20 °C):  $\delta$  = -2032 ppm (m); MS (positive ESI) [ $M$  - 2Br]:  $C_{14}H_{18}Br_2N_3Pt_1$  580.95, found 582.95; elemental anal. calc. for  $C_{14}H_{19}Br_4N_3Pt$  +  $Br_2$ : C 18.60, H 2.12, N 4.65, found: C 18.42, H 2.13, N 4.51.

**7<sub>Br</sub>**. Red solid, 11.3 mg, yield 99%.  $^1H$  NMR ( $CDCl_3$ , 300 MHz, 20 °C):  $\delta$  = 4.54 (s, 3H, N- $CH_3$ ), 6.29 (s, 2H, N- $CH_2$ ), 6.74 (d,  $J$  = 2.1 Hz, 1H,  $CH_{im}$ ), 7.06 (d,  $J$  = 2.1 Hz, 1H,  $CH_{im}$ ), 7.44-7.55 (m, 4H,  $H_{ar}$ ), 7.93 (m, 1H,  $H_{pyr}$ ), 8.22 (m, 2H,  $H_{pyr}$ ), 9.67 (m, 2H,  $H_{pyr}$ );  $^{13}C$  NMR (75 MHz,  $CDCl_3$ ):  $\delta$  = 44.3 (s, N- $CH_3$ ), 58.4 (s, N- $CH_2$ ), 123.9 ( $CH_{im}$ ), 124.1 ( $C_{pyr}$ ), 124.8 ( $CH_{im}$ ), 129.2 ( $C_{ar}$ ), 139.6 ( $C_{ar}$ ), 143.5 ( $C_{ar}$ ), 147.8 ( $C_{ar}$ ), 147.8 ( $C_{pyr}$ ), 154.4 ( $C_{pyr}$ ); the carbene  $^{13}C$  NMR resonance was not observed; HMQC  $^1H$ - $^{195}Pt$  NMR ( $CDCl_3$ , 64.2 MHz, 20 °C):  $\delta$  = -2067 ppm (m); HRMS (positive ESI) [ $M$  +  $CH_3CN$  + Na]:  $C_{18}H_{19}Br_4N_5O_1Pt_1Na_1$  870.7813, found 870.7812.

### General procedure for the synthesis of (NHC)PtCl<sub>4</sub>(amine) complexes

In a 10 mL round bottom flask, the precursor (10 mg, 1 equiv.) was dissolved in  $CH_2Cl_2$  (5 mL) and cooled at 0 °C and  $PhICl_2$  (10 equiv.) was slowly added.<sup>12c</sup> After 1 hour at 0 °C, the addition of pentane (10 mL) caused the precipitation of **1<sub>Cl</sub>**-**7<sub>Cl</sub>** as a light yellow powder, which was filtered off, washed and dried.

**1<sub>Cl</sub>**. Light yellow solid, 8.1 mg, yield 97%.  $^1H$  NMR ( $CDCl_3$ , 300 MHz, 20 °C):  $\delta$  = 4.42 (t, 3H, N- $CH_3$ ), 6.03 (s, 2H, N- $CH_2$ ), 6.77 (d,  $J$  = 2.1 Hz, 1H,  $CH_{im}$ ), 6.95 (d,  $J$  = 2.1 Hz, 1H,  $CH_{im}$ ),

7.35-7.41 (m, 5H,  $H_{ar}$ ), 7.55 (m, 2H,  $H_{pyr}$ ), 7.96 (m, 1H,  $H_{pyr}$ ), 9.31 (m, 2H,  $H_{pyr}$ ); no  $^{13}C$  NMR could be recorded due to very low solubility. HMQC  $^1H$ - $^{195}Pt$  NMR ( $CDCl_3$ , 64.2 MHz, 20 °C):  $\delta$  = -755 ppm (m); HRMS (positive ESI) [ $M$  + Na]:  $C_{16}H_{17}Cl_4N_3Pt_1Na_1$  608.9718, found 608.9634; elemental anal. calc. for  $C_{16}H_{17}Cl_4N_3Pt_1$ : C 32.67, H 2.91, N 7.14, found: C 32.52, H 2.87, N 7.02.

**2<sub>Cl</sub>**. Light yellow solid, 9.2 mg, yield 96%.  $^1H$  NMR ( $CDCl_3$ , 300 MHz, 20 °C):  $\delta$  = 1.26-1.45 (m, 4H,  $CH_2$ ), 1.73-1.80 (m, 2H,  $CH_2$ ), 3.45 (m, 1H, CH), 4.00 (bs, 2H, N- $CH_2$ ), 4.30 (s, 3H, N- $CH_3$ ), 5.89 (s, 2H, N- $CH_2$ ), 6.73 (d,  $J$  = 2.1 Hz, 1H,  $CH_{im}$ ), 6.90 (d,  $J$  = 2.1 Hz, 1H,  $CH_{im}$ ), 7.30-7.33 (m, 5H,  $H_{ar}$ );  $^{13}C$  NMR ( $CDCl_3$ , 125 MHz, 20 °C):  $\delta$  = 24.7 ( $CH_2$ ), 25.3 ( $CH_2$ ), 35.1 ( $CH_2$ ), 41.1 (CH), 52.7 (N- $CH_3$ ), 56.7 (N- $CH_2$ ), 123.7 ( $CH_{im}$ ), 125.3 ( $CH_{im}$ ), 128.5 ( $C_{ar}$ ), 129.0 ( $C_{ar}$ ), 129.1 ( $C_{ar}$ ), 136.1 ( $C_{ar}$ ), the carbene  $^{13}C$  NMR resonance was not observed; HMQC  $^1H$ - $^{195}Pt$  NMR ( $CDCl_3$ , 64.2 MHz, 20 °C):  $\delta$  = -885 ppm (m); elemental anal. calc. for  $C_{17}H_{25}Cl_4N_3Pt_1$ : C 33.57, H 4.14, N 6.91, found: C 33.79, H 4.33, N 6.59.

**3<sub>Cl</sub>**. Light yellow solid, 8.0 mg, yield 96%.  $^1H$  NMR ( $CDCl_3$ , 300 MHz, 20 °C):  $\delta$  = 3.04-3.08 (m, 2H,  $CH_2$ ), 3.49-3.59 (m, 4H,  $CH_2$ ), 3.83-3.90 (m, 2H,  $CH_2$ ), 4.05 (s, 3H, N- $CH_3$ ), 5.71 (m, 2H, N- $CH_2$ ), 6.64 (d,  $J$  = 2.1 Hz, 1H,  $CH_{im}$ ), 6.78 (d,  $J$  = 2.1 Hz, 1H,  $CH_{im}$ ), 7.31-7.43 (m,  $H_{ar}$ );  $^{13}C$  NMR (75 MHz,  $CDCl_3$ ):  $\delta$  = 37.6 (N- $CH_3$ ), 48.8 (O- $CH_2$ ), 54.1 (N- $CH_2$ ), 68.1 (HN- $CH_2$ ), 120.2 ( $CH_{im}$ ), 122.4 ( $CH_{im}$ ), 128.7 ( $C_{ar}$ ), 128.9 ( $C_{ar}$ ), 136.0 ( $C_{ar}$ ), the carbene  $^{13}C$  NMR resonance was not observed; HMQC  $^1H$ - $^{195}Pt$  NMR ( $CDCl_3$ , 64.2 MHz, 20 °C):  $\delta$  = -850 ppm (m); elemental anal. calc. for  $C_{15}H_{21}Cl_4N_3O_1Pt_1$ : C 30.22, H 3.55, N 7.05, found: C 30.03, H 3.37, N 7.08.

**4<sub>Cl</sub>**. Light yellow solid, 9.1 mg, yield 94%.  $^1H$  NMR ( $CDCl_3$ , 300 MHz, 20 °C):  $\delta$  = 0.92 (t,  $J$  = 7.0 Hz, 3H,  $CH_3$ ), 1.41 (m, 4H,  $CH_2$ ), 1.91 (m, 2H,  $CH_2$ ), 4.37 (s, 3H, N- $CH_3$ ), 4.71 (m, 2H, N- $CH_2$ ), 7.01 (d,  $J$  = 2.1 Hz, 1H,  $CH_{im}$ ), 7.11 (d,  $J$  = 2.1 Hz, 1H,  $CH_{im}$ ), 7.53 (m, 2H,  $H_{pyr}$ ), 7.94 (m, 1H,  $H_{pyr}$ ), 9.30 (m, 2H,  $H_{pyr}$ );  $^{13}C$  NMR (75 MHz,  $CDCl_3$ ):  $\delta$  = 13.9 ( $CH_3$ ), 22.3 ( $CH_2$ ), 28.7 ( $CH_2$ ), 41.4 (N- $CH_3$ ), 52.9 (N- $CH_2$ ), 111.5 (C-Pt), 123.1 (s + d,  $J$  = 11.1 Hz,  $CH_{im}$ ), 124.8 ( $C_{pyr}$ ), 125.6 (s + d,  $J$  = 11.1 Hz,  $CH_{im}$ ), 139.7 ( $C_{pyr}$ ), 150.9 ( $C_{pyr}$ ); HMQC  $^1H$ - $^{195}Pt$  NMR ( $CDCl_3$ , 64.2 MHz, 20 °C):  $\delta$  = -810 ppm (m); HRMS (positive ESI) [ $M$  + Na]:  $C_{14}H_{21}Cl_4N_3Pt_1Na_1$  589.0031, found 589.0084; elemental anal. calc. for  $C_{14}H_{21}Cl_4N_3Pt_1$  +  $CH_2Cl_2$ : C 29.59, H 3.73, N 7.40, found: C 29.09, H 3.52, N 7.44.

**5<sub>Cl</sub>**. Light yellow solid, 9.4 mg, yield 98%.  $^1H$  NMR ( $CDCl_3$ , 300 MHz, 20 °C):  $\delta$  = 4.37 (s, 6H, N- $CH_3$ ), 7.54 (m, 2H,  $H_{pyr}$ ), 7.94 (m, 1H,  $H_{pyr}$ ), 9.25 (m, 2H,  $H_{pyr}$ );  $^{13}C$  NMR (75 MHz,  $CDCl_3$ ):  $\delta$  = 31.0 (N- $CH_3$ ), 40.1 (N- $CH_2$ ), 112.9 (C-Pt), 120.8 ( $C_{pyr}$ ), 125.2 (s + d,  $J$  = 18.9 Hz,  $C_{im}$ ), 140.2 ( $C_{pyr}$ ), 151.2 (s + d,  $J$  = 4.6 Hz,  $C_{pyr}$ ); HMQC  $^1H$ - $^{195}Pt$  NMR ( $CDCl_3$ , 64.2 MHz, 20 °C):  $\delta$  = -825 ppm (m); HRMS (positive ESI) [ $M$  + Na]: Calculated for  $C_{10}H_{11}Cl_6N_3Pt_1Na_1$  600.8625, found 600.8624.

**6<sub>Cl</sub>**. Light yellow solid, 9.2 mg, yield 96%.  $^1H$  NMR ( $CDCl_3$ , 300 MHz, 20 °C):  $\delta$  = 1.64-1.85 (m, 6H,  $CH_2$ ), 2.46-2.50 (m, 2H,  $CH_2$ ), 4.36 (s, 3H, N- $CH_3$ ), 6.11 (m, 1H, N-CH), 7.02 (d,  $J$  = 2.1 Hz, 1H,  $CH_{im}$ ), 7.12 (d,  $J$  = 2.1 Hz, 1H,  $CH_{im}$ ), 7.53 (m, 2H,  $H_{pyr}$ ), 7.92 (m, 1H,  $H_{pyr}$ ), 9.30 (m, 2H,  $H_{pyr}$ );  $^{13}C$  NMR (75 MHz,

CDCl<sub>3</sub>):  $\delta$  = 24.6 (CH<sub>2</sub>), 30.8 (CH<sub>2</sub>), 35.4 (N-CH), 41.3 (N-CH<sub>3</sub>), 63.0 (N-CH<sub>2</sub>), 120.9 (CH<sub>im</sub>), 124.9 (C<sub>pyr</sub>), 125.9 (CH<sub>im</sub>), 139.7 (C<sub>pyr</sub>), 151.0 (C<sub>pyr</sub>), the carbene <sup>13</sup>C NMR resonance was not observed; HMQC <sup>1</sup>H-<sup>195</sup>Pt NMR (CDCl<sub>3</sub>, 64.2 MHz, 20 °C):  $\delta$  = -1320 ppm (m); MS (positive ESI) [M + Na]: C<sub>14</sub>H<sub>19</sub>Cl<sub>4</sub>N<sub>3</sub>Pt<sub>1</sub>Na<sub>1</sub> 586.99, found 586.98.

**7<sub>Cl</sub>**. Light yellow solid, 9.2 mg, yield 96%. <sup>1</sup>H NMR (CDCl<sub>3</sub>, 300 MHz, 20 °C):  $\delta$  = 4.45 (s, 3H, N-CH<sub>3</sub>), 6.16 (s, 2H, N-CH<sub>2</sub>), 6.76 (d, *J* = 2.1 Hz, 1H, CH<sub>im</sub>), 7.06 (d, *J* = 2.1 Hz, 1H, CH<sub>im</sub>), 7.51–7.61 (m, 4H, H<sub>ar</sub>), 7.97 (m, 1H, H<sub>pyr</sub>), 8.21 (m, 2H, H<sub>pyr</sub>), 9.26–9.29 (m, 2H, H<sub>pyr</sub>); <sup>13</sup>C NMR (75 MHz, CDCl<sub>3</sub>):  $\delta$  = 41.8 (N-CH<sub>3</sub>), 56.2 (N-CH<sub>2</sub>), 123.9 (CH<sub>im</sub>), 124.2 (C<sub>pyr</sub>), 125.2 (CH<sub>im</sub>), 129.4 (C<sub>ar</sub>), 137.6 (C<sub>ar</sub>), 140.1 (C<sub>ar</sub>), 143.5 (C<sub>ar</sub>), 148.0 (C<sub>pyr</sub>), 151.1 (C<sub>pyr</sub>), the carbene <sup>13</sup>C NMR resonance was not observed; HMQC <sup>1</sup>H-<sup>195</sup>Pt NMR (CDCl<sub>3</sub>, 64.2 MHz, 20 °C):  $\delta$  = -834 ppm (m); MS (positive ESI) [2M + Na]: C<sub>32</sub>H<sub>32</sub>Cl<sub>8</sub>N<sub>8</sub>Pt<sub>2</sub>Na<sub>1</sub> 1284.92, found 1284.89.

#### General procedure for ligand exchange to access (NHC) PtX<sub>4</sub>(amine) complexes

In a 5 mL round bottom flask, **1<sub>Br</sub>** or **1<sub>Cl</sub>** (10 mg, 1 equiv.) was reacted with either cyclohexylamine or morpholine (5 equiv.) in CH<sub>2</sub>Cl<sub>2</sub> (2 mL) at 30 °C overnight. The resulting mixture was concentrated under reduced pressure, then dissolved in dichloromethane and subsequently precipitated by addition of pentane. **2<sub>Br</sub>**, **2<sub>Cl</sub>**, **3<sub>Br</sub>** or **3<sub>Cl</sub>** were afforded as red or light yellow powders in quantitative yield.

#### Protocols of cell culture and proliferation assay

Cancer cell lines were obtained from the American Type Culture Collection (Rockville, MD, USA) and cultured according to the supplier's instructions. Human HCT116 colorectal carcinoma, MCF7 breast adenocarcinoma and PC3 prostate adenocarcinoma cells were grown in RPMI 1640 supplemented with 10% fetal calf serum (FCS) and 1% glutamine. Cell lines were maintained at 37 °C under a humidified atmosphere containing 5% CO<sub>2</sub>. Cell growth inhibition was determined by an MTS assay according to the manufacturer's instructions (Promega, Madison, WI, USA).

Briefly, the cells were seeded into 96-well plates (2.5 × 10<sup>3</sup> cells per well) containing 200 μL of growth medium. After 24 h of culture, the cells were treated with the tested compounds at different final concentrations. After 72 h of incubation, 40 μL of resazurin was added for 2 h before recording the absorbance at 490 nm with a spectrophotometric plate reader. The IC<sub>50</sub> corresponds to the concentration of the compound that induces a decrease of 50% in the absorbance of drug-treated cells compared with untreated cells. Experiments were performed in triplicate.

## Acknowledgements

The authors gratefully acknowledge the CNRS and the Ministère de l'Enseignement Supérieur et de la Recherche (MESR) for a PhD grant to G.D. and M.B. This work has been sup-

ported by the Initiative of Excellence (IdEx), University of Strasbourg and by La Ligue contre le Cancer – Région Grand Est. The authors also thank Dr Corinne Bailly and Dr Lydia Karmazin for X-ray diffraction studies and Dr Bruno Vincent for <sup>195</sup>Pt NMR studies.

## Notes and references

- (a) *Cisplatin: Chemistry and Biochemistry of a Leading Anti-cancer Drug*, ed. B. Lippert, Wiley-VCH, 1999; (b) G. Gasser and N. Metzler-Nolte, *Curr. Opin. Chem. Biol.*, 2012, **16**, 84; (c) G. Gasser, I. Ott and N. Metzler-Nolte, *J. Med. Chem.*, 2011, **54**, 3.
- Z. H. Siddik, *Oncogene*, 2003, **22**, 7265.
- (a) E. R. Jamieson and S. J. Lippard, *Chem. Rev.*, 1999, **99**, 2467; (b) S. Dasari and P. B. Tchounwou, *Eur. J. Pharmacol.*, 2014, **740**, 364.
- D. Wang and S. J. Lippard, *Nat. Rev. Drug Discovery*, 2005, **4**, 307.
- P. C. A. Bruijninx and P. J. Sadler, *Curr. Opin. Chem. Biol.*, 2008, **12**, 197.
- (a) A. Gautier and F. Cisnetti, *Metallomics*, 2012, **4**, 23; (b) K. M. Hindi, M. J. Panzner, C. A. Tessier, C. L. Cannon and W. J. Youngs, *Chem. Rev.*, 2009, **109**, 3859; (c) L. Mercs and M. Albrecht, *Chem. Soc. Rev.*, 2010, **39**, 1903; (d) W. Liu and R. Gust, *Chem. Soc. Rev.*, 2013, **42**, 755; (e) For the synthesis of NHC precursors, see: L. Benhamou, E. Chardon, G. Lavigne, S. Bellemin-Laponnaz and V. César, *Chem. Rev.*, 2011, **111**, 2705.
- Recent general reviews on NHC complexes: (a) M. N. Hopkinson, C. Richter, M. Schedler and F. Glorius, *Nature*, 2014, **510**, 485; (b) S. Bellemin-Laponnaz and S. Dagorne, *Chem. Rev.*, 2014, **114**, 8747; (c) K. Riener, S. Haslinger, A. Raba, M. P. Högerl, M. Cokoja, W. A. Herrmann and F. E. Kühn, *Chem. Rev.*, 2014, **114**, 5215; (d) S. Díez-González, N. Marion and S. P. Nolan, *Chem. Rev.*, 2009, **109**, 3612.
- (a) M. Skander, P. Retailleau, B. Bourrié, L. Schio, P. Mailliet and A. Marinetti, *J. Med. Chem.*, 2010, **53**, 2146; (b) M. Chtchigrovsky, L. Eloy, H. Jullien, L. Saker, E. Ségal-Bendirdjian, J. Poupon, S. Bombard, T. Cresteil, P. Retailleau and A. Marinetti, *J. Med. Chem.*, 2013, **56**, 2074; (c) E. Chardon, G. Dahm, G. Guichard and S. Bellemin-Laponnaz, *Organometallics*, 2012, **31**, 7618; (d) E. Chardon, G. L. Puleo, G. Dahm, S. Fournel, G. Guichard and S. Bellemin-Laponnaz, *ChemPlusChem*, 2012, **77**, 1028; (e) E. Chardon, G. L. Puleo, G. Dahm, S. Fournel, G. Guichard and S. Bellemin-Laponnaz, *Chem. Commun.*, 2011, **47**, 5864; (f) R. W.-Y. Sun, A. L.-F. Chow, X.-H. Li, J. J. Yan, S. S.-Y. Chui and C.-M. Che, *Chem. Sci.*, 2011, **2**, 728; (g) G. Dahm, C. Bailly, L. Karmazin and S. Bellemin-Laponnaz, *J. Organomet. Chem.*, 2015, **794**, 115; (h) T. Zou, C.-N. Lok, Y. M. E. Fung and C.-M. Che, *Chem. Commun.*, 2013, **49**, 5423.
- F. Cisnetti and A. Gautier, *Angew. Chem., Int. Ed.*, 2013, **52**, 11976.

- 10 (a) T. C. Johnstone, K. Suntharalingam and S. J. Lippard, *Chem. Rev.*, 2016, **116**, 3436; (b) C. F. Chin, D. Y. Q. Wong, R. Jothibas and W. H. Ang, *Curr. Top. Med. Chem.*, 2011, **11**, 2602; (c) D. Gibson, *Dalton Trans.*, 2016, DOI: 10.1039/C6DT01414C.
- 11 M. D. Hall, H. R. Mellor, R. Callaghan and T. W. Hambley, *J. Med. Chem.*, 2007, **50**, 3403.
- 12 (a) D. Meyer, S. Ahrens and T. Strassner, *Organometallics*, 2010, **29**, 3392; (b) V. Khlebnikov, M. Heckenroth, H. Müller-Bunz and M. Albrecht, *Dalton Trans.*, 2013, **42**, 4197; (c) T. C. Johnstone, S. M. Alexander, J. J. Wilson and S. J. Lippard, *Dalton Trans.*, 2014, 119.
- 13 E. Chardon, G. Dahm, G. Guichard and S. Bellemin-Laponnaz, *Chem. – Asian J.*, 2013, **8**, 1232.
- 14 (a) A. Biffis, M. Cipani, E. Bressan, C. Tubaro, C. Graiff and A. Venzo, *Organometallics*, 2014, **33**, 2182; (b) N. Tsoureas and A. A. Danopoulos, *J. Organomet. Chem.*, 2015, **715**, 178.
- 15 For a recent example of anticancer Pt(IV) complexes with phosphane ligands, see: M. Á. Medrano, A. Álvarez-Valdés, J. Perles, J. Lloret-Fillol, S. Muñoz-Galván, A. Carnero, C. Navarro-Ranninger and A. G. Quiroga, *Chem. Commun.*, 2013, **49**, 4806.
- 16 M. D. Hall, K. A. Telma, K.-E. Chang, T. D. Lee, J. P. Madigan, J. R. Lloyd, I. S. Goldlust, J. D. Hoeschele and M. M. Gottesman, *Cancer Res.*, 2014, **74**, 3913.
- 17 T. Shi, J. Berglund and L. I. Elding, *J. Chem. Soc., Dalton Trans.*, 1997, 2073.
- 18 J. K. Muenzner, T. Rehm, B. Biersack, A. Casini, I. A. M. de Graaf, P. Worawutputtpong, A. Noor, R. Kempe, V. Brabec, J. Kasparkova and R. Schobert, *J. Med. Chem.*, 2015, **58**, 6283.
- 19 (a) N. A. Kratochwil, Z. Guo, P. del S. Murdoch, J. A. Parkinson, P. J. Bednarski and P. J. Sadler, *J. Am. Chem. Soc.*, 1998, **120**, 8253; (b) T. Lu, J. Dong, C. Nan, S. Huo, S. Shen, S. Sun and T. Shi, *Transition Met. Chem.*, 2015, **40**, 869.
- 20 (a) M. V. Baker, P. J. Barnard, S. J. Berners-Price, S. K. Brayshaw, J. L. Hickey, B. W. Skelton and A. H. White, *Dalton Trans.*, 2006, 3708; (b) J. L. Hickey, R. A. Ruhayel, P. J. Barnard, M. V. Baker, S. J. Berners-Price and A. Filipovska, *J. Am. Chem. Soc.*, 2008, **130**, 12570.
- 21 D. Trachootham, J. Alexandre and P. Huang, *Nat. Rev.*, 2009, **8**, 579.
- 22 Y. Ramiro-Cortés, A. Guemez-Gamboa and J. Morán, *Int. J. Biochem. Cell Biol.*, 2011, **43**, 1373.







# Evaluation of innovative platinum compounds as antitumor agents combining chemotherapy and immunotherapy

## Résumé

Les agents chimiothérapeutiques à base de platine (II) actuellement utilisés en clinique ont de nombreux effets secondaires limitant ainsi leur utilisation. Voilà pourquoi, nous avons décidé de développer des composés innovants à base de platine : les carbènes N-hétérocycliques liés au platine et associés au polyéthylèneimine. Nous avons évalué leur activité cytotoxique ainsi que leur effet sur le système immunitaire étant donné que certains dérivés de platine commercialisés sont capables d'activer le système immunitaire.

Après avoir testé différents conjugués, nous avons sélectionné un candidat qui présente un profil cytotoxique important *in vitro* et *in vivo*, tout en limitant les effets secondaires : le NHC-Pt(II)-PEI30. Ensuite, nous avons pu montrer que ce complexe était également capable de favoriser l'apoptose de cellules souches cancéreuses de glioblastome, des cellules responsables de la réapparition de plusieurs cancers et résistantes à de nombreux traitements anticancéreux. Finalement, nous avons constaté que le NHC-Pt(II)-PEI30 seul induisait seulement une faible mort immunogène des cellules cancéreuses, limitant ainsi l'activation du système immunitaire. Voilà pourquoi, nous avons associé notre composé de platine à un adjuvant pour augmenter la réponse immunitaire antitumorale.

Ces résultats suggèrent que notre composé innovant à base de platine (II) constitue un outil intéressant pour combiner la chimiothérapie et l'immunothérapie.

**Mots-clés :** dérivés de platine, chimiothérapie, mort immunogène, adjuvant, immunothérapie

## Résumé en anglais

Platinum(II)-based chemotherapeutic agents, which are actually used in clinics, have numerous side effects, thus limiting their use. That is why, we decided to develop innovative platinum compounds: N-heterocyclic carbene-platinum complexes associated with polyethylenimine. We assessed their cytotoxic activity and their effect on the immune system, as some commercially available platinum derivatives are able to activate the immune system.

After evaluation of various conjugates, we selected one candidate displaying an important cytotoxic profile *in vitro* and *in vivo*, but with few side effects: NHC-Pt(II)-PEI30. Moreover, we showed that this complex was able to induce apoptosis of glioblastoma-derived cancer stem cells, which are resistant to numerous anticancer therapies and are responsible for cancer relapse. Finally, we observed that NHC-Pt(II)-PEI30 alone only induced a weak immunogenic cell death, limiting this way the activation of the immune system. That is why, we associated our platinum compound with an adjuvant in order to enhance the antitumor immune response.

These results suggest that our innovative platinum(II) compound displays interesting properties for the combination of chemotherapy and immunotherapy.

**Keywords :** platinum derivatives, chemotherapy, immunogenic cell death, adjuvant, immunotherapy