



HAL
open science

Behavioral and molecular adaptations following sucrose bingeing: insight into neuroinflammatory markers

Gaëlle Awad

► **To cite this version:**

Gaëlle Awad. Behavioral and molecular adaptations following sucrose bingeing: insight into neuroinflammatory markers. Neuroscience. Université de Strasbourg, 2022. English. NNT : 2022STRAJ027 . tel-04213575

HAL Id: tel-04213575

<https://theses.hal.science/tel-04213575>

Submitted on 21 Sep 2023

HAL is a multi-disciplinary open access archive for the deposit and dissemination of scientific research documents, whether they are published or not. The documents may come from teaching and research institutions in France or abroad, or from public or private research centers.

L'archive ouverte pluridisciplinaire **HAL**, est destinée au dépôt et à la diffusion de documents scientifiques de niveau recherche, publiés ou non, émanant des établissements d'enseignement et de recherche français ou étrangers, des laboratoires publics ou privés.

Université de Strasbourg

École doctorale des sciences de la vie et de la santé

Laboratoire de Neurosciences Cognitives et Adaptatives (UMR 7364)

Thèse présentée par :

Gaëlle AWAD

Soutenue le : 22 Juin 2022

Pour obtenir le grade de :

Docteur de l'Université de Strasbourg

Spécialité : Neurosciences

« Étude des réponses comportementales et moléculaires suite à une consommation excessive de saccharose: implication de la neuroinflammation »

« Behavioral and molecular adaptations following sucrose bingeing: insight into neuroinflammatory markers »

Thèse dirigée par :

Mme Katia BEFORT : Chargée de recherche CNRS, Université de Strasbourg

Thèse codirigée par :

Mme Mary C. OLMSTEAD : Professeur, Queens University, Kingston, Ontario, Canada

Rapporteurs :

Mme Sylvie GRANON : Professeur, Université Paris-Saclay

Mme Carole ROVERE : Chargée de recherche, IPMC CNRS Université Côte d'Azur Sophia-Antipolis

Examineurs :

M. Benjamin BOUTREL : PD, MER/Senior lecturer, Université de Lausanne

M. Joëffrey ZOLL : Maître de conférences (MCU PH), Université de Strasbourg

Table of contents

Table of contents.....	3
PhD Portfolio.....	5
List of abbreviations.....	8
List of figures.....	9
List of supplementary figures.....	11
Summary.....	12
Résumé.....	13
I. Introduction.....	14
I.1 Addiction and eating disorders.....	14
I.1.1. Addiction: definition.....	14
I.1.2. Neurobiology of reward.....	15
<i>I.1.2.1.</i> Brain circuits of reward.....	15
<i>I.1.2.2.</i> Behavioral tasks to measure reward.....	16
I.1.3. History and concept of food addiction.....	17
I.1.4. Addiction traits in eating disorders.....	19
I.1.5. BED: Definition, epidemiology and neurobiology.....	23
<i>I.1.5.1.</i> Definition and epidemiology.....	23
<i>I.1.5.2.</i> The control of food intake.....	24
a) Homeostatic signals from the periphery.....	24
b) Neural circuits involved in homeostatic and hedonic control of feeding.....	25
<i>I.1.5.3.</i> Shared characteristics between BED and addiction from preclinical and clinical studies.....	28
II. Neuroinflammation.....	30
II.1 The immune system (periphery).....	30
II.1.1. Glia (brain).....	30
II.1.2. Neuroinflammatory signaling in the brain (astrocytes and microglia).....	31
II.1.3. Neuroinflammation in psychiatric disorders.....	33
<i>II.1.3.1.</i> Immune signaling in drugs of abuse.....	33
<i>II.1.3.2.</i> Neuroinflammation in BED?.....	36
<i>II.1.3.3.</i> Neuropathic pain and immune signaling.....	39
<i>II.1.3.4.</i> Neuropathic pain and alcohol use disorder.....	40
II.2 Mini review on BED and pain.....	41
III. BED and sweeteners.....	42

III.1.1.	Generalities on sweeteners.....	42
III.1.2.	Sweeteners and weight gain.....	42
III.1.3.	Sweeteners and inflammation.....	43
III.1.4.	Sweeteners and food intake regulation.....	44
IV.	Hypothesis.....	48
V.	Results.....	53
V.1	MOP in BED.....	53
V.1.1.	Opioid system generalities.....	53
V.1.2.	Opioid system and palatable food.....	53
V.1.3.	Opioid system and BED.....	54
V.2	Endocannabinoid system in BED.....	58
V.2.1.	ECS generalities.....	58
V.2.2.	ECS in homeostatic and hedonic control of food intake.....	59
V.2.3.	ECS and BED.....	59
V.3	Thermal and mechanical sensitivity in substance use and eating disorders.....	64
Intermittent access to 20% ethanol 2-bottle choice.....		67
V.4	Binge eating : a risk factor for addiction ?.....	85
VI.	General discussion.....	112
VI.1	Does neuroinflammation develop in the brain reward pathway following sucrose bingeing?.....	112
VI.2	Can we talk about food addiction ?.....	118
VI.3	Are signs of food addiction more pronounced in females ?.....	120
VI.4	Are comorbidities associated to BED and AUD sex dependent ?.....	121
VII.	Conclusion and perspectives.....	122
VIII.	Acknowledgements.....	127
IX.	References.....	130

PhD Portfolio

Formation

- 2018-aujourd'hui : PhD en neurosciences, équipe : « Abus de Drogues et Neuroadaptations », Dir : K. Befort (LNCA, Strasbourg, France) ; Co-Dir : M.C. Olmstead
- 2016-2018 : Master de Biologie médicale, spécialisation pharmacologie-toxicologie (UNIL, Lausanne, Suisse)
- 2013-2016 : Licence en Biologie (UNIL, Lausanne, Suisse)

Expériences professionnelles scientifiques

- 2017-2018 : Projet de Master en Neurosciences Cognitives et Adaptatives (Dir : K. Befort, M.C. Olmstead, LNCA, Strasbourg, France)
- 2017 : Projet de Prémaster en Neurobiologie des Troubles Addictifs et alimentaires, projet « Behavioral and molecular alterations associated with intermittent access to palatable food in the rat » (Dir : B. Boutrel, CHUV, Lausanne, Suisse)
- 2016: Stage de recherche en génétique au Centre Intégratif de Génomique à Lausanne, projet « Magnetic Bead DNA Purification » (Dir : J. Weber, UNIL, Lausanne, Suisse)
- 2015: Stage de recherche au CMU Genève, projet « Consolidation de la trace mnésique lors du sommeil après un entraînement mental » (Dir : S. Schwartz, U. Debarnot, UNIGE, Genève, Suisse)

Enseignements et encadrements

- 2020-2021 : Tutorat « Modèles génétiques animaux », (Université de Strasbourg, France) 4h/an étudiants *Euridol*
- 2020 : Encadrement étudiant M2 d'*Euridol* (Anne-Sophie Aubry)
- 2019 : Encadrement étudiants de programme d'échange (Georgia Skrempou, Madison Mailhiot)
- 2019 : Monitorat: Physiologie Animale des Métazoaires L2, Histologie et Cytologie L1, Approches Pratiques en Biologie Cellulaire L3 (Université de Strasbourg, France) 64h/an

Publications et prix

- 2021: Attribution du soutien de fin de thèse (*Euridol*, Graduate school of pain, Strasbourg)
- 2021-De Sa Nogueira D;, Bourdy R., Filliol D., **Awad G.**, Andry V., Goumon Y., Olmstead M.C., Befort K. (2021) Binge sucrose-induced neuroadaptations: A focus on the endocannabinoid system. *Appetite*. Apr 14;105258. doi: 10.1016/j.appet.2021.105258. PMID: 33864862. (*Euridol*)
- 2021-**Awad G.**, Befort K., Olmstead M.C. (2021) Artificial Sweeteners in Animal Models of Binge Eating. In: Avena N.M. (eds) *Animal Models of Eating Disorders*. Neuromethods, vol 161. Humana, New York, NY. https://doi.org/10.1007/978-1-0716-0924-8_7. (*Euridol*)
- 2020-**Awad G.**, Roeckel L.A., Massotte D., Olmstead M.C., Befort K. Deletion of Mu Opioid Receptors Reduces Palatable Solution Intake in a Mouse Model of Binge Eating. *2020 Behavioural Pharmacology*, 31, 249-255. doi: 10.1097/FBP.0000000000000496
- 2019-**Awad G.** and Befort K. Troubles de l'alimentation : facteurs de risque pour la douleur et l'addiction ? *Douleur analg.*, 32 2 (2019) 113-114. Publié en ligne : 29 juillet 2019. DOI: 10.3166/dea-2019-0055 (*Euridol*)

- 2021 IRESP (Institut pour la Recherche en Santé Publique) : “Sucrose bingeing : increased risk for alcohol abuse ?” PI : K. Befort
- 2018 FRA (Fondation pour la recherche en alcoologie) : “Sucrose bingeing : increased risk for alcohol abuse ?” PI : K. Befort

Conférences, congrés, présentations

- 2021: INRC (Visioconference). Poster « Impact of alcohol or sucrose bingeing on thermal and mechanical nociceptive thresholds in mice » (*Euridol*)
- 2021: Neurofrance, (Strasbourg, France). Poster « Impact of alcohol or sucrose bingeing on thermal and mechanical nociceptive thresholds in mice » (*Euridol*)
- 2019: IDARS (Casablanca, Morocco). Présentation orale et poster« Sucrose bingeing modifies alcohol reward in mice»
- 2019: Neurofrance, (Marseille, France). Poster « Sucrose bingeing alters reward processing: role of mu opioid receptors »
- 2018: GDR-GPCR, (Strasbourg, France). Poster « Sucrose bingeing alters reward processing: role of mu opioid receptors »

“Perfect as the wing of a bird, it never could raise the bird up without resting on air. Facts are the air of a scientist. Without them you never can fly. Without them your “theories” are vain of effort”.

Ivan Pavlov

List of abbreviations

2-AG: 2-arachidonoylglycerol	GHS-R: growth hormone secretagogue receptor
AEA: anandamide	GLP-1: glucagon-like peptide-1
AGE: advanced glycated end products	GLT: glutamate transporter
AGE: advanced glycated end products	GPCR: G-protein coupled receptor family
AgRP: agouti related peptide	Hipp: hippocampus
AKT: protein kinase B	IA : intermittent access
AN: anorexia nervosa	IBA1: ionized calcium binding adapter molecule 1
AP-1: transcription factor activator protein	JNK: c-Jun N-terminal kinase
ARC: arcuate nucleus	KOP: kappa opioid receptor
AUD: alcohol use disorder	LH: lateral hypothalamus
BAC : blood alcohol concentration	LTD: long term depression
BBB: blood brain barrier	MAGL: monoacylglycerol lipase
BBB: blood brain barrier	MCH: melanin concentrating hormone
BED: binge eating disorder	MG-H1: methylglucosyl
BN: bulimia nervosa	MOP: mu opioid receptor
CA : continuous access	NAcc: nucleus accumbens
CART: cocaine and amphetamine related transcript	NaCl : Sodium chloride
CB1: cannabinoid 1 receptor	NFkB: nuclear factor Kappa B
CB2: cannabinoid 2 receptor	NNS: Non-nutritive sweeteners
CCK: cholecystinin	NPY: neuropeptide Y
CML: N-epsilon-(carboxymethyl) lysine	PAMPS : pathogen associated molecular pattern
CNS: central nervous system	PFC: prefrontal cortex
CNS: central nervous system	PI3K: phosphoinositide 3-kinase
CPP : conditioned place preference	POMC: pro-opiomelanocortin
CPP: conditioned place preference	PRR: pathogen recognition receptors
Cq : quantification cycle	PVT: paraventricular nucleus of the thalamus
CVO: circumventricular organs	RNA : ribonucleic acid
D1: dopamine 1 receptor	RNase : ribonuclease
D2: dopamine 2 receptor	SNI: sciatic nerve injury
DA: dopamine	SOCS3: suppressor of cytokine signaling 3
df : degrees of freedom	SUC : sucrose
DMN: dorsomedial nucleus	SUD: substance use disorder
DOP: delta opioid receptor	TLR: toll like receptor
DRG: dorsal root ganglion	TNF α : tumor necrosis factor
DS: dorsal striatum	V : volume
DS: dorsal striatum	VF : Von Frey
DSM-5: the Diagnostic and Statistical Manual of Mental Disorders 5	VP: ventral pallidum
ECS: endocannabinoid system	VS: ventral striatum
EtOH : ethanol	VTA: ventral tegmental area
F : food	W : weight
FAAH: fatty acid amide hydrolase	
GFAP: glial fibrillary acidic protein	

List of figures

Figure 1 Public reports on food addiction.....	17
Figure 2 Number of scientific publications on addiction.....	18
Figure 3 Food addiction across time.....	22
Figure 4 The food cycle of satiation and satiety.....	24
Figure 5 Appetite controllers.....	25
Figure 6 Schematic representation of regions and projections involved in homeostasis and motivation.....	26
Figure 7 Toll like receptors signaling in central nervous system cells.....	31
Figure 8 Astrocyte and microglia polarization.....	32
Figure 9. The tripartite synapse.....	33
Figure 10 Insulin and leptin signaling pathways.....	36
Figure 11 Schematic presentation of the sweet taste GPCR receptor.....	47
Figure 12 a. Opioid receptor coupled to G_{oi} . b. Opioid neurotransmitter precursors with specific receptor and main effects.....	51
Figure 13 Receptor and enzyme cell localization involved in endocannabinoid signaling. 55	
Figure 14 Binge drinking paradigm in mice.....	65
Figure 15 Blood collection from the submandibular vein in mice.....	65
Figure 16 Calculation of blood alcohol concentration.....	65
Figure 17 Sucrose bingeing paradigm in mice.....	67
Figure 18 Von Frey apparatus and scoring sheet.....	68
Figure 19 The plantar apparatus.....	68
Figure 20. Data corresponds to EtOH intake (g/Kg) on every other day (EOD) which corresponds to IA EtOH access days.....	71
Figure 21 High and low drinkers total intake across the 8 weeks of access after 2 hours (a), 4 hours (b) and 24 hours (c) of access.....	72
Figure 22 Blood alcohol concentration 4 hours after the beginning of Etoh access in the IA group.....	73
Figure 23. Cluster identification according to BAC and total 4 hours EtOH intake in IA and CA groups combined.....	73
Figure 24. Mechanical and thermal sensitivity following EtOH intake 74	
Figure 25 Sucrose intake in mL/Kg.....	75
Figure 26 Body weight gain and consumption of chow and water and total calories intake across the 14 days.....	77
Figure 27 Mechanical and thermal sensitivity during and following sucrose bingeing.....	78
Figure 28. Six different cohorts went through the sucrose bingeing experiment followed by either CPP EtOH (Cohorts A,B,C), EtOH preference (Cohort D), gene expression (Cohort E), or metabolic profiling (Cohort F).....	86
Figure 29 Schematic diagram showing the within day schedule for sucrose bingeing.....	86
Figure 30 The conditioned place preference (CPP) apparatus.....	87
Figure 31 Coronal brain slices displaying brain areas where gene expression was measured	89
Figure 32 Sucrose intake and Weight evolution across the 14 days of access (cohort A).....	93
Figure 33 CPP to distinct concentrations of EtOH following sucrose bingeing.....	94
Figure 34 Sucrose intake across the 14 days of access in old mice (cohort C).....	95
Figure 35 CPP to distinct concentrations of EtOH following sucrose bingeing (Cohort C).....	96

Figure 36 Gene expression in brain regions of interest following sucrose bingeing (Cohort E).97

Figure 37 Spearman rank correlogram of total sucrose intake, percentage of weight gain and gene expression (cohort E).....98

Figure 38 Metabolic profiling following sucrose access (cohort F). No differences in.....99

Figure 39 Schematic representation of gene expression results obtained following sucrose bingeing.....113

Figure 40 Schematic representation of hypothetical modulation in neuronal signaling and gene expression.....113

Figure 41.....122

List of supplementary figures

Supplementary figure 1.....	80
Supplementary figure 2 Sex differences after 2 hours and 4 hours of access.....	81
Supplementary figure 3 Body weight gain in cluster.....	81
Supplementary figure 4 Sex differences in mechanical sensitivity.....	81
Supplementary figure 5 Sucrose intake across the 14 days of access (cohort B).....	99
Supplementary figure 6 Sex differences in CPP to ethanol following sucrose bingeing in young (cohort B) and old (cohort C) mice.....	100
Supplementary figure 7 (Cohort D). EtOH preference following sucrose.....	100
Supplementary figure 8 Sucrose intake across the 14 days of access (cohorts D&E).....	101
Supplementary figure 9 Sucrose intake across the 14 days of access (Cohort F).....	101
Supplementary figure 10 Correlation analysis between EtOH preference and total daily sucrose intake across the 14 days of access (Cohort E).....	102
Supplementary figure 11 Correlation between liver weight and body weight gain, total sucrose intake, and kilocalorie intake (Cohort F).....	103
Supplementary figure 12 EtOH Consumption preference and EtOH CPP set up in control mice.....	103
Supplementary figure 13 Gene expression analysis in Cohort E.....	104
Supplementary figure 14 Distributiou of calories between chow and sucrose (Cohort F)..	104

Summary

Binge eating disorder (BED) received recognition as a specific eating disorder in 2013 in the Diagnostic and Statistical Manual of Mental Disorders 5 (DSM-5). It is characterized by consumption of large amounts of food within a short period of time. Individuals report feelings of distress and lack of control. Bingeing must occur at least once a week over 3 months for the individual to be diagnosed with binge eating disorder. Recent studies have described close similarities between BED and substance use disorders (SUD) but there is no clinical agreement on “food addiction”. Nevertheless, some neurobiological and behavioral adaptations are common to both disorders. Implication of the endogenous opioid and endocannabinoid systems in such adaptations has been proposed. This may help to explain the comorbidity of BED and SUD, with a particularly high prevalence of alcohol use disorder (AUD). Recently evidence points to increases in neuroinflammatory processes within specific brain regions of the reward pathway following consumption of abused drugs. In the same manner, foods high in sugar and fat, which are consumed during binge episodes, also induce neuroinflammation in regions of the reward pathway. These close similarities between BED and SUD led us to investigate neuro-immune signaling in a mouse model of BED. As with all mental health conditions, comorbidity of conditions can reduce efficiency of treatments and increase the risk of relapse. Thus, identifying common mechanisms of BED and SUD may improve therapeutic options and increase the efficacy of targeted or combined treatments. The goals of our study was to look at neuroinflammatory processes in brain reward regions, examine the role of mu opioid (MOP) and cannabinoid 1 receptors, and evaluate EtOH reward and sensitivity to thermal and mechanical stimuli in animal models of BED. For the latter, we will compare results with those from a binge alcohol model, based on evidence that BED patients often present with clinical signs of increased pain.

Please note that some elements of the manuscript are translated in French to follow the rules of ED 414 of the University of Strasbourg.

Résumé

L'hyperphagie boulimique (BED) a été reconnue comme un trouble alimentaire spécifique en 2013 dans le Manuel diagnostique et statistique des troubles mentaux 5 (DSM-5). Elle se caractérise par la prise de grandes quantités de nourriture dans un court laps de temps. Les individus rapportent un sentiment de détresse et une perte de contrôle. Les épisodes d'hyperphagie boulimique doivent produire au moins une fois par semaine pendant 3 mois pour qu'un individu soit diagnostiqué. Des études récentes ont décrit des similitudes entre le BED et l'abus de substances addictives, mais il n'y a pas d'accord clinique sur la "dépendance alimentaire". Néanmoins, des adaptations neurobiologiques et comportementales sont communes aux deux troubles. L'implication des systèmes endogènes opioïde et cannabinoïde a été proposée. On s'intéresse depuis peu aux processus neuroinflammatoires associés à la consommation de drogues dans des régions cérébrales impliquées dans le circuit de la récompense. De la même manière, les aliments riches en sucre et en graisse, qui sont fortement consommés pendant les épisodes de frénésie alimentaire, induisent également une neuroinflammation dans les régions du circuit de la récompense. De telles similitudes entre l'hyperphagie boulimique et l'abus de substances addictives nous ont amenés à étudier la neuroinflammation dans un modèle murin de d'hyperphagie boulimique. Les comorbidités peuvent réduire l'efficacité des traitements et augmenter le risque de rechute. Les personnes peuvent aussi souffrir de dépendance aux drogues, avec une prévalence élevée de troubles liés à l'alcool. Elles rapportent également des douleurs chroniques. Les objectifs de notre étude sont d'examiner les processus neuroinflammatoires dans les régions cérébrales de la récompense, d'évaluer le rôle des récepteurs mu opioïde (MOP) et cannabinoïde 1 (CB1), de mesurer la récompense à l'EtOH et la sensibilité aux stimuli thermiques et mécaniques dans des modèles animaux de BED. Pour ce dernier point, nous comparerons les résultats avec ceux obtenus dans un modèle de binge alcool.

A noter que certaines parties du manuscrit sont traduites en français à la demande de l'école doctorale 414 de l'Université de Strasbourg.

I. Introduction

I.1 Addiction and eating disorders

I.1.1. *Addiction: definition*

There is a high comorbidity between eating disorders and substance use disorders (SUD) (Root et al., 2010). One hypothesis is that drug addiction reflects the development of impaired brain reward circuit function. This is based on evidence that repeated drug use alters dopaminergic signaling in the mesocorticolimbic pathway, as well as other systems including endogenous opioid and cannabinoid systems that mediate reward. Impairments in these systems are thought to underlie the transition to addictive behavior. BED may also be due to reward dysfunction as the behavior is associated with dysfunction in the dopaminergic, opioid, and endocannabinoid systems. Moreover, neurobiological and behavioral similarities of addiction and binge eating suggest that therapeutic advances for BED could be informed by addiction research.

“Addictions involve persistent, compulsive and uncontrolled behaviors that are both maladaptive and destructive” (Adinoff, 2004). Interestingly, the term addiction comes from the Latin, “addicere”, which means “assigned to” and was used to designate slaves. It therefore represents a lack of independence and subservience to a master. In the Diagnostic and Statistical Manual 5 addiction is defined as SUD (Table 1), combining criteria from substance abuse and substances dependence categories in the previous edition (DSM-IV):

- 1- Hazardous use
- 2- Social/interpersonal problems related to use
- 3- Neglected major roles to use
- 4- Withdrawal
- 5- Tolerance
- 6- Used larger amounts/longer
- 7- Repeated attempts to quit/control use
- 8- Much time spent using
- 9- Physical/psychological problems related to use
- 10- Activities given up to use
- 11- Craving

Table 1 DSM-5 SUD 11 criteria. The subject has to demonstrate 2 or more SUD criteria within a 12 months period.

The international classification of diseases by the world health organization also developed its own diagnostic tool, the last version being ICD-11 released in 2016, replacing substance use disorder term with substance dependence.

1.1.2. Neurobiology of reward

1.1.2.1. Brain circuits of reward

Activation of dopamine (DA) neurons play a critical role in the process of reward as shown by pharmacological and neurochemical studies using inhibitors of dopamine reuptake and electrochemical procedures to monitor extracellular dopamine (Le Moal & Simon, 1991). The mesocorticolimbic system is central to reward processing with dopaminergic neurons shown to be specifically important. The ventral tegmental area (VTA) in the midbrain contains a high density of dopaminergic neurons sending projections to the ventral and dorsal striatum (DS), the amygdala (Amy), the hippocampus (Hipp) and the prefrontal cortex (PFC) (Volkow & Morales, 2015). These neurons are activated by motivationally-salient stimuli, informing the organism that they are encountering rewarding or aversive events. The nucleus accumbens (NAcc) is the main target of the dopaminergic projections from the VTA. DA release in the NAcc is increased in response to reward, with the amplitude of release being correlated with reward expectancy (Volkow & Morales, 2015; Zweifel et al., 2009). The Amy is involved in reward valuation (Wassum & Izquierdo, 2016), whereas the Hipp also encodes drug related memories in contextual control of reward seeking (Goodman & Packard, 2016). The DS is involved in goal directed behavior and habitual control of behavior (Malvaez & Wassum, 2019) and the PFC regulates executive control (Juarez & Han, 2016). Taken together, these brain regions produce a coordinated response to environmental stimuli that signal reward.

Drugs of abuse also act on the mesocorticolimbic system to increase DA signaling (Juarez & Han, 2016). Repetitive drug exposure rewires brain signaling and underlies the neurobiological transition from adaptive to maladaptive responses by modulating the dopaminergic system (i.e.: addiction) (Volkow & Morales, 2015).

The neurobiology of drug reward may be described in terms of two dissociable processes. While DA is an essential component of “wanting” drugs (and other rewarding stimuli), the opioid system is an essential component of “liking” (Berridge, 2009). The endogenous opioid system consists of 3 main receptors: the mu, delta, kappa and receptors (MOP, DOP, KOP) and a fourth receptor was cloned later on presenting strong homology with the opioid receptor but less than the homology presented between the 3 main receptors (Toll et al., 2016). These receptors belong to the G-protein coupled receptor family (GPCR) with coupling Gi/Go proteins. Binding to these receptors reduces neuronal excitability and neurotransmitter release). Four main endogenous opioid ligands: beta-endorphin, enkephalin, dynorphin and

nociceptin have been described, each released from post-translational cleavage of the precursor proteins proopiomelanocortin, preproenkephalin, prodynorphin and prepronociceptin respectively (Gavériaux-Ruff C., 2013) and is implicated in diverse functions such as pain, reward and affective processing. Opioid receptors and opioid peptides are expressed throughout the nervous system including in regions of the mesocorticolimbic reward pathway, where they modulate dopaminergic signaling . In the VTA, MOPs are localised, primarily, on GABA presynaptic terminals that normally inhibit DA neuronal activity (Steffensen et al., 2006). As a result, activation of all three opioid receptors potentiate DA release within the NAcc, as evidenced by in vivo microdialysis studies (Devine & Wise, 1993).

As with endogenous opioids, the endocannabinoid system (ECS) has a modulatory effect on DA reward systems (Befort, 2015). The ECS contains 2 main receptors: the cannabinoid 1 receptor (CB1) and the cannabinoid 2 receptor (CB2). Both belong to the GPCR family with coupling Gi/Go proteins. CB1 is one of the most abundant GPCR in the brain (Howlett & Abood, 2017). Binding to these receptors reduces neuronal excitability and neurotransmitter release. This system also comprises endogenous ligands: N-arachidonylethanolamide, named anandamide (from the Sanskrit word Ananda meaning joy/bliss) and 2-arachidonoylglycerol (2-AG). In the same manner as opioids, cannabinoids inhibit GABAergic transmission in the VTA, leading to increased release of DA (Szabo et al., 2002). Systemic administration of an anandamide analog increases NAcc DA levels (Solinas & Justinova, 2006) whereas CB1 antagonists block DA release in rats following drug administration (Cheer et al., 2007).

The opioid and endocannabinoid systems interact and, interestingly, are both located in brain reward regions, such as in the NAcc. Supporting the idea that neural systems of liking and wanting are distinct, DA depletion does not suppress ‘liking’ responses to rewarding stimuli, such as sucrose. In contrast, liking is modulated by the opioid and endocannabinoid systems at the levels of hedonic hotspots (Mitchell et al., 2018).

1.1.2.2. Behavioral tasks to measure reward

Investigations into the neurobiology of reward are informed by animal behavioral experiments that measure reward processes. Reward components may be into motivation, learning and affect (Berridge & Robinson, 2003). We will focus on one of the most commonly used experiment to measure drug reward, which is the conditioned place preference (CPP) paradigm that is based on principles of Pavlovian conditioning (Tzschentke, 1998) and measures associative learning of conditioned and unconditioned stimuli. The CPP

procedure involves conditioning sessions in which one environment is paired with a drug injection and another is paired with a neutral (vehicle) injection. During testing, animals are allowed to freely explore the two environments. Increased time spent in the drug-paired compartment is a measure of the rewarding properties of the drug. Importantly, there is strong concordance between drugs that produce a CPP and those that support self-administration. In 1940, the earliest CPP experiment was used to assess the rewarding effects of morphine in dependent chimpanzees (Szabo et al., 2002). The SA paradigm in rodents was first used by Weeks (1962) to study addictive like responses to morphine. Measuring drug intake at different doses allowed researchers to assess physical dependence when the drug was removed and withdrawal like symptoms were measured (Weeks, 1962).

1.1.3. History and concept of food addiction

An increased number of public reports (Figure 1) and scientific (Figure 2) support the idea that maladaptive eating, including binge eating, can be conceptualized as an addictive



Figure 1 Public reports on food addiction. There is a strong public interest of the concept of food addiction a. “Le sucre, la nouvelle drogue douce » (Dernières nouvelles d’Alsace, December 2017). b. « La nourriture peut-elle être à l’origine d’une addiction ? » (Sciences et Vie, December 2019).

behavior. Within the scientific community, however, the concept of food addiction is still debated (Fletcher & Kenny, 2018). The recognition that food addiction may explain at least some components of eating disorder will affect the policy, prevention and therapeutic programs to treat these disorders.

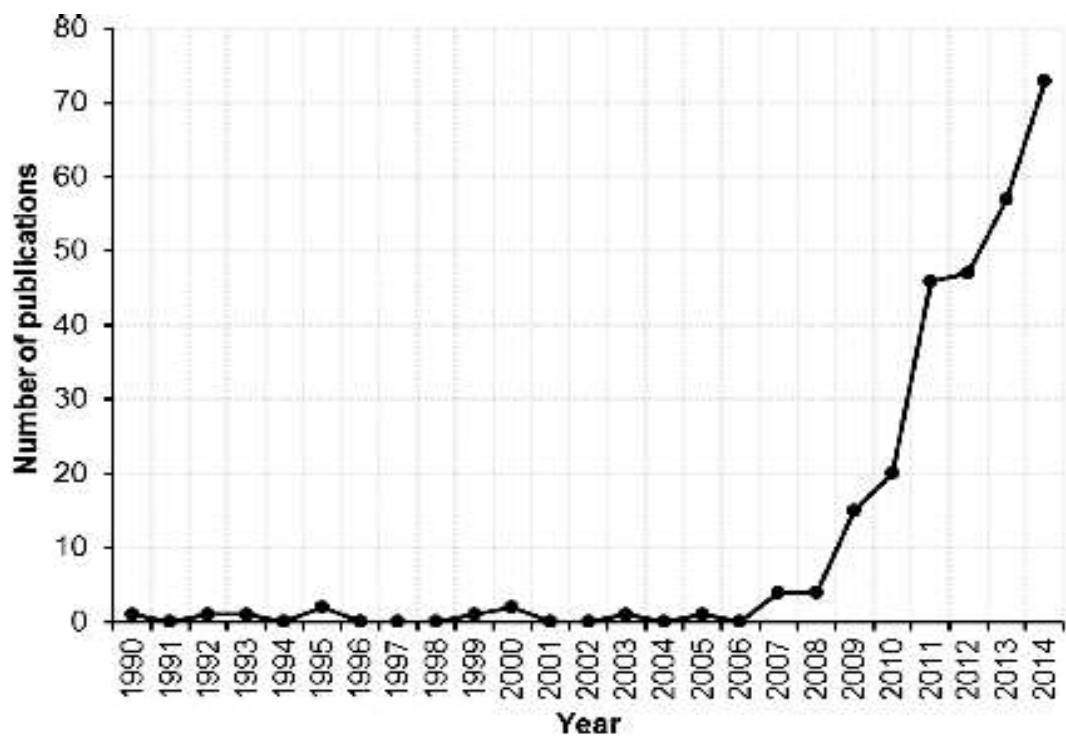

Figure 2 Number of scientific publications on addiction. The graph shows the number of scientific articles on the topic of food addiction published each year over a 25 year period. The database used to perform the research was Web of Science. The search term was “food addiction” as a topic (graph from Meule, 2015).

The term addiction when referred to food has already been used in the past by the scientific community, before gaining public interest, reflected by an increase in media reports of scientific findings (Meule, 2015). The “Journal of inebriety” in 1890, was the first scientific journal mentioning dependence to chocolate. In 1970, Thorner describes a behavior reminiscent of drug addiction in which individuals with bulimia feel trapped in a vicious cycle of eating more and more to escape anxiety but with no feeling of satisfaction (Thorner, 1970). Furthermore, Thorner describes his concerns of overeating as an addictive disorder: *“There is also another problem which I can only touch on; the relationship between overeating and addiction. Overeating has been called addiction to food. It is true that there are some elements which both food and drug addiction have in common, i.e. the compulsive character. But there are other elements which differentiate overeating from drug addiction ; the manic element, on which Freud lays great stress, and idealization of the object of addiction are missing. Also, the intoxicating effect of the drug is not present in overeating.”*

The psychoanalytic theory describes overeating as an oral conflict (Meule, 2015). It is according to Wulff in 1932, an oral erotic introjection of a genital relationship. Freud describes eating disorders as an unconscious sexual conflict, representative of an “oral sadistic, cannibalistic oral fantasy”.

In 1956, Randolph introduces food addiction to the scientific literature. He contrasted the concept of “food addiction” with “food sensitivity”. According to his definition, food sensitivity, also known as an allergic reaction, causes an immediate sharp reaction. On the other hand, food addiction causes reversal delayed effects that he calls “food addiction hangover”. As an example of hangover symptom he describes: “*The milk-sensitive patient, for instance, often learns that raiding the icebox for a piece of cheese is more effective in her case than sleeping pills.*” Interestingly, and in line with current debate of food addiction, Randolph points out that according to the individuals, some addictive eating behaviors lead to obesity and others to binge eating putting forwards the non-constant relationship between binge eating and obesity. Moreover, he compares addiction to refined and non-refined food. A point that is all the more relevant because today there is a debate whether food addiction should rather be called eating addiction described as a behavioral addiction since there is a lack of evidence on specific macronutrient addiction in humans (Hebebrand et al., 2014). He says that the food used to produce the addicted alcoholic beverage can reproduce the same hangover symptoms however in a slower manner since absorption is much faster for alcohol (Randolph, 1956).

Finally, some argue even though food addiction is not in the DSM-5, diagnosing patients as food addicts seems to improve compliance according to his observations. This is also another important point because it has been observed with the *Overeaters anonymous* program bringing support to individuals who perceive themselves as overeaters (Rodríguez-Martín & Gallego-Arjiz, 2018).

1.1.4. Addiction traits in eating disorders

Overeating episodes in eating disorders patients are usually directed towards calorie dense and highly palatable foods (Hill & Peters, 1998). To explain this behavior, evolutionary biologist have proposed 3 theories of overeating:

- 1- The thrifty gene hypothesis by James Neel (1962) suggests that genes which were historically advantageous became detrimental with time e.g. genes which predisposes to diabetes ([Meule, 2015](#)).
- 2- The drift gene hypothesis by Speakman (Speakman, 2008) contradicts the thrifty gene hypothesis. According to the author, the thrifty gene hypothesis insinuates that we should all be obese and diabetic by now. He suggests that the removal of predation as an upper boundary in energy intake and expenditure is one of the reasons for the genetic drift to consume highly palatable foods.

3- Hales and Baker (Hales & Barker, 2001) argue that a nutrient-poor intrauterine environment engages the development of an adaptation that increases the risks of chronic diseases such as obesity and diabetes.

Across time, the term food addiction was used to explain obesity or overeating but also eating disorders such as anorexia nervosa (AN) and bulimia nervosa (BN). AN is characterized by persistent refusal of food, excessive fear of weight gain, refusal to maintain minimally normal body weight, disturbed perception of body image and amenorrhea. BN involves recurrent episodes of binge eating followed by inappropriate compensatory behaviors (e.g.: self-induce vomiting, misuse of laxatives, fasting, excessive exercise) (American Psychiatric Association, 2013). In these disorders, the role of the endogenous opioid system was already reported. AN was first described as a starvation dependence and this idea was subsequently supported by the elevated endogenous opioid activity in the cerebral spinal fluid, described as the auto addiction opioid theory by keeping on a negative energy balance to avoid depletion of opioids (Marrazzi & Luby, 1986). AN individuals also show increases in plasma circulating AEA (Monteleone & Maj, 2009) as well as an increase of CB1 in discrete brain regions Gerard 2011. BN is characterized by excessive eating. Individuals manifests an increase of opioids following eating suggesting a deficiency of the opioid system activity (Gillman, 1986). ECS is also implicated in BN with increased CB1 in the insular cortex (Monteleone & Maj, 2009). In contrast, personality assessments do not support the idea of addictive personality traits in women with BN, having significantly lower scores than women with drug abuse (Hatsukami et al., 1982).

The Yale Food Addiction Scale (YFAS) tool is used to assess food addiction based on the DSM-IV substance abuse diagnostic criteria. It measures 7 symptoms, if at least 3 symptoms are met with clinical impairment or distress, food addiction is diagnosed. This scale has been used to diagnose BED and may represent a subgroup of more disturbed BED individuals since they presented more severe symptoms (Linardon & Messer, 2019). Therefore, BED is an eating disorder that shows addiction traits, at least according to this criterion, which will be explored in the following section.

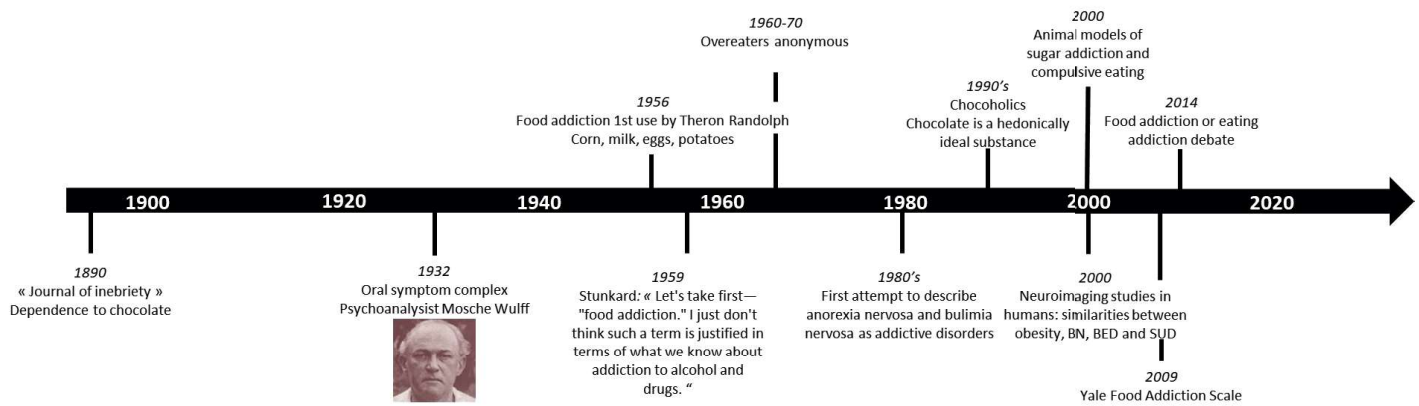

Figure 3 Food addiction across time. Psychological, neurochemical and neuroimaging studies bringing supportive evidence for food addiction overtime.

1.1.5. BED: Definition, epidemiology and neurobiology

1.1.5.1. Definition and epidemiology

Binge eating disorder received formal recognition in 2013 by the DSM-5 with its own diagnostic criteria (American Psychiatric Association, 2013):

DSM-5 diagnostic criteria for Binge Eating Disorder

Criterion A. Recurrent episodes of binge eating. An episode of binge eating is characterized by both of the following:

1. Eating in a discrete period of time (e.g.: within any 2-hour period) an amount of food that is definitely larger than what most people would eat in a similar period of time under similar circumstances
2. A sense of lack of control over eating during the episode (e.g.: a feeling that one cannot stop eating or control what or how much one is eating)

Criterion B. The binge eating episodes are associated with 3 (or more) of the following:

1. Eating much more rapidly than normal
2. Eating until feeling uncomfortably full
3. Eating large amounts of food when not feeling physically hungry
4. Eating alone because of feeling embarrassed by how much one is eating
5. Feeling disgusted with oneself, depressed, or very guilty afterward

Criterion C. Marked distress regarding binge eating is present

Criterion D. The binge eating occurs, on average, at least once a week for 3 months

Criterion E. The binge eating is not associated with the recurrent use of inappropriate compensatory behavior as in bulimia nervosa and does not occur exclusively during the course of bulimia nervosa or anorexia nervosa

Severity grading.

Mild: 1 to 3 episodes per week

Moderate: 4 to 7 episodes per week

Severe: 8 to 13 episodes per week

Extreme: 14 or more episodes per week

Table 2 Diagnostic criteria for BED according to the DSM-5 (adapted from Berkman).

Its prevalence exceeds that of AN or BN ranging from 1.4% to 3.5% and is most common amongst women (Hudson et al., 2008; Kessler et al., 2013a). However, these results are obtained according to criteria from DSM-IV which has different criterion for frequency and duration (at least 2 days a week for 6 months) and does not include severity (Table 2). A more recent study was able to show that the prevalence rate of BED was higher when considering DSM-5 criteria than DSM-IV (Cossrow et al., 2016).

1.1.5.2. The control of food intake

a) Homeostatic signals from the periphery

The regulatory control of food intake is influenced by satiation signals controlling the size of the meal which is regulated by gastric and intestinal mechanisms. Satiety signals control time intervals between meals and are regulated by gut hormones transmitted via the vagal nerve and the spinal nerve as well as fat storage signals which act over a longer term (Figure 4).

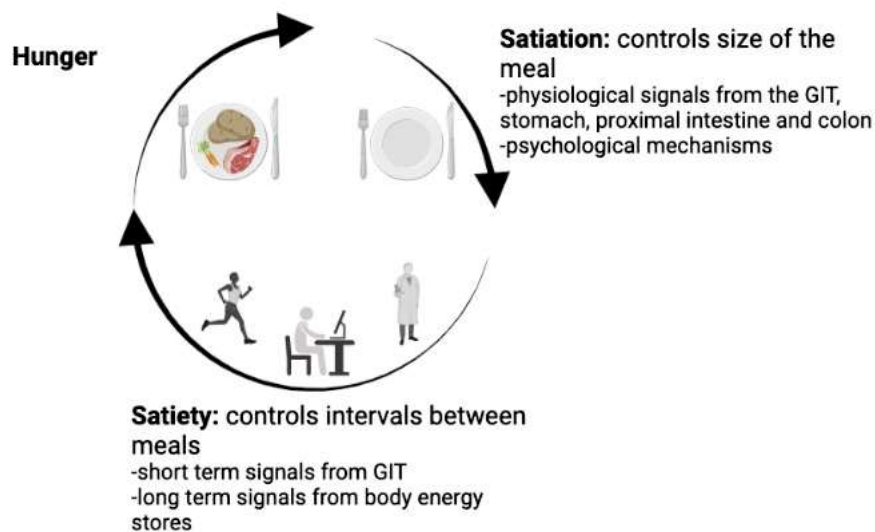

Figure 4 The food cycle of satiation and satiety (adapted from Abdalla M.M.I, 2021)

Mechanisms of satiation have been proposed (Figure 5): the gastric distension is communicated to the brain through the nerves. In the gastrointestinal tract, the gut peptide hormone cholecystokinin (CCK) is secreted postprandially by small intestinal cells and its action is mediated through the CCK1 receptor on vagal nerve afferent. It reaches a peak 15 minutes after the meal. The short term signals of satiety involve ghrelin, the only known gut peptide hormone to have an orexigenic action. It directly acts on its receptor in the hypothalamus, the growth hormone secretagogue receptor. However, ghrelin can also influence long term energy balance since it is inversely correlated with body fat mass. Glucagon-like peptide-1 (GLP-1) is expressed in the intestine and influences increase of insulin secretions as an incretin. It binds to its receptors in the hypothalamus and acts on the nucleus solitary tract through the vagal nerve. There are also satiety signals that communicate fat storage, which is a long term signal. Leptin, a peptide hormone, is expressed in the adipose tissue and can directly inhibit orexigenic neurons and stimulate anorexigenic neurons in the hypothalamus. Insulin is a peptide hormone expressed by β -cells of the pancreas, it has a short

term action by rapidly increasing following food intake to control glycemia and has a long term effect by increasing levels with weight (Benelam, 2009; Marx, 2003).

b) Neural circuits involved in homeostatic and hedonic control of feeding

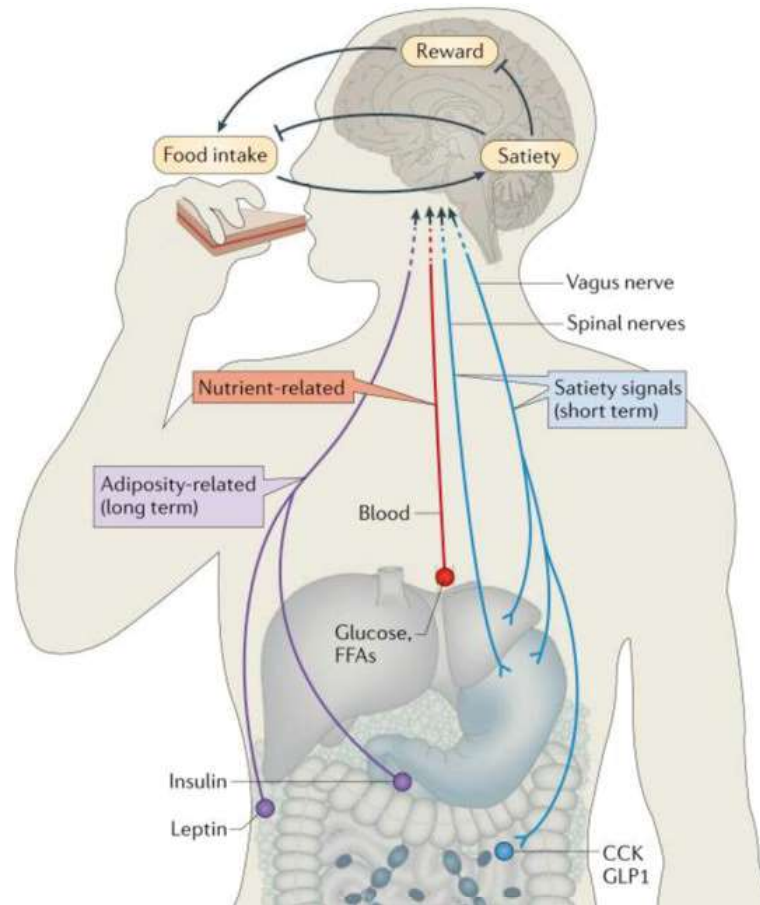

Figure 5 Appetite controllers. The body produces peptide hormones that regulate hunger and satiety in the central nervous system. Insulin and leptin are anorexigenic peptide hormones. Insulin derives from the pancreas and leptin from the adipose tissue. Cholecystokinin is a gut hormone peptide with anorexigenic properties. Most of the information are transmitted through the vagus nerve to the brain stem. (Adapted from abdelhay 2017)

The hypothalamus is the main region of the brain involved in homeostatic control of food intake and integrates the peptide hormone signals from the periphery (Morton et al., 2014). It contains many nuclei, including:

-The arcuate nucleus (ARC) that contains orexigenic neurons co-expressing agouti related peptide (AgRP) and neuropeptide Y (NPY) and anorexigenic neurons co expressing cocaine and amphetamine related transcript (CART) and pro-opiomelanocortin (POMC). AgRP/NPY neurons are activated by ghrelin and inhibited by leptin, insulin and glucose. POMC/CART neurons are activated by leptin and inhibited by ghrelin and insulin (Figure 5). Both neurons send projections to second order neurons of the dorsomedial nucleus (DMN), the paraventricular nucleus of the thalamus (PVT) and the lateral hypothalamus (LH).

-The LH contains orexin/melanin concentrating hormone (MCH) expressing neurons involved in increased feeding and are targeted by the AgRP/NPY and POMC/CART cells of the ARC. It also contains neurons expressing the anorexigenic neuropeptide neurotensin. This peptide has also been found to be expressed in the gastrointestinal tract.

-The PVT contains a high population of glutamatergic neurons and receives major input from the LH orexin and ARC NPY/AgRP neurons.

As shown in Figure 6, hypothalamic regions involved in food intake also communicate with regions from the reward system such as the VTA, DS and NAcc. The VTA contains 70% of DA neurons, 30% of GABA neurons and 2-3% of glutamate neurons approximately. The LH can control the DA neurons activity of the VTA thanks to GABA, glutamate, orexin and neurotensin neurons and promotes incentive, reinforcing and motivational aspects of food intake (Palmiter, 2007). Interestingly, the VTA can directly respond to neuropeptide hormones from the periphery. Ghrelin can activate DA neurons and favor palatable food intake over regular chow (Egecioglu et al., 2010). After binding to its receptor, leptin inhibits DA neurons activity and decreases food intake (Hommel et al., 2006). GLP-1 and insulin also inhibit DA neuron of the VTA and decrease high fat food intake and response to food associated cues respectively (Labouèbe et al., 2013; Wang, 2018). The striatum contains two major populations of medium spiny neurons that express dopamine 1 receptors (D1) and D2 and are involved in the direct and indirect pathway respectively. Briefly, the direct pathway promotes motor activity while the indirect pathway inhibits it (Macpherson et al., 2014). The DS is involved in the initiation of feeding behavior whereas the NAcc is involved in food rewards and associated cues. These behaviors can be stimulated by the glutamatergic projection coming from the PVT.

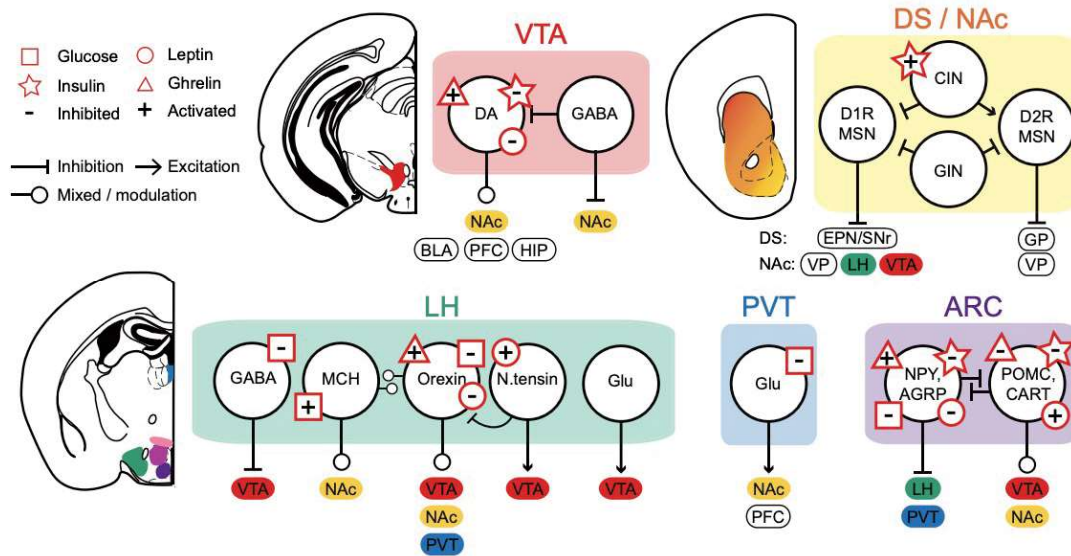

Figure 6 Schematic representation of regions and projections involved in homeostasis and motivation.ARC, Arcuate nucleus; BLA, basolateral amygdala; CART, cocaine- and amphetamine-regulated transcript; CIN, cholinergic interneuron; GIN, GABAergic interneuron; Glu, glutamate; HIP, hippocampus; MCH, melanin-concentrating hormone; NPY, neuropeptide Y; PFC, prefrontal cortex; VP, ventral pallidum, CIN: cholinergic neurons; GIN: GABAergic neurons. (image adapted from Ferrario et al., 2016)

The ECS also plays a critical role in the regulation of feeding. Cannabis users often report increased appetite, “munchies”, suggesting the implication of the ECS in food intake and energy balance (Williams & Kirkham, 1999). Several studies have shown its implication in food intake by modulating signaling in the hypothalamus and in in regions of the mesocorticolimbic pathway (Lau et al., 2017). At the level of the ARC, CB1 agonists can modulate POMC activity in a bimodal manner. Endocannabinoids can mediate depolarization-induced suppression of inhibition on GABAergic and or depolarization-induced suppression of excitation glutamatergic neurons In the LH, leptin inhibits CB1R-mediated DSI by reducing endocannabinoids post synaptic synthesis (Jo et al., 2005). ECS can modulate feeding via actions in the NAcc, since direct brain microinjection of AEA or 2-AG elicits food intake (Kirkham et al., 2002; Mahler et al., 2007). ECS also interacts with insulin signaling in the VTA by inhibiting glutamate neuronal activity since insulin activates the synthesis of endocannabinoids which will then participate in insulin induced long term depression (LTD) (Labouèbe et al., 2013).

Several studies have shown the interrelationship between the opioid system and homeostatic signals. Indeed, opioid signals may regulate antagonist of melanocortin 3

receptor (MC3R) and MC4R and maintains food intake. After blockade of the MOP using naltrexone, a non-selective opioid receptor antagonist, AgRP activity was suppressed (Brugman et al., 2002). It was also shown that AgRP promotes the intake of preferred food rather than normal food, and therefore displays similar functions as opioids (Wirth & Giraud, 2001). So, despite its implication of satisfying energy needs, AgRP might also have opioid like effects due to its interaction with the opioid signals. There is evidence that the opioid system regulates food intake through orexin signaling. Indeed, after selective and non-selective blockage of the opioid receptors using selective and non-selective antagonists, food intake decreased as did the mRNA levels of prepro-orexin (mRNA precursor of OX-A and OX-B) in the LH. Therefore, OX induced intake is prevented by the opioid system blockade. There is growing evidence that OX is implicated in feeding regulation of hedonic food. Indeed, it is shown that OX neurons project to hedonic hotspot of the NAcc and enhance hedonic reactions.

Microinjections of OX elicited positive reactions to sweet taste in rats in the same way as opioid stimulation (Castro et al., 2016; Castro & Berridge, 2014). These findings suggest that opioids interact with orexigenic peptide activity and regulate food intake through homeostatic signals and that orexigenic peptides also have a role in the reward value of food and palatable food intake. Opioids and endocannabinoids can also interact with each other at the level of the hypothalamus as shown by Koch and colleagues. Another similarity is the presence of endocannabinoid and opioid hedonic hotspots localized in the orbitofrontal cortex, the insula, the NAcc shell, the VP and the parabrachial nucleus (Morales & Berridge, 2020).

1.1.5.3. Shared characteristics between BED and addiction from preclinical and clinical studies

Why individuals eat outside of the homeostatic hunger is still under investigation. However, as described in the previous paragraph this may reflect close interactions between regions involved in homeostatic control of food intake with those involved in hedonic control. The balance between those two regulatory systems may be hijacked by food and specifically calorie dense food (usually high in fat and/or sugar). These mechanisms are observed in obesity but also in eating disorder and share similarities with dysregulations observed in drug addiction. There are several factors involved in the loss of a food intake balance. There are

first environmental factors such as increased availability of food and size of meal. These can lead to increased food intake which can perturb the homeostatic regulation over the long term (Rolls, 2003). The palatability of food also has a role in increased food intake, as the French expression foes “l'appétit vient en mangeant” (Sclafani, 2018). These palatable foods are more and more available and accessible. However they can lead to increased intake by activating specific regions of the brain involved in hedonic pathway in a manner that increases desire for food, hunger and craving (Cocores & Gold, 2009; Pelchat et al., 2004; Wang et al., 2004).

Binge eating shares many characteristics with addiction criteria, including reward dysfunction, craving, emotion dysregulation and impulsivity (Schulte et al., 2017). In terms of reward rewards, the reward deficiency theory in addiction, proposed in the 1980s, might explain overeating and eating disorders (Blum et al., 2000). This theory contains 2 main hypotheses, that people experience hypo- or hyper responses to reward. According to the hyporesponse theory, individuals will seek for drug rewards to reach same level of reward related neural circuit activation reached in other individuals with less potent rewards. This is also correlated with adaptations at the neurobiological level, since carriers of the DR2 A1 allele have reduced receptor availability (Volkow, Logan, et al., 1999a). Interestingly, the allele is related to compulsive overeating and is found in individuals with BED (Davis et al., 2008). In line with the reward deficiency syndrome, individuals with addiction show diminished brain activity in specific regions during reward anticipation observed in alcoholics and pathological gambling which is also observed in BED individuals by functional magnetic resonance imaging (fMRI) (Balodis et al., 2013). The hyperresponsive theory supports the idea that individuals that show high response to drug related cues are more prone to develop addiction. This would happen in brain areas such as the dorsolateral anterior cingulate cortex, the dorsal and medial precortices known to be important in executive function such as inhibitory control, the DS involved in automatic drug intake behavior for smoking cues and the VTA and the PFC for heroin associated cues (Engelmann et al., 2012; Yang et al., 2009). In parallel to these observations, BED individuals showed increased striatal dopamine activity in response to food stimuli (Wang et al., 2011). There are also similarities observed in obese patients with BED with patients presenting opioid addiction such as the presence of the MOP allele A118G (Taqi et al., 2019). A recent review summarizes the effects of opioid antagonists in BED as potential treatments (Valbrun & Zvonarev, 2020). Antagonism of MOP in BED animals models (Giuliano et al., n.d.; Katsuura & Taha, 2014a) and opioid antagonist

(GSK1521498 with higher selectivity for MOP than DOP and KOP) in obese individuals with BED (Ziauddeen et al., 2013) reduced binge eating. The ECS is also modulated in BED. Human studies show an increase of plasma AEA (also in AN). The ECS in BED has been more studied in preclinical studies. Pharmacological blockade of CB1 reduces fat or sweetened fat intake in binge rat models (Parylak et al., 2012; Scherma et al., 2013). Endocannabinoid AEA levels decreased in brain related reward regions (DS, Amy and Hipp) and CB1 density decreased in PFC and the NAcc shell (Satta et al., 2018) and its expression decreased in the cingulate cortex (Bello et al., 2003).

Recent evidence shows that BED may be underlined by unbalanced regulation between the homeostatic and hedonic network regulating food intake. These alterations may lead to neurochemical and behavioral alterations similar to those observed in drug addiction. Opioid and endocannabinoid systems are involved in hedonic eating and BED through signaling in regions of the reward pathway.

II. Neuroinflammation

II.1 The immune system (periphery)

Innate immunity is the first line of defense against pathogens. This occurs through a complex interplay of factors that collectively work to reduce invasion. For example, phagocytes recognize pathogen associated molecular patterns (PAMPS) or damaged associated molecular patterns (DAMPS), eliminate foreign substances by phagocytosis and present the antigens to antigen presenting cells which include macrophages, monocytes, dendritic cells and B lymphocytes. In addition, toll like receptors (TLRs) recognize the major PAMPS and DAMPS which activate downstream pathways of two major proteins MyD88 and TRIF. The cytoplasmic domain of TLRs recruits the TIRAP/MyD88/IRAK/TRAF6 complex or the TRAM/TRIF/TRAF6 complex which can activate the nuclear factor Kappa B (NFkB) signaling pathway or the JUN kinase, which activates the transcription factor activator protein (AP-1). Activation of these downstream signaling pathways are required for the induction of pro-inflammatory gene expression.

II.1.1. Glia (brain)

In addition to the neurons which represent barely half of the cells of the central nervous system (CNS), glia including astrocytes, microglia, oligodendrocytes, and ependymocytes participate in the protection of the CNS. Astrocytes have many cytoplasmic extensions. They regulate the setting up of synapses and their stabilization, produce enzymes that allow neurotransmitters to be unhooked from receptors, control the blood supply to neurons and prevent diapedesis by participating in the formation of the BBB. The origin of astrocytes is ectodermal. Microglia function as phagocytes, they remove debris from dead brain cells and they detect the first signs of pathogenic invasion. The origin of the microglia is mesodermal and they migrate to the brain parenchyma before the formation of the blood brain barrier.

II.1.2. Neuroinflammatory signaling in the brain (astrocytes and microglia)

The circumventricular organs (CVO) are devoid of blood brain barrier (BBB), so PAMPS, bacteria or other pathogens can circulate freely between the periphery and brain. The microglia and recruitment of macrophages that access the brain at CVO are activated and express cytokines and chemokines. This neuroinflammatory response is mediated mainly by TLRs expressed on neurons, astrocytes, microglia and oligodendrocytes. They are the main pathogen recognition receptors (PRR) able to recognize various ligands such as RNA, heat shock proteins and so on (Figure 7) (Ashayeri Ahmadabad et al., 2021; Downes & Crack, 2010). The inflammatory response can progress into the parenchyma by activating brain resident microglia. The immune response is mostly mediated by microglia. There is also cross talk between microglia and astrocytes. This cross talk has not been studied as thoroughly but there is evidence that astrocytes are activated later than microglia (Kim & Son, 2021). Another pathway involves the afferent nerves, such as the vagal nerve that leads to cytokine synthesis in response to visceral inflammation (Dantzer et al., 2008).

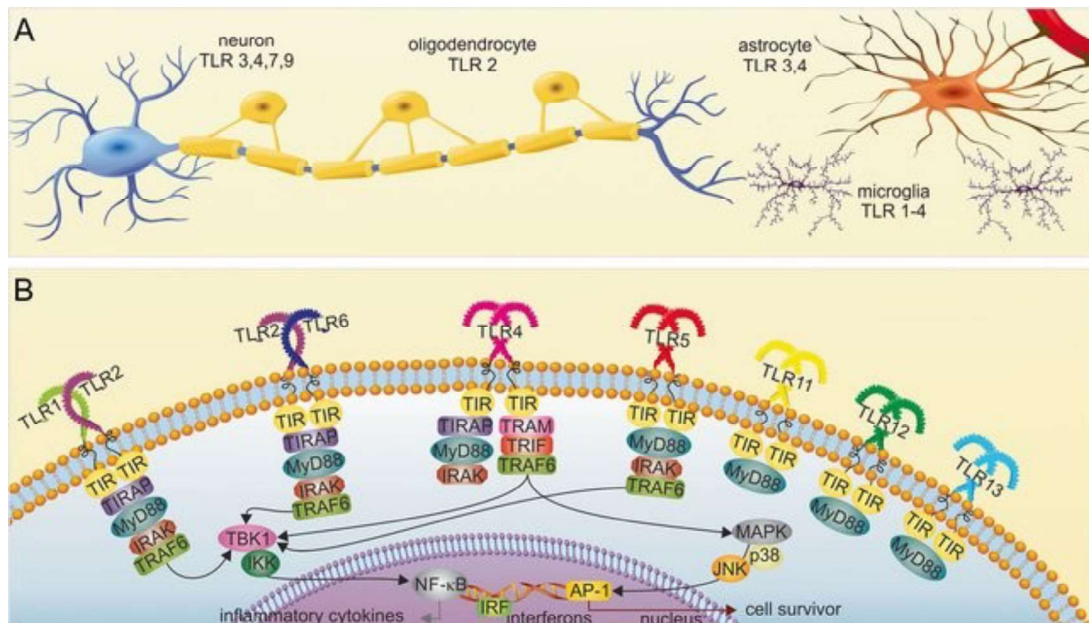

Figure 7 Toll like receptors signaling in central nervous system cells. a. TLRs are a class of PRR. They are expressed in neurons, oligodendrocytes, microglia and astrocytes. TLRs usually activate two signaling pathways. The MyD88 pathway that activates the transcription factor NF-κB and induces the production of various pro-inflammatory cytokines, such as TNF α , IL1 β , IL6, IL8, and IL12. The TRIF which activates IRF regulating the transcription of interferons. TLR: toll like receptor; PRR: pattern recognition receptors; MyD88: myeloid-differentiation primary response gene 88; NF-κB :nuclear factor-kappa B; IL: interleukin; TRIF: TIR-domain-containing adapter-inducing interferon- β ; IRF : interferon regulatory factor (modified from (Paschon et al., 2016)

Activation of TLRs leads to expression of both anti- and pro-inflammatory cytokines. An incorrect balance between anti and pro-inflammatory activity of microglia can lead to a delayed recovery and even detrimental consequences (Figure 8). Traditionally microglia were classified as M1 or M2 phenotype in parallel to the Th1 and Th2 phenotype of the T cells in the periphery. These represent two distinct states according to Horta's first description. However, microglia have a range of activated states, although these phenotype or expression profiles can differ according to the brain region (De Biase et al., 2017; Tan et al., 2020). Microglia are the first immune reactive cells in case of neuroinflammation and transition from M2 (neuroprotective phenotype and ramified morphology) to M1 (proinflammatory phenotype and amoeboid morphology). Microglial activation and polarization influence astrocytic phenotype between A2 (neuroprotective) and A1 (neurotoxic) (Liu et al., 2020).

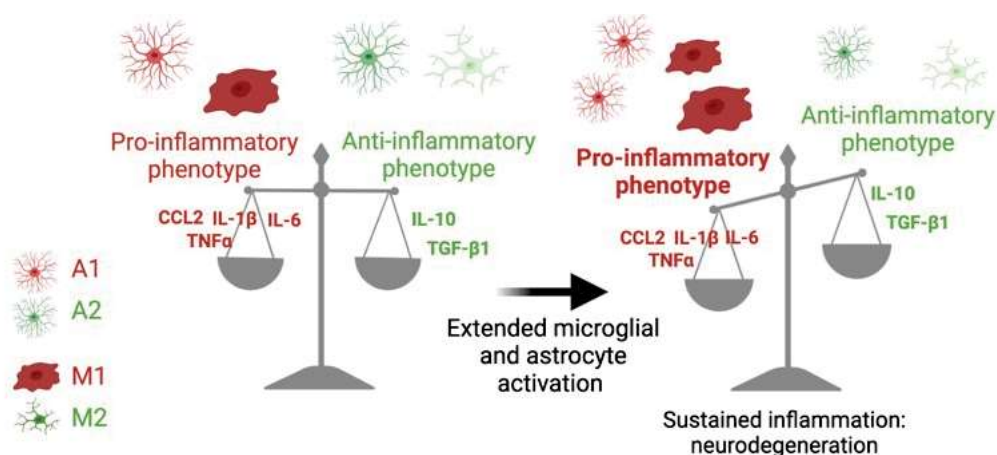

Figure 8 Astrocyte and microglia polarization. Microglia are sensitive to PAMPS, DAMPS or damage. The M2 phenotype of microglia is neuroprotective and the M1 phenotype is neurotoxic. The circulating mediators, such as cytokines, promote the polarization of microglia between M1 and M2. The local environment and the microglia polarization influence astrocytic phenotypes between A2 (proinflammatory) and A1 (neuroprotective).

II.1.3. Neuroinflammation in psychiatric disorders

Inflammation in the periphery has been shown to produce lethargy, depression, anorexia, heightened pain or cognitive impairment (Dantzer et al., 2008). In the case of depression, Smith (1991) postulates that major depressive disorder (MDD) is due to excessive macrophage activity and inflammatory cytokine synthesis, specifically noting that infections, tissue damage, and antigens found in food can trigger depression (Smith, 1991). In addition, some patients on immunotherapy with IL-12 and IFN-gamma develop MDD after the treatment. Finally, levels of serum cytokine IL1 beta may predict depression severity because there is a positive correlation between IL1beta circulating serum and depression scores (Levine et al., 1999).

II.1.3.1. Immune signaling in drugs of abuse

It is now believed that drugs of abuse also act on the glia, and that neural-glia interactions participate in behavioral and neurochemical adaptations following drug exposure. Drugs of abuse increase the CNS immune signaling by acting on glial cells, which then increase the release of pro inflammatory cytokines (Lacagnina et al., 2017). Indeed, upon activation, glial cells express cytokines and chemokines facilitate intercellular communication and modulate protein expression. However, drugs can interact with this tripartite synapse (Figure 9), through an overactivation of glial cells that increase pro-inflammatory cytokine release. This overactivation dysregulates neurotransmitter homeostasis in the synaptic cleft, and initiates inflammatory reactions (Harricharan et al., 2017).

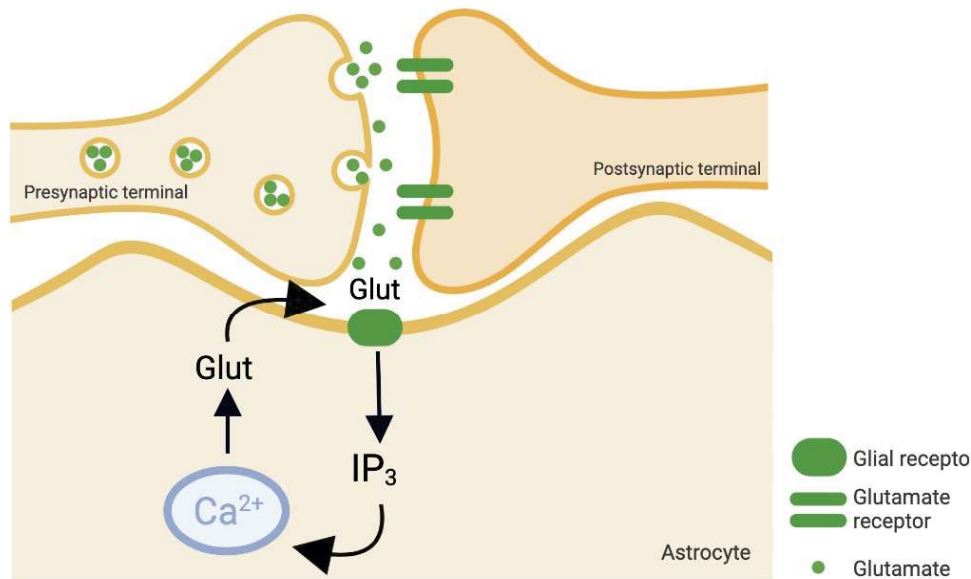

Figure 9. The tripartite synapse. Glutamate is released from the presynaptic cell. The neurotransmitter is taken up by the postsynaptic cell and by astrocytes. Binding to glial receptor activates signaling pathway by production of inositol 1,4,5-triphosphate and mediating intracellular calcium elevation and triggers the release of glutamate. (Sotero & Martínez-Cancino, 2010).

There is increasing evidence that alcohol dependence may involve neuroimmune signaling that contributes to molecular, cellular and behavioral adaptations associated with this condition. The mechanisms underlying the inflammatory responses are explained by increased leaky gut allowing the presence of gut derived products that activate immune responses. The circulating inflammatory molecules can induce neuroimmune activation by entering the CNS through leaky BBB induced by alcohol, by the CVO, through cytokine transporters or through the efferent vagal nerve (Erickson et al., 2019). Interestingly, macroarray analysis on alcoholic human brain autopsy showed a group of altered gene expressions responsive to alcohol and involved in myelination and immune/stress response (Liu et al., 2020).

A number of human studies tried to identify neuroimmune genes involved in alcohol use disorder (AUD). An increase in microglia associated mRNA in parallel to a decrease of neuron associated mRNA was observed, with increases of translocator protein 18 kDa (TSPO) and CCL2 interpreted as an increase of activated microglia (Ponomarev et al., 2013). These observations suggest neurodegeneration and proliferation of microglia manifested in alcohol dependence. There is an association between immune gene polymorphism and AUD. The relationship was confirmed in a study reporting increased levels of *TNF- α -238* tumor necrosis factor (TNF α) polymorphism, 2 single nucleotide polymorphism (SNP) of IL1 beta, in alcohol dependent individuals (Kebir et al., 2011; Liu et al., 2009). Moreover, 12 SNPs identified in

NFkB were associated with high risk and early onset of alcoholism (Edenberg et al., 2008). These studies show that gene profiling is a promising strategy to develop better therapeutic drugs even which is developed to be applied to psychiatric illnesses.

Preclinical studies have identified specific cell alterations in alcohol induced neuroimmune responses. In the cortex and the dentate, increases of microglial (CD11b, IBA1) and astrocyte (GFAP) specific markers were identified following both short- and long-term intragastric EtOH treatment (Alfonso-Loeches et al., 2010; Qin & Crews, 2012). These occurred through activation on NFkB signaling pathway and was reversed in TLR4 knock out (KO) mice or by small interfering TLR4 RNA (Alfonso-Loeches et al., 2013). EtOH consumption was decreased in TLR2 KO mice in a 4 day limited access paradigm whereas only male MyD88 KO mice increased their alcohol intake (Y. A. Blednov et al., 2017). This suggest that gene involvement in alcohol intake varies according to sex. Mice with a KO of the chemokine network, such as C-C chemokine receptor 2 (CCR2) and chemokine ligand 2 (CCL2), also showed a decrease in EtOH consumption and preference, but only in females whereas both males and females with CCL3 KO were affected (Y. Blednov et al., 2005).

There is also growing evidence of region specific neuroimmune activation following EtOH exposure. EtOH drinking in mice increased expression of pro-inflammatory cytokines (IFN-gamma; IL1beta; IL17, TNF α) and chemokines (CCL2, MIP1alpha, CX3CL1) (Pascual et al., 2014). In the VTA, small interfering RNA of TLR4 and CCL2 in neurons of the VTA decreases binge drinking in alcohol preferring rats which initially had elevated levels of TLR4 and CCL2 (June et al., 2015). Post-mortem analysis of humans alcohol brains revealed disruption of BBB in the dorsolateral PFC because of reduced immunoreactivity of membrane proteins (Rubio-Araiz et al., 2017). Sex differences within the NAcc shell were observed following administration of short hairpin RNA inducing a decrease of ethanol intake in alcohol preferring rats (Franklin et al., 2015). As mentioned earlier only female mice show reduced EtOH consumption and preference after CCR2 and CCL2 deletion (Y. Blednov et al., 2005). Taken together, these findings support the notion of alcohol-induced alterations of neuroimmune responses.

Neuroimmune activity has also been observed following alcohol withdrawal. This includes an Increase of pro inflammatory cytokines and chemokines, molecules that were up-regulated after 24 hours of withdrawal (Pascual et al., 2014). Interestingly, inducing

neuroimmune responses with LPS administration accelerates anxiety like behavior in rats withdrawing from alcohol (Breese et al., 2008). This provides the involvement of neuroinflammation in negative affect associated to withdrawal.

//.1.3.2. Neuroinflammation in BED?

Considering the fact that bingeing episodes usually occur on foods high in fat and sugar, it is not surprising that proinflammatory responses in specific brain regions are linked to ingestion of palatable diets. For example, long term consumption of a hyper-lipidic diet (16 weeks) promotes regulation of immune related proteins including the pro-inflammatory cytokines TNF α , IL1-Beta and IL-6, and interacts with metabolic regulation (De Souza et al., 2005b). Specifically, in the ARC and the LH, the hyperlipidic diet promoted an increase of TNF α in neuron bodies. Furthermore, proinflammatory cytokines increase c-Jun N-terminal kinase (JNK) induced insulin resistance following hyperlipidic diet by modulating insulin receptor tyrosine phosphorylation and promoting serine phosphorylation of key elements of the insulin signaling pathway, phosphoinositide 3 kinase (PI3K) or protein kinase B (AKT). Insulin resistance was also demonstrated at a behavioral level with no change in food intake following intracerebroventricular injections of insulin. Insulin resistance induced by the hyperlipidic diet was restored by reducing immune signaling pathway by inhibiting JNK (refer to signaling pathway in Figure 7). In parallel, leptin resistance was observed following a hyperlipidic diet, an effect produced through increased levels of suppressor of cytokine signaling 3 (SOCS3) and decreased phosphorylation of leptin receptor tyrosine phosphorylation. These mechanism were reversed by acting on immune signaling through JNK inhibition. These results provide evidence for a close interaction between food intake and neuroinflammation through insulin signaling in the hypothalamus, a primary region in energy homeostasis (De Souza et al., 2005b).

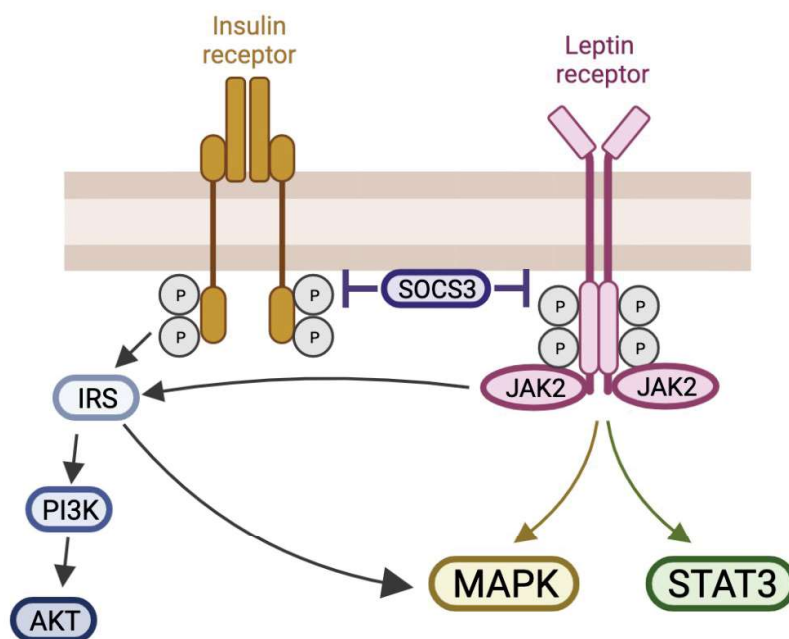

Figure 10 Insulin and leptin signaling pathways. Insulin activates IRS-PI3K resulting in downstream activation of its target Akt. Akt's phosphorylation of the transcription factor forkhead box protein 1 (not shown) suppresses the expression of orexigenic neuropeptides. After binding to its receptor, leptin activates JAK2-STAT3, MAPK or IRS-PI3K pathway. The activation of JAK2 permits STAT3 phosphorylation, nuclear translocation and acts as a transcription factor. (modified from (Reinehr & Roth, 2018).

Hypothalamic inflammation is also observed following 2 months of a sucrose diet with an increase of TNF α mRNAs (Fuente-Martín et al., 2013). Even though there was no increase in the number of astrocytes, there was a decrease in the number of projections in the arcuate nucleus and a decrease of the glutamate transporter 2 (GLT2) in astrocytes. These results could be associated with decreased glucose tolerance observed in these animals, since astrocytes are involved in glucose metabolism (Camandola, 2018). As seen earlier, proinflammatory cytokines can increase levels of JNK and NF κ B, activation which is observed following sucrose access and could lead to insulin resistance. Furthermore, increase of hypothalamic mRNA levels SOCS3, which are inhibitors of leptin and insulin signaling pathways, was measured (Fuente-Martín et al., 2013).

It seems however that microglia and astrocyte reactivity depends on the source of palatable food. Indeed, mice following high fat diets showed increased GFAP immunoreactivity after 4 weeks but only those with access to both high fat and high carbohydrates had increases in IBA1 (Gao et al., 2017). These differences are explained by increased advanced glycated end products (AGEs), which are glycated proteins after exposure

to sugar. When AGES bind to their receptors they can induce oxidative stress and inflammation (Rowan et al., 2018). AGES, such as N-epsilon-(carboxymethyl) lysine (CML), and methylglucoxal (MG-H1), are expressed in POMC and NPY neurons of the ARC. Interestingly their receptors, RAGE, are only expressed in microglia, and following infusion of CML in the hypothalamus this led to increases of IBA1-immunoreactivity. Moreover, mice lacking AGE receptors are resistant to body weight gain, glucose intolerance, and food intake. They also show that mice under a high fat high carbohydrate diet as well as decreased microglial IBA1-immunoreactivity have lower fat and lean mass. These results show that hypothalamic microglia might be key mediators of high carbohydrate/high fat diet induced obesity and metabolic disorders.

The NAcc regulates feeding behavior by receiving inputs from hypothalamic regions and can respond to peptide hormones involved in energy intake and expenditure such as insulin (Ferrario et al., 2016) (Figure 6). Mice on a high fat diet show increased expression of neuroinflammatory genes (GFAP, Iba-1, IL1-Beta, IL1Beta, IFN gamma, CD45, CD11b, Vimentin, TNF α , HSP-72) that was reversed by viral inhibition of NF κ B signaling (D ecarie-Spain et al., 2018). In another study, sucrose bingeing in rats increased levels of TSPO, a biomarker of neuroinflammation expressed in microglia and astrocytes, in the motor cortex, the hippocampus, the thalamus and the DS (Patkar et al., 2021). In the same study microgliosis was observed in the hippocampus, hypothalamus and the Amy with no changes in astrocytes. Therefore, neuroinflammatory responses are observed following high sucrose and/or high fat diets in pivotal regions of reward and energy balance.

Similar to the CNS, high fat diets increase plasma leptin levels in the periphery, an effect that was increased in high fat/high carbohydrate groups (Gao et al., 2017). Interestingly, a sucrose enriched diet increased visceral fat mass while decreasing weight and increasing TNF α mRNA in the adipose tissue. Knowing these animals had hypothalamic inflammation, points to non-obesity dependent inflammatory signaling (Fuente-Mart ın et al., 2013). This is interesting because systemic inflammation in obese individuals is at the origin of infiltrating immune molecules and cells in the brain. However, in this study hypothalamic inflammation occurs without an obese phenotype suggesting that it might be at the origin of abnormal eating. In the plasma of rats fed a high fat diet (palm oil), inflammatory cytokines were significantly higher than controls (D ecarie-Spain et al., 2018). Finally the same study showed

that sucrose bingeing in rats led to increased innate immune cells in the blood (Patkar et al., 2021).

//.1.3.3. Neuropathic pain and immune signaling

Neuropathic pain is caused by injury or disease of the nervous system. It can originate from nerve compression, nerve trauma, immune dysregulation, etc. (Campbell, 2006). The burden of neuropathic pain is related to its complex etiology and symptomatology, affecting 7 to 10% of the general population. The pathobiological mechanisms of neuropathic pain are not fully understood but include local changes in the anatomy, neurochemistry and gene expressions of the nerve as well of alterations in the dorsal root ganglion (DRG) and spinal cord. Individuals suffering from neuropathic pain show an amplification of responses to noxious stimuli (hyperalgesia) or to an innocuous stimuli (allodynia).

An animal model of neuropathic pain, sciatic nerve injury (SNI), reveals that the development of neuropathic pain is associated with neuroimmune mechanisms including degranulation of mast cells at the site of the nerve lesion. Mast cells release $\text{TNF}\alpha$ and histamine that have the ability to sensitize receptors and increase cell firing rates (Sorkin et al., 1997). In addition, serotonin that is released in response to neuropathic pain binds to receptors on afferent fibers leading to increased firing rates of C fibers (Sommer, 2004). Neutrophils, another cell type of the innate immune system, are recruited at the site of injury by chemo-attractants. These release immune molecules such as cytokines $\text{TNF}\alpha$, IL6, IL1Beta. Neuronal excitation by $\text{TNF}\alpha$ injection at the site of injury (Sorkin et al., 1997) and in the DRGs in both uninjured and rats and those with spinal nerve ligation (Schafers et al., 2003). Resident macrophages are recruited later and are involved in tissue regeneration but overactivation can induce neuropathic pain since inhibition of IL1 beta and macrophage inflammatory protein alpha following nicotine injection (suppressor of macrophage activation) prevents tactile allodynia and thermal hyperalgesia (Kiguchi et al., 2010). In addition to cell activation, TLRs are also involved in neuropathic pain since TLR4 $-/-$ rat models of L5 spinal nerve transection show reduced thermal hypersensitization.

In addition to the peripheral nervous system, glia in the CNS are also involved in neuropathic pain. Indeed, specific inhibition in the spinal cord leads to the same attenuation of mechanical and thermal hypersensitivity (Tanga et al., 2005). Following spinal nerve transection, microglial marker (CD11b) increased during the initial phase of pain (day 3 to

day 7) and maintained by astrocytes recruitment (increase of GFAP) (Tanga et al., 2005). Microglia also change phenotype from resting to surveying (Cao et al., 2010). Moreover, disruption of microglial metabolism by fluorocitrate reduces mechanical hyperalgesia and microglial activation (Clark et al., 2007). The most abundant glial cells in the CNS, astrocytes, maintain neuropathic pain since their activation occurs later than microglia (Tanga et al., 2005). This suggests that microglia are involved in the acute phase and astrocytes in the maintenance phase of neuropathic pain.

Neuroimmune interaction in neuropathic pain also affects cortical and subcortical regions of the brain. In fact, pain can impact brain reward regions in that peripheral nerve injury increases IBA1 gene expression in the VTA, NAcc, thalamus and prefrontal cortex of male mice (Taylor et al., 2017). The chronic constriction injury neuropathic pain model also shows evidence of glutamate signaling and neuroimmune interaction in the hypothalamus and the periaqueductal gray regions. In contrast, memantine, an N-methyl-D-aspartic (NMDA) receptor antagonist decreased glial cell activation and mechanical allodynia (Takeda et al., 2009). Even though neuroinflammation in brain regions has not been identified in humans, there is evidence from PET scan studies that individuals with trigeminal neuropathic pain have decreased MOP binding in the NAcc (DosSantos et al., 2017).

11.1.3.4. Neuropathic pain and alcohol use disorder

Alcohol misuse is commonly associated with pain (Boissoneault et al., 2019). Alcoholic neuropathy is a devastating condition since it affects 65% of alcoholic use disorder (AUD) patients in the USA and is largely resistant to treatment (Zeng et al., 2017). Preclinical animal models of alcoholic neuropathy have shown possible mechanisms in the periphery such as reduced density of unmyelinated or small myelinated fibers (Koike et al., 2001), decreased nerve conduction (Bosch et al., 1979), and increased number of glial cells in the spinal cord (Narita et al., 2007). Pain increases microglia (Hore & Denk, 2019) and peripheral pain activates the reward circuit (DosSantos et al., 2017; Taylor & Cahill, 2017) and the hypothalamus through neuroinflammation (Ellis, 2013; Fakhoury et al., 2020). In a mouse model of peripheral nerve injury, increases in IBA1 gene expression were observed in the PFC, NAcc, Amygdala and thalamus was observed (Taylor & Cahill, 2017). In another study, an increase of IBA1 immunoreactivity in the infralimbic cortex was observed in a mouse model of SNI (Chu Sin Chung et al., 2017). Therefore, immune signaling in the brain might have a function in neuropathic pain and may explain comorbidity with AUD.

II.2 Mini review on BED and pain

We previously showed that there is compelling evidence of neuroinflammation due to high amounts of palatable food intake in brain regions of reward. In the following review we summarized evidence that neuroinflammation could be observed in BED and chronic pain. Furthermore, we proposed that individuals with BED could develop neuropathic pain.

Troubles de l'alimentation : facteurs de risque pour la douleur et l'addiction ?

Eating Disorders: Risk Factors for Pain and Addiction?

G. Awad · K. Befort

© Lavoisier SAS 2019

Résumé Les troubles du comportement alimentaire altèrent le circuit cérébral de la récompense et sont caractérisés par une perte du contrôle de la prise alimentaire. Ces troubles sont accompagnés de modifications neurobiologiques associées au comportement de type addictif et impliquent des processus neuro-inflammatoires qui pourraient être à l'origine du développement de douleurs chroniques.

Mots clés Neuro-inflammation · Comportements addictifs · Troubles alimentaires · Nourriture appétente · Récompense · Douleurs chroniques

Abstract Eating disorders impair the brain's reward circuitry and are characterised by a loss of control of food consumption. These disorders are accompanied by neurobiological changes associated with addictive behaviours and involve neuroinflammatory processes that could be at the root of the development of chronic pain.

Keywords Neuroinflammation · Addictive behaviors · Eating disorders · Highly palatable food · Reward · Chronic pain

G. Awad (✉) · K. Befort
Laboratoire de neurosciences cognitives et adaptatives (LNCA),
Centre national de la recherche scientifique,
Faculté de psychologie, Université de Strasbourg,
12, rue Goethe, F-67000 Strasbourg, France
e-mail : g.awad@unistra.fr

* Mme Gaëlle Awad est titulaire d'un master de biologie médicale de l'Université de Lausanne. Son projet doctoral est d'étudier l'effet de la surconsommation de sucre sur le circuit de la récompense, l'impact sur le système endocannabinoïde et la contribution potentielle de la neuro-inflammation dans ces adaptations. Ce travail est codirigé par K. Befort, chercheur CNRS au LNCA et M.C. Olmstead, Pr à Queens' University, Kingston, Canada. Mme Gaëlle Awad bénéficie d'un contrat doctoral du ministère de l'Enseignement et de la Recherche et fait partie de l'École universitaire de recherche interdisciplinaire sur la douleur (EURIDOL Graduate School of Pain), Université de Strasbourg, F-67000 Strasbourg, France.

Les douleurs neuropathiques comprennent des sensations de brûlure spontanées, une hyperalgésie et une allodynie, qui sont particulièrement invalidantes. Cependant, les mécanismes physiopathologiques ne sont pas bien compris et les thérapies ne sont que partiellement efficaces. Parmi les mécanismes proposés, la microglie, constituée de cellules responsables de la réponse immunitaire innée dans le système nerveux central, serait impliquée. L'activation microgliale, ou neuro-inflammation, pourrait jouer un rôle dans la mise en place de ces douleurs en induisant l'expression de facteurs pro-inflammatoires à des niveaux toxiques. Ces cytokines, en périphérie et au niveau central, peuvent engendrer une hyperalgésie ou une allodynie, en augmentant la sensibilité des neurones sensitifs impliqués dans la transduction d'un signal douloureux [1,2].

L'obésité est considérée comme une pathologie caractérisée par un trouble chronique léger de l'inflammation. De plus, les individus ayant une surcharge pondérale sont particulièrement affectés par des douleurs chroniques. Des études précliniques ont examiné l'effet de l'exacerbation d'une inflammation dans un modèle animal d'obésité engendrée par la délétion du récepteur à la leptine, une hormone de satiété. Ces animaux obèses montrent une plus grande sensibilité à un stimulus douloureux, à la fois mécanique et thermique [3]. Cet effet est associé à une dérégulation de marqueurs pro-inflammatoires dans la moelle épinière, ou anti-inflammatoire dans le tissu adipeux. Cependant, les risques de douleurs chroniques seraient plutôt liés au type de régime alimentaire plutôt qu'à la prise de poids. En effet, des animaux suivant un régime obésogène riche en graisses (*high fat diet*), mais résistants à la prise de poids, présentent également une sensibilité à la douleur, associée à une infiltration augmentée des macrophages dans les ganglions rachidiens [4]. De plus, un régime obésogène chez le rat peut entraîner l'expression de facteurs pro-inflammatoires dans l'hypothalamus latéral, région cérébrale impliquée dans la régulation homéostasique [5].

Ainsi, une nourriture déséquilibrée, qu'elle induise ou non de l'obésité, est associée à une réaction immunitaire.

Une prise insuffisante de fruits et légumes, notamment, favorise l'expression de facteurs pro-inflammatoires pouvant entraîner de la douleur [6]. Chez des jeunes enfants souffrant de perte de contrôle de prise alimentaire, une augmentation du niveau de leptine a été observée [7] et pourrait être mise en lien avec l'implication de cette hormone de satiété dans l'activation microgliale, dans les douleurs neuropathiques [8]. De plus, les troubles alimentaires sont définis par une prise excessive de nourriture hédonique caractérisée par une perte de contrôle, une envie irrésistible (*craving*) et une prise augmentée au cours du temps, malgré les effets néfastes. Sur la base d'indicateurs de dépendance [9], l'ensemble de ces symptômes suggèrent donc que les troubles de l'alimentation représentent une forme d'addiction, phénomène actuellement débattu [10]. Parmi les mécanismes sous-jacents à la mise en place de l'addiction, des processus neuro-inflammatoires sont proposés [11]. Ces processus pourraient expliquer l'apparition de douleurs neuropathiques observées par exemple chez des patients souffrant d'addiction à l'alcool [12,13]. Ainsi, l'ensemble de ces observations, à la fois physiologiques et comportementales, suggèrent que les troubles du comportement alimentaire pourraient jouer un rôle dans le développement de douleurs neuropathiques.

Examiner les mécanismes impliqués dans une neuro-inflammation associée à des douleurs chroniques, dans le cas de troubles de l'alimentation, permettrait de mieux comprendre la part du dérèglement physiologique et/ou comportemental impliqué et permettrait de proposer des approches thérapeutiques ciblées.

Liens d'intérêts : les auteurs déclarent ne pas avoir de lien d'intérêt.

Références

1. Huang J, Zhang X, McNaughton PA (2006) Inflammatory pain: the cellular basis of heat hyperalgesia. *Curr Neuropharmacol* 4:197–206
2. Zhang JM, An J (2007) Cytokines, inflammation, and pain. *Int Anesthesiol Clin* 45:27–37
3. Iannitti T, Graham A, Dolan S (2012) Increased central and peripheral inflammation and inflammatory hyperalgesia in Zucker rat model of leptin receptor deficiency and genetic obesity. *Exp Physiol* 97:1236–45
4. Song Z, Xie W, Chen S, et al (2017) High-fat diet increases pain behaviors in rats with or without obesity. *Sci Rep* 7:10350
5. De Souza CT, Araujo EP, Bordin S, et al (2005) Consumption of a fat-rich diet activates a proinflammatory response and induces insulin resistance in the hypothalamus. *Endocrinology* 146:4192–9
6. Seaman DR (2002) The diet-induced proinflammatory state: a cause of chronic pain and other degenerative diseases? *J Manipulative Physiol Ther* 25:168–79
7. Miller R, Tanofsky-Kraff M, Shomaker LB, et al (2014) Serum leptin and loss of control eating in children and adolescents. *Int J Obes (Lond)* 38:397–403
8. Chang KT, Lin YL, Lin CT, et al (2017) Leptin is essential for microglial activation and neuropathic pain after preganglionic cervical root avulsion. *Life Sci* 187:31–41
9. Gearhardt AN, Corbin WR, Brownell KD (2009) Preliminary validation of the Yale Food Addiction Scale. *Appetite* 52:430–6
10. Leigh SJ, Morris MJ (2018) The role of reward circuitry and food addiction in the obesity epidemic: An update. *Biol Psychol* 131:31–42
11. Hutchinson MR, Watkins LR (2014) Why is neuroimmunopharmacology crucial for the future of addiction research? *Neuropharmacology* 76:218–27
12. Chopra K, Tiwari V (2012) Alcoholic neuropathy: possible mechanisms and future treatment possibilities. *Br J Clin Pharmacol* 73:348–62
13. Narita M, Miyoshi K, Narita M, et al (2007) Involvement of microglia in the ethanol-induced neuropathic pain-like state in the rat. *Neurosci Lett* 414:21–5

III. BED and sweeteners

III.1.1. Generalities on sweeteners

Non-nutritive sweeteners (NNS) are commonly used as sugar substitutes. They can either have a synthetic or natural origin (Error: Reference source not found). Their very attractive advantage is that they provide high sweetness with low calories and is an interesting answer to the growing rates of obesity. Paradoxically not all studies show positive associations between NNS and weight loss.

Nutritive sweetener		Dextrose Fructose High fructose syrup Sucrose
Non-nutritive sweetener	Sugar alcohol	Erythritol Maltitol Mannitol Sorbitol Xylitol
	High intensity artificial sweeteners	Acesulfame K (potassium) Advantame Aspartame Neotame Saccharin Sucralose
	High intensity natural sweeteners	Stevioside Luo Han Guo Thaumatococcus Glycyrrhizic acid

Table 3 Sweeteners are divided into 2 categories: nutritive sweeteners and non-nutritive sweeteners including sugar alcohols and high intensity artificial sweeteners.

III.1.2. Sweeteners and weight gain

Animal studies usually show an increase in weight gain (Swithers et al., 2009), despite same levels of calories intake (Feijó et al., 2013; Fowler, 2016). This could be explained by reduced energy expenditure and/or increase of fluid retention. But in human studies the results are contradictory (Fowler, 2016; Mooradian et al., 2017) and when weight gain was observed it was not associated to changes in food patterns (Stellman & Garfinkel, 1988). In the latter study, NNS users show preference for low caloric diets. However it is purely observational and the serving sizes have not been reported. There are marked discrepancies in animal studies, during exposure to NNS, some showing an increase of food intake (Tordoff, 1988) and in others similar amounts compared to controls (Feijó et al., 2013; Swithers et al., 2009). But human studies show no changes and sometimes reduced intake of food in the long term for NNS users (Mattes & Popkin, 2009). However, the controversy surrounding artificial sweeteners and weight gain is difficult to resolve in humans because diet is influenced by a combination of confounding physiological, social and subjective factors.

Sweetness perception is conditioned by the activation of taste 1 receptors T1R2 and T1R3. They recognize artificial sweeteners and are located in the oral cavity, the gastrointestinal epithelial and endocrine cells, the pancreatic islets, the respiratory tissues and the genitourinary structures and send signals through afferent nerve fibers to brain structures mainly the hypothalamus involved in energetic balance. Depending on the NNS, they can stimulate the T1Rs. Via the receptors, NNS induce physiologic changes as summarized in Error: Reference source not found.

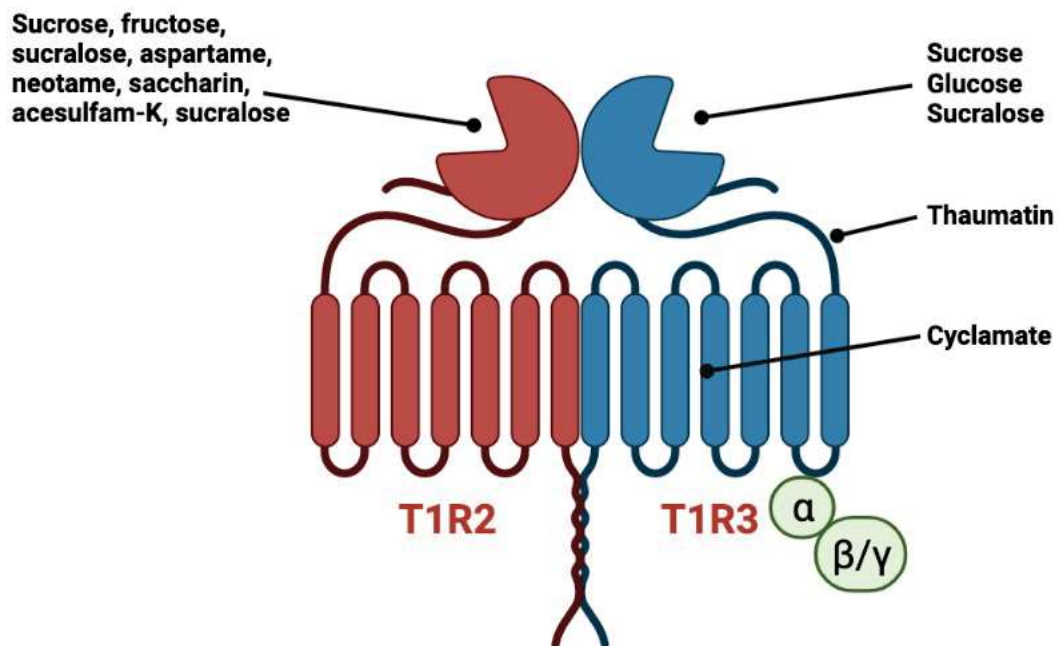

Figure 11 Schematic presentation of the sweet taste GPCR receptor. There are various agonists binding sites of the sweet taste receptor. Upon binding, the G protein is activated, stimulates increase of calcium in the cytoplasm and depolarizes the cell. Cranial nerve allow signal transduction to the nucleus tractus solitarius and then the information is relayed to upper brain regions. (adapted from Smith NJ 2020).

III.1.3. Sweeteners and inflammation

Not mentioned in the book chapter, NNS can also induce inflammatory responses by changing the gut microbiota composition. Stevia, a natural NNS of high intensity, 18 weeks of access to stevia and sucralose induced transminitis just like sucrose but also increased pro-inflammatory cytokine in the serum (Farid et al., 2020). In another study, Balb/c mice models of inflammatory bowel disease with 7 days of stevia administration showed a decrease of clinical signs.

NNS (ADI by FDA)	Effect on inflammation	Actions via taste receptors
Stevia	<ul style="list-style-type: none"> • Short term access: Balb/c IBD mice model + 7 days access to stevioside (50mg/Kg): clinical symptoms (Alavala et al., 2019) • Long term access: Balb/c mice + stevioside 18 weeks (4,2 mg/mL daily): increased inflammation + transaminitis in liver (Farid et al., 2020) 	<ul style="list-style-type: none"> • Short and long term access: CD1 mice + 6 or 12 weeks of stevioside access (4,16 mg/mL) access increases insulin, leptin, GIP secretions and higher glycemia (Hanawa et al., 2021).
Saccharin	<ul style="list-style-type: none"> • Short term access: Rattus Norvegicus rats + 30 days of saccharin access (low: 10mg/Kg; high: 500 mg/Kg) • Long term access: C57BL/6J male mice + 6 months access: hepatic inflammation induced by altered gut microbiota to 0,3 mg/mL saccharin (Bian et al., 2017). 	<p>Sprague Dawley rats 0,3% saccharin 3 days/week: impaired glucose homeostasis (higher) and GLP-1 release following test meal (Swithers et al., 2009).</p>
Aspartame	<ul style="list-style-type: none"> • Long term access: Wistar rats + 90 days of aspartame access 40 mg/Kg: aspartame and metabolites associated to oxidative stress (Ashok & Sheeladevi, 2015). 	<p>The key enzyme expressed from mid to distal section of small intestine so aspartame can bind to sweet receptors of the proximal region (Basson et al., 2021).</p>
Acesulfam-K	<ul style="list-style-type: none"> • Long term access: C57BL6/J + 8 weeks Acesulfam-k 150 mg/Kg: inflammatory cytokines in intestinal microvessels (Hanawa et al., 2021). 	

Table 4 NNS: non-nutritive sweeteners; ADI: acceptable daily intake; FDA: food and drug administration; IBD: inflammatory bowel disease; GLP-1: glucagon like peptide 1; GIP: glucose insulinotropic dependent peptide.

III.1.4. Sweeteners and food intake regulation

NNS can also increase the desire to eat through hypoglycemic response after ingestion (Dhillon et al., 2017; Just et al., 2008), or by increased appetite for sweet foods (Bellisle, 2015) Indeed, the idea of addiction has been used to explain danger of sweet food by the Plan National Nutrition Santé, suggesting that NNS prevents “withdrawal” from sweetness (<http://www.mangerbouger.fr/bien-manger/que-veut-dire-bien-manger-127/les-9-reperes/produits-sucres-a-limiter.html>). However, a review in 2015 concluded that most of the studies show decreased sugar intake in NNS consumers (Bellisle, 2015). What about consumers with eating disorders with BED ?

(French version)

Généralités sur les édulcorants

Les édulcorants sont couramment utilisés comme substituts au sucre. Ils peuvent être d'origine synthétique ou naturelle (tableau 3). Leur avantage très attractif est qu'ils procurent un pouvoir sucrant élevé avec peu de calories et constituent une réponse intéressante aux taux croissants d'obésité. Paradoxalement, toutes les études ne montrent pas d'association positive entre les édulcorants et la perte de poids.

Édulcorants et prise de poids

Les études animales montrent généralement une augmentation de la prise de poids (Swithers et al., 2009), malgré des niveaux d'apport calorique identiques (Feijó et al., 2013 ; Fowler, 2016). Cela pourrait s'expliquer par une réduction des dépenses énergétiques et/ou une augmentation de la rétention d'eau. Mais dans les études humaines, les résultats sont contradictoires (Fowler, 2016 ; Mooradian et al., 2017) et lorsqu'une prise de poids est observée, elle n'est pas associée à des changements dans les habitudes alimentaires (Stellman & Garfinkel, 1988). Dans cette dernière étude, les utilisateurs d'édulcorants montrent une préférence pour les régimes hypocaloriques. Cependant, il s'agit d'une étude purement observationnelle et les tailles des portions n'ont pas été rapportées. Il existe des divergences marquées dans les études animales, lors de l'exposition aux édulcorants, certaines montrent une augmentation de la prise alimentaire (Tordoff, 1988) et d'autres des quantités similaires par rapport aux témoins (Feijó et al., 2013 ; Swithers et al., 2009). Mais les études humaines ne montrent aucun changement et parfois une réduction de la prise alimentaire à long terme chez les utilisateurs d'édulcorants (Mattes et Popkin, 2009). Cependant, la controverse autour des édulcorants artificiels et de la prise de poids est difficile à résoudre chez l'homme car le régime alimentaire est influencé par une combinaison de facteurs physiologiques, sociaux et subjectifs confondants.

La perception du goût sucré est conditionnée par l'activation des récepteurs du goût 1 T1R2 et T1R3. Ils reconnaissent les édulcorants artificiels et sont situés dans la cavité buccale, les cellules épithéliales et endocrines gastro-intestinales, les îlots pancréatiques, les tissus respiratoires et génito-urinaires. Ils envoient des signaux par des fibres nerveuses afférentes à des structures cérébrales, principalement l'hypothalamus, impliquées dans l'équilibre énergétique. Selon les édulcorants, ils peuvent stimuler les T1R. Par l'intermédiaire des récepteurs, les édulcorants induisent des changements physiologiques comme le résume le tableau 4.

Édulcorants et inflammation

Non mentionnés dans le chapitre du livre, les édulcorants peuvent également induire des réponses inflammatoires en modifiant la composition du microbiote intestinal. Le stévia, un édulcorant naturel de haute intensité, 18 semaines d'accès au stévia et au sucralose ont induit une transminite tout comme le saccharose mais ont également augmenté les cytokines pro-inflammatoires dans le sérum (Farid et al., 2020). Dans une autre étude, des modèles de souris Balb/c de maladies inflammatoires de l'intestin avec 7 jours d'administration de stévia ont montré une diminution des signes cliniques.

Les édulcorants et la prise alimentaire

Les édulcorants peuvent également augmenter le désir de manger par une réponse hypoglycémique après l'ingestion (Dhillon et al., 2017 ; Just et al., 2008), ou par une augmentation de l'appétit pour les aliments sucrés (Bellisle, 2015) En effet, l'idée d'addiction a été utilisée pour expliquer le danger des aliments sucrés par le Plan National Nutrition Santé, suggérant que les édulcorants empêche le " retrait " du goût sucré <http://www.mangerbouger.fr/bien-manger/que-veut-dire-bien-manger-127/les-9-reperes/produits-sucres-a-limiter.html>. Cependant, une revue en 2015 a conclu que la plupart des études montrent une diminution de la consommation de sucre chez les consommateurs d'édulcorants (Bellisle, 2015). Qu'en est-il des consommateurs souffrant de troubles du comportement alimentaire avec BED ?

Chapter 6

Artificial Sweeteners in Animal Models of Binge Eating

Gaëlle Awad¹, Katia Befort¹, and Mary C. Olmstead^{2*}

¹Laboratoire de Neurosciences Cognitives et Adaptatives (LNCA), Centre de la Recherche Nationale Scientifique, Université de Strasbourg Faculté de Psychologie, 12 rue Goethe, F-67000, Strasbourg France

²Dept. Psychology, Centre for Neuroscience Studies, Queen's University, Kingston ON, Canada K7L 3N6

i. Summary/Abstract

Rising rates of obesity in most industrialized countries are a major cause of serious medical conditions, including diabetes, heart disease, and mental health disorders. Binge eating, characterized by excessive consumption of highly palatable food within a short period of time, contributes significantly to these problems, even in individuals who are not diagnosed with binge eating disorder (BED). Over the last half century, the use of non-nutritive substitutes has been promoted as a means to reduce fat and sugar consumption, potentially minimizing obesity-related illnesses. Paradoxically, increased intake of artificial sweeteners is associated with weight gain, which may be linked to alterations in metabolic processes. Artificial sweeteners also increase food intake in both humans and rodents, raising intriguing possibilities that these substances are altering biological processes that underlie the homeostatic control of feeding. We explore this idea by summarizing the clinical and preclinical literature on behavioral and biological mechanisms of artificial sweeteners. As a starting point, we review evidence that non-nutritive sweeteners are rewarding in rodent models, then provide a comparison of neural systems mediating the rewarding properties of natural and artificial sweeteners. We then summarize data pointing to sexual dimorphism in behavioral and biological responses to sucrose, with preliminary evidence suggesting that responses to artificial sweeteners may follow a similar pattern. Finally, we provide an overview of the relationship between binge eating and substance use disorders, noting findings from animal studies that artificial sweeteners could contribute to this comorbidity.

ii. Keywords:

feeding, reward, dopamine, opioid, sucrose, saccharin

1. Introduction

Binge eating disorder (BED), the most common of all eating disorders (*1*), is characterized by consumption of large amounts of food within a discrete period of time in the absence of compensatory behaviors (*2*). According to World Health Organization estimates, the lifetime prevalence of BED is 1.9%, with a median onset age of 20 years old (*3*). Not surprisingly, BED is more common in women than men, although these ratios are distributed more evenly than in other eating disorders (*3*). Binge eating is highly comorbid with a number of medical conditions, other psychiatric disorders (*4*), and a reduced quality of life (*5*). Of the medical conditions associated with BED, obesity is one of the most prevalent, likely due to the lack of purging or exercise following binge intake (*6*). Adult patients with BED have significantly higher obesity rates than individuals with no eating disorder (*7*), and even those who are not obese are distressed by their bingeing behavior.

Many patients with obesity and BED attempt to limit caloric intake and counter weight gain by adopting hypocaloric diets, specifically restricting highly palatable foods (*8*). This is generally ineffective, as individuals who are food restricted tend to binge on foods that are high in sugar and/or fat, ingesting significantly more calories than non-restricted individuals (*9*). The pattern is exacerbated in modern society with the prevalence and availability of highly palatable food. Consumption of these foods activates brain reward circuits (*10*), increasing the probability that behaviors leading to their intake will be repeated. These factors undoubtedly contribute to growing rates of obesity (*11*), which have tripled since 1975 (WHO). Obesity dramatically increases the risk of medical conditions such as type 2 diabetes, hypertension, and dyslipidaemia, although these metabolic syndrome disorders may develop in BED patients, even in the absence of obesity (*12*).

Artificial sweeteners are an appealing alternative to restrictive diets in that they allow individuals to consume highly palatable food with minimal calories. If bingeing in humans is

a reaction, at least in part, to restriction of forbidden ‘pleasure’ foods, consumption of these commodities should reduce binge eating. Weight gain should also be minimized when individuals opt for artificial, over natural or processed, sugars simply due to a reduction in calorie intake. It is therefore surprising, that the two have grown in parallel: higher rates of obesity and higher use of artificial sweeteners.

1.1. Animal models of binge eating

Despite the prevalence and associated problems, the etiology of BED is not clearly understood (*13*). Animal models provide a means to unravel the causal mechanisms of this disorder as rodents, like humans, exhibit binge eating when they are provided with intermittent access to highly palatable food or when they undergo periods of food restriction and stress (*14*). The intermittent access protocol (12 hr food deprivation followed by 12 hr access to sucrose or glucose and food) simulates behavioral aspects of BED, including escalation of intake and withdrawal-like symptoms (*15, 16*). This pattern reflects eating patterns of BED as patients often display excessive food intake during the evening after self-imposed restriction during the day (*17*). Importantly, the rat intermittent access model produces compulsive responding for palatable food, mimicking the loss of control over food intake that characterizes patients with BED (*18*). Caloric restriction, itself, is not a necessary pre-requisite for bingeing in that fat bingeing occurs when access to this commodity is limited, but regular chow is freely available (*19*).

Stress is also a potent trigger of binge eating, particularly when it is combined with restriction of palatable food (*20, 21*). For example, manipulations, such as tail pinch, induce hyperphagic for palatable food (*22*) and increased consumption of standard chow (*23*). Females may be more sensitive stress-induced feeding, showing more rapid increase of

palatable food intake than males (24). Developmental factors, including level of maternal care and exposure to stressors during adolescence, also increase vulnerability to binge intake (25).

Few studies have investigated the impact of artificial sweeteners on binge eating: in most animal studies access to these substances is a control condition, used to separate intake that is driven by caloric versus hedonic properties of food (26-29). Nonetheless, inspection of data from these control groups reveals unique patterns of intake associated with access to artificial sweeteners. For example, intermittent access to saccharin produces binge-like intake in mice (26, 29), an effect that appears to be absent in rats (18, 28). In addition to species differences, the concentration of saccharin may be a critical factor in the elicitation of bingeing behaviour, as this was much higher in the rat experiments. Moreover, a 0.4% saccharin solution induced bingeing in rats that matched the intake of rats given access to an isohedonic sucrose solution (4%) (30). Both groups exhibited more rapid escalation of intake than control groups given unlimited access to either solution. Importantly, either intermittent or unlimited access to an isocaloric solution, maltodextrin, that provides calories with no sweet taste did not induce binge intake. Below, we describe the rodent model of intermittent access (14) that produces binge-like eating in both rats and mice.

2. Materials and Methods

2.1 Equipment and setup

2.2 Behavioral Procedure

2.3 Data Analysis

Consumption of food, water, and sweetened solutions should be presented as a percentage of body weight, particularly as baseline differences in this measure be related to sex, genotype, strain, or other variables of interest.

3. Artificial sweeteners

3.1 History of artificial sweeteners

Figure 1 provides a brief overview of the history of natural and artificial sweetener use in Western countries. Artificial sweeteners were introduced to the public on a large scale to deal with sugar rationing during WWII. The use of these compounds expanded in the latter part of the 20th century to address growing rates of obesity, which are often attributed to the overconsumption of added sugars. Health directives generally recommend a maximum sugar consumption of 10% of total calorie intake per day (31, 32), whereas most adults in industrialized countries consume between 15% and 21% of their daily calories in sugar. The proportion of sugar intake in children is even higher (16%-26%) (33). Fructose may be a primary culprit in sugar overconsumption, particularly with the increased use of high fructose corn syrup as a sweetener beginning in the 1970s (34). Fructose is particularly detrimental to secondary medical conditions, such as diabetes, because it increases insulin resistance, oxidative stress, and inflammatory responses (35).

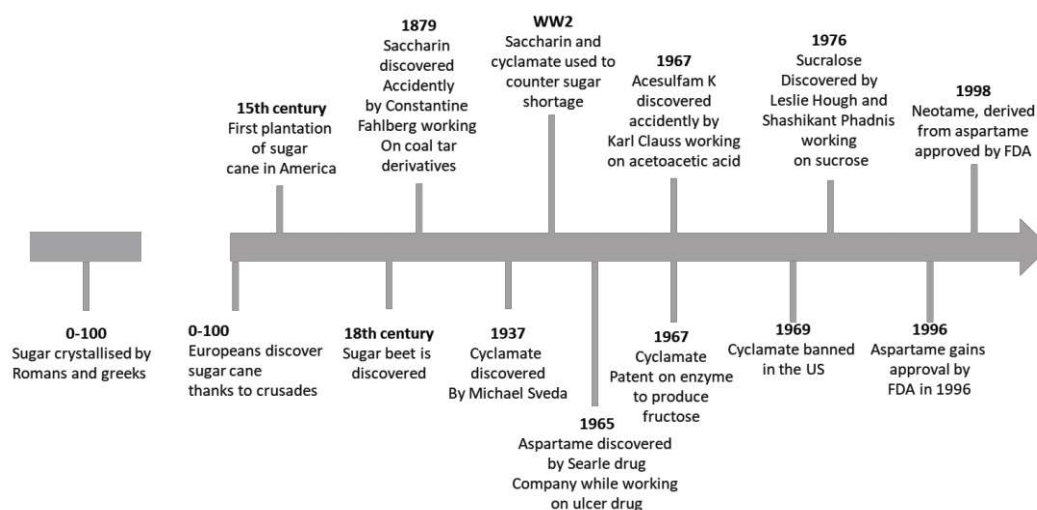

Figure 1. Historical timeline of natural and artificial sweetener availability

Non-nutritive sweetener	Sweetening strength compared to sugar
Acesulfame Potassium	200x
Aspartame	200x
Cyclamate	40x
Neotame	8000x
Saccharin	300x
Sucralose	600x

Table 1 Relative sweetening strength of non-nutritive sweeteners

Note: In animal studies, the concentration of a sugar solution is usually 4% - 20%.

3.2 Paradoxical effects of artificial sweeteners

3.2.1 Artificial sweeteners and weight gain

Despite the apparent appeal, widespread use of artificial sweeteners has not been associated with reduced obesity. Indeed, a number of studies indicate that these substances are linked to both weight gain and metabolic disorders (36, 37). For example, a prospective study of male and female participants who normally consume artificially sweetened beverages revealed a positive correlation between the quantity of beverages consumed and weight gain over time, although the effects were not sweetener specific (38). The findings were confirmed in a separate study, which also showed that weight gain was independent of the macronutrient content of meals. More specifically, both male and female participants using artificial sweeteners consumed the same amount and type of food as a control group (not consuming

artificial sweeteners), but still gained weight (39). Although intriguing, these findings require further investigation, particularly as serving sizes in each study were not reported.

More in line with conventional thinking, other studies report stable or decreased weight in individuals who consume artificial sweeteners (40). This could reflect the fact that people who use artificial sweeteners are often on a weight loss diet, thereby attempting to reduce the number of calories they consume. Indeed, weight loss was observed in an intervention study in which male and female adults followed a 12-week diet, with half of the participants drinking beverages with non-nutritive sweeteners daily (701 mL) and the other half consuming the same amount of water. Moreover, other measures such as systolic pressure, waist circumference, and blood triglycerides improved in the group consuming artificial sweeteners compared to their water consuming counterparts (41). At least in these conditions, non-nutritive sweeteners appear to be beneficial in reducing problems associated with overeating.

The impact of artificial sweeteners on weight gain is also controversial in children, with some studies reporting a positive correlation between diet soda consumption and body mass index (42), although the effect may be limited to males (43). The findings should be viewed with caution as children who drink a lot of sodas also tend to eat more junk food and be less active (44). Indeed, a controlled randomized trial (over 600 healthy children followed for 18 months) found a significant reduction of weight gain and body fat mass in a group that was instructed to consume sugar-free beverages each day, compared to a group that consumed sugar-sweetened beverages (44). In addition, in contrast to adults, children modify their food intake following consumption of artificially sweetened beverages (45) with the timing of the sweetener preload (lunch or snack) differentially impacting the later consumption of calories. Regardless of the mechanism, children's intake of noncaloric beverages requires further

attention because consumption of these drinks often increases over time (46), and the impact of artificial sweeteners on developmental processes is unknown.

The controversy surrounding artificial sweeteners and weight gain is difficult to untangle in humans as eating is influenced by a combination of physiological, social, and subjective factors. For instance, participants consuming artificial sweeteners ingest fewer calories when they are not aware that sucrose has been replaced with a low-calorie substitute (47), but increase their calorie intake when they are informed of the substitution (48). Of note, research studies are often funded by agencies with a potential conflict of interest (e.g., food industry) that could impact the interpretation of scientific or epidemiological studies (49). Animal studies, which minimize extraneous factors that may impact eating in humans, can help to elucidate the relationship between artificial sweeteners and weight gain. At least some of this work supports a positive correlation between the two: rats given intermittent access to saccharin consumed more calories and gained more weight than a group given intermittent access to glucose (50). The findings were confirmed in studies using saccharin or aspartame versus sucrose (51, 52). Although further work needs to be done, preliminary evidence from animal studies supports the idea that consumption of artificial sweeteners is associated with weight gain.

3.2.2 Artificial sweeteners and metabolic changes

The effect of artificial sweeteners on weight gain may be related to reduced basal metabolism as post-prandial thermogenesis is lower in rats given access to a low-calorie sweetener compared to sucrose (50). Moreover, in a mouse model of diet-induced model of obesity, animals given access to the non-nutritive sweetener, aspartame, exhibited reduced oxygen consumption during the dark phase and increased visceral fat due to hyperinsulinemia (53). Similarly, saccharin consuming rats show a decrease in glucagon like peptide 1, an anorexogenic hormone which could explain increased food intake and increased blood

glucose following a glucose tolerance test (54). In contrast to aspartame, saccharin does not appear to affect insulin levels, although this may depend on the overall diet consumption. For example, differences in energy intake, weight gain and adiposity following saccharin versus sucrose consumption are only observed when rats have access to a high-fat diet (55).

If artificial sweeteners do impact weight gain, they may do so by altering metabolic processes in the periphery (56). Like natural sugars, these substances activate sweet taste receptors which are located, primarily, on the tongue but are also expressed in the bladder, pancreas, and gut (57). This provides a mechanism by which artificial sweeteners can alter metabolism. As an example, male rats provided access to saccharin exhibited reduced thermal responses compared to a sucrose group, suggesting that lower energy expenditure and storage of nutrients was responsible for the increased weight gain in these animals (50). Interestingly, the effect of artificial sweeteners on metabolic effects may depend on the molecular structure of the substance. Both saccharin and acesulfame-k (500-fold sweeter than sucrose) stimulate glucose-induced insulin secretion and promote glucose uptake (58), as well as inducing adipogenesis and repressing adipocyte lipolysis (57). In contrast, aspartame, which is only 200-fold sweeter than sucrose, produces the opposite effects, reducing adipogenesis by downregulating the expression of adipogenic markers. The latter effects were produced *in vitro*, so must be replicated using *in vivo* measures (59). These inconsistent effects of artificial sweeteners on metabolism may explain, at least in part, the contradictory findings regarding artificial sweeteners and weight gain.

3.3.3 Artificial sweeteners and eating

Any association between increased use of artificial sweeteners and weight gain is somewhat paradoxical in that individuals who substitute non- or low-nutritive sweeteners for sugary foods should be consuming fewer calories. The literature on this question in humans is controversial. Some studies show no effect of low-calorie sweeteners on appetite (60, 61),

whereas others suggest that artificial sweeteners, specifically aspartame (62) and saccharin (63), reduce food intake. Again, this could be a specific effect of the sweeteners under study (aspartame and saccharin), which are less commonly used in food products today than are sucralose or acesulfame-K (40).

As with weight gain and metabolic effects, animal studies point to a positive relationship between consumption of artificial sweeteners and increased food intake. For example, rats given access to saccharin during the first 2 hours of the dark cycle exhibit a 10-15% increase in food intake, compared to rats given access to water. Sucrose produces the same effect suggesting that sweet tastes stimulate appetite, regardless of the calorie content (64). In line with this idea, saccharin preload increases chow intake in rats (65) and even fruit flies exhibit increased food intake following access to an artificial sweetener (66).

The effect of artificial sweeteners may be exacerbated in binge eating models with food intake being higher in animals given limited access to saccharin, compared to those given limited access to sucrose (26). This difference could not be explained, entirely, by the caloric content of sucrose (i.e., animals consuming calories in sucrose would be expected to eat less food) because animals ingesting saccharin consumed more total calories per day than animals given either intermittent or continuous access to sucrose. Intriguingly, rats are able to monitor food intake in anticipation of sucrose access, but do not show the same effect when provided access to saccharin. More specifically, animals consumed less chow when a sweet-taste cue predicted access to sucrose-flavored yogurt, suggesting that they were regulating calorie intake over the entire session and therefore did not gain weight (50). In contrast, a cue predicting access to saccharin-flavored yogurt increased food intake and led to greater weight gain, suggesting that artificial sweeteners were altering the homeostatic control of energy intake. In sum, artificial sweeteners may impair the ability to predict caloric intake by uncoupling signals related to sweet taste and calorie content (50, 51).

4. Behavioral and biological effects of artificial sweeteners

4.1 Rewarding effects

Animal studies support the idea that artificial sweeteners produce rewarding effects in that saccharin is self-administered by rats (67) and elicits binge-like intake in mice given limited daily access (26) or 2-day intermittent access (68) to a saccharin solution. Interestingly, increasing a no-access period to saccharin reinforces the bingeing behavior (30). Saccharin also elicits ‘craving’ responses in rats, mimicking those produced by either sucrose or cocaine (67). In these experiments, animals learn to self-administer cocaine, sucrose, or saccharin and then undergo 1 or 30 days of forced abstinence. When presented with a cue predicting access to the reinforcer, rats in the prolonged abstinent groups showed significantly higher seeking responses for all three commodities, reflecting a common phenomenon of ‘craving incubation’. Low calorie sweeteners, therefore, produce a similar pattern of reinstatement to those of natural reinforcers in an animal model of relapse. This suggests that artificial sweeteners may be poor substitutes for sugars as they could increase the risk of relapse in eating disorder patients.

On the other hand, the effect of artificial and natural sweeteners on reward-related behaviors in rats does not always overlap. For example, extended intermittent access to sucrose blocks the reinforcing effect of sucrose in the conditioned place preference paradigm (28) and induces compulsive responding for sucrose in the conditioned suppression paradigm (18). These effects were absent in groups given extended intermittent access to saccharin, although it should be noted that saccharin did not elicit binge behaviour in these experiments. Intriguingly, intermittent access to saccharin appears to increase sensitivity to develop a morphine conditioned place preference paradigm in male rats (28), suggesting that it may modulate the rewarding value of other reinforcers. Moreover, rats prefer saccharin over

cocaine in a two-choice operant paradigm, an effect that is independent of prior drug experience (69).

4.2 Neural mechanisms

Artificial sweeteners provide little or no nutritive value, suggesting that consumption of these substances is driven, primarily, by their hedonic properties: these may be mediated by the same neural systems that underlie the rewarding properties of palatable food. In studying this assumption, Frank (70) reported that higher concentrations of both sucrose (up to 32%) and sucralose (concentrations matched to sucrose for sweetness) increased activation in the primary gustatory cortex of humans (frontal operculum and anterior insular), although sucrose activated additional regions implicated in feeding (e.g., midbrain, substantia nigra, and ventral striatum) (70). The study also revealed differential functional connectivity associated with ingestion of the two substances, specifically recruitment of reward pathways for sucrose, but not sucralose.

Similarly, sucrose and low-calorie sweeteners both regulate the hypothalamic neuropeptide, orexin, although the two effects are not completely overlapping. For example, the selective orexin 1 receptor antagonist, SB-334867, blunts saccharin and sucrose drinking in mice (71, 72), and sucrose and saccharin bingeing decrease orexin mRNA in the lateral hypothalamus (73). The latter is associated with reduced phosphorylated cyclic AMP response binding protein (pCREB) in orexin neurons, at least in female rats (74). This reduction was observed in melanin concentrating hormone (MCH) neurons but only following sucrose consumption, pointing to a potential dissociation of mechanisms mediating consumption of natural and artificial sweeteners. The fact that orexin processes are reduced in bingeing animals appears to contradict evidence that this neuropeptide reduces satiety and increases appetite (75). The relationship between orexin levels and binge eating, however, likely involves a complex interaction with brain reward systems that could impact non-

homeostatic eating. More specifically, orexin enhances dopamine levels in brain reward systems, so reduced orexin activity could reflect a hypodopaminergic state. Animals may compensate for this deficit by increased consumption of sucrose or saccharin in an attempt to maintain homeostatic levels of dopamine.

At the same time, there are subtle differences in the impact of dopamine manipulations on the intake of natural versus artificial sweeteners. Administration of either a D1 or D2 receptor antagonist (SCH23339 or raclopride) dose-dependently reduces sucrose, but not saccharin, intake (76) in a two-bottle choice paradigm. In addition, cues associated with either sucrose or saccharin presentation evoke dopamine release in the nucleus accumbens (NAcc) core, but the effect produced by sucrose-paired cues is much larger (77). In line with this evidence, sucrose induces a larger DA release in the ventral striatum compared to saccharin (69). A similar pattern of findings emerges regarding the relationship between feeding-related peptides and artificial versus natural sweeteners. Saccharin, like sucrose, increases mRNA levels of neuropeptide Y (NPY), orexin, and agouti related peptide (AgRP) (78, 79), changes that may underlie sweetener-induced increases in energy intake and weight gain. However, there is a distinct pattern of time-dependent changes following ingestion of the two commodities. More specifically, saccharin consumption leads to an immediate increase in NPY and orexin expression, whereas sucrose produces an immediate decrease in NPY and AgRP that is followed by increased expression of these peptides within 10 minutes post-ingestion. Moreover, NPY infusions into the ventral tegmental area, NAcc, or lateral hypothalamus consistently increase sucrose consumption and/or the motivation to obtain sucrose (80); in contrast, effects of these manipulations on saccharin intake are inconsistent (78, 81).

A separation of neural systems mediating the rewarding effects of sucrose and non-nutritive substitutes could be explained within the context of incentive sensitization.

According to this theory (82), the ‘wanting’ component of reward depends on mesolimbic dopamine systems whereas ‘liking’ is mediated by opioidergic mechanisms. As noted previously, dopamine may have dissociable roles controlling responses to natural and artificial sweeteners, particularly in terms of cues predicting the presentation of one commodity of the other. There is some degree of overlap in the mediation of ‘liking’ natural and artificial sweeteners in that mice with deletion of the ion channel TRPM5 and TRPM4 taste receptors consume less of sucrose and saccharin than wild type mice (83), and mu opioid receptor knock out mice show reductions in both sucrose and saccharin bingeing (26). Moreover, general opioid antagonism dose-dependently decreases palatable food bingeing (84), as well as saccharin preference and consumption (85). On the other hand, mu opioid receptor knockout animals exhibit decreased licking of sucralose, compared to sucrose (86) and the mu opioid receptor agonist, DAMGO, selectively increases saccharin drinking in rats (87, 88). Thus, although the neural substrates mediating hedonic responses to artificial and natural sweeteners share common elements, these are not completely overlapping.

5. Artificial sweeteners and sex differences

As with other basic biological processes, behavioral responses to palatable food often vary across sexes. Sex differences are attributed to a combination of chromosomal and hormonal differences between males and females, combined with gender constructs related to societal expectations (89). These help to explain sex differences in behavioral processes and the disproportional representation of one sex or the other in disorders or diseases. As an example, women transition more rapidly to compulsive drug use in addiction than males (90), and female rats exhibit enhanced escalation of heroin intake compared to male rats (91). An increased rate of developing maladaptive drug use in females could reflect sex differences in dorsal striatal activity as this system controls the transition to compulsive drug use in addiction (92). The effect may also be related to sexual dimorphism in brain reward systems,

as these have been observed for dopamine D1 and D2 receptors in the frontal cortex and striatum of juvenile rats (93). These findings fit with clinical evidence of differential activation of brain reward circuitry during craving in male and female patients with cocaine dependence (94).

Similar to drug reinforcers, sex differences emerge in male/female responses to palatable food. For example, women are more likely than men to exceed recommended limits on sugar intake (95) and to perceive sweet taste more intensely than men (96). Female rats also show a higher preference than males of their species for both glucose and saccharin, an effect that is maintained even at the highest concentrations of saccharin (97). Both males and females in this study preferred saccharin over glucose in conditions of short-term access; when access was extended, only males reverted to a higher preference for the natural sugar. These findings are reflected at the biological level with a higher proportion of female rats showing increased neuronal firing in the parabrachial pons in response to sucrose (98). A similar profile of sex differences was observed in female and male rats provided with a saccharin solution, suggesting that the effect is driven by taste, not nutrient content (99). Gonadal sex hormones likely contribute to these effects in that dopamine release in the NAcc shell is significantly increased when female rats are self-administering sucrose during the estrous phase of their cycle (100). Finally, in choice paradigms, female rats are more likely than their male counterparts to select sucrose over cocaine (101), suggesting that sweet solutions exert a more powerful control over behavior in this sex. Taken together, these data suggest that intake of palatable food is driven more strongly by hedonic properties, regardless of metabolic state, in females than males. It should not be surprising, therefore, that there is a higher proportion of female, compared to male, rats in binge-prone versus binge-resistant groups (102). Sexual dimorphism in binge eating appears to extend to non-nutritive sweeteners as binge intake of saccharin is associated with increased chow intake in female,

but not male, mice (26). Although the data are preliminary, sex differences in reward processing related to palatable food may extend to artificial sweeteners.

6. Artificial sweeteners and substance use disorders

Binge intake of highly palatable food overlaps with many of the behavioral and biological features of drug abuse (15). This suggests that BED and substance use disorder (SUD) may share a common etiology, although this contention remains controversial (103, 104).

Regardless of the interpretation, commonalities in maladaptive feeding and drug intake help to explain the high comorbidity between eating disorders and SUDs (6, 105). Although it is difficult to untangle the causal relationship between the two, animal studies suggest that maladaptive eating precedes drug use in that rats that binge on fat later exhibit increased intake and motivation to consume alcohol (106). Moreover, epidemiological studies in humans reveal that binge eating is associated, prospectively, with alcohol-related problems (107). That is, individuals who met criteria for eating disorders were more likely to report negative consequences of alcohol use even if they did not drink more than non-eating disordered counterparts. Interestingly, the relationship between binge eating and drinking in a student population was stronger in males (108), which could explain the higher comorbidity of SUD with BED in men than women (109).

In humans who binge eat, intake of sweet foods is a significant predictor of the frequency of binge episodes (9). Responses to sweet tastes, therefore, may play an important role in the emergence and acceleration of food or drug intake. This could explain why sucrose bingeing in rats alters subsequent responses to drugs, manifested as increased locomotor sensitization to psychostimulants, such as cocaine or amphetamine (110, 111). There is some evidence that non-nutritive sweeteners produce similar effects. Rats bred for high saccharin intake show more rapid acquisition of cocaine self-administration, slower rates of extinction,

and increased reinstatement to cocaine seeking (101). The relationship could be bidirectional as rats bred for high intake of alcohol show increased saccharin consumption (112).

7. Conclusions

Binge eating is a common element of many eating disorders and one of the primary factors in growing rates of obesity. Both binge eating and obesity are driven by overconsumption of highly palatable food that is high in sugar and/or fat. This intake reflects hedonic, rather than metabolic, processing suggesting that sweet tasting food that contains minimal calories should help to reduce both binge eating and obesity. Neither clinical nor preclinical studies confirm this idea, although the data across experiments is often contradictory. Further work is required to unravel the relationship between behavioral and biological mechanisms mediating the rewarding effects of natural versus artificial sweeteners. Animal models are an important tool in this endeavor, particularly in terms of understanding sex differences in responses to palatable food.

Funding: Université de Strasbourg, Investissements d’Avenir Idex, Centre National de la Recherche Scientifique (CNRS), Projet International de Coopération Scientifique (PICS), and Natural Sciences and Engineering Research Council of Canada (NSERC)

References

1. Guerdjikova AI, Mori N, Casuto LS, and McElroy SL. *Binge Eating Disorder* Psychiatr Clin North Am, 2017. 40(2): p. 255-266.
2. Association AP. *Diagnostic and statistical Manual of Mental Disorders*. Arlington, VA. 2013.
3. Kessler RC, Berglund PA, Chiu WT, Deitz AC, Hudson JI, Shahly V, et al. *The prevalence and correlates of binge eating disorder in the World Health Organization World Mental Health Surveys* Biol Psychiatry, 2013. 73(9): p. 904-14.
4. Javaras KN, Laird NM, Reichborn-Kjennerud T, Bulik CM, Pope HG, Jr., and Hudson JI. *Familiality and heritability of binge eating disorder: results of a case-control family study and a twin study* Int J Eat Disord, 2008. 41(2): p. 174-9.
5. Rieger E, Wilfley DE, Stein RI, Marino V, and Crow SJ. *A comparison of quality of life in obese individuals with and without binge eating disorder* Int J Eat Disord, 2005. 37(3): p. 234-40.
6. Hudson JI, Hiripi E, Pope HG, Jr., and Kessler RC. *The prevalence and correlates of eating disorders in the National Comorbidity Survey Replication* Biol Psychiatry, 2007. 61(3): p. 348-58.
7. Kessler RC, Petukhova M, Sampson NA, Zaslavsky AM, and Wittchen HU. *Twelve-month and lifetime prevalence and lifetime morbid risk of anxiety and mood disorders in the United States* Int J Methods Psychiatr Res, 2012. 21(3): p. 169-84.
8. Fairburn CG, Doll HA, Welch SL, Hay PJ, Davies BA, and O'Connor ME. *Risk factors for binge eating disorder: a community-based, case-control study* Arch Gen Psychiatry, 1998. 55(5): p. 425-32.
9. Allison S and Timmerman GM. *Anatomy of a binge: food environment and characteristics of nonpurge binge episodes* Eat Behav, 2007. 8(1): p. 31-8.
10. Novelle MG and Dieguez C. *Food Addiction and Binge Eating: Lessons Learned from Animal Models* Nutrients, 2018. 10(1).
11. Stojek MMK and MacKillop J. *Relative reinforcing value of food and delayed reward discounting in obesity and disordered eating: A systematic review* Clin Psychol Rev, 2017. 55: p. 1-11.
12. Hudson JI, Lalonde JK, Coit CE, Tsuang MT, McElroy SL, Crow SJ, et al. *Longitudinal study of the diagnosis of components of the metabolic syndrome in individuals with binge-eating disorder* Am J Clin Nutr, 2010. 91(6): p. 1568-73.
13. Hutson PH, Balodis IM, and Potenza MN. *Binge-eating disorder: Clinical and therapeutic advances* Pharmacol Ther, 2018. 182: p. 15-27.
14. Corwin RL, Avena NM, and Boggiano MM. *Feeding and reward: perspectives from three rat models of binge eating* Physiol Behav, 2011. 104(1): p. 87-97.
15. Avena NM, Rada P, and Hoebel BG. *Evidence for sugar addiction: behavioral and neurochemical effects of intermittent, excessive sugar intake* Neurosci Biobehav Rev, 2008. 32(1): p. 20-39.
16. Colantuoni C, Rada P, McCarthy J, Patten C, Avena NM, Chadeayne A, et al. *Evidence that intermittent, excessive sugar intake causes endogenous opioid dependence* Obes Res, 2002. 10(6): p. 478-88.
17. Raymond NC, Neumeyer B, Warren CS, Lee SS, and Peterson CB. *Energy intake patterns in obese women with binge eating disorder* Obes Res, 2003. 11(7): p. 869-79.

18. Maracle AC, Normandeau CP, Dumont EC, and Olmstead MC. *Dopamine in the oval bed nucleus of the stria terminalis contributes to compulsive responding for sucrose in rats* *Neuropsychopharmacology*, 2019. 44(2): p. 381-389.
19. Corwin RL. *Binge-type eating induced by limited access in rats does not require energy restriction on the previous day* *Appetite*, 2004. 42(2): p. 139-42.
20. Cifani C, Polidori C, Melotto S, Ciccocioppo R, and Massi M. *A preclinical model of binge eating elicited by yo-yo dieting and stressful exposure to food: effect of sibutramine, fluoxetine, topiramate, and midazolam* *Psychopharmacology (Berl)*, 2009. 204(1): p. 113-25.
21. Hagan MM, Wauford PK, Chandler PC, Jarrett LA, Rybak RJ, and Blackburn K. *A new animal model of binge eating: key synergistic role of past caloric restriction and stress* *Physiol Behav*, 2002. 77(1): p. 45-54.
22. Rowland NE and Antelman SM. *Stress-induced hyperphagia and obesity in rats: a possible model for understanding human obesity* *Science*, 1976. 191(4224): p. 310-12.
23. Levine AS and Morley JE. *Tail pinch-induced eating: is it the tail or the pinch?* *Physiol Behav*, 1982. 28(3): p. 565-7.
24. Zylan KD and Brown SD. *Effect of stress and food variety on food intake in male and female rats* *Physiol Behav*, 1996. 59(1): p. 165-9.
25. Hancock SD, Menard JL, and Olmstead MC. *Variations in maternal care influence vulnerability to stress-induced binge eating in female rats* *Physiol Behav*, 2005. 85(4): p. 430-9.
26. Awad G, Roeckel LA, Massotte D, Olmstead MC, and Befort K. *Deletion of mu opioid receptors reduces palatable solution intake in a mouse model of binge eating* *Behav Pharmacol*, 2019.
27. Hoebel BG, Avena NM, Bocarsly ME, and Rada P. *Natural addiction: a behavioral and circuit model based on sugar addiction in rats* *J Addict Med*, 2009. 3(1): p. 33-41.
28. Smail-Crevier RL, Maracle AC, Wash SIJ, and Olmstead MC. *Binge-like intake of sucrose reduces the rewarding value of sucrose in adult rats* *Physiol Behav*, 2018. 194: p. 420-429.
29. Yasoshima Y and Shimura T. *A mouse model for binge-like sucrose overconsumption: Contribution of enhanced motivation for sweetener consumption* *Physiol Behav*, 2015. 138: p. 154-64.
30. Rehn S and Boakes RA. *Bingeing in rats: Persistence of high intakes of palatable solutions induced by 1-day-in-4 intermittent access* *Physiol Behav*, 2019. 207: p. 15-27.
31. Agriculture UDo and Services UDoHaH. *Dietary Guidelines for Americans*. Available from: <https://health.gov/dietaryguidelines/2015/guidelines/?linkId=20169028#subnav-4>. 2016 November, 8 2019. 8th:(
32. Glinsmann WH, Irausquin H, and Park YK. *Evaluation of health aspects of sugars contained in carbohydrate sweeteners. Report of Sugars Task Force, 1986* *J Nutr*, 1986. 116(11 Suppl): p. S1-216.
33. Azais-Braesco V, Sluik D, Maillot M, Kok F, and Moreno LA. *A review of total & added sugar intakes and dietary sources in Europe* *Nutr J*, 2017. 16(1): p. 6.
34. Choo VL, Vigiouliouk E, Blanco Mejia S, Cozma AI, Khan TA, Ha V, et al. *Food sources of fructose-containing sugars and glycaemic control: systematic review and meta-analysis of controlled intervention studies* *BMJ*, 2018. 363: p. k4644.
35. Basciano H, Federico L, and Adeli K. *Fructose, insulin resistance, and metabolic dyslipidemia* *Nutr Metab (Lond)*, 2005. 2(1): p. 5.
36. Mooradian AD, Smith M, and Tokuda M. *The role of artificial and natural sweeteners in reducing the consumption of table sugar: A narrative review* *Clin Nutr ESPEN*, 2017. 18: p. 1-8.

37. Pearlman M, Obert J, and Casey L. *The Association Between Artificial Sweeteners and Obesity* Curr Gastroenterol Rep, 2017. 19(12): p. 64.
38. Fowler SP, Williams K, Resendez RG, Hunt KJ, Hazuda HP, and Stern MP. *Fueling the obesity epidemic? Artificially sweetened beverage use and long-term weight gain* Obesity (Silver Spring), 2008. 16(8): p. 1894-900.
39. Stellman SD and Garfinkel L. *Patterns of artificial sweetener use and weight change in an American Cancer Society prospective study* Appetite, 1988. 11 Suppl 1: p. 85-91.
40. Yang Q. *Gain weight by "going diet?" Artificial sweeteners and the neurobiology of sugar cravings: Neuroscience 2010* Yale J Biol Med, 2010. 83(2): p. 101-8.
41. Peters JC, Beck J, Cardel M, Wyatt HR, Foster GD, Pan Z, et al. *The effects of water and non-nutritive sweetened beverages on weight loss and weight maintenance: A randomized clinical trial* Obesity (Silver Spring), 2016. 24(2): p. 297-304.
42. Blum JW. *Nutritional physiology of neonatal calves* J Anim Physiol Anim Nutr (Berl), 2006. 90(1-2): p. 1-11.
43. Berkey CS, Rockett HR, Field AE, Gillman MW, and Colditz GA. *Sugar-added beverages and adolescent weight change* Obes Res, 2004. 12(5): p. 778-88.
44. de Ruyter JC, Olthof MR, Seidell JC, and Katan MB. *A trial of sugar-free or sugar-sweetened beverages and body weight in children* N Engl J Med, 2012. 367(15): p. 1397-406.
45. Birch LL, McPhee L, Shoba BC, Steinberg L, and Krebs R. *Clean Up Your Plate": Effects of Child Feeding Practices on the Conditioning of Meal Size Learning and Motivation*, 1987. 18: p. 301-317.
46. Brown RJ, de Banate MA, and Rother KI. *Artificial sweeteners: a systematic review of metabolic effects in youth* Int J Pediatr Obes, 2010. 5(4): p. 305-12.
47. Porikos KP, Booth G, and Van Itallie TB. *Effect of covert nutritive dilution on the spontaneous food intake of obese individuals: a pilot study* Am J Clin Nutr, 1977. 30(10): p. 1638-44.
48. Mattes R. *Hunger ratings are not a valid proxy measure of reported food intake in humans* Appetite, 1990. 15(2): p. 103-13.
49. Bes-Rastrollo M, Schulze MB, Ruiz-Canela M, and Martinez-Gonzalez MA. *Financial conflicts of interest and reporting bias regarding the association between sugar-sweetened beverages and weight gain: a systematic review of systematic reviews* PLoS Med, 2013. 10(12): p. e1001578; discussion e1001578.
50. Swithers SE and Davidson TL. *A role for sweet taste: calorie predictive relations in energy regulation by rats* Behav Neurosci, 2008. 122(1): p. 161-73.
51. Davidson TL and Swithers SE. *A Pavlovian approach to the problem of obesity* Int J Obes Relat Metab Disord, 2004. 28(7): p. 933-5.
52. Feijo FM, Ballard CR, Foletto KC, Batista BAM, Neves AM, Ribeiro MFM, et al. *Saccharin and aspartame, compared with sucrose, induce greater weight gain in adult Wistar rats, at similar total caloric intake levels* Appetite, 2013. 60(1): p. 203-207.
53. Mitsutomi K, Masaki T, Shimasaki T, Gotoh K, Chiba S, Kakuma T, et al. *Effects of a nonnutritive sweetener on body adiposity and energy metabolism in mice with diet-induced obesity* Metabolism, 2014. 63(1): p. 69-78.
54. Swithers SE, Laboy AF, Clark K, Cooper S, and Davidson TL. *Experience with the high-intensity sweetener saccharin impairs glucose homeostasis and GLP-1 release in rats* Behav Brain Res, 2012. 233(1): p. 1-14.
55. Swithers SE. *Artificial sweeteners produce the counterintuitive effect of inducing metabolic derangements* Trends Endocrinol Metab, 2013. 24(9): p. 431-41.
56. Pepino MY. *Metabolic effects of non-nutritive sweeteners* Physiol Behav, 2015. 152(Pt B): p. 450-5.

57. Simon BR, Parlee SD, Learman BS, Mori H, Scheller EL, Cawthorn WP, et al. *Artificial sweeteners stimulate adipogenesis and suppress lipolysis independently of sweet taste receptors* J Biol Chem, 2013. 288(45): p. 32475-89.
58. Nakagawa Y, Nagasawa M, Yamada S, Hara A, Mogami H, Nikolaev VO, et al. *Sweet taste receptor expressed in pancreatic beta-cells activates the calcium and cyclic AMP signaling systems and stimulates insulin secretion* PLoS One, 2009. 4(4): p. e5106.
59. Pandurangan M, Park J, and Kim E. *Aspartame downregulates 3T3-L1 differentiation* In Vitro Cell Dev Biol Anim, 2014. 50(9): p. 851-7.
60. Anton SD, Martin CK, Han H, Coulon S, Cefalu WT, Geiselman P, et al. *Effects of stevia, aspartame, and sucrose on food intake, satiety, and postprandial glucose and insulin levels* Appetite, 2010. 55(1): p. 37-43.
61. Rolls BJ, Hetherington M, and Laster LJ. *Comparison of the effects of aspartame and sucrose on appetite and food intake* Appetite, 1988. 11 Suppl 1: p. 62-7.
62. Blundell JE, Rogers PJ, and Hill AJ. *Uncoupling sweetness and calories: methodological aspects of laboratory studies on appetite control* Appetite, 1988. 11 Suppl 1: p. 54-61.
63. Rogers PJ and Blundell JE. *Meal patterns and food selection during the development of obesity in rats fed a cafeteria diet* Neurosci Biobehav Rev, 1984. 8(4): p. 441-53.
64. Tordoff MG. *How do non-nutritive sweeteners increase food intake?* Appetite, 1988. 11 Suppl 1: p. 5-11.
65. Pierce WD, Heth CD, Owczarczyk JC, Russell JC, and Proctor SD. *Overeating by young obesity-prone and lean rats caused by tastes associated with low energy foods* Obesity (Silver Spring), 2007. 15(8): p. 1969-79.
66. Wang QP, Lin YQ, Zhang L, Wilson YA, Oyston LJ, Cotterell J, et al. *Sucralose Promotes Food Intake through NPY and a Neuronal Fasting Response* Cell Metab, 2016. 24(1): p. 75-90.
67. Aoyama K, Barnes J, and Grimm JW. *Incubation of saccharin craving and within-session changes in responding for a cue previously associated with saccharin* Appetite, 2014. 72: p. 114-22.
68. Wayner MJ, Greenberg I, Tartaglione R, Nolley D, Fraley S, and Cott A. *A new factor affecting the consumption of ethyl alcohol and other sapid fluids* Physiol Behav, 1972. 8(2): p. 345-62.
69. Lenoir M, Serre F, Cantin L, and Ahmed SH. *Intense sweetness surpasses cocaine reward* PLoS One, 2007. 2(8): p. e698.
70. Frank GK, Oberndorfer TA, Simmons AN, Paulus MP, Fudge JL, Yang TT, et al. *Sucrose activates human taste pathways differently from artificial sweetener* Neuroimage, 2008. 39(4): p. 1559-69.
71. Anderson RI, Becker HC, Adams BL, Jesudason CD, and Rorick-Kehn LM. *Orexin-1 and orexin-2 receptor antagonists reduce ethanol self-administration in high-drinking rodent models* Front Neurosci, 2014. 8: p. 33.
72. Olney JJ, Navarro M, and Thiele TE. *Binge-like consumption of ethanol and other salient reinforcers is blocked by orexin-1 receptor inhibition and leads to a reduction of hypothalamic orexin immunoreactivity* Alcohol Clin Exp Res, 2015. 39(1): p. 21-9.
73. Alcaraz-Iborra M, Carvajal F, Lerma-Cabrera JM, Valor LM, and Cubero I. *Binge-like consumption of caloric and non-caloric palatable substances in ad libitum-fed C57BL/6J mice: pharmacological and molecular evidence of orexin involvement* Behav Brain Res, 2014. 272: p. 93-9.
74. Fukushima A, Hagiwara H, Fujioka H, Kimura F, Akema T, and Funabashi T. *Sex differences in feeding behavior in rats: the relationship with neuronal activation in the hypothalamus* Front Neurosci, 2015. 9: p. 88.

75. Goforth PB and Myers MG. *Roles for Orexin/Hypocretin in the Control of Energy Balance and Metabolism* Curr Top Behav Neurosci, 2017. 33: p. 137-156.
76. Yu WZ, Silva RM, Sclafani A, Delamater AR, and Bodnar RJ. *Role of D(1) and D(2) dopamine receptors in the acquisition and expression of flavor-preference conditioning in sham-feeding rats* Pharmacol Biochem Behav, 2000. 67(3): p. 537-44.
77. McCutcheon JE, Beeler JA, and Roitman MF. *Sucrose-predictive cues evoke greater phasic dopamine release than saccharin-predictive cues* Synapse, 2012. 66(4): p. 346-51.
78. Furudono Y, Ando C, Yamamoto C, Kobashi M, and Yamamoto T. *Involvement of specific orexigenic neuropeptides in sweetener-induced overconsumption in rats* Behav Brain Res, 2006. 175(2): p. 241-8.
79. Gaysinskaya VA, Karatayev O, Shuluk J, and Leibowitz SF. *Hyperphagia induced by sucrose: relation to circulating and CSF glucose and corticosterone and orexigenic peptides in the arcuate nucleus* Pharmacol Biochem Behav, 2011. 97(3): p. 521-30.
80. Pandit R, van der Zwaal EM, Luijendijk MC, Brans MA, van Rozen AJ, Oude Ophuis RJ, et al. *Central melanocortins regulate the motivation for sucrose reward* PLoS One, 2015. 10(3): p. e0121768.
81. Baird JP, Gray NE, and Fischer SG. *Effects of neuropeptide Y on feeding microstructure: dissociation of appetitive and consummatory actions* Behav Neurosci, 2006. 120(4): p. 937-51.
82. Robinson TE and Berridge KC. *The neural basis of drug craving: an incentive-sensitization theory of addiction* Brain Res Brain Res Rev, 1993. 18(3): p. 247-91.
83. Dutta Banik D, Martin LE, Freichel M, Torregrossa AM, and Medler KF. *TRPM4 and TRPM5 are both required for normal signaling in taste receptor cells* Proc Natl Acad Sci U S A, 2018. 115(4): p. E772-E781.
84. Cottone P, Sabino V, Steardo L, and Zorrilla EP. *Opioid-dependent anticipatory negative contrast and binge-like eating in rats with limited access to highly preferred food* Neuropsychopharmacology, 2008. 33(3): p. 524-35.
85. Lynch WC. *Opiate blockade inhibits saccharin intake and blocks normal preference acquisition* Pharmacol Biochem Behav, 1986. 24(4): p. 833-6.
86. Ostlund SB, Kosheleff A, Maidment NT, and Murphy NP. *Decreased consumption of sweet fluids in mu opioid receptor knockout mice: a microstructural analysis of licking behavior* Psychopharmacology (Berl), 2013. 229(1): p. 105-13.
87. Zhang M, Gosnell BA, and Kelley AE. *Intake of high-fat food is selectively enhanced by mu opioid receptor stimulation within the nucleus accumbens* J Pharmacol Exp Ther, 1998. 285(2): p. 908-14.
88. Zhang M and Kelley AE. *Intake of saccharin, salt, and ethanol solutions is increased by infusion of a mu opioid agonist into the nucleus accumbens* Psychopharmacology (Berl), 2002. 159(4): p. 415-23.
89. McCarthy GM, Warden AS, Bridges CR, Blednov YA, and Harris RA. *Chronic ethanol consumption: role of TLR3/TRIF-dependent signaling* Addict Biol, 2018. 23(3): p. 889-903.
90. Becker JB and Chartoff E. *Sex differences in neural mechanisms mediating reward and addiction* Neuropsychopharmacology, 2019. 44(1): p. 166-183.
91. Lynch WJ and Carroll ME. *Sex differences in the acquisition of intravenously self-administered cocaine and heroin in rats* Psychopharmacology (Berl), 1999. 144(1): p. 77-82.
92. Everitt BJ, Belin D, Economidou D, Pelloux Y, Dalley JW, and Robbins TW. *Review. Neural mechanisms underlying the vulnerability to develop compulsive drug-seeking habits and addiction* Philos Trans R Soc Lond B Biol Sci, 2008. 363(1507): p. 3125-35.

93. Orendain-Jaime EN, Ortega-Ibarra JM, and Lopez-Perez SJ. *Evidence of sexual dimorphism in D1 and D2 dopaminergic receptors expression in frontal cortex and striatum of young rats* *Neurochem Int*, 2016. 100: p. 62-66.
94. Goldstein RZ and Volkow ND. *Dysfunction of the prefrontal cortex in addiction: neuroimaging findings and clinical implications* *Nat Rev Neurosci*, 2011. 12(11): p. 652-69.
95. Bennett E, Peters SAE, and Woodward M. *Sex differences in macronutrient intake and adherence to dietary recommendations: findings from the UK Biobank* *BMJ Open*, 2018. 8(4): p. e020017.
96. Barragan R, Coltell O, Portoles O, Asensio EM, Sorli JV, Ortega-Azorin C, et al. *Bitter, Sweet, Salty, Sour and Umami Taste Perception Decreases with Age: Sex-Specific Analysis, Modulation by Genetic Variants and Taste-Preference Associations in 18 to 80 Year-Old Subjects* *Nutrients*, 2018. 10(10).
97. Valenstein ES, Kakolewski JW, and Cox VC. *Sex differences in taste preference for glucose and saccharin solutions* *Science*, 1967. 156(3777): p. 942-3.
98. Di Lorenzo PM and Monroe S. *Taste responses in the parabrachial pons of male, female and pregnant rats* *Brain Res Bull*, 1989. 23(3): p. 219-27.
99. Di Lorenzo PM and Monroe S. *Taste responses in the parabrachial pons of ovariectomized rats* *Brain Res Bull*, 1990. 25(5): p. 741-8.
100. Contini A, Sanna F, Maccioni P, Colombo G, and Argiolas A. *Comparison between male and female rats in a model of self-administration of a chocolate-flavored beverage: Behavioral and neurochemical studies* *Behav Brain Res*, 2018. 344: p. 28-41.
101. Perry JL, Morgan AD, Anker JJ, Dess NK, and Carroll ME. *Escalation of i.v. cocaine self-administration and reinstatement of cocaine-seeking behavior in rats bred for high and low saccharin intake* *Psychopharmacology (Berl)*, 2006. 186(2): p. 235-45.
102. Klump KL, Racine S, Hildebrandt B, and Sisk CL. *Sex differences in binge eating patterns in male and female adult rats* *Int J Eat Disord*, 2013. 46(7): p. 729-36.
103. Corwin RL and Hayes JE. *Are Sugars Addictive? Perspectives for Practitioners*. . Nutrition and Health. New-York, NY: Humana Press. 2014.
104. Ziauddeen H, Farooqi IS, and Fletcher PC. *Obesity and the brain: how convincing is the addiction model?* *Nat Rev Neurosci*, 2012. 13(4): p. 279-86.
105. Grilo CM, White MA, and Masheb RM. *DSM-IV psychiatric disorder comorbidity and its correlates in binge eating disorder* *Int J Eat Disord*, 2009. 42(3): p. 228-34.
106. Blanco-Gandia MC, Minarro J, Aguilar MA, and Rodriguez-Arias M. *Increased ethanol consumption after interruption of fat bingeing* *PLoS One*, 2018. 13(3): p. e0194431.
107. Dunn EC, Neighbors C, Fossos N, and Larimer ME. *A cross-lagged evaluation of eating disorder symptomatology and substance-use problems* *J Stud Alcohol Drugs*, 2009. 70(1): p. 106-16.
108. Rolland B, Naassila M, Duffau C, Houchi H, Gierski F, and Andre J. *Binge Eating, But Not Other Disordered Eating Symptoms, Is a Significant Contributor of Binge Drinking Severity: Findings from a Cross-Sectional Study among French Students* *Front Psychol*, 2017. 8: p. 1878.
109. Wilfley DE, Friedman MA, Dounchis JZ, Stein RI, Welch RR, and Ball SA. *Comorbid psychopathology in binge eating disorder: relation to eating disorder severity at baseline and following treatment* *J Consult Clin Psychol*, 2000. 68(4): p. 641-9.
110. Avena NM and Hoebel BG. *A diet promoting sugar dependency causes behavioral cross-sensitization to a low dose of amphetamine* *Neuroscience*, 2003. 122(1): p. 17-20.
111. Gosnell BA. *Sucrose intake enhances behavioral sensitization produced by cocaine* *Brain Res*, 2005. 1031(2): p. 194-201.

112. Overstreet DH, Halikas JA, Seredenin SB, Kampov-Polevoy AB, Viglinskaya IV, Kashevskaya O, et al. *Behavioral similarities and differences among alcohol-preferring and -nonpreferring rats: confirmation by factor analysis and extension to additional groups* Alcohol Clin Exp Res, 1997. 21(5): p. 840-8.

IV. Hypothesis

(English version)

In addition to the well-studied involvement of dopamine in BED, a role of the endocannabinoid and endogenous opioid systems has been revealed by pharmacological studies. Administration of the cannabinoid antagonist rimonabant reduced the frequency and severity of binge eating in obese subjects with BED (Pataky et al., 2012). The involvement of the opioid system was shown by a significant association between the opioid receptor gene variant A118G and obese subjects with BED, with this variant already known to be highly associated with addiction (C. A. Davis et al., 2009; Taqi et al., 2019). In a recent clinical trial, blocking MOR with naltrexone, in combination with bupropion, an antidepressant, improved the pathological eating behaviors (Carbone et al., 2021). Preclinical studies have also provided evidence for similarities in opioid and cannabinoid involvement in drug addiction and BED. For example, the MOP/KOP antagonist, Nalmefene, decreased preferred food hyperphagia, a measure of binge-like eating in rats. In addition, blocking the cannabinoid receptor 1 using rimonabant reduces fat bingeing in rats (Scherma et al., 2013).

Our first objective was to develop a rodent models of sucrose bingeing in order to better characterize the involvement of MOP and CB1 in this behavior.

- **Hypothesis 1:** MOP KO mice will exhibit reduced sucrose and saccharin bingeing
- **Hypothesis 2:** CB1 blockade will reduce sucrose bingeing

Several reports describe the involvement of neuroinflammation in mental health conditions (Lacagnina et al., 2017), with overlapping mechanisms in BED and addiction (Schulte et al., 2017). Neuroinflammation is increased in rodents given access to high fat and high sugar diets has been described in brain areas related to reward. (De Souza et al., 2005b; Décarie-Spain et al., 2018; Fuente-Martín et al., 2013; Gao et al., 2017). More recently it was shown that 12-week intermittent access to sucrose in rats increased TSPO, a neuroinflammatory marker in discrete brain regions such as the caudate putamen involved in motor control (Patkar et al., 2021). We believe that neuroinflammation in the reward pathway could explain maladaptive eating behaviors and provide a mechanistic link to SUD.

Our second objective was to measure expression of neuroinflammatory markers in regions of the reward pathway.

- **Hypothesis 3:** sucrose bingeing alters gene expression of neuroinflammatory markers in brain regions of the reward pathway in mice

BED is associated with medical and psychiatric comorbidities (Kessler et al., 2013b), with a particularly high prevalence of SUD in BED individuals. In our team we are interested in the dysregulation of reward responses and evidence that BED modifies drug reward because of high prevalence of SUD amongst BED individuals (Grilo et al., 2009; Grilo & O'Malley, 2002). Our third objective was to measure EtOH reward responses in our sucrose bingeing mouse model since BED is often comorbid with AUD (Rolland et al., 2017).

- **Hypothesis 4:** sucrose bingeing alters EtOH reward responses in a conditioned place preference paradigm

During my PhD we also collaborated with Dr. Décosterd's team in Lausanne to work on alcoholic neuropathy. There is increasing evidence that alcohol induces neuroinflammation in the peripheral nervous system. These alterations can increase the risk of developing neuropathy. However, much less is known about the link between neuroimmune signaling associated with alcoholism and alcoholic neuropathy (Chopra & Tiwari, 2012). Therefore, we established a mouse model of binge drinking to measure nociceptive thresholds. Based on evidence that BED individuals report pain (see in Awad & Befort, 2019), we extended the work to our BED model by measuring nociceptive thresholds in sucrose bingeing mice. We observed altered expression of neuroinflammatory factors in the brain and these are supported by previous results (Patkar et al., 2021). Given that neuropathic pain is linked to neuroinflammation, our last objective was to measure nociceptive thresholds in binge drinking and sucrose bingeing mouse models and to assess the relationship of these behavioral measures to brain neuroimmune adaptations.

- **Hypothesis 5:** sucrose bingeing and binge drinking modify thermal and mechanical nociceptive thresholds

(French version)

En plus de l'implication bien étudiée de la dopamine dans le BED, le rôle des systèmes cannabinoïde et opioïde endogènes a été révélé notamment par des études pharmacologiques. L'administration de l'antagoniste cannabinoïde rimonabant a réduit la fréquence et la sévérité des crises de boulimie chez des sujets obèses atteints de BED (Pataky et al., 2012). L'implication du système opioïde a été démontrée par une association significative entre le variant A118G du gène MOP et les sujets obèses atteints de BED, ce variant étant déjà connu pour être fortement associée à la dépendance (C. A. Davis et al., 2009; Taqi et al., 2019). Un essai clinique récent a montré que le blocage MOP par la Naltrexone, en association avec le Bupropion, un antidépresseur, améliorait les symptômes associés au comportement de « binge » chez des sujets atteints de BED (Carbone et al., 2021). Des études précliniques ont également pu fournir des preuves de similitudes entre la toxicomanie et le BED. Des études sur des modèles animaux ont fourni des preuves du rôle du système opioïde dans le BED en montrant que l'antagoniste MOP/KOP, Nalmafene, diminuait l'hyperphagie des aliments préférés, une mesure de la frénésie alimentaire chez les rats. Il existe également des preuves de l'implication du système endocannabinoïde dans l'hyperphagie boulimique en montrant que le blocage de CB1 à l'aide de l'antagoniste rimonabant réduit le comportement d'hyperphagie boulimique chez les rats exposés à une alimentation riche en graisse (Scherma et al., 2013).

Notre premier objectif était de développer des modèles rongeurs de binge au saccharose afin de mieux caractériser l'implication de MOP et CB1.

Hypothèse 1 : Les souris MOP KO réduisent la consommation excessive de saccharose et de saccharine lors d'un comportement de « binge ».

Hypothèse 2 : Le blocage de CB1 réduit la consommation excessive de saccharose lors d'un comportement de « binge ».

Plusieurs rapports décrivent l'implication de la neuroinflammation dans l'addiction (Lacagnina et al., 2017). De plus, plusieurs rapports tentent d'établir des preuves solides sur les mécanismes communs entre le BED et la dépendance (Schulte et al., 2017). Des études ont pu démontrer une neuroinflammation chez les rongeurs ayant accès à des régimes riches en graisses et en sucre, et cela dans des régions impliquées dans les comportements addictifs (De Souza et al., 2005a; Décarie-Spain et al., 2018; Fuente-Martín et al., 2013; Gao et al., 2017). Plus récemment, il a été montré que l'accès intermittent au saccharose pendant 12 semaines chez le rat augmentait la protéine translocator (TSPO), un marqueur de neuroinflammation,

dans des régions cérébrales comme le putamen caudé impliqué dans le contrôle moteur (Patkar et al., 2021). Nous pensons que des mécanismes inflammatoires dans les régions appartenant au système de la récompense pourrait expliquer les comportements alimentaires inadaptés et les similitudes avec les troubles liés à la consommation excessive de substances addictives.

Notre deuxième objectif était de mesurer l'expression des marqueurs neuroinflammatoires dans les régions cérébrales de la récompense.

Hypothèse 3 : le « binge » de saccharose modifie l'expression génétique des marqueurs neuroinflammatoires dans les régions cérébrales de la récompense chez la souris.

Le BED est associé à des comorbidités médicales et psychiatriques (Kessler et al., 2013c). Notamment, la prévalence d'abus de substances chez les personnes souffrant de BED est élevée. Dans notre équipe, nous nous intéressons à la dérégulation de la réponse aux récompenses. En effet, il existe des preuves que le BED modifie la récompense de la drogue au vu de la prévalence d'abus de substances addictives chez des sujets BED (Grilo et al., 2009; Grilo & O'Malley, 2002). Notre troisième objectif était de mesurer la réponse de récompense à l'EtOH dans notre modèle de souris bingeing au sucrose puisque le BED est souvent comorbide avec l'AUD (Rolland et al., 2017).

Hypothèse 4 : la consommation excessive de saccharose lors d'un comportement de « binge » modifie la réponse de récompense à l'alcool dans un paradigme de préférence de place conditionnée.

Pendant mon doctorat, nous avons également collaboré avec l'équipe du Dr. Décosterd à Lausanne pour travailler sur la neuropathie alcoolique. Il existe de plus en plus de preuves que l'alcool induit une neuroinflammation dans le système nerveux périphérique. Ces altérations peuvent augmenter le risque de développer une neuropathie. Cependant, on connaît beaucoup moins le lien entre les mécanismes centraux de neuroinflammation associés à l'alcoolisme et la neuropathie alcoolique (Chopra & Tiwari, 2012). Nous avons donc établi un modèle murin de consommation excessive d'alcool (binge drinking) dans lequel les seuils nociceptifs sont mesurés. Dans notre laboratoire, nous avons décidé de faire un parallèle avec le BED en mesurant les seuils nociceptifs chez des souris qui s'adonnent à la consommation excessive de saccharose. En effet, les individus BED rapportent des douleurs (voir dans Awad & Befort, 2019). Nous avons observé une altération de l'expression des facteurs neuroinflammatoires dans le cerveau, ce qui est confirmé par les résultats de la littérature

(Patkar et al., 2021) . La douleur neuropathique pourrait être associée à la neuroinflammation dans le cerveau. Notre dernier objectif était de mesurer les seuils nociceptifs dans des modèles de souris de consommation excessive d'alcool ou de saccharose afin de les corrélés avec la signalisation neuro-immune du cerveau.

Hypothèse 5 : la consommation excessive de saccharose ou d'alcool lors d'un comportement de « binge » augmente la sensibilité aux stimuli thermiques et mécaniques.

V. Results

V.1 MOP in BED

V.1.1. Opioid system generalities

The opioid system is characterized by four receptors coupled to inhibitory G proteins (G_{α_i} and G_{α_o}), the mu, delta, kappa and nociceptin receptors (MOP, DOP, KOP, NOP) (Kieffer & Evans, 2009). NOP, being the least well characterized with different structural conformation, shows less potential interaction with the other endogenous ligands (Corder et al., 2018). Four main endogenous opioid ligands: beta-endorphin, enkephalin, dynorphin and nociceptin have been described, each released from post-translational cleavage of the precursor proteins proopiomelanocortin, preproenkephalin, prodynorphin and prepronociceptin respectively (Figure 12). The receptors are expressed in a wide range of brain regions which can vary from one receptor to another but usually include regions from the limbic system, the basal ganglia and the cortex (Lutz & Kieffer, 2013; Mansour et al., 1995). Binding to the receptors leads to decreased neuronal excitability, as described in the figure legend (Figure 12).

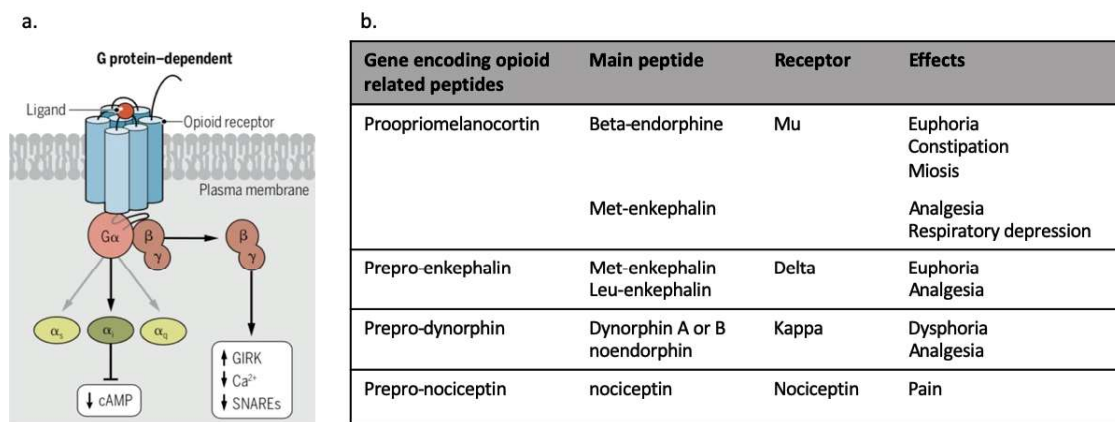

Figure 12 a. Opioid receptor coupled to G_{α_i} . When a ligand binds to opioid receptor, the voltage sensitive calcium channels close and potassium efflux is stimulated leading to hyperpolarization. The alpha subunit also reduces conversion of adenosin triphosphate into cyclic adenosine monophosphate reducing neurotransmitter release (Cartoon modified from Che et al., 2021). **b. Opioid neurotransmitter precursors with specific receptor and main effects.** (Table modified from Corder et al., 2018)

V.1.2. Opioid system and palatable food

The opioid system is involved in homeostatic and hedonic control of food intake. Opioid homeostatic regulation of feeding involves hypothalamic neuronal activity such as POMC, NPY or orexin neurons (Nogueiras et al., 2012). Opioid neurotransmission was shown to be involved in liking in specific regions of the limbic forebrain described as hedonic

spots and involved in the hedonic control of feeding. DAMGO, a synthetic opioid peptide targeting MOP, enhances liking reactions to sucrose in the rostro dorsal medial shell of the NAcc (Pecina, 2005). These results have been extended to all 3 main opioid receptors MOP, KOP and DOP (Castro & Berridge, 2014). The same experiment with DAMGO has been repeated in the ventral pallidum identifying another hedonic hotspot mediated by opioid neurotransmission only in the posterior third part (K. S. Smith, 2005). Both are targeted by orexin neurons of the lateral hypothalamus (Castro & Berridge, 2014). In humans, MOP inverse agonist nalmefene selectively reduces preferred food intake but did not modify hunger or satiety subjective ratings compared to control group (Yeomans et al., 1990).

V.1.3. Opioid system and BED

The role of the opioid system in binge eating has been shown in rat models of palatable food bingeing using MOP antagonists GSK1521498 or naltrexone (Giuliano et al., 2012) and of sucrose bingeing using Naltrexone and Beta-funatrexamine (Katsuura & Taha, 2014a). GSK1521498 administered to obese BED individuals during 28 days reduced binge eating, providing clinical evidence of the opioid system as a therapeutic target (Giuliano & Cottone, 2015).

BED individuals usually binge on high fat/high sugar food. To date only one study antagonized MOPR in the NAcc shell of sucrose bingeing in animal models (Katsuura & Taha, 2014b). However, we do not know if in sucrose bingeing animal models, opioid regulates taste preference and/or calories intake. Therefore, a sweet non-caloric control is needed.

In our study, we decided to use three groups with restricted access to food because it has been shown that food restriction and high concentrations of sucrose (20%) increase burst licking of sucrose in WT and MOP KO mice compared to lower sucrose concentrations (2%) with ad libitum access to food (Östlund et al., 2003). But MOP KO mice showed a reduced intake compared to the WT. This provides evidence that MOP determines palatability responses which is increased under food deprivation. This might be due to interaction with the dopaminergic system since limited access to sucrose associated with restricted feeding increases dopamine transporter binding in the mesoaccumbens compared to unrestricted

animals (Bello et al., 2003), and increases D1 and MOP binding in the NAcc core and shell respectively.

Thus, we predicted that we would see reduced levels of sucrose and saccharin intake in the MOP KO mice. Together, our results support this evidence and might suggest that MOP deletion prevents, but doesn't suppress, sweet solution intake.

(French version)

Généralités sur le système opioïde

Le système opioïde est caractérisé par quatre récepteurs couplés à des protéines G inhibitrices (Gai et Gao), les récepteurs mu, delta, kappa et nociceptine (MOP, DOP, KOP, NOP) (Kieffer & Evans, 2009). Le NOP, étant le moins bien caractérisé avec une conformation structurale différente, présente moins d'interactions potentielles avec les autres ligands endogènes (Corder et al., 2018). Quatre principaux ligands opioïdes endogènes : la bêta-endorphine, l'enképhaline, la dynorphine et la nociceptine ont été décrits, chacun étant libéré par le clivage post-traductionnel des protéines précurseurs que sont respectivement la proopiomélanocortine, la préproképhaline, la prodynorphine et la prépronociceptine (Figure 12). Les récepteurs sont exprimés dans un large éventail de régions du cerveau, qui peuvent varier d'un récepteur à l'autre, mais qui comprennent généralement des régions du système limbique, des ganglions de la base et du cortex (Lutz & Kieffer, 2013 ; Mansour et al., 1995). La liaison aux récepteurs entraîne une diminution de l'excitabilité neuronale, comme décrit dans la légende de la figure 12 (Figure 12).

Système opioïde et aliments appétissants

Le système opioïde est impliqué dans le contrôle homéostatique et hédonique de la prise alimentaire. La régulation homéostatique de l'alimentation par les opioïdes implique une activité neuronale hypothalamique telle que les neurones POMC, NPY ou orexine (Nogueiras et al., 2012). Il a été démontré que la neurotransmission opioïde était impliquée dans le goût dans des régions spécifiques du cerveau antérieur limbique décrites comme des spots hédoniques et impliquées dans le contrôle hédonique de l'alimentation. Le DAMGO, un peptide opioïde synthétique ciblant la MOP, renforce les réactions de goût au saccharose dans l'enveloppe médiane rostro dorsale de la NAcc (Pecina, 2005). Ces résultats ont été étendus aux 3 principaux récepteurs opioïdes MOP, KOP et DOP (Castro & Berridge, 2014). La même expérience avec le DAMGO a été répétée dans le pallidum ventral, identifiant un autre spot hédonique médié par la neurotransmission opioïde uniquement dans la troisième partie postérieure (K. S. Smith, 2005). Tous deux sont ciblés par les neurones à orexine de l'hypothalamus latéral (Castro & Berridge, 2014). Chez l'homme, l'agoniste inverse de la MOP, le nalméfène, réduit sélectivement la prise alimentaire préférée mais ne modifie pas les évaluations subjectives de la faim ou de la satiété par rapport au groupe témoin (Yeomans et al., 1990).

Système opioïde et BED

Le rôle du système opioïde dans l'hyperphagie boulimique a été démontré dans des modèles de rat d'hyperphagie d'aliments appétissants à l'aide d'antagonistes de MOP, le GSK1521498 ou la naltrexone (Giuliano et al., 2012) et d'hyperphagie de saccharose à l'aide de la naltrexone et de la bêta-funatrexamine (Katsuura & Taha, 2014a). Le GSK1521498 administré à des personnes obèses souffrant de BED pendant 28 jours a réduit les crises de boulimie, fournissant des preuves cliniques du système opioïde comme cible thérapeutique (Giuliano & Cottone, 2015).

Les personnes souffrant de BED se gavent généralement d'aliments riches en graisses et en sucres. À ce jour, une seule étude a antagonisé le MOP dans la coquille du NAcc de dans des modèles animaux d'hyperphagie boulimique de saccharose (Katsuura & Taha, 2014b). Cependant, nous ne savons pas si dans les modèles animaux de BED, le système opioïde régule la préférence gustative et/ou la prise de calories. Par conséquent, un contrôle sucré non calorique est nécessaire.

Dans notre étude, nous avons décidé d'utiliser trois groupes avec un accès restreint à la nourriture car il a été démontré que la restriction alimentaire et les concentrations élevées de saccharose (20%) augmentent le léchage du saccharose chez les souris WT et MOPR KO par rapport aux concentrations plus faibles de saccharose (2%) avec un accès ad libitum à la nourriture (Östlund et al., 2003). Les souris MOP KO ont montré une consommation réduite par rapport aux souris WT. Cela prouve que MOP détermine les réponses de palatabilité qui sont augmentées en cas de privation de nourriture. Cela pourrait être dû à une interaction avec le système dopaminergique puisque l'accès limité au saccharose associé à une alimentation restreinte augmente la liaison des transporteurs de dopamine dans le mésoaccumbens par rapport aux animaux non restreints (Bello et al., 2003), et augmente la liaison de D1 et de MOP dans le noyau et l'enveloppe du NAcc respectivement.

Ainsi, nous avons prédit que nous verrions des niveaux réduits de consommation de saccharose et de saccharine chez les souris MOP KO. Ensemble, nos résultats confirment cette évidence et pourraient suggérer que la délétion de MOP prévient, mais ne supprime pas, la consommation de solutions sucrées.

Deletion of mu opioid receptors reduces palatable solution intake in a mouse model of binge eating

Gaëlle Awad^a, Laurie-Anne Roeckel^a, Dominique Massotte^b, Mary C. Olmstead^c and Katia Befort^a

Binge eating in humans is driven by hedonic properties of food, suggesting that brain reward systems may contribute to this behaviour. We examined the role of mu opioid receptors (MOP) in binge eating by examining sweet solution intake in mice with genetic deletion of the MOP. Wildtype and MOP knockout mice had 4 hours access to food in the home cage combined with limited (4 hours) access to sucrose (17.1% w/v) or saccharin (0.09% w/v), or continuous (24 hours) access to sucrose. Only limited access groups exhibited binge intake, measured as increased solution consumption during the first hour. Knockout mice consumed less solution and food during the first hour as well as less food each day compared with wildtype mice. Limited access groups consumed more food and gained more weight than continuous access groups, and the effect was magnified in saccharin-consuming mice. Indeed, the increased food consumption in animals given limited access to saccharin was so excessive that caloric intake of this group was significantly

higher than either of the sucrose groups (limited or continuous access). Within this group, females consumed more food per bodyweight than males, highlighting important sex differences in feeding behaviours under restricted access schedules. *Behavioural Pharmacology* XXX: 000–000 Copyright © 2019 Wolters Kluwer Health, Inc. All rights reserved.

Behavioural Pharmacology 2019, XXX:000–000

Keywords: binge eating disorder, feeding, mu opioid receptor, motivation, reward, saccharin

^aLaboratoire de Neurosciences Cognitives et Adaptatives (LNCA), Centre de la Recherche Nationale Scientifique, Université de Strasbourg Faculté de Psychologie, ^bCentre de la Recherche Nationale Scientifique, Université de Strasbourg, Institut des Neurosciences Cellulaires et Intégratives (INCI), Strasbourg, France and ^cDepartment Psychology, Centre for Neuroscience Studies, Queen's University, Kingston, ON, Canada

Correspondence to Mary C. Olmstead, Department of Psychology, Queen's University, Kingston, ON K7L 3N6, Canada
E-mail: olmstead@queensu.ca

Received 6 January 2019 Accepted 5 June 2019

Introduction

Binge eating disorder (BED), the most prevalent of all eating disorders (Kessler *et al.*, 2013; Solmi *et al.*, 2016), is associated with detrimental health outcomes including obesity (Gruzca *et al.*, 2007; Stojek and MacKillop, 2017) and several mental health conditions (Javaras *et al.*, 2008; Solmi *et al.*, 2016). Treatments for BED are not widely available and generally ineffective, partly because the aetiology of the disorder is poorly understood (Hutson *et al.*, 2018).

Emerging evidence points to alterations in brain reward circuits in BED patients (Balodis *et al.*, 2015; Kessler *et al.*, 2016), matching reports of increased dopamine release in the nucleus accumbens (NAcc) of rats following sucrose bingeing (Rada *et al.*, 2005). In the context of motivated behaviours, disruptions in mesolimbic dopamine function would impact binge eating by altering 'wanting' of food rewards (Kelley and Berridge, 2002).

In contrast, the 'liking' component of natural rewards is mediated through opioid systems, specifically the mu opioid receptor (MOP) (Castro and Berridge, 2014). For instance, intra-NAcc injections of MOP agonists produce hyperphagia of highly palatable food (Zhang and Kelley, 2002; Nogueiras *et al.*, 2012; Katsuura and Taha, 2014); opioid and selective MOP antagonists have the opposite

effect (Ward *et al.*, 2006; Sahr *et al.*, 2008; Katsuura and Taha, 2014). MOPs appear to be linked, specifically, to hedonic responses associated with preferred foods (Giuliano *et al.*, 2012; Nogueiras *et al.*, 2012; Ostlund *et al.*, 2013), which may explain why blockade of MOPs reduces subjective ratings and ad libitum intake of preferred foods in BED patients (Drewnowski *et al.*, 1995; Ziauddeen *et al.*, 2013). Together, clinical and preclinical data suggest that MOPs may contribute to binge eating by regulating the hedonic aspects of palatable food.

We tested the role of MOPs in binge eating by assessing intake of highly palatable food (sucrose or saccharin) and regular chow in mice lacking MOPs. Binge eating, defined as excessive consumption within a discrete period of time, was induced using a limited access protocol (Corwin *et al.*, 2011) adapted for mice (Yasoshima and Shimura, 2015). We focussed, exclusively on sweet solutions, rather than sweet/fat combinations, as the two commodities induce distinct neural and behavioural adaptations (Avena, 2010).

Materials and methods

Subjects

Twelve male and 12 female mice lacking MOP receptors and their wildtype controls (wildtype female $n = 30$; male

$n=24$) were single housed under standard light, temperature, and humidity conditions (12-hour light–dark cycle, $22 \pm 2^\circ\text{C}$, $55 \pm 10\%$ humidity). Knockout mice were generated by homologous recombination (Matthes *et al.*, 1996) on a genetic background of 50% C57/BL6J:50% 129svPas. Mice weighed 23–46.7 g at the start of the experiment, ranging in age from four months to approximately one year (wildtype: 17.7–32.8 weeks; MOP knockout: 18.5–58.8 weeks).

Research was conducted in accordance with the European Communities Council Directive of 22 September 2010 (directive 2010/63/UE). Experiments were approved by the local ethical committee (Comité Régional d’Ethique en Matière d’Expérimentation Animale de Strasbourg CREMEAS) and findings are reported following the ARRIVE Guidelines for experiments involving animals.

Sucrose consumption

The protocol for sucrose consumption, including solution concentrations and access periods, was based on a procedure that induces sucrose bingeing in mice (Yasoshima and Shimura, 2015). Briefly, MOP knockout and wildtype mice were randomly assigned to one of three access conditions: limited sucrose (4 hours sucrose and food, 4SUC/4F); limited saccharin (4 hours saccharin and food, 4SAC/4F); or continuous sucrose (24 hours sucrose and 4 hours food, 24SUC/4F). As far as possible, sex, age, and initial weight were counterbalanced across groups. Sucrose and saccharin were presented at concentrations that are equally preferred in mice (17.1 and 0.09% w/v, respectively).

Mice were habituated to single housing and water presentation in two sipper tubes in the home cage for a minimum of six days. Over the next 14 days, beginning 2 hours into the light cycle, mice were presented with standard chow and solution according to their group assignment. Water was available ad libitum. Solution (mL) and chow (g) intake were measured 1, 4, and 24 hours following presentation. Binge intake was assessed as significantly higher solution consumption during the first hour of access. Animals were weighed daily and sacrificed at the end of the intermittent access period.

Statistical analyses

Solution and food intake were analysed using a Linear Mixed Model (LMM) analysis (Winter, 2013) in which consumption (solution, food, kilocalories) was assessed as a function of group, day, sex, and weight. LMM analyses accounts for both fixed and random effects, the latter reflecting individual differences in baseline intake. Degrees of freedom were calculated using the Welch–Satterthwaite equation (pooled degrees of freedom) as there is no assumption that underlying population variances are equal (Satterthwaite, 1946). Group differences across sessions were analysed using a likelihood ratio test

(LRT) (Luke, 2017) that compares goodness of fit of two models: the full model against one that combines two groups of interest into a single group. Statistically significant effects indicate that the two groups are distinct.

Results

Figure 1 shows that limited access to a sweet solution induces binge intake in both wildtype and MOP knockout mice, confirmed by a significant escalation of sucrose intake across 14 days for the 4SUC/4F wildtype ($t_{(1,424)} = 7.906$; $P < 0.001$), 4SUC/4F MOP knockout ($t_{(1,399)} = 4.545$; $P < 0.001$), 4SAC/4F wildtype ($t_{(1,412)} = 3.878$; $P < 0.001$), and 4SAC/4F MOP knockout ($t_{(1,403)} = 2.890$; $P = 0.003$) groups (Fig. 1a). Intake during the first hour of access did not increase across sessions in wildtype or knockout mice given continuous access to sucrose (i.e., 24SUC/4F groups). LRT analysis revealed that the rate of increased solution intake during the first hour was higher in wildtype compared with MOP knockout mice given limited access to sucrose [$X^2(2) = 12.174$; $P = 0.002$] and saccharin [$X^2(2) = 8.8796$; $P = 0.01$].

Chow consumption during the first hour also increased across sessions in all groups [4SUC/4F MOP knockout ($t_{(1,622)} = 2.688$; $P = 0.007$); 4SAC/4F wildtype ($t_{(1,639)} = 4.983$; $P < 0.001$) and MOP knockout ($t_{(1,625)} = 5.238$; $P < 0.001$); 24SUC/4F wildtype ($t_{(1,622)} = 2.501$; $P = 0.012$) and MOP knockout ($t_{(1,624)} = 3.284$; $P < 0.001$)], with the exception of 4SUC/4F wildtype mice ($t_{(1,644)} = 1.100$; $P = 0.244$). The rate of increased chow intake during the first hour was significantly different in wildtype and MOP knockout mice in the 4SUC/4F group [$X^2(2) = 11.291$; $P = 0.004$], but not in the other two groups: 4SAC/4F [$(2) = 1.342$; $P = 0.511$] and 24SUC/4F [$X^2(2) = 5.935$; $P = 0.051$] (Fig. 1b).

In order to assess overall differences in consumption, we conducted an analysis of variance (ANOVA) on all measures, using access group and genotype as between subjects’ factors. This yielded a generally consistent pattern of results with no significant group \times genotype interaction for any measure of intake or body weight ($P_s > 0.05$), although wildtype mice drank more water than MOP knockout mice ($F_{(1,61)} = 5.686$; $P = 0.020$) (Fig. 1c).

Figure 1d shows that daily sweet solution intake did not differ between wildtype and MOP knockout groups [4SUC/4F ($X^2(2) = 2.437$, $df = 2$; $P = 0.296$); 4SAC/4F ($X^2(2) = 5.775$; $P = 0.056$); and 24SUC/4F ($X^2(2) = 1.1306$; $P = 0.568$)]. LMM analysis also revealed significant escalation of daily solution intake across sessions, only in limited access groups [4SUC/4F wildtype ($t_{(1,238)} = 9.877$; $P < 0.001$) and MOP knockout ($t_{(1,224)} = 6.479$; $P < 0.001$); 4SAC/4F wildtype ($t_{(1,228)} = 9.990$; $P < 0.001$) and MOP knockout ($t_{(1,227)} = 7.092$; $P < 0.001$)].

All six groups showed significant increases in daily chow consumption across sessions, verified by LMM analysis in wildtype [4SUC/4F ($t_{(1,601)} = 3.699$; $P < 0.001$); 4SAC/4F

Fig. 1

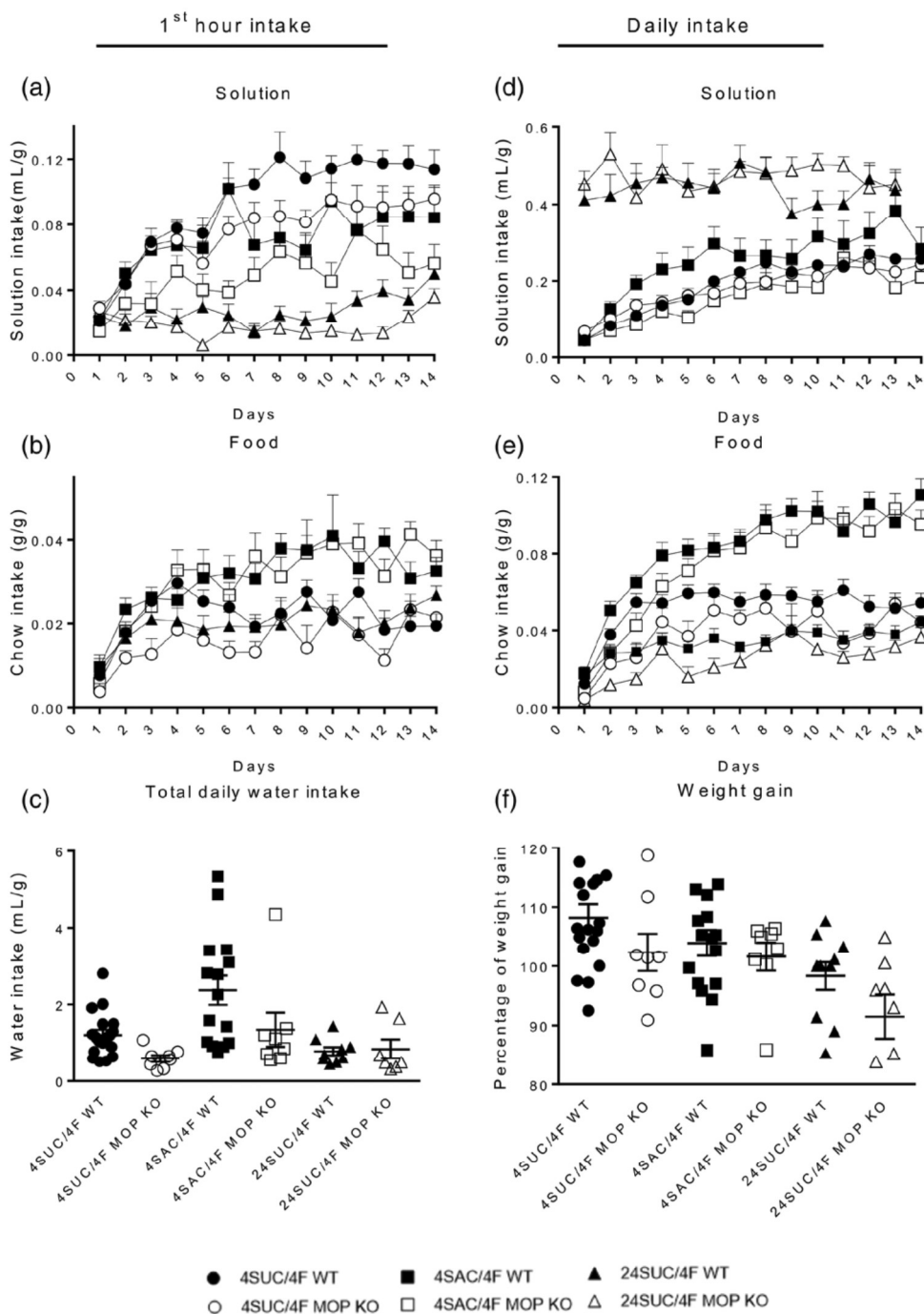

Limited access to sweet solution produces binge intake. Mice were given daily access to sucrose, saccharin, and food for 14 days as follows: 4SUC/4F=4 hours access to sucrose and food; 4SAC/4F=4 hours access to saccharin and food; 24SUC/4F=24 hours access to sucrose and 4 hours access to food. Data are presented as mean intake per body weight (mL/g and g/g) of solution (a) and (d) or food (b) and (e) during the first hour of access (a) and (b) and over each 24-hour period (d) and (e). Total water intake (c) and percentage weight gain from baseline (f) were calculated across the 14 days. Error bars represent SEM. MOP knockout, mu opioid knockout; WT, wildtype.

($t_{(1,591)} = 9.418$; $P < 0.001$); 24SUC/4F ($t_{(1,574)} = 3.450$; $P < 0.001$) and MOP knockout [4SUC/4F ($t_{(1,574)} = 4.071$; $P < 0.001$); 4SAC/4F ($t_{(1,578)} = 9.909$; $P < 0.001$); 24SUC/4F ($t_{(1,572)} = 4.130$; $P < 0.001$)] groups. The rate of daily chow

intake was higher in wildtype groups with limited access to sucrose ($X^2(2) = 10.112$; $P = 0.006$) and saccharin ($X^2(2) = 6.492$; $P = 0.039$) (Fig. 1e). In addition, wildtype mice gained more weight than MOP knockout mice

($F_{(1,62)}=6.927$; $P=0.010$), with the two limited access groups (4SUC/4F and 4SAC/4F) gaining more than the continuous access (24SUC/4F) group ($F_{(2,62)}=7.374$; $P<0.001$) (Fig. 1f).

Data presented in Fig. 2 show that MOP knockout mice consumed less sweet solution ($F_{(1,62)}=12.090$; $P<0.001$)

and food ($F_{(1,62)}=9.594$; $P=0.002$) than wildtype mice during the first hour of access (Fig. 2a and b), as well as less total food ($F_{(1,54)}=11.449$; $P<0.001$) across sessions (Fig. 2e). Total daily intake of sweet solution did not differ across genotypes ($F_{(1,62)}=0.19$; $P=0.665$) (Fig. 2d). In addition, solution intake during the first

Fig. 2

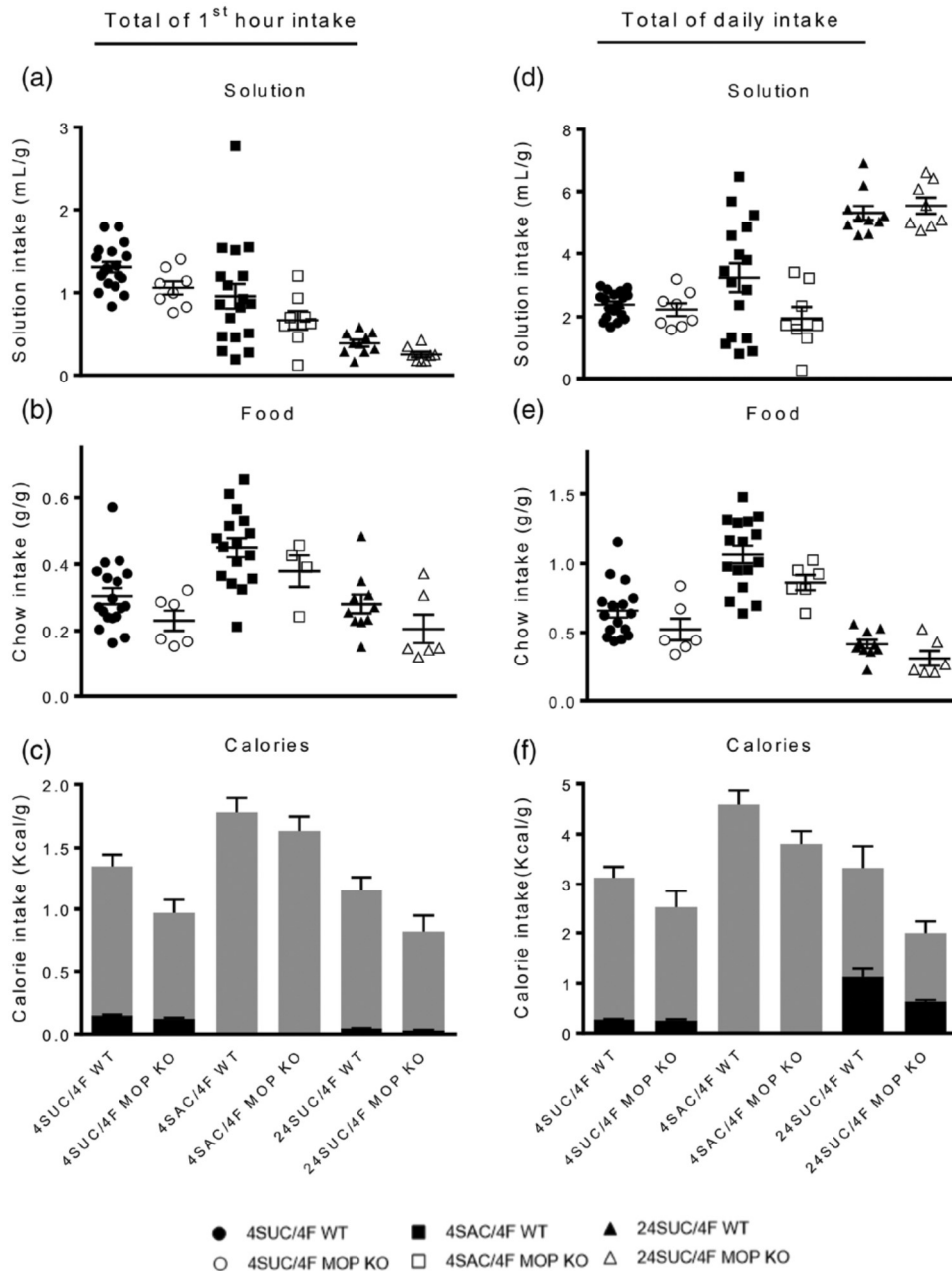

Limited access to saccharin increases total calories consumed. Mice were given daily access to sucrose, saccharin, and food for 14 days as follows: 4SUC/4F=4 hours access to sucrose and food; 4SAC/4F=4 hours access to saccharin and food; 24SUC/4F=24 hours access to sucrose and 4 hours access to food. Data are presented as mean total solution (a) and (d) or food (b) and (e) intake per body weight (mL/g and g/g), summed across 14 sessions. Intake was measured during the first hour of access (a) and (b) and over each 24-hour period (d) and (e). Caloric intake per body weight was summed across 14 sessions for the first hour of intake (c) and for each 24-hour period (f). Error bars represent SEM. MOP knockout, mu opioid knockout; WT, wildtype.

hour was significantly higher in both limited access groups ($F_{(2,62)} = 28.217$; $P < 0.001$), whereas food intake was increased only in the 4SAC/4F group ($F_{(2,62)} = 24.384$; $P < 0.001$). Total daily intake followed a similar pattern with the continuous access group (24SUC/4F) consuming more sweet solution than the limited access groups ($F_{(2,62)} = 49.381$; $P < 0.001$), and the 4SAC/4F group consuming more food ($F_{(2,54)} = 47.367$; $P < 0.001$) and water ($F_{(2,61)} = 10.329$; $P < 0.001$) than the other two groups.

Increased food intake in the saccharin group could simply reflect compensation for the lack of calories in artificial sweetener. To assess this, we compared total calorie intake across groups using the following calculations: chow = 3.952 Kcal/g; sucrose solution = 0.114 Kcal/mL; saccharin = 0.00366 Kcal/mL. Analysis of these data yielded a significant group effect, with the saccharin group consuming more calories than either sucrose group in the first hour ($F_{(2,54)} = 13.124$; $P < 0.001$) (Fig. 2c) and across the entire session ($F_{(2,54)} = 29.324$; $P < 0.001$) (Fig. 2f). Again, wildtype mice consumed more calories than MOP knockout mice ($F_{(1,54)} = 10.121$; $P = 0.002$) (Fig. 2c and f).

We also examined sex differences in all intake measures (data not shown) using LMM analysis, revealing that wildtype females in the 4SAC/4F group consumed more solution ($X^2(2) = 10.170$; $P = 0.006$) and chow ($X^2(2) = 13.753$; $P = 0.001$) than males in the first hour, as well as more chow across the session ($X^2(2) = 33.666$; $P < 0.001$). There were no sex differences in any intake measure of wildtype animals given access to sucrose (i.e., 4SUC/4F or 24SUC/4F). ANOVA on total consumption of both genotypes across sessions confirmed that females in the 4SAC/4F group consumed more chow than males in the first hour ($F_{(1)} = 9.343$; $P = 0.006$), and over the 4-hour access period ($F_{(1)} = 33.333$; $P < 0.001$). In the latter analysis, both the genotype ($F_{(1)} = 7.160$; $P = 0.015$) and sex X genotype interaction ($F_{(1)} = 4.685$; $P = 0.044$) were statistically significant.

Discussion

We successfully reproduced a model of binge intake in mice (Yasoshima and Shimura, 2015), manifested as excessive consumption of a sweet solution within the first hour of access. Mice given limited access to food, but not sucrose (i.e., 24SUC/4F group), did not display binge intake, confirming that restriction of a palatable substance contributes to this maladaptive behaviour. In our preliminary experiments (data not shown), mice given limited access to sucrose and unlimited access to food (i.e., 4SUC/24F) also displayed binge intake, although it was reduced compared with the group with restricted access to both commodities (4SUC/4F). Food restriction, therefore, may exacerbate hyperphagic responses to palatable food. This could occur through physiological stress responses which, themselves, induce binge eating in mice (Micioni Di Bonaventura *et al.*, 2014). Human

studies support a relationship between stress and binge eating in that chronically high levels of glucocorticoids may trigger intake of ‘comfort’ foods (Dallman *et al.*, 2003) and stressful life events initiate both binge eating and cortisol production in BED patients (Gluck, 2006).

Our study also confirmed reduced consumption of food and sweet solution in mice lacking MOPs (Ostlund *et al.*, 2013). The effect was particularly apparent in our measure of binge intake (first hour solution consumption), fitting evidence that MOPs play a role in hedonic responses of binge eating in humans (Cambridge *et al.*, 2013). This genotype profile is also revealed under conditions of food deprivation (Ostlund *et al.*, 2013) or increased effort to obtain a reward (Roberts *et al.*, 2000; Papaleo *et al.*, 2007). In contrast, MOP knockout and wildtype mice show no differences in food intake or seeking responses when access to palatable food is increased or continuous (Tabarin *et al.*, 2005; Papaleo *et al.*, 2007). These differences could reflect a critical role of MOPs in stress responses (LaBuda *et al.*, 2000; Ide *et al.*, 2010), which would be increased under food restriction. A MOP contribution to binge eating may occur through interactions with orexigenic neurons (Castro and Berridge, 2017), which amplify hedonic or liking responses to a sweet solution (Castro and Berridge, 2014). This is supported by evidence that BED patients exhibit a loss of MOP availability in the NAcc (Majuri *et al.*, 2017), an area described as a ‘hedonic hotspot’ in food reward (Castro *et al.*, 2015). Our findings are in general agreement with studies showing decreased consumption of palatable food with MOP antagonism (Taha, 2010; Giuliano and Cottone, 2015), although this effect may not involve the NAcc (Lardeux *et al.*, 2015). We also observed that MOP knockout mice gained less weight than their wildtype controls, which could reflect altered physiological and metabolic responses to food (Wen *et al.*, 2009) as well as increased energy homeostasis and disrupted hunger cues (Tabarin *et al.*, 2005). Indeed, MOPs may have a marginal role in satiation processes in that anticipatory or ‘wanting’ response for food are not affected by food deprivation in MOP knockout mice (Kas *et al.*, 2004). Finally, we cannot rule out the possibility that alterations in functional brain connectivity, characteristic of MOP knockout mice (Mechling *et al.*, 2016), contribute to altered behavioural responses in this genotype.

Somewhat surprisingly, mice given limited access to saccharin ate more food than mice with either limited or continuous sucrose access, even beyond an expected compensation for caloric differences in natural and artificial sweeteners. The increased food intake in saccharin bingeing animals was not dependent on the presence or absence of MOPs, but may be linked to sex differences: binge intake of saccharin escalated more quickly across sessions in females than males, whereas all other intake measures were similar in the two sexes. This matches

previous findings that female, but not male, rats exhibit an increased preference for noncaloric, but not caloric, sweeteners (Valenstein *et al.*, 1967). These findings emphasize the need to critically evaluate the continued and widespread use of artificial sweeteners, particularly as abstinence from saccharin (Aoyama *et al.*, 2014), like sucrose (Grimm *et al.*, 2013), elicits craving in rats and nonnutritive sweeteners induce physiological changes mimicking those of nutritive compounds (Tucker and Tan, 2017). Furthermore, although we did not observe this effect in our mice, noncaloric sweeteners can induce higher levels of weight gain than natural sugars (Feijó *et al.*, 2013), possibly through an increase in orexigenic peptides (Furudono *et al.*, 2006; Gaysinskaya *et al.*, 2011).

In sum, rodent models of sucrose bingeing provide valuable insight into the behavioural and biological underpinnings of maladaptive eating. Restricting access to palatable food increases the propensity to binge, leading to alterations in reward processing (Smail-Crevier *et al.*, 2018) as well as neurophysiological changes associated with compulsive responding (Maracle *et al.*, 2019). We now identify a contribution of MOPs to binge eating, findings that may translate to clinical treatment (Ziauddeen *et al.*, 2013). Our study also points to potential pitfalls in substituting artificial for natural sweeteners, and highlights the need to understand gender differences in eating behaviours.

Acknowledgements

Université de Strasbourg, Investissements d'Avenir IDEX, Centre National de la Recherche Scientifique (CNRS), Projet International de Coopération Scientifique (PICS), and Natural Sciences and Engineering Research Council of Canada (NSERC).

Conflicts of interest

There are no conflicts of interest.

References

Aoyama K, Barnes J, Grimm JW (2014). Incubation of saccharin craving and within-session changes in responding for a cue previously associated with saccharin. *Appetite* **72**:114–122.

Avena NM (2010). The study of food addiction using animal models of binge eating. *Appetite* **55**:734–737.

Balodis IM, Grilo CM, Potenza MN (2015). Neurobiological features of binge eating disorder. *CNS Spectr* **20**:557–565.

Cambridge VC, Ziauddeen H, Nathan PJ, Subramaniam N, Dodds C, Chamberlain SR, *et al.* (2013). Neural and behavioral effects of a novel mu opioid receptor antagonist in binge-eating obese people. *Biol Psychiatry* **73**:887–894.

Castro DC, Berridge KC (2014). Opioid hedonic hotspot in nucleus accumbens shell: mu, delta, and kappa maps for enhancement of sweetness 'liking' and 'wanting'. *J Neurosci* **34**:4239–4250.

Castro DC, Berridge KC (2017). Opioid and orexin hedonic hotspots in rat orbitofrontal cortex and insula. *Proc Natl Acad Sci U S A* **114**:E9125–E9134.

Castro DC, Cole SL, Berridge KC (2015). Lateral hypothalamus, nucleus accumbens, and ventral pallidum roles in eating and hunger: interactions between homeostatic and reward circuitry. *Front Syst Neurosci* **9**:90.

Corwin RL, Avena NM, Boggiano MM (2011). Feeding and reward: perspectives from three rat models of binge eating. *Physiol Behav* **104**:87–97.

Dallman MF, Pecoraro N, Akana SF, La Fleur SE, Gomez F, Houshyar H, *et al.* (2003). Chronic stress and obesity: a new view of 'comfort food'. *Proc Natl Acad Sci U S A* **100**:11696–11701.

Drewnowski A, Krahn DD, Demitrack MA, Nairn K, Gosnell BA (1995). Naloxone, an opiate blocker, reduces the consumption of sweet high-fat foods in obese and lean female binge eaters. *Am J Clin Nutr* **61**:1206–1212.

Feijó FM, Ballard CR, Foletto KC, Batista BAM, Neves AM, Ribeiro MFM, Bertolucci MC (2013). Saccharin and aspartame, compared with sucrose, induce greater weight gain in adult Wistar rats, at similar total caloric intake levels. *Appetite* **60**:203–207.

Furudono Y, Ando C, Yamamoto C, Kobashi M, Yamamoto T (2006). Involvement of specific orexigenic neuropeptides in sweetener-induced overconsumption in rats. *Behav Brain Res* **175**:241–248.

Gaysinskaya VA, Karatayev O, Shuluk J, Leibowitz SF (2011). Hyperphagia induced by sucrose: relation to circulating and CSF glucose and corticosterone and orexigenic peptides in the arcuate nucleus. *Pharmacol Biochem Behav* **97**:521–530.

Giuliano C, Cottone P (2015). The role of the opioid system in binge eating disorder. *CNS Spectr* **20**:537–545.

Giuliano C, Robbins TW, Nathan PJ, Bullmore ET, Everitt BJ (2012). Inhibition of opioid transmission at the μ -opioid receptor prevents both food seeking and binge-like eating. *Neuropsychopharmacology* **37**:2643–2652.

Gluck ME (2006). Stress response and binge eating disorder. *Appetite* **46**:26–30.

Grimm JW, Weber R, Barnes J, Koerber J, Dorsey K, Glueck E (2013). Brief exposure to novel or enriched environments reduces sucrose cue-reactivity and consumption in rats after 1 or 30 days of forced abstinence from self-administration. *Plos One* **8**:e54164.

Gruzca RA, Przybeck TR, Cloninger CR (2007). Prevalence and correlates of binge eating disorder in a community sample. *Compr Psychiatry* **48**:124–131.

Hutson PH, Balodis IM, Potenza MN (2018). Binge-eating disorder: clinical and therapeutic advances. *Pharmacol Ther* **182**:15–27.

Ide S, Sora I, Ikeda K, Minami M, Uhl GR, Ishihara K (2010). Reduced emotional and corticosterone responses to stress in mu-opioid receptor knockout mice. *Neuropharmacology* **58**:241–247.

Javaras KN, Pope HG, Lalonde JK, Roberts JL, Nillni YI, Laird NM, *et al.* (2008). Co-occurrence of binge eating disorder with psychiatric and medical disorders. *J Clin Psychiatry* **69**:266–273.

Kas MJ, van den Bos R, Baars AM, Lubbers M, Lesscher HM, Hillebrand JJ, *et al.* (2004). Mu-opioid receptor knockout mice show diminished food-anticipatory activity. *Eur J Neurosci* **20**:1624–1632.

Katsura Y, Taha SA (2014). Mu opioid receptor antagonism in the nucleus accumbens shell blocks consumption of a preferred sucrose solution in an anticipatory contrast paradigm. *Neuroscience* **261**:144–152.

Kelley AE, Berridge KC (2002). The neuroscience of natural rewards: relevance to addictive drugs. *J Neurosci* **22**:3306–3311.

Kessler RC, Berglund PA, Chiu WT, Deitz AC, Hudson JI, Shahly V, *et al.* (2004). The prevalence and correlates of binge eating disorder in the world health organization world mental health surveys. *Biol Psychiatry* **73**:904–914.

Kessler RM, Hutson PH, Herman BK, Potenza MN (2016). The neurobiological basis of binge-eating disorder. *Neurosci Biobehav Rev* **63**:223–238.

LaBuda CJ, Sora I, Uhl GR, Fuchs PN (2000). Stress-induced analgesia in mu-opioid receptor knockout mice reveals normal function of the delta-opioid receptor system. *Brain Res* **869**:1–5.

Lardeux S, Kim JJ, Nicola SM (2015). Intermittent-access binge consumption of sweet high-fat liquid does not require opioid or dopamine receptors in the nucleus accumbens. *Behav Brain Res* **292**:194–208.

Luke SG (2017). Evaluating significance in linear mixed-effects models in R. *Behav Res Methods* **49**:1494–1502.

Majuri J, Joutsa J, Johansson J, Voon V, Alakurtti K, Parkkola R, *et al.* (2017). Dopamine and opioid neurotransmission in behavioral addictions: a comparative PET study in pathological gambling and binge eating. *Neuropsychopharmacology* **42**:1169–1177.

Maracle AC, Normandeau CP, Dumont ÉC, Olmstead MC (2019). Dopamine in the oval bed nucleus of the stria terminalis contributes to compulsive responding for sucrose in rats. *Neuropsychopharmacology* **44**:381–389.

Matthes HW, Maldonado R, Simonin F, Valverde O, Slowe S, Kitchen I, *et al.* (1996). Loss of morphine-induced analgesia, reward effect and withdrawal symptoms in mice lacking the mu-opioid-receptor gene. *Nature* **383**:819–823.

Mechling AE, Arefin T, Lee HL, Bienert T, Reiser M, Ben Hamida S, *et al.* (2016). Deletion of the mu opioid receptor gene in mice reshapes the reward-aversion connectome. *Proc Natl Acad Sci U S A* **113**:11603–11608.

Micioni Di Bonaventura MV, Ciccocioppo R, Romano A, Bossert JM, Rice KC, Ubaldi M, *et al.* (2014). Role of bed nucleus of the stria terminalis corticotrophin-releasing factor receptors in frustration stress-induced binge-like palatable food consumption in female rats with a history of food restriction. *J Neurosci* **34**:11316–11324.

- Nogueiras R, Romero-Picó A, Vazquez MJ, Novelle MG, López M, Diéguez C (2012). The opioid system and food intake: homeostatic and hedonic mechanisms. *Obes Facts* **5**:196–207.
- Ostlund SB, Kosheleff A, Maidment NT., Murphy NP (2013). Decreased consumption of sweet fluids in μ opioid receptor knockout mice: a microstructural analysis of licking behavior. *Psychopharmacology (Berl)* **229**: 105–113.
- Papaleo F, Kieffer BL, Tabarin A, Contarino A (2007). Decreased motivation to eat in mu-opioid receptor-deficient mice. *Eur J Neurosci* **25**:3398–3405.
- Rada P, Avena NM, Hoebel BG (2005). Daily bingeing on sugar repeatedly releases dopamine in the accumbens shell. *Neuroscience* **134**: 737–744.
- Roberts AJ, McDonald JS, Heyser CJ, Kieffer BL, Matthes HW, Koob GF, Gold LH (2000). Mu-opioid receptor knockout mice do not self-administer alcohol. *J Pharmacol Exp Ther* **293**:1002–1008.
- Sahr AE, Sindelar DK, Alexander-Chacko JT, Eastwood BJ, Mitch CH, Statnick MA (2008). Activation of mesolimbic dopamine neurons during novel and daily limited access to palatable food is blocked by the opioid antagonist LY255582. *Am J Physiol Regul Integr Comp Physiol* **295**:R463–R471.
- Satterthwaite FE (1946). An approximate distribution of estimates of variance components. *Biometrics* **2**:110–114.
- Smail-Crevier RL, Maracle AC, Wash SIJ, Olmstead MC (2018). Binge-like intake of sucrose reduces the rewarding value of sucrose in adult rats. *Physiol Behav* **194**:420–429.
- Solmi F, Hotopf M, Hatch SL, Treasure J, Micali N (2016). Eating disorders in a multi-ethnic inner-city UK sample: prevalence, comorbidity and service use. *Soc Psychiatry Psychiatr Epidemiol* **51**:369–381.
- Stojek MMK, MacKillop J (2017). Relative reinforcing value of food and delayed reward discounting in obesity and disordered eating: a systematic review. *Clin Psychol Rev* **55**:1–11.
- Tabarin A, Diz-Chaves Y, Chaves YD., Carmona Mdel C, Catargi B, Zorrilla EP, *et al.* (2005). Resistance to diet-induced obesity in mu-opioid receptor-deficient mice: evidence for a 'thrifty gene'. *Diabetes* **54**:3510–3516.
- Taha SA (2010). Preference or fat? Revisiting opioid effects on food intake. *Physiol Behav* **100**:429–437.
- Tucker RM, Tan SY (2017). Do non-nutritive sweeteners influence acute glucose homeostasis in humans? A systematic review. *Physiol Behav* **182**:17–26.
- Valenstein ES, Kakolewski JW, Cox VC (1967). Sex differences in taste preference for glucose and saccharin solutions. *Science* **156**:942–943.
- Ward HG, Nicklous DM, Aloyo VJ, Simansky KJ (2006). Mu-opioid receptor cellular function in the nucleus accumbens is essential for hedonically driven eating. *Eur J Neurosci* **23**:1605–1613.
- Wen T, Peng B, Pintar JE (2009). The MOR-1 opioid receptor regulates glucose homeostasis by modulating insulin secretion. *Mol Endocrinol* **23**:671–678.
- Winter B (2013). Linear models and linear mixed effects models in R with linguistic applications. <https://doi.org/http://arxiv.org/pdf/1308.5499.pdf>
- Yasoshima Y, Shimura T (2015). A mouse model for binge-like sucrose overconsumption: contribution of enhanced motivation for sweetener consumption. *Physiol Behav* **138**:154–164.
- Zhang M, Kelley AE (2002). Intake of saccharin, salt, and ethanol solutions is increased by infusion of a mu opioid agonist into the nucleus accumbens. *Psychopharmacology (Berl)* **159**:415–423.
- Ziauddeen H, Chamberlain SR, Nathan PJ, Koch A, Maltby K, Bush M, *et al.* (2013). Effects of the mu-opioid receptor antagonist GSK1521498 on hedonic and consummatory eating behaviour: a proof of mechanism study in binge-eating obese subjects. *Mol Psychiatry* **18**:1287–1293.

V.2 Endocannabinoid system in BED

V.2.1. ECS generalities

Endocannabinoids are derivatives of the lipid membrane, the most active being anandamide (AEA) and 2- arachidonoylglycerol (2-AG). They are synthesized “on demand” following a stimulus but are not stored in lipid vesicles; AEA and 2-AG are quickly degraded predominantly by fatty acid amide hydrolase (FAAH) and monoacylglycerol lipase (MAGL) respectively. They act mainly through cannabinoid receptors CB1 and CB2 coupled to $G_{i/o}$ proteins which are localized in the central and peripheral nervous system. Following post neuronal activation, they act as retrograde messengers and inhibit neurotransmitter release of pre-synaptic neurons. CB1 receptors are highly expressed in neurons of several regions of the central nervous system though levels vary considerably across regions. CB1 receptors are the main target of delta-9 tetrahydrocannabinol (Δ^9 -THC), an organic component of cannabis, and mediate most of the psychomimetic effects of these compounds (Herkenham et al., 1991). As for CB2 receptors, these are expressed at lower levels on neurons, being predominantly on immune cells of the nervous system and the periphery (Cabral, 2005). But the wide distribution of both receptors accounts for their ability to mediate physiological and psychological processes (Schurman & Lichtman, 2017).

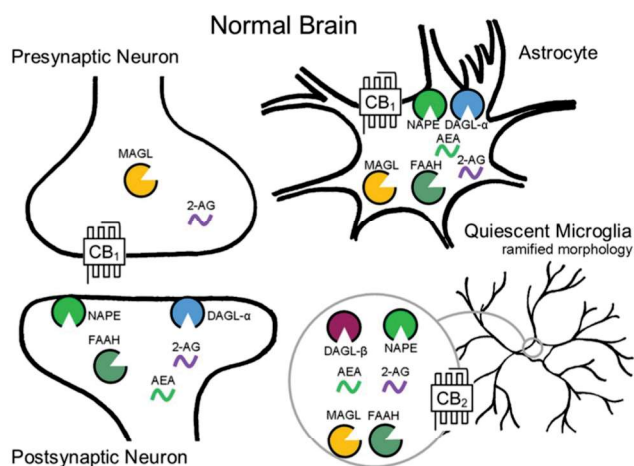

Figure 13 Receptor and enzyme cell localization involved in endocannabinoid signaling. Synthesis of AEA and 2-AG are mostly synthesized from membrane phospholipids by NAPE and DAGL respectively. Degradation of AEA occurs in the post synaptic neuron by FAAH and 2-AG is degraded by MAGL in the pre-synaptic neuro. Synthesis and degradation occur within the astrocyte and microglia. AEA: N-arachidonylethanolamide; 2-AG: 2-arachidonoylglycerol; NAPE: N-acylphosphatidylethanolamide; DAGL: diacylglycerol lipase; CB1: cannabinoid receptor 1; CB2: cannabinoid receptor 2. (Schurman & Lichtman, 2017)

V.2.2. ECS in homeostatic and hedonic control of food intake

There is increasing evidence that the endocannabinoid system (ECS) is involved in food intake and energy balance. Moreover, the ECS modulates homeostatic and hedonic control of food intake. Homeostatic regulation of energy intake involves hypothalamic nuclei, such as the arcuate nucleus and the lateral hypothalamus, whereas hedonic regulation involves the mesolimbic dopamine system (Ferrario et al., 2016). However, both of these systems control food intake interdependently. In hungry animals, the levels of endocannabinoids are increased in response to fasting and return to basal levels once satiated. This occurs specifically in the limbic forebrain a reward related region and in the hypothalamus, an energy balance related region (Kirkham et al., 2002). Injection of AEA in the ventromedial hypothalamus of satiated rats induces hyperphagia reversed by CB1 antagonist (Jamshidi, 2001). CB1 and CB2 antagonists have opposing effects, the first one decreasing food intake and the second one increasing it in food deprived rats (Ting et al., 2015). In humans, the CB1 antagonist, rimonabant, a synthetic compound developed by Sanofi-Aventis, decreases energy intake and body weight with the ECS modulating both homeostatic control and hedonic aspects of food intake. Pharmacological intervention shows that the ECS can modulate feeding by acting on the reward system since injections of 2-AG into the NAcc shell increases food intake in satiated rats and Δ^9 -THC induces hyperphagia and increases activity of dopaminergic neurons in the ventral tegmental area (Kirkham et al., 2002).

There is evidence that the ECS has an important role in palatable food intake. Palatable food was shown to increase dopamine release which is reversed by rimonabant, acting at CB1 receptors (Melis et al., 2009). Taste reactivity (orofacial expression and body response) and dopamine transmission to NAcc shell following intraoral infusion of sucrose were increased by systemic administration of Δ^9 -THC (De Luca et al., 2012). Interestingly, CB2 receptor transcript expression was increased in the ventral tegmental area following 6 weeks of free choice high fat/high sucrose diet and in the NAcc of high sucrose consumers (Bourdy et al., 2021), indicating a role for this receptor in palatable food consumption.

V.2.3. ECS and BED

Our team was interested in investigating the role of ECS in sucrose bingeing animals because we believe it is a promising target for BED. But most of the preliminary results of the

ECS and binge eating focuses on fat (Satta et al., 2018; Scherma et al., 2013) or sweetened fat (Bello et al., 2003; Parylak et al., 2012). Therefore, we reproduced a rat model of sucrose bingeing, measured ECS gene transcripts and levels in brain reward regions and investigated reward response to sucrose using a conditioned place preference paradigm. Finally, we looked at CB1 receptor blockade on sucrose consumption and reward responses.

I followed the work from David De Sa Nogueira, another PhD student in the lab, who worked on a binge sucrose model in rats. He was interested in the role of the endocannabinoid in this bingeing behavior. In this study, I participated in the statistical analysis of behavioral experiments in order to account for the intra-individual variability.

(French version)

Généralités sur le système endocannabinoïde

Les endocannabinoïdes sont des dérivés de la membrane lipidique, les plus actifs étant l'anandamide (AEA) et le 2- arachidonoylglycérol (2-AG). Ils sont synthétisés "à la demande" après un stimulus mais ne sont pas stockés dans des vésicules lipidiques. L'AEA et le 2-AG sont rapidement dégradés, principalement par l'amide hydrolase d'acide gras (FAAH) et la monoacylglycérol lipase (MAGL) respectivement. Ils agissent principalement par le biais des récepteurs cannabinoïdes CB1 et CB2 couplés aux protéines Gi/o qui sont localisés dans le système nerveux central et périphérique. Après l'activation post neuronale, ils agissent comme des messagers rétrogrades et inhibent la libération de neurotransmetteurs par les neurones pré-synaptiques. Les récepteurs CB1 sont fortement exprimés dans les neurones de plusieurs régions du système nerveux central, bien que les niveaux varient considérablement d'une région à l'autre. Les récepteurs CB1 sont la cible principale du delta-9 tétrahydrocannabinol (Δ^9 -THC), un composant organique du cannabis, et médient la plupart des effets psychotropes de ce composé (Herkenham et al., 1991). Quant aux récepteurs CB2, ils sont exprimés à des niveaux plus faibles sur les neurones, étant principalement sur les cellules immunitaires du système nerveux et de la périphérie (Cabral, 2005). Mais la large distribution de ces deux récepteurs explique leur capacité à médier des processus physiologiques et psychologiques (Schurman & Lichtman, 2017).

Le système endocannabinoïde dans le contrôle homéostatique et hédonique de la prise alimentaire

Il existe de plus en plus de preuves que le système endocannabinoïde est impliqué dans la prise alimentaire et l'équilibre énergétique. De plus, le système endocannabinoïde module le contrôle homéostatique et hédonique de la prise alimentaire. La régulation homéostatique de l'apport énergétique implique les noyaux hypothalamiques, tels que le noyau arqué et l'hypothalamus latéral, tandis que la régulation hédonique implique le système dopaminergique mésolimbique (Ferrario et al., 2016). Cependant, ces deux systèmes contrôlent la prise alimentaire de manière interdépendante. Chez les animaux affamés, les niveaux d'endocannabinoïdes sont augmentés en réponse au jeûne et reviennent à des niveaux basaux une fois rassasiés. Cela se produit spécifiquement dans le cerveau antérieur limbique, une région liée à la récompense, et dans l'hypothalamus, une région liée à l'équilibre énergétique (Kirkham et al., 2002). L'injection d'AEA dans l'hypothalamus ventromédial de rats rassasiés induit une hyperphagie inversée par un antagoniste CB1 (Jamshidi, 2001). Les

antagonistes CB1 et CB2 ont des effets opposés, le premier diminuant la prise alimentaire et le second l'augmentant chez des rats privés de nourriture (Ting et al., 2015). Chez l'homme, l'antagoniste CB1, le rimonabant, un composé synthétique développé par Sanofi-Aventis, diminue l'apport énergétique et le poids corporel, le système endocannabinoïde modulant à la fois le contrôle homéostatique et les aspects hédoniques de la prise alimentaire. Une intervention pharmacologique montre que le SCE peut moduler l'alimentation en agissant sur le système de récompense puisque des injections de 2-AG dans la coque du NAcc augmentent la prise alimentaire chez des rats rassasiés et que le Δ^9 -THC induit une hyperphagie et augmente l'activité des neurones dopaminergiques dans l'aire tegmentale ventrale (Kirkham et al., 2002).

Il existe des preuves que le système endocannabinoïde joue un rôle important dans la consommation d'aliments appétissants. Il a été démontré que les aliments appétissants augmentent la libération de dopamine, ce qui est inversé par le rimonabant, qui agit sur les récepteurs CB1 (Melis et al., 2009). La réactivité au goût (expression orofaciale et réponse corporelle) et la transmission de la dopamine à la coque NAcc après infusion intraorale de saccharose ont été augmentées par l'administration systémique de Δ^9 -THC (De Luca et al., 2012). Il est intéressant de noter que l'expression de la transcription du récepteur CB2 a augmenté dans l'aire tegmentale ventrale après 6 semaines de régime à choix libre riche en graisses et en saccharose et dans le NAcc des consommateurs de saccharose élevé (Bourdy et al., 2021), ce qui indique un rôle de ce récepteur dans la consommation d'aliments appétissants.

ECS et BED

Notre équipe était intéressée par l'étude du rôle de l'ECS chez les animaux se livrant à une consommation excessive de saccharose car nous pensons qu'il s'agit d'une cible prometteuse pour le BED. Mais la plupart des résultats préliminaires du système endocannabinoïde et de la frénésie alimentaire se concentrent sur les graisses (Satta et al., 2018 ; Scherma et al., 2013) ou les graisses sucrées (Bello et al., 2003 ; Parylak et al., 2012). Par conséquent, nous avons reproduit un modèle de BED de saccharose chez le rat, mesuré les transcrits et les niveaux des gènes ECS dans les régions cérébrales de récompense et étudié la réponse de récompense au saccharose en utilisant un paradigme de préférence de place conditionnée. Enfin, nous avons étudié le blocage des récepteurs CB1 sur la consommation de saccharose et les réponses de récompense.

J'ai suivi les travaux de David De Sa Nogueira, un autre doctorant du laboratoire, qui a travaillé sur un modèle de consommation excessive de saccharose chez le rat. Il s'est intéressé au rôle de l'endocannabinoïde dans ce comportement de « binge ». Dans cette étude, j'ai participé à l'analyse statistique des expériences comportementales afin de tenir compte de la variabilité intra-individuelle.

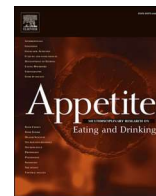

Binge sucrose-induced neuroadaptations: A focus on the endocannabinoid system

David de Sa Nogueira^{a,d}, Romain Bourdy^a, Dominique Filliol^a, Gaëlle Awad^a, Virginie Andry^b, Yannick Goumon^b, Mary C. Olmstead^c, Katia Befort^{a,*}

^a Université de Strasbourg, Laboratoire de Neurosciences Cognitives et Adaptatives (LNCA), Centre de la Recherche Nationale Scientifique, 12 rue Goethe, F-67000, Strasbourg France

^b Institut des Neurosciences Cellulaires et Intégratives (INCI), UPR 3212, CNRS, 8 Allée du Général Rouvillois, 67000, Strasbourg, France

^c Department of Psychology, Center for Neuroscience Studies, Queen's University, Kingston, Ontario K7L 3N6, Canada

^d Current Address: Brain Health Institute, Rutgers University and Rutgers Biomedical and Health Sciences, Piscataway, NJ, USA

ARTICLE INFO

Keywords:

Binge eating disorder
Sucrose
Cannabinoid
Gene expression
Reward
Addiction
Conditioned place preference

ABSTRACT

Binge eating, the defining feature of binge eating disorder (BED), is associated with a number of adverse health outcomes as well as a reduced quality of life. Animals, like humans, selectively binge on highly palatable food suggesting that the behaviour is driven by hedonic, rather than metabolic, signals. Given the links to both reward processing and food intake, this study examined the contribution of the endocannabinoid system (ECS) to binge-like eating in rats. Separate groups were given intermittent (12 h) or continuous (24 h) access to 10% sucrose and food over 28 days, with only the 12 h access group displaying excessive sucrose intake within a discrete period of time (i.e., binge eating). Importantly, this group also exhibited alterations in ECS transcripts and endocannabinoid levels in brain reward regions, including an increase in cannabinoid receptor 1 (CB1R) mRNA in the nucleus accumbens as well as changes in endocannabinoid levels in the prefrontal cortex and hippocampus. We then tested whether different doses (1 and 3 mg/kg) of a CB1R antagonist, Rimonabant, modify binge-like intake or the development of a conditioned place preference (CPP) to sucrose. CB1R blockade reduced binge-like intake of sucrose and blocked a sucrose CPP, but only in rats that had undergone 28 days of sucrose consumption. These findings indicate that sucrose bingeing alters the ECS in reward-related areas, modifications that exacerbate the effect of CB1R blockade on sucrose reward. Overall, our results broaden the understanding of neural alterations associated with bingeing eating and demonstrate an important role for CB1R mechanisms in reward processing. In addition, these findings have implications for understanding substance abuse, which is also characterized by excessive and maladaptive intake, pointing towards addictive-like properties of palatable food.

1. Introduction

Binge-eating disorder (BED), now listed as an independent disorder in DSM-5, is characterized by uncontrollable episodes of eating within a discrete period of time, not followed by compensatory behaviors such as purging or physical exercise (American Psychiatric Association, 2013). BED is the most common of all eating disorders, affecting approximately 3% of the general population (Hudson, Hiripi, Pope, & Kessler, 2007; Kessler et al., 2013; Solmi, Hotopf, Hatch, Treasure, & Micali, 2016).

Binge eating also occurs in other eating disorders (Hudson et al., 2007) and is a likely contributor to the growing obesity epidemic (Stojek & MacKillop, 2017). Although binge eating is linked to serious medical complications, including increased risk for other psychiatric disorders, treatment options for BED are minimal (Hutson, Balodis, & Potenza, 2018). Advancement in this area depends on understanding the etiology and mechanisms that drive binge eating.

Regulation of food intake in both humans and animals is closely linked to activity in the endocannabinoid system (ECS) (Ceccarini et al.,

Abbreviations: 2-AG, 2-arachidonoylglycerol; AEA, anandamide; BED, Binge-eating disorder; CB1R, cannabinoid receptor 1; CB2R, cannabinoid receptor 2; CPP, conditioned place preference; DS, dorsal striatum; ECS, endocannabinoid system; HPC, hippocampus; NAc, Nucleus Accumbens; PFC, prefrontal cortex; RIM, rimonabant [N-(piperidin-1-yl)-5-(4-chlorophenyl)-1-(2,4-dichlorophenyl)-4-methyl-1H-pyrazole-3-carboxamide].

* Corresponding author. Laboratoire de Neurosciences Cognitives et Adaptatives LNCA Université de Strasbourg Faculté de Psychologie, 12 rue Goethe, F-67000 Strasbourg, France.

E-mail address: katia.befort@unistra.fr (K. Befort).

<https://doi.org/10.1016/j.appet.2021.105258>

Received 5 November 2020; Received in revised form 24 March 2021; Accepted 6 April 2021

Available online 14 April 2021

0195-6663/© 2021 Elsevier Ltd. All rights reserved.

2016), the endogenous system activated by Δ -9-tetrahydrocannabinol in the *Cannabis Sativa* plant. For example, blockade of the cannabinoid receptor 1 (CB1R) reduces food intake (Arnove et al., 1997; Colombo et al., 2002; Simiand, Keane, Keane, & Soubrié, 1998), specifically, binge-like eating in rats (Dore et al., 2014; Parylak, Cottone, Sabino, Rice, & Zorrilla, 2012; Scherma et al., 2013), and decreases scores on a binge eating scale in humans (Pataky et al., 2013). Most telling, infusions of the endogenous cannabinoid, 2-arachidonoylglycerol (2-AG), directly into the nucleus accumbens (NAc), dose-dependently increases feeding in rats, an effect that is blocked by CB1R antagonism (Kirkham, Williams, Fezza, & Di Marzo, 2002). Results from these animal studies linking the ECS to excessive eating is not surprising given that cannabis is well known to promote eating in humans (Abel, 1975; Koch et al., 2015; Williams, Rogers, & Kirkham, 1998).

In addition to the direct effects of cannabinoid compounds on feeding, maladaptive eating patterns, themselves, may disrupt ECS function (Gaetani, Kaye, Cuomo, & Piomelli, 2008). The specific details are difficult to disentangle in that a number of studies have yielded conflicting results. In humans, BED is associated with increased plasma levels of the endogenous cannabinoid anandamide (AEA), but not 2-AG, although the same pattern was observed in anorexia nervosa (Monteleone et al., 2005). In animal models, bingeing on a high fat diet decreases AEA levels in the dorsal striatum (DS), amygdala, and hippocampus (HPC), but increases 2-AG levels in the HPC (Satta et al., 2018). Food restriction (Dazzi et al., 2014) and continuous access to a high-fat diet (Blanco-Gandía, Aracil-Fernández et al., 2017) decrease both gene and protein expression of CB1Rs in the prefrontal cortex (PFC), whereas excessive intake of fat/sweet pellets increases CB1R expression in the same region (Mancino et al., 2015). In the NAc, CB1Rs are upregulated, but CB1R transcripts are decreased, following either binge or continuous intake of high fat foods (Blanco-Gandía, Aracil-Fernández et al., 2017; Blanco-Gandía, Cantacorps, et al., 2017). These seemingly contradictory findings likely reflect the use of different feeding protocols and/or type of palatable food, particularly as the biological mechanisms underlying fat and sucrose bingeing are distinct (Wong, Wojnicki, & Corwin, 2009).

The primary goal of this study was to investigate, in more detail, the relationship between ECS function and binge eating. We focused on sweet foods, using a validated model of sucrose bingeing in rats (Avena, Long, & Hoebel, 2005; Avena, 2007; Avena, Bocarsly, Rada, Kim, & Hoebel, 2008; Avena, Rada, & Hoebel, 2008), in order to isolate the effects of this commodity from other palatable foods. A link between binge eating and the ECS likely occurs through brain reward circuits (Maldonado, Valverde, & Berrendero, 2006) in that binge eating is driven by hedonic, rather than metabolic, signals. Thus, our first set of experiments examined whether binge eating alters gene expression of CB1R and cannabinoid type 2 receptor (CB2R), as well as endocannabinoid levels (2-AG and AEA), in brain reward sites including the NAc, DS, PFC, and HPC. We also measured enzyme transcripts for endocannabinoid synthesis (NAPE-PLD/DAGL α) and degradation (FAAH/MAGL) in all four regions. Based on our observation that sucrose bingeing alters CB1R gene expression, we extended these studies by testing whether blockade of CB1Rs alters sucrose bingeing or the rewarding effect of sucrose in the conditioned place preference (CPP) paradigm.

2. Materials and methods

2.1. Subjects

Two hundred and fifteen male Wistar rats (Charles River Laboratories, Montréal QC and Janvier Laboratories, France), weighing 175 g at arrival, were habituated for two weeks to housing conditions in a temperature and humidity-controlled environment on a reverse 12 h light/dark cycle (lights OFF at 4:00 a.m.). Rats were group housed in standard polycarbonate cages with *ad libitum* access to food and water

until 1 day before behavioral experiments. All animals were then single housed to provide accurate measures of individual food and solution consumption. All procedures and animal care were performed according to the European Union laws for animal studies and were in accordance with the guidelines for the ethical use of animals, outlined by the Canadian Council on Animal Care. Experiments were approved by the institutional ethics committee CREMEAS (Comité d'Éthique pour l'Expérimentation Animale de Strasbourg, France) (APA-FIS#2019070816359145) and the Queen's University Animal Care Committee. A timeline displaying the sequence of experimental procedures for each set of experiments is shown in Fig. 1.

2.2. Apparatus

Body weight and food consumption (g) were recorded with a standard scale. Standard chow diet was provided (4RF21, 3.952 Kcal/g, Mucedola, Italy; 4.07 Kcal/g, Canadian Lab Diets, Inc). Liquid solutions were presented to rats in 100 ml graduated glass drinking bottles fitted with rubber stoppers containing ball-tipped sipper tubes (Ancare Inc., Montreal, QUE) or in bottles (Techniplast, Milan, Italy) that were weighed to collect consumption measures. Sucrose was mixed in tap water, measured as g/L. Solution concentration was 10% sucrose. The CB₁ receptor antagonist, rimonabant [N-(piperidin-1-yl)-5-(4-chlorophenyl)-1-(2,4-dichlorophenyl)-4-methyl-1H-pyrazole-3-carboxamide] (RIM) (Cayman Chemicals, Burlington, ON) was dissolved in one drop vehicle of 0.3% polysorbate Tween-80 (Sigma-Aldrich Chemicals, St. Louis, MO) dissolved in 0.9% saline. Fresh solutions of 1 mg/ml and 3 mg/ml were prepared each day.

The CPP apparatus was made of plexiglass and consisted of two large compartments (46 × 46 × 30 cm) connected by a tunnel (19 × 38 × 30 cm). The two large compartments differed in wall colour (black and white stripes or solid white) and floor texture (striated or bumpy). The tunnel walls were clear plexiglass and the floor was made of sheet metal, spray painted with a matt white finish. Guillotine doors, that could be raised or lowered, separated the tunnel from each compartment. Cameras were mounted directly above each set of boxes so that the rats' movements throughout the entire compartment could be monitored and recorded. Movement was tracked using the video tracking software EthoVisionXT (Noldus Information Technology b.v. Wageningen, The Netherlands), which detects and extracts the size and position of the subjects from the digital image captured by the camera.

2.3. Procedures

2.3.1. Effects of sucrose bingeing on neuroadaptations in the ECS

2.3.1.1. Sucrose consumption. Eighty-three rats were assigned to one of three groups that determined daily access to sweet solution and food over 28 days (Fig. 1, experiment 1).

For the primary experimental group, 12 h sucrose (n = 28), chow was removed from the cages 12 h prior to the first access day. Then, beginning 4 h after the onset of the active cycle, rats were provided with 12 h access to standard chow and sucrose solution. The first control group (12 h food, n = 28) underwent the same protocol with no sucrose, providing a control for food restriction. The second control group (24 h sucrose; n = 27) had continuous access to standard chow and sucrose solution, which was introduced on day 1 (4 h after the onset of the active cycle), providing a control for sucrose exposure.

All animals were weighed daily, prior to the presentation of solution and/or food. For intermittent access groups (12 h sucrose, 12 h food), solution intake (ml) was measured 1 h after presentation and on removal (12 h). For animals in the continuous access group (24 h sucrose), solution intake was measured 1, 12, and 24 h after presentation. Food intake (g) was measured at the end of the access period (12 h or 24 h).

Experiment 1

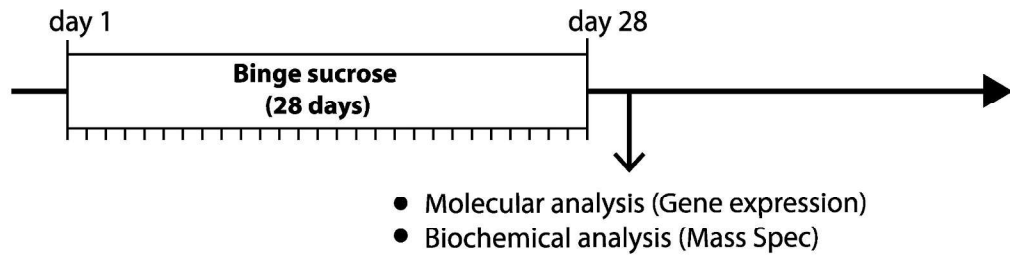

Experiment 2

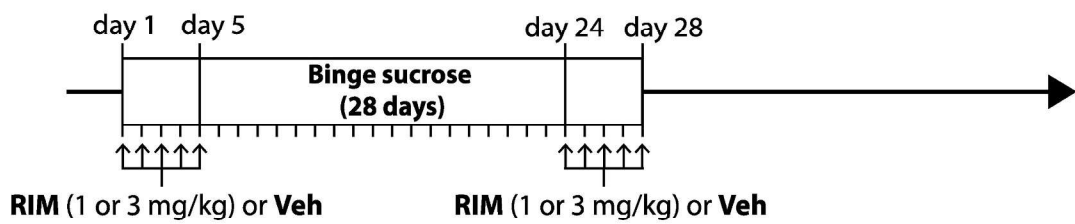

Experiment 3

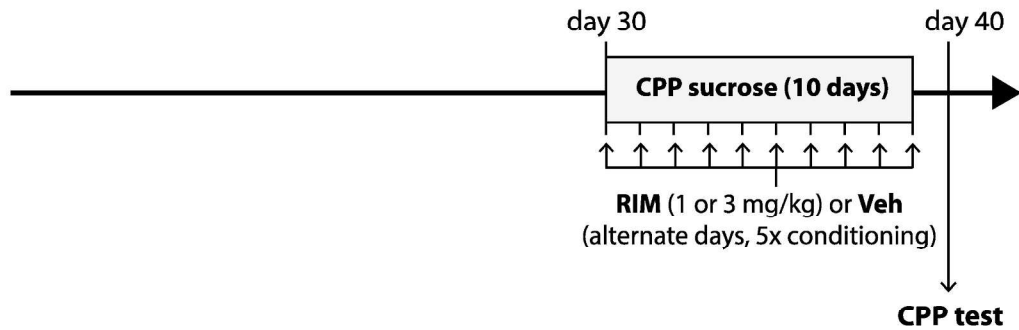

Experiment 4

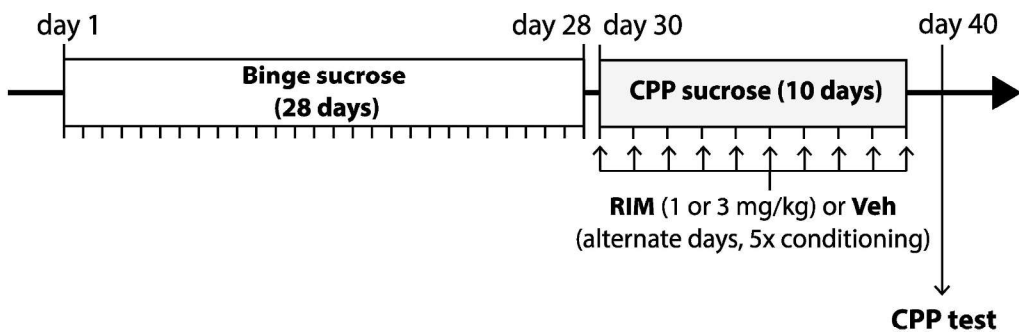

Fig. 1. Timeline of experimental procedures. Four separate experiments examined: ECS alterations following sucrose bingeing (Experiment 1), the effect of RIM on sucrose bingeing on days 1–5 and 24–28 of a 28-day sucrose access protocol (Experiment 2), the effect of RIM on a sucrose CPP (Experiment 3), and the effect of RIM on a sucrose CPP following sucrose bingeing (Experiment 4). CPP: conditioned place preference; ECS: endocannabinoid system; RIM: rimonabant.

2.3.1.2. Brain dissection. The day following the final sucrose access session, rats were given an overdose of pentobarbital (182 mg/kg, i.p.), as required by regulations of the local animal ethics committee, followed by decapitation to perform brain extraction. This time point was selected to minimize acute effects of the last sucrose exposure and to avoid potential circadian effects. Coronal brain slices, 1 mm thick, were cut using a brain matrix chilled on ice (Harvard apparatus, Holliston, MA, USA). Structures of interest were collected according to the rat brain stereotaxic atlas (Paxinos & Watson, 2007) by dissection (dorsal HPC, -2 to 4 mm from bregma, 2 slices) or using punches (PFC, 3 mm puncher, 4.68 to 2.5 mm from bregma, 2 slices; NAc, 1.9 mm puncher, 3 to 0.6 mm from bregma, bilateral, 2 slices; DS, 3 mm puncher, 2 to -0.96 mm from bregma, bilateral, 3 slices). Samples were immediately frozen on dry ice and kept at -80 °C. All extractions were performed in less than 20 min to avoid increased levels of AEA (Schmid et al., 1995).

2.3.1.3. Quantitative real-time PCR. Total RNA was extracted using Ribozol (VWR, Fontenay-sous-bois, France) according to the manufacturer's instructions. RNA quality and quantity were measured with a NanoVue™ (GE healthcare) spectrophotometer (GE healthcare). Reverse transcription was performed on 750 ng of total RNA with iScript (iScript™ cDNA Synthesis Kit, Biorad, France). Real-time PCR was performed in triplicate using a CFX96 Touch™ apparatus (Biorad, France) and Sso Advanced™ Universal SYBR Green supermix (Biorad, France). Thermal cycling parameters were 30 s at 95 °C followed by 40 amplification cycles of 5 s at 95 °C and 45 s at 60 °C. Primer sequences for all tested genes are provided in Table 1. Expression levels were normalized to *Rplp0* housekeeping gene levels, classically used for brain or food related studies (Li et al., 2014; Silberberg, Baruch, & Navon, 2009) and compared between controls and treated samples using the $2^{-\Delta\Delta Ct}$ method (Livak & Schmittgen, 2001).

2.3.1.4. Mass spectrometry. PFC, HPC, NAc and DS tissues ($n = 7-8$ /group) were sonicated in 200 μ l of H₂O with a Vibra Cell apparatus (2 times 5 s, 90 W; Sonics, Newtown, U.S.A.) and the homogenate was centrifuged (20,000 g, 30 min, 4 °C) to recover the supernatant. Protein concentration was determined (Protein Assay, Bio-Rad, Marnes-la-Coquette, France) and 150 μ l of the supernatant was mixed with 50 μ l of acetonitrile (ACN) 100% containing 400.26 pmol of D8-2-AG (sc-480539; Santa Cruz, Heidelberg, Germany) and 100.15 pmol of D4-AEA (Tocris/Biotechne, Lille, France). Samples were centrifuged (20,000 g for 30 min, 4 °C) and the supernatants collected and evaporated to dryness. Samples were re-suspended in 20 μ l of ACN 30%/H₂O 69.9%/formic acid 0.1% (v/v/v). Analyses were performed on a Dionex Ultimate 3000 HPLC system coupled with a triple quadrupole Endura mass spectrometer (Thermo Electron, San Jose, USA). The system was controlled by Xcalibur v. 2.0 software. Samples (3 μ l) were loaded onto a microbore C18 ODS column (1 \times 100 mm, 3 μ m UniJet microbore ODS, ref MF8949, BioAnalytical Systems Inc., West Lafayette, U.S.A.) heated at 40 °C. The presence of 2-AG, AEA, D8-2-AG and D5-AEA was studied using the multiple reaction monitoring mode (MRM). Elution was performed at a flow rate of 50 μ l/min by applying a linear gradient of mobile phases A/B. Mobile phase A corresponded to ACN 1%/H₂O 98.9%/formic acid 0.1% (v/v/v), whereas mobile phase B was ACN

99.9%/formic acid 0.1% (v/v) (see details in Supplemental Table 1).

Electrospray ionization was achieved in the positive mode (spray voltage set at 3500 V). Nitrogen was used as the nebulizer gas. Desolvation (nitrogen) sheath gas was set to 10 Arb and Aux gas was set to 5 Arb. The Ion transfer tube was heated at 287 °C. Q1 and Q2 resolutions were set at 0.7 FWHM, whereas collision gas (CID, argon) was set to 2 mTorr. Identification of the compounds was based on precursor ion, selective fragment ions and retention times obtained for 2-AG, AEA, D8-2-AG and D5-AEA. Selection of the monitored transitions and optimization of collision energy and RF Lens parameters were manually determined (see Supplemental Table 2). Qualification and quantification were performed with the MRM mode and quantification was obtained using Quan Browser software (Thermo Scientific). All amounts of endocannabinoids measured in samples fit within the standard curve limits, with typical analytical ranges from 1 fmol-100 pmol to 150 fmol-100 pmol. Precision (CV% between repeated injections of the same sample) values were <1% for same-day measurements and <5% for inter-day measurements. The amount of 2-AG (nmol) and AEA (pmol) were normalized according to protein levels (mg).

2.3.2. Effects of CB1 antagonism on sucrose bingeing

Sixty rats were randomly assigned to 12 h or 24 h sucrose groups, which determined access to food and sucrose solution over 28 days using the protocol described previously (2.3.1.2). Within each access group, rats were randomly assigned to a drug dose (0, 1, or 3 mg/kg RIM) ($n = 10$ each), and were then injected intraperitoneally (i.p.) with drug 30 min before the start of each sucrose access sessions on days 1-5 and 24-28 (Fig. 1, experiment 2). No injections were administered on days 6-23 inclusive. Doses and timing of pre-treatment with RIM were based on previous studies showing behavioural effects of the drug, including an impact on food intake (Blasio, Rice, Sabino, & Cottone, 2014) and binge eating (Scherma et al., 2013), but also on social play (Achterberg, van Swieten, Driel, Trezza, & Vanderschuren, 2016), cocaine responses (Chaperon, Soubrié, Puech, & Thiébot, 1998; De Vries et al., 2001; Yu et al., 2011), and morphine reward (De Carvalho, Pamplona, Cruz, & Takahashi, 2014).

2.3.3. Effects of CB1 antagonism on sucrose reward

Twenty-four rats, divided randomly into three drug doses ($n = 8$ each) were used to examine the effect of RIM on sucrose reward in the CPP paradigm (Fig. 1, experiment 3). Rats were food restricted for 48 h prior to and throughout the CPP protocol. On day 1 (habituation), rats were placed in the tunnel and had free access to all three compartments for 30 min. Over the next 10 days, rats were confined to one test compartment or the other for 30 min where they had access to a water bottle containing either tap water or 20% sucrose solution. The assignment of sucrose-paired compartment and order of conditioning sessions (water-versus sucrose-paired) were counterbalanced within groups. Rats were injected with RIM (0, 1, or 3 mg/kg i.p.) 30 min prior to conditioning in the sucrose-paired compartment and with vehicle solution (1 ml/kg i.p.) 30 min prior to conditioning in the water-paired compartment. The amount of fluid consumed during each conditioning session was measured. On test day, rats were placed in the tunnel and allowed free access to the entire apparatus. Water bottles were removed from both compartments and the time spent in each compartment was

Table 1
Primer sequences for reference (*Rplp0*) and endocannabinoid system genes.

Target	Forward Primer	Reverse Primer
Rplp0 (NM_022402)	CTGCCCGAGCCGGTGCCATC	TTCAATGGTACCTCTGGAG
Cnr1 (NM_012784)	TCTGCTTGGCATCATCATGGTGT	AGATGATGGGGTTCACGGTC
Cnr2 (NM_001164143)	AATGGCGGCTTGGATTCAA	TAGAGCACAGCCACGGTTCTC
Nape-Pld (NM_199381)	AGAGATCCGTGGCGATTAC	ATCGTGACTCTCCGTGCTTC
Dag1a (NM_001005886)	GGCATGGTACTCTCAGCTGA	GAGGAAGGAGAGAATGGCGG
Faah (NM_001369126)	CCCCAGAGGCTGTGTCTTT	GTCAGATAGGAGGTCACGCA
Mgll (NM_138502)	GTTGAAGAGGCTGGACATGC	TCACGTGCTGCAACAAATCT

recorded across the 30-min session.

In a separate experiment, forty-eight rats, randomly divided into two access groups (12 h and 24 h sucrose), underwent sucrose consumption sessions using the protocol described in 2.3.1.2 (Fig. 1, experiment 4). Rats were then randomly divided into three drug groups ($n = 8$ each) and tested for a sucrose CPP as outlined above (0, 1, and 3 mg/kg RIM).

2.4. Statistical analysis

Solution and food intake (measured per body weight as ml/g and g/g) and weight were analyzed using a repeated-measures analysis of variance (ANOVA) in the mixed effect way (Afex package from R, Rstudio v1.3.1093). For the fixed effects part of the model, the explanatory variables were session as the repeated measure and sucrose access group and drug as between-subjects measures. The random effect part of the model accounts for the individual variation of the subjects across the sessions. In cases in which sphericity was violated (Machley's $p < .001$), the Greenhouse-Geisser correction was used. Post hoc analysis were conducted by multiple pairwise comparisons using the Sidak method for correction (lsmeans package from R).

Biochemical data were analyzed using ANOVA to assess group differences in ECS neuroadaptations, with separate analyses conducted in each brain region. Significant interactions were followed up with simple main-effects analyses and multiple pairwise comparisons using a Bonferroni correction (GraphPad Prism software).

For CPP data, consumption of solution (sucrose and water) during conditioning and time spent in each compartment during testing were analyzed using planned orthogonal comparisons, as described previously (SPSS v27) (Grenier, Mailhot, Cahill, & Olmstead, 2019;

Smail-Crevier, Maracle, Wash, & Olmstead, 2018). A primary advantage of this technique is that it minimizes the number of comparisons to those of interest; because each comparison is independent and tests a unique hypothesis, it can be carried out regardless of the outcome of the overall ANOVA and no correction is made for multiple tests. As such a 5% risk of type I error is accepted for each comparison. Levene's F test was used to examine the assumption of homogeneity of variance and analyses were adjusted if significant. Significance level for all tests was set at $p \leq .05$.

3. Results

3.1. Effects of sucrose bingeing on neuroadaptations in the ECS

3.1.1. Sucrose consumption

Fig. 2 shows data from the sucrose consumption sessions, with intake during the 1st hour of access being significantly higher in rats given intermittent, rather than continuous, access to sucrose, $F(1,32) = 55.11$, $p < .001$, general $\eta^2 = 0.39$ (group) (Fig. 2A). The main effect of session, $F(9.84,314.85) = 4.41$, $p < .001$, general $\eta^2 = 0.08$, as well as the session \times group interaction, $F(9.84,314.85) = 4.95$, $p < .001$, general $\eta^2 = 0.09$, were also statistically significant. With the exception of session 1, intake was higher in the 12 h, compared to the 24 h, sucrose group (*post-hoc* $ps < .0001$), verifying binge-like intake in rats given intermittent access to sucrose. In contrast, there was no significant difference in daily sucrose intake for rats in the 12 h and 24 h sucrose groups, $F(1,33) = 0.46$, $p = .501$, general $\eta^2 = 0.01$ (Fig. 2B). Daily solution intake varied across sessions, $F(5.44,179.55) = 3.04$, $p < .01$, general $\eta^2 = 0.04$, but the effect did not interact with group, $F(5.44,179.55) = 1.70$, $p = .13$, general $\eta^2 = 0.02$.

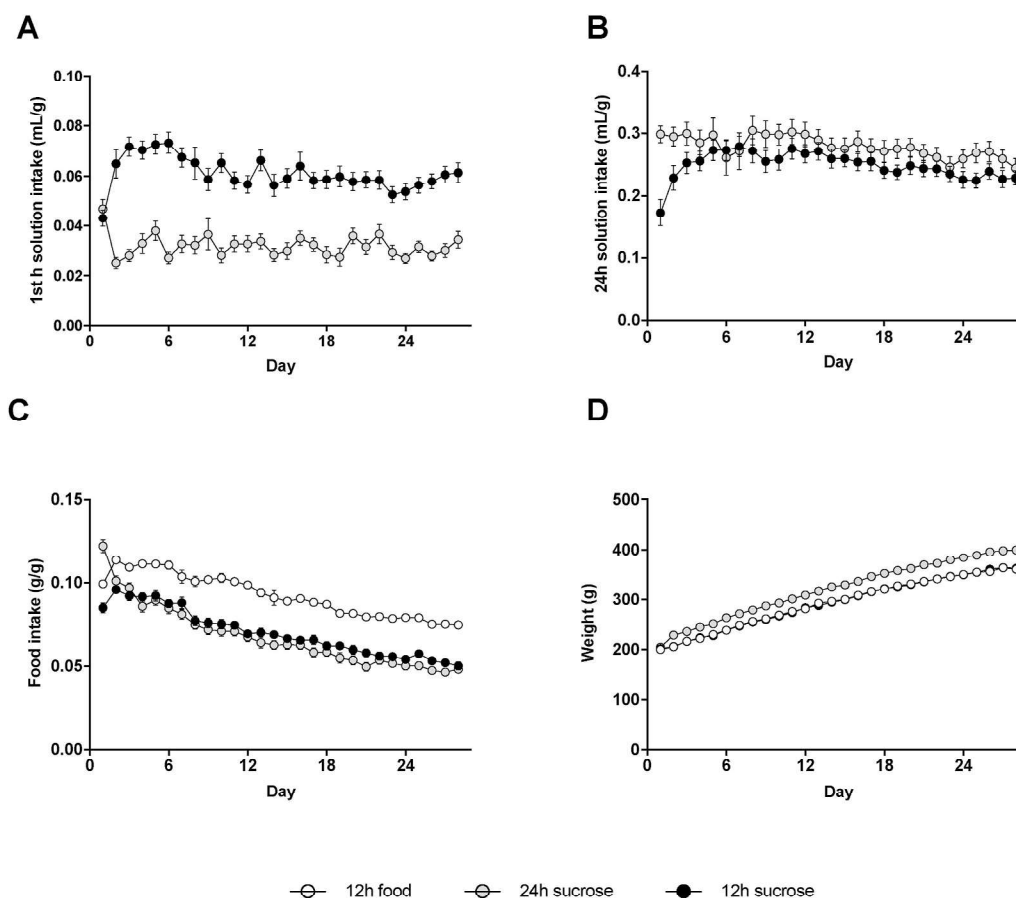

Fig. 2. Intermittent access to sucrose (12h sucrose) induces binge-like intake. (A) Solution intake (mL) per body weight (g) during the first hour of access across 28 days. (B) Daily solution intake (mL) per body weight (g) across sessions. (C) Daily food intake (g) per body weight (g) across sessions. (D) Body weight (g) across sessions. Data are presented as group means (\pm SEM).

Fig. 2C shows that food intake of all groups declined across sessions, $F(11.92,453.05) = 132.49, p < .001$, general $\eta^2 = 0.71$, with higher overall intake in the food only group, $F(2,38) = 70.77, p < .001$, partial $\eta^2 = 0.53$. The significant session \times group interaction, $F(23.84,453.05) = 6.97, p < .001$, partial $\eta^2 = 0.20$, reflected higher food intake in the 12 h food group beginning on day 2 compared to both sucrose access groups, with no significant difference between the other two groups across sessions ($ps > .05$). Finally, body weight increased across sessions in all groups, $F(2.27,147.36) = 2176.71, p < .001$, general $\eta^2 = 0.77$. The significant main effect of group, $F(2,65) = 8.18, p < .001$, general $\eta^2 = 0.18$, and session \times group interaction, $F(4.53,147.36) = 4.55, p = .001$, general $\eta^2 = 0.014$, were due to higher body weight in the 24 h

sucrose group beginning on day 2, compared to both 12 h sucrose and 12 h food groups ($ps < .05$), and no difference in body weight of 12 h sucrose and 12 h food groups across sessions ($ps > .05$) (Fig. 2D).

3.1.2. Gene expression

Fig. 3 shows the effects of sucrose bingeing on gene expression in the ECS throughout brain reward sites. *Cnr1* (CB1R coding gene) expression was increased in the NAc of rats in the 12 h sucrose group, compared to 24 h sucrose groups, $F(2,24) = 4.90, p < .05$ (Fig. 3A). There were no differences in *Cnr1* expression in other regions (PFC: $F(2,20) = 0.84, p = .45$; DS: $F(2,21) = 0.041, p = .96$; HPC: $F(2,20) = 1.36, p = .28$) and no differences in *Cnr2* expression across any site (PFC: $F(2,20) = 0.77, p =$

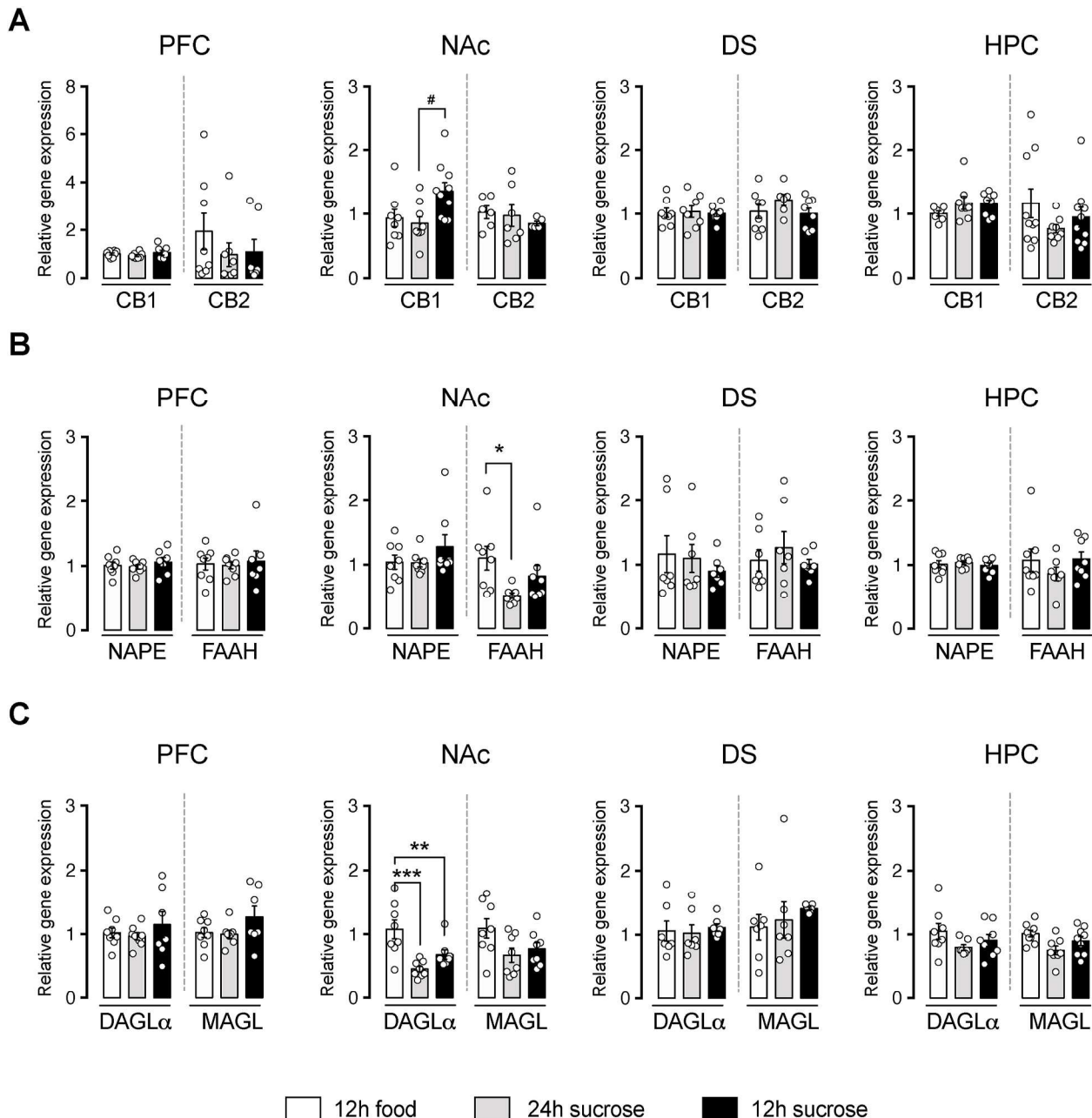

Fig. 3. Intermittent access to sucrose modulates endocannabinoid gene expression in the NAc. Gene expression was examined in the PFC ($n = 7-8$ /group), NAc ($5-10$ /group), DS ($n = 6-8$ /group), and HPC ($n = 7-10$ /group). (A) CB1R gene expression was significantly increased in the NAc of the 12 h sucrose group compared to the other groups. CB2 gene expression remained unchanged. (B) FAAH gene expression was significantly reduced in the NAc of the 24 h sucrose group. (C) DAGL α gene expression was significantly decreased in the NAc of both 12 h and 24 h sucrose groups. Data are presented as group means (\pm SEM). * $p < .05$, ** $p < .01$, *** $p < .001$ compared to 12 h food; # $p < .05$, compared to 24 h sucrose group. CB1/2: cannabinoid receptor gene *Cnr1/Cnr2*; DS: dorsal striatum. HPC: hippocampus; NAc: nucleus accumbens; PFC: prefrontal cortex.

.47; NAc: $F(2,15) = 0.44, p = .65$; DS: $F(2,19) = 1.27, p = .30$; HPC: $F(2,25) = 1.26, p = .30$).

Further analysis showed *Faah* expression was decreased in the NAc, only in the 24 h sucrose group, $F(2,21) = 4.03, p < .05$ (Fig. 3B), whereas *Dagla* expression in this region was decreased in both sucrose groups, $F(2,21) = 10.22, p < .001$ (Fig. 3C). There were no significant differences in enzyme expression in the PFC (*Faah*: $F(2,20) = 0.09, p = .91$; *Dagla*: $F(2,20) = 0.58, p = .57$), DS (*Faah*: $F(2,18) = 0.57, p = .58$; *Dagla*: $F(2,18) = 0.13, p = .88$), or HPC (*Faah*: $F(2,20) = 0.87, p = .43$; *Dagla*: $F(2,20) = 1.67, p = .21$). Pearson's correlation analysis revealed no significant relationship between sucrose intake during the first hour of access and regulated genes for any group (data not shown).

3.1.3. Endocannabinoid levels

In assessing endocannabinoid levels following sucrose bingeing, we observed an increase of AEA in the PFC of the 12 h sucrose group, $F(2,21) = 4.05, p < .05$, with no other differences in this measure (NAc: $F(2,21) = 0.04, p = .96$; DS: $F(2,21) = 0.16, p = .85$; HPC: $F(2,18) = 0.13, p = .87$) (Fig. 4A). In contrast, 2-AG was decreased in the HPC of the 12 h sucrose group, $F(2,18) = 3.75, p < .05$, with no group differences in other brain regions (PFC: $F(2,21) = 0.49, p = .62$; NAc: $F(2,21) = 0.20, p = .82$; DS: $F(2,21) = 0.21, p = .81$) (Fig. 4B). Pearson's correlation analysis revealed no significant relationship between sucrose intake during the first hour of access and regulated eCB levels for any group (data not shown). We did not perform correlation analyses between gene expression and eCB levels as these measures were obtained on two distinct cohorts.

3.2. Effects of CB1 antagonism on sucrose consumption

Fig. 5A(left panel) shows that sucrose intake during the first hour of access increased across days, with the 12 h sucrose groups consuming significantly more solution than the 24 h sucrose groups. These effects were verified, statistically, by a significant session \times group interaction, $F(12.74,688.12) = 10.22, p < .001$, general $\eta^2 = 0.11$, as well as significant main effects of session, $F(12.74,688.12) = 20.70, p < .001$, general $\eta^2 = 0.19$, and group, $F(1,54) = 268.33, p < .001$, general $\eta^2 = 0.65$. The main effect of drug, $F(2,54) = 3.40, p < .05$, general $\eta^2 = 0.04$, reflected decreased intake in sucrose groups following RIM, compared to vehicle, administration ($ps < .01$). The session \times group \times drug interaction was statistically significant, $F(25.49,688.12) = 1.88, p < .01$, general $\eta^2 = 0.042$. *Post-hoc* test revealed that intake of the 12 h sucrose vehicle group was significantly higher than the 24 h sucrose vehicle group ($p < .0001$); in the 12 h sucrose groups, intake was significantly lower following RIM 3, compared to RIM 1, treatment ($p = .0002$) and there was no significant difference between intake of the 24 h sucrose RIM 1 and 24 h sucrose RIM 3 groups. The effects of RIM on binge intake were examined, in more detail, by comparing total intake during the first hour of days 1–5 and days 24–28 in the 12 h sucrose group (Fig. 5A, right panel). This analysis revealed no significant differences across the first 5 sessions, $F(2,96.8) = 1.23, p = .29$, but a significant effect of drug during the final 5 sessions, $F(295.2) = 8.56, p < .001$. Both doses of RIM significantly decreased sucrose intake during the first hour of these 5 sessions, compared to vehicle injections (*post-hoc* $ps < .01$).

Daily sucrose intake also increased across sessions, $F(8.32,449.33) =$

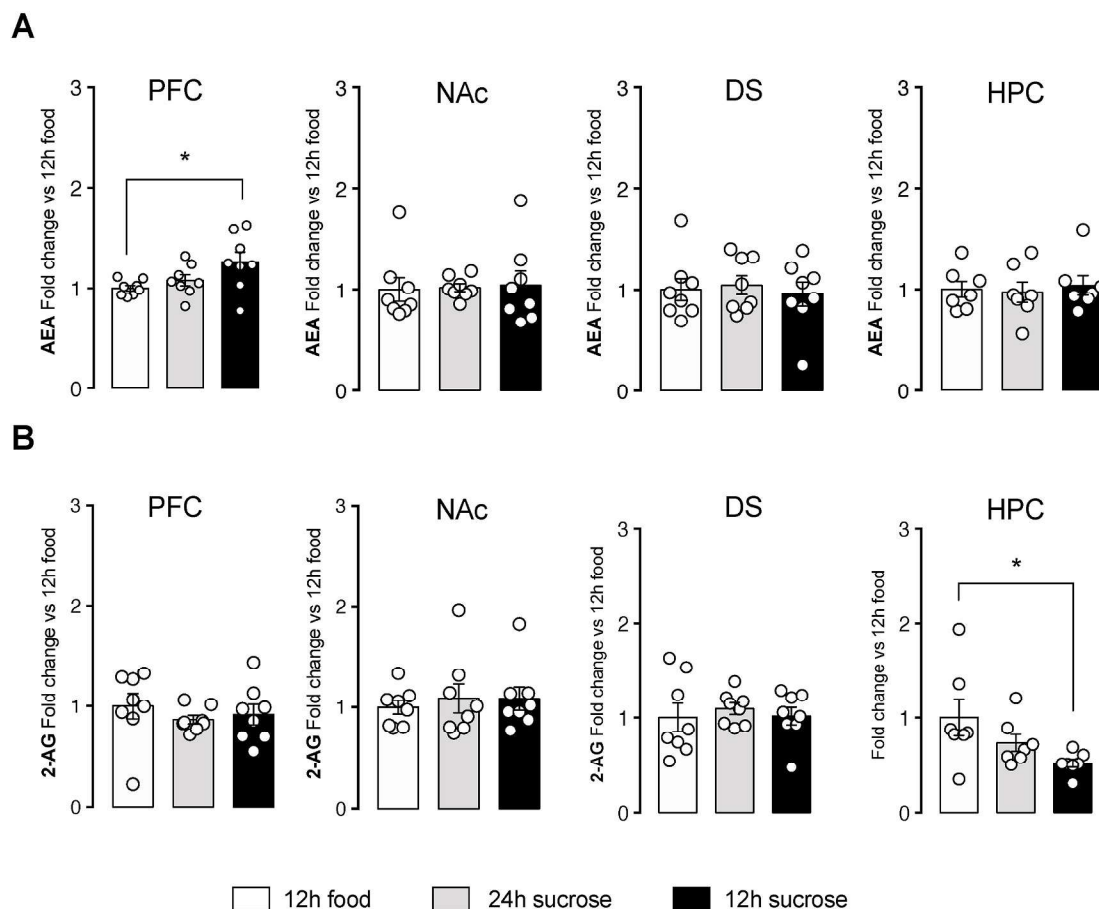

Fig. 4. Intermittent access to sucrose alters endocannabinoid levels. Endocannabinoid levels were examined in the PFC, NAc, DS, and HPC. (A) AEA levels were significantly increased in the PFC of the 12 h sucrose group. (B) 2-AG levels were significantly lower in the HPC of the 12 h sucrose group. Data are presented as group means (\pm SEM). * $p < .01$: compare to 12 h food. 2AG: 2-arachidonoylglycerol; AEA: anandamide; DS: dorsal striatum; HPC: hippocampus; NAc: nucleus accumbens; PFC: prefrontal cortex.

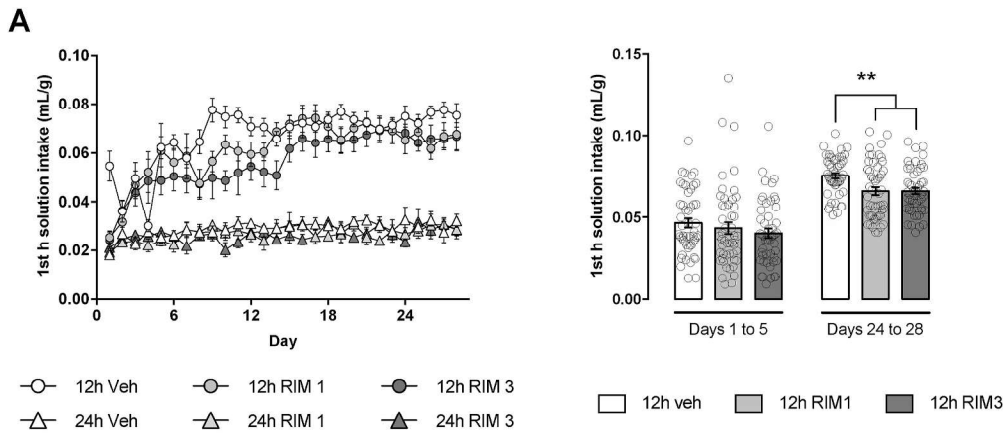
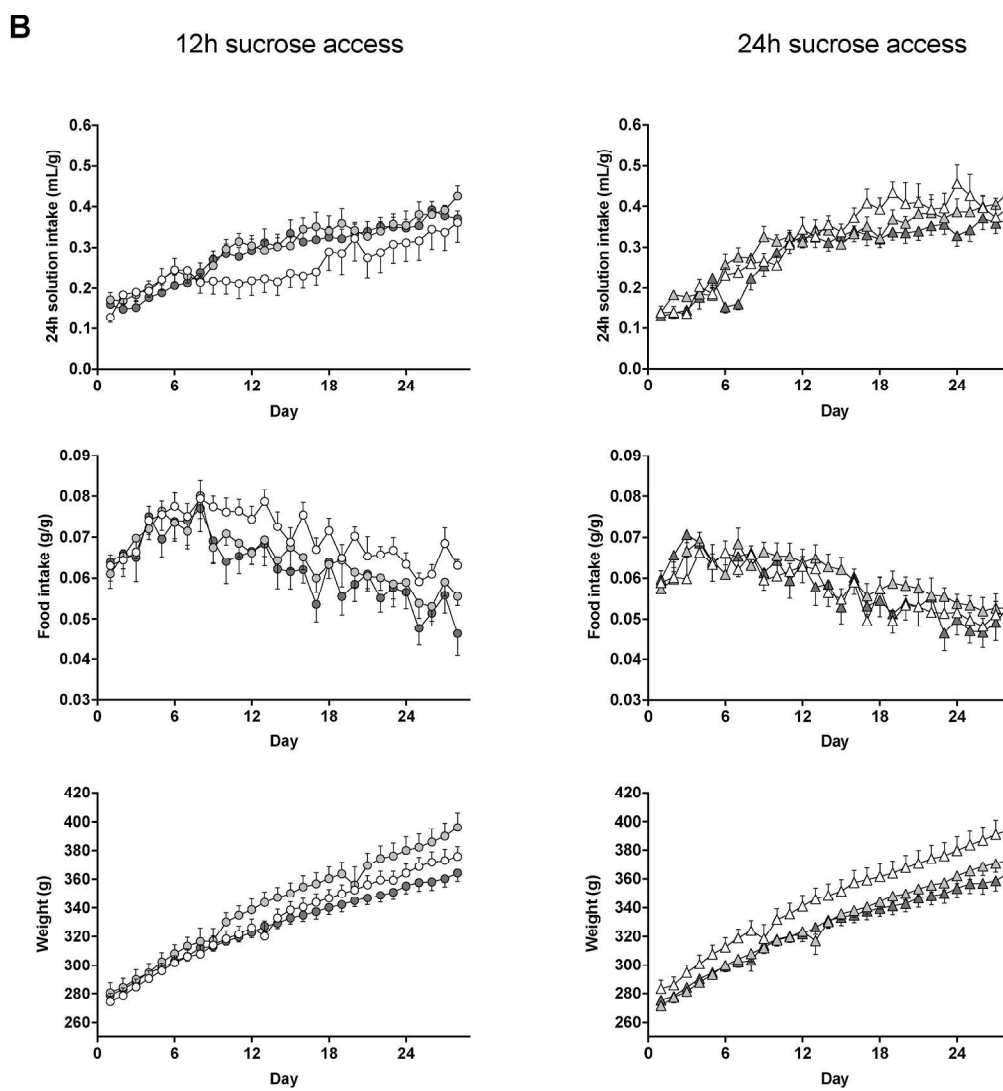

Fig. 5. Rimonabant decreases binge-like intake of sucrose. (A) Solution intake (mL) per body weight (g) during the first hour of access across 28 days (left), and total intake on the drug injection days (days 1–5 and 24–28) for the 12 h sucrose group (right). (B) Daily solution intake (mL) per body weight (g) (top), daily food intake (g) per body weight (g) (middle), body weight (g) (bottom) across sessions, for animals under a 12 h (right panels) or 24 h sucrose access (left panels) protocol. Data are presented as group means (\pm SEM). RIM 1: rimonabant 1 mg/kg; RIM 3: rimonabant 3 mg/kg; Veh: vehicle.



81.80, $p < .001$, general $\eta^2 = 0.42$ (Fig. 5B, top panel) although there were no group or drug differences on this measure and no interaction between the two (main effects and interaction, $ps > .05$). The session \times group \times drug interaction was significant ($F(16.64, 449.33) = 1.88$, $p = .02$, general $\eta^2 = 0.03$), as well as the session \times group interaction ($F(8.32, 449.33) = 2.94$, $p < .01$, general $\eta^2 = 0.03$), suggesting that a

change in sucrose intake across days was dependent on both access condition and drug dose. Post-hoc analyses revealed lower intake in the 12 h, compared to the 24 h, sucrose group following vehicle administration ($p < .0001$), but no significant differences between these groups following RIM administration. In addition, both doses of RIM increased intake, compared to vehicle, in the 12 h sucrose group ($ps < .0001$), with

no significant differences between intake of the two RIM-treated groups. The higher (RIM 3), but not the lower (RIM 1) drug dose decreased intake in the 24 h sucrose group, compared to vehicle-treated rats ($p < .0001$), and intake of the 24 h sucrose group administered RIM 3 was significantly lower than intake of the 24 h sucrose group receiving RIM 1 ($p = .0006$).

Fig. 5B (middle panel) shows that food intake declined across sessions in all groups, $F(13.21,713.24) = 38.50$, $p < .001$, general $\eta^2 = 0.22$, with significant interactions between session and group, $F(13.21,713.24) = 2.14$, $p = .01$, general $\eta^2 = 0.02$; and session and drug dose $F(26.42,713.24) = 1.56$, $p = .04$, general $\eta^2 = 0.02$. The main effect of group, $F(1,54) = 10.61$, $p = .002$, general $\eta^2 = 0.11$, was due to higher food intake in the 12 h sucrose groups ($p < .0001$). *Post-hoc* tests revealed that the highest dose of RIM decreased food intake, compared to vehicle injections, in the 12 h sucrose groups ($ps < .0001$). In contrast, RIM 1 increased food intake in the 24 h sucrose groups ($p = .02$).

As shown in Fig. 5B (bottom panel), body weight increased across sessions in all groups, $F(3.36,186.85) = 559.92$, $p < .001$, general $\eta^2 = 0.7$, and the effect interacted with drug, $F(6.92,186.85) = 3.20$, $p = .003$, general $\eta^2 = 0.03$, indicating that the impact of drug on body weight varied across sessions. *Post-hoc* tests revealed lower body weights in the 12 h sucrose group administered RIM 3, compared to RIM 1, on session average ($p < .0001$). In the 24 h sucrose groups, vehicle-treated rats were heavier than rats treated with the higher and lower RIM doses ($ps < .0001$). None of the other main effects or interactions were statistically significant.

3.3. Effects of CB1 antagonism on sucrose reward

Fig. 6A shows that all rats consumed significantly more sucrose than water across the CPP conditioning sessions (vehicle, $t(42) = 8.44$, RIM 1, $t(42) = 7.71$, RIM 3, $t(42) = 4.90$, all $ps < .01$). The significant main effect drug, $F(2,42) = 3.57$, $p < .05$, partial $\eta^2 = 0.15$, indicated that RIM

significantly reduced overall consumption during conditioning sessions, with RIM 3 reducing total sucrose intake, compared to the vehicle group (*post-hoc*, $p < .05$). In contrast, RIM had no effect on the development of a sucrose CPP, $F(2,42) = 0.93$, $p = .40$, partial $\eta^2 = 0.15$, in that all three groups showed a preference for the sucrose-paired compartment (vehicle, $t(42) = 3.66$, $p < .01$; RIM 1, $t(42) = 2.13$, $p < .05$; RIM 3, $t(42) = 2.81$, $p < .01$) (Fig. 6B).

We also tested the effects of RIM on a sucrose CPP in rats given either intermittent or continuous access to sucrose over 28 days. As with the previous two cohorts (see 3.1.1 and 3.2.), the 12 h sucrose group developed binge-like intake (i.e., increased intake during the first hour of access) that was absent in the 24 h group (data not shown). During subsequent CPP conditioning sessions, both groups consumed more sucrose than water across the 5 days (12 h sucrose: vehicle, $t(84) = 6.62$, RIM 1, $t(84) = 5.28$, RIM 3, $t(84) = 6.33$; 24 h sucrose: vehicle, $t(84) = 7.22$, RIM 1, $t(84) = 5.48$, RIM 3, $t(84) = 5.01$, all $ps < .01$), with no group $F(1,84) = 0.19$, $p = .66$, partial $\eta^2 = 0.01$ or drug, $F(2,84) = 1.38$, $p = .26$, partial $\eta^2 = 0.03$, differences on this measure (Fig. 6C). During CPP testing (Fig. 6D), however, only two groups displayed a significant preference for the sucrose-paired compartment: 24 h sucrose plus vehicle, $t(84) = 4.11$, $p < .01$, and 24 h sucrose plus RIM 1, $t(84) = 1.99$, $p < .05$. None of the other rats showed a preference for either the sucrose- or water-paired side during testing, all $ps > .05$.

4. Discussion

Our study confirms an important role for the ECS, specifically CB1Rs, in sucrose bingeing. More specifically, binge-like intake of sucrose modified ECS signaling in brain reward regions and CB1R blockade reduced this behavior in rats. CB1R antagonism, on its own, had no effect on the development of a sucrose CPP but blocked this effect in animals that had already consumed excessive amounts of sucrose. We propose that excessive sucrose intake modifies ECS signals related to

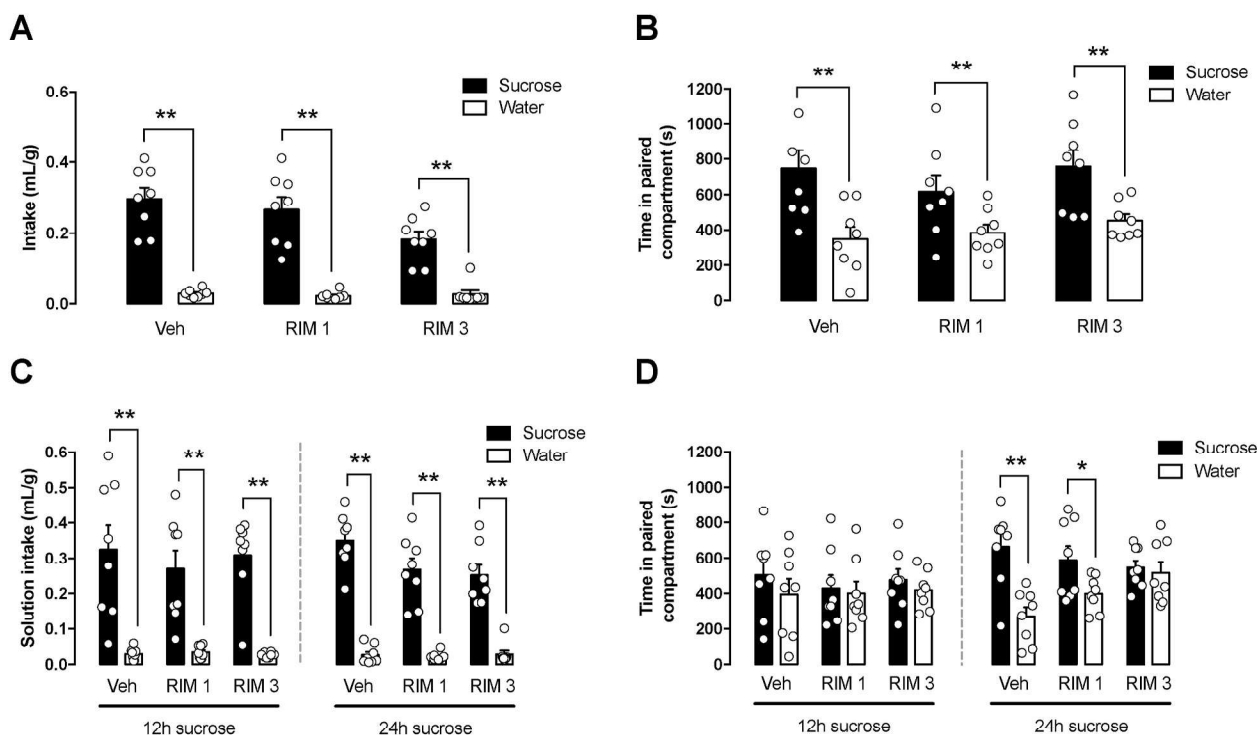

Fig. 6. Rimobant blocks a sucrose CPP following excessive sucrose consumption. (A) Effect of RIM on total solution intake across conditioning sessions (Experiment 3). (B) Time spent in each compartment during CPP testing (Experiment 3). (C) Effect of RIM on total solution intake across conditioning sessions, following sucrose consumption sessions (Experiment 4). (D) Time spent in each compartment during CPP testing following sucrose consumption sessions (Experiment 4). Data are presented as group means (\pm SEM). * $p < .05$, ** $p < .01$. CPP: conditioned place preference; RIM 1: rimobant 1 mg/kg; RIM 3: rimobant 3 mg/kg; Veh: vehicle.

reward processing, rendering animals vulnerable to CB1R antagonism in the CPP paradigm. Taken together, our findings further the understanding of mechanisms sustaining sucrose bingeing, including how these relate to reward processing in brain regions that are also implicated in drug addiction.

Our study provides the first evidence that CB1R antagonism reduces binge-like intake of a sucrose solution, measured in animal models as excessive intake during the first hour of access (Avena et al., 2005; Maracle, Normandeau, Dumont, & Olmstead, 2019; Smail-Crevier et al., 2018). The effect was manifested, specifically, during the final sessions of intermittent sucrose access following administration of RIM. Our findings corroborates previous evidence that CB1R blockade in rats dose-dependently decreases bingeing of palatable foods that are high in sugar (Dore et al., 2014), sugar and fat (Parylak et al., 2012), or fat only (Scherma et al., 2013). The reduction in binge-like eating following RIM administration may reflect a general decline in palatable food intake (Dore et al., 2014), although we did not observe an effect of drug on daily intake of sucrose, or on hourly intake in rats that did not exhibit binge-like eating (i.e., 24 h sucrose group). Admittedly, these measures may be less sensitive to disruption by CB1R antagonism in that binge-like eating is an exaggerated response that occurs within a short period of time and, given the half-life of the drug, effects would have dissipated by two or 3 h into the sessions (Jarbe, Gifford, & Makriyannis, 2010). Thus, although some details require further clarification, it is becoming increasingly clear that CB1Rs play an important role in over consumption of sweet foods.

Our post-mortem assessment revealed an interesting pattern of ECS-related changes following excessive sucrose intake. This included an upregulation of CB1R gene expression in the NAc, increased AEA levels in the PFC, and decreased 2-AG levels in the HPC; importantly, these changes were only apparent in rats that exhibited binge-like intake of sucrose. In contrast to our findings, binge intake of high fat or high fat-high sugar foods decreased CB1R gene expression in the NAc (Bello et al., 2012; Blanco-Gandía, Cantacorps, et al., 2017), providing further evidence that the biological consequences of high fat and high sugar diets are dissociable (Avena, 2010). Our study is the first to assess brain endocannabinoid levels in an animal model of sucrose bingeing, supporting clinical reports of alterations in blood AEA levels in BED patients (Monteleone et al., 2005). We also observed sucrose-induced decreases in ECS enzymes (FAAH and MAGL) that were not restricted to bingeing rats, suggesting that excessive sucrose intake, itself, may impact ECS function. Not surprisingly, these changes were limited to the NAc, an area that is closely associated with consumption of palatable food (Kelley, Baldo, Pratt, & Will, 2005).

A role for the ECS in sucrose bingeing likely occurs through an interaction with brain reward systems. Indeed, both palatable food (Joseph & Hodges, 1990; Phillips, Atkinson, Blackburn, & Blaha, 1993), and endocannabinoids (Solinas, Justinova, Goldberg, & Tanda, 2006) increase dopamine (DA) release in the NAc shell, with the latter acting via CB1Rs in this region (Sperlágh, Windisch, Andó, & Sylvester Vizi, 2009). Moreover, NAc neurons encode signals related to food reward and this effect is attenuated by CB1R antagonism (Hernandez & Cheer, 2012; Thoeni, Loureiro, O'Connor, & Lüscher, 2020). CB1Rs appear to form heteromers with NAc opioid receptors (Rios, Gomes, & Devi, 2006; Rodriguez, Mackie, & Pickel, 2001), which mediate the hedonic aspects of sweet foods (Peciña & Berridge, 2005). Intriguingly, excessive sucrose intake also increases binding of both mu opioid and DA D1 receptors in the NAc (Colantuoni et al., 2001), pointing to an interaction between multiple transmitter systems in the control of palatable food intake. Finally, an ECS contribution to food reward may reflect a more general role for this system in reward processing in that both CB1Rs and endocannabinoids in the NAc play a role in reward linked to social interaction (Manduca et al., 2016; Trezza et al., 2012; Trezza & Vanderschuren, 2008; Wei et al., 2015) and to a morphine CPP (Khaleghzadeh-Ahangar & Haghparast, 2015).

Modifications in ECS processes following extended sucrose access

may explain our seemingly contradictory findings in the CPP paradigm. More specifically, in animals with no prior exposure to sucrose (i.e., rats that had not gone through the sucrose binge experiment), CB1R antagonism did not alter the development of a sucrose CPP. In contrast, the highest dose of RIM eliminated a CPP in rats that had consumed excessive amounts of sucrose during binge sessions (24 h sucrose group). RIM had no effect in the 12 h sucrose groups because these animals did not exhibit a CPP (i.e., there was nothing to block). The elimination of a sucrose CPP across all three drug conditions (vehicle, RIM 1, and RIM 3) in all 12 h sucrose groups matches our earlier report (Smail-Crevier et al., 2018), suggesting that the lack of a CPP in these animals is due to prior binge-like intake. We proposed, previously, that this behavior modifies brain reward systems, impacting the later expression of a CPP. Our current findings add to this discussion by indicating that excessive sucrose intake, itself, may also disrupt ECS function. That is, 28 days of sucrose consumption may have compromised ECS-linked reward processing, rendering animals susceptible to CB1R blockade in the CPP paradigm. This was manifested by the absence of a CPP in the 24 h sucrose, 3 mg/kg RIM group.

An alternative interpretation is that the lack of CPP in RIM-treated animals reflects alterations in neural mechanisms of anxiety in that sucrose bingeing increases anxiety-like behavior in rats (Avena, Bocarsly, et al., 2008), and the ECS plays an important role in regulating stress-related responses, such as anxiety (Morena, Patel, Bains, & Hill, 2016). In support of this idea, the 24 h sucrose group exhibited ECS changes in the mPFC and HPC, brain regions that are particularly vulnerable to stress manipulations. Finally, the fact that CB1R antagonism reduced sucrose consumption during conditioning, but did not block a CPP during testing (i.e., in rats who had no prior experience with sucrose), is consistent with evidence showing a dissociation in mechanisms that control these two processes (Papp, Willner, & Muscat, 1991; Smail-Crevier et al., 2018; White & Carr, 1985; Ágmo, Galvan, & Talamantes, 1995).

To the extent that preclinical research is applicable to drug development, our findings suggest that cannabinoid compounds may be appropriate tools to treat BED. CB1Rs could be the most promising target in that CB1R expression is elevated in eating disorder patients (Friedling et al., 2009). Moreover, CB1R antagonists reduce binge eating in both rats (Dore et al., 2014; Parylak et al., 2012; Scherma et al., 2013) and humans (Pataky et al., 2013), although at least one drug, SR141716 (Rimonabant), produces adverse events in BED patients (Pataky et al., 2013). Selective targets of peripheral, rather than central, CB1Rs may mitigate these negative side effects. As an example, AM6545, a peripherally-restricted CB1R antagonist, diminishes intake of a high fat-high sugar diet in mice, with no alteration in consumption of standard chow (Argueta & DiPatrizio, 2017). In addition, cannabidiol, a CB1R antagonist with CB2R agonist activity, reduces sucrose intake in mice, an effect that is potentiated by CB1R blockade and inhibited by CB2R blockade (Bi, Galaj, He, & Xi, 2020). Currently, there are only two drugs approved by the US food and drug administration to treat BED: lisdexamfetamine (Vyvanse), an inactive prodrug promoting the release of monoamines (Gasior et al., 2017; McElroy et al., 2015), and dasotraline, a DA and norepinephrine reuptake inhibitor (Grilo et al., 2020). Lisdexamfetamine produces multiple adverse effects (Ward & Citrome, 2018) and dasotraline was recently withdrawn from drug development. Given the paucity of alternative therapies for BED (Hutson et al., 2018), a strategic focus on ECS mechanisms may provide the best options for treating this disorder.

Finally, our study adds to the growing discussion concerning addictive-like properties of palatable food. On a general level, our model of sucrose bingeing shares a number of commonalities with drug addiction (Bocarsly & Avena, 2013, pp. 179–191), including escalation of intake (Colantuoni et al., 2001), signs of somatic withdrawal (Colantuoni et al., 2002; Avena, Bocarsly, et al., 2008), and neurochemical changes in the NAc, such as increased DA release (Avena et al., 2005; Rada, Avena, & Hoebel, 2005) and reduced DA D2 receptor

availability (Colantuoni et al., 2001). Most telling, sucrose bingeing induces compulsive responding and electrophysiological changes in the bed nucleus of the stria terminalis (Maracle et al., 2019) that match behavioral and biological consequences of cocaine self-administration in rats (Krawczyk, Georges, et al., 2011; Krawczyk, Sharma, et al., 2011). Further, food craving in humans is associated with enhanced activity in the HPC, NAc, insula, and orbitofrontal cortex (Pelchat, Johnson, Chan, Valdez, & Ragland, 2004; Rolls & McCabe, 2007), the same regions that are activated in drug craving (Everitt & Robbins, 2016; Koob & Volkow, 2010). In addition, future experiments will investigate possible sex differences in the effects of binge intake on ECS processes. Given that baseline levels of endocannabinoids and reactivity towards cannabinoids are sex-dependent (for review see Fattore & Fratta, 2010; Craft, Marusich, & Wiley, 2013), we may expect distinct patterns of ECS changes in males and females following excessive intake of palatable food. These differences may contribute, at least partially, to the higher prevalence of eating disorders in females than males (Bulik, Yilmaz, & HArday, 2015).

The ECS may provide a link between responses to palatable food and addictive behaviors, particularly as cannabinoid mechanisms are intimately linked to drug addiction (Silveira et al., 2017). In support of this idea, CB1R antagonism reduces the proportion of animals that transition from controlled to compulsive feeding in a mouse model of addictive-like eating (Mancino et al., 2015). At the same time, the concept of food addiction is not universally accepted (Treasure, Leslie, Chami, & Fernández-Aranda, 2018; Westwater, Fletcher, & Ziauddeen, 2016; Ziauddeen, Farooqi, & Fletcher, 2012), with a growing awareness that research should focus on identifying biological underpinnings of specific behavioral patterns that lead to excessive intake of food or drugs (Dileone, Taylor, & Picciotto, 2012). Our findings inform this line of investigation by highlighting how endocannabinoid mechanisms in brain reward regions may contribute to binge eating.

Declaration of competing interest

The authors declare no conflict of interest.

Acknowledgments

This project was supported by the Université de Strasbourg, Centre National de la Recherche Scientifique (CNRS), Programme International de Coopération Scientifique (PICS CNRS), the French National Research Agency (ANR) through the Programme d'Investissement d'Avenir (ANR-17-EURE-0022, Euridol, graduate school of pain) and the Natural Sciences and Engineering Research Council of Canada (NSERC). RB received a postdoctoral fellowship from the Fondation pour la Recherche Médicale (FRM). DN and GA received a PhD fellowship from the French Ministère de l'Enseignement Supérieur et de la Recherche and DN received a fourth year PhD fellowship from the Fonds Paul Mendel. We thank Lihua Xue for help with behavioral testing and Alicia Jung for help with biochemical analysis.

Appendix A. Supplementary data

Supplementary data to this article can be found online at <https://doi.org/10.1016/j.appet.2021.105258>.

Author's contribution

Conceptualization: DN, MCO, KB designed the experiments and wrote the paper. Investigation: DN, VA, DF, KB performed the experiments; DN, RB, KB analyzed the data and designed the figures; RB, GA and MCO conducted statistical analysis; YG, VA contributed to the design and analysis of the mass spectrometry experiment. Supervision and funding acquisition: MCO and KB supervised the study and obtained the funding. All authors approved the final version of the manuscript.

Data availability statement

All the data supporting the findings of this study can be provided upon request from the corresponding author.

Ethical statement

All procedures and animal care were performed according to the European Union laws for animal studies and were in accordance with the guidelines for the ethical use of animals, outlined by the Canadian Council on Animal Care. Experiments were approved by the institutional ethics committee CREMEAS (Comité d'Éthique pour l'Expérimentation Animale de Strasbourg, France) (APAFIS#2019070816359145) and the Queen's University Animal Care Committee.

References

- Abel, E. L. (1975). Cannabis: Effects on hunger and thirst. *Behavioral Biology*, *15*, 255–281.
- Achterberg, E. J. M., van Swieten, M. M. H., Driël, N. V., Trezza, V., & Vanderschuren, L. (2016). Dissociating the role of endocannabinoids in the pleasurable and motivational properties of social play behaviour in rats. *Pharmacological Research*, *110*, 151–158.
- Ågmo, A., Galvan, A., & Talamantes, B. (1995). Reward and reinforcement produced by drinking sucrose: Two processes that may depend on different neurotransmitters. *Pharmacology Biochemistry and Behavior*, *52*, 403–414.
- Argueta, D. A., & DiPatrizio, N. V. (2017). Peripheral endocannabinoid signaling controls hyperphagia in western diet-induced obesity. *Physiology & Behavior*, *171*, 32–39.
- Arnone, M., Maruani, J., Chaperon, F., Thiébot, M. H., Poncelet, M., Soubrié, P., et al. (1997). Selective inhibition of sucrose and ethanol intake by SR 141716, an antagonist of central cannabinoid (CB1) receptors. *Psychopharmacology*, *132*, 104–106.
- American Psychiatric Association. (2013). Diagnostic and statistical manual of mental disorders. DSM 5. *Psychiatr. Online, Fifth Edition*. <https://doi.org/10.1176/appi.books.9780890425596>
- Avena, N. M. (2007). Examining the addictive-like properties of binge eating using an animal model of sugar dependence. *Experimental and Clinical Psychopharmacology*, *15*, 481–491.
- Avena, N. M. (2010). The study of food addiction using animal models of binge eating. *Appetite*, *55*, 734–737.
- Avena, N. M., Bocarsly, M. E., Rada, P., Kim, A., & Hoebel, B. G. (2008). After daily bingeing on a sucrose solution, food deprivation induces anxiety and accumbens dopamine/acetylcholine imbalance. *Physiology & Behavior*, *94*, 309–315.
- Avena, N. M., Long, K. A., & Hoebel, B. G. (2005). Sugar-dependent rats show enhanced responding for sugar after abstinence: Evidence of a sugar deprivation effect. *Physiology & Behavior*, *84*, 359–362.
- Avena, N. M., Rada, P., & Hoebel, B. G. (2008). Evidence for sugar addiction: Behavioral and neurochemical effects of intermittent, excessive sugar intake. *Neuroscience & Biobehavioral Reviews*, *32*, 20–39.
- Bello, N. T., Coughlin, J. W., Redgrave, G. W., Ladenheim, E. E., Moran, T. H., & Guarda, A. S. (2012). Dietary conditions and highly palatable food access alter rat cannabinoid receptor expression and binding density. *Physiology & Behavior*, *105*, 720–726.
- Bi, G. H., Galaj, E., He, Y., & Xi, Z. X. (2020). Cannabidiol inhibits sucrose self-administration by CB1 and CB2 receptor mechanisms in rodents. *Addiction Biology*, *25*, Article e12783.
- Blanco-Gandía, M. C., Aracil-Fernández, A., Montagud-Romero, S., Aguilar, M. A., Manzanares, J., Miñarro, J., et al. (2017). Changes in gene expression and sensitivity of cocaine reward produced by a continuous fat diet. *Psychopharmacology*, *234*, 2337–2352.
- Blanco-Gandía, M. C., Cantacorps, L., Aracil-Fernández, A., Montagud-Romero, S., Aguilar, M. A., Manzanares, J., et al. (2017). Effects of bingeing on fat during adolescence on the reinforcing effects of cocaine in adult male mice. *Neuropharmacology*, *113*, 31–44.
- Blasio, A., Rice, K. C., Sabino, V., & Cottone, P. (2014). Characterization of a shortened model of diet alternation in female rats: Effects of the CB1 receptor antagonist rimonabant on food intake and anxiety-like behavior. *Behavioural Pharmacology*, *25*, 609–617.
- Bocarsly, M. E., & Avena, N. M. (2013). *Animal models of binge eating palatable foods: Emergence of addiction-like behaviors and brain changes in the rat*.
- Bulik, C., Yilmaz, Z., & HArday, A. (2015). Genetics and epigenetics of eating disorders. *Advances in Genomics and Genetics*, *5*, 131–150.
- Ceccarini, J., Weltens, N., Ly, H. G., Tack, J., Van Oudenhove, L., & Van Laere, K. (2016). Association between cerebral cannabinoid 1 receptor availability and body mass index in patients with food intake disorders and healthy subjects: A [(18)F]MK-9470 PET study. *Transl. Psychiatry*, *6*, e853.
- Chaperon, F., Soubrié, P., Puech, A. J., & Thiébot, M.-H. (1998). Involvement of central cannabinoid (CB 1) receptors in the establishment of place conditioning in rats. *Psychopharmacology*, *135*, 324–332.

- Colantuoni, C., Rada, P., McCarthy, J., Patten, C., Avena, N. M., Chadeayne, A., et al. (2002). Evidence that intermittent, excessive sugar intake causes endogenous opioid dependence. *Obesity Research*, *10*, 478–488.
- Colantuoni, C., Schwenker, J., McCarthy, J., Rada, P., Ladenheim, B., Cadet, J.-L., et al. (2001). Excessive sugar intake alters binding to dopamine and mu-opioid receptors in the brain. *NeuroReport*, *12*, 3549–3552.
- Colombo, G., Serra, S., Brunetti, G., Gomez, R., Melis, S., Vacca, G., et al. (2002). Stimulation of voluntary ethanol intake by cannabinoid receptor agonists in ethanol-preferring sP rats. *Psychopharmacology*, *159*, 181–187.
- Craft, R. M., Marusich, J. A., & Wiley, J. L. (2013). Sex differences in cannabinoid pharmacology: A reflection of differences in the endocannabinoid system? *Life Sciences*, *92*, 476–481.
- Dazzi, L., Talani, G., Biggio, F., Utzeri, C., Lallai, V., Licheri, V., et al. (2014). Involvement of the cannabinoid CB1 receptor in modulation of dopamine output in the prefrontal cortex associated with food restriction in rats. *PLoS One*, *9*, Article e92224.
- De Carvalho, C. R., Pamplona, F. A., Cruz, J. S., & Takahashi, R. N. (2014). Endocannabinoids underlie reconsolidation of hedonic memories in Wistar rats. *Psychopharmacology*, *231*, 1417–1425.
- De Vries, T. J., Shaham, Y., Homberg, J. R., Crombag, H., Schuurman, K., Dieben, J., et al. (2001). A cannabinoid mechanism in relapse to cocaine seeking. *Nature Medicine*, *7*, 1151–1154.
- Dileone, R. J., Taylor, J. R., & Picciotto, M. R. (2012). iThe drive to eat: Comparisons and distinctions between mechanisms of food reward and drug addiction. *Nature Neuroscience*, *15*, 1330–1335.
- Dore, R., Valenza, M., Wang, X., Rice, K. C., Sabino, V., & Cottone, P. (2014). The inverse agonist of CB1 receptor SR141716 blocks compulsive eating of palatable food. *Addiction Biology*, *19*, 849–861.
- Everitt, B. J., & Robbins, T. W. (2016). Drug addiction: Updating actions to habits to compulsions ten years on. *Annual Review of Psychology*, *67*, 23–50.
- Fattore, L., & Fratta, W. (2010). How important are sex differences in cannabinoid action? *British Journal of Pharmacology*, *160*, 544–548.
- Frieling, H., Albrecht, H., Jedtke, S., Gzner, A., Lenz, B., Wilhelm, J., et al. (2009). Elevated cannabinoid 1 receptor mRNA is linked to eating disorder related behavior and attitudes in females with eating disorders. *Psychoneuroendocrinology*, *34*, 620–624.
- Gaetani, S., Kaye, W. H., Cuomo, V., & Piomelli, D. (2008). Role of endocannabinoids and their analogues in obesity and eating disorders. *Eating and Weight Disorders*, *13*, e42–e48.
- Gasior, M., Hudson, J., Quintero, J., Ferreira-Cornwell, M. C., Radewonuk, J., & McElroy, S. L. (2017). A phase 3, multicenter, open-label, 12-month extension safety and tolerability trial of lisdexamfetamine dimesylate in adults with binge eating disorder. *Journal of Clinical Psychopharmacology*, *37*, 315–322.
- Grenier, P., Mailhot, M. C., Cahill, C. M., & Olmstead, M. C. (2019). Blockade of dopamine D1 receptors in male rats disrupts morphine reward in pain naïve but not in chronic pain states. *Journal of Neuroscience Research*, *1–12*.
- Grilo, C. M., McElroy, S. L., Hudson, J. I., Tsai, J., Navia, B., Goldman, R., et al. (2020). Efficacy and safety of dasotraline in adults with binge-eating disorder: A randomized, placebo-controlled, fixed-dose clinical trial. *CNS Spectrums*, *19*, 1–10.
- Hernandez, G., & Cheer, J. F. (2012). Effect of CB1 receptor blockade on food-reinforced responding and associated nucleus accumbens neuronal activity in rats. *Journal of Neuroscience*, *32*, 11467–11477.
- Hudson, J. I., Hiripi, E., Pope, H. G., & Kessler, R. C. (2007). The prevalence and correlates of eating disorders in the national comorbidity survey replication. *Biological Psychiatry*, *61*, 348–358.
- Hutson, P. H., Balodis, I. M., & Potenza, M. N. (2018). Binge-eating disorder: Clinical and therapeutic advances. *Pharmacology & Therapeutics*, *182*, 15–27.
- Jarbe, T. U., Gifford, R. S., & Makriyannis, A. (2010). Antagonism of (9)-THC induced behavioral effects by rimonabant: Time course studies in rats. *European Journal of Pharmacology*, *648*, 133–138.
- Joseph, M. H., & Hodges, H. (1990). Lever pressing for food reward and changes in dopamine turnover and uric acid in rat caudate and nucleus accumbens studied chronically by in vivo voltammetry. *Journal of Neuroscience Methods*, *34*, 143–149.
- Kelley, A. E., Baldo, B. A., Pratt, W. E., & Will, M. J. (2005). Corticostriatal-hypothalamic circuitry and food motivation: Integration of energy, action and reward. *Physiology & Behavior*, *86*, 773–795.
- Kessler, R. C., Berglund, P. A., Chiu, W. T., Deitz, A. C., Hudson, J. I., Shahly, V., et al. (2013). The prevalence and correlates of binge eating disorder in the world Health organization world mental Health surveys. *Biological Psychiatry*, *73*, 904–914.
- Khaleghzadeh-Ahangar, H., & Haghparast, A. (2015). Intra-accumbal CB1 receptor blockade reduced extinction and reinstatement of morphine. *Physiology & Behavior*, *149*, 212–219.
- Kirkham, T. C., Williams, C. M., Fezza, F., & Di Marzo, V. (2002). Endocannabinoid levels in rat limbic forebrain and hypothalamus in relation to fasting, feeding and satiation: Stimulation of eating by 2-arachidonoyl glycerol. *British Journal of Pharmacology*, *136*, 550–557.
- Koch, M., Varela, L., Kim, J. G., Kim, J. D., Hernández-Nuño, F., Simonds, S. E., et al. (2015). Hypothalamic POMC neurons promote cannabinoid-induced feeding. *Nature*, *519*, 45–50.
- Koob, G. F., & Volkow, N. D. (2010). Neurocircuitry of addiction. *Neuropsychopharmacology*, *35*, 217–238.
- Krawczyk, M., Georges, F., Sharma, R., Mason, X., Berthet, A., Bézard, E., et al. (2011). Double-dissociation of the catecholaminergic modulation of synaptic transmission in the oval bed nucleus of the stria terminalis. *Journal of Neurophysiology*, *105*, 145–153.
- Krawczyk, M., Sharma, R., Mason, X., de Backer, J., Jones, A. A., & Dumont, É. C. (2011). A switch in the neuromodulatory effects of dopamine in the oval bed nucleus of the stria terminalis associated with cocaine self-administration in rats. *Journal of Neuroscience*, *31*, 8928–8935.
- Li, B., Matter, E. K., Hoppert, H. T., Grayson, B. E., Seeley, R. J., & Sandoval, D. A. (2014). Identification of optimal reference genes for RT-qPCR in the rat hypothalamus and intestine for the study of obesity. *International Journal of Obesity*, *38*, 192–197.
- Livak, KJ, & Schmittgen, TD (2001). Analysis of relative gene expression data using real-time quantitative PCR and the 2(-Delta Delta C(T)) Method. *Methods*, *25*, 402–408. <https://doi.org/10.1006/meth.2001.1262>
- Maldonado, R., Valverde, O., & Berrendero, F. (2006). Involvement of the endocannabinoid system in drug addiction. *Trends in Neurosciences*, *29*, 225–232.
- Mancino, S., Burokas, A., Gutiérrez-Cuesta, J., Gutiérrez-Martos, M., Martín-García, E., Pucci, M., et al. (2015). Epigenetic and proteomic expression changes promoted by eating addictive-like behavior. *Neuropsychopharmacology*, *40*, 2788–2800.
- Manduca, A., Lassalle, O., Sepers, M., Campolongo, P., Cuomo, V., Marsicano, G., et al. (2016). Interacting cannabinoid and opioid receptors in the nucleus accumbens core control adolescent social play. *Frontiers in Behavioral Neuroscience*, *10*, 211.
- Maracle, A. C., Normandeau, C. P., Dumont, É. C., & Olmstead, M. C. (2019). Dopamine in the oval bed nucleus of the stria terminalis contributes to compulsive responding for sucrose in rats. *Neuropsychopharmacology*, *44*, 381–389.
- McElroy, S. L., Hudson, J. I., Mitchell, J. E., Wilfley, D., Ferreira-Cornwell, M. C., Gao, J., et al. (2015). Efficacy and safety of lisdexamfetamine for treatment of adults with moderate to severe binge-eating disorder. *JAMA Psychiatry*, *72*, 235–246.
- Monteleone, P., Matias, I., Martiadis, V., De Petrocellis, L., Maj, M., & Di Marzo, V. (2005). Blood levels of the endocannabinoid anandamide are increased in anorexia nervosa and in binge-eating disorder, but not in bulimia nervosa. *Neuropsychopharmacology*, *30*, 1216–1221.
- Morena, M., Patel, S., Bains, J. S., & Hill, M. N. (2016). Neurobiological interactions between stress and the endocannabinoid system. *Neuropsychopharmacology*, *41*, 80–102.
- Papp, M., Willner, P., & Muscat, R. (1991). An animal model of anhedonia: Attenuation of sucrose consumption and place preference conditioning by chronic unpredictable mild stress. *Psychopharmacology (Berl)*, *104*, 255–259.
- Parylak, S. L., Cottone, P., Sabino, V., Rice, K. C., & Zorrilla, E. P. (2012). Effects of CB1 and GRP1 receptor antagonists on binge-like eating in rats with limited access to a sweet fat diet: Lack of withdrawal-like responses. *Physiology & Behavior*, *107*, 231–242.
- Pataky, Z., Gasteyer, C., Ziegler, O., Rissanen, A., Hanotin, C., & Golay, A. (2013). Efficacy of rimonabant in obese patients with binge eating disorder. *Experimental & Clinical Endocrinology & Diabetes*, *121*, 20–26.
- Paxinos, G., & Watson, C. (2007). *The rat brain in stereotaxic coordinates*. Elsevier.
- Peciña, S., & Berridge, K. C. (2005). Hedonic hot spot in nucleus accumbens shell: Where do μ -Opioids cause increased hedonic impact of sweetness? *Journal of Neuroscience*, *25*, 11777–11786.
- Pelchat, M. L., Johnson, A., Chan, R., Valdez, J., & Ragland, J. D. (2004). Images of desire: Food-craving activation during fMRI. *NeuroImage*, *23*, 1486–1493.
- Phillips, A. G., Atkinson, L. J., Blackburn, J. R., & Blaha, C. D. (1993). Increased extracellular dopamine in the nucleus accumbens of the rat elicited by a conditional stimulus for food: An electrochemical study. *Canadian Journal of Physiology and Pharmacology*, *71*, 387–393.
- Rada, P., Avena, N. M., & Hoebel, B. G. (2005). Daily bingeing on sugar repeatedly releases dopamine in the accumbens shell. *Neuroscience*, *134*, 737–744.
- Rios, C., Gomes, I., & Devi, L. A. (2006). Mu opioid and CB1 cannabinoid receptor interactions: reciprocal inhibition of receptor signaling and neurogenesis. *British Journal of Pharmacology*, *148*, 387–395.
- Rodriguez, J. J., Mackie, K., & Pickel, V. M. (2001). Ultrastructural localization of the CB1 cannabinoid receptor in mu-opioid receptor patches of the rat Caudate putamen nucleus. *Journal of Neuroscience*, *21*, 823–833.
- Rolls, E. T., & McCabe, C. (2007). Enhanced affective brain representations of chocolate in cravers vs. non-cravers. *European Journal of Neuroscience*, *26*, 1067–1076.
- Satta, V., Scherma, M., Piscitelli, F., Usai, P., Castelli, M. P., Bisogno, T., et al. (2018). Limited access to a High fat diet alters endocannabinoid tone in female rats. *Frontiers in Neuroscience*, *12*, 40.
- Scherma, M., Fattore, L., Satta, V., Businco, F., Pigliacampo, B., Goldberg, S. R., et al. (2013). Pharmacological modulation of the endocannabinoid signalling alters binge-type eating behaviour in female rats. *British Journal of Pharmacology*, *169*, 820–833.
- Schmid, P. C., Krebsbach, R. J., Perry, S. R., Dettmer, T. M., Maasson, J. L., & Schmid, H. H. O. (1995). Occurrence and postmortem generation of anandamide and other long-chain N-acyl ethanolamines in mammalian brain. *FEBS Letters*, *375*, 117–120.
- Silberberg, G., Baruch, K., & Navon, R. (2009). Detection of stable reference genes for real-time PCR analysis in schizophrenia and bipolar disorder. *Analytical Biochemistry*, *391*, 91–97.
- Silveira, M. M., Arnold, J. C., Lavolette, S. R., Hillard, C. J., Celorrio, M., Aymerich, M. S., et al. (2017). Seeing through the smoke: Human and animal studies of cannabis use and endocannabinoid signalling in corticolimbic networks. *Neuroscience & Biobehavioral Reviews*, *76*, 380–395.
- Simiand, J., Keane, M., Keane, P. E., & Soubrié, P. (1998). SR 141716, a CB1 cannabinoid receptor antagonist, selectively reduces sweet food intake in marmoset. *Behavioural Pharmacology*, *9*, 179–181.
- Smail-Crevier, R. L., Maracle, A. C., Wash, S. I. J., & Olmstead, M. C. (2018). Binge-like intake of sucrose reduces the rewarding value of sucrose in adult rats. *Physiology & Behavior*, *194*, 420–429.

- Solinas, M., Justinova, Z., Goldberg, S. R., & Tanda, G. (2006). Anandamide administration alone and after inhibition of fatty acid amide hydrolase (FAAH) increases dopamine levels in the nucleus accumbens shell in rats. *Journal of Neurochemistry*, *98*, 408–419.
- Solmi, F., Hotopf, M., Hatch, S. L., Treasure, J., & Micali, N. (2016). Eating disorders in a multi-ethnic inner-city UK sample: Prevalence, comorbidity and service use. *Social Psychiatry and Psychiatric Epidemiology*, *51*, 369–381.
- Sperlágh, B., Windisch, K., Andó, R. D., & Sylvester Vizi, E. (2009). Neurochemical evidence that stimulation of CB1 cannabinoid receptors on GABAergic nerve terminals activates the dopaminergic reward system by increasing dopamine release in the rat nucleus accumbens. *Neurochemistry International*, *54*, 452–457.
- Stojek, M. M. K., & MacKillop, J. (2017). Relative reinforcing value of food and delayed reward discounting in obesity and disordered eating: A systematic review. *Clinical Psychology Review*, *55*, 1–11.
- Thoeni, S., Loureiro, M., O'Connor, E. C., & Lüscher, C. (2020). Depression of accumbal to lateral Hypothalamic synapses gates overeating. *Neuron*, *107*, 158–172.
- Treasure, J., Leslie, M., Chami, R., & Fernández-Aranda, F. (2018). Are trans diagnostic models of eating disorders fit for purpose? A consideration of the evidence for food addiction. *European Eating Disorders Review*, *26*, 83–91.
- Trezza, V., Damsteegt, R., Manduca, A., Petrosino, S., Van Kerkhof, L. W. M., Pasterkamp, R. J., et al. (2012). Endocannabinoids in amygdala and nucleus accumbens mediate social play reward in adolescent rats. *Journal of Neuroscience*, *32*, 14899–14908.
- Trezza, V., & Vanderschuren, L. J. M. J. (2008). Bidirectional cannabinoid modulation of social behavior in adolescent rats. *Psychopharmacology*, *197*, 217–227.
- Ward, K., & Citrome, L. (2018). Lisdexamfetamine: Chemistry, pharmacodynamics, pharmacokinetics, and clinical efficacy, safety, and tolerability in the treatment of binge eating disorder. *Expert Opinion on Drug Metabolism and Toxicology*, *14*, 229–238.
- Wei, D., Lee, D. Y., Cox, C. D., Karsten, C. A., Penagarikano, O., Geschwind, D. H., et al. (2015). Endocannabinoid signaling mediates oxytocin-driven social reward. *Proceedings of the National Academy of Sciences of the United States of America*, *112*, 14084–14089.
- Westwater, M. L., Fletcher, P. C., & Ziauddeen, H. (2016). Sugar addiction: The state of the science. *European Journal of Nutrition*, *55*, 55–69.
- White, N. M., & Carr, G. D. (1985). The conditioned place preference is affected by two independent reinforcement processes. *Pharmacology Biochemistry and Behavior*, *23*, 37–42.
- Williams, C. M., Rogers, P. J., & Kirkham, T. C. (1998). Hyperphagia in pre-fed rats following oral δ 9-THC. *Physiology & Behavior*, *65*, 343–346.
- Wong, K. J., Wojnicki, F. H. W., & Corwin, R. L. W. (2009). Baclofen, raclopride, and naltrexone differentially affect intake of fat/sucrose mixtures under limited access conditions. *Pharmacology Biochemistry and Behavior*, *92*, 528–536.
- Yu, L.-L., Zhou, S.-J., Wang, X.-Y., Liu, J.-F., Xue, Y.-X., Jiang, W., et al. (2011). Effects of cannabinoid CB₁ receptor antagonist rimonabant on acquisition and reinstatement of psychostimulant reward memory in mice. *Behavioural Brain Research*, *217*, 111–116.
- Ziauddeen, H., Farooqi, I. S., & Fletcher, P. C. (2012). Obesity and the brain: How convincing is the addiction model? *Nature Reviews Neuroscience*, *13*, 279–286.

V.3 Thermal and mechanical sensitivity in substance use and eating disorders



Hop field (Ittenheim, Alsace)

Increased mechanical sensitivity following alcohol or sucrose forced abstinence in mice

Gaëlle Awad¹, Anne-Sophie Aubry¹, Paul Chu Sin Chung², Isabelle Décosterd², Mary C. Olmstead³, Katia Befort¹

¹Université de Strasbourg, Laboratoire de Neurosciences Cognitives et Adaptatives (LNCA), Centre de la Recherche Nationale Scientifique, 12 rue Goethe, F-67000, Strasbourg France Euridol

²Pain Center, Department of Anesthesiology, University Hospital Center and University of Lausanne, Faculty of Biology and Medicine, Lausanne, Switzerland

³Department of Psychology, Center for Neuroscience Studies, Queen's University, Kingston, Ontario K7L 3N6, Canada

Introduction

Alcoholic neuropathy is a devastating condition since it affects 65% of alcoholic use disorder (AUD) patients in the USA and is largely resistant to treatment (Zeng et al., 2017). It occurs in the nervous system and is caused by damaged or injured neurons. It is characterized by hyperalgesia (enhanced sensitivity to pain) and allodynia (exaggerated pain response to a stimulus that does not normally elicit pain). Alcoholic neuropathy develops following long term excessive alcohol intake with patients usually complaining of pain in the extremities (Chopra & Tiwari, 2012). Alcohol has direct neurotoxic effects caused by its metabolites such as acetaldehyde, a known neurotoxin, or indirectly by nutritional deficiency, especially thiamine (or vitamin B1) resulting in oxidative stress (Chopra & Tiwari, 2012). Preclinical animal models of alcoholic neuropathy have shown possible mechanisms in the periphery such as reduced density of unmyelinated or small myelinated fibers (Koike et al., 2001), decreased nerve conduction (Bosch et al., 1979), and increased number of glial cells in the spinal cord (Narita et al., 2007). A few studies focused on brain mechanisms in pain related regions, identifying an increase of microglia in these sites (Hore & Denk, 2019).

Interestingly, elevated pain is also observed in individuals with eating disorders. Binge eating disorder (BED) a newly recognized eating disorder by the DSM-5, characterized by huge amounts of food intake in a short time and in the absence of compensatory behaviors is comorbid with painful conditions. Cross sectional studies providing community surveys reported significant associations between BED and chronic pain (Kessler et al., 2013a) and in a longitudinal study, recurrent binge eating was associated with chronic or frequent pain (Johnson et al., 2002). Unfortunately, the etiology of chronic pain in these individuals were not further analyzed. We only found an old case study on 2 female patients with anorexia and

bulimia nervosa in which they measured a lack of sural sensory nerve action potential detection (Alloway et al., 1985), a characteristic of demyelinating neuropathies (Surpur & Govindarajan, 2017).

Neuropathic pain involves a sensory experience as well as emotional and cognitive components (IASP), confirming involvement of both peripheral and central nervous systems. The latter may occur through the mesocorticolimbic reward network such as the nucleus accumbens, the ventral tegmental area and the prefrontal cortex contributing to the transition from acute to chronic pain. In parallel, the reward system is also implicated in BED (Boswell et al., 2021) and AUD (Volkow & Morales, 2015). Therefore, the reward network may play a major role in neuropathic pain comorbidities. The biological intersection between neuropathic pain, AUD and BED may involve neuroinflammatory signaling. Preclinical studies show neuroimmune signaling in brain reward involved in reward in spare nerve injured animal models (Chu Sin Chung et al., 2017; Taylor et al., 2017), in preclinical experiments of ethanol consumption, binge drinking and preference (Erickson et al., 2019) and in only one recent preclinical study showing that sucrose bingeing in rats produces microgliosis and morphological changes of the microglia in brain regions associated with reward (Patkar et al., 2021). However the close characteristics between BED and AUD may suggest similar underlying mechanisms (Schulte et al., 2017).

The goal of our study is first to model binge drinking and sucrose bingeing in male and female mice, allowing us to investigate sex difference in the progression of intake. In parallel we measured mechanical and thermal sensitivity to identify any dysregulation in nociceptive responses due to alcohol or sucrose intake in each sex. Finally, we looked at alcohol or sucrose deprivation effects on thermal and mechanical nociception and assessed the impact of withdrawal on nociceptive responses.

Materials and methods

Ethanol intake procedures

Animals and housing

Male (n=22) and female (n=23) C57BL/6J mice (Charles River Laboratories) were 4 weeks old upon arrival and housed 3 or 4 animals/cage under a 12-hour light dark cycle and standard temperature and humidity conditions ($22\pm 2^{\circ}\text{C}$, $55\pm 10\%$). After 2 weeks of acclimation to the environment, animals were isolated in $11,5 \times 29,5 \times 13$ cm (339 cm^2) cages and the following week habituated to a two-bottle choice paradigm. Mice were 8 weeks old. At the start of the experiment, females weighed between 16 and 20,9 grams, and males weighed between 19,5 and 23,3 grams at the beginning of the experiment. . Experiments were approved by the institutional ethics committee CREMEAS (Comité d’Ethique pour l’Expérimentation Animale de Strasbourg, France) (APAFIS#22688-2019110512492230).

Intermittent access to 20% ethanol 2-bottle choice

Ethanol (EtOH) 99.9% (Carlo Erba reagents) was dissolved in tap water (v/v) and delivered in tubes. This procedure is adapted from (Hwa et al., 2011). Mice were habituated to EtOH with access to 3% (Monday and Tuesday), 6% (Wednesday and Thursday) and 10% ethanol v/v (Friday, Saturday and Sunday) in a 2-bottle choice paradigm (Figure 14). For the next 8 weeks, the intermittent access group (IA group) received access to 20% ethanol for 24 hours every Monday, Wednesday and Fridays, beginning 2 hours after the start of the light cycle (Figure 14). EtOH intake, divided by body weight (mL/g and g/Kg), was measured 2 hours, 4 hours and 24 hours after access. To avoid side preferences, the placement (left or right) of the water and EtOH bottles were alternated each session. A control group with continuous access to EtOH (CA group) had access to 20% EtOH v/v in a 2-bottle choice paradigm for 8 weeks.

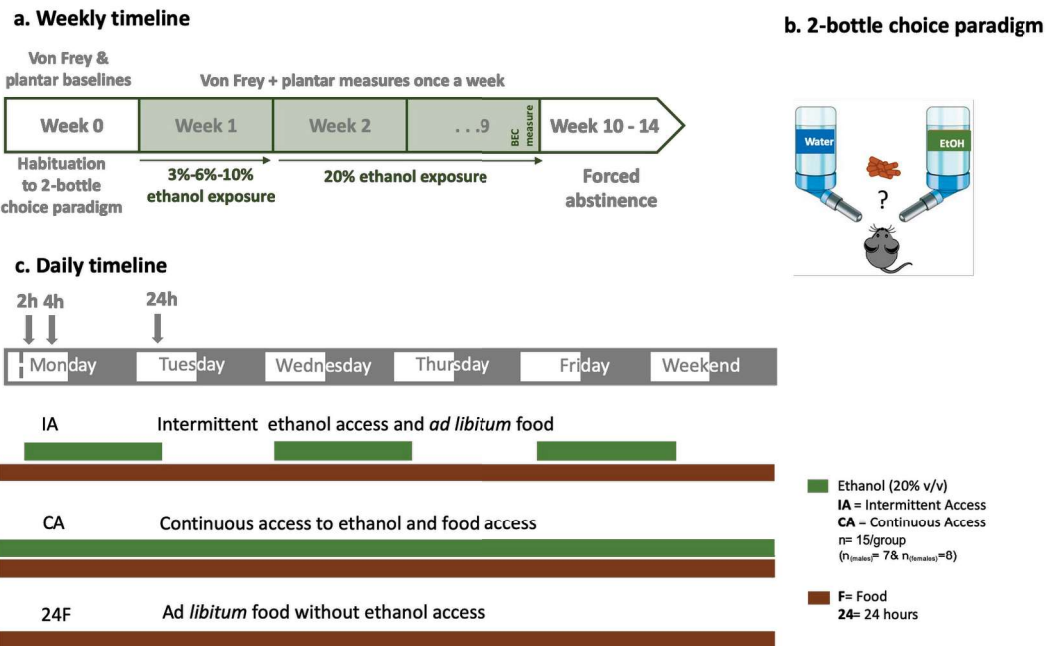

Figure 14 Binge drinking paradigm in mice. Experimental timeline for the intermittent access to ethanol on a weekly (a) or daily (c) basis in a 2-bottle choice paradigm (b). Animals were habituated to the 2 bottles both filled with water (week 0). On the same week, von frey (VF) and plantar baselines were measured. Week 1 was the habituation to EtOH with escalation concentrations of EtOH (3%, 6%, 10%). Week 2 to week 9, the intermittent access (IA) group had access to EtOH (in green) Every Other Day (EOD) on Mondays, Wednesdays and Fridays, and the continuous access (CA) group had access every day. EtOH access started 2 hours after the beginning of the light cycle. There was no food restriction (brown) in any group. Solution and food were measured 2, 4 and 24 hours after the start of access. Weight was measured on alternate days.

Blood Alcohol concentration analysis

On the last Wednesday of 20% ethanol access, 4 hours after the beginning of the access period, blood samples were collected from the submandibular vein (Figure 16). Tubes were centrifuged and serum was collected. NAD-ADH reagent was used for alcohol determination in blood (BAC, mg/dL). Briefly, alcohol dehydrogenase (ADH) catalyzes the oxidation of alcohol to acetaldehyde with the simultaneous reduction of nicotinamide adenine dinucleotide (NAD) to NADH. Calculations were based on 0.08% (w/v) EtOH standard (Figure 15).

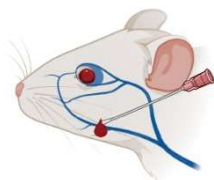

Figure 16 Blood collection from the submandibular vein in mice

Alcohol Concentration =

$$\frac{A_{340} \text{ Sample}}{A_{340} \text{ Standard}} \times \text{Concentration of ethanol std}$$

$$\text{Alcohol (mg/dl)} = \frac{A_{340} \text{ Sample}}{A_{340} \text{ Standard}} \times 80$$

Figure 15 Calculation of blood alcohol concentration. The calculation is based on EtOH 0,08% standard.

Sucrose intake procedures

Animals and housing

Male (n=21) and female (n=22) C57BL/6J inbred lab mice were housed 3 or 4 animals/cage under a 12-hour light dark cycle and standard temperature and humidity conditions ($22\pm 2^{\circ}\text{C}$, $55\pm 10\%$). Two weeks before the beginning of the access, animals were isolated in $11,5 \times 29,5 \times 13$ cm (339 cm^2) cages and the following week habituated to a two-bottle choice paradigm. Mice were 8 weeks old. Females weighed between 17,4 and 20,1 grams. Males weighed between 19,4 and 24,8 grams for males at the beginning of the experiment. Experiments were approved by the institutional ethics committee CREMEAS (Comité d’Ethique pour l’Expérimentation Animale de Strasbourg, France) (APAFIS#22688-2019110512492230).

Limited access to sucrose

Caster sugar (Erstein) was dissolved in tap water (w/v) and delivered in centrifuge tubes. This procedure is adapted from (Yasoshima & Shimura, 2015). For the next 2 weeks (Figure 17.a.), the limited access group (4SUC/24F group) received access to 17,1% sucrose for 4 hours every day during 2 weeks beginning 2 hours after the start of the light cycle (Figure 17.c.). A first control group with continuous access to sucrose (24SUC/24F group) had access to 17,1% solution w/v in a 2-bottle choice paradigm for 2 weeks. The second control group (24F) had no access to sucrose. Sucrose intake, divided by body weight (mL/g), was measured 1 hour, 4 hours and 24 hours after access. To avoid side preference, the placement (left or right) of the water and sucrose bottles was alternated each session (Figure 17.b).

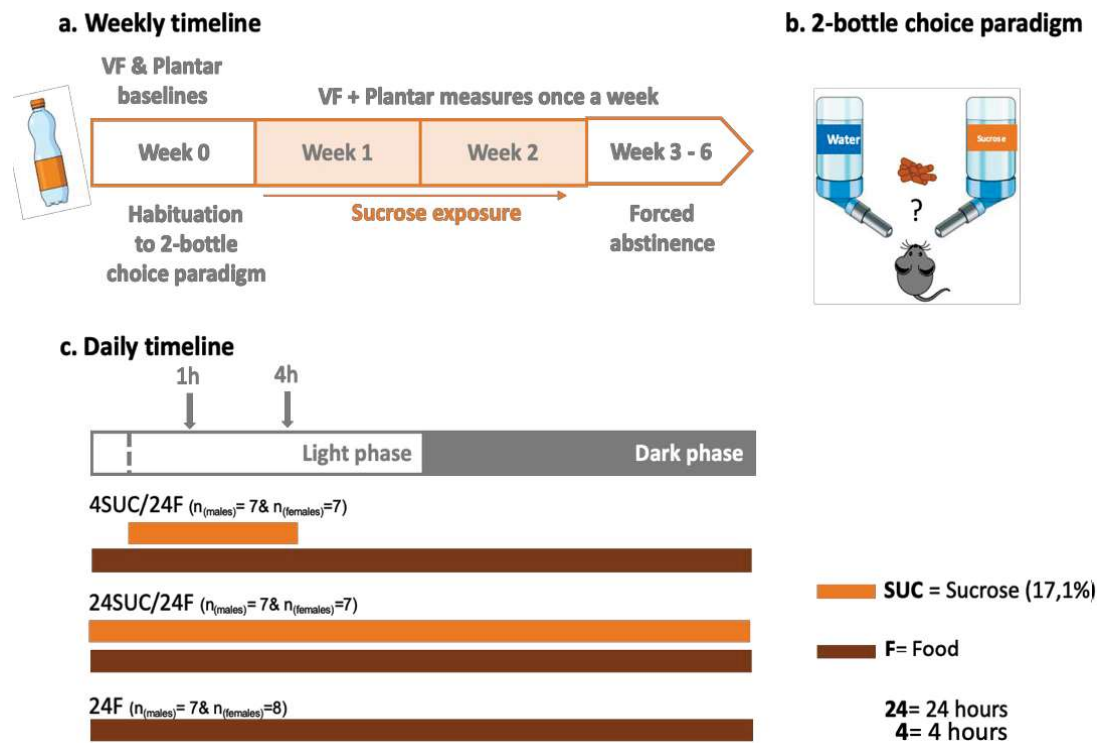

Figure 17 Sucrose bingeing paradigm in mice. Experimental timeline for the intermittent access to ethanol on a weekly (a) or daily (c) basis in a 2-bottle choice paradigm (b). Animals were habituated to the 2 bottles both filled with water (week 0). On the same week, Von Frey (VF) and plantar baselines were measured. Week 1 to week 2, the limited access (4SUC/24F) group had access to sucrose (in orange) every day for 4 hours and the continuous access group (24SUC/24F) had access every day. Sucrose access started 2 hours after the beginning of the light cycle. There was no food restriction (brown). Solution intake were measured 1 hour, 4 hours and 24 hours after the beginning of the access. Weight was measured before the start of the access. (4SUC: 4 hours access to sucrose; 24F: 24 hours access to food).

Assessment of mechanical sensitivity

Mechanical withdrawal thresholds were assessed using the Von Frey test on Tuesdays during the 8 weeks of ethanol access and the 5 weeks of forced abstinence. Animals were first habituated to the apparatus over 3 days. On the first day of habituation, mice were allowed to move freely on the wire mesh. On the second day of habituation, mice were placed in a chamber over the wire mesh. On the third day of habituation, mice were placed in the chamber on the wire mesh and the experimenter moved its hand around under the grid. Three baseline measures were done during week 0 during the 2-bottle choice habituation and the third measure was used for the following analysis (Figure 18).

The procedure was done as follows:

- Animals were placed in the chamber and had 20 minutes to acclimatize to the apparatus.
- The first filament 0,16 from the 6 monofilaments set (0,02-0,04-0,07-0,16-0,4-0,6-1-2) (Figure 18) was applied on the hind paw plantar surface following the Up Down method (Chaplan et al., 1994). The filament was correctly applied when it is bent.

-When the mouse responded, the lower filament was applied. If there was no response, the higher filament was applied.

-Each foot was stimulated 6 times and the scores were recorded on the scoring sheet (Figure 18).

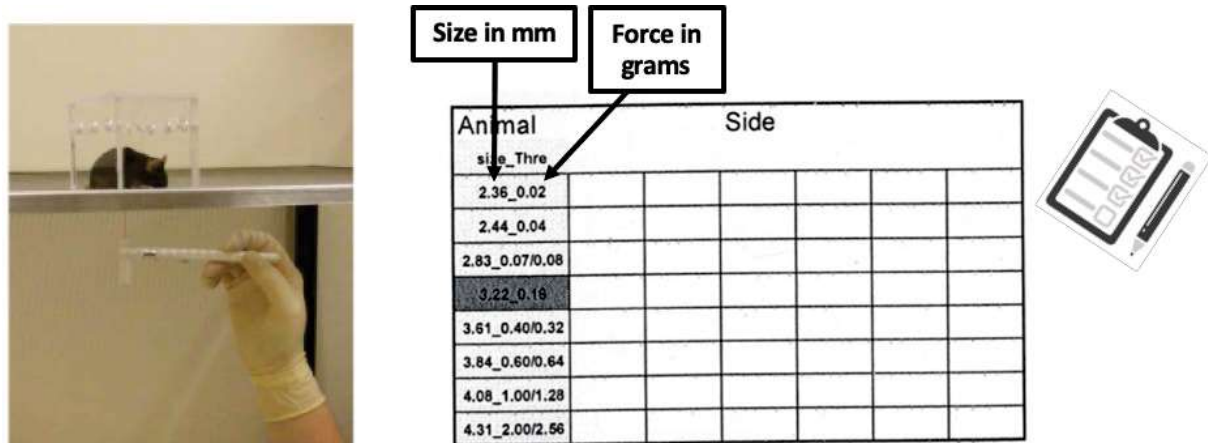

Figure 18 Von Frey apparatus and scoring sheet. Animals were on an elevated wire mesh, confined in a chamber. The experimenter applied the filament to the plantar surface of the mouse hind paw. If they responded, a filament with a smaller diameter was applied. This up and down procedure was repeated 6 times.

Assessment of thermal sensitivity

Thermal sensitivity was assessed using the plantar test on Thursdays during the 8 weeks of ethanol access and the 5 weeks of forced abstinence. Animals were first habituated to the apparatus described in (Figure 19) over 3 days. On the first day of habituation, mice were allowed to freely move on the glass plane. On the second day of habituation, mice were introduced in a chamber placed over the wire mesh. On the third day of habituation, mice were placed in the chamber and the experimenter moved the infrared emitter source for sound and movement habituation.

The procedure was done as follows:

- Animals were placed in the chamber and had 20 minutes to acclimatize to the apparatus.
- The infrared emitter source targeted the hind paw and detected paw withdrawal latencies in seconds. There is a cut off set at 20 seconds to avoid tissue damage. The same measure was repeated on the right hind paw.



Figure 19 The plantar apparatus is composed of an emitter of a laser beam, a glass panel and animal chambers.

Statistical analysis

Ethanol and sucrose consumption

We used RStudio (Version v1.3.1093) and the package lme4 to perform a linear mixed effects analysis. The dependent variable was sucrose, ethanol, kilocalories and water intake and weight evolution. The fixed effects part of the model is the interaction groups*sessions for the binge drinking experiment and groups*days for the sucrose bingeing experiment. The random effect part of the model is the subjects intercept. The intercept and the interaction estimates (e.g. the slope coefficient) reflect the difference from zero for the baseline level group. The other groups intercept and slope coefficient are compared to the baseline group. We used the linear mixed model analysis against the repeated measure ANOVA because it considers the correlated errors that result from multiple measurements per subjects, it can handle missing data as long as it meets the missing random definition and it can handle uneven spacing of repeated measurements.

Nociception

Thermal and mechanical sensitivity thresholds were assessed by a mixed ANOVA design using the Afex package from R, (Rstudio v1.3.1093). The fixed effects part of the model is the interaction groups*weeks. The random effect part of the model is represented by subject error divided by the within-subjects error which are the weeks since the same subjects are tested each week. When sphericity was violated (Machley's $p < 0,001$), the Greenhouse-Geisser correction was used. We checked the homogeneity of variance (Levene test, car package) and the normal distribution of the residuals (Shapiro, moments package). Data with non-normal distribution was transformed. If data were positively skewed we did a squared root, cubed root or logarithmic transformation. If data were negatively skewed, we did a square, a cubed root or logarithmic transformation. Post hoc analysis were conducted by multiple pairwise comparisons for the interaction groups*week (Emmeans package from R) using the Tukey correction method. We compared groups within each week and weeks within each group.

Blood Alcohol concentration

Blood alcohol concentration (BAC) was assessed using an ANOVA modelling the BAC as a function of group and sex. Normality and homogeneity of variance were checked

using the same tests mentioned earlier. Transformation was performed in non-normally distributed data according to the skewness of the distribution as described before.

Cluster analysis

Cluster analysis was used to identify high and low bingers in the ethanol procedures based on total intake over 4 hours across sessions. High and low drinkers were identified based on total daily intake across sessions. The data were partitioned into two groups generated with the k-means clustering using the factoextra package from RStudio (Version v1.3.1093). The goodness of the K means clustering is reported by the ratio Between Sum of Squares / Total Sum of Squares, the percentage representing the minimization of the Within Sum of Squares, to optimize intra class similarity and lower inter class similarity.

Correlation

Correlation analysis between 2 variables was performed using the Spearman method with the Corr package from RStudio (Version v1.3.1093).

Results

Intermittent access to ethanol induces binge drinking in male and female mice.

Figure 20.a. shows that IA and CA groups significantly escalated their ethanol intake over days in the first 2 hours of access (IA: $t= 7,038$; $df= 608,19$; $p=5,27.10^{-12}$; CA: $t=2,11$; $df= 609,13$; $p=0,035$). Moreover, the rate of escalation was significantly higher in the IA group (IA vs CA: $t= -3,56$; $df=608,65$; $p=4,02.10^{-4}$). In addition, intake of the IA group increased significantly over days during the first 4 hours of access (Figure 20.b.) ($t= 7,68$; $df= 607,82$; $p= 6,49.10^{-14}$) and was significantly higher than the CA group ($t= -4,54$; $df= 608,13$; $p= 6,67.10^{-6}$). Daily intake (Figure 20.c.) was significantly increased in both IA ($t=10,68$; $df=607,33$; $p<2.10^{-16}$) and CA ($t=6,43$; $df=607,67$; $p=2,56.10^{-10}$) groups.

The differences reported above are not biased by measurements being taken during the light cycle. As shown in Supplementary Figure 1a and b, daily ethanol intake patterns were equivalent between IA and CA groups. Even though the pattern was the same, the IA group drank more than the CA group on EOD (Supplementary figure 1 f.). Analysis of sex differences (Figure 20.d.) showed that rate of daily intake of females was significantly higher than males in both IA ($t=-2,54$; $df= 303,26$; $p= 0,012$) and CA ($t=-2,14$; $df= 302,71$; $p= 0,033$)

groups. However, no sex differences were found after 2 hours and 4 hours of access (Supplementary figure 2).

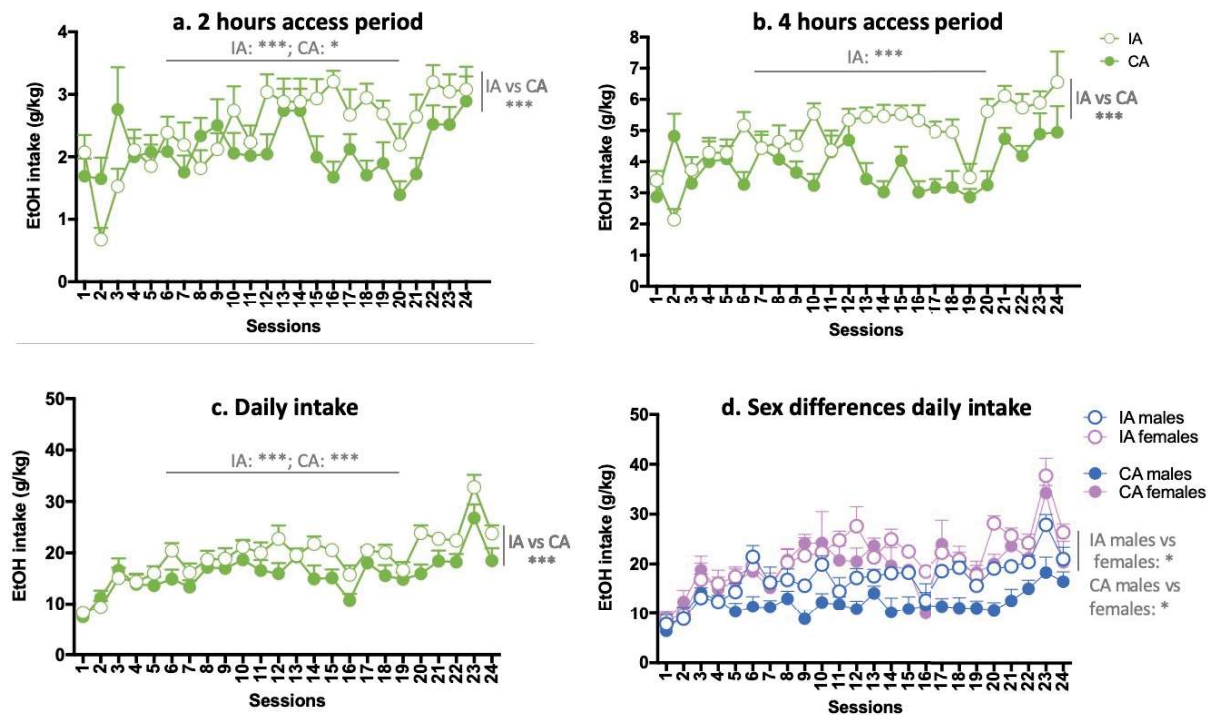

Figure 20. Data corresponds to EtOH intake (g/Kg) on every other day (EOD) which corresponds to IA EtOH access days. **a.** IA and CA groups escalate significantly their EtOH intake after 2 hours of access. IA escalation rate is significantly higher than CA mice. **b.** IA escalates significantly their EtOH intake after 4 hours of access and is significantly higher than CA mice. **c.** IA and CA groups show a significant EtOH daily intake escalation, IA group significantly higher than CA. **d.** Females increase their intake across the 8 weeks at a higher rate than males in both IA and CA groups. ***: $p < 0,001$; **: $p < 0,01$; *: $p < 0,05$.

Identification of clusters

We performed k-means clustering to identify high and low ethanol drinkers within the IA and CA groups. Because 2 hours, 4 hours and 24 hours total ethanol intake across the 2 months are dependent, we determined clusters for each variable separately and compared how much clustering minimizes the sum of squares within (SSW) by comparing the division of between sum of squares (SSB) with the total sum of squares (SST). For the IA group, by assigning 2 clusters for the 2 hours and 4 hours ethanol intake data (g/Kg), we achieved a reduction of SSW of 76.,4%. However, for the CA group, assigning 2 clusters to the 2 hours ethanol intake data (g/kg) achieved a reduction of SSW of 61.,5%, and for the 4 hours ethanol intake data a reduction of 68.,6%.

The division of high and low drinkers was finally based on 4 hour intake for the following reasons: The blood ethanol concentration measures were done at 4 hours after the beginning of access on the testing day. Furthermore, with the 4 hours data the within group

difference was minimized and between group dispersion was maximized. Figure 21 shows total intake over 2 hours and 4 hours EOD as well as the total daily intake for each cluster within each group. IA high drinkers were significantly higher than IA low drinkers in total EtOH intake after 2 hours ($df=26$; $t=3,35$; $p=0.0025$) and 4 hours of access ($df=26$; $t=5,059$; $p<0,0001$), although total daily intake did not differ. The CA high drinkers were significantly higher than the low drinkers ($df=26$; $t=2,854$; $p=0,0084$). In the IA group, 7 out of 8 high drinkers were female mice and in the CA group all high drinkers were females. Moreover, the CA high drinkers were not significantly different from the IA high and low drinkers at 2 and 4 hours. In fact, even though the IA mice drank more in terms of overall intake than CA mice on EOD (Supplementary figure 1), if we repeat the analysis separating the clusters, the significant difference was only found between IA high drinkers and CA low drinkers ($p=0,019$).

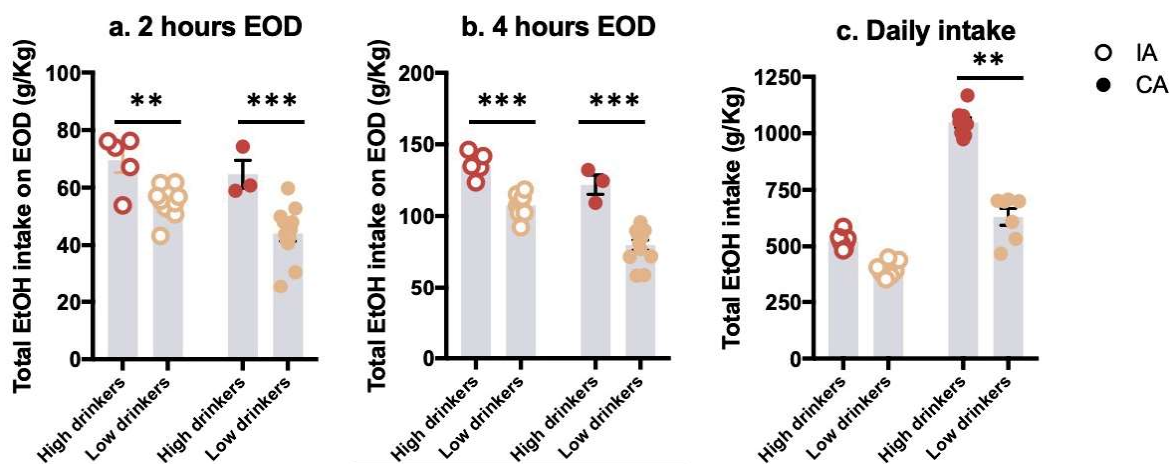

Figure 21 High and low drinkers total intake across the 8 weeks of access after 2 hours (a), 4 hours (b) and 24 hours (c) of access. High and low drinkers defined by the total intake at 4 hours show a significant difference at all measurement timepoints in the CA group (a,b,c). The IA group shows a significant difference between the high and low drinkers after 2 hours and 4 hours of access (a,b) but not in total daily intake (c). ***: $p<0,001$; **: $p<0,01$; *: $p<0,05$.

Blood alcohol concentration (BAC) from the IA, CA and 24F groups.

After 4 hours of cumulative drinking in the IA and CA groups on the day before the final session, BAC was analyzed. The raw data did not fulfill the ANOVA assumptions (homogeneity of variances and normality), so we did a cube root transformation since data were positively skewed. We found a statistical difference for BAC by running ANOVA 2 factors group*sex, according to the independent variable group ($F_{(2,34)}=5,146$; $p=0,011$), sex ($F_{(1,34)}=11,859$; $p=0,0015$), and the interaction between both independent variables ($F_{(2,34)}=9,719$; $p=0.00046$). BAC was higher in females from the IA ($p=0,00041$) and CA

($p=0,0015$) groups than females from the 24F group (Figure 22 b.). BAC was higher in females than in males in IA group ($p=0,0034$) and in CA group ($p=0,019$).

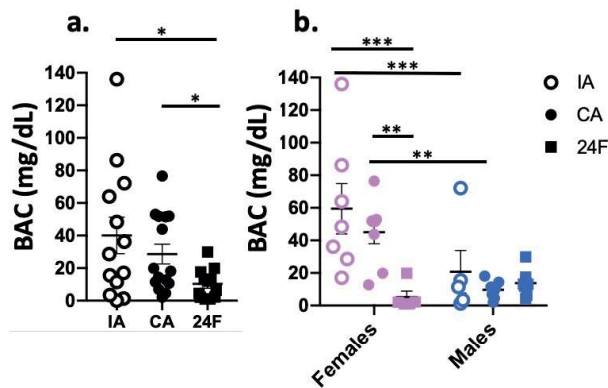

Figure 22 Blood alcohol concentration 4 hours after the beginning of EtOH access in the IA group. BAC was measured on the last week of EtOH access in the serum. a. There was a significant increase of BAC in the sucrose access groups compared to 24F. b. There was a significant interaction effect between group and sex. IA females were significantly higher than the 24F females and the IA males. IA females are significantly higher than the 24F females and the CA females. No differences were found between the males. BAC: blood alcohol concentration. ***: $p < 0,001$; **: $p < 0,01$; *: $p < 0,05$.

K means cluster analysis was performed on BAC measures, groups IA and CA combined, according to the BAC and the 4-hour ethanol intake variables on the test day. The high ethanol and BAC mice, named cluster 1 in Figure 23 a. includes 11/30 mice, 5 of them from the IA group. IA sex distribution in cluster 1 is partitioned as 1/7 male mice and 5/8 female mice are in cluster 1 (Figure 23 c.). In the CA group, 6/15 are in cluster 1, all of them being females (Figure 23 c.). Therefore, most of the cluster 1 are female mice with a highest proportion from the CA group. Correlational analysis revealed that there was a positive significant correlation between ethanol intake and BEC ($r=0,39$; $p=0,042$), the positive slope is represented by the trend line in red (Figure 23 b.)

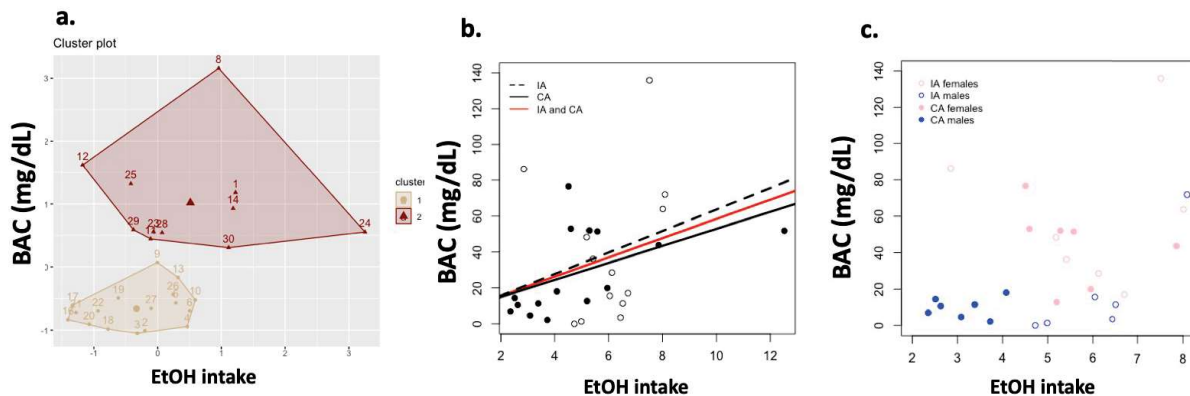

Figure 23.a. Cluster identification according to BAC and total 4 hours EtOH intake in IA and CA groups combined. The SSB/SST ratio was 69,4%. b. Correlation between BAC and EtOH 4 hours total intake is represent in dotted lines for the IA group, full black line for CA group and red line for both groups combined. c. Scatter plot representing the males and females

from IA group (blue and pink open circles respectively) and males and females from the CA group (blue and pink circles). EtOH: ethanol, BAC: blood alcohol concentration.

Nociception results

We evaluated mechanical and thermal sensitivity in mice each week during ethanol exposure and forced abstinence. The graphs in Figure 24 show nociception results during the third baseline level and during the first and before the last week of EtOH access (week 2 to week 8) and forced abstinence (week 10 to week 14). Figure 24 a. shows that withdrawal from alcohol increased mechanical sensitivity between the last week of EtOH access and the last week of forced abstinence in IA ($t= 3,501$; $df= 41$; $p=0,0094$) and CA groups ($t= 3,019$; $df= 41$; $p=0,033$). We also compared pain sensitivity between the clusters (Figure 23 c.). Only IA high drinkers increased mechanical sensitivity between the last weeks of EtOH access and forced abstinence ($t=3,95$; $df=25$; $p=0,0046$).

Withdrawal from alcohol increased thermal sensitivity (Figure 24 b.) in the CA group between the baseline and the last week of withdrawal ($t= 3,32$; $df= 42$; $p=0,015$) and week 2 and the last week of withdrawal ($t= 3.233$; $df= 42$; $p=0,019$). Moreover, the CA low drinkers were significantly different from the IA high ($t=2,93$, $df=26$, $p=0,033$) and low ($t=2,99$, $df=26$, $p=0,029$) drinkers (Figure 24 d.).

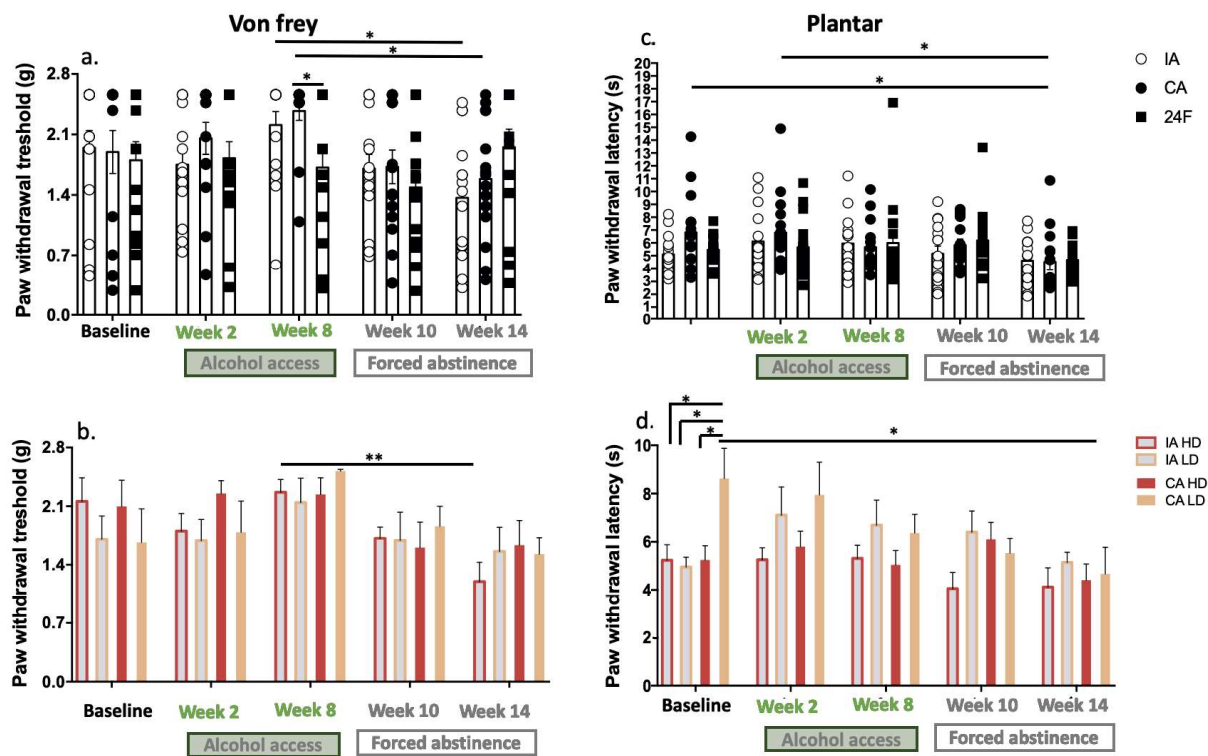

Figure 24. Mechanical and thermal sensitivity following EtOH intake. a. Both EtOH access groups IA and CA showed increased mechanical sensitivity between week 8 (before the last week of EtOH access) and week 14 (last week of EtOH forced abstinence). b. Comparison within the clusters shows that high drinkers of the IA group showed a significant decrease between week 8 and week 14. c. Thermal sensitivity was increased in the CA group between the third baseline and the last week of forced abstinence (week 14) and between the 1st week of EtOH 20% access (week 2) and week 14. d. Low drinkers from the CA group shows a higher 3rd baseline compared to all the other clusters. CA low drinkers significantly increased thermal sensitivity between the 3rd baseline and the last week of forced abstinence. IA HD: Intermittent Access High Drinkers; CA HD: Continuous Access High Drinkers; IA LD: Intermittent Access Low Drinkers; CA LD: Continuous Access Low Drinkers. ***: $p < 0,001$; **: $p < 0,01$; *: $p < 0,05$.

Limited access to sucrose induces binge intake

Figure 25 a. shows that limited access to a sweet solution induces binge intake. The 4SUC/24F group significantly escalated sucrose intake across 14 days during the first hour of access ($t=7,935$; $df=3,64.10^2$; $p=2,63.10^{-14}$). In contrast, the control group 24SUC/24F significantly decreased sucrose intake over days during the first hour ($t=-2,68$; $df=3,64.10^2$; $p=0,00763$). Moreover, the rate of escalation was significantly different between the 4SUC/24F group and the 24SUC/24F group during the first hour ($t=-7,508$; $df=3,64.10^2$; $p=4,67.10^{-13}$) and after 4 hours ($t=-9,744$; $df=3,64.10^2$; $p<2.10^{-16}$) across days (Figure 25 a.b.). The evolution rate of daily intake across the 14 days (Figure 25 c.) increased significantly in the 4SUC/24F group ($t=3,73$; $df=3,64.10^2$; $p=0,00023$) while it decreased in the 24SUC/24F group ($t=-5,24$; $df=3,64.10^2$; $p=2,79.10^{-7}$). Moreover, the evolution rate of daily intake was significantly different between 4SUC/24F and 24SUC/24F ($t=6,34$; $df=3,64.10^2$; $p=6,98.10^{-10}$) groups. Sex differences were only observed in the 4SUC/24F group during the first hour of

access (Figure 25 d.), males showing a higher escalating rate than females ($t=1,99$; $df=1,82.10^2$; $p=0,048$).

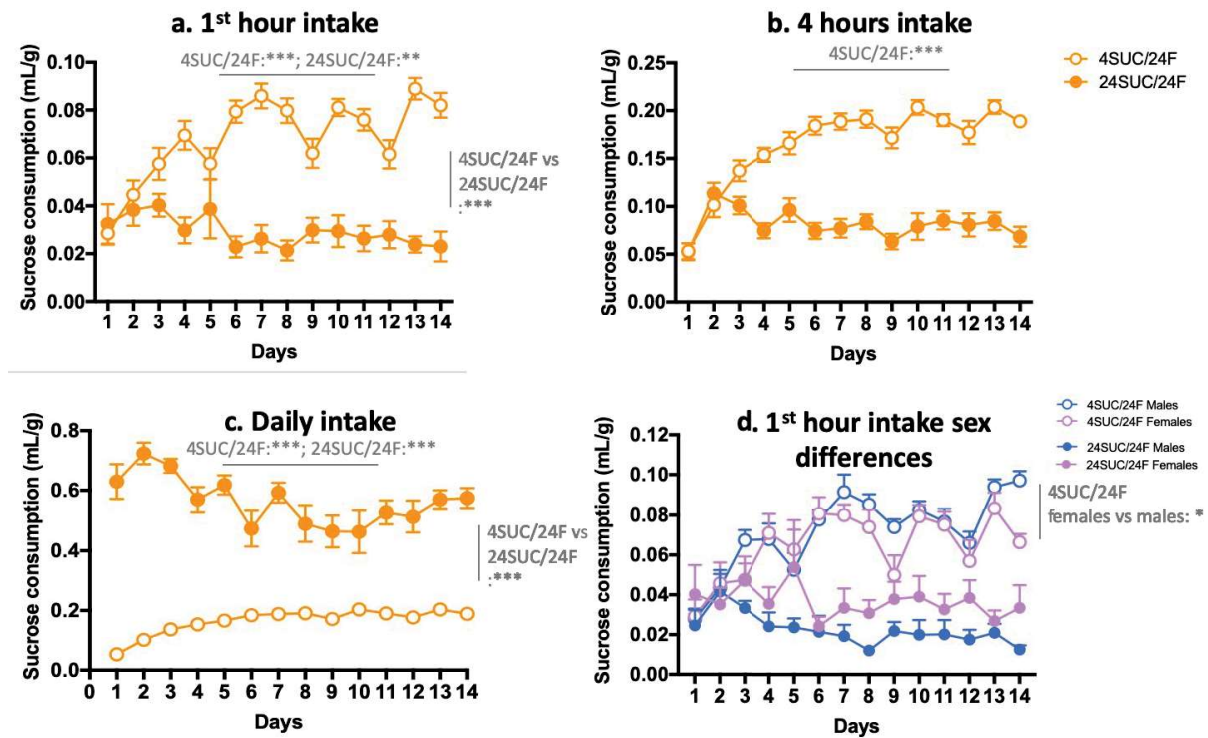

Figure 25 Sucrose intake in mL/Kg. a. Mice with limited access to sucrose (4 hours/day) showed a significant escalation of the intake during the first hour of access as well as in the control group 24SUC/24F. The escalation was significantly higher in the 4SUC/24F group compared to 24SUC/24F. b. 4 hours intake significantly increased across days in the 4SUC/24F group. 4SUC/24F daily intake significantly increased while it significantly decreased in the 24SUC/24F group. Moreover the rate was significantly different between both groups. d. Escalation rate was significantly higher in males than females during the 1st hour of intake in the 4SUC/24F group. ***: $p < 0,001$; **: $p < 0,01$; *: $p < 0,05$.

We tried to partition data into high and low drinkers using k means clustering. However, by assigning the data to 2 clusters, we only achieved a reduction of the sum of squares of 56,9% in the 4SUC/24F group, and 69,9% in the 24SUC/24F group in total first hour intake, as well as a reduction of 72,6% for 4SUC/24F and 59,9% or 24SUC/24F in total daily intake data. By partitioning data of the percentage of weight intake (calculated as $(\text{weight}_{\text{day 14}} - \text{weight}_{\text{day 1}} / \text{weight}_{\text{day 14}}) \times 100$) into 2 clusters, we achieved a reduction of SST of 72,9% for the 4SUC/24F and 71,9% for the 24SUC/24F groups. However, these clusters did not partition the data according to other variables like sex (Supplementary figure 3).

Figure 26 a. shows a significant weight gain across the 14 days only in the CA group 24SUC/24F ($t=6,76$; $df=543,99$; $p=3,57.10^{-11}$). The 24F control group decreased bodyweight during the 2 weeks in a significant manner ($t=-2,32$; $df=543,99$; $p=0,021$), but the rate was significantly lower than the 24SUC/24F group. Intake of the limited access group, 4SUC/24F,

was stable across the 14 days. Figure 26.b. shows that limited and continuous access to sucrose decreased water intake. Interestingly, the rate of intake across the 2 weeks was significantly negative in the 24F control group ($t=-4,42$; $df=5,590.10^2$; $p=1,17.10^{-5}$) and significantly different from 4SUC/24F ($t=-2,68$; $df=5,59.10^2$; $p=0,0077$) and 24SUC/24F ($t=3,31$; $df=5,59.10$; $p=0,00099$). While the 24SUC/24F group significantly decreased their daily rate of sucrose intake (Figure 25.c.), they significantly increase their daily chow intake rate ($t=2.96$; $df=4,99.10^2$; $p=0,0032$) (Figure 26.c.). While 4SUC/24F significantly increased their sucrose daily intake figure 10.c. they decreased their daily chow intake. These results are in line with the stable kilocalories intake Figure 26.d. for 24SUC/24F ($t=-0,30$; $df=4,62.10^2$; $p=0,77$) and 4SUC/24F ($t=-0,063$; $df=4,61.10^2$; $p=0,95$) groups. On the other hand, 24F mice significantly decrease their daily kilocalories intake across the days ($t=-3,98$; $df=4,61.10^2$; $p=8,15.10^5$).

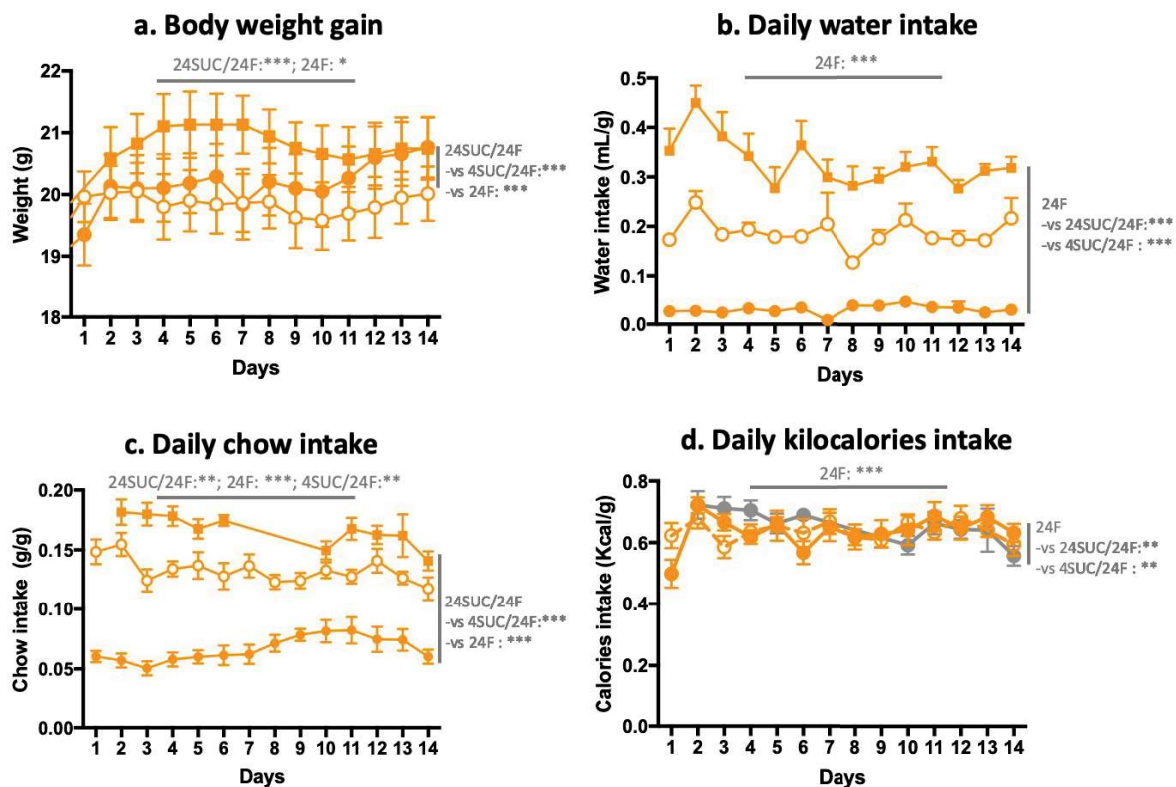

Figure 26 Body weight gain and consumption of chow and water and total calories intake across the 14 days a. Weight significantly increased in both control groups, 24F and 24SUC/24F. the continuous access group 24SUC/24F rate of increase was significantly different to weight evolution rate of the 4SUC/24F and 24F groups. The level of daily water intake was significantly higher in the 24F group compared to the 4SUC/24F and 24SUC/24F groups (intercept). 24F decreases water intake across the days. c. Daily chow intake was significantly increased in the 24SUC/24F group and significantly decreased in the 4SUC/24F and 24F groups. d. Daily calories intake significantly decreased in the 24F groups and was significantly different than the rate of calories intake for 4SUC/24F and 24F groups. ***: $p < 0,001$; **: $p < 0,01$; *: $p < 0,05$.

We evaluated mechanical and thermal sensitivity in mice each week during the 2 weeks of sucrose exposure and 4 weeks of forced abstinence. The graphs in Figure 27 show

the third baseline level, the first and the last week of sucrose access and forced abstinence. Figure 27 a. shows that withdrawal from sucrose increased mechanical sensitivity between the first week of sucrose access and the last week of forced abstinence in 4SUC/24F ($t= 3,56$; $df= 40$; $p=0,0083$) and 24SUC/24F ($t= 3,045$; $df= 40$; $p=0,032$) groups. The 4SUC/24F group also increased their sensitivity between the second week of exposure and the last week of forced abstinence ($t= 3,65$; $df= 40$; $p=0,0064$). We also evaluated sex differences (Supplementary figure 4) , showing that there was a decrease of sensitivity in the 24F control group but only in males between the last week of sucrose access and the last week of forced abstinence ($t=2,903$; $df=37$; $p=0,046$). Only females from the 24SUC/24F ($t=3,022$; $df=37$; $p=0,035$) and 4SUC/24F ($t=3,972$; $df=37$; $p=0,0028$) groups show decreased mechanical sensitivity between the first week of sucrose access and the last week of forced abstinence, and between the last week of sucrose access and the last week of forced abstinence for 4SUC/24F females ($t=3,32$; $df=37$; $p=0,017$).

Figure 27 b. shows that 4SUC/24F group decreased threshold of thermal sensitivity between the first week of access and the first week of forced abstinence ($t= 2,88$; $df= 40$; $p=0,047$).

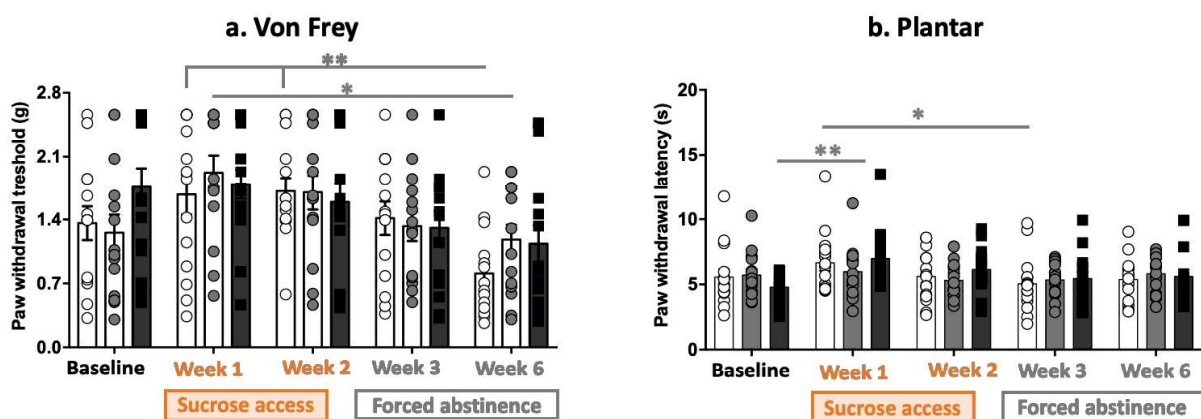

Figure 27 Mechanical and thermal sensitivity during and following sucrose bingeing. The significant decrease between baseline and week 1 thermal sensitivity is explained by data from males ($t=-3,7$; $df=37$; $p=0,0059$) but not females ($t=-0,073$; $df=37$; $p=1$). ***: $p< 0,001$; **: $p< 0,01$; *: $p< 0,05$.

Discussion

In this present study, we show that alcohol deprivation, following either continuous or intermittent access to the drug, significantly decreases nociceptive sensitivity threshold to a mechanical stimulus. In contrast, the threshold to respond to heat stimuli was decreased only in animals that had continuous alcohol access prior to deprivation. This suggests that high

alcohol bingeing (i.e.: displayed by the IA group) may alter sensitivity to mechanical, but not thermal, stimuli during withdrawal. Alcohol induced sensitivity seems to be determined by the amount of EtOH consumption since only mice with higher EtOH intake in the IA group showed significant decreases in mechanical nociceptive sensitivity threshold. The effect could reflect sex differences in that there was a higher proportion of females than males in the IA high drinkers group. This makes it important to highlight sex-specific patterns of alcohol consumption since EtOH withdrawal induced hyperalgesia in preclinical (Dina et al., 2006; Gatch, 1999, 2002) and clinical studies (Jochum et al., 2010) only focus on males.

In a previous study, male mice had higher baseline thermal nociceptive thresholds (tail flick and hot plate tests) than females (Mitrovic et al., 2003). It is well documented that alcohol alleviates pain (Egli et al., 2012). Since females exhibit higher drinking levels than males, they might be more sensitive to the nociceptive stimuli or less sensitive to alcohol analgesic effects. Therefore, to counteract these potential effects, they would drink more and wipe out the sex effect in Von Frey and Hargreave's tests. This could explain the absence of significant sex differences in nociceptive measures. However, our baseline measures did not show sex differences other than in CA group for Hargreave's test ($p=0,038$). To our knowledge, no studies looked at sex differences to tolerance of alcohol induced analgesia.

Pain is modulated by central nervous system which acts as a top down control, such as the mesocorticolimbic reward network, especially the prefrontal cortex (Maleki et al., 2019). To date, there is little evidence on the neuroimmune responses between pain and AUD intersection. However, we do know that alcohol modulates neuroimmune signaling differently such as the chemokine network between in males and females (Y. Blednov et al., 2005) and throughout the mesocorticolimbic circuit with increased astrogliosis and reduced number of neurons following alcohol treatment which tends to be higher in females than males or differently expressed cytokines in region and sex dependent manner (Alfonso-Loeches et al., 2013; Baxter-Potter et al., 2017). These previous results could support our hypothesis in that females show more brain damage in response to alcohol intake, which might increase nociception and therefore alcohol intake for its analgesic effects allowing same level responses as males. Another explanation to higher drinking levels in females is that alcohol is also consumed to alleviate aversive emotional states (Koob, 2021). It is already documented that emotional experience such as anxiety and mood impairments are associated with pain in patients with alcohol disorders (Maleki et al., 2019). Negative affect is more associated with

initiation, maintenance and relapse in AUD in females than males in preclinical and clinical studies (Peltier et al., 2019). Moreover, the course and negative consequences of alcoholism were also shown to be significantly faster (telescoping effect) and higher in women (Diehl et al., 2007). For the next experiments we should therefore measure anxiety and depressive like behaviors and see whether they correlate with the amount of alcohol consumed or the BAC.

Our results provide new insight into the relationship between binge eating and nociception using a validated preclinical model of sucrose bingeing. Compared to thermal nociception, thresholds for mechanical nociception were decreased for a shorter period following sucrose bingeing, suggesting that mechanical and thermal nociceptors might be differently affected by sucrose intake. Males escalated significantly faster than females in sucrose intake during the first hour of access in the 4SUC/24F group. This results is in conflict with sucrose bingeing studies in rats (Smail-Crevier et al., 2018) and our own results from previous cohorts. This might either be a cohort effect or due to the stress induced by the nociceptive tests. Moreover, decrease of mechanical threshold was only observed in females 24SUC/24F, which might be interpreted as a sign of negative emotional state.

Since AUD, BED and neuropathic pain involve the reward circuit, there are several interesting points to look at for future studies. One would investigate the neuroimmune mechanisms underlying these 3 disorders in the reward circuit; identifying commonalities could help in understanding the development of comorbidities (Hildebrandt et al., 2021; Maleki et al., 2019). Targeting similar mechanisms between comorbidities would probably allow better outcomes in therapeutic interventions since one disorder can lead to relapse of another. Therefore, individuals with co-occurring AUD or BED with neuropathic pain pose a unique challenge in the development of therapeutic strategies.

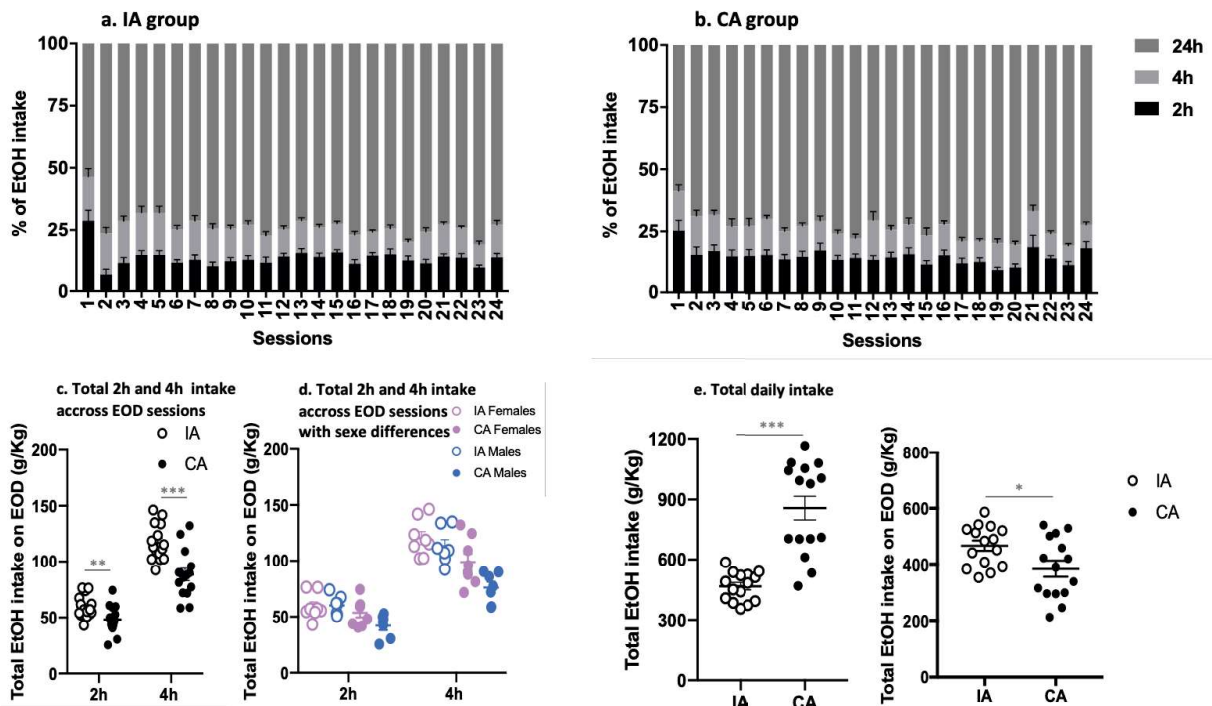

Supplementary figure 1 a&b IA and CA mice drink 13,8% and 14,7% of their total EtOH intake after 2 hours of access respectively (black histograms). IA and CA groups drank 26,9% and 26,5% of their total EtOH intake after 4 hours of access respectively (light grey histograms). Mice from IA and CA groups consumed EtOH during the light cycle. c. On EOD, total intake was significantly higher in the IA than CA group after 2 hours ($p=0,0089$) and after 4 hours ($p=9,2 \cdot 10^{-7}$). d. There were no significant sex effects in 2 hours total intake. In 4 hours total intake there was a significant sex effect, females drinking more than males ($F(1,26)= 5,81$; $p=0,023$), but no significant interaction. e. The CA group drank significantly more across all access periods than the IA group ($p=6,32 \cdot 10^{-34}$) but the IA drank more on EOD ($p=0,023$). f. In EOD daily EtOH access the IA group was significantly higher than the CA group. ***: $p < 0,001$; **: $p < 0,01$; *: $p < 0,05$.

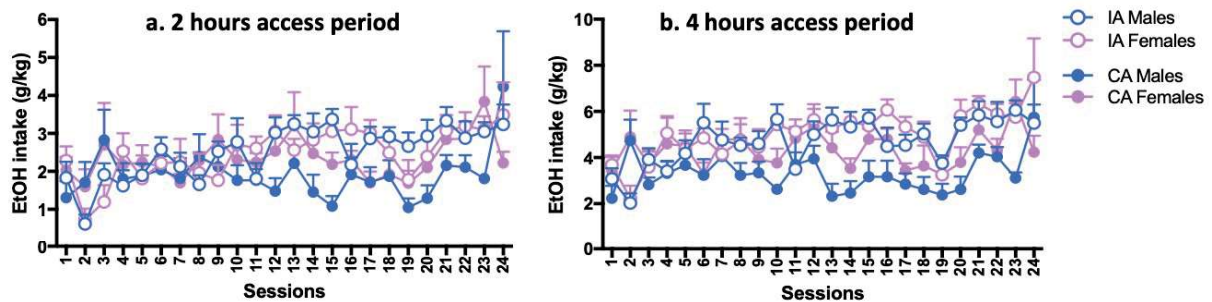

Supplementary figure 2 Sex differences after 2 hours and 4 hours of access. No sex differences were observed after 2 or 4 hours of access.

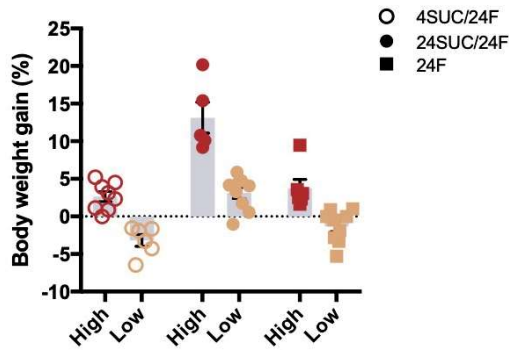

Supplementary figure 3. Body weight gain in cluster. K means clustering in 2 samples High and Low percentage of weight across the 14 days of access were performed within each experimental group.

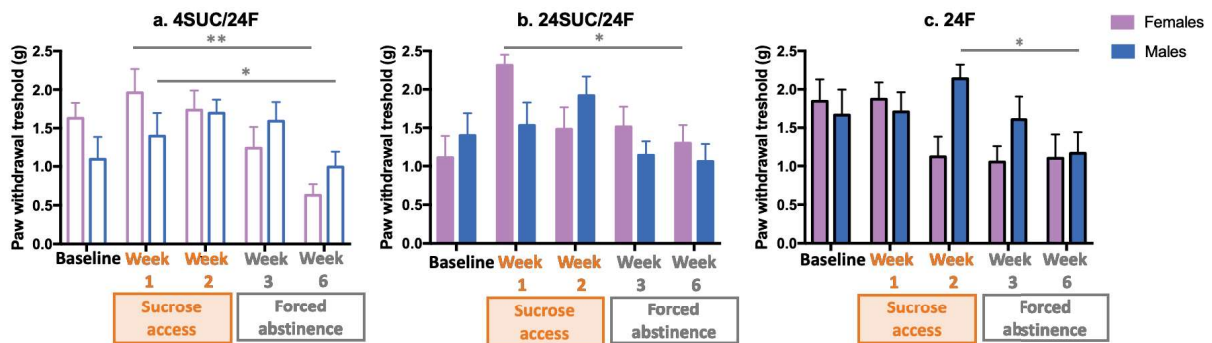

Supplementary figure 4. Sex differences in mechanical sensitivity. a. Both males and females increased mechanical sensitivity between the 1st week of sucrose access and last week of forced abstinence, week 6. b. Only 24SUC/24F females increased sensitivity between week 1 and week 6. Only 24F males increased mechanical sensitivity between week 2 and week 6. ***: $p < 0,001$; **: $p < 0,01$; *: $p < 0,05$.

Acknowledgments

This project was supported by the Université de Strasbourg, Centre National de la Recherche Scientifique (CNRS), Programme International de Cooperation Scientifique (PICS CNRS), the French National Research Agency (ANR) through the Programme d'Investissement d'Avenir (ANR- 17-EURE-0022, Euridol, graduate school of pain), IRESP (Institut pour la recherche en santé publique, IReSP/INCa-21-Addiction), and the Natural Sciences and Engineering Research Council of Canada (NSERC) . Gaëlle Awad received a PhD fellowship from the French Ministère de l'Enseignement Supérieur et de la Recherche.

V.4 Binge eating : a risk factor for addiction ?



Sugar beet field (Eschau, Alsace)

Ethanol preference and neuroinflammation in sucrose bingeing mouse model

Gaëlle Awad¹, Anne-Sophie Aubry¹, Mary C. Olmstead², Katia Befort¹

¹Université de Strasbourg, Laboratoire de Neurosciences Cognitives et Adaptatives (LNCA), Centre de la Recherche Nationale Scientifique, 12 rue Goethe, F-67000, Strasbourg France
Euridol

²Department of Psychology, Center for Neuroscience Studies, Queen's University, Kingston, Ontario K7L 3N6, Canada

Introduction:

Binge eating disorder (BED), which affects 1.4% of females and 0.4% of males (Erskine & Whiteford, 2018), is characterized by excessive consumption of food, usually high in sugar and/or fat (Hildebrandt et al., 2021; Yanovski et al., 1992), within a short period of time. Bingeing episodes are typically accompanied by a sense of loss control over food intake (Colles et al., 2008; Latner & Clyne, 2008). BED was recognized as a distinct eating disorder in 2013 by the Diagnostic and Statistical Manual of Mental Disorders (DSM)-5 after being part of Eating Disorders Not Otherwise Specified (EDNOS) in the DSM-IV. Today, no effective therapeutic strategies exist to treat BED.

BED and substance use disorders (SUD) are commonly comorbid (Yanovsky 2013; Hudson et al., 2008; Wilfley et al., n.d.). For example, the lifetime prevalence of alcohol use disorder (AUD) in BED individuals is 19.9% (Bogusz et al., 2021). AUD usually develops after a diagnosis of BED suggesting that excessive food intake may precipitate the onset of excessive alcohol consumption. If this is true, BED patients may be using alcohol as a coping mechanism as individuals with this disorder report high levels of distress and negative affect (Haedt-Matt & Keel, 2011). In addition, BED individuals use psychoactive substances, especially alcohol, to regulate negative emotions (Azevedo et al., 2021). The relationship between BED and alcohol consumption may also explain poor treatment outcomes in that the severity of symptoms is increased in comorbid conditions (Becker & Grilo, 2015). At least some preclinical studies support the hypothesis that BED may exacerbate the development of AUD: high fat bingeing increases ethanol consumption and motivation to obtain the drug (Blanco-Gandía et al., 2017), with the effect continuing during forced cessation from high fat bingeing (Blanco-Gandía et al., 2018). Sucrose bingeing also increases subsequent ethanol intake in rodents (Avena et al., 2004b).

The high comorbidity of AUD and BED could be explained by a shared dysfunction in neurobiological mechanisms that underlie these disorders. For example, at the behavioral level both are associated with negative affect such as depression and anxiety (Ferriter & Ray, 2011). Individuals suffering from these disorders often engage in drinking or eating to regulate negative emotions (Cooper et al., n.d.; Jackson et al., 2003). In addition, neuroimaging studies reveal increased blood flow in the prefrontal cortex of BED and AUD patients exposed to food- or alcohol-associated cues respectively (George et al., 2001; Karhunen et al., 2000). Most notably, both BED and AUD are linked to alterations in brain reward systems, specifically mesocortical dopamine function (Boswell et al., 2021). In both disorders there is a transition of dopaminergic neurotransmission that progresses from a reward driven behavior localized in the ventral striatum to a goal (dorsomedial) and then habitual (dorsolateral) driven behavior possibly mediating the transition from goal-directed to compulsive behaviors (Everitt & Robbins, 2013; Furlong et al., 2014).

Overconsumption of refined carbohydrates and saturated fat may influence brain reward mechanisms by inducing neuroinflammation (Jamar et al., 2020). For example, high fat (De Souza et al., 2005a; Décarie-Spain et al., 2018; Thaler et al., 2012) and high sucrose (Fuente-Martín et al., 2013; Gao et al., 2017) diets increase neuroimmune signaling in the nucleus accumbens and the lateral hypothalamus. In the same manner, genetic, pharmacological, and behavioral studies point to neuroimmune signaling in reward pathways involved in alcohol addiction (Erickson et al., 2019). Based on this evidence, we proposed that excessive intake of high fat/high sugar induces neuroimmune signaling in brain reward regions, thereby impacting behavioral responses to alcohol.

The primary aim of this study was to evaluate the influence of sucrose bingeing on ethanol reward. To do so, we measured ethanol reward in the conditioned place preference (CPP) paradigm following sucrose bingeing in mice. The secondary aim was to investigate mechanisms that could mediate the effect of sucrose bingeing on ethanol reward, specifically neuroinflammation in brain reward regions. To do so, we measured expression of genes involved in neuroinflammation, as well as specific endocannabinoid genes that are involved in food and alcohol reward. For both systems we targeted the prefrontal cortex, the nucleus accumbens, the dorsal striatum and the lateral hypothalamus for markers of inflammation and ECS genes. Results from this study provide insight into the etiology of comorbid alcohol

abuse in individuals with BED as well as possible brain mechanisms mediating this relationship.

Materials and methods

Subjects

Male and female C57BL/6J mice were either from Charles River Laboratories, 4 weeks old upon arrival, or bred in the lab. They were housed 3 or 4 animals/cage under a 12-hour light dark cycle and standard temperature and humidity conditions ($22\pm 2^{\circ}\text{C}$, $55\pm 10\%$). One week before the beginning of sucrose access, animals were isolated in $11.5 \times 29.5 \times 13$ cm (339 cm^2) cages and habituated to a two-bottle choice paradigm with access to water only. All experiments took place during the light cycle. Experiments were approved by the institutional ethics committee CREMEAS (Comité d'Ethique pour l'Expérimentation Animale de Strasbourg, France) (APAFIS#2018100414319951).

Limited access to sucrose

Animals from 6 distinct cohorts (Figure 28) were exposed to the sucrose bingeing paradigm (cohorts A, B, C, D, E & F). Caster sugar (Erstein) was dissolved in tap water, measured as weight per volume (17.1% g/L), and delivered in centrifuge tubes. This procedure is adapted from (Yasoshima & Shimura, 2015). All groups had access to food ad libitum (24F). For the next 2 weeks, the limited access group (4SUC/24F group) received access to sucrose for 4 hours per day over 2 weeks, beginning 2 hours after the start of each light cycle (Figure 29.a.). One control group had continuous access to sucrose (24SUC/24F group) in a 2-bottle choice paradigm for 2 weeks. A second control group (24F) had no access to sucrose. Sucrose intake, divided by body weight (mL/g), was measured 1 hour, 4 hours and 24 hours after exposure. To avoid side preference, the placement (left or right) of the water and sucrose bottles was alternated each session (Figure 29.b.).

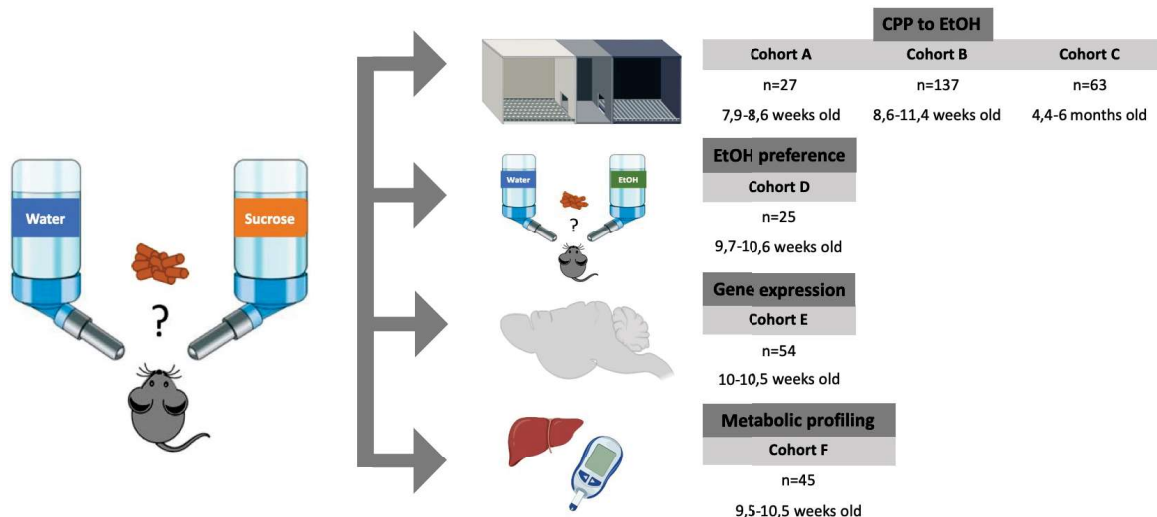

Figure 28. Six different cohorts went through the sucrose bingeing experiment followed by either CPP EtOH (Cohorts A,B,C), EtOH preference (Cohort D), gene expression (Cohort E), or metabolic profiling (Cohort F).

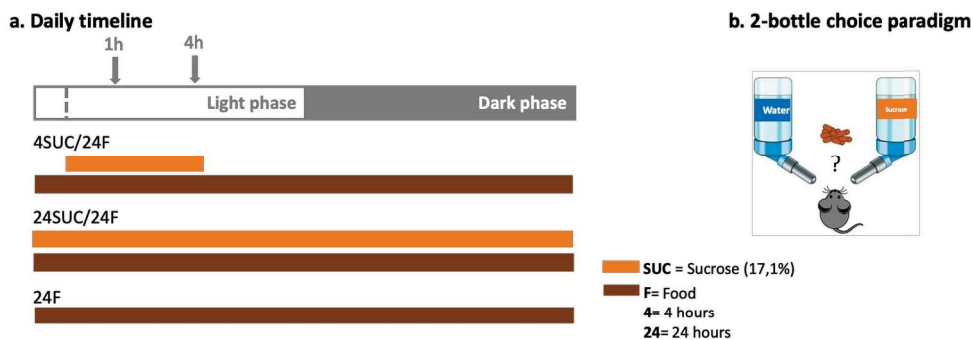

Figure 29 Schematic diagram showing the within day schedule for sucrose bingeing. Mice had ad libitum access to water and chow. The experimental group 4SUC/24F had 2 bottles of water; 2 hours after the start of the light cycle, one bottle was removed and replaced by a bottle of sucrose 17.1% for 4 hours. A first control group received continuous access to a bottle of water and a bottle of sucrose 17.1%. A second control group 24F had access to two bottles of water. To control for side preference, the left/right position of the bottle was alternated daily. Consumption of sucrose and water was recorded following the 1st hour, as well as after 4 hours and 24 hours of access. Animals were weighed every morning before the start of the access to sucrose. (24SUC: 24 hours access to sucrose; 4SUC: 4 hours access to sucrose; 24F: 24 hours access to food)

Conditioned place preference to ethanol

Subjects

Following sucrose access sessions, mice from cohort A were tested for a CPP to EtOH, dose 3g.Kg⁻¹ (20% v/v in saline). Male (n=12) and female (n=15) mice were aged between 7,9 and 8.6 weeks old at the start of the experiment. Females weighed between 15,8 and 19,9 grams and males weighed between 17,1 and 23,9 grams at the beginning of the experiment.

In parallel, after sucrose access sessions, mice from cohort B were tested on distinct EtOH doses (2g.Kg⁻¹, 3g.Kg⁻¹, 4g.Kg⁻¹; 20% v/v in saline). Males (n=69) and females (n=68) were aged between 8,6 and 11,4 weeks old at the start of the experiment. Females weighed between 17 and 21,8 grams and males weighed between 20 and 28.3 grams at the beginning of the experiment.

Older mice from cohort C were tested on distinct EtOH doses (2g.Kg⁻¹, 3g.Kg⁻¹, 4g.Kg⁻¹; 20% v/v in saline). Males (n=31) and females (n=32) were aged between 4.4 and 6 months old at the start of the

experiment. Females weighed between 20.4 and 26.3 grams and males weighed between 23.8 and 32.7 grams at the beginning of the experiment.

Pre-conditioning:

The purpose of the pre-test is to familiarize the animals with the apparatus. Mice were placed in the corridor and once the recording started, they had access to both compartments during 30 minutes. The mice were then returned to their home cage.

Conditioning sessions:

Within each group and sex, mice were randomly assigned to one ethanol (EtOH) associated compartment (2g.Kg⁻¹, 3g.Kg⁻¹; 4g.Kg⁻¹; 20% v/v in saline) and one sodium chloride (NaCl) 0.9% associated compartment in a counterbalanced manner (Figure 30). Mice were brought from the animal house to the testing room and immediately received their intra peritoneal injection. The mice were confined to their compartment for 5 minutes and returned to their home cage. The conditioning trial sessions to EtOH and NaCl occurred on alternating days over 8 days, also in a counterbalanced manner (keeping 48 hours between identical trial sessions).

Preference test:

Mice were placed in the corridor and allowed access to both compartments during 30 minutes. Time spent in each compartment as well as locomotor activity were recorded.

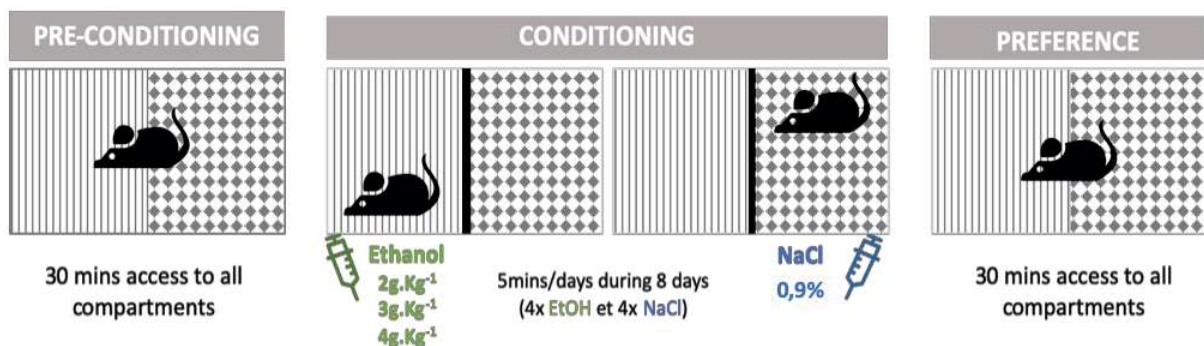

Figure 30 The conditioned place preference (CPP) apparatus consisted of 2 distinct chambers with photo beams sensors. One chamber had a wire mesh floor, while the other chamber had horizontal stripes. They were separated by a corridor with a smooth surface. In the pre-conditioning phase, the animals had access to both compartments through the corridor during 30 minutes. During the conditioning phase, mice received 4 intraperitoneal injections of EtOH (2, 3 or 4 g.Kg⁻¹) alternating with 4 intraperitoneal injections of NaCl 0.9% with one injection/day. After each injection, animals were confined to the EtOH or NaCl 0.9% associated compartment for 5 minutes. The preference test occurred the day after the last conditioning session. Animals had again access to both compartments during 30 minutes through the corridor. (EtOH: ethanol; NaCl: sodium chloride).

2-bottle ethanol preference

Mice from cohort D were tested for EtOH consumption and preference at 5 different concentrations. Males (n=12) and females (n=13) were aged between 9.7 and 10.6 weeks old at the start of the experiment. Females weighed between 17.2 and 23.8 grams and males

weighed between 19.4 and 27.5 grams at the beginning of the experiment. The protocol was based on (Avena et al., 2004a; Y. Blednov et al., 2005). Briefly, 3%, 6%, 9%, 12% and 15% EtOH concentration volume to volume (v/v in tap water) were offered to mice on 4 days, starting with the lowest concentration and increasing to the highest over days. Bottle sides were exchanged every 2 days.

Gene expression following sucrose bingeing

After 17 days of sucrose access, gene expression was measured in mice from cohort E. Males (n=23) and females (n=31) were aged between 10 and 10.6 weeks old at the start of the experiment. Females weighed between 18.2 and 22.1 grams and males weighed between 22,5 and 27,7 grams at the beginning of the experiment.

Brain were microdissected following decapitation on the next day of the 2 weeks sucrose access, at the time sucrose access would have been provided for the 4SUC/24F group (see Figure 4, as previously described REF DN or RB?). Samples were immediately frozen in dry ice and kept at -80°C until use. Gene expression involved in neuroinflammation and the endocannabinoid system (Table 1) PFC, NAcc, DS, LH (Figure 31).

Metabolic profiling

Glycemia and liver weight of mice from cohort F were measured following the sucrose access protocol that was extended to 17 days. Males (n=22) and females (n=23) were aged between 9.5 and 10.5 weeks old at the start of the experiment. Females weighed between 18.2 and 22.1 grams and males weighed between 22.5 and 27.7 grams at the beginning of the experiment.

The metabolic profiling was assessed on the next day at the time sucrose access would have been provided for the 4SUC/24F group. During decapitation, a drop of blood was collected on a test strip (Accu-Chek). This meter displays blood glucose in mg/dL. The 5 lobes of the liver were dissected and weighed (g) for histological analysis, the biggest lobe was cut and frozen in isopentane for 1 minute between -40°C to -45°C. For gene expression analysis, about 120mg of tissue was cut, frozen in a perforated tube in liquid nitrogen and stored at -80°C.

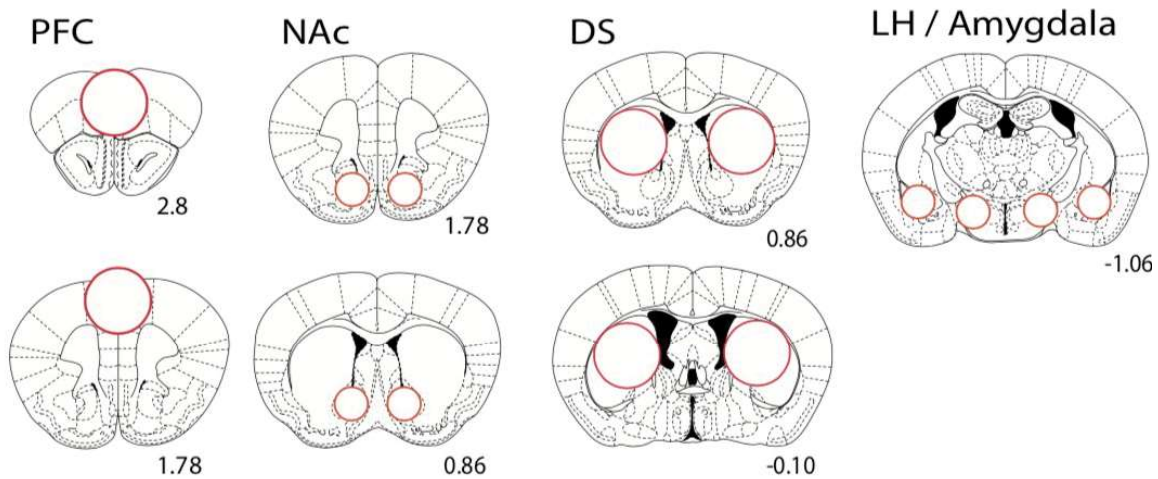

Figure 31 Coronal brain slices displaying brain areas where gene expression was measured. Bregma is indicated under each region. (PFC: prefrontal cortex; NAc: Nucleus Accumbens; DS: Dorsal Striatum; LH: lateral hypothalamus).

Brain dissection, RNA extraction and quantitative polymerase chain reaction (qPCR) (Cohort E).

All along the extraction steps we made sure to get rid of ribonucleases (RNases) by spraying RNaseZAP. To homogenize and lyse the tissue we added 800 μL of ribozol (VWR, Fontenay-sous-bois, France) which has the capacity to isolate RNA and contains a chaotropic agent to denature proteins. We performed up and down with a potter homogenizer. All samples were then left for 10 minutes at room temperature for effective homogenization before going back to ice. We then added 160 μL of chloroform (2:10 ratio; chloroform:ribozol). The tube was turned up and down 10 times, centrifuged at 12 000 relative centrifugal force (rcf) for 2 minutes at 4°C degrees. The solution was separated into 3 phases, the lower phase being denaturated proteins, the middle phase being DNA and the upper phase being RNA. The upper aqueous phase was transferred to a new tube, and we added 400 μL of isopropanol to precipitate RNA. The solution is centrifuged once for 15 minutes and once for 3 minutes at 12000 rcf 4°C, being wash by ethanol 75% (v/v) in between. A final centrifugation is done for 3 minutes and after eliminating ethanol by pipetting and with evaporation, RNA was resuspended in 20 μL of miliQ ultrapure water.

We next measured RNA concentration (ng/dL) with a NanoVue™ (GE healthcare) spectrophotometer (GE healthcare). The absorbance ratio 260/230 was measured to quantify organic components contamination. The absorbance ratio 260/280 was measured to quantify the contamination by DNA.

We collected an amount of 750 ng of RNA as template in reverse transcription to synthesize complementary DNA (cDNA). RNA is incubated with iScript Reverse Transcription Supermix (iScript™ cDNA Synthesis Kit, Biorad, France), which contains: dNTPs, primers, reverse transcriptase (Moloney Murine Leukemia virus), water and buffer. The reaction temperature started with 5 minutes at 25°C for hybridation, 30 minutes at 42°C for inverse transcription and 5 minutes at 85°C for inactivation of the enzyme.

Quantitative polymerase chain reaction was run in triplicate on 0.5 µL cDNA, 3 µL primers (500nM for each forward a reverse primers) 12 µL of Sso Advanced™ Universal SYBR Green supermix (Biorad, France) in a 96-well plate. These were run in a thermal cycler (CFX96 Touch™ apparatus Biorad, France) following the program : 30 s at 95 °C followed by 40 amplification cycles of 5 s at 95° and 45 s at 60 °C. Gene expression is standardized against the housekeeping gene acidic ribosomal phosphoprotein P0 (36B4) and compared to the group control with no access to sucrose (24F). Primers were designed using the primer designing tool from NCBI (Table 1).

Statistics

Sucrose consumption

Data from sucrose access sessions was analyzed using RStudio (Version v1.3.1093) and the package lme4 to perform a linear mixed effects analysis. The dependent variable was sucrose intake. The fixed effects part of the model is the interaction groups*days for sucrose intake and weight evolution. The random effect part of the model is the subjects intercept. The intercept and the interaction estimates (e.g. the slope coefficient) reflect the difference from zero for the baseline level group. The other groups intercept and slope coefficient are compared to the baseline group. We used the linear mixed model analysis against the repeated measure ANOVA because it considers the correlated errors that result from multiple measurements per subject; it can handle missing data as long as it meets the missing random definition and it can handle uneven spacing of repeated measurements.

Conditioned place preference to ethanol

Comparisons of time spent in the ethanol associated compartment versus the NaCl associated compartment were assessed by a mixed ANOVA design using the Afex package from R, (Rstudio v1.3.1093). The fixed effects part of the model is the interaction compartment*group*dose*sex. The random effect part of the model is represented by subject

error divided by the within-subjects error which are the compartments since the same subjects navigated between each compartment. When sphericity was violated (Machley's $p < 0,001$), the Greenhouse-Geisser correction was used. We checked the homogeneity of variances (Levene test, car package) and the normal distribution of the residuals (Shapiro, moments package). Data with non-normal distribution was transformed. If data were positively skewed we did a squared root, cubed root or logarithmic transformation. If data were negatively skewed, we did a square, a cubed root or logarithmic transformation. Post hoc analysis were conducted by multiple pairwise comparisons for the interaction compartment*group*dose*sex (Emmeans package from R) using the Tukey correction method. We compared time spent in the compartments within each sex, group and ethanol dose.

EtOH preference

EtOH preference as a % of intake was analysed with a mixed design ANOVA using the Afex packages from R. The fixed effects were the interaction between sex, group and concentration, the random part of the model was the subjects error divided by the concentration error since the same subjects were tested at each concentration. Multiple pairwise comparisons were performed for the interaction (Emmeans package from R) using the Tukey correction method.

Gene expression

Gene expression was measured as technical triplicates for each subject. Triplicate with more than one quantification cycle (Cq) from the two other values was considered an outlier and removed. From Cq data, the relative gene fold expression was calculated using the delta delta Cq method. The first delta is the difference between the gene of interest Cq and the housekeeping gene Cq for each subject. The second delta is the difference between the Cq of each sample and the average Cq of the control group for the gene of interest (Livak & Schmittgen, 2001). Differences in gene expression between the groups were analysed by a two-way ANOVA, the interaction part of the model being group*sex in each region of interest. We checked the homogeneity of variance (Levene test, car package) and the normal distribution of the residuals (Shapiro, moments package). Data with non-normal distribution were transformed. If data were positively skewed we did a squared root, cubed root or logarithmic transformation. If data were negatively skewed, we did a square, a cubed root or logarithmic transformation. Post hoc analysis were conducted by multiple pairwise

comparisons for the interaction Group*Sex (Emmeans package from R) using the Tukey correction method.

Metabolic profiling analysis

Differences in gene expression between the groups and sexes were analysed by a two-way ANOVA, the interaction part of the model being group*sex for the dependent variables liver weights and glycemia. We checked the homogeneity of variance (Levene test, car package) and the normal distribution of the residuals (Shapiro, moments package). Data with non-normal distribution were transformed. If data were positively skewed, we did a squared root, cubed root or logarithmic transformation. If data were negatively skewed, we did a square, a cubed root or logarithmic transformation. Post hoc analysis were conducted by multiple pairwise comparisons for the interaction Group*Sex (Emmeans package from R) using the tukey correction method.

Correlation

A correlation matrix between gene expressions, sucrose intake and percentage of weight gain was done for each region using the Spearman method and the Bonferroni correction (package psych from R). Data with non-normal distribution were transformed as mentioned previously.

Results

Intermittent access to sucrose induces binge intake

In cohort A (Figure 32), the limited access group 4SUC/24F significantly increased sucrose intake across days during the first hour ($t=6,806$; $df=2,27.10^2$; $p= 8,81.10^{-11}$), although there was no significant escalation at the 4 hour measure ($t=0,858$; $df=228,82$; $p=0,392$). The rate of escalation was significantly higher in the 4SUC/24F group compared to 24SUC/24F group after 1 hour ($t=4,701$; $df=2,272.10^2$; $p=4,48.10^6$) and 4 hours of access ($t=5,557$ $df=228,84$; $p=7,62.10^{-8}$). In fact, Figure 32.b. shows a significant decrease in sucrose intake of the 24SUC/24F group across the days ($t=-7,046$; $df=228,82$; $p=2,14.10^{-11}$). No sex differences were observed. No sex differences were observed within the 4SUC/24F and 24SUC/24F groups after 1 hour (Figure 32.c.) or across daily access (data not shown).

Sucrose bingeing does not increase body weight gain

In Figure 32.d, only the control groups 24SUC/24F ($t=7,70$; $df=348,0002$; $p=1,48.10^{-13}$) and 24F ($df=348,0007$; $t=5,14$; $p=4,61.10^{-7}$), increased their weight significantly across the 14 days and were significantly heavier than the 4SUC/24F group (4SUC/24F vs 24SUC/24F: $t=-6,44$; $df=348,00019$; $4,06.10^{-10}$; 4SUC/24F vs 24F: $t=-4,63$; $df=348,00044$; $p=5,13.10^{-6}$).

EtOH induced CPP at 3g.Kg⁻¹ is blocked by sucrose bingeing

The pairwise comparison test demonstrated significantly greater time spent in the EtOH (3 g.Kg⁻¹) paired compartment compared to the NaCl paired chamber for 24SUC/24F ($t=3,44$; $p=0,0023$) and 24F ($t=2,91$; $p=0,0081$) groups (Figure 33.a.). However, the limited access group showed no significant difference between time spent in each compartment ($t=-0,257$; $p=0,7998$).

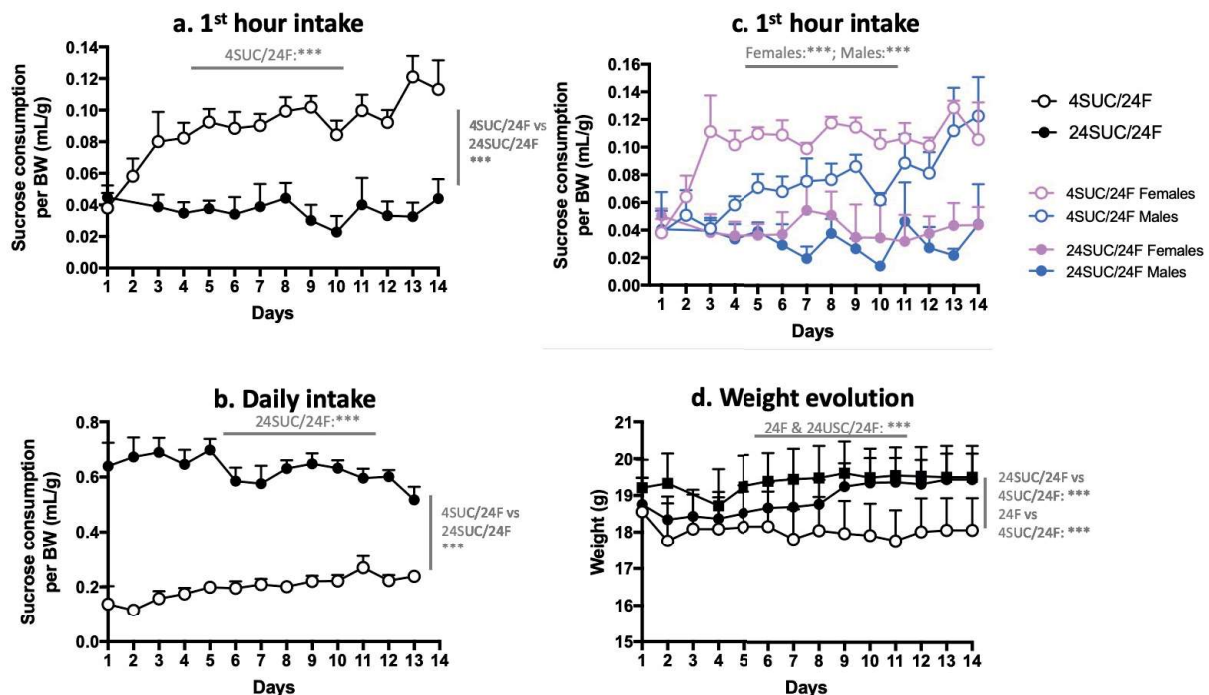

Figure 32 Sucrose intake and Weight evolution across the 14 days of access (cohort A). Mice from the 4SUC/24F group (white circles) significantly escalated their intake compared to the 24SUC/24F group (dark circles) during the first hour (a) and over daily (b) access. The 24SUC/24F group did not significantly increase their intake during the first hour (a) and significantly decreased their daily intake (b). No sex differences were observed during the first hour of access and intake of both females and males from the 4SUC/24F group escalated significantly (c). Weight significantly increased in both control groups 24F and 24SUC/24F and with a significantly higher rate than the experimental group, 4SUC/24F, which was stable (d). (4SUC: 4 hours access to sucrose; 24SUC: 24 hours access to sucrose; 24F: 24 hours access to food; BW: bodyweight).***: $p < 0,001$; **: $p < 0,01$; *: $p < 0,05$.

Limited access to sucrose blocks EtOH induced CPP at all doses

Mice from cohort B that underwent the sucrose access protocol (Supplementary figure 5) were then tested on different EtOH doses for a CPP (Figure 6). Pairwise comparison tests

on data from the 24F group showed a significant difference between EtOH 3 g.Kg⁻¹ and NaCl paired compartments ($t=2,41$; $p=0,018$) as expected from the last cohort. No EtOH induced CPP was observed at 2 g.Kg⁻¹ ($t=0,27$; $p=0,79$) or at 4 g.Kg⁻¹ ($t=0,69$; $p=0,49$). Data from the 4SUC/24F group shows no EtOH induced CPP at 2 g.Kg⁻¹ ($t=0,92$; $p=0,36$), 3 g.Kg⁻¹ ($t=0,63$; $p=0,53$) and 4 g.Kg⁻¹ ($t=0,92$; $p=0,36$). Females but not males with limited access to sucrose showed an EtOH induced CPP at the highest dose. Pairwise comparison tests revealed an EtOH induced CPP for the dose group 4 g.Kg⁻¹ for females ($t=2,57$; $p=0,011$), but not males ($t=-1,48$; $p=0,14$) (Supplementary figure 6). However, no significant differences were observed in a distinct experiment (Cohort D) evaluating EtOH consumption at different concentrations between the groups (Supplementary figure 7).

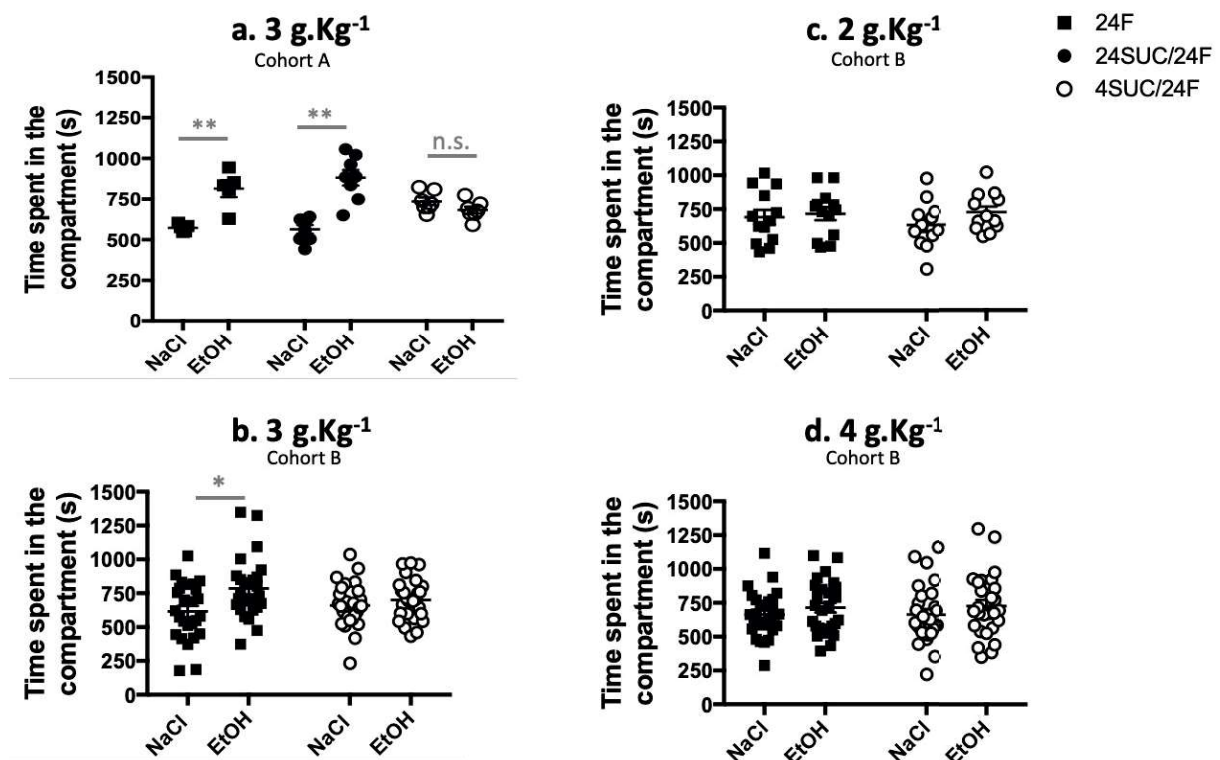

Figure 33 CPP to distinct concentrations of EtOH following sucrose bingeing. CPP was measured at 2, 3 and 4 g.Kg⁻¹ doses. Only the control groups expressed an EtOH induced CPP at 3 g.Kg⁻¹. (EtOH: ethanol; NaCl: sodium chloride; CPP: conditioned place preference). ***: $p < 0,001$; **: $p < 0,01$; *: $p < 0,05$.

Limited access to sucrose induces binge like behavior in old mice of cohort C.

Figure 34.a. shows that the limited access group, 4SUC/24F, significantly increased sucrose intake across days during the first hour of access ($t=12,88$; $df=3,45.10^2$; $p < 2.10^{-16}$) and a significant escalation after 4 hours of access ($t=18,25$; $df=3,44.10^2$; $p < 2.10^{-16}$) (Figure 34.b.). There were no sex differences after one hour of access (Figure 34.c.), however intake

after 4 hours (Figure 34.d.) of access escalated at a higher rate across days in females than males ($t=4,51$; $df=3,44.10^2$; $p=8,72.10^{-6}$).

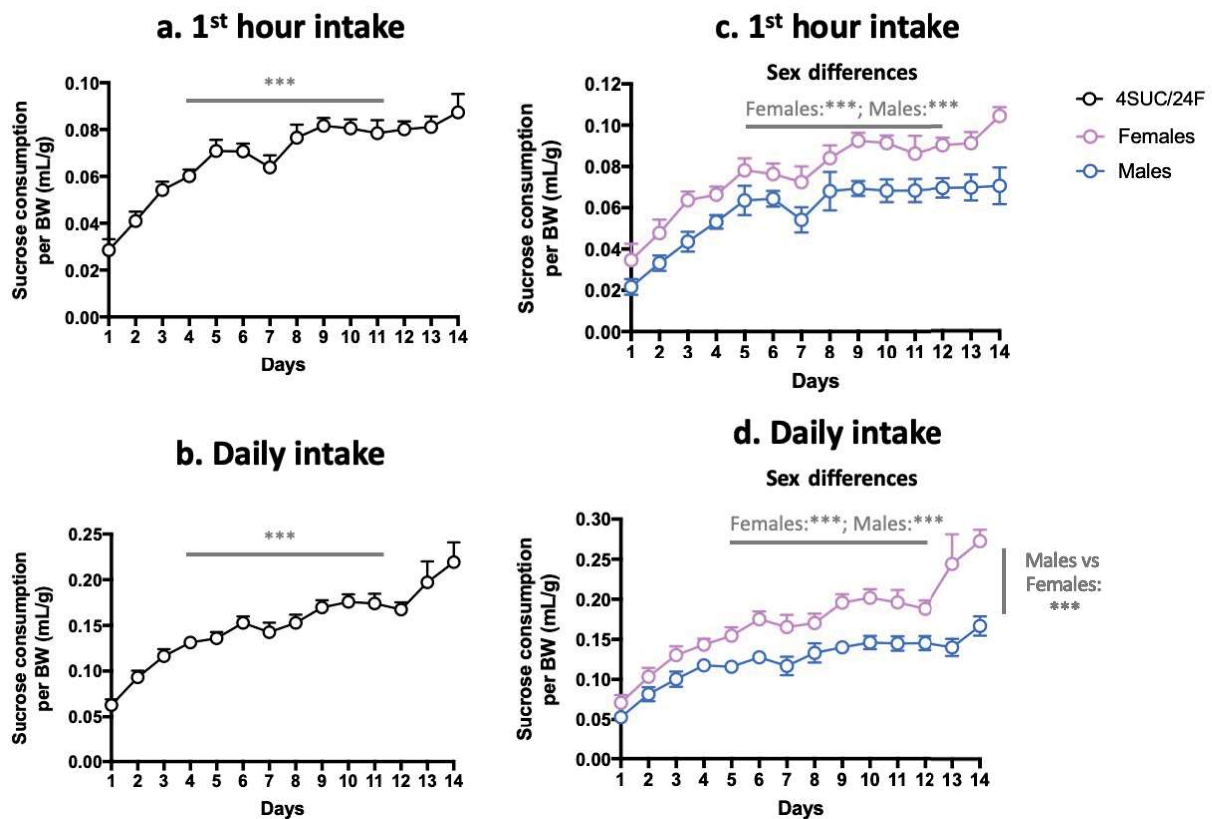

Figure 34 Sucrose intake across the 14 days of access in old mice (cohort C). Graphs show sucrose intake in mL/g. a. Mice with limited access to sucrose (4 hours/day) showed a significant escalation of intake during the first hour and during daily access. b. No sex differences were observed during the 1st hour of access, but both escalated significantly. For daily intake, the rate of sucrose escalation was significantly higher in female than males, though both significantly escalated their daily intake (BW: body weight) ***: $p < 0,001$; **: $p < 0,01$; *: $p < 0,05$.

Pairwise comparison tests on data from old mice in cohort C showed a significant difference between time spent in the EtOH 4 g.Kg⁻¹ and NaCl paired compartments in the 24F group ($t=-4,26$; $p=0,0021$), which expressed a conditioned place aversion to EtOH (Figure 8). The 24F group did not express a CPP at EtOH 3g.Kg⁻¹ as expected from the last cohorts (A and B). However, the 4SUC/24F group did express CPP at EtOH 3g.Kg⁻¹ contrary to young mice ($t=8,89$; $p=0,003$). Sex differences were observed at EtOH 4g.Kg⁻¹ dose in both groups (Supplementary figure 6). Females from the 4SUC/24F group had a higher t-score than males, the difference being close to significant (Females: $t=2,26$; $df=6$; $p=0,064$; Males: $t=1,19$; $df=6$; $p=0,28$). Aversion in the 24F group was expressed by females but not males (Females: $t=-6,89$; $df=8$; $p=0,0001$; Males: $t=-1,34$; $df=6$; $p=0,22$).

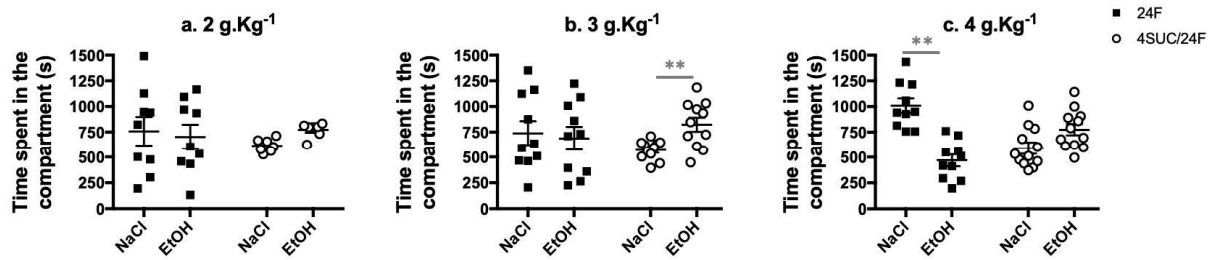

Figure 35 CPP to distinct concentrations of EtOH following sucrose bingeing (Cohort C). CPP was measured at 2, 3 and 4 g.Kg⁻¹ doses. The experimental group 4SUC/24F expressed an EtOH induced CPP at 3 g.Kg⁻¹ and the control group expressed an EtOH induced CPP at 4 g.Kg⁻¹. ***:p< 0,001; **:p< 0,01; *:p< 0,05.

Sucrose bingeing regulates gene expression in regions involved in reward processing and metabolic regulation

In animals from cohort F (Supplementary figure 8) we evaluated gene expression in several reward-related brain structures (Table 5). In the PFC, genes involved in neuroinflammation were regulated with a significant group effect ($F(2,47)=3,62$; $p=0,035$). Figure 36.a. shows increased GFAP expression in the 4SUC/24F group compared to the 24F group ($t=-2,75$; $df=47$; $p=0,023$). Figure 36.b. shows a significant sex effect for CCL2, with a higher expression in females than in males ($t=2,405$; $df=46$; $p=0,02$).

In the DS, GFAP analysis showed a significant interaction between group and sex ($F(2,37)=3,43$; $p=0,043$). Males from the 24F group showed a higher expression of GFAP compared to the 24F females ($t=-2,24$; $df=37$; $p=0,031$) and 24SUC/24F males ($t=-2,75$; $df=37$; $p=0,024$).

Sucrose intake increased TNF α expression in the NAcc ($F(2,41)=3,19$; $p=0,051$). Post hoc analysis did not show any significant differences between the groups, however, t scores were higher between the 24F and 24SUC/24F groups ($t=-2,397$; $df=41$; $p=0,0541$) and between the 24F and 4SUC/24F groups ($t=-2,133$; $df=41$; $p=0,0957$).

In the LH, the analysis showed a significant sex effect for GFAP Figure 36.f. ($F(1,37)=3,59$; $p=0,066$) and IBA1 Figure 36.g. ($F(1,43)=5,82$; $p=0,02$). Males expressed significantly more GFAP ($t=-1,879$; $df=37$; $p=0,068$) and IBA1 ($t=-2,309$; $df=39$; $p=0,026$) than females. Figure 36.g. showed a significant interaction between group and sex for IL10 ($F(2,15)=6,67$; $p=0,0085$). Males in 4SUC/24F ($t=-2,849$; $df=15$; $p=0,031$) and 24SUC/24F ($t=-2,851$; $df=15$; $p=0,031$) groups expressed significantly more IL10 than 24F males. Sucrose access decreased CB1 expression ($F(2,29)=7,16$; $p=0,0029$). The 24F group expressed

significantly more CB1 than 24SUC/24F ($t=2,49$; $df=29$; $p=0,047$) and 4SUC/24F ($t=3,9$; $df=29$; $p=0,0015$) groups.

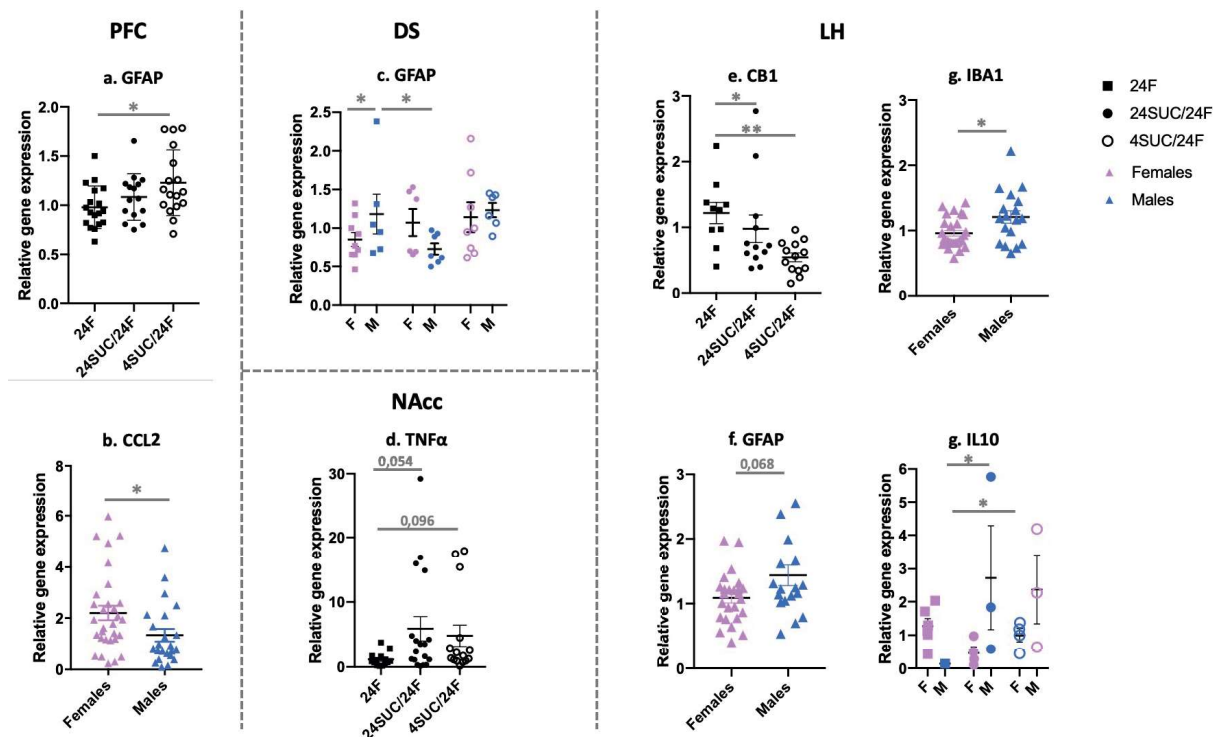

Figure 36 Gene expression in brain regions of interest following sucrose bingeing (Cohort E). In the PFC, genes involved in neuroinflammation were modulated. GFAP was expressed significantly more in the 4SUC/24F group compared to the control 24F group. A sex difference was observed for CCL2, with females expressing more than males. In the DS, males from the 24F group expressed more GFAP than females from the same group and males from the 24SUC/24F group. In the NAcc, TNF α was expressed at lower levels in the 24F group compared to both sucrose access groups. In the lateral hypothalamus, CB1 was expressed at higher levels in the 24F group compared to both sucrose access groups. (PFC: prefrontal cortex; NAcc: Nucleus Accumbens; DS: Dorsal Striatum; LH: lateral hypothalamus, GFAP: glial fibrillary acidic protein, CCL2: C-C Motif Chemokine Ligand 2; TNF α : tumor necrosis factor alpha; CB1: cannabinoid receptor 1; IBA1: Ionized calcium binding adaptor molecule 1; IL10: interleukin 10). ***: $p < 0,001$; **: $p < 0,01$; *: $p < 0,05$.

We next analyzed the correlation of gene expression, total 1st hour and daily sucrose intake across the 14 days, as well as weight gain in cohort E (Figure 37). In the PFC, the catabolic enzyme FAAH increased with CB1 ($r=0,77$; $p=0,044$) in the 4SUC/24F group. In the control group 24SUC/24F, neuroinflammation genes were correlated, with TNF α increasing with the microglial marker IBA1 ($r=0,71$; $p=0,073$). There was a negative correlation between CCL2 and CB1 ($r=-0,88$; $p=0,0021$). When groups were combined, we were able to observe more significant correlations (results in Figure 37).

Even though no changes were observed in GFAP and CCL2 in the NAcc, all groups combined shows a significant positive correlation between CCL2 and the astrocytic marker GFAP ($r=0,62$; $p=0,019$). In the 4SUC/24F group, CCL2 was correlated with the pro-inflammatory cytokine TNF α ($r=0,86$; $p=0,0024$), whereas in the 24SUC/24F group CCL2

was positively correlated with the anti-inflammatory cytokine IL10 ($r=0,88$; $p=0,019$). IBA1 was positively correlated with total daily sucrose intake with a high r coefficient value nearly reaching the statistical significance threshold ($r=0,80$; $p=0,063$).

In the DS, TNF and CB1 were negatively correlated ($r=-0,82$; $p=0,034$) in the 4SUC/24F group. In the 24SUC/24F group IBA1 and the anti-inflammatory cytokine IL-10 were positively correlated ($r=0,92$; $p=0,029$).

In the LH, only the combined groups showed significant correlations (Figure 37).

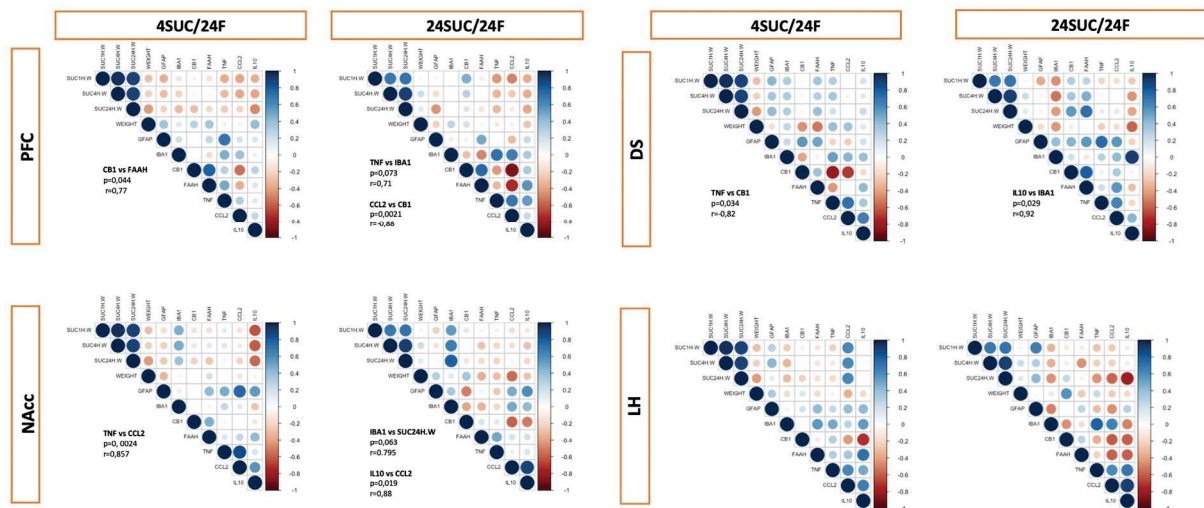

Figure 37 Spearman rank correlogram of total sucrose intake, percentage of weight gain and gene expression (cohort E). In each brain region (PFC, NAcc, DS, LH) relation gene GFAP, IBA1, CB1, FAAH, TNF, CCL2, IL10 expressions, total 1st hour and daily sucrose intake across days and weight gain were analyzed. Color scale represents Spearman's correlation coefficient. Significant p values and the corresponding r coefficient are written next to the correlogram. GFAP: Glial fibrillary acidic protein, IBA1: ionized calcium-binding adapter molecule 1, CB1: Cannabinoid receptor type 1, FAAH: Fatty acid amide hydrolase; TNF α : Tumor Necrosis Factor, CCL2: chemokine (C-C motif) ligand 2, IL-10: Interleukin 10, SUC1H.W: total 1st hour sucrose intake, SUC24H.W: total daily sucrose intake, WEIGHT: percentage of weight gain, PFC: prefrontal cortex; NAc: Nucleus Accumbens; DS: Dorsal Striatum; LH: lateral hypothalamus.

Sex differences in glycemia and liver weight in cohort F was measured (Supplementary figure 9).

Blood glucose concentration was measured the day after the last day of access at the time animals from 4SUC/24F group would have been provided with sucrose. Analysis

showed a significant sex effect ($F(1,39)=5,52$; $p=0,024$), males having higher levels than females (Figure 38.b.). Analysis of liver weights showed a significant group effect ($F(2,39)=7,045$; $p=0,0024$) (Figure 38.c.) and sex effect ($F(1,39)=42,16$; $p=1,075 \cdot 10^{-7}$) (Figure 38.d.). Post hoc analysis revealed lower liver weights in the 4SUC/24F group compared to the control groups 24SUC/24F ($t=2,681$; $df=39$; $p=0,028$) and 24F ($t=3,19$; $df=39$; $p=0,008$). Males had overall heavier livers than females ($t=-6,49$; $df=39$; $p<0,0001$).

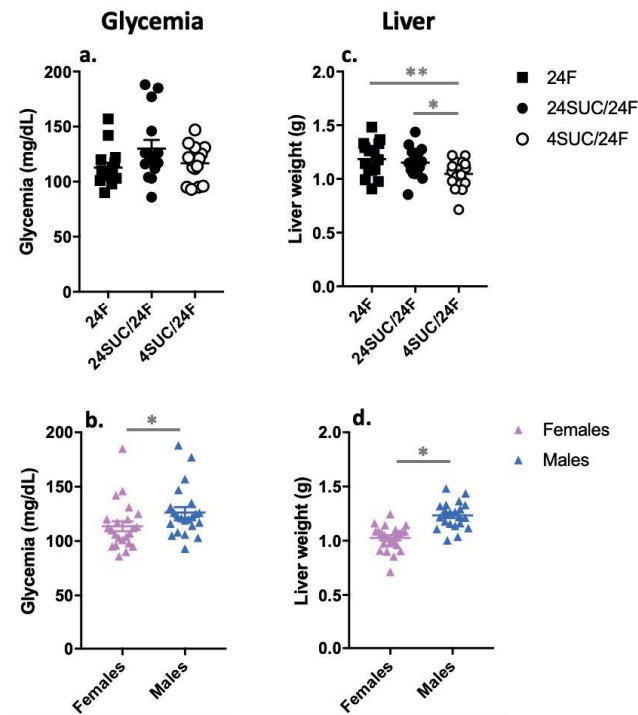
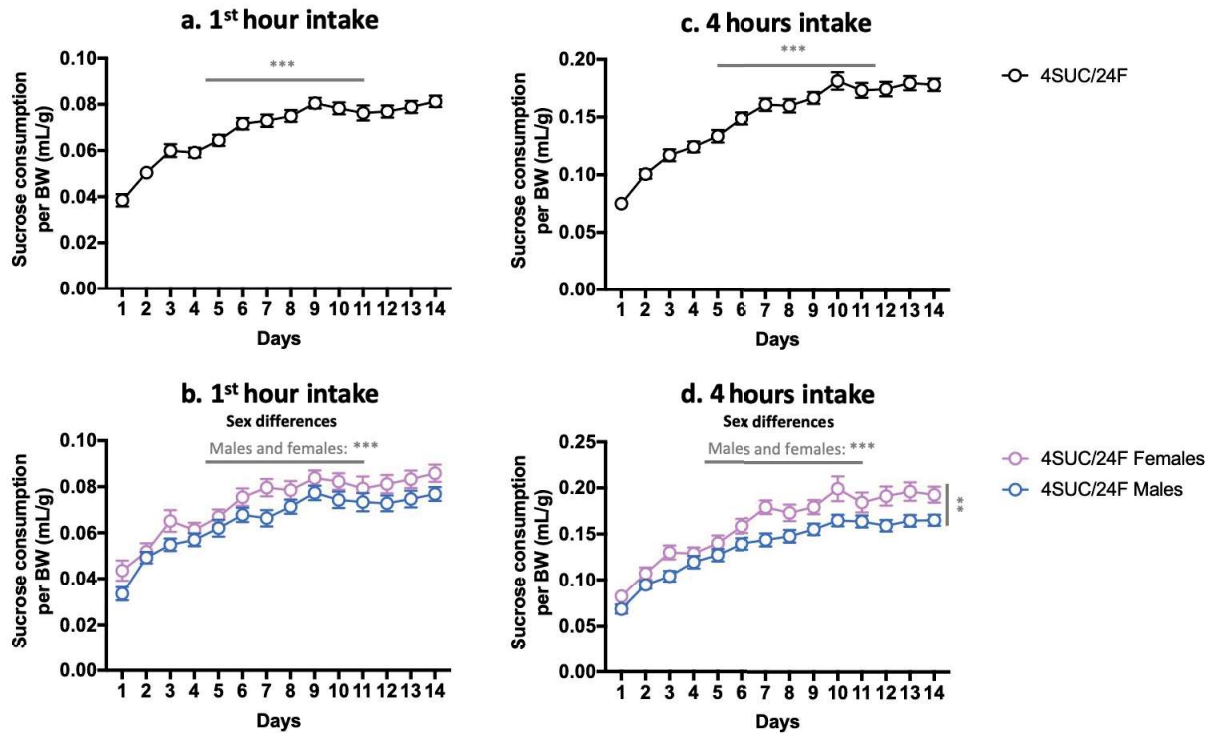
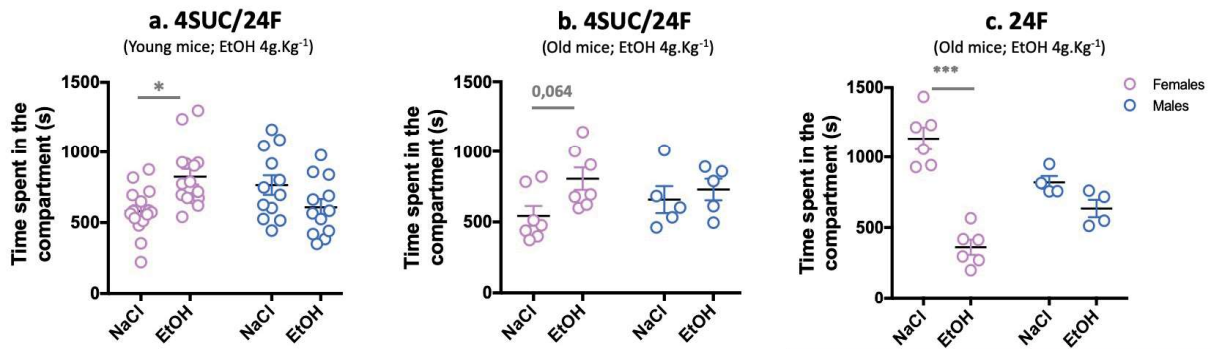

Figure 38 Metabolic profiling following sucrose access (cohort F). No differences in glycemia were observed between the groups (a). However, males had a higher glycemic load than females (b). The control group 24F had heavier livers than both sucrose access groups (c). Moreover, males had heavier livers than females (d). ***: $p<0,001$; **: $p<0,01$; *: $p<0,05$.



Supplementary figure 5 Sucrose intake across the 14 days of access (cohort B). Graphs show sucrose intake in mL/Kg. a. Mice with limited access to sucrose (4 hours/day) showed a significant escalation of intake during the first hour of access (a. $t=22,22$; $df=8,79.10^2$; $p<2.10^{-16}$) and during the 4 hours of access (c. $t=29,84$; $df=8,79.10^2$; $p<2.10^{-16}$). b. No sex differences were observed during the 1st hour of access, but both sexes escalated intake significantly. The rate of sucrose escalation was significantly higher in female than males ($t=2,70$; $df=8,78.10^2$; $p=0,0072$). (BW: body weight) ***: $p<0,001$; **: $p<0,01$; *: $p<0,05$.



Supplementary figure 6 Sex differences in CPP to ethanol following sucrose bingeing in young (cohort B) and old (cohort C) mice. Graphs show time spent in NaCl and EtOH associated compartment in seconds. a. Young female mice from the 4SUC/24F group expressed a CPP to Ethanol. b. Old female mice showed a high t-score with a p value close to significance. c. Females, but not males, in the 24F control group expressed a CPP to the EtOH associated compartment. ***: $p<0,001$; **: $p<0,01$; *: $p<0,05$.

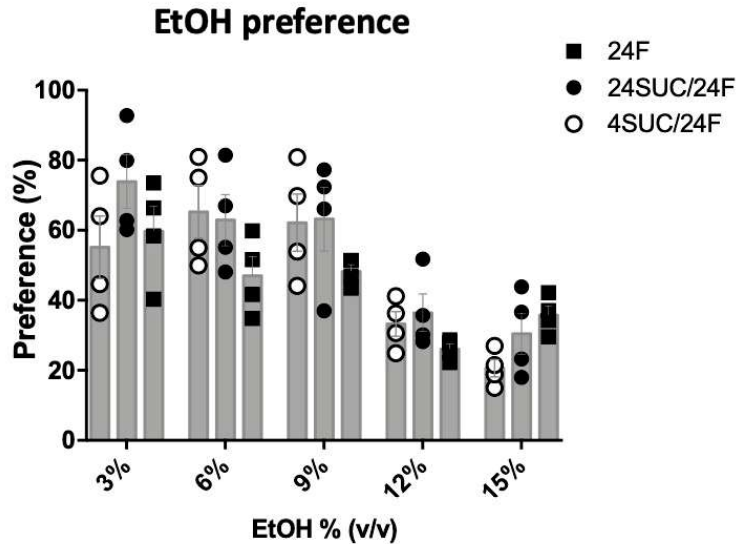

Supplementary figure 7 (Cohort D). EtOH preference following sucrose bingeing. There was a significant effect of EtOH concentration. *EtOH preference at 3%, 6% and 9% were significantly higher than 12% and 15% concentrations.*

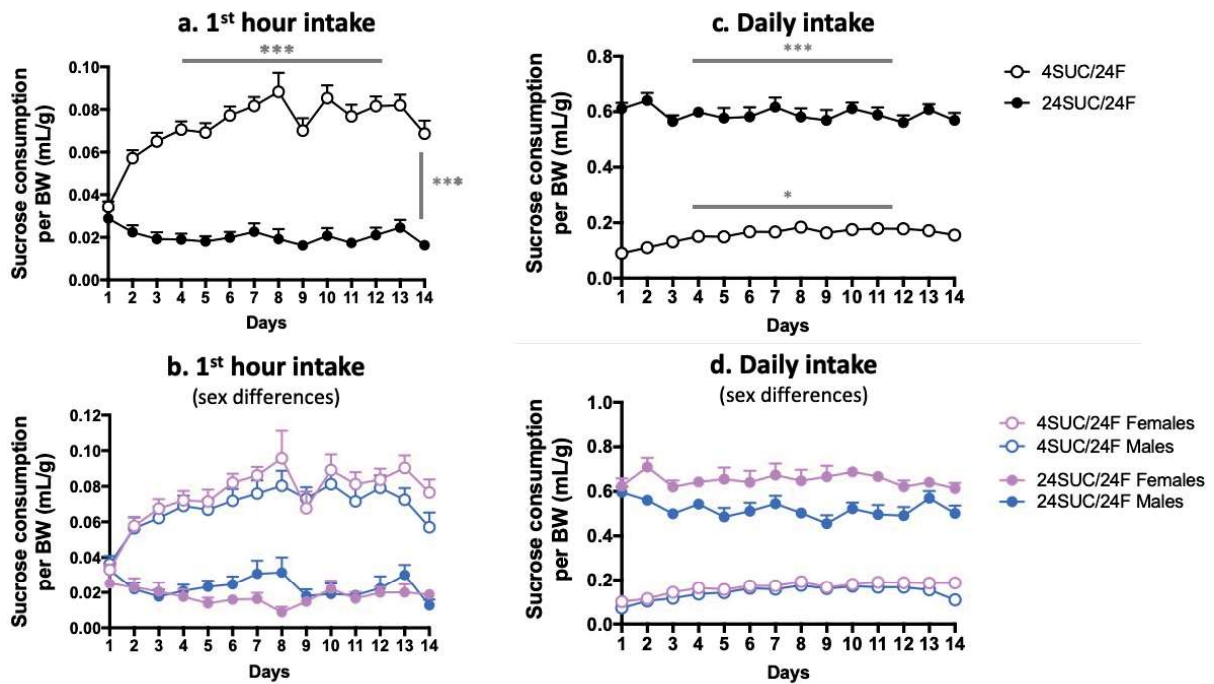

Supplementary figure 8 Sucrose intake across the 14 days of access (cohorts D&E). Graphs show sucrose intake in mL/Kg. a. Mice with limited access to sucrose (4 hours/day) showed a significant escalation of intake during the first hour of access ($t=5,87$; $df=7,95.10^2$; $p=6,53.10^{-9}$) whereas the control group 24SUC/24F was stable ($t=0,36$; $df=7,95.10^2$; $p=0,72$). The escalation was significantly higher in the 4SUC/24F group compared to the 24SUC/24F group ($t=-3,92$; $df=7,95.10^2$; $p=9,68.10^{-5}$). c. Daily intake decreased significantly across days in the control group 24SUC/24F ($t=-7,67$; $df=7,95.10^2$; $p=4,46.10^{-14}$) while it increased significantly in the 4SUC/24F group ($t=2,29$; $df=7,95.10^2$; $p=0,022$). No sex differences were observed during the 1st hour of access (b) or in daily intake (d). ***: $p < 0,001$; **: $p < 0,01$; *: $p < 0,05$.

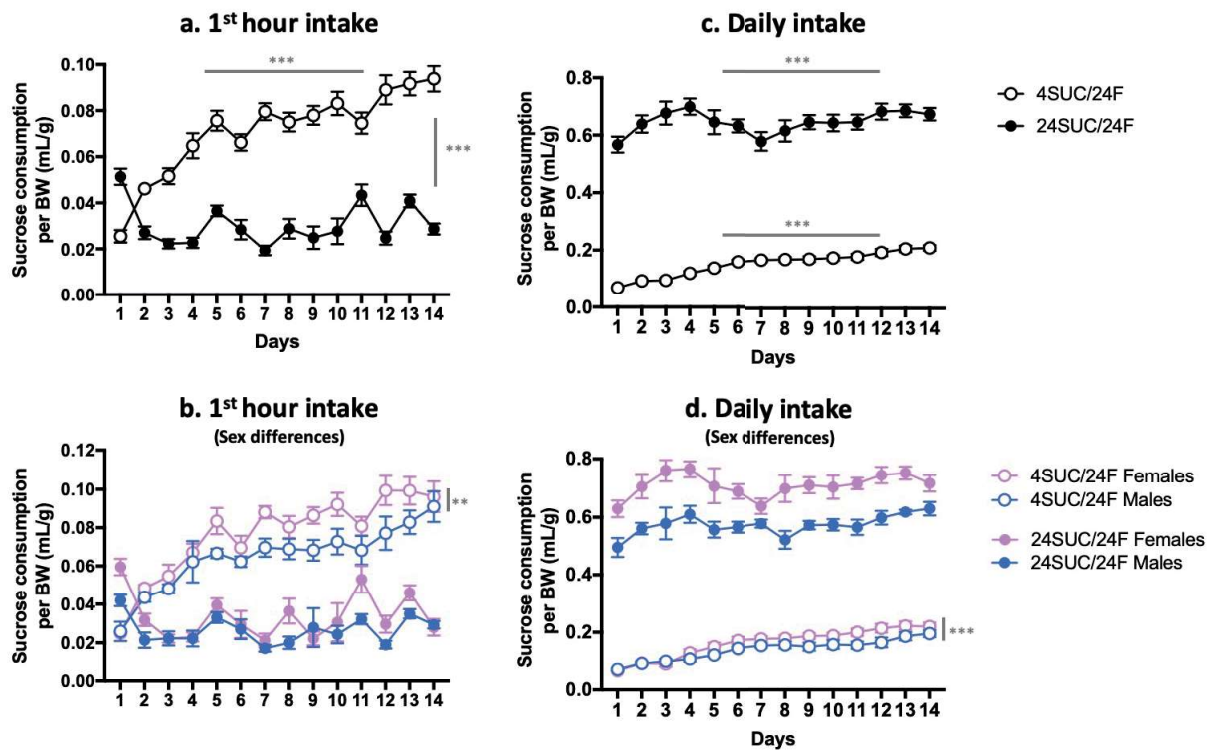

Supplementary figure 9 Sucrose intake across the 14 days of access (Cohort F). Graphs show sucrose intake in mL/Kg. a. Mice with limited access to sucrose (4 hours/day) showed a significant escalation of intake during the first hour of access ($t=17,87$; $df=4,78.10^2$; $p<2.10^{-16}$) whereas the control group, 24SUC/24F, was stable ($t=-1,25$; $df=4,78.10^2$; $p=0,21$). The escalation was significantly higher in the 4SUC/24F group compared to the 24SUC/24F group ($t=13,5$; $df=4,78.10^2$; $p<2.10^{-16}$). c. Daily intake increased significantly across days in the control group 24SUC/24F ($t=3,036$; $df=4,54.10^2$; $p=0,0025$) and the bingeing group 4SUC/24F ($t=10,91$; $df=4,54.10^2$; $p<2.10^{-16}$). The 4SUC/24F group had a significantly higher increase than the 24SUC/24F group ($t=3,036$; $df=4,54.10^2$; $p=0,0025$). b. Females escalated at a higher rate during the 1st hour of access compared to males ($t=2,83$; $df=2,39.10^2$; $p=0,005$). d. No sex differences were observed in daily intake. *** $p< 0,001$; **: $p< 0,01$; *: $p< 0,05$.

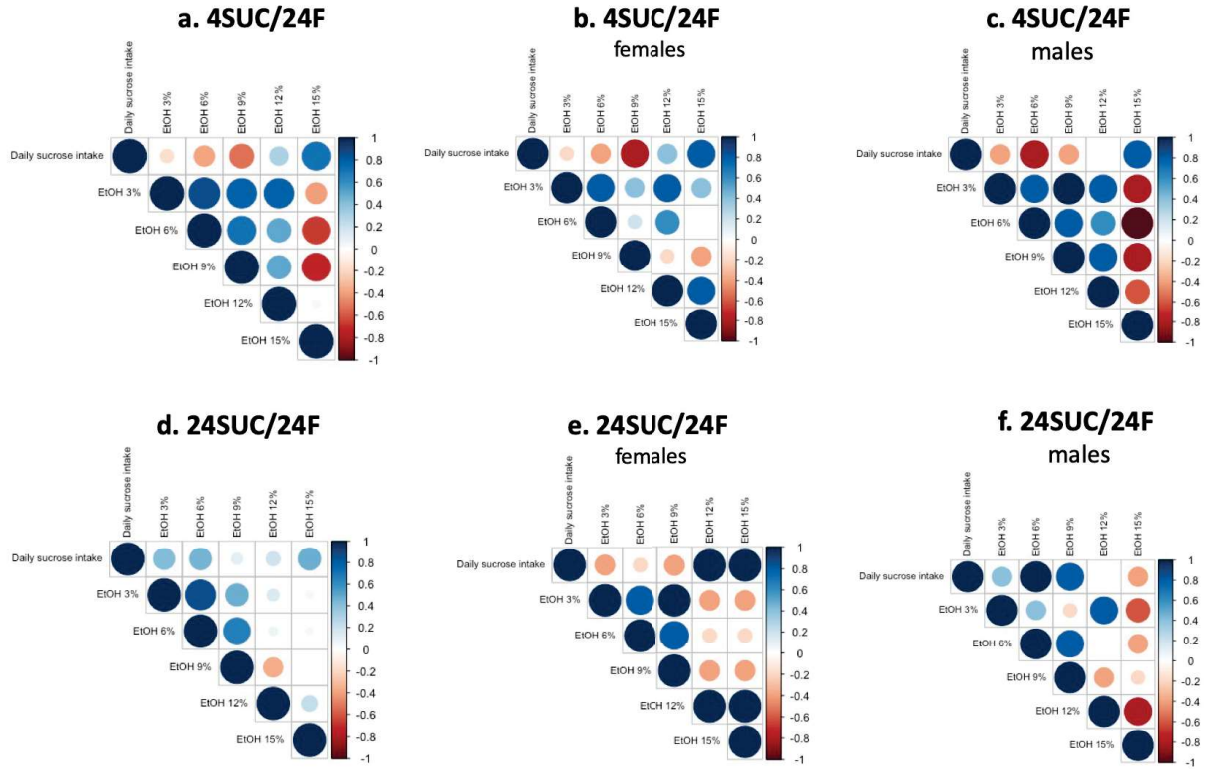

Supplementary figure 10 Correlation analysis between EtOH preference and total daily sucrose intake across the 14 days of access (Cohort E). In the 4SUC/24F group, no correlations were significant (a). There was a positive relation between total daily sucrose intake and EtOH 15% preference in both sexes (b. & c.). In the 24SUC/24F group, there were no significant correlations (d). However, when data were analyzed by sex, females show a significant correlation between daily sucrose intake and preference for EtOH 12% and 15% ($r=1$, $p=0$). Preference for each concentration was negatively correlated in both groups.

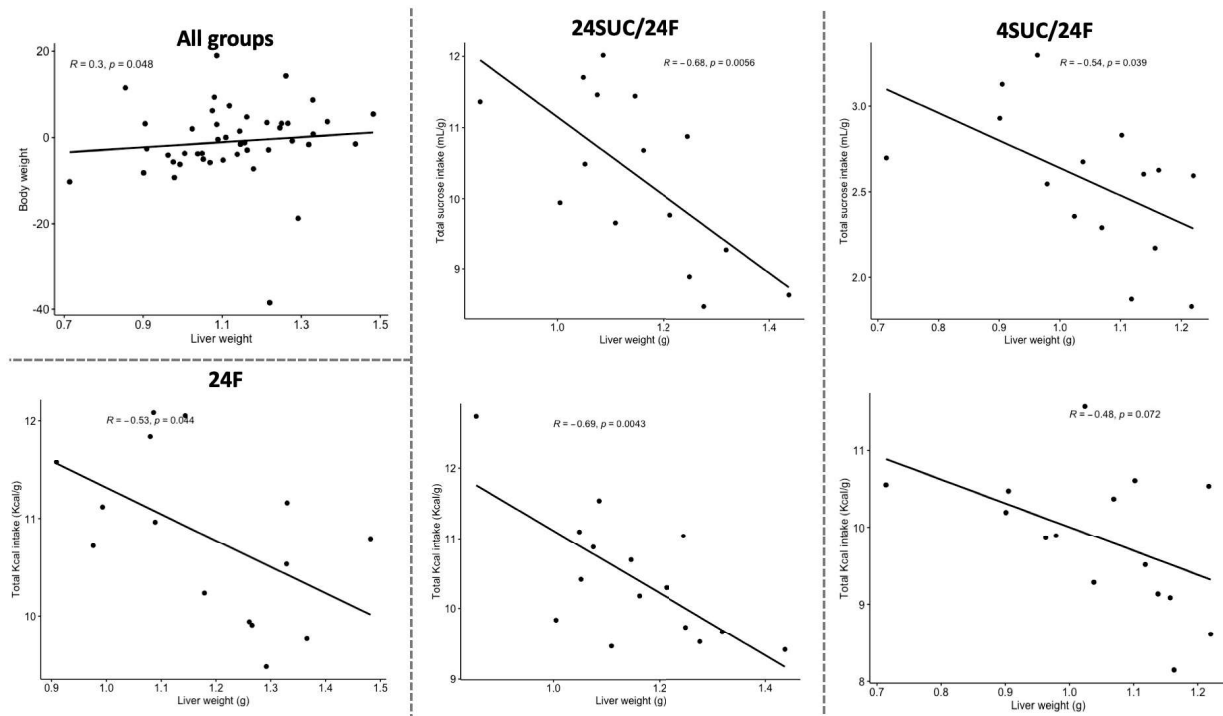

Supplementary figure 11 Correlation between liver weight and body weight gain, total sucrose intake, and kilocalorie intake (Cohort F). There was a positive correlation between weight gain and liver weight in all groups. There was a negative correlation between sucrose intake, kilocalories intake and liver weight.

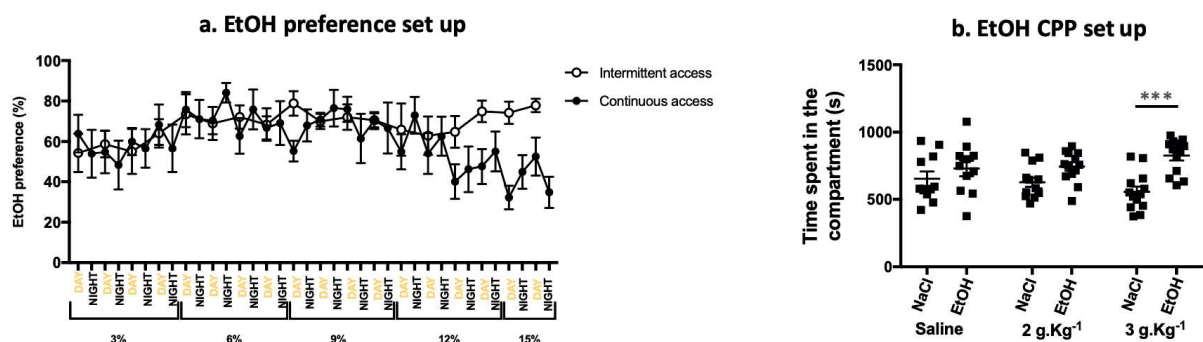

Supplementary figure 12 EtOH Consumption preference and EtOH CPP set up in control mice. We used two different paradigms to measure ethanol reward by voluntary intake and by cue induced reward responding. a. Animals from the intermittent access group had access to EtOH in a 2-bottle choice paradigm only during the day cycle, Animals from the continuous access group had access to EtOH in a 2-bottle choice paradigm during day and night cycles. All concentrations were available for 4 sessions and after every 2 sessions, left and right bottle positions were exchanged in order to control side preference. b. EtOH CPP was measured at 2 doses 2 g.Kg⁻¹ and 3 g.Kg⁻¹ using the same protocol described in the methods. To control for any chamber preference bias, we tested a control group with injections of NaCl 0.9%.

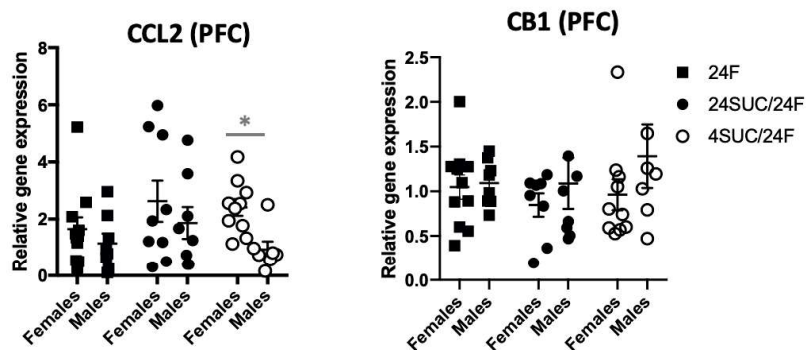

Supplementary figure 13 Gene expression analysis in Cohort E. CCL2 did not show a significant GROUP*SEX interaction, however by still running the post hoc analysis, females expressed significantly more CCL2 than males in the 4SUC/24F group. CB1 in the PFC did not show any significant effects, however by still running the post hoc analysis of the iGROUP*SEX interaction, the t value was higher in the 4SUC/24F group, with CB1 expression higher in males than females.

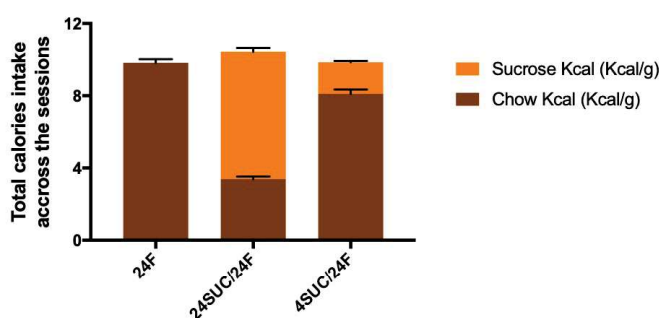

Supplementary figure 14 Distribution of calories between chow and sucrose (Cohort F). Total calorie intake from chow (3,952 Kcal/g) and sucrose 17,1% (0,684 Kcal/mL) across days of access.

GENE	NM	Forward	Reverse
36B4	NM_007475.5	TGAGATTCGGGATATGCTGTTG	TTCAATGGTGCCTCTGGAGAT
GFAP	NM_001131020.1	CAACTGCAGGCCTTGACCT	TCTTCCTGTTCGCGCATTG
IBA1	NM_001361501.1	GTCCTTGAAGCGAATGCTGG	CATTCTCAAGATGGCAGATC
CB1	NM_007726.5	GGGCAAATTCCTTGTAGCA	CAGGCTCAACGTGACTGAGA
FAAH	NM_010173.5	CCCAGAAGCTGTGCTCTTT	TCAGTCAGATAGGAGGTCAC A
TNF α	NM_013693.3	CCGATGGGTTGTACCTTGTCT	GTGGGTGAGGAGCACGTAGT
CCL2	NM_011333.3	CCAACTCTCACTGAAGCCAGC	CAGGCCCAGAAGCATGACA
IL10	NM_010548.2	TGGGTTGCCAAGCCTTATCG	CTCTTCACCTGCTCCACTGC

Table 5 Primer sequences

Discussion

The primary finding in this study is that sucrose bingeing in mice modifies responses to EtOH-related cues. Specifically, sucrose bingeing blocked a CPP to EtOH, at least at one dose (3 g.Kg⁻¹). When we tested lower (2 g.Kg⁻¹) and higher (4 g.Kg⁻¹) doses of EtOH, only sucrose bingeing females expressed a CPP at the higher dose. Thus, we conclude that repeated

binge-like consumption of sucrose reduces EtOH reward in female mice and blocks EtOH reward at all doses we tested in males. These results point to sex differences in the effects of sucrose bingeing o rewarding effects of alcohol which may reflect sex-dependent modifications of brain reward mechanisms. This could also explain why tolerance to sucrose reward, measured behaviorally by escalation of the intake overtime (Avena et al., 2009), was higher in females than in males (Supplementary figure 5).

Our results also provide evidence for differences in the effects of sucrose or fat bingeing on reward responses. More specifically, we did not observe a CPP to EtOH to lower concentrations in male mice following sucrose bingeing, contradicting a previous report that fat bingeing males respond to subthreshold doses of EtOH (Blanco-Gandía et al., 2017). Therefore, we provide new evidence that different macronutrients may differ in reward responses to EtOH. This fits with evidence that sucrose and fat bingeing produce distinct withdrawal signs in animals. However, we should point out that the previous study (Blanco Gandia 2017) was only conducted in males, on a different mouse strain (OF1) and at a younger age.

Our finding that sucrose bingeing did not impact later consumption for EtOH contradicts previous evidence in rats (Avena et al., 2004b). These discrepancies may be due to differences in food access during sucrose bingeing sessions; we provided continuous EtOH access as opposed to intermittent access to EtOH as during the EtOH preference test. Our finding that higher sucrose intake in female bingeing mice is associated with increased consumption of high dose EtOH (Supplementary figure 10.e.) matches evidence that high saccharin intake in rats is associated with increased alcohol consumption (Gosnell & Krahn, 1992). Thus, it may be excessive intake of a sweet solution, not the sucrose itself, that induces changes in alcohol responses. Although we did not observe the same relationship in males, that may be due to a higher level of intake in females.

Hepatocytes play an essential role in carbohydrate and lipid metabolism. The liver has the ability to quickly adjust its size to the rest of the body by cell division or death. This was confirmed by a significant and positive relation between weight gain and liver weights as observed in forensic autopsies (Simon et al., 2020). The livers were significantly heavier in males than females and could be explained by body weight differences. Sucrose access is associated with reduced weight gain and therefore liver weight, which is consistent with some

results in the literature (Sumiyoshi et al., 2006). Since total calorie intake was not significantly different between the groups, the limited access pattern might explain body and liver weight differences (Supplementary figure 14). Further investigation should be run on liver glycogen and lipid content. According to our glycemia results, it seems like hepatic gluconeogenesis might not be affected. Sugar intake might increase fatty acid synthesis in the liver, however we do not know if a large amount of sucrose intake within a short period of time leads to higher synthesis (Wei et al., 2022).

Sucrose bingeing induced specific changes in brain reward regions, including an increase of GFAP expression (an indication of astrogliosis) in the PFC. Given the role of CCL2 which attracts immune cells, neuroimmune modulation in the PFC induced by diet might be higher in females than males and may be confirmed with protein analysis. There was a negative correlation between CCL2 and CB1 expression only in the continuous access group. This is consistent with the literature showing that CB1 agonists decrease CCL2 expression in a mouse microglial cell culture exposed to LPS (Kozela et al., 2010). In addition, the positive correlation between IBA1 and TNF α in the group given continuous access to sucrose might reflect the recruitment of activated microglia releasing TNF α . These differences could explain the absence of an EtOH CPP in this group, given that dopaminergic signaling to the PFC is involved in a CPP to cocaine (Shinohara et al., 2017) and CPP to EtOH (Grolewski et al., 2012) and might be disturbed in sucrose bingeing animals.

In the food control group DS GFAP expression was higher in males than females, but this difference was wiped out in the intermittent sucrose access group. It is important to point out these sex differences in the DS since it is involved in reward driven behaviors. Anti-inflammatory mechanism through the endocannabinoid system might be going on in the DS the intermittent access group due to a negative correlation between CB1 and TNF α and the fact that CB1 agonist has anti-inflammatory effects (Walter & Stella, 2004).

The neuroimmune cells in the NAcc of the sucrose access groups might acquire a pro-inflammatory profile due to increases of TNF α . The intermittent access shows positive correlation between TNF α and CCL2 despite no changes in IBA1 and GFAP levels. CCL2 and IL10 are positively correlated in the 24SUC/24F group. IL10 is an anti-inflammatory cytokine, suggesting that 24SUC/24F might have ongoing neuroprotective mechanisms.

Inflammation in the NAcc might provide evidence of anxiodepressive like behavior as observed following saturated fat diet (Décarie-Spain et al., 2018).

In the LH, sex dependent expression of astrocytes and microglia markers were found independent of the experimental group. These results provide evidence for sex dependent differences in cytoarchitecture and energy metabolism (Berthoud & Münzberg, 2011). Finally, the decrease of CB1 receptor in the LH requires further investigations to identify in which cell types. CB1 is expressed on γ -aminobutyric acid and glutamatergic neurons of the LH and activation results in retrograde inhibition. We could expect a decrease of CB1 on glutamate neurons in the sucrose access groups allowing activation of orexigenic neurons such as melanin-concentrating hormone and orexin neurons that could explain the escalation of sucrose intake (Silvestri & Di Marzo, 2013).

Due to COVID19 lockdown, behavioral experiments have been delayed and older animals were tested for an EtOH CPP following sucrose bingeing. Our results show that age influences reward responses to EtOH as 2 months old sucrose bingeing mice do not exhibit an EtOH CPP at any dose. Older bingeing mice since 3 g/Kg was sufficient to produce CPP unlike the 24F control group suggesting that sucrose bingeing modifies EtOH CPP but at different doses according to the age. However, 2 months old female mice exhibit EtOH CPP at 4 g/Kg suggesting a shift to the right of the dose response curve compared to 24F controls.

Acknowledgments:

This project was supported by the Université de Strasbourg, Centre National de la Recherche Scientifique (CNRS), Programme International de Cooperation Scientifique (PICS CNRS), the French National Research Agency (ANR) through the Programme d'Investissement d'Avenir (ANR- 17-EURE-0022, Euridol, graduate school of pain), IRESP (Institut pour la recherche en santé publique, IReSP/INCa-21-Addiction), and the Natural Sciences and Engineering Research Council of Canada (NSERC) . Gaëlle Awad received a PhD fellowship from the French Ministère de l'Enseignement Supérieur et de la Recherche.

VI. General discussion

Several elements of my results have already been discussed in the corresponding articles.

I decided in this general discussion chapter to develop specific points that I think will provide new elements for ongoing research on BED. In a first step, we will provide our hypothesis on ongoing neurochemical processes in the brain following sucrose bingeing (Figure 40) based on our gene expression results, summarized in Figure 39. In a second step, we will try to relate these findings to behavioral adaptations and compare these to addiction related changes. This will allow us to move on to our third topic, whether BED is a form of food addiction. And finally, we will discuss the importance of comorbidities in BED and AUD. Across these elements of discussion, we will point out and provide interpretations on sex differences results and importance in research (Figure 41).

VI.1 Does neuroinflammation develop in the brain reward pathway following sucrose bingeing?

There is growing evidence that high sucrose diet causes systemic inflammation and preliminary data suggest it also produces neuroimmune responses in the brain (Fuente-Martín et al., 2013; Patkar et al., 2021). In this thesis we investigated whether neuroinflammation could be observed in reward associated brain regions in a BED mouse model, similar to what has been described in models of drug addiction (Lacagnina et al., 2017). Our results provide further knowledge on the underlying neurochemical processes of BED and further evidence on the similarities between BED and SUD.

Our gene expression analysis following 2 weeks of sucrose bingeing shows signs of astrogliosis in the PFC via an increase of GFAP in mice given intermittent access to sucrose (4SUC/24F group). However, we do not know if these changes mirror an anti- or pro-inflammatory environment. CCL2 is a proinflammatory chemokine and its expression in the hypothalamus is increased following LPS administration (Le Thuc et al., 2016). Interestingly, our results investigating CCL2 gene expression in the same region, PFC, show a significant sex effect, with females expressing more CCL2 than males. Since the F value of the group*sex interaction is higher than 1, this means that the variance between the groups is

higher than the variance within the groups. We therefore decided to run the post hoc analysis after the interaction. Sex differences were only observed in the intermittent access to sucrose group (4SUC/24F), which was higher in females than males ($t=2,67$; $df=46$, $p=0,011$). This suggests a polarization towards a proinflammatory profile of PFC astrocytes that might be observed in sucrose bingeing females.

The endocannabinoid system also has an immunomodulatory role (Karoly et al., 2020). Interestingly, we also found a sex difference for PFC CB1 expression within the sucrose bingeing (4SUC/24F) group despite no group*sex significant effect. According to the t-value, males had higher mRNA CB1 levels than females ($t=-1,457$; $df=42$; $p=0,1525$). According to the literature, CB1 binding can induce anti-inflammatory processes. For instance JWH150, a strong CB1 agonist and weak CB2 agonist, reduces the concentration of pro-inflammatory factors in LPS stimulated cells including IL-6 and CCL2 (Bort et al., 2017). After administration of CB1 agonist (WIN55212-2), mRNA of pro-inflammatory cytokine TNF α , IL-6 and IL1- β decreased (Walter & Stella, 2004). This is in line with what we hypothesize in female sucrose bingeing mice, such as a polarization of astrocytes towards pro-inflammatory profile which seems to be absent in males probably due to CB1 anti-inflammatory actions. As described in the introduction, astrocytes are involved in glutamate reuptake, however, in a pro-inflammatory environment, this process can be dysregulated. We can expect spillover of glutamate in females of the 4SUC/24F group, leading to an overexcitation of glutamate receptors. The PFC has glutamate projections to the DS and the NAcc. Therefore gene expression changes in PFC may induce subsequent alterations in these regions.

Gene expression data in the DS, a structure involved in stimulus response learning, show sex differences, with higher expression of GFAP in males than females. Interestingly, these sex differences observed in the 24F control group are wiped out in the 4SUC/24F group. This could reflect an increase of 4SUC/24F female GFAP and supports our hypothesis of increased glutamatergic projections from the PFC. The DS is involved in sensorimotor integration. It is partitioned into the dorsomedial striatum involved in goal directed behaviors and reward processing and the dorsolateral striatum involved in habit learning and instrumental response. According to the rodent stereotaxic atlas, the PFC punches we analyzed included orbitofrontal, prelimbic, infralimbic and anterior cingulate cortex regions. What might be going on in females? We could suggest a decrease of cortical inhibition and

an ongoing transition from goal directed to habit driven behaviors. The infralimbic provides inputs in the dorsolateral striatum and has an important role in the development of habitual behaviors. While the prelimbic provides inputs to the dorsomedial striatum and is implicated in goal directed behaviors (Chen et al., 2021). A rat study looked at the development of habit driven behaviors following restricted access to palatable food by measuring their response in a devaluation test (Furlong et al., 2014). In this task, the animals did not change their behavior in the instrumental task following reward devaluation. Moreover, c-Fos immunoreactivity was increased in the infralimbic, cingulate/motor and somatosensory cortices and in the dorsolateral striatum. Therefore, the restricted animals show accelerated shift to habit driven behaviors. In another study, BED obese individuals exposed to food cues (view and smell) show an increase of striatal DA levels by PET scan (Wang et al., 2011), suggesting a role of this structure in desire, motivation and maybe anticipation of reward. Based on these elements, our results suggest that females might have an ongoing transition from goal directed behaviors to habit learning mirrored by a potential increase of GFAP, as a consequence of potential increase of glutamatergic projections from the PFC (see previous hypothesis). In addition, still in the DS, our correlation analysis revealed a negative relationship between TNF α and CB1 in the bingeing group 4SUC/24F. As mentioned before, cannabinoids have an anti-inflammatory effect. For these reasons we believe there might be some neuroprotective mechanisms going on in the DS, which might be more efficient in males than females.

There are multiple lines of evidence that circulating inflammatory factors can favor the development of anxiodepressive behavior. Recently, an elegant study was able to correlate increase of NAcc inflammation with anxiodepressive-like behavior following a saturated fat diet (D carie-Spain et al., 2018). Indeed, by inhibiting the IKK β , an upstream regulator of NFkB, they reversed anxiodepressive-like behavior but also compulsive seeking of sucrose. These results go in line with the hypothesis that our sucrose bingeing animals are transitioning towards a compulsive phenotype. However the previous study was only performed on male mice. A more recent study from the same authors pointed out the importance of oestrogens in depressive-like behaviors by running the same experiments but this time in females. Signs of neuroinflammation in the NAcc were lower, and anxiodepressive-like behavior was not reversed by inhibiting IKK β (D carie-Spain et al., 2021). However, there was an increase of oestradiol, which has anti-inflammatory properties, and might explain the sex differences. In our results, the NAcc shows an increase of TNF α mRNA expression, suggesting potential inflammation. There was no hint of any sex differences but we should point out a critical

difference which is the duration of the experiment. As we will discuss later on, sex differences should always be assessed to avoid the risk of sex dependent treatment resistance (see paragraphs IV.3 & IV.4). At the mechanistic level, we hypothesized earlier on an increase of glutamate release from the PFC. PFC has glutamatergic inputs to the NAcc. TNF α increases synaptic strength by increasing α -amino-3-hydroxy-5-methyl-4-isoxazolepropionic acid receptors (AMPA) trafficking at the cell surface of neurons (Beattie 2002). Hence, it is possible that TNF α promotes an increase of AMPAR at the neuron cell surface in response to increased glutamate and therefore resulting in increased activity of the NAcc. In fact, the increase of TNF α goes in line with previous studies showing increased activity of the NAcc. Upon sucrose intake, cFOS expression increases in several structures such as hypothalamic nuclei, the prefrontal cortex and the nucleus accumbens (Mitra et al., 2011) which are part of the limbic circuit (Lapidus et al., 2014).

Considering our results in the LH, sex dependent expression of astrocytes and microglia markers were found independent of sucrose exposure. They were higher in males. Despite no significant group effect in GFAP analysis, the F value was equal to 1, (this means that the variance between the groups is equal to the variance within the groups) and the post hoc analysis showed a high t value within the 4SUC/24F group, males expressing more GFAP than females ($t=-1,57$; $df=37$; $p=0,12$). In the same manner IBA1 expression analysis did not show a significant interaction but only a significant sex effect. Despite no significant group effect in GFAP analysis, the F value was higher than 1 (this means that the variance between the groups is higher than the variance within the groups), the highest expression being observed in 4SUC/24F group. The post hoc analysis showed a high t value within the 4SUC/24F group, males expressing more than females ($t=-1,57$; $df=37$; $p=0,12$). In the same manner IBA1 expression analysis also did not show a significant group*sex interaction but only a significant sex effect. However, post hoc of the interaction shows that IBA1 mRNA is significantly higher in males than females only in the 24F control group ($t=-2,34$; $df=39$; $p=0,024$). Our results provide evidence for sex dependent cytoarchitecture and suggest sex differences in energy metabolism since the LH is involved in energy assimilation and expenditure (Berthoud & Münzberg, 2011). We might again believe that females may have a lower inflammatory profile than males as mentioned before because of oestrogens (Décarie-Spain et al., 2021). Metabolic disorders are comorbid with BED so it is important to note that LH expresses leptin receptors on orexin neurons. In pro-inflammatory environment, SOCS3 expression increased and this can decrease phosphorylation of leptin receptor (Figure 10).

However, we would need further metabolic analysis to provide more evidence of any leptin or insulin resistance in our conditions. Furthermore, our results provide molecular evidence in support of gender differences observed at the human level, that men with BED have more metabolic dysregulations than women with BED (Guerdjikova et al., 2014, 2019). Hypothalamic astrocytes are also nutrient sensors thanks to glucose transporters. We may have an increase of astrocytes to regulate coordination with neurons in glucose sensing. Another hypothesis could be that glutamate release from astrocytes is increased and therefore leads to more activation of orexin neurons activity. Astrocytes can also synthesize lactate taken up by orexin neurons through monocarboxylate transporters and maintain neuronal activity (Berthoud & Münzberg, 2011). The observed decrease of CB1 mRNA could suggest decreased retrograde inhibition of LH neurons. The LH sends orexigenic projections to the NAcc and the VTA (Xu et al., 2020), and orexigenic neurons are known to mainly have a glutamatergic phenotype . We could therefore suggest an increase of these projections due to disinhibition because of decreased CB1 on GABA neurons projecting to orexin neurons. This would result in an increase of dopaminergic release from the VTA to the NAcc. Indeed, the animals were sacrificed at a period of sucrose solution expectation. As tested in bees, DA is released during anticipation of palatable food which helps to modulate motivation for the reward (Huang et al., 2022), a process also observed in rodents (de Lartigue & McDougle, 2019). In this case, we should be aware that we are measuring molecular adaptations to sucrose intake anticipation and maybe not changes induced by sucrose exposure.

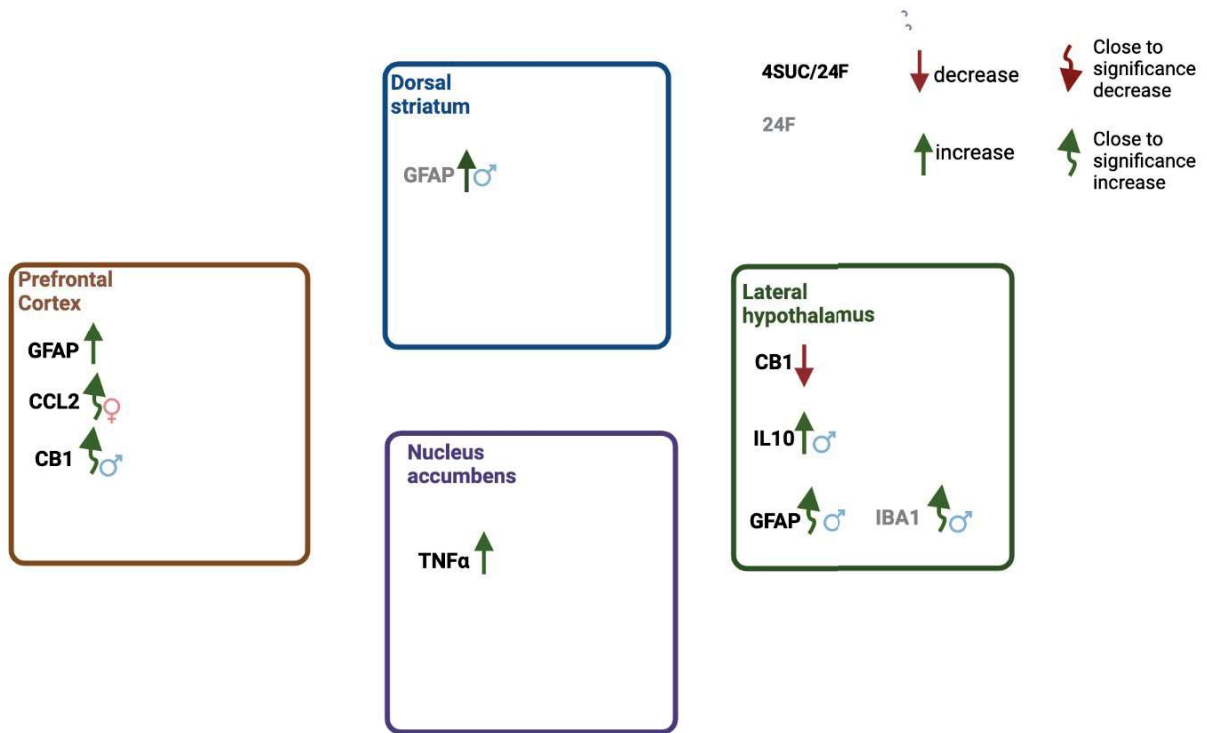

Figure 39 Schematic representation of gene expression results obtained following sucrose bingeing.

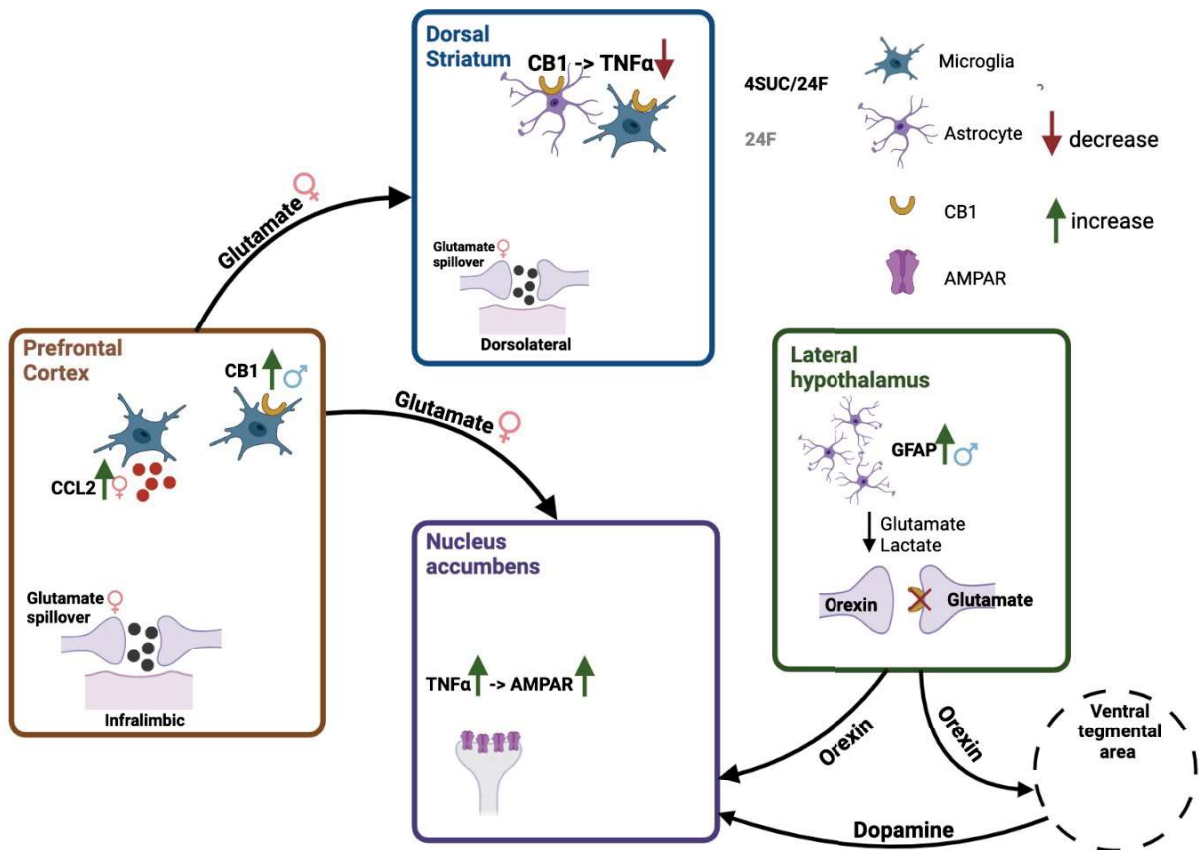

Figure 40 Schematic representation of hypothetical modulation in neuronal signaling and gene expression.

VI.2 Can we talk about food addiction ?

There is no clear consensus within the scientific community about food addiction. In this section, we will provide evidence for food addiction based on the criteria for SUD (DSM-5). We will also talk about sex differences in “food addiction” vulnerability.

One of the criteria of SUD is tolerance. Our results show that animals from the bingeing group increased significantly their intake across the days. According to the literature, this behavior is apparent to signs of tolerance in substance abuse (Avena et al., 2009).

Another component of addiction is craving. According to Nogueiras R. et al, 2012, craving for highly palatable food involves the opioid system (Nogueiras et al., 2012). MOP in the NAcc shell increases liking and enhances wanting for preferred food. This can precipitate the desire for food and relapse into unhealthy eating habits. Our results from the KO study show that MOP is particularly implicated in bingeing. We also show that TNF α expression is increased in the NAcc. There is evidence from the literature that stimulation of microglial MOP by morphine increases PKC ϵ –Akt–ERK1/2 signaling pathway and can induce expression of pro-inflammatory cytokines such as TNF α (Merighi et al., 2013). We could therefore suggest an increase of microglial MOP binding in the NAcc probably through local release of enkephalin and more precisely in the NAcc shell hedonic hotspot as shown in mice exposed to a high fat diet (Nogueiras et al., 2012). In fact, intermittent access to glucose during 30 days increases D1 receptor and MOP binding (Colantuoni et al., 2001).

Craving might be triggered by withdrawal symptoms. Though we did not measure any withdrawal behaviors, it has been shown that after 8 days of intermittent access to glucose, 12 hours glucose deprivation induces opioid like signs of withdrawal suggesting an opioid dependence (Colantuoni et al., 2001). In this case, naloxone, an opioid antagonist, precipitates withdrawal signs but only in the experimental group. Interestingly the authors found a decrease of extracellular DA in the NAcc and an increase of acetylcholine. According to Lewitus GM, TNF α regulates D2 receptor cell surface expression in the striatum (Lewitus et al., 2014). The D2 receptor is involved in preventing withdrawal symptoms notably in the NAcc. We could suggest that TNF α might be involved in the withdrawal symptoms.

Genetic studies have identified a high frequency of *TaqA1* D2 receptor polymorphism (C. A. Davis et al., 2009). This allele is associated with reduced D2 receptor density in the striatal region and hypersensitivity to reward. An argument used to oppose food addiction is the lack of evidence of a specific addictive substance since BED individuals usually binge on processed foods (Novelle, 2018). The addictive potential of sugar has only been shown in preclinical studies. But interestingly, when looking at withdrawal signs, these were not observed in animal models of fat diet bingeing (Bocarsly et al., 2011). This provides evidence that sweet taste might induce more addictive like behaviors than fat.

Overall, in our gene expression results we might have indicators of underlying mechanisms involved in addictive-like behaviors. The PFC and the striatum enhance craving shown in cocaine abusers (Volkow, Logan, et al., 1999b). Our results show changes in PFC and striatum at the level of inflammatory gene expression. Elevated orbitofrontal cortex activity is associated to drug craving (Volkow, Wang, et al., 1999). Our tripartite synapse glutamate spillover theory in the PFC can therefore be associated with sucrose craving. We already know that forced abstinence following glucose bingeing induces craving in rats (Avena et al., 2004a).

Cross-sensitization is another aspect of drug addiction. Avena et al., showed that sucrose bingeing animals increase alcohol consumption at higher concentration (9%) during the first hour of access of alcohol (Avena et al., 2005). In the literature, they refer to this phenomenon as consummatory cross-sensitization which has also been shown for cocaine in sucrose bingeing rats (Caroll 2007). In our experiments we haven't been able to reproduce these results in the EtOH preference test (see discussion of section III.5. of the results for further explanations). However, sucrose bingeing animals show absence of EtOH reward response at lower and higher doses in our experiments. Our results are in agreement with a recent study showing that fat bingeing modified EtOH reward response in the CPP, with bingeing rats responding to a subthreshold of EtOH dose (Blanco-Gandía et al., 2017). We therefore bring evidence of altered sensitivity to drugs depending on the nutrient.

Whether BED is considered as a food addiction or as an eating disorder is an ongoing debate. One aspect to consider in this discussion is the type of criteria and the number of criteria needed to be diagnosed, as these represent critical measures to qualify the behavior towards food as "addiction". When applying the DSM IV SUD criteria to BED women,

92,4% meet the criteria (Cassin & Von Ranson 2007). However, when applying the Yale Food Addiction Scale to BED patients, only 57% meet the criteria (Gearhardt et al., 2009). Therefore, despite similarities between BED and addiction, not all BED individuals meet criteria of food addiction. Therefore in humans, not all BED individuals present addictive-like behaviors. Correlation analysis between symptoms from food addiction and BED show that some have a low correlation, the 2 symptoms from the YFAS that are less present in BED are “consumed more than planned” and “use in physically hazardous situations”. Interestingly, a high correlation between food addiction and BED is observed in individuals with severe forms of BED; Moreover, there is a higher proportion of females with severe BED than males (10,4% vs 1,7% respectively) (Burrows et al., 2017). This suggests that women may be more prone of to having a food addiction phenotype than men.

VI.3 Are signs of food addiction more pronounced in females ?

As mentioned earlier, there is a higher prevalence of women with severe BED than men (Burrows et al., 2017). The overall prevalence presents a female to male ratio of 6:4 (Guerdjikova et al., 2017). Individuals with food addiction according to the YFAS and BED according to the standardized Binge Eating Scale report higher emotion dysregulation, depression, negative affect and low self-esteem (Burrows et al., 2017). Women with BED report higher rates of psychopathology such as depression (Guerdjikova et al., 2014) and mood disorders (Guerdjikova et al., 2007) than men. Moreover, a PET scan study showed that major depressive disorder is associated with active microglia in the PFC and the anterior cingulate cortex (Gritti et al., 2021).

We provide preliminary results on neuroinflammatory basis of depression in BED with increased GFAP in the PFC and a potential increase of CCL2 in the PFC of females (Figure 39). Moreover, we hypothesized an increase of glutamate in the tripartite synaptic cleft in females PFC (Figure 40). Extracellular glutamate measured by microdialysis was increased in the PFC following induced stress in rats (Sanacora et al., 2012). Therefore we could expect a neurochemical alteration due to stress in female sucrose bingeing mice. However, recent evidence shows that chronic stress is associated with PFC inhibition (McKlveen et al., 2016), therefore further behavioral and neurochemical analysis are needed to provide more evidence for sex dependent stress associated with BED.

Our results are in line with the literature showing higher intake of sucrose in females than males (Grimm et al., 2001). A heightened impulsivity may predict the course of development of SUD and in the same manner of BED. It was shown that BED individuals present higher food sensitivity and spontaneous behavior in response to food stimuli (Schag et al., 2013). Also, women display a faster progression from first use to addiction than men, also called the “telescoping effect” (Zakariaeiz & Potenza, 2018). From our results we hypothesize that female sucrose bingeing mice show neurochemical changes that could result in an increase of DS activity through increased glutamate in the tripartite synaptic cleft, and could reflect signs of impulsivity (Figure 40).

VI.4 Are comorbidities associated to BED and AUD sex dependent ?

BED and AUD co-occur with psychiatric and medical comorbidities. Patients may be less efficiently treated if their potential co-morbidities are not evaluated. This could be one of the reasons for poor treatment outcomes. Eating disorders, in particular bulimia nervosa and BED are associated with co-morbid alcohol abuse (Conason & Sher, 2006). Interestingly, an empirical study questioning adolescents about their eating habits and the frequency of drug use revealed that alcohol was the most commonly used drug amongst binge eaters who do not display compensatory behaviors (Crisp, 1967). Individuals engaging drug use show behavioral similarities with those engaging binge eating. They show emotional dysregulation deficits and use bingeing and drugs as coping mechanisms. They also show impulsive behavior that is mainly attention base impulsivity according to the Barrat Impulsiveness Scale and cue craving (Schulte et al., 2017). Interestingly, we found sex differences in EtOH CPP following sucrose bingeing. Only females from the 4SUC/24F group expressed CPP at $4\text{g}\cdot\text{Kg}^{-1}$, whereas their male counterparts did not. This contrasts with human literature showing that men are more prone to develop SUD than women (Wilfley et al., 2000). Consideration should be given to the absence of social and cultural factors in our experiments which play a critical role in the development of SUD in humans. Therefore, we suggest that a history of BED may increase the risk of altered EtOH reward responses in a sex dependent manner. According to the gateway hypothesis, excessive intake of one substance (e.g. sucrose) produces neural adaptations that influences responses to another substance (alcohol). Indeed, according to the age of onset in clinical studies with patients having both ED and SUD, the development of these disorders

seems to follow a gateway pattern (Beary et al., 1986; Lacey & Moureli, 1986). However we were not able to identify this behavior in EtOH consumption preference test as Avena et al. did.

The gateway hypothesis also depends on the age of onset of BED. While 3 g.Kg⁻¹ was a rewarding dose for the control groups in 2 month old mice, which wasn't for mice between 4 and 6 months old expressing an aversion 4 g.Kg⁻¹ dose. These results are in line with the fact that the risk of developing drug dependence decreases with age. An evolutionary explanation of adolescence as a sensitive period suggests that exploration of the environment is necessary to increase survival and reproductive fitness. Impulsivity and novelty seeking are associated with substance abuse during adolescent development (Jordan & Andersen, 2017). Interestingly, while 3 g.Kg⁻¹ was a rewarding dose for the 4SUC/24F mice at 4-6 months old, 4 g.Kg⁻¹ was only rewarding for female 4SUC/24F mice. Therefore these results provide further evidence on the critical impact of both the age of onset of BED and sex in alcohol related disorders in BED individuals.

VII. Conclusion and perspectives

Our results support the hypothesis that neuroinflammatory processes occur following sucrose bingeing in specific brain regions of the reward pathway. We believe that these contribute to the onset and maintenance of BED and may interplay with dopaminergic signaling. One level of investigation to better understand these alterations and get a wider representation of up and down regulated genes, would be to conduct a gene microarray analysis and measure expression of genes involved in neuroinflammation, as well as the opioid, endocannabinoid and dopaminergic systems. This targeted approach would provide insights into specific signaling pathways that may be involved, and connect these results with potential biological mechanisms. However, if no differential gene expressions are found in the microarray analysis, we will move on to RNA sequencing, a method without a priori, allowing the detection new target genes involved in BED. Following the identification of some gene candidates, it is necessary to look at protein levels (see next paragraph). Investigation of gut microbiota dysbiosis and inflammation in the blood and the liver would also provide a better understanding of how sucrose bingeing induces neuroadaptations and neuroimmune signaling. Indeed, following a high fat diet for 4 weeks, hypothalamic inflammation was observed while no inflammation appeared in the liver or the adipose tissue,

suggesting distinct kinetics in the development of inflammation following specific diet. These results would therefore give insight into whether neuroinflammation is induced by systemic inflammation and if targeting systemic inflammation is an efficient method of reducing problems associated with neuroinflammation. Moreover, it will allow a better characterization of obese induced inflammation since this condition is known to cause inflammation in the peripheral tissues.

To localize immune signaling and identify specific cells, fixed brains from animals of sucrose bingeing experiments have been collected to conduct immunofluorescence studies. By the end of my PhD and with A.S. Aubry's help (PhD student in the lab), we have set up immunofluorescence protocols to quantify astrocytes and microglia in the brain. To examine astrocytes, we decided to target SOX9, a transcription factor which expression is not diminished by age or functional astrocyte status. Moreover, the nuclear localization allows a precise analysis, and therefore this analysis would be more conservative than the cytoplasmic marker GFAP (Sun et al., 2017). To examine microglia, we targeted IBA1 combined with the cluster of differentiation 68 (CD68). CD68, a transmembrane glycoprotein localized on lysosomes, is elevated in activated microglia undergoing phagocytosis. Therefore, this will allow us to separate activated from non-activated microglia (Hopperton et al., 2018). These analysis will be conducted in the near future.

We also provided evidence that binge eating alters alcohol reward. We already know that intermittent access to sucrose in rodents is associated with DA release in the NAcc even after repeated binge episodes (Avena et al., 2005), a phenomenon which is also observed with EtOH (Di Chiara & Imperato, 1985). Additionally, we showed that sucrose bingeing involves MOP and CB1 (Awad et al., 2020; de Sa Nogueira et al., 2021), both also known to be involved in EtOH intake (Font et al., 2013; Karoly et al., 2020). With our project we are providing new evidence that there might be neuroimmune similarities between BED and AUD. These common underlying mechanisms might explain comorbidity between BED and AUD. By targeting the immune system in sucrose bingeing animals, with viral-mediated approaches for example as seen in Décarie Spain et al. 2018 & 2021, inhibiting an important enzyme that causes activation of the transcription factor NFkB, we could expect to reinstate normal EtOH CPP behavior. Specific brain structures would be selected for such approaches, on the basis of the immunofluorescence results.

We observed sex differences in inflammatory gene expression following sucrose bingeing. This points out the importance of sex differences in neuroimmune analysis to avoid sex dependent resistance to therapies. Indeed, minocycline, an antibiotic known to reduce neuroinflammation, decreases alcohol intake in mice but affects weight and water intake in a sex dependent manner (Agrawal et al., 2011; Wang, 2018). Tigecycline, an antibiotic structurally similar to minocycline, was also shown to reduce ethanol intake in male and female mice though it was more efficient in males (Bergeson et al., 2016). Indeed, sex differences in escalation of intake of sucrose or alcohol and in EtOH CPP might be due to sex differences in the alteration of immune related genes in the reward pathway. In addition, it is known that neuroinflammation can be neurotoxic for dopaminergic neurons for instance (Crews & Vetreno, 2011), so we could expect distinct neurotoxic effects in males and females.

Negative affect is experienced in BED individuals. There is also growing evidence of the relationship between anxiodepressive behaviors and neuroinflammation. We decided to better characterize our BED mouse models, by examining these behaviors is an ongoing experiment in our team. A first step was to establish well-being measures to assess mice across periods of sucrose access. To that end, A.-S. Aubry, Dr. K. Befort and I have set up the burrowing test in the animal facility (Jirkof, 2014). Briefly, we expose animals to a bottle filled with clay beads and measure their normal digging behavior by evaluating the weight of beads they moved out. We expect sucrose bingeing animals to express a lower digging behavior than controls as an indication of lower well-being levels. We have also set up the nesting test (Deacon, 2006), which is another indicator of well-being, by measuring the construction of the nest in a time dependent manner. To characterize our sucrose bingeing model, we will also test anxiodepressive like behaviors. The splash test that we have previously used in the lab in a pain study (Roedel et al., 2018) will be used to characterize the well-being and depressive like behavior in rodents. A.-S. Aubry is now setting up the elevated plus maze test as a measure of anxiety. Comparisons will be conducted between and within groups to compare individuals with different periods of sucrose access: 2 versus 8 weeks. These ongoing experiments will allow us to characterize time dependent changes in anxiety like behavior and to determine whether the effect is sex-dependent.

Out of personal interest and scientific curiosity, I started to look at the benefits of physical exercise as a therapeutic strategy in SUDs and BED (Figure 41). There is evidence

that physical exercise helps addicts to abstain from drug use and prevent relapse. Indeed, exercise is mood enhancing, has anxiolytic effects and reduces acute distress of withdrawal (Linke et al., 2015). Incorporation of physical exercise in alcoholism treatment programs was shown to be beneficial (Brown et al., 2009; Murphy et al., 1986). Moreover, combining physical exercise therapy with cognitive behavioral therapy in BED treatment programs helps to reduce depressive symptoms in BED individuals. It also represents a driving force towards the engagement of binge episodes which increases maintenance and relapse into BED (Vancampfort et al., 2013). It is also shown that physical exercise in rodent models reduces neuroinflammation (Seo et al., 2019). We could add this parameter in our BED mouse model to examine the evolution of the behavior in parallel of the neuroinflammatory process. In any case, we cannot exclude this area of research and promote access to physical exercise for BED patients and to the population in general.

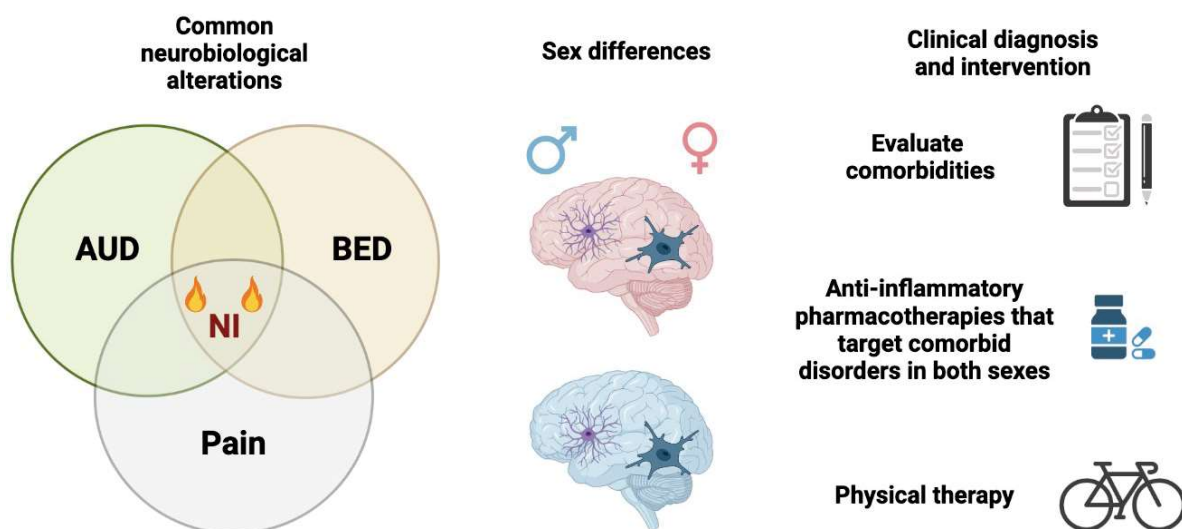

Figure 41 Potential neuroimmune mechanisms are at the intersection between AUD, BED and neuropathic pain. In the literature and our preliminary results, there is evidence that immune system related gene expressions are sex dependent. In humans this could be due to environmental factors, however in preclinical studies we exclude this factor. During clinical diagnosis we believe it is necessary to screen for comorbidities. As mentioned earlier, specific gene polymorphisms are associated to comorbid disorders, one disorder can induce relapse to another, and treatment efficiency can be decreased. Today, the only drug to be approved for BED, is Lisdexamphetamine, which reduces binge episodes in severe forms of BED by reducing appetite. However, there are poor treatment outcomes, and this is because BED is usually comorbid with risk factors of relapse. This is one of the reasons why clinical trials examine drug associations, targeting for instance depression and weight balance by combining Bupropion + Naltrexone or Samidorphan which is a combination of buprenorphine for major depression and olanzapine for weight loss (Heal & Smith, 2021).

VIII. Acknowledgements

My thanks go to the members of the thesis committee, Sylvie Granon, Carole Rovere, Benjamin Boutrel et Joeffrey Zoll, for their availability and for accepting to evaluate my thesis work.

I would like to express special thanks to Jean-Christophe Cassel for opening the doors of the LNCA to me. I would like to point out that I particularly appreciated your mail writing, I have kept one of your expressions aside, which I try to use from time to time “*Presque rien de neuf sous les tropiques du bon sens*”.

My sincere gratitude goes to my thesis supervisors, Katia and Cella. You helped me to evolve in the world of research, while looking after me. I had the chance to express my ideas and doubts without apprehension. I feel clearly lucky to have had such a thesis supervision. Cella, thank you for always being available, even from so far away, for sharing you expertise in behavior and teaching how to write scientific articles in english. Katia, je te remercie d’avoir cru en moi depuis le master, de m’avoir autant soutenu et d’avoir toujours été à l’écoute. J’ai appris grâce à toi à gérer un projet et mettre en place des expériences (et toujours faire des manip pilotes et des groupes contrôles !).

I would like to thank Isabelle, Paul, Guylène and Marie from Lausanne for the collaboration we made. I am glad I got to learn about neuropathic pain during my PhD. It was very enriching and I appreciated exchanging with you!

Special thanks to Benjamin Boutrel, thanks to who I discovered behavioral neurobiology of addiction and eating disorders during ma bachelor studies.

I want to thank my family, my father, my mother and my little brother. You have encouraged me throughout my schooling and my moves. Thank you for your unconditional support. J’ai tant à apprendre de chacun de vous, papa pour sa main verte, maman pour être toujours serviable et Anthony pour son ingéniosité. We will always be the “Beitouna” family. And of course Getchy Habibi, my crazy little dog, who always makes me laugh, you are without a doubt the most beautiful.

I would then like to thank Team 3 "DNA". There is no doubt about it, we are clearly the best. And this is thanks to the cohesion of the team and the human side of each member.

A mes plus anciennes collègues et amies du laboratoire. Dr. Caroline Correia et Dr. Laura Tzeplaeff, un plaisir de vous appeler ainsi. Je vous ai suivi du début à la fin. Nous avons appris à se soutenir durant la thèse, durant le COVID... Merci d’avoir pris le temps d’écouter mes monologues de blagues et de me laisser le fond de la boîte chaude. Cela m’amène biensûr à remercier Théo, qui sait que pour me faire venir, il faut me proposer une boîte chaude. Ta patience est si remarquable face à 3 pipelettes comme nous...mais c’est aussi ta générosité qui me touche à chaque fois que je te vois.

Dr. Laura D., voilà 5 ans qu’on se connaît et à la fin tu as eu la merveilleuse idée de me rejoindre au bureau. Malgré la fatigue des longues journées au laboratoire, je trouvais grâce à toi la force de te chanter du Wejdene.

To my big brothers. Chris, thanks for being such a good friend and colleague to me even though sometimes we could fight like cats and dogs, and the next minute do a karaoke in the office. Those late lab nights coding on R wouldn't have been bearable without you. Wilf, you're like a big brother to me. I can have so much fun (and make fun of you) by your side. Special thanks for still getting along with me despite my crazy stubborn personality. Samy, as soon as I knew you, I could be myself. I admire the topics of conversations you can engage and wish to hang out with you much more often.

Cécile et Marido, mes princesses. Vous avez le cœur sur la main, les yeux à la place du ventre et un sommeil inexistant (sauf devant la biblio). Je ne peux imaginer ma fin de thèse sans vous, et je ne peux exprimer tout l'amour que je vous porte. Cécile ma championne du basket et Marido ma championne de l'équitation, je suis votre number one fan. Je tiens à préciser que nous étions agréables et très gentilles avec notre collègue de bureau Adrien, au cas où il profite de mon départ pour raconter des bobards !

Pascal, je pense que tu sais déjà à quel point j'admire tes connaissances scientifiques mais surtout ton envie de partager. Le bonus, c'est qu'on a toujours le droit à une petite blague. J'irai même jusqu'à dire que ces blagues font partie des meilleurs moments de mes journées.

Romain, merci pour ton soutien pendant ma thèse, pour ton écoute et ton partage de connaissances. Mais je tiens à pointer le plaisir que j'ai eu à discuter avec toi de cyclisme, car on est d'accord, c'est un des plus beaux sport au monde !

Florian et Matthieu, je vous remercie ensemble car votre humour si similaire me manquera énormément. Parfois je me demande d'où est-ce que vous tirez toute ces inspirations.

Anne-Sophie, je suis si heureuse d'avoir pu travailler avec toi pendant la thèse. Je suis très fière de toi car tu as si bien repris le projet. Ta grande intelligence, ta capacité de travail mais aussi et surtout ta bonne humeur faisaient que je me sentais chanceuse de t'avoir à mes côtés pour le projet mais aussi de savoir que je pouvais compter sur toi.

Isabel and Iris, what can I say, the magic of seeing you listening to my crazy life, my dramatic speech (always with irony) and laughing afterwards makes me the happiest comedian on earth!

A Karin et Brigitte, les expertes, les exemples du LNCA, on a tant de chance de vous avoir au laboratoire. Mais vous n'êtes pas que la pour le labo car vous avez une bienveillance remarquable. Merci Brigitte pour tes astuces que tu pouvais nous donner de temps à autre. Merci Karin pour ta si bonne humeur et ton rire qui me réchauffe le cœur.

Sylvie, je te remercie tout d'abord pour ton aide à chaque petit quack informatique. Et biensûr pour ton pot de miel local, qui m'a nul doute donné des forces pour l'écriture. Merci Catherine de me faire un si beau sourire tous les matins quand j'arrive au labo et surtout de prendre le temps de répondre à toutes mes questions administratives.

Aminé, une collègue si douce et si discrète mais si gentille. Merci pour ton aide pour le repros, tu les gères si bien et tu es clairement l'experte souris du labo.

Olivier, merci pour ton aide pendant mes manips, pour tes conseils et ton partage de connaissances sur la vie d'une souris. J'ai beaucoup appris grâce à toi !

Laurie-Anne, je pense que je suis la stagiaire la plus chanceuse du LNCA. Tu m'as si bien supervisé et si bien appris à gérer des manips de comportement et tout cela en étant humble. C'est admirable. Tu as clairement été mon modèle et je suis contente d'avoir pu garder contact avec toi.

Mégane, ma copine <3, ma cycliste, ma pote au caractère que j'adore. Je suis si chanceuse de t'avoir rencontrée et d'avoir pu découvrir une nouvelle passion avec toi. Merci pour ton soutien, pour ta bonne humeur et pour ton honnêteté, grâce à toutes ces qualités j'adore m'amitié que je partage avec toi.

Toujours dans le cyclisme, je remercie Philippe pour ton partage, ton enthousiasme et ta détermination pour m'intégrer dans ce monde de sportifs ! Le vélo c'est l'école de la vie.

Je tiens aussi à remercier mes coéquipières du tennis de la Fraternelle. Merci pour votre bienveillance surtout en fin de thèse quand je venais aux cours à bout de force ! J'attends toutes les semaines vendredi 17h avec impatience. Stéphane, notre coach, j'admire ta patience car nous sommes en effet de sacré pipelettes mais aussi ta capacité d'enseignement, et de transmettre ta passion.

Jad, une belle rencontre en cette dernière année de thèse avec qui je peux faire ma petite libanaise. J'ai de la chance que tu sois patient, car parfois je prends plaisir à t'embêter !

Elie, je pense que je n'ai jamais autant creusé les rides de mon visage qu'après t'avoir rencontré tellement tu me fais rire. Merci pour ces moments de folie qu'on partage ensemble. Tu es une personne exceptionnelle.

Seval et Olga, vous êtes toujours comme des grandes sœurs pour moi. J'attends chaque année avec impatience qu'on s'organise notre voyage annuel car on sait qu'on s'amuse toujours ensemble même à l'autre bout du monde. Merci aussi de toujours être présentes quand je vous sollicite car vous donnez les meilleurs conseils que n'importe quel ami puisse donner.

Sabrina et Yann, ma sœur et mon frère de cœur. On a grandi ensemble et j'ai vécu de si beaux moments avec vous. Nos retrouvailles sont toujours aussi belles, drôles et intenses. Et elles le sont encore plus quand notre belle psychologue, Juliette, se joint à nous <3.

Enfin, j'aimerais remercier ma famille au Liban, qui me réserve toujours un accueil exceptionnel. Votre joie de vivre malgré tout ce qu'il se passe est admirable. Vous me manquez beaucoup et si je le pouvais, je vous rendrais visite beaucoup plus souvent.

IX. References

- Abdalla, M. M. I.. "Central and peripheral control of food intake" *Endocrine Regulations*, vol.51, no.1, 2017, pp.52-70. <https://doi.org/10.1515/enr-2017-0006>
- Adinoff, B. (2004). Neurobiologic Processes in Drug Reward and Addiction. *Harvard Review of Psychiatry*, 12(6), 305–320. <https://doi.org/10.1080/10673220490910844>
- Agrawal, R. G., Hewetson, A., George, C. M., Syapin, P. J., & Bergeson, S. E. (2011). Minocycline reduces ethanol drinking. *Brain, Behavior, and Immunity*, 25, S165–S169. <https://doi.org/10.1016/j.bbi.2011.03.002>
- Alavala, S., Sangaraju, R., Nalban, N., Sahu, B. D., Jerald, M. K., Kilari, E. K., & Sistla, R. (2019). Stevioside, a diterpenoid glycoside, shows anti-inflammatory property against Dextran Sulphate Sodium-induced ulcerative colitis in mice. *European Journal of Pharmacology*, 855, 192–201. <https://doi.org/10.1016/j.ejphar.2019.05.015>
- Alfonso-Loeches, S., Pascual, M., & Guerri, C. (2013). Gender differences in alcohol-induced neurotoxicity and brain damage. *Toxicology*, 311(1–2), 27–34. <https://doi.org/10.1016/j.tox.2013.03.001>
- Alfonso-Loeches, S., Pascual-Lucas, M., Blanco, A. M., Sanchez-Vera, I., & Guerri, C. (n.d.). *Pivotal Role of TLR4 Receptors in Alcohol-Induced Neuroinflammation and Brain Damage*. 11.
- Alloway, R., Reynolds, E. H., Spargo, E., & Russell, G. F. (1985). Neuropathy and myopathy in two patients with anorexia and bulimia nervosa. *Journal of Neurology, Neurosurgery & Psychiatry*, 48(10), 1015–1020. <https://doi.org/10.1136/jnnp.48.10.1015>
- American Psychiatric Association. (2013). *Diagnostic and Statistical Manual of Mental Disorders* (Fifth Edition). American Psychiatric Association. <https://doi.org/10.1176/appi.books.9780890425596>

- Ashayeri Ahmadabad, R., Mirzaasgari, Z., Gorji, A., & Khaleghi Ghadiri, M. (2021). Toll-Like Receptor Signaling Pathways: Novel Therapeutic Targets for Cerebrovascular Disorders. *International Journal of Molecular Sciences*, 22(11), 6153.
<https://doi.org/10.3390/ijms22116153>
- Ashok, I., & Sheeladevi, R. (2015). Oxidant stress evoked damage in rat hepatocyte leading to triggered nitric oxide synthase (NOS) levels on long term consumption of aspartame. *Journal of Food and Drug Analysis*, 23(4), 679–691.
<https://doi.org/10.1016/j.jfda.2014.07.011>
- Avena, N. M., Carrillo, C. A., Needham, L., Leibowitz, S. F., & Hoebel, B. G. (2004a). Sugar-dependent rats show enhanced intake of unsweetened ethanol. *Alcohol*, 34(2–3), 203–209. <https://doi.org/10.1016/j.alcohol.2004.09.006>
- Avena, N. M., Carrillo, C. A., Needham, L., Leibowitz, S. F., & Hoebel, B. G. (2004b). Sugar-dependent rats show enhanced intake of unsweetened ethanol. *Alcohol (Fayetteville, N.Y.)*, 34(2–3), 203–209. <https://doi.org/10.1016/j.alcohol.2004.09.006>
- Avena, N. M., Long, K. A., & Hoebel, B. G. (2005). Sugar-dependent rats show enhanced responding for sugar after abstinence: Evidence of a sugar deprivation effect. *Physiology & Behavior*, 84(3), 359–362.
<https://doi.org/10.1016/j.physbeh.2004.12.016>
- Avena, N. M., Rada, P., & Hoebel, B. G. (2009). Sugar and Fat Bingeing Have Notable Differences in Addictive-like Behavior. *The Journal of Nutrition*, 139(3), 623–628.
<https://doi.org/10.3945/jn.108.097584>
- Awad, G., & Befort, K. (2019). Troubles de l'alimentation: Facteurs de risque pour la douleur et l'addiction ? *Douleur et Analgésie*, 32(2), 113–114. <https://doi.org/10.3166/dea-2019-0055>

- Awad, G., Roeckel, L.-A., Massotte, D., Olmstead, M. C., & Befort, K. (2020). Deletion of mu opioid receptors reduces palatable solution intake in a mouse model of binge eating. *Behavioural Pharmacology*, *31*(2 & 3), 249–255.
<https://doi.org/10.1097/FBP.0000000000000496>
- Azevedo, L. D. S., de Souza, A. P. L., Ferreira, I. M. S., Lima, D. W. da C., & Pessa, R. P. (2021). Binge eating and alcohol consumption: An integrative review. *Eating and Weight Disorders - Studies on Anorexia, Bulimia and Obesity*, *26*(3), 759–769.
<https://doi.org/10.1007/s40519-020-00923-6>
- Balodis, I. M., Kober, H., Worhunsky, P. D., White, M. A., Stevens, M. C., Pearlson, G. D., Sinha, R., Grilo, C. M., & Potenza, M. N. (2013). Monetary Reward Processing in Obese Individuals With and Without Binge Eating Disorder. *Biological Psychiatry*, *73*(9), 877–886. <https://doi.org/10.1016/j.biopsych.2013.01.014>
- Basson, A. R., Rodriguez-Palacios, A., & Cominelli, F. (2021). Artificial Sweeteners: History and New Concepts on Inflammation. *Frontiers in Nutrition*, *8*, 746247.
<https://doi.org/10.3389/fnut.2021.746247>
- Baxter-Potter, L. N., Henricks, A. M., Berger, A. L., Bieniasz, K. V., Lugo, J. M., & McLaughlin, R. J. (2017). Alcohol vapor exposure differentially impacts mesocorticolimbic cytokine expression in a sex-, region-, and duration-specific manner. *Neuroscience*, *346*, 238–246. <https://doi.org/10.1016/j.neuroscience.2017.01.015>
- Beary, M. D., Lacey, J. H., & Merry, J. (1986). Alcoholism and Eating Disorders in Women of Fertile Age. *Addiction*, *81*(5), 685–689. <https://doi.org/10.1111/j.1360-0443.1986.tb00389.x>
- Becker, D. F., & Grilo, C. M. (2015). Comorbidity of mood and substance use disorders in patients with binge-eating disorder: Associations with personality disorder and eating

disorder pathology. *Journal of Psychosomatic Research*, 79(2), 159–164.

<https://doi.org/10.1016/j.jpsychores.2015.01.016>

Bellisle, F. (2015). Intense Sweeteners, Appetite for the Sweet Taste, and Relationship to Weight Management. *Current Obesity Reports*, 4(1), 106–110.

<https://doi.org/10.1007/s13679-014-0133-8>

Bello, N. T., Sweigart, K. L., Lakoski, J. M., Norgren, R., & Hajnal, A. (2003). Restricted feeding with scheduled sucrose access results in an upregulation of the rat dopamine transporter. *American Journal of Physiology-Regulatory, Integrative and Comparative Physiology*, 284(5), R1260–R1268. <https://doi.org/10.1152/ajpregu.00716.2002>

Benelam, B. (2009). Satiating, satiety and their effects on eating behaviour. *Nutrition Bulletin*, 34, 126–173. <https://doi.org/10.1111/j.1467-3010.2009.01753.x>

Bergeson, S. E., Blanton, H., Martinez, J. M., Curtis, D. C., Sherfey, C., Seegmiller, B., Marquardt, P. C., Groot, J. A., Allison, C. L., Bezboruah, C., & Guindon, J. (2016). Binge Ethanol Consumption Increases Inflammatory Pain Responses and Mechanical and Cold Sensitivity: Tigecycline Treatment Efficacy Shows Sex Differences. *Alcoholism: Clinical and Experimental Research*, 40(12), 2506–2515.

<https://doi.org/10.1111/acer.13252>

Berridge, K. C. (2009). ‘Liking’ and ‘wanting’ food rewards: Brain substrates and roles in eating disorders. *Physiology & Behavior*, 97(5), 537–550.

<https://doi.org/10.1016/j.physbeh.2009.02.044>

Berridge, K. C., & Robinson, T. E. (2003). Erratum to: “Parsing reward” [Trends Neurosci. 26 (2003) 507–513]. *Trends in Neurosciences*, 26(11), 581.

<https://doi.org/10.1016/j.tins.2003.09.001>

- Berthoud, H.-R., & Münzberg, H. (2011). The lateral hypothalamus as integrator of metabolic and environmental needs: From electrical self-stimulation to opto-genetics. *Physiology & Behavior, 104*(1), 29–39.
<https://doi.org/10.1016/j.physbeh.2011.04.051>
- Bian, X., Tu, P., Chi, L., Gao, B., Ru, H., & Lu, K. (2017). Saccharin induced liver inflammation in mice by altering the gut microbiota and its metabolic functions. *Food and Chemical Toxicology, 107*, 530–539. <https://doi.org/10.1016/j.fct.2017.04.045>
- Blanco-Gandía, M. C., Ledesma, J. C., Aracil-Fernández, A., Navarrete, F., Montagud-Romero, S., Aguilar, M. A., Manzanares, J., Miñarro, J., & Rodríguez-Arias, M. (2017). The rewarding effects of ethanol are modulated by binge eating of a high-fat diet during adolescence. *Neuropharmacology, 121*, 219–230.
<https://doi.org/10.1016/j.neuropharm.2017.04.040>
- Blanco-Gandía, M. C., Miñarro, J., Aguilar, M. A., & Rodríguez-Arias, M. (2018). Increased ethanol consumption after interruption of fat bingeing. *PLOS ONE, 13*(3), e0194431.
<https://doi.org/10.1371/journal.pone.0194431>
- Blednov, Y. A., Black, M., Chernis, J., Da Costa, A., Mayfield, J., & Harris, R. A. (2017). Ethanol Consumption in Mice Lacking CD14, TLR2, TLR4, or MyD88. *Alcoholism: Clinical and Experimental Research, 41*(3), 516–530. <https://doi.org/10.1111/acer.13316>
- Blednov, Y., Bergeson, S., Walker, D., Ferreira, V., Kuziel, W., & Harris, R. (2005). Perturbation of chemokine networks by gene deletion alters the reinforcing actions of ethanol. *Behavioural Brain Research, 165*(1), 110–125.
<https://doi.org/10.1016/j.bbr.2005.06.026>
- Blum, K., Braverman, E. R., Holder, J. M., Lubar, J. F., Monastra, V. J., Miller, D., Lubar, J. O., Chen, T. J. H., & Comings, D. E. (2000). The Reward Deficiency Syndrome: A

Biogenetic Model for the Diagnosis and Treatment of Impulsive, Addictive and Compulsive Behaviors. *Journal of Psychoactive Drugs*, 32(sup1), 1–112.

<https://doi.org/10.1080/02791072.2000.10736099>

Bocarsly, M. E., Berner, L. A., Hoebel, B. G., & Avena, N. M. (2011). Rats that binge eat fat-rich food do not show somatic signs or anxiety associated with opiate-like withdrawal: Implications for nutrient-specific food addiction behaviors. *Physiology & Behavior*, 104(5), 865–872. <https://doi.org/10.1016/j.physbeh.2011.05.018>

Bogusz, K., Kopera, M., Jakubczyk, A., Trucco, E. M., Kucharska, K., Walenda, A., & Wojnar, M. (2021). Prevalence of alcohol use disorder among individuals who binge eat: A systematic review and meta-analysis. *Addiction*, 116(1), 18–31.

<https://doi.org/10.1111/add.15155>

Boissoneault, J., Lewis, B., & Nixon, S. J. (2019). Characterizing chronic pain and alcohol use trajectory among treatment-seeking alcoholics. *Alcohol*, 75, 47–54.

<https://doi.org/10.1016/j.alcohol.2018.05.009>

Bort, A., Alvarado-Vazquez, P. A., Moracho-Vilrriales, C., Virga, K. G., Gumina, G., Romero-Sandoval, A., & Asbill, S. (2017). Effects of JWH015 in cytokine secretion in primary human keratinocytes and fibroblasts and its suitability for topical/transdermal delivery. *Molecular Pain*, 13, 174480691668822.

<https://doi.org/10.1177/1744806916688220>

Bosch, E. P., Pelham, R. W., Rasool, C. G., Chatterjee, A., Lash, R. W., Brown, L., Munsat, T. L., & Bradley, W. G. (1979). Animal models of alcoholic neuropathy: Morphologic, electrophysiologic, and biochemical findings. *Muscle & Nerve*, 2(2), 133–144.

<https://doi.org/10.1002/mus.880020208>

- Boswell, R. G., Potenza, M. N., & Grilo, C. M. (2021). The Neurobiology of Binge-eating Disorder Compared with Obesity: Implications for Differential Therapeutics. *Clinical Therapeutics*, *43*(1), 50–69. <https://doi.org/10.1016/j.clinthera.2020.10.014>
- Bourdy, R., Hertz, A., Filliol, D., Andry, V., Goumon, Y., Mendoza, J., Olmstead, M. C., & Befort, K. (2021). The endocannabinoid system is modulated in reward and homeostatic brain regions following diet-induced obesity in rats: A cluster analysis approach. *European Journal of Nutrition*, *60*(8), 4621–4633. <https://doi.org/10.1007/s00394-021-02613-0>
- Breese, G. R., Knapp, D. J., Overstreet, D. H., Navarro, M., Wills, T. A., & Angel, R. A. (2008). Repeated Lipopolysaccharide (LPS) or Cytokine Treatments Sensitize Ethanol Withdrawal-Induced Anxiety-Like Behavior. *Neuropsychopharmacology*, *33*(4), 867–876. <https://doi.org/10.1038/sj.npp.1301468>
- Brown, R. A., Abrantes, A. M., Read, J. P., Marcus, B. H., Jakicic, J., Strong, D. R., Oakley, J. R., Ramsey, S. E., Kahler, C. W., Stuart, G., Dubreuil, M. E., & Gordon, A. A. (2009). Aerobic Exercise for Alcohol Recovery: Rationale, Program Description, and Preliminary Findings. *Behavior Modification*, *33*(2), 220–249. <https://doi.org/10.1177/0145445508329112>
- Brugman, S., Clegg, D. J., Woods, S. C., & Seeley, R. J. (2002). Combined Blockade of Both μ - and κ -Opioid Receptors Prevents the Acute Orexigenic Action of *Agouti* -Related Protein. *Endocrinology*, *143*(11), 4265–4270. <https://doi.org/10.1210/en.2002-220230>
- Burrows, T., Skinner, J., McKenna, R., & Rollo, M. (2017). Food Addiction, Binge Eating Disorder, and Obesity: Is There a Relationship? *Behavioral Sciences*, *7*(4), 54. <https://doi.org/10.3390/bs7030054>

- Cabral, G. A. (2005). Cannabinoid receptors in microglia of the central nervous system: Immune functional relevance. *Journal of Leukocyte Biology*, 78(6), 1192–1197. <https://doi.org/10.1189/jlb.0405216>
- Camandola, S. (2018). Astrocytes, emerging stars of energy homeostasis. *Cell Stress*, 2(10), 246–252. <https://doi.org/10.15698/cst2018.10.157>
- Cao, L., Tanga, F. Y., & DeLeo, J. A. (2010). *The Contributing Role of CD14 in Toll-Like Receptor 4 Dependent Neuropathic Pain*. 16.
- Carbone, E. A., Caroleo, M., Rania, M., Calabrò, G., Staltari, F. A., de Filippis, R., Aloï, M., Condoleo, F., Arturi, F., & Segura-Garcia, C. (2021). An open-label trial on the efficacy and tolerability of naltrexone/bupropion SR for treating altered eating behaviours and weight loss in binge eating disorder. *Eating and Weight Disorders - Studies on Anorexia, Bulimia and Obesity*, 26(3), 779–788. <https://doi.org/10.1007/s40519-020-00910-x>
- Castro, D. C., & Berridge, K. C. (2014). Opioid Hedonic Hotspot in Nucleus Accumbens Shell: Mu, Delta, and Kappa Maps for Enhancement of Sweetness “Liking” and “Wanting.” *Journal of Neuroscience*, 34(12), 4239–4250. <https://doi.org/10.1523/JNEUROSCI.4458-13.2014>
- Castro, D. C., Terry, R. A., & Berridge, K. C. (2016). Orexin in Rostral Hotspot of Nucleus Accumbens Enhances Sucrose ‘Liking’ and Intake but Scopolamine in Caudal Shell Shifts ‘Liking’ Toward ‘Disgust’ and ‘Fear.’ *Neuropsychopharmacology*, 41(8), 2101–2111. <https://doi.org/10.1038/npp.2016.10>
- Chaplan, S. R., Bach, F. W., Pogrel, J. W., Chung, J. M., & Yaksh, T. L. (1994). Quantitative assessment of tactile allodynia in the rat paw. *Journal of Neuroscience Methods*, 53(1), 55–63. [https://doi.org/10.1016/0165-0270\(94\)90144-9](https://doi.org/10.1016/0165-0270(94)90144-9)

- Che, T., Dwivedi-Agnihotri, H., Shukla, A. K., & Roth, B. L. (2021). Biased ligands at opioid receptors: Current status and future directions. *Science Signaling*, *14*(677), eaav0320. <https://doi.org/10.1126/scisignal.aav0320>
- Cheer, J. F., Wassum, K. M., Sombers, L. A., Phillips, P. E. M., & Wightman, R. M. (n.d.). *Phasic Dopamine Release Evoked by Abused Substances Requires Cannabinoid Receptor Activation*. 5.
- Chen, A. P., Chen, L., Kim, T. A., & Xiong, Q. (2021). Integrating the Roles of Midbrain Dopamine Circuits in Behavior and Neuropsychiatric Disease. *Biomedicines*, *9*(6), 647. <https://doi.org/10.3390/biomedicines9060647>
- Chopra, K., & Tiwari, V. (2012). Alcoholic neuropathy: Possible mechanisms and future treatment possibilities. *British Journal of Clinical Pharmacology*, *73*(3), 348–362. <https://doi.org/10.1111/j.1365-2125.2011.04111.x>
- Chu Sin Chung, P., Panigada, T., Cardis, R., Decosterd, I., & Gosselin, R.-D. (2017). Peripheral nerve injury induces a transitory microglial reaction in the rat infralimbic cortex. *Neuroscience Letters*, *655*, 14–20. <https://doi.org/10.1016/j.neulet.2017.06.037>
- Clark, A. K., Gentry, C., Bradbury, E. J., McMahon, S. B., & Malcangio, M. (2007). Role of spinal microglia in rat models of peripheral nerve injury and inflammation. *European Journal of Pain*, *8*.
- Cocores, J. A., & Gold, M. S. (2009). The Salted Food Addiction Hypothesis may explain overeating and the obesity epidemic. *Medical Hypotheses*, *8*.
- Colantuoni, C., Schwenker, J., McCarthy, J., Rada, P., Ladenheim, B., Cadet, J.-L., Schwartz, G. J., Moran, T. H., & Hoebel, B. G. (2001). Excessive sugar intake alters binding to dopamine and mu-opioid receptors in the brain: *Neuroreport*, *12*(16), 3549–3552. <https://doi.org/10.1097/00001756-200111160-00035>

- Colles, S. L., Dixon, J. B., & O'Brien, P. E. (2008). Loss of Control Is Central to Psychological Disturbance Associated With Binge Eating Disorder. *Obesity, 16*(3), 608–614.
<https://doi.org/10.1038/oby.2007.99>
- Conason, A. H., & Sher, L. (2006). Alcohol use in adolescents with eating disorders. *International Journal of Adolescent Medicine and Health, 18*(1), 31–36.
<https://doi.org/10.1515/ijamh.2006.18.1.31>
- Cooper, M. L., Frone, M. R., Russell, M., & Mudar, P. (n.d.). *Drinking to Regulate Positive and Negative Emotions: A Motivational Model of Alcohol Use*. 16.
- Corder, G., Castro, D. C., Bruchas, M. R., & Scherrer, G. (2018). Endogenous and Exogenous Opioids in Pain. *Annual Review of Neuroscience, 41*(1), 453–473.
<https://doi.org/10.1146/annurev-neuro-080317-061522>
- Cossrow, N., Pawaskar, M., Witt, E. A., Ming, E. E., Victor, T. W., Herman, B. K., Wadden, T. A., & Erder, M. H. (2016). Estimating the Prevalence of Binge Eating Disorder in a Community Sample From the United States: Comparing DSM-IV-TR and DSM-5 Criteria. *The Journal of Clinical Psychiatry, 77*(08), e968–e974.
<https://doi.org/10.4088/JCP.15m10059>
- Crews, F. T., & Vetreno, R. P. (2011). Addiction, Adolescence, and Innate Immune Gene Induction. *Frontiers in Psychiatry, 2*. <https://doi.org/10.3389/fpsy.2011.00019>
- Crisp, A. H. (1967). The possible significance of some behavioural correlates of weight and carbohydrate intake. *Journal of Psychosomatic Research, 11*(1), 117-IN3.
[https://doi.org/10.1016/0022-3999\(67\)90064-5](https://doi.org/10.1016/0022-3999(67)90064-5)
- Dantzer, R., O'Connor, J. C., Freund, G. G., Johnson, R. W., & Kelley, K. W. (2008). From inflammation to sickness and depression: When the immune system subjugates the brain. *Nature Reviews Neuroscience, 9*(1), 46–56. <https://doi.org/10.1038/nrn2297>

- Davis, C. A., Levitan, R. D., Reid, C., Carter, J. C., Kaplan, A. S., Patte, K. A., King, N., Curtis, C., & Kennedy, J. L. (2009). Dopamine for “Wanting” and Opioids for “Liking”: A Comparison of Obese Adults With and Without Binge Eating. *Obesity, 17*(6), 1220–1225. <https://doi.org/10.1038/oby.2009.52>
- Davis, C., Levitan, R. D., Kaplan, A. S., Carter, J., Reid, C., Curtis, C., Patte, K., Hwang, R., & Kennedy, J. L. (2008). Reward sensitivity and the D2 dopamine receptor gene: A case-control study of binge eating disorder. *Progress in Neuro-Psychopharmacology and Biological Psychiatry, 32*(3), 620–628. <https://doi.org/10.1016/j.pnpbp.2007.09.024>
- De Biase, L. M., Schuebel, K. E., Fusfeld, Z. H., Jair, K., Hawes, I. A., Cimbro, R., Zhang, H.-Y., Liu, Q.-R., Shen, H., Xi, Z.-X., Goldman, D., & Bonci, A. (2017). Local Cues Establish and Maintain Region-Specific Phenotypes of Basal Ganglia Microglia. *Neuron, 95*(2), 341-356.e6. <https://doi.org/10.1016/j.neuron.2017.06.020>
- de Lartigue, G., & McDougle, M. (2019). Dorsal striatum dopamine oscillations: Setting the pace of food anticipatory activity. *Acta Physiologica, 225*(1), e13152. <https://doi.org/10.1111/apha.13152>
- De Luca, M. A., Solinas, M., Bimpisidis, Z., Goldberg, S. R., & Di Chiara, G. (2012). Cannabinoid facilitation of behavioral and biochemical hedonic taste responses. *Neuropharmacology, 63*(1), 161–168. <https://doi.org/10.1016/j.neuropharm.2011.10.018>
- de Sa Nogueira, D., Bourdy, R., Filliol, D., Awad, G., Andry, V., Goumon, Y., Olmstead, M. C., & Befort, K. (2021). Binge sucrose-induced neuroadaptations: A focus on the endocannabinoid system. *Appetite, 164*, 105258. <https://doi.org/10.1016/j.appet.2021.105258>

De Souza, C. T., Araujo, E. P., Bordin, S., Ashimine, R., Zollner, R. L., Boschero, A. C., Saad, M.

J. A., & Velloso, L. A. (2005a). Consumption of a Fat-Rich Diet Activates a Proinflammatory Response and Induces Insulin Resistance in the Hypothalamus.

Endocrinology, 146(10), 4192–4199. <https://doi.org/10.1210/en.2004-1520>

De Souza, C. T., Araujo, E. P., Bordin, S., Ashimine, R., Zollner, R. L., Boschero, A. C., Saad, M.

J. A., & Velloso, L. A. (2005b). Consumption of a Fat-Rich Diet Activates a Proinflammatory Response and Induces Insulin Resistance in the Hypothalamus.

Endocrinology, 146(10), 4192–4199. <https://doi.org/10.1210/en.2004-1520>

Décarie-Spain, L., Hryhorczuk, C., Lau, D., Jacob-Brassard, É., Fiset, A., & Fulton, S. (2021).

Prolonged saturated, but not monounsaturated, high-fat feeding provokes anxiodepressive-like behaviors in female mice despite similar metabolic consequences. *Brain, Behavior, & Immunity - Health*, 16, 100324.

<https://doi.org/10.1016/j.bbih.2021.100324>

Décarie-Spain, L., Sharma, S., Hryhorczuk, C., Issa-Garcia, V., Barker, P. A., Arbour, N.,

Alquier, T., & Fulton, S. (2018). Nucleus accumbens inflammation mediates anxiodepressive behavior and compulsive sucrose seeking elicited by saturated dietary fat. *Molecular Metabolism*, 10, 1–13.

<https://doi.org/10.1016/j.molmet.2018.01.018>

Devine, P., & Wise, A. (1993). *Differential Involvement of Ventral Tegmental Mu, Delta and*

Kappa Opioid Receptors in Modulation of Basal Mesolimbic Dopamine Release: In Vivo Microdialysis Studies. 266, 11.

Dhillon, J., Lee, J. Y., & Mattes, R. D. (2017). The cephalic phase insulin response to nutritive

and low-calorie sweeteners in solid and beverage form. *Physiology & Behavior*, 181,

100–109. <https://doi.org/10.1016/j.physbeh.2017.09.009>

- Di Chiara, G., & Imperato, A. (1985). Ethanol preferentially stimulates dopamine release in the nucleus accumbens of freely moving rats. *European Journal of Pharmacology*, *115*(1), 131–132. [https://doi.org/10.1016/0014-2999\(85\)90598-9](https://doi.org/10.1016/0014-2999(85)90598-9)
- Diehl, A., Croissant, B., Batra, A., Mundle, G., Nakovics, H., & Mann, K. (2007). Alcoholism in women: Is it different in onset and outcome compared to men? *European Archives of Psychiatry and Clinical Neuroscience*, *257*(6), 344–351. <https://doi.org/10.1007/s00406-007-0737-z>
- Dina, O. A., Messing, R. O., & Levine, J. D. (2006). Ethanol withdrawal induces hyperalgesia mediated by PKC ϵ . *European Journal of Neuroscience*, *24*(1), 197–204. <https://doi.org/10.1111/j.1460-9568.2006.04886.x>
- DosSantos, M. F., Moura, B. de S., & DaSilva, A. F. (2017). Reward Circuitry Plasticity in Pain Perception and Modulation. *Frontiers in Pharmacology*, *8*, 790. <https://doi.org/10.3389/fphar.2017.00790>
- Downes, C. E., & Crack, P. J. (2010). Neural injury following stroke: Are Toll-like receptors the link between the immune system and the CNS?: Neural injury and the immune system. *British Journal of Pharmacology*, *160*(8), 1872–1888. <https://doi.org/10.1111/j.1476-5381.2010.00864.x>
- Edenberg, H. J., Xuei, X., Wetherill, L. F., Bierut, L., Bucholz, K., Dick, D. M., Hesselbrock, V., Kuperman, S., Porjesz, B., Schuckit, M. A., Tischfield, J. A., Almasy, L. A., Jr, J. I. N., & Foroud, T. (n.d.). *Association of NFKB1, which encodes a subunit of the transcription factor NF-kB, with alcohol dependence*. 8.
- Egecioglu, E., Jerlhag, E., Salomé, N., Skibicka, K. P., Haage, D., Bohlooly-Y, M., Andersson, D., Bjursell, M., Perrissoud, D., Engel, J. A., & Dickson, S. L. (2010). Ghrelin increases

- intake of rewarding food in rodents: Ghrelin and food reward. *Addiction Biology*, 15(3), 304–311. <https://doi.org/10.1111/j.1369-1600.2010.00216.x>
- Egli, M., Koob, G. F., & Edwards, S. (2012). Alcohol dependence as a chronic pain disorder. *Neuroscience & Biobehavioral Reviews*, 36(10), 2179–2192. <https://doi.org/10.1016/j.neubiorev.2012.07.010>
- Ellis, A. (n.d.). *Neuroinflammation and the generation of neuropathic pain*. 12.
- Engelmann, J. M., Versace, F., Robinson, J. D., Minnix, J. A., Lam, C. Y., Cui, Y., Brown, V. L., & Cinciripini, P. M. (2012). Neural substrates of smoking cue reactivity: A meta-analysis of fMRI studies. *NeuroImage*, 60(1), 252–262. <https://doi.org/10.1016/j.neuroimage.2011.12.024>
- Erickson, E. K., Grantham, E. K., Warden, A. S., & Harris, R. A. (2019). Neuroimmune signaling in alcohol use disorder. *Pharmacology Biochemistry and Behavior*, 177, 34–60. <https://doi.org/10.1016/j.pbb.2018.12.007>
- Erskine, H. E., & Whiteford, H. A. (2018). Epidemiology of binge eating disorder. *Current Opinion in Psychiatry*, 31(6), 462–470. <https://doi.org/10.1097/YCO.0000000000000449>
- Everitt, B. J., & Robbins, T. W. (2013). From the ventral to the dorsal striatum: Devolving views of their roles in drug addiction. *Neuroscience & Biobehavioral Reviews*, 37(9), 1946–1954. <https://doi.org/10.1016/j.neubiorev.2013.02.010>
- Fakhoury, M., Salman, I., Najjar, W., Merhej, G., & Lawand, N. (2020). The Lateral Hypothalamus: An Uncharted Territory for Processing Peripheral Neurogenic Inflammation. *Frontiers in Neuroscience*, 14, 101. <https://doi.org/10.3389/fnins.2020.00101>

- Farid, A., Hesham, M., El-Dewak, M., & Amin, A. (2020). The hidden hazardous effects of stevia and sucralose consumption in male and female albino mice in comparison to sucrose. *Saudi Pharmaceutical Journal*, *28*(10), 1290–1300.
<https://doi.org/10.1016/j.jsps.2020.08.019>
- Feijó, F. de M., Ballard, C. R., Foletto, K. C., Batista, B. A. M., Neves, A. M., Ribeiro, M. F. M., & Bertoluci, M. C. (2013). Saccharin and aspartame, compared with sucrose, induce greater weight gain in adult Wistar rats, at similar total caloric intake levels. *Appetite*, *60*, 203–207. <https://doi.org/10.1016/j.appet.2012.10.009>
- Ferrario, C. R., Labouèbe, G., Liu, S., Nieh, E. H., Routh, V. H., Xu, S., & O'Connor, E. C. (2016). Homeostasis Meets Motivation in the Battle to Control Food Intake. *The Journal of Neuroscience*, *36*(45), 11469–11481. <https://doi.org/10.1523/JNEUROSCI.2338-16.2016>
- Ferriter, C., & Ray, L. A. (2011). Binge eating and binge drinking: An integrative review. *Eating Behaviors*, *12*(2), 99–107. <https://doi.org/10.1016/j.eatbeh.2011.01.001>
- Fletcher, P. C., & Kenny, P. J. (2018). Food addiction: A valid concept? *Neuropsychopharmacology*, *43*(13), 2506–2513. <https://doi.org/10.1038/s41386-018-0203-9>
- Font, L., Luján, M. Á., & Pastor, R. (2013). Involvement of the endogenous opioid system in the psychopharmacological actions of ethanol: The role of acetaldehyde. *Frontiers in Behavioral Neuroscience*, *7*. <https://doi.org/10.3389/fnbeh.2013.00093>
- Fowler, S. P. G. (2016). Low-calorie sweetener use and energy balance: Results from experimental studies in animals, and large-scale prospective studies in humans. *Physiology & Behavior*, *164*, 517–523.
<https://doi.org/10.1016/j.physbeh.2016.04.047>

- Franklin, K. M., Hauser, S. R., Lasek, A. W., McClintick, J., Ding, Z.-M., McBride, W. J., & Bell, R. L. (2015). Reduction of alcohol drinking of alcohol-preferring (P) and high-alcohol drinking (HAD1) rats by targeting phosphodiesterase-4 (PDE4). *Psychopharmacology*, 232(13), 2251–2262. <https://doi.org/10.1007/s00213-014-3852-3>
- Fuente-Martín, E., García-Cáceres, C., Díaz, F., Argente-Arizón, P., Granada, M., Barrios, V., Argente, J., & Chowen, J. A. (2013). Hypothalamic inflammation without astrogliosis in response to high sucrose intake is modulated by neonatal nutrition in male rats. *Endocrinology*, 154(7), 2318–2330. <https://doi.org/10.1210/en.2012-2196>
- Furlong, T. M., Jayaweera, H. K., Balleine, B. W., & Corbit, L. H. (2014). Binge-Like Consumption of a Palatable Food Accelerates Habitual Control of Behavior and Is Dependent on Activation of the Dorsolateral Striatum. *The Journal of Neuroscience*, 34(14), 5012–5022. <https://doi.org/10.1523/JNEUROSCI.3707-13.2014>
- Gao, Y., Bielohuby, M., Fleming, T., Grabner, G. F., Foppen, E., Bernhard, W., Guzmán-Ruiz, M., Layritz, C., Legutko, B., Zinser, E., García-Cáceres, C., Buijs, R. M., Woods, S. C., Kalsbeek, A., Seeley, R. J., Nawroth, P. P., Bidlingmaier, M., Tschöp, M. H., & Yi, C.-X. (2017). Dietary sugars, not lipids, drive hypothalamic inflammation. *Molecular Metabolism*, 6(8), 897–908. <https://doi.org/10.1016/j.molmet.2017.06.008>
- Gatch, M. B. (1999). Effects of Benzodiazepines on Acute and Chronic Ethanol-Induced Nociception in Rats. *Alcoholism: Clinical and Experimental Research*, 23(11), 1736–1743. <https://doi.org/10.1111/j.1530-0277.1999.tb04068.x>
- Gatch, M. B. (2002). Nitrendipine Blocks the Nociceptive Effects of Chronically Administered Ethanol. *Alcoholism: Clinical and Experimental Research*, 26(8), 1181–1187. <https://doi.org/10.1111/j.1530-0277.2002.tb02654.x>

- Gearhardt, A. N., Corbin, W. R., & Brownell, K. D. (2009). Preliminary validation of the Yale Food Addiction Scale. *Appetite*, *52*(2), 430–436.
<https://doi.org/10.1016/j.appet.2008.12.003>
- George, M. S., Anton, R. F., Bloomer, C., Teneback, C., Drobles, D. J., Lorberbaum, J. P., Nahas, Z., & Vincent, D. J. (2001). Activation of Prefrontal Cortex and Anterior Thalamus in Alcoholic Subjects on Exposure to Alcohol-Specific Cues. *Archives of General Psychiatry*, *58*(4), 345. <https://doi.org/10.1001/archpsyc.58.4.345>
- Giuliano, C., & Cottone, P. (2015). The role of the opioid system in binge eating disorder. *CNS Spectrums*, *20*(6), 537–545. <https://doi.org/10.1017/S1092852915000668>
- Giuliano, C., Robbins, T. W., Nathan, P. J., Bullmore, E. T., & Everitt, B. J. (n.d.). *Inhibition of Opioid Transmission at the m-Opioid Receptor Prevents Both Food Seeking and Binge-Like Eating*. 10.
- Giuliano, C., Robbins, T. W., Nathan, P. J., Bullmore, E. T., & Everitt, B. J. (2012). Inhibition of Opioid Transmission at the μ -Opioid Receptor Prevents Both Food Seeking and Binge-Like Eating. *Neuropsychopharmacology*, *37*(12), 2643–2652.
<https://doi.org/10.1038/npp.2012.128>
- Goodman, J., & Packard, M. G. (2016). Memory Systems and the Addicted Brain. *Frontiers in Psychiatry*, *7*. <https://doi.org/10.3389/fpsy.2016.00024>
- Gosnell, B. A., & Krahn, D. D. (1992). The relationship between saccharin and alcohol intake in rats. *Alcohol*, *9*(3), 203–206. [https://doi.org/10.1016/0741-8329\(92\)90054-E](https://doi.org/10.1016/0741-8329(92)90054-E)
- Grilo, C. M., & O'Malley, S. S. (2002). *Eating Disorders and Alcohol Use Disorders*. *26*(2), 10.
- Grilo, C. M., White, M. A., & Masheb, R. M. (2009). DSM-IV psychiatric disorder comorbidity and its correlates in binge eating disorder. *International Journal of Eating Disorders*, *42*(3), 228–234. <https://doi.org/10.1002/eat.20599>

- Grimm, J. W., Hope, B. T., Wise, R. A., & Shaham, Y. (2001). Incubation of cocaine craving after withdrawal. *Nature*, *412*(6843), 141–142. <https://doi.org/10.1038/35084134>
- Gritti, D., Delvecchio, G., Ferro, A., Bressi, C., & Brambilla, P. (2021). Neuroinflammation in Major Depressive Disorder: A Review of PET Imaging Studies Examining the 18-kDa Translocator Protein. *Journal of Affective Disorders*, *292*, 642–651. <https://doi.org/10.1016/j.jad.2021.06.001>
- Groblewski, P. A., Ryabinin, A. E., & Cunningham, C. L. (2012). Activation and role of the medial prefrontal cortex (mPFC) in extinction of ethanol-induced associative learning in mice. *Neurobiology of Learning and Memory*, *97*(1), 37–46. <https://doi.org/10.1016/j.nlm.2011.09.001>
- Guerdjikova, A. I., Blom, T. J., Mori, N., Casuto, L., Keck, P. E., & McElroy, S. L. (2014). Gender Differences in Binge Eating Disorder: A Pooled Analysis of Eleven Pharmacotherapy Trials from One Research Group. *Journal of Men's Health*, *11*(4), 183–188. <https://doi.org/10.1089/jomh.2014.0041>
- Guerdjikova, A. I., McElroy, S. L., Kotwal, R., & Keck, P. E. (2007). Comparison of obese men and women with binge eating disorder seeking weight management. *Eating and Weight Disorders - Studies on Anorexia, Bulimia and Obesity*, *12*(1), e19–e23. <https://doi.org/10.1007/BF03327777>
- Guerdjikova, A. I., Mori, N., Casuto, L. S., & McElroy, S. L. (2017). Binge Eating Disorder. *The Psychiatric Clinics of North America*, *40*(2), 255–266. <https://doi.org/10.1016/j.psc.2017.01.003>
- Guerdjikova, A. I., Mori, N., Casuto, L. S., & McElroy, S. L. (2019). Update on Binge Eating Disorder. *Medical Clinics of North America*, *103*(4), 669–680. <https://doi.org/10.1016/j.mcna.2019.02.003>

- Haedt-Matt, A. A., & Keel, P. K. (2011). Revisiting the affect regulation model of binge eating: A meta-analysis of studies using ecological momentary assessment. *Psychological Bulletin*, 137(4), 660–681. <https://doi.org/10.1037/a0023660>
- Hales, C. N., & Barker, D. J. P. (2001). The thrifty phenotype hypothesis. *British Medical Bulletin*, 60(1), 5–20. <https://doi.org/10.1093/bmb/60.1.5>
- Hanawa, Y., Higashiyama, M., Kurihara, C., Tanemoto, R., Ito, S., Mizoguchi, A., Nishii, S., Wada, A., Inaba, K., Sugihara, N., Horiuchi, K., Okada, Y., Narimatsu, K., Komoto, S., Tomita, K., & Hokari, R. (2021). Acesulfame potassium induces dysbiosis and intestinal injury with enhanced lymphocyte migration to intestinal mucosa. *Journal of Gastroenterology and Hepatology*, 36(11), 3140–3148. <https://doi.org/10.1111/jgh.15654>
- Harricharan, R., Abboussi, O., & Daniels, W. M. U. (2017). Addiction: A dysregulation of satiety and inflammatory processes. *Progress in Brain Research*, 235, 65–91. <https://doi.org/10.1016/bs.pbr.2017.07.012>
- Hatsukami, D., Owen, P., Pyle, R., & Mitchell, J. (1982). Similarities and differences on the MMPI between women with bulimia and women with alcohol or drug abuse problems. *Addictive Behaviors*, 7(4), 435–439. [https://doi.org/10.1016/0306-4603\(82\)90015-6](https://doi.org/10.1016/0306-4603(82)90015-6)
- Heal, D. J., & Smith, S. L. (2021). Prospects for new drugs to treat binge-eating disorder: Insights from psychopathology and neuropharmacology. *Journal of Psychopharmacology*, 026988112110324. <https://doi.org/10.1177/02698811211032475>
- Hebebrand, J., Albayrak, Ö., Adan, R., Antel, J., Dieguez, C., de Jong, J., Leng, G., Menzies, J., Mercer, J. G., & Murphy, M. (2014). “Eating addiction”, rather than “food addiction”,

better captures addictive-like eating behavior. *Neuroscience and Biobehavioral Reviews*, 12.

Herkenham, M., Lynn, A., Johnson, M., Melvin, L., de Costa, B., & Rice, K. (1991).

Characterization and localization of cannabinoid receptors in rat brain: A quantitative in vitro autoradiographic study. *The Journal of Neuroscience*, 11(2), 563–583.

<https://doi.org/10.1523/JNEUROSCI.11-02-00563.1991>

Hildebrandt, B. A., Fisher, H., LaPalombara, Z., Young, M. E., & Ahmari, S. E. (2021).

Corticostriatal dynamics underlying components of binge-like eating in mice

[Preprint]. *Neuroscience*. <https://doi.org/10.1101/2021.11.04.467011>

Hill, J. O., & Peters, J. C. (1998). Environmental Contributions to the Obesity Epidemic.

Science, 280(5368), 1371–1374. <https://doi.org/10.1126/science.280.5368.1371>

Hommel, J. D., Trinko, R., Sears, R. M., Georgescu, D., Liu, Z.-W., Gao, X.-B., Thurmon, J. J.,

Marinelli, M., & DiLeone, R. J. (2006). Leptin Receptor Signaling in Midbrain

Dopamine Neurons Regulates Feeding. *Neuron*, 51(6), 801–810.

<https://doi.org/10.1016/j.neuron.2006.08.023>

Hopperton, K. E., Mohammad, D., Trépanier, M. O., Giuliano, V., & Bazinet, R. P. (2018).

Markers of microglia in post-mortem brain samples from patients with Alzheimer's disease: A systematic review. *Molecular Psychiatry*, 23(2), 177–198.

<https://doi.org/10.1038/mp.2017.246>

Hore, Z., & Denk, F. (2019). Neuroimmune interactions in chronic pain – An interdisciplinary perspective. *Brain, Behavior, and Immunity*, 79, 56–62.

<https://doi.org/10.1016/j.bbi.2019.04.033>

- Howlett, A. C., & Abood, M. E. (2017). CB 1 and CB 2 Receptor Pharmacology. In *Advances in Pharmacology* (Vol. 80, pp. 169–206). Elsevier.
<https://doi.org/10.1016/bs.apha.2017.03.007>
- Huang, J., Zhang, Z., Feng, W., Zhao, Y., Aldanondo, A., de Brito Sanchez, M. G., Paoli, M., Rolland, A., Li, Z., Nie, H., Lin, Y., Zhang, S., Giurfa, M., & Su, S. (2022). Food wanting is mediated by transient activation of dopaminergic signaling in the honey bee brain. *Science*, 376(6592), 508–512. <https://doi.org/10.1126/science.abn9920>
- Hudson, J. I., Hiripi, E., Jr, H. G. P., & Kessler, R. C. (2008). *Comorbidity Survey Replication*. 32.
- Hwa, L. S., Chu, A., Levinson, S. A., Kayyali, T. M., DeBold, J. F., & Miczek, K. A. (2011). Persistent Escalation of Alcohol Drinking in C57BL/6J Mice With Intermittent Access to 20% Ethanol: ESCALATED ALCOHOL AFTER INTERMITTENT ACCESS. *Alcoholism: Clinical and Experimental Research*, 35(11), 1938–1947.
<https://doi.org/10.1111/j.1530-0277.2011.01545.x>
- Jackson, B., Lynne Cooper, M., Mintz, L., & Albino, A. (2003). Motivations to eat: Scale development and validation. *Journal of Research in Personality*, 37(4), 297–318.
[https://doi.org/10.1016/S0092-6566\(02\)00574-3](https://doi.org/10.1016/S0092-6566(02)00574-3)
- Jamar, G., Ribeiro, D. A., & Pisani, L. P. (2020). High-fat or high-sugar diets as trigger inflammation in the microbiota-gut-brain axis. *Critical Reviews in Food Science and Nutrition*, 1–19. <https://doi.org/10.1080/10408398.2020.1747046>
- Jirkof, P. (2014). Burrowing and nest building behavior as indicators of well-being in mice. *Journal of Neuroscience Methods*, 234, 139–146.
<https://doi.org/10.1016/j.jneumeth.2014.02.001>

- Jo, Y.-H., Chen, Y.-J. J., Chua, S. C., Talmage, D. A., & Role, L. W. (2005). Integration of Endocannabinoid and Leptin Signaling in an Appetite-Related Neural Circuit. *Neuron*, 48(6), 1055–1066. <https://doi.org/10.1016/j.neuron.2005.10.021>
- Jochum, T., Boettger, M. K., Burkhardt, C., Juckel, G., & Bär, K.-J. (2010). Increased pain sensitivity in alcohol withdrawal syndrome. *European Journal of Pain*, 14(7), 713–718. <https://doi.org/10.1016/j.ejpain.2009.11.008>
- Johnson, J. G., Cohen, P., Kasen, S., & Brook, J. S. (2002). Eating Disorders During Adolescence and the Risk for Physical and Mental Disorders During Early Adulthood. *Archives of General Psychiatry*, 59(6), 545. <https://doi.org/10.1001/archpsyc.59.6.545>
- Jordan, C. J., & Andersen, S. L. (2017). Sensitive periods of substance abuse: Early risk for the transition to dependence. *Developmental Cognitive Neuroscience*, 25, 29–44. <https://doi.org/10.1016/j.dcn.2016.10.004>
- Juarez, B., & Han, M.-H. (2016). Diversity of Dopaminergic Neural Circuits in Response to Drug Exposure. *Neuropsychopharmacology*, 41(10), 2424–2446. <https://doi.org/10.1038/npp.2016.32>
- June, H. L., Liu, J., Warnock, K. T., Bell, K. A., Balan, I., Bollino, D., Puche, A., & Aurelian, L. (2015). CRF-Amplified Neuronal TLR4/MCP-1 Signaling Regulates Alcohol Self-Administration. *Neuropsychopharmacology*, 40(6), 1549–1559. <https://doi.org/10.1038/npp.2015.4>
- Just, T., Pau, H. W., Engel, U., & Hummel, T. (2008). Cephalic phase insulin release in healthy humans after taste stimulation? *Appetite*, 51(3), 622–627. <https://doi.org/10.1016/j.appet.2008.04.271>
- Karhunen, L. J., Vanninen, E. J., Kuikka, J. T., Lappalainen, R. I., Tiihonen, J., & Uusitupa, M. I. J. (2000). Regional cerebral blood flow during exposure to food in obese binge eating

women. *Psychiatry Research: Neuroimaging*, 99(1), 29–42.

[https://doi.org/10.1016/S0925-4927\(00\)00053-6](https://doi.org/10.1016/S0925-4927(00)00053-6)

Karoly, H. C., Mueller, R. L., Bidwell, L. C., & Hutchison, K. E. (2020). Cannabinoids and the Microbiota-Gut-Brain Axis: Emerging Effects of Cannabidiol and Potential Applications to Alcohol Use Disorders. *Alcoholism, Clinical and Experimental Research*, 44(2), 340–353. <https://doi.org/10.1111/acer.14256>

Katia, B. (2015). Interactions of the opioid and cannabinoid systems in reward: Insights from knockout studies. *Frontiers in Pharmacology*, 6.

<https://doi.org/10.3389/fphar.2015.00006>

Katsuura, Y., & Taha, S. A. (2014a). Mu opioid receptor antagonism in the nucleus accumbens shell blocks consumption of a preferred sucrose solution in an anticipatory contrast paradigm. *Neuroscience*, 261, 144–152.

<https://doi.org/10.1016/j.neuroscience.2013.12.004>

Katsuura, Y., & Taha, S. A. (2014b). Mu opioid receptor antagonism in the nucleus accumbens shell blocks consumption of a preferred sucrose solution in an anticipatory contrast paradigm. *Neuroscience*, 261, 144–152.

<https://doi.org/10.1016/j.neuroscience.2013.12.004>

Kebir, O., Gorsane, M.-A., Blecha, L., Krebs, M.-O., Reynaud, M., & Benyamina, A. (2011). Association of Inflammation Genes with Alcohol Dependence/Abuse: A Systematic Review and a Meta-Analysis. *European Addiction Research*, 17(3), 146–153.

<https://doi.org/10.1159/000324849>

Kessler, R. C., Berglund, P. A., Chiu, W. T., Deitz, A. C., Hudson, J. I., Shahly, V., Aguilar-Gaxiola, S., Alonso, J., Angermeyer, M. C., Benjet, C., Bruffaerts, R., de Girolamo, G., de Graaf, R., Maria Haro, J., Kovess-Masfety, V., O'Neill, S., Posada-Villa, J., Sasu, C.,

- Scott, K., ... Xavier, M. (2013a). The Prevalence and Correlates of Binge Eating Disorder in the World Health Organization World Mental Health Surveys. *Biological Psychiatry*, 73(9), 904–914. <https://doi.org/10.1016/j.biopsych.2012.11.020>
- Kessler, R. C., Berglund, P. A., Chiu, W. T., Deitz, A. C., Hudson, J. I., Shahly, V., Aguilar-Gaxiola, S., Alonso, J., Angermeyer, M. C., Benjet, C., Bruffaerts, R., de Girolamo, G., de Graaf, R., Maria Haro, J., Kovess-Masfety, V., O'Neill, S., Posada-Villa, J., Sasu, C., Scott, K., ... Xavier, M. (2013b). The Prevalence and Correlates of Binge Eating Disorder in the World Health Organization World Mental Health Surveys. *Biological Psychiatry*, 73(9), 904–914. <https://doi.org/10.1016/j.biopsych.2012.11.020>
- Kessler, R. C., Berglund, P. A., Chiu, W. T., Deitz, A. C., Hudson, J. I., Shahly, V., Aguilar-Gaxiola, S., Alonso, J., Angermeyer, M. C., Benjet, C., Bruffaerts, R., de Girolamo, G., de Graaf, R., Maria Haro, J., Kovess-Masfety, V., O'Neill, S., Posada-Villa, J., Sasu, C., Scott, K., ... Xavier, M. (2013c). The Prevalence and Correlates of Binge Eating Disorder in the World Health Organization World Mental Health Surveys. *Biological Psychiatry*, 73(9), 904–914. <https://doi.org/10.1016/j.biopsych.2012.11.020>
- Kieffer, B. L., & Evans, C. J. (2009). Opioid receptors: From binding sites to visible molecules in vivo. *Neuropharmacology*, 56, 205–212. <https://doi.org/10.1016/j.neuropharm.2008.07.033>
- Kiguchi, N., Maeda, T., Kobayashi, Y., Fukazawa, Y., & Kishioka, S. (2010). Macrophage inflammatory protein-1 α mediates the development of neuropathic pain following peripheral nerve injury through interleukin-1 β up-regulation. *Pain*, 149(2), 305–315. <https://doi.org/10.1016/j.pain.2010.02.025>

- Kim, S., & Son, Y. (2021). Astrocytes Stimulate Microglial Proliferation and M2 Polarization In Vitro through Crosstalk between Astrocytes and Microglia. *International Journal of Molecular Sciences*, 22(16), 8800. <https://doi.org/10.3390/ijms22168800>
- Kirkham, T. C., Williams, C. M., Fezza, F., & Marzo, V. D. (2002). Endocannabinoid levels in rat limbic forebrain and hypothalamus in relation to fasting, feeding and satiation: Stimulation of eating by 2-arachidonoyl glycerol: Brain endocannabinoids and appetite stimulation. *British Journal of Pharmacology*, 136(4), 550–557. <https://doi.org/10.1038/sj.bjp.0704767>
- Koike, H., Mori, K., Misu, K., Hattori, N., Ito, H., Hirayama, M., & Sobue, G. (2001). Painful alcoholic polyneuropathy with predominant small-fiber loss and normal thiamine status. *Neurology*, 56(12), 1727–1732. <https://doi.org/10.1212/WNL.56.12.1727>
- Koob, G. F. (2021). Drug Addiction: Hyperkatifeia/Negative Reinforcement as a Framework for Medications Development. *Pharmacological Reviews*, 73(1), 163–201. <https://doi.org/10.1124/pharmrev.120.000083>
- Kozela, E., Pietr, M., Juknat, A., Rimmerman, N., Levy, R., & Vogel, Z. (2010). Cannabinoids Δ^9 -Tetrahydrocannabinol and Cannabidiol Differentially Inhibit the Lipopolysaccharide-activated NF- κ B and Interferon- β /STAT Proinflammatory Pathways in BV-2 Microglial Cells. *Journal of Biological Chemistry*, 285(3), 1616–1626. <https://doi.org/10.1074/jbc.M109.069294>
- Labouèbe, G., Liu, S., Dias, C., Zou, H., Wong, J. C. Y., Karunakaran, S., Clee, S. M., Phillips, A. G., Boutrel, B., & Borgland, S. L. (2013). Insulin induces long-term depression of ventral tegmental area dopamine neurons via endocannabinoids. *Nature Neuroscience*, 16(3), 300–308. <https://doi.org/10.1038/nn.3321>

- Lacagnina, M. J., Rivera, P. D., & Bilbo, S. D. (2017). Glial and Neuroimmune Mechanisms as Critical Modulators of Drug Use and Abuse. *Neuropsychopharmacology*, *42*(1), 156–177. <https://doi.org/10.1038/npp.2016.121>
- Lacey, J. H., & Moureli, E. (1986). Bulimic Alcoholics: Some features of a clinical sub-group. *Addiction*, *81*(3), 389–393. <https://doi.org/10.1111/j.1360-0443.1986.tb00345.x>
- Lapidus, K. A. B., Stern, E. R., Berlin, H. A., & Goodman, W. K. (2014). Neuromodulation for Obsessive–Compulsive Disorder. *Neurotherapeutics*, *11*(3), 485–495. <https://doi.org/10.1007/s13311-014-0287-9>
- Latner, J. D., & Clyne, C. (2008). The diagnostic validity of the criteria for binge eating disorder. *International Journal of Eating Disorders*, *41*(1), 1–14. <https://doi.org/10.1002/eat.20465>
- Lau, B. K., Cota, D., Cristino, L., & Borgland, S. L. (2017). Endocannabinoid modulation of homeostatic and non-homeostatic feeding circuits. *Neuropharmacology*, *124*, 38–51. <https://doi.org/10.1016/j.neuropharm.2017.05.033>
- Le Moal, M., & Simon, H. (1991). Mesocorticolimbic dopaminergic network: Functional and regulatory roles. *Physiological Reviews*, *71*(1), 155–234. <https://doi.org/10.1152/physrev.1991.71.1.155>
- Le Thuc, O., Cansell, C., Bourourou, M., Denis, R. G., Stobbe, K., Devaux, N., Guyon, A., Cazareth, J., Heurteaux, C., Rostène, W., Luquet, S., Blondeau, N., Nahon, J., & Rovère, C. (2016). Central CCL2 signaling onto MCH neurons mediates metabolic and behavioral adaptation to inflammation. *EMBO Reports*, *17*(12), 1738–1752. <https://doi.org/10.15252/embr.201541499>
- Levine, J., Barak, Y., Chengappa, K. N. R., Rapoport, A., Rebey, M., & Barak, V. (n.d.). *Cerebrospinal Cytokine Levels in Patients with Acute Depression*. 6.

- Lewitus, G. M., Pribiag, H., Duseja, R., St-Hilaire, M., & Stellwagen, D. (2014). An Adaptive Role of TNF in the Regulation of Striatal Synapses. *Journal of Neuroscience*, *34*(18), 6146–6155. <https://doi.org/10.1523/JNEUROSCI.3481-13.2014>
- Linardon, J., & Messer, M. (2019). Assessment of food addiction using the Yale Food Addiction Scale 2.0 in individuals with binge-eating disorder symptomatology: Factor structure, psychometric properties, and clinical significance. *Psychiatry Research*, *279*, 216–221. <https://doi.org/10.1016/j.psychres.2019.03.003>
- Liu, L., Hutchinson, M. R., White, J. M., Somogyi, A. A., & Collier, J. K. (n.d.). Association of IL-1B genetic polymorphisms with an increased risk of opioid and alcohol dependence. *8*.
- Liu, L., Hutchinson, M. R., White, J. M., Somogyi, A. A., & Collier, J. K. (2009). Association of IL-1B genetic polymorphisms with an increased risk of opioid and alcohol dependence. *Pharmacogenetics and Genomics*, *19*(11), 869–876. <https://doi.org/10.1097/FPC.0b013e328331e68f>
- Liu, L., Liu, J., Bao, J., Bai, Q., & Wang, G. (2020). Interaction of Microglia and Astrocytes in the Neurovascular Unit. *Frontiers in Immunology*, *11*, 1024. <https://doi.org/10.3389/fimmu.2020.01024>
- Livak, K. J., & Schmittgen, T. D. (2001). Analysis of Relative Gene Expression Data Using Real-Time Quantitative PCR and the 2- $\Delta\Delta$ CT Method. *Methods*, *25*(4), 402–408. <https://doi.org/10.1006/meth.2001.1262>
- Lutz, P.-E., & Kieffer, B. L. (2013). Opioid receptors: Distinct roles in mood disorders. *Trends in Neurosciences*, *36*(3), 195–206. <https://doi.org/10.1016/j.tins.2012.11.002>
- Macpherson, T., Morita, M., & Hikida, T. (2014). Striatal direct and indirect pathways control decision-making behavior. *Frontiers in Psychology*, *5*. <https://doi.org/10.3389/fpsyg.2014.01301>

- Mahler, S. V., Smith, K. S., & Berridge, K. C. (2007). Endocannabinoid Hedonic Hotspot for Sensory Pleasure: Anandamide in Nucleus Accumbens Shell Enhances 'Liking' of a Sweet Reward. *Neuropsychopharmacology*, 32(11), 2267–2278.
<https://doi.org/10.1038/sj.npp.1301376>
- Maleki, N., Tahaney, K., Thompson, B. L., & Oscar-Berman, M. (2019). At the intersection of alcohol use disorder and chronic pain. *Neuropsychology*, 33(6), 795–807.
<https://doi.org/10.1037/neu0000558>
- Malvaez, M., & Wassum, K. M. (2019). *Regulation of habit formation in the dorsal striatum*. 15.
- Mansour, A., Fox, C., Akil, H., & Watson, S. (n.d.). *Opioid-receptor mRNA expression rat CNS: anatomical and functional implications*. 8.
- Marrazzi, M. A., & Luby, E. D. (1986). An auto-addiction opioid model of chronic anorexia nervosa. *International Journal of Eating Disorders*, 5(2), 191–208.
[https://doi.org/10.1002/1098-108X\(198602\)5:2<191::AID-EAT2260050202>3.0.CO;2-I](https://doi.org/10.1002/1098-108X(198602)5:2<191::AID-EAT2260050202>3.0.CO;2-I)
- Marx, J. (2003). Cellular Warriors at the Battle of the Bulge. *Science (New York, N.Y.)*, 299, 846–849. <https://doi.org/10.1126/science.299.5608.846>
- Mattes, R. D., & Popkin, B. M. (2009). Nonnutritive sweetener consumption in humans: Effects on appetite and food intake and their putative mechanisms. *The American Journal of Clinical Nutrition*, 89(1), 1–14. <https://doi.org/10.3945/ajcn.2008.26792>
- McKlveen, J. M., Morano, R. L., Fitzgerald, M., Zoubovsky, S., Cassella, S. N., Scheimann, J. R., Ghosal, S., Mahbod, P., Packard, B. A., Myers, B., Baccei, M. L., & Herman, J. P. (2016). Chronic Stress Increases Prefrontal Inhibition: A Mechanism for Stress-

Induced Prefrontal Dysfunction. *Biological Psychiatry*, 80(10), 754–764.

<https://doi.org/10.1016/j.biopsych.2016.03.2101>

Melis, M., Diana, M., Enrico, P., Marinelli, M., & Brodie, M. S. (2009). Ethanol and acetaldehyde action on central dopamine systems: Mechanisms, modulation, and relationship to stress. *Alcohol*, 43(7), 531–539.

<https://doi.org/10.1016/j.alcohol.2009.05.004>

Merighi, S., Gessi, S., Varani, K., Fazzi, D., Stefanelli, A., & Borea, P. A. (2013). Morphine mediates a proinflammatory phenotype via μ -opioid receptor–PKC ϵ –Akt–ERK1/2 signaling pathway in activated microglial cells. *Biochemical Pharmacology*, 86(4), 487–496. <https://doi.org/10.1016/j.bcp.2013.05.027>

Meule, A. (n.d.). *Back by Popular Demand: A Narrative Review on the History of Food Addiction Research*. 8.

Mitchell, M. R., Berridge, K. C., & Mahler, S. V. (2018). Endocannabinoid-Enhanced “Liking” in Nucleus Accumbens Shell Hedonic Hotspot Requires Endogenous Opioid Signals. *Cannabis and Cannabinoid Research*, 3(1), 166–170.

<https://doi.org/10.1089/can.2018.0021>

Mitra, A., Lenglos, C., Martin, J., Mbende, N., Gagné, A., & Timofeeva, E. (2011). Sucrose modifies c-fos mRNA expression in the brain of rats maintained on feeding schedules. *Neuroscience*, 192, 459–474. <https://doi.org/10.1016/j.neuroscience.2011.06.033>

Mitrovic, I., Margeta-Mitrovic, M., Bader, S., Stoffel, M., Jan, L. Y., & Basbaum, A. I. (n.d.). *Contribution of GIRK2-mediated postsynaptic signaling to opiate and α -2-adrenergic analgesia and analgesic sex differences*. 6.

Monteleone, P., & Maj, M. (n.d.). *Dysfunctions of leptin, ghrelin, BDNF and endocannabinoids in eating disorders: Beyond the homeostatic control of food intake.*

19.

Mooradian, A. D., Smith, M., & Tokuda, M. (2017). The role of artificial and natural sweeteners in reducing the consumption of table sugar: A narrative review. *Clinical Nutrition ESPEN*, *18*, 1–8. <https://doi.org/10.1016/j.clnesp.2017.01.004>

Morales, I., & Berridge, K. C. (2020). ‘Liking’ and ‘wanting’ in eating and food reward: Brain mechanisms and clinical implications. *Physiology & Behavior*, *227*, 113152. <https://doi.org/10.1016/j.physbeh.2020.113152>

Morton, G. J., Meek, T. H., & Schwartz, M. W. (2014). Neurobiology of food intake in health and disease. *Nature Reviews Neuroscience*, *15*(6), 367–378. <https://doi.org/10.1038/nrn3745>

Murphy, T. J., Pagano, R. R., & Marlatt, G. A. (1986). Lifestyle modification with heavy alcohol drinkers: Effects of aerobic exercise and meditation. *Addictive Behaviors*, *11*(2), 175–186. [https://doi.org/10.1016/0306-4603\(86\)90043-2](https://doi.org/10.1016/0306-4603(86)90043-2)

Narita, M., Miyoshi, K., Narita, M., & Suzuki, T. (2007). Involvement of microglia in the ethanol-induced neuropathic pain-like state in the rat. *Neuroscience Letters*, *414*(1), 21–25. <https://doi.org/10.1016/j.neulet.2006.10.062>

Nogueiras, R., Romero-Picó, A., Vazquez, M. J., Novelle, M. G., López, M., & Diéguez, C. (2012). The Opioid System and Food Intake: Homeostatic and Hedonic Mechanisms. *Obesity Facts*, *5*(2), 196–207. <https://doi.org/10.1159/000338163>

Östlund, H., Keller, E., & Hurd, Y. L. (2003). Estrogen Receptor Gene Expression in Relation to Neuropsychiatric Disorders. *Annals of the New York Academy of Sciences*, *1007*(1), 54–63. <https://doi.org/10.1196/annals.1286.006>

- Palmiter, R. D. (2007). Is dopamine a physiologically relevant mediator of feeding behavior? *Trends in Neurosciences*, *30*(8), 375–381. <https://doi.org/10.1016/j.tins.2007.06.004>
- Parylak, S. L., Cottone, P., Sabino, V., Rice, K. C., & Zorrilla, E. P. (2012). Effects of CB1 and CRF1 receptor antagonists on binge-like eating in rats with limited access to a sweet fat diet: Lack of withdrawal-like responses. *Physiology & Behavior*, *107*(2), 231–242. <https://doi.org/10.1016/j.physbeh.2012.06.017>
- Paschon, V., Takada, S. H., Ikebara, J. M., Sousa, E., Raeisossadati, R., Ulrich, H., & Kihara, A. H. (2016). Interplay Between Exosomes, microRNAs and Toll-Like Receptors in Brain Disorders. *Molecular Neurobiology*, *53*(3), 2016–2028. <https://doi.org/10.1007/s12035-015-9142-1>
- Pascual, M., Pla, A., Miñarro, J., & Guerri, C. (2014). Neuroimmune Activation and Myelin Changes in Adolescent Rats Exposed to High-Dose Alcohol and Associated Cognitive Dysfunction: A Review with Reference to Human Adolescent Drinking. *Alcohol and Alcoholism*, *49*(2), 187–192. <https://doi.org/10.1093/alcalc/agt164>
- Pataky, Z., Gasteyger, C., Ziegler, O., Rissanen, A., Hanotin, C., & Golay, A. (2012). Efficacy of rimonabant in obese patients with binge eating disorder. *Experimental and Clinical Endocrinology & Diabetes*, *121*(01), 20–26. <https://doi.org/10.1055/s-0032-1329957>
- Patkar, O. L., Mohamed, A. Z., Narayanan, A., Mardon, K., Cowin, G., Bhalla, R., Stimson, D. H. R., Kassiou, M., Beecher, K., Belmer, A., Alvarez Cooper, I., Morgan, M., Hume, D. A., Irvine, K. M., Bartlett, S. E., Nasrallah, F., & Cumming, P. (2021). A binge high sucrose diet provokes systemic and cerebral inflammation in rats without inducing obesity. *Scientific Reports*, *11*(1), 11252. <https://doi.org/10.1038/s41598-021-90817-z>

z

- Pecina, S. (2005). Hedonic Hot Spot in Nucleus Accumbens Shell: Where Do μ -Opioids Cause Increased Hedonic Impact of Sweetness? *Journal of Neuroscience*, *25*(50), 11777–11786. <https://doi.org/10.1523/JNEUROSCI.2329-05.2005>
- Pelchat, M. L., Johnson, A., Chan, R., Valdez, J., & Ragland, J. D. (2004). Images of desire: Food-craving activation during fMRI. *NeuroImage*, *23*(4), 1486–1493. <https://doi.org/10.1016/j.neuroimage.2004.08.023>
- Peltier, M. R., Verplaetse, T. L., Mineur, Y. S., Petrakis, I. L., Cosgrove, K. P., Picciotto, M. R., & McKee, S. A. (2019). Sex differences in stress-related alcohol use. *Neurobiology of Stress*, *10*, 100149. <https://doi.org/10.1016/j.ynstr.2019.100149>
- Ponomarev, E. D., Veremeyko, T., & Weiner, H. L. (2013). MicroRNAs are universal regulators of differentiation, activation, and polarization of microglia and macrophages in normal and diseased CNS. *Glia*, *61*(1), 91–103. <https://doi.org/10.1002/glia.22363>
- Qin, L., & Crews, F. T. (2012). NADPH oxidase and reactive oxygen species contribute to alcohol-induced microglial activation and neurodegeneration. *Journal of Neuroinflammation*, *9*(1), 5. <https://doi.org/10.1186/1742-2094-9-5>
- Randolph, T. G. (1956). The Descriptive Features of Food Addiction. Addictive Eating and Drinking. *Quarterly Journal of Studies on Alcohol*, *17*(2), 198–224. <https://doi.org/10.15288/qjsa.1956.17.198>
- Reinehr, T., & Roth, C. L. (2018). Inflammation Markers in Type 2 Diabetes and the Metabolic Syndrome in the Pediatric Population. *Current Diabetes Reports*, *18*(12), 131. <https://doi.org/10.1007/s11892-018-1110-5>
- Rodríguez-Martín, B. C., & Gallego-Arjiz, B. (2018). Overeaters Anonymous: A Mutual-Help Fellowship for Food Addiction Recovery. *Frontiers in Psychology*, *9*, 1491. <https://doi.org/10.3389/fpsyg.2018.01491>

- Rolland, B., Naassila, M., Duffau, C., Houchi, H., Gierski, F., & André, J. (2017). Binge Eating, But Not Other Disordered Eating Symptoms, Is a Significant Contributor of Binge Drinking Severity: Findings from a Cross-Sectional Study among French Students. *Frontiers in Psychology, 8*. <https://doi.org/10.3389/fpsyg.2017.01878>
- Rolls, B. J. (n.d.). Portion Size and the Obesity Epidemic. *Nutrition and Behavior, 38*(2), 12.
- Root, T. L., Pisetsky, E. M., Thornton, L., Lichtenstein, P., Pedersen, N. L., & Bulik, C. M. (2010). Patterns of co-morbidity of eating disorders and substance use in Swedish females. *Psychological Medicine, 40*(1), 105–115. <https://doi.org/10.1017/S0033291709005662>
- Rowan, S., Bejarano, E., & Taylor, A. (2018). Mechanistic targeting of advanced glycation end-products in age-related diseases. *Biochimica et Biophysica Acta (BBA) - Molecular Basis of Disease, 1864*(12), 3631–3643. <https://doi.org/10.1016/j.bbadis.2018.08.036>
- Rubio-Araiz, A., Porcu, F., Pérez-Hernández, M., García-Gutiérrez, M. S., Aracil-Fernández, M. A., Gutierrez-López, M. D., Guerri, C., Manzanares, J., O’Shea, E., & Colado, M. I. (2017). Disruption of blood-brain barrier integrity in postmortem alcoholic brain: Preclinical evidence of TLR4 involvement from a binge-like drinking model: TLR4 involvement from a binge-like drinking model. *Addiction Biology, 22*(4), 1103–1116. <https://doi.org/10.1111/adb.12376>
- Sanacora, G., Treccani, G., & Popoli, M. (2012). Towards a glutamate hypothesis of depression. *Neuropharmacology, 62*(1), 63–77. <https://doi.org/10.1016/j.neuropharm.2011.07.036>

- Satta, V., Scherma, M., Piscitelli, F., Usai, P., Castelli, M. P., Bisogno, T., Fratta, W., & Fadda, P. (2018). Limited Access to a High Fat Diet Alters Endocannabinoid Tone in Female Rats. *Frontiers in Neuroscience*, *12*, 40. <https://doi.org/10.3389/fnins.2018.00040>
- Schafers, M., Lee, D. H., Brors, D., Yaksh, T. L., & Sorkin, L. S. (n.d.). *Increased Sensitivity of Injured and Adjacent Uninjured Rat Primary Sensory Neurons to Exogenous Tumor Necrosis Factor- α after Spinal Nerve Ligation*. 11.
- Schag, K., Teufel, M., Junne, F., Preissl, H., Hautzinger, M., Zipfel, S., & Giel, K. E. (2013). Impulsivity in Binge Eating Disorder: Food Cues Elicit Increased Reward Responses and Disinhibition. *PLoS ONE*, *8*(10), e76542. <https://doi.org/10.1371/journal.pone.0076542>
- Scherma, M., Fattore, L., Satta, V., Businco, F., Pigliacampo, B., Goldberg, S., Dessi, C., Fratta, W., & Fadda, P. (2013). Pharmacological modulation of the endocannabinoid signalling alters binge-type eating behaviour in female rats: Endocannabinoid system and binge eating behaviour. *British Journal of Pharmacology*, *169*(4), 820–833. <https://doi.org/10.1111/bph.12014>
- Schulte, E. M., Potenza, M. N., & Gearhardt, A. N. (2017). A commentary on the “eating addiction” versus “food addiction” perspectives on addictive-like food consumption. *Appetite*, *115*, 9–15. <https://doi.org/10.1016/j.appet.2016.10.033>
- Schurman, L. D., & Lichtman, A. H. (2017). Endocannabinoids: A Promising Impact for Traumatic Brain Injury. *Frontiers in Pharmacology*, *8*. <https://doi.org/10.3389/fphar.2017.00069>
- Sclafani, A. (2018). From appetite setpoint to appetite: 50 years of ingestive behavior research. *Physiology & Behavior*, *192*, 210–217. <https://doi.org/10.1016/j.physbeh.2018.01.001>

- Seo, D.-Y., Heo, J.-W., Ko, J. R., & Kwak, H.-B. (2019). Exercise and Neuroinflammation in Health and Disease. *International Neuropsychology Journal*, 23(Suppl 2), S82-92.
<https://doi.org/10.5213/inj.1938214.107>
- Shinohara, F., Kamii, H., Minami, M., & Kaneda, K. (2017). The Role of Dopaminergic Signaling in the Medial Prefrontal Cortex for the Expression of Cocaine-Induced Conditioned Place Preference in Rats. *Biological & Pharmaceutical Bulletin*, 40(11), 1983–1989. <https://doi.org/10.1248/bpb.b17-00614>
- Silvestri, C., & Di Marzo, V. (2013). The Endocannabinoid System in Energy Homeostasis and the Etiopathology of Metabolic Disorders. *Cell Metabolism*, 17(4), 475–490.
<https://doi.org/10.1016/j.cmet.2013.03.001>
- Simon, G., Heckmann, V., Tóth, D., Pauka, D., Petrus, K., & Molnár, T. F. (2020). The effect of hepatic steatosis and fibrosis on liver weight and dimensions. *Legal Medicine*, 47, 101781. <https://doi.org/10.1016/j.legalmed.2020.101781>
- Smail-Crevier, R. L., Maracle, A. C., Wash, S. I. J., & Olmstead, M. C. (2018). Binge-like intake of sucrose reduces the rewarding value of sucrose in adult rats. *Physiology & Behavior*, 194, 420–429. <https://doi.org/10.1016/j.physbeh.2018.06.027>
- Smith, K. S. (2005). The Ventral Pallidum and Hedonic Reward: Neurochemical Maps of Sucrose “Liking” and Food Intake. *Journal of Neuroscience*, 25(38), 8637–8649.
<https://doi.org/10.1523/JNEUROSCI.1902-05.2005>
- Smith, R. S. (n.d.). *The Macrophage Theory of Depression*. 9.
- Solinas, M., & Justinova, Z. (2006). Anandamide administration alone and after inhibition of fatty acid amide hydrolase (FAAH) increases dopamine levels in the nucleus accumbens shell in rats. *J. Neurochem.*, 12.

- Sommer, C. (2004). Serotonin in Pain and Analgesia: Actions in the Periphery. *Molecular Neurobiology*, 30(2), 117–126. <https://doi.org/10.1385/MN:30:2:117>
- Sotero, R. C., & Martínez-Cancino, R. (2010). Dynamical Mean Field Model of a Neural-Glial Mass. *Neural Computation*, 22(4), 969–997. <https://doi.org/10.1162/neco.2009.04-09-1002>
- Speakman, J. R. (2008). Thrifty genes for obesity, an attractive but flawed idea, and an alternative perspective: The ‘drifty gene’ hypothesis. *International Journal of Obesity*, 32(11), 1611–1617. <https://doi.org/10.1038/ijo.2008.161>
- Steffensen, S., Stobbs, S., Colago, E., Lee, R., Koob, G., Gallegos, R., & Henriksen, S. (2006). Contingent and non-contingent effects of heroin on mu-opioid receptor-containing ventral tegmental area GABA neurons. *Experimental Neurology*, 202(1), 139–151. <https://doi.org/10.1016/j.expneurol.2006.05.023>
- Stellman, S. D., & Garfinkel, L. (n.d.). *Patterns of Artificial Sweetener Use and Weight. Change in an American Cancer Society Prospective Study*. 7.
- Sumiyoshi, M., Sakanaka, M., & Kimura, Y. (2006). Chronic Intake of High-Fat and High-Sucrose Diets Differentially Affects Glucose Intolerance in Mice. *The Journal of Nutrition*, 136(3), 582–587. <https://doi.org/10.1093/jn/136.3.582>
- Sun, W., Cornwell, A., Li, J., Peng, S., Osorio, M. J., Aalling, N., Wang, S., Benraiss, A., Lou, N., Goldman, S. A., & Nedergaard, M. (2017). SOX9 Is an Astrocyte-Specific Nuclear Marker in the Adult Brain Outside the Neurogenic Regions. *The Journal of Neuroscience*, 37(17), 4493–4507. <https://doi.org/10.1523/JNEUROSCI.3199-16.2017>
- Surpur, S. S., & Govindarajan, R. (2017). Role of “Sural Sparing” Pattern (Absent/Abnormal Median and Ulnar with Present Sural SNAP) Compared to Absent/Abnormal Median or Ulnar with Normal Sural SNAP in Acute Inflammatory Demyelinating

- Polyneuropathy. *Frontiers in Neurology*, 8, 512.
<https://doi.org/10.3389/fneur.2017.00512>
- Swithers, S. E., Baker, C. R., & Davidson, T. L. (2009). General and persistent effects of high-intensity sweeteners on body weight gain and caloric compensation in rats. *Behavioral Neuroscience*, 123(4), 772–780. <https://doi.org/10.1037/a0016139>
- Szabo, B., Siemes, S., & Wallmichrath, I. (2002). Inhibition of GABAergic neurotransmission in the ventral tegmental area by cannabinoids. *European Journal of Neuroscience*, 5.
- Takeda, K., Muramatsu, M., Chikuma, T., & Kato, T. (2009). Effect of Memantine on the Levels of Neuropeptides and Microglial Cells in the Brain Regions of Rats with Neuropathic Pain. *Journal of Molecular Neuroscience*, 39(3), 380–390.
<https://doi.org/10.1007/s12031-009-9224-5>
- Tan, Y.-L., Yuan, Y., & Tian, L. (2020). Microglial regional heterogeneity and its role in the brain. *Molecular Psychiatry*, 25(2), 351–367. <https://doi.org/10.1038/s41380-019-0609-8>
- Tanga, F. Y., Nutile-McMenemy, N., & DeLeo, J. A. (2005). The CNS role of Toll-like receptor 4 in innate neuroimmunity and painful neuropathy. *Proceedings of the National Academy of Sciences*, 102(16), 5856–5861.
<https://doi.org/10.1073/pnas.0501634102>
- Taqi, M. M., Faisal, M., & Zaman, H. (2019). OPRM1 A118G Polymorphisms and Its Role in Opioid Addiction: Implication on Severity and Treatment Approaches. *Pharmacogenomics and Personalized Medicine*, Volume 12, 361–368.
<https://doi.org/10.2147/PGPM.S198654>
- Taylor, A. M. W., & Cahill, C. M. (2017). Editorial: Modulation of Reward Circuitry by Pain and Stress. *Frontiers in Psychiatry*, 8, 296. <https://doi.org/10.3389/fpsy.2017.00296>

- Taylor, A. M. W., Mehrabani, S., Liu, S., Taylor, A. J., & Cahill, C. M. (2017). Topography of microglial activation in sensory- and affect-related brain regions in chronic pain. *Journal of Neuroscience Research*, *95*(6), 1330–1335. <https://doi.org/10.1002/jnr.23883>
- Thaler, J. P., Yi, C.-X., Schur, E. A., Guyenet, S. J., Hwang, B. H., Dietrich, M. O., Zhao, X., Sarruf, D. A., Izgur, V., Maravilla, K. R., Nguyen, H. T., Fischer, J. D., Matsen, M. E., Wisse, B. E., Morton, G. J., Horvath, T. L., Baskin, D. G., Tschöp, M. H., & Schwartz, M. W. (2012). Obesity is associated with hypothalamic injury in rodents and humans. *Journal of Clinical Investigation*, *122*(1), 153–162. <https://doi.org/10.1172/JCI59660>
- Thorner, H. A. (1970). On compulsive eating. *Journal of Psychosomatic Research*, *14*(3), 321–325. [https://doi.org/10.1016/0022-3999\(70\)90060-7](https://doi.org/10.1016/0022-3999(70)90060-7)
- Ting, C.-H., Chi, C.-W., Li, C.-P., & Chen, C.-Y. (2015). Differential modulation of endogenous cannabinoid CB1 and CB2 receptors in spontaneous and splice variants of ghrelin-induced food intake in conscious rats. *Nutrition*, *31*(1), 230–235. <https://doi.org/10.1016/j.nut.2014.06.008>
- Toll, L., Bruchas, M. R., Calo', G., Cox, B. M., & Zaveri, N. T. (2016). Nociceptin/Orphanin FQ Receptor Structure, Signaling, Ligands, Functions, and Interactions with Opioid Systems. *Pharmacological Reviews*, *68*(2), 419–457. <https://doi.org/10.1124/pr.114.009209>
- Tordoff, M. G. (n.d.). *How Do Non-nutritive Sweeteners increase Food intake? 7*.
- Tzschentke, T. M. (1998). Measuring reward with the conditioned place preference paradigm: A comprehensive review of drug effects, recent progress and new issues. *Progress in Neurobiology*, *56*(6), 613–672. [https://doi.org/10.1016/S0301-0082\(98\)00060-4](https://doi.org/10.1016/S0301-0082(98)00060-4)

- Valbrun, L. P., & Zvonarev, V. (2020). The Opioid System and Food Intake: Use of Opiate Antagonists in Treatment of Binge Eating Disorder and Abnormal Eating Behavior. *Journal of Clinical Medicine Research*, 12(2), 41–63.
<https://doi.org/10.14740/jocmr4066>
- Vancampfort, D., Vanderlinden, J., De Hert, M., Adámkova, M., Skjaerven, L. H., Catalán-Matamoros, D., Lundvik-Gyllensten, A., Gómez-Conesa, A., Ijntema, R., & Probst, M. (2013). A systematic review on physical therapy interventions for patients with binge eating disorder. *Disability and Rehabilitation*, 35(26), 2191–2196.
<https://doi.org/10.3109/09638288.2013.771707>
- Volkow, N. D., Logan, J., & Hitzemann, R. (1999a). Prediction of Reinforcing Responses to Psychostimulants in Humans by Brain Dopamine D2 Receptor Levels. *Am J Psychiatry*, 4.
- Volkow, N. D., Logan, J., & Hitzemann, R. (1999b). Prediction of Reinforcing Responses to Psychostimulants in Humans by Brain Dopamine D2 Receptor Levels. *Am J Psychiatry*, 4.
- Volkow, N. D., & Morales, M. (2015). The Brain on Drugs: From Reward to Addiction. *Cell*, 162(4), 712–725. <https://doi.org/10.1016/j.cell.2015.07.046>
- Volkow, N. D., Wang, G.-J., Fowler, J. S., Hitzemann, R., Angrist, B., Gatley, S. J., Logan, J., Ding, Y.-S., & Pappas, N. (1999). Association of Methylphenidate-Induced Craving With Changes in Right Striato-orbitofrontal Metabolism in Cocaine Abusers: Implications in Addiction. *American Journal of Psychiatry*, 156(1), 19–26.
<https://doi.org/10.1176/ajp.156.1.19>

- Walter, L., & Stella, N. (2004). Cannabinoids and neuroinflammation: Cannabinoids and neuroinflammation. *British Journal of Pharmacology*, *141*(5), 775–785.
<https://doi.org/10.1038/sj.bjp.0705667>
- Wang, G.-J. (2018). Impact of sugar on the body brain and behavior. *Frontiers in Bioscience*, *23*(12), 2255–2266. <https://doi.org/10.2741/4704>
- Wang, G.-J., Geliebter, A., Volkow, N. D., Telang, F. W., Logan, J., Jayne, M. C., Galanti, K., Selig, P. A., Han, H., Zhu, W., Wong, C. T., & Fowler, J. S. (2011). Enhanced Striatal Dopamine Release During Food Stimulation in Binge Eating Disorder. *Obesity*, *19*(8), 1601–1608. <https://doi.org/10.1038/oby.2011.27>
- Wang, G.-J., Volkow, N. D., Telang, F., Jayne, M., Ma, J., Rao, M., Zhu, W., Wong, C. T., Pappas, N. R., Geliebter, A., & Fowler, J. S. (2004). Exposure to appetitive food stimuli markedly activates the human brain. *NeuroImage*, *21*(4), 1790–1797.
<https://doi.org/10.1016/j.neuroimage.2003.11.026>
- Wassum, K. M., & Izquierdo, A. (2016). *The basolateral amygdala in reward learning and addiction*. 30.
- Wei, R., Deng, D., Teng, Y., Lu, C., Luo, Z., Abdulai, M., Liu, H., Xu, H., Li, L., Hu, S., Hu, J., Wei, S., Zeng, X., & Han, C. (2022). Study on the effect of different types of sugar on lipid deposition in goose fatty liver. *Poultry Science*, *101*(4), 101729.
<https://doi.org/10.1016/j.psj.2022.101729>
- Wilfley, D. E., Friedman, M. A., Douchis, J. Z., Stein, R. I., & Welch, R. R. (n.d.). *Comorbid Psychopathology in Binge Eating Disorder: Relation to Eating Disorder Severity at Baseline and Following Treatment*. 9.

- Williams, C. M., & Kirkham, T. C. (1999). Anandamide induces overeating: Mediation by central cannabinoid (CB1) receptors. *Psychopharmacology*, *143*(3), 315–317.
<https://doi.org/10.1007/s002130050953>
- Wirth, M. M., & Giraudo, S. Q. (2001). Effect of Agouti-related protein delivered to the dorsomedial nucleus of the hypothalamus on intake of a preferred versus a non-preferred diet. *Brain Research*, *897*(1–2), 169–174. [https://doi.org/10.1016/S0006-8993\(01\)02087-X](https://doi.org/10.1016/S0006-8993(01)02087-X)
- Xu, L., Nan, J., & Lan, Y. (2020). The Nucleus Accumbens: A Common Target in the Comorbidity of Depression and Addiction. *Frontiers in Neural Circuits*, *14*, 37.
<https://doi.org/10.3389/fncir.2020.00037>
- Yang, Z., Xie, J., Shao, Y.-C., Xie, C.-M., Fu, L.-P., Li, D.-J., Fan, M., Ma, L., & Li, S.-J. (2009). Dynamic neural responses to cue-reactivity paradigms in heroin-dependent users: An fMRI study. *Human Brain Mapping*, *30*(3), 766–775.
<https://doi.org/10.1002/hbm.20542>
- Yanovski, S. Z., Leet, M., Yanovski, J. A., Flood, M., Gold, P. W., Kissileff, H. R., & Walsh, B. T. (1992). Food selection and intake of obese women with binge-eating disorder. *The American Journal of Clinical Nutrition*, *56*(6), 975–980.
<https://doi.org/10.1093/ajcn/56.6.975>
- Yasoshima, Y., & Shimura, T. (2015). A mouse model for binge-like sucrose overconsumption: Contribution of enhanced motivation for sweetener consumption. *Physiology & Behavior*, *138*, 154–164. <https://doi.org/10.1016/j.physbeh.2014.10.035>
- Yeomans, M. R., Wright, P., Macleod, H. A., & Critchley, J. A. J. H. (1990). Effects of nalmefene on feeding in humans: Dissociation of hunger and palatability. *Psychopharmacology*, *100*(3), 426–432. <https://doi.org/10.1007/BF02244618>

Zakariaeiz, Y., & Potenza, M. N. (2018). Gender-related differences in addiction: A review of human studies. *Current Opinion in Behavioral Sciences*, *23*, 171–175.

<https://doi.org/10.1016/j.cobeha.2018.08.004>

Zeng, L., Alongkronrusmee, D., & van Rijn, R. M. (2017). An integrated perspective on diabetic, alcoholic, and drug-induced neuropathy, etiology, and treatment in the US. *Journal of Pain Research*, *Volume 10*, 219–228. <https://doi.org/10.2147/JPR.S125987>

Ziauddeen, H., Chamberlain, S. R., Nathan, P. J., Koch, A., Maltby, K., Bush, M., Tao, W. X., Napolitano, A., Skeggs, A. L., Brooke, A. C., Cheke, L., Clayton, N. S., Sadaf Farooqi, I., O’Rahilly, S., Waterworth, D., Song, K., Hosking, L., Richards, D. B., Fletcher, P. C., & Bullmore, E. T. (2013). Effects of the mu-opioid receptor antagonist GSK1521498 on hedonic and consummatory eating behaviour: A proof of mechanism study in binge-eating obese subjects. *Molecular Psychiatry*, *18*(12), 1287–1293.

<https://doi.org/10.1038/mp.2012.154>

Zweifel, L. S., Parker, J. G., Lobb, C. J., Rainwater, A., Wall, V. Z., Fadok, J. P., Darvas, M., Kim, M. J., Mizumori, S. J. Y., Paladini, C. A., Phillips, P. E. M., & Palmiter, R. D. (2009). Disruption of NMDAR-dependent burst firing by dopamine neurons provides selective assessment of phasic dopamine-dependent behavior. *Proceedings of the National Academy of Sciences*, *106*(18), 7281–7288.

<https://doi.org/10.1073/pnas.0813415106>