



HAL
open science

Insights on the mode of actions of TLR2 agonists against HBV replication

Manon Desmares

► **To cite this version:**

Manon Desmares. Insights on the mode of actions of TLR2 agonists against HBV replication. Virology. Université de Lyon, 2021. English. NNT : 2021LYSE1136 . tel-04213616

HAL Id: tel-04213616

<https://theses.hal.science/tel-04213616v1>

Submitted on 21 Sep 2023

HAL is a multi-disciplinary open access archive for the deposit and dissemination of scientific research documents, whether they are published or not. The documents may come from teaching and research institutions in France or abroad, or from public or private research centers.

L'archive ouverte pluridisciplinaire **HAL**, est destinée au dépôt et à la diffusion de documents scientifiques de niveau recherche, publiés ou non, émanant des établissements d'enseignement et de recherche français ou étrangers, des laboratoires publics ou privés.

N°d'ordre NNT : 2021LYSE1136



THESE de DOCTORAT DE L'UNIVERSITE DE LYON

opérée au sein de
l'Université Claude Bernard Lyon 1

Ecole Doctorale N° 340 BMIC
Biologie Moléculaire Intégrative et Cellulaire

Spécialité de doctorat : Virologie et Immunologie
Discipline : Infectiologie

Soutenue à huis clos le 12/07/2021, par :

Manon DESMARES

Insights on the mode of actions of TLR2 agonists against HBV replication

Devant le jury composé de :

Pr. Christine DELPRAT, PU, CRCL Lyon

Présidente

Dr. Gloria GONZÁLEZ ASEGUINOLAZA, DR CIMA, Université de Navarre, Pamplone

Rapporteuse

Dr. Patrick SOUSSAN, MCU-PH, CIMI Paris

Rapporteur

Pr. Stéphane PAUL, PU-PH, CIRI Lyon

Examineur

Dr. David DURANTELL, DR2 Inserm, CIRI Lyon

Directeur de thèse

Dr Bernard VERRIER, DR CNRS, IBCP Lyon

Co-directeur de thèse

Dr. Uzma HASAN, CR Inserm, CIRI Lyon

Invitée

Université Claude Bernard – LYON 1

Président de l'Université	M. Frédéric FLEURY
Président du Conseil Académique	M. Hamda BEN HADID
Vice-Président du Conseil d'Administration	M. Didier REVEL
Vice-Président du Conseil des Etudes et de la Vie Universitaire	M. Philippe CHEVALLIER
Vice-Président de la Commission de Recherche	M. Petru MIRONESCU
Directeur Général des Services	M. Pierre ROLLAND

COMPOSANTES SANTE

Département de Formation et Centre de Recherche en Biologie Humaine	Directrice : Mme Anne-Marie SCHOTT
Faculté d'Odontologie	Doyenne : Mme Dominique SEUX
Faculté de Médecine et Maïeutique Lyon Sud - Charles Mérieux	Doyenne : Mme Carole BURILLON
Faculté de Médecine Lyon-Est	Doyen : M. Gilles RODE
Institut des Sciences et Techniques de la Réadaptation (ISTR)	Directeur : M. Xavier PERROT
Institut des Sciences Pharmaceutiques et Biologiques (ISBP)	Directrice : Mme Christine VINCIGUERRA

COMPOSANTES & DEPARTEMENTS DE SCIENCES & TECHNOLOGIE

Département Génie Electrique et des Procédés (GEP)	Directrice : Mme Rosaria FERRIGNO
Département Informatique	Directeur : M. Behzad SHARIAT
Département Mécanique	Directeur M. Marc BUFFAT
Ecole Supérieure de Chimie, Physique, Electronique (CPE Lyon)	Directeur : Gérard PIGNAULT
Institut de Science Financière et d'Assurances (ISFA)	Directeur : M. Nicolas LEBOISNE
Institut National du Professorat et de l'Education	Administrateur Provisoire : M. Pierre CHAREYRON
Institut Universitaire de Technologie de Lyon 1	Directeur : M. Christophe VITON
Observatoire de Lyon	Directrice : Mme Isabelle DANIEL
Polytechnique Lyon	Directeur : Emmanuel PERRIN
UFR Biosciences	Administratrice provisoire : Mme Kathrin GIESELER
UFR des Sciences et Techniques des Activités Physiques et Sportives (STAPS)	Directeur : M. Yannick VANPOULLE
UFR Faculté des Sciences	Directeur : M. Bruno ANDRIOLETTI

« La vie n'est facile pour aucun de nous. Mais quoi, il faut avoir de la persévérance, et surtout de la confiance en soi. Il faut croire que l'on est doué pour quelque chose, et que, cette chose, il faut l'atteindre coûte que coûte. »

Marie Curie (1867-1934)

Résumé

Etude des mécanismes d'action de ligands de TLR2 contre la réplication du VHB

Le virus de l'hépatite B (VHB) est un problème de santé publique majeur qui infecte chroniquement près de 250 millions d'individus dans le monde. Les personnes infectées ont un risque élevé de développer des maladies du foie, telles que la stéatose ou la fibrose pouvant évoluer en cirrhose décompensée ou en carcinome hépatocellulaire. Les traitements actuels basés sur l'administration d'interféron- α pegylé (Peg-IFN- α) ou d'analogues de nucléosides ne sont pas assez efficaces pour garantir l'éradication du virus, ni pour éliminer l'ADNccc (ADN circulaire-covalamment-clos), responsable de la persistance du VHB. De plus, l'interféron- α pegylé est faiblement toléré chez les patients, entraînant notamment de nombreux effets secondaires et les traitements à base d'analogues de nucléosides doivent, quant à eux, être administrés à vie. Il est donc nécessaire de développer de nouvelles stratégies thérapeutiques, incluant les immunothérapies, afin de restaurer/améliorer les fonctions immunitaires, nécessaires pour contrôler l'infection par le VHB à long terme. Pour cela, de nombreux stimulateurs de l'immunité innée, dont le rôle est de stimuler les cellules du système immunitaire pour produire des cytokines pro-inflammatoires ou des interférons, sont actuellement en cours d'essais cliniques. Ces médiateurs de l'immunité innée sécrétés sont capables, par la suite, d'inhiber la réplication virale au sein des hépatocytes et d'activer la réponse des lymphocytes T. Notre équipe a précédemment caractérisé différents senseurs de l'immunité exprimés dans des cellules primaires isolées du foie ainsi que des lignées cellulaires hépatiques et étudié l'activité antivirale de différents ligands. Nous avons identifié que Pam3CSK4, un agoniste du récepteur Toll-like (TLR) 2, induisait le plus fort effet antiviral sur la réplication du virus et sur l'ADNccc, au sein des hépatocytes.

Les objectifs de la thèse étaient, dans un premier temps, d'étudier en détails l'activité antivirale induite par Pam3CSK4 ainsi que ses mécanismes d'action dans nos modèles *in vitro*. Pour cela, nous avons déterminé la cinétique de l'effet antiviral, identifié les étapes de la réplication virale ciblées par le ligand, étudié sa spécificité d'action et cherché les effecteurs de l'hôte impliqués dans les phénotypes antiviraux durables. Dans un second temps, nous avons évalué, à la fois *in vitro* et *in vivo*, le potentiel usage thérapeutique de Pam3CSK4, encapsulé dans un vecteur nanoparticulaire (NPs-Pam3CSK4) délivrable au foie. Nous avons également étudié les propriétés antivirales de ces vecteurs, fonctionnalisés par le peptide PreS1 pour un meilleur ciblage et une délivrance préférentielle aux hépatocytes (NPs-Pam3CSK4-PreS1).

Pam3CSK4 a montré une forte et durable inhibition de la réplication du VHB en impliquant le récepteur de l'immunité innée TLR1/2 et la voie sous-jacente NF- κ B canonique. Le phénotype antiviral durable est la double conséquence d'un effet immédiat sur la biogénèse des ARNs viraux, via la réduction de la transcription, l'accélération de la dégradation des ARNs ainsi que la diminution de l'ADNccc. Ce dernier phénotype, qui apparaît dans un second temps, renforce le premier, l'ADNccc étant la matrice principale pour la synthèse des ARNs viraux. Une analyse de séquençage d'ARN et des approches de pertes de fonctions ont permis d'identifier un effecteur de l'hôte, FEN-1, impliqué dans le phénotype antiviral. De façon similaire à Pam3CSK4, les nanoparticules NPs-Pam3CSK4 ont montré une forte et durable diminution de l'ensemble des paramètres viraux et cet effet antiviral a été confirmé *in vivo*, dans un modèle de souris transduites par un virus adeno-associé contenant le génome du VHB. *In vitro*, les nanoparticules NPs-Pam3CSK4-PreS1 ont présenté un effet additionnel d'inhibition de l'entrée du virus. En outre, dans un protocole de vaccination prophylactique, ces NPs-Pam3CSK4-PreS1 ont induit une réponse humorale efficace, produisant des anticorps hautement neutralisants.

Nos travaux de recherches devraient aboutir à l'évaluation clinique d'agonistes de TL1/2 en tant qu'adjuvants immunologiques dans des stratégies d'immunothérapies plus complexes impliquant des combinaisons thérapeutiques avec des vaccins ou des thérapies ciblées.

Mots-clés : Virus de l'hépatite B ; Récepteur Toll-like 2 ; Pam3CSK4 ; Traitements immunomodulateurs; Nanoparticules

Abstract

Insights on the mode of actions of TLR2 agonists against HBV replication

Hepatitis B virus (HBV) is a major health issue that chronically infects over 250 million people worldwide. Infected people are at high risk of developing liver diseases, such as steatosis or fibrosis that can lead to decompensated cirrhosis or hepatocellular carcinoma (HCC). Current available treatments either based on pegylated interferon- α (Peg-IFN- α) or nucleos(t)ides analogues (NAs) administration are not efficient enough to guarantee the total eradication of the virus and to affect the cccDNA (i.e. covalently closed circular DNA), responsible of the persistence of the virus. Besides, Peg-IFN- α presents a poor safety profile in patients, inducing numerous side effects and NA therapies need to be taken lifelong, as their arrest generally lead to a viral rebound. It is therefore necessary to develop new therapeutic strategies, including immune-therapies, which would restore/enhance immune functions, needed to control HBV infection in the long term. To this end, several innate immune stimulators, whose aim is to induce the production of pro-inflammatory cytokines or interferons by stimulation of professional immune cells, are currently under clinical trials. These secreted mediators of innate immunity are subsequently able to inhibit HBV replication, occurring in hepatocytes, and to activate T cell responses. Our team previously characterized the different immune sensors expressed by primary liver cells along with some liver cell lines, and studied the antiviral activity of different agonists. We identified that Pam3CSK4, a Toll-like receptor (TLR) 1/2 agonist, had the strongest antiviral effects on HBV replication and cccDNA in hepatocytes.

The objectives of this thesis was first to get further insights on the description of the antiviral activity of Pam3CSK4 and to decipher its mode of action in our *in vitro* models. To this end, we determined the kinetic of antiviral events, identified the upstream and most relevant step of blockade of HBV replication, worked-out its specificity of action and looked for host-effectors involved in the long-lasting antiviral phenotypes. Finally, we assessed both *in vitro* and *in vivo*, the potential therapeutic use of Pam3CSK4 in a liver-deliverable and nanoparticulate vector (NPs-Pam3CSK4). We assessed, as well, the antiviral properties of these vectors functionalized with the PreS1 peptide for a better targeting and delivery to the hepatocytes (NPs-Pam3CSK4-PreS1).

Pam3CSK4 strongly and durably inhibited HBV replication by engaging the TLR1/2 innate receptor and the downstream canonical NF- κ B pathway. The overall long-lasting antiviral phenotype is the double consequence of an immediate effect on HBV RNA biogenesis, by both reduction of RNA transcription and acceleration of RNA decay, as well as a reduction of cccDNA level; the latter phenotype, which kinetically occurs second, reinforce the first, as cccDNA is the main template of HBV RNA synthesis. RNA-sequencing analyses and loss-of-function approaches allowed the investigation of a host effector, FEN-1, as involved in the antiviral phenotype. In the same way as Pam3CSK4, we observed that NPs-Pam3CSK4 efficiently and durably decreased all viral parameters and anti-HBV effects of NPs-Pam3CSK4 was confirmed *in vivo*, using mice transduced by an adeno-associated virus containing HBV genome. *In vitro*, NPs-Pam3CSK4-PreS1 gained properties regarding inhibition of virus entry. Besides, in prophylactic vaccination procedure, these NPs-Pam3CSK4-PreS1 have led to a very potent humoral response with highly neutralizing antibodies.

Our research efforts should support the clinical evaluation of TLR1/2 agonists as immune adjuvants in more complex immune-therapeutic strategies implying therapeutic combinations with vaccines or targeted therapies.

Keywords: Hepatitis B virus; Toll-like receptor 2; Pam3CSK4; Immune-modulatory drugs; Nanoparticles

Table of contents

Résumé	7
Abstract.....	9
Abbreviations	14
Figures.....	20
TABLES	21
A. Background	23
1. Hepatitis B	23
1.1 Generalities about HBV.....	23
1.1.1 History	23
1.1.2 Viral Classification	27
1.1.3 Transmission pathways	29
1.1.4 Epidemiology	29
1.2 HBV biology: molecular features of the virus	31
1.2.1 HBV genome	31
1.2.2 Viral structures	33
1.2.2.1 Dane particles and subviral particles.....	33
1.2.2.2 Viral DNAs.....	35
1.2.2.3 Viral RNAs	37
1.2.3 Viral proteins and their functions.....	37
1.2.3.1 Surface proteins, forming HBsAg: small, medium and large	37
1.2.3.2 Core protein, HBcAg	39
1.2.3.3 Pre-Core protein and HBeAg	39
1.2.3.4 Viral polymerase, Pol.....	40
1.2.3.5 X protein, HBx.....	41
1.2.3.6 Hepatitis B splicing-regulated protein (HBSP)	42
1.2.4 Viral life cycle.....	45
1.2.4.1 Virus entry into cells.....	45
1.2.4.1.1 Attachment of HBV particles to the cell surface	45
1.2.4.1.2 And to its specific receptor	45
1.2.4.1.3 Internalization via cellular factors.....	45
1.2.4.2 Nuclear replication steps of the virus.....	46
1.2.4.2.1 Nuclear import	46
1.2.4.2.2 rcDNA conversion into cccDNA	46
1.2.4.2.3 Transcriptional regulation of cccDNA	47
1.2.4.2.3.1 By transcription factors	47
1.2.4.2.3.2 By epigenetic modifications.....	49
1.2.4.2.3.3 By HBx.....	50
1.2.4.2.3.4 By HBcAg.....	50
1.2.4.2.3 Co and post-transcriptional regulation of HBV RNAs	52
1.2.4.2.3.1 Post-transcriptional regulatory element (PRE)	52
1.2.4.2.3.2 RNA tailing.....	52
1.2.4.2.3.3 N6-methyladenosine modification	53
1.2.4.2.3.4 Roles of host factors.....	54
1.2.4.4 PgRNA encapsidation and reverse transcription	55
1.2.4.5 Assembly and virus exit	57

1.3	Models for HBV replication	57
1.3.1	<i>In vitro</i> models.....	57
1.3.2	<i>In vivo</i> models.....	58
1.4	Pathogenesis	59
1.4.1	From acute infection.....	59
1.4.2	...to chronicity: infection vs hepatitis	60
1.4.2.1	HBeAg-positive chronic HBV infection	60
1.4.2.2	HBeAg-positive chronic hepatitis B	60
1.4.2.3	HBeAg-negative chronic HBV infection	60
1.4.2.4	HBeAg-negative chronic hepatitis B	60
1.4.3	Occult HBV infection.....	61
1.4.4	Severe liver injuries induced by chronic HBV	63
1.4.5	Treatment according to the phase of the disease	63
1.4.5.1	Currently approved	63
1.4.5.2	When should immunotherapy be administered?	64
2.	Innate immunity of the liver and its interaction with HBV.....	65
2.1	Actors of innate immunity in the liver	65
2.1.1	Cells and structures responsible of a strong hepatic innate immunity.....	65
2.1.1.1	Hepatocytes.....	65
2.1.1.2	Liver sinusoidal endothelial cells (LSECs).....	67
2.1.1.3	Hepatic stellate cells (HSCs)	67
2.1.1.4	Kupffer cells (KCs)	68
2.1.1.5	Innate cells with lymphoid origins.....	69
2.1.1.5.1	Natural killer cells.....	69
2.1.1.5.2	Natural killer T cells.....	70
2.1.1.5.3	Innate lymphoid cells (ILCs).....	70
2.1.1.5.4	Mucosal-associated invariant T-cells (MAIT)	70
2.1.1.6	Dendritic cells (DCs).....	71
2.1.1.7	Intrahepatic myeloid-cell aggregates for T cell population expansion (iMATEs)	73
2.1.2	Innate immune sensors	73
2.1.2.1	Toll-like receptors family (TLR)	73
2.1.2.2	Retinoic acid-inducible gene-I- like receptors family (RLR)	75
2.1.2.3	Nucleotide oligomerization domain receptors family (NLR)	78
2.1.2.4	Cytosolic DNA sensors (CDS)	80
2.1.2.5	C-type lectin receptors (CLRs)	82
2.1.3	Downstream signalling pathways.....	84
2.1.3.1	NF- κ B signalling pathway.....	84
2.1.3.1.1	NF- κ B family, structures and dimers	84
2.1.3.1.2	Canonical Pathway	86
2.1.3.1.3	Non-canonical Pathway	87
2.1.3.1.4	Functions of NF- κ B signalling pathways.....	89
2.1.3.1.4.1	Mediator of inflammation and activation of innate immune cells	89
2.1.3.1.4.2	Regulation of adaptive immunity	90
2.1.3.2	IRF signalling pathway	91
2.1.3.3	IFNAR signalling pathway	92
2.1.3.3.1	Type I IFNs.....	92
2.1.3.3.2	Type II IFN.....	93
2.1.3.3.3	Type III IFNs	93
2.1.3.3.4	Activation of innate immune cells and regulation of adaptive immune responses.....	94
2.1.4	Pro- an anti- inflammatory cytokines.....	96
2.2	HBV recognition by innate immunity.....	98

2.2.1	Activation of host innate immunity.....	98
2.2.1.1	Weak or lack of IFN and/or proinflammatory responses <i>in vivo</i> and <i>in vitro</i>	98
2.2.1.2	Potential host PRRs involved in HBV recognition	99
2.2.1.3	Activation of immune cells by HBV	99
2.2.1.4	Control of HBV by cytokines	101
2.3	HBV escape from innate immunity	102
2.3.1	Targeting professional immune cells.....	102
2.3.1.1	Modulation of count of innate immune cells	102
2.3.1.2	Modulation of phenotypes and functions of innate immune cells	102
2.3.2	Modulation of intracellular innate immune pathways	103
2.3.2.1	Modulation of PRR's downstream signalling pathways	103
2.3.2.2	Modulation of IFN receptor downstream signalling pathway.....	104
3.	Treatments against chronic hepatitis B virus.....	107
3.1	Current available treatments and recommendation	107
3.1.1	Vaccination	107
3.1.2	IFN- α therapy.....	108
3.1.3	Nucleos(t)ide analogues (NA).....	109
3.1.3.1	Long life therapy	109
3.1.3.2	Stopping rules.....	111
3.1.3.3	Combination of NA + Peg-IFN- α	114
3.2	Urgent needs for improvements	118
3.2.1	Clinical outcomes of current treatments vs. "Functional cure"	118
3.2.2	However, can we do better?	119
3.3	Drugs and strategies in R&D.....	120
3.3.1	Direct-Acting Antivirals.....	120
3.3.1.1	Entry inhibitors	120
3.3.1.1.1	Antibodies	120
3.3.1.1.2	Attachment inhibitors	120
3.3.1.1.3	NTCP inhibitors.....	120
3.3.1.2	Core Protein Allosteric Modulators (CpAMs)	122
3.3.1.3	RNA interference	122
3.3.1.4	Nucleic acid polymers (NAPs).....	123
3.3.1.5	Farnesoid X receptor (FXR)- α agonists	124
3.3.1.6	Molecules targeting the cccDNA	125
3.3.2	Immune Modulatory Therapies.....	127
3.3.2.1	Immune Checkpoint Inhibitors (ICI).....	127
3.3.2.2	Therapeutic vaccines	128
3.3.2.3	Engineered T cells.....	129
3.4	PRR agonists: new immune modulatory strategies to cure CHB.....	133
3.4.1	Rational for the development of alternative innate immune stimulators.....	133
3.4.2	Proved and expected modes of anti-HBV action of different PRR.....	133
3.4.2.1	Indirect antiviral properties.....	133
3.4.2.1.1	Induction of effector with direct antiviral effects	133
3.4.2.2	Restoration of functional immune response.....	135
3.4.2.3	Direct antiviral properties: hepatocytes, active participants in innate immune response ..	135
3.4.2.3.1	RIG-I agonist	136
3.4.2.3.2	STING agonist	136
3.4.2.3.3	TLR2 and TLR3 agonists.....	137
3.4.3	Other considerations for the R&D of PRR agonists	139
3.4.3.1	Adjuvants vs stand alone.....	139

3.4.3.2	Delivery and dosage, the keys of decreasing toxicity: example of nanoparticles	140
3.4.3.3	Combination of PRR agonists with other drugs.....	143
B.	Research project	146
1.	Hypotheses and objectives.....	146
2.	Pam3CSK4: insights mechanisms of action of a potent TLR1/2 agonist against HBV replication	149
3.	Nanoparticles: a potent tool against HBV	192
	Supplementary Material and Methods.....	217
C.	Discussion.....	222
	References.....	223
	Appendices.....	268
1.	Submitted Articles	268
2.	Articles in preparation	268
3.	Submitted Review	269
1.	How to get away with liver innate immunity? A viruses' tale.....	269
4.	Congress attendance.....	292
4.1	InnaSCo Symposium II: Innate Sensors in Health and Diseases.....	292
4.2	ANRS "Recherche sur le VIH/Sida et les hépatites virales : quels nouveaux enjeux ?"	292
4.3	ANRS Réunion annuelle AC42 Réseau National Hépatites.....	292
4.4	EASL international liver congress	292
	Acknowledgements/Remerciements.....	293

Abbreviations

Aa	Amino acid
AAV	Adeno-associated virus
ADV	Adefovir dipivoxil
AIM2	Absent in melanoma 2
AL	Antigenic Loop
ALT	Alanine Aminotransferase
AMPK	Adenosine monophosphate-activated protein kinase
AnkR	Ankyrin repeat
AP	Apurinic/Apyrimidinic
AP-1	Activator protein-1
AP-2	Activator protein-2
APC	Antigen-presenting cell
APOBEC	Apolipoprotéins B mRNA editing enzyme, catalytic polypeptide-like
ASC	Apoptosis-associated speck-like protein containing a CARD domain
ATP	Adenosine triphosphate
BAFF	B-cell activating factor
BCP	Basal core promoter
BSA	Bovine Serum Albumin
CAR	Chimeric antigen receptor
CARD	Caspase activation and recruitment domain
cccDNA	covalently closed circular DNA
CCL2	C-C motif chemokine ligand 2
C/EBP	CCAAT-enhancer-binding protein
cGAMP	Cyclic-GMP-AMP
cGAS	cGAMP synthase
CD14	Cluster of differentiation 14
CD36	Cluster of differentiation 36
cDNA	Complementary DNA
CHB	Chronic hepatitis B
CHD	Chronic hepatitis D
ChIP	Chromatin immune-precipitation
CLR	C-type lectin receptor
CNOT	CCR4-NOT
COUP-TF	Chicken ovalbumin upstream promoter transcription factor
CpAM	Core protein allosteric modulator
CREB	cAMP response element-binding protein
CRISPR/Cas9	Clustered regularly interspaced short palindromic repeats/Cas9
CrkL-RAP1	Crk-like protein- Ras related protein 1
crRNA	CRISPR RNA
CsA	Cyclosporin A
CTD	C-terminal domain
CXCL	CXC-chemokine ligand
DAA	Direct-acting antiviral
DAI	DNA-dependent activator of IRFs
DAMP	Damage-associated molecular pattern
DBD	DNA-binding domain
DC	Dendritic cell
DDB1-CUL4	DNA-damage binding protein 1-CUL4
ddPCR	Droplet digital PCR

dHepaRG	Differentiated HepaRG
DLEU2	Deleted in Lymphocytic Leukemia 2
DMSO	Dimethyl sulfoxide
DNA	Deoxyribonucleic acid
DR	Direct repeat
dsDNA	Double-stranded DNA
dsIDNA	Double-stranded linear DNA
EGFR	Epidermal growth factor receptor
ELISA	Enzyme-linked immunosorbent assay
EnI	Enhancer I
EnII	Enhancer II
ER	Endoplasmic reticulum
ERGIC	ER-Golgi intermediate compartment
ERK	Extracellular signal-regulated kinase
ESCRT	Endosomal sorting complex required for transport
ETV	Entecavir
Exo1	Exonuclease 1
EZH2	Enhancer of zeste homolog 2
FBS	Fetal bovine serum
FEN-1	Flap endonuclease 1
FRET	Fluorescence resonance energy transfer
FXR	Farnesoid X receptor
GAF	Complex gamma-activated factor
GAS	IFN- γ activated site
GM-CSF	Granulocyte-macrophage colony-stimulating factor
HAP	Heteroaryldihyropyridine
HAV	Hepatitis A Virus
HBcAg	Core protein
HBeAg	HBe antigen
HBIG	HBV immunoglobulin
HBsAg	HBs antigen
HBSP	Hepatitis B splicing-regulated protein
HBV	Hepatitis B Virus
HBV Pol	HBV Polymerase
HBx	HBx protein
HCC	Hepatocellular carcinoma
HCV	Hepatitis C virus
HDAC	Histone deacetylase
HDV	Hepatitis D Virus
HIV	Human Immunodeficiency Viruses
HNF1	Hepatocyte nuclear factor 1
HNF3	Hepatocyte nuclear factor 3
HNF4α	Hepatocyte nuclear factor alpha
hnRNPs	Heterogeneous nuclear ribonucleoproteins
Hsc70	Heat stress cognate 70
HSC	Hepatic stellate cell
HSP	Heat shock protein
HSPGs	Heparan sulfate proteoglycans
IAD	IRF association domain
ICI	Immune checkpoint inhibitor
iE-DAP	gamma-D-glutamyl-meso-diaminopimelic acid

IFI16	IFN-gamma inducible protein 16
IFIT	IFN-induced proteins with tetratricopeptide
IFN	Interferon
IFNAR	IFN α receptor
iHep	Induced human hepatocyte-like cells
IKKϵ	NF- κ B kinase-epsilon
IL	Interleukin
IL-1β	Interleukin-1 beta
IL-6	Interleukin-6
ILC	Innate lymphoid cell
iMATEs	Intrahepatic myeloid-cell aggregates for T cell population expansion
Indel	Insertion deletion
IRAK	Interleukin-1 receptor-associated kinase
IRF	Interferon regulatory factor
ISG	Interferon Stimulated Gene
ISGF3	IFN-stimulated gene factor 3
ISRE	IFN-stimulated response element
IT	Immune tolerant
JAK1	Janus kinase 1
KC	Kupffer cells
kDa	Kilo Dalton
KO	Knock out
LAM	Lamivudine
LGP2	Laboratory of genetics and physiology 2
L-HBsAg	Large HBsAg
LP	Lipoprotein
LPS	Lipopolysaccharide
LRR	Leucine-rich repeat
LRRFIP1	Leucine rich repeat flightless-interacting protein 1
LSEC	Liver sinusoidal endothelial cell
LTβR	Lymphotoxin beta receptor
LZ	Leucine zipper
m⁶A	N ⁶ -methyladenosine modification
MAIT	Mucosal-associated invariant T-cells
MAPK	Mitogen-activated protein kinase
MAVS	Mitochondrial Antiviral-Signalling
MCPIP1	Monocyte chemotactic protein-1-induced protein-1
MD-2	Myeloid differentiation-2
MDA5	Melanoma differentiation-associated protein 5
mDC	Myeloid DC
MDP	Muramyl dipeptide
M-HBsAg	Middle HBsAg
MHC	Major-histocompatibility complex
mMDSCs	Monocyte myeloid-derived suppressor cells
MoA	Mode of action
MPLA	Monophosphoryl lipid A
mRNA	Messenger RNA
mTORC1	Mammalian target of rapamycin complex 1
MVBs	Multivesicular bodies
MxA	Myxoma resistance protein 1

MyD88	Myeloid differentiation primary response 88
NA	Nucleoside analogue
NAP	Nucleic acid polymer
NEMO	NF- κ B essential modulator
NF-κB	Nuclear factor- κ B
NHEJ	Nonhomologous end joining
NIK	NF- κ B-inducing kinase
NK	Natural killer cell
NKT	Natural killer T cell
NLR	Nucleotide oligomerization domain receptor
NLS	Nuclear location signal
NOD	Nucleotide-binding and oligomerization domain
NPs-Pam3CSK4	Nanoparticles Pam3CSK4
NPs-Pam3CSK4-PreS1	Nanoparticles-Pam3CSK4-PreS1
NT	Non-treated
NTCP	Sodium taurocholate cotransporting polypeptide
NTD	N-terminal assembly domain
ODN	Oligodeoxynucleotide
ORF	Open reading Frame
P300/CBP	P300 CREB-binding protein
PAM	Protospacer adjacent motif
PAMP	Pattern-associated molecular pattern
Par	Parvulin protein
PBMC	Peripheral blood mononuclear cell
PCAF	P300/CBP-associated factor
PCNA	Proliferating cell nuclear antigen
PCR	Polymerase chain reaction
PD-1	Programmed cell death
pDC	Plasmacytoid DC
PD-L1	Programmed death ligand 1
PCNA	Proliferating cell nuclear antigen
Peg-IFN-α	Pegylated Interferon- α
pgRNA	Pregenomic RNA
PHH	Primary human hepatocyte
PI3K	Phosphatidyl-inositol 3-kinase
PIAS	Protein inhibitors of activated STAT
PLA	Poly lactic acid
PLGA	Poly(D,L-lactide-co-glycolide)
POLδ	DNA polymerase delta
PPA	Phenylpropenamide
PPARα	Peroxisome proliferator-activated receptor alpha
PRC2	Polycomb repressive complex 2
PRE	Post-transcriptional regulatory element
PRPF31	Pre-mRNA processing factor 31
PRR	Pattern Recognition Receptor
qPCR	Quantitative PCR
rcDNA	Relaxed-circular DNA
RD	Repressor domain
RFC	Replication factor C
RHD	Rel homology domain
RIG-I	Retinoic acid-inducible gene I

RISC	RNA-induced silencing complex
RLR	RIG-I like receptor
RNA	Ribonucleic acid
RNASEH2	Ribonuclease H2 Subunit A
RP105	Radioprotective lipoprotein 105kDa
RT	Reverse transcription
RXRα	Retinoid X receptor alpha
SD	Standard deviation
sgRNA	Single guide RNA
S-HBsAg	Small HBsAg
SHP-2	Src Homology phosphatase 2
siRNA	Small interfering RNA
SIRT	Sirtuin
SOCS	Suppressor of cytokine signalling
Sp1	Specificity protein 1
ssDNA	Single-stranded DNA
STAT	Signal transducer and activator of transcription
STING	Stimulator of Interferon Genes
SVP	Subviral particle
Syk	Spleen tyrosine kinase
TAB	TAK-1 binding protein
TAD	Transcription activation domain
TAF	Tenofovir alafenamide fumarate
TAK1	Transforming growth factor- β -activated kinase-1
TALE	Transcriptional activator-like effector
TALEN	Transcription activator-like effector nuclease
TARDBP	Trans-active response DNA binding protein
TBK1	TANK-binding kinase I
TBS-T	Tris-Buffered Saline - Tween
TBV	Telbivudine
TCR	T-cell receptor
TDF	Tenofovir disoproxil fumarate
TDP2	Tyrosyl-DNA phosphodiesterase 2
TENT	Terminal nucleotidyl-transferase
TFV	Tenofovir
TGF-β	Tumor growth factor beta
Th	T helper cell
TIR	Toll interleukin-1 receptor
TLR	Toll-like receptor
TNF-α	Tumor necrosis factor alpha
TP	Terminal protein
TR2	Testicular receptor 2
tracrRNA	Trans-activating crRNA
TRAF	TNF receptor associated factor
TRAIL	TNF-related apoptosis-inducing ligand
Treg	Regulatory T cell
TRIM22	Tripartite motif 22
Tyk2	Tyrosine kinase 2
ULN	Upper limit of normal
UNC93B1	Unc-93 homolog B1
USP18	Ubiquitin carboxy-terminal hydrolase 18

WHO	World Health Organization
WNV	West Nile Virus
YTHDF2	YTH-domain family 2
ZF	Zinc finger
ZFN	Zinc finger nuclease

Figures

Figure 1: Major breakthroughs in HBV research and development	24
Figure 2: Geographical distribution of HBV different genotypes.....	26
Figure 3: HBV transmission pathways	28
Figure 4 : Prevalence of HBV infection (HBsAg) in the general population by WHO region in 2015	30
Figure 5 : HBV genome organisation	32
Figure 6: Viral components secreted by HBV-infected hepatocytes and their protein composition ...	34
Figure 7 : Schematic representation of various HBV transcripts and the proteins they encode.....	36
Figure 8: Envelope proteins of HBV.....	38
Figure 9: Molecular structures of HBcAg, PreCore and HBeAg.....	40
Figure 10: Viral polymerase structure	41
Figure 11: Pleiotropic effects of HBx.....	42
Figure 12: Synthesis of HBSP protein	43
Figure 13: Viral life cycle.....	44
Figure 14: Positions of the binding sites of transcription factors on HBV genome	48
Figure 15: Schematic representation of cccDNA under different epigenetic regulation.....	51
Figure 16: Organisation of the Post-transcriptional regulatory element (PRE)	52
Figure 17: RNA tailing.....	53
Figure 18: Model for how m ⁶ A at 5' or 3' epsilon stem loops of HBV transcripts regulates their stability and reverse transcription	54
Figure 19: Reverse transcription and rcDNA synthesis	56
Figure 20: Natural course of chronic hepatitis B infection.....	62
Figure 21: Schematic representation of the anatomy of the liver	66
Figure 22: Schematic organisation of the sinusoids.....	72
Figure 23: TLR and RLR signalling pathways.....	77
Figure 24: NLR signalling pathway.....	79
Figure 25: CDS signalling pathway.....	81
Figure 26: CLR signalling pathway	83
Figure 27: Structures of NF-κB family member.....	85
Figure 28: Dimeric combinations of NF-κB subunits	86
Figure 29: Canonical and non-canonical NF-κB signalling pathway.....	88
Figure 30: IFN signalling pathway.....	95
Figure 31: Schematic representation of HBV recognition.....	100
Figure 32: Main inhibitor mechanisms used by HBV to escape from immunity.....	106
Figure 33: Chemical structures of NAs	110
Figure 34: Illustration of different outcomes in HBeAg-negative patients after NA therapy arrest...	113
Figure 35 : HBsAg seroclearance durability and rate of anti-HBs seroconversion after HBsAg loss...	119
Figure 36: Genome editing strategies	126
Figure 37: Illustration of T-cell therapy	130
Figure 38: Current and in development HBV treatments	131
Figure 39: Chemical structure of Pam3CSK4	137
Figure 40: Schematic representations of antiviral effects of TLR7/8 agonists vs TLR2/3 agonists	138
Figure 41: Representation of PLA-NP loaded with Pam3CSK4.....	142
Figure 42: Road map for therapeutic approaches against HBV	144
Figure 43: Illustration of therapeutic approaches against HBV	145
Figure 44: Purification of PHH and LMNCs from liver resections.....	192

TABLES

Table 1: Type, site and function of known chromatin marks.....	49
Table 2: Functions of different cytokine families.....	97
Table 3 : Results of responses of HBeAg positive- and negative patients 6 months after 48 or 52 weeks of treatment by Peg-IFN- α	108
Table 4 : Results of responses of HBeAg positive- and negative patients 6 months after 48 or 52 weeks of treatment with NAs.....	111
Table 5 : Some recent combination studies using Peg-IFN- α and NAs	117
Table 6: Summary of new antiviral drugs for HBV cure	132
Table 7: Current PRR agonists in development as stand-alone	137

A. Background

1. Hepatitis B

1.1 Generalities about HBV

1.1.1 History

De morbus Internis written by Hippocrates (460-375BC) first described epidemic jaundice and the clinical syndrome of fulminant hepatitis (Khuroo and Sofi 2020). It is only in 1908 that McDonald assumed that jaundice could be caused by a virus and it was later confirmed by autopsy studies made by Eppinger (Harenberg J. and Lesch L, Mackay I.R., Zimmermann H.J. 1976). It was considered as a war infectious disease as it occurred in numerous conflicts such as American Civil war in 1915 and above all, World War II, with more than five millions people affected by it among soldiers and civilians (Sherlock 1984). Large number of cases were observed in venereal disease, diabetic and rheumatology clinics, leading McCallum to think that the disease could be transmitted from one patient to another via syringes and needles that were not correctly sterilized (Harenberg J. and Lesch L, Mackay I.R., Zimmermann H.J. 1976). Voegt demonstrated that oral route could be another path of transmission of hepatitis, by feeding human volunteers with duodenal contents of patients suffering of acute forms of hepatitis (Voegt H. 1942). Krugman's experiments at the Willowbrook State School allowed to hypothesize that two distinct viruses were associated with these two types of hepatitis. One was associated with a short incubation period, a short period of raised transaminase and was highly contagious (currently hepatitis A virus; HAV) and, by contrast, the second showed a long period of incubation and a longer period of raised transaminase, now hepatitis B virus (HBV) (Krugman, Giles, and Hammond 1967). In 1964, during his studies on lipoprotein polymorphisms, Blumberg observed an immunoprecipitation between the sera from transfused haemophilic patients and an Australian aborigine using double immunodiffusion test. The unusual lipoprotein was therefore called "Australia antigen" (Blumberg and Alter 1965). This antigen was first thought to be associated to several conditions, including leukaemia, Down's syndrome or/and hepatitis, as high prevalence of Australia antigen was observed in the sera of those patients (Blumberg et al., 1967). A bit later, different research groups showed that Australia antigen was related to HBV infection and to be the surface protein of the virus (Prince A. M. 1968; Giles et al. 1969). Australia antigen-positive sera were submitted to electron microscopic for further examination, the presence of two types of particles without nucleic acids was observed, spheres with a diameter of 22nm and long filaments with the same width (Millman et al., 1971).

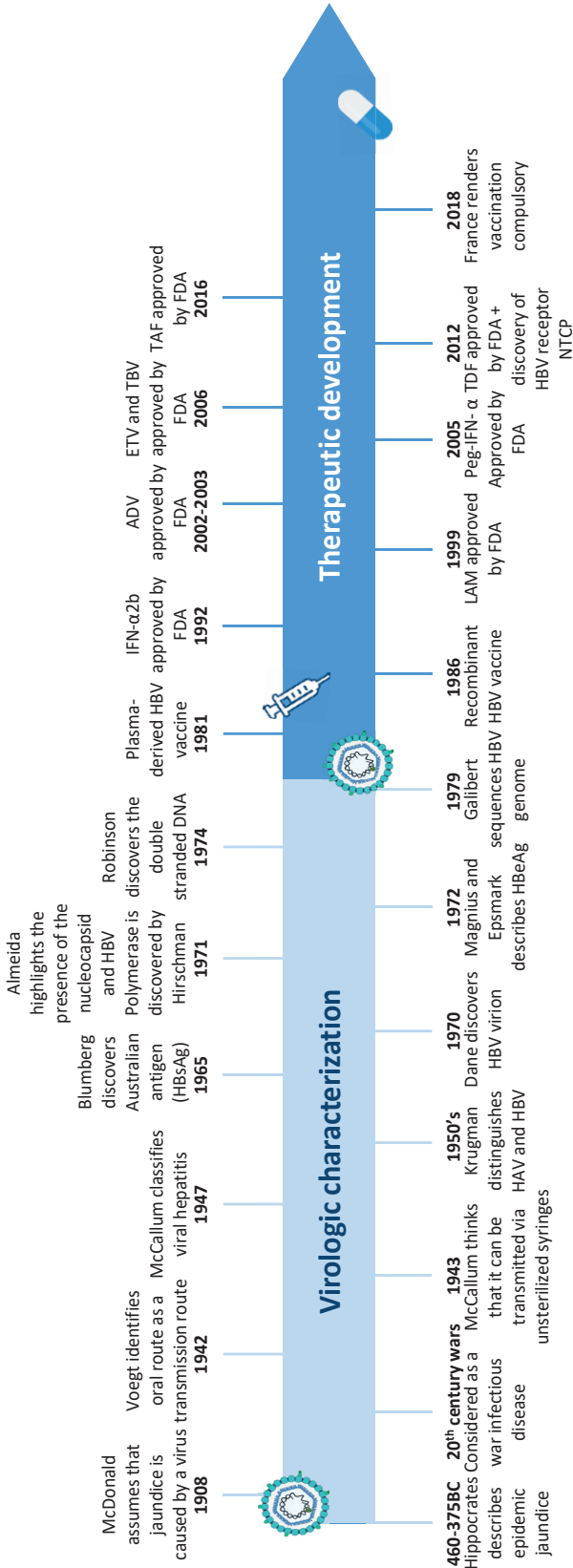

Figure 1: Major breakthroughs in HBV research and development

Adapted from (Thomas, Yoneda, and Schiff 2015).

The same year, David Dane and his group studied the sera of 16 Australia antigen positive sera by immune electron microscopy; all sample contained the spheres and few long filaments. In addition to those structures, tree sera presented larger particles with an inner nucleocapsid and a protein-rich envelope similar to that found in spheres and long filaments. They were suggested to be infectious particles of the virus and were consequently called the “Dane particle” (Dane et al., 1970). The Australian antigen, present at the surface of Dane particles, spheres and long filaments, was later renamed by the World Health Organization (WHO) “HBV surface antigen” (HBsAg). Then, in 1971, Almeida and colleagues applied detergent treatment to disrupt Dane particles and they could separate the outer coat from a 27nm inner icosahedric structure, which was later defined as nucleocapsid (Almeida et al., 1971). In 1972, Magnius and Espmark described a new antigen complex in Australia-antigen positive sera using immunodiffusion tests. This new antigen complex, called e-antigen at that time (later called HBeAg), was found in persistent carriers of Australian antigen and Australian-positive hepatitis cases but no in Australian-antigen carrying blood donor. The latter group even presented antibodies against the e-antigen leading the research team to think about evidences for the possible association of this antigen complex with infectivity (Magnius and Espmark, 1972). Hirschman and colleagues’ experiments detected the presence of a DNA polymerase activity in patient’s sera, which were beforehand concentrated by ultracentrifugation (Hirschman et al., 1971). Robinson and colleagues discovered the DNA template of the polymerase reaction. They treated Dane particles with Nonidet P-40 detergent and could retrieve radioactive DNA product thanks to a sedimentation in a sucrose density gradient; further examination of the radioactive DNA band by electron microscopy showed a circular double stranded DNA molecule of 0.78µm in length (W. S. Robinson and Greenman 1974). To go further into the examination of the biology of the virus, Burrell and colleagues isolated HBV-DNA from Dane particles of HBsAg-/HBeAg-positive donors and digested with endonucleases, the digested fragment were then cloned into *Escherichia coli* (Burrell et al., 1979). Subsequently, those experiments led to the complete nucleotide sequence of HBV genome using Maxam and Gilbert method and the dideoxynucleotide method (Galibert et al. 1979). Finally, HBV-specific DNA sequences were detected in the serum and liver of chimpanzees inoculated with cloned HBV DNA that had led to acute viral hepatitis. It demonstrated that HBV DNA contained in Dane particles is the infectious particle of the virus (Will et al., 1982). The main breakthrough in HBV research and development are summarized in Figure 1.



Figure 2: Geographical distribution of HBV different genotypes

Distribution of HBV genotypes by regions (Classified in decreasing order, from more prevalent to lower prevalent). Adapted from (Velkov et al. 2018).

1.1.2 Viral Classification

HBV is a partially double-stranded DNA virus, which uses its own polymerase to replicate itself via a pregenomic RNA (pgRNA) intermediate; it is therefore classified in the group VII, established by David Baltimore. This particularity renders it similar to many retroviruses found in animals and pararetrovirus in plants (Schaefer, 2007). HBV is a member of the *Hepadnaviridae* family, which is characterized by: (i) transient or persistent hepatotropic infections, (ii) a partially double-stranded DNA genome of 3.0-3.4 kb in length, (iii) expression of at least five distinct proteins (preC/HBeAg, Core/HBcAg (*i.e.* capsid protein), polymerase (HBV pol), as well as preS and S envelop proteins, collectively defining HBsAg), (iv) a bone fide replication step involving reverse-transcription of pgRNA that occurs within nucleocapsids in the cytoplasm of infected hepatocytes (L. Magnius et al. 2020). Five genera of hepadnaviruses have been identified: *parahepadnavirus* and *metahepadnavirus* that can both infect teleost fish and the majority of the viruses in these two genera have been identified via metagenomics approaches; *herpetohepadnavirus* infect reptiles and frogs; *avihepadnavirus* infect birds and *orthohepadnavirus* that infect mammals. HBV is therefore a member of this latter group (L. Magnius et al. 2020). HBV isolates were initially classified into eight genotypes from A to H, with > 8% nucleotide differences between them. Most genotypes have a genome size of 3215 nucleotides, except for genotypes A (3221 nt), D (3182 nt), E (3212 nt) and G (3248 nt), which is due to nucleotide insertion or deletion. Distribution of the HBV genotypes is mainly dependent on the geographical region. Genotypes A-D are the most described; they are essentially found in North America and Africa for genotype A, East Asia for genotypes B and C and Southern Europe and India for genotype D. Genotype E is more prevalent in Sub Saharan Africa, and genotypes F and H are mainly found in South America. Genotype G is often found in co-infection with other HBV genotypes, generally A or H, or in co-infection with HIV (Human Immunodeficiency Viruses), and it affects mostly men who have sex with men (Tong and Revill 2016). Two other genotypes have recently been identified: genotype I, found in Vietnam and Southern China, constitutes a recombination of genotypes A, C and G; and genotype J, initially found in a Japanese soldier probably infected in the forests of Borneo during World War II, resembles to gibbon HBV and may result from a recombination with human genotype C. Most of the genotypes can further be divided into sub-genotypes based on the nucleotide sequence divergence of at least 4% to 8% of their full genome. Only E, G and H do not have sub-genotypes, which is attributed to their recent genesis (Locarnini et al. 2015). It has been shown that different genotypes and sub-genotypes not only present different geographical distribution, but also different disease progression, clinical progression, response to antiviral treatment and prognosis (Sunbul 2014). For instance, a study realised in China investigated the differences between HBV patients infected with genotype C compared with genotype B: higher level of viral replication, high hepatic histological activity, recurrent or persistently high ALT (alanine aminotransferase) levels and low response to treatment were

observed (Xibing et al. 2013). Moreover, five of the ten genotypes causes approximately 96% of chronic HBV infections: genotype C, the most common (26%), genotype D (22%), E (18%), A (17%) and B (14%) (Velkov et al. 2018). Different genotypes and their localization are summarized in Figure 2.

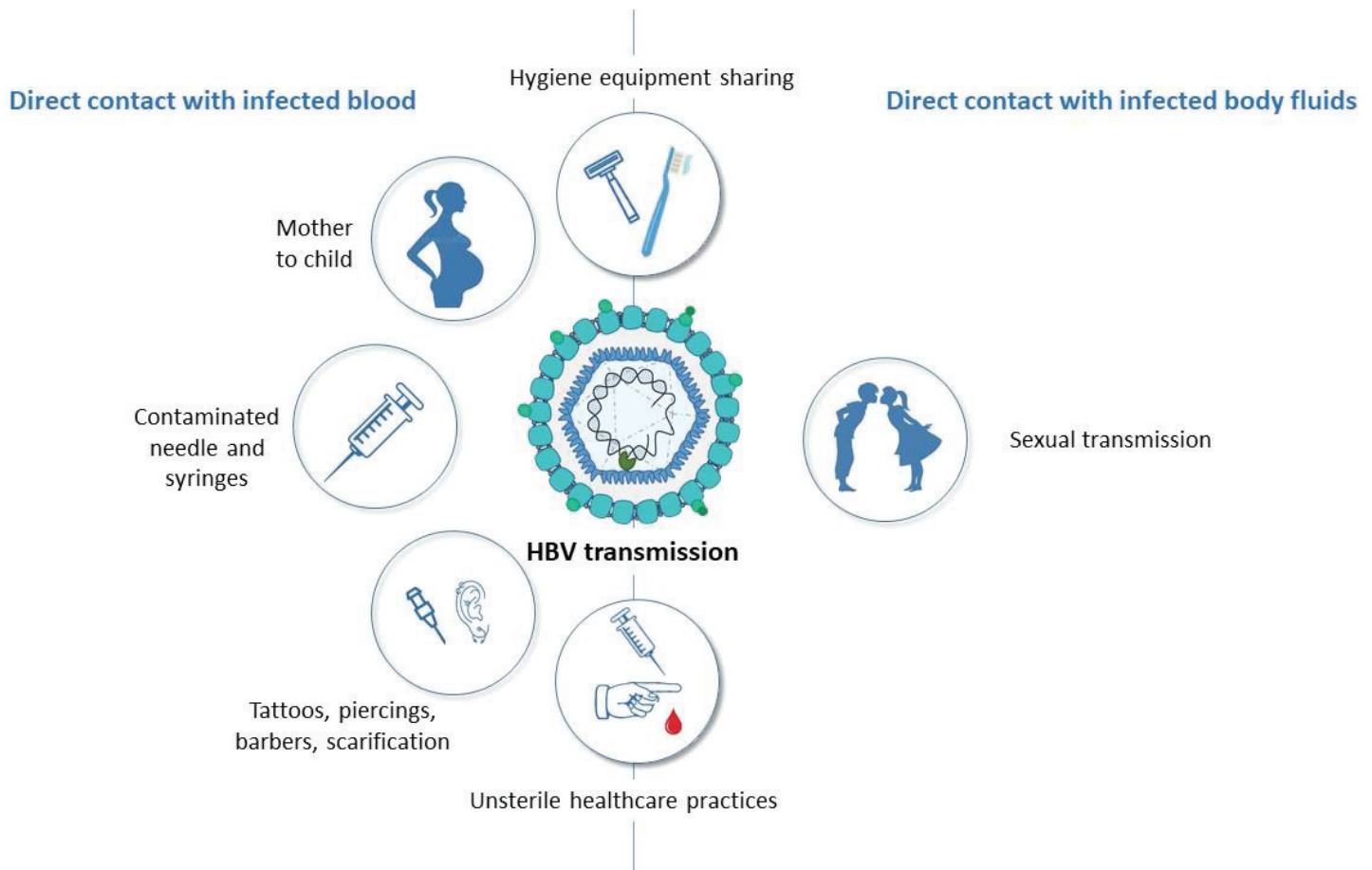

Figure 3: HBV transmission pathways

HBV is most commonly transmitted from mother to child during birth. It is also transmitted through contact with blood or body fluids, including sex with an infected partner, drug injection with sharing needles, unsterilized equipment or exposure to sharp intrusments. Adapted from (World Health Organization, World Health Organization, and Global Hepatitis Programme 2017).

1.1.3 Transmission pathways

- **Mother to child transmission:** represents an important mode of transmission, either vertically via intrauterine transmission and through breastfeeding, or horizontally via daily contact, particularly during the first five years of life (Y. Yan, Xu, and Wang 1999). About 70-90% of babies born to HBsAg and HBeAg double positive mothers will be infected and become HBsAg carriers within 6 months (Cladd E. Stevens et al. 1979; Z. Y. Xu et al. 1985)
- **Horizontal transmission:** infection can occur through infected blood or other body fluids such as saliva, menstrual, vaginal and seminal fluids from an infected person. Common routes of transmission include tribal tattooing and scarification, piercing, sexual contact, blood transfusion, unsafe injection practices, injecting drug use and exposure of health care workers (Locarnini et al. 2015). HBV is particularly stable in comparison to other hepatotropic viruses. It can survive outside the body for at least seven days, remaining infectious. On average, the incubation period of the virus is about 75 days, and can be detected within 30 to 60 days after infection and can persist and develop into chronic infection (WHO data 2020). Transmission pathways are summarized in Figure 3.

1.1.4 Epidemiology

Infection by hepatitis B virus is a major global health challenge and remains the most common chronic viral infection, with approximately 2 billion people that have been exposed to HBV according to WHO estimations. In 2015, WHO estimates that 257 million people were living with a chronic HBV infection, which is defined by the presence of HBsAg in patient's sera for more than six months (Schweitzer et al. 2015). That year, HBV infections were responsible for 887 000 deaths, mostly caused by HBV-related liver disease including cirrhosis and hepatocellular carcinoma (HCC). Endemic disease, assessed by HBsAg prevalence, is extremely variable depending on the geographical zones (Figure 4). In 2015, prevalence was the highest in the African and Western Pacific regions with respectively 6.1% and 6.2% of the population infected by the virus. HCC affects particularly those regions with up to two-thirds of HCC cases found to be HBsAg seropositive (de Martel et al. 2015). In the Eastern Mediterranean Region and South-East Asia Region, an estimated 3.3% and 2.0%

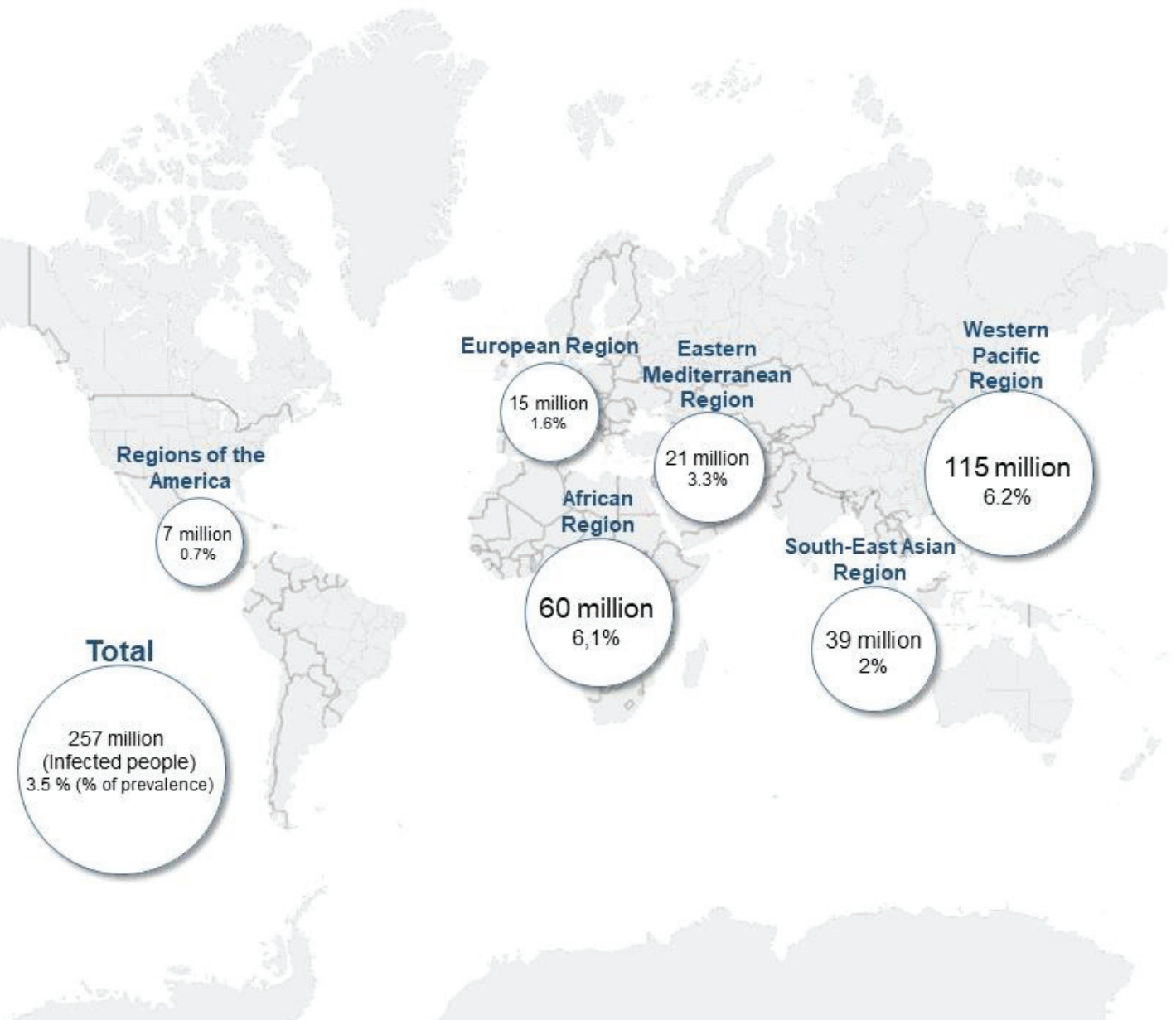

Figure 4 : Prevalence of HBV infection (HBsAg) in the general population by WHO region in 2015

Prevalence of HBV infection, represented by the presence of HBsAg, in different regions of the world. African and Western Pacific regions present the highest prevalence and the largest number of people living with HBV. *Adapted from (World Health Organization, World Health Organization, and Global Hepatitis Programme 2017).*

of the general population are infected. In contrast to those regions, Europe and region of the Americas had lower prevalence with respectively 1.6% and 0.7% of the population infected by HBV. Prevalence is often underestimated due to the lack of public awareness of the disease. In 2016, 27 million people, which represented 10.5% of all people living with hepatitis B, were aware of their infection, and only 4.5 million were under treatment (World Health Organization, World Health Organization, and Global Hepatitis Programme 2017). The diversity of the prevalence of chronic HBV infection in different parts of the world is closely related to the age of infection, which is inversely correlated to the risk of chronicity. In perinatally acquired infection, the progression from acute to chronic HBV infection is about 90% (C. E. Stevens et al. 1975), 20-50% for infections occurring before 5 years (Wasley et al. 2008) and less than 5% for infection acquired during adulthood (Tassopoulos et al. 1987). An Increase proportion of liver diseases and HCC is observed when chronic HBV patients are coinfecting with: (i) HIV, which represents 2.7 million people (WHO data 2020); (ii) hepatitis C virus (HCV), whose worldwide prevalence is about 1 to 15% (Mavilia and Wu 2018); (iii) hepatitis D virus (HDV), a satellite virus of HBV, which represent at least 4.5%, likely more, of HBsAg-positive people (Stockdale et al. 2020).

1.2 HBV biology: molecular features of the virus

1.2.1 HBV genome

As previously seen, HBV is a member of the *Hepadnaviridae* family and possesses a 3.2 kb double-stranded DNA genome, making it the smallest human DNA viruses and one of the most compact. Its genome (as featured in infectious particles) presents a relaxed-circular conformation, commonly called rcDNA, with a complete minus-strand, which is the template for transcription and is covalently linked to the viral polymerase via a phosphodiester bond at its 5' end, and an incomplete positive-strand, leaving a gap that can be filled *in vitro* by the viral polymerase (Summers, O'Connell, and Millman 1975). HBV genome has four open reading frames (ORFs) (Figure 5), which are unidirectional and partially overlap each other, and encompass the entire genome: the PreC/C, polymerase (P), PreS1/PreS2/S and X ORFs. Four distinct promoters control them: PreS1 (also called S1), PreS2 (also called S2 or S) and Core (also called PreC/C). Transcription results in the formation of mRNAs that are modified by 3' polyadenylation signal, which is common to all transcripts, and the addition of a 5' cap, 5' ends that are variable and are determined by the location of each promoters. The P ORF, the longest, which covers 80% of the viral genome, encodes for the viral polymerase (Pol). The X ORF encodes the X protein, called HBx (Moolla, Kew, and Arbuthnot 2002). Three envelope glycoproteins are coded by the alternative use of preS, preS2 and S in the PreS1/PreS2/S ORF, generating a small (S), middle (preS2+S), or a large (preS1+preS2+S) envelope proteins. In a similar way, translation initiation from the precore AUG or core AUG from PreC/C ORF generates Core protein and HBeAg (also called PreC)

respectively (Tong and Reville 2016). Other important elements are also present in HBV genome: (i) two direct repeats (DR1 and DR2) of 11 nucleotides in the 5' ends of the plus strand, which are essential for strand-specific DNA synthesis during replication (Liang 2009); (ii) two enhancers EnI and EnII that exhibit binding sites for liver specific transcription factors, including HNF4 and HNF3 and are required for the activity of the promoters (Seeger and Mason 2016); (iii) a glucocorticoid-responsive element (GRE) sequence within the S domain; (iv) a polyadenylation signal within the core gene and (v) a posttranscriptional regulatory element overlapping EnI and a part of X ORF (Liang 2009). Viral transcripts and proteins will be further described.

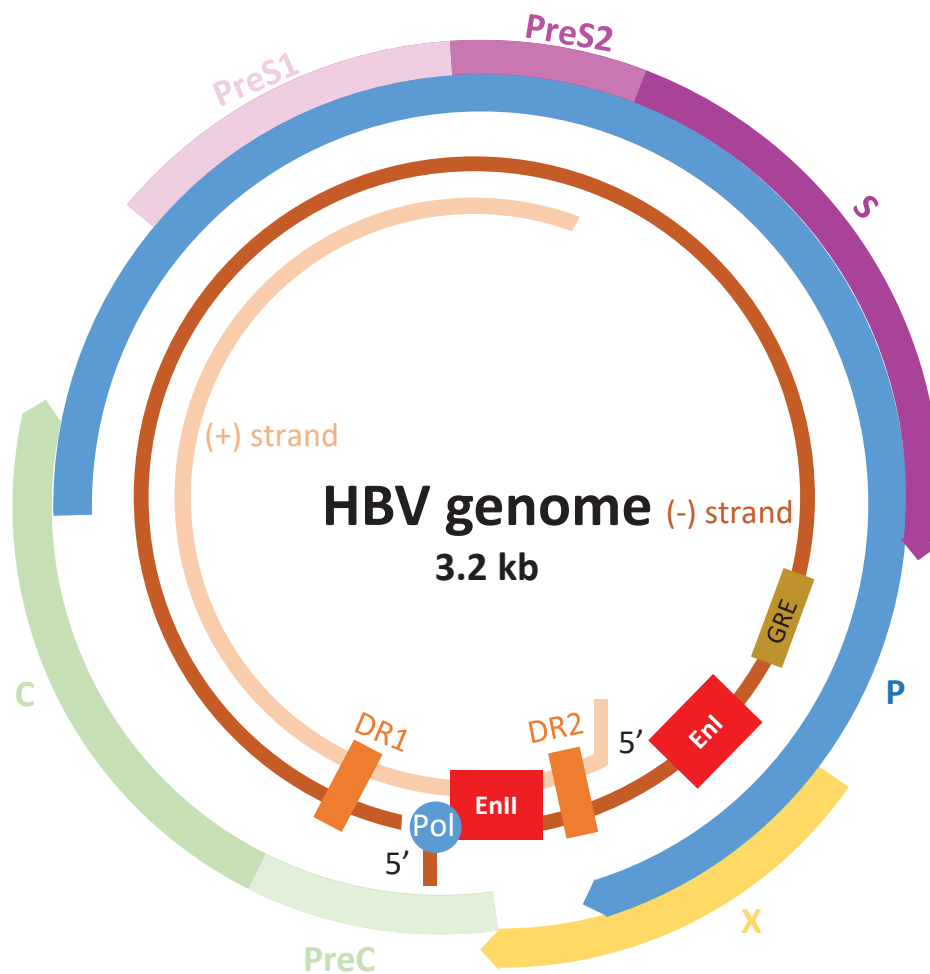

Figure 5 : HBV genome organisation

HBV genome presents a relaxed circular form, called rcDNA, and is composed of minus-strand ((-) strand) and a positive-strand ((+) strand), with four open reading frames (ORFs), PreS1/PreS2/S (encoding HBsAg proteins), P (encoding HBV polymerase, Pol), PreC/C (encoding HBcAg and HBeAg) and X (encoding HBx). It also contains two direct repeats (DR1 and DR2), two enhancers (EnI and EnII) and a glucocorticoid-responsive element (GRE). Pol is linked to the (-) strand. Adapted from (Liang 2009).

1.2.2 Viral structures

1.2.2.1 Dane particles and subviral particles

As previously seen, the Dane particle is the infectious form of the virus, present in patient's sera up to 10-log_{10} copies/ml. It has a diameter of 42nm and is composed of an outer envelope of surface proteins, small (S), middle (M) and large (L) (see 1.2.3.1) (in a S:M:L ratio of 5:2:3) and a 27nm-inner icosahedral nucleocapsid, formed by 120 dimers of the core protein, which contained one single copy of the rcDNA linked to the viral polymerase ([Nassal 2015](#)) (**Erreur ! Source du renvoi introuvable.**).

HBV infection is characterized by the generation of a large quantity of subviral particles (SVPs) lacking capsid and consequently the viral genome. In host sera, their presence exceeds that of Dane particles by a factor comprised between 10^2 and 10^5 . Two types of SVPs exist: 22nm-sphere or filament with the same width, but a variable length. The proportion of surface proteins in SVPs is different from Dane particles. Filaments contain L-HBsAg, M-HBsAg and S-HBsAg at a ratio of approximately 1:1:4, spheres contain less M-HBsAg, and traces of L-HBsAg. Even their presence in large excess they do not seem to interfere with the entry of the virus into hepatocytes, besides, they can represent a decoy for virus-neutralizing antibodies. As they share immunological determinants with Dane particles, SVPs can be efficient immunogens for the induction of a protective immune response ([Ho, Jeevan-Raj, and Netter 2020](#)).

Recently, empty (genome-free) virions, containing surface proteins and the viral capsid with no genome, have been described and were found at 100-fold higher levels over Dane particles in the blood of infected patients. Besides, HBV RNA containing particles were also described, and found at 100 to 1000 fold lower than Dane particles in infected patients. However, the existence of RNA virions remains a matter of debate, as some *in vitro* experiences use supernatants of hepatoma cell cultures as a source of HBV virions without taking care to the fact that naked capsids containing pgRNA, ssDNA (single-stranded DNA) or dsDNA (double-stranded DNA) are released in those supernatants. In addition to this, the DNase digestion could not be efficient enough to completely remove HBV DNA, and consequently it could be measured in some cases ([J. Hu and Liu 2017](#)).

Finally, the secretion of non-enveloped nucleocapsids has been described in HBV-replicating cell lines; however, they are hardly detected in the bloodstream of infected patients or chimpanzees. *In vitro* studies as well as analysis of sera from HBV patients revealed that extracellular RNAs were preferentially incorporated into naked nucleocapsids rather than in virions containing the envelope and the nucleocapsid ([Jiang and Hildt 2020](#)).

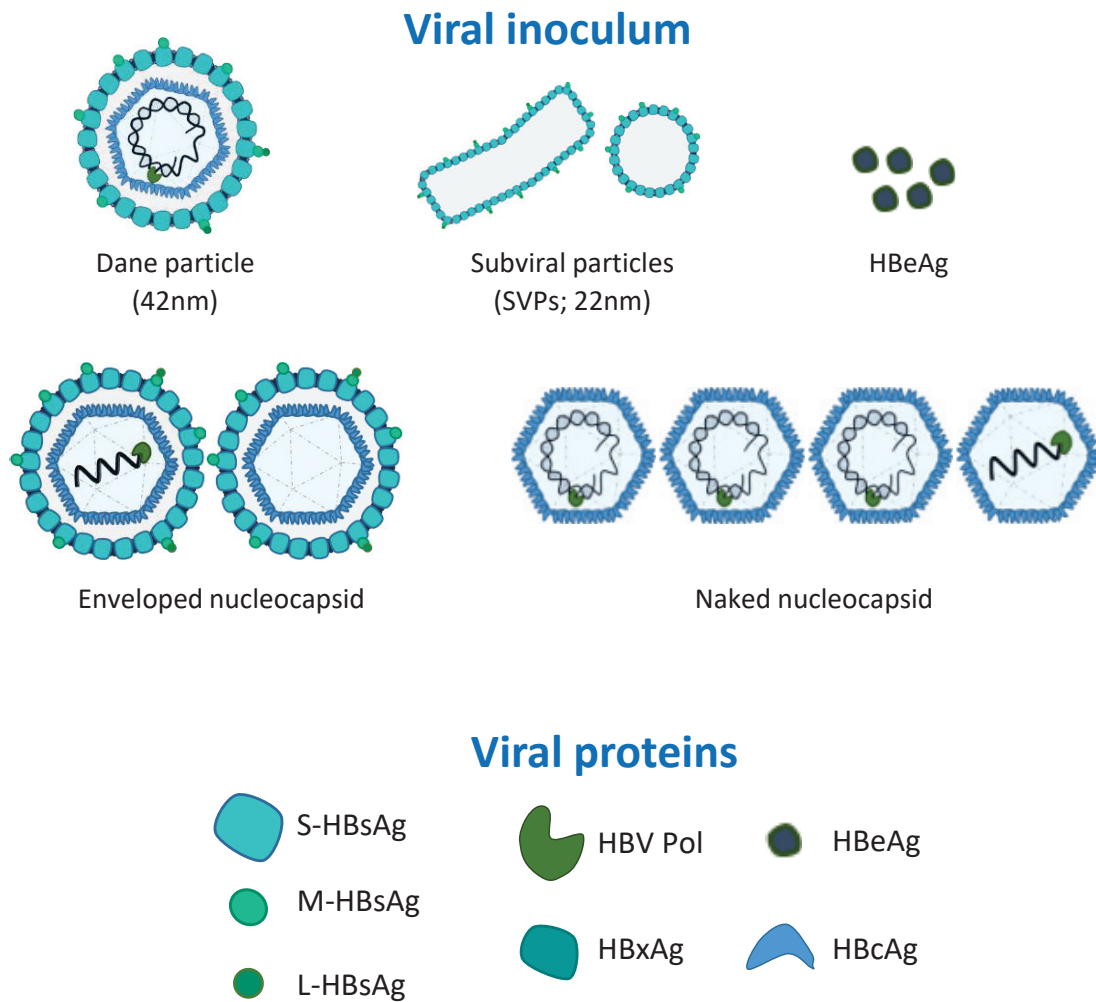

Figure 6: Viral components secreted by HBV-infected hepatocytes and their protein composition

The viral inoculum is composed of the Dane particles (infectious form of the virus), two forms of subviral particles (spheres and filaments) lacking HBV genome and secreted HBeAg. Other forms of enveloped nucleocapsid have been observed in patients' sera. Presence of naked nucleocapsids have been described *in vitro*. The different viral proteins are presented in the lower panel. *Viral particles and proteins designed by Marion Delphin.*

1.2.2.2 Viral DNAs

As indicated previously, HBV virion presents a DNA genome with a relaxed circular form, called rcDNA. In the nucleus of hepatocytes, cellular factors modify HBV genomic DNA to form the cccDNA (more detail in section “rcDNA conversion into cccDNA”). CccDNA, present in nuclei of infected cells, is a stable episomal “minichromosome” that serves as a template for the transcription of all viral RNAs, amongst which is the pre-genomic RNA (pgRNA) (Summers and Mason 1982) (Figure 7). It interacts with cellular histones and nucleosomal proteins (C.-T. Bock et al. 1994) which is epigenetically regulated by host and viral factors (Hong, Kim, and Guo 2017). CccDNA level is maintained in nucleus via re-infection, or in part due to intracellular recycling of newly synthesized rcDNA (Ko et al. 2018). CccDNA half-life has been estimated around 40 days, using hepatocellular model system (Ko et al. 2018), which was closed to *in vivo* studies, with 33 to 50 days in infected-woodchucks and 35 to 37 days in infected-ducks (Y. Zhu et al. 2001; Addison et al. 2002). Even if the half-life has not been evaluated in humans, cccDNA forms a stable pool in the liver of non-treated patients, with a mean of 3 copies/cell in HBeAg-positive patients [0.0003-40 copies/cell] and 0.31 copies/cell in HBeAg-negative patients [0.0003-6.8 copies/cell] (Laras et al. 2006). New method of detection of the cccDNA based upon droplet digital (dd) PCR have been implemented in order to quantify residual intrahepatic cccDNA and overcome detection issues. Around 68% of nucleoside-treated patients had undetectable cccDNA when evaluated by common qPCR, whereas 98% of patients presented cccDNA when assessed by ddPCR (Lebossé et al. 2020). This residual cccDNA could explain rebound of HBV infection observed after treatment arrest (Nassal 2015), highlighting the need of eliminating this cccDNA from infected cells or at least permanently silencing it to achieve a functional cure.

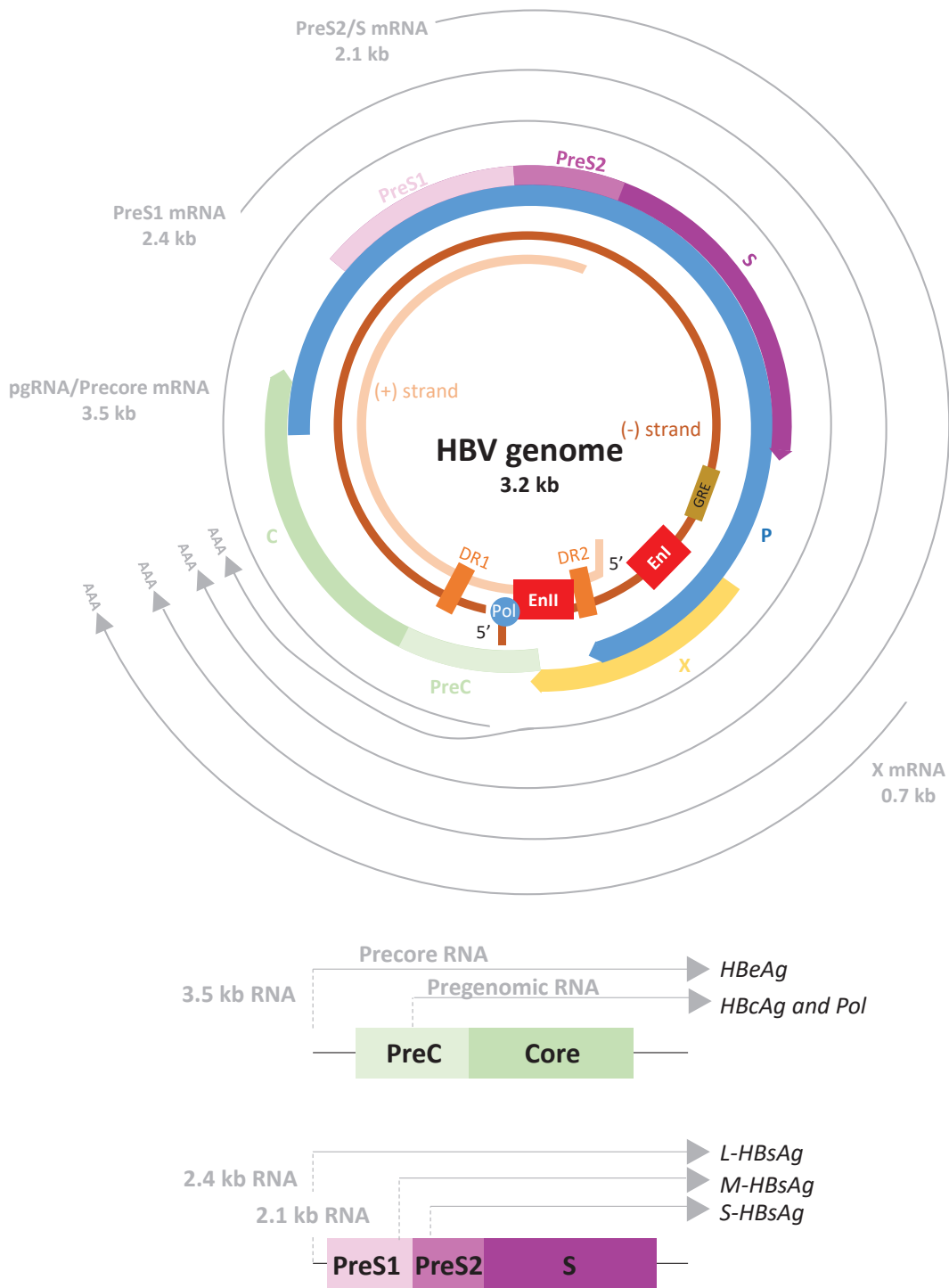

Figure 7 : Schematic representation of various HBV transcripts and the proteins they encode

Two classes of transcripts are synthesized: greater from the genomic length and sub-genomic length. All transcripts are of positive orientation, capped at the 5'-end and polyadenylated at the 3' end. Pregenomic RNA (pgRNA; 3.5kb) is translated into HBcAg and viral polymerase; Precore mRNA (3.5kb) is translated into the precore protein and the soluble and secreted HBeAg; PreS1 mRNA (2.4kb) is translated into L-HBsAg; PreS2/S mRNA (2.1kb) is translated into M- and S-HBsAg; X mRNA (0.7kb) is translated into HBx protein. *Adapted from (Liang 2009).*

1.2.2.3 Viral RNAs

The viral episome or cccDNA is the main template for the transcription of viral RNAs from the four promoters already described. Two classes of transcripts are synthesized: greater from the genomic length and sub-genomic length. All transcripts are of positive orientation, capped at the 5'-end and polyadenylated at the 3' end.

- **Pre-genomic RNA** of 3.5kb is translated into the cytoplasm to produce the core antigen or capsid protein (HBcAg) and the viral polymerase. Besides, it acts as the template for reverse transcription of the viral genome
- **Pre-core mRNA** of 3.5 kb is translated into the pre-core protein (a dimer of it forms HBeAg) and the soluble and secreted HBeAg
- **PreS1 mRNA** of 2.4kb is translated into the large envelope protein, L-HBsAg
- **PreS2/S mRNA** of 2.1 kb is translated into medium and small envelope proteins M-HBsAg and S-HBsAg
- **X mRNA** of 0.7kb is translated into the HBx protein (or HBx) ([Locarnini and Zoulim 2010](#)).

1.2.3 Viral proteins and their functions

1.2.3.1 Surface proteins, forming HBsAg: small, medium and large

As previously mentioned, HBV is an enveloped virus. Its genome encodes three glycoproteins, small (S-HBsAg), middle (M-HBsAg) and large (L-HBsAg) which are incorporated into a host-derived lipid membrane to constitute the viral envelop. They are translated from two HBV sub-genomic mRNA transcripts, with three different ATG but ends at the same terminal stop codon: the 2.4kb-PreS1 mRNA that encodes L-HBsAg and the 2.1kb-PreS2/S mRNA that encodes M-HBsAg and S-HBsAg in the endoplasmic reticulum (ER). Dane particles and the two types of subviral particles contain the three forms but in different ratio. A majority of HBsAg is found in Dane particles and filaments with an equal amount of M-HBsAg and L-HBsAg, whereas spheres mainly contain S-HBsAg and M-HBsAg and traces of L-HBsAg ([Cornberg et al. 2017](#)). HBsAg is therefore the smallest protein and has a length of 226 amino acids, which is the common part of the three proteins at their C-terminus. M-HBsAg presents an additional 55 amino acids at its N-terminus, which is encoded by PreS2, and L-HBsAg further includes an extended region of 108-119 amino acids (depending on the genotype) from the PreS1 region ([Karayiannis 2017](#)). The common S-HBsAg region contains four putative trans-membrane domains and an antigenic loop (AL). The AL is located from residues 100 and 164, between the second and third trans-membrane domains, and it is translocated to the luminal compartment of the ER during synthesis and present at the surface of secreted particles. It bears the immune-dominant "a" determinant, conserved in all strains, and includes a single N-glycosylation site at residue asparagine

146 (50% of HBsAg are glycosylated at this residue). All three proteins have a glycosylated form responsible for viral secretion; L-HBsAg and S-HBsAg may also appear unglycosylated in the viral envelope (therefore, depending on glycosylation S-HBsAg, M-HBsAg and L-HBsAg possess variable sizes, 24 to 27 kDa, 33 to 37 kDa and 39 to 42kDa respectively). AL is determinant for the virus infectivity as it can attach to the hepatocyte membrane via a heparan sulfate-binding motif (Julithe, Abou-Jaoude, and Sureau 2014). The preS1 domain from L-HBsAg is also essential for virus infectivity: its N-terminus, initially inserted into the membrane via the first trans-membrane domain, is modified by a myristic acid that induces a complex translocation process and results at the virion surface. Its domain from 2 to 48 amino acid specifically binds the sodium taurocholate cotransporting polypeptide receptor (NTCP, encoded by *SLC10A1*) on hepatocytes allowing virus entry (Urban et al. 2014). L-HBsAg also facilitates the envelopment of the core particles. Despite the fact that it is conserved among other hepadnaviruses (Gerlich 2013), function of M-HBsAg is still not clear. Some studies found that it is not important for virion envelopment and secretion, whereas others thought that its glycosylation may be involved in the assembly of virions (Schmitt et al. 2004). Structures of envelop proteins are described in Figure 8.

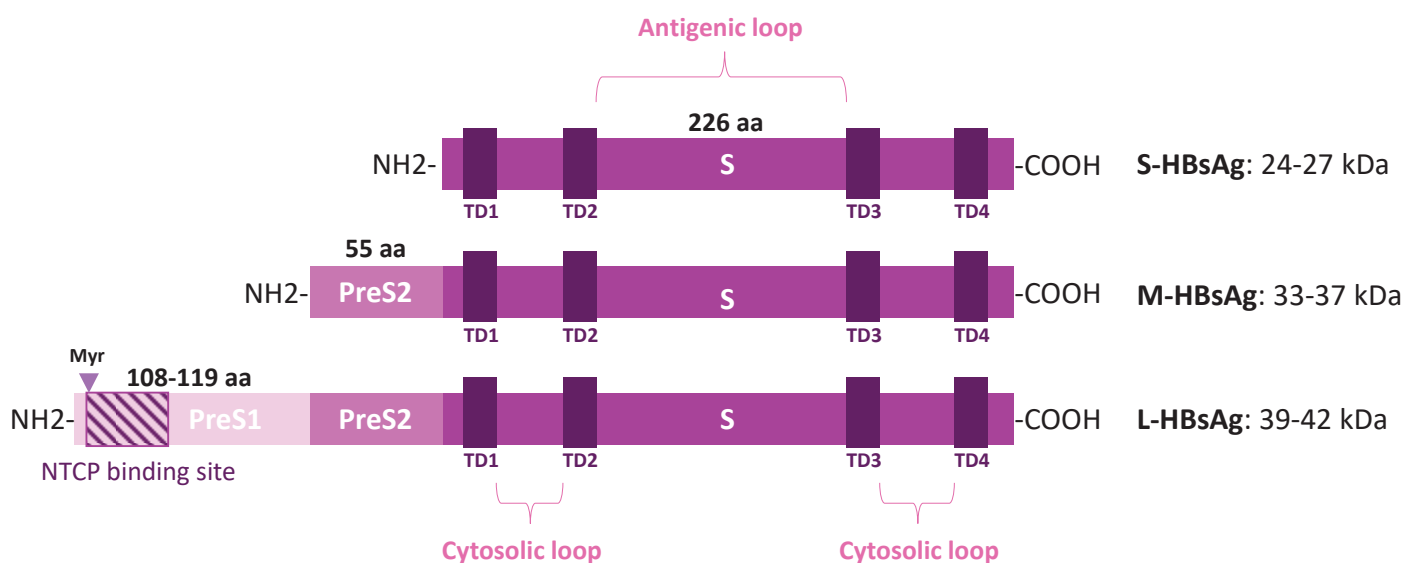

Figure 8: Envelope proteins of HBV

Schematic representation of envelop proteins. They are composed of a common domain S (corresponding do HBsAg), and two extensions PreS2 and PreS1 corresponding to M-and L-HBsAg. Four transmembrane domains are present in the S domain, as well as one antigenic loop and two cytosolic loops. The myristic acid responsible of conformational change necessary for infection is pointed out. The region from 2 to 48 amino acid responsible of NTCP binding is hatched. TD: transmembrane domain; aa: amino acids; Myr: myristic acid. Adapted from (Ho, Jeevan-Raj, and Netter 2020).

1.2.3.2 Core protein, HBcAg

As previously mentioned, HBV genome is found in a viral capsid. Core protein (HBcAg), which contains 183 amino acids and a size of 21 kDa, composes that capsid. HBcAg is translated starting with the second AUG of the preC/Core gene, but the first AUG of pgRNA. Its first 140 amino acids form the N-terminal assembly domain (NTD) that possesses five α helices connected by loops, and it also contains an arginine-rich C-terminal domain (CTD) from 150 to 183 amino acids; a linker of 9 amino acids residues connects these two domains ([Viswanathan et al. 2020](#)). HBcAg preferentially form dimers via the formation of four helix bundles with two helices coming from each half-dimer. HBcAg dimers are able to self-assemble to form the icosahedral virus capsid, which is 34nm in diameter with an inner radius of 13 nm and a thickness of 2nm. It has mainly a T=4 symmetry structure containing 120 HBcAg-dimers, in 95% of cases, while few T=3 capsid are observed in infected human liver ([Zlotnick et al. 2015](#)). The CTD is crucial for capsid assembly and for the viral regulation: it contains four arginine –rich domains with nucleic acid binding activity, their interaction with pgRNA and viral DNA is essential for the viral genome replication; and seven serine/threonine residues, either phosphorylated or dephosphorylated. Recent studies show that hyperphosphorylation was associated with empty capsids whereas lower phosphorylation status regulate specific HBV replication intermediate formation, highlighting the importance of HBcAg dephosphorylation for pgRNA encapsidation ([Z. Zhao and Zlotnick 2018](#)). It may also induces template switching, primer translocations and DNA chain elongation during viral DNA synthesis, highlighting its potential role as a link between viral and cellular factors ([Viswanathan et al. 2020](#)). Finally, the linker region may also be involved in empty virion morphogenesis ([K. Liu et al. 2018](#)).

1.2.3.3 Pre-Core protein and HBeAg

PreCore/C mRNA translation produces the non-structural PreCore protein, composed of core protein, thus contains the three domains, previously described, and an additional N-terminus of 29 residues, which is an ER signal sequence for further processing ([Yeh, Liaw, and Ou 1990](#)). HBeAg protein, a soluble, secreted and dimeric protein composed of two polypeptides of 159 residues and approximately 18kDa, is formed by two cleavages: 34 amino acids from the C-terminus by a furin-like protease and 19 amino acids from the N-terminal signal, leaving behind a 10-residue propeptide ([Z. Zhao and Zlotnick 2018](#)). HBeAg is conserved in all hepadnaviruses, but its exact function during infection is not clear and need further investigation. Various studies showed that it is not involved in viral infection, replication and assembly. Clinically, HBeAg presence in infected patient's sera is used as a surrogate marker of viral replication, infectivity, inflammation, severity of disease and response to treatment. Its presence in high quantity is linked to an active replication of the virus, whereas the seroconversion to anti-HBe, a long-lasting and dynamic process, ends this active replication phase and

it evolves towards a chronic infection or chronic hepatitis state (Kramvis et al. 2018). Mutations in the BCP (basal core promoter) and preC/C ORF also impair or abolish HBeAg expression at the transcriptional, translational and post-translational levels (Kramvis 2016). Besides, HBeAg may act as an immune-regulator. Even if HBeAg and HBcAg share a common part conferring them common antigenic epitopes, they possess different antigenic properties (Salfeld et al. 1989).

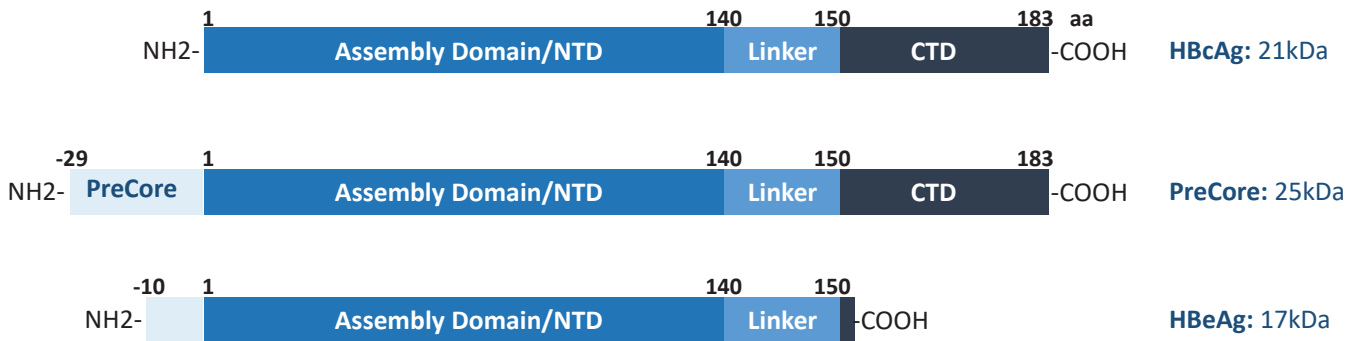

Figure 9: Molecular structures of HBcAg, PreCore and HBeAg

Schematic representation of HBcAg, PreCore and HBeAg, with their protein domains and their positions in the amino acid chains. All three proteins contain a N-terminal assembly domain (NTD), which possesses five α helices connected by loops and a linker of 9 amino acids residues; HBcAg and PreCore possess an arginine-rich C-terminal domain (CTD) from 150 to 183 amino acids; PreCore protein contains an additional N-terminus of 29 residues; HBeAg is formed by two cleavages: 34 amino acids from the C-terminus by a furin-like protease and 19 amino acids from the N-terminal signal, leaving behind a 10-residue propeptide. NTD: N-terminal domain; CTD: C-terminal domain. Adapted from (Viswanathan et al. 2020).

1.2.3.4 Viral polymerase, Pol

The HBV viral polymerase (Pol) is the longest protein encoded by HBV, with its 832 amino acids and a size of 90kDa (Nassal 2008). It contains four structural domains from the N- to C- terminus: a TP (Terminal Protein) domain from 1 aa to 178, a spacer domain from aa 179 to 336, an RT (Reverse Transcription) domain from aa 337 to 680 and a RNaseH domain from aa 681 to 832 (S. A. Jones et al. 2014).

The TP domain, unique to *Hepadnaviridae*, possesses a tyrosine Y63 whose hydroxyl group serves as the substrate for initiating DNA synthesis, step called as protein priming (Scott A. Jones et al. 2012). This tyrosine is able to covalently bind, via a phosphodiester bond, the 5' Epsilon stem-loop of the pgRNA, which acts as the packaging signal (Nassal 2008). This binding induces a conformational change in Pol that allows the delivery of the Y63 residue to the active site in the RT domain (Tavis and Ganem 1996). The RT domain, which contains the main catalytic subdomain of Pol, allows the reverse transcription of the pgRNA into the minus-strand of HBV DNA as well as the DNA synthesis of the positive-strand from the minus-strand cDNA. This domain is the target of current antiviral therapy that

uses nucleoside analogues, preventing the reverse transcription. Mutations of a conserved tyrosine, methionine or two aspartate motif (YMDD) into this domain have been identified as resistance mutations to those treatments (see treatment) (Nassal 2008).

The RNaseH domain is responsible for the pgRNA degradation after synthesis of the minus-strand, yet leaving intact the 5' extremity of the pgRNA, which serves as primer for DNA synthesis of the plus strand (Clark and Hu 2015).

Finally, the spacer domain, often considered as a bridge between the TP and RT domains, is not critical for polymerase function. However, mutations within the spacer has been shown to affect the function of HBsAg, as Pol and S gene overlaps (P. Chen et al. 2013).



Figure 10: Viral polymerase structure

The viral polymerase contains four domains, a terminal protein domain (TP), a spacer, a reverse transcription domain (RT) and an RNaseH domain. Tyrosine 63 (Y63), necessary for reverse transcription is pointed out, as well as the YMDD, the domain in which mutations induce resistance to nucleoside analogues treatment. aa= amino acids. Adapted from (Clark and Hu 2015).

1.2.3.5 X protein, HBx

HBx is the smallest non-structural protein encoded by HBV with 154 amino acids and a size of 17kDa. It is thought to have diverse roles, not yet well determined due to the complexity of studying this small protein in the context of a proper infection, yet avoiding overexpression approaches. HBx is required to initiate and maintain viral replication *in vitro* (Lucifora et al. 2011), as well as *in vivo* in human-liver-chimeric mice (Tsuge et al. 2010) or in the woodchuck model (F. Zoulim, Saputelli, and Seeger 1994). In the nucleus, HBx is able to interact or associate with the cccDNA and modulate its epigenetic regulation (L. Belloni et al. 2009). In order to facilitate viral replication, it has been shown that HBx could bind to DDB1(DNA binding protein 1)-containing E3 ligase, in order to promote the degradation of the structural maintenance of chromosome (Smc) complex 5/6, which has been shown to inhibit transcription from the cccDNA (Livingston et al. 2017). HBx has been shown to stimulate transcription of viral and cellular genes in various cell lines and *in vivo* (Bouchard and Schneider 2004). This could be done not by DNA binding but via direct interaction with transcription factors, such as nuclear factor NF- κ B or activator protein AP-1 and AP-2, and the stimulation cellular signal-transduction pathways that regulate transcription, such as mitogen-activated protein kinase (MAPK) or extracellular signal-regulated kinase (ERK); it cannot be excluded that the increased transcription could be the indirect

result of Smc5/6 complex degradation. HBx, both in vitro and in vivo, may also alter hepatocyte's metabolism by increasing the phosphatidylinositol 3-kinase (PI3K)/ protein kinase B (AKT), mammalian target of rapamycin complex 1 (mTORC1) and adenosine monophosphate-activated protein kinase (AMPK) pathways (Slagle and Bouchard 2018). HBx has also been linked to the regulation of other mechanisms including cell cycle, calcium-signalling pathway, cellular apoptosis and damaged DNA responses. All those regulations induced by HBx suggest that it may contribute to the development of HBV-associated hepatocellular carcinoma (Slagle and Bouchard 2016).

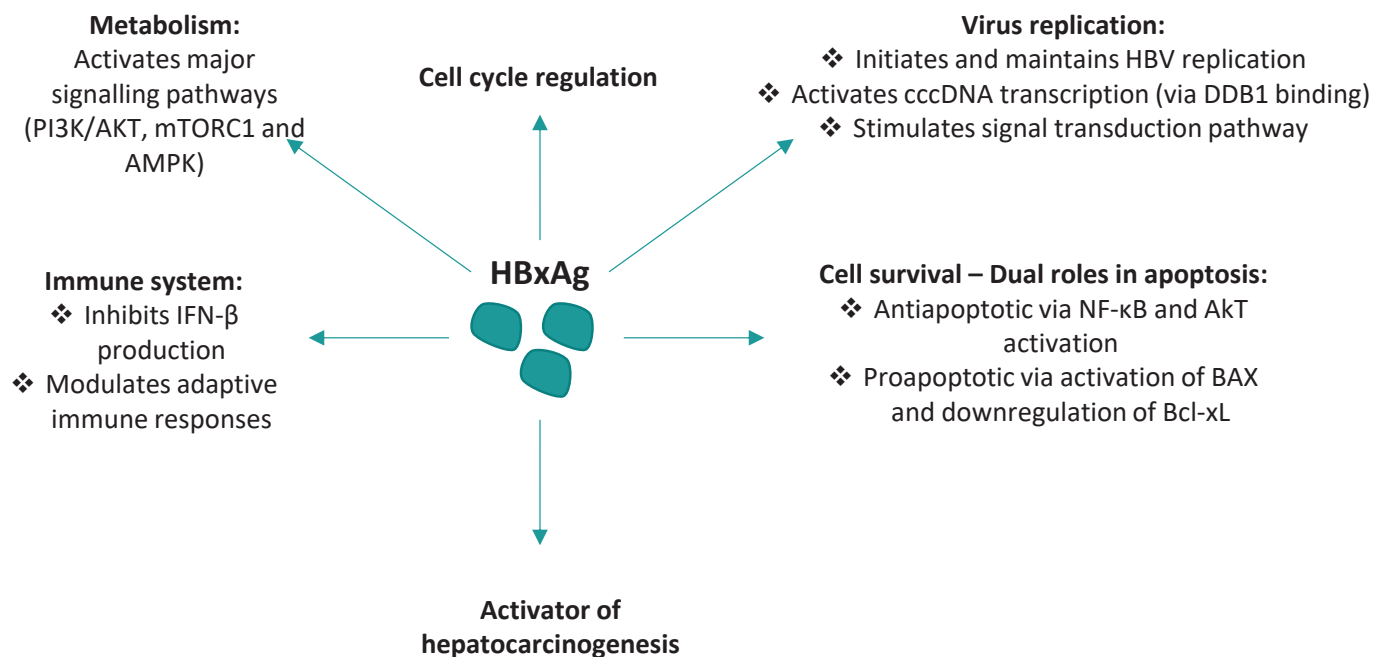

Figure 11: Pleiotropic effects of HBx

HBx is required for virus replication, intervening at different stages of chronic infection. Its effects on apoptosis and metabolism are vital for chronic infection. This multifunctional protein also exhibit activities affecting the cell cycle regulation, calcium-signalling pathway, cellular apoptosis, damaged DNA responses and the immune system. All those regulations induced by HBx suggest that it may contribute to the development of HBV-associated hepatocellular carcinoma. *Adapted from (Quetier and Kremsdorf 2014), (Slagle and Bouchard 2018) and (X.-D. Zhang, Wang, and Ye 2014)*

1.2.3.6 Hepatitis B splicing-regulated protein (HBSP)

Recent studies showed that HBV pgRNA could be subjected to single or multiple splicing. The major 2.2kb-spliced variant, called SP1, lacks intron 2447/489 and can represent up to 30% of total HBV pgRNA depending on conditions. It encodes for the hepatitis B splicing-regulated protein, protein of 12kDa and 93 amino acids. This protein shares its first 46 amino acids with the viral polymerase as its translation begins at the same AUG codon, but the splicing leads to a different C-terminal moiety from other viral proteins (Soussan et al. 2000). HBSP has been detected in liver biopsies from HBV chronic

hepatitis infected patients and, in another study, approximately 50% of them presented antibodies in their sera directed against HBSP (Soussan et al. 2000; Soussan et al. 2003). Although the biological roles of HBSP remain to be well determined, evidence suggest that it may be involved in the pathogenesis and persistence of HBV infection (Soussan et al. 2003). In fact, HBSP can alter liver immunity: it modulates tumour necrosis factor- α (TNF- α) signalling pathway *in vitro* and reduces hepatic infiltration of monocytes and macrophages *in vivo* through the down regulation of C-C motif chemokine ligand 2 (CCL2), which results in attenuated liver damage during fibrosis (Pol et al. 2015; Duriez et al. 2017). *In vitro*, a role of HBSP in apoptosis is still under debate: it possesses a BH3 homology domain in its N-terminal part, which may act as pro-apoptotic motif following interaction with Bcl-2 proteins (Y. W. Lu et al. 2006), or it can prevent apoptosis by increasing resistance of infected hepatocytes to Fas-mediated cell killing (S.-X. Wu et al. 2018).

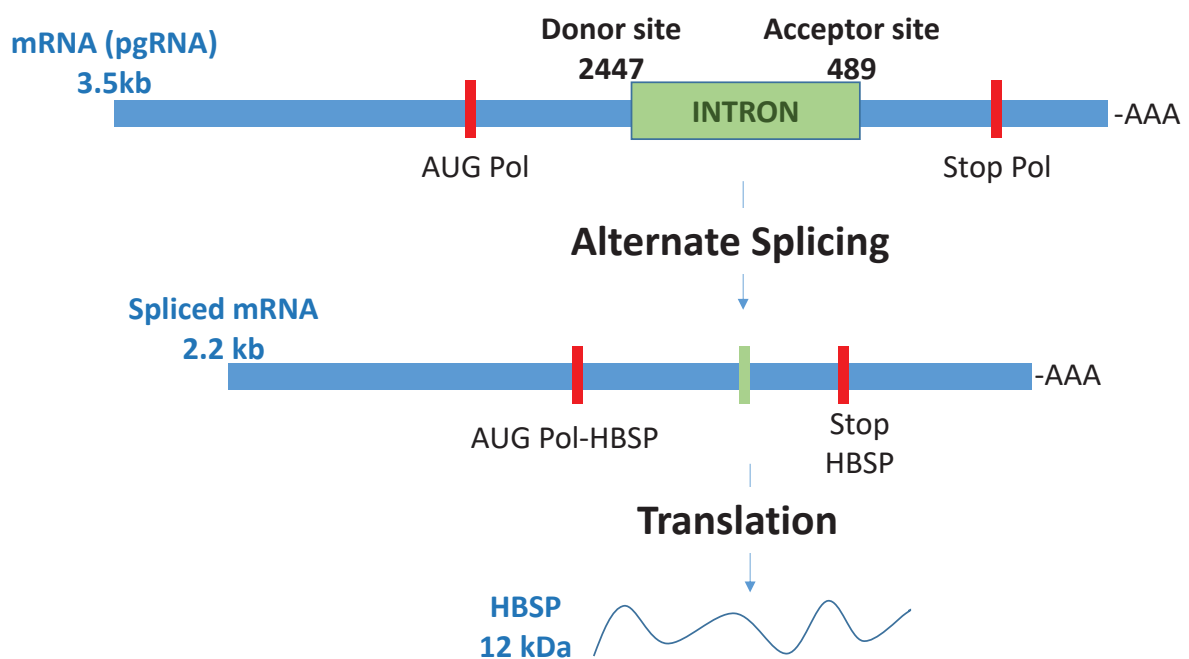

Figure 12: Synthesis of HBSP protein

The pgRNA (3.5 kb) may be spliced into SP1 variant, which lacks intron 2447/489. It encodes for the hepatitis B splicing-regulated protein (HBSP; 12 kDa), which shares its first 46 amino acids with the viral polymerase as its translation begins at the same AUG codon, but the splicing leads to a different C-terminal moiety from other viral proteins. pgRNA: pregenomic RNA; Pol: polymerase ORF; AUG: initiation codon. Adapted from (Kremsdorf et al. 2006).

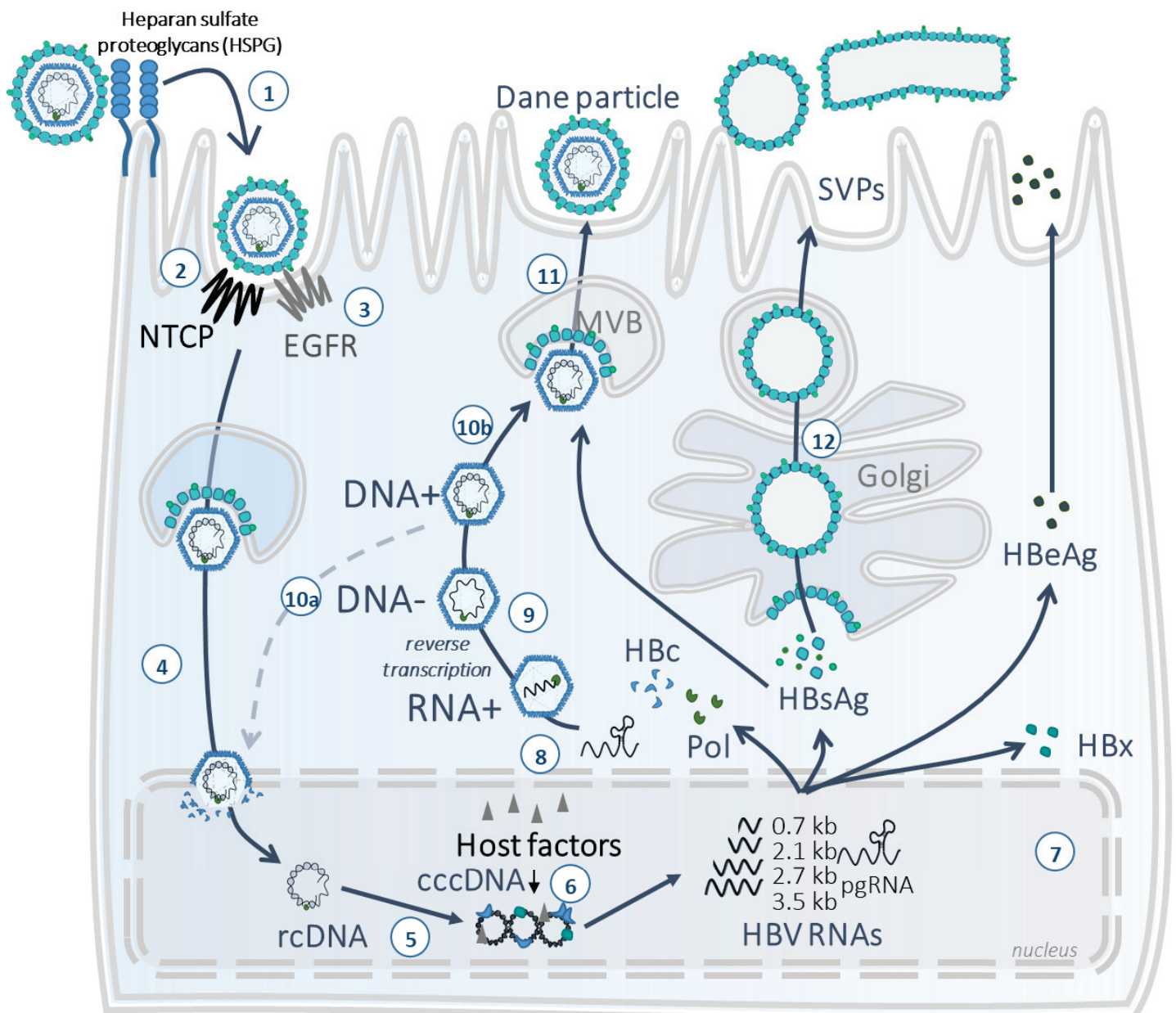

Figure 13: Viral life cycle

1) HBV virion first electrostatically interacts with heparan sulfate proteoglycans. 2) It then binds to its specific receptor, the sodium taurocholate cotransporting polypeptide (NTCP) receptor. 3) Epidermal growth factor receptor (EGFR) has been shown to act as a cofactor of the viral entry, *in vitro*. 4) Envelop loss and nuclear import. 5) The relaxed-circular form of the genome (rcDNA) is converted into closed covalently circular DNA (cccDNA). 6) cccDNA is transcriptionally regulated. 7) HBV RNAs are transcribed and they undergo co- and post-transcriptionally regulation. 8) pgRNA is encapsidated with the viral polymerase. 9) pgRNA is reverse transcribed into minus strand, and the plus strand is further synthesized 10a) The nucleocapsid is transported to the nucleus allowing the amplification of the cccDNA pool. 10b) The nucleocapsid is enveloped through multivesicular bodies (MVBs) and (11) it is then secreted out of the cell. (12) SVPs are secreted using the general secretory pathway dependent on the Golgi apparatus. *Viral life cycle designed by Marion Delphin.*

1.2.4 Viral life cycle

All steps of the viral life cycle are sum up in **Figure 13**.

1.2.4.1 Virus entry into cells

1.2.4.1.1 Attachment of HBV particles to the cell surface

In order to enter hepatocyte, HBV particle interacts first with heparan sulfate proteoglycans (HSPGs) (1), which are glycoproteins with one or more heparan sulfate chains at the cell surface or in the extracellular matrix (A. Schulze, Gripon, and Urban 2007). This electrostatic interaction is made between negatively charged HSPG and two positively charged residues Arg122 and Lys141, present in the antigenic loop region of the S domain of envelope proteins (Sureau and Salisse 2013). HSPGs, present in large majority in the space of Dissé, are required to stabilize the virus at the cell surface, before its interaction with its specific receptor (Urban et al. 2014).

1.2.4.1.2 And to its specific receptor

In 2012, Yan et al. identified the receptor required for HBV entry; the sodium taurocholate cotransporting polypeptide (NTCP) receptor (2) (H. Yan et al. 2012). Encoded by the SLC10A1 gene, NTCP is located on the basolateral membrane of hepatocytes and play a role in enterohepatic circulation of bile salts, via the uptake into the liver of conjugated bile acids from blood (Anwer and Stieger 2014). Following the low-affinity binding with HSPGs, HBV particle specifically binds the NTCP receptor via its PreS1 domain. More precisely, the region comprised between amino acids 2 and 48 with the sequence 9-NPLGF(F/L)P-15 are crucial for NTCP binding, and amino acids 49-75 are required for infection (Urban et al. 2014).

1.2.4.1.3 Internalization via cellular factors

NTCP expression alone may not be sufficient for an efficient viral internalization into hepatocytes; other host factors seem to be required for infection, as infection remains low in cell lines overexpressing NTCP (J. Wang et al. 2019). *In vitro*, epidermal growth factor receptor (EGFR) may play a critical role as a host-entry cofactor for HBV particle internalization, indeed, when the interaction between NTCP and EGFR is disrupted, cells are no longer able to support HBV entry (3) (Iwamoto et al. 2019). In the same manner, the host protein E-cadherin, a calcium-dependent cell-cell adhesion protein, was shown to be involved in the cell-surface distribution of NTCP and therefore in the HBV entry (Q. Hu et al. 2020). In hepatoma cell lines, glypican 5 was also found as a co-entry factor of HBV (Verrier et al. 2016).

Following these interactions, HBV enter the cell by endocytosis, but the exact nature of this entry remains to be elucidated: two internalization pathways could be involved, either via caveolin-1, an

important plasma membrane component, or via clathrin, a vesicle component. *In vitro*, cells expressing mutants for caveolin-1 showed decreased levels of HBV transcripts and antigens (Alina Macovei et al. 2010). However, in primary Tupaia hepatocytes, this hypothesis was not confirmed as the use of caveolin-mediated endocytosis inhibitors did not impair HBV infection (Bremer et al. 2009). Other studies report the use of clathrin-mediated endocytosis for HBV entry *in vitro* instead. In primary human hepatocytes, PreS1 domain interacts both with clathrin and protein adaptor 2 (AP-2), the silencing of those two molecules induces a decrease of HBV infection (H.-C. Huang et al. 2012). HBV internalization was also impaired via RNA-mediated silencing (siRNA) of the clathrin heavy chain, AP-2 and dynamin-2 in hepatoma cell lines expressing NTCP (Herrscher et al. 2020).

1.2.4.2 Nuclear replication steps of the virus

1.2.4.2.1 Nuclear import

(4) After entry into cells, HBV genome needs to be transported to the nucleus. Endosome-associated cellular Rab GTPases Rab5A and Rab7A may be involved in HBV trafficking: after internalization, the virion is transported to Rab5-containing early endosomes followed by the Rab7-containing late endosomes (A. Macovei et al. 2013). EGFR-sorting machinery may also coordinate the transport of incoming hepatitis B virus to the endosomal network (Iwamoto et al. 2020). These observations suggest that transport into late endosome is crucial for infection.

However, the delivery of nucleocapsids into the cytoplasm by viral particles is not clearly understood. Escape from the endosome by membrane fusion or translocation process are two mechanisms that can explain this delivery (Jiang and Hildt 2020). Then, nucleocapsids are transported to the nucleus by the microtubular system (Rabe, Glebe, and Kann 2006).

The entry of the nucleocapsid into the nucleus is a matter of debate. It may enter the nucleus directly through the nuclear pore, its size being compatible to nuclear pore size. Another hypothesis suggests the direct disintegration of the capsid within the nuclear pore: capsid proteins, expressing nuclear location signals (NLS) in their C-terminus, can bind nuclear pore complexes, including importins α and β (Yeh, Liaw, and Ou 1990), which induces the capsid disintegration and further release of the rcDNA in the nucleus. *In vitro*, it has been shown that C-terminus exposure on the capsid surface is linked to genome maturation, suggesting that only mature capsid containing rcDNA and not immature nucleocapsids containing pgRNA can disassemble (Kann 2007).

1.2.4.2.2 rcDNA conversion into cccDNA

(5) Once in the nucleus, rcDNA is converted into cccDNA. This conversion requires a multi-step process:

- Removal of the viral polymerase from the 5' minus-strand of the rcDNA, leading to a deproteinated rcDNA as a putative intermediate of cccDNA formation (H. Guo et al. 2007). *In vitro*, a DNA repair enzyme tyrosyl-DNA phosphodiesterase 2 (TDP2) has been shown to detach the viral polymerase from rcDNA (Cui et al. 2015).
- Removal of RNA primers: recently, another mechanism including a host factor flap structure-specific endonuclease 1 (FEN-1) has been shown to be involved in cccDNA formation: it may cleave the 5' flap-like structure on the negative strand of the rcDNA, which therefore removes the terminal redundant sequence with the viral polymerase (Kitamura et al. 2018).
- The positive-strand is synthesized to form a full-length dsDNA. *In vitro*, it has been shown that different host polymerases seem to be more implied in this process rather than the viral polymerase itself (Qi et al. 2016; L. Tang et al. 2019). Topoisomerases I and II have also been shown to be involved in the circularization of both strands (Sheraz et al. 2019).
- Ligation of both strands mediated by DNA ligase 1 and 3 (Long et al. 2017).

Chromatinization of rcDNA occurs all along this process. Histones and non-histone proteins allow the cccDNA to remain stable in infected hepatocytes (C.-T. Bock et al. 1994). Besides, cccDNA is maintained stable by intracellular genome recycling and secondary infection (Ko et al. 2018).

More rarely, nucleocapsid can contain double-stranded linear DNA (dsDNA) that can be converted into cccDNA, but this latter may be integrated into the host genome at site of double-stranded DNA breaks by non homologous end-joining process (Bill and Summers 2004). In HBV dsDNA, HBcAg promoter is separated from its ORF, resulting in a replication-incompetent form of the virus, but it can induce the expression of HBsAg (Wooddell et al. 2017). Integration is a process found in 10 to 100% of hepatocytes by the time liver cancer starts to develop in chronic carriers (Seeger and Mason 2016).

1.2.4.2.3 Transcriptional regulation of cccDNA

1.2.4.2.3.1 By transcription factors

(6) As previously seen, cccDNA transcription is controlled by two enhancers and four promoters that possess binding sites for ubiquitous and liver-enriched transcription factors and nuclear receptors.

Enhancer I (EnI) is 270 bp long and is located between PreS1/PreS2/S and X ORFs. It induces the activation of HBx mRNA transcription. It contains binding sites for hepatocyte nuclear factor 1 and 3 (HNF1 and HNF3), nuclear factor 1 (NF1), CCAAT-enhancer-binding protein (C/EBP), peroxisome proliferator-activated receptor α (PPAR α), retinoid X receptor α (RXR α), the chicken ovalbumin upstream promoter transcription factor (COUP-TF) 1 and 2 and human testicular receptor 2 (TR2) (Xia and Guo 2020). It also contains an interferon-stimulated response element (ISRE), which binds signal transducer and activator of transcription 1 (STAT1) after IFN- α stimulation, resulting in transcriptional

repression (Laura Belloni et al. 2012). Enhancer II (EnII) is 148 bp in length and is located upstream of the core promoter, and it is involved in the expression of other transcripts. It contains HNF1, HNF3, HNF4α, C/EBP, specificity protein (Sp) 1 and farsenoid X receptor binding sites (Turton et al. 2020).

PreS1 promoter contains binding sites for HNF1 and HNF3. PreS2/S promoter is regulated by SP1, RXRα, PPARα and HNF4α. PreC/C promoter possesses HNF4α, RXRα, PPARα, COUP-TF and TR2 binding sites. Finally, X promoter possesses an activating protein-1 binding site (AP-1) (Xia and Guo 2020).

The NF-κB transcription factors family (detailed in chapter 2), critical regulator of the immediate early pathogen response, was shown to down regulate viral transcription in HepG2 cell line (Xiong et al. 2004). Lin et al demonstrated that NF-κB subunit p65 (RelA) indirectly inhibits HBV gene expression, through its interaction with Sp1 transcription factor, repressing the Sp1-mediated activation of core promoter (Y.-C. Lin, Hsu, and Ting 2009). Interestingly, NF-κB binding sites have been identified in the HBV genome: HBcAg has been shown to activates HBV EnII and pregenomic promoter through the upstream activation of NF-κB binding site (GGGACGTACT, nt 1408-1417) (Kwon and Rho 2002); a NF-κB binding site located at nt 207-216 has also been identified and been shown to be activated by overexpressed p65 (Y.-C. Lin, Hsu, and Ting 2009).

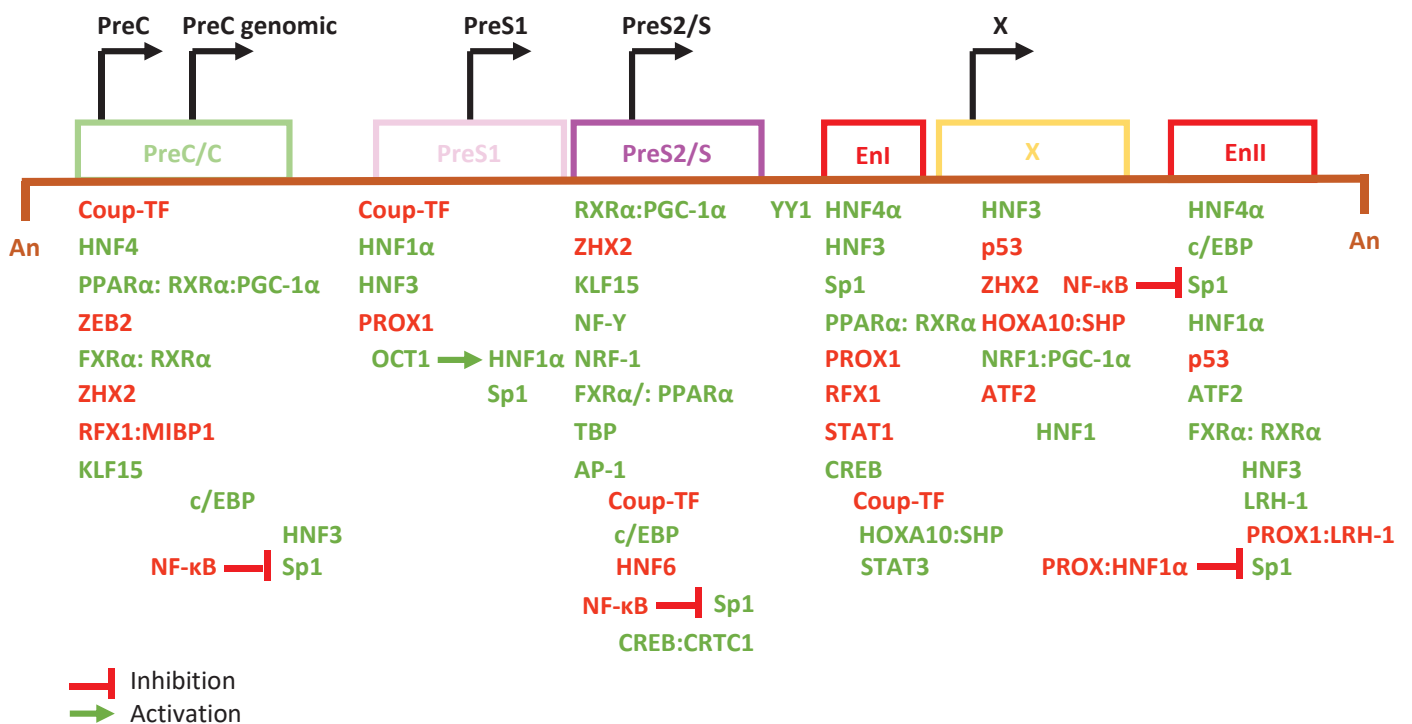

Figure 14: Positions of the binding sites of transcription factors on HBV genome

Both promoters and enhancers are represented by boxes, and angled arrows represent HBV RNA start sites. “An” represents the polyadenylation sites in the linearized HBV genome. Transcription activity has been highlighted in red for inhibition and green for activation. Adapted from (Turton et al. 2020).

1.2.4.2.3.2 By epigenetic modifications

CccDNA is a stable episomal form of the genome that can be decorated with host histones and non-histone proteins (6) (C.-T. Bock et al. 1994). Immunoblotting with HBcAg revealed that histone proteins H3 and H2B were the most present on the cccDNA while lower level of H4, H2A and H1 were also detectable (C. T. Bock et al. 2001). Chromatin immune-precipitation (ChIP) assay confirmed those observations and found that acetylation status of H3/H4 histones regulates HBV replication (Pollicino et al. 2006). Indeed, histones deacetylases and acetyl-transferases can be recruited to modify those histones linked to cccDNA and regulate transcription. An increase of acetylation of histones was associated to initiation of transcription, while a decrease of acetylation allows the recruitment of methyl transferases that methylate histones and DNA, and therefore repress transcription (Levrero et al. 2009).

In addition to histone modifications, cccDNA transcription is regulated by the methylation status of six CpG islands (Yongmei Zhang et al. 2013). Methylation may be associated to the evolution of the disease, and to hepatocarcinogenesis (Jain et al. 2015).

Numerous chromatin-modifying enzymes can bind the cccDNA and promote its transcription, such as cAMP response element-binding protein (CREB), CREB-binding protein (p300/CBP), and p300/CBP-associated factor (PCAF). On the contrary, others such as HDAC1, sirtuin (SIRT1) 1 and 3, chromosome 5/6 complex (Smc5/6) and enhancer of zeste homolog (EZH2) induce its silencing (Xia and Guo 2020).

Mark (DNA or histones)	Site	Effects on transcription
DNA methylation		
Methylated cytosine (meC)	CpG islands	Repression
Histones Post-translational modifications		
Acetylated lysine (K Ac)	H3 (9,14,18,56) H4 (5,8,13,16) H2A, H2B	Activation
Phosphorylated serine/threonine (S/T)	H3 (3,10,28)	Activation
Methylated arginine (R Me)	H3 (17,23), H4 (3)	Activation
Methylated lysine (K Me)	H3 (4,36,79) H3 (9,27), H4 (20)	Activation Repression
Ubiquitylated lysine (K Ub)	H2B (120) H2A (119)	Activation Repression

Table 1: Type, site and function of known chromatin marks

Numerous histone-modification sites have been identified on the cccDNA, inducing either repression or activation of transcription. The number into brackets identifies the aminoacid residues involved in specific modifications. *Adapted from (Levrero et al. 2009).*

1.2.4.2.3.3 By HBx

HBx plays a crucial role in cccDNA regulation either directly by transactivator function, or indirectly, by modulating other host factors, which regulate in turn directly cccDNA transcriptional activity (7). It is implied in epigenetic modifications of the cccDNA, as its recruitment to cccDNA positively correlates with the recruitment of histone acetyltransferases p300, CBP and PCAF and negatively correlates with the recruitment of histones deacetylases HDAC and SIRT1 (Cougot et al. 2007; L. Belloni et al. 2009). It allows the establishment of active chromatin on cccDNA preventing transcriptional repression by SETDB1-mediated histone 3 di- and tri-methylation (H3K9me3) and heterochromatin 1 (HP1) to the cccDNA (Rivière et al. 2015) and PRMT5 (W. Zhang et al. 2017). HBx was shown to activate the expression of the long non-coding RNA (lncRNA), DLEU2 (Deleted in Lymphocytic Leukemia 2), which modulates cccDNA transcription preventing the transcriptional repression by chromatin-modifying enzymes like EZH2 and PRC2 (polycomb repressive complex 2) (Salerno et al. 2020). HBx was shown to interact with parvulin proteins 14 and 17, stabilizing HBx and promoting its translocation to the nucleus and mitochondria; in the presence of HBx the Par 14 and Par17 bind to the cccDNA to promote its transcriptional activation (Saeed et al. 2019).

Furthermore, HBx was shown to promote cccDNA degradation by redirecting DNA-damage binding protein 1 (DDB1)-CUL4 E3 ubiquitin ligase to degrade the host restriction factor Smc5/6 (Decorsière et al. 2016; Rivière et al. 2019). HBx is able to upregulate E3 ubiquitin ligase MSL2, which favours cccDNA activation via degradation of the cytidine deaminase APOBEC3B (Apolipoprotéins B mRNA editing enzyme, catalytic polypeptide-like 3B), responsible of cccDNA deamination leading to its degradation (Y. Gao et al. 2017; Lucifora et al. 2014).

Finally, HBx may promote cccDNA formation via its association with host pre-mRNA processing factor, PRPF31 (Kinoshita et al. 2017).

1.2.4.2.3.4 By HBcAg

HBcAg was shown to regulate cccDNA via epigenetic mechanisms, and in particular via the modulation of the nucleosome spacing of cccDNA-histone complex (C. T. Bock et al. 2001).

HBcAg is a positive regulator of HBV transcription and regulation. CHIP experiments showed that it preferentially binds to cccDNA at CpG island 2, inducing hypo-methylation of that region. This leads to increase binding of CREB protein and in contrast, lower amount of HDAC1 binding, resulting in increased cccDNA transcription (Y.-H. Guo et al. 2011).

Besides, HBcAg has also been shown to promote viral proliferation by binding to PCNA (proliferating cell nuclear antigen), a coordinator of DNA polymerases in maintaining genome integrity and inducing proliferation. Both *in vitro* and *in vivo* experiments showed that this binding not only enhanced HBV

replication but it accelerated the growth of HCC (Feng et al. 2019). Allosteric modifications of HBcAg structure by core protein allosteric modulators (CpAMs) not only inhibit nucleocapsid assembly but also modulate the biosynthesis of cccDNA from *de novo* infection (F. Guo, Zhao, et al. 2017).

Interestingly, HBcAg was also shown to ease the interaction of APOBEC3A and APOBEC3B with the cccDNA, promoting deamination and creation of Apurinic/Apyrimidinic (AP) sites for degradation, respectively up regulated by IFN- α and lymphotoxin- β receptor (LT β R) stimulation (Lucifora et al. 2014).

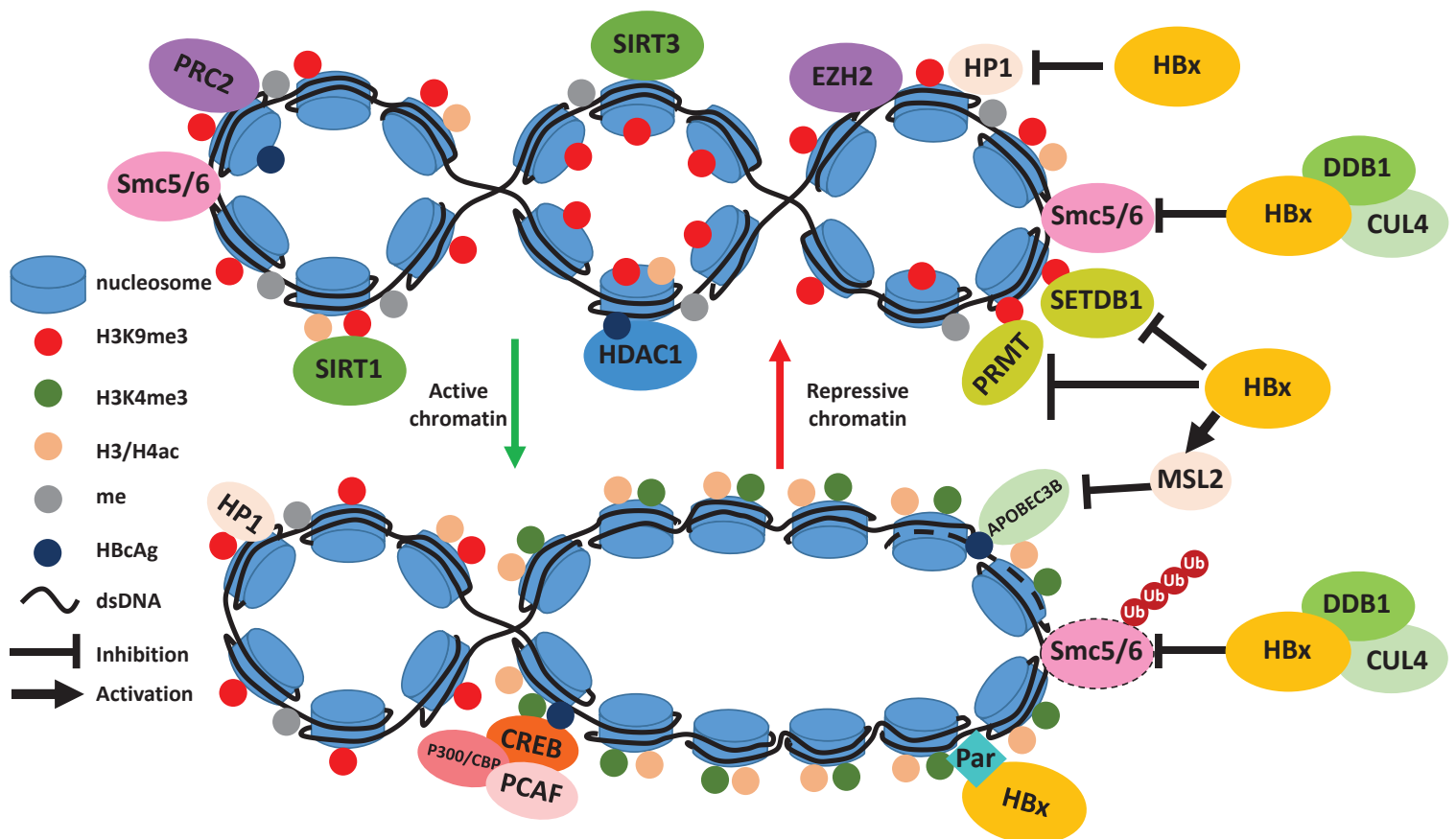

Figure 15: Regulation of cccDNA by histone modifications and transactivation of different transcription factors

Upper panel represents cccDNA under a configuration in which transcription is repressed. Numerous repressive histone marks are present including H3K9me3, and complex proteins induce its silencing, including SIRT1 and SIRT3, EZH2, Smc5/6, SETDB1, HDAC1 or HP1. The lower panel represent cccDNA under an active state of transcription, where numerous active histone marks are present, among those, H3K4me3. Protein complex such as CREB, p300/CBP or PCAF are associated with increase transcriptional activity. Additionally, the role of HBx in the regulation of transcription has been represented. It induces the degradation of Smc5/6, and prevents the repressive role of SETDB1, PRMT and HP1. It activates MSL2, which in turn degrade APOBEC3B, responsible of the cccDNA degradation. Additionally HBx increases the binding of Parvulin proteins (Par) to cccDNA, resulting in transcriptional activation. Adapted from (Z. Wang, Wang, and Wang 2020).

1.2.4.3 Co and post-transcriptional regulation of HBV RNAs

CccDNA serves as a template for viral transcription, and mRNAs are synthesized by polymerase II. All transcripts undergo several modifications to ensure their stability and their expression (7).

1.2.4.3.1 Post-transcriptional regulatory element (PRE)

HBV presents a 3' post-transcriptional regulatory element (PRE), which is a *cis*-acting RNA element of approximately 450 nucleotides encompassing nt 1151 to 1582. It is divided into 3 sub-elements PRE α (nt 1151-1346), PRE β 1 (nt 1347-1457) and PRE β 2 (nt 1458-1582) (Schwalbe et al. 2008; Smith et al. 1998). The three sub-elements synergistically induces the cytoplasmic localization of intron-less surface antigen transcripts without the involvement of any viral protein (Donello, Loeb, and Hope 1998). However, cellular proteins La protein and polypyrimidine tract protein have been shown to interact with PRE in order to increase mRNA stability and nuclear export (Heise, Guidotti, and Chisari 1999; Zang et al. 2001). Two stem loops have been identified by bioinformatics analysis SL α , located in PRE α and SL β located in PRE β (C. S. Lim and Brown 2016).

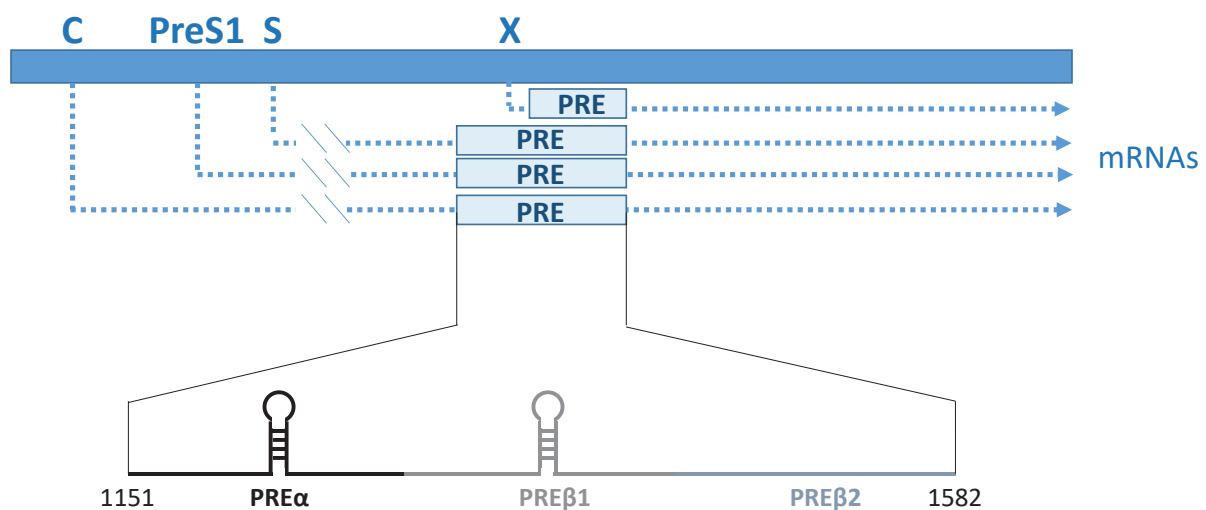

Figure 16: Organisation of the Post-transcriptional regulatory element (PRE)

The PRE domain resides in the 3' region of all viral transcripts. It encompasses nucleotides 1151 to 1582, and possesses three domains: Pre α , PRE β 1 and PRE β 2. Adapted from (Schwalbe et al. 2008).

1.2.4.3.2 RNA tailing

HBV transcripts, as many other viral RNAs, undergo RNA tailing, which is a non-templated nucleotide addition to the 3' end by non-canonical poly(A) polymerases, known as terminal nucleotidyl-transferases (TENTs) (D. Kim et al. 2020). The poly-adenylation signal (UAUAAA) on the terminally redundant genomic transcript of HBV functions poorly, it needs a second encounter with the poly-adenylation machinery to be recognized (Simonsen and Levinson 1983). However, in long poly(A) tails,

guanylation may occur protecting mRNAs from deanylation by CCR4-NOT (CNOT) complex. TENT4A (also known as PAPD7 or TUT5) and TENT4B (also known as PAPD5 or TUT3) are in charge of extending mRNA poly(A) tails with non-adenosine residues, mainly guanosine, in order to generate mixed tails. More precisely, the stem loop SL α binds Zinc Finger CCHC-type containing 14 (ZCCHC14) protein, which in turns recruits TENT4 (D. Kim et al. 2020). The molecule RG7834 has been shown to inhibit the enzymatic activity of TENT4A/B within the ZCCHC14-HBV PRE complex (Hyrina et al. 2019).

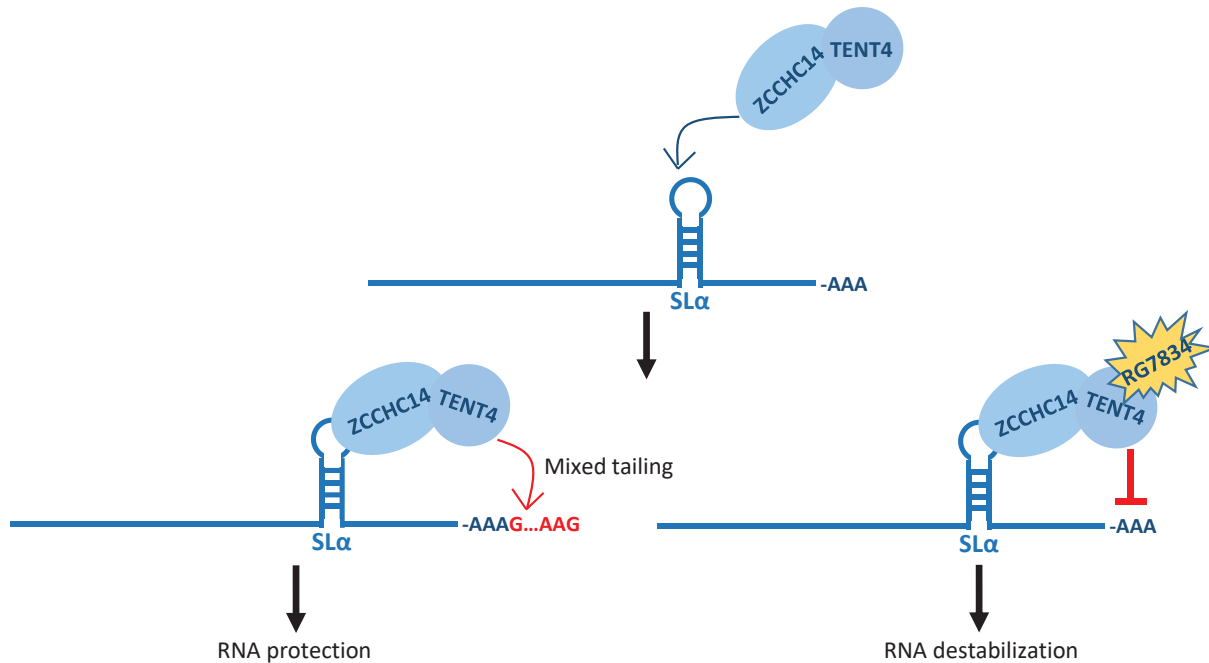

Figure 17: RNA tailing

The stem loop SL α of the PRE domain binds the ZCCHC14 that is able to recruit TENT4, which is in charge of the generation of the mixed tails. RG7834 has been shown to inhibit the enzymatic activity of TENT4A/B, resulting in RNA destabilization. Adapted from (D. Kim et al. 2020) and (Hyrina et al. 2019).

1.2.4.3.3 N⁶-methyladenosine modification

N⁶-methyladenosine modification (m⁶A) is a cotranscriptional modification that regulates numerous aspects of RNA function in eukaryotic cells. m⁶A were found in HBV transcripts both *in vitro* and in liver tissues of chronic HBV patients. Presence of m⁶A at 3'UTRs or within the 3' epsilon loop renders RNAs less stable, therefore affects expression of their proteins. On the contrary, m⁶A at the 5' epsilon loop, which is only present in pgRNA, is required for efficient reverse transcription. m⁶A-modified HBV RNA at A1907 is recognized by YTH-domain family 2 (YTHDF2) and an IFN-induced RNase, ISG20 that induce HBV degradation (Imam et al. 2018).

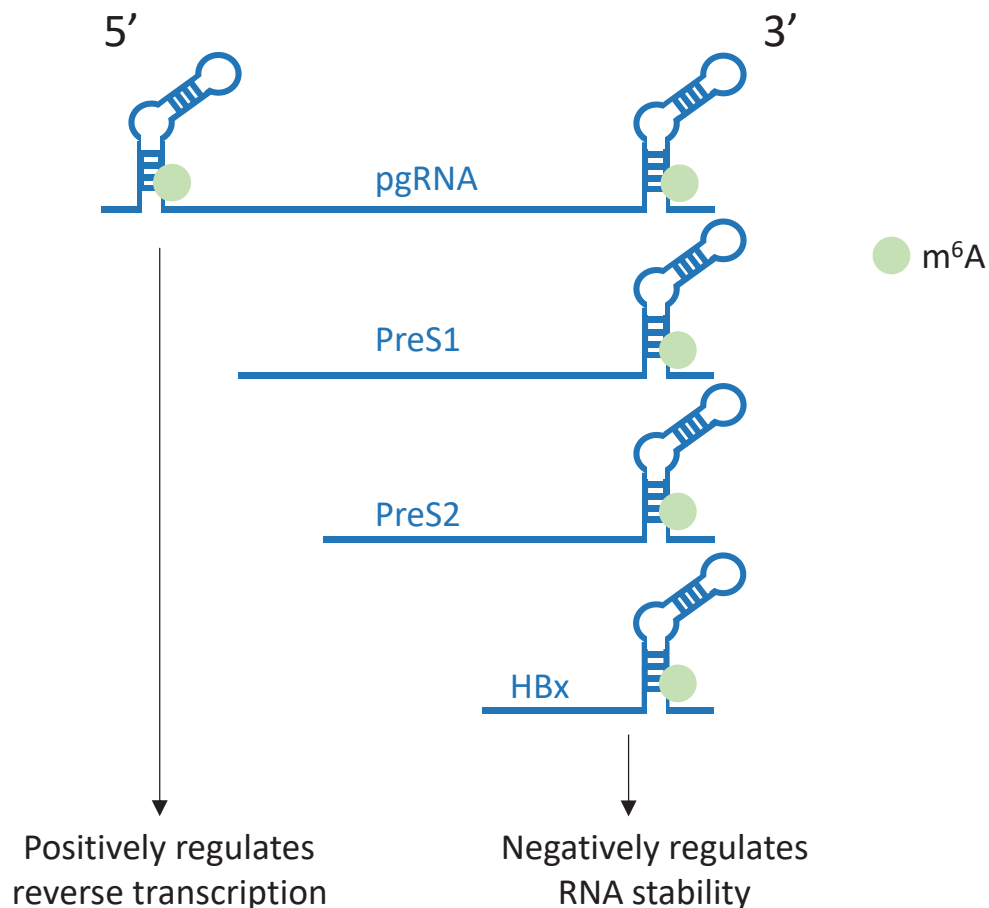

Figure 18: Model for how m⁶A at 5' or 3' epsilon stem loops of HBV transcripts regulates their stability and reverse transcription

Schematic representation of the position of the m⁶A indicated by the green filled circle in all HBV transcripts. It is present at both the 5' and 3' ends of pgRNA and only at 3' ends of the other HBV transcripts. Its position on 5' end of the pgRNA positively regulates reverse transcription, while on 3' ends, it negatively regulates RNA stability. Adapted from (Imam et al. 2018)

1.2.4.3.4 Roles of host factors

Histone deacetylase 5 (HDAC5), an enzyme that removes acetyl groups from histones and non-histones proteins, has been shown *in vitro* to enhance splicing of HBV 3.5 kb RNA, which was associated with a greater stability of both HBV 3.5 kb and spliced 2.2 kb RNAs. The underlying mechanism is not elucidated, and may involve deacetylation of a nuclear host factor regulating stability or splicing (Taha et al. 2020).

The trans-active response DNA binding protein (TARDBP), belonging to the family of heterogeneous nuclear ribonucleoproteins (hnRNPs) that play multiple roles in RNA processing, is known to bind RNA or DNA. *In vitro*, it has been shown to upregulate HBV transcription via direct binding to the core promoter. LC-MS/MS analysis revealed that it may also play a role in transcriptional regulation, RNA

processing, nucleocapsid assembly and could interact with pgRNA to prevent its splicing during nuclear export ([Makokha et al. 2019](#)).

1.2.4.4 PgRNA encapsidation and reverse transcription

TP domain from the viral polymerase binds the epsilon stem loop at the 5' end of the pgRNA to form a ribonucleoprotein complex, which is copackaged into the nucleocapsid by interaction of pgRNA with the C-terminal domain of HBcAg (8) ([Bartenschlager, Junker-Niepmann, and Schaller 1990](#); [Nassal 2015](#)). Host chaperones such as heat shock protein 90 (Hsp90), Hsp40, and heat stress cognate 70 (Hsc70) interact with Pol to optimize its conformation and thus to facilitate this process ([Beck and Nassal 2003](#)).

PgRNA possesses an internal bulge in its the epsilon stem loop that serves as a template for priming and the Pol binding to the pgRNA triggers protein-primed initiation of reverse transcription: a tyrosine residue in the TP domain of Pol at aa 63 is phosphodiester-linked to the short epsilon bulge-templated DNA oligo, which is further translocated to the DR1 sequence at the 3' end of the pgRNA to allow for minus strand DNA synthesis. During synthesis, the pgRNA template is degraded by the RNaseH domain with the exception of the 5' end, which serves as the primer for positive-strand synthesis. While direct extension leads to double-stranded linear DNA, generation of rcDNA is more complex. RNA primer is transferred to DR2 at the 3' terminus and is extended to the 5' terminus of the minus strand DNA, the small terminal redundant sequence allows exchange against the identical 3' redundant sequence on the minus strand DNA, which allows further elongation of the plus strand DNA (9) ([Nassal 2015](#)) (Figure 19). In the meantime, nucleocapsid (HBcAg) undergo a phosphorylation status change, from hyper-phosphorylated (immature capsid) to dephosphorylation (mature capsid) that will allow both interaction with envelope proteins and its entry into the nucleus ([Bruss 2007](#); [Kann, Schmitz, and Rabe 2007](#)).

At this stage, there are two possibilities for the rcDNA in the nucleocapsid: it can be transported to the nucleus thanks to the exposure of the NLS sequence in the CTD of core proteins, this allow the amplification of the cccDNA pool (10a); or it can be enveloped in order to generate new virions (10b).

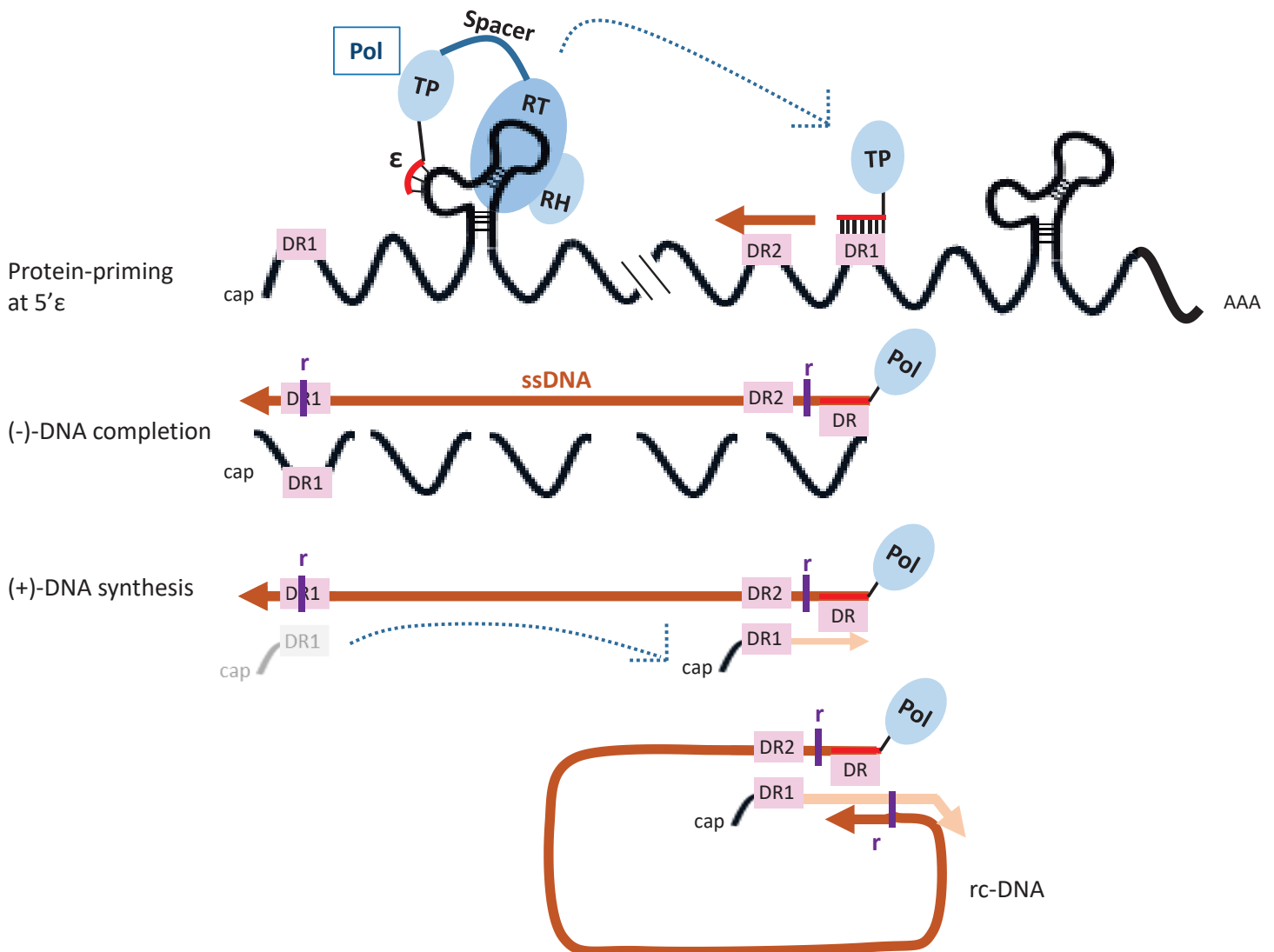

Figure 19: Reverse transcription and rcDNA synthesis

The TP domain of the viral polymerase binds to the internal bulge in the epsilon stem loop at the 5' end of the pgRNA. The short epsilon bulge-templated DNA oligo is further translocated to the DR1 sequence at the 3' end of the pgRNA allowing the minus strand DNA synthesis. During the synthesis, the pgRNA template is degraded by the RNaseH domain with the exception of the 5' end, which further serves as primer for positive-strand synthesis. RNA primer is transferred to DR2 at the 3' terminus and is extended to the 5' terminus of the minus strand; the small terminal redundant sequence allows exchange against the identical 3' redundant sequence on the minus strand DNA, which allows further elongation of the plus strand DNA. DR: Direct repeat; Pol: polymerase; TP: terminal protein domain; RT: reverse transcription domain; RH: RNase H domain; r: small terminal redundant sequence; AAA: poly A tail. Adapted from (Nassal 2015).

1.2.4.5 Assembly and virus exit

Two different pathways are used for virions and subviral particles (SVP) secretion. Nucleocapsids are released into multivesicular bodies (MVBs) where envelope proteins are present. The assembly is facilitated by interaction between nucleocapsid and the PreS1 domain of L-HBsAg. Endosomal sorting complex required for transport (ESCRT) and Vsp4 protein complex are recruited for the budding of the viral capsid at the MVB membrane and their secretion (11) (Selzer and Zlotnick 2015; Glebe and Urban 2007). SVPs are secreted using the general secretory pathway dependent on the Golgi apparatus. First, S-HBsAg assemble into filament within the endoplasmic reticulum and then they are transported to the ER-Golgi intermediate compartment (ERGIC). There, they can be converted into spheres in order to be secreted out of the cells (12) (Selzer and Zlotnick 2015).

Once out of cell, new viral particles can infect other hepatocytes and spread the viral infection in all the liver.

1.3 Models for HBV replication

1.3.1 *In vitro* models

- Primary human hepatocytes

PHH, in particular when they are freshly prepared, represent the most relevant model to study HBV infection *in vitro*; indeed HBV strongly replicates in them, even when they are cultivated in simple 2D conditions (Lucifora et al. 2020). They possess functional metabolic and innate immune pathways rendering them suitable for interaction studies of those pathways with the virus. However, their use is limited due to accessibility to fresh human liver resections, variation between batches, limited life span (1 month) and rapid dedifferentiation (Zeisel et al. 2015).

- Differentiated HepaRG cell line

HepaRG is a bipotent liver progenitor cell line, which is able to differentiate in both hepatocyte-like cells and cholangiocyte-like cells. HepaRG cells can support HBV infection, as they possess NTCP receptor and an entire HBV life cycle can be obtained (Gripon et al. 2002; J. Hu et al. 2019). Like PHH, they possess functional innate immune pathways, making it suitable for further immune studies (Luangsay, Ait-Goughoulte, et al. 2015). However, they present limitations such as a low rate of infection and a long-time differentiation (1 month).

- Human hepatoma cell lines

For years, HBV studies were impaired because of the human hepatocyte tropism of the virus and the difficulty to culture human hepatocytes. To circumvent this, human hepatoma cell lines were used. HepG2, derived from hepatoblastoma or Huh7, derived from hepatocellular carcinoma: they lack the

NTCP receptor, and are therefore transfected by HBV DNA clones, leading to expression of all viral products, as well as the formation and secretion of viral particles. They are mainly used to study later steps of viral replication, after transcription (J. Hu et al. 2019). The recent discovery of the viral receptor NTCP led to the characterization of new cell cultures such as HepG2-NTCP or Huh7-NTCP that can support infection (W. Li and Urban 2016). In those cell lines, innate immune pathways are impaired, rendering them not convenient for immune studies.

- Induced human hepatocyte-like cells

Induced human hepatocyte-like cells (iHep) are obtained from differentiation of human embryonic stem cells, and they have been shown to support complete life cycle of HBV. Despite the fact that they mimic normal hepatocytes better than hepatoma cell lines, their conditions of differentiation may be complicated (Kaneko et al. 2016).

1.3.2 *In vivo* models

Natural infection: Some animals can also be infected by hepadnaviruses that are quite similar to HBV and therefore served as surrogate models to get insights on HBV biology. Among them, they are the woodchuck, (infected by woodchuck hepatitis B virus) and the Pekin duck (infected by duck hepatitis B virus) (J. Hu et al. 2019). However, divergence between viral sequence of those models and HBV restrict their use in HBV researches. *Tupaia* is a non-primate animal susceptible to HBV infection. Despite low levels of HBV replication, *Tupaia* hepatocytes were used to discover HBV receptor, NTCP (Walter et al. 1996; Glebe et al. 2005).

Primate models: Chimpanzees are the only primate to be susceptible to HBV infection and develop cellular immune response similarly to humans. Studies in this model were crucial to develop HBV vaccines in the 1970s. However, due to ethical considerations, studies in chimpanzees is no longer permitted (S. F. Wieland 2015). The recent discovery of NTCP receptor enables appearance of new non-human primate models, including macaques expressing human NTCP, through an AAV-NTCP, that can be infected by HBV (Burwitz et al. 2017). Recently, it has been shown that squirrel monkey (*Saimiri sciureus*) was susceptible to HBV infection, notably thanks to high homology sequence of NTCP between humans and this species (C. Y. Chen et al. 2020). Non-endangered nature of both macaque and squirrel monkey models, render them promising for the *in vivo* study of HBV.

Mice models:

- HBV transgenic mice: models enabling the studies of late steps of HBV replication such as rcDNA synthesis, transcription, viral assembly and virus secretion. Besides, production of all HBV antigens and transcripts are found at similar levels of what is observed in human liver.

However, there is no cccDNA detected during HBV infection in transgenic mice, and they are immune-tolerant, preventing immune studies ([Burwitz, Zhou, and Li 2020](#)).

- Hydrodynamic injection model: obtained with hydro-dynamically injection of a saline solution containing an HBV plasmid or a cccDNA-like minicircle into mouse-tail vein. Viral genome is not integrated into mouse genome, but it is useful for HBV persistence investigations, as well as immune response and pathogenesis studies. However, injection may lead to liver injury rendering results difficult to interpret ([Maura Dandri and Petersen 2017](#)).
- AAV-HBV model: model in which liver-targeted adeno-associated virus (AAV) containing replication competent HBV DNA is injected in immune competent mice by tail vein injection ([Dion et al. 2013](#)). In this model, all HBV viral steps can be studied except viral entry, persistent infection may be observed, recapitulating patients chronic infection features and besides, cccDNA could be detected ([Lucifora et al. 2017](#)).
- Human liver chimeric mice: transplantation of primary human hepatocytes (PHH) into the murine hepatic parenchyma. Two major models have been described so far. Immunodeficient urokinase-type plasminogen activator transgene under the control of mouse albumin promoter (uPA) mice, in which transgene expression results in repopulation of mice liver by PHH resulting in a model supporting HBV infection ([M Dandri 2001](#)). The second model are immunodeficient fumaryl acetoacetate hydrolase (Fah) knockout mice, FRG mice. They present the advantage to be easy to handle and transplantation can be performed at any age ([Azuma et al. 2007](#)).

1.4 Pathogenesis

1.4.1 From acute infection...

HBV is particularly difficult to diagnose. Indeed, primo-infection is generally silent and time before the declaration of the pathology is variable. Acute infection is the first step of the disease, and in approximately two thirds of cases, this phase is asymptomatic. However, the last third of patients may experience jaundice, dark urine, extreme fatigue, nausea, vomiting and abdominal pain. The incubation period of the virus range from 1 to 6 months, and is correlated with the level of virus exposure. Following incubation, a 1 or 2 week pre-icteric phase occurs with general symptoms observed (such as fever, nausea, anorexia and body aches) and high level of serum alanine aminotransferase (ALT), HBsAg and HBV DNA detected. This phase is also characterized by high level of antibodies (IgM) directed against HBcAg and HBeAg, suggesting a high replication rate of the virus. The icteric phase is characterized by jaundice and dark urine, and may last approximately 1-2 weeks during which HBsAg and viral DNA decrease, and become undetectable ([Liang 2009](#)). In 90% of cases,

infection resolves itself via efficient innate and adaptive immune response. A strong T cell response induces the control of infection by expression of antiviral cytokines, and cytotoxic activity; a neutralizing antibody response by B-lymphocytes can also occur ([Lampertico 2017](#)). In less than 1% of cases, acute liver failure can occur, characterized by sudden appearance of symptoms such as disorientation, confusion and coma and a rapid decrease of HBsAg and HBV DNA levels ([Liang 2009](#)). In less than 5% of acute infection in adults will lead to chronic hepatitis, whereas infection during infancy leads to chronic hepatitis in 95% of cases ([WHO data 2020](#)).

1.4.2 ...to chronicity: infection vs hepatitis

Evolution of chronic infection by hepatitis B is divided into five phases taking into account viral factors (HBV DNA or viral load and HBeAg), hepatic factors (ALT) and the presence or absence of liver inflammation. Those five phases establish clear distinction between two main characteristics of chronicity, either infection (with minimal inflammation or immune activity) or hepatitis (driven by inflammation or immune activity) ([Lampertico 2017](#)).

1.4.2.1 HBeAg-positive chronic HBV infection

Patients, positive for HBeAg, present normal ALT levels (under 40 IU/ml), and nor or little liver injury (necroinflammation or fibrosis) is observed. However, high levels of viral DNA ($>10^7$ IU/ml) and hepatocyte proliferation without any liver damage are observed, which might play a role in viral DNA integration phenomenon, leading sometimes to HCC in this early phase.

1.4.2.2 HBeAg-positive chronic hepatitis B

Patients, still positive for HBeAg, develop severe liver injuries associated with high levels of ALT ($>$ ULN, upper limit of normal). The viral load is a bit less important than in the previous phase, but is still high. This stage is characterized by strong to moderate hepatic inflammation as well as fibrosis progression. The evolution of this phase toward HBeAg-negative phase is variable and may last several years; it depends on the ability of patients to produce directed against HBeAg and reduce viral load.

1.4.2.3 HBeAg-negative chronic HBV infection

Patients developed HBeAg seroconversion characterized by the presence of anti-HBe antibodies, present a low viral load ($<2,000$ UI/ml) and a normal ALT level. Those patients present low levels of HBsAg, and seroconversion may even occur in 1 to 3% of cases. Although risk of cirrhosis and HCC remain low in this phase, progression toward chronic hepatitis B may occur.

1.4.2.4 HBeAg-negative chronic hepatitis B

HBeAg-negative patients present a fluctuation of the viral load, high ALT level and severe to moderate hepatic inflammation or fibrosis. HBeAg loss could be also due to mutation in core promoter region of HBV genome, which is therefore associated to a low rate of remission of the disease.

1.4.3 Occult HBV infection

This phase is characterized by absence of HBsAg in the serum, as well as HBeAg seroconversion, and HBsAg in few cases. Patients present a normal ALT level and a low to undetectable viral load. However, cccDNA is still present in patients' liver and reactivation of viral replication may be possible, in case of immunosuppression. Cirrhosis and/or HCC occurrence remain low in those patients, except for those who developed cirrhosis before HBsAg loss.

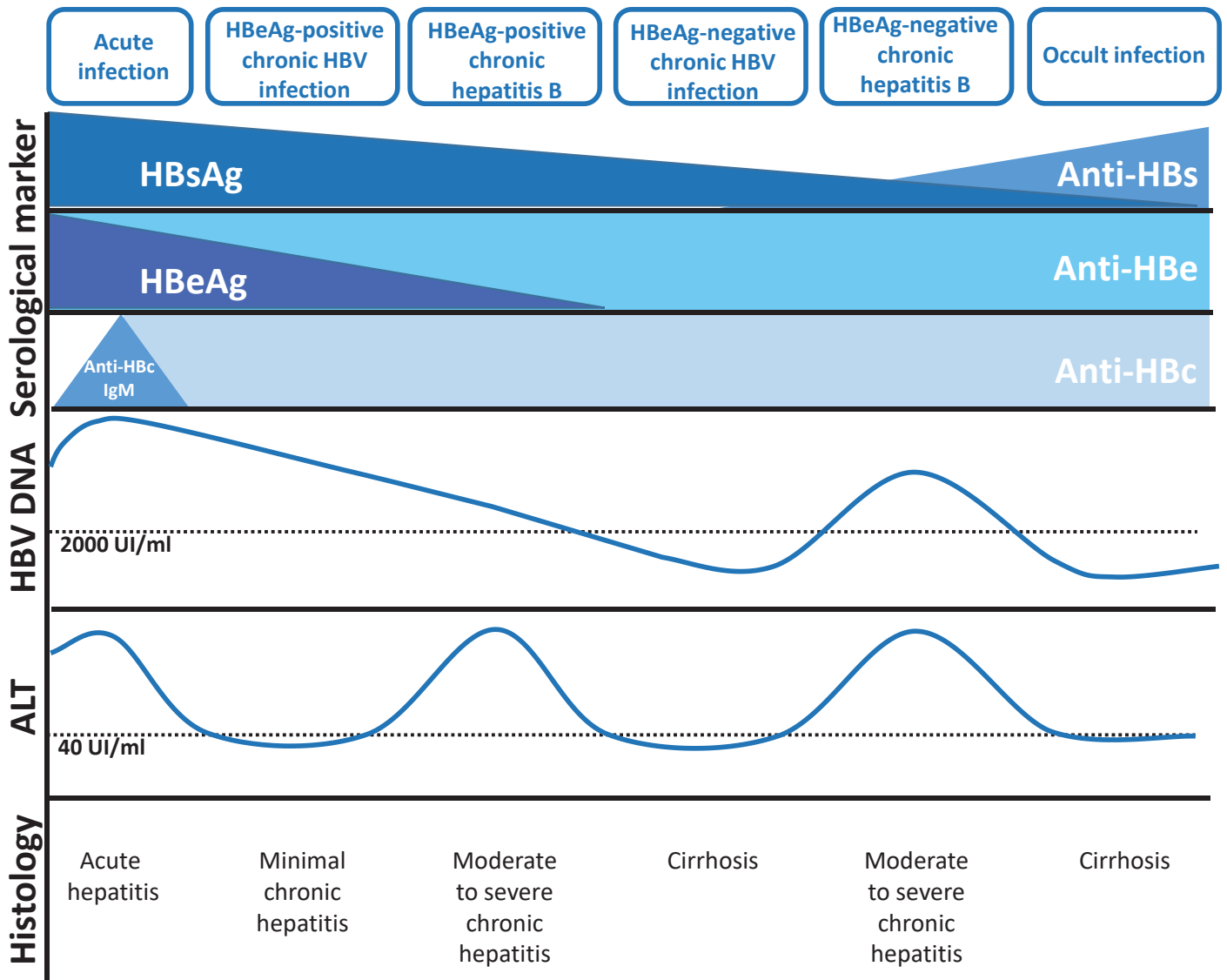

Figure 20: Natural course of chronic hepatitis B infection

Natural evolution of chronic infection by HBV over time with virological monitoring (HBV DNA, HBV antigens), hepatic functions' monitoring (ALT for alanine aminotransferases) and serological monitoring (antibodies anti-HBe, anti-HBs and anti-HBc). Adapted from (Dény and Zoulim 2010)

1.4.4 Severe liver injuries induced by chronic HBV

Chronic hepatitis B virus infection is a high risk factor for development of fibrosis, cirrhosis, and finally HCC. Indeed, HCC caused by HBV is responsible for 50 to 80% of HCC cases in the world (Venook et al. 2010). Risk of progression towards those pathologies is variable and depends of the stage of the disease. The development of cirrhosis in HBeAg-positive patients is around 4-7%, and 2-3% in HBeAg-negative patients if left untreated (van Bömmel and Berg 2013). Cirrhotic patients are at high risk of developing HCC: indeed, in 70 to 90% of HBV-induced HCC cases, patients were beforehand in a fibrotic late stage or cirrhosis (El-Serag 2012). Diverse risk factors are associated to high progression rates such as age of infection, gender, coinfection with another virus, alcohol, exposure to aflatoxin B1, comorbidities (diabetes, obesity), host genetic factors and tobacco (Locarnini et al. 2015). Evolution towards the pathology is also closely linked to host immune response involved against HBV infection. This host immune response is studied in details in chapter 2.

1.4.5 Treatment according to the phase of the disease

1.4.5.1 Currently approved

Currently, the indications for treatment are based on the combination of three criteria: serum HBV DNA levels, serum ALT levels and the severity of liver disease, which determine patients eligible to treatment (mainly treatments based on nucleos(t)ide analogue, NAs):

- All patients with HBeAg-positive or –negative chronic hepatitis B (defined by HBV DNA > 2,000 IU/ml and ALT > ULN) and/or at least moderate liver necroinflammation or fibrosis.
- Patients with compensated or decompensated cirrhosis with any detectable HBV DNA level and regardless of ALT levels.
- Patients with HBV DNA > 20,000 IU/ml and ALT > 2xULN.
- Patients with HBeAg-positive chronic HBV infection older than 30 years.
- Patients with HBeAg-positive or HBeAg-negative chronic HBV infection and family history of HCC or cirrhosis and extrahepatic manifestations.

Treatment is therefore not recommended for patients with HBeAg-positive chronic HBV infection, younger than 30 years, patients with HBeAg-negative chronic infection and serum HBV DNA < 2,000 IU/ml and patients with HBeAg-negative chronic infection and serum HBV DNA \geq 2,000 IU/ml, but a strong monitoring of HBV DNA and ALT levels is required, as well as liver fibrosis assessment (Lampertico 2017).

However, these recommendations have recently been challenged. Patients with HBeAg-positive chronic infection phase, originally called “immune tolerant” (IT) phase, characterized by high levels of circulating HBV DNA and normal ALT level, are not considered for antiviral treatment, because of dormant histological activity and the risk of disease progression is low (Tseng and Kao 2015). However, it has been showed that the IT phase is not immunologically inert, as HBV-specific immune responses can occur (P. T. F. Kennedy et al. 2012). Furthermore, fair proportion of patients have been showed to present significant histologic fibrosis and inflammation, comparable to patient in “immune-active” phase (Lai et al. 2007; Manoj Kumar et al. 2008), suggesting that serum ALT levels is an imperfect surrogate of anti-HBV immunity. Interestingly, HBV-DNA integration and clonal hepatocyte expansion, modifications predisposing to HCC, have been observed in this early phase (Mason et al. 2016); untreated patients from this IT phase being at higher risks of HCC and death/transplantation development than treated patients from the “immune-active” phase (G.-A. Kim et al. 2018).

These results suggest that therapeutic interventions should be considered earlier in the course of infection. A recent study showed that NA therapy for patients with HBeAg-positive chronic HBV infection and have a high load reduces the risk of HCC, despite normal ALT level (Y. Chang et al. 2017).

1.4.5.2 When should immunotherapy be administered?

Patients with HBeAg-positive chronic HBV infection, or IT patients, are not recommended for treatment, however, they are at high risk of developing HCC (G.-A. Kim et al. 2018). A possible explanation might be that patients ,presenting this level of HBV DNA, possess residual HBV-specific T cell immunity (Webster et al. 2004) and persistent activation of few and partially functional T cells is not able to control HBV replication but might be sufficient to sustain inflammation, predisposing to HCC development (Bertoletti, Kennedy, and Durantel 2018). Even if, NA therapies have been shown to suppress liver inflammatory events (Lampertico 2017), but prolonged or even indefinite administration is generally needed. A study showed that administration of an immune stimulator, alpha interferon (IFN- α), combined with NA for one year induced transition from immunotolerance to HBV immune control, characterized by efficient HBV-specific immune responses and prevent viral evasion (Carey et al. 2011). However, considering that IT patients are generally young, the benefits and severe side effects induced by IFN- α (see chapter 3), and the long term administration of NAs should be taken into account (Tseng and Kao 2015). The use of immunotherapies in this “immune-tolerant” phase, prior to the appearance natural inflammation, remains an interesting strategy; it could efficiently boost anti-HBV immunity, needed to control HBV replication, and therefore to prevent inflammation, responsible of HCC development; there is, therefore, a need to develop new immune stimulators.

2. Innate immunity of the liver and its interaction with HBV

2.1 Actors of innate immunity in the liver

2.1.1 Cells and structures responsible of a strong hepatic innate immunity

The liver is the largest organ of the body that accounts for approximately 2 to 3% of the body weight. It plays roles in numerous important physiological processes for a proper functioning and viability of the body. Its main functions are linked to macronutrient metabolism including glucose fabrication, storage and delivery, as well as lipid delivery to the rest of the body. Detoxification is another major role of the liver, allowing elimination of toxic residues and xenobiotic compounds. Besides, it is involved in the destruction and recycling of blood cells, which is linked to blood regulation. It is also involved in endocrine control of growth signalling pathways, and the synthesis of numerous proteins involved in transport, osmosis, or coagulation (Trefts, Gannon, and Wasserman 2017).

Importantly, the liver receives blood from both the systemic circulation and intestine, exposing it to various antigens and microbial products from the intestinal bacteria. In order to defend itself from potential intrusions, it contains numerous immune cells allowing the efficient elimination of pathogens and making it a secondary lymphoid organ (Ian Nicholas Crispe 2009). Besides, the liver is also a tolerogenic organ that can limit hypersensitivity to food-derived antigens and pathogens (Zheng and Tian 2019).

2.1.1.1 Hepatocytes

Hepatocytes are the major parenchymal cells in the liver, accounting for approximately 80% of the mass and volume. They possess a distinct polarity, and their plasma membrane contains three domains: the sinusoidal (basolateral), the intercellular and the canalicular (apical) membranes. The sinusoidal and intercellular domains are in close contact, via the space of Disse, with liver sinusoidal endothelial cells (LSECs), which possess fenestrae allowing the direct uptake of proteins and particles from the sinusoidal blood by hepatocytes. Canalicular membrane contains transporter proteins allowing bile transport (R. J. Schulze et al. 2019). Such characteristics make hepatocytes essential for hepatic metabolic and homeostatic functions, as they such as nutrient uptake, blood detoxification as well as secretion of proteins, lipids and bile. Hepatocytes dysfunction may lead to serious damage and diseases such as haemophilia and jaundice, but they are able to renew in order to prevent liver damage and to restore vital functions of the organism. Hepatocytes also play an important role in liver immunity. Indeed, they express a wide variety of pattern recognition receptors or innate sensors (see 2.1.2), including Toll-like receptors (TLR), or cytoplasmic receptors, allowing an efficient response against pathogens by triggering inflammatory and therefore recruiting/alerting professional immune cells. They are able to secrete proinflammatory cytokines such as interleukin-6 (IL-6) or type I interferon (IFN-I), and even chemokines such IP-10 (Schmidt-Arras and Rose-John 2016; Lercher et al.

2020; Nishioji et al. 2001). Hepatocytes also respond to IL-6, interleukin 1 β (IL-1 β) and other cytokines stimulation, and produce “acute-phase” proteins that kill the pathogen and regulate the immune response. For instance, hepatocytes are able to secrete complement proteins, whose role is to create pores in the membrane of invading bacteria or pathogens to directly kill them or activate immunity by targeting liver non-parenchymal and immune cells (Zhou Zhou, Xu, and Gao 2016). Hepatocytes may act as antigen-presenting cells, directly priming naïve CD8+ T-cells or by cross-presentation, but fail to provide the necessary survival factor to activated CD8+ T-cells resulting in their deletion. *In vitro* experiments demonstrated that under inflammation, hepatocytes could express major-histocompatibility complex (MHC) II leading to CD4+ T-cells activation (Mehrfeld et al. 2018).

Therefore, hepatocytes are immunological agents in their own.

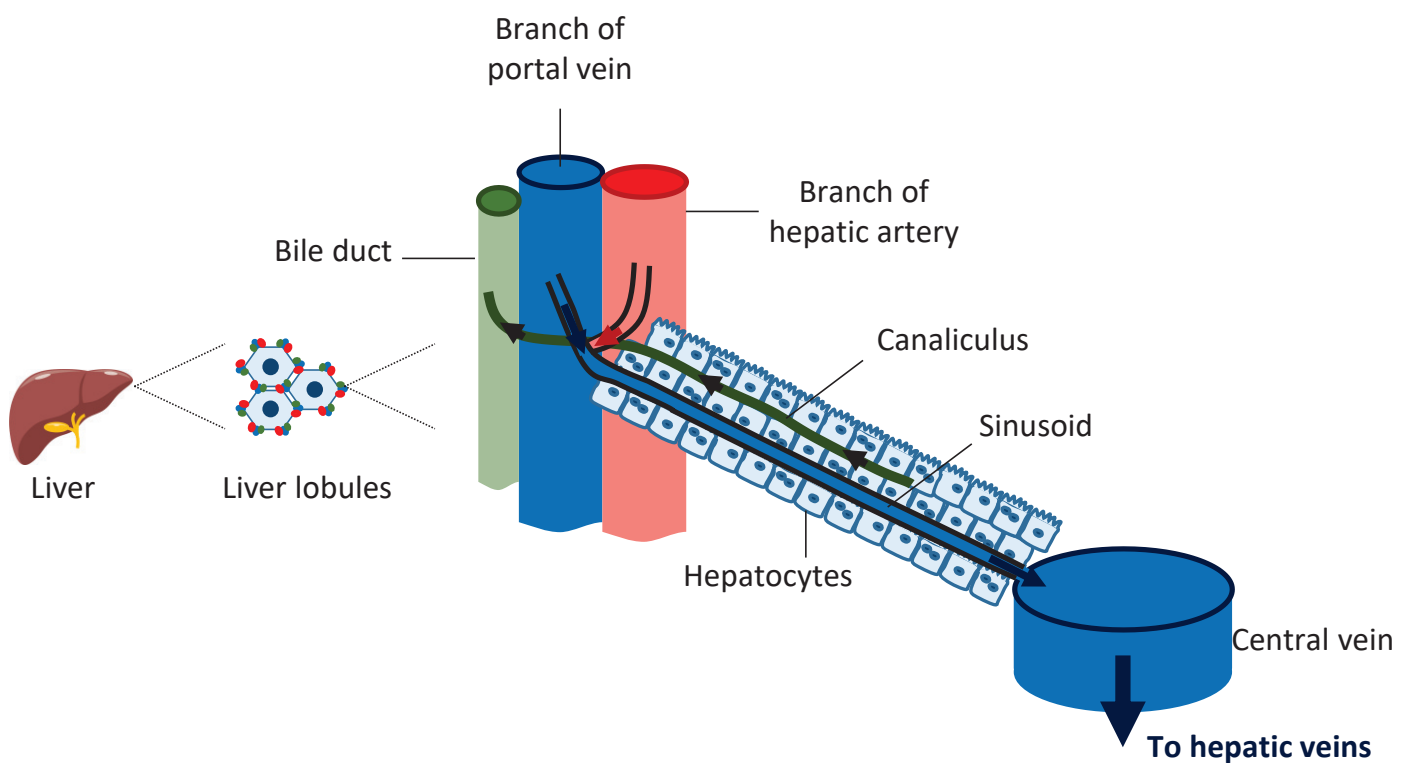

Figure 21: Schematic representation of the anatomy of the liver

Each liver lobe is composed of hepatic lobules in a hexagonal shape, composed of hepatocytes and the central vein in the center. The hepatocytes are arranged in cords with vascular space, called sinusoid, separating them. A portal triad, composed of a bile duct branch, a portal vein branch and a hepatic artery branch, is present at each vertex of the hexagon. Blood flows from the portal vein and the hepatic artery through the sinusoids and ends in the central vein, part of the hepatic vein. Bile leaves the liver in the bile ducts. *Adapted from (Vernon, Wehrle, and Kasi 2021).*

2.1.1.2 Liver sinusoidal endothelial cells (LSECs)

LSECs are endothelial cells that form the wall of the liver sinusoids and represent approximately 15 to 20% of liver cells (3% of the total liver volume). They are the most permeable endothelial cells due to the presence fenestrae in the endothelium and lack of basement membrane, serving for exchanges between blood cells on the one side and hepatocytes and hepatic stellate cells (HSCs) on the other side. Besides, they can scavenge molecules from the bloodstream in a transcytotic manner and transfer them to the hepatocytes surface. LSECs ensure the maintenance of a low portal pressure and inhibit intrahepatic vasoconstriction and fibrosis development by maintaining quiescent hepatic stellate cells (Poisson et al. 2017; Knolle and Wohlleber 2016).

Due to their direct contact with the bloodstream, LSECs are in frontline with pathogens, and thus, LSECs play crucial immunological functions. Indeed, they express scavenger receptors and various TLRs, localized on the plasma membrane at the cell surface or in endocytic compartments, allowing the production of pro-inflammatory cytokines, including IL-6. This release is especially essential to activate the production of complement factors by hepatocytes. Their scavenging function allows them to cross-present endocytosed soluble antigens to CD8 T cells via MHC I.

In addition to this, LSECs express C-type lectin receptors (see 2.1.2.5), such as LSECtin, which are involved in the uptake of pathogens presenting mannose residues on their surface, and therefore their degradation. It has been shown that LSECtin is involved in the inhibition of T-cell activation and proliferation, suggesting that LSECs may play a crucial role in the tolerogenic aspect of the liver (Knolle and Wohlleber 2016).

2.1.1.3 Hepatic stellate cells (HSCs)

Hepatic stellate cells (HSCs) are liver-specific mesenchymal cells counting for approximately 5%-8% of liver cells. Located in the space of Disse, between LSECs and hepatocytes, they are quiescent in a healthy liver and serve as storage for dietary vitamin A in the body. In case of liver injury, they undergo trans-differentiation into contractile myofibroblasts and secrete extracellular matrix, including collagen and proteoglycan, to protect the liver from further damage. However, in chronic liver diseases, repeated activation of hepatic stellate cells may cause the formation of permanent scar tissue, replacing damaged hepatocytes, which results in liver fibrosis and later in cirrhosis (C. Yin et al. 2013). HSC also present immunological functions, as they can act as antigen presentation cells after recognition of pathogen-associated molecular pattern (PAMPs) and damage-associated molecular pattern (DAMPs) by their PRR and is a source of soluble immunological active factors including cytokines, chemokines and interferon- γ that can modulate immune cells properties. Such as LSECs, HSCs are involved in balancing between immunity and tolerance against pathogens, as they can

promote immune-suppressive responses by inhibiting CD8 T cells, inducing regulatory T cells (Treg), and promoting T cell apoptosis via programmed death-ligand (PD-L1). Finally, during regression of liver fibrosis, it has been shown that myofibroblasts may either undergo apoptosis or acquire phenotype similar to quiescent HSC ([Weiskirchen and Tacke 2014](#)).

2.1.1.4 Kupffer cells (KCs)

Kupffer cells (KC) are the resident macrophages of the liver, constituting the largest population of resident tissue macrophages in the body. If liver macrophages can self-renew from resident stem cells during homeostasis, circulating blood monocytes can infiltrate the liver and lead to monocyte-derived macrophages in case of liver injury. However, no specific marker exists to differentiate the two populations of macrophages ([Ju and Tacke 2016](#)).

KCs are localized within blood vessels, in the hepatic sinusoid, and they can pass the sinusoidal fenestrae using pseudopods (cytoplasmic extensions) to interact with hepatocytes. Due to their strategic localization, they play the crucial role of sentinels of the liver, phagocytizing pathogens entering from the portal or arterial circulation. KCs also play a role in the elimination of dead and dying erythrocytes and cells in the hepatic parenchyma. As LSECs and HSCs, they exhibit a tolerogenic phenotype, needed to prevent undesired immune responses, and avoid hepatocellular injury and damage ([Dixon et al. 2013](#)).

KCs present certain plasticity and their mature phenotype is dependent on the local metabolic and immune environment. KCs, and macrophages in general, are historically classified into two extreme polarization: proinflammatory macrophages (also called M1) producing TNF- α , IL-6 or inducible NO synthase (iNOS) and anti-inflammatory macrophages (also called M2) expressing IL-10 ([Gordon and Taylor 2005](#)). This plasticity is crucial to efficiently regulate inflammatory immune responses (phagocytosis, secretion of proinflammatory cytokines, antigen presentation...) and eventual damage reparation (secretion of anti-inflammatory cytokines, elimination of died cells ...). Additional phenotypes for liver macrophages have been identified, such as macrophages inducing resolution of hepatic fibrosis, called scar-associated macrophages ([Fallowfield et al. 2007](#)).

They possess an important function in the innate immune response in the liver. They express various TLRs, such as TLR2, TLR3, TLR9 and TLR4, recognizing PAMPs, inducing either tolerance or activation of macrophages. However, an increased exposure to PAMPs removes the tolerogenic phenotype of KCs and results in an activation of transcription factors such as NF- κ B, activator protein (AP-1) and interferon regulatory factors (IRFs) producing an inflammatory response ([Nguyen-Lefebvre and Horuzsko 2016](#)). Similarly, KCs play the role of antigen presenting cells (APC), as they express MHC class I and II, and can either activate or inactivate specialized immune cells, in particular Natural Killer

(NK) cells depending on innate immune signals they receive ([Ian Nicholas Crispe 2011](#)). Besides, KCs possess functional inflammasomes, such as the absent in melanoma 2 (AIM2) inflammasome or leucine-rich repeat pyrin domain 3 (NLRP3) inflammasome, which induce the secretion of proinflammatory cytokines including IL-1 β and IL-18. Those two cytokines have a strong anti-pathogenic effect and can activate or recruit other immune cells ([Zannetti et al. 2016](#)).

KCs are therefore crucial to maintain homeostasis in the liver, generate a strong inflammatory response in case of danger, recruit and activate adaptive immunity due to their APC role and to restore an equilibrium after an inflammatory state.

2.1.1.5 Innate cells with lymphoid origins

2.1.1.5.1 Natural killer cells

NK cells are a heterogeneous population of innate lymphocytes, playing crucial roles in host defence against microbial infection and are also able to attack and eliminate altered or infected self-cells. They display at least three effector functions contributing in infection control: directly kill infected cells by releasing cytolytic granules, induce apoptosis of the targeted cell via the crosslinking of death receptors and produce immune-modulative cytokines.

They are able to identify and kill tumour-transformed and stressed cells via the decreased expression or the absence of MHC-I on those target cells, known as the “missing-self” principle.

NK cells are found in greater abundance in the liver immune compartment rather than in other tissues and represent approximately 50% of total hepatic lymphocytes. Two populations of NK cells have been described. A population that highly expresses the CD56 marker, (CD56^{bright}), associated with large secretion of cytokines such as IFN- γ , TNF- α or IL-10 allowing the recruitment, activation and regulation of innate and adaptive immune cells; and a population that modestly expresses the CD56 marker (CD56^{dim}) and are specialized in cytotoxic activity. Contrary to peripheral NK cells, which are composed of 90% of cytotoxic NK cells, both populations are present in similar proportion in the liver. CD56^{dim} are able to spontaneously lyse infected or tumour-transformed cells by using perforin, granzyme B and TNF-related apoptosis-inducing ligand (TRAIL)-mediated induction of apoptosis.

NK cells express various receptors on their surface allowing either their activation or their inhibition. Activation receptors include among others Fc receptor for IgG, which eliminate IgG-coated target cells or the NKG2C molecule that binds the stress-inducible MHC class I polypeptide-related proteins A and B (MICA and MICB) on target cells. Killer immunoglobulin-like receptors expressed by NK cells allow their inhibition by recognizing normal levels of MHC class I. Similarly, their activation and inhibition is regulated by cytokines environment ([Doherty 2016](#)).

Several studies showed that NK cells express their own PRR including TLR or RLR, allowing the direct sensing of pathogens, and therefore they can participate with other immune cells to the establishment of an inflammatory response (Oth et al. 2018).

NK cells are therefore crucial in liver immunity, but their activity need to be tightly regulated; immune cells such as dendritic cells endow that role.

2.1.1.5.2 Natural killer T cells

NKT cells are innate-like and tissue-resident lymphocytes named as such because they express specific markers of NK cells and additional T cell receptor (TCR)- $\alpha\beta$ chains. They recognize lipid antigen and can be activated by self or microbial-lipid antigens leading to secretion of pro-inflammatory or anti-inflammatory cytokines and chemokines, which subsequently regulate immune cells functions including DCs, KCs, or NK cells. They are the main producer of IFN- γ . Two types of NKT cells have been described depending of the TCR chains they possess. Their innate-like phenotype allows them to act as a link between innate and adaptive immunities, to respond rapidly to stimuli and regulate immune cells directly or indirectly (S. Zhu, Zhang, and Bai 2018).

2.1.1.5.3 Innate lymphoid cells (ILCs)

Recently described, innate lymphoid cells (ILCs) are a group of heterogeneous innate immune cells that lack antigen-specific receptors and are able to mediate immune responses. They are localized in mucosal surfaces and play crucial role in regulating tissue homeostasis and inflammation. They are divided into three subsets (ILC1, 2, 3) depending on their expression of cytokines.

ILCs are detected in abundance in the liver, mainly ILC1s (95% of total ILCs), producing IFN- γ , high amount of TNF-related apoptosis-inducing ligand (TRAIL) and Fas ligand (FasL), and exhibiting strong cytotoxic activity. Despite their protective role, an excessive activation may lead to chronic pathologies (M. Liu and Zhang 2017).

2.1.1.5.4 Mucosal-associated invariant T-cells (MAIT)

Such as ILCs, mucosal-associated invariant T-cells (MAIT) are newly identified innate-like T cells abundantly found in the liver (10-50% of T cells), which also express TCR- α (in majority) and TCR- β (limited) chains. They promote the liver inflammation by secreting inflammatory and regulatory cytokines, inducing macrophage polarization. They can be activated either by riboflavin metabolites derived from microorganisms presented by MHC class 1-related molecule on APCs surfaces, or by inflammatory cytokines such as IL-12 or IL-18. Such as NKT cells, they are important innate effector cells secreting IFN- γ . However, they may be involved in autoimmune disease to promoting liver fibrosis via enhancing activation of HSCs (Yujue Zhang, Kong, and Wang 2020).

2.1.1.6 Dendritic cells (DCs)

Dendritic cells, characterized by their specific morphology with dendrite-shaped cytoplasmic extension, are a relative rare population of efficient APC in the organism, distributed through lymphoid and non-lymphoid tissues. They have a central role in linking the innate and adaptive immunity and they are involved in the maintaining of homeostasis in the organism. They express multiple PRR including TLR and C-type lectin receptors (CLR) that subsequently lead to production of large amount of cytokines, especially type I and III interferons, and possess the ability to perform antigen cross-presentation and prime T cells. Generally, DCs can be divided into two major subsets depending on their localization, surface markers, molecular phenotype, and antigen-presentation ability: classical or myeloid DCs (mDCs) and plasmacytoid DCs (pDCs). pDCs, expressing TLR7 and TLR9, are important producers of type I interferons (IFNs), mainly IFN- α . mDCs are efficient APC, expressing MHC class II, and can be further divided into two subsets mBDCA1+ and mBDCA3+, the latter being responsible for IFN- λ production through the activation of TLR3 (Ouguia et al. 2019; van der Aa et al. 2015 ; Rahman and Aloman 2013).

In the liver, although rare, hepatic dendritic cells (DCs) are also the most important APC. In a healthy liver, they are typically localized around portal areas, and occasionally in the parenchyma, and are equipped to migrate from liver to lymphoid organs where they present antigens to T cells. They can recruit immune cells either via direct cellular contact or via secretion of cytokines and chemokines.

Resident hepatic DCs may be different from DCs from other tissues due to the environment of the liver, constantly in contact with foreign antigens blood-borne pathogens. Exposition of DC progenitors to anti-inflammatory IL-10 or tumor growth factor (TGF)- β generates suppressive or tolerogenic DCs (A. H. Lau 2003). DCs may play a role in regression of liver fibrosis through regulation of other immune cells (NK cells or HSCs) and by secreting metalloproteinase (Rahman and Aloman 2013).

Despite the fact that those cells remain difficult to study due to their weak survival *ex vivo* and their limit number in samples, it is acknowledged that DCs play a crucial role in liver immunity.

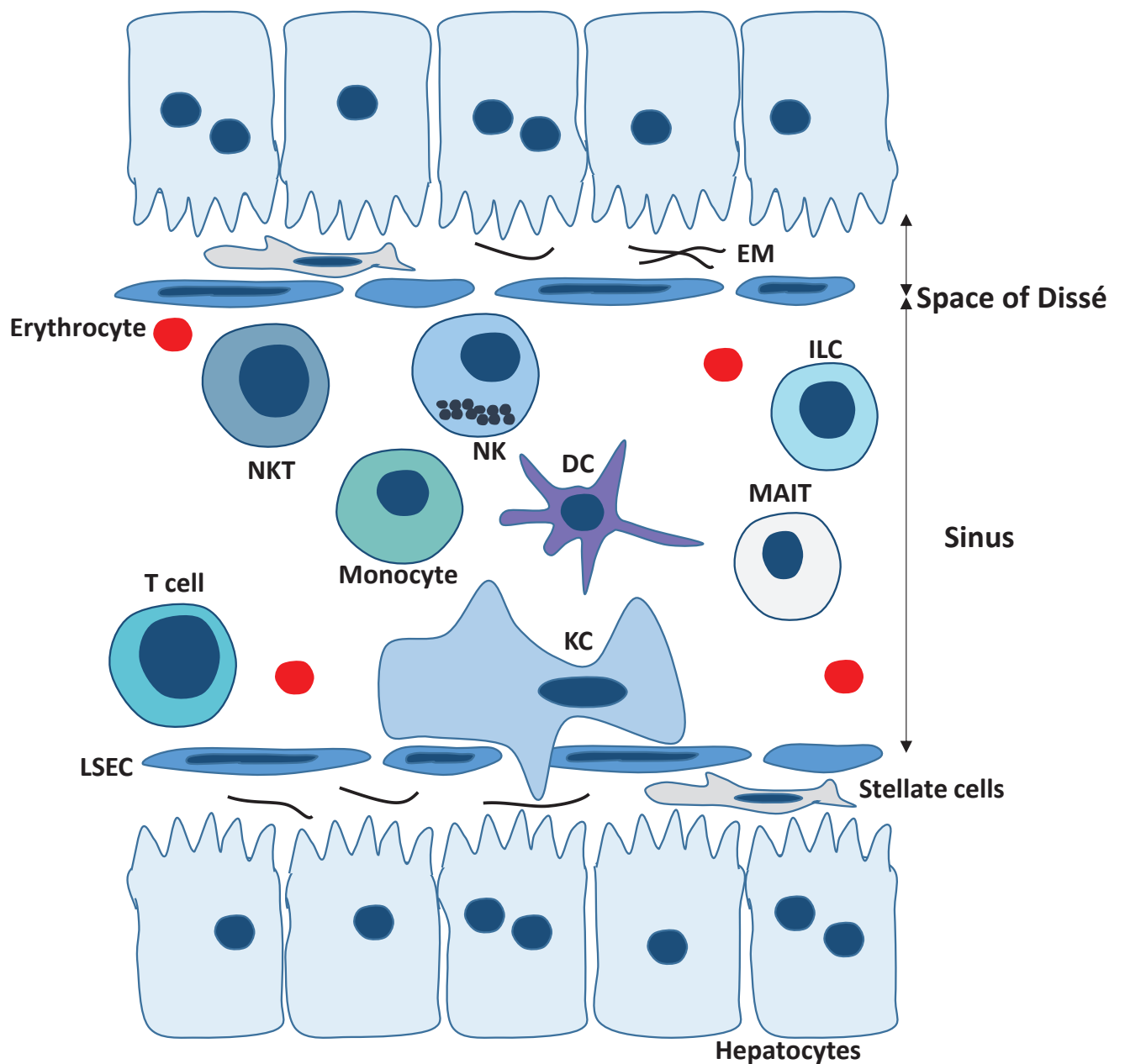

Figure 22: Schematic organisation of the sinusoids

Hepatocytes, the major parenchymal cells of the liver are in close proximity with hepatic stellate cells and liver sinusoidal endothelial cells (LSEC), forming the space of Dissé, in which extracellular matrix (EM) is found. The blood sinus contains immune cells: including liver resident macrophages, the Kupffer cells (KCs), circulating monocytes, dendritic cells (myeloid or plasmacytoid), NK or NKT cells (natural killer and natural killer T receptor), innate lymphoid cells (ILC), mucosal-associated invariant T-cells and different lymphocytes T cells (CD4+, CD8+ or Treg).

2.1.1.7 Intrahepatic myeloid-cell aggregates for T cell population expansion (iMATEs)

The generation of sufficient number of cytotoxic T lymphocytes is needed to control pathogen infection in the liver. However, due to local regulatory cues this expansion may be limited. It has been shown that after a prolonged hepatic inflammation, during PRR activation and viral infection, monocytes-derived inflammatory DCs can form aggregates in the liver, which are functionally and structurally similar to secondary lymphatic tissue. T cells that enter those tertiary structures undergo important proliferation, rendering the liver an expansion site for CD8⁺ T cells and justifying its secondary lymphoid organ status (L.-R. Huang et al. 2013).

2.1.2 Innate immune sensors

Infection by a pathogen leads to an innate immunity response due to the recognition of this intruder by the host. Molecular sensors, called Pattern Recognition Receptors (PRR) allow this recognition via structural or genomic motifs conserved by microorganisms, called Pathogen-Associated Molecular Patterns (PAMPs). Immune cells, such as dendritic cells, macrophages and neutrophils, but also “non-professional” cells, express PRRs. Several families have been described.

2.1.2.1 Toll-like receptors family (TLR)

TLRs are the most described PRR, because they were the first innate immune sensors to be identified in the mid-1990s, as essential receptors for *Drosophila* embryo development (Morisato and Anderson 1994) and their anti-fungal immune responses (Lemaitre et al. 1996). Thirteen mammalian TLRs have been identified, and only ten have been identified so far in human, TLR10 remaining less characterized.

TLRs are type I transmembrane proteins composed of a leucine-rich ectodomain that favours PAMP recognition and attachment; a transmembrane domain and an intracellular Toll interleukin (IL)-1 receptor (TIR) domain required for the signal transduction via the interaction with downstream adaptor proteins. Five adaptor molecules have been described to facilitate TLR signalling: MyD88, TRIF, TRAM, TIRAP/Mal and Sarm1. MyD88 and TRIF are recruited to their respective TLRs via TRAM and TIRAP. MyD88 recruitment induces a cascade of phosphorylation, beginning with interleukin-1 receptor-associated kinase (IRAK) 4, then IRAK 1 and 2. The IRAK complex then interacts with TNF receptor associated factor 6 (TRAF6), which undergoes auto-ubiquitination and further ubiquitinates NF- κ B essential modulator (NEMO). It also activates transforming growth factor- β -activated kinase-1 (TAK1) that is able to phosphorylate IKK α and IKK β , which form the IKK complex with NEMO. This complex further phosphorylates I κ B α , inducing nuclear translocation of NF- κ B subunits, p50/p65, resulting in proinflammatory cytokine production. TRIF-dependent pathway induces downstream kinases TANK binding kinase 1 (TBK1) and IKK ϵ , which activate interferon regulatory factor 3 (IRF3), leading to the production of type I interferon (Caplan and Maguire-Zeiss 2018). All TLRs signal via

MyD88 pathway, except for TLR3, which signals through TRIF. TLR4 is the only one that can signal through both (Farhat et al. 2008).

TLRs can be divided in two classes depending on their cellular localization. TLRs 3, 7, 8, 9 are intracellular TLRs and are exclusively expressed inside endocytic compartments such as endosomes or endolysosomes. They can form homodimers or heterodimers and undergo a conformational change after binding to their ligand (Pandey, Kawai, and Akira 2015). TLR3 can recognize viral dsRNA (either from viral genomes or ssRNA using a dsRNA replication intermediate); it has been shown to recognize several viruses such as West Nile virus (WNV), respiratory syncytial virus (RSV) or herpes simplex virus. It can also recognize the synthetic analog polyinosinic-polycytidylic acid (poly I:C). TLR7, mainly expressed in plasmacytoid dendritic cells, recognize guanosine- or uridine-rich single-stranded RNA (ssRNA) from viruses such as human immunodeficiency virus, vesicular stomatitis virus and influenza virus (Heil et al. 2003; Lund et al. 2004; Diebold 2004). It can also recognize bacterial ssRNA from group B streptococcus (Mancuso et al. 2009). TLR8, mainly expressed in monocytes, mediates the recognition of resiquimod (R-848) and viral ssRNA and is closely related to TLR7, as their genes are highly homologous (Takeda and Akira 2015). So far, TLR9 is the only described TLR to recognize DNA. More specifically, it recognizes unmethylated 2'-deoxyribo(cytidine-phosphate-guanosine) (CpG) motifs frequently found in bacterial or viral DNA. It is therefore a sensor of DNA virus infection such as murine cytomegalovirus, HSV-1 and HSV-2 (Taro Kawai and Akira 2006). In order to avoid detection of host nucleic acids, endosomal TLRs are sequestered in the endoplasmic reticulum in unstimulated cells and traffic to the endolysosomes after ligand stimulation (Y.-M. Kim et al. 2008). The ER-localized protein Unc-93 homolog B1 (UNC93B1), a 12 membrane spanning protein, mediates this trafficking from endoplasmic reticulum to endolysosomes through Golgi complex (Pelka et al. 2018). TLRs finish their maturation in endolysosomes, and they are cleaved by various proteases such as cathepsins, asparagine endopeptidase, and furin-like proprotein convertases (Ewald et al. 2008; Ewald et al. 2011; Park et al. 2008; Sepulveda et al. 2009; Garcia-Cattaneo et al. 2012; Maschalidi et al. 2012; Hipp et al. 2013).

TLRs 1, 2, 4, 5 and 6 are mainly expressed at the external surface of the cell and mainly recognized structural elements from pathogens (proteins, lipids, lipoproteins). TLR4, mainly expressed in macrophages and DCs, is essential for the recognition of LPS, membrane component of Gram-negative bacteria such as *Escherichia Coli* as well as the fusion protein of respiratory syncytial virus (RSV). This activation is mediated either via LPS-binding protein (LBP) and glycosylphosphatidylinositol (GPI)-anchored molecule cluster of differentiation 14 (CD14), or via myeloid differentiation 2 (MD-2) protein (Takeda and Akira 2015). TLR5 is known to recognize flagellin, the major structural protein of bacterial flagella. Neglected for a long time in the liver due to low levels of expression in hepatocytes, KCs and

hepatic DCs, recent studies showed that TLR5 might promote bacterial clearance and protection from chronic inflammatory diseases in the liver ([J. Yang and Yan 2017](#)).

In 1998, TLR2-molecular characterization was published, with other TLRs, and since, numerous researches demonstrated its important role in immunity ([Rock et al. 1998](#)). It is described to form heterodimers with TLR1 and TLR6, and to recognize a wide variety of ligands, including lipoproteins (LP), peptidoglycans, lipoteichoic acids and glycolipids. The latter are expressed by all bacteria, which present a unique NH₃-terminal lipo-amino acid and three (triacyl) or two (diacyl) lipid chains. Triacyl lipoproteins are recognized by TLR2/TLR1, whereas diacyl lipoproteins are recognized by TLR2/TLR6 ([Beutler et al. 2006](#)). Crystallographic studies showed that the leucine-rich-repeats molecules of the TLR ectodomains possess a horseshoe shaped structure, and the heterodimer forms an “m” shaped complex together with the ligand, resulting in a stabilization of the two TLRs. In the absence of ligand, the two TLRs do not interact between their intracellular moieties, resulting in the absence of a downstream signal. Besides, TLR1 ectodomain has been showed to possess a channel able to bind the amide-bound lipid chain of the triacylated LP, channel that is blocked by amino acid residues in TLR6. TLR2 hydrophobic pocket allows the interaction with the remaining lipid chains ([Jin et al. 2007](#)). Heterodimers may be assisted by co-receptors such as CD14, which can either facilitate recognition of triacylated lipoproteins by TLR2/TLR1, or associate with CD36 (cluster of differentiation 36), a ditopic glycosylated plasma membrane protein, belonging to scavenger receptor family, to ensure the recognition of diacylated ligand by TLR2/TLR6 ([Di Gioia and Zanoni 2015](#)). Radioprotective lipoprotein 105kDa (RP105) was also shown to bind mycobacterial lipoproteins, which are TLR2/1 ligands, in order to improve response against this pathogen by acting as an accessory molecule ([Blumenthal et al. 2009](#)). Even if recognition of lipoproteins by TLR2 in the absence of TLR1 or TLR6 was observed, in TLR-knockout mice or using modified ligands, homodimerization has not been observed with current techniques ([Buwitt-Beckmann et al. 2006](#); [Jin et al. 2007](#)) (Figure 23).

2.1.2.2 Retinoic acid-inducible gene-I-like receptors family (RLR)

Retinoic acid-inducible gene I-like receptors are a family of DExD/H box RNA helicases that function as cytoplasmic innate sensors and are able to recognize single or double stranded RNAs, viral or processed self- RNAs. Recently, some studies showed their presence to the cell nucleus ([G. Liu et al. 2018](#)). They induce activation of type I IFN production and of large range of innate immune gene expression to control infection. Three members have been identified so far: retinoic acid-inducible gene I (RIG-I), melanoma differentiation associated gene (MDA5) and the protein Laboratory of genetics and Physiology 2 (LGP2). They are expressed in most tissues and are able to trigger innate immune activation in different type of cells including myeloid cells, epithelial cells, and cells of the central

nervous system. Their expression, maintained at low levels in resting cells, is strongly increased in the presence of IFN and viruses. Concerning their structural aspects, RIG-I and MDA5 are quite similar. They are composed of two caspase activation and recruitment domains (CARD) in N-terminal, a DExD/H box RNA helicase domain with the capacity to hydrolyse ATP and to bind RNA, and a C-terminal domain (CTD) containing a C-terminal repressor domain (RD). The last two domains are essential for attaching and the recognition of foreign RNAs (Loo and Gale 2011). LGP2 only possesses a DEAD helicase and C-terminal domains, and it thought to act as a regulator of RIG-I and MDA5. It can act as a feedback regulator of RIG-I signalling by sequestering immune-stimulatory RNA, preventing the binding between RIG-I and MAVS or inhibiting RIG-I ubiquitylation, and it promotes MDA5-mediated antiviral responses (Mitsutoshi Yoneyama et al. 2005). RIG-I mainly recognizes RNA sequences marked with 5' triphosphorylated ends, which are necessary to define non-self RNA PAMP, whereas MDA5 preferentially recognizes long double stranded RNA possessing a 5' phosphate group or not. This recognition results in the recruitment of MAVS (Mitochondrial Antiviral-Signalling) adaptor molecule (also known as VISA, IPS-1 or Cardif), MAVS then activates TBK1 and IKK ϵ , leading to the activation of IRF3/7 and NF- κ B transcription factors and, finally the production of type I interferon and pro-inflammatory cytokines respectively. Numerous proteins were shown to be involved in RLRs' regulation: the zinc-finger protein ZCCHC3 was shown to act as a co-receptor for RIG-I and MDA5 binding; DEAH-box helicase 15 was shown to bind dsRNA facilitating the ATP hydrolyse by RIG-I and therefore the downstream signal; Riplet, an E3 ligase, was shown to promote RIG-I signalling by inducing aggregates of RIG-I; PACT protein was shown to interact with the CTD of RIG-I and to stimulate its ATPase activity. RIG-I has been shown to be implicated in the recognition of numerous viruses including influenza virus or Sendai virus, and also DNA viruses such as adenovirus, herpes simplex virus that produce small dsRNA during their replication (Rehwinkel and Gack 2020; N. Chen et al. 2017). MDA5 recognizes encephalomyocarditis virus, poliovirus but it was recently shown to be the key sensor for the recognition of HDV, and active replication induces an IFN- β / λ response (N. Chen et al. 2017; Zhenfeng Zhang et al. 2018) (Figure 23).

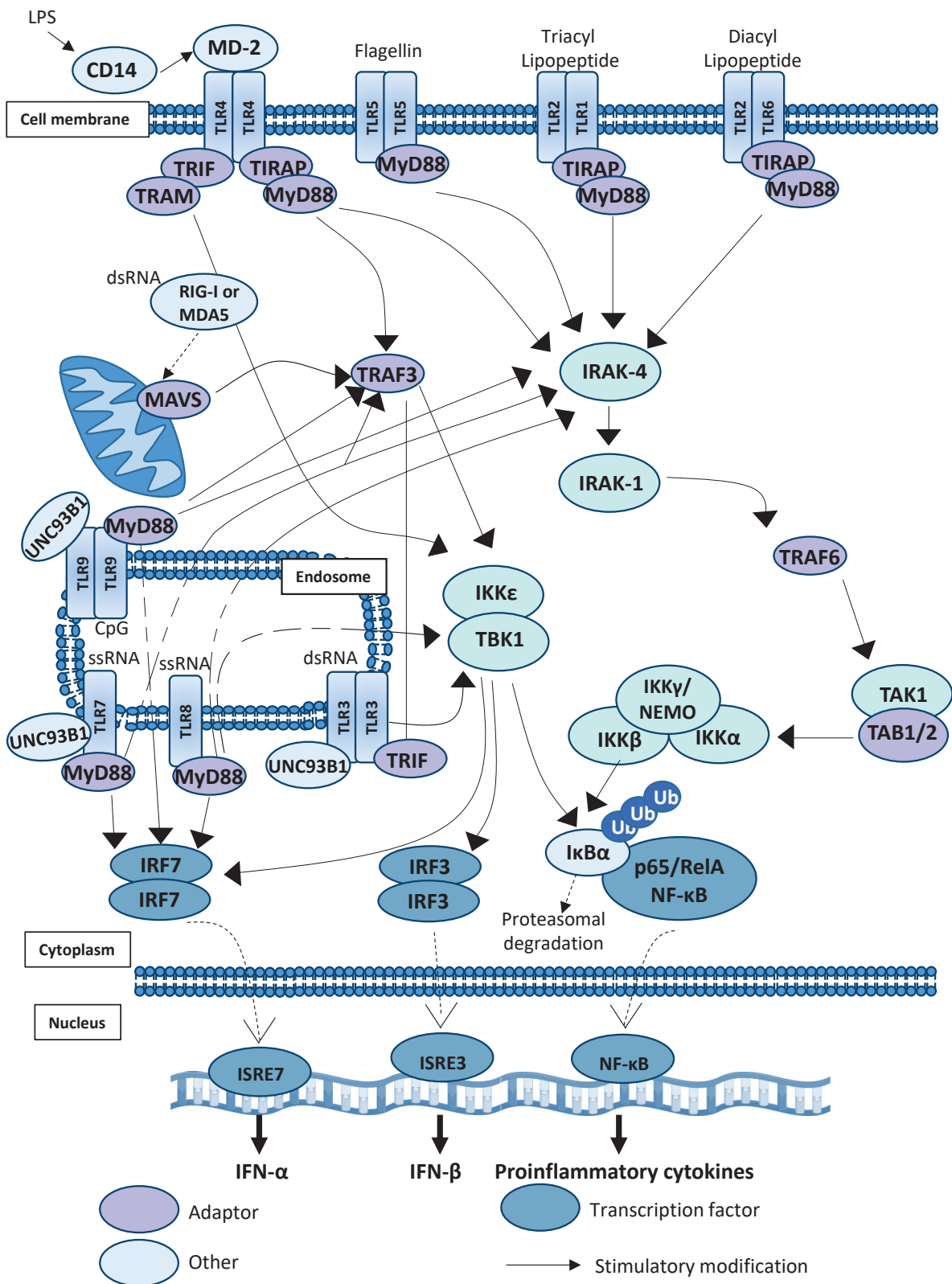

Figure 23: TLR and RLR signalling pathways

Foreign components are recognized by TLRs and RLRs, which recruit adaptor molecules (TIRAP, MyD88 or TRIF), different signalling cascade are then activated leading to the production of interferons and cytokines. dsRNA: double stranded RNA; ssRNA: single stranded RNA; Ub: ubiquitin. Adapted from *Cell Signalling*.

2.1.2.3 Nucleotide oligomerization domain receptors family (NLR)

NLRs family, composed of 22 members are cytoplasmic sensors involved in bacteria detection and sharing similar structural features, in particular a C-terminal leucine-rich repeat (LRR) domain and a nucleotide-binding and oligomerization domain (NOD) but possess different N-terminal domains (Ting et al. 2008). This family can be divided in five subfamilies depending on the nature of the N-terminal: acidic transactivation domain (NLRA), a baculoviral inhibitory repeat-like domain (NLRB), a caspase activation and recruitment domain, CARD (NLRC), a pyrin domain (NLRP) and a NLRX (unknown domain). Their stimulation can induce two signalling pathways, NF- κ B or MAPK-dependent leading to the production of pro-inflammatory cytokines or the activation of multi-protein complexes called inflammasomes. Inflammasomes are assembly of multiple proteins including an NLR, the most common are NLRP1, NLRP3, and NLRC4 (but also non-NLR proteins can also form inflammasome such as AIM2, IFI16 and Pyrin), an adaptor protein apoptosis-associated speck-like protein containing a CARD domain (ASC) and the pro-caspase 1 (Broz and Dixit 2016). The activation of those inflammasomes needs a second signal triggered by the detection of DAMPs (Danger-Associated Molecular Patterns), crystals or microbial toxins in order to produce inflammatory cytokine such as interleukin 1-family (Evavold and Kagan 2019). Activation of inflammasomes can lead to inflammatory programmed cell death, called pyroptosis (Gros Lambert and Py 2018). In particular, NLRP3 recognizes the cytosolic dsRNA/ssRNA of influenza virus and Sendai virus, inducing production of IL-1 and IL-18. NOD1 and NOD2 (also called NLRC2 and NLRC1), are quite different from the other NLRs as they do not induce the inflammasome formation. They recognize bacterial glycopeptides such as iE-DAP (γ -D-glutamyl-meso-diaminopimelic acid) or MDP (muramyl dipeptide), respectively, both found in gram- positive and -negative bacteria. Their activation recruits RIP2 that induces NF- κ B activation, NOD2 is also able to induce MAPK pathway, activating AP-1, which leads in both cases to the production of proinflammatory cytokines. NOD2 is quite similar to RLRs as it possesses two caspase activation and recruitment (CARD) domains, and it was shown to recognize RNAs from respiratory syncytial virus, influenza virus or human cytomegalovirus, which aggregates MAVS, leading to IFN production (N. Chen et al. 2017) (Figure 24).

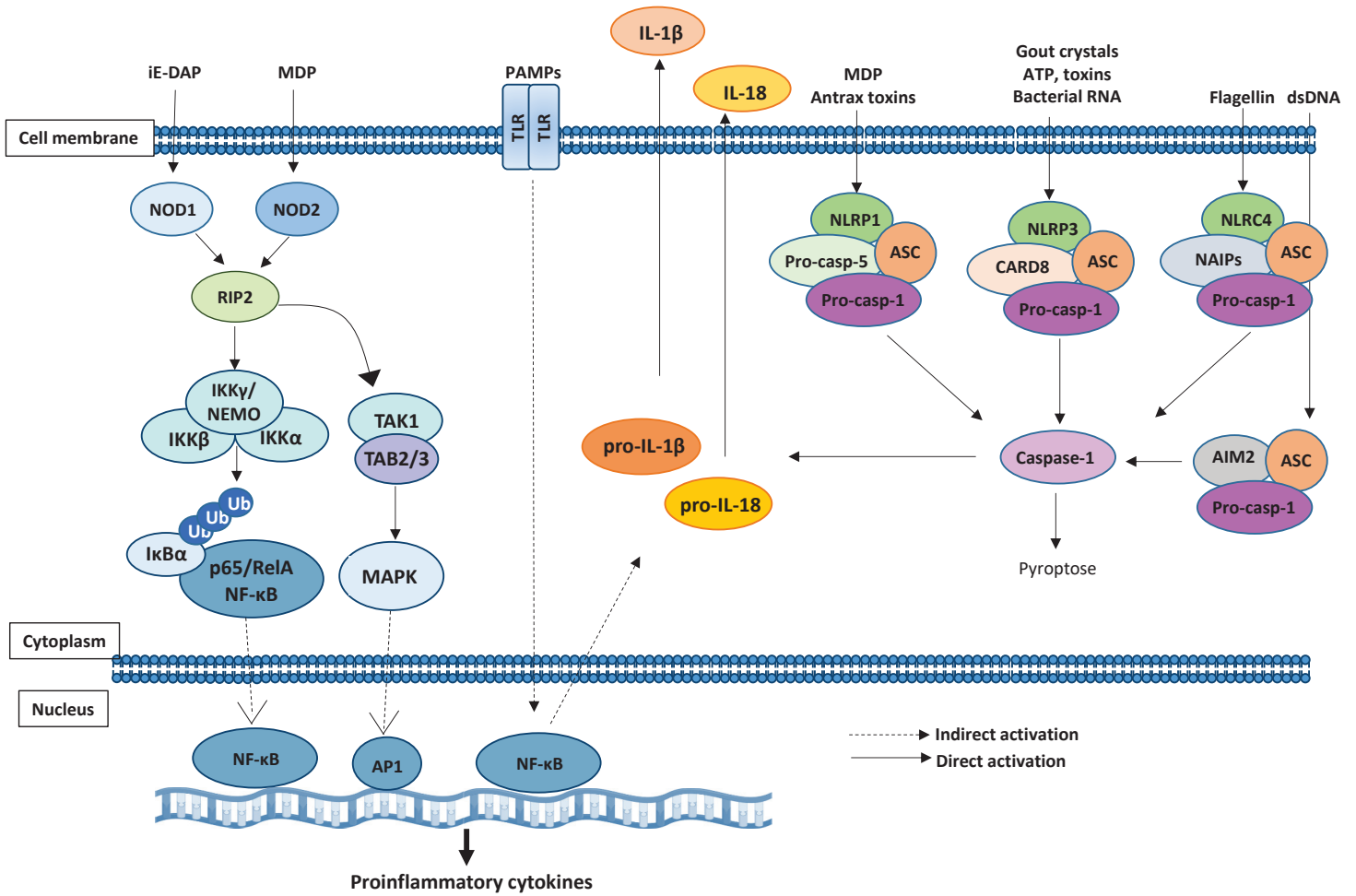

Figure 24: NLR signalling pathway

Activation NOD1 and NOD2 allows the recruitment of RIP2, activating either NF-κB or MAPK signalling pathway, leading to the production of proinflammatory cytokines. Activation of other NLRs induces the recruitment of inflammasomes leading to the maturation of caspase-1, which further promotes the generation of IL-1β and IL-18, with the need of a second signal from TLR activation. Non-NLR proteins such as AIM2 can also form inflammasomes. *Adapted from Invitrogen*

2.1.2.4 Cytosolic DNA sensors (CDS)

For a long period, TLR9 was considered as the only sensor for foreign DNA. Later, the production of interferon was reported in models lacking TLR9, in response to DNA. Since then, the recognition of DNA from plasmids, from dying self-cells or pathogens (virus, bacteria) has been shown to elicit cytokine and IFN-I induction in a TLR-9 independent pathway (Stetson and Medzhitov 2006). Numerous DNA sensors have been identified so far, including absent in melanoma 2 (AIM2), IFN- γ inducible protein 16 (IFI16), leucine rich repeat flightless-interacting protein 1 (LRRFIP1), cGAMP synthase (cGAS), MRE11 or Ku70 (proteins involved in DNA repair), DNA-dependant activator of IFN-regulatory factors (DAI), and stimulator of interferon genes (STING) (Dempsey and Bowie 2015).

STING has recently been described to play a crucial role in DNA sensing either by sensing bacterial derived cyclic dinucleotides (Burdette et al. 2011) or by being an adaptor molecule for other DNA sensors. For instance DAI or IFI16 used STING as an adaptor molecule to induce production of IFN- β (Takaoka et al. 2007; Unterholzner et al. 2010). cGAS induces the production of cyclic-guanosine monophosphate-adenosine monophosphate (cGAMP) in response to DNA stimulation, which itself is recognized by STING. This activation not only lead to endogenous STING activation but was also shown to be involved in the spread of innate immunity from infected cells to uninfected neighbouring cells. This spread is done by the transfer of cGAMP through gap junctions, leading to STING activation and IFNs' production (Ablasser et al. 2013).

Members of DExD/H-box helicase superfamily have been identified as cytosolic DNA sensors, such as DHX9 and DHX36 that induce, using Myd88 adaptor molecule, the production of pro-inflammatory cytokine and IFN via NF- κ B and IRF7 respectively. DDX41, another member of this family, localize with STING to induce IFN β production (Zhiqiang Zhang et al. 2011).

In a STING-independent manner, IFI16 and AIM2 can recruit ASC and procaspase 1 to form inflammasomes after DNA sensing. With a second signal from PRR stimulation, this lead to the expression of IL- β and IL18 (Briard, Place, and Kanneganti 2020).

Those sensors recognize numerous viruses for instance: IFI16 and cGAS are able to detect HIV-1 (Jakobsen et al. 2013; D. Gao et al. 2013); IFI16 detects herpes virus (HSV-1, EBV) (Dempsey and Bowie 2015); DAI recognizes CMV (DeFilippis et al. 2010). Recently, HBV rcDNA was shown to activate DNA sensors in hepatocytes when transfected in sufficient amounts, however, this was not observed in an infection context (Lauterbach-Rivière et al. 2019) (Figure 25).

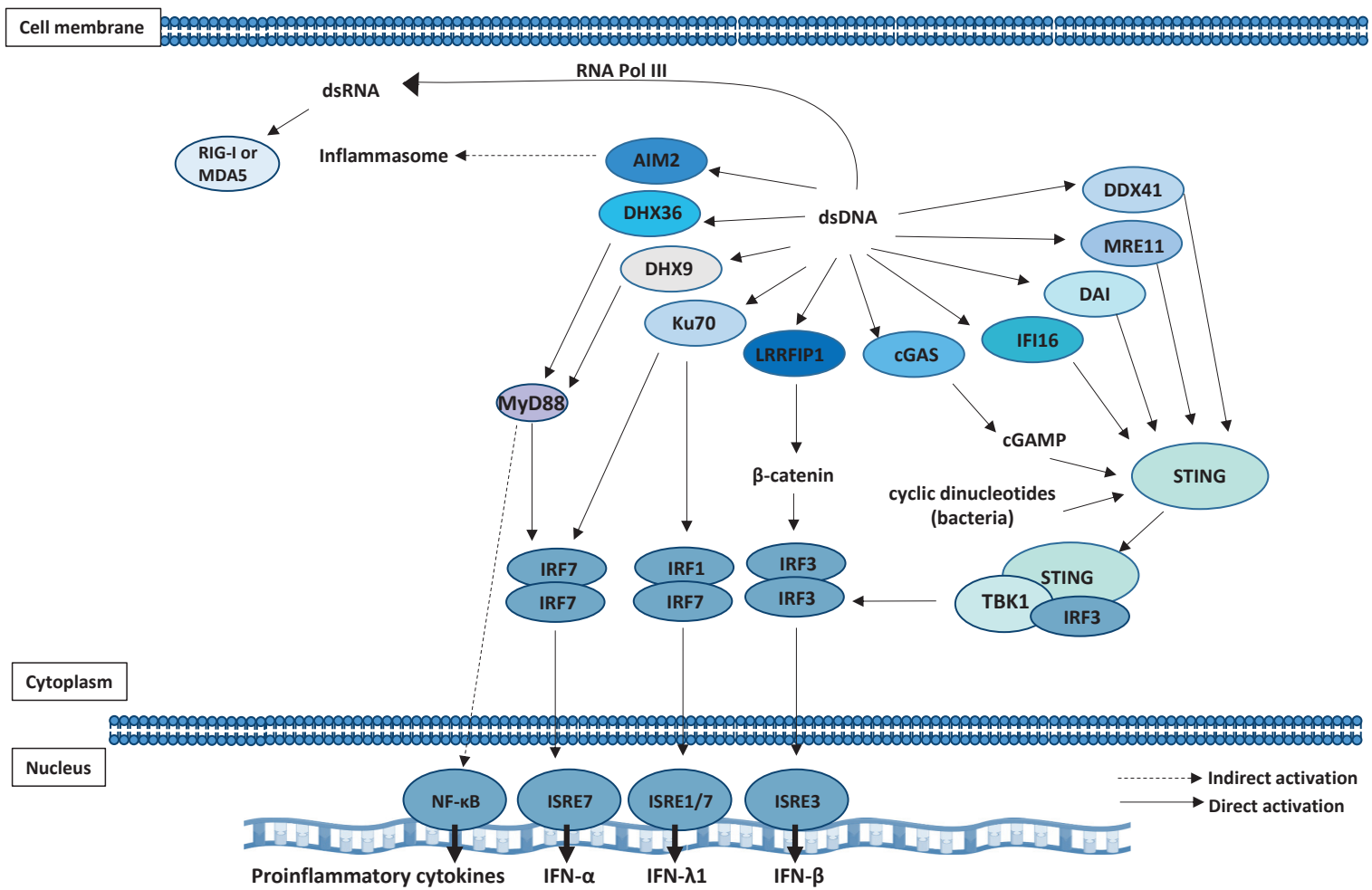

Figure 25: CDS signalling pathway

Foreign dsDNA or altered self dsDNA are recognized by CDS that recruit diverse adaptor molecules (MyD88, STING...), which activate transcription factors (IRF3, IRF7, NF-κB) leading to the production of interferons and proinflammatory cytokines. Adapted from Invitrogen.

2.1.2.5 C-type lectin receptors (CLRs)

C-type lectin receptors are a large family, of transmembrane and soluble receptors acting in cellular adhesion, serum glycoprotein homeostasis, pathogen recognition and innate immunity classified in 17 different groups depending on phylogeny, structural and functional properties (Mayer, Raulf, and Lepenies 2017). They recognize a wide range of pathogens (bacteria, parasite, virus, fungi) via their glycan ligands, proteins, lipids, crystals or inorganic molecules in a calcium dependent manner for most of these receptors (Chiffolleau 2018). They can be divided in four groups depending of their intracellular motifs: hemiTAM motifs (Dectin-1, CLEC-2, CLEC-9A, and SIGN-R3), ITAM motifs (Dectin-2, Mincle, MDL-1, and DCAR), ITIM motifs (DCIR, MICL, and CLEC-12B) and ITAM and ITIM-independent motifs (DC-SIGN, LSECtin, Langerin, DEC-205, and MGL). They do have an impact on immunity at several levels, phagocytosis, production of effector cytokines and chemokines, and to activation of adaptive immunity, as they are mainly expressed by antigen-presenting cells, such as dendritic cells and macrophages. Many of them were shown to signal via the spleen tyrosine kinase (Syk), Raf1 or SHP1/SHP2 activating transcription factors (NF- κ B, NFAT, AP-1), and further inducing the expression of various effectors including pro-inflammatory cytokines (Osorio and Reis e Sousa 2011). However, some CLRs were shown to promote viral transmission and dissemination: DC-SIGN, presents on DCs, mediates endocytosis of HIV-1 and keep virions in multivesicular bodies, which are further disseminate to T-cells (Bermejo-Jambrina et al. 2018). Similarly, DC-SIGN was shown to bind HCV particles and they are then stored in non-lysosomal compartments in immature DCs, which allow their further transmission to hepatocytes (Ludwig et al. 2004)(Figure 26) .

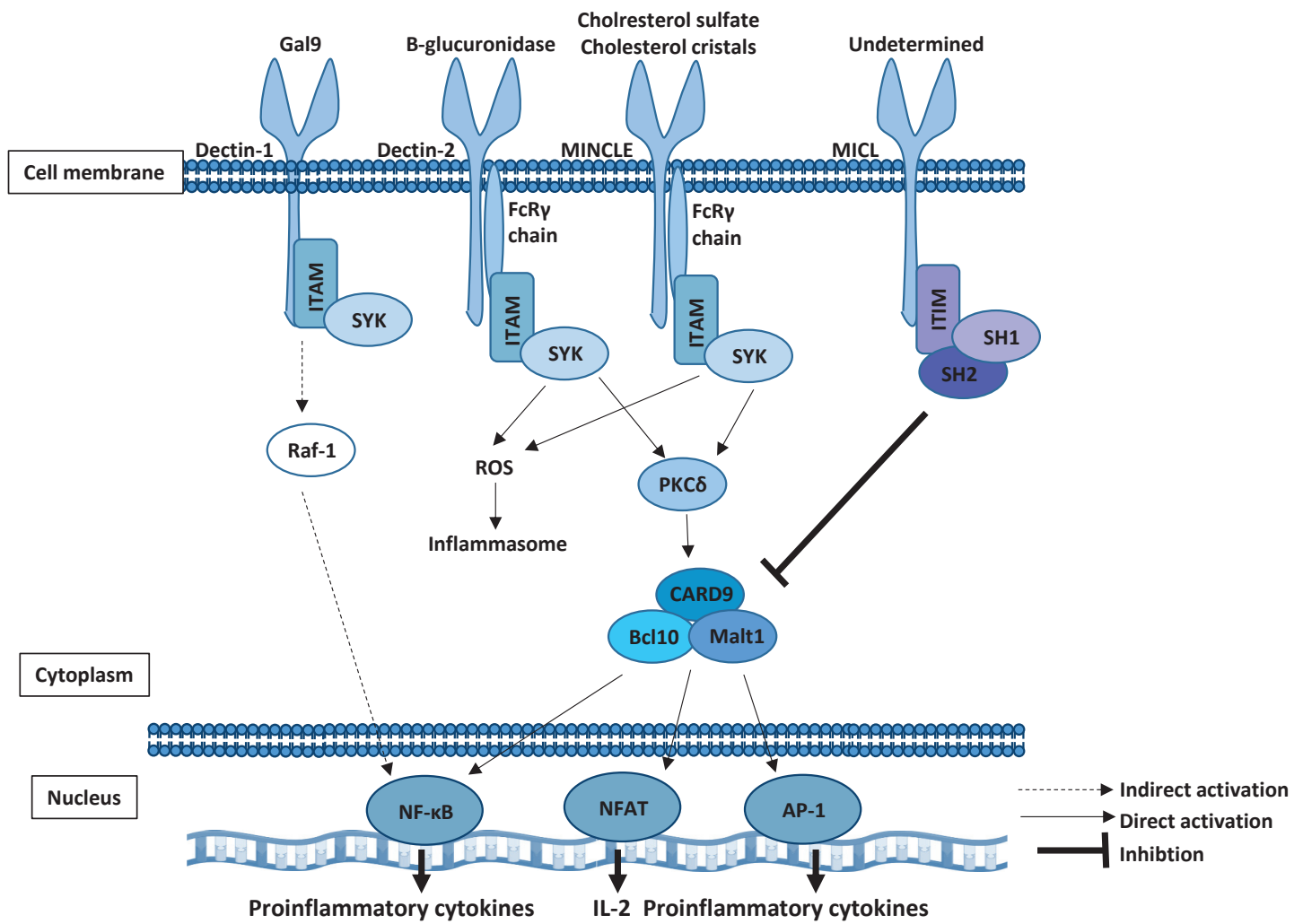

Figure 26: CLR signalling pathway

Foreign compounds are recognized by CLRs, which recruit adaptor molecules (Syk or SH1/SH2), inducing diverse signalling cascades in which numerous complex molecules are involved: Raf-1, PKCγ, CARD9, Bcl10, and Malt1. They induce the recruitment of transcription factors leading to production of proinflammatory cytokines. List non-exhaustive of CLRs. Adapted from (Chiffolleau 2018).

2.1.3 Downstream signalling pathways

2.1.3.1 NF- κ B signalling pathway

2.1.3.1.1 NF- κ B family, structures and dimers

In 1986, Sen and Baltimore identified a protein, able to interact with a defined site in the κ immunoglobulin enhancer and to be induced by stimulation with lipopolysaccharide (LPS) in B lymphocytes; thus, they called it NF- κ B (Nuclear factor κ light chain enhancer of activated B cells) (Sen and Baltimore 1986). Since then, numerous studies have been realized to pursue the biology of this family of transcription factors. NF- κ B transcription factors are key actors of many physiological processes such as innate and adaptive immune responses, cell proliferation, cell death and inflammation. However, aberrant regulations of NF- κ B signalling pathway is source of numerous pathologies, including cancers, inflammatory and auto-immune disease (Baud and Karin 2009), highlighting the need of a perfect understanding of this family and dynamic of signalling pathways that it induces.

The NF- κ B family possesses five members, p65 (also called RelA), RelB, c-Rel, p105 and p100. Both proteins p105 and p100 require proteolytic cleavage to produce the active proteins p50 (NF- κ B1) and p52 (NF- κ B2), respectively. They all undergo posttranslational modifications such as phosphorylation, ubiquitination or proteolytic cleavage important for their biological functions (L. Zhang et al. 2019).

All family members possess a Rel homology domain (RHD), which is 300 aa and able to recognize a DNA sequence with a consensus of 5'-GGGRNWYYCC-3' (N for any base; R for purine; W for adenine and thymine; Y for pyrimidine). Its N-terminal subdomain contains the DNA-binding domain and specifies DNA recognition and its C-terminal subdomain possess hydrophobic residues responsible of the homo- or hetero-dimerization with other NF- κ B family member and the binding to inhibitory proteins. Following the RHD, a nuclear localization sequence is present, responsible of their nucleus translocation. This family can be further divided into two class:

- p65, RelB and c-Rel that possess a transcription activation domain (TAD), needed to activate target gene expression. This domain is missing in p105 and p100 proteins, as well as in their active forms p50 and p52, which render them unable to activate gene transcription.
- p105 and p100 that contain ankyrin repeats (AnkR), of 33 aa in C-terminal subdomain and death domains (DD), post-translationally cleaved to form p50 and p52 respectively.

In addition, RelB possess a leucine zipper (LZ) domain, whose function is not clearly defined yet (Figure 27) (Q. Zhang, Lenardo, and Baltimore 2017).

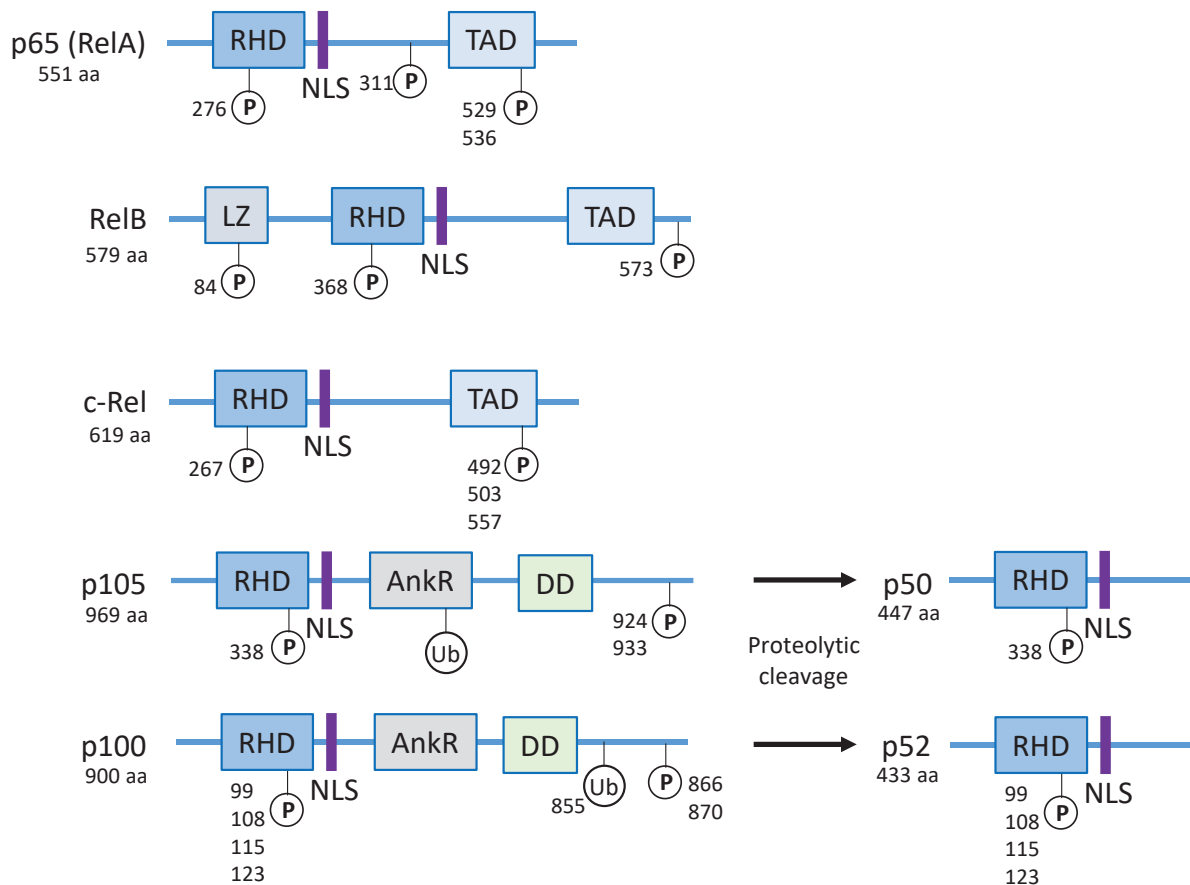

Figure 27: Structures of NF-κB family member

Each family member share the Rel homology domain (RHD), responsible of DNA recognition and binding, dimerization and binding to inhibitory proteins. p65, RelB and c-Rel contain a transactivation domain (TAD) essential for transcription activation. p105 and p100 proteins possess ankyrin repeats, separated from RHD by glycine-rich regions, and death domains (DD). After maturation, p105 and p100 are cleaved to form active protein p50 and p52, respectively. RelB also contains a leucine zipper (LZ) domain. Regulatory phosphorylation (P) and ubiquitination (Ub) sites are shown, as well as the number of amino acids (aa) contain in each protein. *Adapted from (Q. Zhang, Lenardo, and Baltimore 2017).*

The NF-κB subunits, forming homo- and hetero-dimers, are kept inactive in the cytoplasm by inhibitor of κB proteins (IκB), including IκBα, IκBβ, IκBε, Bcl3, IκBζ, and IκBNS, which mask then NLS. Similarly, C-terminal extremities of p105 (IκBγ) and p100 (IκBδ) are responsible of this NLS masking (Ghosh et al. 2012). The first step of NF-κB activation involves modifications of IκB, occurring via two well-defined pathways: canonical and non-canonical pathways (detailed in next paragraphs). The most well-known and studied NF-κB dimer is p50/p65, but several other dimer combinations with different and important functional outputs exist. Dimers containing TAD domain are activator dimers while others have a repressive activity (Concetti and Wilson 2018).

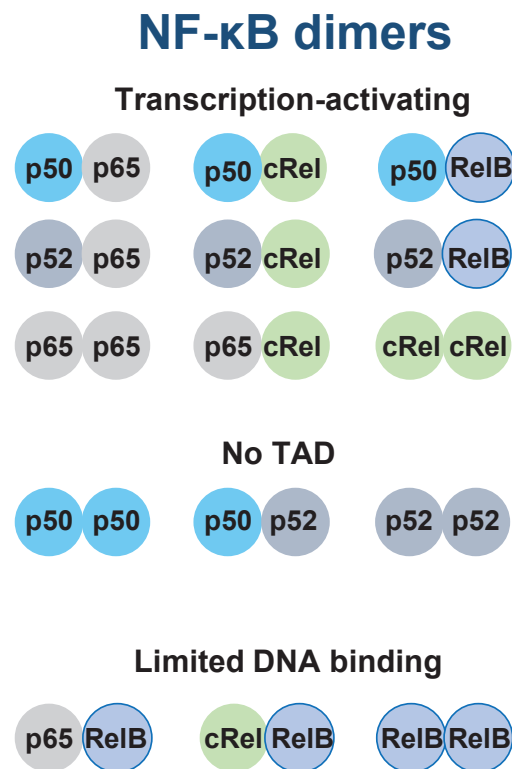

Figure 28: Dimeric combinations of NF- κ B subunits

Dimers are divided into three groups. Dimers containing only p50 and 52 in a homo or hetero dimers do not possess any transcription activation activity. RelB homo-dimers or RelB in heterodimers with RelA or c-Rel possess a transcription activation activity, but their binding to DNA is limited. Other potential dimers are transcriptional activators. TAD= transcription activation domain. *Adapted from (Concetti and Wilson 2018).*

2.1.3.1.2 Canonical Pathway

Numerous cell surface receptors activate the canonical NF- κ B pathway, such as T-cell receptor (TCR), B-cell receptors, TLRs, cytokines and growth receptors. Its activation generally occurs early and transiently during immune activation, and leads to cell proliferation, survival and inflammatory cytokine production (IL-1, IL-6, Tumor necrosis factor alpha (TNF- α)...) (L. Zhang et al. 2019). This pathway is regulated by an IKK complex, composed of NEMO (also known as IKK γ) and two I κ B kinases (IKK α and IKK β). In resting cells, NEMO prevents the activation of both I κ B kinases. They are activated in a different way according to the upstream receptor stimulated:

- TNF receptor engagement induces the recruitment of TRADD (Tumor necrosis factor receptor type 1-associated DEATH domain protein), TRAF2 (TNF receptor-associated factor 2), cIAP (cellular inhibitor of apoptosis protein 1), TAB (Transforming growth factor β -activated protein kinase 1 (TAK1)-binding protein) and TAK1 (Transforming growth factor beta-activated kinase

- 1) proteins into a big complex with the linear ubiquitin assemble complex (LUBAC), which further incorporates NEMO/ IKK α /IKK β (Q. Zhang, Lenardo, and Baltimore 2017).
- Activation of NF- κ B pathway by IL-1R or TLR induces the association of IRAK1/2 and IRAK4 to the adaptor molecule MyD88 to form a complex, called Myddosome. This complex autophosphorylates and is further K-63 ubiquitinated by Pellino-3 (Butler, Hanly, and Moynagh 2007). This complex induces the association and activation of the E3 ubiquitin (Ub) ligase TNF receptor-associated factor 6 (TRAF6). TRAF6 then complexes with TAK1-complex, composed of TAK1 and TAK-1 binding protein 1 (TAB1) and TAB2/3, which further stimulate the activation of IKK complex (Balka and Nardo 2019).

TAK1 then activates IKK α and IKK β , which in turn phosphorylate the NF- κ B inhibitor I κ B α , leading to ubiquitin-dependent I κ B α degradation. The unmasked NLS signal allows NF- κ B dimers to be imported to the nucleus to regulate the transcription of numerous genes (T. Liu et al. 2017). Even if all NF- κ B dimers can be involved, p50/65 remains the most common and most abundant hetero-dimer activated by the canonical pathway (Giridharan and Srinivasan 2018) (Figure 29).

Negative feedback loops ensure the termination of the NF- κ B response, in an organized manner. Some proteins, such as I κ B α and A20 (also called TNFAIP3 for tumor necrosis factor, alpha-induced protein 3), are produced by NF- κ B activation, to terminate NF- κ B response. In addition, NF- κ B response can be prevented at all levels of this signal-transduction cascade via inhibition of the receptor, inhibition of signal transducers, reversing post-translational modifications, degradation of signalling proteins or inhibition of NF- κ B nuclear activity (Renner and Schmitz 2009).

2.1.3.1.3 Non-canonical Pathway

Another signalling pathway, called non-canonical or alternative pathway, has been described to modulate NF- κ B dimers activity, based on the processing of p100 and the predominantly activation of the dimer RelB/p52. It responds to different ligands of TNFR superfamily members such as LT β -R, BAFFR, CD40 and RANK (T. Liu et al. 2017). A central component of the non-canonical pathway is NF- κ B-inducing kinase (NIK) (Sun 2017). In steady state, NIK is targeted for degradation by cIAP-TRAF2-TRAF3 E3 ubiquitin ligase complex, to avoid NIK accumulation and activation of downstream signalling pathway. Stimulation of receptors of TNFR family induces the recruitment of cIAP-TRAF2-TRAF3 to the receptor complex, resulting in TRAF3 degradation, and both stabilization and accumulation of NIK. It is then able to phosphorylate IKK α , which dimerizes. The association NIK-IKK α phosphorylates serines residues; including Ser866 and Ser870 that are essential for p100 processing. These phosphorylations allow the recruitment of the E3 ubiquitin ligase β TrCP, which further induces the p100 ubiquitination

and the generation of p52, allowing the p52/RelB hetero-dimer to enter the nucleus to activate transcription of numerous gene (Yu et al. 2020) (Figure 29).

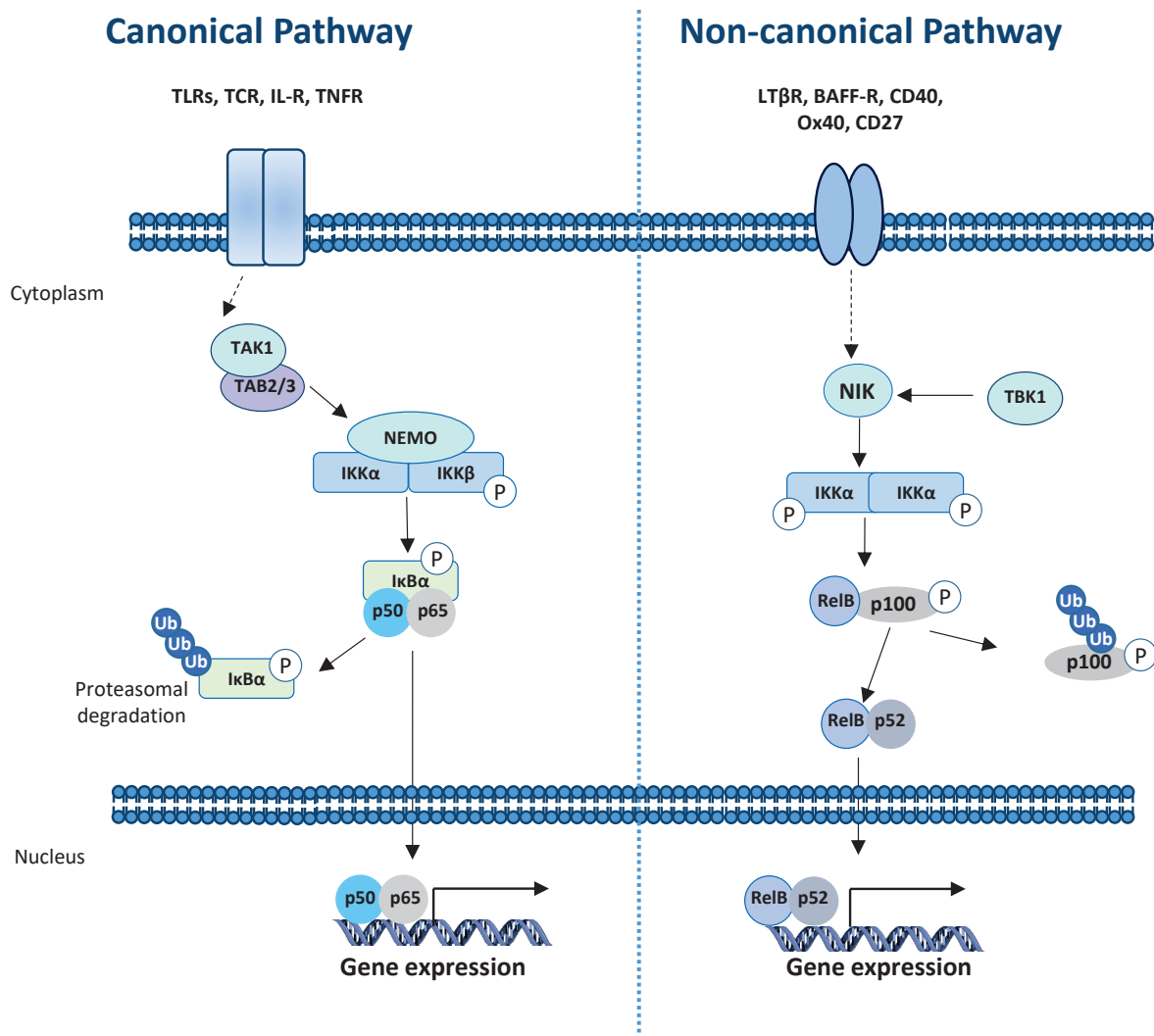

Figure 29: Canonical and non-canonical NF-κB signalling pathway

NF-κB signalling pathway can be induced by two distinct sub-pathways. In canonical pathway, repressor of IKK, NEMO, is poly-ubiquitinated and degraded. IKKα/IKKβ complex phosphorylate IκBα that dissociate from NF-κB dimer p65:p50. NF-κB dimer is imported to the nucleus and act as a transcription factor. In the non-canonical pathway (also called alternative pathway), NIK phosphorylates IKKα that dimerize, and phosphorylates in turn p100. This causes proteolytic cleavage of p100 and the generation of p52. P52: RelB dimer is then translocated to the nucleus and act as a transcription factor. Dashed arrows indicate previous steps not represented in this figure. Adapted from (Yu et al. 2020).

2.1.3.1.4 Functions of NF- κ B signalling pathways

2.1.3.1.4.1 Mediator of inflammation and activation of innate immune cells

Inflammation is a protective process in response to host infections and tissue damage, characterized by vasodilatation, allowing both the recruitment of immune cells to the injured tissue and secretion of pro-inflammatory cytokines and chemokines. NF- κ B plays a crucial role in this inflammation process. Innate immune cells, including macrophages, dendritic cells and neutrophils express PRRs able to recognize different PAMPs and DAMPS (as previously described) to activate NF- κ B pathways, leading to the transcriptional induction of pro-inflammatory cytokines, chemokines and inflammatory mediators (T. Liu et al. 2017). NF- κ B activation leads to the release of mediators, including TNF- α , allowing vasodilation and recruitment of circulating leukocytes to the site of infection (Alcamo et al. 2001). This response is tightly controlled by the release of anti-inflammatory mediators and the induction of leukocyte apoptosis during resolution of inflammation (Lawrence et al. 2001).

Furthermore, macrophages are rapidly activated upon stimulation by PRRs and are mainly differentiated into M1 macrophages, responsible of the production of a large number of pro-inflammatory cytokines, including IL-1 β , IL-6, IL-12, TNF- α and cyclooxygenase-2 and chemokines. IL-12, IL-23 and TNF are mainly responsible of the activation and differentiation of T cells into pro-inflammatory Th1 and Th17 (N. Wang, Liang, and Zen 2014; Sica and Mantovani 2012).

Finally, NF- κ B is crucial for the priming signal of inflammasome activation. As previously seen, inflammasome is a multi-protein complex that assembles in response to stimuli, PAMPs or DAMPS (H. Kumar, Kawai, and Akira 2011). It is composed of an NLR protein (the main studied being NLRP3), AIM2 and ASC. Its main activity is the maturation of pro-caspase 1 (Davis, Wen, and Ting 2011). Upon stimulation, inflammasome recruits pro-caspase-1 via ASC and generates an active caspase 1. Caspase-1 is further able to cleave pro-IL-1 β and pro-IL-18, producing their mature forms and leading to the secretion of pro-inflammatory cytokines (Schroder and Tschopp 2010). NF- κ B activation induces the transcriptional expression of NLRP3 and pro-IL β , via stimulation of TLRs, TNFR or IL-1R (Sun 2011; Sutterwala, Haasken, and Cassel 2014). However, in addition to NF- κ B stimulation, the activation of those inflammasomes needs a second signal triggered by the detection of DAMPs (Danger-Associated Molecular Patterns), such as crystals or microbial toxins (Evavold and Kagan 2019).

2.1.3.1.4.2 Regulation of adaptive immunity

NF- κ B transcription factors play crucial roles in mediating T-cell activation, differentiation and effector function (Lawrence et al. 2001).

The recognition of an antigen by its receptor T-cell receptor, TCR, presented by APCs, mediates the induction of NF- κ B responses. Activation of naïve T cells is biphasic, p50/p65 hetero-dimer is rapidly transported to the nucleus while c-Rel, despite its presence in the cytoplasm of naïve T-cells, is activated later, resulting in the induction of IL-2, necessary for proliferation and survival of T cells (Steve Gerondakis and Siebenlist 2010).

Upon activation, T cells differentiate into different subsets, secreting diverse and distinct cytokines: Th1 (secreting IFN- γ secretion), Th2 (secreting a large range of cytokines including IL-4) and Th17 (secreting IL-17) (T. Liu et al. 2017). NF- κ B is implied at different levels of their differentiation. Indeed, Th1 responses is impaired in c-Rel-deficient mice, mice expressing a non-degradable form of I κ B and in the absence of p65 subunit, resulting in a default of IFN- γ production, which is active against intracellular pathogens, including viruses (Aronica et al. 1999; Hilliard et al. 2002 ; Balasubramani et al. 2010). Both in vivo and in vitro experiments showed that p50 is needed for Th-2 differentiation, as it induces the expression of GATA3, a major regulator of Th2 development (Das et al. 2001). Furthermore, it has been shown that NF- κ B deregulation might promote Th17 responses via indirect hyper-production of IL-6, responsible of Th17 differentiation (M. Chang et al. 2009); other studies showed that c-Rel and p65 were implied in the expression of ROR γ t, major transcription factor responsible of generation of Th17 cells (Ruan et al. 2011). Parallel to the differentiation of T-cells, NF- κ B might be involved in the control of Treg, needed to control immune response, avoiding autoimmunity and chronic inflammation (Josefowicz, Lu, and Rudensky 2012). C-Rel, in particular, is implied in development of Treg, via the induction the transcription factor Foxp3 (Ruan et al. 2009).

NF- κ B pathways also play a major role in memory functions of T cells. Deletion of NIK was associated to an altered development and maintenance of T cell memory subsequently to an acute viral infection (Rowe et al. 2013).

Finally, the development of B cells is also highly dependent on NF- κ B activity. Indeed, deficiency in p50 subunit or p52 is associated with a decreased number of B cells. Absence of both p50 and c-Rel or IKK- β completely eliminates them (Pohl et al. 2002; S. Gerondakis et al. 2006; Pasparakis et al. 2002; Claudio et al. 2002). NF- κ B pathways also promotes B-cell proliferation via B cell receptor, CD40 and TLR4 or TLR9 signals (Steve Gerondakis and Siebenlist 2010).

2.1.3.2 IRF signalling pathway

Interferon regulatory factors (IRF) are transcription factors playing a key in interferon induction; thus, they are major actor of antiviral defense, cell growth regulation and apoptosis. Nine human cellular IRF genes have been identified so far, including *IRF-1*, *IRF-2*, *IRF-3*, *IRF-4/Pip/ICSAT*, *IRF-5*, *IRF-6*, *IRF-7*, *ICSBP/IRF-8* and *ISGF3 γ /p48/IRF-9* (Paun and Pitha 2007).

All IRF members possess an N-terminal DNA-binding domain (DBD), containing five tryptophan-rich repeats. It forms a helix-turn-helix able to recognize a consensus DNA-sequence 5'-AANNGAAA-3', called IFN-stimulated response element (ISRE). The C-terminal region, less conserved, present IRF association domains (IAD), mediating the interaction between IRF members. All IRF members, except IRF1 and IRF2, possess IAD1, while IAD2 is only shared by IRF1 and IRF2 (Yanai, Negishi, and Taniguchi 2012). The resulting complex may acts as an activator or repressor of transcription depending on the proteins forming the complex (Taniguchi et al. 2001).

The "antiviral IRF", IRF-3 and IRF-7, are critical for the activation of type I IFN genes (Honda, Takaoka, and Taniguchi 2006). Activation of numerous PRRs, including different TLRs (TLR3, TLR4, TLR7, TL8 or TLR9), DAI and IFI16, NOD2, DHX9 and DHX36, RNA Pol III, STING or RIG-I/MDA5 have been shown to activate IRFs (S. Ning, Pagano, and Barber 2011). Following activation, adaptor molecules are recruited: TRIF (TLR3 or TLR4), Myd88 (TLR 7, TLR8, TLR9) or MAVS (RIG-I/MDA5) depending on the PRR involved, and other proteins, TRAF3 (for TLR3, TLR4, RIG-I/MDA5, NOD2) (Saha et al. 2006 ; Oganessian et al. 2006; Häcker et al. 2006) and TRAF6 (TLR7, TLR8, TLR9) (Konno et al. 2009 ; Kawai et al. 2004) are also implied in the signalling cascade.

TLR3 and RIG-I/MDA5 signalling recruits the noncanonical I κ B kinases, TBK1 (TANK-binding kinase 1) and IKK- ϵ , which phosphorylates IRF-3 at serine 386 (Honda, Takaoka, and Taniguchi 2006 ; Fitzgerald et al. 2003). Once phosphorylated and activated, it is able to homo- or hetero-dimerizes with IRF-7, and the resulting complex is imported to the nucleus (S. Ning, Pagano, and Barber 2011). In the nucleus, the complex binds CREB binding proteins CBP/300 to activate type I interferon gene transcription, including IFN- β , but also different interferon stimulated genes (ISG), such as RANTES, *ISG56* and *ISG54* (M. Yoneyama et al. 1998; Peters et al. 2002; Grandvaux et al. 2002).

IRF7 is mainly expressed in pDCs, which are high producers of IFN- α in responses to TLR7/8 and TLR9 stimulation (Izaguirre et al. 2003). This production relies on a big complex containing MyD88 and IF7, but also TRAF3, TRAF6, IRAK4, IRAK1, IKK α , Opn-i (intracellular osteopontin) and Dock2 (Shinohara et al. 2006; Gotoh et al. 2008), in which IRF7 is phosphorylated by IRAK1 and/or IKK α , allowing its translocation to the nucleus in order to regulate IFN gene expression.

2.1.3.3 IFNAR signalling pathway

2.1.3.3.1 Type I IFNs

Type I IFNs are the largest family of IFN and contains five subgroups, IFN- α , IFN- β , IFN- ω , IFN- ϵ and IFN- κ . The IFN- α subgroup is the largest and the most studied, which can be further divided into 12 subgroup (Chyuan, Tzeng, and Chen 2019). They are (mainly IFN- α and IFN- β) induced after the sensing of pathogens by PRRs (as described in 2.1.4), bind in a autocrine manner, a hetero-dimeric transmembrane receptor, IFN α receptor (IFNAR), composed of two subunits, IFNAR1 and IFNAR2 (Ivashkiv and Donlin 2014). Activation of IFNAR was shown to recruits two receptor-associated protein tyrosine kinases, Janus kinase 1 (JAK1) and tyrosine kinase 2 (Tyk2), which then phosphorylate transcription factors STAT1 and 2 (signal transducer and activator of transcription) (Levy and Darnell 2002; Stark and Darnell 2012). Once phosphorylated, STAT1 and 2 dimerizes and they bind to IRF9, forming a complex called IFN-stimulated gene factor 3 (ISGF3). This complex further translocates to the nucleus where it binds consensus DNA sequence, called ISRE (IFN-stimulated response elements), activating transcription of hundreds of ISGs, which lead to the establishment of a cellular antiviral response (Schoggins et al. 2011), via inhibition of viral transcription, translation, replication or alteration of viral nucleic acids (MacMicking 2012). Interestingly, the inhibitor of NF- κ B kinase- ϵ (IKK ϵ) has been shown to induce STAT1 phosphorylation, facilitating the antiviral complex ISGF3 (Tenoever et al. 2007). In addition to the canonical ISGF3 complex, other combinations of STAT heterodimer have been identified, which preferentially bind to the IFN- γ activated site (GAS) element, located within the promoter of ISGs (Stanifer, Pervolaraki, and Boulant 2019).

This pathway is tightly regulated by suppressive signals to limit toxicity and to avoid chronic inflammation. Parallel to the activation of ISGF3, IFNAR can activate STAT3 hetero-dimers, which suppress inflammatory responses (Murray 2007). IFNAR also activates negative regulators, such as suppressor of cytokine signalling 1 and 3 (SOCS1 and SOCS3), ubiquitin-specific peptidase 18 (USP18) or miRNAs to limit IFN response. SOCS suppress JAK activity via competitive-binding to IFNAR (Yoshimura, Naka, and Kubo 2007); USP18 blocks the interaction between JAK1 and IFNAR, via competitive binding to IFNAR2 (Sarasin-Filipowicz et al. 2009); miR-146a and miR-155 have been shown to control STAT1 expression and suppress expression of effectors of the IFNAR/JAK/STAT pathway, respectively (L.-F. Lu et al. 2010; Gracias et al. 2013). Besides, other cellular kinases interfere JAK/STAT signalling pathway to limit its activation such as the Src Homology phosphatase 2 (SHP-2), which prevents phosphorylation of STAT1, STAT2 and JAK1, and protein inhibitors of activated STAT (PIAS) family members that have been show to inhibit STAT1 phosphorylation (T. R. Wu et al. 2002; Niu et al. 2018). Another mechanism to limit activation of signalling pathway is the internalization of receptor IFNAR, by clathrin-mediated endocytosis (K. G. S. Kumar et al. 2007), while IFNAR1 is rapidly

degraded by lysosome ([Marijanovic et al. 2006](#)), IFNAR2 can be recycled back to the surface ([Chmiest et al. 2016](#)).

2.1.3.3.2 Type II IFN

Type II IFN only comprises IFN- γ , which present a dimeric structure consisting of two polypeptides with antiparallel symmetry. It is secreted predominantly by activated lymphocytes T cells, and by NK cells and to a lesser extent by NKT cells, B cells and APCs. Its binding to its receptor, IFN- γ R, composed of IFN- γ R1 and IFN- γ R2, activates JAK1 and JAK2, which phosphorylate IFN- γ R1, creating a docking site for STAT1. Once phosphorylated, STAT1 homodimerizes in an antiparallel configuration, resulting in a complex gamma-activated factor (GAF), which translocates to the nucleus to bind gamma-activated site (GAS) ([Castro et al. 2018](#)). It can also activate signal transduction cascades leading to the canonical translocation of the ISGF3 complex, such as type I and II IFNs ([Matsumoto et al. 1999](#)). IFN- γ induces the expression of numerous ISGs, including CXCL-9, CXCL10, ADAR-1, IDO-1 and IRF1, the latter bearing the broadest antiviral activity ([Ahmed and Johnson 2006](#); [Schoggins et al. 2011](#)).

The IFN- γ signalling pathway is negatively regulated by SHP2 from the SHP phosphatases family, or SOCS1 and SOCS3 in the cytoplasm; and protein inhibitor of activated STATs (PIAS) prevents STAT1 phosphorylation ([Jorgovanovic et al. 2020](#)).

2.1.3.3.3 Type III IFNs

Type III IFNs are the most recent IFN members identified; they are composed of IFN- λ 1 (IL-29), IFN- λ 2 (IL-28A), IFN- λ 3 (IL-28B) and IFN- λ 4 ([Chyuan, Tzeng, and Chen 2019](#)). Even if they can be produced by diverse cells, pDCs remain the main producers, as type I IFN ([Z. Yin et al. 2012](#)). They are produced following PRRs (such as TLRs, RLR or cytosolic sensors) stimulation by PAMPs ([Ank et al. 2008](#); [Onoguchi et al. 2007](#); [X. Zhang et al. 2011](#)). Type III IFN receptors are heterodimers composed of high-affinity IFN- λ receptor (IFNLR)1 chains (IL-28R α) and low affinity IL-10R2 chains ([Stanifer, Pervolaraki, and Boulant 2019](#)). Contrary to IFNAR, which is expressed in different cell types, IFNLR1 expression may be limited to epithelial cells, including hepatocytes and intestinal cells ([Sommereyns et al. 2008](#)). Similarly to type I IFN, the activation of receptor leads to the activation of JAK/STAT signalling cascade via STAT1 and STAT2 phosphorylation, recruitment of IRF9 and formation of the antiviral complex ISGF3, which translocates to the nucleus to activate ISGs transcription ([Chyuan, Tzeng, and Chen 2019](#)). This pathway is also tightly regulated by SOCS1, acting as a negative regulator ([Blumer et al. 2017](#)).

In addition to classical JAK/STAT signalling pathway described upper, studies reported that both type I and III IFN to involve other signalling pathway including Crk-like protein (CrkL)-Ras related protein 1 (RAP1) pathway ([Platanias and Fish 1999](#)), the phosphatidylinositol 3-kinase (PI3K)-signalling pathway ([Kaur, Uddin, and Platanias 2005](#)) and the MAPK pathway ([Zhangle Zhou et al. 2007](#)).

2.1.3.3.4 Activation of innate immune cells and regulation of adaptive immune responses

Type I IFNs are able to boost innate immune response via control of DCs by the different mechanisms: generation of DCs with potent antigen-presenting cells from PBMCs along with granulocyte-macrophage colony-stimulating factor (GM-CSF) (Paquette et al. 1998); maturation of DCs by increasing expression of major histocompatibility complex (MHC) class II (Simmons et al. 2012) ; enhanced migration of DCs via cell adhesion molecules secretion (Rouzaut et al. 2010).

Type I IFNs are also able to regulate the adaptive immune responses either by activating it or by inhibiting it. IFN- α has been shown to induce the production of CXC-chemokine ligand 9 (CXCL9) and CXCL10 by DCs, which attract and stimulate CD8⁺ effector T cells (Padovan et al. 2002). However, in case of chronic viral infection, DCs have been shown to exhibit an immune-tolerant phenotype, due to a persistent type I IFN signalling, attenuating T-cell priming against pathogens (Teijaro et al. 2013). In addition to T cells, type I IFN may also promote B cell responses, via the secretion of B-cell activating factor (BAFF) (A. Le Bon et al. 2001) and enhancement of humoral responses (Le Bon et al. 2006), or inhibit B lymphopoiesis (Q. Lin, Dong, and Cooper 1998).

Type III IFNs have also been shown to modulate T and B responses. Indeed, IFN- λ s have been linked to a greater Th1 response, increasing IFN- γ secretion (Koltzida et al. 2011) and reduction of Th2 responses via suppression of IL13 (Srinivas et al. 2008). Interestingly, IFN- λ s possess immune-regulatory functions as it was shown to either up regulate the production of specific antibodies against HIV (Morrow et al. 2009), and also to inhibit B cell proliferation and IgG production during influenza infection (Egli et al. 2014).

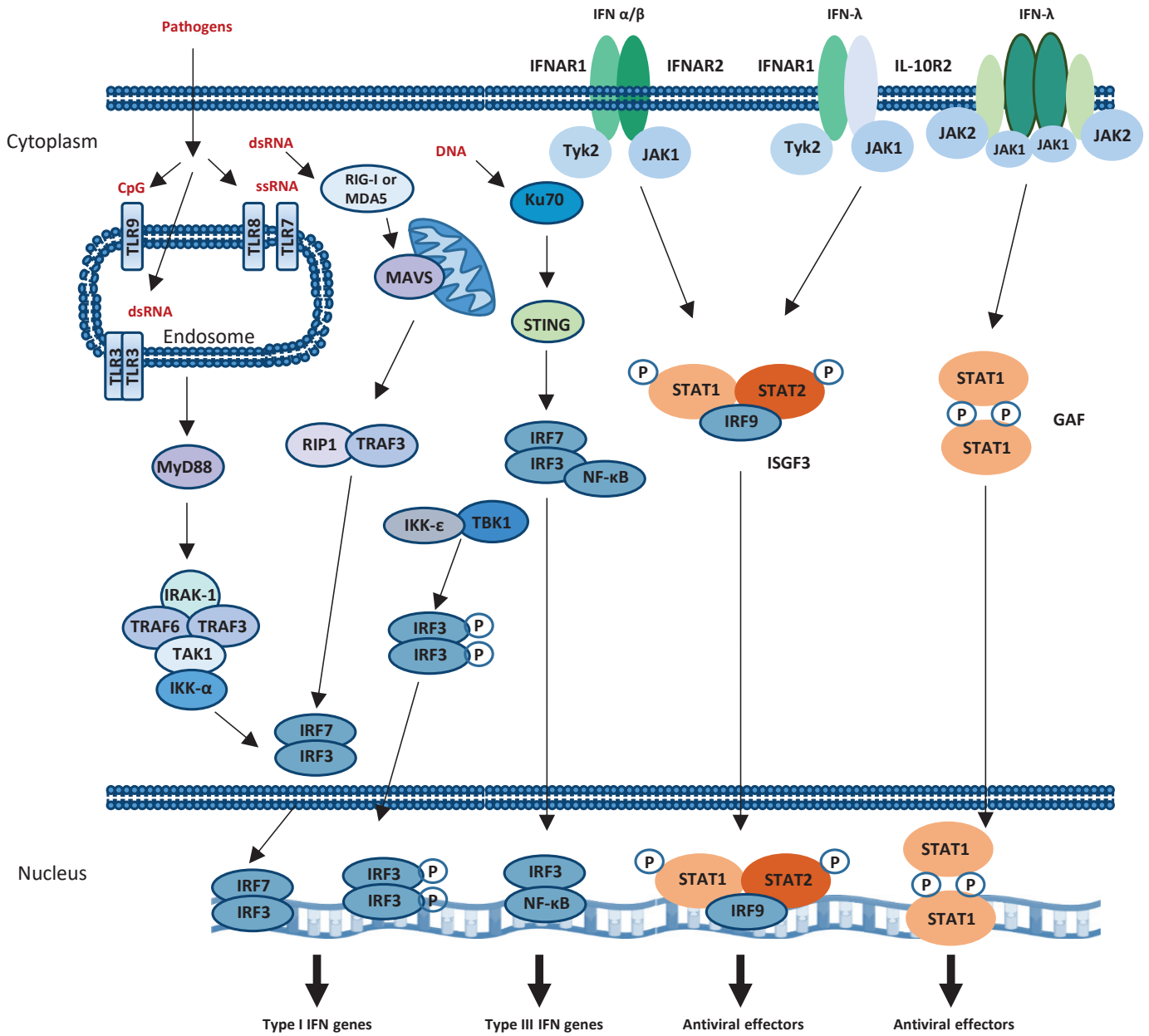

Figure 30: IFN signalling pathway

Production of type I and III interferons can be induced by pathogens sensed by various PRRs, including TLRs and RLR. Diverse downstream molecules lead to the activation of interferon regulatory factors (IRFs) and nuclear factor kappa-light-chain-enhancer of activated B cells (NF-κB) transcription factors. The secreted IFNs bind their receptors, type I IFNs bind to IFNAR1/IFNAR2 receptor while type III IFNs bind to IFNAR1/IL-10R2 receptor. Activation of these receptors leads to the recruitment of Janus kinase 1 (JAK1) and tyrosine kinase 2 (Tyk2), which phosphorylate signal transducer and activator of transcription 1 (STAT1) and STAT2. Phosphorylated STAT1 and STAT2 form with IRF9 a complex called IFN-stimulated gene factor 3 (ISGF3), which translocates to the nucleus to activate transcription of interferon-stimulated genes (ISGs). IFN-γ binding to its receptor, IFN-γR, composed of IFN-γR1 and IFN-γR2, activates JAK1 and JAK2, which phosphorylate IFN-γR1, creating a docking site for STAT1. Once phosphorylated, STAT1 homodimerizes in an antiparallel configuration, resulting in a complex gamma-activated factor (GAF), which translocates to the nucleus to bind gamma-activated site (GAS). *Adapted from (Chyuan, Tzeng, and Chen 2019) and (Isorce et al. 2015).*

2.1.4 Pro- and anti-inflammatory cytokines

PAMPs and DAMPs, recognized by PRR, activate downstream signalling pathways, such as NF- κ B pathways, which induce a cellular response (Takeuchi and Akira 2010). This cellular response involves the induction of adhesion molecules, which accelerates diapedesis of effector cells of innate immunity; it also induces the production and release of pro-inflammatory cytokines including tumor necrosis factor-alpha (TNF- α), interleukin (IL)-1, IL-6 and IL-10, or interferons (Lawrence 2009; T. Kawai and Akira 2006). This release leads to the activation of immune cells, which produce further cytokines (Schaper and Rose-John 2015).

Immune response is tightly regulated in order to achieve pathogen control without inducing excessive inflammation and tissue damage. Anti-inflammatory cytokines, secreted from immune cells, such as regulatory T cells and macrophages allow inflammation and immunity suppression, and the return/maintenance of homeostasis. Major anti-inflammatory cytokines include IL-4, IL-10 and TGF- β (Cicchese et al. 2018).

However, it is important to highlight that cytokines called “pro-“ or “anti-inflammatory” may induce unexpected responses. Indeed, it has been shown that IL-6 also have anti-inflammatory properties (Scheller et al. 2011); similarly TGF- β and IL-10 have been shown to be involved not only in the differentiation of Treg, but also in the differentiation of T cells (M. O. Li and Flavell 2008; Maynard and Weaver 2008). The immune response is therefore not only dependent on secreted cytokines, but it also due to their amounts and the inflammatory environment.

Due to its strategic position, the liver needs this tightly regulation, performed by professional immune cells or not (Rehermann 2013; Schmidt, Nino-Castro, and Schultze 2012). However, this balance may be dysregulated due to important toxic absorption, autoimmune diseases, pathogen infections or proliferation of tumoural cells. This inability to resolve inflammation leads to chronic pathological inflammation, tissue homeostasis disruption, leading to fibrosis, cirrhosis and HCC (M. W. Robinson, Harmon, and O’Farrelly 2016). Besides, some pathogens have been shown to take advantage of the tolerogenic environment of the liver to establish chronic infection, such as HBV (detailed in chapter 2) (Protzer, Maini, and Knolle 2012).

	Cytokine	Main sources	Target cell	Major function
Interleukins	IL-1 (IL-1 α , IL-1 β , IL-1ra, IL-18, IL-33, IL-36 α , IL-36 β , IL-36 γ , IL-36Ra, IL-37 and IL-1Hy2)	Macrophage, B cells, DCs	B cells, NK cells, T-cells	Pyrogenic, pro-inflammatory, proliferation and differentiation, BM cell proliferation
	IL-2	T cells	Activated T and B cells, NK cells	Proliferation and activation
	IL-3	T cells, NK cells	Stem cells	Hematopoietic precursor proliferation and differentiation
	IL-4	Th cells	B cells, T cells, macrophages	Proliferation of B and cytotoxic T cells, enhances MHC class II expression, stimulates IgG and IgE production
	IL-5	Th cells	Eosinophils, B-cells	Proliferation and maturation, stimulates IgA and IgM production
	IL-6 (IL-6, IL-11, IL-31)	Th cells, macrophages, fibroblasts	Activated B-cells, plasma cells	Differentiation into plasma cells, IgG production
	IL-7	BM stromal cells, epithelial cells	Stem cells	B and T cell growth factor
	IL-8	Macrophages	Neutrophils	Chemotaxis
	IL-9	T cells	T cells	Growth and proliferation
	IL-10	T cells	B cells, macrophages	Inhibits cytokine production and mononuclear cell function
	IL-11	BM stromal cells	B cells	Differentiation, induces acute phase proteins
IL-12	T cells	NK cells	Activates NK cells	
IL-17 (IL-17A-F, IL-25 (IL-17E))	Th cells	Epithelial, endothelial and stromal cells	Neutrophil recruitment	
Tumour necrosis factors	TNF- α	Macrophages	Macrophages	Phagocyte cell activation, endotoxic shock
	TNF- β	T cells	Phagocytes, tumour cells	Tumour cytotoxicity
Interferons	Type I IFN (IFN- α , IFN- β , IFN- ω , IFN- κ)	pDCs	Various	Anti-viral, anti-proliferative
	Type II IFN (IFN- γ)	T cells	Various	Anti-viral, macrophage activation, increases neutrophil and monocyte function, MHC-land -II expression on cells
	Type III IFN (IFN- λ 1 (IL-29), IFN- λ 2 (IL-28A), IFN- λ 3 (IL-28B))	pDCs	Various	Anti-viral
Others	TGF- β	T cells and B cells	Activated T and B cells	Inhibit T and B cell proliferation, inhibit haematopoiesis, promote wound healing

Table 2: Functions of different cytokine families

Abbreviations: BM: bone marrow; DCs: dendritic cells; NK cells: Natural killer cells; pDCs: plasmacytoid dendritic cells; Th cells: T helper cells. *Adapted from (Turner et al. 2014).*

2.2 HBV recognition by innate immunity

2.2.1 Activation of host innate immunity

2.2.1.1 Weak or lack of IFN and/or proinflammatory responses *in vivo* and *in vitro*...

Previously, Wieland and colleagues reported that HBV was unable to induce ISGs in the liver of infected chimpanzee model, considering therefore HBV as a “stealth virus”, not recognized by the immune system (Wieland et al., 2004). Similarly, in a study enrolling 21 HBV-infected patients during the pre-symptomatic phase, the cytokine quantification showed that HBV was not able to induce a strong IFN production; however, it induced production of anti-inflammatory cytokine IL-10 (Dunn et al. 2009). In addition to this observation, detectable cytokines including IFN- α , TNF- α , IL-10, IL-6 and IL-1 β were also found in HBV-infected patient sera, before the peak of viremia (Stacey et al. 2009). A weak induction of cytokine production does not mean total absence of cytokines’ production. This dogma was recently challenged by several studies suggesting that HBV could be detected by innate immune system and finally induces innate immune response, including interferon response. Indeed, in chimeric uPA-SCID mice harbouring human hepatocytes a weak activation of ISGs could be detected (Lütgehetmann et al. 2011). *In vitro*, transduction of HepaRG cell line with a baculovirus vector expressing HBV induced a strong and specific innate antiviral response, resulting in a noncytopathic clearance of HBV DNA. Cellular gene expression analyses showed that IFN- β and ISGs were upregulated (Lucifora et al. 2010). Transduction of HepaRG with baculovirus allowed an elevated replication of HBV, therefore suggesting that HBV could induce an interferon response when the replication is important. However, in a more physiologic context, infected dHepaRG leads to a transient and modest increase of IFN and pro-inflammatory gene expression (Luangsay, Gruffaz, et al. 2015). Besides, type III IFN were shown to be predominantly induced in PHH after infection with HBV genotype C (Sato et al. 2015).

In addition to interferon, other cytokines could be induced by HBV. Upon infection of primary human liver cells, HBV is recognized by KCs, although not infected, which leads to the release of IL-6 and other proinflammatory cytokines including TNF- α and IL-1 β . The control of viral infection was attributed to IL-6 via NF- κ B activation (Hösel et al. 2009). TNF- α and IL-1 β were shown to inhibit the early phase of HBV infection as well as the replication in HepaRG (Watashi et al. 2013; Isorce et al. 2016). IL-1 β was also present in liver biopsies of chronic HBV patients (Bortolami et al. 2008). Besides, a recent study showed that HBV-infected patients’ sera as well as HBV-stimulated peripheral blood mononuclear cells (PBMCs) harbour high level of IL-1, IFN- γ and IL-32 transcripts and protein, suggesting that these cytokines may be useful for HBV detection and infection monitoring (Tian et al. 2019).

Finally, several *in vitro* experiments showed that cytokines could be produced in presence of specific HBV molecules: IL-18, produced in presence of HBcAg or HBx in PBMCs or hepatoma cell lines (Lee et al. 2002; Manigold et al. 2003) or TNF- α , produced in presence of HBx, HBcAg or HBsAg in hepatocytes,

in mice model or circulating monocytes respectively ([Lara-Pezzi et al. 1998](#); [Tzeng et al. 2014](#); [Boltjes et al. 2014](#)).

2.2.1.2 Potential host PRRs involved in HBV recognition

Several PRRs have been shown to be involved in HBV recognition. Nucleocapsid was shown to activate TLR2 signalling pathway in THP-1 macrophages, resulting in induction of pro-inflammatory cytokines ([A. Cooper et al. 2005](#)). Similarly, a recent study showed that HBV particles are sensed by TLR2 in primary human hepatocytes leading to NF- κ B activation and IL-6 production ([Zhenhua Zhang et al. 2020](#)). However, the existence of naked nucleocapsids *in vivo* remains a matter of debate. In HBV-transfected HuH7 cell line and in HBV-hydrodynamically injected mice, MDA5 expression was upregulated and was shown to associate with HBV nucleic acids, hypothesizing that MDA5 might sense HBV ([H.-L. Lu and Liao 2013](#)). However, other studies identified RIG-I as a sensor of the 5'- ϵ region of pgRNA, resulting in induction of type-III IFN, mainly IFN- λ , in primary human hepatocytes and hepatoma cell lines ([Sato et al. 2015](#)). Naked HBV DNA, rcDNA or DNA replication intermediates, may be recognized by cGAS/STING pathway in primary human hepatocytes and may induce an immune response. However, in an infection context, the shielding of the viral DNA in the nucleocapsid avoid this recognition ([Lauterbach-Rivière et al. 2019](#)). IFI16, another CDS, has recently been found to sense cccDNA and bind to it leading to inhibition of transcription and HBV replication ([Yuanyuan Yang et al. 2020](#)). Moreover, HBsAg was reported to interact with CD14, a co-receptor of TLR4 in myeloid cells *in vivo*, resulting in their activation ([van Montfoort et al. 2016](#)).

Finally, the molecular recognition of HBV PAMPs by PRR is poorly defined, in particular due to suboptimal *in vitro* models to study HBV replication, and to the “quality” of HBV inoculum used for those experiments. For instance, HBcAg synthesized in bacteria and then purified may be contaminated with LPS structures, resulting in activation of TLRs and confusing results ([Vanlandschoot et al. 2007](#)). It also challenged by recent publications showing that HepaRG cell line, primary human hepatocytes and model for liver biopsies induce neither activation nor inhibition of antiviral signalling ([Mutz et al. 2018](#); [Suslov et al. 2018](#)).

2.2.1.3 Activation of immune cells by HBV

As seen previously, Hösel and colleagues observed a rapid production of IL-6, TNF- α , IL-8 and IL1- β by non-parenchymal cells and particularly KCs. The latter, despite not replicating the virus are able to sense HBV resulting in up-regulation of IL-6; this secretion occurs few hours post infection and relies on NF- κ B activation ([Hösel et al. 2009](#)). Besides, pro-inflammatory cytokines produced upon HBV recognition produced by KCs, might recruit NK and NKT cells during acute HBV infection in the liver ([Boltjes et al. 2015](#)). Indeed, NK and NKT cell activation has been described in numerous studies

following acute HBV infection. In the woodchuck model, early activation of NK and NKT cells was observed after 48 to 72 hours of infection (Guy et al. 2008). In chimpanzees, the clearance of HBV infected hepatocytes by adaptive immunity was preceded by an increase of IFN- γ and TNF- α , which may be produced by NK cells (L. G. Guidotti et al. 1999). In primary human hepatocytes, murine hepatocytes and transgenic mice injected with an adenovirus vector containing HBV, it was shown that presence of HBV in hepatocytes induce the association of lipids, mainly lysophospholipids, to the endoplasmic reticulum that may lead to the direct activation of NKT cells (Zeissig et al. 2012). In humans, increase in NK cell frequencies is observed before the ALT and HBV DNA reached their peaks. Similar kinetics are observed for their cytotoxic activity and IFN- γ production (P. Fiscaro et al. 2009).

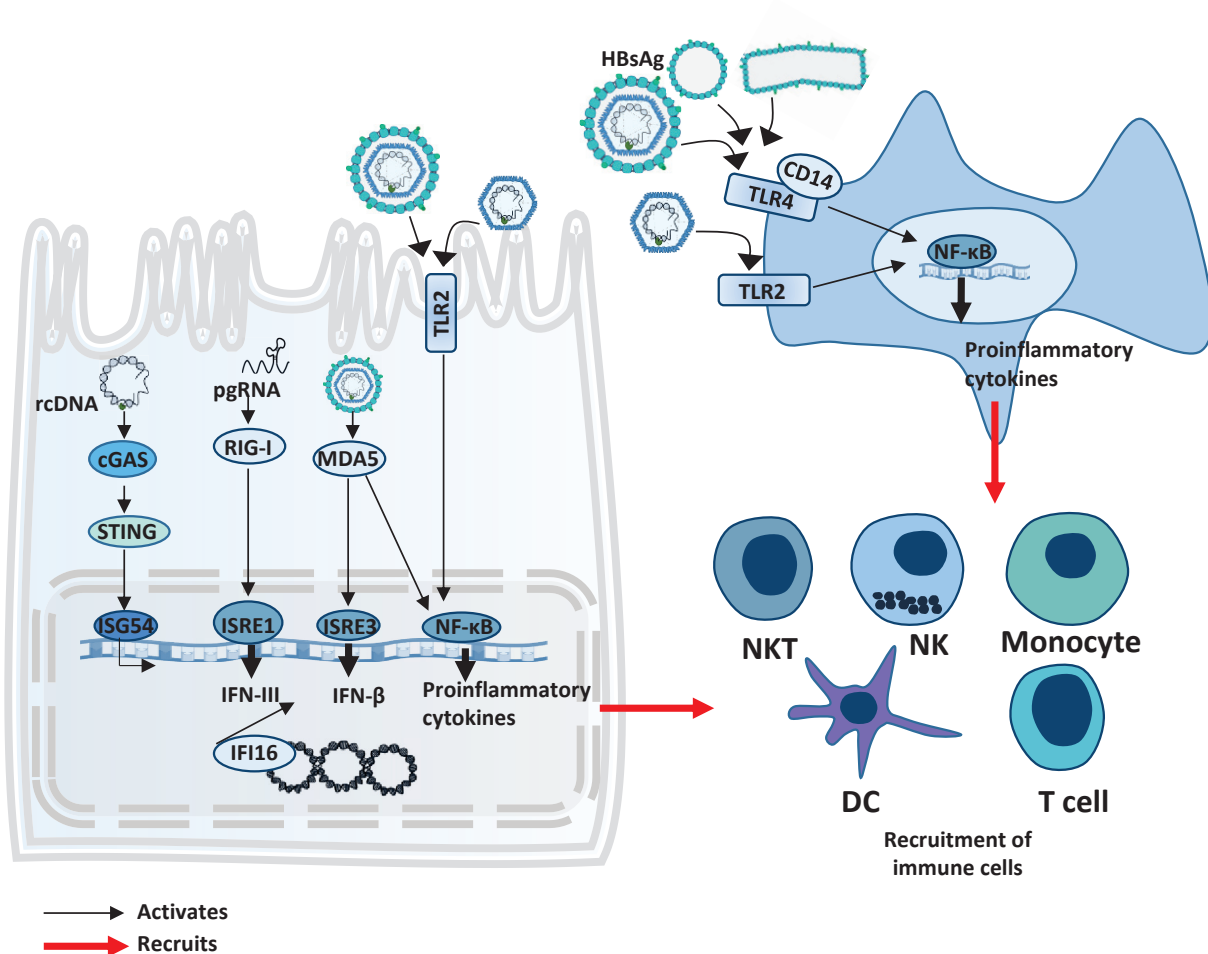

Figure 31: Schematic representation of HBV recognition

Despite low production of IFN and pro-inflammatory cytokines upon infection, it has been seen that HBV and its components are sensed by different PRRs both in hepatocytes and in macrophages, leading to the recruitment of immune cells. DC: Dendritic cells; NK: Natural killer cells; NKT: Natural killer T cells; ISG: IFN-stimulated gene; ISRE: IFN-stimulated response elements.

2.2.1.4 Control of HBV by cytokines

Cytokines and interferons, secreted upon HBV recognition, play an important role in limiting acute HBV infection in patients, mediating a non-cytotoxic clearance of the virus. They are able to control HBV infection at different steps of the viral cycle (Xia and Protzer 2017).

IFN- α , IL-6 and IL-1 β were shown to inhibit virus entry. Indeed, *in vitro* experiments showed that IFN- α treatment induced the release of soluble factors, able to bind HSPGs, preventing HBV attachment (Xia et al. 2017). NTCP expression has been shown to be regulated by IL-6 and IL-1 β , preventing virus entry (Bouezzedine, Fardel, and Gripon 2015; Le Vee et al. 2008).

cccDNA is also targeted by cytokines, inducing its degradation and epigenetic or transcriptional control. IFN- α has been shown to activate the nuclear deaminase APOBEC3A, resulting in deaminated cccDNA further degraded by nucleases (Lucifora et al. 2014). Similarly, *in vitro* studies showed that type III IFNs, and both IFN- γ and TNF- α produced by T cells were also able to reduce cccDNA levels via cccDNA deamination (Bockmann et al. 2019; Xia et al. 2016). TGF- β were shown to trigger cccDNA deamination and degradation in an activation-induced cytidine deaminase (AID)-dependent manner (Qiao et al. 2016). IFN- α has been shown to epigenetically control cccDNA, via the hypoacetylation of histones, bound on the cccDNA, or recruitment of transcriptional corepressors, such as HDAC (Laura Belloni et al. 2012; Tropberger et al. 2015; F. Liu et al. 2013). IL-6 was shown to induce reduction of histone acetylation on cccDNA, resulting in a decrease of transcription (Palumbo et al. 2015) and to reduce the transcription factors HNF4 α and HNF1 α , inhibiting even more HBV replication (Hösel et al. 2009). IL-4 was shown to suppress HBV surface and core promoter activity via the downregulation of CAAT-enhancer-binding protein α (C/EBP α) (S.-J. Lin et al. 2003). IL-32 γ , induced by TNF and IFN- γ in hepatocytes was shown to inhibit viral enhancer activities, by down regulation of HNF4 α and HNF1 α (D. H. Kim et al. 2018). Finally, IL-1 β was shown to induce the binding of NF- κ B subunits to cccDNA, silencing cccDNA transcription (Isorce et al. 2016).

Cytokines have been shown to interfere with HBV replication at post-transcriptional level. Indeed, IFNs and TNF- α were shown to alter the formation of functional HBV capsids (S. F. Wieland, Guidotti, and Chisari 2000; Biermer, Puro, and Schneider 2003). Finally, IFN- α induces numerous ISGs inhibiting HBV replication, such as Myxoma resistance protein 1 (MxA), which was shown to interact with HBcAg, preventing core particle formation (N. Li et al. 2012) or tetherin protein, which was shown to block virus secretion (R. Yan et al. 2015).

Despite HBV recognition by innate immune cells and PRRs that leads to a pro-inflammatory response, and activation of innate immune cells, it is clear that HBV has developed strategies to evade and suppress innate immunity. Strategies that will be discussed in the next paragraphs.

2.3 HBV escape from innate immunity

2.3.1 Targeting professional immune cells

2.3.1.1 Modulation of count of innate immune cells

A strategy used by HBV to circumvent innate immunity is to reduce the number of innate immune cells within the infected liver. Some studies demonstrated that the frequency of pDCs is reduced in chronic HBV patients as compared to healthy controls, demonstrating that chronicity is linked to pDC reduction ([Beckebaum et al. 2002](#); [Duan et al. 2004](#); [Shi et al. 2012](#)). However, number of myeloid BDCA3+ DCs was increased in chronic HBV patients, but HBsAg may impair their function via an unknown mechanism ([van der Aa et al. 2016](#)). HBV is also able to indirectly impair T cell responses. Indeed, a significant increase number of monocyte myeloid-derived suppressor cells (mMDSCs) has been shown to positively correlate with level of HBsAg, those cells are able to secrete high amount of arginase in the liver, which therefore decrease amount of arginine in the liver, the latter being essential for T cell physiology and growth ([Pallett et al. 2015](#); [Fang et al. 2015](#)).

2.3.1.2 Modulation of phenotypes and functions of innate immune cells

Modulation of phenotypes and functions of innate immune cells is probably the main strategy used by HBV to escape innate immunity.

As previously seen, NK cells, present in abundance the liver, are a source of IFN- γ , anti-HBV and immune-stimulatory cytokines and may play a role in resolution of acute HBV infection ([Maini and Peppia 2013](#)). In chronic HBV patients, immune responses of NK cells are altered: including a reduced ability to produce IFN- γ and alteration of their cytolytic activity ([Oliviero et al. 2009](#); [Y. Yang et al. 2017](#)). Inhibition of cytokine secretion by NK cells could be in part due to IL-10 or TGF- β presence in HBV-infected liver ([Peppia et al. 2010](#)). Besides, in chronic HBV patients, hypercytolytic activity of hepatic NK cells correlates with liver injury ([Zheng Zhang et al. 2011](#)).

Even if some studies showed that pDCs are not altered during chronic HBV infection ([Tavakoli et al. 2008](#)). On the contrary, others described that functions of pDCs may be impaired in chronic HBV infection. An *ex vivo* study showed a significant reduction IFN- α secretion by pDCs upon TLR9 agonisation and a reduced ability to activate naïve NK cells ([Martinet et al. 2012](#); [Molen et al. 2004](#); [Beckebaum et al. 2002](#); [DUAN et al. 2004](#); [Shi et al. 2012](#); [Woltman et al. 2011](#); [Vincent et al. 2011](#)). Besides, HBsAg could be the main actor of those regulations; in fact, it was shown to inhibit TLR9-mediated activation and IFN- α production in pDCs ([Y. Xu et al. 2009](#)). As seen previously, myeloid

BDCA3+ cells were shown to be functionally altered in chronic HBV patients. In addition, myeloid DCs of patients showed a decrease ability to produce TNF- α in presence of HBV (Molen et al. 2004). Finally, mDCs isolated from chronic HBV patients have altered functions and maturation in presence of HBsAg, resulting in a more tolerogenic phenotype (Op den Brouw et al. 2009).

Besides, in *ex vivo* experiments using KCs, HBV was shown to block IL-1 β production by AIM2 inflammasome, mechanism driven by HBsAg (Zannetti et al. 2016). Recent study showed that HBV was able to inhibit pro-inflammatory cytokines, such as IL-1 and IL-6, and promote anti-inflammatory cytokines such as IL-10 via HBsAg- and HBcAg- driven mechanisms (Faure-Dupuy et al. 2019). Therefore, chronicity induces a shift of KCs' phenotype towards an anti-inflammatory profile, secreting IL-10, contributing to the persistence of the virus. In hydrodynamically injected mice model, stimulation of TLR2 by HBcAg has been described to upregulate IL-10 secretion by KCs, resulting in the exhaustion of anti-HBV CD8+ T cells (M. Li et al. 2015).

Furthermore, TLRs expression may be impaired during chronic HBV infection not only in immune cells but also in hepatocytes. Indeed, TLR3 expression was found to be decreased in peripheral blood mononuclear cells (PBMCs), in KCs and hepatocytes of chronic HBV patients compared to healthy controls (Y.-W. Huang et al. 2013). A reduction of TLR2 expression was also found in hepatocytes, KCs and PBMCs of chronic HBeAg-positive patients. HBeAg was found to contribute to this reduction. In contrast, *in vitro* experiments using HBV cDNA plasmids encoding the G1896A precore stop codon mutation (abrogating HBeAg production) have no effect on TLR2 expression (Visvanathan et al. 2007). TLR9 expression was also found to be impaired in pDCs, correlating with decrease of IFN- α production (Xie et al. 2009).

Finally, HBV is able to counteract the innate immune system by targeting immune cells either by modulating their number or their phenotype. Furthermore, HBV proteins are also able to impair immune responses by inhibiting downstream signalling pathways, detailed in the next paragraphs.

2.3.2 Modulation of intracellular innate immune pathways

2.3.2.1 Modulation of PRR's downstream signalling pathways

Activation of PRRs triggers two major signalling pathways, which are highly intertwined: IRF and NF- κ B. Key adaptor molecules control their induction: including MyD88, TRIF, mitochondrial antiviral signalling protein (MAVS) and STING. NF- κ B activation is induced through a classical and an alternative pathway, both leading to the translocation of given subunits (p52/p50/RelA/RelB) to the nucleus, modulating different target genes. In the classical pathway, the IKK complex (NEMO/IKK α /IKK β) is activated by TAK1 and phosphorylates I κ B, leading to its ubiquitin-mediated degradation and the further release of NF- κ B subunits. The alternative pathway involves the NIK protein kinase, which

activates and phosphorylates IKK α . This leads to the proteolytic cleavage of the p100-NF- κ B subunit, releasing p52/RelA/RelB subunits, which then translocate into the nucleus. In parallel, TBK1/IKK ϵ activation triggers the phosphorylation of IRF3 and IRF7, which as well translocate into the nucleus to activate target genes. HBV proteins are able to inhibit those pathways at different levels.

In HEK293 and HuH7, HBeAg co-localizes with and sequesters TIR-containing proteins, such as Mal and TRAM, preventing them from recruiting MyD88 (Lang et al. 2011). MAVS degradation was also reported during HBV infection. HBx may either bind MAVS to prevent subsequent RIG-I activation or interact with MAVS to promote its degradation through Lys136 ubiquitination, preventing the induction of IFN- β in hepatoma cell lines (Kumar et al. 2011; Wei et al. 2010).

In vitro experiments in hepatoma cells, showed that HSBP was able inhibit TAK1 phosphorylation, therefore its activation, preventing production of inflammatory cytokines (Pol et al. 2015).

In vitro recent study showed that viral polymerase is able to suppress TNF- α , TLR3, and TLR4-induced NF- κ B signalling by disrupting NEMO/IKK α /IKK β association with Cdc37/Hsp90, which is essential to the IKK signalling (D. Liu et al. 2014). Viral polymerase is able to suppressed IRF signalling by inhibiting effector protein kinase of the IRF3/IRF7 signalling, TBK1/IKK ϵ (H. Wang and Ryu 2010). More specifically, viral polymerase inhibited the interaction between IKK ϵ and DDX3, a DEAD box RNA helicase known to augment IRF signalling and to inhibit viral reverse transcription in HepG2 cell lines (Soulat et al. 2008; H. Wang, Kim, and Ryu 2009). IRF3 activation by STING and nuclear translocation of NF- κ B subunits are also inhibited by viral polymerase (D. Liu et al. 2014; Y. Liu et al. 2015).

In vitro, HBsAg was shown to directly inhibit IRF3 and IRF7 transcription factors, either via degradation of IRF7 mRNA or blockade of IRF7 nuclear translocation (Zannetti et al. 2016; Y. Xu et al. 2009). In macrophage THP-1 cell line, HBsAg could prevent production of pro-inflammatory cytokines induced by TLR4 or TLR2 ligands, such as IL-18 or IL-12 by inhibiting NF- κ B pathway (Cheng et al. 2005; S. Wang et al. 2013).

2.3.2.2 Modulation of IFN receptor downstream signalling pathway

Host infection initiates the synthesis of IFN-I, IFN- α or IFN- β , which can then bind to their receptor both in autocrine or paracrine manner. This binding triggers downstream signalling, oligomerization and tyrosine phosphorylation of Janus kinase 1 and tyrosine kinase 2, which then phosphorylate a single tyrosine residue STAT1 and 2. The phosphorylated STAT 1/2 form with IRF9 the ISGF3 transcription factor complexes, which then translocate into the nucleus to ISRE to upregulate ISGs.

Exogenous Pegylated or not IFN- α is one of the main treatment for CHB (Niederau et al. 1996). Despite severe side effects, it remains ineffective to eradicate the infection. It has been reported that viral

polymerase suppressed IFN-induced STAT1/2 nuclear translocation and STAT1 Ser727 phosphorylation via its binding to the importin- α 5, required for STAT 1/2 recruitment, as well as binding to protein kinase C- δ , needed for STAT1 phosphorylation in HBV-infected cells from liver biopsies of CHB patients (J. Chen et al. 2013). Moreover, HBcAg and HBSP were able to down regulate IFN-inducible myxovirus resistance A (MxA) protein expression, an important antiviral kinase via interaction with the MxA promoter in Huh7 cells (Rosmorduc et al. 1999). Role of HBcAg (from incoming virions) as early negative regulator of the interferon response was further confirmed in HepaRG cell line and primary human hepatocytes (Gruffaz et al. 2013).

HBx desensitised the expression of IFN-mediated induction of TRIM22 protein (tripartite motif 22), a mediator of the IFN-induced antiviral response, through methylation of a single CpG site in the 5'-UTR in mouse model, primary human hepatocytes and human liver tissues (K.-H. Lim et al. 2018). Recently, a study demonstrated that overexpressing-HBx cell line presented less IFNR on their surface in comparison to control cells (Cho et al. 2012).

To conclude, all these data suggest that HBV could be to develop strategies in order to actively escape innate immunity. It uses all its viral proteins to circumvent intracellular signalling pathways, leading to an inhibition of interferon response, explaining why HBV was considered as a "stealth" virus for a long period. Even if majority of those results were determined *in vitro*, they are likely to reflect the *in vivo* reality. Escaping immune response, HBV is therefore able to establish and maintain its persistence.

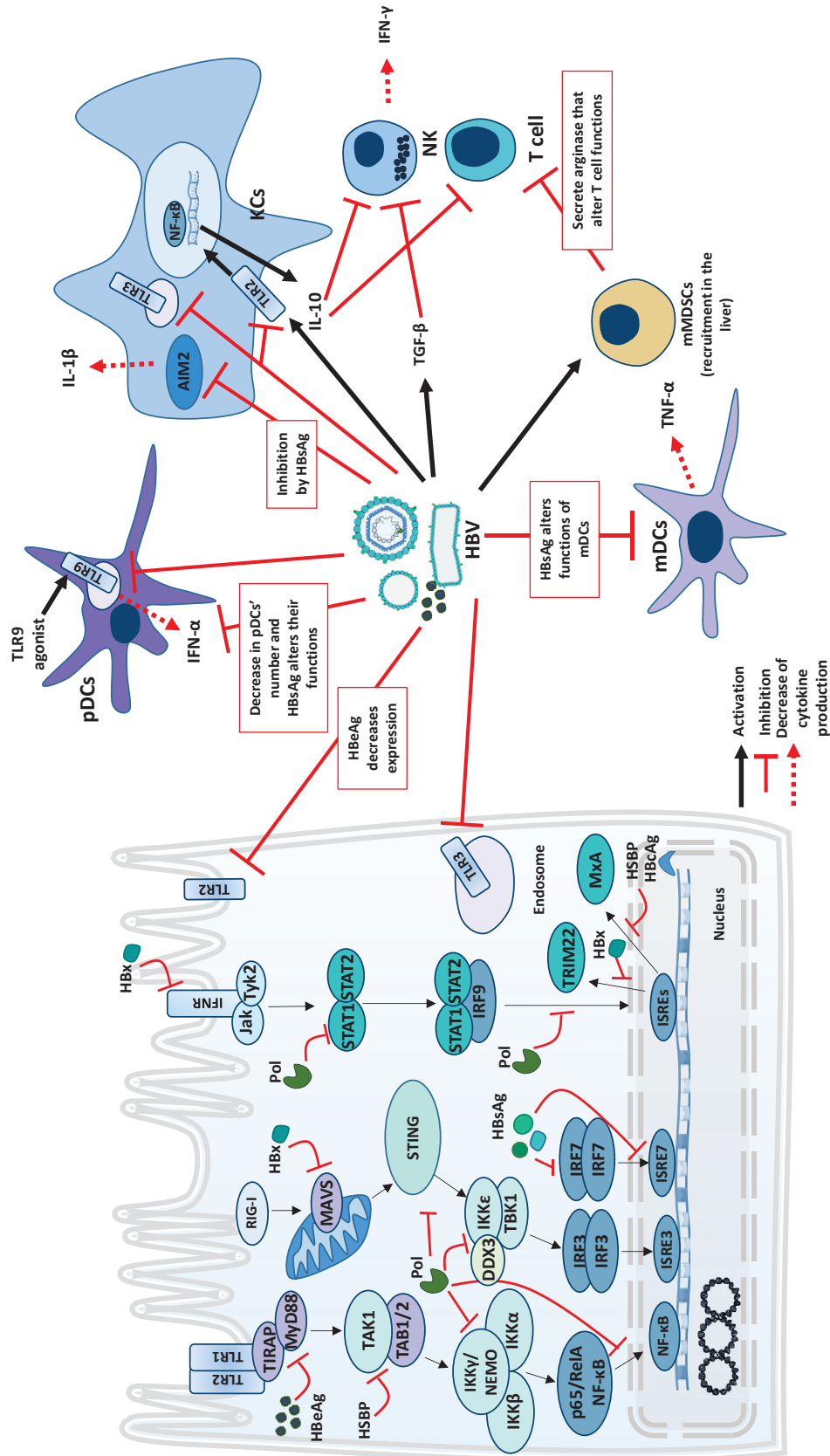

Figure 32: Main inhibitor mechanisms used by HBV to escape from immunity

HBV is able to counteract the innate immune system by targeting immune cells either by modulating their number or their phenotype. HBV proteins are also able to impair immune responses by inhibiting downstream signalling pathways.

3. Treatments against chronic hepatitis B virus

3.1 Current available treatments and recommendation

Despite a huge burden caused by chronic hepatitis B, it is now considered as a treatable and preventable disease thanks to adoption of several public health measures, including vaccination and the use of effective antiviral drugs. No specific treatment exists against acute hepatitis B.

3.1.1 Vaccination

Vaccination remains the most important and effective tool to prevent HBV infection. The first vaccine was available in France since 1981, and it was produced by harvesting HBsAg from plasma of chronic HBsAg carriers. In 1986, manufacturers used recombinant DNA technology to express HBsAg in HBV transfected yeasts, allowing creation of recombinant vaccines and replacing the previous one. Currently, they are the only vaccines authorized in France ([Zanetti, Van Damme, and Shouval 2008](#)). Standard vaccination scheme involves two intramuscular injections, one month apart, and a last booster shot six to twelve months later. Anti-HBs titer superior to 10 IU/l is considered as protective; however, a post-vaccination tier inferior to 10 IU/l is seen as an absence of response. Generally, a titer superior to 10 UI/l is measured 4 to 8 weeks after the last injection in more than 90% of vaccinated people. Despite the decrease of antibody titer with time, available data suggest that protection remains efficient until 30 years post vaccination ([Launay and Floret 2015](#)). WHO recommends an administration of the first dose in the 24 hours post birth, to reduce the risk of mother to child transmission. In 2019, less than 1% of chronic carrier were children under 5 years old, against 5% before the pre-vaccination era ([WHO data 2020](#)). Since 2018, in France, vaccination against HBV is compulsory for all new-borns and is recommended for children under fifteen.

Impact of vaccination of HBV epidemiology has been well documented in countries that adopted immunization programs. In Taiwan, the seroprevalence of HBsAg declined from 9.8% (before vaccination) to 0.6% in children after 20 years of vaccination program. This decrease is in line with decrease of HCC in children ([Ni and Chen 2010](#)). For that matter, vaccination is part of recommendation to prevent HCC in Asia Pacific region.

Despite efficiency of immunization, 10% of vaccinated infants born from an HBeAg-positive HBsAg carrier mother still develop chronic infection ([Locarnini et al. 2015](#)). The decrease of viral load is absolutely needed to avoid this perinatal transmission. In July 2020, WHO published new guidelines recommending that pregnant women presenting a viral load superior to 200 000 UI/ml receive a prophylactic antiviral drug that target HBV replication, more precisely tenofovir. This will more detailed in part 3.1.3 ([WHO data 2020](#)).

3.1.2 IFN- α therapy

The use of IFN- α for treating HBV started back to 1976. Patients with chronic HBV infection, presenting high levels of viral markers, were long-term treated with human leukocyte interferon, resulting in a fall of HBsAg and a decrease of HBeAg in most of patients (Greenberg et al. 1976). Following this, an injection protocol of three doses of IFN- α was adopted to reduce HBV replication (A. S. Lok et al. 1984). At the beginning of 2000s, standard IFN- α was replaced by Pegylated IFN- α (Peg-IFN- α), which not only improved the pharmacokinetics, half-life of IFN- α and results in a greater loss of HBeAg, but also relieved the protocol to once subcutaneous injection of 180 μ g per week during 48 weeks (Liaw et al. 2011). Two formulations of Peg-IFN- α exist, Peg-IFN- α -2a (Pegasys® Roche) and α -2b (Pegintron® Merck) are currently available (L. S. Y. Tang et al. 2018). Peg-IFN- α treatment is recommended as an initial treatment for patients with mild to moderate HBeAg-positive or –negative CHB and for some patients with compensated cirrhosis. Virological and serological responses are defined as such: serum HBV DNA level inferior to 2000IU/ml at the end of treatment and 12 months after the end of treatment, HBeAg loss with development of anti-HBe (in HBeAg-positive patients), HBsAg loss with development of anti-HBs (in all patients). Besides, it needs to be associated with a normalisation of ALT (around 40IU/L) and a decrease of necro-inflammation. The results of main studies for peg-IFN- α treatment are presented in **Table 3**:

	HBeAg-positive patients	HBeAg-negative patients
Dose	180 μ g	180 μ g
Anti-HBeAg seroconversion	32%	Not applicable
HBV DNA <60-80 IU/ml	14%	19%
ALT normalisation	41%	59%
HBsAg loss	3%	7%

Table 3 : Results of responses of HBeAg positive- and negative patients 6 months after 48 or 52 weeks of treatment by Peg-IFN- α

HBeAg-positive or negative were treated for 48 to 52 weeks with 180 μ g of Peg-IFN- α per week. Anti-HBeAg were quantified, as well as the levels of HBV DNA, ALT (alanine aminotransferase) and HBsAg. From (Lampertico 2017).

Even if the exact mechanism of IFN- α on hepatitis remains unclear, several mechanisms have been proposed, among others:

- Induction of diverse Interferon-stimulated genes (ISGs) coding for proteins with direct or indirect antiviral properties. For instance, TRIM22 was shown to inhibit the activity of core

promoter *in vitro* and IFIT 1 and 2 (IFN-induced proteins with tetratricopeptide repeats 1 and 2), which are able to inhibit HBV replication at both transcriptional and posttranscriptional levels (Pei et al. 2014; Gao et al. 2009).

- In cell culture and in humanized mice, IFN- α treatment showed to induce hypo-acetylation of histones present on the cccDNA, resulting in a repression of transcription and a decrease of viral RNAs (Laura Belloni et al. 2012).
- *In vitro*, IFN- α was shown to increase APOBEC3G, which was found to inhibit HBV replication by inducing G to A hypermutation in HBV viral DNA (F. Xu 2016).
- In HBV-infected hepatocytes, IFN- α was shown to degrade cccDNA via activation of APOBEC3A cytidine deaminases (Lucifora et al. 2014)
- In hepatoma cell lines, IFN- α suppresses enhancer I and II activity (Nakao et al. 1999; Nawa et al. 2012 ; Tur-Kaspa et al. 1990).
- In immortalized mouse hepatocytes, IFN- α induces the destabilization of viral nucleocapsid (C. Xu et al. 2010)
- *In vitro* and *in vivo* experiments showed that IFN- α induces MxA, which can inhibit the nuclear export of viral RNAs (Peltekian et al. 2005 ; Gordien et al. 2001)
- IFN- α induces the expression of ISG20 (Interferon-stimulated gene 20), which selectively degrades pgRNA via recognition of m⁶A in the lower stem loop (Imam et al. 2018)
- In HBeAg-negative patients, IFN- α has been shown to boost proliferation, activation and antiviral potential of NK cells (Micco et al. 2013).

However, IFN-based therapy is often complicated by side effects, such as headache, flu-like syndrome, myalgia, fatigue, thyroid dysfunction, anorexia and even neuropsychiatric symptoms. To circumvent those issues, nucleos(t)ide analogues therapy, generally well tolerated, can be considered (Rijckborst and Janssen 2010).

3.1.3 Nucleos(t)ide analogues (NA)

3.1.3.1 Long life therapy

Nucleos(t)ide analogues (NA) are direct-acting antiviral (DAA) that specifically target viral replication. They are inhibitors of the viral polymerase, blocking the reverse transcription step, via the competitive interaction with natural substrates of the polymerase. Once integrated, they induce termination of the nascent DNA chain. They now constitute the most common treatment for CHB and is recommended by all guidelines.

Currently approved NAs for HBV treatment (van Bömmel and Berg 2014; Lampertico 2017; Buti, Riveiro-Barciela, and Esteban 2017).

- **Lamivudine (LAM):** a levogyre enantiomer of 2'-3' dideoxy-3'-thiacytidine, approved in 1999 with a daily dose of 100mg.
- **Adefovir dipivoxil (ADV):** an oral prodrug of adefovir, which is an acyclic nucleotide adenosine analogue, active in its diphosphate form. Approved in 2002 in US and in 2003 in Europe for HBV treatment with a daily dose of 10mg.
- **Telbivudine (TBV):** a thymidine analogue, approved in 2006 for HBV treatment with a daily dose of 600mg.
- **Entecavir (ETV):** a cyclopentyl guanosine analogue, licensed in 2006 for HBV treatment with a daily dose of 0.5 mg.
- **Tenofovir disoproxil fumarate (TDF):** an ester prodrug form of tenofovir, (R)-9-(2-phosphonylmethoxypropyl), which is an acyclic phosphonate, approved in 2012 for HBV treatment with a daily dose of 245mg.
- **Tenofovir alafenamide fumarate (TAF):** is a phosphonamide prodrug of tenofovir, approved in 2016 for HBV treatment with a daily dose of 25mg.

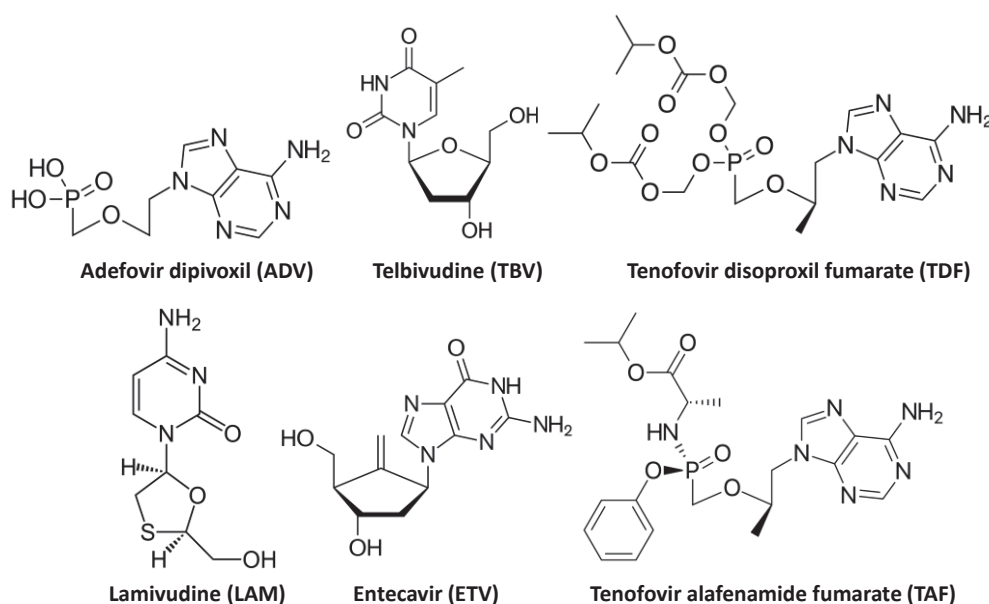

Figure 33: Chemical structures of NAs

They can be classified into those with low barrier (LAM, ADV, and TFV) and high barrier (ETV, TDF and TAF) against HBV resistance. This latter group is preferentially used as a first line of treatment in monotherapy, leading to undetectable viral load (< 10IU/ml) in majority of patients and present a safer profile. The results of main studies for NA treatment are presented in **Table 4**:

	HBeAg-positive patients						HBeAg-negative patients					
	LAM	TBV	ETV	ADV	TDF	TAF	LAM	TBV	ETV	ADV	TDF	TAF
Dose (mg)	100	600	0.5	10	245	25	100	600	0.5	10	245	25
HBeAg seroconversion	16-18%	22%	21%	12-18%	21%	10%	n.a	n.a	n.a	n.a	n.a	n.a
HBV DNA <60-80 IU/ml	36-44%	60%	67%	13-21%	76%	64%	72-73%	88%	90%	51-63%	93%	94%
ALT normalisation	41-72%	77%	68%	48-54%	68%	72%	71-79%	74%	78%	72-77%	76%	83%
HBsAg loss	0-1%	0.5%	2%	0%	3%	1%	0%	0%	0%	0%	0%	0%

Table 4 : Results of responses of HBeAg positive- and negative patients 6 months after 48 or 52 weeks of treatment with NAs

HBeAg-positive or negative were treated for 48 to 52 weeks with indicated dose of NAs per day. Anti-HBeAg were quantified, as well as the levels of HBV DNA, ALT (alanine aminotransferase) and HBsAg. LAM: Lamivudine; TBV: Telbivudine; ETV: Entecavir; ADV: Adefovir dipivoxil; TDF: Tenofovir disoproxil fumarate; TAF: Tenofovir alafenamide fumarate; n.a: not applicable. From (Lampertico 2017).

In addition to his direct antiviral effect, NA therapy may have immune-modulatory effect on innate immunity via the recovery of the function of myeloid dendritic cells in ADV-treated patients or an improvement of IFN- γ production by NK cells in ETV-treated patients. They also may increase frequency and function of the adaptive immune cells including CD4+ and CD8+ T cells, and decrease Treg cells frequency, characterized for their immunosuppressive activity. Finally, TFV and ADV were shown to increase the production of diverse cytokines including TNF- α , IL-6 or IL-10 and to modulation TLR-mediated response in human monocytes (Rehermann and Bertoletti 2015).

Their good tolerance, absence of side effects in general, and the oral administration present an important advantage compared to IFN- α treatment. However, most patients require long-life therapy because of the frequent relapse or HBV reactivation after cessation of treatment. Even if this long life therapy is effective and safe, a significant proportion of patients want to discontinue it for diverse reasons. In order to stop therapy, guidelines have been established that we will detail in the next paragraph (Chong and Lim 2017).

3.1.3.2 Stopping rules

Long-term monotherapy using ETV and TDF have been shown to stop the liver disease and is associated with a reduction of necroinflammation, fibrosis and cirrhosis. However, risk of development of HCC remains unclear. Even if a meta-analysis showed that antiviral therapy reduces death, HCC and hepatic decompensation in observational studies, randomized controlled trials demonstrated that death and

HCC were not improved ([A. S. F. Lok et al. 2016](#)). The goals of CHB therapy in international guidelines are improvement of survival and reduction of complications due to CHB, suggesting that stopping therapy could be an option.

Different studies have been realized to analyse the different patterns of relapse after arrest of NA therapy in HBeAg-negative patients.

HBeAg-positive patients who completed 6 or 12 months of consolidation therapy and who achieved HBeAg seroconversion and have no longer detectable HBV DNA. Approximately 90% of those patients will maintained HBeAg seroconversion and 50% of them will undergo an HBV DNA remission (<2000-20,000 IU/ml) after three years of treatment cessation. Treatment for more than 2 years, in those patients, was associated with less relapses. This suggests that duration of viral suppression might predict time of relapse ([Lampertico 2017](#)).

Another study enrolled 130 HBeAg-negative patients with undetectable HBV DNA for at least 24 months; respectively 35%, 50%, and 55% of them undergo relapses after 6, 12 and 24 months, defined as HBV DNA > 2000 IU/ml and ALT upper limit of normal. Patients were then retreated, before arresting treatment again; cumulative retreatment rates were 15%, 22%, and 40% at 6, 12 and 24 months, respectively. Even if no marker predicted virologic relapses, patients treated with TDF were more subject to relapse compared to those treated with ETV ([Papatheodoridis et al. 2018](#)). Jeng and colleagues analysed the incidence of HBsAg seroclearance after cessation of NA therapy in a large cohort of 691 HBeAg-negative patients (44.6% with cirrhosis). 3 years post treatment arrest, 79% and 61% of cumulative virologic and clinical relapse were observed, respectively. After 6 years, 42 patients presented HBsAg seroclearance. Interestingly, HBsAg levels at the end of treatment predicted HBsAg loss: HBsAg levels at the end of treatment <100 IU/ml leads to a decrease of HBsAg in 30% patients, while HBsAg >100IU/ml did not induce decrease of HBsAg ([Jeng et al. 2018](#)).

NA treatment generally leads to highly variable virologic relapses, and it is not currently possible to predict which patients will undergo significant relapse. Even if a low HBsAg levels might be a strong predictor of absence of relapse, it is not obvious. Indeed, Jeng *et al* studies also observed that patients with clinical relapses remaining untreated had higher HBsAg clearance compared to those who were retreated ([Jeng et al. 2018](#)). Many questions have to be studied to reduce drawbacks associated with relapses after NA therapy: better definition of patients that can benefit from treatment arrest, the need of retreatment and in this case, when to start the retreatment and potential hepatitis flares ([Lampertico and Berg 2018](#)).

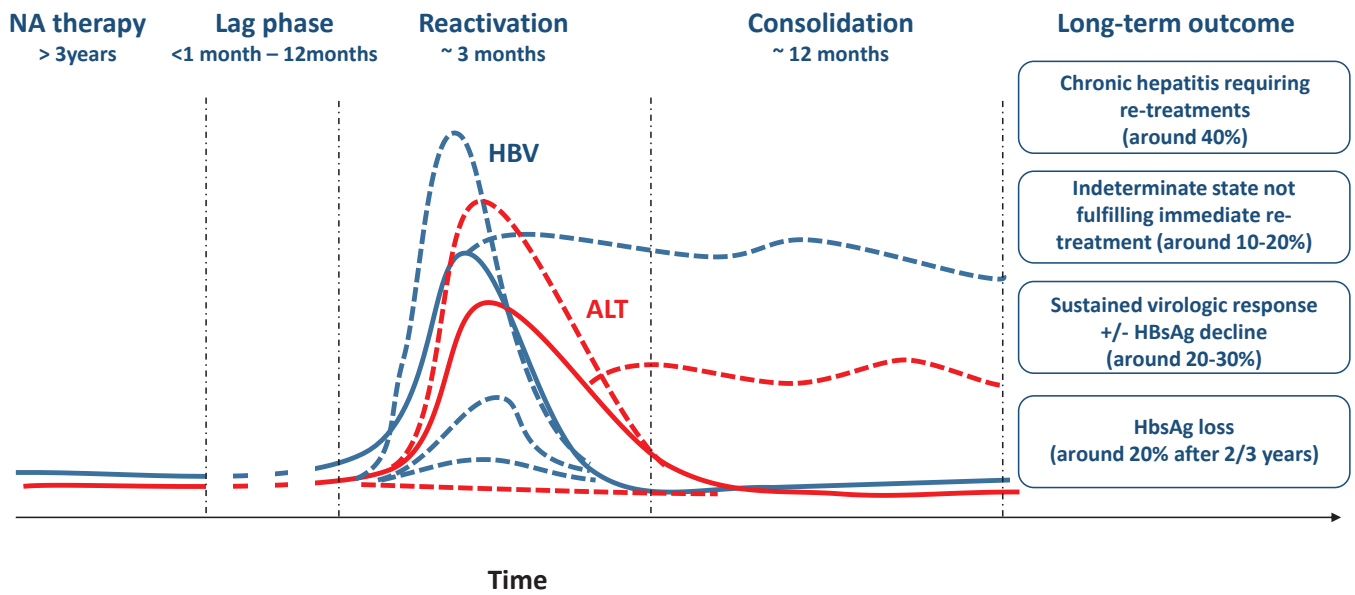

Figure 34: Illustration of different outcomes in HBeAg-negative patients after NA therapy arrest

Four phases are generally observed after NA therapy cessation: a lag phase in which HBV DNA is suppressed for several weeks or months, this duration depends on the viral suppression under NA and the NA used; a reactivation phase in which most of patients present HBV rebound followed by an increase in ALT; a consolidation phase which may be predictive for long-term outcomes; in this last phase, some patients can be divided into four subgroups, those who will require immediate re-treatment, those in an intermediate state who need a strong monitoring to decide whether retreatment is needed and when, patients who achieved a sustained virologic response with more or less decline in HBsAg levels and finally those who present a long lasting decrease of HBsAg levels. *Adapted from (Lampertico and Berg 2018).*

3.1.3.3 Combination of NA + Peg-IFN- α

As strong exposure to IFN- α was associated with NK/NKT-mediated increased killing of HBV-specific T-cells in CHB patients, and the use of NA therapies associated to restoration of T-cell functions, there was a rationale for combining both ([Micco et al. 2013](#); [Carolina Boni et al. 2012](#)). Peg-IFN α and NAs have different mechanisms of action; combination of both therapies could be an interesting approach to synergize their effects in order to improve rates of cure. Numerous studies have been realized using either simultaneous, sequentially or add on administration of these therapies.

- Combinations (simultaneous therapies): Administration of both LAM and Peg-IFN- α -2a, in HBeAg-negative patients, failed to demonstrate stronger antiviral effects during the course of treatment, and in post-therapy, compared to Peg-IFN- α -2a alone ([Marcellin et al. 2004](#)). Similarly, combination of LAM and Peg-IFN- α 2a or combination of LAM and Peg-IFN- α 2b in HBeAg-positive patients did not improve response rates compared to Peg-IFN- α monotherapy ([G. K. K. Lau et al. 2005](#); [Janssen et al. 2005](#)). Similarly another study involving ADV and Peg-IFN- α 2b combination failed to show superiority in virological and biochemical response rates compared to Peg-IFN- α monotherapy ([Piccolo et al. 2009](#)). However, in HBeAg-positive patients, combination of Peg-IFN- α 2b and ADV for 52 weeks resulted in a higher virological response at the end of treatment, but without significant impact on the rate of HBeAg seroconversion compared to Peg-IFN- α 2b monotherapy ([Y.-H. Liu et al. 2014](#)). To improve response rates from combination, a longer treatment duration was suggested; a study showed that HBeAg-positive patients treated with 96 weeks of Peg-IFN- α 2a with either LAM or ADV, induced high rates of HBeAg and HBsAg seroconversion of 72.3% and 27.7%, respectively. However, in this study no comparison with Peg-IFN- α 2a monotherapy was realized ([Cao et al. 2013](#)).

Combination with ETV, which has more potent antiviral effects than LAM, have also been studied in combination with Peg-IFN- α . In a small sample of 17 CHB patients with genotype C, ETV and Peg-IFN- α 2b administration induced HBeAg seroconversion in 36% and 73% of HBeAg-positive cases at the end of treatment and at 24 weeks after the administration, respectively ([Hagiwara et al. 2013](#)). Another study using combination of ETV and Peg-IFN- α 2b for 48 weeks, showed that combination therapy led to greater on-treatment HBV DNA suppression but did not improve virological response and HBsAg loss over monotherapy ([Tangkijvanich et al. 2016](#)). TBV in combination with Peg-IFN- α induced a rapid reduction in HBV DNA levels, but it was associated with an increased risk of peripheral neuropathy. Consequently, this combination should not be used ([Marcellin et al. 2015](#)).

Combination of TDF and Peg-IFN- α 2a showed promising results as patients receiving the combination for 48 weeks presented higher rate of HBsAg loss at week 72 compared to patients who received Peg-IFN- α 2a for 48 weeks (Marcellin et al. 2016).

- Add-on therapies: HBeAg-positive patients who received Peg-IFN- α during 24 weeks, after an initial treatment of 24 weeks with ETV presented higher HBeAg loss compared to ETV monotherapy; it also resulted in more viral decline and prevented relapse after ETV arrest (Brouwer et al. 2015). However, another study showed that neither ETV add-on nor ETV pretreatment to Peg-IFN- α -2a demonstrated superiority compared with 48 weeks of Peg-IFN- α monotherapy (Xie et al. 2014).
- Sequential therapies: Administration of NAs followed by Peg-IFN- α have largely been studied, sometimes leading to antagonistic results: a small sample of patients treated with LAM for 20 weeks, followed by 4 weeks of LAM and Peg-IFN- α combination and an additional 24 weeks of Peg-IFN- α presented HBeAg seroconversion in 45% of cases and negative HBV-DNA in 57% (Serfaty et al. 2001). Another study realized in HBeAg-negative patients, using a different protocol based on LAM monotherapy for 6 months, followed by 6 months of combination of LAM with Peg-IFN- α and 12 months of Peg-IFN- α monotherapy reported no significant differences between sequential therapy and Peg-IFN- α -alone control group (Manesis, Papatheodoridis, and Hadziyannis 2006). Besides, another study showed that treatment with LAM alone for 16-32 weeks, then with both IFN- β and LAM for 4 weeks and finally with IFN- β alone for 20 weeks induced virological effects in 29% of HBeAg-positive patients; same protocol, using ETV and IFN- α instead, demonstrated no higher response rates (Enomoto et al. 2015; Enomoto et al. 2013). Moreover, HBeAg-negative patients treated with 24 weeks TBV followed by 24 weeks of Peg-IFN- α presented higher virological response rates at week 72 compared to patients treated first by Peg-IFN- α and then TBV (Piccolo et al. 2012).

Furthermore, the use of Peg-IFN- α after long-term therapy with NAs has been assessed. HBeAg-positive patients, with prior ETV therapy for at least 2 years, were treated with combination ETV and Peg-IFN- α 2a for 48 weeks, and remained on ETV therapy after 48 weeks. At week 96, it resulted that patients treated with the combination presented greater HBeAg seroconversion than patients who continued ETV monotherapy (G.-J. Li et al. 2015). Similarly, patients long-term-treated with ETV who switched to Peg-IFN- α 2a for 48 weeks achieved higher HBeAg seroconversion at week 48 than those who continued ETV therapy, with 14.9% and 6.1%, respectively (Q. Ning et al. 2014).

In majority of the studies, the combination of Peg-IFN- α 2a and NAs did not improve response rates compared to Peg-IFN- α 2a monotherapy. Furthermore, it must be highlighted that in some of those studies Peg-IFN- α treatment alone is not usually used in comparison, raising the question whether it could have achieved better responses or not.

Despite those promising results obtained with combination of TDF and Peg-IFN- α , rates of HBsAg loss remains under 10%, and further research are needed to identify the optimal combination or sequential therapy and which patients are more likely to respond ([Woo, Kwok, and Ahmed 2017](#)). Some recent combination studies are sum up in **Table 5**.

Strategy used	Patients status	HBV genotype	Treatment regimen used	Duration weeks	HBeAg seroconversion %	HBsAg seroconversion %	HBV DNA suppression %
Add-on Brouwer et al., 2015	HBeAg positive	A,B,C,D	1)ETV for 48 weeks + Peg-IFN α in weeks 24-48 2)ETV for 48 weeks	96	1) 26 2) 13	1) 1 2) 0	1) 77 2) 72 <20 ² IU/ml)
Add-on Xie et al., 2014	HBeAg positive	unknown	1) Peg-IFN α for 48 weeks 2) Peg-IFN α for 48 weeks + ETV in weeks 13-36 3) ETV for 24 weeks + Peg-IFN α in weeks 21-68	72-92	1) 31 2) 25 3) 26	1) 1.4 2) 4.1 3) 1.4	1) 40.3 2) 21.5 3) 37 < 10 ³ copies/ml
Sequential Ning et al., 2014	HBeAg positive treated with ETV for 9-36 months	unknown	1) Peg-IFN α for 48 weeks 2) ETV for 48 weeks	48	1) 14.8 2) 6.1	1) 4.3 2) 0	1) 72 2) 97.8 < 10 ³ copies/ml
Sequential Piccolo et al., 2013	HBeAg negative	D	1) Peg-IFN α for 24 weeks +TBV in weeks 25-48 2) TBV for 24 weeks + Peg-IFN α in weeks 25-48	72	-	1) 0 2) 0	1) 13.3 2) 46.7 <20 ³ IU/ml
Simultaneous Liu et al., 2014	HBeAg positive	Unknown	1) Peg-IFN α + ADV for 52 weeks 2) Peg-IFN α for 52 weeks	52	1) 36.7 2) 25.8	1)3.3 2)0	1) 76.7 2) 29.0 undetectable
Simultaneous Tangkijvanich et al.,	HBeAg negative	B,C	1) Peg-IFN α + ETV for 48 weeks 2) Peg-IFN α for 48 weeks	96	-	1) 3.2 2) 7.9	1) 38.1 2) 41.3 <20 ³ IU/ml
Simultaneous Marcellin et al., 2015	HBeAg positive	A,B,C,D	1) Peg-IFN α + TBV for 24 weeks 2) TBV for 24 weeks 3) Peg-IFN α for 24 weeks	24	1) 8 2) 4 3) 12	1) 0 2) 0 3) 0	1) 71 2) 35 3) 7 <30 ² copies/ml
Simultaneous Marcellin et al., 2016	HBeAg positive or negative	A,B,C,D,E, H	1) Peg-IFN α + TDF for 48 weeks 2) Peg-IFN α for 16 weeks + TDF for 48 weeks 3) TDF for 120 weeks 4) Peg-IFN α for 48 weeks	72	1) 25 2) 23.8 3) 12.8 4) 24.5	1) 8.1 2) 0.6 3) 0 4) 2.9	1) 9.1 2) 6.5 3) 71.9 4) 9.2

Table 5 : Some recent combination studies using Peg-IFN- α and NAs

Doses used in the studies: Peg-IFN- α : 180mg/weeks; ADF: 10mg/day; ETV 0.5 mg/day; TBV: 600mg/day; TDF: 300mg/day.

Adapted from [Arends et al. 2017](#)

3.2 Urgent needs for improvements

3.2.1 Clinical outcomes of current treatments vs. “Functional cure”

As previously seen, current treatments are based on two classes of therapeutic agents Peg-IFN- α and NAs. Therapy based on Peg-IFN- α administration induces immune-regulatory effects and a viral suppression is observed in approximately 25% of patients. It has a finite duration of therapy and HBeAg decrease and anti-HBs seroconversion is more important than in NAs-treated patients. However, it is associated with severe side effects that limits its use (Arends et al. 2017). Stronger viral suppression is obtained in the majority of patients with NA therapies and in particular, drugs with high antiviral potency and barrier to resistance, ETV and TDV, which possess a safer profile and are well tolerated. However, in some endemic areas, due to high costs of those drugs, drugs with low barrier to resistance are still used and it remains an issue as patients develop resistant strains. In addition, long-term administration of those drugs induce healthcare management issues in those countries. Both therapies are associated with a reduced risk of HCC (Durantel and Zoulim 2016).

Even if the goal of HBV therapies is to eliminate HBV with no virological relapse and no risk of liver disease progression (development of cirrhosis, hepatic decompensation, HCC), a complete cure may not be feasible due to HBV DNA integrated into the host genome and the presence of the “minichromosome”, the cccDNA.

A “functional cure” was therefore defined by the American Association for the Study of Liver Diseases and the European Association for the Study of the Liver in 2016. It is based on the loss of HBsAg in the blood with or without anti-HBs seroconversion, and undetectable HBV DNA 6 months after completing treatment (Anna S. Lok et al. 2017). Indeed, HBsAg seroclearance is not only seen as a surrogate for immune control and a durable suppression of HBV replication, but it is associated with improved clinical outcomes in CHB patients, despite HBV DNA presence in the liver. Several studies demonstrated high durability of HBsAg seroclearance several years post-loss of HBsAg, and an increase of anti-HBs, which is not essential to maintain HBsAg loss (Figure 35) (Yip 2020).

Peg-IFN- α and NA therapies induce an HBsAg loss in less than 10% of patients (Durantel and Zoulim 2016). This weak result in term of HBsAg leaves room for improvement, and open the path to new therapies.

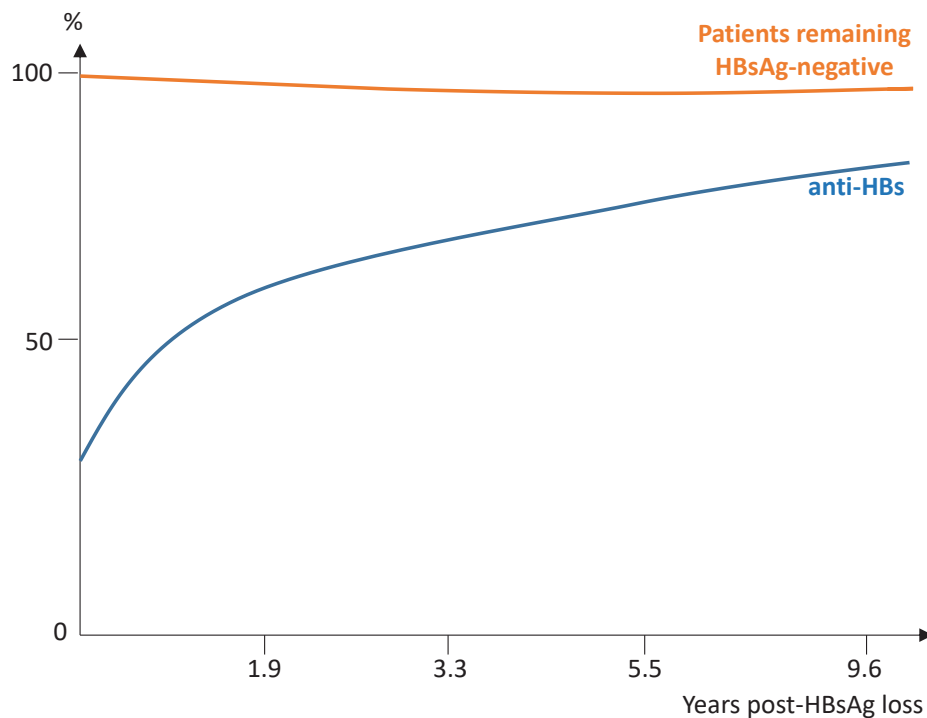

Figure 35 : HBsAg seroclearance durability and rate of anti-HBs seroconversion after HBsAg loss

Summary on durability of HBsAg seroclearance and rate of anti-HBs seroconversion from different studies, several years post HBsAg loss. Adapted from (Yip 2020)

3.2.2 However, can we do better?

It is clear that novel antiviral treatments, with a finite duration and that prevent liver complications, are absolutely needed to increase the rate of functional cure of the infection. Functional cure does not imply loss of HBV DNA and more precisely the HBV cccDNA reservoir, responsible of the persistence of the virus. However, can we do even better than a functional cure?

Many scientists tried to draw a parallel with the spontaneous recovery from acute infection. Acute infection induces elimination of infected hepatocytes by HBV-specific T cell response and by non-cytopathic mechanisms; the further infection of new cells is prevented by anti-HBs. This is infrequently observed with current treatments in CHB patients. Consequently, they thought that the ideal curative treatment is to induce resolution to that is observed in acute-infected patients, and it highlights the need to totally eradicate HBV DNA (Revill et al. 2019). Consequently, a more complete cure is envisaged by the scientific community, either by shutdown of cccDNA transcription or its complete elimination. Since several years, huge improvements in the understanding of the viral life cycle, including the recent discovery of NTCP receptor for the viral entry or enzymes involved in the cccDNA formation, but also mechanisms involved in cccDNA degradation and in HBV-specific T cell exhaustion could be crucial for achieving this complete cure (Durantel and Zoulim 2016).

Number drugs are being evaluated in preclinical models or in clinical development. Drugs that include inhibitor of viral entry, drugs that directly or indirectly target cccDNA or viral RNAs, capsid assembly destabilisers or agents affecting the viral proteome. We will now see the treatment options that are currently in development.

3.3 Drugs and strategies in R&D

3.3.1 Direct-Acting Antivirals

3.3.1.1 Entry inhibitors

3.3.1.1.1 Antibodies

HBV immunoglobulins (HBIG) are the only clinically approved entry inhibitor for HBV made from a mixture of S protein-directed antibodies obtained from the plasma of vaccinated individuals or from patients who have resolved the infection, which prevent its interaction with NTCP receptor. They were used first used for the treatment of infected patients after liver transplantation, which decrease reinfection rate and improve patient survival ([Lempp and Urban 2014](#)). Their use is mainly recommended either in prophylaxis for people who are exposed to the virus, in particular to newborns from HBeAg-positive and HBsAg positive women to prevent vertical transmission, but also in combination with HBV vaccination ([Tu and Urban 2018](#)).

3.3.1.1.2 Attachment inhibitors

Entry of HBV needs the attachment of the virion to HSPGs on the surface of hepatocytes. Both L and antigenic loop of S region mediate this attachment. Heparin, a soluble highly sulphated glycosaminoglycan, and clinically used as an anticoagulant, was shown to inhibit HBV infection *in vitro*, surely due to its binding to HBV surface proteins. Similarly, suramin, a sulphated naphthylamine derivative of urea, approved for treatment of human trypanosomiasis, were used for treatment of HBV-infected patients in a clinical study, but it was withdrawn due to toxicity and lack of efficiency ([Lempp and Urban 2014](#)). However, this interaction still represents an ideal target and some studies are currently investigating new treatment approach. For instance nucleic acid polymers, which possess chemical similarity to heparin sulfate, were shown to efficiently inhibit virus entry *in vitro* probably through a binding-competition mechanism and preS1 binding peptides, such as 4B10, which greatly inhibit virus attachment in hepatic cell ([Guillot et al. 2017](#); [Ye et al. 2016](#)).

3.3.1.1.3 NTCP inhibitors

As previously seen, HBV enters hepatocyte through the recently discovered NTCP receptor, a bile acid transporter, via the interaction of the PreS1 region of the envelope with the amino acids 157 to 165 of the receptor. This discovery renders this receptor particularly interesting as a target for new antiviral

therapy, in particular to prevent the establishment of infection in naïve hepatocytes. Two classes of NTCP inhibitors exist either substrate or allosteric inhibitors.

- **Substrate inhibitors:** screening approach of already approved drugs resulted in identification of five drugs rosiglitazone, zafirlukast, TRIAC, sulfasalazine and Chicago skyblue 6B were found to inhibition HBV infection *in vitro* (Donkers et al. 2017)
- **Allosteric inhibitors:** they irreversibly inactivate NTCP through binding to allosteric sites. Cyclosporin A (CsA), an already approved drug for suppression of the immunological failure of xenograft tissues, was shown to blockade virus infection via NTCP targeting *in vitro* (Watashi et al. 2014). However, this compound also block NTCP transport of bile acids into hepatocytes, which may cause severe side effects. To circumvent this, several CsA derivatives have been synthesized, among the eleven compounds, two of them called SCY450 and SCY995 were able to inhibit HBV with no effect on NTCP-mediate bile transport (Shimura et al. 2017).

Bulevirtide (formerly known as Myrcludex-B) is a myristoylated lipopeptide whose sequence corresponds to the N-terminal amino acids (2-48) of L-HBsAg that specifically targets NTCP receptor. Low dose of bulevirtide is efficient to block de novo HBV infection both *in vitro* and *in vivo* by competing with viral Pres1 motif to bind with NTCP (Volz 2013). A phase 1b/2a clinical trial, performed on 40 HBeAg-negative patients, showed a general decline of HBV DNA and ALT normalization but no patients achieved HBsAg loss after subcutaneous injection of bulevirtide (Bogomolov et al. 2016). It has recently been approved in the European Union for treatment of chronic hepatitis delta in HDV-RNA positive patients with compensated liver disease (Kang and Syed 2020). HDV is a satellite virus of HBV that depends on HBsAg in the same cell to complete its life cycle (Mentha et al. 2019). Most of the eight clinical trials, performed so far, with five completed and three on-going, were realized with HBV/HDV coinfecting patients. Bulevirtide used in combination with Peg-IFN α , resulted in HBsAg loss in around 30% of coinfecting patients at 48 weeks off therapy (Wedemeyer et al. 2019); similarly myrcludex B was used in combination with TDF, and resulted in undetectable HDV RNA and a weaker decrease of HBsAg (NCT035546621). However, under bulevirtide treatment, total plasma bile salts may increase due to altered NTCP function as a bile salts transporter. To circumvent this, recent *in vitro* studies using derivatives of the pentacyclic lupine-type triterpenoid betulin showed selective inhibition of the HBV/HDV virus receptor function of NTCP without interfering with its transporter function (Kirstgen et al. 2020).

Finally, even if those most of the studies were performed in HBV/HDV coinfecting patients, an efficient synergistic effect is expected when entry inhibitors are used in combination with other antivirals in CHB patients.

3.3.1.2 Core Protein Allosteric Modulators (CpAMs)

HBcAg plays a crucial role in both pgRNA packaging and reverse transcription but it has been described to have numerous effects on viral or host gene transcription. Indeed, HBcAg was shown to bind the cccDNA in order to maintain it in an epigenetic permissive state and has the ability to bind to human gene promoters disrupting normal gene expression of a subset of cellular genes involved in innate immunity or inflammation (Y.-H. Guo et al. 2011 ; Y. Guo et al. 2012; Levrero and Zucman-Rossi 2016). Moreover, recently our team has also shown that HBcAg had other nuclear regulatory functions, including regulation of RNA biogenesis, after studying its nuclear interactome (Chabrolles et al. 2020). These numerous functions render HBcAg as a privileged target to fight chronic establishment of HBV. Core allosteric modulators (CpAMs) are drugs that lead to the formation of aberrant or empty capsids depending on the chemical structure of CpAMs. There are two class of CpAMs: class I CpAMs, which are heteroaryldihydropyridines (HAP), form aberrant capsid and class II CpAMs, which are phenylpropenamides (PPA) form capsid lacking viral pgRNA and HBV polymerase (Z. Yan et al. 2019). Different molecules have been tested or are currently in clinical trials for instance (non-exhaustive list):

- NVR 3-778: the first CpAM that demonstrated antiviral activity in a phase I study of HBeAg-positive patients without cirrhosis, antiviral activity that was greater in combination with Peg-IFN α (M. F. Yuen et al. 2019).
- JNJ-6379 (or JNJ-56136379): a class II CpAM that showed potent antiviral activity in patients with CHB in a phase I study. In cultured hepatocytes, it has been shown to inhibit *de novo* cccDNA formation during new infection and to prevent cccDNA formation. A phase II study is ongoing to evaluate JNJ-6379 in combination with NAs (Zoulim et al. 2020).
- RO7049389: a class I CpAM induced a significant decrease of viral DNA in a phase I study (E. Gane et al. 2018).
- ABI-H0731 (or vebicorvir): a class II CpAM that showed a suppression of HBV DNA in 100% of HBeAg-negative patients after 48 weeks of treatment in combination with ETV, TDF or TAF. A phase III is currently ongoing (Assembly Biosciences 2021).
- GLS4: a novel inhibitor of HBV capsid that is currently in phase II (N. Zhao et al. 2019).

Even if HBV DNA is particularly impacted by CpAMs, further long-term studies are important to determine if CpAMs are able to eradicate HBsAg, HBeAg or cccDNA.

3.3.1.3 RNA interference

RNA interference is a specific and efficient method to induce post-transcriptional gene silencing. To summarize, the process is initiated by ribonuclease protein Dicer that cleaves endogenous or exogenous double-stranded RNAs in short fragments, called small interfering RNAs (siRNAs) in the

cytoplasm of the cell. siRNAs contain a “guide” strand (antisense) and a “passenger” strand (sense) that are then separated into single strands within the RISC (RNA-induced silencing complex). The passenger strand is degraded while the guide strand aligns the RISC complex on the target mRNA and the action of catalytic RISC protein, Argonaute 2 induces the cleavage of the target mRNA (Nayagam, Cargill, and Agarwal 2020). Thus, the targeting of viral mRNAs, using synthetic small interfering RNAs, was thought to be very promising.

Few siRNAs are currently in clinical trials:

- ARC520: currently in phase II, it reduced all RNA transcripts, which led to a persistent reduction in viral antigens and HBV DNA in both HBeAg-positive and HBeAg-negative patients as well as in NA-experienced HBV patients (M.-F. Yuen et al. 2020).
- JNJ-3989 (formerly ARO-HBV): currently in phase II, its combination with NAs resulted in significant HBsAg decline ($\geq 1 \log_{10}$ IU/ml) in 39% of CHB patients (Arrowhead Pharmaceuticals 2020).
- VIR-2218: currently in phase II either alone or in combination with Peg-IFN α . It is expected to inhibit HBsAg production and T cell activity directed against HBV (Vir Biotechnology 2020).
- RG6346 (formerly DCR-HBVS): currently in phase I trial to evaluate its safety and tolerability in healthy volunteers and in non-cirrhotic chronic HBV (Dicerna Pharmaceuticals 2020)

Even if those drugs are particularly potent in reducing HBV DNA as well as HBsAg, they do not have an impact on the cccDNA, and may present delivery issues.

Besides, antisense oligonucleotides can be used; they are complementary small nucleic acids that target HBV transcript acting through either steric hindrance or RNA degradation via ribonuclease H cleavage. IONIS-HBVLRx (GSK33389404), currently in phase I, is a liver-targeted antisense oligonucleotide conjugated with N-acetylgalactosamine (GalNAc) moieties that specifically target hepatocytes through asialoglycoprotein receptor. It may be considered as a prodrug, its active form being IONIS-HBVRx (GSK3228836), i.e without N-acetylgalactosamine (GalNAc) moieties (Han et al. 2019).

3.3.1.4 Nucleic acid polymers (NAPs)

HBsAg is the most abundant viral antigen in the blood that plays a crucial role in preventing immune control of HBV and in the maintenance of viral infection (Kondo et al. 2013). It is secreted in the blood mainly via SVPs, the non-infectious particles of the virus, which are produced independently from the viral replication, rendering them difficult to target. As seen earlier, current treatments based either on

Peg-IFN α or NAs are not efficient in inducing HBsAg loss, making it a privileged target for new antiviral strategies.

Nucleic acid polymers (NAPs) have been shown to have antiviral activity *in vitro* and *in vivo* in a large spectrum of viruses as entry inhibitors by attaching to amphipathic structures (helix alpha) conserved in viruses or by interfering with apolipoprotein interactions preventing viral fusion with host cell. In HBV infection, antiviral effect of NAPs is different, and is mainly due to a blockage of secretion of HBsAg from infected hepatocytes by interfering with the assembly and/or the release of SVPs (Real et al. 2017). Several NAPs are already used in clinics, alone or in combination with NAs or Peg-IFN α in both HBeAg-positive and HBeAg-negative CHB patients. Their use in therapy is accompanied with reduction of serum HBsAg, HBV DNA and the appearance of serum anti-HBs antibodies, antibodies that may indicate activation of immunity associated with decrease of viral parameter (Al-Mahtab, Bazinet, and Vaillant 2016; Bazinet et al. 2020). REP 2139-Mg and REP 2165-Mg are the two main NAPs in current phase II clinical trial, their association with both TDF and Peg-IFN α induces HBsAg decrease <0.05IU/ml in 60% of patients and functional cure was maintained in 32.5% of patients 48 weeks post-treatment (Bazinet et al. 2020). Those treatments seem promising as experiences conducted *in vivo* showed not only reductions of HBsAg and HBV DNA, but also clearance of cccDNA, the main cause of the persistence of the virus, which can be attributed to immune recovery in the absence of circulating HBsAg (Noordeen et al. 2015).

3.3.1.5 Farnesoid X receptor (FXR)- α agonists

HBV infection and bile acid metabolism are tightly connected: as previously seen, HBV enters hepatocytes via NTCP, a bile acid transporter and HBV infection can modify the expression of bile acid nuclear receptor farnesoid X receptor (FXR)- α . HBV infection is associated with an increase of FXR and its regulated genes *in vitro*, *in vivo* and in liver biopsies from CHB patients. Further *in vitro* experiments linked those observations with a proviral role of FXR, as its absence decreased cccDNA pool size and prevented viral RNA transcription and virus secretion. FXR α as monomer or heterodimer with RXR α can bind to two sequences on the cccDNA, in the basal core promoter and in the ENh2 region, bindings that may also involve HBx and that subsequently act as a transcriptional activator. However, treatment with the synthetic FXR agonist, GW4064, could reverse this proviral effect, inducing suppression of HBV cccDNA formation and transcription. *In vivo* experiments using mice injected with AAV-HBV vector further confirmed the antiviral effects of GW4064, with a secretion decrease of HBV DNA and HBsAg (Radreau et al. 2016; Mouzannar et al. 2019). ENYO Pharma assessed a novel synthetic non-steroidal FXR agonist, EYP001, in a phase Ib clinical trial, which resulted in a decrease of viral load, HBV RNAs and viral proteins, HBeAg and HBsAg in both HBeAg-positive and HBeAg negative patients. A phase II is currently ongoing (ENYO-Pharma, 2018).

3.3.1.6 Molecules targeting the cccDNA

Even if NA therapies are able to block viral replication, they do not eradicate the cccDNA, which is the cause of the persistence of the virus (Arends et al. 2017). Peg-IFN α has been shown to degrade cccDNA *in vitro* but its efficiency in patients remains to be proved (Lucifora et al. 2014). The direct targeting of cccDNA, either by inducing its degradation or its silencing, could be interesting curative options for HBV infection leading to complete cure.

Gene therapies based on nucleases have been proposed. They induce double-stranded breaks within HBV genome and targeted mutagenesis is performed by host cells' repair machinery. Episomal structure of cccDNA renders it as a privileged target for nuclease gene editing (Bloom et al. 2018).

- **Zinc finger nuclease (ZFN):** zinc fingers are multifunctional proteins that act as transcription factors, therefore able to recognize nucleotide triplet. An endonuclease domain, generally a *FokI*, is added at the C-terminus of ZF, to generate potent ZFNs able to induce double stranded breaks in dimers. They are generally arranged in arrays of three to four ZFs. ZFNs directed against HBV have been tested *in vitro*, resulted in disruption of viral sequences, but no cleavage of cccDNA could be verified (N. D. Weber et al. 2014; Cradick et al. 2010).
- **Transcription activator-like effector nucleases (TALENs):** they are dimeric nucleases comprising a DNA-binding protein (TALE) and an endonuclease domain. The transcriptional activator-like effector (TALE) comprises individual repeats to recognize a single base pair and repeat-variable di-residues, responsible for the binding specificity. Several repeats linked together can therefore render TALE highly specific for a targeted DNA (Bloom et al. 2018). TALEN directed against HBV have been described in HepG2.2.15 cell lines, which resulted in optimal cleavage activity within S and C ORFs associated with disruption of the cccDNA. Similarly, *in vivo* studies using murine hydrodynamic injection model showed decrease of serum HBsAg and viral particles associated with important targeted mutagenesis (Bloom et al. 2013). In Huh-7 cell lines, a synergistic effect was observed when using TALENs in combination with IFN- α , with approximately 60% of reduction of cccDNA copies (J. Chen et al. 2014)
- **Clustered regularly interspaced short palindromic repeats/Cas9 (CRISPR/Cas9):** this system is composed of CRISPR RNA (crRNA) whose sequence is complementary to the target DNA linked to a trans-activating crRNA (tracrRNA), which interacts with the Cas9 endonuclease. Cas9 is able to recognize a short DNA sequence, called the protospacer adjacent motif (PAM) that allows the association of the crRNA to the complementary DNA, and then Cas9 induces DNA cleavage. This cleavage is then repaired by nonhomologous end joining (NHEJ) DNA repair pathway of the cell, which is an error-prone process, resulting in insertion or deletion (indel), which further disrupt the gene function. The fusion of crRNA and tracrRNA into a single guide

RNA (sgRNA) has simplified this system. This system has been used in numerous *in vitro* studies with different cell line models as well as *in vivo* using murine hydrodynamic injection. All models presented a substantial decline in the level of total HBV, a decrease of the secretion of antigens and even for some a decline of cccDNA copies. CccDNA has been seen to be either destroyed or repaired by NHEJ inducing indels (E. M. Kennedy, Kornepati, and Cullen 2015). Despite efficiency observed in preclinical studies, another challenge with CRISPR/Cas9 system remains the delivery of sgRNA with the large Cas9 endonuclease. New tools using transduction of an AAV coding for both sgRNA and Cas9 have been proposed: in both cells lines and in humanized chimeric mice, the use of an AAV serotype 2, coding for a sgRNA targeting PreC region and for Cas9 have been shown to suppress HBcAg, HBsAg and HBV DNA along with cccDNA (Kayesh et al. 2020).

Even if gene-based therapies are very interesting and showed efficiency in targeting the cccDNA, they have to overcome different challenges including an efficient delivery using viral or non-viral vectors, improvement in DNA-binding specificity and limiting off-target leading to side effects (Bloom et al. 2018).

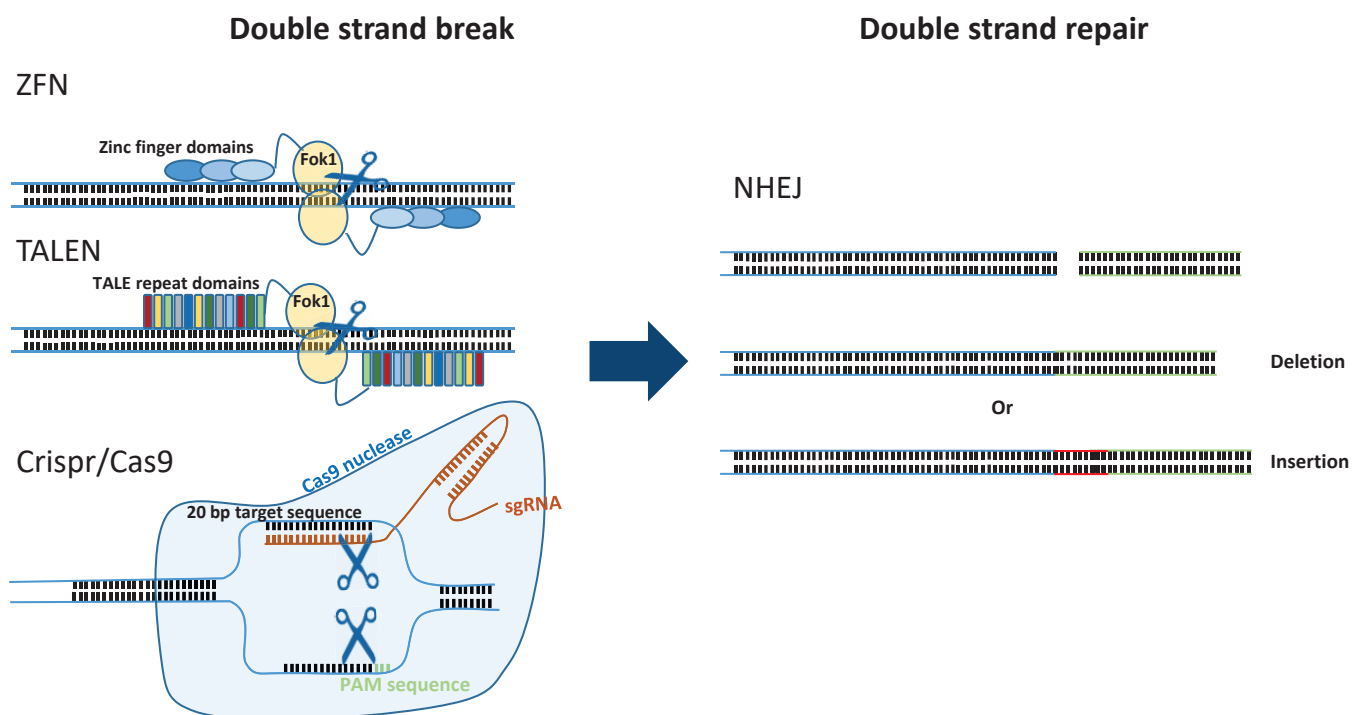

Figure 36: Genome editing strategies

Adapted from (H. Li et al. 2020)

As previously mentioned, cccDNA is an episomal minichromosome decorated host histones and non-histone proteins and is subject to epigenetic regulation via histone modifications (acetylation, methylation, phosphorylation, ubiquitination) and DNA methylation or acetylation. HBx and HBcAg in

cooperation with acetyl-transferases/deacetylases, lysine methyl-transferases, protein arginine methyl-transferases and DNA methyl-transferases are the major actors of these epigenetic modifications (Hong, Kim, and Guo 2017). Epigenetic modifications that are able to induce an inactive status of the cccDNA without damaging it, inducing its silencing. DNA methylation has been shown to impede HBV replication *in vitro*, suggesting that DNA methyl-transferases could be used to inhibit cccDNA transcription (Vivekanandan et al. 2010). Hypo-acetylation of H3 and H4 results in low HBV viremia in infected patients, while hyper-acetylation is associated with high HBV replication (Pollicino et al. 2006). The use of the histone acetyl-transferase inhibitor C646 was shown to block acetylation of H3K27 and H3K122, which resulted in inhibition of HBV transcription in PHH (Tropberger et al. 2015). IFN- α treatment was shown to inhibit transcription cccDNA activity via hypo-acetylation of histones and the recruitment of transcriptional repressor complexes on the cccDNA both *in vivo* and *in vitro* (Laura Belloni et al. 2012). Similarly, in HBV infected duck, avian IFN- α was shown to interfere with structure and function of the cccDNA via hypo-acetylation of H3 and H4 (F. Liu et al. 2013). These epigenetic modifications may seem very interesting to silence cccDNA, but the feasibility of using epigenetic modifiers remains challenging. The replacing of the nuclease domain by an epigenetic silencer in ZFs, TALEs or CRISPR/Cas could be interesting options. One fused the catalytic domain of an DNA methyl-transferase to a ZF targeting HBx promoter sequence, which resulted in methylation of targeted CpG sites, down regulation of viral mRNAs, viral antigens and decline of viral replication in both *in vitro* and *in vivo* (Xirong et al. 2014).

3.3.2 Immune Modulatory Therapies

3.3.2.1 Immune Checkpoint Inhibitors (ICI)

Programmed cell death (PD-1) and cytotoxic T-lymphocyte-associated antigen 4 (CTLA-4) are receptors providing inhibitory signals to T cells. In CHB, their up regulation is associated with both T-cell exhaustion and persistence of the disease. Thus, their inhibition by immune checkpoint inhibitors (ICI) may be an interesting option, restoring HBV-specific T cells and breaking immune tolerance. *Ex vivo* experiments using intrahepatic T cells from CHB patients treated with anti-PD-L1 in combination with CD137, a member of the tumour necrosis factor-receptor family, were shown to increase responses of human liver T cells against HBV (Paola Fiscaro et al. 2012). Moreover, in chronically infected woodchucks, a combination of PD1 ligand (PD-L1) antibodies, therapeutic DNA vaccines (see 3.3.2.2) and ETV led to a sustained immune control and a viral clearance (J. Liu et al. 2014). A phase I pilot study evaluated anti-PD-1 (Nivolumab) alone or in combination with therapeutic vaccines in HBeAg-negative patients. A single dose of anti-PD-1 resulted in a significant decline of HBsAg, with no added benefit of the therapeutic vaccines, suggesting that checkpoint blockade may lead to functional control in those patients (E. Gane et al. 2017). The presence of HBV-specific T cells need to be sufficient for the

efficiency of those drugs, questioning the category of patients susceptible to receive them, as high antigenic load generally lead to T-cell deletion in chronic infections. Combination with other treatments may be needed to decrease viral antigen before the subsequent use of ICI. However, the mechanism of action of ICI brought concerns about severe nonspecific immune-related side effects ([Arends et al. 2017](#)).

3.3.2.2 Therapeutic vaccines

The purpose of therapeutic vaccines is to stimulate the host immune response in order to restore immune control, to suppress HBV replication and to induce HBsAg loss. Different therapeutic vaccination strategies were/are tested (not exhaustive list):

- **Therapeutic vaccination with conventional vaccines:** the first clinical trials were designed based on conventional prophylactic HBsAg vaccines. HBsAg-based vaccines showed HBeAg seroconversion, HBV-specific immune responses and decrease of HBV DNA in patients, but failed to lead to an efficient control of HBV replication. The use of DNA vaccines only expressing HBsAg were not efficient enough in suppressing viral replication in several phase I clinical studies ([J. Liu et al. 2014](#))
- **Combining therapeutic vaccination and antiviral treatment:** GS-4774, a yeast-based T-cell vaccine containing HBV core, surface and X proteins, was the first therapeutic vaccine studied in chronic HBeAg-negative patients in combination with TDF. While T-cell functions improved, no further decrease of HBsAg levels were observed ([Boni et al. 2019](#)). JNJ-64300535, a DNA vaccine is currently assessed in a phase I in chronic NA-treated patients (NCT03463369).
- **Combining therapeutic vaccination and T cell function modulation:** A combination of therapeutic vaccine (based on DNA plasmids expressing woodchuck core and surface antigen), the immune checkpoint inhibitor anti-PDL1 and ETV showed a sustained immunological control, with the development of anti-WHsAg and viral clearance in WHV-infected woodchucks ([J. Liu et al. 2014](#)). Association of GS-4774 and anti-PD1 treatment were recently assessed in a phase I trial in chronic HBeAg-negative patients, even if an important HBsAg decrease was observed, but with no additional benefit of GS-4774 ([E. Gane et al. 2017](#)).
- **Combining therapeutic vaccination and novel adjuvants:** INO-1800 is a DNA vaccines encoding HBsAg, and HBcAg is currently assessed in a phase I study in NA-treated patients with CHB, alone or in combination with INO-9112, which is a DNA plasmid encoding human interleukin 12 (NCT02431312).
- **Therapeutic vaccination targeting preS1 domain:** *In vivo* experiments showed that preS1-polypeptide vaccination induced robust immune responses with antibodies that can both clear HBV virions *in vivo* and block infection to hepatocytes *in vitro*. In addition, it weakened the

tolerized status of HBsAg, allowing a subsequent vaccination with HBsAg to induce anti-HBs seroconversion ([Bian et al. 2017](#)).

Despite few results in clinical trials, therapeutic vaccination in chronic HBV may be effective in therapy strategies combining sequentially different treatments such as: (1) administration of nucleot(s)ide analogues to suppress HBV replication, (2) therapeutic vaccination to induce antiviral immune responses and (3) immunomodulation methods to amplify and maintain the antiviral response ([J. Liu et al. 2014](#)).

3.3.2.3 Engineered T cells

T cell immunotherapy is based on the generation of virus-specific T-cell capable of controlling and generating an efficient adaptive immunity to permanently eradicate infection. The principle of this therapy is to introduce inside T cell HBV-specific receptor that can be either T-cell receptor (TCR) of known target specificity or chimeric antigen receptor (CAR). T cells are retrieved from blood's patients; they are activated *in vitro* to ease gene transfer of a virus -specific receptor. Then, T cells undergo expansion (that can take place before introduction of the HBV-specific receptor), and after quality control, they are reinfused into the patient. HBV-specific TCR- and CAR- T cells, carrying both the endogenous TCR and the transgene, they are respectively activated by recognition of target molecules on MHC or on cell surface, inducing cytokine secretion. CAR-T cells also possess the advantage of recognizing soluble antigen in the periphery. While HBV-specific TCR T-cells are activated via a classical T-cell response, CAR signalling is quite different. It is mediated by costimulatory domains CD28 or 4-1BB, which have been found to induce memory phenotype or longer persistence respectively, in combination with CD3 ζ endodomain, allowing cascade signalling of T cells. CAR signalling do not need antigen presentation by MHC, which is particularly interesting in HBV infection that decreases this mechanism ([Tan and Schreiber 2020](#)). Redirected T cells with either TCR and CAR have been assessed in HBV transgenic mice associated with a decrease of HBV DNA and HBsAg and also in patients with relapses of HBV-related HCC ([Krebs et al. 2013](#); [Kruse et al. 2018](#); [Qasim et al. 2015](#)). Those engineered T cells seem very promising, on condition of controlling their activation to avoid inflammation, a cytotoxicity that could be harmful for the organism.

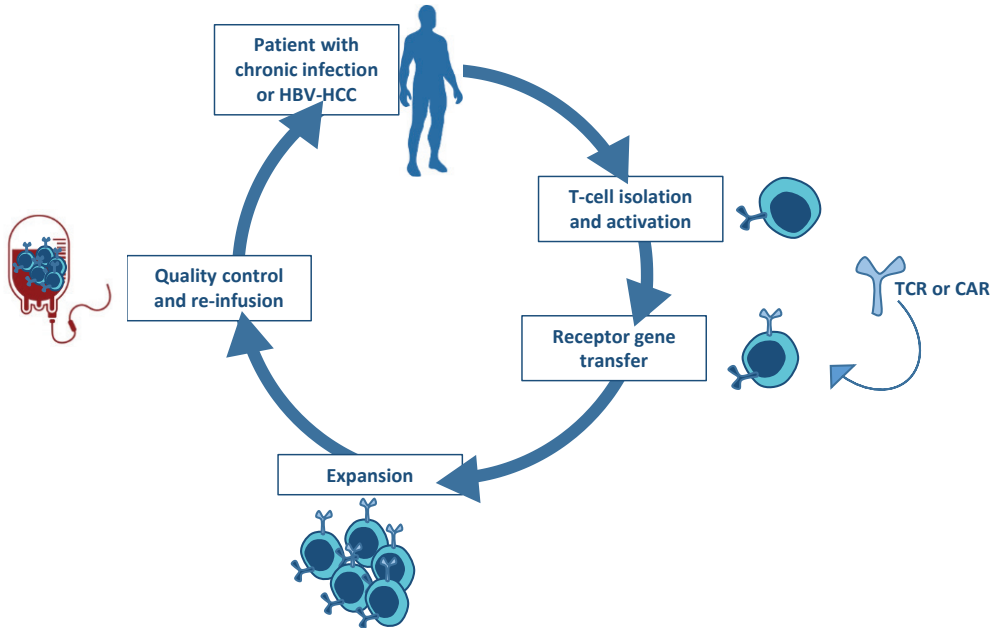

Figure 37: Illustration of T-cell therapy

Schematic representation of T-cell therapy for chronic HBV infection or HBV-HCC. T cells are retrieved from blood's patients; they are activated in vitro to ease gene transfer of a virus -specific receptor. Then, T cells undergo expansion (it can take place before introduction of the HBV-specific receptor), and after quality control, they are reinfused into the patient. *Adapted from (Tan and Schreiber 2020)*

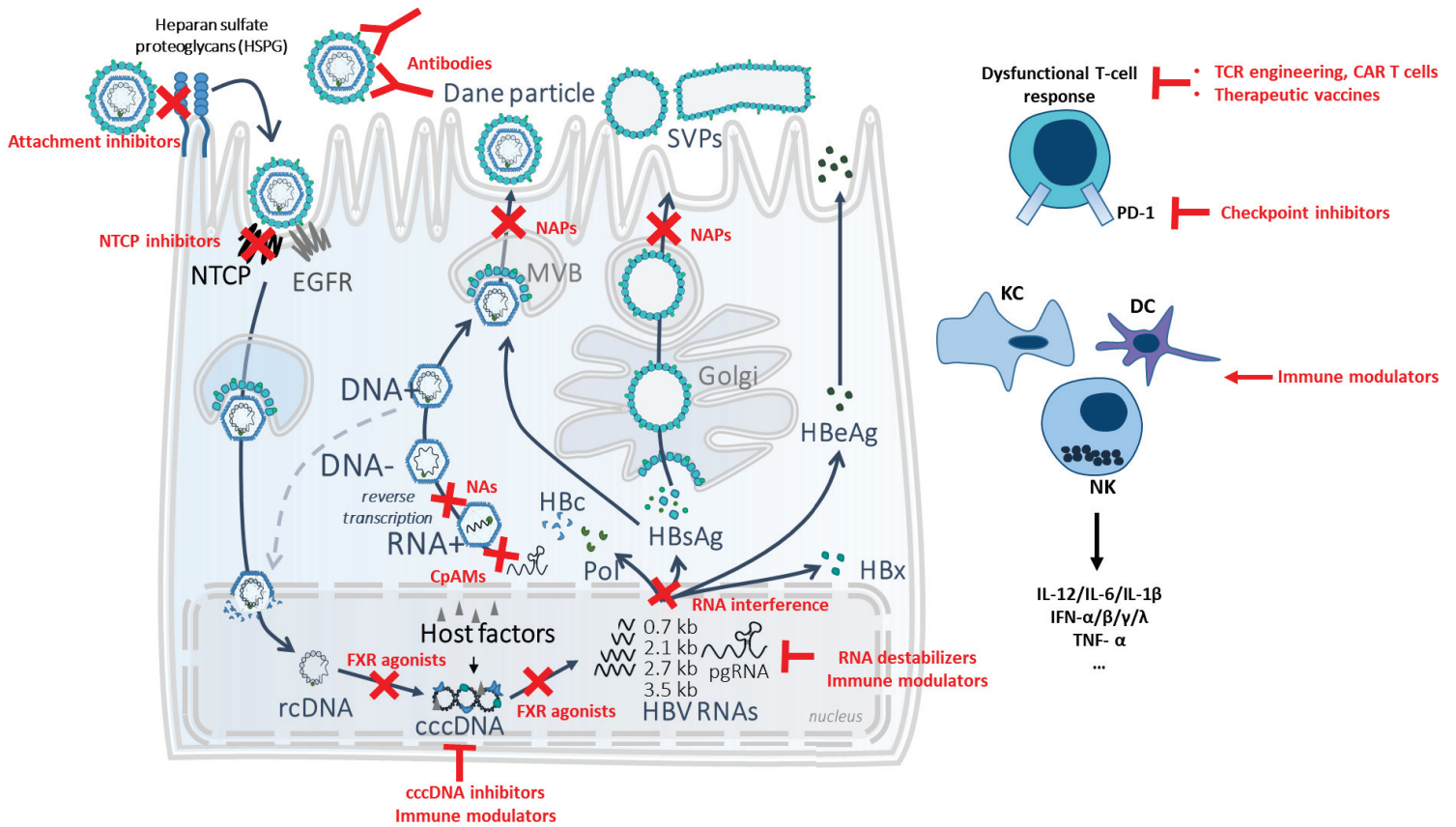

Figure 38: Current and in development HBV treatments

In order to achieve ultimate therapeutic endpoints define as HBsAg loss, inhibition of new hepatocyte infection, eradication of the cccDNA pool, restoration of immune functions to control HBV, new antiviral drugs are currently in development to complete the current treatments based on NA therapies and Peg-IFN-α. Drugs in development are able to block HBV entry into hepatocytes, to silence or deplete the cccDNA pool, to affect the nucleocapsid assembly, to impair secretion of subviral particles (SVPs), to activate the innate immune response and to modulate the adaptive immunity. CpAMs: Core protein allosteric modulators; NAs: Nucleoside analogue; NAPs: Nucleic acid polymers; DC: Dendritic cells; KC: Kupffer cells; NK: Natural killer cell; PD-1: Programmed cell death 1.

	Treatment	Stage of development
Entry inhibitors	HBIG	Approved
	Bulevirtide	Phase II
CpAMs	NVR 3-778	Phase I
	JNJ-6379 (or JNJ-56136379)	Phase I
	RO7049389	Phase I
	ABI-H0731	Phase III
	GLS4	Phase II
RNA interference	ARC520	Phase II
	JNJ-3989	Phase II
	VIR-2218	Phase II
	RG6346	Phase I
	IONIS-HBVLRx (GSK33389404)	Phase I
Inhibition of HBsAg release	REP 2139-Mg	Phase II
	REP 2165-Mg	Phase II
FXR agonist	EYP001	Phase Ib
Inhibitors of cccDNA	TALENs	Preclinical
	CRISPR-Cas9	Preclinical
Immune Checkpoint Inhibitors	Nivolumab	Phase I
	Cemiplimab	Phase I/II
Therapeutic vaccines	GS-4774	Phase II
	INO-1800	Phase I
	JNJ-64300535	Phase I
	TG1050	Phase I

Table 6: Summary of new antiviral drugs for HBV cure

Current drugs in development and the corresponding stage of development. *Adapted from (H. W. Lee, Lee, and Ahn 2020)*

3.4 PRR agonists: new immune modulatory strategies to cure CHB

3.4.1 Rational for the development of alternative innate immune stimulators

As previously seen, during natural HBV infection, the innate system is poorly activated due to both passive (*i.e.* compartmentalisation of potential viral PAMPs) and active escape mechanisms implemented by the virus. The current use of IFN- α is supposed to boost immunity and to break tolerance to the virus. But IFN- α has numerous side effects as whole body exposure can be harmful; development of new innate immune stimulators to boost innate immunity, in particular locally in the liver microenvironment, in HBV infected patients is of importance. The use of Peg-IFN- λ , which possesses antiviral activity *in vitro*, was assessed in clinical trial in CHB patients. Despite efficiency in decreasing HBV DNA and HBsAg levels earlier in treatment, the antiviral effect were comparable for both Peg-IFN- α and Peg-IFN- λ at the end of treatment, with higher rates of HBeAg seroconversion in Peg-IFN- α - treated patients (H. L. Y. Chan et al. 2016). Recently, numerous other interferons or cytokines have been shown to inhibit HBV replication *in vitro*, directly in hepatocytes, with no need of immune cells. In particular, those cytokines, such as IFN- β , IL-6, TNF- α and IL-1 β were shown to inhibit transcription from the cccDNA or even inducing its degradation (Isorce et al. 2016; Xia et al. 2016; Lucifora et al. 2014). However, the direct systemic injection of recombinant cytokines cannot be envisaged, as it may also be very toxic. A strategy that could be interesting to benefit from their antiviral effects would be to induce, in a timely and reversible controlled manner, their endogenous production (ideally within the liver) in CHB patients. Their production can be achieved via stimulation of pattern recognition receptors, some of them are currently in clinical trials.

3.4.2 Proved and expected modes of anti-HBV action of different PRR

3.4.2.1 Indirect antiviral properties

3.4.2.1.1 Induction of effector with direct antiviral effects

Endogenous production of interferons is possible following the stimulation of different PRRs in immune cells, including dendritic cells (pDC, BDCA3+ cells...). Thus, this endogenously and, ideally, locally produced IFN could directly act on the viral infection within hepatocytes and stimulate other immune cells to restore a more global immune response.

Local production of IFNs by stimulation of TLRs expressed in specialized immune cells has already been studied. In HBV infected chimpanzee, GS-9620, a potent and orally active TLR7 agonist provided long-term suppression and a reduction of around 2.2logs of viral DNA in the serum and liver after 4 weeks of treatment associated with a 50% decrease of viral antigen levels (HBeAg and HBsAg) (Lanford et al. 2013). This agonist also induced a decrease of DNA replicative intermediates, including cccDNA and viral RNA, as well as the loss of detectable serum HBsAg in the woodchuck model (Menne et al. 2015).

In human, even if this agonist was well tolerated in treatment-naïve and NA-suppressed patients ([E. J. Gane et al. 2015](#)), its clinical development was halted in phase II due to lack of efficiency in monotherapy at the doses tested.

Other oral TLR7 agonists are currently in clinical trials: RG 7854 (Roche) is currently being assessed in a phase I clinical trial (NCT02956850) and AL-034 (or TQ-A3334) also in a phase I clinical development (NCT03285620), showed potent anti-HBV activity with HBsAg seroconversion in AAV-HBV-infected mice ([Suslov, Wieland, and Menne 2018](#)).

GS-9688 (Selgantolimod) a potent and selective oral agonist of TLR8 induced a sustained antiviral response in WHV-infected woodchucks. More than 95% decrease of viral RNA and DNA and development of anti-WHsAg antibodies was detected with a clinically relevant doses and a short-duration treatment ([Daffis et al. 2021](#)). This agonist was assessed in a phase II multicenter (NCT03491553), randomized, double-blind study of 48 virally suppressed chronic HBV patients, 5% of patients receiving GS-9688 observed a 1log decrease HBsAg levels or loss of HBeAg at 24 weeks post treatment ([Gilead 2019](#)).

CpG oligodeoxynucleotides (ODN) are TLR9 agonists that are able to induce the production of type-I interferon via stimulation of their receptors, mainly expressed in pDCs and B cells. Even if those TLR9 agonists are mostly used as adjuvants in prophylactic vaccines in combination with HBsAg, such as CpG 1018 in HEPLISAV-B or CpG7909 in Engerix-B ([C. L. Cooper et al. 2004](#); [C. Cooper and Mackie 2011](#)), CpG21798 was used as treatment in combination with Entecavir in a woodchuck model of chronic hepadnaviral infection ([Meng et al. 2016](#)). This combination improves the antiviral responses and inhibition of replication compared to each drug alone, but doses or regimens need to be adjusted to observe a seroconversion and avoid viral rebound at the treatment's arrest. *In vitro* experiments showed that TLR9 agonist CpG ODN 2395 could strongly inhibit HBV entry by coating HBV virions, preventing their interaction with cellular receptor ([Aillot et al. 2018](#)).

AIC649 is an inactivated parapoxvirus (iPPVO) particle preparation that is sensed by TLR9 and induces production of IFN- α , IFN- γ and TNF- α by immune cells ([O. Weber et al. 2013](#)). This agonist was as effective as Tenofovir to decrease hepatitis B virus titer in transgenic mice and induced a bi-phasic response in chronically WHB infected woodchuck with an initial increase of HBsAg level followed by a decrease after cessation of treatment ([Paulsen et al. 2015](#)); it was hypothesized that the observed bi-phasic response to AIC649 treatment was the reflect of a physiologically "concerted", reconstituted immune response against WHV. Interestingly, a significant sustained antiviral effect was observed when AIC649 was used in combination with Entecavir ([Paulsen et al. 2017](#)). AIC649's safety and

tolerability were assessed in a phase I trial in HBV-positive volunteers, where a single dose of this agonist were well tolerated by patients ([AiCuris 2018](#)).

Lucifora and Bonnin showed that treatment of human PBMCs with Pam3CSK4 (a TLR2 agonist) strongly induces IL-6, as well as IL-1 β and TNF- α at a lesser level. The supernatants from these stimulated PBMCs reduced the secretion of HBeAg in HBV-infected dHepaRG cell line ([Lucifora et al. 2018](#)).

3.4.2.2 Restoration of functional immune response

In addition to direct antiviral effects observed via production of interferon or pro-inflammatory cytokines, TLR stimulation by PRR agonists has also been shown to restore a functional immune response against the virus. In fact, intrahepatic transcriptional profiles of GS-9620-treated woodchucks revealed that this agonist could induce cytotoxic cells (CD8+ T cell/NK cell), T cells, myeloid cell lineage and B cells. This suggests that the antiviral effect observed induced by GS-9620 was likely mediated, partly, by the cytolytic activity of CD8+ T cells and/or NK cells ([Menne et al. 2015](#)). This was confirmed later in the chimpanzee model in which increased intrahepatic CD8+ T cell and B cell numbers were observed during GS9620 treatment ([L. Li et al. 2018](#)). In HBe-negative patients treated nucleos(t)ide analogue therapy, twelve weeks administration of GS9620 increase T-cell and NK-cell responses and reduce the ability of NK to suppress T cells ([Boni et al. 2018](#)). Both TLR8 agonists, ssRNA 40 and GS-9688 were shown to induce IL-12 and IL-18 secretion by liver monocytes, which stimulates IFN- γ production by MAIT and NK cells, liver-resident innate immune cells ([Jo et al. 2014](#); [Amin et al. 2020](#)). In a mouse model, TLR9 agonists have been shown to induce the formation of iMATES in that are cocoon-like dynamic structures composed of myeloid cells in which T cells proliferate and mature ([L.-R. Huang et al. 2013](#)). It was further reported that therapeutic heterologous HBcore-protein-prime/Modified-Vaccinia-Virus-Ankara (MVA-HBcore) boost vaccination followed by CpG treatment increased vaccine-induced HBcAg-specific CD8 T cell immunity in HBV-transgenic and AAV-HBV-transduced mice liver ([Kosinska et al. 2019](#)).

3.4.2.3 Direct antiviral properties: hepatocytes, active participants in innate immune response

Hepatocytes are the major parenchymal cells in the liver, and they play crucial roles in metabolism and detoxification. Hepatocytes are targeted by HBV, in which it replicates and set up a pool of its genetic material in the nucleus, the cccDNA, the main cause of the persistence of the virus. They are not only replicating cells but also immunological actors as they express a wide variety of pattern recognition receptors ([Ian N. Crispe 2016](#)). The direct targeting of PRR in hepatocytes is a strategy currently under investigation in order to eradicate the virus and more specifically the cccDNA.

3.4.2.3.1 RIG-I agonist

RIG-I was proposed to play a regulating role in HBV replication as it could sense the virus via recognition of the 5'-ε region of HBV-derived pgRNA inducing the production of type III IFN gene induction. Moreover, it was suggested in the same publication that RIG-I could directly act as an antiviral agent by interfering with the interaction of HBV polymerase with the 5'-ε region of pgRNA in a RNA-binding dependent manner, leading to the suppression of HBV replication (Sato et al. 2015). In order to take advantage of those two functions, Inarigivir, a small molecule dinucleotide orally active RIG-I agonist was developed. In pre-clinical studies, Inarigivir was shown to bind CARDs and regulatory domain of RIG-I with an activation of IRF-3, as well as an up-regulation of intra-hepatic RIG-I, an activation of intra-hepatic ISGs and suppression of viral parameters and cccDNA in the woodchuck model and it decreased viral DNA and RNA in CHB patients (Ligat et al. 2020). Its clinical development in human was stopped in phase IIb after a patient's death (NCT04023721). This indicates that a very potent agonisation of RIG-I at whole body level is too toxic and warrant further considerations regarding the potential delivery of PGG agonist to the site of replication of the virus.

3.4.2.3.2 STING agonist

STING is a major pivotal molecule for numerous DNA sensors and thus plays a crucial role in host cellular response to viral infection.

It was recently shown that despite low levels of STING expressed in HBV-infected NTCP-expressing human hepatoma cells as well as immortalized mouse hepatocytes, it is able to mediate a cytokine response upon activation with cGAMP, its natural ligand or its pharmacological agonist, DMXAA. This cytokine response restricted HBV replication and most likely inhibited cccDNA transcription (F. Guo, Tang, et al. 2017). A direct antiviral effect of STING agonists, in addition to the IFNα/β mediated cytokine release in macrophages, which already suppressed HBV replication in mouse hepatocytes and liver (F. Guo et al. 2015). Those studies suggest that STING may be a potential therapeutic target for pharmacological activation of host innate, as well as adaptive, immune responses to prevent chronic HBV infections.

	Treatment	Stage of development
TLR7 agonists	GS9620 (vesatolimod)	Phase II
	RG 7854	Phase I
	AL-034 (TQ-A3334)	Phase I
TLR8 agonist	GS9688 (selgantolimod)	Phase II
TLR9 agonist	AIC649	Phase I
RIG-I agonist	Inarivir	Abandoned

Table 7: Current PRR agonists in development as stand-alone

3.4.2.3.3 TLR2 and TLR3 agonists

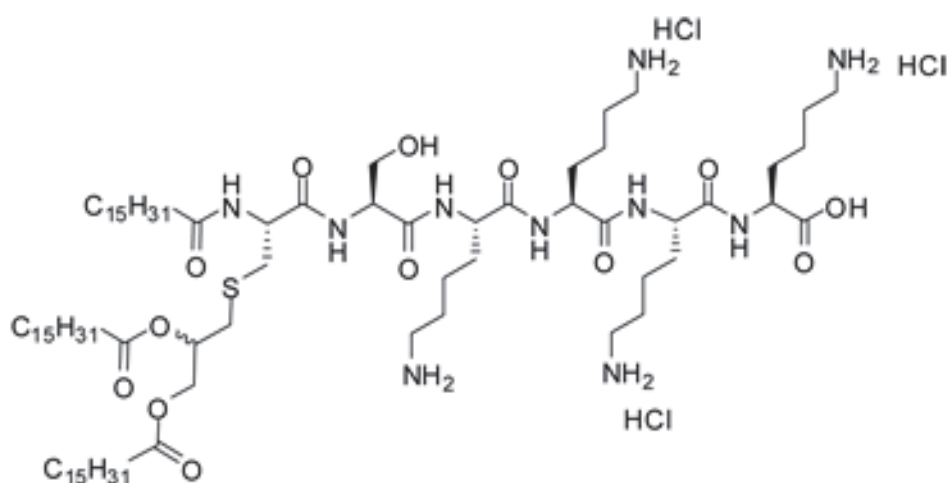

Figure 39: Chemical structure of a TLR1/2 agonist, Pam3CSK4

We previously showed that primary human hepatocytes and differentiated HepaRG cells express several PRR including TLR1/2 and TLR3 (Faure-Dupuy et al. 2018; Luangsay, Ait-Goughoulte, et al. 2015). Our recent studies highlight that ligands of TLR1/2, Pam3CSK4 and TLR3, Poly(I:C)-HMW or Riboxol efficiently decreased levels of all HBV replication markers, with a strong phenotype on viral RNAs. This observation suggests that those treatments are able to prevent transcription of viral RNAs from cccDNA and/or decrease their stability. Furthermore, antiviral effect of these agonists was sustained after treatment arrest contrary to treatment with nucleos(t)ides analogues, and this lack of rebound was associated with a strong decrease of the cccDNA levels in the dHepaRG model (Lucifora

et al. 2018). In contrast to TLR7 (GS-9620) or TLR8 (GS-9688) agonists, which are small and heterocyclic molecules that can be delivered orally, TLR3 and TLR1/2 ligands have more complex structures that require delivery strategies since their IV administration with a dose escalation protocol led to a very moderate decrease of HBV parameters in HBV-infected HuHep mice (Lucifora et al. 2018). This is the reason why, encapsulation strategies need to be implement in order to specifically deliver TLR1/2 ligand to hepatocytes but also to protect the ligands from degradation and avoid iatrogenic effects. Even if TLR2 expression levels was shown to be decreased in both hepatocytes and myeloid cells in HBeAg-positive CHB patients, a study using the woodchuck model showed that its expression was restored after a long-term therapy using NAs. This confirms the rational for a treatment regimen using NAs and TLR2 agonist to restore innate immune functions in the liver micro-environment (Testoni, Durantel, and Zoulim 2017).

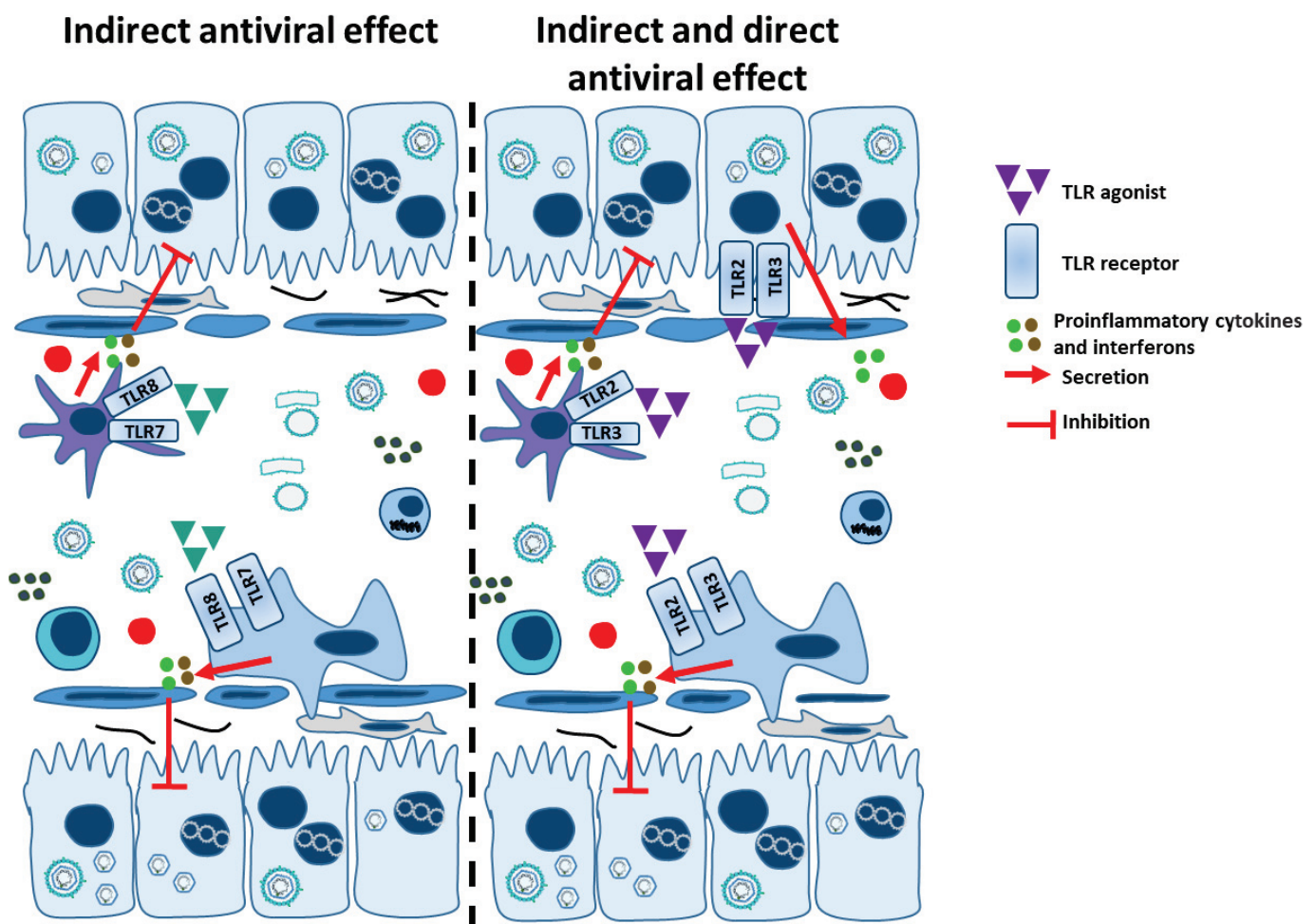

Figure 40: Schematic representations of antiviral effects of TLR7/8 agonists vs TLR2/3 agonists

Left panel: TLR7/8 agonists stimulates their receptors on professional immune cells, inducing the production of pro-inflammatory cytokines and interferons, which further exert their antiviral effects on HBV replication into hepatocytes. Right panel: TLR2/3 agonist stimulates their receptors present both on immune cells and on hepatocytes, leading to the production of pro-inflammatory cytokines and interferons, which further exert their antiviral effects on HBV replication into hepatocytes.

3.4.3 Other considerations for the R&D of PRR agonists

3.4.3.1 Adjuvants vs stand alone

Initial strategies of vaccination were mainly based upon the administration live-attenuated or non-living heterologous variants of the targeted pathogens (Ribeiro and Schijns 2010). However, these strategies have been challenged for lack of efficiency and dangerousness. In fact, even if most people respond well to live-attenuated vaccines, some immunodeficient patients have shown a reversion to virulence (Eibl and Wolf 2015); besides some live-attenuated vaccines as live-attenuated HIV present safety issues (Minor 2015). Regarding non-living pathogen, synthetic or recombinant proteins from pathogens vaccines, even if they are safer, they often present a poor immunogenicity. Adjuvants are immune-stimulatory components that boost vaccines to elicit adequate immunity by leading to the production of diverse cytokines and chemokines, but also improving the initiation of adaptive response by helping DC's migration to lymphoid tissues where they interact with T and B cells. For a long period, the main adjuvant has been aluminium salts (Vasou et al. 2017; Gutjahr et al. 2016), but novel adjuvants have recently been introduced, among them PRR agonists play a crucial role. Several TLR4 ligands are currently present as adjuvants in licensed human vaccine. AS04, which combines aluminium salts and a TLR4 agonist, the LPS-derived component called 3-O-deacylated-4'-monophosphoryl lipid A (MPLA), is found in Fendrix an HBV vaccine or Cervarix, the human papillomavirus cervical cancer vaccine (Didierlaurent et al. 2009). RC-529, a synthetic monosaccharide mimicking MPLA, is used in Argentina in the HBV vaccine, Supervax (Dupont et al. 2006). The vaccine Hecplisav-B uses CpG 1018, a TLR9 agonist, as adjuvant (Dynavax 2021). Those adjuvants are mainly used in prophylactic vaccines to ensure a greater innate response to HBV antigens.

However, due to their potent effects in inducing innate immunity that subsequently activates and develops adaptive immune responses, their use as adjuvants in therapeutic vaccination have also been explored. Their use in cancer vaccine formulations has been widely studied. In oncology, immunotherapies based upon monoclonal antibodies targeting immune checkpoints or immune checkpoint inhibitors have greatly improved cancer treatments but they are particularly efficient in "hot tumours", tumours that already present inflammation signs including T cells infiltration. In many cases tumours have not yet been infiltrated with T cells, making those "cold tumours" difficult to treat by checkpoint inhibitors (Aleynick et al. 2019; Bonaventura et al. 2019). An interesting strategy to reverse cold to hot tumours would be to prime or boost anti-tumour T cell immunity directly into the tumour lesion by injecting PRR agonists in the tumour microenvironment. In fact, PRR agonists' administration can induce local inflammation that can facilitate the recruitment of myeloid cells and help them to efficiently present antigens to T-cells and in order to activate anti-tumour immune response. PRR agonist injection can have a direct antitumor effect and can generate tumour regression

in distant tumour sites ([Shekarian et al. 2017](#)). The use of poly(I:C)/poly-ICLC as an adjuvant in cancer formulations enhances tumour-associated antigen-specific T cell immunity in different cancers, lymphomas, melanomas and lung cancers ([Ammi et al. 2015](#)).

The use of PRR agonist as adjuvants in therapeutic vaccination is currently under studied. The TLR7/8 agonist, CL097, were used in combination with alum-absorbed HBsAg and HBcAg in HBV-transgenic mice, and it was shown to reverse immune tolerance and to induce antigen-specific immune responses, in particular an antigen-specific Th1 response ([Y. Wang et al. 2014](#)). A formulation using novel TLR7 agonist, T7-EA, an alum adjuvant and recombinant HBsAg protein was assessed *in vivo*, and resulted in local stimulation of cytokines and Th1-type immune responses ([Y. Hu 2020](#)). Similarly, in AAV-HBV transduced mice, vaccination using HBsAg and a TLR9-agonist CpG induced strong antibody production and T-cell responses that were able to suppress HBV viremia ([D. Yang et al. 2014](#)).

In addition to their use as adjuvants in prophylactic and therapeutic vaccines, PRR agonists present the advantage to be used as stand-alone. In cancer immunotherapies, FDA has approved several PRR agonists, such as Imiquimod, a TLR7 agonist, used in cream for various cutaneous malignancies; some are currently under clinical phase, ADU-S100 (Aduro Biotech/Novartis) is a STING agonist currently being assessed in phase I clinical trial by intra-tumoral administration for advanced/metastatic solid tumours or lymphomas. ([Motedayen Aval et al. 2020](#)). However, the main issue encountered by the use of PRR agonists is their delivery due to poor pharmacokinetic and physical properties. Similarly in HBV infection, if no PRR agonist is currently approved for treatments several are currently under preclinical or clinical trials (see 3.4). Nevertheless, new delivery systems need to be investigated to improve their use in patients, to avoid pharmacokinetic limitations and to protect the agonist.

3.4.3.2 Delivery and dosage, the keys of decreasing toxicity: example of nanoparticles

Despite high antiviral response observed *in vitro*, a potent antiviral response is difficult to achieve *in vivo*, and high concentrations of PRR agonists are needed to be used in some cases, which therefore may be harmful, as cytokine storm may be triggered ([Lucifora et al. 2018](#)). Moreover, high concentrations are often needed because of agonist deterioration after its administration. Soluble drugs are rapidly cleared from the site of injection limiting activation of innate immune cells. To circumvent this, new delivery strategies need to be investigated. Vectorization and biodegradable delivery systems are promising vehicles. Among them, poly(D,L) lactic acid (PLA) nanoparticles are interesting vectors due to their bioresorbability, biocompatibility and low immunogenicity, and are already approved for human tissue engineering ([Casalini et al. 2019](#)).

In cancer therapies, nanoparticle formulations using biodegradable polymer, poly(D,L-lactide-co-glycolide) (PLGA) encapsulating TLR3, TLR9 or TLR7/8 agonists enable greater and sustained cellular

delivery of agonists. The slow release of agonist from polymeric matrix may facilitate innate immune cells signalling, therefore reducing the need for high or repeated doses. Those formulations were shown to be highly effective as vaccines adjuvants (H. Kim et al. 2018; Y.-R. Lee et al. 2010).

Concerning HBV infection, the vectorization of PRR agonists using nanoparticles could also be an interesting approach. They have been studied in large majority for formulations in prophylactic vaccines. TLR9 ligands have been successfully encapsulated and it was shown to efficiently boost the innate immune system (Lv et al. 2014). HBsAg entrapped nanoparticles containing MPLA, a TLR4 agonist, were designed in order to create new vaccines formulation to be administered directly to the colon. It induced both humoral and cellular counterpart of immune response in rat (Sahu and Pandey 2016). Calcium phosphate nanoparticles loaded with plasmid DNA and different toll-like receptor ligands, CpG or flagellin to activate APCs, have been assessed *in vitro* and *in vivo*, and showed antigen-specific T cell response and antigen-specific antibody response (Rojas-Sánchez et al. 2020).

In addition to vaccines, nanoparticle formulations could also be used as a treatment itself. Our collaborators have realized PLA nanoparticles loaded with a TLR1/2 agonist, Pam3CSK4. Those nanoparticles formed by nanoprecipitation that allows 99% of entrapment efficiency. *In silico* approach showed that Pam3CSK4 is not strictly encapsulated inside the nanoparticle, but is vectorised on the surface of the nanoparticle, with the hydrophobic part inside and the peptidic part outside (Lamrayah et al. 2019). Those nanoparticle formulations were assessed for their antiviral properties during this thesis project.

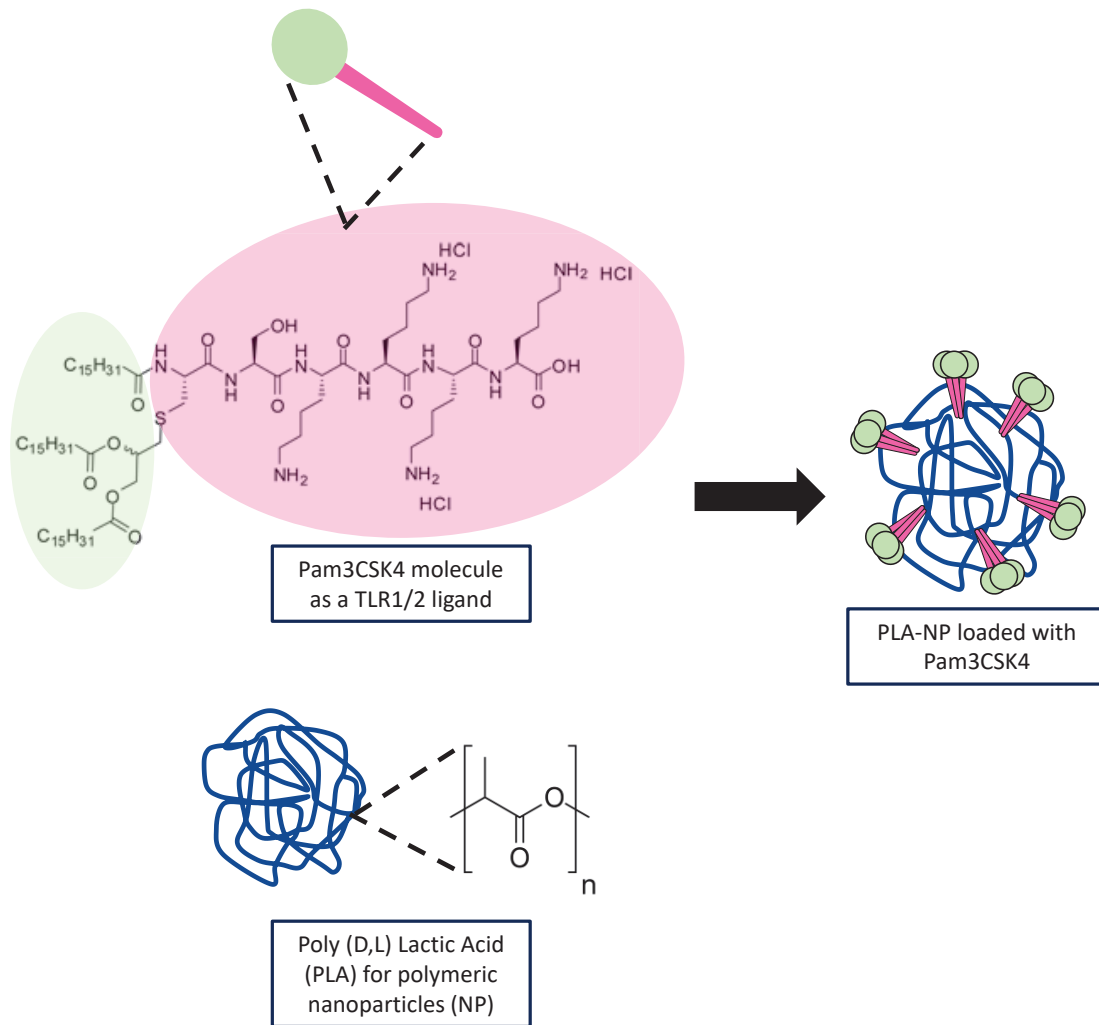

Figure 41: Representation of PLA-NP loaded with Pam3CSK4

Poly(D,L) lactic acid (PLA) nanoparticles loaded with Pam3CSK4 are prepared using the nanoprecipitation technique; the polymer and the molecule are dissolved in acetone, and this organic phase is added dropwise to an aqueous solution (ethanol and carbonate at a ratio of 40:60) under stirring. *Adapted from (Lamrayah et al. 2019).*

3.4.3.3 Combination of PRR agonists with other drugs

As seen earlier, antiviral strategies to fight HBV infections are diverse and numerous, and all seem promising. However, the use of DAAs already approved or currently in development, despite great antiviral activity, may not be efficient to restore a complete immune response, necessary to control infection and/or to eradicate it. Similarly, immunotherapies may not be efficient enough if HBV DNA and antigens are present at high levels, or if innate sensors are down regulated. Combination of those therapies seems to be a promising strategy (Figure 42). A first use of DAA may be advised, such as the use of NAs, CpAMs and NAPs, which may result in a control of infection and lead to a decrease of viral antigens, associated or not with seroconversion. This control by DAAs in a first use may be necessary to prevent the down regulation of innate immune sensors and other immune genes, and in some cases to restore HBV-specific T cells. Restoration of T cells may be associated with checkpoint immune inhibitors that are efficient in breaking immune tolerance (B. Li et al. 2020). Finally, the use of PRR agonists to restore a complete immune system can be envisaged. As seen previously, those ligands may directly stimulate PRRs on hepatocytes, where the viral replication occurs, mediating therefore an autocrine and paracrine response, decreasing infection and affecting the cccDNA; they also boost innate immune response via PRRs stimulation on professional immune cells, which allow the recruitment, activation and proliferation of adaptive immune cells (Ferrari 2015; Testoni, Durantel, and Zoulim 2017; Durantel and Zoulim 2016). Indeed, PRR agonists were shown to both recruit NK/NKT cells that are able to activate CD8 specific T cells and induce iMATEs production, the ternary structures that allow proliferation of activated T cells. If T cells are not sufficient, T cell immunotherapies may be envisaged using TCR-and CAR- T cells.

Even if this scenario seems promising to achieve a functional cure, it needs to be tightly regulated and controlled as a too strong activation of immunity may lead to harmful damages. To circumvent this, doses and duration of these different drugs as well as improved delivery systems are crucial for an efficient antiviral strategy and require more investigations.

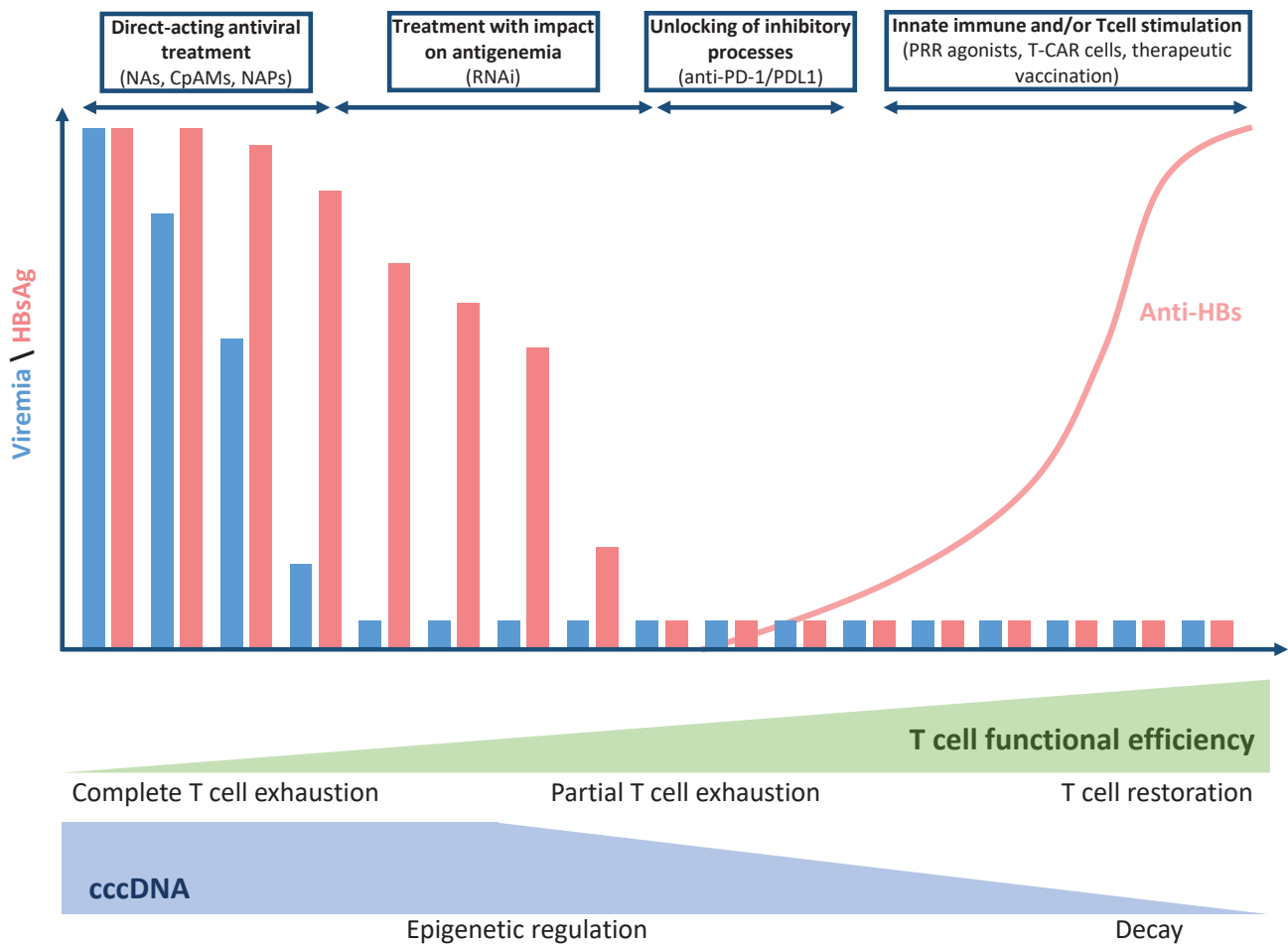

Figure 42: Road map for therapeutic approaches against HBV

A potential strategy against HBV infection would be the combination of different treatments previously seen. A decrease of viral load is needed to control infection (use of DAAs), following this, a decrease of antigenemia is necessary to restore functional immunity, including T cell functionality (use of RNAi). Restoration of T cell functionality may be associated to breaking of immune tolerance (use of checkpoint inhibitors). Finally a re-education of the immune system to definitively eradicate HBV (use of PRR agonists, T-CAR cells, therapeutic vaccination). Adapted from (*Ferrari 2015*).

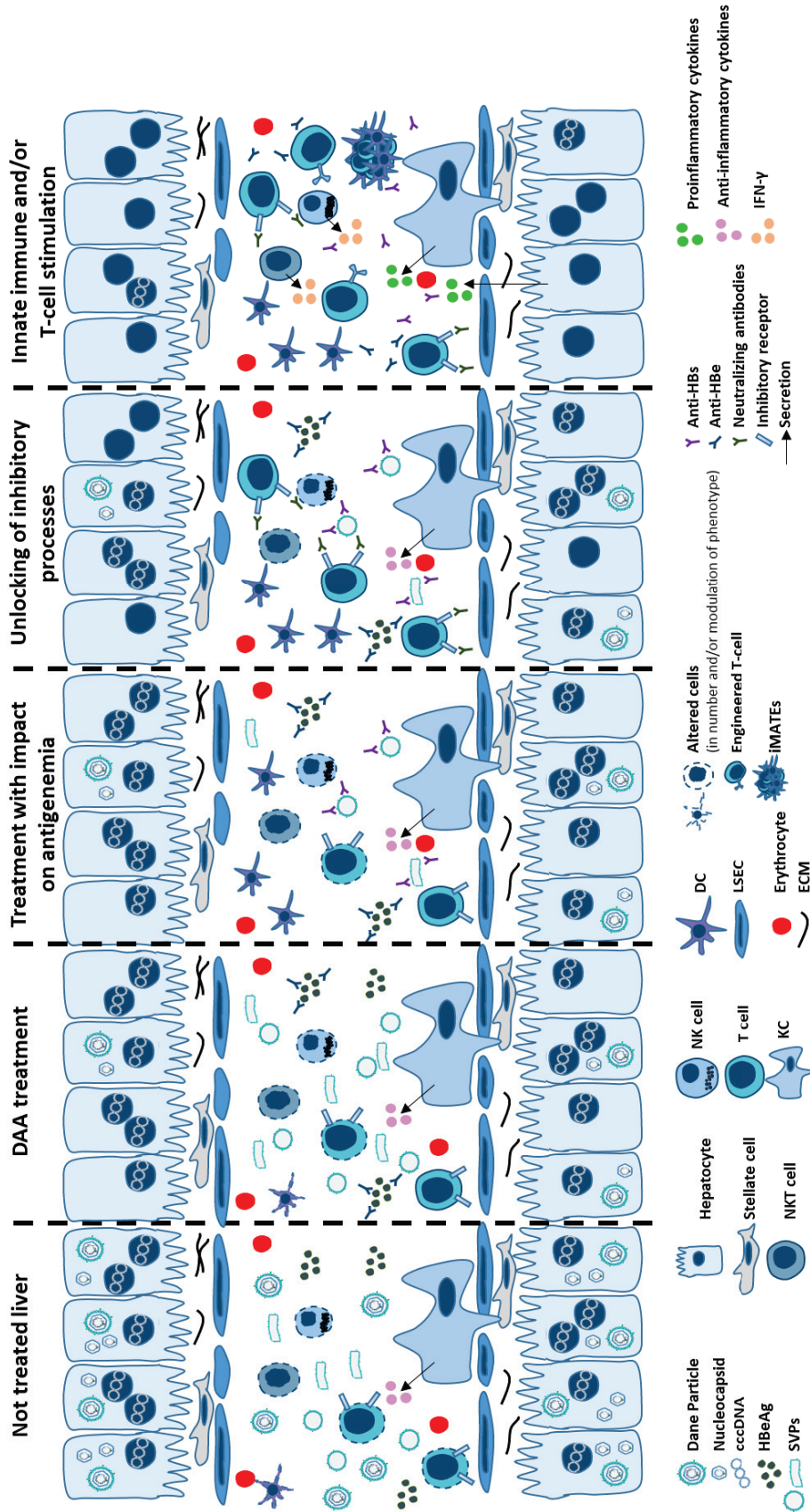

Figure 43: Illustration of therapeutic approaches against HBV

Illustration of the road map for therapeutic approaches against HBV, with the antiviral effects induced by the different drugs at the liver level.

B. Research project

1. Hypotheses and objectives

Around 250 million people are chronically infected by HBV worldwide, and are at high risk of developing liver diseases (steatosis, fibrosis) that can lead to decompensated cirrhosis or hepatocellular carcinoma; those complications may further need hepatic transplantations (Gish et al. 2015). The risk of complications during HBV infection is about 15 to 40%, and it varies depending on HBV genotype, thus the geographical regions, but also depending on comorbidities (exposure to aflatoxin B, alcohol consumption, obesity...) (S. Chan et al. 2015). Current treatments used to cure chronic HBV infection, either based on pegylated interferon- α (Peg-IFN- α) or nucleos(t)ides analogues (NAs) are not efficient enough to guarantee the total eradication of the virus, and to eradicate cccDNA, the main cause of the persistence of the virus. Besides, Peg-IFN- α presents a poor safety profile, generating numerous side effects in patients and NA therapy generally need to be taken lifelong to avoid a rebound of infection. The rate of the *functional cure*, i.e., the loss of HBsAg, obtained by those treatments is inferior to 10%, leaving room for improvement. The need of new direct or indirect antiviral agents is therefore urgent (Durantel and Zoulim 2016). A strategy to increase both virological suppression and the rate of *functional cure* would be to restore or enhance immune functions, needed to control HBV infection in the long term.

Immune and resident cells express PRRs, including TLRs, which play important roles in the induction of innate immunity through sensing of PAMPs, leading to the activation of adaptive immunity, for pathogen-specific immune control. In that matter, several PRR agonists are being investigated in clinical trials in oncology and infectiology, and more precisely the HBV field (Meng, Chen, and Lu 2020; Iribarren et al. 2015). The TLR7 agonist GS-9620, which was particularly efficient at reducing HBV infection in monotherapy in Chimpanzee and Woodchuck models, was not efficient in monotherapy to control HBV replication in humans, despite a good toxicological profile (Menne et al. 2015; Lanford et al. 2013; E. J. Gane et al. 2015; AASLD 2017) . Its clinical development is continued in combination with DAAs (NCT02579382).

Others PRR agonists such as the TLR7 agonist RG7854, TLR8 agonist GS-9688 or TLR9 agonist AIC649 are currently in preclinical or clinical evaluation against HBV infections (Suslov, Wieland, and Menne 2018). Those ligands can stimulate professional immune cells including pDCs or myeloid liver cells to produce pro-inflammatory cytokines or interferons able to inhibit HBV replication, occurring in hepatocytes, and stimulate T cell responses (Isorce et al. 2015; Jo et al. 2014). However, those agonists

are not able to directly inhibit HBV replication in hepatocytes, as the latter do not functionally express their corresponding receptors, i.e., TLR7 to 9 (Luangsay, Ait-Goughoulte, et al. 2015).

Our team investigated the different TLR expressed by liver cells and showed that hepatocytes were positive for the expression of TLR2 and TLR3 receptors, and their agonisation led to direct anti-HBV activity (Luangsay, Ait-Goughoulte, et al. 2015; Lucifora et al. 2018). The direct antiviral activity of a TLR1/2 ligand, Pam3CSK4, was assessed and showed a strong decrease of HBV replication markers, including a strong phenotype on HBV RNAs and cccDNA levels in hepatocytes. Additionally, it was able to activate PBMCs to produce different cytokines (e.g., IL-6), which could also inhibit in turn HBV replication (Lucifora et al. 2018). TLR1/2 ligand can also stimulate antigen presentation functions in macrophage cell and BDCA3+ dendritic cells, in addition to the production of IL-1 β and IFN- λ , which both possess antiviral properties in infected hepatocytes (Isorce et al. 2016). Our team identified IL-1 β , being the most potent cytokine against HBV infection *in vitro*. We thought that antiviral effects produced by stimulation of innate immune cells, combined with direct antiviral effects in hepatocytes could lead to better innate immune stimulators, which make TLR1/2 ligand an interesting option for HBV.

The aim of this thesis project was to get further insights both on the description of the antiviral activity of Pam3CSK4 *in vitro*, to decipher its mode of action, responsible of the antiviral effects observed and to analyse its potential therapeutic use in preclinical investigations.

The first study of this thesis project contained three main parts. The first part aimed at further describing the antiviral effects of Pam3CSK4 *in vitro*, whereas the second aimed at getting further insights on the mode of action (MoA) responsible of these antiviral effects. More precisely, we deciphered the MoA of Pam3CSK4 by first determining its specificity of action in our *in vitro* models, then understanding the kinetic of antiviral events and investigating host-effectors involved in the long-lasting antiviral phenotypes. This study allowed us to highlight the fact that Pam3CSK4 strongly and durably inhibits HBV replication, specifically acting via a heterodimeric TLR1/2 receptor and the canonical NF- κ B pathway. The long-lasting antiviral activity is the consequence of an immediate effect on HBV RNA biogenesis, including a reduction of RNA transcription and an acceleration of RNA decay, but it is also due to a reduction of cccDNA level. A decrease of cccDNA levels was also observed following the initial decrease of HBV RNAs; this secondary decrease, reinforces the phenotype on HBV RNAs, as cccDNA serves as the template for all viral RNA biogenesis *in vitro*. RNA sequencing analyses allowed us to identify host effectors, amongst which MCP1 and FEN-1 were further analysed. The third part of the first study aimed at analysing the combination of Pam3CK4 with both approved and investigational drug including NAs, CpAMs, FXR agonist, RG7834, one kinase inhibitors or IFN- α , in

order to benchmark our Pam3CSK4 and identify potential future therapeutic strategies to test in human to improve the rate of HBV cure.

The second part of the thesis concerned the potential therapeutic use of TLR2 agonist and its preclinical investigations. In contrast to TLR7 agonist, GS9620 or TLR8 agonist, GS-9688 that can be orally delivered to human, Pam3CSK4 cannot and the intravenous administration of free Pam3CSK4 (i.e., unprotected) *in vivo*, in infected-chimeric mice with humanized liver, with a dose escalation protocol (from 20 to 80µg during 3 weeks), only led to a moderate decrease of HBV parameters (Lucifora et al. 2018). As increasing the dose of Pam3CSK4 does not seem judicious as it might cause “cytokine storm”, in the context of a systemic administration, new delivery strategies are therefore necessary. In this respect, nanoparticles are used to reduce the active dose of ligand, protect the ligand from degradation and specifically deliver it to the liver (Tyler et al. 2016). Nanoparticles encapsulating Pam3CSK4, NPs-Pam3CSK4, were synthesized by the team of Bernard Verrier (Lamrayah et al. 2019), and their antiviral activity were assessed in our *in vitro* models. As Pam3CSK4, we observed that NPs-Pam3CSK4 efficiently and durably decreased all viral parameters, which is also the consequence of an immediate effect on HBV RNA biogenesis, including a reduction of RNA transcription, an acceleration of RNA decay and a reduction of cccDNA level. The anti-HBV effect of NPs-Pam3CSK4 was even more convincing *in vivo*, using AAV-HBV transduced mice. Additionally, NPs-Pam3CSK4 can be functionalized by PreS1 peptide, which might increase delivery to the liver and hepatocyte. *In vitro*, these NPs-Pam3CSK4-PreS1 gained properties regarding inhibition of virus entry. Besides, in prophylactic vaccination procedure, these NPs-Pam3CSK4-PreS1 have led to a very potent humoral response with highly neutralizing antibodies. They are purposed as a novel innate immune therapeutic candidate that will be further tested in preclinical models.

2. Pam3CSK4: insights mechanisms of action of a potent TLR1/2 agonist against HBV replication

In a previous publication of the team, it was shown that Pam3CSK4 was one of the best TLR agonist in terms of anti-HBV properties ([Lucifora et al. 2018](#)). However, in that first study, which had a broad scope (i.e., screening of all types of TLR agonists); no detailed analysis of the mode of action was performed. The aim of this novel study was to get further insights on the MoA of Pam3CSK4 using the best relevant *in vitro* models available in the laboratory.

Material and methods

1. Cell cultures

1.1 dHepaRG cell line

HepaRG cells were cultured in Williams' medium E (Invitrogen), supplemented with 10% of FBS (Hyclone FetalClone II Perbio), 5µg/ml of human recombinant insulin (Sigma-Aldrich), 5.10⁻⁵ M hydrocortisone, 2mM GlutaMAX™ (Invitrogen), 100U/ml and 100µg/ml penicillin/streptomycin (Invitrogen) respectively (proliferation medium). To differentiate HepaRG cells into hepatocyte-like cells (dHepaRG), they were cultured two weeks in the medium indicated above followed by two weeks in medium containing 1.8% of dimethyl sulfoxide (DMSO) as previously described (differentiation medium) ([P. Gripon et al. 1988](#)). They were maintained at 37°C and 5% CO₂.

1.2 Primary human hepatocytes isolation

Primary human hepatocytes (PHH) were freshly prepared from human surgical liver resection from the Centre Léon Bérard with French ministerial authorizations (AC-2013-1871, DC 2013-1870, AFNOR NF 96 900 sept 2011), as previously described, ([LeCluyse and Alexandre 2010](#)). In brief, liver resections were perfused with collagenase after being washed by PBS 1X to get rid of peripheral blood cells present in vessels. Once a single-cell suspension obtained, cells were centrifuged to retrieve pellets containing hepatocytes, getting rid of other non-parenchymal cells. They were then plated on collagenated plates, with rat-tail collagen. The day after plating, PHH were gently washed to remove debris and medium is replaced by Williams' medium E (Invitrogen), supplemented with 5µg/ml of human recombinant insulin (Sigma-Aldrich), 5.10⁻⁵ M hydrocortisone, 2mM GlutaMAX™ (Invitrogen), 100U/ml and 100µg/ml penicillin/streptomycin respectively (Invitrogen) without serum and DMSO for 24 hours. Then, they were cultured and infected under the following conditions: 5% of specific fetal bovine serum (FBS), HyClone FetalClone II (Perbio) and 2% of DMSO Hybri-Max™ (Sigma-Aldrich). They are maintained at 37°C and 5% CO₂.

2. HBV viral inoculum preparation and infection

HBV inoculum of genotype D was prepared from HepAD38 cell line, which is a cell line that replicates HBV under conditions regulated with tetracycline. In its presence, this cell line is free of virus, which is due to the repression of pgRNA synthesis. When removed, the cell line expresses pgRNA, accumulates subviral particles in the cytoplasm and is able to secrete virions into the supernatant (Ladner et al. 1997). Cells were cultured into HYPERFlask® (Corning), with Dulbecco's modified Eagle's/F-12 medium (DMEM/F-12, Gibco) supplemented with 10% FBS, 50µg/ml penicillin, 50µg/ml streptomycin and 400µg/ml G418 (Gibco). Supernatant containing infectious particles was clarified through a 0.45 µm filter (Millipore) and precipitated with 8% polyethylene-glycol-MW-8000 (PEG8000, SIGMA), at 4°C overnight. The supernatant with PEG-8000 was centrifuged at 3500g (maximum speed) for 1h and at 4°C. Pellets were resuspended, overnight, in OptiMEM (Invitrogen) in order to achieve a 50X-100X concentration. After DNA extraction, HBV inoculum was titered by quantitative PCR. Viral titers obtained reached at least 1×10^{10} vge (virus genome equivalent)/ml, and they were tested endotoxin free. Infection of dHepaRG and PHH were realized by incubation with HBV inoculum for 16h at a multiplicity of infection of 500 vge/cell, in presence of 4% PEG-8000 in differentiation medium. The day after infection, cells were washed thrice with PBS 1X.

Other HBV genotype inocula (Genotypes A, B, C and E) were prepared from home-made HepG2 cell lines. Plasmids (pcDNA 3.1 + from Thermo Fisher Scientific, which contain a neomycin resistant gene) containing 1.35 genome unit of consensus genotype A, B, C, and E sequences (extracted from the HBV database: <https://hbvdb.lyon.inserm.fr/HBVdb/>) were linearized and transfected into HepG2-ATCC cells. A polyclonal cell line resistant to G418 (500 µg/mL) was initially obtained for all 4 genotypes and frozen. Then two rounds of cell cloning were performed for each cell line by an end-point dilution method (i.e., plating of cells in collagen treated large petri dish at very low density leading to the formation of cell colonies, which could be scratched and grown individually). Four cell lines were thus generated and used to produce HBV inocula. In contrast to the inoculum prepared with HepAD38 supernatant, inocula prepared from our cell lines led to titers ranging from 5×10^8 to 5×10^9 vge after Peg concentration. Infection of HepaRG cells were done using between 10 and 100 vge/cell.

3. Cell treatments

Infection was maintained for at least four days (for PHH) and seven days (dHepaRG) before adding treatments. Generally (exception indicated in figures), PHH were treated thrice every other day. dHepaRG were treated twice, three days apart. Treatments and corresponding concentrations are

indicated in each figure legend. A list of all molecules used in the study is provided in supplementary materials and methods.

4. Nucleic acid extraction

a. Total HBV RNA extraction and reverse transcription

RNAs were extracted using three methods depending on the following experiment: NucleoSpin® RNA (Macherey Nagel), TriReagent® (Molecular Research Center, Inc.) or RNAzol® RT (Molecular Research Center, Inc.) according to the manufacturer's recommendations. After TriReagent® and RNAzol® RT extraction, a DNase treatment (Promega) was realized at 37°C for 30 minutes, which was subsequently inactivated at 65°C for 10 minutes. RNA reverse transcription was performed using Maxima First Strand cDNA synthesis kit (ThermoFisher) according to manufacturer's recommendations. cDNAs were then diluted to the 1/10 prior to qPCR.

b. Total HBV DNA extraction

Total intracellular DNA was extracted from cells using NucleoSpin® Tissue (Macherey Nagel) according to manufacturer's recommendations.

c. cccDNA extraction

CccDNA was extracted using MasterPure™ DNA and RNA Purification Kit (Epicentre) in the absence of the serine protease, Proteinase K. Indeed, as viral polymerase is linked to cccDNA, the step of protein precipitation allowed us to get rid of rcDNA contamination. The next steps were realized according to manufacturer's recommendations before being quantified by qPCR.

5. Viremia analysis

Cells' supernatants were treated with 10mg/ml of RNase and DNase (Sigma) at 37°C for 30 min and 95°C for 5 min. Supernatants were then diluted prior to qPCR.

6. Quantitative polymerase chain reaction (qPCR)

Five to ten ng of cDNA and total intracellular HBV DNA intracellular were used for quantification by qPCR using Luna® Universal qPCR Master Mix Protocol (New England Biolabs) in presence of couple of primers for the gene of interest (final concentration of 0.25µM). The qPCR program used is the following: 95° for 5 minutes; 40 cycles of 10 sec at 95°C, 20 sec at 60°C; 20 sec at 72°C; and a melting curve at 95°C for 1 sec and 65°C for 1 minute on LighCycler480 (Roche). HBV DNA or mRNA expression levels were quantified using the comparative cycle threshold (Ct) method, method in which the target DNA or cDNA was normalized to a housekeeping gene *PRNP* or *RPLP0* following the RNA extraction method used. Treated conditions were then normalized to the untreated condition using $2^{-\Delta\Delta Ct}$. PgRNA

quantification was made with Taqman™ Master Mix (ThermoFisher) according to manufacturer's recommendations in presence of pgRNA probes (TIB MOLBIOL) and specific primers. Taqman reactions were made in duplex with GUSB, a housekeeping gene with the PCR program: 95°C for 20 sec; 40 cycles of 95°C for 1 sec and 60°C for 20 sec on QuantStudio 7 Flex (Applied Biosystems).

Quantification of viremia was realized using Luna® Universal qPCR Master Mix Protocol (New England Biolabs) in presence of primers couple for the gene of interest (final concentration of 0.25µM). The qPCR program used is the following: 95° for 5 minutes; 40 cycles of 10 sec at 95°C, 20 sec at 60°C; 20 sec at 72°C; and a melting curve at 95°C for 1 sec and 65°C for 1 minute on LighCycler480 (Roche). The quantity of viral genome equivalent was calculated according to a standard curve (build with dilutions of a plasmid containing the HBV sequence).

CccDNA was quantified using a fluorescence resonance energy transfer (FRET)-based qPCR approach. Taqman™ Master Mix (ThermoFisher) was used according to manufacturer's recommendations, in presence of specific primers and cccDNA probe (TIB MOLBIOL). The PCR program used was the following: 95°C for 20 sec and 40 cycles of 95°C for 1sec, 60°C for 60 sec on QuantStudio 7 Flex. Human β-globin was used for normalization, with the following PCR program: 95°C for 20 sec; 40 cycles of 95°C for 1 sec and 60°C for 20 sec on QuantStudio 7 Flex.

7. Enzyme-linked immunoassay (ELISA) for secreted HBV antigens

Secreted antigens HBeAg and HBsAg were detected in the supernatant of HBV-infected cells using Autobio kit according to the manufacturer (AutoBio, China). ELISA plates were analysed using Luminoskan™ (ThermoFisher).

8. Blotting methods

a. Western Blot

Cells were harvested in RIPA lysis buffer (NaCl 150mM, Tris HCL pH=8.0 50 mM, SDS 0.1%, NP40 1%, Na Deoxycholate 0.5%) containing protease inhibitors (cOmplete™ Protease Inhibitor Cocktails from Roche) and phosphatase inhibitors (Pierce™ Phosphatase Inhibitor Mini Tablets from ThermoFisher). 30 to 50 µg clarified lysates were denatured in presence of laemmli buffer and were heated at 95°C for ten minutes. Lysates were then loaded on precast protein gels (Novex Wedge well 4-20% or 10% Tris-glycine gels from ThermoFisher) and were subjected to 10% SDS-PAGE. Western Blot transfers were realized onto nitrocellulose membranes using iBlot™ 2 Gel Transfer Device (ThermoFisher) according to manufacturer's recommendations. Membranes were then blocked in 1X Tris-Buffered Saline, containing 0.1% of tween (TBS-T) and 5% BSA (Bovine Serum Albumin). Primary antibodies (listed in supplementary material and methods) were incubated overnight at 4°C, at concentrations

indicated by the supplier. After being washed, membranes were incubated with corresponding secondary HRP antibodies for one hour. Membranes were incubated with chemiluminescent substrate SuperSignal™ according to manufacturer's recommendations (ThermoFisher) after being revealed using Gel Doc™ XR+ Imager (Biorad).

b. Northern Blot

After RNA extraction using TriReagent®, RNAs were quantified by NanoDrop™ ONE (ThermoFisher). Glyoxal was added to 10µg of RNA before denaturation at 50°C for 1 hour. RNA Millenium Marker (Ambion) was used to control size of RNA transcripts. Samples were loaded on 1.2% agarose gel, and migration was realized in phosphate buffer 1X at 60V for 6 hours. Transfer was realized on Hybond N+ membranes (Roche), overnight. RNAs were fixed at 80°C for 2 hours, before being prehybridized in Dig-Easy Buffer at 42°C (from DIG Luminescent Detection kit, Roche). HBV probe is added overnight at 42°C. Membranes were washed: 5 min in 2X SSPE, 0.5% SDS at 42°C, 15 min in 2X SSPE, 0.1% and 30 min in 1X SSPE, 0.1% SDS. Membranes were then blocked in blocking buffer and anti-DIG antibody was added according to manufacturer's recommendations (DIG Luminescent Detection kit, Roche). Membranes were then incubated with CDP-Star (Roche) before being exposed to imaging instrument, Gel Doc™ XR+ Imager (Biorad).

9. Loss of function's analyses

a. siRNA

After infection establishment, cells (either dHepaRG or PHH) were transfected once or twice with siRNAs. Differentiation medium was removed and replaced by Williams' medium E supplemented with 10% of FBS, 5µg/ml of human recombinant insulin, $5 \cdot 10^{-5}$ M hydrocortisone and 2mM GlutaMAX™. Mix containing siRNAs at a concentration of 25nM and Lipofectamine RNAimax reagent (ThermoFisher) was then slightly added to wells. Cells were then incubated at 37°C, 5% CO₂ for at least 72h prior to new transfection, medium changing or treatments.

b. CRISPR GuideRNA

An HepaRG cell line expressing Cas9 under tetracycline was generated by a stable-double transduction with lentiviruses expressing either the tetracyclin repressor (TR) or the Cas9 gene from *Streptococcus pyogenes* serotype M1; a polyclonal cell line HepaRG-TR-Cas9sp was selected with blasticidin (40 µg/mL) and zeocin (400 µg/mL) and then further amplified with blasticidin at 10 µg/mL and zeocin at 100 µg/mL (maintenance conditions). HepaRG-TR-Cas9sp were differentiated as wild type HepaRG for experiments with HBV. The day before transfection with crRNA, which is synthetic guide RNA comprised of 20 nucleotides identical to the genomic DNA target site, together with the tracrRNA to

complete the full ≈ 100 mer guide RNA structure necessary for genomic editing, tetracycline was added to the differentiation medium to induce the expression of Cas9sp. The day of transfection, a mix containing both crRNA and tracrRNA in OptiMEM was added to wells, the final concentration of crRNA and tracrRNA obtained is 25nM. Three transfections, 7 days separating each transfection, were realized in order to obtain a good extinction. 7 days after the last transfection, cells were infected, and treatment protocol began seven days post-infection.

c. dHepaRG-Cas9 KO TLR1, TLR2, TLR3 and MyD88

HepaRG-Cas9 KO cell lines were generated using lentivirus co-expressing codon-optimized Cas9 nuclease along with a single guide RNA (sgRNA) targeting a particular gene (e.g., TLR1, 2, 3, etc.). LentiCRISPR plasmid contains hSpCas9 and the chimeric guide RNA. *BsmBI* is used to digest the vector and a pair of annealed oligos can be cloned into the single guide RNA scaffold. The oligos, designed based on the target site sequence, are flanked on the 3' end by a PAM sequence (NGG). Lentiviral production is performed in HEK293T, lentiCRISPR are cotransfected with packaging plasmids pVSVg and Gag Pol. 5 days post transfection, supernatants are retrieved, filtered and concentrated. Lentiviruses are then transduced in proliferative HepaRG cells. Two sequences (called G1 and G2) for sgRNA TLR1, TLR2, TLR3 and MyD88 were designed for lentiCRISPR plasmid construction (listed in supplementary material and method).

10. RNA-sequencing analysis

mRNAs were extracted from cells using miRNeasy Kit and the extraction machine, Qiacube, according to manufacturer's recommendations (Qiagen). Control of the quality of extracted RNAs for RNA-sequencing was realized by Dr. Mathias Heikenwalder's team at the DKFZ institute of Heidelberg. RNA-sequencing was realized by Dr Thomas Englertner's team at the DKFZ institute of Heidelberg.

11. Toxicity assays

a. Neutral Red uptake assay

Neutral red uptake assay was adapted from (Repetto, del Peso, and Zurita 2008). After three days of treatment (Pam3CSK4, NPs-Pam3CSK4 and Empty NPs), 0.3 ml /cm² of pre-warmed neutral red solution (40 μ g/ml) was added to differentiation medium. After 3-4 hours of incubation at 37°C, 5% CO₂, medium containing the neutral red solution was removed and cells were washed 1x PBS. Cells were then destained with 0.5 ml/cm² of 50% absolute ethanol, 49% deionized water and 1% glacial acetic acid. Optical density was then measured at 540nm.

b. CellTiter-Glo® Luminescent Viability Assay

After three days of treatment (Pam3CSK4, NPs-Pam3CSK4, Empty-NPs) CellTiter-Glo® Luminescent Viability Assay (Promega) was performed according to manufacturer's recommendations. A 100µl of mix of CellTiter-Glo® Buffer and CellTiter-Glo® Substrate was added to cells and differentiation medium. The plate was equilibrated at room temperature for 30 minutes before recording luminescence.

12. Statistical analyses

Results were expressed as means and standard deviation (SD). Statistics were performed using GraphPad software. Mann-Whitney tests were used to compare treatment groups. For all tests, a p value ≤ 0.05 was considered as significant. *Correspond to p value ≤ 0.05 ; **correspond to p value ≤ 0.01 ; ***correspond to p value ≤ 0.001 .

Results

1. Pam3CSK4 impacts HBV intracellular RNA accumulation at very low concentrations.

We needed first to better describe the antiviral effect, in terms of kinetic of events, to find phenotypes that should be further mechanistically analysed. Using a similar regimen (two treatments with Pam3CSK4, 3 days apart), we found that the EC50 for most of viral parameters (total intracellular RNA, HBeAg, and viremia) was around 15 ng/mL, whereas a higher concentration was needed to take down HBsAg level (**Fig.1**). Only total RNA and HBeAg levels could decline below 80% of inhibition, whereas viremia and HBsAg seemed to plateau off at 50-60% of inhibition. It is worth noting that the measure of viremia by qPCR does not account for any potential effect on specific infectivity of virion released, which could occur and contribute to the overall antiviral effect.

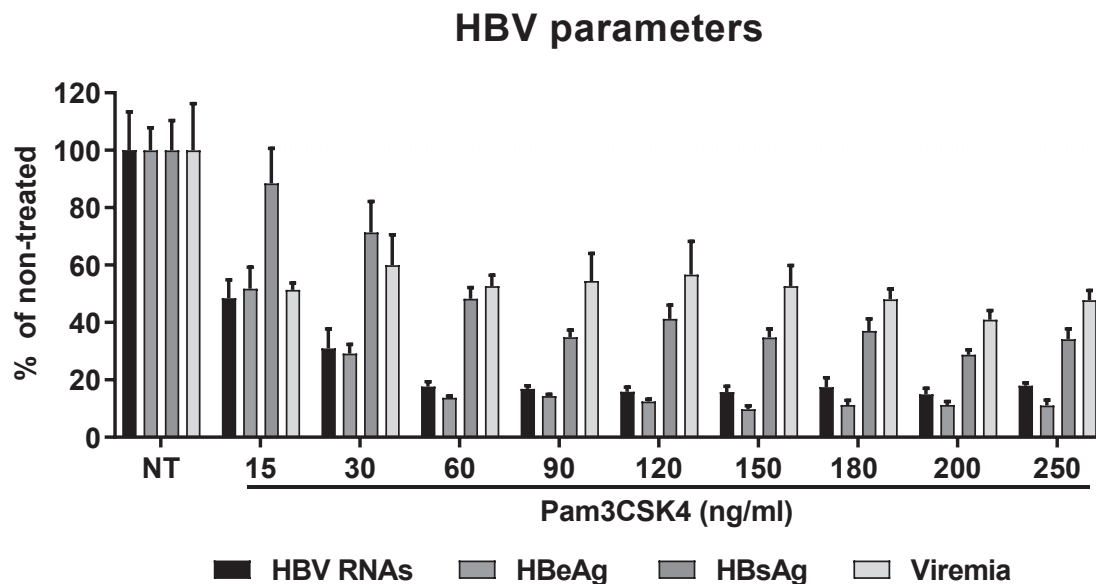

Figure 1: Pam3CSK4 impacts HBV intracellular RNA accumulation at very low concentrations. After 7 days post-infection, dHepaRG were treated twice with indicated concentrations (expressed in ng/ml) of Pam3CSK4 for a total exposure time of 6 days. Intracellular HBV nucleic acids were analysed at 13 days post-infection. Effect on total HBV RNAs was quantified by RT-qPCR, expressed in percentage, normalized to house-keeping gene level (PRNP) and non-treated condition (NT); effects on HBV antigens were quantified by ELISA in supernatants, expressed in percentage and normalized to NT; effects on viremia were quantified by qPCR, according to a standard curve (build with dilutions of a plasmid containing the HBV sequence). All histograms represent the mean of one experiment with three biological replicates and the error bars indicate SD.

This antiviral activity was not due to any cellular toxicity, as no decline of the capacity of lysosomal storage (neutral red uptake) or synthesis of adenosine triphosphate (ATP) (Cell titer Glo) was observed at 24,000 ng/mL of Pam3CSK4, thus indicating a selectivity index > 1600 (**Fig.2**). Yet a significant decline of hepatocyte nuclear factor 4 (HNF4)- α expression was noticed even at rather low concentration of Pam3CSK4 (**Fig.3**); this suggested that a dedifferentiation of cells could also account for the antiviral effect observed. Furthermore, HNF4 α , which is a nuclear receptor protein from the orphan receptor family, is not only an important transcription factor implied in regulation of hepatic cellular

differentiation, but it is also essential for HBV replication (Lucifora, Michelet, Salvetti, et al. 2020). Having said this, very low doses of Pam3CSK4 do not induce either a loss of HNF4 α RNAs nor proteins, suggesting that the antiviral activity of Pam3CSK4 would not be fully due to a loss of morphology, functions and structure of hepatocytes. Moreover, despite affecting HNF4 α RNAs, higher doses of Pam3CSK4 only induce a slight decrease of HNF4- α protein, highlighting the conserved morphology, structures and functions of hepatocytes during treatment. This phenomenon observed on HNF4 α is reversible and does not impair treatment efficiency. It is also important to note that this alteration of HNF4 α expression is also observed with IFN- α treatment, which is used in clinic to treat CHB patients.

Toxicity Assays

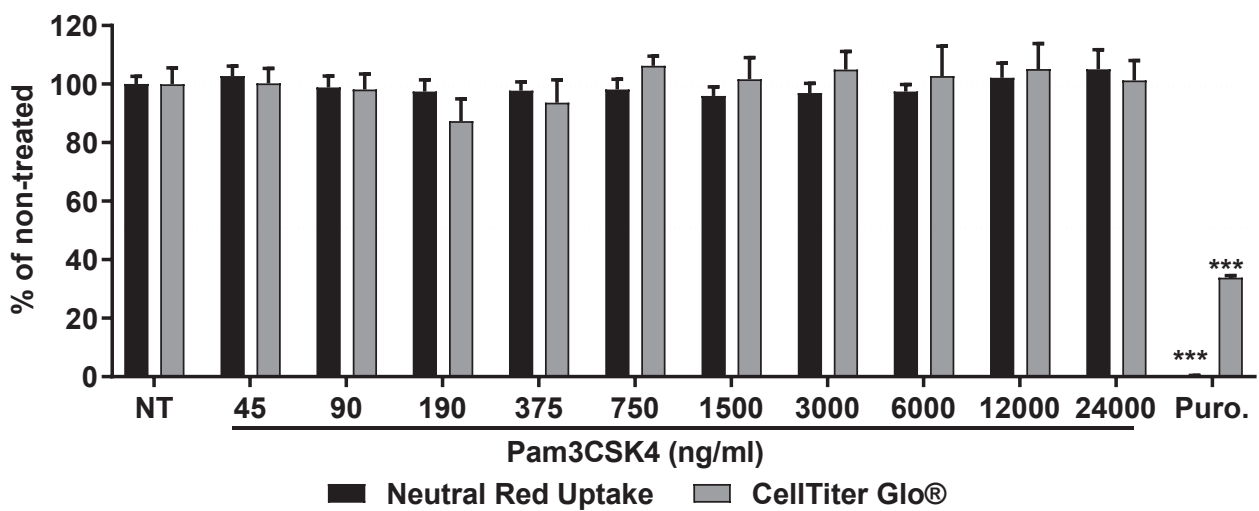
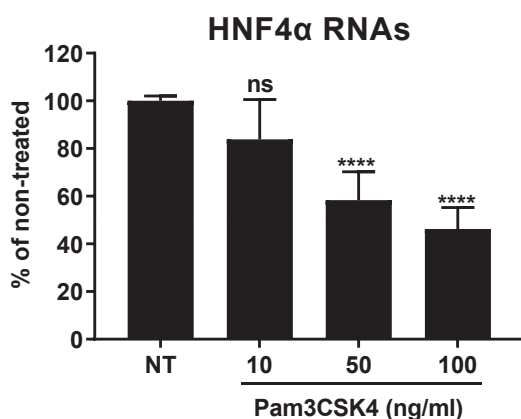
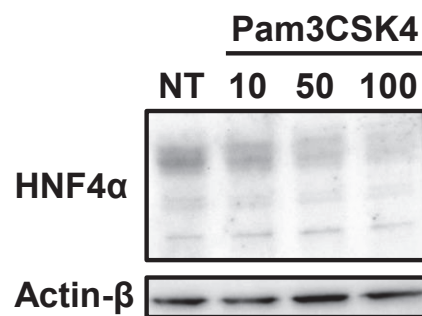

Figure 2: Pam3CSK4 treatments do not induce any toxicity. Cells were treated twice with indicated concentrations of Pam3CSK4 (in ng/ml) for a total exposure time of 6 days. Neutral Red Uptake and CellTiter Glo® Luminescent Cell Viability Assay were then performed. All histograms represent eight biological replicates, expressed in percentage and normalized to non-treated condition (NT) and the error bars indicate SD. Statistically significant differences from NT conditions are indicated by asterisks (ns: non-significant, *P<0.05, **P<0.005, ***P<0.002, ****P<0.0001).

A)



B)



c)

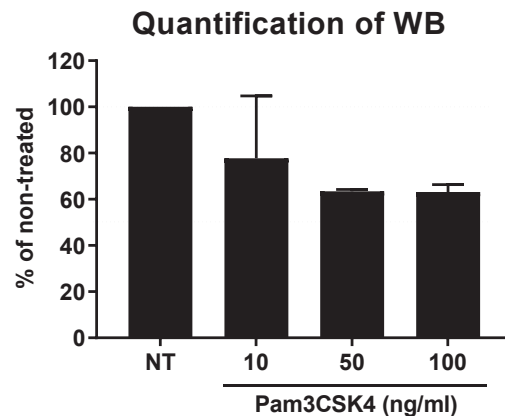

Figure 3: Pam3CSK4 induces a slight loss of HNF4 α . 7 days post-infection, dHepaRG cells were treated twice with indicated concentrations of Pam3CSK4 for a total exposure time of 6 days. Intracellular HBV nucleic acids were analysed at 13 days post-infection. Pam3CSK4 concentrations are expressed in ng/ml. A) Effect on HNF4 α RNAs was quantified by RT-qPCR, expressed in percentage, normalized to housekeeping gene level (PRNP) and non-treated condition (NT). Histograms represent the mean of two independent experiments with three biological replicates and the error bars indicate SD. B) and C) Western Blot analyses indicating HNF4 α proteins, expressed in percentage, normalized to actin- β and to NT condition. Quantification of western blots regroups the quantification for both experiments, and the error bars indicate SD. Statistically significant differences from NT conditions are indicated by asterisks (ns: non-significant, *P<0.05, **P<0.005, ***P<0.002, ****P<0.0001).

2. Pam3CSK4 is active against various HBV genotypes

As indicated in the introduction part, HBV exists as various genotypes with heterologous geographical repartition. Any novel anti-HBV asset need to be checked for its activity against these various genotypes. We assessed the ability of Pam3CSK4 at reducing viremia of other HBV genotypes. For that, dHepaRG cells were infected with five different genotypes of HBV, genotype A, B, C, D (used in all the study) and E. Seven days post-infection, dHepaRG cells were treated twice with 100 ng/ml of Pam3CSK4. At the end of treatment, supernatants were collected for dosing secreted virions (**Fig.4**). Pam3CSK4 was efficiently active on other genotypes B, C, and E compared to genotype D, inducing a half decrease of viremia.

However, in genotype A condition, viremia is not reduced with the actual drug regimen of Pam3CSK4, chosen for *in vitro* treatment. Either an additional treatment or higher dose of Pam3CSK4 could be considered to decrease viremia in that case.

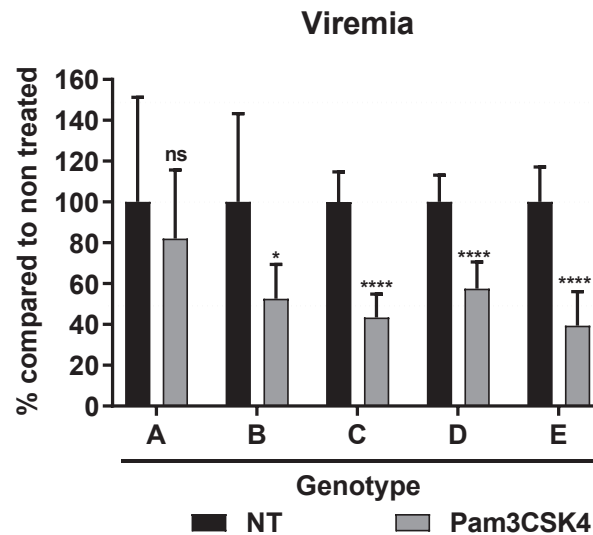

Figure 4: Pam3CSK4 has potent antiviral activity on genotypes B, C, D and E. 7 days post-infection, dHepaRG cells were treated twice with Pam3CSK4 (100 ng/ml) for a total exposure time of 6 days. Effects on viremia were quantified by qPCR, according to a standard curve (built with dilutions of a plasmid containing the HBV sequence). All histograms represent the mean of three independent experiments with three biological replicates and the error bars indicate SD. Statistically significant differences from NT conditions are indicated by asterisks (ns: non-significant, * $P < 0.05$, ** $P < 0.005$, *** $P < 0.002$, **** $P < 0.0001$).

3. The effect of Pam3CSK4 on HBV RNA accumulation can be disconnected from its effect on cccDNA

In the previous study, it was shown that Pam3CSK4 could induce a reduction of the level of cccDNA. As cccDNA is the template for all downstream HBV parameters, we wanted to investigate whether the effect of Pam3CSK4 on HBV RNA accumulation could be either independent or prior to any decline on cccDNA. To this end, 7 days post-infection, when infection was totally established, i.e. it had reached a replicative plateau (Hantz et al. 2009), dHepaRG cells were treated twice with 10, 50 or 100 ng/ml of Pam3CSK4 for a total exposure of 6 days. At the end of treatment, intracellular nuclear acids were extracted, and we could quantify all viral RNA and cccDNA, by RT-qPCR and FRET-qPCR methods respectively as described in materials and methods (Fig.5). Lowest dose of Pam3CSK4, 10 ng/ml, was efficient in decreasing viral RNAs, while cccDNA did not decrease, suggesting mechanism of action of Pam3CSK4 on viral RNAs before impacting cccDNA. Higher doses decreased cccDNA, which also decreased even more viral RNAs. In order to decrease all viral parameters, both intracellular and extracellular, 100 ng/ml was chosen for all subsequent experiments.

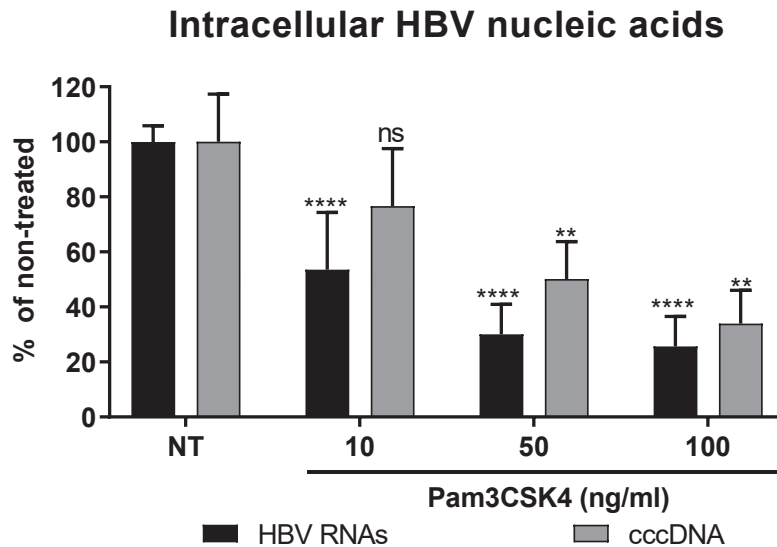

Figure 5: Effect of Pam3CSK4 on HBV RNAs at low concentrations in dHepaRG can be disconnected from effect on cccDNA. 7 days post-infection, dHepaRG cells were treated twice with indicated concentrations of Pam3CSK4 (expressed in ng/ml) for a total exposure time of 6 days. Intracellular HBV nucleic acids were analysed at 13 days post-infection. Effect on HBV RNAs was quantified by RT-qPCR, expressed in percentage, normalized to housekeeping gene level (PRNP) and non-treated condition (NT); effect on cccDNA levels was quantified by FRET-qPCR method, expressed in percentage, normalized to NT. All histograms correspond to the mean of independent experiments and the error bars indicate SD. Statistically significant differences from NT conditions are indicated by asterisks (ns: non-significant, * $P < 0.05$, ** $P < 0.005$, *** $P < 0.002$, **** $P < 0.0001$).

We further investigated whether the effect on HBV RNA accumulation could come faster than the phenotype on cccDNA. dHepaRG cells were treated only one time after establishment of the infection and the levels of total intracellular HBV RNAs and cccDNA were monitored in short term kinetics (**Fig.6**). We observed a 50% reduction of the levels of total intracellular HBV RNAs already 6h after treatment, with a 70% reduction reached 48 hours post-treatment. cccDNA levels remained stable after Pam3CSK4 treatment. This suggested that Pam3CSK4 had first an antiviral effect on viral RNAs before affecting the cccDNA, and the second treatment is required to affect it. The antiviral effects induced by Pam3CSK4 on viral RNAs were then investigated.

Intracellular HBV parameters

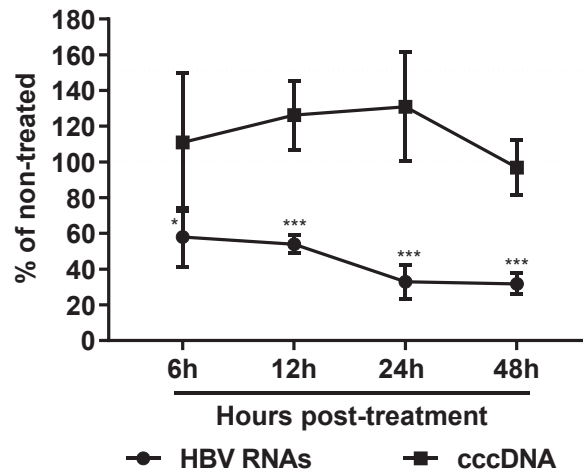

Figure 6: Fast inhibition of HBV RNAs after treatment one Pam3CSK4 treatment. 7 days post-infection, dHepaRG were treated once with Pam3CSK4 (100 ng/ml). HBV RNAs and cccDNA were analysed at indicated time points. Effect on RNAs was quantified by RT-qPCR, expressed in percentage, normalized to house-keeping gene level and non-treated condition (NT); effect on cccDNA levels was quantified by FRET-qPCR method, expressed in percentage, normalized to NT. All histograms represent the mean of at least two independent experiments with four biological replicates and the error bars indicate SD. Statistically significant differences from NT siCtrl conditions are indicated by asterisks (ns: non-significant, *P<0.05, **P<0.005, ***P<0.002, ****P<0.0001).

4. Pam3CSK4 has a long lasting antiviral activity

As Pam3CSK4 has an effect on both cccDNA and HBV RNAs levels, and knowing that the impact on HBV RNA concerns all form of HBV RNA leading to the decrease of all viral protein, including likely HBx and HBcAg, which are involved in cccDNA transcription regulation (Z. Wang, Wang, and Wang 2020), we wondered whether a long lasting inhibition after treatment arrest could be obtained with our ligand. To this end, dHepaRG cells, which were HBV-infected for 7 days and treated twice with treatments, were kept in culture 10 days after the end of treatment. All HBV parameters were quantified at the end of treatment (14 days post infection) and 10 days post the end of treatment (24 days post infection) (**Fig.7**). Intracellular parameters, viral HBV RNAs and cccDNA levels were quantified by RT-qPCR and FRET qPCR; HBeAg, HBsAg (quantified by ELISA) and viremia (quantified by qPCR) were additionally monitored at 18 and 21 days post-infection (**Fig. 8**). IFN- α , RG7834 (HBV RNAs destabilizer) and Tenofovir (TFV) were used as controls. A strong decrease of 50-70% was observed on all HBV parameters, HBV RNAs (**Fig.7A**), secreted HBeAg and HBsAg (**Fig. 7B and C**) and viremia (**Fig. 7D**) at the end of treatment with Pam3CSK4. Interestingly, it is the only drug to induce a strong decrease of cccDNA right after treatment (**Fig. 7B**), while IFN- α , the currently used treatment, does not have any impact on it. In contrast to the rebound of viremia (**Fig. 7D**) observed after the arrest of TFV; the rebound of HBV RNAs (**Fig.7A**) and secreted parameter (**Fig.7C and D**) after the arrest of RG7834,

reduction of intracellular HBV RNAs, cccDNA, secreted antigens and viremia (**Fig. 7 A-D**) were all sustained 10 days after the end of treatment. Pam3CSK4 was, once more, more potent at reducing cccDNA levels compared to IFN- α . The Pam3CSK4-mediated antiviral effect, sustained after arrest of the treatments, contrary to nucleoside analogue and RG7834, may suggest a role of epigenetic regulations, while the reduction of cccDNA levels may imply the triggering of cellular pathways subsequently affecting cccDNA stability, as previously seen with lymphotoxin-beta agonist ([Lucifora et al. 2014](#)).

A)

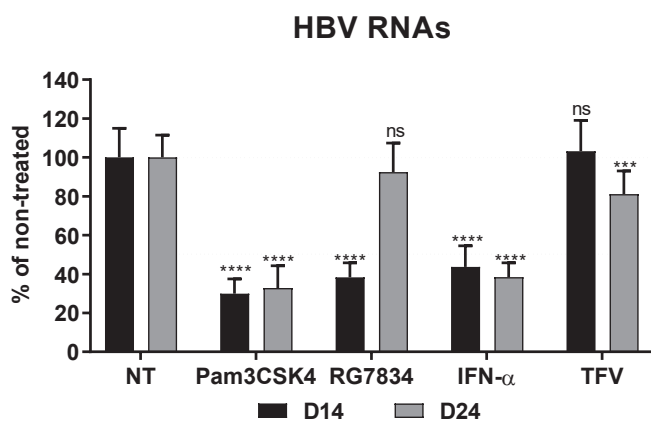

B)

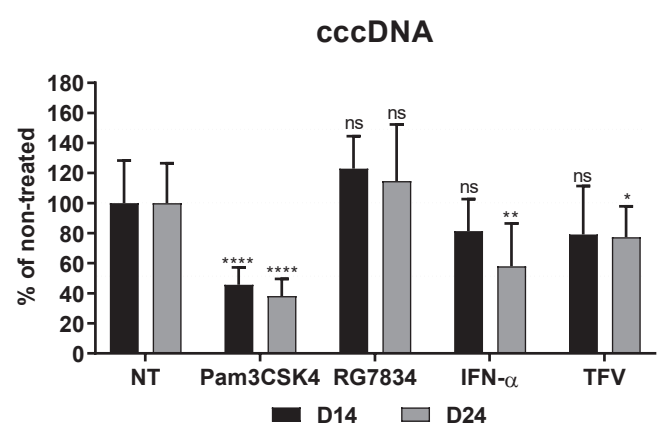

C)

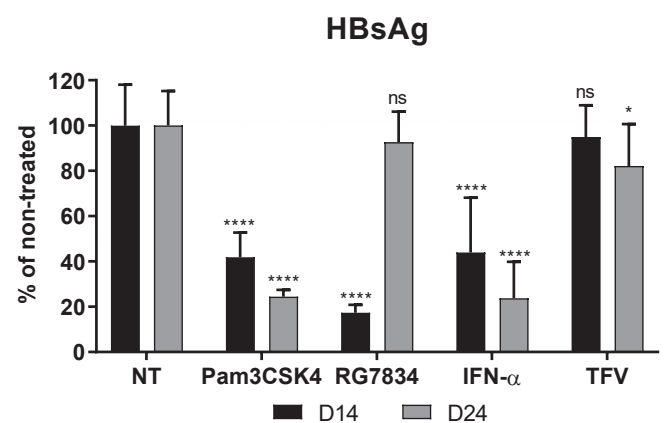
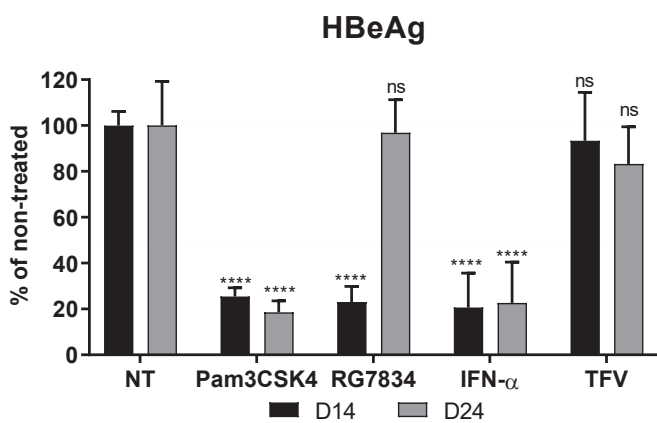

D)

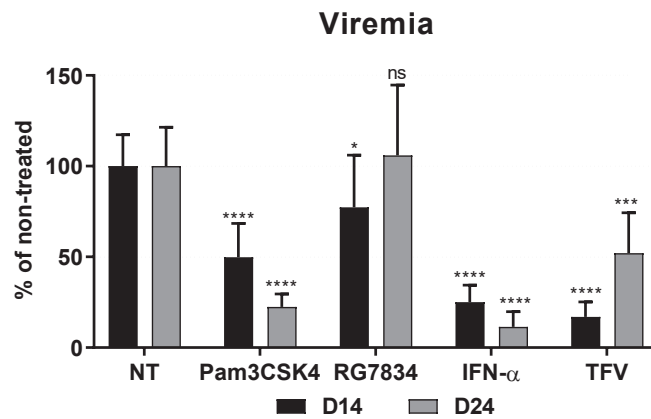
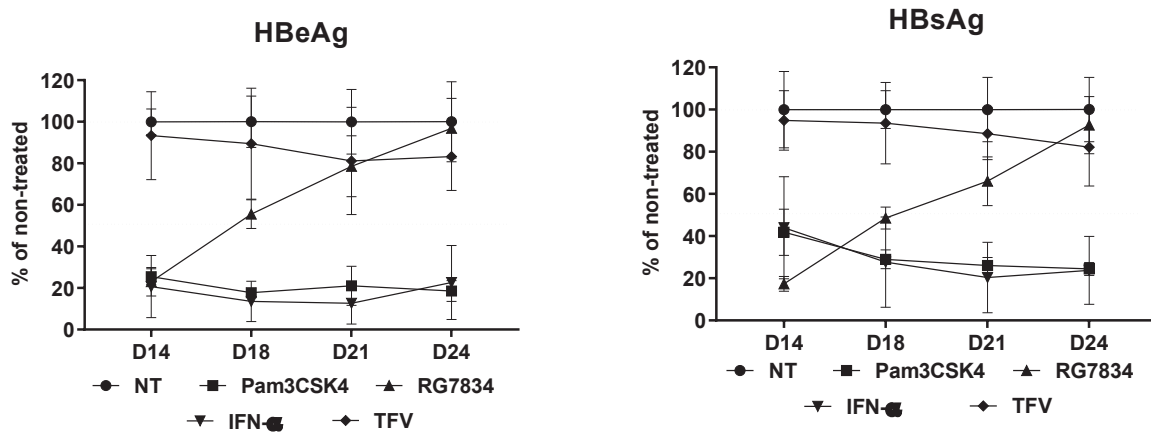

Figure 7: Pam3CSK4 treatment is potent and long lasting. 8 days post-infection, dHepaRG were treated twice with Pam3CSK4 (100ng/ml), IFN α (500UI/ml), RG7834 (0.1 μ M), Tenofovir (TFV: 1 μ M) for a total exposure time of 6 days. HBV parameters were analysed at 14 days post-infection, at the end of treatment, and 24 days post-infection. A) Effect on RNAs was quantified by RT-qPCR, expressed in percentage, normalized to house-keeping gene level (PRNP) and non-treated condition (NT); B) effect on cccDNA levels was quantified by FRET-qPCR method, expressed in percentage, normalized to NT; C) effects on HBV antigens were quantified by ELISA in supernatants, expressed in percentage and normalized to NT; D) effects on viremia were quantified by qPCR, according to a standard curve (build with dilutions of a plasmid containing the HBV sequence). All histograms represent the mean of at least three independent experiments with three biological replicates and the error bars indicate SD. Statistically significant differences from NT conditions are indicated by asterisks (ns: non-significant, *P<0.05, **P<0.005, ***P<0.002, ****P<0.0001).

A)



B)

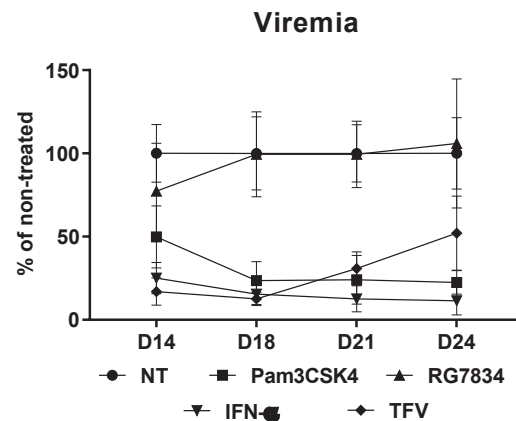

Figure 8: 8 days post-infection, dHepaRG were treated twice with Pam3CSK4 (100ng/ml), Peg-IFN α (500UI/ml), RG7834 (0.1 μ M), Tenofovir (TFV: 1 μ M) for a total exposure time of 6 days. Secreted HBV parameters were analysed at 14 days post-infection, at the end of treatment, 18, 21 and 24 days post-infection. A) Effects on HBV antigens were quantified by ELISA in supernatants, expressed in percentage and normalized to NT; B) effects on viremia were quantified by qPCR, according to a standard curve (build with dilutions of a plasmid containing the HBV sequence). All time points represent the mean of at least three independent experiments with three biological replicates and the error bars indicate SD.

5. Pam3CSK4 inhibits HBV in a TLR1/2 and MyD88 specific manner

As dHepaRG and PHH are both positive for the expression of TLR1/2 and TLR3 (Luangsay, Ait-Goughoulte, et al. 2015), we wondered if the antiviral effects induced by Pam3CSK4 was only mediated by TLR1/2, in the absence of off-target effects. We realized the knockout of TLR1/2 by two different approaches, using either lentiCRISPR or crRNA technologies.

dHepaRG cells were transduced by lentiCRISPR expressing Cas9 endonuclease and a single guide RNA corresponding our interest gene TLR1, TLR2, TLR3 and MyD88 (the adaptor protein used by TLRs, except TLR3, to activate transcription factor NF- κ B) as described in material and methods. Two sgRNAs constructions were realized for each gene, targeted sequences are presented in supplementary material and methods. Only the g2 construction for TLR2 was successfully transduced in dHepaRG cells. Transduced dHepaRG cells underwent normal differentiation as described in materials and methods prior being assessed by western blot for a good extinction of our interest genes (Fig.9). dHepaRG-Cas9 KO TLR1, TLR2 and MyD88 were well knockout while dHepaRG-Cas9 KO TLR3 cells still expressed TLR3 protein. Despite the absence of a good knock out in this cell line, dHepaRG-Cas9 KO TLR3 was then considered as a control cell line for treatment efficiency. dHepaRG-Cas9 KO cells were then HBV-infected, and 7 days post-infection, treated twice with Pam3CSK4, RG7834, IFN- α , and lamivudine (LAM) for a total exposure time of 6 days. At the end of treatment, intracellular parameters HBV RNAs, cccDNA and extracellular parameters HBeAg, HBsAg and viremia were quantified. We observed that all control drugs lamivudine, RG7834 and IFN- α , present the same phenotypic profile in each cell line

on all HBV parameters, suggesting that their antiviral effects is not mediated by our KO genes. (**Fig. 10A-D**). Concerning the strong antiviral effect induced by Pam3CSK4 in dHepaRG-Cas9 KO TLR3, our control cell line, on all HBV parameters (**Fig 10.C**) it is abolished in dHepaRG cells KO for TLR1, TLR2 and MyD88. This suggest that both TLR1 and TLR2 are necessary and sufficient for the antiviral effect induced by Pam3CSK4. It also suggests that MyD88 is crucial for TLR1/2 downstream signalling pathway in hepatocytes.

The second approach used TR-HepaRG Cas9 that were transfected three times with crRNA directed to TLR1, TLR2 or TLR3 and with the tracrRNA (**Fig.11A**). The KO of our genes of interest was assessed by western blot (**Fig 11.B**), TL2 and TLR3 seemed well KO, while residual TLR1 protein seems remaining. Pam3CSK4 still present antiviral activities in TR-HepaRG Cas 9 TLR3, confirming that Pam3CSK4-mediated activity is not dependent on TLR3. Once more, a reverse antiviral activity was observed in the absence of TLR2, confirming its essential role in Pam3CSK4-mediated antiviral activity. However, the reverse phenotype was more moderate in the absence of TLR1. We hypothesized that the residual level of TLR1 protein was sufficient to heterodimerize with TLR2 and to mediate Pam3CSK4 antiviral activity.

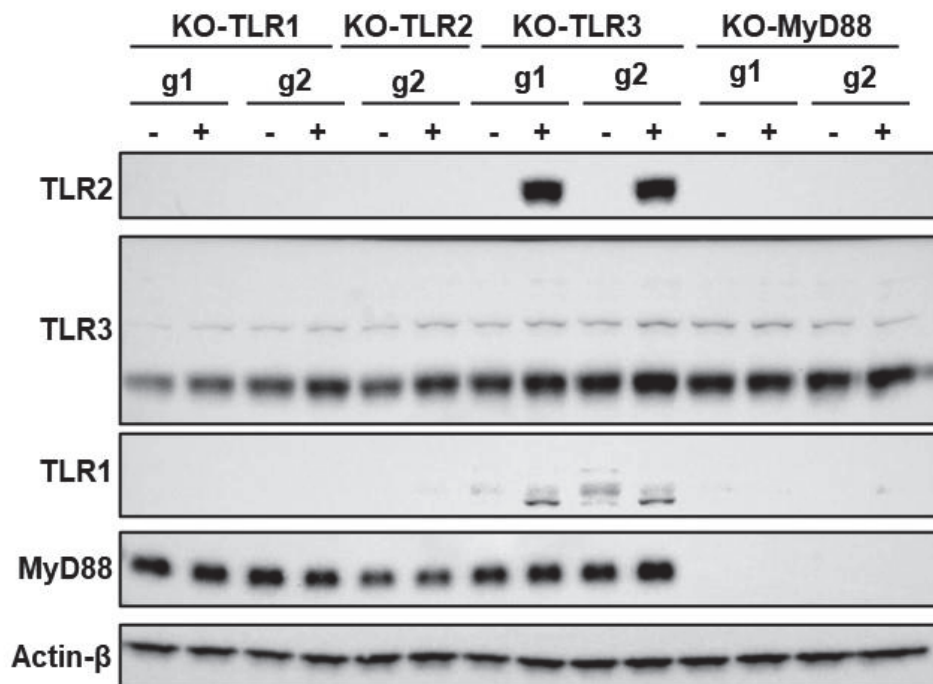
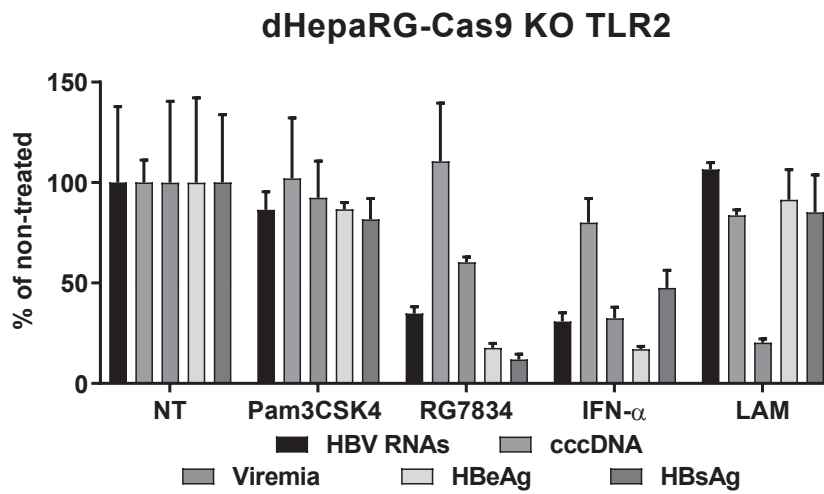
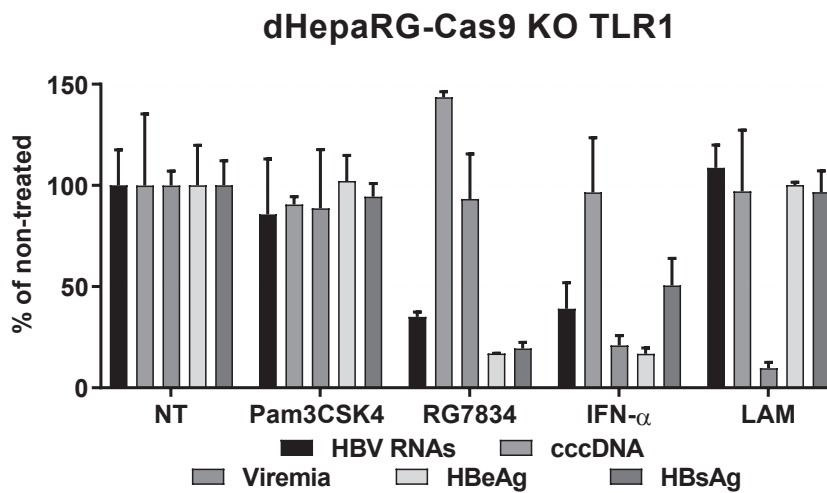

Figure 9: Pam3CSK4 inhibits HBV in a TLR1/2 specific manner. Two constructions of sgRNAs were realized for each interest gene. Knockout of dHepaRG KO cell lines for both constructions realized, was assessed by western blot. dHepaRG-Cas KO were stimulated for 24 hours with Pam3CSK4 before being lysed in RIPA buffer.

A)



B)



C)

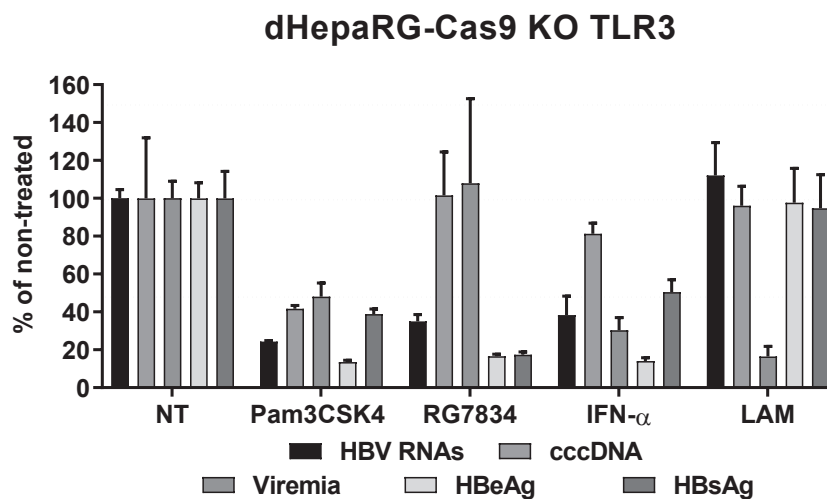

D)

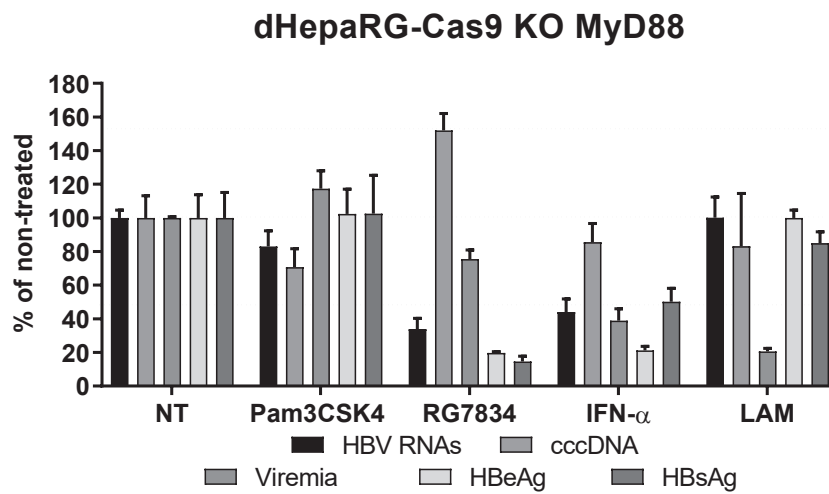
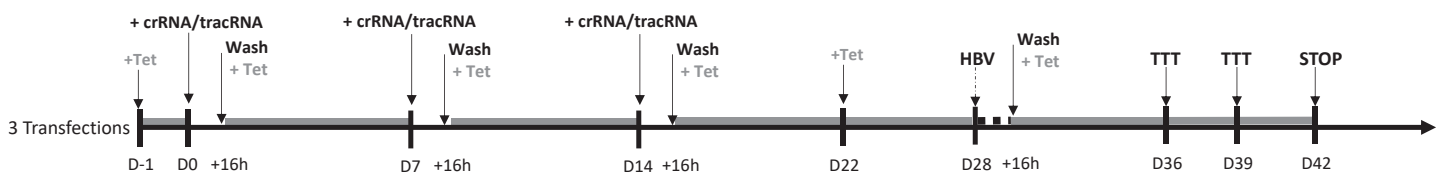
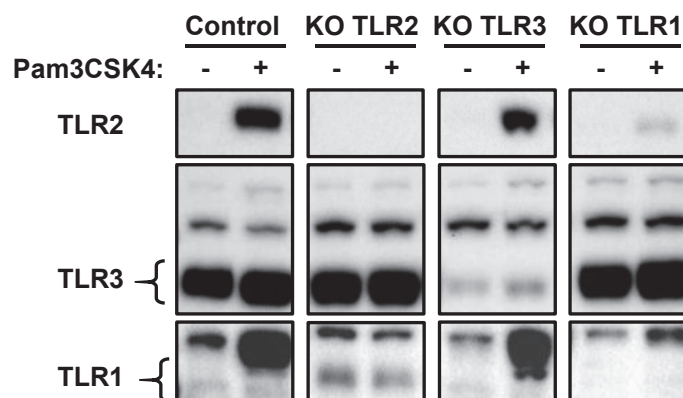

Figure 10: Pam3CSK4 inhibits HBV in a TLR1/2 and Myd88 dependent manner. 7 days post-infection, A) dHepaRG-Cas9 KO TLR2, (B) dHepaRG-Cas9 KO TLR1, (C) dHepaRG-Cas9 KO TLR3 and (D) dHepaRG-Cas9 KO MyD88 were treated twice with Pam3CSK4 (100ng/ml), Peg-IFN α (500UI/ml), RG7834 (0.1 μ M), lamivudine (LAM: 1 μ M) for a total exposure time of 6 days. Effect on RNAs was quantified by RT-qPCR, expressed in percentage, normalized to house-keeping gene level (PRNP) and non-treated condition (NT); effect on cccDNA levels was quantified by FRET-qPCR method, expressed in percentage, normalized to NT; effects on HBV antigens were quantified by ELISA in supernatants, expressed in percentage and normalized to NT; effects on viremia were quantified by qPCR, according to a standard curve (build with dilutions of a plasmid containing the HBV sequence). All histograms represent the mean of three biological replicates and the error bars indicate SD.

A)



B)



C)

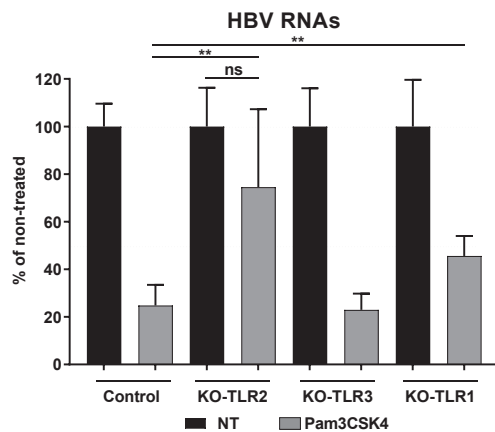

D)

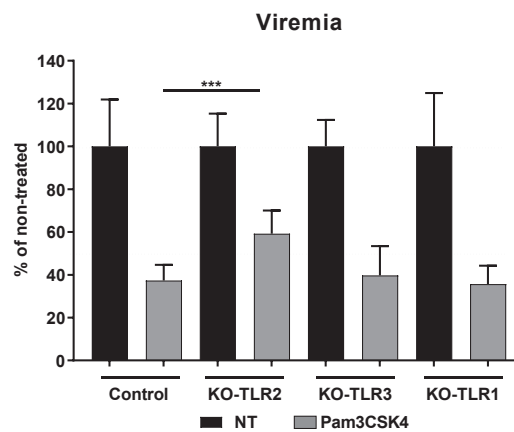

E)

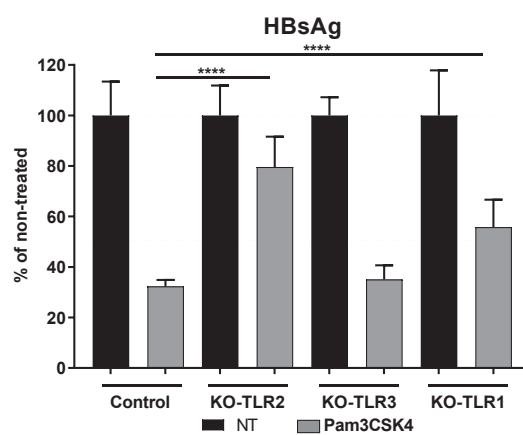
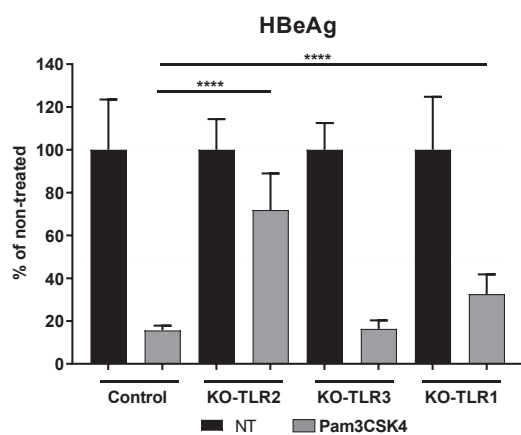

Figure 11: Pam3CSK4 inhibits HBV in a TLR1/2 specific manner. A) TR-HepaRG Cas9 were transfected three times with crRNA directed to either TLR1, TLR2 or TLR3 and with the tracrRNA. After 7 days post-last transfection cells were infected by HBV, and 7 days later treated two times with Pam3CSK4 (100ng/ml) for a total exposure time of 6 days. B) Extinction of targeted genes was assessed by western blot using nitrocellulose membranes. C) Effect on RNAs was quantified by RT-qPCR, expressed in percentage, normalized to house-keeping gene level and non-treated condition (NT). D) Effects on viremia were quantified by qPCR, according to a standard curve (build with dilutions of a plasmid containing the HBV sequence). E) Effects on HBV antigens were quantified by ELISA in supernatants, expressed in percentage and normalized to NT. All histograms represent the mean of two independent experiments with three biological replicates and the error bars indicate SD. Statistically significant differences from NT conditions are indicated by asterisks (ns: non-significant, * $P < 0.05$, ** $P < 0.005$, *** $P < 0.002$, **** $P < 0.0001$).

6. Low expression of TLR2 does not prevent antiviral activity of Pam3CSK4

The experimental approach using TR-HepaRG Cas9 (5.) to knock out genes questioned us about the amount of protein needed to achieve an antiviral effect in hepatocytes. It is acknowledged that TLR agonist activates mRNA expression and therefore protein synthesis of their own receptor in cells such

as macrophages (K. Cheng et al. 2015), however little is known about expression of TLR in hepatocytes. We investigated the ability of Pam3CSK4 to induce antiviral effects in hepatocytes whose TLR1/2 expression is nearly null. To achieve this, we used a siRNA approach allowing a partial but not complete extinction of TLRs. dHepaRG cells were HBV-infected prior to siRNAs transfection, to avoid potential effect of extinction on HBV infection and they were then transfected with siRNAs directed to TLR2, TLR1 and TLR3 and 6 were used as controls. siHBV was used as an experimental control. siRNAs were kept in dHepaRG medium for four days before being removed and cells were further treated twice with Pam3CSK4 (**Fig. 12A**). Extinction of targeted genes were controlled before and after Pam3CSK4 treatment by RT-qPCR and western blot (**Fig. 13 A and B**). siRNA directed to TLR2 decreased the TLR2 mRNA expression of more than 80% compared to other conditions, while the protein is no longer detectable in western blot (**Fig 12B and C**). After treatments, TLR2 mRNAs were upregulated about five times in treated sicontrol (siCtrl) condition and in conditions in which TLR3 and TLR6 are downregulated, compared to non-treated sicontrol (NT siCtrl) condition. However, in condition in which TLR2 mRNA expression was originally low, mRNAs were upregulated about two times compared to NT siCtrl (**Fig. 12B**). TLR2 protein was also detectable in western blot after treatment in siTLR2 condition, despite its absence before treatment (**Fig. 12C**). Interestingly, despite the originally low expression of TLR2 in cells, Pam3CSK4 induced an antiviral phenotype as potent as the phenotype observed in siCtrl condition (**Fig. 12D**). This analysis may be important as some studies reported the downregulation of TLR2 expression in PBMCs, liver macrophages, and hepatocytes from chronic HBV-HBeAg+ patients (Visvanathan et al. 2007). Pam3CSK4 might be an interesting alternative, as it is able to strongly upregulate TLR2 expression from a nearly null extinction, inducing a strong antiviral effect as well.

Interestingly, Pam3CSK4 did not induce any upregulation of TLR1 expression after treatment (**Fig.13A**), resulting in a weaker antiviral effect obtained in siTLR1 condition. TLR1 is therefore necessary for Pam3CSK4-mediated antiviral effect, as its absence was associated with a reverse phenotype (5.), but the ligand presence does not upregulate its expression.

A)

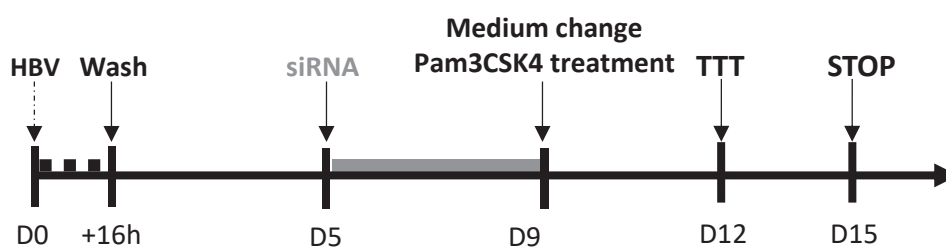

B)

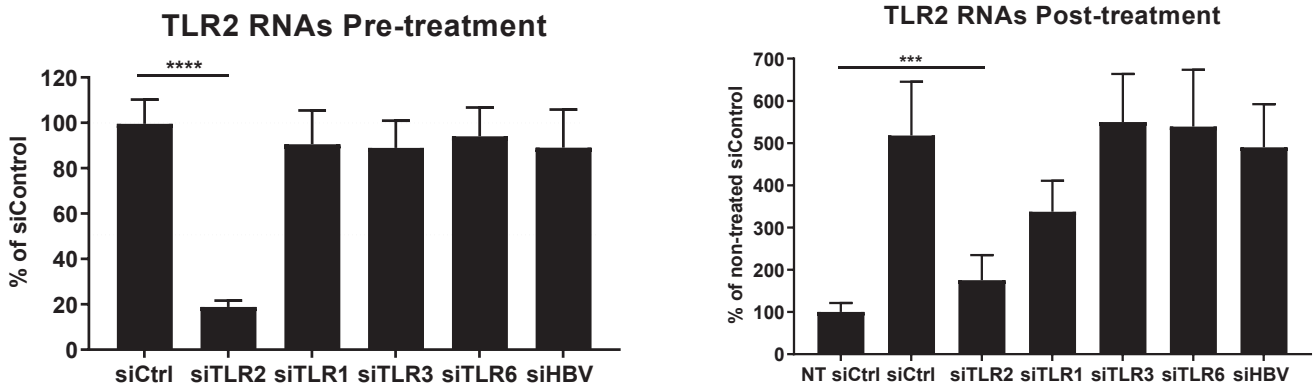

C)

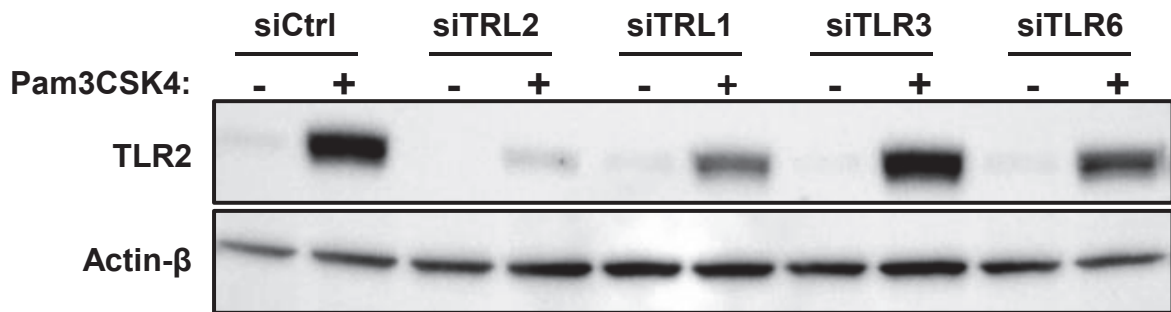

D)

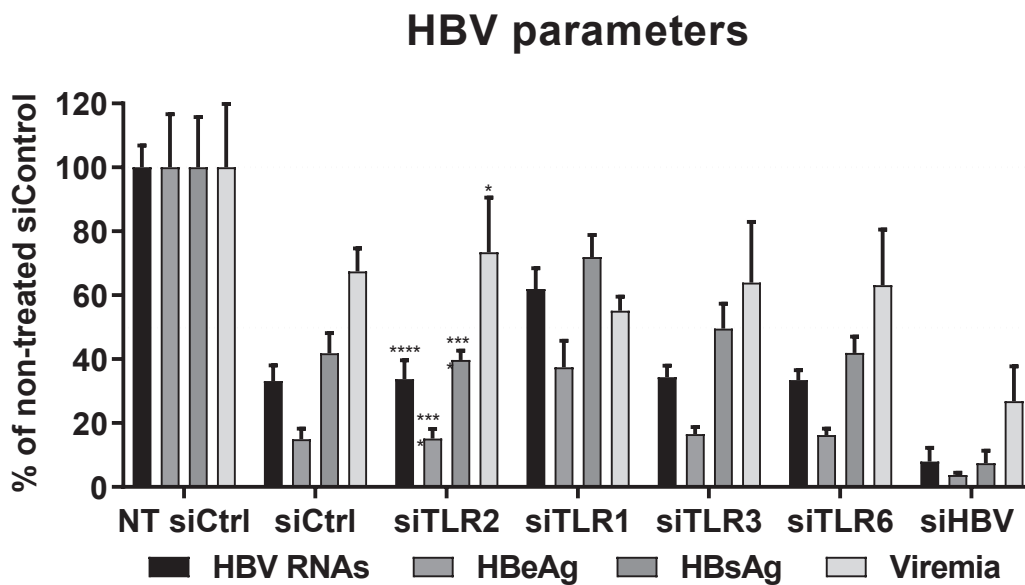
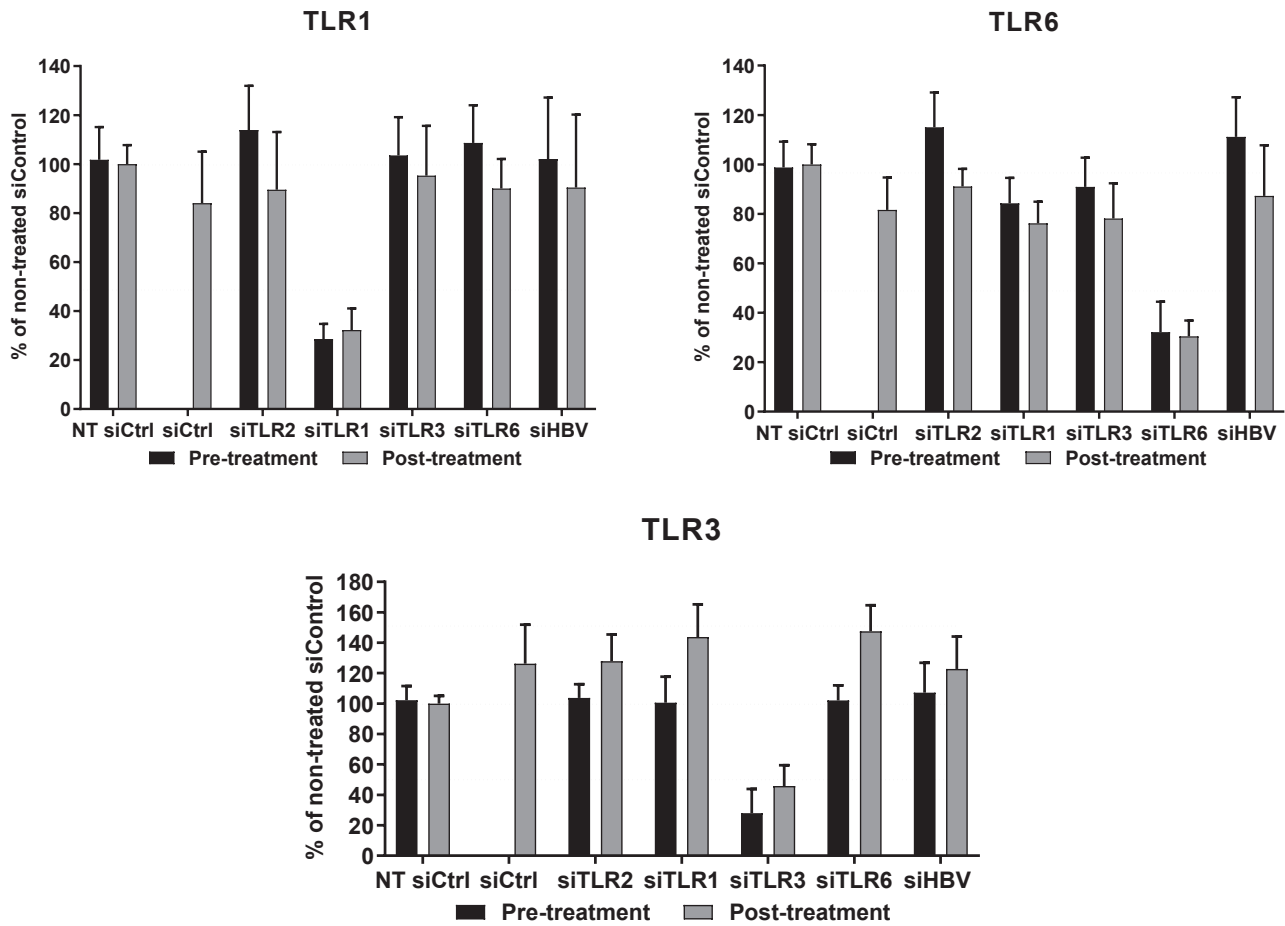

Figure 12: Low expression of TLR2 do not prevent antiviral activity of a TLR2 agonist. A) dHepaRG were infected and at least 5 days post infection, cells were transfected once with siRNAs directed to TLR2. SiRNAs directed to TLR1, TLR3 and TLR6 were used as controls. Four days post-transfection, cells were treated two times with Pam3CSK4 (100ng/ml) for a total exposure time of 6 days. B) TLR2 RNAs prior to treatment and post treatment were quantified by RT-qPCR, expressed in percentage, normalized to housekeeping gene level and non-treated sicontrol condition (NT siCtrl); C) Extinction of targeted genes was assessed by western blot using nitrocellulose membranes. D) Effect on HBV RNAs was quantified by RT-qPCR, expressed in percentage, normalized to housekeeping gene level and NT siCtrl; effects on HBV antigens were quantified by ELISA in

supernatants, expressed in percentage and normalized to NT siCtrl; effects on viremia were quantified by qPCR, according to a standard curve (build with dilutions of a plasmid containing the HBV sequence. All histograms represent the mean of three independent experiments with three biological replicates and the error bars indicate SD. Statistically significant differences from NT siCtrl conditions are indicated by asterisks (ns: non-significant, *P<0.05, **P<0.005, ***P<0.002, ****P<0.0001).

A)



B)

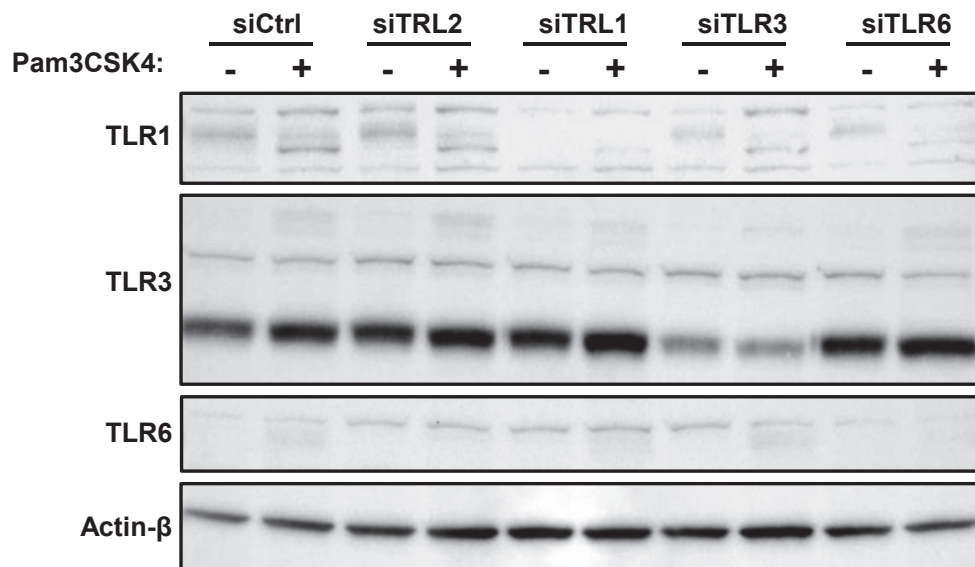

Figure 13: Low expression of TLR2 do not prevent antiviral activity of a TLR2 agonist. dHepaRG were infected and at least 5 days post infection, cells were transfected once with siRNAs directed to TLR2. SiRNAs directed to TLR1, TLR3 and TLR6 were used as controls. Four days post-transfection, cells were treated two times with Pam3CSK4 (100ng/ml) for a total exposure time of 6 days. A) TLR1, TLR3 and TLR6 RNAs prior to treatment and post treatment were quantified by RT-qPCR, expressed in percentage, normalized to housekeeping gene level and non-treated sicontrol condition (NT siCtrl); B) Extinction of targeted genes was assessed by western blot using nitrocellulose membranes. All histograms represent the mean of three independent experiments with three biological replicates and the error bars indicate SD.

7. Antiviral activity of Pam3CSK4 is mediated by an early activation of canonical NF- κ B pathway and expression of pro-inflammatory genes

TLR1/2 activation is known to activate NF- κ B signalling pathway, leading to the expression of pro-inflammatory genes (Taro Kawai and Akira 2007). The kinetics of NF- κ B pathway activation, both canonical and non-canonical, was then investigated after Pam3CSK4 treatment. dHepaRG cells were HBV-infected and 7 days later, treated with Pam3CSK4. The two pathways were analysed at different time right after treatment (**Fig.14 A and B**). Pam3CSK4 induced a rapid activation of canonical NF- κ B pathway with a phosphorylation of the p65 subunit detectable only 30 minutes post treatment and remained detectable until 2 hours post treatment. However, it did not activate non-canonical pathway, p100 and p52 subunits remaining in same proportion than non-treated condition. This early activation of NF- κ B signalling pathway led to the rapid and strong expression of pro-inflammatory gene, IL-6 (**Fig.15**).

Even if this activation is not observable right after the second treatment, we did observe phosphorylation of p65 subunit 3 days post second treatment, suggesting that NF- κ B pathway could undergo a negative feedback loop at first before being reactivated again between second treatment

and the end of experiment. This result highlighted that the treatment regimen, i.e., two Pam3CSK4 treatment, used for all experiences in that study was convenient in *in vitro* models (Fig.16).

A)

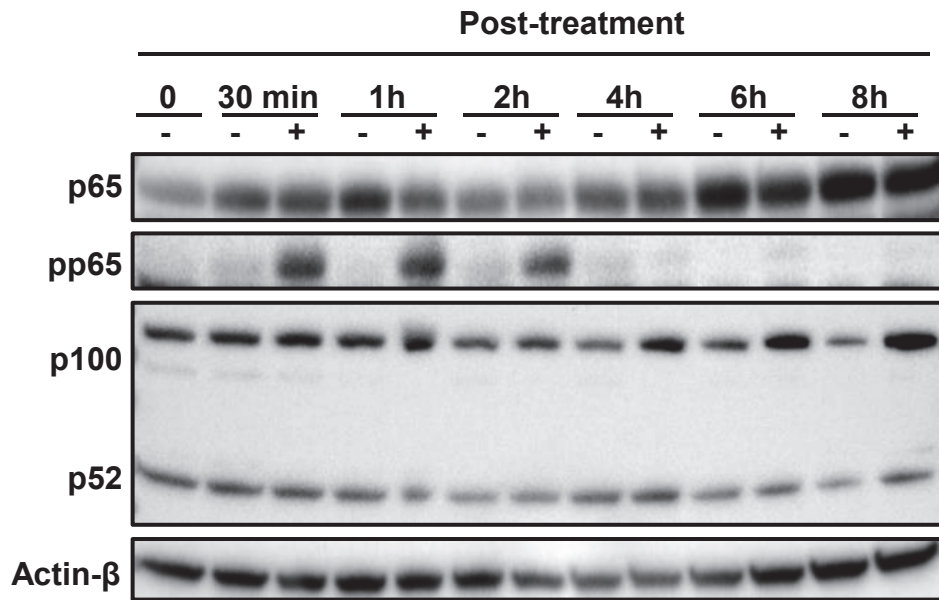

B)

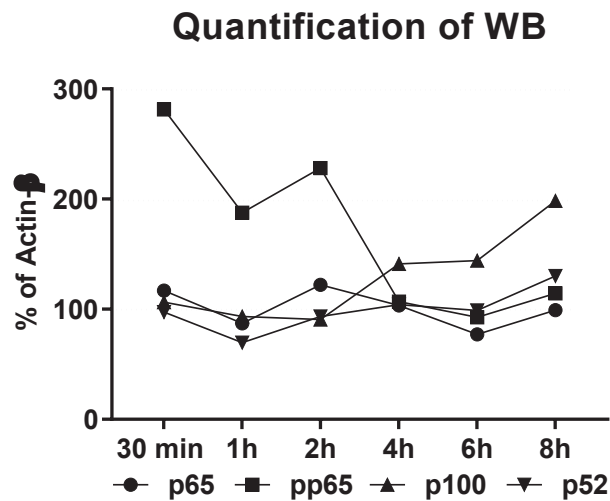

Figure 14: Antiviral activity of Pam3CSK4 is mediated by an early activation of canonical NF-κB pathway. dHepaRG were treated 7 days post-infection with Pam3CSK4 (100 ng/ml). Lysates were generated at different time points to analyse the activation of both canonical and non-canonical activation of NF-κB pathway by western blots.

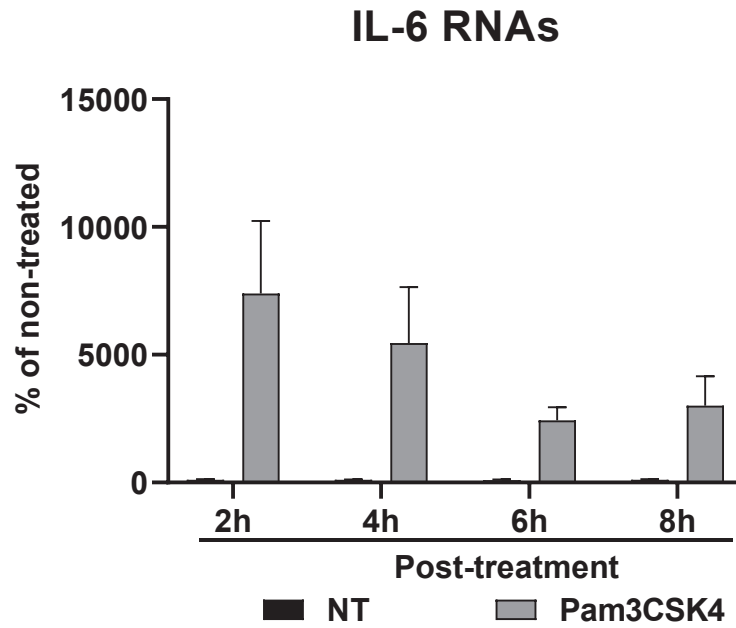
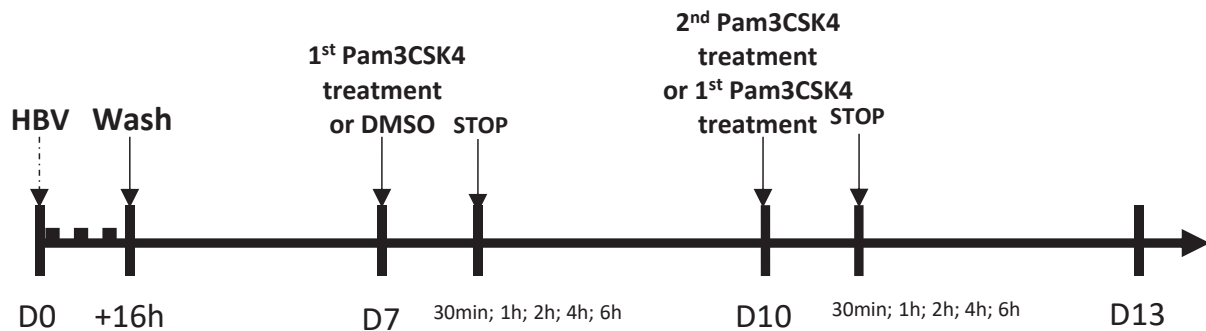

Figure 15: Pam3CSK4 treatment induces a rapid and strong expression of pro-inflammatory genes, IL-6. dHepaRG were treated 7 days post-infection with Pam3CSK4 (100 ng/ml). IL-6 mRNAs levels were analysed and quantified at different time post-treatment by RT-qPCR, expressed in percentage, normalized to housekeeping gene level (PRNP) and non-treated (NT). All histograms represent the mean of three independent experiments with three biological replicates and the error bars indicate SD.

A)



B)

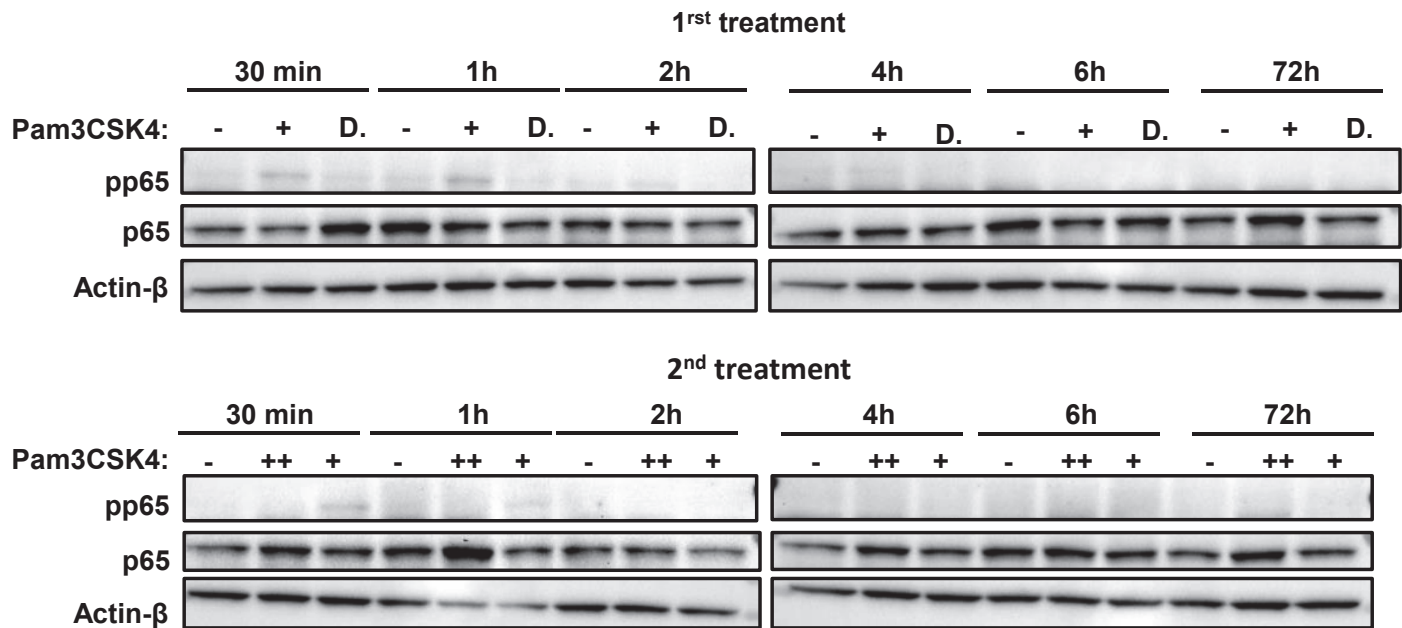

Figure 16: Activation of NF- κ B pathway after one or two treatments. A) dHepaRG were either treated 7 days post-infection with Pam3CSK4 (100 ng/ml) (+) or DMSO (D.) and retreated once with Pam3CSK4 (for both conditions, ++ and +). B) Lysates were generated at different time points to analyse the activation of canonical activation of NF- κ B pathway by western blots.

8. Antiviral activity of Pam3CSK4 on viral RNAs

As Pam3CSK4 first impact viral RNAs, we hypothesized that this decrease could be due to different mechanisms, including inhibition of transcription or degradation of viral RNAs. We also wondered if Pam3CSK4 could induce the rapid synthesis of an effector that in turn led to the decrease of viral RNAs.

a. Inhibition of transcription

We first investigated the ability of Pam3CSK4 to inhibit HBV transcription. dHepaRG cells were infected, and after the establishment of infection, cells were treated twice with Pam3CSK4 for a total exposure time of 6 days. Peg-IFN- α and both RG7834 and lamivudine (LAM) were respectively used as positive and negative controls for transcription inhibition. Effects of treatment on HBV parameters were assessed before proceeding to the following experiment (**Fig. 17**). 13 days post-infection, 5-ethynyl uridine was added to cell media to label nascent RNAs for a total exposure time of two hours. As control, infected but not treated cells were treated with actinomycin D, an inhibitor of transcription, 20 minutes before adding 5-ethynyl uridine. Total intracellular HBV RNAs were then isolated, quantified by RT-qPCR. Labelled RNAs were further extracted using Click-iT™ Nascent RNA Capture Kit and quantified by RT-qPCR (**Fig.18A**). Pam3CSK4 not only had an antiviral effect on total intracellular HBV RNAs, but also decreased HBV nascent RNAs (**Fig.18B**). Similarly to IFN- α , which is an innate

immune stimulator that had already been shown to inhibit transcription (Laura Belloni et al. 2012), Pam3CSK4 seem to trigger same mode of action against HBV RNAs. However, the time of labelling of two hours might be long, but for experimental issues, shorter times were not convenient. We therefore cannot overlook the fact that Pam3CSK4 may inhibit HBV RNAs right after elongation, and therefore RNA decay experiments were further realized.

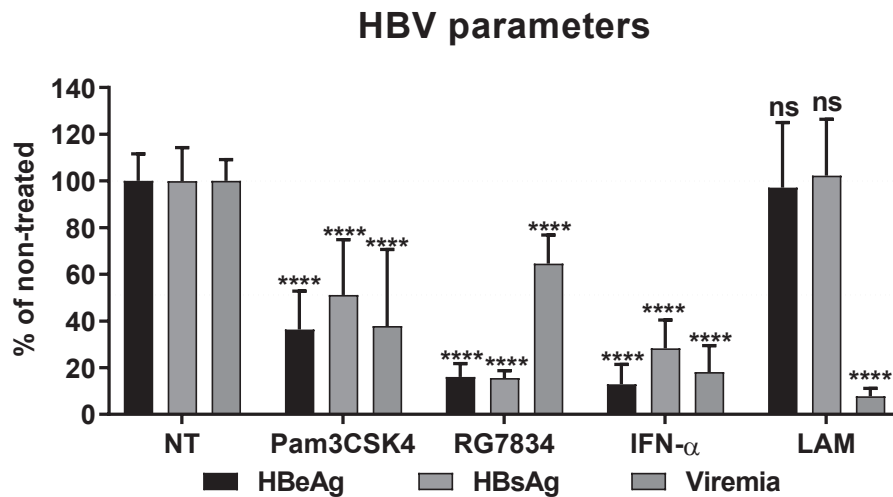
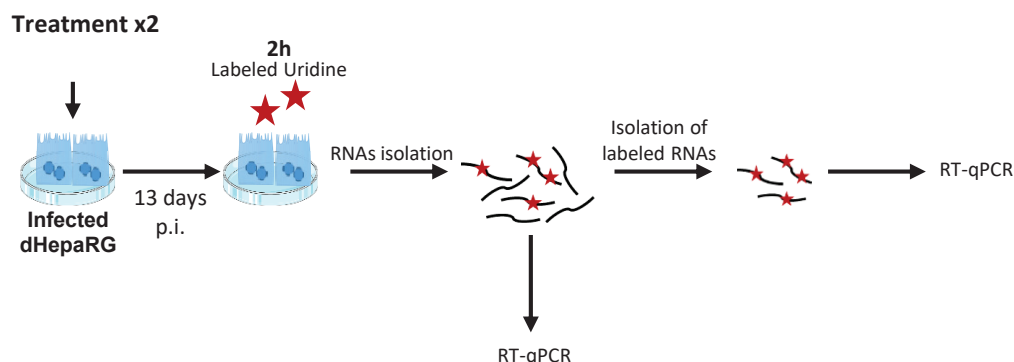

Figure 17: Pam3CSK4 inhibits HBV transcription. dHepaRG were treated 7 days post-infection, with Pam3CSK4 (100 ng/ml), RG7834 (0.1 μ M), IFN- α (1000 UI/ml) and lamivudine (LAM, 1 μ M), for a total exposure of 6 days of treatment. 6 days after treatment (and 13 days post-infection), all HBV parameters were controlled. Effects on HBV antigens were quantified by ELISA in supernatants, expressed in percentage and normalized to NT; effects on viremia were quantified by qPCR, according to a standard curve (build with dilutions of a plasmid containing the HBV sequence). All histograms represent the mean of at least three independent experiments with three biological replicates and the error bars indicate SD. Statistically significant differences from NT conditions are indicated by asterisks (ns: non-significant, *P<0.05, **P<0.005, ***P<0.002, ****P<0.0001).

A)



B)

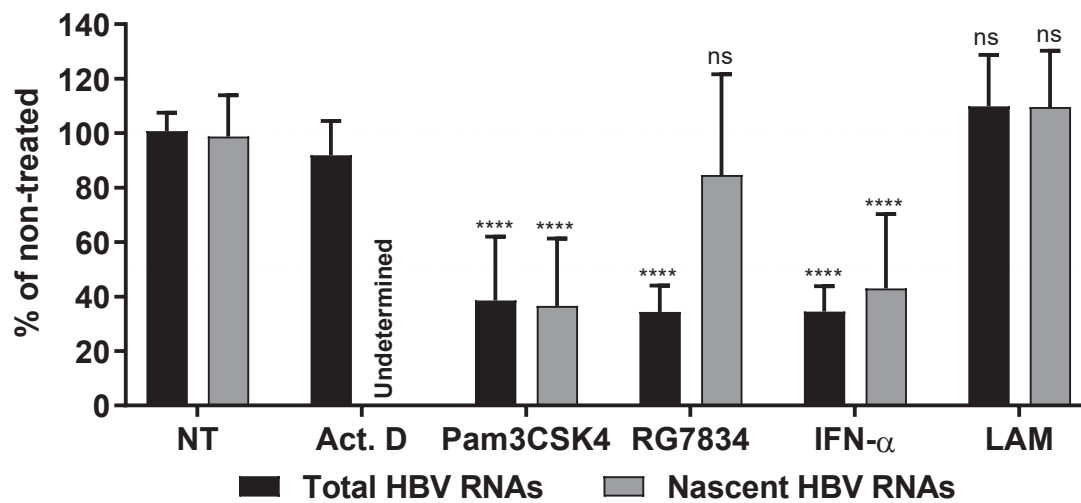
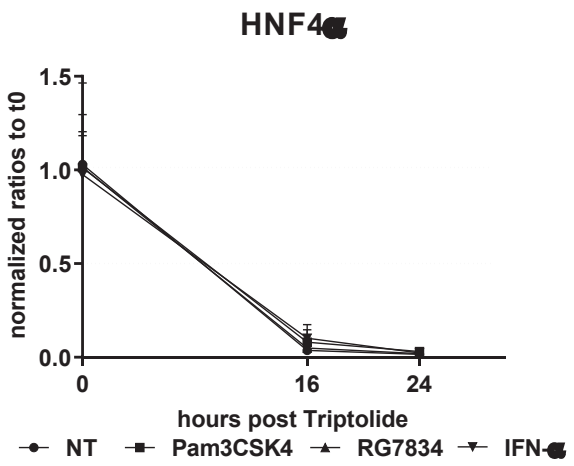
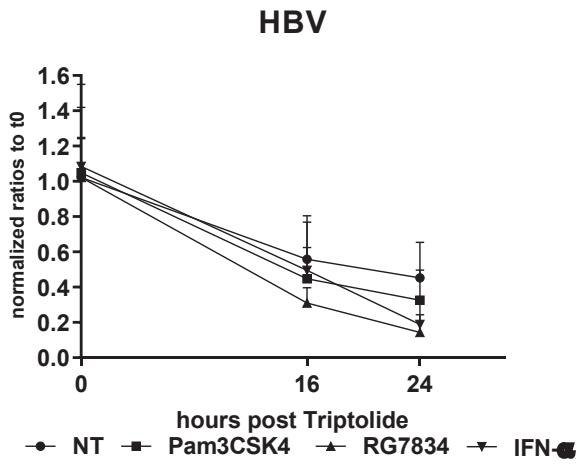
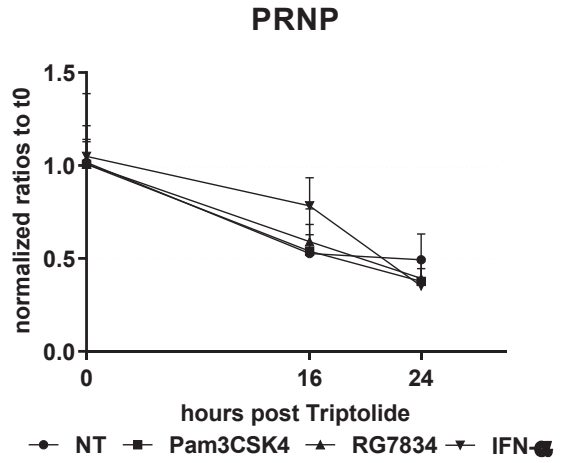
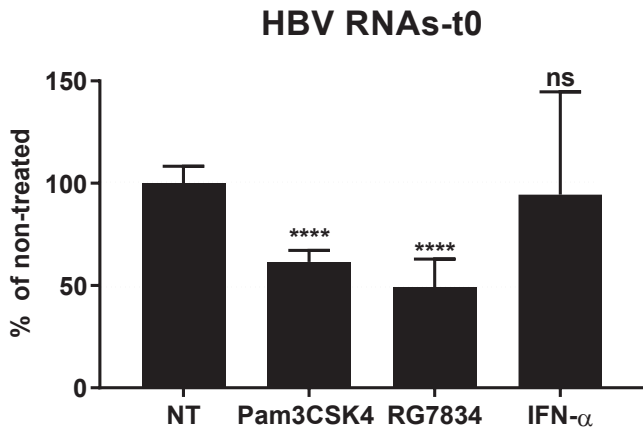

Figure 18: Pam3CSK4 inhibits HBV transcription. A) dHepaRG were treated 7 days post-infection, with Pam3CSK4 (100 ng/ml), RG7834 (0.1 μ M), Peg-IFN- α (1000 UI/ml) and lamivudine (LAM, 1 μ M), for a total exposure of 6 days of treatment. 6 days after treatment (and 13 days post-infection), 5-ethynyl uridine was used to label nascent RNAs for two hours. HBV RNAs were then extracted and quantified by RT-qPCR for total analysis, and labelled RNAs were further extracted using Click-iT™ Nascent RNA Capture Kit according to manufacturer's recommendations. Actinomycin D was used as control: on day 13, cells were treated with actinomycin D at a concentration of 5 μ g/ml and for twenty minutes prior to the addition of 5-ethynyl uridine. B) Effects on total and nascent HBV RNAs was quantified by RT-qPCR, expressed in percentage, normalized to house-keeping gene level and non-treated condition (NT). All histograms represent the mean of at least three independent experiments with three biological replicates and the error bars indicate SD. Statistically significant differences from NT conditions are indicated by asterisks (ns: non-significant, *P<0.05, **P<0.005, ***P<0.002, ****P<0.0001)

b. Induction of RNA decay

We investigated the effect of Pam3CSK4 on the degradation of viral RNAs (**Fig. 19**). Primary human hepatocytes were infected and treated with Pam3CSK4. RG7834, a potent HBV destabilizer was used as control, as well as IFN- α . Two days later, Triptolide, which is a transcription inhibitor, was added to cell media. RNAs were then extracted at different time points. PRNP mRNA, a housekeeping gene, and HNF4- α mRNA whose half-life is short were respectively used as negative and positive controls. Each mRNA was normalized to time 0 (t0) (**Fig. 19.A**), before the adding of Triptolide. Pam3CSK4 seemed to decrease total intracellular HBV RNAs, in a similar way than IFN- α . This effect was also observed in dHepaRG cells (**Fig.19B**).

A)



B)

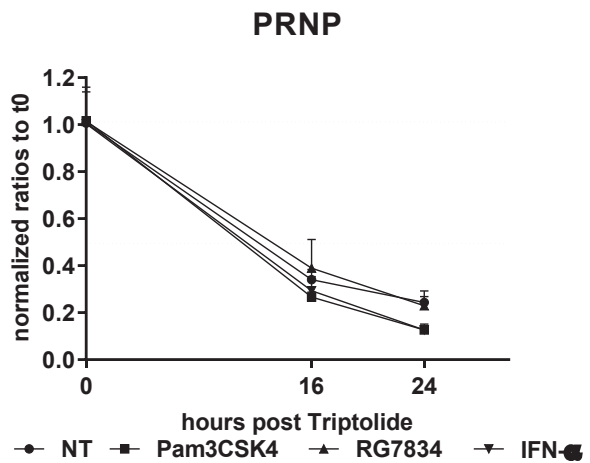
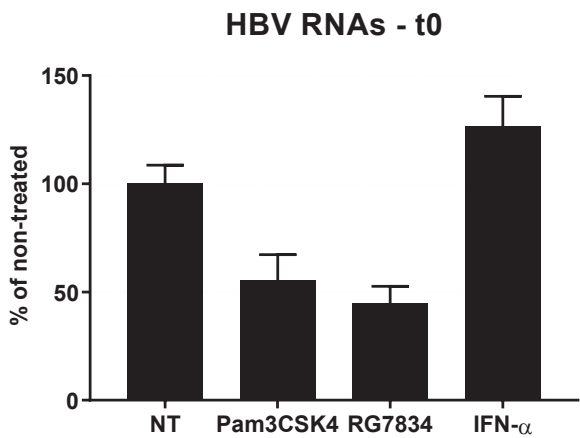

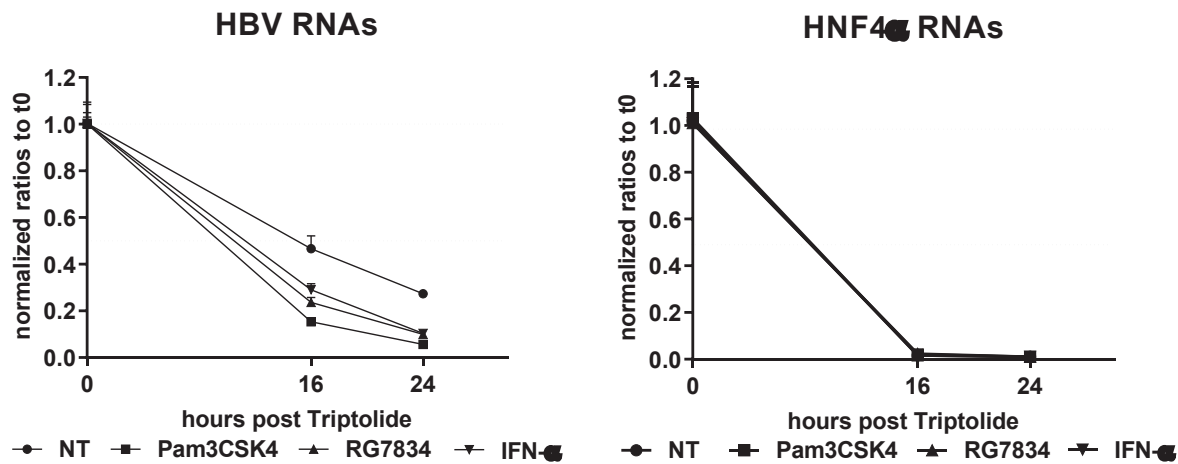

Figure 19: Pam3CSK4 induces RNA decay. A) 5 days post-infection, PHH were treated with Pam3CSK4 (1 μ g/ml), RG7834 (0.1 μ M) and Peg-IFN- α (1000UI/ml) for two days prior to the addition of Triptolide (1 μ g/ml). B) 4 days post-infection dHepaRG were treated with Pam3CSK4 (50ng/ml), Peg-IFN- α (500 UI/ml) and RG7834 (0.1 μ M), 3 days later Triptolide was added to cell medium (containing treatment). PRNP (housekeeping gene), HBV RNAs and HNF4 α were analysed at indicated time points, quantified and normalized to non-treated at t0 (before the addition of Triptolide). For PHH experiments, all time points represent the mean of three independent experiments with three biological replicates and the error bars indicate SD. Statistically significant differences between cycloheximide conditions and without cycloheximide are indicated by asterisks (ns: non-significant, *P<0.05, **P<0.005, ***P<0.002, ****P<0.0001). For dHepaRG experiments, all time points represent the mean of three biological replicates. Reproduction in progress.

Pam3CSK4 induced a rapid degradation of viral RNAs after only one treatment. We therefore wondered if this degradation was due to the induction of an effector right after treatment, and therefore we realized experiments in which we blocked translation, using cycloheximide treatment.

c. Pam3CSK4 does not seem to activate an effector responsible of HBV RNA degradation

We investigated whether Pam3CSK4 treatment could induce the neosynthesis of an effector that could be in turn responsible of viral RNAs degradation. Infected dHepaRG cells were simultaneously treated by Pam3CSK4 and cycloheximide, which an inhibitor of translation. RNAs were then extracted at different time point after treatment. HNF4- α levels were used as control, as IL-6 induced by Pam3CSK4 treatment, is responsible of degradation of HNF4- α transcripts (Hösel et al. 2009). Interestingly, we did not observe significant change between the presence or not of the cycloheximide on HBV RNAs, the small difference the two conditions can be observed in our housekeeping gene control (GusB). This do not exclude the fact that Pam3CSK4 might act at the post-translational level, inducing phosphorylation or dephosphorylations, rendering active effectors already present. (Fig.20).

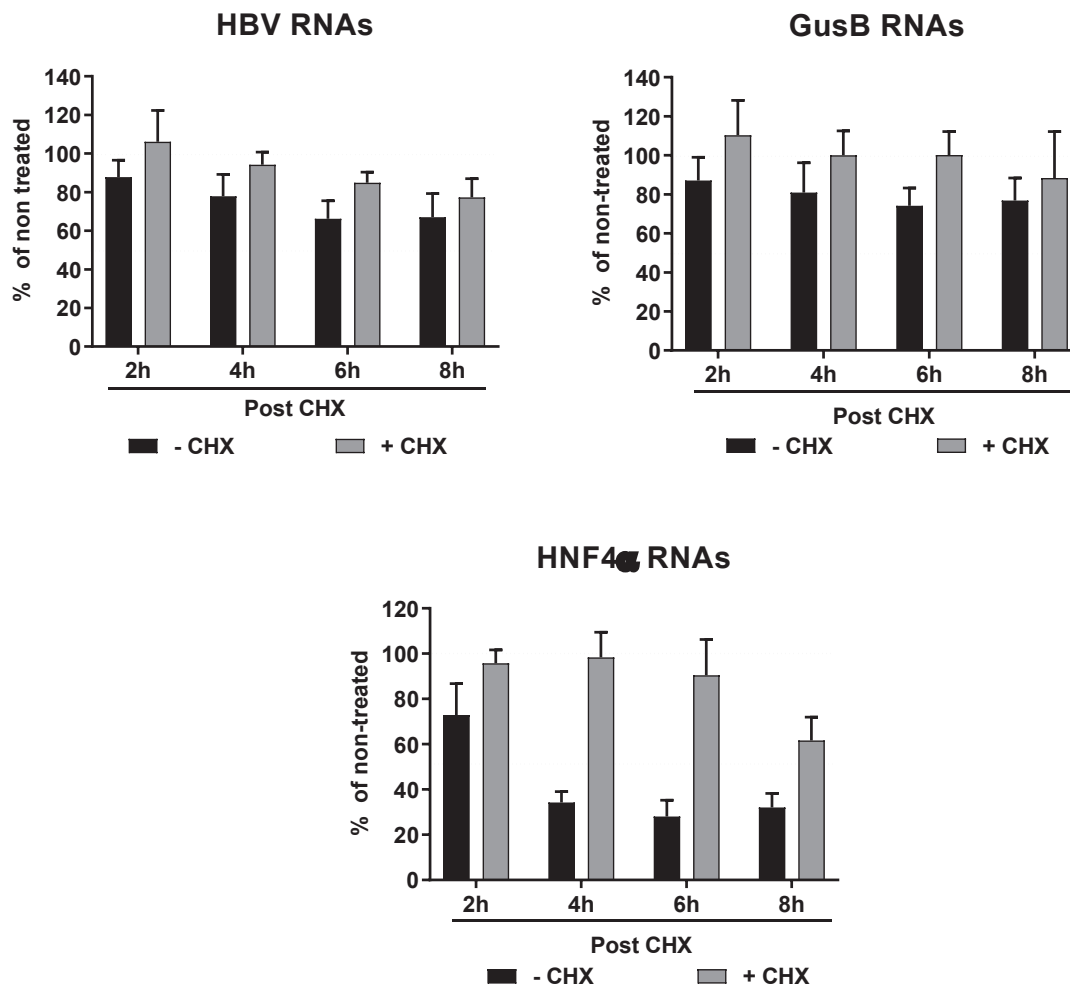

Figure 20: Pam3CSK4 does not seem to induce the synthesis of new effector to degrade RNAs. 7 days post-infection, dHepaRG were treated with Pam3CSK4 (100ng/ml) with or without cycloheximide (100 μ g/ml). GusB RNAs, HBV RNAs and HNF4 α RNAs were analysed at indicated time points, quantified and normalized to housekeeping gene PRNP and non-treated of indicated time point. All time points represent the mean of four independent experiments of three biological replicates and the error bars indicate SD. Statistically significant differences between cycloheximide conditions and without cycloheximide are indicated by asterisks (ns: non-significant, * P <0.05, ** P <0.005, *** P <0.002, **** P <0.0001).

To get further insight on the effectors responsible of the antiviral effects, not only on HBV RNAs but also on cccDNA, we performed RNA sequencing to analyse genes induced or downregulated by Pam3CSK4 after one treatment. Even if the samples used to perform RNA sequencing were generated in a coinfection HBV/HDV, we assumed that hits remained valid for HBV mono-infection.

9. Pam3CSK4 induces a strong activation of NF- κ B and inflammatory pathways

In order to analyse genes up regulated or downregulated by Pam3CSK4, which may be responsible of the antiviral effects obtained on viral RNAs and cccDNA, we performed RNA-sequencing using the following protocol. 7 days post co-infection by HBV/HDV, dHepaRG cells were treated with Pam3CSK4 at a concentration of 100 ng/ml. Non-infected dHepaRG cells were also treated with Pam3CSK4 as

controls. 48 hours post-treatment, RNAs were sequenced, differentially analysed and important biological signatures upregulated by Pam3CSK4 were obtained comparing the list of gene generated by MSigDB (Molecular Signature Database) in the GSEA (Gene set enrichment analysis) software (Subramanian et al. 2005; Liberzon et al. 2015). Pam3CSK4 induces numerous immune pathways, NF- κ B pathway being the most induced by this ligand, in both non-infected and infected conditions, with respectively 74 and 76 significantly modulated genes with an enrichment score of at least 2.5 (Fig. 21 A-B). As expected, this strong induction of NF- κ B pathway is linked to strong IL-6/JAK/STAT3 responses in either auto or paracrine manner, with respectively 36 and 30 upregulated genes in non-infected and infected conditions. Pam3CSK4 inhibits numerous metabolic mechanisms including oxidative phosphorylation, adipogenesis, bile acid and fatty acid metabolism. Some of those mechanisms, such as bile acid and fatty acid metabolism have recently been shown to be inhibited by TLR4 ligands (Katare et al. 2020; Chiang and Ferrell 2020).

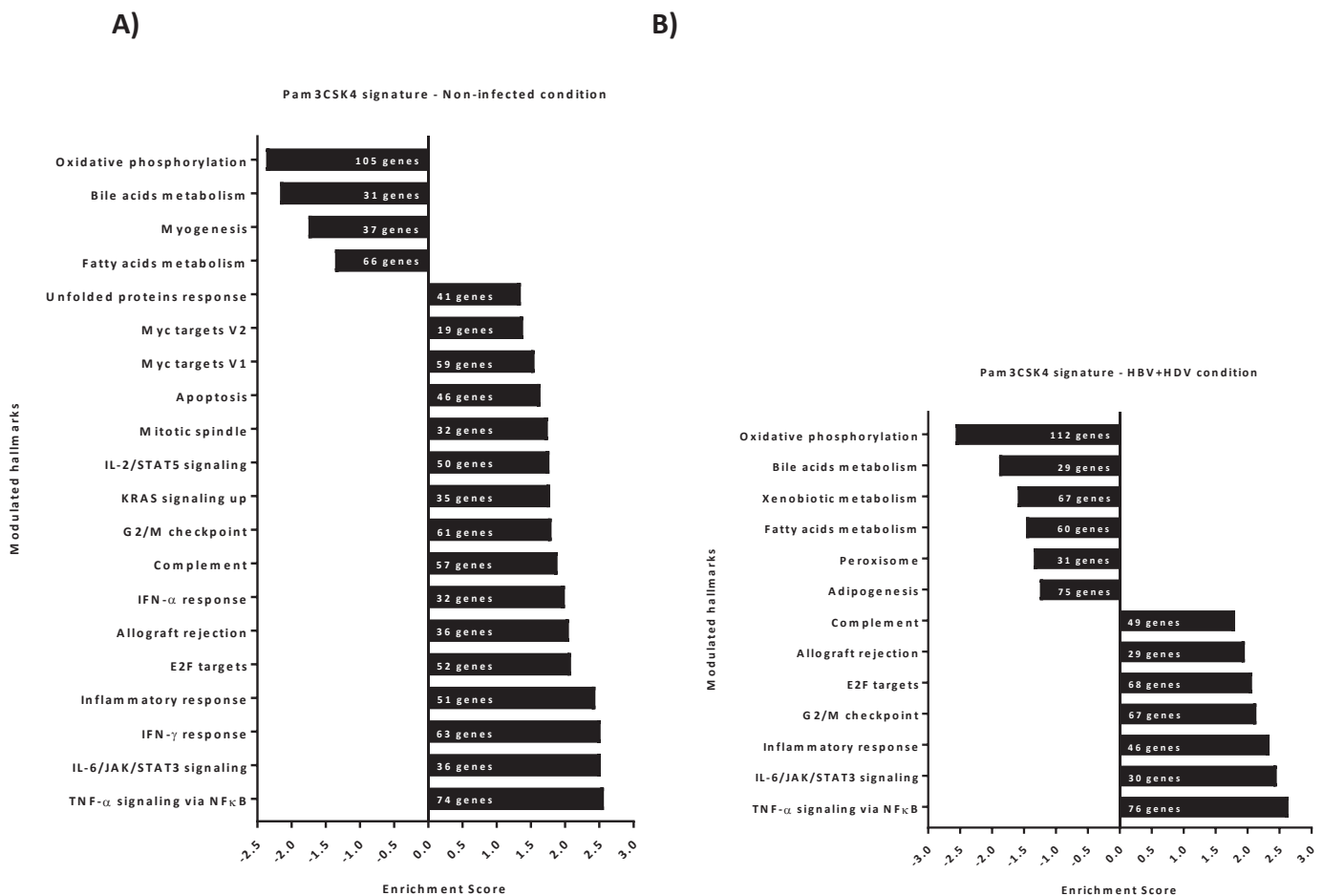

Figure 21: Biological pathways regulated by Pam3CSK4 in both non-infected and infected conditions. A) and B) dHepaRG cells were coinfecting with HBV (100 vge/cell) and HDV (10 vge/cell). Cells were treated 6 days after infection with Pam3CSK4 (100 ng/ml). 48 hours post treatment HBV RNAs were analysed, quantified to ensure antiviral activity of Pam3CSK4 by RT-qPCR, and they were then sequenced. Fold change of genes were calculated in a differential manner comparing modulation of genes in infected conditions with modulation of genes in non-treated conditions, getting rid of genes modulated by the viruses. Upregulated or downregulated genes with a p-value-adj < 0.05 have been selected for further analysis. List of genes

have been submitted to GSEA software (using MSigDB) to identify modulated pathways. Results are the mean of an experiment with two biological replicates and are represented in bar-plots (FDR<0.25).

10. Pam3CSK4 induces mechanisms of RNA and DNA degradation

To get further insight on cellular mechanisms modified by Pam3CSK4, genes modulated by after Pam3CSK4 treatment in coinfecting dHepaRG cells were modelled using Cytoscape software to highlight those that can be responsible of both the decrease of viral HBV RNAs and cccDNA observed *in vitro*. A preliminary analysis using GSEA software using database referenced by Reimand and colleagues (Reimand et al. 2019), which regrouped known biological processes and biological pathways allowed the identification of diverse mechanisms induced by Pam3CSK4. (Fig. 22A). As expected, Pam3CSK4 induced a strong immune response with among others the upregulation of effectors responsible of the regulation of innate immune response, the PRR pathways and IL-6 pathway, NF- κ B signalling or even the regulation of lymphocytes activation. Interestingly, we found that Pam3CSK4 induced not only mechanisms of regulation of RNAs, including their catabolism, the non-sense mediated RNA decay mechanism, but also mechanisms of regulation of DNA, especially responses to DNA damage mechanisms. Monocyte chemotactic protein-1-induced protein-1 (MCP1) and Ribonuclease H2 Subunit A (RNASEH2A) were the two first genes found upregulated in the RNA catabolism cluster, with Log2FC (Rank) of 2.7 and 1.22 respectively; they are two genes encoding for cellular RNases. MCP1 (also called ZC3H12A or Regnase-1), which a member of CCCH zinc finger proteins and a regulator of inflammation by regulating mRNA decay, has recently been shown to restrict HBV replication by targeting terminal redundancies sequences of HBV RNA (M. Li et al. 2020), which it makes an interesting target for the following of our study, as it could be the effector responsible of the phenotype observed on viral RNAs. RNASEH2A encodes for the ribonuclease H2 possessing endonuclease activity, cleaving RNA component of RNA/DNA hybrids and is vital to maintain genome integrity (Hiller et al. 2012). ZFP36L2, which is a zinc-finger RNA-binding protein and a member of the ZFP36 family, involved in mRNA decay is a bit upregulated, with a Log2FC of 0.71. It specifically binds to AU-rich element in the 3' untranslated region of target mRNAs and promotes their deadenylation and degradation (via the CCR4-NOT- deadenylase complex) (Fig. 22B) (Hudson et al. 2004).

Pam3CSK4 also induced mechanisms of regulation of transcription. It upregulated TRIM22, with a Log2FC of 0.55, which has been shown to inhibit the activity of HBV core promoter (B. Gao et al. 2009).

Pam3CSK4 also induced mechanisms of DNA repair. For instance, Exo1 (human exonuclease 1) was upregulated with a Log2FC of 3.15. It possesses a 5'→3' exonuclease activity, contributing to the regulation of cell cycle checkpoint, replication fork maintenance and post replicative DNA repair

pathways (Keijzers et al. 2018). Interestingly, Pam3CSK4 also induced Flap endonuclease 1 (FEN-1), which possesses 5'-flap endonuclease and 5'-3' exonuclease activities and is involved in DNA replication and repair. Intriguingly, it has recently been shown that FEN-1 was involved in the *in vitro* cccDNA formation from rcDNA (Kitamura et al. 2018). More precisely, FEN-1 in association with other human repair factors such as proliferating cell nuclear antigen (PCNA), the replication factor C (RFC) complex, DNA polymerase delta (POL δ) and DNA ligase 1 is needed to induce plus-strand repair, while only FEN-1 and LIG1 are required for the repair of the minus strand (L. Wei and Ploss 2021).

We therefore performed loss of functions experiments of these hits, MCIPI1, RNASEH2 and FEN-1 and analysed if the antiviral activity of Pam3CSK4 was reversed.

A)

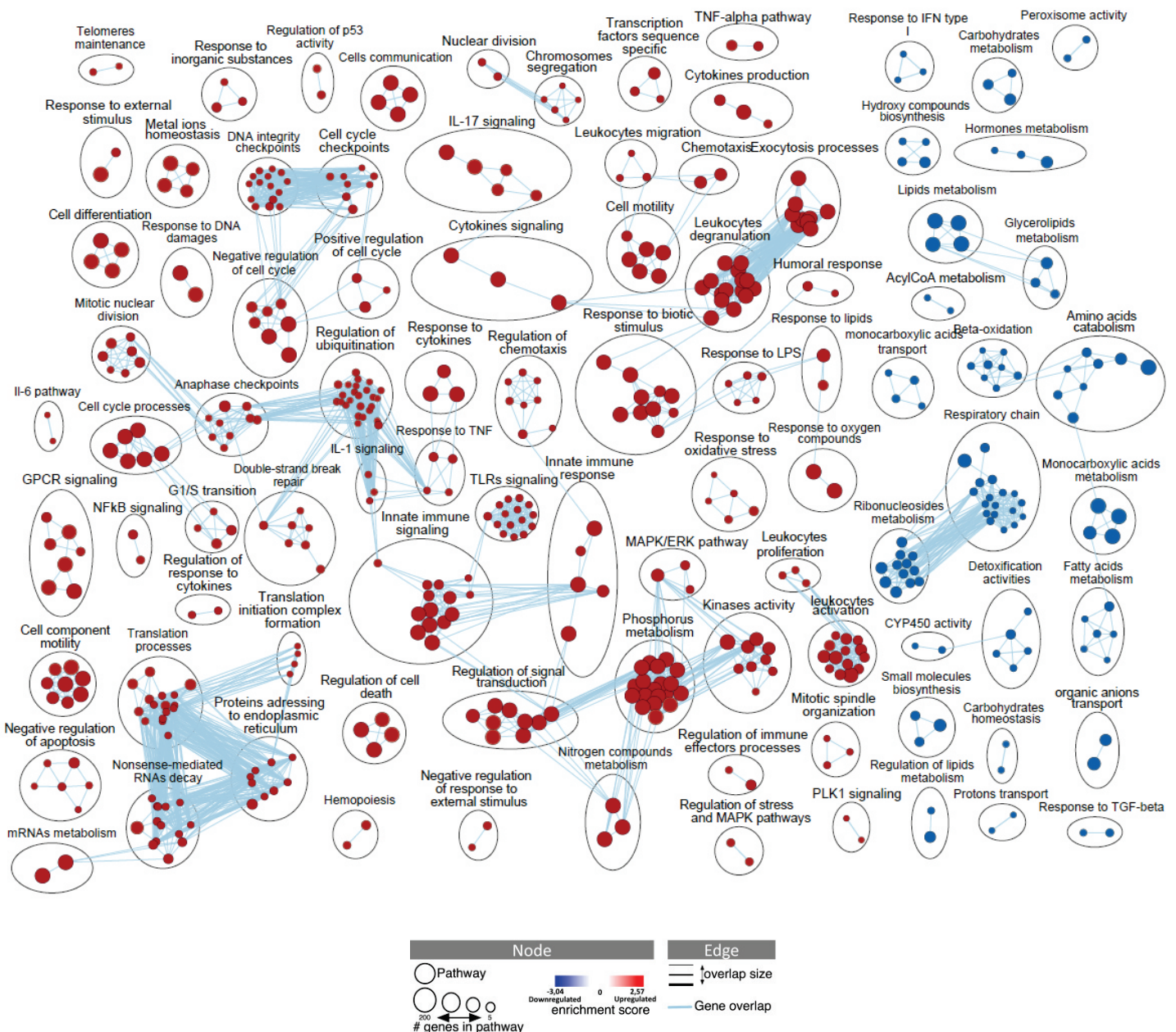

B)

DNA				RNA			
Response to DNA damage		Regulation of sequence specific DNA-binding transcription factor		RNA catabolism		Nonsense-mediated RNA decay	
Genes	Ranks	Genes	Ranks	Genes	Ranks	Genes	Ranks
IGF1	4.4	LTF	3.56	MCPIP1	2.7	LTF	3.56
CCL20	4.2	S100A9	3.23	RNASEH2A	1.22	CNOT6	3.05
CXCL1	3.69	TLR2	2.81	PNRC1	1.13	PACS1	2.84
VNN1	3.69	S100A8	2.76	NUDT15	1.12	MCPIP1	2.7
PTX3	3.64	MCPIP1	2.7	RPL22L1	0.94	EIF4B	1.28
LTF	3.56	TNFAIP3	2.36	ENPP4	0.79	RNASEH2A	1.22
CRP	3.56	CYP1B1	1.96	GPX1	0.77	CALR	1.2
CXCL8	3.46	HMOX1	1.68	RPSA	0.76	FEN1	1.06
CXCL3	3.37	SGK1	1.17	RPS2	0.73	DNAJC3	0.95
LCN2	3.3	NFKBIA	0.68	ZFP36L2	0.71	NUP93	0.92
CCL2	3.28	RPS3	0.62	RPLP0	0.67	RPL22L1	0.86
S100A9	3.23	TRIM22	0.55	RPS10	0.65	PNRC1	0.84
EXO1	3.15	MAD2L2	0.42	HMGB2	0.63	RPS3A	0.83
LBP	3.11	CIB1	0.33	RPL23A	0.62	ZFP36L2	0.71

Figure 22: Biological pathways regulated by Pam3CSK4 dHepaRG cells were coinfecting with HBV (100 vge/cell) and HDV (10 vge/cell). Cells were treated 6 days after infection with Pam3CSK4 (100 ng/ml). 48 hours post treatment HBV RNAs were analysed, quantified to ensure antiviral activity of Pam3CSK4 by RT-qPCR, and they were then sequenced. Fold change of genes were calculated in a differential manner comparing modulation of genes in infected conditions with modulation of genes in non-treated conditions, getting rid of genes modulated by the viruses. Upregulated or downregulated genes with a p-value-adj < 0.05 have been selected for further analysis. List of genes have been submitted to GSEA software (using MSigDB database) to identify modulated pathways. A) Modelling was realized using Cytoscape software and application EnrichmentMap (FDR < 0.1; Node cut-off < 0.1; Edge cut-off < 0.3). Clusters have been generated by AutoAnnotate application. B) Lists of genes upregulated by Pam3CSK4 in four specific clusters. Results are the mean of one experiment with two biological replicates.

11. Hit RNAses do not play a role in Pam3CSK4-mediated antiviral activity

As MCPIP1 and RNASEH2 are two RNAses upregulated after Pam3CSK4 in RNA-seq results, we wanted to investigate their role as effector of the antiviral effect mediated by Pam3CK4. Furthermore, MCPIP1 was considered as an interesting hit as it has already been shown to induce HBV RNAs degradation (M. Li et al. 2020). We first used siRNAs approach for both hits, dHepaRG cells were HBV-infected prior to siRNAs transfection, to avoid potential effect of extinction on HBV infection and they were then

transfected with siRNAs directed to our interest genes. siHBV was used as an experimental control. Cells were treated twice with Pam3CSK4 and HBV RNAs as well as secreted parameters were then analysed. Only RNASEH2A achieved downregulation by this approach, as shown by downregulated level of RNAHE2 RNAs (**Fig.23**).

To achieve MCP1P1 silencing we used the lentiCRISPR approach. dHepaRG cells were transduced by lentiCRISPR expressing Cas9 endonuclease and a single guide RNA corresponding our interest gene as described in material and methods. Two sgRNAs constructions were realized for this gene, targeted sequences are presented in supplementary material and methods.

Unfortunately, the extinction of hits, present in the RNA-sequencing analysis, MCP1P1 and RNASEH2A either in dHepaRG-Cas9 KO MCP1P1 or siRNAs experiments directed to RNASEH2A did not impair the antiviral phenotype observed with Pam3CSK4 treatment (**Fig.23**).

We cannot overlook the fact that these experiments were performed by KO of only one gene, and the antiviral effect on HBV RNAs may come from the synergistic effects of different effectors. Simultaneous knock out of different hits may therefore be investigated.

Ajouter résultats MCP1P1 !!!

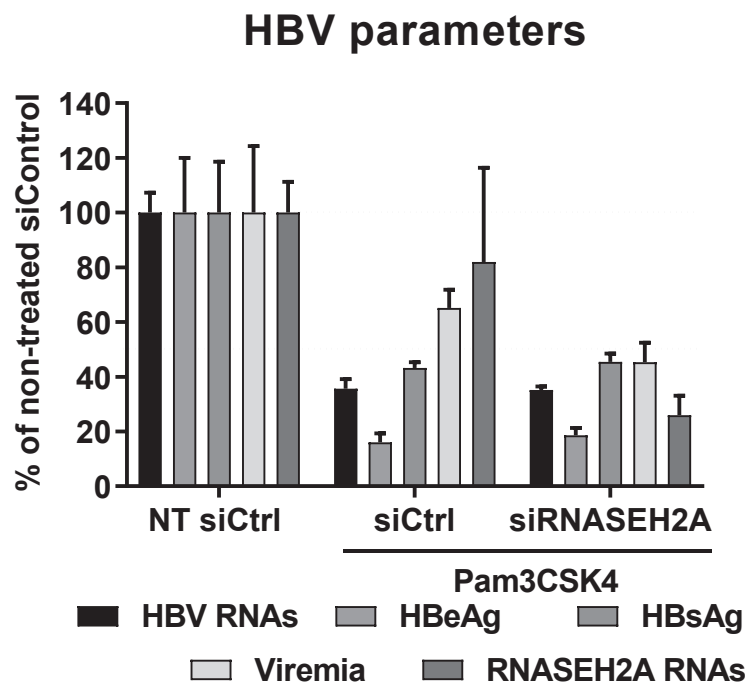

Figure 23: Antiviral phenotype on HBV parameters by Pam3CSK4 is not due to RNASEH2A dHepaRG were infected and at least 7 days post infection, cells were transfected once with siRNAs directed to RNASEH2A. Four days post-transfection, cells were treated two times with Pam3CSK4 (100ng/ml) for a total exposure time of 6 days. HBV RNAs were quantified by RT-qPCR, expressed in percentage, normalized to housekeeping gene level and non-treated sicontrol condition (NT siCtrl); effects on HBV antigens were quantified by ELISA in supernatants, expressed in percentage and normalized to NT siCtrl; effects on

viremia were quantified by qPCR, according to a standard curve (build with dilutions of a plasmid containing the HBV sequence. All histograms represent the mean of two independent experiments with three biological replicates and the error bars indicate SD.

12. Flap endonuclease 1 and Pam3CSK4 synergistically act in decreasing HBV

Interestingly, the Flap endonuclease 1 was one of the hit gene upregulated after Pam3CSK4 treatment, a gene that has paradoxically been shown to be involved in the cccDNA formation (L. Wei and Ploss 2021). To get further insights on its effects on antiviral phenotype mediated by Pam3CSK4, we used siRNA approach to silence it. dHepaRG cells were transfected once with siRNAs directed to FEN-1, and HBV as an experimental control after at least seven days post-infection, when infection is established and cccDNA formed. dHepaRG cells were then treated twice with Pam3CSK4 for a total exposure time of 6 days. Extinction of FEN-1 had been assessed in RNAs and WB at the end of treatment (Fig.24). All HBV parameters were also monitored at the end of treatment: HBV RNAs and pgRNA were quantified by RT-qPCR, cccDNA levels were quantified by FRET based qPCR, antigens were quantified by ELISA, and viremia measured using qPCR (Fig.25). It seems that in the absence of FEN-1 and of Pam3CSK4 treatment, cccDNA is strongly upregulated. Similarly, dHepaRG KO FEN-1 cells treated by Pam3CSK4, did not show decrease of cccDNA, resulting in a slight upregulation of viral RNAs.

We may suggest that FEN-1 might have a dual effect on cccDNA regulation. It may be needed by its formation from rcDNA, and once infection established it may control cccDNA pool. Its absence might increase cccDNA levels, and consequently the other HBV parameters. The absence of FEN-1 prevents Pam3CSK4 from degrading cccDNA, which therefore lead us to think that both could act synergistically to mediate antiviral activity.

A)

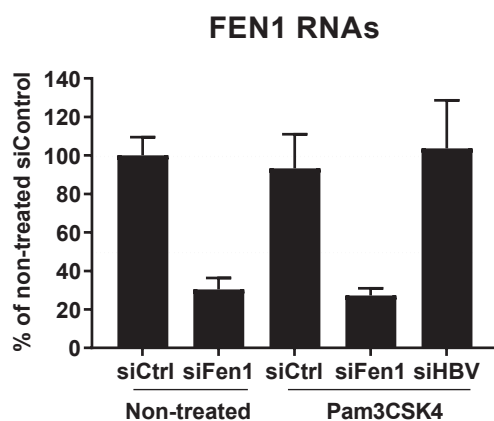

B)

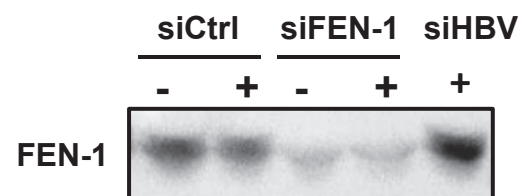

Figure 24: Flap endonuclease 1 and Pam3CSK4 synergistically act in decreasing HBV. dHepaRG were infected and at least 7 days post infection, cells were transfected once with siRNAs directed to FEN-1. siHBV was used as controls. Four days post-transfection, cells were treated two times with Pam3CSK4 (100ng/ml) for a total exposure time of 6 days. Extinction of the target gene has been assessed by A) RT-qPCR and B) Western Blot.

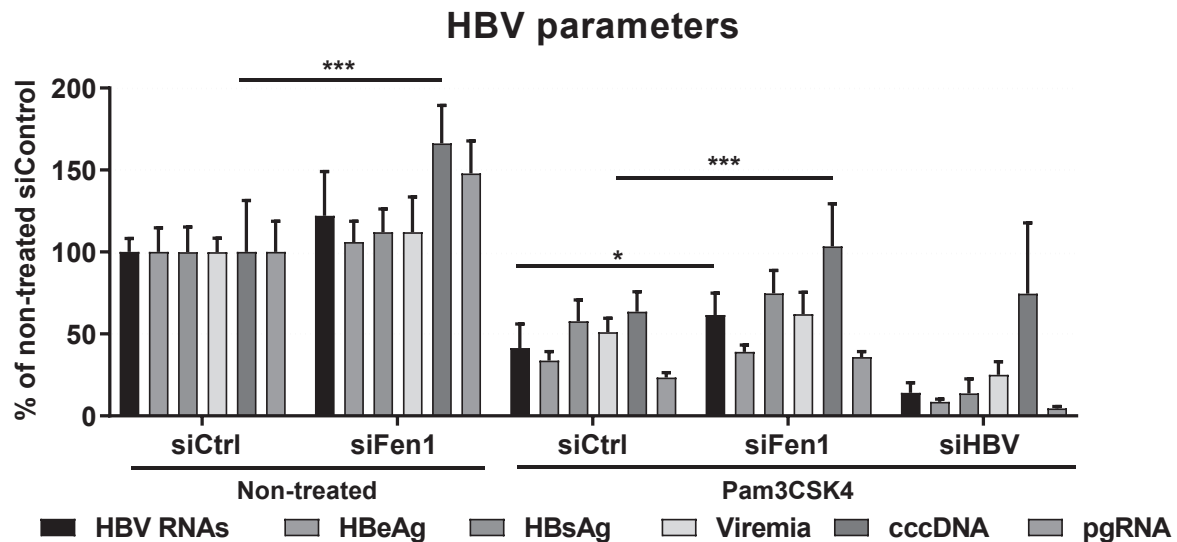

Figure 25: Flap endonuclease 1 and Pam3CSK4 synergistically act in decreasing HBV. dHepaRG were infected and at least 7 days post infection, cells were transfected once with siRNAs directed to FEN-1. siHBV was used as controls. Four days post-transfection, cells were treated two times with Pam3CSK4 (100ng/ml) for a total exposure time of 6 days. HBV RNAs and pgRNA were quantified by RT-qPCR, expressed in percentage, normalized to housekeeping gene level and non-treated sicontrol condition (NT siCtrl); effects on HBV antigens were quantified by ELISA in supernatants, expressed in percentage and normalized to NT siCtrl; effects on viremia were quantified by qPCR, according to a standard curve (built with dilutions of a plasmid containing the HBV sequence); effect on cccDNA levels was quantified by FRET-qPCR method, expressed in percentage, normalized to NT siCtrl. All histograms represent the mean of three independent experiments with three biological replicates and the error bars indicate SD. Statistically significant differences from NT siCtrl (for siFEN-1 NT) or siCtrl (for siFEN-1) conditions are indicated by asterisks (ns: non-significant, *P<0.05, **P<0.005, ***P<0.002, ****P<0.0001).

To get further insight on cccDNA degradation, we investigated the role of APOBEC3B after Pam3CSK4 treatment, as this cytidinedeaminase has already been shown to degrade cccDNA after lymphotoxin- β receptor agonisation by BS1 (Fig.26) (Lucifora et al. 2014). We used siRNA approach to silence it. dHepaRG cells were transfected once with siRNAs directed to APOBEC3B (siA3B), and siRNA directed to HBV (siHBV) as an experimental control, seven days post-infection. dHepaRG cells were then treated twice with Pam3CSK4 for a total exposure time of 6 days. Decrease of APOBEC3B mRNAs levels was assessed by RT-qPCR (Fig26.A). Intracellular and secreted HBV parameters were analysed at the end of treatment. We still observed a strong antiviral activity mediated by Pam3CSK4 on all HBV parameters, suggesting therefore that APOBEC3B is not the effector responsible of this antiviral effect.

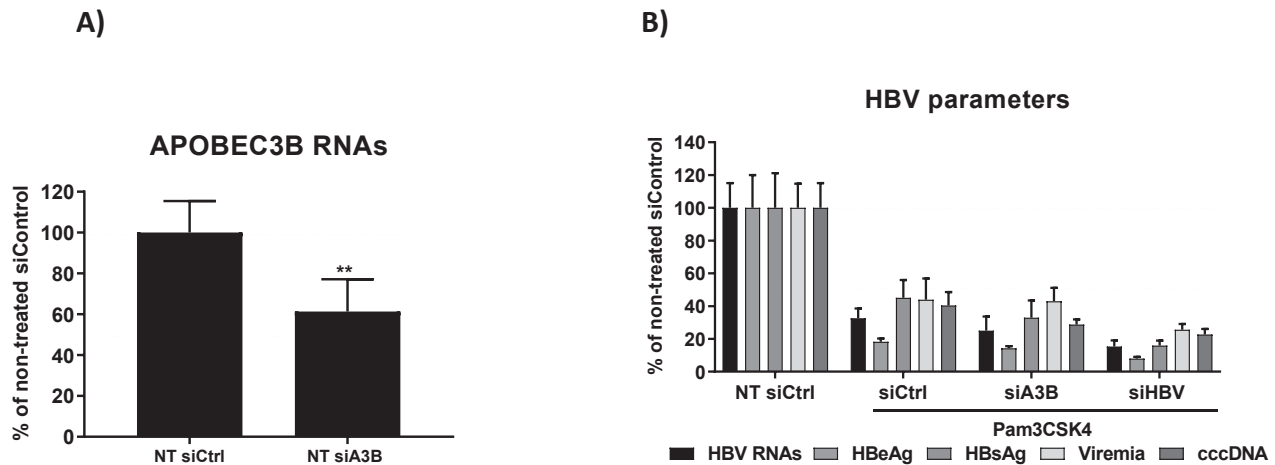

Figure 26: Antiviral phenotype by Pam3CSK4 on cccDNA is not due to APOBEC3B. dHepaRG were infected and at least 7 days post infection, cells were transfected once with siRNAs directed to FEN-1. siHBV was used as controls. Four days post-transfection, cells were treated two times with Pam3CSK4 (100ng/ml) for a total exposure time of 6 days. A) extinction of APOBEC3B RNAs was assessed by RT-qPCR, expressed in percentage, normalized to housekeeping gene level and non-treated sicontrol condition (NT siCtrl) B) HBV RNAs were quantified by RT-qPCR, expressed in percentage, normalized to housekeeping gene level and non-treated sicontrol condition (NT siCtrl); effects on HBV antigens were quantified by ELISA in supernatants, expressed in percentage and normalized to NT siCtrl; effects on viremia were quantified by qPCR, according to a standard curve (build with dilutions of a plasmid containing the HBV sequence; effect on cccDNA levels was quantified by FRET-qPCR method, expressed in percentage, normalized to NT siCtrl. All histograms represent the mean of two independent experiments with three biological replicates and the error bars indicate SD.

13. Antiviral activity of Pam3CSK4 is increased in combination with Peg-IFN- α or kinase inhibitor

We further investigated the potential therapeutic use of Pam3CSK4 in combination with other drugs. Pam3CSK4 is already a potent drug *in vitro* to decrease all HBV parameters. We analysed if antiviral activity in combination with other drugs, currently used in clinic against chronic HBV or in development could be increased, either by reinforcing its own mechanism of action or exerting another mode of action, both resulting in a significant decrease or complete eradication of HBV. Synergies between drugs may also have the advantage to decrease doses used for each drug, which may be less harmful for patients.

We therefore analysed the antiviral effects obtained by Pam3CSK4 in bitherapies with drugs already used in clinic IFN- α or TFV and drugs that are currently in development such as CpAMs JNJ-827 and JNJ-890, an FXR- α -agonist (GW4064) and a kinase inhibitor (1C8). Antiviral activities of tritherapies were also analysed. HBV-infected dHepaRG cells were treated twice with either monotherapies, biotherapies or thritherapies for a total exposure of treatment of six days. All HBV parameters were analysed at the end of treatment (**Fig. 27**). In monotherapy, at low concentration, Pam3CK4 induced the most potent antiviral effect compared to other drugs. Two combinations were found interesting, as increasing antiviral properties of Pam3CSK4 alone on both secreted and intracellular parameters (**Fig.27 A and B**): a combination with an already approved drug, IFN- α and with a drug that is currently

in development, the kinase inhibitor 1C8. Tritherapies induced toxicity and were not considered for following experiments.

A)

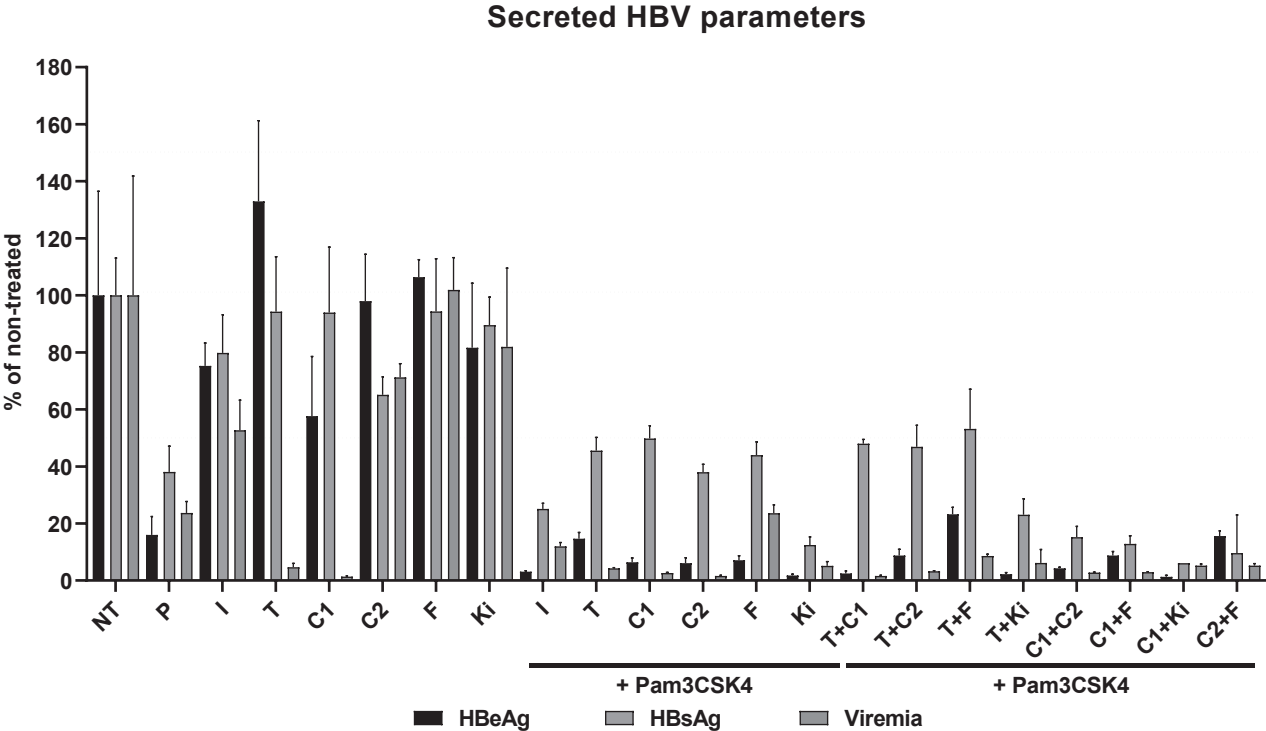

B)

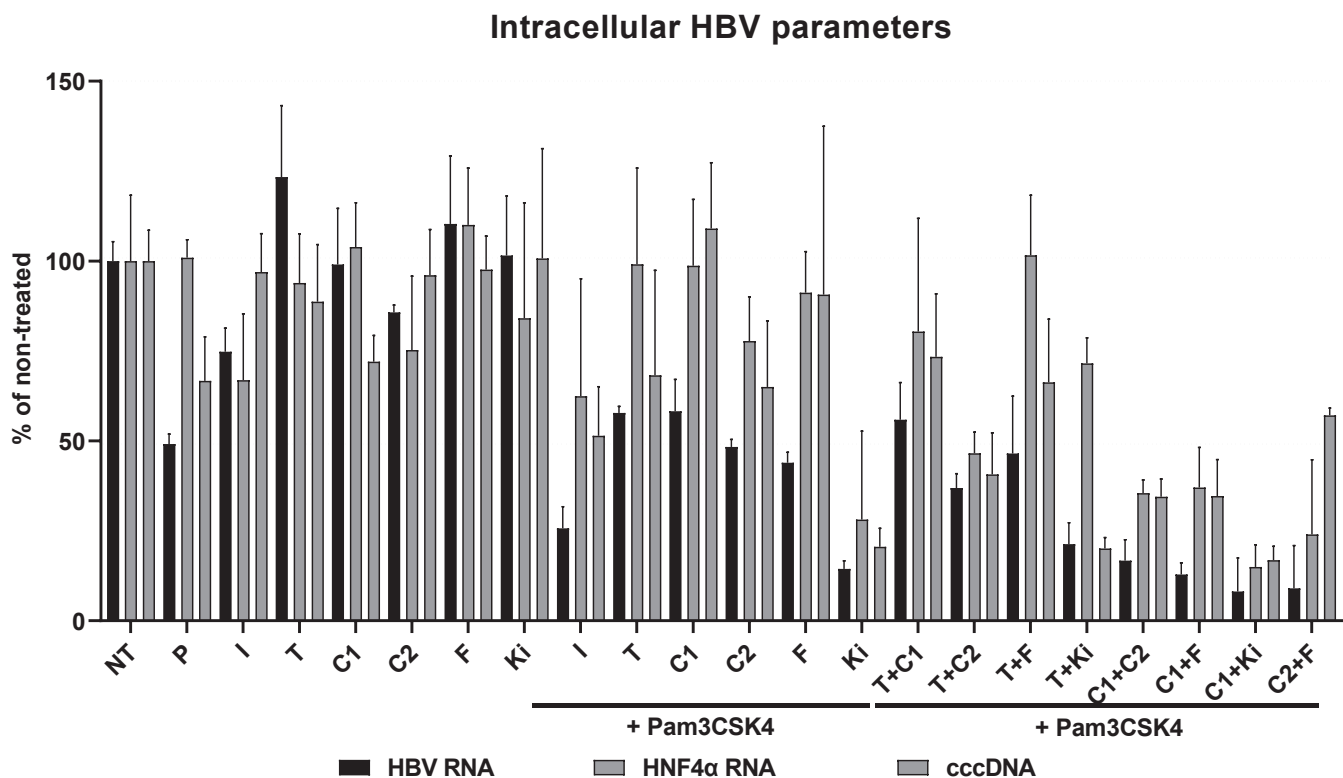
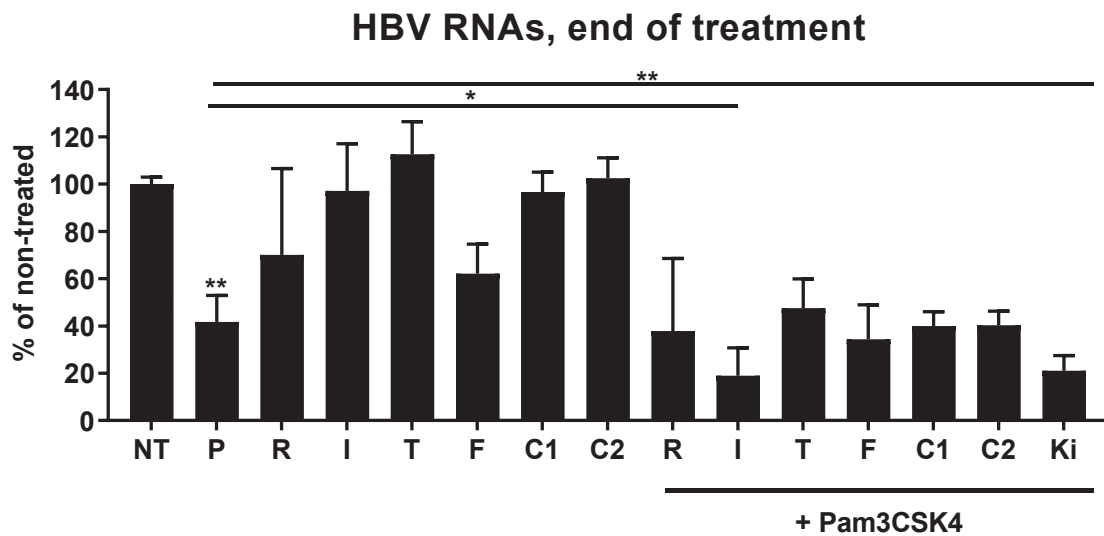

Figure 27: Combinations of Pam3CSK4 with currently approved drugs or drugs in current development. 7 days post-infection, dHepaRG cells were treated twice either drugs in monotherapies Pam3CSK4 (P: 25ng/ml), IFN- α (I: 50UI/ml), TFV (T: 1 μ M), JNJ-827 (C1: 1 μ M), JNJ-890 (C2: 1 μ M), FXR- α agonist (F:100 nM) and a kinase inhibitor (Ki: 5 μ M), and in biotherapies or thritherapies with the same concentrations, for a total exposure of treatment of 6 days. At the end of treatment, A) intracellular parameters were quantified: HBV RNAs were quantified by RT-qPCR, expressed in percentage, normalized to housekeeping gene level (PRNP) and non-treated sicontrol condition (NT) and effect on cccDNA levels was quantified by FRET-qPCR method, expressed in percentage, normalized to NT B) secreted parameters were analysed: effects on HBV antigens were quantified by ELISA in supernatants, expressed in percentage and normalized to NT; effects on viremia were quantified by qPCR, according to a standard curve (build with dilutions of a plasmid containing the HBV sequence). All histograms represent the mean of two independent experiments with three biological replicates and the error bars indicate SD.

We then wondered if those bitherapies could sustain antiviral activity after treatment arrest. Infected dHepaRG cells were treated with the same treatment and concentrations as the previous experiment. In addition to drugs already tested, we analysed Pam3CSK4 in combination with RG7834. HBV RNAs were quantified at the end of treatment (**Fig.28A**), and both HBV RNAs and cccDNA were quantified 35 days after infection (**Fig.28B**). As in the first experiment, Pam3CSK4 was the most potent drug at decreasing viral RNAs at the end of treatment in monotherapy, and the most potent combination to decrease viral RNAs were Pam3CSK4 in combination with either Peg-IFN- α or the kinase inhibitor (**Fig.26A**). This decrease was sustained after the treatment arrest (**Fig.26B-C**).

A)



B)

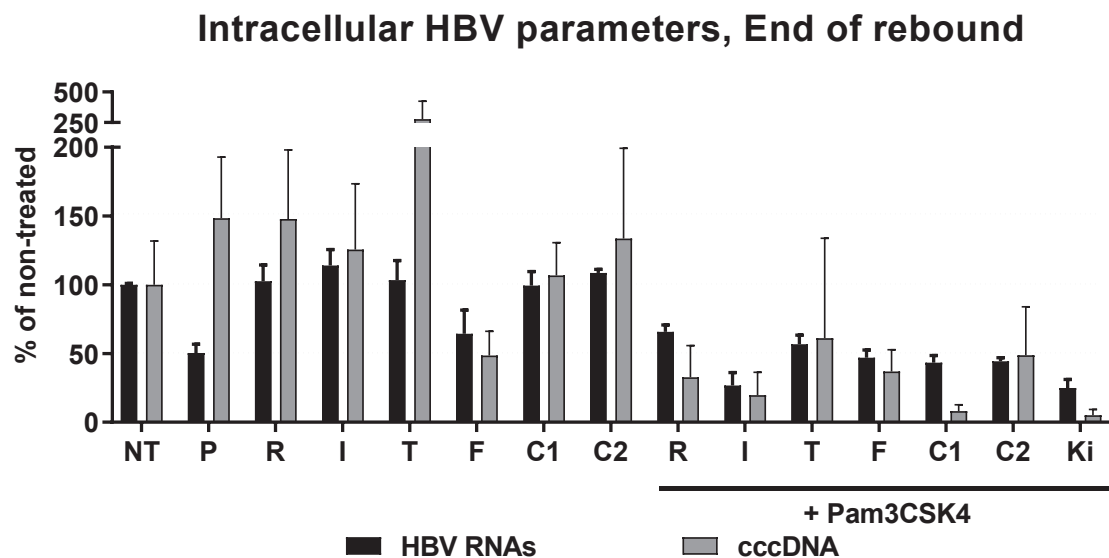

Figure 28: Antiviral activity of combination of Pam3CSK4 with IFN- α and with the kinase inhibitor is long lasting. 7 days post-infection, dHepaRG were treated with Pam3CSK4 (P: 25ng/ml), RG7834 (R: 0.1 μ M), TFV (T:1 μ M), FXR- α agonist (F:100nM), JNJ-827 (C1: 1 μ M), JNJ-890 (C2: 1 μ M), and a combination of Pam3CSK4 with those drugs and a kinase inhibitor (5 μ M), two times for a total exposure of treatment of six days. HBV RNAs were quantified by RT-qPCR, expressed in percentage, normalized to housekeeping gene level and non-treated condition (NT). A) HBV RNAs were quantified at the end of treatment. B) HBV RNAs levels and effect on cccDNA levels were quantified 35 days post-infection, expressed in percentage, normalized to NT. (A): All histograms represent the mean of two independent experiments with three biological replicates and the error bars indicate SD. Statistically significant differences from NT condition are indicated by asterisks (ns: non-significant, *P<0.05, **P<0.005, ***P<0.002, ****P<0.0001). B) All histograms represent the mean of three biological replicates and the error bars indicate SD. Reproduction in progress.

3. Nanoparticles: a potent tool against HBV

It has been shown that the intravenous administration of Pam3CSK4 *in vivo*, in infected-chimeric mice with humanized liver only led to a moderate decrease of HBV parameters (Lucifora et al. 2018). Increase doses of Pam3CSK4 do not seem judicious as it might cause “cytokine storm”, which is deleterious for patients. The vectorization of Pam3CSK4 is an interesting idea to directly targeting the hepatocytes and deliver our TLR2 ligand. The aim of this second study is to assess antiviral effect of polylactic acid nanoparticles encapsulating Pam3CSK4 (NPs-Pam3CSK4) both *in vitro* and *in vivo*.

Material and methods

Material and methods are similar to the first study. Experiments specific to this second part are detailed below.

1. Liver mononuclear cells (LMNCs) isolation

Non-parenchymal cells, retrieved from PHH isolation (in the supernatant), were loaded on Ficoll gradient. After centrifugation, LMNCs were retrieved at the surface of the Ficoll (Figure 44).

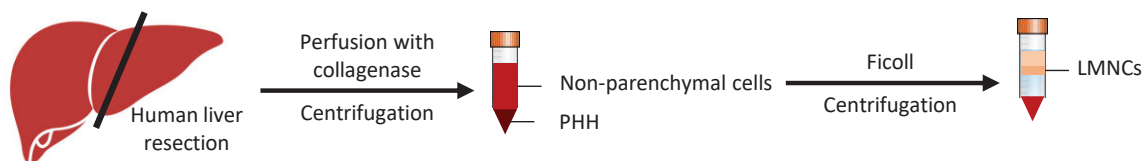

Figure 44: Purification of PHH and LMNCs from liver resections

2. NPs-Pam3CSK4, Empty NPs and NPs-Pam3CSK4-PreS1 synthesis

PLA nanoparticles were prepared by nanoprecipitation technique described in (Lamrayah et al. 2019): the polymer was dissolved in acetone and this solution was added dropwise to an aqueous solution, composed of ethanol and carbonate buffer (5mM, pH=11.0) under 250 rpm stirring. Organic solvents were then removed under reduced pressure at 30°C with a Rotavapor R-300 (Buchi, France). For the encapsidation of Pam3CSK4, the molecule was added to the organic phase before being added to the aqueous phase. PreS1 peptide of the HBV PreS1 peptide with myristoylation in N-terminal modification, was produced by Genscript (USA) (2-48 amino acid sequence: GTNLSVPNPLGFFPDHQLDPAFRANSNPDWDFNPNKDHWPANKVG). The lyophilized PreS1 was rehydrated in DPBS 1X (Thermofisher Scientific, USA) at the desired concentration and added volume to volume in Empty NPs or NPs-Pam3CSK4 suspensions. The adsorption reaction occurred within 2 h

at room temperature with moderate overhead stirring. The coating efficiency was assessed by measuring the unbound peptide. Briefly, a certain volume of NPs-Pam3CSK4-PreS1 was centrifuged 15 min at 15,000 xg and the absorbance of the supernatant was measured at 280 nm using a Tecan i-control Infinite M1000 (Tecan, Männedorf, Switzerland).

3. Enzyme-linked immunoassay (ELISA) for IL-6 and IL-10

Human IL-6 and human IL-10 cytokines were detected in the supernatants using the DuoSet® ELISA kit according to the manufacturer (R&D Systems). ELISA plates were analysed using Multiskan EX (ThermoFisher).

4. Viral entry experiments

dHepaRG cells were simultaneously infected and treated with NPs-Pam3CSK4-PreS1, Empty NPs-PreS1, Myrcludex B (also called PreS1 peptide) (Genscript, USA). One week post-infection, cell culture supernatants were retrieved, and secreted HBeAg were analyzed by ELISA, using a chemiluminescence immunoassay kit (Autobio, China) according to the manufacturer's instructions.

5. *In vivo* experiments

All experiments were performed in accordance with the European guidelines for approval of the protocols by the local ethics committee (Authorization Agreement C2EA-15, "Comité Rhone-Alpes d'Ethique pour l'Expérimentation Animal", Lyon, France).

5.1 Biodistribution studies

C57BL/6 mice were intravenously injected with nanoparticles containing the lipophilic carbocyanine DiOC₁₈ (DiR, ThermoFisher Scientific) fluorophore. Hepatic accumulation and retention were observed by tomography using the FMT4000-Perkin Elmer device according to manufacturer's recommendations for 21 days.

5.2 Antiviral activity assessment

Four groups of eight C57Bl6 mice were transduced by AAV-HBV by retroorbital injection. Five weeks after the establishment of infection, groups were injected intravenously twice a week for three weeks, with Pam3CSK4 (20µg per mouse per injection the first week, 40µg per mouse per injection the second week and 80µg per mouse per injection the third week), NPs-Pam3CSK4 (2.5 µg per mouse per injection the first week, 5µg per mouse per injection the second week, 10µg per mouse per injection the third week), lamivudine (100mg/kg/day) respectively. The last group was left untreated. Sera were collected at different time before and after treatments. Mice were sacrificed ten weeks post AAV-HBV transduction and liver pieces were frozen in liquid nitrogen and kept at -80°C prior to analyses. HBV viremia was determined by DNA extraction from sera (supplemented with a known amount of non-

HBV DNA, pUC19 plasmid from New England Biolabs) using the NucleoSpin® RNA Virus Kit (Macherey Nagel) followed by qPCR. For each serum, quantity of viral genome equivalent was calculated according to a standard curve (using dilutions of a plasmid containing the HBV sequence) and normalized to the ratio between the actual and theoretical amount of recovered pUC19 DNA. Viral antigens HBeAg and HBsAg were measured as previously described. Total DNA, cccDNA, intracellular RNAs were extracted from liver pieces and quantified as previously described.

5.3 Mice immunization

See Appendix for the experimental protocol. Immunized mice sera were analysed in viral entry experiments.

Results

1. Assessment NPs-Pam3CSK4 antiviral properties *in vitro*

a. NPs-Pam3CSK4 decrease all viral parameters, without inducing toxicity

Antiviral activity of NPs-Pam3CSK4 was assessed *in vitro*, in both dHepaRG cells and PHH (**Fig.1**). Cells were HBV-infected, and seven days post-infection, when the infection is established, they were treated two times with increasing doses of NPs-Pam3CSK4 (in ng/ml), for a total exposure of treatment of 6 days. Equivalent number of empty nanoparticles (Empty NPs) were used for comparison with low and high concentrations of NPs-Pam3CSK4, as negative control; Pam3CSK4 was used as positive control. At the end of the experiment, HBV RNAs were quantified by RT-qPCR, viremia quantified by qPCR and antigen secretions were analysed by ELISA. NPs-Pam3CSK4 were particularly potent at decreasing viral RNAs and HBeAg in dHepaRG cells with an IC50 evaluated around 60 ng/ml (**Fig 1 A**). The antiviral effect on viremia and HBsAg secretion were more moderate. Antiviral effects were even more important in PHH with a 50% decrease of HBV RNAs and viral secretions observed at a dose of 60 ng/ml, which is around 80 times less than the Pam3CSK4 dose used on PHH (**Fig.1 B**).

A)

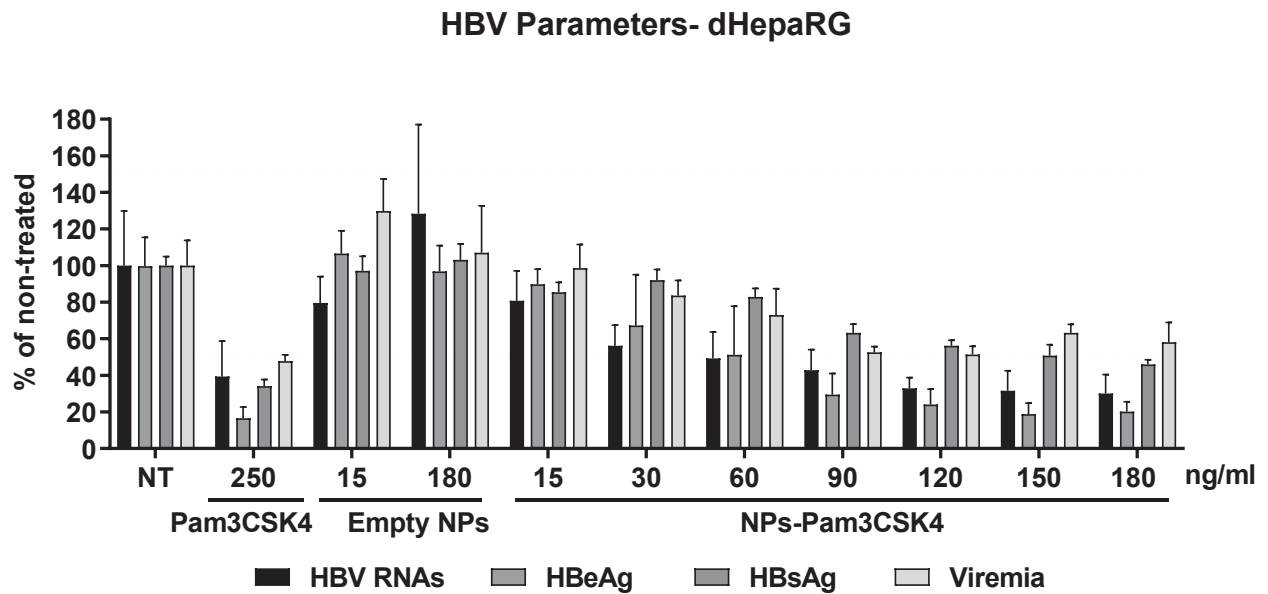

B)

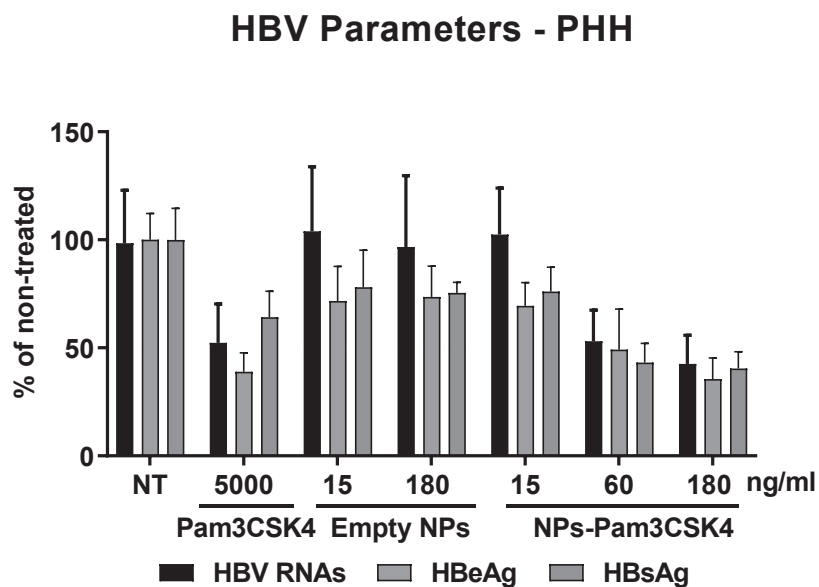

Figure 1: NPs-Pam3CSK4 has potent antiviral activity *in vitro*. A) 7 days post-infection, dHepaRG were treated twice with indicated concentrations (in ng/ml) of Pam3CSK4 and NPs-Pam3CSK for a total exposure time of 6 days. Empty NPs were used as negative control (equivalent number of nanoparticles compared to 15 and 180 ng/ml NPs-Pam3CSK4 were used). B) Four days post-infection, PHH were treated thrice with indicated concentrations (in ng/ml), NPs-Pam3CSK4 and Empty NPs (equivalent number of nanoparticles compared to 15 and 180 ng/ml NPs-Pam3CSK4 were used) for a total exposure time of 6 days. Effect on RNAs was quantified by RT-qPCR, expressed in percentage, normalized to house-keeping gene level and non-treated condition (NT); effects on viremia were quantified by qPCR, according to a standard curve (built with dilutions of a plasmid containing the HBV sequence); effects on HBV antigens were quantified by ELISA in supernatants, expressed in percentage and normalized to NT. All histograms represent the mean of three experiments with four biological replicates and the error bars indicate SD.

We investigated whether NPs-Pam3CSK4 treatment could be associated with cell toxicity in dHepaRG cells. Cells were treated twice before proceeding to toxicity assays, measuring lysosomal storage (neutral red uptake) or synthesis of ATP (Cell titer Glo). We found no significant cytotoxicity at high concentrations of NPs-Pam3CSK4 (concentrations 10 times more than concentration used for dHepaRG and PHH treatment), as compared to positive cytotoxic control, puromycin exposure (**Fig.2**). Same number of nanoparticles without Pam3CSK4 did not induce as well any toxicity on dHepaRG cells.

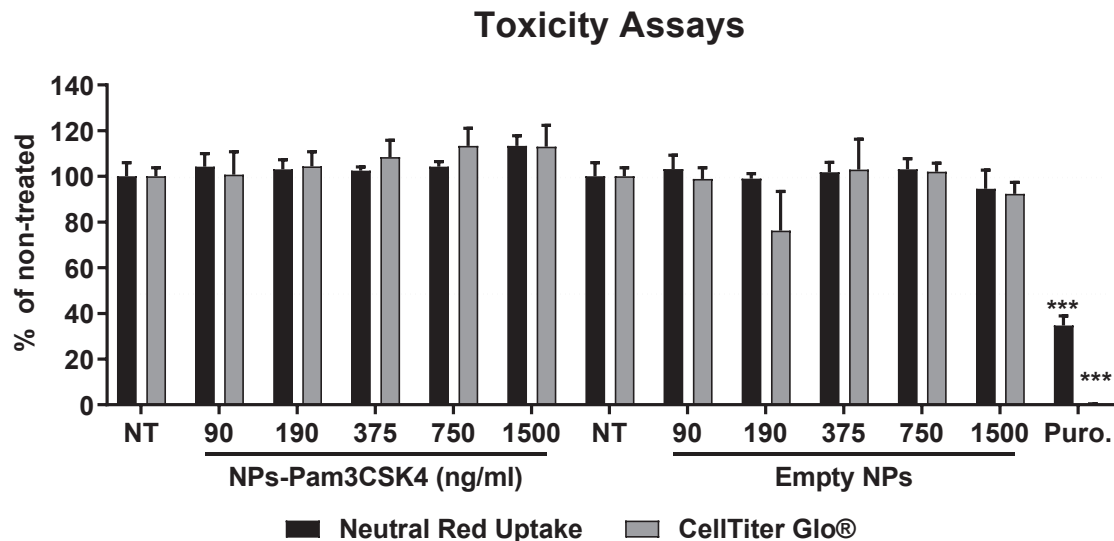

Figure 2: NPs-Pam3CSK4 and Empty NPs do not induce any toxicity *in vitro*. Cells were treated twice with indicated concentrations of NPs-Pam3CSK4 (in ng/ml) and Empty NPs were used at equivalent number of nanoparticles compared NPs-Pam3CSK4 for each given concentration, for a total exposure time of 6 days. Neutral Red Uptake and CellTiter Glo® Luminescent Cell Viability Assay were then performed. All histograms represent eight biological replicates, expressed in percentage and normalized to non-treated condition (NT) and the error bars indicate SD. Statistically significant differences from NT conditions are indicated by asterisks (ns: non-significant, * $P < 0.05$, ** $P < 0.005$, *** $P < 0.002$, **** $P < 0.0001$).

b. NPs-Pam3CSK4 present a strong antiviral phenotype on viral RNAs

In a same way as Pam3CSK4, we investigated the first parameters to be decrease by NPs-Pam3CSK4 treatment. dHepaRG cells were treated after establishment of the infection and the levels of total intracellular HBV RNAs and cccDNA were monitored shortly after the treatment (**Fig.3**). We observed a reduction of the levels of total intracellular HBV RNAs already 6h after treatment, with a 40% reduction reached 48 hours post-treatment. cccDNA levels remained stable after Pam3CSK4 treatment. This suggested that NPs-Pam3CSK4 had first an antiviral effect on viral RNAs before affecting the cccDNA, and that a second treatment is necessary to have a potent antiviral effect on HBV parameters. In the same way as Pam3CSK4, the antiviral effects induced by NPs-Pam3CSK4 on viral RNAs were then investigated.

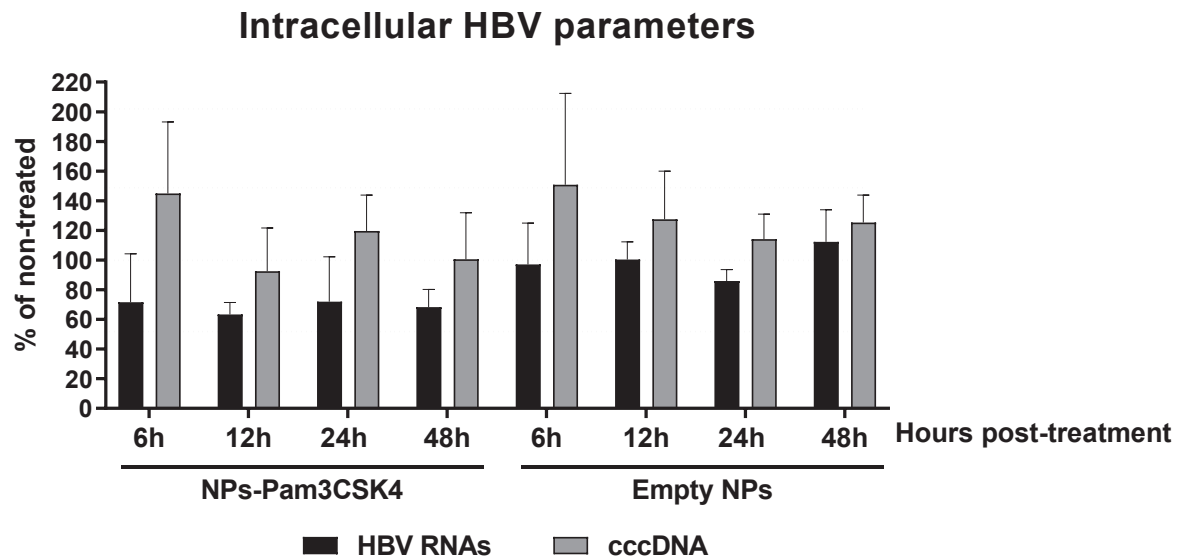

Figure 3: HBV RNAs are decreased by NPs-Pam3CSK4 after one treatment. 7 days post-infection, dHepaRG were treated once with NPs-Pam3CSK4 (100 ng/ml) and Empty NPs (equivalent number of nanoparticles compared to NPs-Pam3CSK4). HBV RNAs and cccDNA were analysed at indicated time points. Effect on RNAs was quantified by RT-qPCR, expressed in percentage, normalized to house-keeping gene level and non-treated condition (NT); effect on cccDNA levels was quantified by FRET-qPCR method, expressed in percentage, normalized to NT.

Pam3CSK4 and NPs-Pam3CSK4 treatment induced a decrease of all HBV RNAs as shown by Northern Blot analysis (Fig.4).

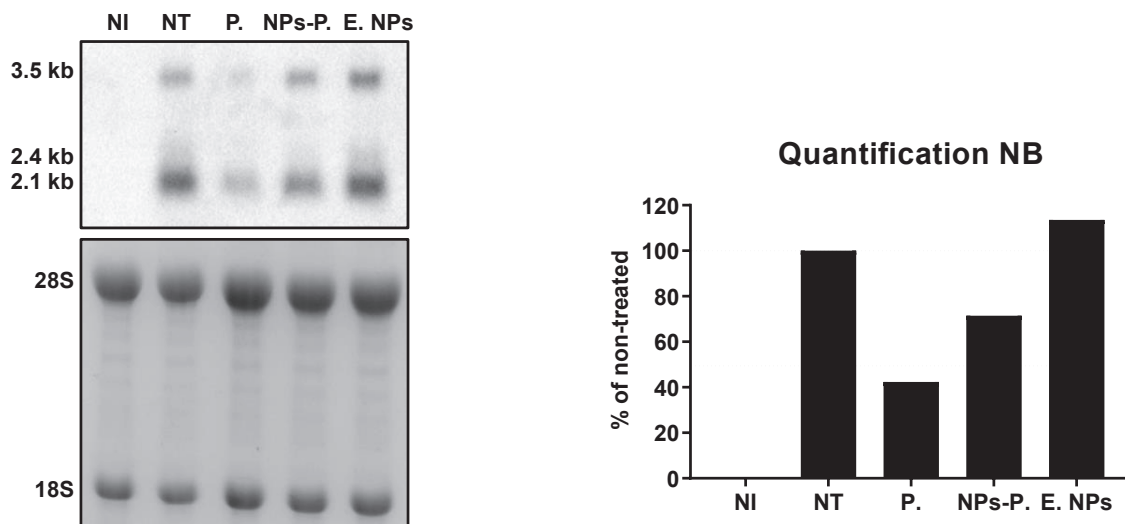
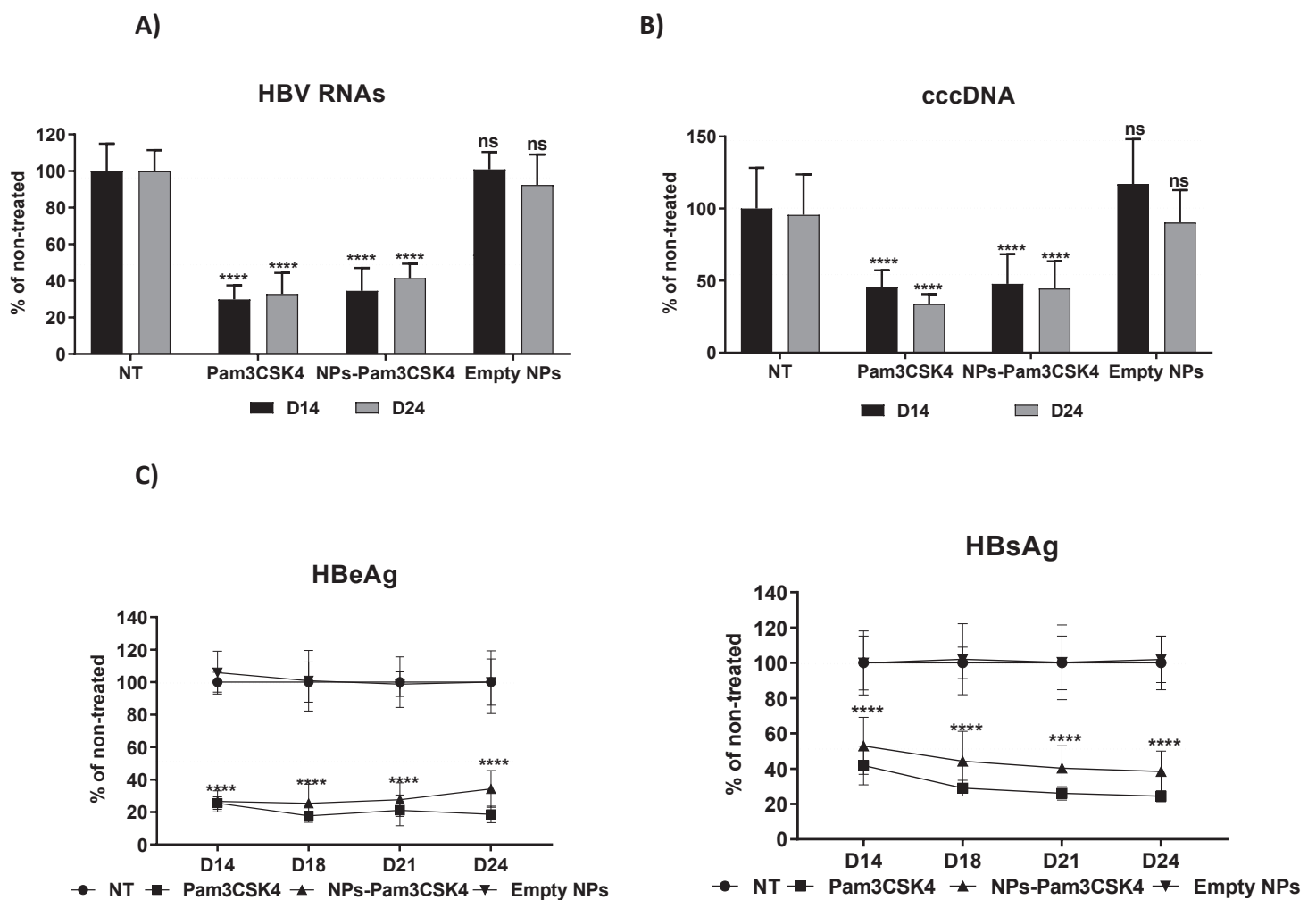

Figure 4: NPs-Pam3CSK4 and Pam3CSK4 induced a decrease of all HBV RNAs. 7 days post-infection, dHepaRG were treated twice with Pam3CSK4 (100 ng/ml), NPs-Pam3CSK4 (100 ng/ml) and Empty NPs (equivalent number of nanoparticles compared to NPs-Pam3CSK4) for a total exposure time of treatment of 6 days. Effects on HBV RNAs were assessed by northern blot at the end of the experiment.

As NPs-Pam3CSK4 presents a strong antiviral phenotype on viral RNAs, we wondered if they trigger the same mode of action than Pam3CSK4 to mediate their antiviral activity. The following parts are dedicated to the mode of actions of NPs-Pam3CSK4.

c. NPs-Pam3CSK4 has long-lasting antiviral activity

In order to assess the ability of NPs-Pam3CSK4 at permanently reducing all HBV parameters, dHepaRG cells, which were HBV-infected for 7 days and treated twice with treatments, were kept in culture 10 days after the end of treatment. All HBV parameters were quantified at the end of treatment (14 days post infection) and 10 days post the end of treatment (24 days post infection) (**Fig.3**). Viral HBV RNAs and cccDNA levels were quantified by RT-qPCR and FRET qPCR; HBeAg, HBsAg were quantified by ELISA and viremia by qPCR. Pam3CSK4 and Empty NPs treatment were respectively used as positive and negative controls. In the same way as Pam3CSK4, NPs-Pam3CSK4 induced a strong decrease of HBV RNAs (**Fig.3A**), cccDNA (**Fig. 3B**), secreted HBeAg and HBsAg (**Fig. 2C**) and viremia (**Fig. 3D**) at the end of treatment. Those decreases on viral parameters were sustained 10 days after the end of treatment, without any rebound of infection. This might suggest that the antiviral effect observed with NPs-might also imply epigenetic regulations, while the reduction of cccDNA levels may imply the triggering of cellular pathways subsequently affecting cccDNA stability.



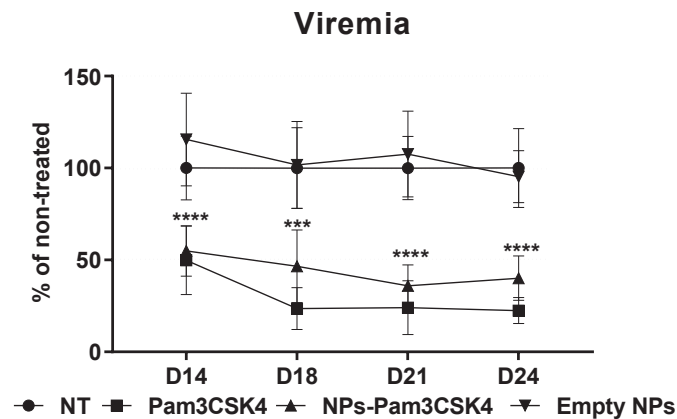

Figure 5: Antiviral activity of NPs-Pam3CSK4 is long lasting. After 8 days post-infection, dHepaRG were treated twice with Pam3CSK4 (100ng/ml), NPs-Pam3CSK4 (100ng/ml) and Empty NPs (equivalent number of nanoparticles compared to NPs-Pam3CSK4 were used) for a total exposure time of 6 days. HBV parameters were analysed at 14 days post-infection, at the end of treatment, 18, 21 and 24 days post-infection to observe potential rebound of infection. A) Effect on RNAs was quantified by RT-qPCR, expressed in percentage, normalized to house-keeping gene level and non-treated condition (NT); B) effect on cccDNA levels was quantified by FRET-qPCR method, expressed in percentage, normalized to NT; C) effects on HBV antigens were quantified by ELISA in supernatants, expressed in percentage and normalized to NT of each time; D) effects on viremia were quantified by qPCR, according to a standard curve (build with dilutions of a plasmid containing the HBV sequence). All histograms represent the mean of at least three independent experiments with three biological replicates and the error bars indicate SD. Statistically significant differences from NT conditions are indicated by asterisks (ns: non-significant, * $P < 0.05$, ** $P < 0.005$, *** $P < 0.002$, **** $P < 0.0001$).

d. Antiviral activity of NPs-Pam3CSK4 is mediated through TLR1/2 and MyD88

We wondered if the antiviral effects induced by NPs-Pam3CSK4 was mediated only by TLR1/2 as Pam3CSK4 or if off-target effects might be induced. dHepaRG cells were transduced by lentiCRISPR expressing Cas9 endonuclease and a single guide RNA corresponding our interest gene TLR1, TLR2, TLR3 and MyD88, which is the adaptor protein used by TLRs, except TLR3, to activate transcription factor NF- κ B. dHepaRG cells underwent normal differentiation as described in materials and methods prior being assessed by western blot for a good extinction of our interest genes (**cf. first study**). dHepaRG-Cas 9 KO TLR1, TLR2 and MyD88 were well knock out while dHepaRG-Cas9 KO TLR3 cells still contained TLR3 protein. This latter was then considered as a control cell line. dHepaRG-KO cells were HBV-infected, and 7 days post-infection, treated twice with NPs-Pam3CSK4, Pam3CSK4 and Empty NPs for a total exposure time of 6 days. At the end of treatment, intracellular parameters HBV RNAs, cccDNA and extracellular parameters HBeAg, HBsAg and viremia were quantified. The antiviral effect induced by NPs-Pam3Ck4 and Pam3CSK4 in dHepaRG-Cas9 KO TLR3 (**Fig 6.C**), the control cell line, it is abolished in dHepaRG cells KO for TLR1, TLR2 and MyD88 (**Fig 6. A B and D**), suggesting that NPs-Pam3CSK4 inhibits HBV in a TLR1/2 specific manner in hepatocytes, in a same way as Pam3CSK4. Experiments performed in TR-HepaRG Cas9 transfected three times with crRNA directed to TLR1, TLR2 or TLR3 and with the tracrRNA confirmed those observations (**Fig.7**).

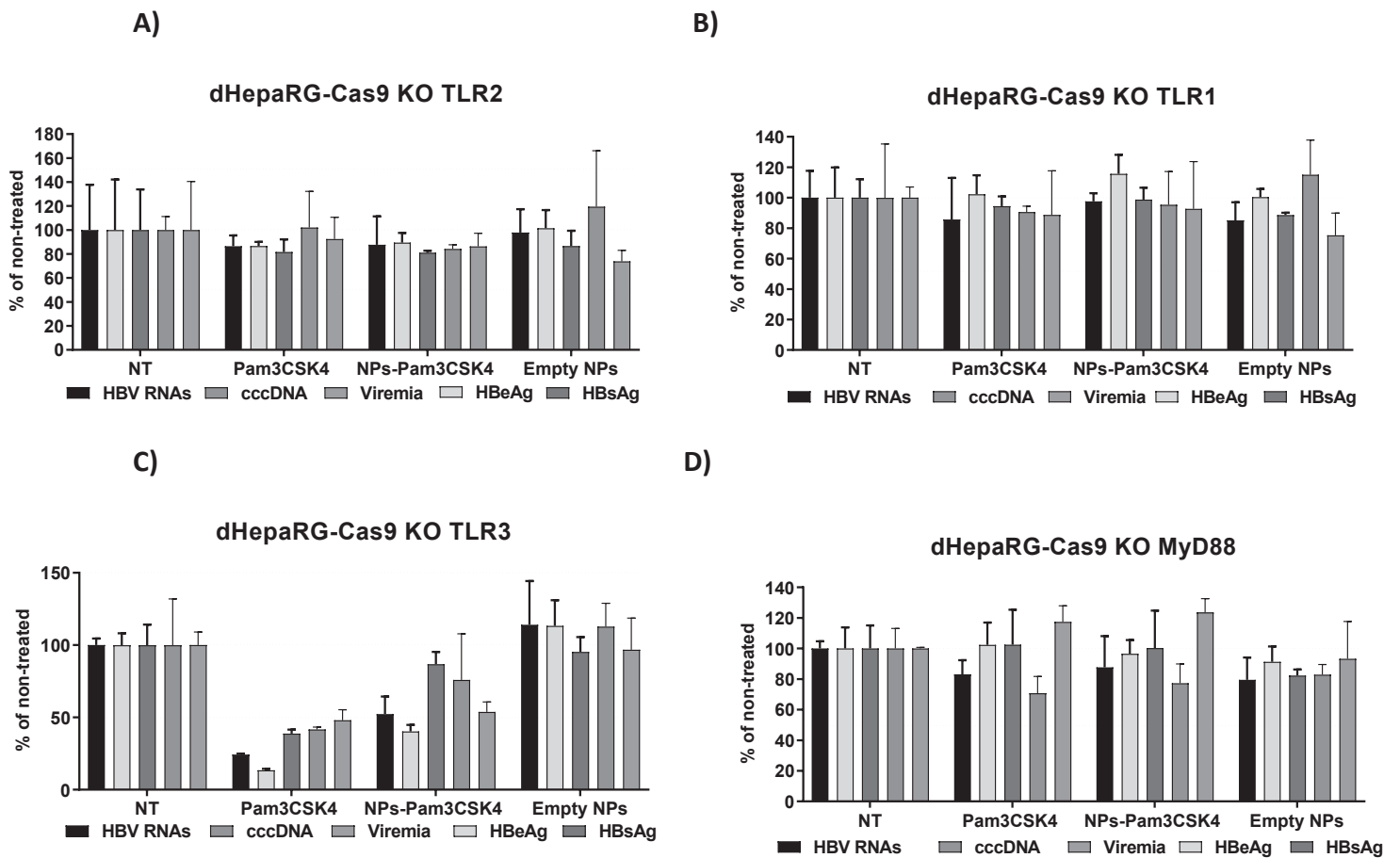
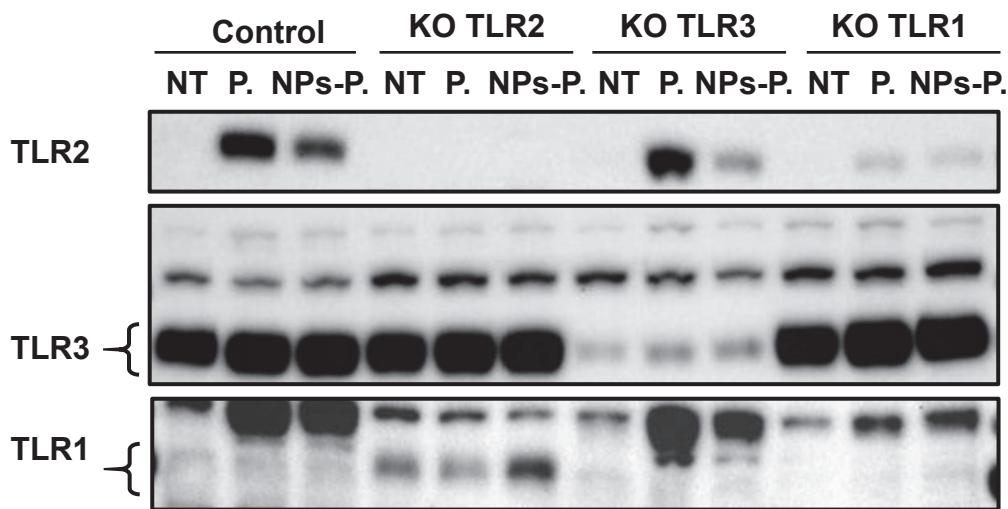
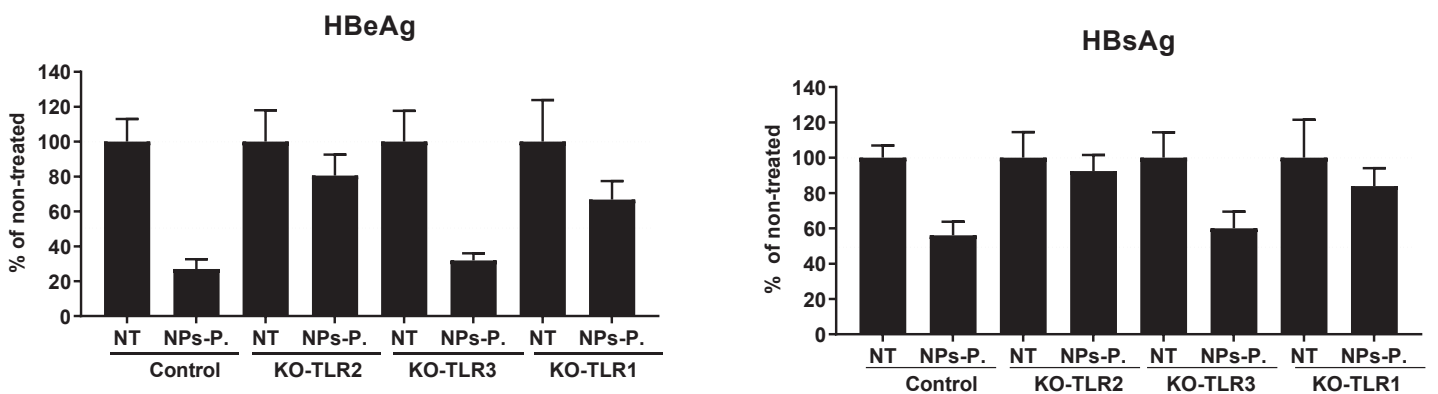

Figure 6: Antiviral activity of NPs-Pam3CSK4 is mediated through TLR1/2 and Myd88. After 7 days post-infection, A) dHepaRG KO-TLR2, (B) dHepaRG KO-TLR1, (C) dHepaRG KO-TLR3 and (D) dHepaRG KO-MyD88 were treated twice with Pam3CSK4 (100ng/ml), NPs-Pam3CSK4 (100 ng/ml) and Empty NPs (equivalent number of nanoparticles compared to NPs-Pam3CSK4) for a total exposure time of 6 days. Effect on RNAs was quantified by RT-qPCR, expressed in percentage, normalized to house-keeping gene level and non-treated condition (NT); effect on cccDNA levels was quantified by FRET-qPCR method, expressed in percentage, normalized to NT; effects on HBV antigens were quantified by ELISA in supernatants, expressed in percentage and normalized to NT; effects on viremia were quantified by qPCR, according to a standard curve (build with dilutions of a plasmid containing the HBV sequence). All histograms represent the mean of three biological replicates and the error bars indicate SD.

A)



B)



C)

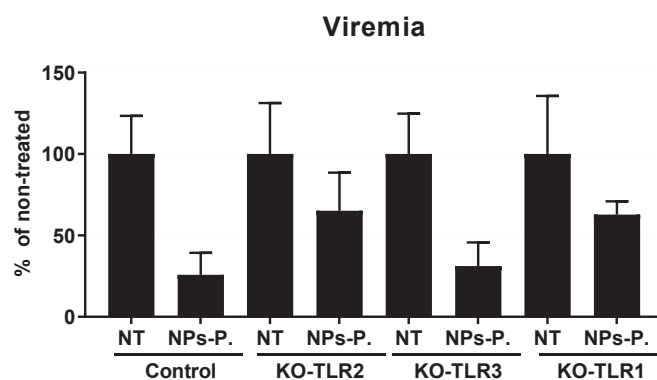

Figure 7: Antiviral activity of NPs-Pam3CSK4 is mediated through TLR1/2. TR-HepaRG Cas9 were transfected three times with crRNA directed to either TLR1, TLR2 or TLR3 and with the tracrRNA. After 7 days post-last transfection cells were infected by HBV, and 7 days later treated two times with NPs-Pam3CSK4 (100ng/ml) for a total exposure time of 6 days. A) Extinction of targeted genes was assessed by western blot using nitrocellulose membranes. B) Effects on HBV antigens were quantified

by ELISA in supernatants, expressed in percentage and normalized to NT. C) Effects on viremia were quantified by qPCR, according to a standard curve (built with dilutions of a plasmid containing the HBV sequence). All histograms represent the mean of at least three biological replicates and the error bars indicate SD.

e. NPs-Pam3CSK4 inhibits HBV transcription

In a same way as Pam3CSK4, the antiviral activity of NPs-Pam3CSK4 on viral RNAs was further analysed. DHePaRG cells were infected, and after the establishment of infection, cells were treated twice with NPs-Pam3CSK4 for a total exposure time of 6 days. Pam3CSK4 and Peg-IFN- α were used as positive control, and RG7834, lamivudine (LAM) and Empty NPs were as negative controls for transcription inhibition. Effects of treatment on HBV parameters were assessed before proceeding to the following experiment (Fig.8). 13 days post-infection, 5-ethynyl uridine was added to cell media to label nascent RNAs for a total exposure time of two hours. As control, infected but not treated cells were treated with actinomycin D, an inhibitor of transcription, 20 minutes before adding 5-ethynyl uridine. Total intracellular HBV RNAs were then isolated, quantified by RT-qPCR. Labelled RNAs were further extracted using Click-iT™ Nascent RNA Capture Kit and quantified by RT-qPCR (Fig. 7). NPs-Pam3CSK4 not only had an antiviral effect on total intracellular HBV RNAs, but also decreased HBV nascent RNAs. We cannot overlook the fact that NPs-Pam3CSK4 and Pam3CSK4 can inhibit HBV RNAs right after elongation, as the time of labelling of two hours might be long.

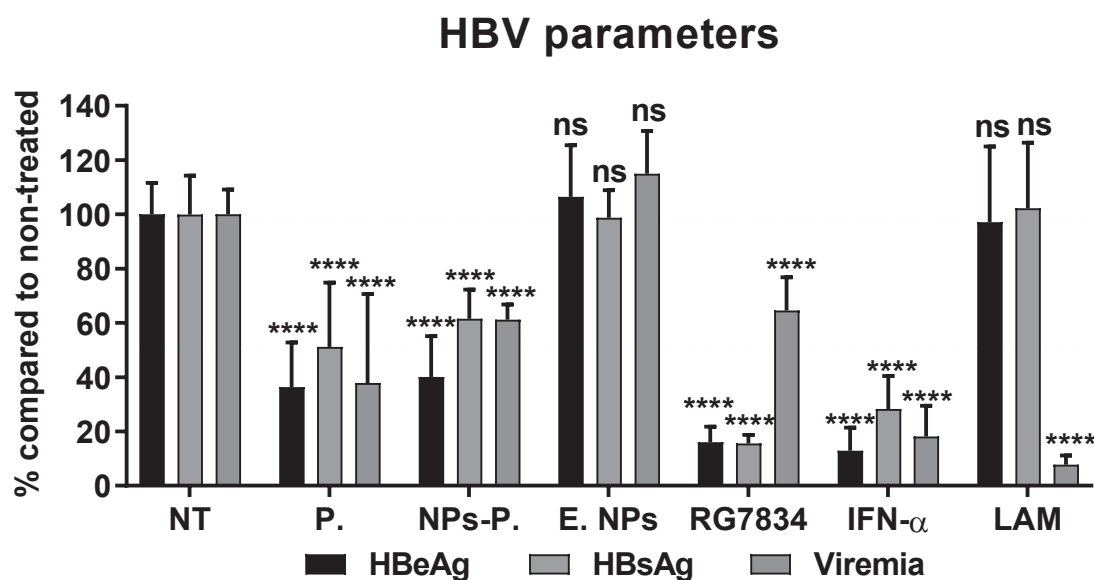

Figure 8: NPs-Pam3CSK4 inhibits HBV transcription. DHePaRG were treated 7 days post-infection, with Pam3CSK4 (100 ng/ml), NPs-Pam3CSK4 (100ng/ml), Empty NPs (equivalent number of nanoparticles compared to NPs-Pam3CSK4), RG7834 (0.1 μ M), Peg-IFN- α (1000 UI/ml) and lamivudine (LAM, 1 μ M), for a total exposure of 6 days of treatment. 6 days after treatment (and 13 days post-infection), all HBV parameters were controlled. Effects on HBV antigens were quantified by ELISA in supernatants, expressed in percentage and normalized to NT; effects on viremia were quantified by qPCR, according to a standard curve (built with dilutions of a plasmid containing the HBV sequence). All histograms represent the mean of at least two independent experiments with three biological replicates and the error bars indicate SD. Statistically significant

differences from NT conditions are indicated by asterisks (ns: non-significant, * $P < 0.05$, ** $P < 0.005$, *** $P < 0.002$, **** $P < 0.0001$).

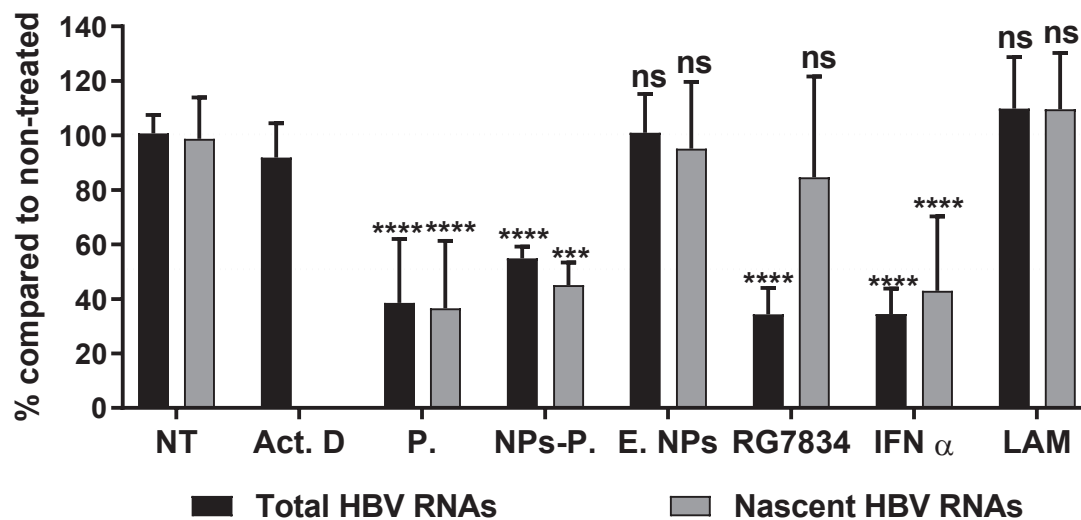

Figure 9: NPs-Pam3CSK4 inhibits HBV transcription. DHePaRG were treated 7 days post-infection, with Pam3CSK4 (100 ng/ml), NPs-Pam3CSK4 (100 ng/ml), Empty NPs (equivalent number of nanoparticles compared to NPs-Pam3CSK4), RG7834 (0.1 μ M), Peg-IFN- α (1000 UI/ml) and lamivudine (LAM, 1 μ M), for a total exposure of 6 days of treatment. 6 days after treatment (and 13 days post-infection), 5-ethynyl uridine was used to label nascent RNAs for two hours. HBV RNAs were then extracted and quantified by RT-qPCR for total analysis, and labelled RNAs were further extracted using Click-iT™ Nascent RNA Capture Kit according to manufacturer's recommendations. Actinomycin D was used as control: on day 13, cells were treated with actinomycin D at a concentration of 5 μ g/ml and for twenty minutes prior to the addition of 5-ethynyl uridine. Effects on total and nascent HBV RNAs was quantified by RT-qPCR, expressed in percentage, normalized to house-keeping gene level and non-treated condition (NT). All histograms represent the mean of at least two independent experiments with three biological replicates and the error bars indicate SD. Statistically significant differences from NT conditions are indicated by asterisks (ns: non-significant, * $P < 0.05$, ** $P < 0.005$, *** $P < 0.002$, **** $P < 0.0001$).

f. NPs-Pam3CSK4 preferentially induce proinflammatory responses *in vitro*

As several nanocarriers have been shown to induce inflammatory and immune response both *in vitro* and *in vivo* (Andrade et al. 2020), we decided to investigate the responses of liver mononuclear cells to the exposure of NPs-Pam3CSK4 in comparison to Pam3CSK4 exposure. Empty NPs (equivalent number of nanoparticles compared to NPs-Pam3CSK4) and LPS were used as controls. Treatments were put in contact with LMNCs for 24 hours, the production of proinflammatory cytokine IL-6 and anti-inflammatory cytokine IL-10 were assessed by ELISA (Fig.10).

Contrary to Pam3CSK4, which moderately induced the production of IL-6, NPs-Pam3CSK4 dose-dependently induced IL-6, reaching high concentrations as LPS control. Interestingly, Empty NPs did not induce any IL-6 before a certain concentration of nanoparticles, i.e., of PLA, in contact with LMNCs, suggesting that PLA alone might induce the production of IL-6. This production induced by PLA might

explain the more important production of IL-6 obtained for high concentrations (500 and 1000 ng/ml) of NPs-Pam3CSK4, production that could be due to both ligand and polymer.

Both NPs-Pam3CSK4 and Pam3CSK4 moderately induced the production of IL-10, reaching a “plateau”, which is not as high as LPS control. Empty NPs seemed to induce IL-10 at a certain concentration of PLA, but no additional effect was observed in conditions of high NPs-Pam3CSK4 concentrations, meaning that the presence of ligand could counterbalance this effect.

These preliminary data are crucial for following *in vivo* experiments, as it showed that a concentration of NPs-Pam3CSK4 exists from which polymer might also induce production of cytokines, therefore too important concentrations of NPs-Pam3CSK4 might lead to a “cytokine storm”.

A)

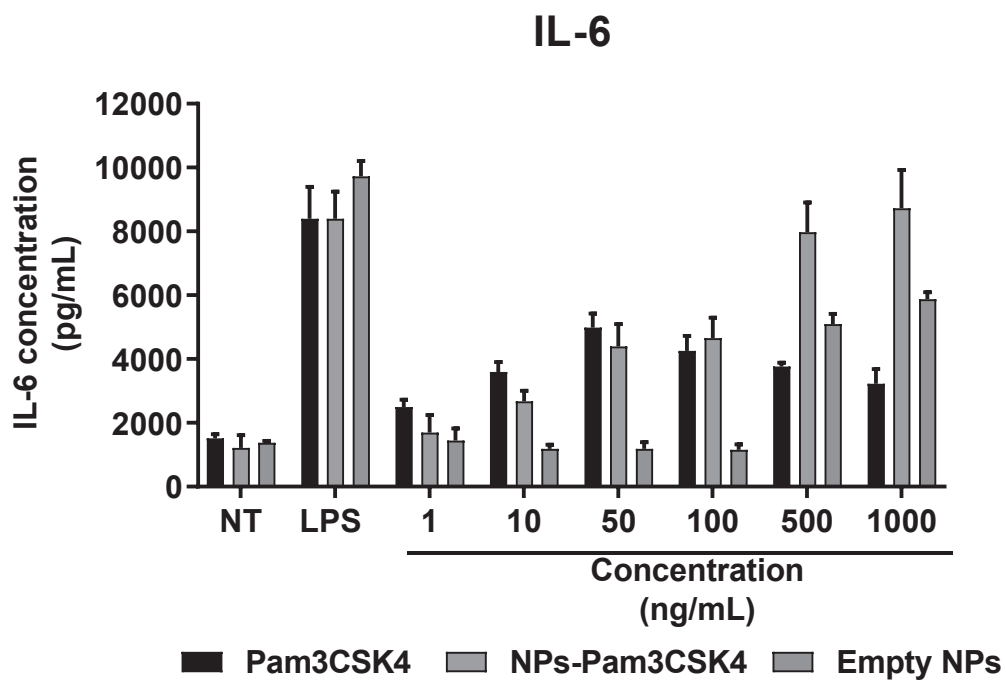

B)

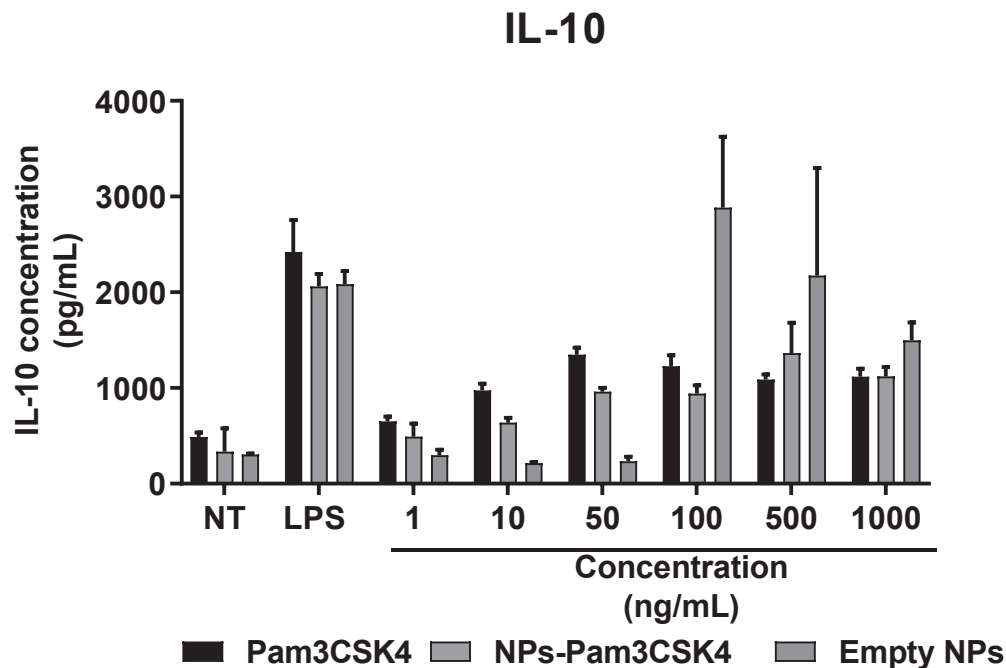

Figure 10: NPs-Pam3CSK4 preferentially induce proinflammatory responses *in vitro*. Liver mononuclear cells were simultaneously plated and treated with increasing doses of Pam3CSK4, NPs-Pam3CSK4 and Empty NPs (equivalent number of nanoparticles compared to NPs-Pam3CSK4). LPS (10 ng/ml) was used as control. 24 hours later A) IL-6 and B) IL-10 were quantified by ELISA. All histograms represent the mean of three biological replicates and the error bars indicate SD.

2. Assessment NPs-Pam3CSK4 antiviral properties *in vivo*

a. Poly lactic acid Nanoparticles are efficiently delivered to the liver

Biodistribution analysis of poly lactic acid showed approximately 90% of nanoparticles were localized in the liver five minutes post administration (**Fig.11A-B**). The hepatic accumulation retention is measurable until 21 days post administration. Those data were important to generate prior to other *in vivo* experiments, highlighting the fact that nanoparticles will be well delivered to the liver in an efficient and lasting way.

A)

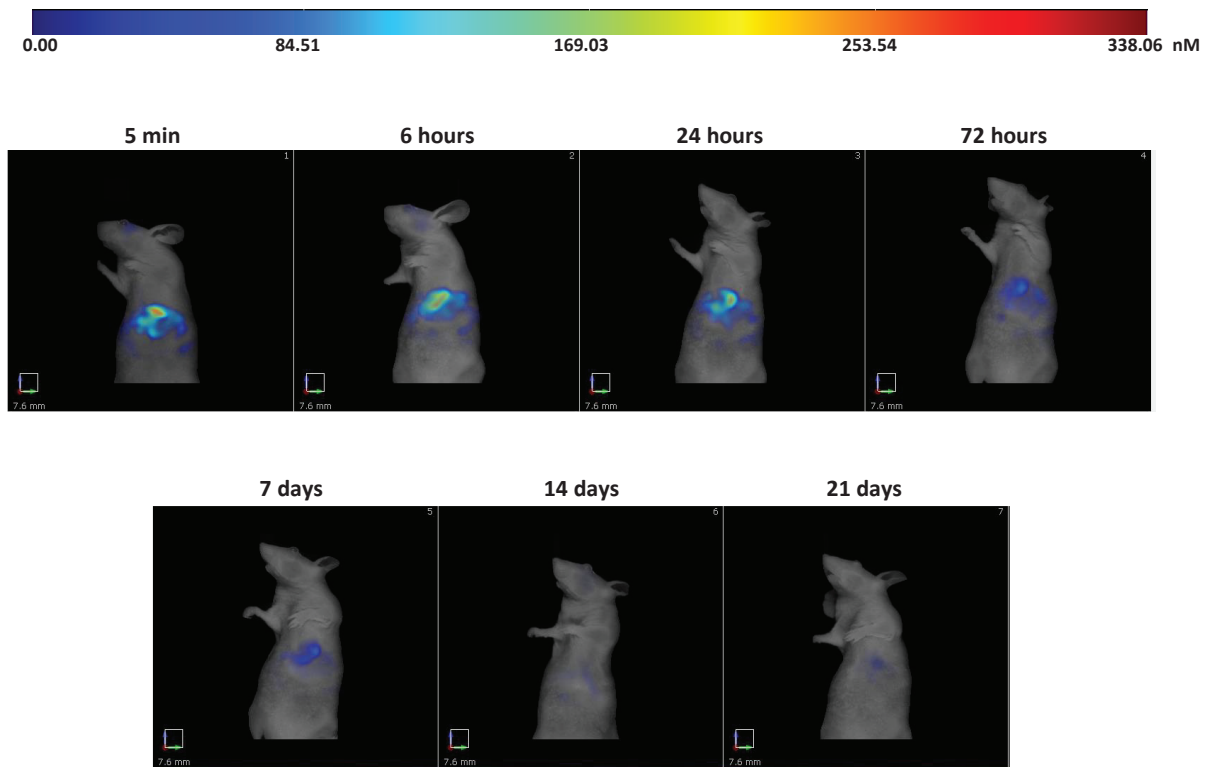

B)

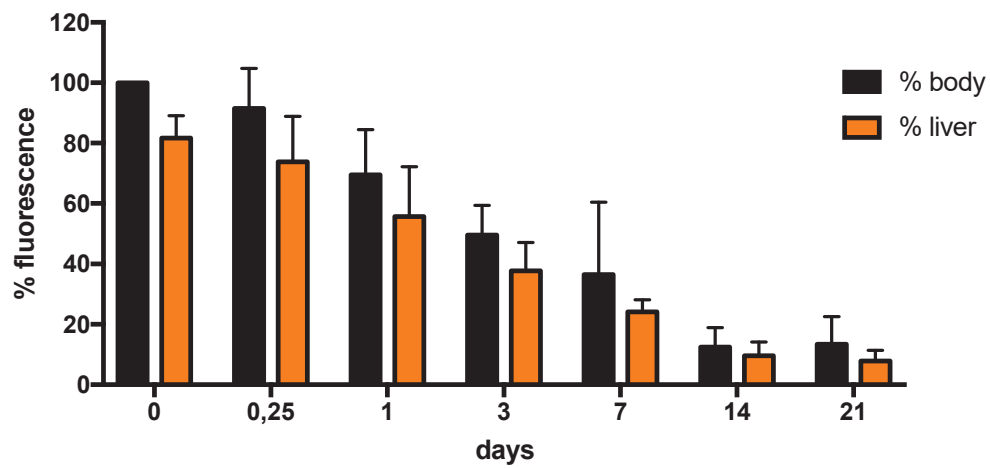

Figure 11: Poly lactic acid Nanoparticles are efficiently delivered to the liver. Poly lactic nanoparticles containing a fluorophore were intravenously injected in 10 C57BL/6 mice. A) Localization of nanoparticles was observed by tomography (Fluorescence Molecular Tomograph 4000) at different times post injection. B) Percentage of fluorescence in the liver compared to all body was quantified.

- b. NPs-Pam3CSK4 induced a strong decrease of all HBV parameters in AAV-HBV transduced mice

Antiviral activity of NPs-Pam3CSK4 was assessed *in vivo*. Four groups of eight C57Bl6 were transduced by AAV-HBV, and five weeks after the establishment of infection, mice were either treated with an escalation dose of NPs-Pam3CSK4 or Pam3CSK4. A group of mice was treated with lamivudine (LAM) as negative control (**Fig.12A**). Sera were collected at different time points to analyse HBV antigens and viremia. 70 days post infection, mice were sacrificed and intracellular parameters, total HBV RNAs, total HBV DNA and cccDNA were quantified. As observed in HupHep mice ([Lucifora et al. 2018](#)), Pam3CSK4 induced a moderate decrease of viral parameters (**Fig.12 B-E**). As mice were sacrificed 7 days post end of treatment, a small rebound of infection was observed in the lamivudine and Pam3CSK4 treatment, while in the NPs-Pam3CSK4 treatment viremia was no longer detected at the day of sacrifice (**Fig. 12B**). Similarly, NPs-Pam3CSK4 was the most potent treatment at decreasing secretion of HBsAg (**Fig. 12C**). The antiviral effect on HBeAg was moderate but still more important than those observed by other treatments (**Fig. 10D**). NPs-Pam3CSK4 was also efficient at decreasing all intracellular parameters, including total HBV RNAs, total HBV DNA and cccDNA (**Fig. 12E**).

Despite a strong decrease of all HBV parameters, we cannot overlook that viral titers observed in mice is not as high as expected (only 10^5 copies HBV/ml) and could ease the decrease induced by treatments. New cohorts with higher viral titers are needed to further investigate the complete antiviral properties of NPs-Pam3CSK4 *in vivo*, and higher concentrations of NPs-Pam3CSK4 may also be needed to get a decrease of all viral parameters.

A)

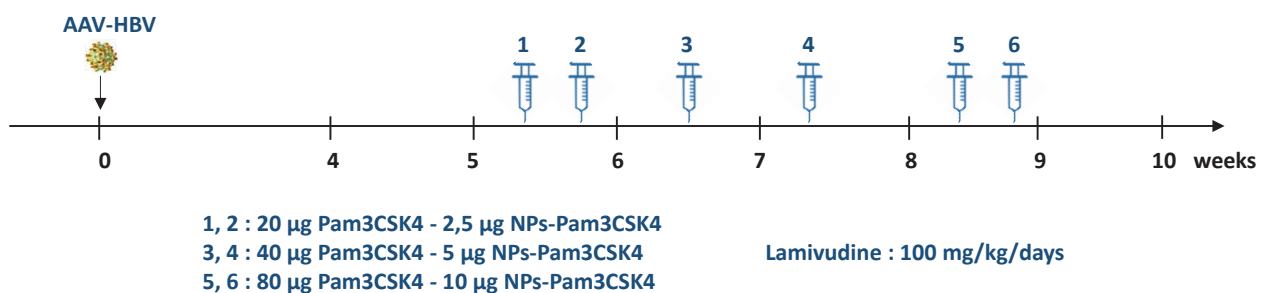

B)

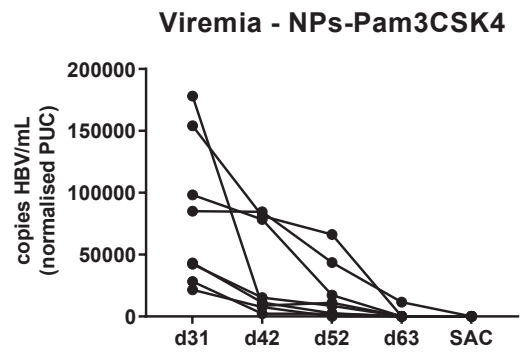
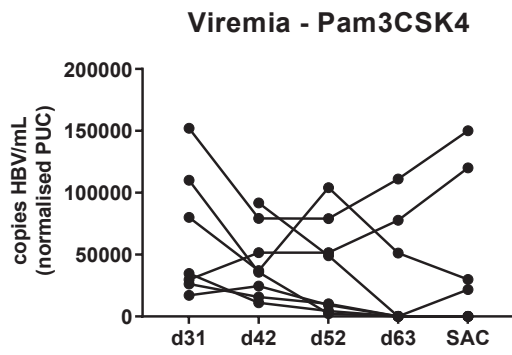
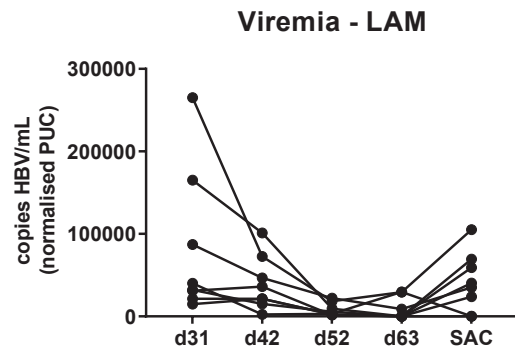
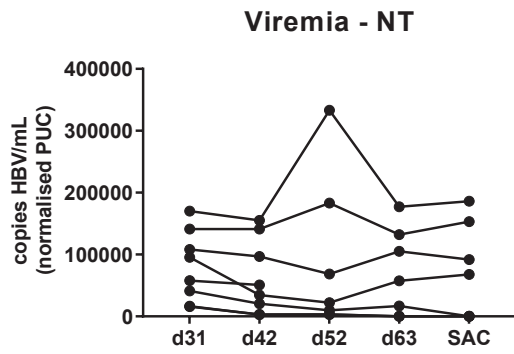

c)

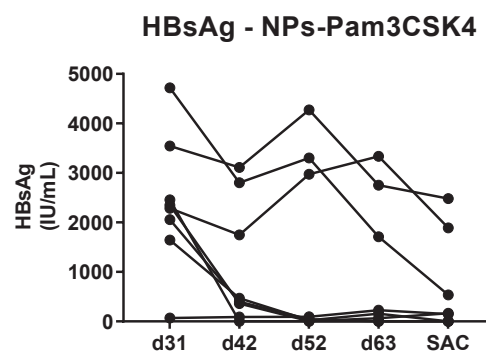
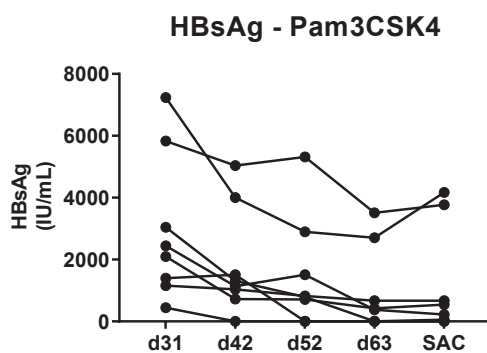
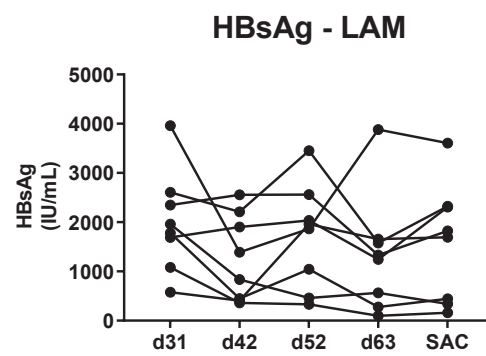
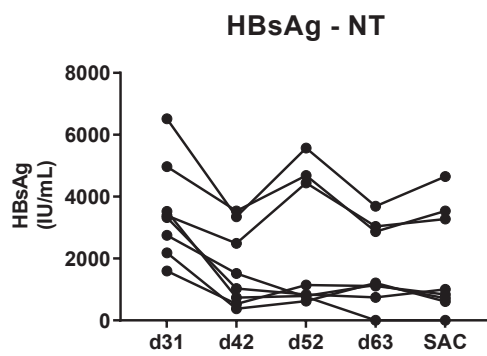

D)

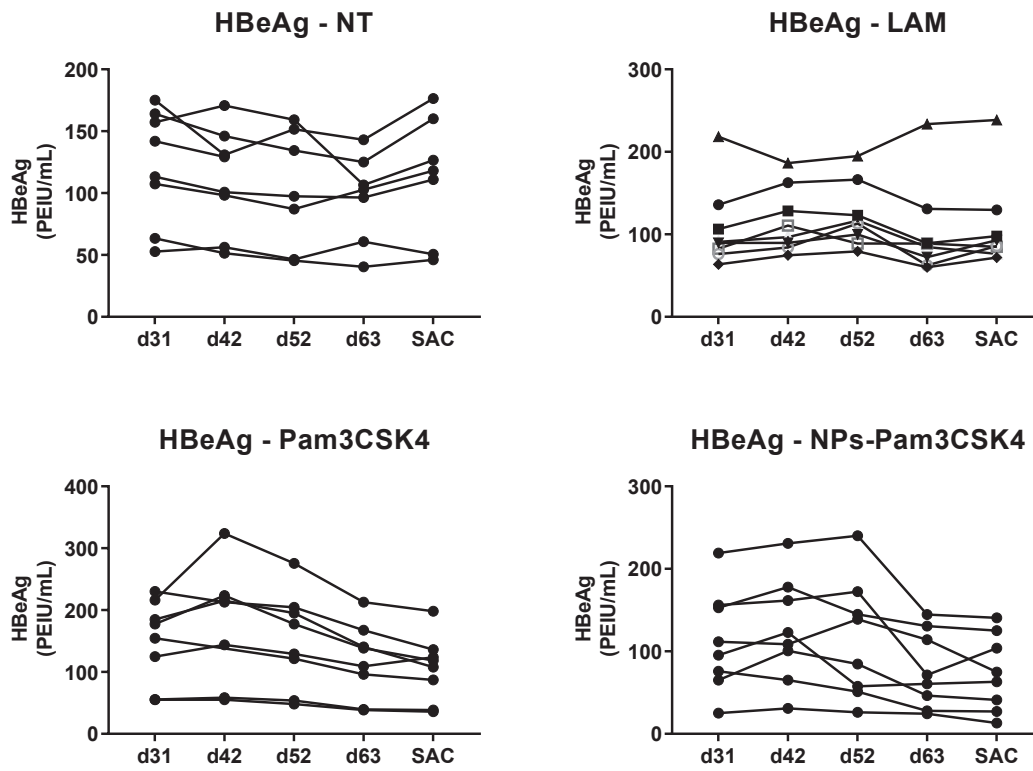

E)

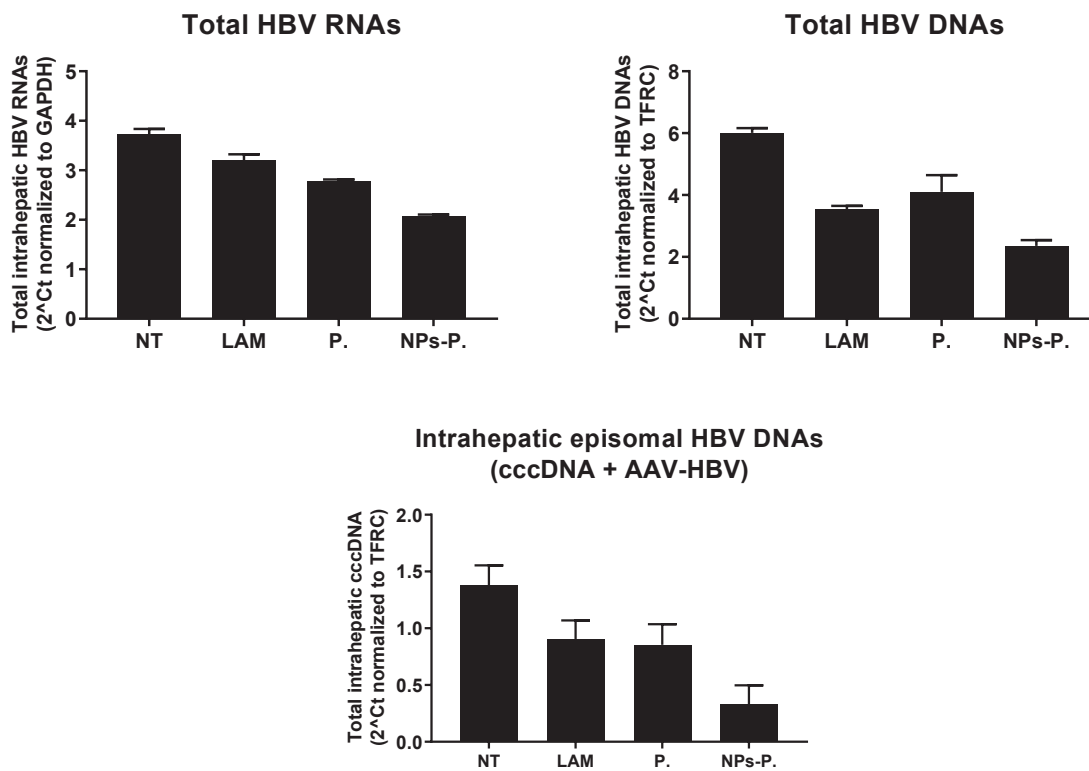

Figure 12: NPs-Pam3CSK4 induce a decrease of all HBV parameters *in vivo*. A) Four groups of eight C57Bl6 mice were transduced by AAV-HBV. Five weeks after the establishment of infection, groups were injected intravenously twice a week for three weeks, with Pam3CSK4 (20µg per mouse per injection the first week, 40µg per mouse per injection the second week and 80µg per mouse per injection the third week), NPs-Pam3CSK4 (2.5 µg per mouse per injection the first week, 5µg per mouse per injection the second week, 10µg per mouse per injection the third week), lamivudine (100mg/kg/day) respectively. The last group was left untreated. Sera were collected at different time points. Mice were sacrificed ten weeks post AAV-HBV transduction. B) HBV viremia was determined by DNA extraction from sera (supplemented with a known amount of non-HBV DNA, pUC19 plasmid from New England Biolabs) using the NucleoSpin® RNA Virus Kit (Macherey Nagel) followed by qPCR. For each serum, quantity of viral genome equivalent was calculated according to a standard curve (using dilutions of a plasmid containing the HBV sequence) and normalized to the ratio between the actual and theoretical amount of recovered pUC19 DNA. C) and D) Viral antigens HBeAg and HBsAg were measured as previously described. E) Intracellular parameters were obtained from liver pieces. Intracellular HBV RNAs were quantified by RT-qPCR, expressed in $2^{-\Delta\Delta Ct}$ and normalized to GADH (housekeeping gene); total HBV DNA were quantified by qPCR, expressed in $2^{-\Delta\Delta Ct}$ and normalized to TFRC (housekeeping gene); cccDNA levels were quantified qPCR, expressed in $2^{-\Delta\Delta Ct}$ and normalized to TFRC (housekeeping gene).

In order to increase delivery to the liver and hepatocytes, NPs-Pam3CSK4 can be functionalized with a PreS1 peptide. This PreS1 peptide is derived from the PreS1 domain of HBsAg, which has been shown to bind to NTCP receptor and allow the entry of the virus (H. Yan et al. 2012). *In vitro* assessment of antiviral properties of these NPs-Pam3CSK4-PreS1 have been realized in the following part.

3. NPs-Pam3CSK4-PreS1: a new weapon against HBV

a. NPs-Pam3CSK4-PreS1 conserved antiviral activity *in vitro*

Antiviral activity of NPs-Pam3CSK4-PreS1 was assessed *in vitro*, in both dHepaRG cells and PHH (Fig.13). Cells were HBV-infected, and seven days post-infection, when the infection is established, they were treated two times with increasing doses of NPs-Pam3CSK4-PreS1 (in ng/ml), for a total exposure of treatment of 6 days. Empty NPs but containing the PreS1 peptide (equivalent number of nanoparticles compared to NPs-Pam3CSK4-PreS1 at low and high concentration) and Pam3CSK4 were respectively used as negative and positive controls. At the end of the experiment, HBV RNAs were quantified by RT-qPCR and HBeAg secretions were analysed by ELISA. NPs-Pam3CSK4-PreS1 were particularly potent at decreasing viral RNAs and HBeAg in dHepaRG cells with an IC50 evaluated around 60 ng/ml (Fig.13 A and B). Antiviral effect was even more important in PHH. A 50% decrease of HBV RNAs, and HBeAg secretions were observed at a dose of 60 ng/ml, which is around 80 times less than the Pam3CSK4 dose used on PHH (Fig.13 C and D).

As NPs-Pam3CSK4, NPs-Pam3CSK4-PreS1 conserved therefore potent antiviral properties *in vitro*.

A)

HBV parameters - dHepaRG

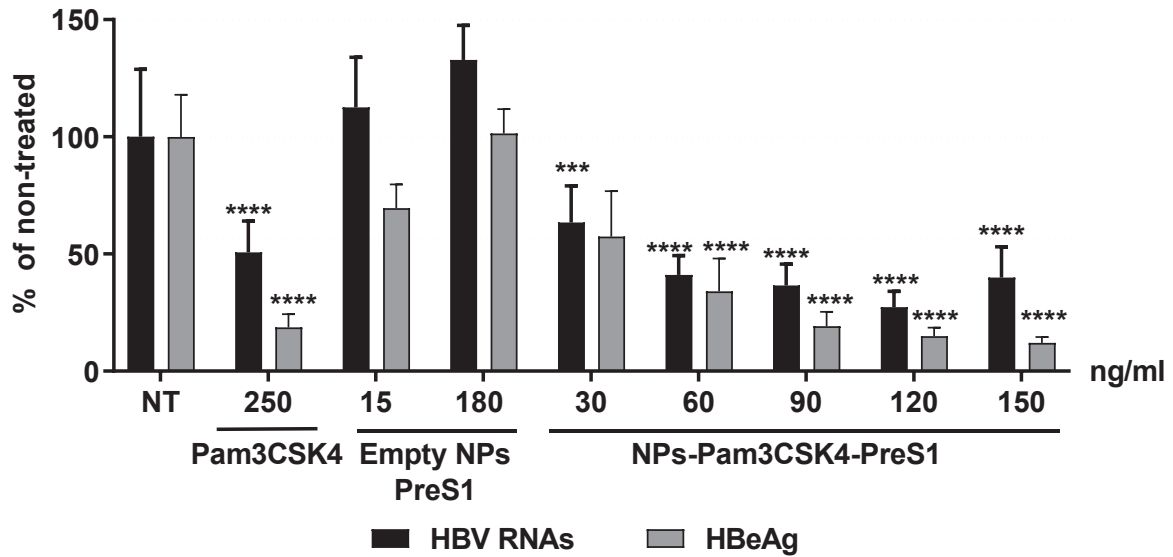

B)

HBV parameters - PHH

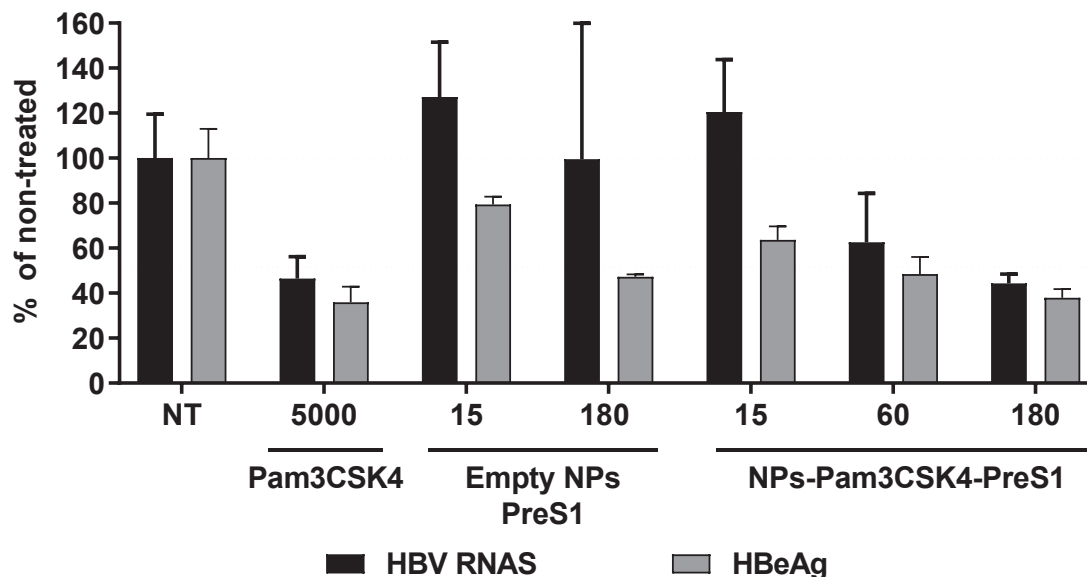

Figure 13: NPs-Pam3CSK4-PreS1 have potent antiviral activity *in vitro*. A) 7 days post-infection dHepaRG cells were treated twice with indicated doses of Pam3CSK4, NPs-Pam3CSK4-PreS1 and Empty NPs (equivalent number of nanoparticles compared to NPs-Pam3CSK4-PreS1). B) 5 days post infection, PHH were treated thrice with indicated doses of Pam3CSK4, NPs-Pam3CSK4-PreS1 and Empty NPs (equivalent number of nanoparticles compared to NPs-Pam3CSK4-PreS1). Effect on HBV RNAs was quantified by RT-qPCR, expressed in percentage, normalized to house-keeping gene level and non-treated

condition (NT); effects on HBeAg were quantified by ELISA in supernatants, expressed in percentage and normalized to NT. A) all histograms represent the mean of two independent experiment with at least three biological replicates and the error bars indicate SD. B) all histograms represent the mean of four biological replicates and the error bars indicate SD. Statistically significant differences from NT conditions are indicated by asterisks (ns: non-significant, * $P < 0.05$, ** $P < 0.005$, *** $P < 0.002$, **** $P < 0.0001$).

b. NPs-Pam3CSK4-PreS1 are efficient in inhibiting virus entry *in vitro*

As the PreS1 peptide used to coat NPs-Pam3CSK4 is derived from the N-terminal myristoylation of HBV PreS1 peptide sequence (2-48 aa), which has been shown to be determinant for viral entry (Urban et al. 2014), we investigated the ability of NPs-Pam3CSK4 PreS1 to inhibit viral entry, in comparison to MyrcludexB, which has recently been approved in the European Union for treatment of chronic hepatitis delta in HDV-RNA positive patients with compensated liver disease (Kang and Syed 2020). dHepaRG cells were simultaneously infected and treated with increasing doses of Myrcludex B, and PreS1 present at the surface of NPs-Pam3CSK4-PreS1 and Empty NPs-PreS1 (equivalent number of nanoparticles compared to NPs-Pam3CSK4 PreS1). NPs-Pam3CSK4 (20 ng/ml) and Empty NPs (equivalent number of nanoparticles compared to NPs-Pam3CSK4) were used as negative controls (Fig. 14). Both NPs-Pam3CSK4 PreS1 and Empty NPs PreS1 dose dependently blocked the viral entry into hepatocytes, with a strong entry inhibition from 1ng/ml of PreS1 present at the surface of nanoparticles. The inhibition is not as high as MyrcludexB at this concentration, which may be due to the spherical position of the peptide, compared to free PreS1 making it more accessible to NTCP receptor. However, higher concentrations of nanoparticles and therefore higher concentrations of PreS1 were able to completely inhibit viral entry.

HBeAg - Inhibition of viral entry

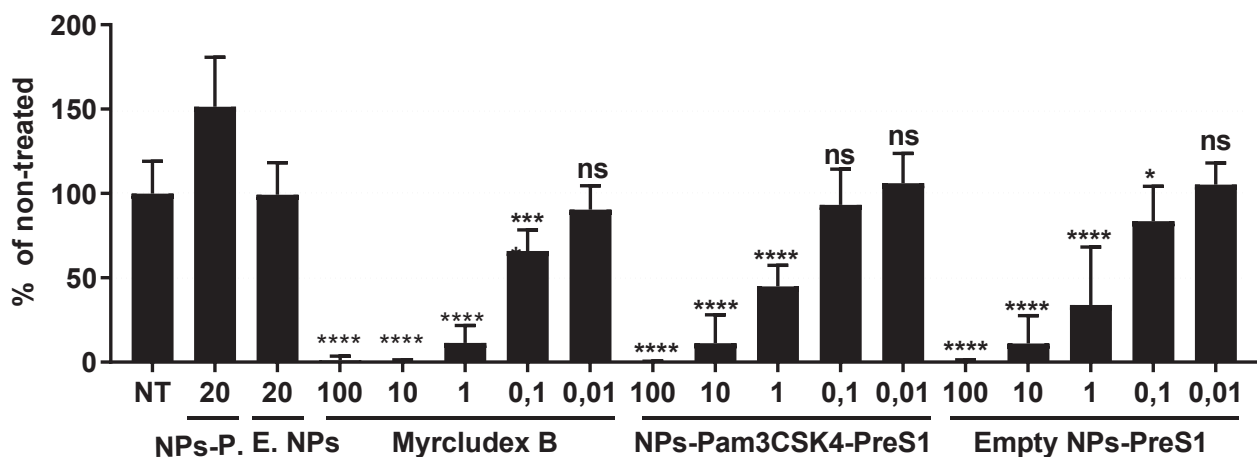

Figure 14: NPs-Pam3CSK4-PreS1 are efficient in inhibiting virus entry *in vitro*. dHepaRG cells were infected and treated at the same time with increasing doses of Myrcludex B, NPs-Pam3CSK4-PreS1 and Empty NPs-PreS1 (equivalent number of nanoparticles compared to NPs-Pam3CSK4 PreS1), concentrations are indicated in ng/ml. NPs-Pam3CSK4 (20 ng/ml) and

Empty NPs (equivalent number of nanoparticles compared to NPs-Pam3CSK4) were used as negative controls. 7 days after infection and treatment, HBeAg was quantified by ELISA. All histograms represent the mean of four independent experiments with four biological replicates and the error bars indicate SD. Statistically significant differences from NT conditions are indicated by asterisks (ns: non-significant, * $P < 0.05$, ** $P < 0.005$, *** $P < 0.002$, **** $P < 0.0001$).

c. Anti-PreS1 IgG in mice sera neutralize HBV entry *in vitro*

As the appearance of anti-PreS1 antibodies in patients have been shown to imply better recovery from primary HBV infection (J. Wei et al. 2002) and the added value of using the PreS1 domain compared to the conventional HBsAg protein in a therapeutic approach against chronic hepatitis B progression have recently been demonstrated (Bian et al. 2017); we assessed the ability of NPs-Pam3CSK4 PreS1 to induce a humoral response *in vivo* (Fig. 13) Eight weeks old female mice (n=36) were randomly distributed into six groups and immunized at weeks 0, 3 and 7 with six formulations PreS1; NPs-Pam3CSK4-PreS1 (SC or IV); NPs-PreS1. Empty NPs and KLH-PreS1 (KLH for Keyhole Limpet Hemocyanin being a carrier protein to produce antibodies) conditions were respectively considered as negative and positive controls. Treatments were administered subcutaneously. One extra condition was tested intravenously to compare immune response by both routes of administration. An additional NPs-PreS1 heterologous boost was realized at week 27. The anti-PreS1 IgG titer was monitored by ELISA. The anti-PreS1 antibodies were assessed for viral entry inhibition at week 11 and 27, and at the day of sacrifice (Fig. 13B). Experiments were controlled using MyrcludexB, antibody directed to HBsAg and antibody F35.35, which is an antibody directed to the PreS1 domain (patent: WO1991005059A1).

NPs-Pam3CSK4 PreS1 formulation, despite less antibodies measured against PreS1 in sera, compared to NPs-PreS1 formulation, seemed to be as efficient as inhibiting the viral entry at all three time points. More details of this study can be found in the appendices.

Thes NPs-Pam3CSK4-PreS1 present numerous advantages compared to NPs-Pam3CSK4, as they present high antiviral activities and prevent viral entry *in vitro*. *In vivo*, they can induce humoral responses with production of potent neutralizing antibodies. Finally, their potent antiviral activities need to be recapitulate *in vivo* in an infection context.

A)

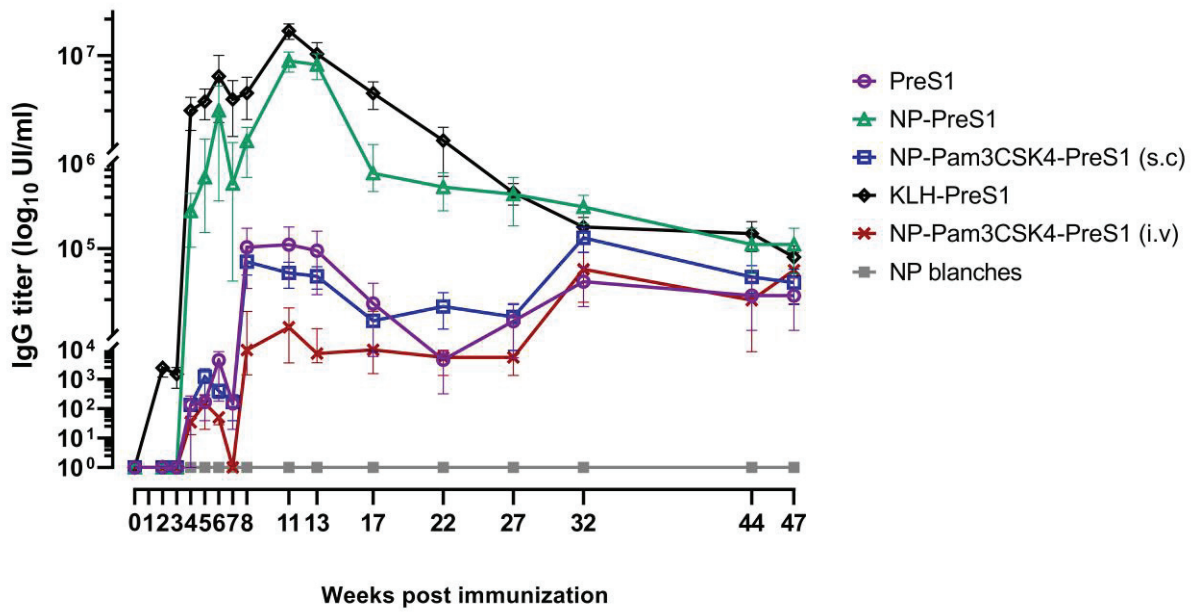

B)

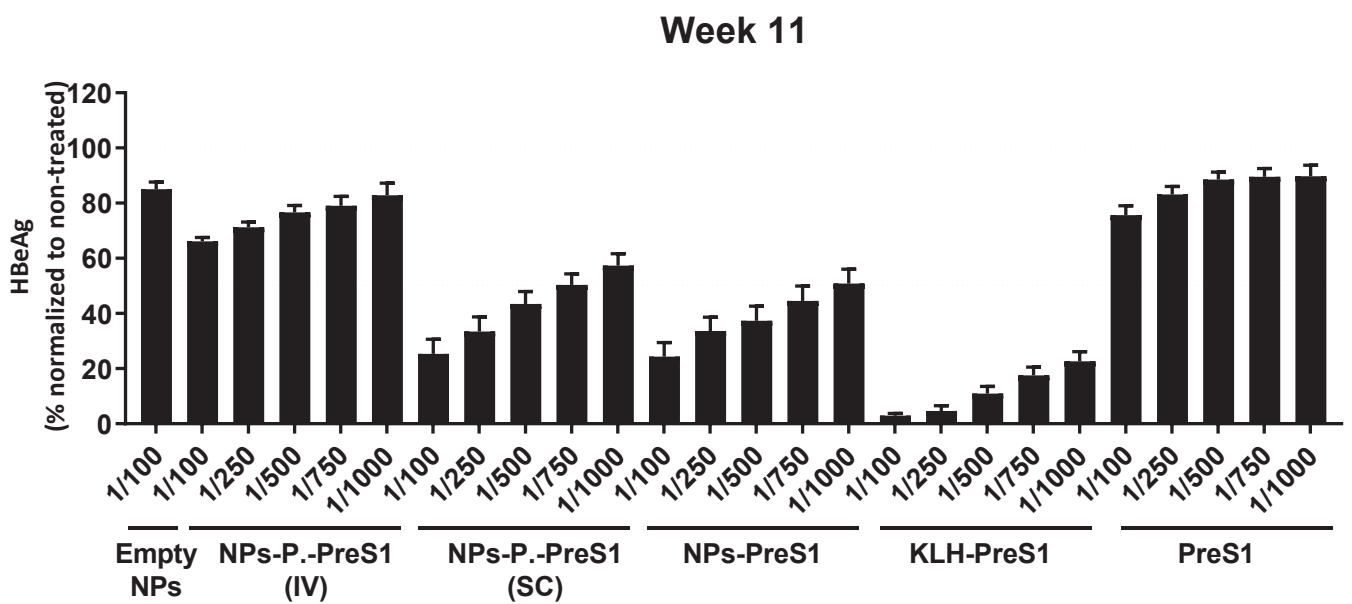

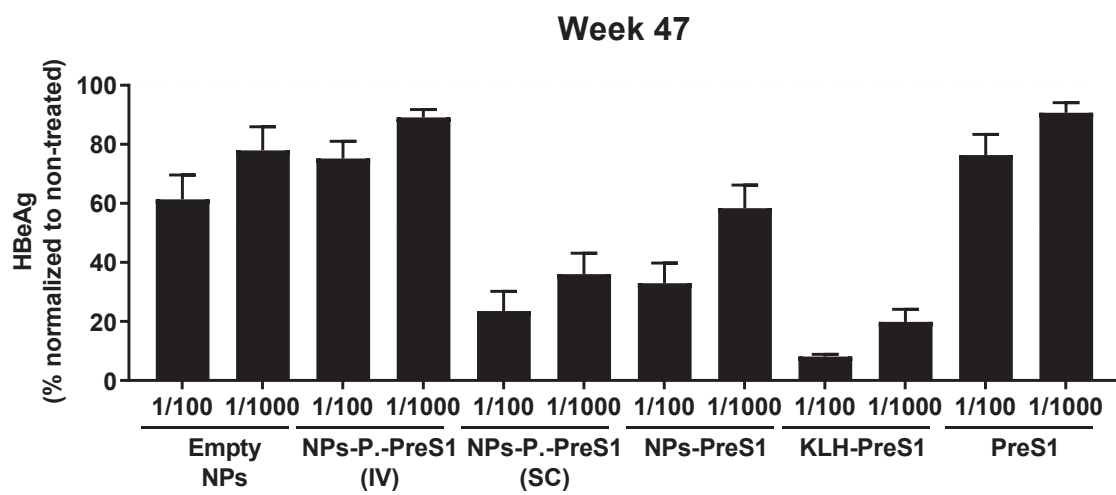
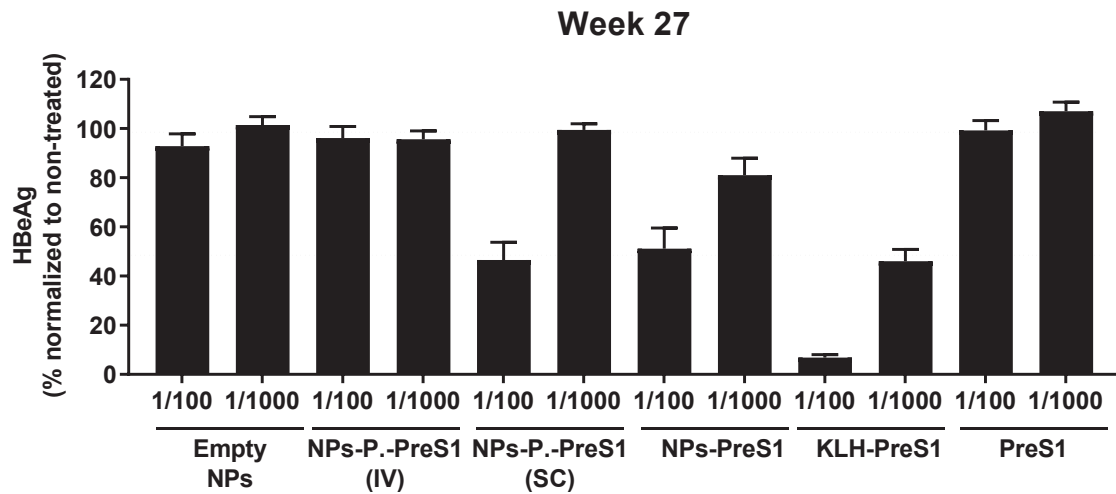

c)

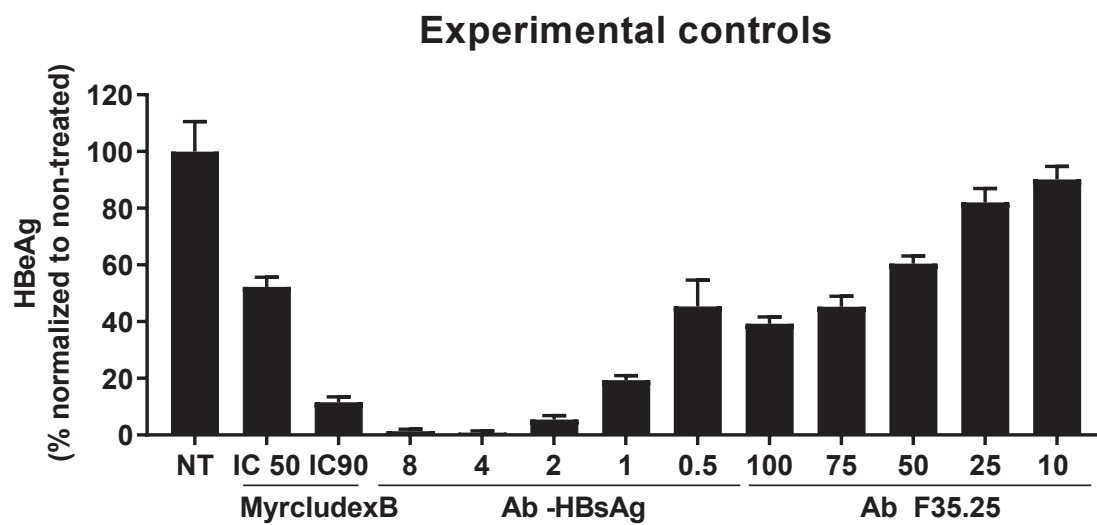

Figure 15: Anti-PreS1 IgG in mice sera neutralize HBV entry *in vitro*. A) Eight weeks old female mice (n=36) were randomly distributed into six groups and immunized at weeks 0, 3 and 7 with six formulations PreS1; NPs-Pam3CSK4-PreS1 (SC or IV); NPs-PreS1. Empty NPs and KLH-PreS1 conditions are respectively considered as negative and positive controls. Treatments were administered subcutaneously. One extra condition was tested intravenously to compare immune response by both routes of administration. An additional NPs-PreS1 heterologous boost was realized at week 27. Anti-PreS1 IgG titer was monitored using ELISA directed against the specific sequence Myr(2-48) derived PreS1. B) HBV-neutralizing activity of sera from W11, W27 and W47 were diluted and incubated simultaneously with HBV on dHepaRG cell cultures in four biological replicates. HBeAg was quantified by ELISA 7 days post infection/treatment. Data is expressed as percentage of non-treated and each histogram represent the mean of HBeAg (in %) obtained for all mice of the considered formulation at the indicated dilution. C) For each viral entry inhibition experiments, experimental controls were used to ensure the feasibility of the study: MyrcludexB at two concentrations (IC₅₀: 0.5 ng/ml and IC:90ng/ml), an increasing dose of an antibody directed to HBsAg (Abott), an increasing dose of F35.25 antibody, which is directed to PreS1 domain (patent: WO1991005059A1).

Supplementary Material and Methods

Table 1: Molecules used for treatments.

	References	Purchaser
Pam3CSK4	tlr-pms	InvivoGen
IFN- α		Roche
RG7834		Roche
Lamivudine		
LPS		
Actinomycin D		
Triptolide		
Cycloheximide		

Table 2: Primers and probes sequences used in the studies.

		Sequences 5' ->3' or References	Supplier
HBV (RNA)	Primer forward	ACCGAATGTTGCCCAAGGTC	Eurogentec
	Primer reverse	TATGCCTCAAGGTCGGTCGT	Eurogentec
PRNP	Primer forward	ACCGAGGCAGAGCAGT	Eurogentec
	Primer reverse	CCCCAGTGTTCCATCCTCC	Eurogentec
RPLP0	Primer forward	CACCATTGAAATCCTGAGTGATGT	Eurogentec
	Primer reverse	TGACCAGCCCCAAGGAGAAG	Eurogentec
HBA (Viremia)	Primer forward	GGAGGATACATAGAGGTTCTTGA	Eurogentec
	Primer reverse	GTTGCCCGTTTGTCTCTAATTC	Eurogentec
cccDNA	Primer forward	CCGTGTGCACTTCGCTTCA	Eurogentec
	Primer reverse	GCACAGCTTGGAGGCTTGA	Eurogentec
	Probe	[6FAM]CATGGAGACCACCGTGAACGCCC[BHQ1]	TIB MOLBIOL
Human β -globin		Hs00758889_s1	Life Technologies
GUSB		Hs99999908_m1	Life Technologies
pgRNA	Primer forward	GGAGTGTGGATTTCGCACTCCT	Eurogentec
	Primer reverse	AGATTGAGATCTTCTGCGAC	Eurogentec
	Probe	[6FAM]AGGCAGGTCCCCTAGAAGAAGAACTCC[BHQ1]	TIB MOLBIOL
TLR1	Primer forward	ACAAGCAGGTTGTCTTGTGTT	Eurogentec
	Primer reverse	GAGGGCCTGGTACCCCTATT	Eurogentec
TLR2	Primer forward	CTCTGGTGCTGACATCCAATGGAA	Eurogentec
	Primer reverse	GGGCTTGAACCAGGAAGACGATAA	Eurogentec
TLR3	Primer forward	AGAAGGTTTTCGGGCCAGCTTT	Eurogentec
	Primer reverse	TGACAGCTCAGGGATGTTGGTATG	Eurogentec
TLR6	Primer forward	ACCCATTCCACAGAACAGCATTCC	Eurogentec
	Primer reverse	TCCTTGGGCCACTGCAAATAAGTC	Eurogentec
Fen1	Primer forward	GCCAATCCAGGAATTCCACC	Eurogentec
	Primer reverse	GATTCGCTCCTCAGAGAAGTCTT	Eurogentec
MCPIP1	Primer forward	AACTGGAGAAGAAGAAGATCCTGG	Eurogentec
	Primer reverse	ATTGACGAAGGAGTACATGAGCAG	Eurogentec
HNF4 α	Primer forward	GAGTGGGCCAAGTACA	Eurogentec
	Primer reverse	GGCTTTGAGGTAGGCATA	Eurogentec
APOBEC3B	Primer forward	GACCCTTTGGTCCTTCGAC	Eurogentec
	Primer reverse	GCACAGCCCCAGGAGAAG	Eurogentec

Table 3: Purchaser and reference list of different antibodies used in the studies

Target	Purchasers	References
FEN1	Abcam	Ab17994
TLR1	Cell Signalling	2209S
TLR2	Cell Signalling	12276S
TLR3	Cell Signalling	6961S
TLR6	Cell Signalling	12717S
MCPIP1	GeneTex	GTX110807
NF-κB p65	Cell Signalling	8242S
Phospho-NF-κB p65	Cell Signalling	3033S
NF-κB2 p100/p52 (WB)	Cell Signalling	4882S
NF-κB2 p100/p52 (IP)	Cell Signalling	37359S
RelB	Cell Signalling	10544S
NF-κB p105/p50	Cell Signalling	3035S
Actin-β	Sigma	A2228
Goat Anti-Mouse Immunoglobulins/HRP	Dako	PO447
Goat Anti-Rabbit Immunoglobulins/HRP	Dako	PO448
HBc	ThermoFisher	MA1-7609
H3K27Ac	Diagenode	C15410196
NF-κB p65	Millipore	17-10060
HBsAg	Abbott	MAb H166
HBsAg (F35.25)	-	-
HNF4α	Abcam	ab41898

Table 4: Sequences of siRNAs with references and purchaser used in studies.

	Target sequences	References	Purchaser
siControl	GCCCUUCUCUGCAGUCAAG	D-001810-01-50	Dharmacon
siHBV	CGACCUUGAGGUUAUACUUCUU	Custom	Dharmacon
siFEN1	GGUGAAGGCUGGCAAAGUC GGGUCAAGAGGCUGAGUAA CAAACUAAUUGCUGAUGUG CAAGUACCCUGUGCCAGAA	L-010344-00-0005	Dharmacon
siTLR1	GGCAAUAUGUCUCAACUAA CCGCAGUACUCCAUUCUA CCA AUUGCUCAUUUGAAUA GUUGAGCACACACACUUA	L-008086-00-0005	Dharmacon
siTLR2	AAAUCUGAGAGCUGCGAUA AGGUAAAGUGGAAACGUUA UGUUUGGAACUGCGAGUA AGUAGGAAUGCAAUAACUA	L-005120-01-0005	Dharmacon
siTLR3	GAACUAAAGAUAUCAUGAUU CAGCAUCUGUCUUUAAUAA AGACCAAUCUCUCAAUUU UCACGCAAUUGGAAGAUUA	L-007745-00-0005	Dharmacon
siTLR6	GGUGAAAAGUGAAUUGGUA CAACUAGUUUUAUUCGCUAU GCACCAAGCACAUUCAAGU CCUGUGGAAUAUCUCAAUA	L-005156-00-0005	Dharmacon
siAPOBEC3B	CACAUGGGCUUUCUAUGCA CCUGAUGGAUCCAGACACA UGACCUACGAUGAGUUUGA GUGAUUAAUUGGUCCAUA	L-017322-00-0005	Dharmacon

Table 5: Sequences of crRNA, references and purchaser used in studies.

	Sequences	References	Purchaser
Edit-R Human Non targeting 2 crRNA	-	U-007502-01-20	Dharmacon
Edit-R Human TLR1 crRNA	GTGTATAGACAAGGCCTTCA	CM-008086-01-0002	Dharmacon
Edit-R Human TLR2 crRNA	AACCTGCTGGCCACGCACAT	CM-005120-01-0020	Dharmacon
Edit-R Human TLR3 crRNA	GTTAGGTTGAGTATGTGTAA	CM-007745-01-0002	Dharmacon
Edit-R tracrRNA	-	U-002005-50	Dharmacon

Table 6: sgRNA designed for lentiCRIPR and generation of dHepaRG-Cas 9 KO cell lines.

	Position	Strand	Sequences	PAM	Exon	Specificity Score	Efficiency Score
TLR1	58784	-1	CACCGTTGTATGCCAAACCAGCTGG AAACCCAGCTGGTTTGGCATAACAAC	AGG	4	41.1574669	69.5526439540046
	58510	1	CACCGGGTCTTAGGAGAGACTTATG AAACCATAAGTCTCTCCTAAGACCC	GGG	4	41.6546525	65.3708047572652
TLR2	153703850	1	CACCGTGAAACGTTAACAATCCGG AAACCCGGATTGTTAACGTTCCAC	AGG	1	93.1811822	74.87917659622852
	153703124	1	CACCGTTAGCAACAGTGACCTACAG AAACCTGTAGGTCAGTGTGCTAAC	AGG	1	68.0714882	73.43170064056989
TLR3	12409	-1	CACCGGGAAATTAACGGGACCACCG AAACCGGTGGTCCCCTTAATTTCCC	GGG	6	48.0648961	75.48276420451064
	11614	-1	CACCGAACCGTTGCCGACATCATGG AAACCCATGATGTCGGCAACGGTTC	AGG	6	46.4477338	71.11165548506018
MyD88	38138900	1	CACCGCCGGCAACTGGAGACACAAG AAACCTTGCTCTCCAGTTGCCGGC	CGG	1	60.374396	68.93936884860913
	38138815	1	CACCGTGTCTCTGTTCTTGAAACGTG AAACCACGTTCAAGAACAGAGACAC	CGG	1	75.6193589	65.1594894182281

C. Discussion

References

- Aa, Evelyn van der, Sonja I. Buschow, Paula J. Biesta, Harry L. A. Janssen, and Andrea M. Woltman. 2016. 'The Effect of Chronic Hepatitis B Virus Infection on BDCA3+ Dendritic Cell Frequency and Function'. *PLOS ONE* 11 (8): e0161235. <https://doi.org/10.1371/journal.pone.0161235>.
- Aa, Evelyn van der, Lianne van de Laar, Harry L. A. Janssen, Nadine van Montfoort, and Andrea M. Woltman. 2015. 'BDCA3 Expression Is Associated with High IFN- λ Production by CD34(+)-Derived Dendritic Cells Generated in the Presence of GM-CSF, IL-4, and/or TGF- β '. *European Journal of Immunology* 45 (5): 1471–81. <https://doi.org/10.1002/eji.201444802>.
- Ablasser, Andrea, Jonathan L. Schmid-Burgk, Inga Hemmerling, Gabor L. Horvath, Tobias Schmidt, Eicke Latz, and Veit Hornung. 2013. 'Cell Intrinsic Immunity Spreads to Bystander Cells via the Intercellular Transfer of CGAMP'. *Nature* 503 (7477): 530–34. <https://doi.org/10.1038/nature12640>.
- Addison, William R., Kathie-Anne Walters, Winnie W. S. Wong, John S. Wilson, Danuta Madej, Lawrence D. Jewell, and D. Lorne J. Tyrrell. 2002. 'Half-Life of the Duck Hepatitis B Virus Covalently Closed Circular DNA Pool In Vivo Following Inhibition of Viral Replication'. *Journal of Virology* 76 (12): 6356–63. <https://doi.org/10.1128/JVI.76.12.6356-6363.2002>.
- Ahmed, Chulbul M. I., and Howard M. Johnson. 2006. 'IFN- γ and Its Receptor Subunit IFNGR1 Are Recruited to the IFN- γ -Activated Sequence Element at the Promoter Site of IFN- γ -Activated Genes: Evidence of Transactivational Activity in IFNGR1'. *The Journal of Immunology* 177 (1): 315–21. <https://doi.org/10.4049/jimmunol.177.1.315>.
- AiCuris. 2018. 'AiCuris Reports Positive Phase 1 Clinical Trial Results with Immunomodulator AIC649 in Patients with Chronic Hepatitis B'. 2018. <https://www.aicuris.com/116n119AiCuris-Reports-Positive-Phase-1-Clinical-Trial-Results-with-Immunomodulator-AIC649-in-Patients-with-Chronic-Hepatitis-B.htm>.
- Aillot, Ludovic, Marc Bonnin, Malika Ait-Goughoulte, Nathalie Bendriss-Vermare, Sarah Maadadi, Laura Dimier, Miroslava Subic, et al. 2018. 'Interaction between Toll-Like Receptor 9-CpG Oligodeoxynucleotides and Hepatitis B Virus Virions Leads to Entry Inhibition in Hepatocytes and Reduction of Alpha Interferon Production by Plasmacytoid Dendritic Cells'. *Antimicrobial Agents and Chemotherapy* 62 (4). <https://doi.org/10.1128/AAC.01741-17>.
- Alcamo, E., J. P. Mizgerd, B. H. Horwitz, R. Bronson, A. A. Beg, M. Scott, C. M. Doerschuk, R. O. Hynes, and D. Baltimore. 2001. 'Targeted Mutation of TNF Receptor I Rescues the RelA-Deficient Mouse and Reveals a Critical Role for NF-Kappa B in Leukocyte Recruitment'. *Journal of Immunology (Baltimore, Md.: 1950)* 167 (3): 1592–1600. <https://doi.org/10.4049/jimmunol.167.3.1592>.
- Aleynick, Mark, Judit Svensson-Arvelund, Christopher R. Flowers, Aurélien Marabelle, and Joshua D. Brody. 2019. 'Pathogen Molecular Pattern Receptor Agonists: Treating Cancer by Mimicking Infection'. *Clinical Cancer Research: An Official Journal of the American Association for Cancer Research* 25 (21): 6283–94. <https://doi.org/10.1158/1078-0432.CCR-18-1800>.
- Al-Mahtab, Mamun, Michel Bazinet, and Andrew Vaillant. 2016. 'Safety and Efficacy of Nucleic Acid Polymers in Monotherapy and Combined with Immunotherapy in Treatment-Naive Bangladeshi Patients with HBeAg+ Chronic Hepatitis B Infection'. *PLOS ONE* 11 (6): e0156667. <https://doi.org/10.1371/journal.pone.0156667>.
- Almeida, J. D., D. Rubenstein, and E. J. Stott. 1971. 'New Antigen-Antibody System in Australia-Antigen-Positive Hepatitis'. *Lancet (London, England)* 2 (7736): 1225–27. [https://doi.org/10.1016/s0140-6736\(71\)90543-5](https://doi.org/10.1016/s0140-6736(71)90543-5).
- Amin, Oliver E., Emily J. Colbeck, Stephane Daffis, Shahzada Khan, Dhivya Ramakrishnan, Divya Pattabiraman, Ruth Chu, et al. 2020. 'Therapeutic Potential of TLR8 Agonist GS-9688 (Selgantolimod) in Chronic Hepatitis B: Re-modelling of Antiviral and Regulatory Mediators'. *Hepatology*, December, hep.31695. <https://doi.org/10.1002/hep.31695>.

- Ammi, Rachid, Jorrit De Waele, Yannick Willemen, Ilse Van Brussel, Dorien M. Schrijvers, Eva Lion, and Evelien L. J. Smits. 2015. 'Poly(I:C) as Cancer Vaccine Adjuvant: Knocking on the Door of Medical Breakthroughs'. *Pharmacology & Therapeutics* 146 (February): 120–31. <https://doi.org/10.1016/j.pharmthera.2014.09.010>.
- Andrade, Raquel G. D., Bruno Reis, Benjamin Costas, Sofia A. Costa Lima, and Salette Reis. 2020. 'Modulation of Macrophages M1/M2 Polarization Using Carbohydrate-Functionalized Polymeric Nanoparticles'. *Polymers* 13 (1). <https://doi.org/10.3390/polym13010088>.
- Ank, Nina, Marie B. Iversen, Christina Bartholdy, Peter Staeheli, Rune Hartmann, Uffe B. Jensen, Frederik Dagnaes-Hansen, et al. 2008. 'An Important Role for Type III Interferon (IFN-Lambda/IL-28) in TLR-Induced Antiviral Activity'. *Journal of Immunology (Baltimore, Md.: 1950)* 180 (4): 2474–85. <https://doi.org/10.4049/jimmunol.180.4.2474>.
- Anwer, M. Sawkat, and Bruno Stieger. 2014. 'Sodium-Dependent Bile Salt Transporters of the SLC10A Transporter Family: More than Solute Transporters'. *Pflügers Archiv - European Journal of Physiology* 466 (1): 77–89. <https://doi.org/10.1007/s00424-013-1367-0>.
- Arends, Joop E., Faydra I. Lieveld, Shazaad Ahmad, and Andrew Ustianowski. 2017. 'New Viral and Immunological Targets for Hepatitis B Treatment and Cure: A Review'. *Infectious Diseases and Therapy* 6 (4): 461–76. <https://doi.org/10.1007/s40121-017-0173-y>.
- Aronica, M. A., A. L. Mora, D. B. Mitchell, P. W. Finn, J. E. Johnson, J. R. Sheller, and M. R. Boothby. 1999. 'Preferential Role for NF-Kappa B/Rel Signaling in the Type 1 but Not Type 2 T Cell-Dependent Immune Response in Vivo'. *Journal of Immunology (Baltimore, Md.: 1950)* 163 (9): 5116–24.
- Arrowhead Pharmaceuticals. 2020. 'Arrowhead and Collaborator Janssen Present Phase 2 Clinical Data on Investigational Hepatitis B Therapeutic JNJ-3989 at The Digital Liver Congress', 2.
- Assembly Biosciences. 2021. 'A Phase 2a, Multi-Center, Double-Blind, Placebo-Controlled Study Evaluating ABI-H0731 as Adjunctive Therapy in Virologically-Suppressed Patients With Chronic Hepatitis B'. Clinical trial registration NCT03576066. clinicaltrials.gov. <https://clinicaltrials.gov/ct2/show/NCT03576066>.
- Azuma, Hisaya, Nicole Paulk, Aarati Ranade, Craig Dorrell, Muhsen Al-Dhalimy, Ewa Ellis, Stephen Strom, Mark A Kay, Milton Finegold, and Markus Grompe. 2007. 'Robust Expansion of Human Hepatocytes in Fah^{-/-}/Rag2^{-/-}/Il2rg^{-/-} Mice'. *Nature Biotechnology* 25 (8): 903–10. <https://doi.org/10.1038/nbt1326>.
- Balasubramani, Anand, Yoichiro Shibata, Gregory E. Crawford, Albert S. Baldwin, Robin D. Hatton, and Casey T. Weaver. 2010. 'Modular Utilization of Distal Cis-Regulatory Elements Controls Irfng Gene Expression in T Cells Activated by Distinct Stimuli'. *Immunity* 33 (1): 35–47. <https://doi.org/10.1016/j.immuni.2010.07.004>.
- Balka, Katherine R., and Dominic De Nardo. 2019. 'Understanding Early TLR Signaling through the Myddosome'. *Journal of Leukocyte Biology* 105 (2): 339–51. <https://doi.org/10.1002/JLB.MR0318-096R>.
- Bartenschlager, R, M Junker-Niepmann, and H Schaller. 1990. 'The P Gene Product of Hepatitis B Virus Is Required as a Structural Component for Genomic RNA Encapsidation.' *Journal of Virology* 64 (11): 5324–32. <https://doi.org/10.1128/JVI.64.11.5324-5332.1990>.
- Baud, Véronique, and Michael Karin. 2009. 'Is NF-KB a Good Target for Cancer Therapy? Hopes and Pitfalls'. *Nature Reviews. Drug Discovery* 8 (1): 33–40. <https://doi.org/10.1038/nrd2781>.
- Bazinet, Michel, Victor Pântea, Gheorghe Placinta, Iurie Moscalu, Valentin Cebotarescu, Lilia Cojuhari, Pavlina Jimbei, et al. 2020. 'Safety and Efficacy of 48 Weeks REP 2139 or REP 2165, Tenofovir Disoproxil, and Pegylated Interferon Alfa-2a in Patients With Chronic HBV Infection Naïve to Nucleos(t)ide Therapy'. *Gastroenterology* 158 (8): 2180–94. <https://doi.org/10.1053/j.gastro.2020.02.058>.
- Beck, Jürgen, and Michael Nassal. 2003. 'Efficient Hsp90-Independent in Vitro Activation by Hsc70 and Hsp40 of Duck Hepatitis B Virus Reverse Transcriptase, an Assumed Hsp90 Client Protein'. *The Journal of Biological Chemistry* 278 (38): 36128–38. <https://doi.org/10.1074/jbc.M301069200>.

- Beckebaum, Susanne, Vito R. Cicinnati, Grzegorz Dworacki, Jan Müller-Berghaus, Donna Stolz, Jo Harnaha, Theresa L. Whiteside, et al. 2002. 'Reduction in the Circulating PDC1/PDC2 Ratio and Impaired Function of Ex Vivo-Generated DC1 In Chronic Hepatitis B Infection'. *Clinical Immunology* 104 (2): 138–50. <https://doi.org/10.1006/clim.2002.5245>.
- Belloni, L., T. Pollicino, F. De Nicola, F. Guerrieri, G. Raffa, M. Fanciulli, G. Raimondo, and M. Levrero. 2009. 'Nuclear HBx Binds the HBV Minichromosome and Modifies the Epigenetic Regulation of CccDNA Function'. *Proceedings of the National Academy of Sciences* 106 (47): 19975–79. <https://doi.org/10.1073/pnas.0908365106>.
- Belloni, Laura, Lena Allweiss, Francesca Guerrieri, Natalia Pediconi, Tassilo Volz, Teresa Pollicino, Joerg Petersen, Giovanni Raimondo, Maura Dandri, and Massimo Levrero. 2012. 'IFN- α Inhibits HBV Transcription and Replication in Cell Culture and in Humanized Mice by Targeting the Epigenetic Regulation of the Nuclear CccDNA Minichromosome'. *The Journal of Clinical Investigation* 122 (2): 529–37. <https://doi.org/10.1172/JCI58847>.
- Bermejo-Jambrina, Marta, Julia Eder, Leanne C. Helgers, Nina Hertoghs, Bernadien M. Nijmeijer, Melissa Stunnenberg, and Teunis B. H. Geijtenbeek. 2018. 'C-Type Lectin Receptors in Antiviral Immunity and Viral Escape'. *Frontiers in Immunology* 9 (March): 590. <https://doi.org/10.3389/fimmu.2018.00590>.
- Bertoletti, Antonio, Patrick T F Kennedy, and David Durantel. 2018. 'HBV Infection and HCC: The "Dangerous Liaisons"'. *Gut* 67 (5): 787–88. <https://doi.org/10.1136/gutjnl-2017-315528>.
- Beutler, Bruce, Zhengfan Jiang, Philippe Georgel, Karine Crozat, Ben Croker, Sophie Rutschmann, Xin Du, and Kasper Hoebe. 2006. 'GENETIC ANALYSIS OF HOST RESISTANCE: Toll-Like Receptor Signaling and Immunity at Large'. *Annual Review of Immunology* 24 (1): 353–89. <https://doi.org/10.1146/annurev.immunol.24.021605.090552>.
- Bian, Yingjie, Zheng Zhang, Zhichen Sun, Juanjuan Zhao, Danming Zhu, Yang Wang, Sherry Fu, et al. 2017. 'Vaccines Targeting PreS1 Domain Overcome Immune Tolerance in Hepatitis B Virus Carrier Mice: Bian et Al.'. *Hepatology* 66 (4): 1067–82. <https://doi.org/10.1002/hep.29239>.
- Biermer, Michael, Robyn Puro, and Robert J. Schneider. 2003. 'Tumor Necrosis Factor Alpha Inhibition of Hepatitis B Virus Replication Involves Disruption of Capsid Integrity through Activation of NF-KappaB'. *Journal of Virology* 77 (7): 4033–42. <https://doi.org/10.1128/jvi.77.7.4033-4042.2003>.
- Bill, C. A., and J. Summers. 2004. 'Genomic DNA Double-Strand Breaks Are Targets for Hepadnaviral DNA Integration'. *Proceedings of the National Academy of Sciences* 101 (30): 11135–40. <https://doi.org/10.1073/pnas.0403925101>.
- Bloom, Kristie, Abdullah Ely, Claudio Mussolino, Toni Cathomen, and Patrick Arbuthnot. 2013. 'Inactivation of Hepatitis B Virus Replication in Cultured Cells and in Vivo with Engineered Transcription Activator-like Effector Nucleases'. *Molecular Therapy: The Journal of the American Society of Gene Therapy* 21 (10): 1889–97. <https://doi.org/10.1038/mt.2013.170>.
- Bloom, Kristie, Mohube Betty Maepa, Abdullah Ely, and Patrick Arbuthnot. 2018. 'Gene Therapy for Chronic HBV—Can We Eliminate CccDNA?' *Genes* 9 (4). <https://doi.org/10.3390/genes9040207>.
- Blumberg, Baruch S., and Harvey J. Alter. 1965. 'A "New" Antigen in Leukemia Sera'. *JAMA* 191 (7): 541–46. <https://doi.org/10.1001/jama.1965.03080070025007>.
- Blumberg BS, Gerstley BJ, Hungerford DA, London WT, Sutnick AI. 1967. 'A Serum Antigen (Australia Antigen) in Down's Syndrome, Leukemia, and Hepatitis.' *Ann Intern Med.*, May 1967. <https://doi.org/10.7326/0003-4819-66-5-924>. PMID: 4225883.
- Blumenthal, Antje, Toshihiko Kobayashi, Lynda M. Pierini, Niaz Banaei, Joel D. Ernst, Kensuke Miyake, and Sabine Ehrt. 2009. 'RP105 Facilitates Macrophage Activation by Mycobacterium Tuberculosis Lipoproteins'. *Cell Host & Microbe* 5 (1): 35–46. <https://doi.org/10.1016/j.chom.2008.12.002>.
- Blumer, Tanja, Mairene Coto-Llerena, Francois H. T. Duong, and Markus H. Heim. 2017. 'SOCS1 Is an Inducible Negative Regulator of Interferon λ (IFN- λ)-Induced Gene Expression in Vivo'. *The*

- Journal of Biological Chemistry* 292 (43): 17928–38.
<https://doi.org/10.1074/jbc.M117.788877>.
- Bock, Claus-Thomas, Peter Schranz, Claus Hobe Schröder, and Hanswalter Zentgraf. 1994. 'Hepatitis B Virus Genome Is Organized into Nucleosomes in the Nucleus of the Infected Cell'. *Virus Genes* 8 (2): 215–29. <https://doi.org/10.1007/BF01703079>.
- Bock, C.Thomas, Susanne Schwinn, Stephen Locarnini, Janet Fyfe, Michael P Manns, Christian Trautwein, and Hanswalter Zentgraf. 2001. 'Structural Organization of the Hepatitis B Virus Minichromosome'. *Journal of Molecular Biology* 307 (1): 183–96.
<https://doi.org/10.1006/jmbi.2000.4481>.
- Bockmann, Jan-Hendrik, Daniela Stadler, Yuchen Xia, Chunkyu Ko, Jochen M Wettengel, Julian Schulze zur Wiesch, Maura Dandri, and Ulrike Protzer. 2019. 'Comparative Analysis of the Antiviral Effects Mediated by Type I and III Interferons in Hepatitis B Virus–Infected Hepatocytes'. *The Journal of Infectious Diseases* 220 (4): 567–77.
<https://doi.org/10.1093/infdis/jiz143>.
- Bogomolov, Pavel, Alexander Alexandrov, Natalia Voronkova, Maria Macievich, Ksenia Kokina, Maria Petrachenkova, Thorsten Lehr, et al. 2016. 'Treatment of Chronic Hepatitis D with the Entry Inhibitor Myrcludex B: First Results of a Phase Ib/IIa Study'. *Journal of Hepatology* 65 (3): 490–98. <https://doi.org/10.1016/j.jhep.2016.04.016>.
- Boltjes, Arjan, Nadine van Montfoort, Paula J. Biesta, Marjoleine L. Op den Brouw, Jaap Kwekkeboom, Luc J. W. van der Laan, Harry L. A. Janssen, André Boonstra, and Andrea M. Woltman. 2015. 'Kupffer Cells Interact With Hepatitis B Surface Antigen In Vivo and In Vitro, Leading to Proinflammatory Cytokine Production and Natural Killer Cell Function'. *The Journal of Infectious Diseases* 211 (8): 1268–78. <https://doi.org/10.1093/infdis/jiu599>.
- Boltjes, Arjan, Dowty Movita, André Boonstra, and Andrea M. Woltman. 2014. 'The Role of Kupffer Cells in Hepatitis B and Hepatitis C Virus Infections'. *Journal of Hepatology* 61 (3): 660–71.
<https://doi.org/10.1016/j.jhep.2014.04.026>.
- Bömmel, Florian van, and Thomas Berg. 2013. 'Treatment of HBV Related Cirrhosis'. *Liver International* 33 (February): 176–81. <https://doi.org/10.1111/liv.12074>.
- . 2014. 'Antiviral Therapy of Chronic Hepatitis B'. *Intervirology* 57 (3–4): 171–80.
<https://doi.org/10.1159/000360945>.
- Bonaventura, Paola, Tala Shekarian, Vincent Alcazer, Jenny Valladeau-Guilemond, Sandrine Valsesia-Wittmann, Sebastian Amigorena, Christophe Caux, and Stéphane Depil. 2019. 'Cold Tumors: A Therapeutic Challenge for Immunotherapy'. *Frontiers in Immunology* 10: 168.
<https://doi.org/10.3389/fimmu.2019.00168>.
- Boni, Carolina, Harry L. A. Janssen, Marzia Rossi, Seung Kew Yoon, Andrea Vecchi, Valeria Barili, Eric M. Yoshida, et al. 2019. 'Combined GS-4774 and Tenofovir Therapy Can Improve HBV-Specific T-Cell Responses in Patients With Chronic Hepatitis'. *Gastroenterology* 157 (1): 227-241.e7. <https://doi.org/10.1053/j.gastro.2019.03.044>.
- Boni, Carolina, Diletta Laccabue, Pietro Lampertico, Tiziana Giuberti, Mauro Viganò, Simona Schivazappa, Arianna Alfieri, et al. 2012. 'Restored Function of HBV-Specific T Cells after Long-Term Effective Therapy with Nucleos(t)Ide Analogues'. *Gastroenterology* 143 (4): 963-973.e9. <https://doi.org/10.1053/j.gastro.2012.07.014>.
- Boni, Carolina, Andrea Vecchi, Marzia Rossi, Diletta Laccabue, Tiziana Giuberti, Arianna Alfieri, Pietro Lampertico, et al. 2018. 'TLR7 Agonist Increases Responses of Hepatitis B Virus-Specific T Cells and Natural Killer Cells in Patients With Chronic Hepatitis B Treated With Nucleos(T)Ide Analogues'. *Gastroenterology* 154 (6): 1764-1777.e7.
<https://doi.org/10.1053/j.gastro.2018.01.030>.
- Bortolami, M., A. Kotsafti, R. Cardin, and F. Farinati. 2008. 'Fas / FasL System, IL-1 β Expression and Apoptosis in Chronic HBV and HCV Liver Disease'. *Journal of Viral Hepatitis* 15 (7): 515–22.
<https://doi.org/10.1111/j.1365-2893.2008.00974.x>.
- Bouchard, Michael J., and Robert J. Schneider. 2004. 'The Enigmatic X Gene of Hepatitis B Virus'. *Journal of Virology* 78 (23): 12725–34. <https://doi.org/10.1128/JVI.78.23.12725-12734.2004>.

- Bouezzedine, Fidaa, Olivier Fardel, and Philippe Gripon. 2015. 'Interleukin 6 Inhibits HBV Entry through NTCP down Regulation'. *Virology* 481 (July): 34–42. <https://doi.org/10.1016/j.virol.2015.02.026>.
- Bremer, Corinna M., Christiane Bung, Nicole Kott, Martin Hardt, and Dieter Glebe. 2009. 'Hepatitis B Virus Infection Is Dependent on Cholesterol in the Viral Envelope'. *Cellular Microbiology* 11 (2): 249–60. <https://doi.org/10.1111/j.1462-5822.2008.01250.x>.
- Briard, Benoit, David E. Place, and Thirumala-Devi Kanneganti. 2020. 'DNA Sensing in the Innate Immune Response'. *Physiology* 35 (2): 112–24. <https://doi.org/10.1152/physiol.00022.2019>.
- Brouwer, Willem Pieter, Qing Xie, Milan J. Sonneveld, Ningping Zhang, Qin Zhang, Fehmi Tabak, Adrian Streinu-Cercel, et al. 2015. 'Adding Pegylated Interferon to Entecavir for Hepatitis B e Antigen-Positive Chronic Hepatitis B: A Multicenter Randomized Trial (ARES Study)'. *Hepatology (Baltimore, Md.)* 61 (5): 1512–22. <https://doi.org/10.1002/hep.27586>.
- Broz, Petr, and Vishva M. Dixit. 2016. 'Inflammasomes: Mechanism of Assembly, Regulation and Signalling'. *Nature Reviews. Immunology* 16 (7): 407–20. <https://doi.org/10.1038/nri.2016.58>.
- Bruss, Volker. 2007. 'Hepatitis B Virus Morphogenesis'. *World Journal of Gastroenterology : WJG* 13 (1): 65–73. <https://doi.org/10.3748/wjg.v13.i1.65>.
- Burdette, Dara L., Kathryn M. Monroe, Katia Sotelo-Troha, Jeff S. Iwig, Barbara Eckert, Mamoru Hyodo, Yoshihiro Hayakawa, and Russell E. Vance. 2011. 'STING Is a Direct Innate Immune Sensor of Cyclic Di-GMP'. *Nature* 478 (7370): 515–18. <https://doi.org/10.1038/nature10429>.
- Burrell C.J, Mackay P, Greenaway P.J., Hofschneider P.H., Murray K. 1979. 'Expression in Escherichia Coli of Hepatitis B Virus DNA Sequences Cloned in Plasmid PBR322', 3 May 1979, Nature edition.
- Burwitz, Benjamin J., Jochen M. Wettengel, Martin A. Mück-Häusl, Marc Ringelhan, Chunkyu Ko, Marvin M. Festag, Katherine B. Hammond, et al. 2017. 'Hepatocytic Expression of Human Sodium-Taurocholate Cotransporting Polypeptide Enables Hepatitis B Virus Infection of Macaques'. *Nature Communications* 8 (1): 2146. <https://doi.org/10.1038/s41467-017-01953-y>.
- Burwitz, Benjamin J., Zhongmin Zhou, and Wenhui Li. 2020. 'Animal Models for the Study of Human Hepatitis B and D Virus Infection: New Insights and Progress'. *Antiviral Research* 182 (October): 104898. <https://doi.org/10.1016/j.antiviral.2020.104898>.
- Buti, Maria, Mar Riveiro-Barciela, and Rafael Esteban. 2017. 'Tenofovir Alafenamide Fumarate: A New Tenofovir Prodrug for the Treatment of Chronic Hepatitis B Infection'. *The Journal of Infectious Diseases* 216 (suppl_8): S792–96. <https://doi.org/10.1093/infdis/jix135>.
- Butler, Marion P., Jennifer A. Hanly, and Paul N. Moynagh. 2007. 'Kinase-Active Interleukin-1 Receptor-Associated Kinases Promote Polyubiquitination and Degradation of the Pellino Family: Direct Evidence for PELLINO Proteins Being Ubiquitin-Protein Isopeptide Ligases'. *The Journal of Biological Chemistry* 282 (41): 29729–37. <https://doi.org/10.1074/jbc.M704558200>.
- Buwitt-Beckmann, Ute, Holger Heine, Karl-Heinz Wiesmüller, Günther Jung, Roland Brock, Shizuo Akira, and Artur J. Ulmer. 2006. 'TLR1- and TLR6-Independent Recognition of Bacterial Lipopeptides'. *Journal of Biological Chemistry* 281 (14): 9049–57. <https://doi.org/10.1074/jbc.M512525200>.
- Cao, Zhen Huan, Li Na Ma, Hong Wei Zhang, Ya Li Liu, and Xin Yue Chen. 2013. 'Extended Treatment with Peginterferon α -2a in Combination with Lamivudine or Adefovir for 96 Weeks Yields High Rates of HBeAg and HBsAg Seroconversion'. *Journal of Digestive Diseases* 14 (8): 446–50. <https://doi.org/10.1111/1751-2980.12065>.
- Caplan, Ian F., and Kathleen A. Maguire-Zeiss. 2018. 'Toll-Like Receptor 2 Signaling and Current Approaches for Therapeutic Modulation in Synucleinopathies'. *Frontiers in Pharmacology* 9: 417. <https://doi.org/10.3389/fphar.2018.00417>.
- Carey, Ivana, Lorenzo D'Antiga, Sanjay Bansal, Maria Serena Longhi, Yun Ma, Irene Rebollo Mesa, Giorgina Mieli-Vergani, and Diego Vergani. 2011. 'Immune and Viral Profile from Tolerance to

- Hepatitis B Surface Antigen Clearance: A Longitudinal Study of Vertically Hepatitis B Virus-Infected Children on Combined Therapy'. *Journal of Virology* 85 (5): 2416–28. <https://doi.org/10.1128/JVI.01449-10>.
- Casalini, Tommaso, Filippo Rossi, Andrea Castrovinci, and Giuseppe Perale. 2019. 'A Perspective on Polylactic Acid-Based Polymers Use for Nanoparticles Synthesis and Applications'. *Frontiers in Bioengineering and Biotechnology* 7. <https://doi.org/10.3389/fbioe.2019.00259>.
- Castro, Flávia, Ana Patrícia Cardoso, Raquel Madeira Gonçalves, Karine Serre, and Maria José Oliveira. 2018. 'Interferon-Gamma at the Crossroads of Tumor Immune Surveillance or Evasion'. *Frontiers in Immunology* 9. <https://doi.org/10.3389/fimmu.2018.00847>.
- Chabrolles, H  l  ne, H  lo  se Auclair, Serena Vegna, Thomas Lahlali, Caroline Pons, Maud Michelet, Yohann Cout  , et al. 2020. 'Hepatitis B Virus Core Protein Nuclear Interactome Identifies SRSF10 as a Host RNA-Binding Protein Restricting HBV RNA Production'. *PLoS Pathogens* 16 (11). <https://doi.org/10.1371/journal.ppat.1008593>.
- Chan, Henry L. Y., Sang Hoon Ahn, Ting-Tsung Chang, Cheng-Yuan Peng, David Wong, Carla S. Coffin, Seng Gee Lim, et al. 2016. 'Peginterferon Lambda for the Treatment of HBeAg-Positive Chronic Hepatitis B: A Randomized Phase 2b Study (LIRA-B)'. *Journal of Hepatology* 64 (5): 1011–19. <https://doi.org/10.1016/j.jhep.2015.12.018>.
- Chan, Stephen, Vincent Wong, Shukui Qin, and Henry Chan. 2015. 'Infection and Cancer: The Case of Hepatitis B'. *Journal of Clinical Oncology : Official Journal of the American Society of Clinical Oncology* 34 (November). <https://doi.org/10.1200/JCO.2015.61.5724>.
- Chang, Mikyoung, Andrew J. Lee, Leo Fitzpatrick, Minying Zhang, and Shao-Cong Sun. 2009. 'NF-Kappa B1 P105 Regulates T Cell Homeostasis and Prevents Chronic Inflammation'. *Journal of Immunology (Baltimore, Md.: 1950)* 182 (5): 3131–38. <https://doi.org/10.4049/jimmunol.0803637>.
- Chang, Young, Won Hyeok Choe, Dong Hyun Sinn, Jeong-Hoon Lee, Sang Hoon Ahn, Hyewon Lee, Jae-Jun Shim, et al. 2017. 'Nucleos(t)ide Analogue Treatment for Patients With Hepatitis B Virus (HBV) e Antigen-Positive Chronic HBV Genotype C Infection: A Nationwide, Multicenter, Retrospective Study'. *The Journal of Infectious Diseases* 216 (11): 1407–14. <https://doi.org/10.1093/infdis/jix506>.
- Chen, Christopher Y., Benjamin Y. Winer, Deborah Chavez, Bernadette Guerra, Kathleen M. Brasky, Stacey Eng, Eduardo Salas, et al. 2020. 'Woolly Monkey-HBV Infection in Squirrel Monkeys as a Surrogate Nonhuman Primate Model of HBV Infection'. *Hepatology Communications* 4 (3): 371–86. <https://doi.org/10.1002/hep4.1471>.
- Chen, Jieliang, Min Wu, Xiaonan Zhang, Wen Zhang, Zhanqing Zhang, Lixiang Chen, Jing He, et al. 2013. 'Hepatitis B Virus Polymerase Impairs Interferon-  -Induced STA T Activation through Inhibition of Importin-A5 and Protein Kinase C-  '. *Hepatology* 57 (2): 470–82. <https://doi.org/10.1002/hep.26064>.
- Chen, Jieliang, Wen Zhang, Junyu Lin, Fan Wang, Min Wu, Cuncun Chen, Ye Zheng, Xiuhua Peng, Jianhua Li, and Zhenghong Yuan. 2014. 'An Efficient Antiviral Strategy for Targeting Hepatitis B Virus Genome Using Transcription Activator-Like Effector Nucleases'. *Molecular Therapy* 22 (2): 303–11. <https://doi.org/10.1038/mt.2013.212>.
- Chen, Nanhua, Pengpeng Xia, Shuangjie Li, Tangjie Zhang, Tony T. Wang, and Jianzhong Zhu. 2017. 'RNA Sensors of the Innate Immune System and Their Detection of Pathogens'. *Iubmb Life* 69 (5): 297–304. <https://doi.org/10.1002/iub.1625>.
- Chen, Ping, Yun Gan, Na Han, Wei Fang, Jiafu Li, Fei Zhao, Kanghong Hu, and Simon Rayner. 2013. 'Computational Evolutionary Analysis of the Overlapped Surface (S) and Polymerase (P) Region in Hepatitis B Virus Indicates the Spacer Domain in P Is Crucial for Survival'. Edited by Yury E. Khudiyakov. *PLoS ONE* 8 (4): e60098. <https://doi.org/10.1371/journal.pone.0060098>.
- Cheng, Jidong, Hiroyasu Imanishi, Hiroko Morisaki, Weidong Liu, Hideji Nakamura, Takayuki Morisaki, and Toshikazu Hada. 2005. 'Recombinant HBsAg Inhibits LPS-Induced COX-2 Expression and IL-18 Production by Interfering with the NF  B Pathway in a Human Monocytic Cell Line, THP-1'. *Journal of Hepatology* 43 (3): 465–71. <https://doi.org/10.1016/j.jhep.2005.02.033>.

- Cheng, Kui, Meng Gao, James I. Godfroy, Peter N. Brown, Noah Kastelowitz, and Hang Yin. 2015. 'Specific Activation of the TLR1-TLR2 Heterodimer by Small-Molecule Agonists'. *Science Advances* 1 (3): e1400139. <https://doi.org/10.1126/sciadv.1400139>.
- Chiang, John Y. L., and Jessica M. Ferrell. 2020. 'Bile Acid Receptors FXR and TGR5 Signaling in Fatty Liver Diseases and Therapy'. *American Journal of Physiology-Gastrointestinal and Liver Physiology* 318 (3): G554–73. <https://doi.org/10.1152/ajpgi.00223.2019>.
- Chiffolleau, Elise. 2018. 'C-Type Lectin-Like Receptors As Emerging Orchestrators of Sterile Inflammation Represent Potential Therapeutic Targets'. *Frontiers in Immunology* 9 (February). <https://doi.org/10.3389/fimmu.2018.00227>.
- Chmiest, Daniela, Nanaocha Sharma, Natacha Zanin, Christine Viaris de Lesegno, Massiullah Shafaq-Zadah, Vonick Sibut, Florent Dingli, et al. 2016. 'Spatiotemporal Control of Interferon-Induced JAK/STAT Signalling and Gene Transcription by the Retromer Complex'. *Nature Communications* 7 (December): 13476. <https://doi.org/10.1038/ncomms13476>.
- Cho, Il-rae, Myungju Oh, Sang Seok Koh, Waraporn Malilas, Ratakorn Srisuttee, Byung Hak Jhun, Sandra Pellegrini, Serge Y. Fuchs, and Young-Hwa Chung. 2012. 'Hepatitis B Virus X Protein Inhibits Extracellular IFN- α -Mediated Signal Transduction by Downregulation of Type I IFN Receptor'. *International Journal of Molecular Medicine* 29 (4): 581–86. <https://doi.org/10.3892/ijmm.2012.879>.
- Chong, Chern Hao, and Seng Gee Lim. 2017. 'When Can We Stop Nucleoside Analogues in Patients with Chronic Hepatitis B?' *Liver International* 37 (S1): 52–58. <https://doi.org/10.1111/liv.13314>.
- Chyuan, I-Tsu, Hong-Tai Tzeng, and Ji-Yih Chen. 2019. 'Signaling Pathways of Type I and Type III Interferons and Targeted Therapies in Systemic Lupus Erythematosus'. *Cells* 8 (9). <https://doi.org/10.3390/cells8090963>.
- Cicchese, Joseph M., Stephanie Evans, Caitlin Hult, Louis R. Joslyn, Timothy Wessler, Jess A. Millar, Simeone Marino, et al. 2018. 'Dynamic Balance of Pro- and Anti-Inflammatory Signals Controls Disease and Limits Pathology'. *Immunological Reviews* 285 (1): 147–67. <https://doi.org/10.1111/imr.12671>.
- Clark, Daniel N, and Jianming Hu. 2015. 'Unveiling the Roles of HBV Polymerase for New Antiviral Strategies'. *Future Virology* 10 (3): 283–95. <https://doi.org/10.2217/fvl.14.113>.
- Claudio, Estefania, Keith Brown, Sun Park, Hongshan Wang, and Ulrich Siebenlist. 2002. 'BAFF-Induced NEMO-Independent Processing of NF-Kappa B2 in Maturing B Cells'. *Nature Immunology* 3 (10): 958–65. <https://doi.org/10.1038/ni842>.
- Concetti, Julia, and Caroline L. Wilson. 2018. 'NFKB1 and Cancer: Friend or Foe?' *Cells* 7 (9). <https://doi.org/10.3390/cells7090133>.
- Cooper, Arik, Guy Tal, Ofer Lider, and Yosef Shaul. 2005. 'Cytokine Induction by the Hepatitis B Virus Capsid in Macrophages Is Facilitated by Membrane Heparan Sulfate and Involves TLR2'. *The Journal of Immunology* 175 (5): 3165–76. <https://doi.org/10.4049/jimmunol.175.5.3165>.
- Cooper, C. L., H. L. Davis, M. L. Morris, S. M. Efler, M. Al Adhami, A. M. Krieg, D. W. Cameron, and J. Heathcote. 2004. 'CPG 7909, an Immunostimulatory TLR9 Agonist Oligodeoxynucleotide, as Adjuvant to Engerix-B HBV Vaccine in Healthy Adults: A Double-Blind Phase I/II Study'. *Journal of Clinical Immunology* 24 (6): 693–701. <https://doi.org/10.1007/s10875-004-6244-3>.
- Cooper, Curtis, and David Mackie. 2011. 'Hepatitis B Surface Antigen-1018 ISS Adjuvant-Containing Vaccine: A Review of HEPLISAV™ Safety and Efficacy'. *Expert Review of Vaccines* 10 (4): 417–27. <https://doi.org/10.1586/erv.10.162>.
- Cornberg, Markus, Vincent Wai-Sun Wong, Stephen Locarnini, Maurizia Brunetto, Harry L. A. Janssen, and Henry Lik-Yuen Chan. 2017. 'The Role of Quantitative Hepatitis B Surface Antigen Revisited'. *Journal of Hepatology* 66 (2): 398–411. <https://doi.org/10.1016/j.jhep.2016.08.009>.
- Cougot, Delphine, Yuanfei Wu, Stefano Cairo, Julie Caramel, Claire-Angélique Renard, Laurence Lévy, Marie Annick Buendia, and Christine Neuveut. 2007. 'The Hepatitis B Virus X Protein Functionally Interacts with CREB-Binding Protein/P300 in the Regulation of CREB-Mediated

- Transcription'. *The Journal of Biological Chemistry* 282 (7): 4277–87. <https://doi.org/10.1074/jbc.M606774200>.
- Cradick, Thomas J, Kathy Keck, Shannon Bradshaw, Andrew C Jamieson, and Anton P McCaffrey. 2010. 'Zinc-Finger Nucleases as a Novel Therapeutic Strategy for Targeting Hepatitis B Virus DNAs'. *Molecular Therapy* 18 (5): 947–54. <https://doi.org/10.1038/mt.2010.20>.
- Crispe, Ian N. 2016. 'Hepatocytes as Immunological Agents'. *The Journal of Immunology* 196 (1): 17–21. <https://doi.org/10.4049/jimmunol.1501668>.
- Crispe, Ian Nicholas. 2009. 'The Liver as a Lymphoid Organ'. *Annual Review of Immunology* 27 (1): 147–63. <https://doi.org/10.1146/annurev.immunol.021908.132629>.
- . 2011. 'Liver Antigen-Presenting Cells'. *Journal of Hepatology* 54 (2): 357–65. <https://doi.org/10.1016/j.jhep.2010.10.005>.
- Cui, Xiuji, Rebecca McAllister, Rajeev Boregowda, Ji A. Sohn, Felipe Cortes Ledesma, Keith W. Caldecott, Christoph Seeger, and Jianming Hu. 2015. 'Does Tyrosyl DNA Phosphodiesterase-2 Play a Role in Hepatitis B Virus Genome Repair?' Edited by Chiaho Shih. *PLOS ONE* 10 (6): e0128401. <https://doi.org/10.1371/journal.pone.0128401>.
- Daffis, Stephane, Scott Balsitis, Jason Chamberlain, Jim Zheng, Rex Santos, William Rowe, Dhivya Ramakrishnan, et al. 2021. 'Toll-Like Receptor 8 Agonist GS-9688 Induces Sustained Efficacy in the Woodchuck Model of Chronic Hepatitis B'. *Hepatology (Baltimore, Md.)* 73 (1): 53–67. <https://doi.org/10.1002/hep.31255>.
- Dandri, M. 2001. 'Repopulation of Mouse Liver with Human Hepatocytes and in Vivo Infection with Hepatitis B Virus'. *Hepatology* 33 (4): 981–88. <https://doi.org/10.1053/jhep.2001.23314>.
- Dandri, Maura, and Joerg Petersen. 2017. 'Animal Models of HBV Infection'. *Best Practice & Research Clinical Gastroenterology* 31 (3): 273–79. <https://doi.org/10.1016/j.bpg.2017.04.014>.
- Dane, D. S., C. H. Cameron, and M. Briggs. 1970. 'Virus-like Particles in Serum of Patients with Australia-Antigen-Associated Hepatitis'. *Lancet (London, England)* 1 (7649): 695–98. [https://doi.org/10.1016/s0140-6736\(70\)90926-8](https://doi.org/10.1016/s0140-6736(70)90926-8).
- Das, J., C. H. Chen, L. Yang, L. Cohn, P. Ray, and A. Ray. 2001. 'A Critical Role for NF-Kappa B in GATA3 Expression and TH2 Differentiation in Allergic Airway Inflammation'. *Nature Immunology* 2 (1): 45–50. <https://doi.org/10.1038/83158>.
- Davis, Beckley K., Haitao Wen, and Jenny P.-Y. Ting. 2011. 'The Inflammasome NLRs in Immunity, Inflammation, and Associated Diseases'. *Annual Review of Immunology* 29: 707–35. <https://doi.org/10.1146/annurev-immunol-031210-101405>.
- Decorsière, Adrien, Henrik Mueller, Pieter C. van Breugel, Fabien Abdul, Laetitia Gerossier, Rudolf K. Beran, Christine M. Livingston, et al. 2016. 'Hepatitis B Virus X Protein Identifies the Smc5/6 Complex as a Host Restriction Factor'. *Nature* 531 (7594): 386–89. <https://doi.org/10.1038/nature17170>.
- DeFilippis, Victor R., David Alvarado, Tina Sali, Stefan Rothenburg, and Klaus Früh. 2010. 'Human Cytomegalovirus Induces the Interferon Response via the DNA Sensor ZBP1'. *Journal of Virology* 84 (1): 585–98. <https://doi.org/10.1128/JVI.01748-09>.
- Dempsey, Alan, and Andrew G. Bowie. 2015. 'Innate Immune Recognition of DNA: A Recent History'. *Virology* 479–480 (May): 146–52. <https://doi.org/10.1016/j.virol.2015.03.013>.
- Dény, P., and F. Zoulim. 2010. 'Hepatitis B Virus: From Diagnosis to Treatment'. *Pathologie Biologie* 58 (4): 245–53. <https://doi.org/10.1016/j.patbio.2010.05.002>.
- Di Gioia, Marco, and Ivan Zanoni. 2015. 'Toll-like Receptor Co-Receptors as Master Regulators of the Immune Response'. *Molecular Immunology* 63 (2): 143–52. <https://doi.org/10.1016/j.molimm.2014.05.008>.
- Dicerna Pharmaceuticals. 2020. 'Information about Dicerna's Drug Candidate DCR-HBVS (RG6346)'. *Dicerna Pharmaceuticals* (blog). 2020. <https://dicerna.com/pipeline/rg6346/>.
- Didierlaurent, Arnaud M., Sandra Morel, Laurence Lockman, Sandra L. Giannini, Michel Bisteau, Harald Carlsen, Anders Kielland, et al. 2009. 'AS04, an Aluminum Salt- and TLR4 Agonist-Based Adjuvant System, Induces a Transient Localized Innate Immune Response Leading to

- Enhanced Adaptive Immunity'. *The Journal of Immunology* 183 (10): 6186–97. <https://doi.org/10.4049/jimmunol.0901474>.
- Diebold, S. S. 2004. 'Innate Antiviral Responses by Means of TLR7-Mediated Recognition of Single-Stranded RNA'. *Science* 303 (5663): 1529–31. <https://doi.org/10.1126/science.1093616>.
- Dion, S., M. Bourguine, O. Godon, F. Levillayer, and M.-L. Michel. 2013. 'Adeno-Associated Virus-Mediated Gene Transfer Leads to Persistent Hepatitis B Virus Replication in Mice Expressing HLA-A2 and HLA-DR1 Molecules'. *Journal of Virology* 87 (10): 5554–63. <https://doi.org/10.1128/JVI.03134-12>.
- Dixon, Laura J., Mark Barnes, Hui Tang, Michele T. Pritchard, and Laura E. Nagy. 2013. 'Kupffer Cells in the Liver'. In *Comprehensive Physiology*, edited by Ronald Terjung, c120026. Hoboken, NJ, USA: John Wiley & Sons, Inc. <https://doi.org/10.1002/cphy.c120026>.
- Doherty, Derek G. 2016. 'Immunity, Tolerance and Autoimmunity in the Liver: A Comprehensive Review'. *Journal of Autoimmunity* 66 (January): 60–75. <https://doi.org/10.1016/j.jaut.2015.08.020>.
- Donello, John E., Jonathan E. Loeb, and Thomas J. Hope. 1998. 'Woodchuck Hepatitis Virus Contains a Tripartite Posttranscriptional Regulatory Element'. *Journal of Virology* 72 (6): 5085–92.
- Donkers, Joanne M., Benno Zehnder, Gerard J. P. van Westen, Mark J. Kwakkenbos, Adriaan P. IJzerman, Ronald P. J. Oude Elferink, Ulrich Beuers, Stephan Urban, and Stan F. J. van de Graaf. 2017. 'Reduced Hepatitis B and D Viral Entry Using Clinically Applied Drugs as Novel Inhibitors of the Bile Acid Transporter NTCP'. *Scientific Reports* 7 (1). <https://doi.org/10.1038/s41598-017-15338-0>.
- DUAN, XUE-ZHANG, MIN WANG, HAN-WEI LI, HUI ZHUANG, DONGPING XU, and FU-SHENG WANG. 2004. 'Decreased Frequency and Function of Circulating Plasmacytoid Dendritic Cells (PDC) in Hepatitis B Virus Infected Humans'. *Journal of Clinical Immunology* 24 (6): 637–46. <https://doi.org/10.1007/s10875-004-6249-y>.
- Dunn, Claire, Dimitra Peppas, Pooja Khanna, Gaia Nebbia, Meleri Jones, Nathan Brendish, R. Monica Lascar, et al. 2009. 'Temporal Analysis of Early Immune Responses in Patients With Acute Hepatitis B Virus Infection'. *Gastroenterology* 137 (4): 1289–1300. <https://doi.org/10.1053/j.gastro.2009.06.054>.
- Dupont, Juan, Javier Altclas, Alejandro Lepetic, Mónica Lombardo, Vicente Vázquez, Claudia Salgueira, Mauricio Seigelchifer, et al. 2006. 'A Controlled Clinical Trial Comparing the Safety and Immunogenicity of a New Adjuvanted Hepatitis B Vaccine with a Standard Hepatitis B Vaccine'. *Vaccine* 24 (49–50): 7167–74. <https://doi.org/10.1016/j.vaccine.2006.06.053>.
- Durantel, David, and Fabien Zoulim. 2016. 'New Antiviral Targets for Innovative Treatment Concepts for Hepatitis B Virus and Hepatitis Delta Virus'. *Journal of Hepatology* 64 (1): S117–31. <https://doi.org/10.1016/j.jhep.2016.02.016>.
- Duriez, Marion, Yassmina Mandouri, Bouchra Lebkaby, Hualin Wang, Aurélie Schnuriger, Francois Redelsperger, Chiara Ida Guerrero, et al. 2017. 'Alternative Splicing of Hepatitis B Virus: A Novel Virus/Host Interaction Altering Liver Immunity'. *Journal of Hepatology* 67 (4): 687–99. <https://doi.org/10.1016/j.jhep.2017.05.025>.
- Dynavax. 2021. 'CpG 1018 | Toll-like Receptor 9 (TLR9) Agonist Adjuvant | Dynavax Technologies'. 2021. <https://www.dynavax.com/science/cpg-1018/>.
- Egli, Adrian, Deanna M. Santer, Daire O'Shea, Khaled Barakat, Mohammedyaseen Syedbasha, Madeleine Vollmer, Aliyah Baluch, et al. 2014. 'IL-28B Is a Key Regulator of B- and T-Cell Vaccine Responses against Influenza'. *PLoS Pathogens* 10 (12): e1004556. <https://doi.org/10.1371/journal.ppat.1004556>.
- Eibl, Martha M., and Hermann M. Wolf. 2015. 'Vaccination in Patients with Primary Immune Deficiency, Secondary Immune Deficiency and Autoimmunity with Immune Regulatory Abnormalities'. *Immunotherapy* 7 (12): 1273–92. <https://doi.org/10.2217/IMT.15.74>.
- El-Serag, Hashem B. 2012. 'Epidemiology of Viral Hepatitis and Hepatocellular Carcinoma'. *Gastroenterology* 142 (6): 1264-1273.e1. <https://doi.org/10.1053/j.gastro.2011.12.061>.

- Enomoto, Masaru, Shuhei Nishiguchi, Akihiro Tamori, Sawako Kobayashi, Hiroki Sakaguchi, Susumu Shiomi, Soo Ryang Kim, et al. 2013. 'Entecavir and Interferon- α Sequential Therapy in Japanese Patients with Hepatitis B e Antigen-Positive Chronic Hepatitis B'. *Journal of Gastroenterology* 48 (3): 397–404. <https://doi.org/10.1007/s00535-012-0645-5>.
- Enomoto, Masaru, Shuhei Nishiguchi, Akihiro Tamori, Ritsuzo Kozuka, Takehiro Hayashi, Madoka Toyama Kohmoto, Hisato Jomura, et al. 2015. 'Long-Term Outcome of Sequential Therapy with Lamivudine Followed by Interferon- β in Nucleoside-Naive, Hepatitis B e-Antigen-Positive Patients with Chronic Hepatitis B Virus Genotype C Infection'. *Journal of Interferon & Cytokine Research: The Official Journal of the International Society for Interferon and Cytokine Research* 35 (8): 613–20. <https://doi.org/10.1089/jir.2014.0234>.
- 'ENYO-Pharma-Press-Release-Phase-Ib-French.Pdf'. n.d. Accessed 2 March 2021. <http://www.enyopharma.com/wp-content/uploads/2018/11/ENYO-Pharma-Press-Release-Phase-Ib-French.pdf>.
- Evavold, Charles L., and Jonathan C. Kagan. 2019. 'Inflammasomes: Threat-Assessment Organelles of the Innate Immune System'. *Immunity* 51 (4): 609–24. <https://doi.org/10.1016/j.immuni.2019.08.005>.
- Ewald, Sarah E., Alex Engel, Jiyoun Lee, Miqi Wang, Matthew Bogyo, and Gregory M. Barton. 2011. 'Nucleic Acid Recognition by Toll-like Receptors Is Coupled to Stepwise Processing by Cathepsins and Asparagine Endopeptidase'. *The Journal of Experimental Medicine* 208 (4): 643–51. <https://doi.org/10.1084/jem.20100682>.
- Ewald, Sarah E., Bettina L. Lee, Laura Lau, Katherine E. Wickliffe, Guo-Ping Shi, Harold A. Chapman, and Gregory M. Barton. 2008. 'The Ectodomain of Toll-like Receptor 9 Is Cleaved to Generate a Functional Receptor'. *Nature* 456 (7222): 658–62. <https://doi.org/10.1038/nature07405>.
- Fallowfield, Jonathan A., Masashi Mizuno, Timothy J. Kendall, Christothea M. Constandinou, R. Christopher Benyon, Jeremy S. Duffield, and John P. Iredale. 2007. 'Scar-Associated Macrophages Are a Major Source of Hepatic Matrix Metalloproteinase-13 and Facilitate the Resolution of Murine Hepatic Fibrosis'. *Journal of Immunology (Baltimore, Md.: 1950)* 178 (8): 5288–95. <https://doi.org/10.4049/jimmunol.178.8.5288>.
- Fang, Zhong, Jin Li, Xiaoyu Yu, Dandan Zhang, Guangxu Ren, Bisheng Shi, Cong Wang, et al. 2015. 'Polarization of Monocytic Myeloid-Derived Suppressor Cells by Hepatitis B Surface Antigen Is Mediated via ERK/IL-6/STAT3 Signaling Feedback and Restrains the Activation of T Cells in Chronic Hepatitis B Virus Infection'. *The Journal of Immunology* 195 (10): 4873–83. <https://doi.org/10.4049/jimmunol.1501362>.
- Farhat, Katja, Sabine Riekenberg, Holger Heine, Jennifer Debarry, Roland Lang, Jörg Mages, Ute Buwitt-Beckmann, et al. 2008. 'Heterodimerization of TLR2 with TLR1 or TLR6 Expands the Ligand Spectrum but Does Not Lead to Differential Signaling'. *Journal of Leukocyte Biology* 83 (3): 692–701. <https://doi.org/10.1189/jlb.0807586>.
- Faure-Dupuy, Suzanne, Marion Delphin, Ludovic Aillot, Laura Dimier, Fanny Lebossé, Judith Fresquet, Romain Parent, et al. 2019. 'Hepatitis B Virus-Induced Modulation of Liver Macrophage Function Promotes Hepatocyte Infection'. *Journal of Hepatology*, July. <https://doi.org/10.1016/j.jhep.2019.06.032>.
- Faure-Dupuy, Suzanne, Serena Vegna, Ludovic Aillot, Laura Dimier, Knud Esser, Mathias Broxtermann, Marc Bonnin, et al. 2018. 'Characterization of Pattern Recognition Receptor Expression and Functionality in Liver Primary Cells and Derived Cell Lines'. *Journal of Innate Immunity* 10 (4): 339–48. <https://doi.org/10.1159/000489966>.
- Feng, Jinyan, Guang Yang, Yunxia Liu, Yuen Gao, Man Zhao, Yanan Bu, Hongfeng Yuan, et al. 2019. 'LncRNA PCNAP1 Modulates Hepatitis B Virus Replication and Enhances Tumor Growth of Liver Cancer'. *Theranostics* 9 (18): 5227–45. <https://doi.org/10.7150/thno.34273>.
- Ferrari, Carlo. 2015. 'HBV and the Immune Response'. *Liver International* 35 (January): 121–28. <https://doi.org/10.1111/liv.12749>.

- Fisicaro, P., C. Valdatta, C. Boni, M. Massari, C. Mori, A. Zerbini, A. Orlandini, L. Sacchelli, G. Missale, and C. Ferrari. 2009. 'Early Kinetics of Innate and Adaptive Immune Responses during Hepatitis B Virus Infection'. *Gut* 58 (7): 974–82. <https://doi.org/10.1136/gut.2008.163600>.
- Fisicaro, Paola, Caterina Valdatta, Marco Massari, Elisabetta Loggi, Lara Ravanetti, Simona Urbani, Tiziana Giuberti, et al. 2012. 'Combined Blockade of Programmed Death-1 and Activation of CD137 Increase Responses of Human Liver T Cells against HBV, but Not HCV'. *Gastroenterology* 143 (6): 1576-1585.e4. <https://doi.org/10.1053/j.gastro.2012.08.041>.
- Fitzgerald, Katherine A., Sarah M. McWhirter, Kerrie L. Faia, Daniel C. Rowe, Eicke Latz, Douglas T. Golenbock, Anthony J. Coyle, Sha-Mei Liao, and Tom Maniatis. 2003. 'IKKepsilon and TBK1 Are Essential Components of the IRF3 Signaling Pathway'. *Nature Immunology* 4 (5): 491–96. <https://doi.org/10.1038/ni921>.
- Galibert, Francis, Elisabeth Mandart, Françoise Fitoussi, Pierre Tiollais, and Patrick Charnay. 1979. 'Nucleotide Sequence of the Hepatitis B Virus Genome (Subtype Ayw) Cloned in E. Coli'. *Nature* 281 (5733): 646–50. <https://doi.org/10.1038/281646a0>.
- Gane, E., A. Gaggar, A.H. Nguyen, G.M. Subramanian, J.G. McHutchison, C. Schwabe, and R. Dunbar. 2017. 'PS-044 - A Phase1 Study Evaluating Anti-PD-1 Treatment with or without GS-4774 in HBeAg Negative Chronic Hepatitis B Patients'. *Abstracts of The International Liver Congress 2017 — 52nd Annual Meeting of the European Association for the Study of the Liver* 66 (1, Supplement): S26–27. [https://doi.org/10.1016/S0168-8278\(17\)30315-X](https://doi.org/10.1016/S0168-8278(17)30315-X).
- Gane, E., A. Liu, M.-F. Yuen, C. Schwabe, Q. Bo, S. Das, L. Gao, et al. 2018. 'RO7049389, a Core Protein Allosteric Modulator, Demonstrates Robust Anti-HBV Activity in Chronic Hepatitis B Patients and Is Safe and Well Tolerated'. *Journal of Hepatology* 68 (April): S101. [https://doi.org/10.1016/S0168-8278\(18\)30422-7](https://doi.org/10.1016/S0168-8278(18)30422-7).
- Gane, Edward J., Young-Suk Lim, Stuart C. Gordon, Kumar Visvanathan, Eric Sicard, Richard N. Fedorak, Stuart Roberts, et al. 2015. 'The Oral Toll-like Receptor-7 Agonist GS-9620 in Patients with Chronic Hepatitis B Virus Infection'. *Journal of Hepatology* 63 (2): 320–28. <https://doi.org/10.1016/j.jhep.2015.02.037>.
- Gao, Bo, Zhijian Duan, Wei Xu, and Sidong Xiong. 2009. 'Tripartite Motif-Containing 22 Inhibits the Activity of Hepatitis B Virus Core Promoter, Which Is Dependent on Nuclear-Located RING Domain'. *Hepatology* 50 (2): 424–33. <https://doi.org/10.1002/hep.23011>.
- Gao, Daxing, Jiayi Wu, You-Tong Wu, Fenghe Du, Chukwuemika Aroh, Nan Yan, Lijun Sun, and Zhijian J. Chen. 2013. 'Cyclic GMP-AMP Synthase Is an Innate Immune Sensor of HIV and Other Retroviruses'. *Science* 341 (6148): 903. <https://doi.org/10.1126/science.1240933>.
- Gao, Yuen, Jinyan Feng, Guang Yang, Shuqin Zhang, Yunxia Liu, Yanan Bu, Mingming Sun, et al. 2017. 'Hepatitis B Virus X Protein-Elevated MSL2 Modulates Hepatitis B Virus Covalently Closed Circular DNA by Inducing Degradation of APOBEC3B to Enhance Hepatocarcinogenesis'. *Hepatology (Baltimore, Md.)* 66 (5): 1413–29. <https://doi.org/10.1002/hep.29316>.
- Garcia-Cattaneo, Alejandra, François-Xavier Gobert, Mélanie Müller, Florent Toscano, Marcella Flores, Aurianne Lescure, Elaine Del Nery, and Philippe Benaroch. 2012. 'Cleavage of Toll-like Receptor 3 by Cathepsins B and H Is Essential for Signaling'. *Proceedings of the National Academy of Sciences of the United States of America* 109 (23): 9053–58. <https://doi.org/10.1073/pnas.1115091109>.
- Gerlich, Wolfram H. 2013. 'Medical Virology of Hepatitis B: How It Began and Where We Are Now'. *Virology Journal* 10 (1): 239. <https://doi.org/10.1186/1743-422X-10-239>.
- Gerondakis, S., R. Grumont, R. Gugasyan, L. Wong, I. Isomura, W. Ho, and A. Banerjee. 2006. 'Unravelling the Complexities of the NF-KappaB Signalling Pathway Using Mouse Knockout and Transgenic Models'. *Oncogene* 25 (51): 6781–99. <https://doi.org/10.1038/sj.onc.1209944>.
- Gerondakis, Steve, and Ulrich Siebenlist. 2010. 'Roles of the NF-KB Pathway in Lymphocyte Development and Function'. *Cold Spring Harbor Perspectives in Biology* 2 (5). <https://doi.org/10.1101/cshperspect.a000182>.

- Ghosh, Gourisankar, Vivien Ya-Fan Wang, De-Bin Huang, and Amanda Fusco. 2012. 'NF-KB Regulation: Lessons from Structures'. *Immunological Reviews* 246 (1): 36–58. <https://doi.org/10.1111/j.1600-065X.2012.01097.x>.
- Gilead. 2019. 'Gilead Announces New Data from Viral Hepatitis Research Programs at The Liver Meeting® 2019', 3.
- Giles, Joan P., Robert W. McCollum, L. W. Berndtson, and Saul Krugman. 1969. 'Viral Hepatitis'. *New England Journal of Medicine* 281 (3): 119–22. <https://doi.org/10.1056/NEJM196907172810302>.
- Giridharan, Sivagami, and Mythily Srinivasan. 2018. 'Mechanisms of NF-KB P65 and Strategies for Therapeutic Manipulation'. *Journal of Inflammation Research* 11 (October): 407–19. <https://doi.org/10.2147/JIR.S140188>.
- Gish, Robert G., Bruce D. Given, Ching-Lung Lai, Stephen A. Locarnini, Johnson Y.N. Lau, David L. Lewis, and Thomas Schlupe. 2015. 'Chronic Hepatitis B: Virology, Natural History, Current Management and a Glimpse at Future Opportunities'. *Antiviral Research* 121 (September): 47–58. <https://doi.org/10.1016/j.antiviral.2015.06.008>.
- Glebe, Dieter, and Stephan Urban. 2007. 'Viral and Cellular Determinants Involved in Hepadnaviral Entry'. *World Journal of Gastroenterology* 13 (1): 22–38. <https://doi.org/10.3748/wjg.v13.i1.22>.
- Glebe, Dieter, Stephan Urban, Eva V. Knoop, Nilgün Çağ, Peter Krass, Stefanie Grün, Aiste Bulavaite, Kestutis Sasnauskas, and Wolfram H. Gerlich. 2005. 'Mapping of the Hepatitis B Virus Attachment Site by Use of Infection-Inhibiting PreS1 Lipopeptides and Tupaia Hepatocytes'. *Gastroenterology* 129 (1): 234–45. <https://doi.org/10.1053/j.gastro.2005.03.090>.
- Gordien, E., O. Rosmorduc, C. Peltekian, F. Garreau, C. Bréchet, and D. Kremsdorf. 2001. 'Inhibition of Hepatitis B Virus Replication by the Interferon-Inducible MxA Protein'. *Journal of Virology* 75 (6): 2684–91. <https://doi.org/10.1128/JVI.75.6.2684-2691.2001>.
- Gordon, Siamon, and Philip R. Taylor. 2005. 'Monocyte and Macrophage Heterogeneity'. *Nature Reviews Immunology* 5 (12): 953–64. <https://doi.org/10.1038/nri1733>.
- Gotoh, Kazuhito, Yoshihiko Tanaka, Akihiko Nishikimi, Ayumi Inayoshi, Munechika Enjoji, Ryoichi Takayanagi, Takehiko Sasazuki, and Yoshinori Fukui. 2008. 'Differential Requirement for DOCK2 in Migration of Plasmacytoid Dendritic Cells versus Myeloid Dendritic Cells'. *Blood* 111 (6): 2973–76. <https://doi.org/10.1182/blood-2007-09-112169>.
- Gracias, Donald T., Erietta Stelekati, Jennifer L. Hope, Alina C. Boesteanu, Travis A. Doering, Jillian Norton, Yvonne M. Mueller, et al. 2013. 'The MicroRNA MiR-155 Controls CD8(+) T Cell Responses by Regulating Interferon Signaling'. *Nature Immunology* 14 (6): 593–602. <https://doi.org/10.1038/ni.2576>.
- Grandvaux, Nathalie, Marc J. Servant, Benjamin tenOever, Ganes C. Sen, Siddarth Balachandran, Glen N. Barber, Rongtuan Lin, and John Hiscott. 2002. 'Transcriptional Profiling of Interferon Regulatory Factor 3 Target Genes: Direct Involvement in the Regulation of Interferon-Stimulated Genes'. *Journal of Virology* 76 (11): 5532–39. <https://doi.org/10.1128/jvi.76.11.5532-5539.2002>.
- Greenberg, Harry B., Richard B. Pollard, Larry I. Lutwick, Peter B. Gregory, William S. Robinson, and Thomas C. Merigan. 1976. 'Effect of Human Leukocyte Interferon on Hepatitis B Virus Infection in Patients with Chronic Active Hepatitis'. *New England Journal of Medicine* 295 (10): 517–22. <https://doi.org/10.1056/NEJM197609022951001>.
- Gripon, P., C. Diot, N. Thézé, I. Fourel, O. Loreal, C. Brechet, and C. Guguen-Guillouzo. 1988. 'Hepatitis B Virus Infection of Adult Human Hepatocytes Cultured in the Presence of Dimethyl Sulfoxide'. *Journal of Virology* 62 (11): 4136–43. <https://doi.org/10.1128/JVI.62.11.4136-4143.1988>.
- Gripon, Philippe, Sylvie Rumin, Stephan Urban, Jacques Le Seyec, Denise Glaise, Isabelle Cannie, Claire Guyomard, Josette Lucas, Christian Trepo, and Christiane Guguen-Guillouzo. n.d. 'Infection of a Human Hepatoma Cell Line by Hepatitis B Virus', 6.

- Gros Lambert, Marine, and Bénédicte F. Py. 2018. 'NLRP3, un inflammasome sous contrôle'. *médecine/sciences* 34 (1): 47–53. <https://doi.org/10.1051/medsci/20183401013>.
- Gruffaz, M., B. Testoni, S. Luangsay, M. Ait-Goughoulte, M.-A. Petit, H. Ma, K. Klumpp, H. Javanbakht, D. Durantel, and F. Zoulim. 2013. '378 HEPATITIS B CORE (HBC) PROTEIN IS A KEY AND VERY EARLY NEGATIVE REGULATOR OF THE INTERFERON RESPONSE'. *Journal of Hepatology* 58 (April): S155–56. [https://doi.org/10.1016/S0168-8278\(13\)60380-3](https://doi.org/10.1016/S0168-8278(13)60380-3).
- Guidotti, L. G., R. Rochford, J. Chung, M. Shapiro, R. Purcell, and F. V. Chisari. 1999. 'Viral Clearance without Destruction of Infected Cells during Acute HBV Infection'. *Science (New York, N.Y.)* 284 (5415): 825–29. <https://doi.org/10.1126/science.284.5415.825>.
- Guillot, Clément, Nora Martel, Françoise Berby, Isabelle Bordes, Olivier Hantz, Matthieu Blanchet, Camille Sureau, Andrew Vaillant, and Isabelle Chemin. 2017. 'Inhibition of Hepatitis B Viral Entry by Nucleic Acid Polymers in HepaRG Cells and Primary Human Hepatocytes'. *PLOS ONE* 12 (6): e0179697. <https://doi.org/10.1371/journal.pone.0179697>.
- Guo, Fang, Yanxing Han, Xuesen Zhao, Jianghua Wang, Fei Liu, Chunxiao Xu, Lai Wei, et al. 2015. 'STING Agonists Induce an Innate Antiviral Immune Response against Hepatitis B Virus'. *Antimicrobial Agents and Chemotherapy* 59 (2): 1273–81. <https://doi.org/10.1128/AAC.04321-14>.
- Guo, Fang, Liudi Tang, Sainan Shu, Mohit Sehgal, Muhammad Sheraz, Bowei Liu, Qiong Zhao, et al. 2017. 'Activation of Stimulator of Interferon Genes in Hepatocytes Suppresses the Replication of Hepatitis B Virus'. *Antimicrobial Agents and Chemotherapy* 61 (10). <https://doi.org/10.1128/AAC.00771-17>.
- Guo, Fang, Qiong Zhao, Muhammad Sheraz, Junjun Cheng, Yonghe Qi, Qing Su, Andrea Cuconati, et al. 2017. 'HBV Core Protein Allosteric Modulators Differentially Alter CccDNA Biosynthesis from de Novo Infection and Intracellular Amplification Pathways'. *PLoS Pathogens* 13 (9). <https://doi.org/10.1371/journal.ppat.1006658>.
- Guo, Haitao, Dong Jiang, Tianlun Zhou, Andrea Cuconati, Timothy M. Block, and Ju-Tao Guo. 2007. 'Characterization of the Intracellular Deproteinized Relaxed Circular DNA of Hepatitis B Virus: An Intermediate of Covalently Closed Circular DNA Formation'. *Journal of Virology* 81 (22): 12472–84. <https://doi.org/10.1128/JVI.01123-07>.
- Guo, Yanhai, Wei Kang, Xiaoying Lei, Yongnian Li, An Xiang, Yonglan Liu, Jinrong Zhao, Ju Zhang, and Zhen Yan. 2012. 'Hepatitis B Viral Core Protein Disrupts Human Host Gene Expression by Binding to Promoter Regions'. *BMC Genomics* 13 (1): 563. <https://doi.org/10.1186/1471-2164-13-563>.
- Guo, Yan-Hai, Yong-Nian Li, Jin-Rong Zhao, Ju Zhang, and Zhen Yan. 2011. 'HBc Binds to the CpG Islands of HBV CccDNA and Promotes an Epigenetic Permissive State'. *Epigenetics* 6 (6): 720–26. <https://doi.org/10.4161/epi.6.6.15815>.
- Gutjahr, Alice, Gérard Tiraby, Eric Perouzel, Bernard Verrier, and Stéphane Paul. 2016. 'Triggering Intracellular Receptors for Vaccine Adjuvantation'. *Trends in Immunology* 37 (9): 573–87. <https://doi.org/10.1016/j.it.2016.07.001>.
- Guy, Clifford S., Patricia M. Mulrooney-Cousins, Norma D. Churchill, and Tomasz I. Michalak. 2008. 'Intrahepatic Expression of Genes Affiliated with Innate and Adaptive Immune Responses Immediately after Invasion and during Acute Infection with Woodchuck Hepadnavirus'. *Journal of Virology* 82 (17): 8579–91. <https://doi.org/10.1128/JVI.01022-08>.
- Häcker, Hans, Vanessa Redecke, Blagoy Blagojev, Irina Kratchmarova, Li-Chung Hsu, Gang G. Wang, Mark P. Kamps, et al. 2006. 'Specificity in Toll-like Receptor Signalling through Distinct Effector Functions of TRAF3 and TRAF6'. *Nature* 439 (7073): 204–7. <https://doi.org/10.1038/nature04369>.
- Hagiwara, Satoru, Masatoshi Kudo, Yukio Osaki, Hiroo Matsuo, Tadashi Inuzuka, Akihiro Matsumoto, Eiji Tanaka, et al. 2013. 'Impact of Peginterferon Alpha-2b and Entecavir Hydrate Combination Therapy on Persistent Viral Suppression in Patients with Chronic Hepatitis B'. *Journal of Medical Virology* 85 (6): 987–95. <https://doi.org/10.1002/jmv.23564>.

- Han, Kelong, Jennifer Cremer, Robert Elston, Stuart Oliver, Sharon Baptiste-Brown, Shuguang Chen, David Gardiner, et al. 2019. 'A Randomized, Double-Blind, Placebo-Controlled, First-Time-in-Human Study to Assess the Safety, Tolerability, and Pharmacokinetics of Single and Multiple Ascending Doses of GSK3389404 in Healthy Subjects'. *Clinical Pharmacology in Drug Development* 8 (6): 790–801. <https://doi.org/10.1002/cpdd.670>.
- Hantz, O., R. Parent, D. Durantel, P. Gripon, C. Guguen-Guillouzo, and F. Zoulim. 2009. 'Persistence of the Hepatitis B Virus Covalently Closed Circular DNA in HepaRG Human Hepatocyte-like Cells'. *The Journal of General Virology* 90 (Pt 1): 127–35. <https://doi.org/10.1099/vir.0.004861-0>.
- Harenberg J., and Lesch L, Mackay I.R., Zimmermann H.J. 1976. *Experimental Production of Diseases, Part 5*.
- Heil, Florian, Parviz Ahmad-Nejad, Hiroaki Hemmi, Hubertus Hochrein, Franziska Ampenberger, Tanja Gellert, Harald Dietrich, et al. 2003. 'The Toll-like Receptor 7 (TLR7)-Specific Stimulus Loxoribine Uncovers a Strong Relationship within the TLR7, 8 and 9 Subfamily'. *European Journal of Immunology* 33 (11): 2987–97. <https://doi.org/10.1002/eji.200324238>.
- Heise, Tilman, Luca G. Guidotti, and Francis V. Chisari. 1999. 'La Autoantigen Specifically Recognizes a Predicted Stem-Loop in Hepatitis B Virus RNA'. *Journal of Virology* 73 (7): 5767–76. <https://doi.org/10.1128/JVI.73.7.5767-5776.1999>.
- Herrscher, Charline, Florentin Pastor, Julien Burlaud-Gaillard, Amélie Dumans, Florian Seigneuret, Alain Moreau, Romuald Patient, et al. 2020. 'Hepatitis B Virus Entry into HEPG2-NTCP Cells Requires Clathrin-mediated Endocytosis'. *Cellular Microbiology* 22 (8). <https://doi.org/10.1111/cmi.13205>.
- Hiller, Bjoern, Martin Achleitner, Silke Glage, Ronald Naumann, Rayk Behrendt, and Axel Roers. 2012. 'Mammalian RNase H2 Removes Ribonucleotides from DNA to Maintain Genome Integrity'. *The Journal of Experimental Medicine* 209 (8): 1419–26. <https://doi.org/10.1084/jem.20120876>.
- Hilliard, Brendan A., Nicola Mason, Lingyun Xu, Jing Sun, Salah-Eddine Lamhamedi-Cherradi, Hsiou-Chi Liou, Christopher Hunter, and Youhai H. Chen. 2002. 'Critical Roles of C-Rel in Autoimmune Inflammation and Helper T Cell Differentiation'. *The Journal of Clinical Investigation* 110 (6): 843–50. <https://doi.org/10.1172/JCI15254>.
- Hipp, Madeleine M., Dawn Shepherd, Uzi Gileadi, Michael C. Aichinger, Benedikt M. Kessler, Mariola J. Edelmann, Rachid Essalmani, Nabil G. Seidah, Caetano Reis e Sousa, and Vincenzo Cerundolo. 2013. 'Processing of Human Toll-like Receptor 7 by Furin-like Proprotein Convertases Is Required for Its Accumulation and Activity in Endosomes'. *Immunity* 39 (4): 711–21. <https://doi.org/10.1016/j.immuni.2013.09.004>.
- Hirschman, ShalomZ, SalvatoreJ Vernace, and Fenton Schaffner. 1971. 'D.N.A. POLYMERASE IN PREPARATIONS CONTAINING AUSTRALIA ANTIGEN'. *Originally Published as Volume 1, Issue 7709 297 (7709): 1099–1103*. [https://doi.org/10.1016/S0140-6736\(71\)91839-3](https://doi.org/10.1016/S0140-6736(71)91839-3).
- Ho, Joan Kha-Tu, Beena Jeevan-Raj, and Hans-Jürgen Netter. 2020. 'Hepatitis B Virus (HBV) Subviral Particles as Protective Vaccines and Vaccine Platforms'. *Viruses* 12 (2): 126. <https://doi.org/10.3390/v12020126>.
- Honda, Kenya, Akinori Takaoka, and Tadatsugu Taniguchi. 2006. 'Type I Interferon [Corrected] Gene Induction by the Interferon Regulatory Factor Family of Transcription Factors'. *Immunity* 25 (3): 349–60. <https://doi.org/10.1016/j.immuni.2006.08.009>.
- Hong, Xupeng, Elena S. Kim, and Haitao Guo. 2017. 'Epigenetic Regulation of Hepatitis B Virus Covalently Closed Circular DNA: Implications for Epigenetic Therapy against Chronic Hepatitis B'. *Hepatology (Baltimore, Md.)* 66 (6): 2066–77. <https://doi.org/10.1002/hep.29479>.
- Hösel, Marianna, Maria Quasdorff, Katja Wiegmann, Dennis Webb, Uta Zedler, Mathias Broxtermann, Raindy Tedjokusumo, et al. 2009. 'Not Interferon, but Interleukin-6 Controls Early Gene Expression in Hepatitis B Virus Infection'. *Hepatology* 50 (6): 1773–82. <https://doi.org/10.1002/hep.23226>.

- Hu, Jianming, You-Yu Lin, Pei-Jer Chen, Koichi Watashi, and Takaji Wakita. 2019. 'Cell and Animal Models for Studying Hepatitis B Virus Infection and Drug Development'. *Gastroenterology* 156 (2): 338–54. <https://doi.org/10.1053/j.gastro.2018.06.093>.
- Hu, Jianming, and Kuancheng Liu. 2017. 'Complete and Incomplete Hepatitis B Virus Particles: Formation, Function, and Application'. *Viruses* 9 (3): 56. <https://doi.org/10.3390/v9030056>.
- Hu, Qin, Feifei Zhang, Liang Duan, Bo Wang, Yuanyuan Ye, Pu Li, Dandan Li, Shengjun Yang, Lan Zhou, and Weixian Chen. 2020. 'E-Cadherin Plays a Role in Hepatitis B Virus Entry Through Affecting Glycosylated Sodium-Taurocholate Cotransporting Polypeptide Distribution'. *Frontiers in Cellular and Infection Microbiology* 10 (February): 74. <https://doi.org/10.3389/fcimb.2020.00074>.
- Hu, Yunlong. 2020. 'A Novel TLR7 Agonist as Adjuvant to Stimulate High Quality HBsAg-Specific Immune Responses in an HBV Mouse Model', 14.
- Huang, H.-C., C.-C. Chen, W.-C. Chang, M.-H. Tao, and C. Huang. 2012. 'Entry of Hepatitis B Virus into Immortalized Human Primary Hepatocytes by Clathrin-Dependent Endocytosis'. *Journal of Virology* 86 (17): 9443–53. <https://doi.org/10.1128/JVI.00873-12>.
- Huang, Li-Rung, Dirk Wohlleber, Florian Reisinger, Craig N Jenne, Ru-Lin Cheng, Zeinab Abdullah, Frank A Schildberg, et al. 2013. 'Intrahepatic Myeloid-Cell Aggregates Enable Local Proliferation of CD8+ T Cells and Successful Immunotherapy against Chronic Viral Liver Infection'. *Nature Immunology* 14 (6): 574–83. <https://doi.org/10.1038/ni.2573>.
- Huang, Yi-Wen, Shih-Chang Lin, Shu-Chen Wei, Jui-Ting Hu, Han-Yu Chang, Shih-Hung Huang, Ding-Shinn Chen, et al. 2013. 'Reduced Toll-like Receptor-3 Expression in Chronic Hepatitis B Patients and Its Restoration by Interferon Therapy'. *Antiviral Therapy* 18 (7): 877–84. <https://doi.org/10.3851/IMP2630>.
- Hudson, Brian P., Maria A. Martinez-Yamout, H. Jane Dyson, and Peter E. Wright. 2004. 'Recognition of the mRNA AU-Rich Element by the Zinc Finger Domain of TIS11d'. *Nature Structural & Molecular Biology* 11 (3): 257–64. <https://doi.org/10.1038/nsmb738>.
- Hyrina, Anastasia, Christopher Jones, Darlene Chen, Scott Clarkson, Nadire Cochran, Paul Feucht, Gregory Hoffman, et al. 2019. 'A Genome-Wide CRISPR Screen Identifies ZCCHC14 as a Host Factor Required for Hepatitis B Surface Antigen Production'. *Cell Reports* 29 (10): 2970–2978.e6. <https://doi.org/10.1016/j.celrep.2019.10.113>.
- Imam, Hasan, Mohsin Khan, Nandan S. Gokhale, Alexa B. R. McIntyre, Geon-Woo Kim, Jae Young Jang, Seong-Jun Kim, Christopher E. Mason, Stacy M. Horner, and Aleem Siddiqui. 2018. 'N6 - Methyladenosine Modification of Hepatitis B Virus RNA Differentially Regulates the Viral Life Cycle'. *Proceedings of the National Academy of Sciences* 115 (35): 8829–34. <https://doi.org/10.1073/pnas.1808319115>.
- Iribarren, Kristina, Norma Bloy, Aitziber Buqué, Isabelle Cremer, Alexander Eggermont, Wolf Hervé Fridman, Jitka Fucikova, et al. 2015. 'Trial Watch: Immunostimulation with Toll-like Receptor Agonists in Cancer Therapy'. *Oncoimmunology* 5 (3). <https://doi.org/10.1080/2162402X.2015.1088631>.
- Isorce, Nathalie, Julie Lucifora, Fabien Zoulim, and David Durantel. 2015. 'Immune-Modulators to Combat Hepatitis B Virus Infection: From IFN- α to Novel Investigational Immunotherapeutic Strategies'. *Antiviral Research* 122 (October): 69–81. <https://doi.org/10.1016/j.antiviral.2015.08.008>.
- Isorce, Nathalie, Barbara Testoni, Maëlle Locatelli, Judith Fresquet, Michel Rivoire, Souphalone Luangsay, Fabien Zoulim, and David Durantel. 2016. 'Antiviral Activity of Various Interferons and Pro-Inflammatory Cytokines in Non-Transformed Cultured Hepatocytes Infected with Hepatitis B Virus'. *Antiviral Research* 130 (June): 36–45. <https://doi.org/10.1016/j.antiviral.2016.03.008>.
- Ivashkiv, Lionel B., and Laura T. Donlin. 2014. 'Regulation of Type I Interferon Responses'. *Nature Reviews. Immunology* 14 (1): 36–49. <https://doi.org/10.1038/nri3581>.
- Iwamoto, Masashi, Wakana Saso, Kazane Nishioka, Hirofumi Ohashi, Ryuichi Sugiyama, Akihide Ryo, Mio Ohki, et al. 2020. 'The Machinery for Endocytosis of Epidermal Growth Factor Receptor

- Coordinates the Transport of Incoming Hepatitis B Virus to the Endosomal Network'. *Journal of Biological Chemistry* 295 (3): 800–807. <https://doi.org/10.1074/jbc.AC119.010366>.
- Iwamoto, Masashi, Wakana Saso, Ryuichi Sugiyama, Koji Ishii, Mio Ohki, Shushi Nagamori, Ryosuke Suzuki, et al. 2019. 'Epidermal Growth Factor Receptor Is a Host-Entry Cofactor Triggering Hepatitis B Virus Internalization'. *Proceedings of the National Academy of Sciences* 116 (17): 8487–92. <https://doi.org/10.1073/pnas.1811064116>.
- Izaguirre, Alexander, Betsy J. Barnes, Sheela Amrute, Wen-Shuz Yeow, Nicholas Megjugorac, Jihong Dai, Di Feng, Eugene Chung, Paula M. Pitha, and Patricia Fitzgerald-Bocarsly. 2003. 'Comparative Analysis of IRF and IFN-Alpha Expression in Human Plasmacytoid and Monocyte-Derived Dendritic Cells'. *Journal of Leukocyte Biology* 74 (6): 1125–38. <https://doi.org/10.1189/jlb.0603255>.
- Jain, Surbhi, Ting-Tsung Chang, Sitong Chen, Batbold Boldbaatar, Adam Clemens, Selena Y. Lin, Ran Yan, et al. 2015. 'Comprehensive DNA Methylation Analysis of Hepatitis B Virus Genome in Infected Liver Tissues'. *Scientific Reports* 5 (1): 10478. <https://doi.org/10.1038/srep10478>.
- Jakobsen, Martin R., Rasmus O. Bak, Annika Andersen, Randi K. Berg, Søren B. Jensen, Tengchuan Jin, Anders Laustsen, et al. 2013. 'IFI16 Senses DNA Forms of the Lentiviral Replication Cycle and Controls HIV-1 Replication'. *Proceedings of the National Academy of Sciences* 110 (48): E4571–80. <https://doi.org/10.1073/pnas.1311669110>.
- Janssen, Harry L. A., Monika van Zonneveld, Hakan Senturk, Stefan Zeuzem, Ulus S. Akarca, Yilmaz Cakaloglu, Christopher Simon, et al. 2005. 'Pegylated Interferon Alfa-2b Alone or in Combination with Lamivudine for HBeAg-Positive Chronic Hepatitis B: A Randomised Trial'. *Lancet (London, England)* 365 (9454): 123–29. [https://doi.org/10.1016/S0140-6736\(05\)17701-0](https://doi.org/10.1016/S0140-6736(05)17701-0).
- Jeng, Wen-Juei, Yi-Cheng Chen, Rong-Nan Chien, I.-Shyan Sheen, and Yun-Fan Liaw. 2018. 'Incidence and Predictors of Hepatitis B Surface Antigen Seroclearance after Cessation of Nucleos(t)ide Analogue Therapy in Hepatitis B e Antigen–Negative Chronic Hepatitis B'. *Hepatology* 68 (2): 425–34. <https://doi.org/10.1002/hep.29640>.
- Jiang, Bingfu, and Eberhard Hildt. 2020. 'Intracellular Trafficking of HBV Particles'. *Cells* 9 (9): 2023. <https://doi.org/10.3390/cells9092023>.
- Jin, Mi Sun, Sung Eun Kim, Jin Young Heo, Mi Eun Lee, Ho Min Kim, Sang-Gi Paik, Hayyoung Lee, and Jie-Oh Lee. 2007. 'Crystal Structure of the TLR1-TLR2 Heterodimer Induced by Binding of a Tri-Acylated Lipopeptide'. *Cell* 130 (6): 1071–82. <https://doi.org/10.1016/j.cell.2007.09.008>.
- Jo, Juandy, Anthony T. Tan, James E. Ussher, Elena Sandalova, Xin-Zi Tang, Alfonso Tan-Garcia, Natalie To, et al. 2014. 'Toll-like Receptor 8 Agonist and Bacteria Trigger Potent Activation of Innate Immune Cells in Human Liver'. *PLoS Pathogens* 10 (6): e1004210. <https://doi.org/10.1371/journal.ppat.1004210>.
- Jones, S. A., D. N. Clark, F. Cao, J. E. Tavis, and J. Hu. 2014. 'Comparative Analysis of Hepatitis B Virus Polymerase Sequences Required for Viral RNA Binding, RNA Packaging, and Protein Priming'. *Journal of Virology* 88 (3): 1564–72. <https://doi.org/10.1128/JVI.02852-13>.
- Jones, Scott A., Rajeev Boregowda, Thomas E. Spratt, and Jianming Hu. 2012. 'In Vitro Epsilon RNA-Dependent Protein Priming Activity of Human Hepatitis B Virus Polymerase'. *Journal of Virology* 86 (9): 5134–50. <https://doi.org/10.1128/JVI.07137-11>.
- Jorgovanovic, Dragica, Mengjia Song, Liping Wang, and Yi Zhang. 2020. 'Roles of IFN- γ in Tumor Progression and Regression: A Review'. *Biomarker Research* 8 (1): 49. <https://doi.org/10.1186/s40364-020-00228-x>.
- Josefowicz, Steven Z., Li-Fan Lu, and Alexander Y. Rudensky. 2012. 'Regulatory T Cells: Mechanisms of Differentiation and Function'. *Annual Review of Immunology* 30: 531–64. <https://doi.org/10.1146/annurev.immunol.25.022106.141623>.
- Ju, Cynthia, and Frank Tacke. 2016. 'Hepatic Macrophages in Homeostasis and Liver Diseases: From Pathogenesis to Novel Therapeutic Strategies'. *Cellular & Molecular Immunology* 13 (3): 316–27. <https://doi.org/10.1038/cmi.2015.104>.

- Julithe, R., G. Abou-Jaoude, and C. Sureau. 2014. 'Modification of the Hepatitis B Virus Envelope Protein Glycosylation Pattern Interferes with Secretion of Viral Particles, Infectivity, and Susceptibility to Neutralizing Antibodies'. *Journal of Virology* 88 (16): 9049–59. <https://doi.org/10.1128/JVI.01161-14>.
- Kaneko, Shun, Sei Kakinuma, Yasuhiro Asahina, Akihide Kamiya, Masato Miyoshi, Tomoyuki Tsunoda, Sayuri Nitta, et al. 2016. 'Human Induced Pluripotent Stem Cell-Derived Hepatic Cell Lines as a New Model for Host Interaction with Hepatitis B Virus'. *Scientific Reports* 6 (July): 29358. <https://doi.org/10.1038/srep29358>.
- Kang, Connie, and Yahiya Y. Syed. 2020. 'Bulevirtide: First Approval'. *Drugs* 80 (15): 1601–5. <https://doi.org/10.1007/s40265-020-01400-1>.
- Kann, Michael. 2007. 'Intracellular Transport of Hepatitis B Virus'. *World Journal of Gastroenterology* 13 (1): 39. <https://doi.org/10.3748/wjg.v13.i1.39>.
- Karayiannis, P. 2017. 'Hepatitis B Virus: Virology, Molecular Biology, Life Cycle and Intrahepatic Spread'. *Hepatology International* 11 (6): 500–508. <https://doi.org/10.1007/s12072-017-9829-7>.
- Katare, Parmeshwar Bajirao, Hina Lateef Nizami, Bugga Paramesha, Amit K. Dinda, and Sanjay K. Banerjee. 2020. 'Activation of Toll like Receptor 4 (TLR4) Promotes Cardiomyocyte Apoptosis through SIRT2 Dependent P53 Deacetylation'. *Scientific Reports* 10 (1): 19232. <https://doi.org/10.1038/s41598-020-75301-4>.
- Kaur, Surinder, Shahab Uddin, and Leonidas C. Plataniias. 2005. 'The PI3' Kinase Pathway in Interferon Signaling'. *Journal of Interferon & Cytokine Research: The Official Journal of the International Society for Interferon and Cytokine Research* 25 (12): 780–87. <https://doi.org/10.1089/jir.2005.25.780>.
- Kawai, T., and S. Akira. 2006. 'TLR Signaling'. *Cell Death and Differentiation* 13 (5): 816–25. <https://doi.org/10.1038/sj.cdd.4401850>.
- Kawai, Taro, and Shizuo Akira. 2006. 'Innate Immune Recognition of Viral Infection'. *Nature Immunology* 7 (2): 131–37. <https://doi.org/10.1038/ni1303>.
- . 2007. 'Signaling to NF-KB by Toll-like Receptors'. *Trends in Molecular Medicine* 13 (11): 460–69. <https://doi.org/10.1016/j.molmed.2007.09.002>.
- Kawai, Taro, Shintaro Sato, Ken J. Ishii, Cevayir Coban, Hiroaki Hemmi, Masahiro Yamamoto, Kenta Terai, et al. 2004. 'Interferon-Alpha Induction through Toll-like Receptors Involves a Direct Interaction of IRF7 with MyD88 and TRAF6'. *Nature Immunology* 5 (10): 1061–68. <https://doi.org/10.1038/ni1118>.
- Kayesh, Mohammad Enamul Hoque, Yutaka Amako, Md Abul Hashem, Shuko Murakami, Shintaro Ogawa, Naoki Yamamoto, Tatsuro Hifumi, et al. 2020. 'Development of an in Vivo Delivery System for CRISPR/Cas9-Mediated Targeting of Hepatitis B Virus CccDNA'. *Virus Research* 290 (December): 198191. <https://doi.org/10.1016/j.virusres.2020.198191>.
- Keijzers, Guido, Daniela Bakula, Michael Angelo Petr, Nils Gedsig Kirkelund Madsen, Amanuel Teklu, Garik Mkrtchyan, Brenna Osborne, and Morten Scheibye-Knudsen. 2018. 'Human Exonuclease 1 (EXO1) Regulatory Functions in DNA Replication with Putative Roles in Cancer'. *International Journal of Molecular Sciences* 20 (1). <https://doi.org/10.3390/ijms20010074>.
- Kennedy, Edward M., Anand V.R. Kornepati, and Bryan R. Cullen. 2015. 'Targeting Hepatitis B Virus CccDNA Using CRISPR/Cas9'. *Antiviral Research* 123 (November): 188–92. <https://doi.org/10.1016/j.antiviral.2015.10.004>.
- Kennedy, Patrick T. F., Elena Sandalova, Juandy Jo, Upkar Gill, Ines Ushiro-Lumb, Anthony T. Tan, Sandhia Naik, Graham R. Foster, and Antonio Bertolotti. 2012. 'Preserved T-Cell Function in Children and Young Adults with Immune-Tolerant Chronic Hepatitis B'. *Gastroenterology* 143 (3): 637–45. <https://doi.org/10.1053/j.gastro.2012.06.009>.
- Khuroo, Mohammad S., and Ahmad A. Sofi. 2020. 'The Discovery of Hepatitis Viruses: Agents and Disease'. *Journal of Clinical and Experimental Hepatology* 10 (4): 391–401. <https://doi.org/10.1016/j.jceh.2020.04.006>.

- Kim, Dongwan, Young-Suk Lee, Soo-Jin Jung, Jinah Yeo, Jenny J. Seo, Young-Yoon Lee, Jaechul Lim, et al. 2020. 'Viral Hijacking of the TENT4-ZCCHC14 Complex Protects Viral RNAs via Mixed Tailing'. *Nature Structural & Molecular Biology* 27 (6): 581–88. <https://doi.org/10.1038/s41594-020-0427-3>.
- Kim, Doo Hyun, Eun-Sook Park, Ah Ram Lee, Soree Park, Yong Kwang Park, Sung Hyun Ahn, Hong Seok Kang, et al. 2018. 'Intracellular Interleukin-32 γ Mediates Antiviral Activity of Cytokines against Hepatitis B Virus'. *Nature Communications* 9 (1): 3284. <https://doi.org/10.1038/s41467-018-05782-5>.
- Kim, Gi-Ae, Young-Suk Lim, Seungbong Han, Jonggi Choi, Ju Hyun Shim, Kang Mo Kim, Han Chu Lee, and Yung Sang Lee. 2018. 'High Risk of Hepatocellular Carcinoma and Death in Patients with Immune-Tolerant-Phase Chronic Hepatitis B'. *Gut* 67 (5): 945–52. <https://doi.org/10.1136/gutjnl-2017-314904>.
- Kim, Hyunjoon, Lin Niu, Peter Larson, Tamara A. Kucaba, Katherine A. Murphy, Britnie R. James, David M. Ferguson, Thomas S. Griffith, and Jayanth Panyam. 2018. 'Polymeric Nanoparticles Encapsulating Novel TLR7/8 Agonists as Immunostimulatory Adjuvants for Enhanced Cancer Immunotherapy'. *Biomaterials* 164 (May): 38–53. <https://doi.org/10.1016/j.biomaterials.2018.02.034>.
- Kim, You-Me, Melanie M. Brinkmann, Marie-Eve Paquet, and Hidde L. Ploegh. 2008. 'UNC93B1 Delivers Nucleotide-Sensing Toll-like Receptors to Endolysosomes'. *Nature* 452 (7184): 234–38. <https://doi.org/10.1038/nature06726>.
- Kinoshita, Wataru, Naoki Ogura, Koichi Watashi, and Takaji Wakita. 2017. 'Host Factor PRPF31 Is Involved in CccDNA Production in HBV-Replicating Cells'. *Biochemical and Biophysical Research Communications* 482 (4): 638–44. <https://doi.org/10.1016/j.bbrc.2016.11.085>.
- Kirstgen, Michael, Kira Alessandra Alicia Theresa Lowjaga, Simon Franz Müller, Nora Goldmann, Felix Lehmann, Sami Alakurtti, Jari Yli-Kauhaluoma, Dieter Glebe, and Joachim Geyer. 2020. 'Selective Hepatitis B and D Virus Entry Inhibitors from the Group of Pentacyclic Lupane-Type Betulin-Derived Triterpenoids'. *Scientific Reports* 10 (1): 21772. <https://doi.org/10.1038/s41598-020-78618-2>.
- Kitamura, Kouichi, Lusheng Que, Miyuki Shimadu, Miki Koura, Yuuki Ishihara, Kousho Wakae, Takashi Nakamura, Koichi Watashi, Takaji Wakita, and Masamichi Muramatsu. 2018. 'Flap Endonuclease 1 Is Involved in CccDNA Formation in the Hepatitis B Virus'. *PLoS Pathogens* 14 (6): e1007124. <https://doi.org/10.1371/journal.ppat.1007124>.
- Knolle, Percy A, and Dirk Wohlleber. 2016. 'Immunological Functions of Liver Sinusoidal Endothelial Cells'. *Cellular & Molecular Immunology* 13 (3): 347–53. <https://doi.org/10.1038/cmi.2016.5>.
- Ko, Chunkyu, Anindita Chakraborty, Wen-Min Chou, Julia Hasreiter, Jochen M. Wettengel, Daniela Stadler, Romina Bester, et al. 2018. 'Hepatitis B Virus Genome Recycling and de Novo Secondary Infection Events Maintain Stable CccDNA Levels'. *Journal of Hepatology* 69 (6): 1231–41. <https://doi.org/10.1016/j.jhep.2018.08.012>.
- Koltsida, Ourania, Michael Hausding, Athanasios Stavropoulos, Sonja Koch, George Tzelepis, Caroline Ubel, Sergei V. Kotenko, et al. 2011. 'IL-28A (IFN- λ 2) Modulates Lung DC Function to Promote Th1 Immune Skewing and Suppress Allergic Airway Disease'. *EMBO Molecular Medicine* 3 (6): 348–61. <https://doi.org/10.1002/emmm.201100142>.
- Kondo, Yasuteru, Masashi Ninomiya, Eiji Kakazu, Osamu Kimura, and Tooru Shimosegawa. 2013. 'Hepatitis B Surface Antigen Could Contribute to the Immunopathogenesis of Hepatitis B Virus Infection'. *ISRN Gastroenterology* 2013: 935295. <https://doi.org/10.1155/2013/935295>.
- Konno, Hiroyasu, Takuya Yamamoto, Kohsuke Yamazaki, Jin Gohda, Taishin Akiyama, Kentaro Semba, Hideo Goto, et al. 2009. 'TRAF6 Establishes Innate Immune Responses by Activating NF-KappaB and IRF7 upon Sensing Cytosolic Viral RNA and DNA'. *PLoS One* 4 (5): e5674. <https://doi.org/10.1371/journal.pone.0005674>.
- Kosinska, Anna D., Abdul Moeed, Nina Kallin, Julia Festag, Jinpeng Su, Katja Steiger, Marie-Louise Michel, Ulrike Protzer, and Percy A. Knolle. 2019. 'Synergy of Therapeutic Heterologous Prime-Boost Hepatitis B Vaccination with CpG-Application to Improve Immune Control of

- Persistent HBV Infection'. *Scientific Reports* 9 (1): 10808. <https://doi.org/10.1038/s41598-019-47149-w>.
- Kramvis, Anna. 2016. 'The Clinical Implications of Hepatitis B Virus Genotypes and HBeAg in Pediatrics'. *Reviews in Medical Virology* 26 (4): 285–303. <https://doi.org/10.1002/rmv.1885>.
- Kramvis, Anna, Evangelia-Georgia Kostaki, Angelos Hatzakis, and Dimitrios Paraskevis. 2018. 'Immunomodulatory Function of HBeAg Related to Short-Sighted Evolution, Transmissibility, and Clinical Manifestation of Hepatitis B Virus'. *Frontiers in Microbiology* 9 (October): 2521. <https://doi.org/10.3389/fmicb.2018.02521>.
- Krebs, Karin, Nina Böttlinger, Li-Rung Huang, Markus Chmielewski, Silke Arzberger, Georg Gasteiger, Clemens Jäger, et al. 2013. 'T Cells Expressing a Chimeric Antigen Receptor That Binds Hepatitis B Virus Envelope Proteins Control Virus Replication in Mice'. *Gastroenterology* 145 (2): 456–65. <https://doi.org/10.1053/j.gastro.2013.04.047>.
- Kremsdorf, D., P. Soussan, P. Paterlini-Brechot, and C. Brechot. 2006. 'Hepatitis B Virus-Related Hepatocellular Carcinoma: Paradigms for Viral-Related Human Carcinogenesis'. *Oncogene* 25 (27): 3823–33. <https://doi.org/10.1038/sj.onc.1209559>.
- Krugman, Saul, Joan P. Giles, and Jack Hammond. 1967. 'Infectious Hepatitis: Evidence for Two Distinctive Clinical, Epidemiological, and Immunological Types of Infection'. *JAMA* 200 (5): 365–73. <https://doi.org/10.1001/jama.1967.03120180053006>.
- Kruse, Robert L., Thomas Shum, Haruko Tashiro, Mercedes Barzi, Zhongzhen Yi, Christina Whitten-Bauer, Xavier Legras, et al. 2018. 'HBsAg-Redirected T Cells Exhibit Antiviral Activity in HBV-Infected Human Liver Chimeric Mice'. *Cytotherapy* 20 (5): 697–705. <https://doi.org/10.1016/j.jcyt.2018.02.002>.
- Kumar, Himanshu, Taro Kawai, and Shizuo Akira. 2011. 'Pathogen Recognition by the Innate Immune System'. *International Reviews of Immunology* 30 (1): 16–34. <https://doi.org/10.3109/08830185.2010.529976>.
- Kumar, K. G. Suresh, Hervé Barriere, Christopher J. Carbone, Jianghuai Liu, Gayathri Swaminathan, Ping Xu, Ying Li, et al. 2007. 'Site-Specific Ubiquitination Exposes a Linear Motif to Promote Interferon-Alpha Receptor Endocytosis'. *The Journal of Cell Biology* 179 (5): 935–50. <https://doi.org/10.1083/jcb.200706034>.
- Kumar, M., S. Y. Jung, A. J. Hodgson, C. R. Madden, J. Qin, and B. L. Slagle. 2011. 'Hepatitis B Virus Regulatory HBx Protein Binds to Adaptor Protein IPS-1 and Inhibits the Activation of Beta Interferon'. *Journal of Virology* 85 (2): 987–95. <https://doi.org/10.1128/JVI.01825-10>.
- Kumar, Manoj, Shiv K. Sarin, Syed Hissar, Chandana Pande, Puja Sakhuja, Barjesh Chander Sharma, Ranjit Chauhan, and Sujoy Bose. 2008. 'Virologic and Histologic Features of Chronic Hepatitis B Virus-Infected Asymptomatic Patients with Persistently Normal ALT'. *Gastroenterology* 134 (5): 1376–84. <https://doi.org/10.1053/j.gastro.2008.02.075>.
- Kwon, Jin Ah, and Hyune Mo Rho. 2002. 'Hepatitis B Viral Core Protein Activates the Hepatitis B Viral Enhancer II/Pregenomic Promoter through the Nuclear Factor KB Binding Site'. *Biochemistry and Cell Biology* 80 (4): 445–55. <https://doi.org/10.1139/o02-133>.
- Ladner, S. K., M. J. Otto, C. S. Barker, K. Zaifert, G. H. Wang, J. T. Guo, C. Seeger, and R. W. King. 1997. 'Inducible Expression of Human Hepatitis B Virus (HBV) in Stably Transfected Hepatoblastoma Cells: A Novel System for Screening Potential Inhibitors of HBV Replication'. *Antimicrobial Agents and Chemotherapy* 41 (8): 1715–20. <https://doi.org/10.1128/AAC.41.8.1715>.
- Lai, Michelle, Benjamin J. Hyatt, Imad Nasser, Michael Curry, and Nezam H. Afdhal. 2007. 'The Clinical Significance of Persistently Normal ALT in Chronic Hepatitis B Infection'. *Journal of Hepatology* 47 (6): 760–67. <https://doi.org/10.1016/j.jhep.2007.07.022>.
- Lampertico, Pietro. 2017. 'EASL 2017 Clinical Practice Guidelines on the Management of Hepatitis B Virus Infection'. *JOURNAL OF HEPATOLOGY* 67: 29.
- Lampertico, Pietro, and Thomas Berg. 2018. 'Less Can Be More: A Finite Treatment Approach for HBeAg-Negative Chronic Hepatitis B'. *Hepatology* 68 (2): 397–400. <https://doi.org/10.1002/hep.29821>.

- Lamrayah, Myriam, Fanny Charriaud, Shangnong Hu, Simon Megy, Raphael Terreux, and Bernard Verrier. 2019. 'Molecular Modelling of TLR Agonist Pam3CSK4 Entrapment in PLA Nanoparticles as a Tool to Explain Loading Efficiency and Functionality'. *International Journal of Pharmaceutics* 568 (September): 118569. <https://doi.org/10.1016/j.ijpharm.2019.118569>.
- Lanford, Robert E., Bernadette Guerra, Deborah Chavez, Luis Giavedoni, Vida L. Hodara, Kathleen M. Brasky, Abigail Fosdick, et al. 2013. 'GS-9620, an Oral Agonist of Toll-Like Receptor-7, Induces Prolonged Suppression of Hepatitis B Virus in Chronically Infected Chimpanzees'. *Gastroenterology* 144 (7): 1508-1517.e10. <https://doi.org/10.1053/j.gastro.2013.02.003>.
- Lang, Tali, Camden Lo, Narelle Skinner, Stephen Locarnini, Kumar Visvanathan, and Ashley Mansell. 2011. 'The Hepatitis B e Antigen (HBeAg) Targets and Suppresses Activation of the Toll-like Receptor Signaling Pathway'. *Journal of Hepatology* 55 (4): 762-69. <https://doi.org/10.1016/j.jhep.2010.12.042>.
- Lara-Pezzi, Enrique, Pedro L. Majano, Marta Gómez-Gonzalo, Carmelo García-Monzón, Ricardo Moreno-Otero, Massimo Levrero, and Manuel López-Cabrera. 1998. 'The Hepatitis B Virus X Protein Up-Regulates Tumor Necrosis Factor α Gene Expression in Hepatocytes: The Hepatitis B Virus X Protein Up-Regulates Tumor Necrosis Factor α Gene Expression in Hepatocytes'. *Hepatology* 28 (4): 1013-21. <https://doi.org/10.1002/hep.510280416>.
- Laras, Andreas, John Koskinas, Evangelini Dimou, Ageliki Kostamena, and Stephanos J. Hadziyannis. 2006. 'Intrahepatic Levels and Replicative Activity of Covalently Closed Circular Hepatitis B Virus DNA in Chronically Infected Patients'. *Hepatology* 44 (3): 694-702. <https://doi.org/10.1002/hep.21299>.
- Lau, A H. 2003. 'Dendritic Cells and Immune Regulation in the Liver'. *Gut* 52 (2): 307-14. <https://doi.org/10.1136/gut.52.2.307>.
- Lau, George K. K., Teerha Piratvisuth, Kang Xian Luo, Patrick Marcellin, Satawat Thongsawat, Graham Cooksley, Edward Gane, et al. 2005. 'Peginterferon Alfa-2a, Lamivudine, and the Combination for HBeAg-Positive Chronic Hepatitis B'. *The New England Journal of Medicine* 352 (26): 2682-95. <https://doi.org/10.1056/NEJMoa043470>.
- Launay, Odile, and Daniel Floret. 2015. 'Vaccination contre l'hépatite B'. *M/S. Médecine sciences [ISSN papier : 0767-0974 ; ISSN numérique : 1958-5381], 2015, Vol. 31, N° 5; p. 551-558*. <https://doi.org/10.1051/medsci/20153105018>.
- Lauterbach-Rivière, Lise, Maiwenn Bergez, Saskia Mönch, Bingqian Qu, Maximilian Riess, Florian W. R. Vondran, Juliane Liese, Veit Hornung, Stephan Urban, and Renate König. 2019. 'HBV DNA Is a Substrate for the CGAS/STING Pathway but Is Not Sensed in Infected Hepatocytes'. Preprint. Microbiology. <https://doi.org/10.1101/867440>.
- Lawrence, Toby. 2009. 'The Nuclear Factor NF-KappaB Pathway in Inflammation'. *Cold Spring Harbor Perspectives in Biology* 1 (6): a001651. <https://doi.org/10.1101/cshperspect.a001651>.
- Lawrence, Toby, Derek W. Gilroy, Paul R. Colville-Nash, and Derek A. Willoughby. 2001. 'Possible New Role for NF-KB in the Resolution of Inflammation'. *Nature Medicine* 7 (12): 1291-97. <https://doi.org/10.1038/nm1201-1291>.
- Le Bon, A., G. Schiavoni, G. D'Agostino, I. Gresser, F. Belardelli, and D. F. Tough. 2001. 'Type I Interferons Potently Enhance Humoral Immunity and Can Promote Isotype Switching by Stimulating Dendritic Cells in Vivo'. *Immunity* 14 (4): 461-70. [https://doi.org/10.1016/s1074-7613\(01\)00126-1](https://doi.org/10.1016/s1074-7613(01)00126-1).
- Le Bon, Agnes, Clare Thompson, Elisabeth Kamphuis, Vanessa Durand, Cornelia Rossmann, Ulrich Kalinke, and David F. Tough. 2006. 'Cutting Edge: Enhancement of Antibody Responses through Direct Stimulation of B and T Cells by Type I IFN'. *Journal of Immunology (Baltimore, Md.: 1950)* 176 (4): 2074-78. <https://doi.org/10.4049/jimmunol.176.4.2074>.
- Le Vee, Marc, Philippe Gripon, Bruno Stieger, and Olivier Fardel. 2008. 'Down-Regulation of Organic Anion Transporter Expression in Human Hepatocytes Exposed to the Proinflammatory Cytokine Interleukin 1beta'. *Drug Metabolism and Disposition: The Biological Fate of Chemicals* 36 (2): 217-22. <https://doi.org/10.1124/dmd.107.016907>.

- Lebossé, Fanny, Aurore Inchauspé, Maëlle Locatelli, Clothilde Miaglia, Audrey Diederichs, Judith Fresquet, Fleur Chapus, Kamal Hamed, Barbara Testoni, and Fabien Zoulim. 2020. 'Quantification and Epigenetic Evaluation of the Residual Pool of Hepatitis B Covalently Closed Circular DNA in Long-Term Nucleoside Analogue-Treated Patients'. *Scientific Reports* 10 (1): 21097. <https://doi.org/10.1038/s41598-020-78001-1>.
- LeCluyse, Edward L., and Eliane Alexandre. 2010. 'Isolation and Culture of Primary Hepatocytes from Resected Human Liver Tissue'. In *Hepatocytes: Methods and Protocols*, edited by Patrick Maurel, 57–82. Methods in Molecular Biology. Totowa, NJ: Humana Press. https://doi.org/10.1007/978-1-60761-688-7_3.
- Lee, Hye Won, Jae Seung Lee, and Sang Hoon Ahn. 2020. 'Hepatitis B Virus Cure: Targets and Future Therapies'. *International Journal of Molecular Sciences* 22 (1): 213. <https://doi.org/10.3390/ijms22010213>.
- Lee, Mi-Ock, Youn-Hee Choi, Eui-Cheol Shin, Hyo-Jin Kang, Young-Mee Kim, Su-Yon Jeong, Je Kyung Seong, et al. 2002. 'Hepatitis B Virus X Protein Induced Expression of Interleukin 18 (IL-18): A Potential Mechanism for Liver Injury Caused by Hepatitis B Virus (HBV) Infection'. *Journal of Hepatology* 37 (3): 380–86. [https://doi.org/10.1016/S0168-8278\(02\)00181-2](https://doi.org/10.1016/S0168-8278(02)00181-2).
- Lee, Young-Ran, Young-Hee Lee, Sun-A Im, In-Ho Yang, Ghe Whan Ahn, Kyungjae Kim, and Chong-Kil Lee. 2010. 'Biodegradable Nanoparticles Containing TLR3 or TLR9 Agonists Together with Antigen Enhance MHC-Restricted Presentation of the Antigen'. *Archives of Pharmacal Research* 33 (11): 1859–66. <https://doi.org/10.1007/s12272-010-1119-z>.
- Lemaitre, Bruno, Emmanuelle Nicolas, Lydia Michaut, Jean-Marc Reichhart, and Jules A Hoffmann. 1996. 'The Dorsoventral Regulatory Gene Cassette Spätzle/Toll/Cactus Controls the Potent Antifungal Response in Drosophila Adults'. *Cell* 86 (6): 973–83. [https://doi.org/10.1016/S0092-8674\(00\)80172-5](https://doi.org/10.1016/S0092-8674(00)80172-5).
- Lempp, Florian A., and Stephan Urban. 2014. 'Inhibitors of Hepatitis B Virus Attachment and Entry'. *Intervirology* 57 (3–4): 151–57. <https://doi.org/10.1159/000360948>.
- Lercher, Alexander, Alexandra M. Popa, Csilla Viczenczova, Lindsay Kosack, Kristaps Klavins, Benedikt Agerer, Christiane A. Opitz, Tobias V. Lanz, Michael Platten, and Andreas Bergthaler. 2020. 'Hepatocyte-Intrinsic Type I Interferon Signaling Reprograms Metabolism and Reveals a Novel Compensatory Mechanism of the Tryptophan-Kynurenine Pathway in Viral Hepatitis'. Edited by Michael D. Robek. *PLOS Pathogens* 16 (10): e1008973. <https://doi.org/10.1371/journal.ppat.1008973>.
- Leverro, Massimo, Teresa Pollicino, Jorg Petersen, Laura Belloni, Giovanni Raimondo, and Maura Dandri. 2009. 'Control of CccDNA Function in Hepatitis B Virus Infection'. *Journal of Hepatology* 51 (3): 581–92. <https://doi.org/10.1016/j.jhep.2009.05.022>.
- Leverro, Massimo, and Jessica Zucman-Rossi. 2016. 'Mechanisms of HBV-Induced Hepatocellular Carcinoma'. *Molecular Biology of Hepatitis B Virus* 64 (1, Supplement): S84–101. <https://doi.org/10.1016/j.jhep.2016.02.021>.
- Levy, David E., and J. E. Darnell. 2002. 'Stats: Transcriptional Control and Biological Impact'. *Nature Reviews. Molecular Cell Biology* 3 (9): 651–62. <https://doi.org/10.1038/nrm909>.
- Li, Bin, Cong Yan, Jiamin Zhu, Xiaobing Chen, Qihan Fu, Hangyu Zhang, Zhou Tong, et al. 2020. 'Anti-PD-1/PD-L1 Blockade Immunotherapy Employed in Treating Hepatitis B Virus Infection-Related Advanced Hepatocellular Carcinoma: A Literature Review'. *Frontiers in Immunology* 11. <https://doi.org/10.3389/fimmu.2020.01037>.
- Li, Guo-Jun, Yi-Qi Yu, Shao-Long Chen, Ping Fan, Ling-Yun Shao, Jia-Zhen Chen, Chang-Shui Li, et al. 2015. 'Sequential Combination Therapy with Pegylated Interferon Leads to Loss of Hepatitis B Surface Antigen and Hepatitis B e Antigen (HBeAg) Seroconversion in HBeAg-Positive Chronic Hepatitis B Patients Receiving Long-Term Entecavir Treatment'. *Antimicrobial Agents and Chemotherapy* 59 (7): 4121–28. <https://doi.org/10.1128/AAC.00249-15>.
- Li, Hongyi, Yang Yang, Weiqi Hong, Mengyuan Huang, Min Wu, and Xia Zhao. 2020. 'Applications of Genome Editing Technology in the Targeted Therapy of Human Diseases: Mechanisms,

- Advances and Prospects'. *Signal Transduction and Targeted Therapy* 5 (1): 1–23. <https://doi.org/10.1038/s41392-019-0089-y>.
- Li, Li, Vivian Barry, Stephane Daffis, Congrong Niu, Erik Huntzicker, Dorothy M. French, Igor Mikaelian, Robert E. Lanford, William E. Delaney, and Simon P. Fletcher. 2018. 'Anti-HBV Response to Toll-like Receptor 7 Agonist GS-9620 Is Associated with Intrahepatic Aggregates of T Cells and B Cells'. *Journal of Hepatology* 68 (5): 912–21. <https://doi.org/10.1016/j.jhep.2017.12.008>.
- Li, Min, Rui Sun, Long Xu, Wenwei Yin, Yongyan Chen, Xiaodong Zheng, Zhexiong Lian, Haiming Wei, and Zhigang Tian. 2015. 'Kupffer Cells Support Hepatitis B Virus–Mediated CD8⁺ T Cell Exhaustion via Hepatitis B Core Antigen–TLR2 Interactions in Mice'. *The Journal of Immunology* 195 (7): 3100–3109. <https://doi.org/10.4049/jimmunol.1500839>.
- Li, Min, Jie Yang, Yinxia Zhao, Yahui Song, Shengxia Yin, Jing Guo, Hongkai Zhang, et al. 2020. 'MCP1 Inhibits Hepatitis B Virus Replication by Destabilizing Viral RNA and Negatively Regulates the Virus-Induced Innate Inflammatory Responses'. *Antiviral Research* 174 (February): 104705. <https://doi.org/10.1016/j.antiviral.2020.104705>.
- Li, Ming O., and Richard A. Flavell. 2008. 'TGF- β : A Master of All T Cell Trades'. *Cell* 134 (3): 392–404. <https://doi.org/10.1016/j.cell.2008.07.025>.
- Li, Ning, Lei Zhang, Liangwei Chen, Wenfeng Feng, Yinfeng Xu, Feng Chen, Xiaohong Liu, Zhi Chen, and Wei Liu. 2012. 'MxA Inhibits Hepatitis B Virus Replication by Interaction with Hepatitis B Core Antigen'. *Hepatology (Baltimore, Md.)* 56 (3): 803–11. <https://doi.org/10.1002/hep.25608>.
- Li, Wenhui, and Stephan Urban. 2016. 'Entry of Hepatitis B and Hepatitis D Virus into Hepatocytes: Basic Insights and Clinical Implications'. *Journal of Hepatology* 64 (1): S32–40. <https://doi.org/10.1016/j.jhep.2016.02.011>.
- Liang, T. Jake. 2009. 'Hepatitis B: The Virus and Disease'. *Hepatology* 49 (S5): S13–21. <https://doi.org/10.1002/hep.22881>.
- Liaw, Y.-F., J.-D. Jia, H. L. Y. Chan, K. H. Han, T. Tanwandee, W. L. Chuang, D. M. Tan, et al. 2011. 'Shorter Durations and Lower Doses of Peginterferon Alfa-2a Are Associated with Inferior Hepatitis B e Antigen Seroconversion Rates in Hepatitis B Virus Genotypes B or C'. *Hepatology (Baltimore, Md.)* 54 (5): 1591–99. <https://doi.org/10.1002/hep.24555>.
- Liberzon, Arthur, Chet Birger, Helga Thorvaldsdóttir, Mahmoud Ghandi, Jill P. Mesirov, and Pablo Tamayo. 2015. 'The Molecular Signatures Database (MSigDB) Hallmark Gene Set Collection'. *Cell Systems* 1 (6): 417–25. <https://doi.org/10.1016/j.cels.2015.12.004>.
- Ligat, Gaëtan, Kaku Goto, Eloi Verrier, and Thomas F. Baumert. 2020. 'Targeting Viral CccDNA for Cure of Chronic Hepatitis B'. *Current Hepatology Reports* 19 (3): 235–44. <https://doi.org/10.1007/s11901-020-00534-w>.
- Lim, Chun Shen, and Chris M. Brown. 2016. 'Hepatitis B Virus Nuclear Export Elements: RNA Stem-Loop α and β , Key Parts of the HBV Post-Transcriptional Regulatory Element'. *RNA Biology* 13 (9): 743–47. <https://doi.org/10.1080/15476286.2016.1166330>.
- Lim, Keo-Heun, Eun-Sook Park, Doo Hyun Kim, Kyung Cho Cho, Kwang Pyo Kim, Yong Kwang Park, Sung Hyun Ahn, et al. 2018. 'Suppression of Interferon-Mediated Anti-HBV Response by Single CpG Methylation in the 5'-UTR of *TRIM22*'. *Gut* 67 (1): 166–78. <https://doi.org/10.1136/gutjnl-2016-312742>.
- Lin, Q., C. Dong, and M. D. Cooper. 1998. 'Impairment of T and B Cell Development by Treatment with a Type I Interferon'. *The Journal of Experimental Medicine* 187 (1): 79–87. <https://doi.org/10.1084/jem.187.1.79>.
- Lin, Sue-Jane, Pei-Yun Shu, Chungming Chang, Ah-Kau Ng, and Cheng-po Hu. 2003. 'IL-4 Suppresses the Expression and the Replication of Hepatitis B Virus in the Hepatocellular Carcinoma Cell Line Hep3B'. *Journal of Immunology (Baltimore, Md.: 1950)* 171 (9): 4708–16. <https://doi.org/10.4049/jimmunol.171.9.4708>.

- Lin, Yen-Cheng, En-Chi Hsu, and Ling-Pai Ting. 2009. 'Repression of Hepatitis B Viral Gene Expression by Transcription Factor Nuclear Factor-KappaB'. *Cellular Microbiology* 11 (4): 645–60. <https://doi.org/10.1111/j.1462-5822.2008.01280.x>.
- Liu, Dan, An'dong Wu, Lei Cui, Ruidong Hao, Yuan Wang, Jing He, and Deyin Guo. 2014. 'Hepatitis B Virus Polymerase Suppresses NF-KB Signaling by Inhibiting the Activity of IKKs via Interaction with Hsp90β'. *PLoS One* 9 (3): e91658. <https://doi.org/10.1371/journal.pone.0091658>.
- Liu, Fei, Matthew Campagna, Yonghe Qi, Xuesen Zhao, Fang Guo, Chunxiao Xu, Sichen Li, et al. 2013. 'Alpha-Interferon Suppresses Hepadnavirus Transcription by Altering Epigenetic Modification of CccDNA Minichromosomes'. *PLoS Pathogens* 9 (9): e1003613. <https://doi.org/10.1371/journal.ppat.1003613>.
- Liu, GuanQun, Yao Lu, Sathya N. Thulasi Raman, Fang Xu, Qi Wu, Zhubing Li, Robert Brownlie, Qiang Liu, and Yan Zhou. 2018. 'Nuclear-Resident RIG-I Senses Viral Replication Inducing Antiviral Immunity'. *Nature Communications* 9 (1): 3199. <https://doi.org/10.1038/s41467-018-05745-w>.
- Liu, Jia, Anna Kosinska, Mengji Lu, and Michael Roggendorf. 2014. 'New Therapeutic Vaccination Strategies for the Treatment of Chronic Hepatitis B'. *Virologica Sinica* 29 (1): 10–16. <https://doi.org/10.1007/s12250-014-3410-5>.
- Liu, Kuancheng, Laurie Luckenbaugh, Xiaojun Ning, Ji Xi, and Jianming Hu. 2018. 'Multiple Roles of Core Protein Linker in Hepatitis B Virus Replication'. Edited by Aleem Siddiqui. *PLoS Pathogens* 14 (5): e1007085. <https://doi.org/10.1371/journal.ppat.1007085>.
- Liu, Meifang, and Cai Zhang. 2017. 'The Role of Innate Lymphoid Cells in Immune-Mediated Liver Diseases'. *Frontiers in Immunology* 8 (June): 695. <https://doi.org/10.3389/fimmu.2017.00695>.
- Liu, Ting, Lingyun Zhang, Donghyun Joo, and Shao-Cong Sun. 2017. 'NF-KB Signaling in Inflammation'. *Signal Transduction and Targeted Therapy* 2 (1). <https://doi.org/10.1038/sigtrans.2017.23>.
- Liu, Yinghui, Jianhua Li, Jieliang Chen, Yaming Li, Weixia Wang, Xiaoting Du, Wuhui Song, Wen Zhang, Li Lin, and Zhenghong Yuan. 2015. 'Hepatitis B Virus Polymerase Disrupts K63-Linked Ubiquitination of STING to Block Innate Cytosolic DNA-Sensing Pathways'. *Journal of Virology* 89 (4): 2287–2300. <https://doi.org/10.1128/JVI.02760-14>.
- Liu, Yu-Hua, Tao Wu, Ning Sun, Guang-Li Wang, Jian-Zhi Yuan, Yu-Rong Dai, and Xiao-Hui Zhou. 2014. 'Combination Therapy with Pegylated Interferon Alpha-2b and Adefovir Dipivoxil in HBeAg-Positive Chronic Hepatitis B versus Interferon Alone: A Prospective, Randomized Study'. *Journal of Huazhong University of Science and Technology. Medical Sciences = Hua Zhong Ke Ji Da Xue Xue Bao. Yi Xue Ying De Wen Ban = Huazhong Keji Daxue Xuebao. Yixue Yingdewen Ban* 34 (4): 542–47. <https://doi.org/10.1007/s11596-014-1312-2>.
- Livingston, Christine M., Dhivya Ramakrishnan, Michel Strubin, Simon P. Fletcher, and Rudolf K. Beran. 2017. 'Identifying and Characterizing Interplay between Hepatitis B Virus X Protein and Smc5/6'. *Viruses* 9 (4). <https://doi.org/10.3390/v9040069>.
- Locarnini, Stephen, Angelos Hatzakis, Ding-Shinn Chen, and Anna Lok. 2015. 'Strategies to Control Hepatitis B: Public Policy, Epidemiology, Vaccine and Drugs'. *Journal of Hepatology* 62 (1): S76–86. <https://doi.org/10.1016/j.jhep.2015.01.018>.
- Locarnini, Stephen, and Fabien Zoulim. 2010. 'Molecular Genetics of HBV Infection'. *Antiviral Therapy* 15 (Suppl 3): 3–14. <https://doi.org/10.3851/IMP1619>.
- Lok, A. S., I. V. Weller, P. Karayiannis, D. Brown, M. J. Fowler, J. Monjardino, H. C. Thomas, and S. Sherlock. 1984. 'Thrice Weekly Lymphoblastoid Interferon Is Effective in Inhibiting Hepatitis B Virus Replication'. *Liver* 4 (1): 45–49. <https://doi.org/10.1111/j.1600-0676.1984.tb00906.x>.
- Lok, Anna S. F., Brian J. McMahon, Robert S. Brown, John B. Wong, Ahmed T. Ahmed, Wigdan Farah, Jehad Almasri, et al. 2016. 'Antiviral Therapy for Chronic Hepatitis B Viral Infection in Adults: A Systematic Review and Meta-Analysis'. *Hepatology (Baltimore, Md.)* 63 (1): 284–306. <https://doi.org/10.1002/hep.28280>.

- Lok, Anna S., Fabien Zoulim, Geoffrey Dusheiko, and Marc G. Ghany. 2017. 'Hepatitis B Cure: From Discovery to Regulatory Approval'. *Hepatology (Baltimore, Md.)* 66 (4): 1296–1313. <https://doi.org/10.1002/hep.29323>.
- Long, Quanxin, Ran Yan, Jieli Hu, Dawei Cai, Bidisha Mitra, Elena S. Kim, Alexander Marchetti, et al. 2017. 'The Role of Host DNA Ligases in Hepadnavirus Covalently Closed Circular DNA Formation'. Edited by Aleem Siddiqui. *PLOS Pathogens* 13 (12): e1006784. <https://doi.org/10.1371/journal.ppat.1006784>.
- Loo, Yueh-Ming, and Michael Gale. 2011. 'Immune Signaling by RIG-I-like Receptors'. *Immunity* 34 (5): 680–92. <https://doi.org/10.1016/j.immuni.2011.05.003>.
- Lu, Hsin-Lin, and Fang Liao. 2013. 'Melanoma Differentiation–Associated Gene 5 Senses Hepatitis B Virus and Activates Innate Immune Signaling To Suppress Virus Replication'. *The Journal of Immunology* 191 (6): 3264–76. <https://doi.org/10.4049/jimmunol.1300512>.
- Lu, Li-Fan, Mark P. Boldin, Ashutosh Chaudhry, Ling-Li Lin, Konstantin D. Taganov, Toshikatsu Hanada, Akihiko Yoshimura, David Baltimore, and Alexander Y. Rudensky. 2010. 'Function of MiR-146a in Controlling Treg Cell-Mediated Regulation of Th1 Responses'. *Cell* 142 (6): 914–29. <https://doi.org/10.1016/j.cell.2010.08.012>.
- Lu, Yi Wei, Tuan Lin Tan, Vincent Chan, and Wei Ning Chen. 2006. 'The HBSP Gene Is Expressed during HBV Replication, and Its Coded BH3-Containing Spliced Viral Protein Induces Apoptosis in HepG2 Cells'. *Biochemical and Biophysical Research Communications* 351 (1): 64–70. <https://doi.org/10.1016/j.bbrc.2006.10.002>.
- Luangsay, Souphalone, Malika Ait-Goughoulte, Maud Michelet, Océane Floriot, Marc Bonnin, Marion Gruffaz, Michel Rivoire, et al. 2015. 'Expression and Functionality of Toll- and RIG-like Receptors in HepaRG Cells'. *Journal of Hepatology* 63 (5): 1077–85. <https://doi.org/10.1016/j.jhep.2015.06.022>.
- Luangsay, Souphalone, Marion Gruffaz, Nathalie Isorce, Barbara Testoni, Maud Michelet, Suzanne Faure-Dupuy, Sarah Maadadi, et al. 2015. 'Early Inhibition of Hepatocyte Innate Responses by Hepatitis B Virus'. *Journal of Hepatology* 63 (6): 1314–22. <https://doi.org/10.1016/j.jhep.2015.07.014>.
- Lucifora, Julie, Silke Arzberger, David Durantel, Laura Belloni, Michel Strubin, Massimo Levrero, Fabien Zoulim, Olivier Hantz, and Ulrike Protzer. 2011. 'Hepatitis B Virus X Protein Is Essential to Initiate and Maintain Virus Replication after Infection'. *Journal of Hepatology* 55 (5): 996–1003. <https://doi.org/10.1016/j.jhep.2011.02.015>.
- Lucifora, Julie, Marc Bonnin, Ludovic Aillot, Floriane Fusil, Sarah Maadadi, Laura Dimier, Maud Michelet, et al. 2018. 'Direct Antiviral Properties of TLR Ligands against HBV Replication in Immune-Competent Hepatocytes'. *Scientific Reports* 8 (1). <https://doi.org/10.1038/s41598-018-23525-w>.
- Lucifora, Julie, David Durantel, Barbara Testoni, Olivier Hantz, Massimo Levrero, and Fabien Zoulim. 2010. 'Control of Hepatitis B Virus Replication by Innate Response of HepaRG Cells'. *Hepatology* 51 (1): 63–72. <https://doi.org/10.1002/hep.23230>.
- Lucifora, Julie, Maud Michelet, Michel Rivoire, Ulrike Protzer, David Durantel, and Fabien Zoulim. 2020. 'Two-Dimensional-Cultures of Primary Human Hepatocytes Allow Efficient HBV Infection: Old Tricks Still Work!' *Journal of Hepatology* 73 (2): 449–51. <https://doi.org/10.1016/j.jhep.2020.03.042>.
- Lucifora, Julie, Maud Michelet, Anna Salvetti, and David Durantel. 2020. 'Fast Differentiation of HepaRG Cells Allowing Hepatitis B and Delta Virus Infections'. *Cells* 9 (10): 2288. <https://doi.org/10.3390/cells9102288>.
- Lucifora, Julie, Anna Salvetti, Xavier Marniquet, Laurent Mailly, Barbara Testoni, Floriane Fusil, Aurore Inchauspé, et al. 2017. 'Detection of the Hepatitis B Virus (HBV) Covalently-Closed-Circular DNA (cccDNA) in Mice Transduced with a Recombinant AAV-HBV Vector'. *Antiviral Research* 145 (September): 14–19. <https://doi.org/10.1016/j.antiviral.2017.07.006>.
- Lucifora, Julie, Yuchen Xia, Florian Reisinger, Ke Zhang, Daniela Stadler, Xiaoming Cheng, Martin F. Sprinzl, et al. 2014. 'Specific and Nonhepatotoxic Degradation of Nuclear Hepatitis B Virus

- CccDNA'. *Science (New York, N.Y.)* 343 (6176): 1221–28.
<https://doi.org/10.1126/science.1243462>.
- Ludwig, Irene S., Annemarie N. Lekkerkerker, Erik Depla, Fons Bosman, René J. P. Musters, Stany Depraetere, Yvette van Kooyk, and Teunis B. H. Geijtenbeek. 2004. 'Hepatitis C Virus Targets DC-SIGN and L-SIGN to Escape Lysosomal Degradation'. *Journal of Virology* 78 (15): 8322–32.
<https://doi.org/10.1128/JVI.78.15.8322-8332.2004>.
- Lund, J. M., L. Alexopoulou, A. Sato, M. Karow, N. C. Adams, N. W. Gale, A. Iwasaki, and R. A. Flavell. 2004. 'Recognition of Single-Stranded RNA Viruses by Toll-like Receptor 7'. *Proceedings of the National Academy of Sciences* 101 (15): 5598–5603.
<https://doi.org/10.1073/pnas.0400937101>.
- Lütgehetmann, Marc, Till Bornscheuer, Tassilo Volz, Lena Allweiss, Jan–Hendrick Bockmann, Joerg M. Pollok, Ansgar W. Lohse, Joerg Petersen, and Maura Dandri. 2011. 'Hepatitis B Virus Limits Response of Human Hepatocytes to Interferon- α in Chimeric Mice'. *Gastroenterology* 140 (7): 2074–2083.e2. <https://doi.org/10.1053/j.gastro.2011.02.057>.
- Lv, Shujuan, Jun Wang, Shuang Dou, Xianzhu Yang, Xiang Ni, Rui Sun, Zhigang Tian, and Haiming Wei. 2014. 'Nanoparticles Encapsulating Hepatitis B Virus Cytosine-Phosphate-Guanosine Induce Therapeutic Immunity against HBV Infection'. *Hepatology* 59 (2): 385–94.
<https://doi.org/10.1002/hep.26654>.
- MacMicking, John D. 2012. 'Interferon-Inducible Effector Mechanisms in Cell-Autonomous Immunity'. *Nature Reviews. Immunology* 12 (5): 367–82. <https://doi.org/10.1038/nri3210>.
- Macovei, A., C. Petrareanu, C. Lazar, P. Florian, and N. Branza-Nichita. 2013. 'Regulation of Hepatitis B Virus Infection by Rab5, Rab7, and the Endolysosomal Compartment'. *Journal of Virology* 87 (11): 6415–27. <https://doi.org/10.1128/JVI.00393-13>.
- Macovei, Alina, Cristina Radulescu, Catalin Lazar, Stefana Petrescu, David Durantel, Raymond A. Dwek, Nicole Zitzmann, and Norica Branza Nichita. 2010. 'Hepatitis B Virus Requires Intact Caveolin-1 Function for Productive Infection in HepaRG Cells'. *Journal of Virology* 84 (1): 243–53. <https://doi.org/10.1128/JVI.01207-09>.
- Magnius, Lars, William S. Mason, John Taylor, Michael Kann, Dieter Glebe, Paul Dény, Camille Sureau, Heléne Norder, and ICTV Report Consortium. 2020. 'ICTV Virus Taxonomy Profile: Hepadnaviridae'. *Journal of General Virology* 101 (6): 571–72.
<https://doi.org/10.1099/jgv.0.001415>.
- Magnius, Lars O, and J Åke Espmark. n.d. 'New Specificities in Australia Antigen Positive Sera Distinct from the Le Bouvier Determinants', 6.
- Maini, Mala Kunti, and Dimitra Peppas. 2013. 'NK Cells: A Double-Edged Sword in Chronic Hepatitis B Virus Infection'. *Frontiers in Immunology* 4. <https://doi.org/10.3389/fimmu.2013.00057>.
- Makokha, Grace Naswa, Hiromi Abe-Chayama, Sajeda Chowdhury, C. Nelson Hayes, Masataka Tsuge, Tadahiko Yoshima, Yuji Ishida, et al. 2019. 'Regulation of the Hepatitis B Virus Replication and Gene Expression by the Multi-Functional Protein TARDBP'. *Scientific Reports* 9 (1): 8462.
<https://doi.org/10.1038/s41598-019-44934-5>.
- Mancuso, Giuseppe, Maria Gambuzza, Angelina Midiri, Carmelo Biondo, Salvatore Papasergi, Shizuo Akira, Giuseppe Teti, and Concetta Beninati. 2009. 'Bacterial Recognition by TLR7 in the Lysosomes of Conventional Dendritic Cells'. *Nature Immunology* 10 (6): 587–94.
<https://doi.org/10.1038/ni.1733>.
- Manesis, E. K., G. V. Papatheodoridis, and S. J. Hadziyannis. 2006. 'A Partially Overlapping Treatment Course with Lamivudine and Interferon in Hepatitis B e Antigen-Negative Chronic Hepatitis B'. *Alimentary Pharmacology & Therapeutics* 23 (1): 99–106. <https://doi.org/10.1111/j.1365-2036.2006.02731.x>.
- Manigold, Tobias, Ulrich Böcker, Jingsan Chen, Jutta Gundt, Petra Traber, Manfred V. Singer, and Siegbert Rossol. 2003. 'Hepatitis B Core Antigen Is a Potent Inductor of Interleukin-18 in Peripheral Blood Mononuclear Cells of Healthy Controls and Patients with Hepatitis B Infection: HBcAg Induces IL-18 in Human PBMCs'. *Journal of Medical Virology* 71 (1): 31–40.
<https://doi.org/10.1002/jmv.10445>.

- Marcellin, Patrick, Sang Hoon Ahn, Xiaoli Ma, Florin A. Caruntu, Won Young Tak, Magdy Elkashab, Wan-Long Chuang, et al. 2016. 'Combination of Tenofovir Disoproxil Fumarate and Peginterferon α -2a Increases Loss of Hepatitis B Surface Antigen in Patients With Chronic Hepatitis B'. *Gastroenterology* 150 (1): 134-144.e10. <https://doi.org/10.1053/j.gastro.2015.09.043>.
- Marcellin, Patrick, George K. K. Lau, Ferruccio Bonino, Patrizia Farci, Stephanos Hadziyannis, Rui Jin, Zhi-Meng Lu, et al. 2004. 'Peginterferon Alfa-2a Alone, Lamivudine Alone, and the Two in Combination in Patients with HBeAg-Negative Chronic Hepatitis B'. *The New England Journal of Medicine* 351 (12): 1206-17. <https://doi.org/10.1056/NEJMoa040431>.
- Marcellin, Patrick, Karsten Wursthorn, Heiner Wedemeyer, Wan-Long Chuang, George Lau, Claudio Avila, Cheng-Yuan Peng, et al. 2015. 'Telbivudine plus Pegylated Interferon Alfa-2a in a Randomized Study in Chronic Hepatitis B Is Associated with an Unexpected High Rate of Peripheral Neuropathy'. *Journal of Hepatology* 62 (1): 41-47. <https://doi.org/10.1016/j.jhep.2014.08.021>.
- Marijanovic, Zrinka, Josiane Ragimbeau, K. G. Suresh Kumar, Serge Y. Fuchs, and Sandra Pellegrini. 2006. 'TYK2 Activity Promotes Ligand-Induced IFNAR1 Proteolysis'. *The Biochemical Journal* 397 (1): 31-38. <https://doi.org/10.1042/BJ20060272>.
- Martel, Catherine de, Delphine Maucort-Boulch, Martyn Plummer, and Silvia Franceschi. 2015. 'World-wide Relative Contribution of Hepatitis B and C Viruses in Hepatocellular Carcinoma'. *Hepatology* 62 (4): 1190-1200. <https://doi.org/10.1002/hep.27969>.
- Martinet, Jeremie, Tania Dufeü-Duchesne, Juliana Bruder Costa, Sylvie Larrat, Alice Marlu, Vincent Leroy, Joel Plumas, and Caroline Aspod. 2012. 'Altered Functions of Plasmacytoid Dendritic Cells and Reduced Cytolytic Activity of Natural Killer Cells in Patients With Chronic HBV Infection'. *Gastroenterology* 143 (6): 1586-1596.e8. <https://doi.org/10.1053/j.gastro.2012.08.046>.
- Maschalidi, Sophia, Signe Hässler, Fany Blanc, Fernando E. Sepulveda, Mira Tohme, Michel Chignard, Peter van Endert, Mustapha Si-Tahar, Delphyne Descamps, and Bénédicte Manoury. 2012. 'Asparagine Endopeptidase Controls Anti-Influenza Virus Immune Responses through TLR7 Activation'. *PLoS Pathogens* 8 (8): e1002841. <https://doi.org/10.1371/journal.ppat.1002841>.
- Mason, William S., Upkar S. Gill, Samuel Litwin, Yan Zhou, Suraj Peri, Oltin Pop, Michelle L. W. Hong, et al. 2016. 'HBV DNA Integration and Clonal Hepatocyte Expansion in Chronic Hepatitis B Patients Considered Immune Tolerant'. *Gastroenterology* 151 (5): 986-998.e4. <https://doi.org/10.1053/j.gastro.2016.07.012>.
- Matsumoto, M., N. Tanaka, H. Harada, T. Kimura, T. Yokochi, M. Kitagawa, C. Schindler, and T. Taniguchi. 1999. 'Activation of the Transcription Factor ISGF3 by Interferon-Gamma'. *Biological Chemistry* 380 (6): 699-703. <https://doi.org/10.1515/BC.1999.087>.
- Mavilia, Marianna G, and George Y Wu. 2018. 'HBV-HCV Coinfection: Viral Interactions, Management, and Viral Reactivation'. *Journal of Clinical and Translational Hepatology* 6: 10.
- Mayer, Sabine, Marie-Kristin Raulf, and Bernd Lepenies. 2017. 'C-Type Lectins: Their Network and Roles in Pathogen Recognition and Immunity'. *Histochemistry and Cell Biology* 147 (2): 223-37. <https://doi.org/10.1007/s00418-016-1523-7>.
- Maynard, Craig L., and Casey T. Weaver. 2008. 'Diversity in the Contribution of IL-10 to T-Cell-Mediated Immune Regulation'. *Immunological Reviews* 226 (December): 219-33. <https://doi.org/10.1111/j.1600-065X.2008.00711.x>.
- Mehrfeld, Christina, Steven Zenner, Miroslaw Kornek, and Veronika Lukacs-Kornek. 2018. 'The Contribution of Non-Professional Antigen-Presenting Cells to Immunity and Tolerance in the Liver'. *Frontiers in Immunology* 9 (March): 635. <https://doi.org/10.3389/fimmu.2018.00635>.
- Meng, Zhongji, Yuanyuan Chen, and Mengji Lu. 2020. 'Advances in Targeting the Innate and Adaptive Immune Systems to Cure Chronic Hepatitis B Virus Infection'. *Frontiers in Immunology* 10. <https://doi.org/10.3389/fimmu.2019.03127>.
- Meng, Zhongji, Xiaoyong Zhang, Rongjuan Pei, Ejuan Zhang, Thekla Kemper, Jörg Vollmer, Heather L. Davis, et al. 2016. 'Combination Therapy Including CpG Oligodeoxynucleotides and Entecavir

- Induces Early Viral Response and Enhanced Inhibition of Viral Replication in a Woodchuck Model of Chronic Hepadnaviral Infection'. *Antiviral Research* 125 (January): 14–24. <https://doi.org/10.1016/j.antiviral.2015.11.001>.
- Menne, Stephan, Daniel B. Tumas, Katherine H. Liu, Linta Thampi, Dalal AlDeghaither, Betty H. Baldwin, Christine A. Bellezza, et al. 2015. 'Sustained Efficacy and Seroconversion with the Toll-like Receptor 7 Agonist GS-9620 in the Woodchuck Model of Chronic Hepatitis B'. *Journal of Hepatology* 62 (6): 1237–45. <https://doi.org/10.1016/j.jhep.2014.12.026>.
- Mentha, Nathalie, Sophie Clément, Francesco Negro, and Dulce Alfaiate. 2019. 'A Review on Hepatitis D: From Virology to New Therapies'. *Journal of Advanced Research* 17 (March): 3–15. <https://doi.org/10.1016/j.jare.2019.03.009>.
- Micco, Lorenzo, Dimitra Peppas, Elisabetta Loggi, Anna Schurich, Lucy Jefferson, Carmela Cursaro, Arianna Martello Panno, et al. 2013. 'Differential Boosting of Innate and Adaptive Antiviral Responses during Pegylated-Interferon-Alpha Therapy of Chronic Hepatitis B'. *Journal of Hepatology* 58 (2): 225–33. <https://doi.org/10.1016/j.jhep.2012.09.029>.
- Millman I Hutanan H. Merino F. Bayer M. E. and Blumberg B. S. 1971. 'Australia Antigen: Physical and Chemical Properties', 1971, Res. Commun. Chem. Pathol. Pharmacol. 2:667. edition.
- Minor, Philip D. 2015. 'Live Attenuated Vaccines: Historical Successes and Current Challenges'. *Virology* 479–480 (May): 379–92. <https://doi.org/10.1016/j.virol.2015.03.032>.
- Molen, Renate G. van der, Dave Sprengers, Rekha S. Binda, Esther C. de Jong, Hubert G. M. Niesters, Johannes G. Kusters, Jaap Kwekkeboom, and Harry L. A. Janssen. 2004. 'Functional Impairment of Myeloid and Plasmacytoid Dendritic Cells of Patients with Chronic Hepatitis B'. *Hepatology* 40 (3): 738–46. <https://doi.org/10.1002/hep.20366>.
- Montfoort, Nadine van, Evelyn van der Aa, Aniek van den Bosch, Hilde Brouwers, Thomas Vanwollegheem, Harry L. A. Janssen, Hassan Javanbakht, Sonja I. Buschow, and Andrea M. Woltman. 2016. 'Hepatitis B Virus Surface Antigen Activates Myeloid Dendritic Cells via a Soluble CD14-Dependent Mechanism'. Edited by J.-H. J. Ou. *Journal of Virology* 90 (14): 6187–99. <https://doi.org/10.1128/JVI.02903-15>.
- Moolla, Naazneen, Michael Kew, and Patrick Arbuthnot. 2002. 'Regulatory Elements of Hepatitis B Virus Transcription'. *Journal of Viral Hepatitis* 9 (5): 323–31. <https://doi.org/10.1046/j.1365-2893.2002.00381.x>.
- Morisato, D., and K. V. Anderson. 1994. 'The Spätzle Gene Encodes a Component of the Extracellular Signaling Pathway Establishing the Dorsal-Ventral Pattern of the Drosophila Embryo'. *Cell* 76 (4): 677–88. [https://doi.org/10.1016/0092-8674\(94\)90507-x](https://doi.org/10.1016/0092-8674(94)90507-x).
- Morrow, Matthew P., Panyupa Pankhong, Dominick J. Laddy, Kimberly A. Schoenly, Jian Yan, Neil Cisper, and David B. Weiner. 2009. 'Comparative Ability of IL-12 and IL-28B to Regulate Treg Populations and Enhance Adaptive Cellular Immunity'. *Blood* 113 (23): 5868–77. <https://doi.org/10.1182/blood-2008-11-190520>.
- Motedayen Aval, Leila, James E. Pease, Rohini Sharma, and David J. Pinato. 2020. 'Challenges and Opportunities in the Clinical Development of STING Agonists for Cancer Immunotherapy'. *Journal of Clinical Medicine* 9 (10): 3323. <https://doi.org/10.3390/jcm9103323>.
- Mouzannar, Karim, Floriane Fusil, Benoît Lacombe, Anaïs Ollivier, Camille Ménard, Vincent Lotteau, François-Loïc Cosset, Christophe Ramière, and Patrice André. 2019. 'Farnesoid X Receptor- α Is a Proviral Host Factor for Hepatitis B Virus That Is Inhibited by Ligands in Vitro and in Vivo'. *The FASEB Journal* 33 (2): 2472–83. <https://doi.org/10.1096/fj.201801181R>.
- Murray, Peter J. 2007. 'The JAK-STAT Signaling Pathway: Input and Output Integration'. *Journal of Immunology (Baltimore, Md.: 1950)* 178 (5): 2623–29. <https://doi.org/10.4049/jimmunol.178.5.2623>.
- Mutz, Pascal, Philippe Metz, Florian A. Lempp, Silke Bender, Bingqian Qu, Katrin Schöneweis, Stefan Seitz, et al. 2018. 'HBV Bypasses the Innate Immune Response and Does Not Protect HCV From Antiviral Activity of Interferon'. *Gastroenterology* 154 (6): 1791-1804.e22. <https://doi.org/10.1053/j.gastro.2018.01.044>.

- Nakao, K., K. Nakata, M. Yamashita, Y. Tamada, K. Hamasaki, H. Ishikawa, Y. Kato, K. Eguchi, and N. Ishii. 1999. 'P48 (ISGF-3gamma) Is Involved in Interferon-Alpha-Induced Suppression of Hepatitis B Virus Enhancer-1 Activity'. *The Journal of Biological Chemistry* 274 (40): 28075–78. <https://doi.org/10.1074/jbc.274.40.28075>.
- Nassal, Michael. 2008. 'Hepatitis B Viruses: Reverse Transcription a Different Way'. *Virus Research* 134 (1–2): 235–49. <https://doi.org/10.1016/j.virusres.2007.12.024>.
- . 2015. 'HBV CccDNA: Viral Persistence Reservoir and Key Obstacle for a Cure of Chronic Hepatitis B'. *Gut* 64 (12): 1972–84. <https://doi.org/10.1136/gutjnl-2015-309809>.
- Nawa, Takatoshi, Hisashi Ishida, Tomohide Tatsumi, Wei Li, Satoshi Shimizu, Takahiro Kodama, Hayato Hikita, et al. 2012. 'Interferon- α Suppresses Hepatitis B Virus Enhancer II Activity via the Protein Kinase C Pathway'. *Virology* 432 (2): 452–59. <https://doi.org/10.1016/j.virol.2012.07.002>.
- Nayagam, Jeremy S, Zillah C Cargill, and Kosh Agarwal. 2020. 'The Role of RNA Interference in Functional Cure Strategies for Chronic Hepatitis B'. *Current Hepatology Reports* 19 (4): 362–69. <https://doi.org/10.1007/s11901-020-00548-4>.
- Nguyen-Lefebvre, Anh Thu, and Anatolij Horuzsko. 2016. 'Kupffer Cell Metabolism and Function', 26.
- Ni, Y.-H., and D.-S. Chen. 2010. 'Hepatitis B Vaccination in Children: The Taiwan Experience'. *Pathologie-Biologie* 58 (4): 296–300. <https://doi.org/10.1016/j.patbio.2009.11.002>.
- Niederrau, Claus, Tobias Heintges, Stefan Lange, Georg Goldmann, Christoph M. Niederrau, Leonhard Mohr, and Dieter Häussinger. 1996. 'Long-Term Follow-up of HBeAg-Positive Patients Treated with Interferon Alfa for Chronic Hepatitis B'. *New England Journal of Medicine* 334 (22): 1422–27. <https://doi.org/10.1056/NEJM199605303342202>.
- Ning, Qin, Meifang Han, Yongtao Sun, Jiaji Jiang, Deming Tan, Jinlin Hou, Hong Tang, Jifang Sheng, and Mianzhi Zhao. 2014. 'Switching from Entecavir to PegIFN Alfa-2a in Patients with HBeAg-Positive Chronic Hepatitis B: A Randomised Open-Label Trial (OSST Trial)'. *Journal of Hepatology* 61 (4): 777–84. <https://doi.org/10.1016/j.jhep.2014.05.044>.
- Ning, S., J. S. Pagano, and G. N. Barber. 2011. 'IRF7: Activation, Regulation, Modification and Function'. *Genes & Immunity* 12 (6): 399–414. <https://doi.org/10.1038/gene.2011.21>.
- Nishioji, K., T. Okanou, Y. Itoh, S. Narumi, M. Sakamoto, H. Nakamura, A. Morita, and K. Kashima. 2001. 'Increase of Chemokine Interferon-Inducible Protein-10 (IP-10) in the Serum of Patients with Autoimmune Liver Diseases and Increase of Its mRNA Expression in Hepatocytes: IP-10 in Autoimmune Liver Diseases'. *Clinical & Experimental Immunology* 123 (2): 271–79. <https://doi.org/10.1046/j.1365-2249.2001.01391.x>.
- Niu, Guo-Juan, Ji-Dong Xu, Wen-Jie Yuan, Jie-Jie Sun, Ming-Chong Yang, Zhong-Hua He, Xiao-Fan Zhao, and Jin-Xing Wang. 2018. 'Protein Inhibitor of Activated STAT (PIAS) Negatively Regulates the JAK/STAT Pathway by Inhibiting STAT Phosphorylation and Translocation'. *Frontiers in Immunology* 9 (October). <https://doi.org/10.3389/fimmu.2018.02392>.
- Noordeen, Faseeha, Catherine A. Scougall, Arend Grosse, Qiao Qiao, Behzad B. Ajilian, Georget Reaiche-Miller, John Finnie, et al. 2015. 'Therapeutic Antiviral Effect of the Nucleic Acid Polymer REP 2055 against Persistent Duck Hepatitis B Virus Infection'. *PLOS ONE* 10 (11): e0140909. <https://doi.org/10.1371/journal.pone.0140909>.
- Oganesyan, Gagik, Supriya K. Saha, Beichu Guo, Jeannie Q. He, Arash Shahangian, Brian Zarnegar, Andrea Perry, and Genhong Cheng. 2006. 'Critical Role of TRAF3 in the Toll-like Receptor-Dependent and -Independent Antiviral Response'. *Nature* 439 (7073): 208–11. <https://doi.org/10.1038/nature04374>.
- Oliviero, Barbara, Stefania Varchetta, Enrica Paudice, Giuseppe Michelone, Marco Zaramella, Domenico Mavilio, Francesca De Filippi, Savino Bruno, and Mario U. Mondelli. 2009. 'Natural Killer Cell Functional Dichotomy in Chronic Hepatitis B and Chronic Hepatitis C Virus Infections'. *Gastroenterology* 137 (3): 1151-1160.e7. <https://doi.org/10.1053/j.gastro.2009.05.047>.
- Onoguchi, Kazuhide, Mitsutoshi Yoneyama, Azumi Takemura, Shizuo Akira, Tadatsugu Taniguchi, Hideo Namiki, and Takashi Fujita. 2007. 'Viral Infections Activate Types I and III Interferon

- Genes through a Common Mechanism'. *The Journal of Biological Chemistry* 282 (10): 7576–81. <https://doi.org/10.1074/jbc.M608618200>.
- Op den Brouw, Marjoleine L., Rekha S. Binda, Mark H. van Roosmalen, Ulrike Protzer, Harry L. A. Janssen, Renate G. van der Molen, and Andrea M. Woltman. 2009. 'Hepatitis B Virus Surface Antigen Impairs Myeloid Dendritic Cell Function: A Possible Immune Escape Mechanism of Hepatitis B Virus'. *Immunology* 126 (2): 280–89. <https://doi.org/10.1111/j.1365-2567.2008.02896.x>.
- Osorio, Fabiola, and Caetano Reis e Sousa. 2011. 'Myeloid C-Type Lectin Receptors in Pathogen Recognition and Host Defense'. *Immunity* 34 (5): 651–64. <https://doi.org/10.1016/j.immuni.2011.05.001>.
- Oth, Tammy, Thomas H. P. M. Habets, Wilfred T. V. Germeraad, Marijke I. Zonneveld, Gerard M. J. Bos, and Joris Vanderlocht. 2018. 'Pathogen Recognition by NK Cells Amplifies the Pro-Inflammatory Cytokine Production of Monocyte-Derived DC via IFN- γ '. *BMC Immunology* 19 (1): 8. <https://doi.org/10.1186/s12865-018-0247-y>.
- Ouaguia, Laurissa, Vincent Leroy, Tania Dufeu-Duchesne, David Durantel, Thomas Decaens, Margaux Hubert, Jenny Valladeau-Guilemond, Nathalie Bendriss-Vermare, Laurence Chaperot, and Caroline Aspod. 2019. 'Circulating and Hepatic BDCA1+, BDCA2+, and BDCA3+ Dendritic Cells Are Differentially Subverted in Patients With Chronic HBV Infection'. *Frontiers in Immunology* 10 (February): 112. <https://doi.org/10.3389/fimmu.2019.00112>.
- Padovan, Elisabetta, Giulio C. Spagnoli, Maria Ferrantini, and Michael Heberer. 2002. 'IFN-Alpha2a Induces IP-10/CXCL10 and MIG/CXCL9 Production in Monocyte-Derived Dendritic Cells and Enhances Their Capacity to Attract and Stimulate CD8+ Effector T Cells'. *Journal of Leukocyte Biology* 71 (4): 669–76.
- Pallett, Laura J, Upkar S Gill, Alberto Quaglia, Linda V Sinclair, Maria Jover-Cobos, Anna Schurich, Kasha P Singh, et al. 2015. 'Metabolic Regulation of Hepatitis B Immunopathology by Myeloid-Derived Suppressor Cells'. *Nature Medicine* 21 (6): 591–600. <https://doi.org/10.1038/nm.3856>.
- Palumbo, Gianna Aurora, Cecilia Scisciani, Natalia Pediconi, Leonardo Lupacchini, Dulce Alfalate, Francesca Guerrieri, Ludovica Calvo, et al. 2015. 'IL6 Inhibits HBV Transcription by Targeting the Epigenetic Control of the Nuclear CccDNA Minichromosome'. *PLOS ONE* 10 (11): e0142599. <https://doi.org/10.1371/journal.pone.0142599>.
- Pandey, Surya, Taro Kawai, and Shizuo Akira. 2015. 'Microbial Sensing by Toll-Like Receptors and Intracellular Nucleic Acid Sensors'. *Cold Spring Harbor Perspectives in Biology* 7 (1): a016246. <https://doi.org/10.1101/cshperspect.a016246>.
- Papatheodoridis, George V., Spilios Manolakopoulos, Tung-Hung Su, Spyros Siakavellas, Chun-Jen Liu, Anastasia Kourikou, Hung-Chih Yang, and Jia-Horng Kao. 2018. 'Significance of Definitions of Relapse after Discontinuation of Oral Antivirals in HBeAg-Negative Chronic Hepatitis B'. *Hepatology (Baltimore, Md.)* 68 (2): 415–24. <https://doi.org/10.1002/hep.29497>.
- Paquette, R. L., N. C. Hsu, S. M. Kiertscher, A. N. Park, L. Tran, M. D. Roth, and J. A. Glaspy. 1998. 'Interferon-Alpha and Granulocyte-Macrophage Colony-Stimulating Factor Differentiate Peripheral Blood Monocytes into Potent Antigen-Presenting Cells'. *Journal of Leukocyte Biology* 64 (3): 358–67. <https://doi.org/10.1002/jlb.64.3.358>.
- Park, Boyoun, Melanie M. Brinkmann, Eric Spooner, Clarissa C. Lee, You-Me Kim, and Hidde L. Ploegh. 2008. 'Proteolytic Cleavage in an Endolysosomal Compartment Is Required for Activation of Toll-like Receptor 9'. *Nature Immunology* 9 (12): 1407–14. <https://doi.org/10.1038/ni.1669>.
- Pasparakis, Manolis, Gilles Courtois, Martin Hafner, Marc Schmidt-Supprian, Arianna Nenci, Atiye Toksoy, Monika Krampert, et al. 2002. 'TNF-Mediated Inflammatory Skin Disease in Mice with Epidermis-Specific Deletion of IKK2'. *Nature* 417 (6891): 861–66. <https://doi.org/10.1038/nature00820>.
- Paulsen, Daniela, Kyle E Korolowicz, Bin Li, Xu Huang, Manasa Suresh, Changsuek Yon, Xuebing Leng, et al. 2017. 'AIC649 in Combination with Entecavir Leads to WHsAg Loss in the Woodchuck Animal Model of Chronic Hepatitis B', 1.

- Paulsen, Daniela, Olaf Weber, Helga Ruebsamen-Schaeff, Bud C. Tennant, and Stephan Menne. 2015. 'AIC649 Induces a Bi-Phasic Treatment Response in the Woodchuck Model of Chronic Hepatitis B'. *PLoS ONE* 10 (12). <https://doi.org/10.1371/journal.pone.0144383>.
- Paun, A., and P.M. Pitha. 2007. 'The IRF Family, Revisited'. *Biochimie* 89 (6–7): 744–53. <https://doi.org/10.1016/j.biochi.2007.01.014>.
- Pei, Rongjuan, Bo Qin, Xiaoyong Zhang, Wandu Zhu, Thekla Kemper, Zhiyong Ma, Martin Trippler, Joerg Schlaak, Xinwen Chen, and Mengji Lu. 2014. 'Interferon-Induced Proteins with Tetratricopeptide Repeats 1 and 2 Are Cellular Factors That Limit Hepatitis B Virus Replication'. *Journal of Innate Immunity* 6 (2): 182–91. <https://doi.org/10.1159/000353220>.
- Pelka, Karin, Damien Bertheloot, Elisa Reimer, Kshiti Phulphagar, Susanne V. Schmidt, Anette Christ, Rainer Stahl, et al. 2018. 'The Chaperone UNC93B1 Regulates Toll-like Receptor Stability Independently of Endosomal TLR Transport'. *Immunity* 48 (5): 911–922.e7. <https://doi.org/10.1016/j.immuni.2018.04.011>.
- Peltekian, Cécile, Emmanuel Gordien, Florianne Garreau, Vannary Meas-Yedid, Patrick Soussan, Virginie Williams, Marie-Laure Chaix, Jean-Christophe Olivo-Marin, Christian Bréchet, and Dina Kremsdorf. 2005. 'Human MxA Protein Participates to the Interferon-Related Inhibition of Hepatitis B Virus Replication in Female Transgenic Mice'. *Journal of Hepatology* 43 (6): 965–72. <https://doi.org/10.1016/j.jhep.2005.06.019>.
- Peppas, Dimitra, Lorenzo Micco, Alia Javid, Patrick T. F. Kennedy, Anna Schurich, Claire Dunn, Celeste Pallant, et al. 2010. 'Blockade of Immunosuppressive Cytokines Restores NK Cell Antiviral Function in Chronic Hepatitis B Virus Infection'. Edited by Luca G. Guidotti. *PLoS Pathogens* 6 (12): e1001227. <https://doi.org/10.1371/journal.ppat.1001227>.
- Peters, Kristi L., Heather L. Smith, George R. Stark, and Ganes C. Sen. 2002. 'IRF-3-Dependent, NFkappa B- and JNK-Independent Activation of the 561 and IFN-Beta Genes in Response to Double-Stranded RNA'. *Proceedings of the National Academy of Sciences of the United States of America* 99 (9): 6322–27. <https://doi.org/10.1073/pnas.092133199>.
- Piccolo, Paola, Iliaria Lenci, Luigi Demelia, Franco Bandiera, Maria R. Piras, Giorgio Antonucci, Lorenzo Nosotti, et al. 2009. 'A Randomized Controlled Trial of Pegylated Interferon-Alpha2a plus Adefovir Dipivoxil for Hepatitis B e Antigen-Negative Chronic Hepatitis B'. *Antiviral Therapy* 14 (8): 1165–74. <https://doi.org/10.3851/IMP1466>.
- Piccolo, Paola, Iliaria Lenci, Daniele di Paolo, Luigi Demelia, Orazio Sorbello, Lorenzo Nosotti, and Mario Angelico. 2012. 'A Randomized Controlled Trial of Sequential Peginterferon-Alpha and Telbivudine or Vice Versa for 48 Weeks in HBeAg-Negative Chronic Hepatitis B'. *Antiviral Therapy* 18 (1): 57–64. <https://doi.org/10.3851/IMP2281>.
- Platanias, L. C., and E. N. Fish. 1999. 'Signaling Pathways Activated by Interferons'. *Experimental Hematology* 27 (11): 1583–92. [https://doi.org/10.1016/s0301-472x\(99\)00109-5](https://doi.org/10.1016/s0301-472x(99)00109-5).
- Pohl, Thomas, Raffi Gugasyan, Raelene J. Grumont, Andreas Strasser, Donald Metcalf, David Tarlinton, William Sha, David Baltimore, and Steve Gerondakis. 2002. 'The Combined Absence of NF-Kappa B1 and c-Rel Reveals That Overlapping Roles for These Transcription Factors in the B Cell Lineage Are Restricted to the Activation and Function of Mature Cells'. *Proceedings of the National Academy of Sciences of the United States of America* 99 (7): 4514–19. <https://doi.org/10.1073/pnas.072071599>.
- Poisson, Johanne, Sara Lemoinne, Chantal Boulanger, François Durand, Richard Moreau, Dominique Valla, and Pierre-Emmanuel Rautou. 2017. 'Liver Sinusoidal Endothelial Cells: Physiology and Role in Liver Diseases'. *Journal of Hepatology* 66 (1): 212–27. <https://doi.org/10.1016/j.jhep.2016.07.009>.
- Pol, Jonathan G., Bouchra Lekbaby, François Redelsperger, Sofieke Klamer, Yassmina Mandouri, James Ahodantin, Ivan Bieche, et al. 2015. 'Alternative Splicing-regulated Protein of Hepatitis B Virus Hacks the TNF- α -stimulated Signaling Pathways and Limits the Extent of Liver Inflammation'. *The FASEB Journal* 29 (5): 1879–89. <https://doi.org/10.1096/fj.14-258715>.
- Pollicino, Teresa, Laura Belloni, Giuseppina Raffa, Natalia Pediconi, Giovanni Squadrito, Giovanni Raimondo, and Massimo Levrero. 2006. 'Hepatitis B Virus Replication Is Regulated by the

- Acetylation Status of Hepatitis B Virus CccDNA-Bound H3 and H4 Histones'. *Gastroenterology* 130 (3): 823–37. <https://doi.org/10.1053/j.gastro.2006.01.001>.
- Prince A. M. 1968. 'An Antigen Detected in the Blood during the Incubation Period of Serum Hepatitis', 1968, Proc. Natl. Acad. Sci. USA edition.
- Protzer, Ulrike, Mala Maini, and Percy Knolle. 2012. 'Living in the Liver: Hepatic Infections'. *Nature Reviews. Immunology* 12 (February): 201–13. <https://doi.org/10.1038/nri3169>.
- Qasim, Waseem, Maurizia Brunetto, Adam J. Gehring, Shao-An Xue, Anna Schurich, Atefeh Khakpoor, Hong Zhan, et al. 2015. 'Immunotherapy of HCC Metastases with Autologous T Cell Receptor Redirected T Cells, Targeting HBsAg in a Liver Transplant Patient'. *Journal of Hepatology* 62 (2): 486–91. <https://doi.org/10.1016/j.jhep.2014.10.001>.
- Qi, Yonghe, Zhenchao Gao, Guangwei Xu, Bo Peng, Chenxuan Liu, Huan Yan, Qiyao Yao, et al. 2016. 'DNA Polymerase κ Is a Key Cellular Factor for the Formation of Covalently Closed Circular DNA of Hepatitis B Virus'. Edited by Jianming Hu. *PLOS Pathogens* 12 (10): e1005893. <https://doi.org/10.1371/journal.ppat.1005893>.
- Qiao, Ying, Xiaoxu Han, Gefei Guan, Na Wu, Jianbo Sun, Vladimir Pak, and Guoxin Liang. 2016. 'TGF- β Triggers HBV CccDNA Degradation through AID-Dependent Deamination'. *FEBS Letters* 590 (3): 419–27. <https://doi.org/10.1002/1873-3468.12058>.
- Quetier, Ivan, and Dina Kremsdorf. 2014. 'La Protéine X Du Virus de l'hépatite B et Son Rôle Dans Le Développement Du Carcinome Hépatocellulaire'. *Virologie* 18 (4): 229–38. <https://doi.org/10.1684/vir.2014.0575>.
- Rabe, Birgit, Dieter Glebe, and Michael Kann. 2006. 'Lipid-Mediated Introduction of Hepatitis B Virus Capsids into Nonsusceptible Cells Allows Highly Efficient Replication and Facilitates the Study of Early Infection Events'. *Journal of Virology* 80 (11): 5465–73. <https://doi.org/10.1128/JVI.02303-05>.
- Radreau, Pauline, Marine Porcherot, Christophe Ramière, Karim Mouzannar, Vincent Lotteau, and Patrice André. 2016. 'Reciprocal Regulation of Farnesoid X Receptor α Activity and Hepatitis B Virus Replication in Differentiated HepaRG Cells and Primary Human Hepatocytes'. *The FASEB Journal* 30 (9): 3146–54. <https://doi.org/10.1096/fj.201500134>.
- Rahman, Adeeb H., and Costica Aloman. 2013. 'Dendritic Cells and Liver Fibrosis'. *Biochimica et Biophysica Acta (BBA) - Molecular Basis of Disease* 1832 (7): 998–1004. <https://doi.org/10.1016/j.bbadis.2013.01.005>.
- Real, Catherine Isabell, Melanie Werner, Andreas Paul, Guido Gerken, Joerg Friedrich Schlaak, Andrew Vaillant, and Ruth Broering. 2017. 'Nucleic Acid-Based Polymers Effective against Hepatitis B Virus Infection in Patients Don't Harbor Immunostimulatory Properties in Primary Isolated Liver Cells'. *Scientific Reports* 7 (1): 43838. <https://doi.org/10.1038/srep43838>.
- Rehermann, Barbara. 2013. 'Pathogenesis of Chronic Viral Hepatitis: Differential Roles of T Cells and NK Cells'. *Nature Medicine* 19 (7): 859–68. <https://doi.org/10.1038/nm.3251>.
- Rehermann, Barbara, and Antonio Bertoletti. 2015. 'Immunological Aspects of Antiviral Therapy of Chronic Hepatitis B Virus and Hepatitis C Virus Infections'. *Hepatology (Baltimore, Md.)* 61 (2): 712–21. <https://doi.org/10.1002/hep.27323>.
- Rehwinkel, Jan, and Michaela U. Gack. 2020. 'RIG-I-like Receptors: Their Regulation and Roles in RNA Sensing'. *Nature Reviews Immunology* 20 (9): 537–51. <https://doi.org/10.1038/s41577-020-0288-3>.
- Reimand, Jüri, Ruth Isserlin, Veronique Voisin, Mike Kucera, Christian Tannus-Lopes, Asha Rostamianfar, Lina Wadi, et al. 2019. 'Pathway Enrichment Analysis and Visualization of Omics Data Using g:Profiler, GSEA, Cytoscape and EnrichmentMap'. *Nature Protocols* 14 (2): 482–517. <https://doi.org/10.1038/s41596-018-0103-9>.
- Renner, Florian, and M. Lienhard Schmitz. 2009. 'Autoregulatory Feedback Loops Terminating the NF- κ B Response'. *Trends in Biochemical Sciences* 34 (3): 128–35. <https://doi.org/10.1016/j.tibs.2008.12.003>.

- Repetto, Guillermo, Ana del Peso, and Jorge L. Zurita. 2008. 'Neutral Red Uptake Assay for the Estimation of Cell Viability/Cytotoxicity'. *Nature Protocols* 3 (7): 1125–31. <https://doi.org/10.1038/nprot.2008.75>.
- Revill, Peter A, Francis V Chisari, Joan M Block, Maura Dandri, Adam J Gehring, Haitao Guo, Jianming Hu, et al. 2019. 'A Global Scientific Strategy to Cure Hepatitis B'. *The Lancet. Gastroenterology & Hepatology* 4 (7): 545–58. [https://doi.org/10.1016/S2468-1253\(19\)30119-0](https://doi.org/10.1016/S2468-1253(19)30119-0).
- Ribeiro, Carla M. S., and Virgil E. J. C. Schijns. 2010. 'Immunology of Vaccine Adjuvants'. *Methods in Molecular Biology (Clifton, N.J.)* 626: 1–14. https://doi.org/10.1007/978-1-60761-585-9_1.
- Rijckborst, Vincent, and Harry L. A. Janssen. 2010. 'The Role of Interferon in Hepatitis B Therapy'. *Current Hepatitis Reports* 9 (4): 231–38. <https://doi.org/10.1007/s11901-010-0055-1>.
- Rivière, Lise, Laetitia Gerossier, Aurélie Ducroux, Sarah Dion, Qiang Deng, Marie-Louise Michel, Marie-Annick Buendia, Olivier Hantz, and Christine Neuveut. 2015. 'HBx Relieves Chromatin-Mediated Transcriptional Repression of Hepatitis B Viral CccDNA Involving SETDB1 Histone Methyltransferase'. *Journal of Hepatology* 63 (5): 1093–1102. <https://doi.org/10.1016/j.jhep.2015.06.023>.
- Rivière, Lise, Barbara Quioc-Salomon, Guillaume Fallot, Boris Halgand, Cyrille Féray, Marie-Annick Buendia, and Christine Neuveut. 2019. 'Hepatitis B Virus Replicating in Hepatocellular Carcinoma Encodes HBx Variants with Preserved Ability to Antagonize Restriction by Smc5/6'. *Antiviral Research* 172 (December): 104618. <https://doi.org/10.1016/j.antiviral.2019.104618>.
- Robinson, Mark W, Cathal Harmon, and Cliona O'Farrelly. 2016. 'Liver Immunology and Its Role in Inflammation and Homeostasis'. *Cellular and Molecular Immunology* 13 (3): 267–76. <https://doi.org/10.1038/cmi.2016.3>.
- Robinson, William S., and Richard L. Greenman. 1974. 'DNA Polymerase in the Core of the Human Hepatitis B Virus Candidate'. *Journal of Virology* 13 (6): 1231–36. <https://doi.org/10.1128/JVI.13.6.1231-1236.1974>.
- Rock, F. L., G. Hardiman, J. C. Timans, R. A. Kastelein, and J. F. Bazan. 1998. 'A Family of Human Receptors Structurally Related to Drosophila Toll'. *Proceedings of the National Academy of Sciences* 95 (2): 588–93. <https://doi.org/10.1073/pnas.95.2.588>.
- Rojas-Sánchez, Leonardo, Ejuan Zhang, Viktoriya Sokolova, Maohua Zhong, Hu Yan, Mengji Lu, Qian Li, Huimin Yan, and Matthias Epple. 2020. 'Genetic Immunization against Hepatitis B Virus with Calcium Phosphate Nanoparticles in Vitro and in Vivo'. *Acta Biomaterialia* 110 (July): 254–65. <https://doi.org/10.1016/j.actbio.2020.04.021>.
- Rosmorduc, O, H Sirma, P Soussan, E Gordien, P Lebon, M Horisberger, C BrV@chot, and D Kremsdorf. 1999. 'Inhibition of Interferon-Inducible MxA Protein Expression by Hepatitis B Virus Capsid Protein.' *Journal of General Virology* 80 (5): 1253–62. <https://doi.org/10.1099/0022-1317-80-5-1253>.
- Rouzaut, Ana, Saray Garasa, Alvaro Teijeira, Iranzu González, Ivan Martinez-Forero, Natalia Suarez, Esther Larrea, et al. 2010. 'Dendritic Cells Adhere to and Transmigrate across Lymphatic Endothelium in Response to IFN- α '. *European Journal of Immunology* 40 (11): 3054–63. <https://doi.org/10.1002/eji.201040523>.
- Rowe, Alexander M., Susan E. Murray, Hans-Peter Raué, Yoshinobu Koguchi, Mark K. Slifka, and David C. Parker. 2013. 'A Cell-Intrinsic Requirement for NF-KB-Inducing Kinase in CD4 and CD8 T Cell Memory'. *Journal of Immunology (Baltimore, Md.: 1950)* 191 (7): 3663–72. <https://doi.org/10.4049/jimmunol.1301328>.
- Ruan, Qingguo, Vasumathi Kameswaran, Yukiko Tone, Li Li, Hsiou-Chi Liou, Mark I. Greene, Masahide Tone, and Youhai H. Chen. 2009. 'Development of Foxp3(+) Regulatory t Cells Is Driven by the c-Rel Enhanceosome'. *Immunity* 31 (6): 932–40. <https://doi.org/10.1016/j.immuni.2009.10.006>.
- Ruan, Qingguo, Vasumathi Kameswaran, Yan Zhang, Shijun Zheng, Jing Sun, Junmei Wang, Jennifer DeVirgiliis, Hsiou-Chi Liou, Amer A. Beg, and Youhai H. Chen. 2011. 'The Th17 Immune

- Response Is Controlled by the Rel–ROR γ –ROR γ T Transcriptional Axis'. *The Journal of Experimental Medicine* 208 (11): 2321–33. <https://doi.org/10.1084/jem.20110462>.
- Saeed, Umar, Jumi Kim, Zahra Zahid Piracha, Hyeonjoong Kwon, Jaesung Jung, Yong-Joon Chwae, Sun Park, Ho-Joon Shin, and Kyongmin Kim. 2019. 'Parvulin 14 and Parvulin 17 Bind to HBx and CccDNA and Upregulate Hepatitis B Virus Replication from CccDNA to Virion in an HBx-Dependent Manner'. *Journal of Virology* 93 (6). <https://doi.org/10.1128/JVI.01840-18>.
- Saha, Supriya K., Eric M. Pietras, Jeannie Q. He, Jason R. Kang, Su-Yang Liu, Gagik Oganessian, Arash Shahangian, et al. 2006. 'Regulation of Antiviral Responses by a Direct and Specific Interaction between TRAF3 and Cardif'. *The EMBO Journal* 25 (14): 3257–63. <https://doi.org/10.1038/sj.emboj.7601220>.
- Sahu, Kantol Kumar, and Ravi Shankar Pandey. 2016. 'Immunological Evaluation of Colonic Delivered Hepatitis B Surface Antigen Loaded TLR-4 Agonist Modified Solid Fat Nanoparticles'. *International Immunopharmacology* 39 (October): 343–52. <https://doi.org/10.1016/j.intimp.2016.08.007>.
- Salerno, Debora, Letizia Chiodo, Vincenzo Alfano, Oceane Floriot, Grazia Cottone, Alexia Paturel, Matteo Pallocca, et al. 2020. 'Hepatitis B Protein HBx Binds the DLEU2 LncRNA to Sustain CccDNA and Host Cancer-Related Gene Transcription'. *Gut* 69 (11): 2016–24. <https://doi.org/10.1136/gutjnl-2019-319637>.
- Salfeld, J, E Pfaff, M Noah, and H Schaller. 1989. 'Antigenic Determinants and Functional Domains in Core Antigen and e Antigen from Hepatitis B Virus.' *Journal of Virology* 63 (2): 798–808.
- Sarasin-Filipowicz, Magdalena, Xueya Wang, Ming Yan, Francois H. T. Duong, Valeria Poli, Douglas J. Hilton, Dong-Er Zhang, and Markus H. Heim. 2009. 'Alpha Interferon Induces Long-Lasting Refractoriness of JAK-STAT Signaling in the Mouse Liver through Induction of USP18/UBP43'. *Molecular and Cellular Biology* 29 (17): 4841–51. <https://doi.org/10.1128/MCB.00224-09>.
- Sato, Seiichi, Kai Li, Takeshi Kameyama, Takaya Hayashi, Yuji Ishida, Shuko Murakami, Tsunamasa Watanabe, et al. 2015. 'The RNA Sensor RIG-I Dually Functions as an Innate Sensor and Direct Antiviral Factor for Hepatitis B Virus'. *Immunity* 42 (1): 123–32. <https://doi.org/10.1016/j.immuni.2014.12.016>.
- Schaefer S. 2007. 'Hepatitis B Virus Taxonomy and Hepatitis B Virus Genotypes', 2007, World J. Gastroenterol. WJG edition.
- Schaper, Fred, and Stefan Rose-John. 2015. 'Interleukin-6: Biology, Signaling and Strategies of Blockade'. *Cytokine & Growth Factor Reviews* 26 (5): 475–87. <https://doi.org/10.1016/j.cytogfr.2015.07.004>.
- Scheller, Jürgen, Athena Chalaris, Dirk Schmidt-Arras, and Stefan Rose-John. 2011. 'The Pro- and Anti-Inflammatory Properties of the Cytokine Interleukin-6'. *Biochimica et Biophysica Acta (BBA) - Molecular Cell Research*, Including the Special Section: 11th European Symposium on Calcium, 1813 (5): 878–88. <https://doi.org/10.1016/j.bbamcr.2011.01.034>.
- Schmidt, Susanne V., Andrea C. Nino-Castro, and Joachim L. Schultze. 2012. 'Regulatory Dendritic Cells: There Is More than Just Immune Activation'. *Frontiers in Immunology* 3: 274. <https://doi.org/10.3389/fimmu.2012.00274>.
- Schmidt-Arras, Dirk, and Stefan Rose-John. 2016. 'IL-6 Pathway in the Liver: From Physiopathology to Therapy'. *Journal of Hepatology* 64 (6): 1403–15. <https://doi.org/10.1016/j.jhep.2016.02.004>.
- Schmitt, Sigrid, Dieter Glebe, Tanja K. Tolle, Günter Lochnit, Dietmar Linder, Rudolf Geyer, and Wolfram H. Gerlich. 2004. 'Structure of Pre-S2 N- and O-Linked Glycans in Surface Proteins from Different Genotypes of Hepatitis B Virus'. *Journal of General Virology* 85 (7): 2045–53. <https://doi.org/10.1099/vir.0.79932-0>.
- Schoggins, John W., Sam J. Wilson, Maryline Panis, Mary Y. Murphy, Christopher T. Jones, Paul Bieniasz, and Charles M. Rice. 2011. 'A Diverse Range of Gene Products Are Effectors of the Type I Interferon Antiviral Response'. *Nature* 472 (7344): 481–85. <https://doi.org/10.1038/nature09907>.

- Schroder, Kate, and Jurg Tschopp. 2010. 'The Inflammasomes'. *Cell* 140 (6): 821–32. <https://doi.org/10.1016/j.cell.2010.01.040>.
- Schulze, Andreas, Philippe Gripon, and Stephan Urban. 2007. 'Hepatitis B Virus Infection Initiates with a Large Surface Protein-Dependent Binding to Heparan Sulfate Proteoglycans'. *Hepatology* 46 (6): 1759–68. <https://doi.org/10.1002/hep.21896>.
- Schulze, Ryan J., Micah B. Schott, Carol A. Casey, Pamela L. Tuma, and Mark A. McNiven. 2019. 'The Cell Biology of the Hepatocyte: A Membrane Trafficking Machine'. *Journal of Cell Biology* 218 (7): 2096–2112. <https://doi.org/10.1083/jcb.201903090>.
- Schwalbe, Martin, Oliver Ohlenschläger, Aliaksandr Marchanka, Ramadurai Ramachandran, Sabine Häfner, Tilman Heise, and Matthias Görlach. 2008. 'Solution Structure of Stem-Loop α of the Hepatitis B Virus Post-Transcriptional Regulatory Element'. *Nucleic Acids Research* 36 (5): 1681–89. <https://doi.org/10.1093/nar/gkn006>.
- Schweitzer, Aparna, Johannes Horn, Rafael T Mikolajczyk, Gérard Krause, and Jördis J Ott. 2015. 'Estimations of Worldwide Prevalence of Chronic Hepatitis B Virus Infection: A Systematic Review of Data Published between 1965 and 2013'. *The Lancet* 386 (10003): 1546–55. [https://doi.org/10.1016/S0140-6736\(15\)61412-X](https://doi.org/10.1016/S0140-6736(15)61412-X).
- Seeger, Christoph, and William S Mason. 2016. 'Molecular Biology of Hepatitis B Virus Infection', 35.
- Selzer, Lisa, and Adam Zlotnick. 2015. 'Assembly and Release of Hepatitis B Virus'. *Cold Spring Harbor Perspectives in Medicine*, November, a021394. <https://doi.org/10.1101/cshperspect.a021394>.
- Sen, R., and D. Baltimore. 1986. 'Inducibility of Kappa Immunoglobulin Enhancer-Binding Protein NF-Kappa B by a Posttranslational Mechanism'. *Cell* 47 (6): 921–28. [https://doi.org/10.1016/0092-8674\(86\)90807-x](https://doi.org/10.1016/0092-8674(86)90807-x).
- Sepulveda, Fernando E., Sophia Maschalidi, Renaud Colisson, Lea Heslop, Cristina Ghirelli, Emna Sakka, Ana-Maria Lennon-Duménil, Sebastian Amigorena, Lucien Cabanie, and Bénédicte Manoury. 2009. 'Critical Role for Asparagine Endopeptidase in Endocytic Toll-like Receptor Signaling in Dendritic Cells'. *Immunity* 31 (5): 737–48. <https://doi.org/10.1016/j.immuni.2009.09.013>.
- Serfaty, L., D. Thabut, F. Zoulim, T. Andreani, O. Chazouillères, N. Carbonell, A. Loria, and R. Poupon. 2001. 'Sequential Treatment with Lamivudine and Interferon Monotherapies in Patients with Chronic Hepatitis B Not Responding to Interferon Alone: Results of a Pilot Study'. *Hepatology (Baltimore, Md.)* 34 (3): 573–77. <https://doi.org/10.1053/jhep.2001.26819>.
- Shekarian, T., S. Valsesia-Wittmann, J. Brody, M.C. Michallet, S. Depil, C. Caux, and A. Marabelle. 2017. 'Pattern Recognition Receptors: Immune Targets to Enhance Cancer Immunotherapy'. *Annals of Oncology* 28 (8): 1756–66. <https://doi.org/10.1093/annonc/mdx179>.
- Sheraz, Muhammad, Junjun Cheng, Liudi Tang, Jinhong Chang, and Ju-Tao Guo. 2019. 'Cellular DNA Topoisomerases Are Required for the Synthesis of Hepatitis B Virus Covalently Closed Circular DNA'. *Journal of Virology* 93 (11). <https://doi.org/10.1128/JVI.02230-18>.
- Sherlock, Sheila. 1984. 'Chronic Hepatitis and Cirrhosis'. *Hepatology* 4 (S1): 25S-28S. <https://doi.org/10.1002/hep.1840040709>.
- Shi, Bisheng, Guangxu Ren, Yunwen Hu, Sen Wang, Zhanqing Zhang, and Zhenghong Yuan. 2012. 'HBsAg Inhibits IFN- α Production in Plasmacytoid Dendritic Cells through TNF- α and IL-10 Induction in Monocytes'. Edited by Volker Thiel. *PLoS ONE* 7 (9): e44900. <https://doi.org/10.1371/journal.pone.0044900>.
- Shimura, Satomi, Koichi Watashi, Kento Fukano, Michael Peel, Ann Sluder, Fumihiro Kawai, Masashi Iwamoto, et al. 2017. 'Cyclosporin Derivatives Inhibit Hepatitis B Virus Entry without Interfering with NTCP Transporter Activity'. *Journal of Hepatology* 66 (4): 685–92. <https://doi.org/10.1016/j.jhep.2016.11.009>.
- Shinohara, Mari L., Linrong Lu, Jing Bu, Miriam B. F. Werneck, Koichi S. Kobayashi, Laurie H. Glimcher, and Harvey Cantor. 2006. 'Osteopontin Expression Is Essential for Interferon- α Production by Plasmacytoid Dendritic Cells'. *Nature Immunology* 7 (5): 498–506. <https://doi.org/10.1038/ni1327>.

- Sica, Antonio, and Alberto Mantovani. 2012. 'Macrophage Plasticity and Polarization: In Vivo Veritas'. *The Journal of Clinical Investigation* 122 (3): 787–95. <https://doi.org/10.1172/JCI59643>.
- Simmons, Daimon P., Pamela A. Wearsch, David H. Canaday, Howard J. Meyerson, Yi C. Liu, Ying Wang, W. Henry Boom, and Clifford V. Harding. 2012. 'Type I IFN Drives a Distinctive Dendritic Cell Maturation Phenotype That Allows Continued Class II MHC Synthesis and Antigen Processing'. *Journal of Immunology (Baltimore, Md.: 1950)* 188 (7): 3116–26. <https://doi.org/10.4049/jimmunol.1101313>.
- Simonsen, C C, and A D Levinson. 1983. 'Analysis of Processing and Polyadenylation Signals of the Hepatitis B Virus Surface Antigen Gene by Using Simian Virus 40-Hepatitis B Virus Chimeric Plasmids.' *Molecular and Cellular Biology* 3 (12): 2250–58. <https://doi.org/10.1128/MCB.3.12.2250>.
- Slagle, Betty L., and Michael J. Bouchard. 2016. 'Hepatitis B Virus X and Regulation of Viral Gene Expression'. *Cold Spring Harbor Perspectives in Medicine* 6 (3): a021402. <https://doi.org/10.1101/cshperspect.a021402>.
- Slagle, Betty L, and Michael J Bouchard. 2018. 'Role of HBx in Hepatitis B Virus Persistence and Its Therapeutic Implications'. *Current Opinion in Virology* 30 (June): 32–38. <https://doi.org/10.1016/j.coviro.2018.01.007>.
- Smith, George J., III, John E. Donello, Thomas J. Hope, Rupert Lück, and Gerhard Steger. 1998. 'The Hepatitis B Virus Post-Transcriptional Regulatory Element Contains Two Conserved RNA Stem-Loops Which Are Required for Function'. *Nucleic Acids Research* 26 (21): 4818–27. <https://doi.org/10.1093/nar/26.21.4818>.
- Sommereyns, Caroline, Sophie Paul, Peter Staeheli, and Thomas Michiels. 2008. 'IFN-Lambda (IFN-Lambda) Is Expressed in a Tissue-Dependent Fashion and Primarily Acts on Epithelial Cells in Vivo'. *PLoS Pathogens* 4 (3): e1000017. <https://doi.org/10.1371/journal.ppat.1000017>.
- Soulat, Didier, Tilmann Bürckstümmer, Sandra Westermayer, Adriana Goncalves, Angela Bauch, Adrijana Stefanovic, Oliver Hantschel, Keiryn L Bennett, Thomas Decker, and Giulio Superti-Furga. 2008. 'The DEAD-Box Helicase DDX3X Is a Critical Component of the TANK-Binding Kinase 1-Dependent Innate Immune Response'. *The EMBO Journal* 27 (15): 2135–46. <https://doi.org/10.1038/emboj.2008.126>.
- Soussan, Patrick, Florianne Garreau, Hervé Zylberberg, Cyrille Ferray, Christian Brechot, and Dina Kremsdorf. 2000. 'In Vivo Expression of a New Hepatitis B Virus Protein Encoded by a Spliced RNA'. *Journal of Clinical Investigation* 105 (1): 55–60. <https://doi.org/10.1172/JCI8098>.
- Soussan, Patrick, Rosella Tuveri, Bertrand Nalpas, Florianne Garreau, Flora Zavala, Annie Masson, Stanislas Pol, Christian Brechot, and Dina Kremsdorf. 2003. 'The Expression of Hepatitis B Spliced Protein (HBSP) Encoded by a Spliced Hepatitis B Virus RNA Is Associated with Viral Replication and Liver Fibrosis'. *Journal of Hepatology* 38 (3): 343–48. [https://doi.org/10.1016/S0168-8278\(02\)00422-1](https://doi.org/10.1016/S0168-8278(02)00422-1).
- Srinivas, Shekar, Jihong Dai, Joyce Eskdale, Grant E Gallagher, Nicholas J Megjugorac, and Grant Gallagher. 2008. 'Interferon- λ 1 (Interleukin-29) Preferentially down-Regulates Interleukin-13 over Other T Helper Type 2 Cytokine Responses in Vitro'. *Immunology* 125 (4): 492–502. <https://doi.org/10.1111/j.1365-2567.2008.02862.x>.
- Stacey, Andrea R., Philip J. Norris, Li Qin, Elizabeth A. Haygreen, Elizabeth Taylor, John Heitman, Mila Lebedeva, et al. 2009. 'Induction of a Striking Systemic Cytokine Cascade Prior to Peak Viremia in Acute Human Immunodeficiency Virus Type 1 Infection, in Contrast to More Modest and Delayed Responses in Acute Hepatitis B and C Virus Infections'. *Journal of Virology* 83 (8): 3719–33. <https://doi.org/10.1128/JVI.01844-08>.
- Stanifer, Megan L., Kalliopi Pervolaraki, and Steeve Boulant. 2019. 'Differential Regulation of Type I and Type III Interferon Signaling'. *International Journal of Molecular Sciences* 20 (6). <https://doi.org/10.3390/ijms20061445>.
- Stark, George R., and James E. Darnell. 2012. 'The JAK-STAT Pathway at Twenty'. *Immunity* 36 (4): 503–14. <https://doi.org/10.1016/j.immuni.2012.03.013>.

- Stetson, Daniel B., and Ruslan Medzhitov. 2006. 'Recognition of Cytosolic DNA Activates an IRF3-Dependent Innate Immune Response'. *Immunity* 24 (1): 93–103. <https://doi.org/10.1016/j.immuni.2005.12.003>.
- Stevens, C. E., R. P. Beasley, J. Tsui, and W. C. Lee. 1975. 'Vertical Transmission of Hepatitis B Antigen in Taiwan'. *The New England Journal of Medicine* 292 (15): 771–74. <https://doi.org/10.1056/NEJM197504102921503>.
- Stevens, Cladd E., Robert A. Neurath, R. Palmer Beasley, and Wolf Szmuness. 1979. 'HBeAg and Anti-Hbe Detection by Radioimmunoassay: Correlation with Vertical Transmission of Hepatitis B Virus in Taiwan'. *Journal of Medical Virology* 3 (3): 237–41. <https://doi.org/10.1002/jmv.1890030310>.
- Stockdale, Alexander J., Benno Kreuels, Marc Y.R. Henrion, Emanuele Giorgi, Irene Kyomuhangi, Catherine de Martel, Yvan Hutin, and Anna Maria Geretti. 2020. 'The Global Prevalence of Hepatitis D Virus Infection: Systematic Review and Meta-Analysis'. *Journal of Hepatology* 73 (3): 523–32. <https://doi.org/10.1016/j.jhep.2020.04.008>.
- Subramanian, Aravind, Pablo Tamayo, Vamsi K. Mootha, Sayan Mukherjee, Benjamin L. Ebert, Michael A. Gillette, Amanda Paulovich, et al. 2005. 'Gene Set Enrichment Analysis: A Knowledge-Based Approach for Interpreting Genome-Wide Expression Profiles'. *Proceedings of the National Academy of Sciences* 102 (43): 15545–50. <https://doi.org/10.1073/pnas.0506580102>.
- Summers, J., and W. S. Mason. 1982. 'Replication of the Genome of a Hepatitis B-like Virus by Reverse Transcription of an RNA Intermediate'. *Cell* 29 (2): 403–15. [https://doi.org/10.1016/0092-8674\(82\)90157-x](https://doi.org/10.1016/0092-8674(82)90157-x).
- Summers, J., A. O'Connell, and I. Millman. 1975. 'Genome of Hepatitis B Virus: Restriction Enzyme Cleavage and Structure of DNA Extracted from Dane Particles'. *Proceedings of the National Academy of Sciences of the United States of America* 72 (11): 4597–4601. <https://doi.org/10.1073/pnas.72.11.4597>.
- Sun, Shao-Cong. 2011. 'Non-Canonical NF-KB Signaling Pathway'. *Cell Research* 21 (1): 71–85. <https://doi.org/10.1038/cr.2010.177>.
- . 2017. 'The Non-Canonical NF-KB Pathway in Immunity and Inflammation'. *Nature Reviews. Immunology* 17 (9): 545–58. <https://doi.org/10.1038/nri.2017.52>.
- Sunbul, Mustafa. 2014. 'Hepatitis B Virus Genotypes: Global Distribution and Clinical Importance'. *World Journal of Gastroenterology* 20 (18): 5427. <https://doi.org/10.3748/wjg.v20.i18.5427>.
- Sureau, Camille, and Jessica Salisse. 2013. 'A Conformational Heparan Sulfate Binding Site Essential to Infectivity Overlaps with the Conserved Hepatitis B Virus A-Determinant'. *Hepatology* 57 (3): 985–94. <https://doi.org/10.1002/hep.26125>.
- Suslov, Aleksei, Tujana Boldanova, Xueya Wang, Stefan Wieland, and Markus H. Heim. 2018. 'Hepatitis B Virus Does Not Interfere With Innate Immune Responses in the Human Liver'. *Gastroenterology* 154 (6): 1778–90. <https://doi.org/10.1053/j.gastro.2018.01.034>.
- Suslov, Aleksei, Stefan Wieland, and Stephan Menne. 2018. 'Modulators of Innate Immunity as Novel Therapeutics for Treatment of Chronic Hepatitis B'. *Current Opinion in Virology* 30 (June): 9–17. <https://doi.org/10.1016/j.coviro.2018.01.008>.
- Sutterwala, Fayyaz S., Stefanie Haasken, and Suzanne L. Cassel. 2014. 'Mechanism of NLRP3 Inflammasome Activation'. *Annals of the New York Academy of Sciences* 1319 (June): 82–95. <https://doi.org/10.1111/nyas.12458>.
- Taha, Taha Y., Varada Anirudhan, Umaporn Limothai, Daniel D. Loeb, Pavel A. Petukhov, and Alan McLachlan. 2020. 'Modulation of Hepatitis B Virus Pregenomic RNA Stability and Splicing by Histone Deacetylase 5 Enhances Viral Biosynthesis'. Edited by Haitao Guo. *PLOS Pathogens* 16 (8): e1008802. <https://doi.org/10.1371/journal.ppat.1008802>.
- Takaoka, Akinori, Zhichao Wang, Myoung Kwon Choi, Hideyuki Yanai, Hideo Negishi, Tatsuma Ban, Yan Lu, et al. 2007. 'DAI (DLM-1/ZBP1) Is a Cytosolic DNA Sensor and an Activator of Innate Immune Response'. *Nature* 448 (7152): 501–5. <https://doi.org/10.1038/nature06013>.

- Takeda, Kiyoshi, and Shizuo Akira. 2015. 'Toll-Like Receptors'. *Current Protocols in Immunology* 109 (1). <https://doi.org/10.1002/0471142735.im1412s109>.
- Takeuchi, Osamu, and Shizuo Akira. 2010. 'Pattern Recognition Receptors and Inflammation'. *Cell* 140 (6): 805–20. <https://doi.org/10.1016/j.cell.2010.01.022>.
- Tan, Anthony T., and Sophia Schreiber. 2020. 'Adoptive T-Cell Therapy for HBV-Associated HCC and HBV Infection'. *Antiviral Research* 176 (April): 104748. <https://doi.org/10.1016/j.antiviral.2020.104748>.
- Tang, Liudi, Muhammad Sheraz, Michael McGrane, Jinhong Chang, and Ju-Tao Guo. 2019. 'DNA Polymerase Alpha Is Essential for Intracellular Amplification of Hepatitis B Virus Covalently Closed Circular DNA'. Edited by Aleem Siddiqui. *PLOS Pathogens* 15 (4): e1007742. <https://doi.org/10.1371/journal.ppat.1007742>.
- Tang, Lydia S. Y., Emily Covert, Eleanor Wilson, and Shyam Kottlilil. 2018. 'Chronic Hepatitis B Infection: A Review'. *JAMA* 319 (17): 1802–13. <https://doi.org/10.1001/jama.2018.3795>.
- Tangkijvanich, P., S. Chittmittraprap, K. Poovorawan, U. Limothai, A. Khlaiphuengsin, N. Chuaypen, N. Wisedopas, and Y. Poovorawan. 2016. 'A Randomized Clinical Trial of Peginterferon Alpha-2b with or without Entecavir in Patients with HBeAg-Negative Chronic Hepatitis B: Role of Host and Viral Factors Associated with Treatment Response'. *Journal of Viral Hepatitis* 23 (6): 427–38. <https://doi.org/10.1111/jvh.12467>.
- Taniguchi, T., K. Ogasawara, A. Takaoka, and N. Tanaka. 2001. 'IRF Family of Transcription Factors as Regulators of Host Defense'. *Annual Review of Immunology* 19: 623–55. <https://doi.org/10.1146/annurev.immunol.19.1.623>.
- Tassopoulos, N. C., G. J. Papaevangelou, M. H. Sjogren, A. Roumeliotou-Karayannis, J. L. Gerin, and R. H. Purcell. 1987. 'Natural History of Acute Hepatitis B Surface Antigen-Positive Hepatitis in Greek Adults'. *Gastroenterology* 92 (6): 1844–50. [https://doi.org/10.1016/0016-5085\(87\)90614-7](https://doi.org/10.1016/0016-5085(87)90614-7).
- Tavakoli, S., I. Mederacke, S. Herzog-Hauff, D. Glebe, S. Grün, D. Strand, S. Urban, A. Gehring, P. R. Galle, and W. O. Böcher. 2008. 'Peripheral Blood Dendritic Cells Are Phenotypically and Functionally Intact in Chronic Hepatitis B Virus (HBV) Infection: Dendritic Cells in Chronic Hepatitis B'. *Clinical & Experimental Immunology* 151 (1): 61–70. <https://doi.org/10.1111/j.1365-2249.2007.03547.x>.
- Tavis, J. E., and D. Ganem. 1996. 'Evidence for Activation of the Hepatitis B Virus Polymerase by Binding of Its RNA Template'. *Journal of Virology* 70 (9): 5741–50. <https://doi.org/10.1128/JVI.70.9.5741-5750.1996>.
- Teijaro, John R., Cherie Ng, Andrew M. Lee, Brian M. Sullivan, Kathleen C. F. Sheehan, Megan Welch, Robert D. Schreiber, Juan Carlos de la Torre, and Michael B. A. Oldstone. 2013. 'Persistent LCMV Infection Is Controlled by Blockade of Type I Interferon Signaling'. *Science (New York, N.Y.)* 340 (6129): 207–11. <https://doi.org/10.1126/science.1235214>.
- Tenover, Benjamin R., Sze-Ling Ng, Mark A. Chua, Sarah M. McWhirter, Adolfo García-Sastre, and Tom Maniatis. 2007. 'Multiple Functions of the IKK-Related Kinase IKKepsilon in Interferon-Mediated Antiviral Immunity'. *Science (New York, N.Y.)* 315 (5816): 1274–78. <https://doi.org/10.1126/science.1136567>.
- Testoni, Barbara, David Durantel, and Fabien Zoulim. 2017. 'Novel Targets for Hepatitis B Virus Therapy'. *Liver International* 37 (S1): 33–39. <https://doi.org/10.1111/liv.13307>.
- Thomas, Emmanuel, Masato Yoneda, and Eugene R. Schiff. 2015. 'Viral Hepatitis: Past and Future of HBV and HDV'. *Cold Spring Harbor Perspectives in Medicine* 5 (2). <https://doi.org/10.1101/cshperspect.a021345>.
- Tian, Zhao-ju, Yu Shen, Xin-rui Li, Ya-nan Wei, Hua Fan, and Qi-kui Ren. 2019. 'Increased Interleukin-32, Interleukin-1, and Interferon-γ Levels in Serum from Hepatitis B Patients and in HBV-Stimulated Peripheral Blood Mononuclear Cells from Healthy Volunteers'. *Journal of Infection and Public Health* 12 (1): 7–12. <https://doi.org/10.1016/j.jiph.2018.06.006>.

- Ting, Jenny P.-Y., Ruth C. Lovering, Emad S. Alnemri, John Bertin, Jeremy M. Boss, Beckley K. Davis, Richard A. Flavell, et al. 2008. 'The NLR Gene Family: A Standard Nomenclature'. *Immunity* 28 (3): 285–87. <https://doi.org/10.1016/j.immuni.2008.02.005>.
- Tong, Shuping, and Peter Revill. 2016. 'Overview of Hepatitis B Viral Replication and Genetic Variability'. *Journal of Hepatology* 64 (1, Supplement): S4–16. <https://doi.org/10.1016/j.jhep.2016.01.027>.
- Trefts, Elijah, Maureen Gannon, and David H. Wasserman. 2017. 'The Liver'. *Current Biology* 27 (21): R1147–51. <https://doi.org/10.1016/j.cub.2017.09.019>.
- Tropberger, Philipp, Alexandre Mercier, Margaret Robinson, Weidong Zhong, Don E. Ganem, and Meghan Holdorf. 2015. 'Mapping of Histone Modifications in Episomal HBV CccDNA Uncovers an Unusual Chromatin Organization Amenable to Epigenetic Manipulation'. *Proceedings of the National Academy of Sciences of the United States of America* 112 (42): E5715–5724. <https://doi.org/10.1073/pnas.1518090112>.
- Tseng, T.-C., and J.-H. Kao. 2015. 'Treating Immune-Tolerant Hepatitis B'. *Journal of Viral Hepatitis* 22 (2): 77–84. <https://doi.org/10.1111/jvh.12370>.
- Tsuge, M., N. Hiraga, R. Akiyama, S. Tanaka, M. Matsushita, F. Mitsui, H. Abe, et al. 2010. 'HBx Protein Is Indispensable for Development of Viraemia in Human Hepatocyte Chimeric Mice'. *Journal of General Virology* 91 (7): 1854–64. <https://doi.org/10.1099/vir.0.019224-0>.
- Tu, Thomas, and Stephan Urban. 2018. 'Virus Entry and Its Inhibition to Prevent and Treat Hepatitis B and Hepatitis D Virus Infections'. *Current Opinion in Virology* 30 (June): 68–79. <https://doi.org/10.1016/j.coviro.2018.04.004>.
- Tur-Kaspa, R, L Teicher, O Laub, A Itin, D Dagan, B R Bloom, and D A Shafritz. 1990. 'Alpha Interferon Suppresses Hepatitis B Virus Enhancer Activity and Reduces Viral Gene Transcription.' *Journal of Virology* 64 (4): 1821–24.
- Turner, Mark D., Belinda Nedjai, Tara Hurst, and Daniel J. Pennington. 2014. 'Cytokines and Chemokines: At the Crossroads of Cell Signalling and Inflammatory Disease'. *Biochimica et Biophysica Acta (BBA) - Molecular Cell Research* 1843 (11): 2563–82. <https://doi.org/10.1016/j.bbamcr.2014.05.014>.
- Turton, Kristi L., Vanessa Meier-Stephenson, Maulik D. Badmalia, Carla S. Coffin, and Trushar R. Patel. 2020. 'Host Transcription Factors in Hepatitis B Virus RNA Synthesis'. *Viruses* 12 (2): 160. <https://doi.org/10.3390/v12020160>.
- Tyler, Betty, David Gullotti, Antonella Mangraviti, Tadanobu Utsuki, and Henry Brem. 2016. 'Polylactic Acid (PLA) Controlled Delivery Carriers for Biomedical Applications'. *Advanced Drug Delivery Reviews* 107 (December): 163–75. <https://doi.org/10.1016/j.addr.2016.06.018>.
- Tzeng, Horng-Tay, Hwei-Fang Tsai, I-Tsu Chyuan, Hsiu-Jung Liao, Chun-Jen Chen, Pei-Jer Chen, and Ping-Ning Hsu. 2014. 'Tumor Necrosis Factor-Alpha Induced by Hepatitis B Virus Core Mediating the Immune Response for Hepatitis B Viral Clearance in Mice Model'. Edited by Haitao Guo. *PLoS ONE* 9 (7): e103008. <https://doi.org/10.1371/journal.pone.0103008>.
- Unterholzner, Leonie, Sinead E. Keating, Marcin Baran, Kristy A. Horan, Søren B. Jensen, Shruti Sharma, Cheryl M. Sirois, et al. 2010. 'IFI16 Is an Innate Immune Sensor for Intracellular DNA'. *Nature Immunology* 11 (11): 997–1004. <https://doi.org/10.1038/ni.1932>.
- Urban, Stephan, Ralf Bartenschlager, Ralf Kubitz, and Fabien Zoulim. 2014. 'Strategies to Inhibit Entry of HBV and HDV into Hepatocytes'. *Gastroenterology* 147 (1): 48–64. <https://doi.org/10.1053/j.gastro.2014.04.030>.
- Vanlandschoot, Peter, Freya Van Houtte, Benedikte Serruys, and Geert Leroux-Roels. 2007. 'Contamination of a Recombinant Hepatitis B Virus Nucleocapsid Preparation with a Human B-Cell Activator'. *Journal of Virology* 81 (5): 2535–36. <https://doi.org/10.1128/JVI.02507-06>.
- Vasou, Andri, Nazife Sultanoglu, Stephen Goodbourn, Richard E. Randall, and Leondios G. Kostrikis. 2017. 'Targeting Pattern Recognition Receptors (PRR) for Vaccine Adjuvantation: From Synthetic PRR Agonists to the Potential of Defective Interfering Particles of Viruses'. *Viruses* 9 (7). <https://doi.org/10.3390/v9070186>.

- Velkov, Stoyan, Jördis J. Ott, Ulrike Protzer, and Thomas Michler. 2018. 'The Global Hepatitis B Virus Genotype Distribution Approximated from Available Genotyping Data'. *Genes* 9 (10). <https://doi.org/10.3390/genes9100495>.
- Venook, Alan P., Christos Papandreou, Junji Furuse, and Laura Ladrón de Guevara. 2010. 'The Incidence and Epidemiology of Hepatocellular Carcinoma: A Global and Regional Perspective'. *The Oncologist* 15 Suppl 4: 5–13. <https://doi.org/10.1634/theoncologist.2010-S4-05>.
- Vernon, Hamilton, Chase J. Wehrle, and Anup Kasi. 2021. 'Anatomy, Abdomen and Pelvis, Liver'. In *StatPearls*. Treasure Island (FL): StatPearls Publishing. <http://www.ncbi.nlm.nih.gov/books/NBK500014/>.
- Verrier, Eloi R., Che C. Colpitts, Charlotte Bach, Laura Heydmann, Amélie Weiss, Mickaël Renaud, Sarah C. Durand, et al. 2016. 'A Targeted Functional RNA Interference Screen Uncovers Glypican 5 as an Entry Factor for Hepatitis B and D Viruses: VIRAL HEPATITIS'. *Hepatology* 63 (1): 35–48. <https://doi.org/10.1002/hep.28013>.
- Vincent, Isabelle E., Claudia Zannetti, Julie Lucifora, Helene Norder, Ulrike Protzer, Pierre Hainaut, Fabien Zoulim, et al. 2011. 'Hepatitis B Virus Impairs TLR9 Expression and Function in Plasmacytoid Dendritic Cells'. Edited by Dennis W. Metzger. *PLoS ONE* 6 (10): e26315. <https://doi.org/10.1371/journal.pone.0026315>.
- Vir Biotechnology. 2020. 'Pipeline | Hepatitis B | Influenza A | HIV | Tuberculosis | Vir Biotechnology'. 2020. <https://www.vir.bio/pipeline/>.
- Visvanathan, Kumar, Narelle A. Skinner, Alex J.V. Thompson, Stephen M. Riordan, Vitini Sozzi, Roslyn Edwards, Sally Rodgers, et al. 2007. 'Regulation of Toll-like Receptor-2 Expression in Chronic Hepatitis B by the Precore Protein'. *Hepatology* 45 (1): 102–10. <https://doi.org/10.1002/hep.21482>.
- Viswanathan, Usha, Nagraj Mani, Zhanying Hu, Haiqun Ban, Yanming Du, Jin Hu, Jinhong Chang, and Ju-Tao Guo. 2020. 'Targeting the Multifunctional HBV Core Protein as a Potential Cure for Chronic Hepatitis B'. *Antiviral Research* 182 (October): 104917. <https://doi.org/10.1016/j.antiviral.2020.104917>.
- Vivekanandan, Perumal, Hubert Darius-J Daniel, Rajesh Kannangai, Francisco Martinez-Murillo, and Michael Torbenson. 2010. 'Hepatitis B Virus Replication Induces Methylation of Both Host and Viral DNA'. *Journal of Virology* 84 (9): 4321–29. <https://doi.org/10.1128/JVI.02280-09>.
- Voegt H. 1942. 'Zur Aetiologie Der Hepatitis Epidemica Munch.', 1942, *Med. Wochenschr.* 89:76. edition.
- Volz, Tassilo. 2013. 'The Entry Inhibitor Myrcludex-B Efficiently Blocks Intrahepatic Virus Spreading in Humanized Mice Previously Infected with Hepatitis B Virus'. *Journal of Hepatology* 58: 7.
- Walter, E, R Keist, B Niederöst, I Pult, and H E Blum. 1996. 'Hepatitis B Virus Infection of Tupaia Hepatocytes *in Vitro* and *in Vivo*: Hepatitis B Virus Infection of Tupaia Hepatocytes *in Vitro* and *in Vivo*'. *Hepatology* 24 (1): 1–5. <https://doi.org/10.1002/hep.510240101>.
- Wang, Haifeng, Seahee Kim, and Wang-Shick Ryu. 2009. 'DDX3 DEAD-Box RNA Helicase Inhibits Hepatitis B Virus Reverse Transcription by Incorporation into Nucleocapsids'. *Journal of Virology* 83 (11): 5815–24. <https://doi.org/10.1128/JVI.00011-09>.
- Wang, Haifeng, and Wang-Shick Ryu. 2010. 'Hepatitis B Virus Polymerase Blocks Pattern Recognition Receptor Signaling via Interaction with DDX3: Implications for Immune Evasion'. Edited by Jing-hsiung James Ou. *PLoS Pathogens* 6 (7): e1000986. <https://doi.org/10.1371/journal.ppat.1000986>.
- Wang, Jingjing, Bingqian Qu, Fang Zhang, Cindy Zhang, Wanyan Deng, Viet Loan Dao Thi, and Yuchen Xia. 2019. 'Stem Cell-Derived Hepatocyte-Like Cells as Model for Viral Hepatitis Research'. *Stem Cells International* 2019 (June): 1–11. <https://doi.org/10.1155/2019/9605252>.
- Wang, Nan, Hongwei Liang, and Ke Zen. 2014. 'Molecular Mechanisms That Influence the Macrophage M1-M2 Polarization Balance'. *Frontiers in Immunology* 5: 614. <https://doi.org/10.3389/fimmu.2014.00614>.

- Wang, Sen, Zhiao Chen, Conghua Hu, Fangxing Qian, Yuming Cheng, Min Wu, Bisheng Shi, Jieliang Chen, Yunwen Hu, and Zhenghong Yuan. 2013. 'Hepatitis B Virus Surface Antigen Selectively Inhibits TLR2 Ligand-Induced IL-12 Production in Monocytes/Macrophages by Interfering with JNK Activation'. *The Journal of Immunology* 190 (10): 5142–51. <https://doi.org/10.4049/jimmunol.1201625>.
- Wang, Ying, Kun Chen, Zhiyuan Wu, Yuetao Liu, Shangmei Liu, Zhongmei Zou, Shu-Hsia Chen, and Chunfeng Qu. 2014. 'Immunizations with Hepatitis B Viral Antigens and a TLR7/8 Agonist Adjuvant Induce Antigen-Specific Immune Responses in HBV-Transgenic Mice'. *International Journal of Infectious Diseases: IJID: Official Publication of the International Society for Infectious Diseases* 29 (December): 31–36. <https://doi.org/10.1016/j.ijid.2014.07.015>.
- Wang, Zhaoning, Weiwei Wang, and Lanfeng Wang. 2020. 'Epigenetic Regulation of Covalently Closed Circular DNA Minichromosome in Hepatitis B Virus Infection'. *Biophysics Reports* 6 (4): 115–26. <https://doi.org/10.1007/s41048-020-00112-z>.
- Wasley, Annemarie, Scott Grytdal, Kathleen Gallagher, and Centers for Disease Control and Prevention (CDC). 2008. 'Surveillance for Acute Viral Hepatitis--United States, 2006'. *Morbidity and Mortality Weekly Report. Surveillance Summaries (Washington, D.C.: 2002)* 57 (2): 1–24.
- Watashi, Koichi, Guoxin Liang, Masashi Iwamoto, Hiroyuki Marusawa, Nanako Uchida, Takuji Daito, Kouichi Kitamura, et al. 2013. 'Interleukin-1 and Tumor Necrosis Factor- α Trigger Restriction of Hepatitis B Virus Infection via a Cytidine Deaminase Activation-Induced Cytidine Deaminase (AID)'. *Journal of Biological Chemistry* 288 (44): 31715–27. <https://doi.org/10.1074/jbc.M113.501122>.
- Watashi, Koichi, Ann Sluder, Takuji Daito, Satoko Matsunaga, Akihito Ryo, Shushi Nagamori, Masashi Iwamoto, et al. 2014. 'Cyclosporin A and Its Analogs Inhibit Hepatitis B Virus Entry into Cultured Hepatocytes through Targeting a Membrane Transporter, Sodium Taurocholate Cotransporting Polypeptide (NTCP)'. *Hepatology (Baltimore, Md.)* 59 (5): 1726–37. <https://doi.org/10.1002/hep.26982>.
- Weber, Nicholas D., Daniel Stone, Ruth Hall Sedlak, Harshana S. De Silva Felixge, Pavitra Roychoudhury, Joshua T. Schiffer, Martine Aubert, and Keith R. Jerome. 2014. 'AAV-Mediated Delivery of Zinc Finger Nucleases Targeting Hepatitis B Virus Inhibits Active Replication'. *PLoS One* 9 (5): e97579. <https://doi.org/10.1371/journal.pone.0097579>.
- Weber, O., A. A. Mercer, A. Friebe, P. Knolle, and H.-D. Volk. 2013. 'Therapeutic Immunomodulation Using a Virus--the Potential of Inactivated Orf Virus'. *European Journal of Clinical Microbiology & Infectious Diseases: Official Publication of the European Society of Clinical Microbiology* 32 (4): 451–60. <https://doi.org/10.1007/s10096-012-1780-x>.
- Webster, George J. M., Stephanie Reignat, David Brown, Graham S. Ogg, Louise Jones, Suranjith L. Seneviratne, Roger Williams, Geoffrey Dusheiko, and Antonio Bertoletti. 2004. 'Longitudinal Analysis of CD8+ T Cells Specific for Structural and Nonstructural Hepatitis B Virus Proteins in Patients with Chronic Hepatitis B: Implications for Immunotherapy'. *Journal of Virology* 78 (11): 5707–19. <https://doi.org/10.1128/JVI.78.11.5707-5719.2004>.
- Wedemeyer, Heiner, Katrin Schöneweis, Pavel O. Bogomolov, Natalia Voronkova, Vladimir Chulanov, Tatyana Stepanova, Birgit Bremer, et al. 2019. 'GS-13-Final Results of a Multicenter, Open-Label Phase 2 Clinical Trial (MYR203) to Assess Safety and Efficacy of Myrcludex B in Cwith PEG-Interferon Alpha 2a in Patients with Chronic HBV/HDV Co-Infection'. *Journal of Hepatology* 70 (1): e81. [https://doi.org/10.1016/S0618-8278\(19\)30141-0](https://doi.org/10.1016/S0618-8278(19)30141-0).
- Wei, Congwen, Caifei Ni, Ting Song, Yu Liu, XiaoLi Yang, Zirui Zheng, Yongxia Jia, et al. 2010. 'The Hepatitis B Virus X Protein Disrupts Innate Immunity by Downregulating Mitochondrial Antiviral Signaling Protein'. *The Journal of Immunology* 185 (2): 1158–68. <https://doi.org/10.4049/jimmunol.0903874>.
- Wei, Jun, Yu-Qin Wang, Zhi-Meng Lu, Guang-Di Li, Yuan Wang, and Zu-Chuan Zhang. 2002. 'Detection of Anti-PreS1 Antibodies for Recovery of Hepatitis B Patients by Immunoassay'. *World Journal of Gastroenterology* 8 (2): 276–81. <https://doi.org/10.3748/wjg.v8.i2.276>.

- Wei, Lei, and Alexander Ploss. 2021. 'Hepatitis B Virus CccDNA Is Formed through Distinct Repair Processes of Each Strand'. *Nature Communications* 12 (1): 1591. <https://doi.org/10.1038/s41467-021-21850-9>.
- Weiskirchen, Ralf, and Frank Tacke. 2014. 'Cellular and Molecular Functions of Hepatic Stellate Cells in Inflammatory Responses and Liver Immunology'. *HepatoBiliary Surgery and Nutrition* 3 (6): 20.
- WHO data. 2020. 'Hepatitis B'. July 2020. <https://www.who.int/news-room/fact-sheets/detail/hepatitis-b>.
- Wieland, S. F. 2015. 'The Chimpanzee Model for Hepatitis B Virus Infection'. *Cold Spring Harbor Perspectives in Medicine* 5 (6): a021469–a021469. <https://doi.org/10.1101/cshperspect.a021469>.
- Wieland, S. F., L. G. Guidotti, and F. V. Chisari. 2000. 'Intrahepatic Induction of Alpha/Beta Interferon Eliminates Viral RNA-Containing Capsids in Hepatitis B Virus Transgenic Mice'. *Journal of Virology* 74 (9): 4165–73. <https://doi.org/10.1128/jvi.74.9.4165-4173.2000>.
- Wieland, Stefan, Robert Thimme, Robert H Purcell, and Francis V Chisari. n.d. 'Genomic Analysis of the Host Response to Hepatitis B Virus Infection', 6.
- Will H. , Koch R., Darai G., Schaller H., Schellekens H., van Eerd P.M. 1982. 'Cloned HBV DNA Causes Hepatitis B in Chimpanzees', 1982, Nature edition.
- Woltman, Andrea M., Marjoleine L. Op den Brouw, Paula J. Biesta, Cui C. Shi, and Harry L. A. Janssen. 2011. 'Hepatitis B Virus Lacks Immune Activating Capacity, but Actively Inhibits Plasmacytoid Dendritic Cell Function'. *PLoS One* 6 (1): e15324. <https://doi.org/10.1371/journal.pone.0015324>.
- Woo, Aaron Shu Jeng, Raymond Kwok, and Taufique Ahmed. 2017. 'Alpha-Interferon Treatment in Hepatitis B'. *Annals of Translational Medicine* 5 (7). <https://doi.org/10.21037/atm.2017.03.69>.
- Wooddell, Christine I., Man-Fung Yuen, Henry Lik-Yuen Chan, Robert G. Gish, Stephen A. Locarnini, Deborah Chavez, Carlo Ferrari, et al. 2017. 'RNAi-Based Treatment of Chronically Infected Patients and Chimpanzees Reveals That Integrated Hepatitis B Virus DNA Is a Source of HBsAg'. *Science Translational Medicine* 9 (409): eaan0241. <https://doi.org/10.1126/scitranslmed.aan0241>.
- World Health Organization, World Health Organization, and Global Hepatitis Programme. 2017. *Global Hepatitis Report, 2017*. <http://apps.who.int/iris/bitstream/10665/255016/1/9789241565455-eng.pdf?ua=1>.
- Wu, Shu-Xiang, Wan-Nan Chen, Zhen-Tang Jing, Wei Liu, Xin-Jian Lin, and Xu Lin. 2018. 'Hepatitis B Spliced Protein (HBSP) Suppresses Fas-Mediated Hepatocyte Apoptosis via Activation of PI3K/Akt Signaling'. Edited by J.-H. James Ou. *Journal of Virology* 92 (23): e01273-18, /jvi/92/23/e01273-18.atom. <https://doi.org/10.1128/JVI.01273-18>.
- Wu, Tong R., Y. Kate Hong, Xu-Dong Wang, Mike Y. Ling, Ana M. Dragoi, Alicia S. Chung, Andrew G. Campbell, Zhi-Yong Han, Gen-Sheng Feng, and Y. Eugene Chin. 2002. 'SHP-2 Is a Dual-Specificity Phosphatase Involved in Stat1 Dephosphorylation at Both Tyrosine and Serine Residues in Nuclei'. *The Journal of Biological Chemistry* 277 (49): 47572–80. <https://doi.org/10.1074/jbc.M207536200>.
- Xia, Yuchen, Xiaoming Cheng, Christoph K. Blossey, Karin Wisskirchen, Knud Esser, and Ulrike Protzer. 2017. 'Secreted Interferon-Inducible Factors Restrict Hepatitis B and C Virus Entry In Vitro'. *Journal of Immunology Research* 2017. <https://doi.org/10.1155/2017/4828936>.
- Xia, Yuchen, and Haitao Guo. 2020. 'Hepatitis B Virus CccDNA: Formation, Regulation and Therapeutic Potential'. *Antiviral Research* 180 (August): 104824. <https://doi.org/10.1016/j.antiviral.2020.104824>.
- Xia, Yuchen, and Ulrike Protzer. 2017. 'Control of Hepatitis B Virus by Cytokines'. *Viruses* 9 (1). <https://doi.org/10.3390/v9010018>.
- Xia, Yuchen, Daniela Stadler, Julie Lucifora, Florian Reisinger, Dennis Webb, Marianna Hösel, Thomas Michler, et al. 2016. 'Interferon- γ and Tumor Necrosis Factor- α Produced by T Cells Reduce

- the HBV Persistence Form, CccDNA, Without Cytolysis'. *Gastroenterology* 150 (1): 194–205. <https://doi.org/10.1053/j.gastro.2015.09.026>.
- Xibing, Gu, Yang Xiaojuan, Wang Juanhua, and Hua Zhong. 2013. 'Relationship Between HBV Genotypes B, C and Follicular Helper T Cells in Patients with Chronic Hepatitis B and Its Significance'. *Hepatitis Monthly* 13 (1). <https://doi.org/10.5812/hepatmon.6221>.
- Xie, Qing, Huai-Cheng Shen, Ni-Na Jia, Hui Wang, Lan-Yi Lin, Bao-Yan An, Hong-Lian Gui, et al. 2009. 'Patients with Chronic Hepatitis B Infection Display Deficiency of Plasmacytoid Dendritic Cells with Reduced Expression of TLR9'. *Microbes and Infection* 11 (4): 515–23. <https://doi.org/10.1016/j.micinf.2009.02.008>.
- Xie, Qing, Huijuan Zhou, Xuefan Bai, Shuhuan Wu, Jian-Jie Chen, Jifang Sheng, Yao Xie, Chengwei Chen, Henry Lik-Yuen Chan, and Mianzhi Zhao. 2014. 'A Randomized, Open-Label Clinical Study of Combined Pegylated Interferon Alfa-2a (40KD) and Entecavir Treatment for Hepatitis B "e" Antigen-Positive Chronic Hepatitis B'. *Clinical Infectious Diseases: An Official Publication of the Infectious Diseases Society of America* 59 (12): 1714–23. <https://doi.org/10.1093/cid/ciu702>.
- Xiong, Wei, Xun Wang, Xiaoying Liu, Li Xiang, Lingjie Zheng, and Zhenghong Yuan. 2004. 'Interferon-Inducible MyD88 Protein Inhibits Hepatitis B Virus Replication'. *Virology* 319 (2): 306–14. <https://doi.org/10.1016/j.virol.2003.11.005>.
- Xirong, L., L. Rui, Y. Xiaoli, H. Qiuyan, T. Bikui, Z. Sibao, and Z. Naishuo. 2014. 'Hepatitis B Virus Can Be Inhibited by DNA Methyltransferase 3a via Specific Zinc-Finger-Induced Methylation of the X Promoter'. *Biochemistry. Biokhimiia* 79 (2): 111–23. <https://doi.org/10.1134/S0006297914020047>.
- Xu, Chunxiao, Haitao Guo, Xiao-Ben Pan, Richeng Mao, Wenquan Yu, Xiaodong Xu, Lai Wei, Jinhong Chang, Timothy M. Block, and Ju-Tao Guo. 2010. 'Interferons Accelerate Decay of Replication-Competent Nucleocapsids of Hepatitis B Virus'. *Journal of Virology* 84 (18): 9332–40. <https://doi.org/10.1128/JVI.00918-10>.
- Xu, Fengchao. 2016. 'HBsAg Blocks TYPE I IFN Induced Up-Regulation of A3G through Inhibition of STAT3'. *Biochemical and Biophysical Research Communications*, 5.
- Xu, Yongfen, Yunwen Hu, Bisheng Shi, Xiaonan Zhang, Jiefei Wang, Zhanqing Zhang, Fang Shen, Qin Zhang, Shuhui Sun, and Zhenghong Yuan. 2009. 'HBsAg Inhibits TLR9-Mediated Activation and IFN- α Production in Plasmacytoid Dendritic Cells'. *Molecular Immunology* 46 (13): 2640–46. <https://doi.org/10.1016/j.molimm.2009.04.031>.
- Xu, Z. Y., C. B. Liu, D. P. Francis, R. H. Purcell, Z. L. Gun, S. C. Duan, R. J. Chen, H. S. Margolis, C. H. Huang, and J. E. Maynard. 1985. 'Prevention of Perinatal Acquisition of Hepatitis B Virus Carriage Using Vaccine: Preliminary Report of a Randomized, Double-Blind Placebo-Controlled and Comparative Trial'. *Pediatrics* 76 (5): 713–18.
- Yan, Huan, Guocai Zhong, Guangwei Xu, Wenhui He, Zhiyi Jing, Zhenchao Gao, Yi Huang, et al. 2012. 'Sodium Taurocholate Cotransporting Polypeptide Is a Functional Receptor for Human Hepatitis B and D Virus'. *ELife* 1 (November): e00049. <https://doi.org/10.7554/eLife.00049>.
- Yan, Ran, Xuesen Zhao, Dawei Cai, Yuanjie Liu, Timothy M. Block, Ju-Tao Guo, and Haitao Guo. 2015. 'The Interferon-Inducible Protein Tetherin Inhibits Hepatitis B Virus Virion Secretion'. *Journal of Virology* 89 (18): 9200–9212. <https://doi.org/10.1128/JVI.00933-15>.
- Yan, Y., D. Xu, and W. Wang. 1999. '[The role of placenta in hepatitis B virus intrauterine transmission]'. *Zhonghua Fu Chan Ke Za Zhi* 34 (7): 392–95.
- Yan, Zhipeng, Daitze Wu, Hui Hu, Jing Zeng, Xin Yu, Zhiheng Xu, Zheng Zhou, et al. 2019. 'Direct Inhibition of Hepatitis B e Antigen by Core Protein Allosteric Modulator'. *Hepatology (Baltimore, Md.)* 70 (1): 11–24. <https://doi.org/10.1002/hep.30514>.
- Yanai, Hideyuki, Hideo Negishi, and Tadatsugu Taniguchi. 2012. 'The IRF Family of Transcription Factors'. *Oncoimmunology* 1 (8): 1376–86. <https://doi.org/10.4161/onci.22475>.
- Yang, Dan, Longchao Liu, Danming Zhu, Hua Peng, Lishan Su, Yang-Xin Fu, and Liguozhang. 2014. 'A Mouse Model for HBV Immunotolerance and Immunotherapy'. *Cellular & Molecular Immunology* 11 (1): 71–78. <https://doi.org/10.1038/cmi.2013.43>.

- Yang, Jingyi, and Huimin Yan. 2017. 'TLR5: Beyond the Recognition of Flagellin'. *Cellular & Molecular Immunology* 14 (12): 1017–19. <https://doi.org/10.1038/cmi.2017.122>.
- Yang, Yinli, Qiuju Han, Zhaohua Hou, Cai Zhang, Zhigang Tian, and Jian Zhang. 2017. 'Exosomes Mediate Hepatitis B Virus (HBV) Transmission and NK-Cell Dysfunction'. *Cellular & Molecular Immunology* 14 (5): 465–75. <https://doi.org/10.1038/cmi.2016.24>.
- Yang, Yuanyuan, Xinzhan Zhao, Ziyu Wang, Wangqin Shu, Lijie Li, Yuqi Li, Zhiwei Guo, Bo Gao, and Sidong Xiong. 2020. 'Nuclear Sensor Interferon-Inducible Protein 16 Inhibits the Function of Hepatitis B Virus Covalently Closed Circular DNA by Integrating Innate Immune Activation and Epigenetic Suppression'. *Hepatology (Baltimore, Md.)* 71 (4): 1154–69. <https://doi.org/10.1002/hep.30897>.
- Ye, Xiaoli, Ming Zhou, Yonggang He, Yanmin Wan, Weiya Bai, Shuai Tao, Yanqin Ren, et al. 2016. 'Efficient Inhibition of Hepatitis B Virus Infection by a PreS1-Binding Peptide'. *Scientific Reports* 6 (1): 29391. <https://doi.org/10.1038/srep29391>.
- Yeh, C T, Y F Liaw, and J H Ou. 1990. 'The Arginine-Rich Domain of Hepatitis B Virus Precore and Core Proteins Contains a Signal for Nuclear Transport.' *Journal of Virology* 64 (12): 6141–47. <https://doi.org/10.1128/JVI.64.12.6141-6147.1990>.
- Yin, Chunyue, Kimberley J. Evason, Kinji Asahina, and Didier Y.R. Stainier. 2013. 'Hepatic Stellate Cells in Liver Development, Regeneration, and Cancer'. *The Journal of Clinical Investigation* 123 (5): 1902–10. <https://doi.org/10.1172/JCI66369>.
- Yin, Zhiwei, Jihong Dai, Jing Deng, Faruk Sheikh, Mahwish Natalia, Tiffany Shih, Anita Lewis-Antes, et al. 2012. 'Type III IFNs Are Produced by and Stimulate Human Plasmacytoid Dendritic Cells'. *Journal of Immunology (Baltimore, Md.: 1950)* 189 (6): 2735–45. <https://doi.org/10.4049/jimmunol.1102038>.
- Yip, Terry Cheuk-Fung. 2020. 'How Do We Determine Whether a Functional Cure for HBV Infection Has Been Achieved?', 3.
- Yoneyama, M., W. Suhara, Y. Fukuhara, M. Fukuda, E. Nishida, and T. Fujita. 1998. 'Direct Triggering of the Type I Interferon System by Virus Infection: Activation of a Transcription Factor Complex Containing IRF-3 and CBP/P300'. *The EMBO Journal* 17 (4): 1087–95. <https://doi.org/10.1093/emboj/17.4.1087>.
- Yoneyama, Mitsutoshi, Mika Kikuchi, Kanae Matsumoto, Tadaatsu Imaizumi, Makoto Miyagishi, Kazunari Taira, Eileen Foy, et al. 2005. 'Shared and Unique Functions of the DExD/H-Box Helicases RIG-I, MDA5, and LGP2 in Antiviral Innate Immunity'. *Journal of Immunology (Baltimore, Md.: 1950)* 175 (5): 2851–58. <https://doi.org/10.4049/jimmunol.175.5.2851>.
- Yoshimura, Akihiko, Tetsuji Naka, and Masato Kubo. 2007. 'SOCS Proteins, Cytokine Signalling and Immune Regulation'. *Nature Reviews. Immunology* 7 (6): 454–65. <https://doi.org/10.1038/nri2093>.
- Yu, Hui, Liangbin Lin, Zhiqiang Zhang, Huiyuan Zhang, and Hongbo Hu. 2020. 'Targeting NF-KB Pathway for the Therapy of Diseases: Mechanism and Clinical Study'. *Signal Transduction and Targeted Therapy* 5 (1): 209. <https://doi.org/10.1038/s41392-020-00312-6>.
- Yuen, Man Fung, Edward J. Gane, Dong Joon Kim, Frank Weillert, Henry Lik Yuen Chan, Jacob Lalezari, Seong Gyu Hwang, et al. 2019. 'Antiviral Activity, Safety, and Pharmacokinetics of Capsid Assembly Modulator NVR 3-778 in Patients with Chronic HBV Infection'. *Gastroenterology* 156 (5): 1392-1403.e7. <https://doi.org/10.1053/j.gastro.2018.12.023>.
- Yuen, Man-Fung, Ingolf Schiefke, Jung-Hwan Yoon, Sang Hoon Ahn, Jeong Heo, Ju Hyun Kim, Henry Lik Yuen Chan, et al. 2020. 'RNA Interference Therapy With ARC-520 Results in Prolonged Hepatitis B Surface Antigen Response in Patients With Chronic Hepatitis B Infection'. *Hepatology* 72 (1): 19–31. <https://doi.org/10.1002/hep.31008>.
- Zanetti, Alessandro R., Pierre Van Damme, and Daniel Shouval. 2008. 'The Global Impact of Vaccination against Hepatitis B: A Historical Overview'. *Vaccine* 26 (49): 6266–73. <https://doi.org/10.1016/j.vaccine.2008.09.056>.
- Zang, Wei-Qing, Bin Li, Pei-Yong Huang, Michael M. C. Lai, and T. S. Benedict Yen. 2001. 'Role of Polypyrimidine Tract Binding Protein in the Function of the Hepatitis B Virus

- Posttranscriptional Regulatory Element'. *Journal of Virology* 75 (22): 10779–86. <https://doi.org/10.1128/JVI.75.22.10779-10786.2001>.
- Zannetti, Claudia, Guillaume Roblot, Emily Charrier, Michelle Ainouze, Issam Tout, François Briat, Nathalie Isorce, et al. 2016. 'Characterization of the Inflammasome in Human Kupffer Cells in Response to Synthetic Agonists and Pathogens'. *The Journal of Immunology* 197 (1): 356–67. <https://doi.org/10.4049/jimmunol.1502301>.
- Zeisel, Mirjam B., Julie Lucifora, William S. Mason, Camille Sureau, Jürgen Beck, Massimo Levrero, Michael Kann, et al. 2015. 'Towards an HBV Cure: State-of-the-Art and Unresolved Questions--Report of the ANRS Workshop on HBV Cure'. *Gut* 64 (8): 1314–26. <https://doi.org/10.1136/gutjnl-2014-308943>.
- Zeissig, Sebastian, Kazumoto Murata, Lindsay Sweet, Jean Publicover, Zongyi Hu, Arthur Kaser, Esther Bosse, et al. 2012. 'Hepatitis B Virus-Induced Lipid Alterations Contribute to Natural Killer T Cell-Dependent Protective Immunity'. *Nature Medicine* 18 (7): 1060–68. <https://doi.org/10.1038/nm.2811>.
- Zhang, Lei, Xiang Xiao, Preston R. Arnold, and Xian C. Li. 2019. 'Transcriptional and Epigenetic Regulation of Immune Tolerance: Roles of the NF- κ B Family Members'. *Cellular & Molecular Immunology* 16 (4): 315–23. <https://doi.org/10.1038/s41423-019-0202-8>.
- Zhang, Qian, Michael J. Lenardo, and David Baltimore. 2017. '30 Years of NF- κ B: A Blossoming of Relevance to Human Pathobiology'. *Cell* 168 (1–2): 37–57. <https://doi.org/10.1016/j.cell.2016.12.012>.
- Zhang, Wen, Jieliang Chen, Min Wu, Xiaonan Zhang, Min Zhang, Lei Yue, Yaming Li, et al. 2017. 'PRMT5 Restricts Hepatitis B Virus Replication through Epigenetic Repression of Covalently Closed Circular DNA Transcription and Interference with Pregenomic RNA Encapsidation'. *Hepatology* 66 (2): 398–415. <https://doi.org/10.1002/hep.29133>.
- Zhang, Xiao-Dong, Yuan Wang, and Li-Hong Ye. 2014. 'Hepatitis B Virus X Protein Accelerates the Development of Hepatoma'. *Cancer Biology & Medicine* 11 (3): 182–90. <https://doi.org/10.7497/j.issn.2095-3941.2014.03.004>.
- Zhang, Xing, Terrence W Brann, Ming Zhou, Jun Yang, Raphael M Oguariri, Kristy B Lidie, Hiromi Imamichi, et al. 2011. 'Cutting Edge: Ku70 Is a Novel Cytosolic DNA Sensor That Induces Type III Rather than Type I IFN'. *Journal of Immunology (Baltimore, Md. : 1950)* 186 (8): 4541–45. <https://doi.org/10.4049/jimmunol.1003389>.
- Zhang, Yongmei, Chenxiao Li, Yijun Zhang, Haoxiang Zhu, Yaoyue Kang, Hongyan Liu, Jinyu Wang, et al. 2013. 'Comparative Analysis of CpG Islands among HBV Genotypes'. *PLoS One* 8 (2): e56711. <https://doi.org/10.1371/journal.pone.0056711>.
- Zhang, Yujue, Derun Kong, and Hua Wang. 2020. 'Mucosal-Associated Invariant T Cell in Liver Diseases'. *International Journal of Biological Sciences* 16 (3): 460–70. <https://doi.org/10.7150/ijbs.39016>.
- Zhang, Zhenfeng, Christina Filzmayer, Yi Ni, Holger Sülthmann, Pascal Mutz, Marie-Sophie Hiet, Florian W. R. Vondran, Ralf Bartenschlager, and Stephan Urban. 2018. 'Hepatitis D Virus Replication Is Sensed by MDA5 and Induces IFN- β / λ Responses in Hepatocytes'. *Journal of Hepatology* 69 (1): 25–35. <https://doi.org/10.1016/j.jhep.2018.02.021>.
- Zhang, Zheng, Shuye Zhang, Zhengsheng Zou, Jianfei Shi, Juanjuan Zhao, Rong Fan, Enqiang Qin, et al. 2011. 'Hypercytolytic Activity of Hepatic Natural Killer Cells Correlates with Liver Injury in Chronic Hepatitis B Patients'. *Hepatology* 53 (1): 73–85. <https://doi.org/10.1002/hep.23977>.
- Zhang, Zhenhua, Martin Trippler, Catherine I. Real, Melanie Werner, Xufeng Luo, Stefan Scheffczyk, Thekla Kemper, et al. 2020. 'Hepatitis B Virus Particles Activate Toll-Like Receptor 2 Signaling Initially Upon Infection of Primary Human Hepatocytes'. *Hepatology* 72 (3): 829–44. <https://doi.org/10.1002/hep.31112>.
- Zhang, Zhiqiang, Bin Yuan, Musheng Bao, Ning Lu, Taeil Kim, and Yong-Jun Liu. 2011. 'The Helicase DDX41 Senses Intracellular DNA Mediated by the Adaptor STING in Dendritic Cells'. *Nature Immunology* 12 (10): 959–65. <https://doi.org/10.1038/ni.2091>.

- Zhao, Nan, Bo Jia, Hong Zhao, Junyu Xu, Xiaoyan Sheng, Lin Luo, Zhangma Huang, et al. 2019. 'A First-in-Human Trial of GLS4, a Novel Inhibitor of Hepatitis B Virus Capsid Assembly, Following Single- and Multiple-Ascending-Oral-Dose Studies with or without Ritonavir in Healthy Adult Volunteers'. *Antimicrobial Agents and Chemotherapy* 64 (1). <https://doi.org/10.1128/AAC.01686-19>.
- Zhao, Zhongchao. n.d. 'Virus Assembly Antagonists from Redesigned Antibodies', 3.
- Zhao, Zhongchao, and Adam Zlotnick. 2018. 'Virus Assembly Antagonists from Redesigned Antibodies'. *Structure* 26 (10): 1297–99. <https://doi.org/10.1016/j.str.2018.09.002>.
- Zheng, Meijuan, and Zhigang Tian. 2019. 'Liver-Mediated Adaptive Immune Tolerance'. *Frontiers in Immunology* 10 (November): 2525. <https://doi.org/10.3389/fimmu.2019.02525>.
- Zhou, Zhangle, Ole J. Hamming, Nina Ank, Søren R. Paludan, Anders L. Nielsen, and Rune Hartmann. 2007. 'Type III Interferon (IFN) Induces a Type I IFN-like Response in a Restricted Subset of Cells through Signaling Pathways Involving Both the Jak-STAT Pathway and the Mitogen-Activated Protein Kinases'. *Journal of Virology* 81 (14): 7749–58. <https://doi.org/10.1128/JVI.02438-06>.
- Zhou, Zhou, Ming-Jiang Xu, and Bin Gao. 2016. 'Hepatocytes: A Key Cell Type for Innate Immunity'. *Cellular & Molecular Immunology* 13 (3): 301–15. <https://doi.org/10.1038/cmi.2015.97>.
- Zhu, Shasha, Huimin Zhang, and Li Bai. 2018. 'NKT Cells in Liver Diseases'. *Frontiers of Medicine* 12 (3): 249–61. <https://doi.org/10.1007/s11684-018-0622-3>.
- Zhu, Y., T. Yamamoto, J. Cullen, J. Saputelli, C. E. Aldrich, D. S. Miller, S. Litwin, P. A. Furman, A. R. Jilbert, and W. S. Mason. 2001. 'Kinetics of Hepadnavirus Loss from the Liver during Inhibition of Viral DNA Synthesis'. *Journal of Virology* 75 (1): 311–22. <https://doi.org/10.1128/JVI.75.1.311-322.2001>.
- Zlotnick, Adam, Balasubramanian Venkatakrishnan, Zhenning Tan, Eric Lewellyn, William Turner, and Samson Francis. 2015. 'Core Protein: A Pleiotropic Keystone in the HBV Lifecycle'. *Antiviral Research* 121 (September): 82–93. <https://doi.org/10.1016/j.antiviral.2015.06.020>.
- Zoulim, F., J. Saputelli, and C. Seeger. 1994. 'Woodchuck Hepatitis Virus X Protein Is Required for Viral Infection in Vivo'. *Journal of Virology* 68 (3): 2026–30. <https://doi.org/10.1128/JVI.68.3.2026-2030.1994>.
- Zoulim, Fabien, Oliver Lenz, Joris J. Vandenbossche, Willem Talloen, Thierry Verbinnen, Iurie Moscalu, Adrian Streinu-Cercel, et al. 2020. 'JNJ-56136379, an HBV Capsid Assembly Modulator, Is Well-Tolerated and Has Antiviral Activity in a Phase 1 Study of Patients With Chronic Infection'. *Gastroenterology* 159 (2): 521-533.e9. <https://doi.org/10.1053/j.gastro.2020.04.036>.

Appendices

1. Submitted Articles
2. Articles in preparation

3. Submitted Review

1. How to get away with liver innate immunity? A viruses' tale

How to get away with liver innate immunity? A viruses' tale

Authors: Marion Delphin^{1,*}, **Manon Desmares**^{1,*}, Svenja Schuehle^{2,3,*}, Mathias Heikenwalder², David Durantel^{1,4}, Suzanne Faure-Dupuy^{2,§}

¹INSERM, U1052, Cancer Research Center of Lyon (CRCL), Université de Lyon (UCBL1), CNRS UMR_5286, France ;

²Division of Chronic Inflammation and Cancer, German Cancer Research Center (DKFZ), Heidelberg, Germany;

³Faculty of Biosciences, Heidelberg University, Heidelberg, Germany;

⁴DEVweCAN Laboratory of Excellence, Lyon, France;

*contributed equally;

§corresponding author.

Corresponding author:

Dr. Suzanne Faure-Dupuy

Division Chronic Inflammation and Cancer (F180), German Cancer Research Center (DKFZ), Im Neuenheimer Feld 242, 69120 Heidelberg, Germany.

Tel.: +49 6221 42-3895

Fax: +49 6221 42-3899

Email: s.faure-dupuy@dkfz.de

Keywords: Innate immunity, hepatic viruses, PRR, NF- κ B, interferon, MHC, anti-inflammatory, pro-inflammatory

Word count: 6001

Figures: 3

Tables: 0

Funding: SS, MH and SFD were supported by SFBTR179, and German-Israeli Cooperation in Cancer Research (DKFZ-MOST). MD, MDS, and DD were supported by INSERM (Institut National de la Santé et de la Recherche Médicale; salaries and core-fundings), and ANRS (*Agence Nationale de Recherche sur le Sida et les hépatites virales*, several grants from study section 12 (CSS12)).

Conflict of interest: The authors have no conflict of interest to declare.

Authors' contribution:

- Data curation: MD, MDS, SS
- Manuscript writing: MD, MDS, SS, MH, DD, SFD
- Figures preparation: MD

Key points:

- Liver viruses subvert the immune system towards efficient internalization and replication;
- Liver viruses escape extracellular recognition by efficiently modulating antibody and complement pathway recognition;
- Intracellular recognition is avoided by inhibiting MHC presentation and PRR/IFN downstream pathways;
- Liver pathogens modify the inflammatory balance toward the establishment of a tolerogenic environment.

Abstract:

Liver viruses represent a major health burden worldwide. These viruses have developed numerous ways to counteract the liver innate immunity to avoid elimination. In this review, we have highlighted the different and common mechanisms employed by liver viruses to (i) establish in the liver (passive entry or active evasion from immune recognition) and (ii) actively inhibit the innate immune response (i.e. modulation of pattern recognition receptor expression and/or signalling pathways, modulation of interferon response, and modulation of immune cells count or phenotype).

1. Introduction

The liver is constantly exposed to a large variety of pathogens (i.e. viruses, bacteria, and parasites) that can primarily infect the host through four different pathways, including (i) contaminated fluids, (ii) infected mosquito bites, (iii) contaminated food, and (iv) aerosols.

In this review, we will focus on viruses that replicate in hepatocytes. Of note, bacterial and parasite infections of the liver have been discussed elsewhere [1,2].

Liver viruses infect approximately 850 million people per year, causing 1.8 million deaths (WHO reports) (Figure 1). While they account for only 38.6% of all liver infections per year, they represent 92% of related deaths. The hepatitis B (HBV), C (HCV), and Delta (HDV) viruses are liver-specific viruses. When established chronically, they can lead to acute hepatitis (AH), fibrosis, cirrhosis, and/or hepatocellular carcinoma (HCC) [3]. A vaccine targeting both HBV and its satellite virus, HDV, is available. However, patients suffering from chronic Hepatitis B (CHB) need to be treated lifelong with nucleos(t)ide analogues (NA) or pegylated interferon alpha (peg-IFN α), which does not cure the infection [3]. Co-infection with HDV, diagnosed in around 5% of the CHB patients [3,4], accelerates the pathogenesis with a low response rate to peg-IFN α [3]. Regarding HCV, new direct antiviral agents (DAAs) can clear the infection in chronically infected patients [3]. The human cytomegalovirus (HCMV) infects the liver as a secondary site through the recruitment of infected macrophages and/or neutrophils, and may cause AH. Despite the lack of vaccines, HCMV infection is controlled by Ganciclovir[5].

Four liver viruses infect their host via mosquito bites (Figure 1), namely Dengue virus (DENV), West Nile virus (WNV), Yellow Fever virus (YFV), and Zika virus (ZIKV). DENV and YFV cause, respectively, AH or jaundice and steatosis. While no specific treatment is available, a vaccine exists for both viruses. Although ZIKV infects the liver, little is known on this virus due to its recent emergence (WHO, 2018). Similarly, neither a vaccine nor a therapy is currently available for WNV.

Finally, two pathogens infect the liver through an enteric contamination (Figure 1): Hepatitis A virus (HAV) and Hepatitis E virus (HEV). They represent 32.4% of all liver infections and 4% of related deaths (WHO). HAV and HEV infections can be prevented by a vaccine and might cause AH.

Whereas the liver is exposed to high concentrations of food-derived antigens, it is widely known as a tolerogenic organ [6]. Often seen as a secondary lymphoid organ, all cells are equipped to recognize and alert the host of an invasion [7]. This dichotomy is mostly attributed to the high threshold that liver cells require to be activated as compared to other organs [8]. Consequently, it is the perfect shelter for pathogens capable of avoiding recognition and/or for which the infection comes with poor immune activation.

A healthy liver is composed of (i) parenchymal cells, the hepatocytes (around 70% of liver cells; participate in liver immune response), (ii) three liver-specific non-parenchymal cells (NPCs): the Liver Sinusoidal Endothelial Cells (LSECs) (around 20%; compose the sinusoidal wall), the Hepatic Stellate cells (HSCs) (5-8% when quiescent; liver fibroblasts), and Kupffer Cells (KCs) (4%; resident macrophages), and (iii) liver-unspecific NPCs, found in the circulation (monocytes) and/or infiltrating the liver: Dendritic Cells (DCs) and lymphocytes. Concerning the latter, some display innate functions. Namely, the Natural Killer T (NKT) cells and Mucosal-associated invariant T (MAIT) cells are equipped with antigen recognition capacities [9]. MAIT cells can be activated by cytokines during virus infections [10]. Moreover, innate lymphoid cells (ILCs), despite lacking antigen-specific receptors, can mediate immune responses and regulate tissue homeostasis and inflammation. Natural Killer cells and type 1 innate lymphoid cells are the most abundant ILCs in the liver [9].

Innate immune responses sense a broad range of Pathogen Associated Molecular Patterns (PAMPs), as well as Danger Associated Molecular Patterns (DAMPs; related to dysregulation of cellular functions). These highly conserved motifs are recognized by Pattern Recognition Receptors (PRRs), of which the Toll-like receptors (TLR) are the largest family [11]. Several PRRs are expressed by hepatocytes and NPCs in the liver, thus permitting a broad sensing [7,12]. Pathogen sensing results in the degradation of the microorganism followed by presentation on the Major Histocompatibility Complex II (MHC-II) molecule [13]. Altogether, these sensing mechanisms enable activation of various immune pathways (nuclear factor-kappa B (NF- κ B), Akt, JAK-STAT, or interferon regulatory factor (IRF) pathways), which, in turn, lead to the production of effectors (cytokines or IFN) responsible for the appropriate orchestration of the immune response [14–16]. These immune mediators can stimulate the named pathways in an autocrine and paracrine manner, thereby increasing the activation of both professional and non-professional immune cells.

Thus, to establish and maintain infection within the liver, evasion from these mechanisms is required by pathogens, which have evolved various ways to hide from and even actively inhibit the innate immune response.

2. How to establish infection in the liver: a virus' perspective

a. The Trojan Horse strategy

Such as ancient Greeks, some liver viruses have developed means to enter cells without being detected, thereby eluding/delaying the activation of an immune response. To establish infection, different problems might arise: (i) reaching the liver, (ii) accessing permissive cells from the blood circulation, and (iii) efficient entering.

Pathogens mainly reach the liver through the blood circulation. Thus, accessing parenchymal cells from the sinusoid, i.e. crossing the endothelium formed by LSECs, is often the first barrier encountered. LSECs are equipped with unique fenestration allowing nutrients, hormones, and most viruses to pass through. It is worth mentioning that, upon specific liver pathologies such as fibrosis, fenestrae are lost, thereby modifying the ability of some viruses to access permissive cells [17]. Active mechanisms are also described, such as HCV transcytosis through LSECs and KCs after interaction with surface molecules [18,19]. Of note, the relevance of this mechanism *in vivo* remains unclear.

In hepatocytes, HCV uses the association of its envelope proteins with high/ very low/ low density lipoproteins (HDLs/VLDLs/LDLs) to enhance cellular entry receptor-mediated or by membrane fusion [20].

Hence, liver viruses are capable of subverting the immune system towards their efficient internalization into permissive cells.

b. Catch me if you can: how liver viruses escape recognition

i. Extracellular escape: complement pathway and pathogenic evasion

The complement pathway enables efficient recognition of circulating pathogens resulting in the production of inflammatory cytokines, recruitment of phagocytes, and lysis of the recognized pathogen; mechanisms that viruses have to avoid to enable viral spreading [21].

Evasion from complement-dependent antibody-recognition can be achieved by association of envelope proteins with host lipoproteins and glycans as described for HCV [20] and secretion of quasi-enveloped forms (i.e. eHAV and eHEV) that hide hyper-immunogenic capsid/core components [22].

RNA viruses from the *Flaviviridae* family (HCV, DENV, ZIKV, YFV, and WNV) hinder antigen presentation by MHC molecules by selecting emerging mutations in the most targeted epitopes, often surface proteins, which generates a need for novel epitope-specific antibodies in patients [23]. In addition, the composition and localization of glycans attached to viral envelope proteins, such as HCV-E2, can be modulated [24]. Finally, non-infectious HBV-subviral particles, secreted in excess (10^4 to 10^5 more than infectious particles), serve as decoy [25].

Several viruses have also developed active mechanisms to evade complement pathways by (i) recruiting host cellular factors serving as inhibitors or (ii) directly interacting with complement proteins. Host factors recruited by viruses include the decay-accelerating factor (CD55), membrane cofactor protein (CD46), membrane inhibitor of reactive lysis (CD59), and the factor H [26–29] (Figure 2, point#1). Although WNV, DENV2 and ZIKV association with these proteins is mostly shown *in vitro*,

evidence from patients suggest incorporation of CD59 in HCV-virion [26]. Moreover, DENV, WNV, and YFV can directly inhibit the formation of C1-C4s complexes, using the soluble surface protein sNS1, which binds complement proteins, and/or induce their degradation [26].

Altogether, these different strategies enable viruses to escape antibody- and complement-mediated death.

ii. Peek-a-Boo: intracellular hiding of viruses

Once they have successfully entered permissive cells, viruses need to prevent intracellular immune recognition by PRRs.

HBV and HCMV establish a host-like or a dormant form/state leading to the sustained presence of the virus within the liver and possible re-activation of the disease. HCMV latent state (discussed here [30]) is transcriptionally repressed whereas HBV genome lays in the nucleus of infected cells as a chromosome-like structure, the cccDNA (covalently-closed circular DNA), thereby not constituting PAMPs. Outside of the nucleus, the nucleocapsid shields HBV from PRR recognition [31]. Thus, even if in some peculiar experimental conditions cytosolic PRRs were able to recognize HBV genome [32], only transient and weak or no innate immune responses are detected in hepatocytes following natural HBV infection [33,34].

Other viruses evade cytosolic recognition and ensure local concentration of replication-relevant factors by modulating host membranes and generating new compartments. Two are described *in vitro*: (i) invagination/spherules of 90 nm diameter with a 10 nm channel to the endoplasmic reticulum (ER) (DENV and suggested for WNV), and (ii) double membrane vesicles of 150 nm diameter for HCV [35]. Besides, HCV structural proteins and RNA are found in patients' exosomes, hiding them from viral recognition [36].

Altogether, these strategies decrease the amount of PAMPs available for recognition.

3. Liver viruses strike back: active inhibition of innate immune sensing

a. Targeting professional immune sensors

i. PRRs

PRR sensing and activation induce NF- κ B and IFN pathways (discussed in part 3.b.), which are essential to initiate pathogen clearance. Therefore, viruses have evolved strategies to dampen PRR expression/activity.

TLR9, TLR3, and TLR2 expression are downregulated in PBMCs, liver macrophages, and/or hepatocytes from chronic HBV-HBeAg⁺ patients [37–39] (Figure 2, point#2). However, TLR downregulation could not

be recapitulated *ex vivo* when using strong immune inducers, suggesting that inhibition by HBV can be overcome above a certain activation threshold [40,41]. Although not clinically confirmed, HCV-NS3/4 targets Riplet, essential for RIG-I activation [42] (Figure 2, point#3).

ii. Targeting MHC presentation

Pathogen recognition results in loading of intracellular- or extracellular-derived peptides onto MHC-I or MHC-II molecules, respectively. The liver is the only organ where presentation is not hindered by the endothelial barrier, which should allow CD8⁺ T cells to be activated [43].

CD8⁺ T cell exhaustion is a hallmark of CHB patients, possibly attributed to hepatocyte priming, whereas KC and hepatic DC priming led to T cell activation correlating with viral clearance, as shown *in vivo* [44]. This indicates a differential modulation and efficiency of MHC presentation during HBV infection by so far unknown mechanisms. In HBV-HDV co-infected patients, HDV acts as an immunogenic adjuvant boosting HBV presentation [45].

Whereas HCV baseline infection does not modulate MHC-I, IFN-induced MHC-I presentation is attenuated, suggesting an inhibition of mechanisms, which are deleterious for the virus [46] (Figure 2, point#4). It is worth mentioning that HCMV, through proteasome/lysosomes addressing of key components of the pathway, is an important MHC modulator [47]. Unfortunately, experiments on hepatic-relevant models are lacking.

Altogether, liver viruses can circumvent activation of immune responses by (i) decreasing innate recognition and (ii) benefiting from tolerogenic environment or modulating MHC-mediated presentation.

b. Modulating intracellular innate immune pathways

i. PRRs' downstream signalling pathways

As mentioned, activation of PRRs triggers two major signalling pathways: IRF and NF- κ B. Their induction is controlled by key adaptor molecules, namely mitochondrial antiviral signalling protein (MAVS) (RNA sensing), STING (DNA sensing), and MyD88 or TIR domain-containing adaptor inducing IFN β (TRIF) (most TLR signalling), resulting in production of IFN-I and pro-inflammatory cytokines.

MAVS is impaired in its function by HCMV, HCV, and HBV [48–50] (Figure 2, point#5i-5ii). Of note, except for HCV, most of these studies were only performed *in vitro* (infection or overexpression of viral proteins). However, this phenotype could explain the reduced pro-inflammatory cytokines observed in patients.

STING, and its interaction with partners, are inhibited by HCV [51] (Figure 2, point#6-7), HBV [52] (Figure 2, point#8), and HEV [53] (Figure 2, point#9), subsequently suppressing downstream IRF3/7 activation. In addition, IRF3/7 are directly targeted by HEV and HBV, as demonstrated *in vitro* only (Figure 2, point#10) [53,54].

Furthermore, *in vitro*, the TLR adaptor molecule TRIF is cleaved and degraded by HCV and HAV viral proteases, respectively [55,56] (Figure 2, point#11). HBV and HCV are able to inhibit MyD88-dependent TLR signalling through sequestration or degradation of signalling molecules [57,58] (Figure 2, point#12-13).

In addition, direct targeting of NF- κ B pathway downstream signalling molecules, mostly concerning the classical activation pathway, is observed in several liver infections. One major target in the cascade is the IKK complex, as shown with *in vitro*-overexpression of HCV-NS3 and HAV-3C [59,60] (Figure 2, point#14i-14ii). Further downstream, the release and translocation of the NF- κ B complex or its subunits are prevented by HEV-ORF2 and HCV proteins [61,62] (Figure 2, point#15-16).

Although confirmation in patients is missing, these disruption mechanisms of NF- κ B and IRF signalling pathways could contribute to the decreased levels of IFN and pro-inflammatory cytokines observed in infected patients.

ii. IFN receptor downstream signalling

IFN-I (IFN α and IFN β) and IFN-II (IFN γ) bind to their respective receptors, IFNAR and IFNGR, and activate downstream signalling. Subsequently, interferon-stimulated genes (ISGs) are induced, promoting antiviral activity.

Firstly, in hepatoma cells, expression or Tyk2-mediated activation of IFNAR are precluded by HCV and HDV, respectively [63,64] (Figure 2, point#17-18). Further downstream, activity of the transcription factors STAT1/2 (signal transducer and activator of transcription) is prevented by HBV-pol and HDV proteins *in vitro* [63,65] (Figure 2, point#19). HBV-mediated inhibition of STAT1/2 nuclear translocation was confirmed in CHB patients' liver biopsies. Moreover, although studies in HDV patients are lacking, the observed inhibition could partially account for the low efficacy of IFN α treatment in HDV patients [65].

Some evidence also suggest direct inhibition of ISG expression, leading to decreased production of important antiviral effectors, such as the myxovirus resistance A (MxA), only observed in HBV-transfected Huh7, and tripartite motif 22 (TRIM22) protein, as seen in primary human hepatocytes and liver biopsies [66,67] (Figure 2, point#20). Furthermore, *in vitro* studies demonstrated reduced IFN- β promoter activity caused by HCV-induced autophagy [68].

In summary, IFN signalling, leading to the expression of ISGs, is crucial to control virus infection making it a privileged target of pathogens.

c. Targeting immune cell responses

i. Modulating innate immune cells count

Viruses are also capable of modulating the number of innate immune cells, through (i) an increase of beneficial immune cells, (ii) an inhibition of proliferation, or (iii) an induction of apoptosis.

Examples are the Myeloid-Derived Suppressor Cells (MDSCs), which favour an immunosuppressive environment. They are found broadly recruited to the liver in HBV-infected patients [69,70] as well as increased in the circulation of HCV-infected patients [71] (Figure 3-A). CHB patients with hepatic damage also show increased number of ILC1s [9] (Figure 3-A).

On the contrary, chronic HCV patients show lower hepatic NK cell numbers, following increased KLRG1 expression [72] (Figure 3-A). Innate-like invariant NKT cells are significantly reduced in CHB patients, and the residual iNKT cells show aberrant activation in response to its specific agonist [73] (Figure 3-A).

Furthermore, MAIT cells are decreased in the blood of patients with chronic HBV, HCV, and HDV infection as well as in HCV/HIV co-infection [74] (Figure 3-A). Whereas the number of liver MAIT cells in HBV patients inversely correlates with liver fibrosis and inflammation, patients with DENV infection show a positive correlation between MAIT activation and disease severity [10]. Of note, no direct induction of MAIT apoptosis by these viruses has been shown and the cell decrease was rather explained by a persistent immune activation during chronic infection.

Altogether, these studies highlight the need of viruses to modulate the number of innate immune cells in order to prevent the implementation of a strong innate immune response.

ii. Modulation of innate immune cells' phenotype

In addition to the cell number, viruses develop strategies to interfere with immune cell polarization, i.e. pro-inflammatory vs. anti-inflammatory phenotypes.

Cytokine secretion profile is a key aspect of immune cell phenotypes. Pro-inflammatory cytokines such as PBMC-derived IL-12 (*ex vivo* stimulation) and/or MAIT cell-derived IFN γ and TNF α are downregulated in chronic HBV and HCV patients [74,75] (Figure 3-B, point#1-2). The reduction of other cytokines such as IL-1 β , TNF α , IL-6, or IFN-I is mostly described *in vitro* (e.g. human KCs), using virions or specific viral proteins, but could also contribute to the reduced pro-inflammatory responses observed in HBV and HCV patients [8,76] (Figure 3-B, point#1,3).

On the other hand, anti-inflammatory cytokines (IL-10, TGF- β) and/or surface markers (CD163) are upregulated in patients with HBV [8,75,77] (Figure 3-B, point#4-5) as well as in patient sera and *in vitro* models of HCV infection (Figure 3-B, point#4) [78].

Viruses further dampen immune responses by modulation of surface receptors and their ligands affecting activation, inhibition, and apoptosis. Indeed, FasL upregulation is observed in HBV patients' KCs, favouring cell death [79] (Figure 3-B, point#6). Of note, similar observations are found with other viral infections, but have yet to be confirmed in patients [76].

More evident is the enhanced expression of inhibitory checkpoint proteins/receptors, impairing CD8⁺ T cell and NK cell activity, as shown in livers from CHB patients (i.e. PD-1) and MAIT cells of chronic HBV and HCV patients (i.e. PD-1, CTLA-4), indicating an exhausted phenotype [80–82] (Figure 3-B, point#7). NK cell activation is directly inhibited by downregulation of the activating receptor NKG2D in HCV [78] and CHB patients [83] (Figure 3-B, point#8). Besides, HCV also downregulates NKp46 and NKp30 expression, *in vitro* [84] (Figure 3-B, point#9).

Finally, DC activation and migration towards lymphoid organs is impaired in HCV infected patients [85,86].

Altogether, these data highlight that liver viruses can modulate the phenotype and response of innate immune cells.

4. Conclusion

This review describes how liver viruses have evolved similar mechanisms to evade innate immune responses and subsequently maintain their infection in the liver. Moreover, whereas we only discussed the effect of viruses on innate immune responses in the liver, common phenotypes/mechanisms could be found in other liver pathogen infections, namely bacteria and parasites. Therapeutically targeting one or several of these mechanisms could enhance efficacy of existing treatments or lead to the successful development of new vaccines and therapies.

Abbreviations:

ACT: Artemisinin-based combination therapy

AH: Acute hepatitis

cccDNA: covalently-closed circular DNA

cGAS: cyclic GMP-AMP synthase

CHB: chronic hepatitis B

DAA: direct antiviral agents

DAMP: danger associated molecular pattern

DC: dendritic cell

DENV: Dengue virus

eHAV: enveloped hepatitis A virus

eHEV: enveloped hepatitis E virus

ER: endoplasmic reticulum

HAV: hepatitis A virus

HBV: hepatitis B virus

HCC: hepatocellular carcinoma

HCMV: human cytomegalovirus

HCV: hepatitis C virus

HDL: high density lipoprotein

HDV: hepatitis delta virus

HEV: hepatitis E virus

HSC: hepatic stellate cell

IFN: interferon

IFN-I: type I interferon

IFNAR: interferon alpha receptor

IFNGR: interferon gamma receptor

IKK: I κ B kinase

ILC: Innate Lymphoid cells

IRF: interferon regulatory factor

ISG: interferon-stimulated genes

ISRE: interferon stimulated response element

JAK1: Janus kinase 1

KC: Kupffer cell

LDL: low density lipoprotein

LSEC: liver sinusoidal endothelial cell

MAIT: Mucosal-Associated Invariant T cells

MAVS: mitochondrial antiviral signalling protein

MDSC: myeloid-derived suppressor cell

MHC-I/II: major histocompatibility complex I/II

MxA: myxovirus resistance A

NA: nucleos(t)ide analogues

NF- κ B: nuclear factor-kappa B

NK: natural killer

NKT: natural killer T cell

NPC: non-parenchymal cell

PAMP: pathogen associated molecular pattern

PBMC: peripheral blood mononuclear cell

PD-1: programmed death 1

pDC: plasmacytoid dendritic cell

PD-L1: programmed death ligand 1

Peg-IFN α : pegylated interferon alpha

PRR: pattern recognition receptor

RIG-1: retinoic acid-inducible gene-1

sNS1: soluble NS-1

STAT: signal transducer and activator of transcription

STING: stimulator of interferon genes

TBK1: TANK-binding kinase

TLR: toll like receptor

TRAM: TRIF-Related Adaptor Molecule

TRIF: TIR domain-containing adaptor inducing IFN β

TRIM22: tripartite motif 22

Tyk2: tyrosine kinase 2

VLDL: very low density lipoprotein

WNV: west Nile virus

YFV: yellow fever virus

ZIKV: Zika virus

References:

- [1] Wisplinghoff H, Appleton DL. Bacterial infections of the liver. In: Weber O, Protzer U, editors. *Comparative Hepatitis*, Basel: Birkhäuser; 2008, p. 143–60. https://doi.org/10.1007/978-3-7643-8558-3_8.
- [2] Ekpanyapong S, Reddy KR. Fungal and Parasitic Infections of the Liver. *Gastroenterol Clin North Am* 2020;49:379–410. <https://doi.org/10.1016/j.gtc.2020.01.009>.
- [3] Lanini S, Ustianowski A, Pisapia R, Zumla A, Ippolito G. Viral Hepatitis: Etiology, Epidemiology, Transmission, Diagnostics, Treatment, and Prevention. *Infect Dis Clin North Am* 2019;33:1045–62. <https://doi.org/10.1016/j.idc.2019.08.004>.
- [4] Alfaiate D, Clément S, Gomes D, Goossens N, Negro F. Chronic hepatitis D and hepatocellular carcinoma: A systematic review and meta-analysis of observational studies. *Journal of Hepatology* 2020;73:533–9. <https://doi.org/10.1016/j.jhep.2020.02.030>.
- [5] Gerna G, Lilleri D. Human cytomegalovirus (HCMV) infection/re-infection: development of a protective HCMV vaccine. *New Microbiol* 2019;42:1–20.
- [6] Racanelli V, Rehermann B. The liver as an immunological organ. *Hepatology* 2006;43:S54-62. <https://doi.org/10.1002/hep.21060>.
- [7] Faure-Dupuy S, Vegna S, Aillot L, Dimier L, Esser K, Broxtermann M, et al. Characterization of Pattern Recognition Receptor Expression and Functionality in Liver Primary Cells and Derived Cell Lines. *J Innate Immun* 2018;10:339–48. <https://doi.org/10.1159/000489966>.
- [8] Faure-Dupuy S, Delphin M, Aillot L, Dimier L, Lebossé F, Fresquet J, et al. Hepatitis B virus-induced modulation of liver macrophage function promotes hepatocyte infection. *Journal of Hepatology* 2019;71:1086–98. <https://doi.org/10.1016/j.jhep.2019.06.032>.
- [9] Liu M, Zhang C. The Role of Innate Lymphoid Cells in Immune-Mediated Liver Diseases. *Front Immunol* 2017;8:695. <https://doi.org/10.3389/fimmu.2017.00695>.
- [10] van Wilgenburg B, Scherwitzl I, Hutchinson EC, Leng T, Kurioka A, Kulicke C, et al. MAIT cells are activated during human viral infections. *Nature Communications* 2016;7:11653. <https://doi.org/10.1038/ncomms11653>.
- [11] Gulati A, Kaur D, Krishna Prasad GVR, Mukhopadhaya A. PRR Function of Innate Immune Receptors in Recognition of Bacteria or Bacterial Ligands. *Adv Exp Med Biol* 2018;1112:255–80. https://doi.org/10.1007/978-981-13-3065-0_18.
- [12] Luangsay S, Ait-Goughoulte M, Michelet M, Floriot O, Bonnin M, Gruffaz M, et al. Expression and functionality of Toll- and RIG-like receptors in HepaRG cells. *J Hepatol* 2015;63:1077–85. <https://doi.org/10.1016/j.jhep.2015.06.022>.
- [13] Blum JS, Wearsch PA, Cresswell P. Pathways of Antigen Processing. *Annu Rev Immunol* 2013;31:443–73. <https://doi.org/10.1146/annurev-immunol-032712-095910>.
- [14] Sun S-C. The non-canonical NF- κ B pathway in immunity and inflammation. *Nat Rev Immunol* 2017;17:545–58. <https://doi.org/10.1038/nri.2017.52>.
- [15] Vergadi E, Ieronymaki E, Lyroni K, Vaporidi K, Tsatsanis C. Akt Signaling Pathway in Macrophage Activation and M1/M2 Polarization. *J Immunol* 2017;198:1006–14. <https://doi.org/10.4049/jimmunol.1601515>.
- [16] Mesev EV, LeDesma RA, Ploss A. Decoding type I and III interferon signalling during viral infection. *Nat Microbiol* 2019;4:914–24. <https://doi.org/10.1038/s41564-019-0421-x>.
- [17] Poisson J, Lemoine S, Boulanger C, Durand F, Moreau R, Valla D, et al. Liver sinusoidal endothelial cells: Physiology and role in liver diseases. *Journal of Hepatology* 2017;66:212–27. <https://doi.org/10.1016/j.jhep.2016.07.009>.
- [18] Pöhlmann S, Zhang J, Baribaud F, Chen Z, Leslie GJ, Lin G, et al. Hepatitis C Virus Glycoproteins Interact with DC-SIGN and DC-SIGNR. *Journal of Virology* 2003;77:4070–80. <https://doi.org/10.1128/JVI.77.7.4070-4080.2003>.
- [19] Gardner JP, Durso RJ, Arrigale RR, Donovan GP, Maddon PJ, Dragic T, et al. L-SIGN (CD 209L) is a liver-specific capture receptor for hepatitis C virus. *PNAS* 2003;100:4498–503. <https://doi.org/10.1073/pnas.0831128100>.

- [20] Di Lorenzo C, Angus AGN, Patel AH. Hepatitis C Virus Evasion Mechanisms from Neutralizing Antibodies. *Viruses* 2011;3:2280–300. <https://doi.org/10.3390/v3112280>.
- [21] Rosbjerg A, Genster N, Pilely K, Garred P. Evasion Mechanisms Used by Pathogens to Escape the Lectin Complement Pathway. *Front Microbiol* 2017;8:868. <https://doi.org/10.3389/fmicb.2017.00868>.
- [22] Feng Z, Lemon SM. Peek-a-boo: membrane hijacking and the pathogenesis of viral hepatitis. *Trends Microbiol* 2014;22:59–64. <https://doi.org/10.1016/j.tim.2013.10.005>.
- [23] Farci P, Shimoda A, Coiana A, Diaz G, Peddis G, Melpolder JC, et al. The outcome of acute hepatitis C predicted by the evolution of the viral quasispecies. *Science* 2000;288:339–44. <https://doi.org/10.1126/science.288.5464.339>.
- [24] Lavie M, Hanouille X, Dubuisson J. Glycan Shielding and Modulation of Hepatitis C Virus Neutralizing Antibodies. *Front Immunol* 2018;9:910. <https://doi.org/10.3389/fimmu.2018.00910>.
- [25] Ferrari C. HBV and the immune response. *Liver Int* 2015;35 Suppl 1:121–8. <https://doi.org/10.1111/liv.12749>.
- [26] Agrawal P, Nawadkar R, Ojha H, Kumar J, Sahu A. Complement Evasion Strategies of Viruses: An Overview. *Front Microbiol* 2017;8. <https://doi.org/10.3389/fmicb.2017.01117>.
- [27] Conde JN, Silva EM, Barbosa AS, Mohana-Borges R. The Complement System in Flavivirus Infections. *Front Microbiol* 2017;8. <https://doi.org/10.3389/fmicb.2017.00213>.
- [28] Alcami A, Koszinowski UH. Viral mechanisms of immune evasion. *Trends Microbiol* 2000;8:410–8. [https://doi.org/10.1016/S0966-842X\(00\)01830-8](https://doi.org/10.1016/S0966-842X(00)01830-8).
- [29] Miller-Kittrell M, Sparer TE. Feeling manipulated: cytomegalovirus immune manipulation. *Virology Journal* 2009;6:4. <https://doi.org/10.1186/1743-422X-6-4>.
- [30] Forte E, Zhang Z, Thorp EB, Hummel M. Cytomegalovirus Latency and Reactivation: An Intricate Interplay With the Host Immune Response. *Front Cell Infect Microbiol* 2020;10. <https://doi.org/10.3389/fcimb.2020.00130>.
- [31] Grimm D, Thimme R, Blum HE. HBV life cycle and novel drug targets. *Hepatol Int* 2011;5:644–53. <https://doi.org/10.1007/s12072-011-9261-3>.
- [32] Megahed FAK, Zhou X, Sun P. The Interactions between HBV and the Innate Immunity of Hepatocytes. *Viruses* 2020;12. <https://doi.org/10.3390/v12030285>.
- [33] Wieland S, Thimme R, Purcell RH, Chisari FV. Genomic analysis of the host response to hepatitis B virus infection. *Proc Natl Acad Sci U S A* 2004;101:6669–74. <https://doi.org/10.1073/pnas.0401771101>.
- [34] Luangsay S, Gruffaz M, Isorce N, Testoni B, Michelet M, Faure-Dupuy S, et al. Early inhibition of hepatocyte innate responses by hepatitis B virus. *Journal of Hepatology* 2015;63:1314–22.
- [35] Paul D, Bartenschlager R. Architecture and biogenesis of plus-strand RNA virus replication factories. *World J Virol* 2013;2:32–48. <https://doi.org/10.5501/wjv.v2.i2.32>.
- [36] Schorey JS, Cheng Y, Singh PP, Smith VL. Exosomes and other extracellular vesicles in host–pathogen interactions. *EMBO Reports* 2015;16:24–43. <https://doi.org/10.15252/embr.201439363>.
- [37] Huang Y-W, Lin S-C, Wei S-C, Hu J-T, Chang H-Y, Huang S-H, et al. Reduced Toll-like receptor 3 expression in chronic hepatitis B patients and its restoration by interferon therapy. *Antiviral Therapy* 2013;18:877–84. <https://doi.org/10.3851/IMP2630>.
- [38] Vincent IE, Zannetti C, Lucifora J, Norder H, Protzer U, Hainaut P, et al. Hepatitis B Virus Impairs TLR9 Expression and Function in Plasmacytoid Dendritic Cells. *PLOS ONE* 2011;6:e26315. <https://doi.org/10.1371/journal.pone.0026315>.
- [39] Visvanathan K, Skinner NA, Thompson AJV, Riordan SM, Sozzi V, Edwards R, et al. Regulation of Toll-like receptor-2 expression in chronic hepatitis B by the precore protein. *Hepatology* 2007;45:102–10. <https://doi.org/10.1002/hep.21482>.
- [40] Mutz P, Metz P, Lempp FA, Bender S, Qu B, Schöneweis K, et al. HBV Bypasses the Innate Immune Response and Does not Protect HCV From Antiviral Activity of Interferon. *Gastroenterology* 2018. <https://doi.org/10.1053/j.gastro.2018.01.044>.

- [41] Suslov A, Boldanova T, Wang X, Wieland S, Heim MH. Hepatitis B Virus Does Not Interfere with Innate Immune Responses in the Human Liver. *Gastroenterology* 2018;154:1778–90. <https://doi.org/10.1053/j.gastro.2018.01.034>.
- [42] Oshiumi H, Miyashita M, Matsumoto M, Seya T. A Distinct Role of Riplet-Mediated K63-Linked Polyubiquitination of the RIG-I Repressor Domain in Human Antiviral Innate Immune Responses. *PLoS Pathog* 2013;9:e1003533. <https://doi.org/10.1371/journal.ppat.1003533>.
- [43] Crispe IN. Liver antigen-presenting cells. *J Hepatol* 2011;54:357–65. <https://doi.org/10.1016/j.jhep.2010.10.005>.
- [44] Fisicaro P, Barili V, Rossi M, Montali I, Vecchi A, Acerbi G, et al. Pathogenetic Mechanisms of T Cell Dysfunction in Chronic HBV Infection and Related Therapeutic Approaches. *Front Immunol* 2020;11. <https://doi.org/10.3389/fimmu.2020.00849>.
- [45] Tham CYL, Kah J, Tan AT, Volz T, Chia A, Giersch K, et al. Hepatitis Delta Virus Acts as an Immunogenic Adjuvant in Hepatitis B Virus-Infected Hepatocytes. *CR Med* 2020;1. <https://doi.org/10.1016/j.xcrm.2020.100060>.
- [46] Kang W, Sung PS, Park S-H, Yoon S, Chang D-Y, Kim S, et al. Hepatitis C virus attenuates interferon-induced major histocompatibility complex class I expression and decreases CD8+ T cell effector functions. *Gastroenterology* 2014;146:1351-1360.e1-4. <https://doi.org/10.1053/j.gastro.2014.01.054>.
- [47] LUCAS M, KARRER U, LUCAS A, KLENERMAN P. Viral escape mechanisms – escapology taught by viruses. *Int J Exp Pathol* 2001;82:269–86. <https://doi.org/10.1046/j.1365-2613.2001.00204.x>.
- [48] Bellecave P, Sarasin-Filipowicz M, Donzé O, Kennel A, Gouttenoire J, Meylan E, et al. Cleavage of mitochondrial antiviral signaling protein in the liver of patients with chronic hepatitis C correlates with a reduced activation of the endogenous interferon system. *Hepatology* 2010;51:1127–36. <https://doi.org/10.1002/hep.23426>.
- [49] Kumar M, Jung SY, Hodgson AJ, Madden CR, Qin J, Slagle BL. Hepatitis B Virus Regulatory HBx Protein Binds to Adaptor Protein IPS-1 and Inhibits the Activation of Beta Interferon. *Journal of Virology* 2011;85:987–95. <https://doi.org/10.1128/JVI.01825-10>.
- [50] Magalhães AC, Ferreira AR, Gomes S, Vieira M, Gouveia A, Valença I, et al. Peroxisomes are platforms for cytomegalovirus' evasion from the cellular immune response. *Sci Rep* 2016;6:26028. <https://doi.org/10.1038/srep26028>.
- [51] Ding Q, Cao X, Lu J, Huang B, Liu Y-J, Kato N, et al. Hepatitis C virus NS4B blocks the interaction of STING and TBK1 to evade host innate immunity. *Journal of Hepatology* 2013;59:52–8. <https://doi.org/10.1016/j.jhep.2013.03.019>.
- [52] Wang H, Ryu W-S. Hepatitis B Virus Polymerase Blocks Pattern Recognition Receptor Signaling via Interaction with DDX3: Implications for Immune Evasion. *PLoS Pathog* 2010;6:e1000986. <https://doi.org/10.1371/journal.ppat.1000986>.
- [53] Nan Y, Yu Y, Ma Z, Khattar SK, Fredericksen B, Zhang Y-J. Hepatitis E Virus Inhibits Type I Interferon Induction by ORF1 Products. *Journal of Virology* 2014;88:11924–32. <https://doi.org/10.1128/JVI.01935-14>.
- [54] Zannetti C, Roblot G, Charrier E, Ainouze M, Tout I, Briat F, et al. Characterization of the Inflammasome in Human Kupffer Cells in Response to Synthetic Agonists and Pathogens. *Journal of Immunology (Baltimore, Md : 1950)* 2016;197:356–67. <https://doi.org/10.4049/jimmunol.1502301>.
- [55] Qu L, Feng Z, Yamane D, Liang Y, Lanford RE, Li K, et al. Disruption of TLR3 Signaling Due to Cleavage of TRIF by the Hepatitis A Virus Protease-Polymerase Processing Intermediate, 3CD. *PLoS Pathog* 2011;7:e1002169. <https://doi.org/10.1371/journal.ppat.1002169>.
- [56] Liang Y, Cao X, Ding Q, Zhao Y, He Z, Zhong J. Hepatitis C virus NS4B induces the degradation of TRIF to inhibit TLR3-mediated interferon signaling pathway. *PLoS Pathog* 2018;14:e1007075. <https://doi.org/10.1371/journal.ppat.1007075>.

- [57] Lang T, Lo C, Skinner N, Locarnini S, Visvanathan K, Mansell A. The Hepatitis B e antigen (HBeAg) targets and suppresses activation of the Toll-like receptor signaling pathway. *Journal of Hepatology* 2011;55:762–9. <https://doi.org/10.1016/j.jhep.2010.12.042>.
- [58] Chan ST, Lee J, Narula M, Ou J-HJ. Suppression of Host Innate Immune Response by Hepatitis C Virus via Induction of Autophagic Degradation of TRAF6. *J Virol* 2016;90:10928–35. <https://doi.org/10.1128/JVI.01365-16>.
- [59] Chen Y, He L, Peng Y, Shi X, Chen J, Zhong J, et al. The hepatitis C virus protein NS3 suppresses TNF- α -stimulated activation of NF- κ B by targeting LUBAC n.d.:11.
- [60] Wang D, Fang L, Wei D, Zhang H, Luo R, Chen H, et al. Hepatitis A Virus 3C Protease Cleaves NEMO To Impair Induction of Beta Interferon. *Journal of Virology* 2014;88:10252–8. <https://doi.org/10.1128/JVI.00869-14>.
- [61] Surjit M, Varshney B, Lal SK. The ORF2 glycoprotein of hepatitis E virus inhibits cellular NF- κ B activity by blocking ubiquitination mediated proteasomal degradation of I κ B α in human hepatoma cells. *BMC Biochem* 2012;13:7. <https://doi.org/10.1186/1471-2091-13-7>.
- [62] Krishnadas DK, Ahn JS, Han J, Kumar R, Agrawal B. Immunomodulation by hepatitis C virus-derived proteins: targeting human dendritic cells by multiple mechanisms. *International Immunology* 2010;22:491–502. <https://doi.org/10.1093/intimm/dxq033>.
- [63] Pugnale P, Paziienza V, Guilloux K, Negro F. Hepatitis delta virus inhibits alpha interferon signaling. *Hepatology* 2009;49:398–406. <https://doi.org/10.1002/hep.22654>.
- [64] Chandra PK, Bao L, Song K, Aboulnasr FM, Baker DP, Shores N, et al. HCV infection selectively impairs type I but not type III IFN signaling. *Am J Pathol* 2014;184:214–29. <https://doi.org/10.1016/j.ajpath.2013.10.005>.
- [65] Chen J, Wu M, Zhang X, Zhang W, Zhang Z, Chen L, et al. Hepatitis B virus polymerase impairs interferon- α -induced STA T activation through inhibition of importin- α 5 and protein kinase C- δ . *Hepatology* 2013;57:470–82. <https://doi.org/10.1002/hep.26064>.
- [66] Rosmorduc O, Sirma H, Soussan P, Gordien E, Lebon P, Horisberger M, et al. Inhibition of interferon-inducible MxA protein expression by hepatitis B virus capsid protein. *Journal of General Virology* 1999;80:1253–62. <https://doi.org/10.1099/0022-1317-80-5-1253>.
- [67] Lim K-H, Park E-S, Kim DH, Cho KC, Kim KP, Park YK, et al. Suppression of interferon-mediated anti-HBV response by single CpG methylation in the 5'-UTR of *TRIM22*. *Gut* 2018;67:166–78. <https://doi.org/10.1136/gutjnl-2016-312742>.
- [68] Ke P-Y, Chen SS-L. Activation of the unfolded protein response and autophagy after hepatitis C virus infection suppresses innate antiviral immunity in vitro. *J Clin Invest* 2011;121:37–56. <https://doi.org/10.1172/JCI41474>.
- [69] Pallett LJ, Gill US, Quaglia A, Sinclair LV, Jover-Cobos M, Schurich A, et al. Metabolic regulation of hepatitis B immunopathology by myeloid-derived suppressor cells. *Nat Med* 2015;21:591–600. <https://doi.org/10.1038/nm.3856>.
- [70] Pal S, Nandi M, Dey D, Chakraborty BC, Shil A, Ghosh S, et al. Myeloid-derived suppressor cells induce regulatory T cells in chronically HBV infected patients with high levels of hepatitis B surface antigen and persist after antiviral therapy. *Aliment Pharmacol Ther* 2019;49:1346–59. <https://doi.org/10.1111/apt.15226>.
- [71] Zhai N, Li H, Song H, Yang Y, Cui A, Li T, et al. Hepatitis C Virus Induces MDSCs-Like Monocytes through TLR2/PI3K/AKT/STAT3 Signaling. *PLOS ONE* 2017;12:e0170516. <https://doi.org/10.1371/journal.pone.0170516>.
- [72] Wang JM, Cheng YQ, Shi L, Ying RS, Wu XY, Li GY, et al. KLRG1 Negatively Regulates Natural Killer Cell Functions through the Akt Pathway in Individuals with Chronic Hepatitis C Virus Infection. *Journal of Virology* 2013;87:11626 LP – 11636. <https://doi.org/10.1128/JVI.01515-13>.
- [73] Tan X, Ding Y, Zhu P, Dou R, Liang Z, Yang D, et al. Elevated Hepatic CD1d Levels Coincide with Invariant NKT Cell Defects in Chronic Hepatitis B Virus Infection. *The Journal of Immunology* 2018;200:3530–8. <https://doi.org/10.4049/jimmunol.1701801>.

- [74] Ussher JE, Willberg CB, Klenerman P. MAIT cells and viruses. *Immunol Cell Biol* 2018;96:630–41. <https://doi.org/10.1111/imcb.12008>.
- [75] Wang S, Chen Z, Hu C, Qian F, Cheng Y, Wu M, et al. Hepatitis B virus surface antigen selectively inhibits TLR2 ligand-induced IL-12 production in monocytes/macrophages by interfering with JNK activation. *J Immunol* 2013;190:5142–51. <https://doi.org/10.4049/jimmunol.1201625>.
- [76] Tu Z, Pierce RH, Kurtis J, Kuroki Y, Crispe IN, Orloff MS. Hepatitis C Virus Core Protein Subverts the Antiviral Activities of Human Kupffer Cells. *Gastroenterology* 2010;138:305–14. <https://doi.org/10.1053/j.gastro.2009.09.009>.
- [77] Dunn C, Peppas D, Khanna P, Nebbia G, Jones M, Brendish N, et al. Temporal analysis of early immune responses in patients with acute hepatitis B virus infection. *Gastroenterology* 2009;137:1289–300. <https://doi.org/10.1053/j.gastro.2009.06.054>.
- [78] Sène D, Levasseur F, Abel M, Lambert M, Camous X, Hernandez C, et al. Hepatitis C virus (HCV) evades NKG2D-dependent NK cell responses through NS5A-mediated imbalance of inflammatory cytokines. *PLoS Pathogens* 2010;6:e1001184. <https://doi.org/10.1371/journal.ppat.1001184>.
- [79] Tang TJ, Kwekkeboom J, Laman JD, Niesters HGM, Zondervan PE, de Man RA, et al. The role of intrahepatic immune effector cells in inflammatory liver injury and viral control during chronic hepatitis B infection. *J Viral Hepat* 2003;10:159–67. <https://doi.org/10.1046/j.1365-2893.2003.00412.x>.
- [80] Yong YK, Saeidi A, Tan HY, Rosmawati M, Enström PF, Batran RA, et al. Hyper-Expression of PD-1 Is Associated with the Levels of Exhausted and Dysfunctional Phenotypes of Circulating CD161+TCR α 7.2+ Mucosal-Associated Invariant T Cells in Chronic Hepatitis B Virus Infection. *Front Immunol* 2018;9:472. <https://doi.org/10.3389/fimmu.2018.00472>.
- [81] Barathan M, Mohamed R, Vadivelu J, Chang LY, Saeidi A, Yong YK, et al. Peripheral loss of CD8(+) CD161(++) TCRV α 7-2(+) mucosal-associated invariant T cells in chronic hepatitis C virus-infected patients. *Eur J Clin Invest* 2016;46:170–80. <https://doi.org/10.1111/eci.12581>.
- [82] Xie Z, Chen Y, Zhao S, Yang Z, Yao X, Guo S, et al. Intrahepatic PD-1/PD-L1 up-regulation closely correlates with inflammation and virus replication in patients with chronic HBV infection. *Immunological Investigations* 2009;38:624–38. <https://doi.org/10.1080/08820130903062210>.
- [83] Sun C, Fu B, Gao Y, Liao X, Sun R, Tian Z, et al. TGF- β 1 Down-Regulation of NKG2D/DAP10 and 2B4/SAP Expression on Human NK Cells Contributes to HBV Persistence. *PLOS Pathogens* 2012;8:e1002594.
- [84] Yang CM, Yoon JC, Park JH, Lee JM. Hepatitis C virus impairs natural killer cell activity via viral serine protease NS3. *PLOS ONE* 2017;12:e0175793.
- [85] Nattermann J, Zimmermann H, Iwan A, von Lilienfeld-Toal M, Leifeld L, Nischalke HD, et al. Hepatitis C virus E2 and CD81 interaction may be associated with altered trafficking of dendritic cells in chronic hepatitis C. *Hepatology* 2006;44:945–54. <https://doi.org/10.1002/hep.21350>.
- [86] Krishnadas DK, Ahn JS, Han J, Kumar R, Agrawal B. Immunomodulation by hepatitis C virus-derived proteins: targeting human dendritic cells by multiple mechanisms. *International Immunology* 2010;22:491–502. <https://doi.org/10.1093/intimm/dxq033>.

Figure 1: Liver viruses' infection route, epidemiology, and treatments. Liver viruses are displayed depending on their entry route: fluids (sexual, blood transfusion, unsanitary drug use), food (ingestion, and mosquitoes bite). Number of infected persons and the subsequent death toll, vaccine and treatment availability, and the liver induced pathologies are indicated. Abbreviations: Acute Hepatitis (AH), Cirrhosis (C), Fibrosis (F), Hepatocellular Carcinoma (HCC), Jaundice (J), Nothing Specific (NoS), Nucleos(t)ides Analogues (NA), Steatosis (S), Unknown (Unk).

Figure 2: Effect of pathogens on intracellular immune signalling pathways. **1.** Induction of CD59 and Factor H expression mediated by WNV, DENV, and ZIKV; **2.** Inhibition of TLR1/2, TLR3 and TLR9 by HBV; **3.** Inhibition of RIG-I by HCV; **4.** Inhibition of MHC-I presentation by HCV; **5.** (5i) Inhibition of MAVS interaction with mitochondria by HCMV or (5ii) MAVS degradation by HAV, HBV, and HCV; **6.** Inhibition of MAVS-STING interaction by HCV; **7.** Inhibition of STING-TBK1 interaction by HCV; **8.** Inhibition of TBK1/IKK ϵ interaction by HBV; **9.** Inhibition of RIG-I/TBK1 interaction by HEV; **10.** Inhibition of IRF3 phosphorylation by HEV; **11.** Degradation of TRIF by HCV and HAV; **12.** Inhibition of TRAM activation by HBV; **13.** Degradation of TRAF6 by HCV; **14.** (14i) Inhibition of NEMO activation by HCV and (14ii) IKK complex degradation by HAV; **15.** Inhibition of I κ B polyubiquitin-mediated proteasome addressing by HEV; **16.** Inhibition of NF- κ B subunits translocation to the nucleus by HCV; **17.** Decrease of IFNAR1 expression by HCV; **18.** Inhibition of Tyk2 phosphorylation by HDV; **19.** Inhibition of STAT1 phosphorylation by HBV, HDV, and HEV; **20.** Inhibition of TRIM22 and MxA expression by HBV. Light coloured arrows: signalling pathway (pink for NF- κ B, orange for IRF, and blue for JAK/STAT; red stopped arrows: inhibition; red dotted: degradation; red arrows: induction. Abbreviation: cGAS: cyclic GMP-AMP synthase; TBK1: TANK-binding kinase, TRAM: TRIF-Related Adaptor Molecule.

Figure 3: Modulation of immune cells count and phenotype by liver viruses. Panel A. Modulation of immune cell count by liver pathogens. **Panel B.** Modulation of immune cell phenotype by liver pathogens. **1.** Downregulation of the secretion of IL-1 β , IL-6, IL-12, and TNF α by HBV in KCs; **2.** Downregulation of IFN- γ and TNF α secretion in MAIT cells by HBV and HCV; **3.** Inhibition of the TLR3-mediated IL-12 and IFN-I secretion by HCV in KCs; **4.** Upregulation of IL-10 and TGF- β secretion by HBV and HCV in KCs; **5.** Upregulation of CD163 by HBV on KCs; **6.** Upregulation of FasL by HBV on KCs; **7.** Downregulation of NKG2D by HBV, and HCV in NKs; **8.** Inhibition of NKp30 and NKp46 by HCV on NKs. Light coloured arrows: secretion pathways; red stopped arrows: inhibitions; red dotted arrows: downregulation; simple red arrows: upregulation.

Figure 1

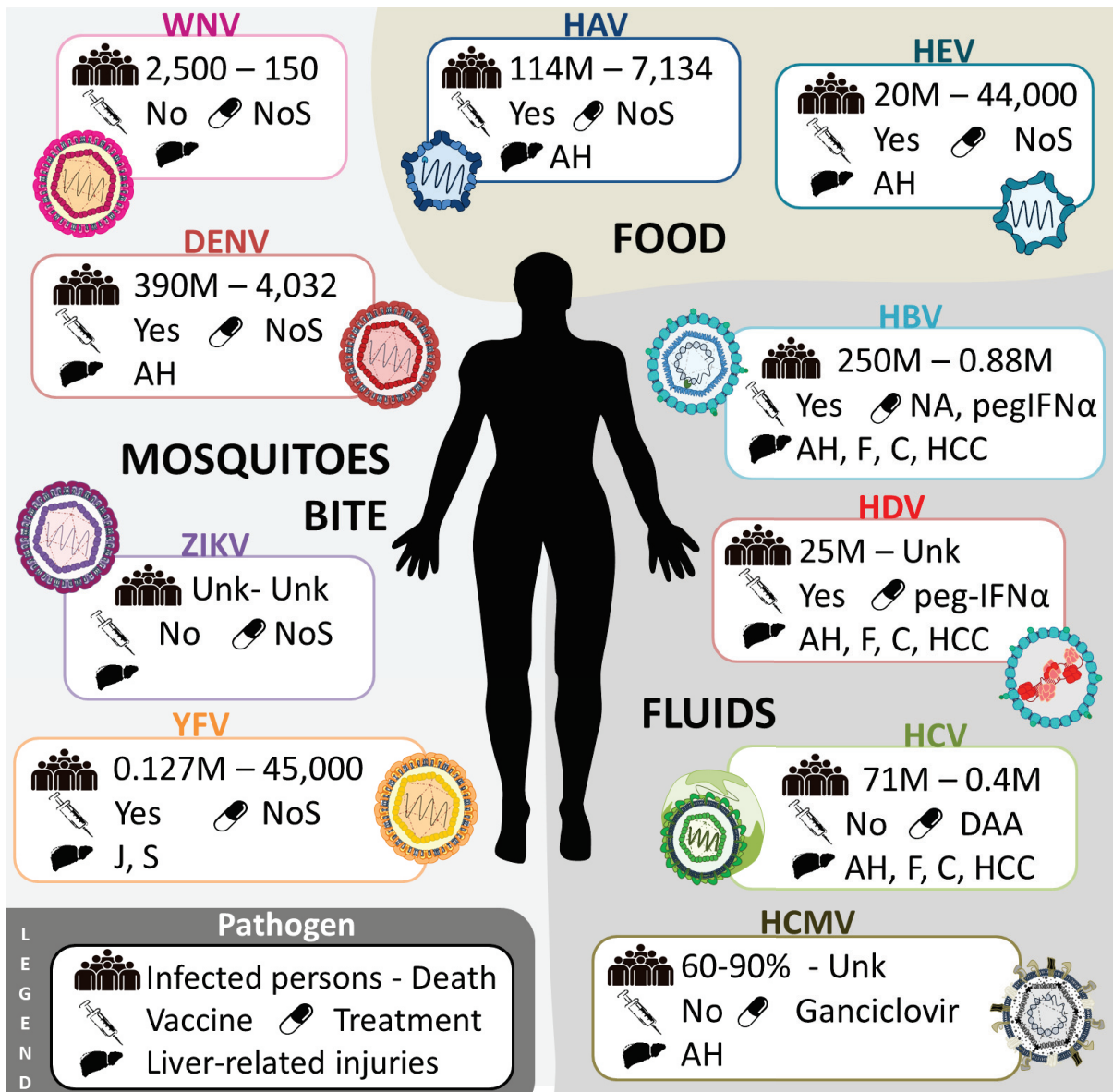

Figure 2

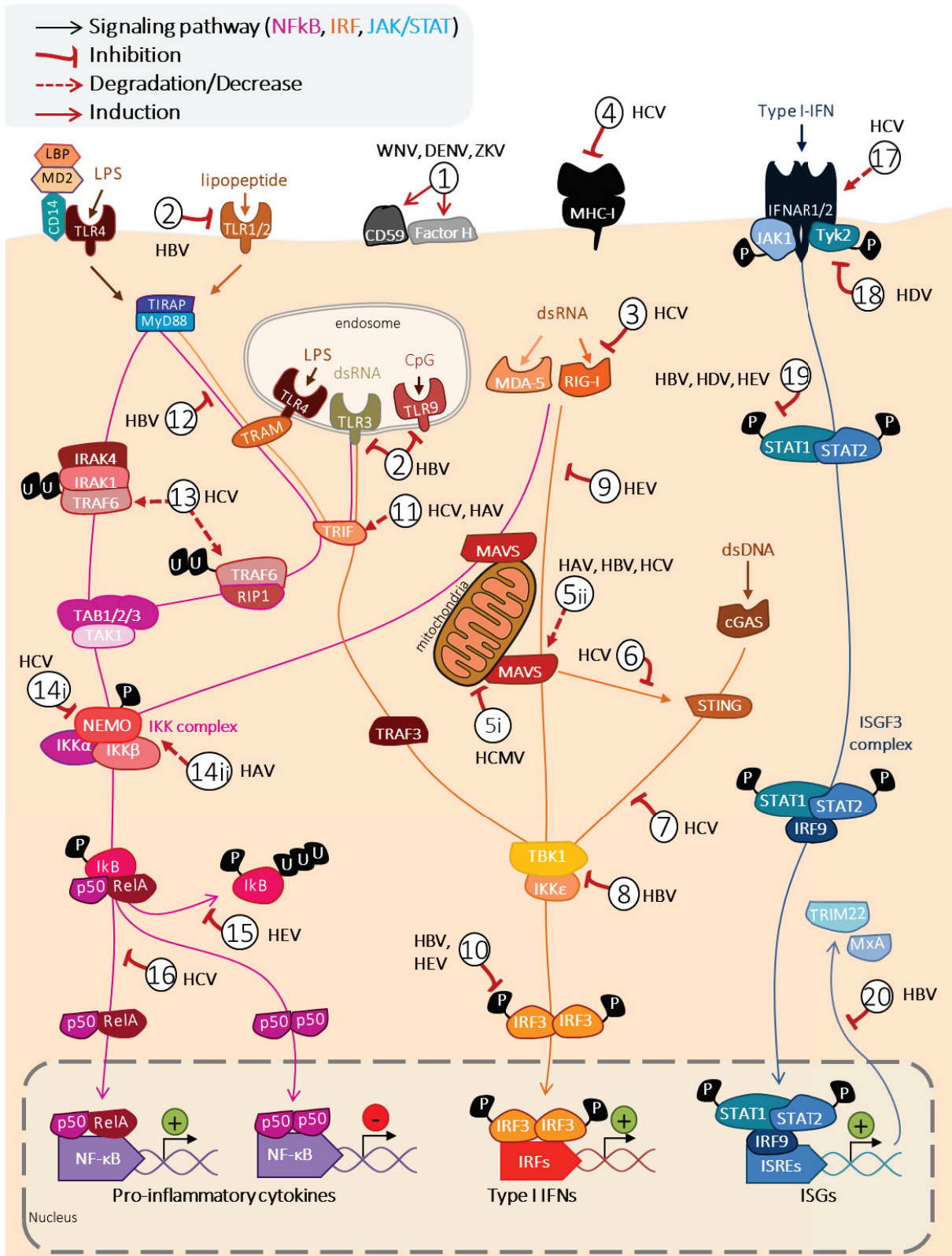
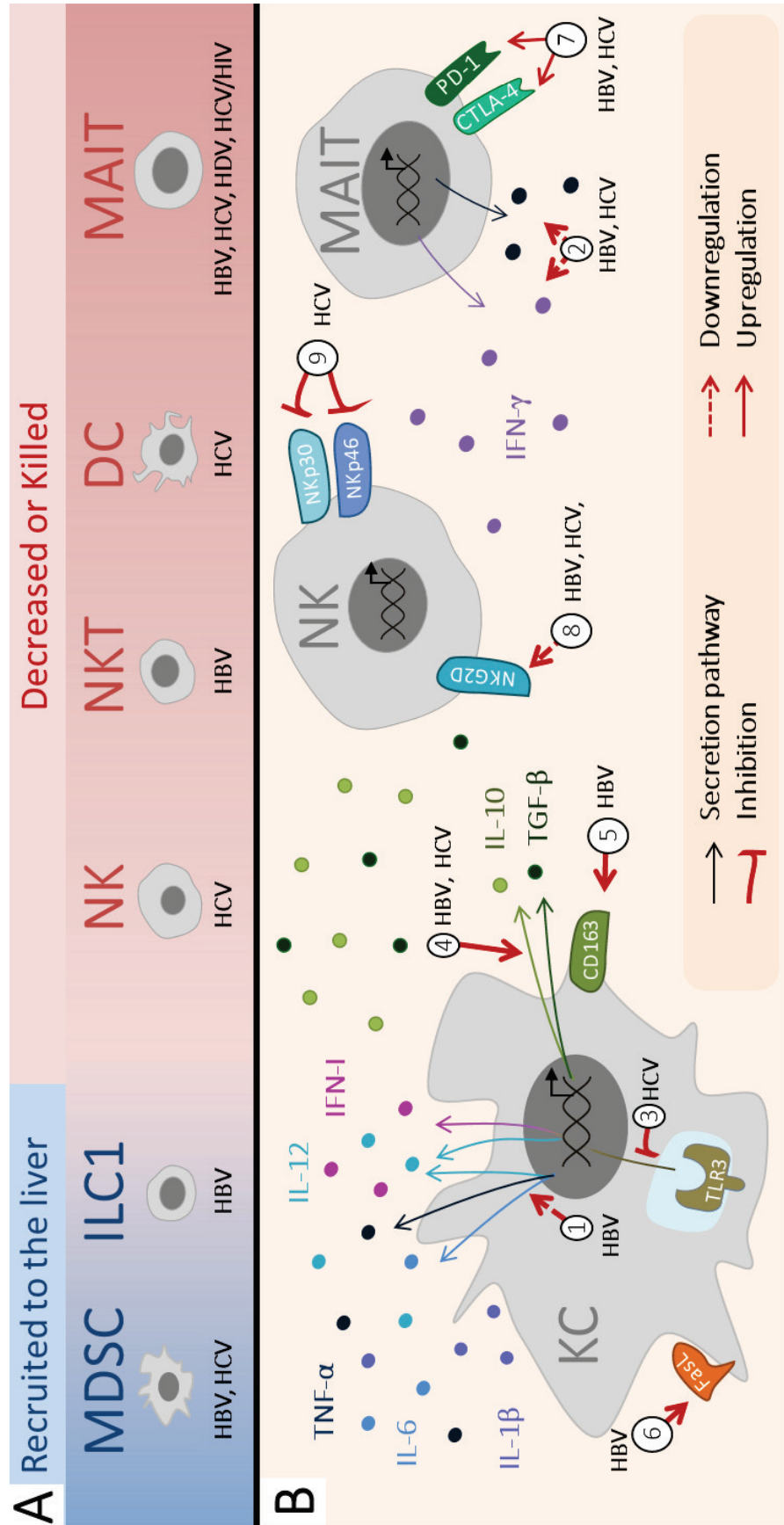

Figure 3



4. Congress attendance

4.1 InnaSCo Symposium II: Innate Sensors in Health and Diseases

Lyon, May 2019

Oral: Preclinical evaluation and study of the action of a TLR2 nanoparticulate ligand in HBV-infected *in vitro* and *in vivo* models

Manon Desmares, Myriam Lamrayah, Laura Dimier, Anna Salvetti, Julie Lucifora, Bernard Verrier* and David Durantel*

4.2 ANRS "Recherche sur le VIH/Sida et les hépatites virales : quels nouveaux enjeux ?"

Paris, November 2019

Poster: Anti-HBV effect & MoA of TLR2 agonists (free or as PLA-nanoparticles) *in vitro* and preclinical mouse model: Towards a functional cure for HBV?

Manon Desmares, Myriam Lamrayah, Laura Dimier, Anna Salvetti, Julie Lucifora, Bernard Verrier* and David Durantel*

4.3 ANRS Réunion annuelle AC42 Réseau National Hépatites

Paris, February 2020

Oral: Insights on the mode of actions of TLR2 agonists against the replication of HBV in hepatocytes

Manon Desmares, Maud Michelet, Caroline Pons, Myriam Lamrayah, Anna Salvetti, Bernard Verrier, Julie Lucifora*, and David Durantel*

4.4 EASL international liver congress

Online, June 2021

Poster: Molecular mechanisms underlying the antiviral activity of a TLR2 agonist on HBV replication in hepatocytes

Manon Desmares, Maud Michelet, Caroline Pons, Myriam Lamrayah, Anna Salvetti, Bernard Verrier, Julie Lucifora*, and David Durantel*

Acknowledgements/Remerciements