



HAL
open science

Ecodesign process for microalgae fractionation: use of supercritical CO₂, membrane technology and low frequency ultrasounds

Sara Obeid

► **To cite this version:**

Sara Obeid. Ecodesign process for microalgae fractionation: use of supercritical CO₂, membrane technology and low frequency ultrasounds. Other. Institut National Polytechnique de Toulouse - INPT; Université Libanaise, 2018. English. NNT : 2018INPT0095 . tel-04221797

HAL Id: tel-04221797

<https://theses.hal.science/tel-04221797v1>

Submitted on 28 Sep 2023

HAL is a multi-disciplinary open access archive for the deposit and dissemination of scientific research documents, whether they are published or not. The documents may come from teaching and research institutions in France or abroad, or from public or private research centers.

L'archive ouverte pluridisciplinaire **HAL**, est destinée au dépôt et à la diffusion de documents scientifiques de niveau recherche, publiés ou non, émanant des établissements d'enseignement et de recherche français ou étrangers, des laboratoires publics ou privés.



Université
de Toulouse

THÈSE

En vue de l'obtention du

DOCTORAT DE L'UNIVERSITÉ DE TOULOUSE

Délivré par :

Institut National Polytechnique de Toulouse (Toulouse INP)

Discipline ou spécialité :

Sciences des Agroressources

Présentée et soutenue par :

Mme SARA OBEID

le lundi 12 novembre 2018

Titre :

Ecodesign process for microalgae fractionation: use of supercritical CO₂,
membrane technology and low frequency ultrasounds

Ecole doctorale :

Sciences de la Matière (SDM)

Unité de recherche :

Laboratoire de Chimie Agro-Industrielle (L.C.A.)

Directeur(s) de Thèse :

M. PIERRE YVES PONTALIER

M. ALI ISMAIL

Rapporteurs :

M. KARIM ALLAF, UNIVERSITE DE LA ROCHELLE

M. LUC MARCHAL, UNIVERSITE DE NANTES

Membre(s) du jury :

M. MOHAMED GHOUL, UNIVERSITÉ LORRAINE, Président

M. ALI ISMAIL, UNIVERSITE LIBANAISE, Membre

M. HOSNI TAKACHE, UNIVERSITE LIBANAISE, Membre

Mme HELENE GREIGE-GERGES, UNIVERSITE LIBANAISE, Membre

M. PIERRE YVES PONTALIER, INP TOULOUSE, Membre

M. YOUSSEF EL RAYESS, UNIVERSITE SAINT-ESPRIT DE KASLIK, Membre

Dedication

This thesis is dedicated to my husband, mother, father, brothers and sisters. You have been my constant support. I owe you the world for that.

Mama, I just want you to be proud and happy...

شكرا طيبا مبارك

Acknowledgment

First of all, I want to acknowledge my kind director Mr. Pierre-Yves Pontalier, for his enthusiasm, guidance, and unrelenting support throughout this Ph.D. His observation and comment helped me to establish the overall direction of the research and to move forward with investigation in depth. He has consistently gone beyond his duties to fight my worries and concerns and has worked magically to instill great confidence in the way I worked during my thesis. Thank you for all the advices, ideas, moral support. Your wealth of knowledge in the field of algorefinery is truly inspiring. Thank you for giving me the opportunity to grow in this field of research.

I would like to thank my director and co-director Mr. Ali Ismail and Mr. Hosni Takache, for their limitless help during my research and study at the Lebanese University. The enthusiasm they have for research was very contagious and motivational for me. I appreciate all their contributions of time and ideas in aim to make my experience productive and stimulating. This thesis would not have been possible without your extraordinary support. I owe you lots of gratitude and appreciation for showing me how to be a real scientist, a good supervisor and a kind person.

I also want to thank my committee members, Mr. Mohamed Ghoul, Mr. Karim Allaf, Mr. Luc Marchal, Mrs. Helene Greige-Gerges and Mr. Youssef El Rayess. Thank you for investing time and providing interesting remarks and feedback. I am thankful that you have accepted to be on my committee.

Special mention goes to Mrs. Laurie Barthe and Mrs. Imane Bnehamed at LGC, my work with you has been an amazing experience, thanks for helping me enormously with the ultrasound assisted extraction and for your time and encouragement.

I extend my sincere gratitude to the administrative and technical staff members of LCA. I am grateful also for your hospitality and for always making me feel so welcome. I had a great stay in France, thanks to you.

All my lab friends at the LCA made it a pleasant place to work. In particular, I would like to thank my office-mates. I would like to thank also my colleagues, Bouchra Sayed Ahmad (my daily

coffee-break partner with the special 'galette'), Esaïe Kouassi (the humorous one), Douaa, Pablo, Jesus, Nicholas, Remi et Marian. Assad Mogni thanks for the friendship and beautiful memories.

My time in Toulouse was amazing thanks to my friend Alaa Hamdar. I am indebted to you and you were always so helpful in numerous ways. Thank you for your unconditional friendship throughout these years.

Much gratitude goes to Rayan and Fleurine, your solid unwavering support, friendship, sense of humor and your constant encouragement was more valuable than you could ever imagine. I love you so much sisters.

I am extremely grateful to my mom, your love, prayers, patience, caring and sacrifices. I have made it this far because of you my all, thank you for offering me encouragement and support in all my accomplishments and for preparing me to face the challenges with faith and humility. Dad, thank you for believing in me and being always by my side. I love you so much!

I also want to thank my brother Mohammad, whom I can't force myself to stop loving. Thank you for your love, for believing in me and being there for practical and emotional support in all those things of life. I know I always have you to count on when times are rough.

Thank you my beloved sisters: Taghrid "nixi", Aya "ouways", Lara "Monti", and my little Lebanese karate champion Walid "walti".

Finally, a good husband makes a good wife. My love Bassem, I enjoy spending each second with you. You are not just my husband, you are my rock and my very best friend. You are my best treasure. I appreciate whatever you do for me. I love you much. Techy!

Abstract

The development of an integrated and simplified biorefinery process able to produce a wide range of multiple molecules of interest is crucial for the commercialization of microalgae. The objective of this study was to simplify the downstream processes of microalgae valorization by optimizing the selectivity of extraction while respecting the principles of ecodesign. On the one hand, using dry microalgae, supercritical CO₂ extraction was carried out for selective recovery of neutral lipids without cell disruption pretreatment. Results showed that up to 97% of neutral lipids from *Chlorella vulgaris* were extracted. Neutral lipids from *Nannochloropsis oculata* represented most of the extracts (83%), whereas the proportion of glycolipids and phospholipids did not exceed 12.1% and 5.3%, respectively. Following the lipophilic recovery via supercritical extraction, 67% of total proteins were released using double stage aqueous extraction. Moreover, up to 84% of the extracted pigments free proteins were obtained using semi-frontal ultrafiltration. On the other hand, a green ultrasound assisted extraction process using water as solvent was performed on wet microalgae for proteins recovery at low frequency (12 kHz). Results of *Chlorella vulgaris* showed that almost all the proteins content (97%) were released in the aqueous medium allowing a high selective extraction while microalgae cells remained intact. In contrary, total proteins content were co-extracted with impurities from totally disintegrated *Spirulina sp.* Thus, for proteins clarification, quasi-frontal ultrafiltration process was carried out leading to 67% of total proteins obtained in the permeate. Furthermore, up to 95% of phycocyanin were retained with other impurities like residues and pigments. Since selective extraction of all the molecules of interest in microalgae biomass remains a challenge, additional research must be conducted to alleviate the downstream process.

Keywords: Microalgae, fractionation, extraction, biorefinery, supercritical CO₂, ultrasound.

Résumé

Le développement d'un procédé intégré et simplifié de bioraffinerie capable de produire une large gamme de molécules d'intérêt est crucial pour la commercialisation des microalgues. L'objectif de cette étude était de simplifier le processus de valorisation des microalgues en optimisant la sélectivité de l'extraction tout en respectant les principes de l'écoconception. Dans un premier temps, les travaux se sont focalisés sur la récupération sélective de lipides neutres sans désintégration préalable des cellules par extraction au CO₂ supercritique de microalgues lyophilisées. Les résultats ont montré que près de 97% des lipides neutres de *Chlorella vulgaris* ont été extraits. Pour *Nannochloropsis oculata*, les lipides neutres représentaient la majorité de l'extrait (83%), tandis que la proportion de glycolipides et de phospholipides ne dépassait pas 12,1% et 5,3% respectivement. Après la récupération de la fraction lipophile par extraction supercritique, 67% des protéines totales ont été libérées par une double extraction aqueuse. En outre, plus que 84% des protéines, exemptes de pigments ont été obtenues, en utilisant l'ultrafiltration semi-frontale. Ensuite, en utilisant des microalgues humides, un procédé d'extraction assistée par ultrasons à basse fréquence a été étudié pour la récupération des protéines. Les résultats sur *Chlorella vulgaris* ont montré que presque toute la teneur en protéines (97%) était libérée dans la phase aqueuse, permettant une extraction hautement sélective tout en conservant l'intégrité cellulaire. En revanche, la totalité des protéines a été co-extraite avec des impuretés à partir de cellules de *Spirulina sp.* entièrement désintégrées. Ainsi, pour la clarification des protéines, un procédé d'ultrafiltration semi-frontale a conduit à 67% des protéines totales obtenues dans le perméat. En outre, jusqu'à 95% de phycocyanine ont été retenus avec d'autres impuretés comme les résidus et les pigments. Les essais montrent l'intérêt de l'extraction sélective des molécules, mais que l'efficacité du procédé dépend de la structure des cellules. Des travaux complémentaires devraient encore être réalisés pour mieux comprendre les mécanismes impliqués dans la libération des molécules.

Mots clés: Microalgues, fractionnement, extraction, bioraffinerie, CO₂ supercritique, ultrasons.

Table of content

Dedication	2
Acknowledgment.....	3
Abstract.....	5
Résumé	6
Table of content.....	7
List of abbreviations	11
General introduction	13
Chapter 1: state of the art on microalgal biomass: algorefinery defies	17
1.1. Generalities on microalgae	17
1.2. Diversity of groups and species.....	18
1.2.1. Green algae (<i>Chlorophyceae</i>).....	19
1.2.2. Cyanobacteria or blue-green algae (<i>Cyanophyceae</i>).....	19
1.2.3. Coccoid (<i>Eustigmatophyceae</i>).....	20
1.3. Microalgal cell wall	21
1.4. Microalgae biochemical composition	22
1.4.1. Pigments	22
1.4.2. Proteins	24
1.4.3. Lipids	27
1.4.4. Sugars	28
1.5. Microalgae cultivation	31
1.5.1. Open ponds culture.....	31
1.5.2. Closed culture or tubular photobioreactor.....	32
1.6. Microalgae harvesting.....	33
1.6.1. Centrifugation.....	33
1.6.2. Flocculation	34
1.6.3. Sedimentation	34
1.6.4. Filtration	34
1.6.5. Flotation.....	34
1.7. Effects of the medium on the growth and biochemical composition of microalgae... 35	
1.7.1. Carbon	36
1.7.2. Nitrogen	37

1.7.3. Phosphorus.....	37
1.7.4. Sulfur	38
1.7.5. Salts	38
1.8. Extraction processes for component recovery	39
1.8.1. Extraction using organic solvents.....	39
1.8.2. Cell disintegrating techniques	40
1.9. Supercritical extraction	46
1.9.1. Influence of extraction parameters	48
1.9.2. Supercritical CO ₂ and microalgae: benefits and drawbacks.....	50
1.10. Membrane filtration.....	51
1.10.1 Limitations.....	52
1.10.2. Influence of operating conditions	55
1.10.3. Membrane efficiency	56
1.11. Algorefinery: advantages and difficulties	56
1.12. Conclusion and thesis action plan.....	57
Chapter 2: Materials and methods.....	61
2.1. Microalgal biomass	61
2.2. Biomass quantification.....	62
2.3. Extraction methods	62
2.3.1. Total lipids content: Conventional extraction according to modified Bligh and Dyer method	62
2.3.2. Supercritical CO ₂ extraction.....	63
2.3.3. Ultrasound	65
2.3.4. Total pigments extraction	67
2.4. Purification technique: ultrafiltration.....	67
2.5. Analytical techniques	69
2.5.1. Proteins analysis	69
2.5.2. SDS-PAGE Analysis	70
2.5.3. Size exclusion chromatography.....	70
2.5.4. Lipids analysis	71
2.5.5. Pigment analysis	72
References	75
Chapter 3: Fractional extraction.....	88
3.1. Introduction	88

3.2. Supercritical carbon dioxide extraction and fractionation of lipids from freeze-dried microalgae <i>Nannochloropsis oculata</i> and <i>Chlorella vulgaris</i>	89
3.2.1. Introduction	89
3.2.2. Materials and methods	91
3.2.3. Results and discussion	94
3.2.4. Conclusion	104
3.2.5. References	104
3.3. Supercritical fluid extraction and solid phase fractionation of pigments from <i>Chlorella vulgaris</i> and <i>Nannochloropsis oculata</i>	107
3.3.1. Introduction	108
3.3.2. Materials and methods	109
3.3.3. Results	114
3.3.4. Conclusion	121
3.3.5. References	122
3.4. Extraction and purification of soluble proteins from <i>Nannochloropsis oculata</i> by pH-shifting and ultrafiltration.....	124
3.4.1. Introduction	125
3.4.2. Materials and methods	126
3.4.3. Results and discussion	130
3.4.4. Conclusion	138
3.4.5. References	138
3.5. Chapter conclusion.....	141
Chapter 4: Extracts purification	142
4.1. Introduction	142
4.2. Proteins and pigments extraction from microalgae <i>Spirulina sp.</i> assisted by ultrasound irradiation: effect of variable low power and pre-treatment conditioning ..	144
4.2.1. Introduction	145
4.2.2. Material and methods	146
4.2.3. Results and Discussion	148
4.2.4. Conclusion	152
4.2.5. References	153
4.3. Clarification of non-pigmented proteins from <i>Spirulina sp.</i> using ultrasound assisted extraction coupled with ultrafiltration.....	155
4.3.1. Introduction	155
4.3.2. Materials and Methods	157
4.3.3. Results and discussions	162

4.3.4. Conclusion	169
4.3.5. References	169
4.4. Selectivity of low-frequency ultrasound-assisted extraction for proteins recovery from the microalga <i>Chlorella vulgaris</i>	173
4.4.1. Introduction	173
4.4.2. Methods	175
4.4.3. Results and discussion	178
4.4.4. Conclusion	183
4.4.5. References	183
4.5. Chapter conclusion.....	187
General Conclusionta	188
Scientific production.....	191
Résumé générale en français.....	193
Chapitre 1: Etat de l'art.....	193
Chapitre 2 : Méthodes et matériels.....	198
Chapitre 3 : Extraction fractionnée.....	200
Publication # 1	200
Publication # 2	201
Publication # 3	202
Chapitre 4 : Purification des extraits	203
Publication # 4	203
Publication # 5	204
Publication # 6	205
Conclusion générale	207

List of abbreviations

APC	Allophycocyanin
BSA	Bovine serum albumin
β-car	β -carotenes
CPC	C-phycoerythrin
Chl a	Chlorophyll a
Chl b	Chlorophyll b
C_{pi}	Concentration of component i in the permeate,
Cri	Concentration of component i in the retentate
DW	Dry weight
DAG	Diacylglycerol
EPS	Exopolysaccharides
FFA	Free fatty acids
GL	Glycolipids
Lut	Lutein
MAG	Monoacylglycerol
MWCO	Molecular weight cut-off
NL	Neutral lipids
NTP	Nitrogen-to-protein factor
OD	Optical density
PEF	Pulsed electric fields
P	Partition-coefficient
PPL	Phospholipids

PE	Phycoerythrin
PES	Polyethersulfone
PC	Phosphatidyl choline
PG	Phosphatidyl glycerol
PBR	Photobioreactor
PE	Phosphatidyl ethanolamine
Rf	Retention factor in%.
ScCO₂	Supercritical carbon dioxide
SCF	Supercritical fluids
SFE	Supercritical fluid extraction
SPE	Solid Phase Extraction
TN	Total nitrogen
TAG	Triacylglycerol
TMP	Trans-membrane pressure
UF	Ultrafiltration
VCR	Volume concentration rate
WHO	World Health Organization

General introduction

To date, more than 20,000 microalgae species have been identified. These organisms afford considerable reservoir of interesting biomolecules like lipids, proteins, pigments, polysaccharides, vitamins and so on [1]–[5]. Recently, scientists, researchers and also entrepreneurs have begun to recognize the potential of this biomass mainly as promising source of sustainable energy. Thus, microalgae have been investigated for the production of a number of different biofuels including biodiesel, bio-oil, bio-syngas, and bio-hydrogen [6]. Besides, development in photobioreactor design, biomass harvesting, drying and extraction processes have begun to lower the overall cost of the biofuel production from microalgae [6]. However, the production dedicated to bioenergy is still uncompetitive in the market. Hence, scientists found that, considering all the benefits this biomass can provide, it is inconvenient to limit the outputs of the microalgae to bioenergy purposes, and this biomass should be optimally exploited into a variety of valuable co-products that could be used in several fields such as pharmaceuticals, nutraceuticals, chemicals, cosmetics, biomaterials, feed and food [2][4][6][7]. In this view, the collaboration between research and private sector commenced to play an important role and a variety of valuable chains started to be developed and established in aim to apply the algorefinery concept by valorizing different co-products from the algae biomass fractions. Scientists are convinced that a sequence of unit operations to achieve the whole fractionation of microalgae would make the industrial sector profitable [7]–[9].

The dominating species of microalgae in commercial production includes *Nannochloropsis*, *Chlorella* and many other green microalgae which are known to have rigid cell wall [9] [10]–[12]. However, the extraction of valuable components outside this rigid wall requires a specific pretreatment for maximum recovery yield [13]–[18]. Various chemical, physical, physico-chemical, and biological methods have been applied for lipids, proteins and pigments recovery [19][16][17][18][19][23][24][25]. Pre-treatments such as high pressure homogenizers, bead mills, enzymatic or chemical treatments, thermal or osmotic shocks (repeated freezing/thawing) are frequently applied allowing a dramatic cell disintegration, while many other components (undesirable) are also co-released [18] [19] [23] [24] [25]. Thus, in absence of a selective extraction, this could lead to complex extracts of hydrophilic and hydrophobic components.

Consequently, additional costly stages in downstream processing for phase separation and compounds purification are mandatory complicating then the downstream processes [26]. Particular challenge in this regard is that the cell integrity has to be maintained while high extraction yield is needed. Thus, since cell wall plays an important role as barrier to hinder the passage of inner compounds, it could be well considered for its importance on extraction selectivity.

The challenge is not only in the selective separation of targeted components to simplify the downstream processing stages, but also in taking into consideration the environmental aspect of the applied extraction procedures. In fact, extraction of lipids from microalgal biomass is generally achieved using chemical solvents like hexane, methanol and other flammable and toxic solvents [27]. For that, this technique is currently being phased out for their environmental, health and safety impacts.

Recently, supercritical carbon dioxide (ScCO₂) extraction [28] has received attention as an alternative to solvent extraction of microalgal lipids. Similarly, ultrasound-assisted extraction (UAE) as an environmental friendly mechanical method, is able to be universally applied to any type of microalgae cell for valuable component like proteins [29]. However in major cases, prior to ScCO₂ extraction, mechanical pretreatment was carried out and high amount of organic co-solvent was used to increase lipids recovery yield all-in sharply decreasing selective extraction. Also, many scientists investigated the addition of toxic solvent during ultrasonic treatment for proteins release resulting in high extraction yield with low extraction selectivity [30]. Furthermore, all UAE studies conducted for microalgae components release (like proteins) have been performed with frequencies comprised between 20 and 100 kHz [31], frequencies known as hazardous and dangerous for human health. However, to our best of knowledge, UAE treatments for microalgal proteins extraction at audible frequencies (12 kHz) have never been reported in the literature.

Concerning the purification/concentration techniques, membrane processes, particularly ultrafiltration, have begun to find new applications in the field of marine bioresources [15] [16][33][34]. Actually, limited studies have investigated the use of membrane technology to purify components from microalgae [33]–[38]. Ultrafiltration technology is considered as an efficient technique with relatively moderate capital and operating costs [32]. Contrary to other separation techniques, membrane processes are isothermal and involve no phase change or chemical reagents

[39] [40], [41]. These separation techniques are particularly suited to the purification of water-soluble biomolecules without neither thermal denaturation nor chemical solvents use.

Hence, in this context, this study proposes to evaluate the selective extraction of neutral lipids, proteins and pigments from *Chlorella vulgaris*, *Nannochloropsis oculata* and *Spirulina sp.*

First, after reducing the water content below 2%, an extraction with ScCO₂ without any previous cell wall disintegration has been performed on dry biomass to selectively recover reserve lipids (neutral lipids), proteins and pigments from *C. vulgaris* and *N. oculata*.

Second, in the absence of any drying treatment, a sequence of purification operations implemented on humid biomass of *C. vulgaris* and *Spirulina sp.* has been applied in order to obtain separated enriched fractions of biomolecules like proteins and pigments. New innovative parameters (low power, low frequency) to achieve some intensification and optimization of UAE techniques have been investigated. Furthermore, water as green solvent, to comply with the criteria of the green-chemistry concept, has been evaluated for proteins selective extraction and high recovery yield. Ultrafiltration has been used as concentration/purification technique.

Our challenge is to effectively separate each component with minimum process stages (enhancing selective extraction) and minor environmental footprint. This study should be harmonious with industrial realities. This challenge represents a part of the global algaefinery concern and could contribute to achieve this goal.

The manuscript is composed of four chapters accessorized with six publications (published or ready to be submitted) that reveal the obtained results:

Chapter one presents a general idea on microalgae, their composition and extraction processing for component recovery. This literature review is followed by a discussion of the algaefinery challenges and concludes on the implemented plan of our work.

Chapter two is composed of materials and methods applied during this research. Chapter three is composed of three articles which investigated the impact of bypassing the cell disruption step on the extraction selectivity and the recovery yield. It also deals with the concept of fractional extraction.

Chapter four contains three publications that deal with the extracts purification and the role of cell wall characteristic on extraction selectivity.

Finally a general conclusion recapitalizes the main results and opens new perspectives in the algorefinery concept.

Chapter 1: state of the art on microalgal biomass: algorefinery defies

1.1. Generalities on microalgae

Microalgae are unicellular aquatic organisms, vary from 10 to 100 microns (figure 1). They most often multiply non-sexually. There are between 200,000 and 1,000,000 species [42] of which 30,000 are known and studied today [43]. Microalgae can develop mainly in suspension in aqueous solutions [44]. They are able to colonize all types of environments, including salty, soft, brackish waters and even wastewater through their survival skills. They can also grow on rigid surfaces, such as tree trunks, submerged structures or walls [45]. A range of microalgae species can nowadays be produced in artificial environment called photobioreactors (PBR) where they are grown under desired light exposure, specified concentration, nutrients and vital factors.

Microalgae are photosynthetic organisms that use sunlight as a source of energy to fix carbon dioxide then to multiply by cell division, therefore having a very rapid growth rate: the fastest in the world of plants. This rate of growth varies from one species to another and some reproduce more quickly. This biomass colonizes its environment by dividing by mitosis quickly and actively if the physicochemical and nutritive conditions are favorable (Table 1). The size of cell decreases until they can no longer divide. Rate of growth, dry and fresh weight, cells number, size of clusters (colonies), and number of microalgal cells per cluster significantly vary in terms of growth conditions like light, nutritive elements in the media, temperature, and CO₂/O₂ ratio [46].

Table 1- Growth rate of different microalgae [47]

	Maximal growth rate (day ⁻¹)	Duplication time (day)
<i>Chlorella vulgaris</i>	1.84	0.37
<i>Nannochloropsis oculata</i>	0.48	0.8
<i>Spirulina platensis</i>	0.5	1.38
<i>Chlamydomonas rheinhardtii</i>	3.8	0.18
<i>Dunaliella tertiolecta</i>	3.5	0.2



Figure 1- *Daphnia sp.* (water flea) and *Volvox sp.* (green microalgae) [48].

1.2. Diversity of groups and species

There are two groups of microalgae, those belonging to the group of eukaryotes, that is to say having cell organelles (chloroplasts, mitochondria and its nucleus surrounded by its envelope, etc.) necessary for the functioning of the biomass and its metabolism, and those belonging to the group of prokaryotes possessing no cellular organelles (Figure 2).

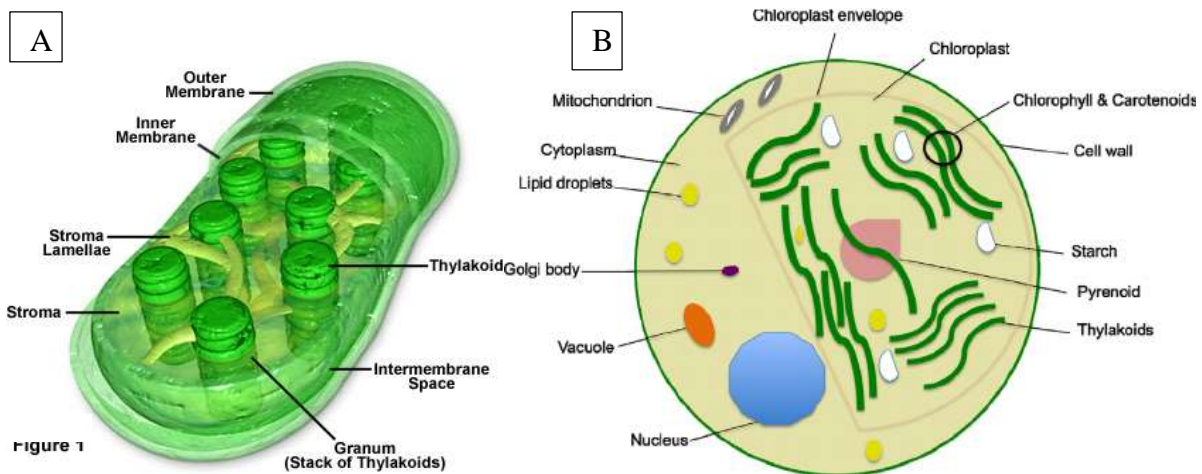

Figure 2- (A) Schematic ultrastructure representing a typical prokaryotic cell [49], (B) different organelles of eukaryotic microalga [50].

By microscopic observation, microalgae present different forms: often spherical (*Porphyridium*), droplet (*Chlamydomonas*), filament (*Spirulina*), spiral (*Arthrospira*), and even star (*Staurastrum*) [51]. In aim to distinguish them, scientists divide them into several classes according to general criteria. From a taxonomic point of view, the classification of the microalgae is based on the diversity of their properties, morphology, pigmentation, size, colors, cell wall characteristics and

biochemical composition. Thus the species are classified into 11 divisions and 29 classes [52]. The most common classes are green algae or *Chlorophyceae*, *Eustigmatophyceae* and cyanobacteria or *Cyanophyceae*.

1.2.1. Green algae (*Chlorophyceae*)

Chlorophyceae are very abundant in freshwater. They can develop in unicellular mode or in colonies that can become very dense. They are able to tolerate several types of conditions and are adapted to varied environments. Some species are also able to live on the ground or on wet surfaces exposed to light. Several strains are promising and contain highly valuable components.

Chlorella vulgaris is a famous *Chlorophyceae*, not much larger than a red blood cell. The name of this single-celled water plant comes from the Greek *chloros* = green or yellow-green and *-ella* = small (Figure 3). The microalgae are spherical in shape and appear everywhere worldwide. They have been discovered in 19th century by M. Beijerinck, a Dutch biologist [53] [54].

Chlorella is among the most known and produced for many purposes and one of the most thoroughly studied plants due to its nutritional physiological properties. For example, this biomass contains 100 µg of total vitamin B₁₂ per 100 g of product, *i.e.* the recommended daily dose of 3 g of *Chlorella* represents 120 % of the daily requirement.

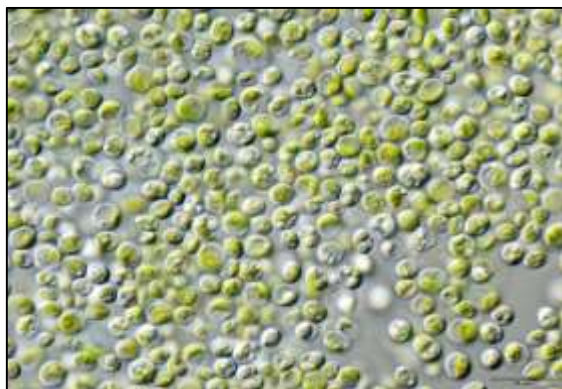

Figure 3- Photography of *Chlorella vulgaris* (*Chlorophyceae*) [55].

1.2.2. Cyanobacteria or blue-green algae (*Cyanophyceae*)

This family of microalgae has about 2,000 species in various habitats. Their structure is similar to that of bacteria. These “prokaryote” organisms are not linked to any other group of algae and are

able to absorb and fix nitrogen directly from the atmosphere. They essentially require only four vital sources: water, light, nitrogen and CO₂. They can be found in aquatic or terrestrial habitats.

Spirulina sp. are among the most known and produced in the world primarily for human consumption [56]. A French phycologist Dangeard (1940) reported that a substance called *Dihé* in the local language (Kanembu) was eaten by the native population, and was obtained by sun drying mats of microscopic algae harvested from the surface of small lakes or ponds around Lake Chad (Orio, 1983). The alga was identified as *Spirulina (Arthrospira) platensis* (Figure 4). Early interest focused mainly on its rich content of proteins, vitamins, essential amino acids, minerals, and essential fatty acids and lots of medical useful properties [57].

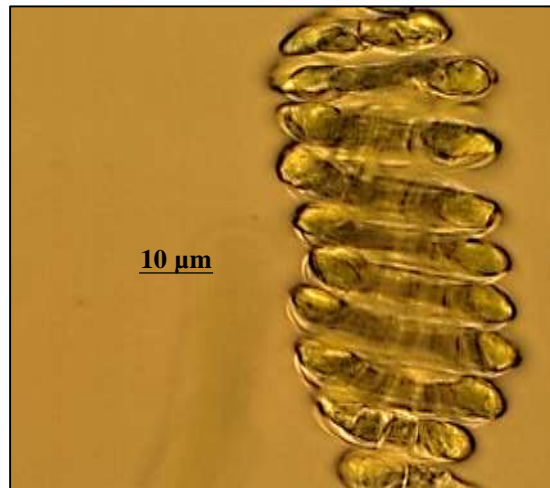

Figure 4- Photography of *Spirulina sp.* (personal picture).

1.2.3. Coccoid (*Eustigmatophyceae*)

Microalgae belonging to this class are called coccoid with polysaccharide cell walls as reported by Barsanti and Gualtieri [58]. Only a few species are known, from both fresh and marine waters. These coccoid cells are microalgae whose cells are non-mobile, spherical in shape, measure about few micrometers in diameter, non-toxic, and acclimate quickly and easily to large variation in salinity. They are easy to experience at different salinities and contain large amount of fatty acids present in the cells which make many of them regularly used in aquaculture [58].

Nannochloropsis oculata (Figure 5) are among the most produced species in the world. It is being studied as an example of algae's biofuel potential for its high lipids content [59]. It offers advancements not only for biofuels but also for agricultural applications and medicine.

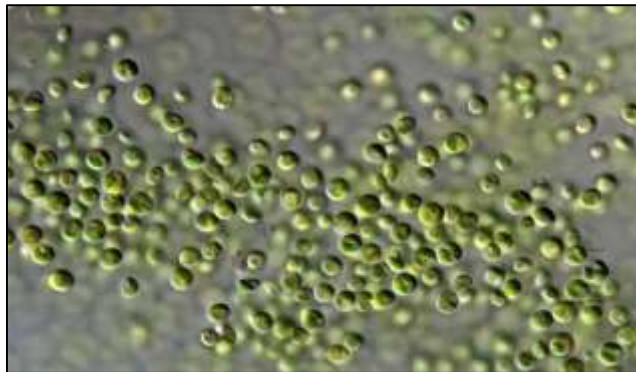

Figure 5- Photography of *Nannochloropsis oculata* (*Eustigmatophyceae*) [60].

1.3. Microalgal cell wall

The chemical substances composing the cell surface are the main agent for indicating the complexity of the wall/ surface structures. Microalgae are showing differences in the distribution of components like phospholipids, glycolipids, glycoproteins, sugars in algal cell membranes (Figure 6) [61].

Phospholipids (PPLs) and glycolipids (GLs) are relatively impervious to the passage of most water-soluble molecules. It is therefore a very effective barrier, even though hydrophobic molecules such as alcohol can easily pass through it. The double layer structure of the plasma membrane is directly due to the amphiphilic properties of phospholipids which have a hydrophilic end, that is to say water-loving, and a hydrophobic end, which on the contrary fears water. Major phospholipids were phosphatidyl choline (PC), phosphatidyl glycerol (PG) and phosphatidyl ethanolamine (PE) [62] [63]. Glycoproteins are embedded in the cell-surface membrane with attached carbohydrate (sugar) chains of varying lengths and shapes. Glycoproteins play major role in cell adhesion and as receptors for chemical signals

Essential proteins that are included between phospholipids and glycolipids are extremely variable from one biomass to another in terms of quantity and properties. These proteins are associated with the membrane in various ways and have many functions:

- Transport of molecules through the membrane;
- Adhesion on surfaces;
- Receiving signals from the environment;

- Signaling in the cell;

Microalgae are considered as solid particles in suspension in the aqueous medium, from which they use the essential elements required for their development. Like any solid, these microalgal surfaces can interact with dissolved compounds [64] through a process named sorption. The sorption process is complex and depends on the nature of the compounds in interaction with cell surfaces and the nature of the cell wall surface itself. When talking about microalgae, several types of cell surface exist. Some microalgae have directly their plasma membrane in contact with the environment. Normally this type of surface are rich in lipids, proteins and carbohydrates. Other microalgal species possess cellular wall with extracellular material [65]. *Euglenophyceae* have cell walls containing intracellular and extracellular materials and a very resistant compound called algaenans [66] [67] [68]. According to the microalgae, the cell surface can be composed of either inorganic or organic materials.

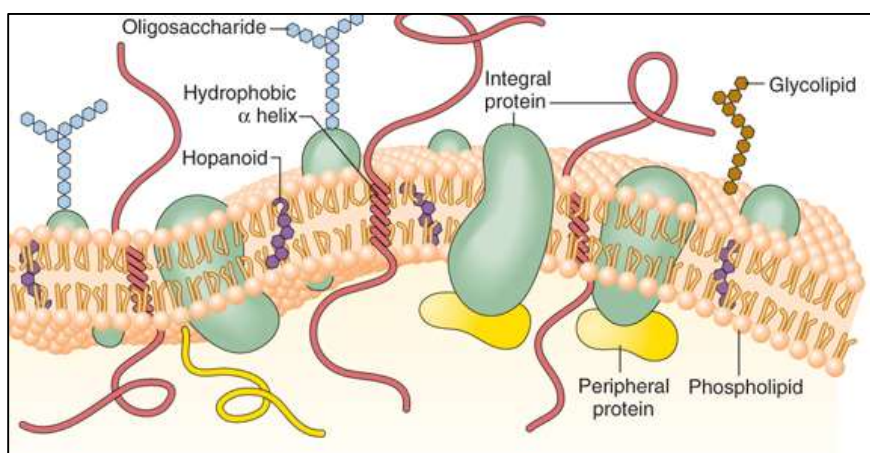

Figure 6- Schematic ultrastructure of cell wall composition [69].

1.4. Microalgae biochemical composition

Microalgae differ mainly from other plants in their richness in lipids, proteins, polysaccharides, vitamins, pigments and antioxidants. They are mainly exploited for their primary components. Lipids, proteins, polysaccharides and pigments.

1.4.1. Pigments

Microalgae have a wide range of pigments which can act as antioxidants. In addition to chlorophyll (a, b, c, d and e), which is the primary photosynthetic pigment in all photosynthetic algae, there is

a range of additional yellow-orange lipid pigments as carotenoids. They serve key roles in microalgae in absorbing light energy for use in photosynthesis and protecting chlorophyll from photo-damage [70]. They split into two classes: xanthophyll (which contain oxygen) and carotenes (which are purely hydrocarbons and contain no oxygen) (Figure 7).



Figure 7- *Chlorella vulgaris* pigments (personal picture).

In addition, phycobiliproteins (phycoerythrin and phycocyanin) are among the mainly exploited microalgal pigments. Phycobiliproteins (PBP) are hydrophilic pigments of a protein (Figure 8). The subunits of these pigments consist of a proteins chain associated with a tetrapyrrolic chain. They are widely used in immunofluorescence techniques as biomarkers [71].

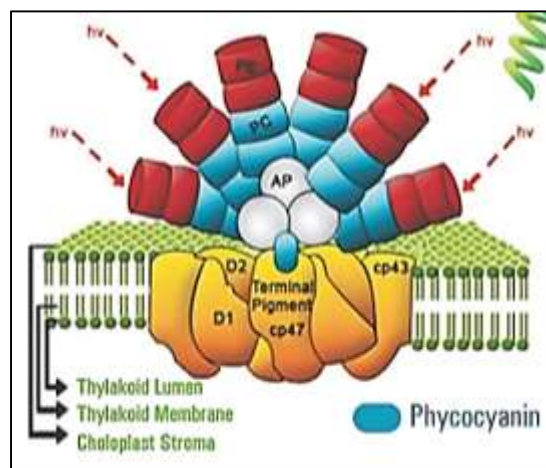

Figure 8- Structure of phycocyanin embedded inside phycobilisome of *Spirulina Platensis* [72].

The availability of large quantities of highly purified pigments (chlorophylls, carotenoids, phycobiliproteins) at reasonable cost, is therefore a key step in pigments industry [71]. To date, the production of some pigments such as fucoxanthin is not industrialized, despite their benefits to public health [73]. In fact, the cost of purified xanthophyll remains very high (more than 8000 € per kilogram for fucoxanthin). Therefore, many researchers are working on the development of new methods of extraction or eco-extraction, and on purification processes of the main promising pigments [16], [19].

1.4.2. Proteins

Most microalgae exhibit a high proteins content depending on the growing conditions. Proteins are of central importance in the chemistry of microalgae. They are playing a major role in growth, repair, and maintenance of the cell. Proteins are found to be bound to the cell wall, internal cytosol, internal organelles or in and out of the cell [74]. *Spirulina*, *Chlorella spp.* and *Dunaliella spp.* are among the richest photosynthetic microorganisms in proteins. The high content of proteins, peptides and amino acids (between 12 and 75% dry matter) of several species of microalgae, make them an unconventional source of proteins in human and marine animal nutrition [2]. *Spirulina platensis*, is well known in developed countries and could be a solution to the problems of malnutrition. The production of *spirulina* makes it possible to obtain nearly 50 tons of proteins per hectare and per year. This is why its culture is promoted by WHO and FAO. *Spirulina* is an interesting food for many reasons: it's rich in iron and proteins and could be given to children without any risk [75].

The nutritional quality of proteins is determined according to its amino acid profile. Like the majority of microalgae, the amino acid profile seemed to be favorable to the standard profile for human nutrition proposed by WHO because this biomass contained essential and non-essential amino acids like eggs, meats and milk (Table 2). It is mainly consumed by people with proteins deficiency and as a dietary supplement by athletes and vegetarians for its proteins intake.

The proteins portion is generally underestimated compared to products such as unsaturated fatty acids or pigments. Today, there are still no significant demands for purified microalgal proteins extracts because the presence of non-proteins components generally leads to undesirable changes

in the color or taste of proteins. Nevertheless, efforts are now turning towards the impressive potential activities of microalgae proteins.

Table 2- Amino acid profile of different microalgae as compared with conventional proteins sources (g per 100g biomass).

Source	Ile	Leu	Val	Lys	Phe	Tyr	Met	Cys	Trp	Thr	Ala	Arg	Asp	Glu	Gly	His	Pro	Ser	Ref
Egg	6.6	8.8	7.2	5.3	5.8	4.2	3.2	2.3	1.7	5.0	-	6.2	11.0	12.6	4.2	2.4	4.2	6.9	[41]
Soybean	5.3	7.7	5.3	6.4	5.0	3.7	1.3	1.9	1.4	4.0	5.0	7.4	1.3	19.0	4.5	2.6	5.3	5.8	[41]
<i>Chlorella</i>	4.4	9.2	6.1	8.9	5.5	4.2	2.2	0.4	-	4.7	8.3	7.1	9.4	12.9	5.4	2.4	4.8	4.0	[42]
<i>Spirulina sp.</i>	5.8	9.0	6.4	5.1	4.8	4.8	2.9	0.3	-	5.1	7.4	7.6	10.2	16.1	4.6	2.0	3.3	4.8	[42]
<i>Dunaliella sp.</i>	4.5	9.3	6.0	6.2	6.0	4.0	2.5	4.0	-	5.0	7.8	6.6	10.5	13.6	5.7	2.5	4.9	4.4	[42]
<i>Aphanizomenon sp.</i>	2.9	5.2	3.2	3.5	2.5	-	0.7	0.2	0.7	3.3	4.7	3.8	4.7	7.8	2.9	0.9	2.9	2.9	[41]
<i>Scenedesmus sp.</i>	4.7	9.4	6.0	6.8	5.5	4.0	2.4	0.1	-	4.9	6.8	6.0	9.2	13.8	5.2	2.6	8.3	4.2	[42]

1.4.3. Lipids

Microalgae can accumulate more than 80% of their dry weight in lipids [76]. Marine lipids can be classified according to two different categories based on their polarity: on the one hand, neutral lipids (NL) including monoacylglycerol (MAG), diacylglycerol (DAG), triacylglycerol (TAG) and free fatty acids (FFA). On the other hand, polar lipids divided into two groups: glycolipids (GLs) and phospholipids (PLs).

For neutral lipids, MAGs and DAGs come from the degradation of TAGs (Figure 9). TAGs complexes are hydrophobic, meaning they are non-dissolvable in water, a property which affects their transport through the water-rich media. Their common feature is their insolubility in water (= hydrophobic) and their solubility in non-polar organic solvents (ether, benzene, chloroform ...).

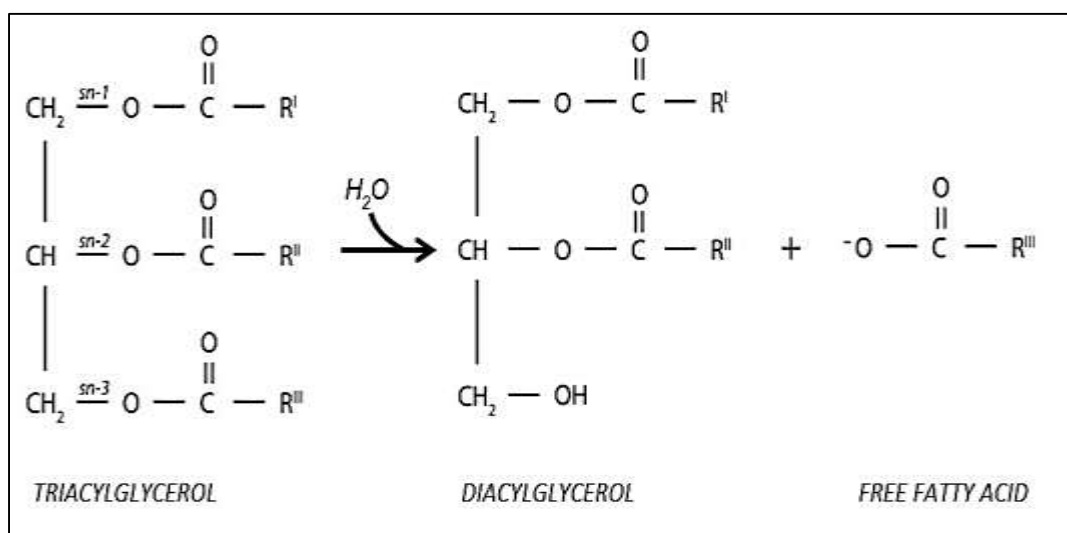

Figure 9- Breakdown of triacylglycerol into diacylglycerol and one free fatty acid [77].

Neutral lipids are difficult to classify. We can classify them according to their chemical structure, their role, their charge, etc. Due to their hydrophobic nature, most lipids droplets are stabilized within the water rich environment by amphiphilic lipids and proteins. Amphiphilic meaning that the molecule has a water-soluble group attached to a nonpolar group, [78]. FFA and MAGs are more hydrophilic, making them easier to dissolve in water comparing to DAGs and TAGs. TAGs molecule consists of a glycerol unit having three hydroxyl functional groups on which three fatty acid chains are esterified.

The PPL molecule has a phosphate group on one of the three hydroxyl functions (figure 10). PLs consist of glycerol (an alcohol with three OH groups) to which two hydrophobic fatty acids residues are bonded via an ester bond. The remaining OH group is connected to a hydrophilic phosphate group which is attached to a polar alcohol. In algae, the most common classes of phospholipids are phosphatidyl inositol, phosphatidyl choline, phosphatidyl glycerol, phosphatidyl ethanolamine and diphosphatidyl glycerol [79]. Whereas, GLs are lipids containing a carbohydrate group and found on the surface of cell membrane. They extend usually from the phospholipids bilayer into the extracellular environment.

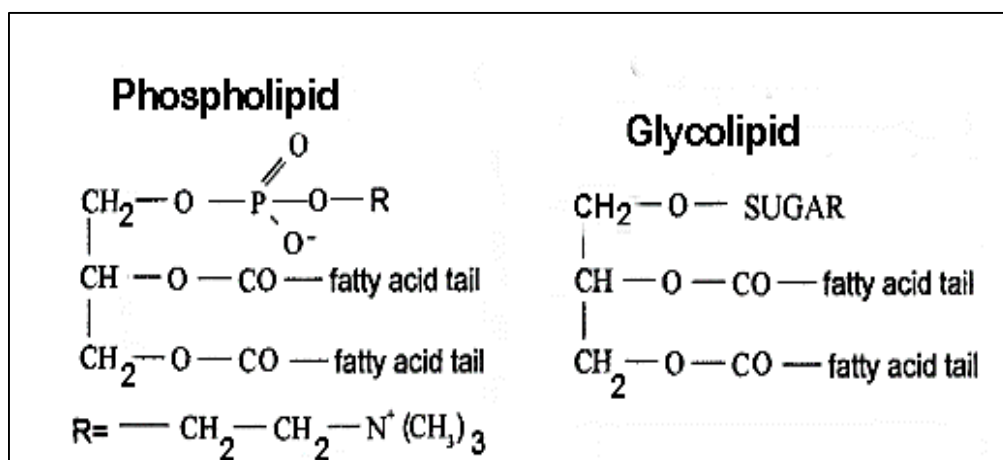

Figure 10- Phospholipids and Glycolipids chemical structure [77].

In microalgae, neutral lipids are accumulated and constitute a reserve element, located mainly in the cytoplasm and also in the form of compounds in the membranes, whereas the polar lipids are called lipids of constitution [43]. The lipids composition of microalgae can in some cases be regulated by the addition or removal of certain substances from their culture medium. Therefore the different nutritional stresses (nitrogen or silicate) can increase the production of lipids [80]. For example, a macronutrient-deficient cell in nitrogen will store the carbon flux from photosynthesis as TAGs neutral lipids [3].

1.4.4. Sugars

Sugars or carbohydrates are composed of carbon, hydrogen and oxygen according to the formula $\text{C}_n (\text{H}_2\text{O})_n$. Simple carbohydrates or monosaccharides are the basic unit of saccharides. They carry at least three carbons (triose), two alcohol functions (OH), a carbonyl function (aldehyde function

(-CHO) or ketone ($-C = O$)), and sometimes an amine ($-NH_2$) or carboxylic function. Polysaccharides are either holosides composed solely of monosaccharides, or glycosides composed of monosaccharides and a non-oxidic part called aglycone. Polysaccharides can have several cellular functions. They can play the role of reserve molecules for the storage of energy (starch and glycogen) by the cells (Figure 11). They have an important role in the storage of information and cellular communication. This is the case of nucleic acids (polyriboses and polydesoxyriboses), glycosylations of proteins (glycoproteins) or lipids (lipopolysaccharides), glycosaminoglycans. They may also have a role in the maintenance and resistance of tissues or cells. Cellulose, chitin or peptidoglycan can play also a major role in cell resistance and rigidity [81].

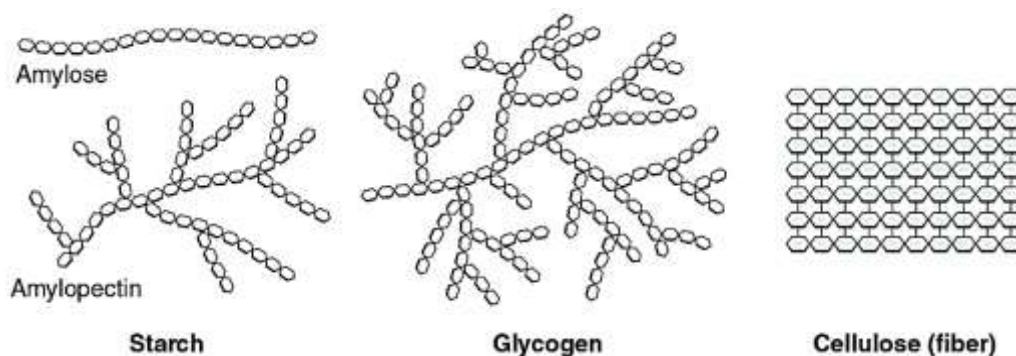

Figure 11- Microalgal saccharides [82].

In microalgae, the degree of polymerization of starch is variable and its cellular localization varies according to the division of the algae. Microalgae accumulate starch as reserve. Starch consists of amylose (20-30%) and amylopectin (70-80%) (Figure 12). This accumulation is not identical for all species of microalgae. There are microalgae that accumulate large quantities of starch such as *Chlorella vulgaris* which can accumulate up to 38-48% of its dry mass (under nitrogen-deficient culture), *Chlamydomonas reinhardtii* can store 35-58% of starch (dry mass) and *Tetraselmis subcordiformis* which can accumulate up to 35% starch (dry mass). The structure of the starch changes with the microalgae species [83].

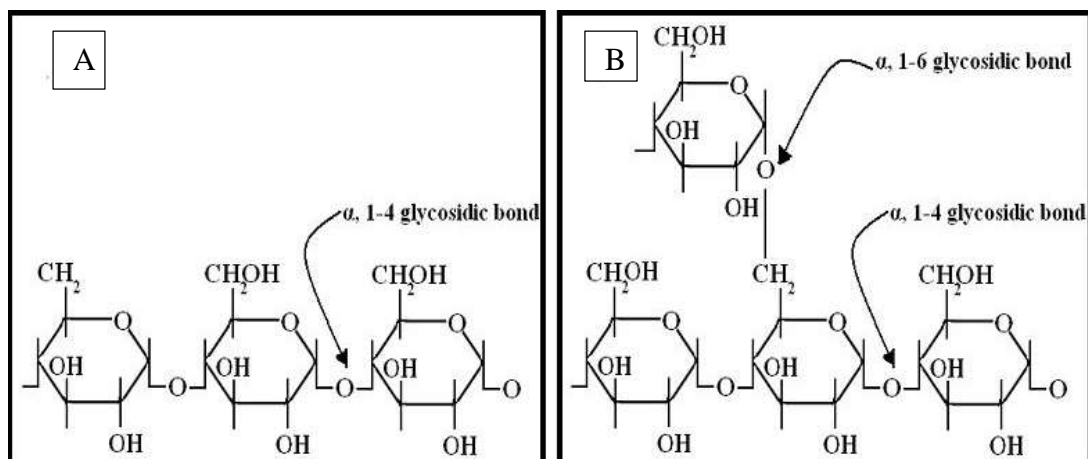

Figure 12- Structure of starch components: (A) amylose and (B) amylopectin [84].

The potential of marine polysaccharides is still underdeveloped and not much exploited, and their structural and functional diversities still little and poorly known. Also their current uses are still limited, whereas the first experiments exploring their biological or medical properties are more than promising. For example, hydrolysates and fractions of large polysaccharides may exhibit biological activities (antiviral, antibiotic) in humans [85].

Microalgae aside with macroalgae and crustaceans, are the most exploited sources today of these marine polysaccharides. Scientists realized the emergence of studies on exopolysaccharides (EPS) especially originated from biomasses (adapted or not to extreme environments) like *Rhodella violacea* (red microalga) [86]. There has been a growing interest in recent years for the discovery and selection of this microalgae producing EPS. Marine polysaccharides have been marketed for many years and are mainly used as texture agents (they are hydrocolloids which, dispersed in an aqueous medium, increase its viscosity and give an agaric texture).

Also several studies have highlighted their applications in the plant domain. For example, in agriculture, marine poly- and oligosaccharides are already used as active ingredients to stimulate the natural defense mechanisms (NDM) of plants in agriculture (Figure 13). In animal sector, marine oligo- and polysaccharides also have interesting prebiotic activities for the nutrition-animal health. Several journals summarize researches conducted in laboratory about the beneficial effects of sulphated polysaccharides on animal health [87].



Figure 13- Microalga protection in vineyards to reduce or even replace copper fungicides. Inhibition of the sporulation of grapevine downy mildew (*Plasmopara viticola*) after use of the protection product based on microalgae sugars [88].

1.5. Microalgae cultivation

The production of microalgae is increasing strongly around the world. The annual production is estimated at 6,000 tons dry matter [89]. Large scale culture can be conducted in two modes, using open ponds “the raceway” or in an enclosure transparent closed medium, photobioreactors, using natural or artificial light.

1.5.1. Open ponds culture

These systems are closed-loop recirculation ponds with a depth of a few tens of centimeters. Mixing and circulation of the medium is possible due to paddle wheel: the flow is guided by the speed of rotation of this wheel. The temperature of the environment fluctuates according to the day/night and seasonal cycles. However, few species of microalgae can be grown in an open environment. For any microalgae growing, the main constraint is the risk of contamination by other species of microalgae or other micro-organisms such as bacteria [90]. This is why current open cultivation concerns microalgae species growing in very selective environments such as *Dunaliella salina* which develops in a hypersaline environment [91] or *Arthrospira platensis* growing in alkaline medium [92].

The yields achieved with these systems are not optimal because of the difficulty to control the environmental factors such as evaporation, wind blowing dust particles into ponds, and rain causing changes in salinity and pH which affect growth of algae. The biomass concentration for

this type of culture is generally low because the agitation of the medium is low and the existence of unstirred areas. For the most part, algae cultivation in open ponds has been pioneered in the following shapes [90] (Figure 14):

- Round.
- Raceway.
- Unstirred.
- Closed pond system.

Closed pond systems idea came as a variation of the open pond system [8]. The pond is close off with a greenhouse-like covers of plastic or other similar clear material. It is an alternative to open ponds built in order to avoid the negative point discussed in the open pond. Normally, with closed ponds the control over the environment can be regulated better than open ponds.

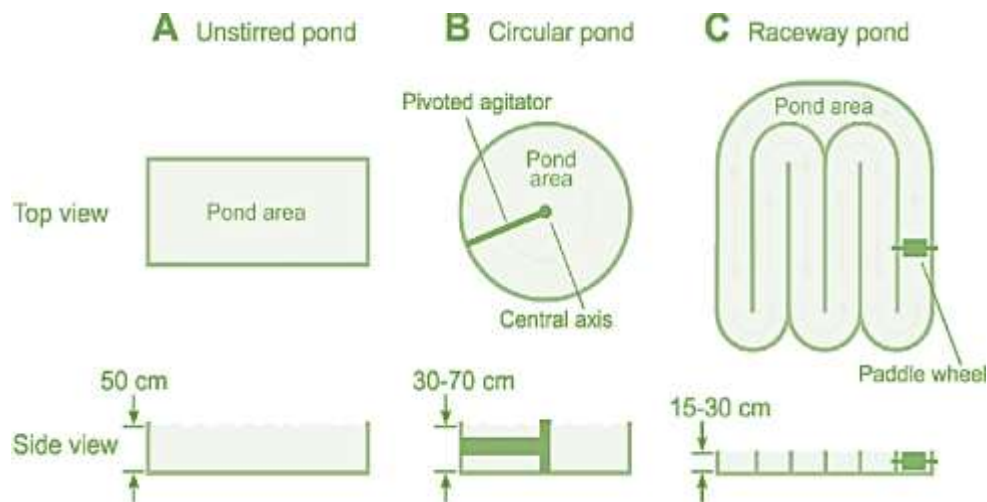

Figure 14- Examples of different types of open pond systems. (A) Unstirred pond (B) Circular pond (C) Raceway pond [93].

1.5.2. Closed culture or tubular photobioreactor

The tubular photobioreactor is a combination of many transparent tubes (plastic or glass). The light source can be natural or artificial. This closed environment helps avoiding external contamination [89]. The injection of air can provide carbon in the form of CO₂. Carbon dioxide helps in stirring the medium and evacuating pockets of toxic oxygen. In the case of natural light, the arrangement of the tubes is often from north to south to ensure maximum sunlight and parallel or horizontal so that each tube can receive the same rate of sunshine [94].

The artificial light of PBR is technically feasible but it adds a significant cost compared to natural light. Temperature control is an important element to consider. Production costs using PBR are much higher than in open basin (Figure 15).

The main benefits of PBRs:

- Exploitation of a wider range of microalgae.
- Achieving better yields.
- Overcoming problems of contamination.
- Reserved for microalgae with high added values.

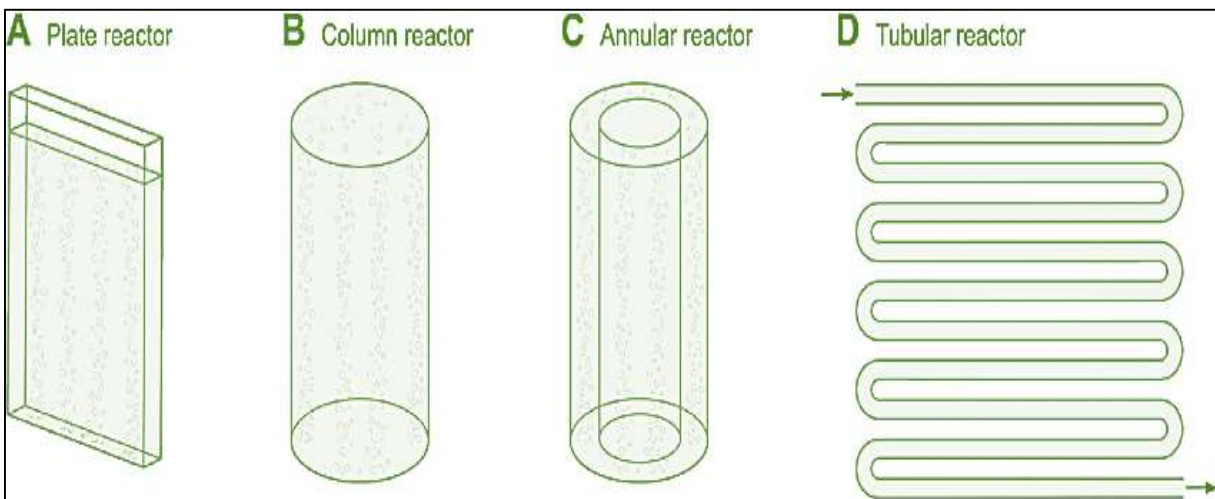

Figure 15- Geometries of closed photo-bioreactor [93]

1.6. Microalgae harvesting

Harvesting of microalgae is not an easy step and it is considered as a limiting step because this biomass have a size most often of the order of few microns. This step can be costly and represents a significant economic part of the cost of an industrial-scale process as reported by Mata *et al.* [7] [95]. Harvesting can be done by many ways: centrifugation, filtration, sedimentation, flotation and flocculation.

1.6.1. Centrifugation

In general, this technique is 90% efficient, fast, and one of the most used methods regarding the industrial scale as reported by Park *et al.*[96]. However, this method has some negative sides

which could be summarized by the fact of being expensive in energy which makes it difficult to achieve economically [97] and could expose cells to damage due to its centripetal force [95].

1.6.2. Flocculation

It is a process in which the microalgae in solution join together to form aggregates called "flocs" [98]. When flocculation is combined with filtration, the efficiency is significantly increased [97]. For example, a study conducted by Gerde *et al.* [99] to flocculate cells of *Scenedesmus* spp., *Chlamydomonas reinhardtii*, and *Schizochytrium limacinum* using aluminum sulfate ($Al_2(SO_4)_3$) and two cationic starches as flocculants, showed that cationic starches provide an efficient and ecologically friendly way to harvest microalgae. A flocculation efficiency >98 % was achieved at both pilot-scale by Ndikubwimana *et al.* [100] using a simple, effective, economic, and environmentally friendly bio-flocculant "broth of *Bacillus licheniformis*".

1.6.3. Sedimentation

Microalgae of large size and high density can be harvested by sedimentation such as *Spirulina sp.* The sedimentation rate can be significantly improved by the addition of flocculants as reported by several authors [95] [98] [101] [99].

1.6.4. Filtration

In this technique, the microalgal suspension passes through filtering membranes to retain only the cells. There are different forms of filtration: microfiltration, vacuum filtration, pressure filtration, ultrafiltration and tangential or frontal flow filtration. The choice of the molecular weight cut-off (MWCO) of the membrane depends on the size of the species to be harvested [102].

1.6.5. Flotation

A process in which gas bubbles are bound to microalgal cells allowing them to float on the surface. Flotation system for microalgae harvesting is an effective method for small size cells such as *Nannochloropsis oculata* [97] [95]. In the dissolved air flotation process, the air bubbles are reduced in size from 10 to 100 μm [95]. The air bubbles pass through the medium, adhere to each other, bind to the particles and thus increase their buoyancy, and create "flocs" on the surface

where a "compacting" zone is formed [96]. In the dispersed air flotation process, air injection and strong agitation form 700 to 1500 μm bubbles inside the medium. These bubbles will "react" with the negative charges of the microalgae cells [95] (Figure 16).



Figure 16- A laboratory model showing electro-coagulation–flocculation of microalgae [103].

The technique can be improved with the addition of surfactants that will bring a positive charge to the environment [97]. For example, Kurniawati *et al.* investigated the harvesting of *Chlorella vulgaris* and *Scenedesmus obliquus* using natural bio surfactant saponin as the collector and chitosan as the flocculent [104].

1.7. Effects of the medium on the growth and biochemical composition of microalgae

The nutritional requirements of microalgae are similar to those of higher plants [105]. The culture medium must satisfy the needs in major elements (or macro-elements) C, H, N, O, P, S and micro-elements called traceable elements. Table 3 indicates the major constituent elements of microalgae. Microalgae (like most cells) are composed mainly of carbohydrate proteins and lipids. The culture medium must be able to support the needs of the organisms, however, cells could be adapted in order to continue their development under certain conditions of stress or deficiency.

Table 3- Major constituent elements of microalgae [106].

Element	Cell composition µg / mg dry weight	Element	Cell composition µg / mg dry weight
C	176-650	Mg	0.5-75
H	205-330	Fe	0.2-34
O	29-100	Zn	0.005-1
N	10-140	Mn	0.02-0.24
Na	0.4-47	Si	0.2-30
K	1-75	B	0.001-0.25

1.7.1. Carbon

Carbon is the main constituent of microalgae [107]. Most microalgae have photoautotrophic metabolism (use of light as a source of energy and of inorganic carbon), others have heterotrophic metabolism (use of organic carbon in the absence of light) or mixotrophic (conjugated photoautotrophic and heterotrophic metabolisms), simultaneously or sequentially. The main source of carbon for microalgae is atmospheric carbon dioxide. Heterotrophic culture is inappropriate for most microalgae. However some of those belonging to the genus *Chlorella* can develop in heterotrophy. Heterotrophic culture is of great interest because it allows to produce biomass (lipids, proteins ...) with a higher yield than in autotrophy [108].

Microalgae cultures in autotrophy use inorganic carbon for the production of carbohydrate molecules. The origin and content of CO₂ have an impact on the efficiency of photosynthesis. The percentage of CO₂ in the air needed to feed the photosynthetic microorganism cultures varies according to the genus to which this microorganism belongs. Many research discussed about the phenomenon "CO₂ inhibitory effect" on the growth starting from a critical concentration (threshold concentration tolerated by the cells). According to Yang and Gao [109], the value of the critical concentration depends on several parameters: the contribution of CO₂, the affinity of the cells for it, the rate of growth, the size of the cells (the faster the cells growth is, the higher is the requirement in CO₂ concentrations) [110].

The carbon source used for heterotrophic cultures and the most effective organic substrate is glucose, the presence of which induces a phenomenon of adaptation characterized by important physiological changes, accompanied by a phenomenon of storage of the molecules. Indeed, the

cells increase the intracellular synthesis of polysaccharides, lipids, proteins, chlorophylls, RNA and vitamins, which leads to an increase in their volume according to Perez-Garcia *et al.* [111].

1.7.2. Nitrogen

For the development of microalgae, nitrogen is essential. Indeed, it is a constituent element of the amino acids that make up the proteins. The nitrogen sources are mainly mineral (NH_4^+ , NO_3^- and NO_2^-), but there are also organic sources such as urea and amino acids.

When microalgae culture medium is deficient in nitrogen, the growth rate of microalgae decreases. Cells enter the stationary phase and accumulate lipids (triacylglycerol) and / or carbohydrates, to the detriment of proteins and pigments [112] [113]. This phenomenon induces an increase in cell volume [113]. Nitrogen deficiency is responsible for a quantitative and qualitative change in the production of molecules by microalgae. Microalgae belonging to the genus *Chlorella* accumulate neutral lipids in response to nitrogen substrate stress as reported by Lin *et al.* [114]. Nitrogen deficiency is known as an effective tool for the production of algal lipids. In addition, researches show a connection between the cellular lipids accumulation (observed in nitrogen deficiency) and autophagy. In the green alga *Chlamydomonas reinhardtii*, Perez-Perez *et al.* [115] identified that autophagy was active in this alga in stress conditions, including nitrogen deficiency, oxidative stress, or the presence of mis-folded proteins in the endoplasmic reticulum.

Other than autophagy and lipids accumulation, nitrogen deficiency can also result in a change of pigmentation of microalgae. To protect against nitrogen deficiency and maintain an available source of nitrogen, microalgae catabolize their constitutive pigments and in particular the supernumerary pigments of collecting antennae such as phycoerythrin [113].

However, the concentration of certain pigments increases during a nitrogen deficiency. This is the case of the intracellular beta-carotene of the microalga *Dunaliella salina* [116]. The same phenomenon has been described, in *Eustigmatos cf. polyphem* for which the intracellular concentration of beta-carotene increases by a factor of 3 following a nitrogen deficiency.

1.7.3. Phosphorus

Phosphorus is not widespread in nature. It is mainly found in the form of phosphate salts (PO_4^{3-}). Phosphorus is an indispensable element for the microalgae growth. It participates in many

metabolic processes, notably through energy exchanges (ATP), in the formation of nucleic acids and phospholipids [117]. Like nitrogen, phosphorus deficiency causes a decrease in cell growth. In *Chlorella vulgaris*, the same deficiency causes a specific decrease in the amount of intracellular inorganic polyphosphate [118]. The affinity of microorganisms for the substrate (phosphate) varies depending on the species. It is 4-5 μM for the genus *Chlorella* as reported by Martinez Sancho *et al.* [119].

1.7.4. Sulfur

Sulfur is also important for the development of organisms. It is used in certain amino acids, such as cysteine and methionine. It is used by photosynthetic organisms mainly in the form of sulphate (SO_4^{2-}) as reported by Prescott *et al.*, [117]. Sulfur deficiency leads to a decrease in growth by a factor of 2 to 2.5 in *Chlorella vulgaris* and *Chlorella sorokiniana*, and leads to an increase in starch reserves.

1.7.5. Salts

Some microalgae are adapted to fresh water, others to marine environments and some are halophiles. Marine microalgae can adapt to media with salt concentrations (NaCl) of 10% to 50% (w/v) depending on the microalgae.

Beyond these threshold values, cell growth is slowed down or even halted as cited by Eggert *et al.* [120]. When the salt concentration becomes too important for the marine microalgae, osmotic stress is created which induces changes in its metabolism. Excess salt has no lethal effect on the cells of marine microalgae. Microalgae of the genus *Scenedesmus* under salt stress conditions accumulate lipids (triacylglycerols) and carotenoids. The morphology of the microalgae is also modified and the cells round out. All of this adaptation is at the expense of cell growth as reported by Vidyashankar *et al.* [121]. During osmotic stress, some microalgae produce an exopolysaccharide that forms a mucilage around the cells. This carbohydrate capsule limits ion exchange and protects cells.

1.8. Extraction processes for component recovery

The potential of microalgae is now well established. They arouse the interest and hope of researchers. The general processing scheme involves the step of production / cultivation of microalgal biomass, harvesting / concentration and extraction of components.

The components extraction stage remains a critical step for which significant efforts must be made. Given the size and nature of the components (hydrophilic or hydrophobic), many of the techniques used in the field are more or less effective.

The valuable compounds of microalgae are stored within the cells that can be protected by a thick wall. Their extraction can be done using specific organic solvents and often requires a step to break the cell walls to make them accessible. To do this, several treatments are possible: grinding, ultrasound, microwaves, osmotic shocks, enzymatic lysis, etc. The choice of the bursting technique depends mainly on the cellular characteristics and the dry matter content of the algal biomass [122].

1.8.1. Extraction using organic solvents

The lipids and pigments can be generally extracted with a water-immiscible organic solvent such as n-hexane, chloroform, petroleum ether, or a mixture of solvents on the basis of the method developed by Bligh and Dyer [123]. This general principle of dissolution is often expressed by the expression "the like dissolves in the like".

The extraction can also be optimized by an intensification of the temperature and pressure conditions thus making it possible to increase the solvating power of the solvent used [95].

The ideal extraction solvent for marine lipids should have a low boiling point to facilitate its removal. For example, chloroform/methanol (1/2: v/v) is the most commonly used solvents mixture for extracting lipids from living tissue. This procedure is known as the Bligh and Dyer method (Bligh and Dyer, 1959), which today constitutes the reference method in the literature. The Soxhlet extraction technique is also a widely used method [124].

There is, moreover, a process for extracting lipids from fresh biocompatible microalgae which makes it possible to keep the cells alive during the extraction step. In this case, the algae are brought into contact with an organic solvent, n-decane, and proceed to a liquid/liquid extraction

operation, followed by phase separation. The treated algae are then put back into cultivation, with in some cases survival rates close to 100%. This process is called "milking" [125]. However, this procedure has limitations because it requires the use of large volume of toxic solvent for human health.

Currently, "green" solvents constitute a potential way of substitution of n-hexane from renewable raw materials. They have the advantage of offering an alternative to fossil resources and can be produced from biomass such as wood, starch, vegetable oils, fruits or even aromatic plants. They are classified according to 3 categories, esters, alcohols and terpenes. Some of these have already been shown to be effective for oilseed oil extraction [126]. However, very little work has been done on the extraction of lipids from microalgae using these solvents. Zbinden *et al.* [127] has used ethyl acetate as an alternative for the extraction of lipids from *Ankistrodesmus falcatus*.

1.8.2. Cell disintegrating techniques

The efficiency of the extraction of microalgal valuable components like lipids, proteins, pigments, polysaccharides is closely linked to the level of cells disintegration. When the intact cells are disintegrated, the intracellular molecules are released from the cell structures and then diffuse into the surrounding medium. The methods of disintegrating cells are classified according to their mechanical or non-mechanical mode of action (Figure 17).

Mechanical and physical methods include bead mill, ultrasound, autoclave, freeze-drying and microwaves, while non-mechanical methods involve cell lysis by enzymes, acidic or basic treatments, or osmotic shock. These different techniques can be used to assist the solvent extraction or can constitute a pretreatment before the actual extraction step.

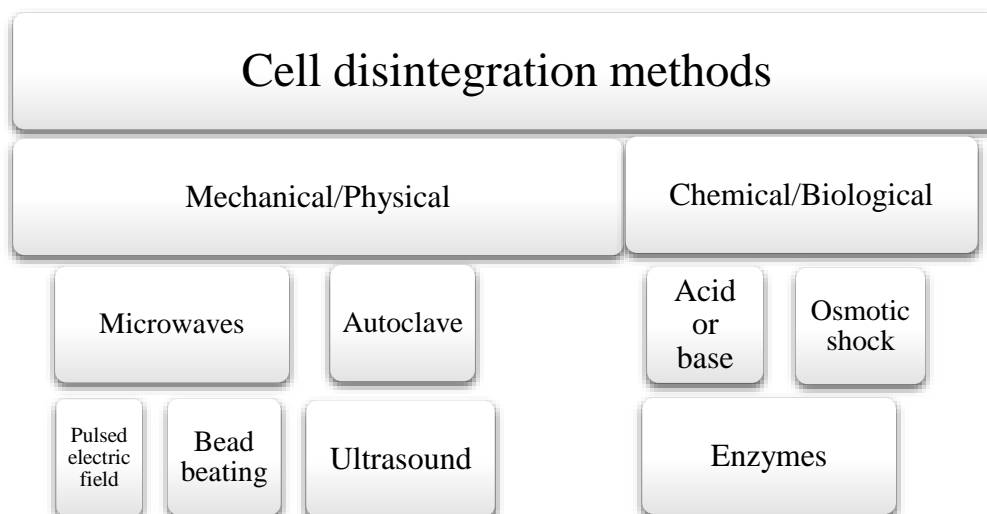

Figure 17- The processes of microalgal cell disintegration.

1.8.2.1. Non-mechanical cell wall disintegration techniques

These methods are labelled as environmental friendly. The first method involves the use of enzymes which allow to break the cell wall with a release of the cellular content without the alteration of the present molecules (Figure 18). However, the difficulty is to choose the appropriate enzyme to hydrolyze the microalgae cells. For this reason, it is desirable to know the composition of the cell wall to be treated. Enzymes like chitinase, lysozyme, pectinase, sulfatase, β -glucuronidase, and laminarinase had the widest effect across *Nannochloropsis* strains. *Chlorella* strains are typically more sensitive to chitinases and lysozymes which degrade the outer surface of the cell wall and removes hair-like fibers protruding from the surface [11].

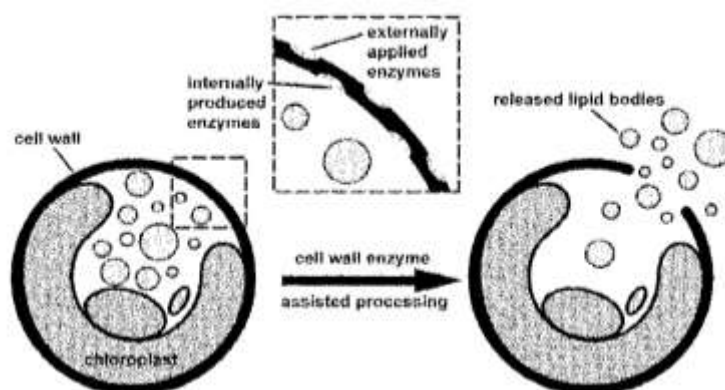

Figure 18- Disruption of cell walls using degrading enzymes for enhanced lipid recovery [128].

A second non-mechanical method is “Osmotic shock”. The increase in salinity in an aqueous medium is at the origin of a hypertonic medium which constitutes an osmotic shock for marine microalgae. As a result, the cells will contract, thus promoting the diffusion of cellular content to the outside. This technique proved to be effective for the extraction of lipids from wet *Chlamydomonas reinhardtii* with NaCl or sorbitol as osmotic agents at different concentrations as reported by Yoo *et al.* [129].

1.8.2.2. Mechanical cell wall disintegration techniques

1.8.2.2.1 The “bead beating”

Bead beating, also known as bead mill, is a very simple technique of cell degradation. It consists of a very strong agitation of the medium comprising the solution of microalgae and quartz or metal beads [130]. The collision and the friction of these beads with the cells cause a disintegration of the latter. It is a very advantageous technique in terms of efficiency and energy consumption and can be applied on an industrial scale (Figure 19).

For the extraction of lipids from *Botryococcus braunii*, among all the techniques tested, bead beating was very effective in pretreatment followed by chloroform / methanol (2/1: v / v) extraction [131].

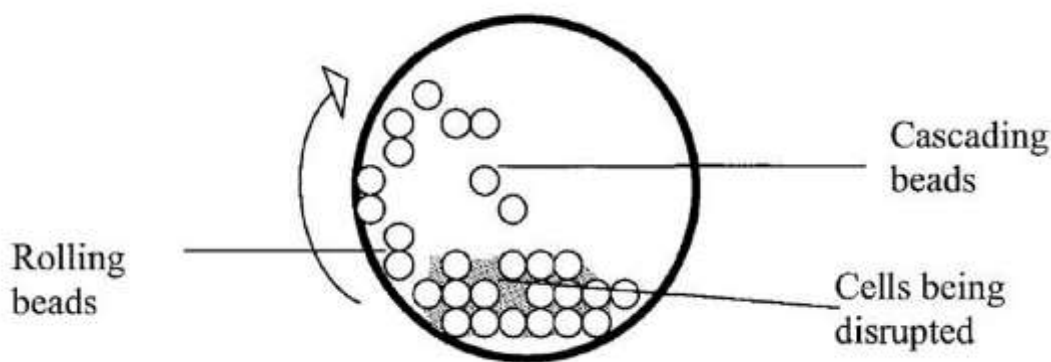

Figure 19- Cell disruption by Bead Milling [132].

Over-disruption may impact and cause denaturation of the desired component. The time to disrupt the cells and the reproducibility of the method become more important factors for production scale processes. It is usually necessary to establish the minimum force of the disruption method that will

yield the best product [133]. Additionally, once the cells are disrupted, it is often essential to protect the desired product from normal biological processes and from oxidation or other chemical events.

1.8.2.2.2 Microwaves

Microwaves have the particularity of instantaneously heating polar molecules and especially water molecules. Since microalgae cells are made up of 65-85% of water, following exposure to microwaves, the cells are subject to significant constraints that result in cells disintegration and thus favoring the release of molecules of interest (Figure 20). The phenomenon can therefore lead to increase the efficiency of microalgae lipid extraction procedures. However, microwaves require working from wet biomass. The study of Lee et al [27] also highlighted the effectiveness of microwaves compared to other techniques (such as bead beating, osmotic shock and autoclave) on different microalgae such as *Botryococcus sp.*, *Chlorella vulgaris* and *Scenedesmus*. This process can reduce the production costs of microalgae biodiesel as reported by Yong-Ming Dai et al, [15].

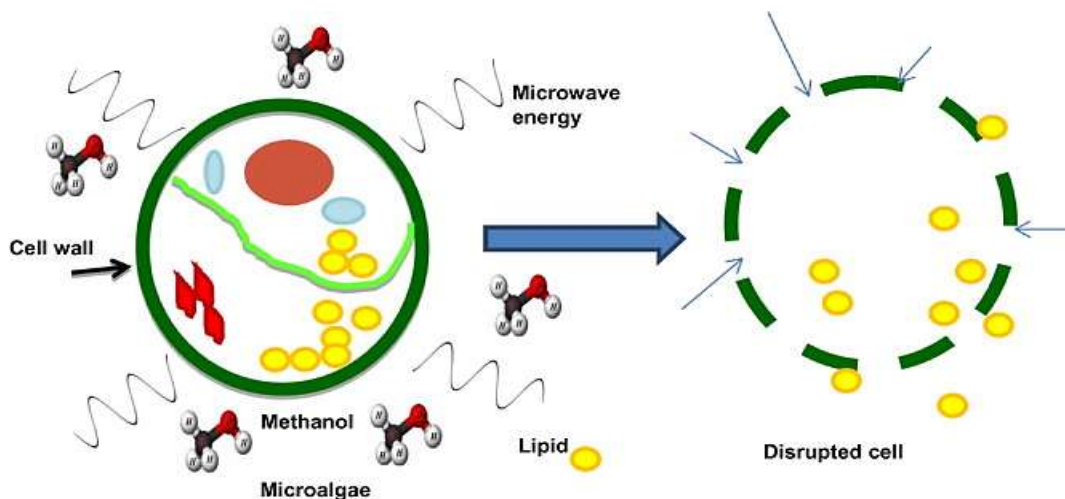

Figure 20- Microalgae extraction mechanism using microwave irradiation [134].

1.8.2.2.3. Pulsed electric fields (PEF)

PEF is another potential technique in which cells are exposed to strong electric fields for very short periods of time. Electrical pulses make the cells permeable, thus implying an increase in the transfer of material through the membranes. This very promising technique can be applied in the

pretreatment of microalgal biomass before solvent extraction. Zbinden *et al.*, [127] showed the effectiveness of PEF on lipid extraction of the microalgae *Ankistrodesmus falcatus*

1.8.2.2.4. Ultrasound Assisted Extraction (UAE)

Ultrasound Assisted Extraction has the advantage of being a technique of disintegration at low temperature, thus leading to a decrease of the thermal denaturation of the sensitive compounds. Ultrasound is easily transposable at industrial scale and can operate continuously [135].

When low frequency ultrasound is applied in a liquid, a cavitation phenomenon occurs, the formation of tiny bubbles within the liquid medium, which is responsible for cell damage [136]. When these bubbles reach resonance size, they collapse releasing mechanical energy in the form of shock waves equivalent to several thousand atmospheres of pressure. The shock waves disrupt cells present in suspension. As ultrasound breaks the cell wall mechanically by cavitation shear forces, and facilitates the transfer of inner components like lipids, proteins, pigments and carbohydrates from the cell into the solvent (Figure 21). In ultrasonic applied field, a frequency range between 20-25 to 600 kHz (mega Sonics) is commonly used for cell disruption and separation of particles from biomass as reported by Pablo Juliano *et al.*, Chemat *et al.*, [31], [137]. The duration of ultrasound needed depends on the cell type, the sample size and the cell concentration. In microalgal field, Jaeschke *et al.*, [138] find ultrasound as an alternative technology to extract carotenoids and lipids from *Heterochlorella luteoviridisultra*. Prabakaram and Ravindram [139] carried out a study on three species of microalgae on which different methods of disintegration were tested (autoclave, bead beating, microwaves, osmotic shock and ultrasound) where ultrasound appears to be the technique of choice to obtain the best lipid yield.

In 2016, Ferreira *et al* [141], studied the effect of low frequency acoustic ultrasound on microalgae *Chlorella vulgaris*, *Nannochloropsis oculata* and *Scenedesmus obliquus* for carbohydrates, proteins, lipids and pigments valorization. But the study did not exclude the use of toxic and harmful organic and high volatile solvent like n-hexane, chloroform, 2-butanol, isopropanol, ethanol and methanol.

As reported by Oohashi *et al.* [142], it is generally accepted that humans cannot perceive sounds in the frequency range above 20 kHz, and the use of such "inaudible" high-frequency components may significantly affect the brain activity of listeners. High noise levels require hearing protection

and sonic enclosures. Thus using ultrasound may cause harmful effect on human health. Therefore, during this thesis, low ultrasonic frequency (having a low acoustic non-hurt able frequency 12 kHz) will be carried out on *Spirulina sp.* and *Chlorella vulgaris* in the absence of any toxic solvent (Figure 22).

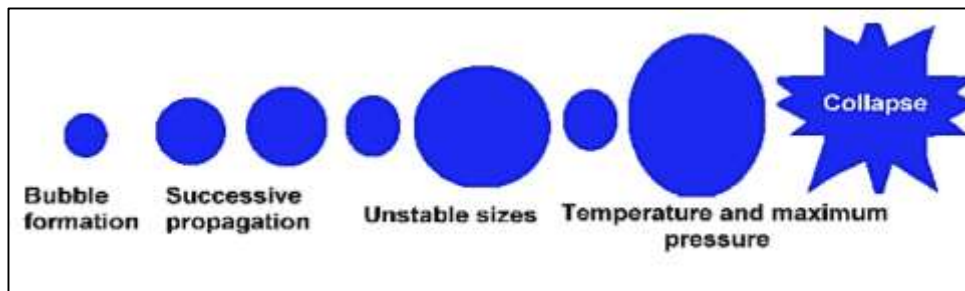
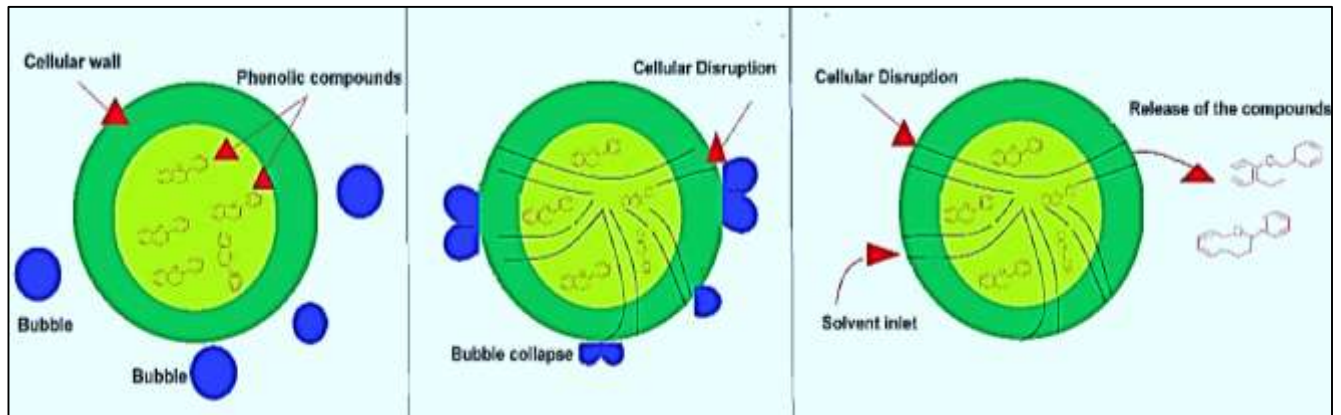

Figure 21- Graphical representation of cavitation-bubble collapsing and releasing inner components in three steps (bubble and cell representation, breakdown of the cell wall and bubble collapse, finally diffusion of the solvent through the cellular disruption and release of the compounds) and the principle of acoustic cavitation [140].

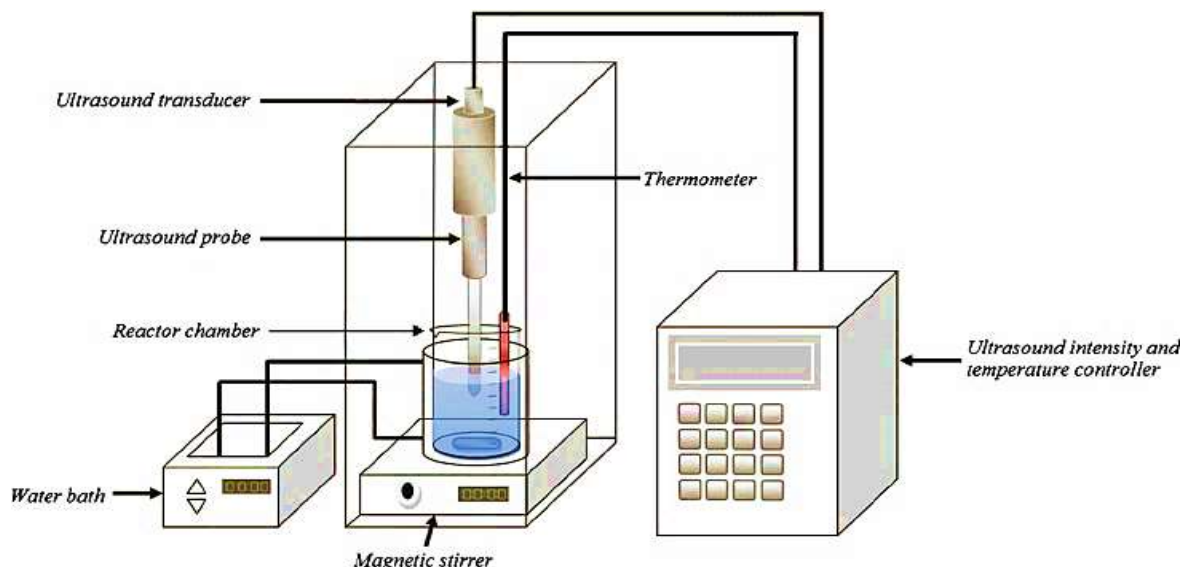

Figure 22- Schematic diagram of experimental apparatus used for microalgal extraction under ultrasound irradiation [143].

1.9. Supercritical extraction

Supercritical fluids have been used at the industrial stage for 30 years and the applications are multiple: solvent-free decaffeination, oil extraction, contaminant removal, purification of proteins, extraction of aromas and essential oils, deodorization and discoloration.

Many supercritical fluids have been used, in particular water and propane, but the most commonly used one remains CO₂ which is positioned today as an alternative to conventional techniques of organic solvent extraction. Supercritical fluid technology provides pure extracts without solvent residues and does not require a separation step in case of non-disintegration pre-step. However, one of the major obstacles to the diffusion of technology is the heaviness of investments, although their costs have fallen in recent years.

A fluid is said to be supercritical when placed under temperature and pressure conditions beyond its critical point. Supercritical fluids have a viscosity close to that of gases, a density close to that of liquids, and a high diffusivity. Thus, supercritical fluids have a so-called "variable geometry" solvent power: the solubility of the compounds evolves with the pressure and temperature conditions of the fluid. In the supercritical state, CO₂ has very particular properties (more than 74 bar and 31 °C). The fluid obtained is characterized by a high diffusivity (of the order of that of the

gases), which gives it a good diffusivity, and a high density which endows it with a large transport and extraction capacity.

A supercritical CO₂ (ScCO₂) extraction process operates in closed circuit. It comprises pressurizing elements (pumps) and temperature (exchangers) in order to bring the solvent above its critical point [144]. The biomass to be treated is placed in an extractor crossed by the supercritical CO₂ flow. The fluid is charged with the extracted compound, then it is expanded, passes into the gaseous phase and separates from the extracted compound. The latter is collected in a separator.

The soluble molecules in ScCO₂, and therefore extractable, are nonpolar such as aromatic compounds, many pigments, neutral lipids, TAG, DAG, and MAG. Non-soluble molecules in supercritical CO₂ are polar like proteins, polysaccharides, glycolipids, phospholipids, sugars, minerals. The ScCO₂ extraction is based on the CO₂ solvent power which can be modulated according to the applied pressure and temperature conditions. It allows selective extraction without denaturing sensitive molecules due to moderate temperature conditions. The products obtained do not contain solvent residues, which is a major regulatory advantage. Moreover, the use of co-solvents modifies the solvent power of ScCO₂ and allows other extraction possibilities [145].

The benefits of ScCO₂ are:

- It is a natural product, abundant in nature and available.
- It is nontoxic, inert, odorless, colorless and tasteless.
- Its use does not alter products, and does not generate polluting residues.
- It is inexpensive which makes the technique attractive and viable.
- It has disinfecting properties vis-à-vis viruses and bacteria, although it is not considered as a sterilization technique.
- It has low critical coordinates (T_c, P_c).

The use of other supercritical fluids is also limited because of their high critical temperatures and pressures such as water [146]. Methanol is a very good supercritical solvent but its critical temperature and pressure are relatively high, making it unsuitable for the treatment of thermo labile compounds. In addition, it is highly corrosive in the presence of oxygen [146][147]. Another alternative fluid is nitric oxide, N₂O. The

disadvantages of N₂O are the risk of oxidation and explosion in the presence of organic compounds [148], [149]. The physical properties of some fluids are presented in (Table 4).

Table 4- Critical coordinates and dipole moment of some supercritical fluids [147].

Fluids	Critical temperature (° C)	Critical pressure (bar)
CO ₂	31.1	74
H ₂ O	374.1	221.1
N ₂ O	36.5	72.6
Methanol	240	79.5
Freon-23 (CHF ₃)	25.9	47.5

1.9.1. Influence of extraction parameters

Unlike conventional liquid extraction (like hexane, chloroform), results found a limited extraction by CO₂ because it is not a very powerful solvent. The thermodynamic parameters (pressure, temperature) then become very influential and determining parameters to enhance its power. It is a flexible process in which it is possible to control the solvent power and therefore the selectivity of the supercritical fluid by modifying the temperature and pressure conditions. The solubility in ScCO₂ changes with the temperature [150]. At a low pressure, the CO₂ solvent power decreases as the temperature increases due to the decrease in its density which determines its solvent power. On the other hand, at high pressure, the solubility increases with temperature. In term of pressure, it is also widely used at much higher pressures, since the CO₂ power increases with pressure increase [151] [152] [153]. In addition, pressure can be used to adjust the selectivity of supercritical extraction. The general rule is that high pressure leads to a higher solvent capacity, but at the same time the selectivity decreases.

Hence extraction with ScCO₂ over time generally involves two distinct phases (Figure 23):

- First phase where the extraction is controlled by the solubility of the solute(s) in CO₂ (thermodynamic control).

- Second phase where the extraction is controlled by the internal diffusion within the particles (control by transfer). A limitation by external transfer is much less common. These phases are visible on the curve of schematically representing extraction kinetics.

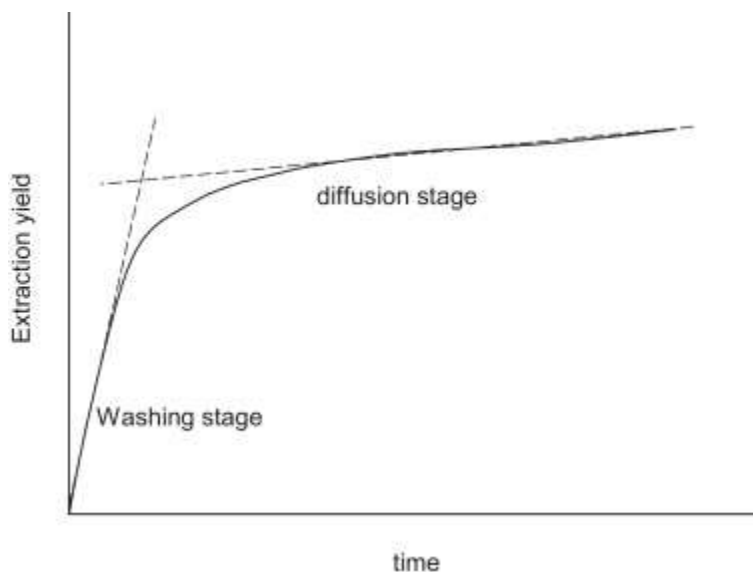

Figure 23- General aspect of an extraction kinetics [154].

Other important parameters of supercritical extraction are CO₂ flow, particle size, extraction time, and pretreatment of the raw material. The appropriate choice of these parameters makes it possible to carry out the complete extraction of a desired component in the shortest time. These parameters are related to thermodynamics (solubility) and material transfer. Also, CO₂ flow rate is a significant parameter if the process is controlled by external material transfer or solubility of the solute in the solvent [155]. In this case, the extraction rate is determined by the amount of CO₂ introduced into the extractor. The size of the particles plays a decisive role if the process is controlled by internal material transfer. A small particle size decreases the duration of solvent diffusion within the particles. However, if the particles are too small, problems of preferential passages (pipes) of the solvent may appear. In this case, part of the solvent can flow through channels formed in the extraction bed without coming into contact with the solutes. The extraction time is usually related to CO₂ flow and particle size and should be minimized to achieve maximum extraction efficiency [156] (Figure 24).

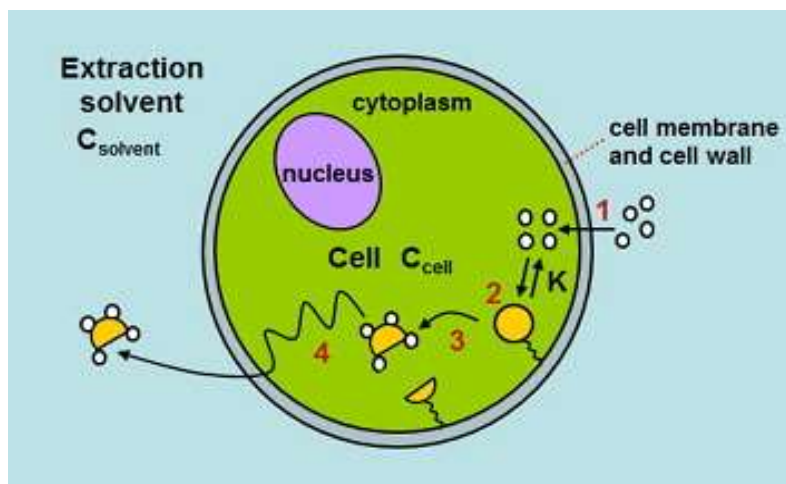

Figure 24- Schematic diagram of the crude lipid extraction mechanism [156].

1.9.2. Supercritical CO₂ and microalgae: benefits and drawbacks

The use of ScCO₂ technology for the extraction of microalgae lipids is relatively recent [157] and since then many researchers have confirmed the potential of this technology for this application: Lorenzen et al, [158] studied the extraction of microalgae derived lipids with supercritical CO₂ in an industrial relevant pilot plant; Sánchez-Camargo et al. [159] studied the extraction of bioactive obtained from microalgae; Crampon et al [160] studied oil extraction from enriched *Spirulina platensis* microalgae.

ScCO₂ technology appears to be suitable for extracting components from microalgae like lipids, pigments and so on. The solubility of microalgal components in supercritical CO₂ depends on studied extraction parameters: temperature, working pressure, and therefore the solubility of the desired compounds. As already mentioned, the supercritical fluid has intermediate properties between the liquid state and the gaseous state. These last allow it to penetrate very quickly in the cells of microalgae. But the most important benefits of s ScCO₂ extraction that is generally faster than traditional methods like Soxhlet or extraction using organic solvents. In addition, this method eliminates costly posterior purification of the extracts by the elimination of the solvent simply by lowering the pressure. It also avoids the use of polluting organic solvents. It is therefore a non-toxic process. CO₂ seemed to be readily available. It is produced in large quantities as a by-product from fermentation, combustion. Therefore, this method has no additional negative impact as a greenhouse gas and seemed to be environmentally friendly.

However, the major concern of supercritical extraction is its high investment costs [161]. This technology requires a significant energy consumption to establish the pressures and temperatures during the various extraction steps (extraction, separation and recycling of the solvent) (Figure 25).

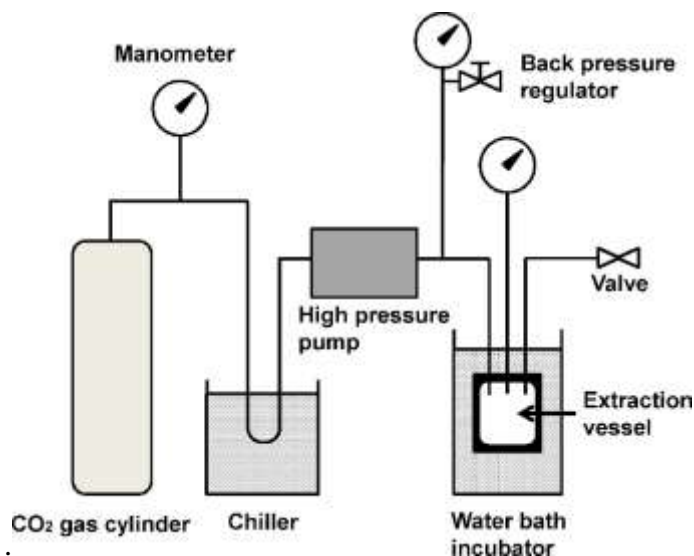

Figure 25- Schematic diagram of the continuous supercritical flow system [162].

1.10. Membrane filtration

The field of membrane separation includes the characterization of membrane materials, membrane fabrication and modification, process engineering, integration of membrane processes in industrial processes, as well as economic and ecological aspects.

Generally, these membranes can be made from inorganic materials or organic polymers. All components (e.g. molecules, particles, microscopic biomasses) larger than the pore size of the membranes are filtered and retained. There are several techniques depending on the pore size of the membranes: microfiltration, ultrafiltration, nanofiltration and reverse osmosis [163].

We will discuss in more detail ultrafiltration, which will be implemented in this work for the purpose of concentration and purification of extracts.

Ultrafiltration is a technique for separating the elements contained in a liquid. It uses semi-permeable membranes whose pore diameter is between 0.001 and 0.1 μm . It thus makes it possible to retain macromolecules, in particular proteins and organic molecules, but also larger particles in

suspension that escape microfiltration: like certain microalgae. Solvent and substances having a lower molecular weight than the pores size pass the membrane, while higher molecular weight substances are retained. The driving force is the pressure difference on both sides of the membrane. Ultrafiltration uses relatively low trans-membrane pressures compared to nanofiltration or reverse osmosis, which has the effect of limiting the operating costs associated with energy consumption [164].

The work presented in the following chapters on ultrafiltration membranes has a MWCO close to 10, 30 and 100 kDa equivalent to 0.005, 0.015 and 0.05 μm respectively (Figure 26).

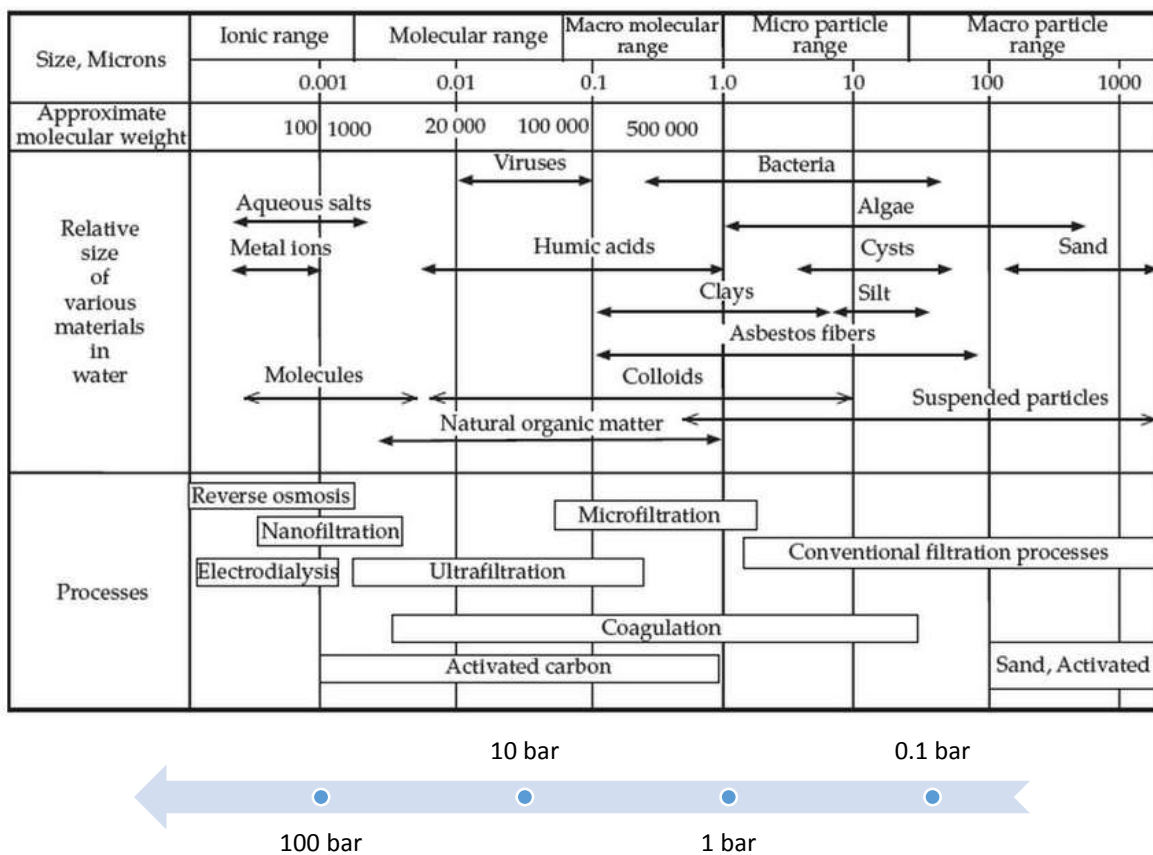

Figure 26- Membrane separation process based on the approximate MWCO range – required/used pressure [165].

1.10.1 Limitations

Ultrafiltration and other membrane separation processes involving a pressure gradient can be conducted in two flow modes: tangential filtration and frontal filtration.

During filtration carried out in tangential mode, the fluid circulates parallel to the membrane thus causing a shear which makes it possible to limit the accumulation of material. This mode of operation can make it possible to work in a continuous way without a sequential need for cleaning machines. In the frontal mode, the filtration is carried out perpendicular to the surface of the membrane; thus, all the material entering the filtration module and retained by the membrane accumulates on its surface (Figure 27).

In fact, this mode of operation implies a continuously transient state and requires a sequential implementation (succession filtrations - cleaning actions) [164].

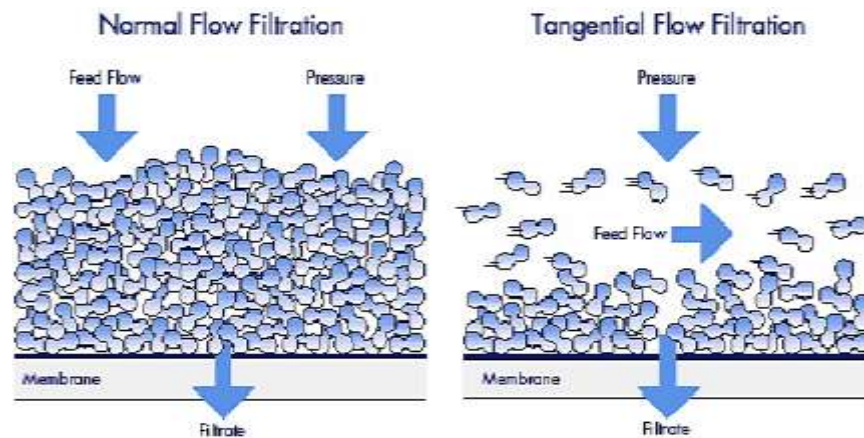

Figure 27: Representation of normal flow filtration and tangential flow filtration [166].

The main obstacle to the development of membrane processes lies in the clogging of membrane which results from the accumulation of material on the surface of membranes. When a system operates at constant transmembrane pressure, the clogging results in a decrease in permeation flow over time. In constant flow operations, the direct consequence is an increase in pressure. Whatever the procedure used, other consequences result from this accumulation of material, whether it is a decrease in the life of membranes due to more frequent washing and additional energy expenditure related to increase the resistance to transfer [164]. In other part, the polarization concentration plays a similar limiting role; it corresponds to an accumulation of solutes retained by the membrane in a liquid layer just next to the membrane. Polarization is characterized by the appearance of a limit flow when the transmembrane pressure grows. The only way to combat this phenomenon is to increase the speed of passage over the membrane which results in significant energy consumption. In the case of a solution of macromolecules, the membrane is mainly permeable to

the solvent. It thus separates a very dilute solution (permeate) from a solution whose concentration in the membrane is greater than the average concentration of the solution. There is thus a difference in osmotic pressure on either side of the membrane which is directed from the diluted solution to the concentrated solution and therefore opposed to the pressure gradient [167]. Some resistance types (gel formation, membrane resistance) result in a decline that reaches a maximum limiting flux asymptote (J_{∞}), whereas others (pore blocking, adsorption, and cake formation) result in a continuously decreasing flux with time, tending towards zero [168] [169] (Table 5) (Figure 28).

Table 5- Phenomena causing decreasing in permeate flux.

Phenomenon type	Definition
Membrane resistance	Caused by friction as a fluid passes through a membrane
Concentration polarization	Solutes retained and accumulated at the membrane surface
Gel layer	Solutes forming a gel on the membrane surface, assuming the concentration will not increase, and a steady state flux will result
Cake layer	Similar to gel layer, but fouling continuously increases with applied pressure, resulting in complete clogging and no flux
Pore blocking	Some macromolecules will enter a membrane partially, and stay lodged in the pore
Adsorption	Happened when macromolecules have affinity to pore walls

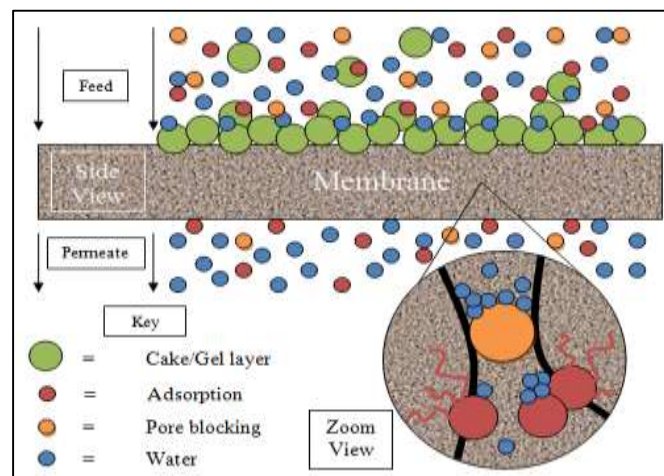

Figure 28- View of fouling, including cake/gel layer, pore blocking, and adsorption [170].

1.10.2. Influence of operating conditions

The role of physico-chemical parameters (pH, temperature, ionic strength, composition of the supernatant...) has a great importance on the clogging of the membranes. The transfer of solute and solvent is also a function of the operating conditions: hydraulic regime, transmembrane pressure, temperature, solute concentration [171].

1.10.2.1. Flow velocity

The increase of tangential velocity reduces the thickness of the polarization layer. It also decreases the deposition of large suspended particles that are more easily entrained. Finally, it generates shear forces in the vicinity of the membrane. All this makes it possible to increase the flow of permeate. However, if the clogging takes place inside the pores or in the form of compact thin layers, the effect of the speed on the flow can become very limited [171].

1.10.2.2 Transmembrane pressure

This parameter ensures the filtration of the solvent. Its increase favors the accumulation of solutes and suspended particles in the vicinity of the membrane. This can increase polarization and clogging. In general, the increase in transmembrane pressure increases the flow of permeate, but sometimes there may be a decrease in flux depending on the composition of the solution [171].

1.10.2.3. Concentration

The concentration of the solution affects the polarization and clogging of the membrane. Its increase leads to an increase in the concentration at the membrane and favors the phenomena involved in clogging [171].

1.10.2.4. Temperature

A rise in temperature improves the ultrafiltration flows by decreasing the viscosity of the solution and increasing the diffusion coefficient of the solutes [171].

1.10.3. Membrane efficiency

The passage of a solute through the membrane is characterized by the rejection rate (R) and calculated as follows:

$$R = \left[1 - \frac{C_{pi}}{C_{ri}} \right] * 100$$

C_{pi} : concentration of component i in the permeate,

C_{ri} : concentration of component i in the retentate,

R: retention factor in%.

In the case of an ideal retention, $R = 100$.

The volume concentration rate (VCR) represents the ratio between the feed rate and the retentate flow rate. It is calculated according to Shukla *et al*, [172]:

$$VCR = \frac{\text{Volume of feed}}{\text{Volume of retentate}}$$

1.11. Algorefinery: advantages and difficulties

Algorefinery opens up a considerable field of biotechnology and enables the production of a very wide range of products, but it is still far from guaranteeing mass production with acceptable economic profitability.

Algal biomass represents a considerable potential in the world and have already been identified for their ability to produce valuable products for food, feed, for the benefit of chemistry, medicine, agriculture and as energy and biofuel source. The algorefinery is now at the stage of research and development in aim to achieve sufficient ecologic/economic profitability [173].

The application of biotechnologies to microalgae enables to "over-accumulate" a precise element in microalgae for the benefits of humankind. The selected species then becomes a real "factory" that produces what the man has ordered. The selected microalgae then have yield per hectare much higher than those of terrestrial plant species. A first step is to select the strains most likely to naturally produce oils, proteins, pigments and other components of interest, and optimize their metabolism to improve their performance.

The transformation of microalgae has advantages over terrestrial biomass:

- Oil, proteins, pigments, sugar yields per hectare could be much higher than those of crops. For example, at the laboratory stage, oil yields per hectare were 20 to 30 times higher than that for terrestrial oilseeds.
- Cultivated areas do not need to be arable land and therefore do not compete with agricultural land.
- The growth of lipids algae requires large amounts of CO₂, which opens up prospects for the recycling of CO₂ emitted by factories or thermal power stations.

However, several difficulties arise for mass production:

- The cultivation requires special conditions of sunshine and water availability, which limits the possible locations.
- It is also needy in nutrients (nitrates and phosphates) and in carbon dioxide.
- Algorefinery downstream (pre-treatment - extraction – purification) consumes a lot of energy [173].

Various coupling schemes for extraction techniques, pretreatment and separation are reported in the literature in order to obtain extracts rich in primary components (lipids, proteins, pigments).

The downstream process requires a sequence of unit operations starting from pre-treating the biomass by a chemical/ mechanical disintegration of the microalgal cell wall. This allows an easier intracellular access of the extraction solvent, and contributes in enhancing the recovery yield of the dedicated biomolecules. As known, disintegration methods are preferred due to the acceleration of mechanism, but these methods are energy demanding and overheat the molecules, which require cooling along the process to avoid denaturation or thermal degradation and then generate additional cost [29].

After the step of pre-treatment and extraction comes the purification stage, which is challenging step for many scientist at lab and at industrial scale.

1.12. Conclusion and thesis action plan

The state of art established in this chapter has shown that microalgae represented an important renewable source for proteins, pigments and lipids.

However many locks are to be lifted to assure as possible an environment/ economic viability of this process. The pre-treatment and extraction conditions of components of interest remain an important bottle neck in the downstream processes. Nowadays deficiencies in the field of extraction from dry microalgae are still faced.

Currently, pretreatment conducted before supercritical fluid extraction processes requires significant energy consumption, addition of subsequent steps for separation and purification of the desired components from other co-extracted components, and increases the percentage of defected final products due to mechanical or thermal effect. In view of this, it appears necessary to make improvement to current practices and to move towards improved and ameliorated processes.

Thus, first, extraction from **dry microalgae** will be carried out using supercritical fluid technique according to the following approaches:

- Cell wall disintegration step is avoided during whole process : after reducing the water content below 2%, an extraction with carbon dioxide as solvent without any previous cell disintegration could be performed to recover only reserve lipids (neutral lipids) without structural lipids (glycolipids and phospholipids) or emulsions formation from *Chlorella vulgaris* and *Nannochloropsis oculata*.
- Process of reserve lipid (neutral lipids) purification will be therefore easier to implement.
- Contrarily to previous studies, supercritical extraction residues composed of defatted cells will not undergo any further disruption. Intracellular hydrophilic components especially proteins will be recovered by a double stage aqueous/alkali extraction.
- Proteins purification from co-extracted hydrophilic components will be executed using membrane process.

To summarize, the process scheme for dry microalgae treatment is the following (Figure 29):

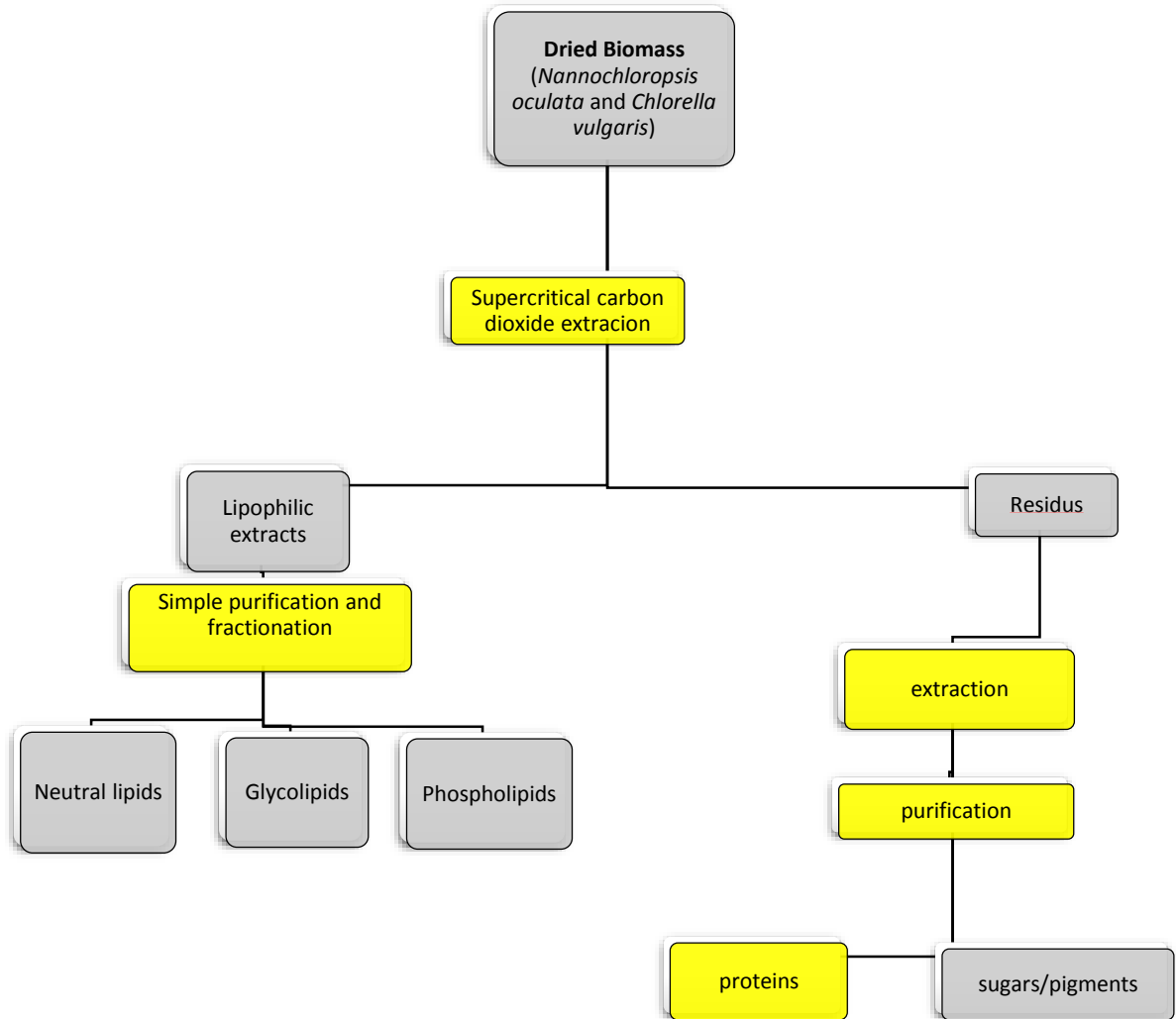

Figure 29 - Process scheme for dry biomass treatment (highlighted in yellow).

Since dry microalgae generates a consequent energy cost and systematic step prior to the extraction, we propose a second scheme constituted of a sequence of extraction/ purification operations implemented on **humid biomass** in order to obtain separated enriched fractions of the biomolecules lipids, pigments and proteins.

Thus, extraction from **wet microalgae** will be performed using ultrasound assisted extraction technique according to the following approach:

- This process starts with breaking the cell wall in an aqueous medium containing between 5% of dry matter.

- New innovative parameters (low power, low frequency) will be used to achieve some intensification and optimization of ultrasound assisted extraction technique
- An emulsified mixture mainly composed of lipids, proteins, pigments will undergo variant purification techniques to obtain specific enriched fractions
- Also, understanding the degree of cell wall resistance will be equivalent to the “selective extraction” to obtain specific enriched compound.

To summarize, our second process scheme for humid microalgae is the following (Figure 30):

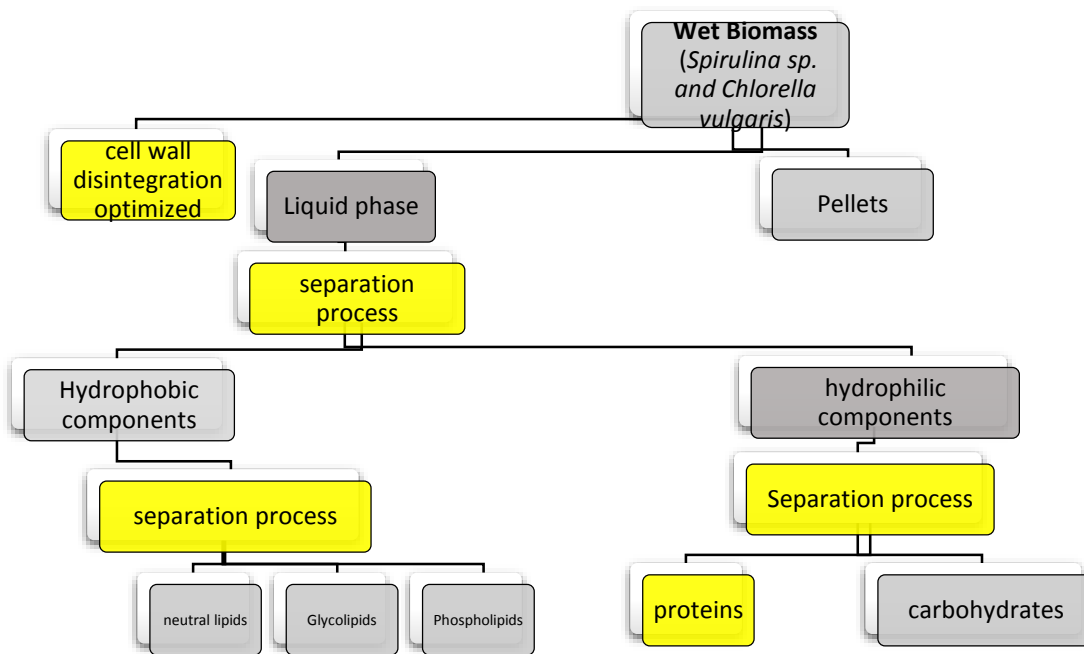

Figure 30 - Process scheme for the wet biomass treatment (highlighted in yellow).

Chapter 2: Materials and methods

2.1. Microalgal biomass

Experiments were carried out on three species of microalgae; each of them have morphological characteristics (constitution of membranes and walls) and different lipids content: *Chlorella vulgaris*, *Nannochloropsis oculata* and *Spirulina sp.*

- *Chlorella vulgaris* and *Nannochloropsis oculata*

The strains used in the framework of this thesis were provided by Alpha Biotech (Assérac, France). *Chlorella vulgaris* (strain SAG 211-19) was cultivated under stressful conditions in Sueoka media under conditions of high N nutrient concentration to favor proteins accumulation. Whereas *Nannochloropsis oculata* was cultured in modified Conway media under conditions of N nutrient deficiency to favor the accumulation of reserve lipids. This microalga has a predisposition to easily store lipids and more particularly neutral lipids; therefore, it is considered a promising microalga for bioenergy application. The biomasses were harvested, centrifuged to obtain an “algal paste” at 20-24% dry matter and then frozen at -20°C. The frozen paste of crude microalgae was freeze-dried in a Fisher Bioblock Scientific Alpha 2–4 LD Plus device (Illkirch, France). During freeze drying, the pressure was reduced to 0.01 bar, and the temperature decreased to -80°C for 48 h to give a completely dry biomass.

- *Spirulina sp.*

The experiments were performed on fresh filamentous *Spirulina sp.* provided in culture media at a concentration of 5% (dry matter) and provided from Alg&You company (Toulouse, France). Fractions of the culture has been frozen at -18° C then freeze-dried by a Fisher Bioblock Scientific Alpha 2-4 LD Plus device (Illkirch, France). After reducing pressure to 0.010 bar, the temperature further decreased to -80°C and freeze drying was conducted under vacuum for 48 h to give dry *Spirulina sp.* biomass.

2.2. Biomass quantification

Dry mass

For dry mass quantification, a few grams of the algal biomass was dried at 110 ° C for 20-24 h until stabilization of the mass (weighing).

Freeze-drying

Freeze-drying consists of removing the water from the microalgal biomass using freezing condition, followed by evaporation under vacuum. When the water is heated to a solid state at very low pressure, the water sublimates and goes into the gaseous state (water vapor). This vapor which is released from the microalgal biomass, is captured thanks to a condenser. This technique permits to preserve the quality of the microalgae which is then freeze-dried. This method permits at a high degree to keep the molecular structure of the different molecules in the native state. During freeze drying, the pressure was reduced to 0.010 bar, the temperature further decreased to 80°C, for 48 hours to give a completely dry biomass (Figure 31).

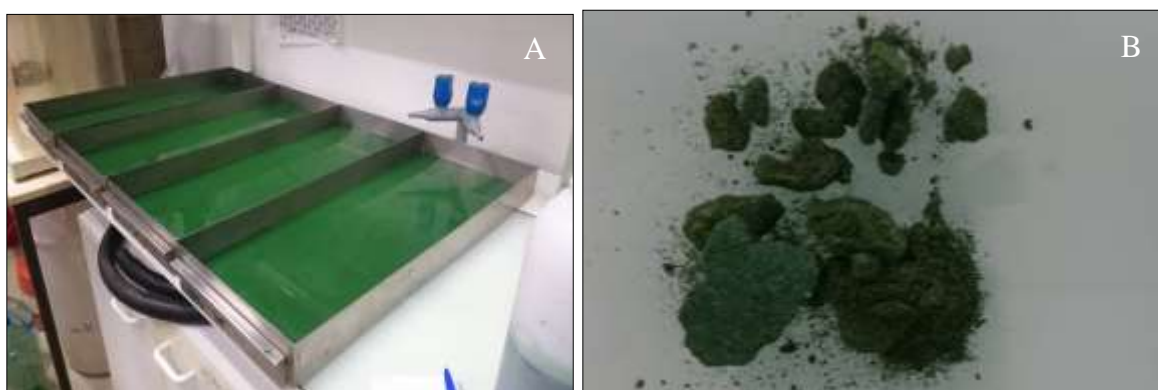

Figure 31-*Spirulina sp.* (A) before, (B) after freeze drying process.

2.3. Extraction methods

2.3.1. Total lipids content: Conventional extraction according to modified Bligh and Dyer method

The so-called conventional reference extractions are carried out using the modified Bligh and Dyer and Folch methods using a mixture of chloroform/methanol (0.35 / 0.65, V/V) [174], [175]. The solid biomass was placed in a filter paper which is then placed in the main chamber of the Soxhlet extractor. 3 mg of dried microalgae are weighed and placed in a 30 x 80 mm cellulose cartridge

(Macherey-Nagel). The Soxhlet device is positioned on a 500 mL distillation flask containing 250 mL solvent (Figure 32). Soluble components (lipids) were slowly transferred to the solvent. After extraction cycles of 1, 2, 6 and 18 hours, the solvent is evaporated under vacuum. The mixture of lipid extracts was then isolated, dried and weighted using a precision balance.

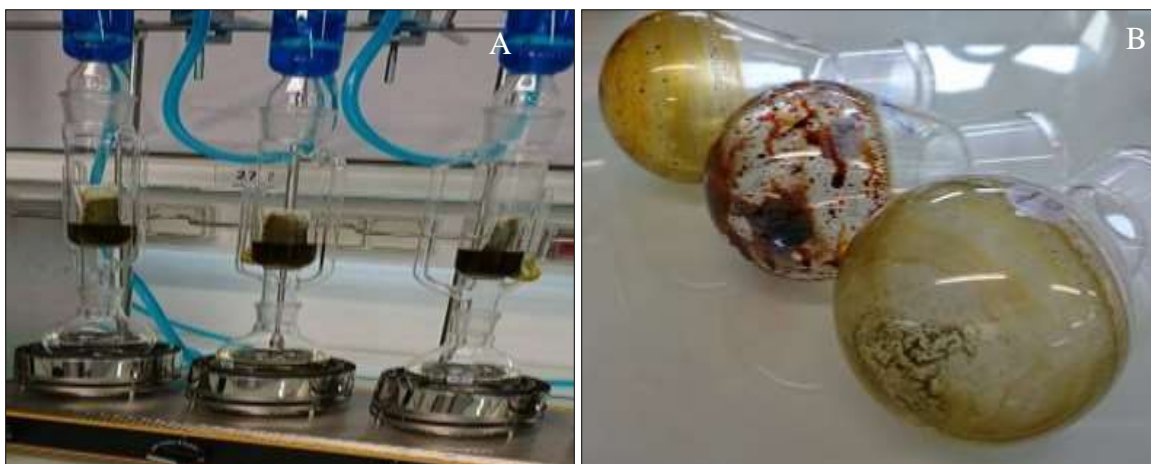

Figure 32- Total lipid extraction from *Chlorella vulgaris*, *Nannochloropsis oculata* and *Spirulina sp.* using modified (Bligh and Dyer,1959) extraction method, (A): Soxhlet apparatus, (B): extracted lipids.

2.3.2. Supercritical CO₂ extraction

The various extractions with ScCO₂ were carried out at the Chemical Engineering Laboratory (LGC, Toulouse) on a pilot unit (SFE100, Separex Chimie fine, France) capable of working at pressures up to 1000 Bar and temperatures up to 250 °C.

Few grams of microalgae is initially introduced into a cell which is then placed within the extractor. The cell is closed by two metal frits allowing the passage of the solvent and the extract while retaining the solid material. Two fiberglass filters are added to retain some fine particles that can form any clogging. Once the extractor has reached the desired temperature, the module is supplied with liquid CO₂ via a pump which is maintained at a temperature below 7 °C to keep the CO₂ in the liquid state. The CO₂ then enters the extractor where temperature and pressure rise. The pressure is controlled by a regulator. Ethanol may be introduced at the extractor inlet as a co-solvent or as a cleaning fluid if it is introduced at the outlet of the extractor (Figure 33). To follow the development of lipids extraction process in the course of time, samples are taken periodically to be analyzed. The operating conditions are shown in Table 6. Several extractions were performed

by varying the working pressure and the presence or absence of co-solvent. A double extraction was also carried out. This consists of a first ScCO₂ extraction followed by a second ScCO₂ extraction with ethanol (10%).

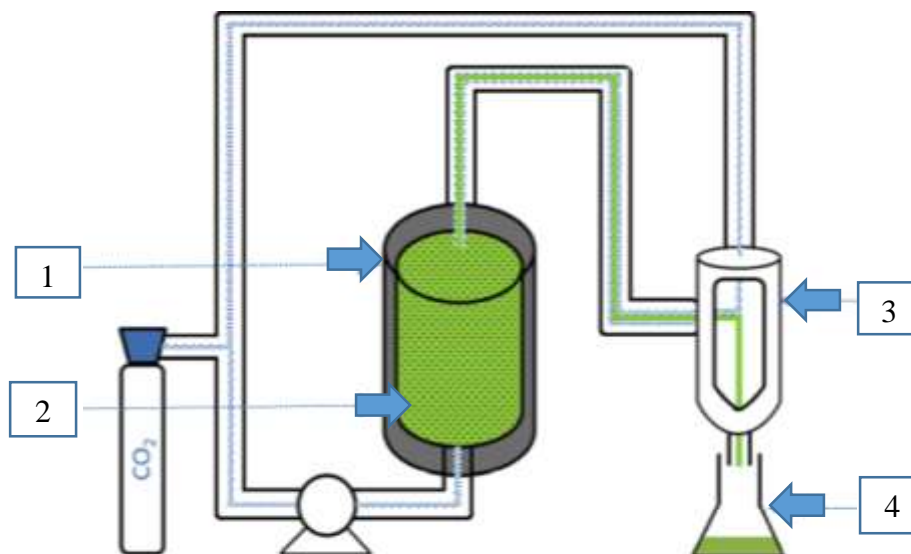

Figure 33- Simplified scheme of ScCO₂ extraction. 1: Autoclave, 2: Biomass, 3: Separator, 4: Extracts.

Table 6- Operating conditions used in ScCO₂ extractions performed on microalgae. T = 50°C; P = 250 bar; CO₂ flow rate = 25 g/min.

<i>Microalgae</i>	T (°C)	P (bar)	CO ₂ flow rate (g/min)	Biomass (g)	Solvent rate (min ⁻¹)*	Ethanol as co-solvent	Ethanol flow rate (g/min)	Operation time (min)
Simple Extraction								
<i>C. vulgaris</i>	50	250	25	12.1	0.45	Yes	1.9	230
<i>N. oculata</i>	50	250	25	25.4	1.02	No	-	210
<i>N. oculata</i>	50	450	25	8.8	0.35	No	-	240
<i>N. oculata</i>	50	750	25	8.8	0.35	No	-	240
Double Extraction								
<i>C. vulgaris</i>	50	250	25	25.4	1.02	No	-	210
<i>Residue</i>	50	250	25	23.4	0.87	Yes	1.9	210

2.3.3. Ultrasound

The extraction tests were carried out using a SinapTec unit (Figure 34) located at the Chemical Engineering Laboratory. This device consists of a generator that brings the power imposed by NexTgen software which is transformed from electrical energy into acoustics through a transducer. Vibration ranges at 12 kHz or 20 kHz is therefore transmitted by the probe into the reactor which is equipped with a stirrer for homogenizing the microalgae permanently. However, these ultrasounds, acting on the product, cause an increase in the temperature in the reactor, and therefore require a cooling system to control the temperature. In addition, a nitrogen inlet was installed in order to act on the pressure in the reactor.

An experimental plan was carried out in order to highlight the factors influencing the *Spirulina sp.* (Table) and *Chlorella vulgaris* (Table) proteins extractions in order to optimize the process thereafter. Four factors were varied in this study: agitation, frequency, pressure and power. A kinetic study is also planned to evaluate if the 60 minutes of operation are necessary or if the extraction could be optimally performed earlier.



Figure 34- Ultrasound assisted extraction unit.

Table 7- Ultrasound assisted extraction conditions for *Spirulina sp.* (relative pressure- power- stirring rate) and biomass pre-treatment (fresh- lyophilized- frozen).

Experiment code	Time	Stirring rate (rpm)	Relative pressure (bar)	Power (watt)	Frequency (kHz)	Biomass pretreatment
F03	60	500	0	300	12	Fresh
F01	60	500	0	100	12	Fresh
F02	60	500	0	200	12	Fresh
F03	60	500	0	300	12	Fresh
F1,51	60	500	1.5	100	12	Fresh
F31	60	500	3	100	12	Fresh
F33	60	500	3	300	12	Fresh
F01	60	500	0	100	12	Fresh
F01	10	500	0	100	12	Fresh
F31	60	500	3	100	20	Fresh
F01	60	500	0	100	20	Fresh
C00	60	500	0	0	0	Frozen
C00	60	500	0	0	12	Frozen
C01	60	500	0	100	12	Frozen
C02	60	500	0	200	12	Frozen
C03	60	500	0	300	12	Frozen
C1.51	60	500	1.5	100	12	Frozen
C1.53	60	500	1.5	300	12	Frozen
C31	60	500	3	100	12	Frozen
L00	0	0	0	0	12	Freeze-dried
L00	60	60	0	0	12	Freeze-dried

Table 8- Ultrasound assisted extraction conditions of frozen-unfrozen *Chlorella vulgaris*: relative pressure, ultrasound power and stirring rate

Experiment code	Time (min)	Stirring rate (rpm)	Relative pressure (bar)	Power (watt)
P0W0-t0	0	0	0	0
P0W0	60	500	0	0
P0W100	60	500	0	100
P0W300	60	500	0	300
P3W100	60	500	3	100

2.3.4. Total pigments extraction

There are different types of pigments in *Chlorella vulgaris*, *Nannochloropsis oculata* and *Spirulina sp.* used strains. These can be classified into two categories: chlorophylls and carotenoids. We did focus on certain pigments in particular: chlorophylls a and b, lutein and β -carotene. Extraction was carried out in cold conditions to protect them from heat denaturation. One gram of microalga was mixed with specific solvent during 24 min at 10 °C with continuous gentle stirring. Ethanol was used as extraction solvent for chlorophylls a and b, whereas β -carotene and lutein were extracted using ethanol. In aim to inhibit any photo degradation during extraction, glass tubes were covered with aluminum paper. Supernatants were taken for analysis after centrifugation under 20,000g for 15 min at 5°C.

2.4. Purification technique: ultrafiltration

The membranes used on this pilot unit are polysulfone flat membranes the cutoff threshold is given at 10- 30- 100 kDa). The membranes were abundantly rinsed with ultrapure water, a crucial step necessary before any use. These membranes are supplied in the form of A4 sheets and then cut manually to fit into the filtration cell (30.2 cm² filtration area). . The pilot unit consists of a 200 mL filtration cell (Amicon® Stirred Cells) housing flat membranes diameter corresponding to a useful area of 30.2 cm² (Figures 35 and 36). This filtration unit offers a small filter surface which makes it possible to study the filtration of relatively small quantities (from 50 mL). In addition, a stirring over the membrane was also applied to minimize concentration polarization effect due to the accumulation of macromolecules at the membrane surface. Experiments were carried out under a trans-membrane pressure from 0.5 to 4 bar.

The remaining suspension is removed gently and the cell is rinsed with ultrapure water with the greatest care. This is repeated three times to ensure complete elimination of the compounds present in the disperse phase.

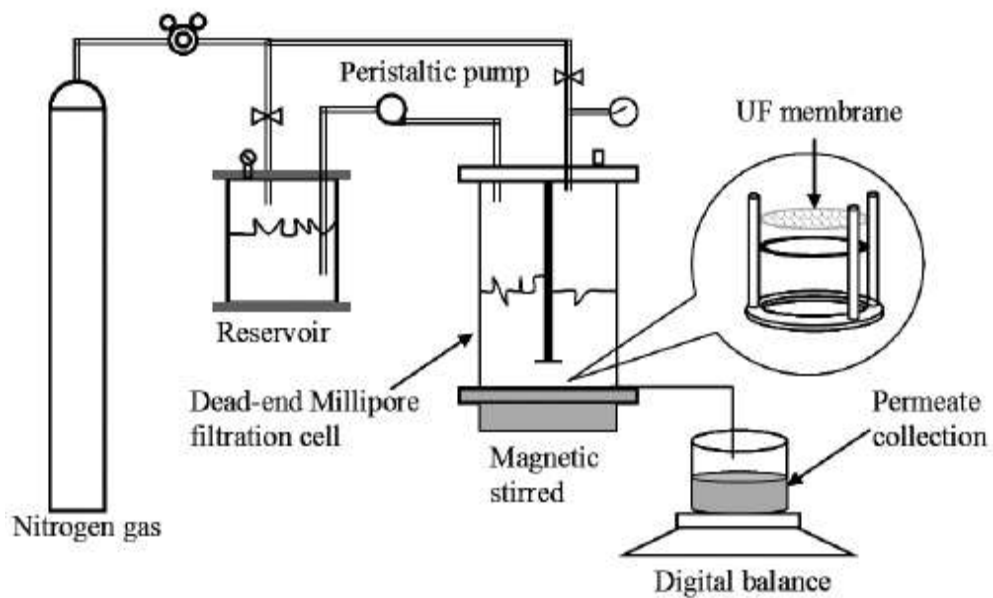

Figure 35- Schematic of dead-end stirred filtration system.



Figure 36- New Millipore Amicon Stirred ultrafiltration cell.

2.5. Analytical techniques

2.5.1. Proteins analysis

2.5.1.1. Total proteins content (Kjeldahl Method)

Total proteins content of the studied biomasses was quantified according to Kjeldahl Method. This analysis method consist of carrying out a mineralization of the organic material by sulfuric acid in the presence of a catalyst, alkalization of the reaction products, distillation and titration of the ammonia released.

The Kjeldahl nitrogen from the biomasses is first converted to ammonia by acid digestion in a batch of mineralization. The addition of a strong base makes it possible to release the ammonia which is then driven by steam and then trapped in a solution of boric acid. The ammonia is then determined by a sulfuric acid solution of known title. The equivalence point is identified by the color change of an indicator. The crude proteins content of the microalgal studied stains is obtained by multiplying the value obtained when determining the nitrogen content by the factor of 6.15 [175].

2.5.1.2. Colorimetric Method: Lowry Method for water-soluble proteins quantification

For solid samples, extraction with sodium hydroxide is necessary in order to solubilize the water-soluble proteins. In the laboratory, this extraction is generally carried out with sodium hydroxide solution at pH 11 for one hour at 40°C. Once the proteins are extracted, the samples are either centrifuged for 10 min at 10,000 g, or filtered by PTF filters with a pore diameter of 0.45 nm. The different methods were compared in situ and showed little difference.

The Lowry method [176] was used to quantify the water-soluble proteins released into the medium. The samples are initially treated with an alkaline cupric reagent (Lowry reagent) before reacting with the phosphotungstomolybdic reagent (Folin reagent: Sigma Aldrich). The Folin reagent is composed of sodium tungstate and sodium molybdate in solution in phosphoric acid and hydrochloric acid (Folin & Ciocalteu's phenol reagent: Sigma Aldrich). This reagent allows the reduction of aromatic amino acids (tyrosine and tryptophan), leading to the formation of a dark blue colored complex whose absorbance can be measured at 750 nm. The standard range is 0 to 1.2 mg.mL⁻¹ with a stock solution of bovin serum albumin

50 μL of sample are mixed with 1000 μL of Lowry reagent and incubated for 10 min at room temperature in the dark. After 10 min, 100 μL of diluted Folin reagent is added to the reaction mixture before allowing the tubes to incubate in the dark for 30 min at room temperature. The optical density is measured at 750 nm (UV-Vis spectrophotometer 1800, Shimadzu).

2.5.2. SDS-PAGE Analysis

SDS-PAGE or electrophoresis on polyacrylamide gel in the presence of sodium dodecyl sulphate, is a known technique used for the separation of protein mixtures, based on their molecular weight only. SDS, an anionic detergent, is used to produce an equal charge to the proteins by loading them into a gel made of polyacrylamide and then applying an electric field to the gel. The electric field plays the driving force. The larger proteins moving more slowly than the small proteins. In order to identify proteins by their weight, proteins standards of known weight are loaded in parallel with the samples and undergo the same conditions. 10 microliters of proteins solutions containing 2 g of protein/l in buffer solution (containing 0.05% bromophenol blue) were loaded onto the gel, and electrophoresis was performed at a constant current of 45 mA per gel for approximately 60 min, using a power supply (Bio-Rad, Bio-Rad Laboratories, Hercules, California, USA). A standard solution, containing proteins with molecular sizes ranging from 6.5 to 200 kDa (mysosin 200 kDa, β -galactosidase 116.25 kDa, phosphorylase B 97.4 kDa, serum albumin 66.2 kDa, ovalbumin 45 kDa, carbonic anhydrase 31 kDa, trypsin inhibitor 21.5 kDa, lysozyme 14.4 kDa, and aprotinin 6.5 kDa), was also applied for molecular size comparison.

2.5.3. Size exclusion chromatography

SEC is a separation method. Unlike HPLC which plays on the affinities between the two phases, the SEC relies on the difference in sizes of the particles present in the solution. The column used is a packing column, which will help retain some molecules rather than others. These molecules will be separated from the largest to the smallest size.

Unlike HPLC, sample concentration and injection volume need to be higher because of a larger column and a lower flow rate. Another difference is the temperature. While liquid chromatography will play a huge role on temperature gradients to optimize separation and avoid co-elution, the SEC will maintain a constant temperature throughout the analysis to avoid possible denaturation of proteins.

Chromatographic conditions

The tests were carried out on the same installation as for the determination of the pigments. The difference comes from the column and conditions used:

- Column: SunFire Waters
- Solvent: 100% phosphate buffer
- Flow rate: 0.7 mL / min
- Temperature: 30 ° C
- Duration: 30 min
- Wavelength: 220 nm, 280 nm, 620 nm

2.5.4. Lipids analysis

Fractionation of lipids by solid phase extraction (SPE)

Fractionation of lipid extracts is a particularly important step in identifying the biomass content in neutral lipids, glycolipids and phospholipids on the first hand, and validating the supercritical extraction efficiency and selectivity on the other hand . Solid phase extraction (SPE) described by Juaneda and Rocqueline [177] (Figure 37) is a technique used because of its speed and efficiency. At the beginning, it is necessary to condition the cartridge by percolating a volume of chloroform in order to activate the cartridges. The cartridge should not dry before depositing the lipids extract. The principle necessitates to depose the lipids extract on the stationary phase slowly before starting the fractionation.

To separate the lipid fractions, passing a specific eluent solvent for each fraction is the key step. Elution of the neutral lipids, glycolipids and phospholipids is carried out with a suitable volume of chloroform, methanol and acetone.

The compounds thus eluted were taken for dosage. It was necessary to dry out the fractions under cold nitrogen before weighing.



Figure 37- Solid Phase Extraction (SPE) technique showing the partitioning of lipids to three classes neutral lipids, glycolipids and phospholipid.

Green microalgae usually contained neutral lipids (non-polar) and glycolipids and phospholipids (polar lipids) at numerous mg per gram of biomass. The proposed SPE extraction method would be useful for the analysis of different lipids classes originally presented in the two microalgae and in the ScCO₂ extracts.

Partitioning of lipids to three classes neutral lipids, glycolipids and phospholipid was possible by eluting them with 10 ml of chloroform, acetone and methanol respectively, using SPE silica cartridges Supelco (500 mg, Sigma-Aldrich). Once eluted and freeze-dried under liquid nitrogen, fractions were measured gravimetrically and expressed in mg/g dry weigh.

2.5.5. Pigment analysis

Total pigments quantification

Total pigment (chlorophylls a and b, β-carotenes and lutein) content was measured according to the general formula developed by Bidigare [178] and mentioned value in (table 9):

$$C(\text{mg/L}) = \frac{\text{OD} \cdot 1000}{\alpha \cdot L} \text{ Where:}$$

- **OD** is optical density read at the specific wavelength in a given solvent
- **α** is the specific extinction coefficient (L g⁻¹cm⁻¹)
- **L** is the optical path length (cuvettes) in cm which is 1 cm

Table 9- Extinction coefficients α of the chlorophylls pigments (a, b) and carotenoids (β -carotene, lutein) and maximal absorption peaks.

	wavelength (nm)	specific extinction coefficient α (L g ⁻¹ cm ⁻¹)	Solvent	References
Chlorophyll a	665	77,9	Methanol	[179] [180]
Chlorophyll b	642	44,5	Methanol	[179] [180]
β -carotene	453	262	Ethanol	[180] [181]
Luteins	445	255	Ethanol	[180] [181]

Preparation of the standards

The pure standard pigments: chlorophylls pigments (a, b) and carotenoids (β -carotene, lutein) necessary for the identification of the compounds in the extract were purchased commercially from Sigma-Aldrich. Standard solutions have been prepared and operative solutions were made by diluting standard solutions with methanol.

Pigments standards usually supplied in powder form, are solubilized in acetone to form a storage solution and kept at -20°C. The mother solution for producing the standards is obtained by diluting the storage solution in methanol. The stock solutions of each pigment was 5 mg/L. The standard solutions have a concentration between 0.5 and 5 mg/L.

High Performance Liquid Chromatography for pigments analysis

High Performance Liquid Chromatography (HPLC) is more frequently used as an analytical separation technique based on the hydrophobicity of the molecules of a compound or a mixture of compounds. The sample to be analyzed is eluted a mobile phase in a column filled with a stationary phase composed of very fine solid grains. The flow of eluent is provided by a high pressure pump. In the column, the various pigments in the sample are separated from each other because of their various affinities with respect to both phases - stationary and mobile (Table 10). At the exit of the column the compounds are detected using a detector. In our studies, UV detectors based on the measurement of the wavelength of the compounds were used.

The HPLC system used for this study consists of:

- Dionex P680 quaternary pump
- Dionex ASI-100 autosampler
- Ultimate 3000 thermostated column compartment
- UV-DAD ThermoScientific Ultimate 3000 detector

Chromatography conditions

- Column: C18 reverse phase
- Solvent: Methanol/ Acetone/ Water (proportions vary according to the experiment)
- Flow rate: 1 mL / min
- Temperature: 40 ° C
- Duration: 30 min
- Wavelength: full spectrum

Table 10: Gradient of solvents for HPLC

Time / Solvent	Acetone	Methanol	Water
1 min	55	25	20
22 min	80	12	8
25 min	83	11	6
27 min	100	0	0
30 min	55	25	20

References

- [1] R. Chaiklahan et al., "Separation and purification of phycocyanin from *Spirulina* sp. using a membrane process," *Bioresource Technology*, vol. 102, no. 14, pp. 7159–7164, Jul. 2011.
- [2] S. Buono, A. L. Langellotti, A. Martello, F. Rinna, and V. Fogliano, "Functional ingredients from microalgae," *Food Funct.*, vol. 5, no. 8, pp. 1669–1685, Jul. 2014.
- [3] Q. Hu et al., "Microalgal triacylglycerols as feedstocks for biofuel production: perspectives and advances," *The Plant Journal*, vol. 54, no. 4, pp. 621–639.
- [4] P. Spolaore, C. Joannis-Cassan, E. Duran, and A. Isambert, "Commercial applications of microalgae," *Journal of Bioscience and Bioengineering*, vol. 101, no. 2, pp. 87–96, Feb. 2006.
- [5] E. W. Becker, "Micro-algae as a source of protein," *Biotechnology Advances*, vol. 25, no. 2, pp. 207–210, Mar. 2007.
- [6] Y. Li, M. Horsman, N. Wu, C. Q. Lan, and N. Dubois-Calero, "Biofuels from Microalgae," *Biotechnology Progress*, vol. 24, no. 4, pp. 815–820, Jul. 2008.
- [7] T. M. Mata, A. A. Martins, and N. S. Caetano, "Microalgae for biodiesel production and other applications: A review," *Renewable and Sustainable Energy Reviews*, vol. 14, no. 1, pp. 217–232, Jan. 2010.
- [8] M. A. Borowitzka, "High-value products from microalgae—their development and commercialisation," *J Appl Phycol*, vol. 25, no. 3, pp. 743–756, Jun. 2013.
- [9] M. Viganì et al., "Food and feed products from micro-algae: Market opportunities and challenges for the EU," *Trends in Food Science & Technology*, vol. 42, no. 1, pp. 81–92, Mar. 2015.
- [10] I. Priyadarshani and B. Rath, "Commercial and industrial applications of micro algae – A review," p. 12, 2012.
- [11] H. G. Gerken, B. Donohoe, and E. P. Knoshaug, "Enzymatic cell wall degradation of *Chlorella vulgaris* and other microalgae for biofuels production," *Planta*, vol. 237, no. 1, pp. 239–253, Jan. 2013.
- [12] C. Safi et al., "Aqueous extraction of proteins from microalgae: Effect of different cell disruption methods," *Algal Research*, vol. 3, pp. 61–65, Jan. 2014.
- [13] P. D. Patil, K. P. R. Dandamudi, J. Wang, Q. Deng, and S. Deng, "Extraction of bio-oils from algae with supercritical carbon dioxide and co-solvents," *The Journal of Supercritical Fluids*, vol. 135, pp. 60–68, May 2018.
- [14] C.-H. Cheng, T.-B. Du, H.-C. Pi, S.-M. Jang, Y.-H. Lin, and H.-T. Lee, "Comparative study of lipid extraction from microalgae by organic solvent and supercritical CO₂," *Bioresource Technology*, vol. 102, no. 21, pp. 10151–10153, Nov. 2011.
- [15] Y.-M. Dai, K.-T. Chen, and C.-C. Chen, "Study of the microwave lipid extraction from microalgae for biodiesel production," *Chemical Engineering Journal*, vol. 250, pp. 267–273, Aug. 2014.

- [16] C. Juin *et al.*, “Microwave-Assisted Extraction of Phycobiliproteins from *Porphyridium purpureum*,” *Appl Biochem Biotechnol*, vol. 175, no. 1, pp. 1–15, Jan. 2015.
- [17] R. D. P. Rodrigues, F. C. de Castro, R. S. de Santiago-Aguiar, and M. V. P. Rocha, “Ultrasound-assisted extraction of phycobiliproteins from *Spirulina (Arthrospira) platensis* using protic ionic liquids as solvent,” *Algal Research*, vol. 31, pp. 454–462, Apr. 2018.
- [18] Nobre *et al.*, “A biorefinery from *Nannochloropsis* sp. microalga – Extraction of oils and pigments. Production of biohydrogen from the leftover biomass,” *Bioresource Technology*, vol. 135, pp. 128–136, May 2013.
- [19] V. Pasquet *et al.*, “Study on the microalgal pigments extraction process: Performance of microwave assisted extraction,” *Process Biochemistry*, vol. 46, no. 1, pp. 59–67, Jan. 2011.
- [20] D.-Y. Kim *et al.*, “Cell-wall disruption and lipid/astaxanthin extraction from microalgae: *Chlorella* and *Haematococcus*,” *Bioresource Technology*, vol. 199, pp. 300–310, Jan. 2016.
- [21] A. Molino *et al.*, “Extraction of astaxanthin from microalga *Haematococcus pluvialis* in red phase by using generally recognized as safe solvents and accelerated extraction,” *Journal of Biotechnology*, vol. 283, pp. 51–61, Oct. 2018.
- [22] M. M. Eldalatony *et al.*, “Pretreatment of microalgal biomass for enhanced recovery/extraction of reducing sugars and proteins,” *Bioprocess Biosyst Eng*, vol. 39, no. 1, pp. 95–103, Jan. 2016.
- [23] R. Seetharam and S. K. Sharma, *Purification and Analysis of Recombinant Proteins*. CRC Press, 1991.
- [24] J. Doucha and K. Lívanský, “Influence of processing parameters on disintegration of *Chlorella* cells in various types of homogenizers,” *Appl Microbiol Biotechnol*, vol. 81, no. 3, p. 431, Dec. 2008.
- [25] Y. W. Sari, M. E. Bruins, and J. P. M. Sanders, “Enzyme assisted protein extraction from rapeseed, soybean, and microalgae meals,” *Industrial Crops and Products*, vol. 43, pp. 78–83, May 2013.
- [26] L. Brennan and P. Owende, “Biofuels from microalgae—A review of technologies for production, processing, and extractions of biofuels and co-products,” *Renewable and Sustainable Energy Reviews*, vol. 14, no. 2, pp. 557–577, Feb. 2010.
- [27] J.-Y. Lee, C. Yoo, S.-Y. Jun, C.-Y. Ahn, and H.-M. Oh, “Comparison of several methods for effective lipid extraction from microalgae,” *Bioresource Technology*, vol. 101, no. 1, Supplement, pp. S75–S77, Jan. 2010.
- [28] S. P. Nalawade, F. Picchioni, and L. P. B. M. Janssen, “Supercritical carbon dioxide as a green solvent for processing polymer melts: Processing aspects and applications,” *Progress in Polymer Science*, vol. 31, no. 1, pp. 19–43, Jan. 2006.
- [29] J. Kim *et al.*, “Methods of downstream processing for the production of biodiesel from microalgae,” *Biotechnology Advances*, vol. 31, no. 6, pp. 862–876, Nov. 2013.
- [30] Z. Duan, X. Tan, K. Dai, H. Gu, and H. Yang, “Evaluation on H₂O₂-aided ultrasonic pretreatment for cell disruption of *Chlorella pyrenoidosa*,” *Asia-Pacific Journal of Chemical Engineering*, vol. 12, no. 3, pp. 502–510.

- [31] F. Chemat, N. Rombaut, A.-G. Sicaire, A. Meullemiestre, A.-S. Fabiano-Tixier, and M. Abert-Vian, "Ultrasound assisted extraction of food and natural products. Mechanisms, techniques, combinations, protocols and applications. A review," *Ultrasonics Sonochemistry*, vol. 34, pp. 540–560, Jan. 2017.
- [32] bilad et al., "Membrane technology in microalgae cultivation and harvesting: A review," *Biotechnology Advances*, vol. 32, no. 7, pp. 1283–1300, Nov. 2014.
- [33] Gerardo et al., "Integration of membrane technology in microalgae biorefineries," *Journal of Membrane Science*, vol. 464, pp. 86–99, Aug. 2014.
- [34] Zhang et al., "Harvesting algal biomass for biofuels using ultrafiltration membranes," *Bioresource Technology*, vol. 101, no. 14, pp. 5297–5304, Jul. 2010.
- [35] Marcati et al., "Extraction and fractionation of polysaccharides and B-phycoerythrin from the microalga *Porphyridium cruentum* by membrane technology," *Algal Research*, vol. 5, pp. 258–263, Jul. 2014.
- [36] Patel et al., "Separation and fractionation of exopolysaccharides from *Porphyridium cruentum*," *Bioresource Technology*, vol. 145, pp. 345–350, Oct. 2013.
- [37] Pugh et al., "Isolation of Three High Molecular Weight Polysaccharide Preparations with Potent Immunostimulatory Activity from *Spirulina platensis*, *Aphanizomenon flos-aquae* and *Chlorella pyrenoidosa* | Request PDF," *ResearchGate*. [Online]. Available: https://www.researchgate.net/publication/11624110_Isolation_of_Three_High_Molecular_Weight_Polysaccharide_Preparations_with_Potent_Immunostimulatory_Activity_from_Spirulina_platensis_Aphanizomenon_flos-aquae_and_Chlorella_pyrenoidosa. [Accessed: 22-Aug-2018].
- [38] Ba, Fatou, Ursu, Alina Violetta, Laroche, Celine, and Djelveh, Gholamreza, "Haematococcus pluvialis soluble proteins: Extraction, characterization, concentration/fractionation and emulsifying properties," *Bioresource Technology*, vol. 200, pp. 147–152, Jan. 2016.
- [39] A.-V. Ursu, A. Marcati, T. Sayd, V. Sante-Lhoutellier, G. Djelveh, and P. Michaud, "Extraction, fractionation and functional properties of proteins from the microalgae *Chlorella vulgaris*," *Bioresource Technology*, vol. 157, pp. 134–139, Apr. 2014.
- [40] Soni et al., "Extraction, purification and characterization of phycocyanin from *Oscillatoria quadripunctulata*—Isolated from the rocky shores of Bet-Dwarka, Gujarat, India," *Process Biochemistry*, vol. 41, no. 9, pp. 2017–2023, Sep. 2006.
- [41] A. G. Waghmare, M. K. Salve, J. G. LeBlanc, and S. S. Arya, "Concentration and characterization of microalgae proteins from *Chlorella pyrenoidosa*," *Bioresour. Bioprocess.*, vol. 3, no. 1, p. 16, Mar. 2016.
- [42] J. Heo, D.-H. Cho, R. Ramanan, H.-M. Oh, and H.-S. Kim, "PhotoBiobox: A tablet sized, low-cost, high throughput photobioreactor for microalgal screening and culture optimization for growth, lipid content and CO₂ sequestration," *Biochemical Engineering Journal*, vol. 103, pp. 193–197, Nov. 2015.

- [43] A. Richmond, *Handbook of Microalgal Culture: Biotechnology and Applied Phycology*. John Wiley & Sons, 2008.
- [44] M. B. Johnson and Z. Wen, “Production of Biodiesel Fuel from the Microalga *Schizochytrium limacinum* by Direct Transesterification of Algal Biomass,” *Energy Fuels*, vol. 23, no. 10, pp. 5179–5183, Oct. 2009.
- [45] G. Becerra-Celis, “Proposition de stratégies de commande pour la culture de microalgues dans un photobioréacteur continu,” phdthesis, Université Paris Sud - Paris XI, 2009.
- [46] L. E. Gonzalez and Y. Bashan, “Increased Growth of the Microalga *Chlorella vulgaris* when Coimmobilized and Cocultured in Alginate Beads with the Plant-Growth-Promoting Bacterium *Azospirillum brasilense*,” *Appl. Environ. Microbiol.*, vol. 66, no. 4, pp. 1527–1531, Apr. 2000.
- [47] J.-P. Cadoret and O. Bernard, “La production de biocarburant lipidique avec des microalgues : promesses et défis,” *J. Soc. Biol.*, vol. 202, no. 3, pp. 201–211, 2008.
- [48] “Daphnia sp. (water flea) and Volvox sp. (green algae) | 2011 Photomicrography Competition | Nikon’s Small World.” [Online]. Available: <https://www.nikonsmallworld.com/galleries/2011-photomicrography-competition/daphnia-sp.-water-flea-and-volvox-sp.-green-algae>. [Accessed: 07-Jul-2018].
- [49] “(<http://micro.magnet.fsu.edu/cells/chloroplasts/chloroplasts.html>) - Yahoo Image Search Results.” [Online]. Available: https://images.search.yahoo.com/search/images;_ylt=AwrNB TBdrj9b1hYA9GZXNy0A;_ylu=X3oDMTB0N2Noc211BGNvbG8DYmYxBHBvcwMxB HZ0aWQDBHNIYwNwaXZz?p=%28http%3A%2F%2Fmicro.magnet.fsu.edu%2Fcells%2Fchloroplasts%2Fchloroplasts.html%29&fr2=piv-web&fr=mcafee#id=4&iurl=https%3A%2F%2Fmicro.magnet.fsu.edu%2Fprimer%2Fflightandcolor%2Fimages%2Fflightenergyfigure3.jpg&action=click. [Accessed: 07-Jul-2018].
- [50] C. Safi, B. Zebib, O. Merah, P.-Y. Pontalier, and C. Vaca-Garcia, “Morphology, composition, production, processing and applications of *Chlorella vulgaris*: A review,” *Renewable and Sustainable Energy Reviews*, vol. 35, pp. 265–278, Jul. 2014.
- [51] F. B. Metting, “Biodiversity and application of microalgae,” *Journal of Industrial Microbiology & Biotechnology*, vol. 17, no. 5–6, pp. 477–489, Nov. 1996.
- [52] M. R. Brown, S. W. Jeffrey, J. K. Volkman, and G. A. Dunstan, “Nutritional properties of microalgae for mariculture,” *Aquaculture*, vol. 151, no. 1, pp. 315–331, May 1997.
- [53] H. V. Ditfurth, *Im Anfang war der Wasserstoff*. Munich: Deutscher Taschenbuch Vrlg, 1972.
- [54] “CiNii Articles - Culturversuche mit Zoochlorellen, Lichenengonidien und anderen niederen Algen.” [Online]. Available: <https://ci.nii.ac.jp/naid/10030356424/>. [Accessed: 07-Jul-2018].
- [55] “*Chlorella vulgaris*.” [Online]. Available: https://botany.natur.cuni.cz/algo/CAUP/H1955_Chlorella_vulgaris.htm. [Accessed: 07-Jul-2018].

- [56] O. Pulz and W. Gross, "Valuable products from biotechnology of microalgae," *Appl Microbiol Biotechnol*, vol. 65, no. 6, pp. 635–648, Nov. 2004.
- [57] M. Soheili and K. Khosravi-Darani, "The Potential Health Benefits of Algae and Micro Algae in Medicine: A Review on *Spirulina platensis*," Nov-2011. [Online]. Available: <https://www.ingentaconnect.com/content/ben/cnf/2011/00000007/00000004/art00007>. [Accessed: 07-Jul-2018].
- [58] T. S. Abu-Rezq, L. Al-Musallam, J. Al-Shimmari, and P. Dias, "Optimum production conditions for different high-quality marine algae," *Hydrobiologia*, vol. 403, no. 0, pp. 97–107, May 1999.
- [59] B. Tamburic, M. Szabó, N.-A. T. Tran, A. W. D. Larkum, D. J. Suggett, and P. J. Ralph, "Action spectra of oxygen production and chlorophyll a fluorescence in the green microalga *Nannochloropsis oculata*," *Bioresource Technology*, vol. 169, pp. 320–327, Oct. 2014.
- [60] "Phycokey-Nannochloropsisimages." [Online]. Available: http://cfb.unh.edu/phycokey/Choices/Eustigmatophyceae/nannochloropsis/Nannochloropsis_Image_page.html. [Accessed: 07-Jul-2018].
- [61] J. D. Wehr, "Algae: Anatomy, Biochemistry, and Biotechnology by Barsanti, L. & Gualtieri, P.," *Journal of Phycology*, vol. 43, no. 2, pp. 412–414.
- [62] G. A. Thompson, "Lipids and membrane function in green algae," *Biochimica et Biophysica Acta (BBA) - Lipids and Lipid Metabolism*, vol. 1302, no. 1, pp. 17–45, Jul. 1996.
- [63] V. M. Dembitsky, O. A. Rozentsvet, and E. E. Pechenkina, "Glycolipids, phospholipids and fatty acids of brown algae species," *Phytochemistry*, vol. 29, no. 11, pp. 3417–3421, Jan. 1990.
- [64] P. Sánchez-Marín, J. Santos-Echeandía, M. Nieto-Cid, X. A. Álvarez-Salgado, and R. Beiras, "Effect of dissolved organic matter (DOM) of contrasting origins on Cu and Pb speciation and toxicity to *Paracentrotus lividus* larvae," *Aquatic Toxicology*, vol. 96, no. 2, pp. 90–102, Jan. 2010.
- [65] V. Evangelista, A. M. Frassanito, V. Passarelli, L. Barsanti, and P. Gualtieri, "Microspectroscopy of the Photosynthetic Compartment of Algae," *Photochemistry and Photobiology*, vol. 82, no. 4, pp. 1039–1046.
- [66] F. Gelin, I. Boogers, A. A. M. Noordeloos, J. S. S. Damste, R. Riegman, and J. W. De Leeuw, "Resistant biomacromolecules in marine microalgae of the classes Eustigmatophyceae and Chlorophyceae: Geochemical implications," *Organic Geochemistry*, vol. 26, no. 11, pp. 659–675, Jul. 1997.
- [67] F. Gelin, J. K. Volkman, C. Largeau, S. Derenne, J. S. Sinninghe Damsté, and J. W. De Leeuw, "Distribution of aliphatic, nonhydrolyzable biopolymers in marine microalgae," *Organic Geochemistry*, vol. 30, no. 2, pp. 147–159, Mar. 1999.
- [68] F. Gelin, I. Boogers, A. A. M. Noordeloos, J. S. S. Damsté, P. G. Hatcher, and J. W. de Leeuw, "Novel, resistant microalgal polyethers: An important sink of organic carbon in the marine environment?," *Geochimica et Cosmochimica Acta*, vol. 60, no. 7, pp. 1275–1280, Apr. 1996.

- [69] “f37_plasma_membrane_st.jpg(800×427).” [Online]. Available: http://usmlefasttrack.com/wp-content/uploads/2014/01/f3-7_plasma_membrane_st.jpg. [Accessed: 07-Jul-2018].
- [70] G. A. Armstrong and J. E. Hearst, “Carotenoids 2: Genetics and molecular biology of carotenoid pigment biosynthesis,” *The FASEB Journal*, vol. 10, no. 2, pp. 228–237, Feb. 1996.
- [71] L. Picot, “Lutter contre les cancers grâce aux pigments de microalgues,” *Biofutur*, Dec. 2014.
- [72] “Nutraculture Phycocyanin Natural Anti-Cancer Supplement for Cancer Prevention & Cancer Cure.” [Online]. Available: <http://www.nutraceutical.com/phycocyanin.html>. [Accessed: 15-Sep-2018].
- [73] A. C. Guedes, H. M. Amaro, and F. X. Malcata, “Microalgae as Sources of Carotenoids,” *Marine Drugs*, vol. 9, no. 4, pp. 625–644, Apr. 2011.
- [74] F. J. Barba, N. Grimi, and E. Vorobiev, “New Approaches for the Use of Non-conventional Cell Disruption Technologies to Extract Potential Food Additives and Nutraceuticals from Microalgae,” *Food Eng Rev*, vol. 7, no. 1, pp. 45–62, Mar. 2015.
- [75] A. Belay, Y. Ota, K. Miyakawa, and H. Shimamatsu, “Current knowledge on potential health benefits of Spirulina,” *J Appl Phycol*, vol. 5, no. 2, pp. 235–241, Apr. 1993.
- [76] Z.-Y. Liu, G.-C. Wang, and B.-C. Zhou, “Effect of iron on growth and lipid accumulation in *Chlorella vulgaris*,” *Bioresource Technology*, vol. 99, no. 11, pp. 4717–4722, Jul. 2008.
- [77] “Digestion of lipids.” [Online]. Available: <http://www.1life63.com/en/omega-in-your-body-digestion-of-lipids/digestion-of-lipids>. [Accessed: 14-Jul-2018].
- [78] V. L. W. Go, *The pancreas: biology, pathobiology, and disease*. Raven Pr, 1993.
- [79] A. Ben-Amotz, T. G. Tornabene, and W. H. Thomas, “Chemical Profile of Selected Species of Microalgae with Emphasis on Lipids¹,” *Journal of Phycology*, vol. 21, no. 1, pp. 72–81.
- [80] F. Pernet, R. Tremblay, E. Demers, and M. Roussy, “Variation of lipid class and fatty acid composition of *Chaetoceros muelleri* and *Isochrysis* sp. grown in a semicontinuous system,” *Aquaculture*, vol. 221, no. 1, pp. 393–406, May 2003.
- [81] J.-M. Kornprobst, *Substances naturelles d’origine marine: chimiodiversité, pharmacodiversité, biotechnologies*, vol. 1. Editions Tec & Doc, 2005.
- [82] “byjus.com/chemistry/importance-of-polysaccharides/ - Recherche Google.” [Online]. Available: <https://www.google.fr/search?hl=fr&q=byjus.com/chemistry/importance-of-polysaccharides/>. [Accessed: 14-Jul-2018].
- [83] C. Yao, J. Ai, X. Cao, S. Xue, and W. Zhang, “Enhancing starch production of a marine green microalga *Tetraselmis subcordiformis* through nutrient limitation,” *Bioresource Technology*, vol. 118, pp. 438–444, Aug. 2012.
- [84] “Action of Alpha- Amylase on starch,” *Biochemistry for Medics - Clinical Cases*, 09-Aug-2014. .
- [85] S. Corinne and C.-J. Sylvia, “Les polysaccharides marins et leurs applications dans le domaine de la santé,” *Techniques de l’Ingénieur*, pp. 1–20, 2014.

- [86] A. Villay, *Production en photobioréacteurs et caractérisation structurale d'un exopolysaccharide produit par une microalgue rouge, Rhodella violacea : application à l'obtention d'actifs antiparasitaires*. Clermont-Ferrand 2, 2013.
- [87] “Prebiotics in animal feed market global industry analysis, size, share, growth, trends and forecast,” *Issuu*. [Online]. Available: https://issuu.com/amyjames1/docs/prebiotics_in_animal_feed_market_-_5481ffd0709757. [Accessed: 14-Jul-2018].
- [88] “Organic plant protection product from microalgae against fungal infestation - Fraunhofer IGB,” *Fraunhofer Institute for Interfacial Engineering and Biotechnology*. [Online]. Available: <https://www.igb.fraunhofer.de/en/research/competences/environmental-biotechnology/microalgae/use-of-microalgae-in-organic-farming/organic-plant-protection-product-from-microalgae-against-fungal-.html>. [Accessed: 14-Jul-2018].
- [89] O. Pulz, “Photobioreactors: production systems for phototrophic microorganisms,” *Appl Microbiol Biotechnol*, vol. 57, no. 3, pp. 287–293, Oct. 2001.
- [90] O. Jorquera, A. Kiperstok, E. A. Sales, M. Embiruçu, and M. L. Ghirardi, “Comparative energy life-cycle analyses of microalgal biomass production in open ponds and photobioreactors,” *Bioresource Technology*, vol. 101, no. 4, pp. 1406–1413, Feb. 2010.
- [91] A. Besson and P. Guiraud, “High-pH-induced flocculation–flotation of the hypersaline microalga *Dunaliella salina*,” *Bioresource Technology*, vol. 147, pp. 464–470, Nov. 2013.
- [92] H. Volkmann, U. Imianovsky, J. L. B. Oliveira, and E. S. Sant’Anna, “Cultivation of *Arthrospira (spirulina) platensis* in desalinator wastewater and salinated synthetic medium: protein content and amino-acid profile,” *Brazilian Journal of Microbiology*, vol. 39, no. 1, pp. 98–101, Mar. 2008.
- [93] “Algae Biotechnology – Green Cell-Factories on the Rise: Ingenta Connect.” [Online]. Available: <https://www.ingentaconnect.com/content/ben/cbiot/2015/00000004/00000004/art00003>. [Accessed: 14-Jul-2018].
- [94] A. Sánchez Mirón, A. Contreras Gómez, F. García Camacho, E. Molina Grima, and Y. Chisti, “Comparative evaluation of compact photobioreactors for large-scale monoculture of microalgae,” *Journal of Biotechnology*, vol. 70, no. 1, pp. 249–270, Apr. 1999.
- [95] C.-Y. Chen, K.-L. Yeh, R. Aisyah, D.-J. Lee, and J.-S. Chang, “Cultivation, photobioreactor design and harvesting of microalgae for biodiesel production: A critical review,” *Bioresource Technology*, vol. 102, no. 1, pp. 71–81, Jan. 2011.
- [96] J. B. K. Park, R. J. Craggs, and A. N. Shilton, “Recycling algae to improve species control and harvest efficiency from a high rate algal pond,” *Water Research*, vol. 45, no. 20, pp. 6637–6649, Dec. 2011.
- [97] I. Rawat, R. Ranjith Kumar, T. Mutanda, and F. Bux, “Dual role of microalgae: Phycoremediation of domestic wastewater and biomass production for sustainable biofuels production,” *Applied Energy*, vol. 88, no. 10, pp. 3411–3424, Oct. 2011.
- [98] N. Uduman, Y. Qi, M. K. Danquah, G. M. Forde, and A. Hoadley, “Dewatering of microalgal cultures: A major bottleneck to algae-based fuels,” *Journal of Renewable and Sustainable Energy*, vol. 2, no. 1, p. 012701, Jan. 2010.

- [99] J. A. Gerde, L. Yao, J. Lio, Z. Wen, and T. Wang, "Microalgae flocculation: Impact of flocculant type, algae species and cell concentration," *Algal Research*, vol. 3, pp. 30–35, Jan. 2014.
- [100] T. Ndikubwimana *et al.*, "Harvesting of freshwater microalgae with microbial bioflocculant: a pilot-scale study," *Biotechnology for Biofuels*, vol. 9, p. 47, Feb. 2016.
- [101] S. Salim, R. Bosma, M. H. Vermuë, and R. H. Wijffels, "Harvesting of microalgae by bio-flocculation," *J Appl Phycol*, vol. 23, no. 5, pp. 849–855, Oct. 2011.
- [102] M. K. Danquah, L. Ang, N. Uduman, N. Moheimani, and G. M. Forde, "Dewatering of microalgal culture for biodiesel production: exploring polymer flocculation and tangential flow filtration," *Journal of Chemical Technology & Biotechnology*, vol. 84, no. 7, pp. 1078–1083.
- [103] N. Mallick, S. K. Bagchi, S. Koley, and A. K. Singh, "Progress and Challenges in Microalgal Biodiesel Production," *Front. Microbiol.*, vol. 7, 2016.
- [104] H. A. Kurniawati, S. Ismadji, and J. C. Liu, "Microalgae harvesting by flotation using natural saponin and chitosan," *Bioresource Technology*, vol. 166, pp. 429–434, Aug. 2014.
- [105] E. W. Becker, *Microalgae: Biotechnology and Microbiology*. Cambridge University Press, 1994.
- [106] B. Sialve and J.-P. Steyer, "Les microalgues, promesses et défis," *Innovations Agronomiques*, vol. 26, pp. 25–39, 2013.
- [107] S. Van Den Hende, H. Vervaeren, and N. Boon, "Flue gas compounds and microalgae: (Bio-)chemical interactions leading to biotechnological opportunities," *Biotechnology Advances*, vol. 30, no. 6, pp. 1405–1424, Nov. 2012.
- [108] F. Bumbak, S. Cook, V. Zachleder, S. Hauser, and K. Kovar, "Best practices in heterotrophic high-cell-density microalgal processes: achievements, potential and possible limitations," *Appl Microbiol Biotechnol*, vol. 91, no. 1, p. 31, Jul. 2011.
- [109] Y. Yang and K. Gao, "Effects of CO₂ concentrations on the freshwater microalgae, *Chlamydomonas reinhardtii*, *Chlorella pyrenoidosa* and *Scenedesmus obliquus* (Chlorophyta)," *Journal of Applied Phycology*, vol. 15, no. 5, pp. 379–389, Sep. 2003.
- [110] R. A. Andersen, *Algal Culturing Techniques*. Elsevier, 2005.
- [111] O. Perez-Garcia, F. M. E. Escalante, L. E. de-Bashan, and Y. Bashan, "Heterotrophic cultures of microalgae: Metabolism and potential products," *Water Research*, vol. 45, no. 1, pp. 11–36, Jan. 2011.
- [112] S.-H. Ho, C.-Y. Chen, and J.-S. Chang, "Effect of light intensity and nitrogen starvation on CO₂ fixation and lipid/carbohydrate production of an indigenous microalga *Scenedesmus obliquus* CNW-N," *Bioresource Technology*, vol. 113, pp. 244–252, Jun. 2012.
- [113] A. F. da Silva, S. O. Lourenço, and R. M. Chaloub, "Effects of nitrogen starvation on the photosynthetic physiology of a tropical marine microalga *Rhodomonas* sp. (Cryptophyceae)," *Aquatic Botany*, vol. 91, no. 4, pp. 291–297, Nov. 2009.

- [114] I.-P. Lin, P.-L. Jiang, C.-S. Chen, and J. T. C. Tzen, "A unique caleosin serving as the major integral protein in oil bodies isolated from *Chlorella* sp. cells cultured with limited nitrogen," *Plant Physiology and Biochemistry*, vol. 61, pp. 80–87, Dec. 2012.
- [115] M. E. Pérez-Pérez and J. L. Crespo, "Autophagy in the model alga *Chlamydomonas reinhardtii*," *Autophagy*, vol. 6, no. 4, pp. 562–563, May 2010.
- [116] P. P. Lamers, M. Janssen, R. C. H. De Vos, R. J. Bino, and R. H. Wijffels, "Carotenoid and fatty acid metabolism in nitrogen-starved *Dunaliella salina*, a unicellular green microalga," *Journal of Biotechnology*, vol. 162, no. 1, pp. 21–27, Nov. 2012.
- [117] L. M. Prescott, J. P. Harley, D. A. Klein, C. M. Bacq-Calberg, and J. Dusart, "Microbiologie (De Boeck Université)," *Applied Clay Science*, vol. 38, pp. 97–103, 2003.
- [118] J.-P. Hernandez, L. E. de-Bashan, and Y. Bashan, "Starvation enhances phosphorus removal from wastewater by the microalga *Chlorella* spp. co-immobilized with *Azospirillum brasilense*," *Enzyme and Microbial Technology*, vol. 38, no. 1, pp. 190–198, Jan. 2006.
- [119] M. Martínez Sancho, J. M. Jiménez Castillo, and F. El Yousfi, "Influence of phosphorus concentration on the growth kinetics and stoichiometry of the microalga *Scenedesmus obliquus*," *Process Biochemistry*, vol. 32, no. 8, pp. 657–664, Nov. 1997.
- [120] A. Eggert, U. Nitschke, J. A. West, D. Michalik, and U. Karsten, "Acclimation of the intertidal red alga *Bangiopsis subsimplex* (Stylonematophyceae) to salinity changes," *Journal of Experimental Marine Biology and Ecology*, vol. 343, no. 2, pp. 176–186, May 2007.
- [121] S. Vidyashankar, K. Deviprasad, V. S. Chauhan, G. A. Ravishankar, and R. Sarada, "Selection and evaluation of CO₂ tolerant indigenous microalga *Scenedesmus dimorphus* for unsaturated fatty acid rich lipid production under different culture conditions," *Bioresource Technology*, vol. 144, pp. 28–37, Sep. 2013.
- [122] Y.-H. Kim *et al.*, "Ultrasound-assisted extraction of lipids from *Chlorella vulgaris* using [Bmim][MeSO₄]," *Biomass and Bioenergy*, vol. 56, pp. 99–103, Sep. 2013.
- [123] E. G. Bligh and W. J. Dyer, "A Rapid Method of Total Lipid Extraction and Purification," *Can. J. Biochem. Physiol.*, vol. 37, no. 8, pp. 911–917, Aug. 1959.
- [124] A. Ranjan, C. Patil, and V. S. Moholkar, "Mechanistic Assessment of Microalgal Lipid Extraction," *Ind. Eng. Chem. Res.*, vol. 49, no. 6, pp. 2979–2985, Mar. 2010.
- [125] M. A. Hejazi and R. H. Wijffels, "Milking of microalgae," *Trends in Biotechnology*, vol. 22, no. 4, pp. 189–194, Apr. 2004.
- [126] M. Virost, V. Tomao, C. Ginies, and F. Chemat, "Total Lipid Extraction of Food Using *Limonene* as an Alternative to *Hexane*," *Chroma*, vol. 68, no. 3–4, pp. 311–313, Aug. 2008.
- [127] M. D. A. Zbinden *et al.*, "Pulsed electric field (PEF) as an intensification pretreatment for greener solvent lipid extraction from microalgae," *Biotechnology and Bioengineering*, vol. 110, no. 6, pp. 1605–1615.
- [128] E. P. Knoshaug, B. S. Donohoe, h. gerken, l. laurens, and s. r. v. wychen, "Disruption of cell walls for enhanced lipid recovery," US20130171721A1, 04-Jul-2013.

- [129] G. Yoo, W.-K. Park, C. W. Kim, Y.-E. Choi, and J.-W. Yang, "Direct lipid extraction from wet *Chlamydomonas reinhardtii* biomass using osmotic shock," *Bioresource Technology*, vol. 123, pp. 717–722, Nov. 2012.
- [130] P. Mercer and R. E. Armenta, "Developments in oil extraction from microalgae," *European Journal of Lipid Science and Technology*, vol. 113, no. 5, pp. 539–547.
- [131] "Effects of harvesting method and growth stage on the flocculation of the green alga *Botryococcus braunii*." [Online]. Available: <https://insights.ovid.com/letters-applied-microbiology/letsam/1998/07/000/effects-harvesting-method-growth-stage/4/00043785>. [Accessed: 12-Aug-2018].
- [132] U. T. Shrestha, "CELL DISRUPTION," *My Scientific Blog - Research and Articles*, 14-Sep-2012. .
- [133] E. Günerken, E. D'Hondt, M. H. M. Eppink, L. Garcia-Gonzalez, K. Elst, and R. H. Wijffels, "Cell disruption for microalgae biorefineries," *Biotechnology Advances*, vol. 33, no. 2, pp. 243–260, Mar. 2015.
- [134] S. Wahidin, A. Idris, and S. R. M. Shaleh, "Rapid biodiesel production using wet microalgae via microwave irradiation," *Energy Conversion and Management*, vol. 84, pp. 227–233, Aug. 2014.
- [135] G. H. Harrison, E. K. Balcer-Kubiczek, and H. A. Eddy, "Potentiation of Chemotherapy by Low-level Ultrasound," *International Journal of Radiation Biology*, vol. 59, no. 6, pp. 1453–1466, Jan. 1991.
- [136] X. Wu, E. M. Joyce, and T. J. Mason, "Evaluation of the mechanisms of the effect of ultrasound on *Microcystis aeruginosa* at different ultrasonic frequencies," *Water Research*, vol. 46, no. 9, pp. 2851–2858, Jun. 2012.
- [137] P. Juliano, M. A. Augustin, X.-Q. Xu, R. Mawson, and K. Knoerzer, "Advances in high frequency ultrasound separation of particulates from biomass," *Ultrasonics Sonochemistry*, vol. 35, pp. 577–590, Mar. 2017.
- [138] D. P. Jaeschke, R. Rech, L. D. F. Marczak, and G. D. Mercali, "Ultrasound as an alternative technology to extract carotenoids and lipids from *Heterochlorella luteoviridis*," *Bioresource Technology*, vol. 224, pp. 753–757, Jan. 2017.
- [139] P. Prabakaran and A. D. Ravindran, "A comparative study on effective cell disruption methods for lipid extraction from microalgae," *Letters in Applied Microbiology*, vol. 53, no. 2, pp. 150–154, Aug. 2011.
- [140] N. Medina-Torres, T. Ayora-Talavera, H. Espinosa-Andrews, A. Sánchez-Contreras, and N. Pacheco, "Ultrasound Assisted Extraction for the Recovery of Phenolic Compounds from Vegetable Sources," *Agronomy*, vol. 7, no. 3, p. 47, Jul. 2017.
- [141] A. F. Ferreira, A. P. S. Dias, C. M. Silva, and M. Costa, "Effect of low frequency ultrasound on microalgae solvent extraction: Analysis of products, energy consumption and emissions," *Algal Research*, vol. 14, pp. 9–16, Mar. 2016.

- [142] T. Oohashi *et al.*, “The role of biological system other than auditory air-conduction in the emergence of the hypersonic effect,” *Brain Research*, vol. 1073–1074, pp. 339–347, Feb. 2006.
- [143] M. A. A. Gasmalla, R. Yang, and X. Hua, “Extraction of rebaudioside-A by sonication from *Stevia rebaudiana Bertoni* leaf and decolorization of the extract by polymers,” *J Food Sci Technol*, vol. 52, no. 9, pp. 5946–5953, Sep. 2015.
- [144] Y. Ahn *et al.*, “Review of supercritical CO₂ power cycle technology and current status of research and development,” *Nuclear Engineering and Technology*, vol. 47, no. 6, pp. 647–661, Oct. 2015.
- [145] K. C. Zancan, M. O. M. Marques, A. J. Petenate, and M. A. A. Meireles, “Extraction of ginger (*Zingiber officinale Roscoe*) oleoresin with CO₂ and co-solvents: a study of the antioxidant action of the extracts,” *The Journal of Supercritical Fluids*, vol. 24, no. 1, pp. 57–76, Sep. 2002.
- [146] L. Wang and C. L. Weller, “Recent advances in extraction of nutraceuticals from plants,” *Trends in Food Science & Technology*, vol. 17, no. 6, pp. 300–312, Jun. 2006.
- [147] T. S. Reighard and S. V. Olesik, “Bridging the Gap Between Supercritical Fluid Extraction and Liquid Extraction Techniques: Alternative Approaches to the Extraction of Solid and Liquid Environmental Matrices,” *Critical Reviews in Analytical Chemistry*, vol. 26, no. 2–3, pp. 61–99, Sep. 1996.
- [148] S. Poh, R. Hernandez, M. Inagaki, and P. G. Jessop, “Oxidation of Phosphines by Supercritical Nitrous Oxide,” *Org. Lett.*, vol. 1, no. 4, pp. 583–586, Aug. 1999.
- [149] Q. Lang and C. M. Wai, “Supercritical fluid extraction in herbal and natural product studies — a practical review,” *Talanta*, vol. 53, no. 4, pp. 771–782, Jan. 2001.
- [150] J. Chrastil, “Solubility of solids and liquids in supercritical gases,” *The Journal of Physical Chemistry*, vol. 86, no. 15, pp. 3016–3021, Jul. 1982.
- [151] M. A. A. Meireles, “Supercritical extraction from solid: process design data (2001–2003),” *Current Opinion in Solid State and Materials Science*, vol. 7, no. 4, pp. 321–330, Aug. 2003.
- [152] A. Cháfer, T. Fornari, A. Berna, E. Ibañez, and G. Reglero, “Solubility of solid carnosic acid in supercritical CO₂ with ethanol as a co-solvent,” *The Journal of Supercritical Fluids*, vol. 34, no. 3, pp. 323–329, Jul. 2005.
- [153] J. Shi, C. Yi, S. J. Xue, Y. Jiang, Y. Ma, and D. Li, “Effects of modifiers on the profile of lycopene extracted from tomato skins by supercritical CO₂,” *Journal of Food Engineering*, vol. 93, no. 4, pp. 431–436, Aug. 2009.
- [154] C.-H. Chan, R. Yusoff, and G.-C. Ngoh, “Modeling and kinetics study of conventional and assisted batch solvent extraction,” *Chemical Engineering Research and Design*, vol. 92, no. 6, pp. 1169–1186, Jun. 2014.
- [155] S. Knaust, M. Andersson, N. Rogeman, K. Hjort, G. Amberg, and L. Klintberg, “Influence of flow rate, temperature and pressure on multiphase flows of supercritical carbon dioxide and water using multivariate partial least square regression,” *J. Micromech. Microeng.*, vol. 25, no. 10, p. 105001, 2015.

- [156] R. Halim, T. W. T. Rupasinghe, D. L. Tull, and P. A. Webley, "Modelling the kinetics of lipid extraction from wet microalgal concentrate: A novel perspective on a classical process," *Chemical Engineering Journal*, vol. 242, pp. 234–253, Apr. 2014.
- [157] P. Subra and P. Boissinot, "Supercritical fluid extraction from a brown alga by stagewise pressure increase," *Journal of Chromatography A*, vol. 543, pp. 413–424, Jan. 1991.
- [158] J. Lorenzen *et al.*, "Extraction of microalgae derived lipids with supercritical carbon dioxide in an industrial relevant pilot plant," *Bioprocess Biosyst Eng*, vol. 40, no. 6, pp. 911–918, 2017.
- [159] *Green Extraction Techniques: Principles, Advances and Applications*. Elsevier, 2017.
- [160] C. Crampon *et al.*, "Oil extraction from enriched *Spirulina platensis* microalgae using supercritical carbon dioxide," *The Journal of Supercritical Fluids*, vol. 119, pp. 289–296, Jan. 2017.
- [161] P. T. V. Rosa and M. A. A. Meireles, "Rapid estimation of the manufacturing cost of extracts obtained by supercritical fluid extraction," *Journal of Food Engineering*, vol. 67, no. 1, pp. 235–240, Mar. 2005.
- [162] P. L. Lau, R. W. K. Allen, and P. Styring, "Continuous-flow Heck synthesis of 4-methoxybiphenyl and methyl 4-methoxycinnamate in supercritical carbon dioxide expanded solvent solutions," *Beilstein J Org Chem*, vol. 9, pp. 2886–2897, Dec. 2013.
- [163] P. Vandezande, L. E. M. Gevers, and I. F. J. Vankelecom, "Solvent resistant nanofiltration: separating on a molecular level," *Chem. Soc. Rev.*, vol. 37, no. 2, pp. 365–405, Jan. 2008.
- [164] K. J. Howe and M. M. Clark, "Fouling of Microfiltration and Ultrafiltration Membranes by Natural Waters," *Environ. Sci. Technol.*, vol. 36, no. 16, pp. 3571–3576, Aug. 2002.
- [165] "(10) Investigation of the Performance of an Anaerobic Membrane Bioreactor in the Treatment of Mixed Municipal Sludge Under Ambient, Mesophilic and Thermophilic Operating Conditions," *ResearchGate*. [Online]. Available: https://www.researchgate.net/publication/294918573_Investigation_of_the_Performance_of_an_Anaerobic_Membrane_Bioreactor_in_the_Treatment_of_Mixed_Municipal_Sludge_Under_Ambient_Mesophilic_and_Thermophilic_Operating_Conditions. [Accessed: 12-Aug-2018].
- [166] "(10) Optimization of Polymer Enhanced Diafiltration system by studying copper removal from aqueous solutions using LambdaCarrageenan," *ResearchGate*. [Online]. Available: https://www.researchgate.net/publication/242239371_Optimization_of_Polymer_Enhanced_Diafiltration_system_by_studying_copper_removal_from_aqueous_solutions_using_LambdaCarrageenan/figures?lo=1. [Accessed: 12-Aug-2018].
- [167] F. Bashtani, S. Ayatollahi, A. Habibi, and M. Masihi, "Permeability reduction of membranes during particulate suspension flow; analytical micro model of size exclusion mechanism," *Journal of Membrane Science*, vol. 435, pp. 155–164, May 2013.
- [168] M.-J. Luján-Facundo, J.-A. Mendoza-Roca, B. Cuartas-Urbe, and S. Álvarez-Blanco, "Membrane fouling in whey processing and subsequent cleaning with ultrasounds for a

- more sustainable process,” *Journal of Cleaner Production*, vol. 143, pp. 804–813, Feb. 2017.
- [169] “Microfiltration and Ultrafiltration: Principles and Applications,” *CRC Press*, 09-Jul-1996. [Online]. Available: <https://www.crcpress.com/Microfiltration-and-Ultrafiltration-Principles-and-Applications/Zeman/p/book/9780824797355>. [Accessed: 12-Aug-2018].
- [170] “Membrane Fouling & Flux Decline - Harvesting Microalgae with Ultrafiltration Membranes.” [Online]. Available: <https://sites.google.com/site/algaeultrafiltration/current-issues/fouling-and-flux-optimisation>. [Accessed: 12-Aug-2018].
- [171] “(10) Whey ultrafiltration: Effect of operating parameters on flux and rejection,” *ResearchGate*. [Online]. Available: https://www.researchgate.net/publication/259186803_Whey_ultrafiltration_Effect_of_operating_parameters_on_flux_and_rejection. [Accessed: 12-Aug-2018].
- [172] R. Shukla, M. Cheryan, and R. E. DeVor, “Solvent Extraction of Zein from Dry-Milled Corn,” *Cereal Chemistry*, vol. 77, no. 6, pp. 724–730, Nov. 2000.
- [173] N. Pragma, K. K. Pandey, and P. K. Sahoo, “A review on harvesting, oil extraction and biofuels production technologies from microalgae,” *Renewable and Sustainable Energy Reviews*, vol. 24, pp. 159–171, Aug. 2013.
- [174] K. Ramluckan, K. G. Moodley, and F. Bux, “An evaluation of the efficacy of using selected solvents for the extraction of lipids from algal biomass by the soxhlet extraction method,” *Fuel*, vol. 116, pp. 103–108, Jan. 2014.
- [175] J. Jeon *et al.*, “New mixture composition of organic solvents for efficient extraction of lipids from *Chlorella vulgaris*,” *Biomass and Bioenergy*, vol. 59, pp. 279–284, Dec. 2013.
- [176] O. H. Lowry, A. L. Rosbrough, and R. J. Randall, “Lowry assay protocol,” *J. Biol. Chem., Lond*, vol. 193, p. 265, 1951.
- [177] P. Juaneda and G. Rocquelin, “Rapid and convenient separation of phospholipids and nonphosphorus lipids from rat heart using silica cartridges,” *Lipids*, vol. 20, no. 1, pp. 40–41.
- [178] R. R. Bidigare, “Analysis of Algal Chlorophylls and Carotenoids,” in *Marine Particles: Analysis and Characterization*, American Geophysical Union (AGU), 2013, pp. 119–123.
- [179] O. Holm-Hansen and B. Riemann, “Chlorophyll a Determination: Improvements in Methodology,” *Oikos*, vol. 30, no. 3, pp. 438–447, 1978.
- [180] V. Brotas and M.-R. Plante-Cuny, “Identification and quantification of chlorophyll and carotenoid pigments in marine sediments. A protocol for HPLC analysis,” *Oceanologica acta. Paris*, vol. 19, no. 6, pp. 623–634, 1996.
- [181] T. W. Goodwin, “Biosynthesis of Carotenoids,” in *The Biochemistry of the Carotenoids*, Springer, Dordrecht, 1980, pp. 33–76.

Chapter 3: Fractional extraction

3.1. Introduction

Several studies reported that the extraction of microalgal valuable components such as neutral lipids, proteins and pigments outside the rigid cell wall requires a specific treatment in order to facilitate their recovery and to obtain a high yield. However, low selectivity of extraction was obtained due to cell disintegration and as result, further purification steps were necessary complicating then the downstream processes. Thus, this chapter is composed of three publications which inspect whether it is possible to bypass the cell disruption step before carrying out the extraction processing on specific components, allowing then a high selectivity of recovery.

Numerous studies reported high neutral lipids extraction yield using ScCO₂ from disintegrated biomasses. Nevertheless, the methods used are nonselective, leading to complex extracts of hydrophilic and hydrophobic components. For that, we investigated the extraction of neutral lipids from *Chlorella vulgaris* and *Nannochloropsis oculata* using ScCO₂ under various parameters and without cell disruption (article 1). The selectivity of NL extraction was evaluated by analyzing the composition of microalgal lipids extracts all long the process using solid phase extraction (SPE) technique.

In addition, scarce studies reported the use of solid phase extraction technique for the quantification or the fractionation of several specific pigments in the same time, in aim to understand their extraction kinetics by ScCO₂. Hence, the extraction kinetics of four pigments: chlorophylls a and b, lutein, β -carotene, from *C. vulgaris* and *N. oculata* by ScCO₂ has been studied using solid phase extraction technique (article 2).

Finally, the semi-defatted *Nannochloropsis oculata* residues (obtained after ScCO₂ extraction) underwent a double stage extraction to study the possibility of a high proteins extraction yield without damaging the properties and the integrity of the cell wall (article 3). Extraction was achieved also on defatted and non-defatted biomasses to understand the effect of defatting on proteins release. Once extraction is done, it was necessary to establish a process for proteins fractionation/concentration. Hence, dead-end ultrafiltration process was investigated.

3.2. Supercritical carbon dioxide extraction and fractionation of lipids from freeze-dried microalgae *Nannochloropsis oculata* and *Chlorella vulgaris*

Published article: *Algal Research* 34 (2018) 49–56

Sara Obeid^{a,b,c,*}, Nicholas Beaufile^a, Séverine Camy^d, Hosni Takache^{b,c}, Ali Ismail^{b,c}, Pierre-Yves Pontalier^a

^a Laboratoire de Chimie Agro-industrielle (LCA), Université de Toulouse, INRA, INPT, 4 allée Emile Monso, 31030 Toulouse cedex 4, France

^b Département des Sciences et Technologies Alimentaires, Faculté des Sciences Agronomiques, Université Libanaise, Dekwaneh, Lebanon.

^c Plateforme de Recherches et d'Analyses en Sciences de l'Environnement (PRASE), Ecole Doctorale des Sciences et Technologies, Université Libanaise, Hadath, Lebanon.

^d Laboratoire de Génie Chimique (LGC), INP-ENSIACET, Université de Toulouse, 31030 Toulouse, France

Abstract

This study deals with the selective extraction of neutral lipids from microalgae. We investigated the consequences of bypassing cell-wall disintegration before supercritical carbon dioxide extraction. Different operating parameters (use of co-solvent, pressure, and time) were tested on freeze-dried *Chlorella vulgaris* and *Nannochloropsis oculata*. The solid phase extraction technique (SPE) was used throughout the extraction process to assess variations in the yield of liberated neutral lipids, glycolipids, and phospholipids. Under operating conditions, 97% of neutral lipids were extracted from *C. vulgaris* using ethanol (10% v/v) as co-solvent. Neutral lipids from *N. oculata* represented most of the extracts (83%), whereas the proportion of glycolipids and phospholipids did not exceed 12.1% and 5.3%, respectively. Microscopic observation showed that cell wall integrity was maintained during the extraction process.

Keywords: Supercritical carbon dioxide extraction; Solid phase extraction; Neutral lipids; *Chlorella vulgaris*; *Nannochloropsis oculata*.

3.2.1. Introduction

Microalgal Lipids can generally be divided into two large classes based on the polarity of the molecular head group: polar and neutral lipids. Polar lipids can be categorized into phospholipids (PPL) and glycolipids (GL). They are essential structural components of cell membranes and

organelle membranes that contribute to their flexibility, fluidity and selective permeability. Neutral lipids (NL) consist of acylglycerol and free fatty acids and are used for energy storage [1]. They are present as droplets in the chloroplast matrix and in the cytoplasm. Their extraction from the cellular matrix into the surrounding medium can be diminished by the rigidity of cell wall. Indeed, the microalgal lipids recovery involves several steps including cultivation, harvesting, drying, and lipid extraction [2] [3]. Based on life cycle assessment studies, the oil extraction process consumes 90% of the energy, which signifies a need to improve the economic viability of the process [4].

Lipid extraction from microalgae is generally carried out using organic solvent. This is because chemical solvent has high selectivity and solubility towards lipids. However, such processes, which give rise to high lipids yields, cannot be used at industrial scale due to the high toxicity of organic solvents on human and environment [5].

In extraction using chemical solvent, diffusion is always the limiting factor in the overall mechanism [6]. However, this factor becomes more critical in microalgae as the cell wall may prohibits solvent from diffusing into the inner cell for lipid extraction. Therefore, mechanical pretreatments are generally introduced to enhance solvent diffusion efficiency and consequently, to improve microalgae lipid recovery rate. However, the methods used are nonselective and generally accompanied by cell-wall destruction, leading to complex extracts of hydrophilic and hydrophobic components. Such treatments require additional costly stages in downstream processing for phase separation and compound purification. For example the presence of phospholipids in lipid extracts implies an additional degumming step to remove them either for food, health and energy applications [3].

Supercritical carbon dioxide (ScCO₂) extraction of microalgal lipids has received attention as an alternative to organic solvent extraction and has been shown to be an ideal method for extracting certain lipids [7]. Several studies reported high extraction yield using ScCO₂ [8] [9] [10]. However, from these works, it appears that the microalgae pretreatment is highly significant to perform an efficient extraction with ScCO₂. In major cases, prior to supercritical extraction, mechanical pretreatment was carried out and high amount of organic co-solvent was used for increasing lipid extraction yield all-in sharply decreasing selective NL extraction. Patil et al. [9] subjected *Nannochloropsis* biomass to microwave pretreatment prior to supercritical extraction and added

an azeotropic mixture (hexane/ethanol) as co-solvent to enhance ScCO₂ affinity towards NL, giving a low selective extraction. Increasing the co-extraction of polar lipids necessitates therefore further purification steps. Cheng et al. [10] studied NL extraction from freeze-dried *Pavlova sp.* subjected to cell disruption prior to extraction. The highest extraction yield of 98.7% was observed using ScCO₂ with bead-beating as pretreatment. However, low selectivity of lipid extraction was obtained due to cell disintegration and as result, further purification steps were necessary. Recently, Crampon et al. [11] reported the use of ScCO₂ at industrial scale for the extraction of NL from *Spirulina platensis* without cell disruption. However *S. platensis* is known to have a vulnerable cell wall and did not require a severe cell disruption contrary to lipid rich microalgae having a robust cell wall like *C. vulgaris* and *N. oculata* [12]. The aim of this study was to investigate the extraction of NL from *C. vulgaris* and *N. oculata* using ScCO₂ without cell disruption. On the one hand, we study the effect of ScCO₂ key parameters on the extraction yield: temperature, pressure and addition of polar modifier (ethanol 10% v/v). Such addition of polar modifier allows to understand the effect of polar lipid co-extraction on NL extraction yield. On the second hand, the selectivity of NL extraction was evaluated by analyzing the composition of microalgal lipid extracts all long the process using solid phase extraction (SPE) technique. To our knowledge, similar study has never been discussed in the literature.

3.2.2. Materials and methods

3.2.2.1. Microalgae biomass

C. vulgaris and *N. oculata* used in this study were provided freeze dried by Alpha Biotech (Assérac, France). These two species were used because they possess an extra rigid membrane, due to their growth under stressful conditions [12]. *N. oculata* was cultivated in modified Conway media under conditions of N nutrient deficiency to favor the accumulation of lipids, whereas the microalga *C. vulgaris* was cultivated in Sueoka media under conditions of high N nutrient concentration to favor proteins accumulation. Biomass have been harvested during the exponential growth phase and concentrated by centrifugation (20–24 % dry weight). The frozen paste of crude microalgae was freeze-dried in a Fisher Bioblock Scientific Alpha 2–4 LD Plus device (Illkirch, France). During freeze drying, the pressure was reduced to 0.01 bar, and the temperature decreased to –80 °C for 48 h to give a completely dry biomass. After freeze drying process, freeze-dried aggregates were slightly spread with a laboratory spatula. The mean diameter of particles was

measured using Mastersizer 2000 granulometer (Malvern Instruments Ltd.) showing a value around 200 μm .

3.2.2.2. Total lipids content

The term “total lipids” represents the amount of all extractable lipids initially present in the algal biomass. This amount served as a reference throughout the study to evaluate the effectiveness of lipid extraction using ScCO_2 . Total extractable lipids were measured after extraction in a Soxhlet apparatus using a slightly modified method based on the two methods developed by Blight and Dyer (1959) and Folch (1957), using a mixture of polar and non-polar solvents: chloroform/methanol (0.35/0.65, V/V) [13] [14] [15]. The microalgal biomass (3 g) was placed in a cartridge filter paper in 200 mL solvent. The Soxhlet extractor was operated for multiple cycles for 18 h to ensure the extraction of all extractable lipids.

3.2.2.3. ScCO_2 extraction

Extraction was carried out using a pilot unit developed by the company Separex (Nancy, France). The pilot was composed of a 25 cm³ autoclave (Fig. 1). This unit could be operated at pressures up to 1000 bar and a temperature up to 250 °C. At the beginning of the experiment, the extractor was filled with determined mass of freeze-dried microalgae powder (Table 1) and the module was supplied with liquid CO_2 through a pump which was maintained at a temperature below 7°C to keep the CO_2 in the liquid state. Ethanol was introduced into the extractor either as a co-solvent or a cleaning fluid.

Several extractions were performed by varying the working pressure and solvent polarity (addition of ethanol 10% v/v). All supercritical extractions were carried out under constant temperature of 50 °C. A simple extraction consisted of one step of ScCO_2 extraction with or without ethanol as co-solvent (10% v/v), whereas a double extraction consisted of first performing ScCO_2 extraction followed by a second ScCO_2 extraction with co-solvent (Table 1).

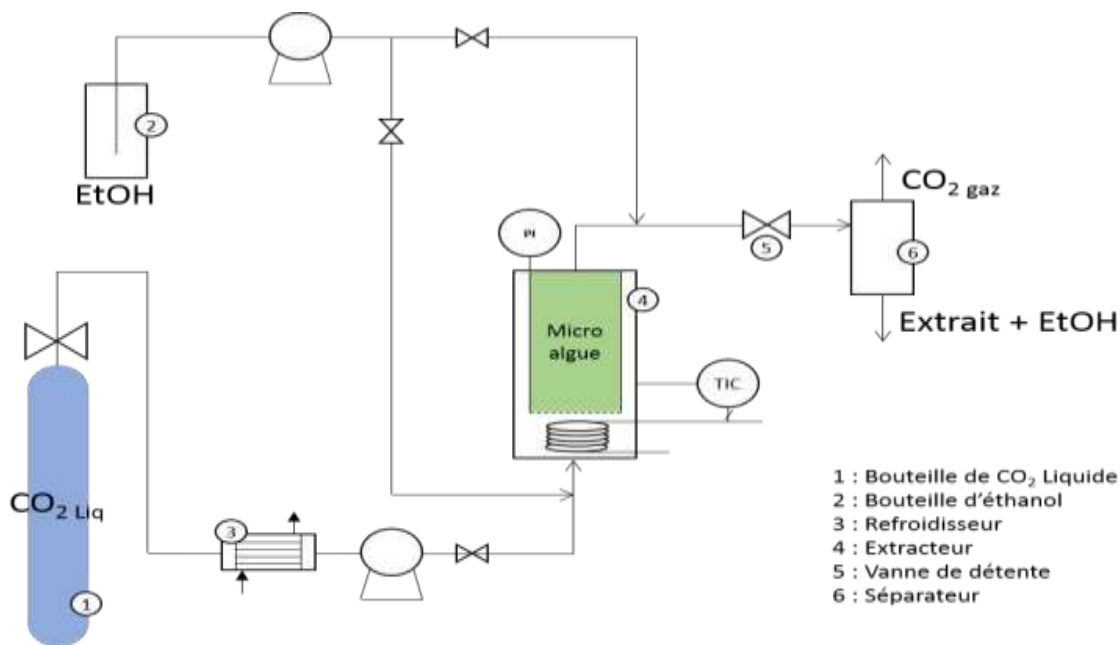

Fig. 1. Description of the supercritical carbon dioxide pilot

Table 1: Operating conditions for ScCO₂ extraction applied to freeze-dried *C. vulgaris* and *N. oculata*, with and without ethanol (10%) as co-solvent.

Microalgae	T (°C)	P (bar)	CO ₂ flow rate (g/min)	Biomass (g)	Solvent rate (g/g·min ⁻¹)	Ethanol as co-solvent	Ethanol flow rate (g/min)	Operation time (min)
Simple extraction								
<i>C. vulgaris</i>	50	250	25	12.1	0.45	Yes	1.9	230
<i>N. oculata</i>	50	250	25	25.4	1.02	No	–	210
<i>N. oculata</i>	50	450	25	8.8	0.35	No	–	240
<i>N. oculata</i>	50	750	25	8.8	0.35	No	–	240
Double extraction								
<i>C. vulgaris</i>	50	250	25	25.4	1.02	No	–	210
Residue	50	250	25	23.4	0.87	Yes	1.9	210

Note: Simple extraction: ScCO₂ extraction with 10% ethanol as co-solvent. Double extraction: ScCO₂ extraction with addition of ethanol at t = 210min. Solvent rate is the ratio of incorporated biomass (g) with respect to the CO₂ flow rate (g/min), as the extraction is semi-continuous.

3.2.2.4. Fractionation of neutral and polar lipids

All lipids extracted from *N. oculata* and *C. vulgaris*, either by ScCO₂ or Soxhlet, were fractionated into neutral and polar lipids using the solid-phase extraction method (SPE) described by Juaneda and Rocquelin [16]. The cartridges were conditioned by slowly adding 5 mL chloroform followed by 5 mL methanol, reaching the top of the gel to ensure good rinsing. A sample of 25 mg lipids was applied to the top of the silica cartridges Supelco (500 mg, Sigma-Aldrich). The NL fraction was eluted with 10 mL chloroform, whereas the GL and PPL fractions were eluted with 10 mL acetone and methanol, respectively. Once eluted and freeze-dried under liquid nitrogen, every fraction was measured gravimetrically. The contents of neutral and polar lipids are expressed in g/g dry biomass.

3.2.2.5. Microscopic observation

Microscopically qualitative approach was done to characterize any cell disintegration of the biomass. Observation at high magnifications ($\times 1000$) was performed before and directly after ScCO₂ treatments. A small quantity of cell suspension was placed on a specific plate (Nikon SMZ 1500). The images were captured under a constant exposure and illumination by Nikon eclipse E600 camera.

3.2.2.6. Statistical analysis

Results for microalgae characterization in terms of lipid content were based on 3 replicates for 3 experiments ($n = 9$). All supercritical extraction data were presented as mean values \pm standard deviations of three experiments. Statistically significant differences ($p < 0.05$) between the means were evaluated using one-way analysis of variance (ANOVA) and the Tukey's test on XLSTAT software version 2018.1.

3.2.3. Results and discussion

3.2.3.1. Microalgae characterization

The lipids composition of the studied microalgae was defined according to the values following Soxhlet extraction [17]. The maximal lipids extraction yield was obtained after 18 h: 0.399 ± 0.016 and 0.244 ± 0.010 g/g dry weigh for *N. oculata* and *C. vulgaris*, respectively (Table 2).

Table 2. Lipids fractions (NL, GL, PPL) relative to total lipids and dry matter in *C. vulgaris* and *N. oculata*. Results are based on 3 replicates for 3 experiments \pm SD (n=9).

	<i>C. vulgaris</i>			<i>N. oculata</i>		
Total lipids (g/g DM)	0.244 \pm 0.010			0.399 \pm 0.016		
Fraction in total lipids (%)	NL	GL	PPL	NL	GL	PPL
	26.0 \pm 0.4	59.0 \pm 0.8	15.0 \pm 0.6	44.0 \pm 1.6	30.1 \pm 0.8	25.9 \pm 0.9

Note: *C. vulgaris*: *Chlorella vulgaris*, *N. oculata*: *Nannochloropsis oculata*, NL: neutral lipids, GL: glycolipids, PPL: phospholipids.

The proportions of various lipids classes were evaluated by SPE fractionation. *N. oculata* was rich in NL, comprising $44.0 \pm 1.6\%$ of its total lipids content. The high lipids content of *N. oculata* may be explained by the growth conditions. In fact, the studied strain was grown under conditions of normal CO₂ concentration and nitrogen depletion.

Cultivation under such conditions can induce lipids accumulation which surpasses that during normal growth conditions, as well as favoring the production of mostly NL [18].

In contrast to *N. oculata*, *C. vulgaris* was grown under conditions of high N nutrient levels. Microalgae grown under such conditions have polar lipids as predominant lipids, which are located in chloroplasts and cell membranes [19].

C. vulgaris had a lower NL content ($26.0 \pm 0.4\%$ of its total lipids) than *N. oculata*. This suggests that *C. vulgaris* did not accumulate large amounts of reserve lipids due to the growth conditions. Hence, most of the available lipids were polar, especially GL, which represented $59.0 \pm 0.8\%$ of the total lipid content. Our results concerning the lipids composition of *N. oculata* and *C. vulgaris* are in accordance with several studies in the literature [20] [21] [22]. These results were used as reference values throughout this study.

3.2.3.2. Supercritical extraction yield and kinetics

3.2.3.2.1. Effect of pressure on lipids extraction from *N. oculata*

Fig. 2 shows the effect of pressure on the extraction yield of microalgal lipids from freeze-dried *N. oculata* by ScCO₂. Extraction at 250 bar resulted in a very low yield (15%). Increasing the pressure to 450 and 750 bar led to an increase of the extraction yield (20%). Several studies reported that the extraction efficiency of ScCO₂ increases with pressure [23] [24]. In fact, increasing the pressure results in an increase in the solubility of NL in ScCO₂. Moreover, the adsorption capacity of solute decreases at high pressure [25] [26]. At least, part of the lipids droplets bounded to the cell matrix may desorb during extraction at high pressure.

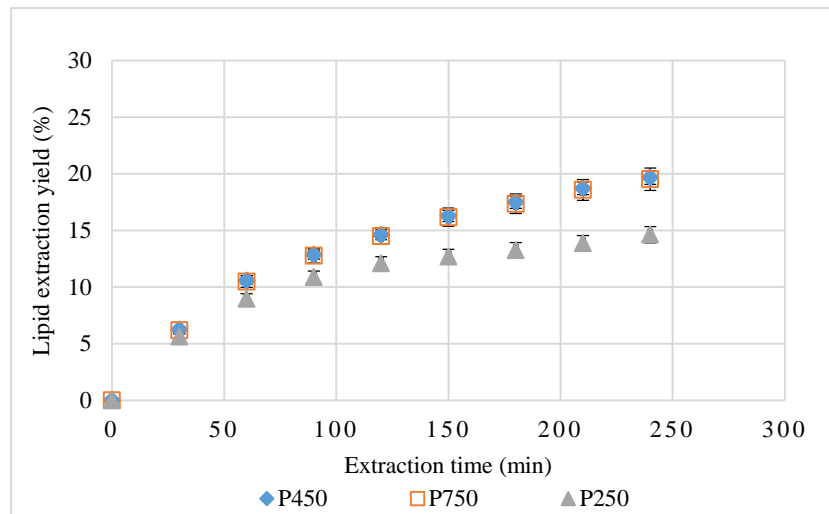

Fig. 2. Lipid extraction yield (extracted/total extractable) from *Nannochloropsis oculata* over time using supercritical CO₂ (ScCO₂) extraction under different applied pressures (P): 250, 450, or 750 bar. Data shown as mean \pm SD (n=3).

Microscopic observation of *N. oculata* subjected to ScCO₂ treatment showed maintained cell wall integrity (Fig. 3). The presence of such structure could limit the mass transfer of the solvent and then the extraction of NL which may explain the low extraction yield obtained for all pressures.

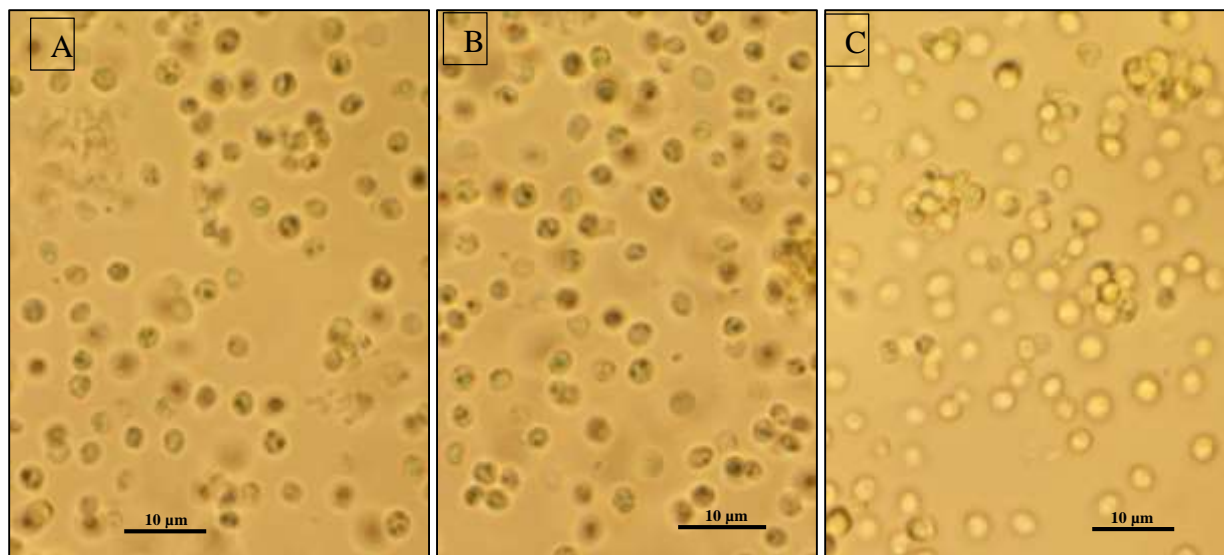

Fig. 3. Microscopic observation at high magnification (x1000) of *Nannochloropsis oculata* cells after supercritical CO₂ (ScCO₂) extraction. **(A)** Control before extraction, **(B)** After extraction under 450 bar, **(C)** After extraction under 750 bar.

3.2.3.2.2. Effect of medium polarity on lipid extraction from *C. vulgaris*

The solubility of lipids in ScCO₂ or ethanol depends on their chemical composition. Studied *C. vulgaris* strain was grown under high N nutrient growth conditions. It was thus expected to have a low lipids content, mainly composed of polar lipids (GL and PPL) as shown in Table 2.

Given the relatively high polarity of the initial lipids fraction, we tested the addition of ethanol as co-solvent to enhance its solubilization/extraction (Fig. 4). The addition of ethanol (10% v/v) at the beginning of the process markedly enhanced the extraction kinetics during the first 100 min relative to the first stage (absence of ethanol) of the double extraction procedure. In the presence of co-solvent, the final yield reached almost $40.3 \pm 1.1\%$ of the total extract (Fig. 4A).

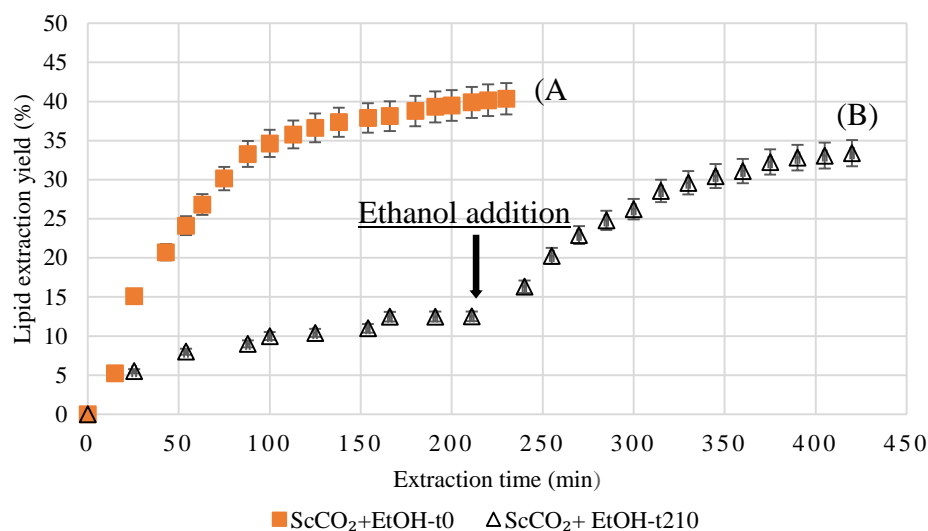

Fig. 4. Lipid extraction yield (extracted lipids/total extractable lipids) from *Chlorella vulgaris* over time under $P=250$ bar. (A) Simple supercritical CO_2 (ScCO_2) extraction with ethanol (10% v/v) as co-solvent, (B) double extraction: ScCO_2 extraction with addition of ethanol at $t=210$ min. Data shown as mean \pm SD ($n=3$).

The extraction of lipids was likely controlled initially by their solubility in ScCO_2 /ethanol and then, after the break of the curve, it was probably related to lipids desorption from the cell matrix [27]. The non-extracted lipids remain adsorbed on the microalgal matrix and the equilibrium phase are described by the adsorption isotherm. The adsorption capacity can be estimated from the point at which the slope of the extraction curve suddenly decreases.

Lipids extraction from *C. vulgaris* using ScCO_2 without ethanol showed stabilization of the extraction yield at almost 12.5 ± 0.6 % after 120 min (Fig. 4B). Ethanol (10% v/v) addition after 210 min increased the yield. The addition of ethanol modified the solvent (CO_2) properties, shown by the increased slope for the linear portion of the curve. Changing solvent polarity allowed further extraction of molecules that were not accessible to the ScCO_2 . Indeed, combining ethanol (a polar solvent) with CO_2 has been shown to improve the extraction of various lipids classes (neutral, polar) as reported in the literature [28]. Microscopic observation showed that *C. vulgaris* microalgae preserve its cell wall integrity after ScCO_2 treatment (Fig. 5).

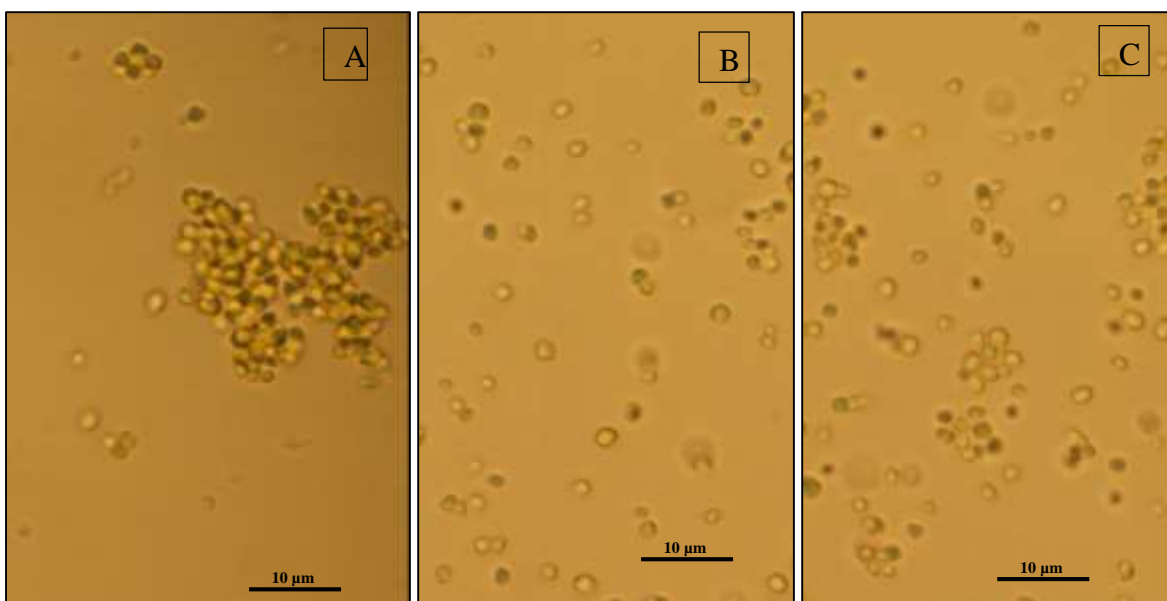

Fig. 5. Microscopic observation at high magnifications (x1000) of the *Chlorella vulgaris* cells after supercritical CO₂ (ScCO₂) extraction. (A) Control before extraction (B) After double extraction (C) After simple extraction.

3.2.3.3. Extracts composition

3.2.3.3.1. *N. oculata* extracts composition

Lipids extraction from *N. oculata* by ScCO₂ under 450 and 750 bar, resulted in comparable quantities of extracted lipids of similar quality. Under 450 bar, NL represented $70.0 \pm 1.3\%$ of the extracts at the beginning and $80 \pm 2\%$ by the end of the extraction (Figure 6A). The fraction of PPL did not exceed $7.1 \pm 0.3\%$ throughout the analysis, while GL made up $26.0 \pm 1.1\%$ of the extracts at the beginning and decreased to $15.2 \pm 0.7\%$ by the end of the extraction. Similar lipids fraction profiles were obtained under higher pressure extraction condition (750 bar), showing no significant difference ($p > 0.05$). NL represented most of the extracts with $70.0 \pm 1.7\%$ at the beginning, rising to $83.0 \pm 3.3\%$ after 211 minutes, whereas the proportion of GL and PPL did not exceed $12.1 \pm 0.65\%$ and $5.3 \pm 0.3\%$, respectively, by the end of the extraction process (Figure 7A). These results are in accordance with those reported by Temelli [29].

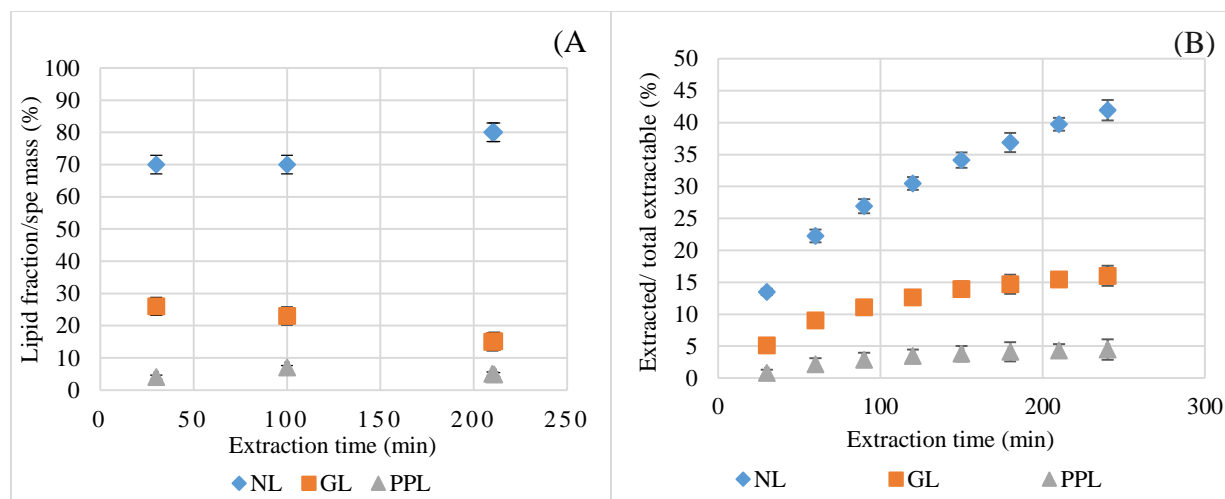

Fig. 6. Variation of proportions (A) and yield (B) of NL (neutral lipids), GL (glycolipids) and PPL (phospholipids) in the supercritical CO₂ (ScCO₂) extracts of *Nannochloropsis oculata* over time (450 bar and 50° C). Data shown as mean \pm SD (n=3).

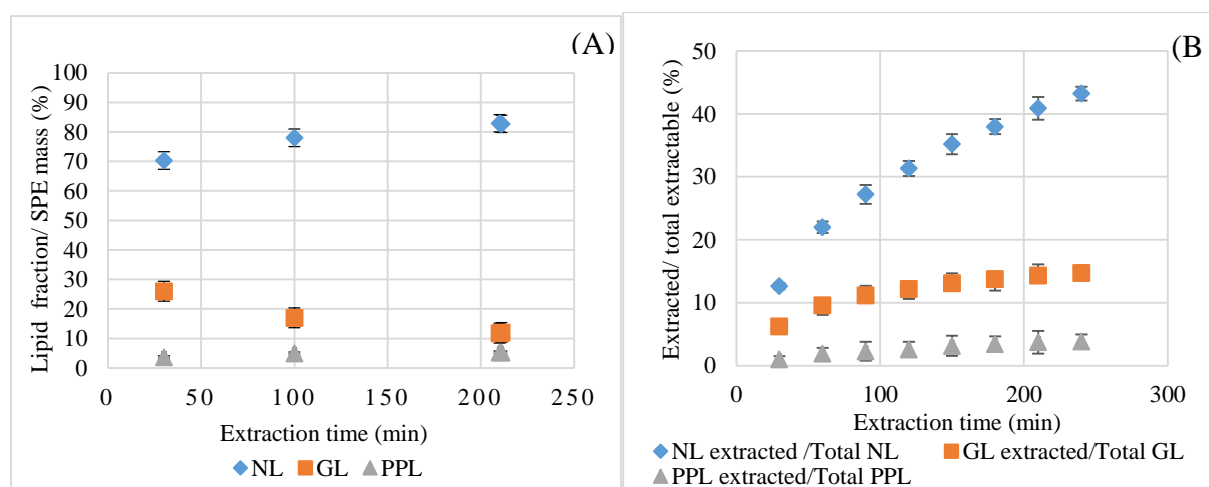

Fig. 7. Variation of proportions (A) and yield (B) of NL (neutral lipids), GL (glycolipids) and PPL (phospholipids) in the supercritical CO₂ (ScCO₂) extracts of *Nannochloropsis oculata* over time (750 bar and 50° C). Data shown as mean \pm SD (n=3).

In this experimental set-up, the yield of extracted lipids under 450 or 750 bar was essentially identical. Processing under a pressure of 450 bar, allowed the extraction of $41.9 \pm 1.2\%$ of total NL, $16.0 \pm 0.8\%$ of total GL and $4.5 \pm 0.2\%$ of total PPL initially contained in *N. oculata* (Figure 6B). Similar results were obtained at 750 bar where $43.2 \pm 1.05\%$ of NL initially contained in *N. oculata* were extracted (Figure 7B). The GL and PPL extraction curves rapidly reached steady state, yielding $14.7 \pm 0.8\%$ and $3.8 \pm 0.2\%$ of their total content, respectively. These results were

better than those obtained by Patil et al. [9] in terms of experimental simplicity, selectivity, and purity of extract. They subjected *Nannochloropsis* biomass to microwave pretreatment prior to supercritical extraction to improve the efficiency of NL extraction and added an azeotropic mixture (hexane/ethanol) as co-solvent to enhance ScCO₂ fluid affinity towards NL. In terms of selectivity, our results were also better than those of Tang et al. [30] who obtained a partial fraction of total lipid content using ethanol (95%, v/v) as co-solvent under high pressure, which increased the co-extraction of polar lipids, necessitating then further purification steps.

Increasing the pressure from 450 to 750 bar did not provide any additional benefit in terms of NL extraction yield. Global yields at $t = 210$ min were essentially the same, in accordance with the results of Crampon et al. [31] who reported a negligible difference in the yield of extracted lipids from *N. oculata* between 500 and 850 bar.

Contrary to GL and PPL, the NL extraction yield continued to linearly increase even after four hours, under both applied pressures, and would have reached much higher values if the extraction time was prolonged. This may be due to high pressure causing the formation of holes in the microalgae cell wall, allowing ScCO₂ to reach the NL located in the cytoplasm as droplets, and extract them. The yield of GL and PPL reached a steady state after two hours, suggesting that the external cell wall and membranes of the inner organelles, rich in polar lipids, were not substantially damaged and supporting the hypothesis of holes formation in the membranes rather than complete disintegration. In general, the amount of extractable solute depends on the percentage of microalgae cells opened by the disintegration step (not used in our study) and the fact that the solute from intact cells is not available for extraction by ScCO₂. The formation of holes through exposure to ScCO₂ was reported in the study of Solana et al [32].

NL extraction may be also influenced by the contact time with the solvent. This suggests an effect of residence time in which more adsorption sites of lipid molecules may be damaged over time, resulting in a longer time for the extraction to reach equilibrium. Our results suggest that a longer extraction time for both extraction conditions (450 and 750 bar) would increase the yield of NL only. Consequently, the final product becomes purer and consists mainly of NL. This may avoid extensive purification steps, which could compensate for the costs associated with the long extraction time.

3.2.3.3.2. *C. vulgaris* extracts composition

We fractionated samples of total lipids extracts obtained from *C. vulgaris* under double extraction (ScCO₂ followed by ScCO₂ + ethanol 10% as co-solvent added at t = 210 min) into NL, GL, and PPL, by the SPE technique (Figure 8). It can be seen that during the first stage of double extraction that NL represented $70.2 \pm 2.5\%$ of the obtained extracts when using only ScCO₂ as solvent. PPL were a minor fraction ($5.0 \pm 0.3\%$), whereas GL represented $25.3 \pm 1.3\%$ of the extracted material (Figure 8A). Moreover, the yield of extracted GL and PPL was relatively low (6.7 and 3.5%, respectively), whereas almost $35.8 \pm 0.9\%$ of the total NL originally contained in *C. vulgaris* were extracted. The addition of ethanol to the stabilized extraction (at t = 210 min) significantly increased the NL, PPL, and GL extraction yield. Almost $72.9 \pm 1.3\%$ of total NL, $26.4 \pm 1.5\%$ of total PPL, and $26.1 \pm 1.2\%$ of total GL were obtained by the end of extraction (Figure 8B). These results may be due to the increase in the polarity of the medium after the injection of ethanol which may boost the extraction of both polar and non-polar lipids as reported by Moreau et al. [28] and Temelli [29].

Adding ethanol (10% v/v) at the beginning of the extraction did not give the same results as those of the double extraction. The NL fraction represented $64.1 \pm 2.9\%$ of the initial extracts but decreased to $34.0 \pm 1.6\%$ by the end of extraction (Figure 9A). The GL and PPL fractions progressively increased over time to reach after 230 min $43.5 \pm 1.7\%$ and $23.0 \pm 0.9\%$ of the total extract, respectively.

Using simple extraction, the steady state was promptly reached for all lipid fractions (Figure 9B). However, in this case, the extraction yield of NL was higher ($97.1 \pm 0.5\%$) than that for GL and PPL ($25.3 \pm 1.0\%$ and $35.9 \pm 1.5\%$, respectively). Our results competed with Moradi-Kheibari and Ahmadzadeh [33] who studied NL extraction from *C. vulgaris* using ScCO₂ with a disruption step and a higher pressure.

Furthermore, the NL extraction yield was higher than that obtained by double extraction. This could be explained by the fact that the extraction of polar lipids may promote the extraction of NL due to existing interactions between different types of lipids (polar/non-polar) [28] [29]. Using double extraction, the lipid molecules remaining in the matrix from the first stage become highly viscous and form agglomerates that hindered their diffusion during the second step [34]. This could

limit the extraction of NL remaining in the biomass which could not pass through the non-disintegrated cell wall as shown by microscopic observation.

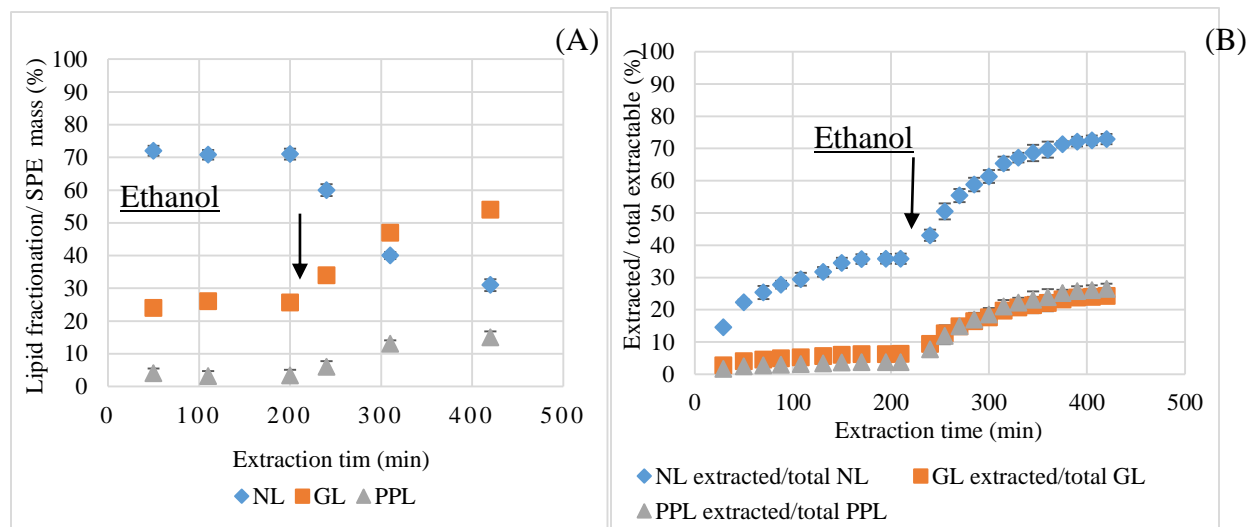

Fig. 8. Variation of proportions (A) and yield (B) of NL (neutral lipids), GL (glycolipids) and PPL (phospholipids) in the supercritical CO₂ (ScCO₂) of *Chlorella vulgaris* extracts after double extraction over time. Data shown as mean \pm SD (n=3).

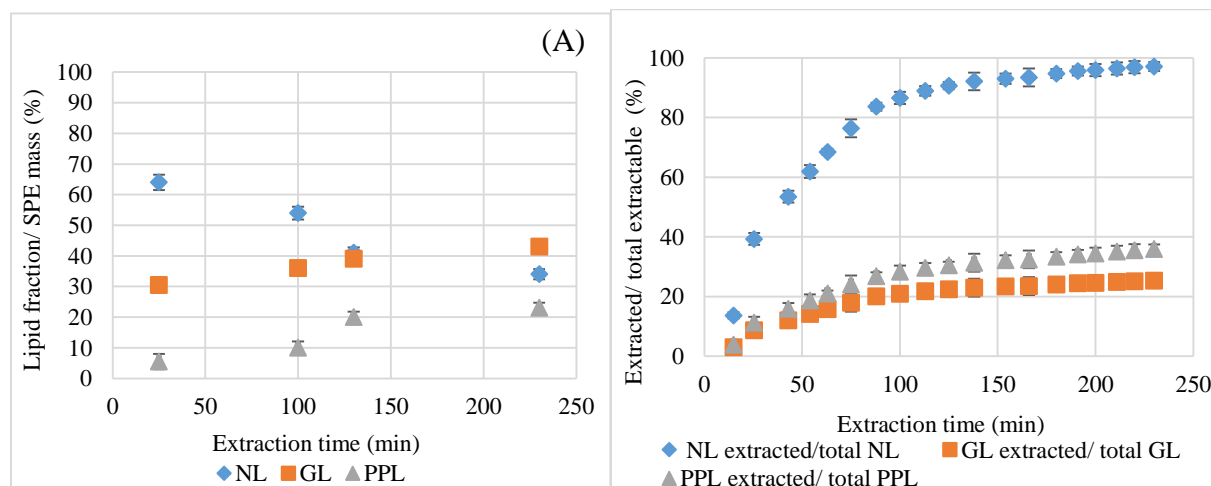

Fig. 9. Variation of proportions (A) and yield (B) of NL (neutral lipids), GL (glycolipids) and PPL (phospholipids) in the supercritical CO₂ (ScCO₂) of *Chlorella vulgaris* extracts after simple extraction over time. Data shown as mean \pm SD (n=3).

3.2.4. Conclusion

During this study, ScCO₂ extraction was carried out for selective recovery of neutral lipids from *C. vulgaris* and *N. oculata* microalgae without preliminary cell disruption step. Extraction yield of total lipids from *N. oculata* at 450 and 750 bar (20 %) was higher than that at 250 bar (15%).

Neutral lipids extracts from *N. oculata* represented 83% of total lipids extracts, whereas the proportion of glycolipids and phospholipids did not exceed 12.1% and 5.3%, respectively. Adding ethanol (10% v/v) as co-solvent led to the extraction of 97% of neutral lipids from *C. vulgaris*.

Residues from ScCO₂ extraction, composed mainly of hydrophilic fraction (proteins, polysaccharides), will undergo in future study an optimized aqueous extraction, in aim to recover total proteins fraction without any cell disruption pretreatment. This deals with the fundamental algorefinery concept, by taking advantages from the whole biomass components, making the large scale application of microalgae feasible and economically viable.

3.2.5. References

- [1] S. Bellou, M. N. Baeshen, A. M. Elazzazy, D. Aggeli, F. Sayegh, and G. Aggelis, "Microalgal lipids biochemistry and biotechnological perspectives," *Biotechnol. Adv.*, vol. 32, no. 8, pp. 1476–1493, Dec. 2014.
- [2] T. Bradley, D. Maga, and S. Antón, "Unified approach to Life Cycle Assessment between three unique algae biofuel facilities," *Appl. Energy*, vol. 154, pp. 1052–1061, Sep. 2015.
- [3] L. Brennan and P. Owende, "Biofuels from microalgae—A review of technologies for production, processing, and extractions of biofuels and co-products," *Renew. Sustain. Energy Rev.*, vol. 14, no. 2, pp. 557–577, Feb. 2010.
- [4] L. Lardon, A. Hélias, B. Sialve, J.-P. Steyer, and O. Bernard, "Life-Cycle Assessment of Biodiesel Production from Microalgae," *Environ. Sci. Technol.*, vol. 43, no. 17, pp. 6475–6481, Sep. 2009.
- [5] R. Ranjith Kumar, P. Hanumantha Rao, and M. Arumugam, "Lipid Extraction Methods from Microalgae: A Comprehensive Review," *Front. Energy Res.*, vol. 2, Jan. 2015.
- [6] M. K. Lam and K. T. Lee, "Microalgae biofuels: A critical review of issues, problems and the way forward," *Biotechnol. Adv.*, vol. 30, no. 3, pp. 673–690, May 2012.
- [7] A. García, A. de Lucas, J. Rincón, A. Alvarez, I. Gracia, and M. A. García, "Supercritical carbon dioxide extraction of fatty and waxy material from rice bran," *J. Am. Oil Chem. Soc.*, vol. 73, no. 9, pp. 1127–1131, Sep. 1996.
- [8] J. Lorenzen *et al.*, "Extraction of microalgae derived lipids with supercritical carbon dioxide in an industrial relevant pilot plant," *Bioprocess Biosyst. Eng.*, vol. 40, no. 6, pp. 911–918, 2017.

- [9] P. D. Patil, K. P. R. Dandamudi, J. Wang, Q. Deng, and S. Deng, "Extraction of bio-oils from algae with supercritical carbon dioxide and co-solvents," *J. Supercrit. Fluids*, vol. 135, pp. 60–68, May 2018.
- [10] C.-H. Cheng, T.-B. Du, H.-C. Pi, S.-M. Jang, Y.-H. Lin, and H.-T. Lee, "Comparative study of lipid extraction from microalgae by organic solvent and supercritical CO₂," *Bioresour. Technol.*, vol. 102, no. 21, pp. 10151–10153, Nov. 2011.
- [11] C. Crampon *et al.*, "Oil extraction from enriched *Spirulina platensis* microalgae using supercritical carbon dioxide," *J. Supercrit. Fluids*, vol. 119, pp. 289–296, Jan. 2017.
- [12] C. Safi *et al.*, "Aqueous extraction of proteins from microalgae: Effect of different cell disruption methods," *Algal Res.*, vol. 3, pp. 61–65, Jan. 2014.
- [13] K. Ramluckan, K. G. Moodley, and F. Bux, "An evaluation of the efficacy of using selected solvents for the extraction of lipids from algal biomass by the soxhlet extraction method," *Fuel*, vol. 116, pp. 103–108, Jan. 2014.
- [14] J. Jeon *et al.*, "New mixture composition of organic solvents for efficient extraction of lipids from *Chlorella vulgaris*," *Biomass Bioenergy*, vol. 59, pp. 279–284, Dec. 2013.
- [15] Y. Du, B. Schuur, S. R. A. Kersten, and D. W. F. Brilman, "Opportunities for switchable solvents for lipid extraction from wet algal biomass: An energy evaluation," *Algal Res.*, vol. 11, pp. 271–283, Sep. 2015.
- [16] P. Juaneda and G. Rocquelin, "Rapid and convenient separation of phospholipids and non phosphorus lipids from rat heart using silica cartridges," *Lipids*, vol. 20, no. 1, pp. 40–41.
- [17] M. Olofsson *et al.*, "Combined Effects of Nitrogen Concentration and Seasonal Changes on the Production of Lipids in *Nannochloropsis oculata*," *Mar. Drugs*, vol. 12, no. 4, pp. 1891–1910, Mar. 2014.
- [18] A. Widjaja, C.-C. Chien, and Y.-H. Ju, "Study of increasing lipid production from fresh water microalgae *Chlorella vulgaris*," *J. Taiwan Inst. Chem. Eng.*, vol. 40, no. 1, pp. 13–20, Jan. 2009.
- [19] M. Piorreck, K.-H. Baasch, and P. Pohl, "Biomass production, total protein, chlorophylls, lipids and fatty acids of freshwater green and blue-green algae under different nitrogen regimes," *Phytochemistry*, vol. 23, no. 2, pp. 207–216, Jan. 1984.
- [20] S. Ötles and R. Pire, "Fatty Acid Composition of *Chlorella* and *Spirulina* Microalgae Species," Nov-2001.
- [21] G. Van Vooren, F. Le Grand, J. Legrand, S. Cuiné, G. Peltier, and J. Pruvost, "Investigation of fatty acids accumulation in *Nannochloropsis oculata* for biodiesel application," *Bioresour. Technol.*, vol. 124, pp. 421–432, Nov. 2012.
- [22] A. L. Stephenson, J. S. Dennis, C. J. Howe, S. A. Scott, and A. G. Smith, "Influence of nitrogen-limitation regime on the production by *Chlorella vulgaris* of lipids for biodiesel feedstocks," *Biofuels*, vol. 1, no. 1, pp. 47–58, Jan. 2010.

- [23] J. Shi, C. Yi, S. J. Xue, Y. Jiang, Y. Ma, and D. Li, "Effects of modifiers on the profile of lycopene extracted from tomato skins by supercritical CO₂," *J. Food Eng.*, vol. 93, no. 4, pp. 431–436, Aug. 2009.
- [24] A. Cháfer, T. Fornari, A. Berna, E. Ibañez, and G. Reglero, "Solubility of solid carnosic acid in supercritical CO₂ with ethanol as a co-solvent," *J. Supercrit. Fluids*, vol. 34, no. 3, pp. 323–329, Jul. 2005.
- [25] G. Andrich, U. Nesti, F. Venturi, A. Zinnai, and R. Fiorentini, "Supercritical fluid extraction of bioactive lipids from the microalga *Nannochloropsis* sp.," *Eur. J. Lipid Sci. Technol.*, vol. 107, no. 6, pp. 381–386.
- [26] H. Xing, B. Su, Q. Ren, and Y. Yang, "Adsorption equilibria of artemisinin from supercritical carbon dioxide on silica gel," *J. Supercrit. Fluids*, vol. 49, no. 2, pp. 189–195, Jun. 2009.
- [27] M. Perrut, J. Y. Clavier, M. Poletto, and E. Reverchon, "Mathematical Modeling of Sunflower Seed Extraction by Supercritical CO₂," *Ind. Eng. Chem. Res.*, vol. 36, no. 2, pp. 430–435, Feb. 1997.
- [28] R. A. Moreau, M. J. Powell, and V. Singh, "Pressurized liquid extraction of polar and nonpolar lipids in corn and oats with hexane, methylene chloride, isopropanol, and ethanol," *J. Am. Oil Chem. Soc.*, vol. 80, no. 11, pp. 1063–1067, Nov. 2003.
- [29] F. Temelli, "Extraction of Triglycerides and Phospholipids from Canola with Supercritical Carbon Dioxide and Ethanol," *J. Food Sci.*, vol. 57, no. 2, pp. 440–443, 1992.
- [30] S. Tang, C. Qin, H. Wang, S. Li, and S. Tian, "Study on supercritical extraction of lipids and enrichment of DHA from oil-rich microalgae," *J. Supercrit. Fluids*, vol. 57, no. 1, pp. 44–49, May 2011.
- [31] C. Crampon, A. Mouahid, S.-A. A. Toudji, O. Lépine, and E. Badens, "Influence of pretreatment on supercritical CO₂ extraction from *Nannochloropsis oculata*," *J. Supercrit. Fluids*, vol. 79, pp. 337–344, Jul. 2013.
- [32] M. Solana, C. S. Rizza, and A. Bertucco, "Exploiting microalgae as a source of essential fatty acids by supercritical fluid extraction of lipids: Comparison between *Scenedesmus obliquus*, *Chlorella protothecoides* and *Nannochloropsis salina*," *J. Supercrit. Fluids*, vol. 92, pp. 311–318, Aug. 2014.
- [33] N. Moradi-kheibari and H. Ahmadzadeh, "Supercritical carbon dioxide extraction and analysis of lipids from *Chlorella vulgaris* using gas chromatography," *J. Iran. Chem. Soc.*, vol. 14, no. 11, pp. 2427–2436, Nov. 2017.
- [34] G. Yoo *et al.*, "An effective, cost-efficient extraction method of biomass from wet microalgae with a functional polymeric membrane," *Green Chem.*, vol. 16, no. 1, pp. 312–319, 2014.

3.3. Supercritical fluid extraction and solid phase fractionation of pigments from *Chlorella vulgaris* and *Nannochloropsis oculata*

(Article submitted to Algal research)

Sara Obeid^{a, b, c, 1}, Nicholas Beaufiles^a, Séverine Camy^d, Hosni Takache^{b, c}, Ali Ismail^{b, c},

Pierre-Yves Pontalier^a.

^a Laboratoire de Chimie Agro-industrielle (LCA), Université de Toulouse, INRA, INPT, Toulouse, France
4 allée Emile Monso, 31030 Toulouse cedex 4, France

^b Département des Sciences et Technologies Alimentaires, Faculté des Sciences Agronomiques, Université Libanaise, Allée Georges Matta, 1500, Hadath, Liban.

^c Université Libanaise, Ecole Doctorale de Sciences et Technologies EDST-PRASE (Plateforme de Recherches et Analyses en Sciences de l'Environnement), Campus Rafic Hariri, 1500, Hadath, Liban.

^d Université de Toulouse, INP-ENSIACET, LGC (Laboratoire de Génie Chimique), 4 allée Emile Monso, 31030 Toulouse cedex 4, France

¹ Pierre-yves.pontalier@ensiacet.fr¹

Abstract:

The aim of this study was to determine the influence of pressure and co-solvent on the supercritical fluid extraction of chlorophyll a, chlorophyll b, lutein and β -carotene from freeze-dried *Nannochloropsis oculata* and *Chlorella vulgaris*. Bypassing the mechanical cells disintegration showed to be good operational conditions for the selective extraction of chlorophyll a. In comparison with the reference extraction process used (Soxhlet), 43% of total chlorophyll a were selectively extracted under 750 bar from freeze-dried *Nannochloropsis oculata* with traceable amount of chlorophyll b, β -carotene and lutein. The effect of adding ethanol (10% v/v) on pigments extraction selectivity was also studied on *Chlorella vulgaris*. When supercritical CO₂ doped with ethanol was used from the beginning of the extraction, it was possible to selectively extract 30% of chlorophyll a comparing to 5% only by adding ethanol at 210 min from the beginning of the

SFE: supercritical fluid extraction

NL: neutral Lipids

GL: glycolipids

PPL: phospholipids

ScCO₂: supercritical carbon dioxide

SPE: solid phase extraction

extraction. The higher selectivity of chlorophyll a extraction should facilitate the recovery of pigments.

Keywords: Supercritical fluid extraction, solid phase extraction, microalgae, pigments, cell wall integrity.

3.3.1. Introduction

Over the last decade, microalgae showed their potential of satisfying the industrial growing demand in natural products beneficial for human health and environment. The algae biomass is widely studied as a source of highly valuable components such as lipids considered as renewable biofuel [1]. Besides to the energy potential, these microorganisms have the capacity to synthesize bioactive molecules such as pigments where particular attention has been given to carotenoids and chlorophylls. Carotenoids are regarded as cancer and health disorders preventives [2] [3], while chlorophylls are widely used in food, feed, cosmetics, biomaterials, nanostructures and pharmaceutical industry [1] [4]. Moreover, microalgal pigments becomes an attractive option due to problems associated with the harmful effects of synthetic colorants and their limited applications due to their negative effect on human health [5].

Extraction of pigments from microalgal biomass is usually achieved using chemical solvents. However, these methods are nonselective and generally accompanied by cell-wall destruction, leading to complex extracts of hydrophilic and hydrophobic components. Such treatments require additional costly stages in downstream processing for phase separation and compounds purification. In addition, a large amount of toxic solvents is needed. For that, this technique is currently being phased out for their environmental, health and safety impacts. Recently, supercritical carbon dioxide (ScCO₂) extraction has become an important alternative to the traditional separation methods. CO₂ is among the most used supercritical solvent because it engenders solvent free product compatible with the use of the label “natural” [6]. In addition, the use of CO₂ gives an advantage in terms of quality, as extracts are not submitted to excessive heating, which would destroy heat sensitive compounds. Many studies have tested ScCO₂ due to its remarkable characteristics like low viscosity, high diffusivity and low surface tension [7] which could improve pigments extraction deep inside the microalgal cell matrix. Furthermore, ScCO₂

enables the recovery of molecules of interest by a simple pressure drop, avoiding additional energy consumption step [8].

Since ScCO₂ is a non-polar solvent, a polar co-solvent is often used in order to increase its extraction capacity. The most often used is ethanol, a green solvent, generally recognized as safe for human and environment. Despite these studies, understanding the extraction and its selectivity under certain supercritical parameters still not well described and only limited information exists [8]. Besides, in supercritical conditions, the degree of cell wall disintegration strongly influenced the pigment (chlorophyll and carotenoids) recoveries [9] [10] [11]. In addition, the before-mentioned studies did neither involve the quantification of several specific pigments nor their fractionation during the extraction process.

The aim of this work is to study the extraction of four pigments (chlorophyll a, chlorophyll b, lutein and β -carotene) from non-disintegrated *C. vulgaris* and *N. oculata* by ScCO₂ followed by solid phase extraction in aim to understand the evolution of their release with manipulation time. Different ScCO₂ extraction parameters were studied on non-disintegrated biomass of both microalgae.

3.3.2. Materials and methods

3.3.2.1. Microalgae

Microalgae *Chlorella vulgaris* and *Nannochloropsis oculata* were supplied as frozen paste from Alpha Biotech (Asserac, France). Both species were cultivated in 10 L tubular air-lift photobioreactor. The Sueoka medium with high N nutrient concentration, and the Conway medium with N nutrient deficiency to favor the accumulation of lipids were used for *C. vulgaris* and *N. oculata*, respectively. The two cultures were growing at a constant temperature of 25 ± 1 °C and constant pH of 7.5. The harvesting of the biomass was carried out at exponential growth phase. The algal suspension was centrifuged at 10,000 g for 15 min. The harvested biomass contained 27 % dry matter (DM). Frozen paste was freeze-dried using Fisher Bioblock Scientific Alpha 2–4 LD Plus device (Illkirch, France), where the pressure was reduced to 0.01 bar and the temperature decreased to -80°C for 48 h to give a completely dry biomass. After freeze drying process, the mean diameter of particles was measured showing a value around 250 μm using Mastersizer 2000

granulometer (Malvern Instruments Ltd.). Aggregates were crushed gently with a laboratory knife grinder and the final size was around 200 μm .

3.3.2.2. Lipids content analysis

Total lipids content in the two microalgae species were measured after extraction in Soxhlet apparatus using a slightly modified method based on both methods developed by Blight and Dyer (1959) and Folch (1957) using a mixture of chloroform/methanol (0.35 / 0.65, V/V) [12] [13] [14]. The microalgal biomass (3 g) was placed in a cartridge filter paper using 200 mL of solvent. The Soxhlet extractor was operated for a number of cycles for 18 hours in order to insure the extraction of all extractable lipids. The amount of total lipids was determined gravimetrically.

3.3.2.3. Supercritical extraction

The experiments were carried out in pilot plant SF100 (Separex Chimie Fine, France) capable of operating at pressures of up to 1000 bar and at a maximal temperature of 200°C. Desired operating pressure in the extractor was adjusted by a backpressure regulator. During this experiment, the extractor of a 25 mL (internal diameter 2 cm, height 8 cm) was filled with powdered freeze-dried microalgae and CO₂ introduced at the bottom. Ethanol was used as a co-solvent when mixed with CO₂ as shown in table 1.

After extraction, the extracts were collected in the separator and stored in the dark at 4°C to prevent degradation of samples for further analysis. Cleaning of the extractor and the separator was done after each experiment.

Table 1- Operating conditions for ScCO₂ extraction on *Nannochloropsis oculata* and *Chlorella vulgaris*

Microalgae	P (bar)	solid mass (g)	Solvent rate (g/g.min ⁻¹)	Ethanol as co-solvent	Ethanol flow rate (g/min)
<i>Nannochloropsis oculata</i>	450	8.8	0.35	No	-
<i>Nannochloropsis oculata</i>	750	8.8	0.35	No	-
<i>Chlorella vulgaris</i> ^(a)	250	12.1	0.45	Yes	1.9
<i>Chlorella vulgaris</i> ^(b)	250	25.4	1.02	Yes	1.9

NB: ^(a) Simple extraction consists of one step ScCO₂ extraction using ethanol (10%) as co-solvent.

^(b) Double extraction consists of a first ScCO₂ extraction, followed by a second ScCO₂ extraction using ethanol (10%) as co-solvent.

3.3.2.4. Lipids classes' fractionation

Partitioning of lipids to three classes: neutral lipids (NL), glycolipids (GL) and phospholipids (PPL) was possible using solid phase extraction (SPE) method described by Juaneda and Rocqueline [15]. This technique consists on putting the mixture of lipids on the top of a conditioned cartridge (SPE silica cartridges Supelco 500 mg, Sigma-Aldrich). The separation of lipids fractions was accomplished by eluting NL, GL and PPL with 10 ml of chloroform, acetone and methanol, respectively. Once eluted and freeze-dried under liquid nitrogen, fractions were measured gravimetrically and results were expressed in mg/g dry weight.

3.3.2.5. Pigments analysis

Total biomass content in chlorophyll a, chlorophyll b, lutein and β -carotene were extracted in cold condition to avoid any denaturation induced by high temperature. For this, 20 mg of freeze-dried microalgae were mixed with 15 ml of specific solvent (table 2) during 24 min at 10 °C with continuous gentle stirring. Glass tubes were covered with aluminum paper to prevent any photodegradation during extraction. Afterward, samples were centrifuged at 20,000g for 15 min at 5°C and supernatants were collected for analysis.

Total pigments (chlorophyll a, chlorophyll b, β -carotenes and lutein) content was measured by HPLC and UV-Vis spectroscopy according to the general formula developed by Bidigare [16]: $C(\text{mg/l}) = \frac{\text{OD} \cdot 1000}{\alpha \cdot L}$

Where OD is the optical density read at the specific wavelength in a given solvent, α is the specific extinction coefficient ($1 \text{ g}^{-1} \text{ cm}^{-1}$) and L is the optical path length (cuvettes) in cm which is 1 cm in our study.

Chapter 3: Fractional extraction

Table 2- Wavelengths, specific extinction coefficients α and solvent used for pigment analysis by HPLC and UV-Vis spectroscopy.

	wavelength (nm)	α (L g ⁻¹ cm ⁻¹)	Solvent	References
Chlorophyll a	665	77.9	Methanol	[17] [18]
Chlorophyll b	642	44.5	Methanol	[17] [18]
β -carotene	453	262.0	Ethanol	[19] [18]
Luteins	445	255.0	Ethanol	[19] [18]

Supernatants resulted from for all ScCO₂ extraction were analysed for pigments quantification. Before analysis, residues have been removed by microfiltration (Polyray 0.22). Pigments analysis was carried out by HPLC Dionex UltiMate™ 3000 quaternary pump (Thermo Scientific, Massachusetts, USA) using a 5 C18 column (250*4.6 mm). A UV/Vis detector was used after elution with acetonitrile: methanol: water (65:35:2) at a flow rate of 1 mL/min. Standard pigments of chlorophyll a, chlorophyll b, lutein and β -carotene (Sigma-Aldrich, France) were prepared in methanol in a concentration range of 0.5 mg/L to 5 mg/L. Absorption measurements were performed using a photodiode array detector.

3.3.2.6. Proteins quantification

The total proteins content of *C. vulgaris* was determined according to the Kjeldhal method, which accounts for all nitrogen present in the biomass, with a 6.15 coefficient [13]. After collection by centrifugation at 20,000g for 25 min, samples of the UAE supernatants were collected for proteins analysis.

3.3.2.7. Structure observation

Microscopically qualitative approach was done to characterize any cell disintegration of the biomass. Observation at high magnifications (x 1000) was performed before and directly after ScCO₂ treatments. A small quantity of cell suspension was placed on a specific plate (Nikon SMZ 1500). The images were captured under a constant exposure and illumination by Nikon eclipse E600 camera

3.3.2.8. Statistics Analysis

Experiments for microalgae characterization in terms of lipids content were resulted based on 3 replicates for 3 experiments \pm SD (n=9). All supercritical extraction data were also presented as mean values \pm standard deviations of three determinations. Statistically significant differences ($p \leq 0.05$) between the means were evaluated using one-way analysis of variance (ANOVA) and the Tukey's test on XLSTAT software version 2018.1.

3.3.3. Results

3.3.3.1. Biomass characterization

3.3.3.1.1. Lipids content

Total lipids content for *N. oculata* was 399 mg/g representing $39.9 \pm 1.6\%$ dry weigh DW which is within the range of 31–68% reported by Spolaore *et al.* [20], while for *Chlorella vulgaris* a value of $24.4 \pm 1.1\%$ DW was obtained which is in accordance with the results reported by Liu *et al.* [21].

Fractionation using SPE showed that *N. oculata* lipids were mainly composed of neutral lipids with a concentration of 175mg/g (representing $44.1 \pm 1.6\%$ of total lipids) contrary to *C. vulgaris* where glycolipids represented the majority of its total lipids content with 143 mg/g ($60.1 \pm 0.8\%$ DW) (Figure 1).

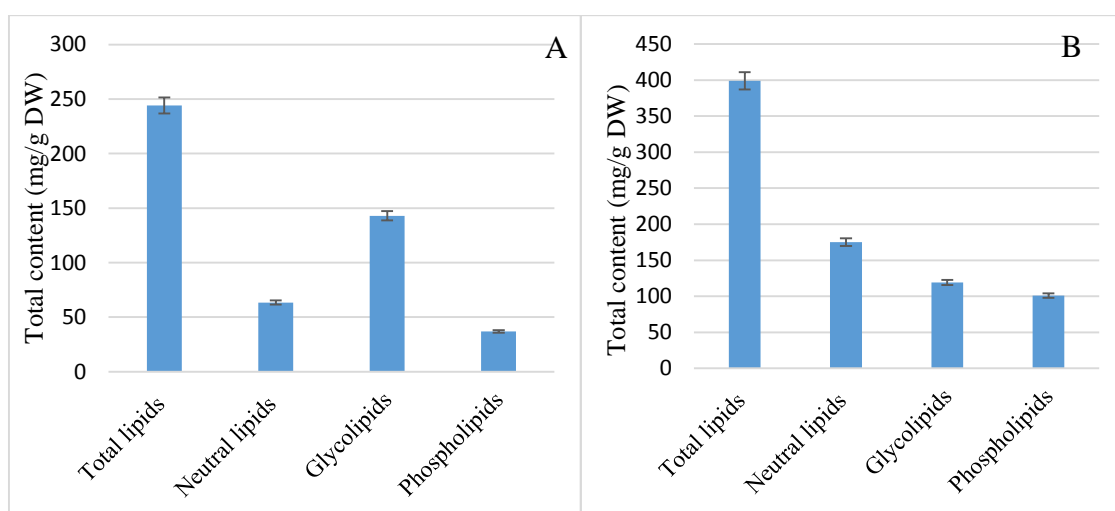

Figure 1- Lipids content for (A): *Chlorella vulgaris* and (B): *Nannochloropsis oculata*. Results are based on 3 replicates for 3 experiments \pm SD (n=9) and expressed in mg/g dry weigh.

The high lipids content in *N. oculata* can be explained by the growth conditions. In fact, the strain used in this study was cultivated under normal CO₂ concentration and nitrogen depletion. Widjaja *et al.* [22] reported that growth condition under low to moderate CO₂ concentration linked to N depletion could induce high lipids productivity and could also surpass the productivity during normal nutrition. Furthermore, these conditions seem to affect not only lipids content but also lipids composition while microalgae metabolism will gradually shift to produce mostly neutral lipids [22].

3.3.3.1.2. Pigments content

Figure 2 showed that concentration of chlorophyll a, b in *C. vulgaris* were of 20.1 and 12.9 mg/g comparing to a 2.8 and 2.9 mg/g of β -carotene and lutein.

Supplied biomass of *C. vulgaris* was grown under high nitrogen concentration. In this condition, *C. vulgaris* studied strain was distinguished by its high proteins content with 0.58 ± 0.03 g/g DW (quantified by Kjeldhal). Piorreck *et al.* [23] suggested that increasing N levels in culture medium leads to a significant increase in proteins content and in chlorophylls. This can explain the high chlorophyll a and b content in the biomass comparing to the low concentration of β -carotene and lutein. (Figure A).

On the other hand, *Nannochloropsis* showed a low chlorophyll a and b content with 8.1 ± 0.3 mg/g and 2.7 ± 0.1 mg/g DW comparing to a high β -carotene and lutein concentration with 5.6 and 5.8 mg/g, respectively. The relationship between pigments (carotenoid and chlorophyll) content and the accumulation of lipids were studied by Solovchenko *et al* [24] who found that microalgae accompanied with accumulation of lipids specially neutral lipids (the case of our biomass rich in neutral lipids) showed an increase in their carotenoid and a decline in chlorophyll content.

Hence, what found in *Chlorella* and *Nannochloropsis* used strains (figure 2) came in accordance with results in literature: **carotenoid-to-chlorophyll ratio** in *Chlorella* (with low neutral lipid content) is lower than carotenoid-to-chlorophyll ratio in *Nannochloropsis* (rich in neutral lipids content).

Chapter 3: Fractional extraction

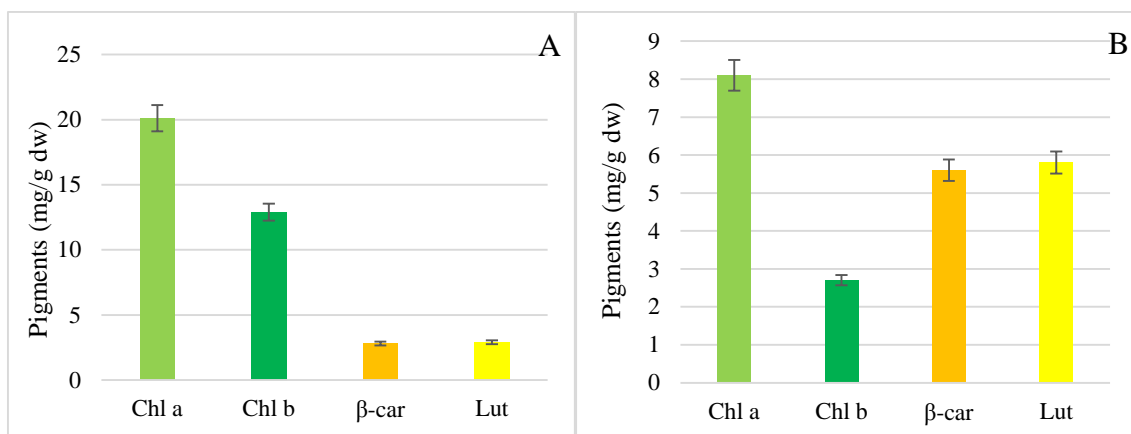

Figure 2- Initial content of each carotenoid (β -car and Lut) and Chl a, b of (A) *Chlorella vulgaris*, (B) *Nannochloropsis oculata*. Results are based on 3 replicates for 3 experiments \pm SD (n=9).

3.3.3.2. Supercritical extraction

3.3.3.2.1. *N. oculata*

When applying 450 bar, chlorophyll a was extracted rapidly and reached a steady state after 30 min. A total concentration of 2.5 mg/g DW (representing 34 % of initial content of Chlorophyll a) has been obtained (Figure 3 A).

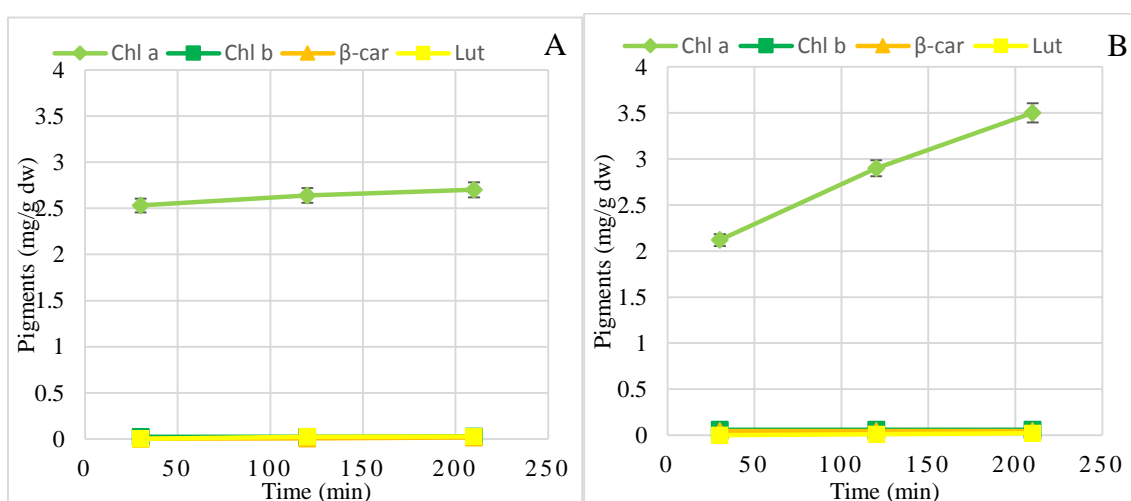

Figure 3- Pigments extraction yield from *Nannochloropsis oculata* as a function of applied pressure using CO₂ as solvent and T= 50°C, (A) Under 450 bar, (B) Under 750 bar. Results are based on 3 replicates for 3 experiments \pm SD (n=9).

Chapter 3: Fractional extraction

However, At 750 bar, Chlorophyll a concentration was 2.2 mg/g DW at 30 min and continued to linearly increase even after 200 min reaching 3.5 mg/g DW (representing 43% of total Chlorophyll a content) (Figure 3B).

Extraction of chlorophyll a from microalgae using ScCO₂ has already been reported by several authors [9] (Supercritical Carbon Dioxide Extraction of Molecules of Interest from Microalgae and Seaweeds., 2011) . Their results showed that the higher the pressure, the higher the yields and the faster the extraction. This significant improvement in the total chlorophyll a yield observed at high pressure, may be due to the thermodynamic parameter (pressure) since the CO₂ power increases with pressure increase under given temperature as cited by Chafer *et al* [25], and to the modification of the algal cell wall properties. The high pressure could cause the formation of holes in the microalgae cell wall [26], which may allow the ScCO₂ to reach the deep located chlorophylls and extract them. In general, the amount of extractable solute depends on the percentage of microalgae cells being affected by the disintegration step (bypassed in our study). Besides, microscopic observation of 750 bar residues showed no deviation in the spherical form of the biomass, which could be an indication of the maintenance of the cell wall integrity (**Figure 4**). The difference in cell color (deviation from dark green to light green) confirmed the partial extraction yield (of 43%) of chlorophyll a as certain to happen.

Besides, β -carotene, lutein and chlorophyll b extraction yield stood insignificant even though the increase of the operational pressure from 450 bar to 750 bar. The extraction yield at 750 bar still not significant at all, representing 2, 0.8 and 0.48% of total content, respectively.

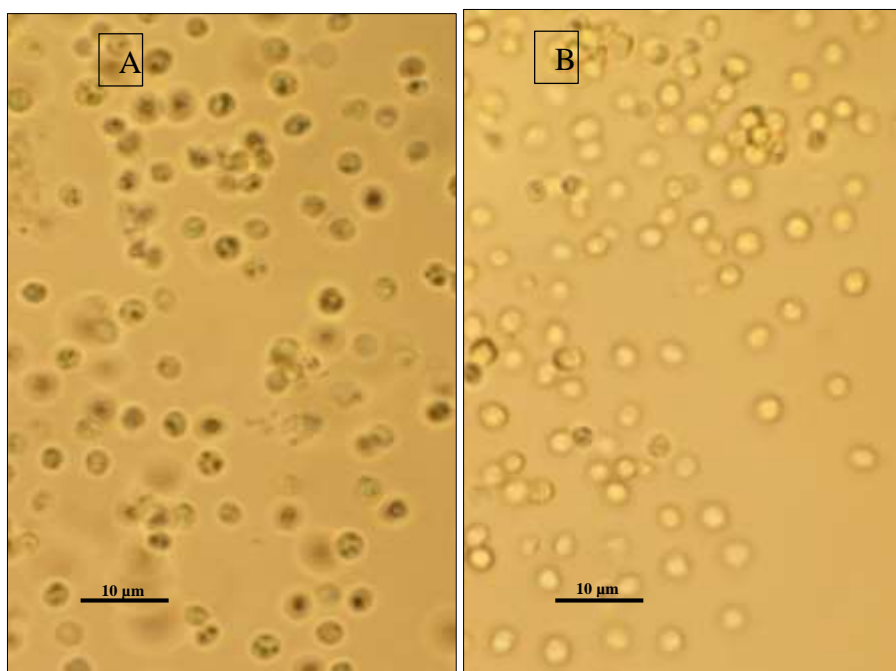

Figure 4 - Microscopic observation at high magnifications (x 1000) of *Nannochloropsis oculata* cells after supercritical CO₂ treatment. (A) Under 450 bar, (B) Under 750 bar.

3.3.3.2.2. *Chlorella vulgaris*

Two experiments were performed to study the influence of the solvent polarity on pigments extraction yield: double and simple extractions. Double extraction (A) was managed by injecting only CO₂ at the beginning and then, after 210 minutes, a mixture of CO₂ and ethanol (10% v/v) are added. Simple extraction (B) was carried out by injecting the mixture of ethanol and CO₂ at the beginning of the experiment.

Under double extraction, during the initial phase, pigments concentration was so low. Analysis showed that pigments were mainly constituted of lutein and β -carotene. When injecting ethanol (10%) with CO₂ at t=210 min (Figure 5 A), the concentration significantly increased ($p < 0.01$) especially for chlorophyll a, with 1.1 mg/g DW obtained, representing 6% of its initial content. Besides, lutein concentration increased after ethanol injection from 170 $\mu\text{g/g}$ dry to 385 $\mu\text{g/g}$ DW (representing 8.1% of its total content). Chlorophyll b extraction yield slightly increased to 0.02 mg/g (representing 0.17 % of its total content). Whereas, β -carotene extraction yield does not change after ethanol injection.

Chapter 3: Fractional extraction

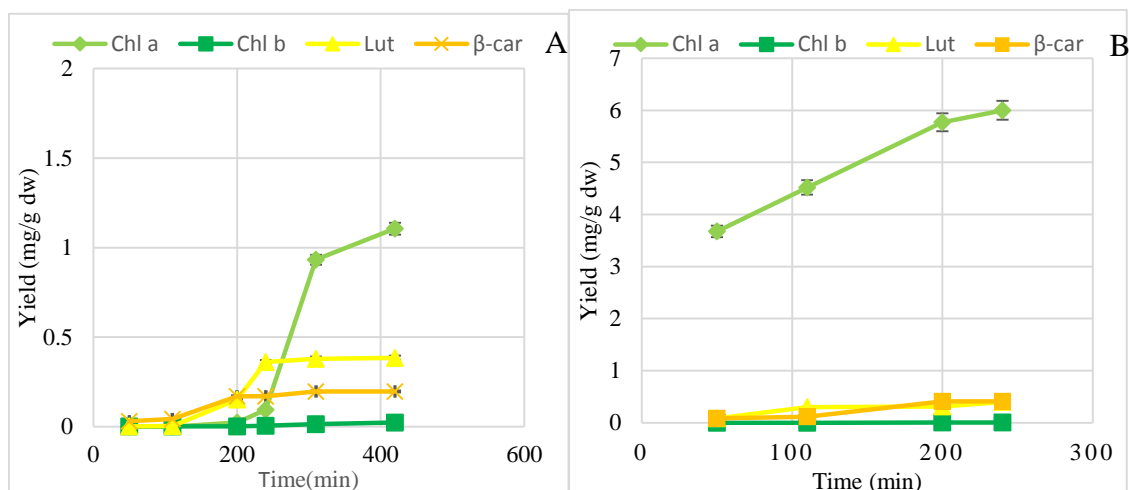

Figure 5- Yield of the extraction of pigments from *Chlorella vulgaris* as a function of solvent polarity, under 250 bar and 50°C, (A) double extraction, (B) simple extraction. Results are based on 3 replicates for 3 experiments \pm SD (n=9).

Results obtained under simple extraction showed that the concentration of the chlorophyll b, β -carotene and lutein were traceable with 5 μ g/g, 0.4 mg/g and 0.38 mg/g, representing 0.04, 14 and 15 % of their initial content, respectively.

In fact, the main difference appeared with chlorophyll a, whom extraction yield was almost 6 fold higher than during the double extraction (from 5 to 30%). This may be explained by the modification of plasmic membrane structure of the chloroplast allowing for the chlorophyll a to diffuse out of the cell.

The use of ethanol as a co-solvent from the beginning accelerated and slightly increased the pigments extraction yield. Obeid *et al.* [27] showed that the use of ethanol as a co-solvent on non-disintegrated *C. vulgaris* rose polar lipids extraction yield and neutral lipid recovery (completely recovered). As GL and PPL are mainly located in the cell wall, extracting them can modify the membranes structure and favor pigments diffusion. Thus chlorophyll a transfer is not further limited by the diffusion through the cells membrane. Nevertheless, microscopic observation (x1000) did not show dramatic modification in the cells round shape (Figure 6).

The addition of polar alcohol could modify ScCO₂ characteristics and led to an enhancement of chlorophyll a recovery. However, an insignificant yield of 0.1% of total chlorophyll b was obtained under both simple and double extractions. In fact, both

Chapter 3: Fractional extraction

chlorophylls contain several polar C-O and C-N bonds and also a magnesium ion chelated to the nitrogen atoms [28]. The distinction between the two molecules is slight and resides in the fact that chlorophyll a has a methyl group (CH₃) in a position where chlorophyll b has an aldehyde (Y=CHO). This makes chlorophyll b slightly more polar than chlorophyll a, so the chemical structure could not explain the difference in extraction yield between the two molecules.

The other explanation could be the location of the two molecules in the chloroplast (Figure 7). Chlorophyll b is mainly present in the PSII mainly located in the adjoining/piled regions of the thylakoids (non in contact with the stroma). Whereas chlorophyll a is present in PSI located mainly in the non-contiguous areas of thylakoids (in contact with the stroma), which make it more reachable by the solvent than chlorophyll b in PSII [29]. This observation would indicate that the membrane modification during the treatment with ethanol would be localized to specific structures in the microalgal cell.

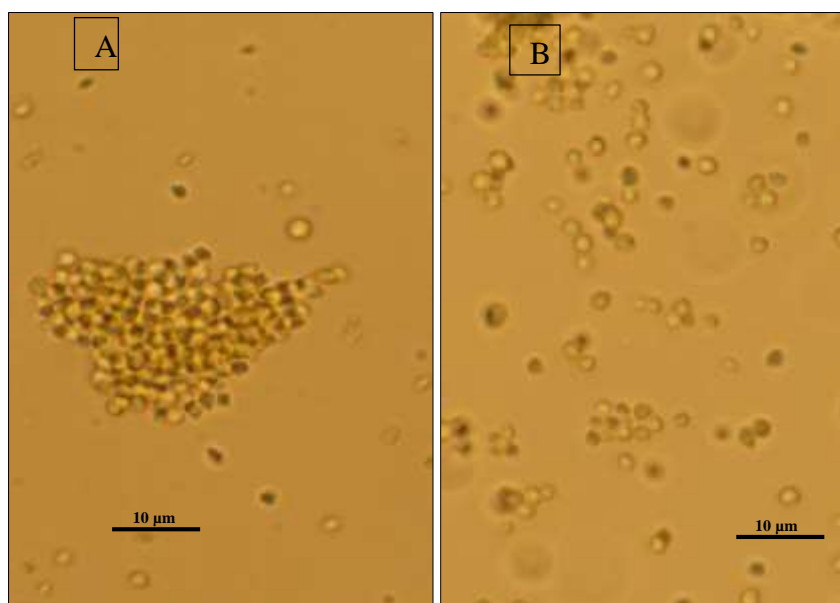

Figure 6- Microscopic observation at high magnifications (x 1000) of *Chlorella vulgaris* cells after supercritical CO₂ treatment. (A) Double extraction, (B) Simple extraction.

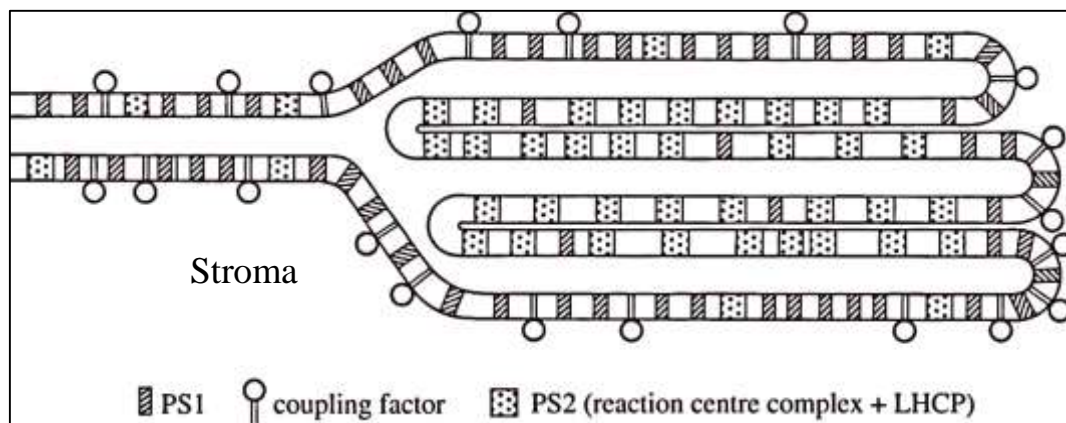

Figure 7- The differentiation of the continuous thylakoid membrane, with morphological reflection of the non-random distribution of photosystem II/ photosystem I [30].

3.3.4. Conclusion

This work demonstrated that ScCO_2 allowed efficient and selective extraction of chlorophyll a from the mechanically untreated microalgae.

Results showed that chlorophyll a could be extracted efficiently and selectively from *Nannochloropsis oculata* reaching 43% of its initial content, whereas others pigments did not come out even at high pressure. This study highlighted the potential and the possibility to eliminate some unit operations (cell disruption) to extract pure chlorophyll a free from other pigments.

The effectiveness of adding co-solvent for selective chlorophyll a from *Chlorella vulgaris* was also covered in other studies. The distinction between chlorophyll a and b extraction yield (30 and 0.04% of their initial content, respectively) would be an indicator that the membrane modification during the treatment with ethanol would be happen to specific structures in the thylakoids system.

Acknowledgements

This research did not receive any specific grant from funding agencies in the public or private sectors.

3.3.5. References

- [1] Nobre et al., “A biorefinery from *Nannochloropsis* sp. microalga – Extraction of oils and pigments. Production of biohydrogen from the leftover biomass,” *Bioresour. Technol.*, vol. 135, pp. 128–136, May 2013.
- [2] Wilhelm Stahl and Helmut Sies, “Bioactivity and protective effects of natural carotenoids,” *Biochim. Biophys. Acta BBA - Mol. Basis Dis.*, vol. 1740, no. 2, pp. 101–107, May 2005.
- [3] J. A. Olson and N. I. Krinsky, “Introduction: the colorful, fascinating world of the carotenoids: important physiologic modulators,” *FASEB J.*, vol. 9, no. 15, pp. 1547–1550, Dec. 1995.
- [4] R. Harun, M. Singh, G. M. Forde, and M. K. Danquah, “Bioprocess engineering of microalgae to produce a variety of consumer products,” *Renew. Sustain. Energy Rev.*, vol. 14, no. 3, pp. 1037–1047, Apr. 2010.
- [5] Petra Amchova, Hana Kotolova, Jana Ruda-Kucerova, “Health safety issues of synthetic food colorants,” *Regul. Toxicol. Pharmacol.*, vol. 73, no. 3, pp. 914–922, Dec. 2015.
- [6] S. B. Hawthorne, “Analytical-scale supercritical fluid extraction,” 06-Jun-2012. [Online]. Available: <https://pubs.acs.org/doi/abs/10.1021/ac00210a722>. [Accessed: 22-Aug-2018].
- [7] J. P. Friedrich and E. H. Pryde, “Supercritical CO₂ extraction of lipid-bearing materials and characterization of the products,” *J. Am. Oil Chem. Soc.*, vol. 61, no. 2, pp. 223–228, Feb. 1984.
- [8] Victor Abrahamsson, Firas Jumaah, Charlotta Turner, “Continuous multicomponent quantification during supercritical fluid extraction applied to microalgae using in-line UV/Vis absorption spectroscopy and on-line evaporative light scattering detection,” *J. Supercrit. Fluids*, vol. 131, pp. 157–165, Jan. 2018.
- [9] M.D. Macías-Sánchez et al, “Supercritical fluid extraction of carotenoids and chlorophyll a from *Nannochloropsis gaditana*,” *J. Food Eng.*, vol. 66, no. 2, pp. 245–251, Jan. 2005.
- [10] L. Gouveia and A. C. Oliveira, “Microalgae as a raw material for biofuels production,” *J. Ind. Microbiol. Biotechnol.*, vol. 36, no. 2, pp. 269–274, Feb. 2009.
- [11] Reyes et al., “Astaxanthin extraction from *Haematococcus pluvialis* using CO₂-expanded ethanol,” *J. Supercrit. Fluids*, vol. 92, pp. 75–83, Aug. 2014.
- [12] K. Ramluckan, K. G. Moodley, and F. Bux, “An evaluation of the efficacy of using selected solvents for the extraction of lipids from algal biomass by the soxhlet extraction method,” *Fuel*, vol. 116, pp. 103–108, Jan. 2014.
- [13] J. Jeon *et al.*, “New mixture composition of organic solvents for efficient extraction of lipids from *Chlorella vulgaris*,” *Biomass Bioenergy*, vol. 59, pp. 279–284, Dec. 2013.
- [14] Y. Du, B. Schuur, S. R. A. Kersten, and D. W. F. Brilman, “Opportunities for switchable solvents for lipid extraction from wet algal biomass: An energy evaluation,” *Algal Res.*, vol. 11, pp. 271–283, Sep. 2015.
- [15] P. Juaneda and G. Rocquelin, “Rapid and convenient separation of phospholipids and non phosphorus lipids from rat heart using silica cartridges,” *Lipids*, vol. 20, no. 1, pp. 40–41.

Chapter 3: Fractional extraction

- [16] R. R. Bidigare, "Analysis of Algal Chlorophylls and Carotenoids," in *Marine Particles: Analysis and Characterization*, American Geophysical Union (AGU), 2013, pp. 119–123.
- [17] O. Holm-Hansen and B. Riemann, "Chlorophyll a Determination: Improvements in Methodology," *Oikos*, vol. 30, no. 3, pp. 438–447, 1978.
- [18] V. Brotas and M.-R. Plante-Cuny, "Identification and quantification of chlorophyll and carotenoid pigments in marine sediments. A protocol for HPLC analysis.," *Oceanol. Acta Paris*, vol. 19, no. 6, pp. 623–634, 1996.
- [19] T. W. Goodwin, "Biosynthesis of Carotenoids," in *The Biochemistry of the Carotenoids*, Springer, Dordrecht, 1980, pp. 33–76.
- [20] P. Spolaore, C. Joannis-Cassan, E. Duran, and A. Isambert, "Commercial applications of microalgae," *J. Biosci. Bioeng.*, vol. 101, no. 2, pp. 87–96, Feb. 2006.
- [21] Z.-Y. Liu, G.-C. Wang, and B.-C. Zhou, "Effect of iron on growth and lipid accumulation in *Chlorella vulgaris*," *Bioresour. Technol.*, vol. 99, no. 11, pp. 4717–4722, Jul. 2008.
- [22] A. Widjaja, C.-C. Chien, and Y.-H. Ju, "Study of increasing lipid production from fresh water microalgae *Chlorella vulgaris*," *J. Taiwan Inst. Chem. Eng.*, vol. 40, no. 1, pp. 13–20, Jan. 2009.
- [23] M. Piorreck, K.-H. Baasch, and P. Pohl, "Biomass production, total protein, chlorophylls, lipids and fatty acids of freshwater green and blue-green algae under different nitrogen regimes," *Phytochemistry*, vol. 23, no. 2, pp. 207–216, Jan. 1984.
- [24] A. E. Solovchenko, I. Khozin-Goldberg, Z. Cohen, and M. N. Merzlyak, "Carotenoid-to-chlorophyll ratio as a proxy for assay of total fatty acids and arachidonic acid content in the green microalga *Parietochloris incisa*," *J. Appl. Phycol.*, vol. 21, no. 3, pp. 361–366, Jun. 2009.
- [25] A. Cháfer et al, "High-pressure solubility data of system ethanol (1)+epicatechin (2)+CO₂ (3)," *J. Supercrit. Fluids*, vol. 24, no. 2, pp. 103–109, Nov. 2002.
- [26] M. Solana, C. S. Rizza, and A. Bertucco, "Exploiting microalgae as a source of essential fatty acids by supercritical fluid extraction of lipids: Comparison between *Scenedesmus obliquus*, *Chlorella protothecoides* and *Nannochloropsis salina*," *J. Supercrit. Fluids*, vol. 92, pp. 311–318, Aug. 2014.
- [27] Obeid et al., "Supercritical carbon dioxide extraction and fractionation of lipids from freeze-dried microalgae *Nannochloropsis oculata* and *Chlorella vulgaris*," *Algal Res.*, vol. 34, pp. 49–56, Sep. 2018.
- [28] "Spinach_Pigments_handout_Spring_2016 (1) - Isolation of Chlorophyll and Carotenoid Pigments from Spinach Adapted from Pavia D.L Lampman G.M Kriz G.S and." [Online]. Available: <https://www.coursehero.com/file/17807812/Spinach-Pigments-handout-Spring-2016-1/>. [Accessed: 29-Aug-2018].
- [29] R. Bassi, F. Rigoni, and G. M. Giacometti, "chlorophyll binding proteins with antenna function in higher plants and green algae," *photochem. photobiol.*, vol. 52, no. 6, pp. 1187–1206, dec. 1990.
- [30] J. M. Anderson, "Lateral heterogeneity of plant thylakoid protein complexes: early reminiscences," *Philos. Trans. R. Soc. Lond. B Biol. Sci.*, vol. 367, no. 1608, pp. 3384–3388, Dec. 2012.

3.4. Extraction and purification of soluble proteins from *Nannochloropsis oculata* by pH-shifting and ultrafiltration

(Article submitted to Biotechnology and Bioengineering Journal)

Sara Obeid^{a, b, c, 1}, Hosni Takache^{b, c}, Nicholas Beaufile^a, Séverine Camy^d, Pierre-Yves Pontalier^a, Ali Ismail^{b, c}

^a Laboratoire de Chimie Agro-industrielle (LCA), Université de Toulouse, INRA, INPT, Toulouse, France 4 allée Emile Monso, 31030 Toulouse cedex 4, France

^b Département des Sciences et Technologies Alimentaires, Faculté des Sciences Agronomiques, Université Libanaise, Allée Georges Matta, 1500, Hadath, Liban.

^c Université Libanaise, Ecole Doctorale de Sciences et Technologies EDST-PRASE (Plateforme de Recherches et Analyses en Sciences de l'Environnement), Campus Rafic Hariri, 1500, Hadath, Liban.

^d Université de Toulouse, INP-ENSIACET, LGC (Laboratoire de Génie Chimique), 4 allée Emile Monso, 31030 Toulouse cedex 4, France

¹ **Pierre-yves.pontalier@ensiacet.fr**

Abstract

A mild biorefinery process was investigated to obtain purified enriched fraction of water soluble proteins from *Nannochloropsis oculata* without prior cell disruption step. Solubilization of proteins has been achieved under double stage extraction from defatted, semi defatted and non-defatted biomasses, in aim to understand the effect of defatting degree and pH shifting on proteins extraction yield. 73.7% of total proteins were released using a combination of aqueous/alkaline condition from defatted biomass. A dead-end ultrafiltration was then performed on the supernatants obtained by testing different membrane cut-off (100, 30, 10 kDa). Enriched fraction of water soluble proteins (83%) free from lipids and pigments was obtained using 100 kDa membrane.

Keywords:

Microalgae; *N. oculata*; extraction; pH shifting; purification; ultrafiltration.

3.4.1. Introduction

Microalgae biomass have been excessively exploited during the last decades regarding their high lipids content for biodiesel production as a substitute for fossil oil [1]. Hence, many studies were focused on lipids, neglecting the potential of other high-value components like proteins. Aside from biofuels and energy sectors, through time, interest in this biomass has been taking a new course especially for its nutritional values. To satisfy the increase on proteins demand as a consequence of rapid world population growth, microalgae became an important proteins source seeing its high proteins content reaching up to 71% dry weight (DW) [2] [3]. Microalgal proteins can be used to enhance the nutritional value of animal feed owing to their chemical composition [4]. They also play a crucial role in aquaculture and they can be incorporated into cosmetics [5].

Among numerous microalgae species, *Nannochloropsis oculata* is one of the few species permitted to be used as a source of proteins for food or feed formulations [6]. In order to improve the nutritional value of proteins fraction, it should be isolated from the rest of biomass components. However, proteins extraction from *N. oculata* is often prevented by the intrinsic rigidity of its cell wall mainly composed of cellulose and hemicellulose [7]. To overcome this barrier, cell disruption should be used to facilitate proteins extraction [8]. Numerous disruption methods have been investigated involving ultra-sonication, high pressure homogenization, bead-beating, blender, manual grinding, etc. [9] [8]. Gerde et al. [6] obtained 30% of total proteins content from *Nannochloropsis spp.* using ultrasound. Safi et al. [10], [11] obtained 49-52.8% of total proteins content from *N. oculata* using high-pressure homogenization. Furthermore, Cavanaugh et al. [12] studied proteins extraction by pH-shift process on *N. oculata* where cells disruption was carried out with glass beads. As a result, up to 85% of proteins and total fatty acids were recovered in the final product.

The main drawbacks in all works cited above could be resumed by: (i) the high cost of cell disintegration process (Growth aspects of the marine microalga *Nannochloropsis gaditana*. , 2003) , (ii) the non-selectivity of the extraction and co-release of undesirable components, (iii) the difficulty in the downstream separation processes due to the micronization of cell debris [13] [14], (iv) the denaturation of heat sensitive proteins [15].

Chapter 3: Fractional extraction

Once extraction is done, it is necessary to establish a process for proteins fractionation/concentration. Many studies have tested the separation of microalgae proteins by pH shifting [12], three phase partitioning [16] and aqueous two-phase extraction [17]. Nevertheless, these methods required large amount of solvents and other chemicals especially at industrial scale. Contrary to other separation techniques, membrane technology process is isothermal, involves no phase change or chemical agents [16], and it is considered as relatively cheap compared to other separation techniques [18]. However, membrane separation technology is not well explored and remains not mature for microalgae applications [11]. Few examples have been reported about the use of membrane process for the purification or concentration of microalgal components: polysaccharides from *Porphyridium cruentum* [19][20], *Spirulina platensis* and *Chlorella pyrenoidosa* [21], proteins from *Chlorella vulgaris* and *Haematococcus pluvialis* [22] [23].

The application of membrane process such as ultrafiltration is largely used at industrial level [24] mainly in the dairy industry. However, this technology has not been investigated for the separation/purification of microalgal proteins, despite this technique could offer some sources of specific industrial interest (efficiency and facility of exploitation)

The goal of the present work is to study **the extraction/purification of proteins** from *N. oculata* while maintaining the integrity of the cell wall and minimizing as possible the fractionation steps. Extraction has been achieved by double stage and pH shifting on defatted, non-defatted and partially defatted biomass to understand the effect of lipids content on proteins release. Besides, proteins rich fraction have been subjected to further purification by semi-frontal ultrafiltration. Size-exclusion chromatography (SEC) analysis has been used for proteins extracts characterization.

3.4.2. Materials and methods

3.4.2.1. Microalga

Nannochloropsis oculata were provided freeze-dried by Alpha Biotech (Assérac, France). After being harvested during the exponential growth phase, the biomass was concentrated by centrifugation to obtain a paste of 20-24% DW. The frozen paste was

Chapter 3: Fractional extraction

then freeze-dried in a Fisher Bioblock Scientific Alpha 2–4 LD Plus device (Illkirch, France). During freeze drying process, the pressure was reduced to 0.010 bar, the temperature further decreased to -80°C, for 48 h to give a completely dry biomass. Freeze-dried aggregates were then slightly spread with a laboratory spatula. The mean diameter of particles was measured using Mastersizer 2000 granulometer (Malvern Instruments Ltd.) showing a value around 250 µm.

3.4.2.2. Chemicals

The Lowry kit (Lowry reagent plus bovine standard albumin (BSA) standards and 2 N Folin–Ciocalteu reagents) was purchased from Thermo Fisher Scientific.

3.4.2.3. Proteins content calculation

Quantitation of total proteins content of the biomass was performed according to Kjeldahl analysis [25] which take into account the totality of the nitrogen present in the biomass, from which 59–98 % of total nitrogen (TN) can belong to proteins [26] [27]. After evaluating the nitrogen content, the proteins content is estimated by multiplying Kjeldahl TN by NTP (nitrogen-to-protein) factor. In case of *N. oculata*, NTP conversion factor is estimated to be 6.28 [28]. Biomass was analyzed in triplicate, using each time 200 mg samples of dry biomass.

Water-soluble proteins were quantified by Lowry method [29] using a standard curve of bovine serum albumin (BSA). This method is based on a reaction catalyzed by the copper content in the Folin and oxidation of the peptide bonds with a Folin-Ciocalteu reagent [30]. Absorbance was measured at 750 nm using a Shimadzu UV-1700 spectrophotometer.

3.4.2.4. Biomass defatting

Proteins extraction has been performed on the **freeze-dried biomass, partially defatted biomass and defatted biomass**.

Two methods of partial defatting have been used: **A)** supercritical carbon dioxide (ScCO₂) extraction, **B)** Soxhlet extraction,

Chapter 3: Fractional extraction

A) ScCO₂ were carried out on an SFE100 apparatus supplied from Separex (Nancy, France). The pilot was composed of a 25 cm³ autoclave. This unit is able to work at pressures up to 1000 bar and temperatures up to 250°C. At the beginning of the experiment, the extractor was filled with powdered freeze-dried microalgae. The module was supplied with liquid CO₂ through a pump maintained at a temperature below 7°C to keep the CO₂ in the liquid state. The operating conditions are presented in table 1.

B) Soxhlet apparatus using a slightly modified method of Blight & Dyer (1959) (A rapid method of total lipid extraction and purification., 1959) using mixture of polar and non-polar solvent [31] [32] chloroform / methanol (0.35 / 0.65, v/v). The microalgal biomass (3 g) was placed in a cartridge filter paper using 200 mL of solvent. The Soxhlet extractor was operated for a number of cycles for 2 and 6 hours for partial lipid extraction.

Table 1- Various ScCO₂ operating conditions applied on freeze-dried biomass of *N. oculata*. All experiments were performed under a constant temperature of 50°C and a constant CO₂ flow rate of 25 g/min.

Pressure (bar)	Biomass (g)	Solvent rate (min ⁻¹)
250	25.4	1.02
450	8.8	0.35
750	8.8	0.35

Defatted biomass was obtained using the Soxhlet method described above but operated for 18 hours in order to insure the extraction of total lipids [33].

3.4.2.5. Proteins extraction by pH shifting

Double stage proteins extraction have been performed using aqueous medium at two pH: neutral (pH 7) and alkaline (pH 11). Stock solutions were prepared with ultrapure water. The pH was adjusted using 1N NaOH solution. All the conditions are summarized in Table 2. In order to limit proteins damage during extraction, temperature was maintained at 25°C. After extraction, the microalgae suspensions were centrifuged at 20,000 g for 15 min at 5°C. Protein-rich supernatants were taken for analysis. It should be emphasized that no cell lysis has been conducted before proteins extractions.

Chapter 3: Fractional extraction

Table 2- Operating conditions for double extraction on non-defatted, partially defatted and defatted *N. oculata*.

Experiment number	Defatting mode	Extraction stage	pH	Ratio Liquid/Solid	Duration (hours)
1	ScCO ₂	1	7	20	20
		2	7	10	1
2	ScCO ₂	1	7	20	20
		2	11	10	1
3	ScCO ₂	1	7	20	5
		2	7	10	5
4	ScCO ₂	1	11	20	5
		2	7	10	5
5	Soxhlet 2 h	1	7	20	20
		2	7	10	1
6	Soxhlet 6 h	1	7	20	20
		2	7	10	1
7	Soxhlet 18 h	1	7	20	20
		2	7	10	1
8	-	1	7	20	20
		2	7	10	1

In order to define proteins solubility and efficiency of the two stage of double extraction process, **partition-coefficient (P)** or **distribution-coefficient** is calculated. The proteins concentration in supernatant 1 and supernatant 2 was divided by the proteins concentration presented in the residue from the first extraction step (R1) and the residue from the second extraction step (R2) respectively, expressed in percent [12]:

$$P1 = \frac{[Protein S1]}{[Protein R1]} * 100 \quad P2 = \frac{[Protein S2]}{[Protein R2]} * 100$$

3.4.2.6. Proteins molecular size determination

In order to determine the molecular weight of extracted proteins, gel electrophoresis and size exclusion chromatography were used. Molecular weight distribution of soluble proteins was estimated through size exclusion chromatography using a capillary HPLC system Dionex UltiMate™ (Thermo Scientific, Massachusetts, USA), equipped with a UV / VIS detector.

Chapter 3: Fractional extraction

Proteins samples filtered to 0.2 microns were loaded on Agilent column (SEC-3, 100Å, 7.8 x 300 mm) with a flow rate of 1.2 ml / min of a solution (0.1 M phosphate and 0.15M NaCl). The column was calibrated with a standard mixture of high molecular weight proteins (Bio-Rad Laboratories) containing thyroglobulin (670 kDa), c-globulin (158 kDa), ovalbumin (44 kDa), myoglobin (17 kDa) and vitamin B12 (1.35 kDa). The eluted proteins were detected at 220 and 280 nm.

3.4.2.7. Proteins purification

To fulfil the purification operation, protein-rich supernatants from both stages were collected and mixed together, then underwent a semi-frontal ultrafiltration using Amicon® Stirred Cells size 200 mL. Membranes with a molecular weight of 10, 30 and 100 kDa cutoff and 30.17 cm² filtration area were used, under a transmembrane pressure (TMP) from 0.5 to 4 bar. A stirring of 100 rpm was applied over the membrane to minimize concentration polarization effect due to the densification of macromolecules at the membrane surface as reported by Burba et al. [34] Before ultrafiltration experiments, semi-frontal ultrafiltration membranes were floated with distilled water for at least 1 hour. After being used, all membranes were immersed in 0.1 M NaOH for 1 hour, then washed and stood in Milli-Q water for 24 h before their storage at 5°C in ethanol/water (1:9) mixtures.

3.4.2.8. Statistical analysis

All treatments and analyses were run in triplicate. Statistical analyses were carried out using Minitab 17 software. ANOVA and Tukey test were carried out and measurements of triplicate for each sample were reproducible for $\pm 5\%$ of the respective mean values.

3.4.3. Results and discussion

Total proteins content of the initial biomass were evaluated at 22% DW. This result is in accordance with what is usually described for *N. oculata* proteins content [12].

3.4.3.1. Effect of extraction time

Proteins extraction test was realized by placing the partially defatted *N. oculata* biomass (by ScCO₂) in contact with water for 20 h, liquid/solid ratio of 20 and T=20°C. Results

showed that almost 35 % of total proteins were extracted after 5h, whereas 50% were obtained after 20h indicating that proteins extraction is a slow phenomenon [9].

3.4.3.2. Effect of pH shifting in the second stage of the double extraction

During this part, the first stage of proteins extraction was carried out using water as solvent at pH=7. Studying the extraction conditions on ScCO₂ semi-defatted residues (experiments 1-2, **table 2**), results showed that when the pH was maintained at 7 during the second stage of the double extraction, the total extraction yield reached 60% of total proteins. Whereas, when the pH was shifted to 11, total yield was higher reaching 70% of total protein. **Partition coefficient values** showed that major part of proteins was released during the first stage of extraction ranging between 50-55% of initial proteins content (Table 3). Alkaline medium (pH 11) was twice more effective than neutral medium (pH 7) for the release of remaining proteins, with P_2 values of 41.7 and 16.6 %, respectively. This result could be explained by the addition of NaOH which may induce a partial permeability through cell wall to liberate the rest part of intracellular proteins as reported by Chronakis and Gerde *et al.* [6], [35]. The increase in the solubility of proteins in alkaline media can be attributed to the net electrical charges. Therefore some presented acidic amino acids may exhibit more solubility under alkaline pH [36].

Table 3- Partition coefficients (P_1 , P_2) of proteins double extraction (first stage: pH=7, ratio L/S=20) second stage: pH=7 or 11, ration L/S=20) resulting from partially defatted *N. oculata* using ScCO₂ extraction 250, 450 750 bar).

Pressure (bar)	250	450	750
First stage			
pH=7			
P_1	50.5	53	54.3
Second stage			
pH=7			
P_2	16.6	19.3	23.1
pH=11			
P_2	41.7	41.9	41.2

3.4.3.3. Effect of pH shifting in the first stage of the double extraction

In experiments 3 and 4 (**table 2**), we studied the effect of pH shifting at the first stage while the pH was maintained at 7 during the second stage. Results showed that shifting pH from 7 to 11 did not enhance the extraction yield as expected (figure 1).

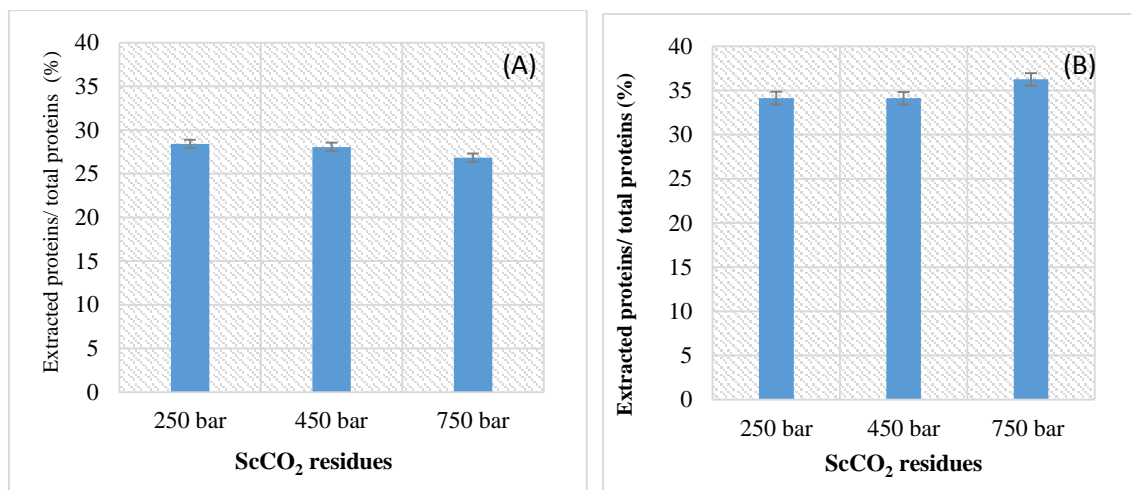

Figure 1 - First stage of the proteins double extraction on partially defatted residues of *N. oculata* using ScCO₂ (250, 450, 750 bar). **A:** in alkaline medium pH=11 **B:** in neutral medium pH=7. Extraction conditions: ratio L/S=20, t= 5h, 150 rpm. Data are shown as Mean +/- SD for n=3.

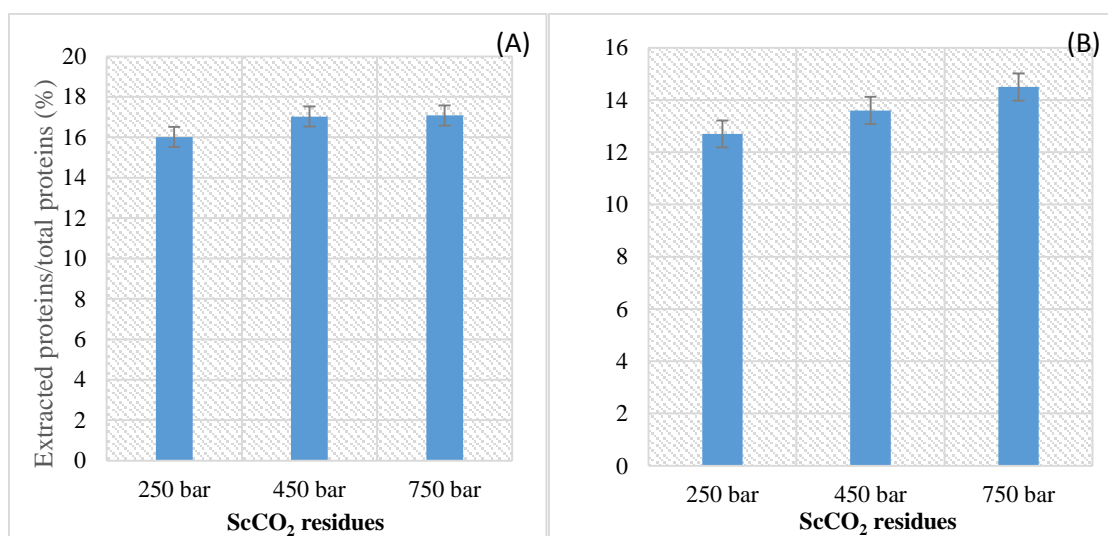

Figure 2 – Second stage of the proteins double extraction from *N. oculata* partially defatted residues using ScCO₂ (250, 450, 750 bar). **A:** alkaline medium pH=11, **B:** in aqueous medium pH= 7. Extraction conditions (ratio L/S=10, t= 5h, 150 rpm). Data are shown as Mean +/- SD for n=3.

Chapter 3: Fractional extraction

Table 4- Partition coefficient resulting from proteins double extraction process from partially defatted residues using ScCO₂ (250, 450, 750 bar). A: at pH=7/7. B: at pH=11/7

(A)	250 bar	450 bar	750 bar	(B)	250 bar	450 bar	750 bar
First stage extraction pH=7				First stage extraction pH=11			
P_1	33	33.7	35.2		28.1	28	26
Second stage extraction pH=7				Second stage extraction pH=7			
P_2	19	20.8	20.4	P_2	23	25	24

By calculating the partition coefficients for the two stages, it should be noted that increasing the pH of the medium from 7 to 11 in the first stage had a negative effect on the solubilization of proteins (table 4). At the opposite, pH shifting was more effective in the second stage of the double extraction (table 3). It should be emphasized that difference in total proteins extraction yield between experiment 1 and 3 (70% and 45%, respectively) could be explained by the difference in operating time (21 and 10 h, respectively).

3.4.3.4. Effect of biomass lipids content on proteins extraction

A double extraction (neutral/ alkaline) of proteins from partially, totally defatted and non-defatted biomass was carried out. Figure 3 showed that increasing the level of defatting led to increase the proteins extraction yield. The non-defatted biomass showed an extraction yield of 54%, while 73% of proteins were obtained from totally defatted biomass. In fact, proteins are presented in the cytoplasm, so their extraction from the cellular matrix into the surrounding medium can be prevented by the rigidity of cell wall mainly due to the presence of high concentration of polar lipids (glycolipids and phospholipids). Where a certain degree of mass transfer limitation could occur through the membrane. According to Yao et al [37]; Henriques and Park [38] the use of mixtures chloroform-methanol could completely extract lipids including structural lipids as phospholipids and glycolipids responsible of regulating cellular membranes fluidity and function [39]. The extraction of polar lipids from the could allow the hole formation in the microalgae cell membrane [40] which facilitate the proteins release.

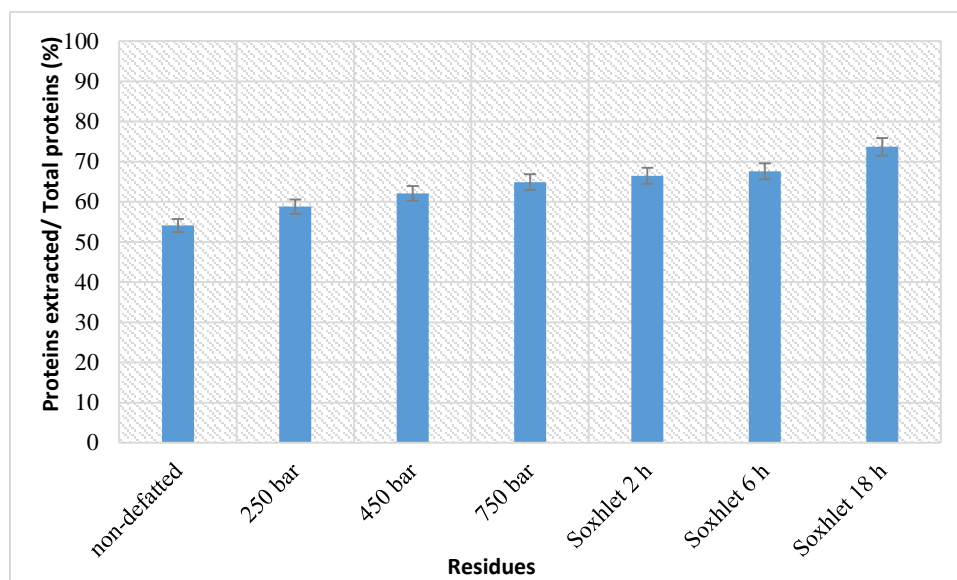

Figure 3- Results of *N. oculata* proteins double extraction (neutral/ alkaline) from: Non-defatted; partially defatted residues using ScCO₂ (250, 450, 750 bar) or Soxhlet method (2 and 6 h) and totally defatted biomass by Soxhlet (18 h). Data are shown as Mean +/- SD for n=3.

3.4.3.5. Molecular size determination of proteins

Size determination of the extracted proteins has been carried out by size exclusion chromatography (Figure 4). The chromatograms of the proteins extracted under single stage neutral extraction condition from *N. oculata* residues under ScCO₂ at 250, 450 and 750 bar were all similar. For all pressures, the proteins have a molecular weight ranging from 1 to 120 kDa were detected. The first peak indicated the presence of macromolecules having high molecular weights (greater than 120 kDa) detected at 220 nm which could be a formation of complex soluble aggregates of proteins with other compounds such as pigments. This assumption was reinforced by the light green color extracts as presented in the figure 5. However, the chromatograms of the proteins from non-defatted biomass showed only small size molecular weight proteins ranging from 1.0-16 kDa. This result confirm our hypothesis about the formation of holes in the cell membrane during defatting which facilitate the extraction of large proteins.

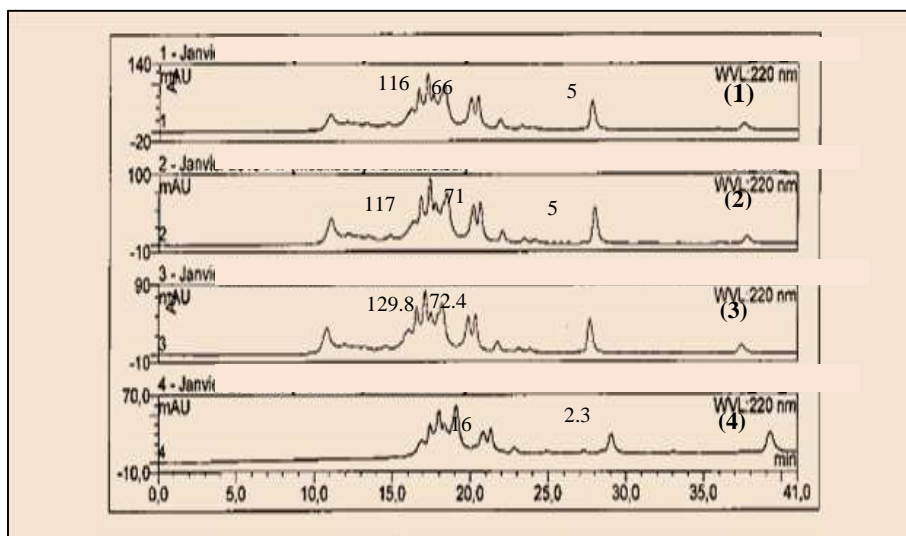

Figure 4- SEC chromatograms (220 nm) of *N. oculata* proteins, extracted from: partially defatted biomass at pH= 7 using ScCO₂ under (1) 250 bar, (2) 450 bar, (3) 750 bar, and non-defatted biomass (4).

3.4.3.6. Proteins purification by dead-end ultrafiltration

A series of dead-end ultrafiltration was carried out on pH-shifting supernatant using 10, 30 and 100 kDa cut-off to evaluate the best molecular weight cut-off membranes for proteins purification (table 4). During filtration, permeate was continuously recovered, leading to the concentration of the feed.

3.4.3.6.1. Ultrafiltration of the supernatant from non-defatted biomass

Results revealed that with the 100 kDa membrane a limiting permeation flux (J) of 10 kg.h⁻¹.m⁻² has been shown. Whereas membranes with 10 and 30 kDa allowed a limiting permeation flux of 15.5 and 14.4 kg.h⁻¹.m⁻², respectively (case 3, 4, Table 5). These results came in accordance with that obtained and reported by Safi et al. [11]. However, they are in opposition with the hypothesis that increasing the molecular weight of the membrane would lead to a higher permeate flow rate. This result could be due to the adsorptive fouling of large molecules such as polysaccharides and proteins into the pores of the PES (polyethersulfone) membrane with large cut-off [24] [41], [42]. However, for the 10 and 30 kDa membranes the adsorption can occur only in front of the membrane surface.

Proteins in the retentate and permeate were quantified at each step of the process in order to calculate the mass balance and evaluate the process efficiency. 100, 30 and 10 kDa

Chapter 3: Fractional extraction

membranes allowed to retain 17%, 45% and 55% of soluble proteins obtained in the supernatants from non-defatted biomass, respectively. The rest passed through the membrane and was recovered in the permeate fraction. Furthermore, the fractions of proteins retained by 10 and 30 kDa membranes were less purified, where colloids and impurities were co-retained with proteins. Results obtained in similar studies on different microalgal species such as Ba et al. [22] and Ursu et al. [23] showed that for all the membranes tested starch and chlorophyll were retained in the retentate. However, membrane of 100 kDa permitted to obtain 83 % of purified proteins in permeate (figure 6). Thus, the 100 kDa ultrafiltration membranes could be used to purify the majority of microalgal proteins from retained impurities like lipids, sugar and chlorophyll co-extracted during the proteins solubilisation.

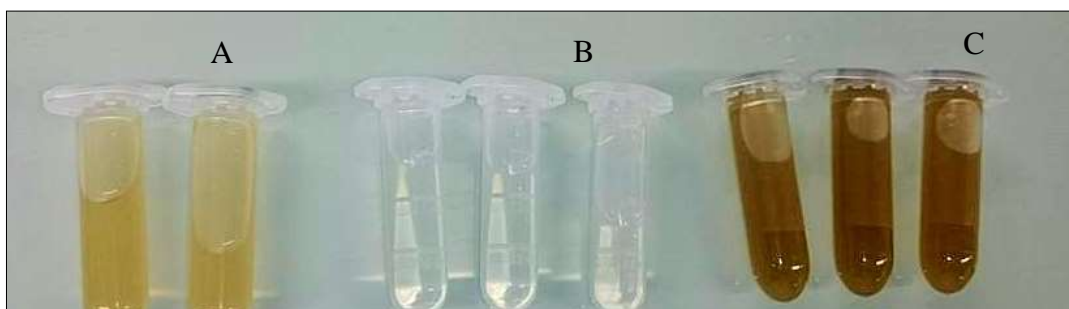

Figure 5 – Deviation of purity and color of isolated proteins in different fractions after 100 kDa molecular weight cut-off membrane by semi-frontal ultrafiltration. A: initial rich proteins supernatant obtained from biomass, B: permeate, C: retentate.

3.4.3.6.2. Pre-purification of supernatant from non-defatted biomass

A pre-purification step of proteins in acid media (pH 3) followed by centrifugation has been carried out in aim to remove impurities like lipids, pigments and polysaccharides. Proteins have been solubilized again at pH=9 followed by ultrafiltration.

Figure 7 shows the observed values of the permeate flow rate, while maintaining a constant TMP (trans-membrane pressure) at 2 bar for supernatants obtained from non-defatted biomass with and without pre-purification step. We can observe that adding the pre-purification step permitted to obtain a limiting permeate flux value twice of that without pre-purification (20 and 10 kg/h.m², respectively). This result may be due to the remove during pre-purification of impurities like polysaccharides that could contribute to the increase of concentrated layer formed near the membrane interface [44], [45].

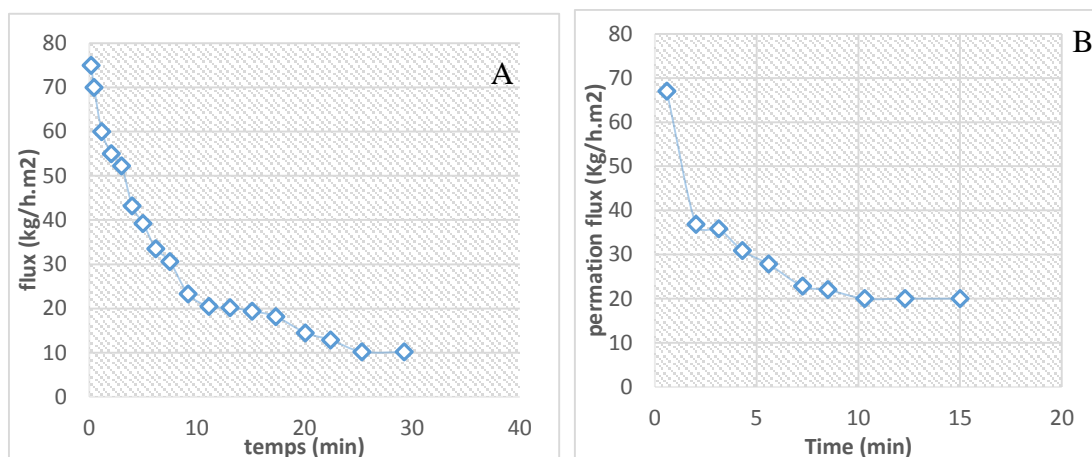

Figure 6- Deviation of permeation flux during time on semi-frontal ultrafiltration (100 kDa) of proteins rich supernatant extracted from non-defatted biomass. A: absence of pre-purification step. B: with pre-purification step. Data are shown as Mean \pm SD for $n=3$.

3.4.3.6.3. Effect of defatting on membrane process

Table 5 showed that, for all cut-off membranes, limiting permeate flux were higher in the case of non-defatted biomass. The permeate flow rate increased by 57, 67 and 70% in case of 10, 30 and 100 kDa MWCO (molecular weight cut-off), respectively (table 5). These results were expected since the remove of lipids and other related molecules such as pigments before ultrafiltration leads to the decrease of the polarization layer and internal adsorption of the membrane [45].

Table 5- Limiting permeation flux obtained from ultrafiltration of defatted and non-defatted *N. oculata* using 100, 30 and 10 kDa MWCO.

Exp. Number	State of <i>N. oculata</i> biomass	Membrane weight cut-off (kDa)	pre-purification step*	Limiting permeation flux (kg/h.min ⁻¹)
1	Non-defatted	100	no	10.1
2	Non-defatted	30	no	15.5
3	Non-defatted	10	no	14.4
4	Defatted	100	no	17.2
5	Defatted	30	no	25.5
6	Defatted	10	no	22.7

Data are shown as Mean \pm SD for $n=3$.

3.4.4. Conclusion

In this study we showed that pH shifting process, under neutral condition (pH 7) and using double stage extraction, was more effective than under alkaline conditions. Furthermore, the use of defatted *N. oculata* biomass increased the release of proteins extraction yield. The remove of lipids and other materials by precipitation or defatting improved the performance of membrane process for proteins purification. Increasing the MWCO membranes led to the increase of proteins purity in the permeate. These results suggest that defatting step is a mandatory stage for high performance extraction/purification of microalgal proteins.

Acknowledgements

Authors gratefully acknowledge GE Healthcare Life Sciences, Laurent VIALAT is gratefully acknowledged for his help during this study.

3.4.5. References

- [1] E. Suali and R. Sarbatly, "Conversion of microalgae to biofuel," *Renewable and Sustainable Energy Reviews*, vol. 16, no. 6, pp. 4316–4342, Aug. 2012.
- [2] E. W. Becker, "Micro-algae as a source of protein," *Biotechnology Advances*, vol. 25, no. 2, pp. 207–210, Mar. 2007.
- [3] J. de la Noue and N. de Pauw, "The potential of microalgal biotechnology: A review of production and uses of microalgae," *Biotechnology Advances*, vol. 6, no. 4, pp. 725–770, Jan. 1988.
- [4] J. L. Guil-Guerrero, R. Navarro-Juárez, J. C. López-Martínez, P. Campra-Madrid, and M. Reboloso-Fuentes, "Functional properties of the biomass of three microalgal species," *Journal of Food Engineering*, vol. 65, no. 4, pp. 511–517, Dec. 2004.
- [5] P. Spolaore, C. Joannis-Cassan, E. Duran, and A. Isambert, "Commercial applications of microalgae," *Journal of Bioscience and Bioengineering*, vol. 101, no. 2, pp. 87–96, Feb. 2006.
- [6] J. A. Gerde, T. Wang, L. Yao, S. Jung, L. A. Johnson, and B. Lamsal, "Optimizing protein isolation from defatted and non-defatted *Nannochloropsis* microalgae biomass," *Algal Research*, vol. 2, no. 2, pp. 145–153, Mar. 2013.
- [7] M. F. Payne and R. J. Rippingale, "Evaluation of diets for culture of the calanoid copepod *Gladioferens imparipes*," *Aquaculture*, vol. 187, no. 1, pp. 85–96, Jul. 2000.
- [8] J. R. McMillan, I. A. Watson, M. Ali, and W. Jaafar, "Evaluation and comparison of algal cell disruption methods: Microwave, waterbath, blender, ultrasonic and laser treatment," *Applied Energy*, vol. 103, pp. 128–134, Mar. 2013.
- [9] C. Safi *et al.*, "Understanding the effect of cell disruption methods on the diffusion of *Chlorella vulgaris* proteins and pigments in the aqueous phase," *Algal Research*, vol. 8, pp. 61–68, Mar. 2015.
- [10] C. Safi *et al.*, "Aqueous extraction of proteins from microalgae: Effect of different cell disruption methods," *Algal Research*, vol. 3, pp. 61–65, Jan. 2014.
- [11] C. Safi *et al.*, "Biorefinery of microalgal soluble proteins by sequential processing and membrane filtration," *Bioresource Technology*, vol. 225, pp. 151–158, Feb. 2017.

Chapter 3: Fractional extraction

- [12] L. R. Cavonius, E. Albers, and I. Undeland, “pH-shift processing of *Nannochloropsis oculata* microalgal biomass to obtain a protein-enriched food or feed ingredient,” *Algal Research*, vol. 11, pp. 95–102, Sep. 2015.
- [13] G. H. Harrison, E. K. Balcer-Kubiczek, and H. A. Eddy, “Potentiation of Chemotherapy by Low-level Ultrasound,” *International Journal of Radiation Biology*, vol. 59, no. 6, pp. 1453–1466, Jan. 1991.
- [14] B. Balasundaram, S. Harrison, and D. G. Bracewell, “Advances in product release strategies and impact on bioprocess design,” *Trends in Biotechnology*, vol. 27, no. 8, pp. 477–485, Aug. 2009.
- [15] A. K. Lee, D. M. Lewis, and P. J. Ashman, “Force and energy requirement for microalgal cell disruption: An atomic force microscope evaluation,” *Bioresource Technology*, vol. 128, pp. 199–206, Jan. 2013.
- [16] A. G. Waghmare, M. K. Salve, J. G. LeBlanc, and S. S. Arya, “Concentration and characterization of microalgae proteins from *Chlorella pyrenoidosa*,” *Bioresour. Bioprocess.*, vol. 3, no. 1, p. 16, Mar. 2016.
- [17] R. K. Desai, M. Streefland, R. H. Wijffels, and M. H. M. Eppink, “Extraction and stability of selected proteins in ionic liquid based aqueous two phase systems,” *Green Chem.*, vol. 16, no. 5, pp. 2670–2679, Apr. 2014.
- [18] D. MacKay and T. Salusbury, “Choosing between centrifugation and crossflow microfiltration,” *Chemical engineer*, no. 447, pp. 45–50, 1988.
- [19] Marcati et al., “Extraction and fractionation of polysaccharides and B-phycoerythrin from the microalga *Porphyridium cruentum* by membrane technology,” *Algal Research*, vol. 5, pp. 258–263, Jul. 2014.
- [20] Patel et al., “Separation and fractionation of exopolysaccharides from *Porphyridium cruentum*,” *Bioresource Technology*, vol. 145, pp. 345–350, Oct. 2013.
- [21] Pugh et al., “(9) Isolation of Three High Molecular Weight Polysaccharide Preparations with Potent Immunostimulatory Activity from *Spirulina platensis* , *Aphanizomenon flos-aquae* and *Chlorella pyrenoidosa* | Request PDF,” *ResearchGate*. [Online]. Available: https://www.researchgate.net/publication/11624110_Isolation_of_Three_High_Molecular_Weight_Polysaccharide_Preparations_with_Potent_Immunostimulatory_Activity_from_Spirulina_platensis_Aphanizomenon_flos-aquae_and_Chlorella_pyrenoidosa. [Accessed: 22-Aug-2018].
- [22] Ba, Fatou, Ursu, Alina Violetta, Laroche, Celine, and Djelveh, Gholamreza, “Haematococcus pluvialis soluble proteins: Extraction, characterization, concentration/fractionation and emulsifying properties,” *Bioresource Technology*, vol. 200, pp. 147–152, Jan. 2016.
- [23] A.-V. Ursu, A. Marcati, T. Sayd, V. Sante-Lhoutellier, G. Djelveh, and P. Michaud, “Extraction, fractionation and functional properties of proteins from the microalgae *Chlorella vulgaris*,” *Bioresource Technology*, vol. 157, pp. 134–139, Apr. 2014.
- [24] H. Susanto, H. Arafat, E. M. L. Janssen, and M. Ulbricht, “Ultrafiltration of polysaccharide–protein mixtures: Elucidation of fouling mechanisms and fouling control by membrane surface modification,” *Separation and Purification Technology*, vol. 63, no. 3, pp. 558–565, Nov. 2008.
- [25] R. Owusu-Apenten, *Food Protein Analysis: Quantitative Effects On Processing*. CRC Press, 2002.
- [26] S. Fujihara, A. Kasuga, and Y. Aoyagi, “Nitrogen-to-Protein Conversion Factors for Common Vegetables in Japan,” *Journal of Food Science*, vol. 66, no. 3, pp. 412–415, Apr. 2001.
- [27] S. O. Lourenço, E. Barbarino, U. M. L. Marquez, and E. Aidar, “Distribution of Intracellular Nitrogen in Marine Microalgae: Basis for the Calculation of Specific Nitrogen-to-Protein Conversion Factors,” *Journal of Phycology*, vol. 34, no. 5, pp. 798–811, Oct. 1998.
- [28] C. Safi, M. Charton, O. Pignolet, F. Silvestre, C. Vaca-Garcia, and P.-Y. Pontalier, “Influence of microalgae cell wall characteristics on protein extractability and determination

Chapter 3: Fractional extraction

- of nitrogen-to-protein conversion factors,” *J Appl Phycol*, vol. 25, no. 2, pp. 523–529, Apr. 2013.
- [29] O. H. Lowry, A. L. Rosbrough, and R. J. Randall, “Lowry assay protocol,” *J. Biol. Chem., Lond*, vol. 193, p. 265, 1951.
- [30] E. Barbarino and S. O. Lourenço, “An evaluation of methods for extraction and quantification of protein from marine macro- and microalgae,” *J Appl Phycol*, vol. 17, no. 5, pp. 447–460, Oct. 2005.
- [31] E. Ryckeboosch, K. Muylaert, and I. Foubert, “Optimization of an Analytical Procedure for Extraction of Lipids from Microalgae,” *Journal of the American Oil Chemists’ Society*, vol. 89, no. 2, pp. 189–198, Feb. 2012.
- [32] Y. Du, B. Schuur, S. R. A. Kersten, and D. W. F. Brilman, “Opportunities for switchable solvents for lipid extraction from wet algal biomass: An energy evaluation,” *Algal Research*, vol. 11, pp. 271–283, Sep. 2015.
- [33] C. Enterman, “General procedures for separating lipid components of tissues. 299-317 IN S. Colowick and N. Kaplan,” *Methods in enzymology*, vol. 3, 1957.
- [34] Burba et al., “Membrane filtration studies of aquatic humic substances and their metal species: a concise overview: Part 1. Analytical fractionation by means of sequential-stage ultrafiltration,” *Talanta*, vol. 45, no. 5, pp. 977–988, Mar. 1998.
- [35] I. S. Chronakis, “Gelation of Edible Blue-Green Algae Protein Isolate (*Spirulina platensis* Strain Pacifica): Thermal Transitions, Rheological Properties, and Molecular Forces Involved,” *J. Agric. Food Chem.*, vol. 49, no. 2, pp. 888–898, Feb. 2001.
- [36] K. J. Flynn, “Composition of intracellular and extracellular pools of amino acids, and amino acid utilization of microalgae of different sizes,” *Journal of Experimental Marine Biology and Ecology*, vol. 139, no. 3, pp. 151–166, Jul. 1990.
- [37] L. Yao, J. A. Gerde, and T. Wang, “Oil extraction from microalga *Nannochloropsis* sp. with isopropyl alcohol,” *Journal of the American Oil Chemists’ Society*, vol. 89, no. 12, pp. 2279–2287, Dec. 2012.
- [38] F. Henriques and R. B. Park, “Compositional characteristics of a chloroform/methanol soluble protein fraction from spinach chloroplast membranes,” *Biochimica et Biophysica Acta (BBA) - Bioenergetics*, vol. 430, no. 2, pp. 312–320, May 1976.
- [39] S. Bellou, M. N. Baeshen, A. M. Elazzazy, D. Aggeli, F. Sayegh, and G. Aggelis, “Microalgal lipids biochemistry and biotechnological perspectives,” *Biotechnology Advances*, vol. 32, no. 8, pp. 1476–1493, Dec. 2014.
- [40] Obeid et al., “Supercritical carbon dioxide extraction and fractionation of lipids from freeze-dried microalgae *Nannochloropsis oculata* and *Chlorella vulgaris*,” *Algal Research*, vol. 34, pp. 49–56, Sep. 2018.
- [41] T. D. la Torre, V. Iversen, A. Moreau, and J. Stüber, “Filtration characterization methods in MBR systems: A practical comparison,” *Desalination and Water Treatment*, vol. 9, no. 1–3, pp. 15–21, Sep. 2009.
- [42] H. Susanto, S. Franzka, and M. Ulbricht, “Dextran fouling of polyethersulfone ultrafiltration membranes—Causes, extent and consequences,” *Journal of Membrane Science*, vol. 296, no. 1, pp. 147–155, Jun. 2007.
- [43] O. Morineau-Thomas, P. Jaouen, and P. Legentilhomme, “The role of exopolysaccharides in fouling phenomenon during ultrafiltration of microalgae (*Chlorella* sp. and *Porphyridium purpureum*): Advantage of a swirling decaying flow,” *Bioprocess Biosyst Eng*, vol. 25, no. 1, pp. 35–42, Apr. 2002.
- [44] W. Richard Bowen and P. M. Williams, “Obtaining the Osmotic Pressure of Electrostatically Stabilized Colloidal Dispersions from Frontal Ultrafiltration Experiments,” *Journal of Colloid and Interface Science*, vol. 233, no. 1, pp. 159–163, Jan. 2001.
- [45] G. B. van den Berg and C. A. Smolders, “Flux decline in ultrafiltration processes,” *Desalination*, vol. 77, pp. 101–133, Mar. 1990.

3.5. Chapter conclusion

During this study, ScCO₂ extraction showed a selective recovery of neutral lipids from *C. vulgaris* and *N. oculata* microalgae without preliminary cell disruption step. Neutral lipids extracts from *N. oculata* represented 83% of total lipids extracts, whereas the proportion of glycolipids and phospholipids did not exceed 12.1% and 5.3%, respectively. Adding ethanol (10% v/v) as co-solvent led to the extraction of 97% of neutral lipids from *C. vulgaris*.

Besides, ScCO₂ allowed efficient and selective extraction of chlorophyll a from the mechanically untreated *N. oculata*. Chlorophyll a could be extracted efficiently and selectively, whereas other pigments did not come out even at high pressure. This study highlighted the potential and the possibility to eliminate some unit operations (cell disruption) to selectively extract chlorophyll a free from other pigments. The effectiveness of adding co-solvent for selective chlorophyll a (free from chlorophyll b) from *C. vulgaris* was also covered. The distinction between the extraction yields of the two chlorophylls a and b would be an indicator of the cell membrane modification during the treatment with ethanol which could be localized at specific structures.

A plausible line of unit operations combined pH-shifting and defatting showed to increase the amount of proteins released in the supernatant of ScCO₂ residues of *N. oculata*. Hence, by following the proposed sequence of unit operations, 83% of extracted proteins were obtained in the permeate. Biomass defatting had the advantage to facilitate the proteins extraction. Over this study, semi-frontal ultrafiltration have proved their efficiency to separate proteins from the various coloring fractions and co-extracted components.

Chapter 4: Extracts purification

4.1. Introduction

One of the special characteristics of microalgae biomass is its cell wall compositions and rigidity, which differs from one species to another according to their growth conditions. Some species are known for their rigid cell wall, contrary to others with fragile one. Cell wall plays an important role as barrier to hinder the passage of valuable inner compounds. This matter was well considered in this chapter due to the important role of the cell wall on extraction selectivity.

Therefore, the main objective of this chapter is to understand the effect of cell wall structures of *Chlorella vulgaris* and *Spirulina sp.* on the extraction of proteins in the aqueous medium.

Besides, while all UAE studies conducted for proteins release have been performed with frequencies comprised between 20 kHz and 100 kHz [24]. UAE treatments for microalgal proteins extraction at audible frequencies (20 Hz-20 kHz) have never been reported in the literature. A soft ultrasound assisted extraction at acoustic frequency (12 kHz) and low intensities treatment was applied in this part of our study.

The results in this chapter are exposed in the form of three publications. **The aim of first publication** was to investigate the effect of working at nearly audible frequency (12 kHz) and under hydrostatic pressure on total extraction of *Spirulina* proteins including C-phycoerythrin. Besides, extraction efficiency has been evaluated by measuring the influence of extraction operating parameters (ultrasound power, hydrostatic pressure, stirring) and conditioning methods (fresh, frozen or freeze-dried) on the extracts compositions.

While all conducted studies have focused on the recovery of pigmented proteins (mainly C-phycoerythrin) from *Spirulina sp.*, the non-pigmented proteins have been neglected without any valorization. For that, **the second publication** focused on the highly clarification of the non-pigmented proteins using membrane process.

Contrary to *Spirulina sp.* fragile cell wall, the apparent rigidity of *C. vulgaris* was exploited for selective extraction of the intracellular proteins, alleviating then the key

Chapter 4: Extracts purification

challenges in the final-stream steps of purification. Hence, in this context, **the third publication** proposed to evaluate the potential of UAE for proteins selective extraction and high recovery yield. In addition, the pigments and UAE residues were quantified to be used as a marker for inner organelle maintenance, cell wall integrity, and absence of lipids liberation.

4.2. Proteins and pigments extraction from microalgae *Spirulina sp.* assisted by ultrasound irradiation: effect of variable low power and pre-treatment conditioning

(Article published in Récents Progrès en Génie des Procédés, Numéro 110 - 2017

ISSN: 1775-335X; ISBN: 978-2-910239-85-5, Ed. SFGP, Paris, France)

OBEID Sara^{a,b,c*}, BENHAMED Imane^d, CHARTON Michael^a, PEYDECASTAING Jérôme^a, TAKACHE Hosni^{b,c}, ISMAIL Ali^{b,c}, PONTALIER Pierre-Yves^a, BARTHE Laurie^d

^aLaboratoire de Chimie Agro-industrielle (LCA), Université de Toulouse, INRA, INPT, Toulouse, France 4 allée Emile Monso, 31 030 Toulouse cedex 4, France

^bUniversité Libanaise, Faculté de Génie Agronomique et de Médecine Vétérinaire, Département des Sciences et Technologie Alimentaires, Hadath, Liban. Allée Georges Matta, 1500, Hadath, Liban.

^cUniversité Libanaise, Ecole Doctorale de Sciences et Technologies EDST-PRASE (Platform de Recherches et d'Analyses en Sciences de l'Environnement), Hadath, Liban. Campus Rafic Hariri, 1500, Hadath, Liban

^dLaboratoire de Génie Chimique, Université de Toulouse, CNRS, INPT, UPS, Toulouse, France. 4 allée Emile Monso, CS 84234, 31 432 Toulouse cedex 4, France

Abstract

Spirulina sp. is a marine biomass with high valuable molecules content, such as proteins and pigments. Low frequency ultrasound has been investigated as selective extraction method in order to reduce the number of downstream steps. In the case of *Spirulina*, the results indicated that proteins extraction was high, at a value of almost 95% of the initial proteins content. According to the cell disruption degree, pigments extraction yield can be favoured under sonication, mainly chlorophylls rather than carotenoids. Storage conditions had a large effect on extraction efficiency, particularly freezing could partially lyse the cell wall and favoured soluble molecules extraction. Application of ultrasound permitted to obtain a high extraction yield of the pigments like chlorophyll a with a concentration in the supernatant 100 times higher. A microscopic structural study for biomass after each ultrasound extraction shows that pigments extraction required a higher disintegration of the cell wall, while proteins are extracted with a low cell lysis.

Keywords: *Spirulina sp.*, ultrasound, proteins, pigments, cell membrane disintegration

* Auteur/s à qui la correspondance devrait être adressée : sara.obeid@ensiacet.fr

4.2.1. Introduction

Cyanobacteria and algae are a source of highly precious molecules like polyunsaturated fatty acid oils as nutritional supplements and pigments including carotenoids, chlorophylls and phycobiliproteins (Henrikson, 1989; Spolaore et al., 2006). *Spirulina* is a cyanobacteria that has been widely studied because of its nutritional and medicinal properties (Piñero Estrada et al., 2001), but also due to its composition in valuable constituents particularly proteins, vitamins and pigments such as β -carotene and phycocyanin. The latter is one of the most promising biochemicals in *Spirulina* because it could be used as natural colorant in food and for its fluorescence properties that could improve the development of phycofluor probes for immunodiagnostics (Kronik and Grossman, 1983). However, the recovery of *Spirulina* molecules usually requires numerous extraction/fractionation methods that have hindered its industrial production.

Different methods have been used for *Spirulina* components extraction, like γ -linolenic acid extraction or fatty acids and carotenoids, by supercritical CO₂ (Canela et al., 2002; Sajilata et al., 2008). However, in addition to process cost, supercritical extraction without co-solvent gives a low yield compared to extraction using a mixture of solvents (Mendes et al., 2006). *Spirulina* cells could also be destroyed using different methods as homogenization in Virtimixer (Sarada et al., 1999), releasing all the cell components in the solvent, leading to a complex of molecules difficult to purify. Hence there is a need for technology development allowing for molecules selective extraction that would simplify the downstream processing like ultrasound assisted extraction (UAE) technology.

Ultrasounds (US) are giving rise to the cavitation phenomenon where bubbles collapse and liquid micro-jets generate interesting mechanical effects, localized on particles/entities of micron size, which can be different according to the ultrasonic irradiation (frequency, power, intensity, etc.) (Mason, 2013). Previous studies have already shown that UAE is efficient in *Spirulina* extraction of carotenes (Dey et al., 2013) and phycocyanin (Furuki et al., 2003; Moraes et al., 2011) but always at frequency higher than 20 kHz and under atmospheric pressure.

The aim of this study is to investigate how UAE could be efficient to selectively extract the main components of *Spirulina*, such as proteins and pigments notably phycocyanin.

Chapter 4: Extracts purification

In order to control the extraction, an innovative process, for cavitation intensification, has been studied by working at nearly audible frequency (12 kHz) and under hydrostatic pressure. Extraction efficiency has been evaluated by measuring the influence of extraction operating parameters (ultrasound power, hydrostatic pressure, stirring) and conditioning methods (fresh, frozen or freeze-dried) on the extracts composition.

4.2.2. Material and methods

4.2.2.1 Microalgae

Fresh *Spirulina Sp.* was provided by Alg&You company (Toulouse, France) in a culture solution at a concentration of 5% (dry matter). Fractions of the culture has been frozen or freeze-dried.

4.2.2.2 UAE

In this study, UAE extraction was carried out with an ultrasonic reactor of 1L capacity that was connected to a pressurized N₂ bottle. The emitting surface of the ultrasound was located at the bottom. The solution temperature was controlled at $30 \pm 2^\circ\text{C}$ by a circulation of cooling water stream in an internal coil. A constant volume of biomass solution (600 mL) was stirred at 500 rpm and sonicated at 12 kHz frequency during 1 hour. Two ultrasonic parameters were investigated to determine their effect on the proteins extraction yield: ultrasound power (100, 200 and 300 W) and relative hydrostatic pressure (0, 1.5 and 3 bar). Moreover, pre-treatment conditions of microalgae were also studied in aim to see the effect of biomass state on molecules extraction yield (table 1).

4.2.2.3 Analysis

a. Total proteins

Total proteins content of *Spirulina sp.* was quantified according to Kjeldhal method that take into account the totality of the nitrogen present in the biomass with a 6.15 coefficient (Fujihara et al., 2001) because only 59–98 % of total nitrogen can belong to proteins (Jeon et al., 2013; Fujihara et al., 2001; Lourenço et al., 1998). Dry *Spirulina sp.* was washed with water and separated from supernatant (culture medium) rich in nitrogen by

Chapter 4: Extracts purification

centrifugation (20,000 g, 15 min, 5C). Biomass was analyzed in triplicate using each time 50 mg samples.

b. Soluble protein

Water-soluble proteins were quantified by Kjeldhal analysis (with a 6.15 coefficient) and Lowry method (Lowry et al., 1951) using a standard curve of bovine serum albumin (BSA) and a Lowry kit (Lowry reagent plus bovine standard albumin (BSA) standards and 2 N Folin–Ciocalteu reagents) purchased from Thermo Fisher Scientific. This method is based on a reaction catalyzed by the copper content in the Folin and oxidation of the peptide bonds with a Folin-Ciocalteu reagent (Barbarino and Laurencu, 2005). The hydro-soluble proteins fraction was evaluated after residues elimination by centrifugation at 15,000g for 15 min. Samples of the supernatant rich in hydro-soluble proteins were taken for analysis by Lowry method. Absorbance was measured at 750 nm using a Shimadzu UV-1700 spectrophotometer

c. Pigments

Samples were analyzed in HPLC Dionex apparatus after filtration using micro-filtration cartridge Polyray 0.22 micron was done to eliminate cell residues. Filtered sample were injected on a 5C18, 250*4.6 mm column and quantified by UV/VIS detector after elution with acetonitrile: methanol: water (65:35:2) at a flow rate of 1 ml/min. The standard pigments, lutein, beta-carotene, chlorophyll a and chlorophyll b (supplied by Sigma-Aldrich) were prepared by dilution of a stock solution (0.1 g/L in acetone) of each of the standard pigments in methanol to a concentration range of 0.5 mg/L to 5 mg/L.

d. Structural characterization

Microscopic observations represent a qualitative approach to characterize the cell disruption. Microalgae observation at high magnifications (* 1000) was performed before and after treatment on a small quantity of cell suspension placed on a specific plate (Nikon SMZ 1500). The images were captured under a constant exposure and illumination by (Nikon eclipse E600) camera.

4.2.3. Results and Discussion

4.2.3.1 Proteins extraction

Characterization of *Spirulina sp.* by Kjeldhal method indicated that this microalgae has a high proteins content at about 70 % dry weight (dw). This result is usually described on *Spirulina*, with low lipids content. The fraction of hydro-soluble proteins released in aqueous medium after each UAE condition has been evaluated by the Lowry and Kjeldhal methods. No significant difference has been detected between values using those two methods.

The ease or difficulty of extracting proteins is due to their location in the cell. Proteins of *Spirulina* with pluri-stratified cell wall, thylakoid lamella system and numerous inclusions, are localized in various compartments. Proteins like ribosome are found in the cytoplasm or bound to the plasma membrane. Phycobiliproteins are located in the thylakoid system or photosynthetic lamellas. The inter-thylakoid space is limited by proteinaceous gas vesicles that give *Spirulina* its floating capacity. Fibrils of DNA and related proteins (Chaperones, and proteins secreted under stress) are generally of central localization (Van Eykelenburg, 1977). The proteins located in the plasma are easily recovered while for the other it requires a higher disruption degree.

Total proteins released content was high in all cases, ranging from 57.9 to 69.8 % of the introduced dry weight (Table 1). When the cells are placed in distilled water in the ultrasound reactor the extracted proteins represent 58% of the introduced matter. *Spirulina* is a filamentous microalgae characterized by its shear-sensitive and fragile membrane. It does not have cellulose walls, but a relatively fragile envelope of murein (Madkourb et al., 2012). This biomass is generally recommended for their high proteins content that can reach up to 70 % of dry weight (Hoseini et al., 2013) and the absence of membrane rigidity (Moreas et al., 2011).

When the ultrasound system is activated, the amount of released proteins increases slightly with increasing the US power and the pressure. Among the tested UAE conditions on *Spirulina sp.*, C31 (frozen-unfrozen biomass-highest pressure applied of 3bar- 100 W) and C1.53 (frozen-unfrozen biomass -1.5 bar- 300 W) were the best conditions for the cyanobacteria proteins release with a recovery yield of 69.8 %w equal to almost the total

Chapter 4: Extracts purification

proteins content. Under hydrostatic relative pressure of 1.5 or 3 bar the cavitation bubbles expand to its maximum volume and collapse violently accompanied by strong shock wave emission (Brujana, et al., 2008) which make the release of proteins more significant, that explain the yield difference between experiments under same power but different pressure (C01 and C31; C03 and C1.53).

The proteins extraction is more efficient from fresh biomass (67.5 %w) than from frozen-unfrozen biomass (64.4 %w) at 300 W, 500 rpm. Ultrasounds are characterized by the mechanical/physical effects: implosion of cavitation bubble which leads to powerful shock waves and fragmentation of interfaces (solid-liquid) and the effects produced on hydrodynamics improve the mass transfer in the solvent (water) (Suslick et al., 1994). A plausible explanation could be that the brutal and rapid cell degradation on the frozen-unfrozen fragile biomass hindered the proteins diffusion to the liquid phase and left a part of proteins attached to the membrane or non-purified detectible molecules.

4.2.3.2 Pigments extraction

The marine microalga *Spirulina* used for this study is a marine biomass richer in chlorophyll (b and a) rather than carotenoids (lutein and β -carotene). Extraction of these pigments requires disintegration of internal compartments because they are mainly located in thylakoid membranes. UAE efficiency has been evaluated for pigments extraction (Table 1).

Among several factors tested, pigments extraction from frozen biomass at a power intensity of 300 watt (C03- 500 rpm) or 100 watt with 3 bar as relative pressure (C31- 500 rpm) were shown to be the most suitable conditions to extract chlorophyll A and β -carotenes from this strain. The results show large influence of the operating conditions on pigments extraction yields.

Contrary to proteins extraction, freeze-drying degradation only allows a small extraction of the pigments, mainly chlorophyll a with 2.15 mg/l. Freezing seems to lead to higher degradation level than freeze-drying with 1137.04 mg/l and 590.74 mg/l of Chlorophyll a under C03 and F03 conditions respectively.

Chapter 4: Extracts purification

Table 1-Ultrasound assisted extraction conditions of *Spirulina sp.* and deviation of fraction of hydro-soluble proteins released in the aqueous phase based on three replicates.

Experiment code	Time (min)	Stirring rate (rpm)	Relative pressure (bar)	US power (watt)	Biomass pretreatment	Proteins extracted (% dw)	Chlorophyll A (g.L ⁻¹)	Chlorophyll B (g.L ⁻¹)	Beta-Carotene (g.L ⁻¹)	Lutein (g.L ⁻¹)
L00-t0	0	0	0	0	Freeze-dried	57.9	3.8	0.3	0.4	0.1
L00-60	60	60	0	0	Freeze-dried	61.3	2.2	0.4	0.2	0.0
C00	60	500	0	0	Frozen	61.5	9.2	1.2	0.3	0.0
C01	60	500	0	100	Frozen	64.1	481	2.5	11.2	2
C02	60	500	0	200	Frozen	64.2	360	2.1	13.8	1.4
C03	60	500	0	300	Frozen	64.4	1150	8.4	42.8	4.5
C1.51	60	500	1.5	100	Frozen	68.7	615	3.2	24.6	2.7
C1.53	60	500	1.5	300	Frozen	69.8	780	4.3	30.1	3.1
C31	60	500	3	100	Frozen	69.8	1020	8.2	39.2	4.3
F03	60	500	0	300	fresh	67.5	591	0.2	2.1	1.7

Chapter 4: Extracts purification

Extraction efficiency of all pigments strongly increased when ultrasounds are applied at a power of 100 W, since the concentrations shifted from 9 g.L⁻¹ and 0.3 g.L⁻¹ to 480 g.L⁻¹ and 11 g.L⁻¹ for chlorophyll A and β -carotene respectively. Increasing the power has no effect until 300 W (like a threshold), that allows for the release of 4 times more pigments, like some new specific membranes has been broken above a limit energy received. A similar effect is observed when increasing the pressure to 3 bars with a power of 100 W but with a much more progressive influence. It is therefore possible to obtain the same extraction yield at 300W under atmospheric pressure or 100 W and 3 bars. The second condition will be preferred as it is more economic.

In all cases, the extraction is much more efficient after freezing than after freeze-drying. When the extraction is operated with fresh *Spirulina*, pigments extraction yield is much smaller, particularly for chlorophyll B and β -carotene that are more difficult to extract. So ultrasound is an efficient method to extract pigment and freezing pre-treatment can enhance its performances.

4.2.3.3 Microscopic observation

During this work, after each UAE treatment, microalgae were then observed under a microscope to determine cell membrane damaging mark (Figure 1). The first photography indicates that *Spirulina* after freezing has still a normal shape, and it can be concluded that the degradation must be only like small holes in the membranes. These holes would allow for the diffusion out of the cell of the soluble molecules, like the proteins, but not for the molecules entrapped in the membranes systems of the cells like the pigments.

Spirulina sp. showed a sensitive cell wall, at frequency of 12 kHz, cell integrity degree decreased with increasing power dose (100 to 300 W). After treatment, the structure of *Spirulina* completely disappeared, which can explain that the pigments are extracted.

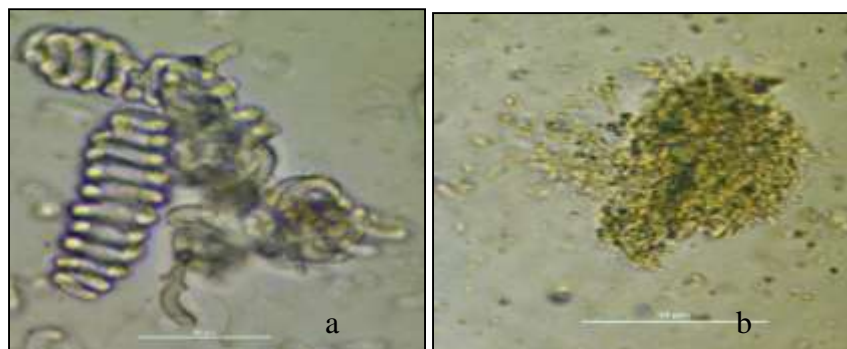

Figure 1. Effect of UAE parameters (300 W, 12 kHz, 0 bar relative, 30°C, 60 min treatment) on *Spirulina sp.* biomass structure: (a) before and (b) after treatment.

4.2.4. Conclusion

The capacity of ultrasound-assisted extraction for the progressive fractionation of microalgae has been evaluated with *Spirulina* that is rich in proteins and pigments. The cells have been frozen or freeze-dried in order to work on the same lot. These pretreatments weaken the cell structure, particularly the outside membrane, leading to high proteins and low pigment release.

The results showed that UAE was efficient for the proteins extraction, with small difference between all the conditions, maybe due to the membrane weakened by the pretreatment. High recovery yield can be obtained with fresh *Spirulina* (67% dw), which is similar to the yield obtained in the same condition with frozen biomass. Hence it can be concluded that proteins can be easily extracted, with low ultrasound power. Under these conditions, internal cell walls are not disrupted and the pigments concentrations remain low. Pigments extraction required harsher conditions to become efficient, only obtained under ultrasound after freezing pretreatment.

4.2.5. References

- Barbarino, E. and S.O. Lourenço, 2005, An evaluation of methods for extraction and quantification of protein from marine macro- and microalgae, *Journal of Applied Phycology*, 17, no. 5, 447-460.
- Brujana, E. A., T. Ikedab and Y. Matsumoto, 2008, On the pressure of cavitation bubbles," *Experimental Thermal and Fluid Science*, 32, 1188-1191.
- Canela, A.P.R.F., P.T.V. Rosa, M.O.M. Marques and M.A.A. Meireles, 2002, Supercritical Fluid Extraction of Fatty Acids and Carotenoids from the Microalgae *Spirulina maxima* Ind, *Eng. Chem. Res.* 41, 3012.
- Dey, S. and V.K. Rathod, 2013, Ultrasound assisted extraction of β -carotene from *Spirulina platensis*. *Ultrasonics Sonochemistry* 20, 271
- Fujihara, S., A. Kasuga. and Y. Aoyagi, 2001, Nitrogen-to-Protein Conversion Factors for Common Vegetables in Japan, *J Food Sci.*, 66, 412-415.
- Furuki T., S. Maeda, S. Imajo, T. Hiroi, T. Amaya, T. Hirokawa, K. Ito and H. Nozawa, 2003, Rapid and selective extraction of phycocyanin from *Spirulina platensis* with ultrasonic cell disruption, *J. Appl. Phycol.* 15, 319.
- Henrikson R., 1989, Earth food *Spirulina*. Ronore Enterprises Inc, Laguna Beach, CA.
- Hoseini, S.M., K. Khosravi-Darani, M.R. Mozafari, 2013, Nutritional and Medical Applications of *Spirulina* Microalgae, *Mini Reviews in Medicinal Chemistry*, 13, 1231-1237(7).
- Jeon, J.-M., H.-W. Choi, G.-C. Yoo, Y.-K. Choi, K.-Y. Choi, H.-Y. Park, S.-H. Park, Y.-G. Kim, H.J. Kim and S.H. Lee, 2013, New mixture composition of organic solvents for efficient extraction of lipids from *Chlorella vulgaris*, *Biomass Bioenergy*, 29, 279-284.
- Kronik, M. and P. Grossman, 1983, Immunoassay techniques with fluorescent phycobiliprotein conjugates, *Clin Chem* 29, 582.
- Lourenço, SO., E. Barbarino., P.L. Lavín, U.M. Lanfer Marquez and E. Aidar, 1998, Distribution of intracellular nitrogen in marine microalgae: basis for the calculation of specific nitrogen-to-protein conversion factors, *J Phycol*, 37, 798-811.
- Lowry, O.H., N.J. Rosebrough, A.L. Far and R.J. Randall, 1951, Protein measurement with the Folin phenol reagent," *J Biol Chem*, 193, 265-275.
- Mason, T.J., 2003, Sonochemistry and sonoprocessing: the link, the trends and (probably) the future, *Ultrason. Sonochem.* 10, 175.
- Madkourb, F., A. Kamila, and H.S. Nasr, 2012, Production and nutritive value of *Spirulina platensis* in reduced cost media, *The Egyptian Journal of Aquatic Research*, 38, no. 1, 51-57.
- Mendes R.L., A.D. Reis and A. F. Palavra, 2006, Supercritical CO₂ extraction of γ -linolenic acid and other lipids from *Arthrospira (Spirulina) maxima*: Comparison with organic solvent extraction, *Food Chemistry*, 99, 57
- Moraes, C.C., L. Sala, G.P. Cerveira and S.J. Kalil, 2011, C-phycocyanin extraction from *Spirulina platensis* wet biomass, *Braz. J. Chem. Eng.* 28, 45.
- Piñero Estrada, J.E., P. Bermejo Bescós and A.M. Villar Del Fresno, 2001, Antioxidant activity of different fractions of *Spirulina platensis* protean extract, *Il Farmaco* 56, 497.

Chapter 4: Extracts purification

Sajilata M.G., R.S. Singhal and M.Y. Kamat, 2008, Supercritical CO₂ extraction of γ -linolenic acid (GLA) from *Spirulina platensis* ARM 740 using response surface methodology, J. Food Eng. 84, 321.

Sarada, R., M. G. Pillai and G.A. Ravishankar, 1999, Phycocyanin from *Spirulina sp*: influence of processing of biomass on phycocyanin yield, analysis of efficacy of extraction methods and stability studies on phycocyanin, Process Biochemistry 34 795.

Spolaore, P., C. Joannis-Cassan, E. Duran and A. Isambert, 2006, Commercial applications of microalgae, J. Biosci. Bioeng. 101, 87.

Suslick, K.S., 1994, The Chemistry of Ultrasound, Encyclopaedia Britannica Yearbook, Chicago, 138-155.

Van Eykelenburg, C., 1977, On the morphology and ultrastructure of the cell wall of *Spirulina platensis*, Antonie van Leeuwenhoek, 43, 89.

Acknowledgements

The authors would like to gratefully thank Alg&You society (Toulouse, France) for providing *Spirulina sp.* biomass.

4.3. Clarification of non-pigmented proteins from *Spirulina sp.* using ultrasound assisted extraction coupled with ultrafiltration

(Article will be submitted to Journal of Bioresource Technology)

S. Obeid^{a,b,c*}, I. Benhamed^d, H. Takache^{b,c}, J. Peydecasting^a, M. Charton^a, L. Barthe^d, A. Ismail^{b,c} and P.Y. Pontalier^{a, 1}

^a Laboratoire de Chimie Agro-industrielle (LCA), Université de Toulouse, INRA, INPT, Toulouse, France 4 allée Emile Monso, 31030 Toulouse cedex 4, France.

^b Département des Sciences et Technologies Alimentaires, Faculté des Sciences Agronomiques, Université Libanaise, Dekwaneh, Liban.

^c Plateforme de Recherches et Analyses en Sciences de l'Environnement (PRASE), Ecole Doctorale des Sciences et Technologies, Université Libanaise, Hadath, Liban.

^d Laboratoire de Génie Chimique (LGC), INP-ENSIACET, Université de Toulouse, 31030 Toulouse, France.

²¹(Pierre-yves.pontalier@ensiacet.fr)

Abstract

A fractionation process was carried out on the cyanobacteria *Spirulina sp.* using ultrasound assisted extraction in order to obtain a highly clarified and uncolored proteins free from chlorophylls, carotenoids, and C-phycoyanin. Effect of pressure and ultrasound intensity were studied for total proteins release. Total proteins content, up to 97%, was obtained in the aqueous medium at atmospheric pressure, 12 kHz frequency and 200W intensity. Precipitation with ammonium sulfate (25% w/v) followed by semi-frontal ultrafiltration (100 kDa) permitted to obtain 67% of proteins in the permeate, while up to 90% of C-phycoyanin was retained in the retentate. Using 10 kDa cut-off membrane allowed to obtain a highly clarified proteins fraction where up to 95% of C-phycoyanin were removed.

Keywords: Proteins purification, *Spirulina sp.*, phycoyanine, ultrasounds, ultrafiltration.

4.3.1. Introduction

Spirulina sp. cyanobacteria has been recognized worldwide as a traditional source of proteins used for human consumption, given their interesting abundance in proteins and essential amino acids

[1] [2]. These edible blue-green algae are known for their high proteins content representing up to 70% of the dry biomass, which is equivalent to three times to beef proteins content or ten times to soy-bean proteins content [3]. Some of *Spirulina* proteins are found in the cytoplasm or bounded to the plasma membrane [4]. Others are found covalently attached and located in the thylakoid system and photosynthetic lamellas like brilliantly colored phycobiliproteins [5].

Phycobiliproteins are water-soluble proteins that play a biological role in collecting and conveying sunlight to a special pair of chlorophyll molecules located in the photosynthetic reaction center [5]. Many phycobiliproteins are produced by *Spirulina* like phycoerythrin (PE), allophycocyanin (APC) and C-phycocyanin (CPC)[6]. The last proteins fraction represents the major phycobiliproteins, and can be synthesized to reach 20% of total dry biomass [7] [8].

CPC is produced commercially as a colorant for food and cosmetics and as fluorescent marker for diagnostic probes. However, other proteins fraction (pigments free proteins) started to find new applications in cosmetics and pharmaceutical industries. However, the use of such proteins in industry is still not significant due to the presence of undesirable elements like CPC leading to significant modifications in flavor and color of the product. Thus, to improve their potential use, *Spirulina* proteins have to be clarified from CPC and undesirable coloring components. However, extraction of proteins from microalgae and cyanobacteria are always challenging. Normally, proteins located in the plasma are easy to recover, while for the other fractions (located in the thylakoid system and photosynthetic lamellas) an intensive cells disruption is required. Scientists are investigating many ways for effective proteins recovery, where cells disintegration is always a neediness to facilitate the intracellular proteins release and maximize their recovery yield.

Ultrasound-assisted extraction (UAE), as cells disruption technique, is used for microalgae and cyanobacteria fractionation [9] [10] [11]. UAE technique is known as a scalable processing step that comply with criteria of green chemistry concept and sustainability [9] [10]. Besides, working with ultrasonic cavitation induced by low frequency UAE could alleviate the key challenges associated with cell disruption techniques during the recovery of total proteins content from *Spirulina* [12]. However, UAE leads to the liberation of all biomass components in the supernatants, which requires additional costly stages in downstream processing for phase separation and compounds purification.

Chapter 4: Extracts purification

Ultrafiltration technology is considered as efficient purification technique with relatively moderate capital and operating costs [13]. Contrary to other separation techniques, membrane processes are isothermal and involve no phase change or chemical reagents [14]. These separation techniques are particularly suited to the purification of water-soluble biomolecules without neither thermal denaturation nor chemical solvents use.

Membrane processes, particularly ultrafiltration, have begun to find new applications in the field of marine bioresources [15] [16] [17]. Actually, limited studies have investigated the membrane technology to purify components from microalgae (Gerardo et al., 2014). Many authors have investigated the use of this technique to purify components from microalgae: polysaccharides from *Porphyridium cruentum* [18] [19], *Spirulina platensis* and *Chlorella pyrenoidosa* [20]. Other studies reported the use of membrane processes to concentrate proteins from *Chlorella vulgaris* and *Haematococcus pluvialis* [21] [22]. Membrane processes have also been used for the recovery of CPC from *Spirulina sp.* [23][24][8]. However, all these studies have focused on the recovery of pigmented proteins (mainly CPC) while the non-pigmented proteins have been neglected without any valorization.

The objective of this work is to study the use of low frequency ultrasound (12 kHz) coupled with ultrafiltration to the recovery and clarification of non-pigmented proteins from *Spirulina sp.* To our best of knowledge no similar studies have been reported on obtaining **highly clarified non-pigmented proteins** fraction from *Spirulina sp.* using the mentioned techniques.

4.3.2. Materials and Methods

The Lowery assay kit was purchased from Fisher Scientific. Chemicals including pigments (Chlorophyll a, Chlorophyll b, lutein and β -carotenes) were purchased from Sigma-Aldrich (France) then used as received.

4.3.2.1. Microalgae

Fresh cyanobacteria *Spirulina Sp.* was purchased from by Alg&You company (Toulouse, France). This strain was grown in photobioreactor under normal growth condition. Fresh biomass was supplied in culture media solution brought at a concentration of 5% dry weight. To ensure that the

condition of the algae did not change, all experiments were performed within two days of the arrival of the algal suspension.

4.3.2.2. Cell disruption

Algal suspensions (600 mL) were subjected to ultrasound assisted extraction (UAE) using water as solvent. Solutions were placed in a stainless steel cylinder of 1L capacity that was connected to a pressurized N₂ bottle (Figure 1). The suspension temperature was kept at $30 \pm 2^\circ\text{C}$ using a cold water circulator in aim to prevent overheating. The solution was stirred at 500 rpm and sonicated at low frequency of 12 kHz. Three ultrasonic parameters were investigated: acoustic intensity (100, 200 and 300 W), relative hydrostatic pressure (0; 1.5; 3 bar) and stirring time in aim to determine their effect on proteins recovery (table 1). After cell disruption, the mixture was centrifuged at 15,000g (15 min, 5°C) and the collected supernatant was analyzed in terms of proteins content.

Table 1- UAE conditions of fresh *Spirulina sp.*

Experiment code	Time	Relative pressure (bar)	US power (W)	Frequency (kHz)
<i>P0W0</i>	60	0	0	0
<i>P0W100-10</i>	10	0	100	12
<i>P0W100-60</i>	60	0	100	12
<i>P0W200</i>	60	0	200	12
<i>P0W300</i>	60	0	300	12
<i>P1.5W100</i>	60	1.5	100	12
<i>P3W100</i>	60	3	100	12
<i>P3W300</i>	60	3	300	12

Note: All solutions were stirred at 500 rpm, UAE: Ultrasound assisted extraction, P0: atmospheric pressure, P3: pressure at 3 bar, W: applied power of 0, 100 and

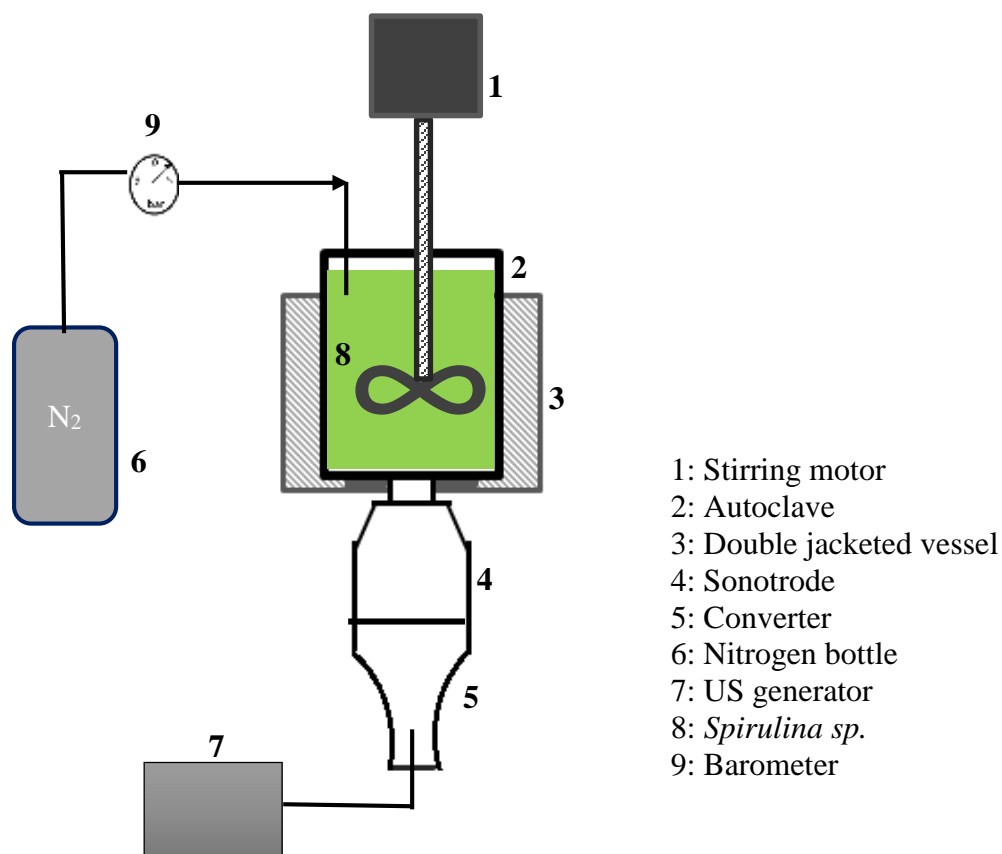

Figure 1: Description of ultrasound pilot.

4.3.2.3. Precipitation of non-proteins fraction

After being subjected to centrifugation to separate big residues, UAE greenish supernatants rich in undesirable lipids and pigments were subjected to fractional precipitation with ammonium sulfate 25%. After being kept overnight at 5 °C in dark, the samples were centrifuged at 15,000 g for 20 min at 5 °C. Supernatants has been collected and went through ultrafiltration for the recovery of uncolored proteins free from CPC and other pigments.

4.3.2.4. Ultrafiltration

Semi-frontal ultrafiltration was carried out using lab scale Amicon® Stirred Cells ultrafiltration unit (Thermo Fisher Scientific, Illkirch, France). This unit consists of 200 mL volume, 30.18 cm² filtration area, fitted with a hydrophobic membrane (polyethersulfone; PES) with a MWCO of 10 kDa or 100 kDa. During ultrafiltration, the feeding solution was constantly stirred (200 rpm) in

the feeding chamber which allows to minimize the concentration polarization effect at the membrane surface [25]. Sample of UAE supernatant with the highest proteins extraction yield went through precipitation of non-proteins fraction before being served as a feed for ultrafiltration (Figure 2). To underline the efficiency of precipitation step, a sample of the same supernatant went directly through ultrafiltration step. The transmembrane difference pressure (TMDP) was maintained constant at 2 bar for all experiments. Free pigments proteins fraction was recovered in the permeate compartment. Samples from permeate and retentate were taken for analysis of total chlorophyll, total carotenoids, proteins and CPC content.

4.3.2.5. Analysis

Total proteins content

The total proteins content of *Spirulina sp.* was determined according to the Kjeldhal method, which accounts for all nitrogen present in the biomass, with a 6.15 coefficient [26]. Biomass was analyzed in triplicate using 50 mg samples each time.

Soluble protein

Samples of the supernatants rich in hydro-soluble proteins were taken for analysis and quantification by Lowry method [27] using a Lowry kit (Lowry reagent plus bovine standard albumin BSA standards, and 2 N Folin–Ciocalteu reagents) purchased from Thermo Fisher Scientific (Illkirch, France).

UAE supernatants rich in hydro-soluble proteins were evaluated after residues elimination by centrifugation at 15,000 g for 15 min. Absorbance was measured at 750 nm using a Shimadzu UV-1800 spectrophotometer

Phycocyanin quantification

The CPC content in UAE supernatants and following ultrafiltration in the permeate/retentate was measured using a UV-VIS Shimadzu UV-1800 spectrophotometer at the wavelengths of 620 nm. The retention rate of phycocyanin was determined using the following equation [7]:

$$Retention\ rate(\%) = 100 - \left[1 - \frac{A_{620}(permeate)}{A_{620}(retentate)}\right]$$

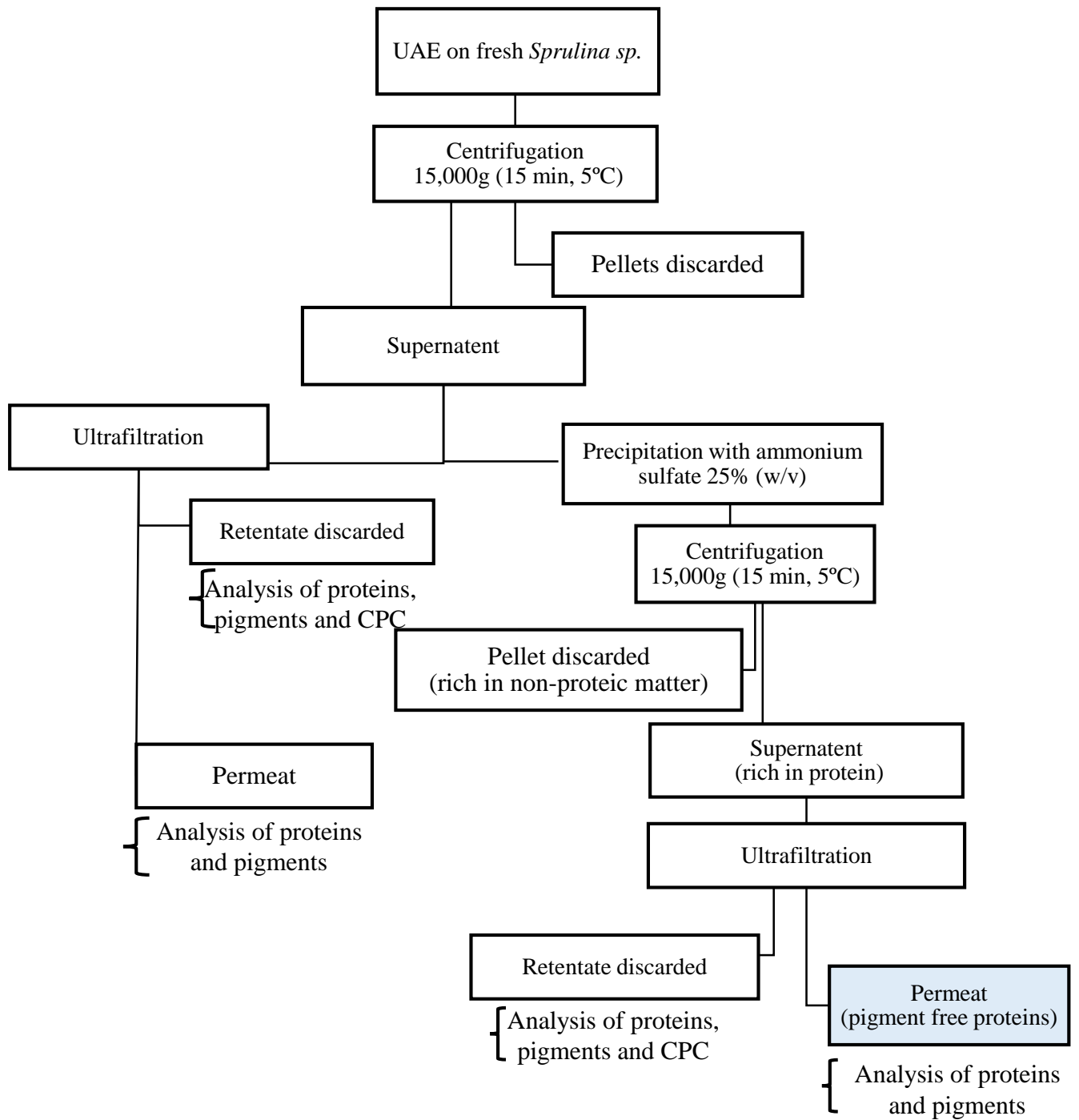

Figure 2: Process scheme, which starts from fresh biomass for proteins pigments free recovery.

Pigments analysis

200 μL of supernatant was mixed with 1300 μL pure methanol, then incubated in dark for 1h at 45°C. Further on, the samples were centrifuged at 10,000 g for 10 min at 20°C. The organic phase (methanol) containing the pigments was recovered. Chlorophyll and carotenoids were determined using the equations proposed by Ritchie [28]:

$$(1) \text{ Total chlorophyll } \mu\text{g.L}^{-1} = (9.3443 \times A_{652}) + (4.3481 \times A_{665})$$

$$(2) \text{ Total carotenoids } \mu\text{g.L}^{-1} = 4 \times A_{480}$$

4.3.2.6. Microscopic observation

To determine the efficiency of cell disruption, an observation was performed before and after treatment on cell suspension placed on a specific plate (Nikon SMZ 1500). Magnification used was 1000 times. The images were captured under a constant exposure and illumination by Nikon eclipse E600 camera.

4.3.2.7. Statistical analysis

Experiments were conducted in triplicate ($n=3$). Statistically significant differences ($p \leq 0.05$) between the means were evaluated using one-way analysis of variance (ANOVA) and the Tukey's test on XLSTAT software version 2018.1.

4.3.3. Results and discussions

4.3.3.1. Influence of ultrasonic parameter on proteins recovery

Crude proteins content of the initial biomass was estimated at 71 %. This value is close to what reported for *Spirulina* in several studies [29] [30].

Effect of stirring rate. Figure 3 shows that, under 500 rpm stirring rate and in the absence of any UAE treatment, the yield of soluble proteins extraction was around 34% of total proteins content after 60 min of treatment (POW0).

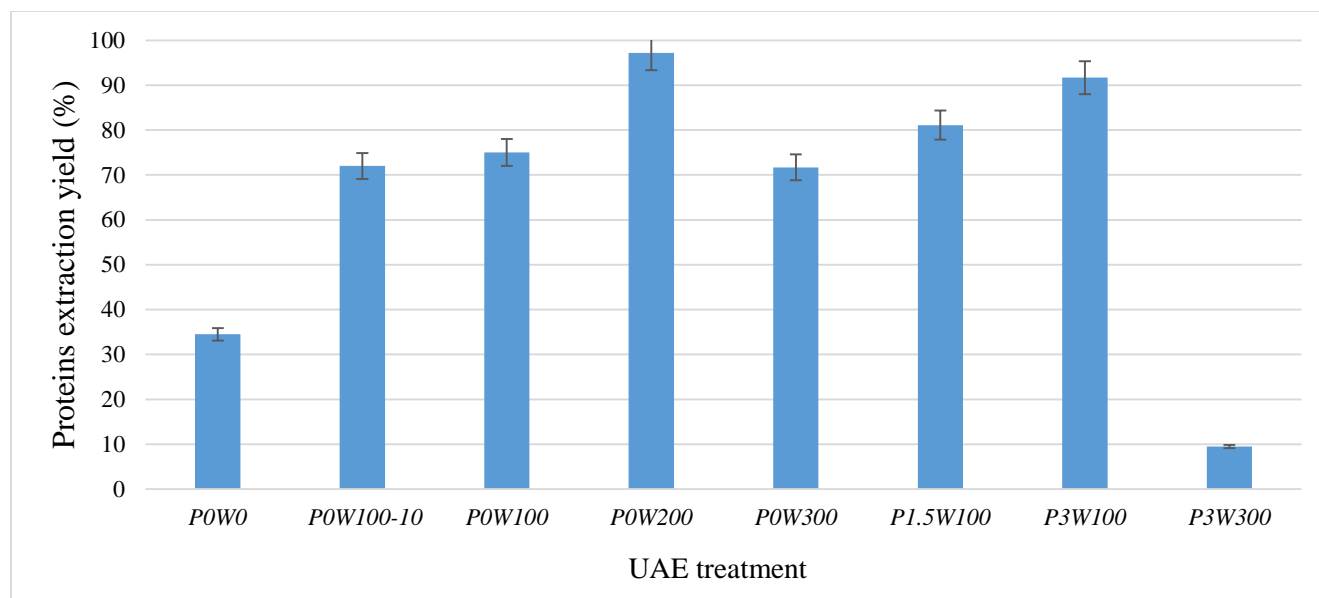

Figure 3: Percentage of the proteins released in the aqueous phase after UAE cell disruption. Results are the mean of three experiments \pm SD (n = 3)

Microscopic observation revealed that stirring led to a dramatic damage to the integrity of the cell wall of this fragile species (Figure 4). In fact, *Spirulina* has a relatively fragile cell wall mainly composed of murein without cellulose as reported by Lu et al [31]. Despite its disintegration during stirring, the extraction yield was low (34%) while 66% of proteins still retained in the intracellular structure. Normally, proteins located in the plasma are easy to recover while for the others with their deep physiological location in the cell a more intensive cell disruption is required [4] [5]. The remaining non-extracted proteins may be still bound in the thylakoid system and photosynthetic lamellas. For that, ultrasound assisted extraction at low frequency (12 kHz) was used to disrupt internal *Spirulina sp.* organelles to allow the recovery of remaining proteins.

Effect of UAE treatment time. Ultrasound exhibited significant effect on the extraction yield ($P < 0.01$). Results revealed that proteins extraction yield at atmospheric pressure did not have any effect on proteins release when carrying out a soft UAE treatment (100 W). In fact, increasing treatment time from for 10 to 60 min of continuous stirring gave a proteins extraction yield of 72% and 75%, respectively.

Effect of UAE intensity. Results showed that ultrasound exhibited significant effect on the proteins extraction yield ($P < 0.01$). When applying a soft UAE treatment at 100 W, 75% of total proteins content were release in the aqueous medium comparing to 34.5% in absence of UAE

Chapter 4: Extracts purification

treatment. Microscopic observation showed total ruptured cells losing their spiral shape when applying UAE treatment.

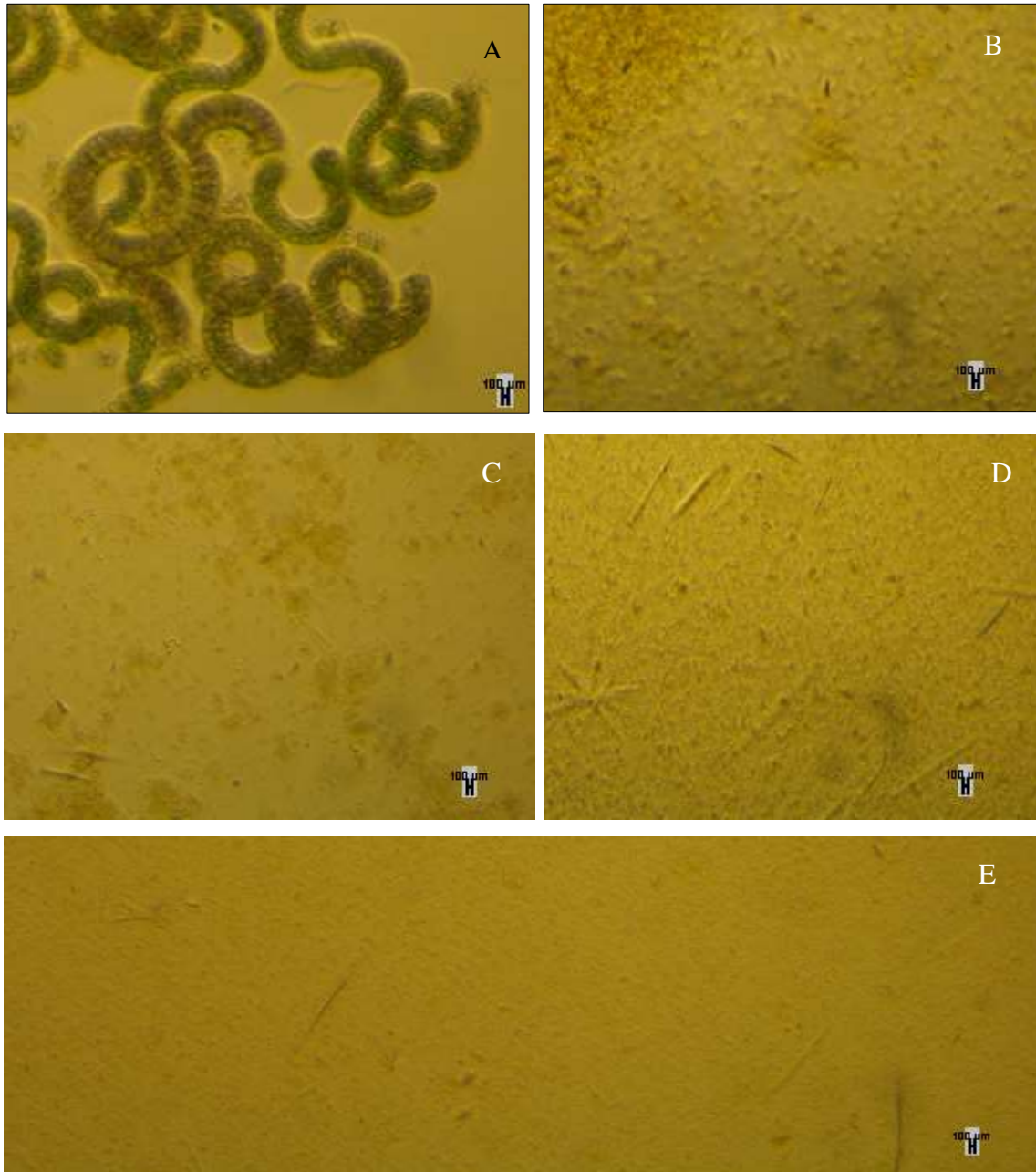

Figure 4. Microscopic observation before and after UAE cell disruption of fresh *Spirulina sp.* (A) Before disruption; (B) P0W0-500 rpm; (C) P0W100; (D) P0W300; (E) P3W300.

Furthermore, the extraction yield increased to 97% when increasing the intensity to 200W, then it decreased unexpectedly at 300W to reach 71%. This decrease could be explained by a possible proteins denaturation, showing that extra cell disruptions might be accompanied by possible alteration of proteins. In fact, ultrasound itself, may have denaturation effect on proteins under specific operating conditions. At low frequency (20-100 kHz [32]) proteins are subjected to physical/mechanical effects like shear force, high-speed microjets, high-pressure microstreams, oscillating bubbles, pyrolysis, and mechanical resonance [33]. In water, sonication has additional effects including direct effect (radiation force and acoustic streaming) and chemical effect (free-radical reactions) [34] [33].

Zhou et al. [35] reported that at low frequency UAE, the mechanical effects of cavitation may be the main reason for the degradation of polysaccharides, while the free-radical reactions are not favorable. Similarly, with a relatively large molecular weight reaching 116 kDa [36], *Spirulina sp.* proteins are denatured at low frequency ultrasound due to mechanical effects making them non-detectable by analytical methods [37] [38]. Increasing the intensity may increase the proteins denaturation phenomenon which explains the decrease in proteins extraction yield at 300W.

Effect of UAE pressure. Increasing pressure under 100W led to an increase in proteins extraction yield. At atmospheric pressure, extraction yield was 71.5% than it increases to 81% at 1.5 bar and reached 92% at 3 bar. Contrary, at 300W, increasing pressure led to a significant decrease in the extraction yield: 72% at atmospheric pressure and 9.4% at 3 bar. These results may be explained by the denaturation of the proteins during ultrasound treatment. In fact, at low intensity (100W) the pressure phenomenon is not significant and in increase in pressure could increase the cumulative collapse pressure of bubbles formed during the acoustic cavitation [39]. However, at high intensity (300W) the denaturation of proteins is more pronounced. Consequently increasing in pressure could enhance the proteins degradation.

Also, a strong correlation between pressure and cell disruptive effect was clearly shown by microscopic observation. Indeed, cell particles/debris go smaller when pressure increases under 300W intensity (Figure 4. D, E).

4.3.3.3. Ultrafiltration

After extraction with UAE and centrifugation, supernatant from experiment at 200W and atmospheric pressure (P0W200) was taken for UF since it has the highest proteins content. Results showed that proteins extract still contained small cell fragments and coloring pigments. To obtain a clarified crude proteins extracts, a precipitation with ammonium sulfate 25% (w/v) was carried out before UF.

As shown in Figure 5, in the absence of precipitation, the permeate flux decreased quickly to reach 2 kg/h.m² whatever the cut-off membrane. However, when applying a precipitation on crude extract before UF, the permeate flux decreased but remained high and reached 4 and 6 kg/h.m² using 10 and 100 kDa cut-off membranes, respectively. This result may be due to the remove of pigments (Figure 6) and cell debris (Figure 7) which may decrease the cake and gel forming on the membrane surface.

Precipitation supernatant extract went through membrane filtration of 10 and 100 kDa molecular weight cut-off. Figure 6 showed that 91% and 95% of CPC were removed in the retentate using 100 and 10 kDa MWCO membranes. This allowed to obtain a CPC free proteins fractions (Figure 8). This results came in accordance with MacColl [40] who reported that CPC can be found as a complex solution of trimers, hexamers and other oligomers with a molecular weight in the range of 44–260 kDa.

Chapter 4: Extracts purification

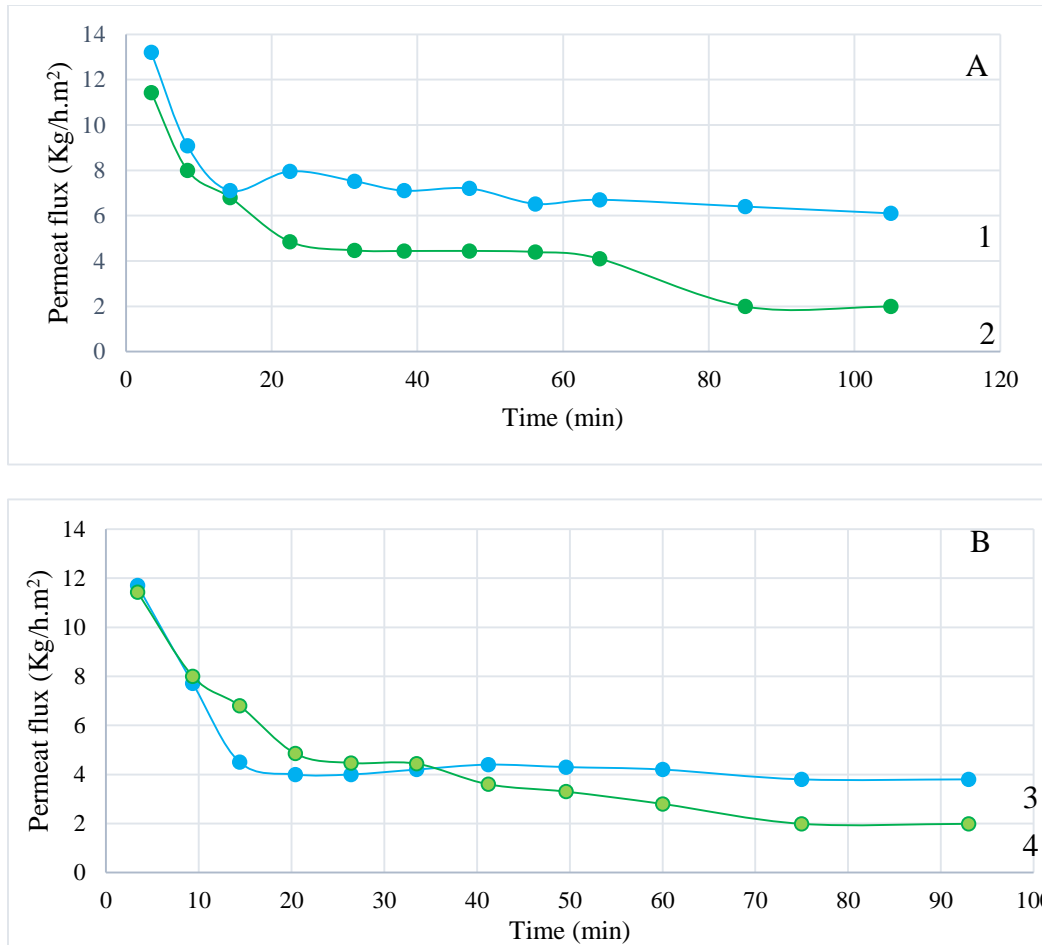

Figure 5. Permeate flux of the proteins crud extract ultrafiltrated at various time. (A) 100 kDa MWCO: 1- with pre-purification step, 2- without pre-purification step. (B) 10 kDa MWCO: 3- with pre-purification step, 4- without pre-purification step.

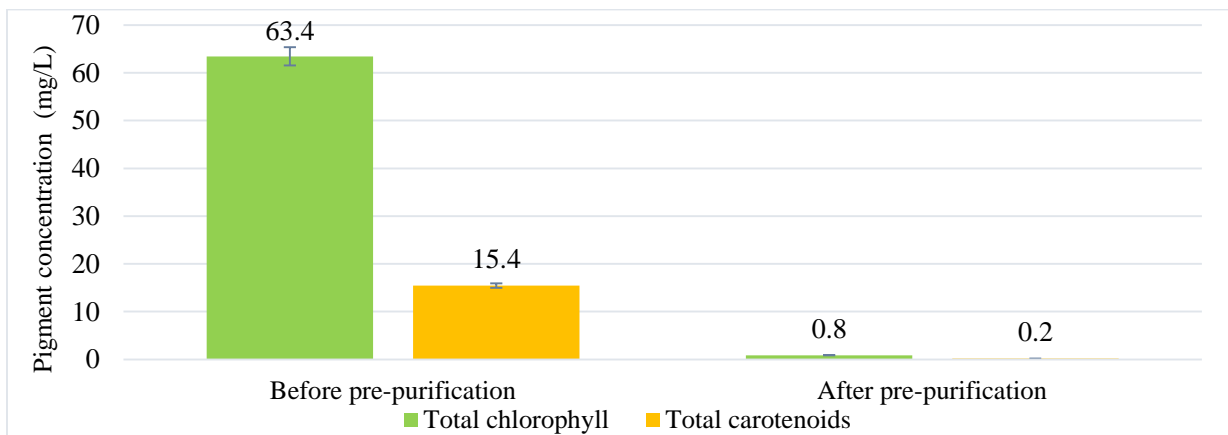

Figure 6. Concentration of total chlorophyll and total carotenoids in F02 proteins crud extract before and after pre-purification step.



Figure 7. Precipitation step: the blue color of proteins crud extract after elimination of greenish pigments and residues by ammonium sulfate 25% (w/v).

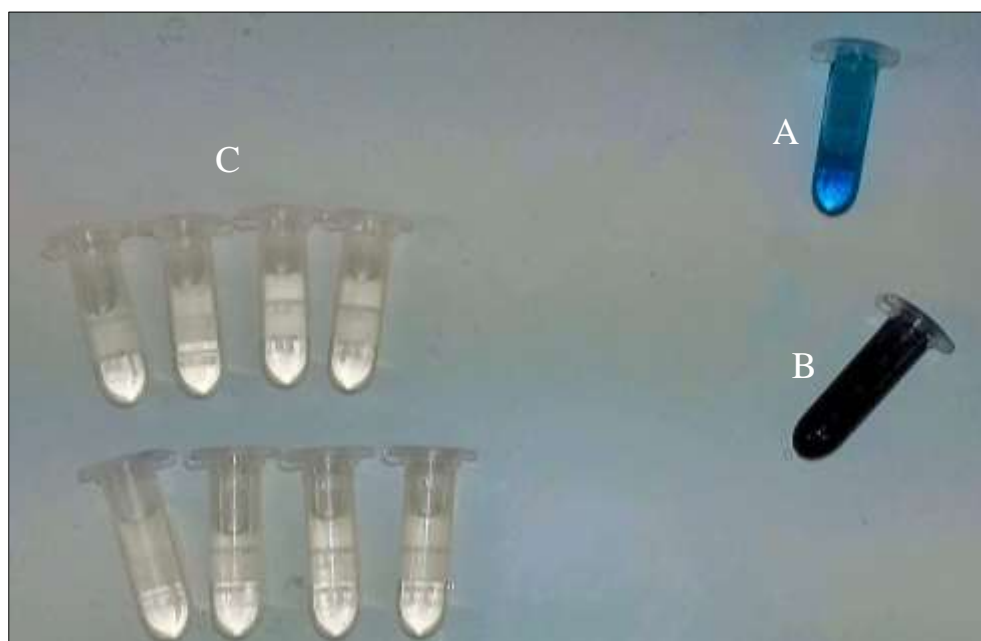

Figure 8. The color of different compartments after UF, (A) pre-purified proteins crud extract; (B) retentate rich in impurities and CPC; (C) purified uncolored proteins fraction in the permeate compartment.

4.3.4. Conclusion

In this study, a proteins-rich fraction was isolated from cyanobacteria *spirulina sp.* using a soft/green low frequency ultrasound extraction.

The release of proteins in water has been shown to be dependent on ultrasound parameters. Proteins recovery and denaturation degree was studied at 12 kHz at the acoustic power of 100, 200, 300 W under 0 and 3 bar relative pressure. The order of power effectiveness under 0 bar was $300 < 100 < 200$ W with 71, 76, and 97 % of total proteins, respectively.

Concerning the effect of pressure, increasing pressure under 100W allowed an additional proteins release in the medium. Contrary, increasing pressure under 300W induced a decrease of 87% of the extraction yield (from 71.7 to 9.4% total proteins content) leading to a dramatic reduction in proteins yield. Increasing pressure under 100 W was safe for protein molecules, whereas high pressure under 300 W leads to an additional powerful bubble explosion leading to a denaturation effect.

Ultrafiltration with prior pre-purification step (precipitation with ammonium sulphate 25%) was very effective in isolating uncoloured proteins from other colouring component. The overall recovery of the proteins was around 67%.

This isolation process can help improving the commercial potential of *Spirulina sp.* where the obtained clear, uncoloured crystal proteins could have unique properties due to the seemingly high degree of purity.

4.3.5. References

- [1] J. Lukavský, “Vonshak, A. (Ed.): *Spirulina platensis (Arthrospira)*. Physiology, Cell Biology and Biotechnology,” *Photosynthetica*, vol. 4, no. 38, pp. 552–552, 2000.
- [2] L. Campanella, M. V. Russo, and P. Avino, “Free and total amino acid composition in blue-green,” p. 11.
- [3] Z. Khan, P. Bhadouria, and P. S. Bisen, “Nutritional and Therapeutic Potential of *Spirulina*,” Oct-2005. [Online]. Available: <https://www.ingentaconnect.com/content/ben/cpb/2005/00000006/00000005/art00002>. [Accessed: 22-Aug-2018].
- [4] C. Van Eykelenburg, “On the morphology and ultrastructure of the cell wall of *Spirulina platensis*,” *Antonie Van Leeuwenhoek*, vol. 43, no. 2, pp. 89–99, Jun. 1977.
- [5] M. G. Rakhimberdieva, V. A. Boichenko, N. V. Karapetyan, and I. N. Stadnichuk, “Interaction of Phycobilisomes with Photosystem II Dimers and Photosystem I Monomers

- and Trimers in the Cyanobacterium *Spirulina platensis*,” *Biochemistry (Mosc.)*, vol. 40, no. 51, pp. 15780–15788, Dec. 2001.
- [6] M. Kissoudi, I. Sarakatsianos, and V. Samanidou, “Isolation and purification of food-grade C-phycoerythrin from *Arthrospira platensis* and its determination in confectionery by HPLC with diode array detection,” *J. Sep. Sci.*, vol. 41, no. 4, pp. 975–981, Feb. 2018.
- [7] P. Jaouen, B. Lépine, N. Rossignol, R. Royer, and F. Quéméneur, “Clarification and concentration with membrane technology of a phycoerythrin solution extracted from *Spirulina platensis*,” *Biotechnol. Tech.*, vol. 13, no. 12, pp. 877–881, Dec. 1999.
- [8] Chaiklahan et al., “Separation and purification of phycoerythrin from *Spirulina* sp. using a membrane process,” *Bioresour. Technol.*, vol. 102, no. 14, pp. 7159–7164, Jul. 2011.
- [9] J. A. Gerde, L. Yao, J. Lio, Z. Wen, and T. Wang, “Microalgae flocculation: Impact of flocculant type, algae species and cell concentration,” *Algal Res.*, vol. 3, pp. 30–35, Jan. 2014.
- [10] R. Giordano, U. Leuzzi, and F. Wanderlingh, “Effects of ultrasound on unicellular algae,” *J. Acoust. Soc. Am.*, vol. 60, no. 1, pp. 275–278, Jul. 1976.
- [11] Araujo et al., “Extraction of lipids from microalgae by ultrasound application: Prospection of the optimal extraction method,” *Ultrason. Sonochem.*, vol. 20, no. 1, pp. 95–98, Jan. 2013.
- [12] E. Roselló-Soto et al., “Clean recovery of antioxidant compounds from plant foods, by-products and algae assisted by ultrasounds processing. Modeling approaches to optimize processing conditions,” *Trends Food Sci. Technol.*, vol. 42, no. 2, pp. 134–149, Apr. 2015.
- [13] Rossignol et al., “Membrane technology for the continuous separation microalgae/culture medium: compared performances of cross-flow microfiltration and ultrafiltration,” *Aquac. Eng.*, vol. 20, no. 3, pp. 191–208, Aug. 1999.
- [14] A. G. Waghmare, M. K. Salve, J. G. LeBlanc, and S. S. Arya, “Concentration and characterization of microalgae proteins from *Chlorella pyrenoidosa*,” *Bioresour. Bioprocess.*, vol. 3, no. 1, p. 16, Mar. 2016.
- [15] bilad et al., “Membrane technology in microalgae cultivation and harvesting: A review,” *Biotechnol. Adv.*, vol. 32, no. 7, pp. 1283–1300, Nov. 2014.
- [16] Gerardo et al., “Integration of membrane technology in microalgae biorefineries,” *J. Membr. Sci.*, vol. 464, pp. 86–99, Aug. 2014.
- [17] Zhang et al., “Harvesting algal biomass for biofuels using ultrafiltration membranes,” *Bioresour. Technol.*, vol. 101, no. 14, pp. 5297–5304, Jul. 2010.
- [18] Marcati et al., “Extraction and fractionation of polysaccharides and B-phycoerythrin from the microalga *Porphyridium cruentum* by membrane technology,” *Algal Res.*, vol. 5, pp. 258–263, Jul. 2014.
- [19] Patel et al., “Separation and fractionation of exopolysaccharides from *Porphyridium cruentum*,” *Bioresour. Technol.*, vol. 145, pp. 345–350, Oct. 2013.
- [20] Pugh et al., “(9) Isolation of Three High Molecular Weight Polysaccharide Preparations with Potent Immunostimulatory Activity from *Spirulina platensis*, *Aphanizomenon flos-aquae* and *Chlorella pyrenoidosa* | Request PDF,” *ResearchGate*. [Online]. Available: https://www.researchgate.net/publication/11624110_Isolation_of_Three_High_Molecular_Weight_Polysaccharide_Preparations_with_Potent_Immunostimulatory_Activity_from_Spirulina_platensis_Aphanizomenon_flos-aquae_and_Chlorella_pyrenoidosa. [Accessed: 22-Aug-2018].
- [21] Ba, Fatou, Ursu, Alina Violetta, Laroche, Celine, and Djelveh, Gholamreza, “Haematococcus pluvialis soluble proteins: Extraction, characterization, concentration/fractionation and emulsifying properties,” *Bioresour. Technol.*, vol. 200, pp. 147–152, Jan. 2016.

- [22] A.-V. Ursu, A. Marcati, T. Sayd, V. Sante-Lhoutellier, G. Djelveh, and P. Michaud, "Extraction, fractionation and functional properties of proteins from the microalgae *Chlorella vulgaris*," *Bioresour. Technol.*, vol. 157, pp. 134–139, Apr. 2014.
- [23] Soni et al., "Extraction, purification and characterization of phycocyanin from *Oscillatoria quadripunctulata*—Isolated from the rocky shores of Bet-Dwarka, Gujarat, India," *Process Biochem.*, vol. 41, no. 9, pp. 2017–2023, Sep. 2006.
- [24] A. Herrera, S. Boussiba, V. Napoleone, and A. Hohlberg, "Recovery of c-phycocyanin from the cyanobacterium *Spirulina maxima*," *J. Appl. Phycol.*, vol. 1, no. 4, pp. 325–331, Dec. 1989.
- [25] Burba et al., "Membrane filtration studies of aquatic humic substances and their metal species: a concise overview: Part 1. Analytical fractionation by means of sequential-stage ultrafiltration," *Talanta*, vol. 45, no. 5, pp. 977–988, Mar. 1998.
- [26] J. Jeon et al., "New mixture composition of organic solvents for efficient extraction of lipids from *Chlorella vulgaris*," *Biomass Bioenergy*, vol. 59, pp. 279–284, Dec. 2013.
- [27] O. H. Lowry, A. L. Rosbrough, and R. J. Randall, "Lowry assay protocol," *J Biol Chem Lond*, vol. 193, p. 265, 1951.
- [28] R. J. Ritchie, "Consistent Sets of Spectrophotometric Chlorophyll Equations for Acetone, Methanol and Ethanol Solvents," *Photosynth. Res.*, vol. 89, no. 1, pp. 27–41, Jul. 2006.
- [29] Bao et al., "Mixed fermentation of *Spirulina platensis* with *Lactobacillus plantarum* and *Bacillus subtilis* by random-centroid optimization," *Food Chem.*, vol. 264, pp. 64–72, Oct. 2018.
- [30] Danesi et al., "An investigation of effect of replacing nitrate by urea in the growth and production of chlorophyll by *Spirulina platensis*," *Biomass Bioenergy*, vol. 23, no. 4, pp. 261–269, Oct. 2002.
- [31] H.-K. Lu, C.-C. Hsieh, J.-J. Hsu, Y.-K. Yang, and H.-N. Chou, "Preventive effects of *Spirulina platensis* on skeletal muscle damage under exercise-induced oxidative stress," *Eur. J. Appl. Physiol.*, vol. 98, no. 2, p. 220, Aug. 2006.
- [32] O. Ngo et al., "Development of low frequency (20-100 kHz) clinically viable ultrasound applicator for chronic wound treatment," *IEEE Trans. Ultrason. Ferroelectr. Freq. Control*, pp. 1–1, 2018.
- [33] Kurokawa et al., "Effect of sonication frequency on the disruption of algae," *Ultrason. Sonochem.*, vol. 31, pp. 157–162, Jul. 2016.
- [34] Papadopoulos et al., "Sonochemical degradation of ethyl paraben in environmental samples: Statistically important parameters determining kinetics, by-products and pathways," *Ultrason. Sonochem.*, vol. 31, pp. 62–70, Jul. 2016.
- [35] Zou and Ma, "Ultrasonic Degradation of Polysaccharide from a Red Algae (*Porphyra yezoensis*)," 01-Mar-2006. [Online]. Available: <https://pubs.acs.org/doi/abs/10.1021/jf052763h>. [Accessed: 22-Aug-2018].
- [36] SChronakis et al., "The behaviour of protein preparations from blue-green algae (*Spirulina platensis* strain Pacifica) at the air/water interface," *Colloids Surf. Physicochem. Eng. Asp.* vol. 173, no. 1–3, pp. 181–192, Nov. 2000.
- [37] Liu et al., "The effects and mechanism of phycocyanin removal from water by high-frequency ultrasound treatment," *Ultrason. Sonochem.*, vol. 41, pp. 303–309, Mar. 2018.
- [38] Liu et al., "Performance and mechanism of phycocyanin removal from water by low-frequency ultrasound treatment," *Ultrason. Sonochem.*, vol. 34, pp. 214–221, Jan. 2017.

Chapter 4: Extracts purification

- [39] E. B. Flint and K. S. Suslick, "The Temperature of Cavitation," *Science*, vol. 253, no. 5026, pp. 1397–1399, Sep. 1991.
- [40] MacColl, "Cyanobacterial Phycobilisomes," *J. Struct. Biol.*, vol. 124, no. 2–3, pp. 311–334, Dec. 1998.

4.4. Selectivity of low-frequency ultrasound-assisted extraction for proteins recovery from the microalga *Chlorella vulgaris*

(Article to be submitted to Journal of Applied Phycology)

Sara Obeid^{a, b, c}, Imane Benhamed^d, Hosni Takache^{b, c}, Jérôme Peydecastaing^a, Ali Ismail^{b, c}, Pierre-Yves Pontalier^{1, a}, Laurie Barthe^d.

^a Laboratoire de Chimie Agro-industrielle (LCA), Université de Toulouse, INRA, INPT, 4 allée Emile Monso, 31030 Toulouse cedex 4, France.

^b Département des Sciences et Technologies Alimentaires, Faculté des Sciences Agronomiques, Université Libanaise, Dekwaneh, Lebanon.

^c Plateforme de Recherches et d'Analyses en Sciences de l'Environnement (PRASE), Ecole Doctorale des Sciences et Technologies, Université Libanaise, Hadath, Lebanon.

^d Laboratoire de Génie Chimique (LGC), INP-ENSIACET, Université de Toulouse, 31030 Toulouse, France.

¹Pierre-yves.pontalier@ensiacet.fr

Abstract

The objective of this study was to evaluate the effectiveness of low-frequency ultrasound assisted extraction (UAE) for selective proteins extraction. The microalga *Chlorella vulgaris* was subjected to a low acoustic frequency (12 kHz) at low power intensity (0-100-300 W) and relative hydrostatic pressure (0-3 bar). UAE was effective in the selective extraction of 96% of total proteins content, shown by limited co-extraction of pigments and lipids. Increasing pressure at low power intensity was highly effective, indicating that pressure played a critical role in proteins extraction yield. The wall structure of *Chlorella vulgaris* plays an important role in the phenomena of selective extraction. Cell integrity was maintained during total proteins extraction.

Keywords: *Chlorella vulgaris*, sono-extraction, selectivity, proteins, cell integrity.

4.4.1. Introduction

Over the last years, several research groups have investigated the use of simple technologies to improve the extraction yield of specific compounds, such as lipids, proteins and intracellular pigments, enclosed in microalgae structures [1]. In fact, microalgae may become a sustainable source for many components by simplifying their recovery using reduced processing temperature,

Chapter 4: Extracts purification

green extraction solvent, short treatment time, and selective extraction methods with limited purification steps [2] [3] [4].

Chlorella vulgaris is a microalga produced at industrial scale for its high proteins contents used in human food [5] [6] [7] [8]. However, the limiting factor for the valorization of this compound is the difficulty associate to its extraction due to the rigid cell wall of *C. vulgaris* [9]. For that, most of the extraction methods are focused on the disruption of the cell wall before the recovery of the proteins fraction [10]. The most used techniques are high pressure homogenizers, bead mills, enzymatic or chemical treatments, thermal or osmotic shocks (repeated freezing/thawing) [11] [10] [12][13]. Whatever the used method, once proteins fraction is recovered, it is necessary to setup additional purification steps to separate the released proteins from the co-extracted components [14].

Ultrasonication as an environmental friendly mechanical method, can be universally applied to any type of microalgae for cell disintegration [15]. Several studies have reported the use of ultrasound assisted extraction (UAE) on cyanobacteria in aim to extract intensely fluorescent hydrosoluble proteins known as phycobiliproteins [16][17][18][19]. However, further purification steps are needed due to dramatic cell disruption and the absence of any extraction selectivity. Contrary to fragile cell wall, UAE treatment has a little acoustic cavitation effect on rigid cell wall microalgae like *Chlorella vulgaris* [20] [21]. In fact, sonication offers a significant degree of cell disruption on weaker walls that allows cells to break more readily [21].

Recently, Duan *et al* [22] investigated the effect of hydroxyl-peroxide-aided ultrasonic treatment for proteins release from *Chlorella sp.* resulting in partial rupture of the cell wall with low proteins extraction yield and the liberation of many other components. However, the apparent rigidity of *C. vulgaris* could be exploited for selective extraction of the intracellular proteins, alleviating then the key challenges in the final-stream steps of purification [23]. Hence, in this context, this study proposes to evaluate the potential of UAE **for high yield and selective extraction of proteins**. Furthermore, all UAE studies conducted for proteins release have been performed with frequencies comprised between 20 and 100 kHz as reported lately by Chemat *et al.* [24]. However, to our best of knowledge, UAE treatments for microalgal proteins extraction at audible frequencies (20 Hz-20 kHz) have never been reported in the literature. Hence, we investigated **the impact and effectiveness of nearly audible frequency (12 kHz)** on *C. vulgaris suspension* for selective

proteins extraction. In addition, to comply with the criteria of the green-chemistry concept, water was used as the extraction solvent [25]. Besides, the effect operating conditions of UAE (e.g. intensity, hydrostatic pressure) (have been studied. To avoid any thermal denaturation, the temperature was kept at $30 \pm 2^\circ\text{C}$ during UAE treatments. Proteins extraction yield for all supernatants was determined in order to evaluate the effectiveness of this technique. In addition, the pigments and UAE residues were quantified to be used as a marker for inner organelles alteration, cell wall disintegration, and lipids liberation. Microscopic observations have been conducted to evaluate any cell disruption or cell morphology changes.

4.4.2. Methods

4.4.2.1. Microalgae *Chlorella vulgaris*

The selected *Chlorophyceae*, *C. vulgaris* (strain SAG 211-19), was supplied as a frozen paste from Alpha Biotech (Asserac, France). This strain was cultivated in Sueoka media under conditions of high N nutrient concentration to favor protein accumulation, and grown in batch mode in an indoor tubular Air-Lift photobioreactor (10 L) at 25°C , harvested during the exponential growth phase, concentrated by centrifugation, and then frozen. The harvested biomass contained 27% dry matter. For UAE experiments, the frozen algal paste of *C. vulgaris* was first thawed at ambient temperature and then diluted with water to prepare algal suspensions with a final concentration of 5% by weight.

4.4.2.2. UAE procedure

Algal suspensions (600 mL) were placed in a 1L-capacity stainless steel ultrasonic reactor connected to a pressurized N_2 bottle allowing adjustment of the relative hydrostatic pressure (0-3 bar). Ultrasonic irradiation was emitted at the reactor bottom (cup-horn type) providing an intensity power of 100, 200, or 300W at a very low frequency of 12 kHz. The constant volume of biomass solution was stirred at 500 rpm and sonicated for 1 h (table 1). The suspension temperature was kept at $30 \pm 2^\circ\text{C}$ by cool water circulation in an internal coil to limit denaturation. After each treatment, samples were centrifuged at 20,000 g for 20 min at 5°C . The mass of the pellets (residues) was measured after all treatments and the supernatants analyzed for proteins and pigment content.

Table 1-UAE conditions of freeze-thawed *C. vulgaris*.

Experiment code	Time (min)	Stirring rate (rpm)	Relative pressure (bar)	Power (watt)
P0W0-t0	0	0	0	0
P0W0	60	500	0	0
P0W100	60	500	0	100
P0W300	60	500	0	300
P3W100	60	500	3	100

Note: UAE: Ultrasound assisted extraction, C. vulgaris: Chlorella vulgaris, P0: atmospheric pressure, P3: pressure at 3 bar, W: applied power of 0, 100 and 300 watt.

4.4.2.3. Analytical procedures

4.4.2.3.1. Proteins quantification

The total proteins content of *C. vulgaris* was determined according to the Kjeldhal method, which accounts for all nitrogen present in the biomass, with a 6.15 coefficient [26].

After collection by centrifugation at 20,000g for 25 min, samples of the UAE supernatants were collected for proteins analysis. Proteins extraction yields were determined by Kjeldhal analysis (with a 6.15 coefficient) and the Lowry method using a bovine serum albumin (BSA) standard curve and a Lowry kit (Thermo Fisher Scientific). Absorbance was measured at 750 nm using a Shimadzu UV-1700 spectrophotometer.

4.4.2.3.2. Pigments

The initial pigment content (chlorophyll a, chlorophyll b, β -carotenes, and lutein) was calculated. 20 mg of microalgae was mixed with 10 ml of solvent (table 2) and gently stirred at 10°C. The sample was then centrifuged at 20,000 g at 5°C and the supernatant was collected into glass tubes. The operation was repeated until the supernatant had no color. The tubes were covered with aluminum foil to inhibit photodegradation during extraction. The pigment concentration was measured by spectrophotometry.

Total pigment content (chlorophyll a, chlorophyll b, β -carotenes, and lutein) was calculated according to the general formula of Bidigare [27].

$$C(\text{mg/l}) = \frac{\text{OD} \cdot 1000}{\alpha \cdot L}$$

OD = optical density read at the specific wavelength in a given solvent.

α = specific extinction coefficient ($1 \text{ g}^{-1}\text{cm}^{-1}$).

L = optical path length (cuvettes) in cm.

Table 2- Specific extinction coefficients (α) of the main chlorophyll pigments (a, b) and carotenoids (β -carotene, lutein), corresponding to maximum absorption peaks, and solvent used for their extraction.

	wavelength (nm)	α ($1 \text{ g}^{-1}\text{cm}^{-1}$)	Solvent	Reference
Chlorophyll a	665	77.9	Methanol	[28] [29]
Chlorophyll b	642	44.5	Methanol	[28] [29]
β -carotenes	453	262	Ethanol	[30] [29]
Luteins	445	255	Ethanol	[30] [29]

The supernatants of the UAE treatments were analyzed for pigment content using HPLC Dionex UltiMate™ 3000 quaternary pump (Thermo Scientific, Massachusetts, USA) after filtration through a Polyray 0.22 μm microfiltration cartridge to eliminate cell residues. Filtered samples were injected onto a 5 C18 column (250 x 4.6 mm) and quantified by a UV/VIS detector after elution with acetonitrile: methanol: water (65:35:2) at a flow rate of 1 ml/min. The standard pigments, lutein, β carotene, chlorophyll a, and chlorophyll b (supplied by Sigma-Aldrich) were prepared by dilution of a stock solution (0.1 g/L in acetone) of each of the standard pigments in methanol to a concentration range of 0.5 to 5 mg/L. Absorption measurements were performed using a photodiode array detector.

4.4.2.3.3. Lipids content

C. vulgaris total lipids content was measured in a Soxhlet apparatus using a slightly modified method based on both methods developed by Blight and Dyer and Folch, using a mixture of polar and non-polar solvents: chloroform/methanol (0.35/0.65, V/V) [31] [26] [32].

The microalgal biomass (3g) was placed in a cartridge filter paper using 250 mL of solvent. The Soxhlet extractor was operated for a number of cycles for 18 hours in order to insure the extraction of all the extractable lipids. The amount of total lipids was determined gravimetrically.

4.4.2.4. Statistical analysis

Experiments characterization were resulted based on 3 replicates for 3 experiments \pm SD (n=9). Statistical analyses and differences ($p < 0.05$) between the means were determined using one-way analysis of variance (ANOVA) and the Tukey's test on XLSTAT software version 2018.1.

4.4.2.5. Cell integrity

Microscopic observations were made to qualitatively characterize cell disruption. Observations were made at high magnification (x1000) before and after treatment on a small quantity of cell suspension (Nikon SMZ 1500). The images were captured under constant exposure and illumination by a Nikon eclipse E600 camera.

4.4.3. Results and discussion

4.4.3.1. Microalgae characterization

Results showed that studied *C. vulgaris* was characterized by a high proteins content ($58.0 \pm 1\%$ DW) and a low lipids content ($24.4 \pm 1.0\%$ DW) (Table 3). The biochemical composition of *C. vulgaris* may be explained by the growth conditions. In fact, the studied strain was grown under conditions of normal CO₂ concentration and high nitrogen concentration. Cultivation under such conditions can induce the accumulation of proteins in the biomass [33].

Table 3- Biochemical composition of *C. vulgaris* relative to its dry matter. Results are based on 3 replicates for 3 experiments \pm SD (n=9).

Proteins content (g/g DW)	Lipids content (g/g DW)	Pigments content			
		Chl a (mg/g DW)	Chl b (mg/g DW)	β -carotenes (mg/g DW)	Lutein (mg/g DW)
0.58 \pm 0.01	0.24 \pm 0.01	27.5 \pm 1.0	12.9 \pm 0.4	2.8 \pm 0.1	2.9 \pm 0.1

As shown in Table 3, concentrations of chlorophyll a, chlorophyll b, β -carotenes and lutein were 27.5, 12.9, 2.8 and 2.9 mg/g DW, respectively. Other secondary metabolites and carbohydrates made up approximately 17.6% of the microalga. High chlorophyll content in *C. vulgaris* is usually

associated with a high proteins concentration [34]. These values of pigments concentration are relatively similar to those reported in literature [35] [36].

4.4.3.2. Proteins extraction yield

Before analyzing the efficiency of various UAE parameters on proteins recovery, applying an extraction blanks (P0W0-t0) had various merits to determine whether the storage conditions (freezing) damaged the cell integrity. Results revealed that a little amount of the proteins (8.1 %) was released in the aqueous phase without neither stirring nor ultrasound treatment (Figure 1).

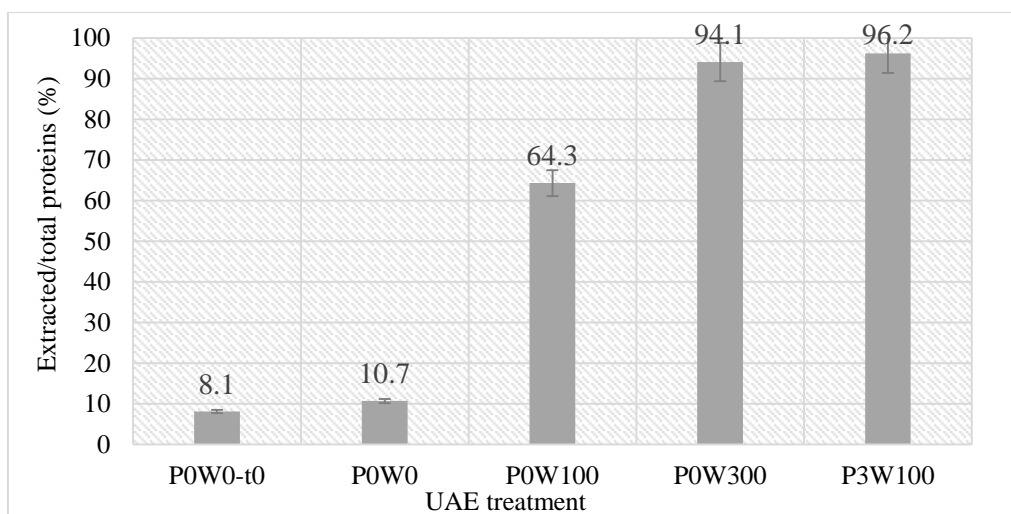

Figure 1- Percentage of proteins released from *Chlorella vulgaris* in the aqueous phase under various UAE conditions (relative hydrostatic pressure-ultrasound intensity-stirring rate). The means \pm SD of three replicates for three experiments are shown (n = 9). Note: UAE: Ultrasound assisted extraction, *C. vulgaris*: *Chlorella vulgaris*, P0: atmospheric pressure, P3: pressure at 3 bar, W: applied power of 0, 100 and 300 watt.

Similarly, in the absence of ultrasound treatment, proteins liberated in the aqueous phase with a stirring rate of 500 rpm did not exceed 10% of the total proteins content. Under constant atmospheric pressure, increasing UAE power from 100W to 300W leads to the increase of the proteins extraction yield from 64.3% to 94.1%. Working at a low frequency of 12 kHz, the main driving force for the extraction effects of sonication is acoustic cavitation [37] [38].

During UAE, there are many thousands of stable and unstable bubbles (known as active bubbles) collapsing violently generated in the medium [39]. Kanthale et al. [40] reported that an increase in the acoustic power can increase the number of active bubbles and also their size, make their collapsing more violent towards the biomass cell wall. Thus, as a result, additional micro channels

and micro fissure could be formed in the cellular matrix allowing greater penetration and accessibility of the water to the internal structure, facilitating then the release of inner proteins [41] [42] [39].

Furthermore, increasing the relative pressure from 0 to 3 bar (under fixed power of 100 W) significantly increased the proteins extraction yield from 64.3 to 96.2% ($p < 0.05$). Under such power, a series of micrometric bubbles in the aqueous solution may collapse and generate shock waves and pressure to hit the cell wall. However, the increase in applied pressure could generate excessive powerful attacking collapses. Thus UAE bubble effects could be more violent at 3 bar than at 0 bar. The additional proteins release under 3 bar could be also explained by an extra microfissure generation in the cell wall [37] [38]. *C. vulgaris* proteins have molecular weights ranging from 12-120 kDa [43] [7]. Thus, the recovery of large cytoplasmic proteins that cannot normally pass through the small pores of the weakened membrane could be achieved under additional micro fissure generated at high pressure [37] [38].

In all cases, no dramatic disintegration cell had taken place. Microscopic observation showed that intact cells maintained their globular shape after extreme UAE applied conditions (P3W100), indicating that no dramatic cell disruption occurred (Figure 2). This result is in accordance with the assessment of Gouveia and Oliveira [44] and Lee *et al.* [45], who reported that UAE treatment was not very effective in breaking the cell wall of *C. vulgaris*.

Non-proteins fraction. While the protein fraction released from the biomass to the aqueous medium vary depending on different UAE conditions, the non-protein fraction (42% DW) constituted mainly of lipids and carbohydrates remained constant during all UAE treatments (Figure 3). This means that lipids were not extracted due to an absence of cell disintegration, this came in accordance with the assessment of Gouveia and Oliveira [44] and Lee *et al.* [45], who used UAE for cell disruption of *C. vulgaris* to recover lipids for bioenergy purposes. They concluded that UAE was ineffective for increasing the lipid recovery yield and breaking the cell wall. Furthermore, our results show that the biomolecules of interest (proteins) simply diffused out of the cells from micro fissure and micro pores [37] [38]. Lipid, and carbohydrate extraction was prevented. This confirms that the rigid cell walls of *Chlorella vulgaris*, along with the intracellular membranes, were not seriously affected during UAE sonication.

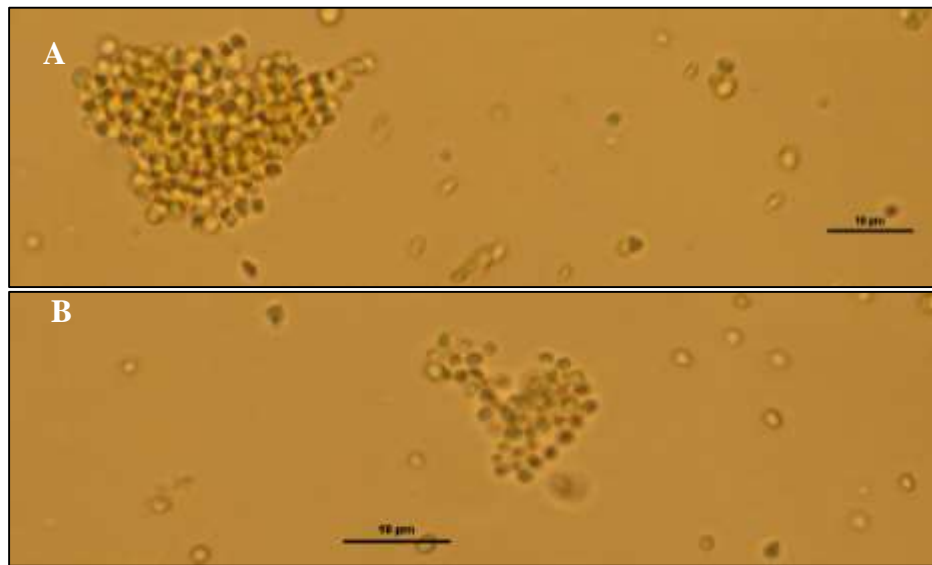

Figure 2- Microscopic observation at high magnifications (x1000) of cells after UAE treatment. **A.** Control **B.** After one hour of treatment at a power intensity of 100 W and at 3 bar relative pressure (P3W100).

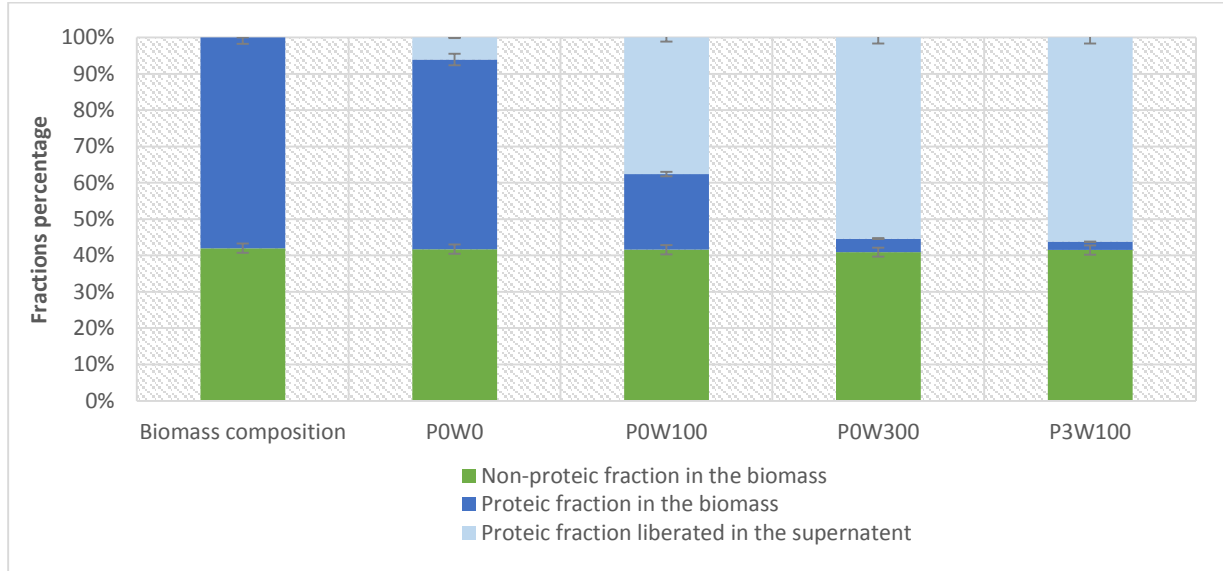

Figure 3- Percentage of protein fraction and non-protein fraction remained and released from the biomass under various UAE treatment. The means \pm SD of three replicates for three experiments are shown (n = 9).

4.4.3.3. Pigments extraction

Analysis of the UAE supernatant samples by HPLC showed a negligible amounts of pigment (chlorophyll a, chlorophyll b, β -carotenes, and lutein) (Table 4). This result showed that applied UAE conditions were not a suitable method for pigment recovery from *C. vulgaris*. Adam *et al.* [46] and Wu *et al.* [47] reported that the cell structure may play a major role in cell acoustic interactions. *C. vulgaris* could not resist UAE treatment unless its cell wall is relatively rigid and its organelles possess the collective mechanical strength of the barrier. The lack of pigments in the aqueous phase suggested that the cells wall structure was maintained and the solvent was not able to penetrate the phospholipids bilayer of the chloroplast and extract pigments, such as chlorophyll and carotenoids embedded in the thylakoids [48].

Our results suggested that applying a mild UAE treatment would be very effective for selective proteins recovery from *C. vulgaris*. Such conditions are very important since they eliminate the necessity of further costly purification steps for pigment removal from proteins extracts.

Table 4- Percentage of extraction yield (extracted/ total content) of Chl a, Chl b, β -Carotenes and Lutein from *Chlorella vulgaris* under various UAE conditions. Results represented the means of three replicates for three experiments (n = 9).

Experiment code	Chl a extraction	Chl b extraction	β -Car extraction	Lut extraction
	yield (%)	yield (%)	yield (%)	yield (%)
P0W0-t0	0	0	0	0
P0W0	0	0	0	0
P0W100	<1	<1	<1	<1
P0W300	<1	<1	<1	<1
P3W100	<1	<1	<1	<1

Note: UAE: Ultrasound assisted extraction, *C. vulgaris*: *Chlorella vulgaris*, P0: atmospheric pressure, P3: pressure at 3 bar, W: applied power of 0, 100 and 300 watt.

4.4.4. Conclusion

This study showed that UAE at a low acoustic frequency of 12 kHz and low intensity power is very effective for selective extraction of proteins from *C. vulgaris*. 94.1% and 96.2% of initial proteins content were released under atmospheric pressure/300W and 3bar/100W, respectively. Although the two conditions resulted in similar and high proteins yields, the second is preferable, because it is more efficient economically. In all conditions, negligible amount of pigments and non-proteins matter were released, showing a selective extraction of protein fraction. The wall structure of *C. vulgaris* played an important role in the release of proteins as a specific component.

Algal protein fraction started to find new applications in cosmetics and pharmaceutical industries [49]. However, current proteins extraction techniques lead to a co-liberation of non-protein compounds (like pigments and lipids) conferring a significant non-desirable flavors and colors in the final product. Our results showed that UAE under specific conditions could be applied for selective proteins recovery with no need of further purification demands. This deals with the principal of the algorefinery concept, making the large scale of microalgae application more economically efficient.

4.4.5. References

- [1] F. J. Barba, N. Grimi, and E. Vorobiev, “New Approaches for the Use of Non-conventional Cell Disruption Technologies to Extract Potential Food Additives and Nutraceuticals from Microalgae,” *Food Eng. Rev.*, vol. 7, no. 1, pp. 45–62, Mar. 2015.
- [2] W. N. Phong, P. L. Show, C. F. Le, Y. Tao, J.-S. Chang, and T. C. Ling, “Improving cell disruption efficiency to facilitate protein release from microalgae using chemical and mechanical integrated method,” *Biochem. Eng. J.*, vol. 135, pp. 83–90, Jul. 2018.
- [3] E. Günerken, E. D’Hondt, M. H. M. Eppink, L. Garcia-Gonzalez, K. Elst, and R. H. Wijffels, “Cell disruption for microalgae biorefineries,” *Biotechnol. Adv.*, vol. 33, no. 2, pp. 243–260, Mar. 2015.
- [4] M. M. Poojary *et al.*, “Innovative Alternative Technologies to Extract Carotenoids from Microalgae and Seaweeds,” *Mar. Drugs*, vol. 14, no. 11, p. 214, Nov. 2016.
- [5] E. W. Becker, “Micro-algae as a source of protein,” *Biotechnol. Adv.*, vol. 25, no. 2, pp. 207–210, Mar. 2007.
- [6] J. A. Lubitz, “The Protein Quality, Digestibility, and Composition of Algae, *Chlorella* 71105a,” *J. Food Sci.*, vol. 28, no. 2, pp. 229–232.
- [7] H. J. Morris *et al.*, “Protein hydrolysates from the alga *Chlorella vulgaris* 87/1 with potentialities in immunonutrition,” *Biotechnol. Apl.*, vol. 26, no. 2, pp. 162–165, Jun. 2009.

- [8] J. Seyfabadi, Z. Ramezanzpour, and Z. A. Khoeyi, "Protein, fatty acid, and pigment content of *Chlorella vulgaris* under different light regimes," *J. Appl. Phycol.*, vol. 23, no. 4, pp. 721–726, Aug. 2011.
- [9] H. J. Morris, A. Almarales, O. Carrillo, and R. C. Bermúdez, "Utilisation of *Chlorellavulgaris* cell biomass for the production of enzymatic protein hydrolysates," *Bioresour. Technol.*, vol. 99, no. 16, pp. 7723–7729, Nov. 2008.
- [10] R. Seetharam and S. K. Sharma, *Purification and Analysis of Recombinant Proteins*. CRC Press, 1991.
- [11] J. Doucha and K. Lívanský, "Influence of processing parameters on disintegration of *Chlorella* cells in various types of homogenizers," *Appl. Microbiol. Biotechnol.*, vol. 81, no. 3, p. 431, Dec. 2008.
- [12] A. P. J. Middelberg, "Process-scale disruption of microorganisms," *Biotechnol. Adv.*, vol. 13, no. 3, pp. 491–551, Jan. 1995.
- [13] Y. W. Sari, M. E. Bruins, and J. P. M. Sanders, "Enzyme assisted protein extraction from rapeseed, soybean, and microalgae meals," *Ind. Crops Prod.*, vol. 43, pp. 78–83, May 2013.
- [14] A.-V. Ursu, A. Marcati, T. Sayd, V. Sante-Lhoutellier, G. Djelveh, and P. Michaud, "Extraction, fractionation and functional properties of proteins from the microalgae *Chlorella vulgaris*," *Bioresour. Technol.*, vol. 157, pp. 134–139, Apr. 2014.
- [15] J. Kim *et al.*, "Methods of downstream processing for the production of biodiesel from microalgae," *Biotechnol. Adv.*, vol. 31, no. 6, pp. 862–876, Nov. 2013.
- [16] H. A. Tavanandi, R. Mittal, J. Chandrasekhar, and K. S. M. S. Raghavarao, "Simple and efficient method for extraction of C-Phycocyanin from dry biomass of *Arthrospira platensis*," *Algal Res.*, vol. 31, pp. 239–251, Apr. 2018.
- [17] R. D. P. Rodrigues, F. C. de Castro, R. S. de Santiago-Aguiar, and M. V. P. Rocha, "Ultrasound-assisted extraction of phycobiliproteins from *Spirulina (Arthrospira) platensis* using protic ionic liquids as solvent," *Algal Res.*, vol. 31, pp. 454–462, Apr. 2018.
- [18] P. Jaouen, B. Lépine, N. Rossignol, R. Royer, and F. Quéméneur, "Clarification and concentration with membrane technology of a phycocyanin solution extracted from *Spirulina platensis*," *Biotechnol. Tech.*, vol. 13, no. 12, pp. 877–881, Dec. 1999.
- [19] R. V. Aftari, K. Rezaei, A. Mortazavi, and A. R. Bandani, "The Optimized Concentration and Purity of *Spirulina platensis* C-Phycocyanin: A Comparative Study on Microwave-Assisted and Ultrasound-Assisted Extraction Methods," *J. Food Process. Preserv.*, vol. 39, no. 6, pp. 3080–3091.
- [20] P. Rajasekhar, L. Fan, T. Nguyen, and F. A. Roddick, "Impact of sonication at 20 kHz on *Microcystis aeruginosa*, *Anabaena circinalis* and *Chlorella* sp.," *Water Res.*, vol. 46, no. 5, pp. 1473–1481, Apr. 2012.
- [21] R. R. dos Santos, D. M. Moreira, C. N. Kunigami, D. A. G. Aranda, and C. M. L. L. Teixeira, "Comparison between several methods of total lipid extraction from *Chlorella vulgaris* biomass," *Ultrason. Sonochem.*, vol. 22, pp. 95–99, Jan. 2015.

- [22] Z. Duan, X. Tan, K. Dai, H. Gu, and H. Yang, "Evaluation on H₂O₂-aided ultrasonic pretreatment for cell disruption of *Chlorella pyrenoidosa*," *Asia-Pac. J. Chem. Eng.*, vol. 12, no. 3, pp. 502–510.
- [23] E. Roselló-Soto *et al.*, "Clean recovery of antioxidant compounds from plant foods, by-products and algae assisted by ultrasounds processing. Modeling approaches to optimize processing conditions," *Trends Food Sci. Technol.*, vol. 42, no. 2, pp. 134–149, Apr. 2015.
- [24] F. Chemat, N. Rombaut, A.-G. Sicaire, A. Meullemiestre, A.-S. Fabiano-Tixier, and M. Abert-Vian, "Ultrasound assisted extraction of food and natural products. Mechanisms, techniques, combinations, protocols and applications. A review," *Ultrason. Sonochem.*, vol. 34, pp. 540–560, Jan. 2017.
- [25] G. Chatel, "How sonochemistry contributes to green chemistry?," *Ultrason. Sonochem.*, vol. 40, pp. 117–122, Jan. 2018.
- [26] J. Jeon *et al.*, "New mixture composition of organic solvents for efficient extraction of lipids from *Chlorella vulgaris*," *Biomass Bioenergy*, vol. 59, pp. 279–284, Dec. 2013.
- [27] R. R. Bidigare, "Analysis of Algal Chlorophylls and Carotenoids," in *Marine Particles: Analysis and Characterization*, American Geophysical Union (AGU), 2013, pp. 119–123.
- [28] O. Holm-Hansen and B. Riemann, "Chlorophyll a Determination: Improvements in Methodology," *Oikos*, vol. 30, no. 3, pp. 438–447, 1978.
- [29] V. Brotas and M.-R. Plante-Cuny, "Identification and quantification of chlorophyll and carotenoid pigments in marine sediments. A protocol for HPLC analysis.," *Oceanol. Acta Paris*, vol. 19, no. 6, pp. 623–634, 1996.
- [30] T. W. Goodwin, "Biosynthesis of Carotenoids," in *The Biochemistry of the Carotenoids*, Springer, Dordrecht, 1980, pp. 33–76.
- [31] K. Ramluckan, K. G. Moodley, and F. Bux, "An evaluation of the efficacy of using selected solvents for the extraction of lipids from algal biomass by the soxhlet extraction method," *Fuel*, vol. 116, pp. 103–108, Jan. 2014.
- [32] Y. Du, B. Schuur, S. R. A. Kersten, and D. W. F. Brilman, "Opportunities for switchable solvents for lipid extraction from wet algal biomass: An energy evaluation," *Algal Res.*, vol. 11, pp. 271–283, Sep. 2015.
- [33] A. L. Stephenson, J. S. Dennis, C. J. Howe, S. A. Scott, and A. G. Smith, "Influence of nitrogen-limitation regime on the production by *Chlorella vulgaris* of lipids for biodiesel feedstocks," *Biofuels*, vol. 1, no. 1, pp. 47–58, Jan. 2010.
- [34] N. F. Y. Tam and Y. S. Wong, "Effect of ammonia concentrations on growth of *Chlorella vulgaris* and nitrogen removal from media," *Bioresour. Technol.*, vol. 57, no. 1, pp. 45–50, Jul. 1996.
- [35] W. Kong, H. Yang, Y. Cao, H. Song, and S. Hua, *Effects of glycerol and glucose on the enhancement of biomass, lipid and soluble carbohydrate production by chlorella vulgaris in mixotrophic culture. Food Technology and Biotechnology*. 2013.

- [36] C. Safi, B. Zebib, O. Merah, P.-Y. Pontalier, and C. Vaca-Garcia, "Morphology, composition, production, processing and applications of *Chlorella vulgaris*: A review," *Renew. Sustain. Energy Rev.*, vol. 35, pp. 265–278, Jul. 2014.
- [37] T. J. Mason, A. J. Cobley, J. E. Graves, and D. Morgan, "New evidence for the inverse dependence of mechanical and chemical effects on the frequency of ultrasound," *Ultrason. Sonochem.*, vol. 18, no. 1, pp. 226–230, Jan. 2011.
- [38] S. Kentish and M. Ashokkumar, "The Physical and Chemical Effects of Ultrasound," in *Ultrasound Technologies for Food and Bioprocessing*, Springer, New York, NY, 2011, pp. 1–12.
- [39] B. K. Tiwari, "Ultrasound: A clean, green extraction technology," *TrAC Trends Anal. Chem.*, vol. 71, pp. 100–109, Sep. 2015.
- [40] P. Kanthale, M. Ashokkumar, and F. Grieser, "Sonoluminescence, sonochemistry (H₂O₂ yield) and bubble dynamics: Frequency and power effects," *Ultrason. Sonochem.*, vol. 15, no. 2, pp. 143–150, Feb. 2008.
- [41] H. Li, L. Pordesimo, and J. Weiss, "High intensity ultrasound-assisted extraction of oil from soybeans," *Food Res. Int.*, vol. 37, no. 7, pp. 731–738, Aug. 2004.
- [42] S. Both, F. Chemat, and J. Strube, "Extraction of polyphenols from black tea – Conventional and ultrasound assisted extraction," *Ultrason. Sonochem.*, vol. 21, no. 3, pp. 1030–1034, May 2014.
- [43] H. M. Khairy, E. M. Ali, and S. M. Dowidar, "Comparative effects of autotrophic and heterotrophic growth on some vitamins, 2,2-diphenyl-1-picrylhydrazyl (DPPH) free radical scavenging activity, amino acids and protein profile of *Chlorella vulgaris* Beijerinck," *Afr. J. Biotechnol.*, vol. 10, no. 62, pp. 13514–13519, Jan. 2011.
- [44] L. Gouveia and A. C. Oliveira, "Microalgae as a raw material for biofuels production," *J. Ind. Microbiol. Biotechnol.*, vol. 36, no. 2, pp. 269–274, Feb. 2009.
- [45] J.-Y. Lee, C. Yoo, S.-Y. Jun, C.-Y. Ahn, and H.-M. Oh, "Comparison of several methods for effective lipid extraction from microalgae," *Bioresour. Technol.*, vol. 101, no. 1, Supplement, pp. S75–S77, Jan. 2010.
- [46] F. Adam, M. Abert-Vian, G. Peltier, and F. Chemat, "'Solvent-free' ultrasound-assisted extraction of lipids from fresh microalgae cells: A green, clean and scalable process," *Bioresour. Technol.*, vol. 114, pp. 457–465, Jun. 2012.
- [47] X. Wu, E. M. Joyce, and T. J. Mason, "Evaluation of the mechanisms of the effect of ultrasound on *Microcystis aeruginosa* at different ultrasonic frequencies," *Water Res.*, vol. 46, no. 9, pp. 2851–2858, Jun. 2012.
- [48] C. Safi *et al.*, "Extraction of lipids and pigments of *Chlorella vulgaris* by supercritical carbon dioxide: influence of bead milling on extraction performance," *J. Appl. Phycol.*, vol. 26, no. 4, pp. 1711–1718, Aug. 2014.
- [49] P. Mehta *et al.*, "High-Value Coproducts from Algae—An Innovational Way to Deal with Advance Algal Industry," in *Waste to Wealth*, Springer, Singapore, 2018, pp. 343–363.

4.5. Chapter conclusion

This chapter spotted the light on the characteristic of the cell walls of *Spirulina sp.* and *Chlorella vulgaris* as well as the role they are capable to play on releasing proteins with respect to soft cell disruption method applied.

The experimental results indicated that UAE under acoustic frequency “12 kHz” and low intensity could be a method for total proteins and selected pigments release from *Spirulina sp.* The results brought additional insight on understanding the recovery of proteins without pigments release. Membrane disruption was efficient for proteins extraction but not enough to recover pigments indicating that total proteins extraction and cell wall destruction is not an indicator on all inner components release. The release of proteins in water has been shown to be dependent on ultrasound parameters employed. The order of power effectiveness under 0 bar was $300 < 100 < 200$ W with 71, 76, and 97 % of total proteins, respectively.

Concerning the effect of pressure, increasing pressure under 100W allowed an additional proteins release in the medium, Contrary, increasing pressure under 300W induce a decrease of 87% of extraction yield (from 71.7 to 9.4% total proteins content) leading to a dramatic reduction in proteins yield.

Ultrafiltration with prior pre-purification step (precipitation with ammonium sulphate 25%) was very effective in isolating uncoloured proteins from other colouring components. The overall recovery of the proteins was around 67%. This isolation process can help improving the commercial potential of *Spirulina sp.* where the obtained clear, uncoloured and crystal proteins could have unique properties due to the seemingly high degree of purity.

Contrary to total disintegrated *Spirulina sp.* cell wall, 96.2% of initial proteins content were released from *C. vulgaris* without cell disintegration. Negligible amount of pigments and non-proteins matter were released, showing a selective extraction of protein fraction. The wall structure of *C. vulgaris* played an important role in the release of proteins as a specific component under the soft extraction conditions.

General Conclusion

Bio-refining of microalgae is considered as a potential source of various biomolecules. The exploitation of this rich biomass does not cease to develop. Numerous research perspectives were unwrapped in aim to optimize various parameters at the different stages of the algorefinery process such as cultivation, extraction and fractionation of the metabolites of interest. Microalgae produce several components whose use is now centered in the markets of biofuels, food and feed, cosmetic, pharmaceutical and aquaculture

In this context, the objective of the algorefinery is to develop a method to fractionate the major biomolecules, using a series of unit operations allowing a "selective" extraction of the compounds of interest without altering the others.

Hence, at the “Laboratoire de Chimie Agro-Industrielle” (LCA) and “Plateforme de Recherche et d'Analyse en Sciences de l'Environnement” (PRASE), we showed major interest on recovering the hydrophilic and the lipophilic fractions by taking into consideration the biomass composition, the cell wall characteristic and the role that can play regarding the extraction technique, the optimization of extraction parameters, and the purification techniques carried out for the fractionation of the heterogeneous phase obtained after cell disruption. The additional mission was to respect the principles of ecoconception and green chemistry.

Since selected species of microalgae and cyanobacteria were investigated in our study, and since the characteristics of the cell wall vary from one species to another, it was important to understand the effect of the cell wall rigidity, biomass pretreatment, and the location of the biomolecule of interest inside cell on extraction efficiency. Furthermore, the internal organelles also showed some resistance toward cell disruption and extraction yield, and revealed that it would hinder the liberation of some biomolecules.

Extraction of dry microalgae

Our work consisted of implementing a continuous fractionation process that takes into account the integrity of the biomolecules in the downstream process. The unit operation of cell disruption was bypassed. The selectivity of reserve lipid and specific pigments extracts using supercritical carbon dioxide was possible by setting optimized parameters. Our results showed that selective

General Conclusion

recovery from freeze-dried *Nannochloropsis oculata* and *Chlorella vulgaris* was possible. This set of studies gave us a clear idea on the role of the cell wall on the release of the lipids.

Then following the lipophilic extraction, the well maintained cell wall biomass underwent a double stage aqueous extraction for proteins recovery. It was interesting to look more in depth on their diffusion behavior regarding the pH of the aqueous media. The effect of biomass defatting degree (partially or totally) on proteins release was studied. Results showed that total defatting allowed a higher proteins release in the aqueous phase. Hence, following high proteins extraction, the aqueous phase of *Nannochloropsis oculata* containing proteins and impurities like sugars and pigments was fractionated to obtain proteins separate fractions. The fractionation process is based on a single ultrafiltration using membrane process.

Therefore, starches and pigments were retained in the retentate while permeate was composed of cleared proteins fraction.

Extraction of wet microalgae

Moreover, a soft algorefinery process was carried on the cyanobacteria *Spirulina sp.* and green algae *Chlorella vulgaris*. The biomasses were subjected to an innovative green/soft ultrasound assisted extraction (UAE) for proteins recovery. Total proteins content was released in the aqueous medium from the dramatically disintegrated cell *Spirulina sp.* contrary to the well maintained *Chlorella vulgaris* allowing a highly selective proteins total release. For clarification/concentration step, membrane technologies were investigated using cross-flow ultrafiltration process. Results showed a high yield (reaching 65%) of pigments free proteins of *Spirulina sp.* in the permeate compartment. Optimization of the ultrafiltration conditions was made by combining a pre-purification step (separation of impurities from proteins using ammonium sulfate 25%) providing higher permeation flux.

The following points could summarize the strong force of our work:

- The principles of “green chemistry” were respected in terms of the extracting solvent used.
- It has been pointed out that even though the distinguished role of the cell wall on biomolecules recovery, the ultrastructure of some microalgae could also show a resistance against some mechanical treatment and allow a selective extraction.

General Conclusion

- The unit operations of cell disruption could be avoided before supercritical carbon dioxide extraction for selective reserve lipids recovery.
- It was possible to understand the release behavior during extraction of lipids, pigments and proteins.
- A fractionation process with simplified steps has been set and could be optimized for an industrial scale up.
- The selectivity of extraction from robust cell wall was investigated using the low frequency ultrasound conducting soft green extraction on wet microalgae, which saved the cost of drying the biomass before the extraction.

Despite all the advantages of our studied process, theoretically every process has its limitations

- The supercritical extraction investigated is considered as costly technique and required high-energy input.
- Regardless of the success of the fractionation process, the recovery of components of interest using membrane process need to be optimized.

These difficulties represent an opportunity to open new perspectives:

- Obtain images by electron microscopy that would follow up the modification of the cell morphology during the extraction.
- For rigid cell wall microalgae, it is a serious challenge to understand and optimize other disruption methods for more selective extraction.
- Optimize the membrane process to improve the purity and the flow rate of the components of interest.

Scientific production

Paper accepted in peer-reviewed international scientific journals

1. Supercritical carbon dioxide extraction and fractionation of lipids from freeze dried microalgae *Nannochloropsis oculata* and *Chlorella vulgaris*, *Algal Research* 34 (2018) 49–56.

S. Obeid, N. Beaufils, S. Camy, H. Takach, A. Ismail, P-Y. Pontalier.

Paper accepted in peer-reviewed international congress

2. Proteins and pigments extraction from microalgae *Spirulina sp.* assisted by ultrasound irradiation: effect of variable low power and pre-treatment conditioning,

Récents Progrès en Génie des Procédés, Numéro 110 – 2017

ISSN: 1775-335X; ISBN: 978-2-910239-85-5, Ed. SFGP, Paris, France.

S. Obeid, I. Benhamed, M. Charton, J. Peydecastaing, H. Takache, A. Ismail, P-Y. Pontalier, L. Barthe

Papers submitted or ready for submission

3. Supercritical fluid extraction and solid phase fractionation of pigments from freeze-dried *Chlorella vulgaris* and *Nannochloropsis oculata*

S. Obeid, H. Takache, N. Beaufils, S. Camy, A. Ismail, P-Y. Pontalier

4. Extraction and purification of soluble proteins from *Nannochloropsis oculata* by pH-shifting and ultrafiltration

S. Obeid, H. Takache, N. Beaufils, S. Camy, A. Ismail, P-Y. Pontalier.

5. Selectivity of low-frequency ultrasound-assisted extraction for proteins recovery from the microalgae *Chlorella vulgaris*.

S. Obeid, I. Benhamed, M. Charton, J. Peydecastaing, H. Takache, A. Ismail, P-Y. Pontalier, L. Barthe.

6. Clarification of non-pigmented proteins from *Spirulina sp.* using ultrasound assisted extraction coupled with ultrafiltration

S. Obeid, I. Benhamed, M. Charton, J. Peydecastaing, H. Takache, A. Ismail, P-Y. Pontalier, L. Barthe.

Poster presentations

1. Etude de procédé de quantification et de purification des lipides et des protéines de microalgues extraites à l'eau et au CO₂ supercritique - LAAS congress 2016 (USEK-Lebanon)

S. Obeid, H. Takache, N. Beaufils, S. Camy, A. Ismail, P-Y. Pontalier

Scientific production

2. Ultrasound-assisted extraction for microalgae proteins recovery - SFGP congress 2017 (Nancy- France)
S. Obeid, I. Benhamed, H. Takache, A. Ismail, P-Y. Pontalier, L. Barthe.
3. A primary algorefinery study on *Nannochloropsis oculata* and *Chlorella vulgaris* - ISAP Congress 2017 (Nantes- France)
S. Obeid, H. Takache, N. Beaufiles, S. Camy, A. Ismail, P-Y. Pontalier
4. Extraction and fractionation of proteins from *Chlorella vulgaris* and *Spirulina sp.* by membrane technology - FPS congress 2018 (Lyon- France)
S. Obeid, I. Benhamed , H. Takache, J. Peydecasting , M. Charton, L. Barthe, A. Ismail , and P.Y. Pontalier.
5. A primary algorefinery study on green microalgae and cyanobacteria using supercritical-EDST Scientific Forum 2017
S. Obeid, I. Benhamed , H. Takache, J. Peydecasting , M. Charton, L. Barthe, A. Ismail , and P.Y. Pontalier

Oral presentations

1. Supercritical carbon dioxide extraction and fractionation of lipids for biofuel production from untreated microalgae *Nannochloropsis oculata* and *Chlorella vulgaris* - 9th Annual Congress and Expo on Biofuels and Bioenergy 2018 (Dubai, UAE)
S. Obeid, H. Takache, A. Ismail, P-Y. Pontalier.
2. Proteins extraction from microalgae *Spirulina sp.* assisted by ultrasound irradiation: effect of variable low power and pre-treatment conditioning - EDST- BAU Scientific Colloquium 2017 (Beirut- Lebanon)
S. Obeid, H. Takache, A. Ismail, P.Y. Pontalier.
3. Quantification et Purification des Lipides et des Protéines Extraits de Microalgues - 2017 EDST (Beirut-Lebanon)
S. Obeid, H. Takache, A. Ismail, P-Y. Pontalier.

Résumé générale en français

Chapitre 1: Etat de l'art

Les microalgues sont des organismes aquatiques unicellulaires. Jusqu'à ce jour, environ 30000 espèces sont connues et analysées. Ils sont capables de coloniser tous les types d'environnements, y compris les eaux salées, douces, saumâtres et même les eaux usées grâce à leurs compétences de survie. Aujourd'hui, une gamme d'espèces de microalgues peut-être produite dans un environnement artificiel appelé photobioréacteur (PBR) où elles sont cultivées sous une exposition lumineuse désirée, une concentration spécifiée d'éléments nutritifs et des facteurs vitaux convenables. Les microalgues diffèrent principalement des autres plantes par leur vitesse de croissance très rapide, leur richesse en lipides, protéines, polysaccharides, vitamines, pigments et antioxydants. Ils sont principalement exploités pour leurs composants primaires : lipides, protéines, polysaccharides et pigments.

Les microalgues sont divisées en deux groupes : celles appartenant au groupe des eucaryotes, c'est-à-dire ayant des organites cellulaires (chloroplastes, mitochondries et son noyau entouré de son enveloppe), et ceux appartenant au groupe des procaryotes, où les organites cellulaires sont absentes. Les microalgues sont classées sous 11 divisions et 29 classes. Les trois classes les plus connues sont les « *Chlorophyceae* » et les « *Eustigmatophyceae* » qui sont des algues vertes, et les « *Cyanophyceae* » ou cyanobactéries. Ces trois classes sont les plus étudiées en raison de leurs propriétés énergétiques, vue leur teneur élevée en lipides, protéines, pigments, sucre, etc. A côté du secteur énergétique, Ils offrent des possibilités pour des applications agricoles, alimentaires, pharmaceutiques et médicales.

La biomasse algale représente un potentiel considérable dans le monde et elle a déjà été identifiée pour sa capacité à produire des produits de valeur. Les scientifiques cherchent à ouvrir et développer de procédés innovants pour permettre la production d'une très large gamme de produits, à l'aide du concept « d'algoraffinerie », mais ils sont loin de garantir une production de masse avec une rentabilité économique/écologique acceptable. L'algoraffinerie est maintenant au stade de la recherche et du développement dans le but d'atteindre une rentabilité écologique/économique suffisante.

Résumé générale en français

La transformation des microalgues présente beaucoup **d'avantages** par rapport à d'autre biomasse terrestres :

- Au stade du laboratoire, les rendements en huile à partir des microalgues (par hectare) sont 20 à 30 fois plus élevés que ceux d'autres oléagineux terrestres.
- Les zones cultivées en microalgues n'ont pas besoin d'être des terres arables et ne sont pas donc en concurrence avec les terres agricoles.
- La croissance des microalgues lipidiques nécessite de grandes quantités de CO₂, ce qui ouvre des perspectives pour le recyclage du CO₂ émis par les usines ou les centrales thermiques.

Cependant, plusieurs **obstacles** se posent encore pour la production de cette biomasse :

- La culture nécessite des conditions spéciales d'ensoleillement et de disponibilité de l'eau, ce qui limite les emplacements possibles.
- Elle a également besoin en nutriments (nitrates et phosphates) et en dioxyde de carbone.
- L'algoraffinerie (prétraitement - extraction - purification) consomme beaucoup d'énergie. Différents schémas de couplage pour les techniques d'extraction, prétraitement et séparation sont rapportés dans la littérature afin d'obtenir des extraits riches en composants primaires (lipides, protéines et pigments).

Le processus nécessite une séquence d'opérations unitaires à partir du prétraitement de la biomasse par une désintégration chimique / mécanique de la paroi cellulaire des microalgues. Ceci permet un accès plus facile du solvant d'extraction face aux composants intracellulaires, et contribue à améliorer le rendement de récupération des biomolécules dédiées. Les méthodes de désintégration sont préférées en raison de l'accélération du mécanisme, mais ces méthodes sont gourmandes en énergie et surchauffent les molécules, ce qui nécessite un refroidissement le long du processus pour éviter la dénaturation ou la dégradation thermique. Après l'étape de prétraitement et d'extraction vient le stade de la purification, ce qui est une étape difficile pour de nombreux scientifiques à l'échelle du laboratoire et à l'échelle industrielle.

Plan d'action de la thèse

L'état de l'art apporté dans ce manuscrit a montré que les microalgues représentent une source renouvelable importante. Certaines microalgues sont riches en protéines, d'autres en pigments et en lipides.

Cependant, de nombreux verrous doivent être levés du processus d'algoraffinerie pour assurer autant que possible une viabilité environnementale / économique. Les conditions de prétraitement et d'extraction des composants d'intérêt restent un défi important dans les processus en aval. De nos jours, les déficiences dans le domaine de l'extraction des microalgues sèches sont toujours confrontées.

Actuellement, le prétraitement exécuté avant les procédés d'extraction nécessite une consommation d'énergie significative, l'addition d'étapes ultérieures pour la séparation et la purification des composants désirés d'autres composants co-extraits, et augmente la proportion de produits finaux altérés dus à un effet mécanique ou thermique. Dans cette perspective, il apparaît nécessaire d'améliorer les processus actuels et de progresser vers une exécution améliorée.

Démarche 1 :

Ainsi, nous avons pris ce problème d'extraction à partir de **microalgues sèches** en utilisant la technique du fluide supercritique selon l'approche suivante (Schéma I) :

- L'étape de désintégration des parois cellulaires a été évitée pendant tout le processus d'extraction : après réduction de la teneur en eau inférieure à 2%, une extraction avec du CO₂ supercritique sans désintégration préalable de la paroi cellulaire a été effectuée pour récupérer uniquement les lipides neutres et pour éviter la formation d'émulsions, à partir des microalgues *Chlorella vulgaris* et *Nannochloropsis oculata*.
- Le procédé de purification des lipides neutres sera donc plus facile à mettre en œuvre.
- Contrairement aux études reportées dans la littérature, les résidus d'extraction supercritiques composés de cellules delipidées riche en protéines ne subiront plus une désintégration, et les protéines seront extraits à l'aide d'une double extraction aqueuse / alcaline.
- La purification des protéines d'autres composants hydrophiles co-extraits sera exécutée en utilisant un procédé à membrane.

Résumé générale en français

Pour résumer, notre premier processus de modélisation est le suivant :



Schéma I : Processus pour la première option, qui part de la biomasse sèche, en jaune les sujets/étapes qui ont été étudiés dans cette thèse.

Démarche 2 :

Puisque le séchage des microalgues génère un coût énergétique conséquent et une étape systématique préalable à l'extraction, le second schéma/option sera constitué d'une séquence d'opérations d'extraction / purification sur une biomasse humide afin d'obtenir des fractions enrichies en lipides, pigments et protéines.

Ainsi, nous avons effectué une extraction **à partir des microalgues humides** en utilisant une technique d'extraction assistée par ultrasons selon l'approche suivante:

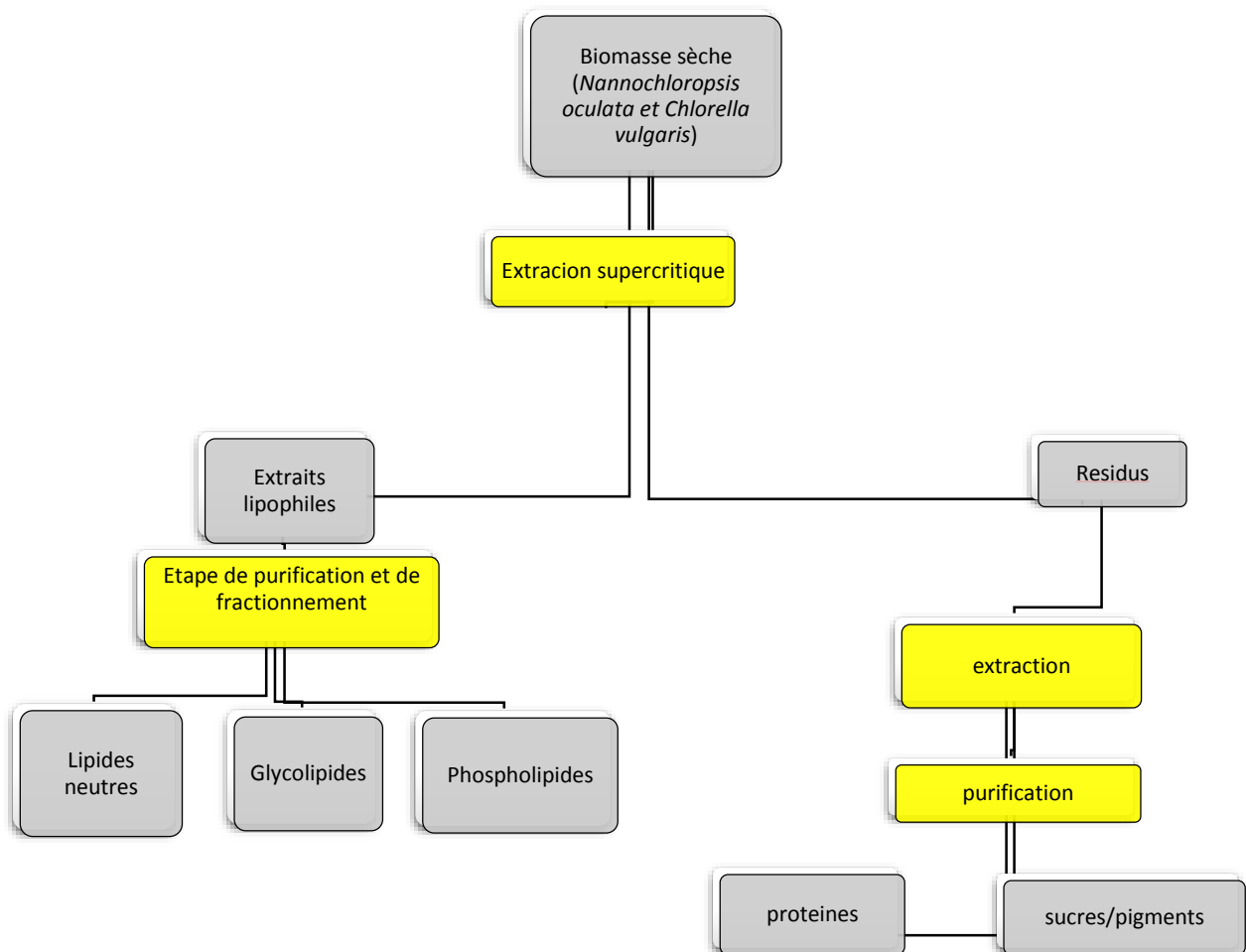
- Ce processus commence par la rupture de la paroi cellulaire dans un milieu aqueux contenant 5% de matière sèche

Résumé générale en français

- De nouveaux paramètres innovants (faible puissance, basse fréquence) ont été utilisés pour obtenir une intensification et une optimisation de la technique d'extraction assistée par ultrasons
- un mélange d'émulsion composé principalement de lipides, de protéines, de pigments subira des techniques de purification variantes pour obtenir des fractions enrichies spécifiques.
- De même, la compréhension du degré de résistance de la paroi cellulaire sera équivalente à «l'extraction sélective» pour obtenir un composé enrichi spécifique.

Pour résumer, notre deuxième processus (Schéma II) de modélisation est le suivant: dans cette figure nous avons mis en évidence (en jaune) les sujets qui pourraient être étudiés dans cette thèse.



Schéma II : Processus pour la deuxième option, qui part de la biomasse humide, en jaune les étapes qui ont été étudiés dans cette thèse.

Chapitre 2 : Méthodes et matériels

Biomasse microalgale

Des expériences ont été réalisées à partir de différentes espèces de microalgues; chacune d'elle a des caractéristiques morphologiques (membranaires) et une composition biochimique différentes. Les trois espèces impliquées dans ce travail sont *Chlorella vulgaris*, *Nannochloropsis oculata* et *Spirulina sp.*

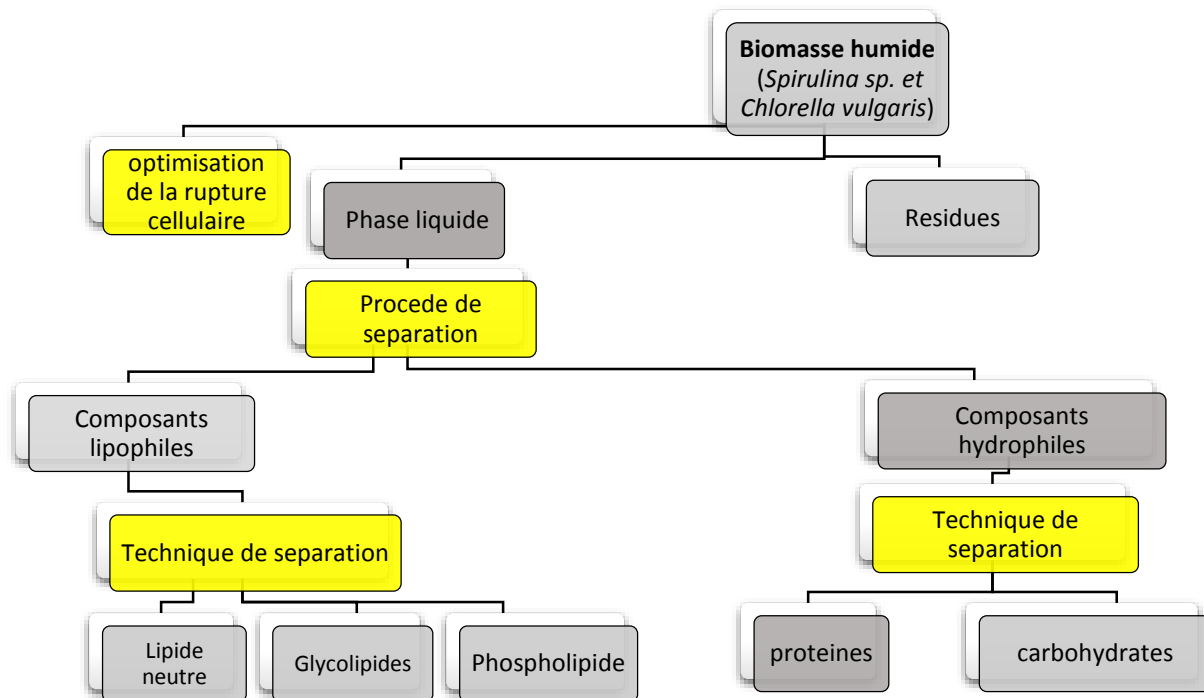
Les souches de *C. vulgaris* et *N. oculata* (Alpha Biotech, Assérac, France) ont été cultivées dans un milieu riche en nutriments azotés pour favoriser l'accumulation de protéines chez *C. vulgaris*. Les souches de *N. oculata* ont été cultivées dans des conditions de carence en nutriments azotés pour favoriser l'accumulation de lipides de réserve. La souche de *Spirulina sp.* (Alg&You, Toulouse, France), à été fournie dans des milieux de culture à 5% MS .Des fractions ont été laissées fraîches, d'autre congelées et d'autre lyophilisées.

Méthodes d'extraction

La teneur totale en lipides a été déterminée à l'aide de l'extraction conventionnelle selon Bligh et Dyer (1959).

Extraction par CO₂ supercritique

Les différentes extractions au CO₂ supercritique ont été réalisées sur des biomasses lyophilisées au Laboratoire d'Ingénierie Chimique (LGC) sur un pilote développé par la société Separex (SFE100, Separex Chimie fine, France), capable de travailler à des pressions jusqu'à 1000 Bar et températures jusqu'à 250 °C. Plusieurs extractions ont été effectuées en faisant varier la pression de travail et la présence ou l'absence d'un co-solvant.

Ultrason

Les tests d'extraction ont été réalisés à l'aide d'une installation SinapTec située au Laboratoire de Génie Chimique (LGC). Un plan expérimental a été réalisé afin de mettre en évidence et d'optimiser les facteurs influençant l'extraction de protéines à partir de *Spirulina sp* et de *Chlorella vulgaris*. Quatre facteurs ont été étudiés: l'agitation, la fréquence, la pression et la puissance.

Résumé générale en français

Extraction totale de pigments

Il existe différents types de pigments dans *C. vulgaris*, *N. oculata* et *Spirulina sp.* Nous nous sommes concentrés sur certains pigments en particulier: les chlorophylles a et b, les lutéines et les β -carotène. La teneur totale en ces pigments a été extraite à froid pour les protéger de la dénaturation thermique.

Technique de purification

Ultrafiltration

Les membranes utilisées sont des planes en polysulfone (dont le seuil de coupure est donné à 10-30- 100 kDa) à l'aide d'une cellule de filtration de 200 mL (Unités d'Ultrafiltration Agitées - Amicon® Stirred Cells) correspondant à une surface de filtration de 30,2 cm². Cette unité offre une surface de filtration réduite qui permet d'étudier la filtration de quantités relativement faibles (à partir de 50 mL). De plus, une agitation sur la membrane a été également appliquée pour minimiser l'effet de la couche de polarisation de concentration due à l'accumulation des macromolécules à la surface de la membrane

Techniques analytiques

Analyse des protéines : La teneur en protéines totales des biomasses étudiées a été quantifiée selon la méthode de Kjeldahl. La teneur en protéines brutes des microalgues étudiées est obtenue en multipliant la valeur obtenue lors de la détermination de la teneur en azote par le facteur 6.2.

Méthode de Lowry (Lowry et al, 1951) : pour la quantification des protéines solubles dans l'eau.

Pour les échantillons solides, l'extraction à l'hydroxyde de sodium est nécessaire pour solubiliser les protéines hydrosolubles. Au laboratoire, cette extraction est généralement réalisée avec une solution d'hydroxyde de sodium à pH 11 pendant une heure à 40 °C. Une fois les protéines extraites, la méthode de Lowry a été utilisée pour quantifier les protéines solubles libérées dans le milieu.

Analyse SDS-PAGE : Afin d'identifier les protéines extraites par leur poids, une électrophorèse sur gel de polyacrylamide en présence de dodécylsulfate de sodium (SDS-PAGE) a été réalisée.

Chromatographie d'exclusion de taille SEC : La méthode SEC a été étudiée pour séparer les petites protéines extraites de celles de plus grande taille dans le but de comprendre les caractéristiques des protéines libérées.

Analyse pigmentaire

La teneur en pigment total (chlorophylles a et b, β -carotènes et lutéine) a été mesurée par HPLC selon la méthode développée par Bidigare (1991).

Fractionnement des lipides par extraction en phase solide (SPE) : Le fractionnement des extraits lipidiques est une étape particulièrement importante dans l'identification de la teneur en biomasse des lipides neutres, des glycolipides et des phospholipides. Il permet aussi d'évaluer l'efficacité et la sélectivité de l'extraction supercritique. C'est une technique utilisée en raison de sa vitesse et de son efficacité.

Le fractionnement des lipides en trois classes de lipides neutres, de glycolipides et de phospholipides était possible. Une fois élues et lyophilisées sous azote liquide, les fractions ont été mesurées par gravimétrie et exprimées en mg / g de poids sec.

Chapitre 3 : Extraction fractionnée

Ce chapitre est composé de trois publications.

Publication # 1

Cette étude porte sur l'extraction sélective de lipides neutres à partir de microalgues en utilisant le ScCO₂ sans rupture de cellule. Les biomasses étudiées étaient cultivées dans des conditions de stress nutritives. *Nannochloropsis oculata* a été cultivé dans un milieu de Conway modifié dans des conditions de carence en azote pour favoriser l'accumulation de lipides, alors que la microalgue *Chlorella vulgaris* a été cultivée dans des milieux de Sueoka dans des conditions de teneur élevée en azotés pour favoriser l'accumulation de protéines. La culture dans de telles conditions induisait l'accumulation de lipides chez *Nannochloropsis oculata* spécifiquement les lipides neutres (triglycérides ou lipides de réserve). Contrairement à *N. oculata*, *C. vulgaris* possède des lipides polaires ou structuraux comme lipides prédominants, situés dans les chloroplastes et les membranes cellulaires

L'extraction des lipides de réserve à l'aide d'une méthode qui respecte l'environnement et sans solvant est un grand défi pour l'industrie d'aujourd'hui. L'extraction à l'aide du CO₂ supercritique comme solvant, présente de nombreux avantages, dont le plus important est l'obtention du produit final sans traces de solvant toxique.

Dans cette partie, nous étudions l'effet des paramètres clés de l'extraction ScCO₂ sur le rendement: la température, la pression et l'ajout de modificateur polaire (éthanol 10%). Une telle addition de modificateur polaire permet de comprendre l'effet de la co-extraction de lipides polaires sur le rendement d'extraction de lipides neutres. D'autre part, la sélectivité de l'extraction de lipides neutres a été évaluée en analysant la composition des extraits en lipides polaires (glycolipides et phospholipides) tout au long du processus, en utilisant la technique d'extraction en phase solide (SPE).

Dans des conditions d'exploitation, 97% lipides neutres de *C. vulgaris* ont été extraits en utilisant l'éthanol à 10% comme co-solvant. Les lipides neutres de *N. oculata* représentaient la plupart des extraits (83%), alors que la proportion de glycolipides et de phospholipides n'excédait pas 12,1% et 5,3% respectivement. L'observation microscopique a montré que l'intégrité de la paroi cellulaire était maintenue pendant le processus d'extraction.

Publication # 2

Le but de ce travail est d'étudier la cinétique d'extraction supercritique de plusieurs composants (chlorophylles a et b, la lutéine, β -carotènes, lipides neutres, glycolipides et phospholipides) dans. L'extraction des composants à l'extérieur de la paroi cellulaire rigide de *N. oculata* et *C. vulgaris* nécessite un traitement spécifique afin de faciliter leur transfert et d'augmenter le rendement d'extraction. Ainsi, nous étudions l'évolution d'extraction sans destruction cellulaire au préalable. Par conséquent, différents paramètres d'extraction de ScCO₂ ont été étudiés sur *C. vulgaris* et *N. oculata*.

La souche de *C. vulgaris* utilisée dans cette étude est distinguée par sa teneur élevée en protéines, chlorophylles a et b et les lipides structuraux. D'autre part, *N. oculata* présentait une teneur en lipides plus élevée notamment en lipides de réserves, et une faible teneur en chlorophylles a et b. La relation entre la teneur en pigments (caroténoïdes et chlorophylles) et l'accumulation de lipides a été étudiée dans les souches de *Chlorella* et *Nannochloropsis* : le

rapport caroténoïde-chlorophylle de *C. vulgaris* (faible teneur en lipides neutres) est inférieur au rapport caroténoïde-chlorophylle de *N. oculata* (riche en lipides neutres).

L'huile et les pigments dérivés de *C. vulgaris* lyophilisés ont été extraits par du CO₂ supercritique. Les résultats obtenus ont montré que le rendement d'extraction des pigments était si bas et qu'une extraction simple avec ScCO₂ + éthanol (10%) comme co-solvant n'a pas modifié le rendement d'extraction de la chlorophylle b et de la lutéine. La principale différence est apparue avec la chlorophylle a, dont le rendement d'extraction était près de 6 fois plus élevé que lors de la double extraction (consiste à faire une première extraction supercritique en utilisant du ScCO₂ comme solvant, suivie d'une seconde extraction en utilisant du ScCO₂ + éthanol comme co-solvant 10%). Cette procédure a modifié la structure de la membrane plasmique du chloroplaste permettant la diffusion hors de la cellule de la chlorophylle a. Les effets des co-solvants ont été trouvés prononcés pour l'extraction des lipides neutres, sous simple extraction, atteignant 97% des lipides neutres totaux.

L'extraction au ScCO₂ de *N. oculata* a révélé que 450 bars étaient la pression optimale pour l'extraction des lipides neutres avec 76 mg / g de poids sec (correspondant à 45% de la teneur totale en lipides neutres), en plus de 34% de chlorophylle a sélectivement extraites parmi les autres pigments.

Publication # 3

Le but de cet article est d'étudier la possibilité d'un rendement élevé d'extraction de microalgues de *N. oculata* sans endommager les propriétés et l'intégrité de la paroi cellulaire afin de respecter le concept de bioraffinerie, et de minimiser les étapes possibles de fractionnement et de purification. L'extraction a été réalisée en double étapes en faisant varier le pH du milieu, sur une biomasse dégraissée, non dégraissée et semi-dégraissée (par extraction au CO₂ supercritique) dans le but de comprendre l'effet de la délipidation sur l'extraction de protéines.

Une fois l'extraction terminée, il est nécessaire d'établir un processus de fractionnement / concentration des protéines. Quelques travaux ont étudié le procédé membranaire pour purifier des composants de microalgues. L'application de l'ultrafiltration pour la séparation des protéines microalgales d'autres composants semble offrir certaines sources d'intérêt industriel spécifique (efficacité et facilité d'exploitation). Par conséquent, l'ultrafiltration frontale sur des surnageants de protéines de *N. oculata* a été étudiée. Ces techniques de séparation ont été utilisées pour la

purification des protéines en éliminant les composants co-extraits non désirés, et pour la concentration en protéines après extraction. Les solutions de perméat et de rétentat ont été analysées afin de vérifier l'efficacité de chaque étape. L'électrophorèse sur gel de polyacrylamide (SDS-PAGE) et une chromatographie d'exclusion de taille (SEC) ont été utilisées pour identifier les protéines extraites.

Les résultats ont montrés que 73,7% des protéines totales ont été libérées en utilisant une combinaison de conditions aqueuses (durant la première étape d'extraction) et alcaline (durant la deuxième étape d'extraction), à partir de la biomasse dégraissée. Une fraction enrichie de protéines hydrosolubles exemptes d'impuretés colorantes a été obtenue. De plus, 84% des protéines extraites ont été obtenues sans pigment dans la fraction de perméat en utilisant une membrane de 100 kDa.

Chapitre 4 : Purification des extraits

Ce chapitre est composé de trois publications

Publication # 4

Le présent document vise à travailler sur une solution innovante, à très basse fréquence et audible (12 kHz) pour l'extraction des protéines et pigments à partir de *Spirulina sp.* De nombreuses publications ont mentionné l'effet négatif des ultrasons en utilisant des fréquences élevées et modérées et comment cela pourrait induire une dégradation des composants d'intérêt.

Au vu de ce qui précède, une extraction verte et douce utilisant de l'eau sera réalisée à basse température en utilisant un procédé d'ultrason à basse fréquence. En outre, une attention particulière a été accordée à l'influence des conditions de stockage (biomasse fraîche, lyophilisée et congelée) et des conditions d'extraction assistée par ultrasons (faible pression - faible puissance- vitesse d'agitation) sur le rendement d'extraction des protéines et des pigments.

Les résultats ont indiqué que l'extraction de protéines pouvait atteindre près de 95%. Presque toute la teneur en protéines a été libérée dans le milieu à partir de la biomasse congelée dans deux conditions variables: Il était possible d'obtenir le même rendement d'extraction à 300 W sous pression atmosphérique ou à 100 W sous pression relative de 3 bars. La deuxième condition est préférée car elle est plus économique. De même, le conditionnement de stockage a également eu un effet important sur l'efficacité d'extraction des pigments. Cependant,

l'application des ultrasons était nécessaire pour obtenir un rendement d'extraction élevé des pigments tels que la chlorophylle a et le β -carotène dont les concentrations dans le surnageant étaient respectivement 120 fois et 140 fois plus élevées qu'en absence des ultrasons. Les prétraitements congelés semblaient affaiblir la structure cellulaire, en particulier la membrane externe, conduisant à une extraction des pigments plus efficace.

Les résultats ont aussi indiqué que l'UAE sous la fréquence acoustique "12 kHz" à faible intensité pourrait être une méthode pour l'extraction des protéines totales et u pour l'extraction sélective des pigments. La libération des pigments nécessitait une forte désintégration de la structure interne, tandis que les protéines ont été libérées avec une simple lyse cellulaire.

La présente étude apporte également un aperçu supplémentaire sur la compréhension de la récupération des protéines sans libération de pigments. La rupture de la membrane était efficace pour l'extraction des protéines, mais pas assez pour récupérer les pigments, ce qui indique que l'extraction totale des protéines et la destruction de la paroi cellulaire ne sont pas un indicateur de la libération de tous les composants.

Publication # 5

Cette étude vise à obtenir une fraction protéique non pigmentée hautement clarifiée de *Spirulina sp.* en utilisant la technologie membranaire.

La fraction protéique de *Spirulina sp.* a commencé à être exploitée dans les industries cosmétiques et pharmaceutiques. Toutefois, le développement de ladite fraction dans ces divers secteurs reste non significatif du fait de la présence d'éléments indésirables durant son extraction conduisant à des modifications significatives de la couleur. Pour améliorer leur potentiel commercial, la fraction protéique doit être clarifiée à partir des composants indésirables après extraction. Un processus doux d'algoraffinerie a été réalisé sur les cyanobactéries *Spirulina sp.* pour obtenir une fraction purifiée de protéine exempte de chlorophylles, de caroténoïdes et de C-phycocyanine (pigments protéiques bleus).

Les protéines ont été libérées dans le milieu aqueux de la cellule *Spirulina sp.* utilisant les ultrasons à basse fréquence (12 kHz) et intensité. Pour l'étape de clarification, la technologie membranaire a été utilisée dans le but d'améliorer la pureté des extraits de protéines résultant

de la rupture par les ultrasons de la paroi cellulaire. Un procédé d'ultrafiltration frontale a été effectué sur les surnageant protéiques enrichis.

Comme résultat, un rendement global de protéines clarifiées important (atteignant 65%) a été obtenu dans le compartiment du perméat. Le rétentat était principalement composé de phycocyanine. L'ultrafiltration avec des membranes ayant un seuil de coupure de 10 kDa présentait les meilleures performances en termes de rétention complète des pigments, des protéines pigmentées et des résidus.

Publication # 6

La microalgue *C. vulgaris* est produite industriellement pour ses teneurs élevées en protéines utilisées dans l'alimentation humaine. Cependant, le principal inconvénient de l'extraction de ces protéines est la faible disponibilité des composants intracellulaires due à la paroi cellulaire rigide de cette souche. Pour cela, de nombreux travaux sont portés sur la rupture de la paroi cellulaire avant l'extraction de la fraction protéique.

En termes d'ultrasons menées sur *C. vulgaris*, la majorité des articles se concentraient sur la rupture de la paroi cellulaire. En conséquence, de nombreux composants internes ont également été co-extraits. La rigidité apparente de *C. vulgaris* pourrait être exploitée pour une éventuelle extraction sélective. L'objectif de cette étude était d'évaluer l'efficacité de l'extraction assistée par ultrasons à basse fréquence (UAE) pour l'extraction sélective de protéines. La microalgue *C. vulgaris* a été soumise à une faible fréquence acoustique (12 kHz), à faibles intensités (0-100-300 W) et à une pression hydrostatique relative de zéro à 3 bar. La cavitation, induite par des ultrasons de faible intensité et de basse fréquence, pourrait récupérer des protéines précieuses sans altérer l'intégrité cellulaire. . Nous avons évalué l'ultrason comme une étape de traitement pour se conformer aux critères du concept de la chimie verte.

Pour éviter toute dénaturation thermique, la température n'a pas dépassé 30 °C pendant le traitement. Nous avons déterminé le rendement d'extraction des protéines pour tous les surnageant. De plus, nous avons quantifié les pigments et les résidus UAE comme marqueur des altérations des organites internes, de la désintégration de la paroi cellulaire et de la libération des lipides. Nous avons suivi les changements dans la morphologie cellulaire pour évaluer la performance du procédé et le degré de perturbation cellulaire.

Résumé générale en français

En conséquence, les ultrasons ont été efficaces dans l'extraction sélective de protéines : 96% des protéines récupérées avec une co-extraction négligeable des pigments et des lipides. L'augmentation de la pression à faible intensité de puissance était très efficace, indiquant que la pression jouait un rôle critique dans l'extraction des protéines. La structure de la paroi de *C. vulgaris* joue un rôle important dans le phénomène d'extraction sélective. L'intégrité des cellules a été maintenue pendant l'extraction des protéines totales.

Conclusion générale

Le bioraffinage des microalgues est considéré comme une source potentielle de diverses biomolécules. L'exploitation de cette riche biomasse ne cesse de se développer. De nombreuses perspectives de recherche ont été exposées dans le but d'optimiser divers paramètres aux différentes étapes du processus d'algoraffinerie tels que la culture, l'extraction et le fractionnement des métabolites d'intérêt. Les microalgues produisent des composants d'intérêt, dont leur utilisation est centrée sur le marché des biocarburants, des aliments, de l'alimentation animale, des cosmétiques, des produits pharmaceutiques et de l'aquaculture.

Dans ce contexte, l'objectif de l'algoraffinerie est de développer une méthode de fractionnement des biomolécules, en utilisant une série d'opérations unitaires permettant une extraction «sélective» des composés d'intérêt sans extraire les autres composés.

Ainsi, au Laboratoire de Chimie Agro-Industrielle (LCA) et à la Plateforme de Recherche et d'Analyse des Sciences de l'Environnement (PRASE), nous avons montré un intérêt majeur pour la récupération de la fraction hydrophile et lipophile en tenant compte de la composition de la biomasse, le rôle de la paroi cellulaire dans l'extraction, l'optimisation des paramètres d'extraction, et les techniques de purification et de fractionnement. Notre objectif principal était de respecter les principes de l'écoconception et de la chimie verte.

Puisque certaines espèces de microalgues et de cyanobactéries ont été étudiées et que les caractéristiques de la paroi varient d'une espèce à l'autre, il était important de comprendre l'effet de la rigidité des parois cellulaires, du prétraitement de la biomasse et de la localisation de la biomolécule d'intérêt à l'intérieur de la cellule sur l'efficacité de l'extraction. En outre, les organites internes ont également montré une certaine résistance à la rupture des cellules et au rendement d'extraction, et ont révélé que cela permettrait la libération de certaines biomolécules.

Extraction à partir des microalgues sèches

Notre travail consistait à mettre en œuvre un processus de fractionnement continu qui prend en compte l'intégrité des biomolécules dans le processus en aval. L'opération unitaire de rupture cellulaire a été éliminée. La sélectivité des extraits de lipides de réserve et de pigments spécifiques à l'aide de ScCO_2 été possible en fixant des paramètres optimisés. Nos résultats ont montré que des récupérations sélectives des composants de *N. oculata* et de *C. vulgaris* lyophilisées étaient

possibles. Ceci nous a donné une idée claire du rôle de la paroi cellulaire sur la libération des molécules d'intérêts notamment les lipides.

Puis, suite à l'extraction lipophile, la biomasse avec paroi cellulaire bien entretenue a subi une extraction aqueuse en deux étapes pour la récupération des protéines. Il était intéressant de regarder en profondeur le phénomène de diffusion en variant le pH du milieu aqueux. L'effet du degré de délipidation de la biomasse (partiellement ou totalement) sur la libération de protéines a été étudié. Les résultats ont montré que la délipidation totale permet une libération de protéines plus élevée dans la phase aqueuse. Par conséquent, après l'extraction de protéines de *N. oculata*, la phase aqueuse contenant des protéines et des impuretés comme des sucres et des pigments ont été fractionnés pour obtenir des fractions séparées de protéines. Le processus de fractionnement est basé sur une ultrafiltration unique utilisant un procédé membranaire. Par conséquent, les amidons et les pigments ont été retenus dans le rétentat tandis que le perméat était composé de fraction de protéines clarifiées.

Extraction à partir des microalgues humides

En outre, un processus d'algoraffinerie doux a été porté sur les cyanobactéries *Spirulina sp.* et l'algue verte *C. vulgaris*. Les biomasses ont été soumises à une extraction assistée par ultrasons verte / douce innovante pour la récupération des protéines. La teneur totale en protéines a été libérée dans le milieu aqueux à partir de la cellule spiruline désintégrée de manière totale, contrairement à *C. vulgaris* dont sa membrane a restée bien maintenue, permettant une libération totale sélective des protéines. Pour l'étape de clarification / concentration, les technologies membranaires ont été étudiées en utilisant un procédé d'ultrafiltration frontale. Les résultats ont montré que 65% des protéines pures ont été obtenues dans le perméat. Les conditions d'optimisation ont été réalisées en combinant une étape de pré-purification (séparation des impuretés des protéines en utilisant du sulfate d'ammonium à 25%) pour fournir un flux de perméat plus élevé.

Les points suivants pourraient résumer les points forts de notre travail:

- Les principes de la «chimie verte» ont été respectés en termes de solvant d'extraction utilisé.
- Il a été souligné le rôle remarquable de la paroi cellulaire sur la récupération des biomolécules. La structure cellulaire de certaines microalgues pouvait également avoir une résistance à certains traitements mécaniques et permettre aussi une extraction sélective de composés cellulaires.
- Le prétraitement de de rupture des cellules pourrait être évité avant l'extraction par ScCO_2 pour la récupération sélective des lipides de réserve.
- Il a été possible de comprendre le comportement de diffusion lors de l'extraction aqueuse à double phase.
- Un processus de fractionnement avec des étapes simplifiées a été défini et pourrait être optimisé pour une mise à l'échelle industrielle.
- La sélectivité de l'extraction à partir d'une paroi cellulaire robuste a été étudiée en utilisant l'extraction verte-douce à basse fréquence par conduction par ultrasons sur des microalgues humides, ce qui a permis d'économiser le coût du séchage de la biomasse avant l'extraction.

Malgré tous les avantages, notre procédé développé présente encore quelques limitations :

- L'extraction supercritique étudiée est considérée comme une technique coûteuse et nécessite un apport énergétique élevé.
- Malgré le succès du processus de fractionnement, la récupération des composants d'intérêt à l'aide d'un procédé membranaire doit être optimisée.

Ces difficultés représentent une opportunité ouvrir de nombreuses perspectives :

- Obtenir d'images par microscopie électronique qui suivraient les modifications morphologiques au cours de l'extraction.
- Pour des microalgues ayant une paroi cellulaire rigide, et pour avoir une extraction sélective, il serait intéressant d'étudier et d'optimiser d'autres méthodes de destruction cellulaire.

Résumé générale en français

- Optimiser le procédé membranaire pour améliorer le taux de pureté et le débit volumique de composé d'intérêt