



HAL
open science

Mechanical and numerical evaluation of an osteosynthesis internal fixation device for the proximal humerus fractures

Jose Elizondo Moreno

► **To cite this version:**

Jose Elizondo Moreno. Mechanical and numerical evaluation of an osteosynthesis internal fixation device for the proximal humerus fractures. Biomechanics [physics.med-ph]. Université de Strasbourg, 2021. English. NNT : 2021STRAD053 . tel-04224539

HAL Id: tel-04224539

<https://theses.hal.science/tel-04224539>

Submitted on 2 Oct 2023

HAL is a multi-disciplinary open access archive for the deposit and dissemination of scientific research documents, whether they are published or not. The documents may come from teaching and research institutions in France or abroad, or from public or private research centers.

L'archive ouverte pluridisciplinaire **HAL**, est destinée au dépôt et à la diffusion de documents scientifiques de niveau recherche, publiés ou non, émanant des établissements d'enseignement et de recherche français ou étrangers, des laboratoires publics ou privés.

ÉCOLE DOCTORALE 269

MATHÉMATIQUES, SCIENCES DE L'INFORMATION ET DE L'INGÉNIEUR

ICUBE - UMR 7357

THÈSE présentée par :

Daniel ELIZONDO-MORENO

soutenue publiquement le : **14 octobre 2021**

pour obtenir le grade de : **Docteur de l'université de Strasbourg**

Discipline/ Spécialité : **Biomécanique**

**Évaluation mécanique et numérique d'un
dispositif d'ostéosynthèse pour les
fractures de l'humérus proximal**

RAPPORTEURS :

M. Laurent OBERT

PU-PH, Université de Besançon

M. Arnaud GERMANEAU

MCF-HDR, Université de Poitiers

EXAMINATEURS :

M. Sébastien LAPORTE

PU, Arts et Métiers

Mme. Christiane WAGNER-KOCHER

MCF-HDR, Université de Montpellier

M. Pedro CORREIA

MCF, Université de Strasbourg

THÈSE dirigée par :

Mme. Nadia BAHLOULI

PU, Université de Strasbourg

M. Philippe CLAVERT

PU-PH, Université de Strasbourg

Résumé

Sans un consensus établi par la communauté médicale lors de la réduction et fixation des fractures instables de l'humérus proximale, plusieurs dispositifs d'ostéosynthèse ont pu voir le jour. Ceci a entraîné le développement d'un large choix de méthodes non-standardisées pour les évaluer biomécaniquement. Ceci exige en conséquence une étude approfondie des méthodes existantes d'évaluation ainsi qu'un cadre qui permet de comparer, voire développer, des dispositifs d'ostéosynthèse, en respectant le cadrage établi par les principaux acteurs de standardisation orthopédique (dont la Foundation AO). Cette thèse s'inscrit ainsi dans cette démarche et propose de développer un système d'évaluation biomécanique qui repose sur des essais *ex vivo* et *in silico*. Pour cela, nous avons conçu un montage mimant l'articulation glénohumérale, qui permet de supporter des sollicitations mécaniques physiologiques. En parallèle, un modèle numérique est développé en par la méthode des éléments finis en se basant sur un jumeau numérique existant. Dans ce travail, nous avons non seulement développé un montage expérimental capable de tester systématiquement l'humérus proximale, avec ou sans un dispositif d'ostéosynthèse, en respectant ses contraintes géométriques et ses charges mécaniques mais aussi qu'un jumeau numérique peut être alimenté et enrichi avec les données issues de cette campagne expérimentale

Mots clés : humérus proximal, fractures, ostéosynthèse, fixation osseuse, modèle numérique, montage, simulations, éléments finis

Résumé en anglais

Without a consensus established by the medical community in the reduction and internal fixation of unstable proximal humerus fractures, several osteosynthesis devices have been developed. A wide range of non-standardized methods have been developed for biomechanical evaluation. As a consequence, it is necessary to conduct a thorough study of the methods for evaluating existing osteosynthesis devices in order to identify a framework that would allow the comparison, or even the development, of osteosynthesis devices, strictly in line with the framework established by the main players in orthopaedic standardisation (including the AO Foundation). The work of this thesis falls within this framework and proposes to develop a biomechanical evaluation system based on *ex vivo*, *in vitro* and *in silico* tests. For this purpose, we have designed an assembly mimicking the glenohumeral joint, which allows to withstand physiological mechanical stresses, and in parallel, a model based on the finite element method based on an existing numerical twin. We show that not only the set-up is capable of systematically testing the proximal humerus, with or without an osteosynthesis device, respecting geometrical constraints and mechanical loading cases, but also that a digital twin can be fed and enriched with data from these experimental campaigns.

Keywords : proximal humerus, fractures, osteosynthesis, bone fixation, digital model, fixture, simulations, finite elements

Évaluation mécanique et numérique d'un dispositif d'ostéosynthèse pour
les fractures de l'humérus proximal

Daniel ELIZONDO-MORENO

14 octobre, 2021

Face au réel, ce qu'on croit savoir clairement offusque ce qu'on devrait savoir. Quand il se présente à la culture scientifique, l'esprit n'est jamais jeune. Il est même très vieux, car il a l'âge de ses préjugés. Accéder à la science, c'est, spirituellement, rajeunir, c'est accepter une mutation brusque qui doit contredire un passé.

— Gaston Bachelard, « La formation de l'esprit scientifique »

Remerciements

Tout d'abord je tiens à remercier vivement les membres du jury de thèse. Pr. **Sébastien Laporte**, merci pour avoir accepté de présider ce jury. Pr. **Laurent Obert**. Dr. **Arnaud Germaneau** merci pour avoir accepté de rapporter et de juger mon travail. Vos commentaires me seront précieux pour la suite de mes recherches. Dr. **Christiane Wagner-Kocher**, merci pour avoir accepté de participer à ce jury en examinant mon travail de recherche. Un grand merci aussi pour le temps consacré aux discussions des méthodes expérimentales et de corrélation numérique d'images, ainsi que pour les chers conseils pour la suite de ma carrière.

Je tiens aussi à exprimer ma profonde gratitude au Pr. **Philippe Clavert**, pour tout le soutien et les précieux enseignements tout au long du travail de thèse. Votre réactivité et votre disponibilité malgré les délais contraignants que parfois les situations nous imposaient ont su rassurer mon esprit et apporter une direction pragmatique et d'intérêt clinique et scientifique à ce travail. Merci pour m'avoir accueilli et guidé.

De la même manière, mes plus vifs remerciements s'adressent à la Pr. **Nadia Bahlouli**, pièce fondamentale de cette belle équipe et de la réussite de cette thèse. Dotée d'une extraordinaire charisme, d'une grande patience et d'une ténacité admirable, Nadia a su me faire découvrir le monde de la recherche scientifique grâce à ses éclats pédagogiques et sociales, et m'a toujours apporté son aide et une oreille à l'écoute à tout moment. Merci infiniment pour m'avoir accueilli dans ton équipe, pour m'avoir soutenu dans tous les situations, et pour m'avoir aidé à croire en moi-même. Ce fût un grand privilège avoir travaillé avec toi, en espérant que l'aventure ne s'arrêtera pas ici.

Je souhaite également manifester ma profonde reconnaissance au Dr. **Pedro Correia** pour avoir accepté d'encadrer un travail dans une ligne de recherche novatrice mais inédite pour l'équipe, et surtout pour ce soutien inconditionnel, rare de nos jours, particulièrement dans les moments les plus difficiles. Certainement la thèse n'aurait jamais vu le jour sans ta précieuse collaboration.

Je remercie de tout cœur à mes chers collègues membres de l'équipe MMB, notamment les Drs. **Hamdi Jmal**, **Jihed Zghal**, **Siham Touchal** et **Charles Francart** pour son talent, sa réactivité, son soutien à toute épreuve et surtout pour son amitié. De même, je souhaite remercier à la Pr. **Sybille Facca**, au Pr. **Yves Rémond** et au Dr. **Daniel George** pour ces précieuses moments d'échange.

J'adresse une mention très spéciale au Pr. **Yannick Hoarau**, précurseur de cette belle expérience scientifique et pédagogique strasbourgeoise au moment de m'avoir accepté dans le master de mécanique numérique et soutenu ma candidature doctorale. Merci Yannick pour les échanges et pour l'aide inconditionnelle.

Mes remerciements s'adressent aussi aux personnes qui m'ont accueilli pendant la thèse, pour des activités de recherche et/ou d'enseignement : Mme. **Linda Nicolini**, de Swallis Medical, Pr. **Patrick Trau**, de l'UFR Physique et Ingénierie, et Dr. **Frédéric Addiego**, du LIST au Luxembourg.

À mes chers amis et collègues, sans vous je n'aurai jamais pu supporter les ennuis de la vie, et pour cela, je suis reconnaissant de tout cœur : **Santiago Salazar, Juan David Arce, Elena Valle, Éloïse Lenormand, Ahmed Abdelkader, Mahdi Rezaei, Abderahmane Marouf, Mohammad Mianroodi, Camille Spingarn, Mehdi Sahli, Sounak Mojumder, Aleksander Leszczynski, Anne Perruisseau-Carrier, Juan José Hidalgo, Naji Kharouf, Samuel Berthe et Jey Nadarasa.**

Je suis pareillement très reconnaissant du précieux travail et du grand soutien que mes stagiaires ont apporté à ce travail de recherche. Un grand merci à **Benoît Andréys, Manon Jouanlanne, Ricardo Chino et Elisé Nacro**, ainsi qu'au reste des collègues stagiaires avec qui j'ai pu partager des bons moments : **Camille Heinz, Marc Shouler, Mélanie Cadet et Quentin Maitenaz.**

Ma gratitude s'adresse aussi à ce que j'appelle ma famille « strasbourgeoise », des gens qui m'ont ouverte leur porte et m'ont accueilli les bras grands ouverts. J'avais toujours une place dans leur table, et m'ont confié son précieuse amitié. À **Jean Kessler, Andrés Muñoz, Brigitte Maurer, Anne-France Befort et Pascal Rouault**, mille fois merci pour m'avoir aidé à rendre plus agréable ce dur chemin.

À mes chers amis qui sont dans d'autres continents, sachez que je vous garde bien au cœur, malgré la distance. Je suis très reconnaissant de votre soutien morale et de votre amitié tout au long de ce chemin, qui n'a pas été de tout repos. Merci **Adrián Cruz, Ernesto López, Iván Aguilar, Natalia Jaime, Zakuan Firdaus, Tadeo Cortez, Rafael Campos**, et le reste que peut-être je n'ai pas mentionné, mais que je n'oublie pas. Je vous aime fort.

Je souhaite finalement remercier à ma si chère famille au Mexique qui m'a tant manqué pendant ce séjour. *Gracias por siempre haber creído en mí, y por su cariño incondicional. Por ustedes, soy lo que soy y estoy donde estoy. Y por ello, les estaré infinitamente agradecido. Los amo. ¡Gracias!*

Contents

Introduction	16
1 État de l'art	19
1.1 Introduction	19
1.2 Anatomie et physiologie de l'épaule	20
1.2.1 Rappels anatomiques	20
1.2.2 L'épaule	20
1.2.3 L'humérus	23
1.2.4 Propriétés mécaniques de l'humérus proximale	23
1.2.5 Sollicitations physiologiques sur l'humérus	29
1.3 Fractures de l'humérus	30
1.3.1 Classification et épidémiologie des fractures de l'humérus proximal	30
1.3.2 Gestion des fractures	32
1.3.3 Dispositifs de fixation interne pour l'humérus proximal	33
1.4 Essais d'évaluation biomécaniques	35
1.4.1 Essais mécaniques	36
1.4.1.1 Niveau musculo-squelettique	36
1.4.1.2 Niveau ostéoarticulaire	39
1.4.2 Essais numériques	40
1.5 Conclusion	43
2 Développement d'un modèle numérique d'une fracture instable dans l'humérus proximal	44
On the Development of an Unstable Proximal Humerus Fracture Finite-Element Model	47
2.1 Introduction	47
2.2 Materials & Methods	48
2.2.1 Segmentation	48
2.2.2 Finite-element model	49
2.2.3 Fracture and intramedullary nail	51
2.2.4 Pulling-load conditions	51
2.2.5 Boundary conditions	54

2.2.6	Material properties	55
2.2.7	Parametric sensitivity study	55
2.3	Results and discussions	56
2.3.1	Mesh convergence analyses	56
2.3.2	Rope-pulled and press-pulled models comparative	57
2.3.3	FE model and experimental data comparison	59
2.3.4	Global and interfragmentary displacement	61
2.3.5	Stress and strain distribution	62
2.3.6	Parametric study	64
2.4	Conclusions	67
3	Conception d'un cadre d'essais expérimentales pour les fractures de l'humérus proximal	69
	Design of a testing framework for osteosynthesis devices in proximal humerus fractures	70
3.1	Introduction	70
3.2	Custom-made fixture design	73
3.2.1	State-of-the-art	73
3.2.2	Proximal and distal interactions	75
3.2.3	Features	76
3.2.4	Final concept	76
3.2.5	Fixture user's guide	78
3.2.6	Finite-element validation	83
3.3	Digital image correlation system	84
3.3.1	Camera and light choice	84
3.3.2	Specimen preparation and speckles application	84
3.3.3	DIC software and camera acquisition setup	85
3.3.4	Data processing and post-processing	86
3.3.5	DICe validation protocol	88
3.4	Experimental setup	89
3.5	Pure-compression setup	92
3.5.1	Materials	92
3.5.2	Methods	93
3.5.2.1	Clinical preparation of the specimens	93
3.5.2.2	Fixture and speckles setup	95
3.5.2.3	Digital image correlation setup	96
3.5.2.4	Universal testing machine setup	96
3.5.3	Results	96
3.5.3.1	General force/displacement data	97
3.5.3.2	Local displacement fields in control group	99

3.5.3.3	Local displacement fields in IM group	102
3.5.3.4	Interfragmentary displacement	106
3.5.3.5	Local strain fields in control group	109
3.5.3.6	Local strain fields in IM group	109
3.5.3.7	Analysis of local strain fields in the elastic zone (<1.5 mm)	110
3.5.4	Partial conclusions	111
3.6	Pulling with head support setup	112
3.6.1	Materials	113
3.6.2	Methods	113
3.6.2.1	Clinical preparation of the specimens	113
3.6.2.2	Fixture and speckles setup	114
3.6.2.3	Universal testing machine setup	115
3.6.2.4	Straps stiffness correction	115
3.6.3	Results	115
3.6.3.1	Straps stiffness	116
3.6.3.2	General and corrected force/displacement data	116
3.6.3.3	Local displacement fields in control group	118
3.6.3.4	Local displacements fields in IM group	120
3.6.3.5	Interfragmentary displacement	120
3.6.3.6	Local strain fields in control group	125
3.6.3.7	Local strain fields in IM group	125
3.6.3.8	Comparative of local strain fields	126
3.6.4	Partial conclusions	127
3.7	Conclusions	128
4	Étude de validation d'un modèle <i>in silico</i> d'une fracture humérale proximale sollicité en compression	130
	Preliminary validation of an unstable proximal humerus fracture in silico model under a compressive load	132
4.1	Introduction	132
4.2	FE model	133
4.2.1	Meshing	133
4.2.2	Material properties	135
4.2.3	Boundary and loading conditions	136
4.3	Results	137
4.3.1	Volumetric strain comparison	137
4.3.2	Local displacement distribution comparison	141
4.3.3	Interfragmentary motion comparison	141

4.3.4	Stiffness comparison	144
4.4	Conclusions and perspectives	145
5	Discussions, conclusions et perspectives	146
5.1	Discussions et conclusions	146
5.2	Perspectives de ce travail de recherche	150
5.3	Perspectives personnelles	151
	Bibliographie	153
	Appendices	161
A	Algorithme de détermination de l'état de connectivité d'une maille VTK	162
B	Plans de conception du montage pour les essais mécaniques	164
C	Algorithme d'acquisition synchronisée d'images avec Pylon 5.0	182
D	Algorithme de calcul de vitesse d'un champs de déplacement	189
E	Résultats des essais en compression	191
F	Résultats des essais en traction	221
G	Bilan des modèles ÉF de l'humérus et de l'articulation gléno-humérale	222

List of Figures

1.1	Références anatomiques	20
1.2	Les structures anatomiques qui forment la ceinture scapulaire	21
1.3	La mobilité de l'épaule	21
1.4	Rythme du mouvement huméro-scapulaire	22
1.5	Anatomie de l'humérus droit	22
1.6	Vue anatomique de l'articulation gléno-humérale	24
1.7	Coupes pour la cartographie des propriétés mécaniques de l'humérus proximal	25
1.8	Rapports de taux de cendres et du module d'élasticité	28
1.9	Coiffe des rotateurs	29
1.10	Point d'insertion des muscles de la coiffe des rotateurs	29
1.11	Classification Neer de fractures selon la zone impactée et le nombre de fragments	31
1.12	Gestion et traitement des fractures	33
1.13	Dispositifs de fixation interne pour les fractures de l'humérus proximal.	34
1.14	Point décalé d'insertion du clou intramédullaire Aequalis©	34
1.15	Clou Intramédullaire Wright© Aequalis	35
2.1	Proximal musculoskeletal of the glenohumeral joint, previously done elsewhere	49
2.2	Tetrahedral element types used	50
2.3	Followed steps to build a tetrahedral 3D mesh of proximal humerus	50
2.4	Cutting planes for the 4-parts simulated fracture	52
2.5	Muscle-wrapping model, with a rope-pulled and a press-pulled model.	53
2.6	Rope-pulled model, with the rope and the glenoid fossa contact position	54
2.7	Simulations time and calculated stiffness for the mesh convergence analyses.	57
2.8	Maximum principal stress for each mesh convergence analysis	58
2.9	Supraspinatus pulling vectors and wrapping angle on the humeral head	58
2.10	Maximum (absolute) principal stress comparison between the two loading modes	59
2.11	Displacement magnitude of the greater tuberosity (GT) in relation to the total applied force	60
2.12	Principal stress at the screw hole zone	60
2.13	Global displacements around the humeral head at maximum load and the direction vectors	61
2.14	Interfragmentary displacement (magnitude) in relation with the total applied force	62

2.15	Principal stress (in MPa) distribution on the proximal humerus	63
2.16	Von Mises stress (in MPa) distribution at the intramedullary nail.	64
3.1	Custom-made fixtures for proximal humerus testing.	71
3.2	Muscle forces decomposition	75
3.3	Typical custom fixture configurations	77
3.4	Exploded view of the custom-made fixture for proximal humerus testing	77
3.5	Exploded view of the mold concave adapter	78
3.6	Bone centering and fixture base positioning	80
3.7	Bone positioning templates	81
3.8	Tensile and compression test fixture positioning	82
3.9	Releasing screws	82
3.10	Series of fixture in silico validation tests	83
3.11	Stereo-rig for the digital image correlation	84
3.12	DIC speckles examples	85
3.13	DIC calibration target	86
3.14	Images post-processing	87
3.15	First validation 2D test	89
3.16	Comparison between the 2D and 3D strain DICe calculation	90
3.17	Comparison between VIC3D and DICe	91
3.18	Four experimental setup cases	92
3.19	Bone preparation for the unstable 2-part fracture with a wedge osteotomy at the surgical neck	94
3.20	General procedure for the preparation and the insertion of the IM nail	95
3.21	Compression setup at the universal testing machine with the stereo cameras	96
3.22	Five Sawbones for the IM group ready to be tested in compression	97
3.23	Four Sawbones for the control group ready to be tested in compression	98
3.24	General (raw) force/displacement data from the compression tests	98
3.25	Synthetic comparative data between the IM and control compression groups	99
3.26	Force/displacement data of the test 4 control group	100
3.27	Displacement magnitude field of the control group test 4 in three different stages of the test	100
3.28	Four displacement points of the control group test 4, under no load and the three different cracking stages	101
3.29	The fractures observed at the control group compression tests are situated at the anterior intertrabecular groove	102
3.30	Full local displacement magnitude field of the control group test 4 in six different positions	102
3.31	Force/displacement data of the test 3 IM group	104
3.32	Local displacement magnitude field at four different stages of the IM group compression test 3	104
3.33	Fracture progression (green arrows), diaphyseal/head contact (orange arrow) and crushing (red arrow) in IM group test 3	106

3.34	3D local displacement magnitude field of the IM group compression test 3 in six subsequent stages of the test	107
3.35	Interfragmentary distance and angle variation in the IM group compression tests	108
3.36	Interfragmentary distance change for each of the 5 tests	108
3.37	Interfragmentary angle variation at the plane XY (medio-lateral) for each one of the 5 tests	109
3.38	Local volumetric strain distribution of the control group test 4	110
3.39	Local volumetric strain distribution of the IM group test 3	111
3.40	Volumetric strain field comparison between the control group and the IM group	112
3.41	Bone preparation for the 4-parts fracture	113
3.42	Positioning of the fixture and the cameras for the pulling case	114
3.43	Linear mechanical model for strap stiffness correction	115
3.44	The five IM group pull tests	116
3.45	The four control group pull tests	117
3.46	Force/displacement mean data of the straps' tensile test.	117
3.47	Force/displacement raw data for control and IM groups of the tensile tests	118
3.48	Force/displacement data after strap stiffness correction for the IM and control groups of the tensile tests	119
3.49	Force/displacement data of the tensile test 2 control group	120
3.50	Full local displacement magnitude field for control group tensile test 2	121
3.51	Force/displacement data of the tensile test 2 IM group	121
3.52	Full local displacement magnitude field for IM group tensile test 2	122
3.53	Interfragmentary distance and angle variation for the IM group pulling test	123
3.54	Interfragmentary distance for each of the 4 IM group pull tests	123
3.55	Interfragmentary 3D angle variation for each of the 4 IM group pull tests	124
3.56	Local volumetric strain distribution of control group tensile test 2	125
3.57	Local volumetric strain distribution of the IM group tensile test 2	126
3.58	Local volumetric strain comparison between the tensile tests	127
4.1	Humerus mesh detail	134
4.2	Screws meshing detail	135
4.3	Full 3D model mesh	135
4.4	Fixture kinematic couplings (KC)	137
4.5	Volumetric strain comparison between the FE and the experimental models loaded at 1 kN (before fracture)	139
4.6	Volumetric strain comparison between the FE and the experimental models loaded at 4 kN (after fracture)	139
4.7	Anterior view of the FE model volumetric strain	140
4.8	Yielded zones (in red) at the end of the test	140
4.9	Local displacement magnitud field comparison between the FE and the experimental models, loaded at 1 kN (before any fracture)	141

4.10 Local displacement magnitude field comparison between the FE and the experimental models, loaded at 4 kN (after fracture)	142
4.11 Interfragmentary motion analysis	142
4.12 Global force/displacement and interfragmentary distance vectors comparison between the FE and the experimental models.	143
4.13 Average interfragmentary distance and rotation motion comparison between the FE and the experimental models.	144

List of Tables

1.1	Comparaison des valeurs de densité apparente le long de la tête humérale	25
1.2	Comparaison des valeurs de densité minérale apparente par section radiale de l'humérus proximale . .	26
1.3	Essais mécaniques	37
1.4	Essais numériques	42
2.1	Range of values used in the parametric sensitivity study	56
2.2	Mesh convergence results data	56
2.3	Parametric study results.	67
2.4	Parameter Sensitivity Index (PSI)	68
3.1	Non-exhaustive list of different custom-fixation testing devices for Proximal Humerus	74
3.2	Bill of materials of the custom-made fixture	79
3.3	Fixture stiffness characterization	84
3.4	Mechanical Properties of the 4th Generation Humeral Sawbones	93
3.5	Mechanical properties of the PMMA	93
3.6	Comparative data between the IM and control groups for the compression test	99
3.7	Detailed data of the force/displacement for the control group compression tests	101
3.8	IM group compression test stiffness and fracture data	105
3.9	Interfragmentary motion data for the IM group compression test	108
3.10	Synthesized stiffness data for both IM and control group.	119
3.11	Interfragmentary motion data of the IM group pull tests	124
4.1	FE model material properties.	136

Introduction

Contexte / problématique générale

Traumatologie des accidents de l'humérus et avancées de la technologie font qu'aujourd'hui la recherche développe de nouveaux outils patients dépendants pour optimiser les implants médicaux standardisés afin d'améliorer la qualité de la consolidation, la qualité de vie et la récupération fonctionnelle d'une manière générale. Les chargements physiologiques ou traumatologiques sont très spécifiques pour le membre supérieur d'où le besoin de développer de nouveaux concepts d'implants adaptés à l'humérus. La traumatologie de l'humérus proximal en général et plus particulièrement celle du sujet âgé devient un enjeu de santé publique puisqu'on estime que d'ici 2030 le nombre de fracture de l'extrémité proximale de l'humérus va être multiplié par 3 [Palvanen *et al.*, 2006]. Contrairement à ce que l'on observe chez les patients présentant une fracture de l'extrémité proximale du fémur, les patients qui ont présentés une fracture de l'extrémité proximale de l'humérus conserve une espérance de vie relativement longue et une demande fonctionnelle importante [Boileau *et al.*, 2019]. Il est donc important pour ces patients de leur proposer une chirurgie et des implants le plus adapté possible à leur type de fracture. Les conséquences fonctionnelles d'une mauvaise prise en charge sont majeures tant l'épaule est sollicitée pour les gestes de la vie quotidienne.

Cadre et motivation

Que ce soit dans une situation traumatique ou à des fins de corrections chirurgicales, la compréhension de la biomécanique de l'épaule repose sur l'analyse de la transmission des efforts. Cette articulation est la plus mobile du corps humain, la plus instable ce qui explique la complexité de la mise en charge et le développement de modèles numériques ou expérimentaux pouvant mimer de façon pertinente cette articulation. Les modèles expérimentaux ou numériques actuels ne peuvent pas être considérés comme des jumeaux numériques parfaits. Ceci peut s'expliquer par le nombre de publications qui reste nettement inférieur au nombre de publications du membre inférieur et le nombre de modèles numériques et expérimentaux disponibles restent limiter pour répondre à une problématique précise.

Afin d'étudier la complexité de l'épaule, son fonctionnement et les problématiques rencontrées, un modèle éléments finis et un montage expérimental de l'extrémité proximal de l'humérus ont été développés. L'humérus a été reconstruit et maillé à partir de traitement d'images médicales, puis un comportement mécanique et des propriétés spécifiques ont été paramétrés. Pour améliorer la fidélité anatomique et physiologique du modèle, un montage expérimental spécifique a été développé. Enfin, le modèle a été validé à partir d'essais dissociés sur les éléments anatomiques pour des champs d'application qui couvrent le traumatisme jusqu'à sa réparation chirurgicale. Les différents essais simulés

doivent reproduire des comportements mécaniques « biomimétiques » et en accord avec les données expérimentales. Une précédente étude de l'équipe sur l'enclouage centro-médullaire d'un humérus traumatique a permis de comprendre le fonctionnement et les conséquences de ce type d'implant pour différents chargements. L'hypothèse de travail est qu'il est possible de mettre au point un modèle mécanique d'humérus proximal fiable et validé permettant de tester différentes situations dégénératives ou traumatologiques. L'objectif primaire de ce travail est donc de développer des outils numériques basée sur la méthode des éléments finis (ÉF) fiables anatomiquement et mécaniquement validés.

Les objectifs secondaires sont l'évaluation biomécanique d'un clou novateur intramédullaire (IM) utilisé pour réduire et ostéosynthéser les fractures de l'humérus proximal. En effet, les prédictions numériques devraient nous permettre de mieux comprendre les interactions mécaniques entre une tête humérale fracturée et le clou IM. L'autre objectif secondaire permettra d'apporter des précisions sur les indications chirurgicales et notamment sur leurs fonctions et sur les causes des faillites de ces implants.

Afin de répondre à la problématique posée, le manuscrit est organisé de la façon suivante :

- L'Introduction expose le contexte et les objectifs généraux de la thèse.
- Le Chapitre 1 présente les résultats d'une étude bibliographique non exhaustive synthétisant les concepts fondamentaux de ce travail de thèse : l'humérus, les dispositifs d'ostéosynthèse présents dans le marché et les moyens pour réaliser des évaluations biomécaniques. Dans un premier temps, l'anatomie de l'épaule, et plus particulièrement de l'humérus est réalisée. Ensuite, les fractures de l'humérus proximal les plus courantes sont présentées. Puis, une revue des différents systèmes de fixation utilisées lors de fractures instables avec une attention particulière portée sur le clou intramédullaire Wright © Aequalis est faite. Finalement, les différents moyens in vitro, ex vivo et in silico dans la littérature sont analysées, afin d'en établir un bilan nous permettant de positionner notre travail.
- Dans le chapitre 2, le développement des outils numériques et le modèle ÉF sont présentés en définissant la géométrie, les propriétés des matériaux, les charges et les conditions aux limites. Ensuite, les prédictions nécessaires pour valider le modèle ÉF proposé sont présentées. Enfin, une étude paramétrique est menée pour évaluer l'influence de différents paramètres tels que le coefficient de friction, le module de Young de l'os cortical et spongieux.
- Le chapitre 3, est consacré au développement d'un montage expérimental. En effet, dans le chapitre précédent, le développement d'un modèle numérique permettant de comprendre le comportement biomécanique des dispositifs d'ostéosynthèse s'est avéré complexe. L'étude paramétrique réalisée par des simulations par éléments finis dans le chapitre deux a montré que plusieurs paramètres doivent être choisis avec soin. Certains paramètres sont fortement liés aux conditions expérimentales. Cependant, le manque de données dans les travaux expérimentaux ne permet pas de définir exactement les conditions limites. Par conséquent, un montage expérimental a été développé pour obtenir toutes les informations nécessaires pour construire un modèle numérique précis. Ce dispositif expérimental permettra de plus de simuler différentes conditions de chargement ainsi que différents types de fractures sur des humérus proximaux (cadavériques ou synthétiques). Un système de stéréo corrélation a été utilisé lors des essais afin de pouvoir dans le chapitre suivant, proposer des confrontations entre modèles éléments finis et résultats des tests.

- Dans le Chapitre 4, une première validation des modèles éléments finis développés dans le chapitre 2 sera réalisé en comparant les forces et déplacements simulées avec les valeurs mesurées par stéréo corrélation.
- Enfin, une conclusion générale reprend les principaux résultats de cette thèse et des perspectives à ce travail sont proposées.

L'outil de modélisation et la méthodologie développée dans ce travail de recherche sur la biomécanique de l'épaule laisse entrevoir des possibilités de compréhension du fonctionnement de cette articulation complexe.

Chapter 1

État de l'art

Dans ce chapitre, nous abordons les concepts fondamentaux de ce travail de thèse : l'humérus, les dispositifs d'ostéosynthèse présents dans le marché et les moyens pour réaliser des évaluations biomécaniques. Une première analyse anatomique de l'épaule, et plus particulièrement de l'humérus est réalisée. Ensuite, les fractures de l'humérus proximal les plus courantes sont présentées, ainsi qu'une revue des différents systèmes de fixation utilisées lors de fractures instables avec une attention particulière portée sur le clou intramédullaire Wright® Aequalis. Finalement, nous examinons les différents moyens in vitro, ex vivo et in silico dans la littérature, afin d'en établir un bilan nous permettant de positionner notre travail.

1.1 Introduction

La gestion des fractures de l'épaule reste un sujet assez complexe du fait de la grande mobilité possible avec le bras, dessinant presque une demie-sphère dans l'espace. Cette action mobilise plusieurs os, sous-articulations et muscles dans un ordre bien défini. Pourtant, nous ne sommes pas à l'abri des accidents ou des pathologies qui peuvent impacter durablement le bon fonctionnement de cette articulation instable par définition. L'humérus particulièrement est un os long qui souffre le plus de fractures au niveau de l'épaule. Une mauvaise prise en charge d'une fracture instable de l'humérus proximal peut fortement dégrader la mobilité du fait que la plupart des mouvements mécaniques du bras trouvent leur origine dans l'articulation qui concerne l'humérus: l'articulation gléno-humérale. Il est donc d'intérêt d'analyser déjà la structure de l'humérus, ainsi que les différents dispositifs d'ostéosynthèse pour gérer les fractures proximales.

Ce chapitre présente dans un premier temps l'objet d'étude : l'humérus proximal et le clou intramédullaire. Ensuite, les deux axes de recherche mis en œuvre pour étudier et comprendre le comportement biomécanique des dispositifs d'ostéosynthèse sont présentés. Ces deux axes correspondent à des approches expérimentale (ex vivo et in vitro) et numérique (in silico). Dans un premier temps, nous décrivons, tout d'abord, une épaule humaine d'un point de vue de l'anatomie et de la physiologie puis, plus en détails, la partie proximale de l'humérus. Ensuite, nous présentons les différents types de fractures qui peuvent survenir au niveau de l'humérus proximal. Les différents dispositifs d'ostéosynthèse sont par la suite abordés brièvement. Enfin, les méthodes d'évaluation biomécanique des dispositifs d'ostéosynthèse seront présentés et discutés. Ce chapitre nous permettra de faire un bilan des différents

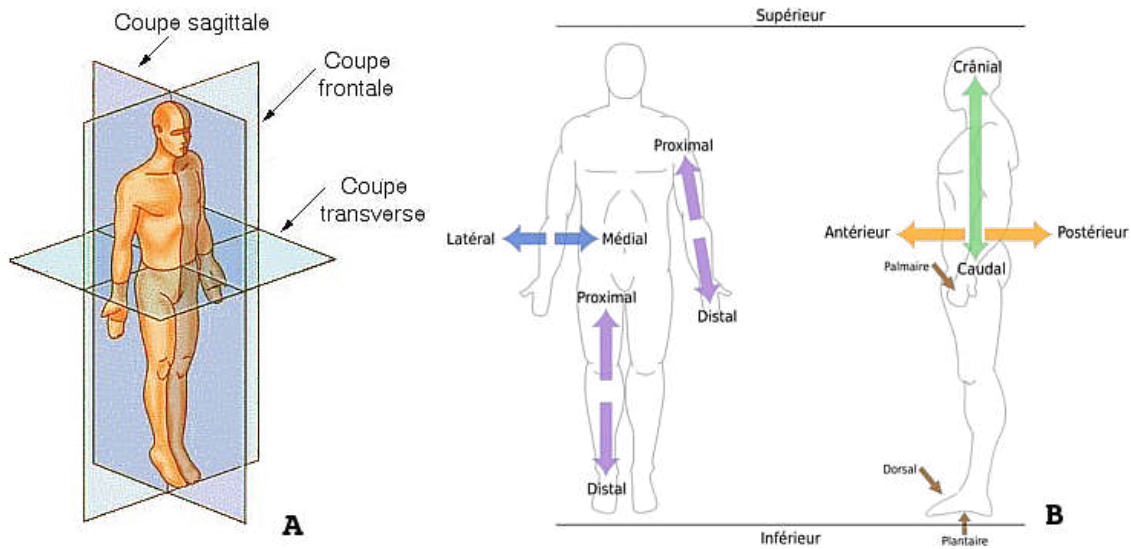

Figure 1.1 – **Références anatomiques.** **A.** Représentation des trois coupes ou plans orthonormaux anatomiques. **B.** Les différentes directions en fonction de chaque plan : latéral ou médial, crânienne ou caudale, antérieure ou postérieure, proximal ou distal.

outils actuellement disponibles pour étudier biomécaniquement un clou intramédullaire utilisé pour réduire différents types de fracture de l'humérus proximal, et de justifier la démarche de notre étude.

1.2 Anatomie et physiologie de l'épaule

1.2.1 Rappels anatomiques

À titre de rappel, le positionnement anatomique s'effectue à l'aide des différents repères dans le corps humain pour définir l'orientation et la direction. Le corps se découpe en trois plans anatomiques orthonormaux : plan **sagittal** (qui coupe à droite et à gauche), plan **frontal** (qui coupe en avant et en arrière) et plan **transversal** (qui coupe en haut et en bas). Les directions normales aux plans anatomiques prennent les appellations suivantes :

- Sagittal : **médiale** (proche du centre), et **latérale** (loin du centre).
- Frontal : **antérieure** (face d'avant) et **postérieure** (face d'arrière).
- Transversal : **crânienne** (partie haute du corps) et **caudale** (partie basse du corps).

Les directions dans les membres supérieures et inférieures se définissent normalement en fonction de la distance du tronc. Une section d'un membre qui est proche du tronc est donc **proximale**, alors qu'une section qui est loin du tronc est **distale**. Une synthèse des références anatomiques est présentée Figure 1.1.

1.2.2 L'épaule

L'épaule est un ensemble d'articulations du membre supérieur du corps humain. À simple vue, il est regardé comme l'articulation qui relie le bras avec le torse, mais, d'un point de vue anatomique, la structure devient plus complexe. À l'épaule, trois os convergent : l'humérus, la scapula et la clavicule. De cette confluence dérivent deux articulations : gléno-humérale et acromio-claviculaire. Mais le mouvement pur et complet du bras par rapport au torse mobilise

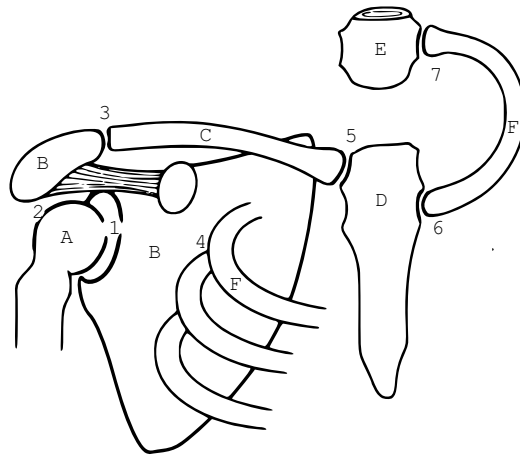

Figure 1.2 – **Les structures anatomiques qui forment la ceinture scapulaire.** Os : **A.** L’humérus. **B.** La scapula. **C.** La clavicule. **D.** Le sternum, **E.** Les vertèbres. **F.** Les côtes. Articulations : **1.** Gléno-humérale. **2.** Subacromiale. **3.** Acromio-claviculaire. **4.** Scapulo-thoracique. **5.** Sterno-claviculaire. **6.** Sterno-costale. **7.** Costo-vertébrale. Image obtenu de : [Cailliet, 2006]

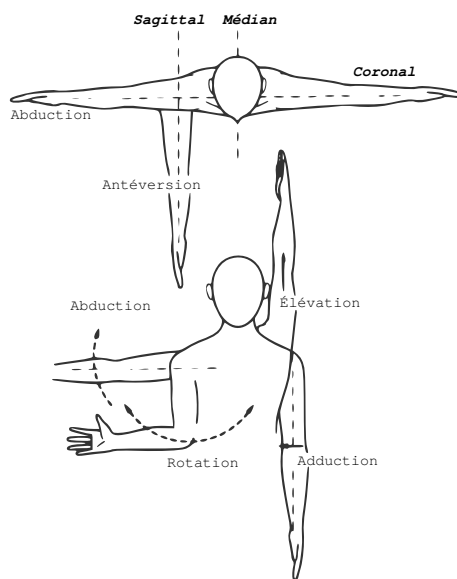

Figure 1.3 – **La mobilité de l’épaule.** Les mouvements sont classifiés selon les plans anatomiques (en gras). Pour le plan sagittal, l’antéversion (et la rétroversion), pour le plan coronal, l’adduction et l’abduction, et pour le plan transverse, la rotation interne et externe, ainsi que l’élévation. [Cailliet, 2006].

aussi d’autres articulations, et donc d’autres os, comme le sternum ainsi que certaines côtes et vertèbres, formant ainsi la **ceinture scapulaire** [Cailliet, 2006]. Elle comprend d’autres articulations comme la sterno-claviculaire, la sterno-costale et la costo-vertébrale (Figure 1.2.)

Cette complexité structurale autorise en revanche une souplesse et flexibilité dans la mobilité du bras, et permet donc d’exécuter plusieurs mouvements. Dans le plan sagittal (Figure 1.3), nous pouvons citer l’**antéversion** ou mouvement vers l’avant du bras, ainsi que la **rétroversion** ou mouvement vers l’arrière du bras. Dans le plan coronal, ce sont les mouvements d’**abduction** et d’**adduction** qui désignent les mouvements qui éloignent et qui rapprochent respectivement le bras du torse. Finalement dans le plan transverse, nous retrouvons le mouvement de **rotation interne** (vers le torse) et **externe** du bras, ainsi que l’**élévation**. La combinaison de ces mouvements individuels peut conduire le bras à se repérer dans un espace quasi-demi-sphérique (dont le rayon est le bras) latéral au torse.

L’articulation anatomique qui est souvent désignée comme *de facto* l’épaule est l’**articulation gléno-humérale**, naturellement à cause de sa grande mobilité par rapport au reste des articulations de la ceinture scapulaire. Cette

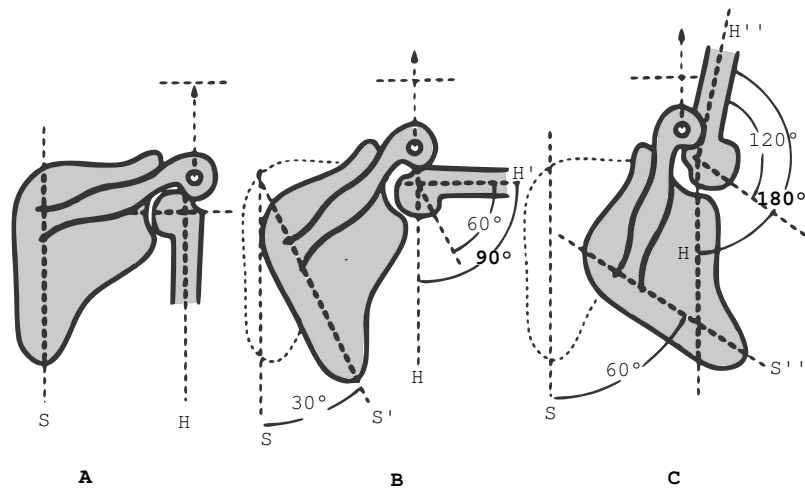

Figure 1.4 – **Rythme du mouvement huméro-scapulaire**. L'abduction du bras mobilise plusieurs os de la ceinture scapulaire, dont la scapula et l'humérus, selon un ordre défini. **A**. Le bras est en position 0, les axes scapulaire (S) et humérale (H) alignés à l'axe du corps (verticale). **B**. Pour atteindre une abduction du bras de 90° par rapport à l'axe verticale, l'humérus (H') tourne 60° et la scapula (S') 30°. **C**. Pour atteindre une abduction complète du bras d'environ 180° (au dessus de la tête), l'humérus (H'') tourne 120° et la scapula (S'') 60°. [Cailliet, 2006].

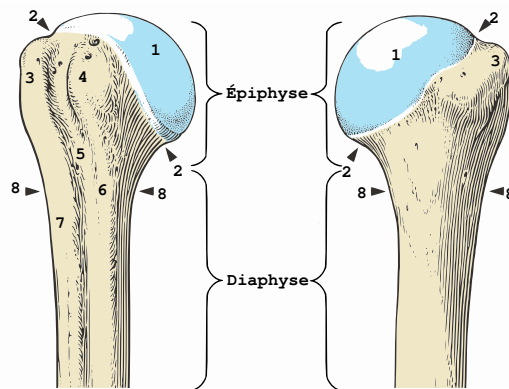

Figure 1.5 – **Anatomie de l'humérus droit**. À gauche, vue antérieure. À droite, vue postérieure. **1**. Tête humérale. **2**. Col anatomique. **3**. Tubercule majeur. **4**. Tubercule mineur. **5**. Sillon intertuberculaire. **6**. Crête du tubercule mineur. **7**. Crête tubercule majeur. **8**. Col chirurgical. [Platzer,].

articulation non-congruente¹ permet des rotations jusqu'à 120° par rapport à la scapula, angle qui en apparence est insuffisant pour permettre au bras un mouvement quasi-illimité dans son espace. Néanmoins, cet inconvénient est pallié par la liaison avec le reste des articulations de la ceinture scapulaire (notamment l'acromio-claviculaire et la scapulo-thoracique) dont son mouvement est étroitement synchronisé. Afin de clarifier cette synchronisation, il est nécessaire d'introduire le rythme du mouvement huméro-scapulaire engendré par l'abduction du bras de 0° à 180°. Dans la Figure 1.4A, Le bras débute sa trajectoire de soulèvement uniquement dans l'articulation gléno-humérale grâce à l'action des muscles (décrite ultérieurement) attachés directement à la tête humérale. Mais une fois que le bras s'approche de l'angle de 90° par rapport à l'axe verticale, 1.4B, la scapula commence à se soulever en même temps que l'humérus à un ratio de 1:2, ce qui entraîne une rotation de la scapula de 30° et de l'humérus de 60°. Lorsque l'humérus atteint sa limite de rotation à 120°, essentiellement restreint par l'acromium, afin que le bras puisse continuer sa trajectoire et compléter sa rotation de 180°, 1.4C, c'est la scapula qui prend intrinsèquement le relais en tournant les 60° restants.

¹La congruence de surfaces articulaires est acquise lorsque deux surfaces anatomiques emboîtent de manière parfaite et stable, comme l'articulation coxo-fémorale (liaison sphérique). Dans le cas de l'articulation gléno-humérale, les deux surfaces arrondies de la tête humérale et de la cavité glénoïde ne suffisent pas à maintenir les deux os stablement liés, et donc, un bourrelet glénoïdale ainsi que des tendons et des ligaments assurent cette congruence et stabilité.

1.2.3 L'humérus

L'humérus est un os long du bras qui relie les articulations de l'épaule par son extrémité proximale et du coude par son extrémité distale. L'épiphyse proximale est constituée par une tête humérale majoritairement recouverte d'une couche cartilagineuse de forme sphéroïdale et délimité par le col anatomique. Puis, toujours dans l'épiphyse proximale, à la face antérieure se trouvent le tubercule mineur (ou petite tubérosité) et le tubercule majeur (ou grande tubérosité) qui se prolonge jusqu'à la face postérieure, les deux séparés anatomiquement par le sillon intertuberculaire. Ce dernier est bordé par les crêtes des deux tubercules. Le col chirurgical est un repère ou limite de séparation entre l'épiphyse proximale et la diaphyse. Voir Figure 1.5.

Il est à noter que la tête humérale est composée majoritairement d'os trabéculaire ou spongieux. En général, l'os spongieux est la phase osseuse dont la densité volumique varie fortement en fonction de la position spatiale, ainsi que des chargements mécaniques subis par cette zone. En effet, l'os spongieux est un tissu constamment en évolution en fonction de la stimulation mécanique ainsi que d'autres facteurs externes (génétiques, hormonales) [van Rietbergen *et al.*, 1995]. La couche osseuse superficielle qui couvre la tête humérale et qui se prolonge sur la diaphyse est l'os cortical. Il s'agit d'un type d'os compact et dont les ostéons (unités minimales que composent le tissu osseux) sont alignés selon un axe local, créant ainsi une distribution de matière isotrope transverse. L'os spongieux, quant à lui, a une distribution bien plus locale en fonction du site, en passant ainsi des zones orthotropes jusqu'aux zones considérées comme totalement anisotropes.

La distribution de densité de l'humérus proximal varie localement dans chaque zone anatomique. La zone la plus dense d'os spongieux (également appelé os sous-chondral) se trouve juste au-dessous du cartilage glénoïdale, borné par la cicatrice épiphysaire [Alidousti *et al.*, 2017]. La direction des trabécules est radiale à la surface glénoïdale. Entre le col anatomique et le col chirurgical, la zone osseuse la plus dense se trouve au niveau du calcar interne (zone médiale de la tête humérale) et dont la direction des trabécules est parallèle à l'axe diaphysaire. Les zones de tubérosités ont une densité plus faible par rapport au calcar, mais la direction orthotropique est plus prononcée, avec des trabécules aplaties plutôt parallèles à l'os cortical latéral, suivant la direction des sollicitations mécaniques en traction de la coiffe des rotateurs (voir sous-section 1.2.5) [Frich et Jensen, 2014]. Du côté distale, la différence de densité osseuse entre l'axe centrale de l'os et les zones périphériques s'accroît du fait que l'os cortical devient plus dominant [Tingart *et al.*, 2003].

1.2.4 Propriétés mécaniques de l'humérus proximale

Il existent plusieurs méthodes d'extraction des propriétés mécaniques de l'os, à savoir les méthodes destructives *in vitro* [Hansen *et al.*, 2018, Keaveny *et al.*, 1997, Dunham *et al.*, 2005] et des méthodes non destructives par imagerie. Cette dernière a plusieurs déclinaisons, en fonction de la stratégie d'imagerie utilisée, à savoir les ultrasons [Laugier et Haïat, 2011, Bossy *et al.*, 2005], la résonance magnétique [Chang *et al.*, 2017, Rajapakse *et al.*, 2018] et plus particulièrement la tomographie quantitative [A. Odgaard, 1997, Maquer *et al.*, 2015]. L'imagerie obtenue par cette dernière permet en outre la transformation des niveaux de gris (unité Hounsfield) en des valeurs d'élasticité apparente. Notamment dans les travaux de [Knowles *et al.*, 2018], il y a une corrélation établie par des moyens de tomographie de niveau clinique (pQCT) et micro-tomographie (μ CT) dans la tête humérale.

La cartographie spatiale de densité osseuse de l'humérus proximale est un moyen efficace pour déterminer la

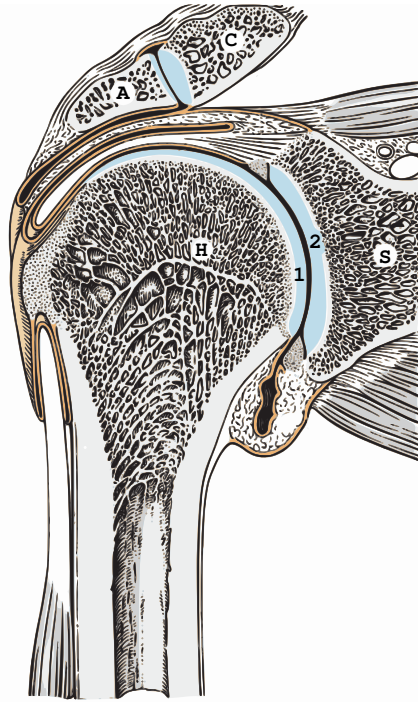

Figure 1.6 – **Vue anatomique de l’articulation gléno-humérale.** Elle est composée de l’humérus (H), de la scapula (S), les deux en contact avec le tissu cartilagineux de la tête humérale (1) et du glénoïde (2). Au-dessus de l’articulation gléno-humérale se trouve l’articulation acromio-claviculaire, composée elle-même de l’acromion (A) qui est une apophyse osseuse scapulaire, et la clavicule (C). [Platzer,]

distribution hétérogène de densité osseuse, notamment l’os spongieux. En [Tingart *et al.*, 2003], la cartographie se réalise en divisant l’humérus proximal en la section au-dessus du col chirurgical (NK) et la section au-dessus du col anatomique (HH), les sections bornées par des coupes normales à l’axe diaphysaire. Chaque section est aussi divisée en 4 sous-sections pour la zone HH (HH₁ à HH₄) et 2 sous-sections pour la zone NK (NK₁ à NK₄). Chaque coupe est divisée radialement en 7 sections : 2 sections radiales articulaires (AS₁ et AS₂), 3 sections radiales du tubercule majeur (GT₁, GT₂ et GT₃) et 2 sections radiales du tubercule mineur (LT₁, LT₂). Dans [Alidousti *et al.*, 2017], l’humérus proximale est divisé en 12 coupes coplanaires au plan du col anatomique (la coupe 6 coïncidant avec le col), en direction caudal. Chaque coupe est divisée radialement en 6 sections équidistantes : A, B, C, D, E et F. La section radiale E correspond aux tubercules, et, diamétralement opposée, la section B correspond au calcar médial. Ces divisions sont illustrées Figure 1.7.

Les valeurs obtenues dans les études de [Alidousti *et al.*, 2017, Tingart *et al.*, 2003] sont visibles dans les Tableaux 1.1 pour les coupes le long de l’épiphyse huméral et 1.2 pour les coupes radiales par rapport à l’axe diaphysaire. Les divergences des valeurs sont dues aux orientations de coupes qui sont manifestement différentes entre chaque étude, ainsi que la méthode choisie d’imagerie et la conversion des unités de niveaux gris à densité apparente. En revanche, en termes qualitatives, les tendances de distribution de la densité minérale apparente ne présentent pas de différence significative entre elles tout au long de l’humérus proximal. En effet, dans le Tableau 1.1A, la densité apparente de l’os cortical de l’humérus proximale décroît avec un minimum dans la coupe près du col anatomique (HH₃) puis elle croît, tendance qui se reproduit dans le tableau 1.1B, dont la valeur minimale se trouve au niveau du col anatomique (coupe 6), avant d’augmenter. Pour l’os spongieux, dans le Tableau 1.1A, la densité apparente décroît, la valeur minimale se trouvant dans la zone la plus distale de l’humérus proximale, tendance qui se confirme dans le Tableau 1.1B. Cela s’explique par le fait que l’os qui prédomine dans la zone la plus proximale de la tête humérale est un os spongieux de

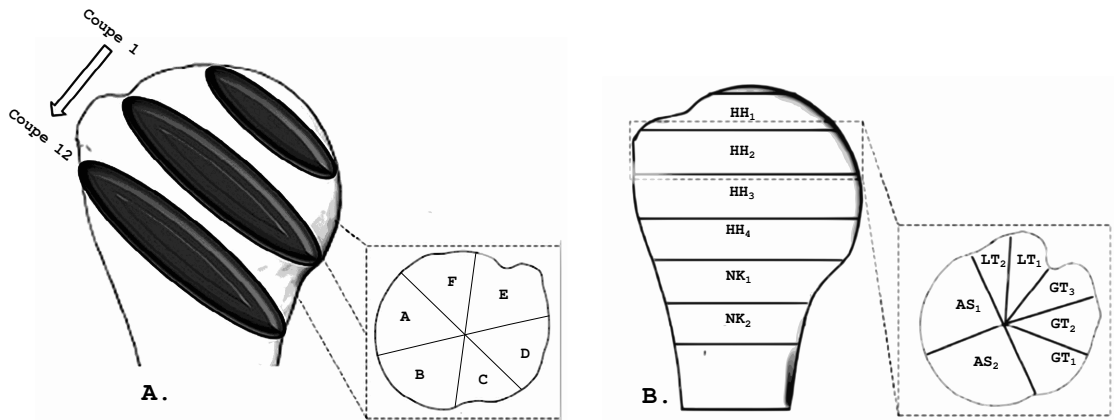

Figure 1.7 – Coupes pour la cartographie des propriétés mécaniques de l’humérus proximal. A. L’humérus est divisé en 12 coupes parallèles, dont la coupe 6 est coplanaire au col anatomique, et radialement en 6 segments [Alidousti *et al.*, 2017]. B. L’humérus est divisé en 6 coupes parallèles (4 coupes de la tête humérale et 2 coupes coplanaires et attenantes au col chirurgical) et radialement en 7 segments [Tingart *et al.*, 2003].

A	Cortical	Spongieux	Total	B	Cortical	Spongieux	Total
HH ₁	0,4939	0,1934	0,2445	1	0,4969	0,4269	0,4444
				2	0,4743	0,2812	0,3295
HH ₂	0,4399	0,1463	0,1898	3	0,4026	0,2276	0,2714
				4	0,3529	0,1958	0,2351
HH ₃	0,3986	0,1188	0,1572	5	0,3128	0,1747	0,2092
				6	0,2756	0,1544	0,1847
HH ₄	0,4183	0,1070	0,1665	7	0,2739	0,1325	0,1679
				8	0,2902	0,1058	0,1519
NK ₁	-	-	0,2596	9	0,3444	0,0954	0,1577
				10	0,4054	0,0928	0,1710
NK ₂	-	-	0,3446	11	0,4495	0,0953	0,1838
				12	0,4862	0,0979	0,1950

Table 1.1 – Comparaison des valeurs de densité apparente le long de la tête humérale. Le tableau A montre les valeurs de densité minérale apparente présentés dans [Tingart *et al.*, 2003] pour les 6 coupes (4 coupes de la tête humérale proximale et 2 coupes au niveau du col chirurgical) obtenues par tomographie quantitative (pQCT). Le tableau B montre les valeurs de densité minérale apparente issues de [Alidousti *et al.*, 2017] le long des 12 coupes sur l’humérus proximal, dont les valeurs de l’os cortical représentent les valeurs de la zone 4 de l’étude et les valeurs de l’os trabéculaire représentent les valeurs moyennes des zones 1 à 3 de l’étude. Toutes les valeurs sont en g/cm^3 .

A	Proximal		Distal		B	Distal		
	Cortical	Spongieux	Cortical	Spongieux		Cortical	Spongieux	Total
AS ₁	0,4422	0,1992	0,3786	0,1390	A	0,5435	0,1688	0,2532
AS ₂	0,4539	0,2323	0,3268	0,1464	B	0,5952	0,1391	0,2532
GT ₁	0,4113	0,1523	0,3978	0,0991	C	0,5300	0,1703	0,2397
GT ₂	0,4838	0,1193	0,3845	0,0739	D	0,4354	0,1167	0,1958
GT ₃	0,4252	0,1193	0,4421	0,0769	E	0,3207	0,1170	0,1688
LT ₁	0,5126	0,1119	0,4954	0,0769	F	0,5097	0,1350	0,2295
LT ₂	0,4422	0,1193	0,4732	0,0858				

Table 1.2 – **Comparaison des valeurs de densité minérale apparente par section radiale de l’humérus proximale.** Le tableau A montre les valeurs de densité minérale des zones découpées sous forme radiale (le calcar, le tubercule majeur et le tubercule mineur) au niveau de la tête humérale proximale (HH₁ - HH₂) et distale (HH₃ - HH₄) issues de [Tingart *et al.*, 2003]. Le tableau B montre les valeurs de densité minérale apparente des zones découpées sous forme radiale (6 sections de A à F) au niveau de la tête humérale distale (coupes 6 à 12) de l’étude de [Alidousti *et al.*, 2017], et dont les valeurs de l’os cortical représentent la zone 4 et les valeurs de l’os spongieux représentent la moyennes des zones 1 - 3. Toutes les valeurs sont en g/cm^3 dans le sous-tableau

type sous-chondral. Dans la partie centrale et puis distale, l’os spongieux devient plus rare et moins dense.

En ce qui concerne la distribution de densité minérale apparente de manière radiale, les disparités entre les deux études citée ci-dessus sont plus larges. En effet, dans le Tableau 1.2A, les valeurs de densité minérale apparente sont obtenues par la moyenne des coupes proximales (HH₁ - HH₂) et coupes distales (HH₃ - HH₄), alors que dans le Tableau 1.2B, les valeurs sont obtenues par la moyenne des coupes distales (6 - 12), sachant que le plan d’orientation des coupes diffère entre les sources des données [Tingart *et al.*, 2003, Alidousti *et al.*, 2017]. Pour le Tableau 1.2A, dans la partie proximale, la valeur moyenne de densité minérale apparente de l’os cortical est de $0,4530 g/cm^3$, dont la valeur max ($0,5126 g/cm^3$) est dans la sous-section du tubercule mineur à côté du sillon intertuberculaire, et la valeur min ($0,4113 g/cm^3$) est dans la sous-section du tubercule majeur proche du glénoïde. Pour ce qui est de l’os spongieux dans la partie proximale, la valeur moyenne est de $0,1505 g/cm^3$, dont les valeurs max ($0,2323 g/cm^3$) sont dans la zone proche du glénoïde et la valeur min ($0,1119 g/cm^3$) est dans la sous-section du tubercule mineur à côté du sillon intertuberculaire. Pour la partie distale, la valeur moyenne de densité minérale apparente de l’os cortical est de $0,4140 g/cm^3$, avec un écart plus important entre la valeur max ($0,4954 g/cm^3$) trouvée dans la sous-section du tubercule mineur à côté du sillon intertuberculaire et la valeur min ($0,3268 g/cm^3$) de la zone proche du glénoïde. Un écart similaire se retrouve au niveau de l’os spongieux dans la partie distale. La valeur moyenne de densité minérale apparente est de $0,0997 g/cm^3$, avec une valeur max ($0,1464 g/cm^3$) proche du glénoïde et une valeur min ($0,0739 g/cm^3$) dans la sous-section centrale du tubercule majeur. Le Tableau 1.2B néanmoins, montre une distribution différente par rapport au Tableau A seulement dans la partie distale, avec une valeur moyenne de densité minérale apparente de l’os cortical de $0,4890 g/cm^3$ avec une valeur max ($0,5952 g/cm^3$) dans une zone proche du glénoïde et une valeur min ($0,3207 g/cm^3$) dans une zone proche des tubérosités. Pour ce qui est de l’os trabéculaire, sa valeur moyenne de densité minérale apparente est de $0,1411 g/cm^3$ avec une valeur max ($0,1703 g/cm^3$) proche du glénoïde et juste à côté une valeur min ($0,1167 g/cm^3$) proche du tubercule majeur.

Plusieurs études montrent que pour chaque type d'os, il existe un rapport de conversion défini entre la densité minérale et le module d'élasticité. Pourtant, chaque étude ayant des moyens et de méthodes expérimentales différentes, ces rapports de conversion divergent pour les même couches osseuses prélevés sur le même type d'os [Helgason *et al.*, 2008]. Dans le cas particulier de l'humérus, des études de validation *ex vivo - in silico* ont été menées afin d'établir un rapport entre les niveaux de gris des images tomographiques (Hounsfield units), la densité tomographique (ρ_{QCT}), le taux de cendres (ρ_{ash}) et la densité minérale apparente (ρ_{app}). Dans [Helgason *et al.*, 2008], le taux d'équivalence entre la densité minérale apparente et le taux de cendres est établi à : $\rho_{app} \approx \rho_{ash}/0,55$, ce qui est équivalent au volume osseux apparent sur le volume total (BV/TV) multiplié par le référent de la masse volumique de l'os compact [Carter et Hayes, 1977] : $\rho_{app} \approx (BV/TV) 1,8 \text{ g/cm}^3$. En d'autres termes, ceci est analogue à affirmer que la masse volumique maximale présent dans l'os humain est de $1,8 \text{ g/cm}^3$. Pourtant, le rapport entre la densité minérale apparente et la densité tomographique est plus susceptible à des imprécisions à cause de la variabilité inhérente inter-tomographe. En général, un tomographe délivre une image volumique discrétisé en voxels (l'équivalent à un pixel en trois dimensions). Comme mentionné précédemment, chaque voxel se représente par un niveau de gris appelé unité de Hounsfield (HU). En fonction de la radio-opacité de l'objet d'étude, une distribution des niveaux de gris y est attribué. Afin d'établir le rapport entre les niveaux de gris et la densité tomographique, une calibration à l'aide des fantômes² est nécessaire pour chaque machine. Mais chaque tomographe ayant plusieurs paramètres d'acquisition d'images (dont la résolution et la méthode de balayage du capteur), le passage entre la densité tomographique (ρ_{QCT}) et le volume osseux apparent sur le volume total peut avoir lieu à des rapports ou des équivalences variées, prenant en compte que le volume osseux apparent est équivalent au taux de cendres ($BV/TV \approx \rho_{ash}$) [Helgason *et al.*, 2008]. Le plus accepté dans la littérature est une équivalence linéaire unitaire ($\rho_{ash} \approx \rho_{QCT}$) [Varga *et al.*, 2017].

Pour apercevoir les différents valeurs de module d'élasticité en fonction de la densité tomographique des Tableaux 1.1 et 1.2, nous présentons quelques rapports de la littérature ayant utilisé l'humérus proximal :

- Dans [Varga *et al.*, 2017], un seul rapport sans faire aucune différence entre les couches osseuses :

$$E(\text{MPa}) = 14664\rho_{ash}^{1,49}, \quad \forall \rho_{ash}(\text{g/cm}^3) \quad (1.1)$$

- Dans [Dahan *et al.*, 2016], à l'aide des fantômes de calibration et à une méthode de conversion des niveaux de gris à masse volumique des cendres, propose trois rapports en fonction de la couche osseuse et du taux de cendres :

$$E_{cort}(\text{MPa}) = 10200\rho_{ash}^{2,01}, \quad \rho_{ash} \geq 0,486(\text{g/cm}^3) \quad (1.2)$$

$$E_{trab}(\text{MPa}) = 2398, \quad 0,3 < \rho_{ash} < 0,486(\text{g/cm}^3) \quad (1.3)$$

$$E_{trab}(\text{MPa}) = 33900\rho_{ash}^{2,2}, \quad \rho_{ash} \leq 0,3(\text{g/cm}^3) \quad (1.4)$$

²Dispositifs de calibration qui ont des propriétés de radio-opacité connues et équivalentes au matériau à analyser, afin d'en établir un rapport.

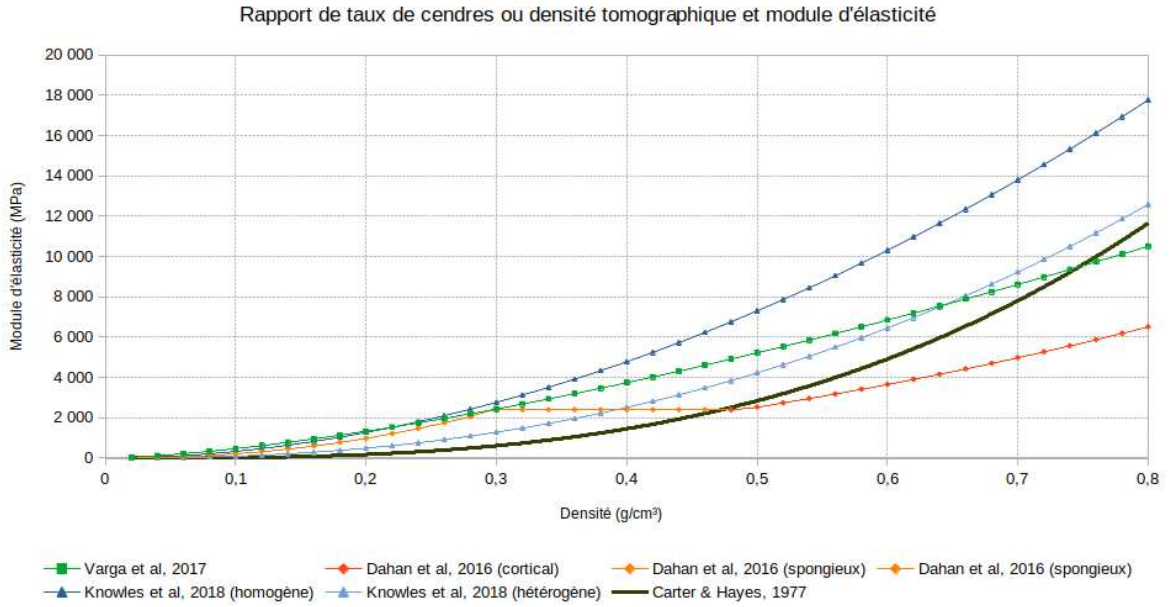

Figure 1.8 – **Rapports de taux de cendres et du module d'élasticité.** Les formules cités dans [Knowles *et al.*, 2018, Carter et Hayes, 1977] ont été convertis à des fonctions de taux de cendres (ρ_{ash}) d'après le taux d'équivalence $\rho_{app} \approx \rho_{ash}/0,55$.

- Dans [Knowles *et al.*, 2018], une étude reliant des μ CT et des régressions paramétriques sur du tissu glénoïdale ont permis d'obtenir les rapports de conversions suivants :

$$E_{homogène}(\text{MPa}) = 38780\rho_{QCT}^{1,88}, \quad \forall \rho_{QCT}(\text{gK}_2\text{HPO}_4/\text{cm}^3) \quad (1.5)$$

$$E_{hétérogène}(\text{MPa}) = 32790\rho_{QCT}^{2,307}, \quad \forall \rho_{QCT}(\text{gK}_2\text{HPO}_4/\text{cm}^3) \quad (1.6)$$

, où la conversion entre densité minérale apparente et densité tomographique est donné par le rapport :

$$\rho_{app}(\text{g/cm}^3) = 2,192\rho_{QCT} + 0,007 \quad \forall \rho_{QCT}(\text{gK}_2\text{HPO}_4/\text{cm}^3) \quad (1.7)$$

- L'étude réalisé dans [Carter et Hayes, 1977] le premier rapport de densité apparente et le module d'élasticité d'un os. Il est souvent cité comme un référent :

$$E(\text{MPa}) = 3790\rho_{app}^3 \quad \rho_{app} \leq 1,8(\text{g/cm}^3) \quad (1.8)$$

Nous illustrons les rapports ci-dessus, Figure 1.8 en fonction uniquement du taux de cendres (ρ_{ash}). Partant de l'équivalence linéaire unitaire $\rho_{ash} \approx \rho_{QCT}$, ces rapports peuvent donner un premier aperçu de la distribution locale du modules d'élasticité dans l'humérus proximale.

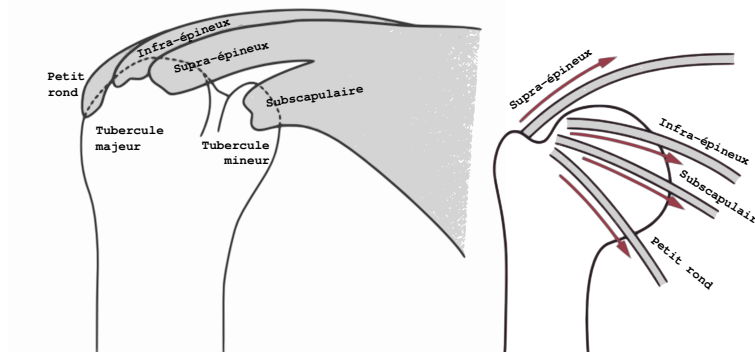

Figure 1.9 – **Coiffe des rotateurs**. Les muscles qui la composent sont : le supra-épineux, l’infra-épineux, le petit rond et le sous-scapulaire. Les efforts appliqués dans la ligne d’action de chaque muscle sont en traction [Cailliet, 2006].

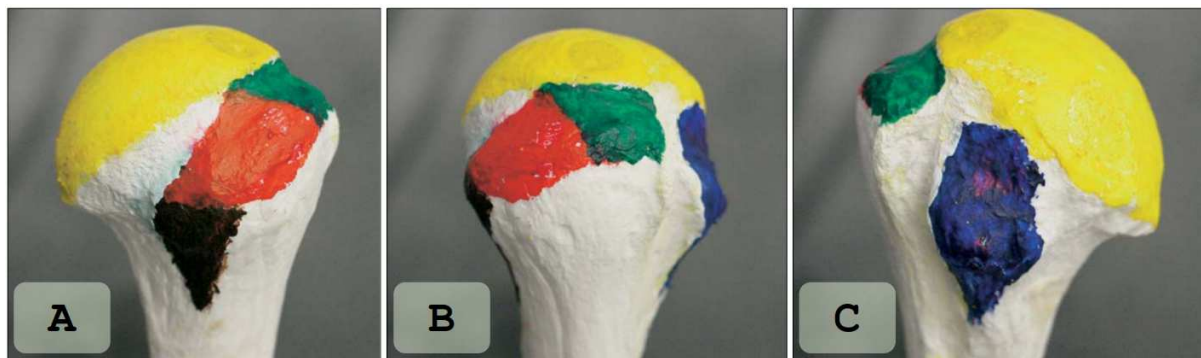

Figure 1.10 – **Point d’insertion des muscles de la coiffe des rotateurs**. Les couleurs représentent les points d’insertion du muscle supra-épineux (vert), infra-épineux (rouge), subscapulaire (bleu) et le petit rond (noir). **A**: Vue postérieure. **B**: Vue latérale. **C**: Vue antérieure [Curtis *et al.*, 2006].

1.2.5 Sollicitations physiologiques sur l’humérus

L’action musculaire sur la tête humérale se traduit par des sollicitations en traction, avec pour but d’assurer la stabilité de l’articulation gléno-humérale, ainsi que comme prélude aux mouvements d’abduction et de rotation. Trois muscles sont attachés au tubercule majeur, dont le petit rond (rotateur latéral), l’infra-épineux (abducteur et rotateur latéral) et le supra-épineux (abducteur). Pour le tubercule mineur, un muscle y est attaché, le sous-scapulaire (abducteur et rotateur médial) [Cailliet, 2006] (voir Figure 1.10). En direction caudal, il y a d’autres muscles attachés à l’humérus, dont le deltoïde, le biceps, le triceps, le latissimus dorsi et le coracobraquialis [Maldonado *et al.*, 2003, Yanagawa *et al.*, 2008].

Les lignes d’action des muscles de la coiffe des rotateurs passent aux côtés de la tête humérale dans son rôle de rotateurs, sauf le supra-épineux. En fonction du mouvement exécuté sur l’épaule, les muscles se comportent comme agonistes ou antagonistes. Un schéma est proposé Figure 1.9.

Les muscles qui entraînent l’abduction et l’élévation du bras comprennent ceux de la coiffe des rotateurs ainsi que le deltoïde. Pourtant ce dernier, le plus puissant par rapport aux autres muscles attachés à l’humérus proximal, n’agit sur l’abduction que lorsque ce mouvement a été amorcé par la coiffe des rotateurs. Outre ces mouvements, la coiffe des rotateurs apporte de la stabilité à l’articulation gléno-humérale grâce à l’effet compressif que la coiffe exerce sur la tête humérale contre la cavité glénoïdale.

Plusieurs auteurs ont mené des études portant sur la mesure de forces musculaires ainsi que ses lignes d’action et ses effets stabilisants/déstabilisants sur l’articulation gléno-humérale [Yanagawa *et al.*, 2008, Ackland et Pandey, 2009]. Les études montrent que la capacité stabilisante du muscle supra-épineux est essentiellement compressive pour tout

l'intervalle de mouvement d'abduction/adduction, le sous-scapulaire et l'infra-épineux étant un cas similaire. Pourtant, pour le cas des forces en cisaillement (déstabilisants), le principal muscle est le deltoïde pour les mouvements d'abduction/adduction ainsi que pour la flexion/extension.

1.3 Fractures de l'humérus

1.3.1 Classification et épidémiologie des fractures de l'humérus proximal

Une fracture osseuse est définie comme une perte de continuité structurale qui entraîne des glissements partiels ou totales de fragments d'os. Bien qu'il existe plusieurs systèmes de classification de fractures de l'humérus proximal dans la littérature, nous pouvons en citer au moins deux, les plus couramment utilisés : la classification de [Neer, 1970], référente de ce document, et la classification plus moderne de l'AO [Müller *et al.*, 1990]. La classification [Neer, 1970] (voir Figure 1.11) permet de décrire les différents types de fracture de l'humérus proximal en fonction du type et de la zone déplacée, ainsi que du nombre de fragments. Six groupes de fractures ont été identifiés :

- I. Déplacement minimal. Le cas le plus fréquent de fracture, où le déplacement des fragments est inférieur à un centimètre et où la variation angulaire des segments ne dépasse pas 45°.
- II. Col anatomique. C'est un cas de fracture rare de déplacement pur sans séparation du col anatomique.
- III. Col chirurgical. Fractures déplacées distales par rapport aux tubérosités, au niveau du col chirurgical. Pour rappel, les fractures sont considérées comme déplacées lorsqu'il y a une séparation de plus d'un centimètre ou une variation angulaire interfragmentaire de plus de 45°. La coiffe des rotateurs reste intacte.
- IV. Déplacement du tubercule majeur. Cas de fracture où le tubercule majeur se rétracte de plus d'un centimètre du reste de l'épiphyse. Dans le cas des fractures à 2 fragments, la structure articulaire reste inchangée, malgré la possible présence des fractures non déplacées au niveau du col chirurgical. En revanche, dans le cas des fractures à 3 fragments, la fracture du col chirurgical est déplacée et la tête humérale tournée par le fragment instable au moment de faire une abduction ou une rotation. Dans le cas à 2 fragments, une possible fracture non déplacée du col chirurgical peut être présente. Dans le cas à 3 fragments, la fracture du col chirurgical se déplace de manière importante, empêchant aussi une bonne réduction anatomique. Ce type de fracture peut également évoluer vers le cas à 4 fragments, où les deux tubercules sont détachés de la tête humérale, ainsi que l'épiphyse du col chirurgical. C'est un cas sévère d'instabilité avec une prognose engagée, la privation de l'irrigation sanguine de la tête humérale mise en cause.
- VI. Dislocation. Cas de fracture où les tissus cartilagineux et ligamenteux environnant sont endommagés, en plus de la rupture des os. C'est un cas de fracture instable dont sa prise en charge peut conduire à la pose d'une prothèse.
- V. Déplacement du tubercule mineur. Cas de fracture similaire au cas précédent qui se développe sous la forme d'une avulsion du tubercule mineur et qui devient instable au moment de faire une abduction ou une rotation. Dans le cas à 2 fragments, une possible fracture non déplacée du col chirurgical peut être observée. Dans le cas à 3 fragments, la fracture du col chirurgical se déplace de manière importante, empêchant aussi une bonne réduction















	2 PART	3 PART	4 PART	
Anatomical Neck II	2  0.3% 50yrs			Minimal Displacement I 1  49% 63yrs
Surgical Neck III	3  28% 70yrs			
Greater Tuberosity IV	4  4% 67yrs	8  9% 73yrs	12  2% 72yrs	
Lesser Tuberosity V	5  0%	9  0.3% 65yrs		
Fracture-Dislocation VI	6  5% 59yrs	10  0.1% 77yrs	13  1% 73yrs	Articular Surface 15  0.7% 73yrs
Anterior				
Posterior	7  0.2% 54yrs	11  0.1% 51yrs	14  0.1% 68yrs	

Figure 1.11 – **Classification Neer de fractures selon la zone impactée et le nombre de fragments** [Neer, 1970, Court-Brown *et al.*, 2001]. Le pourcentage correspond au taux d'incidence de chaque type de fracture, ainsi que l'âge moyen des patients.

anatomique. Ce type de fracture peut également évoluer vers le cas à 4 fragments, où les deux tubercules sont détachés de la tête humérale, ainsi que l'épiphyse du col chirurgicale. C'est un cas sévère d'instabilité avec une prognose engagée, la privation de l'irrigation sanguine de la tête humérale en cause.

VI. Dislocation. Cas de fracture où les tissus cartilagineux et ligamenteux environnant sont endommagés, en plus de la rupture des os. C'est un cas de fracture instable dont la prise en charge peut conduire à la pose d'une prothèse.

Les fractures de l'humérus proximale représentent une moyenne de 4% du total des fractures [Court-Brown *et al.*, 2001], pourtant prévalentes dans les tranches d'âge supérieures (> 60 ans) Dans la Figure 1.11, chaque groupe peut intégrer une ou plusieurs des 15 catégories de fractures reconnues, en fonction du groupe et du nombre de fragments déplacés. D'après l'étude épidémiologique de [Court-Brown *et al.*, 2001], 49% des fractures appartiennent au groupe I de déplacement minimal (catégorie 1). Les fractures en deux fragments du groupe III (col chirurgicale) représentent 28% du total des fractures (catégorie 3) et les fractures en trois fragments du groupe IV au niveau du tubercule majeur et du col chirurgicale représentent 9% du total des fractures (catégorie 8). Ces trois catégories représentent à elles seules 86% du total des fractures.

1.3.2 Gestion des fractures

Lors d'une fracture, une intervention médicale peut s'avérer nécessaire afin de **réduire**³ anatomiquement la fracture. Cette réduction peut s'effectuer soit de manière conservatrice, soit en utilisant des dispositifs de fixation externe ou interne. Pour ces derniers, il existent plusieurs dispositifs qui traitent ce genre de fractures: des vis, des plaques ou des clous intramédullaires. Un exemple des dispositifs est proposée Figure 1.12. Il n'existe pas de protocole unique pour choisir la méthode de fixation interne la plus adaptée au regard du type de fracture [Elsen, 2006, Clavert *et al.*, 2016]. D'après les règles de l'AO⁴, la réduction d'une fracture instable s'effectue en imposant des conditions afin que les sollicitations mécaniques dans la zone concernée soient majoritairement des effort compressifs orientés de manière normale au plan principal de la fracture [Hodgson, 2009].

Qui plus est, selon le type de fracture et la méthode de fixation choisie, le mode de consolidation osseuse peut varier en fonction de la *stabilité primaire*⁵ présente [Perren, 2002] :

Absolute Mode de stabilité plutôt rigide entre les fragments osseux qui permet une consolidation osseuse directe sans passer par la formation du *callus*.

Relative Mode de stabilité plus souple entre les fragments osseux qui déclenche les processus inflammatoires autour de la fracture, afin d'aboutir à une consolidation osseuse indirecte par la formation du *callus*.

Ce mode de stabilité répercute sur le pronostic de guérison. En effet, une première approche qui semble intuitive à première vue est d'assurer une stabilité absolue à travers des moyens techniques pour appliquer une compression permanente suffisamment rigide entre les fragments d'os afin d'empêcher ainsi des déplacements interfragmentaires. Pourtant, des dispositifs de fixation externe comme le dispositif d'Illizarov [Ilizarov, 1990], relativement souple au regard d'autres moyens de fixation, ont largement prouvé leur efficacité [Perren, 2002]. Assurer une stabilité primaire robuste toute en autorisant un certain degré de flexibilité entre les fragments osseux engendre une réponse complexe de l'organisme au moment de la guérison, dite consolidation osseuse indirecte [Mavčič et Antolič, 2012]:

1. La phase inflammatoire (0 - 3 jours après la fracture) consiste en l'inflammation du tissu avoisinant la mobilisation et l'apparition de tissu granulaire. Il faut assurer la réduction anatomique de la zone affectée ainsi qu'une mobilité interfragmentaire minimale pour s'assurer de la colonisation cellulaire et permettre ainsi de récupérer la continuité tissulaire.
2. La phase réparatrice (4 jours - quelques mois après la fracture) consiste en l'angiogenèse et le développement du *callus* souple, puis rigide de la zone impactée. Avec une stimulation mécanique appropriée, de l'ordre de 0.1% - 2% de déformation, le *callus* est ensuite remplacé par du tissu osseux fibré et par du tissu osseux lamellaire [Cheal *et al.*, 1991].
3. La phase de remodelage osseux (quelques mois - quelques ans après la fracture) se base dans le façonnage et la différenciation du tissu osseux entre l'os cortical et l'os spongieux, en fonction des stimulations mécaniques et d'autres facteurs biologiques [Claes et Heigele, 1999].

³une réduction anatomique est la remise en place des fragments d'os, et donc ainsi permettre une consolidation du tissu osseux

⁴Arbeitsgemeinschaft für Osteosynthesefragen ou Association pour l'Étude de la Fixation Interne

⁵Stabilité mécanique donné lors de la pose du dispositif de fixation.

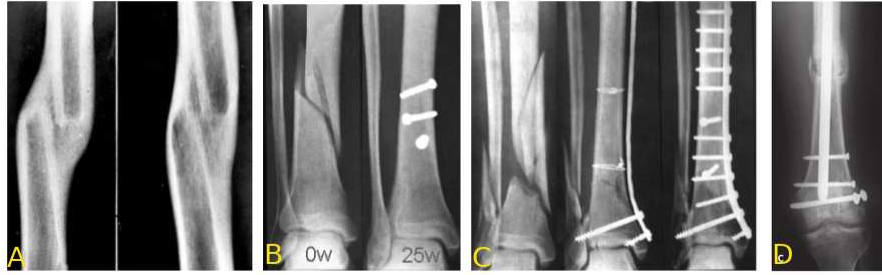

Figure 1.12 – **Gestion et traitement des fractures.** A : Méthode conservative, avec une réduction anatomique mais sans systèmes de fixation. B : Vis de fixation. C : Plaques de fixation D : Clou intramédullaire. [Perren, 2002]

L'importance du mouvement interfragmentaire est donc capital au regard de plusieurs théories mécanobiologiques⁶. En effet, parmi les différents mécanismes déclencheurs de l'ostéogenèse [Capanna et De Biase, 2006], la stimulation mécanique issue de la déformation interfragmentaire joue le rôle prépondérant lors de la consolidation et la remodelage osseuse, bien que pour le moment les mécanismes précis cellulaires ne sont toujours pas élucidés dans leur intégralité. [Oftadeh *et al.*, 2015].

En même temps que le mouvement interfragmentaire, il a été démontré que la vascularisation (la perfusion sanguine) des différents segments osseux est capital pour la bonne consolidation osseuse [Hertel *et al.*, 2004], et donc, le risque d'ischémie dépend du plan de fracture de l'humérus proximal. Ainsi, les observations montrent que les fractures à 4-arts (dont le col anatomique) et les fractures au niveau du col chirurgical présentent le risque les plus élevée d'ischémie du fait de l'impact produit sur la charnière médiale. Une bonne réduction anatomique et reconstruction de la géométrie humérale s'avère donc capital pour une correcte gestion des fractures de l'humérus proximal.

1.3.3 Dispositifs de fixation interne pour l'humérus proximal

Actuellement les fractures de l'humérus proximal étant de l'ordre de 6% parmi toutes les fractures du corps humain, il y a consensus dans la communauté orthopédique pour n'intervenir chirurgicalement sur les fractures que lorsqu'elles sont instables, une chiffre qui s'élève à 12,6% du total des fractures de l'humérus proximal [Wang *et al.*, 2015]. Pour ces dernières, plusieurs dispositifs de fixation interne sont proposés dans le marché, dont des plaques de fixation interne et des clous intramédullaires. À titre d'exemple, voici une liste non-exhaustive des différentes plaques intramédullaires disponibles dans le marché :

- Synthes© PHILOS (Proximal Humeral Interlocking System)
- Synthes© LPHP (Locking Proximal Humeral Plate)
- Stryker© Locking Plate Osteosynthesis
- Mathys© Locking Proximal Humerus Plate

, et une liste non-exhaustive de clous intramédullaires:

- Synthes© MultiLoc Intramedullary Nail
- Synthes© Expert Antegrade Intramedullary Nail

⁶La mécanobiologie est définie comme l'étude de l'influence des sollicitations mécaniques dans les processus des signaux cellulaires. [Giorgi *et al.*, 2016]

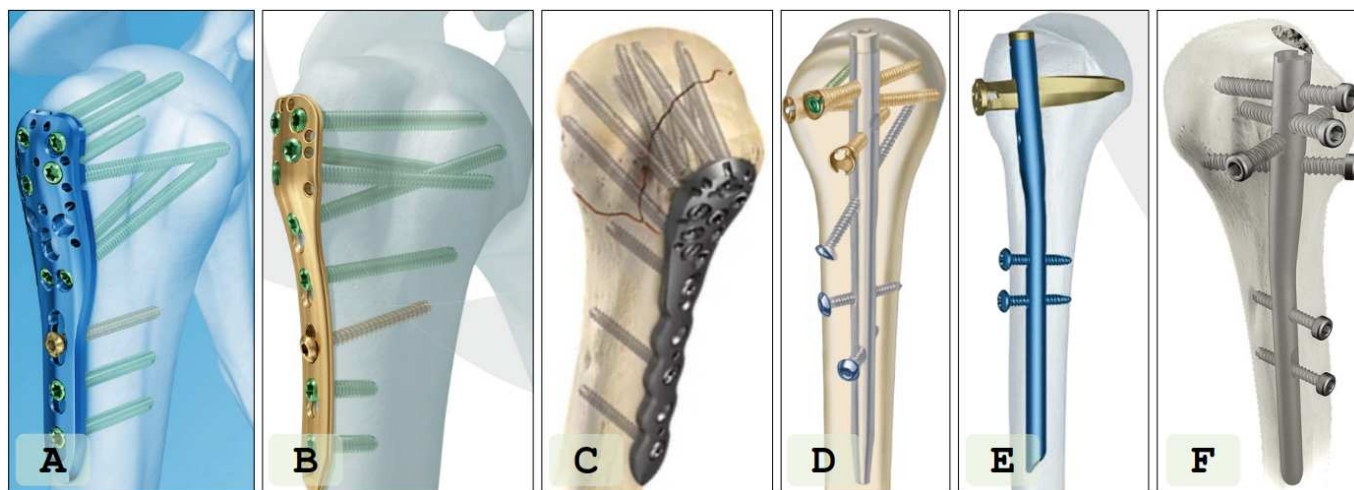

Figure 1.13 – Dispositifs de fixation interne pour les fractures de l’humérus proximal. A: Synthes© PHILOS. B: Synthes© LPHP. C: Stryker© AxSOS 3 Ti. D: Synthes© MultiLoc. E: Synthes© Expert. F: Stryker© T2-PHN.

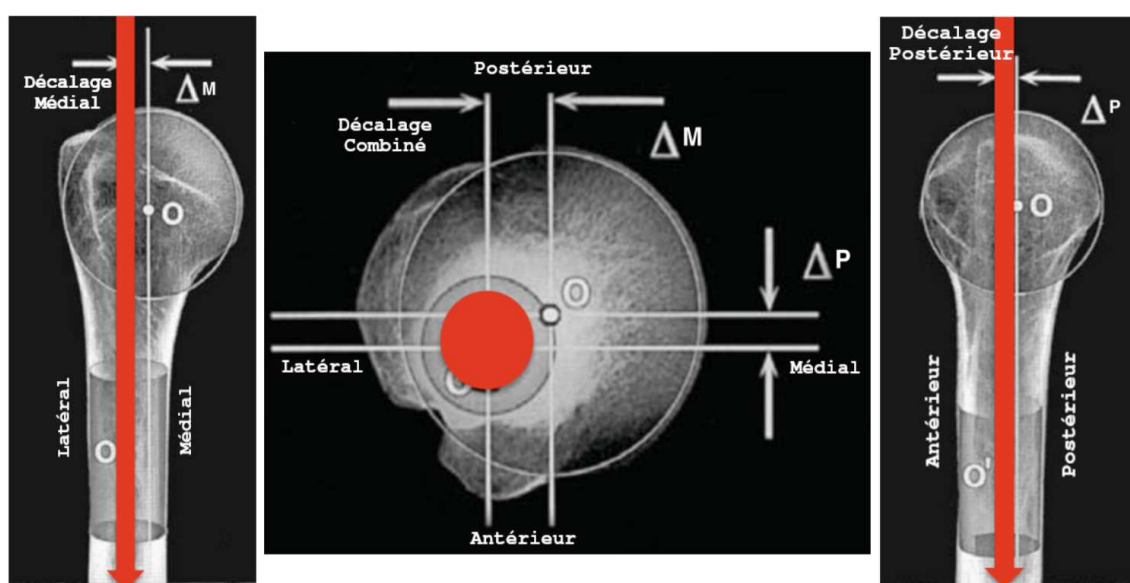

Figure 1.14 – Point décalé d’insertion du clou intramédullaire Aequalis©. Le point d’insertion sur la tête humérale est aligné à l’axe diaphysaire de l’humérus, en passant par le « point charnière ». Le décalage médial au tubercule majeur est de 5mm, ainsi que le décalage postérieur au sillon intertrabéculaire [Boileau *et al.*, 2015].

- Targon© Sliding Stable Interlocking Nail
- Stryker© T2-PHN (Intramedullary Nail)
- Wright© Aequalis Intramedullary Nail

Plusieurs de ces dispositifs de fixation interne sont illustrés Figure 1.13. Bien qu’ils présentent à première vue une certaine similarité, chacun des dispositifs se démarquent des concurrents par certaines particularités, comme les vis poliaxiales, le blocage dynamique distal ou la méthode d’insertion dans l’os. Pourtant, lors de l’évaluation clinique et des études comparatives entre chaque dispositif, aucune différence substantielle n’est observé entre les dispositifs en question [Wang *et al.*, 2015], donnant lieu à une absence de consensus de la part de la communauté orthopédique ou à une certaine « subjectivité » pour la prise des décisions médicales comme le choix du dispositif pour traiter une fracture [LaMartina *et al.*, 2018]. Il y a donc un fort intérêt à approfondir l’étude biomécanique du traitement des fractures de l’humérus proximal.

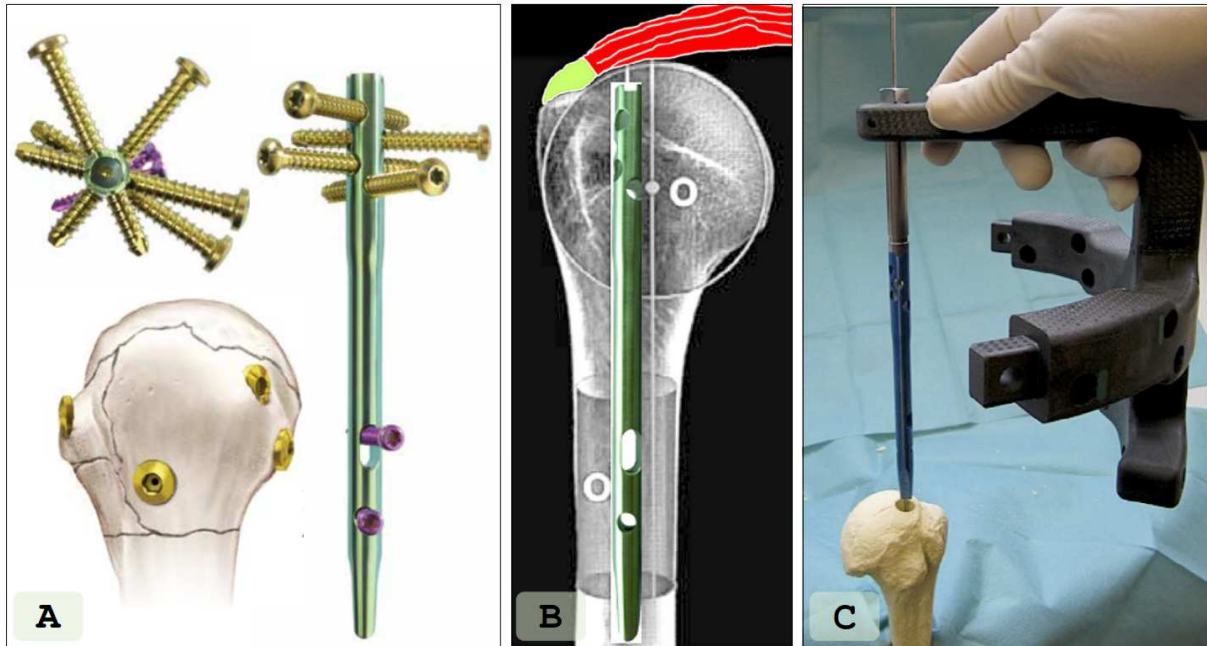

Figure 1.15 – Clou Intramédullaire Wright® Aequalis. **A**: Le clou intramédullaire avec les 4 vis de fixation (2 sur le tubercule majeur, 1 sur le tubercule mineur et 1 vis médiale). **B**: L’axe d’entrée du clou correspond à l’axe métaphysaire et diaphysaire de l’humérus, et le point d’entrée se fait par la zone musculaire (et non pas par la zone tendineuse). **C**: Le clou intramédullaire s’insère dans le canal à l’aide de l’ancillaire.

Puisque l’objet d’étude de cette thèse n’est pas une étude comparative entre les différents systèmes d’ostéosynthèse, nous avons décidé de nous limiter à un seul dispositif, le clou intramédullaire de marque Aequalis®, introduit en [Boileau *et al.*, 2015], manufacturé par Wright® Medical⁷. Il s’agit d’un dispositif de fixation interne qui vise la fixation principalement des tubérosités et non pas de la tête humérale, illustré dans la Figure 1.15. Cette approche est justifiée par le fait que la plupart des efforts mécaniques dans l’humérus proximale sont appliqués dans les tubérosités, sachant qu’ils sont les principaux points d’attaches musculaire [Clavert *et al.*, 2010]. En plus, sa méthode d’insertion peu traumatique par le « point charnière »⁸ (voir Figure 1.14) permet une récupération plus rapide [Elsen, 2006] et empêche un potentiel empiètement acromiale, cas relativement courant pour les clous intramédullaires courbés [Boileau *et al.*, 2015].

Contrairement aux dispositifs de fixation interne Synthes®, considérés comme une référence pour l’AO, le clou intramédullaire Aequalis ne dispose que de peu d’études de caractérisation biomécanique dans la littérature. Parmi eux, nous pouvons citer [Clavert *et al.*, 2016], où une étude anatomique et biomécanique sont réalisées, afin d’étudier l’impact de l’insertion du clou sur le nerf axillaire ainsi que la caractérisation de la tenue mécanique sur d’os synthétique normal et ostéoporotique.

1.4 Essais d’évaluation biomécaniques

Dans la littérature, nous avons identifié deux types d’essai :

- Essais mécaniques : Des essais portés sur l’os cadavérique (*ex vivo*) ainsi que sur l’os artificiel (*in vitro*), notamment le Sawbone®⁹.

⁷Ce travail n’a pas été financé par le fournisseur du clou intramédullaire utilisé.

⁸Point charnière (ou “hinge point” en anglais) est défini comme le point correspondant à l’intersection de l’axe métaphysaire et le plan du col anatomique. [Boileau et Walch, 1997]

⁹Marque déposé d’un os artificiel avec des propriétés mécaniques similaires à de l’os réel. Pour plus d’information : sawbones.com

- Modélisation numérique : Des essais portés sur une ambiance virtuelle (*in silico*) avec l'os numérisé, en utilisant notamment la méthode des éléments finis.

1.4.1 Essais mécaniques

Les objectifs des essais *ex vivo* et *in vitro* sont assez diversifiés, du fait que les tests peuvent être menés à différents niveaux :

- Expériences au niveau musculo-squelettique, afin d'étudier l'état de chargements musculaires, typiquement au niveau des tendons. Ces expériences permettent notamment de connaître les efforts physiologiques que chaque muscle apporte à l'articulation pour s'assurer de sa stabilité et aussi de sa gamme et amplitude de mouvements. De la même manière, ce genre d'études permet de comparer l'amplitude des mouvements lors d'une arthroplastie (remplacement partiel ou total d'une articulation) sur des structures cadavériques.
- Expériences au niveau ostéoarticulaire, afin de visualiser l'état de contraintes et/ou de déformations dans l'os ou dans une sous-articulation sous différentes conditions mécaniques. Ces expériences ont plusieurs buts, parmi eux, la comparaison entre différents dispositifs de fixation interne ou entre différentes méthodes d'attache os-enthèse¹⁰-tendon, la tenue mécanique des vis face à des efforts de traction, ainsi que pour déterminer les conditions de chargement qui mènent à la rupture de l'os.
- Expériences au niveau osseux, afin de caractériser les propriétés mécaniques des différentes couches osseuses.

Les essais mécaniques peuvent en outre être classifiés selon le type de sollicitation mécanique, à savoir : compression, traction, flexion, torsion ou une combinaison entre elles. De la même manière, le régime auquel est réalisé l'essai représente aussi une classification : essai en fatigue (pour simuler les ruptures des dispositifs d'ostéosynthèse par des chargements à répétition, durabilité), essai quasi-statique (pour déterminer la rigidité ainsi que la force avant rupture pour des efforts appliqués sur des temps longs) ou essai dynamique (pour étudier le comportement des os ou la tenue mécanique du matériel soumis à des sollicitations appliquées sur des temps très courts). L'origine de l'os a aussi un impact sur l'étude : des os embaumés, des os cadavériques frais congelés (puis décongelés lors de l'étude), des os d'animaux (notamment porc) et des os synthétiques. Finalement, le type de fracture (2, 3 et 4 parts) et le dispositif d'ostéosynthèse permettent aussi de classer les études explorés dans ce travail de thèse. Une liste non exhaustive des essais mécaniques est présenté dans le Tableau 1.3.

1.4.1.1 Niveau musculo-squelettique

En ce qui concerne les différentes expériences au niveau musculo-squelettique, nous introduisons quatre études. En 1995 [Wuelker *et al.*, 1995] développe un «piano» articulaire, à l'aide des actionneurs reliés chacun aux faisceaux de la coiffe de rotateurs de chaque muscle (sous-scapulaire, supra-épineux, infra-épineux et petit rond) ainsi qu'au deltoïde. Ces actionneurs sont commandés individuellement par un ordinateur. Le but de cet étude est de trouver les différentes charges musculaires lors de l'élévation du bras, et puis de déterminer l'effort supplémentaire du deltoïdes lors de l'abduction au moment de supprimer un ou plusieurs muscles de la coiffe de rotateurs (pour représenter, par exemple, une rupture de l'un des faisceaux de la coiffe). Parmi les observations réalisées, les auteurs de cette étude ont confirmé

¹⁰Zone de transition entre le tendon (relié lui-même au muscle) et l'os, grâce à une formation collagénique et cartilagineuse.

Type d'essai	Origine Os	Type de fracture	Dispositif ostéosynthèse	Sollicitation	Référence
Fatigue	Embaumé	2-parts (ostéotomie à coin)	Synthes LCP Plate	Flex	[Chow <i>et al.</i> , 2012]
Quasi-statique	Composite synthétique	N/D	N/D	Flex	[Dunlap <i>et al.</i> , 2008]
Quasi-statique	Composite synthétique	N/D	N/D	Flex	[Grover <i>et al.</i> , 2011]
Fatigue	Frais congelé	3-parts (ostéotomie à coin sur col anat. et grand tub.)	Synthes Philos Plate	Comp	[Röderer <i>et al.</i> , 2013]
Quasi-statique et Fatigue	Frais congelé	2-parts (ostéotomie)	Litos Tifix Plate	Comp	[Seide <i>et al.</i> , 2007]
Fatigue	Frais congelé	2-parts (ostéotomie)	Synthes MultiLoc PHN Nail	Comp	[Euler <i>et al.</i> , 2017a]
Fatigue	Frais congelé	3-parts (ostéotomie sur col anat. et grand tub.)	Synthes Philos Plate	Comp	[Varga <i>et al.</i> , 2017]
Quasi-statique	Frais congelé	N/D	N/D	Comp	[Dahan <i>et al.</i> , 2016]
Quasi-statique et Fatigue	Composite synthétique	3-parts (ostéotomie à coin sur col chirug. et grand tub.)	Synthes Philos Plate	Comp	[Burke <i>et al.</i> , 2014]
Quasi-statique	Frais congelé, Embaumé et Composite	N/D	N/D	Comp, Flex, Tors	[Aziz <i>et al.</i> , 2014]
Quasi-statique	Composite synthétique	2-parts (ostéotomie)	Mizuho, Trigen et Synthes	Comp, Flex, Tors	[Sakai <i>et al.</i> , 2019]
Quasi-statique et Fatigue	Frais congelé	3-parts (ostéotomie à coin sur col anat. et grand tub.)	Synthes LPHN Nail	Comp, Tract	[Brianza <i>et al.</i> , 2010]
Quasi-statique et Fatigue	Frais congelé	3-parts (ostéotomie à coin sur col anat. et grand tub.)	Synthes MultiLoc PHN Nail	Comp, Tract	[Rothstock <i>et al.</i> , 2012]
Quasi-statique et Fatigue	Frais congelé	3-parts (ostéotomie sur col anat. et grand tub.)	Synthes Philos Plate	Comp, Tors	[Unger <i>et al.</i> , 2012]
Quasi-statique	Frais congelé	2-parts (ostéotomie)	Mathys LCP-PH Plate	Comp, Tors	[Maldonado <i>et al.</i> , 2003]
Quasi-statique et Fatigue	Synthétique et Frais congelé	2-parts (ostéotomie à coin)	Synthes LCP Plate	Comp, Tors	[Mehta <i>et al.</i> , 2018]
Fatigue	Composite synthétique	2-parts (ostéotomie distal)	InSafeLOCK nail and Expert nail	Comp, Tors	[Erden <i>et al.</i> , 2019]
Fatigue	Frais congelé	2-parts (ostéotomie à coin)	Synthes Philos Plate	Tract	[Kathrein <i>et al.</i> , 2013]
Quasi-statique	Frais congelé	N/D	N/D	Tract	[Craft <i>et al.</i> , 1996]
Quasi-statique	Porcin	2-parts (ostéotomie grand tub.)	Tension Band, Double Row, Locking Plate	Tract	[Gaudelli <i>et al.</i> , 2014]
Quasi-statique	Porcin	2-parts (ostéotomie grand tub.)	Double Row, Suture Bridge, Two screws	Tract	[Lin <i>et al.</i> , 2015]
Quasi-statique	Frais congelé	N/D	N/D	Tract	[Barber <i>et al.</i> , 1997]
Quasi-statique	Composite synthétique	4-parts (ostéotomie sur grand tub., col chirug. et anat.)	Aequalis IM Nail	Tract	[Clavert <i>et al.</i> , 2016]

Table 1.3 – **Essais mécaniques.** Liste non-exhaustive des essais mécaniques sur l’humérus proximal. Les types de sollicitation peuvent être Compressive (Comp), Flexion (Flex), Torsion (Tors) et Traction (Tract).

le rôle prépondérant du muscle deltoïde comme abducteur principal, par rapport au rôle du muscle supra-épineux, considéré également comme l'un des principaux muscles abducteurs [Howell *et al.*, 1986].

La deuxième étude menée par [Ackland *et al.*, 2008] a pour objectif l'identification des bras de levier de chaque muscle participant aux mouvements de l'articulation gléno-humérale. Le bras de levier d'un muscle est défini comme la distance qui sépare le centre de rotation d'une articulation en particulière et la ligne d'action d'un muscle [Sherman *et al.*, 2013]. Il est à noter que les muscles intégrés dans cette étude, outre ceux étudiés en [Wuelker *et al.*, 1995], concernent d'autres groupes comme le grand dorsal, le grand rond, et le grand pectoral, attachés eux-mêmes aux différentes protubérances de la zone diaphysaire de l'humérus. Pour l'étudier, un dispositif d'essais dynamiques sur des épaules cadavériques a été conçu. À l'aide des poids attachés librement aux faisceaux tendineux de chaque muscle inclus dans l'étude, et d'un système pour trouver la position spatiale de l'humérus et de la scapula au moment de simuler une flexion ou abduction, les bras de levier ont été calculés en fonction de l'angle de rotation de l'articulation gléno-humérale et de l'excursion des tendons concernés. Pour les mouvement d'abduction et d'élévation du bras, les auteurs de cette étude ont identifié le muscle supra-épineux comme le principal initiateur avec des pics des valeurs du bras de levier tout au début de la course du bras oscillant entre 30 et 40 mm.

Une troisième étude réalisée par [Ackland et Pandey, 2009] se sert du même dispositif d'essais dynamiques sur des épaules cadavériques que [Ackland *et al.*, 2008] afin de déterminer la variation des lignes d'action musculaires en fonction de l'angle de rotation, cela, avec une méthode d'ajustement de courbes de troisième ordre en fonction des positions spatiales des repères anatomiques de l'articulation gléno-humérale. Ils introduisent également un rapport de stabilité en fonction des efforts musculaires mesurés lors des mouvements du bras afin de déterminer les muscles qui ont plutôt un rôle stabilisant (des sollicitations mécaniques sur l'articulation plutôt en compression) ou déstabilisant (des sollicitations mécaniques plutôt en cisaillement). Ils ont observé et confirmé le rôle stabilisateur prépondérant des muscles attachés à la coiffe de rotateurs, ainsi que le rôle déstabilisant des muscles comme le deltoïdes ou le grand pectoral. Finalement, ils ont publié un tableau avec les cosinus directeurs des lignes d'action de chaque muscle en fonction du type de mouvement (abduction ou flexion) ainsi que de l'angle de rotation de l'articulation.

Ce genre de systèmes d'essais sur les tissus cadavériques sert également à analyser la restauration des fonctions de l'articulation pour des interventions majeures, telles qu'une arthroplastie totale de la tête humérale. Dans l'étude menée par [Nyffeler *et al.*, 2006], ils développent un dispositif d'essais sur les tendons de l'humérus proximale à travers des fils et des poids reliés à la coiffe de rotateurs ainsi qu'au tendon du muscle deltoïde. La cavité glénoïde de la scapula est quant à elle remplacée par un insert en polymère attaché à un transducteur de force, le but étant de mesurer l'impact d'un changement d'orientation de la cavité glénoïde une fois la tête humérale remplacé par une prothèse. À l'aide de poids imposant 20 N à chacun des muscles de la coiffe de rotateurs ainsi qu'au deltoïde, la mesure d'une translation antéro-postérieur (sur le plan sagittal) de la tête humérale a été mesurée à plusieurs reprises, tout en faisant varier l'angle d'orientation de la cavité prothétique glénoïde.

Il existe évidemment d'autres études qui portent sur la structure tendineuse de l'articulation, notamment sur la méthode de suture [Craft *et al.*, 1996, Meier et Meier, 2006, Gaudelli *et al.*, 2014, Lin *et al.*, 2015] mais qui ne seront pas détaillées dans ce travail.

1.4.1.2 Niveau ostéoarticulaire

Pour les expériences au niveau de l'humérus et de l'articulation gléno-humérale, plusieurs études ont été menées sous différents paramètres, à savoir :

- Type d'os : os synthétique (essais *in vitro*), os cadavérique ou os animal (essais *ex vivo*).
- Type de chargement : compression, traction, torsion et flexion.
- Type d'essai : fatigue, dynamique et quasi-statique.
- Type de fracture: 2-parts, 3-parts, 4-parts et groupe contrôle (pas de fracture).
- Type de dispositif d'ostéosynthèse : cités dans la Section t1.3.3.

Afin d'illustrer les diverses méthodologies utilisées lors des essais, nous détaillons certaines études. Dans [Chow *et al.*, 2012], une étude de flexion en fatigue a été réalisée sur des fractures proximales instables de l'humérus avec une plaque afin de comparer l'efficacité d'un greffe osseuse pour augmenter la fixation du dispositif d'ostéosynthèse. Sur une cohorte de 8 os cadavériques, une ostéotomie en forme de coin au niveau du col chirurgical a été pratiquée afin de reproduire une comminution médiale, réduite ensuite avec la plaque de fixation. La tête humérale a été immobilisée et une charge cyclique (max 25 000 cycles) a été médialement imposée jusqu'à un nombre maximum de cycles imposées ou jusqu'à la rupture. Comme résultat, ils ont mis en évidence que l'assemblage comprenant la greffe osseuse résiste mieux aux sollicitations en fatigue en mesurant le déplacement interfragmentaire au bout de l'essai mécanique.

En [Euler *et al.*, 2017b], une étude comparative en fatigue compressive a été menée sur une cohorte des humérus proximales cadavériques avec des clous intramédullaires. Le but était d'analyser la pertinence de la mise en place d'une « capsule proximale d'ancrage » (CPA) lors du traitement d'une fracture au niveau du col anatomique avec un clou intramédullaire. Avec un montage développé par les auteurs de l'étude, ils ont fixé le bout distal de l'humérus et la tête sollicitée en compression avec le point d'application de la charge décalé médialement pour maximiser le moment de flexion sur la tête même. L'étude démontre que, sous les conditions citées, la charge avant rupture (définie dans l'étude comme un déplacement supérieur à 5mm par rapport au début de l'essai) est supérieure pour les cas ayant le CPA, sans pour autant avoir une différence statistiquement significative entre les CPA ayant deux diamètres (9,5mm et 11mm) différents.

Certains auteurs, cependant, préfèrent pour l'étude de l'humérus proximal appliquer des cas de chargement plus « physiologique », comme dans [Brianza *et al.*, 2010]. Dans cette étude, une comparaison entre deux dispositifs novateurs d'ostéosynthèse est menée sur des os cadavériques avec des fractures simulées en 3-parts (ostéotomie en coin dans le col anatomique et le tubercule majeur). L'objectif de l'étude est double : étudier la tenue mécanique de la tête humérale sous une sollicitation compressive et étudier la tenue du tubercule majeur face aux sollicitations en traction. Avec une machine d'essais universelle à deux axes (en déplacement linéaire et en rotation) et un montage développé par les mêmes auteurs, les deux sollicitations mécaniques sont appliquées en parallèle, aussi bien en régime quasi-statique (pour analyser la rigidité globale) qu'en régime de fatigue, pour étudier le nombre de déplacements avant rupture. Ils montrent que l'un des dispositifs d'ostéosynthèse examiné (un clou intramédullaire hybride avec une plaque latérale) a une rigidité globale plus élevée et un déplacement inférieur avant rupture.

Pourtant, d'autres auteurs soulignent l'intérêt majeur d'analyser en traction les tubercules face aux études compressives sur la tête humérale, du fait que les évaluations biomécaniques sur des os long s'appuient encore sur des protocoles hérités des premières analyses sur l'os le plus étudié du corps humain : le fémur. Or, bien que l'humérus et ce dernier possèdent certaines similarités, ils ne subissent pas les mêmes sollicitations mécaniques [Boileau *et al.*, 2015]. Qui plus est, certaines études démontrent que le pronostic sur des patients ayant une fracture proximale de l'humérus traitée avec un dispositif d'ostéosynthèse est plus positif si la fixation se focalise sur la bonne tenue mécanique des tubercules et sur une bonne perfusion sanguine de la tête [Clavert *et al.*, 2010]. Donc, dans l'étude comparative menée par [Clavert *et al.*, 2016] sur des os synthétiques, une sollicitation en traction sur le tubercule majeur (au niveau de la zone d'attache du muscle supra-épineux pour simuler une abduction) est appliquée. La tête humérale, en revanche, est supportée par une bride customisée simulant le support glénoïdale, ce qui autorise la tête à travailler en compression suite aux efforts en traction sur le tubercule. L'étude compare deux dispositifs différents : un clou intramédullaire et une plaque de fixation, sur deux type d'os distincts: normal et ostéoporotique, les deux ayant la même fracture : 4-parts (ostéotomie sur le col anatomique, sur le col chirurgicale et à 8mm à droite du sillon intertrabéculaire pour séparer les tubercules). Le clou intramédullaire fixe uniquement le tubercule majeur. Les résultats montrent non seulement que le clou est plus rigide et a une charge avant rupture supérieure par rapport à la plaque, pour les os synthétiques normaux et ostéoporotiques, mais que la seule fixation du tubercule majeur suffit à garder la stabilité de l'ensemble des fragments pour ce type de sollicitation mécanique.

1.4.2 Essais numériques

Grâce au développement de la méthode aux éléments finis¹¹ il est désormais possible de mener des expériences virtuelles plus complexes et reproductibles par rapport aux essais physiques, avec un accès plus approfondi à des données telles que les tenseurs de contraintes ou des déformations dans tout le domaine d'étude. Après que les modèles numériques se popularisent pour les applications biomédicales, nombre de chercheurs se sont penchés pour mener des expériences *in silico* ostéoarticulaires et musculo-squelettiques sur l'épaule et ses divers sous-articulations [Ye *et al.*, 2017]. Dans la Table 1.4 nous avons synthétisé quelques travaux numériques sur l'humérus proximal, en détaillant le modèle d'os, le type d'éléments, le type de chargement et, dans les cas correspondants, le type de fracture de de dispositif d'ostéosynthèse étudié:

- Modèle os: il s'agit des lois de comportement du matériau osseux, dont le plus habituel est le comportement élastique linéaire. Compte-tenu des différents types de tissus osseux (spongieux, cortical), le modèle osseux peut posséder plusieurs « couches » pour différencier l'os cortical de l'os spongieux. Également, vu la nature peu homogène de ce dernier (avec des variations de densité osseuse, comme étudié dans la sous-section 1.2.4), il est également habituel de projeter les variations de densité sur le modèle numérique, afin de faire varier localement les propriétés mécaniques de l'os spongieux. Finalement, l'os peut être modélisé comme une structure isotrope (dont les propriétés mécaniques sont égales dans toutes les directions de sollicitations) ou comme une structure orthotropie (dont les propriétés mécaniques présentent plusieurs plans de symétries).
- Type d'éléments: nous faisons référence au type d'éléments finis utilisés lors de la modélisation. Les plus courants

¹¹Méthode des simulations numériques par discrétisation des domaines physique complexes et de la résolution des équations aux dérivées partielles.

sont les éléments hexaédriques et tétraédriques pour un maillage volumique. Ces éléments peuvent être décrits selon des équations de premier ordre, de deuxième ordre, et plus rarement, d'ordres supérieures. Un ordre plus élevé implique un gain en précision numérique, mais aussi en nombre de degrés de liberté (et donc de complexité computationnelle), ce qui se traduit en simulations plus longues.

- Type de chargement: tout comme les essais mécaniques, le type de chargement sur l'humérus proximale peut être en compression, en traction, en flexion et en torsion, sachant que les zones d'application de la charge peuvent être multiples.

En fonction du périmètre d'étude, l'échelle du modèle numérique peut varier sur l'ensemble des tissus durs et mous du corps humain, et plus particulièrement de l'épaule. À titre d'illustration, nous citons le travail de [Astier, 2010] comme un cas qui balaye l'échelle osseuse, ostéoarticulaire et musculo-squelettique dans son modèle. À partir de l'imagerie tomographique par résonance magnétique sur un sujet volontaire sans pathologies connues, l'humérus, la scapula et la clavicule ont été segmentés puis maillés dans le logiciel Hyperworks© Hypermesh, ainsi que les tissus mous tels que les muscles et ses tendons respectifs, les tissus cartilagineux et les ligaments propres à chaque articulation. La publication ne permet pas d'identifier si les éléments tétraédriques de la maille sont de premier ou de deuxième ordre. Les os ont été modélisés avec des lois de comportement élastoplastiques non homogènes (une projection de la variation de densité osseuse du donateur sur le maillage de la couche spongieuse de l'os pour varier localement son module d'élasticité). Les muscles ont été maillés puis des éléments actifs (qui entraînent une force ou déplacement) unidimensionnels ont été « tissés » dans les muscles, en guise de fibres musculaires, afin de simuler des contractions musculaires. Le reste des tissus mous a été modélisé par des structures viscoélastiques. Avec ce modèle, plusieurs cas physiques ont pu être reproduits pour mener la validation du modèle sous plusieurs scénarios, tels qu'une rupture osseuse par torsion ou la mise en place d'une prothèse au niveau de la tête humérale.

D'autres groupes de recherche se concentrent sur l'os humérale afin de reproduire des expériences mécaniques et obtenir ainsi des données supplémentaires de chaque essai, comme dans [Maldonado *et al.*, 2003]. Un essai mécanique quasi-statique en compression est proposé, *ex vivo* et *in silico*, afin de valider ce dernier, avec et sans dispositif d'ostéosynthèse. Puis, un cas plus « physiologique » n'est réalisé qu'*in silico*, afin de déterminer le comportement de l'os face à des sollicitations en traction et en compression en fonction de chaque muscle.

Dans [Inzana *et al.*, 2016], différentes méthodes de modélisation d'une vis sur du tissu osseux sont étudiées sur un cas similaire. Puis, un essai en compression avec une fracture en 3-parts avec une plaque de fixation est réalisé aussi bien numériquement qu'expérimentalement, afin de comparer les différents paramètres utilisés lors de la modélisation des vis. Ils ont trouvé non seulement une méthode efficace et reproductible pour simuler les fixation vis-os, mais aussi ils ont comparé les différences significatives du champ de déformation autour des vis lorsque les fixations sont modélisées comme des nœuds collés (*tied*, en anglais), et donc, l'erreur qu'ils induisent.

D'autres travaux menés se concentrent uniquement sur le développement d'un modèle de l'humérus sans fracture (dit « sain »), afin de se concentrer sur l'acquisition des données, comme le champ de pression exercé sur la capsule glénoïdale lors d'une rotation humérale [Büchler *et al.*, 2002, Büchler et Farron, 2004], ou une comparaison de la distribution de contraintes et de déformations lors d'une abduction [Clavert *et al.*, 2006].

Modèle Os	Type d'éléments	Type de fracture	Dispositif Ostéosynthèse	Sollicitation	Référence
Élastique non homogène	Hexa 1er	N/D	N/D	Multi-tract	[Büchler <i>et al.</i> , 2002]
Élastique non homogène	Hexa 1er	2-parts (ostéotomie sur col chirug.)	Synthes LCP-PH	Comp & Multi-tract	[Maldonado <i>et al.</i> , 2003]
Élastique multi-couches homogène	Quad	N/D	N/D	Multi-tract	[Wakabayashi <i>et al.</i> , 2003]
Élastique non homogène	Hexa 1er	N/D	N/D	Multi-tract	[Büchler et Farron, 2004]
Élastique multi-couches homogène	Hexa 1er	N/D	N/D	Multi-tract	[Clavert <i>et al.</i> , 2006]
Élastique orthotropique	Hexa 1er	N/D	N/D	Dynamique	[Vandenbulcke, 2012]
Élastique multi-couches non homogène	Tetra 2ème	N/D	N/D	Comp	[Razfar <i>et al.</i> , 2016]
Élastique multi-couches non homogène	Tetra 2ème	3-parts (ost. à coin sur col anat. et grand tub.)	Synthes Philos Plate	Comp	[Inzana <i>et al.</i> , 2016]
Élastique multi-couches homogène	Tetra	2-parts (ostéotomie sur col chirug.)	Plaque Proximal (A+ Biotech.,Taiwan)	Comp	[Zhang <i>et al.</i> , 2016]
Élastique multi-couches homogène	Tetra 2ème	N/D	N/D	Comp	[Favre et Henderson, 2016]
Élastique multi-couches non homogène	Tetra	N/D	N/D	Comp	[Dahan <i>et al.</i> , 2016]
Élastique multi-couches non homogène	Tetra 1er	3-parts (ost. à coin sur col anat. et grand tub.)	Synthes Philos Plate	Comp	[Varga <i>et al.</i> , 2017]
Élastique multi-couches non homogène	Tetra 8ème	N/D	N/D	Comp	[Dahan <i>et al.</i> , 2019]
Élastoplastique multi-couches	Tetra	N/D	N/D	Multi-tract	[Astier, 2010]

Table 1.4 – **Essais numériques.** Liste non-exhaustive des essais *in silico* sur l'humérus proximal.

1.5 Conclusion

Ce chapitre nous a montré une ébauche des différentes couches de complexité inhérente à l'étude de l'une des articulations les plus mobiles du corps humain. Ainsi, nous comprenons que la prise en charge des fractures de l'humérus proximal au niveau de l'articulation gléno-humérale, le noyau du mouvement de l'épaule, manque de consensus dans la communauté médicale au vu de la variabilité des dispositifs de fixation interne disponibles dans le marché. Malgré un nombre croissant d'études d'évaluation biomécanique qui portent sur le traitement de fractures de l'humérus proximale, aussi mécaniques que numériques, nous constatons qu'il n'existe pas, à notre connaissance, une méthodologie dite « standard » pour mener à bon port et avec rigueur les essais biomécaniques. Cependant, nous avons pu observer certains facteurs en commun dans les essais qui expliquent potentiellement la grande variabilité des résultats disponibles. D'après notre étude bibliographique, partant de l'hypothèse qu'elle est représentative de l'univers des essais biomécaniques, nous avons remarqué que 73% des essais mécaniques sont *ex vivo* et 57% des essais numériques sont issus d'un modèle osseux unique (un volontaire), une chiffre importante qui révèle à quel point les modèles osseux sont dépendants d'une distribution osseuse unique. Rappelons que l'os est une structure non homogène dont sa distribution de densité (et donc des propriétés mécaniques) est local. Et même si les essais *ex vivo* basent ses résultats sur des cohortes d'os cadavériques et des analyses statistiques pour prouver qu'aucune différence (ou négligeable) n'est visible dans le groupe d'étude, peu des publications détaillent la variation locale des propriétés mécaniques de son échantillon. Les variables globales peuvent donc être comparables (comme la raideur de l'ensemble os - dispositifs d'ostéosynthèse), mais les variables locales (comme la déformation locale avant rupture) ne le sont pas.

En dépit de la variabilité inhérente des essais *ex vivo* ainsi que des essais *in silico* avec une distribution locale de densité non homogène, chaque étude biomécanique a permis de rajouter une brique supplémentaire de connaissance dans la compréhension du comportement des dispositifs de fixation interne pour les différents types de fracture. Pourtant, l'impact que ces dispositifs ont sur l'articulation gléno-humérale reste discutable, compte-tenu de la nature des sollicitations auxquelles les assemblages os - dispositifs ostéosynthèse ont été assujettis. En effet, 57% des essais mécaniques ont privilégié les sollicitations en compression, alors que seulement 13% ont décidé de reproduire un cas plus « physiologique », à savoir, une traction de la coiffe des rotateurs avec un support médial glénoïdale. Il est bien connu que les protocoles d'essais en compression sur la tête humérale que nous retrouvons dans la littérature ne sont que l'héritage des méthodes suivies initialement sur le fémur, du fait que ce dernier travaille en grand partie en compression. Or, les efforts dans l'humérus proximal sont en grand partie en cisaillement, au moment d'exercer des sollicitations en traction. Donc, continuer à privilégier les sollicitations en compression sur l'humérus proximal pourrait éventuellement mener à des conclusions moins pertinentes à la nature de cet os, objet d'étude.

Cela dit, nous proposons dans les chapitres subséquents des méthodologies d'évaluation biomécanique, aussi mécaniquement que numériquement, en se focalisant notamment sur des sollicitations plus en conformité à l'humérus et à l'articulation gléno-humérale.

Chapitre 2

Développement d'un modèle numérique d'une fracture instable dans l'humérus proximal

Dans ce chapitre, nous proposons de développer un modèle numérique d'une fracture instable à 4-parts de l'humérus proximal avec un clou intramédullaire comme dispositif d'ostéosynthèse. Le but est de reproduire les résultats obtenus par [Clavert et al., 2016] afin de pouvoir avoir une première validation (même partielle) du modèle numérique. Nous décidons, donc, de partir d'un modèle ostéoarticulaire élastique linéaire à l'aide de la méthode des éléments finis. Le chapitre présente les différentes étapes méthodologiques et l'analyse des résultats. Pour la méthode, nous commençons avec la segmentation d'un vrai humérus puis de son maillage volumique. Ce maillage est ensuite optimisé avec un test de convergence afin de choisir une taille moyenne d'éléments dite « optimale ». Puis, les conditions de frontière et la sollicitation mécanique en traction imposée à l'humérus sont détaillées, avec une comparaison entre deux méthodes d'application de la charge différentes afin de minimiser le temps de calcul. Finalement, une analyse de sensibilité paramétrique du modèle numérique est décrite. Pour ce qui concerne les résultats, après illustration des essais comparatifs et de convergence du maillage et de la sollicitation mécanique, nous montrons la distribution des contraintes, des déformations et des déplacements globaux et locaux. Nous concluons avec les résultats de l'analyse de sensibilité paramétrique. Le séquençement du travail est donc représenté dans la figure suivante :

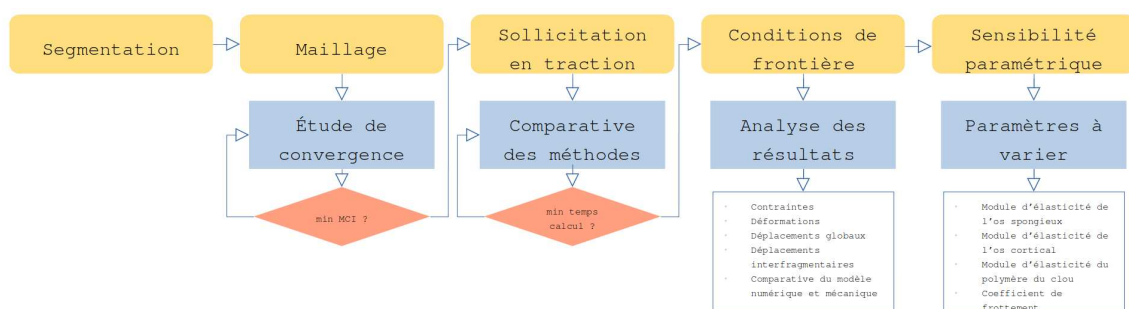

Pour la segmentation, nous avons repris les segmentations sous forme de courbes de niveaux de [Clavert, 2007]

issues de la base de données publiques *Visible Human Project* [Ackerman, 1998]. Ces courbes de niveaux ont été ensuite transformées en éléments unidimensionnels à l'aide de la librairie VTK puis importés dans le logiciel 3D Slicer. En utilisant la boîte à outils SlicerRT, nous avons pu créer des mailles en éléments triangulaires surfaciques pour chaque composant (les muscles de la coiffe des rotateurs, le deltoïdes, la surface cartilagineuse de la tête humérale et les couches osseuses sous-chondral, spongieux et cortical de l'humérus et de la scapula). Puis, ces surfaces ont été filtrées, lissées et exportées en format STL. Pour ce chapitre, nous n'avons utilisé que la collection des surfaces de l'humérus. Vu que notre hypothèse de travail est de travailler sur un os synthétique homogène dans un régime élastique linéaire, nous utilisons des propriétés de matériaux fournies par les fabricants.

Lors du maillage volumique, afin de choisir le type et la taille d'élément fini « optimal », nous avons décidé de mener une étude de convergence avec plusieurs tailles moyenne d'éléments tétraédriques, en variant aussi l'ordre : premier (C3D4) et deuxième (C3D10). Un indice appelé MCI (mesh convergence index ou indice de convergence de maillage) est proposé comme paramètre de décision et prend en compte le temps de calcul et la concentration de contraintes. En ne gardant que les couches osseuses corticale et spongieuse, un humérus proximal sans fracture est maillé dans le logiciel GMSH avec la variation de type et de taille d'éléments comme mentionné précédemment. Puis, cette cohorte de maillages volumiques a été ensuite importée sous le logiciel de simulations Abaqus comme des mailles orphelines. Là, les conditions de frontière et de chargement mécanique ont été définis en suivant l'étude de [Clavert et al., 2016] : bout distal encastré et contact avec une surface fixe glénoïdale. La sollicitation mécanique est de 600N en traction à 90° de l'axe diaphysaire appliquée sur la zone d'attache du muscle supra-épineux sur le tubercule majeur à l'aide d'un couplage cinématique et d'une « chaîne » d'éléments unidimensionnelles de type BEAM de rigidité élevée (module d'élasticité > 106 GPa) et TRUSS de rigidité négligeable (module d'élasticité < 10-6 GPa) . Sept simulations ont été tournées et grâce à l'indice MCI, la taille moyenne d'éléments (0,75mm) de type C3D4 a été retenue pour les maillages subséquents. Ainsi, les surfaces en STL ont été retravaillées sur le module géométrique du logiciel Salome_Meca pour recréer la fracture à 4 fragments et mettre en place le clou intramédullaire Aequalis, pour ensuite être remaillées. Pour les vis, ils ont été simulés avec des éléments volumiques sauf dans l'interface avec le clou intramédullaire, où ils ont été modélisés avec des éléments unidimensionnels BEAM et des couplages cinématiques solidarisent les vis avec l'insert en polymère du clou.

Pour l'application de la charge mécanique en traction, lors de l'étude de convergence de la maille nous avons opté pour simuler la corde de l'essai [Clavert et al., 2016] à l'aide du couplage cinématique avec une chaîne d'éléments unidimensionnelles BEAM et TRUSS et d'une gestion de contacts entre la « corde » et la tête humérale. Pourtant, puisque les contraintes et déformations sur la corde ne sont pas de l'intérêt de ce travail, nous avons proposé une technique d'estimation des forces de réaction de la « corde » afin de la supprimer de la simulation tout en gardant ses effets sur l'humérus. En estimant l'angle d'enveloppe de la corde sur la surface humérale, les efforts compressifs de réaction peuvent être calculés en fonction de la force appliquée sur la corde. Qui plus est, la gestion de la surface de contact du support glénoïdal entraîne aussi davantage d'instabilités numériques et de consommation des ressources. Vu que l'articulation

gléno-humérale peut se comporter de manière similaire à un joint à rotule, nous avons également proposé de remplacer cette surface glénoïdale pour un couplage cinématique dont le centre de rotation est le centre de la sphère ajusté par la méthode des moindres carrés. Donc, une étude comparative a été menée afin de déterminer si la méthode alternative proposée suffit à remplacer la corde sans pour autant affecter les résultats des simulations. Les conditions de frontière sont identiques à celles de l'étude de convergence : bout distal encastré et coefficient de frottement entre les fragments d'os et entre le clou et l'os de 0,1. Deux cas ont été analysés : cas avec corde et surface de support glénoïdal (coefficient de frottement de la corde et de la surface égal à zéro) et cas avec des sollicitations en compression sur la tête humérale, et en traction sur le tubercule majeur. Pour le cas de la corde, afin de s'approcher de la valeur d'une corde réelle, le module d'élasticité assigné aux éléments de type BEAM est de 37,11 MPa suite à des essais en traction sur une corde semblable à celle de l'étude mécanique. Le module d'élasticité des éléments de type TRUSS assigné est de 0,37 MPa. Dans les deux cas, une force de 730 N a été imposée sur le tubercule majeur.

Après analyse des résultats de cette étude comparative, nous avons observé que les deux cas produisent des résultats semblables en termes de distribution de contraintes et déformations, ainsi que les déplacements. Pourtant, pour un ordinateur de bureau (i5-6600, 64 Go de RAM, sous Linux Kernel 5.4), à 4 cœurs, le temps de calcul a été divisé par 4 (~1600 seconds pour le cas avec la corde, ~400 seconds pour le cas sans la corde). Nous poursuivons donc l'analyse des résultats du cas sans la corde.

Comme attendu, la zone du déplacement maximum se trouve dans le tubercule majeur, dans une direction postéro-antérieur, ce qui entraîne une rotation interne de la tête humérale avec un axe de rotation normale au plan de coupe du col anatomique. On déduit de l'analyse du mouvement inter fragmentaire qu'une séparation au niveau du plan de coupe du col chirurgicale est présente, ainsi qu'un cas de cisaillement (frottement) entre les tubercules et la tête humérale. Quant à la distribution de contraintes, elle se focalise dans la zone près du point d'attache du muscle supra-épineux. Ces observations sont compatibles avec celles de [Clavert et al., 2016], où l'arrachement du tubercule majeur est produit suite à la rotation de la tête humérale. Également, nous avons pu observer que la concentration des contraintes de Von Mises sur le clou est 2 fois inférieure à la limite élastique du matériau (titane), malgré une sollicitation mécanique qui dépasse amplement la gamme de valeurs pour un chargement physiologique.

Une analyse de sensibilité des paramètres a été réalisée afin de mieux comprendre l'influence de certains paramètres dans la réponse globale de l'assemblage humérus clou intramédullaire. Les résultats montrent que les propriétés mécaniques de la corticale sont les plus influentes mais pour le glissement inter fragmentaire, c'est la trabéculaire. Nous avons réussi à reproduire numériquement un cas physiologique que nous avons validé qualitativement. Nous avons aussi proposé une méthodologie permettant de réduire de façon significative le temps calculs pour simuler la traction spécifique du muscle supra épineux. Nous constatons cependant qu'il manque des données dans la littérature pour valider dans son intégralité ce modèle numérique. Nous proposons donc dans le chapitre suivant de développer un nouveau montage expérimental nous permettant de valider des éléments complémentaires de notre modèle numérique.

On the Development of an Unstable Proximal Humerus Fracture Finite-Element Model

2.1 Introduction

The management of a proximal humerus fracture (PHF) with an open reduction and internal fixation (ORIF) treatment is still a subject lacking unanimity among the orthopedic community [LaMartina *et al.*, 2018]. This has been the justification for several research works aiming to gain better insight in the fracture management using an internal fixation device, using either an experimental-only framework or either a finite-element (FE) model using gathered experimental data for validation. The latter has been gaining in computational complexity and ability to further evaluate the biomechanical response of an internal fixation device, without the statistically entangling cadaverous experimental framework [Ye *et al.*, 2017]. In [Maldonado *et al.*, 2003], a FE-model obtained from cadaverous donors was digitally tested using a locking plate with a simulated sub-capital osteotomy gap and the simulation performed using the Marc/Mentat suite (Marc K72/Mentat© 3.2; Marc Analysis Research Corp). The diaphyseal zone was fully fixed and the head was under a compressive load. In parallel, an *in vitro* test was developed to correlate both experimental and digital models through the compressive and torsional stiffness for different bone qualities, which yielded to a minimum error. What is more, they concluded that the strain in fractured osteoporotic bones are significantly higher than in normal quality bones. In [Varga *et al.*, 2017], a similar outcome is obtained through the strain measurement around the proximal screws of a locking plate in a three-parts fracture with a similar sub-capital osteotomy gap. This strain quantification was only plausible through the proposed FE-model under the Abaqus v6.13 software (Simulia©, Dassault Systèmes) and an experimental test done using a custom-designed fixture installed on a biaxial servo-hydraulic testing machine (Mini Bionix© II 858, MTS Systems Corp).

A similar approach was followed in [Clavert *et al.*, 2016], where artificial humeri were tested using pulling forces emulating an abduction. The pulling load was transmitted through a rope attached in the supraspinatus attachment zone at the greater tuberosity. The servo-hydraulic machine was operated in traction-only movement. The compressive loads at the cartilaginous surface of the humeral head were passively performed by a glenoid support. This type loading makes contrast with the of the numerical works available in the literature that focus only on the compressive or bending tests when benchmarking the internal fixation devices [Zhang *et al.*, 2016, Jabran *et al.*, 2016, Inzana *et al.*, 2016].

Although it might be positive for standardization and comparative purposes, this does not show the principal loads present at the humeral head and, what is more, it has already been established that the wide use of the compressive tests is an unjustified legacy from the most examined human bone, the femur, when establishing the criteria for the ORIF treatment [Boileau *et al.*, 2015].

As for the experimental-only works, they are usually based on mechanical tests designed to reproduce physiological loads. These works, also called biomechanical studies in the literature, can be performed on cadaverous human or synthetic bones. However, synthetic bones have the advantage of ensuring repeatability of experiments, in a similar manner as the numerical works. Therefore, the aim of the work is to develop numerical tools in order to perform a biomechanical evaluation of an intramedullary (IM) nail used to reduce proximal humerus fractures. In fact, the numerical predictions should allow us to gain better insight in the mechanical interactions between a fractured humeral head and an IM nail. The proposed numerical modeling is based on Finite Element (FE) method. To build a model, we have first to define the geometry, the materials properties and the loading conditions. The geometry of a proximal humerus was defined using the open-access database “Visible Human Project” ([Ackerman, 1998]) and a fictive fracture was created. The geometry was next introduced in the commercial FE code. To simplify, the mechanical bone properties are assumed to be homogeneous and taken equal to the ones of 4th generation humerus Sawbone ©. The fictive fracture was treated with a Wright © Aequalis © IM nail. The anatomical loading conditions were defined following the experimental work of [Clavert *et al.*, 2016]. It should be noted that in FE simulations the loading conditions have to be defined with a particular attention since they affect significantly the numerical predictions.

The present chapter is structured as follows. First, the FE model is introduced by defining the geometry, material properties and loads and boundary conditions. Next the FE predictions necessary to validate the proposed FE model are presented. Finally a parametric study is conducted to assess the influence of different parameters such as friction coefficient, Young modulus of cortical and cancellous bone.

2.2 Materials & Methods

2.2.1 Segmentation

To keep the standardization aim, we used the open-access database Visible Human Project [Ackerman, 1998], already used in previous FE models [Clavert, 2007] and in some musculoskeletal models [Garner et Pandy, 2001]. From the left humerus CT scan images, the cancellous, cortical and the subchondral bone were segmented using the open-source software 3D Slicer¹(ver. 4.10.2) [Fedorov *et al.*, 2012]. From the left humerus computerized tomography (CT) scan images, the cancellous, cortical, cartilage and the subchondral parts of the bone were segmented manually by Pr. Clavert [Clavert, 2007]. The segmentation of proximal humerus is presented in Figure 2.1. This segmentation consists in several unstructured closed-form segments of lines and nodes available in VTK format. No connectivity information regarding the points and the lines was available in the segmentation files. Therefore, an algorithm to acquire the unstructured grid connectivity was developed, Annex A. This allowed the VTK file to be manually converted to a VTP (vtkPolyData class) file. The conversion to VTP was done for the different bone layers (cortical, subchondral and trabecular). These segmentation contour lines were then used as seeds to recreate a surface triangular mesh with

¹3D Slicer available at: <https://www.slicer.org/>

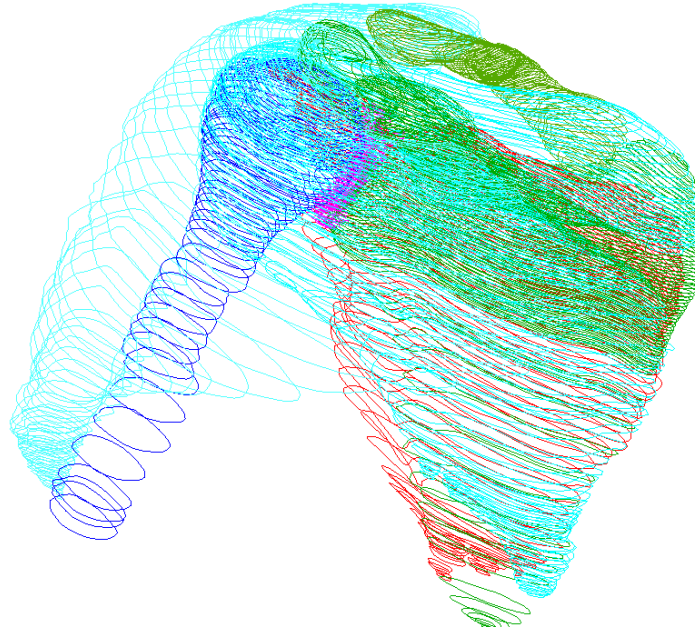

Figure 2.1 – **Proximal musculoskeletal of the glenohumeral joint, previously done elsewhere.** The segmentation was manually done using the CT scans, creating an unstructured grid of contour lines. [Clavert, 2007]

the tool *SlicerRT* of 3D Slicer. During this step, the surfaces artifacts (like staircase artifacts) were also smoothed with Taubin filter (10 iterations with 0.1 as pass-band filter coefficient). Different STL format files were created, one for each part of the bone.

2.2.2 Finite-element model

After pre-processing, the different surface meshes (STL format files) were exported to the open-source meshing software GMSH² (ver. 4.0.0)[Geuzaine et Remacle, 2009]. A proper 2D remesh is done using the MeshAdapt algorithm and then the 3D mesh is executed using the Front algorithm. For the meshing, an unstructured tetrahedral mesh was chosen as it is the most adapted to such complex geometry. Although the hexahedral mesh is considered the golden standard for the volume meshes, with the actual computational resources the difference between the tetrahedral and hexahedral meshes is not significant, even for biomechanical applications [Ramos et Simões, 2006]. Depending on the expected degree of refinement of the mesh, the tetrahedral elements typically can be first-order (linear) or second-order (quadratic) 2.2. The difference relies on the number of integration points and therefore the degrees of freedom for each element. A large number of degrees of freedom generally is related to a less uncertainty in the results, at the cost of longer running times. For this case, the mesh choice will be subjected to a convergence study (detailed hereafter). Once the tetrahedral mesh is completed, it is exported as an orphan Abaqus input file (INP format) and imported back using the Simulia Abaqus 6.14-4 (Dassault Systèmes, Vélizy-Villacoublay, France). For illustration purposes, the different steps to achieve a meshed humerus are detailed Figure 2.3.

As stated before, in order to choose a proper average element-length (AEL) for the 3D mesh, a mesh convergence study is run using 7 different volume meshes, generated with an optimization criteria of volume skew < 0.950 (hence decreasing the AEL at the critical zones with weak thickness and increasing it at the least critical zones) and using

²GMSH available at: <http://gmsh.info/>

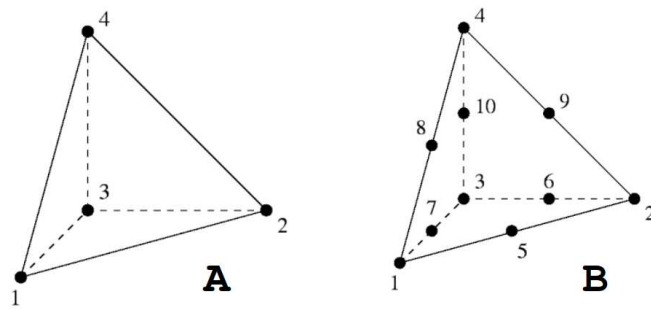

Figure 2.2 – **Tetrahedral element types used.** A: First-order (linear) element. B: Second order (quadratic) element.

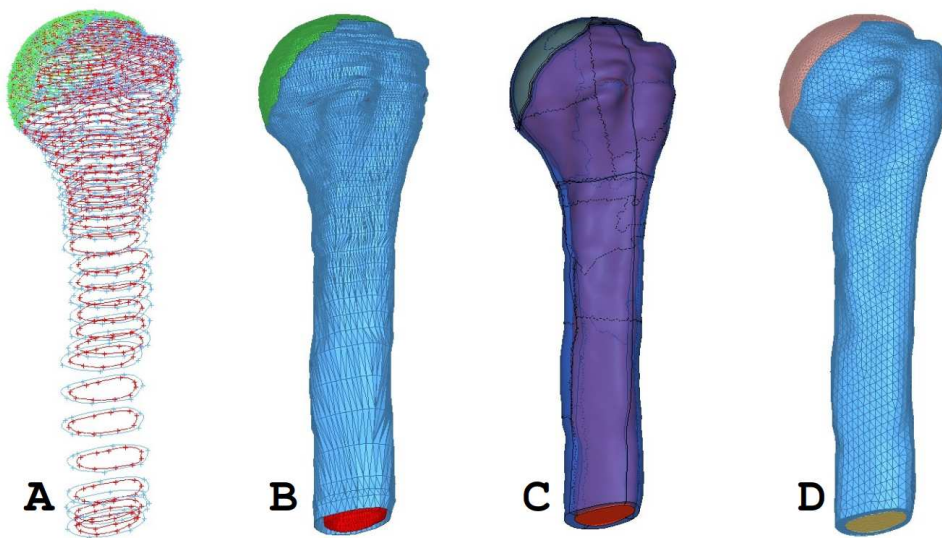

Figure 2.3 – **Followed steps to build a tetrahedral 3D mesh of proximal humerus.** A: Segmentation. B: Surface mesh connectivity. C: Geometric surfaces. D: Full 3D volume mesh.

the load-conditions and boundary conditions described below (except for the fracture cutting planes and the IM nail). The Table 2.2 details the parameters and the variables used to choose a volume mesh. The three parameters are: mesh order (first or second), AEL (in mm) and the number of degrees-of-freedom (DOF). From the results, two variables were directly measured: the execution time (in seconds) and the maximum principal stress (in MPa), measured at the Great Tuberosity (GT). A Mesh Convergence Index (MCI) was established using the execution time t_i and the maximum principal stress σ_i (where $i \in \{A, B, C, D, E, F, G\}$). As there is not an experimental reference value, the chosen value to serve as a reference was the model G, as it contains the largest DOF quantity. Thus, the MCI is calculated as in Equation 2.1:

$$MCI_i = \frac{\Delta t_i / t_G}{\Delta \sigma_i / \sigma_G} \quad (2.1)$$

The convergence criteria is hence defined as the $\max(MCI_i)$, $i \in \{A, B, C, D, E, F\}$. The boundary and loading conditions for the mesh convergence study are following the experimental setup described beforehand [Clavert *et al.*, 2016]: distal segment of the diaphysis fully fixed and the humeral head supported with a fixed glenoid fossa as the boundary conditions. For the loading conditions: a 600N tensile load applied to the supraspinatus attachment zone (at the greater tuberosity) 90° in regard to the diaphyseal axis with the aid of a BEAM element chain (also called the «rope», detailed in the following sections). The material properties are described in subsection 2.2.6. Seven simulations are prepared using an AEL range between 2.5 mm and 0.75 mm and using first-order and second-order tetrahedral elements.

2.2.3 Fracture and intramedullary nail

A 4-parts fracture using the Neer classification [Neer, 1970] was modeled by drawing 3 cutting plane, according to the protocol established in [Brianza *et al.*, 2010, Clavert *et al.*, 2016]. Two cutting planes are coplanar to the surface traced by the surgical (i.e. normal to the diaphyseal axis) and anatomical (i.e. normal 50° oriented to the diaphyseal axis) necks, respectively. The surgical cutting plane is proximally offset by 6.5mm and the anatomical cutting plane, by 10mm (just above the great tuberosity). The third cutting plane is placed 8mm posterior to the intertubercular groove and its normal oriented 65° to the scapula plane. All the 3 planes converges at the medial humeral curvature below the cartilaginous capsule (See Figure 2.4).

For the IM nail modeling, the IM nail CAD files were partially simplified (i.e. removing the unnecessary geometric details) and then used the Front algorithm mesher, with an AEL of 0.5mm and the same optimization criteria as for the previous bone mesh. The IM nail was geometrically placed following the guidelines of the main surgeon implicated in the study. In agreement with the [Clavert *et al.*, 2016] protocol, the proximal portion of the humerus was fixed with the two screws at the GT (first and third screw from top to bottom). The distal section is locked by the static screw. The rest of the screw holes were geometrically drawn but not used in this study.

2.2.4 Pulling-load conditions

As in [Clavert *et al.*, 2016], the FE model should include the pulling load done by the rope attached at the GT that mimics the supraspinatus (SS) muscle in an abduction movement, as well as the scapular support placed at the

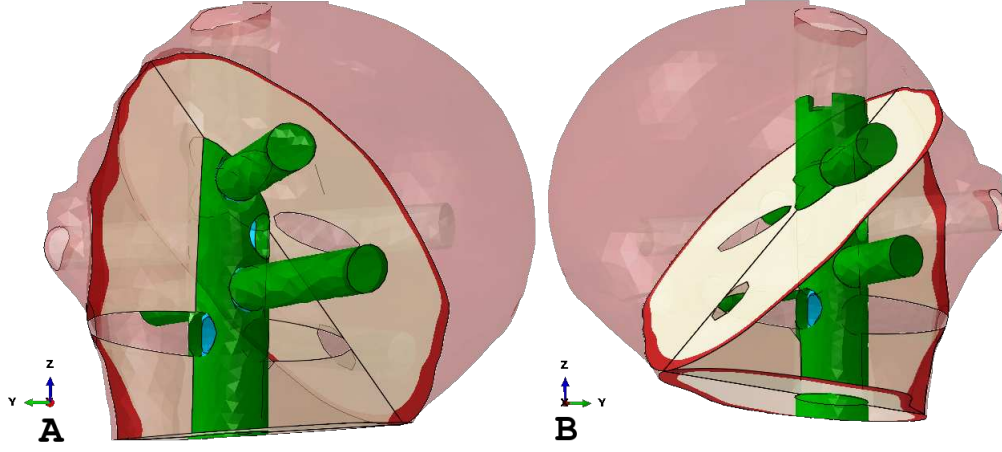

Figure 2.4 – **Cutting planes for the 4-parts simulated fracture.** **A:** Lateral view. **B:** Medial view. The cutting planes are drawn in white (cancellous bone) and red (cortical bone). The green segments correspond to the canals and screw holes for the intramedullary nail.

proximal head in the cartilaginous region. The rope will apply a moment-load at the humeral head. In several research works where the range-of-motion (ROM) is studied [Webb *et al.*, 2014, Iwamoto *et al.*, 2001, van der Helm, 1994], the muscle and the tendon attaching zones are modeled in order to estimate the equivalent moment arm directly to the scapulo-humeral joint. This equivalent moment-load is well documented in the literature [Ackland *et al.*, 2008]. Nevertheless, certain muscles such as the SS uses the cartilaginous capsule as a hinge when applying the force to the GT [Wakabayashi *et al.*, 2003], and therefore, a compressive reaction appears at the same time, combined with the natural compressive reaction force exerted by the scapula’s glenoid labrum. In the Figure 2.5, it is shown a simplified scheme of the problem: a pulling load F_m with a rope partially wrapped in a semi-cylinder projecting a α angle. Assuming static conditions, the pulling load applied by the muscled can be decomposed into a tensile load F'_m tangent to the cylindrical curvature and a equivalent compressive load F_c normal to the curved surface. The latter can be expressed as a function of the force applied by the wrapped string(or muscle) and its projected angle and described in the following Eq 2.2:

$$F_c = 2F_m \sin(\alpha) \quad (2.2)$$

, where F_c is the equivalent compressive force applied at the top of the humeral head, F_m the muscle-line force and α the projected angle of the muscle over the humeral head. It is important to note that most of the rotator’s cuff muscles might potentially follow the above *muscle-wrapping model*.

To the author’s knowledge, the supraspinatus wrapping angle α is not available in the literature, although its estimation from the VHP MRI images should not impose further difficulties. However, as this task is out of the scope of this study, it was therefore decided to calculate the projected angle of the muscle over the humeral head by a first modeling of the pulling rope used in the work of [Clavert *et al.*, 2016]. For this, a chain of 1D elements is designed from the attaching point (the GT) to the direction in which the supraspinatus (SS) applies its load, according to the cadaverous data available in [Ackland et Pandey, 2009]. A rope transmits only axial loads, which is also characteristic from the FE truss elements. However, the absence of any rotational stiffness in the truss elements might instigate instabilities during a static implicit simulations. Consequently, in addition to the truss elements, beam elements with a low elastic modulus were superposed, sharing the same nodes. This will allow the solver to deal with small (but no

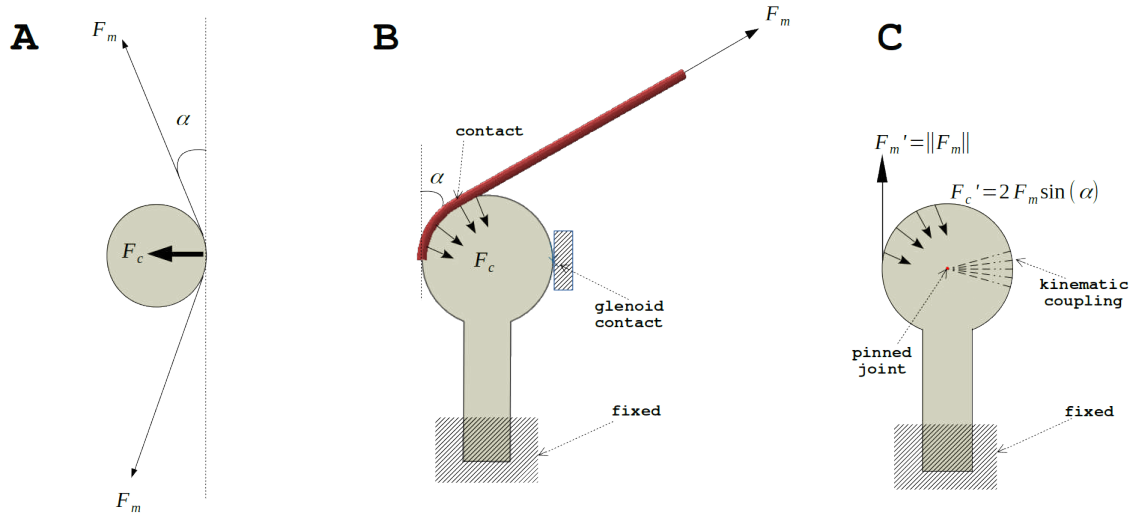

Figure 2.5 – **Muscle-wrapping model, with a rope-pulled and a press-pulled model.** **A:** Simplified version of the decomposition of the muscle line action load F_m into a tangential load F'_m and a compression F_c applied at the top of the humeral head, with a wrapping angle α . **B:** The rope-pulled model, with a glenoid fossa contact and a wrapping angle α equivalent to the angle between the tangential line traced at the muscular loading attaching zone and the direction of the muscle. **C:** The press-pulled model, in which the reaction force F_c at the humeral head is calculated as a function of the muscle line load F_m and the angle α of the rope wrapped around the head. The glenoid fossa contact is replaced by a kinematic coupling allowing the rotation.

zero) moment-loads throughout the rope and thus, assure the simulation stability.

In order to assign material properties to the truss and beams, it is necessary to know beforehand the elastic modulus of the high-modulus polyethylene (HMPE) rope used in [Clavert *et al.*, 2016]. For this, a non-destructive tensile test was made. Five HMPE rope straps using an average length size of 200 mm and an initial diameter of 3 mm were tested at 4 mm/min on a servo-hydraulic testing machine (INSTRON 8500 plus, INSTRON corp., High Wycombe, Buckinghamshire, United Kingdom) with a 50 kN load cell. The testing raw data (force/displacement) is acquired using the Instron MAX (ver 4.2, INSTRON corp.) software at 10Hz using a generic CSV format. From the stress/strain slope the obtained averaged elastic modulus was 37.11 MPa, used as the elastic modulus of the truss elements. Using a truss-to-beam elasticity ratio of 100:1, the beam elements elastic modulus was assigned to a value of 0.37 MPa. The Poisson's ratio assigned for both elements was 0.3.

As for the pulling direction, the direction cosines obtained from the cadaverous study done in [Ackland et Pandy, 2009] were used to fix the line of action of the SS muscle. For this, the FE humerus model was placed in the scapula reference cited in the study. For an abduction with a joint-angle of 90° , two estimated direction cosines corresponding to the anterior and the posterior attaching zones of the SS muscle were extracted: $[-1.000, -0.004, 0.021]$ and $[-0.972, -0.189, -0.141]$, respectively, using the $[\hat{x}, \hat{y}, \hat{z}]$ format. These values were averaged and transformed to a left humerus reference (by inverting the \hat{y} direction), resulting in the following direction cosines $[-0.986, 0.0965, 0.081]$. The force applied F_m was 730 N. It should however be noted that this force is only to be in line with the experimental framework in [Clavert *et al.*, 2016], having in mind that the physiological forces observed at the supraspinatus muscle during a normal abduction does not usually exceed 40 N [Yanagawa *et al.*, 2008], as there are other muscles participating as well.

Although the rope-pulling technique is able to model the experimental test in [Clavert *et al.*, 2016], there are several disadvantages that could lead to an unnecessary computationally-costly FE model due to the rope-cartilage

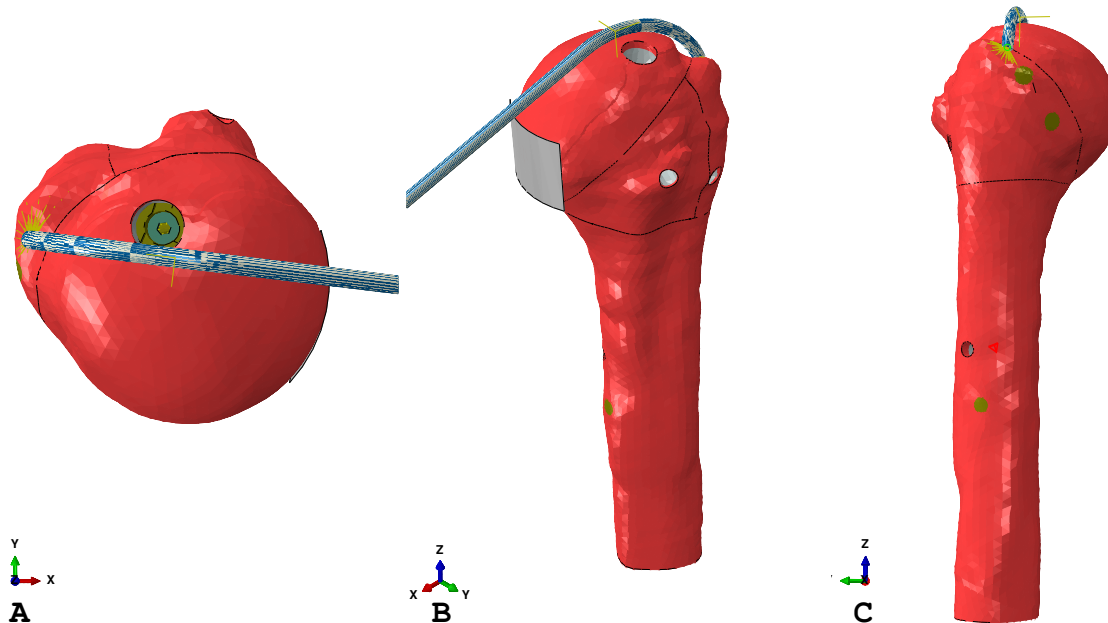

Figure 2.6 – **Rope-pulled model, with the rope and the glenoid fossa contact position.** Original position of the rope and the head support. **A:** Superior view, **B:** Isometric view. **C:** Lateral view. For the press-pulled model, the rope was replaced by a pressure applied at the contact zone and the support, by a kinematic coupling whose master node is located at the center of the best-fitted sphere at the head.

contact tracking management and the large deformations potentially observed at the beam-truss rope. Once the initial (rope-pulled) simulation is run applying a unique F_m force at the end of the rope, the wrapping angle α is estimated using two different approaches:

- The contact force F_c at the cartilaginous zone exerted by the rope is quantified and then, the angle α is obtained.
- The rope arc-length in contact with the head is directly measured from the deformed solution and then, the angle α is estimated.

The purpose of a double measurement of the α angle is to prove convergence in the proposed muscle-wrapping model. Once obtaining the necessary data (F'_m , α and F_c) a less computationally-expensive FE model (press-pulled) is run, replacing the muscle-rope by a compressive force F_c normal to the contact cartilaginous surface of the humeral head and a tangential load F'_m at the GT (using a translational-only kinematic coupling).

2.2.5 Boundary conditions

For the rope-pulled initial simulation, a finite-sliding, node-to-surface contact is established between the rope (nodes of the 1D elements) and the surface elements of the humeral head, with frictionless conditions and a linear stiffness penalty contact.

Following the [Clavert *et al.*, 2016] protocol, the surface nodes at the distal end of the FE model were all linked together using a kinematic coupling to a master node, and fixed in all its 6 DOF. For the proximal head support, two strategies were implemented: a contact with a rigid surface mimicking the original support described in [Clavert *et al.*, 2016] and a kinematic coupling linking the most distal anterior nodes of the cartilaginous region (the contact region) to a master node located at the theoretical center of rotation. For the former, a flat rigid surface is plotted and disposed at the distal anterior zone of the cartilaginous region of the humerus, acting as a glenoid

support. For the latter, using the `pcspherefit` command from Matlab's (ver. 9.7.0.119020, The MathWorks Inc., Natick, Massachusetts, USA) Vision toolbox, the theoretical center of rotation was found and chosen as the kinematic coupling master node, avoiding the discontinuity of the modeling of such rigid surface contact. The rigid glenoid surface was modeled with a frictionless, surface-to-surface contact with a non-linear stiffness penalty contact.

The screws of the IM nail were modeled as solid-meshed beams, with a tie interaction between them and the surrounding surfaces (cortical bone, cancellous bone and the IM nail plastic insert). Both the contacts between the nail and the cancellous bone, and between the bone fragments, were modeled with a fixed friction coefficient of 0.1 and enforced with a penalty linear contact. All these interactions were considered as a finite-sliding surface-to-surface contacts, with overclosure removal done at the first increment.

2.2.6 Material properties

The Sawbone material properties for the 4th Gen composite humerus used in [Clavert *et al.*, 2016] were directly provided by the manufacturer³. The cortical layer made out of short-fibers filled epoxy is a composite material with local-direction dependent properties mostly focused on the diaphyseal zone. According to the manufacturer's guidelines, the epiphysis can be considered with a random distribution of the short-fibers, hence, with an isotropic Young modulus. For this case, a value of 16 000 MPa and an elastic limit of 100 MPa were used. The cancellous layer made out of solid rigid polyurethane foam is a homogeneous foam with a density of 270 kg/m³, and with a Young modulus of 205 MPa. The IM nail and the screws are made of anodized surgical-grade titanium with an elastic modulus of 110 000 MPa and an elastic limit of 950 MPa, and the plastic insert, of high density polyethylene (HDPE), with an elastic modulus 1 000 MPa. All the materials were considered pure elastic with a Poisson's ratio of 0.3.

2.2.7 Parametric sensitivity study

The present study is carried out on a synthetic bone whose properties are reproducible from one to another. But the goal of this FE model being developed is to model real human bones, whose mechanical properties are well known to present an important variability. It is therefore important to quantify the influence of this variability on the simulations. In the same way, the friction coefficient is not identified but evaluated and therefore its influence is also analyzed through this parametric study. Finally, the HDPE nail insert is a polymer which, although supposedly stable, its mechanical properties might tend to age over time and thus, the importance of also analyze its influence on the overall response of the FE model.

From the global parameters contained in this numerical model, such as the material properties, the boundary conditions and the geometric characteristics, four parameters were selected to be swiped over an admissible range of values: the cortical layer, the cancellous layer, the IM plastic insert and the interfragmentary friction coefficient. It is well known that the bone structure is inhomogeneous and thus, presents a local-varying Young modulus all along it [Schileo *et al.*, 2007]. For the humeral case, using the observed density distribution [Alidousti *et al.*, 2017] and using the elastic-density relationship of a FE humerus model [Dahan *et al.*, 2016], the proposed range of Young modulus are from 5 000 to 20 000 MPa for the cortical layer and from 50 to 650 MPa for the cancellous layer. The IM nail manufacturer does not give further details at the mechanical properties of the HDPE insert and thus, a Young

³Available at <https://www.sawbones.com/biomechanical-product-info>

	Reference Value				
Cancellous Young Modulus (MPa)	205	50	350	500	650
Cortical Young Modulus (MPa)	16 000	4 000	8 000	12 000	20 000
Interfragmentary Friction Coefficient	0.1	0.2	0.3	0.4	0.5
IM Nail Plastic Insert Young Modulus (MPa)	1 000	400	700	1 300	1 600

Table 2.1 – **Range of values used in the parametric sensitivity study.** Each value represents a new simulation case, and thus, it makes 16 extra simulations in total (plus the reference one). In bold, the reference (original) values.

	A	B	C	D	E	F	G
Order	1st	1st	1st	1st	2nd	2nd	2nd
AEL (mm)	2.5	1.5	1	0.75	2.5	1.5	0.75
DOF	43 177	142 963	206 230	333 763	323 328	1 133 420	1 642 027
Time (s)	183	682	935	1214	1807	12 058	34 588
Stress (MPa)	63.2	77.9	79.6	293.0	241.5	291.8	351.7
MCI	1.21	1.25	1.25	5.78	3.02	3.82	n/a

Table 2.2 – **Mesh convergence results data.** It presents the 7 different cases {A..G}, detailing the mesh order, the average element-length (AEL), the degrees-of-freedom (DOF), the execution time (in seconds), the max principal stress (in MPa) found and a Mesh Convergence Index (MCI). In bold, the converged model.

modulus range from 400 to 1600 MPa was taken into consideration. As for the interfragmentary friction coefficient in the humeral head, to the author’s knowledge, no study describes it in detail for the purposes of this work. Hence, it was decided to apply a generic range varying from 0.1 to 0.5.

No inter-parametric correlation is studied, only individually-changed parameters. This means a total of 16 extra simulations. The Table 2.1 synthesizes the range of parameters cited above.

2.3 Results and discussions

2.3.1 Mesh convergence analyses

After running the seven simulation cases, according to the values shown at the Table 2.2, the model D is chosen, as it is the mesh which presents the most adapted balance between execution time and the difference on the maximum principal stress between the models A - F and the reference model G, Equation 2.1. The maximum principal stress was chosen based on the assumption that for a tensile (pulling) load, the maximum principal stress will exhibit mostly an increase in the strain volume as the material is teared up apart.

Another useful criteria to illustrate the mesh convergence study is based on the measured stiffness of the model, Figure 2.7. For each simulation, a global stiffness is measured at the loading node, and it is plotted along with the type of mesh (coarse, medium, fine or ultra-fine), the type of element (linear or quadratic), the number of DOF and the simulation time. For the linear type of elements, the tendency is to see the stiffness reduced as the average element length is reduced from 2.5 mm to 0.75 mm. Nevertheless, even for a similar number of DOF (case D vs. case E), the quadratic elements seems to be less stiffer, with a pronounced decrease in the global stiffness as the DOF number increases. This is a typical scenario for the tetrahedral linear elements, which tends to be «stiff» due to its naturally

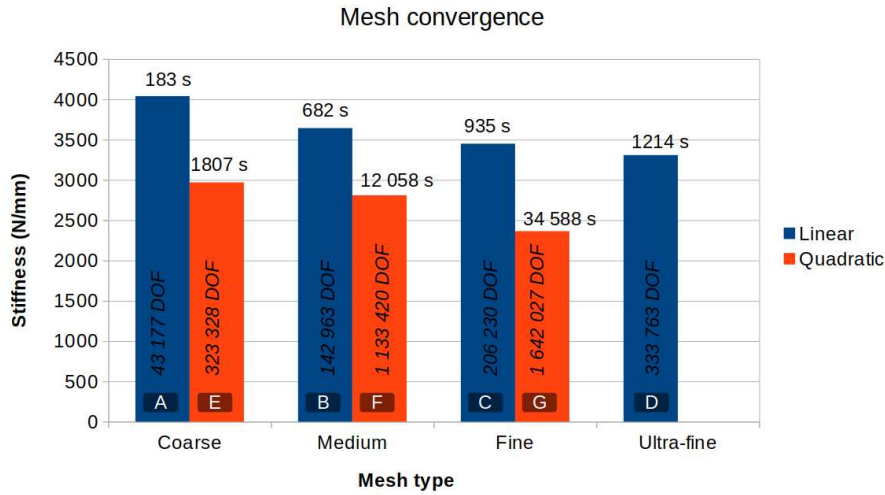

Figure 2.7 – **Simulations time and calculated stiffness for the mesh convergence analyses.** The seven analyses estimated a stiffness value at the tip of the pulling node (kinematic coupling). Inside each bar, there is the number of the degrees of freedom (DOF). Above each bar, the total CPU time. The letters correspond to each test in the Table 2.2.

stable geometry [Bourdin *et al.*, 2007], in contrast to the tetrahedral quadratic elements .

For this particular setup, the stiffness was not picked as a candidate for the MCI because of the observed behavior when running the simulations, as illustrated in Figure 2.8. In general, the humeral head shows a concentration of maximum principal stress (in red) in the supraspinatus footprint, at the greater tuberosity, while the humeral head is heavily impacted by the linear elements wrapping it with a compressive force, exhibiting a minimum principal stress (in blue). The maximum principal stress of the reference model is 351.7 MPa. The first three linear coarse, medium and fine cases exhibits a maximum principal strain of 63.2 MPa, 77.9 MPa and 79.6 MPa, respectively, with the positive stress more diffused around the greater tuberosity, in total contrast to the quadratic fine mesh, in which the positive stress is highly focused with a smaller footprint. This is equivalent to affirm that a higher number of DOF and a higher order element type allows to catch in a finer manner the stress concentration zones. This affirmation is also valid for the minimum principal stress concentrated at the humeral head. The quadratic meshes shows a more important stress and strain concentration in the contact area, and thus, exhibiting a much lesser stiffness value. This could artificially biases a proper selection of the mesh if we are recreating a higher (and physiologically irrelevant) stress concentration zone. Overall, the chosen mesh that provides a balance between the running time and the stress concentration is the ultra-fine (AEL 0.75 mm) linear mesh.

2.3.2 Rope-pulled and press-pulled models comparative

Once the rope-pulled model was run, the compressive force at the top of the cartilaginous head due to the rope-humerus contact was measured as $F_c = 690.72$ N. Using the Eq. 2.1, the wrapping angle was estimated as $\alpha = 28.03^\circ$. In the same way, the tangential vectors of the two extreme portions of the rope making contact with the head were measured as $\vec{v}_1 = [0.7877, 0.01973, 0.6243]$ and $\vec{v}_2 = [-0.63679, 0.1609, -0.67213]$ and thus, the supplement of the angle between these vectors is the double of the wrapping angle. In other words: $\alpha = (180^\circ - \angle \vec{v}_1 \vec{v}_2) / 2 = 28.91^\circ$. With an absolute error of $< 1^\circ$ between both rope vectors, it is possible to validate the convergence in the calculation of this wrapping angle. See 2.9

With this data, the rope is replaced and an equivalent compressive force F_c was applied at the top of the humeral

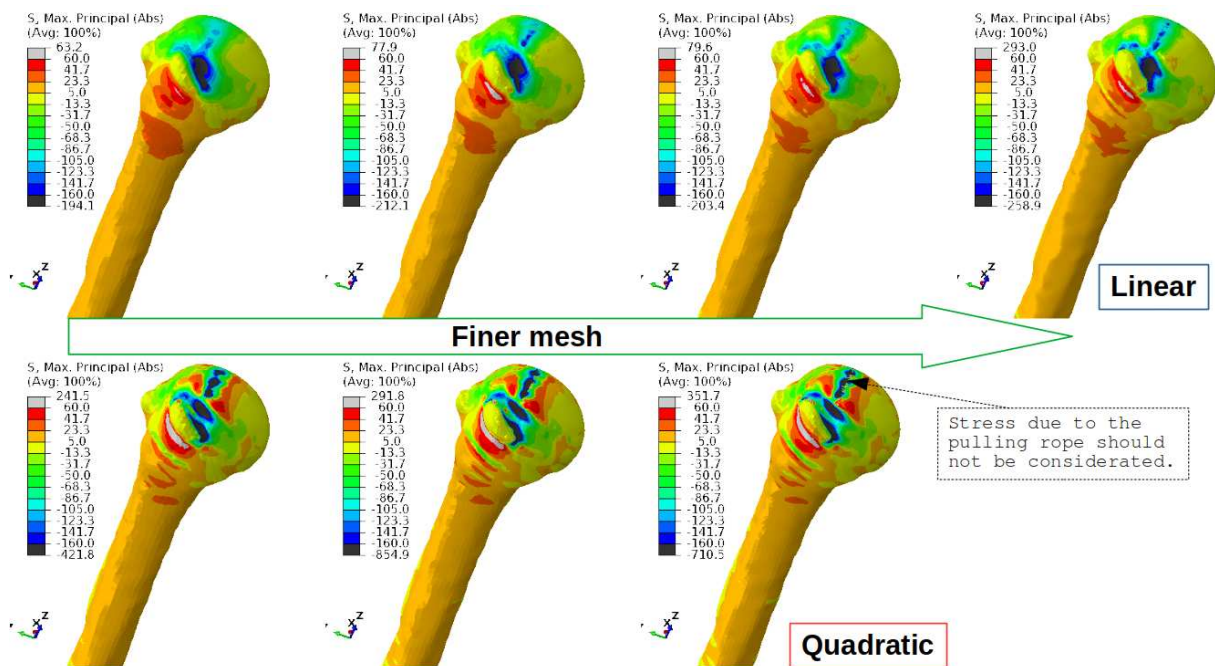

Figure 2.8 – Maximum principal stress for each mesh convergence analysis. The blue (compressive) zone indicates the contact position of the rope.

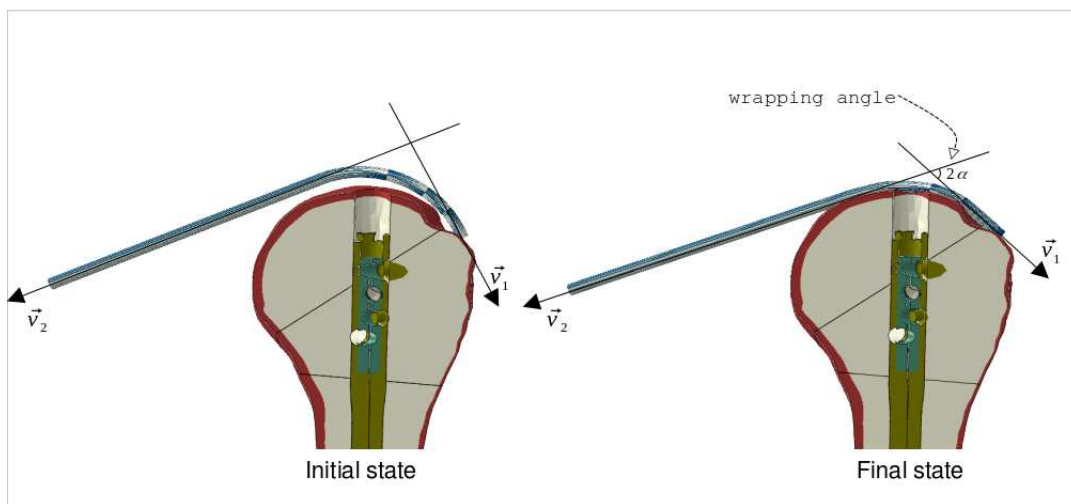

Figure 2.9 – Supraspinatus pulling vectors and wrapping angle on the humeral head. At the initial state, the vector \vec{v}_1 starts in a trivial position before any adjustment while the \vec{v}_2 is defined according to the anatomical muscle studies. At the final state, once the humeral head loaded, the wrapping angle is equivalent to the half of the supplementary angle between both vectors.

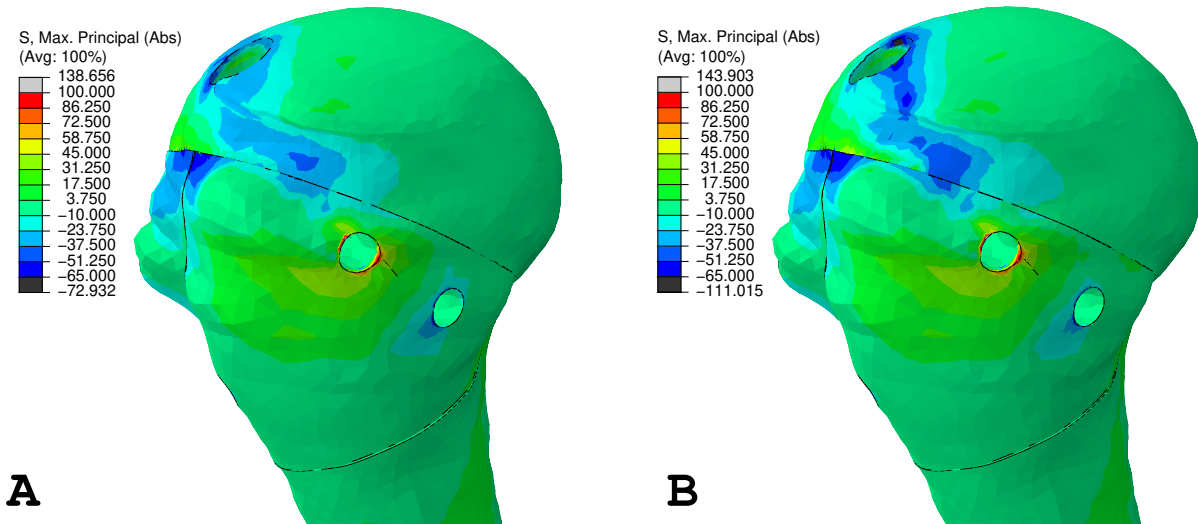

Figure 2.10 – **Maximum (absolute) principal stress comparison between the two loading modes.** Stress values in MPa. **A:** rope-equivalent loaded model. **B:** Rope loaded model. The difference at the maximum positive values (in red), related to the tensile stress, are negligible. Nevertheless, the minimum negative values (in blue), related to the compressive stress, are visibly higher on the top of the humeral head at the rope pulled (B) model.

head as a pressure. For this, a surface of 99.97 mm² was selected and, with the estimated force to be applied, a pressure of 6.909 MPa is configured. As for the force F_m , the chosen direction is the tangential vector \vec{v}_1 .

In the Figure 2.10, the comparative between both the rope-pulled and the press-pulled models is shown, in terms of displacement (top) and in terms of maximum principal stress (bottom). For the displacement, there is an increasing absolute error due to the accommodation of the rope as it tends to slide along the the frictionless, spherical cartilaginous surface. This explains the initially lower displacement of the rope-pulled model, until it reaches a maximum tension at around 590 N in which the force transmission is maximum. Of course the behavior of the press-pulled model is totally linear as the accommodation phase is nonexistent. It should be noted that the displacement vectors points towards the same direction in both rope-pulled and press-pulled models. As for the stress field, both models shows a consistent distribution of the maximum and minimum principal stress at the critical zones. It is important to note that there is a remarkable difference in the minimum (compressive) principal stress at the top of the humeral head, in which the 1D linear elements apply a focused compressive load and thus, creates an unrealistic compressive load.

Finally, between the glenoid rigid surface contact and the kinematic coupling with the master node at the theoretical center of the humeral head, the difference in the observed rotation of the top of the humerus was $< 0.1^\circ$. This makes the kinematic coupling strategy suitable for further reducing the computational cost of the FE model with negligible impact on the results. It is important to note that this is only valid for a quasi-static, small displacements model, as it is well known that the rotation center of the humerus dynamically varies as a function of the spatial position of the arm [Boileau *et al.*, 2015].

2.3.3 FE model and experimental data comparison

Carrying on the comparative between the rope-pulled and press-pulled models, the observed stiffness (the total nodal force applied divided by the displacement observed at the force application-node) for each mode is 525.55 N/mm and 8.2 N/mm, respectively . This substantially high difference is explained by the fact that the rope is the main overall stiffness driver of the model. This can be demonstrated when doing the comparative with the reported stiffness in

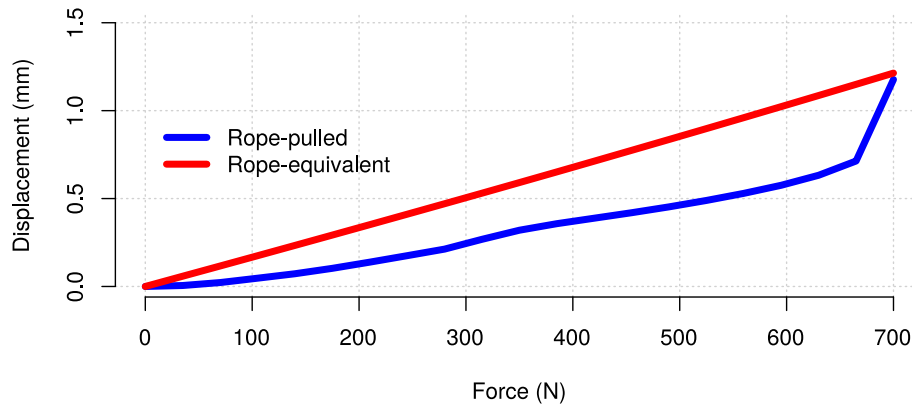

Figure 2.11 – **Displacement magnitude of the greater tuberosity (GT) in relation to the total applied force.** The displacement is shown for both the rope-pulled (blue) and the rope-equivalent (red) loaded cases. Although they both reach the same displacement at the maximal force applied, the divergence in the displacement is due to the sliding and adjustments of the rope over the humeral head under the tensile load. Almost at the end of the test (at 670N), the rope makes a last accommodation movement, which led to the sudden rise of the GT displacement.

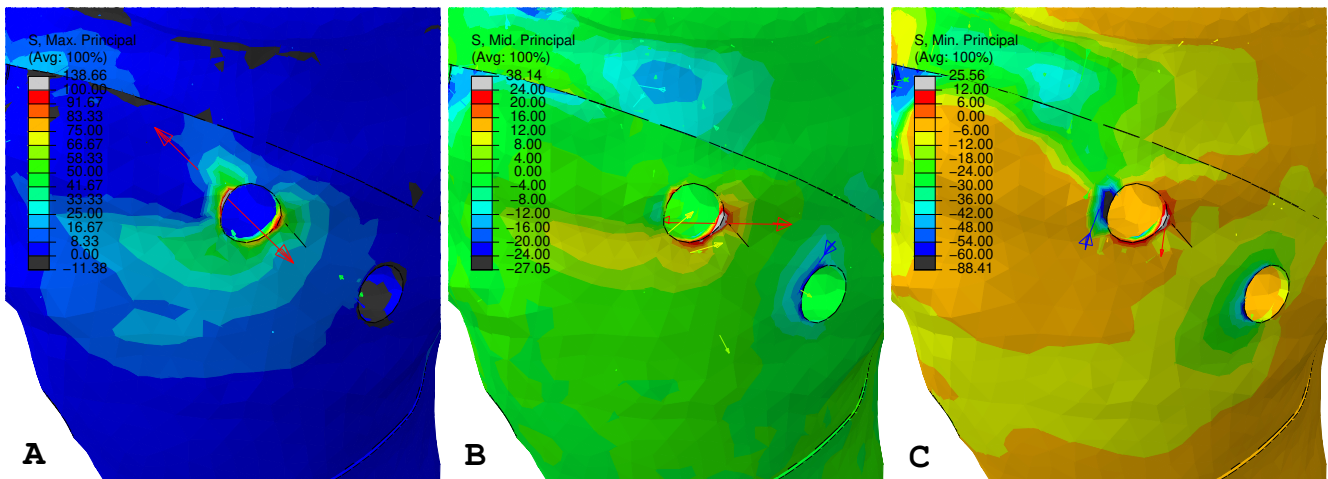

Figure 2.12 – **Principal stress at the screw hole zone.** The arrows indicate the principal directions for each type of stress. As the Sawbone’s cortical layer elastic strength value is around 106MPa, there is a potential risk of failure at the first screw hole due to tensile stress. A: Maximum principal stress. B: Middle principal stress. C: Minimum principal stress.

[Clavert *et al.*, 2016], which is of 21.56 N/mm, much closer to this rope-pulled model. It should be remarked that in [Clavert *et al.*, 2016], the stiffness was measured at the load cell charge, therefore taking into account the local rope displacement due to its lower elasticity modulus in comparison with the bone/nail assembly.

The force to failure reported in the experimental model is 646.82 N, and for the failure mode, quoting the authors, “the greater tuberosity progressively turned around the screws then was compressed on the humeral head before pulling-off”. In the FE model, the maximum principal stress was found around the first proximal screw on the great tuberosity. In the Figure 2.12, it is shown the evolution of the maximum stress at each element around the screw and the average of all of them. Two finite elements around the screw exceeds the elastic limit of the Sawbone cortical layer at 430 N and at 695 N. It is important to recall that this FE model does not take into consideration any plastic strain nor simulate any fracture behavior that could potentially create new stress focal zones. What is more, the force to failure is the last force value measured at the loading cell before the total failure of the assembly, while the value being reported in this FE model is closer to the beginning of the fracture without further evolution.

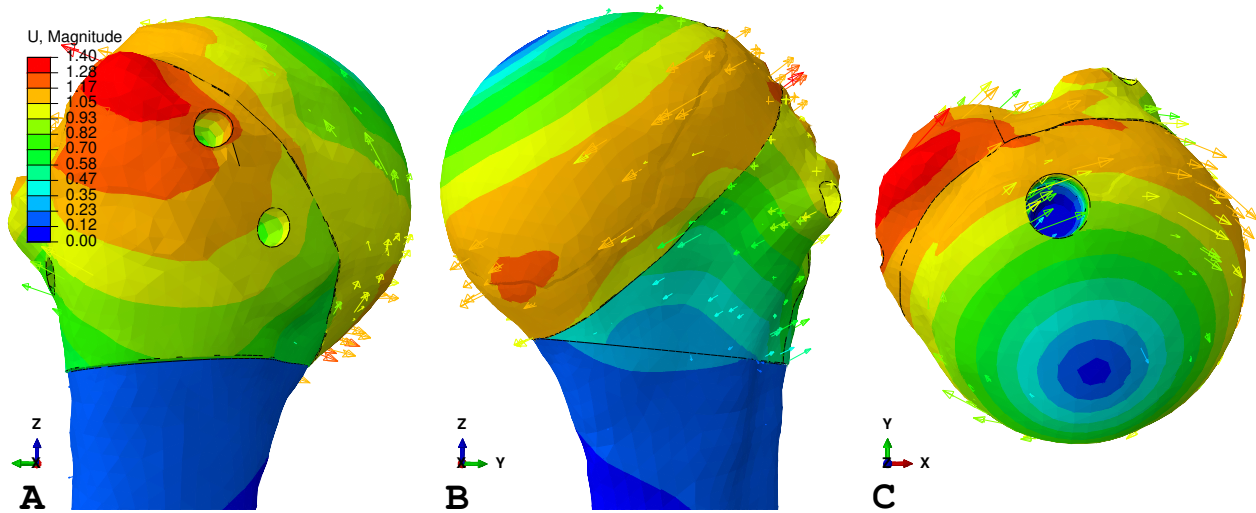

Figure 2.13 – **Global displacements around the humeral head at maximum load and the direction vectors.** Displacement magnitude in mm. The pulling load at the supraspinatus attachment zone on the GT induces a rotational movement, which is expected for such load type. **A:** Lateral view. **B:** Medial view. **C:** Superior view.

2.3.4 Global and interfragmentary displacement

In the Figure 2.13 it is shown the global displacements field and the direction of the movement represented by arrows. At first sight, it can be concluded that the maximum displacement of 1.389 mm is measured at the tip of the great tuberosity, area in which the force is applied, and represented at the lateral view. Unsurprisingly, the failure zone at the first screw is close to the maximum displacement zone. In the medial and superior views, the rotation of the top of the head and of the tuberosities can be distinctly identified with the direction of the arrows and the rotational axis in blue. This axis is better noticed at the lateral half-cut view, showing that it is almost co-linear with the normal axis of the anatomical neck cutting plane. The rotation angle measured at the theoretical spherical center is 2.45° .

In addition to the global displacement, it is important to measure the interfragmentary movement, as an indicator of the healing process based on different bone healing theories [Braun *et al.*, 2015]. In the Figure 2.14, the interfragmentary opening (separation) and slipping was measured. At the first glance, it becomes evident the opening behavior on the zones close to the surgical neck and the slipping (thus a contact) close to the anatomical neck. Even if the IM nail is not designed for fixing directly the humeral head (i.e. above the anatomical neck), this one is not in an unstable configuration, which is in full agreement to the nail expected behavior [Clavert *et al.*, 2016].

When subjected to closer scrutiny, in addition, in the Figure 7 there are two interfragmentary opening and two slipping zones. As said before, the opening zones are located at the most distal part of the cutting plane parallel to the intertubercular groove, with an observed critical value at the zone A of 0.225 mm, and at the lateral side of the cutting plane coplanar to the surgical neck, with an observed critical value at the zone B of 0.746 mm. The two critical slipping zones are found on the cutting plane coplanar to the anatomical neck, at its medial side, with an observed critical value at the zone C of 0.620 mm, and at its lateral side, with an observed critical value at the zone D of 0.180 mm. A small slipping zone is found as well at the medial side of the cutting plane coplanar to the surgical neck, with values less than 0.100 mm.

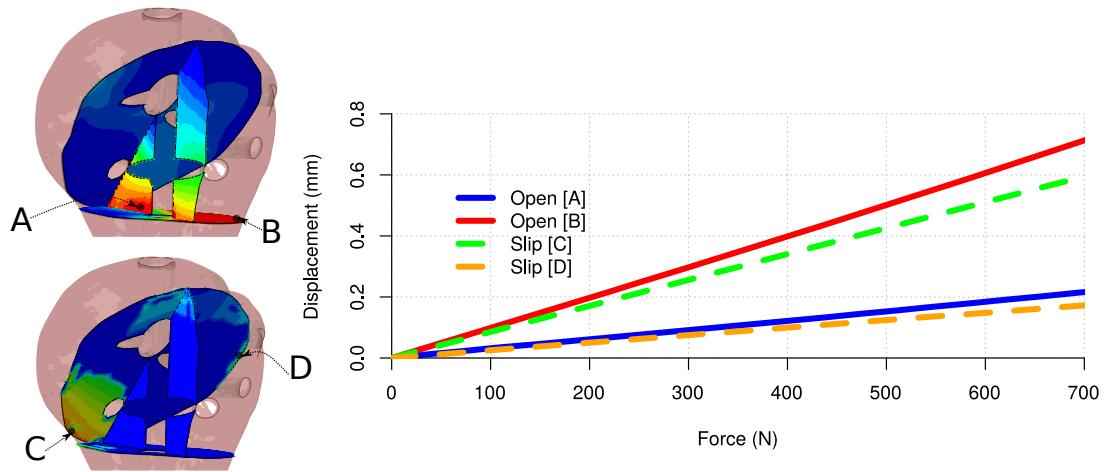

Figure 2.14 – **Interfragmentary displacement (magnitude) in relation with the total applied force.** These values are measured at the four points located at the cutting planes as seen at the anterior view of the humeral head. The opening displacement (Open) is located on the zones A (most distal position between the tuberosities fragments) and B (located between the greater tuberosity fragment and the diaphyseal fragment). The slipping displacement (Slip) is located on the zones C (between the humeral head and the lesser tuberosity fragments) and the zone D (between the humeral head and the greater tuberosity fragments).

2.3.5 Stress and strain distribution

In the Figure 2.15, the maximum and minimum principal stress distribution is shown across the lateral, medial and superior views of the proximal humerus. As stated before, the maximum stress, averaged at 50 MPa with peaks surpassing 150 MPa as seen in the Figure 2.12, is focused in the zone around the first screw at the greater tuberosity, making it the most probable region in which a fracture could appear. This apparent tensile stress is then propagating in a parallel direction to the rotating vector.

As for the minimum stress, there are two concentration zones: a medial-anterior cartilaginous zone and in the superior intersection of the greater and lesser tuberosities fragments. For the former, this compressive stress of around 60 MPa at the maximum load is undoubtedly related to the reaction force of the “glenoid” support, that was lastly replaced by a kinematic coupling. It’s interesting to remark that this stress-focused compressive zone is also observed with the rigid surface acting as glenoid support, confirming once more that the kinematic coupling is an appropriated and inexpensive replacement. For the latter, the minimum principal stress concentration in the superior intersection between both tuberosities fragments, around 50 MPa at the maximum load, shows the compressive load exerted in the tip of the fragments due to the tensile load applied at the greater tuberosity. The slipping displacement in that zone is less than 0.1 mm, suggesting that the compressive stress is closer to the normal to the cutting plane, which is in good agreement with the AO Foundation fracture management guidelines referring that the union between fracture fragments should be as normal as possible to its plane [Boileau *et al.*, 2015].

A similar distribution in the strain field is observed in the Figure ???. The maximum principal strain values are concentrated around the first IM nail screw at the greater tuberosity, with a mean value of 0.3% strain at maximum load and peaks of 1% in the cortical surface. As for the minimum principal stress values, there are concentrated in the medial-anterior cartilaginous zone, glenoid support, with an average value of 0.4% at maximum load and at the superior intersection between the tuberosities fracture, with an average value of 0.3% at maximum load.

At the maximum load, the IM nail shows a stress concentration in the zone between the 3rd and 4rd proximal screws, as seen in the Figure 2.16. At the lateral view, the maximum Von Mises stress concentration reaches the 465

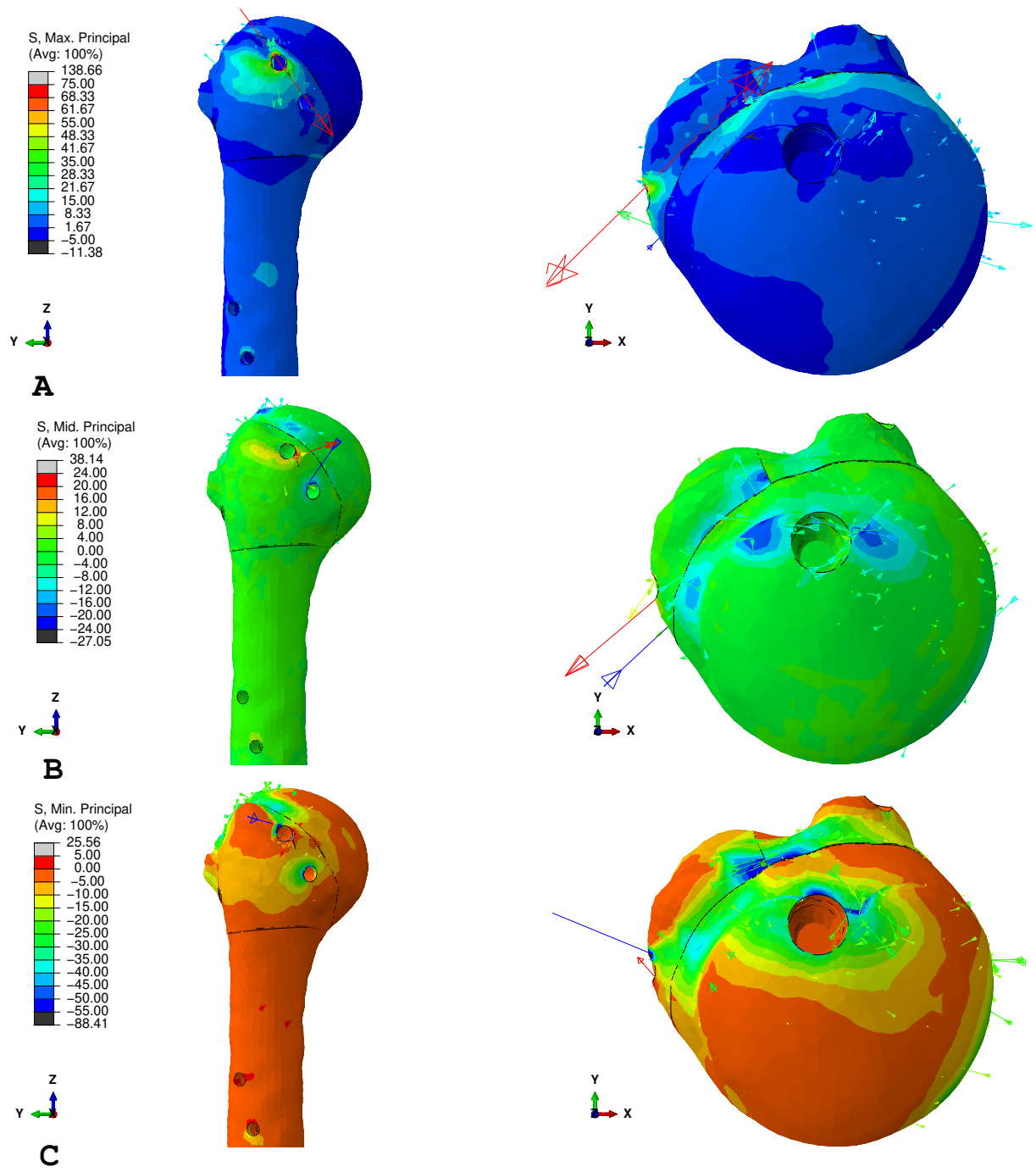

Figure 2.15 – **Principal stress (in MPa) distribution on the proximal humerus.** The arrows shows each one of the principal axis vectors. **A:** Maximum principal stress. **B:** Mid principal stress. **C:** Minimum principal stress. Lateral (left) and superior (right) views.

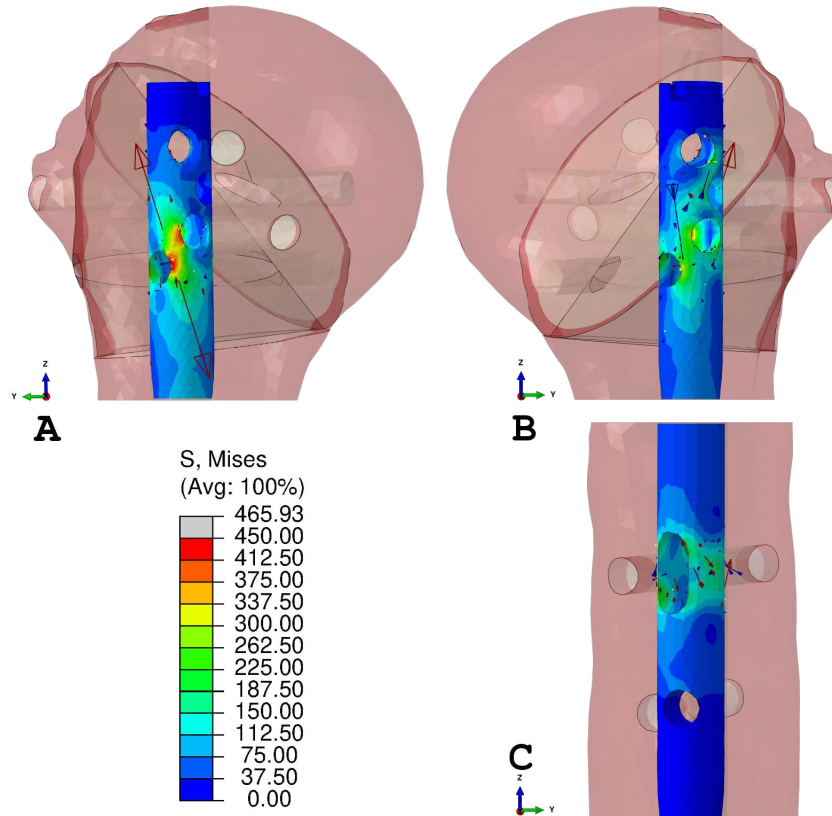

Figure 2.16 – **Von Mises stress (in MPa) distribution at the intramedullary nail.** The arrows shows the principal axis vector and its direction: red for maximum principal and blue for minimum principal. The nail material’s (Ti-6Al-4V) yield strength is 1000 MPa, value that it is not reached even under a beyond-physiological load. **A:** Lateral-proximal view. **B:** Medial-proximal view. **C:** Medial-distal views.

MPa with a maximum principal axis pointing 18° obliquely to the nail shaft. At the medial view, there is a Von Mises stress concentration zone reaching 280 MPa with a minimum principal axis pointing 8° obliquely to the nail shaft. This bipolar maximum/minimum principal concentrations clearly shows a bending with a less important twist effort at the weakest zone between the 3rd proximal and the locking distal screw. Even at the physiologically-out-of-range loads, the probability of a fatigue failure at the IM nail is virtually zero, as it does not even reach the minimum 850 MPa for a failure at 10^7 cycles [Akahori et Niinomi, 1998].

As for the distal zone (Figure 2.16), the stress is concentrated at the dynamical locking distal screw oblong hole, with a peak value of 200 MPa. The arrows indicating the principal axes shows mainly a twist-driven effort, which is totally expected as the distal end of this setup is fixed and the pulling load applies a torque at the humeral head.

2.3.6 Parametric study

The results of the parametric study are shown in the Table 2.3. The parameters used as a reference values are located at the top of the table. The following variables were used to compare the results:

- Maximum Principal Stress [MPa]: maximum stress value located at the surrounding hole area of the 1st screw (see Figure 2.15).
- Minimum Principal Stress [MPa]: minimum stress value located at the top of the fracture between the lesser and the greater tuberosities (see Figure 2.15).

- IM Nail Von Mises Stress [MPa]: maximum stress value located at the area between the 3rd and 4th proximal screw holes at the IM nail (see Figure 2.16).
- Humeral Head Rotational Magnitude [degrees]: maximum angle observed at the theoretical rotational center of the humeral head (see Figure 2.13).
- Humeral Head Displacement Magnitude [mm]: maximum displacement magnitude observed at the tip of the greater tuberosity (see Figure 2.13).
- Contact Opening zone A [mm]: separating displacement magnitude observed at the zone A of the interfragmentary cutting planes (see Figure 2.14).
- Contact Opening zone B [mm]: separating displacement magnitude observed at the zone B of the interfragmentary cutting planes (see Figure 2.14).
- Contact Slipping zone C [mm]: slipping displacement magnitude observed at the zone C of the interfragmentary cutting planes (see Figure 2.14).
- Contact Slipping zone D [mm]: slipping displacement magnitude observed at the zone D of the interfragmentary cutting planes (see Figure 2.14).

Starting with the cancellous layer elastic modulus variation, it can be observed that its most positive and negative impact are located at the contact slipping zone D, with an increase of 121.9% of its reference value for a elastic modulus of 50 MPa, and a decrease of -56.5% of its reference value for an elastic modulus of 650 MPa. The slipping zone C is also the second most impacted variable by the sweeping of the cancellous elastic modulus. In general, a decrease of the modulus by 50 MPa increases the rotational and displacement of the humeral head by 35.1% and 38% respectively under the same loading conditions, increases the maximum principal, and the nail von Mises stress by 27.9%, -12.8% and 28.5% respectively and increases as well the opening displacement in the contacts zones A and B by 47.5% and 33.2% respectively. However, the minimum principal stress at the same maximum load decreases by -12.8%. In other words, the impact is mostly reflected in the motion of the humeral head, increasing as well the chance to initiate a fracture at lower loading charges. This is particularly important for an osteoporotic bone, in which the cancellous bone structure is most likely to be degraded.

As for the increase in the cancellous elastic modulus, its impact is more moderated, with a mild reduction of the maximum principal stress of -11.8% for an elastic value of 650 MPa (thus marginally decreasing the risk of fracture at this zone), and a more notorious reduction in the minimum principal stress of -27.4%, lower the risk of a crushing fracture at the cortical bone in this particular interfragmentary area. The increase of the cancellous elastic modulus also induces a notorious reduction in the contact opening and slipping of -35% at zone A, -16.4% zone B, -44% zone C and -56.5% zone D. This unsurprisingly leads to think that a denser and “stiffer” cancellous bone allows less interfragmentary motion.

The cortical bone layer elastic modulus variation shows a clear division between the 4000 MPa and the 8000 MPa, particularly in the rotational (45.8% vs. 20.9%) and displacement (48.9% vs. 22%) magnitudes and in the contact opening zone A (178.1% vs. 18.8%) and zone B (30.7% vs. 15%), respectively. This gap is subsequently trimmed-down as the elastic modulus approaches the reference value, with a variation of 10.6% and -10.9% of the maximum and

minimum principal stresses, respectively, for the case of an elastic modulus of 12000 MPa, and a negative reduction as well of -11.3% for the contact opening zone B.

Similar case of an increase of the cortical layer elastic modulus above the reference value. An increase to 20000 MPa shows a mitigated variation in the measured variables, the highest being a 8.2% change at the minimal principal stress and the lowest, a -9.0% change at the maximum principal stress, meaning a negligible reduction at the risk of fracture around the first greater tuberosity area and a negligible increased chance of fracture by crushing at the top of the interfragmentary tuberosities fracture plane.

The variation from 0.1 (reference value) to 0.5 of the friction coefficient at the interfragmentary cutting planes showed an expected decrease in the interfragmentary and global motion of the humeral head, as well as a reduction of the stress concentration at the screw areas and at the IM nail, as the interfragmentary shearing forces absorbed most of the kinematic energy. For the highest friction coefficient value, the contact opening and slipping were reduced by (-57.1%, -39.1%, -58.7% and -98.6% for the zones A, B, C and D, respectively). This led to a decrease of the rotational and displacement global magnitudes (-54.2% and -46.8% respectively), and a reduction of the maximum principal, minimum principal and IM nail Von Mises stresses of -34.6%, -14.8% and -23.8% for each one. A similar behavior is observed for the rest of the cases, observing an almost linear correlation at the contact opening and slipping, but a plateauing at the friction coefficient value of 0.4 for the maximum principal and IM nail Von Mises, and a passage of a positive to a negative variation change at the minimum principal stress. As stated before, there is little or no information at all about the observed friction coefficient values at the proximal humerus fractures, and what is more, this value should tend to evolve as the fracture healing process begins. The important noticed variations related to the friction coefficient might indicate that either further investigation in this matter could be needed or either, further standardize the use of the apparently worst-case scenario (very low values).

Lastly, the variation in the elastic modulus of the IM nail plastic insert didn't lead to important changes. The highest values were observed at the rotational and displacement global magnitudes (12.8% and 11.8%, respectively), as well as at the contact opening at both zones (10.8% and 14%, respectively) for an elastic modulus of 400 MPa. This leads to think that the most influential impact of a softened plastic insert could be at the overall humeral head motion. A stiffening would insignificantly modify any of the observed variables.

In a way to synthetize the impact of each parameter over the variables, a Parameter Sensitivity Index (PSI) is proposed, in a similar fashion as the MCI presented in Eq. 2.1, and it is defined in the Eq. 2.3:

$$PSI_{ij} = \left| \frac{\Delta V_i / V_R}{\Delta P_j / P_R} \right| \quad (2.3)$$

, where $\Delta X = \max(X) - \min(X)$, $i \in \{\text{nine variables list}\}$, $j \in \{\text{four parameters list}\}$, V_R the reference variable value and P_R the reference parameter value. This index will then show in positive-only values how the impact of each parameter range ΔP_j will affect the output of each variable a range ΔV_i without, nevertheless, giving any clue of the correlation impact behavior (linear, non-linear, positive, negative).

In the Table 2.4, it can be seen the 36 different PSI. It is easily noticed how each parameter affects each of the nine selected variables to be analyzed. The cortical elastic modulus parameter variation its the most influential in the behavior of the contact opening A and B zones, in the displacement and rotational global magnitudes, and in the

		Max Prin Stress [MPa]	Min Prin Stress [MPa]	Nail Mises Stress [MPa]	Rot Mag [degrees]	Disp Mag [mm]	Open A [mm]	Open B [mm]	Slip C [mm]	Slip D [mm]
Cancellous [MPa]	205									
Cortical [MPa]	16000									
Friction Coeff.	0.1									
Polymer [MPa]	1000									
	50	27.9%	-12.8%	28.5%	35.1%	38.0%	47.5%	33.2%	75.1%	121.9%
Cancellous [MPa]	350	-5.9%	-9.5%	-6.0%	-9.0%	-9.8%	-17.5%	-8.5%	-22.6%	-31.0%
	500	-9.3%	-19.1%	-10.0%	-14.0%	-15.4%	-27.4%	-13.2%	-35.3%	-46.9%
	650	-11.8%	-27.4%	-13.1%	-17.4%	-19.1%	-35.0%	-16.4%	-44.0%	-56.5%
Cortical [MPa]	4000	35.4%	-51.2%	25.9%	45.8%	48.9%	178.1%	30.7%	22.1%	-3.6%
	8000	22.9%	-26.3%	11.9%	20.9%	22.0%	18.8%	15.0%	20.9%	0.0%
	12000	10.6%	-10.9%	4.7%	8.2%	8.6%	7.4%	-11.3%	8.3%	0.6%
	20000	-9.0%	8.2%	-3.3%	-5.9%	-6.2%	-6.0%	-4.4%	-6.0%	-1.1%
Friction Coefficient	0.2	-13.0%	3.7%	-7.9%	-21.2%	-18.2%	-15.6%	-14.7%	-13.5%	-42.1%
	0.3	-24.8%	7.5%	-16.1%	-34.9%	-29.9%	-32.0%	-24.2%	-29.2%	-85.0%
	0.4	-32.0%	-2.3%	-23.4%	-45.2%	-38.9%	-45.7%	-31.9%	-44.5%	-98.3%
	0.5	-34.6%	-14.8%	-23.8%	-54.2%	-46.8%	-57.1%	-39.1%	-58.7%	-98.6%
Nail Polymer Insert [MPa]	400	-2.2%	4.1%	-1.6%	12.8%	11.8%	10.8%	14.0%	6.7%	-2.5%
	700	-0.6%	1.4%	-0.6%	3.8%	3.5%	3.7%	4.1%	2.7%	-1.3%
	1300	0.3%	-0.9%	0.3%	-2.2%	-2.0%	-2.9%	-2.3%	-2.0%	1.1%
	1600	0.4%	-1.6%	0.5%	-3.7%	-3.3%	-4.7%	-3.8%	-3.5%	2.1%

Table 2.3 – **Parametric study results.** At the top-left, the reference parameters (elastic modulus of the cancellous bone, cortical bone and nail polymer insert, and the friction coefficient between the bone fragments), and at the top-right, the reference values. Each group of rows represented by a parameter shows the variation and its variation rate, in percentage, relative to the reference value (i.e. a positive percentage value in the maximum principal stress implies a higher or more positive value, while for the minimum principal stress means a lower or more negative value). The light-gray lines shows the position of the original parameter value, in which the variation rate is zero.

maximum principal, minimum principal and IM nail Von Mises stresses. In other words, the cortical bone variation is of capital importance for this static analysis. As previously stated, it should however be noted that the PSI does not show the causality behavior of the variable change in relation with the parameter variation. Indeed, the most significant repercussion of the cortical bone elastic modulus variation occurs only below the 8000 MPa, as already found out in the Table 2.3, information not stipulated by the PSI.

The rest of the PSI values shows how the cancellous bone parameter variation has its greater impact on the contact slipping zones C and D, and how the friction coefficient and IM nail polymer insert parameter variations has a much more mitigated impact in the variables change.

2.4 Conclusions

In this chapter, we developed and tested a new finite element model of an unstable proximal humerus fracture based on the available open-access medical images database “Visible Human Project” [Ackerman, 1998], osteosynthesized with an intramedullary nail. Several assumptions have been made in order to simplify the modeling and optimize the simulation running times, such as homogeneous isotropic elastic behavior of the bone and equivalent loads simulating the muscle-wrapping scenario of an abduction.

First, a mesh convergence study was performed to optimize the mesh size and the computation time. Then, in order to simplify the pull-out test with the rope, it was successfully proposed to replace the rope by an external force torsor mimicking the effect of the rope on the bone. Finally, in order to assess the behavior of this model under different mechanical behavior of the bone, a sensitivity study of the parameters involved in the finite element calculation was performed. The detailed parametric study has shown that the stiffness of the cortical bone is the most influential parameter on the state of stress in the humerus, the displacements and angles between the bone fragments and the

Cancellous	0.1355	0.0937	0.1423	0.1794	0.195	0.2818	0.1694	0.4067	0.6097
Cortical	0.4434	0.5937	0.2921	0.5172	0.5509	1.841	0.4199	0.2804	0.0426
Friction	0.0865	0.0558	0.0596	0.1354	0.117	0.1428	0.0977	0.1468	0.2465
Polymer	0.0218	0.0468	0.0174	0.137	0.1257	0.1292	0.1487	0.0853	0.0379
	Max Prin Stress	Min Prin Stress	Nail Mises Stress	Rot Mag	Disp Mag	Open A	Open B	Slip C	Slip D

Table 2.4 – **Parameter Sensitivity Index (PSI) table that estimates the impact of the variation of the variables (columns) in relation to the variation of the parameters (rows).** The higher the index, the most impact a parameter variation has over the variable. The parameters are the elastic modulus of the cortical bone, cancellous bone and the nail polymer insert, and the interfragmentary friction coefficient. The variables are the maximum and minimum principal stress measured at the humeral bone, the Von Mises maximum stress at the nail, the rotation and the displacement of the humeral head, and the opening and slipping interfragmentary displacements.

contact zones, i.e. on the static analysis.

As any other FE model present in the literature, this numerical model has some limitations in terms of validation with the restricted available experimental data. In order to improve it, we propose to develop an experimental set-up to not only feed the finite element model but also to validate it through structural tests. This work is presented in the next chapter.

Chapitre 3

Conception d'un cadre d'essais expérimentales pour les fractures de l'humérus proximal

Dans ce chapitre, nous proposons la conception d'un cadre d'essais expérimentales afin d'approfondir dans l'étude et la caractérisation de l'humérus proximal sous conditions mécaniques physiologiques, à l'aide d'une machine d'essai universelle à mono-vérin. Cela comprend un équipement de fixation mécanique de l'humérus de conception interne qui s'adapte dans le vérin d'une machine d'essai universelle, un système de stéréo-corrélation numérique d'images afin d'avoir accès aux champs de déplacements et des déformations surfaciques de l'humérus, ainsi qu'un protocole pour tester deux cas de fractures instables de relevance clinique : à 2 fragments comminutive médialement au niveau du cou anatomique, et à 4 fragments au niveau des tubérosités. Les résultats issus de la campagne expérimentale nous montrent que le cadre d'essais proposé est fonctionnel pour des cas de sollicitations mécaniques physiologiquement équivalentes et les données, exploitables pour une étude comparative ultérieure avec un autre modèle in vitro ou in silico.

Design of a testing framework for osteosynthesis devices in proximal humerus fractures

3.1 Introduction

As discussed in the previous chapter, it is a challenging task to develop an *in silico* model to understand the biomechanical behavior of osteosynthesis devices. The parametric study performed by FE simulations has shown that several parameters have to be carefully chosen. Some parameters are strongly linked to the experimental conditions. However, there is a lack of data in the experimental works that does not allow to exactly define the boundary conditions. What is more, there is a lack of consensus when choosing the right osteosynthesis device among the clinicians, as a non-negligible number of proximal humerus fractures (PHF) are unstable and therefore requires open reduction and internal fixation [Clavert *et al.*, 2010]. Consequently, a testing apparatus has been developed to get to all the information needed to build an accurate *in silico* model.

Of course, several different custom-made testing apparatuses that help elucidating the behavior of reduced proximal fractures under different mechanical charges mimicking the physiological loading, have been developed and proposed in literature. For instance, the works of [Dahan *et al.*, 2016] or of [Seide *et al.*, 2007] are based on a compression load applied to the humeral head (physiologically similar to a force applied in the extended arm axis). In other works, such as in [Lin *et al.*, 2015] or [Clavert *et al.*, 2016], the experimental setups allows to reproduce a pulling load (physiologically similar to an arm abduction/rotation/extension) in which the mechanical loads mimic the forces exerted by the muscles of the rotator cuff. In [Brianza *et al.*, 2010] (see Figure 3.1A), a testing set-up consisting of a cardan-joint for the fixation of the distal part of the diaphysis and a PMMA-cup for the head compression (simulating the glenoid) was proposed. The pulling forces at the great tuberosity were independently controlled by a torsional actuator using a cable and two pulleys. [Varga *et al.*, 2017] (see Figure 3.1B) proposed as well a cardan-joint device for the distal fixation and a PMMA-cup acting as a glenoid for the compressive forces at the proximal humerus (head). Nevertheless, there are no pulling forces acting in this set-up. [Seide *et al.*, 2007] (see Figure 3.1C) developed, in turn, a particular fixture, having mounted the distal humeral shaft on a metal ball to allow ball-joint degrees of freedom. The proximal humerus (head) was compressed using a Teflon cup to simulate the glenoid cavity. As for [Euler *et al.*, 2017a] (see Figure 3.1D), both the proximal head and the distal part (diaphysis) were embedded in

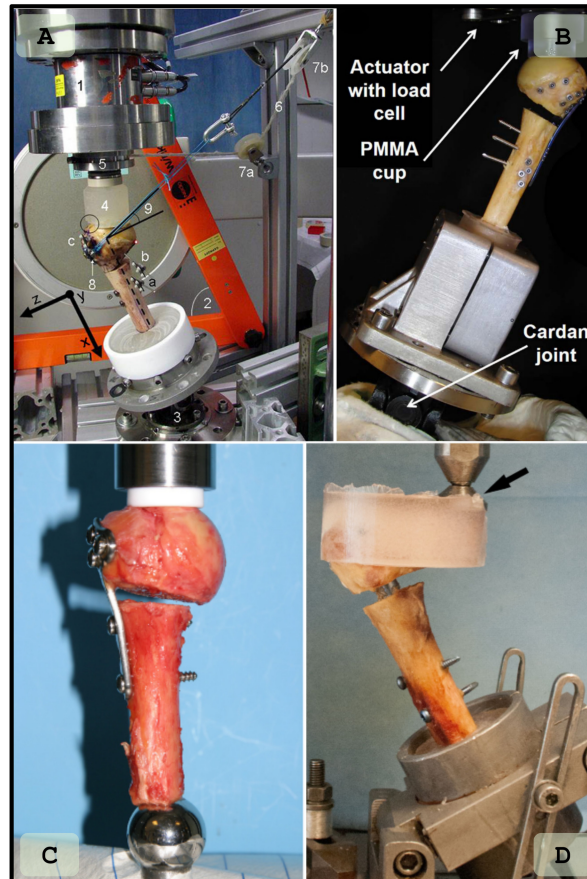

Figure 3.1 – **Custom-made fixtures for proximal humerus testing.** **A:** Fixture for a bi-axial testing machine presented in [Brianza *et al.*, 2010]. **B:** Fixture for an uni-axial testing machine presented in [Varga *et al.*, 2017]. **C:** A simple fixture for an uni-axial machine presented in [Seide *et al.*, 2007]. **D:** Fixture developed and presented in [Euler *et al.*, 2017a].

PMMA. Then, using an angle-varying device, the distal part was fully fixed while the head was supported with a ball-joint, for a compression-only test.

From the literature review, the biomechanical evaluation of osteosynthesis devices can be conducted in quasi-static conditions or in fatigue. Even if fatigue tests seem more relevant, the present work focuses in quasi-static loading conditions.

What is more, the data it can be obtained from the mechanical tests may require further development of strategies in the acquisition. In [Grassi et Isaksson, 2015] and in [Barak *et al.*, 2009], a literature review is done showing different types of measurements commonly used in the biomechanical field. The main devices for such measurement are presented:

- Strain gauges: small devices whose electrical resistance is changed when subjected to a mechanical deformation in a single or multiple axes. They can be glued at the surface of certain critical zones of the bones. The electrical properties change can be related to a local accurate strain measurement.
- Fibre Bragg grating sensors: a device with a combination of fibers with different refractive index, in which the change at the periodicity of the grating is related to a mechanical stretching of the fibers. This devices are particularly useful for the strain measurement at the interface between two materials (e.g. bone and a prosthesis).
- Digital Image Correlation: an image-based measurement system in which a series of image shots of a randomly-

textured object subjected to mechanical forces can result in a 2D full-field strain measurements. This is done using an array of a single or multiple cameras.

- Digital Volume Correlation: in biomechanics, it is a volume-based measurement system obtained from a series of tomographic shots of a mechanically tested sample. It is particularly used for the bone characterization as its near-random internal structure is well suited for this type of analysis, and it's the only known method able to deliver a 3D full-field strain measurement.
- Polariscope: a no-contact, stress-measurement system relying on the birefringence property that is modified when a transparent object is illuminated with polarized light. Although is the only known method for a direct stress measurement, the main limitation is that only few materials shows this property in which the refractive index is anisotropic.
- Holographic interferometry: a strain-measurement method that relies on the interference caused by a double holographic exposure of a sample in an unloaded and loaded state.
- Electronic speckle pattern interferometry: an optical method based on a coherent source of light (e.g. a laser) illuminating an optically-rough surface. This surface will allow the reflected light beams to interfere with themselves, creating a grainy image. When subjected to mechanical loads, the difference in the speckle of the unloaded and loaded images can give an estimation of the strain field at the surface.

Among the different measurement techniques, the strain gauges and the digital image correlation (DIC) are the most used methods in the biomechanical field [Grassi et Isaksson, 2015]. The main advantage of the strain gauges is the ease and reliability of its use. Its main limitation is the overly-local strain measurement, perhaps not well suited for heterogeneous structures such as the bone. As for the DIC the main advantage is the ability to provide full-field strain measurements with relatively few instruments (e.g. a camera). Its main limitation is the lack of rigorous studies in the literature for the optimal parameters needed in the biomechanical field.

The proposed main goal of this work is to develop an experimental setup which allows to mimic different loading conditions as well as different fracture types on proximal (cadaverous or synthetic) humeri, able to provide enough data to validate *a posteriori* a FE model. The present chapter is structured as follows. First, a fixture design is justified and proposed. Then, the proposed experimental framework is presented for a dual scenario: compression and pulling loads applied on proximal humeri with an osteotomy. The osteosynthesis device used in the work is an Aequalis© Intramedullary (IM) Nail (Tornier©, part of Wright Inc.) and it was implanted in synthetic proximal humeri (4th generation humerus Sawbone ©). Next, the results of a set of experimental tests are presented with a special emphasize on force-displacement curves and strains distributions. The experimental results of this work should give a better understanding of the biomechanical behavior of implanted proximal humerus. Finally, this work provides experimental results that will be helpful for the assessment of *in silico* models of the proximal humerus.

3.2 Custom-made fixture design

3.2.1 State-of-the-art

To validate a FE model of bone-implant construct, it is necessary to carry out biomechanical tests to establish its behavior. By designing and using our own test apparatus, the access to important data is controlled and guaranteed. For instance, loading conditions are clearly defined and thus known. Furthermore, global and local results will be provided such as: load-displacement data, interfragmentary displacements, strains, etc.

Consequently, it was decided that the proximal humerus-nail constructs would be investigated with biomechanical tests. The tests will be performed on the mechanical universal testing machine available in our research group (Servo-hydraulic Instron© 8500 two-columns, single-axis universal testing machine rated to 50kN). Using the load cell of the testing machine, the load-displacement data will be provided. The custom fixture must therefore be able to adapt to this testing machine. Moreover, it is aimed that the custom fixture would allow to use several physiological loading configurations. Finally, the motions of each humerus fragment have to be tracked and recorded.

In general, the different custom-made testing devices test for either a compressive charge applied to the humeral head (physiologically similar to a force applied in the extended arm axis), either a pulling load (physiologically similar to an arm abduction/rotation/extension) in which the charges mimics the loads of the main rotator cuff muscles. This is synthesized in the Table 3.1. Despite the variety of test configurations proposed in the literature when it comes to biomechanically evaluate the osteosynthesis devices, we are still able to remark the common ground in three fields: the loading type, the type of test and the proximal/distal interactions.

In Table (3.1), different custom-made testing devices replicate either a compression load applied to the humeral head (physiologically similar to a force applied in the extended arm axis) or a pulling load (physiologically similar to an arm abduction/rotation/extension) that mimics the load of the main muscle of rotator cuff. The pulling forces nevertheless seems to be the most physiological load to evaluate osteosynthesis devices for PHF, as the main loads are made by the rotator cuff. When performing a flexion or an abduction, it has been proven that the maximum moment arms are achieved by the supraspinatus and the infraspinatus muscles at the greater tuberosity (GT) and by the subscapularis muscle at the lesser tuberosity (GT) [Ackland *et al.*, 2008]. This is particularly true at the beginning of the abduction movement. Then the pectoralis and deltoid muscles (inserted at the diaphyseal zone) take over for the rest of the movement [Wuelker *et al.*, 1995]. Thus, pulling loads at the GT and LT should be a crucial loading scenario during a biomechanical testing, as displacement failures in a reduced unstable PHF tends to be directly correlated to flawed osteosynthesis devices, that fails to properly support such pulling loads at the horizontal plane [Boileau *et al.*, 2015]. Moreover, the pulling test conditions should account a convenient glenoid support, as most of the pulling loads acting at the humeral head are equivalent to passive compression loads when assuming a free-body diagram of the humerus [Yanagawa *et al.*, 2008], in which the maximum compression-equivalent contribution are made by the supraspinatus, subscapularis and infraspinatus muscles. Except in few research works [Brianza *et al.*, 2010, Rothstock *et al.*, 2012, Clavert *et al.*, 2016], this principle is often not fully respected when evaluating screws, fixation plates or intramedullary nails (IMN) at the proximal humerus. Instead, the compression load become the main active mechanical charge, which might not accurately demonstrate a proper tuberosity fixation [Boileau *et al.*, 2015]. This active compression load might however be relevant when studying highly unstable fractures at the surgical neck, often

Loading type	Type of test	Proximal Interaction	Distal Interaction	Force Max [N]	Max Number Cycles	Reference
Bending	Fatigue	Encastred	Free	110	25 000	[Chow <i>et al.</i> , 2012]
Compressive	Fatigue	Ball-joint	Rotational bearing	315	7 600	[Röderer <i>et al.</i> , 2013]
Compressive	Quasi-static & Fatigue	Ball-joint	Ball-joint	95	1 000 000	[Seide <i>et al.</i> , 2007]
Compressive	Fatigue	Ball-joint & Knee	Encastred	1 000	2 000	[Euler <i>et al.</i> , 2017a]
Compressive	Fatigue	Ball-joint	Cardan-joint	100	16 400	[Varga <i>et al.</i> , 2017]
Compressive	Quasi-static	Ball-joint & Free Sliding	Encastred	3 000	n.a.	[Dahan <i>et al.</i> , 2016]
Compressive & Pulling	Quasi-static & Fatigue	Ball-joint & Pulling device	Cardan-joint	1 450	10 000	[Brianza <i>et al.</i> , 2010]
Compressive & Pulling	Quasi-static & Fatigue	Ball-joint & Pulling device	Cardan-joint	1 200	20 000	[Rothstock <i>et al.</i> , 2012]
Compressive & Torsion	Quasi-static & Fatigue	Ball-joint & Knee	Encastred & Free-sliding	350	9 450	[Unger <i>et al.</i> , 2012]
Compressive & Torsion	Quasi-static	Encastred	Encastred	n.a.	n.a.	[Maldonado <i>et al.</i> , 2003]
Pulling	Quasi-static	Pulling device	Encastred	255	n.a.	[Craft <i>et al.</i> , 1996]
Pulling	Quasi-static	Pulling device	Encastred	1 900	n.a.	[Gaudelli <i>et al.</i> , 2014]
Pulling	Quasi-static	Pulling device	Encastred	800	n.a.	[Lin <i>et al.</i> , 2015]
Pulling	Quasi-static	Pulling device & Head support	Encastred	720	n.a.	[Clavert <i>et al.</i> , 2016]
Multi-point Pulling	Cyclic Range-Of-Motion	Ball-joint	Shaft linear bearing	500	500	[Kathrein <i>et al.</i> , 2013]

Table 3.1 – Non-exhaustive list of different custom-fixation testing devices for Proximal Humerus.

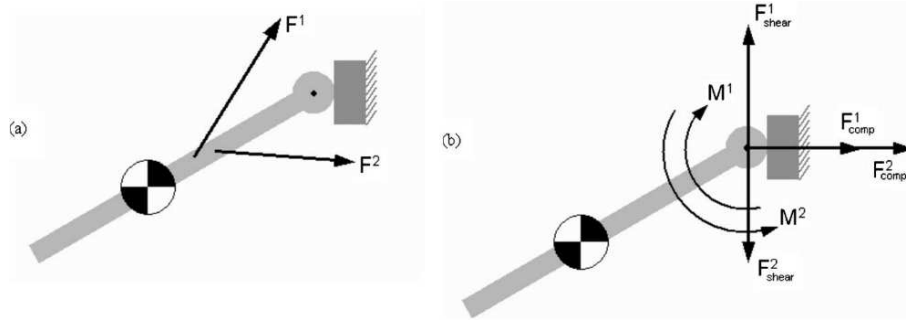

Figure 3.2 – **Muscle forces decomposition.** Diagram showing the basis of the decomposition of the muscle vectors (a) into compressive and shear loads, as well as moments (b) at the center of the hinge-like joint. [Yanagawa *et al.*, 2008].

simulated by an osteotomy [Brianza *et al.*, 2010, Maldonado *et al.*, 2003]. The typical applied forces (in compression and in traction) vary along a widespread range of values, being 3kN the max compressive force and 1,9kN the max pulling force observed at the Table 3.1. The same for the fatigue tests, most of the authors targeted a low cyclical set, ranging from 500 to 25 000 cycles per sample. Only one author [Seide *et al.*, 2007] used a high cyclical ($> 1\ 000\ 000$) set for the mechanical tests.

3.2.2 Proximal and distal interactions

At the Table 3.1, we can divide the proximal interactions in two large groups: ball-joint interaction for the compressive loading devices and a simple pulling device for the tension loading devices. With the exceptions of [Chow *et al.*, 2012, Maldonado *et al.*, 2003], focused only on bending loads in the reduced fractures with an osteotomy gap at the surgical neck, the need ball-joint interaction seems a relevant choice when it comes to simulate the glenoid fossa, inherently unstable except under a limited range of compressive loads. It is important to remark here that part of the challenge when it comes to evaluate the biomechanical devices is to reproduce as much as possible the anatomical conditions, and therefore, the glenohumeral congruency, which certainly happens only under this type of loads. However, as seen in the Chapter 1, the proximal humerus is mainly loaded in tension due to the rotator cuff muscles. Among other, the compressive loads are therefore the resultant of the anatomical forces by which the humerus is being subjected to. This is better described in [Yanagawa *et al.*, 2008], and synthesized in the Figure 3.2. For a proper evaluation of an osteosynthesis device for PHF, it is hence necessary to reproduce the shearing loads and the moments as well. This can be done using a pulling device as in [Brianza *et al.*, 2010, Rothstock *et al.*, 2012, Clavert *et al.*, 2016], as well as the head support to prevent the diaphyseal bending (as in [Craft *et al.*, 1996, Gaudelli *et al.*, 2014, Lin *et al.*, 2015], which could not be properly adapted to thoroughly evaluate PHF).

As for the distal interactions, the list can be roughly divided into two groups: fixed and using a cardan-joint. The former facilitates the reproducibility of the tests by restraining the available degrees-of-freedom (DOF) and the later allows a managed range-of-motion of the diaphyseal segment and facilitates the angle positioning of the bone. As the ultimate purpose of the fixture to develop is to make reproducible tests to validate an *in silico* model (discussed in the Chapter 4), a fixed interaction, but with angle positioning seems to fulfill the needs, as in [Euler *et al.*, 2017a, Dahan *et al.*, 2016].

3.2.3 Features

With the above information, we are able to identify a number of requirements for an apparatus able to perform a biomechanical evaluation of proximal humerus-implant constructs:

- Two type of tests should be considered: fatigue and quasi-static.
- The distal zone of the proximal humerus should be recessed to minimize the total displacements when charging under load the bone.
- The proximal interaction should allow a compression and a pulling load in a single-axis fashion, to avoid undesirable lateral or torsional forces.
- The fixture should be able to be loaded in compression and traction.
- In order to simulate the glenohumeral joint, a humeral head support should be contemplated.

3.2.4 Final concept

A custom-made fixture was designed taking into account the main aspects of the different fixtures already analyzed in the literature (Figure 3.3). The main structure has been designed and manufactured in AISI 304 stainless steel. The structure is composed in a plate fixed to the machine hydraulic piston, a moving base that allows the translation of the fixture, a base with a receptacle in which the bone is embedded with a synthetic resin and a head support. It allows three possible loading configurations : pulling-only, pulling with head support and compression-only. The angle variation of the base ranges from 0 to 90° (in regard of the diaphyseal axis) and the clamping is done with two shrink disks (HPC Europe© TTQ30-45-OE) at each side of the diaphyseal support. The head support able to mimic the glenoid support can rotate up to almost 300° (though the average angles used should be within the 90° range to keep up with a proper physiological setup) and is clamped using a bolt-and-nut configuration.

The most critical parts of this fixture are the shrink disks. Each shrink disk is rated to stand up to 541 Nm for transmissible moment and up to 36 kN for transmissible force. The center axis of the shrink disks being 20 mm above the bottom of the receptacle, for an average 170 mm length proximal humerus bone the **maximum allowed tensile or compressive force off-axis** of the testing machine (base angle $\neq 0^\circ$) is $2 \times 541 \text{ Nm} / (0.17 \text{ m} - 0.02 \text{ m}) \approx 7.2 \text{ kN}$. As for the **maximum allowed tensile or compressive force on-axis** of the testing machine (base angle = 0°) is **> 50 kN**.

In the Figure 3.4, an exploded view of the full fixture assembly is shown, along with each component. The bill of materials (BOM) is available in the Table 3.2. The detailed technical drawings and the instructions on how to assembly it are available in the Annex B.

For the compression load application, a bi-concave adapter (article number 12 at the BOM, Table 3.2, also called “cup”) was designed to adapt a ball-joint support with the humeral head, partially reproducing the glenoid fossa. Nevertheless, the contact between the stainless steel cup and the bone might create undesirable stress concentration zones in the bone surface due to the significant difference in the material’s elastic modulus (200 GPa for stainless steel versus 16 GPa for the cortical bone). This was confirmed with a finite-element simulation that showed important and localized stressed zones around the contact with the cup, as both spherical surfaces are not fully congruent. Therefore,

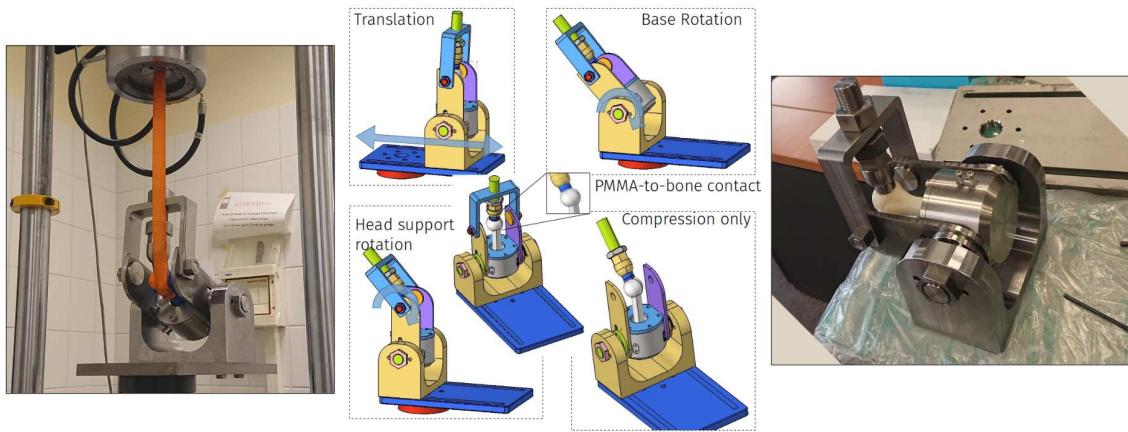

Figure 3.3 – **Typical custom fixture configurations.** The photos at both sides show an example of a tensile or pulling test with head support.

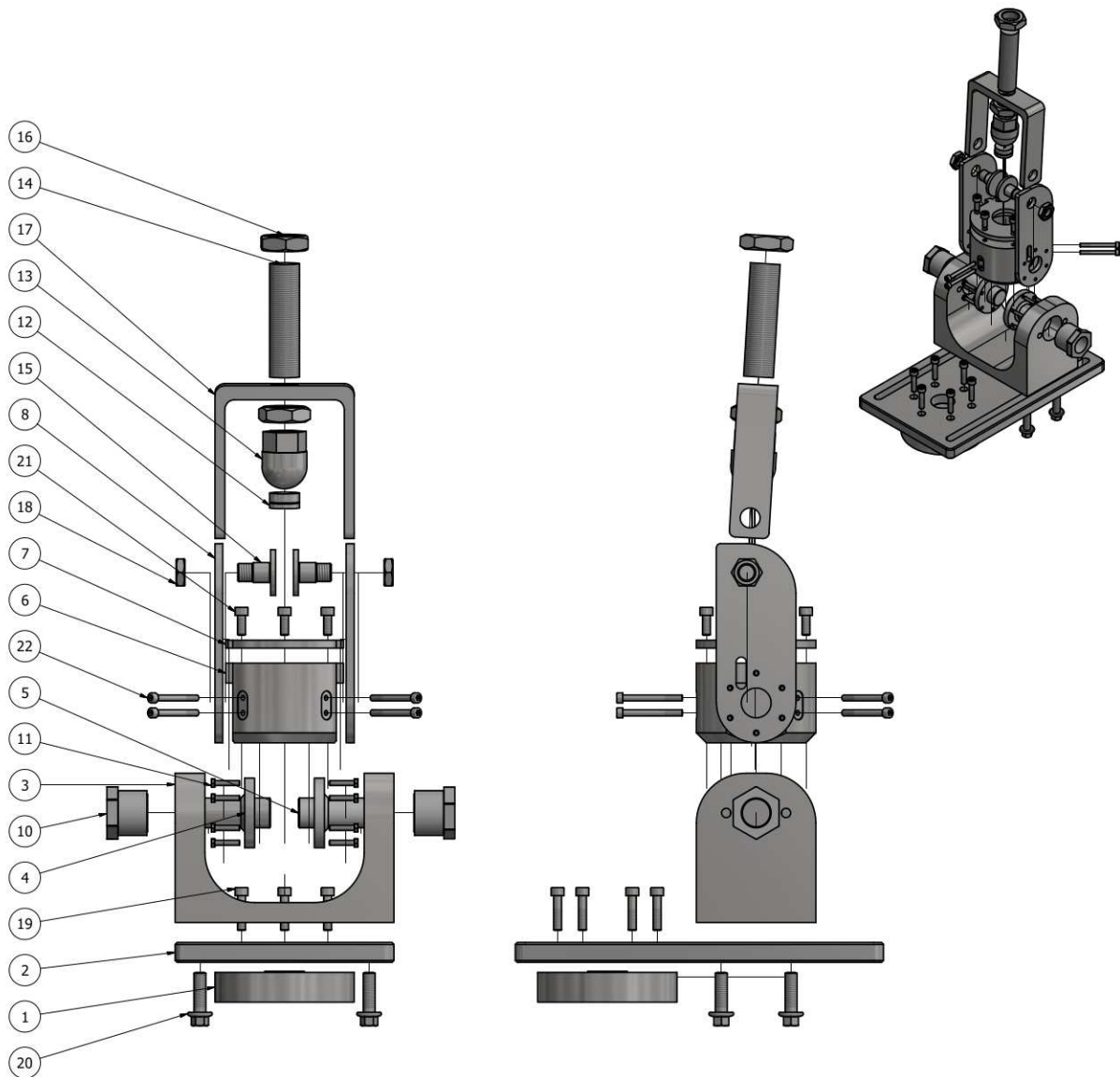

Figure 3.4 – **Exploded view of the custom-made fixture for proximal humerus testing.** The bill of materials is available at the Table 3.2

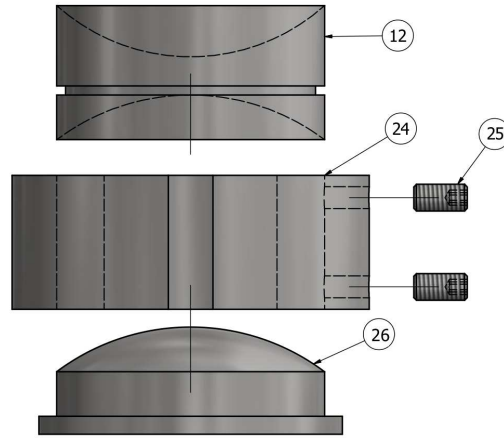

Figure 3.5 – **Exploded view of the mold concave adapter.** For the compression and the head support, a PMMA concave cup can be made by filling in this mold. The bill of materials is available in the Table 3.2.

we proposed to add an intermediate layer of a softer material (such as a synthetic resin) in order to decrease the stress concentration zones around the bone contact surface. For this, we designed a small ring-shaped mold with the bi-concave adapter and a lid to contain a resin during the polymerization process. It is shown in the Figure 3.5. Once the poured material is hardened, the ring mold and the lid are taken apart and the resin adapter put between the cup and the humeral head.

3.2.5 Fixture user’s guide

In this subsection we detail the instructions on how to use the fixture for the three design cases: pulling only, pulling with head support and compression. For any case, there are certain preparation steps when positioning the proximal humerus. As most of the cases a resin will be used to embed the bone to the fixture, the releasing screw holes (Figure 3.9) at the bottom of the receptacle (BOM art. # 6) should be covered with a nonstick clay, such as playdough, in order to avoid the resin in its liquid state to penetrate through the threaded holes. Then, it is highly recommended to apply a layer of mold release agent in the receptacle, under the lid (BOM art. # 7) and around the centering screws (BOM art. # 22), in order to facilitate the resin block removal. Naturally, the bone should not be in contact with the mold release agent.

With the lid in place, the bone is inserted in the receptacle, using the centering screws to keep it in place, as illustrated in the Figure 3.6A. To guarantee the reproducibility of the bone positioning, we recommend using a protractor template and a custom-designed stick to orient vertically the bone and to adjust the rotation angle using anatomical landmarks such as the intertrabecular groove. This operation is illustrated in the Figure 3.7. Once the bone is in the desired position and orientation, a first layer of resin is poured over the receptacle. We recommend pouring just below the centering screws level, to avoid embedding them with the hardened resin. Based on our experience, even with the release mold agent covering the threaded area, the centering screws can be hard to remove when fully embedded with the polymerized resin due to their length (60 mm). Hence, once the first layer of resin hardened, the centering screws can be partially unscrewed back leaving around a 10 mm of the threaded screw tip inside the receptacle. After this, the rest of the resin can be poured in (see Figure 3.6B). This will prevent any rotation of the full resin block inside the receptacle.

Article	Qty.	Name	Material	Note
1	1	Machine Adapter	Steel	
2	1	Plate	Stainless Steel	To manufacture
3	1	Base	Stainless Steel	To manufacture
4	2	Main Pivot	Stainless Steel	To manufacture
5	2	Pivotal rods	Stainless Steel	To manufacture
6	1	Receptacle	Stainless Steel	To manufacture
7	1	Lid	Stainless Steel	To manufacture
8	2	Lateral support	Stainless Steel	To manufacture
10	2	Shrink Disk HPC TTQ30-45-OE	Steel	
11	12	Screw CHC, M5×25	Stainless Steel	
12	1	Bi-concave adapter “cup”	Stainless Steel	To manufacture
13	1	Ball-joint support	Stainless Steel	To manufacture
14	1	Threaded rod M30×2, 114m long	Stainless Steel	To manufacture
15	2	Head support pivot	Stainless Steel	To manufacture
16	2	Fine-threaded Nut H M30	Stainless Steel	To manufacture
17	1	Head support “horseshoe”	Stainless Steel	To manufacture
18	2	Nut H, M18	Stainless Steel	
19	6	Screw CHC, M8×35	Stainless Steel	
20	4	Screw H, M12×40	Stainless Steel	
21	6	Screw CHC, M8×20	Stainless Steel	
22	8	Screw CHC, M6×60	Stainless Steel	
24	1	Mold Ring	Stainless Steel	To Manufacture
25	2	Headless screw HC, M3×6	Stainless Steel	
26	1	Mold Lid	Stainless Steel	to Manufacture

Table 3.2 – **Bill of materials of the custom-made fixture.** The drawing is shown in the Figure 3.4.

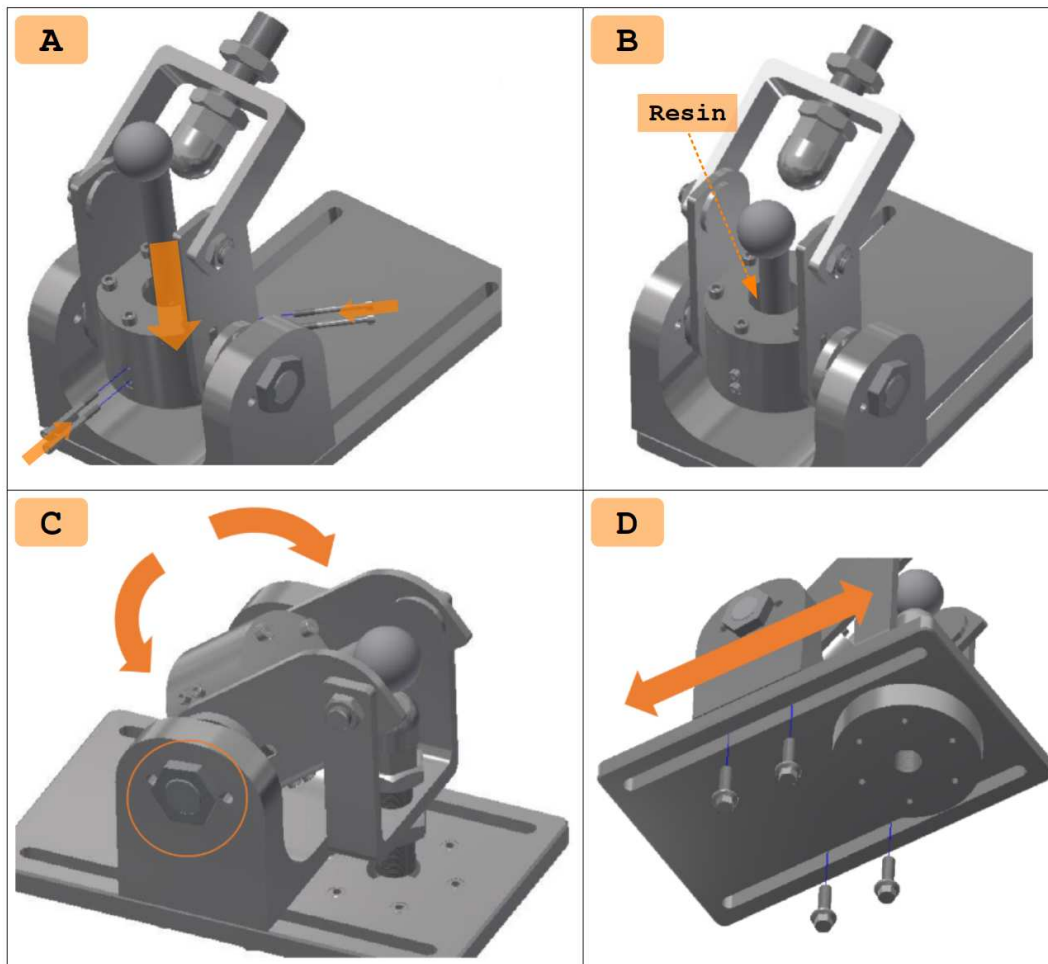

Figure 3.6 – **Bone centering and fixture base positioning.** **A:** With the receptacle with a layer of mold release agent and playdough filling in the bottom screw holes, the bone is placed inside the receptacle and centered using the 6 lateral screws (BOM art. # 22). **B:** Once the bone is in its position, the resin is poured over the receptacle. **C:** The base can be rotated by loosening the shrink disks with a 42 mm wrench. Once positioned, the shrink disks are tightened again. **D:** The base translation is necessary to align the humeral head with the testing machine axis. This is done using the 4 screws at the bottom of the plate. For a tensile test without head support, it can be either rotated to avoid interactions or completely removed.

Based on the desired configuration for the mechanical test, the base (BOM art. # 3) can be either rotated (see Figure 3.6C) or translated (see Figure 3.6D). Usually the rotation is to satisfy a specific testing condition (i.e. a particular abduction angle) and the translation is to keep the humeral head in the same axis of the universal testing machine. For the rotation, each shrink disk (BOM art. # 10) is carefully loosened using a 42 mm wrench and the base is then pivoted to the desired orientation. We recommend using a custom-tailored protractor placed on the shrink disk in order to better control the measured angle, as in the Figure 3.7. Once the adequate orientation is found, the shrink disks are then tightened up to 200 Nm. As for the translation, the bottom screws (BOM art. # 20) of the plate (BOM art. # 2) are loosened and the base displaced to a position in which the loading axis of the testing machine coincides with the humeral head. Then, the screws are tightened.

As stated before, we recommend using a resin-molded adapter between the bi-concave adapter (BOM art. # 12), also called “cup” and the bone, as the lack of it could induce unwanted locally-concentrated zones of stress on the bone surface. For this, we use the mold ring (BOM art. # 24) along with its lid (BOM art. # 26) on one side and the cup on the opposite side, creating a mold chamber, as in the Figure 3.5. With the aid of the small screws (BOM art. # 25), both the lid and the cup are kept in place. A small window between the screws was anticipated in order to pour

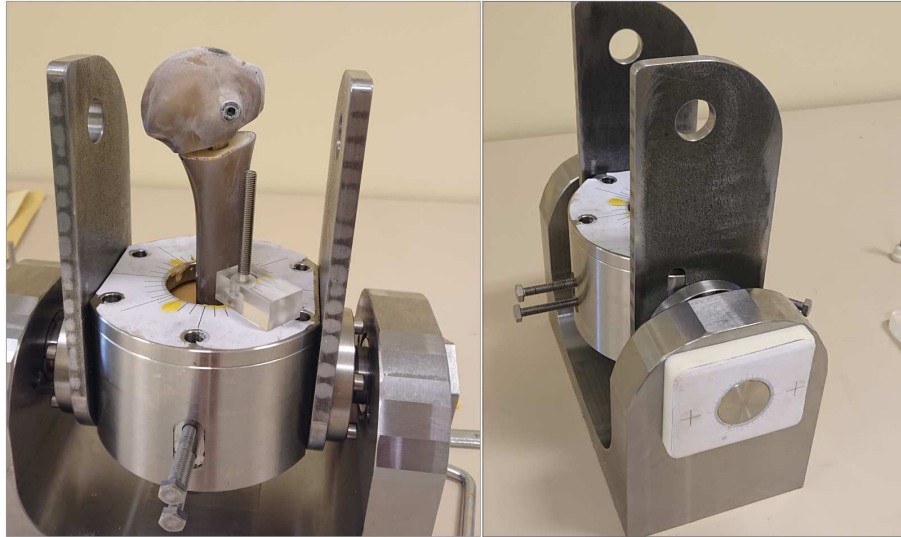

Figure 3.7 – **Bone positioning templates.** A printed custom protractor is glued on the top of the lid and on the lateral base shrink disk to verify the angle positioning of the humerus in two planes. The transversal-plane angle is controlled with the aid of a acrylic base with a screw stick that matches the intertrabecular groove.

the liquid resin. As for the receptacle, we also recommend applying a thin layer of mold release agent in the internal cavity of the mold prior to the resin application.

For the **tensile (pulling) only test** case, after completing the steps detailed in the Figure 3.6, the bone along with the fixture are ready to be tested. Nevertheless, for the cases in which the ball-joint and the cup are needed, further alignment steps are required. For the **tensile test with head support**, once the bone along with the receptacle are oriented according to the specifications, the cup and the resin adapter are placed over the humeral head, making sure that the the cup's circular groove is closer to the bone. This, because the radii in both concave surfaces are different. This step is illustrated in the Figure 3.8A. Then, the head support is aligned with the loading axis of the testing machine as seen in the Figure 3.8B. The threaded rod is placed along with the ball-joint. Finally, the rod and the ball-joint are tighten so the humeral head is slightly compressed (supported) by the cup once the tensile tests using a strap or a string are done.

The **compression test** case requires as well to orient the base to a desired angle and the humeral head aligned with the loading axis of the testing machine. Then, the cup and the resin molded adapter are placed over the humeral head, while the ball-joint is screwed on the upper cross-head of the testing machine, as illustrated in the Figure 3.8E. Once the good positioning of the bone is found, the actuator of the testing machine is moved so the ball-joint slot in the cup. For all the cases, we recommend applying a thin layer of oil between the ball-joint and the cup.

Once the tests are concluded, we need to follow a particular procedure to remove the bone from the fixture. First, the centering screws must be completely removed from the receptacle. Then, the lid screws (BOM art. # 21) are also removed, but keeping the lid in place. After this, using a wrench, the releasing screws (see Figure 3.9) are turned they pushes out the block of the bone along with the resin. Finally, the bone can be pulled out and the resin block cracked up to free the lid.

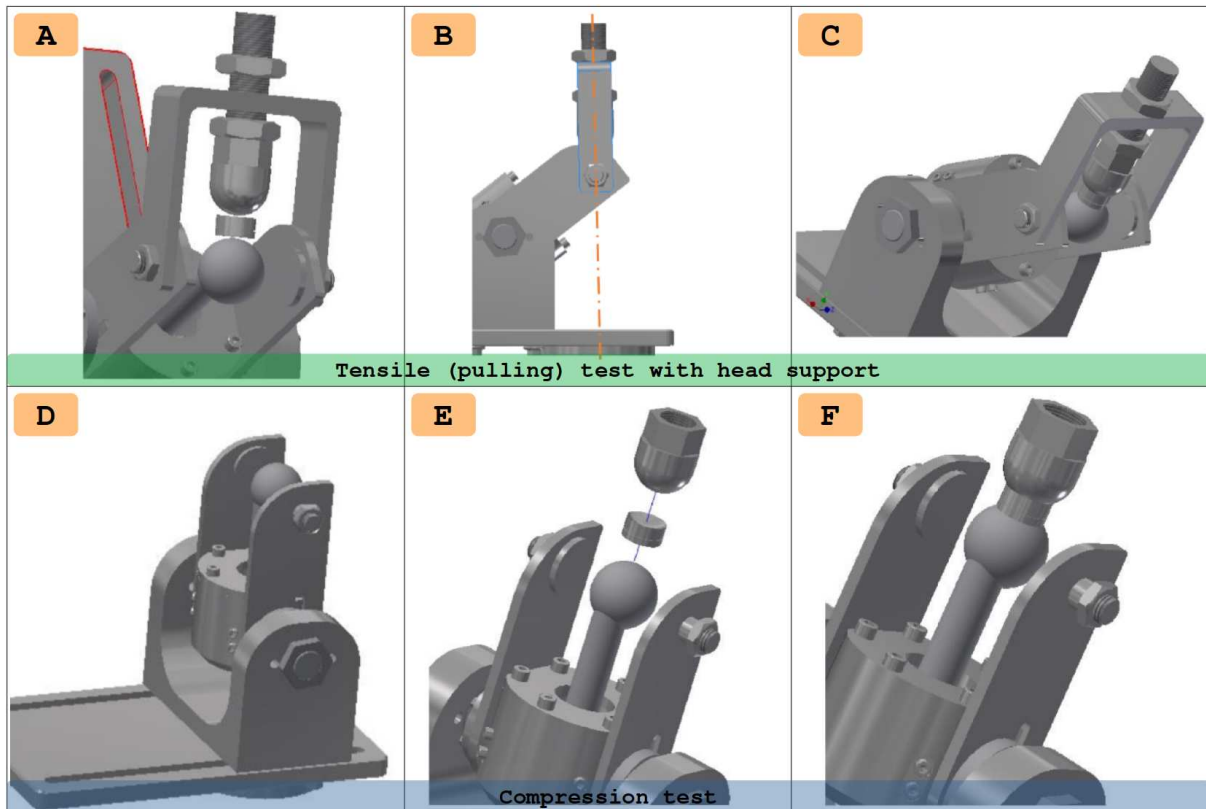

Figure 3.8 – Tensile and compression test fixture positioning. **A:** For a *tensile test with head support*, place the bi-concave adapter between the ball-joint and the bone, the circular groove closer to the bone. If there is a resin molded adapter, place it between the bi-concave adapter and the bone. **B:** Center the head support rod to the testing machine axis. **C:** Tighten the rod and the ball-joint in order to apply a small compression to the humeral head. **D:** For a *compression test*, rotate the base to the desired angle and place it so the humeral head is aligned with the machine axis. **E:** Adapt the ball-joint to the upper cross-head and place the bi-concave adapter (and the resin molded adapter if any) above the humeral head, the circular groove closer to the bone. **F:** Move the testing machine actuator so the ball-joint is positioned on the bi-concave adapter.

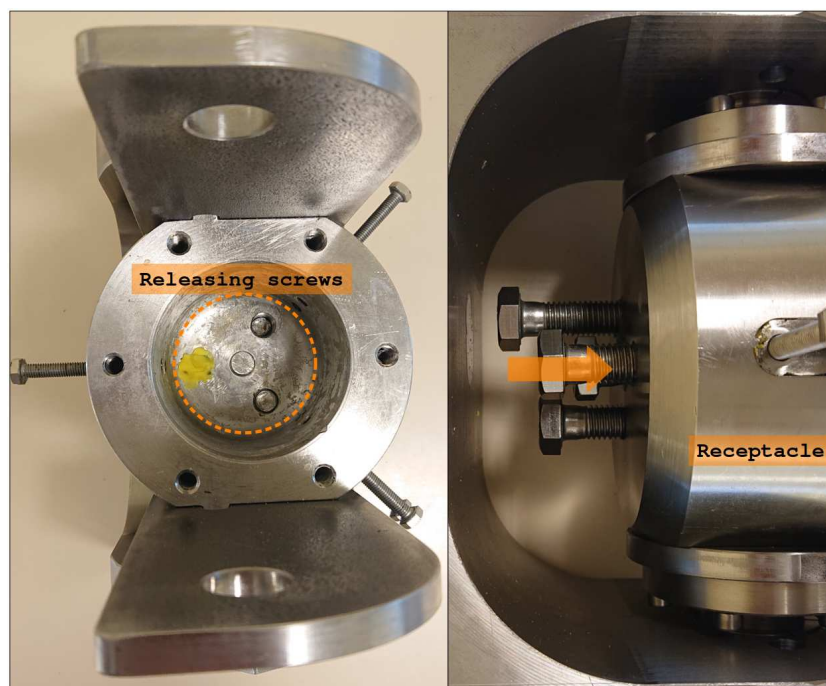

Figure 3.9 – **Releasing screws.** Once the mechanical test is done, this screws aids the extraction process of the bone along with the resin.

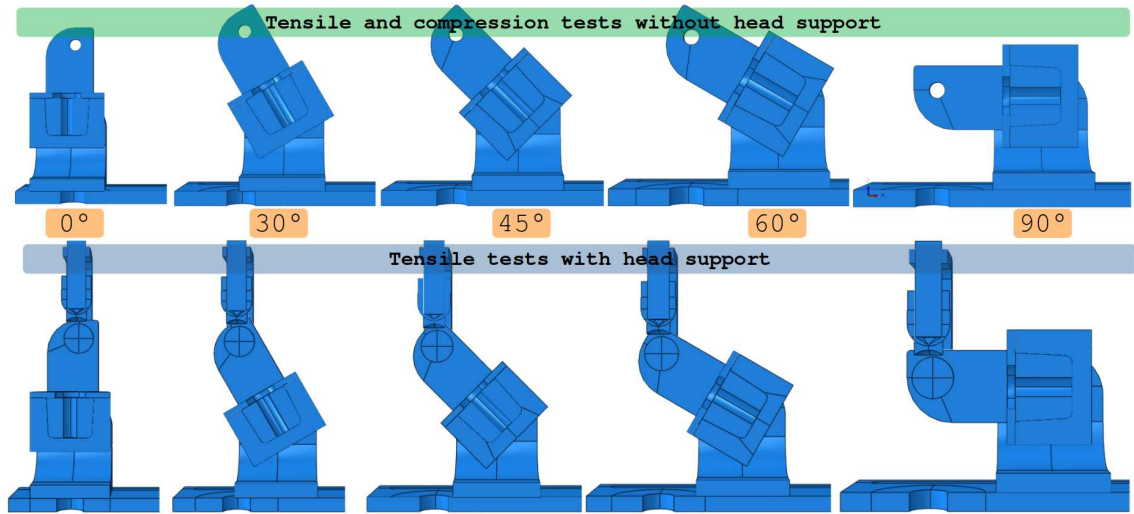

Figure 3.10 – Series of fixture *in silico* validation tests. Five different angles were considered for the three loading cases: tensile test, tensile test with head support and compression test.

3.2.6 Finite-element validation

In order to validate the fixture and be able to determine the maximum stress zone distribution for the different loading cases, a numerical simulation using the finite-element method was done using the Abaqus© software (ver. 6.14-4, Dassault Systèmes©). The detailed explanations of the simulations parameters can be found in [Andréys, 2019] and therefore, we present here only a synthesis of the validation work done. The CAD solid files (ver. 2017, Autodesk© Inventor) were imported into Abaqus as IGES files, manually meshed using a structured grid with hexahedral elements. The choice of the specific element type was based on a mesh convergence analysis. The materials considered for this simulation were the AISI 304 stainless steel (Young modulus: 193 GPa, Poisson ratio: 0.29) and the PMMA resin (Young modulus: 2.24 GPa, Poisson ratio: 0.4). The screw interactions were considered as “ties”. The PMMA-receptacle interaction was modeled with a friction coefficient of 0.5. The ball-joint and cup interaction was modeled with a friction coefficient of 0.1. The bone was considered as a rigid link. The shrink disk was modeled using two kinematic couplings between the main pivot and the base, the two master nodes being linked along all the degrees-of-freedom. For the 3 cases, a load of 1.5 kN was applied either in tension or compression.

Using the Von Mises criteria, the maximum equivalent stress values were found at the main pivot (BOM art. # 4) and the shrink disk zone, with an observed value of 58.5 MPa for the case with the base oriented 90°. The second most critical case is when the base is rotated at 0°. The maximum equivalent stress values using the Von Mises criteria are found on the head support (39.3 MPa) and the ball-joint (23.6 MPa). Considering that the AISI 304 stainless steel has a yield stress of 200 MPa, we can confirm that we rest within a safety range for a load not exceeding 1.5kN.

As for the stiffness characterization, the data is available at the Table 3.3. The stiffness was measured as the ratio between the applied force in the rigid link mimicking the bone and its displacement magnitude. As expected, the compression stiffness of 267.60 kN/mm at a base angle of 0° is the highest value as there is not any leverage caused by a rotated base. Nevertheless, as the base is being rotated, the stiffness values drops for both the tensile and the compression test, as it becomes entirely dependent of the leveraging with the the shrink disk as pivot. What is interesting is the tensile test with the head support case. Although the stiffness value is comparable with the one without the head support when the base is at 0°, this value decreases slower for the following base angle situations.

Base angle	Tensile w/head support	Tensile	Compression
kN/mm			
0°	141.12	137.17	267.60
30°	54.51	32.75	38.58
45°	39.40	16.50	18.14
60°	32.42	10.75	11.36
90°	27.67	7.55	7.55

Table 3.3 – **Fixture stiffness characterization.** The stiffness measured at the vertical component is shown for each loading case, as a function of the base angle.



Figure 3.11 – **Stereo-rig for the digital image correlation.** **A:** The cameras and the LED lamp. **B:** The angle used for the cameras ranges between 10° and 20°. **C:** The normal distance is measured from the baseline to the front of the sample.

This can be due to the head support that compensates the pure leveraging of the precedent loading cases.

3.3 Digital image correlation system

3.3.1 Camera and light choice

In order to acquire further data of bone samples during the mechanical tests, a 3D Digital Image Correlation (3D-DIC) system was developed to record the local displacements and strains at a given surface of the samples. For this, two area scan cameras were used (acA2500-60um, Basler AG©) both with a C-mount, 25mm focal length lens (LM25HC, Kowa©), placed in a tripod with a customized fixture that allows an easy manipulation of the angle and the distance of the cameras. The illumination was assured by a powerful 4000 lumens LED lamp (RS-PRO© Ministar 50W) placed just behind the two cameras. This guarantees an increased depth-of-field by reducing the lens aperture [Sutton *et al.*, 2012]. An illustration of the camera rig setup is shown in the Figure 3.11. Parameters of this 3D-DIC system includes the baseline length (distance between the central part of the area scan for both cameras), the stereo angle (angle between the two cameras) and the normal distance (distance between the objective and the lens).

3.3.2 Specimen preparation and speckles application

The good application of the speckles are crucial for the detection of the local stress and strain distributions [Jones *et al.*, 2018]. In general, the DIC algorithm sweeps along the region of interest (ROI) using a squared subset window. This window should contain two to three speckle dots randomly distributed, so it can be easily localized by the feature matching

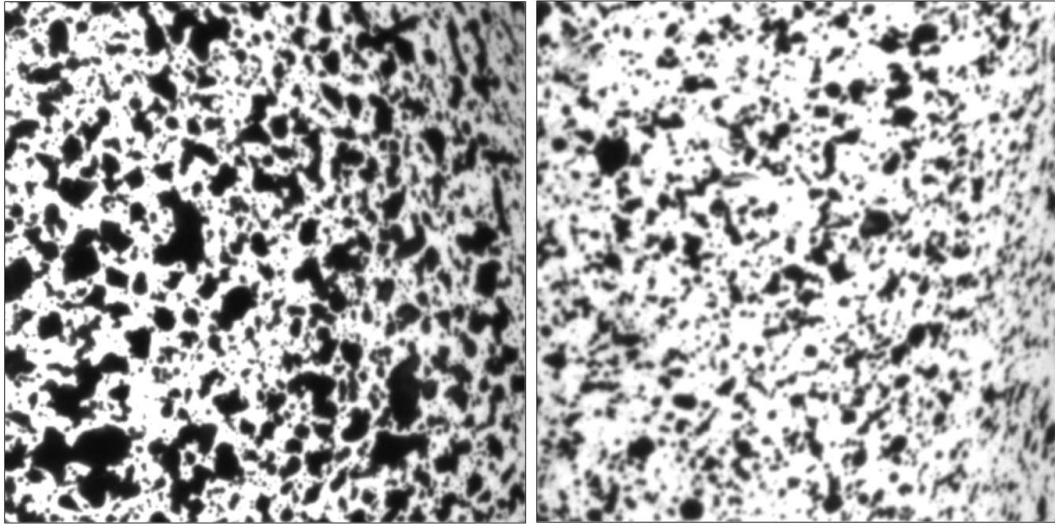

Figure 3.12 – **DIC speckles examples.** Two 350×350 pixels images taken from two different zones of two experimental samples.

algorithm in the further deformed state images. Depending on the camera resolution, the lens, the rig normal distance and the sample size, the dots distribution should be varying between 3 to 10 pixels of size for a minimum 30 pixel subset size.

Several techniques for the patterning techniques are available on the literature [Sutton *et al.*, 2012]. For our case, and based on other DIC-based bones experimental works, as reviewed in [Grassi et Isaksson, 2015], we decided to use spray paint. The application was therefore done using small shots of black spray paint on the previously white sprayed humeral heads. Only mat paint was used, to avoid reflections during the image recording process. The average size of the speckles were around 10 pixels (for an image scaling of 0,0041mm/pixel) with our rig configuration values. Examples of the speckles application are illustrated in the Figure 3.12.

3.3.3 DIC software and camera acquisition setup

The Basler© cameras purchased for this 3D-DIC includes a basic software suite for visualization and configuration purposes called Pylon. Using the Pylon Suite, we were able to acquire and save continuous shoots of images but, according to the user’s guide, for the camera synchronization (i.e. taking two pictures at the same time), an external (software or hardware based) trigger was necessary. Therefore, using the API headers and sample C++ codes included in the Pylon suite, we coded a custom-made script (compiled in Linux Kernel 5.3.0-45, GCC 7.5.0 and Pylon Camera Software Suite Libraries 5.2.0, all freely available) that guaranteed the synchronization in the triggering for both cameras during the image acquisition. The triggering Algorithm 3.1 is part of the code used to synchronize the cameras. The full code is available in the Annex C. Using a simple loop to acquire the images and a text-based interface, the images were saved using the lossless compression TIFF format.

The 3D-DIC analysis is done using the open-source DICe engine software¹ (DICe 2.0-beta16, Sandia National Laboratories©) [Turner *et al.*, 2015], compiled in Linux Kernel 5.3.0-45, GCC 7.5.0, OpenCV 3.2.0 and Trilinos 12.10.1, all freely available. Its primary capability is the computing of full-field displacements and strains, but can also be used in other applications such as trajectory tracking. Some of the features of the DICe engine includes the library

¹<https://github.com/dicengine/dice>

Algorithm 3.1 Acquisition triggering algorithm for each camera. The acquisition is done in a loop and not in parallel threads. Nevertheless, the acquisition delay for each camera is less than 1ms.

```
// Triggers and retrieves an image for each camera
// The cameras are instantiated using the CInstantArray class
// CInstantCameraArray cameras( min( devices.size(), c_maxCamerasToUse));
// c_maxCamerasToUse limited to 8.
for ( size_t j = 0; j < cameras.GetSize(); ++j)
{
    if ( cameras[ j ].WaitForFrameTriggerReady( 5000,
        TimeoutHandling_ThrowException))
    // Wait up to 5000ms for the camera to be ready to trigger.
    {
        cameras[ j ].ExecuteSoftwareTrigger();
        // Trigger the acquisition of an image
    }
}
```

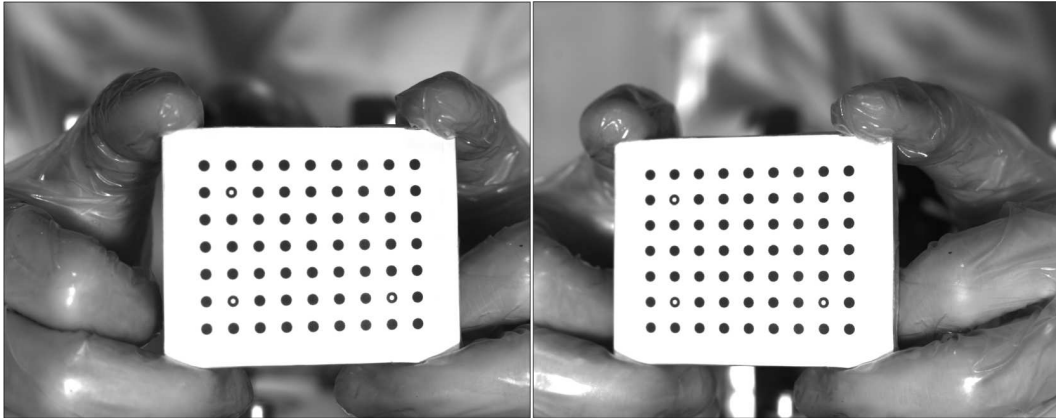

Figure 3.13 – **DIC calibration target.** Images from both cameras of the calibration target used for the tests.

interface to be used as an external application, and the high performance computing ability to reduce the running time. This software uses the pin-point camera model² based on the OpenCV library, henceforth requiring a proper calibration process to identify the camera and the sample local coordinate systems, along with the transformation matrix for the data projection. For this, a “calibration target” composed of an uniform array of dots printed in a flat surface is used, illustrated in the Figure 3.13. Three dots are then used as reference points. This calibration target is then moved in front of both cameras in recording mode as close as possible from the object of study (for this specific case, just in front of the bone to be tested). The filmed images are then processed by the Calibration tool present at DICE. Based on the rig configuration and the manipulation of the calibration target, a calibration error is calculated. Any calibration parameters obtained with the aforementioned tool showing an RMS error value larger than 1.5 was systematically rejected and the calibration process was restarted. In average, for the calibration process, we acquire 50 images at 2 Hz each time the 3D-DIC system configuration was slightly modified (i.e. a camera moved, a new experimental setup, etc.), to ensure a proper DIC process.

3.3.4 Data processing and post-processing

In order to reduce the amount of data storage, for mechanical quasi-static tests, we use a fairly low image acquisition frequency ($\sim 1\text{Hz}$) and a relatively high exposure time ranging from 50ms to 150ms, depending on the lightning conditions. The configuration (acquisition frequency, exposure tie) are selected by the use of the custom-based script

²<https://raw.githubusercontent.com/dicengine/dice/master/doc/reports/Triangulation.pdf>

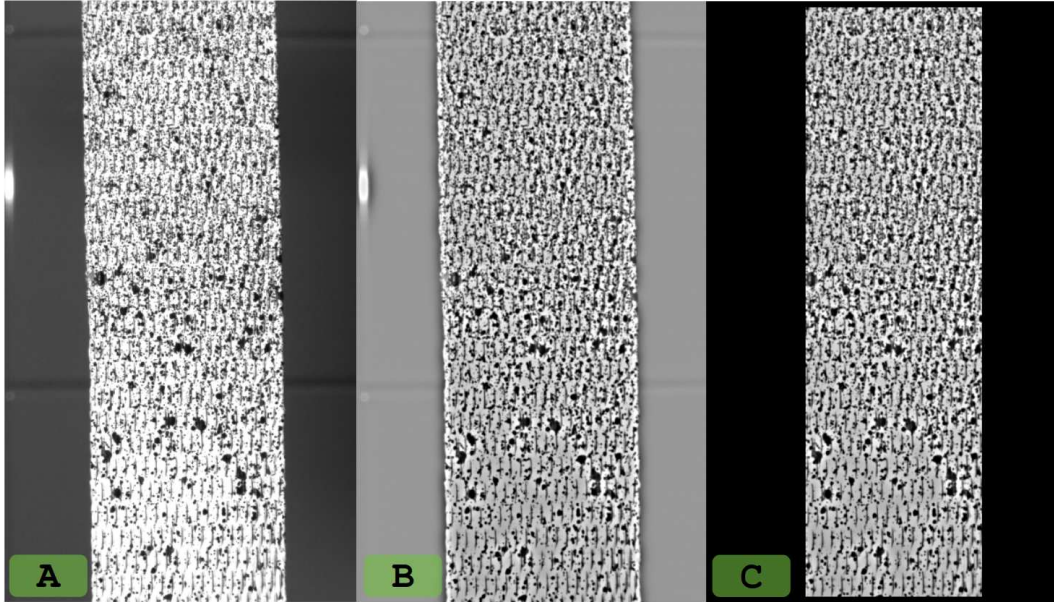

Figure 3.14 – **Images post-processing**. **A**: The raw image acquired by the camera. **B**: In order to highlight the speckles, a band-pass filter is applied using a range of values close to the average dots size. **C**: The region of interest (ROI) is cropped.

described before. Based on our experience, the acquired images are pre-processed using the ImageJ software (ver 1.53c). For this, each image sequence (one per camera and per mechanical test) are imported and then FFT filtered using a bandpass filter between 3 and 40 pixels in order to highlight the speckles and “neutralize” the regions that are not dotted. Then, in order to minimize the errors during the DICe cross-correlation process³, a mask is applied for all the image sequences in order to crop the region outside the ROI, to clear it out. An example of a raw image and a treated image are presented in the Figure 3.14.

The pre-processed images sequences are then imported under the available GUI of DICe⁴. Depending on the experimental configuration, the subset size and subset step are ranged from 24px to 50px and from 11px to 21px respectively. We give priority to parallelize the data processing using OpenMPI (ver 2.1.1) in 4 threads in a Linux PC (Kernel ver 5.4.0, CPU Intel i5-9400H @ 4.3 Ghz, RAM 16GB DDR4), in order to optimize the running time (reducing it approximately by 50%). The output data can be written in Exodus (.e) or in a comma-separated file (.CSV) format. The Exodus format is inherently compressed, reducing the data overhead in contrast to the ASCII-based CSV format.

Once the data processing is concluded, the output files are imported under the open-source visualization software Paraview (ver 5.8, Kitware©). We chose to display the point data at the image space (2D coordinate system of the left undeformed image), instead of the physical space (3D coordinate system of the sample). The 3D visualization using the physical space leads to a more realistic visualization, but disables the ability to register the point data with the acquired images due to the different coordinate systems and scales.

The image space cloud point data was then transformed to a surface mesh data using a Delaunay 2D filter with an alpha value of 40 and the default mesh tolerance value of 1×10^{-5} . As DICe calculates only the virtual strain gauge (VSG) data in the image space (dependent of its coordinate system), we calculate the two invariant ϵ_1 and ϵ_2 as:

³The cross-correlation in digital image correlation involves the pattern recognition and feature matching process between the left and the right image.

⁴<https://github.com/dicengine/dicgui>

$$\epsilon_1 = \frac{\epsilon_{xx} + \epsilon_{yy}}{2} + \sqrt{\left(\frac{\epsilon_{xx} - \epsilon_{yy}}{2}\right)^2 + \epsilon_{xy}^2} \quad (3.1)$$

$$\epsilon_2 = \frac{\epsilon_{xx} + \epsilon_{yy}}{2} - \sqrt{\left(\frac{\epsilon_{xx} - \epsilon_{yy}}{2}\right)^2 + \epsilon_{xy}^2} \quad (3.2)$$

In order to have a scalar way to measure the strain data, we also calculated the effective Von Mises strain as:

$$\epsilon_{vm} = \frac{2}{3} \sqrt{\epsilon_{xx}^2 - \epsilon_{xx}\epsilon_{yy} + 3\epsilon_{xy}^2 + \epsilon_{yy}^2} \quad (3.3)$$

, and the volumetric strain as:

$$\epsilon_{vol} = \epsilon_1 + \epsilon_2 = \epsilon_{xx} + \epsilon_{yy} \quad (3.4)$$

The speed motion was also analyzed using the image space displacement data. For this, a custom-made Python script extracted the displacements in both the X and Y direction of the DIC processed data using the ASCII-based result files and available in the Annex D. A 4th order centered difference approximation was used as shown in the following equation:

$$f'(x) = \frac{-f(x + 2\Delta x) + 8f(x + \Delta x) - 8f(x - \Delta x) + f(x - 2\Delta x)}{12\Delta x} \quad (3.5)$$

3.3.5 DICe validation protocol

When we started using the DICe, the available version was the pre-release version 2.0-beta15, compiled with the same aforesaid libraries. After passing the CMake internal tests, we decided to make a first test in 2D using an aluminum specimen. The dimensions of the specimen are 34.92mm × 4mm and a thickness of 1.18mm. After applying the speckles and the tensile test run, the images were filtered as explained before and run using a subset size of 27px and a subset step of 7px. The max principal strain was calculated in order to compare it with the true strain. Both values seems to correspond at different time shots, as seen in the Figure 3.15.

The next validation test implies a comparison between 2D and 3D data from a sample data called `stereo_d_sample`, included in the DICe examples repository⁵. The sample folder includes a double pair of images, one pair in t_0 , the other in t_1 , as well as the calibration images. As the ROI is planar and the angle between the cameras is not important, we hypothesized that the strain distribution from a 2D analysis using single-camera images would be close to the 3D analysis. We used the following parameters for both the 2D and 3D tests: subset size: 39px, step size: 10px, virtual gauge size: 30px, gauss filter: 7px, calibration RMS error [only for 3D]: 0.328. We ran 3 analyses : 2D with left images, 2D with right images, and a 3D.

⁵https://github.com/dicengine/dice/releases/download/v2.0-beta.15/DICe_examples.zip

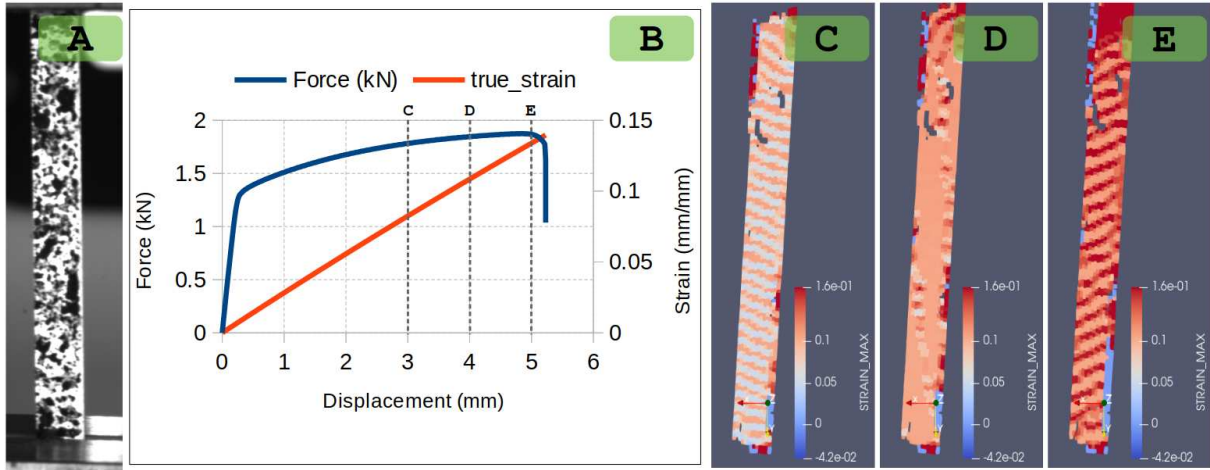

Figure 3.15 – **First validation 2D test**. Using an aluminium specimen under a tensile test, the calculated true strain data based on the dimensions of the sample is compared against the maximum principal strain. **A**: The specimen. **B**: The force/displacement data along with the true strain calculated data. **C**: The image taken at 3mm of displacement, with a 0.0828 true strain. **D**: The image taken at 4mm of displacement with a 0.1088 true strain. **E**: The image taken at 5mm of displacement with a 0.1341 true strain.

Both 2D tests from left and right images show similar results as expected. Nevertheless, we remarked the strain distribution values from the 3D data are roughly sub-estimated by an order of magnitude in contrast with the 2D data. This was later confirmed as a systematic error for other tests with different datasets in different PCs, regardless of the origin of the software, either using the pre-compiled Windows version available at the repository, either compiling the source files. An issue was submitted (#161⁶) with a possible solution to the 3D strain miscalculation error, which derived in a bug fix commit⁷ integrated in the following pre-release version (2.0-beta16). After the correction done in the source files, the 2D and 3D strains using the initial sample images now matched with a negligible error distribution. The comparative between the 2D and 3D strain data before and after the bug correction is illustrated in the Figure 3.16.

Finally, the DICe code was tested with a simple tensile test of a strap against the commercial DIC software VIC3D© (Correlated Solutions, Inc.). For this, using the strap shown in the Figure 3.14A was prepared with the speckles and then tested under a quasi-static load of 1kN. With an RMS calibration error of less than 0.5 for both DICe and VIC3D, the test images were treated in each solver using the same parameters (subset size: 30px, subset step: 7px, virtual strain gauge: 21px) and then visually compared under the ParaView software, as seen in the Figure 3.17. Both DIC algorithms calculate the same displacement but the strain values, although similar in a global sense, may differ due to an internal filtering done in VIC3D. As for the DICe, it seems it is capable of even reproducing the “texture” of the sample (the strap tissue) with a more detailed local strain distribution.

In general, after running the tests and correcting the major bug in the strain calculation, we conclude that the DICe algorithm could be enough and useful for the purposes of this work.

3.4 Experimental setup

The purpose of the experimental setup is twofold:

⁶<https://github.com/dicengine/dice/issues/161>

⁷<https://github.com/dicengine/dice/commit/3505fd58482549ff3e8efed4166bf22e342cbaee>

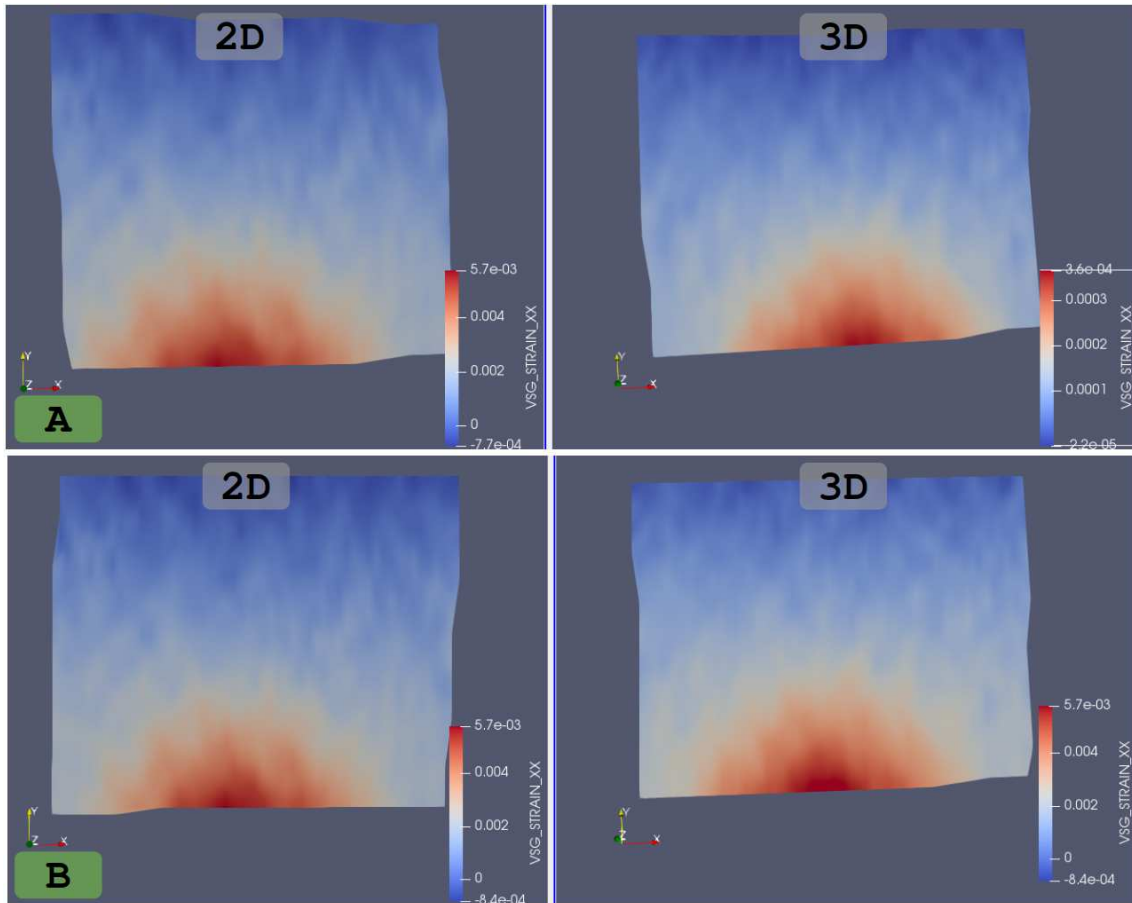

Figure 3.16 – **Comparison between the 2D and 3D strain DICe calculation.** Using a single (2D) or a pair (3D) of images in an undeformed and deformed state, we compared the difference in the strain distribution. In this figure, we show the ϵ_{xx} strain. **A:** Significant difference in the strain distribution before the bug fix commit. Notice the 3D scale underestimated by an order of magnitude. **B:** Unperceived difference in the strain difference after the bug fix correction.

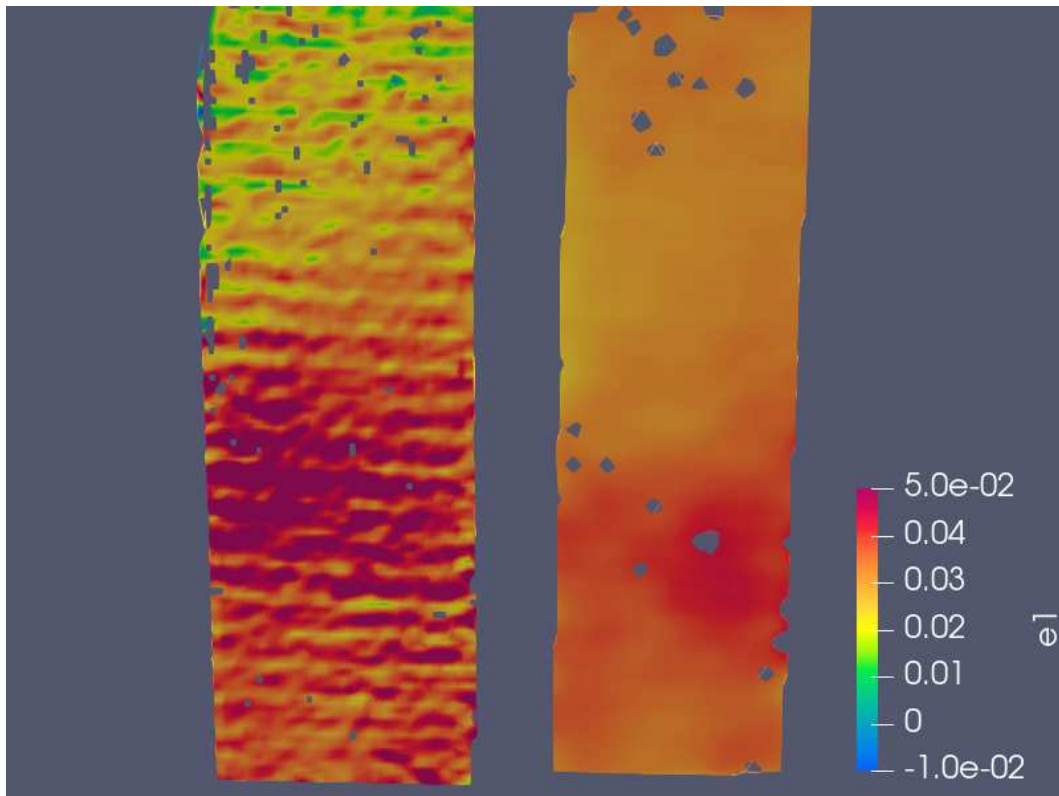

Figure 3.17 – **Comparison between VIC3D and DICE.** A strap is tested under a tensile load and recorder using a stereo rig. The max principal strain is shown at both digital image correlation results as it is the most representative for this tensile test. At **left**, the DICE result and at the **right**, the VIC3D result.

- to prove that the experimental framework is able to biomechanically characterize an assembly PHF - osteosynthesis device in physiological and beyond-physiological situations and
- to gather basic data out of some well studied and clinically-relevant fracture cases. Thus, two configurations replicated several times in the litterature were chosen to represent the clinically relevant cases: a 2-parts fracture at the surgical neck ([Maldonado *et al.*, 2003, Kathrein *et al.*, 2013, Gaudelli *et al.*, 2014, Seide *et al.*, 2007, Euler *et al.*, 2017a]) and a 4-parts fracture ([Clavert *et al.*, 2016, Brianza *et al.*, 2010, Rothstock *et al.*, 2012]), both naturally unstable.

The main problem to make a comparative study is the lack of standardization in all the tests, as each author decided to follow a particular protocol that better suited their own purposes. This means, the boundary conditions (e.g.: using PMMA or screws to fix the bone and/or to apply a load directly) and the different fixtures with their own rigidity values can difficult the task to make a truthful comparison between their presented data, particularly the cycles-to-failure and the global stiffness. For the later, it has already been shown in the Chapter two that flexible attachments (such as the strap to pull) can greatly impact the overall stiffness and therefore the global displacement values.

Hence, we propose to present as well an interfragmentary movement analysis, to determine an “interfragmentary stiffness” for a particular fracture type and load type, that could be used in a further comparative work for the sake of a standardized comparison. What is more, as discussed in the previous chapters, a better understanding of the interfragmentary movement is capital to determine the quality of the healing process [Claes *et al.*, 2018, Cheal *et al.*, 1991]. So, for the sake of testing this experimental framework, we propose to test the two aforementioned cases: humerus

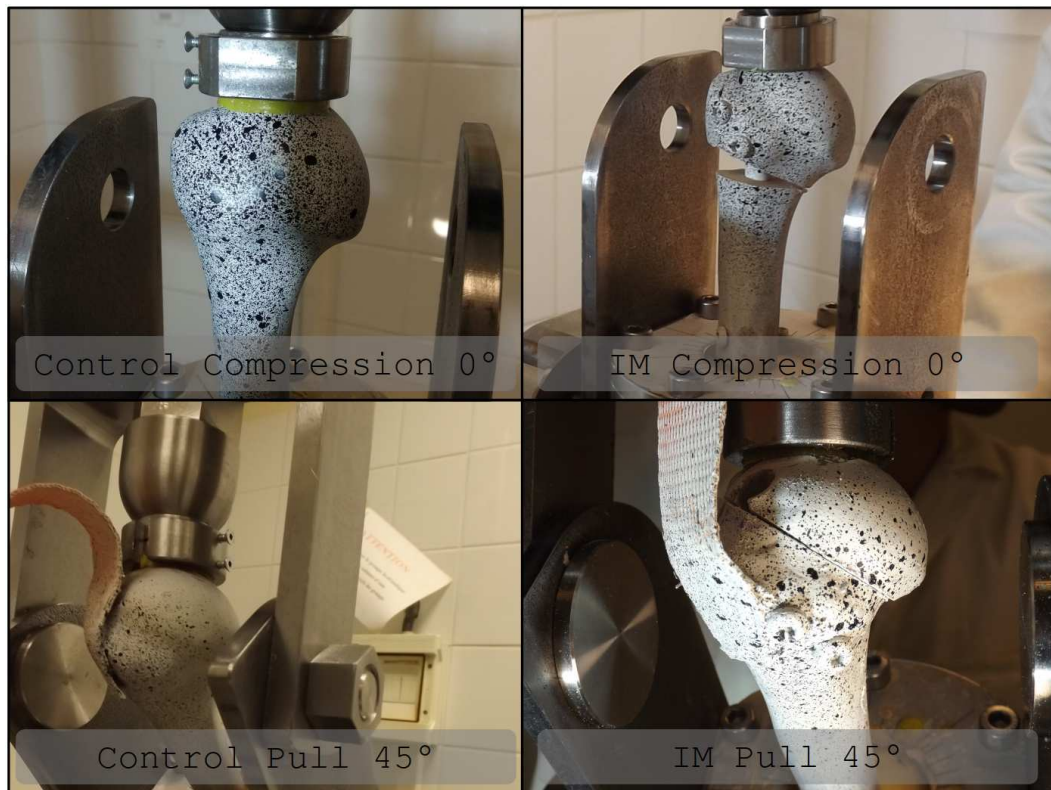

Figure 3.18 – **Four experimental setup cases.** Two in compression for 2-parts fractures (A), two in traction for 4-parts fracture (B), with (1) and without (0) the Aequalis IM nail.

with a 2-parts fracture at the surgical neck and humerus with a 4-parts fracture, in compression and in pulling loading cases, both with their respective Control Group (CG, no fracture nor osteosynthesis device) and the IM Group (with the Aequalis Intramedullary Nail). Thus, the setup is divided into four testing groups of 5 Sawbones each (see Figure 3.18):

- Control Group compression load at 0° , no fracture, no IM nail.
- IM Group compression load at 0° , 2-part fracture with wedge-like osteotomy, IM nail.
- Control group pulling load with head support at 45° , no fracture, no IM nail.
- IM group pulling load with head support at 45° , 4-part fracture, IM nail.

3.5 Pure-compression setup

3.5.1 Materials

As stated before, the osteosynthesis device tested was the Aequalis[®] Intramedullary (IM) Nail (Wright Inc.), a 130mm long straight nail with 4 proximal divergent interlocking screws and two distal divergent screws (with a dynamically locking hole) [Boileau *et al.*, 2015]. This nail was tested on five 4th-generation humeral Sawbones[®] (SKU: 3404, Division of Pacific Research Laboratories Inc.), a composite bone that mimics the mechanical properties of the real human bone [Dunlap *et al.*, 2008]. It is composed in a cortical phase and in a cancellous phase. The cortical phase is made of epoxy filled with short fibers with an apparent direction while the cancellous phase is made of solid rigid

		Canc	Cort (L)	Cort (T)
	Density (kg/m ³)	270	1640	
	Poisson's Ratio		0.26	
	Vol. Fraction	0.23		
Compression	Strength (MPa)	62	157	
	Modulus (GPa)	0.155	17	
Tension	Strength (MPa)	4.6	106	93
	Modulus (GPa)	0.205	16	10
	Ult. Strain (%)		1.4	1.2
Shear	Strength (MPa)	3.4		
	Modulus (GPa)	0.049		
Hardness	Shore D	29	90+	

Table 3.4 – **Mechanical Properties of the 4th Generation Humeral Sawbones.** The data for the [Canc]ellous and [Cort]ical bone in both [L]ongitudinal and [T]ransverse axes are provided by the manufacturer.

Property	Value
Mass density	1170 - 1200 kg/m ³
Young's modulus	1800 - 3100 MPa
Poisson's ratio	0.35 - 0.40
Tensile or fracture strength	48 - 76 MPa

Table 3.5 – **Mechanical properties of the PMMA.**

polyurethane foam. The mechanical properties of both phases are available in the Table 3.4. As for the control group (no fractures), four 4th-generation humeral Sawbones were used. All the Sawbones were cut in half, keeping only the proximal segments (175 mm length)

The contact interactions withing the humeri and the fixture are made using a cement-like polymethylacrylate (PMMA, Technovit© 3040, powder/liquid application's ratio 2:1 according to manufacturer guidelines). This is a rapid polymerizing material, whichs tends to be hard and brittle, well adapted to “glue” synthetic and cadaverous bone. The typical mechanical properties for this material are presented in the Table 3.5⁸.

3.5.2 Methods

3.5.2.1 Clinical preparation of the specimens

First of all, the IM nail used in the work possesses a length of 130 mm, an outer diameter values of 9 mm in the proximal part and of 8 mm in the distal part. It should be noted that the humeral Sawbones of 4th generation are already pre-hollowed along their entire length with a 8 mm diameter canal. The canal axis coincides with the diaphyseal axis of humerus. Furthermore, all the synthetic humeri were carefully cut in half and only the proximal parts were retained. The cutting plane was perpendicular to the humeral shaft axis. The set of proximal synthetic humeri was then divided into two groups. The first group of five proximal humeri was used to build the bone-implant construct, the second one of four proximal humeri was used without changes as a reference group (intact bone). All the specimens of the first group have been prepared following the same steps.

⁸Source: <http://www.mit.edu/~6.777/matprops/pmma.htm>

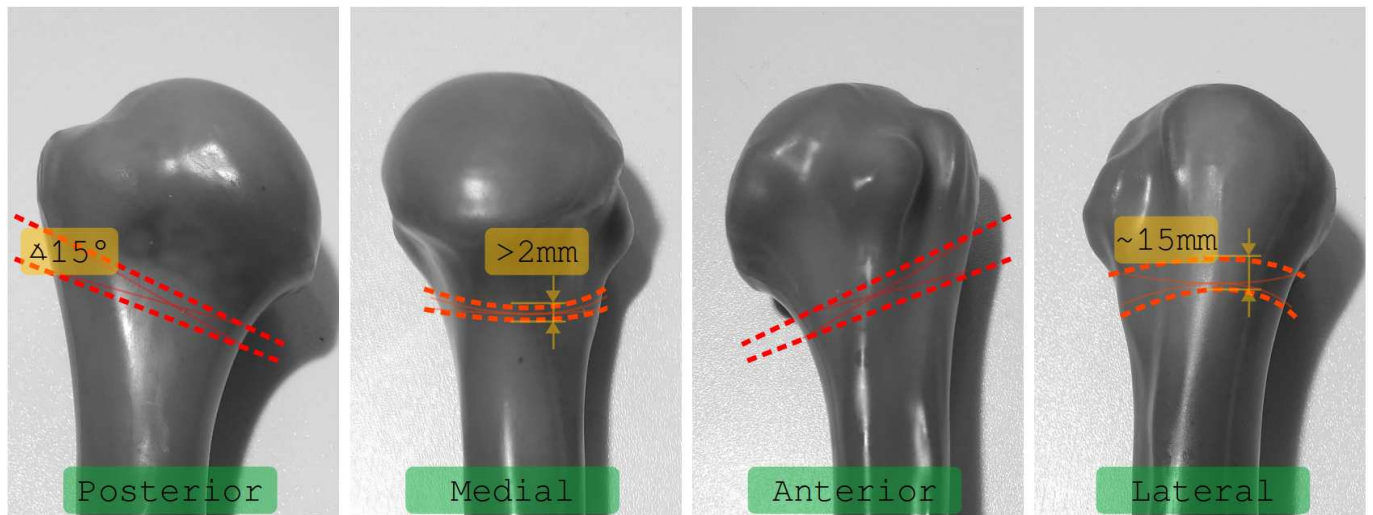

Figure 3.19 – **Bone preparation for the unstable 2-part fracture with a wedge osteotomy at the surgical neck.** The dashed lines correspond to the zones to be cut, and the crossed lines, the area to be removed.

As the proximal diameter of the IM nail is slightly larger⁹ than the initial inner diameter value of diaphysis, the Sawbone canal was partially reamed with a 9 mm diameter surgical reamer. According to Neer classification [Neer, 1970], for the IM group, the 2-part fracture was done recreating a wedge-like osteotomy at the surgical neck, normal to the antero-posterior (AP) plane. To reach this goal, anatomic landmarks were defined and two reference lines were drawn on the synthetic bone surface with an angle between them of 15°. Both lines converge at the medial point of the surgical neck just below the cartilaginous head (see Figure 3.19). Following the reference curves, the synthetic bone was then manually cut with a 24 teeth-per-inch (TPI), standard 300 mm hacksaw. The wedge was finally removed.

After cutting the humeral head, the synthetic bone was vertically fixed with a vice in the diaphyseal area. The IM nail was placed according to the manufacturer’s guidelines: the anatomical reduction was done by inserting the nail through the hollowed canal of the Sawbone in the diaphyseal axis, with two screws at the Greater Tuberosity and an additional single Lesser Tuberosity screw, and locked distal screw (see Figure 3.20). The IM nail was then coupled with its aiming guide in order to insert it in the correct direction. The IM nail was next inserted into the Sawbone canal with its axis coincident with that of the humeral diaphysis, according to the manufacturer’s guidelines. Finally, the IM nail was fully buried below the humeral head.

The assembly consisting of the jig, the IM nail and the synthetic humerus were then cautiously turned at 180° and the jig is clamped in the vice. With the help of the jig, the different holes were drilled with the guiding sleeves into the proximal (Greater and Lesser Tuberosities) and distal areas of the synthetic proximal humerus. In agreement with the manufacturer’s recommendations, the holes in the humeral head were drilled to a depth of at least 2 cm past the IM nail; while the hole in the diaphysis was drilled through the second cortical wall.

At last, the screws are inserted into the synthetic proximal humerus. The screw lengths were chosen by senior surgeon and in accordance with the manufacturer guidelines. It should be mentioned that all the steps of the procedure were performed by the same senior surgeon. For this 2-parts fracture, the first 3 (two at the GT, one at LT) proximal screws (5mm diameter) were considered, and for the distal part, the static-fixed screw (4.5mm diameter) was used.

⁹The largest part of the IM nail is 9mm diameter, please see https://www.wrightmedia.com/ProductFiles/Files/PDFs/CAW-5040_EN_LR_LE.pdf

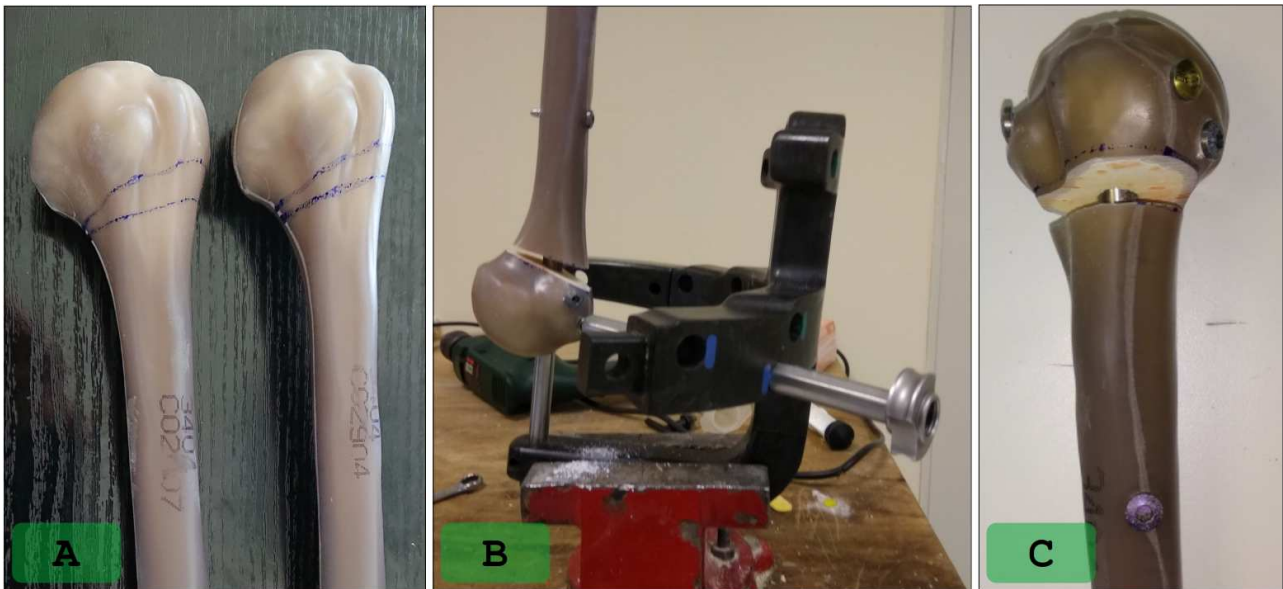

Figure 3.20 – **General procedure for the preparation and the insertion of the IM nail.** **A:** the cutting lines were drawn and then cut using a standard hacksaw. **B:** the aiming guide is fixed in order to facilitate the IM nailing and drilling the holes for the screw fixation. **C:** The resulting bone with the unstable 2-parts fracture at the surgical neck, along with the osteosynthesis device.

3.5.2.2 Fixture and speckles setup

As explained beforehand, for the speckles application, both IM and control group bones are spray-painted with black and white paints. First, the bone surface to be camera-recorded is fully covered with mat-white paint. After around 10 minutes of drying, the mat-black dots are carefully applied by making small shots of paint at a reasonable distance (~40 cm away). If for any reason the process goes wrong (the speckles are too big or too small for the camera), the painting process is redone.

Following the fixture's user guide (Section 3.2.5), once each the bone is prepared, it is disposed at the fixture and aligned using the guiding system (Figure 3.7). For this, the fixture's receptacle is sprayed with a mold remover (to facilitate the removal of the PMMA distal plaster after the test) and the screw holes were filled in with plasticine (Play-Doh©) (to avoid penetration of the PMMA in its fluid stage). Then the distal part of the bone is placed inside the fixture's receptacle, and centered using the six screws disposed in delta configuration. The centering process is done by screwing and unscrewing them, using the following criteria:

- The vertical axis is verified using a reference stick.
- The diaphyseal orientation alignment is verified using a template protractor placed at the shrink disks axes.
- The humeral head is centered using the ball-joint PMMA cup , which is fixed at the load cell, placing this one over the hollowed canal.

Once the previous criteria is met, the PMMA preparation is poured over the fixture's receptacle and the polymerization process is started. As this process is exothermic, the manufacturer advise to do the polymer application by layers of maximum 100gr of mass, in order to avoid a substantial formation of bubbles or excessively heating the bone. For each bone, 450gr of PMMA (300gr of powder, 150gr of liquid) were used. The polymerization process takes around 15 minutes per layer, taking around 1 hour to fill in the inox receptacle.



Figure 3.21 – **Compression setup at the universal testing machine with the stereo cameras.** The green arrow shows the direction of the compressive load.

3.5.2.3 Digital image correlation setup

All the tests except the first two from the IM group were configured as following: the stereo angle used was 16° , with a baseline of 7.5 cm and a normal distance of 25 cm. In order to account for at least 3 speckles per subset window, a subset size of 60 px was chosen for all the tests, with a subset step of 20 px and a virtual strain gauge size of 60 px. As for the first two IM group compression tests used a stereo angle of 17° with a baseline of 15cm and a normal distance of 60cm, with a subset size of 30 px and a subset step of 10 px.

3.5.2.4 Universal testing machine setup

The compressive load on both control and IM group applied on the top of the head, at 0° according to the dyaphiseal axis (or 90° according to the scapula reference frame). No pulling load is applied on the head.

The full experiment is done using a servo-hydraulic testing machine (INSTRON 8500 plus, INSTRON corp., High Wycombe, Buckinghamshire, United Kingdom) with a 50 kN load cell. This testing machine has an upper fixed cross-head in which the load cell is installed. The load is applied with the lower piston. Thus, the compressive displacements are in the upper direction. The testing raw data (force/displacement) is acquired using the Instron MAX (ver 4.2, INSTRON corp.) software at 10Hz using a generic CSV format. With a preload of 20N, a 4 mm displacement load is applied at 4mm/min. This particular setup is widely studied, as it implies a fully unstable case with a torsion-like load applied directly to the head, which could be seen as the worst-case scenario [Maldonado *et al.*, 2003, Euler *et al.*, 2017a, Seide *et al.*, 2007]. The final setup is shown in the Figure 3.21.

3.5.3 Results

For this type of compression biomechanical experiment, 9 Sawbones were tested, 5 for the IM group (Figure 3.22) and 4 for the control group (Figure 3.23), the fifth one was not available during the testing stage. The results presentation is synthesized in several data tables but the data visualization is shown only for one test for each group (IM Group

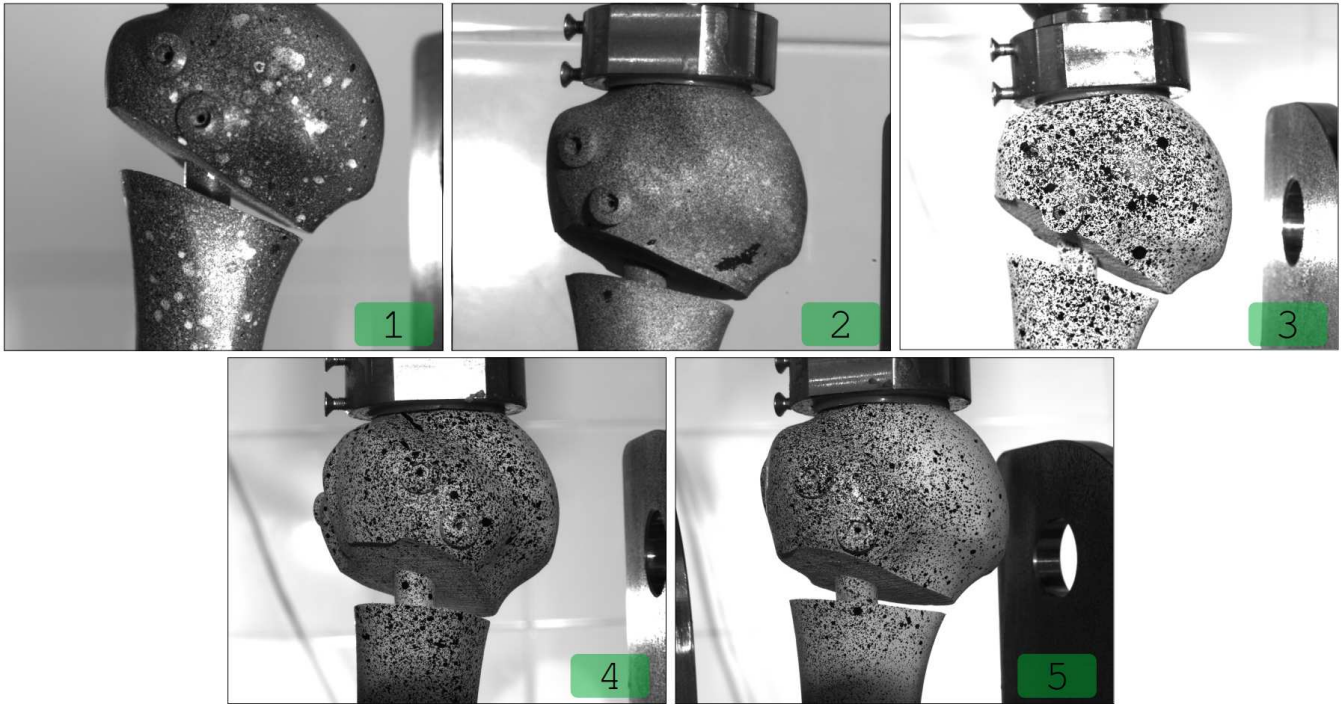

Figure 3.22 – Five Sawbones for the IM group ready to be tested in compression.

test 3 and Control Group test 4). The full analyses for the rest of the tests are available in Annex E. The results are detailed as following:

- The general (raw) force/displacement data directly obtained from the universal testing machine for each test, along with the general stiffness and load to fracture values.
- The local displacements data for each test and its data visualization of a single test per group, along with the recorded fractures.
- The interfragmentary displacement (relative displacement between the proximal and distal parts of the humerus) at the IM group for all the tests and visualized for a single test.
- The local 2D volumetric strain distribution for a single test for each group.
- A comparative of the local volumetric strain for the elastic segment of the test.

3.5.3.1 General force/displacement data

The general force/displacement data directly acquired from the universal testing machine is shown at the Figure 3.24, with the IM group data at the left and the Control group data at the right. Before any fracture appearing ($\sim 1.5\text{mm}$ of global displacement), the elastic segment of the test tends to be quite reproducible, with an average stiffness value of $1340 \pm 62 \text{ N/mm}$ and $5540 \pm 261 \text{ N/mm}$ for the IM group and control group respectively (see Table 3.6). This is an expected value, as the humeral head, mechanically supported by the intramedullary nail at the IM group, relies on the screw fixation of both the proximal and the distal parts during the compression load phase, whereas the control group, as it keeps its continuity along the bone surface, keeps its natural rigidity as well.

The 4mm displacement programmed at the universal testing machine triggered a crack propagation in different zones between the two groups. The fracture initiation is shown as a sudden force drop at the force/displacement

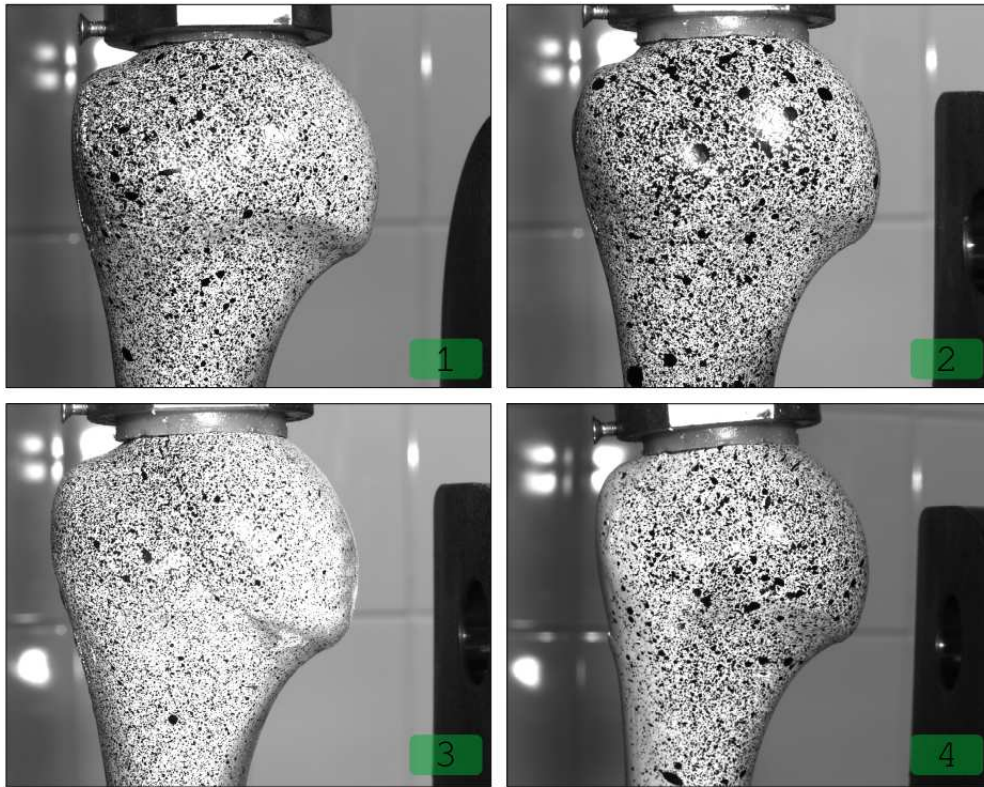

Figure 3.23 – Four Sawbones for the control group ready to be tested in compression.

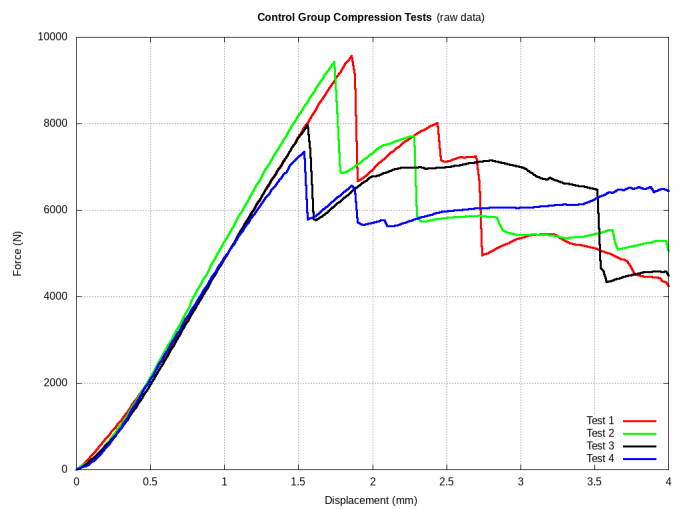
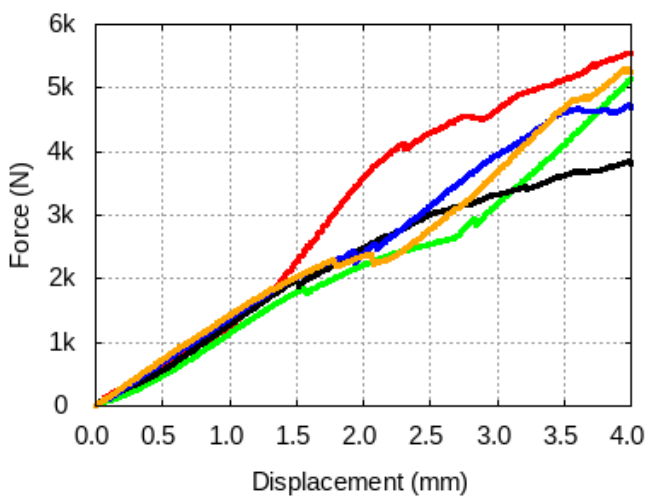

Figure 3.24 – General (raw) force/displacement data from the compression tests. At the left: the IM group. At the right, the control group.

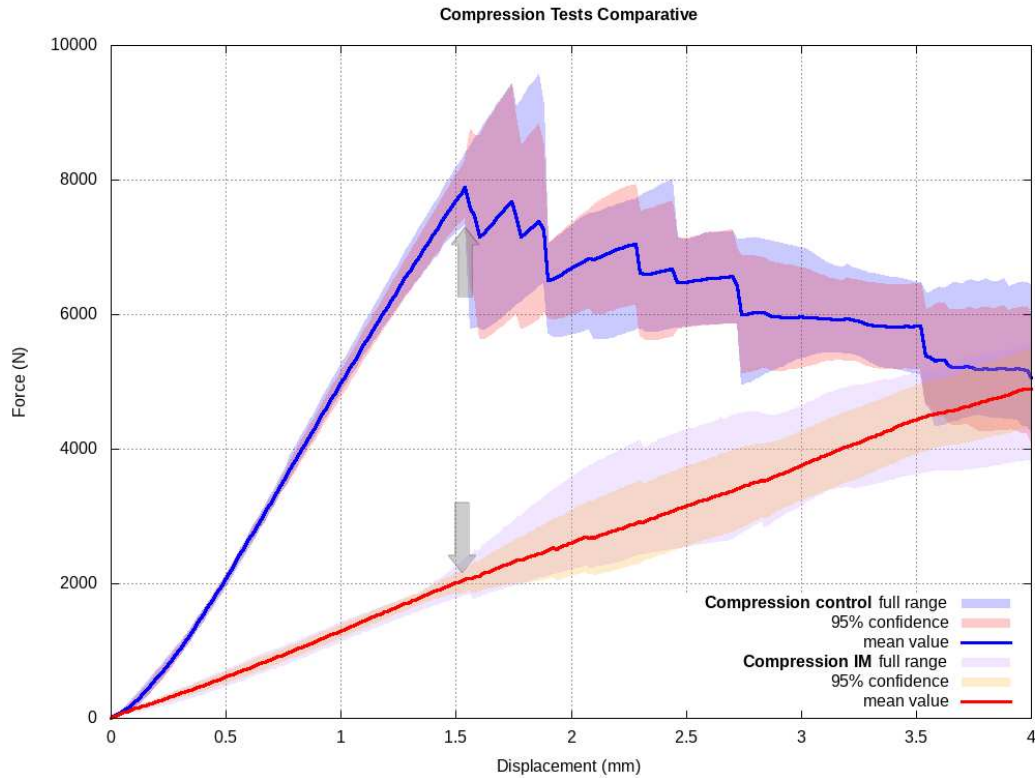

Figure 3.25 – **Synthetic comparative data between the IM and control compression groups.** The values shown are the mean value, the 95% confidence value and the full data range for each group. The arrows indicate the mean zone in which the first fracture appeared.

	Load to Failure (N)		Displacement to Failure (mm)		Stiffness (N/mm)	
	Mean Value	S.D.	Average Value	S.D.	Average Value	S.D.
Control	8646.75	1117.54	1.68	0.16	5540.53	261.24
IM	2062.07	306.90	1.72	0.38	1340.45	62.54

Table 3.6 – **Comparative data between the IM and control groups for the compression test.**

curves, as remarked by the arrows in the Figure 3.25. Although the load to failure of the control group (CG) is 4 times larger than the IM group (CG: 8646 ± 1117 N , IM: 2062 ± 306 N), the global displacement to failure remains at a similar value (CG: 1.68 ± 0.16 mm, IM: 1.72 ± 0.38 mm). Even if the fracture’s modes are different (further discussed in the following subsections), this reveals the relatively poor strength of the synthetic bone assembly (with or without the IM nail), in terms of global displacement applied at its diaphyseal axis.

3.5.3.2 Local displacement fields in control group

In general, the force/displacement curve for each test shows 3 fracture events, as it can be seen in the Figure 3.26 which is a plot of the CG test 4. The elastic stiffness (the estimated stiffness before the first fracture event) for all the tests is 5540 ± 261 N/mm for a maximal observed force of 8607 ± 1114 N (data synthesized in Table 3.7). During the elastic evolution of the test, the displacement almost follows the diaphyseal axis in the cranial direction (the direction of the testing machine piston), as it can be seen in the Figure 3.27a. Once the first fracture event occurs, the displacement changes abruptly to a cranial-medial movement as the PMMA cup starts to penetrate the top of the humeral head, and the stiffness drops to 2603 ± 369 N/mm, approximately half the elastic value. The second and the third fracture

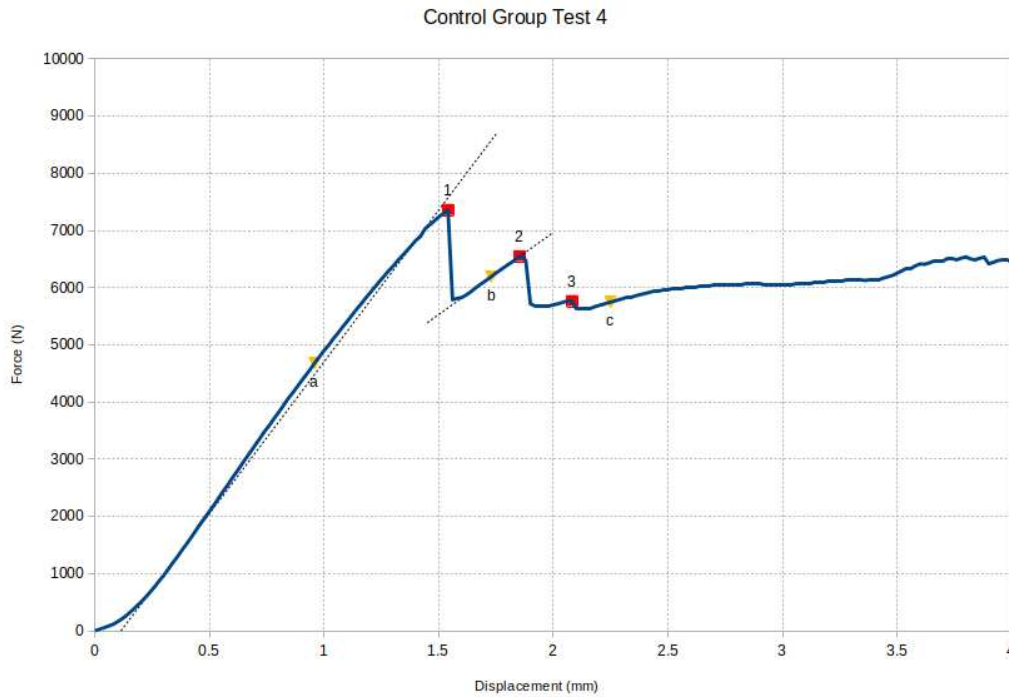

Figure 3.26 – Force/displacement data of the test 4 control group. 1: First fracture. 2: Second fracture. 3: Third fracture. The letters a, b and c are trivially chosen points to show the evolution of the local displacement in the Figure 3.27. The dashed lines corresponds to the elastic and the first fracture stiffness, detailed at the Table 3.7.

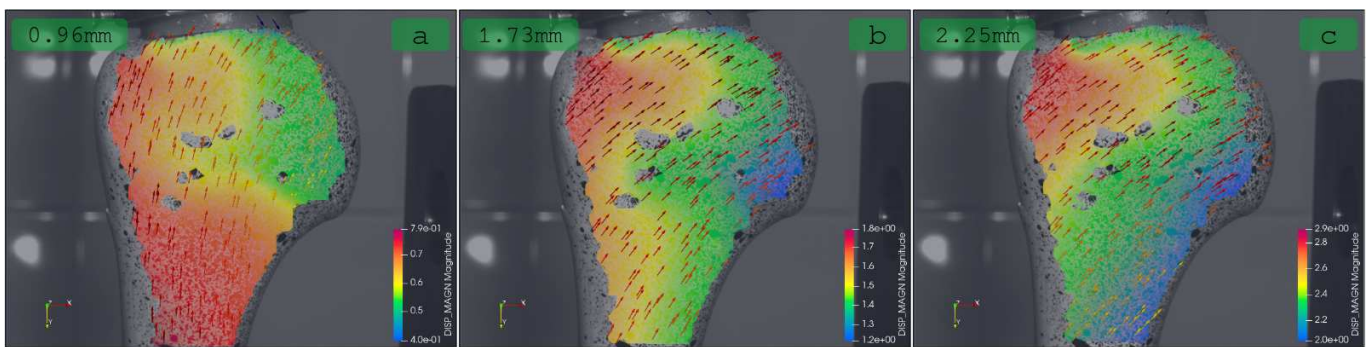

Figure 3.27 – Displacement magnitude field of the control group test 4 in three different stages of the test. The displacement is in mm. Most of the displacements are in-plane. The arrows show the speed direction of the movement.

events don't change the overall local displacement field if we compare the Figures 3.27b and 3.27c.

The succession of the fractures occurred at the 1.68 ± 0.15 mm, 2.14 ± 0.26 mm and 2.99 ± 0.72 mm, respectively. Nevertheless, the lack of displacement direction change could be due to the fact that the fractures unfortunately were not recorded by the cameras. For the CT test 4, in the Figure 3.28, we can observe the aspect of each fracture event: only a progressing penetration of the PMMA cup in the humeral head. A possible explanation of the crack initiation is the presence of the hole of the hollowed canal of the Sawbone, which could be acting as a stress concentrator.

Although the crack propagation was not camera-recorded, the aspect of the fractures were snapshotted and are shown in the Figure 3.29. The crack follows the intertrabecular groove, probably initiated at the hollowed canal, and stops past the surgical neck. It can also be noted a collapse of the humeral head around the PMMA cup.

In order to figure out the movement done during the displacement of the humeral head, in the Figure 3.30, the local displacement field is enhanced by temporal pathlines which are particules fixed to local points and whose movement leaves a colored “tail” indicating the path of the displacement. Before 1.54 mm of displacement (first fracture event),

Point	First Fracture		Second Fracture		Third Fracture		Stiffness	
	1	2	2	2	3	3	(N/mm)	
	Disp (mm)	Force (N)	Disp (mm)	Force (N)	Disp (mm)	Force (N)	Elastic	First Fracture
Test 1	1.87	9606.21	2.44	8015.00	2.71	7236.12	5408.04	2361.26
Test 2	1.75	9486.63	2.27	7710.35	3.63	5547.27	5904.72	2058.37
Test 3	1.56	7980.81	2.00	6789.04	3.52	6468.96	5542.36	2850.18
Test 4	1.54	7357.65	1.85	6547.88	2.08	5763.18	5306.99	2874.35
<i>Average</i>	<u>1.68</u>	<u>8607.83</u>	<u>2.14</u>	<u>7265.57</u>	<u>2.99</u>	<u>6253.88</u>	<u>5540.53</u>	<u>2603.54</u>
<i>S.D.</i>	<u>0.15</u>	<u>1114.32</u>	<u>0.26</u>	<u>707.49</u>	<u>0.72</u>	<u>764.01</u>	<u>261.23</u>	<u>369.59</u>

Table 3.7 – Detailed data of the force/displacement for the control group compression tests. In bold, the test studied in this section.

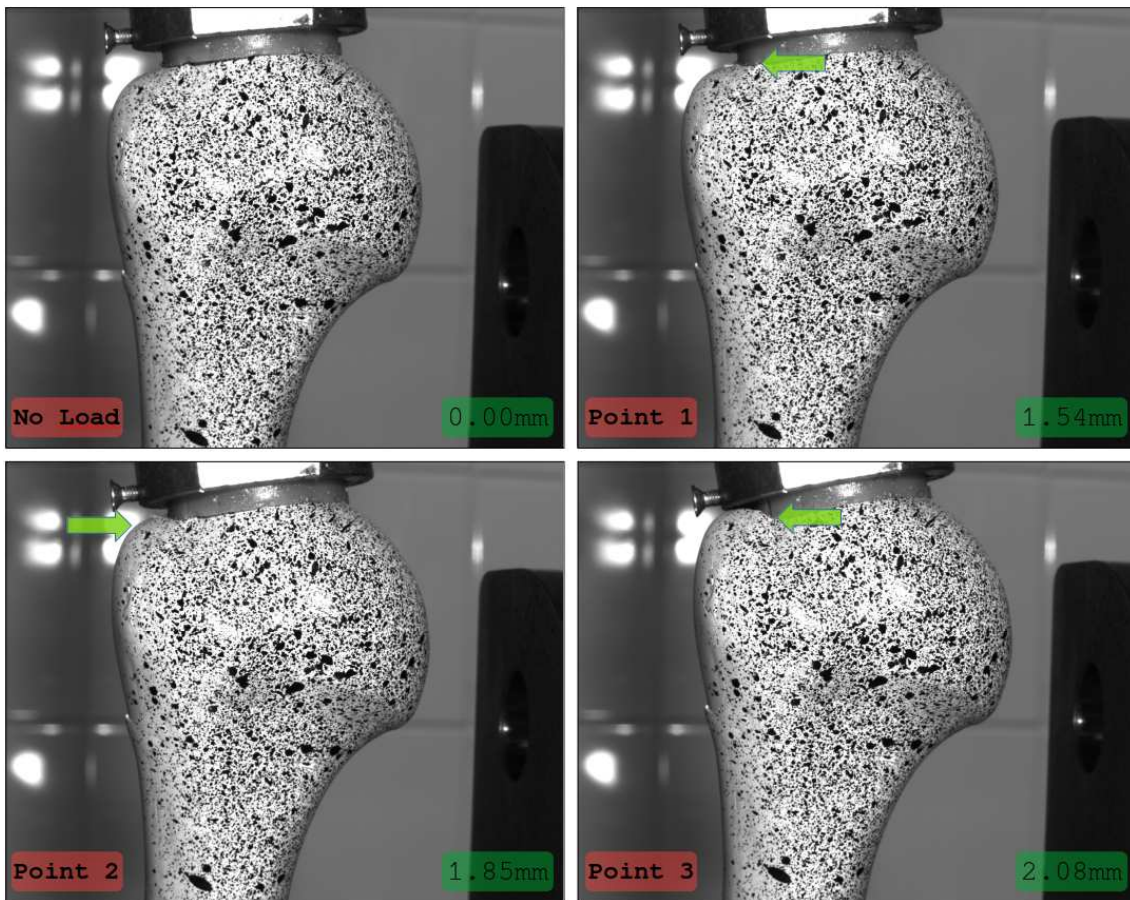

Figure 3.28 – Four displacement points of the control group test 4, under no load and the three different cracking stages.

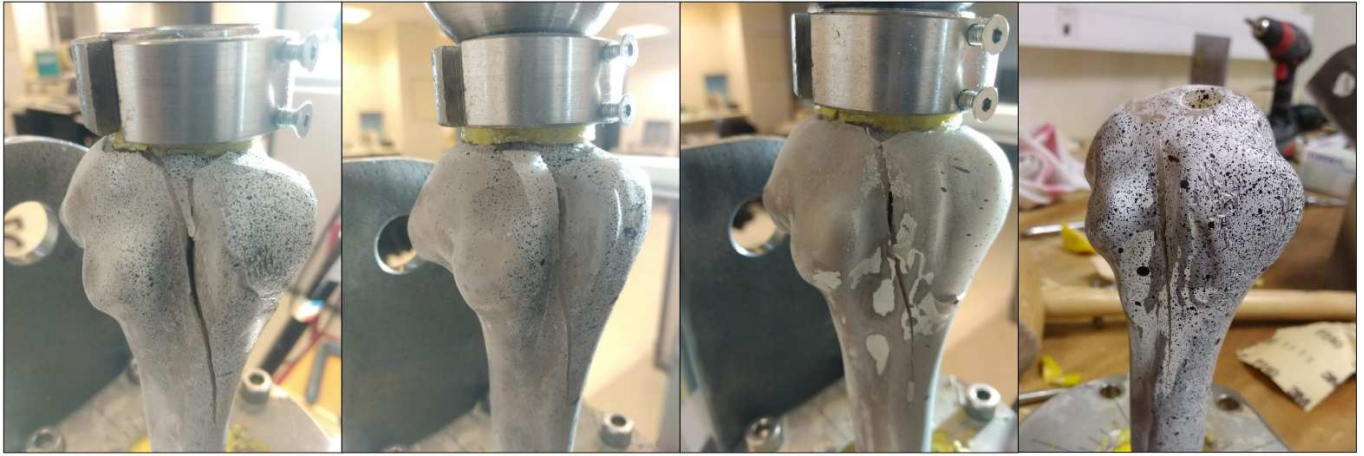

Figure 3.29 – The fractures observed at the control group compression tests are situated at the anterior intertrabecular groove.

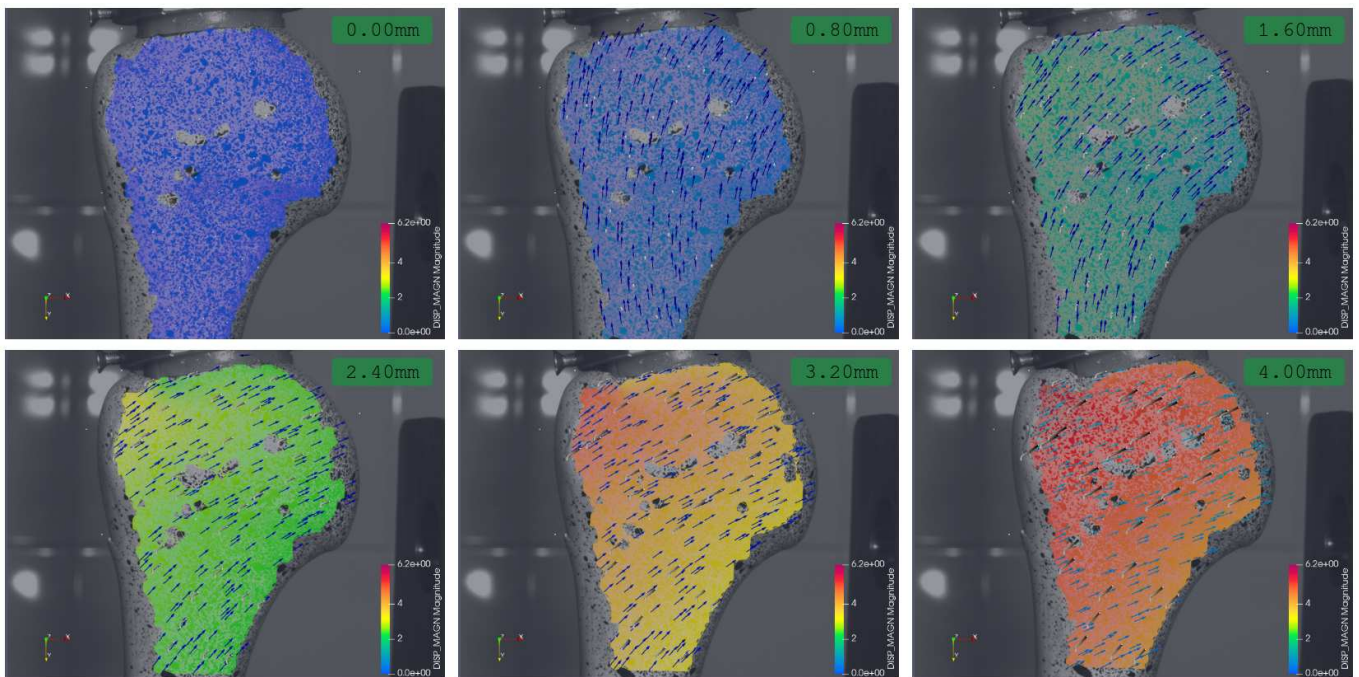

Figure 3.30 – Full local displacement magnitude field of the control group test 4 in six different positions. The displacement is in mm. The arrows indicate the speed direction and the temporal pathlines (in greyscale) shows the actual displacement.

the movement of the humeral head is in a straight cranial (upper) direction. Once the fracture event occurs, the displacement is suddenly deviated to the medial direction while the PMMA cup keeps penetrating and pushing the head in a bending movement.

3.5.3.3 Local displacement fields in IM group

The 4 mm of global displacement of the IM compression tests progression can be divided into four consecutive events (synthesized in Table 3.8a):

1. The appearance of the first fracture, occurred at 1.66 ± 0.30 mm of global displacement.
2. The head making contact with the medial part of the diaphysis, occurred at 2.04 ± 0.49 mm of global displacement.

3. The crushing of the medial part of the diaphysis in contact with the head, occurred at 3.00 ± 0.66 mm of global displacement.
4. The appearance of the second fracture, occurred at 3.37 ± 0.31 mm of global displacement.

Each one of these events has an impact on the global stiffness value. For instance, in the Figure 3.31, the force/displacement plot of the IM group test 3 is shown along with each one of the aforesaid numbered events and the slopes representing the stiffness of each part of the test. In general, it is possible to describe the global force/displacement behavior in a series of 4 stiffness values (synthesized data in Table 3.8b):

- Elastic The elastic behavior (before any fracture) of the humeral head. The average value is 1340 ± 62 N/mm.
- Head Touch Once the head makes contact with the tip of the diaphysis. The average value is 1133 ± 716 N/mm.
- Head Spurt When the movement of the head speed up in the medial-cranial direction, due to the diaphysis pushing up and the PMMA cup acting as a hinge. The average value is 1796 ± 485 N/mm.
- Diaphysis Crushing The collapse of the diaphyseal tip under the pressure of the humeral head, closely related to the appearing of the second fracture. The average value is 686 ± 401 N/mm.

The variability of each one of the test events can be evaluated with the standard deviation shown in the same Table 3.8. The first and second fracture events, for instance, shows the least divergence (S.D. ≈ 0.31 mm), in contrast to the diaphyseal contact (S.D. = 0.49 mm) and the diaphyseal crushing (S.D. = 0.66 mm), which was not event present at the test 2. This is mostly due to the influence of the hand-cutting process when performing the osteotomy.

Similar case is present when analyzing the stiffness variability for each of the 4 cases. The standard deviation for the elastic stiffness is 62 N/mm, in contrast to the head touch range (S.D. = 716 N/mm), the head spurt range (S.D. = 485 N/mm and the diaphyseal crushing (S.D. = 401 N/mm). What is more, for certain tests such as the test 1 and the test 3, the contact of the diaphyseal tip with the humeral head did not impact the global stiffness, resulting in equal values for these two ranges.

As a general rule, the local displacement field is divided in three phases: the clockwise rotation of the humeral head (during the elastic stage) with a moving rotation center within the head, the (small) counterclockwise rotation of the humeral head with a rotation center at the PMMA cup (during the head touching stage) and a spurted linear medial-cranial displacement of the humeral head (between the head spurt and the diaphyseal crushing stages). For the IM test 3, in the Figure 3.32a and 3.32b, the clockwise rotation can be seen, as well as the humeral head rotation center displacement while the screws are creating a moment at the head. Then, the direction of the rotation changes to counterclockwise once the diaphyseal tip touches the humeral head, Figure 3.32c, producing an opposite moment along with the displacement in the medial-cranial direction, which eventually becomes predominant as the diaphyseal tip collapses, stage presented in the Figure 3.32d.

For the particular case of the IM test 3, the numbered events are shown in Figure 3.33. The first event occurring at the global displacement value of 1.46 mm is the first fracture appearing above the first GT screw, marked with a red line. This fracture is reproducible along the rest tests, and it's probably caused by the hole of the screw acting as a stress concentrator. After the first fracture, the diaphyseal medial tip makes contact with the calcaneal zone of the

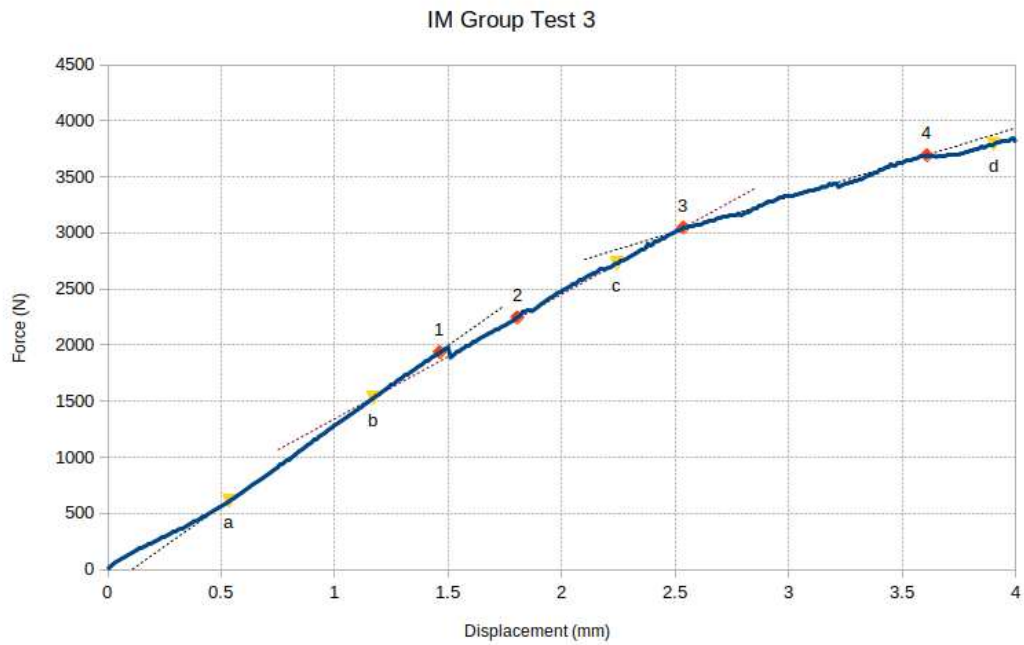

Figure 3.31 – Force/displacement data of the test 3 IM group. **1**: First fracture. **2**: Proximal head starting to touch the diaphysis at the medial zone. **3**: The medial diaphysis is being crushed. **4**: Second fracture. The letters **a**, **b**, **c** and **d** are trivially chosen points to show the movement of the humeral head during the test. The slope dashed lines represent the stiffness in delimited ranges.

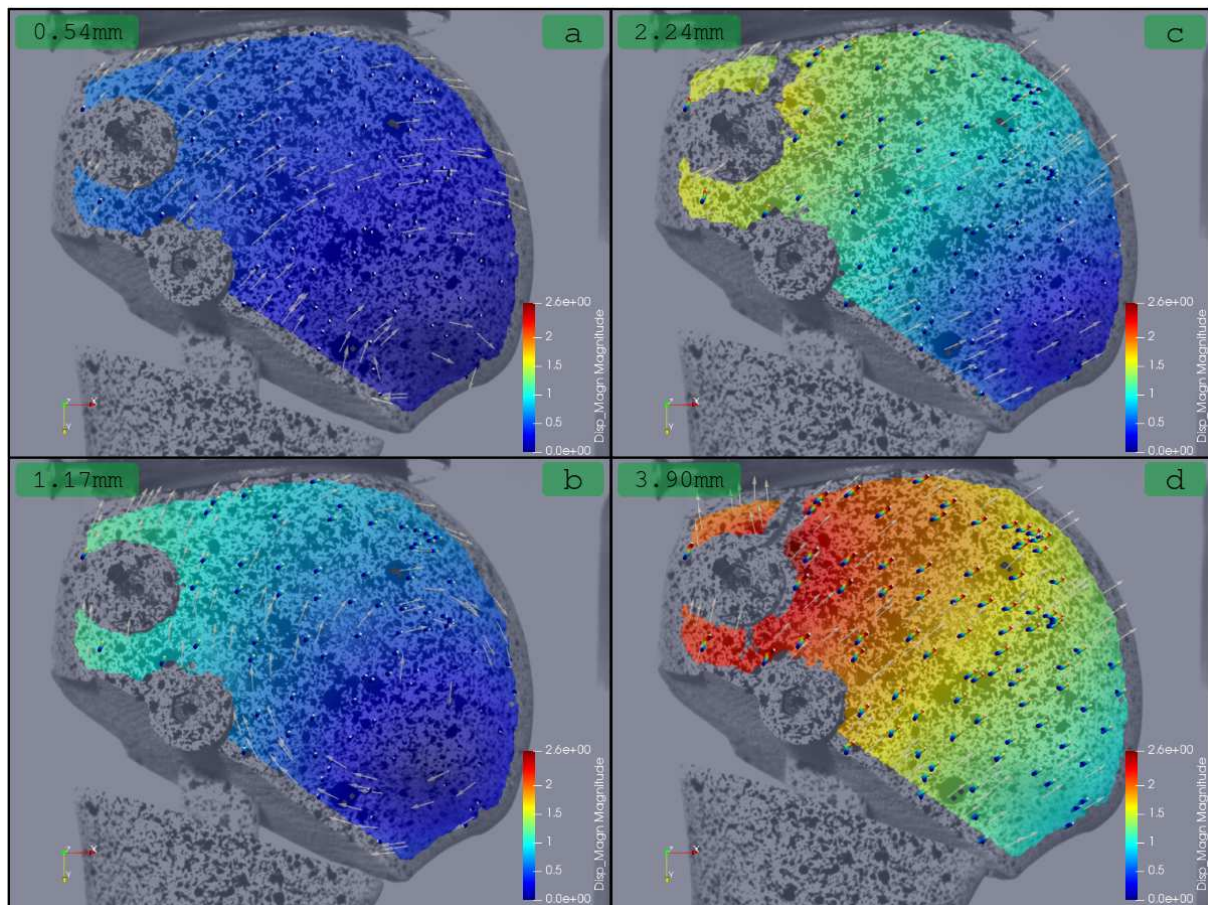

Figure 3.32 – Local displacement magnitude field at four different stages of the IM group compression test 3. Displacement in mm. Before the head-diaphysis contact, the head rotation center is moving and stabilizing in the middle of the humeral head. After this contact, the head shows a medial-cranial translation, pushed by the PMMA cup.

	First fracture		Diaphyseal contact		Diaphyseal crushing		Second fracture	
Point	1		2		3		4	
	Disp (mm)	Force (N)	Disp (mm)	Force (N)	Disp (mm)	Force (N)	Disp (mm)	Force (N)
Test 1	1.32	1818.18	1.48	2206.74	2.31	4032.91	2.90	4518.21
Test 2	1.58	1772.35	2.76	2802.34	-	-	3.21	3566.17
Test 3	1.46	1936.37	1.80	2246.10	2.54	3047.47	3.61	3691.74
Test 4	1.90	2401.33	1.85	2326.93	3.55	4645.28	3.55	4645.28
Test 5	2.04	2382.12	2.29	2431.02	3.59	4800.36	3.59	4800.36
<i>Average</i>	<u>1.66</u>	<u>2062.07</u>	<u>2.04</u>	<u>2402.63</u>	<u>3.00</u>	<u>4131.50</u>	<u>3.37</u>	<u>4244.35</u>
<i>S.D.</i>	<u>0.30</u>	<u>306.89</u>	<u>0.49</u>	<u>239.36</u>	<u>0.66</u>	<u>795.02</u>	<u>0.31</u>	<u>572.31</u>

(a) Fractures and other events.

	Stiffness			
	(N/mm)			
	Elastic	Head touch	Head spurt	Diaph crush
Test 1	1365.06	2378.99	2378.99	866.73
Test 2	1274.49	765.80	1922.34	-
Test 3	1433.77	1109.29	1109.29	616.99
Test 4	1332.17	754.67	1544.34	162.22
Test 5	1296.75	658.87	2027.83	1099.10
<i>Average</i>	<u>1340.45</u>	<u>1133.52</u>	<u>1796.56</u>	<u>686.26</u>
<i>S.D.</i>	<u>62.53</u>	<u>716.90</u>	<u>485.92</u>	<u>401.00</u>

(b) Stiffness variation after each of the test events.

Table 3.8 – **IM group compression test stiffness and fracture data.** Detailed data from the force/displacement curves along with the displacement image analyses. In **bold**, the test studied in this section.

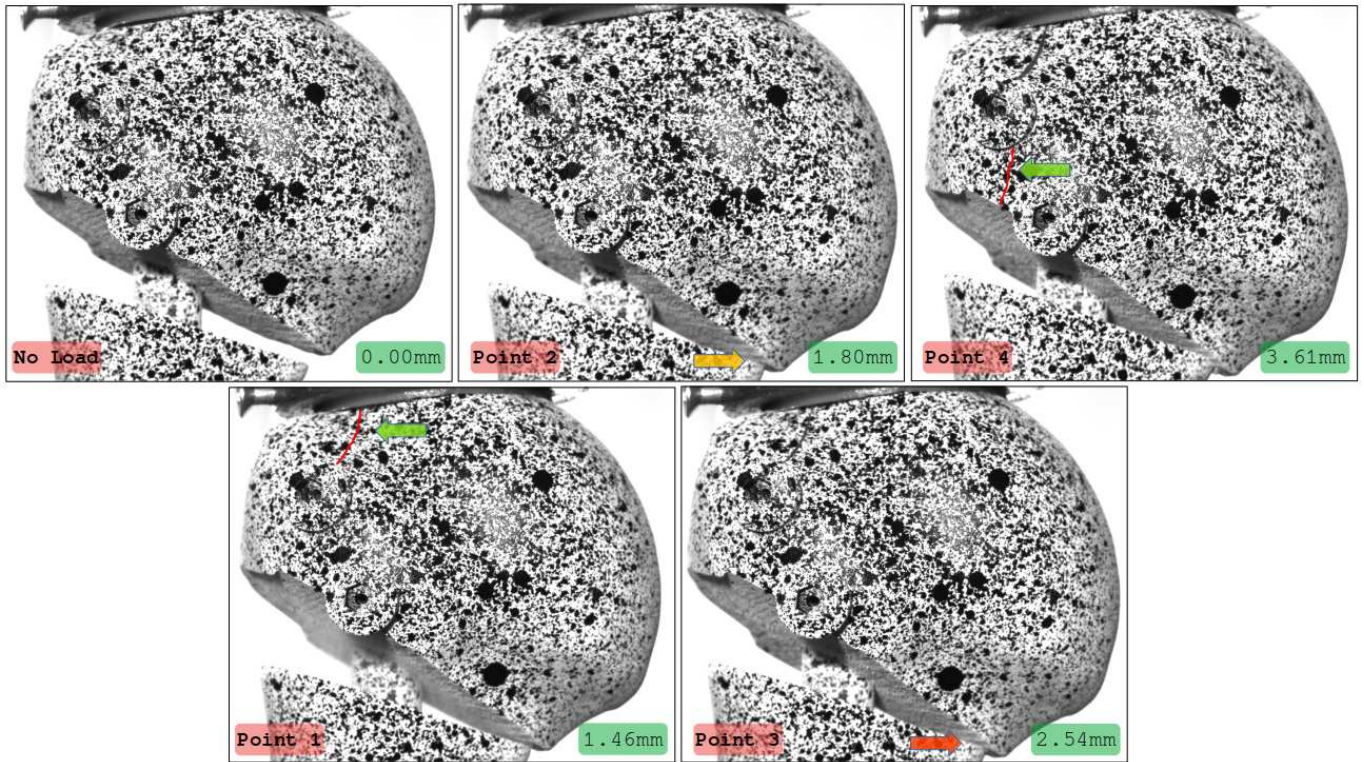

Figure 3.33 – Fracture progression (green arrows), diaphyseal/head contact (orange arrow) and crushing (red arrow) in IM group test 3. The values at the lower right corner shows the global displacement (raw) data from the universal testing machine.

humeral head at the global displacement value of 1.80 mm, and it's marked with the orange arrow (3.33). And while the compressive load still pushes the diaphysis against the humeral head, the diaphyseal tip starts being crushed, as seen in the picture marked with the red arrow (3.33), at the global displacement value of 2.54 mm. The last stage of the test is the occurrence of the second fracture below the first GT screw, and pointing towards the second GT screw, at the global displacement value of 3.61 mm. To reach to this stage, as the first fracture evolves by opening the crack, it is plausible that the second fracture is the continuation of the first fracture through the hole of the first screw. No damage was observed at the (not visible) LT screw, on the anterior face.

The local displacement magnitude field of the IM test 3 shown in the Figure 3.34 comes as a detailed presentation of the local displacement fields description made in the Figure 3.32. Before the diaphyseal tip touches the head (<1.80mm), the rotation of the humeral head with its moving rotation center is clearly seen and followed with the greyscale pathlines. Even the crack present in the Figure at the 1.60mm of global displacement does not change the direction of the movement. The diaphysis clearly is not impacted with any movement change. Then, the rotation changes before disappearing in the following local displacement plots. The direction change is manifested with the pathlines particularly at the 4.00 mm plot.

3.5.3.4 Interfragmentary displacement

As mentioned earlier, the interfragmentary movement analysis might give a wider insight of the behavior of a PHF with an osteosynthesis device in a well-known clinical case. For this particular fracture case, we decided to evaluate the distance between the proximal and distal fragments by measuring the distance change between 3 pairs of points, placed in the lateral (V1), central (V2) and medial (V3) sides of the humerus. In the same way, the angle between the

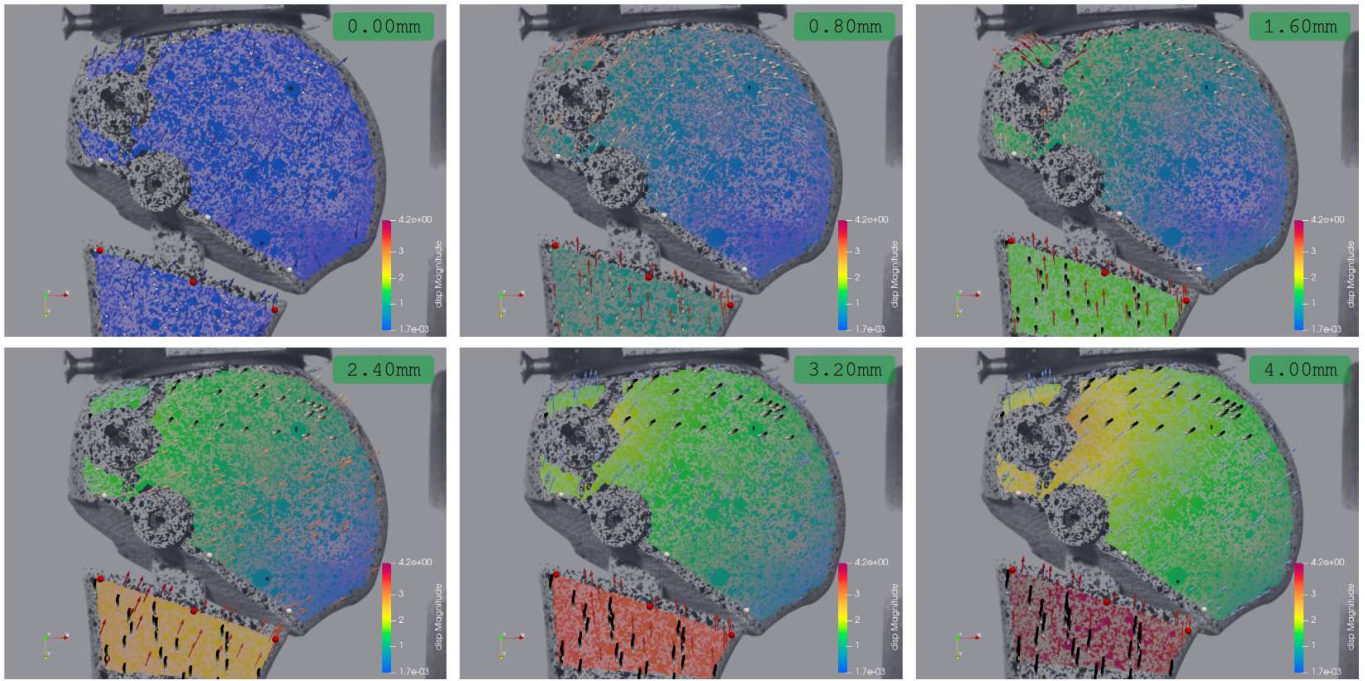

Figure 3.34 – **3D local displacement magnitude field of the IM group compression test 3 in six subsequent stages of the test.** The arrows indicate the speed direction. The displacement is in mm. The temporal pathlines (in greyscale) show the path of the displacement of several points of the local field.

upper (proximal) and lower (distal) points (defined as the vectors B and A, respectively) provides the medio-lateral angle variation of the humeral head. The measured points are visible in Figure 3.35.

In general, the average interfracture gap for all the 5 tests (Figure 3.36) changed with a similar dynamic to the global force/displacement plot (Figure 3.24), with the maximum (minimum) distance gap varying from -2 mm to -3 mm (average -2.44 mm) with an average observed force of 4.8 kN (Table 3.9). This leads to an average interfracture stiffness value of 2089 N/mm for this loading and fracture scenario. It comes to our attention the difference between the (elastic) stiffness value obtained from the global force/displacement data (Table 3.8) which is 1340 N/mm and the interfracture stiffness value. This is due to the influence of the boundary conditions of each test, including the PMMA-bone interface, the IM nail internal friction and other data unique to this test configuration.

The interfracture medio-lateral angle variation, which represents a measurement of the angle between the two osteotomy planes in the frontal plane, shows an initial lateral opening in valgus of the osteotomy, Figure 3.37. This angle widening is abruptly stopped and inverted once the medial diaphyseal corner touches the humeral head, acting as a hinge point. This leads to closing gap angle in varus, without reaching the initial angle state before the halt of the test. The maximum reached angle for the five tests ranges from 1.92° to 3.41°, with a mean force of 2303 N. Such a wide angle variation is due to the errors during the manual osteotomy preparation. Nevertheless, despite the important maximum angle variation, the angular stiffness presents a low standard deviation with an average value of 1029 N/° for the elastic (before any fracture) region. Even for an unstable 2-parts comminuted fracture in varus, for this loading condition the angle variation before the medial diaphyseal hinge is still done in the opposite valgus direction.

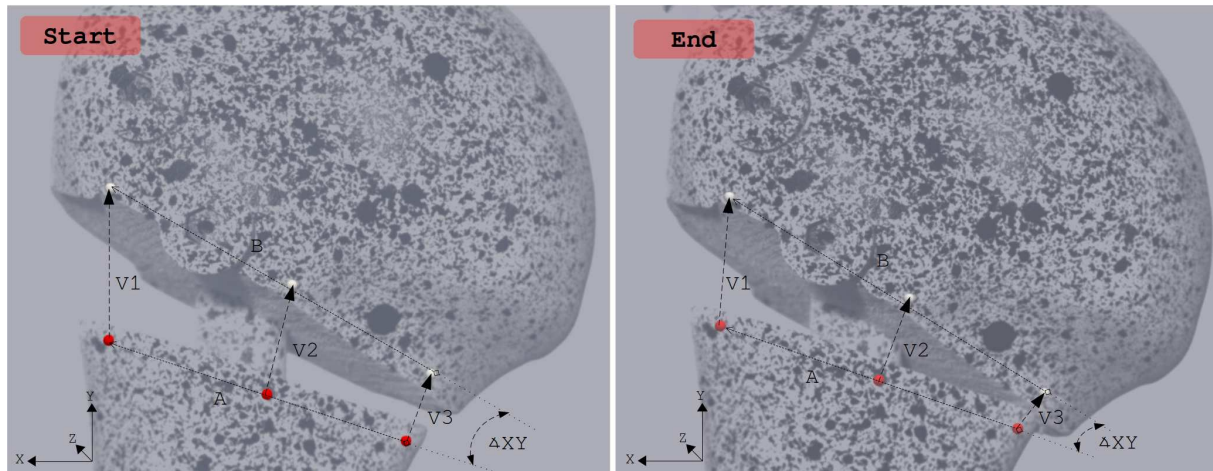

Figure 3.35 – **Interfragmentary distance and angle variation in the IM group compression tests.** The distance is measured between the upper (white) points of the humeral head and the lower (red) points of the diaphysis with the definition of the 3 vectors, V1, V2 and V3. As for the angle measurement, it is measured as the angle between the vectors A and B. The coordinate system is shown at the lower left corner of the image. At the left, the starting image at t=0 and at the right, the ending image.

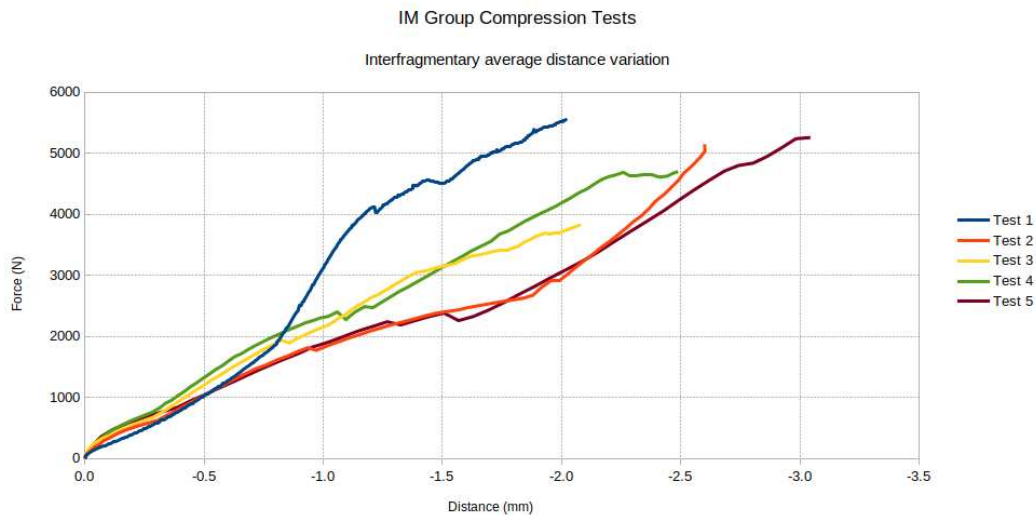

Figure 3.36 – **Interfragmentary distance change for each of the 5 tests.** The value presented is the average distance between V1, V2 and V3, plotted with the global applied force. Please mind the negative values at the X-axis, as they represent a shorter (closing) distance between the two fragments.

	Maximum (minimum) values			Stiffness		
	Distance (mm)	Force (N)	Angle (°)	Force (N)	Translation (N/mm)	Angular (N/°)
Test 1	-2.01	5550.77	1.92	1876.88	2485.70	974.20
Test 2	-2.60	5029.92	3.41	2624.84	1941.63	1036.19
Test 3	-2.07	3806.81	1.93	2182.38	2261.88	1084.14
Test 4	-2.48	4698.30	2.16	2401.33	2225.15	1002.11
Test 5	-3.04	5258.31	2.42	2431.01	1498.22	1048.65
<i>Mean</i>	<i>-2.44</i>	<i>4868.82</i>	<i>2.37</i>	<i>2303.29</i>	<i>2089.11</i>	<i>1029.06</i>

Table 3.9 – **Interfragmentary motion data for the IM group compression test.** The maximum (minimum) values show the extreme values of the average distance and angle variation measurements. The closest interfragmentary gap for each test is shown at the column Distance, along with the maximum force. The maximum opening medio-lateral angle is shown at the column Angle, along with its value in force. The translation and angular stiffness values were measured in the elastic (< 1500 N, before any fracture) region. In bold, the data for the test analyzed in detail in this Chapter.

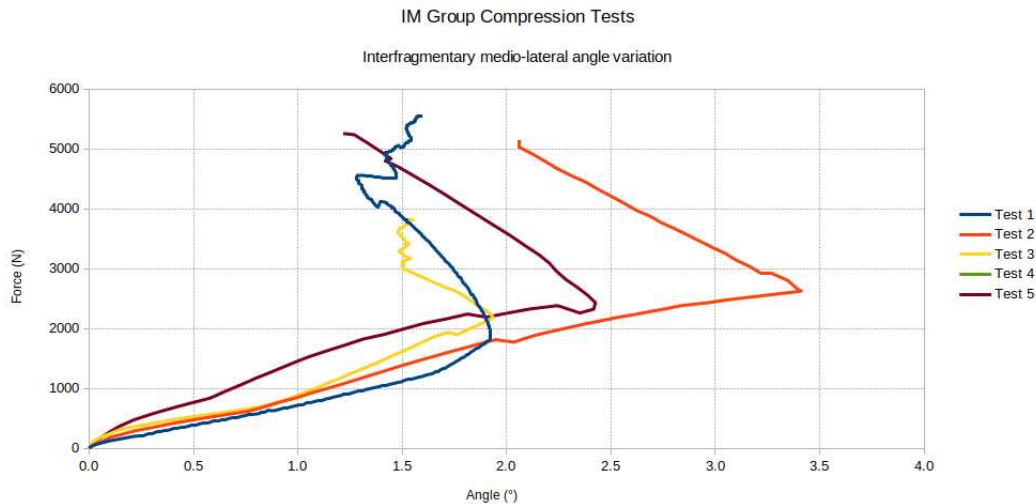

Figure 3.37 – **Interfragmentary angle variation at the plane XY (medio-lateral) for each one of the 5 tests.** The angle is measured between the vector traced by the white proximal head points (B) and the vector traced by the red diaphyseal points (A), in its projection in the plane XY. A wider angle means the “opening” of the lateral (V1) side in contrast to the medial (V3) side in valgus. The abrupt angle change (~ 2000 N) corresponds to the diaphyseal contact event.

3.5.3.5 Local strain fields in control group

For the control group compression test, the volumetric strain (Figure 3.38) highlights three critical regions in which the deformation is maximum (absolute value):

- the humeral head (just below the PMMA cup),
- the lateral side of the greater tuberosity,
- the metaphysis.

It is expected that the humeral head below the PMMA cup highlights a negative (decreasing volume) strain due to the compression load applied in this zone. After the 2.40 mm of global displacement, the -6% of strain is reached and even overcame as the cup continues to sink into the top head. This negative strain is also shown in the metaphysis, just below the anatomical neck. As the compression load keeps being applied, the humeral head starts being “flattened” not only the top of the humeral head, but also around the metaphysis, which is the transition between the mostly trabecular bone to a rigid cortical-only structure. This can be observed in the figure, in which, after reaching 3.20 mm of global displacement, the force gets closer to 3500 N, and the volumetric strain reaches -6%. The GT lateral side, nevertheless, has the highest risk to fracture under this compression load with the positive (increased volume) strain ranging from 2% to 6%. An important observation is that the fracture indeed happens in the lateral side, close to the intertrabecular groove, unfortunately not visible on the acquired images. Only in one test, we observed a full GT detachment with a visible crack close to the end of the test (~ 5000 N). This might be due to the apparent penetration of the PMMA cup at the top of the humeral head, that “tears” this particular affected zone.

3.5.3.6 Local strain fields in IM group

The local strain distribution on the IM group compression (Figure 3.39) tests clearly shows two critical (and expected) zones:

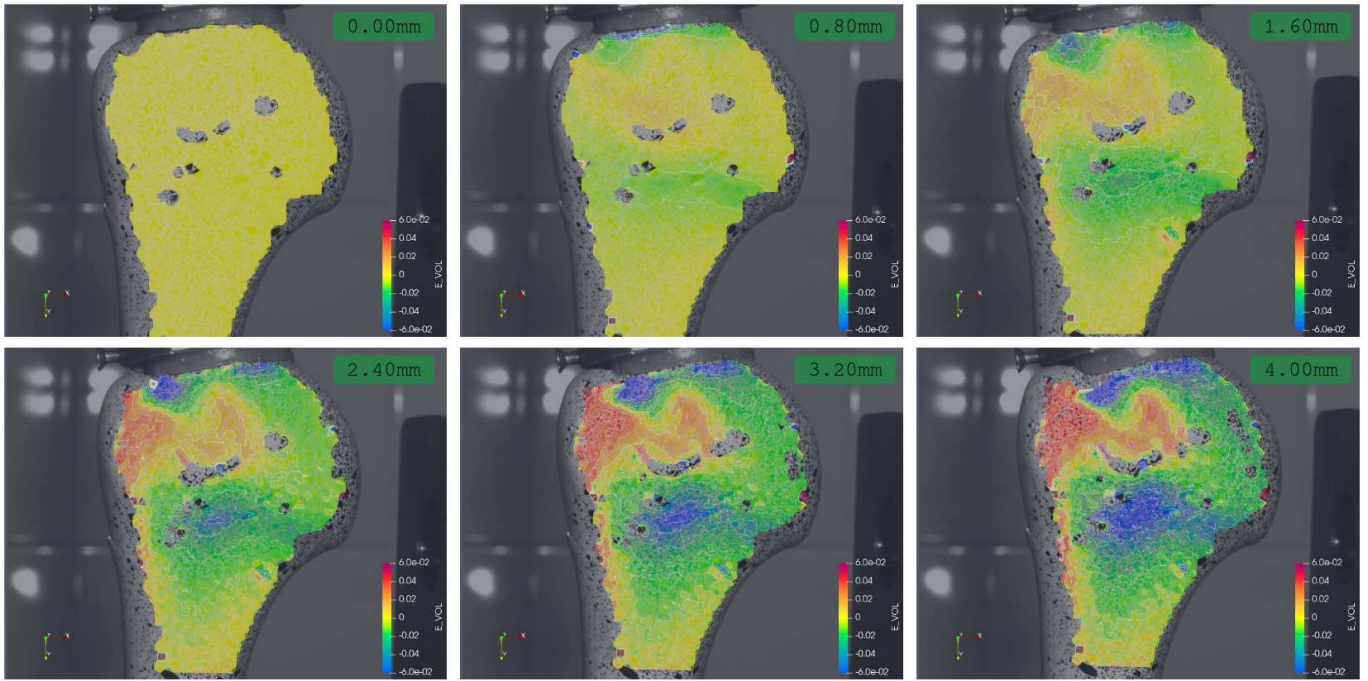

Figure 3.38 – **Local volumetric strain distribution of the control group test 4.** Starting from the upper left image, the global displacement value is shown in the upper right corner of each image until the end of the test, image lower right.

- around the first GT screw,
- around the second GT screw.

As the compression load is applied on the top of the humeral head, the region around the screws starts to show a “dipole” of volumetric strain: positive (volume increase) and negative (volume decrease). The first region to show this behavior is the first (most proximal) GT screw. This is mostly caused by the tilting of the screws as the intramedullary nail is being pushed upwards inside the humeral head. As the first fracture appears when the global displacement is $\sim 1.50\text{mm}$, the snapshot at 1.60mm shows the cracking zone that goes from the first screw to the humeral head. It is important to recall that the screw holes might be considered as stress risers, and therefore, fracture precursors. Once the first fracture appears with a strain beyond 3%, we can see on the images located at the displacement 2.40 mm two positive strain concentration zones at the first and second screw, with strain values reaching 2%. The volume strain increases leading to a second fracture between the GT screw holes at the end of the test. In the rest of the humeral head, the local strain variation is negligible.

3.5.3.7 Analysis of local strain fields in the elastic zone ($<1.5\text{ mm}$)

Although the local strain distribution between the IM group and the control group are dissimilar due to the presence of an osteosynthesized fracture in the IM group, two “common strain” can be identified when comparing both groups before the any fracture occurs ($<1.5\text{ mm}$) (Figure 3.40):

- the top of the humeral head (below the PMMA cup),
- the lateral greater tuberosity zone.

The top of the humeral head, in which the compression load is applied, shows a negative strain, reaching on the edge -0.7% for the IM group and, almost ten times more (-7%) for the control group. Even at the beginning of the test,

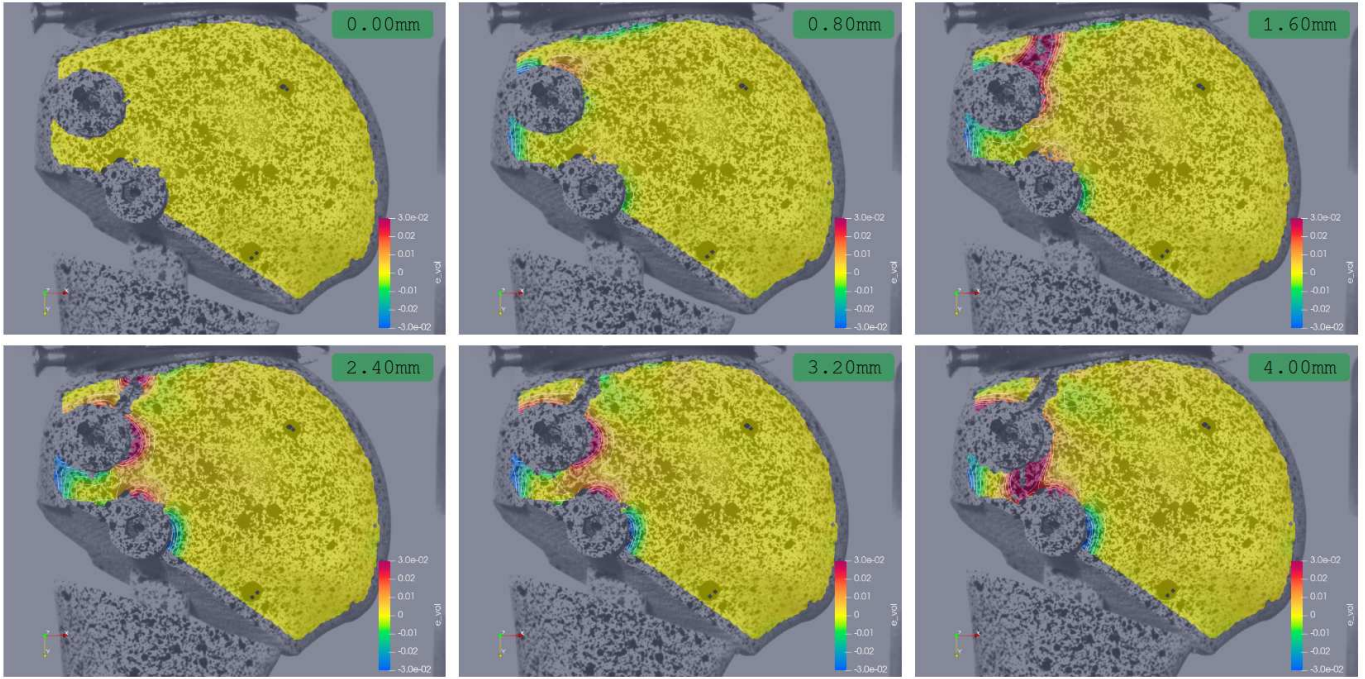

Figure 3.39 – **Local volumetric strain distribution of the IM group test 3.** Starting from the upper left image, the global displacement value is shown in the upper right corner of each image until the end of the test, image lower right.

image at 0.30 mm, in the control group, negative strain appears and seems to far surpass the minimum -0.7% of the used scale, whereas in the IM group test, the negative strain becomes apparent when reaching already 0.90 mm of global displacement. This is not only because the force applied for the same global displacement is four times larger than the control group, but also because the control group humeral head is stiffer.

As for the positive strain present in the greater tuberosity zone, as stated before, for the IM group it is mainly due to the presence of the GT screws while for the control group, it could be due to the compensation of the surrounding negative strain that prone this area to be a risk of fracture. Although the initiation and the propagation of the fracture in the GT is completely different between the IM group and the control group, the positive strain values are not highly dissimilar, averaging 0.5% at the 0.90 mm of global displacement and peaking 0.7% at the 1.50 mm of global displacement.

3.5.4 Partial conclusions

In this section, we have carried out a compression test with the load applied at the humeral head on the diaphyseal axis using synthetic bones. From a physiological point of view, it corresponds to a glenohumeral position in which the arm is abducted 90°, with no muscles action on it, and a mechanical pressure imposed on the distal end of the arm parallel to the arm axis. The relevance of this test comes when doing a biomechanical evaluation of such unstable osteosynthesized configuration, comparing different internal fixation devices. In such configuration where the glenoid support becomes the source of the load, the head fixation stiffness, strength and the cycles to failure are the predominant evaluated variables [Maldonado *et al.*, 2003, Seide *et al.*, 2007, Varga *et al.*, 2017]. Except for the cycles to failure of the head fixation, the presented experiment was able to determine in a quasi-static, reproducible scenario, the stiffness of the construct humerus + IM nail, in global terms (Table 3.6) and in local terms for both the IM group (Table 3.7) and the control group (Table 3.8) for a single, representative test. Although the stiffness and the load

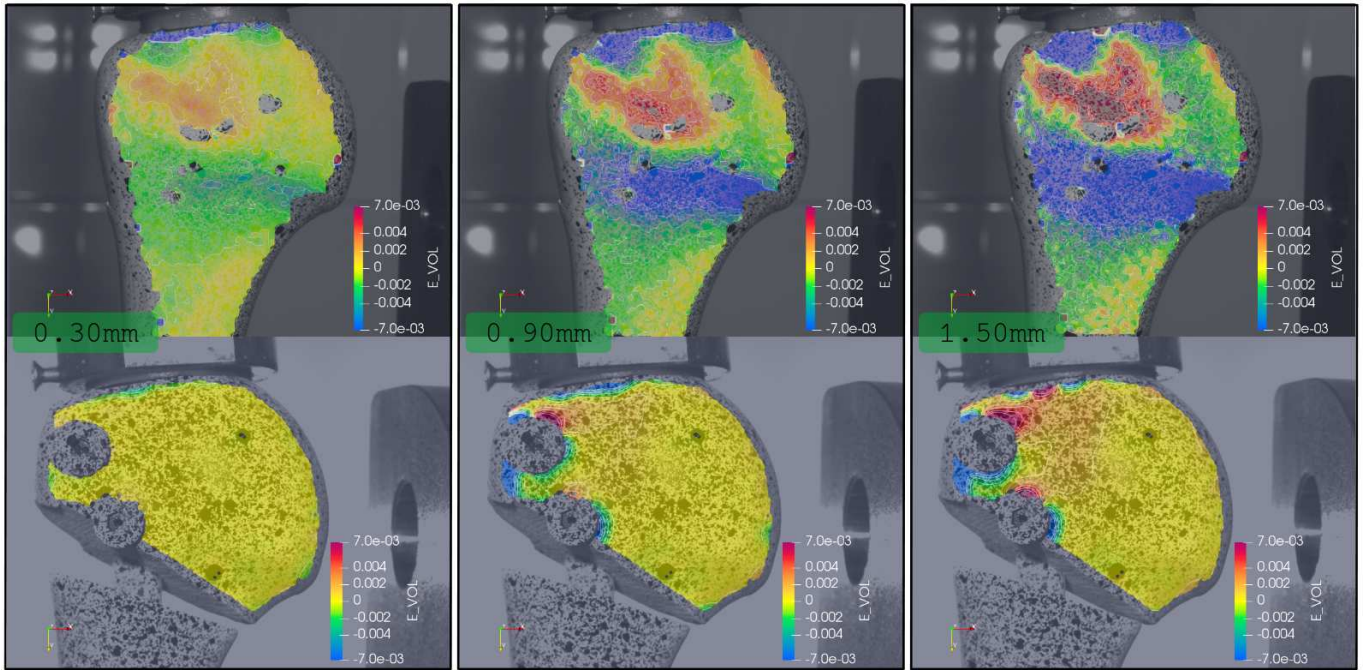

Figure 3.40 – **Volumetric strain field comparison between the control group and the IM group.** The upper images show the control group and the lower images, the IM group. The global displacement for both tests is shown in the middle. The comparison is done at the same global displacement for each pair of images, in the elastic region (<1.5mm of global displacement, before any fracture appearing).

to failure values were different for both groups, surprisingly the displacement to failure (global displacement value in which a first fracture event was recorded) was statistically similar for both groups. While the crack initiation and propagation were different in both groups of study, unfortunately the fracture observed in the control group (located close to the intertrabecular groove, Figure 3.29) was not recorded and therefore, not analyzed using the Digital Image Correlation (DIC) algorithm.

The DIC algorithm was indeed useful for the local measurement in terms of displacement and strain on the surface of the bone. The interfragmentary motion observed for the fracture case might be relevant to be used for comparative studies between other osteosynthesis devices in terms of the local observed interfragmentary stiffness (ratio of the local displacement and the applied force). In a similar outcome, the local strain data can be used for comparative purposes, although it is important to underscore that the used DIC algorithm does not take into account the discontinuities, and therefore, this will not allow to properly compare the data when cracks initiate.

In general, this compression test not only validate that the fixture designed for the humerus testing is suitable for such high loading scenarios, but also the important amount of data issued from the test can enrich an *in silico* model in detail, as it is expected in the following Chapter.

3.6 Pulling with head support setup

The objective of the tensile tests with glenoid support, is to simulate an abduction [Clavert *et al.*, 2016], applying the pulling load at the Greater Tuberosity in the supraspinatus anatomical zone. This is justified in regard of the muscle that participates the most at the pulling load on the humeral head [Yanagawa *et al.*, 2008]. As the materials and methods used in this protocol is similar in several aspects to the compression setup, we will briefly review the details, stressing only in the differences for this test.

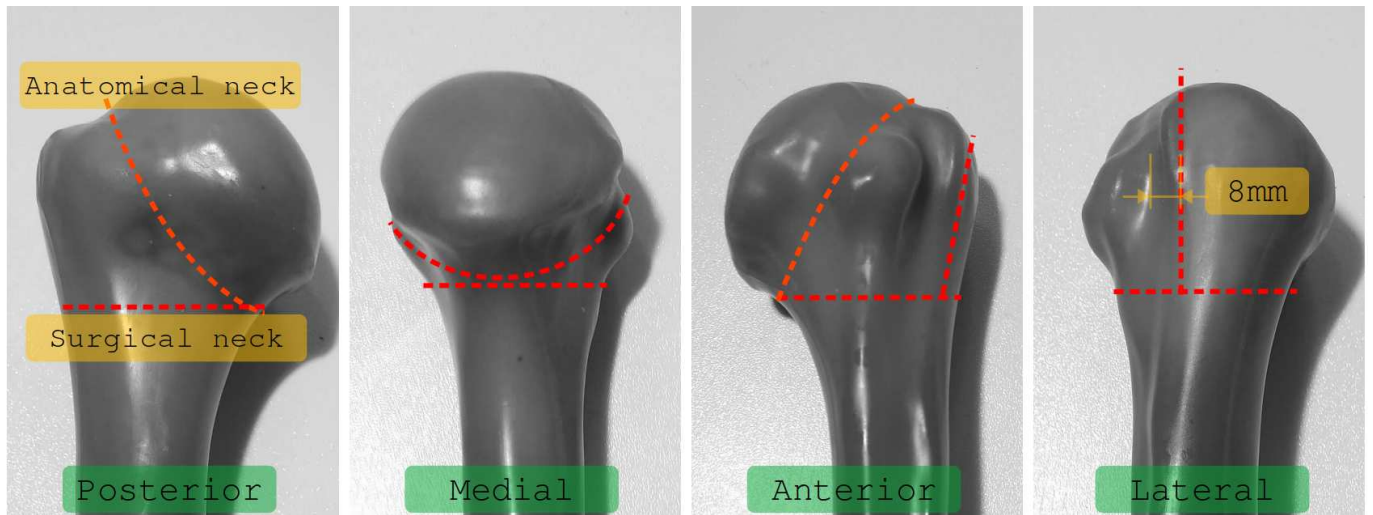

Figure 3.41 – **Bone preparation for the 4-parts fracture.** Following the [Clavert *et al.*, 2016] protocol, the anatomical neck and the surgical neck were cut, the fracture planes reaching the medial calcar. The tuberosities were also separated by a cutting plane in a coronal orientation, 8 mm posterior to the intertubercular groove.

3.6.1 Materials

As stated before, the pulling test was divided in the control group (no fracture) and in a 4-parts fracture treated with the Aequalis© IM nail, hereby called the IM group. The bones used for this test are the 4th-generation humeral Sawbone© (details of the mechanical properties Table 3.4) cut in half. We kept only the proximal segments (175 mm length). The IM group consisted in five bones, and the control group is consisted on four bones. The bones were embedded in the fixture using the resin PMMA (properties Table 3.5).

3.6.2 Methods

3.6.2.1 Clinical preparation of the specimens

The preparation starts by paper-sanding with 120 grain size the bone surface of the greater tuberosity in order to increase the adherence of the straps glue, done in a posterior stage. Then, for the IM group bones, the 4-parts fracture must be recreated according to [Clavert *et al.*, 2016]: two osteotomy lines were drawn around the surgical and the anatomical neck and a third intertuberosity osteotomy line at 8 mm lateral to the bicipital groove (Figure 3.41). For this, as in the compression IM group, we start riming the hollowed canal of the Sawbones with a 9 mm diameter tool. Then, clamping the distal part of the humerus using a vice, we proceeded to manually cut with a 24 teeth-per-inch (TPI), standard 300 mm hacksaw the synthetic bone, following the previously drawn reference curves. The aiming guide jig is then clamped to the vice, the IM nail fixed to it, and the bone fragments are put in place. The IM nail was placed according to the manufacturer’s guidelines: the anatomical reduction was done by inserting the nail through the hollowed canal of the Sawbone in the diaphyseal axis, with two screws at the greater tuberosity (GT) and a locked distal screw. The screw holes were made using the guide sleeves attached to the aiming jig.

Once the IM nail is well positioned, the fixation screws of the GT are removed and a high-modulus polyester strap (CHAPUIS© GMAR07 25mm width) is glued using a bi-component resin (Sader© Epoxy Progressive) 24 hours prior to the test. This is important in order to avoid the strap to tear away. The total length of each strap is 280 mm. The effective length, between the clamped and the glued ends, is 200 mm.

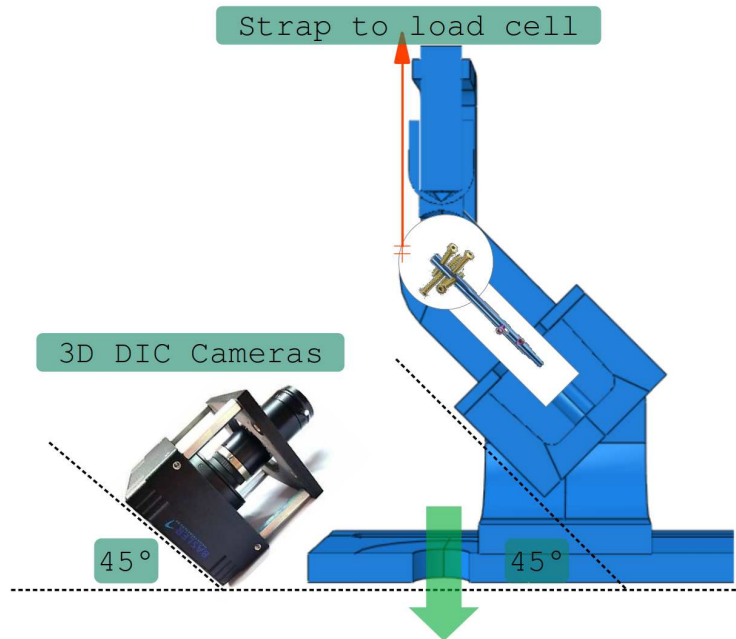

Figure 3.42 – **Positioning of the fixture and the cameras for the pulling case.** The fixture base was inclined to 45° and the head support aligned to the testing machine axis. The strap was fixed to the load cell at the fixed upper crosshead. The cameras were fixed to the floor with a tripod and inclined 45° to record the full humerus lateral face. The green arrow shows the hydraulic piston translation direction.

3.6.2.2 Fixture and speckles setup

Once the strap is glued, both the control group and the IM group bones are prepared for the speckles application. As described before, the procedure implies a first application of a mat-white spray painting over the face to be recorded (lateral, for this case) and then, with small shots of spray, mat-black dots are randomly applied over the surface. The bones are then left to dry for about 15 minutes.

The next step is embedding the bones on the fixture. Following the fixture's user guide (Section 3.2.5), the bone is placed in the middle of the receptacle (already treated with the mold removal agent and the modeling clay) and centered using the assigned screws for this step. Using the positioning templates (Figure 3.7), the bone diaphysis is oriented parallel to the receptacle axis, with the lateral face towards the cameras. Then, the receptacle is turned 45° and the base moved so the humeral head aligns with the loading axis of the testing machine (Figure 3.42). The head support is then placed according to the guidelines, in a vertical position. Minor centering adjustments of the bone might be necessary when placing the humeral support. Once the full setup is in a satisfactory position, the centering screws are locked and a small layer of Technovit PMMA resin (in a 2:1 powder-liquid volume ratio) is poured over the inclined receptacle to keep in position. Once the layer is polymerized, the head support is put apart and the base tilted to the 0° orientation. The centering screws are partially removed. As for the compression tests, an average of 450 gr of PMMA (300 gr of powder, 150 gr of liquid) were used for each bone, taking around 1 hour per bone preparation.

The tilted humeral face to be recorded required a tilted configuration of the stereo rig, also in 45°. For all the tests, the stereo angle used was 16°, with a baseline of 7.5 cm and a normal distance of 25 cm. For the digital image correlation analyses, a subset size of 60 px was chosen for all the tests, with a subset step of 20 px and a virtual strain gauge size of 60 px.

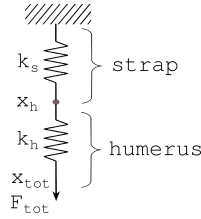

Figure 3.43 – **Linear mechanical model for strap stiffness correction.** The pulling test was modeled using linear springs in series, meaning that the global measured force (F_{tot}) is the same along the series. The strap stiffness (k_s) is to be measured and later used in order to estimate the corrected global humerus displacement ($x_{tot} - x_h$).

3.6.2.3 Universal testing machine setup

After the fixture mounted on the hydraulic piston of the testing machine, the strap end is attached via a hydraulic jaw to the load cell located at the upper fixed crosshead. The full experiment is done using a servohydraulic testing machine (INSTRON 8500 plus, INSTRON corp.) with a 50 kN load cell. As the load is applied with the lower piston, the tensile load is done in the lower direction, as indicated in the green arrow Figure 3.42. The testing raw data (force/displacement) is acquired using the Instron MAX (ver 4.2, INSTRON corp.) software at 10Hz using a generic CSV format. With a preload of 20N, two displacement cases were applied:

- IM group: 20 mm total displacement at 4 mm/min.
- Control group: 10 mm total displacement at 4 mm/min.

3.6.2.4 Straps stiffness correction

In order to account for the elastic properties of the strap used in this tensile test, a strap stiffness correction protocol is proposed. Modeling the tensile test as a spring series of a strap + humerus assembly (fixture, bone, IM nail) (Figure 3.43), if the strap stiffness k_s is known, it can be used to estimate the corrected humerus displacement, Equation 3.6:

$$x_h = \frac{F_{tot}}{k_s} \quad (3.6)$$

, therefore, estimating the humerus displacement as the simple subtraction $x_{tot} - x_h$.

For this, an experimental protocol testing strap segments is proposed. Using the same strap as described before (CHAPUIS© GMAR07 25mm width), five strap segments were cut, averaging 280 mm length. Using the same Instron 8500 servohydraulic testing machine, both strap ends were clamped using hydraulic jaws and pre-loaded with 20 N. After clamping, the effective strap length is 200 mm. Using a speed of 4 mm/min, the strap were tested in tension with a displacement of 10 mm. The raw data was acquired using the Instron MAX ver 4.2 software at 10 Hz, in a generic CSV format file.

3.6.3 Results

Similarly to the outcome analyses for the past compression protocol, the results are presented individually for both the four control group Sawbones (Figure 3.45) and the four IM group Sawbones (Figure 3.44) in the following terms:

- Straps tensile test results and strap stiffness for data correction.

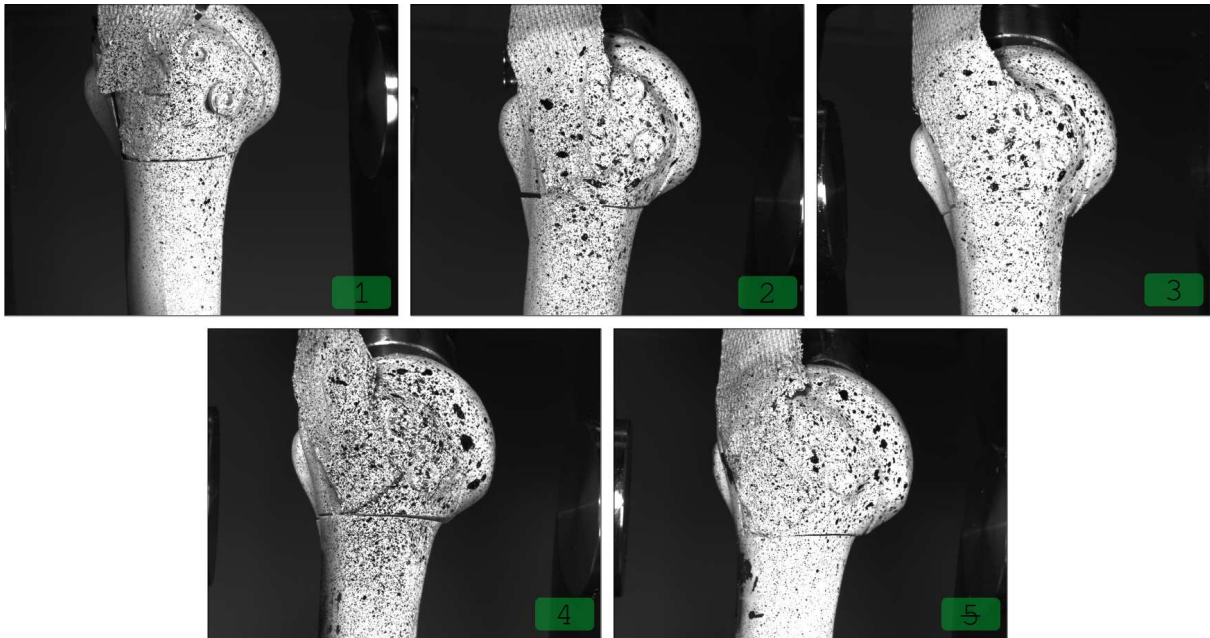

Figure 3.44 – **The five IM group pull tests.** Note that the 5th test failed due to a strap teared off from the greater tuberosity and therefore was not included in the results presentation.

- The general force/displacement data, raw and corrected with the strap stiffness removal, directly obtained from the universal testing machine for each test, along with the general stiffness.
- The local displacements data for each test and its data visualization of a single test per group.
- The interfragmentary displacement (relative displacement between the proximal and the distal parts of the humerus) at the IM group for all the tests.
- The local 2D volumetric strain distribution for a single test for each group.
- A comparison of the local volumetric strain for a given segment of the test.

Only one case per group is detailed in the following subsections. The full analyses for the tensile tests are available in Annex F.

3.6.3.1 Straps stiffness

As discussed previously in the Chapter 2, the strap or rope used to simulate a muscle during an experimental test can significantly influence the global measured displacement results for a tensile test. This is due to the elastic properties of the rope or strap used. Hence, the displacement/force curves obtained after tensile tests on five strap segments are shown Figure 3.46. The mean value is represented by a blue line, the full range as a light blue area and the 95% confidence estimated with the standard deviation of the data as a light red area. The outcome of the test are homogeneous and reproducible, with a quasi-linear behavior. A linear regression was then used to approximate the data to a straight slope, leading to a mean stiffness value of 266.81 N/mm for a 200 mm strap with a R^2 of 0.989.

3.6.3.2 General and corrected force/displacement data

The global force and displacement data is shown Figure 3.47, showing a similar steady linear progression in both groups, with a slightly steep increment in the IM group after the 10 mm global displacement. In contrast to the

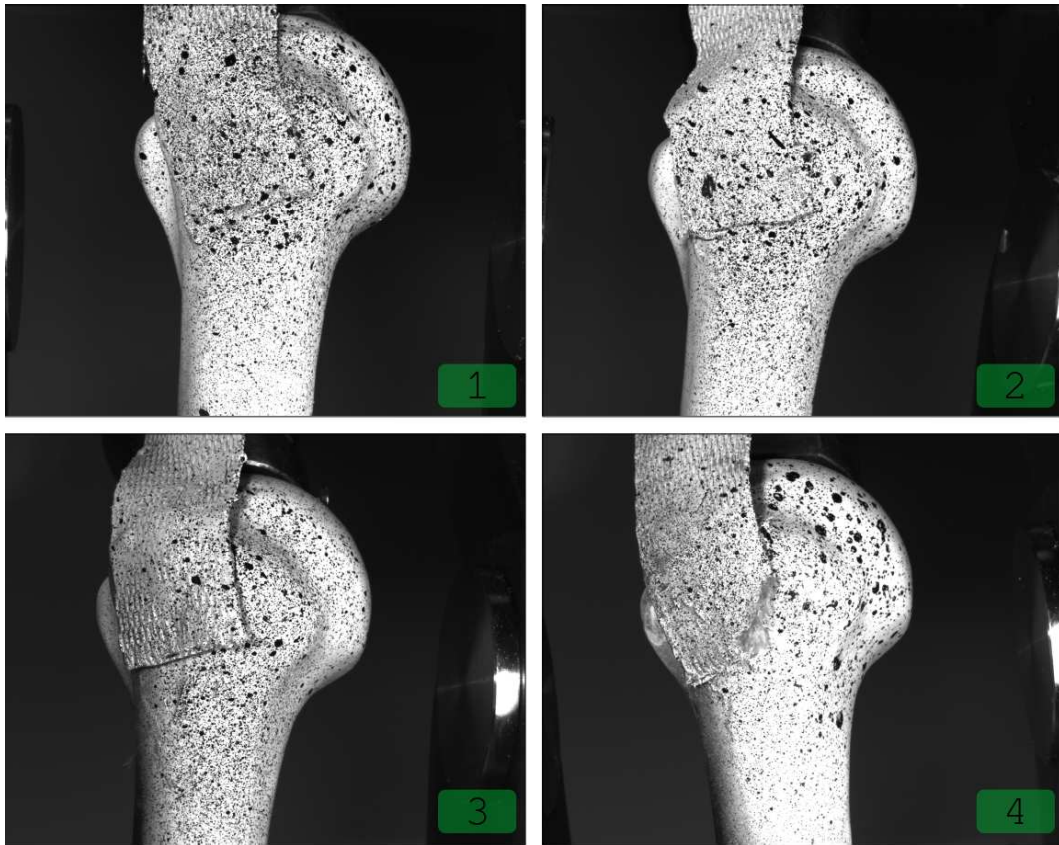

Figure 3.45 – The four control group pull tests.

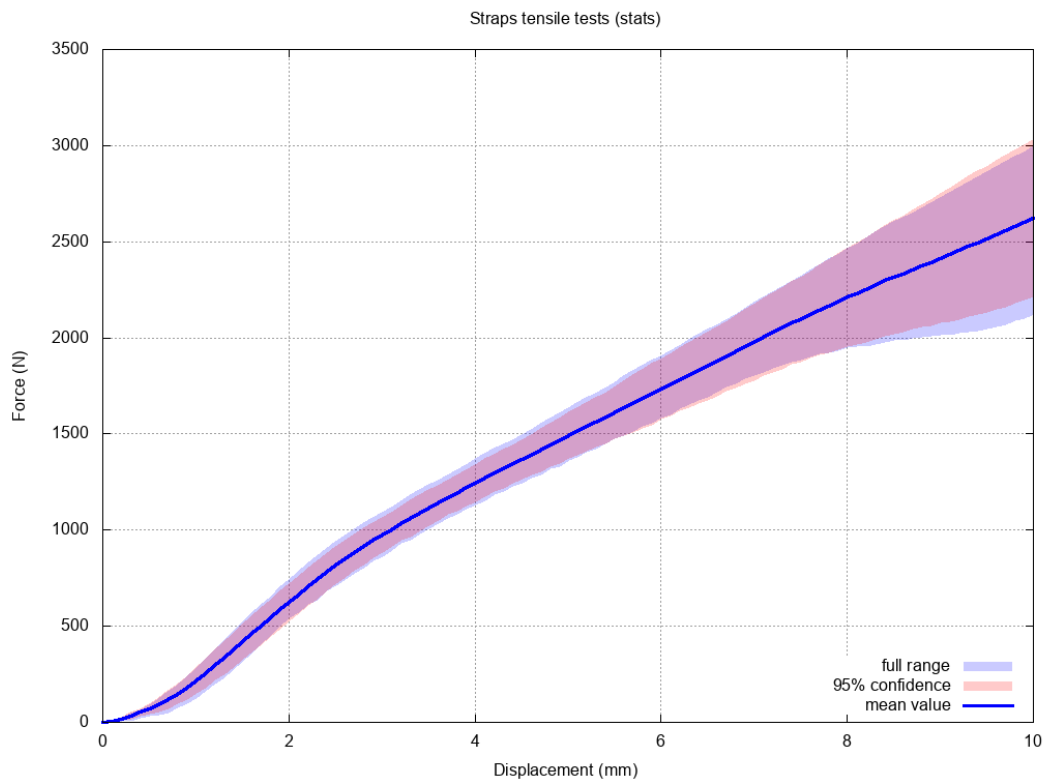

Figure 3.46 – Force/displacement mean data of the straps' tensile test. Although the straps, as a weaved structure, might show variations of the stiffness along the test, the mean stiffness was approximated using a linear regression, giving a value of 266.81 N/mm.

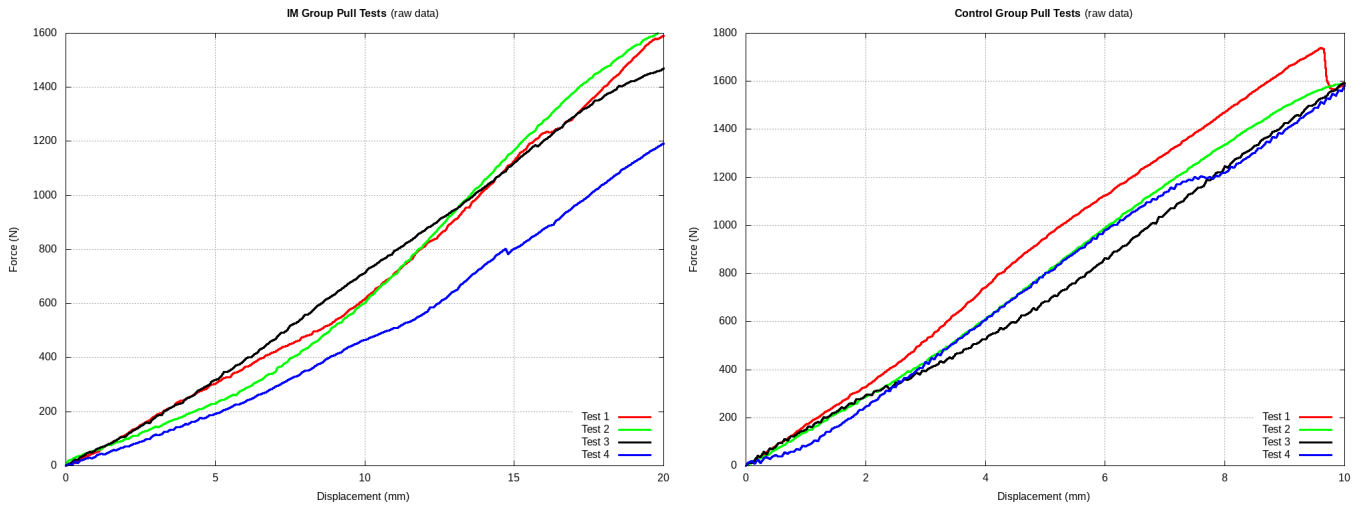

Figure 3.47 – Force/displacement raw data for control and IM groups of the tensile tests.

compression test, there were no observed events such as fractures or sudden changes, perhaps due to the relatively low maximum force present in the test (~ 1600 N). This force nevertheless is still higher than the average observed force in the supraspinatus muscle [Yanagawa *et al.*, 2008].

As previously discussed, the strap stiffness is eliminated from the raw force/displacement data, in order to have a better estimation of the corrected humerus displacement and its stiffness. Using the Equation 3.6 and the estimated strap stiffness of 266 N/mm, we calculate a corrected displacement for both the IM and control group, shown Figure 3.48. Both plots shows the mean value, the full range and the 95% confidence area based on the standard deviation of the tests. The IM group shows a maximum corrected displacement value of 15.53 mm (out of 20 mm) for the test 4, and an average corrected displacement of 14.5 mm, with a maximum measured force value of 1611 N and an average value of 1466 N. The control group shows a maximum corrected displacement of 4.07 mm and an average corrected displacement value of 4.04 mm, with a maximum measured force value of 1592 N and an average force value of 1588 N.

For the stiffness estimation, each force/displacement curve was modeled using a linear regression. The control group showed a good prediction quality ($R^2 > 0.99$) for the whole plot, while the IM group was necessary to split the predictions in two sides: before 10 mm of global (uncorrected) displacement and after 10 mm global (uncorrected) displacement. Using this criteria, both stiffness showed a good prediction quality ($R^2 > 0.99$). The data modeling was applied for both the uncorrected and corrected strap stiffness data. Unsurprisingly, the control group showed higher stiffness values in contrast to the IM group, Table 3.10. The control group average stiffness value for the raw and corrected data is 168 N/mm and 465 N/mm, respectively, a +250% difference. The IM group average stiffness values for the raw and corrected data are 59 N/mm and 76 N/mm respectively for the range < 10 mm of global displacement, while the values for the range > 10 mm of global displacement are 89 and 137 N/mm respectively, a difference less than 150%.

3.6.3.3 Local displacement fields in control group

For the sake of simplicity and in order to avoid redundancy, the test 2 is analyzed in both the control group and IM group. As stated before, the control group tests showed a linear force/displacement behavior all along the 10 mm of

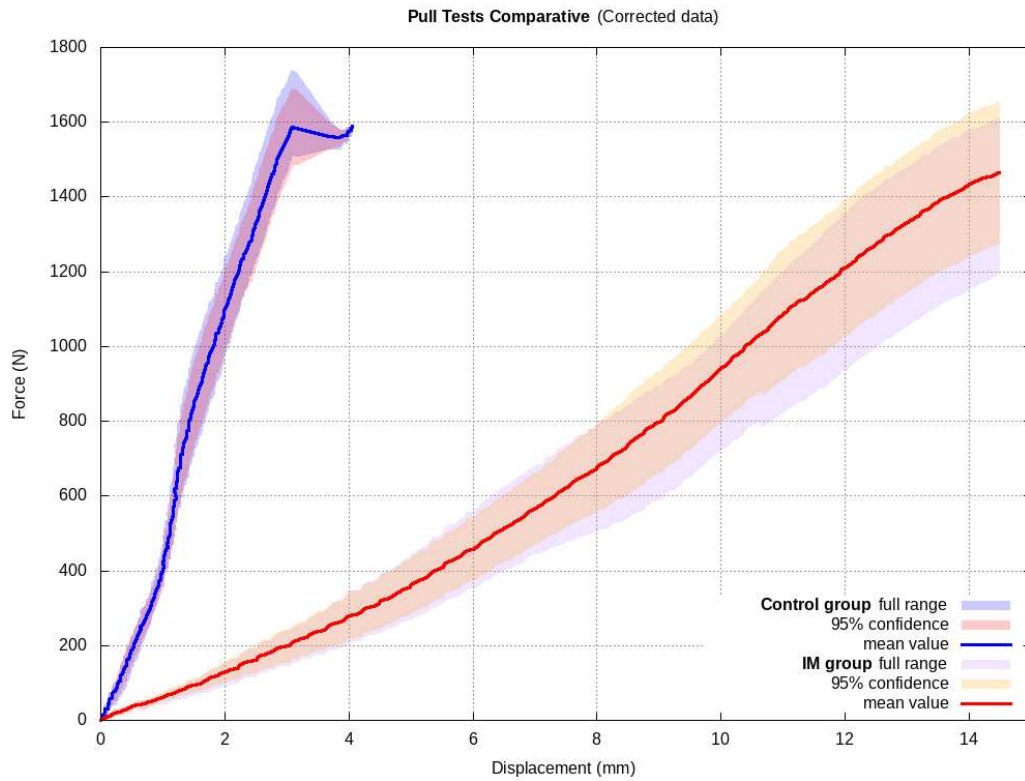

Figure 3.48 – Force/displacement data after strap stiffness correction for the IM and control groups of the tensile tests.

	IM Group				Control group	
	Stiffness (<10mm)		Stiffness (>10mm)		Stiffness	
	Raw [N/mm]	Corr. [N/mm]	Raw [N/mm]	Corr. [N/mm]	Raw [N/mm]	Corr. [N/mm]
Test 1	60.83	78.80	98.79	156.88	181.80	570.60
Test 2	56.74	72.07	105.17	173.62	170.20	470.10
Test 3	72.44	99.43	79.71	113.67	159.17	394.57
Test 4	46.50	56.31	76.18	106.63	164.18	426.82
<i>Mean</i>	<u>59.13</u>	<u>76.65</u>	<u>89.96</u>	<u>137.70</u>	<u>168.84</u>	<u>465.52</u>

Table 3.10 – Synthesized stiffness data for both IM and control group. The data is presented as raw (before strap stiffness correction) and corrected. In bold, the tests analyzed in detail.

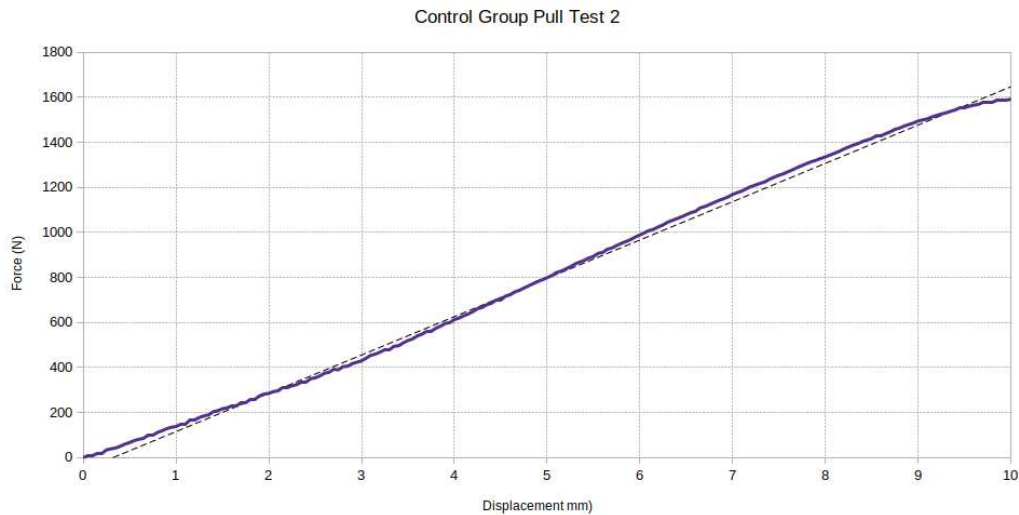

Figure 3.49 – **Force/displacement data of the tensile test 2 control group.** The blue line represents the raw (uncorrected) machine data, and the dashed line, the slope to estimate the stiffness value.

global displacement, as seen Figure 3.49. During the mechanical test, the local displacement magnitude field (Figure 3.50) shows a monotone and regular movement downwards, with unchanging speed arrows and pathlines confirming that no exceptional motion event occurred during the test.

3.6.3.4 Local displacements fields in IM group

The IM group tensile test 2 (Figure 3.51) shows a linear elastic progression along the 20 mm of global (uncorrected) displacement, with a soft increase transition in the stiffness at around 8.5 mm of displacement. This change in the stiffness is mainly due to an “adjustment” phase, in which the pulled GT is firstly being rotated medially or internally, pushing the LT and the humeral head against the head support. This can be seen following the greyscale pathlines, Figure 3.52, where the GT rotation is traced as an anterior motion while the humeral head keeps descending (the global displacement is downwards). By default, the GT internal rotation is constant along the full test, while the caudal motion (downwards) becomes slowly dominant after the 8 mm of global displacement. At the same manner, the tensile force exerted to the GT pushes it against the humeral head, leading to a slightly internal rotation in addition to the expected caudal and medial (compressive) motion. As an additional observation, we see that the fracture plane between the GT and the diaphysis is heavily impacted by the rotation and the separation of the GT, while the fracture plane of the GT and the humeral head shows mostly a shearing motion between the fragments. The interfragmentary movement is further analyzed in the following subsection.

3.6.3.5 Interfragmentary displacement

For this unstable configuration, three fracture planes are present. However, due to the camera configuration, only two fracture planes were recorded and analyzed: the greater tuberosity - diaphysis (GT-D) plane and the greater tuberosity - humeral head (GT-H) plane. As discussed before, when the traction load is applied to the strap, the GT fragment tends to rotate and to separate from the rest of the proximal humerus. This motion can be measured calculating and averaging the distance between a set of 2 pair of points (V1 - V2 and V3 - V4) for each fracture plane. This results in the averaged GT-D and GT-H distances (Figure 3.53). As for the rotation and the opening of the fracture planes,

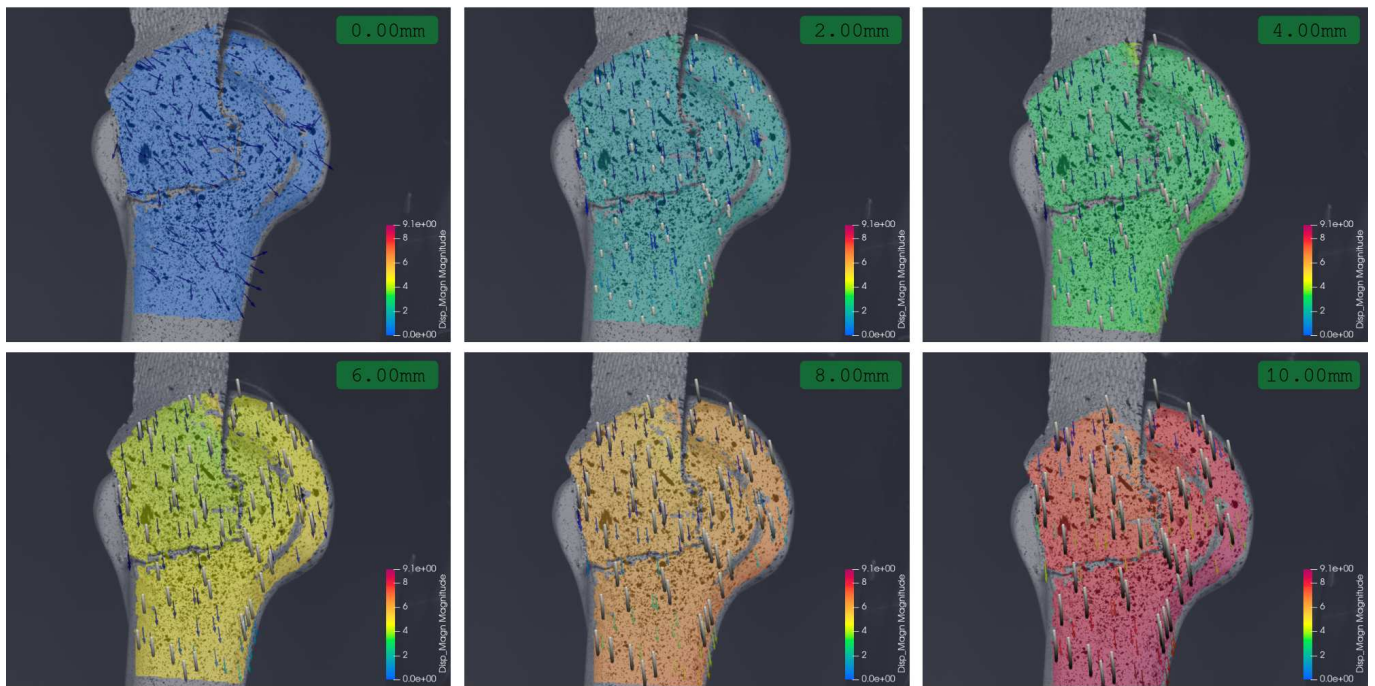

Figure 3.50 – **Full local displacement magnitude field for control group tensile test 2.** The magnitude distribution (in mm) is shown for six subsequent stages of the test, the global displacement shown in the green rectangle. The arrows indicate the speed direction (the pulling is done downside). The temporal pathlines (in greyscale) show the path of the displacement of several points of the local field.

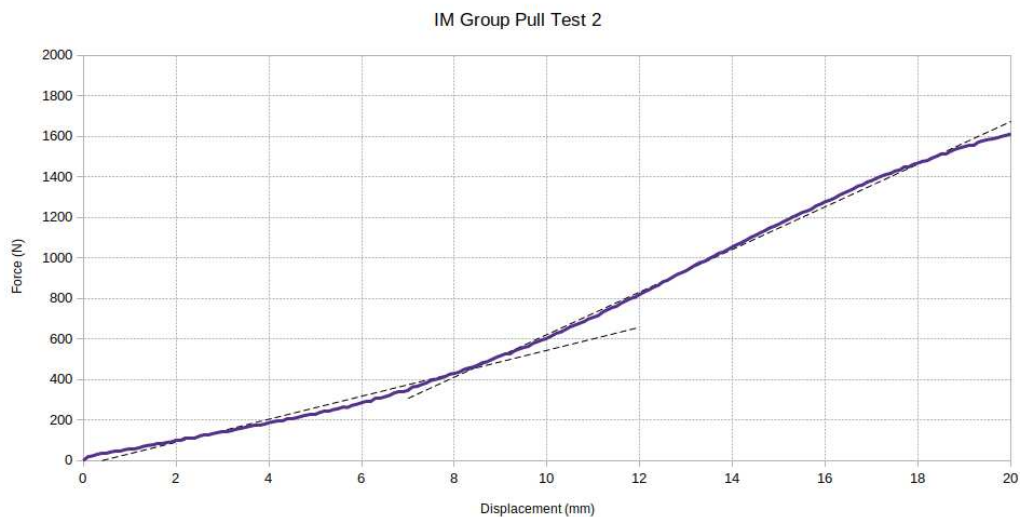

Figure 3.51 – **Force/displacement data of the tensile test 2 IM group.** The blue line represents the raw (uncorrected) machine data, and the dashed lines, the slopes to estimate the stiffness values before and after the average 10 mm transition point (8.5 mm in this case).

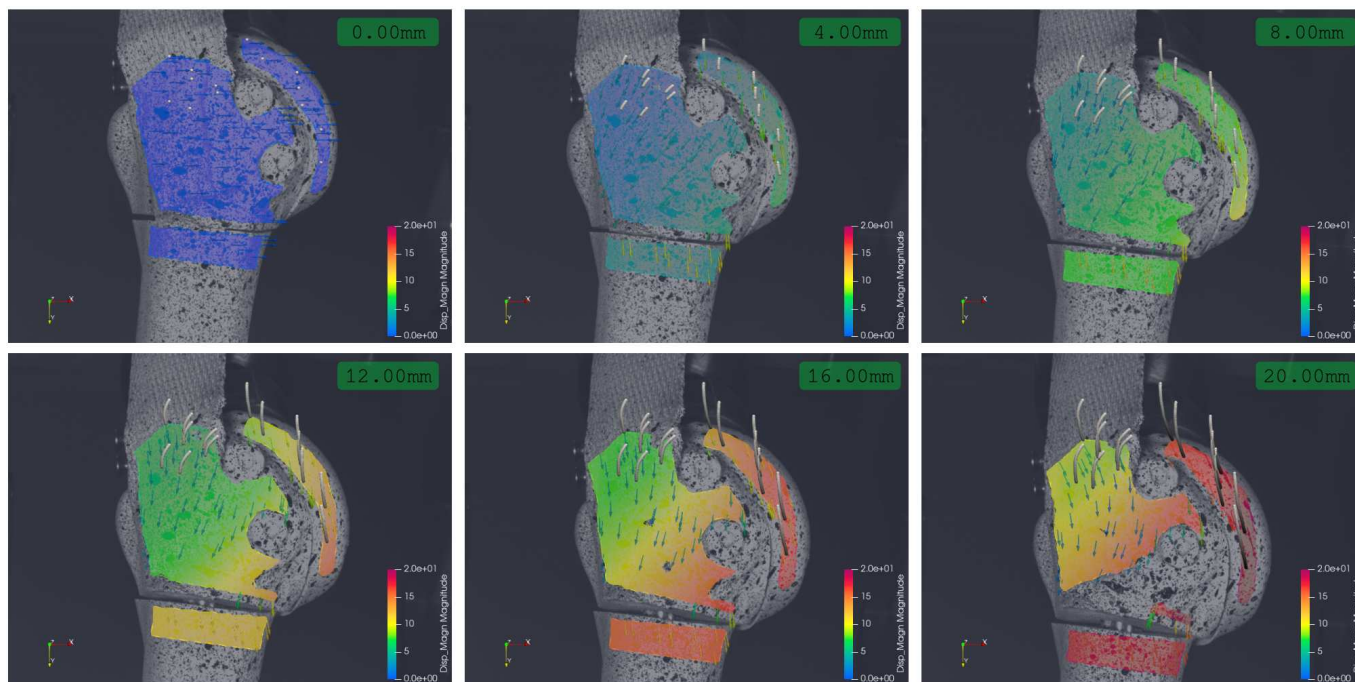

Figure 3.52 – Full local displacement magnitude field for IM group tensile test 2. The magnitude distribution (in mm) is shown for six subsequent stages of the test, the global displacement shown in the green rectangle. The arrows indicate the speed direction (the pulling is done downside). The temporal pathlines (in greyscale) show the path of the displacement of several points of the local field.

they are measured calculating the 3D angle between the vectors formed by sets of 2 pair of points (B - A, D - C) for each plane. This angle can give an indication of how much movement or “distortion” is seen in the particular area where the measurements are done. But it cannot provide the details of the direction nor orientation of the movement. For instance, the interfragmentary GT-D distance in the the test number 1 shows a maximum value of 2.67 mm (see Table 3.11) with a 3D angle variation of 2.04°, means that most of the movement between the greater tuberosity and the diaphysis was normal to the fracture plane with a low rotation or opening of the fracture itself. This is contrast to the case of the test number 2, in which the maximum distance value is 3.49 mm with a 3D angle variation of 17.23°, meaning that an important amount of the interfragmentary movement was distorted with a rotation and/or opening observed on the GT-D fracture plane.

In general, the interfragmentary movement at the GT-D fracture plane follows the same dynamic, with distances ranging from 1.87 mm to 3.49 mm (average value: 2.63 mm) and with interfragmentary stiffness ranging from 505 N/mm to 708 N/mm (average value: 592 N/mm) (Figure 3.54). Nevertheless, the 3D angle measurement of the GT-D fracture plane revealed important differences (Figure 3.55). The 3D angle variation ranged from 2.04° to 17.23° (average value: 10.68°), meaning that for certain tests, particularly the tests 2 and 4, the distortion produced by the rotation and opening of the fracture plane was the main factor that impacted the change in the interfragmentary distance. This is reflected as well in the angular stiffness for the GT-D fracture plane, whose values are ranging from 103 N/° to 501 N/° (average value: 283.23 N/°). This is mostly due to the manual incorporation of the strap at the greater tuberosity, slightly changing the pulling direction among the tests.

As for the interfragmentary movement at the GT-H fracture plane, in general during the first part of the test, while the GT is being pushed against the humeral head during the tensile load, the GT-H interfragmentary gap tends to close (Figure 3.54), reaching negative distance values. This distance, however, becomes positive once the GT is

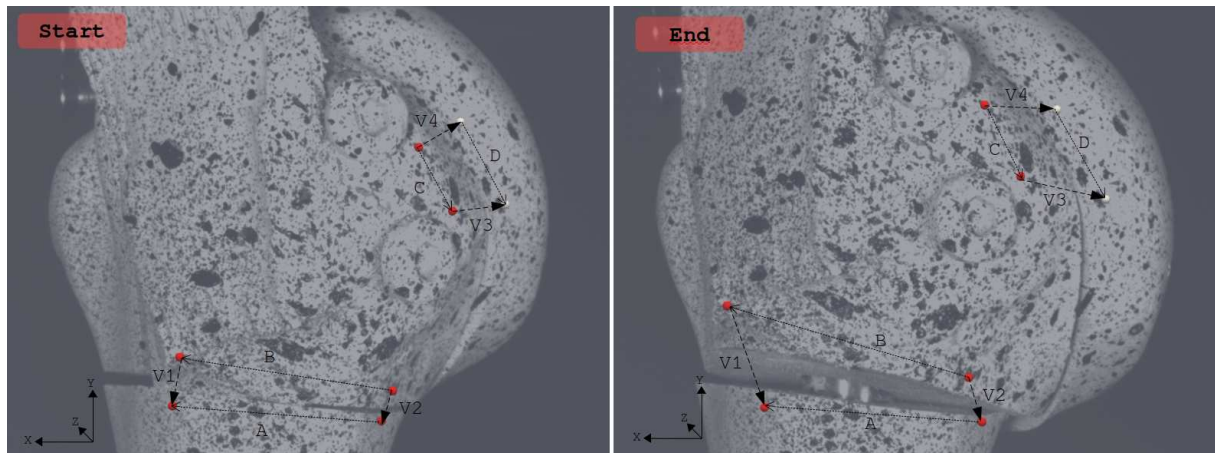

Figure 3.53 – Interfragmentary distance and angle variation for the IM group pulling test. For each fracture plane (GT - Diaphysis and GT - head), four vectors are defined to measure the distance and the angle variation. The vectors V1, V2, V3 and V4 measures the distance change between the GT and the other two fragments of the humerus. The 3D angle between the vectors A and B, as well as the vectors C and D, measures the torsion and the opening between the greater tuberosity and each fragment.

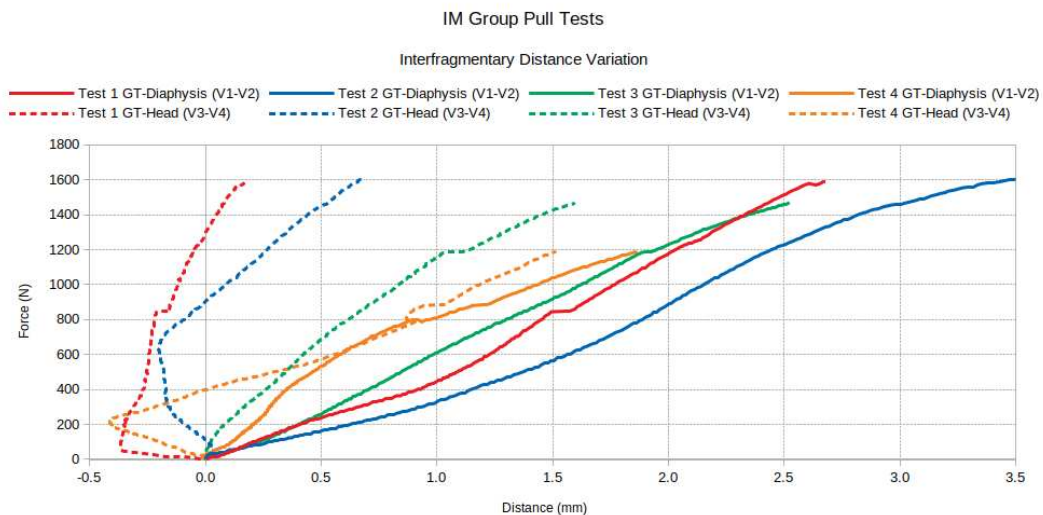

Figure 3.54 – Interfragmentary distance for each of the 4 IM group pull tests. A positive distance means an opening gap. A negative distance implies a closing gap.

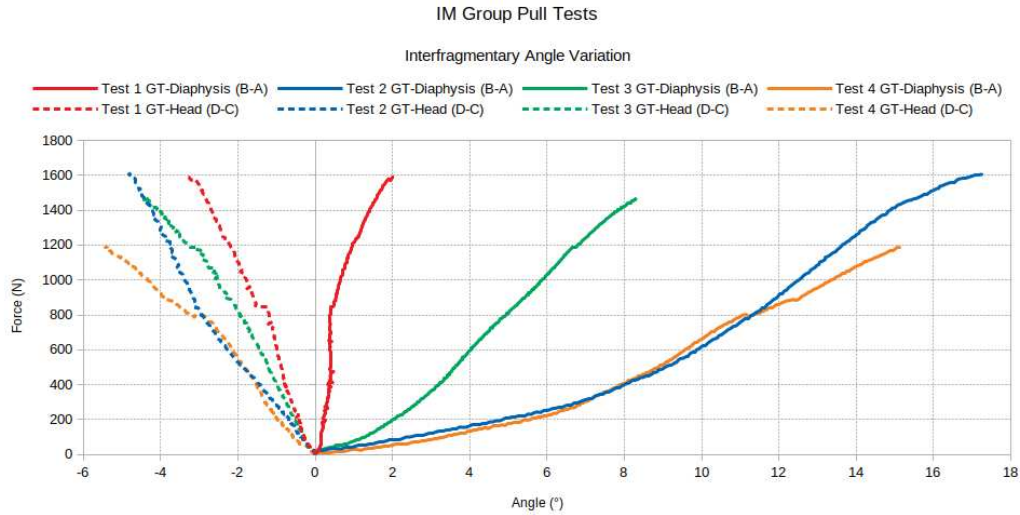

Figure 3.55 – **Interfragmentary 3D angle variation for each of the 4 IM group pull tests.** A positive or negative value means a change of the direction of the greater tuberosity vectors (B and C) in relation to the diaphysis (A) and head (D) vector. The higher (in absolute terms) it is, the more distorted the interfragmentary plane motion is, by means of the rotation or opening of the fragments. The positive and negative are conventions established during the calculations, making them positive for the GT-D motion and negative for the GT-H motion. Therefore, it should be read in absolute values.

		Test 1		Test 2		Test 3		Test 4		Average	
		Stiffness	Total	Stiffness	Total	Stiffness	Total	Stiffness	Total	<i>Stiffness</i>	<i>Total</i>
GT-D.	Dist. V1-V2	708.05	2.67	572.32	3.49	582.53	2.50	505.09	1.87	<u>592.00 N/mm</u>	<u>2.63 mm</u>
	Angle B-A	501.12	2.04	146.44	17.23	202.19	8.32	103.17	15.12	<u>283.23 N/°</u>	<u>10.68°</u>
GT-H.	Dist. V3-V4	2527.26	0.54	1187.01	0.87	737.14	1.58	542.84	1.92	<u>1248.56 N/mm</u>	<u>1.23 mm</u>
	Angle D-C	451.44	3.30	402.62	4.79	287.58	4.43	193.52	5.45	<u>333.79 N/°</u>	<u>4.49°</u>

Table 3.11 – **Interfragmentary motion data of the IM group pull tests.** The measurements are classified into the greater tuberosity - diaphysis (GT-D) and the greater tuberosity - humeral head (GT-H) fracture planes. Each classification comes with the interfragmentary average distance (V1-V2 and V3-V4) as well as the 3D angle variation (B-A and D-C). The data presented is the maximum (total) distance and angle values for each test, as well as the stiffness. At the far right columns, the average values for all the tests are shown. In bold, the analyzed tests in this Chapter.

being rotated as it is being pulled off. This creates a shear motion in the GT-H fracture plane. The interfragmentary distance for the GT-H fracture plane ranges from 0.54 mm to 1.92 mm (Table 3.11), with an average value of 1.23 mm and an average stiffness of 1248 N/mm, twice as stiffer as the value for the GT-D fracture plane. We remind that this IM nail configuration does not fix the humeral head. Without the glenoid compression support, the humeral head would freely fall apart. This pull test can prove (although only for this configuration) that the humeral head fixation might not be the main concern when reducing and treating an unstable proximal humerus fracture [Mehta *et al.*, 2018].

As for the 3D angle variation at the GT-H fracture plane, the measurements shows a range from 3.30° to 5.45° (average value: 4.49°), with an average angular stiffness value of 333 N/°, which is not very far from the 283 N/° found for the GT-D fracture plane. Most of the observed movement within the GT-H fracture plane consists on a shear motion between the two fragments. Thus, the 3D angle measurement can be a good indicator of this shearing, although further motion analyses should be considered, to better detail the motion dynamics.

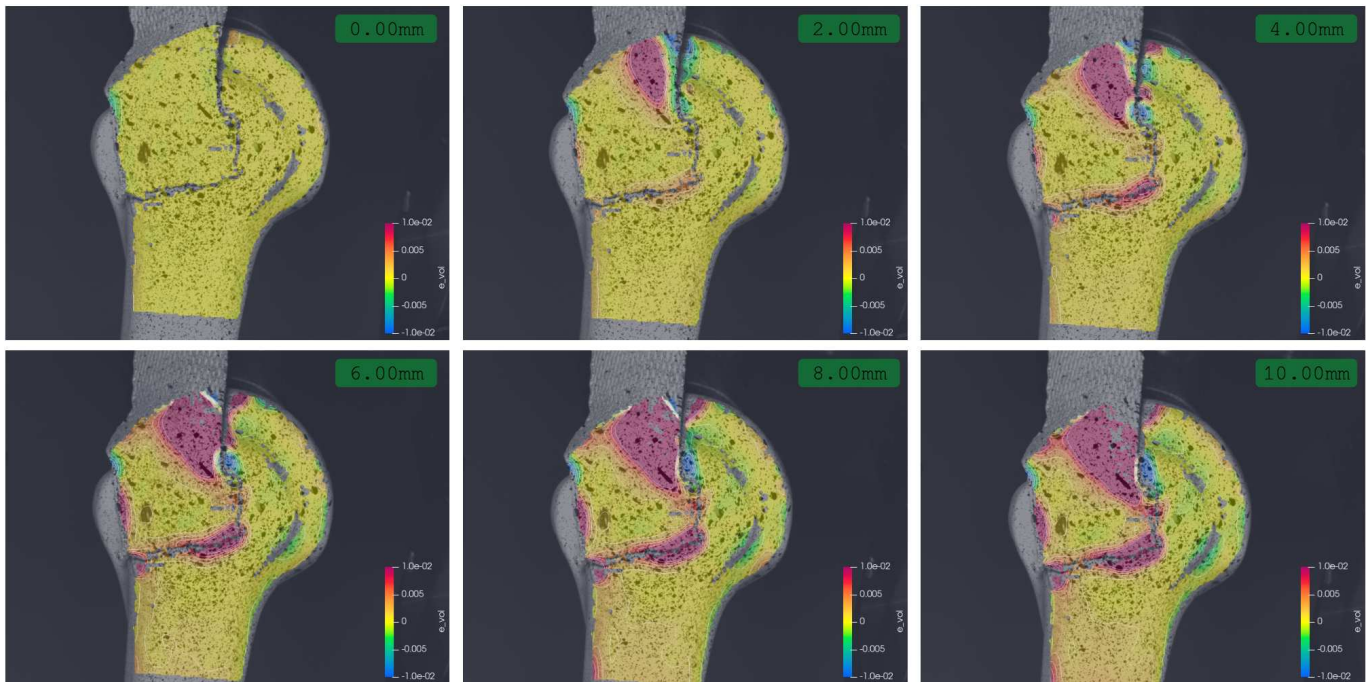

Figure 3.56 – **Local volumetric strain distribution of control group tensile test 2.** In the green rectangles, the global displacement progression.

3.6.3.6 Local strain fields in control group

The volumetric strain field in the control group test 2 shows in general three critical regions in which the strain is locally focused (Figure 3.56):

- A positive strain concentration in the strap region. In certain zones, the strain easily reaches and surpasses 1% of value. Although this is expected due to the tensile load applied through the strap, unfortunately it is physiologically irrelevant as this strain depends solely on the materials used (strap and resin).
- A negative strain concentration around the anatomical neck of the humerus. As the strap is pulling the humeral head against the glenoid support, the anatomical neck fold is compressed, showing strain values that can reach up to 0.5% at the end of the test.
- A negative strain concentration in the distal anterior diaphysis region ($\sim 0.8\%$ at the end of the test).

As previously discussed, this test does not show a particular event during the load application. Therefore, the strain values are almost linearly increasing in relation with the global displacement.

3.6.3.7 Local strain fields in IM group

The volumetric strain fields of the IM group shows in general a similar behavior to the control group: an important but rather irrelevant strain concentration on the strap attachment area, and a mild negative strain concentration in the humeral head ($\sim 0.9\%$ at the end of the test). The latter shows a linear progression along the test, and its mostly focused on the center and closer to calcar.

In addition to the aforementioned, there are also two other regions in which it was observed a strain concentration:

- Around the GT screws. The first screw boundary exhibits a high positive strain concentration ($> 1\%$) even at the beginning of the test (4 mm of global displacement), suggesting that this is a potential fracture zone. The

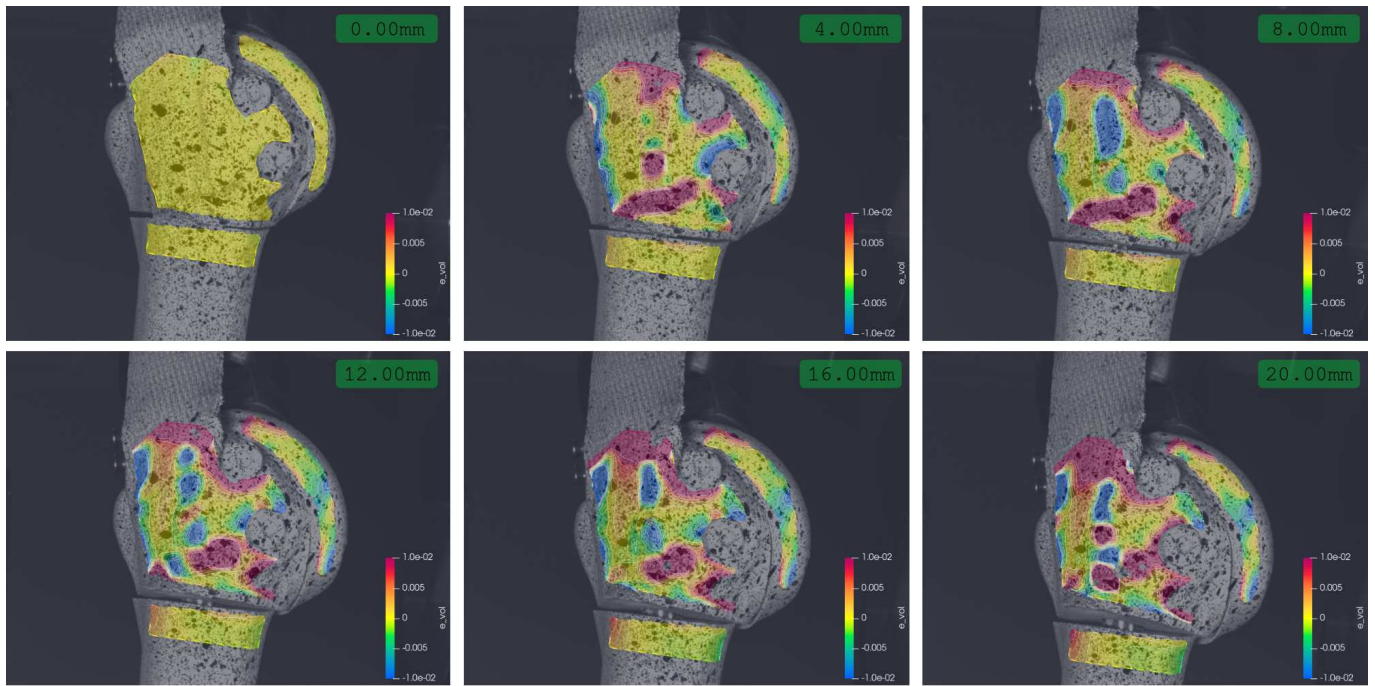

Figure 3.57 – **Local volumetric strain distribution of the IM group tensile test 2.** In the green rectangles, the global displacement progression.

second screw boundary shows at the beginning of the test a double positive ($\sim -1\%$) and negative ($\sim 1\%$) strain concentration, until the end of the test, in which only negative strain is present.

- At the diaphysis. As the GT is being pulled along the test, the anterior side shows a positive strain concentration ($\sim 0.7\%$ at the end of the test) and a negative strain concentration at the posterior side ($\sim 0.4\%$ at the end of the test), mostly due to the GT hinge support.

We highlight that doing a pure quantitative analysis of these zones might be inaccurate, as the regions of interest is close to the boundaries. This might lead to a higher level of uncertainty. Hence, a qualitative interpretation should be preferred in these areas. As in the control group, the IM groups showed no particular events that changed fundamentally the linear evolution of the local strain field, except for the screw boundaries.

3.6.3.8 Comparative of local strain fields

Although both control and IM groups have a different overall configuration, and thus, a rather different local strain field distribution, there are certain critical zones that shows some similarity:

- The humeral head. For both configurations (IM and CG), the humeral head is subjected to a compressive load. This is an expected trending behavior, as in physiological terms, the humeral head is in contact with the glenoid fossa. Only a slightly higher strain value ($\sim -0.5\%$) is measured at the humeral head for the IM group.
- Diaphysis. A similar trend is observed in the diaphyseal zone, in which a slight positive strain ($\sim 0.5\%$) is measured in the anterior part, while in the posterior part, a slight negative strain ($\sim -0.4\%$) is measured as well.

The strain state seems to be not significantly altered by the osteosynthesis compared to healthy bone.

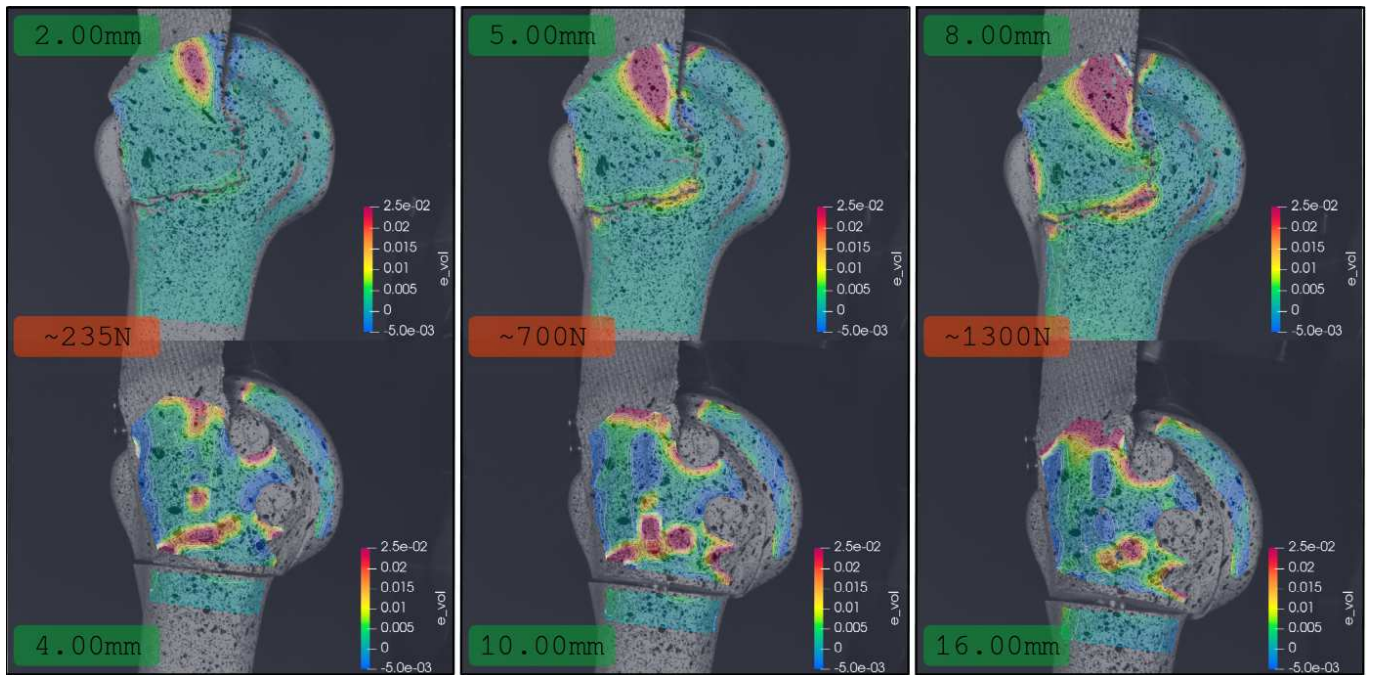

Figure 3.58 – **Local volumetric strain comparison between the tensile tests.** The comparison was done using both CG and IM groups test 2 data at the relatively same force level (red rectangles) but different global displacement (green rectangles).

3.6.4 Partial conclusions

For this experimental test, we implemented a tensile test for the humeral bone with a head support simulating the glenoid fossa. This test was done for two configurations for comparative purposes: in a control (not fractured) bone and in a 4-parts fractured bone with an intramedullary (IM) nail. The tensile (pulling) load was applied using a strap, that was previously mechanically characterized to determine its stiffness and be able to remove its effect from the global force/displacement data. The results show an almost linear displacement trajectories along the test for both the control and the IM groups, with a clear greater tuberosity (GT) local rotation and displacement for the IM group. Indeed, the positive volumetric strain concentration on the IM groups was observed at the GT screws boundaries, which is a zone prone to fail when overloaded [Clavert *et al.*, 2016]. This is also correlated with the results presented in Chapter 2, in which a first *in silico* model was developed under similar loading conditions. There, we showed that the stress (and strain) concentration zones were also the screw boundaries, as well as the supraspinatus muscle footprint, which for this experimental case, is analog to the strap attaching zone.

Despite the fact that both IM and control group configurations imply a distinctive local strain field, the humeral head and the diaphysis showed similar trends: a negative volumetric strain at the visible humeral head zone, and an anterior positive and posterior negative volumetric strain at the metaphysis and proximal diaphysis, with slightly higher (absolute) values for the IM case. As for the interfragmentary motion, an opening and rotating movement was observed between the GT and the diaphysis. As for the GT and the head, a shear movement was dominant all along the test, with important deviations between the tests. This might lead to conclude that this experimental setup is highly sensitive to certain parameters such as the strap gluing process or the 4-parts osteotomy process.

As a clinical conclusion, the outcome of this experiment confirmed in a certain sense two of the main features of the Aequalis© Intramedullary nail: fixing the tuberosities as a priority to restore the biomechanical strength of the proximal humerus, and the uselessness of the humeral head fixation [Clavert *et al.*, 2016, Boileau *et al.*, 2015]. As

stated before, the proximal humerus main loads comes from the rotator cuff whose footprint is on the tuberosities. This pulling loads stand for the stability of the glenohumeral joint and for certain arm movements, such as the rotation and the beginning of the abduction and extension. For this experimental setup, trying to force an abduction by pulling the greater tuberosity with only a two screws fixation proved that the proximal humerus is still stable (the lesser tuberosity and the humeral head do not collapse despite the lack of fixation). Other authors might contradict what we expose [Mehta *et al.*, 2018, Euler *et al.*, 2017a], but mainly due to the compression-only setup, which might not properly reflect the typical physiological loading at the proximal humerus.

Although this setup is comparable to some other in the literature, particularly for the tensile load and the head support [Clavert *et al.*, 2016, Brianza *et al.*, 2010, Rothstock *et al.*, 2012, Kathrein *et al.*, 2013], to our knowledge no other study has presented a detailed interfragmentary motion analysis for such conditions, nor the local strain field distribution for a particular osteosynthesis device. That said, it can be seen as an original contribution to set a precedent, but at the same time, it can be seen as a limitation due to the lack of available data as a reference frame when testing the setup. What is more, the tests were arbitrarily stopped at 10 mm and 20 mm of global displacement for the control and the IM groups, respectively, limiting the load and the displacement to failure data.

3.7 Conclusions

In this Chapter, we developed and tested an experimental framework able to biomechanically characterize a proximal humerus with an osteosynthesis device. The main advantages of this framework are the adaptable fixture design to be used under tensile and compressive loads, and the digital image correlation system able to acquire in detail the local displacement and strain fields. A pure-compression and a tensile (pulling) configurations were tested, in order to verify the capabilities of the system and also, to begin with the characterization of the Aequalis© Intramedullary nail used for the two proximal humerus fractures models. For both configurations, the overall and interfragmentary stiffness and the local strain concentration zones were evaluated, giving a first insight of the fracture bone behavior under two extreme loading conditions, even for comminuted unstable fractures. As already mentioned, the compression test might not reflect the proper typical physiological loading state of the proximal humeral bone. Nevertheless, the available literature for this type of test and its consequent popularity is rather higher than for the other types of tests. This might bias the outcome and the decision taking when selecting an appropriate osteosynthesis device, as already discussed in the tensile test conclusion, in which the humeral head fixation become capital instead of reinforcing the actively mechanically loaded tuberosities. This, we dare to hypothesize, might be the consequence of the willingness to treat the humerus as the femur [Boileau *et al.*, 2015], which is naturally more prone to be under a compression load

There are several limitations of this study:

- The use of synthetic composite bone. Although the use of this type of bone was decided as an approach to limit the natural human bone variability in terms of mechanical properties, it becomes evident that testing with cadaverous bone is essential, not only to validate the full capabilities of this framework, but also to compare the different anatomical parameters that might affect the internal fixation device mechanical characterization.
- Quasi-static mono-cyclical regime. The low speed (~ 4 mm/min) and the single cycle used for this tests might not represent the typical physiological responses when subjected to an arm movement or an external stimulus.

This neglects the viscoelastic bone properties and the cumulative micro-damaging that might lead to fixation failures or additional fractures. Further tests in fatigue and in a dynamic regime should be considered for a richer characterization of the internal fixation device.

- Partial full-field digital image correlation analyses. Recording only a single face of the full proximal humerus led us to miss important events and local behaviors in other zones, such as the lesser tuberosity or the intertrabecular groove, when loaded. Having a set of cameras to record and to analyze the full surface field could give us more detailed information about the interfragmentary motion and the strength of the screw holes.

Despite these limitations, the contribution of this Chapter is the reproducibility of the framework and of the tests, the biomechanical quasi-static characterization of the IM nail and the amount of outcome data that might aid to do comparatives among osteosynthesis devices and the development and validation of *in silico* models, which will be done in the following Chapter.

Chapitre 4

Étude de validation d'un modèle *in silico* d'une fracture humérale proximale sollicité en compression

*Dans ce chapitre, nous reprenons le modèle aux éléments finis (ÉF) issu du chapitre 2 afin de simuler le cas de compression d'un humérus proximal avec une fracture comminutive à deux fragments, comme décrite dans le chapitre 3. Cela, afin d'établir le cadre d'une première étude de validation partielle du modèle numérique avec une cohorte plus riche de données expérimentales. La procédure mise en place a impliqué le remaillage du modèle numérique du 2 avec des nouveaux plans de coupes. Nous détaillons ensuite la nouvelle méthode de modélisation des vis, ainsi que le reste des conditions limites et propriétés mécaniques, le plus fidèles à celles des expériences *in vitro*. Puis, les résultats des simulations sont confrontés à des données expérimentales avant fracture (régime élastique) et après la fracture (régime plastique).*

Le modèle numérique détaillé dans le 2 est repris, mais avec des plans de coupe de fracture redessinés pour ce cas de compression, détaillés dans le 3. Une fracture à deux fragments comminutive en varus avec une ostéotomie en forme de coin à 15° est ainsi reproduite. L'ostéosynthèse se réalise avec le clou intramédullaire Aequalis, avec trois vis en fixation proximal (deux dans le tubercule majeur, une dans le tubercule mineur) et une vis statique distale. La modélisation des vis est sensiblement différent par rapport à celle présentée dans le 2, les vis ont été dessinées uniquement avec des éléments unidimensionnels de type poutre, attachées à la zone corticale environnante et au clou intramédullaire par des couplages cinématiques. Une précharge est imposé aux vis, afin de simuler le serrage. Le modèle comporte également le montage de fixation afin de tenter de reproduire le plus fidèlement possible les conditions expérimentales. Comme détaillé dans le 3, le segment distal diaphysaire de l'humérus a été imbibé dans la résine à l'intérieur du sceau du montage, alors que pour la tête, une coupelle également en résine est posé au-dessus en contact direct. Ces éléments sont donc modélisés le plus fidèlement possible au cadre expérimentale, avec des cas de contacts « durs » et des coefficients moyens de frottement issus de la littérature. Les propriétés mécaniques utilisés dans cette simulation sont similaires à celles de la simulation précédente, sauf pour les propriétés plastiques parfaites

intégrés dans l'os, le but étant de prédire les zones dépassant la limite élastique susceptibles de se fracturer, sans pour autant mettre en place le comportement plastique exacte de l'os. L'étude comparative montre que le champs local de déplacement ainsi que des déformations est similaire qu'en comparant les essais mécaniques avec les numériques dans une étape encore « élastique » ($< 1000\text{ N}$) de l'essai. Au-delà de la zone élastique, les régions osseuses plastifiées et fracturées dans les essais mécaniques poussent à des changements fondamentaux de son comportement. En dépit de cela, l'analyse des déformations ainsi que des valeurs qui ont dépassé la limite élastique s'avèrent des bons indicateurs du risque de fracture pour notre cas.

Preliminary validation of an unstable proximal humerus fracture *in silico* model under a compressive load

4.1 Introduction

In Chapter 2, we developed a finite-element model based on the work of Clavert et al 2016 as a way to validate it against *in vitro* experimental data. Nevertheless, it became clear that the available experimental data was not enough to rigorously compare both *in vitro* and *in silico* models, only in a fair qualitatively fashion.

Several research works focuses on the validation of a particular set of parameters on the *in silico* model, with the aid of an experimental protocol. For instance, in [Varga *et al.*, 2017] it was proposed a numerical model segmented from a combined multi-registered cadaverous bone tomographies used as well for the experimental protocol. Considering ideal boundary conditions, the purpose of the model was to find a correlation between the strain value around the fixation screws of the osteosynthesis device, obtained from the FE model, and the cycles to failure, done in the experimental protocol. In [Maldonado *et al.*, 2003], a bi-axial test protocol using cadaverous bone was proposed to identify the stiffness in compression and in torsion of a humerus bone with an osteotomy and an osteosynthesis device, carrying out both *ex vivo* and *in silico* tests. After finding a good correlation between these two parameters (with a mean difference of around 10% in value), they conducted further tests with the *in silico* model using different and complex loading cases closer to a physiological scenario. Other research works focus on the validation of a FE model with no fracture. In [Dahan *et al.*, 2016], a cadaverous humerus bone was modeled using a high-order mesh and validated against a compression test.

All these studies share in common the validation strategy:

1. The bone mechanical properties of the *in silico* model are in-homogeneous and bone-specific from the *ex vivo* samples.
2. The validation is done using a restricted sample size of cadaverous bones.

While the models presented in the previous studies are validated using their experimental data, having only the unique in-homogeneous mechanical properties distribution from the cadaverous bones refrain from having a standardized *in silico* model with the same locally-distributed mechanical properties and geometrical characteristics. To illustrate this

point, in Chapter 2, the parameter sensitivity analysis showed how the cortical and the cancellous bone properties variation might heavily influence the local stress distribution, even using homogeneous mechanical properties.

Although there are efforts towards the development of FE model with statistically-trained mechanical properties (i.e. orthotropic local properties matched from macro-scale and micro-scale CT images) to homogenize and standardize the data [Lekadir *et al.*, 2015], the use of composite bone (such as the Sawbone©) mechanical properties might be a good starting point towards a standardized and reproducible FE model. We remind that the 4th generation Sawbone©, used at the experimental protocol done in Chapter 3, has been already proved to be similar to the real bone [Dunlap *et al.*, 2008, Aziz *et al.*, 2014].

Therefore, the purpose of this chapter is to begin a comparative study between the numerical and experimental frameworks in order to elucidate the different variables that can determine the “validity” of the *in silico* model using homogeneous bone mechanical properties. For this, we propose to start modeling the IM group compression test done in 3.

4.2 FE model

4.2.1 Meshing

For the FE model, we reuse the humerus bone mesh, developed in Chapter 2 and the experimental apparatus FE mesh presented for validation purposes in Chapter 3. As the objective of this chapter is merely exploratory, we decided to include the full fixture mesh, in order to get closer to the physical boundary conditions present in the experimental framework.

For the humerus bone mesh, following the clinical preparation protocol for the IM group compression tests presented in Chapter 3, a 2-parts varus comminuted fracture was reproduced with a wedge osteotomy at the surgical neck level. The wedge angle is 15° , with the hinge zone medially located. In order to achieve this, the original surfaces segmented and cleaned in Chapter 2 were used. In Salome_Meca (ver. 2019), two surfaces intersecting the humerus at the surgical neck and recreating the wedge were used as a cutting tool to remove the surfaces in between and close the proximal and distal fragments. A similar method was followed for the intramedullar hollowed canal and the screws: a 9 mm (diameter) \times 140 mm (length) cylinder was used as a cutting tool for the hollowed canal. The proximal screws cutting tool was a 5 mm \times 44 mm cylinder, and a 4.5mm \times 26 mm cylinder for the distal screw. The osteosynthesis device used to treat this fracture is Wright© Aequalis intramedullary nail (IM). It was positioned according to the manufacturer’s guidelines (see Chapters 2 and 3 for further details). Three proximal screws and one distal were used. The proximal screws are the two ones at the greater tuberosity (GT) and one at the lesser tuberosity (LT). The distal screw is a static one.

Once the fracture, the IM nail position and the screws were validated by the main surgeon of this work, we proceeded with the meshing process. For this, the surfaces were converted to STL format (triangular surface mesh) and imported using GMSH (ver 4.3.0) [Geuzaine et Remacle, 2009]. Using an average element length of 0.75 mm (according to the mesh convergence result from Chapter 2), each bone layer (cortical and trabecular) as well as each component of the IM nail (nail and the polymer insert) were meshed using an advance front meshing technique, and then optimized using the Netgen module, creating an unstructured mesh, Figure 4.1.

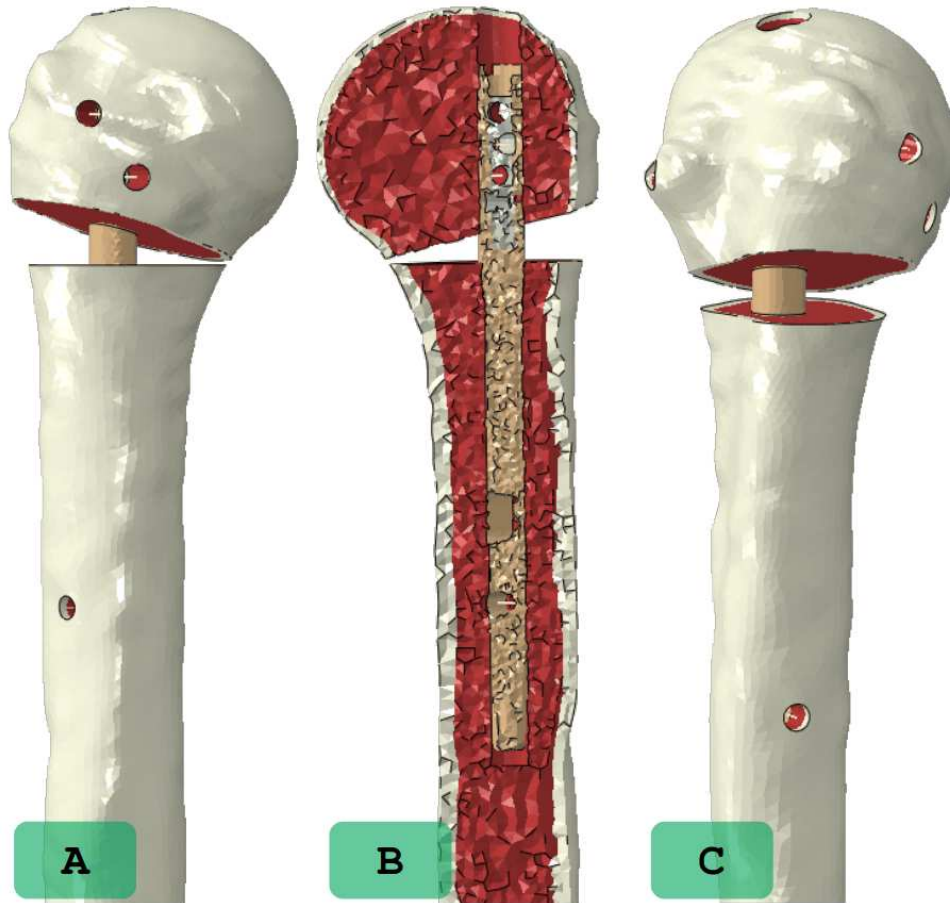

Figure 4.1 – **Humerus mesh detail**. The humerus and IM nail mesh accounts for 59 567 nodes and 295 075 first order tetrahedral elements. **A**: Posterior view. **B**: Cut-anterior view. **C**: Lateral view.

Once the humerus meshing process was done, it was imported as orphan mesh in Abaqus© (ver. 6.14-4, Dassault Systèmes). The mechanical properties (detailed in the following subsection) were assigned to each element set. The screws were modeled using linear beam elements all along the screw holes (three at the proximal head, one at the distal head). The main axis for each beam element was defined as the beam axis. The section part for the proximal screws was defined as a thick-walled pipe with a radius of 2.50 mm and a thickness of 2.00 mm. The distal screw was also defined as a thick-walled pipe with a radius of 2.25 mm and a thickness of 1.75 mm. The link between the humeral head and the polymer insert of the IM nail was ensured by two kinematic couplings (KC) with the six degrees of freedom (DOF) constrained. One KC uses the boundary of the screw holes at the cortical bone surface as slave nodes, and the other KC uses the inner surface of the polymer surface as slave nodes. Both master nodes are within the beam elements. It is illustrated Figure 4.2.

The CAD STEP files from the fixture assembly were as well imported as geometric parts in Abaqus. Each geometric part was partitioned in such manner to be seeded and meshed using the Abaqus hexahedral mesh module, Figure 4.3. This was done for all the fixture components, except for the resin mold (Figure 4.3B, in blue). As the humerus is embedded in the resin, this was done by manually meshing the interface between the geometry of the resin mold (structural grid) and the distal diaphysis of the humeral head, resulting in an unstructured mesh. The nodes of the diaphysis outer surface and the resin inner surface are shared (DOF linked). All the screwed components were simply tied together, except for the shrink disks, which were also linked using fully constrained KC.

The full mesh is composed as follows:

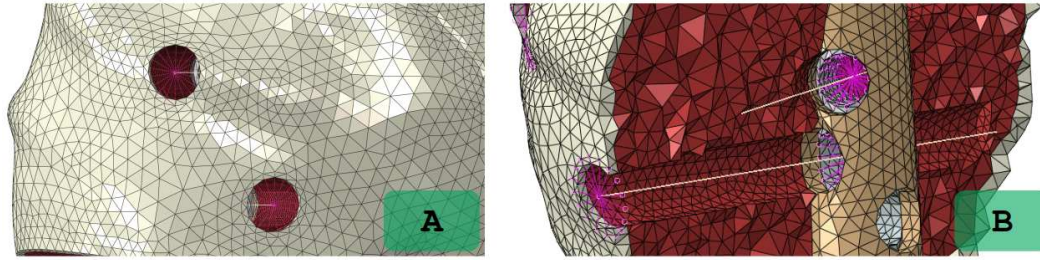

Figure 4.2 – **Screws meshing detail.** **A:** The screw heads were modeled as kinematic couplings with the 6 constrained DOF. **B:** The screws were modeled as linear beam elements (B31) with a pretension (tightening) load. The interface with the polymer insert of the IM nail was done using a kinematic coupling with the 6 constrained DOF.

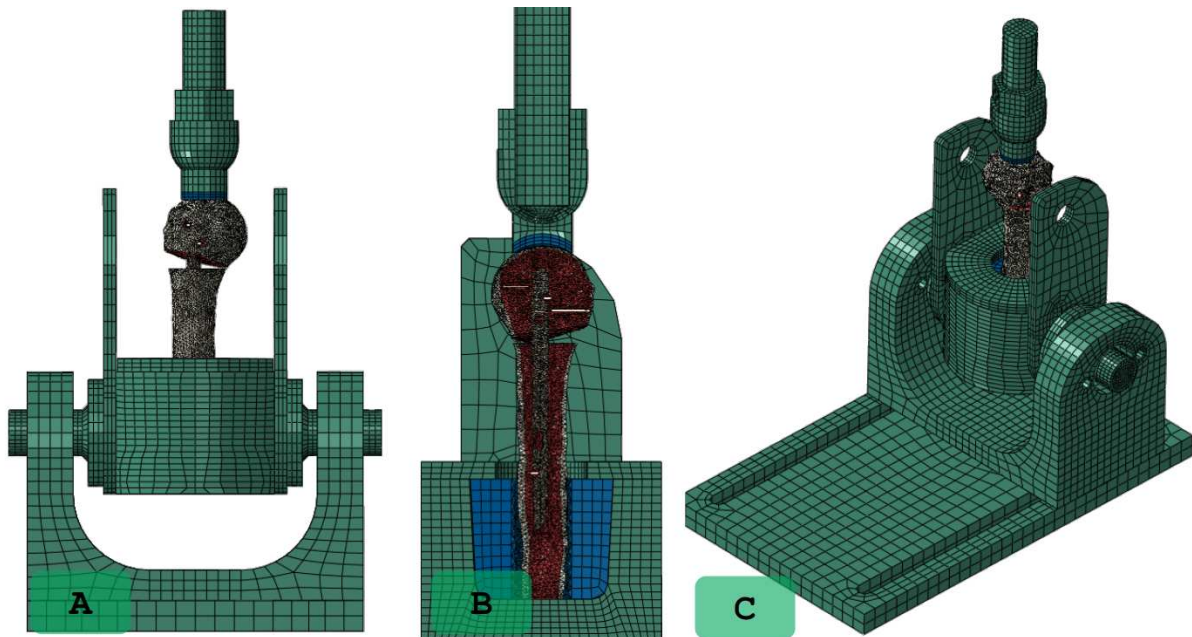

Figure 4.3 – **Full 3D model mesh.** The model includes a structured mesh of the fixture and a unstructured mesh of the bone and the intramedullary nail. **A:** Posterior (anatomical) view of the assembly. **B:** Cut-lateral (anatomical) of the humerus with the IM nail, the resin mold and the receptacle. **C:** Iso view of the full assembly.

- 98 068 nodes.
- 160 linear beam elements (screws).
- 24 166 first order hexahedral elements.
- 318 885 first order tetrahedral elements.
- 683 086 degrees of freedom.

4.2.2 Material properties

The material properties used in Abaqus for the FE model are detailed in Table 4.1. The full fixture assembly is constituted of AISI 304 Stainless steel, except the resin mold and the cup adapter, both made of custom-poured polymethylmethacrylate (PMMA). The Aequalis intramedullary nail is made out of titanium alloy Ti-6Al-4V, with a plastic insert of high density polyethylene in which the screws are fixed. The modeled humerus uses the synthetic bone properties of the Sawbone, with the short-fiber filled epoxy as the cortical bone and the internal solid foam as the cancellous bone. These properties were issued from the manufacturer, and were previously detailed (Table3.4).

Material	Young Modulus (MPa)	Poisson's ratio	Yield strength (MPa)
Titanium Ti-6Al-4V	110 000	0.30	1 200
Short-fiber filled epoxy (cortical)	16 000	0.30	106
Solid foam (cancellous)	155	0.30	62
HDPE (Polymer)	1 000	0.30	
AISI 304 Stainless Steel	193 000	0.29	
PMMA	2 240	0.4	

Table 4.1 – FE model material properties.

As the cortical and cancellous bone have an asymmetric behavior under tension and under compression with an apparent direction, these properties were simplified under certain assumptions, avoiding in this first model iteration the development of a custom Abaqus material (UMAT).

All the materials were supposed to be linear isotropic elastic. A perfect plastic behavior was added for the materials showing a yield strength Table 4.1. Once an element's integration point reaches the yield strength, the modulus plateaus and the element keeps deforming and accumulating strain. It is not the purpose to simulate a crack propagation nor a realistic plastic behavior, but rather as a strategy to assess the risk of a possible failure by analyzing the yielded zones and comparing it with the experimental data.

4.2.3 Boundary and loading conditions

Five contact regions were manually defined using a surface-to-surface type of contact:

- Humeral head - PMMA cup. Discretization method: node-to-surface, with a friction coefficient of 0.1.
- Humeral head - diaphysis fracture surfaces. Discretization method: surface-to-surface, with a friction coefficient of 0.1.
- Inner canal of humeral head - IM nail. Discretization method: surface-to-surface, with a friction coefficient of 0.1.
- Inner canal of diaphysis - IM nail. Discretization method: surface-to-surface, with a friction coefficient of 0.1.
- Ball-joint - cup. Discretization method: node-to-surface, with a friction coefficient of 0.03.

All the contacts use the finite-sliding formulation and an automatic stabilization factor of 1 was defined in the contact controls, with a damping coefficient of zero at the end of the step. The normal behavior (surface contact) use a penalty constraint enforcement method, with the default nonlinear stiffness. An initial slave surface adjustment was configured only to remove any possible overclosure at the beginning of the step.

A pretension of 40 N was applied to each of the screws in a single beam element. This was done in order to simulate the tightening process during the screw insertion.

A KC in the top of the ball-joint screw simulates the fixed crosshead on the universal testing machine, in which the six DOF are constrained. A KC in the bottom of the plate simulates the attachment to the hydraulic piston that applies the load. All the DOF were constrained except the vertical axis, in which a ramp force of 4000 N was set up (Figure 4.4).

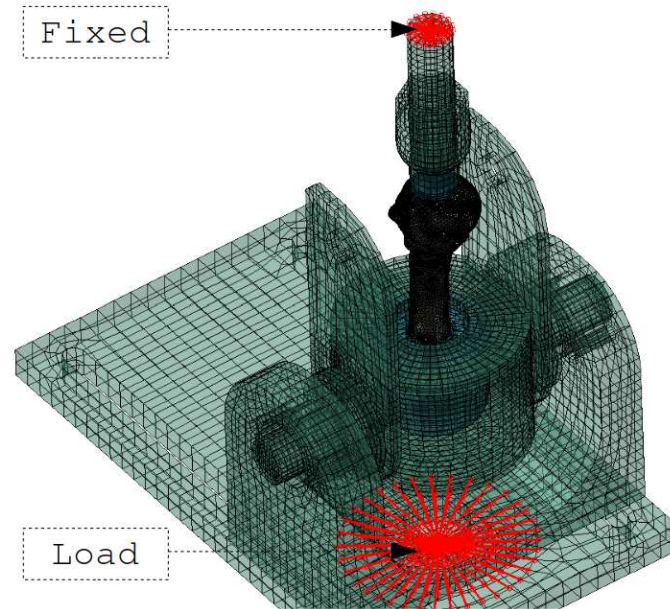

Figure 4.4 – **Fixture kinematic couplings (KC)**. The upper KC is fully constrained. The lower KC is constrained except for the vertical D.O.F., in which the load is applied.

4.3 Results

Once the simulation were run, a post-processing stage was done in order to extract the local displacement and strain fields. The results are presented as a comparison between the five IM group compression tests (described in detail, Chapter 3) and the FE model. Therefore, the data presented is:

- Volumetric strain comparison, in an elastic range and a plastic range.
- Comparison between the yielded (fractured) zones.
- Local displacement behavior comparison, in an elastic and a plastic ranges.
- Interfragmentary motion comparison.
- Stiffness comparison.

4.3.1 Volumetric strain comparison

The volumetric strain, which is equivalent to the first strain invariant, is measured using the digital image correlation (DIC) system with plane strain assumptions (axis z corresponding to the depth, $\epsilon_{zz} = 0$). However, for the FE case, the full-field strain tensor is available. In order to obtain an equivalent FE volumetric strain complying with the DIC plane strain assumption, we approximated a surface volumetric strain in Abaqus as the sum of the trace of the strain tensor, neglecting the depth component, Equation 4.1:

$$\epsilon_{vol} \approx \epsilon_{xx} + \epsilon_{yy} \quad (4.1)$$

, where ϵ_{xx} and ϵ_{yy} are the coronal in-plane axis. Of course, as the humeral head is a round object, the uncertainty is likely to be higher in the extreme sides of the posterior face.

The comparison between the FE model and the experimental data is done in two different states of the compression test:

- The “elastic” state, in which the applied load is 1 kN. This is before any event during the experimental test is observed, such as a cracking around the screw area, or the diaphysis medial hinge making contact with the humeral head.
- The “plastic” state, in which the applied load is 4 kN. This is the maximum force applied to the FE model and likely close to the end of the experimental tests, after the first fracture and diaphyseal contact events.

The volumetric strain at the elastic state, Figure 4.5, shows the maximum strain concentrated around the GT screw holes. The first GT screw (top) exhibits a positive (volume increase) strain in the upper zone with an average strain value of 0.5%, reaching locally 0.8% in the 5 experimental datasets except for the C2 test. This is in agreement to what it is seen in the FE model, in which the upper zone is also displaying positive strain, averaging 0.5% of strain. At the same time, the lower zone shows a negative (volume decrease) strain, ranging from -0.2% to -0.5% locally, which for the FE model, it is rather seen at the lateral sides of the screw hole within the same values range, probably due to a difference in the displacement mode (analyzed in detail in the following subsections). The second GT screw (bottom), exhibits mainly a negative strain around the hole (except for the C5 test), with the values ranging from -0.2% to -0.5%, in correlation to what it is observed in the FE model. These observations suggest that the first GT screw is more stressed rather than the second screw during the compression test, causing the higher (absolute) strain concentration screw at an early stage of the test.

As for the volumetric strain at the plastic state, Figure 4.6, the comparison becomes trickier as the apparent fractures observed during the compression tests might bias the strain analysis, as the DIC algorithm used in the previous Chapter 3 does not treat correctly the discontinuities. The first GT screw, as the cracking initiation source, cannot be directly compared to the FE model without further data processing to take into account the discontinuities. Regarding the second GT screw, the experimental data shows a similar behavior as the first GT screw during the elastic state: an upper zone with an important positive strain (0.4% to 1.0%) and a lower zone with similar but negative strain values (-0.4% to -1.0%). This might slightly contrast with the FE model, in which the second GT screw exhibits a local concentration of negative strain (ranging from -0.7% to -1.2%), but with a moderated positive strain in the lower zone (0.8% to 1.0%). This suggests that, as the first GT screw hole fails in the experimental tests, the second GT screw is now the main mechanical support, showing the same signs of a “strain dipole” (positive and negative strain values in opposite sides) as the first GT screw during the elastic state. Ultimately, the second GT screw hole fails with a crack. Nevertheless, for the FE model, in which the first crack is not modeled, the second GT screw is unable to display the experimental volumetric strain field, due to the apparent difference in its motion behavior.

Although the anterior face of the humeral head was not recorded during the experiments, the FE model data is presented to show the behavior of the LT screw hole during the compression test, Figure 4.7. The volumetric strain at the anterior FE humeral head face shows the same characteristics of a “strain dipole” as described beforehand, with values ranging from $\pm 0.2\%$ to $\pm 0.7\%$ for the elastic state and from $\pm 0.6\%$ to $\pm 1.2\%$ for the plastic state. This is a high fracture risk zone due to the yielding present around the LT screw hole. It is better illustrated Figure

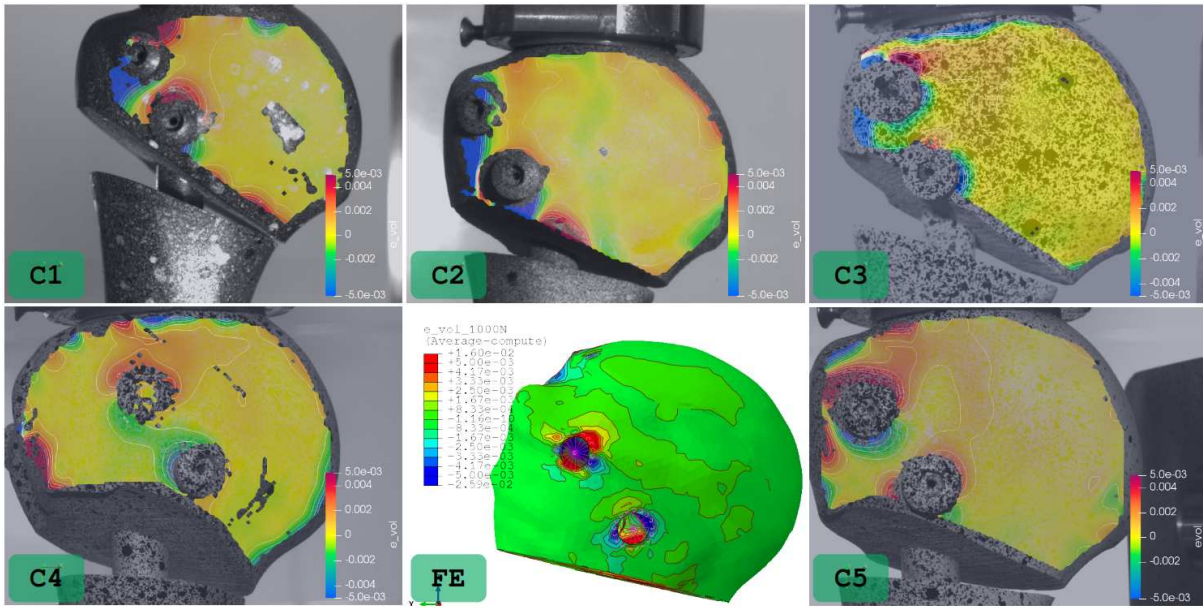

Figure 4.5 – Volumetric strain comparison between the FE and the experimental models loaded at 1 kN (before fracture). The C1 - C5 correspond to the 5 compression tests done beforehand. The volumetric strain scale is the same for all the images ($\pm 0.5\%$).

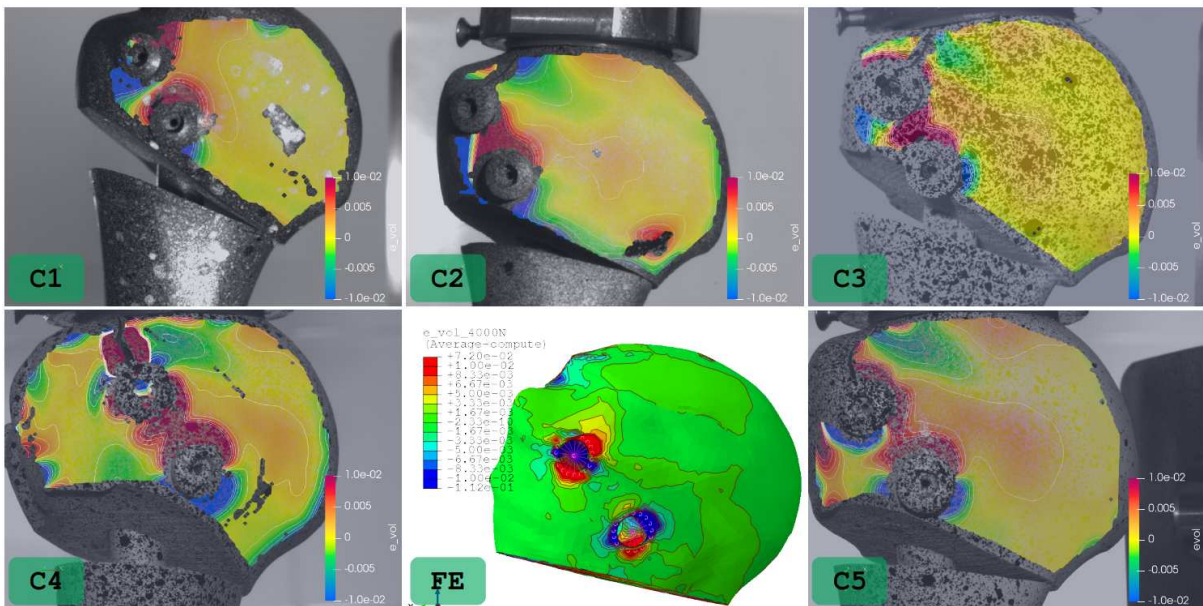

Figure 4.6 – Volumetric strain comparison between the FE and the experimental models loaded at 4 kN (after fracture). The C1 - C5 correspond to the 5 compression tests done beforehand. The volumetric strain scale is the same for all the images ($\pm 1\%$).

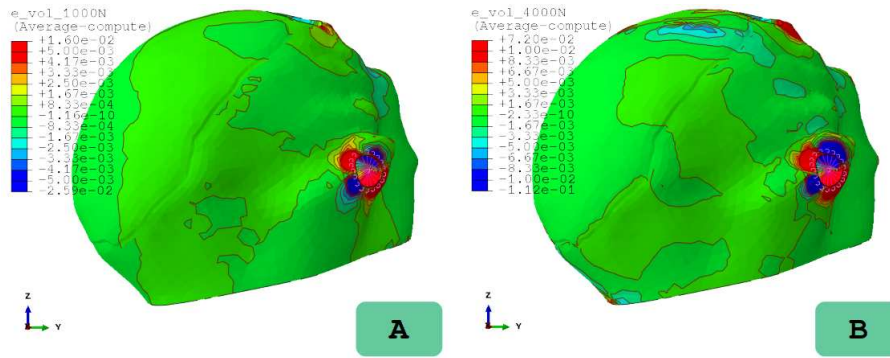

Figure 4.7 – **Anterior view of the FE model volumetric strain.** **A:** Loaded at 1 kN (scale: $\pm 0.5\%$). **B:** Loaded at 4 kN (scale: $\pm 1\%$).

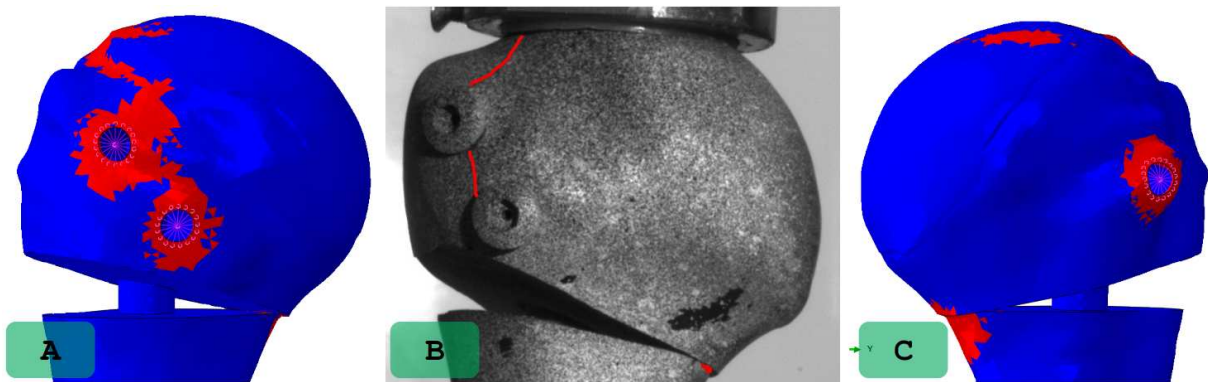

Figure 4.8 – **Yielded zones (in red) at the end of the test.** **A:** Posterior view of the yielded zone of the FE humeral head. **B:** The corresponding fractures (in red) visible in the 5 experimental tests. **C:** Anterior view of the yielded zone of the FE humeral head. A crack initiation was also observed around the lesser tuberosity screw for the 5 experimental bones (no available image).

4.8C, in which the LT screw zone is marked with red color, meaning that the yield strength value was colored in red. Unfortunately there is not an available image to show the LT crack initiation at the end of each one of the five experimental compression tests.

As for the posterior face, Figure 4.8A, shows the yielded zone in red, highlighting the wider zone around the first GT screw rather than the second one, confirming that the first screw is most likely to fail under a significant compression load for this comminuted fracture. This is indeed observed, Figure 4.8B, showing in red the two cracking paths at the end of one of the tests. It is important to emphasize that these two cracks were observed in the five compression tests. What is more, the direction in which the first crack appears (first GT screw), coincides with both FE and experimental positive strain fields. The mechanical properties for the cortical layer of the Sawbone (Table 3.4) stipulates that the yield strength for the cortical bone longitudinal to the short-fibers direction under compression is 157 MPa, while in tension is 106 MPa, while the elastic modulus is not significantly different (17 GPa in compression, 16 GPa in tension), suggesting that a failure is more likely to occur under a positive (tensile) load. If we come back to the Figure 4.5, we see that the upper positive strain in the first GT screw is pointing to a cranial-medial (upper-right) direction for both the experimental and FE tests. This coincides with the observed cracking direction in the five tests (visible images Annex E). As a side note, the manufacturer stated that there is not a privileged short fibers orientation on the humeral epiphyses, and thus, it recommends to consider only the cortical bone longitudinal mechanical properties.

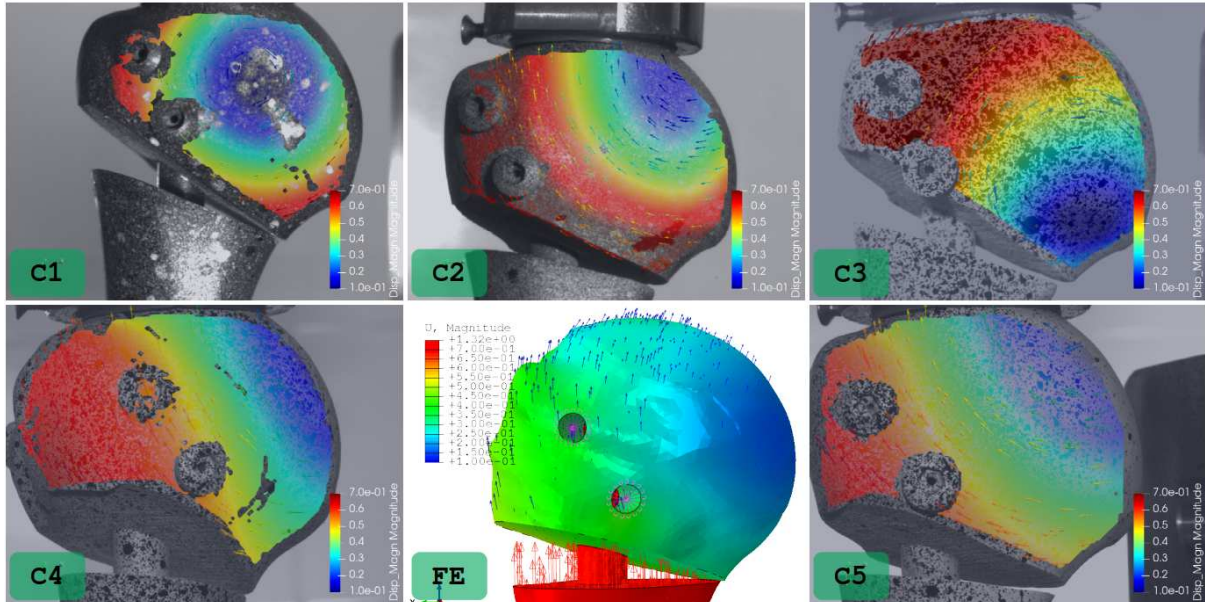

Figure 4.9 – Local displacement magnitude field comparison between the FE and the experimental models, loaded at 1 kN (before any fracture). The C1 - C5 correspond to the 5 compression tests done beforehand. The scale is the same for all the images (0.1 mm - 0.7 mm). The arrows shows the direction of the movement.

4.3.2 Local displacement distribution comparison

In like manner as the volumetric strain field comparison, the local displacement magnitude fields were compared between the experimental tests and the FE model in two different stages of the test: elastic (loaded at 1 kN) and plastic (loaded at 4kN).

In Figure 4.9, the local displacement fields are shown for the five compression tests as well as the FE model. At first sight, the five experimental models exhibits a clear rotation around the medial side of the humeral head as the intramedullary nail, through the screw fixation, is pushing upwards the lateral side of the head. The displacement magnitude varies from 0.1 mm at the rotation center to more than 0.7 mm for the C3 case at the lateral side. This behavior is mitigated in the FE model, in which the maximum displacement magnitude is around 0.5mm for the lateral side. The rotation is less manifested in the FE model.

As for the displacement field analyses in the plastic state, Figure 4.10, the compression tests changes the dynamic of motion as the medial diaphyseal hinge makes contact with the humeral head and exhibiting a cranial-medial movement except for the C2. This behavior coincides with the one observed on the FE model, in which the humeral head is also displaced in a cranial-medial direction. Nevertheless, the difference in the magnitude values are apparent, as the FE model shows an average displacement magnitude value of 1.45mm while the maximum values observed in the experimental compression are around 1.8 mm, except for the C1 test.

4.3.3 Interfragmentary motion comparison

The interfragmentary motion analysis for both the experimental and the FE tests followed the same protocol: three points at the humeral head and three points at the diaphysis, close to the fracture planes, were chosen to form five vectors illustrated in Figure 4.11. Three vectors (V1, V2 and V3) correspond to the distance change between the two bone fragments in a lateral, central and medial position of the osteotomy. Two vectors (A and B) are drawn parallel to each fracture plane and their purpose is to measure their angle variation during the tests.

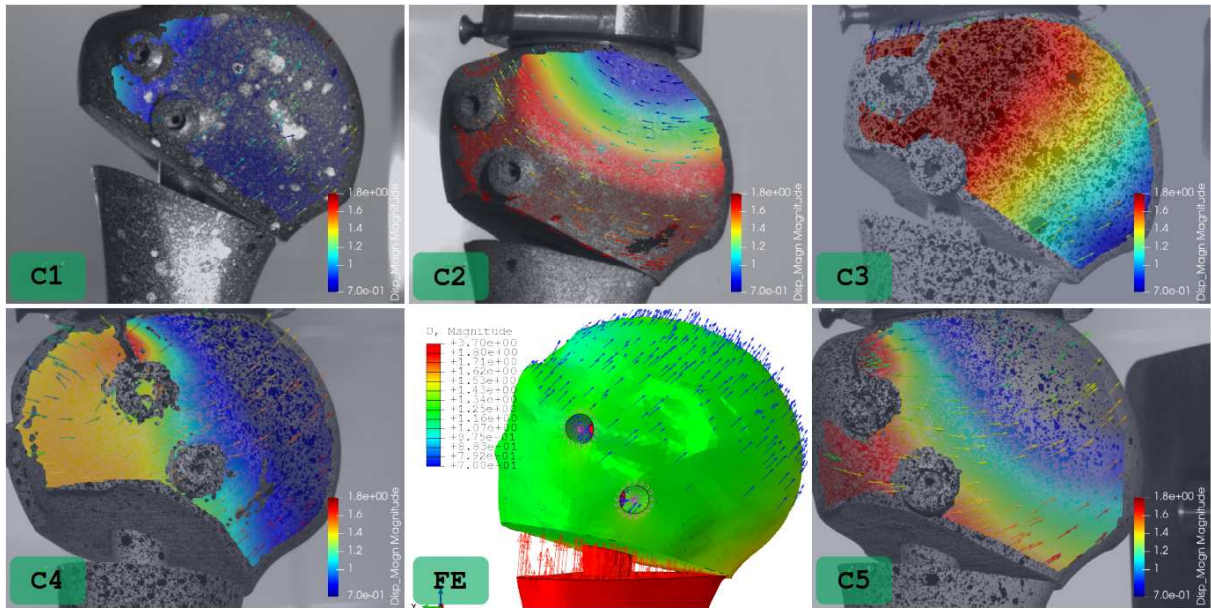

Figure 4.10 – Local displacement magnitude field comparison between the FE and the experimental models, loaded at 4 kN (after fracture). The C1 - C5 correspond to the 5 compression tests done beforehand. The scale is the same for all the images (0.7 mm - 1.8 mm). The arrows shows the direction of the movement.

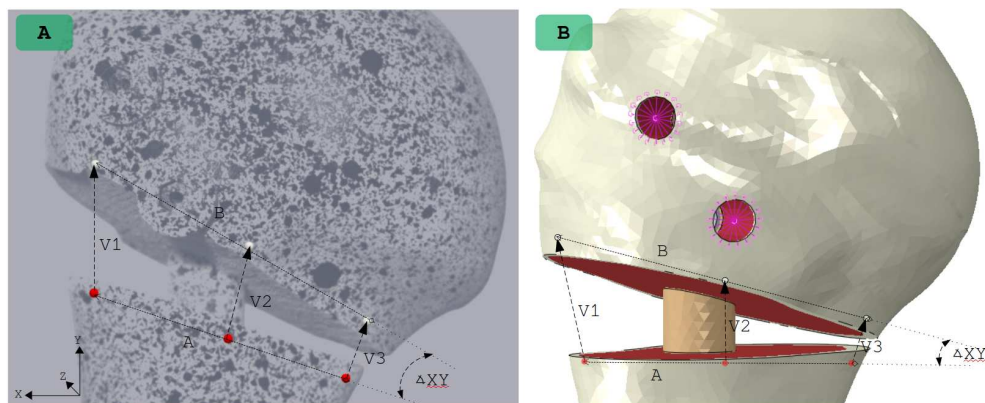

Figure 4.11 – Interfragmentary motion analysis. Three pair of points were chosen to form 3 vectors (V1 - V3), whose magnitude is the measured distance. The two vectors A and B shows the angle of movement of the head with respect to the diaphysis. **A**: The experimental setup. **B**: The FE model.

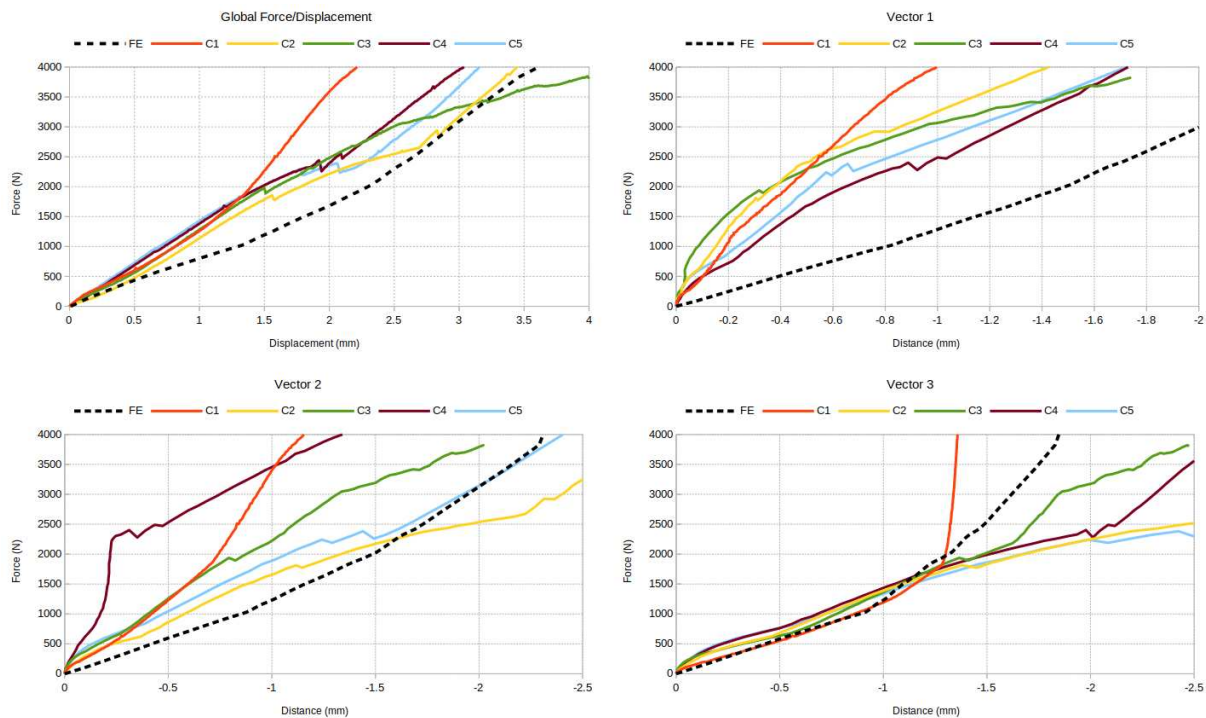

Figure 4.12 – **Global force/displacement and interfragmentary distance vectors comparison between the FE and the experimental models.** The global force/displacement plot shows the five different experimental tests (solid colored lines) being compared to the FE (dash lines) force/displacement data measured at the main load node of the numerical model. A similar comparison is done with the interfragmentary distance change at the three vectors (vector 1: lateral, vector 3: medial) between the numerical and experimental models.

In Figure 4.12, the global force/displacement data and each of the distance vectors (V1, V2 and V3) comparison between the experimental and the FE tests are shown. Clearly, the FE model tends to be less stiff than the average of the experimental tests according to the global force/displacement plot, with a notorious increase in the stiffness after past around 2000 N of force. Interestingly, at that stage of the FE test, no special event was observed, except for the diaphyseal contact, which happened around the force of 1000 N. The vector 3 (medial) plot follows the average experimental tests distance change, with a slightly increase in the stiffness at the FE model diaphyseal contact event. Nevertheless, the vector 1 (lateral) for the FE model shows a much more flexible behavior in contrast to the experimental data, most likely due to the already commented screw modeling strategy, which apparently tends to be too soft.

In Figure 4.13 it is illustrated the average distance of the already discussed distance vectors (V1, V2 and V3) as well as the angle variation in the three anatomical planes: medio-lateral (coronal), internal-external (transversal) and antero-posterior (sagital). First of all, the average distance (which exhibits similar values compared to the vector 2 plot) shows a softer interfragmentary behavior for the FE model in regard to the experimental tests average. This might be explained with the fact that the FE humeral head rotated less in the medio-lateral and the antero-posterior planes than the experimental ones, as seen on the plots. The medio-lateral angle variation shows a modest angle opening before the diaphyseal contact that arrives at the force of 1000 N, in which the medio-lateral angle tends to close. This is in contrast to the average experimental values, which are few dispersed and changes its rotation motion at around the same force level (~ 2000 N). Similar case was observed at the antero-posterior angle variation, in which the C4 and C5 tests exhibit a large positive angle variation before the diaphyseal contact, making contrast with the FE model in which the positive rotation is prematurely reversed due to the diaphyseal contact event. The C1, C2 and C3

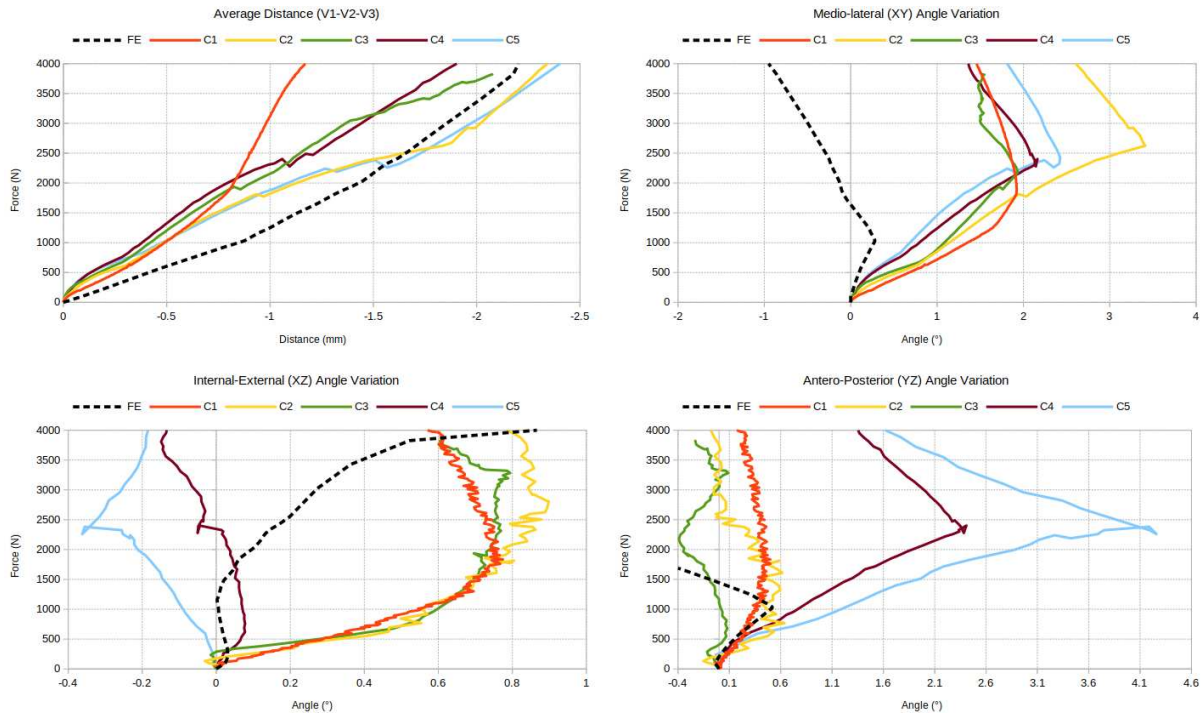

Figure 4.13 – Average interfragmentary distance and rotation motion comparison between the FE and the experimental models. The average interfragmentary distance (mean value of vectors 1, 2 and 3) comparison between the numerical and the experimental model is shown in the upper-left plot. The rotation components comparison along the three orthogonal and anatomical planes are also presented.

showed almost no rotation in the sagittal plane. Interestingly, the opposite tendency is observed in the internal-external angle variation in which the C1, C2 and C3 experimental tests shows a large positive angle variation at the beginning of the test, before stopping the rotation, clearly in contrast to the FE model in which the internal-external motion is primed by the diaphyseal contact event. The C4 and C5 exhibits a negligible internal-external rotation.

4.3.4 Stiffness comparison

The experimental stiffness data was measured before any fracture or motion event (e.g. diaphyseal contact with the head), which is in the range of force less than 1500 N. As for the FE stiffness data, it was measured before the diaphyseal contact ($< 1000\text{N}$). The average global stiffness from the experimental tests (measured using the raw force/displacement data from the testing machine) is 1340 N/mm , while the FE global stiffness is 763 N/mm (measured at the load node). In general terms, this shows that the FE model is “softer” than the experimental bone, most likely due to the screws modeling and the relatively low friction coefficient between the IM nail and the bone.

The average translational interfragmentary motion (the average of the vectors magnitude V1 - V3) stiffness from the experimental is 2089 N/mm while the FE translational stiffness is 1189 N/mm . As already discussed for the global stiffness, the translational interfragmentary motion is mainly driven by the friction coefficient between the IM nail and the bone, as well as the screw modeling. The actual FE parameters allowed a more flexible motion, in contrast to the experimental setup.

The average medio-lateral interfragmentary rotational stiffness (the angle XY) from the experimental tests is 1029 N/° , while the FE rotational stiffness is 3410 N/° (measured before the diaphyseal contact with the humeral head). This shows that the FE medio-lateral angle of the humeral head does not vary at the same pace as the experimental angle. This was discussed and observed already, Figure 4.9, where the experimental compression tests showed a well-

defined rotation center while the head was pushed upwards. This, in contrast to the movement of the FE humeral head, which showed a less defined rotational motion. This is also shown in Figure 4.12, in which the FE Vector 1 (lateral) is more elastic than the average of the experimental Vector 1 data, in contrast to the FE Vector 3 (medial), which have the same average stiffness as the experimental data.

4.4 Conclusions and perspectives

In this chapter, we reworked on the finite-element model already developed in Chapter 2 to simulate a 2-parts unstable comminuted fracture at the surgical neck level, treated with the Aequalis© intramedullary nail. The purpose was to reproduce the experimental protocol for the compression tests presented in Chapter 3 and use the resulting data as a basis to compare and criticize the FE model, with the aim to fully validate it. Using standard techniques for the *in silico* modeling, the outcome of this exercise showed closer results for the volumetric strain and displacement field comparison, particularly during the elastic stage (applied force < 1000 N). The matching was less likely for the plastic stage (> 4000 N) as the cracking and the plasticized regions changes the behavior of the proximal humerus for such important loading values. It is however important to remark that the yielded zones and the positive strain exhibited in the FE model were a good predictor for the failure and the crack initiation observed in the experimental tests.

The detailed interfragmentary motion analysis revealed differences in the distance variation behavior, probably due to the chosen strategy to model the screws, and the modest head rotation in the medio-lateral plane. Having FE models softer than the experimental tests is not particularly common, as some authors have already make the observation that homogeneous FE models tend to be stiffer [Synek *et al.*, 2015]. Some preliminary tests in which the screw modeling was replaced by simple ties between the linear beam elements and the inner surfaces of the screw hole changed dramatically the overall stiffness and the strain distribution, leading to think that is is necessary to carry out a parameter sensitivity analysis to determine the possible range of results that our model is able to produce. This is specially advised for such complex bone-screw-nail or plates assemblies, in which a set of several FE tests with parameters variation are run as a way to determine the scope and limitations of the model [Inzana *et al.*, 2016, Varga *et al.*, 2017].

Chapitre 5

Discussions, conclusions et perspectives

Dans ce chapitre final, nous présentons une synthèse du fil conducteur des idées qui a découlé dans la présente thèse. En analysant avec un regard critique, nous nous sommes interrogés sur la pertinence à l'heure actuelle de certains types d'essais mécaniques et numériques sur les fractures de l'humérus proximale, afin de tenter de répondre à la question d'amorçage : comment évaluer biomécaniquement un dispositif de fixation interne ? À travers les résultats obtenus grâce à des expériences aussi physiques que numériques, nous sommes arrivés à énoncer quelques conclusions qui visent le type de sollicitation mécanique préférable pour l'humérus proximale ainsi que les différentes contraintes et limitations dont nous nous sommes fait face pour finalement se pencher sur les multiples voies en guise de perspectives dont le présent travail de thèse en débouche.

5.1 Discussions et conclusions

Dans le cadre de l'intégration du groupe d'études en biomécanique ostéoarticulaire de Strasbourg (GEBOAS) au laboratoire ICube, une proposition de collaboration transdisciplinaire entre les orthopédistes et les mécaniciens se développe, ayant pour objectif un examen approfondi du comportement mécanique d'un clou intramédullaire dans une fracture instable de l'humérus proximal, cette thèse entraînant marquant le début de cette collaboration. La conception de ce clou intramédullaire (Wright© Aequalis Intramedullary Nail), dont le Pr. Philippe Clavert, co-directeur de cette thèse est concepteur, est suite aux nombreuses problèmes cliniques observés lors de la pose d'autres dispositifs de fixation interne [Clavert *et al.*, 2010] ou à une évaluation biomécanique pas adapté pour un humérus proximal [Boileau *et al.*, 2015]. Cela a posé plusieurs questions fondamentales par rapport à ce que la notion d'analyse biomécanique de l'humérus proximal englobe. Au cours de ces discussions, trois interrogations ont émergé comme étant piliers pour permettre de s'adresser plus concrètement à l'objectif de la thèse :

1. Qu'est-ce que une évaluation biomécanique de l'humérus proximal et diaphysaire ?
2. Quels sont les outils nécessaires afin de mener une évaluation biomécanique de l'humérus proximal et diaphysaire ?
3. Quelle est la stratégie d'évaluation qui permet de mieux représenter le comportement mécanique physiologique d'un humérus proximal ?

Une évaluation biomécanique (humaine) vise à caractériser, sur plusieurs échelles et sous plusieurs optiques et conditions mécaniques, les différents variables mesurables d'un domaine ou région du corps humain. Les échelles peuvent varier de l'ordre microscopique (interactions protéiniques, par exemple) jusqu'à la macroscopie (pour illustrer, le mouvement d'un bras). Les optiques passent par la rhéologie, la tribologie, la mécanique des matériaux, la cinématique et la dynamique des corps rigides, parmi d'autres. En d'autres termes, une évaluation biomécanique peut s'avérer assez large dans son domaine d'application, d'où donc l'intérêt d'identifier plus précisément et de restreindre le champ d'action de ce travail de thèse. L'étude bibliographique qui mène à l'état de l'art des évaluations biomécaniques des dispositifs d'ostéosynthèse pour l'humérus proximale cible notamment les essais mécaniques et numériques ayant pour but la réponse aux essais de fatigue dans la majorité de cas, et aux essais musculo-squelettiques qui visent à reproduire le plus fidèlement possible l'état des chargements physiologiques lors du mouvement du bras. Or, l'épaule étant l'articulation la plus mobile du corps humain, une première approche pour le développement d'un premier modèle consiste à cibler la sous-articulation de l'épaule la plus significative pour notre étude, à savoir, l'articulation gléno-humérale. En effet, certains auteurs ont identifié, lors des essais cadavériques que le mouvement d'abduction (et par conséquence, d'antéversion) reste le plus critique pour ce qui est la maximisation des sollicitations mécaniques dans la tête humérale [Ackland *et al.*, 2008]. Cette limite du champs d'action s'avère cruciale pour la conception d'un modèle de l'humérus, où l'amplitude du mouvement se voit restreinte et donc, plus « standardisable ».

La notion de standardisation est, en effet, essentiel pour la reproduction et la comparaison entre différents dispositifs d'ostéosynthèse, strictement sous les mêmes conditions limites. Des normes et des protocoles standards sont conçus pour la caractérisation des propriétés mécaniques (parmi d'autres) des matériaux, et donc, nous nous interrogeons sur la possibilité d'appliquer la même optique dans le cadre de la caractérisation des structures de fixation osseuse. L'étude bibliographique nous a également permis de nous repérer dans l'historique des études biomécaniques menés à ce jour sur les fractures de l'humérus proximal. En général, nous avons remarqué que nombre d'auteurs ont proposé des essais mécaniques, en régime quasi-statique et en fatigue, sur une cohorte des os cadavériques, en privilégiant les sollicitations en compression. Si bien cet approche cible l'optique de la soi-disant standardisation des essais biomécaniques, il est pourtant contradictoire qu'un nombre non négligeable d'essais mécaniques privilégient une action mécanique de compression pure sur la tête humérale, alors que la plupart des sollicitations présentes sont en cisaillement, suite aux efforts de traction de la coiffe de rotateurs au moment de réaliser une abduction ou une rotation, par exemple. Cette critique a été formulé notamment par [Boileau *et al.*, 2015], qui suggérait que la propension à effectuer des essais en compression sur les humérus n'est qu'un héritage des protocoles d'essais biomécaniques appliqués pour les fémurs. Pourtant, le fémur est sollicité principalement en compression, contraire à l'humérus. Une logique similaire s'applique aussi aux essais en fatigue de l'humérus proximal, où la direction des effort oscillants sont compressives, plutôt qu'en traction/cisaillement.

Pour ce qui est des essais numériques, les résultats de la révision bibliographique nous montrent que la plupart des modèles numériques contemporains (approximativement à partir de 2005) ont privilégié l'utilisation des propriétés mécaniques non homogènes, notamment pour le cas de l'os spongieux. En effet, plusieurs études ont montré que les propriétés mécaniques de l'os varient substantiellement en fonction de la localisation, de sa densité apparente et de la configuration de la structure interne (trabécules). Ce sont des paramètres qui sont uniques à chaque individu, créant ainsi des modèles numériques personnalisés (*patient specific* en anglais). Si bien cela permet une validation plus

réussie des modèles, du fait que le comportement mécanique local de l'os est transféré vers le modèle numérique, les données issues de ces simulations peuvent ne pas être reproductibles ailleurs à cause de ses propriétés mécaniques et géométriques uniques et personnalisées, et en conséquence, cela nous éloigne encore une fois de la standardisation des essais biomécaniques.

Malgré l'absence d'un cadre totalement reproductible pour les essais biomécaniques lors de l'étude bibliographique, nous restons persuadés que les outils d'essais que nous avons identifiés peuvent mener à des expériences reproductibles qui ouvrent une voie en vue de sa standardisation. Les outils dont nous parlons correspondent à des cadres d'essais *in vitro* et *in silico*. Les essais *in vitro* permettent de modéliser une fracture dans un modèle d'os synthétique, ce qui nous garantit la reproductibilité des conditions, une démarche pour le moins souhaitée dans un cadre rigoureusement scientifique. Bien entendu, la reproduction des conditions est également possible à travers l'approche des essais *ex vivo* (os cadavériques). En revanche, ces derniers restent onéreux et parfois compliqués à mettre en place à cause des démarches administratives, voire éthiques, à prévoir pour la manipulation et le stockage des tissus cadavériques humains.

Donc, au cours de ce travail, nous proposons deux cadres d'étude d'essais biomécaniques sur l'humérus proximal, complémentaires entre eux, afin de permettre la caractérisation d'un dispositif novateur d'ostéosynthèse. Le dispositif en question est un clou intramédullaire de marque Aequalis© développé par la société Tornier© (rachetée ensuite par Wright© Medical). Malgré quelques études cliniques et anatomiques qui ont été menées pour caractériser ce clou, seulement une étude est disponible dans la littérature qui concerne son évaluation biomécanique [Clavert *et al.*, 2016]. Les deux cadres proposés sont :

- Essais *in vitro* : Il s'agit de la conception d'un montage d'essais sur l'humérus proximal en compression et en traction, avec un support glénoïdal, couplé à un système de caméras pour avoir un champ local de déplacement et de déformation d'une partie de l'os mécaniquement sollicité.
- Essais *in silico* : Nous proposons le développement d'un modèle numérique tridimensionnel d'un humérus proximal issu d'une base de données d'images médicales de libre accès, testé sous les mêmes conditions que les essais *in vitro* afin de permettre une validation du modèle.

Pour chaque type d'essai, deux configurations de fractures instables ont été aussi proposées :

- Fracture comminutive à deux fragments au niveau du col chirurgical : fracture simulée à travers une ostéotomie en forme de coin dont la charnière se situe au niveau du calcar (médial).
- Fracture à quatre fragments : fracture simulée à travers des plans de coupe au niveau du col anatomique, du col chirurgical et parallèle au sillon intertuberculaire, séparant ainsi la petite tubérosité de la grande tubérosité, et la tête humérale.

Bien que chaque configuration de fracture peut être sollicitée sous plusieurs types de chargements mécaniques, nous mettons en avant deux types de sollicitations mécaniques, et ce pour chaque type de configuration de fracture :

- Sollicitation en compression suivant l'axe diaphysaire pour la fracture comminutive à deux fragments. D'un point de vue mécanique, des efforts compressifs parallèles à l'axe diaphysaire sur la tête humérale peut être le

cas le plus critique pour la fixation des vis, qui supporteront intégralement ce type de sollicitation. En plus, ce format d'essai reste le plus étudié dans la littérature scientifique.

- Sollicitation en traction avec appui glénoïdal pour la fracture à quatre fragments. Pour ce type de fractures extrêmement instables, différentes équipes de recherche se focalisent sur la fixation de la tête humérale à travers des vis dites « calcars » (vis ciblant la fixation de la tête humérale), que ce soit pour un clou intramédullaire ou pour une plaque de fixation. Or, nombre d'études physiologiques qui se focalisent sur la stabilité gléno-humérale montrent que, en fixant les tubérosités (qui accueillent d'ailleurs les tendons de la coiffe de rotateurs), la tête humérale restera en compression en permanence dans la cavité glénoïdale, stabilisant ainsi la réduction. Cela est une fonction tout à fait naturelle de l'articulation gléno-humérale. En d'autres termes, en privilégiant la fixation des zones d'attachement musculaires (les tubérosités), la fixation de la tête humérale n'est plus une priorité. Pour démontrer cela, nous avons donc fait le choix de tester ce cas de fracture instable avec une sollicitation en traction, avec une fixation uniquement dans la tubérosité où la sollicitation se produit.

Donc, pour les essais *in vitro*, nous avons mise en place quatre groupes d'essais :

- Fracture deux fragments avec clou intramédullaire en compression à 0° de l'axe diaphysaire.
- Os sain en compression (groupe contrôle).
- Fracture quatre fragments avec clou intramédullaire en traction avec appui glénoïdal à 45° de l'axe diaphysaire.
- Os sain en traction avec appui glénoïdal (groupe contrôle)

Pour cela, on a préalablement conçu et fabriqué un montage en acier inoxydable qui s'adapte à une machine d'essais universelle et qui permet faire des essais aussi en compression qu'en traction, avec et sans appui glénoïdal. Le cahier de charges a été défini en fonction des caractéristiques d'autres montages décrites dans la littérature. En complément, nous avons également mise en place un système d'acquisition d'images en stéréo, afin d'utiliser un algorithme de corrélation numérique d'images de libre accès. Cet algorithme nous permet en outre d'avoir un champs de déplacement et de déformation suivant une région surfacique d'intérêt. Malheureusement le système proposé ne peut que filmer une seule face, nous empêchant ainsi d'analyser le reste de la tête humérale.

Les essais en compression ont montré un cas très reproductible de fracture autour des vis de fixation du tubercule majeur pour le cas avec le clou. Pour le cas contrôle, une fracture au niveau du sillon intertuberculaire apparaît de façon aussi reproductible, avec une charge à la rupture différente mais avec une déplacement à la rupture très similaire entre les deux cas, laissant suggérer que le comportement de l'os est bien plus dépendant des déformations plutôt que des efforts. L'analyse du mouvement interfragmentaire a été un atout puisque cela a permis une comparaison en termes de raideur au niveau local (fracture), aussi en rotation qu'en translation.

Quant aux essais en traction, même si la fracture est à quatre fragments, une sangle se voulant muscle de la coiffe des rotateurs a été attaché au tubercule majeur, et seul ce tubercule a été fixé à l'aide de deux vis sur le clou intramédullaire. Ni le tubercule mineur ni la tête humérale n'ont été directement fixés par le clou. Pourtant, même à des sollicitations dépassant les valeurs physiologiques (>1 800 N), la tête humérale s'est très peu déplacée, d'après les études sur les images. En plus, les mouvements interfragmentaires du tubercule majeur face aux efforts appliqués ont été caractérisés et rapportés afin de les comparer *a posteriori* avec d'autres modèles *ex vivo*, *in vitro* ou *in silico*.

Pour ce qui est des essais *in silico*, deux études numériques en se basant sur la méthodes des éléments finis ont été développées. Cela correspond aux deux essais *in vitro* : 1) en compression, avec fracture à deux fragments et 2) en traction avec appui glénoïdal avec fracture à quatre fragments. Le modèle de l’humérus a été segmenté d’une base d’images médicales d’accès libre (Visible Human Project©) [Ackerman, 1998] ayant pour but faire un modèle standard et non pas un modèle personnalisé. La première itération de validation a consisté en faire une comparaison entre le modèle numérique et l’essai à quatre fragments qui précède ce travail de thèse [Clavert *et al.*, 2016]. Pour cela, nous avons développé un cadre numérique fidèle à l’expérience physique, y compris pour la modélisation de la corde qui a agi en tant que muscle supra-épineux. Et bien que les résultats des simulations numériques ont permis sa validation partielle et de manière qualitative, nous sommes aussi arrivés à la conclusion que ce modèle est bien sensible aux variations des propriétés mécaniques de l’os ainsi qu’à la stratégie d’interaction entre les vis et l’os (le modèle *in silico* semble être bien plus raide que son homologue expérimental) et qu’il est nécessaire une cohorte plus large de données expérimentales pour faire une validation et une calibration au plus juste du modèle numérique.

Avec ces conclusions préliminaires à l’esprit, nous avons poursuivi la conception d’une deuxième itération du modèle numérique, en se basant sur le cadre expérimentale de l’essai en compression pour le cas de fracture à deux fragments. Le modèle de l’humérus maillé dans la première itération a été retravaillé afin d’y incorporer la nouvelle configuration de fracture et de fixation des vis. En reproduisant au plus près les conditions limites et de chargement, et en imposant une stratégie d’interaction entre les vis et l’os plus souple, nous nous sommes retrouvés avec un modèle capable de reproduire dans une certaine mesure le champs local de déplacement et de déformation pour des sollicitations mécaniques ne dépassant pas le cadre physiologique. Cela revient à faire une étude comparative que dans la zone élastique, vu que le comportement mécanique de l’os synthétique au-delà de sa limite élastique n’est pas totalement caractérisé. Malgré tout, le modèle a été capable aussi de prédire les zones de fracture autour des trous de vis. Et finalement, le changement de stratégie de fixation des vis a radicalement changé la raideur globale observée dans l’ensemble du système, ce qui se traduit par une forte sensibilité aux paramètres de l’interaction entre les vis et l’os.

Accomplie cette batterie d’essais, le présent travail a su être capable de fournir des informations détaillées concernant le comportement biomécanique de l’humérus proximal face à deux fractures distinctes, à deux modes de sollicitation différents et avec un dispositif d’ostéosynthèse qui pour l’instant ne bénéficie que de peu d’études disponibles et des données expérimentales, contrairement à d’autres dispositifs de fixation interne qui se veulent standards (comme les plaques et les clous de marque Synthes©, dont ses études sont privilégiées par l’institut de standardisation du traitement des fractures AO). Outre les apports en termes de données, ce travail permettra au laboratoire ICube d’hériter le montage expérimental pour poursuivre les essais *in vitro* et *ex vivo* sur des os longs, à part bien entendu l’humérus. Également, ils seront à disposition du laboratoire les différents modèles numériques développés, discutés et validés au cours de cette thèse. Finalement, à l’heure de la rédaction de ce chapitre, deux articles scientifiques sont en train d’être préparés afin de finir notre apport à la communauté scientifique.

5.2 Perspectives de ce travail de recherche

Outre que quelques améliorations techniques évidents, comme l’extension du système de caméras pour avoir plus d’images et plus de surfaces filmés, plusieurs axes de recherche se délimitent suite aux interrogations et aux hypothèses

qu'on en a fait face pendant le déroulement de la thèse, à savoir :

- Extension du protocole expérimentale pour y incorporer des essais en fatigue et des essais dynamiques. L'évaluation biomécanique d'un dispositif d'ostéosynthèse reste incomplète si l'endommagement cumulatif par fatigue, ou la mécanique des chocs sont négligés, vu l'importance physiologique que ces deux régimes mécaniques peuvent en avoir.
- Consolidation et remodelage osseux. Pendant l'analyse de la littérature, la plupart des cadres expérimentales et numériques sont situés que dans le temps t_0 suite à la fracture. Cela veut dire, aucune considération sur le cas de consolidation osseuse n'a été pris. Or, il existent nombre de modèles théoriques et partiellement validés qui ciblent la consolidation et le remodelage osseux suite à une fracture [Giorgi *et al.*, 2016].
- Étude de l'anisotropie et l'hétérogénéité de l'os spongieux. La tête humérale est composée dans sa majorité de tissu spongieux distribué de manière inhomogène, en affichant localement des directions privilégiées. Une connaissance plus approfondie de cette distribution, de son acquisition (par micro-tomographie ou par résonance magnétique à haut champs) et de sa caractérisation (par moyens numériques ou expérimentales) pourrait fortement enrichir les modèles *in silico* en vue d'une validation plus complète.
- Développement d'un modèle numérique musculo-squelettique afin de reproduire des cas de chargements physiologiques plus réalistes. Plusieurs travaux de recherche ont déjà permis d'avoir des modèles musculo-squelettiques de l'articulation gléno-humérale et même de l'ensemble des articulations sous-jacentes de l'épaule. En utilisant une stratégie de simulations par corps rigides, la cinématique et même la dynamique du mouvement peuvent être obtenues, en se privant néanmoins de la distribution de contraintes et de déformations sur l'os. Des techniques qui ciblent des co-simulations (deux stratégies de simulation opérant en parallèle et de manière complémentaire) pourraient palier ce problématique, afin d'avoir accès aux champs de contraintes d'un solide déformable tout en reproduisant fidèlement la cinématique de l'articulation gléno-humérale. Une liste des modèles numériques qui ciblent la simulation cinématique tout en gardant la stratégie des solides déformables a fait partie du travail de cette thèse et est présentée dans l'Annexe G.

En effet, plusieurs voies pour poursuivre la recherche autour de la question fondamentale de l'évaluation biomécanique d'un dispositif d'ostéosynthèse sont présentées et discutées, dont certaines déjà à ses débuts. Il faut surligner qu'effectivement, plusieurs travaux exploratoires pour améliorer ce travail de recherche ont été réalisés mais pas exploités dans le cadre de cette thèse. Certains axes ont dû être privilégiés, voulant ainsi mener à bon port ce projet.

5.3 Perspectives personnelles

Comme un immense forêt, la recherche scientifique peut être perçue comme un travail qui mise à pousser d'un cran les limites de nos connaissances humaines à travers des sentiers qu'à l'heure actuelle, ne sont pas balisés. Cela permet à tout explorateur amateur dans ses débuts de s'égarer, parfois tomber sur un champs de mines, ou tout simplement devoir faire face à jeter l'éponge à mi-parcours. Et bien que je me suis retrouvé peut-être à deux doigts de ces situations si complexes, nul ne peut douter de la force et de l'inspiration que la communauté peut exercer sur les individus, à savoir, les accompagnateurs de cette aventure et d'autres chercheurs qui s'y connaît mieux.

Tout cela, pour dire que ce travail de thèse m'a permis d'explorer non seulement une thématique aussi passionnante qui est la biomécanique, mais aussi la communauté vivante et dynamique derrière qui m'a inspiré de continuer à apprivoiser cette curiosité scientifique.

À l'heure actuelle de la rédaction de cette dernière partie, j'ai le plaisir de dire que je continuerai toujours dans le domaine de la biomécanique, plus particulièrement dans le développement des jumeaux numériques des articulations du corps humain, au sein d'une entreprise grenobloise appelé TwInsight, poste à pourvoir en CDI.

Une heureuse fin comme doctorant, et un satisfaisant début comme scientifique.

Bibliographie

- [A. Odgaard, 1997] A. ODGAARD (1997). Three-Dimensional Methods for Quantification of Cancellous Bone Architecture. *Bone*, 20(4):315–328.
- [Ackerman, 1998] ACKERMAN, M. J. (1998). The visible human project. *Proc. IEEE*, 86(3):504–511.
- [Ackland *et al.*, 2008] ACKLAND, D. C., PAK, P., RICHARDSON, M. et PANDY, M. G. (2008). Moment arms of the muscles crossing the anatomical shoulder. pages 383–390.
- [Ackland et Pandey, 2009] ACKLAND, D. C. et PANDY, M. G. (2009). Lines of action and stabilizing potential of the shoulder musculature. pages 184–197.
- [Akahori et Niinomi, 1998] AKAHORI, T. et NIINOMI, M. (1998). Fracture characteristics of fatigued Ti-6Al-4V ELI as an implant material. *Mater. Sci. Eng. A*, 243(1-2):237–243.
- [Alidousti *et al.*, 2017] ALIDOUSTI, H., GILES, J. W., EMERY, R. J. et JEFFERS, J. (2017). Spatial mapping of humeral head bone density. *J. Shoulder Elb. Surg.*, 26(9):1653–1661.
- [Andréys, 2019] ANDRÉYS, B. (2019). Validation, caractérisation, amélioration et utilisation d’un banc d’essai pour humérus proximal avec et sans clou intramédullaire. Mémoire de D.E.A., Université de Strasbourg.
- [Astier, 2010] ASTIER, V. (2010). *Un Modèle Elements Finis De L’épaule : Du Traumatisme A La Rehabilitation*. Thèse de doctorat, Université de la Méditerranée.
- [Aziz *et al.*, 2014] AZIZ, M. S. R., NICAYENZI, B., CROOKSHANK, M. C., BOUGHERARA, H., SCHEMITSCH, E. H. et ZDERO, R. (2014). Biomechanical Measurements of Stiffness and Strength for Five Types of Whole Human and Artificial Humeri. *J. Biomech. Eng.*, 136(5):051006.
- [Barak *et al.*, 2009] BARAK, M. M., SHARIR, A. et SHAHAR, R. (2009). Optical metrology methods for mechanical testing of whole bones. *Vet. J.*, 180(1):7–14.
- [Barber *et al.*, 1997] BARBER, F. A., FEDER, S. M., BURKHART, S. S. et AHRENS, J. (1997). The relationship of suture anchor failure and bone density to proximal humerus location : A cadaveric study. *Arthroscopy*, 13(3):340–345.
- [Boileau *et al.*, 2015] BOILEAU, P., D’OLLONNE, T., CLAVERT, P. et HATZIDAKIS, A. M. (2015). Intramedullary Nail for Proximal Humerus Fractures : An Old Concept Revisited. *In Simple Complex Fract. Humerus*, numéro 3, pages 91–112. Springer Milan, Milano.

- [Boileau *et al.*, 2019] BOILEAU, P., D’OLLONNE, T., BESSIÈRE, C., WILSON, A., CLAVERT, P., HATZIDAKIS, A. M. et CHELLI, M. (2019). Displaced humeral surgical neck fractures : classification and results of third-generation percutaneous intramedullary nailing. *Journal of shoulder and elbow surgery*, 28(2):276–287.
- [Boileau et Walch, 1997] BOILEAU, P. et WALCH, G. (1997). The Three-Dimensional Geometry of the Proximal Humerus : Implications for Surgical Technique and Prosthetic Design. *J. Bone Jt. Surg.*, 79(5):857–865.
- [Bossy *et al.*, 2005] BOSSY, E., PADILLA, F., PEYRIN, F. et LAUGIER, P. (2005). Three-dimensional simulation of ultrasound propagation through trabecular bone structures measured by synchrotron microtomography. *Phys. Med. Biol.*, 50(23):5545–5556.
- [Bourdin *et al.*, 2007] BOURDIN, X., TROSSELLE, X., PETIT, P. et BEILLAS, P. (2007). Comparison of tetrahedral and hexahedral meshes for organ Finite Element Modeling : An application to kidney impact. *20th Century Enhanc. Saf. Veh. Conf. Innov. Saf. Appl. Challenges*, (Figure 1):1–10.
- [Braun *et al.*, 2015] BRAUN, B. J., ROLLMANN, M., VEITH, N. et POHLEMANN, T. (2015). Fracture healing redefined. *Med. Hypotheses*, 85(6):940–943.
- [Brianza *et al.*, 2010] BRIANZA, S., PLECKO, M., GUEORGUIEV, B., WINDOLF, M. et SCHWIEGER, K. (2010). Biomechanical evaluation of a new fixation technique for internal fixation of three-part proximal humerus fractures in a novel cadaveric model. *Clin. Biomech.*, 25(9):886–892.
- [Büchler et Farron, 2004] BÜCHLER, P. et FARRON, A. (2004). Benefits of an anatomical reconstruction of the humeral head during shoulder arthroplasty : A finite element analysis. *Clin. Biomech.*, 19(1):16–23.
- [Büchler *et al.*, 2002] BÜCHLER, P., RAMANIRAKA, N. A., RAKOTOMANANA, L. R., IANNOTTI, J. P. et FARRON, A. (2002). A finite element model of the shoulder : Application to the comparison of normal and osteoarthritic joints. *Clin. Biomech.*, 17(9-10):630–639.
- [Burke *et al.*, 2014] BURKE, N. G., KENNEDY, J., COUSINS, G., FITZPATRICK, D. et MULLETT, H. (2014). Locking plate fixation with and without inferomedial screws for proximal humeral fractures : A biomechanical study. *J. Orthop. Surg.*, 22(2):190–194.
- [Cailliet, 2006] CAILLIET, R. (2006). *Anatomia Funcional, Biomechanica*.
- [Capanna et De Biase, 2006] CAPANNA, R. et DE BIASE, P. (2006). Osteoinduction : Basic Principles and Developments. In *Pract. Intramedullary Locked Nails*, pages 23–42. Springer Berlin Heidelberg, Berlin, Heidelberg.
- [Carter et Hayes, 1977] CARTER, D. et HAYES, W. (1977). The compressive behavior of bone as a two-phase porous structure. *The Journal of Bone and Joint surgery. American Volume*, 59(7):954–962.
- [Chang *et al.*, 2017] CHANG, G., BOONE, S., MARTEL, D., RAJAPAKSE, C. S., HALLYBURTON, R. S., VALKO, M., HONIG, S. et REGATTE, R. R. (2017). MRI assessment of bone structure and microarchitecture. *J. Magn. Reson. Imaging*, 46(2):323–337.
- [Cheal *et al.*, 1991] CHEAL, E. J., MANSMANN, K. A., DIGIOIA, A. M., HAYES, W. C. et PERREN, S. M. (1991). Role of interfragmentary strain in fracture healing : Ovine model of a healing osteotomy. *J. Orthop. Res.*, 9(1):131–142.

- [Chow *et al.*, 2012] CHOW, R. M., BEGUM, F., BEAUPRE, L. A., CAREY, J. P., ADEEB, S. et BOULIANE, M. J. (2012). Proximal humeral fracture fixation : Locking plate construct - intramedullary fibular allograft. *J. Shoulder Elb. Surg.*, 21(7):894–901.
- [Claes *et al.*, 2018] CLAES, L., MEYERS, N., SCHÜLKE, J., REITMAIER, S., KLOSE, S. et IGNATIUS, A. (2018). The mode of interfragmentary movement affects bone formation and revascularization after callus distraction. *PLoS One*, 13(8):1–12.
- [Claes et Heigele, 1999] CLAES, L. E. et HEIGELE, C. A. (1999). Magnitudes of local stress and strain along bony surfaces predict the course and type of fracture healing. *J. Biomech.*, 32(3):255–266.
- [Clavert, 2007] CLAVERT, P. (2007). *Mise au point d'un modèle aux éléments finis de l'articulation gléno-humérale. Application à l'étude de la prothèse inversée d'épaule*. Thèse de doctorat, Université Louis Pasteur Strasbourg.
- [Clavert *et al.*, 2010] CLAVERT, P., ADAM, P., BEVORT, A., BONNOMET, F. et KEMPF, J. F. (2010). Pitfalls and complications with locking plate for proximal humerus fracture. *J. Shoulder Elb. Surg.*, 19(4):489–494.
- [Clavert *et al.*, 2016] CLAVERT, P., HATZIDAKIS, A. et BOILEAU, P. (2016). Anatomical and biomechanical evaluation of an intramedullary nail for fractures of proximal humerus fractures based on tuberosity fixation. *Clin. Biomech.*, 32:108–112.
- [Clavert *et al.*, 2006] CLAVERT, P., ZERAH, M., KRIER, J., MILLE, P., KEMPF, J. F. et KAHN, J. L. (2006). Finite element analysis of the strain distribution in the humeral head tubercles during abduction : Comparison of young and osteoporotic bone. *Surg. Radiol. Anat.*, 28(6):581–587.
- [Court-Brown *et al.*, 2001] COURT-BROWN, C. M., GARG, A. et MCQUEEN, M. M. (2001). The epidemiology of proximal humeral fractures. *Acta Orthop.*, 72(4):365–371.
- [Craft *et al.*, 1996] CRAFT, D. V., MOSELEY, J. B., CAWLEY, P. W. et NOBLE, P. C. (1996). Fixation strength of rotator cuff repairs with suture anchors and the transosseous suture technique. *J. Shoulder Elbow Surg.*, 5(1):32–40.
- [Curtis *et al.*, 2006] CURTIS, A. S., BURBANK, K. M., TIERNEY, J. J., SCHELLER, A. D. et CUNAN, A. R. (2006). The insertional footprint of the rotator cuff : An anatomic study. *Arthroscopy*, 22(6):603–609.
- [Dahan *et al.*, 2016] DAHAN, G., TRABELSI, N., SAFRAN, O. et YOSIBASH, Z. (2016). Verified and validated finite element analyses of humeri. *J. Biomech.*, 49(7):1094–1102.
- [Dahan *et al.*, 2019] DAHAN, G., TRABELSI, N., SAFRAN, O. et YOSIBASH, Z. (2019). Finite element analyses for predicting anatomical neck fractures in the proximal humerus. *Clin. Biomech.*, 68(March):114–121.
- [Dunham *et al.*, 2005] DUNHAM, C. E., TAKAKI, S. E., JOHNSON, J. A. et DUNNING, C. E. (2005). Mechanical properties of cancellous bone of the distal humerus. *Clin. Biomech.*, 20(8):834–838.
- [Dunlap *et al.*, 2008] DUNLAP, J. T., CHONG, A. C. M., LUCAS, G. L. et COOKE, F. W. (2008). Structural properties of a novel design of composite analogue humeri models. *Ann. Biomed. Eng.*, 36(11):1922–1926.

- [Elsen, 2006] ELSÉN, A. (2006). Intramedullary Nailing of Proximal Humeral Fractures. *In Pract. Intramedullary Locked Nails*, pages 169–177. Springer-Verlag, Berlin/Heidelberg.
- [Erden *et al.*, 2019] ERDEN, T., KAPICIOGLU, M., DEMIRTAS, A., BILSEL, K., AKPINAR, F. et KUDUZ, H. (2019). Biomechanical comparison of humeral nails with different distal locking mechanisms : Insafelock nails versus conventional locking nails. *Acta Orthop. Traumatol. Turc.*, 53(6):490–496.
- [Euler *et al.*, 2017a] EULER, S. A., PETRI, M., VENDERLEY, M. B., DORNAN, G. J., SCHMOELZ, W., TURNBULL, T. L., PLECKO, M., KRALINGER, F. S. et MILLETT, P. J. (2017a). Biomechanical evaluation of straight antegrade nailing in proximal humeral fractures : the rationale of the proximal anchoring point. *Int. Orthop.*, 41(9):1715–1721.
- [Euler *et al.*, 2017b] EULER, S. A., PETRI, M., VENDERLEY, M. B., DORNAN, G. J., SCHMOELZ, W., TURNBULL, T. L., PLECKO, M., KRALINGER, F. S. et MILLETT, P. J. (2017b). Biomechanical evaluation of straight antegrade nailing in proximal humeral fractures : the rationale of the “proximal anchoring point”. *Int. Orthop.*, 41(9):1715–1721.
- [Favre et Henderson, 2016] FAVRE, P. et HENDERSON, A. D. (2016). Prediction of stemless humeral implant micro-motion during upper limb activities. *Clin. Biomech.*, 36:46–51.
- [Fedorov *et al.*, 2012] FEDOROV, A., BEICHEL, R., KALPATHY-CRAMER, J., FINET, J., FILLION-ROBIN, J.-C., PUJOL, S., BAUER, C., JENNINGS, D., FENNESSY, F., SONKA, M., BUATTI, J., AYLWARD, S., MILLER, J. V., PIEPER, S. et KIKINIS, R. (2012). 3D Slicer as an image computing platform for the Quantitative Imaging Network. *Magn. Reson. Imaging*, 30(9):1323–1341.
- [Frich et Jensen, 2014] FRICH, L. et JENSEN, N. (2014). Bone properties of the humeral head and resistance to screw cutout. *Int. J. Shoulder Surg.*, 8(1):21.
- [Garner et Pandey, 2001] GARNER, B. A. et PANDY, M. G. (2001). Musculoskeletal Model of the Upper Limb Based on the Visible Human Male Dataset. *Comput. Methods Biomech. Biomed. Engin.*, 4(2):93–126.
- [Gaudelli *et al.*, 2014] GAUDELLI, C., MÉNARD, J., MUTCH, J., LAFLAMME, G. Y., PETIT, Y. et ROULEAU, D. M. (2014). Locking plate fixation provides superior fixation of humerus split type greater tuberosity fractures than tension bands and double row suture bridges. *Clin. Biomech.*, 29(9):1003–1008.
- [Geuzaine et Remacle, 2009] GEUZAINÉ, C. et REMACLE, J. F. (2009). Gmsh : A 3-D finite element mesh generator with built-in pre- and post-processing facilities. *Int. J. Numer. Methods Eng.*, 79(11):1309–1331.
- [Giorgi *et al.*, 2016] GIORGI, M., VERBRUGGEN, S. W. et LACROIX, D. (2016). In silico bone mechanobiology : modeling a multifaceted biological system. *Wiley Interdiscip. Rev. Syst. Biol. Med.*, 8(6):485–505.
- [Grassi et Isaksson, 2015] GRASSI, L. et ISAKSSON, H. (2015). Extracting accurate strain measurements in bone mechanics : A critical review of current methods. *J. Mech. Behav. Biomed. Mater.*, 50:43–54.
- [Grover *et al.*, 2011] GROVER, P., ALBERT, C., WANG, M. et HARRIS, G. F. (2011). Mechanical characterization of fourth generation composite humerus. *Proc. Inst. Mech. Eng. Part H J. Eng. Med.*, 225(12):1169–1176.
- [Hansen *et al.*, 2018] HANSEN, U., ZHAO, S., ARNOLD, M., BOUGHTON, O., MA, S., COBB, J. P. et ABEL, R. L. (2018). Standardizing compression testing for measuring the stiffness of human bone. *Bone Joint Res.*, 7(8):524–538.

- [Helgason *et al.*, 2008] HELGASON, B., PERILLI, E., SCHILEO, E., TADDEI, F., BRYNJÓLFSSON, S. et VICECONTI, M. (2008). Mathematical relationships between bone density and mechanical properties : A literature review. *Clin. Biomech.*, 23(2):135–146.
- [Hertel *et al.*, 2004] HERTEL, R., HEMPFING, A., STIEHLER, M. et LEUNIG, M. (2004). Predictors of humeral head ischemia after intracapsular fracture of the proximal humerus. *J. Shoulder Elb. Surg.*, 13(4):427–433.
- [Hodgson, 2009] HODGSON, S. (2009). *AO Principles of Fracture Management*, volume 91.
- [Howell *et al.*, 1986] HOWELL, S. M., IMOBERSTEG, A. M., SEGER, D. H. et MARONE, P. J. (1986). Clarification of the role of the supraspinatus muscle in shoulder function. *J. Bone Jt. Surg. - Ser. A*, 68(3):398–404.
- [Ilizarov, 1990] ILIZAROV, G. A. (1990). Clinical application of the tension-stress effect for limb lengthening. *Clin. Orthop. Relat. Res.*, (250):8–26.
- [Inzana *et al.*, 2016] INZANA, J. A., VARGA, P. et WINDOLF, M. (2016). Implicit modeling of screw threads for efficient finite element analysis of complex bone-implant systems. *J. Biomech.*, 49(9):1836–1844.
- [Iwamoto *et al.*, 2001] IWAMOTO, M., MIKI, K. et YANG, K. H. (2001). Development of a Finite Element Model of the Human Shoulder to Investigate the Mechanical Responses and Injuries in Side Impact. *JSME Int. J. Ser. C*, 44(4):1072–1081.
- [Jabran *et al.*, 2016] JABRAN, A., REN, L., PEACH, C. et ZOU, Z. (2016). A Methodology for Biomechanical Assessment of Proximal Humerus Fractures Using an Integrated Experimental and Computational Framework. *Procedia CIRP*, 49:139–142.
- [Jones *et al.*, 2018] JONES, I., BIGGER, R., BLAYSAT, B., BOO, C., GREWER, M., HU, J., JONES, A., KLEIN, M., RAGHAVAN, K., REU, P., SCHMIDT, T., SIEBERT, T., SIMENSON, M., TURNER, D., VIEIRA, A. et WEIKERT, T. (2018). A Good Practices Guide for Digital Image Correlation. *Int. Digit. Image Correl. Soc.*, page 94.
- [Kathrein *et al.*, 2013] KATHREIN, S., KRALINGER, F., BLAUTH, M. et SCHMOELZ, W. (2013). Biomechanical comparison of an angular stable plate with augmented and non-augmented screws in a newly developed shoulder test bench. *Clin. Biomech.*, 28(3):273–277.
- [Keaveny *et al.*, 1997] KEAVENY, T. M., PINILLA, T. P., CRAWFORD, R. P., KOPPERDAHL, D. L. et LOU, A. (1997). Systematic and random errors in compression testing of trabecular bone. *J. Orthop. Res.*, 15(1):101–110.
- [Knowles *et al.*, 2018] KNOWLES, N., LANGOHR, G., FAIEGHI, M., NELSON, A. et FERREIRA, L. (2018). Development of a Validated Glenoid Trabecular Density-Modulus Relationship. *J. Mech. Behav. Biomed. Mater.*
- [LaMartina *et al.*, 2018] LAMARTINA, J., CHRISTMAS, K. N., SIMON, P., STREIT, J. J., ALLERT, J. W., CLARK, J., OTTO, R. J., ABDELFAHAT, A., MIGHELL, M. A. et FRANKLE, M. A. (2018). Difficulty in decision making in the treatment of displaced proximal humerus fractures : the effect of uncertainty on surgical outcomes. *J. Shoulder Elb. Surg.*, 27(3):470–477.
- [Laugier et Haïat, 2011] LAUGIER, P. et HAÏAT, G. (2011). *Bone quantitative ultrasound*. Springer Netherlands, Dordrecht.

- [Lekadir *et al.*, 2015] LEKADIR, K., HAZRATI-MARANGALOU, J., HOOGENDOORN, C., TAYLOR, Z., van RIETBERGEN, B. et FRANGI, A. F. (2015). Statistical estimation of femur micro-architecture using optimal shape and density predictors. *J. Biomech.*, 48(4):598–603.
- [Lin *et al.*, 2015] LIN, C. L., SU, F. C., CHANG, C. H., HONG, C. K., JOU, I. M., LIN, C. J. et Su, W. R. (2015). Effect of shoulder abduction on the fixation of humeral greater tuberosity fractures : A biomechanical study for three types of fixation constructs. *J. Shoulder Elb. Surg.*, 24(4):547–554.
- [Maldonado *et al.*, 2003] MALDONADO, Z. M., SEEBECK, J., HELLER, M. O. W., BRANDT, D., HEPP, P., LILL, H. et DUDA, G. N. (2003). Straining of the intact and fractured proximal humerus under physiological-like loading. *J. Biomech.*, 36(12):1865–1873.
- [Maquer *et al.*, 2015] MAQUER, G., MUSY, S. N., WANDEL, J., GROSS, T. et ZYSSET, P. K. (2015). Bone volume fraction and fabric anisotropy are better determinants of trabecular bone stiffness than other morphological variables. *J. Bone Miner. Res.*, 30(6):1000–1008.
- [Mavčič et Antolič, 2012] MAVČIČ, B. et ANTOLIČ, V. (2012). Optimal mechanical environment of the healing bone fracture/osteotomy. *Int. Orthop.*, 36(4):689–695.
- [Mehta *et al.*, 2018] MEHTA, S., CHIN, M., SANVILLE, J., NAMDARI, S. et HAST, M. W. (2018). Calcar screw position in proximal humerus fracture fixation : Don't miss high! *Injury*, 49(3):624–629.
- [Meier et Meier, 2006] MEIER, S. W. et MEIER, J. D. (2006). The Effect of Double-Row Fixation on Initial Repair Strength in Rotator Cuff Repair : A Biomechanical Study. *Arthrosc. - J. Arthrosc. Relat. Surg.*, 22(11):1168–1173.
- [Müller *et al.*, 1990] MÜLLER, M. E., KOCH, P., NAZARIAN, S. et SCHATZKER, J. (1990). *The Comprehensive Classification of Fractures of Long Bones*. Springer Berlin Heidelberg, Berlin, Heidelberg.
- [Neer, 1970] NEER, C. S. (1970). Displaced proximal humeral fractures. I. Classification and evaluation. *J. Bone Joint Surg. Am.*, 52(6):1077–89.
- [Nyffeler *et al.*, 2006] NYFFELER, R. W., SHEIKH, R., ATKINSON, T. S., JACOB, H. A., FAVRE, P. et GERBER, C. (2006). Effects of glenoid component version on humeral head displacement and joint reaction forces : An experimental study. *J. Shoulder Elb. Surg.*, 15(5):625–629.
- [Oftadeh *et al.*, 2015] OFTADEH, R., PEREZ-VILORIA, M., VILLA-CAMACHO, J. C., VAZIRI, A. et NAZARIAN, A. (2015). Biomechanics and Mechanobiology of Trabecular Bone : A Review. *J. Biomech. Eng.*, 137(1):010802.
- [Palvanen *et al.*, 2006] PALVANEN, M., KANNUS, P., NIEMI, S. et PARKKARI, J. (2006). Update in the epidemiology of proximal humeral fractures. *Clinical Orthopaedics and Related Research (1976-2007)*, 442:87–92.
- [Perren, 2002] PERREN, S. M. (2002). Evolution of the internal fixation of long bone fractures : The scientific basis of biological internal fixation : choosing a new balance between stability and biology. *J. Bone Jt. Surg.*, 84(8):1093–1110.
- [Platzer,] PLATZER, W. *Atlas de Poche : Anatomie*.

- [Rajapakse *et al.*, 2018] RAJAPAKSE, C. S., KOBE, E. A., BATZDORF, A. S., HAST, M. W. et WEHRLI, F. W. (2018). Accuracy of MRI-based finite element assessment of distal tibia compared to mechanical testing. *Bone*, 108:71–78.
- [Ramos et Simões, 2006] RAMOS, A. et SIMÕES, J. A. (2006). Tetrahedral versus hexahedral finite elements in numerical modelling of the proximal femur. *Med. Eng. Phys.*, 28(9):916–924.
- [Razfar *et al.*, 2016] RAZFAR, N., REEVES, J. M., LANGOHR, D. G., WILLING, R., ATHWAL, G. S. et JOHNSON, J. A. (2016). Comparison of proximal humeral bone stresses between stemless, short stem, and standard stem length : A finite element analysis. *J. Shoulder Elb. Surg.*, 25(7):1076–1083.
- [Röderer *et al.*, 2013] RÖDERER, G., SCOLA, A., SCHMÖLZ, W., GEBHARD, F., WINDOLF, M. et HOFMANN-FLIRI, L. (2013). Biomechanical in vitro assessment of screw augmentation in locked plating of proximal humerus fractures. *Injury*, 44(10):1327–1332.
- [Rothstock *et al.*, 2012] ROTHSTOCK, S., PLECKO, M., KLOUB, M., SCHIUMA, D., WINDOLF, M. et GUEORGUIEV, B. (2012). Biomechanical evaluation of two intramedullary nailing techniques with different locking options in a three-part fracture proximal humerus model. *Clin. Biomech.*, 27(7):686–691.
- [Sakai *et al.*, 2019] SAKAI, R., MASATAKA, U., YOSHIDA, K. et UJIHIRA, M. (2019). Risk Assessment of Retrograde Intramedullary Nailing for Proximal Humeral Fracture. *J. Biomed. Sci. Eng.*, 12(05):277–284.
- [Schileo *et al.*, 2007] SCHILEO, E., TADDEI, F., MALANDRINO, A., CRISTOFOLINI, L. et VICECONTI, M. (2007). Subject-specific finite element models can accurately predict strain levels in long bones. *J. Biomech.*, 40(13):2982–2989.
- [Seide *et al.*, 2007] SEIDE, K., TRIEBE, J., FASCHINGBAUER, M., SCHULZ, A. P., PÜSCHEL, K., MEHRTENS, G. et JÜRGENS, C. (2007). Locked vs. unlocked plate osteosynthesis of the proximal humerus - A biomechanical study. *Clin. Biomech.*, 22(2):176–182.
- [Sherman *et al.*, 2013] SHERMAN, M. A., SETH, A. et DELP, S. L. (2013). What is a Moment Arm? Calculating Muscle Effectiveness in Biomechanical Models Using Generalized Coordinates. *In Vol. 7B 9th Int. Conf. Multibody Syst. Nonlinear Dyn. Control*, volume 21, pages 51–60. American Society of Mechanical Engineers.
- [Sutton *et al.*, 2012] SUTTON, M. A., ORTEU, J. J., SCHREIER, H. W. et REU, P. (2012). Introduction to digital image correlation : Best practices and applications. *Exp. Tech.*, 36(1):3–4.
- [Synek *et al.*, 2015] SYNEK, A., CHEVALIER, Y., BAUMBACH, S. F. et PAHR, D. H. (2015). The influence of bone density and anisotropy in finite element models of distal radius fracture osteosynthesis : Evaluations and comparison to experiments. *J. Biomech.*, 48(15):4116–4123.
- [Tingart *et al.*, 2003] TINGART, M. J., BOUXSEIN, M. L., ZURAKOWSKI, D., WARNER, J. P. et APRELEVA, M. (2003). Three-Dimensional Distribution of Bone Density in the Proximal Humerus. *Calcif. Tissue Int.*, 73(6):531–536.
- [Turner *et al.*, 2015] TURNER, D., CROZIER, P. et REU, P. (2015). Digital image correlation engine, version 00.
- [Unger *et al.*, 2012] UNGER, S., ERHART, S., KRALINGER, F., BLAUTH, M. et SCHMOELZ, W. (2012). The effect of in situ augmentation on implant anchorage in proximal humeral head fractures. *Injury*, 43(10):1759–1763.

- [van der Helm, 1994] van der HELM, F. C. T. (1994). A finite element musculoskeletal model of the shoulder mechanism. *J. Biomech.*, 27(5):551–569.
- [van Rietbergen *et al.*, 1995] van RIETBERGEN, B., WEINANS, H., HUISKES, R. et ODGAARD, A. (1995). A new method to determine trabecular bone elastic properties and loading using micromechanical finite-element models. *J. Biomech.*, 28(1):69–81.
- [Vandenbulcke, 2012] VANDENBULCKE, F. (2012). On the Mechanical Characterization of Human Humerus using Multiscale Continuum Finite Element Model. *IRCOBI Conf. 2012*, pages 598–609.
- [Varga *et al.*, 2017] VARGA, P., GRÜNWARD, L., INZANA, J. A. et WINDOLF, M. (2017). Fatigue failure of plated osteoporotic proximal humerus fractures is predicted by the strain around the proximal screws. *J. Mech. Behav. Biomed. Mater.*, 75(March):68–74.
- [Wakabayashi *et al.*, 2003] WAKABAYASHI, I., ITOI, E., SANO, H., SHIBUYA, Y., SASHI, R., MINAGAWA, H. et KOBAYASHI, M. (2003). Mechanical environment of the supraspinatus tendon : a two-dimensional finite element model analysis. *J. Shoulder Elb. Surg.*, 12(6):612–617.
- [Wang *et al.*, 2015] WANG, G., MAO, Z., ZHANG, L., ZHANG, L., ZHAO, Y., YIN, P., GAO, L., TANG, P. et KANG, H. (2015). Meta-analysis of locking plate versus intramedullary nail for treatment of proximal humeral fractures. *J. Orthop. Surg. Res.*, 10(1):122.
- [Webb *et al.*, 2014] WEBB, J. D., BLEMKER, S. S. et DELP, S. L. (2014). 3D finite element models of shoulder muscles for computing lines of actions and moment arms. *Comput. Methods Biomech. Biomed. Engin.*, 17(8):829–837.
- [Wuelker *et al.*, 1995] WUELKER, N., WIRTH, C. J., PLITZ, W. et ROETMAN, B. (1995). A dynamic shoulder model : Reliability testing and muscle force study. *J. Biomech.*, 28(5).
- [Yanagawa *et al.*, 2008] YANAGAWA, T., GOODWIN, C. J., SHELBURNE, K. B., GIPHART, J. E., TORRY, M. R. et PANDY, M. G. (2008). Contributions of the Individual Muscles of the Shoulder to Glenohumeral Joint Stability During Abduction. *J. Biomech. Eng.*, 130(2):021024.
- [Ye *et al.*, 2017] YE, Y., YOU, W., ZHU, W., CUI, J., CHEN, K. et WANG, D. (2017). The Applications of Finite Element Analysis in Proximal Humeral Fractures. *Comput. Math. Methods Med.*, 2017.
- [Zhang *et al.*, 2016] ZHANG, Y. K., WEI, H. W., LIN, K. P., CHEN, W. C., TSAI, C. L. et LIN, K. J. (2016). Biomechanical effect of the configuration of screw hole style on locking plate fixation in proximal humerus fracture with a simulated gap : A finite element analysis. *Injury*, 47(6):1191–1195.

Appendices

Annexe A

Algorithme de détermination de l'état de connectivité d'une maille VTK

```
1  #!/usr/bin/env python2.7
2  import os
3  # Algorithm to determine the connectivity of an unstructured grid
4  # Setup
5  fileName = 'SCAPULA/<filename>.vtk' # replace filename with the VTK unstructured grid
6  points = 'points.dat'
7  polylines = 'lines.dat'
8  connect = 'connect.dat'
9  # Variables
10 P = [] # Points
11 L = [] # Lines
12 C = [] # connectivity (polylines)
13 O = [] # offsets
14 # Reading
15 with open(fileName, 'r') as f:
16     for i in range(5): # header of 5 lines
17         data = f.readline() # forward carriage
18     F = data.split(' ') # Separate the words in an array
19     if F[0] == 'POINTS': # starting with points
20         NoPoints = int(F[1]) # Get the number of points
21         for i in range(NoPoints):
22             data = f.readline()
23             G = data.split(' ')
24             P.append([float(n) for n in G[0:3]]) # save each point value
25         for i in range(2): # continuing with cells
26             data = f.readline()
27             G = data.split(' ')
28             SkipNum = int(G[1]) - NoPoints
29             for i in range(SkipNum):
30                 data = f.readline()
31             for i in range(NoPoints):
```

```

32         data = f.readline()
33         G = data.split(' ')
34         L.append([int(n) for n in G[1:3]])
35         if C == []: # Considering that the lines are fully in order
36             C.append([L[i][0],L[i][1]])
37         elif C[-1][-1] == L[i][0]:
38             C[-1].append(L[i][1])
39         else:
40             C.append([L[i][0],L[i][1]])
41 # Write the data
42 with open(points,'w') as fp:
43     fp.write('\n'.join([' '.join(['{:1}'.format(item) for item in row])for row in P]))
44 with open(polylines,'w') as fo:
45     fo.write('\n'.join([' '.join(['{:1}'.format(item) for item in row])for row in C]))
46 with open(connect,'w') as fc:
47     for i in range(len(C)):
48         if i == 0:
49             O = [len(C[i])]
50         else:
51             O.append(len(C[i]) + O[i-1])
52     fc.write(' '.join(str(x) for x in O))
53     fc.write('\n\n')
54     fc.write('Number of points: {} , Range Min: {} and Range Max: {} \n'.format(NoPoints,min(min(
55         P)),max(max(P))))
56     fc.write('Number of lines: {} , Range Min: {} and Range Max: {} \n'.format(len(C),min(min(C))
57         ,max(max(C))))
58     fc.write('Connectivity , Range Min: {} and Range Max: {} \n'.format(min(O),max(O)))

```

Annexe B

Plans de conception du montage pour les essais mécaniques

8

7

6

5

F

E

D

C

B

A

16

14

17

13

12

15

8

21

18

7

6

22

5

11

3

10

4

19

2

1

20



8

7

6

5

4

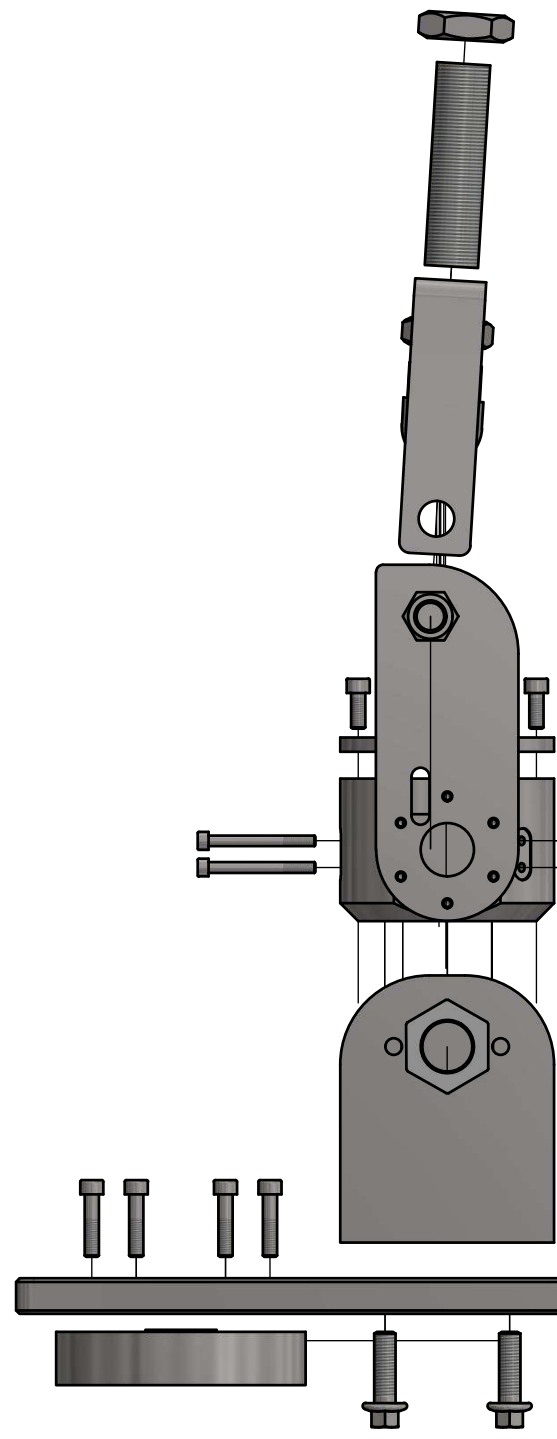

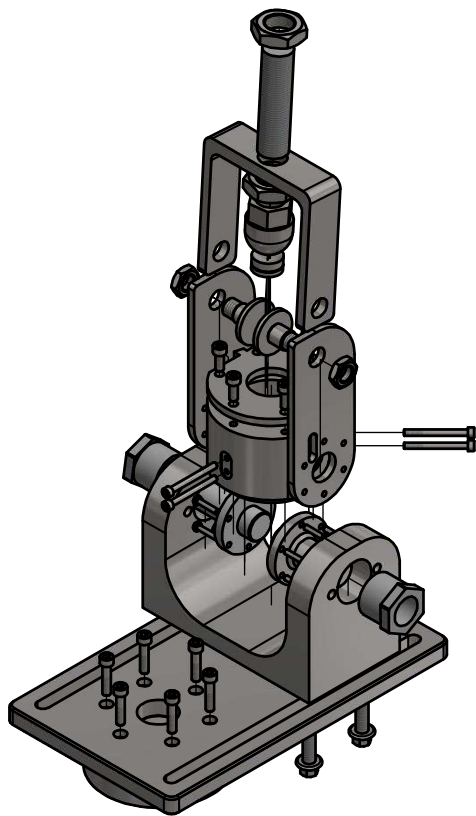

LISTE DE PIECES						
ARTICLE	QTE	NOM	MATIERE	DESCRIPTION		
1	1	Base	Acier inoxydable	Pièce existante		
2	1	table	Acier inoxydable	Pièce à usiner		
3	1	Support-rotulé	Acier inoxydable	Pièce à usiner		
4	2	pivot-support	Acier inoxydable	Pièce à usiner		
6	1	Seau	Acier inoxydable	Pièce à usiner		
7	1	Couvercle-os	Acier inoxydable	Pièce à usiner		
8	2	support-tete-os	Acier inoxydable	Pièce à usiner		
10	2	HPC - TTQ30-45-OE	Acier	Pièce à commander (HPC Europe) Frette de serrage		
11	12	Vis CHC, M5 x 25	Acier inoxydable	Pièce à commander		
12	1	Coupelle	Acier inoxydable	Pièce à usiner		
13	1	RotuleCoupelle2	Acier inoxydable	Pièce à usiner		
14	1	Tige filetté longueur mini de 114 mm, M30 x 2	Acier inoxydable	Pièce à commander ou à usiner		
15	2	AxeBras	Acier inoxydable	Pièce à usiner		
16	2	Ecrou H pas fin, M30	Acier inoxydable	Pièce à commander ou a usiner Ecrou hexagonal pas fin (pas de 2)		
17	1	Feracheval	Acier inoxydable	Pièce à usiner		
18	2	Ecrou H, M18	Acier inoxydable	Pièce à commander		
19	6	Vis CHC, M8 x 35	Acier inoxydable	Pièce à commander		
20	4	Vis H, M12 x 40	Acier inoxydable	Pièce à commander		
21	6	Vis CHC, M8 x 20	Acier inoxydable	Pièce à commander		
22	8	Vis CHC, M6 x 60	Acier inoxydable	Pièce à commander Fileté sur toute la longueur		
Conçu par andreys		Vérifié par	Approuvé par	Date 1 : 3	Date 09/11/2018	A2
			Montage		Modification	Feuille 1 / 1

8

7

6

5

F

E

D

C

B

A

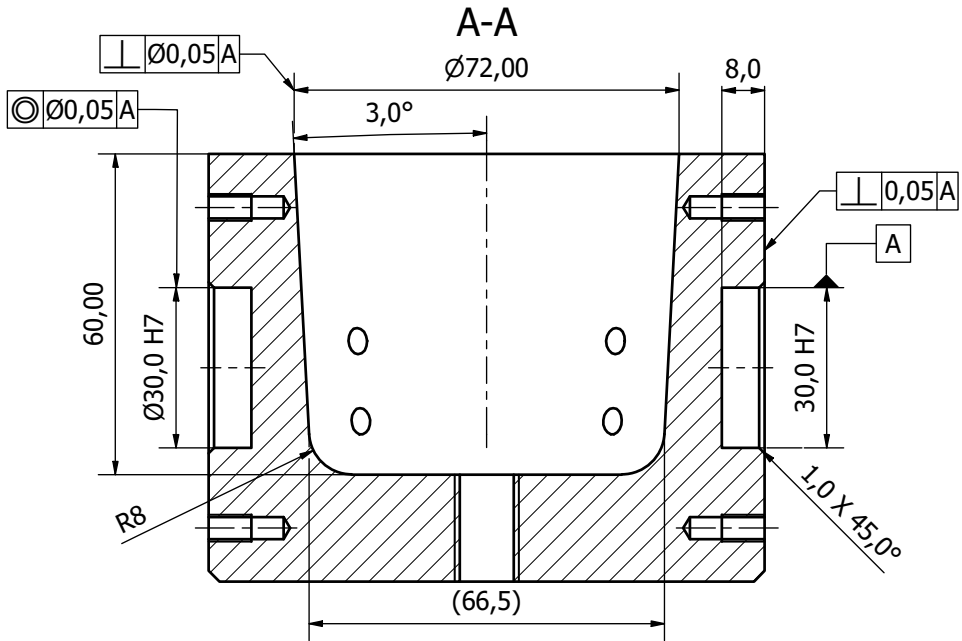

D (2 : 1)

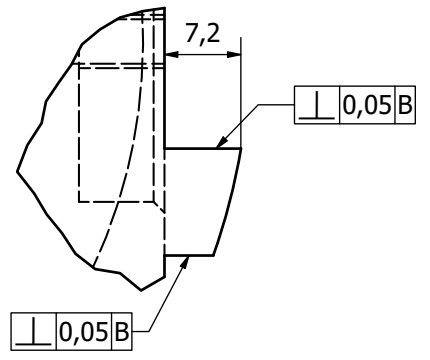

6x M5x0.8 à 60°
 Profondeur 14,00
 Profondeur de filetage 8,00

$\varnothing 60,0$

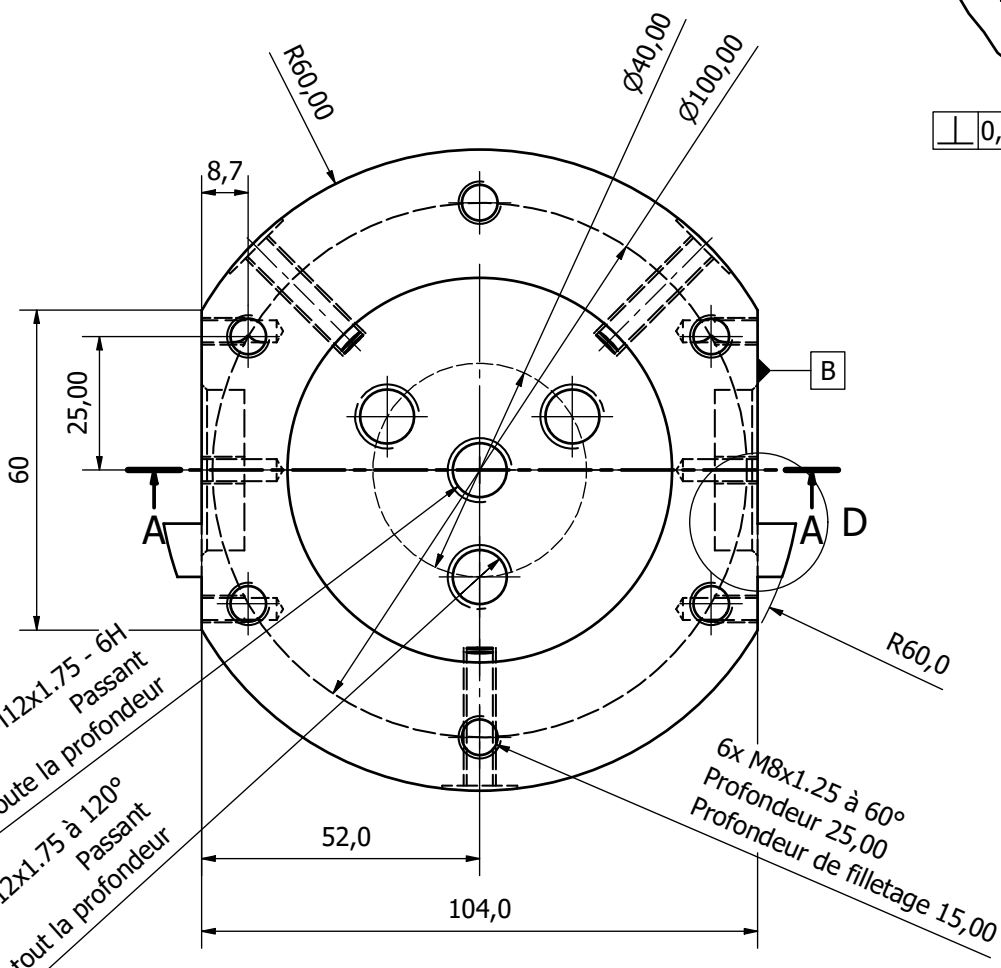

M12x1.75 - 6H
 Passant

3x M12x1.75 à 120°
 Passant

6x M8x1.25 à 60°
 Profondeur 25,00
 Profondeur de filetage 15,00

8

7

6

5

4

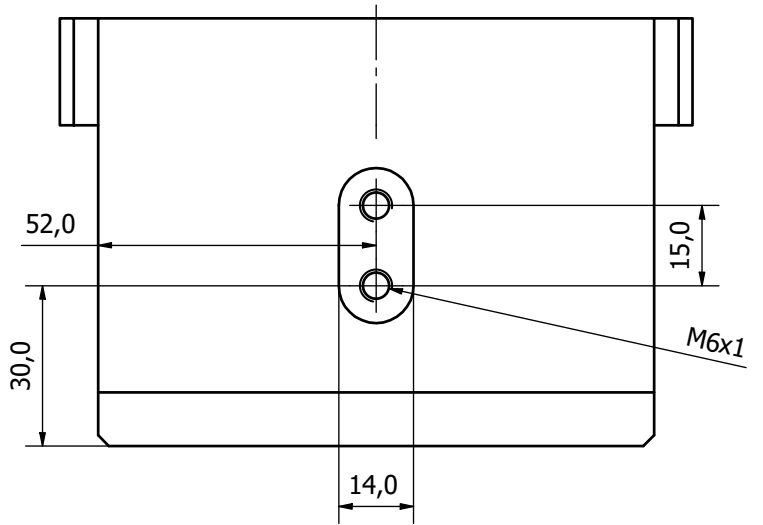
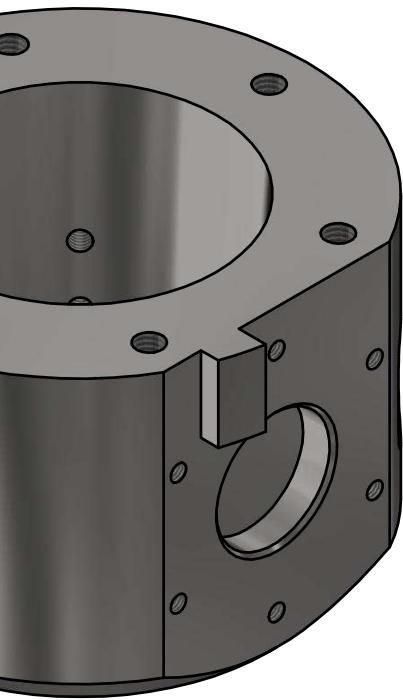

C (3 : 1)

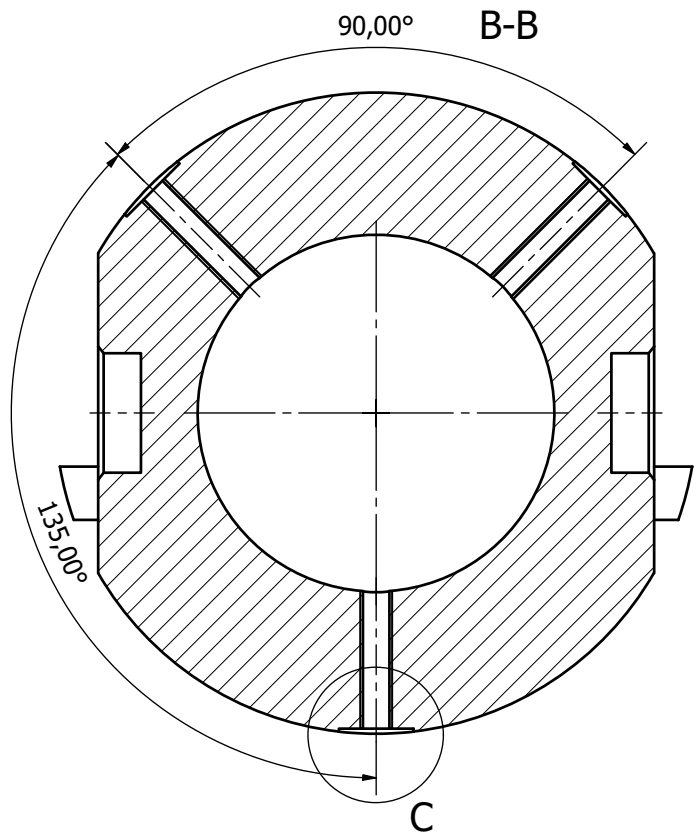
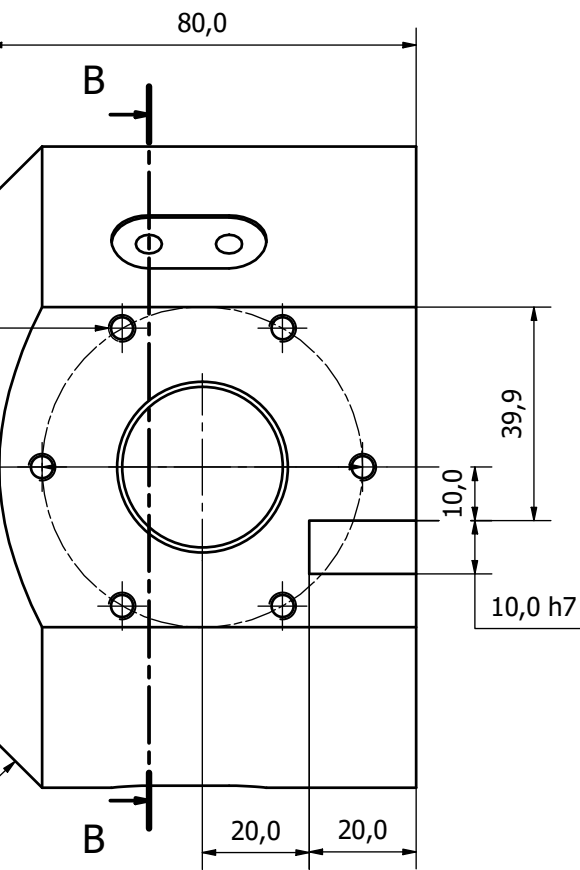
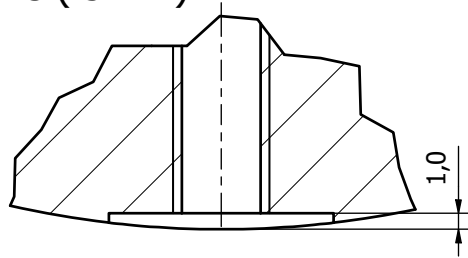

Tolérances générales selon ISO 2768 fH

Acier Inoxydable 316L (Afnor X2 Cr Ni Mo 17 12 2)

Conçu par callondann	Vérifié par	Approuvé par	Date 1 : 1	Date 08/11/2018	A2
			Seau		
			Modification		Feuille 1 / 1

8

7

6

5

F

E

D

C

B

A

Ø45,0 H7

Ø45,0 H7

⊙ 0,05 A

// 0,1 B

R50

A

B

25,0

170,0

60,0

4 x M1
Profondo
Profondo

30,0

160,0

220,0

8

7

6

5

4

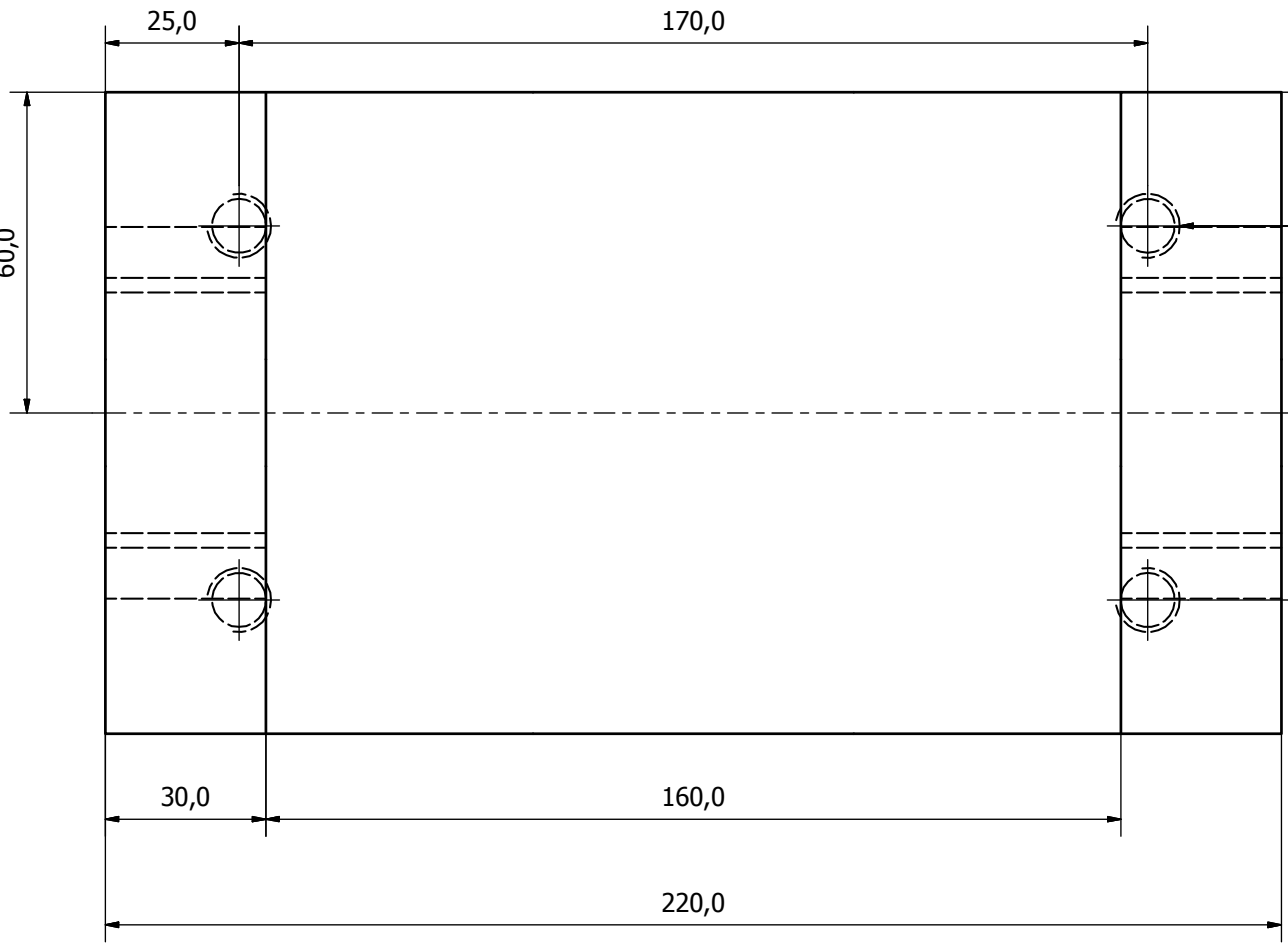
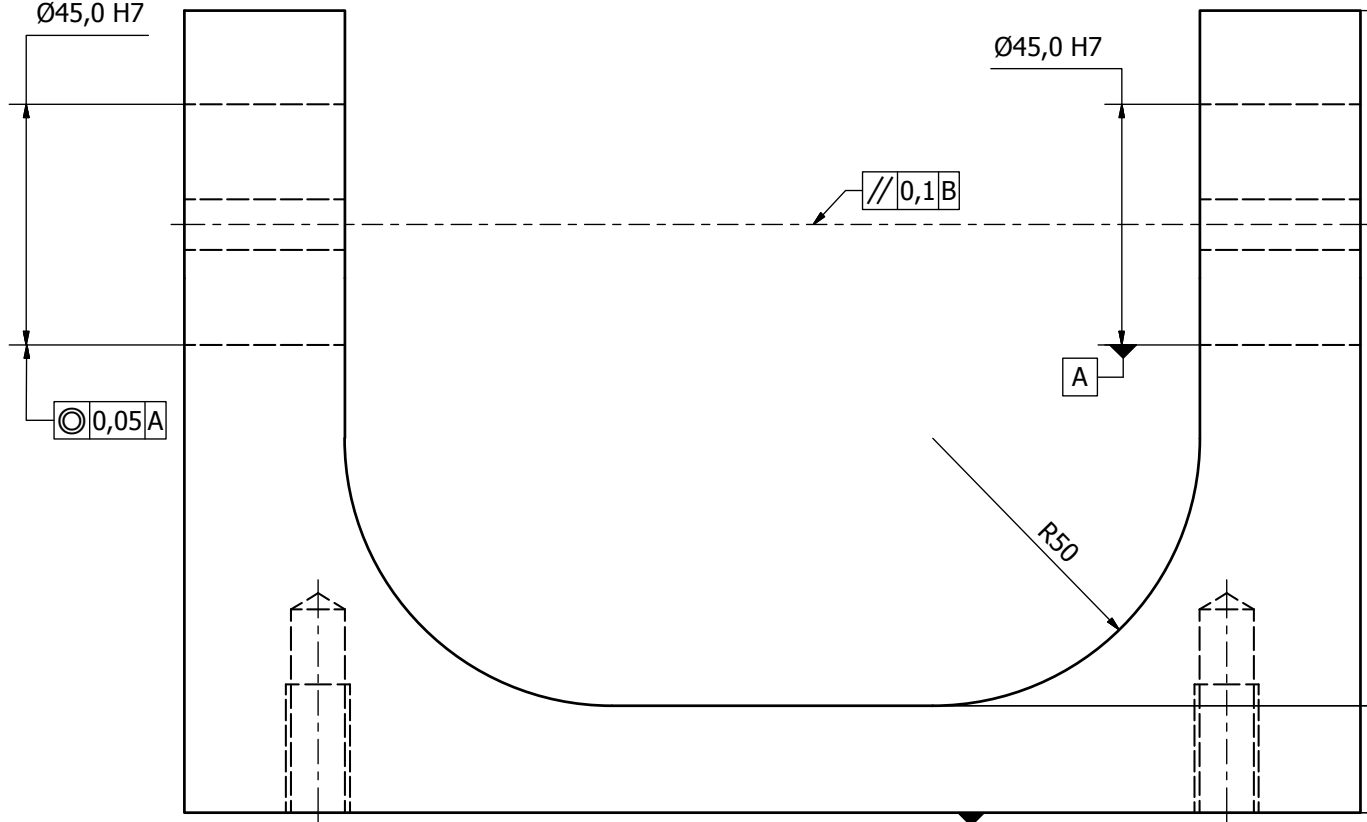

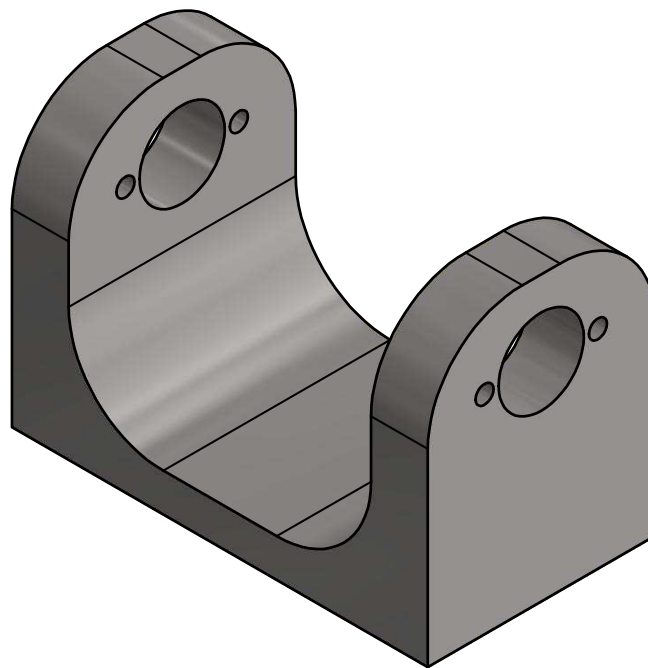
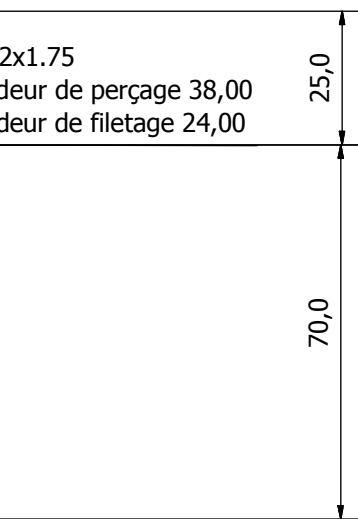
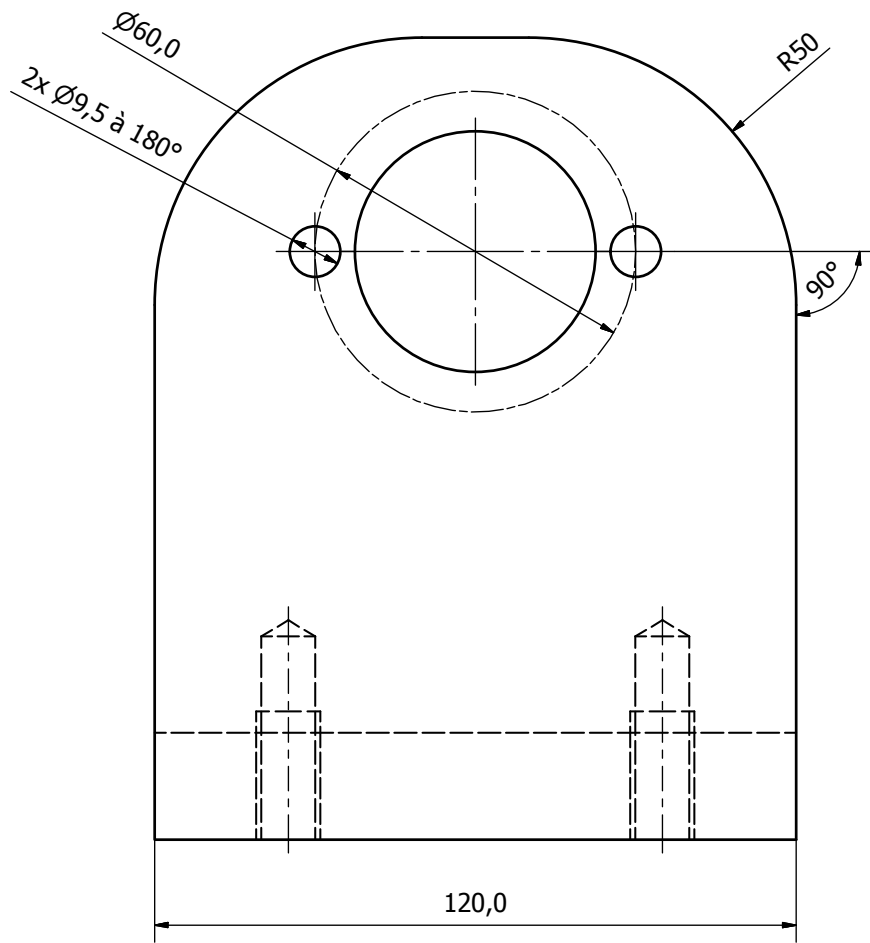
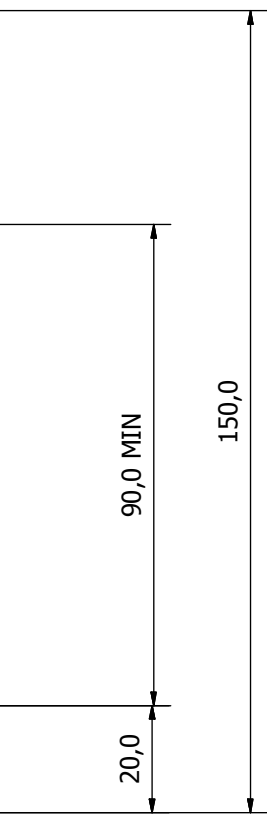

Tolérances générales selon ISO 2768 fH

Acier Inoxydable 316L (Afnor X2 Cr Ni Mo 17 12 2)

Conçu par tbenlakhdar	Vérifié par	Approuvé par	Date 1 : 1	Date 02/11/2018	A2
			Support Rotulé		
			Support-rotulé	Modification	Feuille 1 / 1

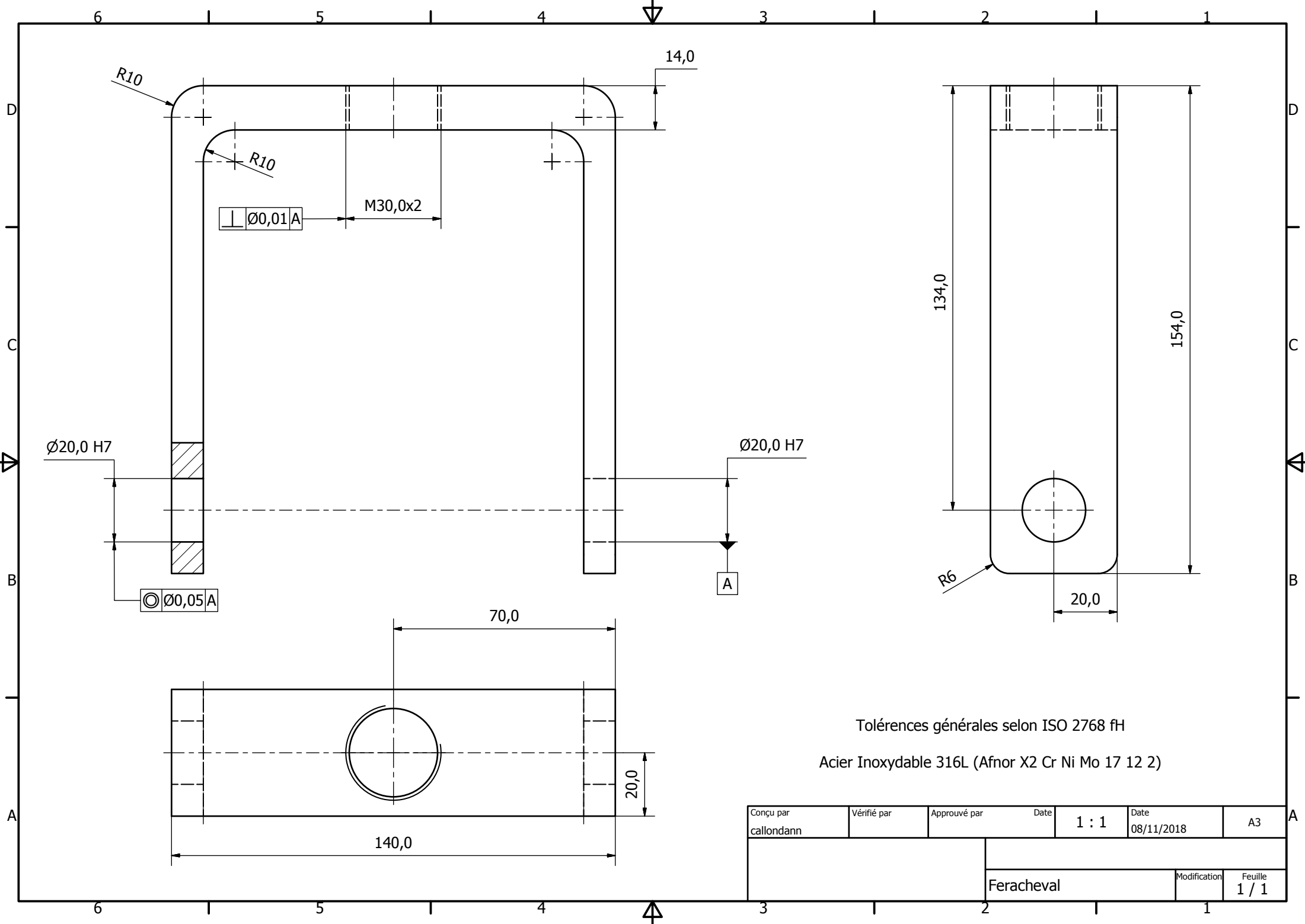

Tolérances générales selon ISO 2768 fH

Acier Inoxydable 316L (Afnor X2 Cr Ni Mo 17 12 2)

Conçu par callondann	Vérifié par	Approuvé par	Date 1 : 1	Date 08/11/2018	A3
		Feracheval		Modification	Feuille 1 / 1

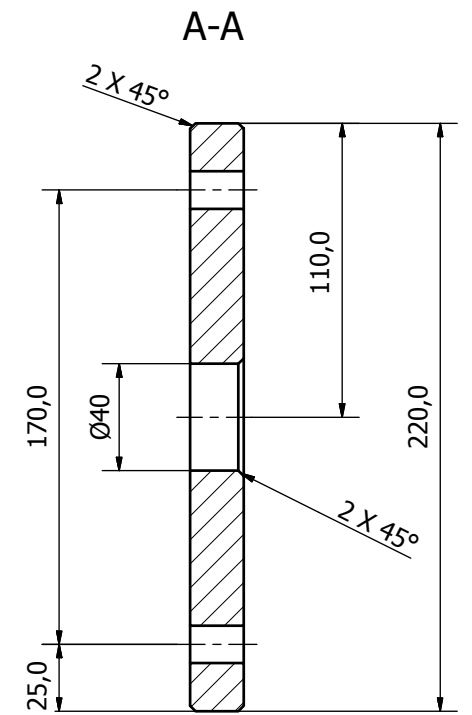
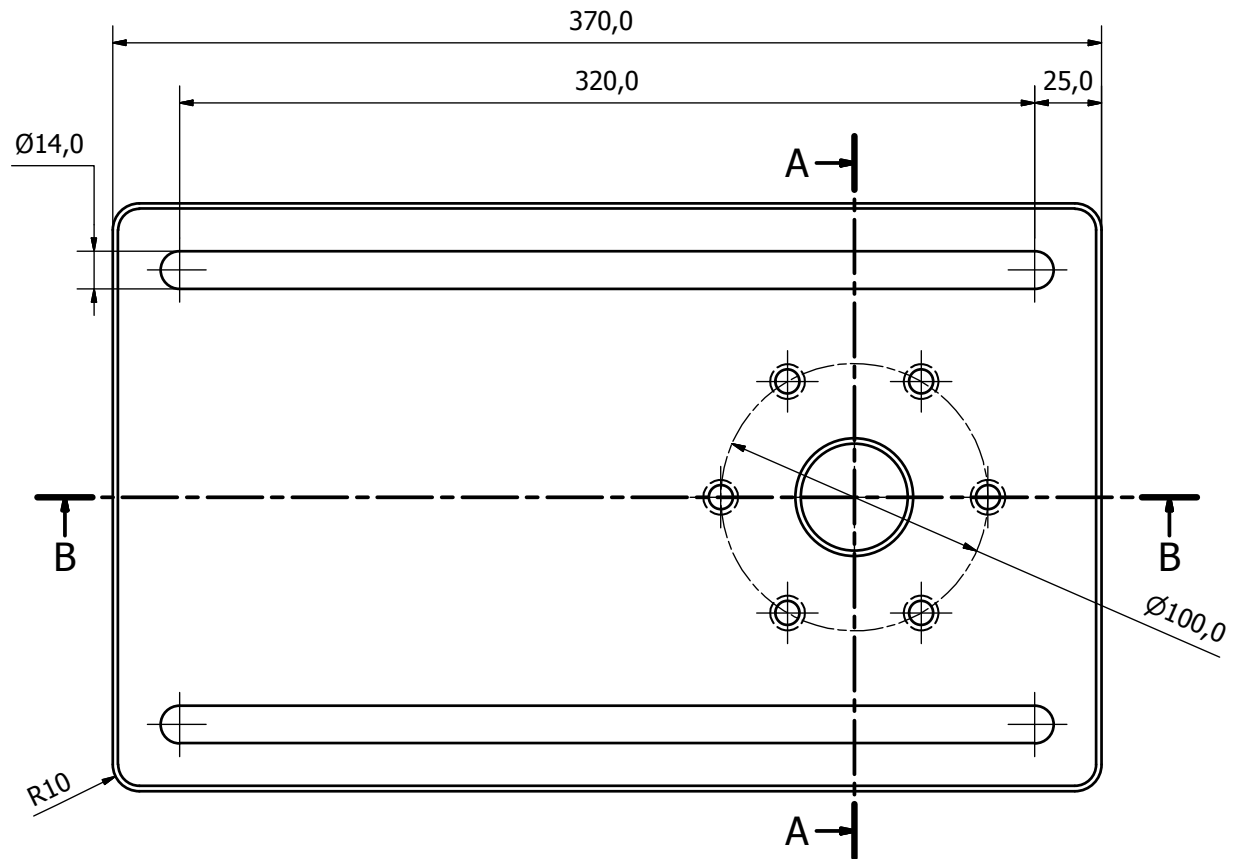
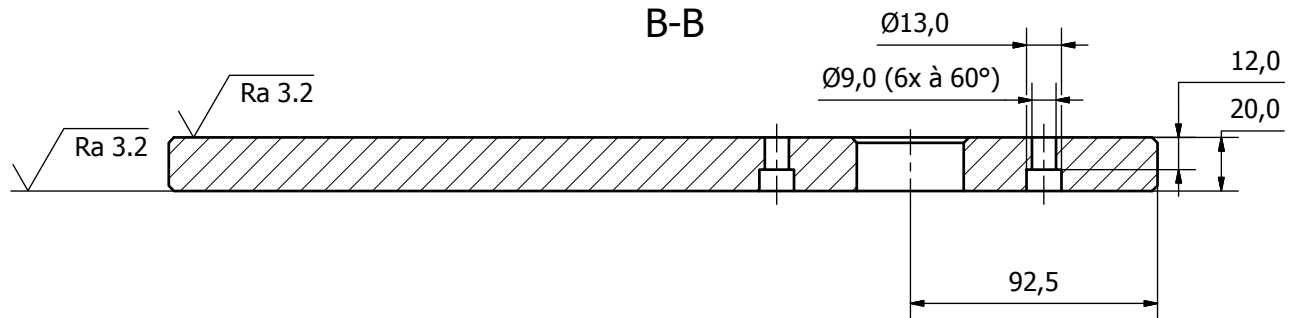

Tolérances générales selon ISO 2768 fH
 Acier Inoxydable 316L (Afnor X2 Cr Ni Mo 17 12 2)

Conçu par tbenlakhdar	Vérifié par	Approuvé par	Date 1 : 2	Date 02/11/2018	A3
			Table		
				Modification	Feuille 1 / 1

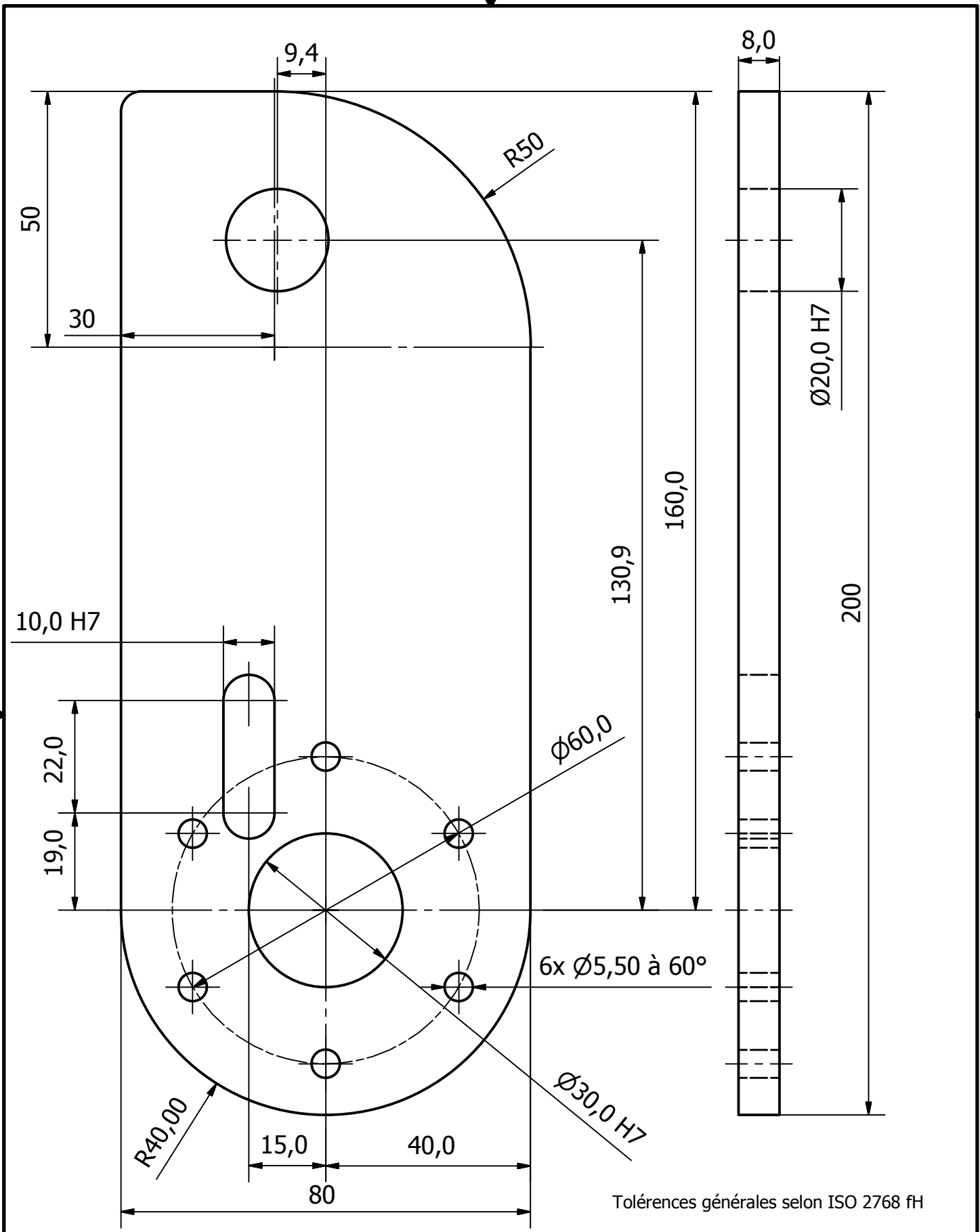

Tolérances générales selon ISO 2768 fH
 Acier Inoxydable 316L (Afnor X2 Cr Ni Mo 17 12 2)

Conçu par callondann	Vérifié par	Approuvé par	Date 1 : 1	Date 08/11/2018	A4
			support-tete-os		Modification
					Feuille 1 / 1

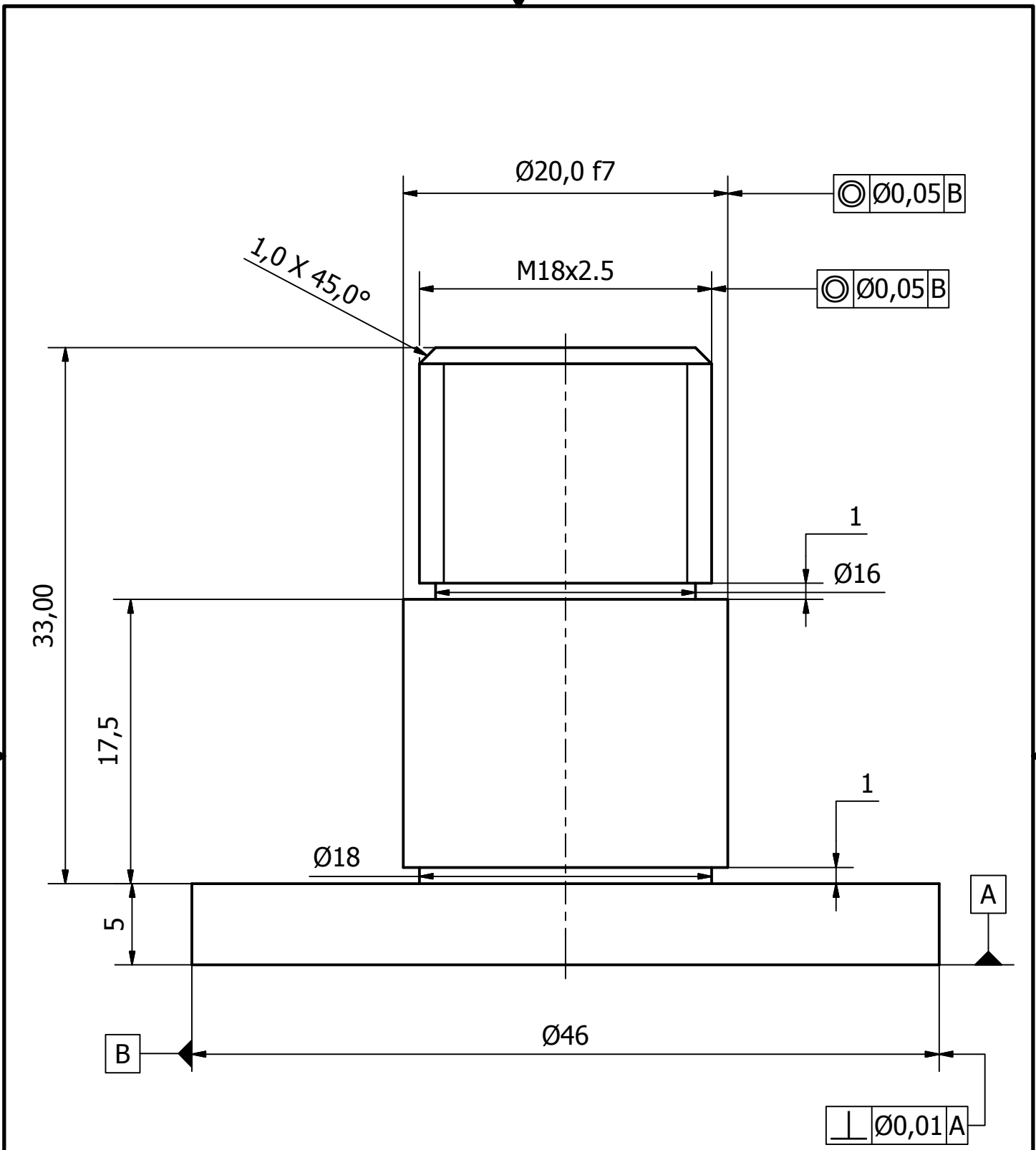

Tolérances générales selon ISO 2768 fH

Acier Inoxydable 316L (Afnor X2 Cr Ni Mo 17 12 2)

Conçu par callondann	Vérifié par	Approuvé par	Date 3 : 1	Date 08/11/2018	A4
			AxeBras		Modification
					Feuille 1 / 1

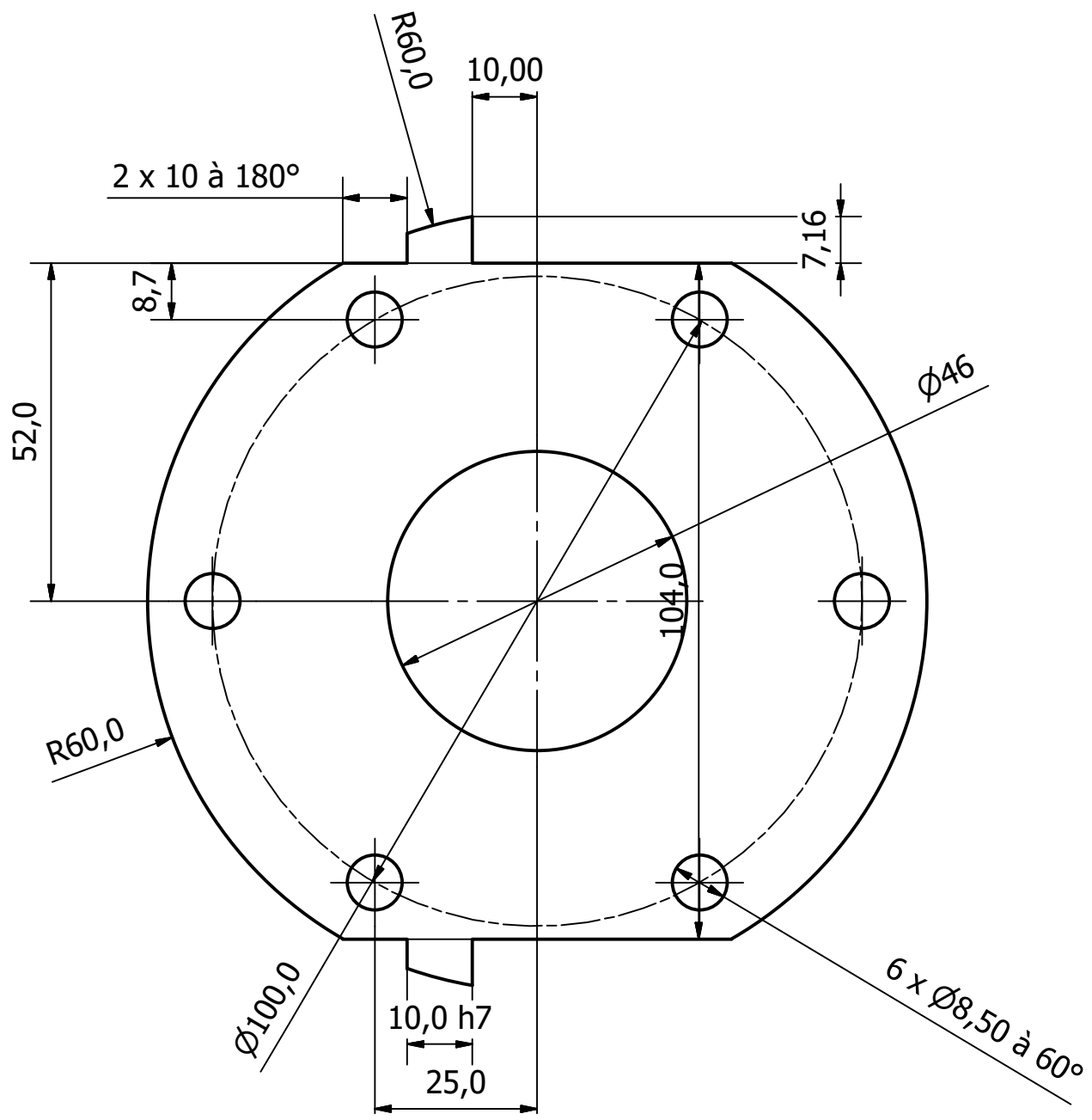
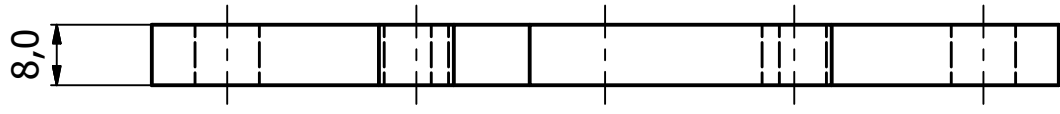

Tolérances générales selon ISO 2768 fH

Acier Inoxydable 316L (Afnor X2 Cr Ni Mo 17 12 2)

Conçu par callondann	Vérifié par	Approuvé par	Date	1 : 1	Date	A4
			Couvercle			
			Couvercle-os	Modification	Feuille 1 / 1	

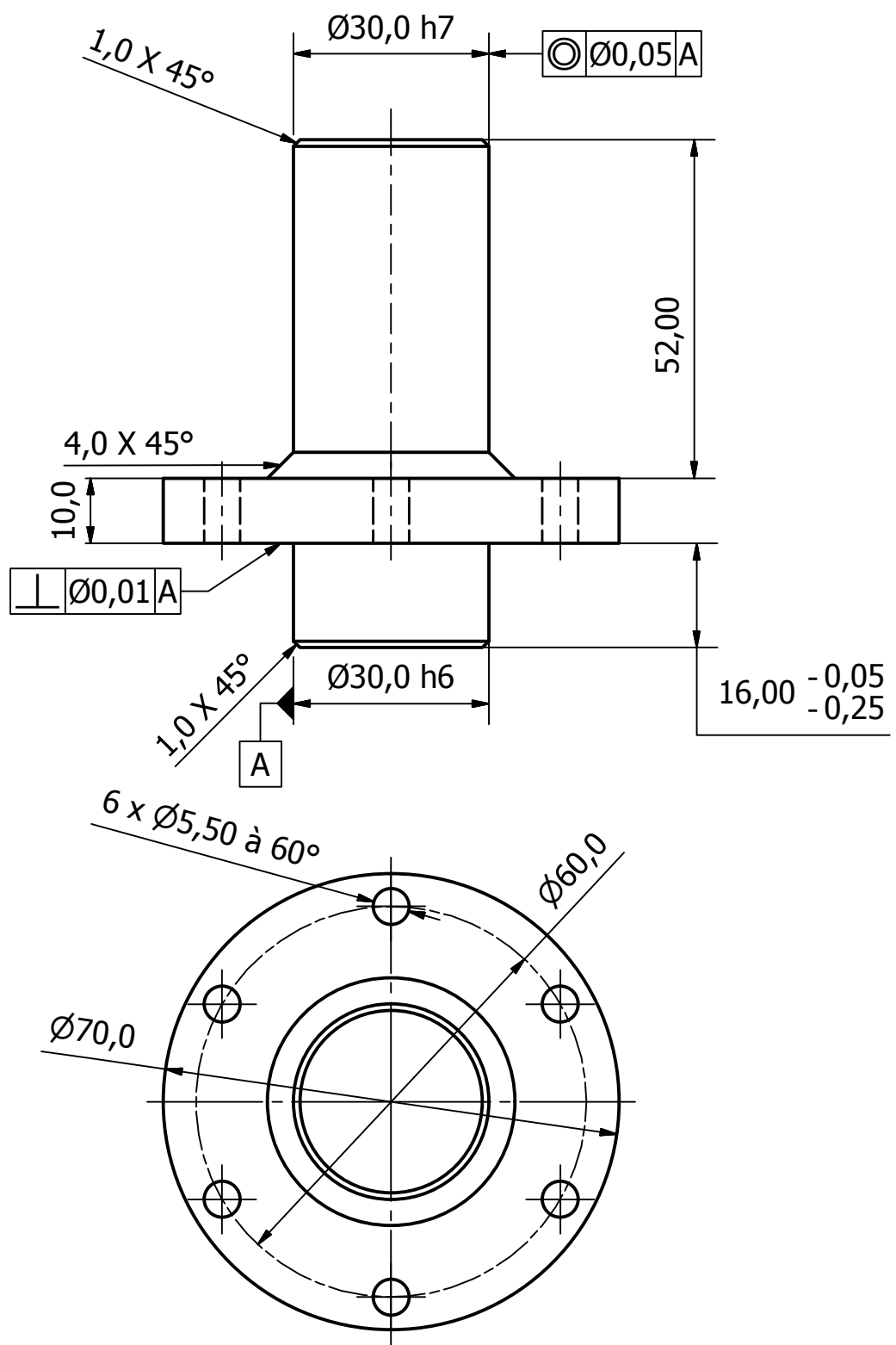

Tolérances générales selon ISO 2768 fH

Acier Inoxydable 316L (Afnor X2 Cr Ni Mo 17 12 2)

Conçu par tbenlakhdar	Vérifié par	Approuvé par	Date	1 : 1	Date	A4
			pivot-support		Modification	Feuille
						1 / 1

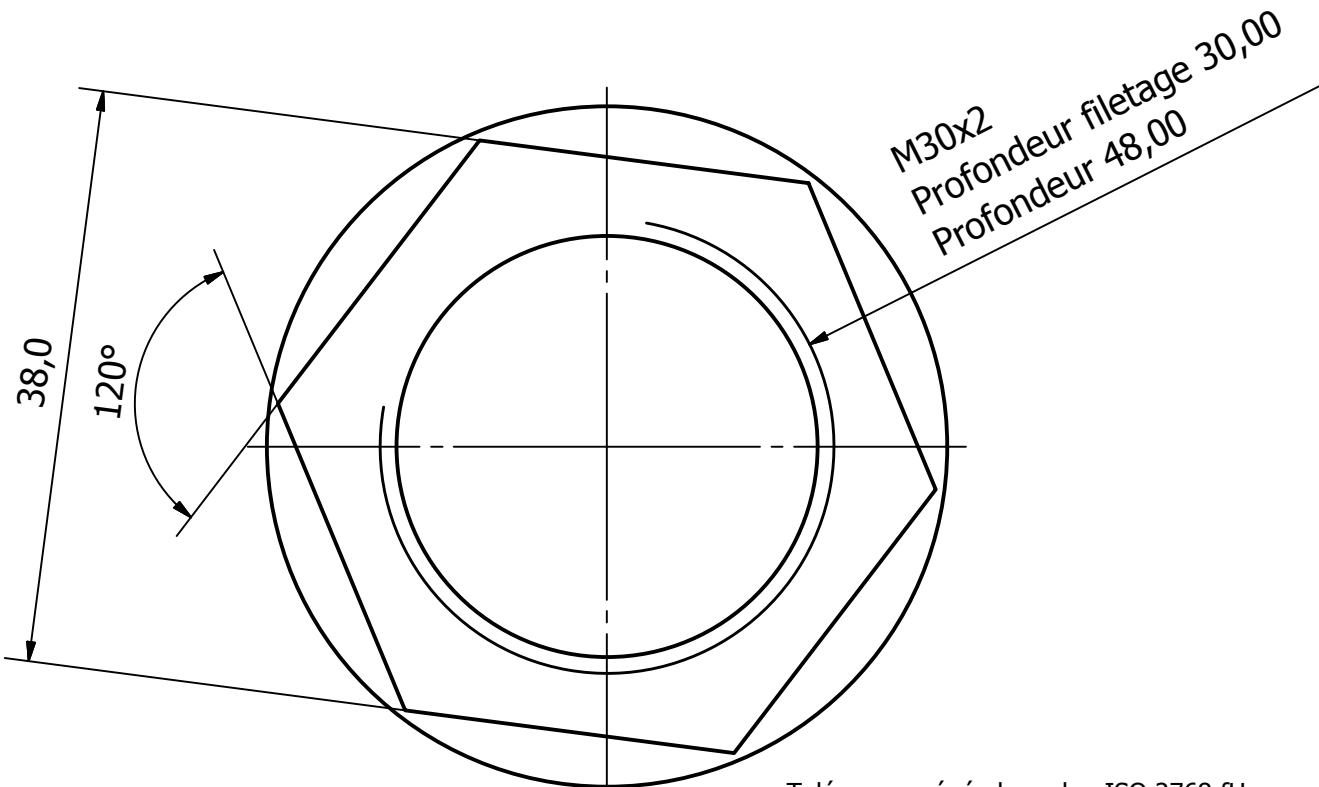
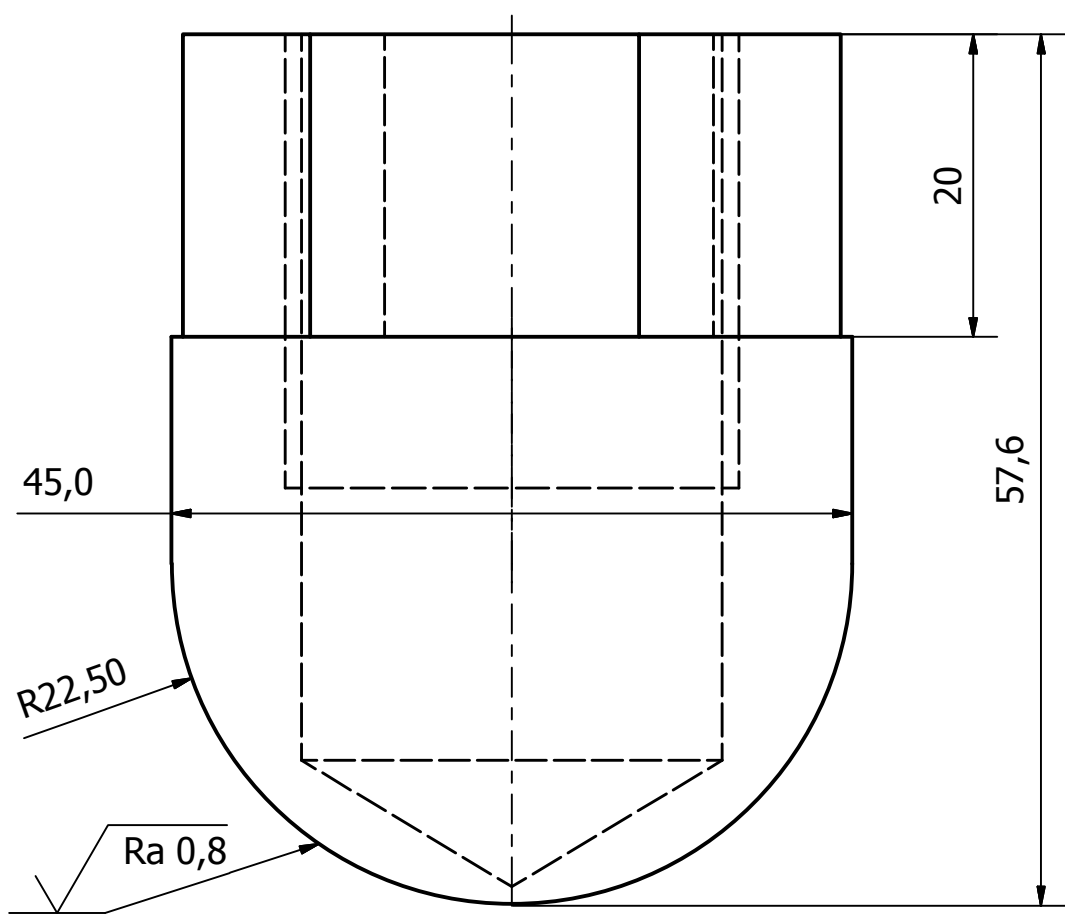

Tolérances générales selon ISO 2768 fH

Acier Inoxydable 316L (Afnor X2 Cr Ni Mo 17 12 2)

Conçu par andreys	Vérifié par	Approuvé par	Date 2 : 1	Date 09/11/2018	A4
			RotuleCoupelle	Modification	Feuille 1 / 1

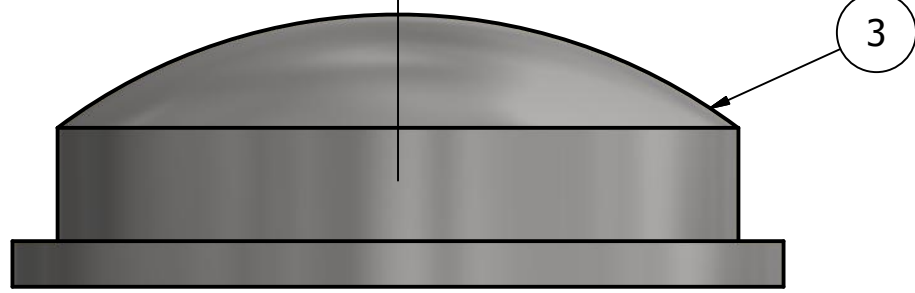
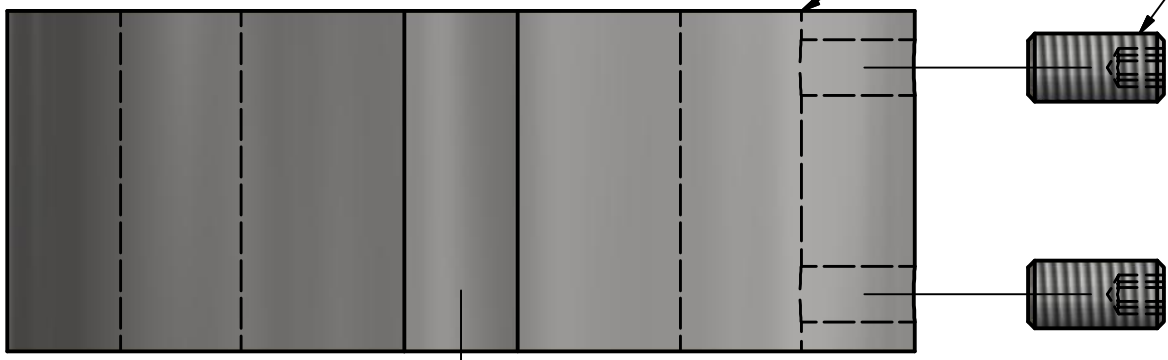
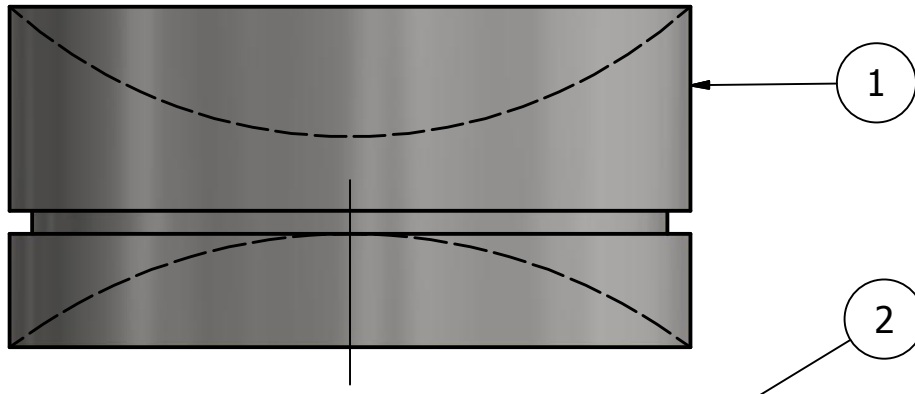

LISTE DE PIECES

ARTICLE	QT	NOM	MATIERE	DESCRIPTION
1	1	Coupelle	Acier inoxydable	Pièce à usiner
2	1	MouleCoupetteTour	Acier inoxydable	Pièce à usiner
3	1	MouleCoupette	Acier inoxydable	Pièce à usiner
4	2	Vis sans tête à bout plat HC, M3 x 6	Acier inoxydable	Pièce à commander

Conçu par andreys	Vérifié par	Approuvé par	Date	3 : 1	Date	A4
----------------------	-------------	--------------	------	-------	------	----

MoulageEclaté		Modification	Feuille
			1 / 1



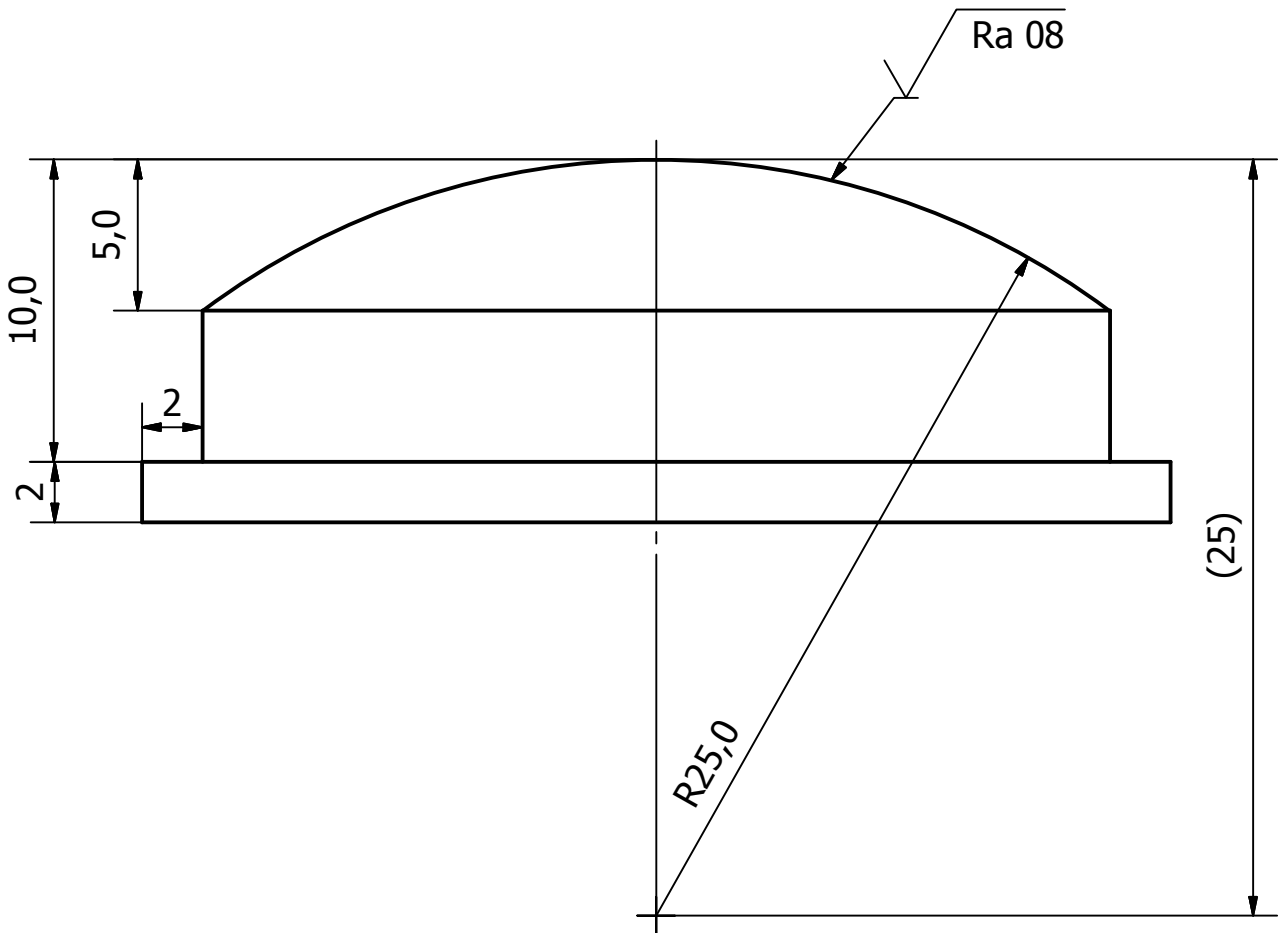
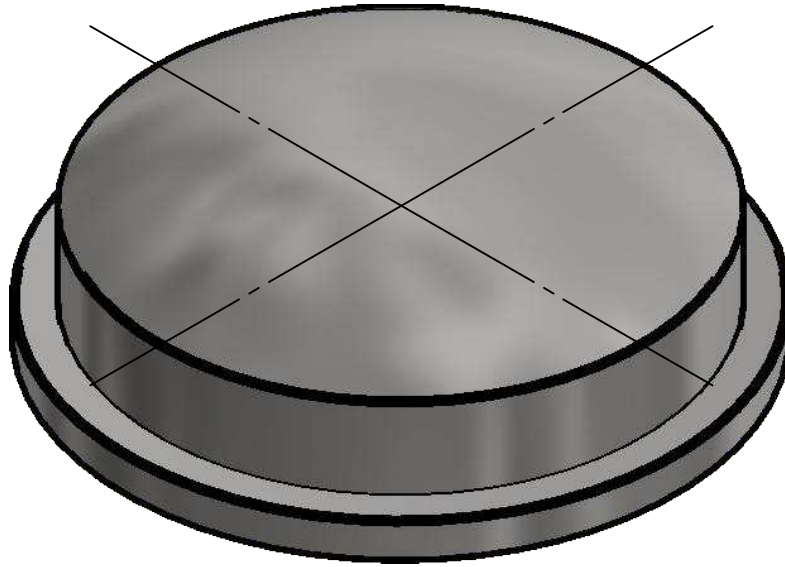

Tolérances générales selon ISO 2768 fH

Acier Inoxydable 316L (Afnor X2 Cr Ni Mo 17 12 2)

Conçu par callondann	Vérifié par	Approuvé par	Date 4 : 1	Date 08/11/2018	A4
			MouleCouquette-1	Modification	Feuille 1 / 1

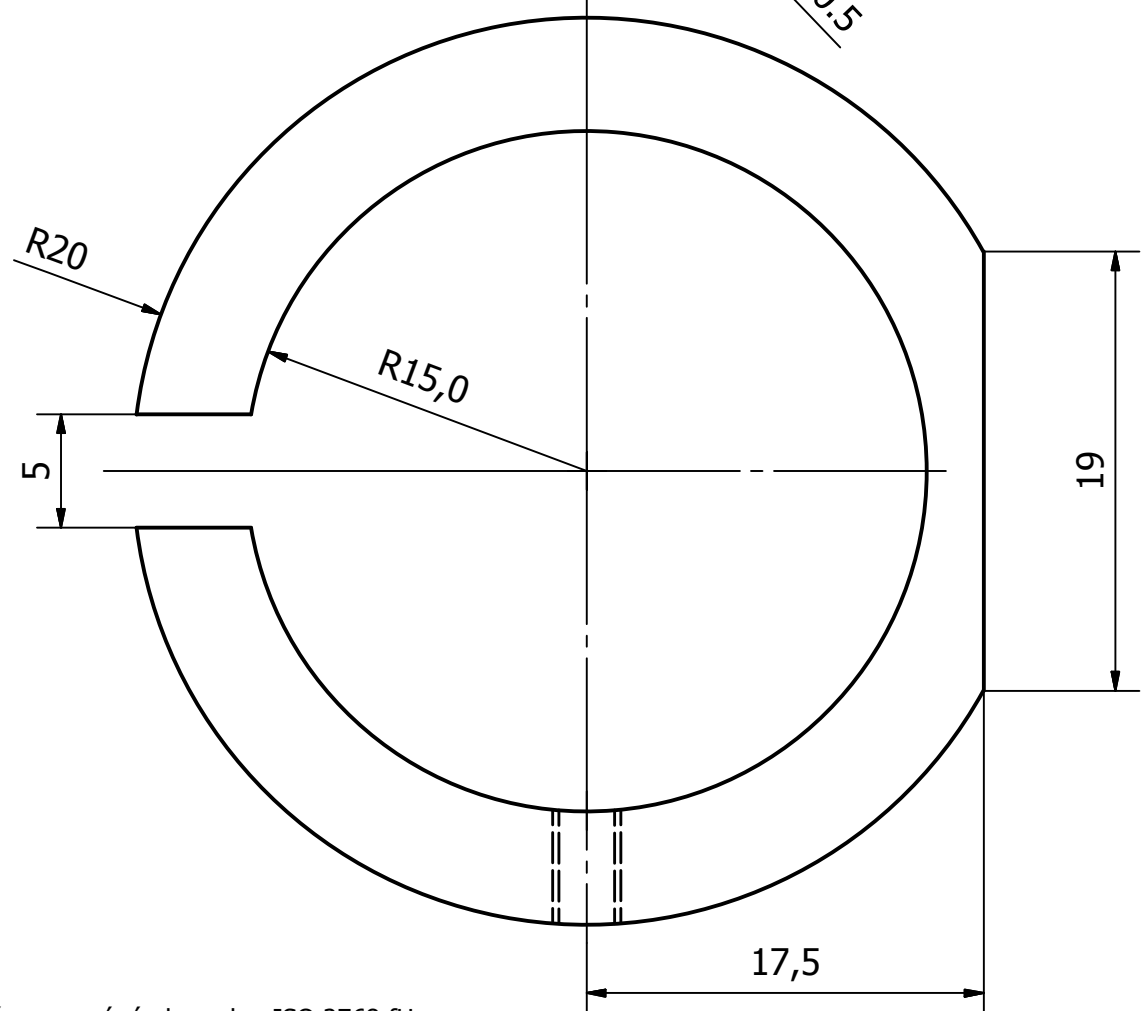
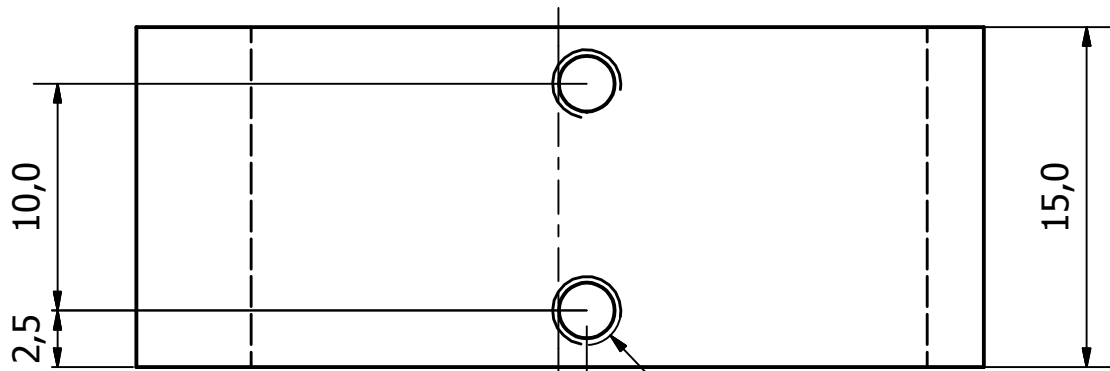

Tolérances générales selon ISO 2768 fH

Acier Inoxydable 316L (Afnor X2 Cr Ni Mo 17 12 2)

Conçu par callondann	Vérifié par	Approuvé par	Date 3 : 1	Date 08/11/2018	A4
			Modification		Feuille 1 / 1
			MouleCoupletteTour		

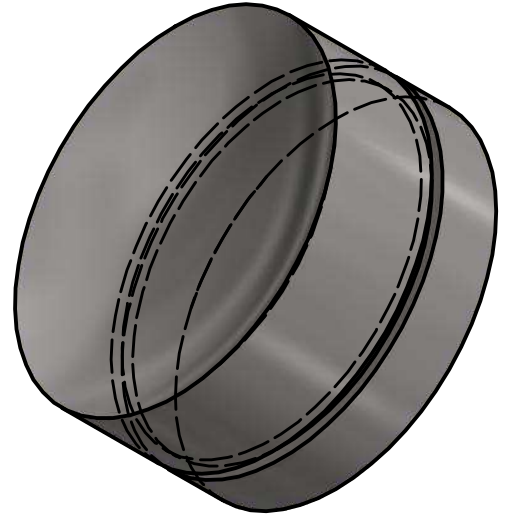
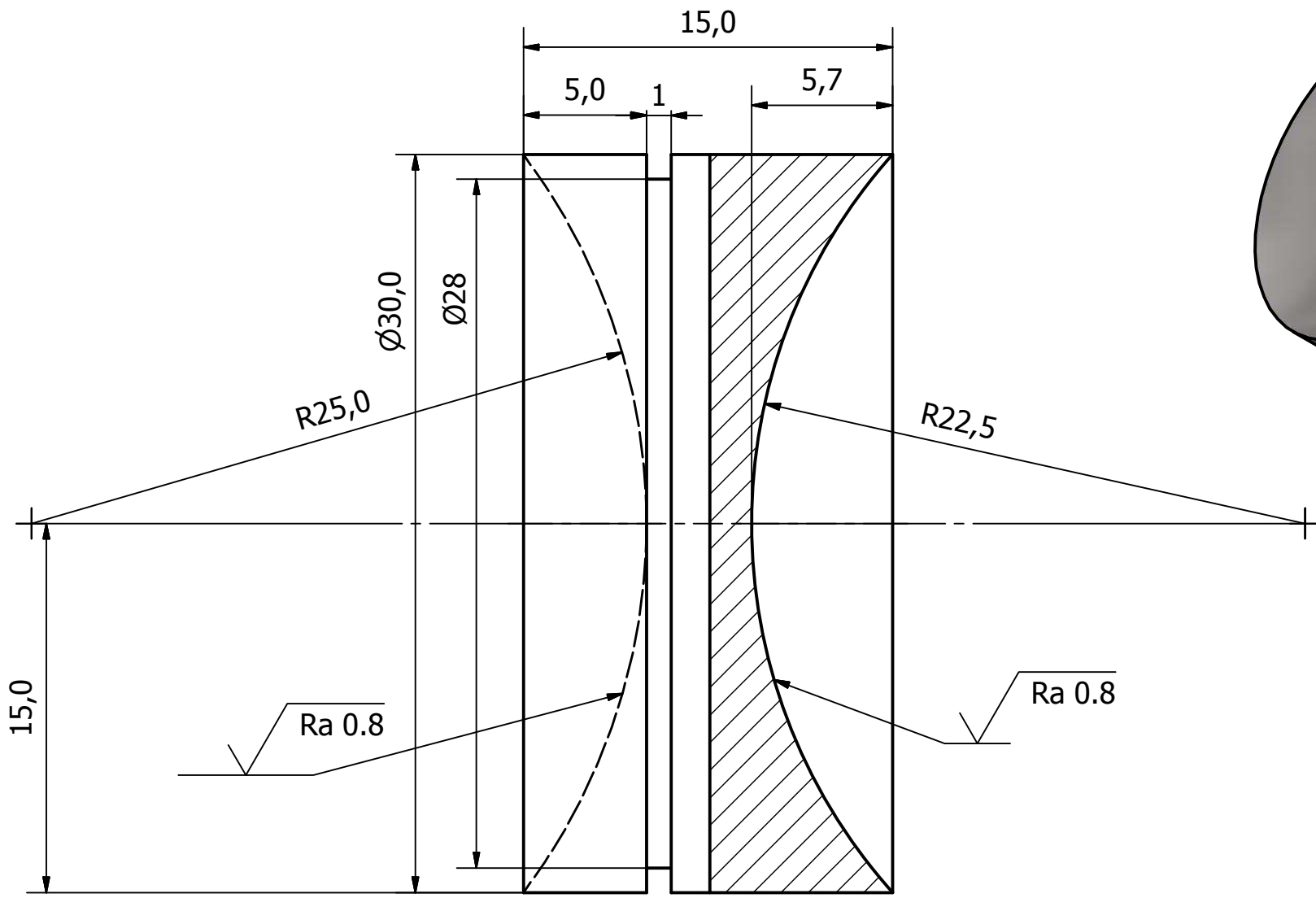

Tolérances générales selon ISO 2768 fH

Acier Inoxydable 316L (Afnor X2 Cr Ni Mo 17 12 2)

Conçu par callondann	Vérifié par	Approuvé par	Date 4 : 1	Date 08/11/2018	A4
			Coupelle		
			Modification	Feuille 1 / 1	

Annexe C

Algorithme d'acquisition synchronisée d'images avec Pylon 5.0

```
1 // MultiCameraSynchro.cpp
2 /*
3     Note: Before getting started, Basler recommends reading the "Programmer's Guide" topic
4     in the pylon C++ API documentation delivered with pylon.
5     If you are upgrading to a higher major version of pylon, Basler also
6     strongly recommends reading the "Migrating from Previous Versions" topic in the pylon C++ API
7     documentation.
8
9     By: Daniel ELIZONDO MORENO
10        ICube Laboratory
11        2 - 4 rue Boussingault
12        67000 Strasbourg
13        dem@mailo.com
14
15     Software that allows to take sequential images from up to 8 BASLER cameras from
16 */
17 // Include files to use the pylon API.
18 #include <pylon/PylonIncludes.h>
19 #include <sys/stat.h>
20
21 // Namespace for using pylon objects.
22 using namespace Pylon;
23
24 // Namespace for using cout.
25 using std::cout;
26 using std::endl;
27
28 // Include files to print the camera events
29 #include "../include/ConfigurationEventPrinter.h"
30 #include "../include/ImageEventPrinter.h"
```

```

31 //Include files for the Images Visualization using OpenCV
32 #include "opencv2/highgui/highgui.hpp"
33 #include "opencv2/imgproc/imgproc.hpp"
34 #include "opencv2/core/core.hpp"
35
36 // Namespace for OpenCV
37 using namespace cv;
38
39 // Limits the amount of cameras used for grabbing.
40 static const size_t c_maxCamerasToUse = 8;
41
42 //=====
43 int main(int argc, char* argv[])
44 {
45     std::string foldername;
46     std::uint32_t i_countOfImagesToGrab;
47     std::uint16_t i_timeWait;
48     float f_frameRate;
49     char dummyKey;
50     std::uint32_t i_grabbedImages=0;
51
52     // The exit code of the sample application.
53     int exitCode = 0;
54
55     // Before using any pylon methods, the pylon runtime must be initialized.
56     PylonInitialize();
57
58     try
59     {
60         // Get the transport layer factory.
61         CTlFactory& tlFactory = CTlFactory::GetInstance();
62
63         // Get all attached devices and exit application if no device is found.
64         DeviceInfoList_t devices;
65         if ( tlFactory.EnumerateDevices(devices) == 0 )
66         {
67             throw RUNTIME_EXCEPTION( "No camera present.");
68         }
69         else
70         {
71             std::cout << "\nDetected: " << std::to_string(tlFactory.EnumerateDevices(devices))
72                 << " cameras.\n";
73         }
74
75         // Create an array of instant cameras for the found devices and avoid exceeding a maximum
76         // number of devices.
77         CInstantCameraArray cameras( min( devices.size(), c_maxCamerasToUse));

```

```

77         std::cout << "Please, enter the name of the test: ";
78         std::getline (std::cin, foldername);
79         do
80         {
81             std::cout << "Maximum number of images to be acquired (from 1 to 19999): ";
82             std::cin >> i_countOfImagesToGrab;
83         }
84         while ( ( i_countOfImagesToGrab < 1) || ( i_countOfImagesToGrab > 19999));
85         do
86         {
87             std::cout << "Frame rate (images per second) (from 0.25Hz to 30Hz): ";
88             std::cin >> f_frameRate;
89         }
90         while ( ( f_frameRate < 0.25) || ( f_frameRate > 30));
91         do
92         {
93             std::cout << "Sleep time before acquisition (from 0s to 60s): ";
94             std::cin >> i_timeWait;
95         }
96         while ( ( f_frameRate < 0) || ( f_frameRate > 60));
97
98
99         // Create and attach all Pylon Devices.
100        for ( size_t i = 0; i < cameras.GetSize(); ++i)
101        {
102            cameras[ i ].Attach( tlFactory.CreateDevice( devices[ i ]));
103
104            // Print the model name of the camera.
105            cout << "Using device " << cameras[ i ].GetDeviceInfo().GetModelName() << endl;
106
107            // Register the standard configuration event handler for enabling software
108            // triggering.
109            // The software trigger configuration handler replaces the default configuration
110            // as all currently registered configuration handlers are removed by setting the
111            // registration mode to RegistrationMode_ReplaceAll.
112            cameras[ i ].RegisterConfiguration( new CSoftwareTriggerConfiguration,
113            RegistrationMode_ReplaceAll, Cleanup_Delete);
114
115            // For demonstration purposes only, add sample configuration event handlers to
116            // print out information
117            // about camera use and image grabbing.
118            cameras[ i ].RegisterConfiguration( new CConfigurationEventPrinter,
119            RegistrationMode_Append, Cleanup_Delete);
120            cameras[ i ].RegisterImageEventHandler( new CImageEventPrinter,
121            RegistrationMode_Append, Cleanup_Delete);
122
123            // The MaxNumBuffer parameter can be used to control the count of buffers
124            // allocated for grabbing. The default value of this parameter is 10.

```

```

119         cameras[ i ].MaxNumBuffer = 15;
120
121         // Open the camera.
122         cameras[ i ].Open();
123
124         // Opens a CV_Window for each camera in order to visualize the acquired
125         // images
126         cv::namedWindow("CV_Image" + std::to_string(i), WINDOW_NORMAL);
127
128         // Can the camera device be queried whether it is ready to accept the next
129         // frame trigger?
130         if (!cameras[i].CanWaitForFrameTriggerReady())
131         {
132             throw RUNTIME_EXCEPTION( "This sample can only be used with cameras
133             that can be queried whether they are ready to accept the next
134             frame trigger.");
135         }
136
137     }
138
139     // Configures the OpenCV Image Windows
140     CPylonImage image;
141     CImageFormatConverter fc;
142     fc.OutputPixelFormat = PixelType_RGB8packed;
143
144     // This smart pointer will receive the grab result data.
145     CGrabResultPtr ptrGrabResult;
146
147     std::cout << "\nStarting image preview...\n";
148
149     cameras.StartGrabbing();
150
151     std::cout << "\nEnter \"S\" to start the acquisition or ESC to stop and quit at any
152     moment (S/ESC)\n";
153     do
154     {
155         cin.get(dummyKey);
156         for ( size_t j = 0; j < cameras.GetSize(); ++j)
157         {
158             if ( cameras[ j ].WaitForFrameTriggerReady( 5000,
159             TimeoutHandling_ThrowException))
160             {
161                 cameras[ j ].ExecuteSoftwareTrigger();
162             }
163
164             // Retrieves the results from the camera
165             cameras[ j ].RetrieveResult( 5000, ptrGrabResult,
166             TimeoutHandling_ThrowException);
167
168         }
169     } while ( dummyKey != 'S' );
170
171     cameras.StopGrabbing();
172
173     image.SaveImage( "image.png", ptrGrabResult );
174 }
175
176 int main()
177 {
178     PylonImageGrabber grabber;
179     grabber.Initialize( 1 );
180     grabber.StartGrabbing();
181     grabber.WaitForFrameTriggerReady( 5000, TimeoutHandling_ThrowException );
182     grabber.ExecuteSoftwareTrigger();
183     grabber.RetrieveResult( 5000, TimeoutHandling_ThrowException );
184     grabber.SaveImage( "image.png" );
185 }

```

```

160             // Shows the image at the CV_Window
161             fc.Convert(image, ptrGrabResult);
162             cv::Mat cv_img(ptrGrabResult->GetHeight(), ptrGrabResult->
                    GetWidth(), CV_8UC3,(uint8_t*)image.GetBuffer());
163             imshow("CV_Image" + std::to_string(j),cv_img);
164             waitKey(1);
165             // Stops the acquisition if ESC key is pressed
166             if(waitKey(30)==27){
167                 cameras.StopGrabbing();
168                 throw RUNTIME_EXCEPTION( "Stopped by user...");
169             }
170                 if (dummyKey == 27)
171                 {
172                     throw RUNTIME_EXCEPTION( "Stopped by user...");
173                 }
174             }
175         }
176     }
177     while ( (dummyKey != 's') && (dummyKey != 'S'));
178
179     cameras.StopGrabbing();
180
181     if (i_timeWait > 0)
182     {
183         do
184         {
185
186             std::cout << "Time remaining before start: " << std::to_string(
                    i_timeWait) << endl;
187             WaitObject::Sleep(1000*i_timeWait);
188             i_timeWait = i_timeWait - 1;
189         }
190         while (i_timeWait > 0);
191     }
192
193     // Getting date and time to add at the directory test name
194     auto t = std::time(nullptr);
195     auto tm = *std::localtime(&t);
196
197     std::ostringstream oss;
198     oss << std::put_time(&tm, "[%d-%m-%Y_%H-%M-%S]");
199     auto str = oss.str();
200
201     // Creating a directory
202     std::ostringstream os_FR; os_FR << std::fixed; os_FR << std::setprecision(2); os_FR
        << f_frameRate;
203     std::string str_fn = foldername + "(" + os_FR.str() + ")" + str;
204     if (mkdir(str_fn.c_str(), 0777) == -1)

```

```

205         cerr << "Error: " << strerror(errno) << endl;
206
207     // Starts grabbing for all cameras starting with index 0. The grabbing
208     // is started for one camera after the other. That's why the images of all
209     // cameras are not taken at the same time.
210     // However, a hardware trigger setup can be used to cause all cameras to grab images
211     // synchronously.
212     // According to their default configuration, the cameras are
213     // set up for free-running continuous acquisition.
214     cameras.StartGrabbing();
215
216     std::cout << "\nStarting test: " << foldername << "!\n";
217
218     // Grab a maximum of i_countOfImagesToGrab from the cameras.
219     for( uint32_t i = 0; i < i_countOfImagesToGrab && cameras.IsGrabbing(); ++i)
220     {
221         // Images counter
222         ++i_grabbedImages;
223
224         // Triggers and retrieves an image for each camera
225         for ( size_t j = 0; j < cameras.GetSize(); ++j)
226         {
227             if ( cameras[ j ].WaitForFrameTriggerReady( 5000,
228                 TimeoutHandling_ThrowException))
229             {
230                 cameras[ j ].ExecuteSoftwareTrigger();
231             }
232
233             for ( size_t j = 0; j < cameras.GetSize(); ++j)
234             {
235                 // Retrieves the results from the camera
236                 cameras[ j ].RetrieveResult( 5000, ptrGrabResult,
237                     TimeoutHandling_ThrowException);
238
239                 // Shows the image at the CV_Window
240                 fc.Convert(image, ptrGrabResult);
241                 cv::Mat cv_img(ptrGrabResult->GetHeight(), ptrGrabResult->
242                     GetWidth(), CV_8UC3,(uint8_t*)image.GetBuffer());
243                 imshow("CV_Image" + std::to_string(j),cv_img);
244                 waitKey(1);
245                 // Stops the acquisition if ESC key is pressed
246                 if(waitKey(30)==27){
247                     cameras.StopGrabbing();
248                     throw RUNTIME_EXCEPTION( "Stopped by user...");
249                 }
250             }
251         }
252     }

```

```

249         // Print the index and the model name of the camera.
250         std::cout << "Camera:_" << j << "_Image:_" << std::to_string(
                i_grabbedImages) << endl;
251
252         try
253         {
254             // The pylon grab result smart pointer classes provide a cast
                operator to the IImage
255             // interface. This makes it possible to pass a grab result directly
                to the
256             // function that saves an image to disk.
                std::stringstream ss;
257             ss << std::setw(5) << std::setfill('0') << i;
258             std::string img_no = ss.str();
259             std::string imgfilename = str_fn + "/IMG_" + img_no + "_" +
                std::to_string(j) + ".tiff";
260
261             CImagePersistence::Save( ImageFileFormat_Tiff, String_t(imgfilename.
                c_str()), ptrGrabResult);
262         }
263         catch (const GenericException &e)
264         {
265
266             cerr << "Could not grab an image:" << endl
267                 << e.GetDescription() << endl;
268         }
269     }
270     // Pause the triggering for a certain time (in ms), in order to decrease the
        frame rate
271     WaitObject::Sleep(1000/f_frameRate);
272 }
273 }
274 catch (const GenericException &e)
275 {
276     // Error handling
277     cerr << "An exception occurred." << endl
278         << e.GetDescription() << endl;
279     exitCode = 1;
280 }
281 // Releases all pylon resources.
282 PylonTerminate();
283
284 std::cout << "\nSuccessfully saved:" << std::to_string(i_grabbedImages) << "_images.\n";
285
286 return exitCode;
287 }

```

Annexe D

Algorithme de calcul de vitesse d'un champs de déplacement

```
1  #!/usr/bin/env python3.8
2  import pandas as pd
3  import numpy as np
4  import os
5  path = os.getcwd()
6  av=2 # Forward to the starting (undeformed) result file
7  df = pd.read_csv('DICE_solution_00'+str(av)+'.txt', usecols = [1,2], names = ['x', 'y'], skiprows =
    1)
8  listfiles = [f for f in os.listdir(path) if f.endswith('.txt')]
9  listfiles.sort()
10 for f in listfiles:
11     df1 = pd.read_csv(f, usecols = [1,2,3,4], names = ['x', 'y', 'u'+f[-17:-15], 'v'+f
        [-17:-15]], skiprows = 1)
12     df = df.merge(df1,on=['x', 'y'])
13 mVel = np.zeros(shape=(len(df),len(listfiles)*2))
14 h = 1.0
15 for i in range(2,len(listfiles)-2):
16     mVel[:,2*i] = (1*np.array(df)[: ,2*i-2]-8*np.array(df)[: ,2*i]+0*np.array(df)[: ,2*i+2]+8*np.
        array(df)[: ,2*i+4]-1*np.array(df)[: ,2*i+6])/(12*1.0*h**1)
17     # X component of velocity
18     mVel[:,2*i+1] = (1*np.array(df)[: ,2*i-1]-8*np.array(df)[: ,2*i+1]+0*np.array(df)[: ,2*i+3]+8*
        np.array(df)[: ,2*i+5]-1*np.array(df)[: ,2*i+7])/(12*1.0*h**1)
19     # Y component of velocity
20     df2 = pd.DataFrame({'x':df.iloc[: ,0], 'y':df.iloc[: ,1], 'v_u': mVel[:,2*i], 'v_v': mVel[:,2*i
        +1], 'u': np.array(df)[: ,2*i+2], 'v': np.array(df)[: ,2*i+3]})
21     df2.to_csv(path+'vel/'+ 'vel'+str(i+av)+'.csv', index = False, sep = ',', encoding = 'utf-8'
        )
22 df2 = df2 = pd.DataFrame({'x':df.iloc[: ,0], 'y':df.iloc[: ,1], 'v_u': mVel[:,0], 'v_v': mVel[:,1], 'u':
        np.array(df)[: ,2], 'v': np.array(df)[: ,3]})
23 df2.to_csv(path+'vel/'+ 'vel'+str(av)+'.csv', index = False, sep = ',', encoding = 'utf-8')
24 df2 = df2 = pd.DataFrame({'x':df.iloc[: ,0], 'y':df.iloc[: ,1], 'v_u': mVel[:,2], 'v_v': mVel[:,3], 'u':
```



```

    np.array(df)[: ,4], 'v': np.array(df)[: ,5]})
25 df2.to_csv(path+'vel/'+vel+str(av+1)+'.csv', index = False, sep = ',', encoding = 'utf-8')
26 df2 = df2 = pd.DataFrame({'x':df.iloc[: ,0], 'y':df.iloc[: ,1], 'v_u': mVel[: ,len(listfiles)-6], 'v_v':
    mVel[: ,len(listfiles)-5], 'u': np.array(df)[: , -4], 'v': np.array(df)[: , -3]})
27 df2.to_csv(path+'vel/'+vel+str(len(listfiles)-2+av)+'.csv', index = False, sep = ',', encoding =
    'utf-8')
28 df2 = df2 = pd.DataFrame({'x':df.iloc[: ,0], 'y':df.iloc[: ,1], 'v_u': mVel[: ,len(listfiles)-6], 'v_v':
    mVel[: ,len(listfiles)-5], 'u': np.array(df)[: , -2], 'v': np.array(df)[: , -1]})
29 df2.to_csv(path+'vel/'+vel+str(len(listfiles)-1+av)+'.csv', index = False, sep = ',', encoding =
    'utf-8')

```

Annexe E

Résultats des essais en compression

Essai compression

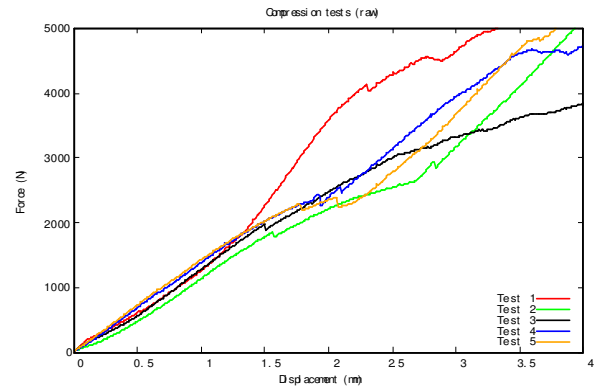
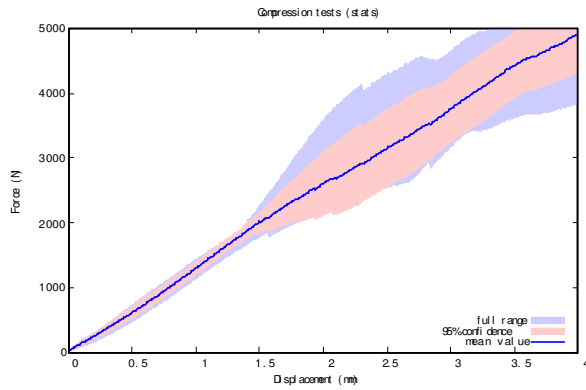

Résultats pour chaque essai

- Essai divisé en 6 périodes : Début (0), 20 % (1), 40 % (2), 60 % (3), 80 % (4) et fin (5).
- Résultats affichés : Déplacement, déformation 1er et 2ème invariant, Von Mises et volumétrie

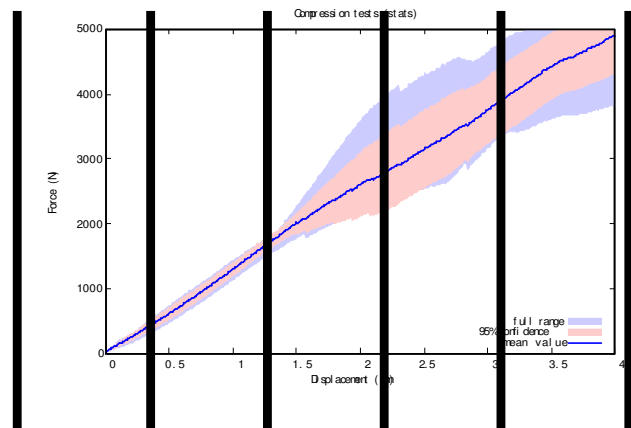

Compression 1



Compression 1

Compression Test 1

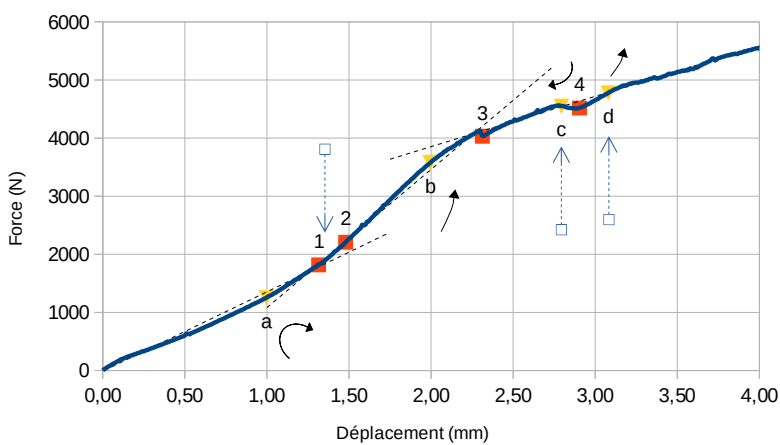

#	Dépl (mm)	Force (N)	
1	1,32	1818,18	Première rupture
2	1,48	2206,74	Diaphyse touche tête (T)
3	2,31	4032,91	Pointe diaphyse s'écrase
4	2,90	4518,21	Deuxième petite rupture

(T) Transition sens vitesse

Pente (N/mm)	
1365,06	Élastique
2378,99	Poussée par diaphyse et par tête fracturée
866,73	Diaphyse écrasée

Compression 1 : Déplacement

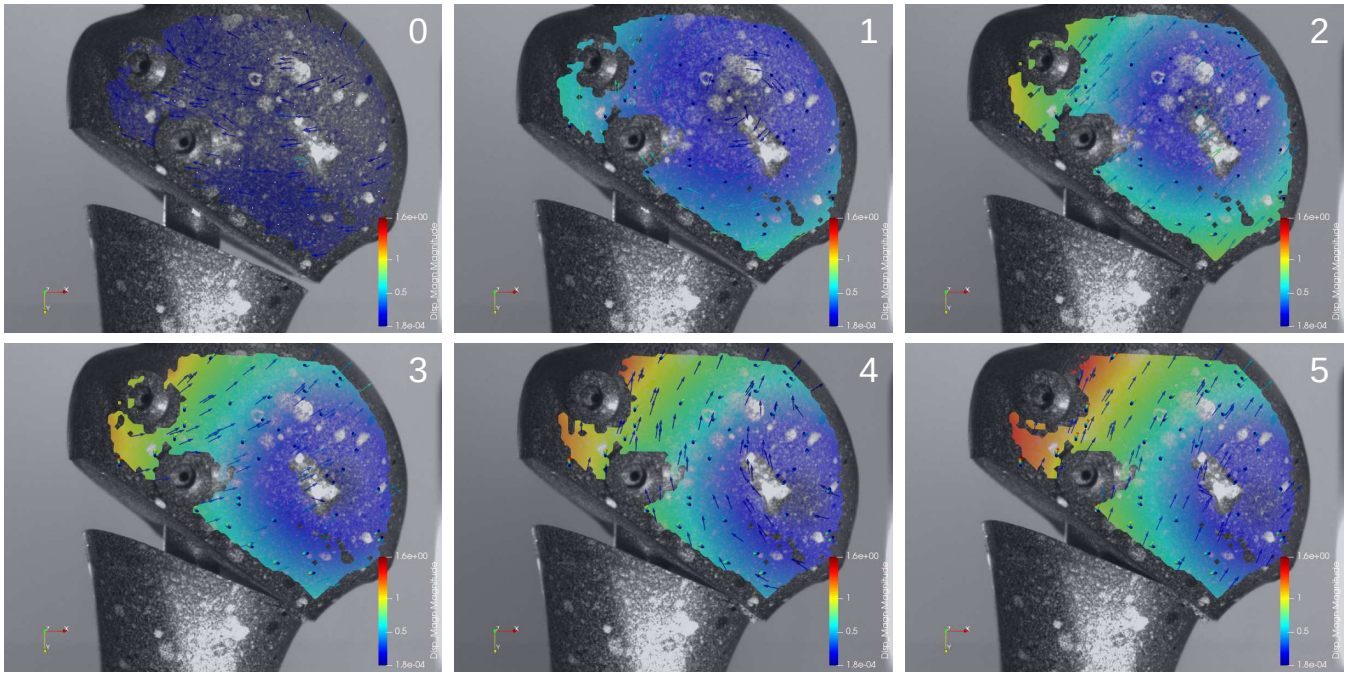

Compression 1 : Déformation Vol.

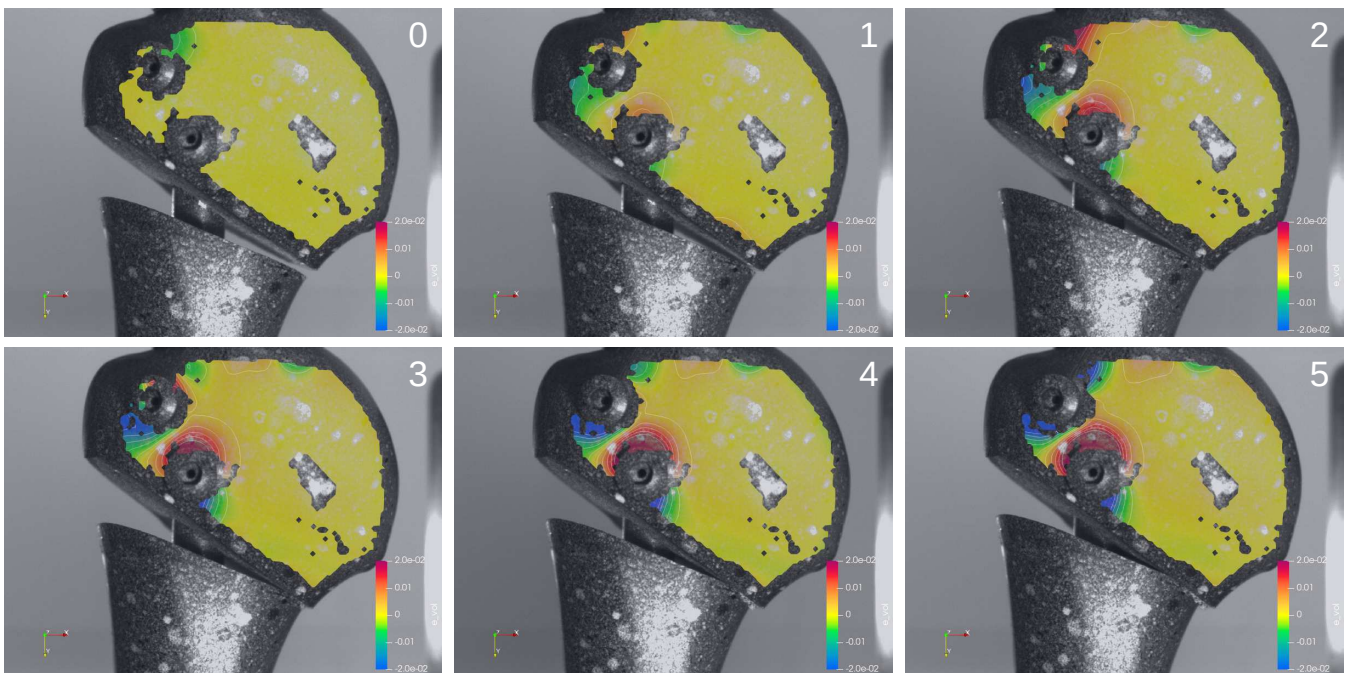

Compression 1

1: Première rupture

4: Deuxième petite rupture

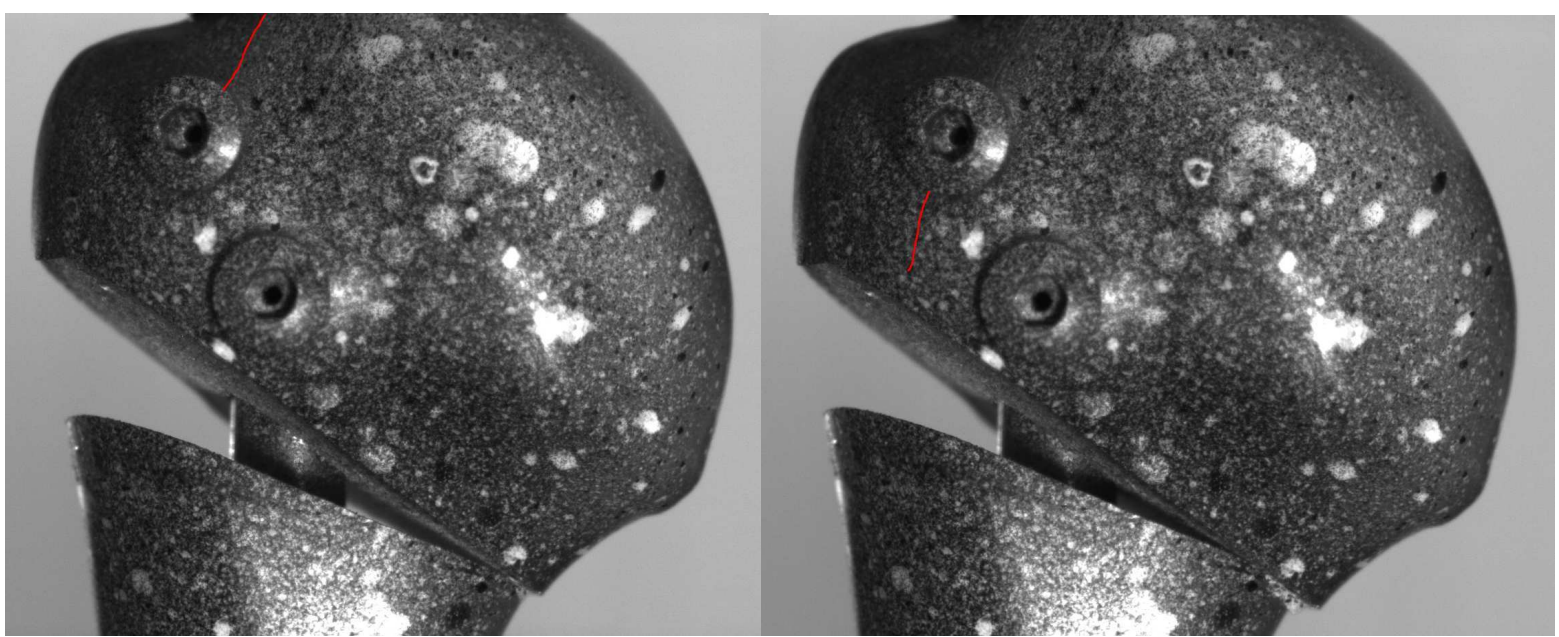

Compression 1

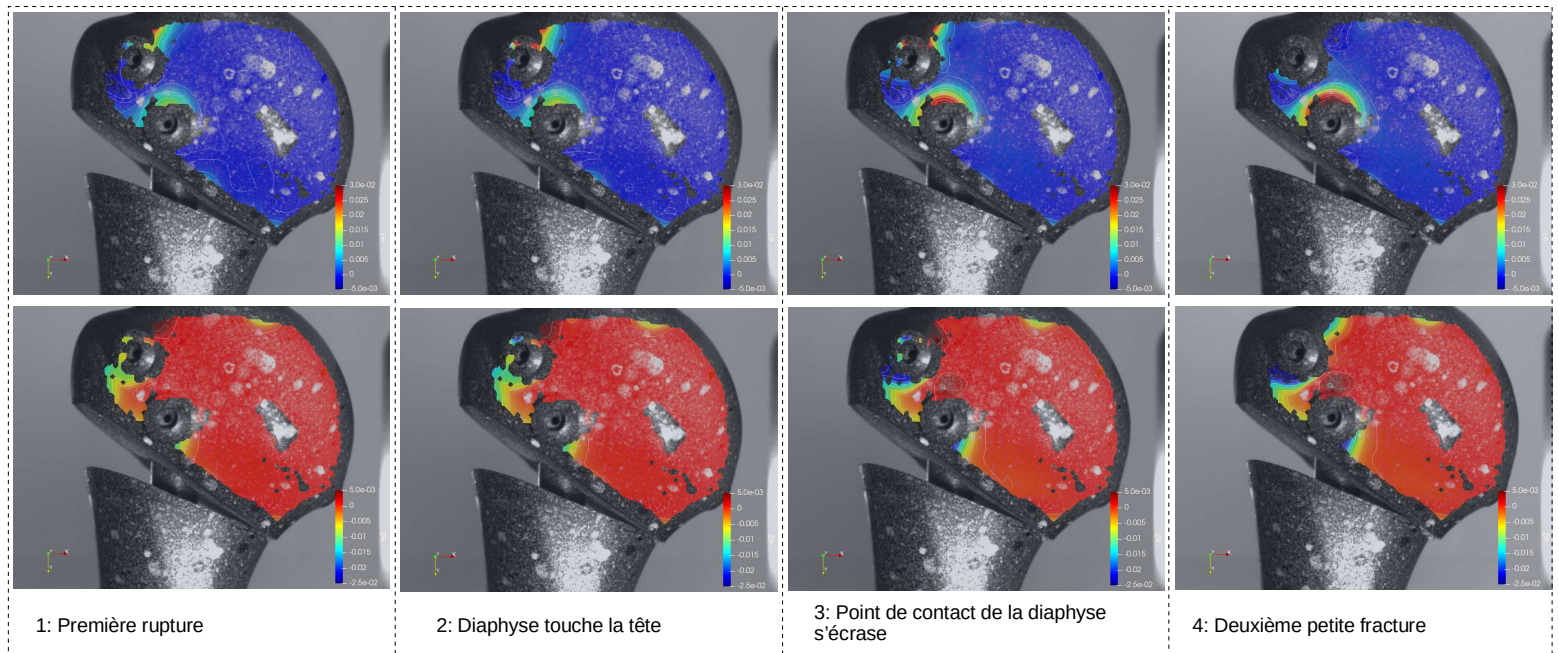

Compression 2

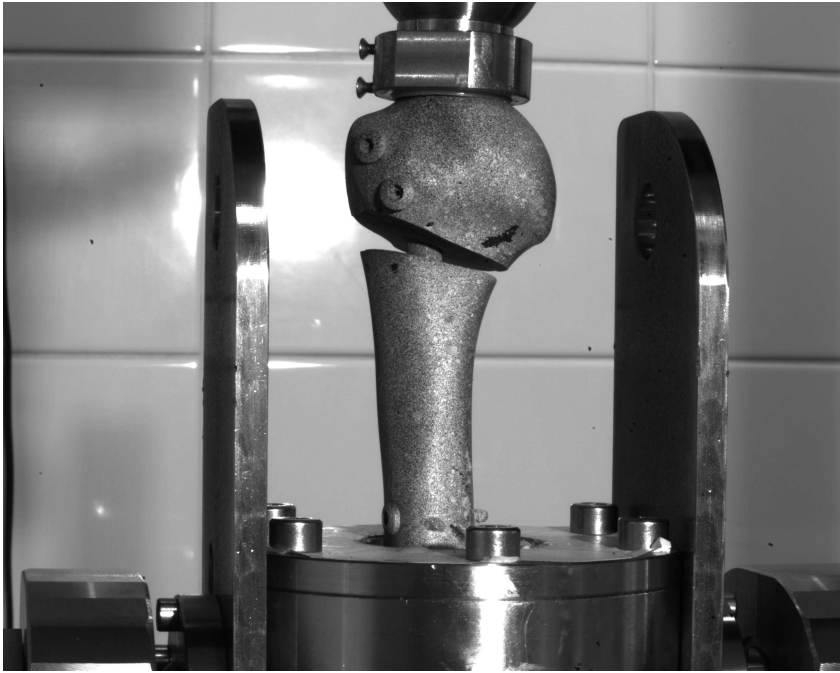

Compression 2

Compression 2

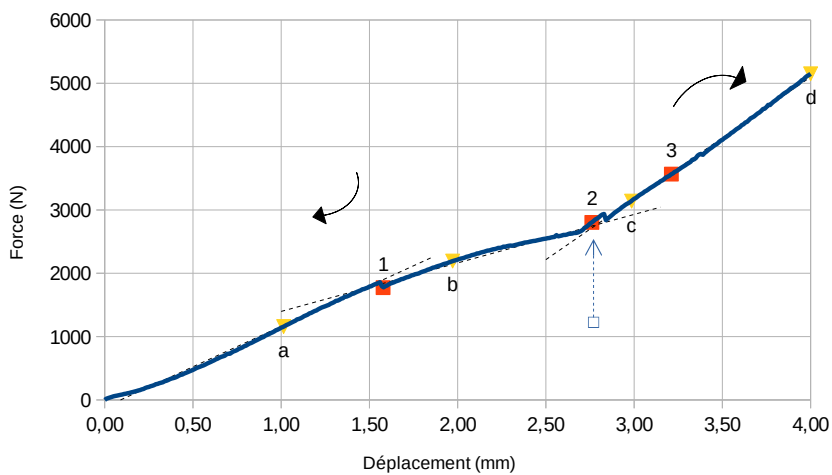

#	Dépl (mm)	Force (N)	
1	1,58	1772,35	Première rupture
2	2,76	2802,34	Diaphyse touche tête (T)
3	3,21	3566,17	Deuxième rupture

(T) Transition sens vitesse



Pente (N/mm)	
1274,49	Élastique
765,80	Tête fracturée
1922,34	Poussée par diaphyse

Compression 2 : Déplacement

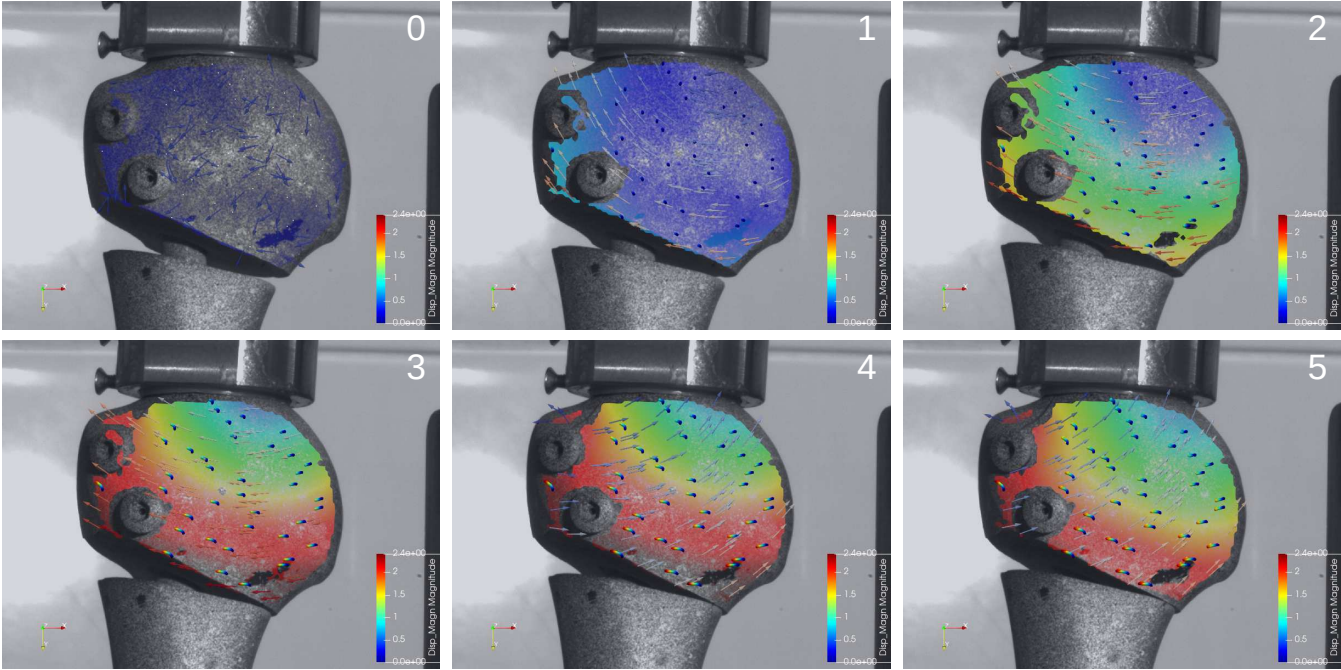

Compression 2 : Déformation Vol.

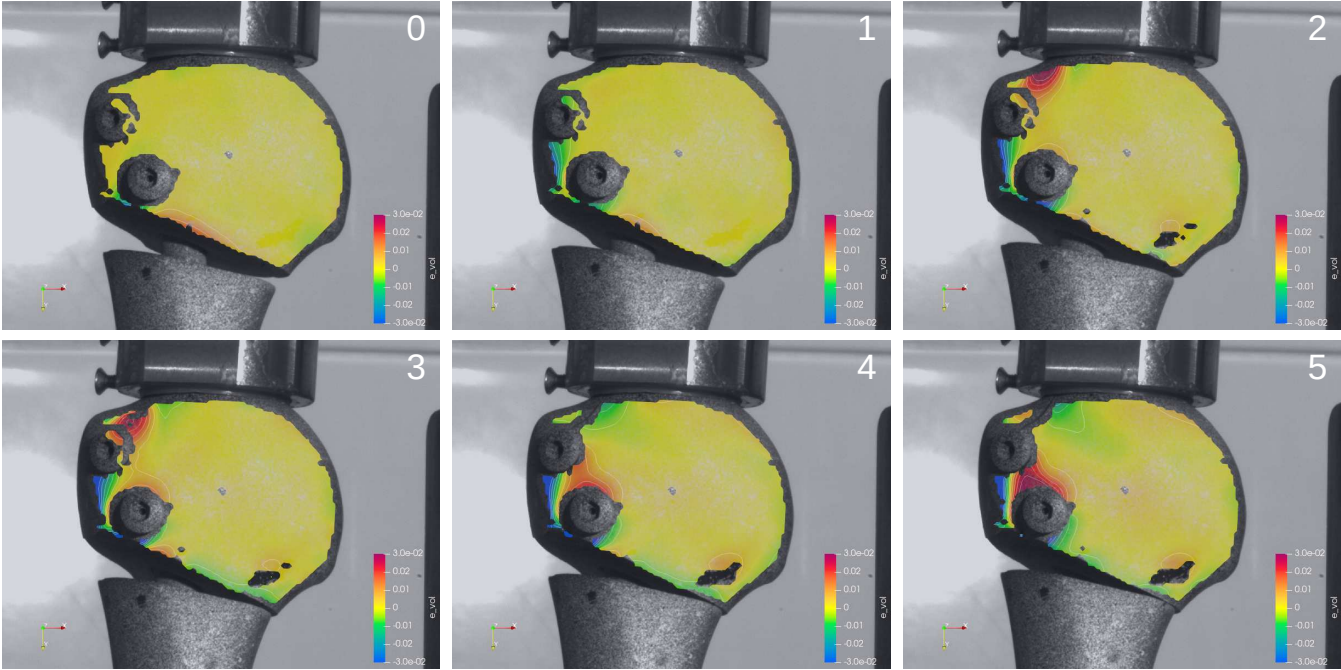

Compression 2

1: Première rupture

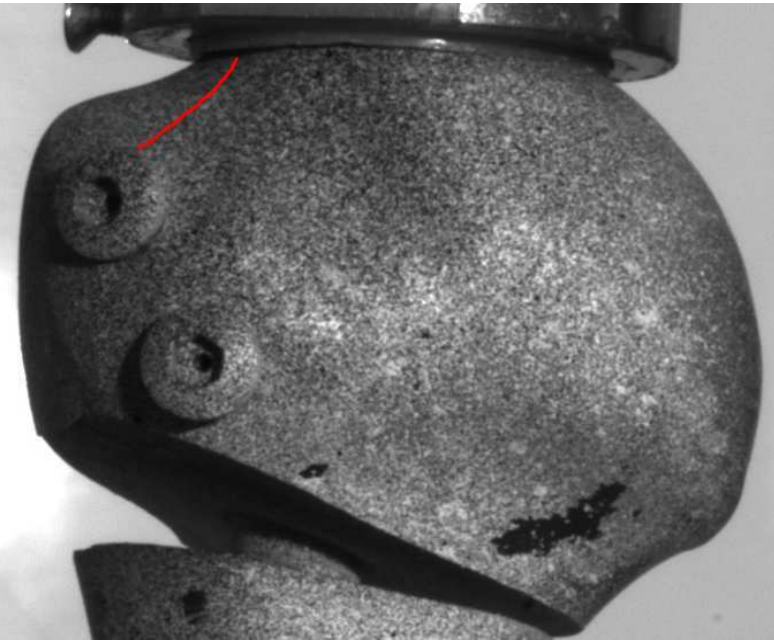

4: Deuxième petite rupture

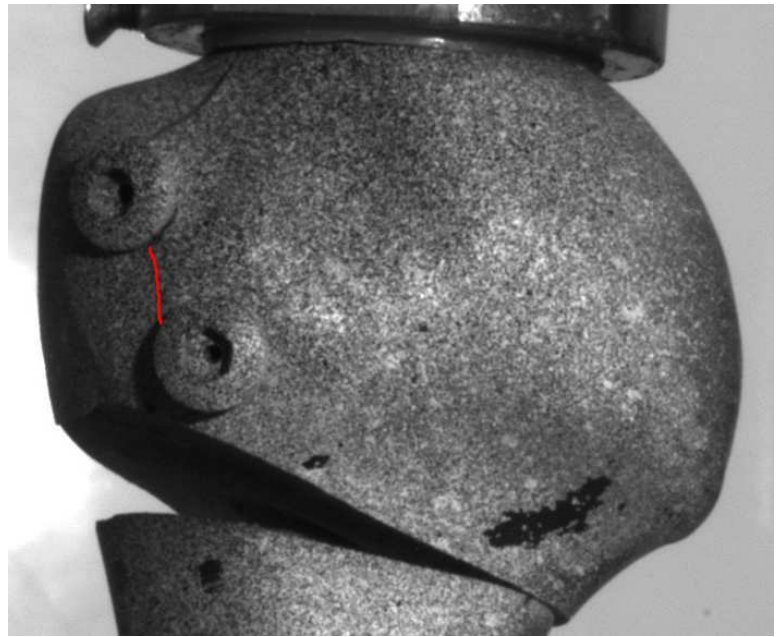

Compression 2

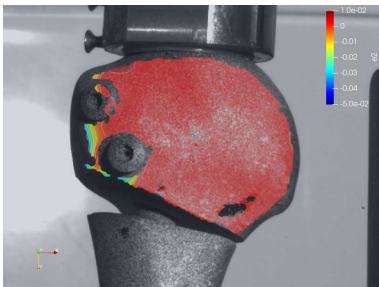
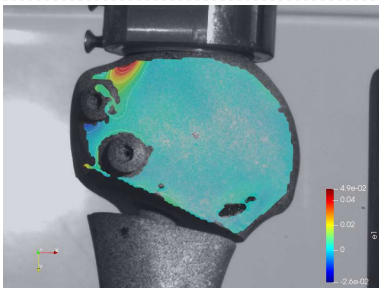

1: Première rupture

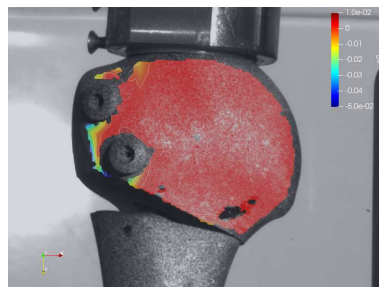
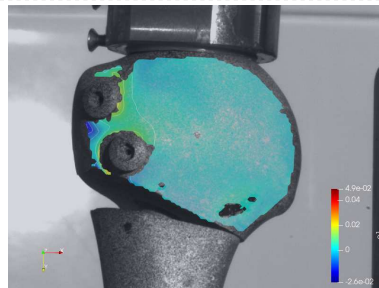

2: Diaphyse touche la tête

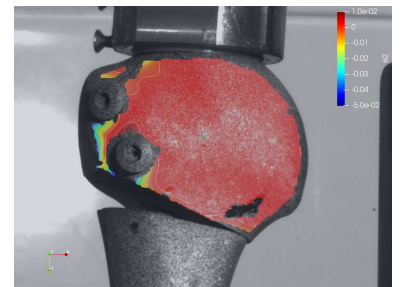
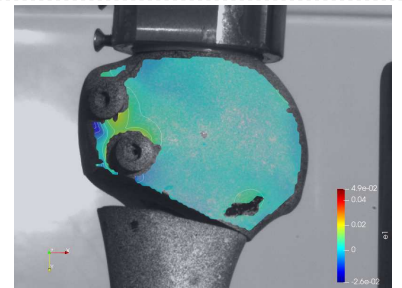

3: Deuxième rupture

Compression 3

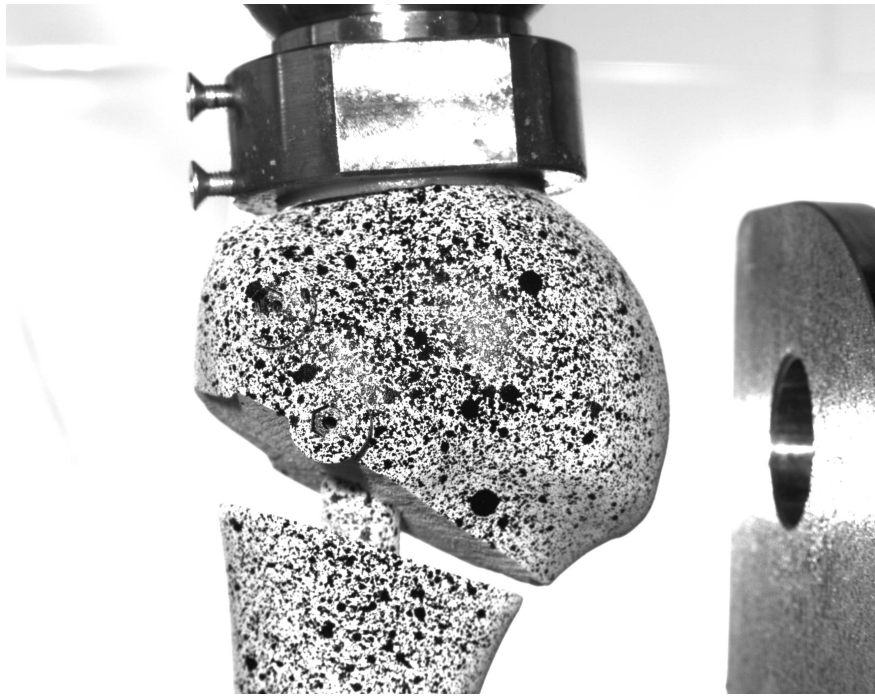

Compression 3

Compression Test 3

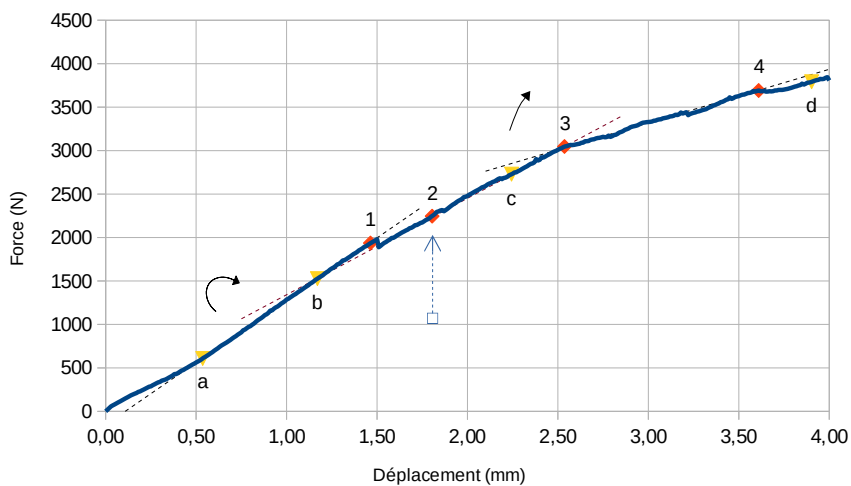

# T	Dépl (mm)	Force (N)	
1	1,46	1936,37	Première rupture
2	1,80	2246,10	Diaphyse touche tête (T)
3	2,54	3047,47	Écrasement pointe diaphyse
4	3,61	3691,74	Deuxième petite rupture

(T) Transition sens vitesse



Pente (N/mm)	
1433,77	Élastique
1109,29	Poussée par diaphyse et par tête fracturée
616,99	Diaphyse écrasée

Compression 3 : Déplacement

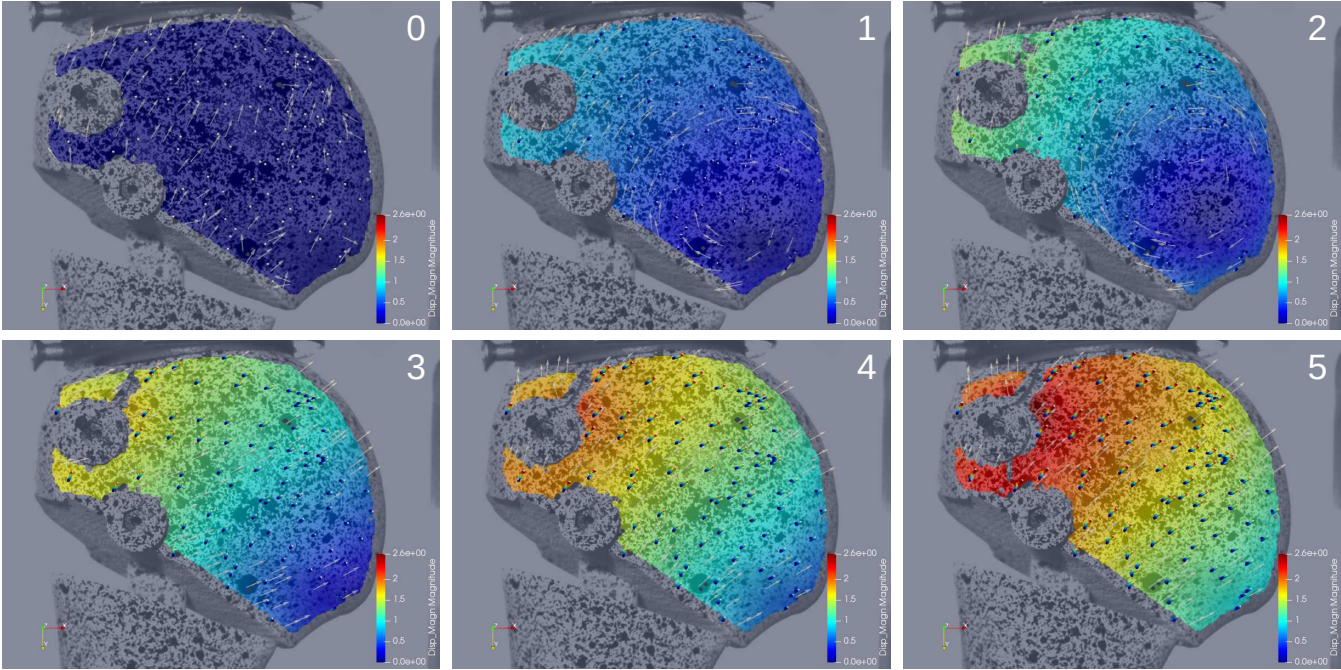

Compression 3 : Déformation vol.

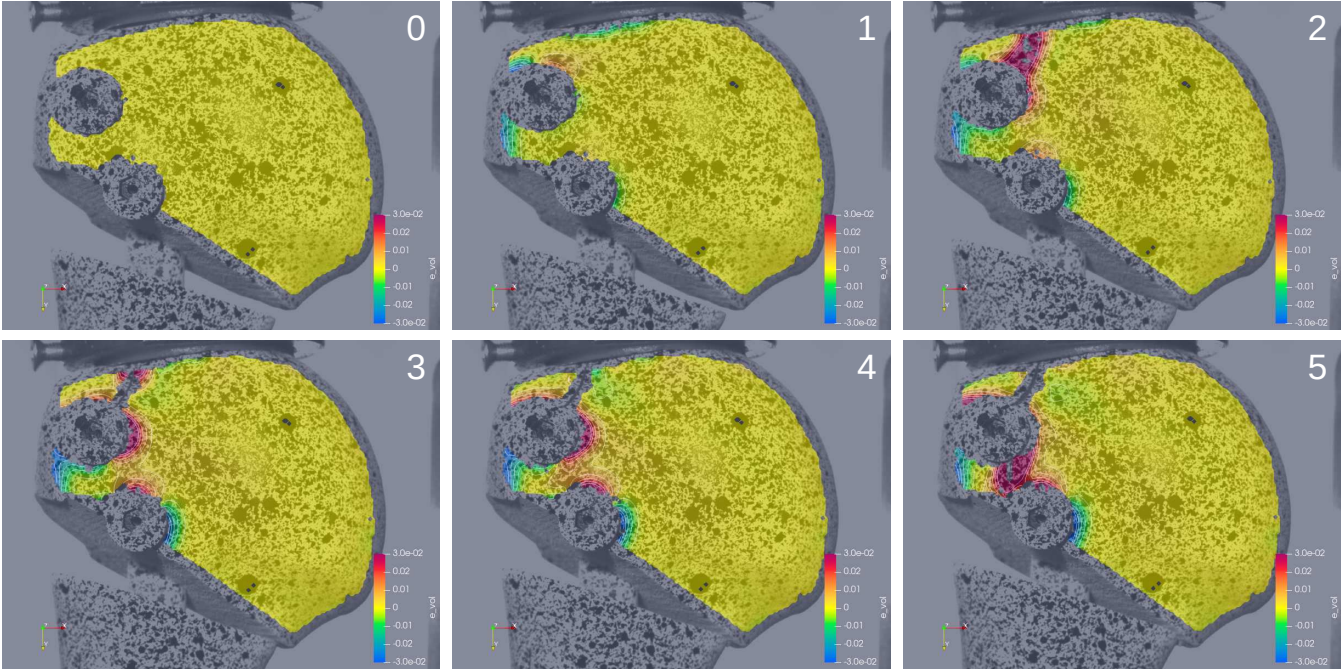

Compression 3

1: Première rupture

4: Deuxième petite rupture

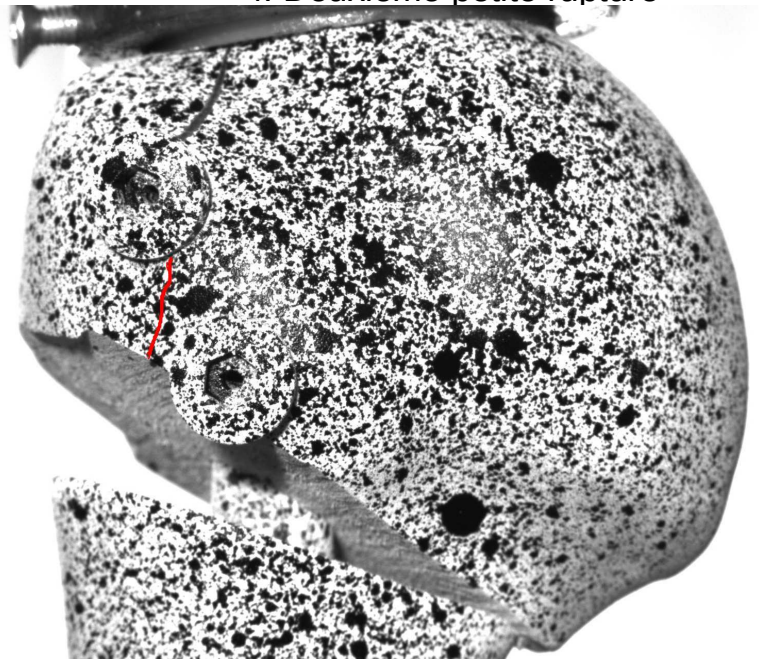
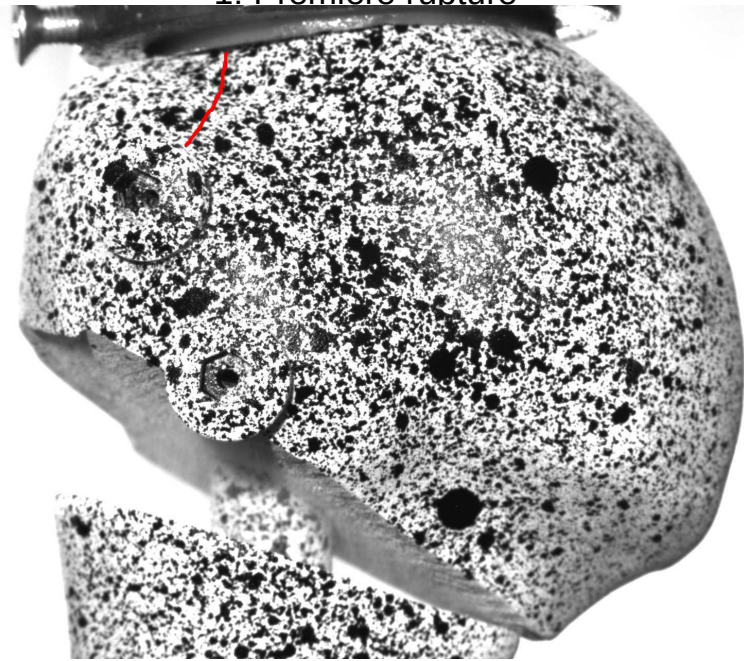

Compression 3

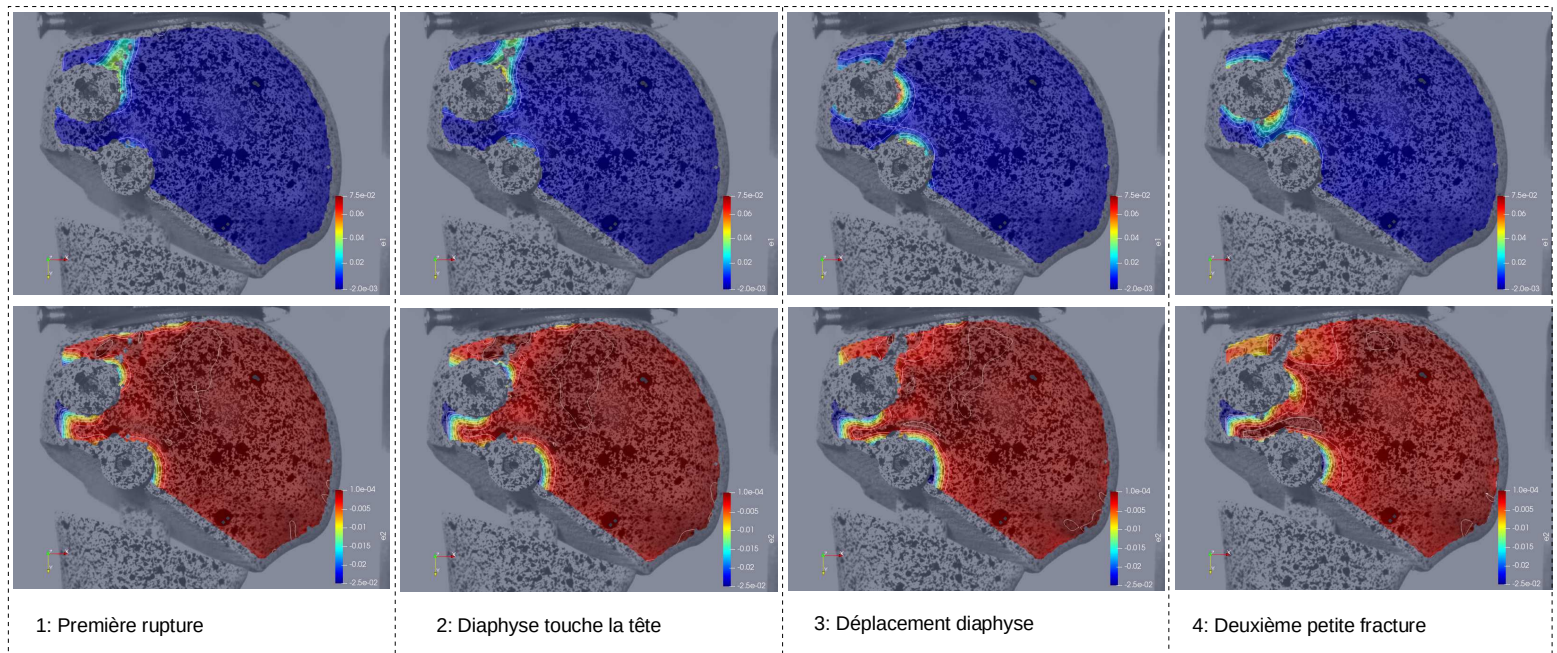

Compression 4

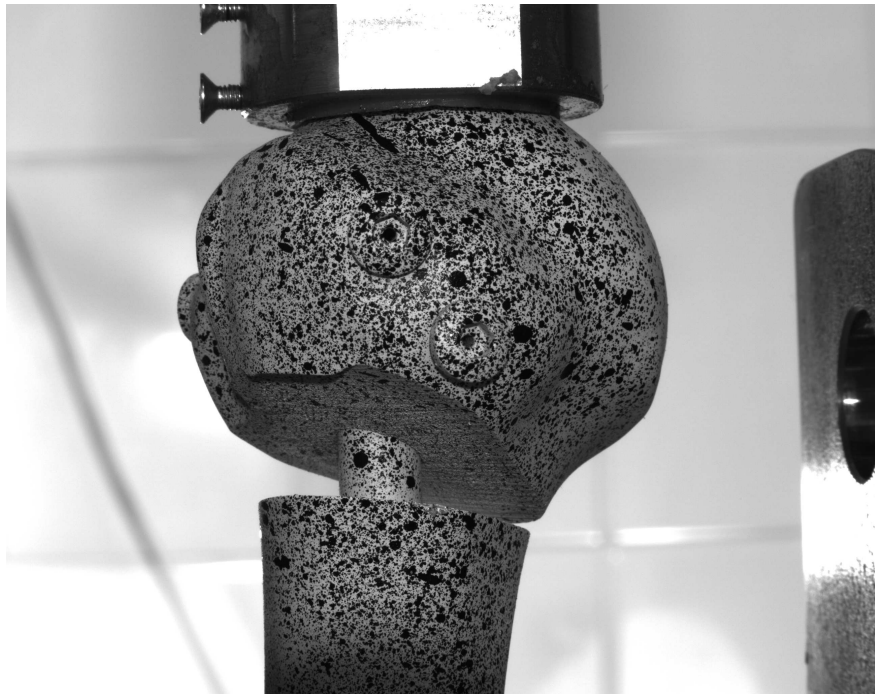

Compression 4

Compression Test 4

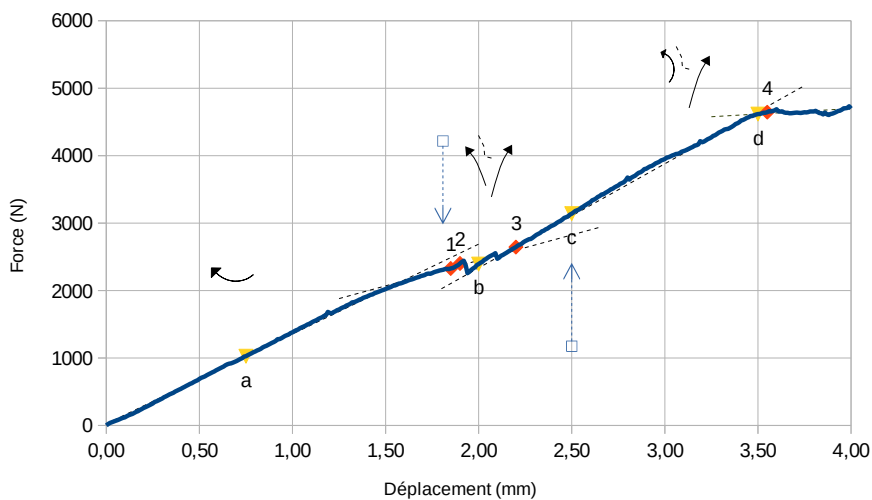

#	Dépl (mm)	Force (N)	
1	1,85	2326,93	Diaphyse touche tête
2	1,90	2401,33	Première rupture (T)
3	2,20	2643,87	Diaphyse s'enfonce
4	3,55	4645,28	Deuxième petite rupture et diaphyse s'écrase

(T) Transition sens vitesse

Pente (N/mm)	
1332,17	Élastique
754,67	Tête fracturée
1544,34	Poussée par diaphyse
162,22	Diaphyse écrasée

Compression 4 : Déplacement

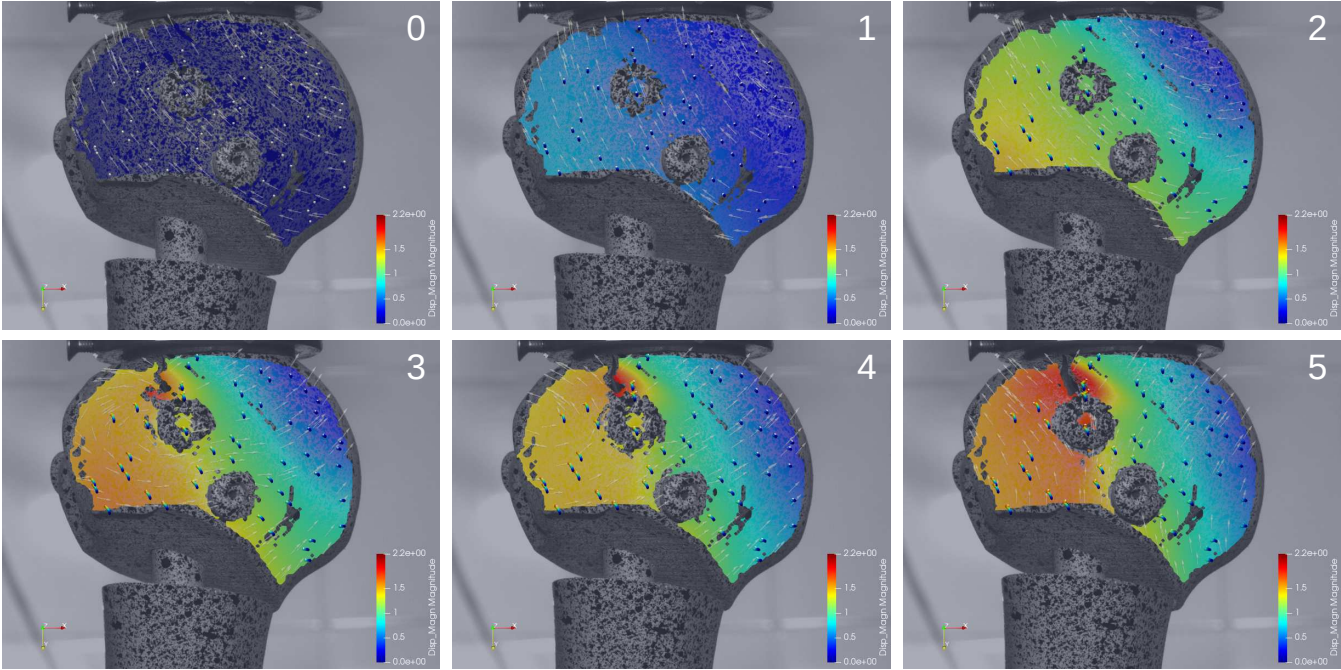

Compression 4 : Déformation vol.

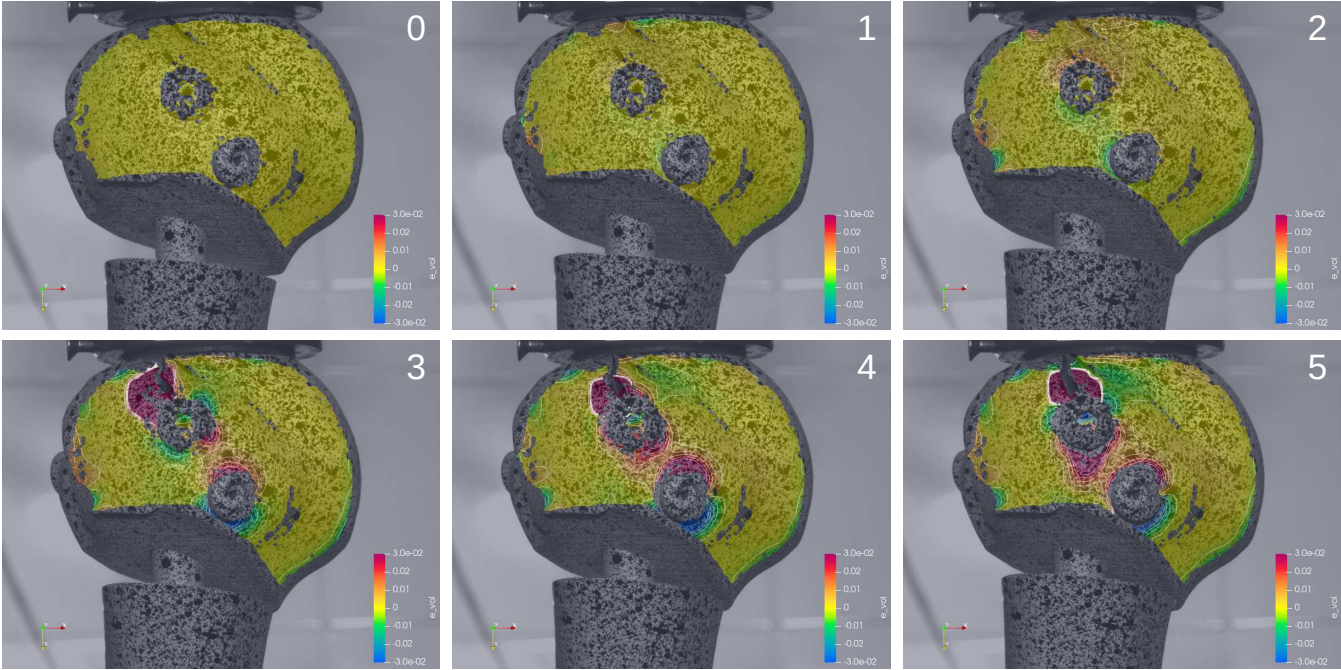

Compression 4

1: Première rupture

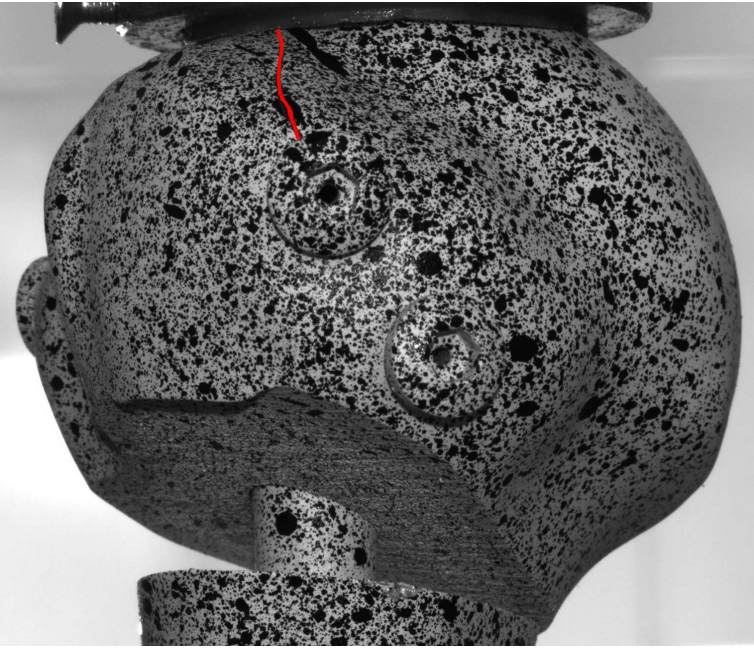

4: Deuxième petite rupture

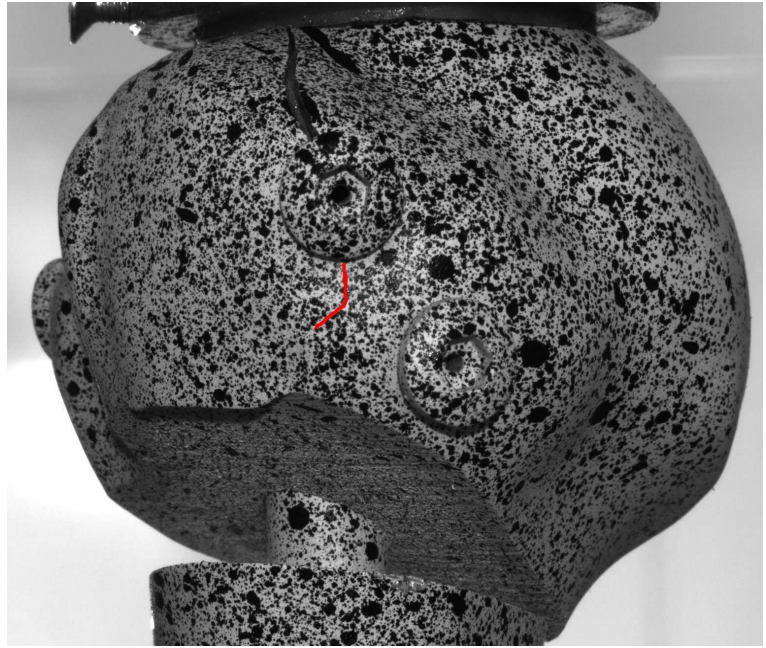

Compression 4

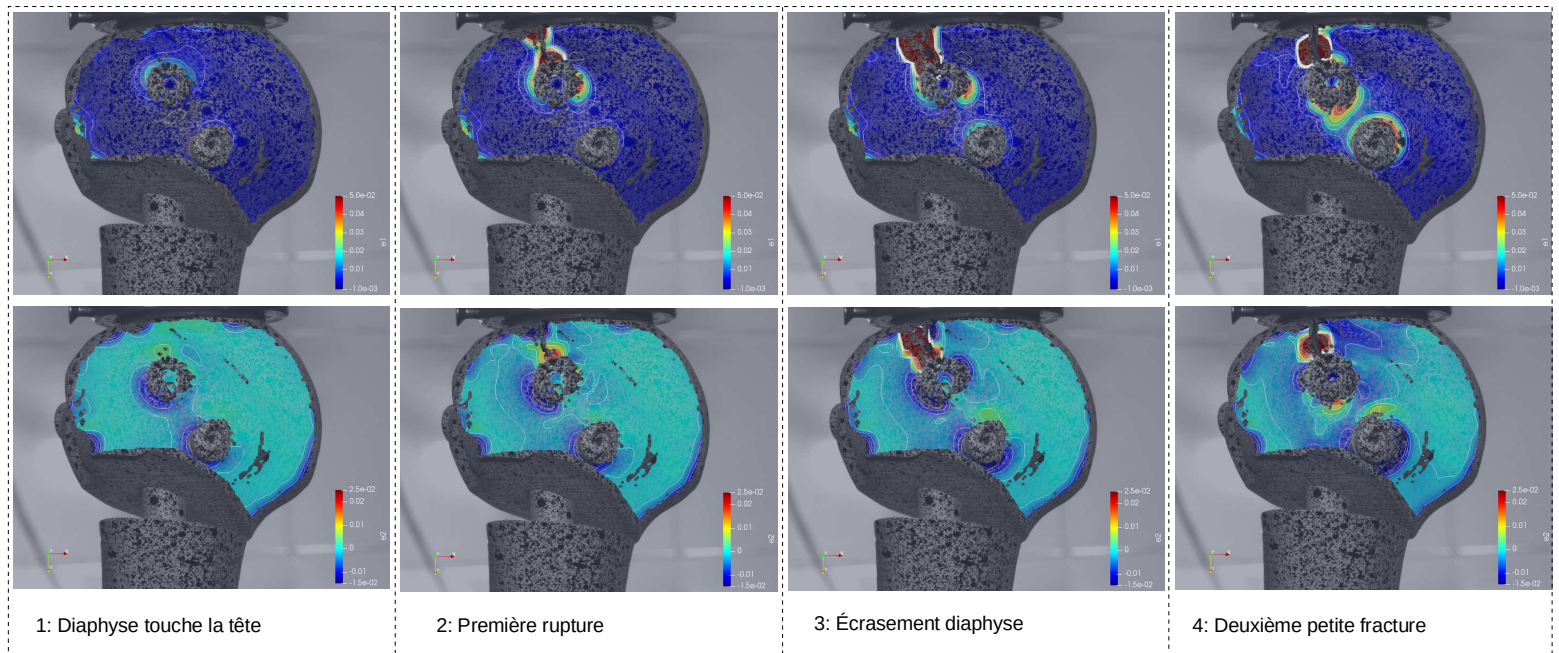

Compression 5

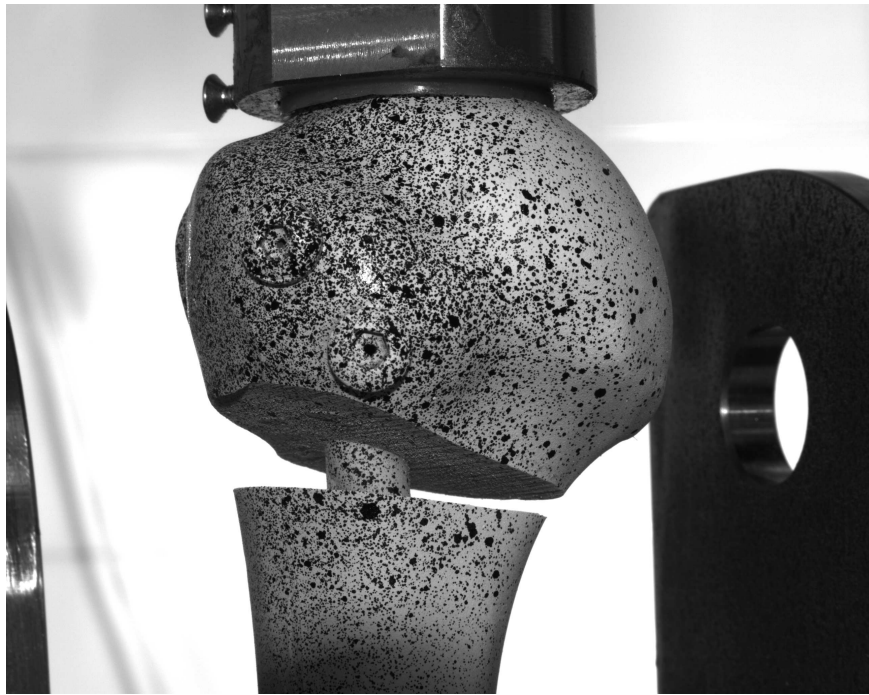

Compression 5

Compression Test 5

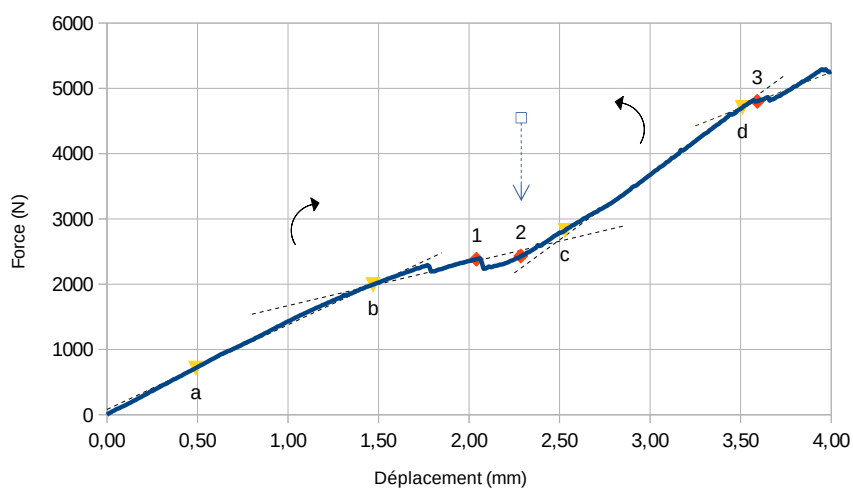

#	Dépl (mm)	Force (N)	
1	2,04	2382,12	Première rupture
2	2,29	2431,02	Diaphyse touche tête (T)
3	3,59	4800,36	Deuxième petite rupture et écrasement pointe diaphyse

(T) Transition sens vitesse

Pente (N/mm)	
1296,75	Élastique
658,87	Tête fracturée
2027,83	Poussée par diaphyse
1099,10	Diaphyse écrasée

Compression 5 : Déplacement

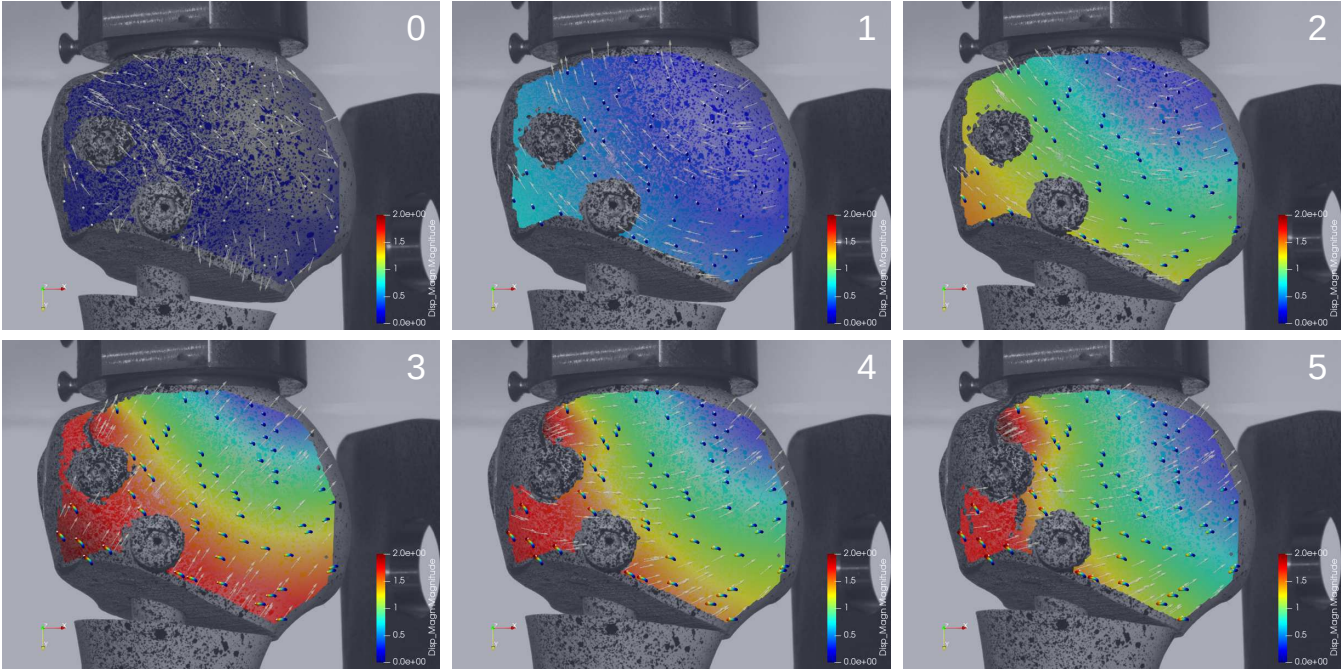

Compression 5 : Déformation vol.

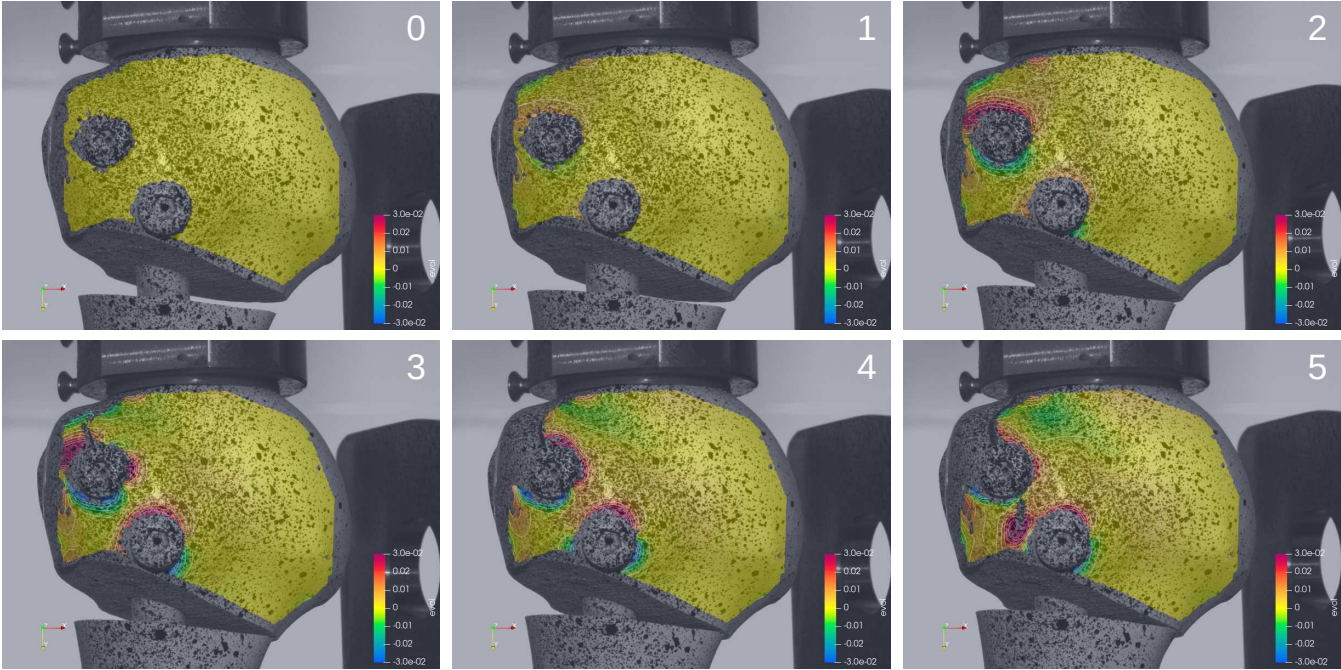

Compression 5

1: Première rupture

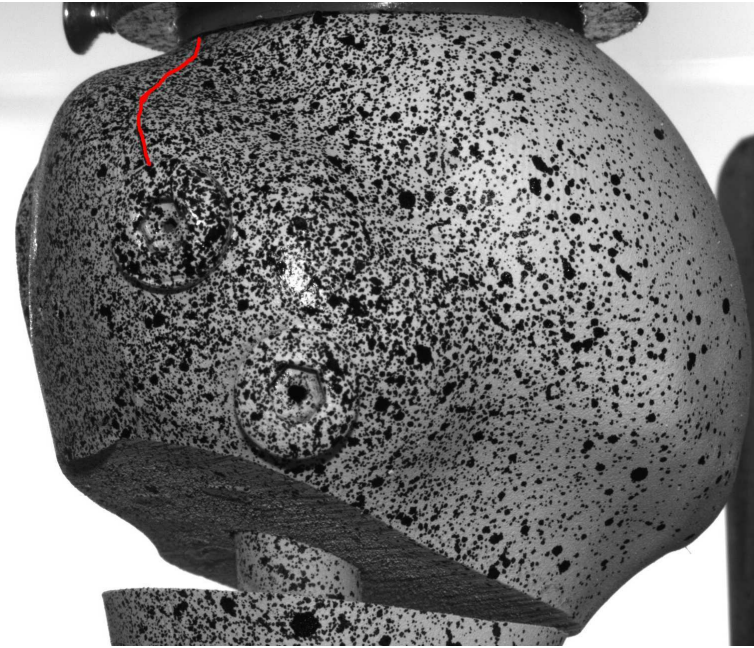

4: Deuxième petite rupture

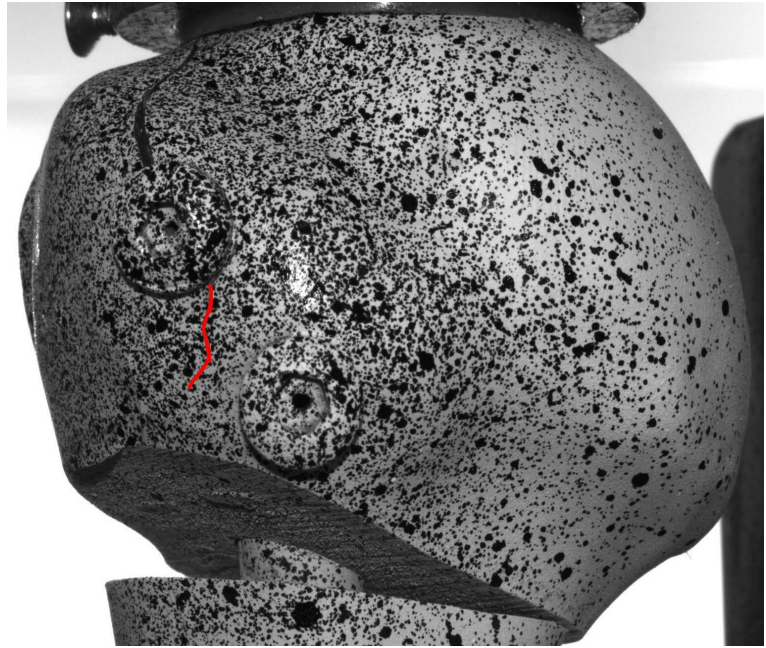

Compression 5

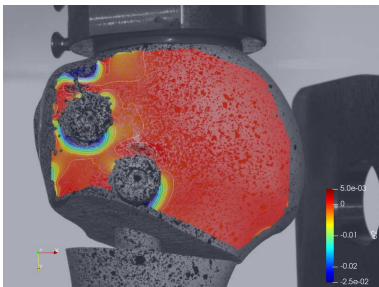
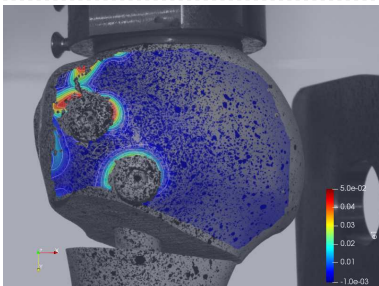

1: Première rupture

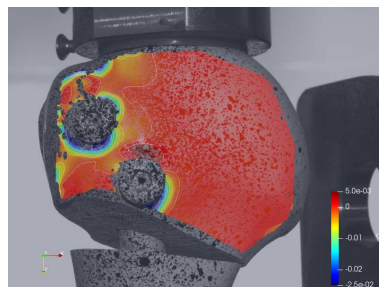
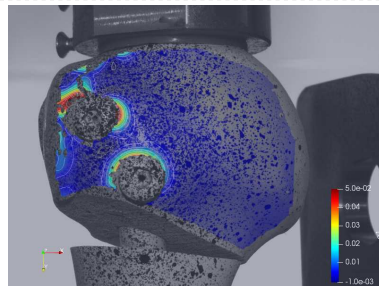

2: Diaphyse touche la tête

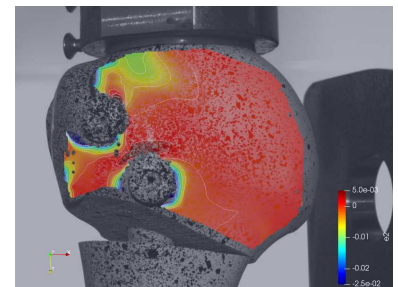
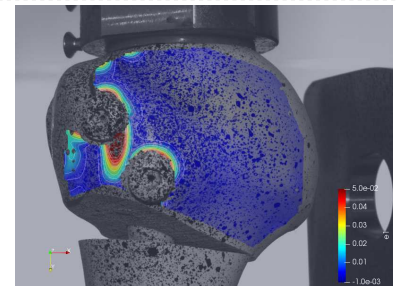

3: Deuxième rupture

Essai compression sain

- 4 Sawbones 4ème génération
- Partie distale fixé avec du PMMA, compression appliqué dans la tête par une coupelle PMMA.
- Essai : 4mm à 4mm/min.



Coupelle en PMMA

Résultats pour chaque essai

- Essai divisé en 6 périodes : Début (0), 20 % (1), 40 % (2), 60 % (3), 80 % (4) et fin (5).
- Résultats affichés : Déplacement, déformation 1er et 2ème invariant, Von Mises et volumétrie

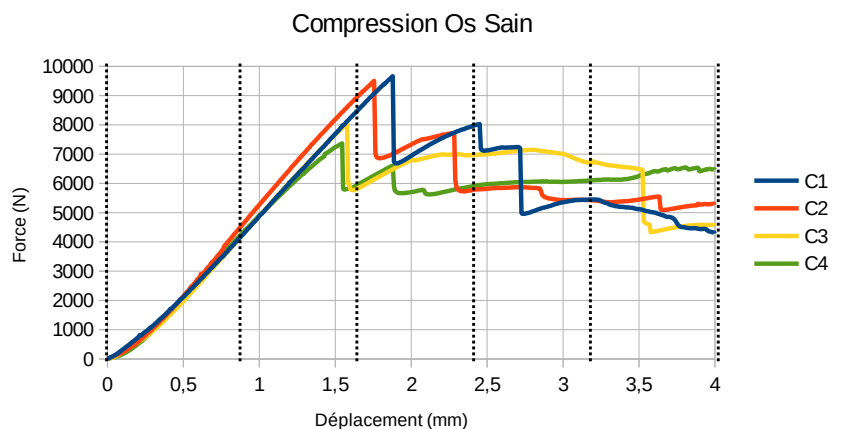

Compression Sain 1



Compression Sain 1

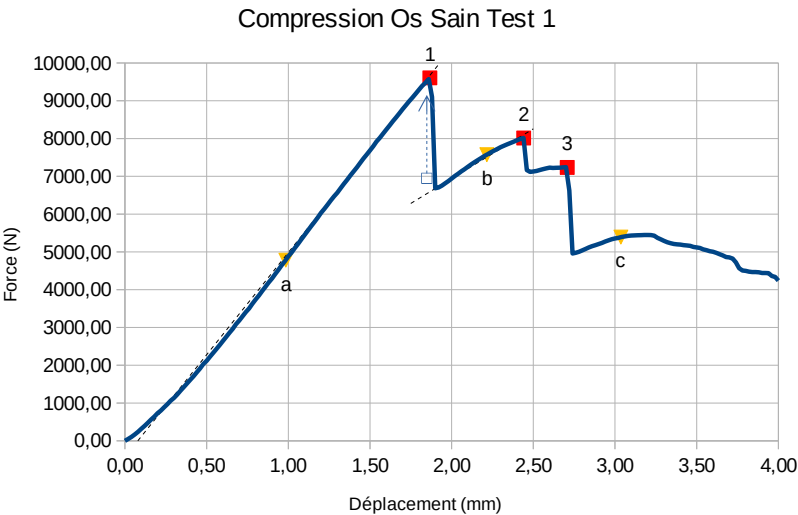

#	Dépl (mm)	Force (N)	
1	1,87	9606,21	Première rupture
2	2,44	8015,00	Deuxième rupture
3	2,71	7236,12	Troisième rupture

(T) Transition sens vitesse



Pente (N/mm)	
5408,04	Élastique
2631,26	Poussée par diaphyse et par tête fracturée

Compression 1 : Déplacement

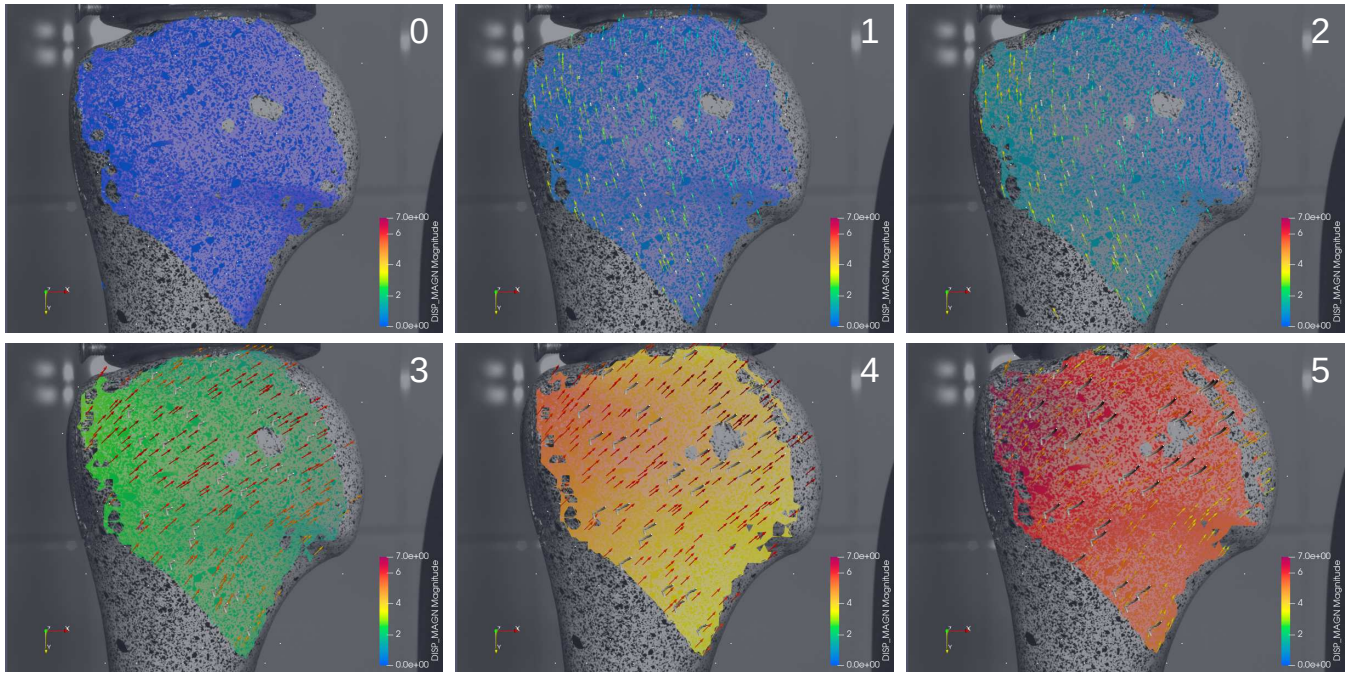

Compression 1 : Déformation Vol.

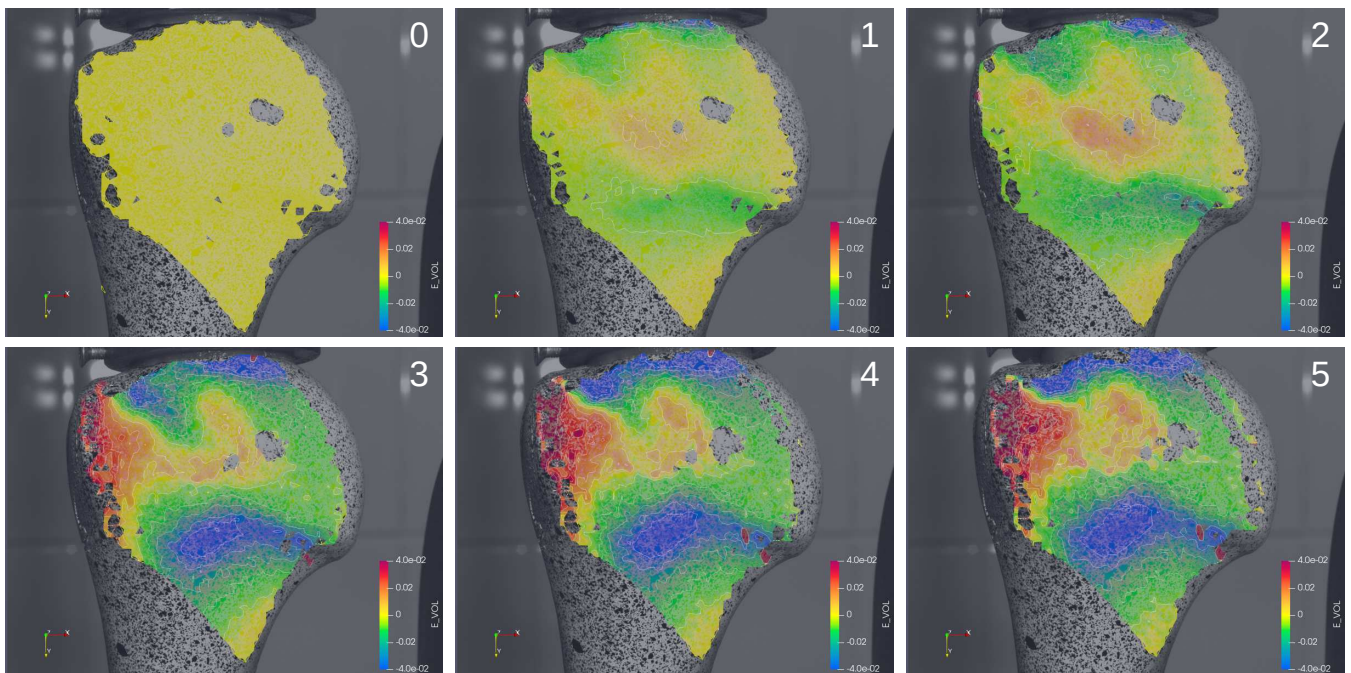

Compression 1 : Ruptures

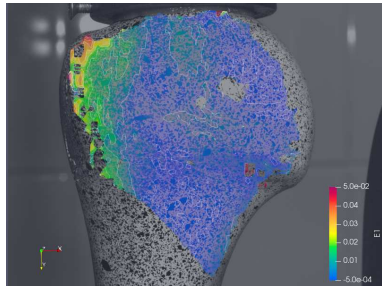

1: Première rupture

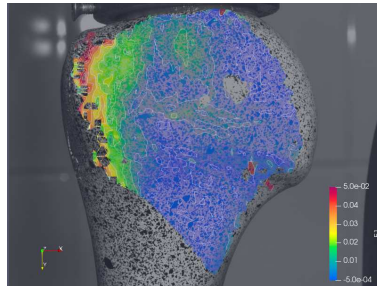

2: Deuxième rupture

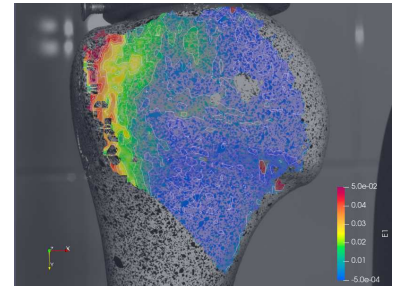

3: Troisième rupture

Compression 1 : Mode de déplacement

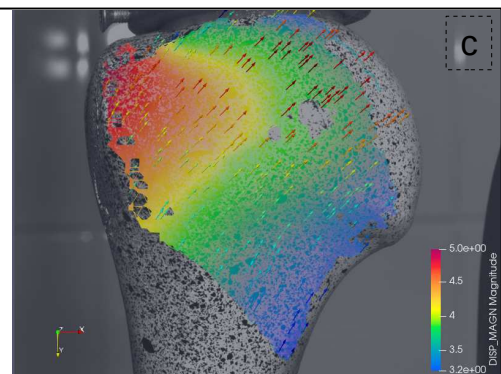
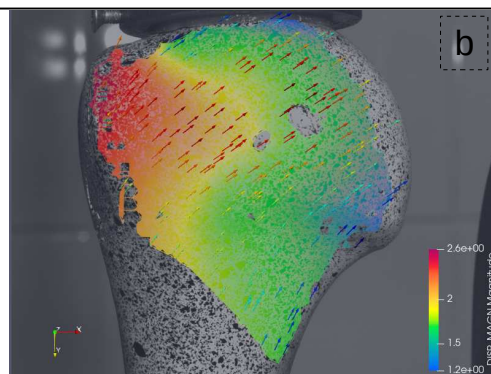
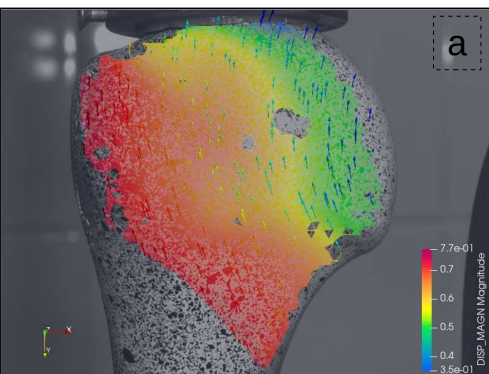
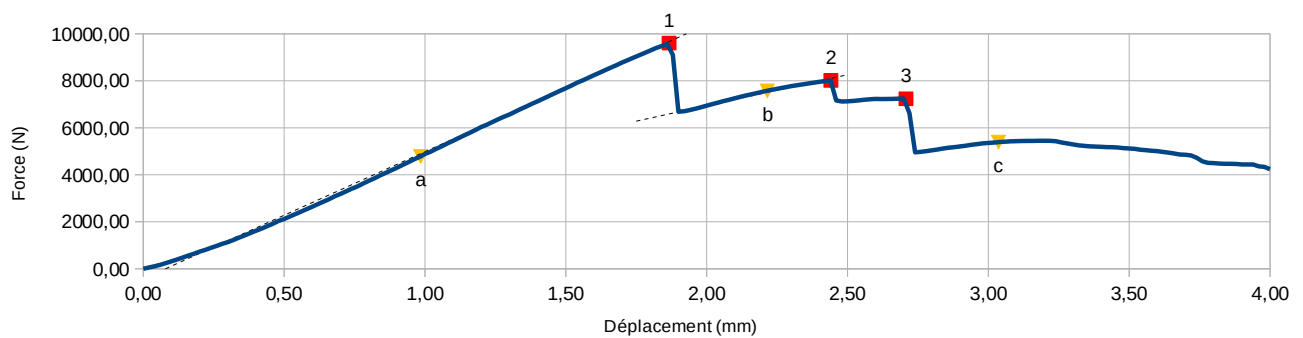

Compression Sain 2



Compression Sain 2

Compression Os Sain Test 2

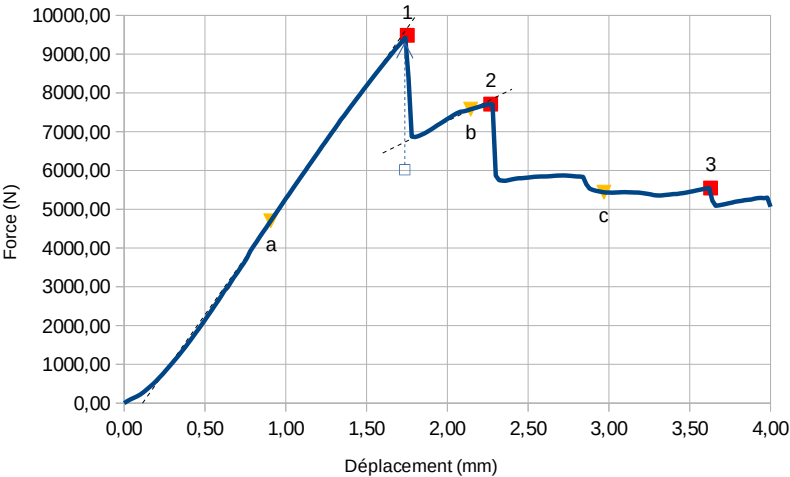

#	Dépl (mm)	Force (N)	
1	1,75	9486,63	Première rupture
2	2,27	7710,35	Deuxième rupture
3	3,63	5547,27	Troisième rupture

(T) Transition sens vitesse



Pente (N/mm)	
5904,72	Élastique
2058,37	Poussée par diaphyse et par tête fracturée

Compression 2 : Déplacement

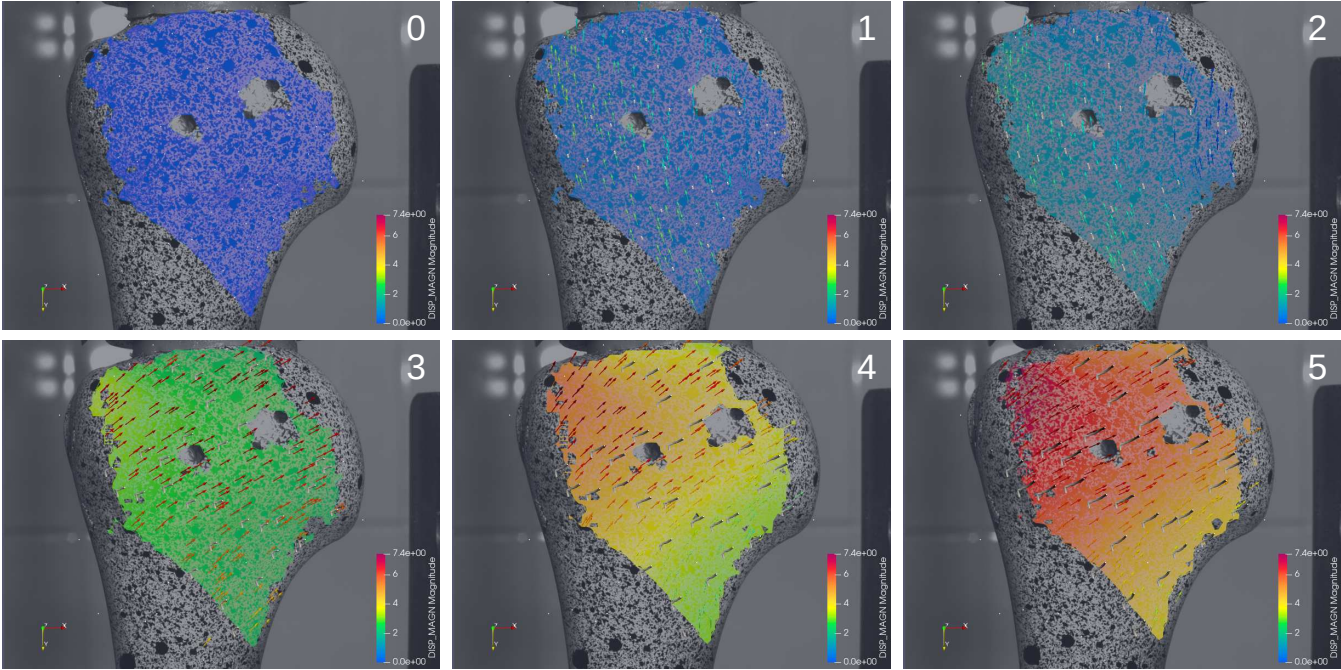

Compression 2 : Déformation Vol.

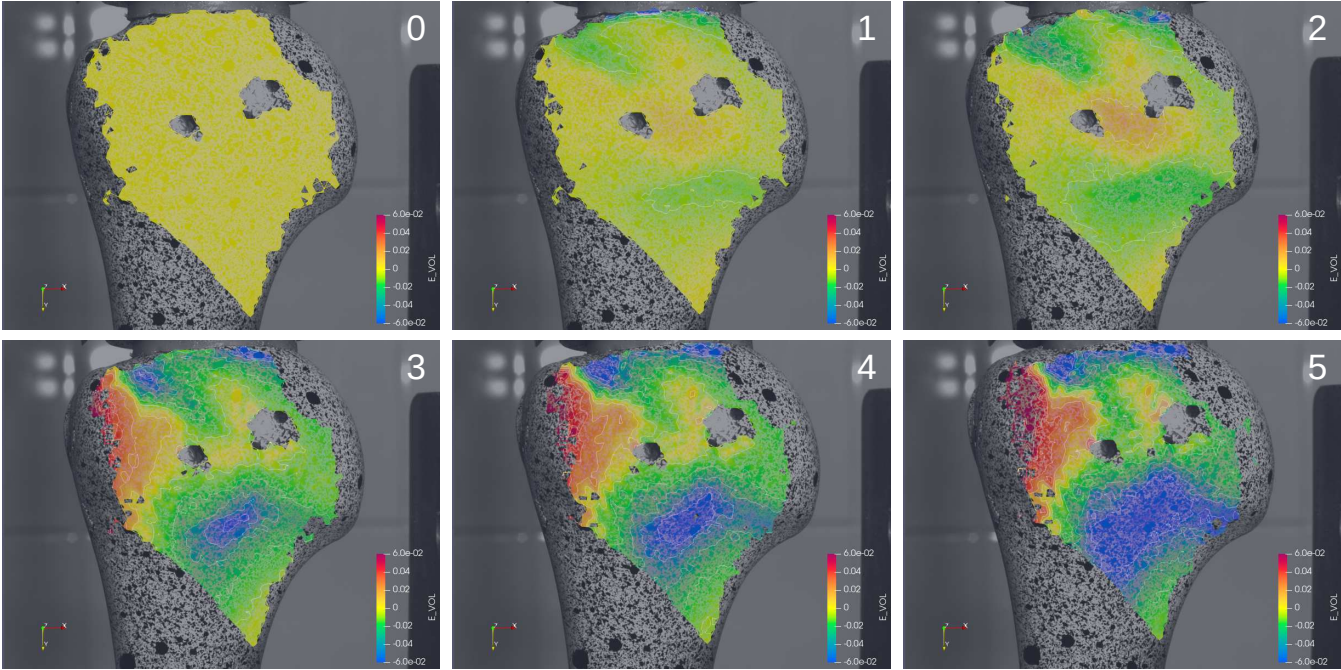

Compression 2 : Ruptures

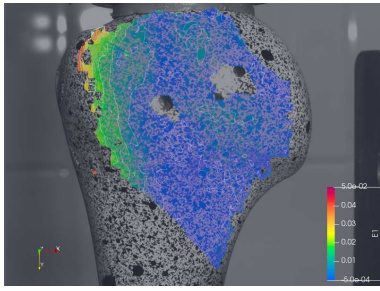

1: Première rupture

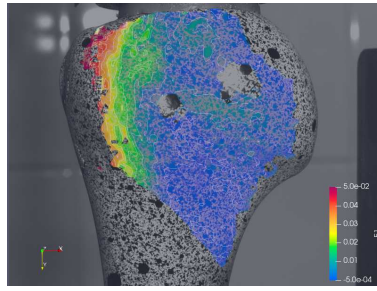

2: Deuxième rupture

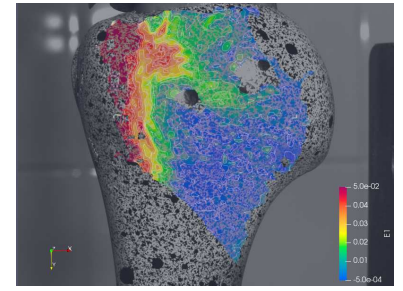

3: Troisième rupture

Compression 2 : Mode de déplacement

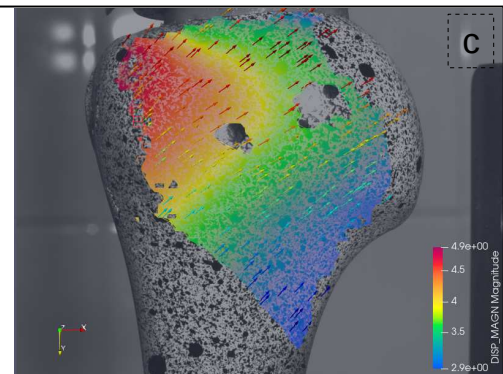
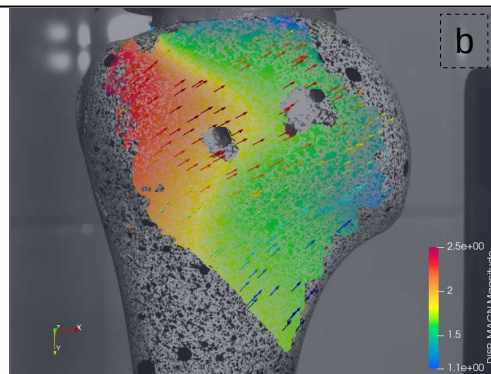
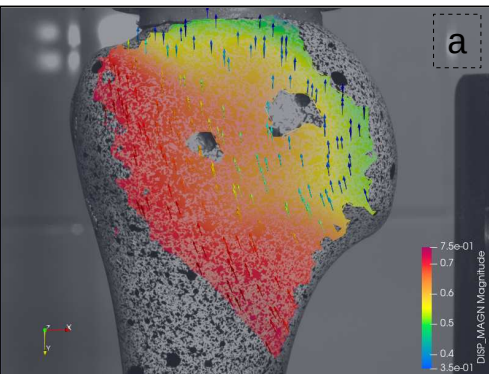
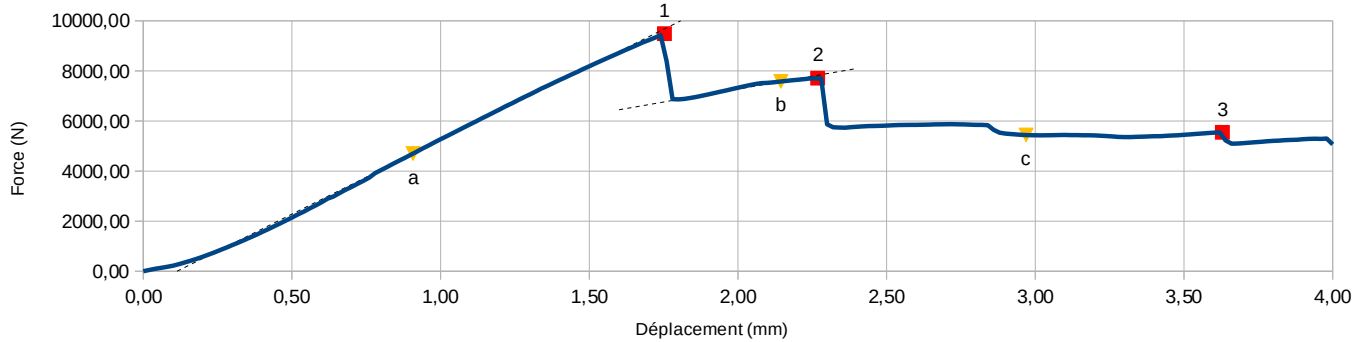

Compression Sain 3



Compression Sain 3

Compression Os Sain Test 3

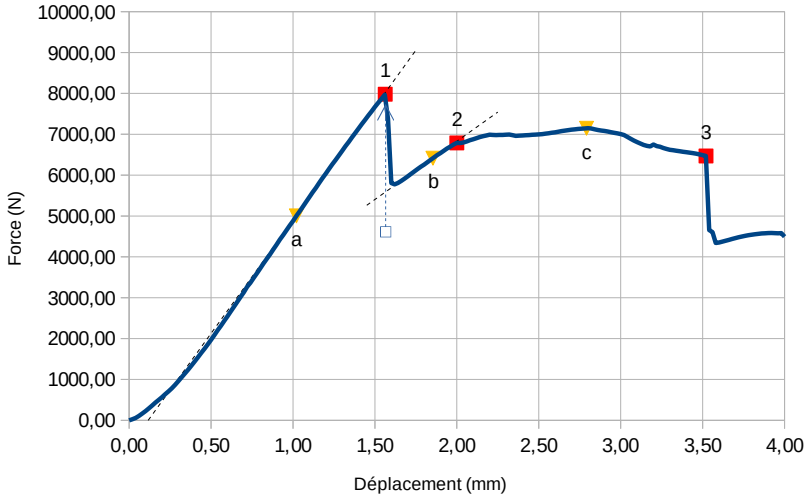

#	Dépl (mm)	Force (N)	
1	1,56	7980,81	Première rupture
2	2,00	6789,04	Deuxième rupture
3	3,52	6468,96	Troisième rupture

(T) Transition sens vitesse



Pente (N/mm)	
5542,36	Élastique
2850,18	Poussée par diaphyse et par tête fracturée

Compression 3 : Déplacement

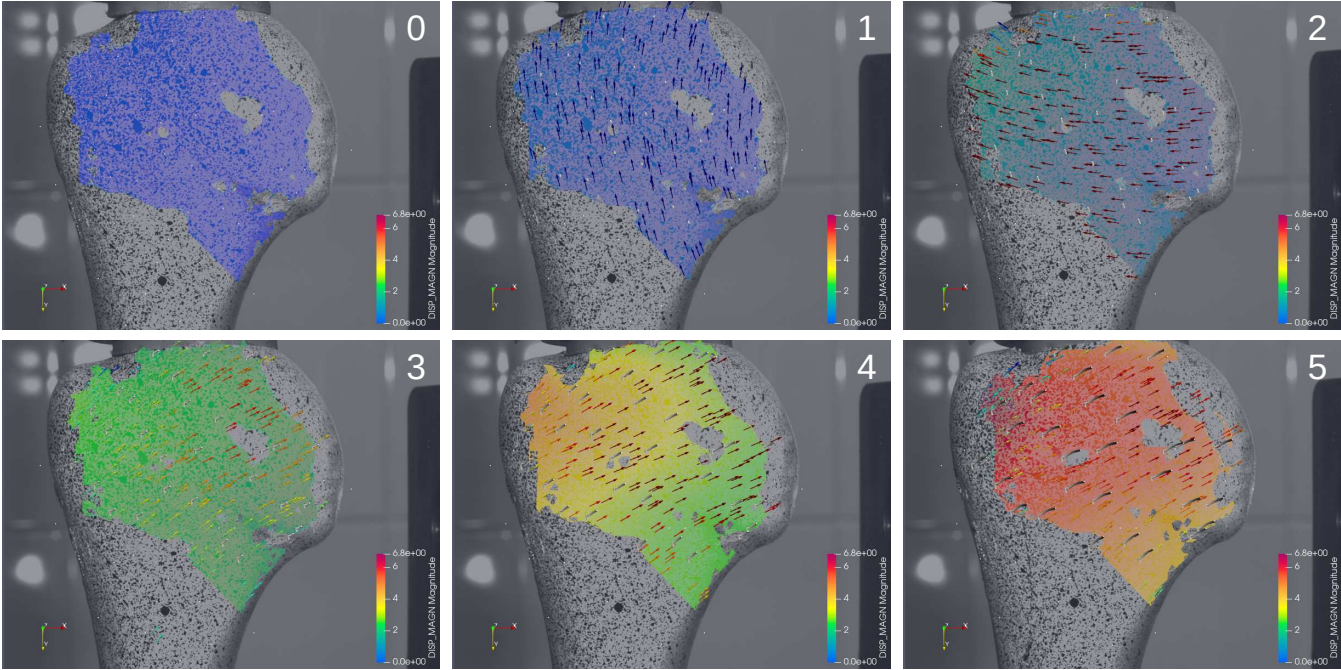

Compression 3 : Déformation Vol.

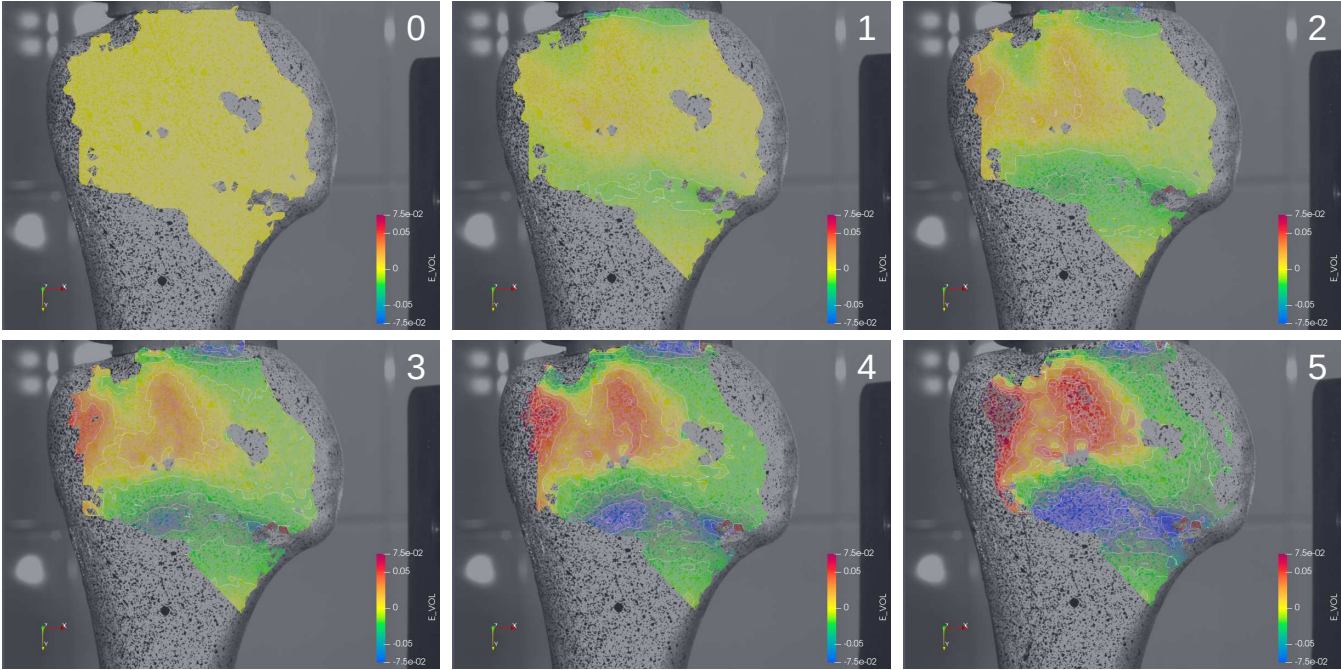

Compression 3 : Ruptures

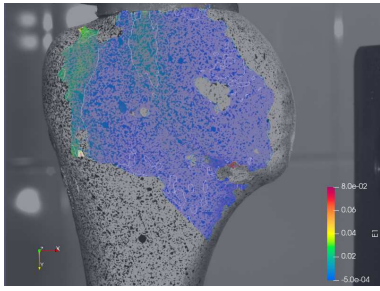

1: Première rupture

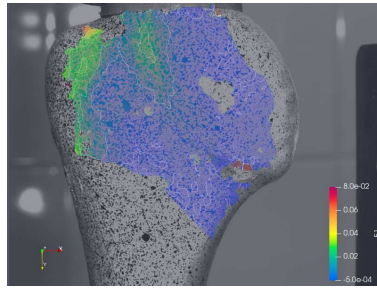

2: Deuxième rupture

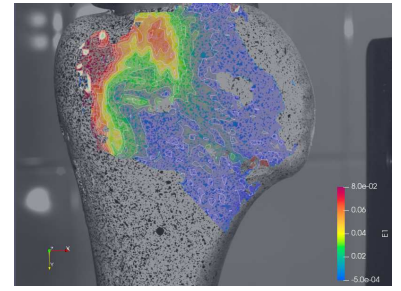

3: Troisième rupture

Compression 3 : Mode de déplacement

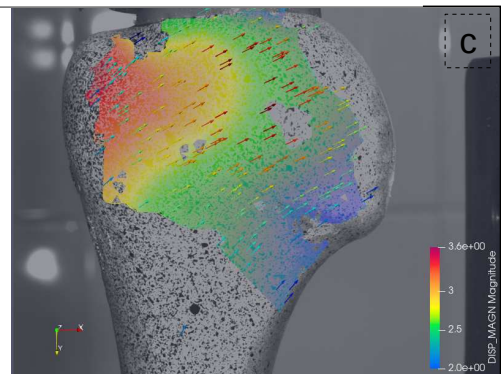
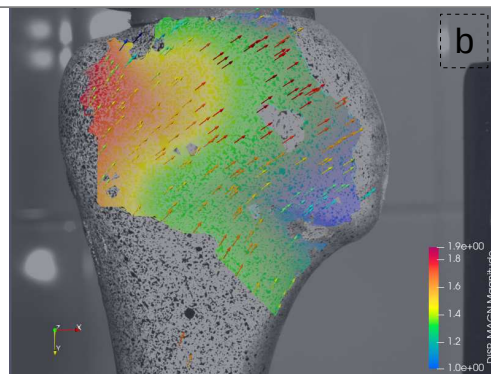
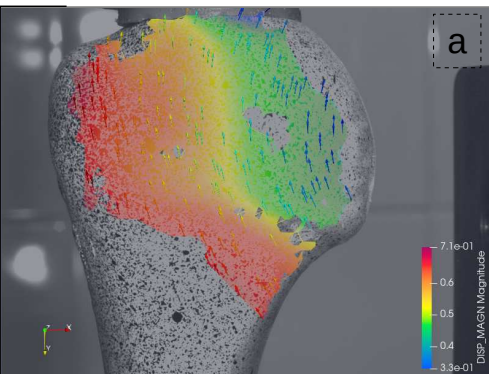
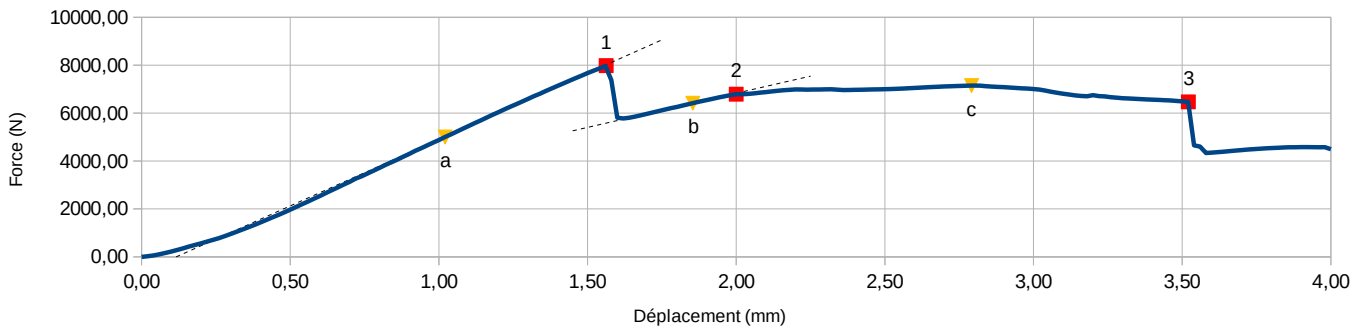

Compression Sain 4

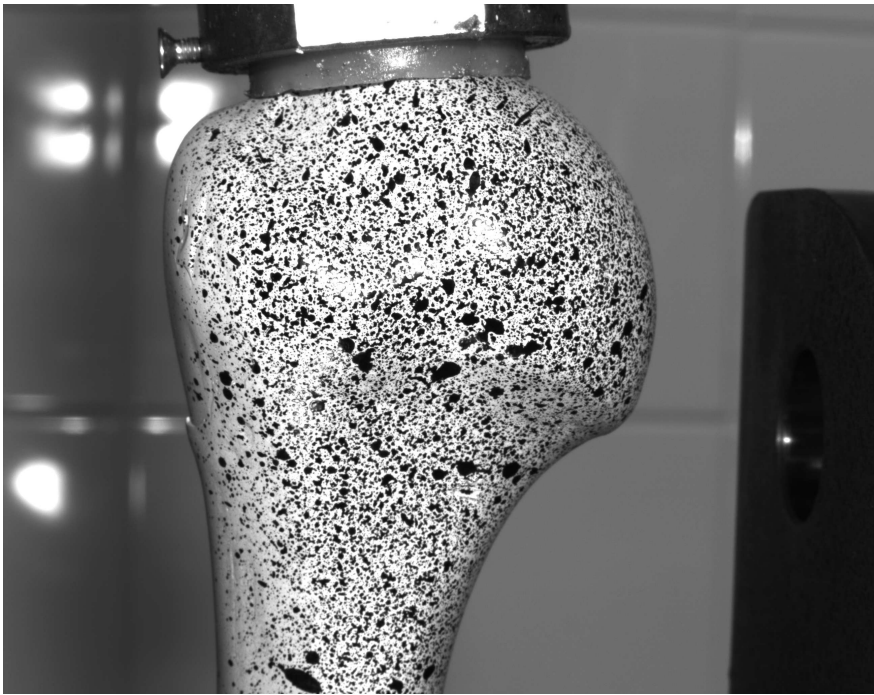

Compression Sain 4

Compression Os Sain Test 4

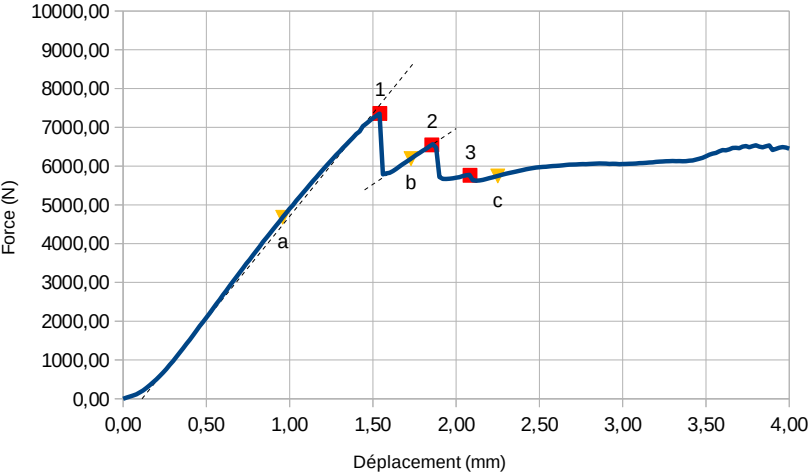

#	Dépl (mm)	Force (N)	
1	1,54	7357,65	Première rupture
2	1,85	6547,88	Deuxième rupture
3	2,08	5763,18	Troisième rupture

(T) Transition sens vitesse



Pente (N/mm)	
5306,99	Élastique
2874,35	Poussée par diaphyse et par tête fracturée

Compression 4 : Déplacement

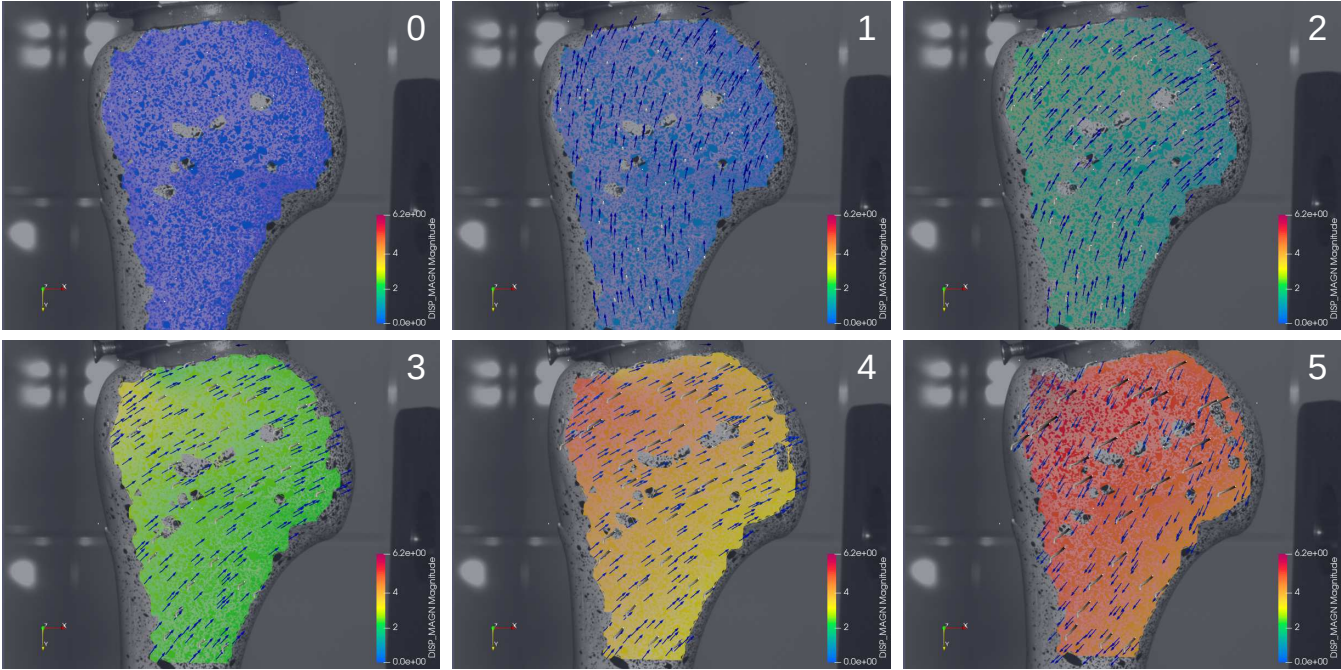

Compression 4 : Déformation Vol.

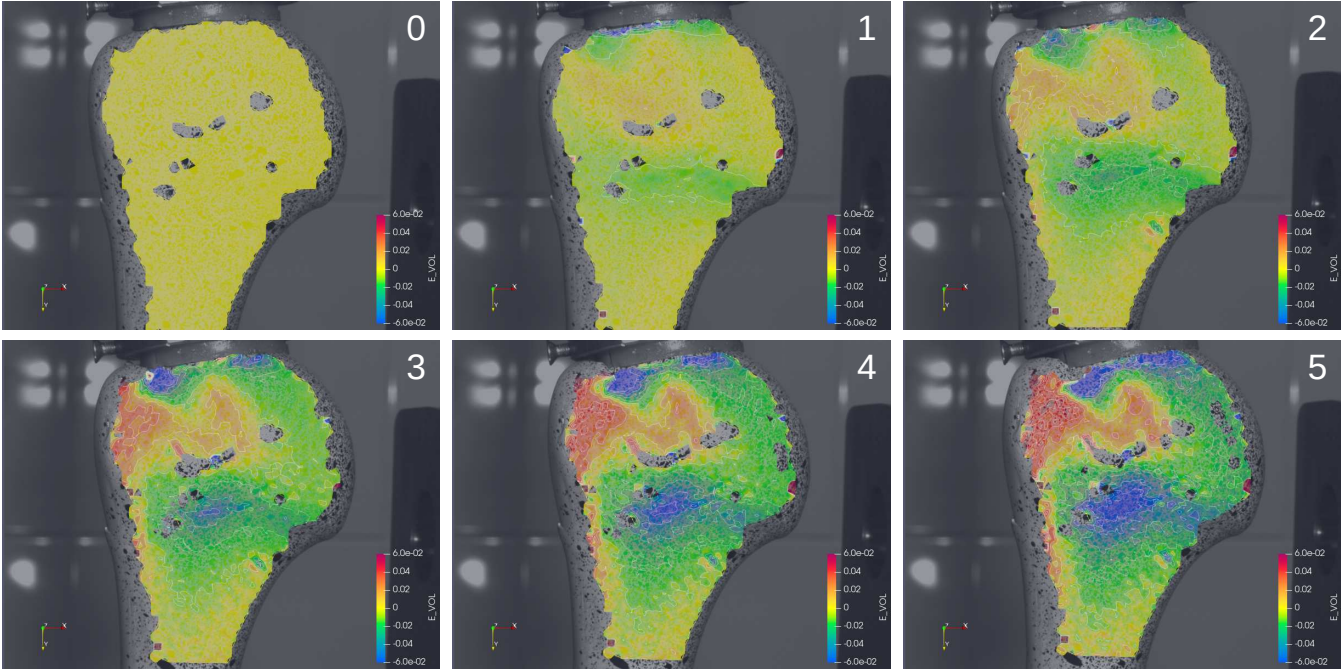

Compression 4 : Ruptures

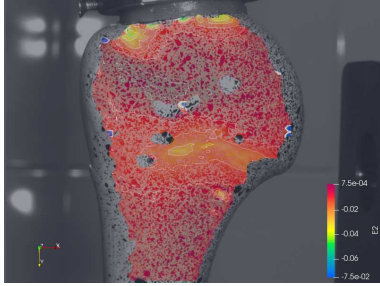
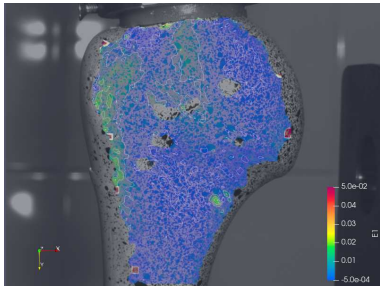

1: Première rupture

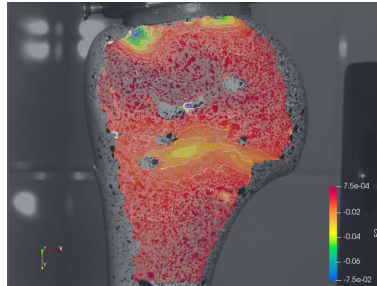
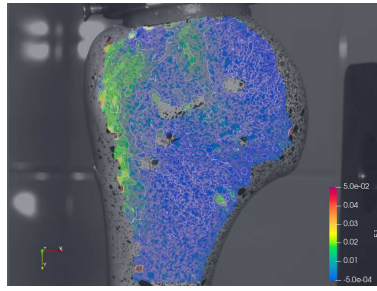

2: Deuxième rupture

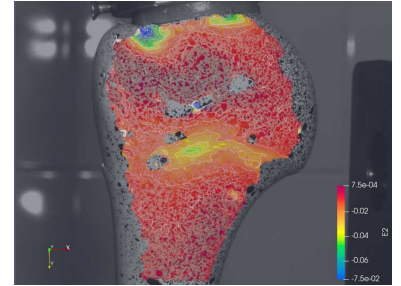
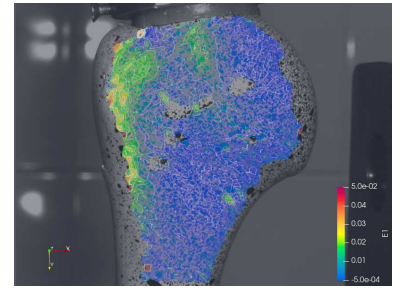

3: Troisième rupture

Compression 4 : Mode de déplacement

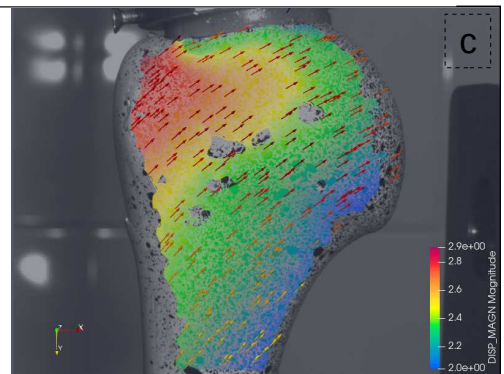
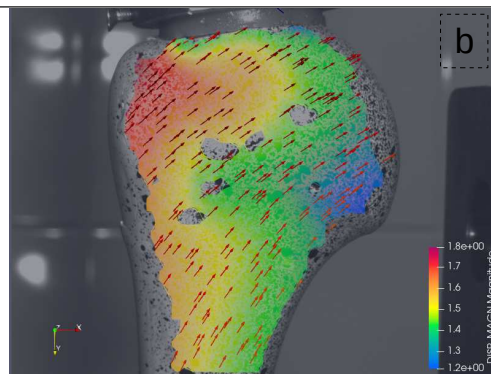
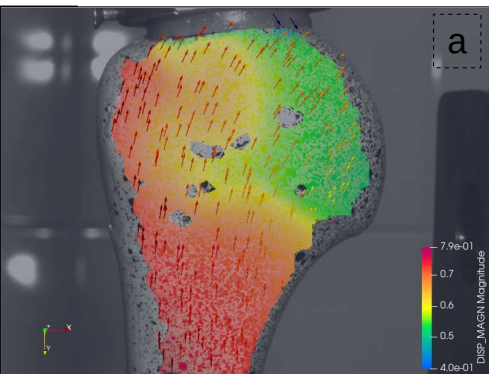
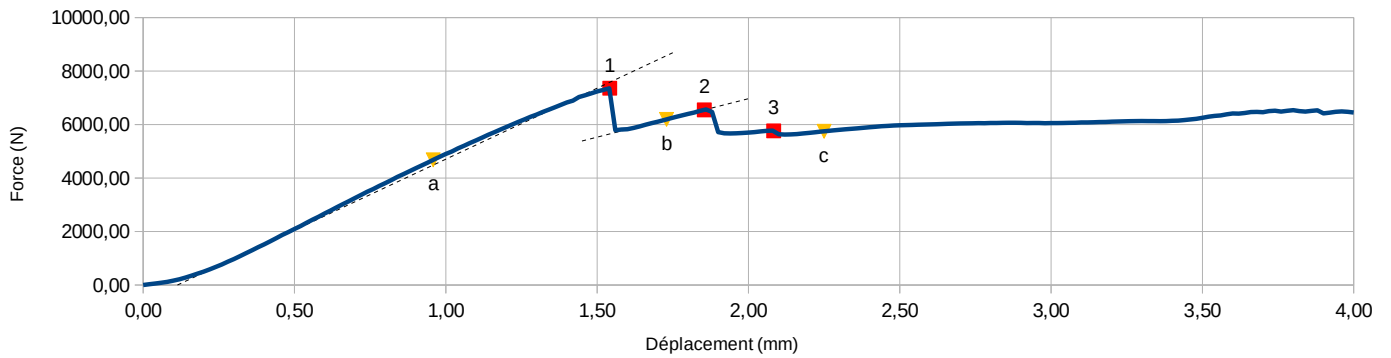

Annexe F

Résultats des essais en traction

Annexe G

Bilan des modèles ÉF de l'humérus et de l'articulation gléno-humérale

Comparative Modèles Abaquus

Nom fichier	Modèle	Image	Description	Propriétés matériau:Interactions
Hum_10_Unin.cae	Humerus_90_lignes		Récupération du modèle de la thèse de Clavert (humérus et bourrelet glénoïdien)	Os : Spongieux [350], Cortical [16000], Cartilage [2], Sous-chondral [3500] Contact Cartilages : Finite sliding, Surf-to-surf, Stabilisation automatique, Frictionless hard contact non-linear penalty Couplin Distal : Surface transverse distale, U1 – U6
model_A0.cae	A0i A0ii A0iii A0iv A0v A0vi A0viii		Humerus sain (Cort, Trab, Sawbone) avec corde (duo beam/truss) pour traction à 90° (comme Clavert)	Corde : Beam [0.1], Truss [1e6], corde radius 2 Os : Canc [155], Cort [16000] [MPa] Contacts : Small Sliding, Node-to-Surface, Hard Contact, Frictionless Coup-Kins : Proximale, Distale [U1 – U6], Corde [U1 – U3]
Model_A1.cae	A1i A1i-C		Humerus (Cort, Trab, Sawbone) cassé 4 fragments avec IM et avec corde (duo beam/truss), vis simulés avec coupkins et éléments type poutres, traction à 90° comme Clavert	Corde : Beam [0.1], Truss [1e6], corde radius 2 Clou : vis prox radius 2.5, vis dist radius 2.25, Polymer [1000], Titan [110000] [MPa] Os : Canc [155], Cort [16000] Contacts corde/os : Small Sliding, Node-to-Surface, Hard Contact, Frictionless Contacts osos et os/clou : Small Sliding, Surf-to-Surf, Initial overclosure removal, Hard contact, Frictionless Coup-Kins Os : Proximale, Distale [U1 – U6], Corde [U1 – U3] Coup-Kins vis : U1 – U6 deux bouts
Model_V1.cae	Modele_v1		Humerus Sain (Cartilage, Sous-chondral et trabéculaire) avec Scapula, Bourrelet, pour reproduire essai thèse Clavert	Os : Cartilage [2], Cortical [16000], Sous-chondral [3500], Spongieux [550] Contact : Humérus / Bourrelet Glenoïdien, Finite Sliding, Surf-to-Surf, Frictionless, Linear Stiffness 1, Stabilisation Auto Coup-kin : Distale, U1 – U6
Model_V2.cae	VHP_v1_abd30		Humerus Sain (Cartilage, Sous-chondral et trabéculaire) à 30° avec Scapula, Bourrelet	Os : Cartilage [2], Cortical [16000], Sous-chondral [3500], Spongieux [550] Contact : Humérus / Bourrelet Glenoïdien, Small Sliding, Surf-to-Surf, Friction 0.03, Penalty Linear Stiffness 1, Stabilisation Step 1, plus de stabilisation Step 2 Coup-kin : Distale, U1 – U6
Model_Cale_V2.cae	Hume_Cale_V1-0 Hume_Cale_V1-30 Hume_Cale_V1-60 Hume_Cale_V1-90 Hume_Cyl_V1-0 Hume_Cyl_V1-30 Hume_Cyl_V1-60 Hume_Cyl_V1-90		Humérus fracture 2-fragments, deux cas analysés : ostéotomie cunéiforme (selon Brianza) et cylindrique. Avec clou et tous les vis mis en place. 4 chargements compressives appliqués, à 0°, 30°, 60° et 90° par rapport à l'axe diaphysaire. Modèle VHP mais avec des propriétés mécaniques de Sawbone, donc, sans cartilage pris en compte.	Os : Spongieux [155], Cortical [16000] Clou et vis : Polymère [1000], Titan [114000], r = 2.5 (prox) et 2.25 (dist) Contact : Os / Clou, Finite sliding, surf-to-surf, Initial overclosure removal, stabilisation automatique, coeff frot = 0.3, hard contact non-linear penalty (max stiff 10) Contact : Os / Os, Finite sliding, surf-to-surf, Initial overclosure removal, SANS stabilisation automatique, coeff frot = 0.3, hard contact non-linear penalty (max stiff 10) Couplin proximale : Nœuds de zone d'appui sur la tête humérale – nœud maître. U1 – U6 Couplin distale : Nœuds de la section transverse de la diaphyse distal – nœud maître. U1 – U6 Vis : Voir NOTE 1
Hum_Cune_Comp_Lin			Humérus fracture 2-fragments ostéotomie cunéiforme inverse (même	Os : Spongieux [155], Cortical [16000] Contact : Os / Os, Finite sliding, surf-to-surf, Coeff frot = 0.3, Hard contact non-linear penalty Contact : Os / Clou, Finite sliding, surf-to-surf, Initial overclosure removal, Coeff frott 0.3, Hard contact non-linear penalty

Essais_GEBOAS_v2.cae

Hum_Cune_Comp_Qua



que Kathrein2013) (comme l'expérience fait chez nous) testé en compression 0° avec les 3 vis, CF parfaites

Clou et vis : Polymère [1000], Titan [110000], r = 2.5 (prox) et 2.25 (dist)

Couplin Proximale : Nœuds de zone d'appui sur la tête humérale – nœud maître. U1 – U6

Couplin distale : Nœuds de toute la surface « couvert » par le PMMA de la diaphyse – nœud maître. U1 – U6

Vis : Voir NOTE 1

Essais_GEBOAS_v3.cae

Montage_Comp

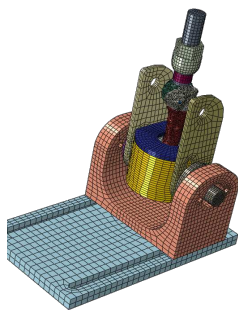

Humérus fracture 2-fragments ostéotomie cunéiforme inverse (même que Kathrein2013) (comme l'expérience fait chez nous) avec les 3 vis, simulé avec le montage complet pour égaliser les CF avec celles de l'expérience

Os : Spongieux [155], Cortical [16000]
Clou et vis : Polymère [1000], Titan [110000], r = 2.5 (prox) et 2.25 (dist)
Montage : Acier 304 = 193000, 0.29 ; PMMA = 2240, 0.4

Contact : Os / Os, Finite sliding, surf-to-surf, Coeff frot = 0.3, Hard contact non-linear penalty

Contact : Os / Clou, Finite sliding, surf-to-surf, Initial overclosure removal, Coeff frott 0.3, Hard contact non-linear penalty

Contact : PMMA / Os, Finite sliding, node-to-surf, overclosure removal tol = 0.1, Stabilisation automatique, Hard contact coeff = 0.2

Contact : Rotule/Couppelle (montage), Finite sliding, node-to-surf, initial overclosure removal, hard contact non-linear penalty coeff = 0.03

Couplin proximale : Nœuds de la surface transverse d'appui, U1 – U6
Couplin Distale : Nœuds du support du vérin, U1 – U6

Vis : Voir Note 1

Ties montage : Toutes les surfaces «visés» du montage ont été collés par des «ties» avec une tol = 0.5

Sim_Banc.cae

- Compression-0
- Compression-30
- Compression-60
- Compression-90
- Traction-0
- Traction-30
- Traction-60
- Traction-90
- Mixte-0
- Mixte-30
- Mixte-60
- Mixte-90

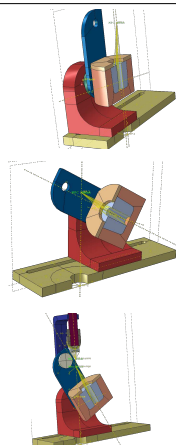

Simulation du montage développé par les étudiants GICE afin de caractériser sa résistance et sa raideur pour les 3 cas de chargements : Compression, Mixte et Traction, à 4 angles différents : 0°, 30°, 60° et 90°

Montage : Acier 304 = 193000, 0.29 ; PMMA = 2240, 0.4

Contact PMMA / Seau, small sliding, initial overclosure removal, surf-to-surf, coeff frot = 0.5, hard contact

Contact Seau / Bras et Taquets, small sliding, initial overclosure removal, surf-to-surf, coeff frot = 0.1, hard contact

Contact Coupelle/Rotule (cas traction et mixte) : finite sliding, initial overclosure removal, surf-to-surf, coeff frot = 0.1, hard contact

MPC beam axes rotation : nœuds esclaves les deux surfaces, nœud maître = orphan

Couplin base : Nœuds de support vérin U1 - U6

MPC beam PMMA Seau / Humérus (RP) : Nœuds du moulage PMMA, nœud maître = RP

MPC beam PMMA Coupelle / Humérus (RP2) : Nœuds du moulage coupelle PMA, nœud maître = RP2 (cas mixte)

MPC Link (cas mixte) : Link entre RP et RP2

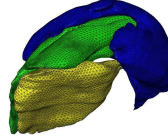
Conditions de Frontière	Maillage	Rapport	Notes	Annexes
Surface « Extérieur » du Bourrelet : U1 – U3 fixé Coup-kin Distale : U1, U3 et UR1 libres, pour permettre abduction Forces. SS [-33.46, -56.952, 23.1]; SE [-22.0406, -11.7551, 1.01436]; IE [-28.0067, -43.5366, 30.3345]; DELT [-74.8757, -76.0659, -45.4269]	Nodes : 12047, Éléments C3D4 = 4100, C3D6 = 1256, C3D8I = 9181	Pres3 du 21 Mars 2017	Modèle tourné également sur Code_ASTER	
	Nodes : 67822; Éléments : C3D4 = 378 719, T3D2H et B31H = 112 Nodes : 46865; Éléments : C3D4 = 260898, T3D2H et B31H = 112 Nodes : 13812; Éléments : C3D4 = 71146, T3D2H et B31H = 112		Corriger CAE	
Coup-Kin Proximale et Distale : Pinned; Bout de la corde : U2, U3 fixés, U1 = 5; Corde : U2 fixé (empêcher mouv perp)	Nodes : 522239; Éléments : C3D10I = 378 719, T3D2H et B31H = 112 Nodes : 360160; Éléments : C3D10I = 260898, T3D2H et B31H = 112 Nodes : 102007; Éléments : C3D10I = 71146, T3D2H et B31H = 112 Nodes : 109962; Éléments : C3D4 = 576411, T3D2H et B31H = 112	Pres_NOV2018, PRES_MAY2018		
	Nodes : 83964; Éléments : C3D4 = 450742, T3D2H et B31H = 112, B32H = 12		Essai avec corde idéalisé, vis quad	
Coup-Kin Proximale et Distale : Pinned; Bout de la corde : U2, U3 fixés, U1 = 10; Corde : U2 fixé (empêcher mouv perp)	Nodes : 83956; Éléments : C3D4 = 446177, T3D2H et B31H = 112, B31H = 8	Pres_NOV2018	Essai avec corde réel (valeurs issues expérience), vis linéaires	
Forces : Deltoid = 32,4 N ; SS = 16,6 ; SE= 6,8 ; IE = 19,6 ; Pesanteur = 19 (Direction obtenus de Ackland & Pandy 2009 pour abduction à 0°) [voir Forces_Humerus] Coup-kin Humérus : U2, UR1 et UR3 fixés (mouvement abduction sur plan) Côté Proximale Scapula : Bloqué	Nodes : 61202, Éléments C3D4 = 300204	Pres_NOV2018	Simulations qui peinent à tourner, car forces ne sont pas cohérents au modèle traction (corde) et car mauvaise gestion contact bourrelet glenoïdien	NOTE 0
Forces : Deltoid = 32,4 N ; SS = 16,6 ; SE= 6,8 ; IE = 19,6 ; Pesanteur = 19 (Direction obtenus de Ackland & Pandy 2009 pour abduction à 30°) [voir lines_action.ods] Coup-kin Humérus : U2, UR1 et UR3 fixés (mouvement abduction sur plan) Côté Proximale Scapula : Bloqué	Nodes : 61202, Éléments C3D4 = 300204	Pres_NOV2018	Problèmes avec les CF, notamment pour stabiliser la simulation en appliquant les forces. 2 Steps, premier avec stabilisation, deuxième sans stabilisation. Doute sur l'application des forces.	Les muscles ont été aussi segmentés, mais jamais testés 
Coup-kin Distale : Encastré Coup-kin proximale : Déplacement 3 mm sur l'axe d'application de la force [U1 local] (0°, 30°, 60°, 90°), [U2, U3 locales = 0] [UR1 – UR3 = autorisés]	Nodes : 50063, Éléments C3D4 = 234978, B31 = 232	Pres_V1 du 21 Feb 2019	Faut révisiter les CF ainsi que les vis (trop de vis peut-être?)	NOTE 1
	Nodes : 59733, Éléments C3D4 = 295075, B31 = 160		La raideur globale ne colle pas avec celle issue des expériences au GEBOAS, probablement pour les CF « trop » parfaites. Par contre, je n'ai pas encore vérifié si les champs de déformations sont différents par rapport aux expériences. A voir	
Coup-kin Proximale : U1 – U3				

Coup-kin Distale : U1 – U6 bloqués
avec U3 = 4mm

Nodes : 434031, Éléments C3D10I
= 295075, B31 = 160

Même si la raideur globale semble trop élevée par rapport aux expériences, la dynamique du mouvement « apparent » semble être très similaire

NOTE 2

Coup-kin Proximale : Encastré
Coup-kin Distale : Encastré sauf U
(axe vérin) = 4

Nodes : 98068, Éléments C3D4 =
318885, C3D8I = 24166, B31 = 160

ESB Vienne 2019

Modèle qui s'approche beaucoup plus à l'expérience physique, même s'il y a encore des « zones à raffiner ». Faudra voir comment convertir ce montage en CF pour un modèle simplifié

J'avais aussi commencé à préparer le modèle GEBOAS de traction mixte, mais plus de temps de tourner la simulation

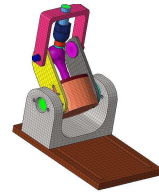

Charge sur RP humérus : -750 N
(compression) sur l'axe du vérin, pour les 4 angles

Nodes : 55036, Éléments C3D20R =
10776

CF Base : Encastrement
CF symétrie : Y-Symm (sur plan Y,
donc modèle coupé à moitié)

Charge sur RP humérus : 750 N
(traction) sur l'axe du vérin
Y-Symm

Nodes : 55036, Éléments C3D20R =
10776

Rapport Stage Benoit
Andreys

Charge sur RP humérus : 750 N
(traction) sur l'axe du seuil (0°, 30°,
60° et 90°)

Nodes : 70015, Éléments C3D20R =
13547

Charge sur RP2 coupelle : 750 N
(traction) sur l'axe du vérin
Y-Symm

Révoir les CF sur ce modèle car pas convaincu que les deux forces appliqués soient pertinents pour caractériser cette configuration