



HAL
open science

Data collection of mobile sensor networks by drones

Xiaoyan Ma

► **To cite this version:**

Xiaoyan Ma. Data collection of mobile sensor networks by drones. Other [cs.OH]. Institut National Polytechnique de Toulouse - INPT, 2017. English. NNT : 2017INPT0099 . tel-04228452

HAL Id: tel-04228452

<https://theses.hal.science/tel-04228452>

Submitted on 4 Oct 2023

HAL is a multi-disciplinary open access archive for the deposit and dissemination of scientific research documents, whether they are published or not. The documents may come from teaching and research institutions in France or abroad, or from public or private research centers.

L'archive ouverte pluridisciplinaire **HAL**, est destinée au dépôt et à la diffusion de documents scientifiques de niveau recherche, publiés ou non, émanant des établissements d'enseignement et de recherche français ou étrangers, des laboratoires publics ou privés.



Université
de Toulouse

THÈSE

En vue de l'obtention du

DOCTORAT DE L'UNIVERSITÉ DE TOULOUSE

Délivré par :

Institut National Polytechnique de Toulouse (INP Toulouse)

Discipline ou spécialité :

Réseaux, Télécommunications, Systèmes et Architecture

Présentée et soutenue par :

Mme XIAOYAN MA

le lundi 6 novembre 2017

Titre :

Data Collection of Mobile Sensor Networks by Drones

Ecole doctorale :

Mathématiques, Informatique, Télécommunications de Toulouse (MITT)

Unité de recherche :

Institut de Recherche en Informatique de Toulouse (I.R.I.T.)

Directeur(s) de Thèse :

M. RIADH DHAOU

M. RAHIM KACIMI

Rapporteurs :

Mme HOUDA LABIOD, TELECOM PARISTECH

M. SIDI MOHAMMED SENOUCI, UNIVERSITE DE BOURGOGNE

Membre(s) du jury :

Mme VÉRONIQUE VEQUE, UNIVERSITE PARIS 11, Président

M. ANDRE LUC BEYLOT, INP TOULOUSE, Membre

M. MICHEL MAROT, TELECOM SUD PARIS, Membre

M. RAHIM KACIMI, UNIVERSITE TOULOUSE 3, Membre

M. RIADH DHAOU, INP TOULOUSE, Membre

Acknowledgment

I'm indebted to numerous people who have helped me in understanding this research field and in writing this thesis. A prominent place and heartfelt thanks are owed to my two supervisors at the Institut de Recherche en Informatique de Toulouse (IRIT) group, Prof. Riadh DHAOU and Prof. Rahim KACIMI. They encouraged me to learn the wireless sensor network from the foundation. And they provide me research discussion seminars at least one time each week. Meanwhile, they also provide me suggestions via email, phone, meeting whenever I meet problems in my study. They help me write the thesis and correct it word by word. Also, I'm grateful to many colleagues with whom I had the pleasure and the privilege to discuss sensor network research issues, especially Prof. André-Luc BEYLOT. I am honored to have the opportunity to take part in the group seminars that organized by him, and he provide me lot of ideas on my research field. Prof. Houda LABIOD from TELECOM ParisTech and Prof. Sidi Mohammed SENOUCI from université de Bourgogne did an excellent job in proofreading and criticizing an intermediate version of this thesis. Prof. Michel MAROT from TELECOM Sud-Paris and Prof. Véronique VEQUE from Université de Paris-Sud provided me with many useful comments.

I'm also want to express my deep gratitude to all the researchers in the field who have made their results and publications easily available over the World Wide Web. Without this, collecting the material discussed in the thesis would have been too big a challenge to embark on.

And last, but most importantly, I'm very deeply indebted to my family for bearing with me during the writing of thesis, hoping, and working.

Resume

La collecte de données par des réseaux de capteurs autonomes mobiles peut être couplée à l'utilisation de drones qui constituent une solution de backhauling facilement déployable à faible coût. Ces moyens de collecte peuvent servir lors de l'organisation d'événements temporaires (sportifs ou culturels) ou encore pour mener des opérations dans des terrains difficiles d'accès ou hostiles. L'objectif de cette thèse est de proposer des solutions efficaces pour la communication à la fois entre capteurs mobiles au sol et sur la liaison bord-sol. A ces fins, nous nous intéressons à l'ordonnancement des communications, au routage et au contrôle de l'accès sur la liaison capteurs/drone, le collecteur mobile. Nous proposons une architecture répondant aux contraintes du réseau. Les principales sont l'intermittence des liens et donc le manque de connectivité pour lesquelles des solutions adaptées aux réseaux tolérants aux délais sont adoptées. Vu la limitation des opportunités de communication avec le drone et la variation importante du débit physique, nous avons proposés des solutions d'ordonnancement qui tiennent compte à la fois des durées de contact que du débit physique. Le routage opportuniste est également fondé sur ces deux critères à la fois pour la sélection des nœuds relais que pour la gestion des files d'attente. Nous avons souhaité limiter l'overhead et proposer des solutions efficaces et équitables entre capteurs mobiles au sol. Les solutions proposées ont montré leur supériorité par rapport aux solutions d'ordonnancement et de routage classiques. Nous avons enfin, proposé une méthode d'accès combinant un accès aléatoire avec contention ainsi qu'un accès avec réservation tenant compte des critères précédemment cités. Cette solution flexible permet à un réseau de capteurs mobiles denses de se rapprocher des performances obtenues dans un mode oracle. Les solutions proposées peuvent être mises en œuvre et appliquées dans différents contextes applicatifs pour lesquels les nœuds au sol sont mobiles ou aisément adaptées au cas où les nœuds sont statiques.

Abstract

Data collection by autonomous mobile sensor arrays can be coupled with the use of drones which provide a low-cost, easily deployable backhauling solution. These means of collection can be used to organize temporary events (sporting or cultural) or to carry out operations in difficult or hostile terrain. The aim of this thesis is to propose effective solutions for communication between both mobile sensors on the ground and on the edge-to-ground link. For this purpose, we are interested in scheduling communications, routing and access control on the sensor / drone link, the mobile collector. We propose an architecture that meets the constraints of the network. The main ones are the intermittence of the links and therefore the lack of connectivity for which solutions adapted to the networks tolerant to the deadlines are adopted. Given the limited opportunities for communication with the drone and the significant variation in the physical data rate, we proposed scheduling solutions that take account of both the contact time and the physical flow rate. Opportunistic routing is also based on these two criteria both for the selection of relay nodes and for the management of queues. We wanted to limit the overhead and propose efficient and fair solutions between mobile sensors on the ground. The proposed solutions have proved superior to conventional scheduling and routing solutions. Finally, we proposed a method of access combining a random access with contention as well as an access with reservation taking into account the aforementioned criteria. This flexible solution allows a network of dense mobile sensors to get closer to the performance obtained in an oracle mode. The proposed solutions can be implemented and applied in different application contexts for which the ground nodes are mobile or easily adapted to the case where the nodes are static.

Abbreviations and notations

Abbreviations

AD-PS MAC	Adaptive inter-beacon duration and proactive scheduling MAC protocol
AHC	Average hop count
AL	Average latency
ANOR	All node opportunistic routing algorithm
BOP	Beacon only period
CBP	Contention based period
CDT	Contact duration time algorithm
CDT/DR	Contact duration time/Data-rate algorithm
CFP	Contention free period
CSMA	Carrier Sense Multiple Access
DR	Data-rate algorithm
DR/CDT	Data-rate/Contact duration time algorithm
DTN	Delay-tolerant networking
FANET	Flying ad hoc network
FD-PS MAC	Fixed inter-beacon duration and proactive scheduling MAC protocol
F-SS	Communication between forwarders and simple nodes
HVOR	Highest velocity opportunistic routing algorithm
IBD	Inter-beacon duration
MAC	Medium Access Control

MANET	Mobile ad hoc network
PDR	Packet delivery ratio
PGT	Periodically generated traffic
PRR	Packet received ratio
RGT	Randomly generated traffic
ROR	Routing overhead ratio
SCH	Scheduling information
TC	Transmission capacity
TOCC	Transmission with opportunistic competition capacity algorithm
UAV	Unmanned aerial vehicle
UAV-F	Communication between UAV and forwarders
VANET	Vehicular ad hoc network
WSN	Wireless sensor network

Notations

\mathbb{F}	The set of forwarders
\mathbb{S}	The set of sensors
\mathbb{T}	The set of time slots
\mathbb{G}	The set of simple nodes
\mathbb{V}	The set of sensors velocities
\mathbb{S}_{t_i}	The set of sensors that within the range of the UAV in time slot t_i
α	The duration time of one time slot
$d(U, S_i)$	The distance between UAV and sensor S_i ($S_i \in \mathbb{S}$)
$d(S_k, S_i)$	The distance between the sensor S_k and S_i ($S_k, S_i \in \mathbb{S}$)
$Dr(j)$	The data-rate of level j ($j = 1, 2, 3, 4$)
$Dr(j, i)$	The data rate between sensor S_i ($S_i \in \mathbb{S}$) and the UAV within time slot t_j ($t_j \in \mathbb{T}$)
h	The fly height of the UAV
N	The number of mobile sensors
N_s	The number of sensors that send at least one packet in time T ;
N_{ts}	The number of time slots
$N_{pk}(i)$	The number of packets that the UAV has collected from sensor S_i ($S_i \in \mathbb{S}$) in time T
$N_{ts}(i)$	The number of time-slots allocated to sensor S_i ($S_i \in \mathbb{S}$) within T
$N_{pk}(j, i)$	The number of packets collected by the UAV from sensor S_i ($S_i \in \mathbb{S}$) within time-slot t_j ($t_j \in \mathbb{T}$)
$N_{tss}(j, i)$	$N_{tss}(j, i) = 1$ means that time slot t_j ($t_j \in \mathbb{T}$) is allocated to sensor S_i ($S_i \in \mathbb{S}$)
P_d	The total number of packets delivered in time T
P_g	The total number of packets that are generated in time T
P_r	The total number of relayed packets
$Pk_Ge(i, j)$	The number of packets generated by sensor S_j ($S_j \in \mathbb{S}$) till time-slot t_i ($t_i \in \mathbb{T}$)

$Pk_Re(i, j)$	The number of remaining packets of sensor S_j ($S_j \in \mathbb{S}$) till time-slot t_i
$Pk_Se(i)$	The number of packets that S_i ($S_i \in \mathbb{F}$) successfully sent to the UAV
$Pk_Sum(i)$	The sum of packets that S_i has
r	The communication range of the UAV and the mobile sensors
$S_i(x_{it_k}, y_{it_k})$	The coordinates of sensor S_i ($S_i \in \mathbb{S}$) in time slot t_k ($t_k \in \mathbb{T}$)
T	The simulation time
T_{icdt}	The contact duration time of sensor S_i ($S_i \in \mathbb{S}$) when it is within the communication range of the UAV
T_{k-CBP}	The contention based period in $k - th$ inter-beacon duration
T_{k-CFP}	The contention free period in $k - th$ inter-beacon duration
T_{Ubd}	The upper bound of inter-beacon duration
v	The velocity of the UAV
v_i	The velocity of the mobile sensor S_i ($S_i \in \mathbb{S}$)
w_i	The weight of contact duration time of sensor S_i ($S_i \in \mathbb{S}$)
WF_{pk}	The weighted fairness in terms of the number of collected packets
WF_{ts}	The weighted fairness in terms of the number of allocated time slots

Table of contents

Acknowledgment	iii
Resume	v
Abstract	vii
Abbreviations and notations	ix
1 Introduction	1
1.1 Context	2
1.2 Motivation and Assumptions	3
1.3 Contributions	4
1.4 Structure of the Thesis	5
2 State of Art	7
2.1 Introduction	8
2.2 Wireless Sensor Networks	8
2.2.1 Categories of sensors	9
2.2.2 Heterogeneous WSN	10
2.3 Unmanned Aerial Vehicles	11
2.3.1 Categorizes of the UAV	11
2.3.2 Fling Ad-Hoc Network (FANET)	12

2.3.3	Applications of UAV-based WSN	14
2.4	Unmanned Aerial Vehicles as a Communication Node	15
2.4.1	Functionalities	16
2.4.2	Trajectory planning and placement	18
2.5	Data Collection Applications	20
2.5.1	Performance Parameters	21
2.5.2	Classification of the Data Collection Underlying Protocols	22
2.6	Underlying Layers for UAV assisted Networks	23
2.6.1	Routing Protocols	23
2.6.2	Medium Access Control Protocols	31
3	Scheduling Algorithms in Mobile Wireless Sensor Networks	37
3.1	State of Art	40
3.2	Problem Statement	41
3.3	Scheduling Algorithms	43
3.3.1	Analysis of influencing factors	43
3.3.2	Proposed Algorithms	47
3.4	Performance Evaluation	49
3.4.1	Performance Metrics	50
3.4.2	Simulation Results and Discussion	52
3.5	Conclusion	58
4	Opportunistic Communications in WSN Using UAV	61
4.1	Introduction	64
4.2	Problem Statement	65
4.2.1	Sensors Mobility	67
4.2.2	Simple Example to Present the Mobility	68
4.3	Implementing Opportunistic Routing Protocols for UAV-assisted WSN without Guarantee Forwarders	68

4.3.1	Performance Metrics	68
4.3.2	Time slot based Opportunistic Routing Algorithms	70
4.3.3	Simulation Setup	72
4.3.4	Simulation Results and Discussion	72
4.3.5	Summary	77
4.4	Implementing Opportunistic Routing Protocols for UAV-assisted WSN with Guarantee Forwarders	77
4.4.1	Opportunistic Multi-hop Communications	77
4.4.2	Scheduling based Competition Multi-hop Routing Protocols	78
4.4.3	Performance Metrics	81
4.4.4	Evaluation of the proposed algorithms	84
4.4.5	Results and Analysis	86
4.5	Conclusion	91
5	Medium Access Control Protocols	93
5.1	State of Art	95
5.2	Problem Statement	96
5.3	Adaptive Hybrid MAC Protocols	97
5.3.1	Inter-Beacon Duration	97
5.3.2	Hybrid Protocols in UAV-assisted mobile WSN	98
5.4	Network Efficiency Evaluation	104
5.4.1	System Performance	104
5.4.2	Simulation Setup	105
5.4.3	Results and Analysis	106
5.5	Conclusion	111
6	Conclusions and Perspectives	113
6.1	Conclusion	113
6.2	Perspectives	115

6.2.1	Irregular movement paths and areas	115
6.2.2	Irregular movement model	115
6.2.3	Multi-UAVs	116
6.2.4	Experiments	116

Bibliography		130
---------------------	--	------------

Table of figures

2.1	The relationship between FANET, VANET and MANET [10].	14
2.2	Simple Scenario with 1 UAV and 1 Sensor	21
2.3	The categorizes of data collection underlying protocols.	30
3.1	An illustration of time slots covered by sensors S_i and S_j	42
3.2	The different phases of the procedure of allocation.	43
3.3	The impact of UAV velocity on #Packets, WF_{pk} and WF_{ts}	53
3.4	The impact of UAV height on #Packets, WF_{pk} and WF_{ts}	55
3.5	The impact of sensors mobility on #Packets, WF_{pk} and WF_{ts}	56
3.6	The impact of sensors density on #Packets, WF_{pk} and WF_{ts}	57
4.1	Scenario in multi-hop case.	65
4.2	An illustration of multi-hop data collection covered by UAV in time-slot t_k	66
4.3	A simple example to present the contact duration time.	69
4.4	Comparison of <i>HVOR</i> , <i>ANOR</i> and <i>DC</i> , with PGT.	73
4.5	Comparison of <i>HVOR</i> , <i>ANOR</i> and <i>DC</i> , with RGT.	74
4.6	The impact of traffic load on the <i>HVOR</i> , <i>ANOR</i> and <i>DC</i> protocols.	76
4.7	The impact of network size on the delivery ratio, energy consumption and fairness.	86
4.8	The impact of time-slot length on the delivery ratio, energy consumption and fairness.	88
4.9	The comparisons of the proposed protocol and the existed protocols.	90
5.1	Superframe architecture.	96
5.2	The upper bound of inter-beacon duration.	98

5.3	Hybrid protocols based on fixed inter-beacon duration.	99
5.4	Hybrid protocols based on adaptive inter-beacon duration.	100
5.5	The simulated protocols in this work.	106
5.6	Evaluation of the proposed protocols.	107
5.7	Comparison with existing protocols.	108
5.8	The impact of inter-beacon duration.	110

List of tables

2.1	Summary of Sensors Categories	9
2.2	Altitude and Weight Classification of Current UAVs	12
2.3	Classification of the Current UAVs according to Range and Endurance	13
2.4	Comparison of existing MAC protocols	32
3.1	Multi-data-rate values	43
3.2	Summary of notations used in this chapter	45
3.3	Simulation parameters	52
4.1	Notations applied in this chapter	67
4.2	Simulation Parameters used in the evaluation of <i>HVOR</i> protocol	72
4.3	Notations applied in <i>TOCC</i> algorithm	81
4.4	Simulation parameters used in <i>TOCC</i> algorithm	85
5.1	The relationship between CBP, CFP and IBD in this work	102
5.2	Simulation parameters	106

CHAPITRE 1

Introduction

Contents

1.1	Context	2
1.2	Motivation and Assumptions	3
1.3	Contributions	4
1.4	Structure of the Thesis	5

1.1 Context

Unmanned aerial vehicles (UAVs) such as balloons and quadcopters are enabled by the advances in computing, communication, and sensing as well as miniaturization of devices. They are receiving significant attention in the research community [42]. Due to their ease of deployment, low maintenance cost and high maneuverability, UAVs become an integral component in critical applications such as border surveillance, disaster monitoring, traffic monitoring, and remote sensing. Such vehicles have also been used in military [7, 74], agriculture [1], and industrial [112] applications. Single or multiple UAVs usually used as communication relays or aerial base stations for network provisioning [50].

More recently, new possibilities for commercial applications and public service for UAVs have begun to emerge, with the potential to change significantly our daily lives such as air delivery service. 2014 has been a pivotal year that has witnessed an unprecedented proliferation of personal drones.

UAVs have also been proposed for delivering broadband data rates in emergency situations through low-altitude platforms. Indeed, several projects in Europe have been investigating the use of aerial base stations to establish opportunistic links and ad-hoc radio coverage during unexpected and temporary events. Moreover, incorporating UAVs into ground networks has attracted more attention from the research community nowadays. For instance, in [105] the authors proposed a cooperative networking framework for multi-UAV guided ground ad hoc networks. A cooperative aerial-ground robotic system is developed for a ground vehicle navigation system through visual feedback from a quadcopter in [79].

The UAV-assisted networks, classified as fly ad hoc networks (FANET) [10], is a special form of mobile ad hoc networks (MANET) and vehicular ad hoc networks (VANET). FANETs have different characteristics from other forms of ad hoc networks, such as, the node mobility, frequency change of node density and network topology, etc. Mobility is a major concern in a UAV-assisted network. Such different characteristics call for the need to design and test new communication protocols in a layered approach suitable for FANETs.

Employing UAVs to provide connectivity for ground sensor networks has been studied in [25]. In this thesis, an aerial-ground cooperative sensor networking architecture is proposed. An unmanned aerial vehicle aids the ground sensor subnetwork for data collection through air-to-ground and ground-to-air communications.

1.2 Motivation and Assumptions

Data collection is an important task in wireless sensor networks and this task has been guided for several years by the most investigated theme among researchers which is energy efficiency. Indeed, data collection was studied first in WSNs with one single Sink then with multiple Sinks to balance the energy consumption among the relay sensor nodes. Moreover, other data collection schemes have been proposed based on the use of mobile sinks. It has been argued in the literature that a mobile sink may improve the energy dissipation compared to a static one. Indeed, The drawbacks of using a static sink are well know. For instance, the nodes that are in the sink vicinity deplete their energy much earlier compared to the nodes located farther away from the sink due to higher data relaying load.

Mobility in WSNs has been extensively studied [38, 57]. Most mobile WSNs use custom protocols, developed for each specific application, e.g. crop monitoring [115], pipelines safety detecting [6], etc. However, in highly dynamic networks, it is principal for most of nodes to build connection with the destination because of the limited contact duration time between the source nodes and the destination. We need standard mechanisms that is specific for such highly dynamic networks.

In this thesis, we argue for the use of the UAV as a flying Sink. Although it is clear that such sink improves load balancing among the nodes, it is an open question whether this also leads to improvements in fairness and number of collected packets. Thus, we aim to study those performance metrics in UAV-assisted WSNs. And we concentrate on the MAC and network layers since they are fundamental and crucial blocks for all networks.

Obviously, using a flying sink to collect data from a mobile on-ground sensor network is a challenging task because of the link intermittence and the dynamicity of the network.

Considering all the movement paths can be refined into multiple straight path, we decide to focus on the linear motion mobile networks.

1.3 Contributions

The primary goal of this thesis is to tackle the data collection problem in UAV-aided mobile wireless sensor networks and to propose efficient solutions for data collection in such systems. All the algorithms that we come-up with and the metrics defined in the following chapters follow this goal.

The performance of the data collection relies on different levels. The medium should be shared carefully, giving the limited opportunities for communication between the mobile sensors and the flying UAV, as well as the high variation of the physical parameters (such as data rate which depend on the relative position of communicating nodes). This issue suggests to adapt the medium access layer and to manage the communications according to an efficient transmission scheduling.

The network is delay tolerant, and we focus on noncritical applications, useful for covering sportive events or organizing rescue operations.

Moreover, as a consequence of the mobility of nodes, the network topology is highly dynamic, and the opportunities given to each node to be in a direct contact with the data collector rely heavily on the nodes positions which require opportunistic communications and adapted routing.

Indeed, this thesis proposes innovative data collection scheduling schemes, it also modifies the MAC and routing levels, to meet the requirements of the studied system.

Firstly, we propose four new contention free algorithms for data collection in UAV-assisted mobile WSN.

The main performance metric in data collection issues is the packet delivery ratio. And the main factors that affect the performance are the data-rate and contact duration time between the source nodes and the destinations. Based on the two metrics, we proposed four data collection algorithms in Chapter 3. To ensure the contention free, we divide the time into short unit time slots, and only one node has an opportunity to send data in the time slot.

Secondly, we highlight the impact factors of data-rate and contact duration time and study the in-depth factors : the sensors velocities. Combining these factors, we propose a highest velocity opportunistic routing algorithm.

Each routing protocols is different regarding the application environment. In UAV-assisted mobile WSN, both

source nodes and destination move. Thus, the nodes speed has a huge impact on the performance metrics. Then, we propose a highest velocity opportunistic routing (*HVOR*) algorithm. In *HVOR*, the source nodes only build connections with the one that has the highest velocity among its neighbors. Similar to traditional opportunistic routing algorithms, the selected nodes in *HVOR* cannot guarantee the communication between the relay nodes and the destinations.

Thirdly, we propose an opportunistic routing protocol which provides a guaranteed communication between the forwarders and the destination.

Combing all the aforementioned impact factors, we define the *competition compacity* for each relay node. We propose a forwarder selection algorithm and make a *scheduling* between the forwarders and the UAV. The *scheduling* guarantees that each forwarder has an opportunity to communicate with the UAV. Finally, the transmission with an opportunistic competition capacity (*TOCC*) algorithm is proposed for the communication between forwarders and the simple nodes.

Finally, we introduced two adaptive hybrid MAC protocols based on beacons that improve the packet delivery ratio and the fairness.

In beacon based IEEE 802.15.4 protocol, the scheduling information in the beacon is used for next inter-beacon duration.

This metric has a limitation in our studied scenarios. That is because the contact duration time between the source node and the destination is limited in highly dynamic networks. Based on the dynamic characters, we define an upper bound for the inter-beacon duration. During each inter-beacon duration, we define the contention-based duration and contention-free duration adaptively according to the real-time topology information of the network. In the proposed adaptive hybrid MAC protocols, we fully take into account the real-time dynamic topology of the network.

1.4 Structure of the Thesis

This thesis is organized in six chapters. The first chapter presents a context to the wireless sensor networks, the motivation and contributions of this thesis. The second chapter concentrates on the state of art on

unmanned aerial vehicles assisted WSN. The categories of sensor, UAV and their applications are presented in this chapter. It also introduces the functionalities of the UAV as a communication node, as well as the trajectory planning and placement. Furthermore, the second chapter gives the readers the context on data collection, routing and medium access control for understanding the rest of this thesis.

From Chapter 3, each of chapter presents at least one contribution of this thesis. In Chapter 3, we start with four contention free data collection algorithms in one-hop communications. And we continue on studying the opportunistic routing in multi-hop communications in Chapter 4.

In Chapter 5, we present two novel adaptive hybrid MAC protocols. The two MAC protocols enhance the packet delivery ratio and the fairness of the network. Chapter 6 concludes this thesis and opens up some perspectives.

CHAPITRE 2

State of Art

Contents

2.1	Introduction	8
2.2	Wireless Sensor Networks	8
2.2.1	Categories of sensors	9
2.2.2	Heterogeneous WSN	10
2.3	Unmanned Aerial Vehicles	11
2.3.1	Categorizes of the UAV	11
2.3.2	Fling Ad-Hoc Network (FANET)	12
2.3.3	Applications of UAV-based WSN	14
2.4	Unmanned Aerial Vehicles as a Communication Node	15
2.4.1	Functionalities	16
2.4.2	Trajectory planning and placement	18
2.5	Data Collection Applications	20
2.5.1	Performance Parameters	21
2.5.2	Classification of the Data Collection Underlying Protocols	22
2.6	Underlying Layers for UAV assisted Networks	23
2.6.1	Routing Protocols	23
2.6.2	Medium Access Control Protocols	31

2.1 Introduction

The story of sensor networks can be tracked back to the 1960s, when the United States Navy had deployed a Sound Surveillance System (SOSUS) using hydrophones (microphones deployed underwater) on the bottom of the ocean to detect submarines. They applied 40 hydrophones to trail, then, they extended the project to the entire East and West Coasts [120]. At that time, the transmissions were done through multi-conductor armored cables. Nowadays, wireless sensor nodes are used to detect the earthquakes in the Pacific [62]. Indeed, a new class of networks has appeared in the last decade : the so-called Wireless Sensor Network (WSN). They consist of individual nodes that are able to interact with their environment by sensing or controlling physical parameters ; these nodes have to collaborate to fulfill their tasks as, usually, a single node is incapable of doing so ; and they use wireless communication to enable this collaboration [63].

Wireless Sensor Networks are widely used in several applications such as military, environmental, health-care, and home applications.

2.2 Wireless Sensor Networks

A Wireless Sensor Network (WSN) is a network composed of a large number of low-power devices that sense the environment and send their readings to one or more Sinks [8]. The devices composing a WSN are called sensor nodes, or motes, and they have the following characteristics

- they are small ;
- they have limited memory, processing power, and energy (most of them are battery powered) ;
- they are composed of sensing, data processing, and communication components.
- they have limited communication range and data-rate.

Generally, the WSNs are densely deployed because of these characteristics.

2.2.1 Categories of sensors

Handling a wide range of application types will hardly be possible with any single type of a sensor node. Nonetheless, certain common traits appear, especially with respect to the characteristics and the required mechanisms of such networks. Indeed, in the majority of applications, the sensors require readiness for field deployment in terms of economic and engineering efficiency. The scalability of the sensor is also important in distributed environmental monitoring tasks, which require that the sensors be small and inexpensive enough to scale up to many distributed systems. Sensors are deployed in hundreds of thousands. Therefore, it is expected that the cost will drop but current generation sensors are still expensive to allow widely deployment [94].

Sensors can be classified in terms of where they are deployed or used (Table 2.1 [94]) :

Table 2.1. Summary of Sensors Categories

Sensor Category	Parameter	Field-Readiness	Scalability
Physical	Temperature	High	High
	Humidity (soil, leaf, ambient)	High	High
	Wind (speed and direction)	High	High
	Pressure	High	High
Chemical	Dissolved Oxygen	High	High
	pH	High	High
	Heavy metals	Low	Low
	Nutrients (Nitrate, Ammonium)	Low-Medium	Low-High
Biological	Microorganisms	Low	Low
	Biologically active contaminants	Low	Low

For instance, for water quality monitoring, physical sensors are generally more field-ready and scalable than chemical sensors, that are in turn, substantially more field-ready and scalable than biological sensors.

2.2.2 Heterogeneous WSN

Sensor nodes can be heterogeneous by constructions, that is, some nodes have larger batteries, farther-reaching communication devices, or more processing power. They can also be heterogeneous by evolution, that is, all nodes started from an equal state, but because some nodes had to perform more tasks during the operation of the network, they have depleted their energy resources or other nodes had better opportunities to scavenge energy from the environment (e.g. nodes in shade are at a disadvantage when solar cells are used).

Whether by construction or by evolution, heterogeneity in the network is both a burden and an opportunity. Heterogeneous WSN consists of sensor nodes with different abilities, such as various sensor types and communication range, thus provides more flexibility in deployment. For example, we can construct a WSN in which nodes are equipped with different kinds of sensors to provide various sensing services [63].

In the thesis, we consider that the studied systems are heterogeneous as the sensors are either on-ground mobile (fixed on bicycles) or flying (UAV). Moreover, we also considered that the sensors may have different speeds.

Several issues are still to be solved in heterogeneous wireless networks such as determining the theoretical capacity of heterogeneous WSN, interpretability of different technologies, mobility, Quality of Service, and so on. There are several benefits to a heterogeneous WSN as opposed to a traditional homogeneous wireless network including increased reliability, improved spectrum efficiency, and increased coverage. Reliability is improved because when one particular access technology within the heterogeneous WSN fails, it may still be possible to maintain a connection by falling back to another access technology. Spectrum efficiency is improved by making use of access technologies which may have few users through the use of load balancing across access technologies and coverage may be improved because different access technologies may fill holes in coverage that any one of the single networks alone would not be able to fill.

2.3 Unmanned Aerial Vehicles

Unmanned aerial vehicles (UAVs) have gained much popularity in a variety of applications which do not need human interaction or are dangerous (e.g. In Hurricane Katrina, two UAVs were used to search and rescue for the trapped survivors [5].) for human operators. UAVs have been widely applied for human life, from early military, environmental and urban applications to modern-day Facebook, Google and Amazon applications. Facebook has successfully tested its internet-beaming drones [3] and Amazon provides a special product delivery within 30 minutes in 2016 [2].

Enabled by the advances in computing, communication, and sensing as well as the miniaturization of devices, UAVs such as balloons, quadcopters, and gliders, have been receiving significant attention in the research community. They become an integral component in several critical applications such as border surveillance, military operations [7, 74], disaster monitoring, traffic monitoring, remote sensing, and the transportation of goods, medicine, and first-aid. More recently, new commercial applications are emerging, with the potential to dramatically change the way in which we lead our daily lives.

Among the many technical challenges accompanying the aforementioned applications, leveraging the use of UAVs for delivering broadband connectivity plays a central role in next generation communication systems [42]. Facebook and Google announced in 2014 that they will use a network of drones which circle in the stratosphere over specific population centers to deliver broadband connectivity. UAVs have also been proposed as an effective solution for delivering broadband data rates in emergency situations through low-altitude platforms. They can serve as a temporary, dynamic, and agile infrastructure for enabling broadband communications, and quickly localizing victims in case of disaster scenarios.

2.3.1 Categorizes of the UAV

An unmanned aerial vehicles (UAV), commonly known as a drone is an aircraft with no human on board. UAVs can be remotely controlled aircraft (e.g. flown by a human at a ground control station) or can fly autonomously based on pre-programmed flight plans or more complex dynamic automation systems. UAVs can be drones, quadcopters, gliders and balloons etc, and also can be their improved models carrying

Table 2.2. Altitude and Weight Classification of Current UAVs

Category	Size	Weight	Examples	Description
Micro-UAVs	smaller than 6 <i>in</i>	less than 1 pound	Microstar ; Wasp	Micro-UAVs operate at low altitudes, have limited space for fuel and batteries to power their system.
Mini-UAVs	between 6 <i>in</i> and 10 <i>ft</i>	between 1 and 40 pounds	Dragon Eye ; Azimut	Mini-UAVs must maintain line of sight between the aircraft and the ground station.
Tactical UAVs	between 10 <i>ft</i> and 18,000 <i>ft</i>	between 60 and 1000 pounds	Solar Bird ; Fox	Tactical UAVs operate at low to medium altitudes, and provide farther range and longer loiter capabilities.
Medium/High altitude UAVs	between 18,000 <i>ft</i> and 45,000 <i>ft</i>	larger than 1000 pounds	Global Hawk	Operate at high altitudes, and provide tracking or monitoring.

payloads (e.g. microdrones, carrying cameras)

There is more than one category when it comes to the classification of UAV. Generally, UAVs are classified by size, range and endurance, etc. Endurance is the amount of flying time of the UAV, and the range is the working radius of the UAV. For classification according to size, one can come up with the following sub-classes (Table 2.2 [22, 23]). If we take into account the range and the endurance, the UAVs are classified as in Table 2.3 [22, 23].

2.3.2 Fling Ad-Hoc Network (FANET)

Ad hoc networks are wireless networks capable of organizing without previously defined infrastructure. Each node communicates directly with its neighbors. To communicate with other nodes, it is necessary to pass on its data to others which will be responsible for forwarding it. To do this, it is first and foremost important that the nodes are situated in relation to each other, and are able to construct routes between them : this

Table 2.3. Classification of the Current UAVs according to Range and Endurance

Category	Range	Endurance	Description
Close range UAVs	about 5 to 50 <i>km</i>	smaller than 6 hours	These UAVs will usually be micro-UAVs, mini-UAVs and some tactical UAVs. They are usually used for reconnaissance and surveillance tasks.
Short range UAVs	about 150 <i>km</i>	about 6 to 12 hours	These vehicles will usually be some tactical UAVs. They are mainly utilized for reconnaissance and surveillance purposes.
Mid-range UAVs	about 650 <i>km</i>	about 10 to 30 hours	They usually are some tactical UAVs and some of medium altitude and high altitude UAVs. They are also used for reconnaissance and surveillance purposes in addition to gathering meteorological data.
Endurance UAVs	about 300 <i>km</i>	about 30 to 40 hours	This class of vehicles are usually medium altitude and high altitude UAVs, and use for reconnaissance and surveillance purposes.

is the role of the routing protocol. Thus, the operation of an ad-hoc network significantly differentiates it from a network such as the Cellular network or Wi-Fi networks with access points : where one or more base stations are required for most communications between the different nodes of the network (Infrastructure mode), the ad-hoc networks organize themselves and each node can play different roles.

Similarly, a Fling Ad-Hoc Network (FANET) is simply an Ad-hoc network between several UAVs. It is part of the Vehicular Ad-hoc Networks (VANETs) themselves forming part of Mobile Ad-hoc Networks (MANETs) (The relationship is presented in figure 2.1). A FANET is a multi-UAV communication network where the mobility degree of nodes is much higher than the mobility degree of MANET (Mobile Ad-hoc Network) or VANET (Vehicular Ad-Hoc Network) nodes. While typical MANET and VANET nodes are walking men and cars respectively, FANET nodes fly in the sky [10].

In this thesis, we consider a Single-UAV system where the UAV is linked to a ground wireless sensor network.

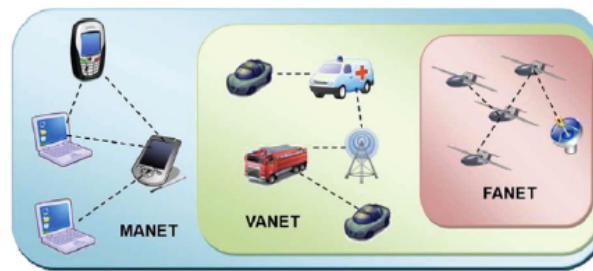

Figure 2.1. The relationship between FANET, VANET and MANET [10].

2.3.3 Applications of UAV-based WSN

Using UAVs extends significantly the deployment possibilities and its envisioned applications will be much more diverse in our daily life. Applications for UAV-assisted WSNs may either be traditional ones as home automation ; environmental and habitat monitoring ; industrial monitoring and control ; military ; security ; and health-care or completely new types of applications. Indeed, UAVs will allow rapid and easy deployments especially to rough and dangerous environments. They can offer to the sensor network quick access to more important technology in terms of end-to-end delay and throughput allowing the transport of different types of data, including global positioning systems (GPS) location, streaming video/voice, images, etc. This is much more important in new emergent applications such as rescue operations, traffic monitoring in smart-cities, and disaster management.

Hereafter we summarize some already deployed applications, we group them as follows,

- Military applications, including military combat [7], battlefield operation and military communication [74].
- Environmental applications, Homeland Surveillance & Electronics (HSE) offers 11 models of agriculture UAV crop dusters sprayers, 6 helicopters and 5 multi-rotor UAV crop dusters, to monitoring moisture, parasite and crop growth, etc [1].
- Urban applications, like traffic monitoring, urban surveillance and civilian security [80].
- Industrial applications, including product quality monitoring and Smart-Grid measurements [112].

Furthermore, the applications can be also classified with respect to the area where the sensors are deployed. In the first class, the nodes are scattered either on ground for crop monitoring [115] or underground such as

for pipelines safety and monitoring [6]. This category is the most widely used and usually can not be used under water. The second class corresponds to underwater deployments wherein the sensors use acoustic communications [84]. This class of application usually cost a lot due to the protection of sensors from water when they were deployed for a long time under water. The third class is the hybrid one ; it combines both of the previous deployment modes, which not only widen the scope of application but also decreases the cost. In [52] for instance, sensor nodes are floating within a restricted area on the sea surface for the monitoring of marine disasters.

Regardless of the application domain, either the UAVs or the WSN have different application functionalities. The UAV is mainly involved in packet relaying, data collection, WSN connectivity maintaining and Localization. Elsewhere, the WSN is in charge of data gathering, monitoring, object tracking, event detection and processing.

Thereafter, data collection and retrieval mode is a key characteristic in those applications and has an important impact on the whole system performance. Moreover, it decides on the UAV flight path (planned or unplanned trajectory, stationary or moving). Data collection and retrieval modes can be categorized into [9] : *i) query driven*, where the nodes send data only when required. *ii) event driven*, the nodes transmit data to the UAV only when an event occurs. *iii) time driven*, the sensor nodes communicate their readings to the UAV periodically. Time driven application is the most common one and has been broadly used in military and environmental applications.

2.4 Unmanned Aerial Vehicles as a Communication Node

One of the primary goals of the WSN applications is to process meaningful information from data obtained by sensor nodes deployed on the field. Thus, the sensed data must be transferred to a sink for processing and obtaining meaningful inferences. Traditionally, the data collection was processed in multiple hops. The nodes that are closer to the collector end up being relay nodes for the data of other nodes which are further away from the collector. As a result, these nodes lose energy much faster as compared to those who do not have to act as relay nodes frequently. Consequently more rapid death of these nodes results in getting the

network disconnected, which in turn leads to a loss of coverage. To address this issue mobile nodes were introduced.

The traditional mobile nodes usually move on the ground with limited speeds and movement conditions. It is challenging to apply the traditional mobile nodes in harsh areas (such as snow mountain, wild forest, etc.). UAV become a better choice for such applications because of its extensive and flexible conditions. As a communication node in WSN, the main functionalities of the UAV, including data collection, maintaining connectivity and localization, will be detailed in the following.

2.4.1 Functionalities

– Data collection

The traditional data collection protocols were based on the assumption of dense networks so that any two nodes could communicate with each other through multi-hop paths. Hence, sensors were usually assumed to be static, and mobility was not considered. After the introduction of mobile nodes, it is a challenging task in WSN to collect the data from the mobile nodes and send it to the base station for processing.

Numerous applications are constrained by the difficulty of data collection, especially when working in harsh terrains (e.g. snow mountains, highly dense forest, vast and hot desert, etc.). Thus, many kinds of research have been done in both energy scheme (e.g. energy conservation [60, 61], incremental deployment [88] and environmental energy harvesting [86]), collecting data scheme [85] and optimal speed control of UAV scheme [111] to collect data efficiently. Pang et al. [85] formulate the data collection in rechargeable WSNs into an optimization problem with the objective of maximizing data collection utility. They also give a novel side matching algorithm and a novel greedy algorithm to solve the distributed issues. In 2007, Kurs et al. [71] have a major breakthrough on wireless power transfer to provide a promising alternative for energy replenishment of sensors.

– Connectivity Maintaining/Relaying

Connectivity is a central problem in WSNs because the failures occurrence will lead to partially disconnecting of networks. One of the most powerful methods used for such network problems is to provide a reliable

connection to support the connectivity via other kinds of nodes (e.g. mobile sink) that communicate with the sensor nodes. Extensive research has been conducted on maintaining UAV-assisted networks connectivity. Fodor et al. [37] focus on optimizing the routing in WSN with mobile sinks. However, this method does not maintain connectivity all the time. Thus, other approaches assume that the UAVs movement is predictable that can improve the WSN connectivity [57]. Kuiper and Nadjm-Tehrani [70] present a method combining position scheme and beacon-less strategy to maintain intermittent connection in ad hoc networks. Similarly, Edison et al. [25] apply a beacon-based mechanism to support WSN connectivity. Kuiper's method handles the disconnection problems in his paper while Edison avoids the issues through the UAVs movement.

– Localization

Location-based service plays a more and more important role in humans' daily life. Location information is of great value to understand events detected in the sensing field. Localization of sensors is essential for the normal operation of WSN. Location-awareness of sensors is a fundamental and crucial problem in a wireless sensor network.

To guarantee the sensed coverage and good localization accuracy, WSN is usually composed of a large number of sensor nodes with high dense deployment in a field. Typically, sensors are deployed without their position information known in advance. A simple way to get the location information is to place them at certain positions manually. However, when the number of sensors is large, this becomes tedious. GPS [28] is another popular way which can offer good localization accuracy. However, it is not possible to equip every sensor node with a GPS module when taking into account the factors of power consumption, volume and cost. Localization mechanisms with mobile vehicles then have been proposed to overcome the shortage of the above methods. With the beacons provided by vehicles, sensors can realize self localization with few methods. The vehicles localization based schemes are categorized into static vehicle localization and mobile vehicle localization. In static case [34], the localization accuracy highly depends on the number and the position of the vehicles. The feature of uniform distribution and dense deployment of vehicles will lead to a better localization accuracy, but also with added cost. To overcome the problem, schemes with mobile vehicles are proposed. A mobile vehicle can obtain its own location information with the use of GPS or other localization technologies, and it travels around the sensing field while broadcasting its current coordinates

in the form of a beacon message. A sensor that has received the beacon could conduct that it is within the communication range of the mobile vehicle. When enough beacons are received, the sensor can estimate its location with a few methods that have been proposed.

In the context of UAV-assisted WSNs, authors in [117], the authors address the problem of 3D localization in WSNs using an UAV. The UAV is equipped with GPS and it flies over the monitoring area broadcasting its geographical position. Thus, the sensor nodes are able to estimate their geographical position without being equipped with GPS receiver. GPS is an efficient technique in the estimation of position in outdoor applications. It is better for the GPS to be used far enough from buildings or obstacles otherwise GPS signals become unreliable. In UAV-aided WSNs, the UAVs require an additional estimation, to remain operating after GPS failure. In [99], the authors proposed a real-time localization algorithms to estimate the position and velocity of an UAV using an Extended Kalman Filter [125] based on time difference of arrivals. Their algorithm makes a good estimation of position and velocity. Halder et al. [43] give a review on mobility-assisted localization techniques in WSNs.

2.4.2 Trajectory planning and placement

As mentioned in Chapter 2.4.1, localization is a fundamental and crucial problem in WSN. A few methods [48, 114] have been proposed to deal with this issue, while schemes with mobile vehicles stand out, due to the characteristics of mobility and flexibility. One key issue of the vehicles based scheme is path planning. Proper path planning can guarantee good coverage of the whole sensing field while keeping the path length reduced at the same time. In recent years, a wide range of researches has been done on this topic, with many algorithms proposed. The objective functions and optimization methods are different according to different applications.

The objectives of path planning in a mobility based sensor network are listed as follows :

- Reliable coverage of the whole sensing field. We have to make sure that the path of the vehicle will cover all the sensors that need to be localized. Shazly et al. [106] formulate an area coverage reliability problem that quantifies the likelihood that the network can be in an operating state where the coverage condition is satisfied.

- Path length reduction. The whole path length should be controlled to reduce energy consumption and the localization delay. Kashuba et al. [64] proposed an effective path length reduction algorithm for UAV path planning in a sensor network where flying platform is used for data gathering. Their proposed algorithm has low computational complexity and it can be implemented not only on control center equipment but on UAV controller.
- Fine localization accuracy. Path planning makes it possible to choose the optimal position to send beacon messages to improve accuracy. Authors in [121] studied on UAV path planning accuracy problem and presented an novel algorithm which takes into account both the efficiency of flying and accuracy of positioning.
- Minimization of energy consumption and maximization of the quality of data communication. In [29], the authors proposed an energy efficient mechanism based on genetic algorithm for autonomous mobile robots. The constraints of natural terrains : obstacles and relief are considered. In [107], Sahoo et al. proposed Infrastructure based Data Gathering Protocol (IDGP) and Distributed Data Gathering Protocol (DDGP) to plan the data gathering path for a mobile sink.

The simplest way for the vehicle to move around the whole field is random walking. The author in [59] proposed a random mobility model based on random directions and speeds, whose current speed and direction are independent of its past ones. However, too frequent change randomly may lead to effortless moving, so trajectory planning/placement of mobile vehicles was introduced.

Path planning makes sure that the vehicles will move with definite purpose. Generally, according to whether there is interaction between vehicles and sensors, path planning of vehicles can be classified into two categories,

- Static path planning, which determines the trajectory for mobile vehicles in advance and then vehicles move along the pre-determined trajectory strictly. Research in [44] proposed a path planning scheme based on trilateral to achieve maximum performance with minimum movement ; the vehicle moves according to an equilateral triangle trajectory to send beacon messages. With the distance measured by received signal strength, then a sensor, with three beacons received, can calculate its location. The feature of triangle trajectory can provide three different beacons, which can efficiently solve the collinearity

problem.

- Dynamic path planning, in which no trajectory is set in advance and the vehicles determine their next walking direction with specific strategies, according to the information obtained by interaction with sensors that have not been localized during the localization procedure. Dac-Tu Ho et al. applied UAVs as mobile vehicles [48], they focus on minimizing the total flight time of the UAV and energy consumption of the nodes and maximizing the quality of data communication via the wireless channel between any node and its cluster head, and between the cluster heads and the UAV. They aim to provide a list of nodes which are then to be visited by the UAV and provide a path for the UAV to follow to complete one round of data collection.

2.5 Data Collection Applications

As aforementioned, WSNs are widely used in several applications ranging from military, agriculture to health monitoring. Data Collection is one of the most important issues in WSN, and this problem has witnessed a significant amount of researches over the decades. Traditionally data gathering schemes based on the static topology where the nodes are statically deployed but later on mobile nodes which are more energy efficient. The main idea of data-gathering is to sense data and forward these data to the collectors for further processing. Traditionally, the data transmissions were done in multiple hops. The relay nodes help the simple nodes to forward their data. Thus, they die out (lose energy) fastly which eventually lead to loss of coverage. Then, mobile nodes in such context were introduced. Mobile nodes move around the network in a pre-defined or random path to collect and forward the data. Data collection using mobile nodes consists of three phases [26] :

i) Discovery : In this phase, the mobile collectors broadcasts "hand-shake" messages to its coverage to inform the nodes within its range the collector is coming. The sensors that received the message can identify the presence of the mobile collector. *ii) Data Transfer* : The nodes start to send data after they identify the presence of the collector. The goal of the data transfer phase is to achieve maximum data throughput during the limited contact duration time between the collector and the simple nodes. More generally, both the

nodes and the collectors are mobile, the data gathering in such dynamic context involves many important parameters among which the contact duration time and the data-rate between the collectors and the simple nodes present tremendous impact on data collection. *iii) Routing* : The mobile collectors forward the collected data to the sink or the base-station in this phase.

2.5.1 Performance Parameters

– Contact Duration Time

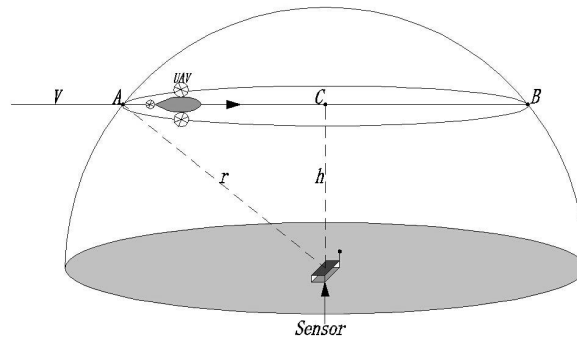

Figure 2.2. Simple Scenario with 1 UAV and 1 Sensor

Considering that the "one UAV and one sensor" was the basic unit in UAV-assisted WSNs, we take the scenario like in figure 2.2 for example to calculate the communication time. The common scenarios will be taken into account in the following chapters.

In figure 2.2, UAV moves along a path to provide continuous connectivity and help in balancing the load on nodes. The sensor has an opportunity to communicate with the UAV when the UAV within its communication range. It is crucial to know the link intermittency in such context.

According to [58], the contact duration time between the UAV and the sensor (T_{cdt}) can be written as in

$$T_{cdt} = \frac{2\sqrt{r^2 - h^2}}{v}, \quad (2.1)$$

where, r is the communication range of the UAV and the sensor. Indeed, we assume that the UAV and the Sensors have the same communication range for definiteness and without loss of generality. v and h are the

velocity and the flying height of the UAV respectively. As shown in figure 2.2, when the UAV flies on the top of a sensor, T_{cdt} can achieve its maximum value. This is present in equation (2.1). The longer the contact duration time between the UAV and the sensor, the more messages were gathered between them.

– Multi-rate Mechanism

The communication performance is affected by the path loss, interference, and shadowing, etc. The data-rate between the UAV and nodes depends on the relative distance between them and the relative distance is changing over time. Thereby the data-rate is varying with the movement of the network also. Thus, it is more reasonable to use a multiple data-rate mechanism among different nodes during different times. A 4-pairwise communication parameters setting [77] is adopted in many applications. The higher the data-rate between the UAV and the node, the more data were transmitted between them.

According to the deployed environment where the application is used, the data collection schemes can be roughly divided into i) *Data Collection Schemes based on the Static Topology*. In this category, both the sensor nodes and the collector are statically deployed. ii) *Data Collection Schemes based on the Mobile Topology*. In mobile topology, the design of nodes and collectors depends on the applications ; some applications only need moving nodes or only need moving collectors while other applications should consider both of them moving. For instance, in rescue field or animal tracking, both the collector and the interest objects are moving.

If we take into account the hops of the schemes that the applications need, the data collection schemes can be classified as *One-hop communication protocols* and *Multi-hop communication protocols*.

2.5.2 Classification of the Data Collection Underlying Protocols

– One-hop communication protocols

In this case, source nodes that are within the range of the destination node can directly communicate with the collectors. The transmission in this context requires appropriate distance between the source nodes and the destination nodes, and there are no obstacles between them and obstruct them to communicate with each other. If there are multiple nodes within the range of the destination node at the same time, the medium can be shared according to different protocols that can be further classified as *Contention-based*

protocols, *Contention-free* protocols and *Hybrid* protocols. Many protocols have been proposed on these three classifications, such as B-MAC [91] (Contention-based), FLAMA [93] (Contention-free), Z-MAC [97] (Hybrid) and so on, Which will be detailed in Chapter 2.6.2 on medium access control protocols.

– Multi-hop communication protocols

It is better for the source nodes that are out of the range of the destination node or have poor transmission conditions (e.g. high energy consumption, high packet losses, etc.) to send packets by means of intermediate nodes that are within the range of the destination node and the source node at the same time or have better communication situations. The group of intermediate nodes is usually called *Potential Forwarders*. The use of mechanisms mainly depends on the network information provided by each node. In this sense, the multi-hop protocols can be further categorized and detailed in Chapter 2.6.1 on routing protocols.

2.6 Underlying Layers for UAV assisted Networks

2.6.1 Routing Protocols

Routing protocols in sensor networks is very challenging due to several characteristics : *i*) generally, sensor nodes are battery powered, they are tightly constrained regarding transmission power, on board energy, processing capacity and storage and thus require careful resource management. *ii*) in large scale sensor networks, it is difficult to design a global addressing scheme for the sensor deployment. *iii*) in most WSN applications, the sensed data are usually required to be transmitted from multiple source nodes to a single destination node. *iv*) the data generation traffics have some redundancy in many applications since multiple sensors may generate the same data. Such redundancy needs to be exploited by the routing protocols to improve the network performance.

General Classifications of Routing Protocols

Several protocols are used in FANET. Some are more effective where others are simpler to implement. Most of routing protocols can be classified as data-centric, hierarchical, location-based or QoS-aware. Data-centric protocols are query-based and depend on the naming of desired data. Hierarchical protocols

aim at clustering the nodes so that cluster heads can do some aggregation and reduction of data to save energy. Location-based protocols utilize the position information to relay the data to the desired regions. The QoS-aware are based on general network flow modeling for meeting some QoS requirements.

– Data-centric protocols

Since transmitting data from each sensor node within the deployment region might result in significant unnecessary redundancy in data and incur in unnecessary energy and traffic expenditure, routing protocols that can select a set of sensor nodes and utilize data aggregation during the relaying of data have been considered.

In data-centric routing, the sink sends queries to selected regions which might be selected using clusters and waits for data from the nodes located in the regions. Since data is being requested through queries, attribute-based naming is necessary to specify the properties of data. Sensor Protocols for Information via Negotiation (SPIN) [47] is the first data-centric protocol, which considers data negotiation between nodes to eliminate redundant data and save energy. Later, Directed Diffusion [55] has been developed and has become a breakthrough in data-centric routing. Many other protocols have also been proposed based on Directed Diffusion, such as Energy-aware routing [101], Rumor routing [13] and Gradient-Based Routing [104].

– Hierarchical Routing protocols

Hierarchical clustering, originally proposed in wired networks, is well-known technique in WSNs. The hierarchical routing protocol is an energy efficient approach through sensor nodes, base station, and cluster heads. The main aim of cluster-based routing is to efficiently maintain the energy consumption of sensor nodes and improve network lifetime. In a hierarchical architecture, higher-energy nodes can be used to process and send the information, while low-energy nodes can be used to sense the target. The introduction of clusters can greatly contribute to overall system scalability, lifetime, and energy efficiency. Cluster-based routing is mainly two-layer routing where one layer is used to select cluster heads and the other for routing. Cluster formation is typically based on the energy reserve of sensors and sensor's proximity to the cluster head. Low Energy Adaptive Clustering Hierarchy (LEACH) [46] is an initial hierarchical routing approaches which considers homogenous wireless sensor network. The selection of cluster heads in LEACH depends

on the highest residual energy. LEACH rotates cluster head to evenly distribute the energy load among the sensors in the network and extend the network lifetime.

– Location-based protocols

Most of the routing protocols for sensor networks require location information of sensor nodes. In most cases, location information is needed to calculate the distance between two particular nodes so that energy consumption can be estimated. Relative coordinates of neighboring nodes can be obtained by exchanging such information between neighbors [15]. Alternatively, the location of the nodes may be directly available using GPS if nodes are equipped with a small low-power GPS receiver. Location-Aided Routing (LAR) [69] is a location-based routing protocol with an objective to limit the area to build a new route to a smaller request zone. In LAR, the route requests were sent to the whole network. Senouci et al. [103] optimized LAR, and only the nodes in the request zone have opportunities to forward the requests. Thus, the routing overhead is widely reduced.

– QoS-aware Protocols

The network needs to ensure Quality of Service (QoS) besides ease of implement, energy efficiency and low cost. One of the major design goals of WSNs is reliable data communication under minimum energy depletion to extend the lifetime of the network. Some of the routing challenges and design issues that affect the routing process in WSN are : node deployment, coverage, connectivity, node and link heterogeneity, fault tolerance, scalability, transmission media, data aggregation, and QoS. In QoS-based routing protocols, the network has to balance between energy consumption and data quality. Particularly, the network has to satisfy certain QoS metrics (delay, energy, bandwidth) when delivering data to the base station.

SPEED [45] is a QoS-aware routing protocol which is designed for real-time communication in sensor networks. SPEED handles congestion and provides soft real-time communication by using feedback control and non-deterministic geographic forwarding. A node computes speed to each neighbor and then forwards the packet to a neighbor which is close to the destination and has higher speed than other neighbors. In [27], Marot et al. propose a local load balancing routing protocol which aims to help source nodes to apply neighbor nodes potential capabilities without knowing their information. Their protocol improves the reliability and efficiency of the link quality indicator.

Multi-hop Protocols

Several multi-hop protocols exist in the literatures, they can be categorized as deterministic and random, according to the topologies.

(i) Deterministic Topologies

– Static Routing

This scheme establishes a pre-computed static table that is loaded when initializing the network. Unlike a dynamic routing protocol, static routes are not automatically updated and must be manually reconfigured by a network administrator when the network topology changes. Static routing provides ease of routing table maintenance in small scale networks. The route used to send data is known in advance. Thus, it uses little bandwidth as routers do not exchange routes. However, configuring the route table is time-consuming and error-prone, especially in large scale networks.

Load-carry-and-deliver (LCAD) [17] is a static routing protocol using UAVs to relay messages between two ground nodes. The route is configured on the ground before takeoff. In LCAD, the authors object to maximize throughput by configuring nodes positions. This type routing protocols are used for repetitive tasks, such as periodically surveillance missions. Adaptive Routing using Clustered Hierarchies (ARCH) [11] creates a multi-level hierarchy that adjusts its depth dynamically in response to the network topology. These hierarchical routing protocols, such as ARCH which is based on multilevel clustering, consist of a number of different components, such as clustering, routing and location management. Here, clustering is the process by which nearby nodes form groups, called clusters. In [110], the authors study the theoretical scalability aspects of multi-level hierarchical routing in MANET. In the general scheme they analyze, nodes organized in clusters, which are then grouped in higher level clusters. The number of levels is logarithmic in the network size. [110] is one of the crucial papers with comprehensive theoretical results of multi-level hierarchical routing protocols.

– Dynamic Routing

Unlike static routing, dynamic routing helps the network administrator to manage the time-consuming and exacting process of configuring and maintaining static routes. Dynamic routing is able to find remote networks, maintain the routing information, and select the best path to destinations. Therefore, it is suitable in all topologies when multiple routers are required.

1. Application in Connex Topologies

The typical applications in connex topology are based on mobile ad hoc networks (MANET). They can be divided into proactive, reactive and hybrid routing protocols.

– Proactive Routing Protocols

In WSNs, sensors are used to store routing information for a specific region of the network. However, many of the tables must be updated when the topology is changed. Proactive routing protocols are based on periodic exchange of control messages. The main advantage of proactive routing is that it immediately provides the required routes when needed. Thus, a large number of messages are required to keep the system up to date. However, negative points are also present such as the bandwidth constraints on each communication link or the addition of a delay to each topological change (slow reaction). This will present a real disadvantage for time sensitive applications.

Optimized Link State Routing (**OLSR** [56]) is a proactive routing protocol used for mobile sensor networks. It maintains the topology information of the network through exchanging messages periodically at each node. Furthermore, multi-point relaying scheme is used to efficiently and economically flood its control messages. **OLSR** provides optimal routes regarding the number of hops, which are immediately available when needed. **OLSR** is an optimization protocol over a pure link state. Other examples of this kind of protocols are DSDV [89], STAR [39] and TBRPF [82].

– Reactive Routing Protocols

In reactive routing approach, a routing protocol does not respond to finding a route to a destination node, until it has a reservation request. The reactive routing protocol attempts to find a route only on-required by flooding its query in the sensor networks. The routing information will be stored only for the duration of the communication.

The removal of exchange messages periodicity improves the availability of bandwidth and eliminates the control traffic overhead. However, the implementation and closure of roads occurs more frequently.

It also increases the latency in finding a route to a destination node.

There are two classes of reactive protocols : *source* routing and *hop-by-hop* routing. In *source* routing, each packet contains the full path in its header, so the nodes only make switching, and no periodic information is required to maintain the connectivity. Dynamic Source Routing (**DSR**) [59] protocol is an example of *source* routing protocols. It adapts quickly to routing changes when host movement is frequent, yet requires little or no overhead during periods in which hosts move less frequently. However, *source* routing has bad scalability because one of the sensitive points remains the loss of a communication link, and the larger the network size, the greater the likelihood of loss.

In the case of *hop-by-hop* routing, each node stores and maintains routing information to be able to switch packets. All the nodes must also be attentive to their neighbors, and to the periodic exchange of messages. Ad-hoc On Demand Distance Vector Routing (**AODV**) [90]) is a *hop-by-hop* reactive routing protocol. In **AODV**, each mobile host operates as a specialized router, and routes are obtained as needed (i.e., on-demand) with little or no reliance on periodic requirements. It is suitable for a dynamic self starting network, as required by users wishing to utilize ad-hoc networks. Based on **AODV**, Senouci et al. [102] use energy consumption as a routing metric and propose three extensions (LEAR-AODV, PAR-AODV, and LPR-AODV) to the shortest-path routing algorithm. The three algorithms reduce the nodes energy consumption through routing packets using energy-optimal routes. Labiod et al. [113] present a comprehensive performance comparison of five multipath reactive routing in ad hoc networks : three node-disjoint multipath routing protocols and two routing protocols based on a untrusted node disjoint path scheme.

– Hybrid Routing Protocols

The hybrid routing protocols bring together the advantages of the two techniques to reduce the impact of the weaknesses in each type. They keep routes available for some destinations all the time, but find routes for other destinations when required. Hybrid protocols minimize the latency of reactive protocols and reduce the overhead of proactive protocols.

Hybrid routing will be particularly efficient when the network is divided into several zones where inter-zone and intra-zone routing is applied (inter-zone with reactive routing and intra-zone with proactive routing). [72] shows an analysis of Zone Routing Protocol (**ZRP**) in MANET.

However, this strategy remains difficult to implement due to the dynamics of the nodes and their continuous activities.

2. Application in Delay Tolerant Networks

The primary focus of researchers studying on Delay Tolerant Networks (DTNs) are routing issues. Many studies have been performed on how to handle the sporadic connectivity between the nodes and provide a successful and efficient delivery of messages to the destination. One of the pioneering algorithms for DTNs is Epidemic Routing [68] which is published by Vahdat and Becker. The source nodes in the epidemic scheme can send packets to all neighborhood nodes without any filter. Thus, the source nodes may build surplus routes which may never be used in communication.

In some large-scale networks, it is complex to take into account the details of each node, the global information of the network topology would be a better choice. The characteristics of the wireless links and nodes are the main factors when selecting and prioritizing the potential forwarders. In other words, the calculated metric for each node depends on the cost of the remaining path from the neighbors of a source node to its destination node.

The Opportunistic Routing in dynamic Ad Hoc Networks (OPRAH) [119] is a simple hops-count mechanism reflecting the number of hops that build the route between two nodes. In OPRAH, the nodes with a smaller number of hops to the destination node are a better choice than those with a larger amount of hops. Each node needs to know the topology information and its hops-count to the destination. The OPRAH metric does not consider the delivery ratio between the source nodes and the PFs. Thus, in OPRAH, the source node may select some of its neighbors with smaller hops-counts, while the transmission rate to reach them is very low. Another metric that is also based on traditional routing protocols is the *Expected Transmission Count* metric (ETX) [21]. ETX measures the average number of times that a packet must be transmitted or retransmitted on a link or on a route, to be received by the destination node. ETX serves to calculate and implement if knew the link delivery probability between the source nodes and the PFs. However, authors in [128] presented that the ETX does not always find an acceptable potential relay node. Lu et al. [75] showed that the performance of the network might degrade when the combination of OR with ETX is applied.

(ii) Random Topologies

In some applications, such as animal tracking or rescuing, the targets move randomly, and consequently the network topology is randomly changing. Random routing protocols play a crucial role in such context. The categorizes and applications of random routing have been detailed in aforementioned sections.

The categorizes of data collection protocols are presented in figure 2.3.

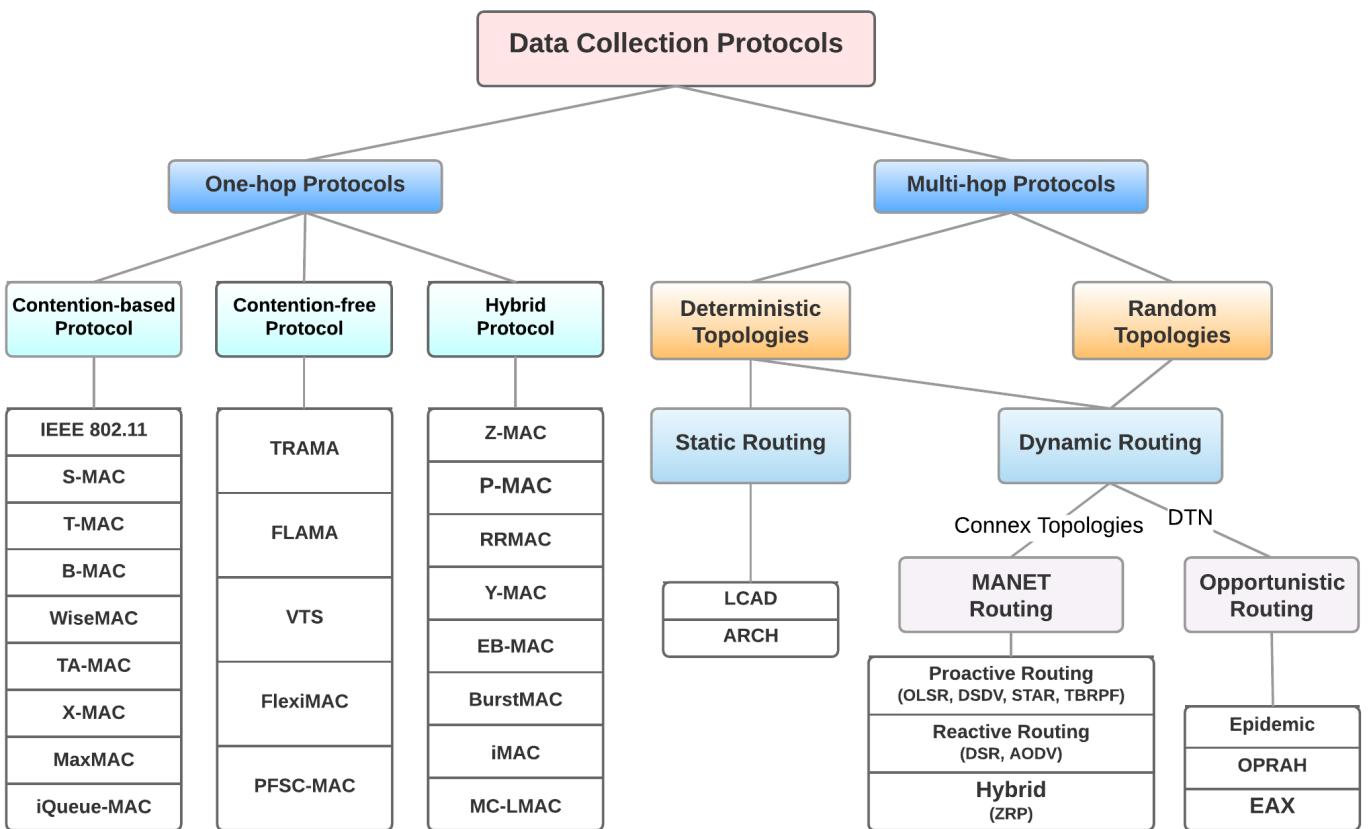

Figure 2.3. The categorizes of data collection underlying protocols.

2.6.2 Medium Access Control Protocols

Various MAC protocols have been extensively proposed during the past decades. They can be roughly categorized into contention-free, contention-based and hybrid protocols.

The contention free protocols are based on one of the three classical techniques to manage multiple accesses : Time Division Multiple Access (TDMA), Frequency Division Multiple Access (FDMA) or Code Division Multiple Access (CDMA). Each of these techniques presents its challenges : time synchronization in case of TDMA, frequency generation/filtering, in the case of FDMA, and power control in the case of CDMA. Contention-free techniques rely either on fixed assignment or demand assignment. By allocating the resources dynamically, the Demand Assignment Multiple Access (DAMA) methods are more flexible than the fixed assignment methods. They aim to give QoS guarantees on the base of requests issued from the user terminal and grants allocated by a network control system. The demand assignment methods are suitable for bulk data transfer and are widely used, in the satellite systems, but they typically require a random access channel for initial capacity allocation. The capacity dimensioning of this channel is a challenging issue.

The contention based protocols may accommodate a large number of terminals with sporadic traffic but they are not scalable. Table 2.4 makes a comparison between the existing schemes according to the main MAC performance criteria.

The Hybrid MAC protocols are the most promising, as the node densities in the system may vary between different orders of magnitude. By combining the advantages of contention-free and contention-based protocols, the hybrid protocols may allow a dynamic switching between random access for low traffic loads and scheduled access for high traffic load levels. This adaptation to the context of UAV-WSN communications may result in a better channel utilization.

This part presents an overview of these protocols which have been applied in WSNs and discusses their appropriateness from previous requirements to evaluated which protocol is suitable for such application.

Table 2.4. Comparison of existing MAC protocols

Protocols	Performance Objective	Topology	Scalability ^①	Range ^②	Fairness ^③	Adaptability ^④	#Channels
Contention-Based Protocols (CBPs)							
IEEE 802.11	↓energy ↑throughput ↓latency	Multiple/Flat	scalable	Medium	Medium	Medium	1
S-MAC [124]	↓energy	Multiple/Flat	scalable	Medium	No	Medium	1
T-MAC [116]	↓energy	Multiple/Flat	No	Medium	No	Medium	1
B-MAC [92]	↓energy	Multiple/Flat	scalable	Medium	Medium	Medium	1
WiseMAC [33]	↓energy	Multiple/Flat	scalable	Medium	No	Medium	1
TA-MAC [83]	↓energy ↓latency	Multiple/Flat	scalable	Medium	No	Medium	1
X-MAC [14]	↓energy ↓latency	Multiple/Flat	scalable	Medium	Medium	Medium	1
MaxMAC [51]	↓energy ↓latency ↑delivery	Multiple/Flat	scalable	Medium	No	Good	1
iQueue-MAC [129]	↓energy ↑throughput	Clustered	scalable	Medium	Medium	Good	Many
Contention-Free Protocols (CFPs)							
TRAMA [41]	↓energy	Multiple/Flat	--	Medium	Medium	Medium	1
FLAMA [93]	↓energy ↓latency	Multiple/Flat	Scalable	Medium	Medium	Medium	≥ 1
VTS [32]	↓latency	Clustered	Scalable	Medium	Medium	Medium	1
FlexiMAC [73]	↓energy ↑delivery	Multiple/Flat	Scalable	Long	Medium	Good	1
PFSC-MAC [50]	↓energy	Single/Flat	Scalable	Long	--	Good	Many
Hybrid Protocols (HPs)							
Z-MAC [97]	↑throughput	Multiple/Flat	scalable	Medium	Medium	Good	Many
P-MAC [127]	↓energy ↑throughput	Multiple/Flat	Good	Medium	Medium	Good	1
RRMAC [66]	↑delivery ↓latency	Multiple/Flat	--	Medium	Medium	Medium	Many
Y-MAC [67]	↓energy	Multiple/Flat	Scalable	Medium	Medium	Good	Many
EB-MAC [81]	↑delivery ↓latency	Clustered	No	Medium	No	Medium	1
BurstMAC [98]	↓overhead ↑throughput	Multiple/Flat	--	Medium	Medium	Good	Many
i-MAC [18]	↓latency	Multiple/Flat	Scalable	Medium	Medium	Medium	Many
MC-LMAC [54]	↓energy ↑throughput	Multiple/Flat	Scalable	Short	Medium	Medium	Many

-- We cannot certain about this item only from the given references which listed in this table.

① Depending on the number of nodes (n). No : $n < 10$; Scalable : $10 \leq n < 100$; Good : $n \geq 100$. ② Depending on the value of communication range (r). Short : $r < 100$ m; Medium : $100 \leq r < 1000$; Long : $r \geq 1000$. ③ We have more consideration on the number of nodes (n). No : $n < 10$; Medium : $10 \leq n < 100$; Good : $n \geq 100$. ④ Traffic adaptability : Here, we take into account the network scale. Good : If the MAC protocols works well on large scale network (the number of nodes is larger than 200), we define it has good traffic adaptability, or we define it has medium traffic adaptability.

Classifications of Medium Access Control Protocols

– Contention-Based Protocols

Contention-based protocols are more appropriate for small-scale sensor networks where the sensor nodes contend to access to the shared medium. The main drawback is that contention-based protocols do not have good scalability when they are applied in large scale networks because the collisions increase as the number of nodes increases. However, contention-based protocols are scalable in small size networks, such as WiseMAC [33] (40 nodes), MaxMAC [51] (46 nodes) etc.

Random Access (RA) schemes by nature have good scalability regarding the number of nodes when the

traffic is bursty (with low duty-cycle). One of the widely applied RA protocols is used in IEEE 802.11, whose delay and throughput will degrade quickly as the increase of nodes. Random access (RA) techniques include Synchronous RA protocols and Asynchronous RA protocols. The earliest RA scheme is ALOHA protocols, a pure asynchronous RA protocol. The typically, synchronous RA protocol is Contention Resolution Diversity Slotted ALOHA (CRDSA [16]) protocol, the classic asynchronous RA scheme is Asynchronous Contention Resolution Diversity ALOHA (ACRDA [40]). ACRDA protocols do not require synchronization mechanism, and their topologies are single/flat with long communication range (more than 1000 meters). Thus, ACRDA is usually used in satellite networks. Some RA protocols have a high rate of collisions which lead to low values of throughput, such as ALOHA, its throughput rate over 15%. Both Carrier Sense Multiple Access (CSMA) based protocols and ALOHA based protocols have been tested to reduce the collisions. CRDSA adopts interference cancellation mechanism for reducing collisions effectively (reduced to 5 bit/s/Hz [16]), and improving the packet loss ratio.

– Contention-Free Protocols

Contention-free protocols eliminate collisions problem through allocating the available resources in advance in the network. The traffic-adaptive medium access protocol (TRAMA [41]) was an early example which was based on traffic information and provides a distributed election scheme for each node. TRAMA scheme presents which node can transmit at a given time slot and when it can return to sleep mode. It is energy efficient and collision free.

CDMA employs special coding technology to make certain that each transmitter had a code to allow multiple users could transmit in shared channel. Dac-Tu Ho and Shigeru Shimamoto combine Prioritized Frame Selection scheme by CDMA method and provide PFSC-MAC [50] protocol. PFSC-MAC protocol has been validated for UAV-assisted WSNs because it obtains a high frequency of data transmission and a low packet error rate.

TDMA divides time into smaller and fixed-length slots to ensure devices can communicate without contention. Ho and Shimamoto obtain a novel protocol [49] through employing PFS scheme and Frame based Random Access scheme in TDMA for the nodes' information is known and unknown, respectively. The new protocol has high reliability and works well on transmission between UAV and activated sensors.

– Hybrid Protocols

The hybrid protocols were developed to overcome drawbacks of both Contention-based and Contention-free protocols. They can classify the packets (e.g. data, control, low priority, high priority) and choose the appropriate way to access the medium regarding the belonging class of that particular packet. Another method is a combination of them, which let the non owner sensor nodes of a previously assigned TDMA time slot to contend for transmission chance. A novel hybrid MAC protocol, ER-MAC [109], which adopts a TDMA approach to schedule collision-free slots. Nodes wake up for their scheduled slots, but otherwise, switch into power-saving sleep mode. When an emergency occurs, the nodes that participate in the emergency monitoring change their MAC behavior by allowing contention in TDMA slots to achieve high delivery ratio and low latency. In its operation, ER-MAC prioritizes high priority packets and sacrifices the delivery ratio and latency of the low priority ones. ER-MAC also guarantees fairness over the packets' sources and offers a synchronized and loose slot structure to allow nodes to join or to leave the network.

A taxonomy of the protocols surveyed in MAC protocols along with their properties, scalability and fairness are shown in Table 2.4.

Discussion

In practical applications, we can conclude which protocol is better for this application according to the criteria the application needs. For example, if we apply UAV-assisted WSNs to realize real-time monitoring which needs high data throughput, low energy and latency. The standard, IEEE 802.11 works well on data throughput, efficiency energy and low latency. Moreover, on other criteria, such as communication range, fairness and traffic adaptability also suitable to this application. Thus, we can choose IEEE 802.11 in this application. Additionally, there are many other conditions we needs to consider when we choose a MAC protocol.

- Application constraints. All applications are real-time or non real-time applications. Normally, the protocols with high data throughput are suitable for real-time applications.
- Traffic model. The traffic models could be classified into periodic, sporadic event based according to the information type.

- Network conditions. The different network conditions needs different performances that have an impact on choosing MAC protocols.
- Others, such as UAV and node mobility, hardware constrains such as memory constrains etc.

CHAPITRE 3

Scheduling Algorithms in Mobile Wireless Sensor Networks

Contents

3.1	State of Art	40
3.2	Problem Statement	41
3.3	Scheduling Algorithms	43
3.3.1	Analysis of influencing factors	43
3.3.2	Proposed Algorithms	47
3.4	Performance Evaluation	49
3.4.1	Performance Metrics	50
3.4.2	Simulation Results and Discussion	52
3.5	Conclusion	58

Data collection applications have been studied in Chapter 2.5. Traditional data collection schemes assume that nodes are deployed statically, and most of them are considered in WSNs with mobile sensors only or with flying UAV only. Indeed, the combination of UAVs and mobile sensors have board applications such as detecting on maritime or rescuing in wilderness where the targets are moving.

In mobile case, data collection algorithms are based on sinks that are usually moving on the ground with lower speeds and static sensors. UAVs differ with the traditional mobile sinks as the UAVs fly at a given height with a higher speed, thus, there have been some limitations if existing data collection schemes are fully applied in UAV-based scenario. One common weakness is the very short contact duration time which rises a limited collection.

Moreover, most of existing data gathering algorithms aim to improve various performance metrics of static networks. Wei et al. [118] use multi-UAVs to collect data from static sensors with the objective to minimize the average sensing time of each sensor. Ren et al. [96] use a mobile sink and multi-data-rate schemes to maximize data collection on static nodes. They divide the collection time into equal time slots and allocate them according to the data rate of the covered sensors. Indeed, the data collection maximization has two meanings : maximizing the use of time slots and maximizing the number of sensors that transmit at least one packet during the collecting time.

In this chapter, we focus on the data gathering issues of UAV-assisted mobile WSNs. Here, we will study the simple scenario that the UAV and mobile sensors are moving along a predefined linear path with different speeds. The simultaneous movement of UAV and sensors greatly aggravate the performance of the system. To overcome the dynamics of the network topology, in this chapter, we refresh the network information along time. We propose to use an UAV to collect data from mobile sensors that are randomly deployed in an area of interest. Our main contributions are summarized as follows [77] :

- We study the impact of UAV velocity, flying height, sensors density and velocities, and then mathematically formulate the data collection problem into the optimization with the objective of maximizing the collected packets and the number of sensors that successfully send at least one packet.
- To solve the problem, we combined the multi-data-rate schemes and the contact duration time to provide four algorithms : *DR*, *CDT*, *DR/CDT* and *CDT/DR* algorithms.

- Furthermore, we define a weighted fairness metric (weighted fairness regarding the collected packets and regarding the number of allocated time slots) to evaluate the fairness of the four algorithms.
- Through extensive simulations, we present how the algorithm combining multi-data-rate and contact duration time and examine the effectiveness of the propose algorithms under different configurations regarding the number of collected packets and the weighted fairness.

3.1 State of Art

In traditional WSN architectures, sensors are considered to be static and battery powered. Thus, energy consumption of sensors is a precious resource. In such static networks, data collection is based on multi-hop data propagation. The source nodes will use its neighbor nodes to relay the data to the static sink if it is far away from the destination. The relay nodes result in a fast death of the network because of the relay nodes lose energy faster and die out faster than the other nodes. Then the mobile sinks are introduced to reduce and balance energy consumption by traveling among the whole interesting area.

The main role of mobile sinks is to gather data from source nodes. Mobile sinks could be classified into mobile collectors and mobile relay nodes, according to its role in WSNs. Maximum Amount Shortest Path (MASP) [38] was proposed for a dynamic network with mobile sink as a mobile collector in the sensing path. MASP mechanism divides the sensing path into two parts : MCA (Multi hop Communication Area) and DCA (Direct Communication Area). DCA is for one-hop communication, and another one is for sub-sink. The mobile sink identifies the nodes that are within its communication range : either sub-sinks or communicating static nodes and the mobile sink collects data only from sub-sinks. Jain et al. [57] provide a data collection algorithm that apply the middle node as a relay node, in their three tier scenarios. The upper node is the destination node. The relay node is responsible to collect information from the lower node and forward them. However, they are mostly focus on static networks.

UAVs have been widely used in many fields (as presented in Chapter 2.3) as mobile sinks. The main functionalities of UAVs are maintaining connectivity, localization, and data collection. Maintaining connectivity is the essential functionality of UAVs, especially when UAVs are applied in harsh terrains (e.g. snow mountains, highly dense forest, vast and hot desert, etc.) [85] where they are difficult for the normal mobile sinks to operate. Kuiper et al. [70] combine position scheme and beacon-less strategy to maintain the intermittent connections in ad hoc networks. Localization was committed as an important functionality of UAVs in tracking or monitoring applications [115]. Typically, localization is carried out after the deployment of sensor nodes and the traditional techniques are based on the use of GPSs. The UAVs are equipped with GPSs and fly over the sensing area to estimate the geographical position of nodes [12]. Data collection is the crucial functionality of UAVs because the limited buffer space of sensor nodes that may result in the

data loss if the nodes have to wait for a long time to communicate.

Based on UAV-assisted WSNs, some researches have been done on data collection. Wei et al., [118] apply multi-UAVs and proposed IBA-IP (Iterative Balanced Assignment with Integer Programming) algorithm to collect data from static sensors. They apply Genetic Algorithm (GA) to facilitate the WSN to deploy the UAVs and evaluate the connectivity of UAVs. They object to minimize the average upload time cost of all the sensors. However, in some special applications (e.g. wilderness search and rescue [20]), the importance of maximizing the collected data from the sensing area is not less than to minimize the average upload time. Ren [96] provides a mechanism for this maximization problem.

In [122, 123], the authors studied several mobility metrics. Their studies indicate that the node density distribution plays a critical role in accuracy of mobility metrics. The Link Duration metric is the best metric through their evaluation based on a scenario approach [123], particularly for routing [122]. Thus, we introduce the contact duration time along with the time variant multi-data-rate. In this chapter, we will focus on the data collection maximization problem in linear motion model. We combine the multi-data-rate scheme and the contact duration time to maximize the number of collected packets from mobile sensors and share the communication opportunity with the UAV as fair as possible. Indeed, if the local time slot is allocated to the one that has the highest data rate or the one that has the lowest contact duration time can provide a maximizing data collection during the collecting time. Focused on data collection in high mobility, we provide four algorithms based on the two factors and define the weighted fairness metric to evaluate the algorithms.

3.2 Problem Statement

In this chapter, we consider a UAV-assisted mobile sensor network with N mobile sensors. $\mathbb{S} = \{S_1, S_2, \dots, S_N\}$ is a set of mobile sensors. The sensors are deployed along a predefined path (Figure 3.1). The UAV is flying along this path with a velocity v to collect data from the mobile sensors. The sensor S_i has the velocity v_i , and $\mathbb{V} = \{v_1, v_2, \dots, v_N\}$ is the set of sensors velocities. Finally, let $S_i(x_{i,t_k}, y_{i,t_k})$ is the coordinate of S_i in time slot t_k , and its corresponding initial position is $S_i(x_{i0}, y_{i0})$.

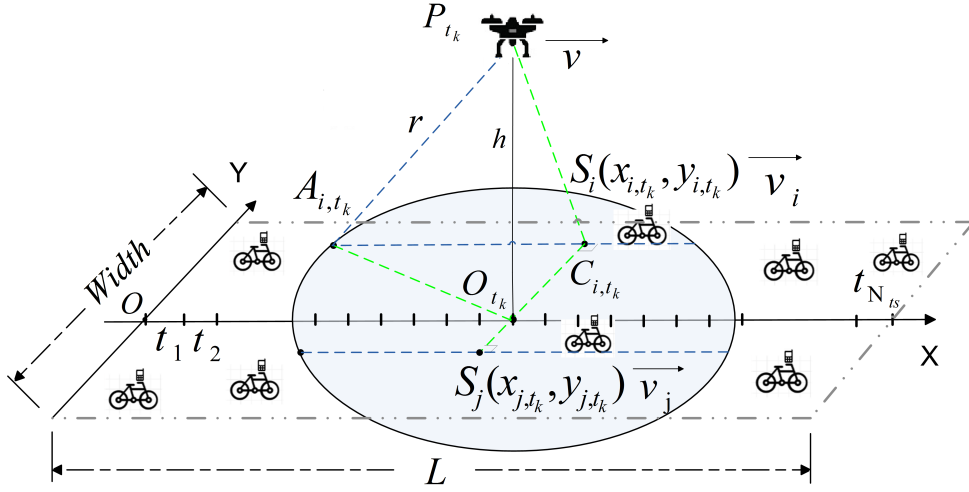

Figure 3.1. An illustration of time slots covered by sensors S_i and S_j .

Given the path length L , the total flying time T of the UAV is determined by the UAV and the sensors velocities. Moreover, we consider a discrete-time system where the total flying time is divided into N_{ts} time slots with each lasting α time units, and $N_{ts} = \lfloor \frac{T}{\alpha} \rfloor$. Assume that the time slots along the path are indexed as $t_1, t_2, \dots, t_{N_{ts}}$ (Figure 3.1), and the set is denoted by \mathbb{T} .

According to figure 3.1, the mobile sensors that are covered by the UAV and deployed nearby (e.g. S_i and S_j in figure 3.1.) share some time slots at which both of them can transfer their data to the UAV. In other words, multiple sensors that are sharing the same time slot compete for it to communicate. Hence, how to allocate N_{ts} time slots to the optimal mobile sensors so as to maximize the data collection is a challenging task. One of our contributions is to provide allocation algorithm such that each time slot is allocated to one mobile sensor only with the objective to maximize the amount of the collected data by the UAV.

Here, we present a distributed solution to the data collection maximization problem as follows.

The collecting time T is divided into N_{ts} time slots. As it is shown in figure 3.2, at the beginning of every time slot, UAV sends a *SYNC* message to inform the sensors that it is coming. Then, the UAV updates the network. The new comers in current coverage send *JOIN* messages including their coordinates and velocities to the UAV. The UAV detects whether the sensors are within its communication range or not according to the *JOIN* packet, and then calculates the contact duration time, data rate, and potential time slots for each

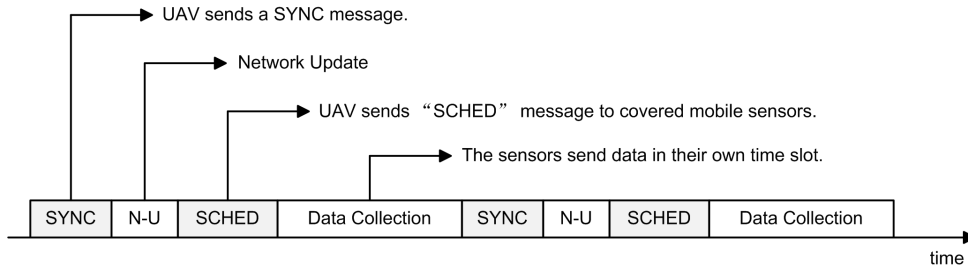

Figure 3.2. The different phases of the procedure of allocation.

Table 3.1. Multi-data-rate values

Level	Distance	Data-rate
1	$(0, 20] m$	$250 Kbs^{-1}$
2	$(20, 50] m$	$19.2 Kbs^{-1}$
3	$(50, 120] m$	$9.6 Kbs^{-1}$
4	$(120, 200] m$	$4.8 Kbs^{-1}$

mobile node that are within its coverage. According to the time slot allocation algorithms that we proposed in Chapter 3.3.2, the UAV provides a scheduling for the covered sensors, and broadcasts them a *SCHED* message which contain the time slots assignment. Each sensor transmits its data within its own time slots once *SCHED* message is received.

3.3 Scheduling Algorithms

3.3.1 Analysis of influencing factors

– Multi-rate mechanism

The communication performance is affected by path loss, interference, and shadowing, etc. The data rate depends on the distance between the sensors and the UAV, which leads the sensors to have different data rate in different time slots. A multi-rate communication metric between sensor S_i and UAV is adopted. Dr_{ji} is the data rate when the time slots t_j is allocated to the sensor S_i (Table 3.1 [96]).

– Contact duration time

During the collection time, mobile sensors have the opportunity to communicate with the UAV when it is within their communication range. Thus, every mobile node has limited contact duration time because of the dynamics of the network.

Considering the scenario illustrated in figure 3.1, for example, to show the calculation of the contact duration time.

In this chapter, we assume that the UAV and mobile sensors are equipped with the same communication technology. (e.g. ZigBee/IEEE-802.15.4, etc.). Consequently, when the UAV within the mobile sensors communication range, the mobile sensors are also within the UAV range. We also assume that the velocity of the UAV is no smaller than the mobile sensors velocities. The parameters that are used in this work as defined in Table 3.2.

In figure 3.1, sensor S_i is within the range of the UAV, and $|\overrightarrow{O_{t_k}C_{it_k}}| = y_{i0}$, $|\overrightarrow{O_{t_k}P_{t_k}}| = h$, $|\overrightarrow{P_{t_k}A_{it_k}}| = r$. The relative distance on the ground between S_i and the UAV along the X-axis direction in time slot t_k is denoted by $d(U, S_i)_k$. From figure 3.1, $\overrightarrow{A_{it_k}S_i} = \overrightarrow{A_{it_k}C_{it_k}} + \overrightarrow{C_{it_k}S_i}$, $|\overrightarrow{A_{it_k}C_{it_k}}| = \sqrt{P_{t_k}A_{it_k}^2 - O_{t_k}P_{t_k}^2 - O_{t_k}C_{it_k}^2} = \sqrt{r^2 - h^2 - (y_{i0})^2}$.

If sensor S_i is at the front of UAV, that is, point S_i is on the right side of point C_{it_k} . Then, $|\overrightarrow{A_{it_k}S_i}| = |\overrightarrow{A_{it_k}C_{it_k}}| + |\overrightarrow{C_{it_k}S_i}| = \sqrt{r^2 - h^2 - (y_{i0})^2} + x_{it_k} - x_{t_k}$. On the contrary, if sensor S_i is behind the UAV, then, $d(U, S_i)_k = |\overrightarrow{A_{it_k}C_{it_k}}| - |\overrightarrow{C_{it_k}S_i}| = \sqrt{r^2 - h^2 - (y_{i0})^2} + x_{it_k} - x_{t_k}$. Thus, $|\overrightarrow{S_iB_{it_k}}| = |\overrightarrow{A_{it_k}B_{it_k}}| - |\overrightarrow{A_{it_k}S_i}| = \sqrt{r^2 - h^2 - (y_{i0})^2} - x_{it_k} + x_{t_k}$. When $V > V_i$, the relative distance is $d(U, S_i)_k = |\overrightarrow{A_{it_k}S_i}|$, and when $V \leq V_i$, $d(U, S_i)_k = |\overrightarrow{S_iB_{it_k}}|$.

Thus, we can get the contact duration time of S_i from equation (3.1),

$$T_{icdt} = \frac{d(U, S_i)}{v - v_i}, i = 1, 2, \dots, N. \quad (3.1)$$

– Time slot definition

The duration of time slot is also a challenge in such context. One time slot only could be assigned to one sensor. There is a compromise in selecting the time slot duration. The longer the time slot duration, the

Table 3.2. Summary of notations used in this chapter

Notation	Description
r	The communication range of the UAV and the mobile sensors ;
v	The velocity of the UAV ;
v_i	The velocity of the mobile sensor S_i ($i = 1, 2, \dots, N$) ;
h	The height of the UAV ;
α	The duration time of one time slot ;
N	The number of mobile sensors ;
N_{ts}	The number of time slots ;
N_s	The number of sensors that send at least one packet in time T ;
S_{pk}	The packet size that the mobile sensor send to the UAV ;
$Dr(j, i)$	The data rate between sensor S_i ($i = 1, 2, \dots, N$) and the UAV within time slot t_j ($j = 1, 2, \dots, N_{ts}$) ;
T_{icdt}	The contact duration time of sensor S_i ($i = 1, 2, \dots, N$) when it is within the communication range of the UAV ;
w_i	The weight of contact duration time of sensor S_i ($i = 1, 2, \dots, N$) ;
$N_{pk}(i)$	The number of packets that the UAV has collected from sensor S_i ($i = 1, 2, \dots, N$) in time T ;
$N_{ts}(i)$	The number of time slots that sensor S_i ($i = 1, 2, \dots, N$) was allocated in time T ;
$d(U, S_i)$	The distance between UAV and sensor S_i ($i = 1, 2, \dots, N$) ;
$Tcdt(j, i)$	The contact duration time of sensor S_i ($i = 1, 2, \dots, N$) within time slot t_j ($j = 1, 2, \dots, N_{ts}$) ;
$Npk(j, i)$	The number of packets that the UAV has collected from sensor S_i ($i = 1, 2, \dots, N$) within time slot t_j ($j = 1, 2, \dots, N_{ts}$) ;
$Ntss(j, i)$	$Ntss(j, i) = 1$ means that time slot t_j is allocated to sensor S_i ;
$S_i(x_{it_k}, y_{it_k})$	The coordinates of sensor S_i ($i = 1, 2, \dots, N$) in time slot t_k .

more remaining time is wasted. In the contrary, if the time slot duration is short, the relevant sensor that being allocated this time slot do not have enough time to send at least one packet. Thus, in this chapter, we

consider the time slot capability when dividing the time.

In our work, the time slot is considered as the time that the mobile sensor need to successfully send one packet with the lowest data rate (4.8 Kb/s). The duration of time slot is denoted by α , which can be written by,

$$\alpha = t_{pk} = \frac{S_{pk}}{D_r}. \quad (3.2)$$

Algorithm 1 DR Algorithm

Require: $\mathbb{S}, \mathbb{V}, \alpha, v, r, h, T, N_{ts}, L$ and *Width*

Ensure: # Packets, WF_{pk} and WF_{ts} .

- 1: $N_s = 0; j = 1;$
 - 2: **while** $j < N_{ts}$ **do**
 - 3: $T_c = (j - 1) * \alpha;$
 - 4: Refreshment of the network :
 - 5: **for** $i = 1 \rightarrow N$ **do**
 - 6: Calculate : $S(x_i, y_i)$ and $d(U, S_i)_j;$
 - 7: If S_i within the range of the UAV in t_j , calculate $Dr(j, i);$
 - 8: **end for**
 - 9: $\mathbb{A} = \{S_i \mid S_i \in \mathbb{S}, Dr(j, i) \text{ is the maximum}\};$
 - 10: t_j allocated to $S_{i_0}, (S_{i_0} \in \mathbb{A}), N_s = N_s + 1;$
 - 11: Calculate $N_{pk}(j, i_0)$ and $N_{ts}(j, i_0);$
 - 12: $j = j + 1;$
 - 13: **end while**
 - 14: For all $S_i \in \mathbb{S}$, calculate $N_{pk}(i), N_{ts}(i), T_{cdt}(i)$ and $w(i);$
 - 15: Calculate : # Packets, WF_{pk} and $WF_{ts};$
 - 16: **End of algorithm.**
-

3.3.2 Proposed Algorithms

The maximizing data collection problem is to maximize the number of collected packets by the UAV through allocating the N_{ts} time slots to individual mobile sensors according to the proposed algorithms. The more data is collected per time slot, the more data is collected in total. Hence, in the issue of data collection optimization, we consider two factors. One factor is allocate the time slot to the mobile sensor that has the highest data rate to maximize the usage of it. The other factor tries to allocate the time slot to the one that has the shortest contact duration time so as to collect data from mobile sensors as much as possible. According to this, we combined multi-data-rate mechanism and contact duration time scheme and proposed four algorithms, which will be detailed in the following.

Algorithm 2 CDT Algorithm

Require: $\mathbb{S}, \mathbb{V}, \alpha, v, r, h, T, N_{ts}, L$ and $Width$

Ensure: # Packets, WF_{pk} and WF_{ts} .

- 1: $N_s = 0; j = 1;$
 - 2: **while** $j < N_{ts}$ **do**
 - 3: $T = (j - 1) * \alpha;$
 - 4: Refreshment of the network :
 - 5: **for** $i = 1 \rightarrow N$ **do**
 - 6: Calculate : $S(x_i, y_i)$ and $d(U, S_i)_j;$
 - 7: If S_i within the range of the UAV in t_j , calculate $T_{cdt}(j, i);$
 - 8: **end for**
 - 9: $\mathbb{B} = \{S_i \mid S_i \in \mathbb{S}, T_{cdt}(j, i) \text{ is the minimum}\};$
 - 10: t_j allocated to $S_{i_0}, (S_{i_0} \in \mathbb{B});$
 - 11: $N_s = N_s + 1;$
 - 12: Calculate : $N_{pk}(j, i_0), N_{ts}(j, i_0);$
 - 13: $j = j + 1;$
 - 14: **end while**
 - 15: For all $S_i \in \mathbb{S}$, calculate $N_{pk}(i), N_{ts}(i), T_{cdt}(i)$ and $w(i);$
 - 16: Calculate : # Packets, WF_{pk} and $WF_{ts};$
 - 17: **End of algorithm.**
-

In a given time slot t_i ($t_i \in \mathbb{T}$, $\mathbb{T} = \{t_1, t_2, \dots, t_{N_{ts}}\}$), there are multiple sensors within the range of the UAV, the sensors set is denoted by \mathbb{S}_{t_i} . The details for each algorithms are presented as follows :

- **DR Algorithm.** It gives high priority to the sensor that has the highest data rate. Time slot t_i is allocated to the sensor that has the highest data-rate in \mathbb{S}_{t_i} . This helps to achieves the maximize usage in every time-slot. **DR** Algorithm is detailed in Algorithm 1.
- **CDT Algorithm.** It gives high priority to the sensor that has the shortest contact duration time. Time slot t_i is allocated to the sensor that has the shortest contact duration time in \mathbb{S}_{t_i} . This helps the one that has the shortest contact duration time has a bigger opportunity to send packets. **CDT** Algorithm is described in Algorithm 2.
- **DR/CDT Algorithm.** It gives high priority to the sensors that have the highest data rate first and then gives the priority to the sensors that have the lowest contact duration time for the sensors that have the same data rate. Generally, there are multiple sensors that have the same highest data-rate in \mathbb{S}_{t_i} . Thus, we combine multi-data-rate and contact duration time in **DR/CDT** because they could have different contact duration time even they have the same highest data-rate. Time slot t_i , in **DR/CDT**, is assigned to the one that has the shortest contact duration time among those that has the same highest data-rate in \mathbb{S}_{t_i} . **DR/CDT** Algorithm is detailed in Algorithm 3.
- **CDT/DR Algorithm.** It gives high priority to the sensors that have the lowest contact duration time first and then gives the priority to the sensors that have the highest data rate for the sensors that have the same contact duration time. Similarly to **DR/CDT** algorithm, time slot t_i , in **CDT/DR** algorithm, is assigned to the one that has the highest data-rate among those having the same shortest contact duration time in \mathbb{S}_{t_i} . **CDT/DR** Algorithm is described in Algorithm 4.

From the details in Algorithm 1, 2, 3, and 4, we can see that, the four algorithms share the same refreshment part till the calculation of $S(x_i, y_i)$ and $d(U, S_i)_j$. The following parts have a little difference in the calculation of $Dr(j, i)$ and $Tcdt(j, i)$, and this part has a time complexity which is a constant multiple of $O(N_j)$. N_j is the number of sensors that are within the range of the UAV in time slot t_j . $O(N * N_{ts} * c * N_j) + O(N * N_j) = O(N * N_{ts} * N_j)$. Thus, they share the same time complexity, $O(N * N_{ts} * N_j)$.

Algorithm 3 DR/CDT Algorithm

Require: $\mathbb{S}, \mathbb{V}, \alpha, v, r, h, T, N_{ts}, L$ and *Width***Ensure:** # Packets, WF_{pk} and WF_{ts} .

```

1:  $N_s = 0; j = 1;$ 
2: while  $j < N_{ts}$  do
3:    $T = (j - 1) * \alpha;$ 
4:   Refreshment of the network :
5:   for  $i = 1 \rightarrow N$  do
6:     Calculate :  $S(x_i, y_i)$  and  $d(U, S_i)_j;$ 
7:     if  $d(U, S_i)_j \leq r$  then
8:       Calculate  $T_{cdt}(j, i)$  and  $Dr(j, i);$ 
9:     end if
10:  end for
11:   $\mathbb{A} = \{S_i \mid S_i \in \mathbb{S}, Dr(j, i) \text{ is the maximum}\};$ 
12:   $\mathbb{B} = \{S_i \mid S_i \in \mathbb{A}, T_{cdt}(j, i) \text{ is the minimum}\};$ 
13:   $t_j$  allocated to  $S_{i_0}, (S_{i_0} \in \mathbb{B});$ 
14:   $N_s = N_s + 1;$ 
15:  Calculate :  $N_{pk}(j, i_0)$  and  $N_{ts}(j, i_0);$ 
16:   $j = j + 1;$ 
17: end while
18: for  $i = 1 \rightarrow N$  do
19:   Calculate :  $N_{pk}(i), N_{ts}(i), T_{cdt}(i)$  and  $w(i);$ 
20: end for
21: Calculate :# Packets,  $WF_{pk}$  and  $WF_{ts};$ 
22: End of algorithm.

```

3.4 Performance Evaluation

The purpose of our simulations is to evaluate the effectiveness of our algorithms. In order to establish whether the proposed algorithms really has a positive impact on the data collection process we opted to study its performance in terms of the number of collected packets and the weighted fairness. In this study,

Algorithm 4 CDT/DR Algorithm

Require: $\mathbb{S}, \mathbb{V}, \alpha, v, r, h, T, N_{ts}, L$ and *Width*

Ensure: # Packets, WF_{pk} and WF_{ts} .

```

1:  $N_s = 0; j = 1;$ 
2: while  $j < N_{ts}$  do
3:    $T = (j - 1) * \alpha;$ 
4:   Refreshment of the network :
5:   for  $i = 1 \rightarrow N$  do
6:     Calculate :  $S(x_i, y_i)$  and  $d(U, S_i)_j;$ 
7:     If  $S_i$  within the range of the UAV in  $t_j$ , calculate  $Dr(j, i)$  and  $Tcdt(j, i);$ 
8:   end for
9:    $\mathbb{A} = \{S_i \mid S_i \in \mathbb{S}, Tcdt(j, i) \text{ is the minimum}\};$ 
10:   $\mathbb{B} = \{S_i \mid S_i \in \mathbb{A}, Dr(j, i) \text{ is the maximum}\};$ 
11:   $t_j$  allocated to  $S_{i_0}, (S_{i_0} \in \mathbb{B});$ 
12:   $N_s = N_s + 1;$ 
13:  Calculate :  $Npk(j, i_0)$  and  $Ntss(j, i_0);$ 
14:   $j = j + 1;$ 
15: end while
16: for  $i = 1 \rightarrow N$  do
17:   Calculate :  $Npk(i), Nts(i), Tcdt(i)$  and  $w(i);$ 
18: end for
19: Calculate :# Packets,  $WF_{pk}$  and  $WF_{ts};$ 
20: End of algorithm.

```

we have not studied the energy efficiency of the algorithms. Moreover, even if the sensor nodes are assumed to be mostly-on during the data collection phase (i.e., when they are within the range of the UAV), we can easily claim that sensors save energy by going to sleep mode when they are out of the range.

3.4.1 Performance Metrics

– The number of collected packets

In this chapter, allocating the N_{ts} time slots to N mobile sensors under multi-rate mechanism is equivalent to maximize the usage of time slots, that is the generalized assignment problem (GAP), which is defined as follows [19].

Instance : A pair (\mathbb{B}, \mathbb{S}) where \mathbb{B} is a set of M bins (knapsacks) and \mathbb{S} is a set of N items. Each bin $C_j \in \mathbb{B}$ has capacity c_j , and for each item i and bin C_j we are given a size $s(i, j)$ and a profit $p(i, j)$.

Objective : Find a subset $\mathbb{U} \subseteq \mathbb{S}$ of items that has a feasible packing in \mathbb{B} , such that the profit is maximized.

GAP is applicable in many fields, including data storage and retrieval in disks [108], inventory matching [24], and distributed caching [36].

Given N_{ts} time slots, N mobile sensors, and a predefined path L . Each time slot t_j , there are N_{tj} mobile sensors, potentially available for the allocation of the time slot t_j , where Dr_{ji} is the average data rate of mobile sensor S_i if it does transmit its packets at time slot t_j . Let,

$$Ntss(j, i) = \begin{cases} 1 & \text{time slot } t_j \text{ is allocated to sensor } S_i, \\ 0 & \text{otherwise.} \end{cases}$$

The data collection maximization problem is to maximize P (equation 3.3),

$$P = \sum_{i=1}^N \sum_{j=1}^{N_{ts}} Ntss(j, i) \cdot Dr_{ji} \cdot \alpha. \quad (3.3)$$

– Weighted fairness

Fairness is a key question under high mobility context. Indeed, each mobile sensor should communicate in all available time slots to take full advantage of the data collection from the entire network. Meanwhile, some mobile sensors share some time slots where they could communicate with UAV. However, the UAV can communicate with only one sensor at any given time slot, otherwise a collision occurs. Thus, fairness plays a key role in evaluating the four algorithms.

In the design of fairness, we only take into account the mobile sensors that have successfully transmitted at least one packet during the collection time. In this scenario, the sensor nodes are moving and are randomly deployed. Therefore, they may have different contact duration time and the number of sent packets should be proportional to the contact duration time of every node. Therefore, weighted fairness regarding the

Table 3.3. Simulation parameters

Parameter	Value	Parameter	Value
Move path	10 m × 3000 m	Time slot duration	0.2117 s
Deployed path	10 m × 3000 m	Packet size	127 Bytes

contact duration time is required when evaluating the fairness of the proposed algorithms. For sensor S_i , $w_i = \frac{T_{icdt}}{T}$, we define the weighted fairness as follows,

$$WF_{pk} = \frac{(\sum_{i=1}^N N_{pk}(i) \cdot w_i)^2}{N_s \cdot \sum_{i=1}^N (N_{pk}(i) \cdot w_i)^2}, \quad (3.4)$$

$$WF_{ts} = \frac{(\sum_{i=1}^N N_{ts}(i) \cdot w_i)^2}{N_s \cdot \sum_{i=1}^N (N_{ts}(i) \cdot w_i)^2}. \quad (3.5)$$

During the collecting time, WF_{pk} evaluates the fairness in terms of the number of packets that each sensor successfully send. The larger value of WF_{pk} , the greater value of fairness for mobile sensors that transmit at least one packet. $WF_{pk} = 1$ means they send the same number of packets during time T . WF_{ts} evaluates the opportunity that every mobile sensor had to communicate. The larger value of WF_{ts} , the greater value of fairness for mobile sensors that transmit at least one packet. $WF_{ts} = 1$ means the N_s mobile sensors were allocated with the same number of time slots.

3.4.2 Simulation Results and Discussion

The following simulations are conducted with one UAV and sensors moving within a predefined path. In this chapter, we consider the main factors, UAV velocity and height, sensors mobility and density, that have an impact on the data collection. The simulation parameters applied in this chapter are presented in Table 3.3.

The purpose of our simulations is to evaluate the effectiveness of our design in terms of number of collected packets and weighted fairness. Under all these simulation settings, we done 50 simulations. The results presented in this chapter are given by the mean value of 30 simulations except the 10 best simulations and the 10 worst simulations.

– The impact of UAV’s velocity

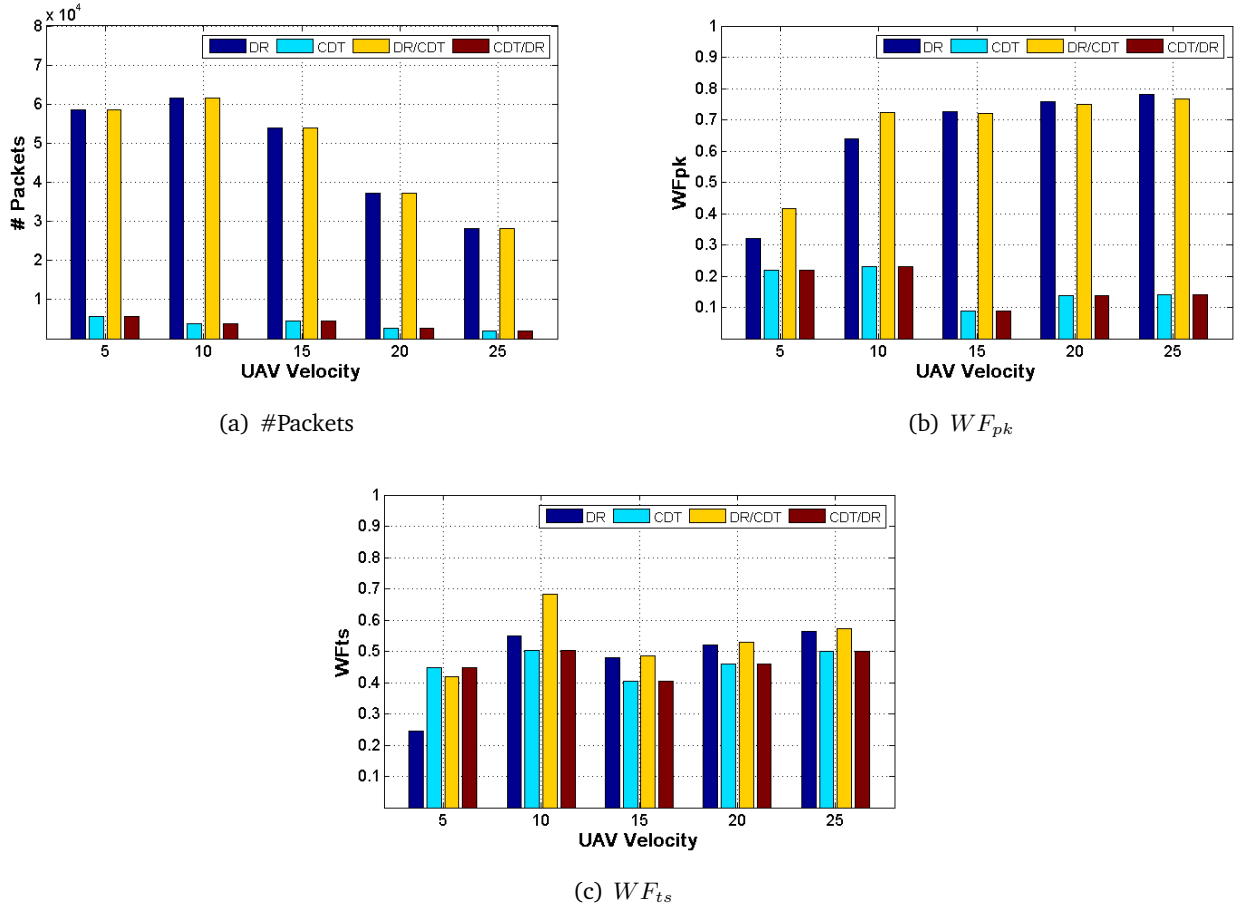

Figure 3.3. The impact of UAV velocity on #Packets, WF_{pk} and WF_{ts} .

In this scenario, the UAV flies at 15 m, and its velocity varies from 5 ms^{-1} to 25 ms^{-1} considering the upper-bound. Meanwhile, mobile sensors velocities can not be greater than the minimum speed of the UAV. Thus, in this simulation, their velocities are within 0 ms^{-1} and 5 ms^{-1} .

From figure 3.3(a), DR and DR/CDT algorithms have absolute advantages on data collection compared with CDT and CDT/DR algorithms. The number of collected packets by DR and DR/CDT is increasing as the UAV speed increases when the UAV velocity below 10 ms^{-1} and then decreasing as UAV speed is increasing. Indeed, when the UAV velocity is closely to the sensors velocities, the UAV will miss many sensors that

are deployed faraway from the beginning where the UAV flies. Thus, the larger the UAV velocity, the more opportunity the UAV has. In contrast, if the UAV velocity is much faster than sensors speeds, the contact duration time will very shortly between them, then the collected value decreases as UAV velocity increases. The number of collected packets by *CDT* and *CDT/DR* algorithms presents steadily down as UAV velocity climbs because *CDT* and *CDT/DR* algorithms give priorities to the contact duration time which steadily decreases as UAV velocity increases.

Figure 3.3(b) and 3.3(c) present both *DR* and *DR/CDT* algorithms work better than *CDT* and *CDT/DR* algorithms. From figure 3.3(c), we can see that the WF_{pk} has grown steadily, and achieved its maximum when the UAV flies at 25 m.s^{-1} . Indeed, almost all sensors have a tiny chance to send data when a huge gap velocity between them. This also be shown in figure 3.3(c). The main difference is the WF_{ts} of *DR/CDT* algorithm has the optimal value when the UAV flies at 10 m.s^{-1} , this is very consistent with the figure 3.3(a).

Figure 3.3 presents the UAV has the optimal velocity (10 m.s^{-1}), we will apply it in the following simulations.

– The impact of UAV's height

In this scenario, the UAV flies at a constant velocity (10 m.s^{-1}) and its height varies from 5 m to 90 m . 200 mobile sensors deployed at the predefined path and moving with constant but different velocities. Their velocities vary from 1 m.s^{-1} to 10 m.s^{-1} .

Figure 3.4(a) shows the number of collected packets of the four algorithms. The collected value follows a step-like curve as the height increases because of our multi-rate mechanism. The contact duration time gives a slight effect on the number of collected packets when the UAV's height exceeds 20 m while the data rate has a continuous impacting on the collected value till 50 m especially when the height is smaller than 20 m . From figure 3.4(a) and 3.4(b), it is clear that *DR* and *DR/CDT* algorithms always work better than *CDT* and *CDT/DR* algorithms.

From figure 3.4(b) and 3.4(c), both WF_{pk} and WF_{ts} are presented in a step curve which match with our multi-data-rate schemes. *DR/CDT* algorithm has a significant impact on these two weighted fairness in the second level. In figure 3.4(b) and 3.4(c), *CDT* algorithm presents continuous trend in different levels because the contact duration time is decreasing as the height is increasing under the same network topology. *DR/CDT* algorithm as a whole is the one that works better among the four algorithms no matter which level

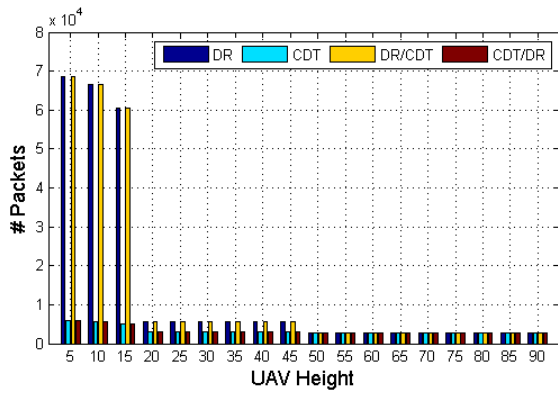

(a) #Packets

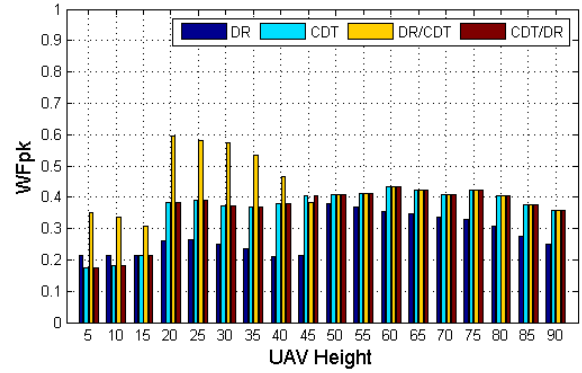

(b) W_{Fpk}

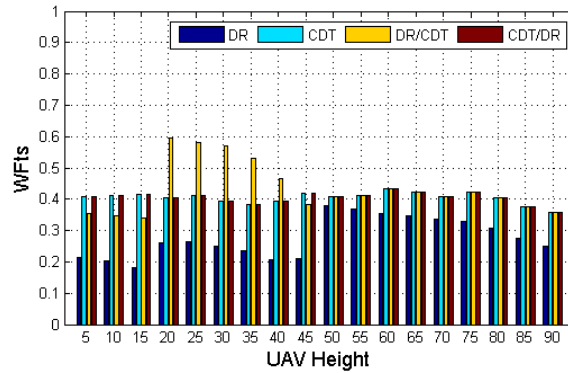

(c) W_{Fts}

Figure 3.4. The impact of UAV height on #Packets, W_{Fpk} and W_{Fts} .

the four algorithms work on excepting the level one in figure 3.4(c).

From figure 3.4(a), we will set the UAV flies height at 15 m in the following simulations in order to fully take into account the impact of other parameters.

– **The impact of sensors mobility**

In this simulation, we use the result in the above two simulations, the UAV is flying at constant height (15 m) and velocity (10 ms^{-1}), 200 mobile sensors are deployed in a predefined path. We divide the sensor speeds into ten levels. Take the velocity '5' in figure 3.5, for example, this means that all the sensors velocities are within $[4, 5] \text{ ms}^{-1}$.

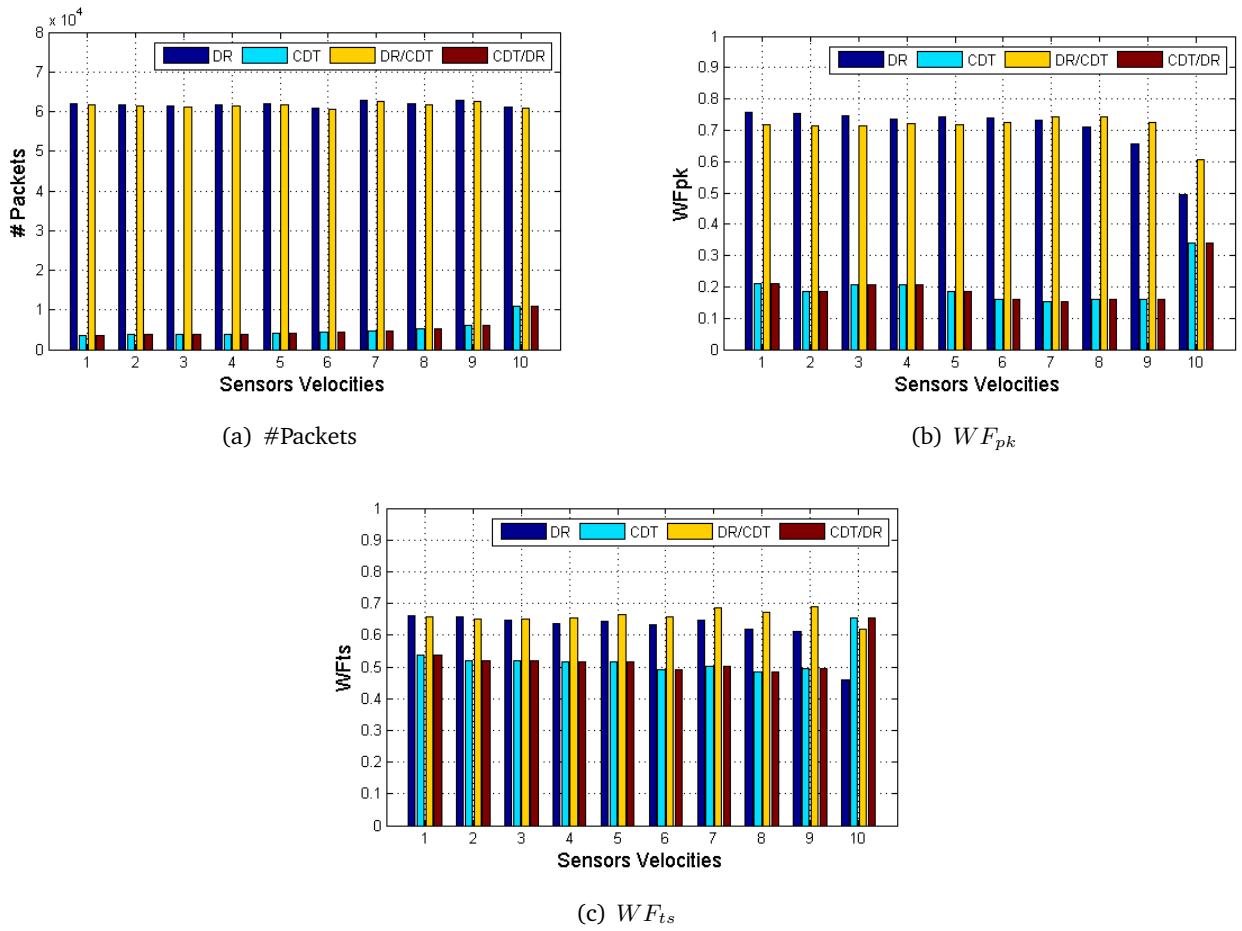
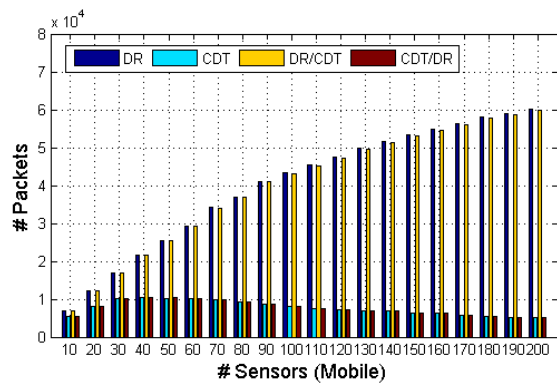

Figure 3.5. The impact of sensors mobility on #Packets, WF_{pk} and WF_{ts} .

From figure 3.5, we can conclude that **DR** and **DR/CDT** algorithms work well, their collected packets, and weighted fairness have huge advantages than **CDT** and **CDT/DR** algorithms. We can see from figure 3.5 that the #Packets, WF_{pk} and WF_{ts} are not changing dramatically as the speed increases. Thus, sensors velocities have a small effect on all the algorithms. Meanwhile, the higher the sensor velocities, the better the **DR/CDT** algorithm works, except the special case, sensors velocities within $[9, 10] \text{ ms}^{-1}$. None algorithm keeps continuous trend because almost all sensors velocities are near the UAV velocity, their data rate and contact duration time are also quite near.

– The impact of density



(a) #Packets (Mobile)

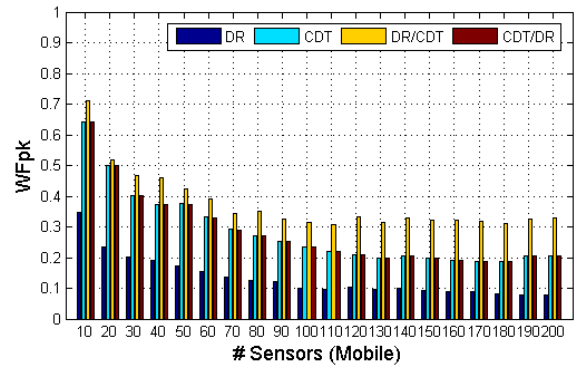

(b) WF_{pk} (Mobile)

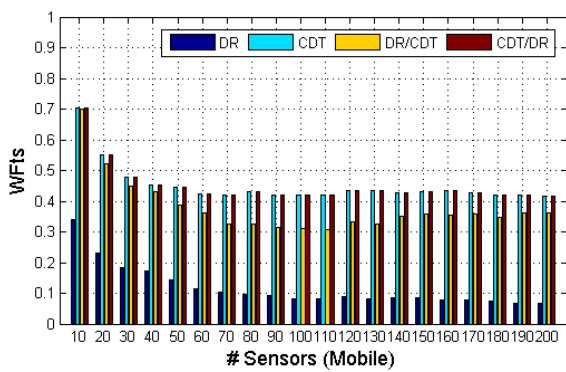

(c) WF_{ts} (Mobile)

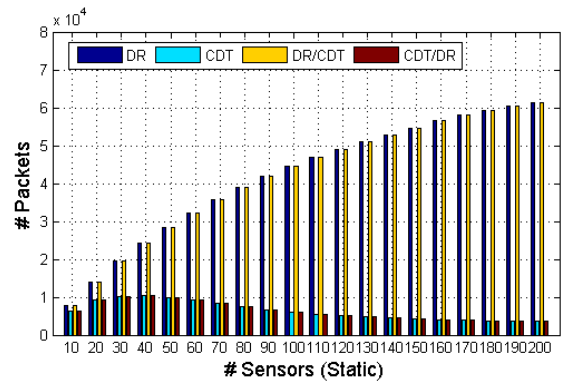

(d) #Packets (Static)

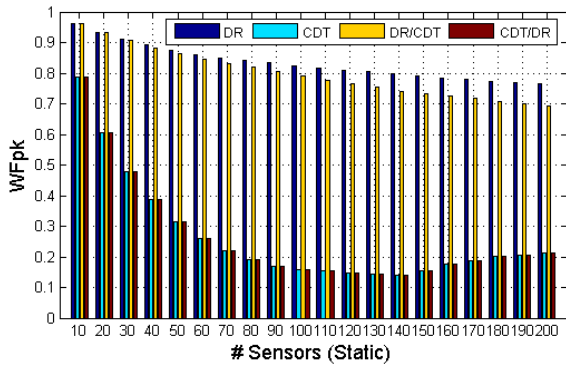

(e) WF_{pk} (Static)

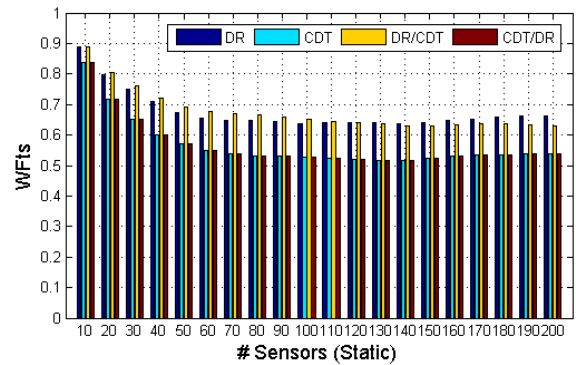

(f) WF_{ts} (Static)

Figure 3.6. The impact of sensors density on #Packets, WF_{pk} and WF_{ts} .

Here, we consider two scenarios, the mobile case and the static one. The same parts of the two scenarios are UAV's height (15 m) and velocity (10 $m s^{-1}$), the mobile sensors are deployed on a given path and the number of mobile sensors varies from 10 to 200. The only difference between them is mobile sensors velocities, varying from 1 $m s^{-1}$ to 10 $m s^{-1}$ for mobile case and 0 $m s^{-1}$ for static case.

Figure 3.6(a) and 3.6(d) show the number of packets collected by **DR** and **DR/CDT** algorithms along with the gap between the **DR**, **DR/CDT** and **CDT**, **CDT/DR** algorithms are increasing as density is increasing. Moreover, both **DR** and **DR/CDT** algorithms work very well on the maximizing problem. Figure 3.6(a) and 3.6(d) demonstrate that the density has a slight impact on **CDT** and **CDT/DR** algorithms because of its small gap between different levels. The **DR/CDT** algorithm shows high scalability in terms of sensors density.

Figure 3.6(c) and 3.6(f) show that the weighted fairness in terms of allocated time slots is slowly decreasing as density increases and has small fluctuations when the number of sensors exceeds 120 in mobile case.

From figure 3.6(b) and 3.6(e), the weighted fairness with reference to sent packets is decreasing as density increasing. Moreover, WF_{pk} values of **CDT** and **CDT/DR** algorithms decreasing when the number of sensors is smaller than 140, and increasing when the number of sensors is larger than 140 mobile sensors in the static case. It can be seen from figure 3.6(e) that the density is responsible for the changement trend. When the the number of sensors is smaller than 140, the higher density the sensors deployed, the higher intensity of sensor competes for transmitting in one time slot. When the number of sensors is larger than 140, there are too many sensors, competing for communication, so that almost all sensors within the communication range have a small opportunity to transmit. However, the mobile case presents a different situation because of the mobility of the sensor nodes.

In mobile case, **DR/CDT** algorithm shows an absolute advantage in terms of WF_{pk} for each density. Additionally, WF_{ts} of **DR/CDT** algorithm almost 2 times larger than **DR** algorithm.

3.5 Conclusion

In this chapter, we studied how to collect data through a UAV-assisted mobile sensor network. This scheme can overcome the limitations of the traditional data collection methods where the generated packets are

forwarded to the base station hop by hop. We presented four data collection algorithms taking into account the multi data-rate transmissions and the contact duration time between the sensors and the UAV. We also proposed a weighted fairness metric calculation to evaluate the algorithms. We examined the performance of the algorithms under different conditions and demonstrated how the algorithm that combine multi-data-rate and contact duration time outperforms the others in terms of the number of collected packets and the weighted fairness.

Since all the proposed algorithms are focus on the one-hop data collection mechanism, we will concentrate on the multi-hop case in next chapter. The multi-hop mechanisms give opportunities to the sensors that are out of the range of the UAV, which will be more efficient than one-hop case.

CHAPITRE 4

Opportunistic Communications in WSN Using UAV

Contents

4.1 Introduction	64
4.2 Problem Statement	65
4.2.1 Sensors Mobility	67
4.2.2 Simple Example to Present the Mobility	68
4.3 Implementing Opportunistic Routing Protocols for UAV-assisted WSN without Guarantee Forwarders	68
4.3.1 Performance Metrics	68
4.3.2 Time slot based Opportunistic Routing Algorithms	70
4.3.3 Simulation Setup	72
4.3.4 Simulation Results and Discussion	72
4.3.5 Summary	77
4.4 Implementing Opportunistic Routing Protocols for UAV-assisted WSN with Guarantee Forwarders	77
4.4.1 Opportunistic Multi-hop Communications	77
4.4.2 Scheduling based Competition Multi-hop Routing Protocols	78
4.4.3 Performance Metrics	81
4.4.4 Evaluation of the proposed algorithms	84
4.4.5 Results and Analysis	86
4.5 Conclusion	91

The algorithms proposed in Chapter 3 are one-hop protocols, where the source nodes send packets to the destination node directly. There is no opportunity for those nodes, which are out of the range of the destination node, to send packets. Thus, the multi-hop concept was introduced.

As mentioned in Chapter 2.6, opportunistic routing protocols are different from traditional protocols since they take advantage of the broadcasting nature of WSNs when forwarding packets and selecting routes which can be managed well with unpredictable and unreliable wireless links. They can strengthen the transmission links through combining multiple weak links and enhance the throughput by applying opportunistic transmissions.

In multi-hop data collection, forwarder selection, and routing concern which relay node should be selected, how many forwarders would be involved and how many hops should be used for data transmission. All these issues impact the network performance. One of the major challenges in opportunistic routing protocol is the maximizing transmission without re-transmissions or incurring significant coordination overhead. Therefore, it is crucial for OR to support diverse traffic patterns, such as multiple simultaneous flows, and achieve significant performance gain in real wireless networks.

In this chapter, we consider the same scenario as discussed in Chapter 3. The multi-hop data collection issues, in such scenario, are to select the forwarders from mobile sensors first and then establish the communication between forwarders and simple nodes along with UAV and forwarders. In such dynamic network, the mobility is the most striking feature. It should be considered as one of the main factors when designing protocols. The major challenges of multi-hop data collection issues in such scenario can be summarized as :

1. *What factors should be considered when selecting forwarders ? Which nodes will be selected as forwarders and how many forwarders were selected ?*

If one protocol solves these problems, they still face new challenges in such dynamic network,

2. *The selected relay nodes can not guarantee that it have the opportunities to communicate with the UAV.*
3. *The selected forwarders also can not guarantee that all the collected packets from simple nodes have opportunities to send to the UAV even they had opportunities to communicate with the UAV.*

In this chapter, we present two categories protocols according to the mentioned challenges. **Class 1** : the selected forwarders can not guarantee that they have opportunities to communicate with the UAV [76].

Class 2 : each selected forwarder at least have an opportunity to transmit data to the UAV [78]. Our main contributions presented as following [76, 78] :

Class 1 :

- We introduce two new opportunistic routing protocols, All Neighbors Opportunistic Routing (*ANOR*) protocol in which the source node will share its traffic to all the neighbors that are within its range and Highest Velocity Opportunistic Routing (*HVOR*) protocol where the source node sends packets to a single node that has the highest speed.
- We dynamically chooses route and determines which sensor is the forwarder and build the connection. The proposed algorithms are compared with *DR/CDT* algorithm, which is proposed in Chapter 3, in terms of delay, overhead, and delivery ratio.

Class 2 :

- We proposed a new forwarder selection algorithm that could guarantee the transmission between the selected forwarders and the UAV.
- We introduced the remaining packets queue size, the transmission capacity (TC) features, the competition capacity, and proposed Transmission with Opportunistic Competition Capacity (*TOCC*) protocol for each relay node when implementing the data collection between relay nodes and simple nodes.
- The delivery ratio, energy consumption, and Fairness are defined and optimized by formulating an optimization problem.

4.1 Introduction

In UAV-assisted wireless sensor networks, their rapid deployment and practical relocation make the UAVs highly effective in self-organizing and providing appropriate communications coverage for on-ground users. Opportunistic Routing (OR) protocol is essential to the performance and reliability of wireless networks ([87, 95, 126]).

OR protocols are different from traditional protocols since they take advantage of the broadcasting nature of WSNs when forwarding packets and selecting routes which can be managed well with unpredictable and unreliable wireless links. They can strengthen the transmission links through combining multiple weak links and enhance the throughput by applying opportunistic transmissions.

There are many challenges in opportunistic routing issues, authors in [30] present the problem of minimizing energy consumption and maximizing lifetime of a many-to-one WSN. Maximizing transmission without re-transmissions or incurring significant coordination overhead is also a major challenge in WSN even it is not as many addressed as aforementioned. It is crucial for OR to support diverse traffic patterns, such as multiple simultaneous flows, and achieve significant performance gain in real wireless networks. In multi-hop data collection, forwarder selection, and routing concern which relay node should be selected, how many forwarders would be involved and how many hops should be used for data transmission. All these issues impact the network performance.

In this chapter, we consider a UAV-assisted mobile WSN where the sensor nodes are moving along a predefined route, and the UAV is flying at a given altitude and velocity to collect data (Figure 4.2). The multi-hop data collection issues, in such scenario, are to select the forwarders from mobile sensors first and then establish the communication between forwarders and simple nodes along with UAV and forwarders. Furthermore, the forwarder selection, in our work, based on the assumption that if one sensor node was chosen as a forwarder, it should have an opportunity to transmit data to the UAV. Because of the network dynamics, if the forwarders are selected first, it is not certain that all the chosen relay nodes have opportunities to communicate with the UAV. Otherwise, if we fixed the communication scheduling between UAV and forwarders first, the number of forwarders corresponding is known. The scheduling is determined

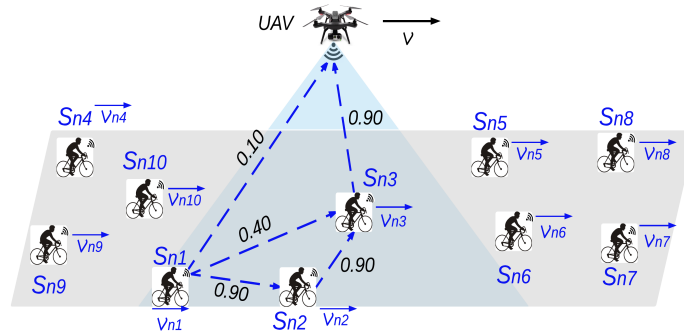

Figure 4.1. Scenario in multi-hop case.

according to the designed algorithms and the system objective function. Therefore, in this chapter, we focus on the design of scheduling algorithms instead of finding out the optimal number of forwarders.

Furthermore, the remaining packets queue size and the transmission capacity (TC) features for each relay node, the limited contact duration time and the multiple-data-rate are considered. We also combined the number of time-slots that the forwarder already got in the past with the number of contenders for the same time-slot and proposed a *Forwarder Selection* algorithm to select forwarders and implement the UAV-Forwarder communications. We propose the Transmission with Opportunistic Competition Capacity (*TOCC*) algorithm taking into account the multi-data-rate scheme, the transmission capacity, and the contact duration time between the sensors and the UAV. Meanwhile, the delivery ratio, the energy consumption, and *Fairness* are defined and optimized by formulating an optimization problem.

4.2 Problem Statement

For the purpose to establish an intuitive understanding for why there might be room for improvement of opportunistic routing in multi-hop WSN using UAV, it is helpful in this chapter to introduce the scenario in figure 4.1. In this scenario, the UAV is flying at given height and speed to collect data from sensor nodes that are moving along a predefined path at the same direction as the UAV. As the network topology is changing under the mobility of the UAV and the nodes, each sensor has limited opportunities to communicate with

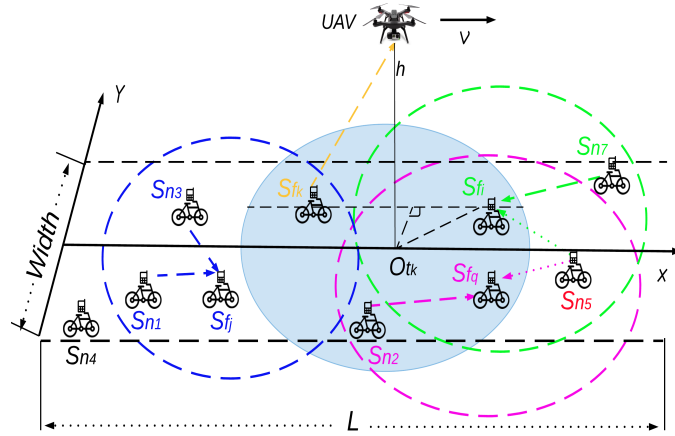

Figure 4.2. An illustration of multi-hop data collection covered by UAV in time-slot t_k .

the UAV.

Suppose there are a number of mobile nodes, such as S_{n1} , S_{n2} , S_{n3} in figure 4.1, within the communication range of the UAV in a given moment and S_{n1} wants to transmit its data to the UAV. It can be seen from figure 4.1 that there is a certain number of different possible routes for S_{n1} to send its packets to the UAV. S_{n1} could directly transmits data to the UAV in one-hop but with low transmission rate. In this situation, S_{n1} has to send each packet many times to avoid packet losses. S_{n1} could also use 2-hop or 3-hop routes through S_{n2} and S_{n3} . However, S_{n1} also needs to retransmit each packets many times since there are multiple hops. In fact, each particular route has its own limitation performance on the table. When S_{n1} uses the 3-hop route by sending packets to S_{n2} , S_{n3} and the UAV receives data at the same time. Thus, it is useless for S_{n2} to work as the forwarder and forward such data to S_{n3} . If S_{n1} tries to send its data to the UAV in one-hop, the UAV may lose most of the transmitted data but the S_{n2} and S_{n3} hear it in many cases. Hence, it would be better for either of them to forward the data to the UAV than S_{n1} to send directly.

Let $\mathbb{F} = \{S_{f_1}, \dots, S_{f_m}\}$ and $\mathbb{G} = \{S_{n_1}, \dots, S_{n_l}\}$ are the sets of forwarders and simple nodes respectively ($1 \leq f_1 \leq f_m < N$, $1 \leq n_1 \leq n_l < N$, and $m + l = N$). $\mathbb{F}_p(t_i)$ represents the set of potential forwarders that all of them are within the transmission range of the UAV in the time-slot t_i ($t_i \in \mathbb{T}$). If $|\mathbb{F}_p(t_i)| > 1$, all the forwarders within the set will compete to communicate with the UAV. If $S_{f_k} \in \mathbb{F}_p(t_i)$ wins the competition and is selected to transmit a packet to the UAV in t_i , the remaining forwarders \mathbb{F}_{rm} ($\mathbb{F}_{rm} = \mathbb{F} - \{S_{f_k}\}$) will

Table 4.1. Notations applied in this chapter

Notations	Descriptions
P_d	The total number of packets delivered ;
P_g	The total number of packets that are generated in time T ;
P_r	The total number of relayed packets ;
$d(S_k, S_i)$	The distance between the sensor S_k and S_i ($k, i \in \mathbb{N}$) ;

collect data from \mathbb{G} . Let $\mathbb{G}_p(S_{f_j})$ a set of simple nodes from which the forwarder $S_{f_j} \in F_{rm}$ can choose one to collect its traffic. Practically, both $\mathbb{F}_p(t_i)$ and $\mathbb{G}_p(S_{f_j})$ are determined by the velocity and the communication range of both UAV and sensor nodes.

Notice that, if $\mathbb{G}_p(S_{f_j}) \cap \mathbb{G}_p(S_{f_q}) \neq \emptyset$, i.e., forwarders S_{f_j} and S_{f_q} share some simple nodes from which they can collect data from them. Moreover, S_{f_j} has a transmission capacity indicating that even S_{f_j} has many potential simple nodes, it also won't be able to choose anyone from $\mathbb{G}_p(S_{f_j})$ to collect data because of its limited collection capacity.

4.2.1 Sensors Mobility

From figure 4.1 we can see that both the UAV and the sensors are moving, the network topology is changing dynamically along time. Thereby, the nodes have limited contact duration time when they are within the transmission range of the UAV. The contact duration time between S_i and UAV (T_{icdt}) is the same definition as in Chapter 3.3. The main parameters that are used in this chapter are the same definition in Table 3.2 (in Chapter 3), and the new parameters that applied here are described in Table 4.1.

Similar to Chapter 3, a 4-pairwise data-rate mechanism, is used here. When the distance is smaller than 20 m , we use the highest data-rate, 250 Kbs^{-1} . When the distance is between 20 m and 50 m , 19.2 Kbs^{-1} is used. When the distance is between between 50 m and 80 m , the data-rate is 9.6 Kbs^{-1} and when it is between 80 m and 100 m , the data-rate is 4.8 Kbs^{-1} .

4.2.2 Simple Example to Present the Mobility

From the definition of contact duration time, we notice that it is unreasonable for the network to select forwarders according to the distance between source node and the destination node in such scenario because T_{icdt} depends not only on the relative distance but also on the relative velocity. Take the simple scenario, which is illustrated in figure 4.3, for example to show the impact of different parameters.

The contact duration time of each mobile node can be seen from figure 4.3(a) and the node information are detailed in figure 4.3(b). From figure 4.3(a) and 4.3(b), we can conclude that the sensor that has the longest contact duration (S_3) and the one that has the shortest contact duration (S_5) have the highest speed (9 ms^{-1}) and lowest speed (4 ms^{-1}) respectively. From figure 4.3, we can also notice that, even if the node S_8 is deployed far away from the UAV at the beginning, it still has longer contact duration than S_1 which is deployed near the UAV at the beginning.

However, when the speed of a sensor is almost the same as the UAV, it is possible that the UAV will never achieve the range of the sensor during the duration T when it is deployed far away from the UAV at the beginning. Here, we only consider the speed of the UAV is twice that of the sensors. Thus, the velocity has a significant impact on the contact duration time, and the original position has small impact on it. The contact duration time directly affects the opportunity of the source node to communicate with the UAV. For this reason, the one that has the highest velocity is selected to serve as a forwarder in this work.

4.3 Implementing Opportunistic Routing Protocols for UAV-assisted WSN without Guarantee Forwarders

In this section, we study the time slot allocation issues without guarantee forwarders.

4.3.1 Performance Metrics

Here, we focus on the performance metrics including packets delivery ratio, routing overhead ratio, average latency and average hop count.

4.3 - Implementing Opportunistic Routing Protocols for UAV-assisted WSN without Guarantee Forwarders69

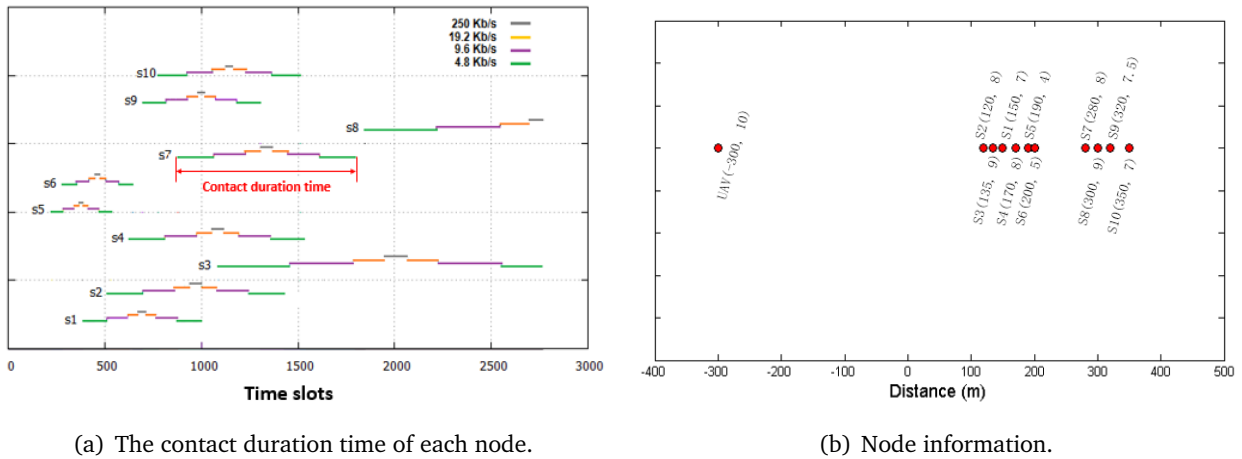

Figure 4.3. A simple example to present the contact duration time.

– Packets Delivery Ratio (PDR)

The packet delivery ratio measures the percentage of the number of packets received out of the number of generated packets. The *PDR* of the system is computed in equation (4.1),

$$R_d = P_d/P_g, \quad (4.1)$$

where P_d is the total number of delivered packets, P_g is the total number of packets that are generated by the sensor network.

– Routing Overhead Ratio (ROR)

The *ROR* of the system is the ratio of the total number of packets delivered over the total number of relayed packets during the simulation time T . *ROR* is an important metric as it measures the scalability of a mechanism, the degree to which it will function in congested or low bandwidth environments. The routing overhead ratio of the network is given in equation (4.2),

$$R_o = P_d/P_r, \quad (4.2)$$

where P_r is the total number of relayed packets.

– Average Latency (AL)

The *AL* metric measures the average time that the network takes for all the delivered packets to be routed from the source nodes to the UAV. The lower the *AL* is, the better performance the application has.

– Average Hop Count (AHC)

We introduce this metric to measure the average number of hops of each packet used from the source node to the UAV. The hop count metric [35] of a packet generated by a source node (S_i) and delivered to the destination node (UAV) can be defined as the number of intermediate devices (such as routes) through which the packets should pass between the S_i and the UAV and each route along the data path constitutes a hop. In our scenario, the larger the value of *AHC*, the more opportunities for the mobile nodes to transmit packets to the UAV.

4.3.2 Time slot based Opportunistic Routing Algorithms

It is flexible for the system to select the forwarders if there is no guarantee on the communication between the selected nodes and the UAV. The mobile nodes can send packets to all their neighbors that are within the range to improve their opportunities. In addition, they can send packets to the one that has the highest velocity which has biggest opportunity to communicate with the UAV. According to this, we proposed *ANOR* and *HVOR* algorithms, and compare them with the well examined one-hop data collection algorithm (*DR/CDT*) that we proposed in Chapter 3.

- **ANOR Algorithm.** The source nodes create routes with all the neighbor nodes that are within its communication range and relay packets to them.
- **HVOR Algorithm.** The source nodes build connections with the one that has the highest velocity among its neighbors. As it is shown before, the one that has the highest velocity has longer contact duration time with the UAV than other nodes, which means it has more opportunities to communicate with the destination.

Here, we present the *HVOR* algorithm for multi-hop data collection problem in Algorithm 5.

Algorithm 5 HVOR Algorithm

Require: $N, V, \alpha, r, h, T, N_{ts}, L, Width, Dr(N_{ts}, N)$ and $N_s(N)$.**Ensure:** R_d, R_0, AL and AHC .

```

1:  $N_s = 0; j = 1;$ 
2: while  $j < N_{ts}$  do
3:    $T = (j - 1) * \alpha;$ 
4:   Refreshment of the network :
5:   for  $i = 1 \rightarrow N$  do
6:     Calculate :  $S(x_i, y_i)$  and  $d(U, S_i);$ 
7:     if  $d(U, S_i) \leq r$  then
8:       Calculate  $Tcdt(j, i)$  and  $Dr(j, i);$ 
9:     end if
10:  end for
11:   $A = \{S_i \mid S_i \in S, Dr(j, i) \text{ is the maximum}\};$ 
12:   $B = \{S_i \mid S_i \in A, Tcdt(j, i) \text{ is the minimum}\};$ 
13:   $t_j$  allocated to  $S_{i_0}, (S_{i_0} \in B);$ 
14:   $N_s = N_s + 1;$ 
15:  for  $i = 1 \rightarrow N$  do
16:    for  $i = k \rightarrow N$  do
17:      Calculate :  $S(x_i, y_i), S(x_k, y_k), d(S_k, S_i)$  and  $d(S_k, U);$ 
18:      if  $d(S_k, S_i) < r$  and  $d(S_k, U) > r$  then
19:        Calculate  $C = \{S_{k0} \mid S_{k0} \in S, v_{k0} \text{ is the minimum}\};$ 
20:      end if
21:    end for
22:    In  $t_j, S_i$  communicates with  $S_{k0};$ 
23:  end for
24:   $j = j + 1;$ 
25: end while
26: Calculate :  $R_d, R_0, AL$  and  $AHC;$ 
27: End of algorithm.

```

Table 4.2. Simulation Parameters used in the evaluation of *HVOR* protocol

Parameter	Value	Parameter	Value
Network size	200	UAV fly height	15 <i>m</i>
UAV velocity	10 $m s^{-1}$	Simulation time	300 <i>s</i>
Time slot duration	0.2117 <i>s</i>	Packet size	127 <i>Bytes</i>
Move path	100 <i>m</i> × 3000 <i>m</i>	Sensors velocities	(0,5] $m s^{-1}$

4.3.3 Simulation Setup

As illustrated in figure 4.1, in the following simulations, we study the UAV and the sensors moving in the same direction along a predefined *Path*. The UAV flies at a height (*h*) with constant speed (*v*). 200 mobile sensors are randomly deployed on the path and moving with constant but different speeds v_i ($v_i < v$). The simulation time is *T*. The duration of time slot is defined similarly as in Chapter 3. The simulation parameters are given in Table 4.2.

4.3.4 Simulation Results and Discussion

In this chapter, we use the Opportunistic Network Environment (ONE) simulator [65], which is an extensible tool for evaluating Delay-Tolerant Networking (DTN) protocols and applications under different types of mobility patterns.

The following simulations use two different event generators : (i) Periodically generated traffic (PGT) : All the mobile sensors will continuously generate packets per second. (ii) Randomly generated traffic (RGT) : At every second, only one packet will be generated from a random sensor. The PGTs are usually applied in some monitoring applications which need to share the monitoring data once in a while. And RGTs are mostly used in some scenarios such as disaster rescue. In such applications, a session is initiated when the nature disaster occurs and a rescue work is triggered.

– Periodically generated traffic (PGT)

Figure 4.4 shows the simulation results when each sensor generates one packet per second. So, for 300

4.3 - Implementing Opportunistic Routing Protocols for UAV-assisted WSN without Guarantee Forwarders73

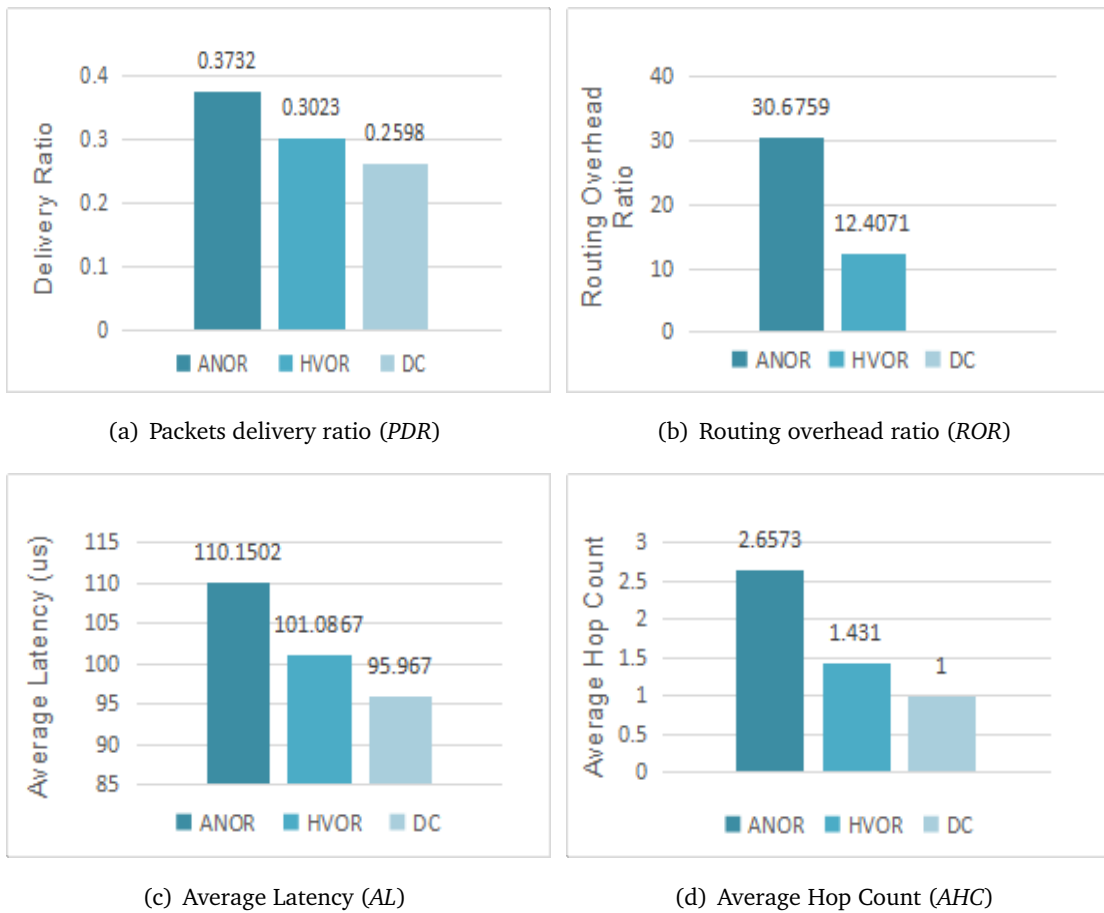

Figure 4.4. Comparison of *HVOR*, *ANOR* and *DC*, with PGT.

seconds of simulation, we have a total of 60.000 packets generated. From the figure, we notice that when the number of connections between sensors increases, all the metrics increase. It is because that more connections between sensors are created, more packets are relayed and delivered (figure 4.4(a)), thereby more sensors have the opportunity to send packets to the UAV. In figure 4.4(c), we can see that the average latency also increases as the number of connections increases. This is because more connections help more packets to be delivered. In addition, all delivered packets that have the larger *AHC* ($AHC > 1$) in this scenario, also have a larger latency value.

From figure 4.4(b), we also notice that when sensor nodes relay their packets to all neighbors that are within

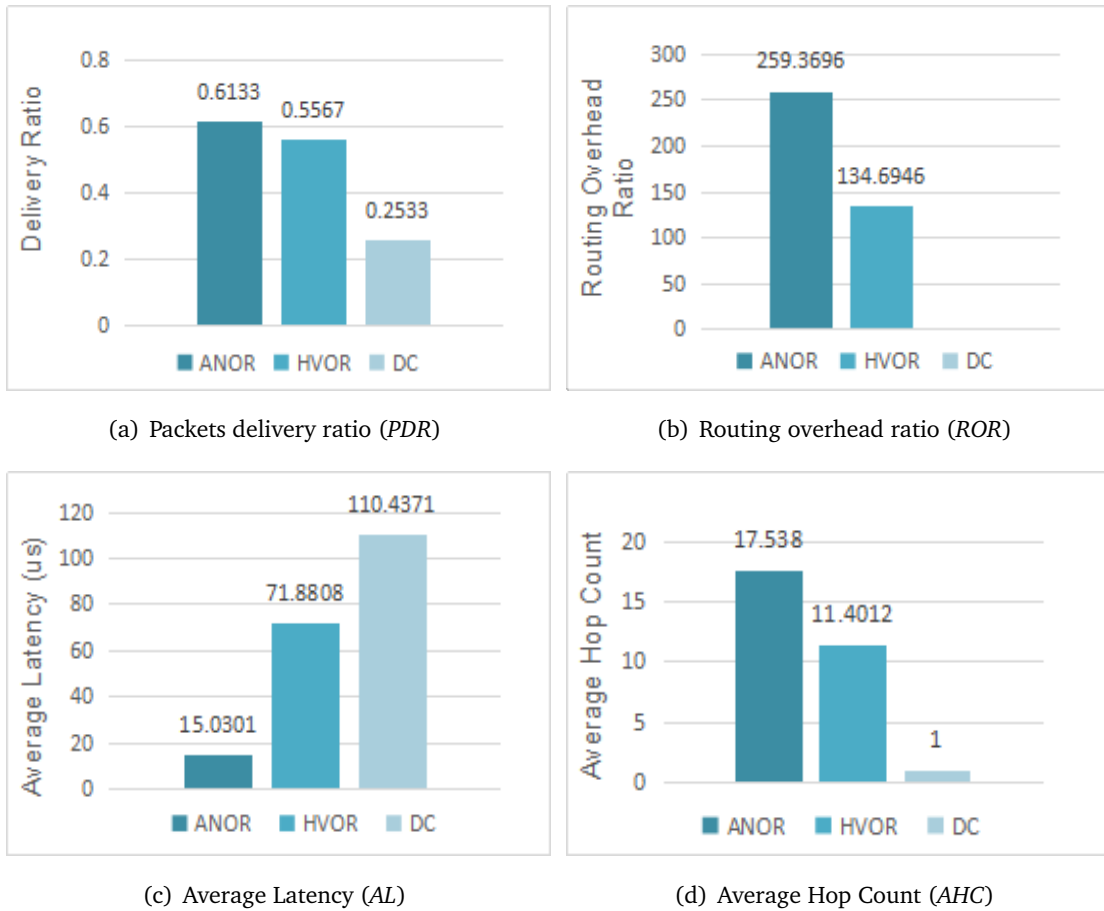

Figure 4.5. Comparison of *HVOR*, *ANOR* and *DC*, with RGT.

its range (*ANOR* algorithm), there is a significant growth of the overload ratio and this is not recommended in any network. The difference between the other metrics obtained for each metric (*AL* and *AHC*) is not as significant as the difference on the overhead ratio.

– Randomly generated traffic (RGT)

Figure 4.5 shows the simulation results in RGT case. In this scenario, the system only have one packet generated per second by a random sensor node. Hence, in 300 seconds of simulation, we will have a total of 300 packets generated.

We notice that when the number of connections between sensors increases, all the metrics increase except

the average latency (figure 4.5(c)). The explanation of this phenomenon is that the network only have a small amount of packets. Thus, they will be delivered faster when more connections exist between the sensors. If there is no connections (*DC* case) between nodes, the generated packets will be buffered on the sensors queues until the sensors are within the communication range of the UAV.

From figure 4.5(c), we also notice that the overhead has greater values than in the figure 4.4(c). This is because, in this scenario, the number of created messages is significantly less than the number of relayed packets.

Comparing the results of *HVOR* and *ANOR* algorithms with the results of *DC* algorithm, it is also obvious that, multi-hop transmissions in such scenario perform better than direct transmission (*DR/CDT* algorithm).

– The impact of traffic load with PGT

Factually, the above simulations apply a very high generation metric (the sensor nodes generate one packet per second) when it tends to be low in practical applications.

In this subsection, we study the impact of the traffic load on the proposed performance metrics. We increase the interval of one second to see how the metrics (*ROR*, *AL* and *AHC*) will change. Taking the traffic load value '5' in figure 4.6 for example, the '5' means that each sensor will generate one packet every five seconds. From figure 4.6(a), we can see that the delivery ratio tends to increase when there are less packets in the network. We also notice that the more connections, the more visibilities increase.

We can conclude from figure 4.6(b) that the routing overhead ratio increases as the generation interval increases. The longer the generation interval, the more relayed packets, the higher routing overhead ratio. From figure 4.6(d) we find that the *AHC* has the same evolution as the overhead ratio. This is because of the relayed packets, less packets generated, more relayed packets.

Figure 4.6(c) presents the evolution of the average latency. Here, we can see an interesting combination of the above scenarios latency results. We notice that the more packets generated, the greater the latency is. This is because there are more connections for flooding. However, when sensors generate less packets, the average value tends to decrease because the number of connections increases. That is why for the first simulations, when the interval of generated packets is shorter than 5 seconds, *ANOR* metric has the highest

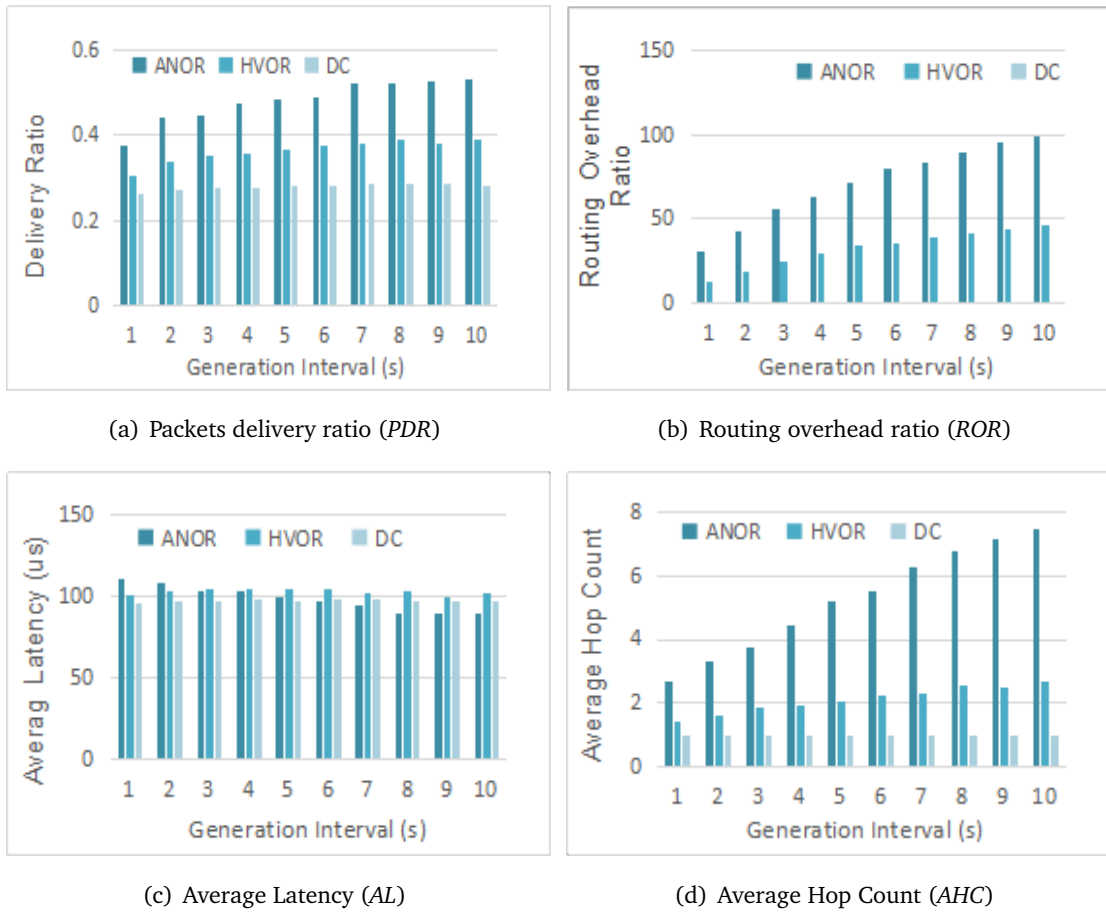

Figure 4.6. The impact of traffic load on the *HVOR*, *ANOR* and *DC* protocols.

latency, and then when the interval between generated packets increases, directly communication has the highest latency and *ANOR* metric has the lowest latency.

Consequently, we can conclude that when sensors generate more packets, the latency increases when the number of connections increases, but when the sensors generate less packets, the latency decreases when the connections number decreases. The proposed *HVOR* algorithm outperforms the other two algorithms (*ANOR* and *DR/CDT*) regarding the evaluated performance metrics.

4.3.5 Summary

Here, we presented **ANOR** and **HVOR** algorithms. They are opportunistic routing algorithms that dynamically select forwarder in UAV-assisted WSN. We apply the performance metrics, including Packets Delivery Ratio, Routing Overhead Ratio, Average Latency and Average Hop Count, to evaluate the proposed algorithms and to compare them with one-hop communication algorithm. Results from simulation show that multi-hop transmissions are better than one-hop communications. By having flooding in the on-ground sensor network, we maximize the number of collected packets and also the opportunities for each sensor to send at least one packet to the UAV. But also, taking into account the overhead average value, we can conclude that **HVOR** algorithm is a better choice for a multi-hop transmission in a UAV-assisted WSN applications.

4.4 Implementing Opportunistic Routing Protocols for UAV-assisted WSN with Guarantee Forwarders

To detail the problem, we divide the multi-hop communication into two groups : Communication between UAV and Forwarders (UAV-F) and Communication between Forwarders and Simple Nodes (F-SS).

4.4.1 Opportunistic Multi-hop Communications

– Communication between UAV and Forwarders (UAV-F)

As depicted in figure 4.2, there are 4 sensors within the UAV range during the time-slot t_k . In the case of one-hop communications, only one of them has an opportunity to send its data in t_k . Thus, the others should be in sleep mode. However, in a multi-hop algorithm, some of them will be selected as forwarders (e.g. in figure 4.2, S_{fk} , S_{fq} and S_{fi} are selected as forwarders), and the others behave as simple nodes (e.g. only S_{n2} is a simple node in figure 4.2). Among the forwarders, only S_{fk} wins the contention and sends its packets to the UAV in the current time-slot. The remaining two forwarders (S_{fq} and S_{fi}) will collect packets from simple nodes at the same time. Thus, the multi-hop algorithm helps the nodes having no opportunity to communicate with the UAV to pass their traffic through the forwarders.

Hence, there is a problem when the sensor nodes have to choose between many potential forwarders. Indeed, which one does UAV choose in order to enhance the system performance? The choice depends on many factors. The first and the most important is the application objective. For instance, if the application focuses on data delivery, the UAV may choose the one that has the maximum number of remaining packets. If the application takes into account the system fairness, the algorithm also needs to consider the number of time-slots that the forwarder already got in the past and the number of contenders within the same time-slot in the future. Moreover, the data-rate, the neighborhood, and the queue size of the forwarders also impact the selection.

– Communication between Forwarders and Simple Nodes (F-SS)

Contention also happens between the simple nodes after the forwarder has been selected. In figure 4.2, the nodes S_{n1} and S_{n3} are within the range of S_{fj} in t_k . So they have to compete for sending their packets, and S_{fj} makes a decision according to their remaining traffic.

The system performance will be different if the decision was made from the perspective of the simple sensors and forwarders receptively. The system will be a little unfairer and ineffective if the communications between forwarders and simple nodes are made from the simple node point of view. For example, in figure 4.2, S_{n2} has only one relay sensor S_{fq} . So, S_{n2} sends its traffic to S_{fq} . Then, S_{n5} has no choice but transmit its traffic to S_{fi} . However, S_{fq} and S_{fi} could make more effective choices from S_{n2} and S_{n5} , S_{n5} and S_{n7} respectively.

4.4.2 Scheduling based Competition Multi-hop Routing Protocols

To design an efficient multi-hop communication algorithm, we proposed the following algorithms :

– Forwarder Selection Algorithm

The scheduling between UAV and forwarders is based on many factors : *i.*) the number of contenders (#C) for a given time-slot t_i . If there is no node within the range of the UAV, it will not collect any data in t_i when #C = 0. If #C = 1, there is one sensor within the range of the UAV, so t_i is allocated to the only one sensor without considering any other factor. Otherwise, if #C > 1 (the set of these sensors is denoted by $\mathbb{C}_p(t_i)$), i.e., more than one sensor are within the range of the UAV in t_i . Thus, there is a need to compare

Algorithm 6 Forwarder Selection Algorithm

Require: $m, L, Width, \mathbb{T}, \mathbb{S}, \mathbb{V}, (X(i), Y(i)), v, h, (x_u, y_u)$ **Ensure:** SCH

```

1: 1. Scheduling;
2: for each time-slot  $t_i$  in  $\mathbb{T}$  do
3:   Get  $\mathbb{C}_p(t_i)$ ;
4:   if  $|\mathbb{C}_p(t_i)| = 0$  then
5:     The UAV will not communicate with any sensor in the current time-slot  $t_i$ ;
6:   else
7:     if  $|\mathbb{C}_p(t_i)| = 1$  then
8:       Allocate  $t_i$  to the only one node;
9:     else
10:      if  $|\mathbb{C}_p(t_i)| > 1$  then
11:        Calculate the transmission capacity set  $\mathbb{Q}_{TC} = \{DR\_M\_CDT(k)\}_{k=1}^{|\mathbb{C}_p(t_i)|}$ ;
12:        Calculate  $M\mathbb{Q}_{TC} = \max\{\mathbb{Q}_{TC}\}$ ;
13:        if  $|M\mathbb{Q}_{TC}| = 1$  then
14:          Allocate  $t_i$  to the node that has the highest TC;
15:        else
16:          if  $|M\mathbb{Q}_{TC}| > 1$  then
17:            Calculate  $\mathbb{Q}_{\#Ts}$  and  $L\mathbb{Q}_{\#Ts} = \min\{\mathbb{Q}_{\#Ts}\}$ ;
18:            If  $|L\mathbb{Q}_{\#Ts}| = 1$ , Allocate  $t_i$  to the node that has the smallest value of #Ts.
19:            If  $|L\mathbb{Q}_{\#Ts}| > 1$ , Allocate  $t_i$  to the one from the  $L\mathbb{Q}_{\#Ts}$  that has smaller sensor ID.
20:          end if
21:        end if
22:      end if
23:    end if
24:  end if
25: end for
26: 2. Return;
27: Calculate and return SCH;
28: 3. End of algorithm.

```

the other factors before making a decision. *ii.*) the *Transmission Capacity* (TC) between each sensor in $\mathbb{C}_p(t_i)$ and the UAV. When $\#C > 1$, the system has to consider the TCs of the nodes that are within the range of the UAV and to allocate the current time-slot to the one that has the highest TC. The *Transmission Capacity* is detailed in Definition 1. The set of nodes that have the same and highest TC is denoted by \mathbb{MQ}_{TC} . Thus, if $|\mathbb{MQ}_{TC}| = 1$, it is easy for the system to assign t_i to the only one node. If $|\mathbb{MQ}_{TC}| > 1$, there are $|\mathbb{MQ}_{TC}|$ nodes having the same highest TC, and the system needs to compare the new factors. *iii.*) the number of time-slots ($\#Ts$) that the sensors have got in the past. When the competitive sensors have the same TC, the system takes into account the $\#Ts$. The larger is the $\#Ts$, the smaller is the remaining traffic of the sensor. Hence, the system has to assign the current time-slot to the one that has the smallest value of $\#Ts$ to achieve the maximum data collection capacity in the current time-slot.

Definition 1 $Dr(j)$ is the data-rate of level j ($j = 1, 2, 3, 4$), and $T_{cdt}(i, j)$ is the duration of level j of S_i ($S_i \in \mathbb{S}$) in given time-slot. The transmission capacity of S_i is :

$$DR_M_CDT(i) = \sum_{j=1}^3 Dr(j) * T_{cdt}(i, j). \quad (4.3)$$

The notations that are used in the following are detailed in Table 4.3 The *Forwarder Selection* Algorithm is detailed in Algorithm 6. The scheduling stored in the time-slot index and the relevant forwarder ID. From the output (*SCH*) of the *Forwarder Selection* Algorithm, we obtain the set of forwarders \mathbb{F} and use it in the *TOCC* Algorithm.

– Transmission with Opportunistic Competition Capacity (*TOCC*) Algorithm

In a given time-slot t_i ($t_i \in \mathbb{T}$), there are $|\mathbb{F}_p(t_i)|$ potential forwarders within the transmission range of the UAV. $Pk_Re(i, j)$ is the number of remaining packets that a mobile sensor S_j ($S_j \in \mathbb{S}$) has till t_i . In other words, it is the queue size of S_j . We define the *competition capacity* of a forwarder S_{f_k} , which is used by UAV to select one optimal forwarder in the current time-slot, as follows :

Definition 2 For the $S_{f_k} \in \mathbb{F}_p(t_i)$, the capacity of S_{f_k} in the current time-slot is denoted by $\theta(S_{f_k})$. Let

$$\begin{aligned} \phi(f_k) &= \max\{\theta(S_{f_k}), Pk_Re(i, f_k)\}, \\ \varphi(f_k) &= \min\{\theta(S_{f_k}), Pk_Re(i, f_k)\}, \\ \Phi &= \max_{S_{f_k} \in \mathbb{F}_p(t_i)} \{\theta(S_{f_k})\}, \end{aligned}$$

the competition capacity of forwarder S_{f_k} is defined according to equation (4.4).

$$C_{f_k} = \frac{\theta(S_{f_k})}{\Phi} \cdot \frac{\phi(f_k) - \varphi(f_k)}{\phi(f_k)} \cdot \varphi(f_k). \quad (4.4)$$

If C_{f_k} has the largest *competition capacity* and a small ID in $\mathbb{F}_p(t_i)$, it wins the competition and broadcasts packets to the UAV in the current time-slot. Similarly, the forwarders select a simple node from their potential nodes also according to *competition capacity* based algorithm. After all the forwarders or all the simple nodes have selected their next hops in the current time-slot, the route is constructed.

As depicted in Algorithm 7, given a time-slot t_i ($t_i \in \mathbb{T}$), $\mathbb{F}_p(t_i)$ is the set of potential forwarders. If $\mathbb{F}_p(t_i) \neq \emptyset$, there are $|\mathbb{F}_p(t_i)|$ forwarders competing to communicate with the UAV in t_i , and the one that has the largest C_{f_k} and small ID in $\mathbb{F}_p(t_i)$ wins. If $\mathbb{F}_p(t_i) = \emptyset$, each forwarder in \mathbb{F} will communicate with one simple node in \mathbb{G} according to *competition capacity* mechanism. For each remaining forwarder $S_{f_j} \in \mathbb{F}_{rm}$, we continue using the *competition capacity* mechanism to choose a simple node from $\mathbb{G}_p(S_{f_j})$ to collect data and proceed iteratively for the remaining forwarders and simple nodes.

4.4.3 Performance Metrics

Here, we define the performance metrics including packets received ratio, energy consumption and fairness.

– Packets Received Ratio (PRR)

Table 4.3. Notations applied in **TOCC** algorithm

Notation	Descriptions
$Dr(j)$	The data-rate of level j ($j = 1, 2, 3, 4$);
$N_{ts}(i)$	The number of time-slots allocated to sensor S_i ($i \in \mathbb{N}$) within T ;
$Npk(j, i)$	The number of packets collected by the UAV from sensor S_i ($i \in \mathbb{N}$) within time-slot t_j ($t_j \in \mathbb{T}$);
$Pk_Se(i)$	The number of packets that S_i ($S_i \in \mathbb{F}$) successfully sent to the UAV;
$Pk_Ge(i, j)$	The number of packets generated by sensor S_j ($S_j \in \mathbb{S}$) till time-slot t_i ($t_i \in \mathbb{T}$);
$Pk_Re(i, j)$	The number of remaining packets of sensor S_j ($S_j \in \mathbb{S}$) till time-slot t_i .

Algorithm 7 TOCC Algorithm

Require: $L, Width, \mathbb{T}, \mathbb{S}, \mathbb{V}, (X(i), Y(i)), v, h, (x_u, y_u), SCH$

Ensure: $D_{sys}, E_{sys}, F_{sys}$

- 1: **1. Competing ;**
- 2: **for** each time-slot t_i in \mathbb{T} **do**
- 3: Get $\mathbb{F}_p(t_i)$;
- 4: **if** $\mathbb{F}_p(t_i) \neq \emptyset$ **then**
- 5: **i. Matching FDs and UAV ;**
- 6: Calculate $\mathbb{Q}_u = \{C_{f_k}\}_{k=1}^{|\mathbb{F}_p(t_i)|}$;
- 7: Check the *Scheduling*, the one ($S_{f_{k0}}$) in the current time-slot wins and sends its traffic ($Npk(i, f_{k0})$) to the UAV ;
- 8: **ii. Matching FDs and Simple Nodes ;**
- 9: $\mathbb{F}_{rm} = \mathbb{F} - \{S_{f_{k0}}\}$;
- 10: $G_{rm} = G$;
- 11: $j = 1$;
- 12: **while** $j < |\mathbb{F}_{rm}|$ **and** $|\mathbb{G}_{rm}| > 0$ **do**
- 13: Get set $\mathbb{G}_p(S_{f_j})$ and Calculate the *Competition Capacity* for each node in the set and get the $\mathbb{Q}_f = \{C_{n_q}\}_{q=1}^{|\mathbb{G}_p(S_{f_j})|}$;
- 14: The maximum ($S_{n_{q0}}$) of \mathbb{Q}_f win and sends its traffic ($Npk(i, n_{q0})$) ;
- 15: $\mathbb{G}_{rm} = \mathbb{G} - \{S_{n_{q0}}\}$;
- 16: $j = j + 1$;
- 17: **end while**
- 18: **else**
- 19: $\mathbb{F}_{rm} = \mathbb{F}$ and go to Step 1 – *ii* ;
- 20: **end if**
- 21: **end for**
- 22: **2. Return ;**
- 23: Calculate and return : $D_{sys}, E_{sys}, F_{sys}$;
- 24: **3. End of algorithm.**

The first step of this work is to design an algorithm to select the forwarders for the multi-hop data collection. The proposed algorithm ensures that the selected forwarders have the opportunities to communicate with

the UAV. Therefore, we introduce the Packets Received Ratio (PRR) of the system as the ratio of the number of packets received by the UAV over the number of packets generated by all the mobile sensors. The PRR of the system can be computed by the following equation :

$$D_{sys} = \frac{\sum_{S_i \in \mathbb{F}} Pk_Se(i)}{\sum_{i=1}^N Pk_Ge(N_{ts}, i)}. \quad (4.5)$$

where $Pk_Se(i)$ is the number of packets that S_i ($S_i \in \mathbb{F}$) successfully sent to the UAV. $Pk_Ge(j, i)$ is the number of packets that a sensor S_i ($S_i \in \mathbb{S}$) generated till time-slot t_j ($t_j \in \mathbb{T}$). Thus, the total number of generated packets by S_i is $Pk_Ge(N_{ts}, i)$.

– Energy Consumption

We consider the energy consumption during transmission E_t and reception E_r in our network. E_t contains the radio dissipation for running (E_e J/bit) and the amplifier consumption (E_a J/m²) for transceiver to achieve an acceptable signal to noise ratio [46]. Considering that sending D bits to a receiver, which is at a distance of $d_{t,r}$. Then, the radio expends $E_t(D, d_{t,r}) = D(E_e + E_a \cdot d_{t,r}^2)$, and the corresponding energy consumption of the receiver is $E_r(D, d_{t,r}) = DE_e$, where d_{S_k, S_j} is the distance between a simple node and a forwarder. $d_{S_i, u}$ is the distance between the forwarder and the UAV. Hence, the energy consumption for the network communication can be defined as :

$$E_{sys} = \sum_{\substack{S_j \in \mathbb{F} \\ S_k \in \mathbb{G}}} (E_t(D, d_{S_k, S_j}) + E_r(D, d_{S_k, S_j})) Pk_Se(j) \\ + \sum_{S_i \in \mathbb{F}} (E_t(D, d_{S_i, u}) + E_r(D, d_{S_i, u})) Pk_Se(i). \quad (4.6)$$

The proposed algorithms work well on both maximizing the D_{sys} and minimizing E_{sys} . From equation (4.5) and (4.6), we notice that higher network delivery ratio leads to higher energy consumption. It is contradictory for the proposed algorithms to enhance both D_{sys} and E_{sys} at the same time. Therefore, this work aims to reduce the transmission energy consumption on the basis of increasing the packets delivery ratio.

– Fairness

According to the fairness definition given in [31], a WSN is fair when the number of received packets (over a given period) from each sensor node is approximately the same. This definition was widely used. However, the packets can be lost for many reasons, such as obstacles, the contention level, etc. Furthermore, sensor nodes have different characteristics from each other. For instance, consider S_{n4} and S_{fk} in figure 4.2, S_{fk} has the absolute advantage when both of S_{n4} and S_{fk} have the same velocity. Thus, S_{fk} has longer contact duration time and higher transmission rate with the UAV than S_{n4} because S_{fk} is close to the UAV. In this case, it is fairer for the two nodes to use their own delivery ratio to measure the fairness. Hereafter, we give a *Fairness* definition as follows : The network is fair, over a given period, if the delivery ratio of each node is approximately the same. To this end, we use the standard deviation to measure the fairness as in Definition 3.

Definition 3 For each sensor S_i ($S_i \in \mathbb{S}$), the PRR of S_i is referred to as P_i , which is given in equation (4.7),

$$P_i = Pk_Se(i)/Pk_Ge(N_{ts}, i), \quad (4.7)$$

thus, the Fairness of the system is defined by the equation (4.8) :

$$F_{sys} = \left(\frac{1}{N-1} \sum_{i=1}^N \{P_i - \frac{1}{N} \sum_{j=1}^N P_j\}^2 \right)^{1/2}. \quad (4.8)$$

F_{sys} is the standard deviation of the sensors PRRs. F_{sys} evaluates the fairness of the system through the delivery ratio of each node in the network. Smaller F_{sys} gives high network Fairness. Hence, $F_{sys} = 0$ is the best case concerning fairness, i.e., all the sensor nodes have the same delivery ratio.

The primary goal of the proposed algorithms is to maximize D_{sys} and minimize F_{sys} . Therefore, the major concerns are forwarders selection and time-slots allocation.

4.4.4 Evaluation of the proposed algorithms

The following part studies a general scenario, with one UAV and 200 mobile nodes moving along a *Path* ($10 m \times 6000 m$). For each simulation, uniform distribution is applied to initialize the sensors positions and velocities and the 200 nodes are deployed at the beginning ($10 m \times 100 m$, named $Path_d$). If 200 nodes

Table 4.4. Simulation parameters used in *TOCC* algorithm

Parameter	Value
E_e	5 nJ/bit, $d < 30$ m
	50 nJ/bit, $d \geq 30$ m
E_a	1000 pJ/m ² , $d < 30$ m
	100 pJ/m ² , $d \geq 30$ m
Packet size	127 Bytes
Time slot duration	0.2117 s
UAV fly height	15 m
UAV velocity	10 m s ⁻¹
Simulation time	10 min
Deployed path	10 m × 100 m
Packets generation intervals	[0.5, 2] s

are deployed in the whole $Path_d$, the random topology will have a huge impact on the simulation. Hence, we divide the $Path_d$ evenly into 10 segments (each segment is 10 m × 10 m) and then apply uniform distribution to initialize the sensors information segmentally (20 nodes for each segment). When increasing the network size, taking '50' and '100' in figure 4.7 for instance, we will randomly and evenly select '50' nodes from all segments (5 nodes from each segment) and denoted by sensor set A_1 , then select another '50' from the remaining 150 nodes using the same approach and denoted by sensor set A_2 . We will get 100 nodes through ' $A_1 + A_2$ '. This method ensures that the larger the network size and the higher of the deployed density. This division not only helps to reduce the difference of distribution density for each segment, but also helps to ensure that the distribution density increases as the network size increases. Meanwhile, to reduce the impact of network topology on the simulation results, this chapter runs 50 simulations. The final results, in the figures, are given by the mean value of 30 simulations by excluding the 10 best simulations and the 10 worst simulations. The simulation parameters applied in this chapter presented in Table 4.4.

The time-slot, used in the following, is similarly defined as in Chapter 3.3. The generation Packet Interval (PI) used in our simulations is 0.5 seconds and 2 seconds.

4.4.5 Results and Analysis

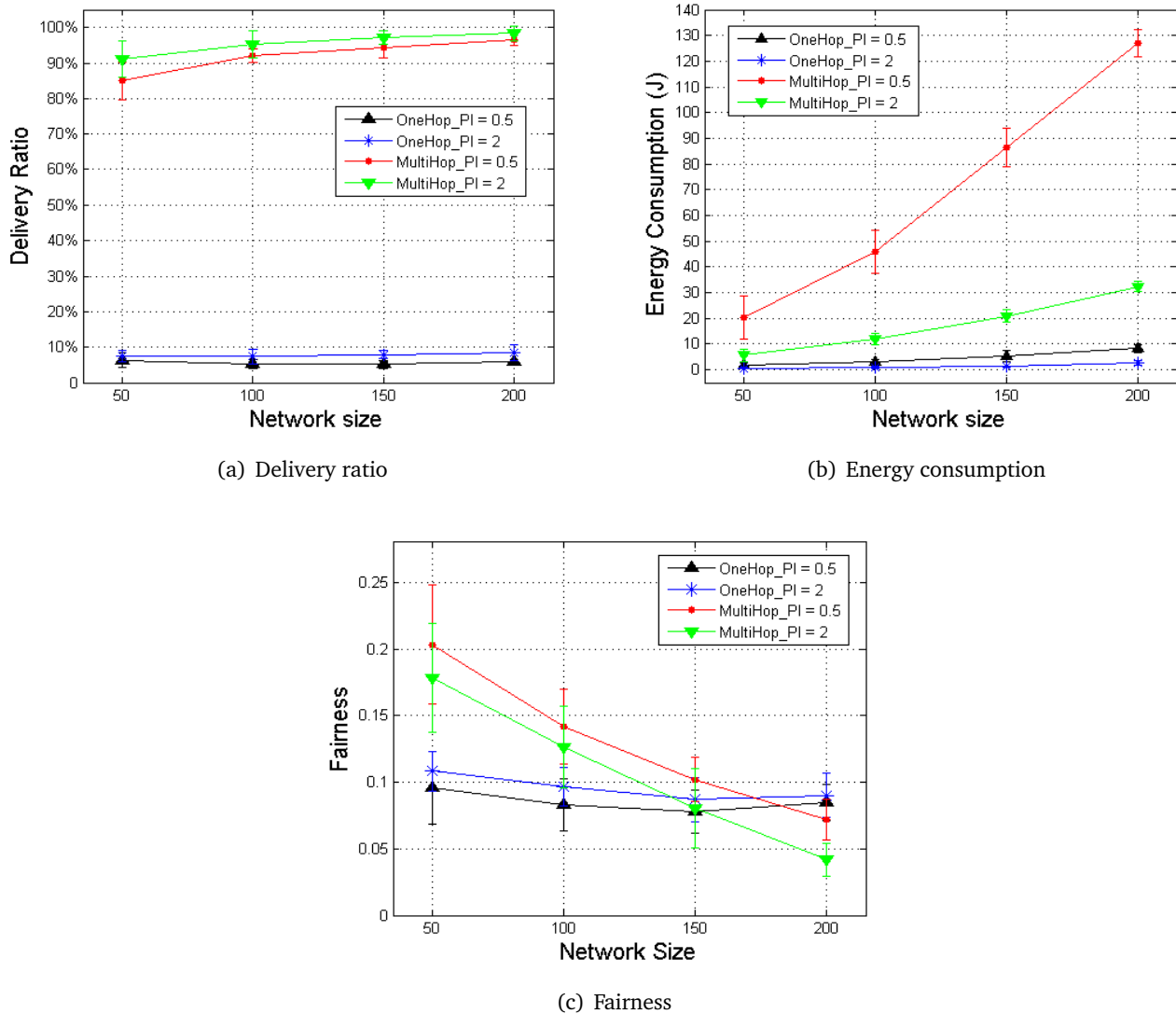

Figure 4.7. The impact of network size on the delivery ratio, energy consumption and fairness.

– The impact of the network size

In this scenario, the network size vary from 50 to 200, and the time-slot duration is fixed at 0.2117 s.

Figure 4.7 presents the evolution of the *PRR*, energy consumption and fairness according to the network size.

The larger the network size, the smaller the confidence intervals, the smaller impact of the network topology. From figure 4.7(a), the multi-hop *PRR* shows a growth tendency as the network size increases, and the *PRR* of multi-hop is almost eight times larger than in one-hop protocol, the *PRR* when packets generation interval is 2 seconds is always better than 0.5 seconds whether it is one-hop or multi-hop. The energy consumption, which is shown in figure 4.7(b), is steady increasing where the number of nodes increases because with the increase of nodes, the total data collection is improved, but the corresponding energy also raised.

Practically, with the growth of the number of mobile nodes, the forwarders have more potential neighbors, to collect data. Thus D_{sys} increases, and the corresponding energy and fairness also rise, they are shown in figure 4.7(b) and 4.7(c). From figure 4.7(c), we can conclude that the network size has slight impact on the one-hop case because the nodes that are out of the range of the UAV still have fewer opportunities to send their traffic. The system is more equitable when there are more mobile nodes. In smaller scale network, for example, when the network size is 50, the one-hop data aggregation owns an advantage in fairness, but when the network size is increased to 200, it becomes worse. In fact, in multi-hop case, the fewer nodes, the fewer opportunities for the simple sensors to transmit their traffic. When the network size achieves 200 nodes, almost all the simple nodes have the same small opportunity to send their packets, so it is fairer for all of them compared to small scale networks.

– The impact of time-slot length

In this simulation, we considered 100 mobile nodes deployed in a $10\ m \times 100\ m$ area. The time-slot duration is varying from 0.2117 *s* to 5 *s*.

Figure 4.8 shows the impact of the time-slot duration on *PRR*, energy consumption and fairness. The *PRR* achieves the maximum and minimum when the time-slot is 0.2117 *s* and 5 *s* respectively. The energy consumption (Figure 4.8(b)) maintains the same trend as *PRR*. As described previously, the forwarder can only select one simple node during one time-slot. Therefore, the longer is the time-slot duration, the longer the time it takes for each forwarder, the smaller chance for the simple nodes to send its traffic to the forwarders. Hence, the network fairness (Figure 4.8(c)) is decreasing as the time-slot duration increases.

– The impact of the traffic generation rate

Figure 4.7 and figure 4.8 show that the packets generation intervals have a small impact on the *PRR* and

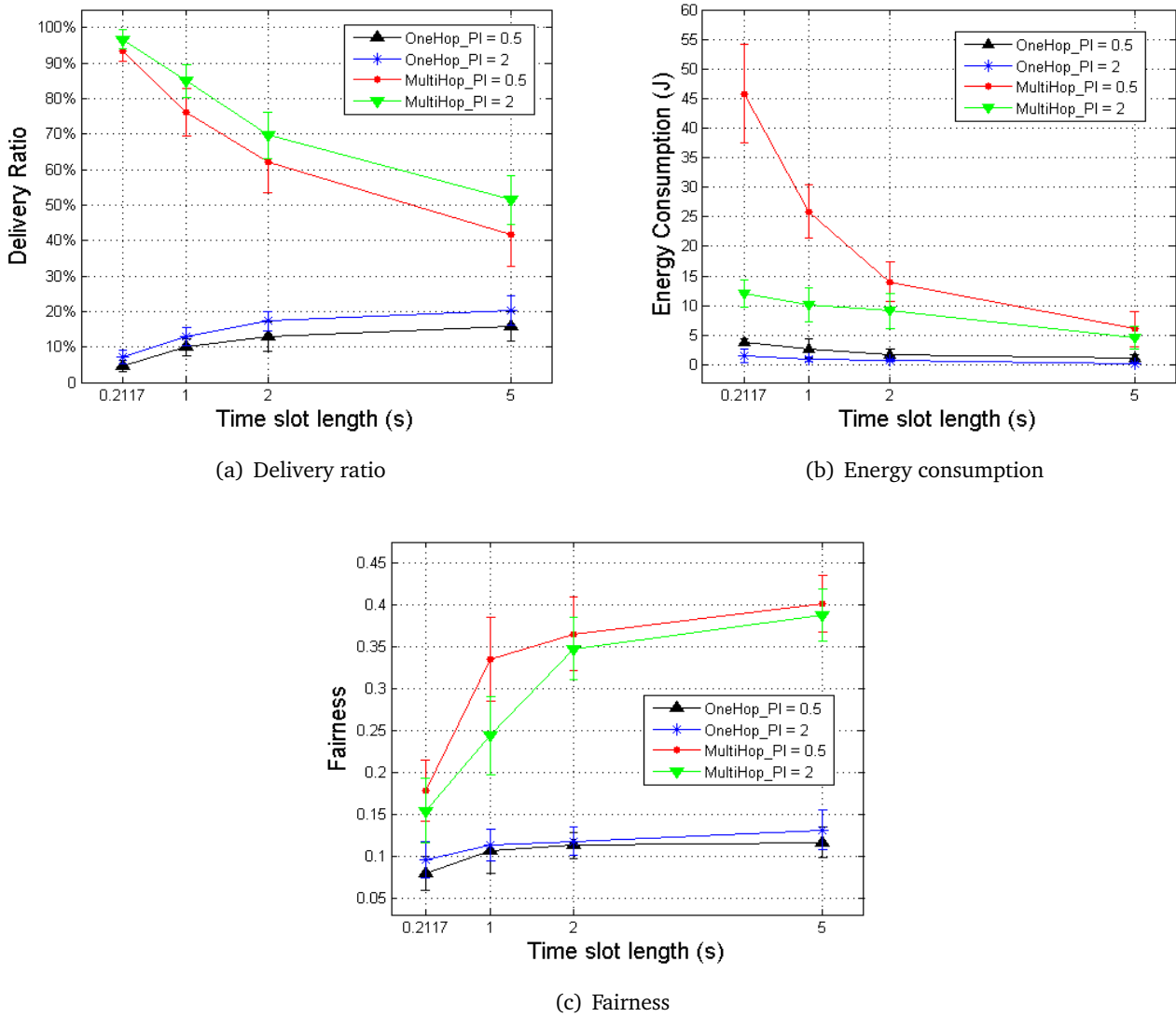

Figure 4.8. The impact of time-slot length on the delivery ratio, energy consumption and fairness.

system fairness under the influence of the network size and the time-slot duration. However, it has a significant effect on the energy consumption because the generation intervals directly control the number of packets.

Figure 4.7(c) and figure 4.8(c) present the same results, the more packets generated, the fairer the network

in one-hop case, which has the opposite result in multi-hop network. In one-hop communications, each node has limited opportunity to send data, the more packets generated, the more packets lose for each node, the lower delivery ratio for each sensor, the fairer is the network. On the contrary, sensors have more opportunities to transmit packets than in one-hop case. Thus, the fewer packets generated, the higher delivery ratio for each node. And consequently, the fairer is the system.

Furthermore, we can also notice, from figure 4.7(b) and figure 4.8(b), that the gap between different generation traffic become also bigger when the generation interval is larger. Factually, when the traffic intervals are too long so that there is a small difference, in terms of the number of packets, between the different sessions.

Moreover, the E_{sys} (Figure 4.7(b)) significantly climbs as the number of nodes increases when the sensors generate packets every 0.5 s. In this traffic, the frequency is very large, so the number of generated packets is also large for the receivers that have limited T_{cdd} to collect. Therefore, the E_{sys} grows significantly also. Inversely, the E_{sys} , in 2 seconds case, shows a moderate growth. Clearly, it can be seen from figure 4.7 and figure 4.8 that the randomly deployed mechanism has big impact on the simulation results.

– Comparison with existing Protocols

This section compares our proposed algorithm with the exist algorithm (*Epidemic*) and our proposed algorithm in the first half of this chapter (*HVOR*). In the following simulations, 200 mobile nodes are deployed in the $10\ m \times 100\ m$, and the time-slots duration is fixed at 0.2117 s.

Figure 4.9 clearly shows that the proposed metric outperforms the *Epidemic* and *HVOR* on *PRR*. And *Epidemic* algorithm works better than *HVOR* algorithm. In *HVOR*, the source nodes only send data to the ones that have the highest velocities among their neighbors. In *Epidemic*, the source sensors build connection to all its neighbor nodes. Thus, the nodes in *Epidemic* protocol have more opportunities to transmit packets than in *HVOR* algorithm. However, the *Epidemic* protocol did not consider about the transmission capacity of the potential forwarders. Take the scenario illustrated in figure 4.2 for example. In time-slot t_k , S_{fi} sends its traffic to all its neighbors (only S_{n5} and S_{n7} as an assumption) if S_{fk} was selected to communicate with the UAV. S_{n5} and S_{n7} are simple nodes (according to the concept of our proposed algorithm) which means that the two nodes have fewer opportunities than potential forwarders S_{fi} . Hence, the source nodes may

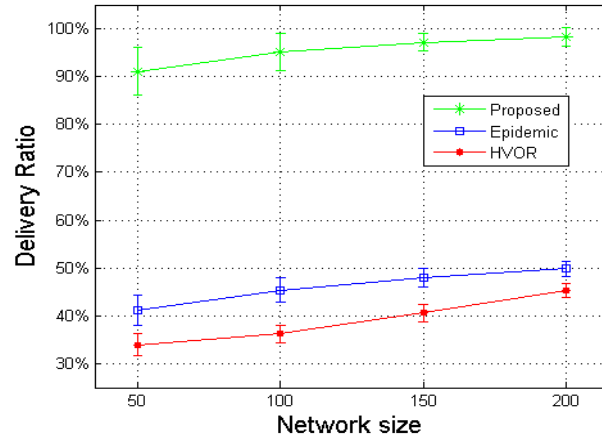

(a) Delivery ratio on network size

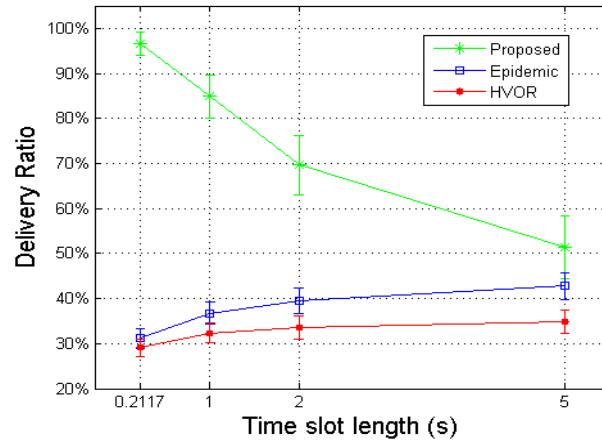

(b) Delivery ratio on time-slot duration

Figure 4.9. The comparisons of the proposed protocol and the existed protocols.

transmit packets to the one who has fewer opportunities than itself, which may cause the source nodes loss the opportunity to communicate with the UAV. In *TOCC* metric, the S_{fi} will keep its traffic and continue collecting data from simple nodes that among its neighbors. Hence, the source node in *TOCC* algorithm has more opportunities than in *Epidemic* protocol, therefore, has a higher *PRR*.

The gap between *Epidemic* and *HVOR* in figure 4.9(b) becomes bigger as the time-slot duration is bigger.

This simulation result match with the one presented in Chapter 3.4. The longer the time-slot duration, the larger number of neighbors that nodes can transmit data in *Epidemic*, the more opportunities for each sensor to communicate with the UAV. However, in *HVOR* algorithm, the source node only has a limited number of neighbors that have the highest velocities. Thus, the longer the time-slot duration, the fewer opportunities for each sensor in HVOR than in *Epidemic*, then, the bigger gap between them.

On the contrary, the larger the network size, the smaller gap between the *Epidemic* and *HVOR* (Figure 4.9(a)). The reason is that the larger the number of nodes, the more potential forwarders in *HVOR*, the closer the two metrics works, the smaller the gap between them.

4.5 Conclusion

In this work, we investigate the data aggregation in UAV-assisted mobile WSNs. We formulated the data collection as delivery ratio optimization, energy consumption minimization, and fairness under multiple constraints, such as the packets queue size, the transmission capacity for each relay nodes, and the limited contact duration time and the multiple data-rate which are inversely proportional to the relative distance between the sender and the receiver. To enhance the system performance and solve the defined problems, we proposed the *scheduling determination* algorithm and *TOCC* algorithm to implement the UAV-F communications and the F-SS transmissions respectively. Meanwhile, the delivery ratio (D_{sys}), the energy consumption (E_{sys}) and the *Fairness* (F_{sys}) are introduced and optimized by formulating the studied problem into an optimization one. Through extensive simulations using the real mobility, we have examined the one-hop and multi-hop communications under different configurations and observed that the optimal performance is achieved by the multi-hop routing based algorithm.

CHAPITRE 5

Medium Access Control Protocols

Contents

5.1	State of Art	95
5.2	Problem Statement	96
5.3	Adaptive Hybrid MAC Protocols	97
5.3.1	Inter-Beacon Duration	97
5.3.2	Hybrid Protocols in UAV-assisted mobile WSN	98
5.4	Network Efficiency Evaluation	104
5.4.1	System Performance	104
5.4.2	Simulation Setup	105
5.4.3	Results and Analysis	106
5.5	Conclusion	111

From Chapter 2.6, Medium Access Control (MAC) Protocols have been extensively analyzed. As a mobile sink, UAVs are equipped with various types of smart sensors and antennas to collect more effectively. And they are more flexible, energy efficient and robust for data transmission compared to other traditional WSNs due to highly free characteristics. Thus, each mobile node needs to coordinate to achieve real time data and faster response, in such application.

Beacon based IEEE 802.15.4 protocol [4], which used a Beacon-only Period (BOP) slot for dedicated beacon transmission, has been shown as an efficient hybrid MAC protocol. However, the idea that being used in IEEE 802.15.4 MAC that the beacon contains the scheduling information for the next inter-beacon duration has limitations in our studied scenarios that is presented in Chapter 3 and 4 because of the limited contact duration time.

In this chapter, to reduce the impact of the limitations of beacon based IEEE 802.15.4 MAC, we combined the ideas of beacon based IEEE 802.15.4 MAC and *DR/CDT*, and proposed and compared two efficient mechanisms to address the aforementioned issues. The main contributions of this chapter are as following :

- The upper bound of inter-beacon duration is defined in this work.
- Two hybrid MAC protocols, Fixed inter-beacon Duration and Proactive Scheduling (named *FD-PS* MAC) and Adaptive inter-beacon Duration and Proactive Scheduling (called *AD-PS* MAC), were proposed to coordinate the data communication between sensors.
- The two hybrid MAC protocols were further divided into *FD-PS* MAC I, *FD-PS* MAC II, *AD-PS* MAC I and *AD-PS* MAC II respectively according to whether the duration of contention-based period and contention-free period are adaptive or not. Through extensive simulations, the proposed schemes offer a high-performance gain in delivery ratio and fairness.

5.1 State of Art

UAVs are equipped with various types of smart sensors and antennas to collect data more effectively. As a mobile sink, the UAV is more flexible energy efficient and robust for data transmission compared to other traditional WSNs due to highly free characteristics. Thus, each mobile node needs to coordinate to achieve more real time data and faster response in such application. Hence, efficient data communication in such scenario becomes great challenging in large scale networks.

As studied in Chapter 2, various works have been proposed for WSN employing UAV. They are divided into three categories : *Contention-based*, *Contention-free*, and *Hybrid* protocols.

i.) Contention-based Protocols. Shigeru et al. [53] proposed an effective data gathering scheme for WSN employing UAV. In this scheme, they minimize the number of redundant sensors communicating with UAV by assigning the sensors inside the coverage area of UAV's beacon into different priority groups. Once Circularly Optimized Frame Selection (COFS) is defined, data communication is handled from higher to lower transmission priority frame sequentially. Therefore, the plausible algorithms employing the scheme COFS are proposed to engage in effective data collection. *ii.) Contention-free Protocols.* The Prioritized Frame Selection based CDMA MAC protocol (PFSC-MAC), an important MAC protocol for data collection in WSN employed with one UAV is proposed in [49, 50]. In this protocol, the sensors are classified into different groups based on priorities and communicate with the UAV by a CDMA-based transmission scheme. This protocol provides a low rate of failed packet due to the mobility of the UAV, which is the most critical metric in these types of applications. However, this scheme pays little attention to the contact duration time between the nodes and the UAV which plays a hugely important role in such dynamic aerial networks. In Chapter 3, we proposed a contention-free algorithm, *DR/CDT*. In this algorithm, we take into account the multi-data-rate and the contact duration time between the source node and the destination node with the objective of maximizing data collection. *DR/CDT* is based on an assumption that the UAV knows the details about the mobile nodes. *iii.) Hybrid Protocols.* Say et al. [100] studied a novel MAC scheme for a super dense aerial sensor network (maximum is 100 UAVs in the simulations in [100]) using UAV. These UAVs are used to sense and collect a real-time data from a disaster area, and they consist of one master UAV and many actor UAVs. The proposed mechanism, collision coordination based MAC (CC-MAC), combines

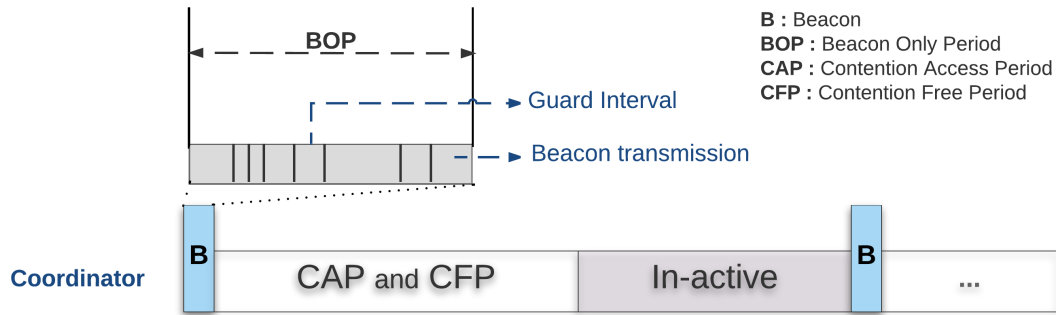

Figure 5.1. Superframe architecture.

CSMA/CA and TDMA protocols, which assume that the actor UAVs remain close to another actor UAVs. This would be a strong assumption when there is a big gap between their velocities.

5.2 Problem Statement

In this chapter, a UAV and a swarm of mobile nodes (maximum is 2000) are considered (as presented in figure 3.1). Sensors are deployed on a predefined path and moving along the path, the UAV is also flying along the path to collect data from the nodes. The speeds of the sensors are no larger than the UAVs. Both multi-data-rate and contact duration time are considered in this work.

In the beacon model of IEEE 802.15.4 protocol [4], the beacon-only period is divided into 16 single slots and the first slot is reserved for the PAN coordinator. The other slots are used by neighbor nodes. The overall structure is shown in figure 5.1. During the time synchronization, each node transmits messages to the neighbor nodes. These messages describe the time information of beacon transmissions and make the whole network synchronized. The neighbor nodes determine the time slot duration by themselves with an internal timer such as the beacon interval, beacon-only period and transmission time of beacon. All these factors measure the time interval of each slot and the overall scenario of each node for determining the time slot is as follows.

Firstly, beacons were transmitted. When the beacon frame is successfully transmitted, the coordinator

runs the beacon timer during the beacon interval. Then other nodes should check their neighbors' beacon transmission time slot as well as two hops distance neighbors' beacon transmission time slot in order to avoid beacon collisions. If an end node overhears these beacon frames, it records the link quality indicator information in the descriptor. Then the node requests the association process to the coordinator with the best link quality value. Therefore, we consider that the medium access in beacon based IEEE 802.15.4 protocol faces the following problems :

- those having the best link quality maybe not within the range of the UAV in dynamic network.
- the beacon used in [4] contains the scheduling information which reserves the association for the next inter-beacon duration. This idea has limitations in our studied scenarios because of the limited contact duration time.
- during the contention free period, impact factors are not fully considered. For example, the mobility, the contact duration time between nodes and the collectors.

In this chapter, we concentrate on design an adaptive mechanism based on IEEE 802.15.4.

5.3 Adaptive Hybrid MAC Protocols

5.3.1 Inter-Beacon Duration

As the network topology dynamically changes along time, the data aggregation issue should be considered in a given duration. The UAV sends 'Beacon' at the beginning of each duration to synchronize the mobile nodes. Thus, we can divide the time into different durations, named Inter-Beacon Duration (IBD). If the IBD is divided densely, it will cause that some mobile nodes that have long contact duration time to be repeatedly accessed. On the contrary, if the period is divided sparsely, it will make some mobile nodes miss opportunities to communicate with the UAV due to short contact duration time. Thus, the time is divided with an appropriate duration to increase the performance of network transmission.

Let's assume that the UAV flying along a predefined path ($width \times L$ as shown in figure 3.1) with a given velocity (v) and height (h), wherefore, we divide the flying time with the overlapping diameter of each adjacent two transmission areas no less than $\frac{1}{2}width$ (Figure 5.2). Therefore, the upper bound of

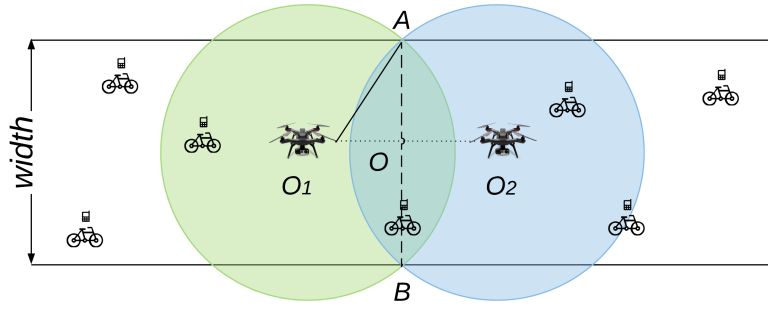

Figure 5.2. The upper bound of inter-beacon duration.

inter-beacon duration, T_{Ubd} is defined as in,

$$T_{Ubd} = \frac{O_1 O_2}{v}, \quad (5.1)$$

where r is the communication range of the UAV and sensors.

5.3.2 Hybrid Protocols in UAV-assisted mobile WSN

This section describes the proposed protocols. As a matter of fact, the network performance in the aforementioned scenario mostly depends on the multi-data-rate and contact duration time. Thus, we introduce new proposals based on the two schemes. The proposed approaches, Fixed inter-beacon Duration and Proactive Scheduling (**FD-PS**) MAC and Adaptive inter-beacon Duration and Proactive Scheduling (**AD-PS**) MAC, are developed based on both beacon based **CSMA/CA** and **DR/CDT**. In **FD-PS** MAC, the duration between the two adjacent beacons is fixed. In **AD-PS** MAC, the inter-beacon duration is adaptive according to the dynamic topology of the network.

The UAV broadcasts a 'Beacon' message which contains the details and scheduling information at the end of each inter-beacon duration to coordinate the data communication for the next inter-beacon duration. The covered sensors that received the 'Beacon' message compete to communicate with the UAV in the following contention-based period. It is worth noting that only one packet is sent to the UAV if the node have an opportunity to send a packet to the UAV in contention-based period. The 'first packet' in each node contains the properties of the node such as the node ID, position, velocity, the remaining packets and so on.

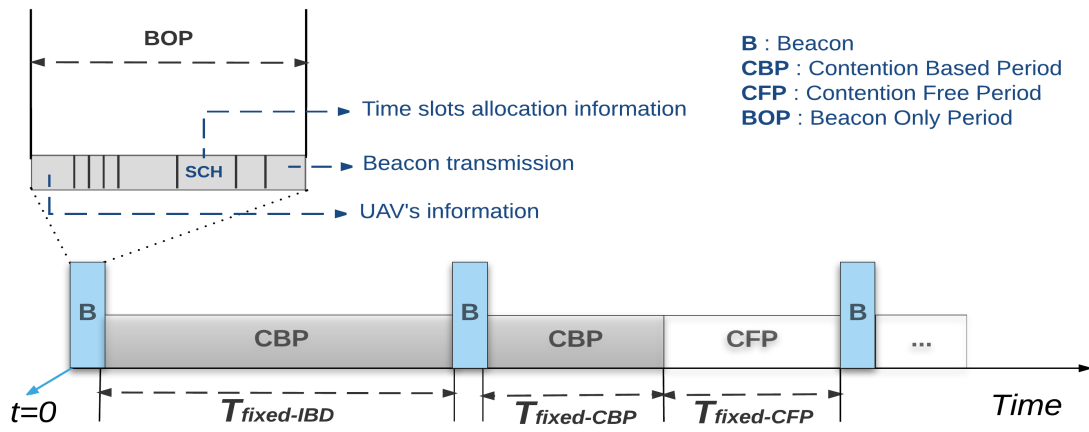

(a) fixed CBP and fixed CFP

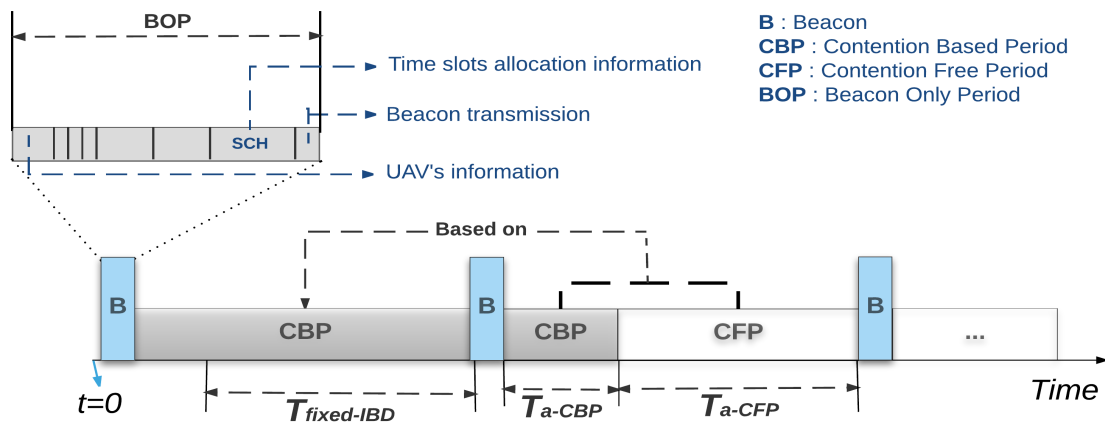

(b) adaptive CBP and CFP

Figure 5.3. Hybrid protocols based on fixed inter-beacon duration.

After receiving the first packet, the UAV gets the details of the node, then, processes the data and gets the scheduling information for contention free period. The details of the proposed protocols are as follows :

– **FD-PS MAC**

Figure 5.3 presents the **FD-PS** MAC. Similarly, two models of **FD-PS** MAC are introduced : **FD-PS** MAC I (Figure 5.3(a)) and **FD-PS** MAC II (Figure 5.3(b)). In **FD-PS** MAC I, both contention based period and

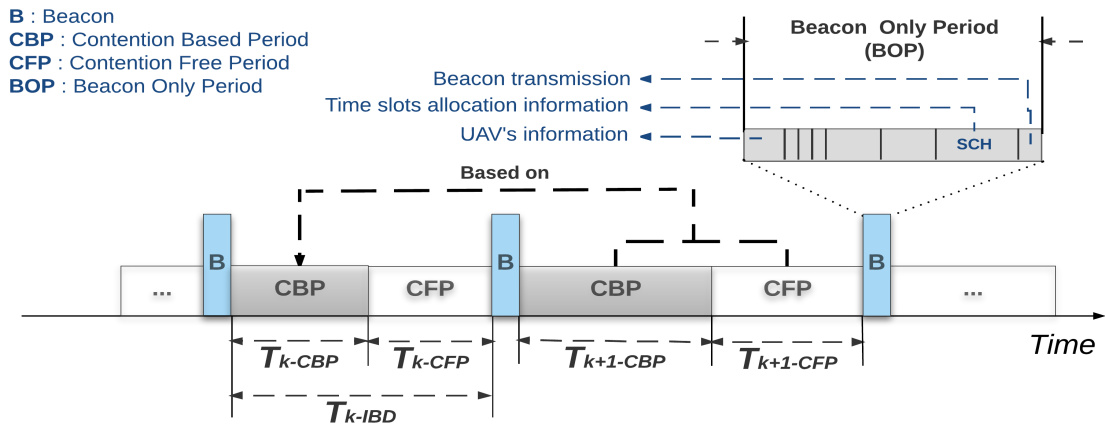

(a) 'SCH' is included in beacon

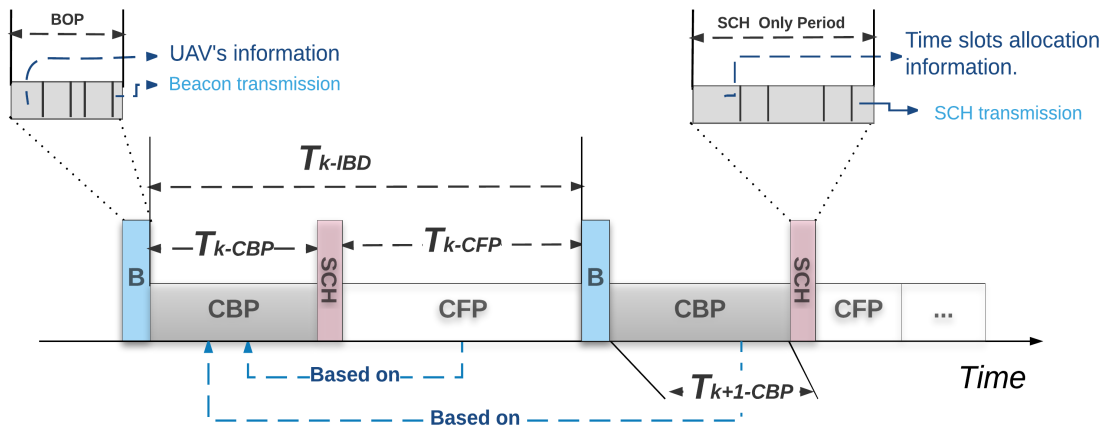

(b) 'SCH' is independent

Figure 5.4. Hybrid protocols based on adaptive inter-beacon duration.

proactive scheduling period are fixed. The UAV gets the details of the nodes and broadcasts a beacon which contains scheduling information for contention free period in the next inter-beacon duration. However, the time slots reservation for the detected nodes is not guaranteed because of the fixed contention free period. Thus, *FD-PS* MAC II, which has adaptive CBP and CFP, is proposed.

The first IBD is fixed at T_0 ($T_0 \leq T_{Ubd}$). In the following, we will introduce how to design the contention-based period and contention free period from the second IBD.

The CBP and CFP in the k^{th} ($k \geq 2$) inter-beacon duration are denoted by T_{CBP}^k and T_{CFP}^k respectively. The number of nodes that the UAV detected in the k^{th} inter-beacon duration is denoted by N_k . The set of the sensors that successfully sent first packet in k^{th} contention-based period is denoted by $\mathbb{S}_k = \{S_{r_1}, \dots, S_{r_{N_k}}\}$. The multi-data-rate between these nodes and the UAV is denoted by $\mathbb{DR}_k = \{DR_{r_1}, \dots, DR_{r_k}\}$. The remaining packets queue size of these nodes is denoted as $\mathbb{Q}_{sk} = \{Q_{sr_1}, \dots, Q_{sr_{N_k}}\}$. Then, the contention free period in the k^{th} inter-beacon duration is theoretically calculated by

$$T_{CFP}^k = \sum_{i=1}^{N_k-1} \left\lceil \frac{Pk_Size \cdot Q_{sr_i}}{DR_{r_i} \cdot \alpha} \right\rceil \cdot \alpha. \quad (5.2)$$

where α is the duration of one time slot.

The theoretical value calculated in equation (5.2) makes sure that each node that is detected in the $k-1^{th}$ contention-based period was allocated enough time slot in k^{th} contention free period. This is also the theoretical case in **AD-PS** MAC.

If $T_{CFP}^k < T_0$, then, $T_{CBP}^k = T_0 - T_{CFP}^k$. If $T_{CFP}^k \geq T_0$, then $T_{CBP}^k = 0$. Hence, $T_{CFP}^{k+1} = 0$, $T_{CBP}^{k+1} = T_0$. This phenomenon is normal in high density network. The longer the CBP, the unfairer is the network. In order to overcome this limitation, **AD-PS** MAC, which has adaptive inter-beacon duration, was proposed.

– AD-PS MAC

AD-PS MAC is a hybrid protocol that partially adopts beacon based IEEE 802.15.4 MAC and **DR/CDT** mechanisms. This protocols is introduced to coordinate not only control frames but also the collisions between the joint sensors and the UAV.

Based on the assumption that there is small difference between the deployed density within the adjacent two IBD, we get the theoretical value of CBP from equation (5.3),

$$T_{CBP}^k = \frac{N_{k-1}}{N} \cdot \frac{L}{v}. \quad (5.3)$$

Table 5.1. The relationship between CBP, CFP and IBD in this work

Protocols	Parameters	N_{k-1}	T_{CFP}^k	T_{CBP}^k	T_{IBD}^k
FD-PS MAC	$T_{CBP}^{k-1} \downarrow$	\downarrow	\downarrow	\uparrow	T_0
	$T_{CBP}^{k-1} \uparrow$	\uparrow	\uparrow	\downarrow	
AD-PS MAC	$T_{CBP}^{k-1} \downarrow$	\downarrow	\downarrow	\downarrow	If $T_{CBP}^k + T_{CFP}^k \leq T_{Ubd}$, $T_{IBD}^k = T_{CBP}^k + T_{CFP}^k$; if $T_{CBP}^k + T_{CFP}^k > T_{Ubd}$, $T_{IBD}^k = T_{Ubd}$
	$T_{CBP}^{k-1} \uparrow$	\uparrow	\uparrow	\uparrow	

In theoretical case, if $T_{CBP}^k + T_{CFP}^k \leq T_{Ubd}$, we have

$$T_{IBD}^k = T_{CBP}^k + T_{CFP}^k .$$

If $T_{CBP}^k + T_{CFP}^k > T_{Ubd}$, in the design of **AD-PS MAC**, we keep the T_{CFP}^k , and let

$$\begin{aligned} T_{IBD}^k &= T_{Ubd} , \\ T_{CBP}^k &= T_{Ubd} - T_{CFP}^k . \end{aligned}$$

According to equation (5.2), keeping T_{CFP}^k in **AD-PS MAC** makes sure that each node in CFP has at least one time slot.

Furthermore, the shorter is the T_{CBP}^{k-1} , the smaller is the N_{k-1} . From equation (5.2) and (5.3), we conclude that, both T_{CBP}^k and T_{CFP}^k are proportional to the N_{k-1} . And, the shorter is the T_{IBD}^k , the more beacons will be sent. The relationship between them can be summarized as in Table 5.1.

i.) Proposed AD-PS MAC I : The frame of **AD-PS MAC I** is similar to **FD-PS MAC II** except for the change in inter-beacon duration with the number of nodes that the UAV detected in the last contention-based period.

Algorithm 8 AD-PS MAC I**Require:** $L, T, T_0, v, width, T_{Ubd}$ **Ensure:** *PDR, Fairness* $T_{current} = 0, k = 1;$ **while** $T_{current} < T$ **do****Step 1. Synchronization;**

UAV sends 'Beacon' messages;

Network update, get \mathbb{S}_k ;**Step 2. Data Communication;***i. CBP :*Sensors in \mathbb{S}_k send 'first packet' to the UAV through CSMA/CA protocol. Nodes that successfully send 'first packet' to the UAV in CBP period was denoted by \mathbb{S}_{kB} .*ii. CFP :*Calculate T_{CBP}^{k+1} and T_{CFP}^{k+1} ;Sensors in \mathbb{S}_{kB} reserve time slots for CFP according to *DR/CDT* algorithm and send packets to the UAV in the reserved time slots;Update $T_{current}, k = k + 1$.**end while**Calculate and **return** PDR, Fairness;**End of algorithm.**

It is also a combination of beacon based *CSMA/CA* and *DR/CDT* and that contains a predefined number of time slots in scheduling information for detected nodes. The *AD-PS* MAC I is presented in Algorithm 8. Sensors will change into 'Sleep' mode if they finish transmissions or the UAV is out of range.

ii.) Proposed AD-PS MAC II : In aforementioned dynamic network, the contact duration time between nodes and UAV is limited because both are moving. The idea that the beacon contains the scheduling information (used in beacon based IEEE 802.15.4 MAC) has limitations in such scenario. That is because some nodes will be out of the range of the UAV before the next CFP coming. The *AD-PS* MAC II (Figure 5.4) considers an independent scheduling information after contention-based period which helps the nodes reserve time slots in the current inter-beacon duration. To a certain degree, the *AD-PS* MAC II overcomes the limitations

of *AD-PS* MAC I.

5.4 Network Efficiency Evaluation

Now, we will introduce the performance metrics used in this work.

5.4.1 System Performance

– Packets Delivery Ratio

The packets delivery ratio (*PDR*) of the system is defined as the ratio of the number of packets received by the UAV over the sum of packets of all mobile sensors that successfully sent one packet to the UAV. Then, the packets delivery ratio of the system is given by

$$PDR = \frac{\sum_{S_i \in \mathbb{F}} Pk_Se(i)}{\sum_{S_i \in \mathbb{F}} Pk_Sum(i)}. \quad (5.4)$$

Where \mathbb{F} is the sensor set that successfully sent one packet to the UAV. $Pk_Se(i)$ is the number of packets that S_i ($S_i \in \mathbb{F}$) successfully sent to the UAV. $Pk_Sum(i)$ is the sum of packets that S_i has.

– Fairness

The delivery ratio of each node is taken into account to measure the fairness. The network is fair, over a given period, if the delivery ratio of each node is approximately the same. To this end, this work adopts the standard deviation to measure the fairness as in equation (5.5),

$$Fairness = \left[\frac{1}{M-1} \sum_{i=1}^M \left(P_i - \frac{1}{M} \sum_{j=1}^M P_j \right)^2 \right]^{1/2} \quad (5.5)$$

Where $M = |\mathbb{F}|$, $P_i = Pk_Se(i)/Pk_Sum(i)$ ($S_i \in \mathbb{F}$).

Fairness is defined as the standard deviation of the sensors packets delivery ratio. The smaller the fairness value, the fairer the network. Hence, *Fairness* = 0 is the best case in terms of fairness, i.e., all the sensor

nodes have the same delivery ratio.

The main objective of the proposed algorithms is maximizing the *PDR* and minimizing the *Fairness*.

5.4.2 Simulation Setup

In this section, we run the simulation with several parameters, including network size, the inter beacon duration and the deployed topology. Simulations are conducted in MATLAB. The simulation results are obtained from multiple runs and finally results are the mean value of 30 simulation runs (with a 95% confidence level and 5% confidence intervals).

The system model is evaluated by means of a UAV and a swarm of mobile nodes moving along a *Path* ($10\text{ m} \times 6000\text{ m}$). The swarm consists of 2000 mobile nodes that are randomly deployed within an area of $10\text{ m} \times 1000\text{ m}$ (named *Path_d*). Uniform distribution is applied to initialize the sensors positions and velocities. If 2000 nodes are deployed in the whole *Path_d*, the random topology will have huge impact on the simulation results. Hence, we divide the *Path_d* evenly into 10 segments (each segment is $10\text{ m} \times 100\text{ m}$) and then apply uniform distribution to initialize the sensors information segmentally (200 nodes for each segment). When increasing the network size, taking '1000' and '1200' in figure 5.6 for instance, we will randomly and evenly select '1000' nodes from all segments (100 nodes from each segment) and denoted by sensor set A_1 , then select another '200' from the remaining 1000 nodes using the same approach and denoted by sensor set A_2 . We will get 1200 nodes through ' $A_1 + A_2$ '. This method ensures that the larger the network size and higher the deployed density. This division not only helps to reduce the difference of distribution density for each segment, but also helps to ensure that the distribution density increases as the network size increases.

Meanwhile, in order to reduce the impact of network topology on the simulation results, 50 simulations are done. The results in the figures are given by the mean value of 30 simulations except the 10 best simulations and the 10 worst simulations. The simulation parameters applied in the following are presented in Table 5.2.

The time slot used in the following is considered as the time that the sensor needs to successfully send one packet at the lowest data-rate (4.8 Kb/s). Hence, $\alpha = \text{Pk_Size} / \text{DR}_{\text{lowest}}$, that is 0.2117 s . The 4-pairwise communication parameters setting are defined as in Chapter 3. All simulated protocols are presented in

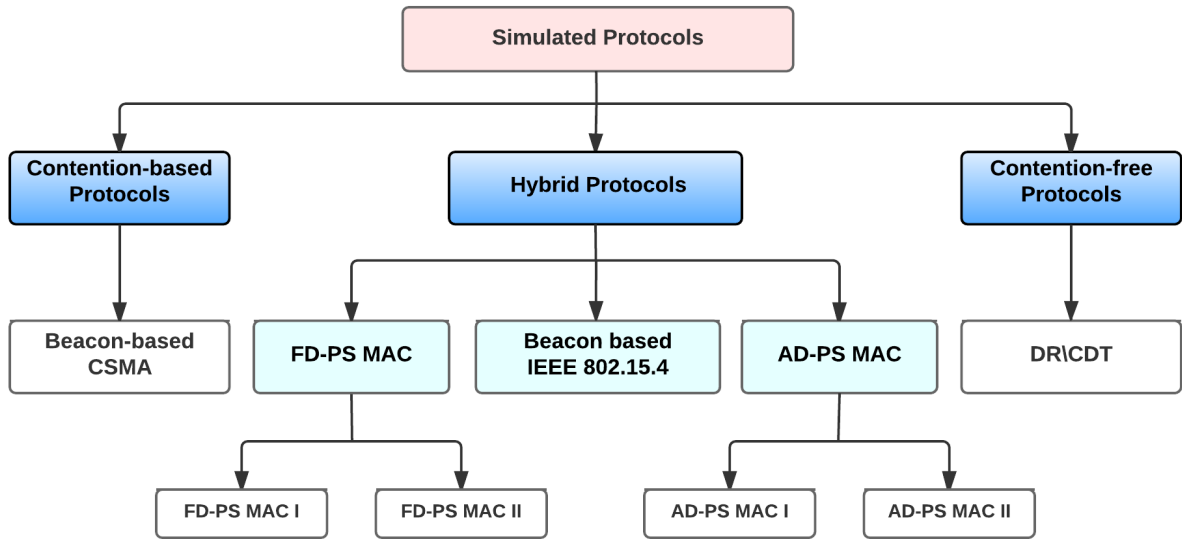

Figure 5.5. The simulated protocols in this work.

figure 5.5.

5.4.3 Results and Analysis

– Evaluation of the proposed protocols

Figure 5.6 shows the change of packet delivery ratio and fairness as function of the network size. In figure 5.6(a), we notice that, when the network size is smaller than 1000, the PDR is increasing as the network size increases. When the network size is bigger than 1000, the PDR is decreasing as the network size increases.

Table 5.2. Simulation parameters

Parameter	Value	Parameter	Value
Network size	2000	Sensors velocities	$[0,10]m s^{-1}$
UAV velocity	$10 m s^{-1}$	Packet size	127 Bytes
UAV fly height	15 m	$T_0(T_{IBD}^1)$	10 s
Deployed path	$10 m \times 1000 m$	Simulation time	10 minutes

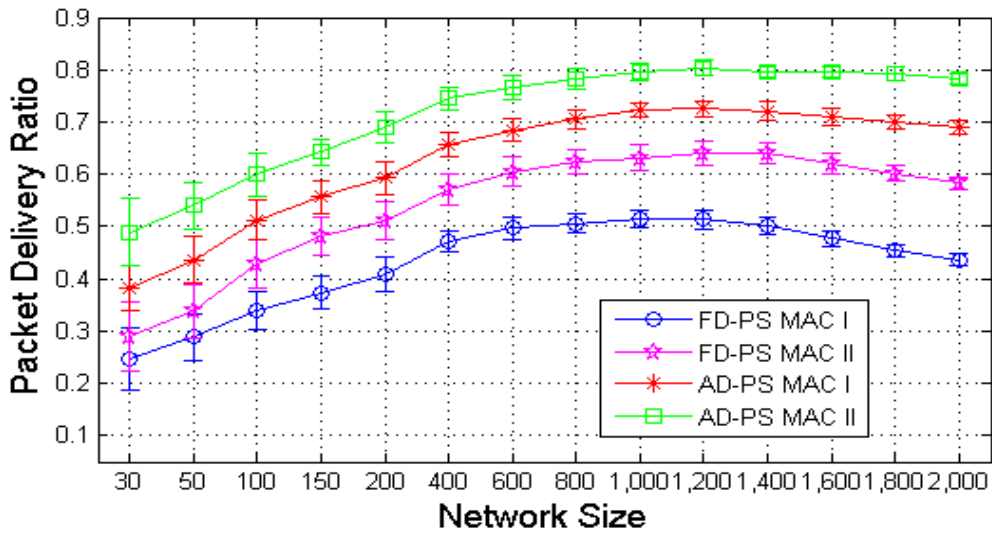

(a) PDR

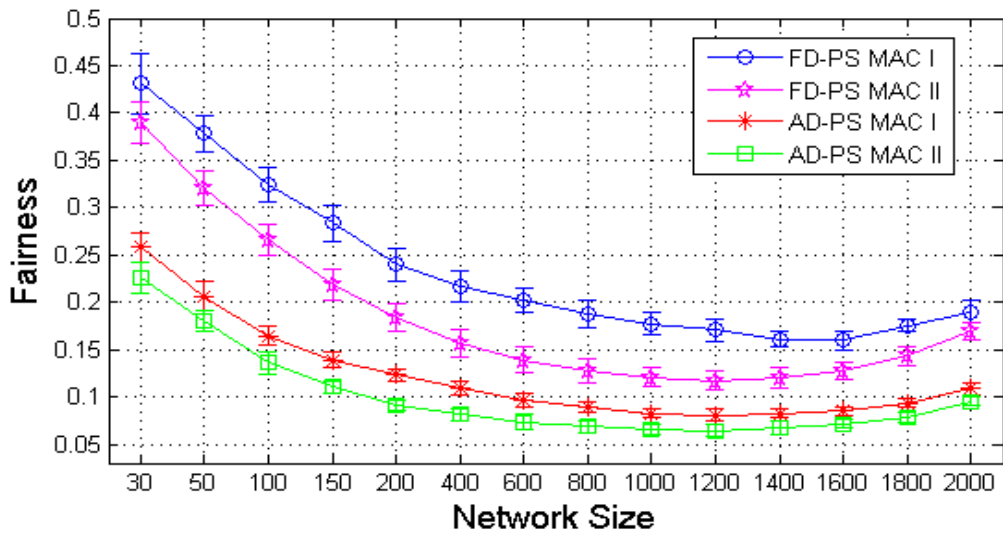

(b) Fairness

Figure 5.6. Evaluation of the proposed protocols.

The fairness, presented in figure 5.6(b), shows steady variations. In fact, as the network size increases, the number of sensors within IBD also increases. Thus, the UAV has more opportunities to collect packets, and

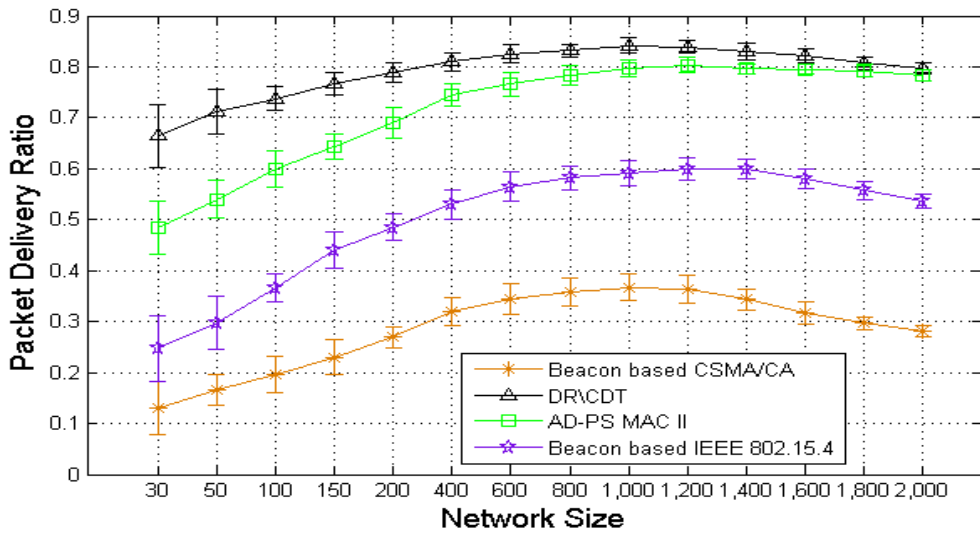

(a) PDR

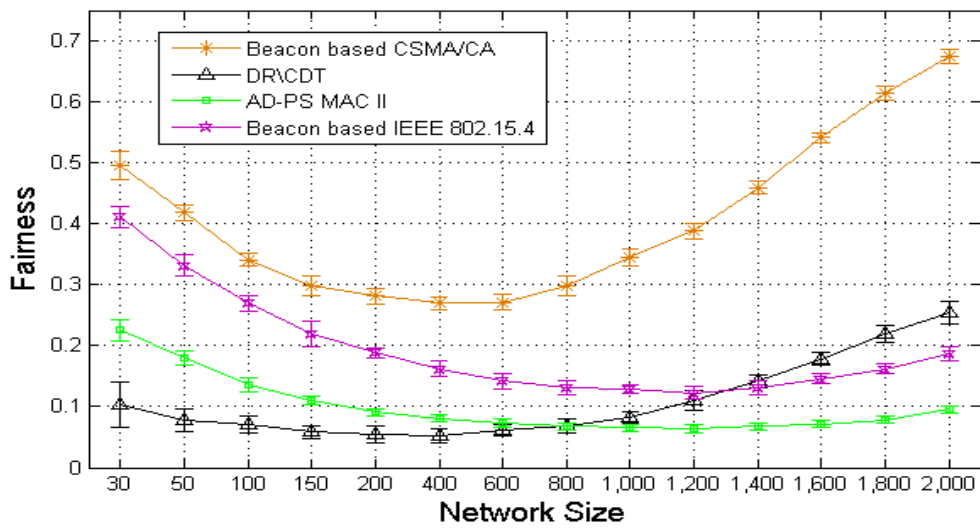

(b) Fairness

Figure 5.7. Comparison with existing protocols.

the PDR increases. However, when the number of sensors exceeded the transmission capacity of an IBD, the PDR will decrease as the network size increases.

From figure 5.6, the *AD-PS* MAC II works best in all proposed schemes. That is because, in *AD-PS* MAC II, sensors reserve time slots for CFP in the current IBD instead of in the next IBD. This mechanism provides more opportunities to the nodes that have shorter contact duration time with the UAV.

– **Comparison of the proposed protocols to the existing protocols**

Figure 5.7 shows a comparison of an average delivery ratio and fairness using different access schemes by the network size. The results present that the *AD-PS* MAC II outperforms the beacon based *CSMA/CA* and IEEE 802.15.4 in terms of the delivery ratio and fairness. *DR/CDT* outperforms the proposed protocols in terms of packet delivery ratio. That is because *DR/CDT* is based on an assumption that the UAV knows the network evolution details at the beginning. However, when the network size is larger than 1000, the network is fairer in *AD-PS* MAC II than in *DR/CDT*. This happens as a result of time slots reservation in *AD-PS* MAC II. More sensors will result in fewer time slots were allocated to the nodes that have lower multi-data-rate or longer contact duration time.

– **The impact of inter-beacon duration**

Equation (5.1) presents the upper bound of the inter-beacon duration, and it is about 19.75 seconds according to the given parameters in Table 5.2. This section will present the impact of the IBD on the system performance. The only difference from the above scenario is that the network size is fixed at 2000, and the IBD changes from 2 seconds to 25 seconds.

Figure 5.8 shows a comparison of an average delivery ratio and fairness between proposed MAC and the beacon based IEEE 802.15.4. From figure 5.8(a) We can notice that when IBD is smaller than 10 s, the PDR of the three hybrid schemes is increasing as the IBD increasing and it shows opposite phenomenon when IBD is larger than 10 s. On the contrary, the fairness shows different change. All metrics achieve the optimal performance around 10 s. In fact, the shorter the IBD is, the fewer number of sensors that detected in last CBP have opportunities to reserve time slots, the lower delivery ratio and the unfaier of the network. Similarly, the longer the IBD is, the longer waiting time for the detected sensors to send packets in the next CFP, the lower delivery ratio of the system. In fact, many of them are out of the range of the UAV before the next CFP coming, they only send packets during CBP, thus, it is unfaier for the nodes.

According to the results, *FD-PS* MAC II and *AD-PS* MAC II perform very well with a larger number of mobile

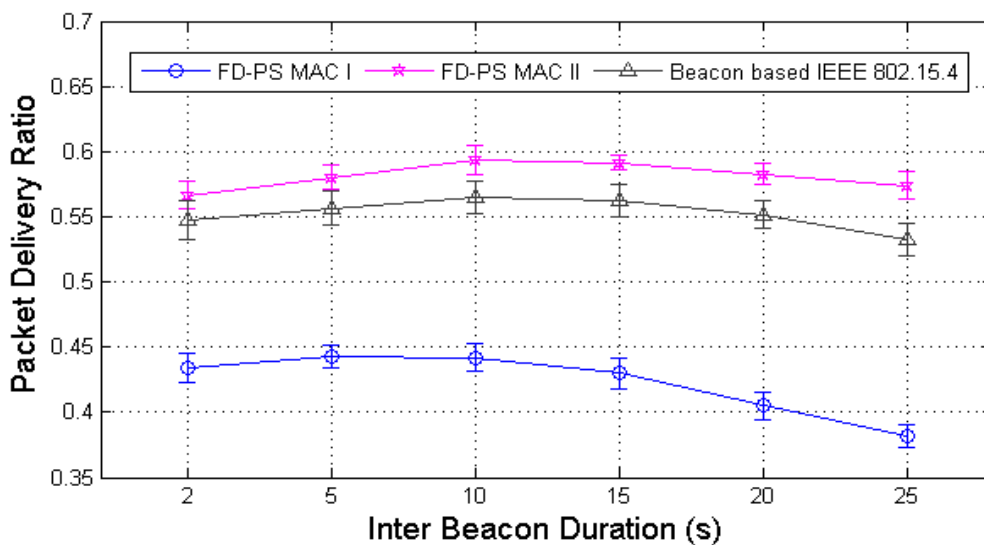

(a) PDR

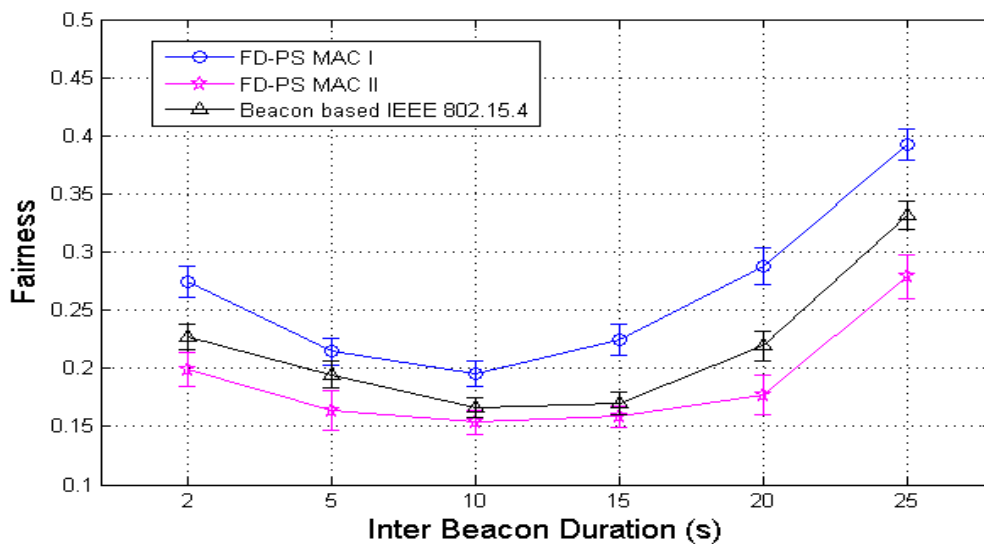

(b) Fairness

Figure 5.8. The impact of inter-beacon duration.

nodes.

5.5 Conclusion

This chapter has introduced efficient MAC protocols, *FD-PS* MAC and *AD-PS* MAC, for data collection in UAV-assisted mobile networks. Both of them adopt a combination of beacon based *CSMA/CA* and *DR/CDT*. *FD-PS* MAC fixes the inter-beacon duration while this duration is adaptive with *AD-PS* MAC. Furthermore, the *FD-PS* MAC was refined into *FD-PS* MAC I and *FD-PS* MAC II. Both contention based period and contention free period are fixed in *FD-PS* MAC I and adaptive in *FD-PS* MAC II. *AD-PS* MAC was also refined into *AD-PS* MAC I and *AD-PS* MAC II. The 'Beacon' in *AD-PS* MAC I contains the schedule while *AD-PS* MAC II uses an independent schedule. The simulation results confirmed that the *FD-PS* MAC II and *AD-PS* MAC II outperform the others in larger scale mobile WSN with a flying Sink.

CHAPITRE 6

Conclusions and Perspectives

This chapter concludes the thesis, reminding the addressed problems, highlighting the contributions, and opening up perspectives.

6.1 Conclusion

The goal of this thesis was to improve the efficiency of data collection in UAV-assisted mobile wireless sensor networks.

Since the data-rate and contact duration time between the collectors and the source nodes are the main factors influencing data collection, we focused on the two factors and started by enhancing the contention-free algorithms in Chapter 3. At the beginning of each time slot, the UAV sends a beacon to its coverage, the sensors that received the beacon send a join message which is including the details (such as position, speed, etc.) to the UAV. After having received the join message, the UAV processes these data and decides which sensor will be allocated to the current time slot according to the proposed algorithms. The sensors only send data in their time slots. Based on the proposed algorithms, the time slots are always allocated to the nodes that have the advantage of optimal transmission. For example, the node which has higher data-rate gets the time slot than the one who has lower data-rate according to the *DR* algorithm (in Chapter 3.3). Extensive simulations presented that the proposed algorithms achieve a high delivery ratio (sometimes, more than 95%, which shown in Chapter 3.4) in such context.

To study the impact of the two factors on data collection, the proposed algorithms in Chapter 3 use one-hop communication. In one-hop case, the sensors that are out of the range of the UAV don't have any opportunity to communicate with the UAV. Then, in Chapter 4, we used multi-hop and proposed

opportunistic communication protocols. According to the mobile characteristic of mobile networks, we proposed *HVOR* algorithm in which the sensors that have the highest speeds will be selected as the relay nodes. Through extensive simulations, the multi-hop algorithms present an absolute advantage concerning delivery ratio compared to the *DR/CDT* algorithm. Similar to other multi-hop algorithms, the relay nodes used in *HVOR* algorithm cannot guarantee that the data collected from simple nodes can be successfully sent to the destination nodes. Then, we proposed a scheduling based forwarder selection algorithm. The communication between the forwarders and the UAV are fixed in a scheduling which will be generated by the algorithm. The algorithm helps us to select forwarders that can guarantee that the data collected from simple nodes have opportunity to be sent to the UAV. In our work, the selection of guaranteed forwarders is based on the assumptions that presented in Chapter 4. This is because the transmission capacity was used in such algorithm. If the transmission capacity of the forwarder reaches the maximum, no more data will be collected. The simple nodes should find other forwarders who have remaining capacity and send data to them. Finally, we evaluated the proposed algorithms with the **Epidemic** protocol in terms of delivery ratio, energy consumption, and fairness. The opportunistic algorithm with guaranteed forwarders (*TOCC* algorithm in Chapter 4) present obvious advantage than other ones.

In Chapter 5, we studied the MAC protocols by enhancing the beacon based IEEE 802.15.4 with beacon only period. According to the UAV speed, the path width, and the communication range, we introduced the unbound of the inter-beacon-duration. At the beginning of each super-frame, the UAV sends a beacon (the beacon includes the information of the UAV, the scheduling information for contention free period), sensors in its coverage that received the beacon will compete to communicate with the UAV in the contention-based period. In our protocols, sensors send the only first packet to the UAV if they have an opportunity. The first packet including the details of the sensors. After contention-based period, the UAV processes all the information collected in contention-based period and gives a scheduling for contention-free period. Sending only first packet can help the UAV to collect from as many nodes as possible in contention-based period. This also helps more the nodes in the contention-free period to have the opportunities to send data. Furthermore, we adapt the duration of contention-based period and contention-free period according to the dynamic topology of the mobile network. We compared the proposed protocols with beacon-based **CSMA/CA** and **IEEE 802.15.4** in terms of delivery ratio and fairness. The simulation results confirmed that the proposed

MAC protocols (*FD-PS* MAC II and *AD-PS* MAC II) outperform the others in larger scale mobile WSN with a flying sink.

6.2 Perspectives

The contributions of this thesis can be extended in several directions. Now, we present some of them as follows.

6.2.1 Irregular movement paths and areas

The main purpose of this thesis is to study the performance impact of various factors on data collection in mobile WSN. Thus, we simplify the external conditions and reduce the interference of external factors. However, in the actual operations and applications, linear motion distance in 3 or 6 *km* is the ideal situation. There are usually irregular movement paths or areas in many applications. In such context, the UAV, and sensors should change their direction and speed when they reach the border. Our proposed algorithms can be extended to be applied to irregular path and areas if there is no change in speed. This is because the irregular path can be divided into several linear paths, and our algorithms can be used in each short linear path. In areas, the fly route of the UAV can be seen as a combination of linear path and curves, similar to irregular paths, the curves also can be divided into several linear paths.

6.2.2 Irregular movement model

All sensors move at constant speed in this thesis. This is the ideal situation in some applications. More generally, the movement of sensors is non-uniform. It includes acceleration and deceleration. Acceleration and deceleration have an impact on the calculation of contact duration time and the data-rate between the sensors and the UAV. These also have an impact on the data collection. In irregular movement model, some short-term motion can be predicted by prediction algorithms. However, the predict data is not perfect. There is a gap between the predicted motion and the actual motion, which will have a significant effect on the performance metrics.

6.2.3 Multi-UAVs

In this thesis, to study the impact of each factor more deeply, we focused on one UAV with N mobile sensors. However, collaboratively working multi-UAVs can significantly improve the effectiveness of data collection in such a context. How multiple UAVs cooperate? How do many drones and large-scale nodes work together? Compared to the current research background, these issues will be a new research direction.

6.2.4 Experiments

One of the directions for continuing the works presented in this thesis is a validation through experiments. While we used a realistic mobile model in our simulations, experiments would allow revealing more interesting details of this research.

In Chapter 3, we studied the fly height and velocity of the UAV, the mobility and the deployment density of the sensors. In simulations, there is no collision in motion, but in experiments, there may be collisions, especially in large scale networks. After the collision, the position of the node, the direction of movement and speed are changing which will amplify the problem. Moreover, the road obstacles, wind speed, also have an impact on the experiments.

The transmission rate in experiments also has an impact on the proposed algorithms which only used 4-pairwise communication data rate. In experiments, the transmission rate between the UAV and the source nodes is gradually changed with the distance between them. However, in our simulation, we use the statistical results which roughly divided the data-rate into four levels.

Bibliographie

- [1] Agriculture application. Available : <http://www.hse-uav.com>.
- [2] Amazon prime air. Available : <http://www.amazon.com/b?node=8037720011>.
- [3] Facebook. Available : <http://www.politico.com/story/2014/03/mark-zuckerberg-facebook-drones-satellites-lasers-105117.html> Internet.org by facebook : <http://www.gizmag.com/facebook-internet-drones/36747/>.
- [4] Ieee 802.15.4 :. <http://www.ieee802.org/15/>.
- [5] Nsf-hurricane katrina, 2006. Available : <http://www.nsf.gov/news>.
- [6] Pipeline safety and monitoring. Available : <http://napipelines.com/unmanned-aircrafts-pipeline-safety-monitoring/>.
- [7] W. A and K. M. *Unmanned aerial vehicles*, volume 134 of *In :Combat modeling, international series in operations research & management science*. US : Springer, 2009.
- [8] I. F. Akyildiz, W. Su, Y. Sankarasubramaniam, and E. Cayirci. A survey on sensor networks. *IEEE Communications Magazine*, pages 102–114, 2002.
- [9] G. Barrenetxea, F. Ingelrest, G. Schaefer, M. Vetterli, O. Couach, and M. Parlange. Sensorscope : Out-of-the-box environmental monitoring. In *2008 International Conference on Information Processing in Sensor Networks (IPSN 2008)*, pages 332–343, Apr. 2008.

- [10] I. Bekmezci, O. K. Sahingoz, and S. Temel. Flying ad-hoc networks (fanets) : A survey. *Ad Hoc Networks*, 11(3) :1254 – 1270, 2013.
- [11] E. M. Belding-Royer. Multi-level hierarchies for scalable ad hoc routing. *Wireless Networks*, 9(5) :461–478, Sep. 2003.
- [12] A. Boukerche, L. A. Villas, D. L. Guidoni, G. Maia, F. D. Cunha, J. Ueyama, and A. A. Loureiro. A new solution for the time-space localization problem in wireless sensor network using uav. In *Proceedings of the Third ACM International Symposium on Design and Analysis of Intelligent Vehicular Networks and Applications*, DIVANet '13, pages 153–160, New York, NY, USA, 2013. ACM.
- [13] D. Braginsky and D. Estrin. Rumor routing algorithm for sensor networks. In *Proceedings of the 1st ACM International Workshop on Wireless Sensor Networks and Applications*, WSNA '02, pages 22–31, New York, NY, USA, 2002. ACM.
- [14] M. Buettner, G. V. Yee, E. Anderson, and R. Han. X-mac : A short preamble mac protocol for duty-cycled wireless sensor networks. In *Proceedings of the 4th International Conference on Embedded Networked Sensor Systems*, SenSys '06, pages 307–320, New York, NY, USA, 2006. ACM.
- [15] N. Bulusu, J. Heidemann, and D. Estrin. Gps-less low-cost outdoor localization for very small devices. *IEEE Personal Communications*, 7(5) :28–34, Oct. 2000.
- [16] E. Casini, R. De Gaudenzi, and O. R. Herrero. Contention resolution diversity slotted aloha (crdsa) : An enhanced random access scheme for satellite access packet networks. *Trans. Wireless. Comm.*, 6(4) :1408–1419, Apr. 2007.
- [17] C. M. Cheng, P. H. Hsiao, H. T. Kung, and D. Vlah. Maximizing throughput of uav-relaying networks with the load-carry-and-deliver paradigm. In *2007 IEEE Wireless Communications and Networking Conference*, pages 4417–4424, Mar. 2007.
- [18] Chintalapudi and Krishna. I-mac - a mac that learns. In *International Conference on Information Processing in Sensor Networks (IPSN)*. Association for Computing Machinery, Inc., Apr. 2010.

- [19] R. Cohen, L. Katzir, and D. Raz. An efficient approximation for the generalized assignment problem. *Information Processing Letters*, 100(4) :162–166, 2006.
- [20] J. Cooper and M. A. Goodrich. Towards combining uav and sensor operator roles in uav-enabled visual search. In *Proceedings of the 3rd ACM/IEEE International Conference on Human Robot Interaction*, HRI '08, pages 351–358, New York, NY, USA, 2008. ACM.
- [21] D. S. J. D. Couto, D. Aguayo, J. Bicket, and R. Morris. A high-throughput path metric for multi-hop wireless routing. In *Proceedings of the 9th Annual International Conference on Mobile Computing and Networking*, MobiCom '03, pages 134–146, New York, NY, USA, 2003. ACM.
- [22] Crouch and C. Craig. Integration of mini-uavs at the tactical operations level implications of operations, implementation, and information sharing, 2005.
- [23] K. Dalamagkidis. *Classification of UAVs*. Springer Netherlands, Dordrecht, 2015.
- [24] M. Dawande, J. Kalagnanam, P. Keskinocak, F. Salman, and R. Ravi. Approximation algorithms for the multiple knapsack problem with assignment restrictions. *Journal of Combinatorial Optimization*, 4(2) :171–186, Jun. 2000.
- [25] E. P. de Freitas, T. Heimfarth, I. F. Netto, C. E. Lino, C. E. Pereira, A. M. Ferreira, F. R. Wagner, and T. Larsson. Uav relay network to support wsn connectivity. In *International Congress on Ultra Modern Telecommunications and Control Systems*, pages 309–314, Oct. 2010.
- [26] M. Di Francesco, S. K. Das, and G. Anastasi. Data collection in wireless sensor networks with mobile elements : A survey. *ACM Trans. Sen. Netw.*, 8(1) :7 :1–7 :31, Aug. 2011.
- [27] C. Diallo, M. Marot, and M. Becker. Link quality and local load balancing routing mechanisms in wireless sensor networks. In *2010 Sixth Advanced International Conference on Telecommunications*, pages 306–315, May 2010.
- [28] G. M. Djuknic and R. E. Richton. Geolocation and assisted gps. *Computer*, 34(2) :123–125, Feb. 2001.

- [29] S. Dogru and L. Marques. Energy efficient coverage path planning for autonomous mobile robots on 3d terrain. In *2015 IEEE International Conference on Autonomous Robot Systems and Competitions*, pages 118–123, Apr. 2015.
- [30] A. Dumbrava, R. Kacimi, R. Dhaou, and A. L. Beylot. Proportion based protocols for load balancing and lifetime maximization in wireless sensor networks. In *2010 The 9th IFIP Annual Mediterranean Ad Hoc Networking Workshop (Med-Hoc-Net)*, pages 1–8, Jun. 2010.
- [31] C. T. Ee and R. Bajcsy. Congestion control and fairness for many-to-one routing in sensor networks. In *Proceedings of the 2Nd International Conference on Embedded Networked Sensor Systems, SenSys '04*, pages 148–161, New York, NY, USA, 2004. ACM.
- [32] E. Egea-López, J. Vales-Alonso, A. S. Martínez-Sala, J. García-Haro, P. Pavón-Mariño, and M. V. Bueno Delgado. A wireless sensor networks mac protocol for real-time applications. *Personal Ubiquitous Comput.*, 12(2) :111–122, Jan. 2008.
- [33] A. El-Hoiydi and J.-D. Decotignie. *WiseMAC : An Ultra Low Power MAC Protocol for Multi-hop Wireless Sensor Networks*, pages 18–31. Springer Berlin Heidelberg, Berlin, Heidelberg, 2004.
- [34] S. H. Fang and T. Lin. Principal component localization in indoor wlan environments. *IEEE Transactions on Mobile Computing*, 11(1) :100–110, Jan. 2012.
- [35] A. Fei, G. Pei, R. Liu, and L. Zhang. Measurements on delay and hop-count of the internet. In *in IEEE GLOBECOM'98 - Internet Mini-Conference*, 1998.
- [36] L. Fleischer, M. X. Goemans, V. S. Mirrokni, and M. Sviridenko. Tight approximation algorithms for maximum general assignment problems. In *Proceedings of the Seventeenth Annual ACM-SIAM Symposium on Discrete Algorithm, SODA '06*, pages 611–620, Philadelphia, PA, USA, 2006. Society for Industrial and Applied Mathematics.
- [37] K. Fodor and A. Vidács. Efficient routing to mobile sinks in wireless sensor networks. In *Proceedings of the 3rd International Conference on Wireless Internet, WICON '07*, pages 32 :1–32 :7, ICST,

- Brussels, Belgium, Belgium, 2007. ICST (Institute for Computer Sciences, Social-Informatics and Telecommunications Engineering).
- [38] S. Gao, H. Zhang, and S. K. Das. Efficient data collection in wireless sensor networks with path-constrained mobile sinks. *IEEE Transactions on Mobile Computing*, 10(4) :592–608, Apr. 2011.
- [39] J. J. Garcia-Luna-Aceves and M. Spohn. Source-tree routing in wireless networks. In *Proceedings. Seventh International Conference on Network Protocols*, pages 273–282, Oct. 1999.
- [40] R. D. Gaudenzi, O. del Río Herrero, G. Acar, and E. G. Barrabés. Asynchronous contention resolution diversity aloha : Making crdsa truly asynchronous. *IEEE Transactions on Wireless Communications*, 13(11) :6193–6206, Nov. 2014.
- [41] H. Gong, M. Liu, Y. Mao, L. Chen, and X. Li. *Traffic Adaptive MAC Protocol for Wireless Sensor Network*, pages 1134–1143. Springer Berlin Heidelberg, Berlin, Heidelberg, Aug. 2005.
- [42] I. Guvenc, W. Saad, M. Bennis, C. Wietfeld, M. Ding, and L. Pike. Wireless communications, networking, and positioning with unmanned aerial vehicles [guest editorial]. *IEEE Communications Magazine*, 54(5) :24–25, May 2016.
- [43] S. Halder and A. Ghosal. A survey on mobility-assisted localization techniques in wireless sensor networks. *Journal of Network and Computer Applications*, 60 :82–94, 2016.
- [44] G. Han, H. Xu, J. Jiang, L. Shu, T. Hara, and S. Nishio. Path planning using a mobile anchor node based on trilateration in wireless sensor networks. *Wireless Communications and Mobile Computing*, 13(14) :1324–1336, 2013.
- [45] T. He, J. A. Stankovic, C. Lu, and T. Abdelzaher. Speed : A stateless protocol for real-time communication in sensor networks. In *Proceedings of the 23rd International Conference on Distributed Computing Systems, ICDCS '03*, pages 46–55, Washington, DC, USA, 2003. IEEE Computer Society.
- [46] W. R. Heinzelman, A. Chandrakasan, and H. Balakrishnan. Energy-efficient communication protocol for wireless microsensor networks. In *Proceedings of the 33rd Hawaii International Conference on*

System Sciences-Volume 8 - Volume 8, HICSS '00, page 8020, Washington, DC, USA, 2000. IEEE Computer Society.

- [47] W. R. Heinzelman, J. Kulik, and H. Balakrishnan. Adaptive protocols for information dissemination in wireless sensor networks. In *Proceedings of the 5th Annual ACM/IEEE International Conference on Mobile Computing and Networking*, MobiCom '99, pages 174–185, New York, NY, USA, 1999. ACM.
- [48] D. T. Ho, E. I. Grotli, P. B. Sujit, T. A. Johansen, and J. B. Sousa. Cluster-based communication topology selection and uav path planning in wireless sensor networks. In *2013 International Conference on Unmanned Aircraft Systems (ICUAS)*, pages 59–68, May 2013.
- [49] D. T. Ho and S. Shimamoto. Highly reliable communication protocol for wsn-uav system employing tdma and pfs scheme. In *2011 IEEE GLOBECOM Workshops (GC Wkshps)*, pages 1320–1324, Dec. 2011.
- [50] T. D. Ho and J. Park. Novel multiple access scheme for wireless sensor network employing unmanned aerial vehicle. In *29th Digital Avionics Systems Conference*, pages 5.C.5–1–5.C.5–8, Oct. 2010.
- [51] P. Hurni and T. Braun. *MaxMAC : A Maximally Traffic-Adaptive MAC Protocol for Wireless Sensor Networks*, pages 289–305. Springer Berlin Heidelberg, Berlin, Heidelberg, 2010.
- [52] M. Iacono, E. Romano, and S. Marrone. Adaptive monitoring of marine disasters with intelligent mobile sensor networks. In *2010 IEEE Workshop on Environmental Energy and Structural Monitoring Systems*, pages 38–45, Sep. 2010.
- [53] H. Inata, S. Say, T. Ando, J. Liu, and S. Shimamoto. Unmanned aerial vehicle based missing people detection system employing phased array antenna. In *2016 IEEE Wireless Communications and Networking Conference Workshops (WCNCW)*, pages 222–227, Apr. 2016.
- [54] O. D. Incel, L. van Hoesel, P. Jansen, and P. Havinga. Mc-lmac : A multi-channel {MAC} protocol for wireless sensor networks. *Ad Hoc Networks*, 9(1) :73 – 94, 2011.

- [55] C. Intanagonwiwat, R. Govindan, and D. Estrin. Directed diffusion : A scalable and robust communication paradigm for sensor networks. In *Proceedings of the 6th Annual International Conference on Mobile Computing and Networking, MobiCom '00*, pages 56–67, New York, NY, USA, 2000. ACM.
- [56] P. Jacquet, P. Muhlethaler, T. Clausen, A. Laouiti, A. Qayyum, and L. Viennot. Optimized link state routing protocol for ad hoc networks. In *Proceedings. IEEE International Multi Topic Conference, 2001. IEEE INMIC 2001. Technology for the 21st Century.*, pages 62–68, 2001.
- [57] S. Jain, R. C. Shah, W. Brunette, G. Borriello, and S. Roy. Exploiting mobility for energy efficient data collection in wireless sensor networks. *Mobile Networks and Applications*, 11(3) :327–339, 2006.
- [58] I. Jawhar, N. Mohamed, J. Al-Jaroodi, and S. Zhang. Data communication in linear wireless sensor networks using unmanned aerial vehicles. In *2013 International Conference on Unmanned Aircraft Systems (ICUAS)*, pages 492–499, May 2013.
- [59] D. B. Johnson and D. A. Maltz. *Dynamic Source Routing in Ad Hoc Wireless Networks*, pages 153–181. Springer US, Boston, MA, 1996.
- [60] R. Kacimi. Techniques de conservation d'énergie pour les réseaux de capteurs sans fil. *PhD Thesis, INPT*, 2009.
- [61] R. Kacimi, R. Dhaou, and A.-L. Beylot. Load balancing techniques for lifetime maximizing in wireless sensor networks. *Ad Hoc Networks*, 11(8) :2172 – 2186, 2013.
- [62] P. P. Kamble. Wireless sensor networks for earthquake detection and damage mitigation system. *International Journal of Innovative Research in Computer and Communication Engineering*, 4 :6209–6214, Mar. 2016.
- [63] H. Karl and A. Willig. *Protocols and Architectures for Wireless Sensor Networks*. John Wiley & Sons, 2005.
- [64] S. V. Kashuba, V. I. Novikov, O. I. Lysenko, and I. V. Alekseeva. Optimization of uav path for wireless sensor network data gathering. In *2015 IEEE International Conference Actual Problems of Unmanned Aerial Vehicles Developments (APUAVD)*, pages 280–283, Oct. 2015.

- [65] A. Keranen, J. Ott, and T. Karkkainen. The one simulator for dtn protocol evaluation. In *Proceedings of the 2Nd International Conference on Simulation Tools and Techniques, Simutools '09*, pages 55 :1–55 :10, ICST, Brussels, Belgium, Belgium, 2009. ICST (Institute for Computer Sciences, Social-Informatics and Telecommunications Engineering).
- [66] J. Kim, J. Lim, C. Pelczar, and B. Jang. Rrmac : A sensor network mac for real time and reliable packet transmission. In *2008 IEEE International Symposium on Consumer Electronics*, pages 1–4, Apr. 2008.
- [67] Y. Kim, H. Shin, and H. Cha. Y-mac : An energy-efficient multi-channel mac protocol for dense wireless sensor networks. In *Proceedings of the 7th International Conference on Information Processing in Sensor Networks, IPSN '08*, pages 53–63, Washington, DC, USA, 2008. IEEE Computer Society.
- [68] J. Kleinberg. Computing : The wireless epidemic. *Nature*, 449 :287–288, Sep. 2007.
- [69] Y.-B. Ko and N. H. Vaidya. Location-aided routing (lar) in mobile ad hoc networks. *Wirel. Netw.*, 6(4) :307–321, Jul. 2000.
- [70] E. Kuiper and S. Nadjm-Tehrani. Geographical routing in intermittently connected ad hoc networks. In *22nd International Conference on Advanced Information Networking and Applications - Workshops (aina workshops 2008)*, pages 1690–1695, Mar. 2008.
- [71] A. Kurs, A. Karalis, R. Moffatt, J. D. Joannopoulos, P. Fisher, and M. Soljačić. Wireless power transfer via strongly coupled magnetic resonances. *Science*, 317(5834) :83–86, 2007.
- [72] K. I. Lakhtaria. Analyzing zone routing protocol in MANET applying authentic parameter. *CoRR*, abs/1012.2510, 2010.
- [73] L. Lee, W. A. Datta, and R. Cardell-Oliver. *FlexiMAC : A flexible TDMA-based MAC protocol for fault-tolerant and energy efficient wireless sensor networks*, volume 2, pages 337–342. IEEE, singapore edition, 2006.

- [74] S. H. Lee, S. Lee, H. Song, and H. S. Lee. Wireless sensor network design for tactical military applications : Remote large-scale environments. In *Proceedings of the 28th IEEE Conference on Military Communications, MILCOM'09*, pages 911–917, Piscataway, NJ, USA, 2009. IEEE Press.
- [75] M. Lu and J. Wu. Opportunistic routing algebra and its applications. In *IEEE INFOCOM 2009*, pages 2374–2382, Apr. 2009.
- [76] X. Ma, S. Chisiu, R. Kacimi, and R. Dhaou. Opportunistic Communications in WSN Using UAV (regular paper). In *IEEE Consumer Communications and Networking Conference (CCNC), Las-Vegas, 08/01/2017-11/01/2017*, pages 1–6, <http://www.ieee.org/>, Jan. 2017. IEEE.
- [77] X. Ma, R. Kacimi, and R. Dhaou. Fairness-aware uav-assisted data collection in mobile wireless sensor networks. In *2016 International Wireless Communications and Mobile Computing Conference (IWCMC)*, pages 995–1001, Sep. 2016.
- [78] X. Ma, R. Kacimi, and R. Dhaou. Adaptive Hybrid MAC Protocols for UAV-Assisted Mobile Sensor Networks (regular paper). In *IEEE Consumer Communications and Networking Conference (CCNC), Las-Vegas, 12/01/2018-15/01/2018*, <http://www.ieee.org/>, Jan. 2018. IEEE.
- [79] G. Mario, V. Joao, Z. David, and B. Antonio. An aerial-ground robotic system for navigation and obstacle mapping in large outdoor areas. *Sensors*, 13(1) :1247–1267, 2013.
- [80] I. Maza, F. Caballero, J. Capitán, J. R. Martínez-de Dios, and A. Ollero. Experimental results in multi-uav coordination for disaster management and civil security applications. *Journal of Intelligent & Robotic Systems*, 61(1) :563–585, Jan. 2011.
- [81] Z. Merhi, M. Elgamel, and M. Bayoumi. Eb-mac : An event based medium access control for wireless sensor networks. In *2009 IEEE International Conference on Pervasive Computing and Communications*, pages 1–6, Mar. 2009.
- [82] R. G. Ogier. Efficient routing protocols for packet-radio networks based on tree sharing. In *Mobile Multimedia Communications, 1999. (MoMuC '99) 1999 IEEE International Workshop on*, pages 104–113, 1999.

- [83] S. Pack, J. Choi, T. Kwon, and Y. Choi. Ta-mac : Task aware mac protocol for wireless sensor networks. In *2006 IEEE 63rd Vehicular Technology Conference*, volume 1, pages 294–298, May 2006.
- [84] J. Palmer, N. Yuen, J. P. Ore, C. Detweiler, and E. Basha. On air-to-water radio communication between uavs and water sensor networks. In *2015 IEEE International Conference on Robotics and Automation (ICRA)*, pages 5311–5317, May 2015.
- [85] Y. Pang, Y. Zhang, Y. Gu, M. Pan, Z. Han, and P. Li. Efficient data collection for wireless rechargeable sensor clusters in harsh terrains using uavs. In *2014 IEEE Global Communications Conference*, pages 234–239, Dec. 2014.
- [86] C. Park and P. H. Chou. Ambimax : Autonomous energy harvesting platform for multi-supply wireless sensor nodes. In *2006 3rd Annual IEEE Communications Society on Sensor and Ad Hoc Communications and Networks*, volume 1, pages 168–177, Sep. 2006.
- [87] L. Pelusi, A. Passarella, and M. Conti. Opportunistic networking : data forwarding in disconnected mobile ad hoc networks. *IEEE Communications Magazine*, 44(11) :134–141, Nov. 2006.
- [88] Y. Peng, Z. Li, W. Zhang, and D. Qiao. Prolonging sensor network lifetime through wireless charging. In *2010 31st IEEE Real-Time Systems Symposium*, pages 129–139, Nov. 2010.
- [89] C. E. Perkins and P. Bhagwat. Highly dynamic destination-sequenced distance-vector routing (dsv) for mobile computers. *SIGCOMM Comput. Commun. Rev.*, 24(4) :234–244, Oct. 1994.
- [90] C. E. Perkins and E. M. Royer. Ad-hoc on-demand distance vector routing. In *Mobile Computing Systems and Applications, 1999. Proceedings. WMCSA '99. Second IEEE Workshop on*, pages 90–100, Feb. 1999.
- [91] J. Polastre, J. Hill, and D. Culler. Versatile low power media access for wireless sensor networks. In : *Proc. 2nd Int'l Conf. Embedded Networked Sensor Systems (SenSys'04)*, pages 95–107, 2004.
- [92] J. Polastre, J. Hill, and D. Culler. Versatile low power media access for wireless sensor networks. In *Proceedings of the 2Nd International Conference on Embedded Networked Sensor Systems, SenSys '04*, pages 95–107, New York, NY, USA, 2004. ACM.

- [93] V. Rajendran, J. J. Garcia-Luna-Aveces, and K. Obraczka. Energy-efficient, application-aware medium access for sensor networks. In *IEEE International Conference on Mobile Adhoc and Sensor Systems Conference (MASS'05)*, 2005.
- [94] Rakocevic and Goran. Overview of sensors for wireless sensor networks. *Transactions on Internet Research*, 2009.
- [95] M. Ren, L. Khoukhi, H. Labiod, J. Zhang, and V. Vèque. A new mobility-based clustering algorithm for vehicular ad hoc networks (vanets). In *2016 IEEE/IFIP Network Operations and Management Symposium, NOMS 2016, Istanbul, Turkey, April 25-29, 2016*, pages 1203–1208, Apr. 2016.
- [96] X. Ren, W. Liang, and W. Xu. Use of a mobile sink for maximizing data collection in energy harvesting sensor networks. In *2013 42nd International Conference on Parallel Processing*, pages 439–448, Oct. 2013.
- [97] I. Rhee, A. Warriier, M. Aia, and J. Min. Z-mac : a hybrid mac for wireless sensor networks. In : *Proc. 3rd Int'l Conf. Embedded Networked Sensor Systems (SenSys'05)*, pages 90–101, 2005.
- [98] M. Ringwald and K. Römer. Burstmac : An efficient mac protocol for correlated traffic bursts. In *Proceedings of the 6th International Conference on Networked Sensing Systems, INSS'09*, pages 1–9, Piscataway, NJ, USA, 2009. IEEE Press.
- [99] J.-L. Rullán-Lara, S. Salazar, and R. Lozano. Real-time localization of an uav using kalman filter and a wireless sensor network. *Journal of Intelligent & Robotic Systems*, 65(1) :283–293, Jan. 2012.
- [100] S. Say, H. Inata, and S. Shimamoto. A hybrid collision coordination-based multiple access scheme for super dense aerial sensor networks. In *2016 IEEE Wireless Communications and Networking Conference*, pages 1–6, Apr. 2016.
- [101] C. Schurgers and M. B. Srivastava. Energy efficient routing in wireless sensor networks. In *2001 MILCOM Proceedings Communications for Network-Centric Operations : Creating the Information Force (Cat. No.01CH37277)*, volume 1, pages 357–361, 2001.

- [102] S.-M. Senouci and M. Naimi. New routing for balanced energy consumption in mobile ad hoc networks. In *Proceedings of the 2Nd ACM International Workshop on Performance Evaluation of Wireless Ad Hoc, Sensor, and Ubiquitous Networks*, PE-WASUN '05, pages 238–241, New York, NY, USA, 2005. ACM.
- [103] S.-M. Senouci and T. M. Rasheed. *Modified Location-Aided Routing Protocols for Control Overhead Reduction in Mobile Ad Hoc Networks*, pages 137–146. Springer US, Boston, MA, 2007.
- [104] R. C. Shah and J. M. Rabaey. Energy aware routing for low energy ad hoc sensor networks. In *2002 IEEE Wireless Communications and Networking Conference Record. WCNC 2002 (Cat. No.02TH8609)*, volume 1, pages 350–355, Mar. 2002.
- [105] V. Sharma and R. Kumar. A cooperative network framework for multi-uav guided ground ad hoc networks. *Journal of Intelligent & Robotic Systems*, 77(3) :629–652, Mar. 2015.
- [106] M. Shazly, E. S. Elmallah, J. Harms, and H. M. F. AboElFotoh. On area coverage reliability of wireless sensor networks. In *2011 IEEE 36th Conference on Local Computer Networks*, pages 580–588, Oct. 2011.
- [107] J.-P. Sheu, P. K. Sahoo, C.-H. Su, and W.-K. Hu. Efficient path planning and data gathering protocols for the wireless sensor network. *Computer Communications*, 33(3) :398 – 408, 2010.
- [108] D. B. Shmoys and E. Tardos. An approximation algorithm for the generalized assignment problem. *Math. Program.*, 62(3) :461–474, Dec. 1993.
- [109] L. Sitanayah, C. J. Sreenan, and K. N. Brown. Er-mac : A hybrid mac protocol for emergency response wireless sensor networks. In *2010 Fourth International Conference on Sensor Technologies and Applications*, pages 244–249, Jul. 2010.
- [110] J. Sucec and I. Marsic. Hierarchical routing overhead in mobile ad hoc networks. *IEEE Transactions on Mobile Computing*, 3(1) :46–56, Jan. 2004.
- [111] R. Sugihara and R. K. Gupta. Optimal speed control of mobile node for data collection in sensor networks. *IEEE Transactions on Mobile Computing*, 9(1) :127–139, Jan. 2010.

- [112] J. Toth and A. Gilpin-Jackson. Smart view for a smart grid 2014; unmanned aerial vehicles for transmission lines. In *2010 1st International Conference on Applied Robotics for the Power Industry*, pages 1–6, Oct. 2010.
- [113] V. Toubiana, H. Labiod, L. Reynaud, and Y. Gourhant. Performance comparison of multipath reactive ad hoc routing protocols. In *2008 IEEE 19th International Symposium on Personal, Indoor and Mobile Radio Communications*, pages 1–6, Sep. 2008.
- [114] J. N. Tsitsiklis. Efficient algorithms for globally optimal trajectories. In *Proceedings of 1994 33rd IEEE Conference on Decision and Control*, volume 2, pages 1368–1373, Dec. 1994.
- [115] J. Valente, D. Sanz, A. Barrientos, J. d. Cerro, n. Ribeiro, and C. Rossi. An air-ground wireless sensor network for crop monitoring. *Sensors*, 11(6) :6088–6108, 2011.
- [116] T. van Dam and K. Langendoen. An adaptive energy-efficient mac protocol for wireless sensor networks. In *Proceedings of the 1st International Conference on Embedded Networked Sensor Systems, SenSys '03*, pages 171–180, New York, NY, USA, 2003. ACM.
- [117] L. A. Villas, D. L. Guidoni, and J. Ueyama. 3d localization in wireless sensor networks using unmanned aerial vehicle. In *2013 IEEE 12th International Symposium on Network Computing and Applications*, pages 135–142, Aug. 2013.
- [118] P. Wei, Q. Gu, and D. Sun. Wireless sensor network data collection by connected cooperative uavs. In *2013 American Control Conference*, pages 5911–5916, Jun. 2013.
- [119] C. Westphal. Opportunistic routing in dynamic ad hoc networks : the oprah protocol. In *2006 IEEE International Conference on Mobile Ad Hoc and Sensor Systems*, pages 570–573, Oct. 2006.
- [120] E. C. Whitman. Sosus the "secret weapon" of undersea surveillance. In *:Undersea Warfare*, 2005.
- [121] C. D. Wu, J. Y. Yang, Y. Sun, and Y. Z. Zhang. Study on uav path planning oriented to optimization of positioning error. In *Advanced Materials Research*, pages 1357–1361, 2013.

- [122] C. Yawut, B. Paillassa, and R. Dhaou. *Mobility Versus Density Metric for OLSR Enhancement*, pages 2–17. Springer Berlin Heidelberg, Berlin, Heidelberg, 2007.
- [123] C. Yawut, B. Paillassa, and R. Dhaou. On metrics for mobility oriented self adaptive protocols. In *Third International Conference on Wireless and Mobile Communications, 2007. ICWMC '07.*, pages 11–16, Mar. 2007.
- [124] W. Ye, J. Heidemann, and D. Estrin. An energy-efficient mac protocol for wireless sensor networks. In *Proceedings. Twenty-First Annual Joint Conference of the IEEE Computer and Communications Societies*, volume 3, pages 1567–1576, 2002.
- [125] J. Yim, C. Park, J. Joo, and S. Jeong. Extended kalman filter for wireless lan based indoor positioning. *Decision Support Systems*, 45(4) :960 – 971, 2008. Information Technology and Systems in the Internet-Era.
- [126] K. Zeng, W. Lou, and H. Zhai. On end-to-end throughput of opportunistic routing in multirate and multihop wireless networks. In *IEEE INFOCOM 2008 - The 27th Conference on Computer Communications*, Apr. 2008.
- [127] T. Zheng, S. Radhakrishnan, and V. Sarangan. Pmac : an adaptive energy-efficient mac protocol for wireless sensor networks. In *19th IEEE International Parallel and Distributed Processing Symposium*, pages 65–72, Apr. 2005.
- [128] Z. Zhong, J. Wang, S. Nelakuditi, and G.-H. Lu. On selection of candidates for opportunistic anypath forwarding. *SIGMOBILE Mob. Comput. Commun. Rev.*, 10(4) :1–2, Oct. 2006.
- [129] S. Zhuo, Z. Wang, Y. Q. Song, Z. Wang, and L. Almeida. iqueue-mac : A traffic adaptive duty-cycled mac protocol with dynamic slot allocation. In *2013 IEEE International Conference on Sensing, Communications and Networking (SECON)*, pages 95–103, Jun. 2013.