



HAL
open science

Considering the flexibility of human resources in planning and scheduling industrial activities

El-Awady Atalla El-Awady Attia

► **To cite this version:**

El-Awady Atalla El-Awady Attia. Considering the flexibility of human resources in planning and scheduling industrial activities. Other. Institut National Polytechnique de Toulouse - INPT, 2013. English. NNT : 2013INPT0018 . tel-04233797

HAL Id: tel-04233797

<https://theses.hal.science/tel-04233797v1>

Submitted on 9 Oct 2023

HAL is a multi-disciplinary open access archive for the deposit and dissemination of scientific research documents, whether they are published or not. The documents may come from teaching and research institutions in France or abroad, or from public or private research centers.

L'archive ouverte pluridisciplinaire **HAL**, est destinée au dépôt et à la diffusion de documents scientifiques de niveau recherche, publiés ou non, émanant des établissements d'enseignement et de recherche français ou étrangers, des laboratoires publics ou privés.

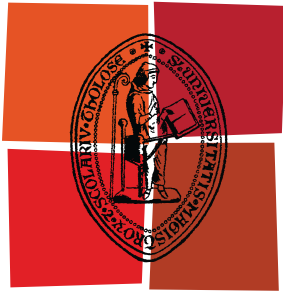

Université
de Toulouse

THÈSE

En vue de l'obtention du
DOCTORAT DE L'UNIVERSITÉ DE TOULOUSE

Délivré par :
Institut National Polytechnique de Toulouse (INP Toulouse)

Discipline ou spécialité :
Systèmes Industriels

Présentée et soutenue par :
El-Awady ATALLA EL-AWADY ATTIA
le : vendredi 5 avril 2013

Titre :
Prise en compte de la flexibilité des ressources humaines dans la planification
et l'ordonnancement des activités industrielles

Ecole doctorale :
Systèmes (EDSYS)

Unité de recherche :
Laboratoire de Génie Chimique, UMR 5503

Directeur(s) de Thèse :
M. Jean-Marc LE LANN
M. Philippe DUQUENNE

Rapporteurs :
M. Eric BONJOUR
M. Emmanuel CAILLAUD

Membre(s) du jury :
M. Alexandre DOLGUI
M. Bernard GRABOT

ABSTRACT

The growing need of responsiveness for manufacturing companies facing the market volatility raises a strong demand for flexibility in their organization. This flexibility can be used to enhance the robustness of a baseline schedule for a given programme of activities. Since the company personnel are increasingly seen as the core of the organizational structures, they provide the decision-makers with a source of renewable and viable flexibility. First, this work was implemented to model the problem of multi-period workforce allocation on industrial activities with two degrees of flexibility: the annualizing of the working time, which offers opportunities of changing the schedules, individually as well as collectively. The second degree of flexibility is the versatility of operators, which induces a dynamic view of their skills and the need to predict changes in individual performances as a result of successive assignments. The dynamic nature of workforce's experience was modelled in function of learning-by-doing and of oblivion phenomenon during the work interruption periods. We firmly set ourselves in a context where the expected durations of activities are no longer deterministic, but result from the number and levels of experience of the workers assigned to perform them.

After that, the research was oriented to answer the question "What kind of problem is raises the project we are facing to schedule?": therefore the different dimensions of the project are inventoried and analysed to be measured. For each of these dimensions, the related sensitive assessment methods have been proposed. Relying on the produced correlated measures, the research proposes to aggregate them through a factor analysis in order to produce the main principal components of an instance. Consequently, the complexity or the easiness of solving or realising a given scheduling problem can be evaluated. In that view, we developed a platform software to solve the problem and construct the project baseline schedule with the associated resources allocation. This platform relies on a genetic algorithm. The model has been validated, moreover, its parameters has been tuned to give the best performance, relying on an experimental design procedure. The robustness of its performance was also investigated, by a comprehensive solving of four hundred instances of projects, ranked according to the number of their tasks.

Due to the dynamic aspect of the workforce's experience, this research work investigates a set of different parameters affecting the development of their versatility. The results recommend that the firms seeking for flexibility should accept an amount of extra cost to develop the operators' multi functionality. In order to control these over-costs, the number of operators who attend a skill development program should be optimised, as well as the similarity of the new developed skills relative to the principal ones, or the number of the additional skills an operator may be trained to, or finally the way the operators' working hours should be distributed along the period of skill acquisition: this is the field of investigations of the present work which will, in the end, open the door for considering human factors and workforce's flexibility in generating a work baseline program.

KEYWORDS: Project planning and scheduling, human resources allocation, flexibility, Multi-skills, annualised working hours, experience evolution, principal component analysis, genetic algorithms.

RÉSUMÉ

Le besoin croissant de réactivité dans les différents secteurs industriels face à la volatilité des marchés soulève une forte demande de la flexibilité dans leur organisation. Cette flexibilité peut être utilisée pour améliorer la robustesse du planning de référence d'un programme d'activités donné. Les ressources humaines de l'entreprise étant de plus en plus considérées comme le cœur des structures organisationnelles, elles représentent une source de flexibilité renouvelable et viable. Tout d'abord, ce travail a été mis en œuvre pour modéliser le problème d'affectation multi-périodes des effectifs sur les activités industrielles en considérant deux dimensions de la flexibilité: L'annualisation du temps de travail, qui concerne les politiques de modulation d'horaires, individuels ou collectifs, et la polyvalence des opérateurs, qui induit une vision dynamique de leurs compétences et la nécessité de prévoir les évolutions des performances individuelles en fonction des affectations successives. La nature dynamique de l'efficacité des effectifs a été modélisée en fonction de l'apprentissage par la pratique et de la perte de compétence pendant les périodes d'interruption du travail. En conséquence, nous sommes résolument placés dans un contexte où la durée prévue des activités n'est plus déterministe, mais résulte du nombre des acteurs choisis pour les exécuter, en plus des niveaux de leur expérience.

Ensuite, la recherche a été orientée pour répondre à la question : « quelle genre, ou quelle taille, de problème pose le projet que nous devons planifier? ». Par conséquent, les différentes dimensions du problème posé sont classées et analysés pour être évaluées et mesurées. Pour chaque dimension, la méthode d'évaluation la plus pertinente a été proposée : le travail a ensuite consisté à réduire les paramètres résultants en composantes principales en procédant à une analyse factorielle. En résultat, la complexité (ou la simplicité) de la recherche de solution (c'est-à-dire de l'élaboration d'un planning satisfaisant pour un problème donné) peut être évaluée. Pour ce faire, nous avons développé une plate-forme logicielle destinée à résoudre le problème et construire le planning de référence du projet avec l'affectation des ressources associées, plate-forme basée sur les algorithmes génétiques. Le modèle a été validé, et ses paramètres ont été affinés via des plans d'expériences pour garantir la meilleure performance. De plus, la robustesse de ces performances a été étudiée sur la résolution complète d'un échantillon de quatre cents projets, classés selon le nombre de leurs tâches.

En raison de l'aspect dynamique de l'efficacité des opérateurs, le présent travail examine un ensemble de facteurs qui influencent le développement de leur polyvalence. Les résultats concluent logiquement qu'une entreprise en quête de flexibilité doit accepter des coûts supplémentaires pour développer la polyvalence de ses opérateurs. Afin de maîtriser ces surcoûts, le nombre des opérateurs qui suivent un programme de développement des compétences doit être optimisé, ainsi que, pour chacun d'eux, le degré de ressemblance entre les nouvelles compétences développées et les compétences initiales, ou le nombre de ces compétences complémentaires (toujours pour chacun d'eux), ainsi enfin que la façon dont les heures de travail des opérateurs doivent être réparties sur la période d'acquisition des compétences. Enfin, ce travail ouvre la porte pour la prise en compte future des facteurs humains et de la flexibilité des effectifs pendant l'élaboration d'un planning de référence.

MOTS CLÉS : Planification du projet, affectation des ressources humaines, la flexibilité, polyvalence, annualisation du temps de travail, évolution d'expérience, analyse en composantes principales, algorithmes génétiques.

REMERCIEMENTS

Ce travail a été préparé sous la direction de Monsieur Philippe DUQUENNE, Maître de conférences au département PSI et le responsable du département "Génie Industriel de l'ENSIACET", et Monsieur Jean-Marc Le LANN, Professeur d'Université et directeur de l'ENSIACET /INP-Toulouse. Je ne sais comment exprimer ma gratitude à M. DUQUENNE et M. Le LANN. Avant tout, je tiens à les remercier de m'avoir accueilli, de m'avoir fait confiance, de m'avoir soutenu et notamment de leur disponibilité tout au long de la période d'étude.

Je remercie mes rapporteurs de thèse, d'abord pour avoir accepté la charge d'être rapporteurs et pour l'intérêt qu'ils ont porté à mon travail : Monsieur Emmanuel CAILLAUD, Professeur des Universités, Directeur du Centre de Metz des Arts et Métiers, ParisTech, et Monsieur Éric BONJOUR, Professeur des Universités, École nationale Supérieure en Génie des Systèmes Industriels, Université de Nancy/INPL.

Je remercie également les membres du Jury: Monsieur Alexandre DOLGUI, Professeur de classe exceptionnelle, Directeur délégué du Laboratoire LIMOS, UMR 6158 CNRS et de l'Institut Henri Fayol de Saint-Étienne, et Éditeur en chef de la revue « International Journal of Production Research (Taylor & Francis) », et Monsieur Bernard GRABOT, Professeur des Universités, École Nationale d'Ingénieurs de Tarbes qui m'ont fait l'honneur de discuter de mes travaux et qui m'ont permis d'entrevoir des perspectives très intéressantes.

Je tiens également à exprimer ma gratitude à tous les personnels de l'ENSIACET, du LGC, et de l'école doctorale systèmes industriels, et plus particulièrement à Mme Caroline Bérard, Mme Beatrice Biscans, Mme Danièle Bouscary, Mme Hélène Dufrénois, Mme Chantal Laplaine, Mme Christine Taurines et Mme Hélène Thirion pour leur soutien administratif.

Je souhaite également exprimer tous mes sincères remerciements à l'ensemble des membres de département PSI et plus particulièrement à : Jesús M. B. Ferrer, Guillaume Busset, Laszlo Hegely, Ferenc Dénes, Anthony Ramarosan, Jean-Stéphane Ulmer et Eduardo R. Reyes pour leur temps et pour leurs discussions très intéressantes. Je tiens à souligner l'aide substantielle que Guillaume et Jean-Stéphane m'ont apportée par rapport l'amélioration de ma langue française. J'exprime également mes remerciements à mes amis Sofia De-Leon, Raul P. Gallardo, Sayed Gillani, et Marie Roland pour leur soutien infini pendant le jour de soutenance de thèse.

Considérant que cette thèse a été financée par le gouvernement égyptien qui m'a permis de rester complètement et uniquement concentré sur ma recherche, je tiens à remercier mon cher pays, l'Égypte. En outre, je remercie tous les membres du Bureau culturel de l'ambassade d'Égypte à Paris qui ont contribué le bon déroulement de ma thèse. Aussi, mes remerciements sont adressés à toutes les équipes administratives et scientifiques de la faculté d'Ingénierie à Shoubra, Université de Benha, où je travaille. Un remerciement très particulier est adressé à mes professeurs M. Moustafa Z. Zahran, M. Attia H. Gomma, et M. Mamdouh Soliman pour leurs conseils et leur soutien pendant mes études de master qui ont influencé ma façon de penser rationnelle. Également, je tiens à saluer tous mes amis Hassan Ait-Haddou, Ahmed Akl, Mohamed Gad, Hany Gamal, Ossama Hamouda, Mahmoud Mostafa, Yasser Nassar, Khalid Salih, Hassan Tantawy et Ussama Zaghlool pour leur soutien au cours de mon séjour à Toulouse.

Je termine en remerciant ma famille: ma mère, ma femme Mme M. Emam, mes frères, mes fils, pour leur soutien émotionnel, pour leur encouragement continu, ce qui m'a aidé à rester sur la bonne voie et à surmonter des situations difficiles.

Encore Merci.

Table of contents

1	INDUSTRIAL PROJECT MANAGEMENT AND FLEXIBILITY	1
1.1	INDUSTRIAL PROJECT MANAGEMENT.....	2
1.1.1	<i>Project hierarchical planning.....</i>	3
1.1.2	<i>Project scheduling with resource loading and levelling</i>	6
1.2	UNCERTAINTIES IN PROJECT MANAGEMENT.....	7
1.3	FLEXIBILITY VERSUS UNCERTAINTY	7
1.3.1	<i>Flexibility theoretical concept.....</i>	8
1.3.2	<i>Flexibility dimensions in manufacturing.....</i>	9
1.3.3	<i>Human resources flexibility</i>	10
1.4	HUMAN FACTOR IN PLANNING AND SCHEDULING	11
1.5	CONCLUSION.....	12
2	STATE OF THE ART REVIEW ON INDUSTRIAL PROJECT PLANNING AND SCHEDULING WITH WORKFORCE ALLOCATION.....	13
2.1	Project planning and scheduling.....	14
2.1.1	Rough Cut Capacity Planning “RCCP” problem	14
2.1.2	Resource Constraint Project Scheduling Problem.....	15
2.2	Uncertainty and project scheduling.....	20
2.2.1	Reactive scheduling	20
2.2.2	Proactive-reactive scheduling.....	21
2.2.3	Schedule robustness.....	22
2.2.4	Flexible schedules.....	23
2.3	Considering manpower in scheduling	24
2.3.1	Workforce allocation problem.....	24
2.3.2	Workforce flexibility	26
2.3.3	Modelling of workforce productivity	29
2.3.4	Dynamic vision of workforce performance.....	31
2.4	Conclusion:	37

3	CHARACTERIZATION AND MODELLING OF THE MULTI-PERIOD WORKFORCE ALLOCATION PROBLEM.....	39
3.1	Project Characterisation.....	40
3.1.1	Tasks characterisation.....	40
3.1.2	Scheduling dependencies between tasks	41
3.1.3	Project due date and contractual duration.....	41
3.2	Workforce Characterisation	42
3.2.1	Working time flexibility	42
3.2.2	Multi-functional flexibility	42
3.3	Project scheduling with workforce allocation optimization problem	47
3.3.1	Problem representation	47
3.3.2	Modelling of problem objectives.....	47
3.3.3	Modelling of problem constraints.....	50
3.4	Model analysis	53
3.4.1	Variables dependency investigation	54
3.4.2	Variables expected values	54
3.4.3	Variable domain investigations	54
3.4.4	Dynamic investigation.....	57
3.4.5	Continuity investigation	57
3.4.6	Linearity investigation.....	57
3.5	Model complexity	58
3.6	Conclusion.....	58
4	PROJECT CHARACTERISTICS AND COMPLEXITY ASSESSMENT RELYING ON PRINCIPAL COMPONENT ANALYSIS	59
4.1	Introduction	60
4.2	Activities-related parameters	61
4.2.1	Network based parameters.....	61
4.2.2	Parameters related to time	70
4.2.3	Parameters based on temporal - Network:.....	71
4.2.4	Parameters based on the work content	72
4.2.5	Parameters based on temporal-Network-Work content.....	73
4.3	Parameters related to resources.....	76
4.3.1	Resources availability.....	76
4.3.2	Overall average productivity	76

4.4	Activities- resources interaction.....	77
4.5	Composition of project main dimensions.....	79
4.6	Conclusion.....	86
5	SOLUTION TECHNIQUES AND PROBLEM SOLVING USING GENETIC ALGORITHMS.....	87
5.1	Introductions.....	88
5.2	Exact methods.....	88
5.2.1	Calculation-based methods.....	88
5.2.2	Numeration-based methods.....	89
5.3	Approximated methods.....	91
5.3.1	Heuristic algorithms.....	91
5.3.2	Metaheuristics algorithms.....	92
5.3.3	Hybrid algorithms.....	97
5.4	The proposed approach.....	97
5.4.1	The proposed genetic algorithm.....	98
5.4.2	Scheduling algorithm.....	103
5.4.3	Approach validation.....	105
5.4.4	Tuning the algorithm's parameters.....	107
5.5	Conclusion.....	116
6	PERFORMANCE INVESTIGATION AND RESULT ANALYSIS.....	117
6.1	Defining the managerial strategy.....	118
6.1.1	The economic strategy:.....	118
6.1.2	Experience development strategy.....	119
6.1.3	Compromise between savings and experience development strategies.....	121
6.2	Results analysis and discussions.....	121
6.2.1	Data set #I.....	121
6.2.2	Data set #II.....	126
6.2.3	Data set #III.....	130
6.2.4	Data set #IV.....	133
6.3	robustness of the approach.....	138
6.4	Conclusion.....	139

7	FACTORS AFFECTING THE DEVELOPMENT OF WORKFORCE VERSATILITY....	141
7.1	Factors to be investigated	142
7.1.1	Parameters associated to human resources	142
7.1.2	Skills associated parameters	144
7.1.3	Firms' policies about the use of flexibility	145
7.2	Illustrative example.....	146
7.3	Experimental design.....	149
7.4	Results and discussion.....	149
7.4.1	Number of flexible workers.....	149
7.4.2	Average occupational rate	152
7.4.3	Flexibility degree of workers.....	154
7.4.4	The minimum level of workers' productivity.....	156
7.4.5	Learning and forgetting rates.....	157
7.4.6	The similarity degree between skills	158
7.5	Conclusions	160
8	GENERAL CONCLUSION AND PERSPECTIVES	161
8.1	Overall conclusion	162
8.2	Future perspectives	163
	BIBLIOGRAPHY	167
	INSTANCE GENERATION AND THE REQUIRED DATA.....	183
	ON PROJECT COMPLEXITY.....	189
	STATISTICAL ANALYSIS.....	199
	RESULTS OF SIMULATIONS	211

LIST OF FIGURES

Figure 1.1 Appropriate project life cycle (Heagney, 2011).....	3
Figure 1.2 Anthony’s hierarchical classification of the project planning decisions	4
Figure 1.3 A Hierarchical framework for planning and control (Hans et al., 2007)	4
Figure 2.1 classification of activities durations.....	16
Figure 3.1 the tasks dependency relations (Eppinger et al., 1991).....	41
Figure 3.2 the project delivery date and its related costs	42
Figure 3.3 The interaction between skills’ domains of actors who can participate.....	43
Figure 3.4 The effect of learning and forgetting on the working efficiency of operators	46
Figure 3.5 The distribution of average daily interest rate “Euro LIBOR”, (homefinance, n.d.)	49
Figure 4.1 Classification of project scheduling complexity parameters.....	60
Figure 4.2 Interaction of activities characteristics.....	61
Figure 4.3 an aggregated plot of the standardised parameters of (C, CNC, NT, RT, CI).....	66
Figure 4.4 plot of the standardised values of the network length, width and aspect ratio	68
Figure 4.5 the distribution of SASyM for a set of 400 projects	69
Figure 4.6 the plot of the networks bottleneck measure TD_{max}	70
Figure 4.7 the plot of the average load factors: ARLF, ARPF, and PCE.....	75
Figure 4.8 the plot of the average maximum load: AMLF, ARB, and RBL.....	75
Figure 4.9 the project different quantifiers.....	80
Figure 4.10 Scree plot of the different Eigenvalues for the PCA of all quantifiers.....	81
Figure 4.11 the contributions of different quantifiers on the axis of F1, and F2	81
Figure 4.12 the hierarchical cluster analysis of the standardised measures	82
Figure 5.1 The genetic algorithm	98
Figure 5.2 chromosome representation priority lists	99
Figure 5.3 representation of the parameterized uniform crossover	102
Figure 5.4 The next generation reproduction scheme	103
Figure 5.5 Workforce allocation algorithm.....	105
Figure 5.6 treating the algorithm during the validation.....	106
Figure 5.7 machine running time versus IP_size and β	112
Figure 5.8 running time versus probability of regeneration and P_c	112
Figure 5.9 running time versus P_m and stopping criterion.....	112
Figure 5.10 objective function versus IP_size and (β)	113
Figure 5.11 objective function versus probability of regeneration and P_c	113
Figure 5.12 objective function versus P_m and stopping criterion	113
Figure 5.13 total work versus IP_size and (β).....	113
Figure 5.14 total work versus probability of regeneration and P_c	114
Figure 5.15 total work versus P_m and stopping criterion.....	114

Figure 5.16 overtime versus IP_size and (β).....	114
Figure 5.17 overtime versus probability of regeneration and P_c	114
Figure 5.18 overtime versus P_m and stopping criterion.....	114
Figure 5.19 workforce occupation versus IP_size and (β).....	115
Figure 5.20 workforce occupation versus probability of regeneration and P_c	115
Figure 5.21 workforce occupation versus P_m and stopping criterion.....	115
Figure 6.1 Evolution of the fitness function and objectives functions during exploration.....	118
Figure 6.2 Best cost strategy: The evolution of actors' skills during the project horizon.....	119
Figure 6.3 Skills development strategy: The evolution of actors' skills during the project horizon.....	120
Figure 6.4 the Distribution of PSI, NFI, PWI, PLLI, TDI, and NBI for the data set #I.....	122
Figure 6.5 the distribution of the fitness function: F for projects of the data set#1.....	122
Figure 6.6 distribution of the different objectives for the data set #1.....	124
Figure 6.7 percentage of the excess of labour cost to the optima costs.....	124
Figure 6.8 the different number of generations versus computational time for data set #I.....	126
Figure 6.9 Distribution of the indices PSI, NFI, PWI, PLLI, TDI, and NBI for the data set #II.....	127
Figure 6.10 distribution of the fitness function: F for data set #II.....	127
Figure 6.11 the linear relation between f1 and project indices for data set #II.....	128
Figure 6.12 the percentage of the excess of labour cost to the optima costs against PSI and PWI.....	129
Figure 6.13 the different number of generations verses computational time for data set #II.....	130
Figure 6.14 Distribution of the proposed indices PSI, NFI, PWI, PLLI, TDI, and NBI for data set #III.....	131
Figure 6.15 distribution of the fitness function: F for data set #III.....	131
Figure 6.16 the linear relation between f1 and project indices for the data set #III.....	132
Figure 6.17 distribution of the excess of labour cost to the optima costs.....	132
Figure 6.18 different number of generations verses computational time for data set #II.....	133
Figure 6.19 distribution of indices PSI, NFI, PWI, PLLI, TDI, and NBI for the data set #IV.....	134
Figure 6.20 Distribution of the indices PSI, NFI, PWI, PLLI, TDI, and NBI after modification.....	135
Figure 6.21 distribution of the fitness function: F for projects in data set #VI.....	135
Figure 6.22 the linear relation of f1 and f2 with the project indices for the data set #IV.....	136
Figure 6.23 the excess of labour cost to the optima costs against project parameters.....	137
Figure 6.24 the different number of generations and computational time for data set #IV.....	138
Figure 7.1 Evolution of actors' skills after modification of actors' efficiencies.....	147
Figure 7.2 Cost of skills betterment.....	148
Figure 7.3 The distribution of different workers efficiencies on five levels.....	150
Figure 7.4 distribution of %AWEE for different efficiency levels and different levels of SD.....	151
Figure 7.5 Percentage of labour over-cost for different levels of workforce's efficiencies.....	151
Figure 7.6 effect of actors' occupational rates on %AWEE.....	153
Figure 7.7 The effect of workforce occupational rates on %AWEE for the same project.....	154
Figure 7.8 interval plot of the percentage of different flexibly levels within the data set.....	154
Figure 7.9 interval plot of %AWEE for different levels of workers flexibility at different "SD" levels.....	155
Figure 7.10 The effect of θ_k^{\min} on the "%AWEE".....	156

Figure 7.11 interval plot of the different learning and forgetting levels results	157
Figure 7.12 The effect of SD on the actors' skills attrition.	159

LIST OF TABLES

Table 1.1 Different forms of flexibility (Goudswaard and De Nanteuil, 2000)	11
Table 2.1 Three resource allocation processes with their specific goals (Hendriks et al., 1999)	24
Table 2.2 A subset of the previously proposed learning curves models	33
Table 2.3 Classification of related works	37
Table 3.1 Model unknown variables and their characteristics.	54
Table 3.2 model given variables and their characteristics	56
Table 3.3 Model objectives and their linearity characteristics	57
Table 3.4 Model constraints and their linearity characteristics	58
Table 4.1 project float related parameters	71
Table 4.2 Factor loading after Varimax rotation	84
Table 4.3 Squared cosines of the variables after Varimax rotation	85
Table 4.4 Component score coefficients after Varimax rotation	85
Table 5.1 GA's parameters used during validation	106
Table 5.2 the extreme limits of the genetic algorithms factors	109
Table 5.3 the results of the selected parameters combinations vectors	110
Table 5.4 Pearson's correlation coefficient test for the machine running time	111
Table 5.5 Pearson's correlation coefficient test for the aggregated objective function	111
Table 5.6 Pearson's correlation coefficient test for the separated objective functions	111
Table 5.7 Pearson's correlation coefficient test for the separated objective functions	112
Table 5.8 The values of tuned parameters that will be used in simulations	115
Table 6.1 Exploration results related to labour costs f_L and the skills development f_5	121
Table 6.2 linear regression of the computational time	126
Table 6.3 the confidence interval for the estimated mean values for the results	138
Table 6.4 the significant predictors of each performance criterion	139
Table 7.1 Initial efficiencies of actors after modification	147
Table 7.2 Exploration results related to labour costs f_L and skills development f_5 after modification	147
Table 7.3 ANOVA results of different levels of workforce follows PMSD on %AWEE	152
Table 7.4 ANOVA results of the effect of different levels of workforce availability on %AWEE	153
Table 7.5 Correlation analysis results between “%AWEE” and workforce flexibly levels	154
Table 7.6 ANOVA results of the workforce flexibility levels on %AWEE	155
Table 7.7 ANOVA results of the effect of different levels of “SD” on the “%AWEE”	156
Table 7.8 ANOVA Results for the effect of “project, learning, and forgetting” on the %AWEE	158
Table 7.9 ANOVA results of the effect of different levels of “SD” on the “%AWEE”	159
Table 7.10 ANOVA results of the four levels of “SD” on the %AWEE	159
Table 7.11 Two-way ANOVA of SD-levels and project characteristics effect on %AWEE	160

LIST OF NOMENCLATURES

Abbreviations:

%AWEE	: Percentage of average evolution of workforce efficiencies
ACO	: Ant colony optimisation,
AD	: Adjacency matrix of a graph.
AH	: Annualised hours,
ALBP	: Assembly line balancing problem
ANOVA	: Analysis of variance
AoA	: Activity on arc
AoN	: Activity on node
B&B	: Branch and bound,
CNC	: Coefficient of network complexity
CSP	: Constraint satisfaction problem,
DCSP	: Dynamic constraint satisfaction problem,
DRC	: Dual resource constrained,
DTCTP	: Discrete Time/Cost trade-off problem
GAs	: Genetic algorithms,
GPC	: Generalized precedence constraint,
HC	: Hard constraints,
ISM	: Interpretive structural modelling
KMO	: Kaiser-Meyer-Olkin measure of sampling adequacy
LC	: Learning curve,
LFCM	: Learning-forgetting curve model,
LFL	: learn-forget-learn model
LIBOR	: London Interbank Offered Rate.
LP	: linear programming,
MA	: Memetic algorithms,
MILP	: Mixed integer linear programming,
MIP	: Mixed integer programming,
MSPSP	: Multi-skilled project scheduling problem,
NBI	: Network bottleneck index,
NFI	: Network flexibility index,
NP-Hard	: Non-deterministic polynomial-time hard
PCA	: Principal component analysis
PERT	: Program Evaluation and Review Technique.
PGS	: Parallel generation scheme,
PID	: Power integration diffusion model,
PLLI	: Project load location index,
PMSD	: Program of multi-skilled development
PSI	: Project scales index,
PSO	: Particle swarm optimisation,
PWI	: Project weight index,
R&D	: Research and development,
RCCP	: Rough Cut Capacity Planning problem,
RCPSP	: Resource constrained project scheduling problem
RCPSVP	: Resource constrained project scheduling variable intensity problem,
RLP	: restricted linear programming,
RMP	: Restricted master problem,
SA	: Simulated annealing,
SC	: Soft constraints,
SGS	: Serial generation scheme,
TDI	: Task durations index,
TS	: Tabu search,
VRIF	: Variable regression to invariant forgetting model,
WBS	: Work break-down structure,

Indices:

a	: indicates a given worker.
g	: indicates generation.
i, c	: indicates tasks.
j	: indicates temporal periods or days.
k	: indicates skills or a specified resource type.
n	: indicates work repetition.
s	: indicates working week.
t	: indicates temporal intervals.

Variables and parameters:

A	: Set of the actors, also used as the cardinality of this set (integer): $A = \{1, 2, \dots, a, \dots, A\}$.
$AMLF$: Average maximum load factor for resources, in number of resources, real number.
AR	: Graph aspect ratio, (real positive number), dimensionless.
ARB	: Normalized average resources bottleneck factor, real number $\in [0, 1]$.
$ARLF_l$: Average resource loading factor of project l , in number of resources, real number.
ARP	: Average resources requisite per period, in number of resources, (real number).
$ARPF$: Normalized average resources requisite per period, real number, real number $\in [0, 1]$.
ARW	: Average of available real workforce, integer number.
$ASyM$: Asymmetry measure of the network, dimensionless, (real number).
$ATFF$: Average tasks possessing positive free floats, dimensionless, real number $\in [0, 1]$.
$ATMD$: Average of tasks' mean duration, in days, real positive number.
$ATSD$: Average standard variation of tasks' duration, <i>dimensionless</i> , real positive number.
$ATTF$: Average tasks possessing positive total float, dimensionless, real number $\in [0, 1]$.
b	: Learning curve slope, dimension less, real number.
C	: Network complexity index relying on the non-redundant edges, real number.
C_{time}	: Computational time, in seconds, integer number.
$C_4^{max}, C_5^{max}, C_6^{max}$: Constants used to normalise respectively the value of $f4, f5, and f6$.
Cl	: Network complexity measure considering its length, dimensionless, real number $\in [0, 1]$.
C_{max}	: Constant used to convert the problem from minimisation to maximization one, dimensionless, real positive number.
CNC	: Coefficient of network complexity, real positive number.
CP	: Project critical path length, in days, integer number.
CP^{min}	: Critical path considering that all tasks have their minimum durations (D_i^{min}) in days.
C_{SO}	: Standard number of working hours per week, integer number.
CV	: Coefficient of variance of resources profiles, dimensionless, real number.
Det_{ii}	: Tree-generating determinant at nod i .
DFF	: Network density based free-float, dimensionless, real number $\in [0, 1]$.
dF_i	: Finish date of task i , integer number.
D_i	: Standard duration for the task $i \in I$, in days, integer number.
d_i	: Make-span for the task $i \in I$, in days, integer number.
$d_{i,k}$: Actual execution time for a job " $\Omega_{i,k}$ ", from task i that required skill k , in days, integer.
D_i^{max} / D_i^{min}	: Maximum/ Minimum duration for the task $i \in I$, in days, integer.
DIP	: Work interruption period, in hours, real positive number.
$DMax12S$: Maximum value of average weekly hours for a period of twelve consecutive weeks, in hours, integer number.
$DMaxJ$: Maximum duration of daily work, in hours, integer number.
$DMaxMod$: Normal weekly work set by the collective agreement, in hours, integer number.
$DMaxS$: Maximum duration of weekly work, in hours, integer number.
DSA	: Maximum annual work for one individual, in hours, integer number.
dS_i	: Start date of task $i \in I$, integer number.
E^n	: The number of non- redundant arcs in the network, integer number.
E_{max}^n / E_{min}^n	: Upper / lower bound of non- redundant arcs for a network of size N_n , integer number.
EE_k	: Equivalent workforce available to master skill k , real positive number.
ER	: Group of actual workforce indicts also its cardinality (integer).
$E_{SS} - E_{SF}, E_{FS} - E_{FF}$: Set of temporal relations between pairs of tasks; S means the start event of task and F means the finish one.
F	: The cost objective to be minimised, real number.

f	: Forgetting curve slope during interruption period, dimension less, real number.
f_1	: Direct labour standard costs, in currency units, real positive number.
f_2	: Direct labour overtime costs, in currency units, real positive number.
f_3	: Fictive costs related to the loss of future working capacity, in currency units, real number.
f_3^{max}	: Maximum estimated value of f_3 , in currency units, real positive number.
f_4	: Project delivery date associated costs, in currency units, real positive number.
f_5	: Experience development associated costs, in currency units, real positive number.
f_6	: Constraints satisfaction related costs, in currency units, real positive number.
$f_{ab}(\varepsilon)$: Absolute fitness of a given chromosome “ ε ”, dimensionless, real number.
FF	: Sum of activities free floats, in days, (real positive number).
\overline{FF}	: Average free float per activity, in days, real positive number.
$FF_{i,c}^{min} / FF_{i,c}^{max}$: Minimum/ maximum delay between the finish-finish events of two tasks i and c , in days.
ff_i	: Free float of activity $i \in I$, in days, (real positive number).
f_L	: Direct labour costs ($f_L = f_1 + f_2$), in currency units, real positive number.
f_L^{max} / f_L^{min}	: Maximum / Minimum estimated value of f_L , in currency units, real positive number.
$FS_{i,c}^{min} / FS_{i,c}^{max}$: Minimum/ maximum delay between finish-start events of two tasks i and c , in days.
GN	: Number of generation, integer number.
HAS	: Maximum annual overtime for an actor, in hours, integer number.
$HS_{a,s}$: Overtime hours for the actor a during the week s , in hours, real number.
HSP_a	: Overtime for the actor a previously worked during the current year, in hours, real number.
I	: Set of tasks in the work package (or project), also its cardinality: $I = \{1, 2, \dots, i, \dots, I\}$.
IP_size	: Initial population size, integer number.
K	: Set of the required skills, also its cardinality: $K = \{1, 2, \dots, k, \dots, K\}$.
L	: Contractual duration of the work package (or project), in days, integer number.
LV	: Actual duration of the work package (or project), in days, integer: $LV = \{1, 2, \dots, j, \dots, LV\}$.
$MaxWC / MinWC$: Maximum / Minimum percentage of work content required from resource type $k \in K$, dimensionless, (real number $\in [0, 1]$).
MLF_k	: <i>Maximum Load Factor</i> for resources k , in resource amount, real number.
MW	: Network width, the maximum number of tasks within the same rank, integer.
N_a	: Number of arcs in the network graph, integer number.
NA_k	: Set of the actors mastering skill k , also used to present its cardinality, integer.
Nbi	: A pre-specified number of individuals, used to calculate the convergence of <i>GAs</i> fitness.
n_{eq}	: Equivalent number of work repetitions for a given worker “ a ” in a given skill “ k ” at a given date, real positive number.
NJS	: Number of days worked per week, identical for all workers, integer.
nk_a	: Set of the skills mastered by the actor a , – it also means its cardinal (integer)
nk_i	: Set of the skills needed to perform the task i , also used as its cardinality (integer).
NK_{li}	: Number of resources required by task i in project l , integer number.
NL	: The network length, $NL = TI - I$, integer number.
N_n	: Number of nodes in the network graph, integer number.
NS	: The network serialism degree, (real number $\in [0, 1]$), dimensionless.
NT	: Number of maximum distinct trees in a graph, integer number.
NW	: Set of the working weeks during which the project is carried out, also represents its cardinality, $NW = \{S_{SW}, \dots, s, \dots, S_{FW}\} $.
OC	: Average occupation of the workforce, dimensionless, real number.
OCW	: Overall available capacity of the workforce, in number of workers, real number.
OF	: Average obstruction factor of resources, dimensionless, real number $\in [0, 1]$.
O_k	: Obstruction factor of resource type $k \in K$, dimensionless, real number $\in [0, 1]$.
OS	: Network order strength, dimensionless, real number $\in [0, 1]$.
P_value	: The estimated probability of rejecting a null hypothesis that is true, real number $\in [0, 1]$.
P_c	: Probability of crossover, dimensionless, real number $\in [0, 1]$.
$PCDF$: Project contractual duration factor, dimensionless, real number $\in [0, 1]$.
PCF	: Average profile central factor for the project, dimensionless, real number $\in [0, 1]$.
PCF_k	: Profile central factor for resource $k \in K$, dimensionless, real number $\in [0, 1]$.
P_{HC}	: Penalties associated to violation of hard constraint, in currency units, real number.
PLD	: Project load density, dimensionless, real number $\in [0, 1]$.
PL_i	: Progressive level (the rank) of task i , integer number.
P_m	: Probability of mutation, dimensionless, real number $\in [0, 1]$.

PN	: Set of projects, also indicate its cardinality, integer number, $PN = \{1, 2, \dots, l, \dots, PN\}$.
PR_i	: Set of immediate predecessors of tasks i , also used as its cardinality (integer number).
P_s	: Probability of survival, dimensionless, real number $\in [0, 1]$.
P_{SC}	: Penalties associated to violation of soft constraint, in currency units, real number.
$P\text{-Size}$: Normalised number of tasks indicates project size, real number $\in [0, 1]$.
Q_k	: Average available capacity per-period of resource $k \in K$, in working hours, real number.
R	: Person product-moment correlation coefficient of two variables, real number $\in [-1, 1]$.
R_k^{\max}	: Peak demand required from resource type $k \in K$, in resources units, real number.
R_k^{\min}	: Minimum demand required from resource type $k \in K$, in resources units, real number.
\overrightarrow{RA}_k	: Vector of daily availability from resource k along CP , in number of workers.
$r_{a,k}$: Learning rate of worker a in competence k , dimensionless, real number $\in [0, 1]$.
$RA_{k,t}$: Availability of resource k , at the period t , in resources amount, integer number.
RC	: Resources-Constrainedness, dimensionless, real number $\in [0, 1]$.
RF	: Resources factor, dimensionless, real number $\in [0, 1]$.
\overrightarrow{RR}_k	: Vector of daily needs from resource k along CP , in working hours (integer).
$RR_{k,t}$: Requisites from resource k , at period/day t , in resource units, integer number.
RR_k^{\max}	: The maximum peak in the destitution of the demand profile from resource type $k \in K$, along the critical path of the project(s), in number of resources, real number.
RS	: <i>Resource-Strength</i> , dimensionless, real number.
RSI	: Resources scarcity index, dimensionless, real number $\in [0, 1]$.
RT	: The restrictiveness estimator, dimensionless, real number $\in [0, 1]$.
$SASyM$: Normalised asymmetry measure of the network, <i>dimensionless</i> , (real number $\in [0, 1]$).
$SD_{k_1 \leftrightarrow k_2}$: Similarity degree between a pair of skills k_1 and k_2 , dimensionless, real number $\in [0, 1]$.
$SF_{i,c}^{\min} / SF_{i,c}^{\max}$: Minimum/ maximum delay between the start-finish events of two tasks i and c , in days.
S_{FW}	: The finish week of work-package (or project), week number, integer.
$SS_{i,c}^{\min} / SS_{i,c}^{\max}$: Minimum/ maximum delay between the start-start events of two tasks i and c , in days.
S_{SW}	: The start week of work-package (or project), week number, integer.
SU_i	: Set of immediate successors of tasks i , also used as its cardinality (integer number).
T	: Signifies the set of schedule time periods, in days, integer number.
t_ε	: Time period at which a maximum peak RR_k^{\max} has been observed in specified profile.
Ta	: Duration of uninterrupted exercise of a given competence, during which the efficiency was developed, in days, real positive number.
Tb	: The interruption period after which, if this skill is no longer practiced at all, the actor efficiency has decreased back to its initial value $\theta_{a,k}^{ini}$, in days, real number.
TD_i	: Task degree of activity $i \in I$, in number of tasks, integer.
TD_{max}	: Maximum task degree in the network, in number of tasks, integer.
TF	: Sum of activities total floats, in days, real positive number.
\overline{TF}	: Average total float per activity, in days, real positive number.
TFF	: Number of tasks possessing positive (non-zero) free float, integer.
tf_i	: Total floats of activity $i \in I$, in days, real positive number.
TI	: The number of ranks in the given network, integer number.
\overline{TR}_k	: Average requisite per activity from resource k , real positive number.
TRC	: Average resource constrainedness along CP , dimensionless, real number $\in [0, 1]$.
TTF	: Number of tasks possessing positive (non-zero) total float, integer.
u	: Multiplicative factor applied to the standard hourly cost U_a to compensate the overtime working hours, dimensionless, real positive number.
U_a	: Standard hourly cost of the actor a , in currency units, real positive number.
UF_a	: Virtual value associated to temporal flexibility of actor a , in monetary units, real number.
U_k	: Virtual value associated to the development of actors' efficiency in competence k , in currency units, real positive number.
UL	: Daily lateness penalty, in monetary units, real number.
W	: Total work-content required to create the project, in working hours, integer number.
WI	: Width indicator of the network or rank, dimensionless (real number $\in [0, 1]$).
W_k	: Percentage of work content required from $k \in K$, <i>dimensionless</i> , real number $\in [0, 1]$.
$WL(l)$: Number of activities at a given rank, integer number.

α_level	: Pre-specified significant level of type <i>I-error</i> in the hypothesis test, real number $\in [0, 1]$.
β	: Grace period in project delivery without delay penalties, in days, integer number.
γ_i	: Pre-specified weight associated to each objective within the set $\{f_1, f_2, f_3, f_4, f_5, f_6\}$, dimensionless, real number $\in [0, 1]$.
$\Delta_{a,i,k}$: The difference in real working time of job “ $\Omega_{i,k}$ ” from the nominal value, due to the assignment of actor a , in hours, real positive number.
$\Delta_{a,i,k}^{(1)}$: The extra cost found from the nominal value at the first time actor a working for skill k , in hours, real positive number.
$\Delta_{a,k}^f$: The extra costs that will be produced if actor a assigned to work with skill k after an interruption period.
$\Delta_{a,k}^{f(1)}$: The extra cost that can be found at the first repetition relying on the forgetting curve.
ε_o	: Number of observations of the maximum peak RR_k^{max} in the profile of resource k , integer.
Θ	: Workforce overall productivity level, dimensionless, real number $\in [0, 1]$.
$\theta_{a,k} / \theta_{a,k}(n_{eq}^{SP})$: Effectiveness of the actor a in the competence k , at the start date of the project, dimensionless, real number $\in [0, 1]$.
$\theta_{a,k}(n_{eq})$: Effectiveness of the actor a in the competence k , at an equivalent number of work repetitions “ n_{eq} ”, dimensionless, real number $\in [0, 1]$.
$\theta_{a,k}(n_{eq}^{FP})$: Effectiveness of the actor a in the competence k , at the finish date of the project, dimensionless, real number $\in [0, 1]$.
$\theta_{a,k}^{dIP}$: Actor’s efficiency level in mastering skill k after a given interruption period “ dIP ”, dimensionless, real number $\in [0, 1]$.
$\theta_{a,k}^{ini}$: Initial efficiency level of actor a on competence k , dimensionless, real number $\in [0, 1]$.
θ_k^{min}	: Minimum level of efficiency required to practice the competence k , real number $\in [0, 1]$.
$\lambda_{a,k}$: Number of work repetitions for worker a in practicing skill k corresponding to the interruption period, assuming that interruption had not been occurred, real number.
μd_i	: Mean duration of the activity $i \in I$, in days, real positive number.
vd_i	: Variance of the activity duration $i \in I$, dimensionless, real positive number.
ξ	: Minimum temporal ratio between the work-interruption time “ Tb ” and the practicing work “ Ta ” that will achieve total forgetting, dimensionless, real number.
ρ	: Set of the tasks under progress at a given date – it also means its cardinality.
$\sigma_{a,i,k,j}$: The allocation decision of the actor a for his skill k on the activity i and at the time instance j : $\sigma_{a,i,k,j} = 1$ if this actor is assigned under these conditions, and $\sigma_{a,i,k,j} = 0$ otherwise.
τ_j	: Factor associated to daily storage costs (can be considered as a daily discount ratio), dimensionless, real number.
v	: Boolean variable expressing the violation state of a given constraint: $v=1$ for constraint violation and $v=0$ for the constraint satisfaction.
$\varphi_{i,j}$: Represents an element of the network reachability matrix, $\varphi_{i,j}=1$ if node j is reached from node i , and $\varphi_{i,j}=0$ otherwise.
$\Omega_{i,k}$: The required workload from resource type k to perform task $i \in I$, number of hours, integer.
$\omega_{a,i,k}(n)$: The evolution function of the working time for actor a in the skill k in function of the work repetitions, in hours, real number.
$\omega_{a,i,k,j}$: Working time for the actor a on the workload $\Omega_{i,k}$, during the day j , in hours, real number.
ωp_a	: Work already performed by an actor a on the current year on previous projects, in hours, real number.
$\omega s_{a,s}$: Working time for the actor a on the week s in hours, real number.



GENERAL INTRODUCTION

Achieving a given programme of industrial activities requires two main procedures before starting: the estimation of different works, then the generation of the road-map of work. First, the projects office “PO” starts to analyse the different aspects of the project; then constructs the project break-down structure that divides the work into a set of work-packages. Each work-package can be divided to a group of tasks, by its turn each task may require a set of skills to be realised. For each task, the PO starts estimating the workload required from each skill, and the available manpower to provide these skills. After the definition of these ingredients the PO should generate the work-plan that defines the temporal window for the realisation of each job, with the associated manpower, inventory of required machines, equipments, materials, etc. This road-map is known as the project “baseline schedule”.

But this baseline schedule is generally modified during the project realisation phase, due to the high levels of uncertainty in the estimation of the project ingredients, uncertainty of resources availability in time, uncertainty of environmental changes, even uncertainty of the demand according to market changes. Preventing changes in the baseline schedule or even reducing them is greatly appreciated, because all engagements between the different stakeholders of the project rely on this schedule. And based on this plan, commitments are made to subcontractors to deliver materials, support activities, and due dates are set for the delivery of project results. This importance cultivates the need of developing firms’ responsiveness in order to face market volatility without modifying this baseline schedule. The ability of organisation to respond and react towards unexpected changes is always viewed as synonyms of flexibility. Since the company personnel are increasingly seen as the core of the organizational structures, strong and forward-looking human resources flexibility is crucial for performance in many industries. The human resources flexibility can be viewed mainly on two axes:

- The quantitative axis: represents the human resources flexibility resulting from contractual flexibility and working time modulation. Contractual flexibility includes for example seasonal hiring or job contracts...etc. The working time flexibility represents here the annualising and modulation of individual work amount that relies on policies of changing schedules, individual as well as collective. These changes should respect a set of working milestones.
- The qualitative axis: represents the human resources flexibility produced from the firms’ internal manpower by developing their multi-functional flexibility. This versatility of each worker provides the firms with a dynamic working capacity using stable number of workers.

Many recent academic works were conducted dealing with these flexibility dimensions in different applications. The development of workers versatility (the qualitative flexibility) has a great attention. This development can be assured by adopting job-rotation policy when performing resources allocations. In such case, it is important to take into consideration the dynamic nature of experience acquisition. This dynamic nature can be viewed relying on the learning-by-doing at the work-centre, and avoid as most as possible the undesirable effect of knowledge losses due to forgetting effect.

Responding to this growing need to generate a robust baseline schedule while developing the employee's qualitative flexibility, the objective of this research is to model, to solve and investigate the problem of workforce allocation on industrial activities. This model considers two dimensions of human resources flexibility, moreover to the dynamic nature of their experience. The first flexibility results from the annualising of working time and its modulation. The second flexibility is the versatility of each operator.

Organisation of the manuscript

The consideration of human factor in the problem of workforce allocation, simultaneously with industrial activities schedule, will be the main subject of this thesis. It is organised and constructed in seven chapters, shown by the schematic figure (i.1) at the end of this section.

The first chapter presents a brief context of the industrial project management. The different hierarchical levels of manufacturing planning will be discussed. The uncertainty in project planning and scheduling will be presented. Then, the flexibility concept and its different dimensions will be considered. In the end, the human factors in planning and scheduling will be briefly introduced.

The second chapter presents a review of literature related to the project planning and scheduling problem. The different classical and non classical problems will be discussed. The many strategies that were developed to deal with the uncertainty in scheduling will be discussed. In addition, the numerous considerations of the role of human resource in this domain will be presented.

The third chapter aims to model the problem of staff allocation with the two degrees of flexibility: the working time modulation, and multi-skills of operators. With induces a dynamic view of their skills and the need to predict changes in individual performance as a result of successive assignments. The mathematical model of this problem will be presented altogether with the analysis of its variables and constraints.

The fourth chapter seeks to define an instance of the current problem and measure its complexity. First the project and the required resources will be divided into a set of dimensions. These dimensions contain the project network, tasks durations, required workload, required skilled, the available resources. The different parameters related to each dimension will be presented and quantified. For each dimension a sensitive quantifier will be investigated and selected. After that, a principal component analysis and a cluster analysis will be performed to define linearly the minimum quantifiers needed to measure the problem complexity.

The fifth chapter aims at presenting simultaneously two main parts. The first one is a brief discussion of resolution techniques for optimisation problems. The second part is the detailed presentation of the proposed approach that relays on genetic algorithms and the schedules serial generation scheme. Moreover, it presents the proposed approach validation and the tuning of its parameters.

The sixth one presents a detailed investigation of the proposed approach through the examination of a vast number of projects with different characteristics. First the respective weights associated to different objectives

will be adjusted. After that, a comparison between the scheduling results obtained for these different projects will be carried out, in order to show the robustness in the approach performance.

The seventh chapter planned to present and investigate the different variables that can affect the development of workforce experience and the multi-skilled flexibility in the company. First these different variables will be presented. After that an excessive variables investigations with the associated statistical analysis will be demonstrated.

Finally, the main conclusions and recommendations will be discussed, and the future perspectives of this work will be presented.

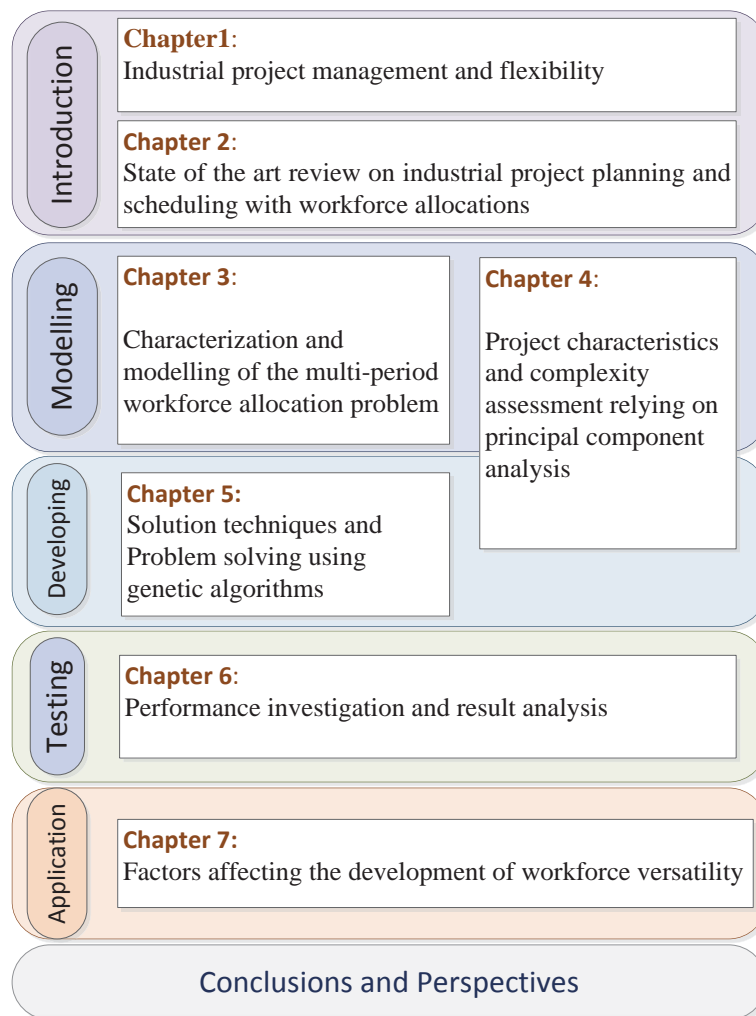

Figure i.1 the structure of the manuscript

INDUSTRIAL PROJECT MANAGEMENT AND FLEXIBILITY

This chapter presents a brief introduction to the management of industrial projects, and aims to raise awareness about issues of responsiveness. First, the different hierarchical levels of manufacturing planning will be discussed. The sources of uncertainty in project planning and scheduling will be presented; the flexibility concept and its different dimensions will be pointed out. Furthermore, a brief discussion of human *factors* in planning and scheduling will be introduced.

1.1 INDUSTRIAL PROJECT MANAGEMENT

A project can be defined as a set of coordinated activities with a clearly defined objective that can be achieved through synergetic, coordinated efforts within a given time, and with a predetermined amount of human and financial resources (Tonchia, 2008). The project can be intended to create products or services. Kumar and Suresh (2007) distinguished between the manufacturing operations and services ones by some criteria: the *tangible or intangible* nature of outputs (products in manufacturing), the nature of work, the customer contact (is little in manufacturing), and the measurement of output. Managing a project is the “application of knowledge, skills, tools, and techniques to project activities to achieve project requirements”, (Heagney, 2011). Lewis, (2000) defined project management as the “facilitation of the planning, scheduling, and controlling of all activities that must be done to meet project objectives”. Generally, project management deals with activities, tools (work analysis, scheduling algorithms or software; risk analysis ...), people and systems under a set of performance, budget and time constraints during the project phases. As shown by (Figure 1.1), project life contains five phases: initiating or concept, definition, planning and scheduling, executing controlling and coordinating, and closing. Demeulemeester and Herroelen, (2002) discussed each phase of the project as:

- ◆ *The concept phase*: is the point at which the customer (funds provider) identifies the needs that must be met for a product or service in order to solve a given problem. The needs identification can result in customer request for a proposal from organisations (contractors). The contractors’ proposals usually contain the description of the problem’s solution, with the associated costs and schedules. At this stage there is a rather fuzzy definition of the solution, therefore feasibility studies should be conducted.
- ◆ *The definition phase*: presents a clear approach of what is going to be developed as a proposal to solve the problem. It contains three main parts: - *Project objectives*; it refers to the end state that the project management is trying to achieve. - *Project scope*; it identifies the project outcomes, and what is the expectation of the customer by project completeness. - *Project strategy*; it describes clearly the organisation approach to reach the project scope and optimising the project objectives. Additionally, the different economic, environmental, technological, legal, geographic, or social factors that may affect the project should be identified and investigated. At the end of this phase, we can answer the fundamental project questions of: what we are going to do? How we are going to do it?
- ◆ *The planning and scheduling phase*: contains a set of steps of identifying the project work content and different activities, estimates the temporal and resources requirements considering uncertainty, itemizes the required competences and skills, and specifies the dependencies relations between activities and the scheduling constraints. In order to manage the project efficiently, it should be broken down to manageable portions (Work-breakdown-structure: WBS). This WBS translates the results of the systems engineering analysis and requirements into a structure of the products and services which comprise the entire work effort (Wiley et al., 1998). *The scheduling*: represents the project base plan which specifies to each activity a start and completion date, the amount and type of each resource. The development of a well-thought-out plan is essential to a successful achievement of the project.
- ◆ *The executing and control phase*: represents the implementation of the baseline plan; by performing the required work and controlling the advancements in order to meet the project scope within the estimated

budget and temporal windows. The project controlling can be performed using monitoring, and measurement of the actual work progress for comparison with the baseline schedule.

- ◆ *The termination phase:* is the last stage of the project, whatever the results of the project it will have to be terminated, after the customer has formally accepted the project's deliverables. The termination phase includes the release of the project resources and their redistribution, the evaluations and *lessons-learned*, the closure of the financial records, and the redaction of the final reports.

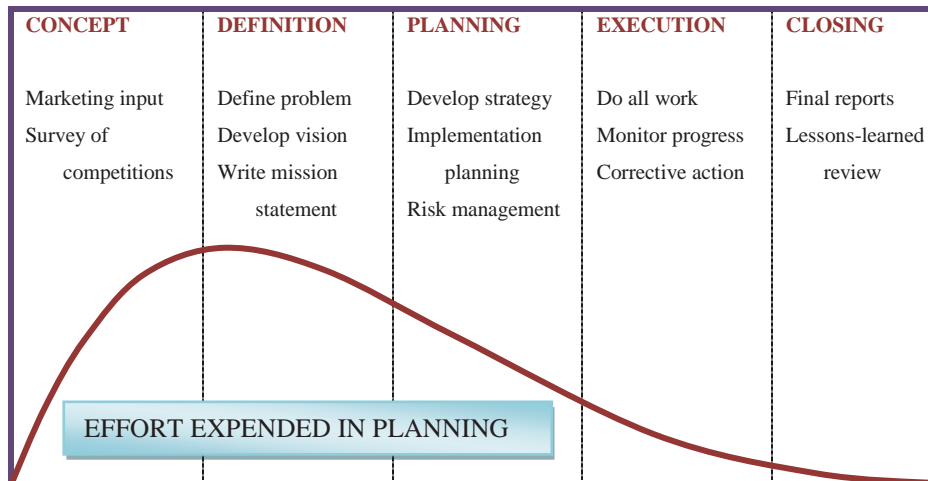

Figure 1.1 Appropriate project life cycle (Heagney, 2011)

The discipline of project management is receiving a continuous and increasing attention from a vast number of academics and industrials starting from Henry Gantt (who is famous for having developed the Gantt chart in the 1910s) to nowadays. This highly focused attention was developed as a reaction to the turbulent changes of the working environments. Here we are interested in the phase of project planning and scheduling with resources allocations. Therefore, the following section will focus to the planning and scheduling phases of the project.

1.1.1 Project hierarchical planning

Planning can be described as the function of selecting the enterprise objectives; establishing the policies, the procedures, and the necessary programs for achieving them; taking into account uncertainty in the estimate. There are two planning approaches in the project management depending on the level of decision-making that is involved (Masmoudi, 2011): the monolithic approach solves the problem as a whole whereas the hierarchical approach divides it into smaller manageable sub-problems according to the various objectives, the managerial levels, time horizons, planning frequencies, different modelling assumptions and levels of details. One of the most advantages of the hierarchical structure is the avoidance of local optimization without considering the global context of the problem. Often, the planning decisions hierarchy follows the Anthony's classifications (Anthony, 1965), as shown by (Figure 1.2).



Figure 1.2 Anthony's hierarchical classification of the project planning decisions

As shown in (Figure 1.3), this hierarchical classification can represent the vertical dimension of planning problems. While the horizontal one represents the focusing context of application. Which includes: process planning, resource and capacities planning, supply chain management, business planning ... etc.

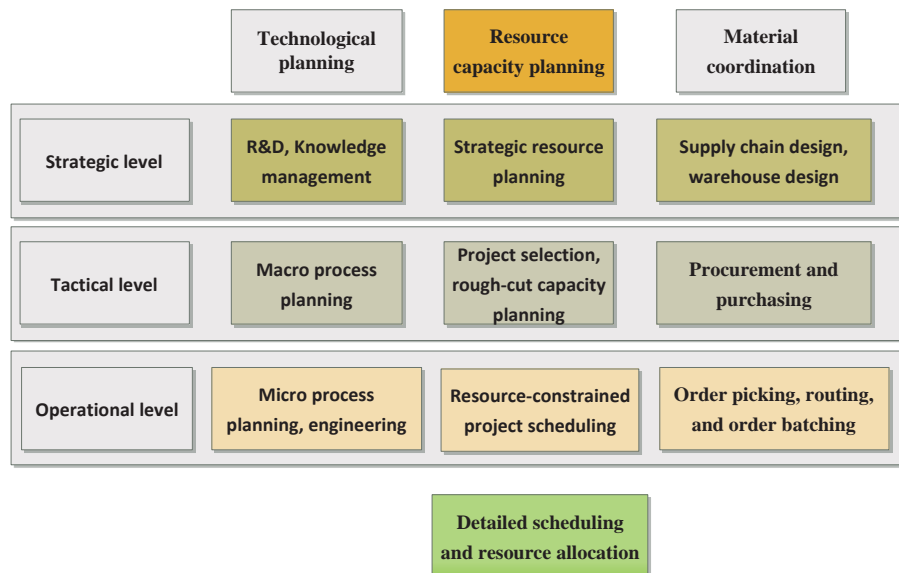

Figure 1.3 A Hierarchical framework for planning and control (Hans et al., 2007)

1.1.1.1 Strategic level

First the strategic level is concerned with long-term decisions made by senior management to precise the overall approach and orientations considering competitors (Lewis, 2000). The planning at this level deals with the big picture of how the project fits the overall and long-term organisation goals (Badiru, 1996). Strategic decisions include (but are not limited to): - The project portfolio management, - the investments concerning the development of resources capacities, - the decisions about firms human capital (such as the workforce hiring/release or developing their skills by training), - out-sourcing as well as make-or-buy decisions, - or the intension to make sub-contracting either from employees or production points of views. Out-sourcing should not be confused with sub-contracting, as explained by Dolgui and Proth, (2010), sub-contracting refers to tasks or services that are simply handed over to a company that has the required specific skill and/or resources to be efficient. But, outsourcing is the purchasing of services, semi-finished products and components from outside

companies (vendors). The main function of strategic planning is to establish a game plan capable to meet the overall targets of the firm (Hans, 2001). The temporal horizon of this level may vary from one to several years according to the changes in the working environment.

1.1.1.2 Tactical level

The tactical level (Macro-level) contains all decisions of the medium-range planning horizon. After the consideration of a set of executable projects based on the strategic decisions, internally within the firm, a set of projects can be activated at the beginning of the planning horizon. According to the classification of De Boer, (1998) there are two planning levels: the first known as Rough-Cut Capacity Planning (RCCP), and the second is the Resources Constrained Project Scheduling Problem (RCPSp). RCCP addresses the medium-term capacity planning problems. The selected projects are split up into relatively large work packages, which are planned over time taking into account the availability of scarce resources, (Gademann and Schutten, 2005). On the other hand, the RCPSp addresses the operational, short term scheduling: the work packages are broken down into smaller activities which are scheduled over time in an executable detailed level. As discussed by Gademann and Schutten (2005), the main goal of the RCCP is to match roughly available and required capacity. It can help the company to increase or not its capacity, through outsourcing, sub-contracting, hiring additional workforce, working time modulation,... The RCCP can be divided to two categories: *Time-driven* RCCP and *Resource-driven* one. In the *Time-driven* RCCP, the desired project delivery time must be met, so time can be considered as the hard constraint, according to which the resources (regular and no-regular) have to be tuned. In the case of *Resource-driven* RCCP, the company can only use its own regularly available capacity, and the objective is to minimize project duration. Since time and cost are equally important at this level, in practice both approaches should be used simultaneously (monolithic approach), or iteratively with some interaction (iterative approach), for more details see the model represented by Hans, (2001).

1.1.1.3 Operational level

Finally, the operational planning level (Micro-level) is the short term that presents day-to-day planning. This level can be started after fixing the project milestones. At this level and before the project schedule a micro-process planning is performed (as shown in Figure 1.3). The objective of the micro-process planning is to provide the scheduling process with the required information from the engineering (Hans, 2001), as example: - a detailed definition of each task with the required skills, - a standard estimation of the required workloads, - the materials requirements, - a standard estimation of each activity duration, - a detailed analysis of the temporal and technological dependencies between activities, - an availability plan of the different resources. Then the detailed scheduling decisions are made at the end of this level and just before the activities execution. The aim of this planning level is to produce a detailed, robust, and executable working plan (Edi, 2007). As discussed by Demeulemeester et al. (2007), this level involves the allocation of specific resource units to project activities and the scheduling of those activities in time together with reacting to schedule changes when needed. This type of problems is known as the RCPSp, additionally to the resource levelling. The operational planning horizon may vary from several weeks to several months, Edi, (2007) stated that it can take about 10 to 20% of the tactical duration.

1.1.1.4 Interaction between planning levels

The three hierarchical planning levels cannot be isolated from each others, and information is promulgated from the higher levels to the lower one(s). Feedback is essential from lower to higher levels, in order to enhance the process, and appreciate the return of experience. Hans et al. (2007) discussed the interaction (changing information) between the three levels of the hierarchical planning with respect to two variables: the variability and the dependency. For project organisations with high dependency, the “matrix-organisation structure” is generally adopted. On the other hand, low dependency cases can be represented by the dedicated or pure “project organisations”. Hans et al. (2007) proposed another interaction way: since the resources are dedicated to the project, they proposed to allocate them during the tactical level; therefore, the information transferred to the operational level contains due dates, milestones, capacity levels, and resources allocation decisions. This type of organisation is preferable for complex projects, (Hobday, 2000). Generally, the tactical and operational levels are very interdependent levels (Kovács et al., 2005).

1.1.2 Project scheduling with resource loading and levelling

The scheduling was defined by Leung and Anderson (2004) as “the allocation of scarce resources to activities with the objective of optimising one or more of the performance measures”. Resources and activities can be taken in many forms, or specification, e.g. resources can be workers and/or machines in manufacturing plants, utilities, runway at airport, I/O devices in computer system, etc. Activities can be any action which monopolizes or consumes resources during a specified period of time. In manufacturing context, the schedules often describe the sequencing and assignment of products (activities) to machines (resources) (Hans, 2001), or workforce to specified jobs, during specified temporal milestones. This is known also as resources loading. The temporal milestones of the schedule contain: the release date, the processing time, the due/completion date of each activity, moreover to the program deadline. This operational plan is known as “Baseline schedule” also called a predictive schedule or pre-schedule. As discussed by Herroelen and Leus (2005), the baseline schedules serve as a basis for communication and coordination with external entities in the company’s inbound and outbound supply chain. The scheduling problem is often NP-hard complex, (Neumann and Zhan, 1995; Shue and Zamani, 1999; and Brucker and Knust, 2011 P.34).

Resource levelling refers to the process of reducing the period-to-period fluctuations (load smoothing) in resource’s loading. The resource levelling was discussed by Badiru (1996) in the way of resource profiling during the project horizon, i.e. developing a graphical representation to convey information about the resource availability, utilization, responsibilities loading and assignment. The variations of the graph can be used to conclude information about depletion rate of the project budget. Also, the resources idleness and critical resource diagrams are effective tools used to manage a program of activities. This graphical representation may be done for all types of resources involved in the project. The advantages of stable loading plans include the improvement of workers’ learning opportunity at work–station. The pattern of resource usage versus time might be more important than the peak demand of the schedule, (Demeulemeester and Herroelen, 2002). In such cases, the *RCPSP* can be shifted to a resource levelling problem, where the objective is to complete the activities program before its deadline with a resource loading profile that would be as even as possible over the entire project horizon – for more details, see e.g. Younis and Saad (1996); or Leu et al. (2000).

1.2 UNCERTAINTIES IN PROJECT MANAGEMENT

The project risks management is mainly relying on the analysis of uncertainties in the different dimensions of a project, and putting the suitable strategy(ies) to control the estimated outcomes, if any. As explained by Ward and Chapman (2003), managing the project uncertainty is managing the project risk. Regarding the sources of uncertainty, Atkinson et al. (2006) argue that uncertainty can be produced in a given project relying on three attributes: uncertainty in estimates, uncertainty associated with project stakeholders, and uncertainty associated with different phases in project life cycle. According to Herroelen and Leus (2004), the uncertainty is also associated with the size of the project parameters (such as time, cost, and quality) and the process (what is to be done, how, when, by whom and at what cost). The main reasons for uncertainties in estimates are: - the lack of specification of what is exactly required, lack of the required knowledge, - complexity associated to interdependencies between activities. -Insufficient analysis of the different activities, - possible occurrence of particular events or conditions which might affect the activity, or even the estimator's bias, (Ward and Chapman, 2003; Atkinson et al., 2006). The uncertainty associated with the project stakeholders often concerns large projects, where the project deliverance can be shared by some parties. In such situations, uncertainty can be produced from: the objectives and motivations of each party, the alignment of the parties' objectives and that of the owner, the abilities and availabilities of each party, or the fundamental relationships between the various project parties involved. This type of uncertainty reduces as the parties are embedded in the same organisation. In such situations, the dependency of project on internal coordination is more important than that on the external one. Concerning the uncertainty associated with different phases in project life cycle, we propose the work of Atkinson et al. (2006) for more details.

1.3 FLEXIBILITY VERSUS UNCERTAINTY

Organizations face significant uncertainty from continuous and dynamic changes: -Customers are demanding a greater variety of high quality, low cost goods and services. -The difficult competition between companies requires rapid responses to the customers' desires, with low costs and best quality. Organizations continuously develop new methods and perspectives to meet these needs in a timely and cost effectiveness fashion. Thus creating flexible organizations is one response to dealing with such challenges (Koste and Malhotra, 1999; Zaeh and Mueller, 2007). And organizations need to be internally and/or externally flexible to face uncertainties, (Hitt et al., 1998). The use of flexibility to accommodate uncertainty of the environment has received a significant recognition. As example, Groote (1994) defined the flexibility as "a hedge against the diversity of the environment", while flexibility is considered as a property of technologies and diversity is a property of environments. The more flexible technology is the one which benefits from the diversity of environments with more desirable changes in its performance than its others competitors under the same conditions. The word "diversity" was used to represent the variability, variety, or complexity of the customers' requirements types and quantities. The word "technology" was used too as a general representation of the firm aspects. Others as Beach et al. (2000) argue strongly that each specific type of uncertainty requires a given form of flexibility to accommodate its effects (reactive response), and each type of uncertainty in its turn requires a different and a particular type of flexibility to accommodate it (proactive response). But Treville et al. (2007) suggested that the

firm flexibility can be evaluated by the manner in which the firm reacts to environmental uncertainty by responding efficiently, responding in reactive and ad hoc way. Or limiting the uncertainty instead of responding may depend on the firm's scanning level of environmental changes and whatever this environment is analyzable or not. And the active firm is that one which views its environment as an analyzable one and established its own strategic flexibility. But the passive firms that view their environment as un-analyzable, are more likely firms to respond in ad hoc way. The firms must work to reduce environmental uncertainty by becoming proactive/offensive rather than reactive/defensive ones.

1.3.1 Flexibility theoretical concept

For several decades the concept of flexibility received a lot of attention from researches, in many fields like design, manufacturing systems, management, planning and scheduling, information technology, etc, but still there isn't any exact definition for its general concept and its measurements (Bordoloi et al., 1999). And there is only a diversity of its concepts that depend only on some specified subject. Why does the general concept of flexibility seem so difficult to be introduced? The answer to this question has been introduced in many works. A lot of authors link the difficulties of the general concept of flexibility to its multidimensional aspects and varieties of contexts in which flexibility has been employed, or to the variety of entities where it has been applied (Sethi and Sethi, 1990; Mitchell, 1995; Shewchuk and Moodie, 1998; Koornhof, 2001; Démary-Lebrun, 2005). According to Golden and Powell (2000), the flexibility definitions "are often coloured by particular managerial situations or problems". The most frequent definitions of flexibility always relate to other terms such as adaptability, rapidity, responsiveness, resilience, efficiency, and sometimes to complexity and reliability (Bordoloi et al., 1999), and other terms like ability or capacity to react, to respond, to adjust, or to cope with the environmental changes. We represent here some definitions of flexibility:

Adaptability: flexibility was defined as the ability of the manufacturing system to adapt to the customers demand for each production horizon. Recently Zaeh and Mueller (2007) defined it as "the company's ability to adapt its manufacturing capacity to changes in customer demand with little or no effort". Sethi and Sethi (1990) also defined the flexibility of a system as its adaptability to a wide range of possible environments that it may encounter: a flexible system must be capable of changing in order to deal with a changing environment. Golden and Powell (2000) supported the definition that the flexibility is "the capacity to adapt", and they explained why they used the word "capacity" rather than the word "capability": they mentioned that the capacity is "the power of containing, receiving, experiencing or producing", and it represents well the multidimensional aspects of flexibility, whereas the capability is "the power to do something". With a similar approach, Valverde et al. (2000) argued that organizations need to have the ability to adapt to fluctuations in demand and to changes in their environment in order to be successful or even in order to survive.

Rapidity and responsiveness: many authors defined the flexibility in terms of rapidity and responsiveness in dealing with the environmental conditions. Sanchez (1995) defined the firm flexibility as "a firm's abilities to respond to various demands from dynamic competitive environments". In the field of human resources management, Wright and Snell (1998) defined it as "a firm's ability to quickly reconfigure resources and activities in response to environmental demands". But Mitchell (1995) describes the flexibility relying on two sides: the first side is the change: "the flexibility itself involves the characteristic of rapid and significant

change”, and the other side of flexibility is the reaction: “the characteristic of being unable – or intellectually unwilling – to change in any degree or with any speed”. Youndt et al. (1996) also defined flexibility in general terms as it refers to firm’s agility, adaptability, and responsiveness. More precisely Koornhof (2001) defined it as: “flexibility is the ability and capacity to reposition resources and functions of the organization in a manner consistent with the evolving strategy of management as they respond, proactively or reactively, to change in the environment”. He argues strongly within this definition that flexibility is both an organisational and individual variable, and it contains the operation, financial, strategic, marketing, manufacturing and behavioural flexibility aspects. And it recognises the dynamic relationship that can exist between the organisation and its environment.

Resilience: it refers to the ability of organizations to recover from the environmental disturbance by returning to its previous state or gain some fitness in its performance. The ability of an organization to re-compete and share the market landscape after meeting an environmental disturbance is an example of organization’s resilience flexibility. For more details, we propose the work of Hu et al. (2008) and De Haan et al. (2011).

1.3.2 Flexibility dimensions in manufacturing

Within companies there are many dimensions and levels of flexibility that must be defined and classified; such as: internal, external, quantitative, qualitative, static, dynamic, offensive, and defensive. And each type contains subcategories of flexibility elements. With all these types and multi-forms, the company’s overall flexibility is the mixture results of these forms’ with given levels and tolerances for each form (Démery-Lebrun, 2005). Thus, it is helpful to classify the firm’s flexibility levels and sub-dimensions. Authors such as (Golden and Powell, 2000; Koste and Malhotra, 1999; Shewchuk and Moodie, 1998) have tried to distinguish between these sub-dimensions, and they have introduced four flexibility dimensions: intension, focus, range, and temporal. The intension represents the strategy of firms to accommodate to working changes, whether, the organisation is being proactive or reactive (offensive or defensive, active or passive). In the proactive policy, the organizations attempt to control the environment changes by accommodating unknown uncertainty in the way that they can gain competitive advantage. But in the reactive policy the organizations treated the changes after they have occurred. The “focus” dimension symbolizes that the flexibility is gained internally within the organisation, or by managing external relationships with trading partners. The “range” represents the number and varieties of the alternatives. Associated to these alternatives with the range dimension, one can find the uniformity and the mobility. Uniformity represents the similarity of performance outcomes within the range which can include quality, costs, time, etc. Where, mobility represents the easiness or penalties associated to switching between alternatives.

Finally, the temporal dimension classifies flexibility based on time scale to: long, medium or short terms that can be represented as the three subcategories of strategic, tactical, and operational flexibilities. The strategic flexibility represents the actions that presently taken out by companies with a future expected returns, such as investments in machines, labour training or education (Golden and Powell, 2000). The tactical flexibility can be represented as the action flexibility, where the outside intervention is required before the system response to the change, (Shewchuk and Moodie, 1998). The operational level of flexibility concerns the short term flexibility, the ability to replan in alternative ways, due to events that suddenly happened, (Golden and Powell, 2000; Treville et al., 2007). This level can be formed from numerous manufacturing components; Koste and Malhotra

(1999) distinguish between several types of operational flexibility in manufacturing systems and they give a brief description and definition of each type:

- *Labour flexibility*: “the number and heterogeneity (variety) of tasks/operations a worker can execute without incurring high transition penalties or large changes in performance outcomes”. - *Product flexibility*: includes new product flexibility and product modification flexibility. *New product flexibility*: the range of new products which are introduced into production. Where the *Product modification flexibility*: it addresses the ability of making modification on the current product according to the customer requests without incurring high transition penalties. - *Operation flexibility*: the number of products which have alternate sequencing plans. - *Machine flexibility*: is the range of operations a machine can execute. - *Volume flexibility*: represents the ability of the enterprise to respond quickly and efficiently to the turbulent demand. - *Mix flexibility*: represents the number of products that the enterprise produces and also the varieties between products models. - *Material handling flexibility*: the number of existing paths between processing centres and the heterogeneity of material which can be transported along those paths. - *Routing flexibility*: represents the ability to use alternate processing work-centres to execute operations, its significant impact can be appreciated in case of machine breakdowns or overlaps. And - *Expansion flexibility*: is the range of expansions which can be accommodated without producing high transition penalties or large changes in performance.

1.3.3 Human resources flexibility

Human resources can be considered as one of the most flexible resources in the manufacturing processes in their nature. They have the ability to migrate from work stations to others, when/where needed. As classified by Goudswaard and De Nanteuil (2000) shown in (Table 1.1), workforce flexibility can be achieved relying on two main sources: the external and internal sources of flexibility. External flexibility refers to the adjustment of the workers number from the external market for a short term contracts, to balance between the required workforce and that actually available. This can be achieved by employing workers on temporary work or fixed-term contracts or through relaxed hiring and firing regulations. Solutions of this kind seem to provide the companies with a rapid and costless strategic flexibility when facing the problem of turbulent changes in customer demands. But, the resulting high staff turnover has a serious effect on the development of core competences, health and safety, recruitment costs and time. According to Hitt et al. (1998), this strategy produces a static flexibility rather than a dynamic one, reduces the development or the evolution of the core competences, and in addition the firm loose workers' loyalty, motivation: most of the time, they are less productive compared to the permanent workers.

The internal flexibility relies on two sub-dimensions: the multi-skills flexibility and the temporal one. Multi-skills flexibility is the ability of employees to transfer to and carry out different activities and tasks required by firms changing workload, production methods and/or technology. This kind of flexibility requires heavy training programs to provide the firm with a multi-skilled workforce that would be ready to face and respond rapidly to environment changes (Valverde et al., 2000). This kind of flexibility is known as “functional flexibility” and represents the qualitative side of workforce flexibility. It can have a significant impact on the firms' capacity, quality and performance. With functional flexibility, workers are able to work with a high performance level for their own competences, and they have an acceptable efficiency or performance for other competences from the

quality and cost points of views. On the other side, functional flexibility requires training as a long term investment, and development policies planed by the organizations to develop their core competences and gain an important flexibility lever.

The quantitative part of the workforce flexibility can be developed relying on the working time specifications. This kind of flexibility is known as “temporal flexibility”, as shown by (Table 1.1), and relies mainly on the distribution of employees’ working hours over the week: that can be defined by answering two questions: when does the worker go to work? (At morning, afternoon, evening, or at night), and how many are his daily working hours? The different answers to these two questions shape the temporal flexibility. Here we are interested to the new working time modulation with annualized working hours (see section 3.2.1).

Table 1.1 Different forms of flexibility (Goudswaard and De Nanteuil, 2000)

Forms of flexibility	Quantitative flexibility	Qualitative flexibility
External flexibility	<i>Employment status:</i> - Permanent contracts - Fixed-term contracts - Temporary agency contracts - Seasonal work - Work on demand/call Numerical flexibility and/or contract flexibility	<i>Production system:</i> - Subcontracting - Outsourcing - Self employed Productive and/or geographical flexibility
Internal flexibility	<i>Working time:</i> - Reduction of working hours - Overtime/part-time work - Night and shift work - Weekend work - Compressed working week - Varying working hours - Irregular/unpredictable working time Temporal flexibility	<i>Work organisation:</i> - Job enrichment/job rotation - Teamwork/autonomous work - Multitasking, multi-skilling - Project groups - Responsibility of workers over: planning, budget, innovation, technology Functional flexibility

1.4 HUMAN FACTOR IN PLANNING AND SCHEDULING

The human resource is one of the most crucial sectors in an organisation. The individuals might be responsible for the majority of activities sequencing and resource allocation decisions from the initial demand until the delivery to the customer. An individual might be responsible for setting up machines, initiating parameters of scheduler algorithms, coding machines, or creating the activity manually using the required equipments. According to McKay and Wiers (2006), human resources can be characterised by a set of dimensions such as flexibility, adaptability, learning, communications, negotiation, and intuition in case of missing information. As previously discussed, the flexibility and adaptability represent the capability of human individuals to desirably react against a specified change for a specified period of time under a set of goals and constraints (stated, not-stated, or incomplete). Humans are also capable to learn and store knowledge, and retrieve the suitable amount from it for a specified situation. This process of learning-storage-retrieval of knowledge is known as the memory dynamics either on the macro or micro levels of knowledge acquisition, (Wickelgren, 1981). The storage phase induces two phenomena: the consolidation and forgetting. Assuming that memory can be constructed in traces, strengthening these traces represents the consolidation; and weaken them represents forgetting. The strength of these memory traces can be increased by work repetitions: it is well known that “practice makes perfection”.

Therefore, one of the important factors that can be found in the product pricing is the learning curve effect. Thus, the production cost per item of a given product reduces as the number of items grows, this reduction in production cost resulting from the labour knowledge accumulation, or experience development. Moreover, humans are able to communicate and transfer knowledge and negotiate with the different parties of the project., Human resource also have intuition, i.e. the ability of humans to fill-in the blanks of missing information required to perform a specified job, which requires a great amount of ‘tacit knowledge’ (McKay and Wiers, 2006). All of these aspects enable human resources to deal with the uncertainties of the working environment. On the other side, there are differences between individuals with respect to all human aspects, behaviour, learning rate, forgetting rate, ability to communicate, to negotiates, fatigue, stress...etc. For example, individuals exhibiting different behaviours towards a given situation, this behaviour can be represented in terms of individual motivations, adaptability, as opposed to the routine behaviour. Beltrán-Martín et al. (2008) distinguished between the rigid behaviour and the flexible one; when a worker who applied a certain script in repetitive work situations selects the same script for the novel situation, his behaviour is considered as rigid. But when they look for new procedures or actions to deal with new works, their behaviour can be considered as flexible. These human factors can affect the project schedule outcomes; therefore, we argue that it is important to consider them in humans-to-tasks allocation problems.

1.5 CONCLUSION

In this chapter an overall introduction of project management and flexibility were discussed. First, the different phases of a project life cycle were introduced. After that the different hierarchical levels of project planning are presented: the strategic, the tactical and the operational levels. The uncertainty in the context of project management had been discussed. And due to the important of using flexibility as a hedge against uncertainty, the theoretical concept of flexibility has been discussed in terms of adaptability, ability to respond, and resilience. Afterwards, the different dimensions of flexibility in manufacturing context have been presented. The different types of human flexibilities had been highlighted, more over to the human factors that can be considered in the current context, such as the learning and forgetting.

As discussed in this chapter, developing flexibility is an important aspect to help firms to remain competitive in the new turbulent working environment. As it was discussed, the human resource is the main sector offering such important characteristic. Therefore, we are motivated to model the project planning and scheduling problem, with integrating both aspects of the workforce flexibility.

STATE OF THE ART REVIEW ON INDUSTRIAL PROJECT PLANNING AND SCHEDULING WITH WORKFORCE ALLOCATION

This chapter aims to review the literature related to the project planning and scheduling problem. The different classical and non classical problems will be discussed. One can find various strategies that were developed as a response to the uncertainty at work, such as the reactive, proactive-reactive, robustness, and flexible schedules. Moreover, the different considerations of human resource in planning and scheduling will be also discussed.

2.1 PROJECT PLANNING AND SCHEDULING

As discussed earlier in chapter 1, the hierarchical classification of project management is based on three levels: strategic, tactical and operational levels. In this section we review the recent works that are oriented towards the tactical and operational levels of planning and scheduling. We present in some details some tools used in project planning and scheduling, starting from the rough cut capacity planning, resource scheduling, handling uncertainty and generating a robust schedule.

2.1.1 Rough Cut Capacity Planning “RCCP” problem

The RCCP is a process of balancing the required aggregated work to the available regular and/or irregular capacity. More precisely it can be described as stated by Daniel et al. (1997), relying on the “APICS Dictionary” (Dougherty and Wallace, 1992): “*The process of converting the production plan and/or the master production schedule (MPS) into capacity needs for key resources: work force, machinery, warehouse space, suppliers’ capabilities, and in some cases, money. Bills of resources are often used to accomplish this. Comparison of capacity required of items in the MPS to available capacity is usually done for each key resource. RCCP assists the master scheduler in establishing a feasible MPS*”. Knowing that, the MPS is what a company uses to determine how many products/work-content will be processed for (a) given period(s) of time. Hans (2001) identified three goals of the RCCP problem:

- Determine the capacity utilization of new and accepted orders,
- Perform a due date analysis on new or accepted orders, and/or to quote realistic due dates,
- Minimize the usage of non-regular capacity (overtime and/or outsourcing).

To satisfy the first aim of pre-specified the capacity; Daniel et al. (1997) proposed a model to calculate the capacity planning in remanufacturing environment based on the RCCP. After that a comparison between the available capacity and the requirement can be done for each work centre or for a specified resource. They computed a rough capacity from the temporal availability factor, the productivity rate of the work centre, and the rate of utilisation to the work centre. Zhang et al. (2001) presented a macro-level scheduling problem in manufacturing cells. The product’s processing at each cell is treated as an aggregated operation. They adopted the elasticity nature of the operation’s processing time at each cell according to the allocated resources. Hans (2001) formulated a RCCP problem for a job shop as a mixed integer linear programming, in which every aggregated order contains a set of specified jobs, with specified precedence constraints, to be loaded on a set of resources. Two types of resource capacities are considered: machine group fixed capacity (independent machines: they don’t share tools) and operators’ capacity. He adopted the assumption that operators are fully cross-trained and can thus operate any machine in any machine group. For operators, they distinguished between regular and non-regular capacities (i.e., working overtime and hiring staff). Kis (2005) studied a similar model to that of Hans (2001), in which the resource consumption of each activity may vary over time proportionally to its varying intensity. In other words, the activity performance-speed or intensity is determined by a continuous, non-decreasing function of the amount of resource allocated to it at any moment. The novelty of the proposed mixed integer linear programming “MILP” lays in the modelling of the precedence constraints, in function of binary variables that represent the activity allocation to the temporal buckets, and the overlap conditions for two

activities. The regular and un-regular capacities restrictions were adopted too. The objective is to minimize the weighted sum of external capacity requirement, where the weights represent the activities completion dates.

Gademann and Schutten (2005) studied the problem of RCCP within a capacity-driven multi-project organisation. The problem contains a set of jobs to be planned on resources that were aggregated from different projects. The aim is to allocate these jobs on a temporal horizon divided in to buckets (weeks in this case) while complying with the resources availability. The main variables denote the fractions of job that are performed by given resources during a specified week. These fractions can differ from week to week, respecting a maximum value. For each job there is a specified temporal interval that should contain the job release and due dates with respecting the precedence constraints, if any. The objective is to reduce the total cost of using non-regular resources. Recently, Bassan, (2010), and Masmoudi and Haït (2012) proposed fuzzy approach to deal with the uncertainty associated to the *RCCP*. Bassan (2010) proposed a rough-cut capacity requirements planning under fuzzy environment that includes fuzzy setup times per lot, fuzzy run time per part, and fuzzy lot of each part. Masmoudi and Haït (2012) modelled the problem of helicopter maintenance planning, the model integrates uncertainties into tactical and operational multi-project planning.

2.1.2 Resource Constraint Project Scheduling Problem

The scheduling problem is the object of great consideration from researchers and industrials, starting from Henry Laurence Gantt (1861-1919) who developed his famous chart during the World War I, in order to evaluate the production schedules. The huge varieties of problems encouraged stakeholders to invent a set of classification schemes. A first classification scheme was presented by Graham et al. (1979), related to production machine schedule, that holds three fields: *Alpha* | *Beta* | *Gamma*. The first field *Alpha* represents the machine of single kind, or various types of parallel machines, flow shops, general shops, open shops, multi-processor task system. The second field *Beta* is reserved for the activities and resources characteristics, such as possibility of task pre-emption, precedence constraints, due dates, task processing times, batching, or additional resources. The third term *Gamma* represents the performance measure or objective function as example, project makespan, minimise the lateness/tardiness, unit penalty. Relying on the three fields' classification, Herroelen et al. (1997) presented a classification scheme of the operational project schedule problem. The resources field contains a set of $Alpha\{1, 2, 3\}$ representing respectively the number of resources, the specific resource type, and the resource availability. The second field *Beta* specifies the activity characteristics of a project scheduling problem, where $Beta\{1, 2, 3, 4, 5, 6, 7, 8\}$ are, respectively, {possibility of activity pre-emption, precedence constraints, activities ready times, activities duration characteristics, project or/activities deadlines, activities-resource requirements, activities execution modes, activities financial implications}. The third field "*Gamma*" is the optimised performance that can contain {project makespan, the average flow time over all subprojects or activities, project due date performance, resources levelling, financial performance, stochastic cases, multiple objectives, multi-criteria optimisation} – the list is not exhaustive. For more details about this classification see, e.g. Herroelen et al. (1997); Brucker et al. (1999); Demeulemeester and Herroelen (2002); or Kocsis (2011).

The resources-constrained project scheduling problem "*RCPS*" is a very general operational level of activities scheduling problem which may be used to handle a varieties of different applications in practice. For example, manufacturing processes (Dorn et al., 1995; Artigues et al., 2008), maintenance (Yang et al., 2003; Masmoudi,

2011), service centers (Valls et al., 2009), professional service firms (Hoeck, 2008), software developing projects (Drezet and Billaut, 2008), call centers (Gulati and Malcolm, 2001), airports' runways schedule (Atkin et al., 2007), gates assignment at airports (Pinedo, 2008), school timetables (Erben and Keppler, 1996), or construction projects (Yang and Chang, 2005), for other application, see, e.g. Demeulemeester and Herroelen (2002), Brucker and Knust (2006); or Artigues et al. (2008).

The objective of the *RCPSP* is to schedule a set of activities while respecting the capacities of the scarce resources and optimizing specified objective(s) (Brucker and Knust, 2006). The standard *RCPSP* is usually formulated as the problem of finding a feasible schedule which minimizes the program due date. (Artigues et al., 2008) defined it as a combinatorial optimization problem with a tuple (activities, durations, temporal relations, scarce resources, availability, demand). We will discuss the main parameter (from our point of view) in the modelling of the *RCPSP*, which is the way of treating the activity duration within the literature. According to Demeulemeester and Herroelen (2002), the whole idea of planning and scheduling of a project depends upon activities time estimates which are based upon judgement of the human factor. Within literature, there are two shapes for the activity durations: the deterministic and uncertain estimation. As shown by (Figure 2.1), the deterministic represents two sub categories: -the first is the single value estimation, -the second is the alternative scenario, e.g. the result of a job/resources trade off that we call "elastic durations" of activities.

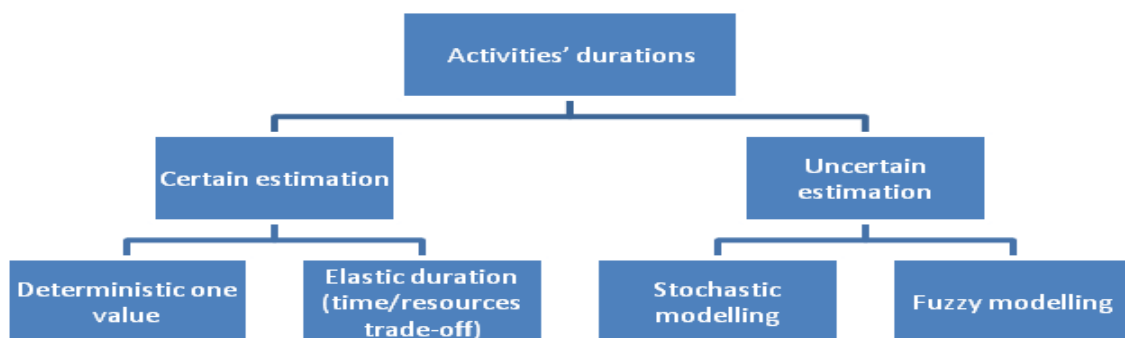

Figure 2.1 classification of activities durations

2.1.2.1 Deterministic task modelling

Over the last decades a considerable amount of research effort has been focused on deterministic scheduling. It supposed that the model data are known with certainty. This certainty can be produced from previous experience for repetitive technologies. There are many survey papers in the area of project scheduling, e.g. Herroelen et al. (1998) discussed the classical *RCPSP* in manufacturing industries, which is a generalisation of the job-shop scheduling with deterministic time. Kolisch and Padman (2001) and Neumann et al. (2006) discussed the different models and algorithms for some classes of the problem.

Regarding the benchmark problems, Patterson, (1984) accumulated from literature a set of 110 test problems with from 7 up to 50 activities, and from 1 up to 3 renewable resource types. According to Herroelen et al. (1998) these instances over the years became a *de facto* standard for validating optimal and suboptimal procedures. Agrawal et al. (1996) presented a methodology to generate source-terminal directed acyclic graphs of given complexity index. Kolisch and Sprecher (1997) presented a set of benchmark problems that were generated by the standard generator "ProGen" of Schwindt (1995). These benchmark problems are "open

access” and available at (PSPLib, 1996). Demeulemeester et al. (2003) developed a project generator for the activities-on-nodes networks. More recently, Browning and Yassine (2009) developed instance generator for the multi-projects scheduling with resource constrained, where project interdependencies might exist beyond common resources.

Regarding the mathematical modelling, Demassey (2008) presented the different mathematical formulations of the *RCPSP* based on two main classes of decision variables: sequence-based formulation, and time-indexed formulation. In the sequence-based formulation, the scheduling is performed in two steps: first, determination of the sequence of activities that satisfies the precedence constraints, and then fixing the processing times of the activities according to the resources constraints. The sequence-based formulation contains the minimum forbidden sets and the resources flow concept (Artigues et al., 2003). The time-based formulation relies on a time discretization describing the resources consumption and activities durations over time. This type contains the resource-conflict modelling and the feasible configurations of Mingozzi et al. (1998). Xu et al. (2008) formulate the traditional deterministic *RCPSP* as a sequential decision problem and solved it using combination of rollout algorithm with priority rule heuristics and justification. Carlier et al. (2009) adopted the double constrained problem with both renewable and non-renewable resources.

2.1.2.2 Elastic task modelling

This consideration of activity’s duration is always related to the resources characteristics, either quantitative (e.g. number of workers) or qualitative (e.g. the workers’ productivity rates). We called it elastic, as a simulation to the metal spring elasticity: the spring length is inversely related to the applied force. By the same principle the activity duration is inversely related to the allocated resources capacity. Within literature one can find some similar consideration; (Talbot, 1982; Sprecher et al., 1997; Vidal et al., 1999; De Reyck and Herroelen, 1999). Demeulemeester et al. (2000) proposed a discrete model of the activity duration known as “Discrete Time-Resource Trade-off”, in order to obtain more realistic model. Where, the duration of an activity is assumed to be a discrete, non-increasing function of the amount of a single renewable resource allocated to it. The proposed problem is strongly NP-Hard. The problem is known also as multi-mode *RCPSP*, (Mori and Tseng, 1997; Lova et al., 2006). Zhang et al. (2006) adopted the problem of multi-mode consideration with renewable and non-renewable resources and solved it using particle swarm optimization. Zhang et al. (2001) considered the time-resources trade-off in the aggregated level of the macro-activity planning, in which the processing time required to complete a given operation depends on the allocated resources. But in order to simplify the problem, they considered only discrete values of the operations processing time. Daniels and Mazzola (1994) and Daniels et al. (2004) proposed the elastic processing time of jobs as non-increasing function on the number of allocated workers.

For the non-renewable resources, the problem is known as time-cost trade-off problem, where it is assumed that the direct activity cost is a linear non-increasing function. As explained by Vanhoucke (2005) the objective was to determine the activity durations and to schedule the activities in order to minimize the sum of the direct costs of activities and the time-dependent indirect project costs, within a specified project deadline. The activity crushing is the reduction of its duration resulting from the allocation of additional resources. Knowing that, the

activity costs are a function of the activity durations, which are bounded within the interval of: the minimum duration that represents the most crushed one, and the maximum corresponding to the normal duration.

Tareghian and Taheri (2006) took into consideration the quality along with the time and cost tradeoffs. They argued that the project crushing affects the quality of the jobs performed, as well as it inflates the required costs. Discrete elastic processing time is adopted by Turkcan et al. (2009) in the manufacturing applications where the processing times can be controlled by using additional resources, or by changing machining conditions, such as cutting speed and feed rate. They assumed that the manufacturing cost is a convex function on the processing times. More recently Węglarz et al. (2011) presented a survey study to this class of problems with the different solution approaches.

The elastic task modelling can be considered generally as time-resource trade-off and resource-resource (time-cost) trade-off problems. As explained by Demeulemeester and Herroelen (2002), the different alternatives of the quantitative allocation of workforce to a given activity can be considered as “time-resource trade-off”. And the different alternatives of allocating workers with different productivities (qualitative allocation) to a given activity can be considered as “time-cost trade-off”. This concept of task modelling was adopted by Attia et al. (2012c); the proposed problem is extended and explained in details in chapter 3.

2.1.2.3 Probabilistic/Possibilistic task modelling

The activity duration is always associated to uncertainty, due to the unpredictability and rapidly changes of the working environment, e.g. unexpected external events such as weather changes, or internal events such as manpower availability, some activities may take more or less time than estimated, material may arrive behind schedule, human performance variability, etc. Within literature, in order to increase the robustness of the generated baseline schedules, there are two ways to deal with activity durational uncertainty: the first uses probabilistic models, and the second fuzzy models. The schedule robustness means the insensitivity of planned activities dates to schedule disruptions. In this section we discuss some approaches proposed to deal with the uncertain scheduling problem.

2.1.2.3.1 Probabilistic activity durational modelling

First, during the “Polaris” Navy project, General Electric raised a scheduling method known as “PERT: Program Evaluation and Review Technique”, in which tasks durations were represented by three values (optimistic, realistic and pessimistic durations) instead of one only (Malcolm et al., 1959). The expected activity duration was then calculated from these three values relying on beta distribution. Afterwards, a growing number of works have been proposed dealing with different classes of project scheduling problems, considering probabilistic distributions of activity durations. The probabilistic modelling is rational when the descriptions of the uncertain parameters are available from the historical data (Kilic, 2007).

Rubinovitch (1972) considered the variable representation of the amount of time needed to perform a given job. He proposed a model of activity duration composed of two parts, a fixed deterministic one, which would be a normal execution time, and the second part which is a random delay to deal with uncertainty. The delay part was assumed to be an independent random variable with a known distribution function. Another variable was coupled to the normal execution time to represent the time-cost trade-off, in order to ensure that the job

execution time could be shortened, within given limits, and with an increased cost. Golenko-Ginzburg and Gonik (1998) considered activities random durations for the R&D activities. The activity duration depending on the resource amounts assigned to it: duration of activity = required workload / the speed of operating activity. The speed of operating a given activity is assumed to be linearly dependent on the resource capacities. To simulate a random distribution of the realisation speed, they introduced a multiplier factor that holds the distribution function over a pre-specified interval.

Ke and Liu (2005) considered project scheduling problem with stochastic activity durations, with the objective of minimizing the total cost under some completion time limits; Creemers et al. (2008) adopted the project scheduling with net-present-value objective and exponential activity durations; Sobel et al. (2009) modelled the scheduling problem to maximise the project net present value with stochastic activity duration by presenting activities as pairs of random variables: each pair holds respectively the cash flow and activity duration; Zhu et al. (2007) studied the problem of how to set the due dates of the project activities under their uncertain durations during the early stages of the project. Each activity was presented by a set of discrete future scenarios; each scenario occurs with a given probability. Then a two-stage decision model was developed: in the first step, the activities due dates are computed from the probabilistic information; from these due dates, a detailed schedule is derived in the second stage that represents the operational level. The objective is to minimize the penalty costs associated to a deviation of due dates from the original plan. In order to overcome the difficulties associated to calculating the activities floats in a stochastic environment, Yakhchali, (2011) proposed an approach to determine the exact cumulative distribution functions of earliest and latest starting and finishing and floats of activities, based on confidence interval. The concept of confidence interval was used to obtain networks with imprecise durations, represented by intervals. After computing the intervals of project quantities at each confidence level, cumulative distribution functions of the different quantities are reconstructed from their interval. They investigated the results of the different discrete and continuous distribution function with the results of Monte Carlo simulation.

2.1.2.3.2 Possibilistic activity durational modelling

The Possibilistic models are often coupled with Fuzzy Logic approaches or Fuzzy Sets. As illustrated by Fortemps (2000), and Liberatore, (2008), fuzzy sets are an approach for measuring imprecision or vagueness in expert estimation. It may be preferred to probability theory in capturing activity duration uncertainty in situations where past data are either unavailable or not relevant from a statistical point of view. Or, the definition of the activity itself is somewhat unclear, or the notion of the activity's completion is vague. Fuzzy modelling is a suitable tool for the situations where it can be effectively described in a linguistic manner rather than with mathematical terms (Majozi and Zhu (Frank), 2005).

Kilic (2007) coped with the problem of flow-shop scheduling with fuzzy processing times and flexible due dates. According to him, considering fuzzy processing times is more suitable to describe and characterize real-world problems closely. And concerning due dates, he argued that fuzzy values are particularly suitable in human-incorporated systems, since on every occasion of human interference, there may be some deviation from deterministic values, inducing difficulties in applying the reference schedule. Liberatore (2008) presented a methodology for fuzzy critical path analysis in project networks, in order to determine both the fuzzy critical

path lengths and activities' fuzzy criticality. The uncertainty in activity duration was represented by three possible time estimates (triangular membership function) in a way that is similar to that of the original PERT approach. Chen and Tsai (2011) proposed an approach for the time-cost trade-off analysis of a project network relying on the fuzzy theories. The membership function of the project fuzzy minimum total crush cost was constructed relying on alpha-cuts (standard method in fuzzy for performing arithmetic operations), so that it completely conserves all the fuzziness of parameters, and the corresponding optimal activity time for each activity under different possibility levels. Using alpha-cuts principle, the fuzzy number can be represented by different levels of confidence intervals. The triangular fuzzy numbers are assumed for all parameters.

2.2 UNCERTAINTY AND PROJECT SCHEDULING

In the activities scheduling environment there are two main approaches dealing with uncertainty of the project execution phase: the reactive scheduling and proactive-reactive scheduling. Herroelen and Leus (2005) reviewed project scheduling under uncertainty. They also include fuzzy scheduling and sensitivity analysis among the techniques that are used to cope with uncertainty. Sensitivity analysis is a post-schedule analysis that tries to answer several "what-if" questions, or to check the schedule robustness. Within literature one can find many expressions such as: reactive scheduling, predictive-reactive scheduling, proactive-reactive scheduling, robust/insensitive scheduling, realised schedule, and flexible scheduling. In this section we will distinguish between these types and the different approaches developed to cope with the uncertain working environment.

2.2.1 *Reactive scheduling*

According to Herroelen and Leus (2005); Hans et al. (2007) and Van de Vonder et al. (2007b), the reactive approaches aim at generating the best possible reaction to a disturbance that cannot be absorbed by the baseline schedule without changing it. The reaction is usually done by re-planning approaches, which re-optimize or repair the complete plan after the occurrence of an unexpected event. These unexpected events include for example arrival of new orders, cancelling of some orders, shortage of raw material, power shortage, workforce unavailability, machine break-down, accidents at work, over/under estimation of the work-content, etc. The reactive schedule does not cope with uncertainty during the creation of the baseline schedule. Repairing or regenerating a new baseline schedule to take into account the unexpected events is known as: *predictive-reactive scheduling*. Many research works were conducted dealing with this type of scheduling: Raheja and Subramaniam (2002) reviewed the reactive and repairing approaches of the job-shop schedule problem. Wang, (2005) provided a flexible framework to detect and repair schedule conflicts in the product development project scheduling problem. The developed model can handle a set of changing events that can occur within the project execution phase such as: - Shifting of an activity, - Modification in activity duration, - Change in certain resource capacities, - Adding or removing of a temporal constraint. Van de Vonder et al. (2007a) proposed a procedure relying on priority rules and scheduling generation scheme that can be used during project execution to repair the initial project schedule when needed.

Guéret and Jussien (2008) discussed a predictive-reactive approach for a situation where no stochastic model of possible disruptions can be provided. They addressed two main questions in this kind of schedules: - When is a

new schedule needed? -How should a new schedule be computed? In order to deal with the difficulties associated with these questions, they proposed a dynamic constraint satisfaction problem (*DCSP*) to the project scheduling. The *DCSP* is a sequence of static constraint satisfaction problems “*CSP*”, each new *CSP* resulting from some change in the definition of the previous one. The changes can affect any of the *CSP* components including variables and/or constraints. To solve the proposed model, they proposed to use explanation-based constraint programming approaches. The approach is mainly relying on two steps: first the tree-based search embedded within a constraint solver, and the second is the active use of explanations. An initial schedule is generated using the tree search for the initial problem; afterwards the modifications are incrementally taken into account according to the kind of change:

- ◆ Adding new information: the schedule feasibility will be checked, and if a contradiction is introduced by the new information, a re-optimization step is performed. That starts from the initial solution using the explanations provided by the solver to determine the set of decisions induced by the contradiction. Then, it dynamically starts to remove from this set one or more decisions in order to compute a new solution;
- ◆ Removing information: re-optimization is asked after incrementally removal of all the constraints related to this information;
- ◆ Modifying information: a removal (of the old information) followed by an addition (of the new information) is performed.

Turkcan et al. (2009) adopted the machine scheduling problem with controllable processing times in the unrelated parallel-machines environment. The objective is to minimize the manufacturing costs including the processing time, and total weighted earliness and tardiness. They proposed a predictive-reactive construction approach, which aims to include the disruption and find a new schedule that is close to the predictive schedule in terms of both stability and efficiency. Measuring the efficiency of the predictive-reactive schedule was performed by the same way than that used for the predictive scheduling, i.e. manufacturing costs and earliness and tardiness. For the measurement of the stability, they used the absolute difference between the completion times of the parts in the predictive and the predictive-reactive schedules. Other reactive approaches such as: right-shift rescheduling approach (Raheja and Subramaniam, 2002), or knowledge-based approaches (Noronha and Sarma, 1991; Novas and Henning, 2010); for other rules see the work of Deblaere et al. (2011).

2.2.2 Proactive-reactive scheduling

In the proactive schedule, the statistical knowledge of uncertainty is used by the scheduling generation algorithms to constructs the baseline schedule or a family of schedules. So, it tries to alleviate the consequences of uncertainty prior to the start of the project execution by considering a set of alternatives (Hans et al., 2007). As previously discussed, the levels and varieties of uncertainties have to be estimated and analyzed in the project planning phase. Therefore, the consideration of uncertainty information is used to make the predictive schedule more robust, to cope with the disruptions that may happen during the project execution. It can be concluded that the proactive schedule is a baseline schedule that is built before the project execution phase, and that takes into account some predicted uncertainties. During the execution phase and in case of schedule disruptions that cannot be absorbed by the baseline schedule, one needs to bring modifications to the planned schedule in order to cope with the new events. The repaired plan that handles the changes is known as proactive-reactive schedule. Demeulemeester et al. (2008) defined the proactive-reactive scheduling as: a procedure that tries to cope with

working disruptions that may occur during project execution through the combination of the proactive baselines generated with a reactive procedure. These reactive procedures are taken to cope with some changes that were not absorbed by the initial schedule. Vonder et al. (2006) argued too that the proactive technique will always require a reactive component to deal with schedule disruptions that cannot be absorbed by the old schedule.

Concerning the proactive approaches, Van de Vonder et al. (2008) developed a number of heuristic for generating a proactive baseline schedule. The robustness of the proposed model was assured by adopting stochastic durations with time buffers between activities. The baseline schedule was generated relying on a two-stage approach: the first stage solves the *RCPSP* using average activities durations, then at the second stage, safety time buffers were added to assure the robustness of the schedule. The temporal buffers are inserted to act as cushions to prevent the propagation of any disruption throughout the schedule. The buffer size in front of an activity is estimated based on two factors: first, the temporal variability of all the predecessors of the considered activity (in function of their standard deviation); the second is the baseline cost deviation that reflects how costly it is to disrupt the starting time of a given activity in relation to its predecessors and successors in the schedule. Lambrechts et al. (2008) adopted the concept of uncertainty in resource availabilities that are subject to unforeseen breakdowns. They developed eight proactive approaches relying on three main strategies: -the addition of time buffers in front of the activity's schedule, -generating schedules based on resources buffering, -schedule first, the activity with highest cumulative instability weight. The resource buffer size was computed from the probabilistic distribution of the resources availability.

2.2.3 *Schedule robustness*

The realised schedule is the schedule that can be known after finishing the project: at this level, the complete and certain information about the activities durations, their start dates will be known certainty, even for the resources used to perform these activities. The actual robustness of a planned schedule can be defined as a function of the deviation between this realised schedule and the predictive one, (Van de Vonder et al., 2007a). According to Lambrechts et al. (2008), it is necessary to protect the baseline schedule against the adverse effects of possible disruptions, in order to avoid the schedule repair consequences especially in some cases including subcontracted activities or jobs executed by resources that are not exclusively reserved for the current project. In such situations, the changes in activities start dates could lead to infeasibilities or penalties to the stakeholders, or at least causes system nervousness (Goren and Sabuncuoglu, 2008). The robustness of a baseline schedule is defined from the number of interventions of the reactive components during the execution phase, and the robustness of the predictive baseline schedule will be all the lower as this number is important (Demeulemeester et al., 2008).

Developing metric measures to estimate the schedule robustness is essential for building robust scheduling algorithms (Hazır et al., 2010). At planning level all the quantitative metrics of sensitivity analysis and robustness are surrogate measures. Ali et al. (2004) developed metrics to measure the robustness degree of the resources allocation in parallel and distributed computing. This robustness measure follows a four step process: -determination of the system performance parameters, -identification of the "perturbations" of the environment parameters that could affect the system performance, - "mathematical" mapping of the impact of the perturbation parameters on the system performance features, -then determination of the smallest collective variation in the

perturbation parameters that will violate the performance features acceptable variation (this represents robustness degree). Hazır et al. (2010) proposed slack-based measures to assess schedule robustness; some measures can be computed as: -Average total slack, - the sum of weighted total slacks, -The slack utility function, -the coefficient of variation of activities slacks, -Potential criticality of the activity, -the project buffer size, which is a temporal tolerance between the project contractual delivery date and the project planned completion date, proposed by Vidal et al. (1999) and adopted by Edi, (2007) and Attia et al. (2012c). The project buffer is used as an aggregated safety factor, instead of allowing a safety factor to each activity. They provided empirical evidence that the project buffer size is the more appropriate robustness measure regardless of the project network complexity. Goren and Sabuncuoglu (2008) proposed two surrogate measures related to the schedule robustness and stability in the application of single machine with random breakdown events: the robustness measure is relying on the expected real performance, and the stability measure is relying on the expected deviation of the real schedule from the baseline schedule.

2.2.4 *Flexible schedules*

Schedule flexibility is the freedom allowed at the execution phase for building the final realised schedule (Billaut et al., 2010). According to Herroelen and Leus (2005) or Aloulou and Portmann (2005), integrating proactive schedules with some built-in flexibility minimises the need of complex search procedures for the reactive algorithm, and increases the robustness of the system. Billaut et al. (2010) also illustrated that building a robust schedule is all the easier as the schedule is more flexible. Introducing flexibility in scheduling can be done following two directions: activities-based flexibility, and resources-based flexibility.

In *activities-based flexibility*, one can develop the flexibility *via* activities temporal events, such as the activities start dates, or the sequence of their execution. Activities-based flexible schedules can be generated according to the partial order scheduling proposed by Policella et al. (2004) or Aloulou and Portmann (2005), or performed with the ordered group assignment representation (Artigues et al., 2005). Aloulou and Portmann (2005) presented a proactive-reactive approach for the single machine scheduling. First, they aimed to develop the schedule flexibility by building a set of schedules restricted to follow a partial order of jobs. Then, this flexibility can be used on-line (during the execution phase) as a hedge against some changes in the workshop environment. It can also be used by the decision-maker to take into account some preferences or some non-modelled constraints. They proposed two types of scheduling flexibility: the job sequencing flexibility –and the temporal flexibility. The job sequence flexibility was measured as the number of feasible partial ordered schedule scenarios; the temporal flexibility was measured as the ratio between the time window in which the jobs can be executed and the total processing time of the jobs. During the execution they proposed the reactive approach that has to perform the following: - fix the remaining schedules decisions, - react to the perturbation that can occur, - detect the unfeasibility of in-process schedule with respect to the stakeholders' objectives, and if necessary, switch to another feasible one.

Resources-based flexibility refers to the easiness of dynamic reallocation of one or more resource(s) during the execution phase, without disturbing the activities predictive schedule. Dautère-Pérès et al. (1998) adopted the general workshop problem with integrating: -The multi-resource (an operation may be created by more than one machine), -The resource flexibility (a resource may be selected from a given set to create a specified operation

with machine-dependent processing time), - And a nonlinear routing of the products in the workshop (each job can have many predecessors or/and successors). Considering the manpower flexibility, Daniels and Mazzola (1994) and Daniels et al. (2004) explored the operational benefits of the job-shop problem by adopting the manpower partial flexibility (cross-trained workers). The operations processing times are elastic, depending on the number of allocated workers. They proposed a flexibility measure based on the workforce degree of cross-training, for the total workforce and for each work-station, known as “station balance”. Other human resources flexibilities were adopted in literature, such as workers polyvalence, and working time modulation: they will be presented in some details in (section 2.3.2).

2.3 CONSIDERING MANPOWER IN SCHEDULING

2.3.1 Workforce allocation problem

Hendriks et al. (1999) discussed a hierarchical approach of workforce allocation in a large R&D organisation, which considers long-term, medium-term, and short term workforce allocations (as shown by Table 2.1). The long-term plan is based upon the business plan that specifies the workforce required from each skill, for at least the coming year(s). This intention of developing certain discipline is translated into yearly budgets for a given department or teamwork. According to them, the distribution of the resource budgets must give a rough indication of the future efforts expected from each discipline. As previously discussed (chapter 1), the first result of the medium term must be the work contents, therefore this level can be used as a good tool to provide a link between the budget and a rough resource-allocation, when the appropriate projects are selected. The resulting *RCCP* (rough-cut capacity planning) has to be an agreement between the project leaders and the resources managers. The main inputs of the short-term-resource-allocation are the *RCCP* and the assignment decisions, and the main output is the day-to-day scheduling of each operator, and his working calendar for the schedule horizon. The links between the long, medium and short-term allocation process provide the organisation with the needed information and decisions for doing business. During the different levels, the decisions should be evaluated by comparing the input decisions to the real outcomes, and then ensuring the feedback can enhance the business performance. According to Franchini et al. (2001) and Edi (2007), the short-term human resource management in manufacturing systems is a difficult task to perform because of the increasing complexity of existing working conditions and regulations, and the need to take into account the context of the manufacturing.

Table 2.1 Three resource allocation processes with their specific goals (Hendriks et al., 1999)

Resource allocation process	Purpose	Output	Frequency	Horizon
Long term	needed capabilities for accomplishing the Business Plan	<ul style="list-style-type: none"> • department plan, budget per capability 	yearly	5 years
Medium term	rough cut capacity planning for the project portfolio	<ul style="list-style-type: none"> • portfolio check, which projects must be executed • decision rules for group leaders • analysis of the effects on the milestones of the projects (changes in targets) • agreed rough allocation as input for the short term resource allocation 	quarterly	±1 year
Short term	operational day-to-day assignment of people	<ul style="list-style-type: none"> • assignment of tasks to persons, within the medium term resource allocation assignment 	Bi-weekly	±6 weeks

Hlaoittinun (2009) classified the workforce allocation problem into two main categories relying on the periods of assignment: Single-period allocation and multi-period allocation. The single-period deals with allocation of staff

according to a fixed schedule (day, week ...), whatever the tasks allocated during this period: the ordering constraints between tasks have then no impact on the work of actors since they are already taken into account in the original schedule; in contrast, multi-periods allocation is defined according to both manpower allocation constraints as well as activities ordering constraints, which take into account the temporal relationships between tasks.

2.3.1.1 Single period allocation

Single period allocation contains the personal scheduling such as shift scheduling or employee time-table, line of work, or more generally rostering edition (Meisels and Schaerf, 2003; Demassej et al., 2005). The line of work is usually called “tour scheduling” when dealing with flexible demand, and “crew rostering” when dealing with crew pairings (Ernst et al., 2004). According to Eitzen (2002), there are three types of employees’ rostering: Fixed rostering: employee repeats the same typical roster from week to week (assuming one week as the roster cycle), - Cyclic rostering: the operator works the same sequence of shafts (i.e. sequence of day morning, day afternoon, or nights) over the active roster cycle (e.g. week), and for the next cycle he/she will be shifted to work on the other sequence, -Dynamic roster is a reactive action to changes in operators’ availability or their requirements relying on the previous and current information.

There are numerous models concerning this problem; Brusco and Jacobs (2000) presented an implicit tour-scheduling formulation of the "7 × 24" problem that incorporates both meal-break and start-time flexibility; Eitzen (2002) investigated mathematical models coping with rostering of multi-skilled workforce, and proposed a dynamic rostering approach; he stated five steps to solve the rostering problem: - demand determination – translate demand into workforce for each skill, - determination of the schedule horizon, construction of the tour of shifts (lines of work or individuals rosters), -Assign tours to employees. Yoshimura et al. (2006) propose a human resources assignment approach within R&D projects: first, selecting the projects portfolio, taking into account the availability of different skills. The assignment decision represents the total working time allocated to an operator to work for a given project. Heimerl and Kolisch (2009a) considered a problem similar to that of Yoshimura et al. (2006), considering the scheduling of IT-projects, and staffing internal and external people with heterogeneous static efficiencies. Hertz et al., (2010) modelled the multiple shift workforce allocation problem taking into account holidays constraints. Recently, Shahnazari-Shahrezaei et al. (2012) modelled and solved a problem of multi-skilled manpower allocation on a continuous production line: the problem was to allocate workers with two specializations and three skill levels (i.e., senior, standard, and junior) in each specialization, these workers should be allocated on three 8-hour shifts, during a planning period of 28 days (four-weeks). Two sets of objectives were considered, one related to employers and the other related to employees. For more details about the problem classification and the different models, one can see Eitzen (2002); Ernst et al. (2004); or Brucker et al. (2011).

2.3.1.2 Multi-period allocation

In the multi-period allocation, the tasks schedule is done simultaneously while allocating the workforce to different missions. The project scheduling and resources staffing cannot be easily separated in some contexts, especially when the schedule is based on specific productivities of the assigned workforce. Thus both decision problems are aggregated and should be decided simultaneously. Different works in the literature have considered

simultaneously the human resources allocation with activities scheduling problems. Cavalcante et al., (2001) adopted the problem of minimizing the project makespan, subject to the precedence and labour constraints. Hanne and Nickel (2005) adopted a problem related to software development, in which the project contains a set of five sequenced activities (coding, inspection, reworking, testing, and reworking). Bellenguez-Morineau and Néron (2007) treated the problem by considering the homogenous static multi-skill workforce concurrently with the project scheduling problem. The model objective is classically to minimize the project due date respecting the classical finish-start precedence and resources availabilities. Edi (2007) adopted the problem with multi-skilled workforce with static heterogeneous productivities, with respecting the legal and working time restrictions. The proposed model takes into consideration the different temporal relations between activities with temporal delay. Drezet and Billaut (2008) adopted the multi-skilled workforce and introducing the temporal regulation of the minimum and maximum number of working periods per day. Their model introduced the classical finish-start precedence constraints with zero time lags. Noack and Rose (2008) presented the allocation of workforce on assembly lines of aviation industries with the objectives of reducing the workforce quantity and the slack time. In this case, jobs can have different routes in the assembly process; each route consists in a well-defined sequence of more than 200 activities.

Other models introduced the generalised temporal relations between activities: Li and Womer (2009) considered the problem with generalized temporal constraints including tasks due dates, minimum and maximum time lags. In their model the completion of each task may require multiple skills simultaneously, the same view as Edi (2007), and each skill requires only one individual selected from the group of the actors who are qualified for this skill. Valls et al. (2009) modelled the multi-period project schedule problem with generalized precedence constraints (GPC): the time lags between tasks can be represented either by a certain amount of time, by a given work progress on the task, or simply by a percentage of the task duration. According to them the percentage-based representation in time lags allows to model practical situations where the durations of the tasks depend on the mix of resources assigned to it. Recently, Yannibelli and Amandi (2012) adopted a multi-period employees allocation within the context of software development, with objectives involving the assignment of the most effective set of human resources to each activity. Attia et al. (2012c) treated the problem with general temporal relations, heterogeneous multi-skilled workforce, under different kinds of working time constraints. Details of the model dimensions will be presented in chapter 3.

2.3.2 Workforce flexibility

The flexibility can be viewed as the creation of firms' capabilities that can exist in different forms throughout the organization Koste and Malhotra (1999). Human resources are one of the important dimensions of firm's structure to develop flexibility. Their capacities should be planned and scheduled with some levers of flexibility in order to cope with unforeseen events. Works as Youndt et al. (1996) argued that the manufacturing flexibility depends much more on people than on technical factors, and firms must develop multi skilled, adaptable, high responsiveness workforce that can deal with the non-routine and circumstances that require creativity and initiative, for a successful flexibility strategy. The workforce flexibility can be gained by adopting one or more strategem(s) from the following: – external quantitative flexibility – out-sourcing – internal quantitative flexibility – functional flexibility – remunerations flexibility. As explained in Démercy-Lebrun (2005), external quantitative flexibility enables the company to fluctuate the workforce by hiring people with short-term

contracts. Manpower outsourcing consists in contracting with the firm's partners to perform given activities with their own resources – the contract may also consider only individuals. The internal quantitative flexibility can be achieved relying on the workers working hours, by allowing overtime or/and adopting the working time modulation with annualised hours. The functional flexibility is based on the multi-skill nature of the workers. Remunerations flexibility enables to vary the employees' salaries. In the present work, we are interested to the internal workforce flexibility: qualitative (known here as temporal flexibility) or multi-functional flexibilities.

2.3.2.1 Temporal flexibility

Workforce temporal flexibility comes from two main axes. The first is the traditional overtime working hours, and the second is the working time modulation under annualised hours "AH". AH strategy is the opportunity to spread irregularly a predefined number of working hours on a pre-specified period (often one year), respecting a set of pre-defined constraints. According to Corominas et al. (2002, 2007), it provides a great flexibility with reasonable costs, but on the other side it can result in a worsening of the staff's working conditions. To minimise these negative consequences, this strategy of working time has to be negotiated and may be accompanied by some kind of reward or incentive: such as a reduction in annual working time (e.g. *35 hours' law* in France), additional holidays or financial compensation. Simultaneously, legal constraints or collective bargaining agreement constraints must be respected to avoid excessively overburdening workers during long high-demand periods.

Responding to the importance of such flexibility, numerous works were conducted; Hung, (1999) proposed different scenarios of weekly manpower planning based on the AH. The shift length can be varied according to the workload requirements from week to week. Grabot and Letouzey (2000) presented a software prototype to check the feasibility between the required workload and workforce capacities for discrete manufacturing short-term planning and scheduling. The proposed model considers the AH framework moreover to actors' polyvalence on different machines within the workshop. Filho and Marçola (2001) estimated the rough cut capacity planning in manufacturing agriculture equipments relying on the AH flexibility. Corominas et al. (2002) presented a mixed-integer linear program to the planning of two categories of workforce all over the year, supposing that the vacation weeks are pre-specified. The model's objectives is to reduce the overtime costs, the cost of outsourcing and the penalties associated with allocating a non-qualified worker to a given mission. The constraints arise from the French laws on working hours. This enforces the model to respect the different milestones of working hours such as the number of working hours per year, the overtime number of working hours, the variation in weekly work relying on the number of strong and weak periods. After solving the allocation problem, they proposed a smoothing approach to distribute easily the workers' hours on the corresponding weeks while keeping the same objectives. Azmat et al. (2004) adopted the problem of single shift workforce scheduling under AH with Swiss legal constraints. They proposed a MILP model taking into account the maximum working hours per week, overtime hours, and the holiday's constraints. Corominas and Pastor (2010) proposed a reactive re-planning approach of the short-term workforce allocation with the objective of minimizing the cost associated to the new plan and the impact on the baseline schedule. The yearly baseline schedule was generated in a similar way to that of Corominas et al. (2002).

2.3.2.2 Multi-functional flexibility and job-rotation

Workforce multi-functional flexibility is the ability of a given worker to develop a set of competences required to perform different tasks, associated with multiple activities resulting from changing load-contents, production methods or technology. This flexibility is naturally embedded in the workforce, where they have the ability to migrate from a workstation to others, when and where needed. However it requires heavy training programs to produce and develop a multi-skilled workforce. Koste and Malhotra (1999) defined it as “the number and variety of tasks/operations a worker can execute without incurring high transition penalties or large changes in performance outcomes”.

This flexibility dimension has had a great attention in literature in many applications, starting by Nelson (1970) who investigated the cross-training configurations in job-shop with dual resources. Brusco and Johns (1998) examined different cross-training configurations in planning the maintenance operations in a large paper-mill factory, aiming to minimise the staffing costs associated to the heterogeneous productivity levels. Bokhorst and Gaalman (2009) explored the effect of cross-training workers on dual machines that have different mean processing times. In project scheduling problem, Bellenguez-Morineau and Néron (2007) and Al-Anzi et al. (2010) extended the traditional *RCPSP* with the objective of minimizing the project makespan by integrating the homogenous workforce multi-skilled flexibility. In software development Hanne and Nickel (2005); Li and Womer (2009); and Yannibelli and Amandi (2012), introduced the multi-skilled personnel into *RCPSP* to minimize the total staffing costs. Hanne and Nickel (2005) integrated quality objectives expressed by the number of defects depending on the developers’ skill levels. Yannibelli and Amandi (2012) adopted the objective of assigning the most effective resources for achieving a given job. In call-centres, Avramidis et al. (2010) examined a day schedule problem with multi-skilled employees; the model specifies the stochastic data for the call arrivals and the duration of each call. In health care and hospitality sectors, Caron et al. (1999) proposed the problem of nurse schedule under seniority and job priority constraints. Recently Shahnazari-Shahrezaei et al. (2012) modelled the multi-shift workforce problem in manufacturing of polyethylene pipes and connections for drip irrigation.

On the other side, Hoyt and Matuszek (2001) empirically showed that there is no direct relationship between employees’ skill diversity and financial performance in high technological industries. And companies should be aware of over-skilled workforce when considering plans to expand employee skill sets as part of a strategy for improving their responsiveness. The same conclusion was adopted by Attia et al. (2012a), over-skilled workforce can be misleading and have negative consequences on the financial aspects, especially during the experience acquisition periods (this will be discussed in chapter 7). However, the multi-skill capabilities may be associated with systemic changes that result in improved financial performance.

2.3.2.3 External labour flexibility

As mentioned earlier, the external flexibility refers to the adjustment of the required workforce from external sources. According to Goudswaard and De Nanteuil (2000); Valverde et al. (2000) or Démary-Lebrun (2005), this can be achieved by employing workers on temporary work or fixed-term contracts or through relaxed hiring and firing regulations, where employers can hire and fire permanent employees according to the firms’ needs. The main reason of this flexibility is the cost reduction strategy by means of transferring risks and costs to other employment situations. This type seems to provide the companies with a rapid and costless strategic flexibility

countering turbulent changes in customer demands, but it has a serious effect on the development of core competences (Hitt et al., 1998). In addition to the direct cost and time resulting from the recruitment of high staff turnover, a non-productive time comes from the establishment of new workers in the job (Valverde et al., 2000). For more details about the factors that manage the choice between external and internal labour flexibilities, one can refer to the work of Caroli (2007). In the problem of planning and scheduling human resources, the external flexibility is often introduced at the tactical level in order to balance the requirements (Hans, 2001). Kis (2005) used the outsourcing capacities to resolve the problem of *RCPSP* with varying the intensity of activities per period with the objective of minimizing the cost associated to the use of the external resources. Heimerl and Kolisch (2009a) supposed that the outsourcing cost per worker is higher than that of internal workforce in order to favour the staffing of internal workforce on the multi-projects activities.

2.3.3 Modelling of workforce productivity

The modelling of the workers effectiveness has taken many faces in the literature. The scaling levels adopted by Grabot and Letouzey (2000) give each worker a grade within the interval [1, 5]. Then the hierarchical levels proposed by Bellenguez and Néron (2005) give to each worker a specified skill level in a specified job (the job processing time is predefined). Yoshimura et al. (2006) ranked workers according to their skill levels in the set {0, 0.5, 1, 2}, this four ranks corresponding to employees' skills of {novice, informed, experienced, expert}. Similar to this modelling, Heimerl and Kolisch (2009a) proposed three categories of modelling the workforce efficiency: $-\ (\theta > 1)$ for people with high productivity rates, $-\ (\theta < 1)$, for low productivity rates – and $(\theta = 1)$ for all out-sourcing employees. Valls et al. (2009) sorted the workers according to their skills in three categories (senior, standard and junior) and give to each category a skill value (1, 2 and 3), respectively; in their model, the execution time of a given task varies according to the skill category with $\pm 25\%$ from the standard one, i.e. the senior worker requires $(0.75 \times \text{Activity-Standard-Time})$, and the junior worker requires $(1.25 \times \text{Activity-Standard-Time})$. With the same classification, Shahnazari-Shahrezaei et al. (2012) classified the labour into the same three categories (senior, standard and junior) with the assumption that a high skilled person can perform any mission initially devoted to a lower-skilled person. In order to avoid the assignment of over-experienced people to a given activity, they associated penalties to the allocation of an expert to lower levels of skill.

The workers effectiveness was also presented as a fraction normalised over the interval [0, 100%] (Brusco and Johns, 1998), or over the interval of [0, 1] (Bobrowski and Park, 1993; Kher et al., 1999; Duquenne et al., 2005; Thompson and Goodale, 2006; Edi, 2007; Gutjahr et al., 2008; Certa et al., 2009; Corominas and Pastor, 2010; Attia et al., 2012c). Campbell and Diaby (2002) named it as worker capability that was presented as a real value within [0, 1]. Also, in this representation, the zero values indicate that the operator hasn't any qualification to perform the given skill, and the maximum value (100% or 1) means that the worker is an expert. In the following, we will discuss the measurement of this critical parameter and the different ways to take it into consideration in the problem of human-resources allocation.

2.3.3.1 Workforce performance measure

Estimating the human-resources effectiveness is an obvious action to compute their available capacities, and so the activities schedule performance. Due to the importance of this factor many scholars integrate the effectiveness concept in their task allocation models (Bennour et al., 2005; Yoshimura et al., 2006; Edi, 2007;

Valls et al., 2009; Corominas and Pastor, 2010; Attia et al., 2012c). Relying on the three-axis (temporal, financial and quality) performance, Bennour et al. (2005) described a methodology adopted by their industrial partners to estimate the activity performance: it is based on three main parameters: -The estimated nominal performance -The modulation coefficient associated to each skill, - And the skill important weight. The essential parameter in the activity performance model is the quantification of the resources performance that was assumed to be available. This availability assumption was adopted by many authors (Yoshimura et al., 2006; Valls et al., 2009; Corominas and Pastor, 2010; Edi, 2007; and Attia et al., 2012c) supposed that this effectiveness can be calculated relying on the ratio between the worker actual productivity rate and a nominal one. In job-shops, Kher et al. (1999) supposed to estimate it relying on the learning-forgetting effects. Majozi and Zhu (Frank), (2005) presented an application of fuzzy sets theory within the context of integrated batch processes planning and scheduling. In their model, the operators are fuzzy evaluated to (not competent, reasonably competent, and highly competent) based on the linguistic terms that can be used to produce a fuzzy decision table, relying on their age, experience, expertise, health, and availability. Hanne and Nickel (2005), Yannibelli and Amandi, (2011), Yannibelli and Amandi (2012) aligned with Doerr and Arreola-Risa (2000), proposed to estimate the productivity of an employee relying on activities and persons attributes: - the nature of the activity and work contents, domain of knowledge, complexity etc. – the employee characterisation is based on the available information such as curriculum vitae, expert evaluations, information about his/her participation on previous projects, etc. – the other employees assigned to the same activity, - the required skill. Then these parameters can be used to attribute the employee an effectiveness value within the interval [0, 1].

2.3.3.2 Homogenous workforce performance

In the problem of multi-skilled workforce allocation to different activities, there are two ways of considering employees' performance: homogeneous or heterogeneous productivity. One should differentiate between the worker-based homogeneous productivity and the skill-based homogeneous productivity. In the first, each worker can master a set of different skills with equal productivity rates, whatever the skills. In the second case (skill-based), all workers can behave the same performance rates in practicing a given skill. In this vision, Cai and Li (2000) proposed two types of resources: the first is unary-skill and the second is multi-skill with homogeneous productivity (more expensive). Fraser (2009) adopted this homogeneous nature in his investigation of the impact of labour flexibility on team processes and team effectiveness in cellular manufacturing. Bellenguez-Morineau and Néron (2007) modelled the multi-skilled project scheduling problem “*MSPSP*”, in which each actor can master a set of skills with equal performance rates, and all workers perform the same rates in any skill. Others like Daniels et al. (2004) considered the homogeneous productivity in flow-shop activities scheduling. They adopted the concept of cross-trained workers for different workstations, with the ability of performing a given task or not: in their model, all actors having this skill are able to perform a given task with equal amount of time. Corominas et al. (2006) assumed homogeneous working efficiencies for all of the completely multi-functional workers in service centres. Drezet and Billaut (2008) and Li and Womer (2009) considered this multi-skilled workforce characteristic in the software industries. Avramidis et al. (2010) presented it in call centres. Recently, Kazemipoor et al. (2013) applied this vision in project portfolio scheduling with multi-skilled workforce.

2.3.3.3 Mixed workforce performance

The case where the two workforce productivities, the “worker-based” and the “skill-based”, one is homogeneous and the other is heterogeneous, is called “mixed workforce performance”: Grabot and Letouzey (2000) proposed a mixed model of homogeneous/heterogeneous workforce performance. They scaled the workers skills in five levels, and each activity requires a pre-specified skill level, therefore, the allocation process relies on the activity satisfaction by assigning the workers with the required skill levels. The allocated workers may have the same required skill level; therefore this case is considered as a mixed model. Considering the heterogeneous performance-based workers, Eitzen et al. (2004) proposed an employee rostering model that considers a multi-skilled nature of workforce, taking into account that each worker has a core competence and one or more additional one(s). In order to avoid the loss of these supplementary skills, they supposed that during each fortnight, every worker should be allocated for his/her additional skill during at least one shift. Bellenguez and Néron (2005) modelled the problem of MSPSP, considering that each worker can master a set of different skills, with a maximum operational skill level associated to each one of them. On the other side; the performances of all workers in practicing a given skill are equal (workers’ homogeneous performance), so we considered it as a worker’s heterogeneous performance. In qualitative models of workforce productivity (such as: senior, standard, and junior), all workers of the same category can be considered as a homogeneous, therefore this modelling view can be considered as a mixed one (Yoshimura et al., 2006; Valls et al., 2009; Shahnazari-Shahrezaei et al., 2012).

2.3.3.4 Heterogeneous workforce performance

We call multi-skilled workforce as completely heterogeneous in the case where neither worker-based productivity, nor skill-based productivity, are homogeneous. According to the best of our knowledge, the first work in this heterogeneous workforce characteristic is the work of Nelson (1970) in a dual resource constrained “DRC” job-shop with two work centres. He examined the effect of limited employee productivity policies (referred as “labour efficiency”), along with policies concerning the degree of centralized control and queue discipline. The results suggested a strong interaction between the degree of centralized control and labour efficiency. Then Bobrowski and Park (1993) considered this heterogeneous vision in investigating the staffing rules on job-shop problems. Campbell and Diaby (2002) introduced this performance diversity in staffing a cross-trained workforce on multiple departments. Cowling et al. (2006) introduced the productivity function of staff allocation on the problem of multi-site activities scheduling. Heimerl and Kolisch (2009a) and Kolisch and Heimerl (2012) adopted this heterogeneous vision in staffing and scheduling multi-skilled workforce on IT-multiple projects activities. In order to preserve the company’s core competences, they constrained a given minimum percentage of the work to be performed by the internal workforce. Hanne and Nickel (2005), Al-Anzi et al. (2010) adopted it in staffing employees and scheduling the different activities of software production. Recently, we can find the work of Yannibelli and Amandi (2011), Attia et al. (2012c) or Yannibelli and Amandi (2012) that adopted the heterogeneous workforce productivities.

2.3.4 Dynamic vision of workforce performance

The dynamic vision of the workers performance is the continuous changes in their productivities as a function of experience accumulation: “learning-by-doing”, or loss of capacities in reasons of forgetting. Considering this dynamics vision of experience, the assignment of workers to different activities has received relatively little

attention in the literature. This is partially due to the difficulty in collecting detailed performance data at the individual level (Nembhard, 2001). Microscopically within the industrial context, there are two levels of learning; the first is the managerial or organizational learning and the second is the individual learning. In this section, we will discuss the different modelling of these phenomena (learning, forgetting), and review a subset of works which considered them.

2.3.4.1 Experience development

The amount of time or effort required to complete a given task will decrease every time the task is repeated, i.e. the actors can perform their tasks more efficiently and more rapidly if they go on working on the same activity as long as possible. According to DeJong (1957), this skill development phenomenon includes not only the under-skilled workmen but also the skilled and experienced operators. This phenomenon has been followed in product cost estimation, since the period between the two world wars. It has many labels in literature, such as the learning curve, progression function, product acceleration curve, improvement curve, performance curve, experience curve, efficiency curve, even learning-by-doing and cost-quality relationships, (Badiru, 1996). It was first described by Wright (1936) who reported it as one of the factors that affects the cost of airplanes; in his research work, the labour cost of an aircraft is declined significantly with the accumulated experience gained from the repetition of the manufacturing process. This cost showed a constant reduction percentage with each doubling of the cumulative production. He then plotted his empirical relationship “unit cost versus serial number” on a log-log scale as a straight line, and named it the “eighty percent curve”, since he found that a value of “eighty percent” represents the exponent of the learning curve based on the relation (learning curve exponent = $\log(0.8)/\log(2)$). Since this finding, the phenomenon is admitted but there is a hard debate between scholars about its most representative mathematical model.

2.3.4.1.1 Modelling of learning phenomenon

Within the literature we can find many formulations of the learning curve “LC”, starting from the power model of Wright (1936). According to the review paper of Yelle (1979), the reason for searching other models than the log-linear of Wright (1936) is that the log-linear model does not always provide the best fit in all simulations. But on the other side, it is the most used model in reasons of its simplicity and generality of applications. Nembhard and Uzumeri (2000a) classified the LC’s according to two attributes relying on the originated bases: aggregated models or individual models, where Badiru, (1992) classified them according to univariate or multivariate models. Relying on the work of Badiru, (1992, 1996), Nembhard and Uzumeri (2000a) and Osothsilp (2002) we present a set of these models on Table 2.2.

The variable b is computed in function of the learning rate; the lowercase is the value of learning curve slope, and the uppercase is the learning effect. According to Badiru (1992) the set of models listed in (Table 2.2) are univariate models (there is only one independent variable). And to accommodate numerous factors that can influence how fast, how far, and how well a worker learns within a specified horizon, multivariate models were proposed: for more details, we propose the works of Badiru (1992), Badiru (1996) or Shafiei-Monfared and Jenab (2010).

Table 2.2 A subset of the previously proposed learning curves models

	Name	Form	Number of parameters	Author(s)	Remarks
Aggregated models	Log-linear	$y = C_1 x^b$	(C_1, b)	Wright, 1936	y : production cost at unit x , C_1 : first unit production Cost, b : learning curve exponent, B : equivalent experience at the process start (previous produced units), M : incompressibility factor. μ : first part production index κ : constant used to flatten the learning curve for large values of x (the produced units).
	Stanford-B	$y = C_1 (x + B)^b$	(C_1, b, B)	Asher, 1956	
	DeJong	$y = C_1 [M + (1 - M)x^{-b}]$	(C_1, b, M)	DeJong, 1957	
	S-Curve	$y = C_1 [M + (1 - M)(x + B)^b]$	(C_1, b, B, M)	Carr, 1946	
	Levy's function	$y = [\frac{1}{\mu} - (\frac{1}{\mu} - \frac{x^b}{C_1})\kappa^{-\alpha}]^{-1}$	(C_1, b, μ, κ)	Levy, 1965	
individual models	Exponential	$y = Y(1 - e^{-x/h})$ $y = Y(1 - e^{-(x+B)/h})$	(Y, h) (Y, h, B)	Mazur and Hastie, 1978	y : production rate at unit x Y : nominal production rate h : cumulative production required to attain one half of the nominal performance
	Hyperbolic	$y = Y[x/(x + h)]$ $y = Y[(x + B)/(x + B + h)]$	(Y, h) (Y, h, B)		
Combined	Pegels function	$y = Aa^{x-1} + b$	(A, a, b)	Pegels, 1969	(A,a,b): parameters based empirical data analysis
	Knecht's	$y = C_1 x^b e^{cx}$	(C_1, b, c)	Knecht, 1974	c : is a constant

2.3.4.1.2 Individual versus organization learning

The overall organisation learning is deduced from the aggregation of individuals' learning, and other parameters' accumulation over time, including improvement of tools, quality control, improvements in methods, incremental design modification, etc. Therefore, the organisational learning refers to total learning accumulated in an organisation relying on continuous improvement (Kim and Seo, 2009). Organisations can learn independently of any specific individual, but it cannot learn independently of all individuals, and it is difficult to distinguish between the different sources of learning. Anderlhorre (1969) divided company learning into five elements: personal learning, supervisory learning, continuity of productivity (related to the physical positioning of the production line), methods, and special tooling. Distinguishing between individual learning and the organisational one is a hard task, however, Dierkes et al. (2003) presented in detailed the different points of view about the link between individual learning and organisational learning. Howick and Eden (2007) discussed the desegregation of the organisation learning, such that learning within a given organisation is made up of two dominant elements: individual learning and corporation learning (known as organisational learning). They defined the corporative learning clearly as the part or overall learning that remains intact after an individual worker has been removed from the task. (Castaneda and Rios, 2007) details some models of organisational learning based on two cyclic processes: from the individual to the organization (feed forward) and from the organization to the individual (feedback). They stated that: "organizational learning is a process based on individual learning through private and public organizations engaged in creating and obtaining knowledge for the purpose of institutionalizing it, in order to adapt as an organization to the changing conditions of the environment, or to change the environment proactively, depending on its level of development". Recently, Bolívar-Ramos et al. (2012) showed that the organisational learning has an impact on the individual learning (e.g. changing a given procedure required to be relearned by a specified operator). And organization learning is influenced by top management support.

2.3.4.1.3 Considering learning in industry

Learning effects have been found to operate in many manufacturing situations including aviation industries (Wright, 1936; Asher, 1956; Hartley, 1969). In assembly lines, Chakravarty and Shtub (1992) introduced the learning phenomena in the mixed assembly lines as one of the parameters that make lines unbalanced. Therefore,

they developed a methodology for redesigning the line. The objective is to minimize inventory costs, setup costs, and labour costs subject to dynamic capacity constraints dictated by the learning effect while satisfying demand without back orders. In software development, Hanakawa et al. (1998) proposed to use the developer's learning curve to compute developer's productivity and the quantity of gain to the developer's knowledge after executing an activity. Their model contains three attributes: activity, knowledge and productivity attribute. The different levels of knowledge required by the sub-jobs of an activity attribute were defined relying on the normal distribution for the knowledge type. The developer productivity was modelled in function of the required level of knowledge by the activity and the actual level of the developer. The knowledge attribute represents the gain of knowledge of an individual after performing a given activity it was modelled based on individual efficiency of gain knowledge (learning) and the maximum amount to be learned. In resources planning, Liao (1979) incorporated learning effect in resource planning for product-mix problem and production scheduling. Khoshnevis and Wolfe (1986) also introduced the learning effect in the aggregated workforce planning. Nembhard (2001) proposes a heuristic approach for worker assignment based on individual learning rates. In project scheduling and personal staffing, Wu and Sun (2005) considered the learning effect in allocating staff to multi-project activities in the research and development (R&D) departments. The objective function is to minimize the outsourcing costs that will be applied whenever any task cannot be completed before its due date. The cumulative average efficiency was used to estimate the particular efficiency of a given employee. Also In R&D organisations, Certa et al. (2009) presented the heterogeneous workforce allocation problem with incorporation of leaning effect, and workforce social relations. In concurrent engineering on software industry, Huang and Chen (2006) proposed to estimate the project completion time relying on a set of parameters including learning effect.

2.3.4.2 Experience degradation

Reciprocally to the development of the actors' experience, thanks to learning-by-doing effect, we can find the erosion of this experience due to the lack of practice of a specified discipline. This phenomenon is known as 'forgetting effect' (Elmaghraby, 1990), and it has many names including: experience degradation, experience deterioration, experience depreciation or experience erosion. The amount of experience deterioration depends on the amount of experience gained prior to the interruption, the rate of forgetting, and the length of the interruption period (Bailey, 1989; Globerson et al., 1989; Jaber and Bonney, 1996). Within the industrial environment, the lack of practice induced by work interruptions, which can be produced from machines breakdown, product modifications, changing tools, discontinuous production of a given product, transforming workers between skills, introducing new machines, new technologies, production breaks, and vacations. According to Jaber (2006), scientists and practitioners have not developed yet a full understanding of the behaviour and factors affecting the forgetting process. And on the organisation level, knowledge can depreciate because of worker turnover and changes in products or processes that make previous knowledge obsolete. By the following, we will review a set of different attempts to model the forgetting and the industrial applications.

2.3.4.2.1 Modelling of forgetting phenomenon

In order to model the forgetting and computing the experience deterioration, within literature, one can find three types of the modelling of forgetting effect on individuals' performance, as classified by Jaber and Sikström (2004). The first is the use of mathematical modelling without using empirical data such as that of the learn-

forget-learn model of Carlson and Rowe (1976), the variable regression to invariant forgetting (VRIF) of Elmaghraby (1990), the learning-forgetting curve model (LFCM) of Jaber and Bonney (1996). The second uses empirical data from real-life setting as a basis of model regression for the individuals' performance decline formula, known as the "*Recency Model*" of Nembhard and Uzumeri (2000b) that was used by Sayin and Karabati (2007). The third type of modelling is the one using empirical data obtained from laboratory experiments as a basis of stochastic regression and analysis of variances: Bailey (1989) considered mechanical assembly/disassembly highly procedural tasks with different complexities; Globerson et al. (1989) considered computer data entry, the tasks was to complete a specific form for a company's employees, each form related to a specific employee; Hewitt et al. (1992) examined assembly of pegboards (as a low cognitive task), and design a spread sheet (as a moderately high cognitive task). According to Jaber and Sikström (2004) there are two limitations of these laboratory experiments-based models of the forgetting curve: the first is the use of short-duration breaks, rather than long interruptions, to simulate periods without practice. The second is the application of these models to experimental settings that often differ from the industrial ones. Other models such as the "power integration diffusion (PID)" of Sikström and Jaber (2002) that relies on strengthen of memory traces during learning and diffusion of these traces during forgetting. And recently, Kim and Seo (2009) proposed a learning curve model that measures acquisition and depreciation of knowledge in a single framework but governed by two different rules: the knowledge acquisition relying on learning-by-doing, and knowledge transfer between production lines.

For the comparison between the different models, Jaber and Bonney (1997) conducted a comparative study between three models of LFL, VRIF and LFCM, noting that the three models are based on the Wright (1936) formula. Jaber and Sikström (2004) conducted a numerical comparison of three potential learning-forgetting models: learn-forget curve model "LFCM" (Jaber and Bonney, 1996), "Recency" model (Nembhard and Uzumeri, 2000b), and "PID" (Sikström and Jaber, 2002). Results indicate that for a moderate learning scenario (where the learning rate classifies a task as being more cognitive than motor skills), the three models, on the average, produced very close predictions for all values of production breaks and initial processing times. So in such learning scenarios the differentiation between the three models by empirical data is quite difficult. But if the task becomes more cognitive than motor skills, the learning becomes faster, and the predictions of LFCM and "Recency model" are below those of PID. Reciprocally, as the task becomes more motor skill than cognitive (slow learning rate) the prediction of the LFCM and "Recency model" are above those of PID. They indicated that the prediction by LFCM is closer to PID than "Recency model". They concluded with: the two models of LFCM and PID suggest that the learning becomes slower as the forgetting becomes faster, in opposite to that of "Recency model", which suggests that, the fast (slow) learners forget faster (slower).

2.3.4.2.2 Considering forgetting in industry

The learning-forgetting phenomena have been considered in industrial applications for decades. Consequently, this section will briefly introduce the most relevant research works and refers the reader to more comprehensive reviews, e.g. the work of Jaber (2006). First, starting from the model of learn-forget-learn of Carlson and Rowe (1976), Kher et al. (1999) performed a numerical analysis on workers learning and forgetting effects in DRC systems. They applied the study to complex tasks where the learning and relearning phenomena have managerial interests, and a direct impact to the firm performance. Therefore, they used the initial processing time as 400% of

the standard one, learning rate of 85% and forgetting rates varies between 85% and 95%. Kher (2000) extended this work, by considering flexibility acquisition in stochastic DRC job-shop environment, and measuring the impact of learning, relearning, and worker attrition on inventory and customer service measures. Yue et al. (2007) too investigated the cross-training policies in DRC parallel job-shop using the same model (LFL), where new part types are regularly introduced and where learning and forgetting play a role. They investigated three factors: the level of multi-functionality, the pattern of skill overlaps, and the distribution of skills. Results showed that limited level of multi-functionality workers gives the best results in most cases. High levels of multi-functional negatively affect performance. The significant effect of the pattern of skills overlaps depends on the lengths of the new part life cycles. Equal distribution of two skills is preferable due to equal worker assignment opportunities.

In assembly lines under learning and forgetting consideration, McCreery and Krajewski (1999) investigated the amount of cross training given to each employee, and the deployment policy on the performance under product varieties and tasks' different complexities. In environment in which workers are learning to process jobs on different machines, Jaber et al. (2003) reviewed and examined factors that influence worker forgetting in industrial settings, and analyzed the degree to which existing mathematical models comply with observed human forgetting behaviour. They used LFCM and VRVF forgetting models to show the effects of cross-training and deployment policies in reducing the forgetting effect. In lot sizing problems, Elmaghraby (1990) integrated VRIF model, where Jaber and Bonney (1996) and Jaber et al. (2009) used the LFCM to determine the economic manufacturing quantities for finite and infinite planning horizons. Others, such as Bailey and McIntyre (2003) developed a parameters prediction model relying on a project management simulator, in order to provide early estimates of post-interruption production times.

In the assignment of workers to tasks based on learning-forgetting behaviour, Osothsilp (2002) introduced workers learning and forgetting based on the assignment on tasks of varying complexity, aiming to enhance the workstation performance. Sayin and Karabati (2007) proposed a framework of two stages to solve the workforce assignment problem with incorporating learning and forgetting effects. The first-stage maximizes the total departmental utility subject to typical assignment constraints (assign the most efficient worker to each department). The optimal values of department utilities were then fed to the second stage model that seeks to maximize total skill improvement while respecting a given deviation to the first model optimal results. Gutjahr et al. (2008) introduced the problem of portfolio selection and projects scheduling with resources allocation, taking into account the strategic development of their competences. They presented the actors' efficiencies for working in a given skill as a function of the allocation scores. In other words, the working of the actor for a given skill increases his score for this one and also increases his efficiency, but shifting the actor away from this skill reduces his score, and hence his efficiency. Then the actor efficiency was normalized over the [0, 1] interval using the "logistic function: $y(x) = 1/(1+e^x)$ ". In products design, Hlaioittinun et al. (2010) modelled and solved staff allocation to different tasks relying on the task-compatibility indicators. By integrating the learning-forgetting, their models aims to optimise the supplementary salary cost due to the extended task duration when using under-competent employees and the financial penalties when the goals of competency development have not been reached. Attia et al. (2011) adopted the *LFCM* in the project scheduling and flexible resources allocations (chapter 3).

2.4 CONCLUSION:

The uncertainty in working environment increases the importance of developing firms' flexibility. This flexibility can be used as a hedge against uncertainty. Therefore, it is appreciated to integrate human resources flexibility in generating a robust activities baseline schedule. And relying on the fact that a high quality product depends mainly on high-skilled workers, we are oriented to consider also the development of human resources experience. This work will refer simultaneously to four dimensions according to the literature classification presented in (Table 2.3). The first is the workforce *allocation period* that can be single or multi period. The second is the modelling vision of the working efficiency of the multi-skilled workforce, can be divided to *static or dynamic*. The third is the consideration of the employees working time that can be *classical or flexible*. And the fourth is the characteristics of the activities durations that can be *rigid or elastic*. Relying on the literature review, considering these dimensions altogether represents an original work.

Table 2.3 Classification of related works.

	Period		Skill modelling			Working time		Task duration	
	Single	Multi	Static	Dynamic modelling		Classical	Flexible	Rigid	Elastic
				Learning	Forgetting				
The present thesis									
Attia <i>et al.</i> , 2012c		x ^G	x	--	--		x		x
Azmat <i>et al.</i> , 2004	x		--	--	--		x	--	--
Cai and Li, 2000	x		x			--	--	--	--
Cavalcante <i>et al.</i> , 2001		x	x			x ^A			x
Certa <i>et al.</i> , 2009	x			x		x		x	
Corominas and Pastor, 2010	x		x				x		x
Corominas <i>et al.</i> , 2007	x		x				x	--	--
Corominas <i>et al.</i> , 2006	x		x			x		x	
Cowling <i>et al.</i> , 2006		x	x			x			x
Daniels <i>et al.</i> , 2004	x		x			x			x
Drezet and Billaut, 2008		x ^T	x				x ^D	x	
Edi, 2007		x	x				x		x
Eitzen <i>et al.</i> , 2004	x		x			x [*]		--	--
Gutjahr <i>et al.</i> , 2008		x ^T		x	x	x ^{**}			x
Hanne and Nickel, 2005		x ^T	x			x			x
Heimerl and Kolisch, 2009a	x ^M		x			x ^{OE}			x
Hertz <i>et al.</i> , 2010	x		--	--	--		x ^{SH}	--	--
Hlaoittinun, 2009	x	x ^{T-Pre}		x	x	x ^{**}			x
Kazemipoor <i>et al.</i> , 2013		x ^P	x			--	--	--	--
Li and Womer, 2009		x ^G	x			x ^{**}		x	--
Morineau and Néron, 2007		x ^T	x			x [*]		x	
Nembhard, 2001	x			x	x	--	--		x
Noack and Rose, 2008		x	x			x			x
Perron, 2010	x		x			x		x	
Sayin and Karabati, 2007	x			x	x	--	--	--	--
Shahnazari-Shahrezaei <i>et al.</i> , 2012	x		x			x		--	--
Valls <i>et al.</i> , 2009		x ^G	x			--	--		x
Vidal <i>et al.</i> , 1999		x ^T	x			x [*]			x ^C
Wu and Sun, 2005	x			x		x ^{**}			x
Yannibelli and Amandi, 2011-12		x ^T	x			x		x	

x^{*}: Resources with binary availabilities: 0 or 1.
 x^{**}: Maximum capacity of work per each scheduling period without considering overtime.
 x^A: Given labour availability per period and variable labour profiles to each job.
 x^C: Concerns the cycle time of a workstation centre.
 x^D: the flexibility of working with maximum and minimum working periods per day, without overtime.
 x^G: multi period project scheduling with generalized temporal relations.
 x^M: multi-project scheduling without precedence constraints (each project has pre-specified interval of early and late start).
 x^{OE}: with overtime flexibility and external labour resourcing.
 x^P: Project portfolio scheduling.
 x^{SH}: flexibility of working time without overtime.
 x^T: multi period project scheduling with traditional finish-start constraints.
 x^{T-Pre}: with the consideration of: "the project breakdown and its tasks schedule over the project periods are data entry".

CHARACTERIZATION AND MODELLING OF THE MULTI-PERIOD WORKFORCE ALLOCATION PROBLEM

In this chapter, we look at the line-up of multi-period project, considering the problem of staff allocation with two degrees of flexibility: the first results from the annualizing of working time, and relies on policies of changing schedules, individually as well as collectively. The second degree of flexibility is the versatility of the operators, which induces a dynamic view of their skills and the need to predict changes in individual performance as a result of successive assignments. We are firmly in a context where the expected durations of activities is no longer deterministic, but results from the performance of the operators selected for their execution. We present a mathematical model of this problem and the analysis of its variables and constrains.

3.1 PROJECT CHARACTERISATION

A project consists of a number of activities or tasks that have to be shaped according to a pre-specified order. The feasible orders of performing these tasks are known as precedence constraints, and they generally are temporal relations. Each task has to be performed in an associated time window depending on the availability of the required resources. The set of resources contains different kinds, which include manpower, raw materials, machines, tools, equipments, knowledge, skills, technical documents, etc. The most important – and considered as the most difficult to handle – are the human resources, due to their unpredictable related factors, e.g. diseases, sickness, accidents, social life problems, working regulations, etc. Therefore developing flexibility in one of the firms' most important factors such as human resources enhances the firms' competitiveness. By the following sub sections, we will discuss the different characteristics of the current problem features, especially those which are related to the project and the human resources.

3.1.1 Tasks characterisation

Here each project is broken down into a work breakdown structure (*WBS*), which describes the different work packages, each of which can be decomposed into a set of I unique and original tasks. We only consider a set of tasks (project) at a time. We assume that the structure of the *WBS* is well defined and accessible, including the tasks' analysis, which allows to define precisely the required set of skills (nk_i) needed to carry out each task $i \in I$. In that view, a task $i \in I$ is characterized qualitatively and quantitatively. The qualitative description is the set of all the skills (nk_i) required to complete this task: they may be several, taken from a group K of all the skills represented in the company, and needed to run the current project. The quantitative measurement is the workload (we often call it "job") requested from each competence $k \in nk_i$. For this reason, there can be several tasks that require the same skill, but with different workloads.

3.1.1.1 Tasks work content

Each task $i \in I$ requires a set of skills (nk_i) in order to be performed. Associated to each skill $k \in (nk_i)$, we have a well defined standard workload ($\Omega_{i,k}$) expressing the standard working time (in hours for instance) of this skill needed to perform the current task. Beside this workload, this task i can as well have in parallel the workloads $\Omega'_{i,k'}$, $\Omega''_{i,k''}$, ... from other skills k' , k'' , ...

3.1.1.2 Tasks durations

For each task $i \in I$, we provide three estimated values corresponding to the task's execution durations: a minimal (D_i^{min}), a standard (D_i), and a maximal (D_i^{max}), all expressed in days. As stated by Hans (2001), a minimal duration of a job is usually a result of technical limitations of resources, e.g., in a situation when no more than two persons can jointly perform a given activity. The real duration (d_i) of the task must verify the relation: $D_i^{min} \leq d_i \leq D_i^{max}$. As discussed earlier, one of the task characteristics is the number of skills (nk_i) required for its achievement, and for each skill a workload ($\Omega_{i,k}$) is specified. Hence, for each skill-related workload, there is a real duration $d_{i,k}$ (in days), depending on how many workforce in the skill have been allowed. As a result, the activity duration can be calculated for each task as: $d_i = \text{Max}(d_{i,k}) \forall i$, and $\forall k \in nk_i$. The most important variables for the determination of the project schedule are the variables ($d_{i,k}$): these durations are deduced from

the equivalent total productivity of the actors ($EE_{i,k}$) allocated to achieve the corresponding workload ($\Omega_{i,k}$), taking into account their daily working capacity ($\omega_{a,i,k,j}$):

$$d_{i,k} = \frac{\Omega_{i,k}}{\omega_{a,i,k,j} \times EE_{i,k,j}}, \quad \forall k \in nk_i \text{ et } \Omega_{i,k} \neq 0, \quad (3.1)$$

Without loss of generality, we assumed in this equation (for instance) that the work ($\omega_{a,i,k,j}$) is constant for all actors ($a \in ER_{i,k,j}$), during the duration $d_{i,k}$. For unstable working hours ($\omega_{a,i,k,j}$) from day to day and from worker to another, equation (3.1) is no longer valid. Thus the duration $d_{i,k}$ can be computed as difference between job's finish date " $dF_{i,k}$ " and its start one " $dS_{i,k}$ ". And the daily working hours ($\omega_{a,i,k,j}$) becomes one of the decision variables (in the current model). We assumed also the start date is the same for all task's related workloads corresponding to its different required skills *i.e.* $dS_i = dS_{i,k} \forall i$, and $\forall k \in nk_i$, where dS : is the start date. In the other side we determine the task delivery date as the maximum achievement date of its associated workloads, *i.e.* $dF_i = \text{Max}(dF_{i,k}) \forall i$, and $\forall k \in nk_i$, where dF : is the finish date.

3.1.2 Scheduling dependencies between tasks

The technical relationship between two tasks i and c can be described by three types of dependencies between them: dependent, independent and interdependent relations (Eppinger et al., 1991). *The dependent relationships*: the task c requires an output of the task i in order to be performed. This relation can be represented by the traditional precedence constraints where the two tasks are in series, as shown in (Figure 3.1). *The independent relationships*: this type of relations can be found when either of task (i) or task (c) can be executed without any necessities or information from the other task. We consider either of the two tasks is isolated from the other, so we can conduct them in parallel according the available resources, as in (Figure 3.1). *The interdependent relationships*: each one of the two activities requires information from the other during its execution process. Therefore, neither of the two activities can be performed separately from the other one without an exchange of a given stream of information (or material) flow. The best example to describe these relationships is the concurrent engineering working environment. This relationship can dominate a huge number of relations between the start dates of the tasks or their finish dates. Therefore, we can find for example the start-start relation with minimum/maximum temporal delay or work percentage.

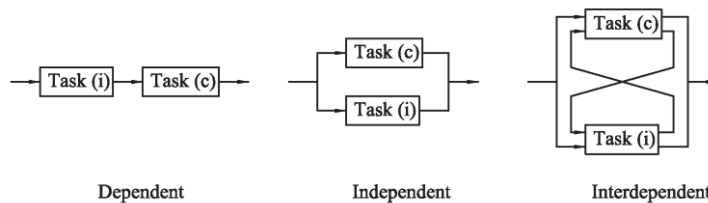

Figure 3.1 the tasks dependency relations (Eppinger et al., 1991)

3.1.3 Project due date and contractual duration

From the first phase of the project's lifecycle, the price and delivery date (contractual date) should be quoted to the customer, despite at this early stage the level of uncertainty is very high. In order to overcome the risk, we assume that the project is held to a contractual delivery date L , to which we can attach a "grace period" β (Vidal

et al., 1999; Edi, 2007). This grace period can be considered as project temporal buffer, which is used as an aggregated safety factor instead of using a safety factor to each activity, that known as “activities buffer (see section 2.2.2). As shown by (Figure 3.2), if the results are delivered to the client with a delay greater than β , some lateness penalty will be taken into account; reciprocally, we avoid to achieve the project earlier than $(L-\beta)$ with the intention of avoiding storage costs. Accordingly, it is necessary that the real project delivery date (LV) is located within the interval:

$$L - \beta \leq LV \leq L + \beta \quad (3.2)$$

This project real delivery date (LV) will be the result of the project schedule, after determining the tasks’ durations from the actors’ different allocations on the different project missions.

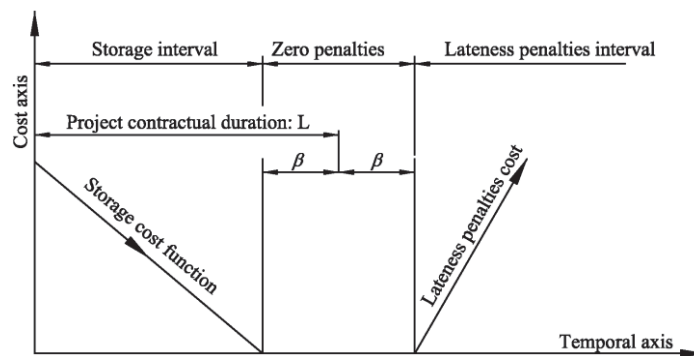

Figure 3.2 the project delivery date and its related costs

3.2 WORKFORCE CHARACTERISATION

The workforce can be characterised relying on three dimensions: the working time modulation flexibility, the workforce versatility and their dynamic competences. We present each dimension in the following sub-sections.

3.2.1 Working time flexibility

This dimension represents the new working time flexibilities such as annualised hours working strategy with working hours’ modulation. In which each actor has a fixed amount of working hours per year that can be irregularly spread during weeks. Each individual can have his own timetable, which can vary on daily or weekly bases. This variation should obey some pre-specified milestones, as the minimum/maximum number of working hours per day, a maximum number of working hours per week, and a maximum number of average working hours per a number of weeks, called the reference period (implicitly 12=weeks, according to the French working law), see section (3.3.3.4).

3.2.2 Multi-functional flexibility

Recently the importance of multi-functional work-teams was increased responding to the variable customer demands and unforeseen working environment. In this characterisation each operator can master a set of skills with a specified productivity level to each one. In order to characterise this flexibility dimension, we need to precise some parameters: - the first is the way to measure and model the operators’ productivities, - the second is

the interaction and the common basis between one operator’s skills, i.e. the degree of similarity between these skills, -the third is the variation of an operator’s experience with working time.

3.2.2.1 Modelling of operators’ productivities

In this work we adopted the actors’ characterisations discussed by Edi (2007) and Attia et al. (2012c), based on the actors’ temporal-based performance for completing a job that needs the skill k . Therefore, we express an actor’s ability to achieve a given job via a variable called “efficiency of the actor a in practising the skill k ” denoted by $(\theta_{a,k})$ (Kher et al., 1999; Duquenne et al., 2005). This efficiency will be calculated as the ratio $(\theta_{a,k} = \Omega_{i,k} / \omega_{a,i,k})$, where $\Omega_{i,k}$ represents the standard workload from competence k (in hours) required to realize the activity i , and $\omega_{a,i,k}$ is the actual working time (in hours too) required by the worker a to achieve this workload. Consequently, if the actor a is considered as an expert in this skill, he will perform the job within the standard duration, thus we consider his efficiency to have a nominal value $(\theta_{a,k} = 1)$. But, if the actor’s work $(\omega_{a,i,k})$ is greater than the required workload $(\Omega_{i,k})$, in this case we consider the actor’s efficiency to be within the interval $]0,1[$. The excess between the work actually needed and the standard workload will represent the over cost resulting from the use of actors’ versatility.

3.2.2.2 Characteristics of operators’ polyvalence

Each actor may have acquired some knowledge and competences that allow him to master a set of skills in addition to his basic one, with a given efficiency level for each of them. As illustrated by (Figure 3.3): actors may acquire more than one skill, one of the characteristics of these skills is how much they are similar. The qualitative flexibility of developing multi-skills employees can be achieved by a policy of job-rotations, or by operating actors’ cross-training programmes: see for example the work of Slomp et al. (2005) to develop the labour flexibility in cellular manufacturing, or the study of Yang et al. (2007) to show the impact of such strategies on the performances. Often, firms try to train a given operator with additional competence that matches with his/her initial knowledge; therefore one can find a great amount of similarities between his new skills and the already acquired one(s). As approved by Attia et al. (2012a), as the degree of similarity between operator’s new skill and his previous one increases, the easier it will be to acquire this new one.

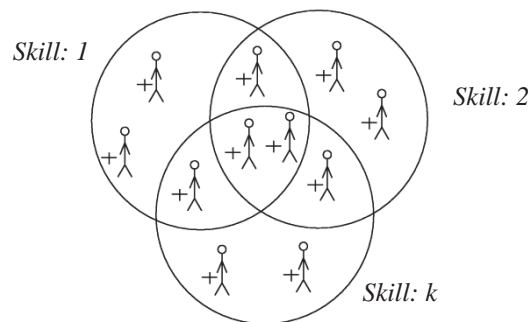

Figure 3.3 The interaction between skills’ domains of actors who can participate

Similarity is a tool used to compare two objects in order to determine how much they are related to each other. Almost it was used in many scientific fields, the information retrieval or documents clustering are mainly relying on such methods. A huge number of similarity measurement applications can be found, for example: in biology

one can find the use of similarity measure to compare protein structures (Betancourt et al., 2001), in chemistry (Nikolova and Jaworska, 2003), in data mining (Boriah et al., 2008), in addition to the human face recognition (Moghaddam and Pentland, 1998), etc. The use of an approximate similarity measurement tool can lead to a good reasoning about a specified problem. We adopt the similarities concept between the skills that an actor can master. The similarity degree can be calculated from the common attributes between two skills, such as the raw material used and its physical properties, the equipments and tools, the required knowledge...etc. It can be represented as the fraction of attributes in common between the two skills, $SD \in [0, 1]$. A value of “0” indicates two completely different skills, and a value of “1” represents two identical skills.

This similarity degree between actor’s skills affects the developments of his efficiencies and may reduce the consequences of the loss of learning phenomenon. According to Jaber et al. (2003), “*the worker who is being trained on two or three similar tasks is likely to experience relatively less forgetting as compared to those being trained on very dissimilar tasks*”. To illustrate this point of view, let us consider an actor a with two skills k_1 and k_2 , and the similarity degree between the two skills is $SD_{k_1-k_2} = 0.6$, and let us imagine that this actor was selected to work with skill k_1 to perform a required job during a period of 10 days. As results of this allocation decision, the efficacy levels of the actor for his two competences will be calculated as follows: For the skill in practice k_1 , there is no forgetting effect, thus we can consider this 10 days period as a full-time learning period. For the second skill k_2 we take into account the learning and forgetting simultaneously with percentages of 60% learning (the similar attributes to the skill in practice k_1) and 40% forgetting (these 40% concerns the attributes of skill k_2 actually in interruption). This concept can be represented by the equation (3.3) adopted by Jaber et al. (2003) and Attia et al. (2012a). Here we will use it to represent the actors’ efficiencies as a function of the learning and forgetting effects, and of skills similarities, at the finish date ($j = dF_{i,k}$) of practicing a specified workload $\Omega_{i,k}$.

$$\theta_{a,k_2} = SD_{(k_1 \leftrightarrow k_2)} \times \theta_{a,k_2}^{Learning} + (1 - SD_{(k_1 \leftrightarrow k_2)}) \theta_{a,k_2}^{Forgetting} \quad (3.3)$$

3.2.2.3 Operators’ productivity evolution

3.2.2.3.1 Learning by doing

Regarding the modelling of this fact (shown in section 2.3.4.1.1), the most common representation of experience curves is the exponential function of Wright (1936), and it can be used to estimate the progress function relying either on the unit production or on the bulk quantity produced.

Based on the exponential representation, we present a model that analyzes the extra cost, expressed in terms of working time increase ($\Delta_{a,i,k}$), arising from the allocation on a job of an actor whose efficiency is not optimal. Equation (3.4) describes the evolution of this additional cost with the number of repetitions of work (n):

$$\Delta_{a,i,k}(n) = \Delta_{a,i,k}^{(1)} \times (n)^b \quad (3.4)$$

In this equation, the extra cost $\Delta_{a,i,k}(n)$ is represented by the processing time difference ($\omega_{a,i,k}(n) - \Omega_{i,k}$) for an actor whose efficiency is $\theta_{a,k}(n)$, and who is allocated for his competence k on a task i defined by a standard workload $\Omega_{i,k}$ on this competence. $\Delta_{a,i,k}^{(1)}$ is the extra cost found at the first time this actor is required for this job: he will perform it with his initial (*i.e.* minimal) efficiency. Therefore, ($\Delta_{a,i,k}^{(1)} = \Omega_{i,k} / \theta_{a,k}^{ini} - \Omega_{i,k}$). In equation

(3.4), the parameter “ b ” can be expressed as: $b = \log(r_{a,k})/\log(2)$, where $(r_{a,k})$ expresses the learning rate of the actor a in the competence k . This rate may vary from one actor to another and from a competence to another. As a result, the evolution of the processing time for a given operator evolves with the number of repetitions (n) of a same job according to the equation:

$$\omega_{a,i,k}(n) = \Omega_{i,k} + \left(\frac{\Omega_{i,k}}{\theta_{a,k}^{ini}} - \Omega_{i,k} \right) \times (n)^b \quad (3.5)$$

This formula is similar to the model of DeJong, (1957), which, unlike Wright, involves an incompressible runtime ($\Omega_{i,k}$ in our case) corresponding to an optimal execution of work, when performed by an actor whose efficiency is ideal ($\theta_{a,k} = 1$). We can then derive the evolution of the efficiency of an actor from the number of repetitions of job (n), as shown by equation (3.6):

$$\theta_{a,k}(n) = \frac{1}{1 + (1/\theta_{a,k}^{ini} - 1) \times (n)^b} \quad (3.6)$$

Three factors are essential for a good estimate of the actual work of an actor to carry out a given job. The first two are related to the actor himself: his learning speed ($r_{a,k}$) in the considered skill and his initial efficiency in the same competence ($\theta_{a,k}^{ini}$): we assume here that these two factors, deduced from the record of past activities, are part of the data set of the simulation. The third factor is related to the interpretation of the repetitions of work (n). Here, “repetition” does not refer to the repeated execution of a given task, but to the constant practice of the same skill on jobs that may differ: (n) will reflect the equivalent duration of uninterrupted practice of the relevant competence during previous assignments, expressed in 7 hour-long periods, as standard working days. However, the application to repetitive tasks (such as “production”) is of course conceivable. In all cases, the efficiency is assumed to remain constant for one given allocation, from the beginning to the end of a same job, and equal to the efficiency calculated (or read from data) at the beginning of the job: the evolution of the efficiency, whatever its way, will only be considered on the next allocation.

3.2.2.3.2 Experience degradation

As mentioned above, the efficiencies of actors increase with the working time cumulated on the same skill, due to the “learning-by-doing” effect. On the other hand, this efficiency is degraded when the actors have to stop working, or have to work on other skills, as shown by Figure 3.4. We now come to consider a model of weakening of competences, a phenomenon caused by oblivion, loss of reflexes and gestures. Among several approaches to model this phenomenon (see section 2.3.4.2.1), the literature provides results especially when interruptions of production influence the effect of forgetting (Globerson et al., 1989; Jaber and Bonney, 1996). In our view, an interruption occurs when an actor is assigned to work on another skill – or is not assigned at all. We adopted the model presented by Jaber and Bonney (1996), Hlaoittinun (2009), and Huang et al. (2012), inspired by Wright’s exponential curve rather than the “hyperbolic model with two variables” of Mazur and Hastie (1978) that was modified into the “Recency model” by Nembhard and Uzumeri (2000b); according to this exponentially-decreasing representation, we can model the depreciation of efficiency of stakeholders based on the number of repetitions ($\lambda_{a,k}$) corresponding to the interruption periods, for a given worker a in practicing skill k , as:

$$A_{a,k}^f = A_{a,k}^{f(1)} \times (\lambda_{a,k})^f \quad (3.7)$$

In this equation, $A_{a,k}^f$ represents the extra costs that will result if the actor a is assigned to work with his skill k after an interruption period (dIP) corresponding to $(\lambda_{a,k})$. $A_{a,k}^{f(1)}$ is the extra cost that can be found at the first repetition relying only on the forgetting curve. In the same way as Jaber and Bonney (1996), also used by Huang et al. (2012), we can express the evolution of the actor's efficiency, depending on the duration of the interruption period (dIP) and on the number of previous equivalent work repetitions (n_{eq}):

$$\theta_{a,k}^{dIP} = \frac{1}{1 + (1/\theta_{a,k}^{ini} - 1) \times (n_{eq})^{b-f} \times (n_{eq} + \lambda_{a,k})^f} \quad (3.8)$$

Where $\theta_{a,k}^{dIP}$ is the actor's efficiency level after a period of interruption " dIP ", $\lambda_{a,k}$ is the number of work repetitions (expressed in 7 hour-long periods) corresponding to the period " dIP ", and f is the slope of the "unlearning curve". The curve parameters (n_{eq} , and f) will be determined for each individual during simulated periods and for the specified skill; n_{eq} can be determined from the continuous nature of the learning-forgetting-relearning curve (Figure 3.4), so it can be calculated after equalling the right sides of equations (3.6) and (3.8), and take ($n = n_{eq}$). The slope of the forgetting curve " f " can be calculated as follows:

$$f = -b \times (b + 1) \times \log(n_{eq}) / \log(\xi + 1) \quad (3.9)$$

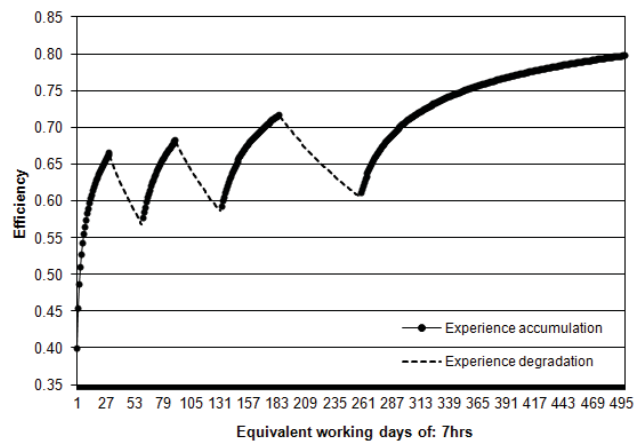

Figure 3.4 The effect of learning and forgetting on the working efficiency of operators

ξ is the ratio between two periods ($\xi = Tb / Ta$): a learning period Ta corresponding to the duration of uninterrupted exercise of a given competence, during which the efficiency increases, and Tb is the interruption period after which, if this skill is no longer practiced at all, the efficiency would decrease back to its initial value. Of course, the parameters involved in equations (3.4) to (3.9) are difficult to appreciate finely in industry. Works such as those of Dar-El et al. (1995) and NASA, (2007) provide some values for some industries - values that can be considered as averages. More precise, and especially individual, determinations will have to be implemented.

3.3 PROJECT SCHEDULING WITH WORKFORCE ALLOCATION OPTIMIZATION PROBLEM

3.3.1 Problem representation

The present project scheduling and workforce allocation problem can be presented as follows: A project consists in a set I of unique and original tasks with predefined temporal relations. Each task $i \in I$ requires a given set of skills for its execution, taken within a group K of all the skills, present in the company. Each of these competence-specific jobs that build up the task will require a specified workload. On another side, we consider set A of human resources; each individual or actor “ a ” from these resources is able to perform one or more competence(s) “ nk_a ” from the set K , with a dynamic time-dependent performance. *i.e.*, we consider the actors as multi-skilled. For each actor “ a ”, we have a value, known as his efficiency $\theta_{a,k}(n)$ that indicates his performance for practicing a given competence “ k ”. This efficiency is a real number $\theta_{a,k}(n) \in [0,1]$ varying with time according to the previous allocations represented by the work repetitions “ n ”. Moreover, the efficiency is each actor’s one, and is measured for each skill k that he practices: it is therefore natural to find, for one given actor with two skills k and k' , that $\theta_{a,k} \neq \theta_{a,k'}$. In order to make our model more similar to industrial reality, we introduced for each skill k a lower limit of efficiency θ_k^{min} below which an assignment will not be considered acceptable, for economic or quality reasons: $\theta_{a,k}(n) \in [\theta_k^{min}, 1]$. If the actor has an efficiency $\theta_{a,k}(n) = 1$, then this actor can be considered as expert with nominal competence in the skill “ k ”. So when this actor is allocated for this skill on a given job, he will perform his work in the standard job’s duration, whereas other actors, whose efficiencies are lower than unity for this skill, will require a longer working time. While the activity is being processed, competence k of a task i requires a workload $\Omega_{i,k}$. For this execution process, if the actor is considered as an expert (*i.e.* $\theta_{a,k}(n) = 1$) then the actual execution time $\omega_{i,k}$ equals the standard one, thus $\omega_{i,k} = \Omega_{i,k}$. But, in the other case when an actor is assigned, for whom $\theta_{a,k}(n) < 1$, then the actual work will be $\omega_{i,k} = \Omega_{i,k} / \theta_{a,k}(n) > \Omega_{i,k}$, resulting in an increase of both execution time and labour cost. As we have seen, the efficiency of an operator determines the effective working time needed to achieve a standard defined workload: the actual execution time ($d_{i,k}$) required in the competence k for the task i is not predetermined, but results from the previous allocations of the actors chosen. In addition to the multi-skill, we consider that the company is managed according to a working time modulation strategy: *i.e.* the timetables of its employees may be changed according to the required workloads to be executed.

Thus, we aim simultaneously at optimizing a set of objectives while respecting a vast number of constraints: this leads to a huge optimization and project scheduling problem. The mathematical model (objectives and constraints) is presented by the following.

3.3.2 Modelling of problem objectives

First the objective function, we wish to minimize the sum of four terms of costs (f_1, \dots, f_4), in addition to the maximization of a virtual profit function (f_5):

$$\text{Minimize: } F = f_1 + f_2 + f_3 + f_4 - f_5 \quad (3.10)$$

3.3.2.1 Direct labour standard costs

The first objective (f_1) represents the actual cost of work executed during “normal opening” hours, with a standard hourly cost “ U_a ”. Knowing that, S_{SW} and respectively S_{FW} are respectively the start week and the finish week of the project, $\omega_{S_{a,s}}$ is the work scheduled for the worker a during the week s in hours.

$$f_1 = \sum_{a=1}^A \left[U_a \times \sum_{s=S_{SW}}^{S_{FW}} \omega_{S_{a,s}} \right] \quad (3.10-a)$$

3.3.2.2 Direct labour over costs

The second objective is the excess cost due to overtime (f_2), which is added to the cost of normal hours (f_1) in order to determine the labour direct cost. It is determined by applying a multiplier “ u ” to standard hourly cost. According to the French law this multiplier can be estimated at 25% of the standard working hourly rates. The actor’s weekly overtime ($HS_{a,s}$; overtime of actor a during week s) can be rewarded by either money or time off, or combination of both. Without loss of generality, here we considered only the money-compensated way. The implementation of other rewarding method can be directly implemented by subtracting the temporal compensation hours from the yearly remaining number of working hours for the worker considered. The overtime is calculated according to the company-level agreement.

$$f_2 = \sum_{a=1}^A \left[U_a \times u \times \sum_{s=S_{SW}}^{S_{FW}} HS_{a,s} \right] \quad (3.10-b)$$

3.3.2.3 Cost associated to loss of temporal flexibility

The third objective (f_3) is a virtual cost associated to the loss of temporal flexibility (the future working capacity) of the actors at the end of the simulation horizon. In this equation, the cost derives from the weekly occupancy rates of the actors, compared to the standard duration of work per week “ C_{S0} ”; this term f_3 is intended to distinguish and favour solutions involving the minimum effort for a given load – *i.e.* it is intended to preserve the future flexibility of the company (Attia et al., 2012c). Considering that UF_a is the virtual value associated with the residual flexibility of the actor a , in monetary units (real number), and NW is the cardinality of the set of project working weeks.

$$f_3 = \sum_{a=1}^A UF_a \times \left(\sum_{s=S_{SW}}^{S_{FW}} \frac{\omega_{S_{a,s}}}{NW \times C_{S0}} - 1 \right), \text{ where: } NW = \{S_{SW}, \dots, S_{FW}\} \quad (3.10-c)$$

3.3.2.4 Project due date earliest/tardiness associated costs

As discussed in section (3.1.3), a penalty is associated to the completion of a work outside of its tolerance range (Vidal et al., 1999), resulting either from storage costs (or financial immobilization) or from payment of penalties for late; the objective (f_4) can be calculated from the difference between the actual duration “ LV ” of the project and its contract term “ L ”, compared to a tolerance window $[L - \beta, L + \beta]$, where β is the a negotiable temporal tolerance, or grace period.

$$f_4 = \begin{cases} f_L \times \left((1 + \tau_j)^{L-LV-\beta} - 1 \right) & \text{if } LV < L - \beta \\ UL \times (LV - (L + \beta)) & LV > L + \beta \\ 0 & L - \beta \leq LV \leq L + \beta \end{cases} \quad (3.10-d)$$

When $LV < L - \beta$, the storage cost that may figure the cost of the resulting financial immobilization (Attia et al., 2012c). The financial value consists of normal wages plus overtime costs $f_L = f_1 + f_2$, this economic cost is stated at the end of the actual duration of the activity; thus the penalty cost can be formulated as a function of the activity realization cost and a daily discount rate “ τ_j ”. In order to estimate this daily ratio, we can refer to the average interest rates at which large international banks lend money one to another, known as “Euro LIBOR” (shown by Figure 3.5).

Note that in the previous equation, we only took into account the labour cost, and we neglected the cost of raw materials and purchased equipments; we assumed that, normally they were ordered before the start date of the activity and were ready to be used around its start date, regardless to an earlier or later activity completion); some other costs such as amortizing (depreciation) of tools, equipments or machines were neglected too, because they are fixed in all cases. Anyway, this consideration about a storage cost, if it is not essential, can be omitted by choosing for τ_j a value of zero. The choice of a negative value for τ_j can also reveal the existence of incentives paid by the customer in the event of an anticipated delivery compared to contractual duties.

In the other hand, if the real completion date of the activity exceeds the zone of zero penalties, the time of going beyond is identified. The resulting penalty is calculated with a daily rate, which we suppose to be constant, UL .

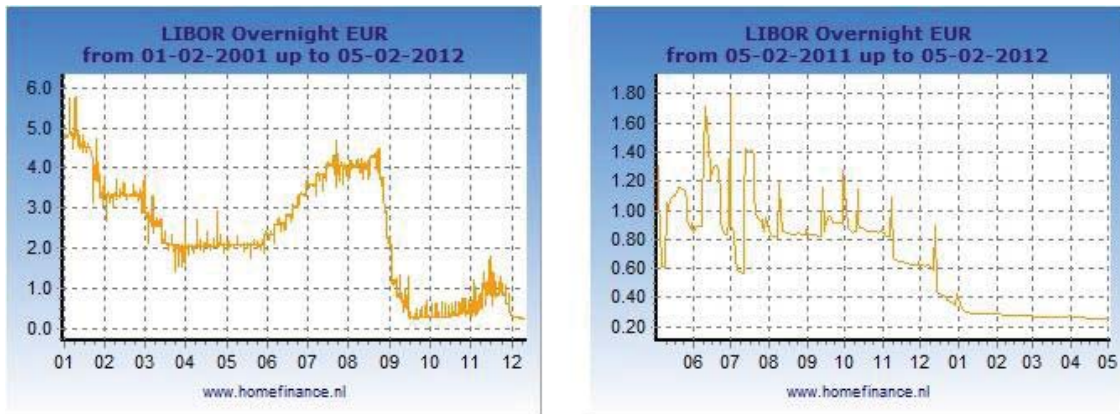

Figure 3.5 The distribution of average daily interest rate “Euro LIBOR”, (homefinance, n.d.)

3.3.2.5 Experience developing objective

The last objective (f_5) is related to the overall evolution of the skills of the actors in the company: the model will promote solutions leading to an overall improvement of skills during the simulation period.

$$f_5 = \sum_{k=1}^K \frac{U_k}{NA_k} \times \left[\frac{\sum_{a=1}^A [\theta_{a,k}(n_{eq}^{FP}) - \theta_{a,k}(n_{eq}^{SP})]}{\sum_{a=1}^A \theta_{a,k}(n_{eq}^{SP})} \right] \quad (3.10-e)$$

Equation (3.10-e) determines the difference in efficiency for each actor from the beginning to the end of the project. $\theta_{a,k}(n_{eq}^{SP})$ and $\theta_{a,k}(n_{eq}^{FP})$ are, respectively, the efficiencies of the actor a in the competence k , at the start date and at the finish date of the project. The constant (U_k) reflects the economic value associated to the competence k and allows us to penalize more or less a degradation of efficiency; it may vary from a skill to

another according to how critical the competence is considered. NA_k expresses the number of operators who master the skill k .

3.3.3 Modelling of problem constraints

3.3.3.1 Workforce assignment constraints

Regarding the workforce assignment decisions, there are two strategies for modelling them, as discussed by Heimerl and Kolisch (2009b): the first is the discrete binary resource-to-task allocation, the second one is a fractional assignment of resource to tasks that can be considered as continuous variable. The first strategy is suitable when the relocate time between tasks is large and cannot be neglected, or when the lengths of the allocation periods are relatively short. On the other hand the fractional modelling is suitable to model multi-tasking of resources, which is realistic for large periods (weeks or months); they commented this one as easier than the first way from the mathematical point of view and problem complexity. In our work we adopted the first modelling of this set of variables, so that the set of constraints (3.11) ensures that any actor “ a ” can be assigned to only one task i , for only one skill k , on the same day j :

$$\sum_{i=1}^I \sum_{k \in nk_a} \sigma_{a,i,k,j} \leq 1, \quad \forall a \in A, \forall j \in \{LV\}, \quad (3.11)$$

Here, $\sigma_{a,i,k,j}$ is the allocation decision of the actor a for his skill k on the activity i and at the time instance j : $\sigma_{a,i,k,j} = 1$ if this actor is assigned, and $\sigma_{a,i,k,j} = 0$ otherwise. We consider that once the actor is assigned to a given job, he will stay working for it until it is achieved, afterwards he can be assigned to another job using one of his skills.

Beside the assignment constraints the availability of resources should be checked. Thus we ensure that for the set “ ρ_j ” of all the tasks that are under progress at the date “ j ”, the staff required to perform the work corresponding to the competence “ k ” is always lower than or equal to the overall capacity of the personnel who master this skill (A_k).

$$\sum_{i \in \rho_j} ER_{i,k,j} \leq A_k, \quad \forall j, \forall k \in K \quad (3.12)$$

ER is the actual number of persons needed, regardless their efficiencies – *i.e.* ER is an integer number.

3.3.3.2 Work-content satisfaction constraints

As previously discussed each task $i \in I$ requires a given set of skills associated to each one a pre-specified standard workload. Therefore each work-content should be satisfied, qualitatively as well as quantitatively; by the following we discuss the related constraints.

3.3.3.2.1 Quantitative satisfaction

The set of constraints (3.13) checks that the hours provided by the qualified actors, taking into account their efficiencies, are sufficient to balance the workload required for each skill. Considering that $\theta_{a,k}(n_{eq})$ is the efficiency of the actor a in the competence k , calculated *via* equation (3.6) at the start date of the activity “ $dS_{i,k}$ ”. To get it, we first should calculate the equivalent work repetition “ n_{eq} ” of the current actor “ a ” during the previous allocation periods, as described in section (3.2.2.3.2), after that we consider $n = n_{eq}$ in equation (3.6).

During the execution of a given job, we assumed that $\theta_{a,k}(n_{eq})$ is constant during the period $[dS_{i,k}, dF_{i,k}]$ corresponding to the job start date “ $dS_{i,k}$ ” and its finish date “ $dF_{i,k}$ ”. Due to this assumption, and to the consideration of the numeric rounding approximation on the daily effort of each operator, we modelled this set of constraints as a “greater than” inequality. Knowing that, the exact modelling would be an equality relationship rather than inequality one.

$$\sum_{a \in ER_{i,k}} \left(\sum_{j=dS_{i,k}}^{dF_{i,k}-1} \omega_{a,i,k,j} \times \sigma_{a,i,k,j} \times \theta_{a,k}(n_{eq}) \right) \geq \Omega_{i,k}, \forall i, \forall k \quad (3.13)$$

The variable $\omega_{a,i,k,j}$ represents the working time for the an actor a on the job $\Omega_{i,k}$, during the day j , (in hours), and it is computed from equations (3.14) and (3.15) relying on the required workload:

$$\omega_{a,i,k,j} = \frac{\Omega_{i,k}}{d_{i,k} \times EE_{i,k,j}}, \forall a \in ER_{i,k,j} \quad (3.14)$$

$$EE_{i,k,j} = \sum_{a \in ER_{i,k,j}} \theta_{a,k}(n_{eq}) : \theta_{a,k}(n_{eq}) \geq \theta_k^{\min} \text{ and } \sigma_{a,i,k,j} \neq 0 \quad (3.15)$$

Each term $ER_{i,k,j}$ can be defined as the actual number of the staff allocated to achieve the job $\Omega_{i,k}$ during the period j ; if one considers the efficiency $\theta_{a,k}(n_{eq})$ of each of the individuals of this staff, the whole becomes an equivalent workforce $EE_{i,k,j}$, knowing that ER represents the integer number of individuals, whereas EE , which is a sum of efficiencies, can be a real number. Here, we assumed that the set of employees “ ER ” are available during the duration “ $d_{i,k}$ ”.

3.3.3.2.2 Qualitative satisfaction

Skills satisfaction constraints ensure that no actor can be allocated on a workload without the minimum level of qualification θ_k^{\min} .

$$\theta_k^{\min} \leq \theta_{a,k}(n_{eq}) \times \sigma_{a,i,k,j} \leq 1, \forall a \in A, \forall k \in K, \forall j \quad (3.16)$$

3.3.3.3 Temporal constraints

3.3.3.3.1 Tasks temporal constraints

For each job, the duration “ $d_{i,k}$ ” resulting from the different allocation decisions of actors must respect the temporal limits defined for the corresponding task i : $d_{i,k} \in [D_i^{\min}, D_i^{\max}]$, so that we have the following constraints:

$$D_i^{\min} \leq d_{i,k} \leq D_i^{\max}, \forall i \in I, \forall k \in K : \Omega_{i,k} \neq 0 \quad (3.17)$$

After that, we can compute the time required to complete the task i as:

$$d_i = \text{Max}_{k=1}^K \{d_{i,k}\}, \forall i \in I : \Omega_{i,k} \neq 0 \quad (3.18)$$

3.3.3.3.2 Project due date constraints

In order to deliver the project with zero penalty cost, the project actual date can be constrained within the interval of zero penalties. But, as discussed in section (3.3.2.4), we considered this date as a soft constraint and integrated within the objective function f_d to penalise the schedules out of the zero-cost interval.

3.3.3.3.3 Tasks dependency constraints

Constraints equations (3.19) to (3.22) indicate the sequencing relationships between tasks:

$$dS_i + SS_{i,c}^{\min} \leq dS_c \leq dS_i + SS_{i,c}^{\max}, \forall (i,c) \in E_{SS} \quad (3.19)$$

$$dS_i + SF_{i,c}^{\min} \leq dF_c \leq dS_i + SF_{i,c}^{\max}, \forall (i,c) \in E_{SF} \quad (3.20)$$

$$dF_i + FS_{i,c}^{\min} \leq dS_c \leq dF_i + FS_{i,c}^{\max}, \forall (i,c) \in E_{FS} \quad (3.21)$$

$$dF_i + FF_{i,c}^{\min} \leq dF_c \leq dF_i + FF_{i,c}^{\max}, \forall (i,c) \in E_{FF} \quad (3.22)$$

These constraints express dependency relationships of various types, with minimum/maximum “advance” or “delay” offsets, or more simply the traditional “finish-start” precedence relations. A minimum time lag between jobs can handle some technological constraints. The values of time lags can be represented either as time durations or percentage of work progress, as discussed in section 2.3.1.2.

3.3.3.4 Working time regulation constraints

As discussed earlier, the working time modulation and the annualised hours assign each operator to a fixed amount of working hours per year. This fixed amount can be irregularly spread over each operator’s time-table. But some constraints should be respected:

3.3.3.4.1 Constraints based on the daily work

The maximum daily working time of any actor must be lower than or equal to a maximum amount of daily work ($DMaxJ = 10$ Hours, according to the French working law):

$$\sum_{i=1}^I \sum_{k=1}^K \sigma_{a,i,k,j} \times \omega_{a,i,k,j} \leq DMaxJ, \forall a \in A, \forall j \quad (3.23)$$

3.3.3.4.2 Constraints based on the weekly work

Constraints (3.24) and (3.25) express that the actors’ weekly working hours “ $\omega_{a,s}$ ” (calculated as equation 3.24) must always be lower than or equal to the maximum amount of weekly work “ $DMaxS$ ”: ($DMaxS = 48$ Hours, according to the French working regulation):

$$\omega_{a,s} = \sum_{j=NJS \times (s-1) + 1}^{NJS \times s} \left(\sum_{i=1}^I \sum_{k=1}^K \sigma_{a,i,k,j} \times \omega_{a,i,k,j} \right), \forall a, \forall s \quad (3.24)$$

$$\omega_{a,s} \leq DMaxS, \forall a \in A, \forall s \in \{S_{SW}, \dots, S_{FW}\} \quad (3.25)$$

3.3.3.4.3 Constraints based on the work for a reference period

The average weekly work, calculated on a floating horizon of 12 consecutive weeks (as a reference period in France), is also subject to regulatory constraints “ $DMax12S$ ”, expressed by equation (3.26). We of course

assumed that the data about operators' working time on activities performed before our simulation window have been properly recorded and are available at any time. These data should be included in the data file concerning the company (Attia et al., 2012c).

$$\frac{1}{12} \times \left(\sum_{p=s-11}^s \omega s_{a,p} \right)_{p \geq 1} \leq DMax12S, \forall a \in A, \text{ and } \forall s \in \{S_{SW}, \dots, S_{FW}\} \quad (3.26)$$

3.3.3.4.4 Constraints based on the annual work

The set of constraints equation (3.27) guarantees that for each actor, the total number of working hours for the current activity is always below his yearly quota "DSA". Here " ωp_a " represents the working hours of the actor a on other previous activities during the considered year, and "DSA" is the maximum number of annual working hours of each actor.

$$\sum_{s=S_{SW}}^{S_{FW}} \omega s_{a,s} \leq DSA - \omega p_a, \forall a \in A \quad (3.27)$$

3.3.3.4.5 Constraints based on overtime

Finally, we have to compute for each operator the weekly overtime "HS" as equation (3.28). Every actor has for each week "s" a number of overtime hours ($HS_{a,s}$). Knowing that, $DMaxMod$ represents the maximum weekly standard work (*i.e.* "non-overtime"), according to internal modulation and agreements adopted by the company. These overtime hours must verify that $HS_{a,s} \in [0, DMaxS - DMaxMod]$. Here we assume that the actual amount of overtime hours already performed by any operator on previous activities " HSP_a " are available. Equation (3.29) checks that overtime on our project always respect an annual limit "HSA" for each actor:

$$HS_{a,s} = \begin{cases} \omega s_{a,s} - DMaxMod & \text{if } \omega s_{a,s} \geq DMaxMod \\ 0 & \text{otherwise} \end{cases}, \forall a \in A, \forall s \in \{S_{SW}, \dots, S_{FW}\} \quad (3.28)$$

$$\sum_{s=S_{SW}}^{S_{FW}} HS_{a,s} \leq HSA - HSP_a, \forall a \in A \quad (3.29)$$

3.4 MODEL ANALYSIS

A mathematical model is an abstraction which uses the mathematical language to describe a natural phenomenon or objects' behaviour. The basic ingredient to construct any mathematical model is the set of the variables and the interactions between them to formulate the goals and restrictions. After the declaration phase of variables, they can be classified according to many properties such as: – The dependency: dependent or independent on each others. – The expected value of the variable: deterministic or probabilistic. – The nature of their domain that can contain real, binary, or integer numbers. –The variation with the temporal axis; it can be static, or change dynamically. Moreover, they can be classified according to the discrete or continuous nature along the temporal axis. On the other side the way that these variables interact with each others represents the linearity of the model: linear or nonlinear model. So by the following we present the analytical description of the proposed model.

3.4.1 Variables dependency investigation

For any problem analysis, one needs to define first the problem unknown variables, variables' domains with a finite set of possible values. These values can be assigned to the corresponding variable, considering some relations with other dependent or independent variables. As shown in (Table 3.1) we listed a set of unknown variables of the problem. The problem decision variables can be represented by the independent variables: $(\sigma_{a,i,k,j}, dS_i, \omega_{a,i,k,j})$, respectively the workers assignment decisions, the activities start dates, and the amount of working hours per day for each worker. Referring to equation (3.1) the jobs durations $d_{i,k}$ can be selected as decision variables rather than the workers daily amount of work: this selection can be suitable for solving the static model of this problem with constraints programming for example, with constant $\omega_{a,i,k,j}$ during $d_{i,k}$. But here, and due to the dynamic nature of some data we consider, we are motivated to solve it with meta-heuristic (see chapter 5). Therefore, we adopted the selection of " $\omega_{a,i,k,j}$ " as a decision variable in order to reduce the representation length of the problem. All the other unknown variables dependent on these selected decision variables, with linear or nonlinear dependency relations, as shown by (Table 3.1).

3.4.2 Variables expected values

For each known or unknown variable there is an expected value. This value can be either deterministic or probabilistic. The deterministic variables are the set of all variables that have given expected values, knowing the input states of their independent variables. In contrast, the probabilistic variables represent the set of the variables whose expected values depend on the chance or probabilities. All the unknown and known variables of (Table 3.1 and Table 3.2) can be considered as deterministic variables except the problem decision variables, and the workers parameters as their speed of learning $(r_{a,k})$ and the maximum interruption period after which, the efficiency of a given worker has decreased back to its initial value (T_b) . For the later variables $(r_{a,k})$, and (T_b) , we assumed a deterministic case. Therefore, this model can be classified as a deterministic rather than stochastic one.

3.4.3 Variable domain investigations

In order to solve the optimisation problems, the domain of each variable should be defined. The variable domain represents the set of values that it can take. The domain of each unknown variables in the current model is listed in the domain column in (Table 3.1); in addition in (Table 3.2) the expected values of the known variables (assumed to be given) are listed. The natures of the domains of variables normally overcome the method used to solve the problem, furthermore it can increase the complexity of solving it. As example the problems with continuous variables can be considered as easier to be optimally solved especially for linear relations. But it can't be solved with some exact methods as for example branch and X (bound, infer,...).

Table 3.1 Model unknown variables and their characteristics

Variable	Description	Dependency				Expected value			Domain		Dynamics (along the project horizon)		
		Dependent	Relation		Independent	Deterministic	Probabilistic	Type	Interval	Static		Dynamic	
			linear	Non-linear						Discrete	Continuous	Discrete	Discrete
$\lambda_{a,k}$	The number of work repetitions corresponding to an interruption period	$\sigma_{a,i,k,j}$	<input checked="" type="checkbox"/>		<input checked="" type="checkbox"/>		Integer	$[0, LY^{Upper}]$					<input checked="" type="checkbox"/>
$\sigma_{a,i,k,j}$	Assignment decision of the actor a on the workload $\Omega_{a,k}$ during the day j			<input checked="" type="checkbox"/>		<input checked="" type="checkbox"/>	Binary	$\{0,1\}$					<input checked="" type="checkbox"/>
dF_i	Activity finish date	$dS, d_{i,k}$	<input checked="" type="checkbox"/>		<input checked="" type="checkbox"/>		Integer	$[0, LY^{Upper}]$	<input checked="" type="checkbox"/>				
d_i	Activity duration	$d_{i,k}$	<input checked="" type="checkbox"/>		<input checked="" type="checkbox"/>		Integer	$[D_i^{min}, D_i^{max}]$	<input checked="" type="checkbox"/>				
$d_{i,k}$	Job duration	$\Omega_{a,k}, EE, \omega_{a,i,k,j}$	<input checked="" type="checkbox"/>		<input checked="" type="checkbox"/>		Integer	$[D_i^{min}, D_i^{max}]$	<input checked="" type="checkbox"/>				
dS_i	Activity start date			<input checked="" type="checkbox"/>		<input checked="" type="checkbox"/>	Integer	$[0, LY^{Upper}]$	<input checked="" type="checkbox"/>				
$EE_{i,k}$	Equivalent workforce	$ER_{i,k}, \theta_{a,k}$	<input checked="" type="checkbox"/>		<input checked="" type="checkbox"/>		Real	$[0, A]$	<input checked="" type="checkbox"/>				
$ER_{i,k}$	Actual workforce	$\sigma_{a,i,k,j}$	<input checked="" type="checkbox"/>		<input checked="" type="checkbox"/>		Integer	$[0, A]$	<input checked="" type="checkbox"/>				
$HS_{a,s}$	Weekly overtime	$OS_{a,s}, DMaxMod$	<input checked="" type="checkbox"/>		<input checked="" type="checkbox"/>		Real	$[0, DMaxS-DMaxMod]$	<input checked="" type="checkbox"/>				<input checked="" type="checkbox"/>
LV	Project duration	dF_i	<input checked="" type="checkbox"/>		<input checked="" type="checkbox"/>		Integer	$[0, LY^{Upper}]$	<input checked="" type="checkbox"/>				
n_{eq}	Equivalent work repetitions	$\sigma_{a,i,k,j}, \omega_{a,i,k,j}, r_{a,k}, f_{a,k}$	<input checked="" type="checkbox"/>		<input checked="" type="checkbox"/>		Real	$[0, \infty]$					<input checked="" type="checkbox"/>
$\theta_{a,k}$	Efficiency	$r_{a,k}, n_{eq}, \theta_{a,k}^{ini}$	<input checked="" type="checkbox"/>		<input checked="" type="checkbox"/>		Real	$[0,1]$				<input checked="" type="checkbox"/>	
$\omega_{a,i,k,j}$	Daily working time			<input checked="" type="checkbox"/>		<input checked="" type="checkbox"/>	Real	$[0, DMaxJ]$					<input checked="" type="checkbox"/>
$OS_{a,s}$	Weekly working time	$\omega_{a,i,k,j}$	<input checked="" type="checkbox"/>		<input checked="" type="checkbox"/>		Real	$[0, DMaxS]$					<input checked="" type="checkbox"/>

Table 3.2. model given variables and their characteristics

Variable	Description	Expected value	Domain	
			Type	Interval
β	Grace period without delay penalties	Deterministic	Integer	In days $\in \{1, 2, \dots, Z^*\}$ - Or % L.
ξ	The ratio between the maximum interruption period and the duration of actual exercise period of a given competence	Deterministic	Real	3 (assumed)
Ω_k	Standard workload defined for the task i , in the competence k ,	Deterministic	Real	In hours $\in [0, R^*]$
A	Set of the actors, also used as the cardinality,	Workers ID	Name, number	$\{1, 2, \dots, a, \dots, A\}$
C_{30}	Standard number of working hours per week,	Constant	Integer	35 hours
D	Standard duration of a task,	Deterministic	Integer	- In days $\in \{1, 2, \dots, Z^*\}$
D_i^{\min}, D_i^{\max}	Minimum and maximum durations for the task i	Deterministic	Integer	- In days $\in \{1, 2, \dots, Z^*\}$
$DMax12S$	Maximum value of the average weekly hours worked over a period of twelve consecutive weeks,	Constant	Integer	44 hours*
$DMaxJ$	Maximum duration of daily work,	Constant	Integer	10 hours*
$DMaxMod$	Normal weekly work set by the collective agreement,	Constant	Integer	39 hours (assumed)
$DMaxS$	Maximum duration of weekly work, in hours (integer).	Constant	Integer	48 hours*
DSA	Maximum annual work for one individual,	Constant	Integer	≈ 1600 hours*
$E_{SS} - E_{SP} - E_{FS} - E_{FP}$	Set of temporal relations between pairs of tasks; S means the start date of task and F means the finish date of task.	Tasks ID	Name, number	$\in \{\text{task_}\#1=1, \text{task_}\#2=2, \dots, I\}$
HAS	Maximum annual overtime for an actor, in hours (integer).	Constant	Integer	180 hours*
I	The set of tasks in the work package (or project), also its cardinality	Deterministic	Integer	$\{1, 2, \dots, i, \dots, I\}$
K	The set of required skills, or the total number of skills,	Deterministic	Integer	$\{1, 2, \dots, k, \dots, K\}$
L	Contractual duration of the work package (or project),	Deterministic	Integer	- In days $\in \{1, 2, \dots, Z^*\}$
NA_k	The set of the actors mastering the skill k , also used to present its cardinality	Workers ID	Name, number	$\in \{1, 2, \dots, a, \dots, A\}$
r_{ak}	The learning rate of the actor a in the competence k	Probabilistic	Real	$\in [0, 1]$, (assumed to be ≈ 0.8 as Deterministic)
$SD_{kk'}$	The similarity degree between two skills k and k'	Deterministic	Real	$\in [0, 1]$
S_{SP}	The start week of work-package (or project),	Deterministic	Integer	$\in \{1, 2, \dots, 52\}$
T_b	The maximum interruption period after which, the efficiency has decreased back to its initial value	Probabilistic	Real	$\approx 3 \times$ Practicing period (assumed as Deterministic)
u	Multiplicative factor applied to the standard hourly cost U_a for overtime, dimensionless	Constant	Real	0.25 (assumed)
U_a	Standard hourly cost of the actor a ,	Deterministic	Real	in monetary units $\in [0, R^*]$
UF_a	Virtual value associated with the residual flexibility of the actor a ,	Deterministic	Real	in monetary units $\in [0, R^*]$
U_k	Virtual value associated with the development of the actors' efficiency in competence k ,	Deterministic	Real	in monetary units $\in [0, R^*]$
UL	Daily rate of delay penalties,	Deterministic	Real	in monetary units $\in [0, R^*]$
$\theta_{ak}(\eta_{eq}^{SP})$	Worker Effectiveness at the project start date SP	Deterministic	Real	$\in [0, 1]$
$\theta_{a,k}^{\min}$	Initial level of efficiency of actor a on competence k ,	Deterministic	Real	0.4 (assumed)
θ_k^{\min}	Minimum level of efficiency required to practice the competence k ,	Deterministic	Real	$\in [0, 1]$
τ_j	Daily average interest rate related to final products storage costs,	Deterministic	Real	0.2% (assumed)
opt_a	Work already performed by an actor a on the current year on previous projects,	Deterministic	Real	in hours $\in [0, R^*]$

3.4.4 Dynamic investigation

Dynamic investigation of the variable “ χ ” is the description of its behaviour along the temporal axis “ t ”: $(d\chi/dt)$. The model’s unknown parameters were investigated along the project horizon by looking whether or not the variable value will be statically or dynamically distributed along the temporal axis. As listed in (Table 3.1), there are some parameters that change with time, e.g. the workers’ assignment decisions will be changed in a daily manner from one skill to the others; this distribution will be different from one skill to another for the same worker, and also from one worker to another for the same skill. Corresponding to the workers’ assignment profile, the dynamic characteristics of his/her competency levels will be produced. Furthermore, due to the working time flexibly, the daily amount of working hours for each actor can be changed dynamically.

3.4.5 Continuity investigation

The continuous feature of a given function is considered when any small change in one of the function input results to a small modification of its output. The continuity is often related to the real variables. As shown by (Table 3.1), this model can be classified as a discrete optimisation model, in which each variable can be calculated at a discrete time scale (days). In the current mathematical model, the only continuous variable is the workforce performance rates (their efficiencies: $\theta_{a,k}$). But one also can consider it as a discrete: we calculate the efficiency of an actor at the job start date, referring to previous allocations; during the execution of the job, we consider it as a fixed value, the enhancement of the actor’s efficiency resulting from the practice in only taken into account for his next allocation. We adopted this assumption in order to simplify the calculations, considering that the effect of this adoption is very small especially if the job duration is several days – if the job duration is longer, this assumption should be abandoned.

3.4.6 Linearity investigation

For each mathematical relation the linearity can be investigated by assuring two properties. The first is the homogeneity, known as the proportionality: let us consider an independent variable “ x ” and a dependent variable “ y ”, and “ f ” is the relation function between x and y ; the proportionality between x and y is verified if $f(CI \cdot x) = CI \cdot y$, where CI is a constant. The second property is the additivity, also called superposition. Based on these two criteria we have investigated the linearity of each relation to get the unknown variables as functions of their related one(s); as shown in (Table 3.1). Concerning the model objectives and constraints, the linearity investigation was done in function of the model basic independent variables ($\sigma_{a,i,k,j}$, $\omega_{a,i,k,j}$, and dS_i), as shown in (Table 3.3) and (Table 3.4).

Table 3.3 Model objectives and their linearity characteristics

Objective	linearity		Basic variables
	Linear	Non-linear	
Labour normal working hours	<input checked="" type="checkbox"/>		$\omega_{a,i,k,j}$
Labour overtime working hours	<input checked="" type="checkbox"/>		$\omega_{a,i,k,j}$
Labour residual temporal flexibility	<input checked="" type="checkbox"/>		$\omega_{a,i,k,j}$
Storage costs		<input checked="" type="checkbox"/>	dS_i , $\sigma_{a,i,k,j}$, $\omega_{a,i,k,j}$
Lateness penalties	<input checked="" type="checkbox"/>		
Workforce experience evolution		<input checked="" type="checkbox"/>	$\sigma_{a,i,k,j}$, $\omega_{a,i,k,j}$

Table 3.4 Model constraints and their linearity characteristics

Constraint		Constrain type		linearity		Basic variables
		Soft	Hard	Linear	Non-linear	
Project	Tasks' durations		☑		☑	$\sigma_{a,i,k,j}, \omega_{a,i,k,j}$
	Tasks' temporal relations		☑		☑	$dS_i, \sigma_{a,i,k,j}, \omega_{a,i,k,j}$
	Job's qualitative satisfaction		☑		☑	$\sigma_{a,i,k,j}, \omega_{a,i,k,j}$
	Job's quantitative satisfaction		☑		☑	$\sigma_{a,i,k,j}, \omega_{a,i,k,j}$
Workforce	Assignment constraints		☑	☑		$\sigma_{a,i,k,j}$
	Availability		☑	☑		$\sigma_{a,i,k,j}$
	Daily working time		☑		☑	$\sigma_{a,i,k,j}, \omega_{a,i,k,j}$
	Weekly working time		☑		☑	$\sigma_{a,i,k,j}, \omega_{a,i,k,j}$
	Average work on reference period	☑			☑	$\sigma_{a,i,k,j}, \omega_{a,i,k,j}$
	Annual work	☑			☑	$\sigma_{a,i,k,j}, \omega_{a,i,k,j}$
	Weekly over-time work		☑		☑	$\sigma_{a,i,k,j}, \omega_{a,i,k,j}$
	Annual over-time	☑			☑	$\sigma_{a,i,k,j}, \omega_{a,i,k,j}$

3.5 MODEL COMPLEXITY

As presented above, the implementation of a dynamic vision of the actors' skills, in addition to the elastic durations of tasks, leads us to a highly nonlinear model with mixed variables, as shown by Table 3.1 and Table 3.3. Therefore, solving it with mathematical programming is difficult due to the huge numbers of constraints and variables which produce a combinatorial explosion, increasing the computation time (Oliveira et al., 2011). The traditional *RCPSP* propose a great challenge in the arena of operational research due to its *NP-hard* complex nature (Brucker and Knust, 2011, Page 34). This complexity was gradually increased, first by adopting the discrete Time-Cost trade problem, next by considering multi-skilled workforce with homogeneous productivity levels, and then with the addition of working time constraints (Attia et al., 2012c). Moreover, the consideration of dynamic productivities along the project horizon increases the difficulty to solve the problem optimally. On the other side, we can consider the vast development done in the field of heuristics and metaheuristics, and their capacities to reduce the gap between the best found solution and the optimal one, or even to return the global optima (Hansen and Mladenović, 2003). Therefore, in our work we are oriented to solve such model using evolutionary algorithms, or heuristic-based approaches. But as any NP-hard problem the complexity is highly increased with respect to the problem size, so in the next chapter we will analysis the different measures that can be used to specify the problem complexity.

3.6 CONCLUSION

In this chapter, we have modelled the problem of multi-period staff allocation on the industrial activities, taking into account the flexibility of working time modulation, and the actors' heterogeneous versatility, and evolution of workforce productivities. The workforce experience evolution was modelled in function of the learning and forgetting phenomena. Moreover, the activities durations are considered as elastic, since they depend on the number of actors allocated to perform the given job, and moreover on their experience levels. The different characterisations of the problem were discussed, that related to the activities, or related to the human resources. The different mathematical relations are investigated relying on different properties such as: - dependency, linearity, continuity, dynamical nature, and the domain of each variable.

PROJECT CHARACTERISTICS AND COMPLEXITY ASSESSMENT RELYING ON PRINCIPAL COMPONENT ANALYSIS

This chapter seeks to characterize different projects in terms of complexity, and to sort them through the use of the smallest number of measures as possible. Therefore, the different parameters related to each of the dimensions according to which the complexity of a given project could be linked will be presented and quantified. For each dimension, a sensitive quantifier will be selected. After that and in order to reduce the number of the project correlated dimensions, a principal component analysis and cluster analysis will be performed. By the end of this chapter, the resulting smallest number of measures will be presented, that explain most of the variance amongst the different instances.

4.1 INTRODUCTION

Complex schedules can complicate the process of planning and coordinating project activities, and the need of measuring complexity is essential since what cannot be measured cannot be controlled or improved. But, project complexity is often recognized in a general way, it is not completely understood, and not with the same manner, by everyone (Ireland, 2007). There is a mix between measuring the project schedule complexity and the project complexity itself, (Mo et al., 2008). Ireland (2007) explained the project complexity by defining the word complex, where “Complex” comes from the Latin word “*complexus*”, meaning entwined, twisted together, which implicitly refers to an aggregate of parts. This interpretation of the project complexity is aligned with that of Nassar and Hegab (2008): the project overall complexity is the aggregation of a set of measures, such as schedule complexity, resources involvement, cash requirements, technical and technological issues, workforce issues...etc. Despite the difficulties associated to assess scheduling complexities, measuring them can be useful in many directions.

Regarding to the problem at hand, measuring its complexity can be linked to a set of different quantifiers (related to the project and resources). Thus, after the scaling of these quantifiers, the ease of performing or not a given programme of activities can be measured. These quantifiers can be grouped according to the problem dimensions which contribute in forming the project and so its complexity, as shown by (Figure 4.1). Generally they can be divided into three groups: the project activities, the available resources, and the interaction between activities and resources. We classified the project parameters into three main groups: network related parameters; temporal related parameters, and work-content related parameters.

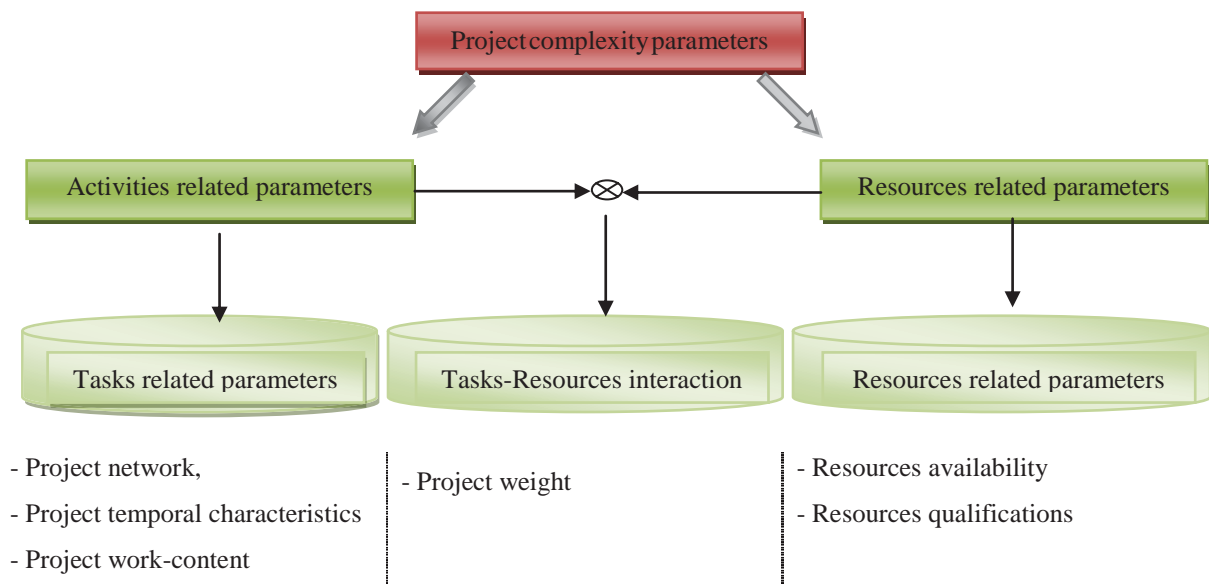

Figure 4.1 Classification of project scheduling complexity parameters

What are the characteristics of a good measure? Latva-Koivisto (2001) discussed some criteria of a good measure, which include: - *Validity*: the measure actually measures what it is supposed to measure. - *Reliability*: The measures obtained with different observations of the same process are consistent. - *Computability*: A computer program can calculate the value of the measure in a finite time, and preferably quickly. - *Ease of*

implementation: the difficulty of implementation of the method that computes the complexity measure is kept within reasonable limits. – *Intuitiveness*: it easy to understand the definition of the measure and see how it relates to instinctive notion of complexity. – *Independence of the other related measures*: ideally, the value of the complexity measure is independent of other properties that are sometimes seen as related to complexity. Additionally, referring to the works of Thesen (1977), we added two other characteristics: a suitable measure should be sensitive and standardised. Sensitive means that the measure should evolve when changes occur in some of the conditions of a given project. Standardization means that it should be normalised over a given range (e.g. [0, 1]), where, ideally, the lower limit represents the easiest case, and the upper limit, the hardest one.

In this chapter, the most widespread measures of project complexity will be presented. Some of them are developed in order to characterise the problem we are dealing with. To conduct this study, database files were proposed (discussed in appendix A). They gather four groups of projects with different number of tasks (30, 60, 90, and 120 tasks), and each group contains a set of 100 projects. For each project, different metrics were computed with the help of a numeric program (coded in C++ Microsoft visual studio 2010). After that, in order to develop a reliable and sensitive complexity measure, we adopted the principal component analysis to present the smallest group of aggregated measures.

4.2 ACTIVITIES-RELATED PARAMETERS

The parameters associated to the project activities were classified into three main heads, as shown by (Figure 4.2): the network that reflects the dependencies of processing different activities. The second is the temporal limitation of each activity that expresses the restrictions on activities durations. The third deals with the required workload that can be translated to resources depending on their skills. Each one of these heads can interact with the others to give a specified project complexity. By the following, we will list and discuss the different complexity measures based on these three heads.

- I. Network size, shape, and topology parameters
- II. Activities' temporal parameters
- III. Work-content related parameters
- IV. Interaction between network and work content
- V. Interaction between network topology and temporal parameters
- VI. Interaction between temporal parameters and work content
- VII. Interaction between network, temporal and the work content

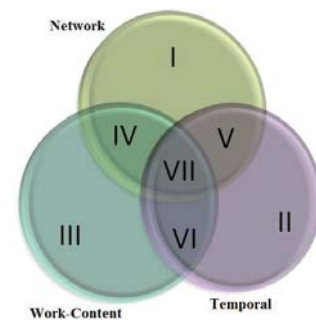

Figure 4.2 Interaction of activities characteristics

4.2.1 Network based parameters

4.2.1.1 Project network size

It is obvious that the number of tasks I in the project is a good measure of the problem size (De Reyck and Herroelen, 1996a). According to the complexity theory, the traditional decision problem of the project scheduling with single constrained resource and no precedence constraints is *NP-complete* in the strong sense.

Therefore, the *RCPS*P belongs to the class of the *NP-Hard* in strong sense (Artigues et al., 2008). The number of tasks is one of the essential parameters that was previously used in almost all publications, as example in *RCPS*P (Kolisch et al., 1995; De Reyck and Herroelen, 1996b; Valadares Tavares et al., 1999; Mendes et al., 2009), assembly line balancing problem (Otto et al., 2011), supply chain , transportation problems ...etc. It was used by Valadares Tavares et al. (2002), as one of their indicators to present the project size, in order to compare between the available problems and/or data issued from benchmark generators of Patterson (1984); Kolisch et al. (1995); Agrawal et al. (1996); and Valadares Tavares et al. (1999). As they noted, project networks counting more than 200 activities are the most common in any engineering field. Therefore, we will adopt it to represent the project size. And, in order to normalize it over [0, 1] interval, we propose the following equation: $P\text{-Size} = (2 / (1 + e^{-\log(I)})) - 1$ for $I \geq 1$. It reaches unity when the number of activities I reaches infinity; and it takes the value of zero for a project with only one activity.

4.2.1.2 Project network topology

The word topology here refers to the study of continuity, connectivity and structure of the project network. Measuring this network factor has a great attention from researchers since mid-sixties, where it used to represent the level of interconnection / interdependence between the project activities. It can also directly reflex the complexity degree in the schedule of the project or the combinatorial complexity of the network. It can also be used as an evaluation of the difficulty of analysing a given network. According to Elmaghraby and Herroelen (1980), De Reyck and Herroelen (1996a) the structure of the network, whatever the way it is measured, will not be sufficient to reflect the difficulty encountered in the solution of the “*RCPS*P” instances. Thereafter, we will adopt the use of this parameter as one of the factors that measure the project complexity. This agreement is aligned with that of Nassar and Hegab (2008). This measure has been used as one of the predictors of the processing time required by software to solve a given problem, or simply to compare the performances of two algorithms. It is often called the network complexity measure. Nassar and Hegab (2006) adopted it as an indicator for the times required for scheduling projects when they used specific software. Obviously, the more project activities will be interdependent, the more complex the schedule will be, but it is not always true according to De Reyck and Herroelen (1996a) or Latva-Koivisto (2001). Many correlations have been presented to measure the nature of projects’ networks structure; here we will discuss and compare some of these measures especially for “activity-on-nodes” networks (*AoN*).

4.2.1.2.1 Coefficient of Network Complexity (CNC)

First, Kaimann (1974) presented a measure of the network complexity, either for “*AoN*” or for activities-on-arcs “*AoA*” networks, it can be calculated as a function of the numbers of Arcs “ N_a ” and of nodes “ N_n ”, as:

$$\text{- For } AoN: CNC = \frac{(\text{Preceding Work Items})^2}{\text{Work Items}} = N_a^2 / N_n \quad \text{- For } AoA: CNC = \frac{(\text{Number of Activities})^2}{\text{Number of events}} = N_a^2 / N_n \quad (4.1)$$

Regardless the drawbacks of *CNC*, and considering that “*The redundant arcs should not increase a network’s complexity*”, Kolisch et al. (1995) modified this measure, considering only the non-redundant arcs in their project generator of (*AON*) networks “*PROGEN*”. This network complexity measure (known here as *C*) was presented as the average number of non-redundant arcs per node (including the fictive super-source and the sink). Moreover, Nassar and Hegab (2006) adopted it to appreciate the network topology relying only on the

number of project activities and on the number of edges. This measure was developed as an add-in to commercial scheduling software “*MS project*”. They also proposed to determine the maximum and minimum possible number of edges in the network (equation 4.2) with a given number of activities (with the assumption that the network may have more than one terminal task). Then the complexity of any network can be assessed relying on the bounds of network edges:

$$\text{Maximum edges} = \begin{cases} (N_n^2 - 1)/4, & \text{if } N_n \text{ is odd} \\ N_n^2/4, & \text{if } N_n \text{ is even} \end{cases} \quad \text{and the minimum edges} = N_n - 1 \quad (4.2)$$

Then, using a logarithmic projection, they introduced the percentage of the network complexity within the interval [0, 100]. Another linear projection was proposed by Mo et al. (2008) for the same measure as Nassar and Hegab (2006) (equation 4.3), considering that the maximum number of non-redundant edges is equal to that of Nassar and Hegab minus one, under the assumption that the network has only one start and only one end event. In addition, redundant edges should be eliminated before computing the network complexity. Fortunately, Bashir (2010) proposed a methodology adapted from the *Interpretive Structural Modelling* “*ISM*” that transfers the AON project network into a minimum-edge diagraph which contains no redundant relationships (appendix B.4).

$$\text{CNC} = 100 \times \begin{cases} \left(\frac{4 \times (N_a - N_n + 1)}{N_n^2 - 4 \times N_n - 1} \right) \% & \text{if } N_n \text{ is odd} \\ \left(\frac{4 \times (N_a - N_n + 1)}{N_n^2 - 4 \times N_n} \right) \% & \text{if } N_n \text{ is even} \end{cases} \quad (4.3)$$

4.2.1.2.2 Number of maximum generated trees

Temperley (1981) introduced a classification of graphs based on their connectivity-quantified complexity; he proposed to use the number of distinct trees that a graph contains as the measure of its complexity. The number of distinct trees that a graph contains (NT) is calculated using the so-called tree-generating determinant (Det_{II}). This determinant can be calculated for any graph containing no cycles and not more than one undirected or two directed lines joining a pair of nodes. According to Latva-Koivisto (2001) it can be applied for directed graphs. The tree-generating determinant is defined as follows: let AD be the adjacency matrix of the graph, built *via* the association of a variable a_{ij} to the directed edge from node (v_i) to node (v_j). In case of existence of such arc, $a_{ij} = 1$, otherwise, $a_{ij} = 0$. Then based on the AD matrix the determinant can be constructed as:

$$\text{Det}_{II} = \begin{vmatrix} \sum_{j \neq 1} a_{1j} & -a_{12} & -a_{13} & \dots & -a_{1I} \\ -a_{21} & \sum_{j \neq 2} a_{2j} & -a_{23} & \dots & -a_{2I} \\ -a_{31} & -a_{32} & \sum_{j \neq 3} a_{3j} & \dots & -a_{3I} \\ \vdots & \vdots & \vdots & \ddots & \vdots \\ -a_{I1} & -a_{I2} & -a_{I3} & \dots & \sum_{j \neq I} a_{Ij} \end{vmatrix} \quad (4.4)$$

Where the non-diagonal elements (a_{ij}) are simply ($-a_{ij}$), and the diagonal elements are the negative sums of all non-diagonal elements in the same row. The negative signs ensure that all cycles, whatever their length, are subtracted out. The number of trees rooted at the node i is obtained by calculating the diagonal minor Det_{ii} . We need to calculate the number of trees rooted at each sink node if the graph has many of them, i.e. we only need to calculate the minor Det_{ii} at the sink nodes. According to Latva-Koivisto (2001), the total number of distinct trees

(NT) can be calculated as $NT = \sum_{i \in \{Sink\ Nodes\}} Det_{ii}$. And the computational complexity of the number of distinct trees

(NT) is bounded by $O(I^3)$, taking into account that the redundant arcs should be eliminated prior the calculation of NT .

4.2.1.2.3 Restrictiveness measure

This measure was originally introduced by Thesen (1977) as a measure of networks reflecting the degree to which the imposition of precedence relations eliminates possible scheduling sequences. This measure is designed in the way that it reflects the relationship between the actual count of different scheduling sequences for a specific network and the maximum count of the possible sequences for any network of that size. The main problem is the exponential effort to determine the number of possible sequences: in practice, it is impossible to calculate it exactly for sufficiently large networks (Elmaghraby and Herroelen, 1980). In reasons of the difficulties, other restrictiveness estimators were suggested. Relying on one of Thesen's indirect estimators of restrictiveness, Schwindt (1995) presented the *restrictiveness* estimator to be used in the context of the *RCPSP* as shown by equation (4.5):

$$RT = \frac{2 \sum_{i,j} \varphi_{i,j} - 6(I-1)}{(I-2)(I-3)} \quad (4.5)$$

Where $\varphi_{i,j}$ is an element of the "reachability" matrix, defined as the reflexive transitive closure of the adjacency matrix ($I \times I$ matrix, any element = {1, there is an arc $\langle i,j \rangle \in$ network edges; 0, otherwise}. $\varphi_{i,j} = \{1, \text{ if } j \text{ is reachable from } i; 0, \text{ otherwise}\}$, *i.e.* $\varphi_{i,j} = 1$ there is a direct path between nodes (i,j) with an origin start i and terminus j , or $i=j$. RT is defined so that it is restricted to the interval $[0, 1]$. It takes the value of "0" for parallel diagraph and the value of "1" for a series one. The variable I include two dummy nodes, one as the project start node and the other is the project finish. If project has real activities for the start and end nodes, a modification should be done by considering $I = \text{number of project real activities} + 2$. One of the interesting properties of this measure is its sensitivity to the insertion of non-redundant arcs, while redundant ones leave it unchanged. According to Latva-Koivisto (2001) in reasons of the standardisation of RT within the interval $[0,1]$, it measures the network complexity relative to the problem size. The computational effort to calculate RT is polynomial. In order to get the reachability matrix, the transitive closure of the adjacency matrix is sought. Yannakakis (1990) stated that the best known algorithm to get the transitive closure has a computational effort of $O(I^{2.376})$. In general, this is the theoretically fastest algorithm known, but the constants are too large for it to be of practical use. But Warshall's algorithm (Warshall, 1962) and its modification by Warren (1975) are practical matrix-based algorithms of a worst complexity of $O(I^3)$. The RT was recently applied to measure the supply chain network complexity by Modrak and Semanco, (2011).

4.2.1.2.4 Order strength-based measure

Due to the similarity between the *RCPSP* and the assembly line balancing problem (*ALBP*), especially for the network typology, some measures have been adopted from *ALBP* to be used in *RCPSP* and vice versa. For example; the order strength was introduced by Mastor (1970) for characterising the problems of *ALBP*. He explained the effect of product structure on the results of the assembly line balancing. The order strength is

defined as the ratio between the numbers of the actual network dependency relations (including redundant relations) to the maximum possible number of dependencies, as : $OS = 2 \times N_d / (N_n \times (N_n - 1))$

Recently Otto et al. (2011) presented a new data generation for the ALBP-type 1, relying on pre-specified values of the OS and the number of tasks to generate a network structure. De Reyck and Herroelen (1996a) showed that among the network complexity measures (CNC , OS , and CI “presented in appendix B”) the OS succeeds the best in explaining variations in required CPU time, when using $B\&B$ in solving the $ALBP$. The use of the network order strength measure in characterising the project topology was recently adopted by Demeulemeester et al. (1996) in their project generator “RanGen”. Based on the modified complexity measure of (Kolisch et al., 1995) and OS , Browning and Yassine (2009) introduced a new network complexity measure normalized over $[0, 1]$, they presented it as follows:

$$CI = \frac{E^n - E_{\min}^n}{E_{\max}^n - E_{\min}^n} \quad (4.6)$$

Where, E^n is the number of non- redundant arcs, E_{\min}^n is the lower bound of E^n (for a network of “ N_n ” nodes, $E_{\min}^n = N_n - 1$, which occurs for fully series network). E_{\max}^n is an upper bound of the same network (the start and finish fictive nodes are not considered when measuring the complexity). Their main idea is to use the project number of ranks (TI) as an indicator of the network length: there is no arc between activities in the same rank. Relying on the number of ranks as a measure of parallelism, the completely serial network has $TI = N_n$, and the completely parallel network has $TI=2$ (within all activities except one: the project start or the end node). Based on a specified arrangement of tasks on the network ranks “ ν ” the maximum value of E_{\max}^n can be computed as equation (4.7).

$$E_{\max}^n(N, TI, \nu) = \begin{cases} \frac{N_n^2}{4} & \text{if } TI \in [2,3] \text{ and } N_n \text{ is even} \\ \frac{(N_n^2 - 1)}{4} & \text{if } TI \in [2,3] \text{ and } N_n \text{ is odd} \\ \frac{(N_n - TI + 2)^2}{4} + (N_n - 2) & \text{if } TI \geq 4 \text{ and } (N_n - TI) \text{ is even} \\ \frac{(N_n - TI + 1)(N_n - TI + 3)}{4} + (N_n - 2) & \text{if } TI \geq 4 \text{ and } (N_n - TI) \text{ is odd} \end{cases} \quad (4.7)$$

4.2.1.2.5 The significant parameters for network topology

In order to select the most significant parameter to represent the network topology among (C , CNC , NT , RT , CI), we conducted a comparative study between them. This study consists in first on calculating the values of each parameter for a set of 400 projects, and then investigating their sensitivity in function of topology changes. After having computed the parameters and standardised all of them over the interval $[0, 1]$ (then re-named $S-C$, $S-CNC$, $S-NT$, $S-RT$, $S-CI$), we found that the C and CNC are typically the same for the groups of projects counting the same number of tasks (Figure 4.3). In addition, both of them are not sensitive at all to the changes of the network topology for the same number of tasks and the same number of non-redundant relations. So we agreed with Elmaghraby and Herroelen (1980) and Latva-Koivisto (2001) about the inability of C and CNC to efficiently measure the network topology.

Regarding the number of generated trees “ NT ”, it seems to be very sensitive before standardisation, but it has a problem of order of magnitude. The returned magnitude of “ NT ” grows exponentially with the number of non-redundant relations. E.g. for the group of 30 tasks, the returned minimum and maximum values are respectively (1.2E+04 and 2.4E+09) corresponding to a number of non-redundant relations of (48 and 68 relations). Moreover, for the group of 120 tasks the returned minimum and maximum values are respectively (3.5E+15 and 2.8E+34) corresponding to a number of non-redundant relations of (183 and 257 relations). This explosion in magnitude produces a high difference between the maximum and the minimum values; therefore, after standardisation it looks insensitive.

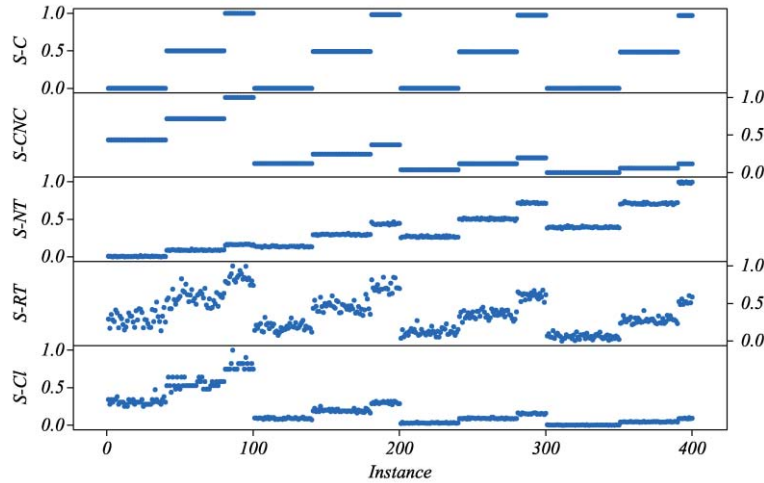

Figure 4.3 an aggregated plot of the standardised parameters of (C, CNC, NT, RT, CI)

In order to accommodate this problem we calculated $NT' = \log(NT)$, then the results was standardised and named $S-NT$. As displayed on (Figure 4.3), it shows very small variations compared to C and CNC for the same number of tasks. By investigating the correlation analysis (see appendix C) between NT' and CNC with the number of tasks (P -size), we found the correlation coefficient “ R ” between NT' and P -size is ($R = 0.756$) and that between CNC and P -size is: ($R = -0.895$). This relation with the P -size translates the negative correlation between NT' and CNC ($R = -0.513$), shown in (Figure 4.3). Relying on this small sensitivity in NT' , it cannot be used to measure the network topology in an efficient way. Concerning CI , it showed some sensitivity compared to CNC , and NT' , even it is highly correlated with them with respectively ($R = 0.991$, and -0.490), and moreover with the correlation with the P -size ($R = -0.869$). As we see on (Figure 4.3), the most sensitive parameter to represent the changes in network topology is RT , where the impact of tasks number is very small. As shown, RT is sensitive to changes of the network topology for the same number of non-redundant relations, and even more sensitive to the changes of non-redundant relations. RT can easily dominates both NT and CI ; i.e. - by multiplying RT with the number of tasks, the correlation between $(RT \times I)$ and NT' is very high ($R = 0.969$), - by just dividing RT by the number of tasks the correlation between (RT/I) and CI is even higher ($R = 0.987$). Therefore, we will adopt RT to represent the project network topology. Moreover, RT is often standardised over the interval $[0, 1]$.

4.2.1.3 Network shape

The shape is a characteristic of the network, which can be distinguished relying only on its surroundings and outlines. The network shape can be specified on the basis of some parameters: measure of the network length,

measure of network width, and the measure of the relationships between the length and width. We added to them the measure of network divergence and convergence (see appendix B), and the tasks distribution along the network and its asymmetry measure.

4.2.1.3.1 Parallelism and “serialism” measure

Elmaghraby and Herroelen (1980) argued that the network complexity can be measured by measuring the network parallelism. They argue that the non-efficiency of *CNC* to indicate the network difficulty results from the fact that this parameter neglects to measure the parallelism of the network. In project management context, measuring parallelism and “serialism” of a network can be performed relying on measuring respectively the network width and its length.

☞ *Network length*: The network length is defined by Valadares Tavares et al. (1999) as the longest path measured in terms of hierarchical levels. Simply, these hierarchical levels can be defined as a sequence of the stages or ranks in the network. Each stage represents a specific progression level. Network length can be considered as the maximum progressive level, it can be calculated as: $NL = \text{Max}_{i=1}^I(PL_i)$. Considering that PL_i is the

progressive level (or rank) of task i : $PL_i = \text{Max}_{j=1}^{PR_i}(PL_j) + 1$, where PR_i is the set of activities directly preceding the task i . In order to measure how serial is the shape of the network they proposed to use the relative length as an indicator to the network serialism, “horizontal depth”. This indicator can be computed as equation (4.8).

$$NS = \frac{NL-1}{I-1}, \quad (4.8)$$

This measure is normalized over the interval of [0, 1]. With $NS = 0$, being the completely parallel network, and $NS=I$ for completely serial network, knowing that two fictive nodes represent the start and finish events of the project. The dummy node of the project beginning corresponds to “ $i = 0$ ”, it has $PL_{(i=0)} = 0$. According to the study of Valadares Tavares et al. (2002), most of the networks have a value of $NS \leq 0.5$ (for example, the benchmark problems of Kolisch et al. (1995) have $NS \leq 0.46$). Aligned with this idea of using the number of ranks to characterise the project network, Haberle et al. (2000) presented this network measure, in the context of product design with concurrent engineering.

☞ *Network width*: If the network length is evaluated along the horizontal axis, then the network width considers the vertical one. The network width can be defined relying on the number of activities at each rank in the network, (Valadares Tavares et al., 1999). First, the number of activities at each rank or progressive level ($WL(l)$, with $l = 1, 2, \dots, NL$) can be computed. Afterwards, a width indicator for each progressive level can be calculated based on the equation (4.9). The produced indicator is normalized over the interval [0, 1].

$$WI(l) = \frac{WL(l)-1}{I-NL}, \forall l \in (1, 2, \dots, NL) \quad : \quad \sum_{l=1}^{NL} WI(l) = 1 \quad (4.9)$$

Where, the maximum width denoted by: $MW = \text{Max}_{l=1}^{NL}\{WL(l)\}$, can be used to signify the network width. Also the network width index can be represented as: $WI = \text{Max}_{l=1}^{NL}\{WI(l)\}$.

✍ **Length width interaction:** In order to show the interaction between the length and width of the network, we adopted the aspect ratio (AR): this dimensionless value is commonly considered as a measure of the interaction between the length and width of any planer shape, images or videos. Pascoe (1966) proposed to include it amongst the network complexity measures. He defined it as the ratio of the rank of project network to the maximum number of parallel paths. Referring to the previous discussion about the network length and width, it can be easy to determine an aspect ratio for AoN network: the length of the network is the number of progressive levels NL , and its width is the maximum number of tasks per level MW ; the aspect ratio can thus be defined as: $AR = NL / MW$. The more a network become serial and narrow, the higher the corresponding AR will be; on the opposite, as AR gets lower than unity, the network becomes thicker and shorter. As a parallel network is more complex in scheduling than a serial one, we adopted the inverse value of this aspect ratio. As shown by (Figure 4.4) the responsiveness of $1/AR$ is better than that of length or width measures taken alone: after standardisation, the coefficients of variation of NS , WI and $1/AR$ are 0.3287, 0.2760 and 0.5906, respectively. Hence, we propose it to characterize the network shape.

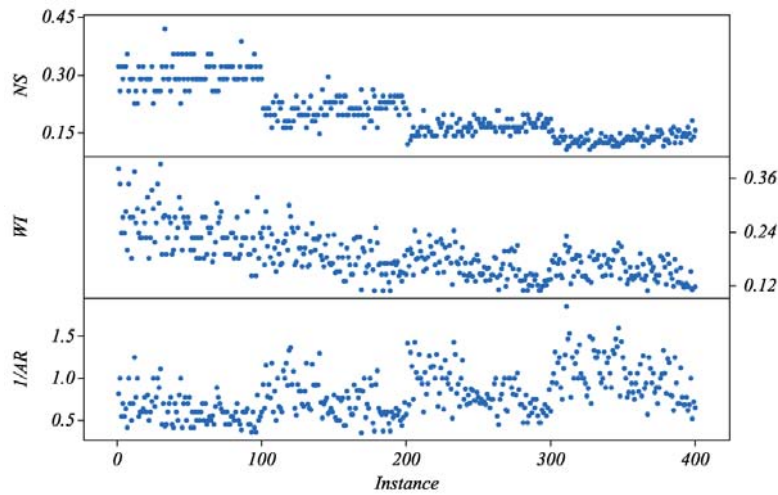

Figure 4.4 plot of the standardised values of the network length, width and aspect ratio

4.2.1.3.2 Tasks distribution and asymmetry measure

In order to reflect the network shape with respect to the distribution of tasks along the network length “ NL ”, we propose to use one of the descriptive statistics such as the asymmetrical measure “skewness”. The asymmetry measure “ $ASyM$ ” is a dimensionless measure of the asymmetry of data distribution around its mean. It can be calculated as presented by equation (4.10) (Nist-Sematech, 2003). In this equation, PL_i is the rank level of the task i , \overline{PL} is the average progressive level, VPL is the variance of the numbers of tasks distributed on the “ PL_i ” levels.

$$ASyM = \frac{\sum_{i=1}^I (PL_i - \overline{PL})^3}{(I-1) \times VPL^{\frac{3}{2}}} \quad (4.10)$$

The value of $ASyM$ can be positive, negative, or even zero; by interpreting the value of $ASyM$, the distribution of tasks and network shape can be figured out. The different interpretations of $ASyM$ are discussed in appendix B. The drawback of using the $ASyM$ is a null sensitivity in case of symmetry (whatever the shape, concave, convex). However, in project networks the case of $ASyM$ values exactly equal to zero is quite unlikely for real-world data. Even if it exist, knowing just that the project network is asymmetric is however useful.

In order to standardise this measure, we propose to use the logistic function, and to name the result the “standardised asymmetry measure”, $SASyM = 1/(1+e^{-ASyM})$. Examining this standardised form, one can find that as the tasks concentrate at the beginning of the network, the $SASyM$ approaches zero, (as shown in Figure B.3 in appendix B). For exactly symmetrical networks $SASyM = 0.5$. On the other side, the value of $SASyM$ approaches unity when tasks are concentrated at the end of the project. In this case, we will consider that the project schedule is more complex, since the risk of discovering the project unfeasibility can be higher. As shown by (Figure 4.5), the behaviour of the “ $SASyM$ ” is remarkable for the set of 400 projects, responding to variations of the tasks distribution along the network length. As we see, almost all the projects have a value lower than 0.5. Therefore, one can infer that the majority of these projects have tasks concentrated at the first half.

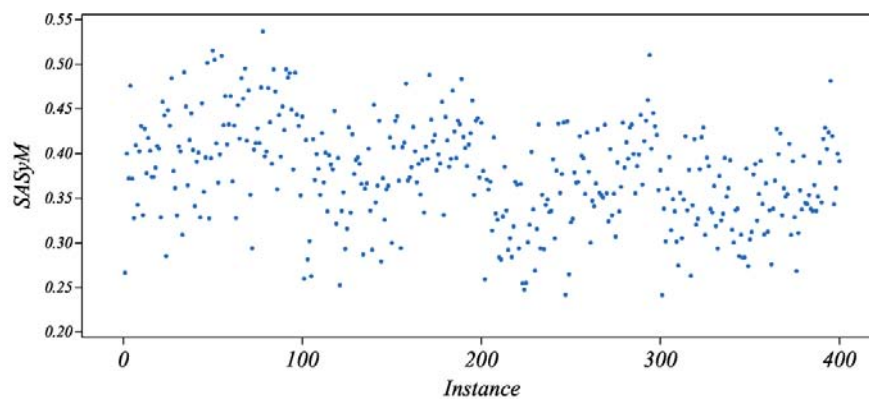

Figure 4.5 the distribution of $SASyM$ for a set of 400 projects

4.2.1.4 Network bottleneck measure

A bottleneck is a phenomenon where the resulting performance of an entire dynamic system can be limited by a single or limited number of components or resources. Usually, any facility, function, department or resource which is not able to meet the demand placed upon it at a specified time, becomes a bottleneck. For instance, in production lines, it can be defined as the most charged workstation, so that any lateness occurring at this workstation will slow down or even stop the whole production line. For supply chain networks, performance indicator can be revealed by the network bottleneck(s), especially at the interfaces between its members (Stadtler, 2005). In scheduling, the bottlenecks can result from the dependent and interdependent relations between activities. Each bottleneck may bring two associated risks: blocking and starving. Blocking occurs upstream the bottleneck, and the starving occurs downstream it. The degree of considering a given task as a bottleneck in a network is determined in function of its immediate predecessors (PR_i) and successors (SU_i). The network bottlenecks can be formulated by considering PR_i of a given task as its blocking activities and SU_i as its starving ones. In literature, Johnson (1967) proposed a measure called activity density, relying on PR_i and SU_i of each activity. The concept of “task degree” in the context of assembly lines networks was proposed also relying on PR_i and SU_i (Otto et al., 2011). The task degree of a task is the sum of the numbers of its direct predecessors and of its direct successors $TD_i = \{PR_i + SU_i\}$. By constructing the tasks’ degrees vector: $\{TD_1, TD_2, \dots, TD_n\}$, the maximum value TD_{\max} can be considered as one of the network measures. As shown in (Figure 4.6), this measure cannot be used independently, but it should be usefully aggregated with other measures in order to reflect the network complexity.

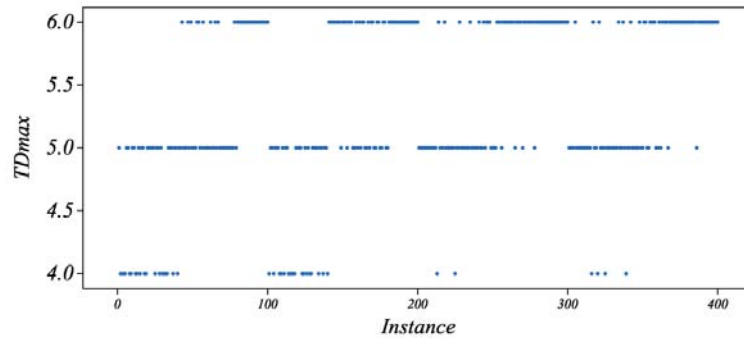

Figure 4.6 the plot of the networks bottleneck measure TD_{max}

4.2.2 Parameters related to time

4.2.2.1 Parameters based on tasks duration

The temporal characteristics of a project play a role in its complexity and affect the performance of a given project scheduler. The temporal characteristics have been previously used in the analysis of the performance of the heuristic methods by Patterson (1976). Some temporal indicators can be used relying on activities' durations, such as: - Sum of activities' durations, - Average activity duration, - and the variance in activity durations. These parameters represent the case of pre-determined activities' durations, but actually these durations are not always known in advance with certainty. In the case of our study, the exact activities durations are not known in advance and they depend on the productivity of the operators selected to perform them: we only have for each task three associated values (D_i^{min} , D_i , D_i^{max}). Here, we will use these three values simultaneously to represent the nature of activities durations, relying on a beta-distribution. The task mean duration can be computed as: $\mu d_i = (D_i^{min} + 4 \times D_i + D_i^{max}) / 6$ and the variance as: $vd_i = (D_i^{max} - D_i^{min})^2 / 36$. Other methods relying on the use of uniform, triangular, or gamma function distribution can be used. Consequently, one can calculate the average of tasks' mean durations ($ATMD = \sum \mu d_i / I$), and the average of their standard deviations " $ATSD = \sum vd_i / I$ ".

4.2.2.2 Project contractual duration and flexibility in project delivery

We assumed (in section 3.1.3) that the project is compelled to obey a contractual duration, which is possibly associated with a grace period. Any violation of this flexible interval by the project duration will result in extra costs for the contractor, such as storage costs or tardiness penalties (Vidal et al., 1999). The relative relation between the project contractual duration with respect to the project critical path length (neglecting resource constraints) can affect the project schedule complexities. *i.e.* if the project delivery date is loose enough, then the easier will be the project with the same resources. The reverse is true, if the project contractual date is tight enough then the problem resolution will suffer from the scarce of resources.

We propose to consider this factor in the characterisation of the project difficulties, known as project contractual duration factor " $PCDF$ ". It computed as equation (4.11), where L is the project contractual duration, CP^{min} is the project critical path duration if all tasks have their minimum durations (D_i^{min}). This complexity indicator is normalized over the interval $[0, 1]$, if $L \leq \sum D_i^{max}$; otherwise, it has a negative value, which indicates the bad estimation of the project contractual duration with respect to the activities maximum durations (D_i^{max}). The value of $PCDF = 0$ indicates the easiest case the (project duration is loose) but if it tends to unity, it indicates the tightness of the project contractual duration.

$$PCDF = 1 - (L - CP^{\min}) / (\sum_{i=1}^I D_i^{\max} - CP^{\min}) \quad (4.11)$$

4.2.3 Parameters based on temporal - Network:

This category introduces the parameters that reflect in some way the integration between the topology of the network and activities durations. These parameters include measures based on the floats - by the following we discuss some of them.

4.2.3.1 The project temporal density

According to Davies (1973), the density of the network is the measure of the free float under critical path conditions. The free float of an activity i “ ff_i ” is the float associated with it in a early schedule, and it measures the possibility to delay this task without effect on any other job. Therefore, the correlation of Pascoe (1966) expressing the network density based free-float (DFF) was adopted as:

$$DFF = \left(\sum_{i=1}^I \mu di \right) / \left(\sum_{i=1}^I \mu di + \sum_{i=1}^I ff_i \right) \quad (4.12)$$

The DFF measure is always within the interval] 0, 1], its upper bound indicates small average free float, and thus less possibilities to make sequencing decisions without causing further resource conflicts or without affecting the total completion date. According to Alvarez-Valdes and Tamarit (1989) this factor has an influence on the performance of a given scheduler. Projects with high $DFFs$ ’ are less flexible to endure delays on some activities than the low $DFFs$ ’ ones. In our case, we computed the free floats from tasks’ mean durations.

4.2.3.2 Project floats

Patterson, (1976) studied the effect of problem structure on some heuristic performance, and some of his listed parameters are the floats-related parameters. These parameters are listed in (Table 4.1):

Table 4.1 project float related parameters

Independent Parameter	Formula
Total float of all activities	: $TF = \sum_{i=1}^I ff_i$
Number of tasks Possessing positive (non-zero) total float	: $TTF = \sum_{i=1}^I \begin{cases} 1 & \text{if } ff_i > 0 \\ 0 & \text{if } ff_i = 0 \end{cases}$
Average tasks possessing positive total float	: $ATTF = TTF / I$
Average total slack per activity	: $\overline{TF} = TF / I$
Free sack of all activities	: $FF = \sum_{i=1}^I ff_i$
Number of tasks Possessing positive (non-zero) free float	: $TFF = \sum_{i=1}^I \begin{cases} 1 & \text{if } ff_i > 0 \\ 0 & \text{if } ff_i = 0 \end{cases}$
Average tasks possessing positive free float	: $ATFF = TFF / I$
Average total float per activity	: $\overline{FF} = FF / I$

Concerning these factors, we calculated only the average tasks processing free float “ $ATFF$ ”.

4.2.4 Parameters based on the work content

4.2.4.1 Resources requirements by activities

The resource requirements can be represented by the density of the jobs-skills requisition matrix (if the activity i requires the skill k , the matrix element takes the value of “1”, and “0” otherwise). This density can be measured with the *Resources Factor (RF)*:

$$RF = \frac{1}{I \times K} \sum_{i=1}^I \sum_{k=1}^K \begin{cases} 1 & \text{If } \Omega_{i,k} > 0 \\ 0 & \text{Otherwise} \end{cases} \quad (4.13)$$

The RF was developed by Pascoe (1966) to reflect the jobs-resources requirement relation, it reflects the average portion requested of resources per each job, relying on equation (4.13); if $RF = 1$, it means that each activity requires all the resources for its execution. If $RF = 0$, it indicates that there is no resources constrained problem where no activity requires any of the resources. The RF is normalised over the interval $[0, 1]$, and was used by Patterson (1976) under the name of average percent of demands. It was also modified by Kolisch et al., (1995) to reflect the density of the three-dimensions matrix of job-resources requirements for multi-mode project scheduling. (Kolisch et al., 1995) indicated that a growth of RF increases the computational effort to solve the problem; Yet, Alvarez-Valdes and Tamarit (1989) observed that the computational effort of heuristic algorithms are influenced by the RF , and that problems with $RF = 0.5$ are more likely to show bottleneck activities expanding the difficulty to be schedule than other problems with $RF = 1$. We expect that the temporal performance effort of our problem will validate that of Kolisch et al. (1995).

4.2.4.2 Activities work content

This parameter can be used to highlight the critical resources in the firm, *i.e.* the most charged ones. As the work content increases, scheduling the project gets harder for a given set of resources. The work-content per skill “ W_k ” can be calculated as:

$$W_k = \frac{\sum_i \Omega_{i,k}}{W}, \quad \forall k \in K, \text{ and } W = \sum_{i=1}^I \sum_{k=1}^K \Omega_{i,k} \quad (4.14)$$

Where W is the total project work content. We adopted the minimum and maximum resource work contents among all resources, respectively “*MinWC*” and “*MaxWC*”. Moreover, the “*total work content W*” will be used as a gross measure of the total resources requirements of the project. This gross measure can be represented as a required effort per person as a way of sizing the project.

4.2.4.3 Technical complexity of the Work-content

In the proposed problem, the technical complexity can be considered as one of the parameters that affect the productivities of workforce and their experience accumulation. As previously discussed (in section 3.2.2.3) the workforce productivities are functions of learning and forgetting rates. These rates are highly correlated to the technical complexity of the required work and task complexity (Osothsilp, 2002). Therefore, the number of technologies involved (e.g. mechanical, electrical, hydraulic, aeronautic, digital...), as well as their nature, affect the overall project complexity. The technical complexity can be simply represented as a novelty degree for the considered skill or resource (machines, equipment, tools, the required raw material...), *i.e.* it simply reflects the

similarity degree between the new work and what has been performed prior by the same workforce. This novelty degree can be measured relying on the ratio between the new required resource and the total resources. The value of “0” means well-mastered work, and a value of “1” indicates a novel one. We propose to integrate only the similarity degree between skills, as discussed in (3.2.2.2), this similarity degree can affect the productivity of workforce secondary skills. It can be computed as the average value of all the pairs of skills, known as “*SD*”.

4.2.5 Parameters based on temporal-Network-Work content

By constructing the profile of each resource along the critical path, a set of variables can be computed, such as: the maximum, minimum, average and variance of demand, or the centre of the workload profile area. In order to characterise a given profile, we should distinguish between two types of variables: the location factors, representing the variable location relative to the critical path (e.g. the location of the maximum demand of a given resource profile), and the magnitude of variables or the description of the workload distribution. Therefore, we propose to measure each kind of parameters separately. First, the resource requirement vector can be computed by: - Construct the project early schedule, and get the project duration corresponding to the length of critical path “*CP*” (in time periods or days). - For each resource type, construct the resource-workload profile based on project schedule, such that, it can be represented as a vector of resource requirement at each time interval $t \in CP$, $\overrightarrow{RR}_k = \{RR_{k,1}, RR_{k,2}, RR_{k,t}, \dots, RR_{k,CP}\}$, $\forall k \in K$. This vector will be calculated for each resource, for each project (if there are many). Thereafter, the different quantifications can be modelled, as follows.

4.2.5.1 Characterisation of resource work-content

☞ **Average load:** One of the integration between the network, temporal and work-content parameters is the Average Resource Loading Factor (*ARLF*), proposed by Kurtulus and Davis (1982). This *ARLF* identifies whether the peak of total resource requirements is located in the first or the second half of the project’s original critical path. First, Davis (1975) presented a measure called “*Product Moment*” *PM*. It was used to indicate the predominant location of resource requirement along the project temporal periods. Relying on the same principle of the *Product Moment*, and with the modification of dividing the project duration into two segments, the *ARLF* measure of Kurtulus and Davis (1982) was presented for multi-project scheduling. Recently Browning and Yassine, (2009) presented a measure of resources constrained multi-projects scheduling problem, by adopting the (*ARLF*) indicator. They normalised *ARLF* over the projects’ maximum *CP* rather than over each individual project’s *CP* length. This modification was carried out in order “to identify whether the bulk of a problem’s total resource requirements fall in the front or back half of its critical path duration”. In order to present clearly the average resource load factor magnitude, we propose to use the average resources requirement per period:

$$ARP = \sum_{k=1}^K \sum_{t=1}^{CP} RR_{k,t} / K \times CP$$
. And in order to use it as complexity indicator, we propose to normalise it over the interval [0, 1] using the logistic function of its log scale, as: $ARPF = 2 / (1 + e^{-\log(ARP)}) - 1$.

☞ **Maximum load:** In a multi-project scheduling, Kurtulus and Narula (1985) developed a project summery relying on the maximum consumption of a given resource, called the *Maximum Load Factor* (*MLF*). They present the localisation of the peak in a resource’s profile as one of the project measures. In order to eliminate the contribution of the number of tasks in the problem, they proposed to divide the *MLF* by the total number of tasks. As previously mentioned, we propose to separate the values of factors from their locations. Therefore; we

propose to measure the average resources maximum loads, as average resources' bottlenecks factor “ ARB = $\frac{\sum_{k=1}^K RR_k^{\max}}{K}$ ”, then normalise it over the interval $[0, 1]$ using the logistic function of its log scale, as: $ARB = 2/(1 + e^{-\log ARB}) - 1$.

☞ **Profile central factor:** we propose a dimensionless factor, named “profile central factor PCF ”: it is simply a centre of area of a given workload profile. It can be calculated based on the product moment of Davis (1975) as in equation (4.15). The proposed formula calculates the central of the work-content with respect to the project critical path length. It is always located within the interval $[0, 1]$. It simply indicates the date, related to the critical path, at which the required workload is exactly halved. Therefore, $PCF_k < 0.5$ indicates that the workload is concentrated at the first half of the project, and conversely, if $PCF_k > 0.5$, the work-content is concentrated in the second half of the project horizon. A value of $PCF_k = 0.5$ indicates that the work-content is exactly symmetric.

$$PCF_k = \frac{\sum_{t=1}^{CP} [RR_{k,t}(t-1/2)]}{CP \times \sum_{t=1}^{CP} RR_{k,t}} \quad (4.15)$$

Another purely location measure can be proposed, the *resource-bottleneck location* “ RBL ”: it gives the location of the maximum required load: $RBL_k = \frac{\sum_{\varepsilon=1}^{E_o} t_{\varepsilon}}{CP \times E_o}$, where t_{ε} is the time period at which a maximum peak has been observed, and E_o is the number of observations of the maximum peaks. This measure is dimensionless and can be considered as the ratio between the locations of the bottlenecks with respect to the critical path length. It is normalised over the interval $[0, 1]$. A value near zero indicates that the resource bottleneck occurs at the project beginning, and a value that approaches unity expresses that this location moves towards the project termination. For a set of resources, the mean value can be used to indicate the bottleneck location:

$$RBL = \sum_{k=1}^K RBL_k / K \cdot$$

To show the difference between $ARLF$, $ARPF$, and PCF , we conducted a simple comparison which results are displayed on (Figure 4.7). The average location of workload can be read from $ARLF$: it is negative for almost all projects, meaning that the first half of these projects contain greater workload than the second. By separating the magnitude from the location, the same conclusions can be extracted, moreover, the exact percentage of load concentration can be figured out by the PCF values.

In the case of project sizing, $ARLF$ can be misleading where there is no exact value for location and magnitude (compared to the use of PCF and $ARPF$). As well, the $ARPF$ can be translated easily to the average resource requirements in number of working hours. Concerning the average maximum workload and its location, as shown by (Figure 4.8), the use of $AMLF$ can figure the location of the average maximum load, but it can be misleading about the value. Therefore, we prefer to separate the location and the value. Moreover, in order to use both of them as indicators of complexity measures we propose to use the normalised form over the interval $[0, 1]$. The value of ARB can simply be translated into the required number of working hours, where $AMLF$ cannot.

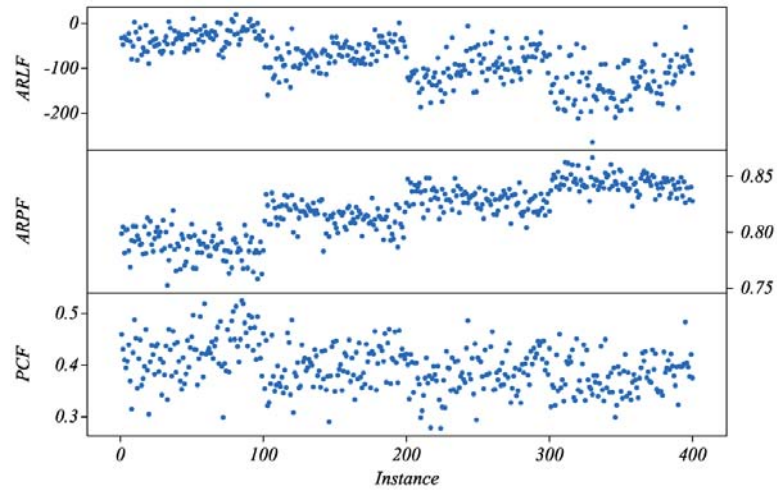

Figure 4.7 the plot of the average load factors: ARLF, ARPF, and PCE.

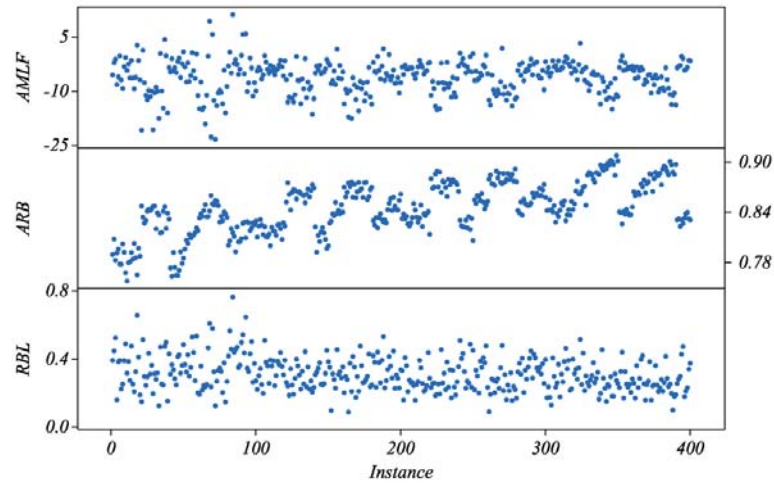

Figure 4.8 the plot of the average maximum load: AMLF, ARB, and RBL.

4.2.5.2 Variation of resource work-content

By considering the work profile of a given resource as a distribution function, the descriptive statistics can be appealed to figure out the profile. Relying on these statistics and the resources' profile vectors $\overrightarrow{RR_k}$, the variation of the resource demand can be computed. We propose to use the coefficient of variation, as follows:

$$CV_k = \sqrt{\frac{\sum_{t=1}^{CP} (RR_{k,t} - \overline{RR_k})^2 / (CP-1)}{\overline{RR_k}}} \quad (4.16)$$

The coefficient of variation is simply the ratio between the standard deviation of the demand and its mean value. The advantages of this coefficient are that it is dimensionless, and that it always provides a variation degree relative to the mean. It always takes a real non-negative value. A zero value indicates a constant demand, and as this value increases, the higher its variation will be, compared to the mean value. After calculating the coefficient of variation for each kind of resource, the mean value can be computed: $CV = \sum_{k=1}^K CV_k / K$.

4.3 PARAMETERS RELATED TO RESOURCES

4.3.1 Resources availability

The availability is always measured relative to the requirements, *i.e.* it reflects the relation between demands and accessibility of a given resource. The computational effort to solve a given problem is logically a function of resources number and availability; some authors such as Elmaghraby and Herroelen (1980) argued that there is a bell-shaped relationship between the computational effort and the resource availability. As they explained this hypothesis, if resource are only available in extremely small amounts, there will be relatively little freedom in scheduling activities: as a result, the activities may have to be placed in series and the resulting project duration will be equal to the sum of tasks' durations. At the other side, if the resources are amply available the activities can be scheduled in parallel and the resulting project duration will be equal to that of the critical path, the complexity will be reduced. This conjecture is then confirmed by De Reyck and Herroelen (1996a) by using the Resources-Constrainedness (*RC*) introduced by Patterson (1976).

Within literature some measures can be found concerning the resources constrainedness in project scheduling. For example, Davies (1973) developed a resources limitations measure that stated the proportion of the expected maximum demand for resources. The expected maximum demand is the product of average activity demand and the number of real parallel activities, *i.e.* which could be theoretically under progress at the same time. By the following, we detail some of them. But in order to measure only the availability of a resource type k , the availability per period for each resource can be constructed as a vector of real resources (workers) $\overline{RA}_k = \{RA_{k,1}, RA_{k,2}, RA_{k,3}, \dots, RA_{k,CP}\}$. Afterwards, the average availability related to the project critical path can be estimated as $\overline{RA}_k = \sum_{t=1}^{CP} RA_{k,t} / CP$. In case of constant resources per period " $|A_k|$ ", the average availability can be computed as $\overline{RA}_k = |A_k| = RA_{k,t} \forall t \in CP$, then the average real workforce can be computed as $ARW = \sum_{k=1}^K |A_k| / K$.

4.3.2 Overall average productivity

Due to the heterogeneous productivities of a versatile workforce in our model, we propose to use the operators' overall average productivity. As the productivity of each operator in practicing a specified skill is already normalised over the interval $[0, 1]$, the overall mean productivity " Θ " will also be normalized, and can be computed as follows:

$$\Theta = \frac{1}{K} \times \sum_k \sum_a \theta_{a,k} / \sum_k |A_k| \quad (4.17)$$

Where $|A_k|$ is the cardinality of the set of operators who can master the skill k . The value of " Θ " approaches unity: when firm's staff are all experts in practicing all of their skills. In order to predict the labour capacity, we propose to integrate " Θ " with the real number of resources. This available capacity can be expressed either as a number of working hours, or as an equivalent workforce. The overall available capacity of the workforce

“OCW” (in equivalent number of persons) can be defined as $OCW = \Theta \times A$. The effective number of operators

for each skill can be computed as $A_k^e = \sum_{a=1}^A \theta_{a,k}$, thus the average effective workforce per skill can be computed

as: $AEW = \frac{\sum_{k=1}^K A_k^e}{K}$.

By investigating the correlation between the average real workforce per skill “ARW”, the average effective workforce per skill “AEW”, and overall available capacity “OCW”, we found a correlation coefficient between OCW and ARW of ($R=0.993$), and ($R=0.994$) between OCW and AEW. Therefore, we propose to use only the OCW and Θ to represent the workforce availability.

4.4 ACTIVITIES- RESOURCES INTERACTION

The assessment of the interaction between project activities and resources can be represented as an obstruction or scarcity factor. This scarcity can be defined as the condition at which at any given time t the demand for one or more resource(s) exceeds the supply. As explained by Pascoe (1966), the resource scarcity is the main problem of resources allocation problems. An increase in network complexity or resource requirement is likely to increase the obstruction to realizing a given project. Accordingly, measuring scarcity of resource is very important, thus by the following we discuss some of these measures.

Resource scarcity index (RSI)

In order to quantify the relation between resources requirements and their availabilities a *Resource-Strength (RS)* was proposed by Cooper (1976). It can be defined as the ratio between the available amounts of the resource k to the average requirements from this resource per job. Kolisch et al. (1995) stated three drawbacks of this measure: RS is not standardized within the interval [0, 1]; small values of “RS” do not guarantee a feasible solution; the scarcity of resources is calculated in a “myopic” fashion. In order to overcome these three drawbacks, they modified it for multi-mode RCPSPs’ as:

$$RS_k = \frac{RA_k - R_k^{\min}}{R_k^{\max} - R_k^{\min}} \quad (4.18)$$

For renewable resources, $R_k^{\min} = \text{Max}_{i=1}^I [\text{Min}_{m=1}^{M_i} [RR_{i,m,k}]]$ is the minimum demand and “ R_k^{\max} ” is the peak demand for resources of kind k in precedence-preserving early start schedule; RA_k is the total available capacity for this resource, and “ M_i ” is the number of modes of activity “ i ”. Relying on this expression, if we have only one mode, we can rewrite and calculate R_k^{\min} as: $R_k^{\min} = \text{Max}_{i=1}^I [RR_{i,k}]$, R_k^{\max} being unchanged. Now, RS is always within the interval [0, 1]. As noted by De Reyck and Herroelen (1996a) this new RS incorporates information about the network structure.

We can adapt this measure to the current problem, relying on the fact that the project should be executed with the minimum resources if all tasks are expanded to their maximum durations while it cannot when durations are minimum. Therefore the minimum requirements can be calculated as $R_k^{\min} = \text{Max}_{i=1}^I [\Omega_{i,k} / D_i^{\max}]$. In order to determine

the maximal demand per period of job i from resources with skill k , we can calculate R_k^{\max} as the peak demand of resource mastering the skill k in early start schedule, when all tasks have their minimum durations. As a result the resources strength can be measured by the equation (4.19), taking into account that the maximum available capacity per-period Q_k was calculated based on the French regulation considering the standard working hours per week $C_0 = 35$ hours, (an illustrative example shown in appendix B.4).

$$RS_k = \frac{Q_k - R_k^{\min}}{R_k^{\max} - R_k^{\min}} \text{ Where: } Q_k = \Theta \times |A_k| \times \frac{C_{S0}}{NJS} \quad (4.19)$$

As shown, RS gives the easiness of conducting a project, and not its complexity related to resources scarcity. In order to use it as a project complexity scale, we propose to normalise it as shown by equation (4.20). We call this new measure the *resources scarcity index RSI*: it is computed from the average resources strengths of all skills (\overline{RS}). The new RSI is always within the interval $[0, 1]$ whatever the resources capacity and the demand.

$$RSI = 2 / (1 + e^{-\frac{1}{\overline{RS}}}) - 1 \quad (4.20)$$

Resources-Constrainedness “RC”

This measure was first developed by Patterson (1976) to be used in his heuristic investigation of the performance. As discussed by De Reyck and Herroelen (1996a), RC can be considered as a pure measure of resource availability, since it does not integrate information about the network. They showed that the “ RC ” can distinguish between easy and hard problems while RS can not, and that there is a negative correlation between the RC and RS . As presented by Patterson (1976), this measure can be calculated from only two attributes: the requirements of each activity from each resource, and the availability of this resource. First, we will calculate the average demand per activity from the kind of resource k , then by a simple comparison between the resource requirement and its availability, the RC can be computed. We adopted this measure, and then adapted it to be used as one of the problem quantifiers. The task’s average requirement (\overline{TR}_k) can be modelled in a number of working hours per day, as equation (4.21).

$$\overline{TR}_k = \sum_{i=1}^I \left(\frac{\Omega_{i,k}}{\mu d_i} \right) / \sum_{i=1}^I \begin{cases} 1 & \text{If } \Omega_{i,k} > 0 \\ 0 & \text{Otherwise} \end{cases} \text{ For each } k \in K \quad (4.21)$$

In order to get non-dimensional “ RC_k ”, we need to express the resource capacity “ Q_k ” in available hours per day. As shown by equation (4.22), we propose to calculate it by using the average resource-productivity (Θ), and the available number of operators mastering the skill k “ $|A_k|$ ”. Considering that, we suppose to use the standard number of working hours per week without overtime (C_{S0}), and the number of working days per week (NJS). By integrating these values, the average available number of working hours per day “ Q_k ” can be computed. As a result, we can compute “ RC_k ” per skill as equation (22). The project RC is an average value $RC = \sum_{k=1}^K RC_k / K$.

$$RC_k = \overline{TR}_k / Q_k, \text{ where } Q_k = \Theta \times |A_k| \times \frac{C_{S0}}{NJS} \quad (4.22)$$

Temporal resources-constrainedness

This measure integrates the previous (RC) with the temporal dimension; it was presented by Patterson (1976). The tasks durations and the project duration (L) were integrated. It simply represents the ratio between two

parameters: the average task-resource requirement and resource availability during the period “ L ”. We modified it as equation (4.23): the temporal task constrainedness TRC_k can measure the ratio between the average requirement of task for resources of competence k to the total number of available hours during the project duration for this skill. We integrated the contractual duration “ L ” and the flexibility tolerance, L being computed as explained in (section 4.2.2.2). This factor can be used to figure out the degree of difficulties of performing a project with respect to the available skills. The average value: $TRC = \frac{\sum_{k=1}^K TRC_k}{K}$ can be used for the whole project.

$$TRC_k = \frac{\sum_{i=1}^I \Omega_{i,k}}{\left[\sum_{i=1}^I \begin{cases} 1 & \text{If } \Omega_{i,k} > 0 \\ 0 & \text{Otherwise} \end{cases} \right] \times \left[\Theta \times |Ak| \times \frac{C_{S0}}{NJS} \times (L + \beta) \right]} \quad \text{For each } k \in K \quad (4.23)$$

Obstruction factor

The obstruction factor is first proposed by Davis (1975), relying on four attributes: the network typology, temporal characteristic presented by the length of the schedule, the resource requirements, and the resource availability. What he named “O-factor” is the ratio of excessive resource requirements to the total workload. First, an obstruction factor “ O_k ” should be calculated for each kind of resource: the O-factor “ OF ” is then their average value:

$$O_k = \frac{\sum_{t=1}^{CP} \text{Max}\{0; RR_{k,t} - RA_{k,t}\}}{W_k} \quad \text{For each } k \in K, \quad OF = \frac{\sum_{k=1}^K O_k}{K} \quad (4.24)$$

Project load density

Davies (1973) presented a measure relying on the integration of resource utilization and its availability during the project period. This measure integrates mainly four attributes: resources requirements, activities durations, resources availability, and the length of the critical path (CP , in time periods). He called it the utilization of the resource k . Aligned with this measure, we propose a measure that represents the project load density per skill, we get it as the ratio between the total workload required from a given skill to the probabilistic available standard operators’ capacity from this skill. This *Project load density* PLD_k is given by:

$$PLD_k = \frac{\sum_{i=1}^I \Omega_{i,k}}{\left[\frac{C_{S0}}{NJS} \times (L + \beta) \times \sum_{a=1}^A \frac{\theta_{a,k}}{nk_a} \right]} \quad \text{For each } k \in K \quad (4.25)$$

Where nk_a is the number of skills that the operator a masters with a productivity level greater than the minimum required. We propose the average value of the different PLD_k s’ to represent the project load density “ PLD ”.

4.5 COMPOSITION OF PROJECT MAIN DIMENSIONS

From all of the previous discussed quantifiers, and after selecting the most sensitive one(s) to represent each dimension of complexity, we count mainly five of these dimensions (Figure 4.9): the network, the temporal

characteristics, the workload, the resources, and the weight of workload on resources. All quantifiers in this figure are already normalised on $[0, 1]$ except those in blue $\{TDmax, ATMD, ATSD, W, CV, \text{ and } OCW\}$. In order to normalise all of them, we propose to project each of these quantifiers over the interval $[0, 1]$ using the logistic function of their log scale: $2/(1+e^{-\log(x)})-1$. For simplicity, we kept the same variables notations.

Now we propose to aggregate these quantifiers using the principal component analysis “PCA”, (see appendix C). PCA is one of the extraction methods of factor analysis used to reduce the number of variables, relying on the linear algebra. PCA accounts for most of the variance in a set of observed variables. The main purpose is to reduce probably-correlated multi-dimensional data to a smaller set of un-correlated ones, this smaller number of variables being able to represent most of the information from the original data (Jolliffe, 2002).

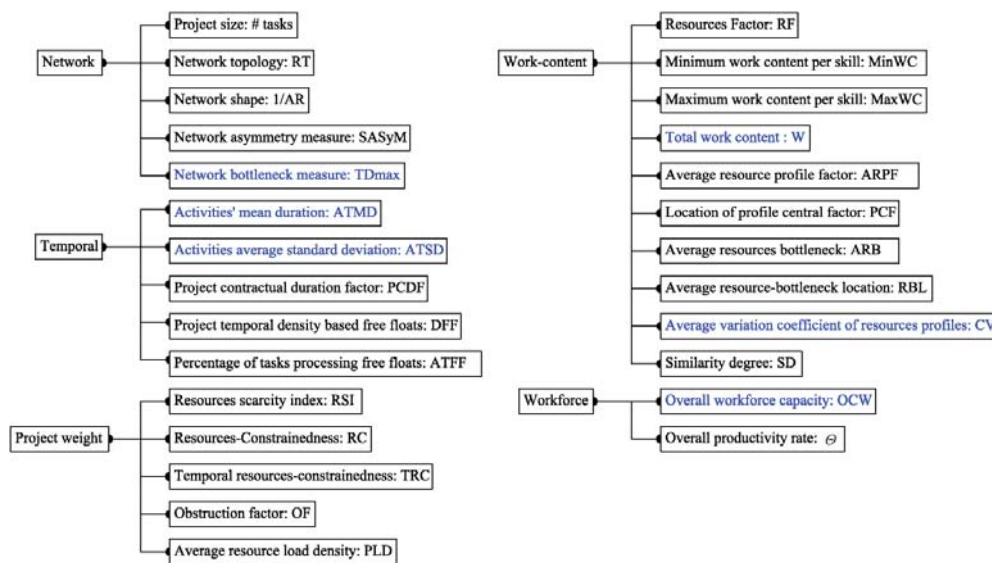

Figure 4.9 the project different quantifiers

To conduct this study, let us set up the data matrix “M”, built with the original measures; it is a $[MI \times NV]$ matrix, where MI is the number of project instances (in our case, 400 projects), and NV is the number of quantifiers (in our case, they are: P_size, RT, 1/AR, SASyM, ..., PLD). According to (Pallant, 2010), the presence of outlier values in the original data can affect the results, so we conducted a preliminary check so that these outliers can be removed from the original data before conducting the PCA. The applicability of factor analysis to data should also be checked, by investigating: - the correlation matrix between variables (correlations recommended to be greater than 0.3 between any pair of variables), - Bartlett's sphericity test ($P_value < 0.05$) - Kaiser-Meyer-Olkin measure of sampling adequacy (KMO should be greater than 0.5). For more details see (appendix C). As shown in (table B.4 & B.5, in appendix B), the correlation matrix contains many values higher than 0.3, Bartlett's sphericity test ($P_value = 0.0$), and KMO test ($KMO = 0.760$) are satisfied, thus the adequacy of using PCA to the current data was approved.

By employing the PCA analysis (using XLSTAT addinsoft), a set of principal components (PC_i) or factors of maximum size $[1 \times NV] = [F_1, F_2 \dots F_{27}]$ can be obtained (Figure 4.10). The analysis is conducted based on the correlation matrix to avoid the problems related to the data scales (we even normalised all quantifiers). As results, each element within this list of factors has a specified rank (eigenvalue) indicating its contribution to

explain the total variances in the original data, and these principal factors are arranged in the order of decreasing eigenvalues. As indicated in (Figure 4.10 and table B.6), the first factor explains about 28.45% of the total variance, and the second one is capable to explain about 16.586%, etc. Each factor is loaded from all the quantifiers according to a specified contribution, as shown by (Figure 4.11), by projecting the variable to the factor axis. The quantifiers that have the highest projection cosine are those whose contributions are the highest in building the axis. Nevertheless, the question is how many components should be taken into account?

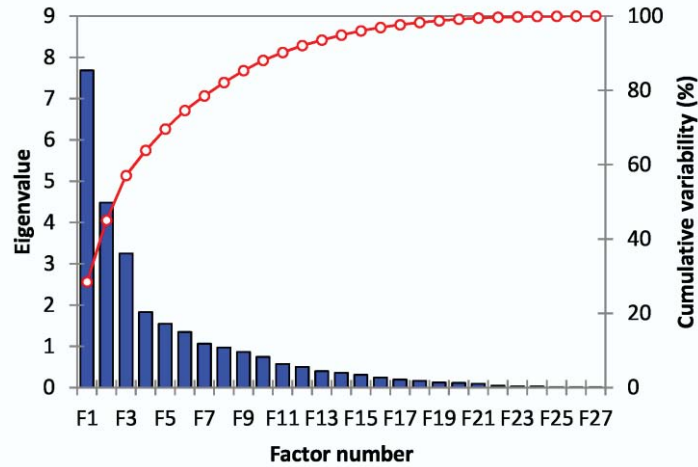

Figure 4.10 Scree plot of the different Eigenvalues for the PCA of all quantifiers

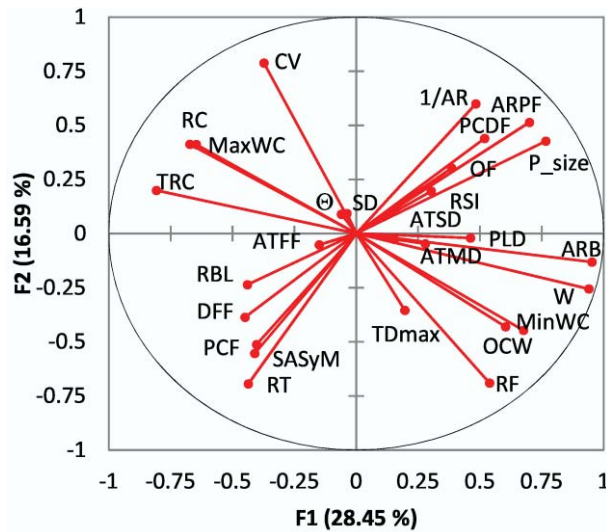

Figure 4.11 the contributions of different quantifiers on the axis of F1, and F2

In order to determine the number of components, Franklin et al. (1995) and Pallant (2010) appreciated the use of parallel analysis. Parallel analysis involves the comparison of the magnitudes of factors' eigenvalues with those obtained from a randomly-generated data set of the same size. If the eigenvalue of a principal factor is greater than that of a randomly-generated data, we accept the corresponding factor as representative, otherwise we reject it. In order to calculate these eigenvalues issued from random data, we used a software called “*Monte Carlo PCA for parallel analysis*” developed by Watkins (2000). The results shown in (table B.6 in appendix B) indicate that only the first six factors “ F_1, \dots, F_6 ” could be accepted, these six factors explaining all together about 75% of the total variance in the original data.

From this result, the rotation of axes using “*Varimax rotation*” (Pallant, 2010) was carried out after having identified the number of composite factors to be only six components “ PC_1, \dots, PC_6 ”. These new components were built out from the projection of the different quantifiers to the principal component axis after “*Varimax*” rotation. The loading of the different components relying on quantifiers is showed in (Table 4.2), it simply represents the correlation between each principal component and the quantifiers after the rotation. The quantifiers that had the highest projection cosine on axes after rotation are those whose contributions are the highest in building the principal components. The projections of these quantifiers on components’ axes are presented in table (Table 4.3), as cosines squared. The higher the cosine squared is, the higher will be the contribution of the quantifier in building the corresponding principal component. The loading (correlation) or squared cosines help to a good understanding of the analysis results. As shown in (Table 4.3), for a specified principal component, the bold values indicate that the corresponding quantifiers are the most suitable in building it.

In order to understand the composition of the new principal components, we performed a hierarchical clustering (see appendix C) of all quantifiers, shown in (Figure 4.12). This analysis grouped the similar variables in clusters. At level of similarity = 0.30, we found ten clusters. Based on factor loading, squared cosines and cluster analysis, we can identify and understand the elements of each principal component and get their scores from (Table 4.4). By the following, we discuss the construction of each principal component.

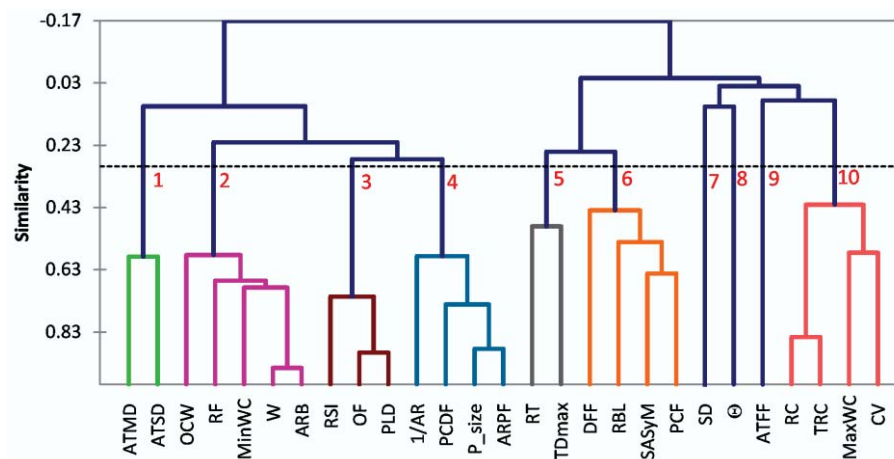

Figure 4.12 the hierarchical cluster analysis of the standardised measures

❖ The first principal component “PC1”

As shown by squared cosines (Table 4.3), the PC_1 is highly dependent on the work-content variables (RF , $MinWC$, $MaxWC$, W), resources profiles (ARB and CV), workforce overall capacity (OCW), and constrainedness quantifiers both per task (RC) and along the project (TRC). Relying on (Figure 4.12), the PC_1 contains two clusters (cluster #2, and #10). The cluster #2 contains variables related to resources, workload, and resources bottleneck, so it can represent the project sizing. These variables are somewhat similar correlated. The other cluster #10, contains constrainedness per task “ RC ” and that of the project “ TRC ”, moreover to the resources profiles variables (ARB and CV). It represents in some way the interaction between the work-content and the resources without highly integrating the network and temporal characteristics. This principal component can be

computed as equation (4.26), by subtracting cluster #10 from cluster #2. Therefore, we named it “*project scales index PSI*” to represent the project sizing.

$$PSI = [0.192 \times RF + 0.139 \times MinWC + 0.114 \times W + 0.123 \times ARB + 0.150 \times OCW] - [0.142 \times RC + 0.090 \times TRC + 0.135 \times MaxWC + 0.158 \times CV] \quad (4.26)$$

❖ The second principal component “PC2”

The second component (equation 4.27) is composed of network parameters (P_size , RT , $1/AR$), temporal ($PCDF$) and one of the resources-temporal-network parameters ($ARPF$). It composed of cluster #4 and one element of cluster #5 “ RT ”. The question is why the variable “ RC ” was put in cluster #5 with $TDmax$ and not in cluster #4? To answer this question, we investigated the correlation between RT and all variables in cluster #4 and #5. We found that the correlation of RC with all variables in cluster #4 are negative at $R=\{-0.744, -0.515, -0.502, -0.644\}$ respectively with $\{1/AR, PCDF, P_size, ARPF\}$, where that with $TDmax$ is positive at $R=0.492$. Therefore, RC is gathered with $TDmax$, but for the principal component analysis the sign does not affect the results. Thus it is suitable to place RC in cluster #4. We call this component “*network flexibility index NFI*”. It is positively correlated with the factors that increase the combinatorial arrangements of the network (increase flexibility), and negatively correlated with dependency between tasks (reduced flexibility).

$$NFI = [0.162 / AR + 0.306 \times PCDF + 0.222 \times P_size + 0.265 \times ARPF] - [0.104 \times RT] \quad (4.27)$$

❖ The third principal component “PC3”

The third principal component is a pure project-weighting index. It relies on the resources scarcity index “ PSI ”, obstruction factor “ OF ”, and project load density “ PLD ”. These three quantifiers are grouped in only one cluster #3, named “*Project weight index PWT*”. According to the scores displayed in (Table 4.4), it can be computed as follows:

$$PWI = [0.267 \times PSI + 0.271 \times OF + 0.249 \times PLD] \quad (4.28)$$

❖ The fourth principal component “PC4”

The next principal component is a project geometrical factor; it is based upon the asymmetry measure “ $SASyM$ ”, the average load location “ PCF ”, the location of maximum load “ RBL ”, and the flexibility-based free floats “ DFF ”. These four quantifiers are grouped in one only cluster #6, named “*Project load location index PLLI*”:

$$PLLI = [0.289 \times SASyM + 0.278 \times DFF + 0.324 \times PCF + 0.302 \times RBL] \quad (4.29)$$

❖ The fifth principal component “PC5”

The fifth principal component can be composed of cluster #1, #7 and #8, representing, respectively, the characteristics of tasks duration $ATMD$ and $ATSD$, the similarity degree between skills SD , and the workforce

productivity Θ . But as we can see from the squared cosines, the contributions of SD and Θ in building this principal component are very small, the main contributions being that of $ATMD$ and $ATSD$. Therefore, we call it “Tasks durations index TDF ”:

$$TDI = [0.507 \times ATMD + 0.559 \times ATSD] - [0.088 \times SD + 0.157 \times \Theta] \quad (4.30)$$

❖ The six principal component “PC6”

The last principal component relies on cluster #9 “ $ATFF$ ” and the remaining from cluster #5 $TDmax$. We can find that the contribution of $TDmax$ is twice as that of $ATFF$ – thus we called it the “network bottleneck index NBI ”:

$$NBI = [0.520 \times TDmax + 0.321 \times ATFF] \quad (4.31)$$

Table 4.2 Factor loading after Varimax rotation

	PC1	PC 2	PC 3	PC 4	PC 5	PC 6
P_size	0.230	0.824	0.181	-0.316	0.104	0.239
RT	0.025	-0.617	-0.043	0.426	0.031	0.519
1/AR	0.036	0.691	0.101	-0.260	-0.042	-0.403
SASyM	-0.027	-0.331	0.002	0.705	-0.004	0.213
TDmax	0.223	0.062	0.073	0.130	0.019	0.805
ATMD	0.131	0.184	0.006	0.055	0.836	0.059
ATSD	0.047	0.010	0.012	-0.029	0.883	-0.042
PCDF	0.060	0.877	0.075	0.048	0.049	-0.017
DFF	-0.089	-0.263	-0.080	0.717	0.022	-0.229
ATFF	-0.128	-0.195	-0.007	-0.183	-0.142	0.462
RF	0.897	-0.256	0.136	0.058	-0.042	-0.060
MinWC	0.793	0.001	0.286	-0.059	-0.001	0.099
MaxWC	-0.769	-0.019	-0.280	0.061	-0.060	-0.050
W	0.836	0.372	0.254	-0.135	0.142	0.158
ARPF	0.155	0.910	0.196	-0.153	0.087	-0.032
PCF	-0.051	-0.204	0.005	0.841	0.010	0.132
ARB	0.811	0.425	0.232	-0.215	0.027	-0.009
RBL	-0.244	-0.029	-0.095	0.715	-0.017	0.079
CV	-0.772	0.224	-0.208	-0.427	-0.022	-0.045
SD	-0.076	0.092	0.090	0.099	-0.139	-0.095
OCW	0.800	0.163	-0.524	-0.086	0.043	-0.048
Θ	-0.050	0.116	-0.084	0.108	-0.248	-0.199
RSI	0.034	0.087	0.874	-0.094	0.130	-0.012
RC	-0.804	-0.226	0.493	0.074	-0.067	0.001
TRC	-0.726	-0.424	0.260	0.246	-0.111	-0.240
OF	0.033	0.260	0.929	-0.092	-0.047	0.002
PLD	0.293	0.169	0.862	0.095	-0.028	0.049

Table 4.3 Squared cosines of the variables after Varimax rotation

	PC1	PC 2	PC 3	PC 4	PC 5	PC 6
P_size	0.053	0.679	0.033	0.100	0.011	0.057
RT	0.001	0.381	0.002	0.182	0.001	0.269
1/AR	0.001	0.478	0.010	0.067	0.002	0.162
SASyM	0.001	0.110	0.000	0.497	0.000	0.045
TDmax	0.050	0.004	0.005	0.017	0.000	0.648
ATMD	0.017	0.034	0.000	0.003	0.699	0.004
ATSD	0.002	0.000	0.000	0.001	0.780	0.002
PCDF	0.004	0.769	0.006	0.002	0.002	0.000
DFE	0.008	0.069	0.006	0.514	0.000	0.052
ATFF	0.016	0.038	0.000	0.034	0.020	0.213
RF	0.805	0.066	0.018	0.003	0.002	0.004
MinWC	0.630	0.000	0.082	0.004	0.000	0.010
MaxWC	0.592	0.000	0.078	0.004	0.004	0.003
W	0.698	0.138	0.065	0.018	0.020	0.025
ARPF	0.024	0.828	0.038	0.024	0.008	0.001
PCF	0.003	0.042	0.000	0.708	0.000	0.017
ARB	0.658	0.180	0.054	0.046	0.001	0.000
RBL	0.059	0.001	0.009	0.511	0.000	0.006
CV	0.595	0.050	0.043	0.183	0.000	0.002
SD	0.006	0.009	0.008	0.010	0.019	0.009
OCW	0.640	0.027	0.275	0.007	0.002	0.002
Θ	0.002	0.013	0.007	0.012	0.061	0.040
RSI	0.001	0.008	0.764	0.009	0.017	0.000
RC	0.646	0.051	0.243	0.005	0.005	0.000
TRC	0.527	0.179	0.068	0.060	0.012	0.058
OF	0.001	0.068	0.864	0.008	0.002	0.000
PLD	0.086	0.029	0.742	0.009	0.001	0.002

Values in bold correspond for each variable to the factor for which the squared cosine is the largest

Table 4.4 Component score coefficients after Varimax rotation

	PC1	PC2	PC3	PC4	PC5	PC6
P_size	-0.034	0.222	-0.001	-0.008	0.000	0.212
RT	0.006	-0.104	0.002	0.051	0.025	0.279
1/AR	-0.006	0.162	0.004	0.029	-0.049	-0.209
SASyM	0.007	0.025	0.005	0.239	-0.008	0.085
TDmax	-0.023	0.087	-0.012	0.028	-0.040	0.520
ATMD	-0.025	0.014	-0.008	0.032	0.507	0.004
ATSD	-0.026	-0.068	0.011	-0.033	0.559	-0.069
PCDF	-0.042	0.306	-0.033	0.175	-0.031	0.045
DFE	0.025	0.025	-0.010	0.278	0.025	-0.202
ATFF	-0.044	-0.048	-0.001	-0.135	-0.087	0.321
RF	0.192	-0.144	0.047	-0.007	-0.045	-0.134
MinWC	0.139	-0.068	0.076	-0.026	-0.035	0.000
MaxWC	-0.135	0.068	-0.075	0.023	-0.006	0.032
W	0.114	0.044	0.043	0.001	0.028	0.063
ARPF	-0.030	0.265	0.005	0.092	-0.006	0.034
PCF	0.002	0.088	-0.002	0.324	-0.007	0.034
ARB	0.123	0.047	0.038	-0.013	-0.037	-0.034
RBL	-0.040	0.144	-0.038	0.302	-0.022	0.037
CV	-0.158	0.061	-0.061	-0.151	0.015	0.075
SD	-0.007	0.051	0.023	0.066	-0.088	-0.053

Table 4.4 Component score coefficients after Varimax rotation (*continued*)

	PC1	PC2	PC3	PC4	PC5	PC6
OCW	0.150	0.021	-0.179	0.010	-0.018	-0.062
Θ	0.012	0.070	-0.030	0.085	-0.157	-0.113
RSI	-0.016	-0.053	0.267	-0.041	0.085	-0.033
RC	-0.142	-0.045	0.175	-0.023	0.008	0.028
TRC	-0.090	-0.090	0.119	0.035	-0.005	-0.154
OF	-0.020	0.019	0.271	-0.006	-0.039	-0.004
PLD	0.033	0.010	0.249	0.060	-0.040	-0.007

Values in bold correspond to the significant variable in constructing the principal component in question

4.6 CONCLUSION

The use of one dimension only is not able to represent the actual characteristics of the project scheduling complexity. Therefore, in this chapter, the different dimensions of the project are classified and analysed. For each dimension, we proposed the related quantifiers describing respectively the complexities of the project network, the temporal characteristics, the work content, the resources, and the project weight. Relying on these measures, we proposed to aggregate them in order to produce the main principal components of project complexity with a number of indices as small as possible, while considering all possible aspects. We succeeded to reduce these “27” quantifiers to only “six” aggregated indices using the principal component and cluster analysis. The new indices are capable to explain a percentage of nearly 75% of the total variance in the original data. These indices can be useful if one needs to study the performance of a given project scheduler, or to compare some scheduler algorithms. It can be used also to compare different modifications of the same project in the planning phase. The validation of these indices will be presented in (chapter 6), by investigating the complexity associated to solving each project. Moreover, we will investigate the temporal performance of the proposed solver for the different parameters and select the best group. As perspectives of this work, other measuring tools can be proposed to quantify the technical complexity of the required work content, *i.e.* measuring the required technological complexity.

SOLUTION TECHNIQUES AND PROBLEM SOLVING

USING GENETIC ALGORITHMS

This chapter aims at presenting simultaneously two main parts. The first is a brief discussion of resolution techniques for highly-combinatorial optimisation problems. The second part is the detailed presentation of the approach we propose, based on genetic algorithms.

5.1 INTRODUCTIONS

After the characterisation of the planning and scheduling problem with or without human factors, the proposed models often lead to highly-combinatorial problems. These can be solved exactly or approximately, depending on the performance criteria granted for the solution. As discussed by Russell and Norvig (2002) these performance criteria contain: –completeness: the guarantee that the algorithm will find a solution if there is one, –optimality: the capability of the solving method to return the optimal solution with respect to pre-defined objectives, –time complexity: the computing time required to come to a solution, – space complexity: the machine memory required to conduct the solution search procedures. These four criteria can be used to measure the efficiency and applicability of any proposed method to solve a given problem. By the following we will discuss briefly some exact and approximate methods adopted in literature. For more extensive details of these methods, one can refer to the academic books such as Demeulemeester and Herroelen (2002); Artigues et al. (2008); Brucker and Knust (2011).

5.2 EXACT METHODS

The exact methods are proposed to provide the most accurate results with guarantee of optimality. Almost all the problems of project scheduling with resources constraints are *NP-Hard* problems (section 3.5); relying on the works of Cavalcante et al. (2001), solving exactly such problems is valid only for medium-size instances, from the computing time point of view. However, in many applications the exact solutions are essential; therefore, the research efforts continue in order to develop exact methods that can return optimal solutions with acceptable CPU time. These methods can be classified into two main categories: the first is the calculation-based methods, where the second is the enumeration of spanning trees-based approaches. In this section we will discuss some approaches recently developed in this matter.

5.2.1 Calculation-based methods

According to Demassez (2008), the earliest studies of project scheduling with resources constraints were oriented towards exact methods. She reviewed the different forms of mathematical programming of the problem. Demeulemeester and Herroelen (2002) discussed too the different linear programming formulations of the *RCPSP*; Cavalcante et al. (2001) discussed several integer programming models for the minimum make-span project scheduling problem, with precedence and labour constraints. The difficulties of solving such models optimally were proved. Moreover, they discussed the linear programming based on ordering heuristics. Recently, Sayin and Karabati (2007) proposed a mixed integer programming model to solve the problem of staff scheduling taking into account learning/forgetting effect. They modelled the problem as a set of two linear programming serial optimization models, and solved them by the “CPLEX” solver after encoding them with OPL script language. Turkcan et al. (2009) proposed a two-stage algorithm in order to solve the unrelated parallel-machine scheduling problem with continuously controllable processing times. In the first stage, a time-indexed integer programming model was used to assign parts to machines and to determine the sequence of parts on each machine. In the second stage, a non-linear programming model was used to determine the optimal start

times and processing times for a given sequence of parts on each machine. This non-linear model was converted to a minimum-cost network flow model by piece-wise linearization of the convex cost objective function. The models were coded in C language and solved optimally using CPLEX. Heimerl and Kolisch (2009a) proposed a mixed-integer linear program for simultaneous scheduling and staffing of multiple projects with a multi-skilled human workforce, with heterogeneous and static efficiencies solved by CPLEX.

5.2.2 Numeration-based methods

Numeration (or branching) techniques can be considered as heuristics that guarantee to return the optimal solution, if it can be allowed to construct the complete search tree. In industrial problems, construction of the complete search tree by all the enumerations is almost impossible, in reasons of the required time, and machine memory. Therefore, many methods are proposed to reduce the number of enumerations by truncating the search tree according to a set of specified rules, to limit the search to only the promising solutions. Truncating or pruning is a technique aiming at a reduction of the search by cutting branches that proved to lead to unfeasible or non-optimal solution.

5.2.2.1 Branch and X family

In discrete combinatorial optimisation problems, methods from Branch and X family can be applied to solve linear/nonlinear models and provide the optimal solutions. Branch and X is a set of algorithms including: Branch and Bound, Branch and Cut, Branch and Price, Branch and Infer. The first member of this family is the *branch and bound* “*B&B*”, in which the systematic search is governed by three main acts: -the first is the branching or splitting scheme. It represents the search space corresponding to the current node is partitioned into subsets such that the union of these subsets is the set of solutions of the node (Néron, 2008). - The second is the bounding; it is the process of computing the upper and lower bound of the objective function at each node. Depending on these values, some sub-nodes can be discarded from further considerations; - The third tool is the search strategy: which sub-node should be selected first. There are many search strategies such as “depth-first-search”, “depth-limited-search”, “width first search”, “breadth-first-search”, “iterative deepening-search”, “bidirectional search” for more details about these types, see Russell and Norvig (2002). The *B&B* algorithms were intensively used to solve the *RCPSPs*’ with their different characteristics; the study of Demeulemeester and Herroelen (2002) shows many of these researches and the determination of the different lower bounds. Néron (2008) too, discussed the various branching schemes in *RCPSP* problems. In the multi-mode *RCPSP*, Sprecher et al. (1997) developed an extended *B&B* algorithm that relies on the concept of delay alternatives proposed by Demeulemeester and Herroelen (1992) for single mode *RCPSP*. Vanhoucke (2005) solved the time-cost trade-off problem with time-switch constraints using *B&B* algorithms. Daniels et al. (2004) developed *B&B* algorithm to optimally solve the problem of production scheduling with multi-skilled individual assignment. In multi skilled project scheduling with resources allocations, Bellenguez-Morineau and Néron (2007) solved the problem by a *B&B*, moreover they presented a lower bound.

Branch and Cut algorithms used to solve *MILP* problems relying on the relaxation. These algorithms consisting of a combination of a cutting plane method with a *B&B* algorithm. As discussed by Hans (2001) and Mitchell (2002), these methods work by solving a sequence of linear programming “*LP*” relaxations of the integer programming problem, known as the restricted linear programming “*RLP*” relaxation. This *RLP* is then solved

until optimality. Cutting plane methods improve the relaxation of the problem to approximate more closely the integer programming problem “*ILP*”. In that way, if the optimal solution for the *RLP* is not reachable for the *ILP*, a sub-problem called the “separation problem” is solved to try to identify the violated inequalities. If one or more violated inequalities are found, some are added to the *LP* relaxation to cut-off the infeasible solution. Then the “*LP*” is solved optimally. Branching occurs when no violated inequalities are found to cut-off an infeasible solution. The procedure is continued until no violated inequalities exist anymore: at this point the optimal solution to the *RLP* is also the optimal solution to the original problem. Aykin (1998) presented a branch and cut algorithm for optimal shift scheduling. Kis (2005) proposed branch and cut to solve *MILP* models of project scheduling with variable intensity of resource requirement.

Branch and Price method is simply a generalisation between *B&B* and *LP* relaxation. The main difference from branch and cut is that: it applies column generations during *B&B* search tree to tight the *LP* relaxation. First, the original problem is reformed by one of the decomposition algorithms, to give a *LP* relaxation “known as master problem”. Align with the branch and cut, a “*LP*” relaxation is optimally solved by considering the restricted *LP* relaxation (called restricted master problem: *RMP*), where many columns (variables) are lift out. For optimality verification a pricing algorithm is used at each node. If the solution of *RMP* is not optimal, the pricing algorithm identifies at least one column (variable) with negative reduced cost. This column is added to the *RMP* and the procedures continued until there are no more columns with negative reduced cost. The optimal solution of the *RMP* is also the optimal one for original problem. In scheduling, Jacquet-Lagrèze and Lebar, (1999) adopted it to solve the scheduling with maintenance constraints. Hans, (2001) used it to solve the resources loading problem and the rough-cut capacity planning problem. Recently, Coughlan et al., (2010) proposed branch and price algorithm to solve the multi-mode project scheduling with resources constraints, and availability per period constraints.

Branch and Infer algorithms refer to the implementation of constraints programming “*CP*” techniques. In *CP* the problem is modelled as a “*constraint satisfaction problem CSP*”. In this kind of problem, one needs to define the variables, and their domains with a finite set of possible values. These values can be assigned to the corresponding variables without any contradiction in the problem constraints. The *CSP* links the problem variables together with some relations or instructions. Based on this principle, the scheduling problem can be formulated with two groups of variables: the temporal variables and the resources allocation variables. The *temporal variables* gather all the variables related to the time, e.g. the tasks’ start dates $dS_i \in \{dS_i^{min}, \dots, dS_i^{max}\}$, and tasks’ durations $\in [D_i^{min}, \dots, D_i^{max}]$ (if it is known in advance). During the solution search procedures, constraints propagation methods are used, in order to infer the contradiction or the infeasibility of continuing the search process (at the current node), or to indicate a solution (occurs at the bottom levels of the search tree). Bockmayr and Kasper (1998) introduced a framework that proposed to integrate the *ILP* and finite domain *CP*. The framework is called “branch and infer”, it unifies the branch and cut approach with *CP*. Modelling problems as *CSP* and solving them using *CP* has attracted the attention of the operational research community, so numerous applications can be found on the arena. Meisels and Schaerf (2003) proposed to solve employee timetable problem using *CP*, after coded it in *ECLiPS^e*. For the same problem, Demassej et al. (2005) proposed a hybrid constraints-linear programming approach based on column generation. in which sub-problems are modelled as *CSP* and solved using *CP*. De la Fuente and Lozano (2008) proposed a *CP* paradigm to provide one

year-wide calendars for multi-shift employees schedule. Li and Womer (2009) present an application in software production technology. They solved the proposed *MILP* by using benders decomposition algorithm and *CP*. For more details about *CP* in scheduling and different propagation algorithms, we propose the academic book of Baptiste et al. (2001) or Laborie and Nuijten (2010).

5.2.2.2 Dynamic programming

In mathematical optimisation, the dynamic programming “*DP*” is a complete enumeration scheme that attempts to minimise the amount of computations to solve a problem, by convert it into a sequence of interrelated sub problems arranged in stages. It is based on the concept that the decision in one stage cannot be taken separately due to problem constraints. It determines the optimal solution to each sub-problem and its contribution to the objective function. Also, it avoids re-computation by storing the solutions of sub-problems. *DP* characterised by three types of equations: -Initial conditions, -Recurrence relations, and -Contribution function. Zhang et al. (2001) proposed to solve a macro-level scheduling problem using Lagrangian relaxation, in which the resource capacity constraints were relaxed by the Lagrange multiplier for the use of resources at each time unit. The “relaxed problem” then decomposed into smaller sub-problems. The solutions of these sub-problems were obtained by the *DP*. Stanimirovic et al. (2009) proposed a heuristic algorithm to solve the *RCPSP* based on the *DP* of knapsack problem.

5.3 APPROXIMATED METHODS

Real industrial optimisation problems are often NP-Hard, even when they are deterministic. Therefore, no algorithm reveals to be efficient to solve them optimally, especially for large size problems (Sevaux et al., 2010). In the scheduling problems under resources constraints, Kolisch and Hartmann (1998) stated that the heuristic solution procedures are indispensable when solving large problem instances – as they usually appear to be in practical cases. Heuristics and metaheuristics have become reference tools, guaranteeing a compromise between the solution quality and the computing time. Demeulemeester and Herroelen (2002) classified the heuristic methods into two main categories: the constructive heuristics (referred here as heuristics) and the improvement heuristics. Constructive heuristics start from an empty schedule and add one task after the other until it constructs a feasible schedule. On the other hand, the improvement heuristics start from an initial schedule (feasible as well as unfeasible), and repetitively try to improve it. Gademann and Schutten (2005) classified these algorithms into three categories by dividing the improvements into two types: – the first category starts by infeasible schedule – and the second starts with feasible schedule. In order to avoid cycling around local optima, many algorithms were developed as local search-oriented, and population search algorithms. By the following we discuss briefly some of these methods.

5.3.1 Heuristic algorithms

The constructive algorithms can be classified as “*Greedy algorithms*”, in which the problem solution is obtained by a very intuitive idea that depends mainly on the problem nature. As stated before the constructed algorithms start from scratch to construct the schedule by adding activities in a successive way according to a predefined list. The definition of this list depends on the intuitive idea to design the algorithm. In scheduling under resources constraints, the list predefinition relies on a set of rules that known as priority rules. As discussed in

Demeulemeester and Herroelen (2002), there are five types of priority rules:- activity-based priority rules – network-based priority rules – critical path-based priority rules – resources-based priority rules – composite priority rules. Kolisch and Hartmann (1998) explained two schedule generation schemes to be adopted when using priority rules: the first is the parallel generation scheme “PGS” – the second is the serial generation scheme “SGS”. The PGS iterates over time by searching at each decision step as many unscheduled activities as possible considering the temporal and resource constraints. For each iteration in the SGS, the next unscheduled activity in the priority list is selected and assigned at the first possible start date that satisfies the constraints. Van de Vonder et al. (2007a) added three other generation schemes for generating the robust schedule: The stochastic SGS, robust PGS, and robust SGS. The greedy heuristics based on priority rules were extremely adopted in many applications: Nembhard (2001) examined the problem of worker-to-task assignment based on the worker’s learning rates. The proposed heuristic assigns fast learners to short duration tasks and slow learners to longer duration tasks in a greedy manner. Edi (2007) proposed a greedy heuristic to solve the project scheduling with flexible workforce annual hours. Gutjahr et al. (2008) adopted a greedy algorithm to assign workforce to the different activities of project portfolio according to a set of priority lists. Browning and Yassine (2010) conducted a comprehensive analysis of 20 priority rules to solve resource-constrained multi-project scheduling problem. Recently, Attia et al. (2012b) used the priority rules for encoding the chromosomes of a genetic algorithm model developed to solve the problem of project scheduling with dynamic productivities (section 5.4).

5.3.2 *Metaheuristics algorithms*

Metaheuristics algorithms have become a kind of general problem solvers, and are applied to numerous applications for solving the most difficult optimisation problems. Metaheuristics represent the improvement type of heuristics, in which the solution can be improved iteratively over time starting from the initial solution(s). Each meta-heuristic algorithm can belong to one or more of the following classification: population-based algorithms, nature-inspired algorithms, evolutionary algorithms, swarm-based algorithms, memory-based algorithms, stochastic algorithms, and local search algorithms. By the following, we will highlight only two classes: the population-based and the local search methods.

5.3.2.1 *Population-based methods*

Population-based metaheuristics represent the set of algorithms that handle a number of individuals at each trial, where each individual represents a solution to the problem. Here we present some of these types that were used for scheduling and resources allocation: genetic algorithms “GA”; ant colony optimization “ACO”; particle swarm optimisation “PSO”. There are numerous kinds of metaheuristics algorithms, but many of them share some characteristics (such as: natural inspiration, stochastic nature, evolution strategy, etc). For example, Abboud (1998) proposed a metaheuristics method for the problem of manpower allocation. The developed heuristics known as mutate and spread metaheuristics (MSM), a sibling of GA. It differs from GA only in the selection and mating operation. For more algorithms, we propose the metaheuristics books of Glover and Kochenberger (2003) and Doerner et al. (2007).

5.3.2.1.1 *Genetic algorithms*

Genetic algorithms are an artificial intelligence probabilistic search method emulating the nature evolution: a population of problem solutions evolves over time under the influence of specified genetic operators. These

operators were adopted from the biological processes known as crossover, mutation, and survival of the fittest individual(s). First, the solutions of the problem, whatever feasible or not, should be coded in a vector called chromosome. Each chromosome is composed of a finite number of genes describing this solution, via either a direct or indirect representation; the gene can take any kind of value: alphabetic string, binary, integer, real number, etc. This process is known as the chromosome encoding. On the other side, if the chromosome carries an indirect representation of a solution, a decoding process should convert the genes to the problem solution. After defining the problem representation (encoding process), the initial population should be generated by either constructed heuristics or randomly. Then iteratively, the solution state space can be explored by performing the following procedures: evaluation of the current population, select individuals (named “*parents*”) for mating, mate individuals to produce offsprings, mutate offspring, build the next population, evaluate the individuals and check the stopping criteria.

For manufacturing problems, GAs’ were successfully applied to numerous problems with especially difficult levels. Mori and Tseng (1997) used GAs’ to solve the non-pre-emptive multi-mode project scheduling problem (time-resource trade-off). The chromosomes were encoded directly with all of the required data: the activity mode, the schedule order, and start/finish dates. Aloulou and Portmann (2005) developed multi-criteria GAs’ to find a compromise between the schedule flexibility and its aptitude to generate a proactive baseline schedule for a job shop problem. Wang (2005) modelled the problem of repairing the schedule of product development process as a dynamic constraints satisfaction problem. The proposed GAs’ were planned to solve the problem based on activity priority rules for the chromosomes encoding. Relying on the priority rules held by the chromosomes, a generation scheme was used to build the schedule.

Wu and Sun (2005) presented a mixed non-linear integer program for a multi-project scheduling problem taking into account actors’ competences evolutions, with objective to reduce the outsourcing costs resulting from hiring external staff. They solved the proposed model using GAs’, with a direct encoding chromosome for the actors’ assignment decisions. Their model handled two other variables, the outsourcing actors’ number and the task completion percentage: after fixing the allocation decisions, the model would be transformed to a linear one, which was solved by using “ILOG CPLEX 7.5”. Cowling et al. (2006) used the open source genetic algorithms *NSGA-II* in order to solve the multi-objectives multi-site scheduling. Yoshimura et al. (2006) solved the problem of project portfolio selection with allocation of multi-skilled workforce using GAs’. Van Peteghem and Vanhoucke (2008) proposed a bi-population GAs’ to solve multi-mode RCPSP: One population for the right-justified schedule and the other for left-justified schedule. The chromosomes were encoded relying on two vectors: the topological ordered random key and the modes list. After that a schedule generation scheme was developed relying on *SGS* to build the schedule. Gutjahr et al. (2008) adopted GAs’ to solve the problem of project portfolio selection with optimisation of the economic objective versus the strategic workforce competency. Yannibelli and Amandi (2011) solved the multi-skilled workforce allocation with knowledge-based genetic algorithms. This knowledge arises from historical information about the participation of the employees in previously executed projects. Recently in scheduling *IT* project with multi-skilled workforce staffing, Kolisch and Heimerl (2012) proposed a two stages metaheuristics approach: the first stage used GAs’ for solving the *MIP* model of the problem, afterwards a Tabu search algorithm was called to enhance the best obtained solution from GAs’.

5.3.2.1.2 Ant colony optimization

Ant colony optimisation “ACO” is one of the swarm intelligence and population-based metaheuristics that combines stochastic search and learning mechanisms. Learning through the cooperation of large number of homogeneous agents (artificial Ants) in the environment when they foraging. The information is stored throughout the interaction with the environment by producing pheromones. This mechanism is called stigmergy. For more details about the algorithms, we propose the work of Glover and Kochenberger (2003). The ACO has been applied to scheduling with resources constraints problem. Merkle et al. (2002) developed an ACO approach for RCPSP, while, Luo et al. (2003) developed an approach to solve the RCPSP with generalised precedence constraints. Kilic (2007) used ACO approach to generate a flow shop schedule for the cases where the processing times are uncertain and due dates are flexible in some range. Processing times and flexible due dates are handled respectively as fuzzy processing time and due dates. Gutjahr et al. (2008) adopted the ACO to solve the project portfolio selection. Problem solutions are encoded as walks in a so-called construction graph, assigning to each arc a visibility value depending on the pheromone strength.

5.3.2.1.3 Particle swarm algorithms

Particle swarm optimisation “PSO” uses a population of particles to explore the best solutions in a multi-dimensions search space. PSO is inspired by the social behaviour of foraging flocks of birds: here, particles in a swarm fly through the environment, following the particle flow but biasing their movements towards the good areas. Similar to the meta-heuristic methods, PSO starts with initial solutions and develop them over time. As discussed by Doerner et al. (2007), each particle represents a candidate solution of the problem, and has an associated position, velocity, and memory vectors. The memory stores the particle’s best position encountered so far (known as personal best). Also, the best position found so far by the whole swarm (known as global best) is memorised during the exploration. The PSO was adopted in scheduling and resources allocation; Zhang et al. (2006) proposed PSO for multi-mode RCPSP considering renewable and non-renewable resources. The particles was represented as a priority list vector for the activities and modes, a SGS was adopted to construct the feasible solution. Chen (2011) presented a “justified” particle swarm optimisation to the traditional RCPSP. The justification technique adjusts the start time of each activity of a given schedule to shorten the project makespan. Kazemi and Tavakkoli-Moghaddam (2011) proposed a PSO for solving multi-objective multi-mode RCPSP. The proposed algorithm uses GAs’ operators for updating the particles’ positions. Shahnazari-Shahrezaei et al. (2012) used the same concept in the developed PSO algorithm to solve the problem of single-period multi-skilled manpower scheduling, considering the employees’ preferences. They generated a number of particles, for each particle they assign randomly feasible solutions relying on greedy algorithms-based procedures. Local heuristics were used to improve the particles’ solution.

5.3.2.1.4 Other algorithms

There are some other population-based algorithms that were adopted in scheduling under resources constraints, as example, the Scatter algorithm, GRASP algorithms (Greedy Randomised Adaptive Search Procedures), bees algorithms...etc. The scatter algorithms rely on combining decision rules and constraints (Glover and Kochenberger, 2003). According to Brownlee (2011), the strategy involves an iterative process, where a population of diverse (stored information about the global optima) and high-quality candidate (elite set) solutions. These solutions are partitioned into subsets and linearly recombined to create weighted centroids of sample-based neighbourhoods. The GRASP is a multi-start metaheuristics, and each iteration contains two

phases: construction and local search (improvement phase). The best overall solution is kept as the result. Alvarez-Valdes et al. (2008) proposed a *GRASP* algorithm to solve project scheduling with partially renewable resources. The bees' algorithm is a one of population and swarm based metaheuristics that is inspired by the way that the honey bees forage for food. The principal, the flowers batches that have a lot of nectar will be visited more than those that have less nectar. The bees communicate with each other by a dance known as "waggle dance". Akbari et al. (2011) proposed a "bees' algorithm" for the scheduling problem with resource constraints.

5.3.2.2 Local search-based methods

Local search methods are iterative algorithms, which explore the solution space by using a single solution, and moves step by step from this current solution to its neighbour according to a set of pre-defined rules. The search loops are continued until it reaches a stopping criterion. The local search methods have two basic elements: the search space and the neighbourhood structure. The neighbourhood structure is the set of solutions obtained by applying a single local transformation to a current solution. According to Russell and Norvig (2002), local search methods have two main advantages: they use very little memory, usually constant and they can often find reasonable solution in large or continuous spaces for which systematic algorithms are unsuitable. On the other side, using such algorithms bring two drawbacks: the size of the neighbourhood of the current solution (the search of the best neighbour can be another problem), and the incapability to avoid local optima (Widmer et al., 2010). By the following we review the most utilisable algorithms.

5.3.2.2.1 Simulated annealing method

Simulated annealing "SA" is a global optimisation algorithm that belongs to the stochastic search metaheuristics. SA is inspired by a metallurgy process called annealing: a heat treatment process used to increase the toughness of steel elements by increasing their microstructure grains size. It usually starts with an initial solution and improves the solution repeatedly by moving around the neighbourhood of the current solution until no further improvement can be found. According to Wang (2005), SA approach attempts to avoid entrapment in a local optimum by accepting a move that deteriorates the objective value with a certain probability. While exploring solution space, the new obtained neighbour solution will be accepted if $e' < e$ for minimisation problems, where e : is the energy (objectives value) of the current solution; e' : is the energy of the candidate solution. On the other hand it can be accepted or rejected, based on the probabilistic function: $(\exp(e-e')/T) | e' > e$, where T is the current temperature. The temperature can be controlled by a cooling scheme that specifies how it should be progressively reduced. According to Bouleimen and Lecocq (2003), the total number of iterations depend on the initial temperature and the reduction factor within]0, 1[, the process is called cooling chains. The SA was applied to scheduling with resources constraints. As example, for single-period manpower schedule problem, Brusco and Jacobs (1993) proposed SA to solve flexible labour schedule problem (discontinuous tour schedule) with the objective of minimizing the number of full-time employees. Recently, Hlaoittinun (2009) proposed a SA algorithm for manpower allocation to activities of a product development, considering their dynamic experience.

Józefowska et al. (2001) and Bouleimen and Lecocq (2003) proposed to solve the *RCPSP* and its multi-mode extension by SA algorithms with the objective of minimum makespan. They used activity list representation where a precedence-feasible solution is represented by an ordered list of activities, and then a *SGS* was used to construct solution. Mika et al. (2005) adopted it in solving multi-mode project scheduling problem with discounted cash flows and four payment models with the aim to maximise the net present value. The problem

was encoded relying on the list of feasible activities and modes assignment as that was used by Józefowska et al. (2001), and then a *SGS* was adopted to decode the solution. The neighbour probabilistic generated relying on the three bases: the rearranging of the activities list, of the mode list, and the combination of both.

5.3.2.2.2 Tabu search method

Tabu search “*TS*” is a control strategy for local search algorithms relying on machine memory. In order to avoid cycling, a tabu list imposes restriction to guide the search process. The tabu list imposes a short term memory of the specific changes of recently performed moves within the search space, in order to prevent the same moves as that listed. A tabu list is managed using a method known as tabu navigation method (as example *FIFO* method) (Mika et al., 2005). According to Brownlee (2011) *TS* was designed to manage the hill climbing algorithm, it can be adopted to manage any neighbourhood method. *TS* algorithms were used in solving the scheduling with resources constraints. Thomas and Salhi (1998) proposed it for the traditional *RCPSP*, the tabu list was put relying on the project network complexity. De Reyck and Herroelen (1999) adopted it for the multi-mode *RCPSP* with generalised precedence relations and divided the problem into two successive phases: mode assignment phase and *RCPSP* phase. Deblaere et al. (2011) also adopted it for the reactive schedule to repair the baseline schedule of a multi-mode *RCPSP*. Atkin et al. (2007) proposed a hybrid algorithm “*Aid to Runway Scheduling*” at London Heathrow Airport to find the best order for take-off for the aircraft under considerations relying on *TS*. Van de Vonder et al. (2008) proposed it to solve project scheduling with stochastic activities duration and temporal buffers between activities. Drezet and Billaut (2008) proposed a model for multi-period project scheduling with workforce allocation. In their model the release date and completion date of the activity are “time-dependent activities”. They solved the presented model with the integration of the priority rules and *TS*, by using priority rules to generate the initial solution and *TS* as a local search technique to enhance the solution. Recently, Kolisch and Heimerl (2012) used *TS* as a local search to enhance the best solution obtained by *Gas*’ for project scheduling with manpower allocation. Shahnazari-Shahrezaei et al. (2012) solved single-period multi-skilled manpower scheduling considering the employees’ preferences using *TS*.

5.3.2.2.3 Other algorithms

There are many other local search techniques, as example, the “*Hill climbing algorithms*” that try to continuously improve the solution initially generated by a specified construction algorithm. It is continuously moves on the direction of increasing value- that is uphill. The search loop terminates when it reaches the peak, such that no neighbour has a higher value than that reached. Russell and Norvig (2002) stated that the hill clamping algorithm sometimes called greedy local search where it grabs a good neighbourhood state without thinking ahead about where to go next. The hill clamping is not a single local search technique but rather a family of techniques based on the idea of performing only moves that improve or leave unchanged value of the cost function (Meisels and Schaerf, 2003). As reviewed by Demeulemeester and Herroelen (2002) there is another family of local search algorithms called “descent approaches” that can be divided into steepest descents, fastest descents, and iterated descents. The steepest descent, called “best fit approach”, evaluates all solutions in the neighbourhood of the current solution, selects the one with the best objective and continues the search with this new one. Fastest descent, “first fit approach”, evaluates all solutions in the neighbourhood of the current one in a random order, and stops as soon as a better solution is found, then the procedure is repeated with the new position. In the iterated descent both steepest and fastest descent approaches can be extended with a random restart procedure that randomly regenerates initial solution upon which the algorithm is restarted.

5.3.3 Hybrid algorithms

In metaheuristics, hybrid algorithm is an approach that combines two different algorithms. The hybrid algorithms that combine evolutionary population-based metaheuristics with local search metaheuristics are known as “Memetic algorithms: *MA*”. *MAs* are inspired by the interplay of genetic evolution and memetic evolution, the term “meme” being used to refer to a piece of discrete cultural information (Brownlee, 2011). Chen and Shahandashti (2009) proposed a hybrid algorithm relying on *GAs*’ and *SA* in order to solve multi-project scheduling problems with resources constraints. They used the *SA* probabilistic function to manage the replacement of the new produced offspring by crossover and mutation. In order to solve project scheduling with allocating of multi-skilled operators, Valls et al. (2009) proposed a hybrid approach relying on *GAs* and some local search approaches. The approach starts with a *GA* population, then for each individual a *SGS* scheduler than a local search used to enhance the schedule before computing the individual fitness. For a similar problem, Yannibelli and Amandi (2012) proposed a Memetic algorithm that combines *GA* and local search algorithms.

5.4 THE PROPOSED APPROACH

From the previous survey, it can be concluded that both exact methods and heuristics are proposed to solve the scheduling problem with resources constraints. The exact methods are capable to solve small and medium sized problems in acceptable running time, the approximate methods are preferred to return high quality solution in acceptable running time for large problems. As presented previously (in section 3.2.2.3), the implementation of a dynamic vision of the actors’ skills, in addition to the elastic durations of the tasks, leads us to a highly nonlinear model with mixed integer variables. Therefore, solving it with mathematical programming will be difficult due to the huge numbers of constraints and variables, producing a combinatorial explosion. On the other side and relying on the previous section, a vast development was done in the subject of heuristics and metaheuristics. We therefore directed towards metaheuristics. Genetic algorithms are one of the most used among the population-based search methods, and have proven to be effective in providing solutions more than adequate in a timely manner for many industrial applications, or to solve extremely difficult problems (Munawar et al., 2011; Yun and Moon, 2011). This choice of genetic algorithms is also based on the experience of previous researchers in the same team, and their conclusions in terms of performance and computation time. Experience had then shown that as soon as the problem size reaches a still very modest extent as an industrial example, the computing time made prohibitive the use of an exact method, while genetic algorithms provided the optimal solution – or approached it with an excellent approximation. In view of this demonstration, we did not in that time focus carefully on the relative performances of the different heuristics available, and genetic algorithms were chosen for their robustness and ease of implementation. By the following, the approach adopted to bring a solution will be discussed: first, the *GAs*’ will be presented, and then, the scheduling procedure based on the chromosomes will be discussed. Also Figure 5.1 shows the main elements of the approach based *GAs*.

```
The Genetic algorithm:
{
  Generate the initial population “ $g=1$ ”, numbering  $IP\_size$  individuals
  Apply the schedule generation and actors’ allocation procedures to the current population “ $g=1$ ”,
  Evaluate the population  $g=1$ 
  IF none of the stopping criteria is fulfilled, repeat
  {
    Select some individuals from  $g$  for copy to  $g+1$ 
    Crossover some individuals from  $g$  and copy the result to  $g+1$ 
    Regenerate some new individuals to be added into  $g+1$ 
    Mutate some individuals taken from  $g+1$ 
    Apply the schedule generation and actors’ allocation procedures to “ $g+1$ ”
    Evaluate the population  $g+1$ 
     $g = g+1$ 
  }
}
```

Figure 5.1 The genetic algorithm

5.4.1 The proposed genetic algorithm

To solve any allocation problem, there are some decisions to be taken, depending on the problem type. These decisions may be the choice of the resources appointed to handle some tasks within a given period, or the order of execution of these tasks. For the coding of the genetic material, Goldberg (1989 page 80) warns that “*the user should select the smallest alphabet that permits a natural expression of the problem*”. We assert that it is possible to present activity scheduling and the corresponding resources allocation by answering to the following four questions: what task will be processed first? Then which actor(s) will be selected to complete this task? What is the daily working time of each actor, during the activity realization? And what skill will be prioritized amongst the others? In our approach, we introduce a GA based on randomly generated answers to the first three questions (as section 5.4.1.1), but the fourth one will be answered according to the critical skill principle (Edi, 2007): (see section 5.4.2.2). The implementation of GAs’ requires the definition of procedures intended to simultaneously explore, as comprehensively as possible, the solutions space, while guiding this exploration to the best solutions: many parameters associated with the conduct of this progression must be worked out. First, an encoding of the problem variables that provides a genotype. Then produce an initial population, and finally apply the GAs’ operators. In the following section we present the genetic algorithm structure and its genotype.

5.4.1.1 Chromosomes encoding and construction of the first population

The proposed GA model is based on an indirect encoding of the problem, mainly for two reasons: First, the direct coding of problem’s variables creates very long strings, which increases the computing time. For example the representation of a problem of 30 tasks, 82 actors, and 4 skills leads to chromosomes having 3,879 genes, whereas with the indirect encoding presented further in this section, it drops down to 117 genes. The second reason is the relations between the different decision variables in the problem, which can lead to the presence of “epistasis” (Gibbs et al., 2006): there are interactions between some of the chromosome’s genes; some of their alleles may affect other genes’ alleles. To avoid these two points we adopted an indirect encoding.

As mentioned above, our chromosomes contain three parts (as shown by Figure 5.2); the first presents the priority of realizing tasks. Thus, the number of genes in this part equals the number of tasks in the project; the *locus* of the gene represents the task identification number. But the value of the gene, or its *allele* (generated

randomly), represents the corresponding task priority in the project. Based on this part of the chromosome we can build a tasks' priority list, by arranging these numbers in a descending order, the position of the task in the rearranged list represents its priority. Of course, in the scheduling procedure that will be introduced in the following section, the temporal relations between tasks will be respected. The second sub-chromosome holds the actors' priorities for the allocation process. Thus, each gene's *locus* represents the corresponding actor identification number, and holds his priority indicator value as its *allele*, for the allocation process. Based on this part we can construct the actors' priority list for the project execution. Finally, the third part of the chromosome represents priorities of working time strategies. From the working time regulatory constraints, we have five intervals (expressed in daily hours), which can be described as follows, according to French regulations:

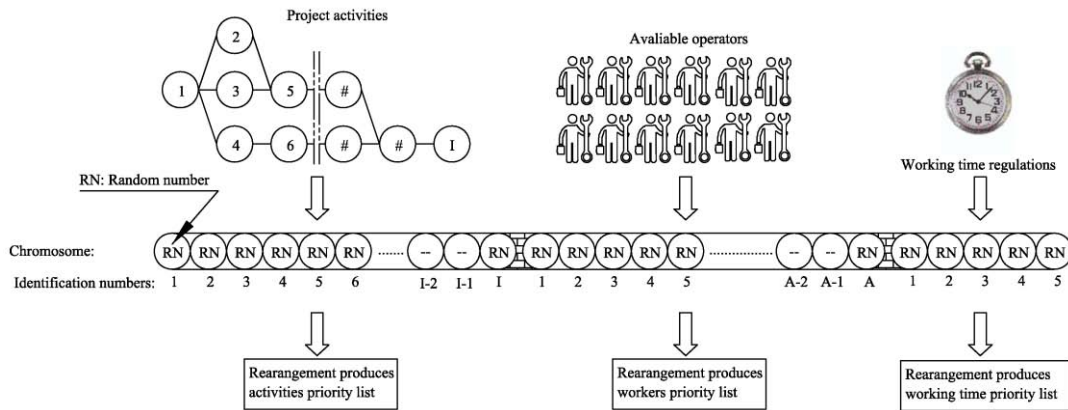

Figure 5.2 chromosome representation priority lists

[X, 7]: Represents the daily working time strategy within the standard weekly hours C_{0s} limits, where X can represent a social willing of a minimum number of working hours per day, under which the daily profit for the actor can be considered as non-effective. Considering that an employee would not appreciate to be called on duty for a too little time, we arbitrarily fixed it at $X = 4$ hours; we assume that the company has adopted a standard daily working time of 7 hours, so the first time range is [4, 7]. The second interval represents the work above the standard weekly hours C_{s0} limits, and is limited by the constraints of the company's internal modulation of weekly working time; we assumed it to be $MaxMod = 39$ hours per week, which gives, in our example, the second interval to be [7, 7.8] hours per day for a 5-day week. The next interval will then be limited by the constraints of the maximum average weekly working time for a period of 12 successive weeks; if we assume it to be 44 hours a week, according to French regulations, the third interval will be [7.8, 8.8] hours per day. The fourth interval will then integrate the maximum number of working hours per week; this number is of 48 hours per week in France, and in this case we get] 8.8, 9.6] hours per day for our 4th interval. Finally, the last interval considers the daily constraint of maximum working time – if it is 10 hours per day, the 5th and last interval will be]9.6, 10] hours per day.

Thus, considering the different working time constraints, we get five time intervals for the decision of: what is the actor's daily work? These decisions are represented by the third sub-chromosome. Each gene position in this part, exactly as for the two previous sub-chromosomes, will represent the daily work range identification number, and its value represents the priority assorted to each range. With the aid of this part we can construct the time intervals priority list, which manage the actors work during the simulations. With this method, we are able to randomly generate all individuals of the initial population of size " IP_size ". Based on this indirect encoding

of the problem, we can gain some benefits towards the feasibility of the chromosome after the reproduction processes, and avoid some correction procedures to the individuals, such as fixing the distortions that could result from crossovers or mutations.

5.4.1.2 Fitness calculation

For each individual, the scheduling algorithm (described in section 5.4.2) will take place, for decoding the chromosome, and constructing the project schedule. After that, the corresponding objectives, expressed by five cost functions (f_i), can be calculated as described in (section 3.3.2, equations 3.10); the next step consists in determining the fitness of each of the chromosomes. In this view, we first have to normalize the cost functions (f_i); the normalization is intended to standardise the order of magnitude of the objectives, in order to project the value of each objective over a given interval: $[0, 1] \times C_{max}$, where C_{max} is a pre-specified constant.

First, the labour cost (that represents the sum of standard hours cost f_1 plus the extra-hours cost f_2) is treated as a single objective. It can be expressed by $f_L = f_1 + f_2$; this labour cost will be minimal (f_L^{min}) if all the missions in the project can be performed by fully-qualified persons ($\theta = 1$) during standard hours; on the opposite, the maximum labour cost (f_L^{max}) will be encountered if unfortunately all the jobs have to be undertaken by beginners ($\theta = \theta_{min}$) during their extra hours. The labour cost f_L can then be normalized to the new function $f'_L = (f_L - f_L^{min}) / (f_L^{max} - f_L^{min})$.

In a similar way, the occupation of any operator may be bounded: by zero if he is not allocated at all during the project, and by $[DMaxS/ C_{S0}]$ if he is required as much as possible. So the virtual cost (f_3) associated to the loss of flexibility can be normalized too, as $f'_3 = (f_3) / (f_3^{max})$. The objectives functions (f_4, f_5, f_6) were rescaled by simply dividing each of them by its maximum value ($C_4^{max}, C_5^{max},$ and C_6^{max} respectively).

In the case where one or more constraint(s) would be violated, we should distinguish between the feasible and unfeasible schedules by the use of penalties to weight and highlight these unsatisfied constraints. These penalties are expressed in monetary units so that they can be added to the other (f_i)s' – we named this the penalty function (f_6) as the sum of all the penalties related to the working time constraints violations, if any; it was calculated according to equation (5.1). In this equation, P_{HC} and P_{SC} are, respectively, the penalties related to sets of the hard (HC) and soft (SC) constraints, and v is a Boolean variable expressing the violation state of a given constraint: $v=1$ for constraint violation and $v=0$ for the constraint satisfaction.

$$f_6 = \sum_{h=1}^{HC} P_{HC} \times v_h + \sum_{g=1}^{SC} P_{SC} \times v_g \quad (5.1)$$

After normalisation, it can be added with an associated weight to the fitness function as (f'_6), accordingly and after the normalization of different terms (f'_i), we get the fitness function as:

$$fitness(\varepsilon) = \gamma_L f'_L + \gamma_3 f'_3 + \gamma_4 f'_4 - \gamma_5 f'_5 + \gamma_6 f'_6, \quad \varepsilon \in Population \quad (5.2)$$

Where, the γ_i are the objectives' weights, the sum of all the weights being equal to unity, so that the fitness function is normalized too. We treated f_1 and f_2 as a single objective " f_L " with " $\gamma_L = \gamma_1 = \gamma_2$ ". Using this normalization method enables us first to favour the feasible solutions with zero-penalties, and then to monitor the compromise between execution costs and skills development.

The evaluation phase consists in calculating the force of each individual within the population (*i.e.* its adaptation to environmental constraints in the spirit of the comparison with a natural evolutionary process). Despite the genetic algorithms are usually implemented to maximize an objective function (Goldberg, 1989), our problem consists in minimizing an economic cost. Therefore, it is necessary to map the objective function so that its minimum value will correspond to the strongest individuals. Based on Goldberg's work, it is possible to associate a constant C_{max} as large as possible to the fitness function of each individual (ϵ) in order to get a new function $f_{ab}(\epsilon) = C_{max} - f(\epsilon)$. We refer to it as the “*individual absolute force f_{ab}* ”. This method makes it possible to overcome the problems related to the sign of the function, if any. The value of C_{max} can be estimated relying on maximum extreme values of the different terms: the project realisation cost, the maximum cost value of the constraints that may be violated, and the penalty costs that may arise from the date of completion of the project. Based on this absolute force, we can perform the different selection procedures that build the next generation.

5.4.1.3 Selection

The selection procedure is the determination of the opportunity given to some individuals from the current generation to play a role in the process of production of the next generation. The selection process is very sensitive to the values of the individuals' fitness, especially the worst, average, and the best values in the population. These three values determine the selection tendency, and control the force of individuals that can be selected for the reproduction procedure. According to Goldberg (1989), if the average value is very close to the fittest one, then the search becomes as a random walk, because the average-fitting individuals have the same probability of being selected as the best individuals. The same problem is stated by Davis (1996): when the three values are very close, then the effect of the natural selection becomes negligible. But if the average value is much closer to the best fit compared to the worst one, then we encounter a strong selection pressure that favours the best chromosomes against the worst ones. For the creation of the next generation described in the following section, we will present how we can overcome this problem. The selection was done based on two selection methodologies. The first one is the elitist selection, with a pre-specified elitist size equal to a probability of survival \times population size ($P_s \times IP_size$). This selection type forces GA to retain a number of the best individuals at each generation. These fittest individuals will be copied directly to the selected list of candidates for survival and/or passing through the mating pool. This selection approach can enhance the GA performance and ensure no loss among the best solutions found. The second methodology is the stochastic sampling with replacement, or the “*roulette wheel selection*”, where the probability of one individual to be chosen is proportional to its fitness $f_{ab}(ind)$. For each individual a slice of the wheel is assigned; the size of each slice is proportional to the individual's fitness. Then the wheel is spun “ IP_size ” times, and at each turn a specified individual is selected. The selected individuals will be directly inserted in the mating pool for performing the crossover.

5.4.1.4 Crossover

In order to perform the crossover (shown in Figure 5.3), we construct the mating pool containing two sets of parents: The first one is the group of “*survivors*” (the best individuals) selected by elitist selection as described above, of size $P_s \times IP_size$. The second one has the same size (IP_size) as the previous population, but its individuals are selected from this population via a roulette-wheel selection, a process for which random is weighted by the individual's fitness: the number of the population is the same, but some individuals, according to their fitness, may be replicated many times, whereas others may have disappeared. Afterwards we apply the

parameterized uniform crossover discussed in Mendes et al. (2009), in which two parents are selected randomly, one from each group. We also avoid mating the same individual with himself, or the multiple mating of the same parents. In the parameterized uniform crossover, for each gene in the chromosome a random number between [0, 1] is generated (as shown in Figure 5.3). The child will inherit from the first parent’s allele if this random number is lower than a given crossover rate (P_c), and from his second parent’s allele otherwise. The resulting child is then directly introduced into the new generation. We set the size of the children group exactly as the crossover rate: the children group then represents a size of $(P_c \times IP_size)$ from the new population.

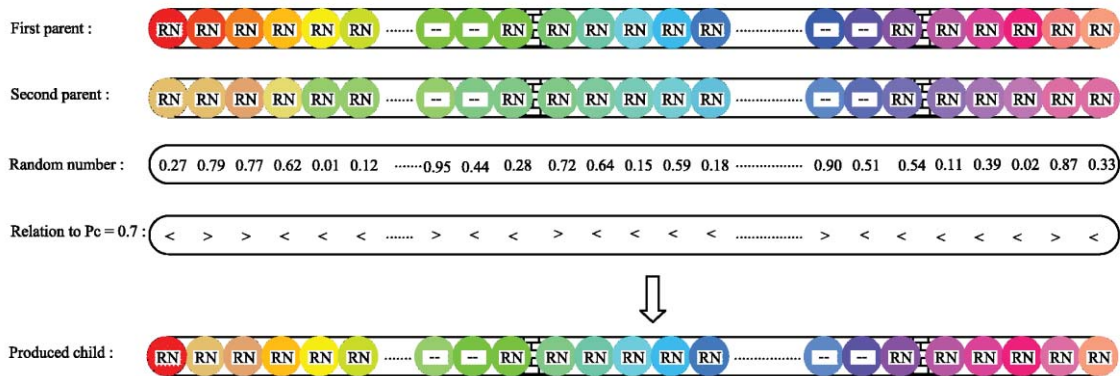

Figure 5.3 representation of the parameterized uniform crossover

5.4.1.5 Composition of the next population

In this approach we avoid the use of reproduction with replacement technique for all individuals, because of its drawbacks: as explained by Davis (1996) many of the best individuals found may be not reproduced at all, and their genetic material could be lost for further exploration trials. Or perhaps, crossovers and mutations may destroy the best found individuals’ structure. Neither of the two points is desirable. The scheme we used for the construction of the next generation is similar to those of Edi (2007), Mendes et al. (2009) and Attia et al. (2012c), as shown in (Figure 5.4). It is based on four groups of individuals: The first group is the group of “survivors”, who have been selected upon their fitness through an elitist selection, in order to preserve the best individuals from one generation to another. But this approach increases the probabilities of convergence towards local optima, according to Edi (2007); one can reduce this problem via high mutation rates, which can be achieved by changing the genetic material of some chromosomes, and inserting some new individuals to the population. The second group is the “children group” of size equal to $[P_c \times IP_size]$, which results from the crossover between parents. In order to preserve the diversity of the population, and also to ensure a comprehensive exploration of the solutions deposit, the individuals of the third group are generated randomly, as were the ones that made up the initial population. We adopted here the “random immigration scheme” (Yang, 2007), that proved to be efficient in dynamic optimization problems. The size of the third group is predefined to be $[(1 - P_s - P_c) \times IP_size]$ of the new population, minus one: the last group building the new generation consists of only one individual: the best one ever found since the very beginning of the search. Then, when the population is built, the mutation procedure takes place to develop some of the population genotypes with the uniform mutation.

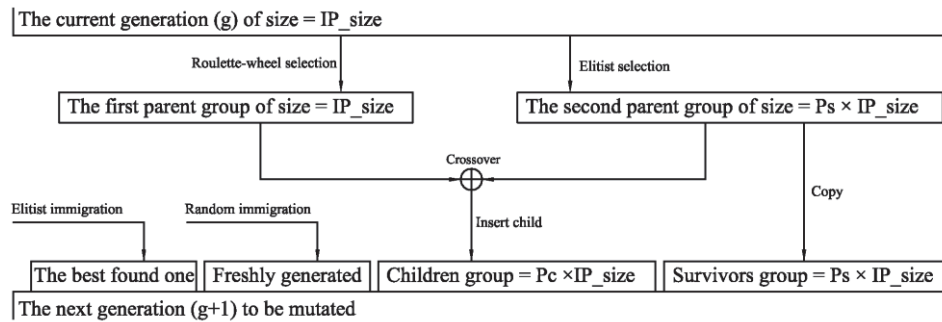

Figure 5.4 The next generation reproduction scheme

After that, the process of creating generations, evaluating individuals and building new generations is repeated until one of the stopping criteria halts the process, as shown by (Figure 5.1).

5.4.1.6 Mutation

After the selection, crossover, and reproduction, the mutation takes place in the evolution process. The mutation helps to prevent the search to converge towards some local optima, by changing some of the population genetic materials. The uniform mutation is used (Davis, 1996) with a mutation probability of (P_m). Increasing the number of mutated instances increases the algorithm's ability to search outside the currently explored region of the search space - but if the mutation probability is set too high, the search may become a random search. Among the whole population, we select randomly a number of genes to be mutated, equal to the $P_m \times (IP_size - 1) \times \text{Chromosome length}$, rounded to the next whole number. For each mutation process, an individual and a gene's *locus* within it are selected randomly. After that, the corresponding gene's *allele* will be changed with a uniform random value, as was generated the whole initial population.

5.4.1.7 Termination Procedure

As in any iterative algorithm, the implementation of genetic algorithms requires the definition of a criterion by which the exploration procedure decides whether to go on searching or to stop. The termination criterion is checked after each generation, to know if it is time to stop or to complete the exploration. In our approach, we define two termination criteria, and when any one of them is valid, the exploration will be stopped:

- The first criterion is related to the average evolution of the objective function, as it was used by Attia et al. (2012c). We call it 'Average convergence', in which the convergence is the evolution or, more exactly, the non-evolution of the average value of the fitness for a number "*Nbi*" of the best individuals, for a given number of successive generations: when the average fitness value no longer seems to evolve, the process is considered to have converged.
- The second termination procedure simply depends on the total number of generations that were produced and evaluated since the very beginning of the search. When this maximum number of generations has been run, then the termination procedure occurs: this just makes it possible to stop a search which does not seem to be successful, or to limit the procedure running time.

5.4.2 Scheduling algorithm

For each individual of the population, the scheduling procedures are conducted, to translate the individuals' genetic materials into the corresponding tasks' schedule and actors' allocation. The following steps describe

these decoding procedures, starting from the first day of the project execution and based on the serial scheduling generation scheme. This builds up a feasible schedule by sequentially adding the tasks one by one until a complete schedule is obtained. The scheduling algorithm has mainly two sub-procedures: search for sets of feasible tasks, and workforce allocation. At each time instance (or day), the feasible sets (fs) are generated, which represent the group of tasks that may be scheduled together according to the temporal relations between tasks, resources availability, or even the workforce regulations. First of all, a set of three lists are generated based on the priorities carried by the chromosome: a list of the tasks, a list of the actors, and the list of the working time policies. Then the following procedures for decoding the chromosomes will be applied for each chromosome in order to construct the project plan it carries.

5.4.2.1 Tasks feasible sets

First, at each time interval we consider the set of the activities that can be performed in parallel without constraints violation. After a search of all the tasks that can be considered as feasible (considering only the temporal constraints), they are grouped into a set of “the candidates list”. With the aid of tasks priorities, which are hold by the corresponding chromosomes, we can select the most prioritized task. After that, other procedures of checking feasibility based on the extremes values of the resources availabilities, and regulation constraints should be conducted. We then assign to the selected activity the maximum permissible duration, and for each available actor, we assign the maximum permissible number of working hours per day (10 hours according to the French law). According to these conditions if ever a reason of unfeasibility was proven (because the need for resources exceeds their availabilities for example), the task with the next maximum priority in the list is selected. We follow this procedure until we can find the suitable task, then we call the resources allocation procedures (as explained in section 5.4.2.2). If a feasible task was found that respects all the hard constraints, the candidate list will be updated. All tasks within the candidates list will be checked, until we can find a feasible set of tasks, considering precedence relations, resources’ availabilities and working time regulations, all together. Thus, first we look for a feasible set fs , so that:

- For any pair of tasks (i, c) in the feasible set (fs), there is no restriction for performing them simultaneously at the current time instance, considering the precedence constraints.
- The workload requirements by the tasks within the set (fs) must be satisfied, qualitatively as well as quantitatively.
- The total resources requirement by the feasible set must be lower than or equal to the resources availabilities.
- Each actor always works without any violation of the working time regulations.

5.4.2.2 Resources allocation

The skills’ criticality list is used to prioritize the different skills within the same task. This list is established, considering skills scarcity, and a given skill will be all the more prioritized as it is critical, *i.e.* scarce. We are now ready to conduct actors’ allocation. By the end of actors’ allocation algorithm, we should be able to assign a value to each variable ($\omega_{a,i,k,j}, EE_{i,k}, d_{i,k}$), according to the relation $\omega_{a,i,k,j} = \Omega_{i,k} / (d_{i,k} \times EE_{i,k})$. Therefore, we can compute all the possibilities of every task’s workload durations $d_{i,k}$ and the resulting actors’ daily number of working hours ($\omega_{a,i,k,j}$). Regarding the actors’ working time strategies hold by the chromosome, we can start a search for the actors’ values of daily working hours ($\omega_{a,i,k,j}$) which would satisfy the task execution window and

the working time regulation constraints. By the following procedure described by (Figure 5.5), we present the workforce allocation algorithm. This procedure for the scheduling generation scheme will be continued until all the tasks' workloads are scheduled – unless we state the failure of the corresponding chromosome to give rise to an acceptable schedule. In this case, the chromosome will be penalized by charging it with a large penalty cost, and thus reducing its probability to be reproduced in the next generation.

As shown in (Figure 5.5), this procedure for actors' allocation is repeated for each workload, until it is verified that all the workloads of the considered task have been allocated with the required workforce. If the operators are not sufficient to undertake the current task's workloads, the model searches again for another feasible task to be scheduled rather than the current one within the candidate list. This actors-to-tasks allocation process will be continued until all tasks have their sufficient teams. During the current day, if none of the tasks to be done may find enough resources to be performed, then we look for another allocation period, where actors would be released by ending missions, and the checking procedures are repeated. In the worst case, if at least one task cannot be performed at any date due to resources scarcity, the infeasibility of project will be concluded.

- Sort the available actors according to their priorities holding on the chromosome,
- Update the productivity levels $\theta_{a,k(n \rightarrow d_{i,k})}$ of the available actors,
- Sort workloads within the tasks according to skills' criticality list.

While (all workloads of the current task have their team-works), **do**
While (all available actors are checked), **do**
Allocate (most prioritised actor with $(\theta_{a,k} \geq \theta_k^{min})$), $EE_{i,k} = EE_{i,k} + \theta_{a,k}$
Construct a matrix of $\omega_{a,i,k,j}$, $\forall d_{i,k} \in \{D_i^{min}, D_i^{max}\}$,
For (*working interval* = most prioritised *working interval*)
Search within the matrix for a value of $\omega_{a,i,k,j} \in [\text{working interval}]$
If it exists check working time constraints
If (working time constraints are feasible)
 Store this allocation and mark actors as unavailable during the period corresponding to $d_{i,k}$. Fix the value of $d_{i,k}$, update all variable that depends to this allocation.
Break to next workload
Next for
End while
If (there are no available actors) **break while with conclusion of: the unavailability proven to realise the current task.**
End while

Figure 5.5 Workforce allocation algorithm

5.4.3 Approach validation

In order to validate the current algorithm, and avoid the time expenditure generated by the validation procedures, we need to run and test only subsets of instances and analyse their results. To perform this study, a number of instances should be selected to be tested. The size of this sample is an important parameter, the goal being to make some inferences and extract some knowledge about the whole population. Therefore, as this size increases, the significance of the test increases, but the associated time will be increased too. Therefore, we selected only 20 instances from all instances that were modified from the open-access library (PSPLib, 1996), as discussed in (Appendix A). The choice was performed by selecting a random sampling from the whole population, via the use of statistical software. The instances are taken with different numbers of tasks (30, 60, 90, and 120), each instance having its appropriate number of actors and tasks temporal relations. The validation procedures are simply based on functional tests, *i.e.* we review the algorithm response with what we expect from the data. Thus

any contradiction between the data entry and results will be concluded as a failure of the functional test. In this way, we treated the algorithm as a black box, as shown by Figure 5.6: four sets of inputs, such as tasks temporal relations, tasks durations, tasks workload requirements per skill, and the efficiencies of each actor in each of his/her skills. The simulation parameters of the genetic algorithm are kept unchanged during the exploration (as shown in Table 5.1), because at this step we are interested in validating the capability of the algorithm to deliver a feasible and applicable schedule, not to study its performance. The parameters to be checked have been sorted into two groups according to the outputs of the algorithm;

- ❖ *The project*:- Tasks’ start and finish dates, tasks’ durations, - The tasks relations will be checked from their start and finish dates, - The workloads per task and per skill should be fulfilled with the required manpower, both quantitatively and qualitatively.
- ❖ *Human Resources*: - Each actor should be assigned only once per each period of his working timetable, - The assigned actors should master the required skills with productivities higher than or equal to the minimum prefixed qualifications,- The evolution of the actors’ experience (known from their prior allocations) should be checked, - Each actor’s timetable must satisfy the legal conditions of working hours, especially the hard constraints.

We proved that the proposed model is capable to return a feasible and applicable project schedule with the corresponding workforce allocation. Here, the checking has been carried out manually; all the hard constraints have been checked and proved to be satisfied, as well to some of soft constraints, thanks to workforce flexibility.

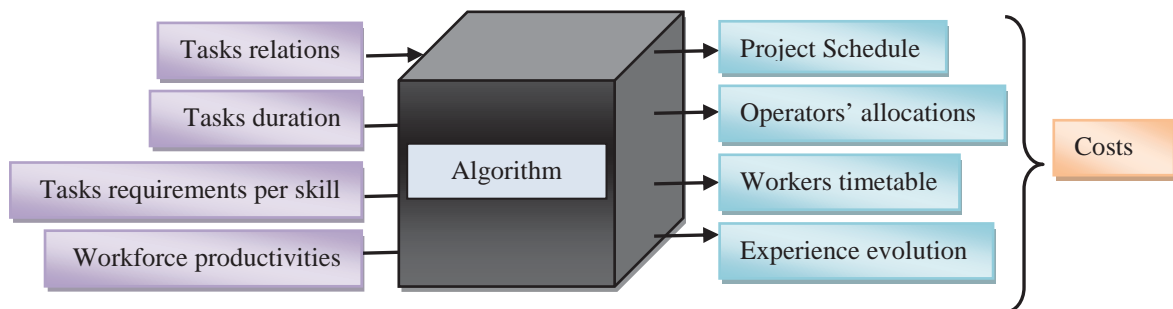

Figure 5.6 treating the algorithm during the validation

Table 5.1 GA’s parameters used during validation

Max. number of generations	= 400 generations
Population size (IP_size)	= 50 individuals
Crossover probability	= 0.7
Mutation probability	= 0.01
Regeneration Probability	= 0.2
Max. gen. without evolution	= 100 generations
Size of “Nbi”	= 10 individuals
Losing flexibility cost	= 20 MU
Tolerance period (β)	= 20 % \times L

5.4.4 Tuning the algorithm's parameters

The behaviour of any evolutionary algorithm (*EA*) could be modified by changing the value of one or more of its parameters. The way of setting the *EA*'s parameters is crucial for a good performance and robustness aspects. Regarding to the lack of knowledge about the fitness search-space that will be explored, one of the somewhat tough processes of any *EA* consists in figuring out the values of its parameters, because of the huge number of iterations required to set some parameters with respect to a particular problem. This procedure is generally a high time-consumer, and CPU-time expensive. In the spirit, one should answer the question: How to fix the appropriate value to each parameter, in order to explore efficiently the problem solutions landscapes?

According to Eiben et al. (2007) there are two forms of parameter settings: the parameter tuning, and the parameter control. The parameter tuning consists in assigning a suitable value to each parameter before running the algorithm, then fixing these values after the algorithm running procedures. In parameters control, the algorithm starts with some values at the initialization phase, and then these values will be changed during the running procedures. Generally speaking, in parameters tuning, one can design an experimental study to test the different values and select the ones which gives the best results. Recently, Eiben and Smit (2011) considered the parameters tuning from two aspects: - configuring an evolutionary algorithm by choosing parameters values that optimize its performance. - Analyzing an evolutionary algorithm by studying how its performance depends on the values of its parameters. By the following we will discuss the algorithm quality and the experimental design proposed to tune the proposed approach.

5.4.4.1 The algorithm quality

In order to test the quality of a given algorithm, one needs to test its performance and robustness. The algorithm performance measures usually result from the quality of the solution, and the fastness to return this solution back. The solution quality can be measured as a function of the individual fitness. Eiben and Jelasity (2002) discussed some performance measuring tools based on the calculating time and fitness values: - if the maximum running time is defined then one can measure the algorithm performance as the best fitness at termination. - If the minimum fitness value is defined, one can measure the algorithm performance as the running time to reach this limit. If both are defined, the performance measure is the binary "yes/no" answer to a successful search. If the optimal value is not known in advance, one can use the "Mean Best Fitness: *MBF*" at termination. The *MBF* should be calculated under a pre-specified running period. Finally, one can use the progress function in terms of the best/average/worst fitness of successive populations, and plot them against the time axis. This plot provides much more information about the algorithm performance than the other methods. In our model we used the "*MBF*" at termination. In our case, the termination condition depends on the model stopping criteria (as previously discussed in section 5.4.1.7), so we considered the maximum number of generations without convergence as one of the parameters that will be tuned. On the other side, the main objective of measuring the robustness of a given algorithm is to check its performance stability under the presence of uncertainty conditions within the data input. And it is strongly related to the algorithm performance variance in function of three dimensions: – Robustness to a change in the parameter vectors, – Robustness to changes in the random seed that was used to render the stochastic nature, – Robustness to changes in the problem instances. By the following we introduce an experiment to tune the approach parameters, where its robustness will be analysed in next chapter.

5.4.4.2 Experimental design

The purpose of any experiment is the collection of data that will be analysed in order to infer one or many conclusion(s). The ways to collect the data are observations, surveys, computer simulations, and experiments. Here, in order to test the performance of our algorithm to solve the problem presented previously, we need to know the values of the performance measuring indicators, which can be determined by tests. As discussed above, testing all the parameters combinations by enumerating them is almost impossible. Therefore, we needed to design an experimental study to test a selected sample from all parameters which will perfectly reflect the nature of independent variables. In general, any experimental study has three phases: the sampling phase, the testing phase, and the results analysis. Thus, in order to manage all the aspects of any experiment, it seems indispensable to conduct a “Design Of Experiment: *DOE*”. According to Dean and Voss (1998), there are three basic techniques in *DOE*: replication, blocking, and randomization. The replication and blocking help to increase the precision in the experiment; but the randomization is used to decrease personal bias. By the following we will discuss the different features of experiment.

5.4.4.2.1 Problem definition

Any scientific study conducted to solve a problem rests on three bases: objectives definition, methods to reach these objectives, and the evaluation of these methods in reaching the objectives. Our main objectives are to tune the parameters of the algorithm in order to have the best performance. To reach these objectives one should investigate all the possible interaction between parameters combinations. But investigating comprehensively all the parameters by factorial design is almost impossible due to the related time. The factorial design produces a combinatory explosion making the experimental effort excessive. Especially, we have a set of factors with many levels. The effort in this case is exponential and can be calculated as “test effort = levels^{factors numbers}”, in order to avoid the fully factorial experimental, we propose to use fractional factorial (see section 5.4.4.2.2).

First of all, we need to precise the parameters that have to be set. Generally, genetic algorithms contain two main categories of parameters, the qualitative parameters and the quantitative. The qualitative group represents the chromosome encoding, crossover type (one point, multi-point or uniform crossover), mutation type (bit-flip, uniform or Gaussian mutation), and selection (elitist, tournament, uniform random...etc). The quantitative or the numerical category represents all the parameters that can have specified numerical values. The most obvious parameter to be defined of this category is the population size that will be fixed during the search procedures. Afterwards, we need to define the reproduction parameters monitoring the variation degree between parent and offspring generations. In the present genetic algorithm, the reproduction of a given population (as discussed in section 5.4.1.5) depends on four static parameters: crossover percentage, survival percentage, regenerated percentage, mutation probability. Two other factors are the termination criteria. After the identification of the algorithm parameters, one needs to define the domain of each variable, so as to define the factors levels. In other words one needs to answer the following three questions:

Q1: What are the lowest and highest measurable value of each factor?

Q2: What is the number of steps between factor extremes limits?

Q3: What are the increments between each two consecutive steps?

To answer the first question, we adopted the attitude of being guided by the previous practical and experimental researches. Relying on previously published works, we can have the perspective to figure out the factors discrete

values and their extremes points. As shown in (Table 5.2), we present the domain related to each factor; in addition to *GAs*' parameters we also present another factor related to the project delivery date, "the tolerance β ". To answers the second and third questions, we need to solve another optimization problem that will provide the best value for each factor, the value that maximizes the performance of our algorithm. As previously discussed, the implementation of such optimization problem forms another challenge problem in the artificial intelligence, see for example Eiben and Smit (2011). But in the other side there are some methods that will give us a good exploration of the surface response; these methods will be presented and discussed in the following section.

5.4.4.2.2 Initialization phase

As mentioned previously, the experimental effort increased exponentially in function of factors and the number of their levels in the complete factorial. One of the cheapest methods adopted to avoid this problem is the fractionally replicated factorial design. Then, and relying on the "no free lunch theorem" of (Wolpert and Macready, 1997), one can use these parameters values in solving other instances. There are some methods which used to generate the response surface such as: - Taguchi method that has been developed in the industrial manufacturing by Genichi Taguchi (Taguchi, 1995), - Latin-square orthogonal matrix, - Central composite, it has five levels for each factor, $\pm 1, \pm\alpha, 0.$, - Doehlert design, - Box–Behnken designs. We adopted the box- Behnken method to generate the parameters combination vectors. According to Ferreira et al. (2007), one of the most important aspects of it is the requirement of fewer treatment combinations in comparison with the others. It is a second-order design method based on incomplete three-levels for each factor. These three levels are the minimum, centre, and maximum values, (see appendix C.9). One of its drawbacks is the "missing of corners", so, the factors extremes limits should be increased. Using parameters' extreme values shown in (Table 5.2), the parameters combination was generated with software devoted to statistics (minitab).

Table 5.2 the extreme limits of the genetic algorithms factors

The factors	Extreme limits that will be used
Population size	[20 to 200] individuals
Crossover probability	[0.50 to 0.90]
Mutation probability	[0.01 to 0.2]
Regeneration percentage	[0.0 to 0.2]
Maximum number of generations without divergence	[50 to 200] generations
Flexibility of project delivery (as percentage from the contractual duration)	[0.0% to 60%]

5.4.4.2.3 Testing phase

After the generation of the parameters with the Box-Behnken method we have a set of 54 vectors to be tested, as shown in (Table 5.3). We selected randomly a project instance of 30 tasks to be used during this investigation. In order to avoid the stochastic nature of *GAs*' , we decided to run each simulation at least 10 times, and to take the average of their results. The averages of these results are illustrated within (Table 5.3). In this step, we abandoned the objective of developing the resources skills due to the contradiction between this objective and the other problem objectives. Based on the "free lunch theorem" the produced parameters will be used for all the next investigation for the rest of this work.

Table 5.3 the results of the selected parameters combinations vectors

Parameters combination							Average results of 10 simulation of each vector								
#	IP_						Total								
set	size	β	Pc	Preg	Pm	Stop	Work	Overtime	Flexibility	Average	Objectives	Time	Gen.		
							(hrs)	(hrs)	cost	occupation	Function	(sec)	number	LV	Penalty
1	20	0	0.7	0.2	0.055	125	25794.05	1992.8	1190.2137	0.566768	310215.92	161.5	490.4	60.4	19810.8
2	20	30	0.7	0.2	0.01	125	23713.14	1091.93	852.56904	0.405986	264699.78	305.8	932.2	76.5	0
3	20	60	0.7	0.0	0.055	125	23985.92	372.21	741.76281	0.35322	265610.45	173.2	493.4	89.9	0
4	200	30	0.7	0.0	0.1	125	24346.83	1229.48	886.97748	0.422371	272083.75	6998.8	995.6	76.1	0
5	110	60	0.9	0.1	0.1	125	23728.96	383.272	738.29589	0.351569	262810.99	3213.5	1069.3	90.2	0
6	200	30	0.7	0.2	0.01	125	22588.24	1582.8	812.07387	0.386703	253635.54	3741.4	1289.1	77.3	0
7	110	30	0.7	0.1	0.055	125	23987.86	805.82	862.43391	0.410682	266944.73	2096.3	1049	77.2	0
8	110	0	0.9	0.1	0.01	125	25083.41	1757.3	1194.4483	0.568785	281944.82	694.4	450.3	60	0
9	110	30	0.7	0.2	0.055	50	24076.64	935.9	871.30437	0.414907	268287.96	823.8	402.8	76.4	0
10	110	30	0.7	0.1	0.055	125	23807.64	1264.29	850.27304	0.404892	266210.86	1761.9	851.1	77.8	0
11	110	30	0.5	0.0	0.055	200	24331.47	1000.99	880.55299	0.419311	271279.66	2505.2	1248.6	75.8	0
12	110	60	0.5	0.1	0.1	125	24019.84	381.8	754.92868	0.35949	266023.22	3211	1054.1	90	0
13	110	0	0.7	0.1	0.1	200	25348.89	1749.5	1207.091	0.574805	284856.91	3405.6	1141.6	60	0
14	20	60	0.7	0.2	0.055	125	23777.12	326.336	750.84641	0.357545	263196.78	277.9	874.2	88.3	0
15	110	30	0.7	0.1	0.055	125	23787.57	1394.59	855.20483	0.40724	266353.28	2507.8	1249.5	77.2	0
16	200	60	0.7	0.0	0.055	125	23572.34	307.17	728.63424	0.346969	260869.15	4916.1	1118	89.5	0
17	200	30	0.5	0.1	0.055	200	24263.39	807.927	878.07061	0.376388	269997.12	9066.5	2121.1	76.5	0
18	110	30	0.9	0.0	0.055	50	23756.61	1317.9	859.72481	0.409393	265806.85	672.6	334.7	76.8	0
19	20	30	0.7	0.0	0.01	125	23587.05	1107.05	853.61979	0.406486	263355.83	213	746	76.6	0
20	20	30	0.7	0.0	0.1	125	24653.11	676.22	898.04459	0.42764	273941.77	202.3	644	76.3	0
21	200	0	0.7	0.2	0.055	125	25059.46	1775.6	1193.3078	0.568241	281730.51	3209.5	934.6	60	0
22	110	60	0.7	0.1	0.01	50	22591.77	273.53	698.31605	0.332533	249960.23	1091.4	640.5	91	0
23	110	30	0.7	0.1	0.055	125	23819.21	1215.71	856.37136	0.407796	266210.82	1996.1	997.6	77.1	0
24	110	60	0.7	0.1	0.1	200	23863.47	255.93	742.50843	0.353575	263944.55	5656.2	1761.8	90	0
25	110	30	0.9	0.0	0.055	200	23711.03	1445.7	846.82249	0.403248	265643.94	2437.4	1216.6	77.1	0
26	110	30	0.7	0.1	0.055	125	23847.55	1232.69	863.03611	0.410969	266576.51	1874.8	934.6	76.7	0
27	20	30	0.9	0.1	0.055	50	24390.8	892.97	882.60602	0.420289	271637.16	84.7	279.8	76.4	0
28	20	0	0.7	0.0	0.055	125	25498.6	1985.3	1204.9096	0.573769	291988.88	114.2	394.3	60.1	4839.8
29	20	30	0.9	0.1	0.055	200	24054.92	971.42	870.50655	0.414528	268146.14	373.4	1254.8	77	0
30	200	0	0.7	0.0	0.055	125	25134.78	1692	1196.8938	0.569949	282332.46	2841.7	697.3	60	0
31	110	60	0.9	0.1	0.01	125	22952.88	299.629	713.27272	0.339653	254018.89	1758.6	1030.9	90.3	0
32	200	30	0.7	0.0	0.01	125	22480.98	1462.2	813.61427	0.387434	252125.52	3989.9	1436.4	76.5	0
33	110	60	0.5	0.1	0.01	125	11445.26	152.7	344.21837	0.163913	126662.04	2227.1	1256.7	92.6	0
34	110	0	0.9	0.1	0.1	125	25334.83	1774.7	1206.4206	0.574486	284770.08	2195.3	739.2	60	0
35	110	0	0.7	0.1	0.1	50	25567.11	1752.5	1208.1377	0.575305	292122.82	622.7	209.1	60.1	4856.9
36	200	30	0.9	0.1	0.055	200	23633.25	1023.15	849.61372	0.404579	263629.46	5434.6	1264.3	76.9	0
37	110	30	0.5	0.2	0.055	50	24361.29	999.9	875.91616	0.417102	271599.98	1097	545.2	76.5	0
38	110	0	0.5	0.1	0.01	125	24989.58	1784.5	1189.9808	0.566657	280982.46	1209.8	775.5	60	0
39	200	60	0.7	0.2	0.055	125	23386.87	312.971	727.20079	0.346287	258843.16	6047.9	1374.9	90	0
40	110	0	0.5	0.1	0.1	125	25483.87	1790.3	1213.5175	0.577865	286459.75	2195.9	735.7	60	0
41	110	60	0.7	0.1	0.1	50	23939.44	398.216	748.43001	0.356395	265177.43	1267.6	420	88.4	0
42	200	30	0.5	0.1	0.055	50	24313.94	982.05	868.3556	0.413504	271022.52	2038.2	482.6	76.9	0
43	200	30	0.9	0.1	0.055	50	23906.52	880.64	859.42474	0.409249	266253.2	1336	313.5	77.2	0
44	200	30	0.7	0.2	0.1	125	24228.81	747.168	876.89736	0.417571	269448.56	7702.8	1118.9	77.1	0
45	110	30	0.5	0.2	0.055	200	24292.73	906.28	873.374	0.415892	270585.41	3509.9	1728.5	77.1	0
46	110	0	0.7	0.1	0.01	50	25090.13	1874.9	1194.7685	0.568939	282342.38	358.4	229.8	60	0
47	110	30	0.5	0.2	0.055	200	24366.38	711.88	887.63359	0.422684	270875.74	2813.2	1403.3	76.3	0
48	20	30	0.5	0.1	0.055	50	24449.22	852.86	897.13034	0.427204	272184.12	106.2	346.9	75.7	0
49	110	0	0.7	0.1	0.01	200	24615.92	1897.9	1172.1863	0.558184	277166.64	2349.2	1509.3	60	0
50	20	30	0.7	0.1	0.055	200	24289.37	625.45	884.77669	0.421321	269787.82	477.5	1557	76.1	0
51	110	30	0.7	0.1	0.055	125	23923.84	1091.73	871.45714	0.414981	267036.13	2351.4	1171.1	76.8	0
52	110	60	0.7	0.1	0.01	200	22527.13	282.68	689.18603	0.328184	249265.04	3432.7	1988	91.6	0
53	110	30	0.7	0.0	0.055	50	24425.6	1406.55	889.78094	0.423706	273439.82	743.9	374.8	75.7	0
54	20	30	0.7	0.2	0.1	125	24447.42	1012.68	879.01748	0.41858	272585.81	296.9	869.8	76.8	0

5.4.4.2.4 Results analysis

To know the significant variable(s) in this algorithm, we have conducted the correlation analysis (Appendix C), using Pearson's correlation coefficient (R) as the measure of the relation strength. The correlation test between two variables assesses whether the two variables are linearly related or not. Accordingly to the results of this test (shown by tables and figures at the end of this chapter), we found that the running time is linearly related to the population size, and number of non-convergence generations (stopping criterion), as shown in Table 5.4. But there is no evidence for a linear relation between the running time and the other parameters (tolerance in project delivery, crossover probability, individuals' regeneration, mutation probability). These non linear relations presented graphically as shown by (Figure 5.7, Figure 5.8, and Figure 5.9).

Table 5.4 Pearson's correlation coefficient test for the machine running time

		IP_Size	β	P_c	$P_{reg.}$	P_m	$Stop$
Running time	R	0.741	0.189	-0.138	0.057	0.212	0.424
	$P\text{-Value}$	0.000	0.171	0.319	0.684	0.124	0.001

Regarding the solution quality represented by the aggregated objective function, we found that increasing the mutation rate increases the returned project cost, and that increasing the flexibility tolerance in the project due date (β) linearly reduces its cost (Table 5.5). But there is no evidence for a linear relation between the objective function and the other parameters such as the population size, crossover probability, individuals' regeneration, and the stopping criteria. These non linear relations presented graphically as shown by (Figure 5.10, Figure 5.11, and Figure 5.12).

Table 5.5 Pearson's correlation coefficient test for the aggregated objective function

		IP_Size	β	P_c	$P_{reg.}$	P_m	$Stop$
Objective function	R	-0.107	-0.563	0.127	0.022	0.322	-0.031
	$P\text{-Value}$	0.443	0.000	0.362	0.877	0.017	0.825

With respect to the different objectives functions: direct working hours, overtime hours, workforce average occupation (flexibility cost) and the penalties related to the delivery date, we found that all of these objectives are linearly related to the tolerance in project delivery date as indicated (Figure 5.13 to Figure 5.21) and Table 5.6. And they all are nonlinearly related to the genetic algorithms quantitative parameters such as: population size, crossover probability, regeneration of the new individuals, mutation rate and stopping criteria. These nonlinear relations are shown by (Figure 5.13 to Figure 5.21).

Table 5.6 Pearson's correlation coefficient test for the separated objective functions

		IP_Size	β	P_c	$P_{reg.}$	P_m	$Stop$
Total Work (hrs)	R	-0.085	-0.491	0.129	0.009	0.345	-0.023
	$P\text{-Value}$	0.542	0.000	0.351	0.949	0.011	0.867
Overtime (hrs)	R	0.046	-0.933	0.079	-0.083	-0.073	-0.046
	$P\text{-Value}$	0.740	0.000	0.569	0.551	0.600	0.742
Flexibility cost	R	-0.033	-0.928	0.043	-0.002	0.129	-0.011
	$P\text{-Value}$	0.811	0.000	0.757	0.990	0.353	0.937
Average Occupation	R	-0.047	-0.925	0.057	-0.002	0.128	-0.025
	$P\text{-Value}$	0.738	0.000	0.681	0.990	0.355	0.860
Penalty cost	R	-0.245	-0.293	0.006	0.149	0.048	-0.048
	$P\text{-Value}$	0.075	0.032	0.967	0.284	0.729	0.729

As shown be Table 5.7, the number of generations are highly linear related to the corresponding stopping criterion (the max number of generations without enhancement), furthermore to the tolerance in the project due date. The tolerance in the project due date increases with the number of feasible solutions, and as the project due date becomes tight; the number of feasible solutions will be reduced.

Relying on the previous results with the shown tables and figures the best combination of the parameters can be approximated. We determined the best combination of parameters, displayed in (Table 5.8). With these parameters, the robustness of the proposed approach when solving the different instances will be discussed in the next chapter using different (tasks, actors, skills) combinations: (30, 60, 90, 120) tasks, (10: 199) actors, and 4 skills.

Table 5.7 Pearson's correlation coefficient test for the separated objective functions

		PI	B	P_c	$P_{reg.}$	P_m	$Stop$
Generations number	R	0.260	0.291	-0.183	0.138	-0.093	0.830
	P -Value	0.058	0.033	0.185	0.320	0.504	0.000

Machine running time

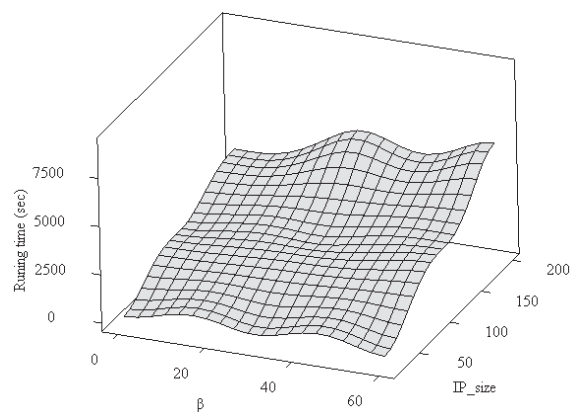

Figure 5.7 machine running time versus IP_size and β

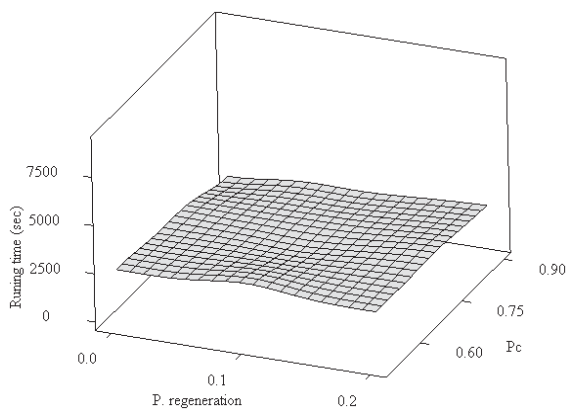

Figure 5.8 running time versus probability of regeneration and P_c

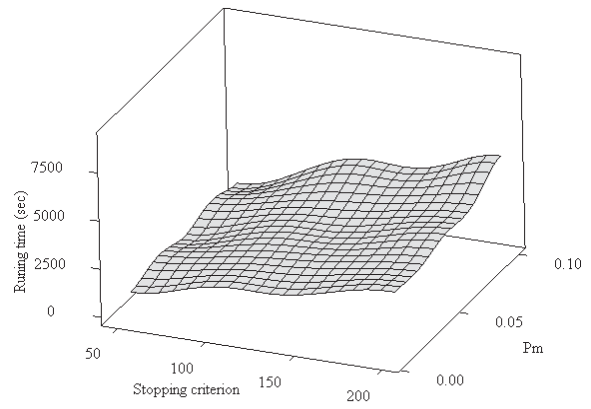

Figure 5.9 running time versus P_m and stopping criterion

Objective function:

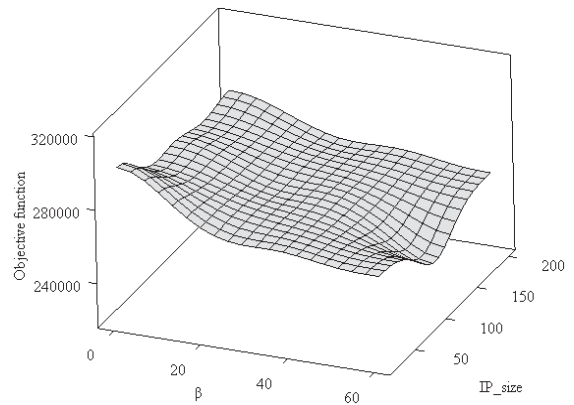

Figure 5.10 objective function versus IP_size and (β)

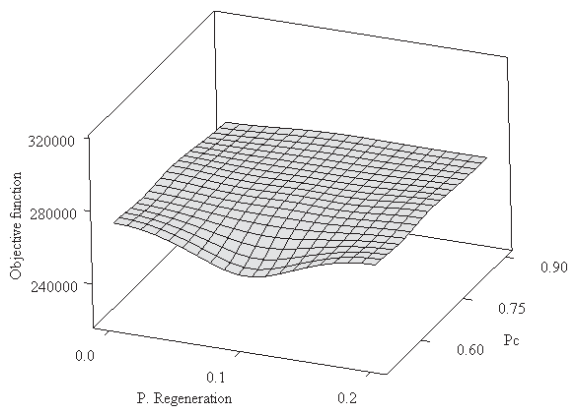

Figure 5.11 objective function versus probability of regeneration and P_c .

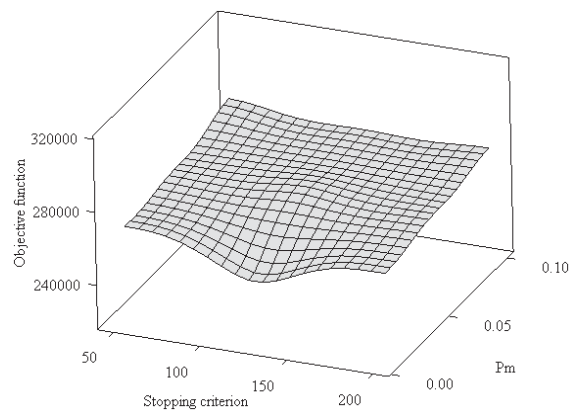

Figure 5.12 objective function versus P_m and stopping criterion

Workforce total work:

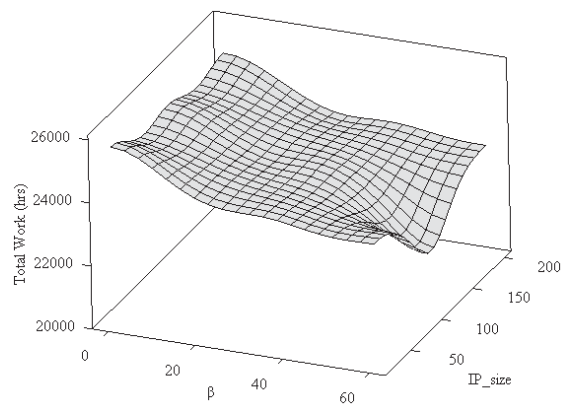

Figure 5.13 total work versus IP_size and (β)

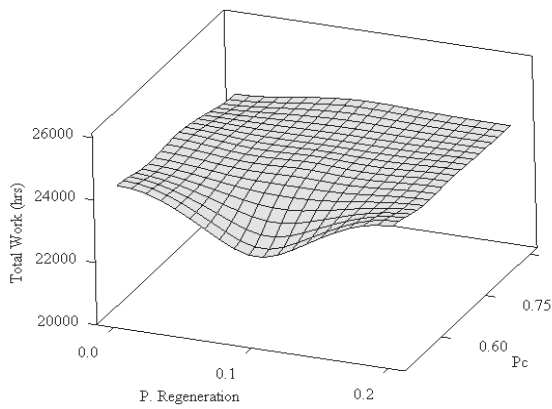

Figure 5.14 total work versus probability of regeneration and P_c

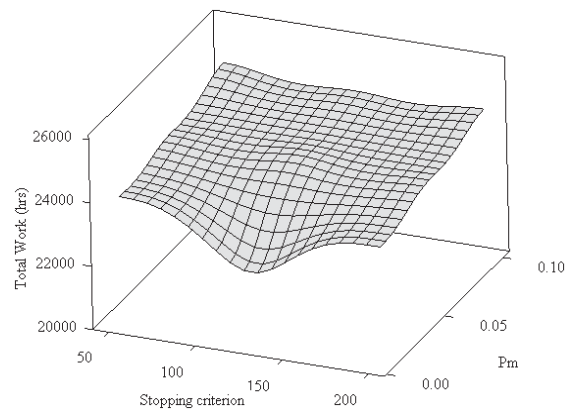

Figure 5.15 total work versus P_m and stopping criterion

Workforce overtime hours

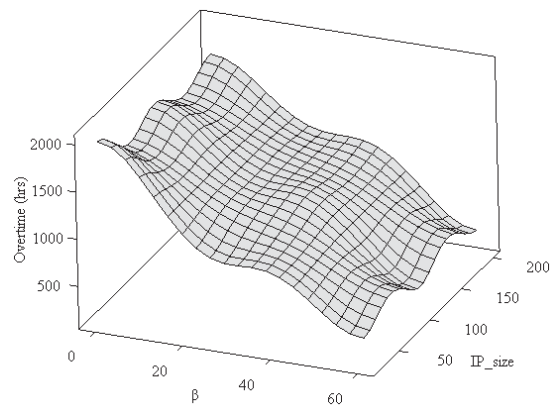

Figure 5.16 overtime versus IP_size and (β)

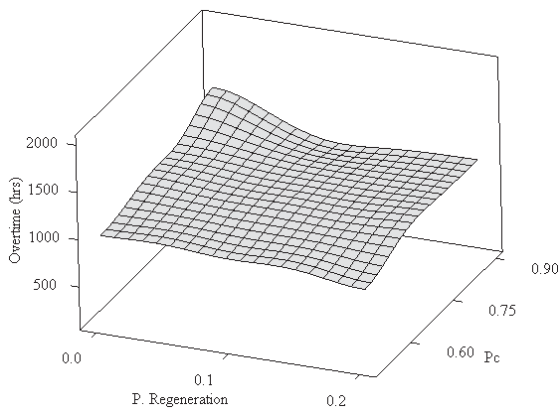

Figure 5.17 overtime versus probability of regeneration and P_c

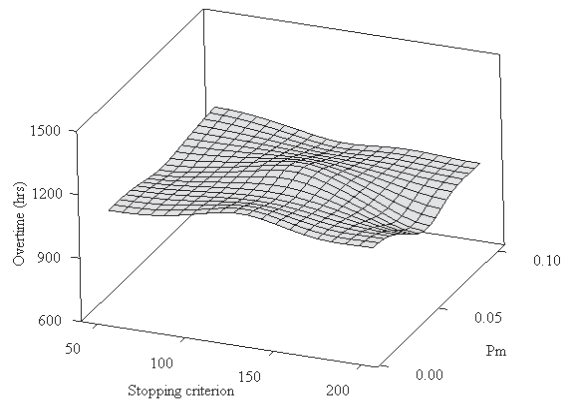

Figure 5.18 overtime versus P_m and stopping criterion

Workforce occupation:

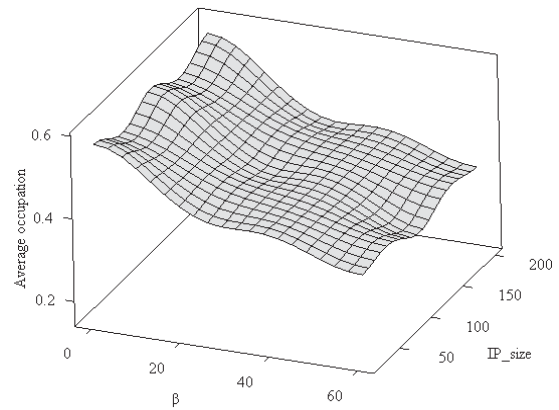

Figure 5.19 workforce occupation versus IP_size and (β)

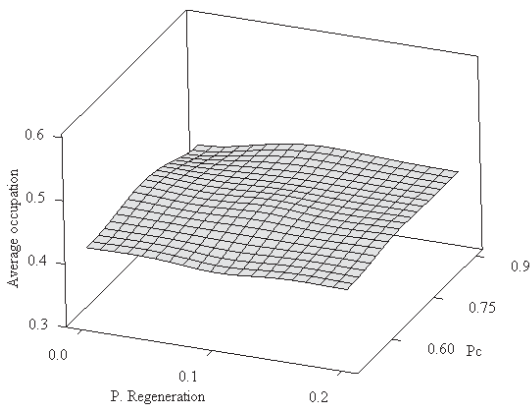

Figure 5.20 workforce occupation versus probability of regeneration and P_c

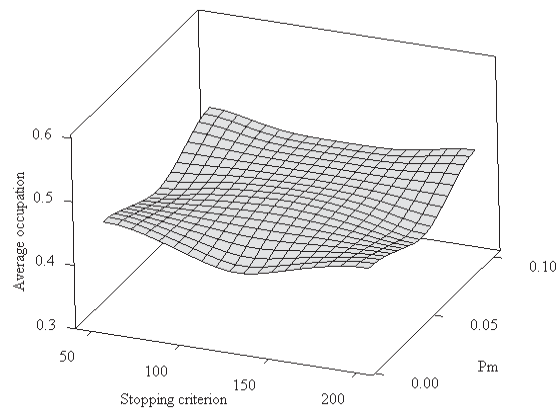

Figure 5.21 workforce occupation versus P_m and stopping criterion

Table 5.8 The values of tuned parameters that will be used in simulations

Population size (IP_size)	$\in [50, 100]$ according to the problem size
Crossover probability	$= 0.7$
Mutation probability (P_m)	$= 0.01$
Regeneration Probability	$= 0.1$
Maximum number of non-evolved generations (SC)	$= 100$ generations
Tolerance period (β)	$= 20 \% \times L$

5.5 CONCLUSION

A genetic algorithm-based approach to solve the problem of project schedule with workforce allocations was developed and described. Our approach relies mainly on the answers to three questions defining the process priorities: what task will be processed next? Then which actor(s) will be allocated to realise this task? What is the working time strategy that the actors will respect, during the activity realization? A serial schedule generation scheme is adopted to construct the project schedule and then allocated the workforce according to the randomly-generated priority lists. The model has been validated, moreover, its parameters has been tuned to give the best performance. The model robustness to return a feasible solution despite changes in the genetic algorithms parameters was proven and investigated. By the next chapters this approach will be used to solve numerous project instances with variable characteristics as a step to prove its robustness towards changing the problem characteristics. Then it will be used as a vehicle to investigate the factors that affect the multi-skilled resources.

PERFORMANCE INVESTIGATION AND RESULT ANALYSIS

In this chapter a detailed analysis of our approach will be conducted. The analysis used a vast number of projects with different characteristics. First the firms' managerial policies will be defined, which is translated by different objectives and their weights. After that, the scheduling results obtained with 4 groups of problems (Appendix A) will be analysed and discussed. Each of these groups gathers one hundred projects with different characteristics. By the end of the chapter, a brief comparison between the results of these four groups will be carried out in order to show the robustness of the approach.

6.1 DEFINING THE MANAGERIAL STRATEGY

The robustness is always conducted in order to investigate the capability of a given system to deal with uncertain changes in inputs. We present an experiment to investigate the performance of our approach (presented in section 5.4) when facing problem changes. But before solving the different problems, one should define the managerial aspects, *i.e.* the management priorities between the different objectives should be defined: - Firms can aim at a minimization of the working hours required by any industrial program (thus making the maximum use of the most competent available resources, and therefore develop a culture of mono-skilled operators); - They can as well try to expand the versatility of the actors (with the inflation of hours hence costs that entails), - Or they can seek a compromise between these two extremes. The choice between the three alternatives can be done by setting the different objectives weights in the objective function (shown in equation 5.2). In the following section, we illustrate these managerial interests using a small example of 10 tasks, 10 actors and 4 skills, detailed in section B.4 in appendix B.

6.1.1 The economic strategy:

As previously discussed in section 5.4.1.2, the fitness functions of the GAs' individuals are calculated based in equation (5.2). First, we sought to solve the problem with minimum cost by taking the weights in this equation as: $(\gamma_i = \{0.6; 0.1; 0.1; 0.1; 0.1\})$, considering that we treated $f_1 + f_2$ as a single objective. As shown by (Figure 6.1); after a number of 369 generations (and a CPU time of 53 seconds), the GA were able to reduce the project labour cost by 6.88% from the best random initial situation. The best schedule represents a surcharge of only 0.39% compared to an ideal cost¹ " f_o " of 12,408 CU – "Currency Units". Moreover, the indirect encoding of chromosomes' genotype with a special decoding algorithm leads to feasible schedules starting from the first generation. On the other hand, the company loses an average accumulation of (-2.895%) of the secondary skills of its operators, due to the unlearning effect. This is illustrated in (Figure 6.2), which shows the evolution of actors' efficiencies during the project horizon (30 days).

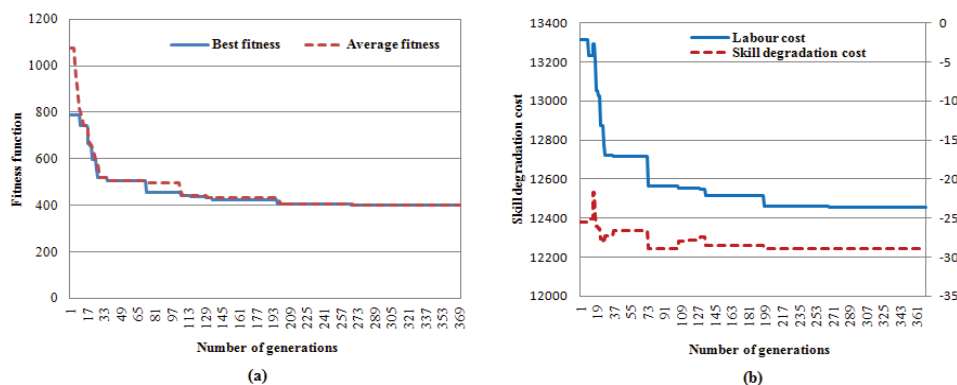

Figure 6.1 Evolution of the fitness function and objectives functions during exploration

Figure 6.2 reveals that all the actors experienced a degradation of their secondary skill(s) efficiencies, except actors #6 and #10. First, the degradation effect was produced due to the optimal economic assignment of actors $\#\{1, 2, 3, 4, 5, 7, 8, 9, 10\}$: they were appointed to work with their principal skills, in order to avoid the direct

¹ It was calculated assuming that all jobs are completed within standard hours, appointing only experts for each skill.

over-cost associated to the use of non-optimal productivities. For actors #6 and #10, this effect of degradation (about 0.11%) is not that visible, due to their high initial efficiencies in their secondary skills, as detailed in Table B.2 ($\theta_{6,1} = \theta_{10,2} = 0.9$); the loss of competence resulting from a lack of practice has an higher effect on beginners than on experts. This conclusion can also be deduced from actor #2 in skill #3, actor #7 in skill #2, or actor #9 in skill #2. Although, actor #6 was selected to work in task #2 using his secondary skill #1, the evolution is also tiny. As a conclusion, we check here that, as expressed by equations (3.6) to (3.9), if an actor has a high efficiency level, the evolutions of his skill, whatever the way, increase or decrease, will be slow and non-remarkable, so that his operational flexibility can be used periodically without risk.

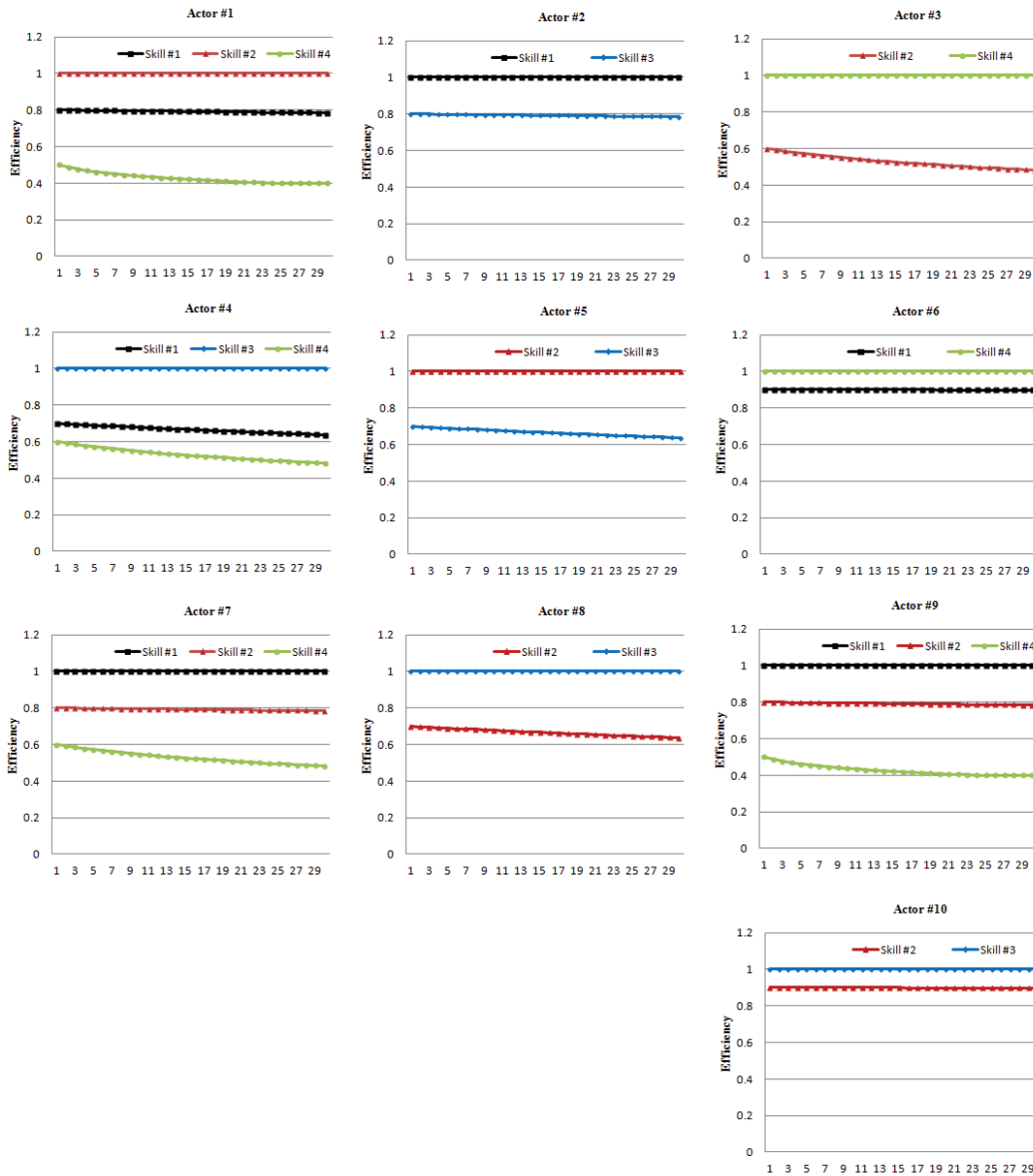

Figure 6.2 Best cost strategy: The evolution of actors' skills during the project horizon

6.1.2 Experience development strategy

The other extreme management strategy of the companies would be to expand the actors' flexibility, implicitly agreeing to sacrifice part of their profits. In order to obey this strategy, we solved the previous example with changing some of the objectives weights of $\gamma_L = 0.1$ and $\gamma_5 = 0.6$. In new set, we give the heaviest weight to the

economic interest of developing the actors' skills (f_5), implicitly allowing the associated extra costs. The search procedures stopped after 175 generations (26 seconds). It stopped due to convergence of the average fitness computed on a specified set of individuals (10 of the best individuals). This exploration procedure succeeded in increasing the actors' average efficiency by about (+0.94%) for all skills (accumulated value). In addition, it reduced the best fitness (*i.e.* the lowest ones) of the feasible schedules by about 111.89%; this value exceeds 100%, since the fitness function may be negative (*Equation 5.2*, especially with high values of γ_5), which will likely be the case for the best individuals compared to the best individual in the initial population. By the same time, the labour cost was increased by about 7.42%, which represents an over costs of about 36.94% compared to the optimal labour cost.

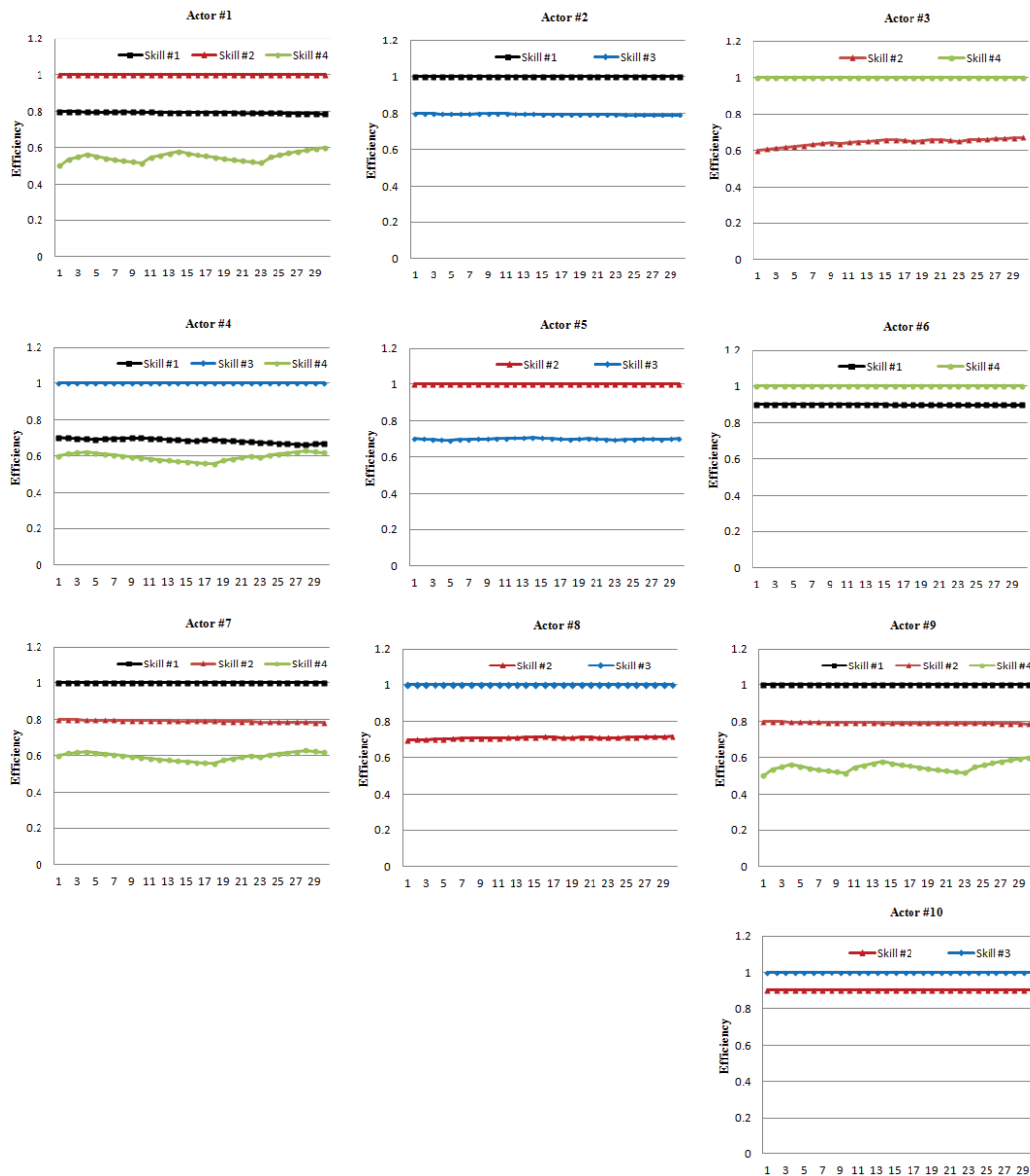

Figure 6.3 Skills development strategy: The evolution of actors' skills during the project horizon

As shown by Figure 6.3, these over costs result from the intense use of actors' secondary skills in order to develop their versatility; this evolution can be shown for actors #1, #3, #4, #5, #7, #8, and #9. But for actors with high levels of secondary skills such as actors #2, #6, #10, we can see that the model prefers to use their

functional flexibility (actor #2 and actor #10), or preserve their future temporal flexibility by reducing their involvement and put them aside (actor #6), and assign the ones with low efficiency levels. Indeed, this strategy looks expensive, and it may make no sense to pay about 37% more than the project ideal manpower cost for a sum gain of about only +0.9% of actors' efficiencies in all skills. This illustrates that a compromise should be investigated between the labour cost and the actors benefits from learning-by-doing.

6.1.3 *Compromise between savings and experience development strategies*

We propose to get a compromise between the two strategies by changing the weights to the values of $\gamma_L = 0.35$ and $\gamma_S = 0.35$, by assigning equal weights to the labour cost and to the skills development. Afterwards the algorithm was run ten times: for each run Table 6.1 displays the solution found; as we can check, the returned values are always within the two extremes of the previous strategies. But, in the other side most of these solutions suffer from skills depreciation as well as extra cost: finding such a compromise is not self-evident. Therefore, we will investigate this dilemma in the next chapter, by discussing the factors that affect the development of the workforce experience. But here, we continue to solve the different data sets using the objectives weights as $\gamma_i = \{0.35, 0.1, 0.1, 0.35, 0.1\}$.

Table 6.1 Exploration results related to labour costs f_L and the skills development f_S .

	Exploration number									
	1	2	3	4	5	6	7	8	9	10
$\% (f_L - f_o)/f_o$	10.79	23.29	14.95	14.10	20.50	12.86	11.86	8.13	22.63	25.10
$\% f_S/U_k$	-1.19	0.10	-0.58	-0.70	-0.07	-0.94	-1.13	-1.51	0.20	0.39

6.2 RESULTS ANALYSIS AND DISCUSSIONS

As previously mentioned, the proposed approach was encoded with C++ using “Microsoft visual studio 2010” on Intel® core™ i5 CPU @ 2.53 GHz, 4G RAM, with “Windows 7” as an operating system. The different projects within each data set are successfully solved with feasible schedules. In order to overcome the stochastic nature of the genetic algorithms, we conducted three simulations for each instance. In total we conducted 1200 simulations. And depending on the running time of each instance, the simulations with either the minimum or the maximum running times were exempted, so the results of the third one that located between these two extremes were considered. The results of simulations corresponding to the projects in each data set are shown in appendix D, where tables (D.1), (D.2), (D.3) and (D.4) respectively provide the results of data sets #I, #II, #III, and #IV. As we can see all the constraints are satisfied “ $f_6 = 0$ ” for all instances of all data sets. By the following we will discuss the robustness of the model with respect to the problems changes.

6.2.1 *Data set #I*

Each project is composed of thirty tasks, plus two fictive tasks (start and finish events of the project). Each task is characterised by a specified workload related to one or more skills (we have four skills). These required workloads vary from 4,389 to 32,501 working hours. Between each pair of skills, there is a similarity degree within a specified interval from [0, 25%] or [25, 50%], the choice of the interval was done randomly for each project. The available workers vary from (41 to 143 persons). Some of workers are unary-skilled, others are multi-skilled. As discussed in chapter 4, the projects variations regarding these parameters (workload, resources,

network ...etc) can be represented by a set of indices, as shown in (Figure 6.4). The data set can be divided according to the project sizing “*PSI*” to five clusters of different complexity. The structure of projects networks and their flexibilities (*NFI*) vary from one instance to another. As well, there is variation in the availability of resources from one instance to others, which can be presented by the project weighting index *PWI*. There are also variations in the workload location *PLLI*, the temporal characteristics *TDI* and network bottleneck *NBI*.

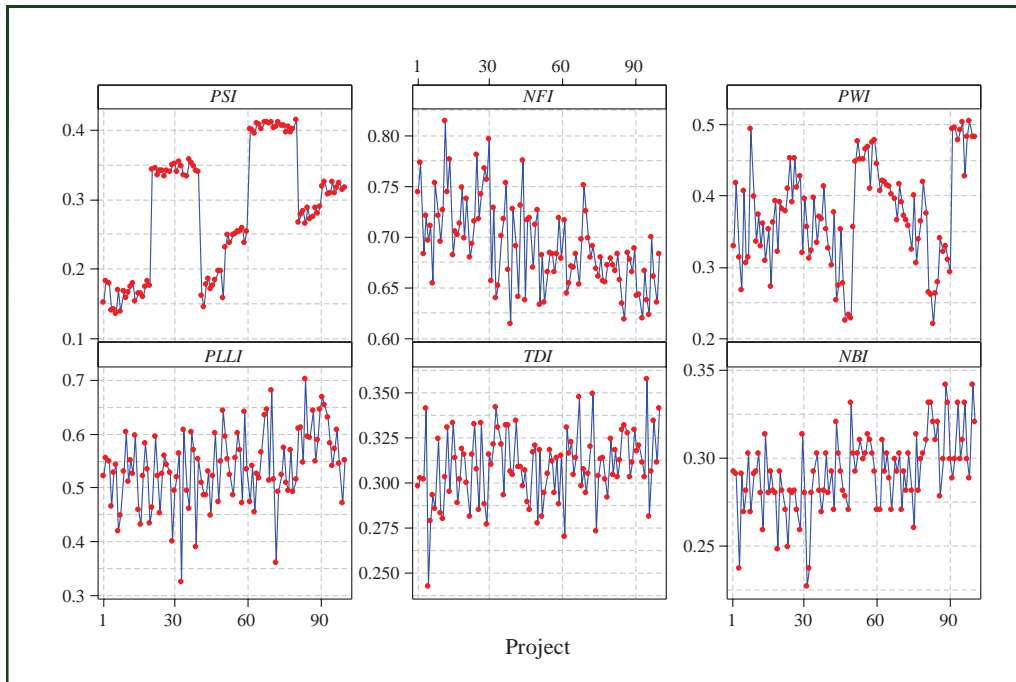

Figure 6.4 the Distribution of *PSI*, *NFI*, *PWI*, *PLLI*, *TDI*, and *NBI* for the data set #1

6.2.1.1 Variation of fitness function

As discussed in section 5.4.1.2, the fitness function represents the normalised version of the weighted sum of objectives. The distribution of this function is shown in a log scale with respect to the different projects within the data set, shown in (Figure 6.5). We can observe two groups of projects: the major one contains about 89% of all the projects, and represents all instances that have sufficient resources to deliver the projects within $[L-\beta, L+\beta]$. The variation of the returned values is small and depends mainly on values of the objectives (f_1, f_2, f_3, f_5).

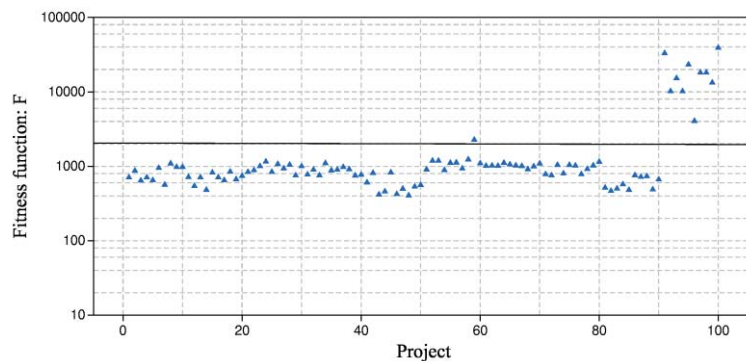

Figure 6.5 the distribution of the fitness function: *F* for projects of the data set#1

The second group represents the projects with high workload for the available resources, (shown by Figure 6.4, for *PWI*). Consequently to this scarcity of available resources, the project is achieved with high lateness

penalties, corresponding to the objective f_d . By analyzing the correlations between fitness function and project indices, we found high evidence for a positive linear correlation between “ F ” and each of: PWI ($R= 0.483$), TDI ($R = 0.249$), NBI ($R = 0.208$). We found a negative correlation between “ F ” and NFI ($R = - 0.241$). This small negative correlation seems to be normal where finding a feasible solution is difficult due to the flexibility reduction. Due to the normalization of the different components of “ F ”, we didn’t find any correlation between PSI and “ F ”, where ($R = 0.122$). As well, the correlation between F and $PLLI$ cannot be accepted at ($R = 0.196$).

6.2.1.2 Variation of objectives

The objectives distributions are shown in (Figure 6.6), knowing that all of them were represented in “ $CU - currency units$ ”. First, concerning the standard labour cost “ f_1 ”, by analyzing the correlation between it and the different indices of the project (shown in Figure 6.4), we found a positive correlation between “ f_1 ” and PSI ($R= 0.947$). This highly linear relation is common when the project scales increased (especially the work-content), f_1 will be increased. If all workers have a nominal efficiency for each skill, this linear relation will be increased. We found also a positive correlation between f_1 and PWI ($R = 0.418$). This positive relation results from the high lateness penalties compared to working costs: *i.e.* as the PWI increases, the difficulty of solving the project with the available resources without lateness penalties grows. Furthermore, TDI influences positively f_1 at ($R = 0.309$). On the other side, there is also indication for a negative correlation between f_1 and NFI ($R = -0.253$). In order to overcome the partial correlation of indices we performed the multiple regression analysis to know the best predictors of f_1 . We found the significant predictors of f_1 are “ PSI , PWI , and TDI ”: they are capable to explain the variance in f_1 with coefficient of determination “ $R^2= 93.7\%$ ” at a linear aggregation formula of the computed f_1 : $f_1^C = 10.7E5 PSI + 2.7E5 PWI + 6.6E5 TDI - 3.9E5$. Regarding to the overtime costs “ f_2 ”; we find a linear relation with PSI ($R = 0.807$). The resources availability represented by PWI represents another factor on the required overtime with ($R = 0.532$). As the PWI increases, we can consider that the project brings an intense use of the available resources, so the overtime increases too. Aligned with “ f_1 ”, the TDI influences positively the overtime costs “ f_2 ” ($R = 0.219$). There is small negative correlation between “ f_2 ” and NFI , ($R = -0.262$).

Concerning the economic quality of the solution, the approach robustness can be shown by comparing the returned labour cost ($f_L=f_1+f_2$) and the optimal one (f_o). We calculate (f_o): $f_o = \text{work-content (hours)} \times \text{salary cost per hour}$. We then calculate the percentage between the excess of labour cost and the optimal one as: $\%(f_L-f_o)/f_o$. As shown by (Figure 6.7-a) the excess in labour costs is always kept within limits: these limits depend on the complexity of the project. By analyzing the correlation between this economic quality and project indices, it reveals to be highly correlated to PWI ($R = 0.838$). This relation arises for two reasons: the first is the utilization of overtime to achieve the project without penalties, the second is the use of all the available workers, whatever their efficiency levels. Also, it was proven to be positively related to PSI ($R = 0.536$), and negatively related to NFI ($R = -0.244$). We conducted a multiple regression analysis that helped us to investigate the significant parameters to explain this economical aspect. As shown by figure (Figure 6.7-b), we found PWI and PSI are the significant parameters to explain this variation, with $R^2= 80.3\%$ with a regression linear function of: Computed $\%(f_L-f_o)/f_o = 24.2 PSI + 68.6 PWI - 10.2$. This result is logical, since as the availability of resources is reduced, the project becomes complex, and the economic quality of solution is degraded to avoid lateness penalties.

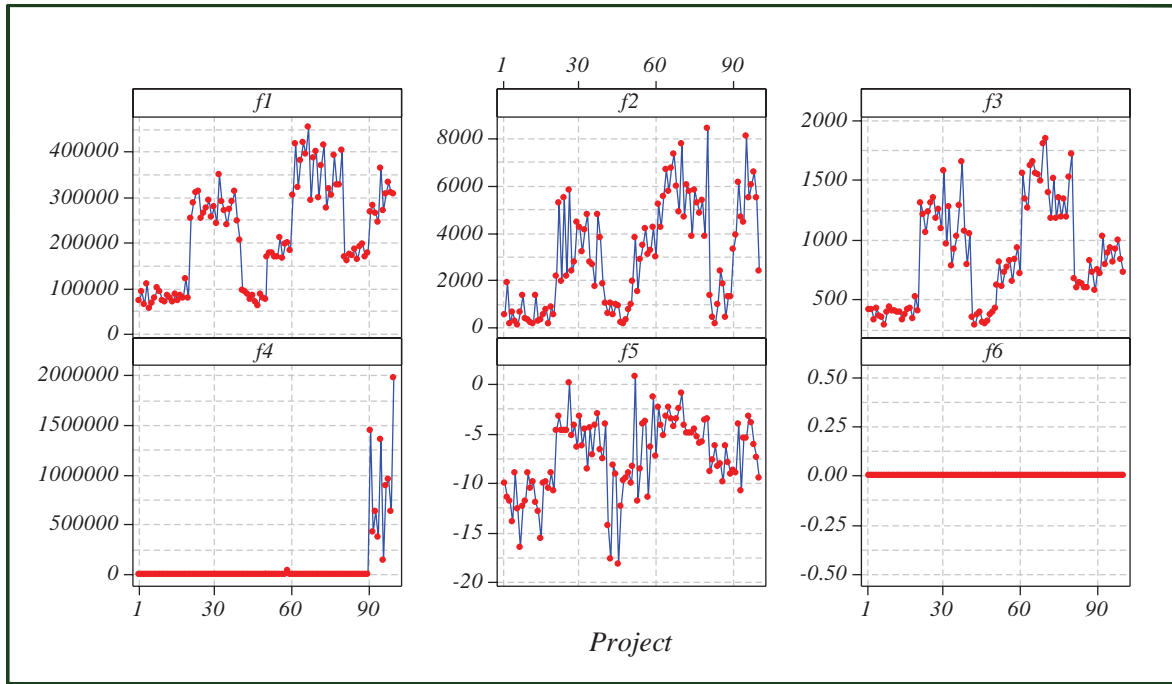

Figure 6.6 distribution of the different objectives for the data set #1

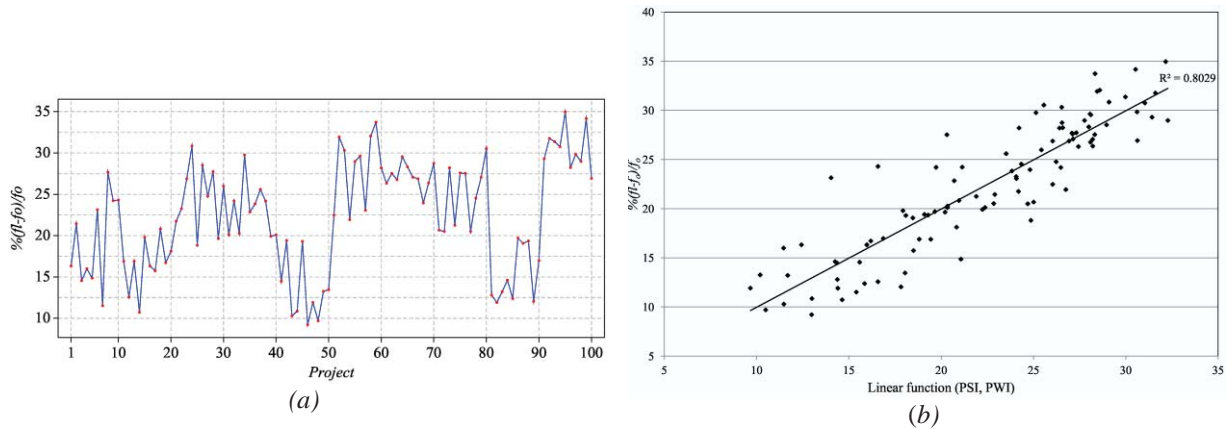

Figure 6.7 percentage of the excess of labour cost to the optima costs

The third objective is the cost resulting from the loss of temporal flexibility “ f_3 ”; we expect the same tendency of performance as (f_1 , and f_2), showed in Figure 6.6. By investigating the linear correlation between the three function we found high correlation between f_3 and each of f_1 ($R = 0.911$), and f_2 ($R = 0.807$). This highly relation with (f_1 , and f_2) produced from the correlation between f_3 and PSI ($R = 0.925$) and that with PWI ($R = 0.331$). There are not any evidence for a linear correlation between f_3 and each of NFI , $PLLI$, and TDI . By using the multiple regression analysis, it was recommended to use PSI , NFI , and PWI to explain the variation in f_3 with $R^2 = 91.6\%$ and a regression equation as $f_3^C = 4573 PSI + 2484 NFI + 685 PWI - 2408$.

The fourth objective expresses the storage cost/lateness penalties related to project completion date “ f_4 ”. As previously illustrated by Figure 6.5, about 89% of the projects have “ $f_4=0.0$ ”, the other 11% of the projects were solved with lateness penalties due to the shortage of resources, with a correlation of ($R = 0.454$) between f_4 and PWI . Relying on the nature of f_4 , the exit values represent lateness penalties of projects. Thus, as the shortage of resources (PWI) is increased over a certain limit ($PWI_{critical}$), lateness penalties will exist. Therefore, we

investigated this limit by getting the best correlation between f_4 , and $Max[(PWI - PWI_{critical}), 0]$. We found that when ($PWI_{critical} = 0.455$), f_4 has a high correlation with the new variable $Max[(PWI - 0.455), 0]$ ($R = 0.754$), and that it can explain the variance of f_4 with $R^2 = 56.9\%$. Also the regression analysis indicates that using $max[(PWI - PWI_{critical}), 0]$, and TDI are significant predictors with $R^2 = 59.4\%$.

The fifth objective “ f_5 ” means the development of workforce experience in practicing the project skills, shown within (Figure 6.6). As previously discussed in chapter 3, this objective is highly related to the learning-by-doing for the operators. Therefore, we expect a positive correlation between f_5 and all variables that increase the use of resources such as PSI and PWI . After performing correlation analysis, we found high correlations with the two indices: ($R = 0.770$) with PSI and ($R = 0.348$) with PWI . Also we found small correlation between f_5 with f_3 . This small correlation is normal where f_3 is related to an excessive use of resources that increases their practice and thus the learning-by-doing effect. The analysis of multiple regression introduced the significant indices to predict f_5 respectively as PSI , NFI , $PLLI$, PWI , and TDI with determination coefficient $R^2 = 72.6\%$.

6.2.1.3 Variation of number of generations and computational time

Generally in GAs the quality of the solution returned depends on the number of generations “ GN ”. As discussed in (section 5.4.1.7) there are two stopping criteria: the first examines the convergence (or more exactly the non-convergence) of the average best fitness of some of the best individuals in the population, and the second simply limits the maximum number of generations (8000). As shown by (Figure 6.8-a), all of our simulations were stopped by fitness convergence. And almost all the projects converged for a GN located between 300 and 800 generations. By analyzing the correlation between the number of generations and the different proposed indices, we found evidence for a linear correlation only with PWI ($R = -0.445$). This negative correlation means that as PWI increases, the algorithm stops faster, due to the difficulties of enhancing any feasible schedule once it is found.

Concerning the computational time “ C_time ”, it depends on the number of generations ($R = 0.589$) and the different characteristics of each project, as shown by (Figure 6.8-b). The number of variables too, affect directly the computational time. These variables can be held by the project scales index “ PSI ”. Thus, the correlations between “ C_time ” and PSI is ($R = 0.727$), and between “ C_time ” and TDI is ($R = 0.312$). In addition, the NFI showed a negative correlation with the “ C_time ” ($R = -0.316$). But PWI showed no correlation with “ C_time ” ($R = 0.056$). Beside the problem characteristics and the number of generations, we can find also the effect of the project delivery date ($R = 0.382$). We performed a linear regression analysis to give a clear view especially for small correlations. The $ANOVA$ results of the test (shown within Table 6.2) indicates that these variables can significantly explain the variance of the “ C_time ”, with $R^2 = 88.3\%$. The P_values for the estimated coefficients of PSI , GN are both (0.000), indicating that they are significantly related to “ C_time ”. The P_values for the estimated coefficients of $PLLI$, TDI , and LV are lower than the α -level = 0.05, therefore there is evidence that each one of them are significantly related to “ C_time ”. Relying on the fact that the P_values of the estimated coefficients of PWI and NFI that are greater than this α -level = 0.05, we conclude that a model with only GN , PSI , TDI , LV , and $PLLI$ may be more significant to explain the variation in the running time at ($R^2 = 86.7\%$) and a regression equation: $C_time^C = 1.19 GN + 2454 PSI + 2207 TDI + 7.00 LV - 383 PLLI - 1445$.

From these results, the variation in performance of our solving approach depends mainly on the variation of projects. And the returned objectives are always held within certain limits that depend on the problem characteristics. Consequently, we can rely on the proposed approach to return a feasible schedule that satisfies the specified constraints (as shown within Figure 6.5, $f_6 = 0.0$), thanks to the flexibility dimensions. The robustness of the approach can be confirmed for this data set.

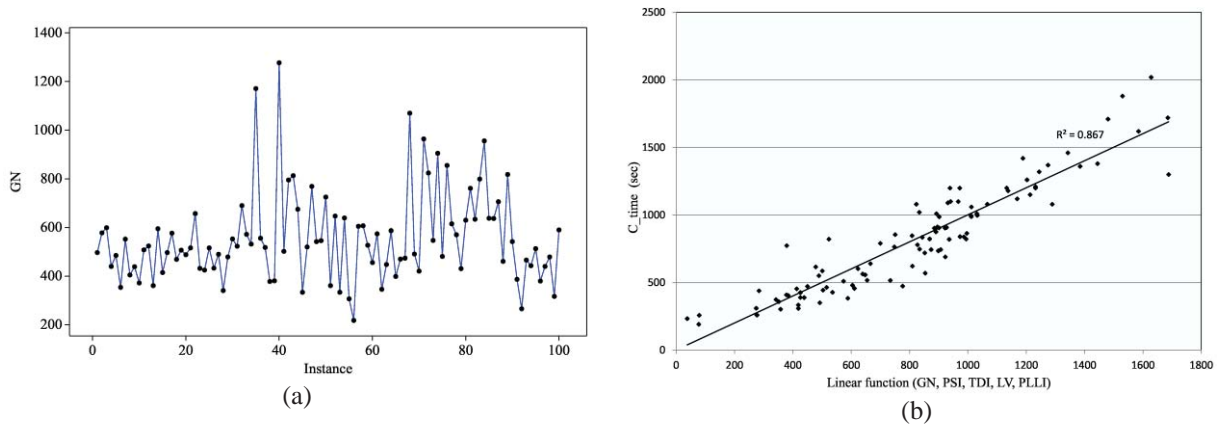

Figure 6.8 the different number of generations versus computational time for data set #I.

Table 6.2 linear regression of the computational time

Predictor	Coefficient	Standard error	T-score	P_value
Constant	-1277.9	495.8	-2.58	0.012
PSI	2263.7	177.8	12.73	0.000
NFI	-854.7	437.4	-1.95	0.054
PWI	731.8	247.2	2.96	0.004
PLLI	-525.5	209	-2.51	0.014
TDI	2893.9	840	3.45	0.001
NBI	630.8	691.1	0.91	0.364
LV	3.981	1.575	2.53	0.013
GN	1.32073	0.0911	14.5	0.000

$S = 140.418$ $R^2 = 88.3\%$ $R^2_{adjusted} = 87.3\%$

Analysis of Variance "ANOVA"

Source of variation	Degree of freedom	Sum of squares	Mean squares	F_ratio	P_value
Regression	8	13596031	1699504	86.19	0.000
Residual Error	91	1794262	19717		
Total	99	15390293			

6.2.2 Data set #II

The second data set also contains one hundred projects, each of sixty tasks, plus two start and finish events. The required workload for this group varies from 9,198 to 65,478 working hours – this is approximately doubled comparing to data set #I. Between each pair of skills, we have a specified similarity degree randomly generated within [0, 25%] or [25, 50%]. The available workforce varies from (48 to 199 persons), some of them are unary-skilled, and others are multi-skilled. As previously mentioned, the projects variation regarding to workload,

resources, network ...etc, can be represented by a set of indices that shown by (Figure 6.9). Exactly as the data set #I, the characteristics vary from instance to another, as shown by *PSI*, *NFI*, and *NBI*, *PWI*, *PLLI*, and *TDI*.

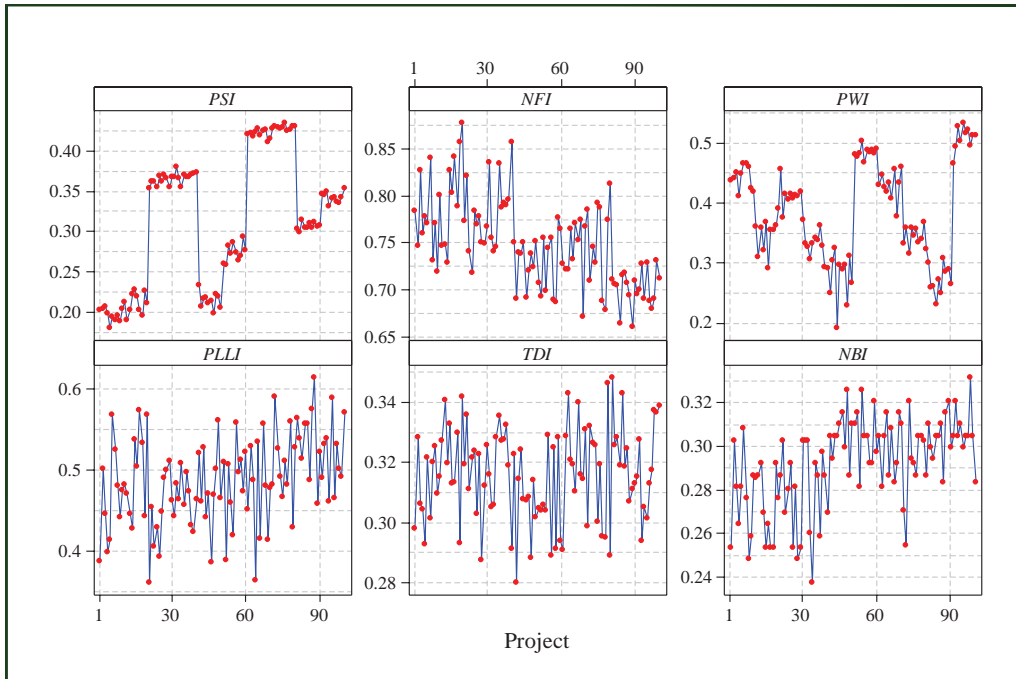

Figure 6.9 Distribution of the indices *PSI*, *NFI*, *PWI*, *PLLI*, *TDI*, and *NBI* for the data set #I

6.2.2.1 Variation of fitness function

Figure 6.10 represents the fitness function in a log scale to accommodate the variation between the similar projects. As the previous data set, we can divide projects into two groups: the first one contains about 79% of projects, and represents all instances that have sufficient resources to deliver projects at zero-penalties. The second group represents about 21% of instance; it contains the projects with lateness penalties.

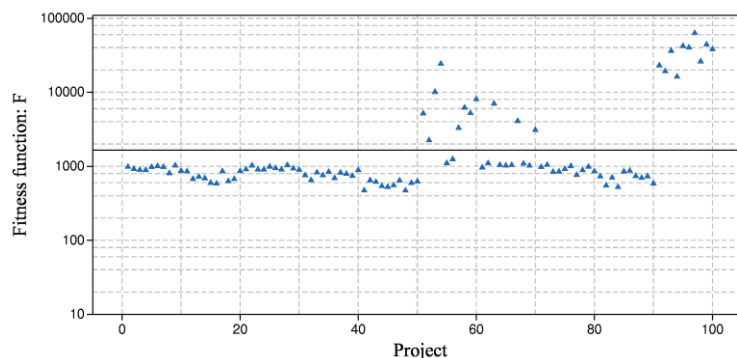

Figure 6.10 distribution of the fitness function: *F* for data set #II

The second group is produced by the scarcity of resources that can be figured out by the index *PWI*. By analyzing the correlation between the fitness function and the project indices, we found high evidence for a linear correlation between “*F*” and each of *PWI* ($R = 0.561$), *NBI* ($R = 0.238$), *PLLI* ($R = 0.200$), *NFI* ($R = -0.312$). This negative correlation with *NFI* is normal where as the network flexibility reduced as it is difficult to find a feasible solution (or improving it). We didn’t found any correlation between *PSI* and *F*.

6.2.2.2 Variation of objectives

The first objective is the labour costs: the direct labour costs related to working hours “ f_1 ” and the one related to the over-time hours “ f_2 ”. Exactly as for the previous data set #I, the normal direct labour costs “ f_1 ” are linearly related to PSI ($R = 0.953$), as shown by (Figure 6.11-a). We found a positive small correlation between “ f_1 ” and PWI at ($R = 0.276$). The index TDI has a positive correlation with f_1 ($R = 0.206$). Unlike the previous data set, there is no evidence of a correlation between f_1 and neither NFI , nor NBI . We can explain it by a predominance of the difficulty linked to the workload and to the resources shortage rather than the complexity of the network. Regression analysis indicates that the significant predictors are (PSI , PWI , and TDI). Using all together to get a computed f_1 as [$f_1^C = (2.4 PSI + 0.5 PWI + 1.3 TDI - 0.9) \times 10^6$] explains 95.4% of the variance of f_1 , as shown by (Figure 6.11-b). Concerning the overtime cost “ f_2 ”, we also find evidence of linear relations with each of PSI ($R = 0.797$), and PWI ($R = 0.427$). Due to the high constraints of workload and resources shortage, the influences of the other indices (NFI , $PLLI$, TDI and NBI) on f_2 are unremarkable. This relation also was proven by using the regression analysis, where the results recommended a linear function of the computed f_2 as: ($f_2^C = 33295 PSI + 15605 PWI - 11356$). Using only these two indices can explain the variation in f_2 with $R^2 = 76.5\%$.

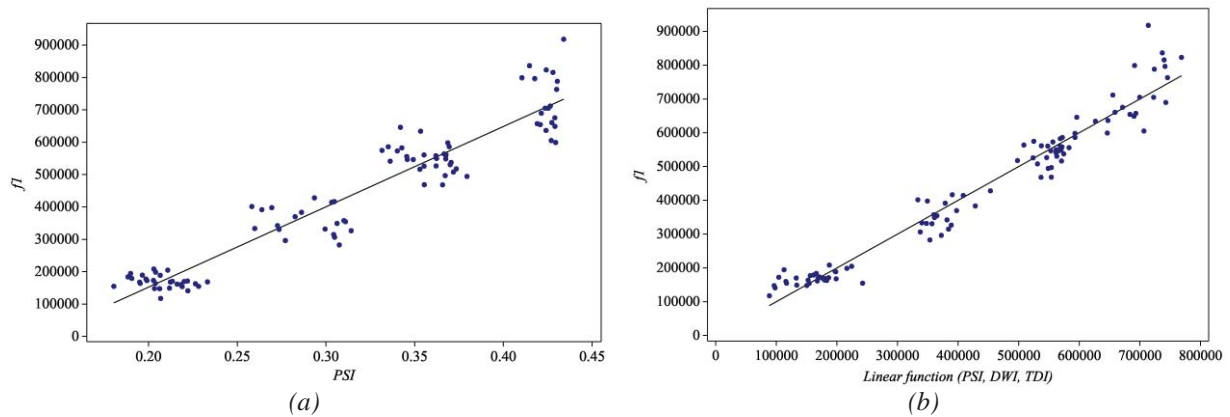

Figure 6.11 the linear relation between f_1 and project indices for data set #II

Concerning the solution quality, as previously the approach robustness can be shown by comparing the labour cost ($fl = f_1 + f_2$) with the optimal one (f_o) as: $\%(fl - f_o)/f_o$. The excess in labour costs always remains within certain limits (similar to data set #I): as previously discussed these limits depend on the project scales PSI ($R = 0.404$), and resources availability PWI ($R = 0.828$). We conducted the regression analysis to control the effect of indices to each other's and to know: which the best predictors for solution quality. As shown by (Figure 6.12) we found that PSI and PWI are the suitable indices to predict solution quality with $R^2 = 79.8\%$. And the produced linear regression function was constructed as: (the computed $\%(fl - f_o)/f_o = 23.4 PSI + 55.4 PWI - 4.76$).

The third objective is the cost related to the loss of temporal flexibility “ f_3 ”. It is highly correlated to the project scales index PSI ($R = 0.944$). But, we did not found any evidence for a correlation with the other indices. By using multiple regression analysis, it was recommended to use PSI and NFI to explain the variation in f_3 , with a formula: $f_3^C = 7042 PSI + 2389 NFI - 2780$. Using only these indices explains the variation in f_3 with $R^2 = 92.7\%$.

The storage/lateness penalty “ f_4 ”, as shown in (Figure 6.10), about 79% of the projects have “ $f_4 = 0.0$ ”, and other 21% of the projects were solved with lateness penalties due to the shortage of resources. By investigating the

correlation analysis between f_4 and each one of the proposed indices, we found a correlation between f_4 and PWI ($R= 0.534$), and no relation between f_4 and PSI . After investigating the critical limit ($PWI_critical$) of PWI , we found it as $PWI_critical = 0.48$. And using only this value explains the variance of f_4 with $R^2 = 84.3\%$, with a correlation of ($R= 0.918$). We found also a correlation between f_4 and each of NFI ($R = -0.276$), NBI ($R = -0.219$), and $PLLI$ ($R = 0.228$). By using regression analysis, we found the most significant predictors of f_4 are: $Max(PWI - 0.48; 0)$ and TDI , with a formula of $(f_4^C = 9.6E7 (Max(PWI - 0.48; 0)) + 9.0E6 TDI - 2.8E6)$ and $R^2 = 85.9\%$

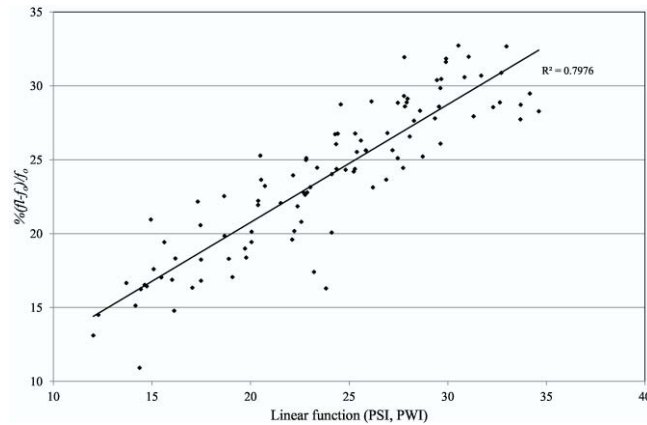

Figure 6.12 the percentage of the excess of labour cost to the optima costs against PSI and PWI

The development of workforce experience “ f_5 ” is very similar to that of the previous data set. As previously discussed (in section 6.2.1.2 for data set #1), “ f_5 ” is highly related to the learning-by-doing effect, thus there are positive correlations between f_5 and each one of PSI ($R = 0.849$) and PWI ($R = 0.252$). Using the multiple regression we found the significant indices to predict f_5 are PSI , and PWI with the equation $(f_5^C = 30.5 PSI + 6.6 PWI - 18.2)$ and determination coefficient $R^2 = 75.3\%$.

6.2.2.3 Variation of number of generations and computational time

Concerning the number of generations “ GN ” (shown in Figure 6.13-a), all simulations were stopped before the pre-specified number of maximum generations (8000 generations): they were stopped by the fitness convergence. Almost all projects converged at a number of generations GN located between 400 - 800 generations. By analyzing the correlations between GN and the different indices, we found evidence for a medium linear correlation only with “ PWI ” ($R = -0.420$). This negative correlation means that as the search for a good solution stops all the more rapidly than the project weight “ PWI ” is important, due to the difficulty of enhancing a feasible solution.

Concerning the computational time “ C_time ” it depends on “ GN ” ($R = 0.511$) and the different characteristics of each project. By analysis the correlation between the indices of projects and “ C_time ”, we found correlations between “ C_time ” and each of PSI ($R = 0.678$), and PWI ($R = -0.206$). We found also a small partial correlation with the project delivery date ($R = 0.207$) after controlling the effect of “ GN ”. In order to know the most appropriate variables to explain the variation in “ C_time ”, we performed multiple linear regression analysis using project indices, LV , and GN as predictors. The ANOVA results of the test show that the using of these predictors can significantly explain the variance in the C_time , with $R^2 = 83.4\%$. The P_values for the estimated coefficients of PSI , and GN are both equal to (0.000), which indicates that they are significantly related to

C_time . The P_values for the estimated coefficients of NFI is lower than (α -level = 0.05), therefore there is evidence that it significantly explains variance in computational time. Relying on the P_values of the other predictors of PWI , $PLLI$, TDI , NBI , and LV that are greater than α -level = 0.05, they cannot significantly explain the variation in C_time for this data set. This terminate that a model with only PSI , GN , and NFI may be more significant to explain the variation in the running time at ($R^2 = 82.6\%$). This relation can be illustrated by (Figure 6.13-b) using the regression function of the computed $C_time^C = 7193 PSI + 2.44 GN - 2167 NFI - 234$.

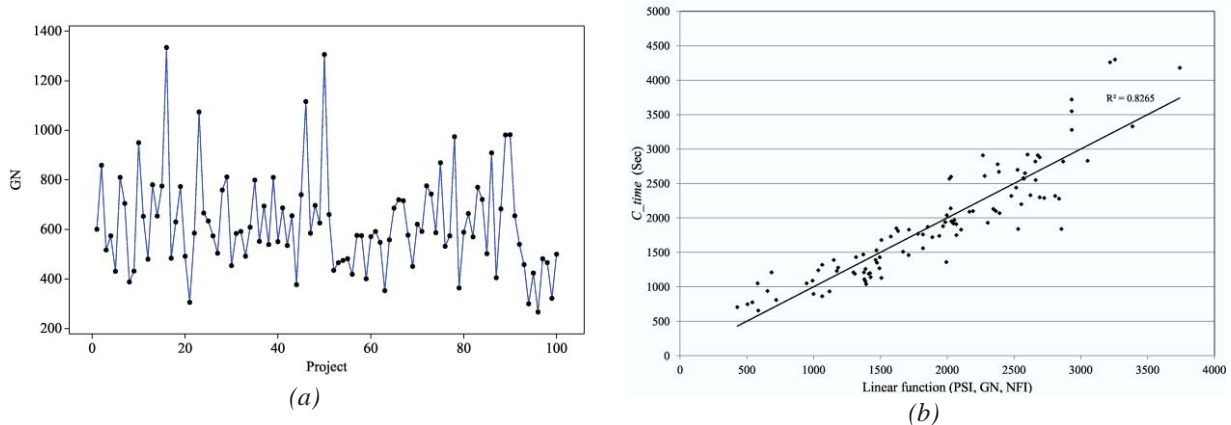

Figure 6.13 the different number of generations verses computational time for data set #II.

As previously discussed, the variation in the performance of the solving approach depends mainly on the variation of projects within the data set. Consequently, we can rely on this approach to return a feasible schedule that satisfies the specified constraints (as shown in table D.2 for $f_6=0.0$).

6.2.3 Data set #III

The current data is exactly as the previously described data sets #I and #II, concerning the tasks utilisation of resources, the similarity degree between skills, but each project is now composed of ninety real tasks and workloads vary from 15,988 to 82,194 working hours. The available workforce varies from (54 to 199 persons). Some of these workers are unary-skilled, others are multi-skilled. The variations of the complexity indices for these projects are displayed on (Figure 6.14).

6.2.3.1 Variation of fitness function

As previously, the fitness function was presented on a log scale to accommodate the small variation between similar projects (Figure 6.15). Here again most of projects (79%) have sufficient resources to end without penalties. By analysis the correlation between the fitness function and project indices, we found evidence for a linear correlation between “ F ” and each of PWI ($R = 0.638$), $PLLI$ ($R = 0.355$), NFI ($R = -0.417$), as well NBI ($R = 0.295$). We didn’t find any correlation between project scales index “ PSI ”. We have the same performance as that of the previous data sets.

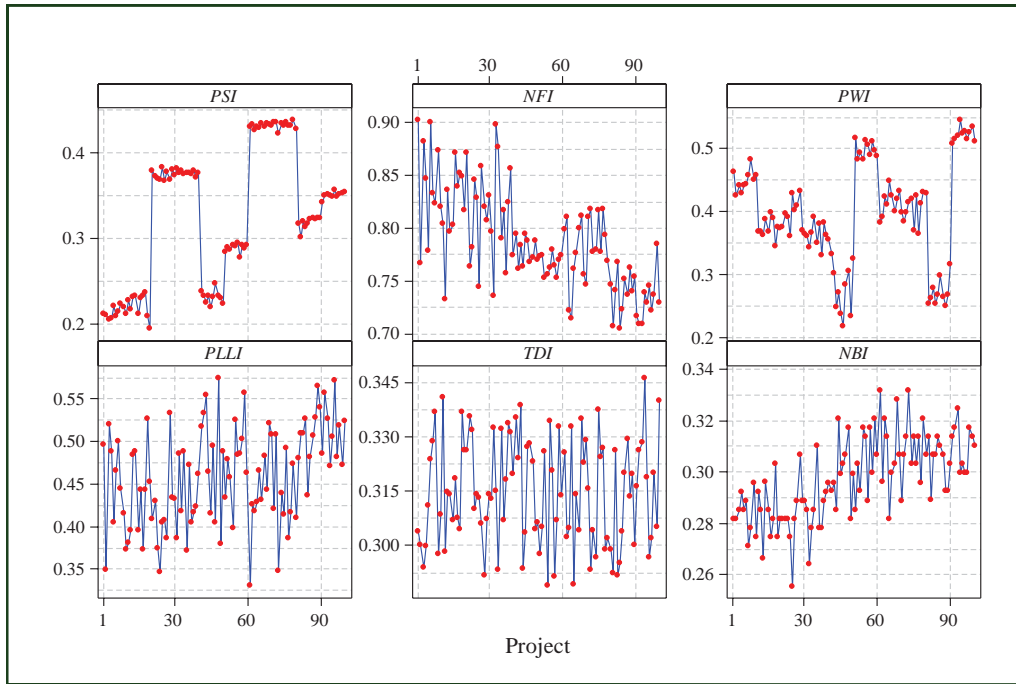

Figure 6.14 Distribution of the proposed indices PSI, NFI, PWI, PLLI, TDI, and NBI for data set #III

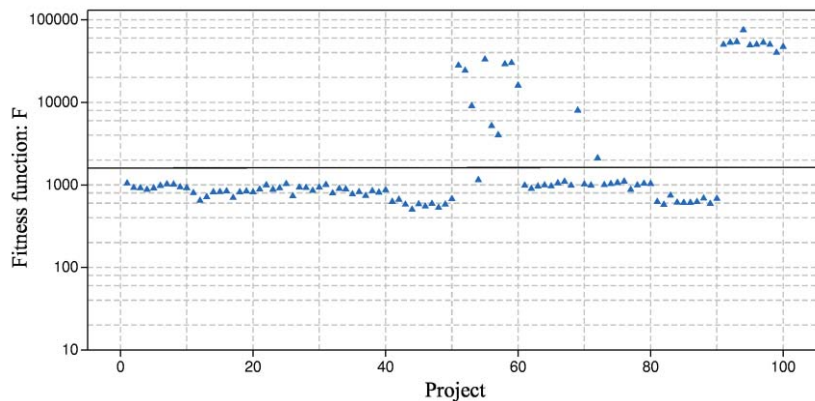

Figure 6.15 distribution of the fitness function: F for data set #III.

6.2.3.2 Variation of objectives

First, we consider the cost of labour working hours’ f_1 . After having analyzed the correlation between it and the different project indices, we found a linear relation between f_1 and each of PSI ($R = 0.963$), PWI ($R = 0.335$) and NBI ($R = 0.335$). Unlike the previous data set #II, but in accordance with the data set #I, there is evidence for a negative small correlation between “ f_1 ” and NFI ($R = -0.208$). And there is no evidence for a correlation with TDI and the load location $PLLI$. Using regression analysis to control the effect of small correlations, the results indicate the significant of using four predictors (PSI , PWI , and TDI), which can be used to explain the variance of the f_1 with high determination coefficient ($R^2 = 97.0$).

Figure 6.16 shows this highly correlation by presenting regression formula of the computed f_1 ($f_1^C = 3.6E6 PSI + 7.6E5 PWI + 1.4E6 TDI - 1.3E6$) against the observed one. These results are very similar to that of previous data sets. Regarding the costs “ f_2 ”; we found a high linear correlation with each of PSI ($R = 0.815$), and PWI ($R = 0.544$). For this data set, the project network presents another factor that affects the required overtime,

where there are correlations between f_2 and NBI ($R = 0.363$), and NFI ($R = -0.282$). Also, there is a null effect of the other indices such as $PLLI$, and TDI on “ f_2 ”. By using multiple regressions, the results introduce (PSI and PWI) as the best predictors for “ f_2 ”. Using only these two indices can explain the variation in f_2 with $R^2 = 85.1\%$ and ($f_2^C = 48615 PSI + 27296 PWI - 19358$).

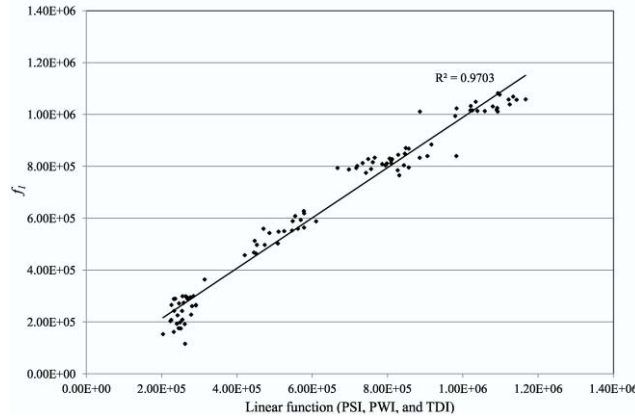

Figure 6.16 the linear relation between f_1 and project indices for the data set #III.

About the solution quality, as usual, the excess of labour cost related to the optimal cost $\%(f_l - f_o)/f_o$ will be an indicator of robustness, shown by (Figure 6.17); this excess ratio is always comprised within certain limits, depending on the project scale PSI ($R = 0.447$) and the availability of resources PWI ($R = 0.867$). After analysis, the best predictors of this overcost are PWI , PSI and NFI composed a linear equation of ($Overcost = 52.0 PWI + 22.6 PSI + 8.00 NFI - 9.93$) at $R^2 = 86.6\%$.

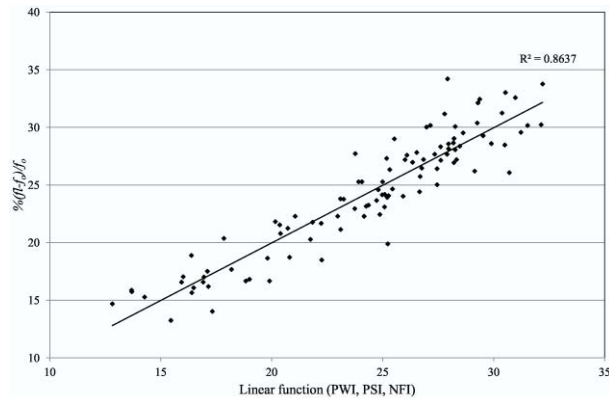

Figure 6.17 distribution of the excess of labour cost to the optima costs

The cost related to future working flexibility “ f_3 ”, it is highly correlated to the project scales index PSI ($R = 0.929$). But there is no evidence for a linear correlation with the other indices. Using regression analysis indicates that the best predictors for f_3 are PSI and NFI with $R^2 = 93.0\%$, with a regression equation of ($f_3^C = 9388 PSI + 4263 NFI - 4907$). These results are very similar to that of the previous data sets.

The fourth objective “ f_4 ” renders the storage or lateness penalty costs. As previously showed (Figure 6.15), about 21% of projects were solved with lateness penalties. By investigating the critical value of PWI influencing f_4 provided $PWI_{critical} = 0.48$. In order to control the effect of the partial correlations, we conducted the multiple regression analysis with all indices. As the previous data sets, we found the most significant predictors of the

lateness penalties is: $\text{Max}(PWI - 0.48; 0)$, with $R^2 = 85.8\%$, with an estimated formula of f_4 as: $(f_4^C = 1.51E8 \times \text{Max}(PWI - 0.48; 0) + 9571)$.

The fifth objective is the experience evolution one " f_5 ". As for the other data sets, " f_5 " is related to each of the indices PSI ($R = 0.791$), PWI ($R = 0.232$). We found the significant indices to predict f_5 are PSI , TDI , NFI , and $PLLI$ with determination coefficient $R^2 = 70.0\%$, with equation: $f_5^C = 31.0 PSI - 37.2 TDI + 11.2 NFI + 8.26 PLLI - 16.3$.

6.2.3.3 Variation of number of generations and computational time

Figure 6.18-(a) shows the distribution of numbers of generations and the running time. Exactly the previous data sets, all simulations were stopped before the maximum number of generations. And almost all converged at a number of generations located between 450 and 900. We found a linear correlation only with PWI ($R = -0.461$). This is the same trend as in the previous data sets. We also found that the computational time " C_time " depends on the number of generations GN ($R = 0.529$) and the different indices; PSI ($R = 0.660$), NFI ($R = -0.241$) and NBI ($R = 0.273$), PWI ($R = -0.267$). It matches the results of data set #I and #II. We performed also regression analysis using project indices, LV , and GN as predictors. The *ANOVA* results of the test shows its statistical significant F -ratio = 57.52. The P -values for the estimated coefficients of PSI , GN , PWI and $PLLI$ are lower than (α -level = 0.05), therefore there is evidence that they can significantly explain variance in C_time among all variables. This terminates that a model with only PSI , GN , $PLLI$, and PWI may be more significant to explain the variation in the running time at $R^2 = 81.2\%$ and F -ratio = 102.35, as shown by Figure 6.18-(b). The estimated time can be represented as: $C_time^C = 10984 PSI + 3.48 GN - 2480 PLLI - 1605 PWI - 926$.

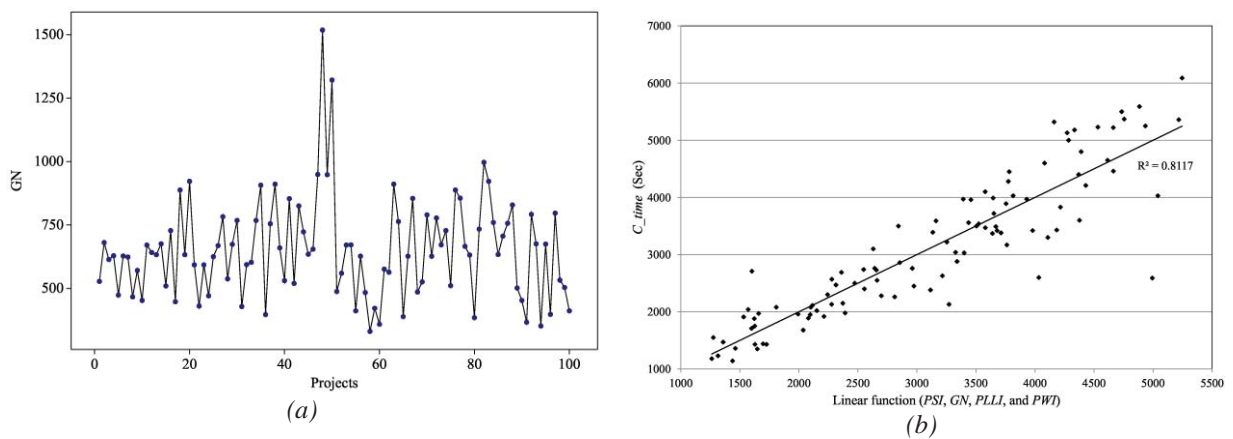

Figure 6.18 different number of generations verses computational time for data set #II.

For this data set too, we can rely on the solving approach to return a feasible schedule that satisfies the specified constraints (as shown in table D.3 where $f_6=0.0$ for all instances). Therefore, the robustness of the approach can be stated here too.

6.2.4 Data set #IV

This one is similar to the previous sets, but each project is composed of 120 real tasks, with workloads varying from 20,902 to 111,041 working hours. We consider this data set as the most difficult among all the four.

However, the available workforce varies from (47 to 199 persons), approximately the same resources availability as for previous data sets. The diversity of the complexity factors for these projects is displayed on (Figure 6.19

By comparing the distribution of “*PWI*” of this data set with that of the previously solved ones, we found here that *PWI* takes higher values (greater than 0.55). These high values give the impression of high weights of the corresponding projects. In other words, the required workload is greater than the capacity of the resources. As previously discussed for data sets #I, #II and #III, the lateness penalties started to appear after ($PWI \approx 0.45$). Thus for the instances that have *PWI* greater than 0.55, we can fear that they will be unfeasible with the available resources.

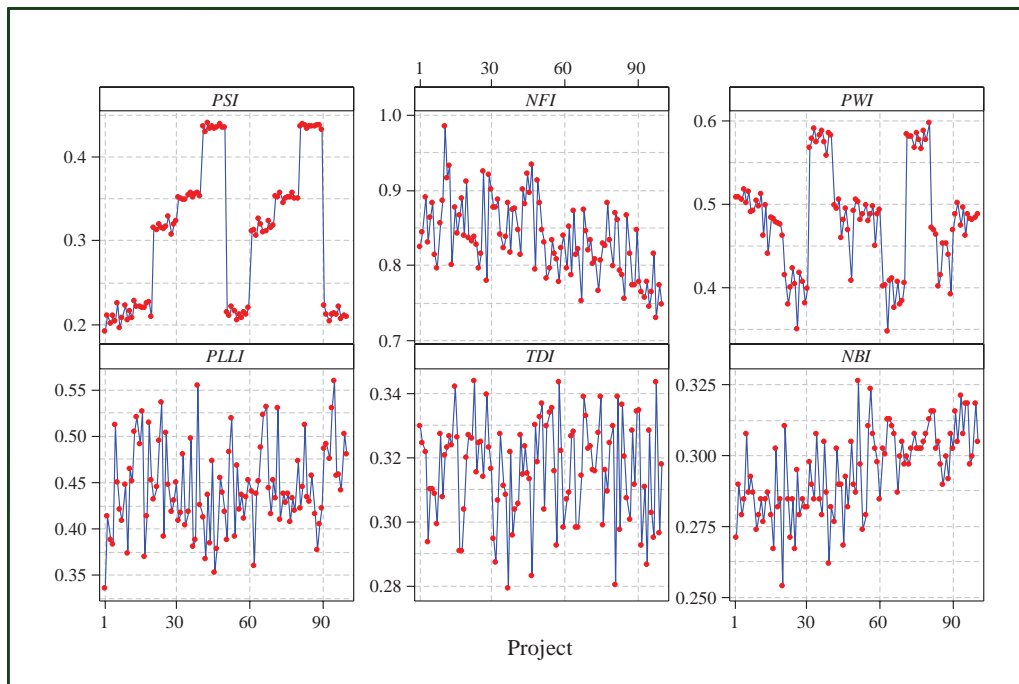

Figure 6.19 distribution of indices *PSI*, *NFI*, *PWI*, *PLLI*, *TDI*, and *NBI* for the data set #IV

After processing this data set, we succeeded to get feasible solutions for all instances having a *PWI* lower than about “0.55”. For all projects that have values of *PWI* greater than this limit, we didn’t find any feasible solution even with high lateness penalties. So this variable seems to be a predictor for the capability of the firm to carry out a given project with specified resources during a specified period. In order to investigate this hypothesis, we increased the resources for the unsolved problems until their *PWI* value reaches the previously determined common range (Figure 6.20). After this modification we succeeded to get feasible solutions for these projects. As shown, the modification of the project resources has a largest impact on the factor *PWI*, a little impact on *PSI*, and almost zero impact on the other indices.

We then tried to determine the critical value of *PWI*, above which the project cannot be achieved at all. In order to get this value, we took the following projects: instance 94 from data set #II, instances {31, ..., 40} and instances {71, ..., 80} from data set #IV. For these projects, we started to increase the *PWI* by reducing gradually the workforce by one person at each time. Then, we investigated the presence of feasible solution or not. This process was repeated until we have the critical number of workforce, under which any reduction will result in

unfeasibility. At this point, we calculate the corresponding *PWI* value for each instance. We found these critical values located within the interval [0.531, 0.563], with a confidence level of 95%; we estimated the confidence interval for the mean as [0.54634, 0.55346], and the mean exact value equals 0.5499. Therefore, we propose the value of “*PWI* = 0.55” to represent the critical edge above which the project has no feasible schedule.

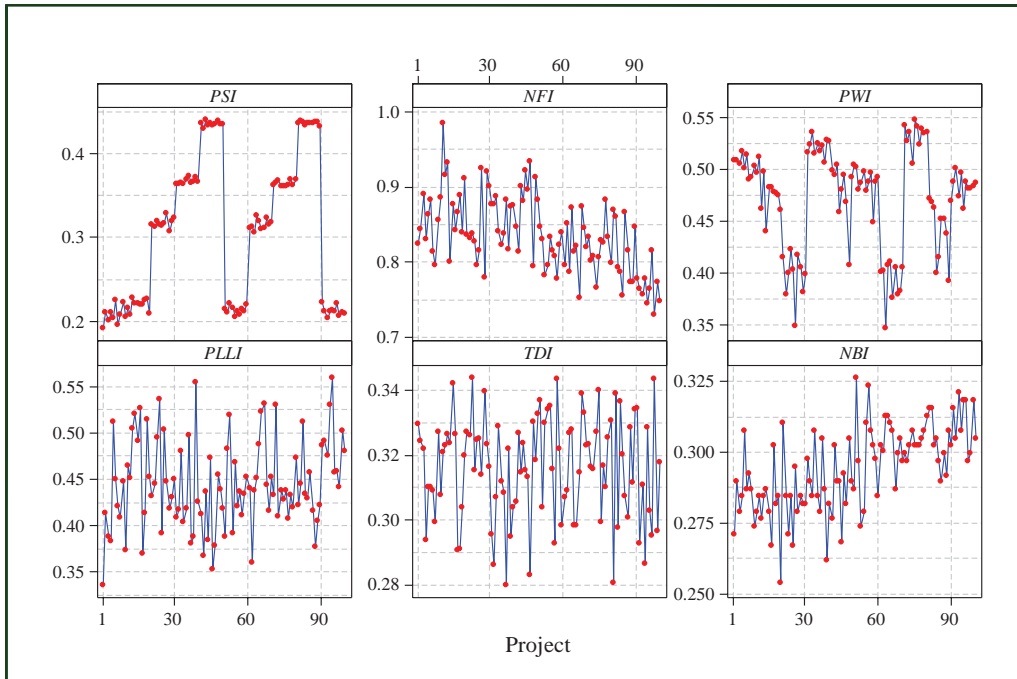

Figure 6.20 Distribution of the indices *PSI*, *NFI*, *PWI*, *PLLI*, *TDI*, and *NBI* after modification.

6.2.4.1 Variation of fitness function

Exactly as the previous data sets, after solving the different projects, the fitness function was presented as shown in (Figure 6.21). About 60% of the projects incur zero-penalties, the other 40% experience lateness penalties, no storage costs. We found a positive linear correlation between “*F*” and project weight index *PWI* ($R = 0.615$), and no evidence for a correlation with the other indices (*NFI*, *PLLI*, *TDI*, *NBI*). Unlike the previous data sets, we found a medium correlation with *PSI* ($R = 0.407$).

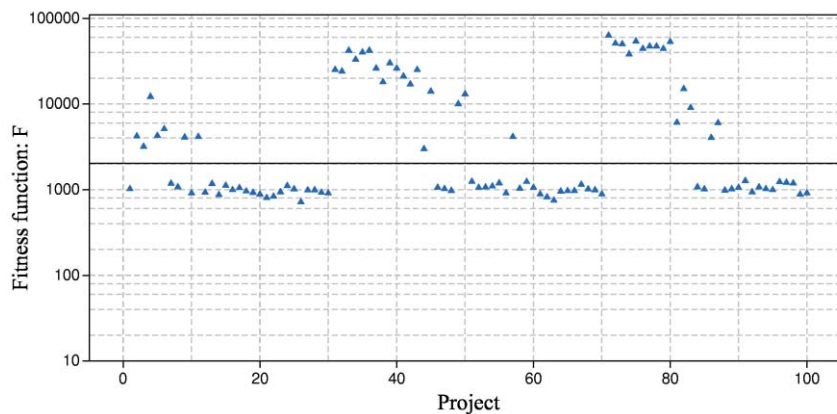

Figure 6.21 distribution of the fitness function: *F* for projects in data set #VI

6.2.4.2 Variation of objectives

The costs of working hours ‘ f_1 ’, we examined the correlation between ‘ f_1 ’ and the different project indices. We found a correlation with each of PSI ($R = 0.981$) and $PLLI$ ($R = -0.214$). We did not find any evidence of a correlation with the other indices ‘ NFI , PWI , TDI , and NBI ’. But, the value of PWI should logically affects f_1 . Thus, we used regression analysis to control the effect of small or partial correlations if any. The results indicate the significant of using the four predictors of PSI , PWI , TDI , and NFI . As shown by Figure 6.22-(a), they can be used to explain the variance of the f_1 with high determination coefficient ($R^2 = 97.9\%$). The estimated equation can be formed as: $f_1^C = (48.1 PSI + 10.6 PWI + 14.5 TDI - 3.8 NFI - 13.4)10^5$. Also we found $F_ratio = 1115.2$, which indicates the consistency of the regression model. These results are very similar to that of previous data sets. Concerning overtime costs ‘ f_2 ’; we found evidence for a high linear correlation with each of PSI ($R = 0.905$), and PWI ($R = 0.216$). A null effect of the other indices (NFI , $PLLI$, TDI , NBI) on f_2 was verified. This relation with PSI and PWI was proven by using multiple regression analysis, where using only PSI and PWI explains the variation in f_2 with $R^2 = 90.7\%$. But the results of the regression analysis indicate a small significant of adding TDI , the determination coefficient becomes $R^2 = 91.3\%$, and the estimated f_2 given as ($f_2^C = 61347 PSI + 36781 PWI + 30827 TDI - 36241$).

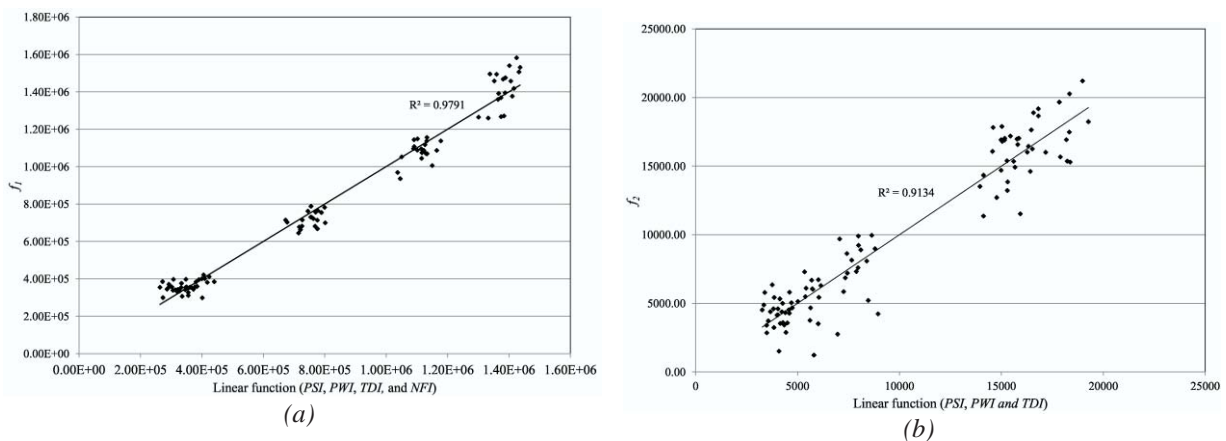

Figure 6.22 the linear relation of f_1 and f_2 with the project indices for the data set #IV.

The solution quality is presented as usual by the excess of labour costs from the optimal: $\%(f_1 - f_o)/f_o$, it was shown by Figure 6.23). The excess of labour costs is always within certain limits, as for the pervious data sets. Using the correlation and regression analysis, we found these limits depend mainly on the availability of resources, as availability reduced the project become more complex, so the quality of the solution reduced to avoid lateness penalties. The regression analysis indicated that the best predictor for solution quality is PWI , but the coefficient found ($R^2 = 27.0\%$) is very low compared to those encountered for previous data sets. The analysis recommended the use of ‘ Θ ’ nearby PWI to predict solution quality with $R^2 = 71.6\%$, and a linear formula (excess cost = $28.8 PWI - 172 \Theta + 144$). As discussed in (section 4.5), the actors’ productivity level ‘ Θ ’ was linearly aggregated with the tasks’ duration characteristics to produce the TDI index. But the contribution of ‘ Θ ’ in constructing TDI was very small compared to the other dimensions. Thus, here we did not find a significant relation with TDI .

The third objective is the cost related to the loss of working flexibility ‘ f_3 ’. It is correlated to each of PSI ($R = 0.947$), and NFI ($R = 0.264$). But there is no evidence for a linear correlation with the other indices. Using

regression, we can estimate f_3 as ($f_3^C = 9265 \text{ PSI} + 2396 \text{ NFI} - 1318 \text{ PWI} - 2570$). This result being very similar to that of the previous data sets. Using only these three indices explains the variation in f_3 with $R^2 = 91.8\%$.

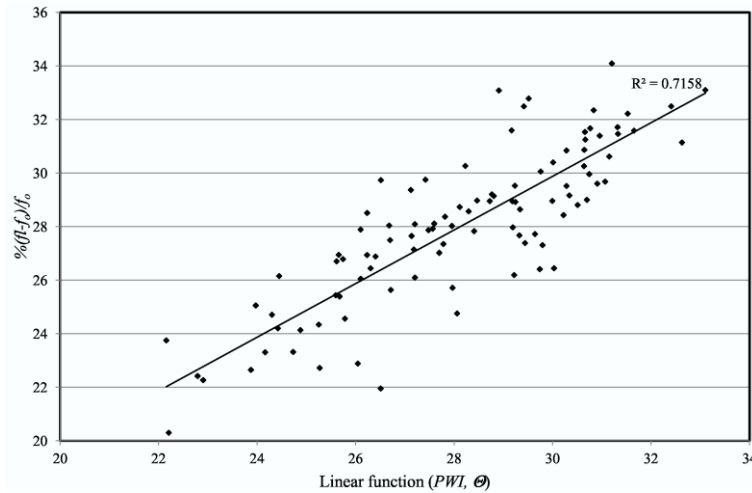

Figure 6.23 the excess of labour cost to the optima costs against project parameters

The fourth objective “ f_4 ” (storage or lateness penalty), as previously discussed using (Figure 6.21), about 40% of projects were solved with lateness penalties. By investigating the correlation between f_4 and each one of the proposed indices, we found relation between f_4 each of PSI ($R = 0.446$), PWI ($R = 0.6$). The NFI , $PLLI$, TDI and NBI showed no correlation with f_4 . As the previous data sets we investigated the $PWI_{critical}$. We found that at $PWI_{critical} = 0.495$, only this value explains the variance of f_4 with $R^2 = 76.0\%$. We also conducted the regression analysis with all indices. We found the most suitable and significant predictor of the lateness penalties is: $Max(PWI - 0.495; 0)$, PSI and $PLLI$ with $R^2 = 83.3\%$, the produced correlation is: $f_4^C = -5.9E6 + 2.1E8 (Max(PWI - 0.495; 0)) + 11.4E6 \text{ PSI} + 6.2E6 \text{ PLLI}$.

The fifth objective “ f_5 ” is related to experience evolution. As previously discussed, “ f_5 ” is highly related to the learning by doing, thus, there are positive correlations between f_5 and PSI ($R = 0.674$). Using the multiple regressions to get the significant predictors of f_5 among the proposed indices, we found the significant indices to predict f_5 are PSI , NFI , TDI , with determination coefficient $R^2 = 70.7\%$.

6.2.4.3 Variation of number of generations and computational time

About the number of generations “ GN ”, as shown by (Figure 6.24-a), almost all simulations were stopped by the convergence criterion with GN within [400 – 800] generations. We observed a small linear correlation with PSI ($R = 0.283$). Concerning to the computational time “ C_time ”, we found a linear correlation with GN ($R = 0.651$), and PSI ($R = 0.866$). We performed regression analysis using project indices, LV , and GN as predictors to control the problem of partial correlations, if any. The $ANOVA$ results of the test has ($P_value = 0.000$) shows that the C_time estimated by regression procedures is significant at (α -level = 0.05). As previously discussed, this indicates that at least there is one good predictor in estimating C_time within the proposed predictors. Using all of these predictors can significantly explain the variance in C_time , with $R^2 = 94.7\%$. Relying on the P -value and T-score, this terminate that a model with only PSI , GN , TDI , and NFI (shown by Figure 6.24-b) may be

more significant to explain the variation in the running time ($C_time^C = 15705 PSI + 5.84 GN + 10251 TDI - 3037 NFI - 5232$) and $R^2 = 94.5\%$ and enhancement of F -ratio = 409.71.

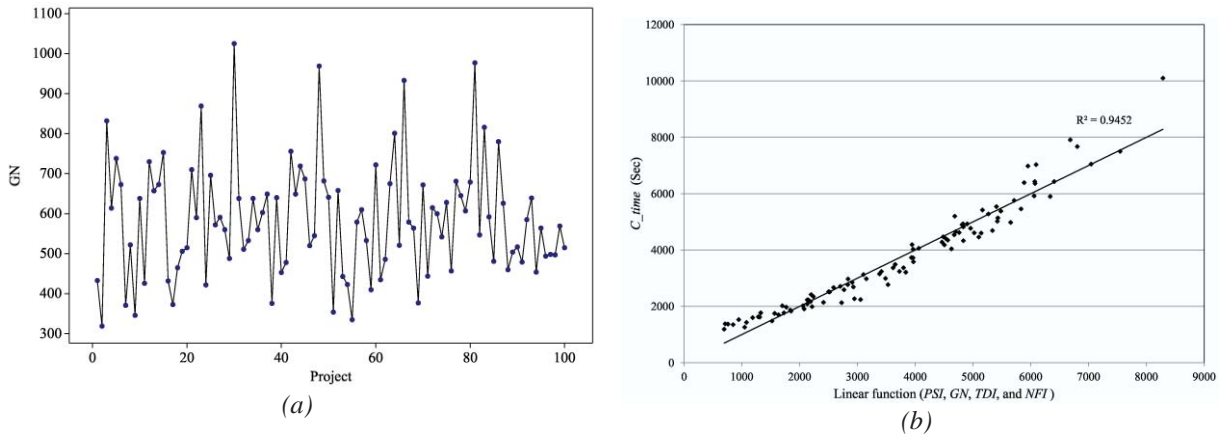

Figure 6.24 the different number of generations and computational time for data set #IV.

6.3 ROBUSTNESS OF THE APPROACH

The robustness of the approach was approved for the same data set for different instances. To demonstrate the robustness between the different groups, we estimated for each performance criteria the confidence interval (at a confidence level of 95% and using one-sample *t*-test, (see appendix C), as shown in (Table 6.3). We estimated the confidence interval of the average values for each of: - number of generations, - computational time, - percentage of labour cost excess from the optimal, - percentage of overtime hours to total work content, - workforce average occupational percentage, - benefits/costs of workforce experience development. Within the same data set, the difference between the upper and lower limits of each confidence interval is small compared to the changes of the data set parameters [network, work-content, resources, see the description of data for each group] , which indicates the robustness of the model in solving the different projects within the same data set. Moreover, the variation between the confidence intervals from data set to the others is also small compared to the inflation of the projects size from one data set to the others. These results indicate the stability and robustness of our approach in solving the different instances with different specifications.

Table 6.3 the confidence interval for the estimated mean values for the results

Average variable	Estimated interval at 95% confidence level			
	Data set #I	Data set #II	Data set #III	Data set #IV
Number of generations	[517, 590]	[584, 662]	[611, 688]	[556, 612]
Computational time (seconds)	[742.2, 898.7]	[1754.1, 2073.2]	[2874, 3360]	[3364, 4089]
% the excess in working hours due to workers multi-skills	[19.6, 22.0]	[21.5, 23.5]	[22.0, 23.9]	[25.8, 26.9]
% the excess in labour costs	[21.0, 23.6]	[22.7, 24.9]	[23.2, 25.3]	[27.4, 28.5]
% overtime hours to total workload	[5.3, 6.6]	[4.7, 5.7]	[4.6, 5.5]	[6.0; 6.7]
% Workforce occupational	[51.8, 59.4]	[52.9, 60.8]	[56.1, 64.3]	[75.9, 80.8]
% Average experience degradation/development (for each worker/skill= $f_s/(K \times U_k)$)	[-0.21, -0.16]	[-0.17, -0.14]	[-0.15, -0.12]	[-0.14, -0.11]

The approach robustness can also be observed in (Table 6.4), in function of the different project indices proposed in chapter 4. Knowing that, this table presents the most significant predictors for each performance criterion. The

arrangement of these predictors was done relying on the “T-score” method of the regression analysis; therefore the most significant predictor was put as the first one, and then the second, and so on. We present also the determinate coefficient R^2 . First, the computational time can be predicted using only the project scales index and number of generations, as shown they are the first predictors for it in all data sets. Also, the excess in the labour costs can be predicted using the project weight index PWI for most of cases. Moreover, the different objectives can be predicted relying mainly on the same indices; this indicates the robustness of the approach.

As well, the complexity indices of project are proven to be reliable in explaining the variance of the different performance criteria, especially the proposed project scale index “ PSI ”. This index simply sizes the project in a normalized interval $[0, 1]$, it can be simply used by comparing the size of the new projects with those already performed and analyzed. Therefore, the risk related to the project size can be controlled. The second significant index is the project weight index PWI : a value of about $PWI = 0.48$ was showed to be a good predictor of project lateness, whereas a value of about $PWI = 0.55$ indicates the toughness to conduct the project with the available resources. Therefore, this index has very important managerial aspect in the planning phase of projects, especially in estimating the required resources, and investigating the project feasibility. Here, the complexity related to the project scales and available resources show a high impact on the computational time compared to the complexity related only to the project network.

Table 6.4 the significant predictors of each performance criterion

Performance criterion	The significant predictor(s)			
	Data set #I	Data set #II	Data set #III	Data set #IV
Computational time	GN, PSI, TDI, PWI, LV, PLLI at $R^2 = 87.7\%$	PSI, GN, NFI at $R^2 = 82.6\%$	PSI, GN, PLLI, PWI at $R^2 = 81.2\%$	PSI, GN, TDI, NFI at $R^2 = 94.5\%$
Excess in labour costs	PWI, PSI $R^2 = 80.3\%$	PWI, PSI $R^2 = 79.8\%$	PWI, PSI, NFI $R^2 = 86.6\%$	\emptyset , PWI $R^2 = 71.6\%$
Direct normal labour cost: f_1	PSI, PWI, TDI, $R^2 = 93.7\%$	PSI, PWI, TDI, $R^2 = 95.4\%$	PSI, PWI, TDI, $R^2 = 97.0\%$	PSI, PWI, TDI, NFI $R^2 = 97.9\%$
Over time costs: f_2	PSI, PWI, $R^2 = 75.5\%$	PSI, PWI, $R^2 = 76.5\%$	PSI, PWI, $R^2 = 85.1\%$	PSI, PWI, TDI $R^2 = 91.3\%$
Loss of temporal future flexibility: f_3	PSI, NFI, PWI $R^2 = 91.6\%$	PSI, NFI $R^2 = 92.7\%$	PSI, NFI $R^2 = 93.0\%$	PSI, NFI, PWI $R^2 = 91.8\%$
Storage/ lateness penalties costs: f_4	Max(PWI – 0.455; 0), TDI $R^2 = 59.4\%$	Max(PWI – 0.48; 0) and TDI $R^2 = 85.9\%$	Max(PWI – 0.48; 0) $R^2 = 85.8\%$	Max(PWI – 0.44; 0), PSI, PLLI $R^2 = 83.3\%$
Experience development or degradation: f_5	PSI, NFI, PLLI, PWI, TDI $R^2 = 72.6\%$	PSI, PWI $R^2 = 75.3\%$	PSI, TDI, NFI, PLLI $R^2 = 70.0\%$	PSI, NFI, TDI $R^2 = 70.7\%$

6.4 CONCLUSION

The solving algorithm was tested intensively on four groups of problems. It has showed stable performance and robustness with respect to the changes in projects instances not only within the same group, but for all the different groups. The variances of the results were explained by the variances in the different complexity parameters of the projects, with an especially large importance for those expressing the project scales and the resources shortage.

FACTORS AFFECTING THE DEVELOPMENT OF WORKFORCE VERSATILITY

This chapter aims to present and investigate the different variables that affect the development of workforce's experience and their multi-skill flexibility. First, these different variables will be presented. Then, using an illustration example, the factors that affect the costs of developing such flexibility will be discussed. Afterwards, a comprehensive investigation of these variables will be conducted. At the end of the chapter, the conclusions and some recommendations will be discussed.

7.1 FACTORS TO BE INVESTIGATED

In order to develop the actors' versatility with acceptable additional costs, one needs to investigate the effect of some factors. This investigation can be intended to reduce the cost resulting from the learning-forgetting-relearning cycles. In this section we discuss three groups of parameters, related to the human resources themselves, to the characteristics of the firm's core competences, and to the firms' managerial policy, respectively.

7.1.1 Parameters associated to human resources

7.1.1.1 Number of flexible workers

It is the number of employees involved within the program of multi-skills development "PMSD": the overhead cost of developing their secondary skills will be all the higher as this number is important. It can be represented by the number of actors whose productivity levels are within the experience acquisition interval, $\theta_{a,k} \in [\theta_k^{min}, 0.8$ (roughly estimated)]. As indicated in the work of Attia et al. (2011), firms should accept an augmentation of overhead costs just to preserve the productivity levels of their operators, even though serious reduction of the firm's profits may result. Part of this cost may be misplaced, if it happens that the workforce's productivity levels decrease during the project execution, due to the learning/learning-loss/relearning cycles. These cycles result from the periodic utilisation of the actors' polyvalence, which may interrupt the practice of a secondary skill during its acquisition period. If a large number of actors are following the skills development program, one should find a compromise between reducing the overhead costs and avoiding the interruptions in the practice of the secondary skills. In the study presented by Sayin and Karabati, (2007) relying on the "Recency" model of Nembhard and Uzumeri (2000a), the impact of the number of actors involved in the skills development program did not showed any significant impact. We argue here that it can have a noteworthy effect.

7.1.1.2 The occupational rates of the workforce

This factor can be presented as the total number of actors (versatile or not) available to provide the workloads required for a given project. We assert that this factor has a great influence on the skills attrition rate (experience depreciation). When the number of available actors increases, we can expect that the average workforce's occupational rate will reduce, that a high level of workforce's future temporal flexibility will be preserved, and hence, that the workers' practice will decrease. Consequently to the reduction of workers' practice of the skills under development, the skills degradation can be shaped. Sayin and Karabati (2007) investigated this factor in the allocation of workforce in different departments. Under the name of tightness of human resources, they investigated the shortage of workforce in the development of workforce experience. Their results showed that this factor is the most noteworthy in affecting the total skills development, with statistical significance. Other variables that can be much correlated to the workforce occupation is the *Resources loading*: it refers to the requirements profile of a resource. Sayin and Karabati (2007) studied two profile variables: the first is the temporal pattern that can be repeated at every time period. The second factor is the variation in demand from a period to another; it was represented by the standard deviation of demand. The results indicate the positively significant effects of both of them on the development of skills.

7.1.1.3 Actor's number of skills

It is the number of skills that an actor can master, either with optimal or sub-optimal performance. This number is sometimes used to represent the workforce flexibility degree (Kher et al., 1999). As the average number of actors' skills increases, the probability of practice interruption increases, and hence the skills attrition may occur, especially in cases of low similarities levels between these skills. Kher et al. (1999) stated that managers should decide the number of different tasks for which a worker should be trained, how to train the workers, and how to assign the workers in order to increase the learning and reduce the loss of learning. The investigation carried out by Sayin and Karabati (2007) showed that the number of departments (that can be considered as skills) is not significant at all in their analysis model. Contrary to their results, we expect this variable to be significant in the current investigation. As well, this flexibility degree of workforce was investigated using the *LFL* (*learning-forgetting-learning*) curve of Carlson and Rowe (1976) by Yue et al. (2007) in dual resources constraint. Their results showed the significant effect of the number of skills per worker in a job-shop system performance, whereas more specialised workers are especially important to gain optimal performance in dynamic environments (short products' production campaigns). For most of the investigated cases, a number of two skills per worker showed a great influence on performance for all of the working conditions.

7.1.1.4 Minimum productivity level

This is the minimum accepted efficiency level for any actor to practice a given skill k , noted θ_k^{min} . An actor whose efficiency is above this level can be assigned to perform any workload with this skill. This limit was set to 0.5 for the previous simulations discussed in chapters "5" and "6". That is to say, the time required from a beginner to perform a specified task is twice the standard time required from a fully-efficient operator. In this chapter, we will investigate the effect of this factor in the skills attrition, to show whenever one can use the actor's versatility. We expect that, as this limit increases, the risk of workers losing their experience due to work interruption will decrease.

7.1.1.5 Rate of learning/forgetting

As shown in chapter "3", the workforce's efficiency evolution is function of the actors' learning rates and forgetting speeds. These parameters can vary from an actor to another, and from one skill to another, which can be related to the skill complexity as discussed by Osothsilp (2002) and also in section (2.3.4). The reduction of forgetting rate has a beneficial impact on the worker efficiency (Kher et al., 1999). It was also proven in experimental studies by Bailey (1989) and Globerson et al. (1989) that the efficiency attrition is function of the duration of learning prior interruption, and of the duration of the interruption period (that increases the forgetting rates). According to Jaber et al. (2003), the level of forgetting depends upon the rate of learning, and Nembhard and Uzumeri (2000a) found, relying on empirical data, that the actor who learns faster is likely to forget rapidly. Here also, we will investigate this effect in presence of the working time flexibility. In addition, Sayin and Karabati (2007) proved the direct effect of learning speed on skills development, especially under the normal availability of workforce.

7.1.1.6 Teamwork structure

The composition of the teamwork affects the knowledge transfer and thus the efficiency of individuals' learning process. Hung-Chun Huang et al. (2010) considered the teamwork structure as a micro social system, hence different teamwork structures conduct different members' performances, so the teamwork structure can be used

as a way to manage indirectly the knowledge transfer. More about this factor can be found in Eurofound (2007). Sayin and Karabati (2007) represented the team structure by introducing a variable called homogeneity of the workforce: it is simply represented by the coefficient of variance in the workforce steady state productivity level in a specified department (or skill). They found that the more homogeneous the teamwork is, the more flexibility is gained in allocating workers: this variable has a statistical significant influence on skill development.

7.1.1.7 Social relations

The social relations between the team members and their consequences on the transfer of knowledge can affect the multi-functional developments. This factor was investigated by Alexopoulos (2008), he found that the effective transfer of knowledge hinges upon the extent to which individuals share common attitudes for communication and entrusting each other, both professionally and personally. In particular, personal trust was found to be a key to the transfer of tacit knowledge, thereby underlining the importance of positive affect as a criterion for the formation of productive knowledge exchange relations.

7.1.1.8 Actors' attitudes

Actors' attitudes gather the motivation, willingness, innovation ability, stress at work, degree of knowledge, etc. As investigated by Dam (2003), an enquiry based on a questionnaire addressed to 165 employees showed that experts are generally motivated about developing multi-skill flexibility, and that experts' willingness to take part in development programmes is highly related to their motivations. Concerning the versatility development, he concluded that the individual factors have more influence on flexibility development than organizational ones.

7.1.2 Skills associated parameters

7.1.2.1 Similarity degree

The similarity degree figures the resemblance between an actor's main skill and the secondary skill under development. This parameter can be calculated from the attributes that are common between the two considered skills (different knowledge fields, tools, machines, raw material, etc). According to the attributes in common, one can estimate the degree of similarity between the two skills. Thus, it is simply the fraction of the elements in common between the two skills $SD \in [0, 1]$.

7.1.2.2 Skill type

Each competency is a mix of two main categories (cognitive or motor skills): according to these ingredients, the kinetic of learning or forgetting a given skill is determined. According to Globerson et al. (1998) the individuals are more likely to forget the cognitive skills than the motor skills. Concerning the learning speed, Dar-El et al. (1995) proposed to estimate the actors' learning parameters from these two ingredients. The skill type is also investigated practically by Nembhard and Uzumeri (2000a) based on their "Recency model", the nature of a presently performed task influencing the amount of forgetting (Jaber et al., 2003). The effect of task complexity in presence of product diversity was investigated by McCreery and Krajewski (1999): the results showed a significant impact of the task complexity degree on the cross-training flexibility and on the firms' performance. As the task complexity increases, it is useful to restrict the deployment of the workers. And an intensive use of cross-training flexibility can be useful to face numerous product varieties, especially for low-complexity tasks.

7.1.2.3 Mechanization of labour

This factor was presented by Yelle (1979) and he concluded that the plateauing (steady state productivity) is more likely to occur in machine-intensive manufacturing, rather than for labour-intensive industries: in the case of machine-intensive operations, the progress ratio ($= 1 - \text{learning rate}$) is small, so the amount of practical knowledge to be acquired is small too, consequently the plateauing phase can be reached more rapidly.

7.1.3 Firms' policies about the use of flexibility

7.1.3.1 Acquisition policies

The companies may assign or not the actors during the competency acquisition periods: they will fix a minimal degree of training before benefitting from the actor flexibility. Kher et al. (1999) tested three *flexible allocation policies* (*FAP-0*, *FAP-1*, and *FAP-2*): in *FAP-0*, the actors have no restriction to be transferred to an eligible department after completing a given batch size in the first department, *i.e.* it represents the policy of capitalizing on the actors' flexibility during the cross-training program. *FAP-1*: there is restriction of using actors' flexibility until a desired productivity level is achieved. For us it can be represented by the workforce's *Minimum productivity levels* (θ_k^{min}), as previously discussed about the workforce-related factors (section 7.1.1.4). *FAP-2*: there is restriction of using actors' flexibility until the actor trained to produce twice the number of products or work repetitions necessary to reach the pre-specified productivity level of *FAP-1*.

Another managerial variable expressing the company's policy about versatility is the workers-to-skills-distribution pattern: that signifies the way in which actors are distributed to the different skills (known as cross-training pattern). Yue et al. (2007) investigated the impact of skills-training pattern on the system performance, they found that the long "chaining" pattern can enhance the performance by insuring workload smoothing between workers. The distribution of actors on skills can introduce another strategic variable that was also analysed by Yue et al. (2007), by allowing the fast-learning workers to be trained on more skills than the slow-learning ones. Their results showed that training the fast-learning actors and the slow-learning ones to the same number of skills (two skills) produces a good performance for all the conditions of working dynamics. They recommended the consideration of differences between workers in the development of versatility with respect to the dynamics of the working environment. That is, in stable working environments the slow-learning workers can be trained for more than one skill, while in highly unsteady working environments, only the fast-learning workers can have the opportunity to be trained for more skills.

7.1.3.2 Transfer frequency

The investigation of flexibility acquisition policies in dual resources constrained job shops can be found in Kher et al. (1999) and Kher (2000). They used the Learning-Forgetting-Learning model of Carlson and Rowe (1976), involving two parameters: forgetting and worker attrition (loss of stable workers) rates. They indicated that when affected by high attrition and forgetting rates, a worker may not be able to reach full efficiency in as little as two departments. They introduced the concept of the transfer frequency rate, based on a "batch size" concept: they mentioned that smaller batch sizes will reduce worker's residence time in any department and lead to more frequent interruptions in the learning process; in contrast, larger batch sizes restrict the benefits of flexibility, and reduce the relearning losses. As discussed in (section 2.3.4.2.2), this strategy was also investigated by McCreery

and Krajewski (1999), they recommended the use of workers flexibility in case of low tasks complexities and to face recurrent production changes.

7.1.3.3 Firms' motivation to develop flexibility:

This motivation of the firm to develop versatile workforce can be expressed by how much overhead costs it will agree for this development, how far it will consider it as a productive investment.

7.2 ILLUSTRATIVE EXAMPLE

As previously discussed in section 6.1, it is difficult to find a compromise between the development of employees' experience using learning-by-doing, and the overhead costs induced. As previously shown (Table 6.1), most of the solutions found suffer from skills depreciation as well as extra costs, even after adjusting the objectives weights to get a compromise between the two extremes (developing the workers experience whatever the bill, or reducing the cost regardless the versatility). Moreover, the comprehensive application of our model on four hundred projects, the results about workers' skills evolution showed an average depreciation in almost all cases. Therefore, we were motivated to investigate the reasons of this phenomenon.

Using the same illustrative example discussed in (section 6.1), we examined a set of factors that can help the search for this compromise. This example contains mainly 10 tasks and 10 actors with 4 skills; it was presented in appendix (B). As previously discussed (in section 7.1.1), the first obvious factor is the fraction of the actors whose secondary skills are within the transition interval (roughly estimated $[\theta_{a,k}^{mi}, 0.8]$). As shown in (table B.2 in Appendix B), we can find seven actors out of ten (actors #1, #3, #4, #5, #7, #8, #9) having secondary skills within this range. This high percentage of adequately skilled workforce inflates the cost of versatility development, since the planner is inclined to assign non-ideally-skilled people. The second factor is the number of skills under development within the transition interval for the same actor (as for actor #4): either this actor is set apart from the allocation procedure (which penalizes the company's flexibility), or his availability is taken into account and, as his secondary skills will be favoured, his assignments will be more expensive. At this moment, only these two reasons make the procedure of searching a compromise notably difficult, especially for dissimilar workers' skills. In order to show the effect of these two variables, we reduced the fraction of actors whose efficiencies in their secondary skills within the interval $[\theta_{a,k}^{mi}, \approx 0.8]$ from 70% to only 20%; additionally we avoided to develop more than one secondary skill at a time for the same operator. Table 7.1 highlights (in grey) these changes from Table B.2.

After running the solving process ten times with the weights $\gamma_i = \{0.35, 0.1, 0.1, 0.35, 0.1\}$, we found that all the resulting schedules have a positive value for (f_5) as shown in (Table 7.2), *i.e.* there is an average development of actors' secondary skills, of course with the associated extra costs. These costs can be considered as an investment for the development of the workforce versatility. For a detailed analysis, we considered the schedule of minimum cost (exploration number 6 in Table 7.2). Figure 7.1 displays the actors' skills evolutions during the project execution period. This time, the effect of skills depreciation is annihilated, for individuals as well as for the whole population – and the actors' secondary skills been have developed, as shown for actor #1 and actor #4.

Table 7.1 Initial efficiencies of actors after modification

Actors	$\theta_{a,k}(n_{eq}^{SP})$			
	k=1	K=2	k=3	k=4
1	0.8	1.0	0.0	0.5
2	1.0	0.0	0.8	0.0
3	0.0	0.0	0.0	1.0
4	0.0	0.0	1.0	0.6
5	0.0	1.0	0.0	0.0
6	0.9	0.0	0.0	1.0
7	1.0	0.8	0.0	0.0
8	0.0	0.0	1.0	0.0
9	1.0	0.8	0.0	0.0
10	0.0	0.9	1.0	0.0

Table 7.2 Exploration results related to labour costs f_L and skills development f_S after modification

	Exploration number									
	1	2	3	4	5	6	7	8	9	10
$\% (f_L - f_0)/f_0$	15.44	15.98	15.61	13.61	15.39	12.98	15.69	15.61	15.53	14.98
$\% f_S$	1.48	1.50	1.46	1.23	1.43	1.22	1.47	1.50	1.50	1.44

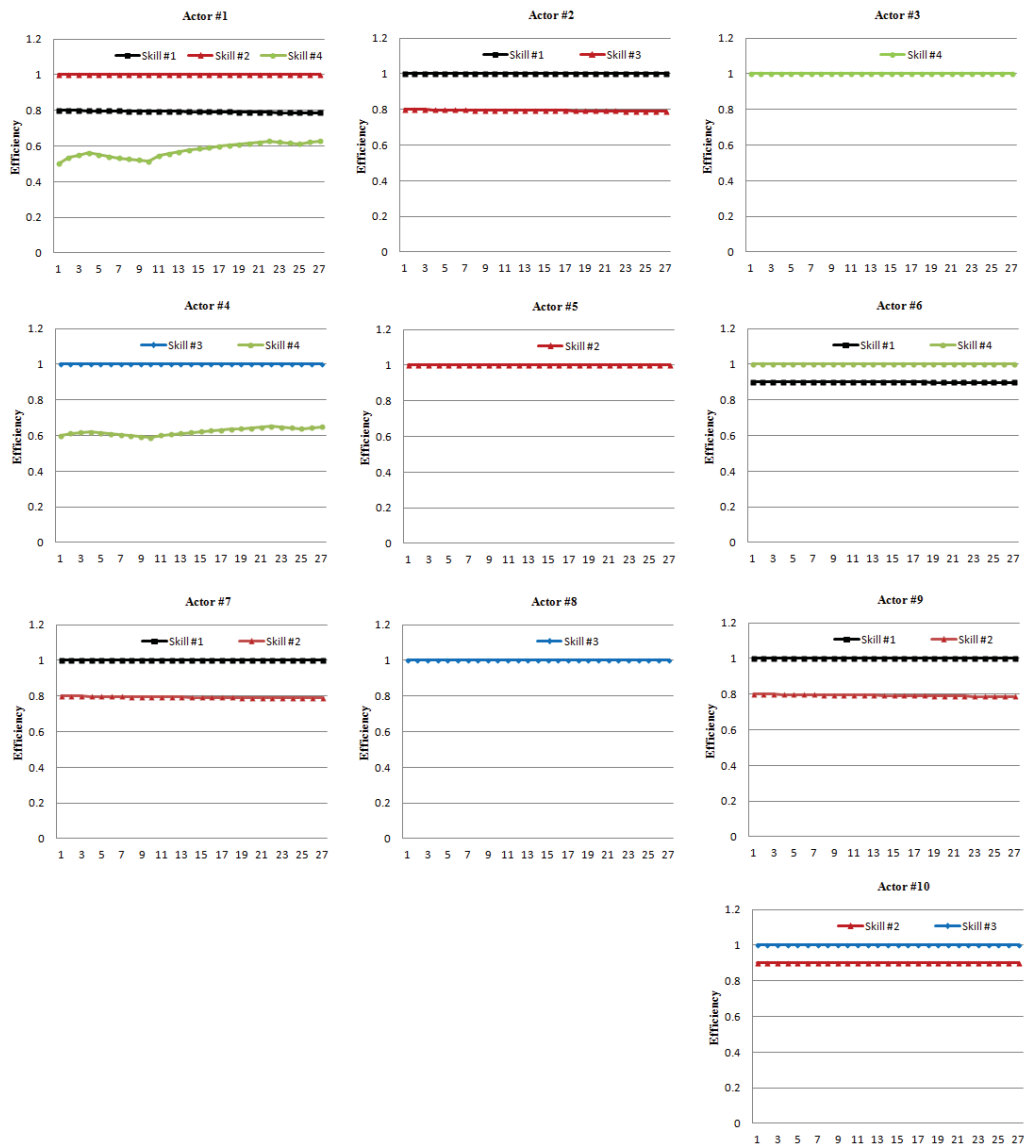

Figure 7.1 Evolution of actors' skills after modification of actors' efficiencies

In order to evaluate the impact of the previously discussed factors on the associated over-costs, and to find the best compromise between the two objectives, Figure 7.2 displays a graphical comparison between the results from (Table 6.1) and (Table 7.2). As we see, companies must accept extra costs just to preserve the productivity level of their actors (*i.e.* $\%f_5 = 0.0$). But these extra costs are all the more important as the number of actors enrolled in the development program increases. In other words, with 70% of actors following the program of multi-skilled development (*PMSD*), this over-cost can be estimated at 21% over the optimal labour cost, whereas with only 20% of actors involved, it should drop down to 2.36%. According to this model, the number of the actors engaged in a development program should be optimised.

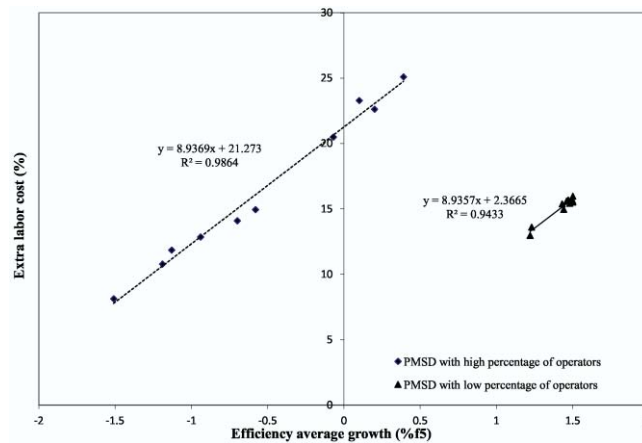

Figure 7.2 Cost of skills betterment

Figure 7.2 indicates a linear growth of labour costs versus skills evolution, whatever the percentage of weakly-qualified actors that can be assigned on activities. The y-values of these lines, all positive here, may result from the difficulty for the project to meet the customer's deadline with the optimally-skilled workforce, thus causing the deliberate choice of the company to allocate non-ideally qualified workforce. What is more significant is that the two sets of data lead to the same slopes for the curves expressing the impact of skills average change on labour cost. In order to investigate the main reason that produces this constant slope, we performed an *ANOVA* analysis between the two results of the two cases. We found there is no significant difference in the percentage of over-costs of the two cases: with the results obtained (*F-ratio* = 0.49 and *P-value* = 0.492 > $\alpha_{level} = 0.05$), we concluded that there is no difference between the over-costs before and after modification (secondary skills reduction). By the same way, we investigated the variance in the percentage of workforce's experience development ($\%f_5$): here, results indicate a significant difference of this development before and after modifications (with *F-ratio* = 85.65 and *P-value* = 0.000 < $\alpha_{level} = 0.05$). In the two cases, we optimised the cost with respect to skills evolution by adjusting the weights of the fitness function (equals in the two cases). So the slopes of the two curves are constant, which represents the compromise between the two criteria. As previously mentioned, the changes between the two cases consist in deleting the misleading secondary skills of the workforce, skills that were already avoided in the results of the first case by the optimisation approach. Moreover, before modification, the depreciation of these avoided secondary skills was integrated in the results of the workforce experience. The contribution of the secondary skills appears only on the constant of the regression model. Thus, the difference between the two cases can be found between constants of the regression models. That is to say, these misleading secondary skills shifted the results to the negative side (experience degradation side). Now, the question is: why are the results before modification largely distributed around the regression line,

whereas after modification they are more concentrated? We argue this to the impact of workforce multi-skills: feasible solutions are all the more numerous as the actors are more polyvalent. Thus in the second case the degree of flexibility is smaller than in the first one, so the problem is tighter and the solution space smaller. This explanation can be supported by comparing the average computational times: 31.0 seconds before modification and 25.7 seconds after, this reduction of processing times resulting from the reduction of the combinatorial degree, via the reduction of the secondary skills. By the following we will investigate the different variables that can affect the development of workforce polyvalence or the resulting costs.

7.3 EXPERIMENTAL DESIGN

To investigate the effect of some of the previously mentioned parameters on the skills' acquisition, and try to avoid attrition effect on the workforce experience, we designed an experiment based on data sets (discussed in chapter 6). By the following, and as discussed in (section 7.1), we will investigate the effect of the following parameters: -The percentage of flexible workforce: the ratio of the flexible workers who have secondary skills to the total workforce available. - The number of total actors or their average occupational rate, - The number of skills under development per actor with efficiency greater than " θ_k^{min} ". - The minimum level of workers' efficiency θ_k^{min} - The workforce's speeds of learning and forgetting. Furthermore, we will investigate the similarity degree (SD) between actor's skills. First we will analyse the results of data sets solved in chapter 6. Another investigation will take place by changing the levels of the variable to be investigated for the same project(s). As well, in order to control the stochastic nature of genetic algorithms, each case will be presented by an average value of 10 simulations, for the same instance with the same parameters.

7.4 RESULTS AND DISCUSSION

7.4.1 Number of flexible workers

This variable presents the number of workers with secondary skills in the transition phase who attend the *PMSD*. First we will use the data set of 400 projects. As discussed in (Appendix A), the workforce productivities were generated randomly for each project. One can find different distributions of workers efficiencies over the interval $[\theta_k^{min}, 1.0]$. For each project, we ranked the values of workforce efficiencies into 5 levels to distinguish between the different levels of skills under development of: $[\theta_k^{min}, 0.6[$, $[0.6, 0.7[$, $[0.7, 0.8[$, $[0.8, 0.9[$, and $[0.9, 1.0]$. For each level, we computed the number of workers. Afterwards, we calculated the fraction of this number of workers to the accumulated number of workers for all levels. The boxplot of these fractions can be represented by (Figure 7.3): it appears that within the same level, there is no significant variation (the limits of the box are very close to a value of 0.2). Moreover, almost all instances have a fraction around 0.2 for all levels. Due to this invariant distribution of the number of workers on the different levels, we expect the non capability of using this data to show the effect of this variable on the average percentage of workforce experience evolution (%AWEE). To valid this observation, we used the regression analysis, which uses %AWEE as a response function and the five levels as the predictors. The test results showed the non-significance of these data to explain the variance in %AWEE, where, F-ratio is very small equals "0.97", and P-value = 0.424 > $\alpha_value = 0.05$).

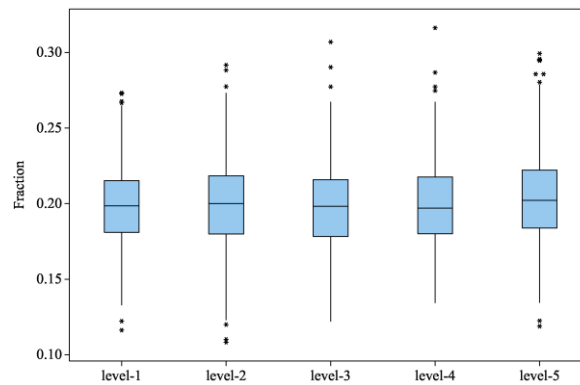

Figure 7.3 The distribution of different workers efficiencies on five levels.

In order to test this variable, we used only one project selected randomly from the 30 tasks-data set. Afterwards we randomly generated five resources data files. Each file is simply a matrix of workers \times efficiencies and represents a specified combination of the five levels: the first file represents a high percentage of workforce skills within level-1; 60% of the total number of workers efficiencies (considering only those for whom $\theta_k > \theta_k^{min}$) are located within the interval of level-1 = [0.5, 0.6]. The other four levels account for a low percentage of 10% each. In the same way, the other four files were constructed; each one represents a high percentage (60%) of a specified level of workers efficiencies, where the other levels are set to the low value of percentage (10%). Each combination of these levels was simulated 10 times with a specified degree of similarities between skills (we have four *SD-levels*: “small *SD*” $\in [0.0, 0.25[$, “medium *SD*” $\in [0.25, 0.5[$, “high *SD*” $\in [0.5, 0.75[$, and “very-high *SD*” $\in [0.75, 1.0[$). We performed a total of 200 simulations. The %*AWEE* (*average workforce’s experience evolution*) of these simulations is presented with respect to the different levels of workforce’s efficiencies, and different similarity degrees, as shown by the boxplot in (Figure 7.4). As illustrated, for small similarity degrees between skills, a high percentage of workers with low efficiency (level-1) produces high degradation to the average workers experience. This effect is reduced when increasing the similarity degree between skills. Moreover, this level shows instability and is very sensitive to the similarity degree between skills, compared to the other levels. We can wonder why this level shows a development of workforce experience at high similarity levels compared to the other levels? As previously mentioned, this level represent 60% of workers’ skills located in the interval $[\theta_k^{min}=0.5, 0.6[$; at high similarity degrees between skills (*SD* $\in [0.5, 0.75[$, very-high *SD* $\in [0.75, 1.0[$), all of these 60% workers skills are approximately under learning. Each time no sufficiently-skilled resources were available to perform activities, the model would allocate them. On the other side, at high levels of similarities, whatever the skill the worker masters, there is an impact to the other secondary skill(s). Therefore, after finishing the project, and computing the relative average workers experience (by comparing the workers efficiencies at project closure to that at the project start, and get percentage of evolution), we find these evidences for experience development. This effect of similarity degree is decreased with respect to the level-2 (60% of the workers skills are within [0.6, 0.7[).

On the other side, the induced over costs for these two levels are very high, as shown by (Figure 7.5) , even though the simulations searches for a compromise between cost and experience development. Regarding the most economical cost, we found the results of level-5 are very interesting, where the corresponding workforce have high efficiencies levels: 60% of workers’ skills efficiencies are in the range [0.9, 1.0]. By investigating the

main reasons for the negative values of %*AWEE*, we selected only one simulation and calculated the number of daily allocations corresponding to each level, whatever the worker: we get for level-1 (12 days), level-2 (37 days), level-3(48 days), level-4 (66 days), and level-5 (2 054 days). The cost is very low due to high allocations of expert workers (level-5), this leads to experience degradation for other levels. In order to avoid this trouble with experience degradation, we propose to reduce the number of workers who attend the *PMSD*, and maintain them at work with their secondary skills (under development) until they reach a solid experience level. Afterwards, the firm can use their versatility. The results of level-4 and level-5 are very similar, so the safe range of using multi-skilled flexibility can be located within the level-4 $\in [0.8, 0.9]$.

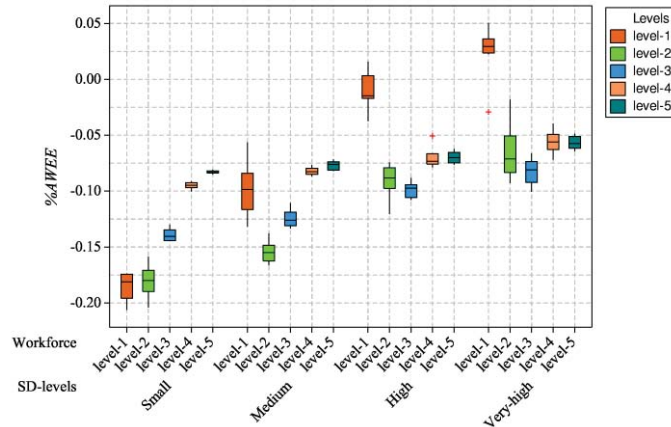

Figure 7.4 distribution of %*AWEE* for different efficiency levels and different levels of *SD*.

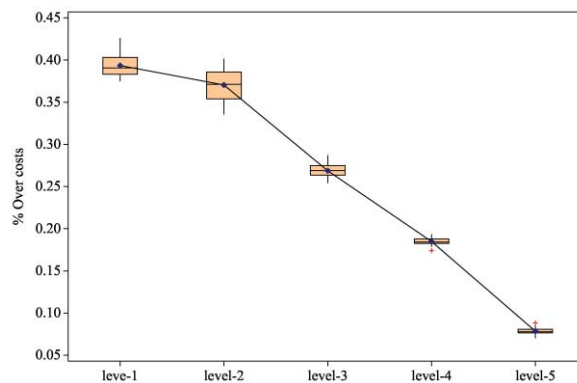

Figure 7.5 Percentage of labour over-cost for different levels of workforce's efficiencies.

In order to show the impact of these workforce levels, similarity between skills on the %*AWEE*, we conducted the *ANOVA* test. The results are listed in (Table 7.3): as shown, the different levels of workforce reveal statistically significant effect on the variation of %*AWEE*. The different level of similarities between skills have a significant impact too (this will be discussed later). In addition the results showed interaction effect (the effect of one variable depends on the level of the other) between the two variables on the experience evolution.

The results of the five levels' of the workforce show some similarity, indicated by the confidence intervals (plotted in the same table): the first level experiences the highest development of workforce's experience, due to the persistence of workforce to work with their low efficiency skills – but in return, cost increases. The results of level-2 and level-3 are very similar. The same comment of similarity between the results of level-4 and those of level-5 can be pointed out as previously. So we argue that the safe value to use workforce versatility can be taken

intervals of %AWEE (plotted in the same table), corresponding to each level of OC, indicate the impact of preserving workforce’s working flexibility during the experience development. The preservation of workers temporal flexibility reduces the rate of practice, which produces a negative effect on developing their skills.

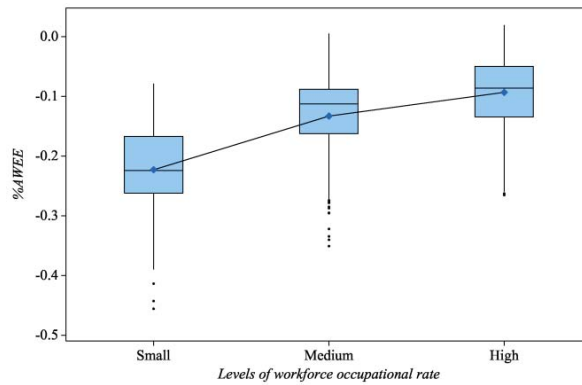

Figure 7.6 effect of actors’ occupational rates on %AWEE.

Table 7.4 ANOVA results of the effect of different levels of workforce availability on %AWEE

Source of variation	Degree of freedom	Sum of squares	Mean squares	F_ratio	P_value
OC- Levels	2	0.99909	0.49954	113.40	0.000
Error	397	1.74881	0.00441		
Total	399	2.74789			
S = 0.06637		R ² = 36.36%		R ² _{adjusted} = 36.04%	
OC Levels	Number of observations	Mean	Standard deviation	95% confidence interval*	
Small	115	-0.22298	0.07425	---◆---	
Medium	181	-0.13301	0.06697	---◆---	
High	104	-0.09323	0.05513	---◆---	

To control the effect of changes between different projects, we conducted another investigation using only one project. This investigation was carried out by reducing the number of available unary-skilled actors (those who have only one nominal skill), in order to increase the occupational rates of the flexible actors. As discussed earlier, one can consider the number of total available actors as a variable that affects the average occupational rate. For this investigation, we generated four scenarios of the available workers: i) 30 workers out of 75 are flexible, ii) 40 workers out of 75 are flexible, iii) 30 workers out of 64 are flexible, and iv) 40 workers out of 56 are flexible. A flexible worker here is an operator who has one secondary skill beside his nominal one. For each scenario, there are four levels of similarity degree between skills. We have 16 combinations of variables and for each combination, we performed 10 simulations. After solving these instances, and using the same classification of occupational rate as before, we found two levels (the *medium* and *high*), as shown by (Figure 7.7). The high levels of occupational rate give better results for %AWEE than the medium levels. It takes the same tendency as previously found for the data set of 400 projects.

One of our conclusions concerning the workers’ occupational rates is: “if an operator has to attend a multi-skills development program, the strategy of preserving his future temporal flexibility can be put aside, and it is better to spread regularly a sufficient part of his annual hours on the skill’s acquisition period, which can enhance the skill’s development and reduce the attrition effect”.

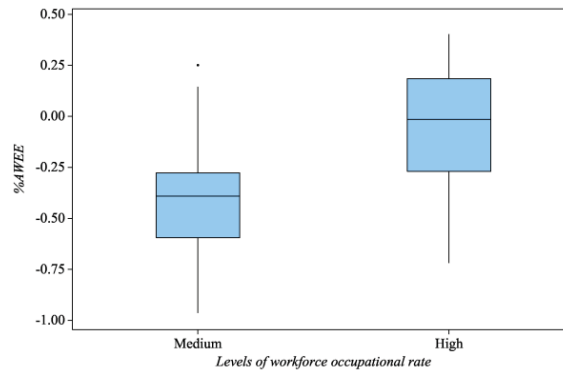

Figure 7.7 The effect of workforce occupational rates on %AWEE for the same project.

7.4.3 Flexibility degree of workers

In order to investigate this variable we classified the workers into four categories: not-flexible workers have only one skill, “one-flexible” ones have two skills, “two-flexible” have three skills), and “fully-flexible” can practice all of the four skills. From the data sets (section 6.2) the percentage of each level with respect to the total number of workers was calculated. First, we used the correlation analysis to investigate the correlation between the %AWEE and the different levels of flexibilities using the data set results. We found that there is no evidence for a linear correlation between %AWEE and the different levels of flexibilities, where the Pearson correlation coefficient “R” is very small, and the P-value is greater than the α -level (equals 0.05) (Table 7.5). We also conducted a regression analysis, which results confirmed those of correlation analysis. We link this to the very small variation of these percentages of workforce flexibility degrees from one project to another. To illustrate this variation, (Figure 7.8) displays the confidence intervals and means of each level of workforce flexibility with respect to the total number of workers. As shown, the intervals are very short, which points out the small variations in the data.

Table 7.5 Correlation analysis results between “%AWEE” and workforce flexibly levels

		%Inflexible	%One-flexible	%Two-flexible	%Full-flexible
%AWEE	R	0.092	-0.065	-0.033	-0.057
	P-value	0.065	0.196	0.514	0.256

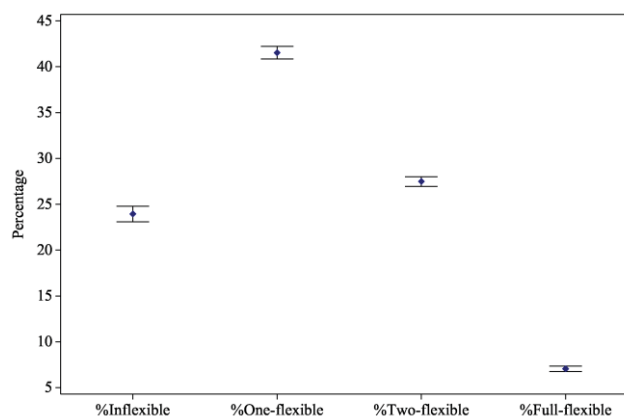

Figure 7.8 interval plot of the percentage of different flexibly levels within the data set

In order to investigate the influence of the polyvalence degree on %AWEE, we used only one project (selected randomly) to fix all the related variables. For this problem we designed an experiment of two levels of flexibility

(one-flexible and two-flexible) at three families of flexible workers ratios (*Flex-20*: 20 workers out of 75 are flexible, *Flex-32*: 32 workers out of 75 and *Flex-40*: 40 workers out of 75). Each combination was simulated 10 times for a given similarity degree between skills (we have four levels). In total we have 24 combinatorial arrangements, thus we conducted 240 simulations. The different results of this experiment are illustrated by the 95% confidence intervals plotted in (Figure 7.9). As shown, the impact of the workers flexibility (one-flexible or two-flexible) is significant at all levels of similarity degree between skills, and for all levels of the number of flexible workers. For all cases, the results of one flexible are better than that of two-flexibility.

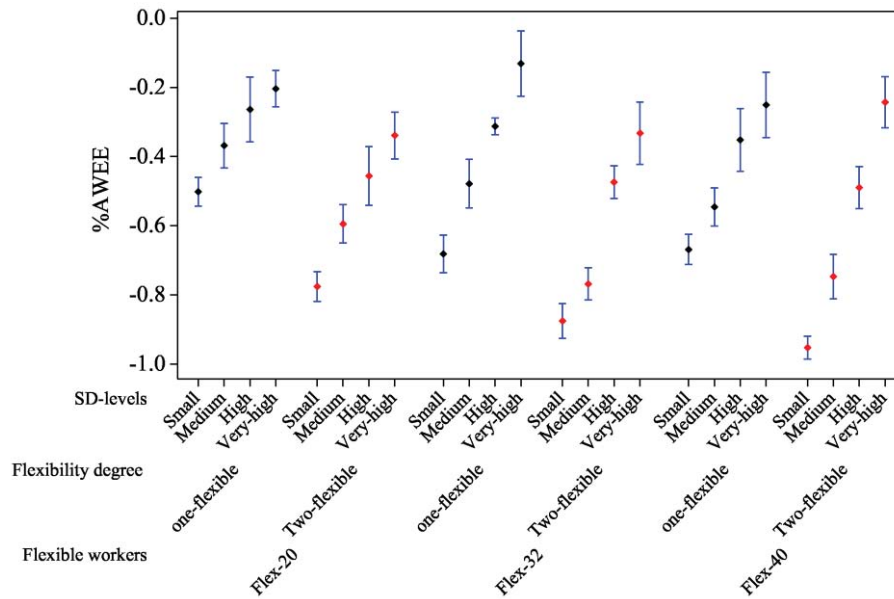

Figure 7.9 interval plot of %AWEE for different levels of workers flexibility at different “SD” levels

In order to confirm these results, we used ANOVA analysis, which results are presented in (Table 7.6). The results show the significant effect of the workers’ degree of flexibility on experience development represented by %AWEE. Relying on the *F-ratio* of the test, the levels of “SD” also represent a significant effect on the experience development. Moreover, the interaction between the workers’ flexibility degree and the similarity degree between skills shows a statistical significant effect at (α -level=0.05): at high similarity degrees between skills, the impact of flexibility degree on experience development can vanish. For dissimilar skills, the decision maker should be cautious to develop one and only one secondary skill at a time.

Table 7.6 ANOVA results of the workforce flexibility levels on %AWEE

Source of variation	Degree of freedom	Sum of squares	Mean squares	F_ratio	P_value
Flexibility degree	1	2.1847	2.18472	188.56	0.000
SD-levels	3	8.4014	2.80047	241.7	0.000
Interaction	3	0.1986	0.0662	5.71	0.001
Error	232	2.6881	0.01159		
Total	239	13.4728			

PWI Levels	Number of observations	Mean	Standard deviation	95% confidence interval*
One-flexible	120	-0.3968	0.1949	-----◆-----
Two-flexible	120	-0.5876	0.2385	-----◆-----

-0.630 -0.560 -0.490 -0.420
%AWEE

7.4.4 The minimum level of workers' productivity

As a consequence of company's policy in terms of versatility, it represents the minimum level to appeal to workers' multi-functional flexibility. In order to investigate the effect of this variable " θ_k^{min} " on the experience evolution (represented by "%AWEE"), we selected only one project, with $SD = zero$. Then, we changed the level of θ_k^{min} from 50% to 80% using incremental steps of 5% – which provides seven ranges of " θ_k^{min} ". For each level, we conducted a number of ten simulations. As shown by (Figure 7.6), the significant effect of " θ_k^{min} " can be noticed: as θ_k^{min} increases, the effect of skills' attrition decreases. Here again, we performed an "ANOVA" analysis of variance (Table 7.7). There is a noteworthy influence of θ_k^{min} on experience degradation. As shown, the (P-value = 0.00) indicates that there is significant difference between the mean values of "%AWEE" corresponding to the different levels of θ_k^{min} . By comparing the results of "%AWEE" corresponding to different θ_k^{min} levels, we found that there is no great difference between the neighbour levels e.g. between 50% and 55%, 55% and 60%, 60% and 65%, also between 75% and 80%. This can be also observed from (Figure 7.6), where the boxplots of data can be intersected. In general, increasing the acceptable limit of θ_k^{min} has direct impact on protecting the workforce from the loss of learning phenomenon. We connect this effect to the experience level; as the worker becomes an expert, his rate of skill attrition decreases.

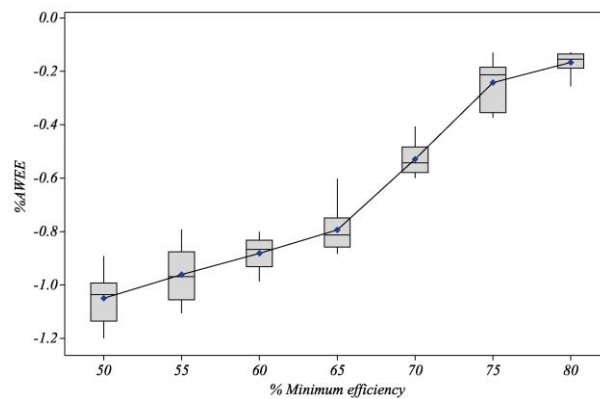

Figure 7.10 The effect of θ_k^{min} on the "%AWEE".

Table 7.7 ANOVA results of the effect of different levels of " SD " on the "%AWEE"

Source of variation	Degree of freedom	Sum of squares	Mean squares	F_ratio	P_value
θ_k^{min} Levels	6	7.44831	1.24139	202.32	0.000
Error	63	0.38655	0.00614		
Total	69	7.83487			

θ_k^{min} Levels	Number of observations	Mean	Standard deviation	95% confidence interval*
50%	10	-1.0498	0.0908	-♦ -
55%	10	-0.9612	0.1069	-♦ -
60%	10	-0.8812	0.0575	-♦ -
65%	10	-0.7936	0.0829	-♦ -
70%	10	-0.5289	0.0605	-♦ -
75%	10	-0.2422	0.0887	-♦ -
80%	10	-0.1663	0.0394	-♦ -

S = 0.07833 $R^2 = 95.07\%$ $R^2_{adjusted} = 94.60\%$

7.4.5 Learning and forgetting rates

As said above, all our previous simulations were performed with constant learning and forgetting rates ($r = 0.8$ and $\zeta = 3$; see section 3.2.2.3.2). In order to evaluate the effect of these two important parameters on the experience development, we designed an experiment that contains three different projects with 30, 60, and 90 tasks. The learning rate is defined as: 1- progress ratio, where the “progress ratio” is the ratio between the cost reduction due to work repetition and the initial cost (at first job execution). For each project, we planned to investigate three progress levels: “level-1” is “slow- progress” ($r = 0.8$), “level-2” is the “medium- progress” ($r = 0.7$), and “level-3” is the “high- progress” = 0.4 ($r = 0.6$). For the forgetting phenomenon, we planned to have also three levels as {Fast ($\zeta = 3$), Medium ($\zeta = 6$), and Slow ($\zeta = 9$)}. The combination of the three projects and the levels of the two variables give in total 27 instances to be tested. As usual, we conducted 10 simulations for each instance (a total of 270 simulations). The results of this exploration are represented by the confidence intervals of each instance (Figure 7.11). Concerning the learning speed, it is clear that the results of level-3 are better than that of level-2, and the results of the two levels are better than that of level-1: as the progress speed increases, it becomes easier to develop the workers’ experience. Concerning the forgetting speed (ζ), results show that as it decreases, the attrition of workers’ efficiency is noticeably reduced. Moreover, the kind of project plays an important role, as we can see the impact of learning and forgetting are remarkable on the project 30-tasks, and this impact reduced in the project 90-tasks. By investigating reasons, we found that the main difference is the occupation rate of workers: the occupation rate in the 30-tasks project is greater than that of 60-tasks, and that of 90-tasks. As previously discussed (section 7.4.2), increasing the occupational rates decreases the skills attrition and increases the experience development.

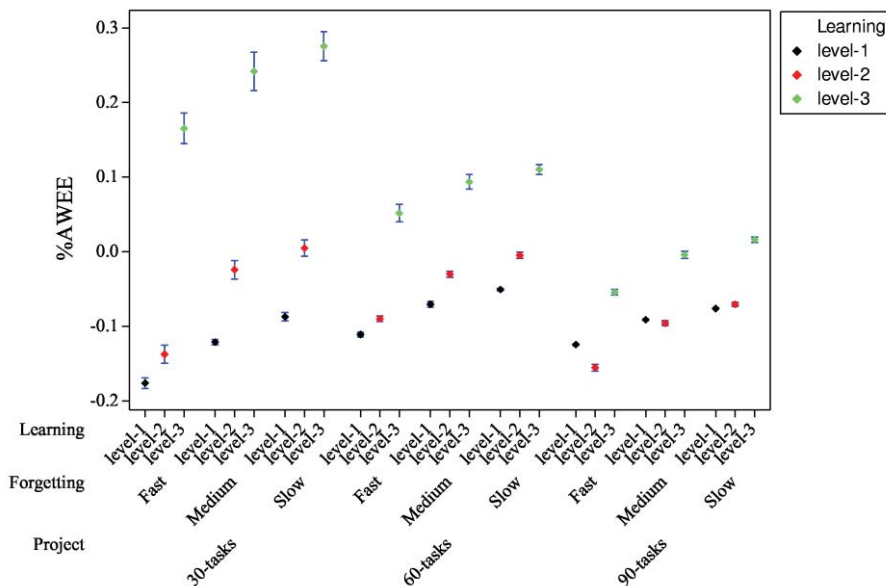

Figure 7.11 interval plot of the different learning and forgetting levels results

The ANOVA analyses are performed using the levels of “Project”, “Learning” and “Forgetting” (Table 7.8). According to “F-ratio” and “P-value” the effects of three variables on the workforce %AWEE are statistically significant. The learning levels effect can be shown by the confidence intervals of different levels (Table 7.8): developing workers’ experience for skill with high progress ratio ($r = 0.6$) is easier than developing another one

projects, and for each project we generated four levels of similarity degree between skills, and then conducted ten simulations for each pair (project, *SD*) – a total of 320 simulations. Afterwards the ANOVA test was performed (Table 7.10): the results indicate that there is a significant effect of *SD* levels on “%*AWEE*”. This influence is also clear from the confidence intervals of the results corresponding to each level, shown in the same table. Concerning the determinate coefficient, the new values are ($R^2 = 41.02$), which expresses the great capacity of *SD*-levels to explain the variance in %*AWEE* results.

Table 7.9 ANOVA results of the effect of different levels of “*SD*” on the “%*AWEE*”

Source of variation	Degree of freedom	Sum of squares	Mean squares	F_ratio	P_value
SD-levels	1	0.09141	0.09141	13.70	0.000
Error	398	2.65648	0.00667		
Total	399	2.74789			

S = 0.08170		R ² = 3.33%		R ² _{adjusted} = 3.08%	
SD Levels	Number of observations	Mean	Standard deviation	95% confidence interval*	
Small	214	-0.16263	0.07959	-----◆-----	
Moderate	186	-0.13232	0.08406	-----◆-----	

Table 7.10 ANOVA results of the four levels of “*SD*” on the %*AWEE*

Source of variation	Degree of freedom	Sum of squares	Mean squares	F_ratio	P_value
SD-levels	3	28.456	9.485	73.25	0.000
Error	316	40.918	0.129		
Total	319	69.375			

S = 0.3598		R ² = 41.02%		R ² _{adjusted} = 40.46%	
SD Levels	Number of observations	Mean	Standard deviation	95% confidence interval*	
Small	80	-1.1071	0.4010	-----◆-----	
Moderate	80	-0.8949	0.3844	-----◆-----	
High	80	-0.5314	0.3361	-----◆-----	
Very high	80	-0.3463	0.3105	-----◆-----	

Moreover, one can see the influence of this parameter on Figure 7.12, it displaying the effect of *SD*-levels for all of the projects: for each project, the similarity degree between skills prevents from efficiency attrition. This effect can be reduced by changing other parameters, such as the minimum efficiency level (presented in section 7.4.4) as shown by instance (30-tasks-1) for which $\theta_k^{min} = 0.7$ whereas $\theta_k^{min} = 0.5$ for all the other cases.

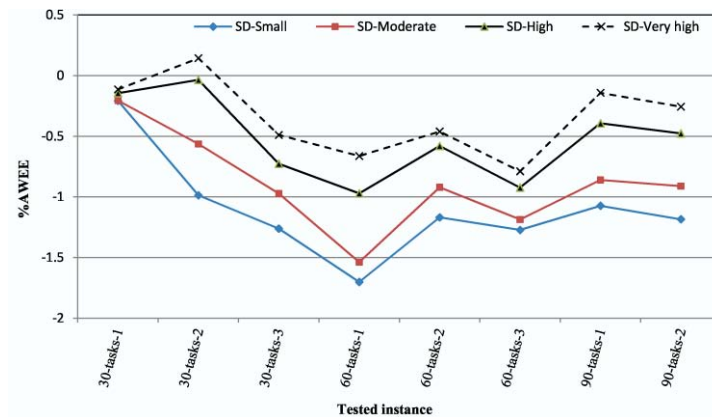

Figure 7.12 The effect of *SD* on the actors’ skills attrition.

The influence of the interaction between *SD-levels* and project-level on the %*AWEE* can be investigated through a two-way *ANOVA* test (Table 7.11). Relying on the determinate coefficient ($R^2 = 95.92\%$), the *SD-levels* and project changes explain most of the variation in the observed %*AWEE*. Also, the statistical significant effects on %*AWEE* of the two variables are proven relying on F-ratio and the associated P-value.

Table 7.11 Two-way ANOVA of SD-levels and project characteristics effect on %*AWEE*

Source of variation	Degree of freedom	Sum of squares	Mean squares	F_ratio	P_value
Project-levels	7	32.8545	4.69350	477.35	0.000
SD-levels	3	28.4562	9.48541	964.72	0.000
Interaction	21	5.2322	0.24915	25.34	0.000
Error	288	2.8317	0.00983		
Total	319	69.3746			
S = 0.09916 $R^2 = 95.92\%$ $R^2_{adjusted} = 95.48\%$					

7.5 CONCLUSIONS

In this chapter, we have discussed and investigated some of the parameters that affect the development of the workforce multi-functional flexibility. The model and its solving approach were used as a vehicle of this investigation. The analysis showed that the percentage of workers involved in a *PMSD* has a direct impact on the workforce experience development, and thus on the cost of implementing it. This variable should be optimised or kept as little as possible in order to reduce the un-profitable over-costs, due to learning-forgetting-relearning cycles. The preservation of temporal flexibility was investigated too; for the workers who attend a *PMSD*, results show that the strategy of preserving their responsiveness for future activities could be set aside, for it looks better to spread regularly a sufficient part of annual hours on the skill acquisition period.

About the number of skills under development per actor, there is no problem to develop more than one secondary skill beside the basic one, when similarities degree between skills is high. But the interest of a generalised learning of new skills decreases when activities tend to differentiate. Amongst the decision variables concerning the development of versatility, the minimum efficiency level θ_k^{min} required for the practice of a skill shows a great influence on the experience development. When the value of this θ_k^{min} increases, the opportunities of assigning multi-skilled workers diminish. The workforce’s speeds of learning and of forgetting also show a great impact on the development of workforce’s versatility. In parallel, the similarity degree between skills was investigated for it has an important impact on the experience development; the results point out the vital role of this parameter on experience development. As the similarity degree between skills increases, the effects of all of the previous variables tend to fade. Therefore, when firms need to reinforce one of their core competences with other workers, they should logically select the workers with the nearest basic skill to that in question.

Amongst the development perspectives for this chapter, one should integrate and explore the social aspects (such as teamwork compositions for instance), and study their impact on the development of workforce’s performance, especially during the skill’s acquisition periods.

GENERAL CONCLUSION AND PERSPECTIVES

8.1 OVERALL CONCLUSION

Responding to the growing need of generating a robust baseline schedule, first, this research was implemented to model the problem of multi-period workforce allocation on industrial activities. This model considers the heterogeneous productivities of operators, the qualitative workforce flexibility that known as multi-function flexibility, the working time flexibility, and the dynamic nature of experience. The dynamic nature of workforce experience was modelled in function of learning-by-doing and forgetting during the work interruption periods. Moreover, the activities durations are considered as elastic, so that the jobs' durations depend on the number of workers allocated to perform them in addition to the levels of their experience.

Second, this research was oriented to answer the question "What is an instance of the current problem?", therefore the different dimensions of the problem are classified and analysed. For each dimension, the related sensitive assessment method had been proposed. These dimensions include the project network, the project temporal characteristics, the project work content, the available resources, and work-content to resources weighting quantifiers. Relying on these measures, this research proposed to aggregate them using factor analysis in order to produce the main principal components of an instance. Relying on these main components, an instance of the problem can be defined; moreover the difference between instances can be evaluated. Consequently, the complexity or easiness of solving or realising a given problem instance can be evaluated.

Third, this research developed platform software to solve the proposed problem and construct the project baseline schedule with the associated resources allocation. The proposed platform relies on a genetic algorithm-based approach. This genetic algorithm relies mainly on answering three questions based on the priority encoding: what task will be processed first? Then which actor(s) will be allocated to realise this task? What is the working time strategy that the actors will respect, during the activity realization? After that a serial schedule generation scheme was adopted to gradually construct the project schedule and allocated the workforce according the random generated priority lists. The model has been validated, likewise, its parameters has been tuned to give the best performance.

Fourth, the research investigated the robustness of the proposed approach by excessively solving four hundred problems. Which contains four groups according to number of tasks (30 tasks, 60 tasks, 90 tasks, and 120 tasks); each group contains a number of one hundred projects with different characteristics. The proposed approach was showed a stable performance and robustness with respect to the changes in projects instances within the same group, moreover within the different groups. The variances of the different results were explained by the variances between project instances. Knowing that these different project instances were represented by the smallest principal components obtained from factor analysis and cluster analysis of the problem variables.

Fifth, this research was used the developed model and the proposed problem solving approach as a vehicle of investigation of the different parameters that can affect the development of workforce multi-function flexibility. The parameters that had been investigated are the percentage of employees who are integrated in the program of multi-skilled development, the preservation of temporal flexibility, the workers' flexibility degree (the number of

skills under development per each worker), the minimum level of workers' productivity θ_k^{min} , the workforce speed of learning and forgetting, and the similarity degree between skills.

Based on the research analysis, some conclusions about the model and its resolution method can be drawn. Regarding the behaviour of the model, some reasons for satisfactory raise from results that show to be consistent regarding the way we modelled facts. Beside the fact that these results always provide feasible schedules (with or without lateness penalties), without any hard constraint violation, they also express a logical relationship between the use of versatility and the cost inflation; the actors who have low levels of efficiency are more likely to lose their skills than their highly-efficient colleagues during equivalent interruption periods – and reciprocally, they can learn faster; tuning the objectives weight set of parameters $\{\gamma_i\}$ has always resulted in the expected behaviour. These points witness a good transcription of the published observations on which the model is based: they help the user to feel more comfortable towards the model's reliability, concerning details of encoding procedures that are more awkward to test than are the feasibility of the schedules provided.

Some managerial lessons can also be learnt from this research: – The firms seeking for reactivity should accept an amount of extra cost to develop their operators' multifunctional flexibility. Therefore the number of operators who will follow a skill development program should be optimised in order to find a good compromise between the over costs induced and the overall average skills developments. – In order to enhance the acquisition of secondary skills, the operators in question should be regularly practicing their new skills, and avoid to preserve before all their future temporal flexibility. –Moreover, firms should allocate these operators to work with their new skills until they have reached a sufficient degree of mastering that can protect them from the loss of learning produced during the use of multifunctional flexibility. – The same recommendation may be formulated for economic reasons: the effort of growing up a new skill is costly and must be continued until this skill is consolidated. –The surplus of developing the actors' secondary skills can be misleading or become out of control especially for non-similar skills. – Developing an operator with more than one secondary skill beside his basic one is very difficult and costly, especially for completely different skills. The company should select the workers with high speed of learning and slow forgetting to develop their multi-functional flexibility. Finally, the similarity degree between skills showed the vital role of workforce experience development. Therefore, firms should select workers with the nearest basic skill to the skill in question for the development.

8.2 FUTURE PERSPECTIVES

This work can be extended relying on many axes, including – but not limited to: mathematical modelling, industrial project management, computer-aided decision making, and problem solving techniques. By the following we will discuss the possible extension of each axis.

The axis of mathematical modelling: We considered only one project at time, transforming the problem to a multi-project planning and scheduling can be appreciated, to approach this model to the real industrial situations. Moreover, one can integrate labour mobility constraints between project activities, which can signify transportations cost. In other words, considering the cost of actors' transportation means: if an actor a is allocated to work in project " p_1 " at a working day t , and if it is planned to allow him to work in project " p_2 " for

the same working day t , a transportation cost/time should be considered. These costs represent the displacements from location of project p_1 to location of project p_2 , or they can figure the difficulty for the actor to switch his state of mind from the p_1 context to the p_2 . These costs can be estimated relying on two dimensions: the transportation time, and transportations fees. Moreover, the distance between actor's home and the project location can be considered. Also, the relation between tasks can be modelled using dependency structure matrix, which allows us to consider all the dependency relation between activities. Especially when the information exchange streams between activities is required.

Regarding the worker's productivity assessment, we considered only the temporal performance as a basis of measurement of the worker productivity rates. There is often a trade-off between temporal performance and production quality aspects. Therefore, adding the dimension of work quality to the current model increases the workability and applicability of the model. The assessment of the worker production quality can be reviewed with the product required specifications. Consequently, one can estimate the worker's working quality level, and define the minimum required level for each skill.

Concerning the uncertainty of estimating the project and resources characteristics, the problem at hand can be expanded into two branches: the stochastic estimation of parameters, or the possibilistic one. The stochastic or/and fuzzy modelling can be adopted for many variables in the current model; the project related parameters or the resources ones. The stochastic models apply if there are historical data at hand; if it is not the case, the estimation of these parameters is often done by an expert, therefore, it is quite logical to model them relying on fuzzy numbers instead of crisp numbers. That is, the estimator gives for each variable a possibilistic values, associated to each value a possibilistic index (weight) within the interval $[0, 1]$. The relation between the weights and the possibilistic values known as the membership function. These variables contains (but not limited to) the workload required from each skill, the duration of each workload.

The employees social aspects will express the workers' own satisfaction or the social relation between a group of workers. First, the worker's own satisfaction can be modelled by integrating his preferences in selecting tasks, skills, working days, and /or vacations. These preferences of human resources can be modelled with linguistic terms and the use of fuzzy logic. Recently, there has been considerable effort in applying fuzzy sets theory in social sciences with more emphasis on performance evaluation. Moreover, the relation between the individuals of the same team can be enhanced by considering and comparing the linguistic working preferences between workers. Adopting these social criteria enhances the communication between members of the team, and as a result, the rate of knowledge transfer between them can be enhanced.

Regarding the assessment of learning and forgetting parameters such as (r, ζ) for a given worker with respect to a specified skill, one can evaluate them based on the social factors, job technical nature, working environmental, stress at work, incentive systems etc. As mentioned previously, each factor can be modelled with fuzzy numbers and then aggregated using fuzzy logic. Consequently, the learning and forgetting parameters of each individual can be evaluated relying on the fuzzy estimation of an expert and considering as many as possible of the individual, technical, environmental and economic aspects.

The axis of project management: The current work was oriented to generate a robust baseline schedule with human resources allocation relying on the human resources flexibility. But in real situations and during the activities' realisation phases some changes often occur, in reasons of the dynamic working environment: e.g. new incoming orders, cancelling of some orders, shortage of raw material, power shortage, machine break-down, workers' absence, accidents at work, etc. One of our future works consists in modelling and solving the problem of constructing a predictive-reactive schedule, considering a set of efficiency and stability objectives. The efficiency objectives can be the schedule costs of the number of working hours and overtime hours, project delivery date. And the stability objectives can be the deviation of the new schedule from the old one. These deviations can be calculated from the activities start and finish dates, or from the changes in actors' allocations. This deviation can be considered as a reaction cost to the new event.

We proposed to measure the project complexity relying on principal component analysis by using the static dimensions of project activities and resources. One of the possible extensions of this work would be to development a generic approach to accommodate also the project technical complexity measure. This technical complexity can be measured by comparing the project required knowledge to the available resources knowledge (explicit and tacit), which seems to be specific to the applied context and difficult to be evaluated. Therefore, this extension can be performed by studying the different tools of project technical analysis and the different techniques of capitalising the workforce's knowledge. This generic approach should lead to a software platform that would handle both the project technical characteristics and the human resources knowledge, and possibly refer to data mining algorithms to compare the knowledge requirements and the available one to conclude on the project technical complexity.

Axis of computer-aided decision-making: In the current work we modelled the problem as a multi-objective one, using a weighted sum as unique criterion. As a logical extension of this work, we propose to model the problem as a multiple-criteria decision-making system. These criteria can be defined relying on: the economic objectives, workforce experience evolution and the social aspects if they are integrated as previously discussed. After that and based on Pareto front, the decision maker can select the suitable project schedule according to the situations.

Axis of problem solving techniques: In this work, our problem was solved using one of the metaheuristics, the genetic algorithms. As a future expansion of this axis, the problem can also be solved with many other methods such as particle swarm optimisation, ant colony optimisation, or by one of the local search methods such as simulated annealing, tabu search or even the hybridisation of two algorithms such as the memetic algorithms. Concerning exact methods, our model is nonlinear, so in order to solve it exactly and with acceptable computing times, one should first make it linear and then apply one of the decomposition techniques, such as Bender's decomposition or Dantzig wolf decomposition, in order to solve it optimally. The hybridisation between exact methods and metaheuristics can be adopted too to accommodate the problem of nonlinearity.

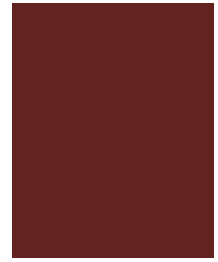

Bibliography

- Abboud, M.S., 1998. Fuzzy manpower allocation using the mutate and spread metaheuristics. In: Second International Conference on Knowledge-Based Intelligent Electronic Systems, KES '98. 1, 87–93.
- Agrawal, M.K., Elmaghraby, S.E., Herroelen, W.S., 1996. DAGEN: A generator of test sets for project activity nets. *European journal of operational research*, 90, 376–382.
- Akbari, R., Zeighami, V., Ziarati, K., 2011. Artificial Bee colony for resource constrained project scheduling problem. *International Journal of Industrial Engineering Computations*, 1, 45–60.
- Al-Anzi, F.S., Allahverdi, A., Al-Zamel, K., 2010. Weighted multi-skill resources project scheduling. *Journal of Software Engineering and Applications*, 3, 1125–1130.
- Alexopoulos, A., 2008. Social relations, human resource management, and knowledge transfer in work organisations: toward an integrated approach. PhD thesis, Dublin City University, Ireland.
- Ali, S., Maciejewski, A.A., Siegel, H.J., Kim, J.-K., 2004. Measuring the robustness of a resource allocation. *IEEE Transactions on parallel and distributed systems*, 15, 630 – 641.
- Aloulou, M.A., Portmann, M.-C., 2005. An Efficient proactive-reactive scheduling approach to hedge against shop floor disturbances. in: Kendall, G., Burke, E.K., Petrovic, S., Gendreau, M. (Eds.), *Multidisciplinary Scheduling: Theory and Applications*. Springer US, pp. 223–246.
- Alvarez-Valdes, R., Crespo, E., Tamarit, J.M., Villa, F., 2008. GRASP and path relinking for project scheduling under partially renewable resources. *European Journal of Operational Research*, 189, 1153–1170.
- Alvarez-Valdes, R., Tamarit, J.M., 1989. Heuristic algorithms for resource-constrained project scheduling: A review and an empirical analysis, in: *Advances in Project Scheduling*, Elsevier, Amsterdam. Slowinski, R. and Weglarz, Amsterdam.
- Anderlhore, G., 1969. What Production Breaks Cost. *Industrial Engineering*, 34–36.
- Anthony, R.N., 1965. Planning and control systems: a framework for analysis. Division of Research, Graduate School of Business Administration, Harvard University.
- Artigues, C., Billaut, J.-C., Esswein, C., 2005. Maximization of solution flexibility for robust shop scheduling. *European Journal of Operational Research*, 165, 314–328.
- Artigues, C., Demasse, S., Neron, E., 2008. *Resource-Constrained Project Scheduling: Models, Algorithms, Extensions and Applications*. ISTE Publishing Company.
- Artigues, C., Michelon, P., Reusser, S., 2003. Insertion techniques for static and dynamic resource-constrained project scheduling. *European Journal of Operational Research*, 149, 249–267.
- Asher, H., 1956. Cost-quantity relationships in the airframe industry (No. R291), Rand Corp. Santa Monica, CA.
- Atkin, J.A.D., Burke, E.K., Greenwood, J.S., Reeson, D., 2007. Hybrid metaheuristics to aid runway scheduling at London Heathrow airport. *Transportation Science*, 41, 90–106.
- Atkinson, R., Crawford, L., Ward, S., 2006. Fundamental uncertainties in projects and the scope of project management. *International Journal of Project Management*, 24, 687–698.
- Attia, E.-A., Dumbrava, V., Duquenne, P., 2012a. Factors affecting the development of workforce versatility, in: Theodor, B. (Ed.), *Information Control Problems in Manufacturing*. 14th IFAC Symposium on Information Control Problems in Manufacturing, Elsevier, Bucharest, Romania - May 23-25, pp. 1221–1226.
- Attia, E.-A., Duquenne, P., Le-Lann, J.-M., 2011. Prise en compte des évolutions de compétences pour les ressources humaines. In: CIGI-2011, 12-14 octobre 2011, Saint-Sauveur, Québec, Canada.
- Attia, E.-A., Duquenne, P., Le-Lann, J.-M., 2012b. Decision-based genetic algorithms for solving multi-period project scheduling with dynamically experienced workforce. In: 9th International Conference on Modeling, Optimization & SIMulation, MOSIM-2012, 6-8 June. Bordeaux, France.
- Attia, E.-A., Edi, H.K., Duquenne, P., 2012c. Flexible resources allocation techniques: characteristics and modelling. *Int. J. Operational Research*, 14, 221–254.
- Avramidis, A.N., Chan, W., Gendreau, M., L'ecuyer, P., Pisacane, O., 2010. Optimizing daily agent scheduling in a multiskill call center. *European journal of operational research*, 200, 822–832.
- Aykin, T., 1998. A composite branch and cut algorithm for optimal shift scheduling with multiple breaks and break windows. *The Journal of the Operational Research Society*, 49, 603–615.
- Azmat, C.S., Hürlimann, T., Widmer, M., 2004. Mixed integer programming to schedule a single-shift workforce under annualized hours. *Annals of Operations Research*, 128, 199–215.

- Badiru, A., 1992. Computational survey of univariate and multivariate learning curve models. *IEEE Transactions on Engineering Management*, 39, 176–188.
- Badiru, A.B., 1996. Project management in manufacturing and high technology operations. John Wiley & Sons.
- Bailey, C.D., 1989. Forgetting and the learning curve: a laboratory study. *Management Science*, 35, 340–352.
- Bailey, C.D., McIntyre, E.V., 2003. Using parameter prediction models to forecast post-interruption learning. *IIE – Transactions*, 35, 1077.
- Baptiste, P., Pape, C.L., Nuijten, W., 2001. Constraint-based scheduling: applying constraint programming to scheduling problems. Springer.
- Bashir, H.A., 2010. Removal of redundant relationships in an AON project network for evaluating schedule complexity. *Journal of Construction Engineering and Management*, 136(7), 787–793.
- Bassan, G.S., 2010. Capacity planning under Fuzzy environment using possibilistic approach. Master thesis, University of Manitoba, Canada.
- Beach, R., Muhlemann, A.P., Price, D.H.R., Paterson, A., Sharp, J.A., 2000. A review of manufacturing flexibility. *European Journal of Operational Research*, 122(1), 41–57.
- Bein, W.W., Kamburowski, J., F, M., Stallmann, M., 1992. Optimal reduction of two-terminal directed acyclic graphs. *SIAM Journal on Computing*, 21(6), 1112–1129.
- Bellenguez, O., Néron, E., 2005. Lower bounds for the multi-skill project scheduling problem with hierarchical levels of skills, in: E. Burke and M. Trick (Eds.): PATAT 2004, LNCS. Springer, pp. 229–243.
- Bellenguez-Morineau, O., Néron, E., 2007. A Branch-and-Bound method for solving multi-skill project scheduling problem. *RAIRO Operations Research*, 41(2), 155–170.
- Beltrán-Martín, I., Roca-Puig, V., Escrig-Tena, A., Bou-Lluisar, J.C., 2008. Human resource flexibility as a mediating variable between high performance work systems and performance. *Journal of Management*, 34(5), 1009–1044.
- Bennour, M., Crestani, D., Crespo, O., Prunet, F., 2005. Computer-aided decision for human task allocation with mono- and multi-performance evaluation. *International journal of production research*, 43(21), 4559–4588.
- Betancourt, M.R., Skolnick, J., Donald, T., Plant, D., 2001. Universal similarity measure for comparing protein structures. *Biopolymers*, 59(5), 305–309.
- Billaut, J.-C., Moukrim, A., Sanlaville, E., 2010. Introduction to flexibility and robustness in scheduling, in: Billaut, J.-C., Moukrim, A., Sanlaville, E. (Eds.), *Flexibility and Robustness in Scheduling*. ISTE, Wiley Online Library, pp.15–33.
- Bobrowski, P.M., Park, P.S., 1993. An evaluation of labor assignment rules when workers are not perfectly interchangeable. *Journal of Operations Management*, 11(3), 257–268.
- Bockmayr, A., Kasper, T., 1998. Branch and Infer: A unifying framework for integer and finite domain constraint programming. *INFORMS Journal on Computing*, 10(3), 287–300.
- Bokhorst, J.A.C., Gaalman, G.J.C., 2009. Cross-training workers in dual resource constrained systems with heterogeneous processing times. *International Journal of Production Research*, 47(22), 6333–6356.
- Bolívar-Ramos, M.T., García-Morales, V.J., García-Sánchez, E., 2012. Technological distinctive competencies and organizational learning: Effects on organizational innovation to improve firm performance. *Journal of Engineering and Technology Management*, 29(3), 331–357.
- Bordoloi, S.K., Cooper, W.W., Matsuo, H., 1999. Flexibility, adaptability, and efficiency in manufacturing systems. *Production and Operations Management*, 8(2), 133–150.
- Boriah, S., Chandola, V., Kumar, V., 2008. Similarity measures for categorical data: a comparative evaluation. In. *SIAM International Conference on Data Mining - SDM*, April 24–26, Atlanta, Georgia, pp. 243–254
- Bouleimen, K., Lecocq, H., 2003. A new efficient simulated annealing algorithm for the resource-constrained project scheduling problem and its multiple mode version. *European Journal of Operational Research*, 149(2), 268–281.
- Browning, T.R., Yassine, A.A., 2009. A random generator of resource-constrained multi-project network problems. *Journal of Scheduling*, 13(2), 143–161.
- Browning, T.R., Yassine, A.A., 2010. Resource-constrained multi-project scheduling: Priority rule performance revisited. *International Journal of Production Economics*, 126(2), 212–228.

- Brownlee, J., 2011. *Clever Algorithms: Nature-Inspired Programming Recipes*. ISBN: 978-1-4467-8506-5.
- Brucker, P., Drexl, A., Mohring, R., Neumann, K., Pesch, E., 1999. Resource-constrained project scheduling: Notation, classification, models, and methods. *European Journal of Operational Research*, 112(1), 3–41.
- Brucker, P., Knust, S., 2006. Scheduling models, in: complex scheduling, GOR-Publications. Springer Berlin Heidelberg, pp. 1–22.
- Brucker, P., Knust, S., 2011. *Complex Scheduling*. 2nd ed. Springer Verlag.
- Brucker, P., Qu, R., Burke, E., 2011. Personnel scheduling: Models and complexity. *European Journal of Operational Research*, 210(3), 467–473.
- Brusco, M.J., Jacobs, L.W., 1993. A simulated annealing approach to the solution of flexible labour scheduling problems. *The Journal of the Operational Research Society*, 44, 1191–1200.
- Brusco, M.J., Jacobs, L.W., 2000. Optimal models for meal-break and start-time flexibility in continuous tour scheduling. *Management Science*, 46(12), 1630–1641.
- Brusco, M.J., Johns, T.R., 1998. Staffing a multi skilled workforce with varying levels of productivity: an analysis of cross-training policies. *Decision Sciences*, 29(2), 499–515.
- Burstyn, I., 2004. Principal component analysis is a powerful instrument in occupational hygiene inquiries. *Annals of Occupational Hygiene*, 48(8), 655–661.
- Cai, X., Li, K., 2000. A genetic algorithm for scheduling staff of mixed skills under multi-criteria. *European Journal of Operational Research*, 125(2), 359–369.
- Campbell, G.M., Diaby, M., 2002. Development and evaluation of an assignment heuristic for allocating cross-trained workers. *European Journal of Operational Research*, 138(1), 9–20.
- Carlier, J., Moukrim, A., Xu, H., 2009. The project scheduling problem with production and consumption of resources: A list-scheduling based algorithm. *Discrete Applied Mathematics*, 157(17), 3631–3642.
- Carlson, J.G., Rowe, R.G., 1976. How much does forgetting cost? *Industrial Engineering*, 8, 40–47.
- Caroli, E., 2007. Internal versus external labour flexibility : the role of knowledge codification. *National Institute Economic Review*, 201(1), 107-118.
- Caron, G., Hansen, P., Jaumard, B., 1999. The assignment problem with seniority and job priority constraints. *Operations Research*, 47(3), 449–453.
- Carr, G.W., 1946. Peacetime cost estimation requires new learning curves. *Aviation*, 45, 76–77.
- Castaneda, D.I., Rios, M.F., 2007. From individual learning to organizational learning. *The Electronic Journal of Knowledge Management*, 5(4), 363–372.
- Cavalcante, C.C.B., Carvalho de Souza, C., Savelsbergh, M.W.P., Wang, Y., Wolsey, L.A., 2001. Scheduling projects with labor constraints. *Discrete Applied Mathematics*, 112(1), 27–52.
- Certa, A., Enea, M., Galante, G., Manuela La Fata, C., 2009. Multi-objective human resources allocation in R&D projects planning. *International Journal of Production Research*, 47(13), 3503–3523.
- Chakravarty, A.K., Shtub, A., 1992. The effect of learning on the operation of mixed-model assembly lines. *Production and Operations Management*, 1(2), 198–211.
- Chen, P.-H., Shahandashti, S.M., 2009. Hybrid of genetic algorithm and simulated annealing for multiple project scheduling with multiple resource constraints. *Automation in Construction* 18, 434–443.
- Chen, R.-M., 2011. Particle swarm optimization with justification and designed mechanisms for resource-constrained project scheduling problem. *Expert Systems with Applications*, 38(6), 7102–7111.
- Chen, S.-P., Tsai, M.-J., 2011. Time–cost trade-off analysis of project networks in fuzzy environments. *European Journal of Operational Research*, 212(2), 386–397.
- Cooper, D.F., 1976. Heuristics for scheduling resource-constrained projects: An experimental investigation. *Management Science*, 22(11), 1186–1194.
- Corominas, A., Lusa, A., Pastor, R., 2002. Using MILP to plan annualised working hours. *Journal of the Operational Research Society*, 53, 1101–1108.
- Corominas, A., Lusa, A., Pastor, R., 2007. Using a MILP model to establish a framework for an annualised hours agreement. *European Journal of Operational Research*, 177(3), 1495–1506.

- Corominas, A., Ojeda, J., Pastor, R., 2006. Multi-Objective allocation of multi-function workers with lower bounded capacity. *The Journal of the Operational Research Society*, 56(6), 738–743.
- Corominas, A., Pastor, R., 2010. Replanning working time under annualised working hours. *International Journal of Production Research*, 48(5), 1493–1515.
- Coughlan, E., Lübbecke, M., Schulz, J., 2010. A Branch-and-Price algorithm for multi-mode resource leveling, In: Festa, P. (Ed.), *Experimental Algorithms, Lecture Notes in Computer Science*. Springer Berlin / Heidelberg, pp. 226–238.
- Cowling, P., Colledge, N., Dahal, K., Remde, S., 2006. The trade off between diversity and quality for multi-objective workforce scheduling. In: *Evolutionary computation in combinatorial optimization*, Springer, pp.13–24.
- Creemers, S., Leus, R., De Reyck, B., Lambrecht, M., 2008. Project scheduling for maximum NPV with variable activity durations and uncertain activity outcomes, In: *IEEE International Conference on Industrial Engineering and Engineering Management, IEEM 2008*. pp.183–187.
- Dam, K. van, 2003. Understanding experts' attitudes towards functional flexibility. *International Journal of Human Resources Development and Management*, 3(2), 138–153.
- Daniel, V., Guide, R., Spencer, M.S., 1997. Rough-cut capacity planning for remanufacturing firms. *Production Planning & Control*, 8(13), 237–244.
- Daniels, R.L., Mazzola, J.B., 1994. Flow shop scheduling with resource flexibility. *Operations Research*, 42(3), 504–522.
- Daniels, R.L., Mazzola, J.B., Shi, D., 2004. Flow shop scheduling with partial resource flexibility. *Management Science*, 50(5), 658–669.
- Dar-El, E.M., Ayas, K., Gilad, I., 1995. Predicting performance times for long cycle time tasks. *IIE-Transactions*, 27(3), 272.
- Dauzère-Pérès, S., Roux, W., Lasserre, J.B., 1998. Multi-resource shop scheduling with resource flexibility. *European Journal of Operational Research*, 107(2), 289–305.
- Davies, E.M., 1973. An experimental investigation of resource allocation in multi activity projects. *Operational Research Quarterly*, 24, 587–591.
- Davis, E.W., 1975. Project network summary measures constrained- resource scheduling. *AIIE Transactions*, 7(2), 132–142.
- Davis, L., 1996. *Handbook of genetic algorithms*. International Thomson Computer Press.
- De Boer, R., 1998. *Resource-constrained multi-project management - A hierarchical decision support system*. Febodruk, Enschede.
- De Haan, J., Kwakkel, J.H., Walker, W.E., Spirco, J., Thissen, W.A.H., 2011. Framing flexibility: Theorising and data mining to develop a useful definition of flexibility and related concepts. *Futures*, 43(9), 923–933.
- De la Fuente, D., Lozano, J., 2008. Management of working shifts using the constraint programming paradigm, In: *IEEE International Conference on Industrial Engineering and Engineering Management, 2008. IEEM 2008*. pp. 1991–1995.
- De Reyck, B., Herroelen, W., 1996a. On the use of the complexity index as a measure of complexity in activity networks. *European Journal of Operational Research*, 91(2), 347–366.
- De Reyck, B., Herroelen, W., 1996b. Assembly line balancing by resource-constrained project scheduling techniques - A critical appraisal. *Poznan Polytechnic University: Poznan, Poland*, pp. 79 – 83.
- De Reyck, B., Herroelen, W., 1999. The multi-mode resource-constrained project scheduling problem with generalized precedence relations. *European Journal of Operational Research*, 119(2), 538–556.
- Dean, A.M., Voss, D., 1998. *Design and Analysis of Experiments*. Springer, Berlin.
- Deblaere, F., Demeulemeester, E., Herroelen, W., 2011. Reactive scheduling in the multi-mode RCPS. *Computers & Operations Research*, 38(1), 63–74.
- DeJong, J.R., 1957. The effects of increasing skill on cycle time and its consequences for time standards. *Ergonomics*, 1, 51–61.
- Dekking, F.M., Kraaikamp, C., Lopuhaa, H.P., Meester, L.E., 2005. *A Modern Introduction to Probability and Statistics*. Springer-Verlag London.

- Demasse, S., 2008. Mathematical programming formulations and lower bounds for the RCPSP. In: Christian Artigues, S.D., Néron, E. (Eds.), *Resource-Constrained Project Scheduling – Models, Algorithms, Extensions and Applications*. ISTE/Wiley, pp. 49–62.
- Demasse, S., Pesant, G., Rousseau, L.-M., 2005. Constraint programming based column generation for employee timetabling, in: Barták, R., Milano, M. (Eds.), *Integration of AI and OR Techniques in Constraint Programming for Combinatorial Optimization Problems*, Lecture Notes in Computer Science. Springer Berlin / Heidelberg, pp. 830–833.
- Démery-Lebrun, M., 2005. Regard sur la flexibilité des ressources humaines: une approche exploratoire systémique de la flexibilité, appliquée aux entreprises aérospatiales. Paris -15-16 septembre, France.
- Demeulemeester, E., De Reyck Bert, Herroelen, W., 2000. The discrete time/resource trade-off problem in project networks: a branch-and-bound approach. *IIE Transactions*, 32(11), 1059–1069.
- Demeulemeester, E., Deblaere, F., Herbots, J., Lambrechts, O., Vonder, S.V. de, 2007. A Multi-level Approach to project management under uncertainty. *Review of Business and Economics*, 52(3), 391–409.
- Demeulemeester, E., Herroelen, W., 1992. A Branch-and-Bound procedure for the multiple resource-constrained project scheduling problem. *Management Science*, 38(12), 1803–1818.
- Demeulemeester, E., Herroelen, W., Leus, R., 2008. Proactive-reactive Project Scheduling, In: Artigues, C., Demasse, S., Néron, E. (Eds.), *Resource-Constrained Project Scheduling*. ISTE, pp. 203–211.
- Demeulemeester, E., Vanhoucke, M., Herroelen, W., 2003. RanGen: A random network generator for activity-on-the-node networks (Open Access publications from Katholieke Universiteit Leuven). Katholieke Universiteit Leuven.
- Demeulemeester, E.L., Herroelen, W., 2002. *Project scheduling: a research handbook*. Springer.
- Demeulemeester, E.L., Herroelen, W.S., Elmaghraby, S.E., 1996. Optimal procedures for the discrete time/cost trade-off problem in project networks. *European Journal of Operational Research*, 88(1), 50–68.
- Dierkes, M., Antal, A.B., Child, J., Nonaka, I., 2003. *Handbook of organizational learning and knowledge*. Oxford University Press.
- Doerner, K.F., Gendreau, M., Greistorfer, P., Gutjahr, W., Hartl, R.F., Reimann, M. (Eds.), 2007. *Metaheuristics: Progress in Complex Systems Optimization*, 1st ed. Springer.
- Doerr, K.H., Arreola-Risa, A., 2000. A worker-based approach for modeling variability in task completion times. *IIE Transactions*, 32(7), 625–636.
- Dolgui, A., Proth, J.-M., 2010. *Supply chain engineering: Useful methods and techniques*, 1st ed. Springer London Ltd.
- Dorn, J., Kerr, R., Thalhammer, G., 1995. Reactive scheduling: improving the robustness of schedules and restricting the effects of shop floor disturbances by fuzzy reasoning. *International Journal of Human-Computer Studies*, 42, 687–704.
- Dougherty, J.R., Wallace, T.F., 1992. *APICS Dictionary*, 7th ed. Amer Production & Inventory.
- Drezet, L.-E., Billaut, J.-C., 2008. A project scheduling problem with labour constraints and time-dependent activities requirements. *International Journal of Production Economics*, 112(1), 217–225.
- Duquenne, P., EDI, H.K., Le-Lann, J.-M., 2005. Characterization and modelling of flexible resources allocation on industrial activities. Presented at :7th World Congress of Chemical Engineering, Glasgow, Scotland.
- Edi, H.K., 2007. *Affectation flexible des ressources dans la planification des activités industrielles: prise en compte de la modulation d'horaires et de la polyvalence*. PhD thesis, Paul Sabatier University, Toulouse, France.
- Eiben, A.E., Jelasity, M., 2002. A critical note on experimental research methodology in EC. In: *Proceedings of 2002 congress on evolutionary computation, CEC'2002*, 1, 582–587.
- Eiben, A.E., Michalewicz, Z., Schoenauer, M., Smith, J.E., 2007. Parameter control in evolutionary algorithms, In: Lobo, F.G., Lima, C.F., Michalewicz, Z. (Eds.), *Parameter Setting in Evolutionary Algorithms*. Springer Berlin Heidelberg, Berlin, Heidelberg, pp. 19–46.
- Eiben, A.E., Smit, S.K., 2011. Evolutionary algorithms parameters and methods to tune them, in: *Autonomous Search*. Springer London, Limited.
- Eitzen, G., 2002. *Integer programming methods for solving multi-skilled workforce optimization problems*. PhD thesis, School of Mathematics, University of South Australia.

- Eitzen, G., Panton, D., Mills, G., 2004. Multi-skilled workforce optimisation. *Annals of Operations Research*, 127(1), 359–372.
- Elmaghraby, S.E., 1990. Economic manufacturing quantities under conditions of learning and forgetting (EMQ/LaF). *Production Planning & Control*, 1(4), 196.
- Elmaghraby, S.E., Herroelen, W.S., 1980. On the measurement of complexity in activity networks. *European Journal of Operational Research*, 5(4), 223–234.
- Eppinger, S., Whitney, D., Smith, R., Gebala, D., 1991. Organizing the tasks in complex design projects, in: Sriram, D., Logcher, R., Fukuda, S. (Eds.), *Computer-Aided Cooperative Product Development*, Lecture Notes in Computer Science. Springer Berlin / Heidelberg, pp. 229–252.
- Erben, W., Keppler, J., 1996. A genetic algorithm solving a weekly course-timetabling problem, in: Burke, E., Ross, P. (Eds.), *Practice and theory of automated timetabling*, Lecture notes in computer science. Springer Berlin / Heidelberg, pp. 198–211.
- Ernst, A., Jiang, H., Krishnamoorthy, M., Sier, D., 2004. Staff scheduling and rostering: A review of applications, methods and models. *European Journal of Operational Research*, 153(1), 3–27.
- Eurofound, europa, 2007. Teamwork and high performance work organisation. European Foundation for the Improvement of Living and Working Conditions. [Online document] available at: < <http://www.eurofound.europa.eu/ewco/reports/TN0507TR01/TN0507TR01.pdf> > (Accessed October, 2011).
- Ferreira, S.L.C., Bruns, R.E., Ferreira, H.S., Matos, G.D., David, J.M., Brandão, G.C., Da Silva, E.G.P., Portugal, L.A., Dos Reis, P.S., Souza, A.S., Dos Santos, W.N.L., 2007. Box-Behnken design: An alternative for the optimization of analytical methods. *Analytica Chimica Acta*, 597(2), 179–186.
- Filho, E.V.G., Marçola, J.A., 2001. Annualized hours as a capacity planning tool in make-to-order or assemble-to-order environment: An agricultural implements company case. *Production Planning & Control*, 12 (4), 388–398.
- Fortemps, P., 2000. Introducing flexibility in scheduling: the preference approach. In: R. Slowinski, M. Hapke (Eds.). *Advances in Scheduling and Sequencing under Fuzziness*. Springer Verlag. ed.
- Franchini, L., Caillaud, E., Nguyen, P., Lacoste, G., 2001. Workload control of human resources to improve production management. *International Journal of Production Research*, 39(7), 1385–1403.
- Franklin, S.B., Gibson, D.J., Robertson, P.A., Pohlmann, J.T., Fralish, J.S., 1995. Parallel analysis: a method for determining significant principal components. *Journal of Vegetation Science*, 6(1), 99–106.
- Fraser, K., 2009. Labour flexibility: Impact of functional and localised strategies on team-based product manufacturing. *International journal of cocreation in design and the arts*, 5(3), 143–158.
- Gademann, N., Schutten, M., 2005. Linear-programming-based heuristics for project capacity planning. *IIE Transactions*, 37(2), 153–165.
- Gibbs, M.S., Maier, H.R., Dandy, G.C., Nixon, J.B., 2006. Minimum number of generations required for convergence of genetic algorithms, In: *IEEE Congress on Evolutionary Computation, CEC 2006*. CEC 2006, 565–572.
- Globerson, S., Levin, N., Shtub, A., 1989. The impact of breaks on forgetting when performing a repetitive task. *IIE – Transactions*, 21(4), 376.
- Globerson, S., Nahumi, A., Ellis, S., 1998. Rate of forgetting for motor and cognitive tasks. *International Journal of Cognitive Ergonomics*, 2(3), 181–191.
- Glover, F., Kochenberger, G.A., 2003. *Handbook of metaheuristics*. Springer.
- Goldberg, D.E., 1989. *Genetic algorithms in search, optimization and machine learning*, 1st ed. Addison-Wesley Longman Publishing Co., Inc.
- Golden, W., Powell, P., 2000. Towards a definition of flexibility: in search of the Holy Grail? *Omega*, 28(4), 373–384.
- Golenko-Ginzburg, D., Gonik, A., 1998. A heuristic for network project scheduling with random activity durations depending on the resource allocation. *International J. of production economics*, 55(2), 149–162.
- Goren, S., Sabuncuoglu, I., 2008. Robustness and stability measures for scheduling: single-machine environment. *IIE Transactions*, 40(1), 66–83.

- Goudswaard, A., De Nanteuil, M., 2000. Flexibility and working conditions: a qualitative and comparative study in seven EU Member States. (Article No. TJ-31-00-247-EN-C), European Foundation for the Improvement of Living and Working Conditions. Luxembourg.
- Grabot, B., Letouzey, A., 2000. Short-term manpower management in manufacturing systems: new requirements and DSS prototyping. *Computers in Industry*, 43(1), 11–29.
- Graham, R.L., Lawler, E.L., Lenstra, J.K., Kan, A.H.G.R., 1979. Optimization and approximation in deterministic sequencing and scheduling: a survey. *Annals of Discrete Mathematics*, ((2), 287–326.
- Groote, X. de, 1994. The flexibility of production processes: a general framework. *Management Science*, 40(7), 933–945.
- Guéret, C., Jussien, N., 2008. Reactive approaches, in: Artigues, C., Demasse, S., Néron, E. (Eds.), *Resource-Constrained Project Scheduling*. ISTE, pp. 191–201.
- Gulati, S., Malcolm, S.A., 2001. Call center scheduling technology evaluation using simulation. In: *Simulation Conference, 2001. Proceedings of the Winter*, 2, 1438–1442.
- Gutjahr, W.J., Katzensteiner, S., Reiter, P., Stummer, C., Denk, M., 2008. Competence-driven project portfolio selection, scheduling and staff assignment. *Central European J. of Operations Research*, 16(3), 281–306.
- Haberle, K.R., Burke, R.J., Graves, R.J., 2000. A note on measuring parallelism in concurrent engineering. *International Journal of Production Research*, 38(8), 1947–1952.
- Hanakawa, N., Morisaki, S., Matsumoto, K., 1998. A learning curve based simulation model for software development. In: *Proceedings of the 1998 International Conference on Software Engineering*, pp.350–359.
- Hanne, T., Nickel, S., 2005. A multi objective evolutionary algorithm for scheduling and inspection planning in software development projects. *European Journal of Operational Research*, 167(3), 663–678.
- Hans, E.W., 2001. *Resource Loading by Branch-and-Price Techniques*. Twente University Press.
- Hans, E.W., Herroelen, W., Leus, R., Wullink, G., 2007. A hierarchical approach to multi-project planning under uncertainty. *Omega*, 35(5), 563–577.
- Hansen, P., Mladenović, N., 2003. Variable neighborhood search. In: *Handbook of Metaheuristics*, International Series in Operations Research & Management Science. Springer.
- Hartley, K., 1969. Estimating military aircraft production outlays: the British experience. *The Economic Journal*, 79, 861–881.
- Hazır, Ö., Haouari, M., Erel, E., 2010. Robust scheduling and robustness measures for the discrete time/cost trade-off problem. *European Journal of Operational Research*, 207(2), 633–643.
- Heagney, J., 2011. *Fundamentals of project management*, Fourth Edition. Ed. AMACOM.
- Heimerl, C., Kolisch, R., 2009a. Scheduling and staffing multiple projects with a multi-skilled workforce. *OR Spectrum*, 32(2), 343–368.
- Heimerl, C., Kolisch, R., 2009b. Work assignment to and qualification of multi-skilled human resources under knowledge depreciation and company skill level targets. *International Journal of Production Research*, 48(13), 3759–3781.
- Hendriks, M., Voeten, B., Kroep, L., 1999. Human resource allocation in a multi-project R&D environment: resource capacity allocation and project portfolio planning in practice. *International Journal of Project Management*, 17 (3), 181–188.
- Herroelen, W., De Reyck, B., Demeulemeester, E., 1998. Resource-constrained project scheduling: A survey of recent developments. *Computers & Operations Research*, 25, 279–302.
- Herroelen, W., Demeulemeester, E., De Reyck, B., 1997. A classification scheme for project scheduling problems. (DTEW Research Report No. 09727), K.U.Leuven - Departement toegepaste economische wetenschappen. German
- Herroelen, W., Leus, R., 2004. Robust and reactive project scheduling: a review and classification of procedures. *International Journal of Production Research*, 42(8), 1599–1620.
- Herroelen, W., Leus, R., 2005. Project scheduling under uncertainty: Survey and research potentials. *European Journal of Operational Research*, 165(2), 289–306.
- Hertz, A., Lahrichi, N., Widmer, M., 2010. A flexible MILP model for multiple-shift workforce planning under annualized hours. *European Journal of Operational Research*, 200(3), 860–873.

- Hewitt, D., Sprague, K., Yearout, R., Lisnerski, D., Sparks, C., 1992. The effects of unequal relearning rates on estimating forgetting parameters associated with performance curves. *International Journal of Industrial Ergonomics*, 10(3), 217–224.
- Hitt, M.A., Keats, B.W., DeMarie, S.M., 1998. Navigating in the new competitive landscape: building strategic flexibility and competitive advantage in the 21st century. *The Academy of Management Executive*, 12(4), 22–42.
- Hlaoittinun, O., 2009. Contribution à la constitution d'équipes de conception couplant la structuration du projet et le pilotage des compétences. PhD thesis, Université de Franche comté, Besançon, France.
- Hlaoittinun, O., Bonjour, E., Dulmet, M., 2010. Managing the competencies of team members in design projects through multi-period task assignment. *Collaborative Networks for a Sustainable World*, 338–345.
- Hobday, M., 2000. The project-based organisation: an ideal form for managing complex products and systems? *Research Policy*, 29(7), 871–893.
- Hoeck, M., 2008. Decision rules for the project selection and scheduling problem of professional service firms. *International Journal of Services and Operations Management*, 4(4), 427–440.
- homefinance, n.d. Euro LIBOR interest rates [Online document]. HomeFinance.nl. URL <<http://www.homefinance.nl/english/international-interest-rates/libor/libor-interest-rates-eur.asp>> (accessed 5 Mars 2012).
- Horn, J.L., 1965. A rationale and test for the number of factors in factor analysis. *Psychometrika*, 30, 179–185.
- Howick, S., Eden, C., 2007. Learning in disrupted projects: on the nature of corporate and personal learning. *International Journal of Production Research*, 45(12), 2775–2797.
- Hoyt, J., Matuszek, T., 2001. Testing the contribution of multi-skilled employees to the financial performance of high-tech organizations. *The Journal of High Technology Management Research*, 12(2), 167–181.
- Hu, Y., Li, J., Holloway, L.E., 2008. Towards modeling of resilience dynamics in manufacturing enterprises: Literature review and problem formulation. In: IEEE International Conference on Automation Science and Engineering, 2008. CASE 2008. CASE 2008, 279–284.
- Huang, E., Chen, S.-J. (Gary), 2006. Estimation of project completion time and factors analysis for concurrent engineering project management: A simulation approach. *Concurrent Engineering*, 14(4), 329–341.
- Huang, Y., Chu, F., Chu, C., Wang, Y., 2012. Determining the number of new employees with learning, forgetting and variable wage with a Newsvendor model in pull systems. *Journal of Intelligent Manufacturing*, 23(1), 73–89.
- Hung, R., 1999. Scheduling a workforce under annualized hours. *International Journal of Production Research*. 37(11), 2419–2427.
- Hung-Chun Huang, Hsin-Yu Shih, Sheng-Cheng Hsu, 2010. Team structure to accelerate knowledge diffusion: A case study in computer software developer. In: IEEE International Conference on Management of Innovation and Technology, (ICMIT), 928–933.
- Ireland, L., 2007. PrezSez: Project complexity: A brief exposure to difficult situations, by Iew Ireland [Online Document]. asapm “the American Society for the Advancement of Project Management”. URL <<http://www.asapm.org/asapmag/resources/2007-Oct.htm>> (Accessed 11 December 2012)
- Jaber, M.Y., 2006. Learning and forgetting models and their applications. In: Handbook of Industrial and Systems Engineering. CRC Press (Taylor & Francis Group), pp. 30_1–30_27.
- Jaber, M.Y., Bonney, M.C. address, 1996. Production breaks and the learning curve: the forgetting phenomenon. *Applied Mathematical Modelling*, 20(2), 162–169.
- Jaber, M.Y., Bonney, M., 1997. A comparative study of learning curves with forgetting. *Applied Mathematical Modelling*, 21(8), 523–531.
- Jaber, M.Y., Bonney, M., Moualek, I., 2009. Lot sizing with learning, forgetting and entropy cost. *International Journal of Production Economics*, 118(1), 19–25.
- Jaber, M.Y., Kher, H.V., Davis, D.J., 2003. Countering forgetting through training and deployment. *International Journal of Production Economics*; 85(1), 33–46.
- Jaber, M.Y., Sikström, S., 2004. A numerical comparison of three potential learning and forgetting models. *International Journal of Production Economics*, 92(3), 281–294.

- Jacquet-Lagrèze, E., Lebbar, M., 1999. A column generation model for a scheduling problem with maintenance constraints. *Electronic Notes in Discrete Mathematics*, 1, 1–12.
- Jolliffe, I.T., 2002. *Principal Component Analysis*. Springer.
- Józefowska, J., Mika, M., Różycki, R., Waligóra, G., Węglarz, J., 2001. Simulated annealing for multi-mode resource-constrained project scheduling. *Annals of Operations Research*, 102(1), 137–155.
- Kaimann, R.A., 1974. Coefficient of network complexity. *Management Science*, 21(2), 172–177.
- Kazemi, F., Tavakkoli-Moghaddam, R., 2011. Solving a multi-objective multi-mode resource-constrained project scheduling problem with particle swarm optimization. *Int. J. of Academic Research*, 3, 103–110.
- Kazemipoor, H., Tavakkoli-Moghaddam, R., Shahnazari-Shahrezaei, P., Azaron, A., 2013. A differential evolution algorithm to solve multi-skilled project portfolio scheduling problems. *The International Journal of Advanced Manufacturing Technology*, 64, 1099–1111.
- Ke, H., Liu, B., 2005. Project scheduling problem with stochastic activity duration times. *Applied mathematics and computation*, 168(1), 342–353.
- Kher, H.V., 2000. Examination of flexibility acquisition policies in dual resource constrained job shops with simultaneous worker learning and forgetting effects. *The Journal of the Operational Research Society*, 51, 592–601.
- Kher, H.V., Malhotra, M.K., Philipoom, P.R., Fry, T.D., 1999. Modeling simultaneous worker learning and forgetting in dual resource constrained systems. *European J. of Operational Research*, 115(1), 158–172.
- Khoshnevis, B., Wolfe, P.M., 1986. A short-cycle product aggregate planning model incorporating improvement curve productivity. *Engineering Costs and Production Economics*, 10(1), 217–233.
- Kilic, S., 2007. Scheduling a Fuzzy Flowshop Problem with flexible due dates using ant colony optimization. In: Giacobini, M. (Ed.), *Applications of Evolutionary Computing*, Lecture Notes in Computer Science. Springer Berlin / Heidelberg, pp.742–751.
- Kim, I., Seo, H.L., 2009. Depreciation and transfer of knowledge: an empirical exploration of a shipbuilding process. *International Journal of Production Research*, 47(7), 1857–1876.
- Kis, T., 2005. A branch-and-cut algorithm for scheduling of projects with variable-intensity activities. *Mathematical Programming*, 103(3), 515–539.
- Knecht, G.R., 1974. Costing, technological growth and generalized learning curves. *Operational Research Quarterly*, 25, 487–491.
- Kocsis, T., 2011. Study on application possibilities of case-based reasoning on the domain of scheduling problems. PhD thesis, Toulouse University, France.
- Kolisch, R., Hartmann, S., 1998. Heuristic algorithms for solving the resource-constrained project scheduling problem: classification and computational analysis. In: Węglarz, J. (Ed.), *Project Scheduling: Recent Models, Algorithms and Applications*. Springer, pp. 147–178.
- Kolisch, R., Heimerl, C., 2012. An efficient metaheuristic for integrated scheduling and staffing IT projects based on a generalized minimum cost flow network. *Naval Research Logistics (NRL)* 59, 111–127.
- Kolisch, R., Padman, R., 2001. An integrated survey of deterministic project scheduling. *Omega*, 29, 249–272.
- Kolisch, R., Sprecher, A., 1997. PSPLIB - A project scheduling problem library: OR Software - ORSEP Operations Research Software Exchange Program. *European J. of Operational Research*, 96(1), 205–216.
- Kolisch, R., Sprecher, A., Drexl, A., 1995. Characterization and generation of a general class of resource-constrained project scheduling problems. *Management Science*, 41(10), 1693–1703.
- Koornhof, C., 2001. Developing a framework for flexibility within organisations. *South Africa Journal of Business Management*, 32(4), 21–30.
- Koste, L.L., Malhotra, M.K., 1999. A theoretical framework for analyzing the dimensions of manufacturing flexibility. *Journal of Operations Management*, 18(1), 75–93.
- Kovács, A., Egri, P., Kis, T., Váncza, J., 2005. Proterv-II: An integrated production planning and scheduling system. In: van Beek, P. (Ed.), *Principles and practice of constraint programming - CP 2005*, Lecture Notes in Computer Science. Springer Berlin / Heidelberg, pp. 880–880.

- Kumar, A., Suresh, N., 2007. Production and operations management (with skill development, caselets and cases), 2nd ed. New Age International (P) Ltd. Available at: universitas pendidikan indonesia Library website <<http://tn.upi.edu/?x=Ebooks>>, [e-book] New Delhi.
- Kurtulus, I., Davis, E.W., 1982. Multi-Project Scheduling: Categorization of Heuristic Rules Performance. *Management Science*, 28(2), 161–172.
- Kurtulus, I.S., Narula, S.C., 1985. Multi-project scheduling: Analysis of project performance. *IIE Transactions*, 17, 58–66.
- Laborie, P., Nuijten, W., 2010. Constraint programming formulations and propagation algorithms. In: Artigues, C., Demasse, S., Néron, E. (Eds.), Resource-Constrained Project Scheduling. ISTE, pp. 63–72.
- Lambrechts, O., Demeulemeester, E., Herroelen, W., 2008. Proactive and reactive strategies for resource-constrained project scheduling with uncertain resource availabilities. *Journal of Scheduling*, 11(2), 121–136.
- Latva-Koivisto, A.M., 2001. Finding a complexity measure for business process models. Research Rep.prepared for Helsinki University of Technology, Systems Analysis Laboratory, Espoo, Finland.
- Leu, S.-S., Yang, C.-H., Huang, J.-C., 2000. Resource leveling in construction by genetic algorithm-based optimization and its decision support system application. *Automation in Construction*, 10(1), 27–41.
- Leung, J.Y.-T., Anderson, J.H., 2004. Handbook of scheduling: algorithms, models, and performance analysis, 1st ed. Chapman and Hall/CRC.
- Levy, F.K., 1965. Adaptation in the production process. *Management Science*, 11(6), B136–B154.
- Lewis, J.P., 2000. Project planning, scheduling & control, 3rd Edition, McGraw-Hill.
- Li, H., Womer, K., 2009. Scheduling projects with multi-skilled personnel by a hybrid MILP/CP benders decomposition algorithm. *Journal of Scheduling* 12(3), 281–298.
- Liao, W.M., 1979. Effects of learning on resource allocation decisions. *Decision Sciences*, 10(1), 116–125.
- Liberatore, M.J., 2008. Critical path analysis with fuzzy activity times. *IEEE Transactions on Engineering Management*, 55(2), 329–337.
- Lova, A., Tormos, P., Sanchís, F.B., 2006. Multi-mode resource constrained project scheduling: scheduling schemes, priority rules and mode selection rules. *Inteligencia artificial: Revista Iberoamericana de Inteligencia Artificial*, 10(30), 69–86.
- Luo, S., Wang, C., Wang, J., 2003. Ant colony optimization for resource-constrained project scheduling with generalized precedence relations. In: 15th IEEE International Conference on Tools with Artificial Intelligence. pp. 284 – 289.
- Majoz, T., Zhu (Frank), X.X., 2005. A combined fuzzy set theory and MILP approach in integration of planning and scheduling of batch plants—Personnel evaluation and allocation. *Computers & Chemical Engineering*, 29, 2029–2047.
- Malcolm, D.G., Roseboom, J.H., Clark, C.E., Fazar, W., 1959. Application of a technique for research and development program evaluation. *Operations Research*, 7(5), 646–669.
- Marques de Sa Joaquim P., 2007. Applied statistics using SPSS, STATISTICA, MATLAB and R. Springer Berlin / Heidelberg.
- Masmoudi, M., 2011. Tactical and operational project planning under uncertainties: application to helicopter maintenance. PhD thesis, Toulouse University, France.
- Masmoudi, M., Häit, A., 2012. Fuzzy uncertainty modelling for project planning: application to helicopter maintenance. *International Journal of Production Research*, 50(13), 3594–3611.
- Mastor, A.A., 1970. An experimental investigation and comparative evaluation of production line balancing techniques. *Management Science*, 16(11), 728–746.
- Mazur, J.E., Hastie, R., 1978. Learning as accumulation: A reexamination of the learning curve. *Psychological Bulletin*, 85, 1256–1274.
- Mccreery, J.K., Krajewski, L.J., 1999. Improving performance using workforce flexibility in an assembly environment with learning and forgetting effects. *Int. J. of Production Research*, 37(9), 2031–2058.
- McKay, K.N., Wiers, V.C.S., 2006. The human factor in planning and scheduling. In: Herrmann, J.W., Hillier, F.S., Price, C.C. (Eds.), Handbook of production scheduling, international series in operations research & management science. Springer USA, pp. 23–57.

- Meisels, A., Schaerf, A., 2003. Modelling and solving employee timetabling problems. *Annals of Mathematics and Artificial Intelligence*, 39(1), 41–59.
- Mendes, J.J.M., Gonçalves, J.F., Resende, M.G.C., 2009. A random key based genetic algorithm for the resource constrained project scheduling problem. *Computers & Operations Research*, 36(1), 92–109.
- Merkle, D., Middendorf, M., Schneck, H., 2002. Ant colony optimization for resource-constrained project scheduling. *IEEE Transactions on Evolutionary Computation*, 6(4), 333 – 346.
- Mika, M., Waligóra, G., Węglarz, J., 2005. Simulated annealing and tabu search for multi-mode resource-constrained project scheduling with positive discounted cash flows and different payment models. *European Journal of Operational Research*, 164(3), 639–668.
- Mingozi, A., Maniezzo, V., Ricciardelli, S., Bianco, L., 1998. An exact algorithm for the resource-constrained project scheduling problem based on a new mathematical formulation. *Management Science*, 44, 714–729.
- Mitchell, C., 1995. Flexibility: nature, sources, and effects. *The ANNALS of the American Academy of Political and Social Science*, 542, 213–218.
- Mitchell, J.E., 2002. Branch-and-Cut algorithms for combinatorial optimization problems. In: Panos M. Pardalos and Mauricio G. C. Resende, Handbook of Applied Optimization, pp.65–77.
- Mo, J., Yin, Y., Gao, M., 2008. Discussion of “Developing a complexity measure for project schedules” by Khaled M. Nassar and Mohamed Y. Hegab. *Journal of Construction Engineering and Management* 134, 228–230.
- Modrak, V., Semanco, P., 2011. A comparative study of complexity metrics for supply chains. In: 3rd IEEE International Symposium on Logistics and Industrial Informatics (LINDI), , pp. 235–239.
- Moghaddam, B., Pentland, A., 1998. Probabilistic matching for face recognition. IN: IEEE Southwest Symposium on Image Analysis and Interpretation, pp. 186–191.
- Mori, M., Tseng, C.C., 1997. A genetic algorithm for multi-mode resource constrained project scheduling problem. *European Journal of Operational Research*, 100(1), 134–141.
- Munawar, A., Wahib, M., Munetomo, M., Akama, K., 2011. Solving extremely difficult MINLP problems using adaptive resolution micro-GA with Tabu Search. In: Learning and Intelligent Optimization, Lecture Notes in Computer Science. pp. 203–217.
- NASA, 2007. Cost Estimating Web Site: Learning Curve Calculator [www Document]. Available at: <<http://cost.jsc.nasa.gov/learn.html>>, (Accessed 18 April 2010).
- Nassar, K.M., Hegab, M.Y., 2006. Developing a complexity measure for project schedules. *Journal of Construction Engineering and Management*, 132, 554–561.
- Nassar, K.M., Hegab, M.Y., 2008. Closure of “Developing a complexity measure for project schedules” by Khaled M. Nassar and Mohamed Y. Hegab. *Journal of Construction Engineering and Management*, 134, 230–232.
- Nelson, R.T., 1970. A Simulation of labor efficiency and centralized assignment in a production model. *Management Science*, 17(2), B97–B106.
- Nembhard, D.A., 2001. Heuristic approach for assigning workers to tasks based on individual learning rates. *International Journal of Production Research*, 39(9), 1955–1968.
- Nembhard, D.A., Uzumeri, M.V., 2000a. An individual-based description of learning within an organization. *IEEE Transactions on Engineering Management*, 47(3), 370–378.
- Nembhard, D.A., Uzumeri, M.V., 2000b. Experiential learning and forgetting for manual and cognitive tasks. *International Journal of Industrial Ergonomics*, 25(4), 315–326.
- Néron, E., 2008. Branching schemes for branch-and-bound. In: Artigues, C., Demasse, S., Néron, E. (Eds.), Resource-Constrained Project Scheduling. ISTE, pp. 73–85.
- Neumann, K., Schwindt, C., Zimmermann, J., 2006. Resource-constrained project scheduling with time Windows. in: Józefowska, J., Węglarz, J., Hillier, F.S., Price, C.C. (Eds.), Perspectives in modern project scheduling, International Series in Operations Research & Management Science. Springer US, pp. 375–407.
- Neumann, K., Zhan, J., 1995. Heuristics for the minimum project-duration problem with minimal and maximal time lags under fixed resource constraints. *Journal of Intelligent Manufacturing*, 6(2), 145–154.
- Nikolova, N., Jaworska, J., 2003. Approaches to measure chemical similarity – a review. *QSAR & Combinatorial Science*, 22, 1006–1026.

- Nist/Sematech, 2003. e-handbook of Statistical Methods [Online Document]. Available at: <<http://www.itl.nist.gov/div898/handbook/index.htm>> (Accessed 10 September 2012).
- Noack, D., Rose, O., 2008. A simulation based optimization algorithm for slack reduction and workforce scheduling. In: Proceedings of the 40th Conference on Winter Simulation, WSC '08. Winter Simulation Conference, pp. 1989–1994.
- Noronha, S.J., Sarma, V.V.S., 1991. Knowledge-based approaches for scheduling problems: a survey. In: IEEE Transactions on Knowledge and Data Engineering, 3, 160–171.
- Novas, J.M., Henning, G.P., 2010. Reactive scheduling framework based on domain knowledge and constraint programming. *Computers & Chemical Engineering*, 34(12), 2129–2148.
- Oliveira, F., Hamacher, S., Almeida, M.R., 2011. Process industry scheduling optimization using genetic algorithm and mathematical programming. *Journal of Intelligent Manufacturing*, 22(5), 801–813.
- Osothsilp, N., 2002. Worker-task assignment based in individual learning, forgetting, and task complexity. PhD thesis, University of Wisconsin-Madison, USA.
- Otto, A., Otto, C., Scholl, A., 2011. SALBPGen - A systematic data generator for (simple) assembly line balancing (Jena Research Papers in Business and Economics - Working and Discussion Papers No. 05/2011). Friedrich-Schiller-University Jena, School of Economics and Business Administration.
- Pallant, J., 2010. SPSS Survival Manual: A step by step guide to data analysis using SPSS. McGraw-Hill International.
- Pascoe, T.L., 1966. Allocation of resources C.P.M. *Revue Francaise de Recherche Operationelle*, 38, 31–38.
- Patterson, J.H., 1976. Project scheduling: The effects of problem structure on heuristic performance. *Naval Research Logistics Quarterly*, 23, 95–123.
- Patterson, J.H., 1984. A Comparison of exact approaches for solving the multiple constrained resource, project scheduling problem. *Management Science*, 30(7), 854–867.
- Pegels, C.C., 1969. On Startup or learning curves: An expanded view. *AIIE Transactions*, 1, 216–222.
- Pinedo, M.L., 2008. Scheduling: theory, algorithms, and systems, 3rd Ed. Springer.
- Policella, N., Oddi, A., Smith, S., Cesta, A., 2004. Generating robust partial order schedules. In: Wallace, M. (Ed.), Principles and practice of constraint programming – CP 2004, Lecture Notes in Computer Science. Springer Berlin / Heidelberg, pp.496–511.
- PSPLib, 1996. PSPLIB: library for project scheduling problems [www Document]. Available at: <<http://129.187.106.231/psplib/>> (accessed 16 Mai 2011).
- Raheja, A.S., Subramaniam, V., 2002. Reactive recovery of job shop schedules – A review. *The International Journal of Advanced Manufacturing Technology*, 19, 756–763.
- Rubinovitch, M., 1972. A probabilistic model for optimal project scheduling. *Operations Research*, 20, 309–317.
- Russell, S., Norvig, P., 2002. Artificial Intelligence: A Modern Approach, 2nd Ed. Prentice Hall.
- Sanchez, R., 1995. Strategic flexibility in product competition. *Strategic Management Journal*, 16, 135–159.
- Sayin, S., Karabati, S., 2007. Assigning cross-trained workers to departments: A two-stage optimization model to maximize utility and skill improvement. *European Journal of Operational Research*, 176(3), 1643–1658.
- Scholl, A., 1999. Balancing and sequencing of assembly lines. Physica-Verlag.
- Schwindt, C., 1995. ProGen/max: A new problem generator for different resource-constrained project scheduling problems with minimal and maximal time lags (Technical report WIOR-449, Institut für Wirtschaftstheorie Und Operations Research, UNIVERSITÄT KARLSRUHE).
- Sethi, A.K., Sethi, S.P., 1990. Flexibility in manufacturing: A survey. *Int. J. Flex. Manuf. Syst.*, 2, 289–328.
- Sevaux, M., Sörensen, K., Le Quééré, Y., 2010. Metaheuristics for robust planning and scheduling. In: Billaut, J.-C., Moukrim, A., Sanlaville, E. (Eds.), Flexibility and robustness in scheduling. ISTE, pp.123–141.
- Shafiei-Monfared, S., Jenab, K., 2010. Complexity analysis of an operation in demand-based manufacturing. *International Journal of Production Research*, 49(17), 5303–5315.
- Shahnazari-Shahrezaei, P., Tavakkoli-Moghaddam, R., Kazemipoor, H., 2012. Solving a new fuzzy multi-objective model for a multi-skilled manpower scheduling problem by particle swarm optimization and elite tabu search. *The International Journal of Advanced Manufacturing Technology*. 1–24

- Shewchuk, J.P., Moodie, C.L., 1998. Definition and classification of manufacturing flexibility types and measures. *International Journal of Flexible Manufacturing Systems*, 10(4), 325–349.
- Shue, L.-Y., Zamani, R., 1999. An intelligent search method for project scheduling problems. *Journal of Intelligent Manufacturing*, 10(3), 279–288.
- Sikström, S., Jaber, M.Y., 2002. The power integration diffusion model for production breaks. *Journal of Experimental Psychology: Applied*, 8(2), 118–126.
- Slomp, J., Bokhorst, J.A.C., Molleman, E., 2005. Cross-training in a cellular manufacturing environment. *Computers & Industrial Engineering*, 48(3), 609–624.
- Sobel, M.J., Szmerekovsky, J.G., Tilson, V., 2009. Scheduling projects with stochastic activity duration to maximize expected net present value. *European Journal of Operational Research*, 198(3), 697–705.
- Sprecher, A., Hartmann, S., Drexl, A., 1997. An exact algorithm for project scheduling with multiple modes. *OR Spectrum*, 19, 195–203.
- Stadtler, H., 2005. Supply Chain Management — An Overview. In: Stadtler, H., Kilger, C. (Eds.), *Supply Chain Management and Advanced Planning*. Springer-Verlag, Berlin/Heidelberg, pp.9–35.
- Stanimirovic, I., Petkovic, M., Stanimirovic, P., Ciric, M., 2009. Heuristic algorithm for single resource constrained project scheduling problem based on the dynamic programming. *The Yugoslav Journal of Operations Research*, 19(2). 281–298
- Taguchi, G., 1995. Quality engineering (Taguchi methods) for the development of electronic circuit technology. *IEEE Transactions on Reliability*, 44(2), 225 –229.
- Talbot, F.B., 1982. Resource-constrained project scheduling with time-resource tradeoffs: The nonpreemptive case. *Management Science*, 28(10), 1197–1210.
- Tan, P.-N., Steinbach, M., Kumar, V., 2006. *Introduction to data mining*. Addison-Wesley, USA.
- Tareghian, H.R., Taheri, S.H., 2006. On the discrete time, cost and quality trade-off problem. *Applied Mathematics and Computation*, 181(2), 1305–1312.
- Temperley, H.N.V., 1981. *Graph theory and applications*. Ellis Horwood Limited.
- Thesen, A., 1977. Measures of the restrictiveness of project networks. *Networks*, 7(3), 193–208.
- Thomas, P.R., Salhi, S., 1998. A Tabu Search Approach for the resource constrained project scheduling problem. *Journal of Heuristics*, 4(2), 123–139.
- Thompson, G.M., Goodale, J.C., 2006. Variable employee productivity in workforce scheduling. *European Journal of Operational Research*, 170(2), 376–390.
- Tonchia, S., 2008. *Industrial project management: planning, design, and construction*, 1st Ed. Springer.
- Treville, S. de, Bendahan, S., Vanderhaeghe, A., 2007. Manufacturing flexibility and performance: bridging the gap between theory and practice. *Int. J. Flexible Manufacturing Systems*, 19(4), 334–357.
- Turkcan, A., Akturk, M.S., Storer, R.H., 2009. Predictive/reactive scheduling with controllable processing times and earliness-tardiness penalties. *IIE Transactions*, 41(12), 1080–1095.
- Valadares Tavares, L., Antunes Ferreira, J., Silva Coelho, J., 1999. The risk of delay of a project in terms of the morphology of its network. *European Journal of Operational Research*, 119(2), 510–537.
- Valadares Tavares, L., Antunes Ferreira, J., Silva Coelho, J., 2002. A comparative morphologic analysis of benchmark sets of project networks. *International Journal of Project Management*, 20(6), 475–485.
- Valls, V., Perez, A., Quintanilla, S., 2009. Skilled workforce scheduling in service centres. *European Journal of Operational Research*, 193(3), 791–804.
- Valverde, M., Tregaskis, O., Brewster, C., 2000. Labor flexibility and firm performance. *International Advances in Economic Research*, 6(4), 649–661.
- Van de Vonder, S., Ballestín, F., Demeulemeester, E., Herroelen, W., 2007a. Heuristic procedures for reactive project scheduling. *Computers & Industrial Engineering*, 52(1), 11–28.
- Van de Vonder, S., Demeulemeester, E., Herroelen, W., 2007b. A classification of predictive-reactive project scheduling procedures. *Journal of Scheduling*, 10(3), 195–207.
- Van de Vonder, S., Demeulemeester, E., Herroelen, W., 2008. Proactive heuristic procedures for robust project scheduling: An experimental analysis. *European Journal of Operational Research*, 189(3), 723–733.

- Van Peteghem, V., Vanhoucke, M., 2008. A genetic algorithm for the multi-mode resource-constrained project scheduling problem (Working Papers of Faculty of Economics and Business Administration, Ghent University, Belgium). Ghent University, Faculty of Economics and Business Administration.
- Vanhoucke, M., 2005. New computational results for the discrete time/cost trade-off problem with time-switch constraints. *European Journal of Operational Research*, 165(2), 359–374.
- Vidal, E., Duquenne, A., Pingaud, H., 1999. Optimisation des plans de charge pour un flow-shop dans le cadre d'une production en Juste A Temps: 2- Formulation mathématique. In : 3ème Congrès Franco-Quebequois de Génie Industriel, Montréal, Québec, Canada, pp.1175–1184.
- Vonder, S., Demeulemeester, E., Leus, R., Herroelen, W., 2006. Proactive-reactive project scheduling trade-offs and procedures. In: Józefowska, J., Weglarz, J., Hillier, F.S., Price, C.C. (Eds.), *Perspectives in Modern Project Scheduling*. Springer US, pp. 25–51.
- Wang, J., 2005. Constraint-based schedule repair for product development projects with time-limited constraints. *International Journal of Production Economics*, 95(3), 399–414.
- Ward, S., Chapman, C., 2003. Transforming project risk management into project uncertainty management. *International Journal of Project Management*, 21(2), 97–105.
- Warren, Jr., H.S., 1975. A modification of Warshall's algorithm for the transitive closure of binary relations. *Communication of the ACM*, 18(4), 218–220.
- Warshall, T., 1962. A Theorem on Boolean Matrices. *Journal of the ACM*, 9(1), 11–12.
- Watkins, M.W., 2000. Monte Carlo PCA for parallel analysis [computer software]. State College, PA: Ed & Psych Associates.
- Węglarz, J., Józefowska, J., Mika, M., Waligóra, G., 2011. Project scheduling with finite or infinite number of activity processing modes – A survey. *European Journal of Operational Research*, 208(3), 177–205.
- Wickelgren, W.A., 1981. Human learning and memory. *Annual review of psychology*, 32(1), 21–52.
- Widmer, M., Hertz, A., Costa, D., 2010. Metaheuristics and Scheduling. In: Lopez, P., Roubellat, F. (Eds.), *Production Scheduling*. ISTE, pp. 33–68.
- Wiley, V.D., Deckro, R.F., Jackson Jr., J.A., 1998. Optimization analysis for design and planning of multi-project programs. *European Journal of Operational Research*, 107(2), 492–506.
- Wolpert, D.H., Macready, W.G., 1997. No free lunch theorems for optimization. *IEEE Transactions on Evolutionary Computation*, 1(1), 67–82.
- Wright, P.M., Snell, S.A., 1998. Toward a unifying framework for exploring fit and flexibility in strategic human resource management. *The Academy of Management Review*, 23, 756–772.
- Wright, T., 1936. Factors affecting the cost of airplanes. *Journal of Aeronautical Sciences*, 3, 122–128.
- Wu, M.-C., Sun, S.-H., 2005. A project scheduling and staff assignment model considering learning effect. *The International Journal of Advanced Manufacturing Technology*, 28(11), 1190–1195.
- Xu, N., McKee, S.A., Nozick, L.K., Ufomata, R., 2008. Augmenting priority rule heuristics with justification and rollout to solve the resource-constrained project scheduling problem. *Computers & Operations Research*, 35(10), 3284–3297.
- Yakhchali, S.H., 2011. A Simple approach to project scheduling in networks with stochastic durations. In: *Proceedings of the World Congress on Engineering*. WCE 2011, July 6 - 8, 2011, London, U.K.
- Yang, I.-T., Chang, C.-Y., 2005. Stochastic resource-constrained scheduling for repetitive construction projects with uncertain supply of resources and funding. *International Journal of Project Management*, 23, 546–553.
- Yang, K.-K., Webster, S., Ruben, R.A., 2007. An evaluation of worker cross training and flexible workdays in job shops. *IIE – Transactions*, 39(7), 735.
- Yang, S., 2007. Genetic Algorithms with elitism-based immigrants for changing optimization problems. In: Giacobini, M. (Ed.), *Applications of evolutionary computing*. Springer Berlin Heidelberg, Berlin, Heidelberg, pp.627–636.
- Yang, T.-H., Yan, S., Chen, H.-H., 2003. An airline maintenance manpower planning model with flexible strategies. *Journal of Air Transport Management*, 9(4), 233–239.
- Yannakakis, M., 1990. Graph-theoretic methods in database theory. In: *Proceedings of the ninth ACM SIGACT-SIGMOD-SIGART symposium on Principles of database systems*, New York, USA, pp. 230–242.

- Yannibelli, V., Amandi, A., 2011. A knowledge-based evolutionary assistant to software development project scheduling. *Expert Systems with Applications*, 38(7), 8403–8413.
- Yannibelli, V., Amandi, A., 2012. A Memetic approach to project scheduling that maximizes the effectiveness of the human resources assigned to project activities. In: Corchado, E., Snášel, V., Abraham, A., Wozniak, M., Graña, M., Cho, S.-B. (Eds.), *Hybrid Artificial Intelligent Systems, Lecture Notes in Computer Science*. Springer Berlin / Heidelberg, pp.159–173.
- Yelle, L.E., 1979. The learning curve: historical review and comprehensive survey. *Decision Sciences*, 10(2), 302–328.
- Yoshimura, M., Fujimi, Y., Izui, K., Nishiwaki, S., 2006. Decision-making support system for human resource allocation in product development projects. *International Journal of Production Research*, 44(5), 831–848.
- Youndt, M.A., Snell, S.A., Dean, J.W., Lepak, D.P., 1996. Human resource management, manufacturing strategy, and firm performance. *The Academy of Management Journal*, 39, 836–866.
- Younis, M.A., Saad, B., 1996. Optimal resource leveling of multi-resource projects. *Computers & Industrial Engineering*, 31(1), 1–4.
- Yue, H., Slomp, J., Molleman, E., Van Der Zee, D.J., 2007. Worker flexibility in a parallel dual resource constrained job shop. *International Journal of Production Research*, 46(2), 451–467.
- Yun, Y., Moon, C., 2011. Genetic algorithm approach for precedence-constrained sequencing problems. *Journal of Intelligent Manufacturing*, 22(3), 379–388.
- Zaeh, M.F., Mueller, N., 2007. A modeling approach for evaluating capacity flexibilities in uncertain markets. *International Journal of Flexible Manufacturing Systems*, 19(3), 151–172.
- Zhang, H., Tam, C.M., Li, H., 2006. Multimode project scheduling based on particle swarm optimization. *Computer-Aided Civil and Infrastructure Engineering*, 21(2), 93–103.
- Zhang, Y., Luh, P.B., Narimatsu, K., Moriya, T., Shimada, T., Fang, L., 2001. A macro-level scheduling method using Lagrangian relaxation. *IEEE Transactions on Robotics and Automation*, 17(1), 70–79.
- Zhu, G., Bard, J., Yu, G., 2007. A two-stage stochastic programming approach for project planning with uncertain activity durations. *Journal of Scheduling*, 10(3), 167–180.

INSTANCE GENERATION AND THE REQUIRED DATA

As previously discussed, we deal with project scheduling and human resources allocations problem. The proposed model considers the heterogeneous efficiencies of a multi-skilled workforce, either with the static or the dynamic nature. Due to the originality of the problem, within literature one could not find any standard benchmark problems. In order to investigate the managerial features of the proposed model, we need to generate some instances of different characteristics. These instances should be neither too general nor too specific; therefore we selected a set of traditional *RCPSP* benchmark problems. Then we carried out some modifications to these problems, in order to match the requirements. The modifications that have been brought are related to the required resources, in order to generate their levels of efficiencies. The problems seem specific considering the project structure, but in the same time they seem general since the efficiencies of actors are randomly generated. This generality of the actors productivity levels can in some manner reflect real actors' situations (the heterogeneous nature), where the productivity to perform a given task may vary from one actor to another – or even for the same actor, from skill to another.

We adopted the benchmark problems of the traditional *RCPSP* that generated by the standard project generator *ProGen* (Kolisch et al., 1996). It can be found in *PSPiB* library site (PSPLib, 1996). Within this library, we can find different data sets, J30 (480 instances each with 30 tasks), J60 (480 instances each with 60 tasks), J90 (480 instances each with 90 tasks), and J120 (480 instances each with 120 tasks). From each case we taken a sample of 100 instances (for example for 30 tasks problem we taken instances of: J301.1,..., J302.10; J3010.1,..., J3011.10; J3020.1,..., J3021.10; J3030.1,..., J3031.10; and J3040.1,..., J3041.10). As we can see, each data set contains five groups of 20 projects; the different parameters of these 20 projects are in some way within a specified range. In total we selected a sample of 400 instances (containing projects of 30, 60, 90, 120 tasks). We then modified the selected instances according to project activities and the required resources; which presented by the following.

A.1 Project related data

A.1.1 Precedence relations

In order to produce a specific instances and ovoid cycling in the temporal relations between tasks, we left the precedence relations as they are within the original files. Thus, the precedence relations between tasks are feasible for all of the adopted instances.

A.1.2 The tasks durations

As previously discussed, for task duration we assumed that each task i is defined by three durations (in number of working days): standard D_i , minimum D_i^{min} and maximum D_i^{max} . For the standard durations D_i , we kept the tasks' deterministic durations that were precisely defined in the original files. For the two others durations, we operated the Microsoft Excel random numbers in order to generate integer values for D_i^{min} and D_i^{max} , so that $1 \leq D_i^{min} \leq D_i$, and $D_i \leq D_i^{max} \leq 2 \times D_i$. The results of this step are stored within project data file shown in (Table A.1).

A.1.3 The required workload from each resource

As previously discussed, each task k requires a specified number of workloads $\Omega_{i,k}$ (in hours) from each skill $k \in K$. Therefore, we computed the required workload of each task from the data of the original file as: $\Omega_{i,k} =$

standard working hours per day \times [number of resources requirement \times task duration] from the original file, assuming that durations of tasks in the original file are in days. We also assumed that the standard working time is 7 hours per day, according to the French standards. As a result, we get the project requirements as exposed in the sample shown by Table A.1.

Table A.1 Sample of project's tasks requirements data file

Task	Tasks durations (Days)			Required workloads (Hours)			
	D_i^{min}	D_i	D_i^{max}	$\Omega_{i,1}$	$\Omega_{i,2}$	$\Omega_{i,3}$	$\Omega_{i,4}$
0	0	0	0	0	0	0	0
1	6	1	8	42	84	168	0
2	5	4	9	0	175	315	350
.	9	9	14	441	0	0	189
.	9	9	12	63	189	0	630
I	5	5	7	0	140	175	35

A.1.4 Skills' similarity degree

In order to reflect the real situation in manufacturing likewise to examine the effect of similarities between skills on the development of actors' efficiencies, a symmetrical matrix with unity diagonal had to be generated, as shown in (Table A.2). Here again, the generation of this matrix was performed via the random function of Microsoft Excel, to assign random values within two extremes [SD_{min} ; SD_{max}] to the degrees of similarity $SD_{k-k'}$ between any pair of two non identical skills k and k' . In our investigation we planned to generate similarity degrees with different maximum levels ($SD_{max} = 0.25$, or 0.50) where ($SD_{max} - SD_{min} = 0.25$).

Table A.2 Similarity degree between project skills generated between $SD_{min} = 0.25$ and $SD_{max} = 0.5$

	$k1$	$k2$	$k3$	$k4$
$k1$	1.0000	0.4500	0.4200	0.2800
$k2$	0.4500	1.0000	0.2600	0.4800
$k2$	0.4200	0.2600	1.0000	0.3400
$k4$	0.2800	0.4800	0.3400	1.0000

A.2 Workforce related data

In the current work, one of the most important characteristics is operators' versatility. Therefore, it is required to assign to each operator a productivity value that means his/her level for practicing a given competence. To fulfil to this requirement, we generated a resources file, as the model presented in (Table A.3). We generate for each operator random values $\theta_{a,k} \in [0, 1]$.

Table A.3 Sample of workforce generated data file

Actors	Hour rate (MU)	Actors' efficiencies			
		k_1	k_2	k_3	k_4
1	11	0.86862	0.00000	0.00000	0.00000
2	11	0.94485	0.00000	0.90417	0.85754
3	11	0.99999	0.84601	0.00000	0.00000
.	11	0.00000	0.61306	0.86094	0.82778
A	11	0.78373	0.00000	0.92713	0.00000

But, in order to make these generated values render reality, we adopted the following assumptions:

- ◆ If the generated value is lower than 0.5, the corresponding actor efficiency is set to zero (to represent the non qualified operator).
- ◆ If this value is within the interval [0.95, 1.0], the actor efficiency will be considered as equal to unity: accordingly, we will consider this actor as an expert with nominal productivity level; we will also consider the nominal efficiency of an actor as $0.9999 \approx 1.0$, since in accordance to the learning power model, the efficiency of 1.0 can be reached only after an infinite number of work repetitions.
- ◆ When the value is in the interval [0.5; 0.95], it remained unchanged to express the actor's efficiency.
- ◆ Also we assumed that the working hourly cost is constant for all operators.

Due to these modifications, and in order to be actually sure that the generated efficiencies are randomly distributed around the minimum accepted value of $\theta_{min} = 0.5$, we checked the randomness of these data. The test was carried out using the statistical software "Minitab" using the "Runs-Test on the following assumptions: H_0 : Generated efficiencies are randomly distributed around the value of 0.5, and H_1 : They are not.

All instances proved to be randomly generated with P -values greater than 0.05, therefore we could accept the (H_0) hypothesis to be satisfied with a confidence of 95%.

A.3 Regulation data

Another type of required data is the working regulations milestones and the company internal agreement, as shown by (Table A.4): - it provides different values of working time regulations, such as the maximum work per day, week, reference period, or year. Moreover to the adopted overtime working rules and the compensation system that can vary from company to another.

Table A.4 Regulation data

Maximum average weekly work over a period of twelve consecutive weeks	: $DMax12S = 44^*$ hours.
Maximum daily work.	: $DMaxJ = 10^*$ hours
Maximum weekly work	: $DMaxS = 48^*$ hours
Maximum yearly overtime	: $HAS = 180$ hours/year (we assumed it)
Maximum yearly work	: $DSA \approx 1600^*$ hours
Normal weekly work set by the collective agreement	: $DMaxMod = 39$ hours (we assumed it)
Number of weekly working days	: $NJS = 5$ days (we assumed it)
Over cost related to the overtime working hours	: $u = 0.25 \times U_a$

* According to the French working laws.

A. 4 Simulation data

Beside the activities, and regulation data, we need other data sets to conduct the simulations. The first is related to the actors and gathers the various parameters describing learning and forgetting phenomena. We assume that all actors have an initial efficiency $\theta_{a,k}^{ini}$ of 0.4. We assumed that the learning rates ($r_{a,k}$ in Equation (3.3)) are the same for all operators, and equal to 0.8 (Wright 1936; McCreery and Krajewski 1999). The slope of the "unlearning curve" (f) can be estimated relying on Equation (3.6) as a function of the slope of learning curve (b), of the ratio ($\xi=3$), and of the equivalent number of repetitions (n_{eq}) before the interruption of practice.

The last set of data provides the parameters of the genetic algorithm, such as population size, probabilities of crossover and mutation, the composition of the new generations, and the stopping criteria of the search algorithm, as shown in the (Table A.5). They were fixed after an exploration intended both to validate the model and to set these parameters to reliable values (as discussed in chapter 5).

Table A.5 Exploration data

Population size	= 100 individuals
Crossing probability	= 0.7
Mutation probability	= 0.01
Fraction of immigrated individuals in the new generation	= 0.2
Max. n° of generations	= 8000 generations
N° of iterations without convergence	= 100 generations
N° of the best individuals on which convergence is computed	= 10 individuals

ON PROJECT COMPLEXITY

B.1 Other network complexity measures

☞ *Complexity index: CI:* Bein et al. (1992) introduced a way to measure the topological structure of a graph based on the reduction sequence of the two terminal acyclic graphs. This complexity measuring is relying on the minimum number of node reductions. The graph reduction mainly done based on three types: parallel, series and node reductions in order to reach a single edge graph. Parallel reductions: a parallel reduction of nodes v, w replaces two or more edges e_1, \dots, e_k joining v to w by a single edge $g=(v, w)$. Series reductions: if there is an edge $e=(u, v)$ is a unique edge to v , and $f=(v, w)$ is the unique edge out of v , then e and f are replaced by $g=(u, w)$. After all parallel and series reductions, one can have a new graph $[G]$, if the obtained graph $[G]$ = the initial G , then G is said to be irreducible. In the irreducible graph, the node v is eligible for a node reduction when it has *in-degree*=1 or *out-degree* = 1. In case of *in-degree*=1: let $e=(u, v)$ be the edge into the node v , let $f_1=(v, w_1), \dots, f_k=(v, w_k)$ be the edges out of v . replace $\{e, f_1, \dots, f_k\}$ by $\{g_1, \dots, g_k\}$, where $g_i=(u, w_i)$. The case of *out-degree* = 1 is symmetric, where $e=(v, w), f_i=(u_i, v)$ and $g_i=(u_i, w)$. After the graph reduction one can define the reduction complexity of graph “ G ” as: the minimum number of node reductions sufficient to reduce “ G ” to a single edge, in other words, one can calculate complexity index as: $CI = C(\text{number of reduction sequences})$, which there exists a reduction sequences v_1, \dots, v_c such that $[... [[G] \circ v_1] \circ v_2] \dots \circ v_c]$ is a single edge. The complexity of this reduction algorithm is $O(I^{2.5})$, where I is the number of tasks.

☞ *Network divergence and convergence:* Scholl (1999)(Section 2.2.1.5 page 34) presented measures of the network degree of divergence and convergence. These measures can be defined and presented by considering the network as a digraph $G(V,E)$, where V is the set of graph nodes with cardinality $|V|$ and E is the set of its edges. $|E|$ is the cardinality of the network set of edges $E = \{ \langle i, c \rangle \mid i \in V, c \in SU_i \}$. Where, SU_i is set of successors of i , a non-cyclical directed graph $G(V,E)$ with a single source v_0 is transformed to an *out-tree* by arbitrarily eliminating $\delta_i - 1$ of the entering arcs for each node $i \in V - \{v_0\}$. Therefore, the positive degree of divergence for G can be defined as:

$$DIV(G) = 1 - \sum_{i \in V - \{v_0\}} (\delta_i - 1) / |E| \tag{B.1}$$

An analogous degree of convergence is the $CNV(G)$ is achieved by considering the reverse precedence graph. According to Otto et al. (2011) the mathematical formulation can be reformulating to take the shape as presented in equations (B.2) and (B.3), where NWP_i is the number of tasks without predecessors, and NWS_i is the number of tasks without successors.

$$\text{Degree of divergence: } DIV = 1 - \frac{|E| + NWP_1 - |V|}{ED}, \text{ such that } ED = \begin{cases} |E| + NWP_1 & \text{if } NWP_1 > 1, \\ |E| & \text{if } NWP_1 = 1 \end{cases} \tag{B.2}$$

$$\text{Degree of convergence: } CNV = 1 - \frac{|E| + NWS_1 - |V|}{EC}, \text{ such that } EC = \begin{cases} |E| + NWS_1 & \text{if } NWS_1 > 1, \\ |E| & \text{if } NWS_1 = 1 \end{cases} \tag{B.3}$$

As discussed by Scholl (1999) in the case of $DIV(G)=1$, G is an *out-tree*, i.e. it is strictly diverging. If $DIV(G)$ is smaller than but near to 1, the graph is almost diverging or almost-tree. The precedence graph can be transformed into a single-source graph by adding a fictitious source node with operation time “0” and arcs to the

original sinks. For the single *ALBP* with a high degree of divergence (convergence) are expected to be less complex than such with a low degree for forward (backward) solution procedure. After calculating *DIV* and *CNV* for the 400 projects, the two measures take exactly the same values for each instance. This happened because in all projects there is only one start and end events, so $NWPI=NWSI$, it results that equations B.2 and B.3 give the same values for each instance. Also, comparing the distributions of *DIV* with the standardised *C*, or *CNC* in (Figure B.1), we found the distribution is almost inversely the same, by investigating the correlation between the two variables (*DIV*, and *Standardised C* “*S-C*”) we found that the Pearson correlation of is $R=-0.971$. Therefore, the network divergence or/and convergence can take the same drawbacks of *C* and *CNC*.

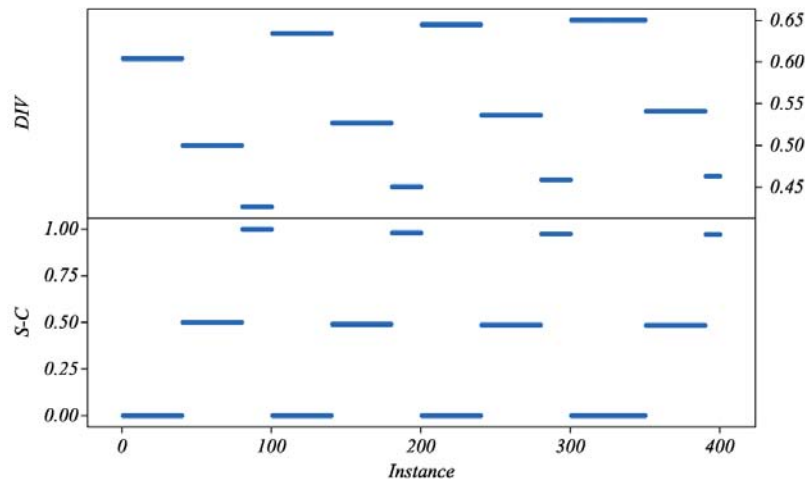

Figure B.1 the aggregate plot of the networks divergence and standardised “C” (*S-C*)

B.2 Interpretation of *ASyM*

The value of the *ASyM* can be positive, negative, or even zero. By interpreting the value of *ASyM* the distribution of tasks and so, the network shape can be figured out. To introduce the interpretation of *ASyM*, we present some possible distribution of real “nine” tasks on “five” progressive levels, as illustrated by (FigureB.2). In general, the interpretation can be summarised as:

- Positive $ASyM > 1.0$, (highly right skewed distribution): the distribution is far from symmetry; many tasks are concentrated at the beginning of the project, this concentration reduced towards the project sink (project end point), as shown by figure (B.2-a).
- Positive $ASyM > 0.0$, (Right skewed distribution): most tasks are concentrated on left of the mean progressive level, with extreme values to the right, as shown by figures (B.2-b, c, ..., and f).
- Null $ASyM = 0.0$ (mean rank = median), the distribution is symmetrical around the mean progressive level, as shown by figures (B.2-g, h and i).
- Negative $ASyM < 0$, (Left skewed distribution): most tasks are located on the right of the mean progressive level, with only extreme values to the left, as shown by figures (B.2-j, k, ... and n).
- Negative $ASyM < -1.0$, (highly left skewed distribution): many tasks allocated at the end of the project, this concentration reduced towards the project start point, as shown by figure (B.2-o).

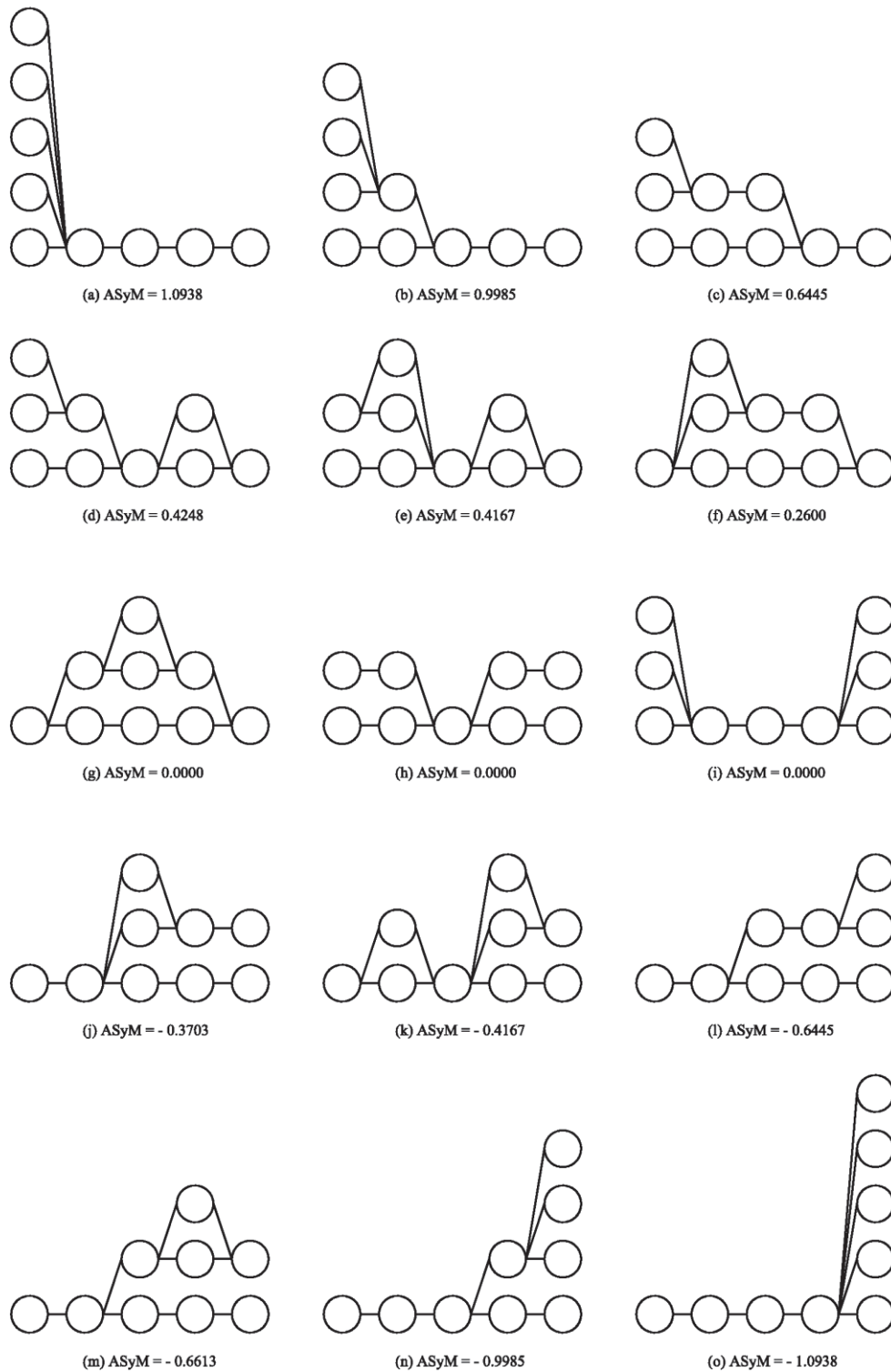

Figure B.2 Illustrations of the tasks distribution $ASyM$

After standardisations the different $SASyM$ can be shown as the following figure:

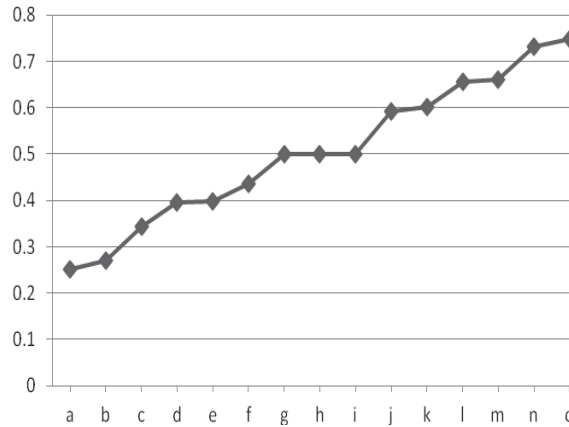

Figure B.3 plot of the SASyM measure for networks in figure (B.2).

B.3 Non-redundant number of network edges

Relying on the work of Bashir (2010) the *ISM* is a method which can be applied to a system – such as a network or a society – to better understand both direct and indirect relationships among the system’s components. The methodology adopted to compute the number of non-redundant edges of a given network is based on four steps: 1- construction of the matrix of immediate predecessors “*MIP*”; 2-Transformation of the *MIP* into a lower-triangular format “*LTF*”; 3-Transformation of the *LTF* into a minimum edge adjacency matrix; 4- construction of the minimum edge diagram. The *LTF* matrix be constructed by a sorting procedure as: - search in sequence each row of the *MIP* to identify any row containing only one entry of 1. Then enter sequentially the rows that contain a single 1 into lower triangle matrix. These rows and the corresponding columns are not considered in the procedure of searching the reachability matrix. These steps of sorting will be repeated until reached the lower triangular format. The minimum edge adjacency matrix can be constructed by: -replace all diagonal entries in *LTF* by zeros, - the rows are then sequentially searched from the first to the last for entry e_{ij} of 1, the corresponding i column is searched for entries of 1 in the rows greater than i , and the corresponding entries of column j is constrained to be 0. This process is continued until all entries of 1 are considered.

B.4 Illustrative Example:

In order to illustrate the calculation of *RS*, we used an example of 10 tasks, 4 skills, and 10 operators, it has been withdrawn from the manuscript of Edi (2007) and presented by tables (B.1 and B.2). In table (B.1), we present the activities durations, and tasks dependency relation, moreover to the required work-content. In table (B.2) we present the productivity levels of the operators. As we can see each operator masters more than one skill but with different productivity levels.

Regarding the calculation of *RS*, the value of R_k^{\min} for each skill k can be computed, by dividing each workload “ $\Omega_{i,k}$ ” by its corresponding maximum task duration D_i^{\max} , and selecting the maximum value (based on the relation $R_k^{\min} = \text{Max}_{i=1}^I [\frac{\Omega_{i,k}}{D_i^{\max}}]$). In order to calculate the values of R_k^{\max} , the project schedule should be constructed

by assigning to each task its minimum duration, as shown in (Figure B.4). Based on this schedule, the work-content profile required from each skill of type k can be constructed as shown by Figures (B.5, to B.8). After

that, the peak point can be obtained, which represents the value of the maximum consumption R_k^{max} for a given skill k . Then we calculate the average available capacity of workers ($\Theta = 0.829$). After that we get the fictive workforce $\sum \theta_{a,k}$ for each skill, and the real number of available operators per skill $|A_k|$, as shown in table (B.3). As results, one can calculate the average available capacity per-period for each skill Q_k , as equation (4.19).

Finally, the values of resources strength can be calculated as shown by (Table B.3). Within this table, we can find that $RS_{k=1, 2, \text{ and } 3} \in [0, 1]$, it means that there is a problem of resources availability for the three skills, but for skill $k = 4$ we find that $RS_{k=4} > 1.0$, it means that there is no problem of resources availability in comparison with the requirement. The average RS can be computed “ $\overline{RS} = 0.7909$ ”, so as equation (4.20), $RSI = 0.3936$.

Table B.1 Project data

Task i No.	D_i	D_i^{min}	D_i^{max}	$\Omega_{i,k}$ (hours)				Successors	Relation	Delay
				K=1	k=2	K=3	k=4			
1	4	2	6	0	60	0	50	2 – 3 – 4	F-S	+0
2	5	3	7	45	68	0	0	3 – 5 – 7	F-S	+0
3	4	3	7	0	63	45	35	5 – 6	F-S	+0
4	7	5	10	53	0	60	0	6 – 9	F-S	+0
5	4	2	6	0	65	0	60	7 – 8	F-S	+0
6	3	1	5	60	0	35	0	8 – 9	F-S	+0
7	5	3	7	35	56	0	40	10	F-S	+0
8	5	3	8	0	0	47	50	10	F-S	+0
9	4	2	5	0	45	26	0	10	F-S	+0
10	3	2	4	35	30	35	30	---	---	---

Table B.2 Data of operators' productivities

Actor	$\theta_{a,k}$			
	k=1	k=2	k=3	k=4
1	0.8	1	0	0.5
2	1	0.0	0.8	0.0
3	0	0.6	0.0	1
4	0.7	0.0	1	0.6
5	0.0	1	0.7	0.0
6	0.9	0.0	0.0	1
7	1	0.8	0.0	0.6
8	0.0	0.7	1	0.0
9	1	0.8	0.0	0.5
10	0	0.9	1	0.0

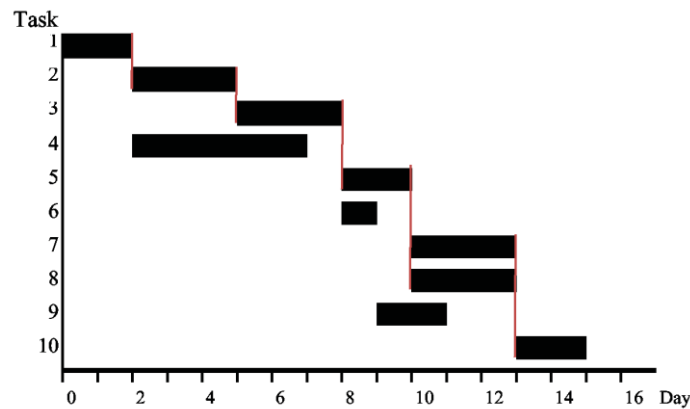

Figure B.4 Project schedule Gantt chart based minimum task duration

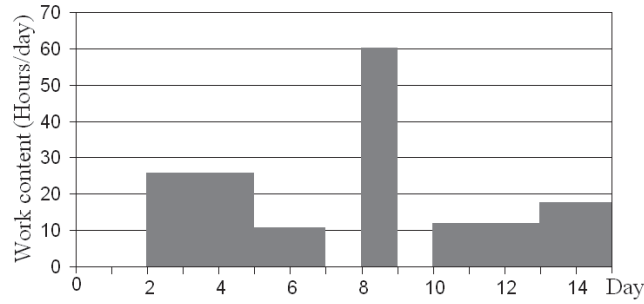

Figure B.5 Work content profile for skill #1, corresponding to the project schedule

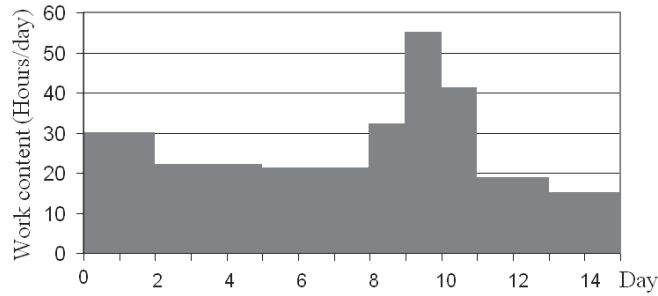

Figure B.6 Work content profile for skill #2, corresponding to the project schedule

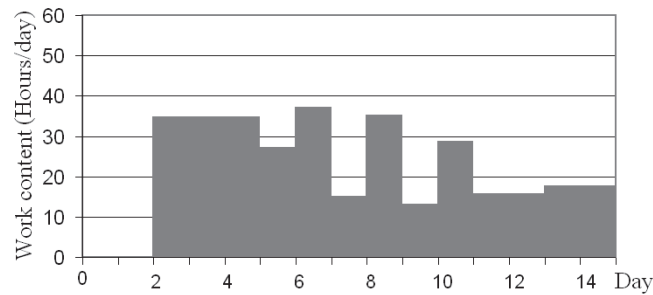

Figure B.7 Work content profile for skill #3, corresponding to the project schedule

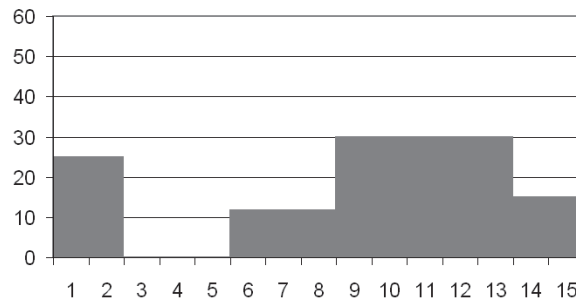

Figure B.8 Work content profile for skill #4, corresponding to the project schedule

Table B.3 Resource- strength of the different project resources

	$k=1$	$k=2$	$k=3$	$k=4$	Unit
$\sum \theta_{a,k}$	5.4000	5.8000	4.5000	4.2000	--
$ A_k $	6	7	5	6	Operator
Q_k	34.8250	40.6292	29.0208	34.8250	Hours/ day
R_k^{\min}	12.0000	10.8333	8.7500	10.0000	Hours/ day
R_k^{\max}	60.0000	55.0000	35.0000	30.0000	Hours/ day
RS_k	0.4755	0.6746	0.7722	1.2413	--

B.5 Results of principal component analysis

Table B.4 Correlation matrix between the normalised variables (Pearson (n)):

Variables	P_size	RT	I/AR	SASYM	TDmax	ATMD	ATSD	PCDF	DIFF	ATFF	RF	MinWC	MaxWC	W	S-ARPF	PCF	S-ARB	RBL	CV	SD	OCW	RSI	RC	TRC	OF	PLD				
P_size	1.00																													
RT	-0.50	1.00																												
I/AR	0.51	-0.74	1.00																											
SASYM	-0.43	0.55	-0.49	1.00																										
TDmax	0.23	0.49	-0.22	0.13	1.00																									
ATMD	0.23	-0.03	0.08	0.00	0.10	1.00																								
ATSD	0.11	-0.02	0.01	-0.05	0.02	0.59	1.00																							
PCDF	0.69	-0.51	0.56	-0.27	0.03	0.23	0.04	1.00																						
DIFF	-0.56	0.47	-0.20	0.45	0.02	-0.02	-0.01	-0.17	1.00																					
ATFF	-0.13	0.16	-0.10	0.10	0.12	-0.07	-0.06	-0.13	-0.19	1.00																				
RF	-0.05	0.15	-0.09	0.08	0.17	0.05	0.03	-0.13	0.02	-0.02	1.00																			
MinWC	0.29	0.03	0.02	-0.07	0.25	0.13	0.02	0.10	-0.16	-0.07	0.65	1.00																		
MaxWC	-0.30	0.00	-0.08	0.06	-0.20	-0.17	-0.08	-0.11	0.16	0.06	-0.62	-0.82	1.00																	
W	0.66	-0.19	0.26	-0.19	0.31	0.16	0.37	-0.35	-0.11	0.68	0.71	-0.70	1.00																	
S-ARPF	0.89	-0.64	0.69	-0.40	0.05	0.21	0.11	0.79	-0.32	-0.18	-0.10	0.19	-0.20	0.54	1.00															
PCF	-0.41	0.46	-0.41	0.64	0.11	-0.02	-0.01	-0.15	0.51	0.06	0.05	-0.09	0.09	-0.21	-0.32	1.00														
S-ARB	0.63	-0.35	0.41	-0.30	0.18	0.18	0.10	0.41	-0.34	-0.11	0.67	0.66	-0.65	0.95	0.60	-0.31	1.00													
RBL	-0.29	0.29	-0.26	0.46	-0.01	-0.03	-0.03	-0.11	0.36	0.01	-0.18	-0.19	0.20	-0.31	-0.24	0.63	-0.38	1.00												
CV	0.09	-0.32	0.24	-0.35	-0.25	-0.10	-0.03	0.08	-0.24	0.07	-0.80	-0.60	0.58	-0.57	0.08	-0.42	-0.47	-0.04	1.00											
SD	-0.01	-0.03	0.07	0.04	-0.02	-0.01	-0.05	0.05	0.02	0.00	-0.04	-0.05	0.03	-0.06	0.02	-0.01	-0.04	0.02	0.06	1.00										
OCW	0.23	-0.12	0.15	-0.15	0.11	0.15	0.10	0.14	-0.11	-0.09	0.63	0.45	-0.43	0.61	0.20	-0.15	0.64	-0.20	-0.43	0.08	1.00									
Θ	-0.03	-0.05	0.07	-0.03	-0.05	-0.08	-0.08	0.04	0.06	-0.04	-0.06	-0.08	0.05	-0.08	0.01	-0.05	-0.05	0.05	0.07	0.11	-0.01	1.00								
RSI	0.31	-0.13	0.17	-0.09	0.06	0.09	0.13	0.10	-0.18	-0.06	0.10	0.27	-0.27	0.33	0.30	-0.08	0.29	-0.12	-0.17	0.07	-0.38	-0.07	1.00							
RC	-0.29	0.14	-0.16	0.15	-0.15	-0.19	-0.11	-0.19	0.14	0.10	-0.61	-0.46	0.45	-0.65	-0.25	0.15	-0.66	0.19	0.43	0.08	-0.96	0.01	0.36	1.00						
TRC	-0.65	0.20	-0.22	0.27	-0.30	-0.25	-0.11	-0.32	0.42	0.13	-0.45	-0.52	0.51	-0.80	-0.47	0.30	-0.76	0.29	0.31	0.08	-0.77	0.06	0.10	0.85	1.00					
OF	0.40	-0.23	0.30	-0.16	0.09	0.02	-0.02	0.29	-0.19	-0.03	0.12	0.26	-0.25	0.37	0.42	-0.15	0.40	-0.16	-0.09	0.07	-0.41	-0.04	0.78	0.35	0.09	1.00				
PLD	0.31	-0.07	0.17	0.00	0.19	0.07	0.01	0.23	-0.08	-0.05	0.38	0.41	-0.38	0.52	0.33	0.03	0.50	-0.09	-0.41	0.05	-0.20	-0.07	0.66	0.12	-0.05	0.90	1.00			

Table B.5 Kaiser-Meyer-Olkin measure of sampling adequacy:

P_size	0.753	ATFF	0.403	CV_S	0.616
RT	0.752	RF	0.766	SD	0.466
I/AR	0.880	MinWC	0.895	OCW	0.702
SASyM	0.922	MaxWC	0.884	⊖	0.622
TDmax	0.729	W	0.761	RSI	0.828
ATMD	0.402	ARPF	0.722	RC	0.790
ATSD	0.476	PCF	0.818	TRC	0.807
PCDF	0.850	ARB	0.862	OF	0.609
DFD	0.695	RBL	0.788	PLD	0.750
KMO	0.760				

Table B.6 Eigenvalues based PCA analysis of the quantifiers and the corresponding random generated ones

	<i>F</i> ₁	<i>F</i> ₂	<i>F</i> ₃	<i>F</i> ₄	<i>F</i> ₅	<i>F</i> ₆	<i>F</i> ₇	<i>F</i> ₈	<i>F</i> ₉
Eigenvalue	7.682	4.478	3.250	1.830	1.548	1.348	1.062	0.972	0.865
Proportion	28.450	16.586	12.038	6.779	5.733	4.992	3.932	3.599	3.202
Cumulative	28.450	45.036	57.074	63.853	69.586	74.578	78.510	82.108	85.311
R. Eigenvalue*	1.5083	1.4418	1.3734	1.3287	1.286	1.2455	1.2081	1.1691	1.1367
	<i>F</i> ₁₀	<i>F</i> ₁₁	<i>F</i> ₁₂	<i>F</i> ₁₃	<i>F</i> ₁₄	<i>F</i> ₁₅	<i>F</i> ₁₆	<i>F</i> ₁₇	<i>F</i> ₁₈
Eigenvalue	0.744	0.574	0.502	0.399	0.361	0.310	0.245	0.196	0.166
Proportion	2.755	2.126	1.861	1.476	1.336	1.148	0.906	0.727	0.615
Cumulative	88.066	90.192	92.052	93.529	94.864	96.012	96.918	97.645	98.260
R. Eigenvalue*	1.1065	1.0702	1.0375	1.0108	0.979	0.9544	0.9217	0.8917	0.8649
	<i>F</i> ₁₉	<i>F</i> ₂₀	<i>F</i> ₂₁	<i>F</i> ₂₂	<i>F</i> ₂₃	<i>F</i> ₂₄	<i>F</i> ₂₅	<i>F</i> ₂₆	<i>F</i> ₂₇
Eigenvalue	0.124	0.114	0.091	0.051	0.033	0.027	0.013	0.010	0.006
Proportion	0.460	0.422	0.338	0.187	0.122	0.100	0.050	0.039	0.022
Cumulative	98.720	99.142	99.480	99.667	99.789	99.889	99.939	99.978	100.000
R. Eigenvalue*	0.8387	0.8088	0.7811	0.7502	0.7218	0.693	0.6626	0.6295	0.5802

* Random Eigenvalue using Monte Carlo PCA for Parallel Analysis

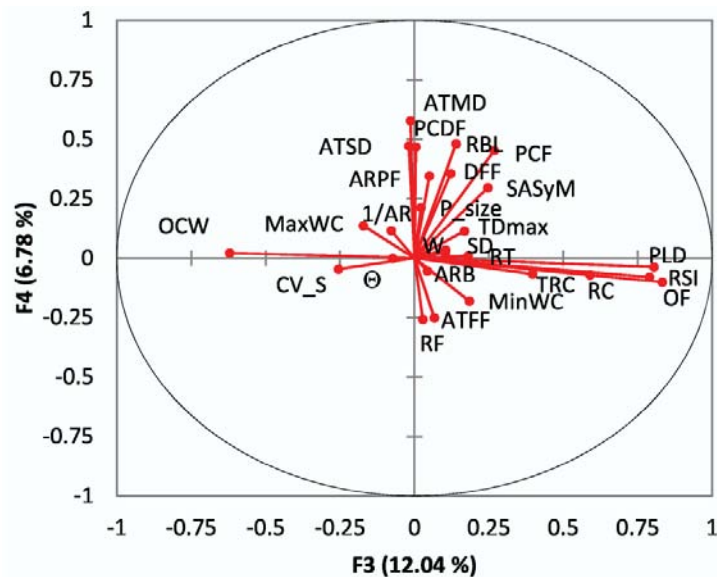

Figure B.9 the contributions of different quantifiers on the axis of F3, and F4

APPENDIX



STATISTICAL ANALYSIS

C.1 principal component analysis

Principal component analysis is one of the factor analysis techniques. It is used mainly to reduce the dimensionality of data containing a large number of inter-correlated variables into only the smallest manageable factors, while retaining as much as possible the variation of the original data. This smallest number of factors is called principal components. Each principal component is a linear combination of a subset of the original variables that have some similar characteristics. It is constructed as follows: $PC_l = \sum_{i=1}^n (b_i \times v_i)$, where b_i is the score of variable v_i in constructing the principal component PC_l . As the score of the variable approaches zero, the impact of the associated variable can be neglected in constructing the PC_l in question. All principal components are ranked according to their ability in explaining the variance in the original data set. That is to say, the first component has the most significant impact in explaining the original data variance. The second component is computed under the constraints of being orthogonal to the first one, and explaining as much as possible the largest amount of the remaining variance. Likewise, this continues until the last principal component (the n^{th} component) is computed, it has the smallest impact in explaining the variance of the original data. Relying on linear algebra, principal components are computed using either the correlation matrix or the covariance matrix. That is used to produce what is known as eigenvalues and orthogonal eigenvectors. This eigenvalue is used to indicate the proportion of the total variance explained from the original data by the corresponding principal component. So the ranking of the different components is done relying on these eigenvalues. As it is well known, the covariance between two variables is not standardised, so the scale of each variable affects the results of the test. Therefore, in order to use the covariance matrix, the data should be standardised before performing the test. Standardisation is performed by the following formula: $v'_{i,o} = (x_{i,o} - \bar{v}_i) / Sv_i$, $\exists o \in \{\text{observations of } v_i\}$, where: $v'_{i,o}$ is the standardised version of the observation "o" of variable v_i , $x_{i,o}$ the real observation "o" of the variable v_i , \bar{v}_i the average value of the different observations of v_i , and Sv_i is the standard deviation of v_i . The use of the correlation matrix controls the problem associated with the scale of variables, where the correlation is always standardised. For more details about the theoretical bases, we recommend the book of Jolliffe (2002). But here we focused more on the practical application to conduct the factor analysis using principal component as an extraction method. Therefore, we present by the following the different conditions to investigate the sample adequacy to conduct this analysis. We discuss also the different methodologies to select the smallest number of components, the rotation of axis, projection of variable on component axis "square cosines", the loading of variables, and finally the scores of each variable.

C.1.1 Adequacy of data to the test

According to Pallant (2010), there are two issues that should be considered to investigate the adequacy of the data to the factor analysis: the sample size and the inter-dependency strength between the variables. First the sample size: they discussed that as much as the sample size increased, it is more reliable to conduct such factor analysis. And a sample of at least 300 cases can be considered as comfortable to conduct the test. There is a ratio to determine the minimum number of cases depending on the variables number; this ratio is 10 cases for each variable. Finally, they advised to make more literature investigation about the effect of small sample size, especially if we have a sample size less than 150 cases. The second issue is the strength of the inter-association between the different variables. This strength can be checked using one of the following three methods:

- *Correlation analysis*, the test is conducted simply by constructing correlation matrix of all variables. After that investigating the number of correlations greater than “0.3”, as this number is high as the adequacy of the test will be good. If few correlations above this level are found, then factor analysis may not be appropriate. Knowing that, each element of the correlation matrix can be computed as the Person correlation coefficient (see section C.6) between the corresponding two variables (row, column).

- *Bartlett's sphericity test*, It is a hypothesis test (see section C.3) that used to test the null hypothesis H_0 : There is no correlation significantly different from 0 between the variables. And the alternate hypothesis H_1 : At least one of the correlations between the variables is significantly different from 0. If the observed significance level is very small (the test P-value < α -value), we can reject the null hypothesis without any significant error. It is concluded that the strength of the relationship is strong at least for a pair of variables. Therefore, conducting the factor analysis seems to be adequacy for the data.

- *Kaiser-Meyer-Olkin measure of sampling adequacy: KMO*, is a popular diagnostic measure in factor analysis. It provides a factor between 0 and 1, according to Pallant (2010), a value of “KMO” between 0.6 and 1 indicates the adequacy of using factor analysis for the data in question. And value of “KMO” of less than 0.5 is probably not appropriate to use factor analysis on data.

C.1.2 Components to be retained

The principal component analysis is conducted in order to have the smallest number of factors that best describe the variance of the data. Therefore, we have to get a compromise between the minimum components and the largest variance explication. To get this compromise and relying on Pallant (2010), there is three methods: - Kaiser’s criterion –Scree test and -Parallel analysis.

Kaiser’s criterion; is the criterion that most frequently utilised by practicing social scientists. The criterion is very simple, where we retain only the factors with eigenvalue equals or greater than a value of “1.0”. And all the factors with eigenvalues less than “1.0” can be neglected.

Scree test; the scree plot is a graph within it we plot the different eigenvalues ranked from the largest to the smallest. Then by investigating this plot one can decide the factors that may be significantly explain the data total variance. Within this plot, we search to find a point at which the shape of the curve becomes approximately horizontal. Relying on this plot, we can retain only the factors above the elbow, where they have almost the major cumulated value in explaining the data total variance.

Parallel analysis; according to Pallant (2010), this technique is also utilised by social scientists and first presented by Horn (1965). This analysis started by generating randomly a data matrix of size exactly equals that of the original data matrix. For this random generated matrix, its eigenvalues are computed by the same way as that of the original data matrix. Then by comparing these eigenvalues (driven from the random data) with eigenvalues driven from the real data, we can decide the minimum number of principal components. That is, if a real eigenvalue is greater than a random eigenvalue we accept the corresponding factor, otherwise we reject it. In order to calculate these “eigenvalues” based random data, we used a software called “Monte Carlo PCA for parallel analysis” developed by Watkins (2000).

C.1.3 Axis rotation

After determining the number of minimum factors, the great task is to interpret them; one of the ways that enhance this interpretation is the rotation of axis. This rotation does not change the underlying solution - rather, it presents the pattern of loadings in a manner that is easier to interpret. There are two main types of rotations that can be used: the first is the orthogonal (uncorrelated), the new axes are also orthogonal to each other. The second is the oblique (correlated), the new axes are not required to be orthogonal to each other. Associated to each rotation type there are some techniques to perform it: Varimax, Quartimax, Equamax are associated to the orthogonal type, and direct Oblimin and Promax are oblique methods. according to Pallant (2010) the most commonly used orthogonal approach is the Varimax rotation, which maximizes the sum of the variances of the squared loadings. Thus, the number of variables that have high impact on each factor can be distinguished by inspecting the squared correlation with the factor. The goal is to associate each variable to at most one factor.

C.1.4 Results interpretation

Due to the rotation of coordinates, the angles between each variable vector and the axes of the principal factors were changed. The projection of each variable on the factors axes can be used as a good indicator to the association between this variable and factors. Therefore “XLSTAT” presents a table of squared cosines (to reflect the different projection of variables on each factor), which used to avoid interpretation errors due to projection effects. For each variable there is a high squared cosine associated with only one factor. Observing this value indicates that this variable may be highly contributed in constructing this factor rather than any of the others. Also the variable contribution in building a given factor can be computed based on the squared cosines. The linear correlation (Pearson correlation coefficient, see section C.6) between variables and principal components can be used in the interpretation of results, to know the association of variables to different components. The linear correlation matrix between variables and components is exactly equals the factors loading for the normalised principal component analysis. After define the variables that highly associated to each factor, for each one there is a multiplier coefficient “score” that used in constructing the formula of the corresponding component. For more details about the computations of these scores we propose the work of Burstyn (2004).

C.2 Cluster analysis

Cluster analysis is one of the data mining techniques that divided data to meaningful groups that share specified characteristics. Clustering is a common technique in biology, information retrieval (search engines), climate, psychology and medicine, business and marketing, etc. Clustering is used to understanding the nature of the data in question. According to Tan et al. (2006), the goal is that the objects within a group be similar (or related) to one another and different from the objects in the other group. There are many types of clustering: hierarchical (nested) versus partitional (un-nested), exclusive versus overlapping versus fuzzy, complete versus partial. Here, we are interested to the most common one, the hierarchical clustering. In hierarchical clustering the sub clustering is permitted, thus it can be nested looks like a tree. The main idea is to build a binary nested tree of the data that successively merged the similar groups. It relies on a measure of similarity between the data; this similarity can be a correlation between groups. The common technique used is known as agglomerative hierarchical clustering. It starts by placing each data point by its own singleton group, and repetitively merges

the two closest groups (known as proximity method), until constructing the full tree that known as the “dendrogram”. Visualising this dendrogram provides a good picture with a lot of information about the data. The similarity degree between groups reduced as the level of clustering increased. In other words, the aggregation of objects at level zero (the bottom of the dendrogram) indicates the two variables have a 100% similarity, and the aggregation at the last level indicate the smallest similarity between the objects in question. As shown by Figure C.1, at level zero (similarity 100%) we have 8 clusters corresponding to the 8 variables. After investigating the similarity matrix between the 8 variables, only variables 3 and 4 are proved to be very similar (at about 99%). Therefore they grouped in only one cluster, called “C34”. After that the similarity matrix was investigated between all of the seven clusters. The highest similarity was proven between variable 6 and 7 with a similarity level of about 82%, thus the grouped into one cluster called “C67”. The process of investigated similarity between different clusters is repeatedly investigated and each time two clusters grouped into only one, until we have only one cluster. But, what about the proximity method that used in grouping clusters? There are some proximity methods that come from the graph based view (Tan et al., 2006), such as: *MIN*, *MAX*, and Group Average. *MIN* defines the cluster proximately as the shortest edge between two nodes in different subsets of nodes. *MAX* defines proximity as the longest edge between two nodes in different subsets of nodes. These two types respectively are known as “Single link” for the MIN and “Complete link” for the MAX type. The third type is the average pair-wise of all pairs of points from different clusters that known as “Group average”. The Group average represents a natural compromise between the two extremes of Single and Complete links. However, it is sensitive to similarities scale; this problem can be controlled by using standardised scales of similarity. Other methods can be used relying clusters’ centroids, such as centroid method and Ward’s method. The two methods suppose that the cluster is represented by its centroid point. Moreover, Ward’s method attempts to minimise the sum of the squared distances of points from their cluster centroids.

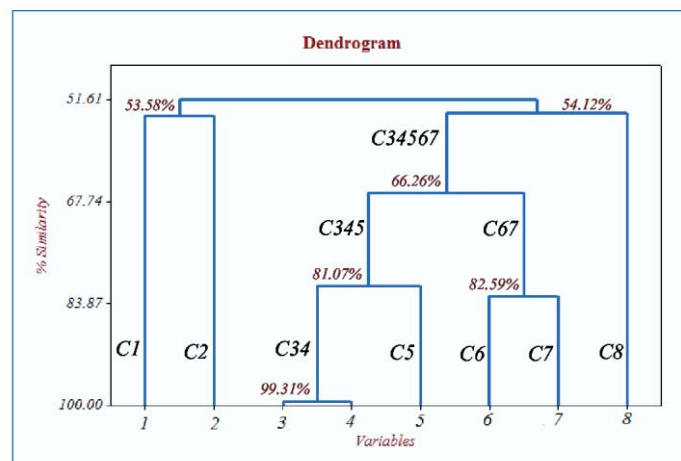

Figure C.1 the dendrogram of the hierarchical clustering

C.3 Hypothesis tests

Hypothesis test are statistical methodologies concerned with choosing between two conflicting decisions that known as hypotheses. Any hypothesis test starts with formulating the two conflicting decisions to be verified. The first decision is called the null hypothesis denoted by H_0 and the conflicting decision known as the alternate hypothesis denoted by H_1 . Often, the null hypothesis proposes that the phenomena in question occurred by

chance. A level of significance is associated to this test, known as “ α -level”. This α -level allows us to accept or reject the null hypothesis with a certain probability of error. It is linked to the confidence degree to accept or reject the null hypothesis, so, α -level = 1- confidence degree. We usually set this α -level as low as possible, because it represents the probability of wrongly rejected the null hypothesis. A popular value of α -level is 5% corresponding to a significant level of 95%. Associated to this decision of “rejecting the null hypothesis”, an error that called type I-error, as shown by Figure C.2. On the other side, if we falsely accept the null hypothesis and reject the alternative hypothesis, the error known as type II-error. Relying on Dekking et al. (2005) and Marques de Sa Joaquim (2007), Figure C.2 presents the different situation of hypothesis test, according to them, we can define type I-error and type II-error as:

Type I-error: α -value= Probability (H_0 is true and, based on the test; we rejected H_0 and accept H_1).

Type II-error: β -value = Probability (H_0 is false and, based on the test; we accept H_0 and reject H_1).

The degree of protection against alternative hypothesis is measured by so called power of the test, (1- β -level). Which measure the probability of rejecting the null hypothesis when it is false (thus it should be rejected).

		Decision	
		Accept H_0	Accept H_1
Reality	H_0	Correct decision	Type I-error α -value
	H_1	Type II-error β -value	Correct decision

Figure C.2 the different situation for deciding about H_0

C.4 Randomness test

Randomness test is verification of the sequence of observations to follow a random sequence with independent relations. This test can be performed using “Runs test”. Relying on the work of Marques de Sa Joaquim (2007), “Runs test” is a non-parametrical statistical test used to decide if the data set is from a random process. The run is defined as a series of decreasing or increasing value, the values is the length of the run. Based on the number of runs within the population and the critical values of the test statistics, the hypothesis test can be verified. The test hypotheses are:

H_0 : the sequence of the population (variable) was produced in a random manner.

H_1 : the sequence of the population (variable) was not produced in a random manner.

To accept or reject the null hypothesis, we calculate P-value (the probability of Z-scores for two tailed test), if P-value > α -level of the test we accept the null hypothesis, otherwise, we reject it. Also we can compare directly Z-scores with the Z-critical (computed relying on the α -level). The value of Z-scores is calculated as: Z-scores =

$$\frac{\text{observed number of runs} - \text{expected number of runs}}{\text{Standard deviation of the number of runs } (Sn)}$$

Where: expected number of runs = $\frac{2n_1n_2}{n_1+n_2} + 1$, and

$$(Sn)^2 = \frac{2n_1n_2(2n_1n_2 - n_1 - n_2)}{(n_1 + n_2)^2(n_1 + n_2 - 1)}$$

, and n_1 and n_2 are respectively the two sides of the data (positive or negative, if

we check he run test around a given value). For small sample runs test, there are tables that give the critical values of Z-critical depending on n_1 and n_2 , otherwise the standard normal tables can be used.

C.5 1-sample t-test

1-sample t-test is a statistical methodology that used to estimate the confidence interval of the population mean for unknown population standard deviation relying on a sample drawn from it. Moreover, it can be used to perform a hypothesis test for a proposed population mean. The estimation of the confidence interval of the population mean is necessary where the estimate of only one mean value can vary from sample to another. And in order to good estimate this unique value, one should have a very large sample size that can be costly. Instead of that, we relying on the confidence interval of the population mean. In order to estimate this confidence interval, the confidence degree should be defined (the most common confidence degree = 95 %). Based on Nist/Sematech (2003), the limits of the interval can be computed as follows: $\bar{\mu} \pm t(1- (\alpha\text{-level}/2), n-1) \sigma / \sqrt{n}$, where: $\bar{\mu}$ is the sample mean, $t(1- (\alpha\text{-level}/2), n-1)$ is the t-distribution score corresponding to $(1-\alpha\text{-value}/2)$ and degree of freedom equals $(n -1)$, $\alpha\text{-value} = 1-$ confidence degree, n is the sample size, and σ is the sample standard deviation.

C.6 Correlation analysis

Correlation analysis is used to describe the strength and direction of a linear relationship between pair of variables. There are many indicators used to describe this relationship, one of them is the ‘‘Pearson product moment correlation coefficient’’ simply known as Pearson correlation coefficient ‘‘ R ’’. Relying on the work of Dekking et al. (2005), the correlation coefficient ‘‘ R ’’ can be defined as: Let X and Y be two random variables the correlation coefficient $R(X,Y)$ is defined to be 0 if $Variance(X) = 0$, or/and $Variance(Y) = 0$, otherwise

$$R(X,Y) = \frac{\text{Covariance}(X, Y)}{\sqrt{\text{Variance}(X) \times \text{Variance}(Y)}}. R \text{ can take any value within the interval } [-1, 1]. \text{ The negative side of the}$$

interval used for the negative correlation, where the positive side used for a positive one. According to Pallant (2010), a small relationship can be found for $R = \pm 0.1 : \pm 0.29$, and a medium $R = \pm 0.3 : \pm 0.49$, and large relationships $R = \pm 0.5 : \pm 1$. In order to know how much the two variables share the same amount of variance, we can get the coefficient of determination ‘‘ R^2 ’’. It can be simply calculated as: ‘‘ $R^2 = 100 \times (R)^2$ ’’.

In order to investigate the existence of a correlation between two variables, a hypothesis test can be conducted. That is, between a pair of variables, we can accept or reject the hypothesis for a linear correlation between them according to the calculated Pearson correlation coefficient ‘‘ R ’’, as follow:

H_0 : there is no linear correlation between the two variables.

H_1 : there is a linear correlation between the two variables.

At a specified confidence degree, we get type I -error or that known as α -level = $(1-$ confidence degree). This value signifies the limit at which we can make the decision about any of the hypothesis ‘‘ H_0 ’’ and ‘‘ H_1 ’’. That is, if the estimated probability that known as P-value is greater than the α -level we accept the null hypothesis and reject the alternative hypothesis. On the other side, if P-value is smaller than α -level we reject the null hypothesis and accept the alternative i.e. there is evidence for a linear correlation between the two variables.

C.7 Partial correlation

Partial correlation is used when we need to explore the relationships between two variables, while controlling the effect of other variable(s). According to Pallant (2010), controlling the effect of a variable means that partially

removing the inference of this variable (that might be contaminating or influencing the relationship) on the desired pair of variables. The partial correlation between two variables (X, Y) after controlling the effect of a set of n variables $\{v_1, v_2, \dots, v_n\}$ can be done simply as follows:

- Make the regression of X in $\{v_1, v_2, \dots, v_n\}$, and save the residuals in $Res-X$.
- Make the regression of Y in $\{v_1, v_2, \dots, v_n\}$, and save the residuals in $Res-Y$.
- Compute the Pearson correlation coefficient between $Res-X$ and $Res-Y$.

The resultant *Pearson correlation coefficient* is the partial correlation strength between X and Y after controlling the effect of $\{v_1, v_2, \dots, v_n\}$. Exactly as the correlation analysis, we can perform the hypothesis test to investigate the significant of the partial correlation between the two variables.

C.8 Regression analysis:

It used to investigate how well a set of variables are able to predict an outcome of dependent variable. Or it can be used to tell us how much the proposed predictors explain the variance of that response. Moreover, it gives the relative contribution for each predictor that enables us to know which predictor is significantly explaining the variance of the response. To conduct a good multiple regression analysis Pallant (2010) gives a small formula for the observation size: sample size $> 50 + 8 \times$ number of independent variables used in the regression. Also, the Multi-collinearity and singularity should be checked. Multi-collinearity produced due to high correlation between the independent variables ($R > 0.9$). In order to avoid multi-collinearity, the correlation matrix between any pairs of the predictors should be less than “0.7”. In case of high correlation between variables, they can be composed with a specified score for each to give only one predictor. Moreover, the *variance inflation factors* can be used to check the multi-collinearity. Singularity produced when one independent variable is a combination of some others independent variable. Also, the test residuals should be investigated. Residuals represent the differences between the real and the predicted dependent variable (response). They should be investigated against normality, linearity, homoscedasticity and independence of residuals.

C.8.1 Investigating the most significant predictors:

After conducting the multiple linear regressions using any method such as least squares, we have an estimated function performed from a composition of a set of predictors. Associated to each predictor we have a specified multiplier, known as “Coefficient” (as shown by table C.1). Therefore, the estimated response can be represented from table C.1 as $Y_c = \text{Coefficient of constant} + \sum \text{Coefficient}_{\#i} \times \text{Predictor}_{\#i}$. For each predictor we can calculate the standard error, as example for simple regression: standard error = $(\sum_{i=1}^n (Y_i - Y_{c_i})^2 / (n - 2)) / \sqrt{\sum (x_i - \bar{x}_i)^2}$, where Y is the response and x is the predictor, and n is the number of observations. In order to know the significant impact of a specified predictor on the regression model, one can conduct the hypothesis test for the regression slope using the student t-test with the following hypothesis:

H_0 : the coefficient of the specified predictor is equal to zero (the statistical significant $p_value \geq \alpha_level$).

H_1 : the coefficient of the specified predictor is different from zero (the statistical significant $p_value < \alpha_level$).

The t-test scores “T-score” then calculated relying on the coefficient and the standard error as: $T\text{-score} = \text{coefficient} / \text{standard error}$. The largest the T-score is the highest the impact of the predictor in explaining the variance of the response. Therefore, one can rearrange or select the most important predictors based on their T-

score. The statistical significant of using a specified predictor P_value then determined based on the t-distributions tables relying on the T-score and the degree of freedom. If the p-value is less than the specified α_{level} we accept the alternative hypothesis “H₁”, else we accept the null hypothesis “H₀”.

Table C.1 linear regression analysis results

Predictor	Coefficient	Standard error	T-score	P_value
Constant	--	--	--	--
Predictor #1	--	--	--	--
Predictor #2	--	--	--	--
•	•	•	•	•
Predictor #N	--	--	--	--

C.8.2 Variance analysis in the regression model:

For a given regression model “Y_c”, it is often capable to explain a certain amount of the total variation from the response “Y”. One the other side, there is often unexplained amount from the total variation of the response.

There are three types of variations can be calculated as follows:

- ◆ The total variation (SST: Sum of total squares): $SST = \sum(Y_i - \bar{Y})^2$, where Y_i is the different observations, and \bar{Y} is the mean value of all observations.
- ◆ The explained variation (SSR: Sum of squares regression): $SSR = \sum(Y_c - \bar{Y})^2$, where Y_c is the different estimated response, and \bar{Y} is the mean value of all observations.
- ◆ The unexplained variation (SSE: Sum of total squares unexplained): $SSE = \sum(Y_i - Y_c)^2$.

Then the variance can be calculated relying on the variation as: variance = variation /degree of freedom (DF); knowing that the degree of freedom is a statistical concept that is used to adjust the bias of sample size estimating the population mean. It depends on the sample size and the number of variable in the model. We used it to estimate the mean of the different variations as follows:

- ◆ Mean square regression: $MSR = SSR/DF$, for two variable linear regression DF=1, so $MSR = SSR$.
- ◆ Mean square error: $MSE = SSE/DF$, for two variable linear regression DF= sample size (n)-2, so $MSE = SSE/(n-2)$.

To represent these different characteristic of the model we used the analysis of variance “ANOVA” table, it constructed as:

Table C.2 Analysis of Variance “ANOVA”

Source of variation	DF	Sum of squares	Mean squares	F_ratio	P_value
Regression	--*	SSR	6695452	$\frac{\text{Explained variance (MSR)}}{\text{Unexplained variance (MSE)}}$	
Residual Error	--**	SSE	114738		
Total	n-1	SST			

--*: DF = number of predictors used, for simple regression DF =1.

--**: DF = Sample size – number of predictors, for simple regression DF = Sample size-2.

C.8.3 Measuring how well the regression equation fits the data:

In order to know the “goodness of fit” for a regression model, in statistics there are three ways:

- ◆ Coefficient of determination R^2 . It measures the strength of the association between the dependent and independent variable(s), $R^2 \in [0, 100]\%$. $R^2 = 0.0$, there is no linear relation between the response and the model predictors. $R^2 = 100\%$, there is a perfect linear relation between the response and the model predictors. Therefore, if R^2 is close to 100%, it means that the regression relation fits the data at a level of R^2 . It can be computed as $R^2 = 100 \times SSR/SST$, so $R^2 = 80\%$ means that 80% of the variation in the response observations has been explained by the predicted function. There is another form to calculate R^2 based on the SSE , as: $R^2 = 100 \times (SST - SSE)/SST$. We can also compute the adjusted R^2 based on the variance instead of the variation: $R^2_{adjusted} = 100 \times (MST - MSE)/MST$, where $MST = SST/Degrees\ of\ freedom$. Using adjusted $R^2_{adjusted}$ is useful especially for small size observations, where for small sample size R^2 seems to be an optimistic over estimation of the real value.
- ◆ Standard error of the estimate (S): it measures the accuracy of the regression equation. It represents the variability of observations around the regression line. Such that, for each value of the independent variable there is an array of possible response, which is normally distributed around the regression line. The mean of this distribution (located on the regression line) is one of the regression points corresponding to these independent variables. The interpretation of S is similar to the interpretation of the standard deviation of the normal distribution curve: $Y_c = S$ (contains approximately 68% of the total observations of Y_i); $Y_c = 2S$ (contains approximately 95% of the total observations of Y_i); $Y_c = 3S$ (contains approximately 99% of the total observations of Y_i). This standard deviation is calculated as the root square of “MSE”: $S = \sqrt{MSE}$.
- ◆ F_ratio for the significant of the regression equation: by using the f-distribution and assuming that the variance of both observed and estimated responses are equals. One can use the F-ratio or the associated P-value to decide the significant of the regression model to explain the variance in the response. The hypothesis test: H_0 : the linear regression function is not significant in explaining the response so all predictors have a coefficient equals zero. And H_1 : the linear regression function has at least one significant predictor to explain the variance in the response with a confidence level = 1-P_value. Therefore, for a specified confidence level (= 1- α_{level}), and based on the estimated P-value, we can accept or reject the significant of the regression function. If P-value < α_{level} , we reject H_0 and accept H_1 . The selection of the significant level “ α_{level} ” is a management decision. That is, the management decide the level of risk associated with an estimate function, which it will be accept. The common value is $\alpha_{level} = 0.05$, corresponding to a confidence level of 95%. The large value of the F-ratio gives evidence towards the alternate hypothesis H_1 . The corresponding probability P_value can be calculated based on F-ratio and the degrees of freedom (table C.2) by using the f-distribution tables.

C.9 Box-Behnken design:

As described by Dean and Voss (1998) the box-behnken design is a one of a second-order response models, simply it can be graphically represented as in Figure C.3-(a). As we can see there are 13 different treatments conditions for three factors with only one central point. To calculate this number of treatments, first we should know that the Box-Behnken designed based on only three levels to each factor, these three levels are the minimum, centre, and maximum values. The matrix representation of these iterations can be represented as shown in Figure C.3-(b), taking into account that (+1) represents the maximum extreme point of the factor, (-1)

the minimum extreme limit and $(-)$ is the central point value of that factor. The design matrix for three factors (X, Y, Z) with a corresponding domain of $X \in [x_1, x_2]$, $y \in [y_1, y_2]$, and $z \in [z_1, z_2]$, and domains centre point is (x_c, y_c, z_c) : The balanced incomplete block design, shown at the left, consists of all possible combinations between the three factors taken two at a time (X, Y, Z) . Then, we have a factorial vector of 2^2 design. Each block can be replaced by the factorial design of 2^2 . At the right we can construct the box-behnken design.

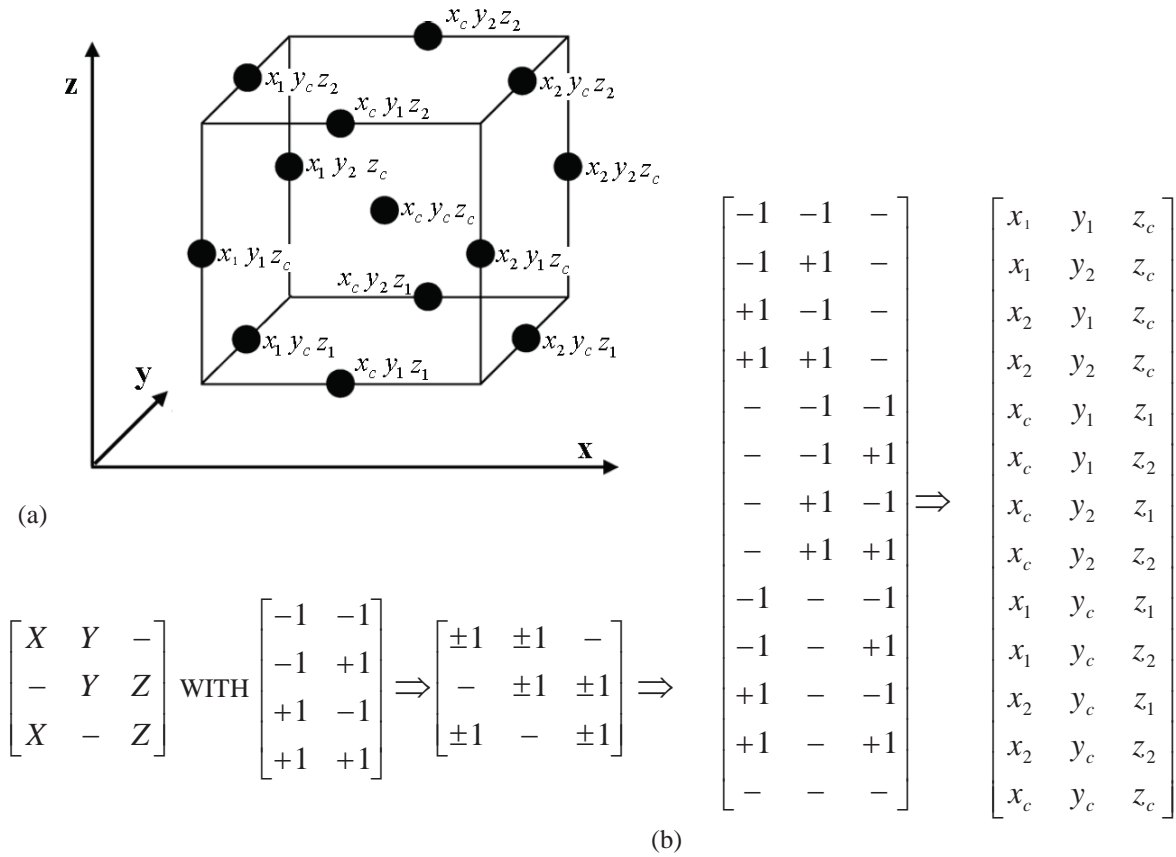

Figure C.3 three factors three levels with one central point representation based on Box-Behnken design

RESULTS OF SIMULATIONS

Table D.1 results of data set of 30 tasks

Instance	F	f ₁	f ₂	f ₃	f ₄	f ₅	f ₆	OC	LV	GN	C_time
j301-1	708.3	71387.1	536.6	408.9	0.0	-9.94	0.0	0.487	43	497	261
j301-2	870.6	89867.9	1869.7	415.6	0.0	-11.40	0.0	0.424	51	578	444
j301-3	643.6	63246.6	112.1	328.0	0.0	-11.78	0.0	0.381	47	599	351
j301-4	707.4	107001.4	622.6	425.1	0.0	-13.87	0.0	0.483	63	440	389
j301-5	648.4	55454.7	226.5	358.6	0.0	-8.98	0.0	0.427	38	485	191
j301-6	949.0	65995.6	89.9	342.4	0.0	-12.57	0.0	0.389	46	354	233
j301-7	565.1	77024.1	611.3	283.5	0.0	-16.54	0.0	0.338	68	552	384
j301-8	1090.1	99106.3	1354.3	390.6	0.0	-12.30	0.0	0.407	64	405	439
j301-9	978.0	92501.1	342.1	435.2	0.0	-11.79	0.0	0.463	51	439	303
j301-10	981.7	69965.7	309.1	402.1	0.0	-8.99	0.0	0.490	43	372	258
j302-1	716.5	69483.8	172.5	400.1	0.0	-10.48	0.0	0.426	41	508	260
j302-2	542.6	82691.9	158.0	389.8	0.0	-9.90	0.0	0.382	52	524	390
j302-3	709.5	76779.2	1313.7	392.0	0.0	-11.95	0.0	0.377	46	361	310
j302-4	481.8	68385.4	254.7	321.8	0.0	-12.78	0.0	0.287	51	595	309
j302-5	822.3	85881.3	303.7	370.5	0.0	-15.54	0.0	0.343	58	415	334
j302-6	708.3	71387.1	536.6	408.9	0.0	-9.94	0.0	0.487	43	497	409
j302-7	649.7	81724.0	716.2	420.8	0.0	-9.79	0.0	0.376	49	577	454
j302-8	846.6	78058.0	114.1	337.4	0.0	-10.44	0.0	0.392	57	469	404
j302-9	668.8	119528.1	841.2	513.8	0.0	-8.96	0.0	0.408	59	507	464
j302-10	741.4	78128.4	497.6	403.3	0.0	-10.78	0.0	0.373	47	488	426
j3010-1	839.3	253786.2	2137.6	1307.3	0.0	-4.70	0.0	0.623	50	516	835
j3010-2	883.7	285222.4	5245.0	1212.0	0.0	-3.22	0.0	0.681	60	657	822
j3010-3	1003.3	308250.1	1939.0	1060.8	0.0	-4.68	0.0	0.639	72	432	875
j3010-4	1154.4	313237.7	5465.8	1229.9	0.0	-4.64	0.0	0.723	64	425	744
j3010-5	839.3	253786.2	2137.6	1307.3	0.0	-4.70	0.0	0.623	50	516	748
j3010-6	1070.9	265034.1	5793.4	1346.7	0.0	0.20	0.0	0.732	48	433	564
j3010-7	934.3	274586.8	2364.9	1178.5	0.0	-5.16	0.0	0.589	57	490	905
j3010-8	1047.0	291898.1	2725.6	1251.8	0.0	-4.15	0.0	0.719	60	341	557
j3010-9	753.0	255096.1	4412.0	1085.2	0.0	-6.35	0.0	0.527	59	479	570
j3010-10	1001.7	276658.4	4198.0	1572.6	0.0	-3.29	0.0	0.735	45	553	735
j3011-1	773.9	242509.8	3206.9	956.3	0.0	-6.24	0.0	0.569	61	523	690
j3011-2	899.2	348029.0	4128.9	1276.1	0.0	-4.50	0.0	0.541	68	690	1150
j3011-3	756.8	288756.3	4761.4	776.5	0.0	-8.62	0.0	0.363	95	572	1360
j3011-4	1098.2	268485.9	2772.1	920.2	0.0	-4.44	0.0	0.561	72	532	1060
j3011-5	881.4	238073.5	2615.8	1019.3	0.0	-7.07	0.0	0.622	57	1171	1720
j3011-6	899.2	273002.7	1717.7	1281.2	0.0	-4.11	0.0	0.572	53	556	820
j3011-7	974.1	289546.2	4745.3	1643.9	0.0	-2.98	0.0	0.632	41	518	780
j3011-8	911.6	310783.9	3781.6	1063.2	0.0	-6.59	0.0	0.591	71	378	823
j3011-9	750.8	245527.8	1828.4	791.2	0.0	-7.48	0.0	0.416	79	381	908
j3011-10	768.6	203174.8	1028.3	1050.1	0.0	-3.96	0.0	0.515	46	1277	1300
j3020-1	607.2	92998.3	566.9	343.0	0.0	-14.27	0.0	0.277	69	502	510
j3020-2	814.5	92226.2	1025.9	278.7	0.0	-17.70	0.0	0.268	84	795	1100
j3020-3	416.5	85605.1	522.3	368.3	0.0	-8.15	0.0	0.236	57	813	720
j3020-4	458.9	75032.8	924.3	385.0	0.0	-9.13	0.0	0.296	49	675	457
j3020-5	828.4	83966.9	888.6	308.3	0.0	-18.22	0.0	0.315	68	334	359
j3020-6	423.2	68791.3	172.0	297.1	0.0	-12.28	0.0	0.270	58	520	472
j3020-7	498.6	61185.9	155.5	317.0	0.0	-9.66	0.0	0.260	48	769	517
j3020-8	405.9	85653.6	289.1	369.5	0.0	-9.43	0.0	0.253	60	542	603
j3020-9	531.9	75960.8	756.4	390.7	0.0	-8.93	0.0	0.260	50	546	428
j3020-10	559.7	73392.0	967.7	418.0	0.0	-10.00	0.0	0.317	44	725	616
j3021-1	905.4	167960.5	1929.4	616.1	0.0	-8.30	0.0	0.716	68	361	586
j3021-2	1187.1	174835.0	3771.5	807.9	0.0	0.78	0.0	0.824	51	647	790
j3021-3	1184.6	176821.4	1478.7	607.2	0.0	-11.80	0.0	0.607	72	334	551
j3021-4	890.3	168732.2	2853.4	718.1	0.0	-8.57	0.0	0.733	60	639	1020
j3021-5	1110.5	166345.6	3456.9	769.2	0.0	-4.06	0.0	0.754	51	307	773
j3021-6	1121.6	209913.6	4151.7	822.2	0.0	-3.76	0.0	0.776	64	218	374
j3021-7	931.5	164213.5	3055.6	644.0	0.0	-11.40	0.0	0.619	64	605	474
j3021-8	1233.2	195128.6	3219.2	830.8	0.0	-6.32	0.0	0.814	57	607	1080
j3021-9	2268.3	199779.2	4208.7	923.6	33962	-1.25	0.0	0.871	53	527	822
j3021-10	1095.2	182510.3	2951.6	717.5	0.0	-7.30	0.0	0.732	65	456	640
j3030-1	1015.5	304741.8	5181.2	1556.2	0.0	-2.26	0.0	0.855	48	574	1200
j3030-2	1024.4	417463.7	4209.7	1341.7	0.0	-4.12	0.0	0.721	77	346	988
j3030-3	1014.3	319993.1	5511.8	1256.7	0.0	-5.13	0.0	0.731	61	448	997
j3030-4	1112.1	380463.5	6667.9	1618.2	0.0	-3.20	0.0	0.801	60	587	1420
j3030-5	1058.9	418555.4	5773.4	1649.5	0.0	-2.34	0.0	0.778	61	399	1090
j3030-6	1025.1	394264.4	6741.5	1548.5	0.0	-3.46	0.0	0.833	65	470	997
j3030-7	1007.3	453608.2	7327.6	1545.6	0.0	-4.29	0.0	0.773	74	474	1120
j3030-8	910.8	291794.1	5974.1	1484.8	0.0	-3.51	0.0	0.619	48	1070	1620
j3030-9	997.5	386393.4	4865.3	1801.8	0.0	-2.39	0.0	0.745	53	491	864

Instance	F	f ₁	f ₂	f ₃	f ₄	f ₅	f ₆	OC	LV	GN	C_time
j3030-10	1089.0	399113.0	7761.3	1848.2	0.0	-0.89	0.0	0.880	51	421	847
j3031-1	782.6	299105.8	4671.6	1390.5	0.0	-4.19	0.0	0.527	52	964	1880
j3031-2	755.0	369366.2	5997.7	1179.8	0.0	-4.85	0.0	0.413	76	824	2020
j3031-3	1041.8	413648.4	5725.5	1513.6	0.0	-4.93	0.0	0.578	68	547	1370
j3031-4	801.5	276073.9	3837.6	1178.5	0.0	-4.95	0.0	0.512	59	905	1380
j3031-5	1041.9	316836.1	5806.5	1346.4	0.0	-4.47	0.0	0.716	57	481	840
j3031-6	1020.1	303322.1	5234.0	1191.2	0.0	-5.37	0.0	0.522	63	855	1710
j3031-7	780.0	389764.2	4837.7	1333.1	0.0	-6.02	0.0	0.629	72	615	1080
j3031-8	918.9	324708.3	5345.1	1185.0	0.0	-5.89	0.0	0.564	69	570	1180
j3031-9	1025.3	325006.0	3846.2	1516.7	0.0	-3.56	0.0	0.729	55	431	1010
j3031-10	1147.8	403869.0	8433.4	1711.8	0.0	-3.54	0.0	0.807	58	630	1320
j3040-1	514.4	167976.9	1319.0	666.0	0.0	-8.82	0.0	0.392	62	761	838
j3040-2	465.2	160198.5	416.0	592.9	0.0	-7.71	0.0	0.296	66	634	903
j3040-3	501.4	172252.6	148.5	638.6	0.0	-6.18	0.0	0.280	68	799	1200
j3040-4	571.2	171034.1	943.5	631.1	0.0	-8.23	0.0	0.367	67	956	1200
j3040-5	480.8	185100.0	2361.2	593.3	0.0	-7.97	0.0	0.303	78	638	1080
j3040-6	758.5	162503.0	1831.7	596.2	0.0	-9.84	0.0	0.368	69	637	1100
j3040-7	719.6	189129.8	413.0	817.0	0.0	-6.16	0.0	0.385	56	706	1200
j3040-8	736.7	194839.0	1263.0	718.3	0.0	-7.90	0.0	0.399	69	461	855
j3040-9	487.4	166940.4	1302.2	573.6	0.0	-9.03	0.0	0.372	75	818	1260
j3040-10	664.7	175548.8	3268.6	745.8	0.0	-8.65	0.0	0.429	60	542	622
j3041-1	33120.1	266239.4	3911.2	717.2	1448343	-8.89	0.0	0.677	92	387	903
j3041-2	10200.4	281156.0	6115.0	1020.6	430168	-3.99	0.0	0.895	68	266	480
j3041-3	15217.5	263915.5	4649.5	792.3	628118	-10.76	0.0	0.777	85	466	987
j3041-4	10169.9	243332.2	4446.3	886.4	372298	-5.42	0.0	0.821	66	443	764
j3041-5	23297.3	363526.6	8089.9	923.2	1359589	-5.37	0.0	0.810	98	513	1210
j3041-6	4059.7	270553.8	5462.9	810.1	137982	-3.18	0.0	0.827	81	380	516
j3041-7	18118.2	306535.0	6041.7	918.2	885886	-3.87	0.0	0.835	85	440	912
j3041-8	18103.2	332395.1	6555.0	995.7	960621	-6.13	0.0	0.873	83	479	1010
j3041-9	13283.3	310458.1	5484.0	833.8	633334	-7.44	0.0	0.758	95	317	744
j3041-10	39032.6	307467.1	2384.8	720.4	1986237	-9.49	0.0	0.655	109	590	1460

Table D.2 results of data set of 60 tasks

Instance	F	f ₁	f ₂	f ₃	f ₄	f ₅	f ₆	OC	LV	GN	C_time
j601-1	982.58	172893.30	450.06	526.95	0.00	-9.51	0.00	0.5377	83.0	601.0	1090.0
j601-2	922.78	198639.70	2107.65	638.09	0.00	-11.06	0.00	0.5697	77.0	859.0	1460.0
j601-3	891.23	188653.40	1104.64	573.11	0.00	-11.38	0.00	0.4698	81.0	517.0	809.0
j601-4	890.53	177050.50	643.67	482.32	0.00	-10.85	0.00	0.4466	92.0	574.0	1050.0
j601-5	978.55	154639.40	833.06	532.66	0.00	-10.01	0.00	0.5549	75.0	431.0	705.0
j601-6	1008.52	167538.90	1419.45	663.81	0.00	-8.75	0.00	0.6146	63.0	810.0	1350.0
j601-7	978.02	178994.30	1470.14	614.80	0.00	-7.46	0.00	0.5912	71.0	705.0	1240.0
j601-8	806.44	189453.60	2501.64	647.45	0.00	-6.84	0.00	0.6348	72.0	388.0	775.0
j601-9	1022.96	183753.70	1405.26	557.21	0.00	-10.77	0.00	0.5463	81.0	432.0	749.0
j301-10	866.19	163696.50	509.52	470.96	0.00	-15.58	0.00	0.4906	90.0	950.0	1360.0
j602-1	855.48	167978.20	578.84	579.74	0.00	-10.74	0.00	0.3971	71.0	653.0	1390.0
j602-2	674.43	194586.70	2415.06	499.15	0.00	-10.17	0.00	0.3241	97.0	480.0	1210.0
j602-3	720.93	208257.70	628.93	599.22	0.00	-9.46	0.00	0.4049	90.0	780.0	1680.0
j602-4	686.71	171063.30	648.56	491.82	0.00	-11.27	0.00	0.3464	88.0	654.0	1110.0
j602-5	596.04	154528.30	546.23	615.31	0.00	-9.33	0.00	0.3996	64.0	775.0	1130.0
j602-6	584.25	153806.10	569.74	530.69	0.00	-9.85	0.00	0.3491	73.0	1334.0	1840.0
j602-7	856.03	147804.40	430.10	637.98	0.00	-9.80	0.00	0.4311	59.0	484.0	656.0
j602-8	629.64	163727.20	759.12	529.12	0.00	-10.89	0.00	0.4009	80.0	630.0	897.0
j602-9	671.60	162614.90	309.78	526.96	0.00	-9.66	0.00	0.3175	77.0	773.0	1200.0
j602-10	862.49	204768.90	2375.02	657.12	0.00	-10.19	0.00	0.4628	77.0	492.0	1050.0
j6010-1	906.71	516337.30	3379.25	1268.91	0.00	-5.38	0.00	0.6042	102.0	306.0	1210.0
j6010-2	1025.74	558256.30	6589.73	2047.00	0.00	-3.52	0.00	0.6603	70.0	585.0	2570.0
j6010-3	903.32	549806.20	5203.46	1664.18	0.00	-4.73	0.00	0.6765	84.0	1074.0	3330.0
j6010-4	904.64	468528.30	3000.48	1209.16	0.00	-6.52	0.00	0.6046	96.0	666.0	2070.0
j6010-5	988.64	597976.60	6201.58	1617.98	0.00	-3.96	0.00	0.6577	95.0	634.0	2910.0
j6010-6	946.23	526570.60	5854.37	1690.64	0.00	-4.37	0.00	0.6262	80.0	574.0	1830.0
j6010-7	904.94	586007.70	6958.69	1769.44	0.00	-4.57	0.00	0.6554	83.0	504.0	1880.0
j6010-8	1035.60	468307.10	6131.64	1500.57	0.00	-3.95	0.00	0.6581	77.0	759.0	2330.0
j6010-9	931.12	560575.10	6050.82	1600.36	0.00	-4.06	0.00	0.6203	88.0	812.0	2910.0
j6010-10	895.74	548588.70	6996.43	1562.95	0.00	-4.96	0.00	0.5582	88.0	454.0	1870.0
j6011-1	753.51	561358.90	7274.98	1693.15	0.00	-3.65	0.00	0.5427	84.0	584.0	2140.0
j6011-2	648.79	494328.30	7095.83	1687.39	0.00	-3.98	0.00	0.5113	74.0	592.0	1930.0
j6011-3	825.35	563642.30	6513.01	1523.25	0.00	-4.59	0.00	0.4790	91.0	492.0	2040.0
j6011-4	754.88	525824.30	6334.08	1587.44	0.00	-4.67	0.00	0.5256	83.0	609.0	2100.0
j6011-5	842.28	537553.60	6107.13	1725.48	0.00	-4.15	0.00	0.5293	77.0	799.0	2570.0

Results of simulations

Instance	F	f ₁	f ₂	f ₃	f ₄	f ₅	f ₆	OC	LV	GN	C_time
j6011-6	690.23	496851.60	5696.96	1500.85	0.00	-4.72	0.00	0.4604	84.0	552.0	1920.0
j6011-7	819.34	559627.80	5791.08	1692.40	0.00	-4.68	0.00	0.5641	82.0	694.0	2670.0
j6011-8	789.01	530476.60	1225.54	1617.27	0.00	-3.80	0.00	0.4729	82.0	539.0	1950.0
j6011-9	739.01	507844.80	3202.00	1747.68	0.00	-3.74	0.00	0.4575	75.0	810.0	2880.0
j6011-10	887.24	517663.60	4306.94	1904.85	0.00	-2.80	0.00	0.5321	70.0	551.0	1740.0
j6020-1	469.79	168498.00	1269.68	620.51	0.00	-6.04	0.00	0.2873	69.0	687.0	1270.0
j6020-2	646.13	117385.30	526.40	337.26	0.00	-13.20	0.00	0.2594	88.0	535.0	863.0
j6020-3	614.29	161299.50	1364.59	488.72	0.00	-9.02	0.00	0.2545	83.0	655.0	1430.0
j6020-4	536.76	159661.90	763.28	393.07	0.00	-8.24	0.00	0.1739	103.0	377.0	939.0
j6020-5	525.01	149007.80	1019.48	427.09	0.00	-8.97	0.00	0.2248	86.0	740.0	1530.0
j6020-6	552.15	170052.20	656.07	366.66	0.00	-10.62	0.00	0.1930	116.0	1116.0	2700.0
j6020-7	643.41	172319.40	606.13	524.72	0.00	-9.10	0.00	0.2598	84.0	585.0	1320.0
j6020-8	470.33	140858.80	438.38	486.30	0.00	-8.39	0.00	0.2643	72.0	697.0	1390.0
j6020-9	594.73	169428.90	1366.09	513.56	0.00	-10.77	0.00	0.3250	84.0	626.0	1190.0
j6020-10	622.85	147445.80	915.58	447.76	0.00	-10.45	0.00	0.2634	83.0	1306.0	2320.0
j6021-1	5176.50	333239.40	6490.89	848.70	226602	-6.18	0.00	0.8007	96.0	660.0	1830.0
j6021-2	2242.05	401433.90	7714.33	889.26	68243	-4.79	0.00	0.7801	112.0	435.0	1280.0
j6021-3	10105.87	369686.80	6722.64	1047.52	565620	-3.96	0.00	0.8729	87.0	466.0	1210.0
j6021-4	24280.32	342033.10	5578.79	873.91	1337350	-7.56	0.00	0.7666	100.0	475.0	1470.0
j6021-5	1100.38	383347.60	7487.99	1084.73	0.00	-6.04	0.00	0.7748	88.0	482.0	1260.0
j6021-6	1245.27	330556.60	6176.53	1053.18	0.00	-1.90	0.00	0.8777	76.0	419.0	933.0
j6021-7	3291.25	391594.90	6229.76	1000.95	133142	-6.76	0.00	0.8205	98.0	576.0	1730.0
j6021-8	6185.77	397700.00	7048.52	922.44	338045	-3.33	0.00	0.7817	107.0	575.0	1850.0
j6021-9	5211.36	428033.60	8528.40	1210.69	291062	-3.80	0.00	0.8902	87.0	401.0	1230.0
j6021-10	8055.80	296205.20	3828.81	1084.89	352484	-5.15	0.00	0.9041	69.0	571.0	1430.0
j6030-1	963.97	654374.10	9202.29	1971.50	0.00	-2.69	0.00	0.7248	83.0	592.0	2550.0
j6030-2	1098.85	689658.50	8188.90	2212.56	0.00	-2.47	0.00	0.8850	78.0	548.0	2580.0
j6030-3	7019.47	796459.80	9818.10	1945.93	812389	-4.08	0.00	0.7316	102.0	353.0	1750.0
j6030-4	1041.51	704978.40	3253.89	1918.59	0.00	-3.79	0.00	0.6149	92.0	558.0	2440.0
j6030-5	1020.06	815615.10	9471.21	2326.53	0.00	-1.56	0.00	0.7968	86.0	686.0	3280.0
j6030-6	1036.66	657367.80	9223.53	1980.58	0.00	-3.66	0.00	0.6515	82.0	720.0	2820.0
j6030-7	4080.48	823201.90	11504.52	2108.30	419832	-2.75	0.00	0.8433	96.0	716.0	3550.0
j6030-8	1086.62	704965.60	14545.35	2241.63	0.00	-2.59	0.00	0.7049	76.0	577.0	2200.0
j6030-9	1017.99	798974.10	9725.13	1708.33	0.00	-3.79	0.00	0.7178	118.0	451.0	2100.0
j6030-10	3088.73	836480.20	10691.36	2144.91	284403	-2.84	0.00	0.8512	100.0	621.0	2920.0
j6031-1	979.68	660512.40	7175.47	2121.22	0.00	-3.13	0.00	0.5357	76.0	592.0	2650.0
j6031-2	1047.32	788088.40	8220.34	2250.70	0.00	-2.87	0.00	0.6505	88.0	776.0	4260.0
j6031-3	841.00	648912.80	8942.09	2216.35	0.00	-3.63	0.00	0.5926	75.0	743.0	2830.0
j6031-4	847.03	605074.40	9542.60	1933.55	0.00	-3.84	0.00	0.6319	80.0	587.0	2300.0
j6031-5	917.42	675306.10	10706.63	1918.04	0.00	-3.15	0.00	0.4819	86.0	869.0	4300.0
j6031-6	1007.08	918023.90	10700.79	2772.57	0.00	-2.10	0.00	0.7183	84.0	532.0	2320.0
j6031-7	762.39	636386.10	7461.39	1815.08	0.00	-4.26	0.00	0.6091	89.0	574.0	2290.0
j6031-8	884.09	711789.40	10081.93	2025.13	0.00	-3.75	0.00	0.5853	90.0	974.0	4180.0
j6031-9	984.36	763143.60	11586.12	1859.14	0.00	-4.10	0.00	0.5164	103.0	364.0	1910.0
j6031-10	855.47	599080.80	6016.69	2200.61	0.00	-2.86	0.00	0.6147	67.0	589.0	1840.0
j6040-1	728.54	414178.80	3170.05	1016.72	0.00	-7.57	0.00	0.3851	104.0	664.0	2600.0
j6040-2	548.52	331600.70	1637.36	857.05	0.00	-7.16	0.00	0.3374	98.0	570.0	1770.0
j6040-3	701.41	326608.20	3521.89	987.28	0.00	-5.61	0.00	0.3404	82.0	770.0	2780.0
j6040-4	524.17	306430.50	671.14	756.36	0.00	-6.69	0.00	0.2608	105.0	721.0	2610.0
j6040-5	851.33	416310.50	5845.21	1066.14	0.00	-6.81	0.00	0.4101	97.0	502.0	1810.0
j6040-6	868.99	357439.30	3362.04	1081.98	0.00	-5.10	0.00	0.3837	82.0	909.0	2820.0
j6040-7	738.28	314640.50	1640.78	956.45	0.00	-6.37	0.00	0.3491	81.0	405.0	1190.0
j6040-8	696.60	354388.90	3731.69	958.73	0.00	-6.29	0.00	0.3577	93.0	683.0	2090.0
j6040-9	730.98	348979.00	2381.98	818.41	0.00	-8.59	0.00	0.3274	107.0	981.0	3720.0
j6040-10	585.23	282654.10	1653.59	810.97	0.00	-8.06	0.00	0.3496	88.0	982.0	2280.0
j6041-1	23030.71	546443.60	7416.84	1037.09	2043699	-3.74	0.00	0.8364	132.0	655.0	2130.0
j6041-2	19174.46	555772.80	7082.16	1187.64	1700665	-6.01	0.00	0.8483	116.0	540.0	1970.0
j6041-3	36212.31	546334.80	9905.75	1326.97	3250693	-3.15	0.00	0.9089	105.0	458.0	1760.0
j6041-4	16192.66	574685.30	11405.68	1083.75	1465448	-2.62	0.00	0.8883	135.0	300.0	1080.0
j6041-5	42114.32	572820.80	8412.39	1172.80	3992560	-2.02	0.00	0.8752	122.0	424.0	1510.0
j6041-6	40104.23	582478.10	7826.52	1066.14	3861829	-5.05	0.00	0.8329	138.0	267.0	1040.0
j6041-7	63151.24	541194.20	5140.79	870.22	5704187	-7.14	0.00	0.7252	157.0	482.0	1720.0
j6041-8	26133.75	585976.70	6471.52	1075.15	2490401	-4.25	0.00	0.8533	139.0	466.0	1560.0
j6041-9	44095.63	646049.60	9150.18	1181.63	4722624	-3.80	0.00	0.8440	139.0	322.0	1140.0
j6041-10	38030.41	633991.80	10287.28	1296.01	3987807	-5.29	0.00	0.8416	123.0	500.0	1940.0

Table D.3 results of data set of 90 tasks

Instance	F	f ₁	f ₂	f ₃	f ₄	f ₅	f ₆	OC	LV	GN	C_time
j901-1	1047.56	280378.00	3780.13	898.05	0.00	-5.12	0.00	0.8018	80.0	528.0	1180.0
j901-2	922.02	242315.80	1807.40	594.95	0.00	-10.97	0.00	0.5042	101.0	681.0	1920.0
j901-3	915.22	225468.60	1565.57	830.81	0.00	-5.74	0.00	0.7288	69.0	614.0	1360.0
j901-4	878.68	254940.00	1050.33	775.83	0.00	-5.79	0.00	0.6806	83.0	629.0	1750.0
j901-5	912.61	236026.10	853.63	581.75	0.00	-11.82	0.00	0.5387	101.0	474.0	1140.0
j901-6	980.62	226024.50	2048.35	775.68	0.00	-7.38	0.00	0.7182	73.0	628.0	1440.0
j901-7	1022.52	284629.30	3866.19	729.25	0.00	-10.93	0.00	0.6511	98.0	624.0	1880.0
j901-8	1014.73	314042.40	3541.25	806.50	0.00	-8.90	0.00	0.6953	99.0	467.0	1550.0
j901-9	940.88	258384.70	3373.67	827.96	0.00	-7.32	0.00	0.6272	76.0	571.0	1430.0
j901-10	919.63	290556.60	3093.30	711.10	0.00	-9.51	0.00	0.5829	104.0	453.0	1230.0
j902-1	799.31	266542.30	297.67	601.34	0.00	-10.42	0.00	0.3378	112.0	671.0	2150.0
j902-2	644.05	248755.60	1511.53	458.71	0.00	-11.68	0.00	0.2832	136.0	642.0	2110.0
j902-3	713.49	246106.00	605.52	708.52	0.00	-8.79	0.00	0.4072	89.0	633.0	1680.0
j902-4	819.76	276125.60	1077.60	952.55	0.00	-6.98	0.00	0.4910	73.0	676.0	2020.0
j902-5	825.11	261183.70	2259.28	560.44	0.00	-12.38	0.00	0.3639	116.0	510.0	1710.0
j902-6	839.28	255288.00	1310.81	776.10	0.00	-9.31	0.00	0.4128	81.0	728.0	1980.0
j902-7	698.64	268248.00	855.46	661.45	0.00	-8.41	0.00	0.3758	102.0	448.0	1350.0
j902-8	817.18	291156.80	592.16	794.43	0.00	-8.40	0.00	0.4226	93.0	888.0	2380.0
j902-9	839.07	278243.00	1617.95	756.32	0.00	-9.00	0.00	0.4347	94.0	633.0	1970.0
j902-10	815.44	232140.40	2197.77	597.25	0.00	-13.82	0.00	0.4148	96.0	922.0	2280.0
j9010-1	883.97	765751.00	3877.65	2083.05	0.00	-3.28	0.00	0.5884	92.0	593.0	3420.0
j9010-2	995.60	905979.60	9592.45	2024.59	0.00	-4.24	0.00	0.6840	114.0	431.0	2760.0
j9010-3	878.98	809700.90	7727.71	1543.00	0.00	-5.51	0.00	0.5433	135.0	593.0	3720.0
j9010-4	913.31	831138.80	10579.78	1937.56	0.00	-3.00	0.00	0.5072	108.0	471.0	3040.0
j9010-5	1027.99	848240.80	9038.39	2294.47	0.00	-2.96	0.00	0.5975	93.0	625.0	3890.0
j9010-6	732.26	667067.20	8564.74	1554.91	0.00	-5.08	0.00	0.5289	108.0	669.0	4280.0
j9010-7	934.68	811919.10	10316.31	2082.09	0.00	-3.02	0.00	0.5627	98.0	783.0	5180.0
j9010-8	921.50	716840.50	8945.75	1838.69	0.00	-3.77	0.00	0.7072	97.0	538.0	2450.0
j9010-9	850.15	797957.80	10192.19	1948.71	0.00	-3.76	0.00	0.5941	104.0	674.0	3970.0
j9010-10	931.00	697164.70	7373.45	1990.74	0.00	-3.85	0.00	0.6680	90.0	768.0	3430.0
j9011-1	1004.95	809383.30	9054.82	2078.78	0.00	-3.00	0.00	0.5774	99.0	429.0	2630.0
j9011-2	793.23	785753.90	7966.59	1683.52	0.00	-4.76	0.00	0.5649	118.0	594.0	3540.0
j9011-3	898.78	733609.40	4750.35	2227.22	0.00	-2.74	0.00	0.5653	83.0	603.0	3380.0
j9011-4	887.90	756259.20	8753.50	2426.97	0.00	-2.38	0.00	0.6779	77.0	768.0	2600.0
j9011-5	770.49	760679.50	8261.14	1954.33	0.00	-3.44	0.00	0.4910	98.0	907.0	5590.0
j9011-6	821.43	843323.20	10387.00	2277.34	0.00	-2.85	0.00	0.5869	94.0	397.0	2260.0
j9011-7	738.11	742682.20	6562.62	1662.61	0.00	-5.05	0.00	0.4375	113.0	755.0	5000.0
j9011-8	843.37	845663.80	8110.15	2175.46	0.00	-4.06	0.00	0.5550	99.0	911.0	5370.0
j9011-9	812.47	794514.80	6482.44	2046.84	0.00	-3.58	0.00	0.5222	97.0	660.0	4030.0
j9011-10	866.48	719242.30	4252.53	1857.12	0.00	-4.03	0.00	0.5306	97.0	531.0	2880.0
j9020-1	626.00	263657.00	411.92	683.75	0.00	-7.96	0.00	0.2825	97.0	854.0	3500.0
j9020-2	664.92	233091.00	1616.56	632.88	0.00	-9.49	0.00	0.3296	92.0	520.0	1430.0
j9020-3	578.55	240025.80	1057.58	591.14	0.00	-9.71	0.00	0.2687	101.0	825.0	2760.0
j9020-4	502.62	245031.40	1393.45	602.69	0.00	-7.82	0.00	0.2816	103.0	723.0	2400.0
j9020-5	584.72	262039.40	571.42	646.80	0.00	-6.72	0.00	0.2432	105.0	635.0	2570.0
j9020-6	548.24	250797.50	358.45	650.49	0.00	-7.57	0.00	0.2602	99.0	655.0	2470.0
j9020-7	592.35	232389.60	1434.08	631.46	0.00	-6.58	0.00	0.2356	95.0	949.0	3370.0
j9020-8	529.53	254018.60	672.40	658.04	0.00	-7.48	0.00	0.2964	98.0	1518.0	2590.0
j9020-9	578.78	203544.30	1145.10	553.38	0.00	-6.31	0.00	0.2112	91.0	948.0	3470.0
j9020-10	675.53	223345.40	693.23	550.78	0.00	-11.25	0.00	0.2993	103.0	1321.0	4800.0
j9021-1	28072.17	561720.10	7401.89	1199.82	2578295	-1.95	0.00	0.8954	119.0	488.0	1960.0
j9021-2	24257.96	578071.80	7205.78	1098.35	2260261	-5.65	0.00	0.8321	135.0	560.0	2300.0
j9021-3	9051.86	610011.60	8630.79	1201.56	829615	-3.50	0.00	0.8344	130.0	671.0	3100.0
j9021-4	1149.64	510350.90	7113.92	1244.87	0.00	-3.78	0.00	0.8527	103.0	672.0	2860.0
j9021-5	33197.88	577416.20	6841.63	1140.01	3141144	-6.21	0.00	0.8143	128.0	412.0	2040.0
j9021-6	5180.99	578383.70	7405.49	1348.24	393300	-3.19	0.00	0.9110	109.0	627.0	2500.0
j9021-7	4020.57	508436.80	8217.27	1129.80	259302	-2.96	0.00	0.8431	113.0	484.0	2080.0
j9021-8	29104.26	569339.70	7584.62	1122.39	2710057	-1.54	0.00	0.8503	130.0	331.0	1470.0
j9021-9	30093.06	554598.40	6469.15	1016.94	2734171	-6.44	0.00	0.7478	139.0	422.0	1910.0
j9021-10	16039.51	548034.40	8951.15	1217.58	1397488	-4.28	0.00	0.8455	113.0	359.0	2710.0
j9030-1	984.14	1091155.00	11284.30	2243.89	0.00	-3.60	0.00	0.6303	122.0	576.0	4400.0
j9030-2	898.38	886004.90	10003.44	2528.14	0.00	-2.98	0.00	0.6908	89.0	564.0	3300.0
j9030-3	962.57	1025267.00	12545.85	2104.35	0.00	-3.65	0.00	0.7307	123.0	911.0	5360.0
j9030-4	991.12	1142719.00	14220.18	2344.93	0.00	-3.86	0.00	0.7516	125.0	764.0	5500.0
j9030-5	964.41	983236.10	12057.49	2522.54	0.00	-1.97	0.00	0.8522	96.0	389.0	2130.0
j9030-6	1052.16	1166635.00	15361.53	2718.47	0.00	-2.61	0.00	0.6900	107.0	627.0	5130.0
j9030-7	1096.25	1092393.00	15252.44	2797.77	0.00	-2.07	0.00	0.8229	100.0	855.0	5250.0
j9030-8	983.58	1093237.00	10672.54	2811.86	0.00	-2.76	0.00	0.7173	99.0	486.0	3170.0

Instance	F	f ₁	f ₂	f ₃	f ₄	f ₅	f ₆	OC	LV	GN	C_time
j9030-9	7994.43	1133631.00	11417.81	2649.85	1349021	-1.66	0.00	0.8493	106.0	526.0	3490.0
j9030-10	1018.20	1034216.00	12786.23	2411.88	0.00	-3.40	0.00	0.8040	107.0	790.0	5220.0
j9031-1	989.41	1020886.00	13379.66	2754.63	0.00	-2.66	0.00	0.7652	95.0	627.0	3600.0
j9031-2	2109.04	1058387.00	14002.06	3191.40	179925	-0.68	0.00	0.8768	84.0	778.0	4460.0
j9031-3	999.42	979767.40	14916.78	2004.88	0.00	-4.09	0.00	0.5664	121.0	672.0	5230.0
j9031-4	1028.73	1079542.00	15623.74	2908.87	0.00	-2.26	0.00	0.7536	94.0	728.0	4650.0
j9031-5	1061.42	1124566.00	15254.03	3032.98	0.00	-2.55	0.00	0.7898	94.0	511.0	3420.0
j9031-6	1099.57	1097693.00	13423.92	2964.51	0.00	-2.73	0.00	0.7969	95.0	888.0	4030.0
j9031-7	874.83	1089667.00	7678.46	2341.97	0.00	-3.99	0.00	0.6036	116.0	856.0	6090.0
j9031-8	993.68	1020105.00	15972.75	2608.14	0.00	-2.61	0.00	0.7671	100.0	666.0	4210.0
j9031-9	1039.77	1121445.00	16032.29	3190.22	0.00	-1.41	0.00	0.8016	87.0	632.0	3830.0
j9031-10	1034.66	1038665.00	11732.58	2222.80	0.00	-2.70	0.00	0.6946	119.0	385.0	3030.0
j9040-1	624.62	445012.00	2942.56	998.46	0.00	-5.83	0.00	0.3351	112.0	734.0	3500.0
j9040-2	576.75	450781.40	2439.32	1058.66	0.00	-6.18	0.00	0.3350	107.0	997.0	5320.0
j9040-3	743.62	473608.80	2768.16	1358.85	0.00	-4.60	0.00	0.3882	90.0	922.0	4600.0
j9040-4	611.60	420609.70	2283.66	835.82	0.00	-7.44	0.00	0.3142	126.0	760.0	3560.0
j9040-5	608.63	452840.00	3073.13	1062.02	0.00	-6.19	0.00	0.3319	109.0	634.0	3220.0
j9040-6	609.88	470455.80	1715.14	1159.53	0.00	-5.62	0.00	0.3257	102.0	706.0	3970.0
j9040-7	622.02	525451.90	2178.06	1294.43	0.00	-5.05	0.00	0.3556	105.0	757.0	4100.0
j9040-8	686.87	447004.50	5180.00	1208.00	0.00	-4.86	0.00	0.3196	93.0	829.0	4450.0
j9040-9	590.77	486260.50	4125.61	1043.58	0.00	-5.46	0.00	0.3069	116.0	502.0	2740.0
j9040-10	682.17	546424.10	4895.92	1339.59	0.00	-5.27	0.00	0.3917	104.0	453.0	2690.0
j9041-1	50062.50	826683.10	13729.60	1206.61	6886270	-8.32	0.00	0.8044	172.0	367.0	1890.0
j9041-2	53147.52	885275.10	18735.49	1216.62	7825838	-6.08	0.00	0.8690	182.0	792.0	3960.0
j9041-3	53971.98	828251.00	14630.47	1142.32	7462539	-7.48	0.00	0.8160	181.0	676.0	3390.0
j9041-4	75227.39	916272.00	17255.33	1262.22	11526690	-4.79	0.00	0.8529	181.0	352.0	1950.0
j9041-5	49195.99	748494.30	10630.86	1236.47	6107713	-5.61	0.00	0.8708	155.0	675.0	3590.0
j9041-6	50098.73	810117.30	13545.06	1334.85	6748279	-3.32	0.00	0.8668	153.0	398.0	2080.0
j9041-7	53045.45	856285.90	14040.12	1215.36	7569564	-5.10	0.00	0.8559	178.0	797.0	3990.0
j9041-8	50065.39	982630.50	14007.29	1397.73	8185308	-1.15	0.00	0.9076	179.0	533.0	2730.0
j9041-9	40096.86	805329.90	11935.76	1526.49	5339336	-1.23	0.00	0.9086	132.0	504.0	2550.0
j9041-10	47210.48	856177.70	11226.75	1254.10	6695307	-6.31	0.00	0.8590	172.0	412.0	2130.0

Table D.4 results of data set of 120 tasks

Instance	F	f ₁	f ₂	f ₃	f ₄	f ₅	f ₆	OC	LV	GN	C_time
j1201-1	1019.01	347975.90	4320.50	743.84	0	-8.38	0.00	0.7748	119.0	433.0	1600.0
j1201-2	4202.70	354217.70	7294.34	819.18	180651	-8.84	0.00	0.8031	107.0	319.0	1190.0
j1201-3	3183.90	371092.00	5804.70	903.62	126171	-5.47	0.00	0.8215	101.0	832.0	3150.0
j1201-4	12178.06	353693.60	4669.60	824.14	661407	-0.49	0.00	0.8241	106.0	614.0	2230.0
j1201-5	4256.11	362729.70	4998.14	774.31	184992	-4.72	0.00	0.7445	116.0	738.0	2970.0
j1201-6	5113.61	298332.40	3510.79	900.91	202866	-3.16	0.00	0.8663	82.0	673.0	2130.0
j1201-7	1180.64	354495.30	4881.84	756.74	0	-2.76	0.00	0.7883	116.0	371.0	1380.0
j1201-8	1073.89	341153.20	4602.20	832.53	0	-4.52	0.00	0.8325	102.0	522.0	1770.0
j1201-9	4086.27	381243.40	5436.65	887.38	194434	-7.84	0.00	0.8700	110.0	346.0	1260.0
j1201-10	909.49	344462.20	5326.42	800.79	0	-6.43	0.00	0.7700	106.0	638.0	2170.0
j1202-1	4136.07	376056.50	6054.27	1067.83	191789	-3.85	0.00	0.7969	87.0	426.0	1530.0
j1202-2	928.39	299386.10	2851.60	855.80	0	-7.41	0.00	0.6583	87.0	730.0	2770.0
j1202-3	1173.18	421263.80	6298.62	1134.56	0	-4.03	0.00	0.8342	92.0	657.0	2710.0
j1202-4	871.47	310784.90	3394.71	725.83	0	-9.67	0.00	0.6257	106.0	673.0	2240.0
j1202-5	1116.39	400017.80	4663.87	933.54	0	-7.01	0.00	0.7911	110.0	753.0	2990.0
j1202-6	992.07	383226.30	5130.57	1091.19	0	-5.56	0.00	0.8267	90.0	432.0	1480.0
j1202-7	1047.37	342761.00	3231.21	881.90	0	-5.48	0.00	0.7112	98.0	373.0	1370.0
j1202-8	960.32	306467.40	1508.64	833.79	0	-6.34	0.00	0.6617	91.0	465.0	1620.0
j1202-9	922.18	357185.10	3572.69	834.98	0	-5.46	0.00	0.6844	107.0	506.0	1830.0
j1202-10	882.21	385192.50	5786.18	1037.34	0	-5.32	0.00	0.7517	94.0	515.0	1750.0
j12010-1	804.10	713581.10	5211.93	1362.90	0	-6.46	0.00	0.5086	133.0	710.0	5200.0
j12010-2	833.48	681834.10	2746.15	1603.51	0	-5.03	0.00	0.4830	109.0	590.0	4190.0
j12010-3	938.73	782326.70	9957.43	1671.80	0	-5.71	0.00	0.6333	118.0	869.0	5460.0
j12010-4	1106.06	756375.40	8078.75	1766.93	0	-3.54	0.00	0.7068	109.0	422.0	2850.0
j12010-5	1018.22	681491.30	7316.49	1459.25	0	-5.99	0.00	0.5570	117.0	696.0	4540.0
j12010-6	718.16	644601.00	6720.81	1506.21	0	-5.48	0.00	0.4828	107.0	572.0	3730.0
j12010-7	988.57	754623.50	4224.98	2051.67	0	-2.61	0.00	0.7380	92.0	591.0	3370.0
j12010-8	991.17	722395.90	7595.84	1375.28	0	-6.87	0.00	0.6309	132.0	560.0	3580.0
j12010-9	924.22	662145.80	6856.73	1791.63	0	-4.20	0.00	0.5148	93.0	488.0	2980.0
j12010-10	908.18	730080.20	9224.78	2340.44	0	-3.03	0.00	0.6063	80.0	1025.0	5900.0
j12011-1	25133.66	1052173.00	11361.29	2002.52	6313041	-1.47	0.00	0.9446	132.0	638.0	4350.0
j12011-2	24050.97	935548.10	14340.67	1993.96	5379402	-1.84	0.00	0.9405	117.0	511.0	3240.0
j12011-3	42086.92	1107462.00	13224.75	1833.66	11351480	-2.84	0.00	0.8901	153.0	533.0	4060.0
j12011-4	33097.40	1094982.00	17027.33	1866.59	8759856	-4.33	0.00	0.9150	148.0	638.0	4610.0

Instance	F	f ₁	f ₂	f ₃	f ₄	f ₅	f ₆	OC	LV	GN	C_time
j12011-5	39939.03	1155896.00	13848.34	1853.97	11269990	-3.42	0.00	0.8828	156.0	560.0	4400.0
j12011-6	42053.71	1136979.00	16895.37	1876.97	11654030	-3.61	0.00	0.8771	151.0	603.0	4620.0
j12011-7	26083.99	968825.30	13516.90	1985.06	6055159	-2.72	0.00	0.9636	124.0	649.0	4280.0
j12011-8	18063.36	1044405.00	12709.54	1984.98	4438721	-3.02	0.00	0.9105	131.0	376.0	2770.0
j12011-9	30074.50	1087730.00	17890.73	2223.04	7886042	-0.89	0.00	0.9582	121.0	640.0	4650.0
j12011-10	26019.69	1096194.00	14696.37	2080.80	6851212	-3.22	0.00	0.9545	133.0	453.0	3370.0
j12020-1	21049.47	1457415.00	15360.03	2881.23	4955211	-1.53	0.00	0.8575	127.0	478.0	4770.0
j12020-2	16994.53	1418259.00	15293.10	2699.31	3857664	-3.43	0.00	0.8435	135.0	756.0	7670.0
j12020-3	25076.31	1581979.00	21208.65	3525.17	6454473	-0.71	0.00	0.9632	113.0	649.0	6980.0
j12020-4	2985.02	1359893.00	16007.25	3173.29	462364	-2.07	0.00	0.8815	109.0	719.0	6430.0
j12020-5	14028.24	1267109.00	15669.19	3250.49	2800310	-1.87	0.00	0.8335	96.0	687.0	5920.0
j12020-6	1057.76	1271139.00	16923.35	3257.70	0	-1.97	0.00	0.8396	96.0	520.0	4460.0
j12020-7	1021.89	1264808.00	16439.34	3242.52	0	-0.74	0.00	0.9007	98.0	545.0	4330.0
j12020-8	972.57	1467716.00	17029.34	3014.41	0	-2.72	0.00	0.8191	123.0	969.0	10100.0
j12020-9	10023.02	1475215.00	17480.82	3628.23	2257079	-1.36	0.00	0.9116	105.0	682.0	6430.0
j12020-10	13060.70	1530866.00	18232.55	3571.74	3122967	-1.37	0.00	0.9499	110.0	641.0	6360.0
j12021-1	1243.05	395842.60	6019.51	843.77	0	-10.38	0.00	0.8272	118.0	354.0	1430.0
j12021-2	1055.74	338671.00	4387.53	826.92	0	-6.83	0.00	0.8269	103.0	658.0	2520.0
j12021-3	1064.69	411555.70	6099.62	780.10	0	-10.61	0.00	0.8126	134.0	443.0	1870.0
j12021-4	1095.24	400511.30	3754.92	763.36	0	-11.13	0.00	0.7202	131.0	423.0	1700.0
j12021-5	1192.96	340529.80	3592.01	761.01	0	-11.49	0.00	0.7610	114.0	335.0	1350.0
j12021-6	908.49	341930.80	2877.52	733.88	0	-9.09	0.00	0.7195	116.0	579.0	2350.0
j12021-7	4132.92	356393.20	6351.28	909.20	181761	-4.00	0.00	0.9092	98.0	610.0	2230.0
j12021-8	1029.77	347788.60	4157.73	615.55	0	-13.60	0.00	0.6156	144.0	533.0	2140.0
j12021-9	1237.67	356631.80	4276.09	871.63	0	-7.21	0.00	0.8545	102.0	410.0	1630.0
j12021-10	1055.21	327197.60	4525.30	838.11	0	-7.83	0.00	0.8059	99.0	722.0	2270.0
j12030-1	884.84	715080.90	9691.53	1465.74	0	-5.41	0.00	0.5726	122.0	435.0	2690.0
j12030-2	820.48	677191.30	5847.90	1291.67	0	-7.15	0.00	0.5427	134.0	486.0	3130.0
j12030-3	748.85	702605.10	5487.71	1392.84	0	-6.49	0.00	0.5399	130.0	675.0	4470.0
j12030-4	955.95	699792.60	8977.03	1794.33	0	-4.36	0.00	0.6597	96.0	801.0	5280.0
j12030-5	965.47	729308.90	8144.04	1971.74	0	-2.65	0.00	0.8081	94.0	521.0	3240.0
j12030-6	968.43	714347.20	1222.98	1949.76	0	-3.84	0.00	0.6456	95.0	933.0	4980.0
j12030-7	1145.86	787925.00	8627.70	1760.13	0	-4.63	0.00	0.6471	112.0	579.0	4030.0
j12030-8	1014.53	764855.60	9899.84	2064.13	0	-3.46	0.00	0.5966	94.0	564.0	3720.0
j12030-9	989.95	762164.40	7198.04	1705.18	0	-4.56	0.00	0.6410	112.0	377.0	2590.0
j12030-10	884.47	667644.50	8895.94	1629.56	0	-5.29	0.00	0.5658	104.0	672.0	4180.0
j12031-1	63072.48	1069157.00	11518.46	1569.78	11268930	-6.29	0.00	0.9127	173.0	444.0	3210.0
j12031-2	50973.92	1070015.00	15387.80	1826.19	9095127	-5.46	0.00	0.9131	149.0	615.0	4930.0
j12031-3	50070.34	1005328.00	16974.33	1770.45	8374376	-5.05	0.00	0.8852	145.0	600.0	4820.0
j12031-4	38148.54	1074668.00	16070.58	1571.20	6759660	-6.38	0.00	0.8729	172.0	542.0	4040.0
j12031-5	54005.74	1086710.00	16251.88	1635.54	9791267	-5.53	0.00	0.8889	170.0	628.0	4600.0
j12031-6	44142.11	1143963.00	16798.83	1774.36	8362366	-3.09	0.00	0.9053	165.0	457.0	3490.0
j12031-7	47129.34	1148634.00	16920.50	1633.07	8982323	-3.98	0.00	0.8780	178.0	681.0	5420.0
j12031-8	47050.03	1087125.00	16576.92	1737.90	8501324	-4.06	0.00	0.8777	157.0	645.0	4930.0
j12031-9	44125.35	1117188.00	14920.45	1735.17	8166645	-5.63	0.00	0.8506	162.0	607.0	4900.0
j12031-10	53145.93	1137393.00	16016.51	1820.42	10054560	-4.25	0.00	0.9384	160.0	679.0	5380.0
j12040-1	6075.63	1259730.00	17635.71	3226.22	1070770	-0.66	0.00	0.9271	99.0	977.0	7500.0
j12040-2	15008.11	1506367.00	20265.17	3088.00	3585152	-2.46	0.00	0.8301	122.0	547.0	5760.0
j12040-3	9056.54	1394511.00	19180.02	3106.34	1896535	-1.20	0.00	0.9190	113.0	816.0	7050.0
j12040-4	1073.47	1493837.00	17190.60	2841.07	0	-2.76	0.00	0.7477	132.0	592.0	7030.0
j12040-5	1015.71	1368458.00	15343.09	2811.67	0	-3.02	0.00	0.7209	122.0	481.0	5540.0
j12040-6	4035.32	1458058.00	18890.92	3250.52	743609	-1.13	0.00	0.8167	111.0	780.0	7910.0
j12040-7	6005.64	1391511.00	14613.22	3109.88	1182785	-0.80	0.00	0.8360	115.0	626.0	6390.0
j12040-8	982.48	1376518.00	18657.94	3066.88	0	-2.34	0.00	0.8113	115.0	460.0	4690.0
j12040-9	1017.02	1495264.00	17817.12	2741.09	0	-3.25	0.00	0.7531	140.0	504.0	5020.0
j12040-10	1055.89	1539968.00	19664.01	3433.78	0	-2.13	0.00	0.8942	115.0	517.0	5140.0
j12041-1	1267.25	384384.40	6688.46	784.82	0	-10.50	0.00	0.8175	124.0	479.0	2090.0
j12041-2	936.33	397299.90	4380.54	850.47	0	-3.09	0.00	0.8859	117.0	585.0	2420.0
j12041-3	1067.60	397081.20	4516.85	703.21	0	-5.63	0.00	0.7481	143.0	639.0	2670.0
j12041-4	1018.73	335439.30	5425.83	816.36	0	-5.59	0.00	0.8504	103.0	454.0	1770.0
j12041-5	991.83	343808.60	4138.44	653.53	0	-13.37	0.00	0.6952	135.0	564.0	2510.0
j12041-6	1232.36	355119.20	4599.44	827.67	0	-4.96	0.00	0.8446	109.0	494.0	1970.0
j12041-7	1212.64	349740.90	3533.27	817.49	0	-5.97	0.00	0.8342	110.0	498.0	2020.0
j12041-8	1187.68	359375.70	5045.52	681.73	0	-14.03	0.00	0.7101	131.0	497.0	1990.0
j12041-9	879.63	330817.40	3722.11	738.78	0	-7.34	0.00	0.7696	114.0	569.0	1910.0
j12041-10	909.37	355204.70	3421.16	630.15	0	-12.88	0.00	0.6430	141.0	515.0	2020.0