



HAL
open science

Chi-boundedness, Geometric Graph Theory, and Burling Graphs

Pegah Pournajafi

► **To cite this version:**

Pegah Pournajafi. Chi-boundedness, Geometric Graph Theory, and Burling Graphs. Combinatorics [math.CO]. Ecole normale supérieure de lyon - ENS LYON, 2023. English. NNT : 2023ENSL0033 . tel-04235331

HAL Id: tel-04235331

<https://theses.hal.science/tel-04235331v1>

Submitted on 10 Oct 2023

HAL is a multi-disciplinary open access archive for the deposit and dissemination of scientific research documents, whether they are published or not. The documents may come from teaching and research institutions in France or abroad, or from public or private research centers.

L'archive ouverte pluridisciplinaire **HAL**, est destinée au dépôt et à la diffusion de documents scientifiques de niveau recherche, publiés ou non, émanant des établissements d'enseignement et de recherche français ou étrangers, des laboratoires publics ou privés.



THESE

en vue de l'obtention du grade de Docteur, délivré par
l'ÉCOLE NORMALE SUPÉRIEURE DE LYON

École Doctorale N°512
École Doctorale Informatique, Mathématiques de Lyon (InfoMaths)

Discipline : Informatique

Soutenue publiquement le 07/07/2023, par :

Pegah POURNAJAFI

Chi-boundedness, Geometric Graph Theory, and Burling graphs

Chi-boundedness, théorie géométrique des graphes et graphes de Burling

Devant le jury composé de :

CHALOPIN, Jérémie	DR CNRS	Aix Marseille Université	Rapporteur
DUJMOVIĆ, Vida	Professeure	Université d'Ottawa	Rapporteuse
MOREL, Sophie	DR CNRS	ENS de Lyon	Examinatrice
ROSENFELD, Matthieu	MCF	Université de Montpellier	Examinateur
TROTIGNON, Nicolas	DR CNRS	ENS de Lyon	Directeur de thèse



Chi-boundedness, geometric graph theory, and Burling graphs

Pegah Pournajafi

École Normale Supérieure de Lyon

A thesis presented for the degree of
Doctor of Philosophy
in *Mathematics*

7 July 2023

Thesis committee

Jérémie Chalopin	DR CNRS	Aix Marseille Université	Reviewer
Vida Dujmović	Professeure	Université d'Ottawa	Reviewer
Sophie Morel	DR CNRS	ENS de Lyon	Examiner, president of the jury
Matthieu Rosenfeld	MCF	Université de Montpellier	Examiner
Nicolas Trotignon	DR CNRS	ENS de Lyon	Thesis supervisor

To my parents, Matin and Peiman.

*A mathematician will never be a perfect mathematician,
unless he [or she] is somewhat of a poet.*

— Karl Weierstrass

Acknowledgements

Finishing the writing of my thesis, I realize how fortunate I am to be pursuing what I have always loved, mathematics. In this journey, and in particular, during the three years of my PhD, many people have accompanied me scientifically or personally and I cannot possibly thank them all appropriately. This section, however, is my try to tell everyone how grateful I am for their presence in my personal and academic life.

I would like to start by expressing my gratitude toward my supervisor, Nicolas Trotignon. I have learned so much from his experience and invaluable insight in research. I am particularly grateful for our regular online meetings during the period of COVID, which overlapped with the beginning of my PhD. I am glad to have had the chance to work with one of the greatest researchers in the field.

I would also like to thank the jury of my thesis, Jérémie Chalopin, Sophie Morel, Matthieu Rosenfeld, and Vida Dujmović for their helpful comments and for reading my dissertation. In particular, the very detailed review of Jérémie Chalopin and the insightful comments of Sophie Morel have notably contributed to improving the final version of this dissertation.

Words cannot describe my gratitude to my parents: my father, Peiman Pournajafi, and my mother, Matin Ziraki. They are the first to teach me mathematics and encourage me in my path throughout my life. During my PhD as well, even from thousands of kilometers away, their constant love and support have been the most important resource for me to pursue my journey. Dedicating this thesis to them is my way of telling them how much I value their role in my pursuit of my dreams and how lucky I feel to be their daughter.

I cannot thank Paul Meunier enough, my partner in life and in mathematics, for his incredible love and support. His presence is a constant source of happiness and motivation in my personal and scientific life and has made enduring hard moments much easier and enjoying happy ones much more delightful. Besides, our mathematical discussions are some of my all-time favorite moments. Moreover, his reading of my thesis has been extremely useful for me.

My heartfelt thanks go to my sister, Pouna Pournajafi. Talking to her is always a burst of energy and a source of strength and motivation for me. She has also kindly helped me with her expertise in English in the writing of my thesis. It is her name that appears in this dissertation to describe some particular sets – the Pouna sets.

I have had many amazing professors who shaped my path, and the period of my PhD was not an exception. I express my profound appreciation to Samir Perlaza, for his invaluable support and his confidence in me, and to Damien Gaboriau, for his insightful guidance and for encouraging me to follow mathematical events in French.

My sincere appreciation goes to Temple and Koren Burling, the children of James Burling, whose research is the mathematical foundation on which my thesis rests upon. Getting to meet them was a lovely event during my PhD, and thanks to them, I got to know their father better – a truly amazing person – and include a short biography of him in my dissertation.

I cannot have a complete acknowledgment without thanking my amazing friends whose friendship has made a difference for me. Many thanks to Zhila Nayebossadrian for always being there for me. I am thankful to Yasaman Yektaeian for her confidence in me, to Jean-Pierre Salamand for his remarkable kindness, to Abbas K. Rizi for our pleasant conversations, to Aida Javadian for her unwavering kindness, and to Omid Momenzadeh for his genuine friendship.

Last but not least, I would like to thank my loving grandmother, Farangis Vafaei, for her everlasting encouragement. I would also like to thank Magali Meunier, for her kindness, Natacha Portier, for her advocacy for positive changes, Laure Savetier and Chiraz Benamor, for helping me out with my numerous administrative tasks, and Jean-Claude Sikorav, for kindly answering my questions. Finally, I am glad to have had access to the coffee room of UMPA at ENS Lyon, the library of ENS Lyon, and the café of my neighborhood, which were my favorite workplaces. There are several individuals, near and far, who have contributed to my journey and whose names remained unmentioned. I am thankful to every and each of them.

Pegah Pournajafi
July 2023
Lyon, France

Summary

This dissertation is mainly about the theory of χ -boundedness and geometric graph theory. In particular, we put much focus on a topic at the intersection of the two: Burling graphs. The class of Burling graphs, defined by Burling [Bur65] in 1965, is a class of triangle-free graphs with arbitrarily large chromatic number that has been the object of much research since the 1960s until today. In this dissertation, we study Burling graphs from different aspects: their characterizations, their structure, and their applications.

We give several equivalent characterizations of Burling graphs with different flavors: a combinatorial one (called derived graphs), an axiomatic one (called abstract Burling graphs), and some geometric ones (called constrained graphs). The two former ones, being the first non-inductive definitions of Burling graphs, allow deriving new results (see under). Historically, Burling graphs have been viewed as subclasses of geometric graphs. The geometric characterizations, by introducing Burling graphs as an exact class of geometric graphs for the first time, complete this historical viewpoint.

We then study several structural properties of Burling graphs using the derived graph definition. Among other results, we give decomposition theorems, study the structure of holes in Burling graphs, and analyse the effects of several operations on the class. Using these results, we introduce new techniques for providing new triangle-free graphs that are not Burling graphs. In addition, we prove probabilistic results about the size of the class.

Finally, we provide some applications of our results to the theory of χ -boundedness. We disprove a conjecture of Scott and Seymour from [SS20] and answer a question of Trotignon from [Tro13], both about wheel-free graphs. We also obtain the complete classification of weakly pervasive complete graphs, and provide new families of non-weakly pervasive graphs (i.e. counterexamples to Scott's conjecture).

A major part of this thesis is contained in [PT23, PT21a, PT21b] (joint works with Nicolas Trotignon), in [Pou22], and in the author's master's thesis [Pou20].

– *Keywords:* graph theory, χ -boundedness, Burling graphs, intersection graphs of geometrical objects

Contents

1	Introduction	1
I	Preliminaries	5
2	Main topics and notation	6
3	A brief history of Burling graphs and their applications	22
II	Characterizations of Burling graphs	32
4	Definitions of Burling graphs and examples	33
5	Equivalence of definitions	49
6	Intersection graphs of boxes	81
III	Structure of Burling graphs	84
7	Structure of Burling graphs	85
8	Burling graphs and non-Burling graphs	106
9	More operations on Burling graphs	127
IV	Applications and open problems	132
10	Applications to χ -boundedness	133
11	Open problems	137

V Appendix	141
A Biography of James Perkins Burling	142
B Intersection graphs that do not contain Burling graphs	145
C Other proofs	148
Summary in French	155
References	160
List of Figures	163
List of Notations	164
Alphabetical Index	166

Chapter 1

Introduction

This dissertation, in the broadest sense, is about the chromatic number of graphs¹, a concept that ages back to at least 1852, when Francis Guthrie made the famous four-color conjecture: in any map drawn in the plane, one can color the regions with at most four colors such that neighboring regions receive different colors. This conjecture captures the general idea of graph coloring: coloring a set of objects so that any two objects that are related receive different colors. It is common for graph coloring problems to have simple statements, but to be hard to solve. For example, the simple-looking four-color conjecture remained open for more than a century.² This charming property of such problems, along with their vast applications, not only has enlivened research on graph coloring but has made it expand into diverse areas.

One of these areas is χ -boundedness, a field that aims to understand the behavior of the chromatic number of graphs with respect to their structural properties. A typical method in χ -boundedness is to set global or local (structural) restrictions on graphs and ask whether these restrictions affect the behavior of chromatic number. That is why the objects under study in χ -boundedness are often classes of graphs rather than individual graphs. Such studies age as back as at least the 1950s (see for example [Des54] and [Myc55]), long before the first formalization of χ -boundedness in today's terminology from the historic article of Gyárfás [Gyá85] in 1985. The four-color theorem is an example of the global restrictions. We discuss more examples of the global point of view when studying the intersection graphs of geometric objects. In the local point of view, it is common to study the chromatic number in classes of graphs defined by forbidding fixed substructures for some containment relation. Different substructures and different containment

¹Chromatic number and any other notion in this introduction will be defined precisely later in the dissertation. We keep this introduction informal.

²Kenneth Appel and Wolfgang Haken proved the four-color theorem in 1976. Their proof included an extensive use of computers. Up to this date, all the existing proofs of this theorem are computer-assisted.

relations result in different types of results and conjectures. It is worth noting that often, there is a duality between the global and the local point of view. For example, due to Kuratowski's theorem [Kur30]³ and four-color theorem, the absence of some precise local structures (namely subdivisions of K_5 and $K_{3,3}$ as subgraphs) forces the chromatic number to be at most 4.

Let us give an example of a question from the local point of view that is important in this dissertation. Let H be any graph, and consider the class \mathcal{C} of graphs that do not contain the topological shape of H (formally, they do not contain any subdivision of H as an induced subgraph). number. But aside from this obvious reason, is there any other reason Is it true that for every k , there exists a constant $c = c(H, k)$ such that all graphs in \mathcal{C} with no clique of size k have chromatic number at most c ? The idea being, is the topology of H necessary for having arbitrarily large chromatic number? When the answer to this question is positive, we say that H is weakly pervasive. This question was first asked and studied by Scott [Sco97], who proved that for all trees, the answer is positive, i.e. trees are weakly pervasive. He then conjectured that all graphs are weakly pervasive.⁴

It is easy to see that K_3 , the complete graph on 3 vertices, is weakly pervasive: if a graph does not contain any subdivision of K_3 , then it is a forest, and thus is 2-colorable. The complete graph on 4 vertices, K_4 , is weakly pervasive as well (see [LMT12]). When we started this research, what intrigued me was to know the answer for K_5 , which was still open at the time. On the other hand, the question for K_5 , as we explain in the dissertation, is related to well-known conjectures such as Hajós' conjecture and Hadwiger's conjecture.

Research, like any other adventure, has surprises. Our work on finding the answer for K_5 led us to study Burling graphs, a class of triangle-free graphs with arbitrarily large chromatic number. They are defined by Burling [Bur65] in 1965, in his Ph.D. thesis. Since then, they have appeared in other research with a variety of applications (see, for instance, [Che12, CELOdM16, FJM⁺18, PKK⁺14, KPW14]) – in particular, the first graphs that are not weakly pervasive are found thanks to Burling graphs [PKK⁺14]. Besides their numerous applications, Burling graphs happened to be fascinating objects on their own, and soon we realized that there is still so much to unveil about them. So, we began to focus our research on the class itself. This led to new characterizations of Burling graphs and structural results about them, which in turn enabled us to deduce some applications, including the answer to our first question: no K_n , for $n \geq 5$, is weakly pervasive.

To begin with, we realized that the existing definition of Burling graphs is not easy to work with and can be clarified. Therefore, we redefined them in other

³Kuratowski's theorem, proved by Casimir Kuratowski in 1930, states that a graph is planar if and only if it contains no subdivision of $K_{3,3}$ and K_5 as a subgraph.

⁴This conjecture remained open for another 15 years until the first non-weakly pervasive graphs were found in [PKK⁺14].

terms: we give new equivalent definitions for this class of graphs. Among these definitions, one is combinatorial, one is axiomatic, and some are geometric (since Burling graphs are historically defined as intersection graphs of geometrical objects). Those definitions gave us more flexibility in our studies: some are easier for deriving structural properties of the graphs, and some are more general and help us with the proofs, as well as finding examples of Burling graphs. Moreover, we realized we can benefit from regarding Burling graphs as oriented graphs instead of (non-oriented) graphs. See [PT23].

Since Burling graphs were historically discovered [Bur65] (and rediscovered [PKK⁺14]) as intersection graphs of geometric objects, we also define the precise subclass of intersection graphs of transformations of a set S (for some general family of sets in \mathbb{R}^2 that we call Pouna sets and for boxes in \mathbb{R}^3) that is equal to the class of Burling graphs. See [Pou22].

Later, we used these new characterization to study the structural properties of Burling graphs: properties of their orientation, star cutsets in them, attachments of holes in them, their closedness under different operations, etc. Among the advantages of such studies were finding a decomposition theorem for the class of Burling graphs and finding examples of graphs that are not in the class while introducing new techniques to do so. See [PT21a].

Finally, we present some applications in χ -boundedness. We disprove a conjecture of Scott and Seymour in [SS20], answer a question of Trotignon in [Tro13], and provide new techniques and several examples of graphs that are not weakly pervasive. See [PT21b].

Conventions and proofs

To improve the readability of the text, we have placed some of the proofs in Appendix C. The results whose proofs are postponed to the appendix are either folklore or belong to a topic not directly related to the rest of the thesis (such as probabilities and point-set topology). However, we have not left any statements without proof unless a reference is given.

Moreover, at some points, we would like to motivate or give insight into the topic at hand, and it might require references to future or past texts in the thesis. In such situations, to separate such explanations from the main text, and to increase the readability, we include such texts in an environment titled “a breach in time”.

Thesis outline

Part 1. Preliminaries

We first cover the bases of the topics in this dissertation, including the graph theoretical definitions, χ -boundedness, and geometric graph theory. We also present the notation used throughout this dissertation. We end this part with a brief history of Burling graphs and their applications from 1965 until today.

Part 2. Characterizations of Burling graphs

We introduce the several definitions of Burling graphs, briefly discuss the advantages of each, and finally prove that they are all equivalent.

Part 3. Structure of Burling graphs

We prove some results about the structure of Burling graphs, including a decomposition theorem for the class. We also provide examples of Burling graphs and non-Burling graphs.

Part 4. Applications and open problems

We present some applications of Burling graphs using the results from previous parts and then introduce some open problems.

Appendix.

In the appendix, we first provide a short biography of James Perkins Burling, the discoverer of Burling graphs. Then, to answer a natural question that arises in the thesis, we provide an example of a class of intersection graphs with unbounded chromatic number which has no containment relations with Burling graphs. Finally, the proofs that are not in the body of the thesis can be found in [Appendix C](#).

We have written a summary in French, and then, we have provided a list of figures, a list of notations, and an alphabetic index to facilitate the reading of this document.

Part I
Preliminaries

Chapter 2

Main topics and notation

2.1	Graphs and oriented graphs	6
2.2	χ-boundedness	10
2.3	Geometric graph theory	15
2.4	Notation	17

In this chapter, we introduce the main topics of this dissertation. In Section 2.1, we fix our graph theory notions and definitions. In Section 2.2, we introduce the basics of χ -boundedness and some questions that we will consider, such as Scott's conjecture. In Section 2.3, we introduce the intersection graphs of geometrical objects and their relation to the topics that we discuss. Finally, we introduce the notation used in this thesis in Section 2.4.

2.1 Graphs and oriented graphs

Graphs and oriented graphs

A *graph* G is a pair (V, E) where V is a set and E is a set of two-element subsets of V . The elements of V are called the *vertices* of G and the elements of E are called the *edges* of G . We often denote the vertex-set and the edge-set of a given graph H by $V(H)$ and $E(H)$ respectively.

We say that two vertices u and v of a graph G are *adjacent* if $\{u, v\} \in E(G)$. We often denote an edge by uv or vu instead of $\{u, v\}$, if there is no confusion.

A graph G is called *finite* if $V(G)$ is finite. Finite graphs are often visualized by considering a distinct point on the plane for each vertex and joining two vertices u and v by an injective path in the plane whenever they are adjacent. A graph is called *planar* if there exists such a visualization on the plane such that each path is disjoint from the interior of any other path.

An *oriented graph* G is a pair (V, A) where V is a set and A is a binary relation on V that is irreflexive and antisymmetric. The elements of V are called the *vertices* of G and the elements of A are called the *arcs* of G . We often denote the vertex-set and the arc-set of a given oriented graph H by $V(H)$ and $A(H)$ respectively. Also, to refer to arcs, we often write uv instead of (u, v) .

Similar to graphs, an oriented graph is called *finite* if $V(G)$ is finite. A finite oriented graph G is often visualized by considering a distinct point on the plane for each vertex in $V(G)$ joining two vertices u and v by an injective path in the plane with an arrow showing the direction from u to v whenever $(u, v) \in A(G)$.

To highlight, we sometimes use the term *non-oriented graph* to refer to a graph.

Notice that with these definitions, an oriented graph is not a graph. However, there is a close relation between the two notions.

Underlying graph of an oriented graph. Given an oriented graph $G = (V, A)$, we define the *underlying graph* of G to be the graph $\hat{G} = (V, E)$ where

$$E = \{\{u, v\} \mid (u, v) \in A \text{ or } (v, u) \in A\}.$$

Orientations of a graph. Given a graph $G = (V, E)$, an orientation of G is any oriented graph $\vec{G} = (V, A)$ such that G is the underlying graph of \vec{G} . Informally, an orientation of a graph G is assigning an orientation to each of its edges.

In this thesis, we only deal with finite graphs and finite oriented graphs, even though some of the definitions and theorems can be stated for infinite graphs as well.

Graph homomorphisms and isomorphisms

Let G and H be two graphs (resp. oriented graphs). A *graph homomorphism* (resp. *oriented graph homomorphism*) is a function $\phi : V(G) \rightarrow V(H)$ such that if $uv \in E(G)$, then $\phi(u)\phi(v) \in E(H)$ (resp. if $uv \in A(G)$, then $\phi(u)\phi(v) \in A(H)$). A homomorphism ϕ is an *isomorphism* if it is a bijection and ϕ^{-1} is also a homomorphism. We say that G and H are isomorphic, and we write $G \simeq H$, if there exists an isomorphism $\phi : V(G) \rightarrow V(H)$.

All the structural properties that we consider in this thesis, such as chromatic number, clique number, stable sets, etc. are invariant under graph isomorphism. They are properties that do not depend on the labels of the vertices of the graph.

Let $n \in \mathbb{N}^1$. A *labeled (oriented or non-oriented) graph* G on n vertices, is a graph such that $V(G) = \{1, 2, \dots, n\}$ (in particular, the only labeled graph on 0 vertices is (\emptyset, \emptyset)). We use without a proof the fact that every finite graph is isomorphic to a labeled graph.

¹In this first appearance of \mathbb{N} in this thesis, we emphasize that in this document, \mathbb{N} is the set of all non-negative integers. So, $0 \in \mathbb{N}$. We sometimes denote $\mathbb{N} \setminus \{0\}$ by \mathbb{N}^* .

Classes of graphs

Remember that we deal only with finite graphs in this dissertation. From the definition of a graph, it is clear that the collection of all (finite) graphs is not a set. The collection of all labeled graphs, however, is a set. We define the *class of all graphs* to be the set of all labeled graphs quotiented by isomorphism.

A *class* of graphs, in general, is a subset of the class of all graphs. Even though the elements of a class of graphs are isomorphism classes of graphs, we lose precision by referring to them as graphs.

Let us give some examples. Let $n \in \mathbb{N}$ and $[n] := \{1, 2, \dots, n\}$ (so $[0] = \emptyset$). We call any graph G isomorphic to $([n], \{\{i, j\} \mid i, j \in [n], i \neq j\})$, the complete graph on n vertices and denote it by K_n . In other words, the isomorphism class of the graph mentioned above and any of its representatives are referred to as the complete graph on n vertices.

Similarly, the path on n vertices, denoted by P_n , the cycle on n vertices, denoted by C_n , and the complete bipartite graph with parts of size m and n , denoted by $K_{m,n}$ are any graph isomorphic to $([n], \{\{i, i+1\} \mid i \in [n-1]\})$, $([n], \{\{i, i+1\} \mid i \in [n-1]\} \cup \{n, 1\})$, and $([n+m], \{\{i, j\} \mid i \in \{1, \dots, n\}, j \in \{n+1, \dots, n+m\}\})$, respectively.

Induced subgraphs, subdivisions, minor

Let G be a graph (resp. oriented graph) and let $S \subseteq V(G)$. The subgraph of G induced by S is the graph (resp. oriented graph) H such that $V(H) = S$ and $E(H) = \{uv \in E(G) \mid u, v \in S\}$ (resp. $A(H) = \{uv \in A(G) \mid u, v \in S\}$). We denote H by $G[S]$.

We say that a graph H is an *induced subgraph* of a graph G if H is isomorphic to a graph H' induced by a subset of $V(G)$.

A graph H is a *subgraph* of G if it is isomorphic to a graph H' such that $V(H) \subseteq V(G)$ and $E(H) \subseteq E(G)$. The subgraph relation for oriented graphs is defined similarly by replacing the edge-sets by the arc-sets.

Subdividing k times an edge xy of a graph G , where $k \geq 1$, is the operation of replacing the edge by a path on k vertices. Formally, it is obtaining a graph G' by setting $V(G') = V(G) \cup \{v_1, \dots, v_k\}$ and

$$E(G') = (E(G) \setminus \{xy\}) \cup \{xv_1, v_1v_2, \dots, v_{k-1}v_k, v_ky\}.$$

A *subdivision* of a graph G is any graph obtained from G by subdividing some (possibly none) of the edges of G . We denote the set of all subdivisions of a graph G by G^* .

Let G be a graph (resp. oriented graph). *Contracting* an edge (resp. arc) xy of G is the operation of obtaining another graph (resp. oriented graph) G' as follows:

Let $G_0 = G \setminus \{x, y\}$, i.e. the subgraph of G induced by $V(G) \setminus \{x, y\}$. We set $V(G') = V(G_0) \cup \{v_{xy}\}$, where $v_{xy} \notin V(G_0)$ is a new vertex, and

$$E(G') = E(G_0) \cup \{v_{xy}u : u \in N_G(x) \cup N_G(y)\}$$

(resp. $A(G') = A(G_0) \cup \{v_{xy}u : u \in N_G^+(x) \cup N_G^+(y)\} \cup \{uv_{xy} : u \in N_G^-(x) \cup N_G^-(y)\}$).

. Informally, we identify x and y and remove the created loop.

We say that graph H is a *minor* of a graph G if it is obtained from a subgraph G' of G by a sequence of edge contractions. A similar definition can be stated for oriented graphs.

We remark that the relations (H, G) 's such that

- H is an subgraph of G ,
- H is an induced subgraph of G ,
- G is a subdivision of H ,
- H is a minor of G ,

are all (partial) order relations on the class of all graphs.

Cliques and stable sets. Let G be a graph. A set $S \subseteq V(G)$ is called a *clique* if for all distinct $x, y \in S$, we have $xy \in E(G)$, and it is called a *stable set* if for all distinct $x, y \in S$, we have $xy \notin E(G)$. A clique or a stable set in an oriented graph is a clique or a stable set in its underlying graph. A *triangle* is a clique of size 3. We say that a graph G is *triangle-free* if it has no clique of size 3.

We denote the size of the biggest clique in G by $\omega(G)$ and we call this value the *clique number* of G .

Hereditary classes of graphs

We say that the class \mathcal{C} of graphs is *hereditary* if it is closed under taking induced subgraphs, i.e. if, for every $G \in \mathcal{C}$, we have that if H is an induced subgraph of G , then $H \in \mathcal{C}$.

Let \mathcal{S} be a class of graphs. The hereditary class of graphs *generated* by \mathcal{S} is the smallest hereditary class of graphs containing all elements of \mathcal{S} . Equivalently, it is the class of graphs consisting of all induced subgraphs of graphs in \mathcal{S} .

Let \mathcal{C} be a hereditary class of graphs. Let \mathcal{H} denote the class of minimal (for the induced subgraph relation) elements of the complement of \mathcal{C} in the class of all graphs. Notice that a graph G is in \mathcal{C} if and only if it contains no graph of \mathcal{H} as an induced subgraph. We refer to \mathcal{C} as \mathcal{H} -free graphs and we denote it by $\text{Forb}(\mathcal{H})$. If $\mathcal{H} = \{H\}$ is a singleton, then we write H -free graphs and $\text{Forb}(H)$, instead of $\{H\}$ -free graphs and $\text{Forb}(\{H\})$.

An important example of \mathcal{H} -free graphs for us is when \mathcal{H} is the class of all subdivisions of a graph H , i.e. the class of H^* -free graphs or $\text{Forb}(H^*)$.

2.2 χ -boundedness

Chromatic number

Let k be a positive integer. A *proper k -coloring* of a graph G is a function $\phi : V(G) \rightarrow \{1, 2, \dots, k\}$ such that if $uv \in E(G)$, then $\phi(u) \neq \phi(v)$. When G admits a proper k -coloring, we say that it is *k -colorable*.

The *chromatic number* of a graph G , denoted by $\chi(G)$, is the smallest integer k such that G admits a proper k -coloring. Equivalently, it is the smallest integer k such that $V(G)$ can be partitioned into k stable sets.

It is worth mentioning that equivalently, the chromatic number of G is the smallest integer k such that there exists a homomorphism from G to K_k .

The chromatic number of an oriented graph G , also denoted by $\chi(G)$, is defined to be the chromatic number of its underlying graph.

Triangle-free graphs with arbitrarily large chromatic number

It is clear that for every graph G , we have $\chi(G) \geq \omega(G)$. Therefore, it is easy to see that for every positive integer n , there exist graphs with chromatic number at least n , namely K_n . But we can build less trivial examples: for every n , there exist graphs with chromatic number at least n and clique number at most 2. Examples of such graphs have been known for decades. See, for instance, Tutte's construction [Des54]², Mycielski graphs [Myc55], Erdős random graphs [Erd59], and Burling graphs [Bur65]. For more examples, see Section 2 of [SS20].

Among these examples, we will discuss Burling graphs in detail. In particular, Chapter 3 and Chapter 4 are devoted respectively to a brief history of Burling graphs and to several equivalent definitions of Burling graphs. The reader might refer to Definition 3.2 for a first definition of these graphs. For now, we just explain that the *Burling sequence* is a sequence $(G_k, \mathcal{S}_k)_{k \in \mathbb{N}^*}$ where G_k is a triangle-free graph of chromatic number k and \mathcal{S}_k is a set of stable sets of G_k (whose role will be clarified later). The *class of Burling graphs* is the hereditary class generated by $\{G_k \mid k \in \mathbb{N}^*\}$, i.e. the class of all induced subgraphs of G_k 's.

The existence of triangle-free graphs with arbitrarily large chromatic number assures us that there is no function f such that $\chi(G) \leq f(\omega(G))$, and that chromatic number does not only depend on the clique number. Given this fact, one may ask which other structural properties of graphs other than the clique number affect the

²The history of this example is pretty interesting. The Tutte's construction, in the form that we know today, is from [Des54] signed by Blanche Descartes, a collaborative pseudonym used by Rowland Leonard Brooks, Arthur Harold Stone, Cedric Smith, and William Thomas Tutte, as an answer to a question proposed by Peter Ungar. However, the ideas of the construction are already present in [dC48] as a response to a problem [dC47] by the same author, but under the name F. de Cartebianche.

chromatic number, and which structural properties do not. Let us make this clearer in what follows.

χ -boundedness

Let \mathcal{C} be a hereditary class of graphs. We say that \mathcal{C} is χ -bounded by a χ -binding function $f : \mathbb{N} \rightarrow \mathbb{N}$ if for every $G \in \mathcal{C}$ we have $\chi(G) \leq f(\omega(G))$. This notion is defined by Gyárfás in the renowned paper [Gyá85] as a generalization of perfect graphs. A graph G is called a *perfect graph* if, for every induced subgraph H of G , we have $\chi(H) \leq \omega(H)$.

As we explained above, the class of all graphs and the class of triangle-free graphs are not χ -bounded. The class of forests (i.e. graphs with no cycles), however, is χ -bounded by the constant function 2, and the class of perfect graphs is χ -bounded by the identity function.

Let us give some examples. Let \mathcal{C} be the class of H -free graphs for some graph H . Assume that H is not a forest, and let g be the *girth* of H , i.e. the length of a shortest cycle in H . Erdős [Erd59] showed that for every $k \in \mathbb{N}$, there are graphs with girth strictly bigger than g (consequently, H -free) and chromatic number at least k . So, \mathcal{C} is not χ -bounded. Gyárfás [Gyá73] and Sumner [Sum81], independently, conjectured the converse.

Conjecture 2.1 (Gyárfás-Sumner). *For every forest F , the class of F -free graphs is χ -bounded.*

Conjecture 2.1 is still widely open. In [Sco97], proved a topological version of this conjecture. He proved that the class of graphs that do not contain any subdivision of a forest F as an induced subgraph is indeed χ -bounded.

Theorem 2.2 (Scott 1997). *For every forest F , the class of F^* -free graphs is χ -bounded.*

This paper [Sco97] lead to the study of χ -boundedness of H^* -free graphs, and to Scott's conjecture, as follows.

Conjecture 2.3 (Scott 1997). *For all graphs H , the class of H^* -free graphs is χ -bounded.*

We refer to the conjecture above as *Scott's conjecture*. This conjecture was disproved in 2012 [PKK⁺14]. They showed that for every graph H obtained from a non-planar graph by subdividing each edge at least once, the class of H^* -free graphs contains Burling graphs; therefore, it is not χ -bounded. We discuss this in Chapter 3. The disproof of this conjecture created an interesting research path to understand for which graphs the statement of the conjecture holds and for which ones it does not, and why. We discuss in the following section.

Scott’s conjecture and weakly pervasive graphs

Definition 2.4. *A graph H is said to be weakly pervasive if the class of H^* -free graphs is χ -bounded.*

So, Conjecture 2.3 can be restated as “all graphs are weakly pervasive”, and Theorem 2.2 can be restated as “every forest is weakly pervasive”.

Let us repeat the examples in the introduction in this setting. Consider the case where H is a complete graph. The class of K_3^* -free graphs is exactly the class of forests and thus is χ -bounded. Also, Scott observed that a structural description of K_4^* -free graphs by Lévêque, Maffray, and Trotignon [LMT12] implies that the class of K_4^* -free graphs is χ -bounded. Thus both K_3 and K_4 are weakly pervasive graphs. In Chapter 10, we prove that K_n is not weakly pervasive for $n \geq 5$. We also prove that many other graphs, including some series-parallel graphs and graphs with star cutsets, are not weakly pervasive.

A widely open problem in this regard is to characterize weakly pervasive graphs which motivates numerous research on finding more examples of graphs that are and are not weakly pervasive.

Remark 2.5. *The term weakly pervasive opposes the term pervasive. A graph is pervasive if all its subdivisions are weakly pervasive. Therefore, if a graph is not weakly pervasive, it is not pervasive either. In [SS20], Scott and Seymour suggest the problem of characterizing pervasive graphs as a possibly easier question than characterizing weakly pervasive graphs.*

For more explanations about Scott’s conjecture, see [SS20].

The complete graph K_n , from Hadwiger to Scott

The case of K_n in Scott’s conjecture has other motivations as well. Let us describe this case here.

As explained in the introduction, in 1852, Guthrie conjectured that every planar graph is 4-colorable. In other words, the class of planar graphs is χ -bounded with the constant function 4. Appel and Haken proved this conjecture in 1977.

Theorem 2.6 (4-color theorem, Appel and Haken, 1977). *Every planar graph is 4 colorable.*

Two famous characterizations of planar graphs in terms of their forbidden substructures are due to Kuratowski [Kur30] and Wagner [Wag37] and are as follows.

Theorem 2.7 (Kuratowski [Kur30], 1930). *A graph is planar if and only if it contains no subdivision of K_5 or $K_{3,3}$ as a subgraph.*

Theorem 2.8 (Wagner [Wag37], 1937). *A graph is planar if and only if it contains no minor of K_5 or $K_{3,3}$.*

Using the 4-color theorem, we can see Theorem 2.8 as follows: if a graph G has chromatic number at least 5, then it contains either a minor of K_5 or a minor of $K_{3,3}$. In 1943, Hadwiger [Had43] conjectured that in such case, G always contains a minor of K_5 . Indeed, more generally, he conjectured that for $n \in \mathbb{N}^*$, if G has chromatic number at least n , then it contains a minor of K_n .

Similarly, knowing the 4-color theorem, Theorem 2.7 states that if a graph G has chromatic number at least 5, then it contains either a subdivision of K_5 or a subdivision of $K_{3,3}$ as a subgraph. Hajós conjectured that in such case G contains a subgraph isomorphic to a subdivision of K_5 . More generally, he conjectured that if a graph has chromatic number at least n , then it contains a subdivision of K_n as a subgraph.

Let us state these two conjectures in the terminology of this chapter.

Conjecture 2.9 (Hadwiger [Had43], 1943). *For all $n \in \mathbb{N}^*$, the class of graphs that do not contain a minor of K_n is χ -bounded with the constant function $n - 1$.*

Conjecture 2.10 (Hajós, 1950s). ³ *For all $n \in \mathbb{N}^*$, the class of K_n^* -free graphs is χ -bounded by the constant function $n - 1$.*

Let us denote the class of graphs that contain no subdivision of K_n as a subgraph by K_n^* -subgraph-free graphs, and the class of graphs that contain no minor of K_n by K_n -minor-free graphs. Remember that K_n^* -free-graphs denotes the class of graphs that do not contain any subdivision of K_n as an induced subgraph. Notice that K_n -minor-free graphs are contained in K_n^* -subgraph-free graphs and the latter is contained in the class of K_n^* -free graphs. Hence, in particular, Hajós' conjecture is stronger than Hadwiger's conjecture.

Hadwiger's conjecture is true for $n \leq 6$. Indeed, for $n \leq 2$, it is trivial. For $n = 3$, it is followed from the fact that any graph with an odd cycle has a minor of K_3 , thus K_3 -minor-free graphs are bipartite. Hadwiger [Had43], proved the case of $n = 4$ and

³There is a difficulty regarding the reference for this conjecture. In the literature, the conjecture is mostly attributed to Hajós. However, there is no general agreement on the year in which it was made. On the one hand, in several articles and books, including the one of Catlin [Cat79] (where Hajós' conjecture is disproved) and [GYZ13], Hajós' [Haj61] from 1961 is cited as the reference of the conjecture. On the other hand, some other references such as [BM08] and [Tho05] point out that in 1952, Dirac [Dir52] was already aware of this conjecture and therefore suggest, without a precise reference, that the conjecture is from the 1950s. Even though it is clear that Dirac was aware of this conjecture (see the first sentence of Section 1 of [Dir52]), he does not refer to it as Hajós' conjecture and mentions it without any attribution. Therefore, it seems possible that the conjecture was known to Dirac from other sources. In this dissertation, we refer to the conjecture as it is generally known, i.e. Hajós' conjecture, and we date it to the 1950s, as it is clear that it was already a conjecture in 1952.

Conjecture	true	open	false
Hadwiger 1943	$n = 1, 2, 3$ $n = 4$ (Hadwiger) $n = 5$ (Wagner) $n = 6$ (Robertson, Seymour, Thomas)	$n \geq 7$	
Hajós 1950s	$n \leq 4$ (Dirac)	$n = 5, 6$	$n \geq 7$ (Catlin)
Scott (for K_n) 1994	$n = 1, 2, 3$ $n = 4$ (Lévêque, Maffray, Trotignon)		$n \geq 5$ (Pournajafi, Trotignon)

Table 2.1: Hadwiger, Hajós, and Scott’s conjecture

Wagner [Wag64] prove the case of $n = 5$. Finally, Robertson, Seymour, and Thomas [RST93] prove the conjecture for $n = 6$. For $n \geq 7$, the conjecture is open.

Hajós’ conjecture, on the other hand, is true for $n \leq 4$ (which implies Hadwiger’s conjecture for $n \geq 4$) and this is proved by Dirac [Dir52]. Catlin [Cat79] disproved the conjecture for $n \geq 7$. The cases of $n = 5$ and $n = 6$ are still open.

It is noteworthy that if in each conjecture we ask that the class is χ -bounded by a constant function depending on n (instead of the constant function $n - 1$), then both are true. Indeed, it is not hard to show that for every n , there exists a constant $C = C(n)$ such that every graph that contains no subdivision of K_n as a subgraph has a vertex of degree at most $C - 1$ (see, for instance, [KS94]), which implies C -colorability of such graphs. So, we have the following folklore theorem.

Theorem 2.11. *For every $n \in \mathbb{N}^*$, the class of K_n^* -subgraph-free graphs, and therefore the class of K_n -minor-free graphs, is χ -bounded.*

Now, let us see what happens if we want to strengthen this theorem. The class of K_n^* -free graphs contains the class of K_n -free graph. So, one might make the following guess which is indeed a special case of Scott’s conjecture.

Conjecture 2.12 (Scott [Sco97], 1994). *For every $n \in \mathbb{N}^*$, the class of K_n^* -free graphs χ -bounded.*

Notice that this question is a special case of Scott’s conjecture. In particular, if the answer to the question above is positive for some n , it means that n is weakly pervasive.

But surprisingly, as explained, Conjecture 2.12 is true for $n \geq 4$, and as we will prove in Chapter 10, it is false for $n \geq 5$.

Let us summarize the explanations of this section in Table 2.1

2.3 Geometric graph theory

Intersection graphs

Let \mathcal{F} be a family of sets. The *intersection graph* of \mathcal{F} is the graph G where $V(G) = \mathcal{F}$ and $E(G) = \{ST \mid S \neq T, S \cap T \neq \emptyset\}$. A *geometrical object*, in this setting, is a subset of a Euclidean space \mathbb{R}^d .

Intersection graphs appear in different contexts in graph theory. Let us give some examples:

- The Kneser graph $\text{Kn}(n, k)$ is complement of the intersection graph of k -element subsets of $\{1, 2, \dots, n\}$.
- The line graph of a graph G is the intersection graph of $E(G)$.
- Interval graphs are intersection graphs of families of intervals of \mathbb{R} . Interval graphs are therefore intersection graphs of geometrical objects.
- A chordal graph is the intersection graph of a set of subtrees of a tree.
- Every graph G is an intersection graph (e.g. of $\{S_v \mid v \in V(G)\}$ where S_v is the union of $\{v\}$ and the set of all edges containing the vertex v).
- Every graph G is even an intersection graph of geometrical objects (this can be seen by applying the same idea as above to an embedding of G in \mathbb{R}^3 , or see [Tie05]).

For more examples see Chapter 9 of [GYZ13].

S -graphs

The class of S -graphs is a class of intersection graphs of geometrical objects. For this section, fix $d \in \mathbb{N}$ and let S be a subset of \mathbb{R}^d . Let us introduce some notations.

In this dissertation, we deal with the following type of *transformations* of \mathbb{R}^d : transformations $T : \mathbb{R}^d \rightarrow \mathbb{R}^d$ of the form

$$T(x_1, \dots, x_d) = (a_1x_1 + b_1, \dots, a_dx_d + b_d)$$

where $a_i \in \mathbb{R}^* = \mathbb{R} \setminus \{0\}$ and $b_i \in \mathbb{R}$. In other words $T = (T_1, \dots, T_d)$ where each T_i is an affine function from \mathbb{R} to itself.

For a set S , we call every set of the form $T(S)$, where T is a transformation, a *transformed copy* of S . So a transformed copy of S is a set obtained from a translation of S and independent scalings parallel to the axis.

Definition 2.13. *Let $S \subseteq \mathbb{R}^d$ be a set. Let G be the intersection graph of a family \mathcal{F} of sets. We say that G is an S -graph if every element of \mathcal{F} is a transformed copy of S .*

For example, interval graphs can be defined as S -graphs where S is a non-empty interval in \mathbb{R} . Another example is the class of *frame graphs*, that is, the class of S -graphs for S being the boundary of an axis-parallel rectangle in \mathbb{R}^2 with non-empty interior.

χ -boundedness and intersection graphs

χ -boundedness of different families of intersection graphs has been studied numerously. We give examples that are relevant to the topic of this thesis.

It is well-known that the class of interval graphs is χ -bounded (since it is a subclass of perfect graphs – see [Tro13]). In [AG60], Asplund and Grünbaum generalized this result to \mathbb{R}^2 : the class of intersection graphs of axis-parallel rectangles in \mathbb{R}^2 is χ -bounded (see Theorem 2.16 below).

Starting from the third dimension, however, the situation changes. In 1965, in [Bur65], Burling proved that the intersection graphs of axis-parallel boxes (cuboids) in \mathbb{R}^n is not χ -bounded when $n \geq 3$. The core of his proof was to define a sequence of triangle-free graphs with arbitrarily large chromatic number, known as the Burling sequence, as the intersection graphs of axis-parallel boxes in \mathbb{R}^3 . We describe Burling’s work in detail in Chapter 3.

In 1970s, Erdős asked the following question:

Question 2.14 (Erdős). *Is the class of intersection graphs of line segments in \mathbb{R}^2 a χ -bounded class?*

In 2012, Pawlik, Kozik, Krawczyk, Lasoń, Micek, Trotter, and Walczak [PKK⁺14] proved that the class of line segment graphs contains all graphs of the Burling sequence and thus is not χ -bounded.

Later, the same authors generalized this result to any other set $S \subseteq \mathbb{R}^2$ that has some reasonable constraints.

Theorem 2.15 (Pawlik, Kozik, Krawczyk, Lasoń, Micek, Trotter, and Walczak , 2013). *For every compact and path connected set S different from an axis-parallel rectangle, the class of S -graphs contains the Burling sequence and therefore is not χ -bounded.*

It is worth noting that if S is an axis-parallel rectangle, then by the following theorem from [AG60], the class of S -graphs is not χ -bounded, which along with Theorem 2.15, completes the study of χ -boundedness of S -graphs for compact and path-connected subsets of \mathbb{R}^2 .

Theorem 2.16 (Asplund and Grünbaum, 1960). *The class of intersection graphs of axis-parallel rectangles in \mathbb{R}^2 is χ -bounded by the χ -binding function $f(k) = 4k^2 - 3k$.*

Disproof of Scott’s conjecture

Let us finish this chapter by explaining how the answer of [PKK⁺14] to Question 2.14 leads to a disproof of Scott’s conjecture.

Let us start by the following folklore theorem. We could not find the first mention of it, so we add a sketch of proof in Appendix C for the sake of completeness. A graph obtained from G by subdividing every edge at least once is said to be a (≥ 1) -subdivision of G .

Theorem 2.17. *If G is a (≥ 1) -subdivision of a non-planar graph H , then G is not a line-segment graph.*

Therefore for every graph G that is a (≥ 1) -subdivision of a non-planar graph, the class of G^* -free graphs contains line segment graphs and thus is not χ -bounded by Theorem 2.15. So, every (≥ 1) -subdivision of a non-planar graph is a non-weakly pervasive graph, i.e. a counterexample to Scott’s conjecture.

Burling graphs as intersection graphs

It is noteworthy that not all S -graphs are Burling graphs. In Section 4.4, by setting some conditions on the interactions of the sets, we define the class of *constrained S -graphs*, the (proper) subclass of S -graphs equal to the class of Burling graphs.

Moreover, we remark that Burling graphs are not the only reason for a class of intersection graphs of geometric objects to have unbounded chromatic number. We prove in Appendix B that there exist classes of intersection graphs of geometric objects that are not χ -bounded and yet they do not contain Burling graphs.

2.4 Notation

We have already introduced some notation used in this dissertation throughout the current chapter. In this last section, we present other general notations that we need. It is important to make our terminology and notation clear since we often work simultaneously with different objects (e.g. trees and graphs derived from them, oriented graphs and graphs, etc.) and it is important to make the distinction using different terminologies.

Graphs and oriented graphs

The notation for graphs and oriented graphs are the standard definitions in graph theory. For any graph theoretical notion not defined here, we refer to [BM08].

Let G be a graph and $v \in V(G)$. The set of *neighbors* of v , denoted by $N(v)$ is the set $\{u \in V(G) \mid vu \in E(G)\}$. The *closed neighborhood* of v , denoted by $N[v]$, is the set $N(v) \cup \{v\}$. The degree of v , denoted by $d(v)$ is the number of neighbors of v . An *isolated vertex* is a vertex v such that $N(v) = \emptyset$.

A *path* (resp. a *cycle*) in G is a subgraph of G isomorphic to a path P_n (resp. a cycle C_n), as defined in Section 2.1, for some $n \in \mathbb{N}$. The *length* of a path or a cycle is its number of edges (so, a vertex forms a path of length zero). A *hole* in G is an induced cycle. We say that a path P joins vertices v and u or that it is a path from u to v if v and u are the vertices of P that are not of degree 2 (notice that v and u are not necessarily distinct).

We say that a graph G is *connected* if for every $u, v \in V(G)$ there exist a path joining u and v . A *connected component* of a graph is any of its inclusion-wise maximal connected induced subgraph.

Let G be an oriented graph and let $v \in V(G)$. An *in-neighbor* (resp. *out-neighbor*) of v is any vertex $u \in V(G)$ such that $uv \in A(G)$ (resp. $vu \in A(G)$). The *in-degree* and *out-degree* of v is the number of its in-neighbors and out-neighbors respectively. The set of all in-neighbors and all out-neighbors of V are denoted respectively by $N^-(v)$ and $N^+(v)$. A *source* (resp. *sink*) is a vertex $v \in V(G)$ such that $N^-(v) = \emptyset$ (resp. $N^+(v) = \emptyset$).

Terms from the non-oriented realm, such as *degree*, *neighbor*, *isolated vertex*, *connected component*, and *path*, when applied to an oriented graph, implicitly apply to its underlying graph.

Star cutsets

A *full in-star cutset* in an oriented graph G is a set $S = N^-[v]$ for some vertex $v \in V(G)$ such that $G \setminus S$ is disconnected.

A *full star cutset* in a graph or oriented graph G is a set $S = N[v]$ for some vertex $v \in V(G)$ such that $G \setminus S$ is disconnected.

A *star cutset* in a graph or oriented graph G is a set S such that for some vertex $v \in V(G)$, we have $\{v\} \subseteq S \subseteq N[v]$, and $G \setminus S$ is disconnected.

In all cases above, we say that the star cutset S is *centered* at v (thus a star cutset might have more than one center).

We say that in graph G , the star cutset S *separates* two vertices u and v if u and v are in two distinct connected components of $G \setminus S$.

Trees and rooted trees

A *tree* is a graph T such that for every pair of vertices $u, v \in V(T)$, there exists a unique path from u to v . Equivalently, a tree is a connected graph that contains no cycles. A *leaf* of a tree is any vertex of degree at most 1. Every tree has at least one leaf. We denote by $L(T)$ the set of all leaves of T .

A *rooted tree* is a pair (T, r) such that T is a tree and $r \in V(T)$. The vertex r is called the *root* of (T, r) . When r is clear from the context, we often refer to (T, r) as T . In a rooted tree, each vertex v except the root has a unique *parent* which is the neighbor of v in the unique path from the root to v . We denote the parent of v by $p(v)$. If u is the parent of v , then v is a *child* of u . A *leaf* of a rooted tree is a vertex that has no children. Notice that with this definition, the leaves of (T, r) are not equal to the leaves of T . For instance, if $d(r) = 1$, then it is not a leaf of (T, r) , but it is a leaf of the underlying tree T .

A *branch* in a rooted tree is a path $v_1 v_2 \dots v_k$ such that for each $i \in \{1, \dots, k-1\}$, the vertex v_i is the parent of v_{i+1} . We say that this branch *starts* at v_1 and *ends* at v_k . A branch that starts at the root and finishes at a leaf is a *principal branch*.

Let (T, r) be a rooted tree. The *descendants* of a vertex v are all the vertices that are on a branch starting at v . The *ancestors* of v are the vertices on the unique path from v to the root of T . Notice that a vertex is a descendant and an ancestor of itself. Any descendant of a vertex v , other than itself, is called a *proper descendant* of v .

An *in-tree* is any oriented graph obtained from a rooted tree (T, r) by orienting every edge towards the root. Formally, $e = uv$ is oriented from u to v if and only if v is on the unique path of T from u to r . A *leaf* in an in-tree is a vertex with no in-neighbors (so the root is not a leaf unless the in-tree has only one vertex). Notice that in an in-tree, every vertex but the unique sink has a unique out-neighbor. An *in-forest* is an oriented forest whose connected components are in-trees.

To avoid any confusion, when working with rooted trees, we avoid using terms such as *neighbors* and *adjacent* and use *parent*, *child*, *descendant*, and *ancestor* only.

Binary relations

Let S be a set, and let R be a binary relation on S , that is, $R \subseteq S \times S$. We write $x R y$ for $(x, y) \in R$, and $x \not R y$ for $(x, y) \notin R$. For an element $s \in S$, we denote by $[sR]$ the set $\{t \in S : s R t\}$.

The relation R is *asymmetric* if for all $x, y \in S$, $x R y$ implies $y \not R x$, and it is *transitive* if for all $x, y, z \in S$, $x R y$ and $y R z$ implies $x R z$. The relation R is a *strict partial order* if it is asymmetric and transitive.

A *directed cycle* in R is a set of elements x_1, x_2, \dots, x_n , with $n \in \mathbb{N}$, such that $x_1 R x_2, x_2 R x_3, \dots, x_n R x_1$. Note that when we deal with relations, we allow cycles on one or two elements. So, strict partial orders do not have directed cycles. In fact, a relation R has no directed cycles if and only if its transitive closure is a strict partial order.

An element $s \in S$ is said to be a *minimal element* with respect to R if there exists no element $t \in S \setminus \{s\}$ such that $t R s$. Notice that if a relation R on a finite set S has no directed cycle, then S has a minimal element with respect to R .

Subsets of \mathbb{R}^n and their transformations

We refer to [Mun00] for any topological notion not defined in the thesis. We introduce the notions for \mathbb{R}^n even though they are mostly defined for general topological spaces.

We always consider \mathbb{R}^n with its usual topology. As explained in Section 2.3, in this dissertation, we only consider transformations of \mathbb{R}^n whose projection on each axis is an affine function.

For a set S in \mathbb{R}^d , we denote the *interior* and the *closure* of S respectively by S° and \bar{S} . Moreover, we denote the *boundary* of S by ∂S , i.e. $\partial S = \bar{S} \setminus S^\circ$. We denote the ball of radius r and center c in \mathbb{R}^d by $D(c, r)$. For a function f , we denote its image by $im(f)$, and its restriction to a set A in its domain by $f|_A$. We denote the projection on the i -th axis in \mathbb{R}^n by ρ_i .

A *path* in \mathbb{R}^n is a continuous function $\gamma : I \rightarrow \mathbb{R}^n$ where I is a closed interval in \mathbb{R} . We say that the path $\gamma : [0, 1] \rightarrow \mathbb{R}^n$ *joins* the two points $\gamma(0)$ and $\gamma(1)$. Two paths $\gamma_1 : [0, 1] \rightarrow \mathbb{R}^n$ and $\gamma_2 : [0, 1] \rightarrow \mathbb{R}^n$ are said to be *internally disjoint* if

$$\gamma_1([0, 1]) \cap \gamma_2([0, 1]) \subseteq \{\gamma_1(0), \gamma_1(1)\} \cap \{\gamma_2(0), \gamma_2(1)\}.$$

A set $S \subseteq \mathbb{R}^n$ is *path-connected* if for every $x, y \in S$, there exists a path γ joining x and y with $im(\gamma) \subseteq S$. We say that a set S is *compact* if every covering of S with open subsets of \mathbb{R}^n has a finite subcovering. In our case, equivalently, S is compact if it is closed and bounded.

A subset S of \mathbb{R}^2 is said to be a *Pouna set* if it is path-connected and compact, and is not an axis-parallel rectangle.

A *box* in \mathbb{R}^d , is a set of the form $B = \prod_{i=1}^d I_i$, where I_i is a closed interval (thus possibly empty) in \mathbb{R} . So, boxes in \mathbb{R} are intervals, in \mathbb{R}^2 are axis-parallel rectangles, and in \mathbb{R}^3 are axis-parallel cuboids. A *frame* is the boundary of a box with non-empty interior in \mathbb{R}^2 .

Now let us focus on \mathbb{R}^2 . Let S be a bounded subset of \mathbb{R}^2 . We define the following notions on S :

$$\begin{aligned} \mathfrak{l}(S) &= \inf\{x : \exists y (x, y) \in S\}, \\ \mathfrak{r}(S) &= \sup\{x : \exists y (x, y) \in S\}, \\ \mathfrak{b}(S) &= \inf\{y : \exists x (x, y) \in S\}, \\ \mathfrak{t}(S) &= \sup\{y : \exists x (x, y) \in S\}. \end{aligned}$$

The letters \mathfrak{l} , \mathfrak{r} , \mathfrak{b} , and \mathfrak{t} stand for *left*, *right*, *bottom*, and *top*, respectively. If S is a compact set in \mathbb{R}^2 , then all the values above are finite and also, we can replace \inf and \sup by \min and \max respectively. In this case, we also define $\mathfrak{w}(S) = \mathfrak{r}(S) - \mathfrak{l}(S)$ and $\mathfrak{h}(S) = \mathfrak{t}(S) - \mathfrak{b}(S)$. The letters \mathfrak{w} and \mathfrak{h} stand for *width* and *height* respectively. Notice that if $S' \subseteq S$, we have $\mathfrak{l}(S') \geq \mathfrak{l}(S)$, $\mathfrak{r}(S') \leq \mathfrak{r}(S)$, $\mathfrak{b}(S') \geq \mathfrak{b}(S)$, and $\mathfrak{t}(S') \leq \mathfrak{t}(S)$.

The *bounding box* of a bounded set $S \subseteq \mathbb{R}^2$, denoted by $\mathbf{box}(S)$, is the (inclusion-wise) smallest closed rectangle in \mathbb{R}^2 containing S . Equivalently,

$$\mathbf{box}(S) = [\mathbf{l}(S), \mathbf{r}(S)] \times [\mathbf{b}(S), \mathbf{t}(S)].$$

So, $\mathbf{l}(\mathbf{box}(S)) = \mathbf{l}(S)$, $\mathbf{r}(\mathbf{box}(S)) = \mathbf{r}(S)$, etc. If \mathcal{F} is a family of bounded subsets of \mathbb{R}^2 and T is a transformation (of the form mentioned earlier), we use the unconventional notation $T(\mathcal{F})$ for the family $\{T(S) : S \in \mathcal{F}\}$. It is easy to see that $\mathbf{box}(T(\mathcal{F})) = T(\mathbf{box}(\mathcal{F}))$.

With the mentioned constraint on transformations of \mathbb{R}^n , any transformation $T : \mathbb{R}^2 \rightarrow \mathbb{R}^2$ of \mathbb{R}^2 that we deal with is of the form

$$T(x, y) = (ax + c, by + d),$$

for some $a, b \in \mathbb{R}^* = \mathbb{R} \setminus \{0\}$ and $c, d \in \mathbb{R}$. We say that T is a *positive* transformation if $a > 0$ and $b > 0$. It is easy to see that positive transformations with composition form a group. In particular:

- the composition of two positive transformations is a positive transformation,
- every positive transformation has an inverse.

Several times, we use the fact that if $T : (x, y) \mapsto (ax + c, by + d)$ is a positive transformation and S is a Pouna set, then setting $S' = T(S)$, we have:

$$\mathbf{l}(S') = a.\mathbf{l}(S) + c, \quad \mathbf{r}(S') = a.\mathbf{r}(S) + c, \quad \mathbf{b}(S') = b.\mathbf{b}(S) + d, \quad \text{and} \quad \mathbf{t}(S') = b.\mathbf{t}(S) + d.$$

In particular, $\mathbf{box}(T(S)) = T(\mathbf{box}(S))$.

We say that S' is a *positive transformed copy* of S if $S' = T(S)$ for some positive transformation T . The *horizontal reflection* of S is $T(S)$ where T is the transformation that maps (x, y) to $(-x, y)$.

Chapter 3

A brief history of Burling graphs and their applications

In this chapter, we explain briefly the history of Burling graphs and some of their applications from 1965 until today. For coherence, the order of sections is not chronological. See Figure 3.1 for a visualization of the content of this chapter in chronological order.

The discovery and χ -boundedness of intersection graphs of polytopes, 1965

In 1965, Burling introduced Burling graphs in his Ph.D. thesis [Bur65]. The language of his thesis is mostly geometrical, even though he mentions the graph theoretical view of his work (See 1.2 in [Bur65]).

Let us describe the study in [Bur65] more precisely. Let $n, m, k \in \mathbb{N}$ with $m \geq k$. A finite family \mathcal{F} of sets is of type (n, m, k) if

- the elements of \mathcal{F} are convex polytopes in \mathbb{R}^n ,
- there are m fixed vectors in \mathbb{R}^n such that for each polytope $P \in \mathcal{F}$, there are at most k vectors v_1, \dots, v_k among these m vectors such that each edge of P is parallel to one of the v_i 's.

The question under study in [Bur65] is the following. Consider the set $\mathcal{S}(n, m, k, r)$ of all finite families of type (n, m, k) such that the number of two-by-two intersecting polytopes in every family in $\mathcal{S}(n, m, k, r)$ is at most r . Is there a constant $c \in \mathbb{N}$ such that for every $\mathcal{F} \in \mathcal{S}(n, m, k, r)$, one can partition \mathcal{F} into at most c sets each containing mutually disjoint polytopes?

One can rephrase the question above and the theorems of Burling into the following setting. Let $\mathcal{C}(n, m, k)$ be the class of intersection graphs of type (n, m, k) families. Is $\mathcal{C}(n, m, k)$ a χ -bounded class of graphs? However, the notion of

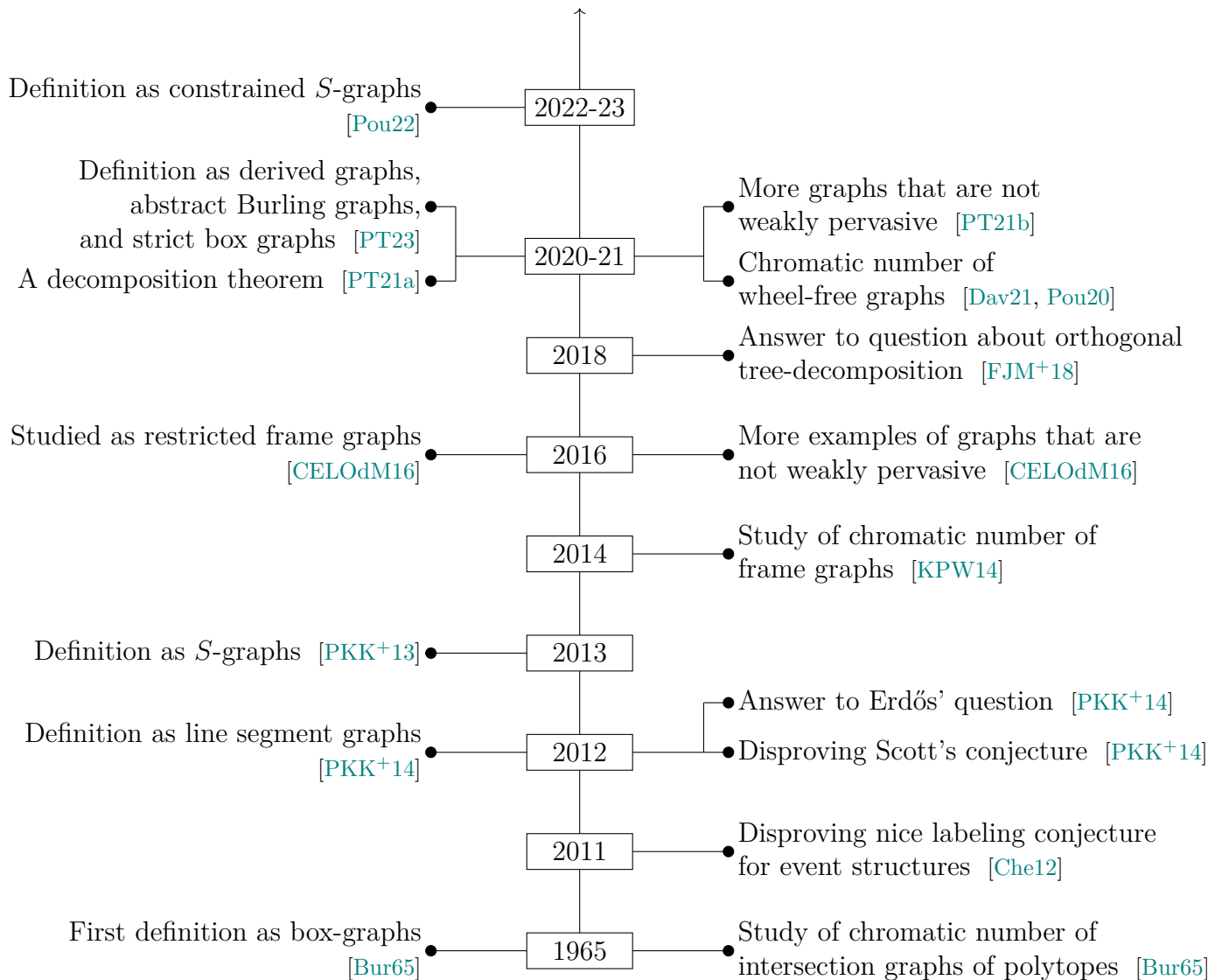

Figure 3.1: History of Burling graphs and their applications.

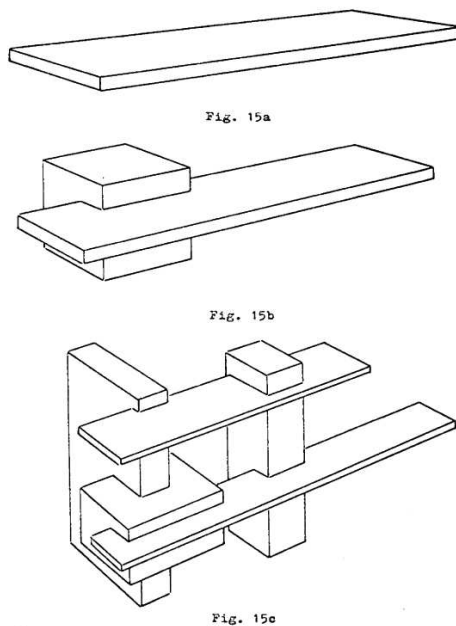

Figure 3.2: Figure from [Bur65]. The first three families in the sequence defined by Burling.

χ -boundedness was not introduced until more than two decades after the Ph.D. of Burling (by Gyárfás in [Gyá85]). Burling proved the following (see Theorems 9, 10, and 11 of [Bur65]).

Theorem 3.1 (Burling 1965). *With the notation above, we have:*

- $\mathcal{C}(2, m, k)$ is χ -bounded by χ -binding function $f(\omega) = \binom{m}{k} 4k\omega^{\binom{2k}{3}+1}$, for every $m, k \in \mathbb{N}$ with $m \geq k$,
- $\mathcal{C}(n, m, k)$ is not χ -bounded for every $n \geq 3$ and $k \geq 3$.

To prove the second item in the theorem above, Burling first reduced the problem to the case $\mathcal{C}(3, 3, 3)$, i.e. without loss of generality, the intersection graphs of axis-parallel boxes in \mathbb{R}^3 . Then, he showed that there is a sequence $\{\mathcal{F}_k\}_{k \in \mathbb{N}}$ of axis-parallel boxes in \mathbb{R}^3 (thus, of type $(3, 3, 3)$) such that:

- no three polytopes are mutually intersecting (i.e. the intersection graph is triangle-free),
- the chromatic number of the intersection graph of \mathcal{F}_k is at least k .

See Figure 3.2.

Let us present the graph theoretical rephrasing of Burling's work.

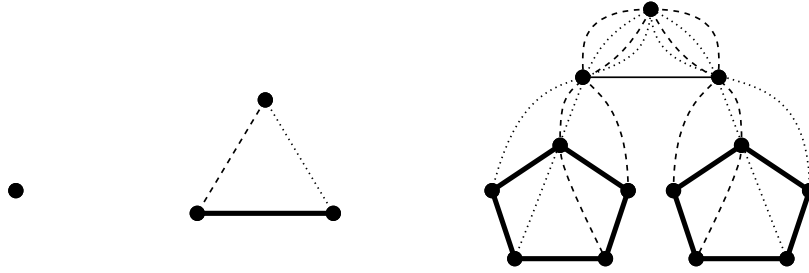

Figure 3.3: The first three graphs in the Burling sequence.

Definition 3.2 (due to [Bur65]). We define, inductively, a pair (G_k, \mathcal{S}_k) of a graph G_k and a set of its stable sets \mathcal{S}_k . For $k = 1$, define G_1 to be the complete graph on 1 vertex, and set $\mathcal{S}_1 = \{V(G_1)\}$. Assume that (G_k, \mathcal{S}_k) is defined. Let us define $(G_{k+1}, \mathcal{S}_{k+1})$.

For each $S \in \mathcal{S}_k$, consider a copy (G_k^S, \mathcal{S}_k^S) of (G_k, \mathcal{S}_k) . Also, consider $|\mathcal{S}_k|$ new vertices $v_{S,Q}$ corresponding to each $Q \in \mathcal{S}_k^S$.

First, define

$$V(G_{k+1}) = V(G_k) \sqcup \bigsqcup_{S \in \mathcal{S}_k} \left(V(G_k^S) \sqcup \{v_{S,Q} \mid Q \in \mathcal{S}_k^S\} \right),$$

and

$$E(G_{k+1}) = E(G_k) \sqcup \bigsqcup_{S \in \mathcal{S}_k} E(G_k^S) \sqcup \bigsqcup_{S \in \mathcal{S}_k} \bigsqcup_{Q \in \mathcal{S}_k^S} \{qv_{S,Q} \mid q \in Q\}.$$

Informally, in each copy (G_k^S, \mathcal{S}_k^S) of (G_k, \mathcal{S}_k) , for each stable set $Q \in \mathcal{S}_k^S$, we add a vertex $v_{S,Q}$ and join it to all of the vertices in Q and define G_{k+1} to be the disjoint union of these new graphs and the first copy of (G_k^S, \mathcal{S}_k^S) .

Second, define:

$$\mathcal{S}_{k+1} = \{S \cup Q, S \cup \{v_{S,Q}\} \mid S \in \mathcal{S}_k, Q \in \mathcal{S}_k^S\}.$$

The pair $(G_{k+1}, \mathcal{S}_{k+1})$ is the new pair.

The sequence $\{(G_k, \mathcal{S}_k)\}_{k \in \mathbb{N}^*}$ is called the Burling sequence.

When there is no risk of confusion, we call the sequence $\{G_k\}_{k \in \mathbb{N}^*}$, the Burling sequence as well. Figure 3.3 shows the first three graphs in the Burling sequence.

The class of *Burling graphs* is the hereditary class generated by the graphs in this sequence, i.e. the class of all induced subgraphs of G_k 's.

Burling graphs: definitions and structure, 2021

It will become clear throughout this chapter that understanding the structure of Burling graphs plays a crucial role in providing applications of them in graph theory. So, in 2021, as a start of a study on Burling graphs, Nicolas Trotignon and the author provided several equivalent definitions for Burling graphs, in [PT23] and later in [Pou22]. We introduce all these definitions in Chapter 4 and prove that they are equivalent in Chapter 5. Here, we only present a list of them.

- *Derived graphs*: a class of graphs defined completely combinatorially from a tree structure.
- *Abstract Burling graphs*: a class of graphs defined axiomatically from a poset S and a relation \curvearrowright on it which satisfies a set of 4 axioms.
- Some geometric definitions (*constrained graphs*, *strict graphs*): classes of graphs that are defined as intersection graphs of geometrical objects.

An important point is that all these definitions give us classes of oriented graphs. Of course, by taking the underlying graphs we can go back to the classical setting of Burling graphs as non-oriented graphs. But it appears that the information encoded in the orientation is crucial in the study of the structure of Burling graphs (see Chapter 7).

Burling graphs as intersection graphs and the question of Erdős, 2012-2023

Burling graphs were not only defined as intersection graphs of boxes, but also appeared to be closely related to intersection graphs of many other objects. Let us describe this connection in this section. We have partially explained this in Section 2.3.

As explained in Section 2.3, Erdős asked in 1970s whether the triangle-free intersection graphs of line segments have bounded chromatic number. In 2012¹, Pawlik, Kozik, Krawczyk, Lasoń, Micek, Trotter, and Walczak answered the question of Erdős in [PKK⁺14] by showing that there is a sequence $\{G_k\}_{k \in \mathbb{N}}$ of triangle-free intersection graphs of line segments such that $\chi(G_k) \geq k$ (thus the class of line segment graphs is not χ -bounded). The sequence that they defined appeared to be exactly the same as the Burling sequence, and thus once more, Burling graphs were the core of a proof about the chromatic number of intersection graphs of geometrical objects.

Later, Pawlik, Kozik, Krawczyk, Lasoń, Micek, Trotter, and Walczak, generalized their ideas in [PKK⁺14] to define a sequence of intersection graphs of S -graphs for any Pouna set S that is the same as the Burling sequence, thus showing that for any

¹The paper is published in 2014, however, the first version on arXiv is from 2012

Pouana set S the class of S -graphs is not χ -bounded. Among Pouana sets are *frames*. In [KPW14] and [CELOdM16], the presentation of Burling graphs as frame graphs play an important role.

In 2014, Krawczyk, Pawlik, and Walczak [KPW14] prove the following (see Theorems 1 and 2 of [KPW14]).

Theorem 3.3 (Krawczyk, Pawlik, and Walczak, 2014). *For every $n \in \mathbb{N}^*$, an intersection graph of n frames has a proper coloring with $O(\log \log n)$ colors. Moreover, this bound is best possible, i.e. there is a sequence $\{G_k\}_{k \in \mathbb{N}^*}$ of intersection graphs of frames with increasing number of vertices such that the chromatic number of G_k is $\Theta(\log \log |V(G_k)|)$.*

To show the optimality of the bound, Krawczyk, Pawlik, and Walczak used the presentation of Burling graphs as frame graphs and used the fact that the chromatic number of the k -th graph G_k in the Burling sequence is k which is $\Theta(\log \log |V(G_k)|)$.

In 2016, Chalopin, Esperet, Li, and Ossona de Mendez [CELOdM16] study the structure of *restricted frame graphs*, a subclass of frame graphs introduced in [KPW14]. Let us present the definition of restricted frame graphs as in [CELOdM16].

Definition 3.4 (Definition 2.2 of [CELOdM16]). *A graph G is a restricted frame graph if it is the intersection graph of a family of frames with the following restrictions:*

1. *corners of a frame do not coincide with any point of another frame,*
2. *the left side of any frame does not intersect any other frame,*
3. *if the right side of a frame intersects a second frame, this right side intersects both the top and bottom of this second frame,*
4. *if two frames have non-empty intersection, then no frame is (entirely) contained in the intersection of the regions bounded by the two frames.*

Chalopin, Esperet, Li, and Ossona de Mendez also provided a decomposition theorem for triangle-free restricted frame graphs: a triangle-free restricted frame graph either has a star cutset or belongs to a “simple” class of graphs. A *luxury chandelier* is any graph G that can be obtained as follows: start with tree T with the property that the unique neighbor of each leaf has degree 2, and then add a new vertex v and add an edge between v and every leaf of T to obtain G .

Theorem 3.5 (Chalopin, Esperet, Li, and Ossona de Mendez, 2016). *Suppose that H is a connected triangle-free graph with no full star-cutset and G is a subdivision of H . Then G is a restricted frame graph if and only if H is either a path on at most 4 vertices or a luxury chandelier.*

As a result of their theorem, the authors of [CELOdM16] showed that triangle-free restricted frame graphs are indeed a strict subclass of triangle-free frame graphs: they form a proper subclass of triangle-free intersection graphs with unbounded chromatic number.

This discussion raises the following question: can we find a strict subclass of restricted frame graphs that is exactly the class of Burling graphs? The answer is positive, in [PT23], Nicolas Trotignon and the author defined the class of *strict frame graphs* by adding an extra restriction to the class of restricted frame graphs and proved that they are exactly the class of Burling graphs. This definition is given in Section 4.3. To follow the historical definitions of Burling graphs, we also gave a similar definition for the classes of *strict line segment graphs*, a subclass of triangle-free line segment graphs, and *strict box graphs*, a subclass of box graphs, that are both equal to the class of Burling graphs. The latter definition is given in Chapter 6.

In [Pou22], we generalized the ideas above to define the class of *constrained S -graphs*, the strict subclass of S -graphs that is equal to the class of Burling graphs, for every set S by setting a set of restrictions on the transformed copies of S . This definition is given in Section 4.4.

Burling graphs and Scott's conjecture

As explained in Section 2.3, the presentation of Burling graphs as line segment graphs provided the first counterexample to Scott's conjecture (Conjecture 2.3). Remember that weakly pervasive graphs are graphs for which Scott's conjecture holds.

Remember that a graph obtained from G by subdividing every edge at least once is said to be a (≥ 1) -subdivision of G .

Theorem 3.6 (Pawlik, Kozik, Krawczyk, Lasoń, Micek, Trotter, and Walczak, 2012). *If G is a ≥ 1 -subdivision of a non-planar graph, then it is not a weakly pervasive graph.*

Burling graphs were also used later to find more examples of graphs that are not weakly pervasive.

The studies in [CELOdM16] on restricted frame graphs led to the finding of new graphs that are not weakly pervasive.

Theorem 3.7 (Chalopin, Esperet, Li, and Ossona de Mendez, 2016). *Let H be a connected triangle-free graph with no full star cutset which is neither a path on at most 4 vertices, nor a luxury chandelier. Then H is not a weakly pervasive graph.*

We remark that some of the graphs that the theorem above provides as examples of graphs that are not weakly pervasive are line segment graphs, thus this theorem improves Theorem 3.6. The theorem above is indeed an immediate corollary of Theorem 3.5 which follows from the careful study of restricted frame graphs without star cutsets.

In [PT21b], Nicolas Trotignon and the author followed the path of using Burling graphs to provide more examples of graphs that are not weakly pervasive. Our study, however, instead of focusing on the study of structural properties of intersection graphs, was based on the study of the oriented derived graphs (whose underlying graphs are Burling graphs). As a result, we could provide some new examples of graphs that are not weakly pervasive. Some terms in the following theorem are not defined so far and will be defined later (see Section 8.3).

Theorem 3.8 (Pournajafi, Trotignon, 2021). *The following graphs are not weakly pervasive:*

- *The complete graph K_n for $n \geq 5$ and any of its subdivisions.*
- *Necklaces with 2 disjoint beads, three long beads, or more than 3 beads.*
- *Dumbbells of any two graphs with global subordinate vertices.*
- *Graphs in Figures 8.14, 8.15, and 8.16.*

Some graphs that are provided in the theorem above as graphs that are not weakly pervasive are restricted frame graphs, and therefore this theorem also improves the previous results.

Other applications to χ -boundedness, 2016-2022

Chromatic number of wheel-free graphs

A *wheel* is a graph made of hole H called the *rim* together with a vertex c called the *center* that has at least three neighbors in H . The class of wheel-free graphs is the class of graphs that contain no wheel as an induced subgraph. In 2013, Trotignon [Tro13] asked whether wheel-free graphs are χ -bounded (see Question 5.1 in [Tro13]). In 2020, Scott and Seymour [SS20] made a related conjecture (see Conjecture 12.16 in [SS20]).

In 2020, Nicolas Trotignon and the author [Pou20, PT21a] proved that Burling graphs contain no wheels, which answers negatively to the question in [Tro13] and disproves the conjecture in [Sco97]. We explain this in more details in Chapter 10, Davies [Dav21] also, independently, proved the same result with a different technique, in 2021.

Star cutsets and chromatic number

In [CPST13], the following question is asked (see Question 3 in [CPST13]).

Question 3.9 (Chudnovsky, Penev, Scott, Trotignon, 2013). *Is there a constant c such that if a graph G is triangle-free and all induced subgraphs of G either are 3-colorable or have a star cutset, then G is c -colorable?*

Burling graphs also answers negatively to Question 3.9: by Theorem 3.5, luxury chandelier are 3-colorable and Burling graphs are triangle-free graphs of unbounded chromatic number.

k -tree-width, 2018

Let G be a graph. A *tree-decomposition* (resp. *path-decomposition*) of G is a tuple (T, β) where T is a tree (resp. a path) and $\beta = \{\beta_t : t \in V(T)\}$ is a set of subsets of $V(G)$ such that:

1. for every $uv \in E(G)$, there exist a $t \in V(T)$ such that $u, v \in \beta_t$,
2. for every $v \in V(G)$, the set $\{t \in V(T) : v \in \beta_t\} \subseteq V(T)$ induces a connected subgraph of T .

Let G be a graph and let $k \in \mathbb{N}^*$ be a positive integer. Let $(T^1, \beta^1), (T^2, \beta^2), \dots, (T^k, \beta^k)$ be k tree-decompositions of G . The *k -width* of these decompositions is defined as follows:

$$k\text{-width}((T^1, \beta^1), \dots, (T^k, \beta^k)) = \max_{(t_1, \dots, t_k) \in V(T^1) \times \dots \times V(T^k)} |\beta_{t_1}^1 \cap \dots \cap \beta_{t_k}^k|.$$

The *k -tree-width* (resp. *k -path-width*) of a graph G , denoted by *k -tw* (resp. *k -pw*) is the minimum k -width of a k -tuple of its tree-decompositions (resp. path decompositions).

Setting $k = 1$, one finds back the well-known notion of tree-width and path-width in graphs.

It is known that for every graph G , the chromatic number of G is at most the 2-path-width of G (see [DJM⁺18]). Based on this observation, Dujmović, Joret, Morin, Norin, and Wood [DJM⁺18] ask the following question (Open problem 3 in [DJM⁺18]): is there a function f such that for every graph G , we have $\chi(G) \leq f(2\text{-tw}(G))$?

In 2018, Felsner, Joret, Micek, Trotter, and Wiechert [FJM⁺18] answer negatively to the question above by showing that the graphs in the Burling sequence have bounded 2-tree-width (see Theorem 2 of [FJM⁺18]).

Nice labeling for event structures, 2011

An *event structure* is a triple $(\mathcal{E}, \leq_{\mathcal{E}}, \#)$ where

- \mathcal{E} is a set (whose elements are called *events*),
- $\leq_{\mathcal{E}}$ is a partial order on \mathcal{E} (called the *casual dependency*),
- $\#$ is an irreflexive and symmetric relation (called the *conflict*),

such that

- for every $e \in \mathcal{E}$, the set $\{e' \in \mathcal{E} \mid e' \leq_{\mathcal{E}} e\}$ is finite,
- for every $e_1, e_2, e_3 \in \mathcal{E}$, if $e_1 \leq_{\mathcal{E}} e_2$ and $e_1 \# e_3$, then $e_2 \# e_3$.

From now on, let us phrase everything in the language of graph theory. One can define a graph $H = H(\mathcal{E}, \leq_{\mathcal{E}}, \#)$ from the event structure as follows: $V(H) = \mathcal{E}$, and $ee' \in E(H)$ if and only if at least one of the following happens:

- neither $e \leq_{\mathcal{E}} e'$, nor $e' \leq_{\mathcal{E}} e$, nor $e \# e'$,
- $e \# e'$ and for every $e'' \notin \{e, e'\}$ if $e'' \leq_{\mathcal{E}} e$, then we do not have $e'' \# e'$ and if $e'' \leq_{\mathcal{E}} e'$, then we do not have $e'' \# e$.

The nice labeling conjecture for event structures can then be stated as follows.

Conjecture 3.10 (Rozoy and Thiagarajan, 1991). *The class of graphs defined as above from event structures is χ -bounded.*

In [Che12], Chepoi disproved this conjecture using Burling graphs.

Part II

**Characterizations of Burling
graphs**

Chapter 4

Definitions of Burling graphs and examples

4.1	Burling sequence and Burling graphs	34
4.2	Derived graphs	36
4.3	Abstract Burling graphs	39
4.4	Constrained graphs and constrained <i>S</i>-graphs	42
4.5	About definitions	47

In this chapter, we introduce several equivalent definitions for the class of Burling graphs. We postpone the proof of their equivalence to Chapter 5 and only describe a few proof ideas in this chapter. Some of these definitions complete historical works on Burling graphs, and some have applications in the next chapters. We briefly discuss the differences and usages of these definitions in each section.

- We start with the classical definition of Burling graphs in the literature in Section 4.1 which is an inductive definition.
- In Section 4.2, we introduce the definition of *derived graphs*, a more combinatorial definition which is the main topic of study in Part 3.
- We then describe *abstract Burling graphs* that have a more axiomatic definition in Section 4.3.
- Lastly, in Section 4.4, we introduce the more geometric definitions: *constrained graphs* and *constrained S-graphs*.

A point that is worth mentioning is that we are working with different mathematical objects in different sections of this chapter: Section 4.2 deals with rooted trees with two functions defined on their vertex sets, Section 4.3 deals with posets with an extra binary relation defined on them that satisfy some axioms, and

Section 4.4 deals with families of subsets of \mathbb{R}^2 with restrictions on their interactions. We could, of course, only study the properties of these mathematical objects as they are, and define structure preserving morphisms between those objects. However, we find it convenient to define a class of graphs using those objects (and then prove that these classes are all equal to each other and to the class of Burling graphs), and regard the graphs as the common point to all these words. We, however, later use specific properties of these mathematical objects to study the properties of the classes of graphs defined from them.

Before presenting the definition, we need to point out that each definition has two versions: oriented and non-oriented. Indeed, in each section, we define a class \mathcal{C} of oriented graphs and the non-oriented version is the class of all underlying graphs of graphs in \mathcal{C} . This, however, does not create much of complication, as in Chapter 5 we will show that the classes defined in this chapter as classes of oriented graphs are all equal, and thus are their underlying graph classes. Whenever we talk about an oriented graph, we emphasize that it is oriented. But for non-oriented graphs, we do not always emphasize.

The content of this chapter is mainly from [PT23] and [Pou22].

4.1 Burling sequence and Burling graphs

In Chapter 3, we gave a first definition of Burling graphs based on [Bur65]. Here, we describe an oriented version of Definition 3.2.

Definition 4.1. *Let (G, \mathcal{S}) be a pair where G is an oriented graph and \mathcal{S} is a set of stable sets of G . We define a function $\mathfrak{S}_{\mathfrak{B}}$ associating to a pair (G, \mathcal{S}) another pair (G', \mathcal{S}') as follows:*

1. *Make a copy of (G, \mathcal{S}) .*
2. *For each stable set $S \in \mathcal{S}$, make a new copy of (G, \mathcal{S}) and denote it by (G_S, \mathcal{S}_S) .*
3. *For each $S \in \mathcal{S}$ and $Q \in \mathcal{S}_S$, add a new vertex $v_{S,Q}$ adjacent to all vertices in Q . Orient the arcs from $v_{S,Q}$ to Q .*
4. *Denote by G' the graph obtained by the union of all graphs in the previous steps, i.e.*

$$V(G') = V(G) \sqcup \bigsqcup_{S \in \mathcal{S}} (V(G_S) \cup_{Q \in \mathcal{S}_S} \{v_{S,Q}\}),$$

and

$$A(G') = A(G) \sqcup \bigsqcup_{S \in \mathcal{S}} (A(G_S) \cup_{Q \in \mathcal{S}_S} \cup_{q \in Q} \{v_{S,Q}q\}).$$

5. *Define*

$$\mathcal{S}' = \{S \cup Q, S \cup \{v_{S,Q}\} : S \in \mathcal{S}, Q \in \mathcal{S}_S\}.$$

The pair (G', \mathcal{S}') is defined to be $\mathfrak{S}_{\mathfrak{B}}(G, \mathcal{S})$.

Definition 4.2. *The Burling sequence is a sequence $\{G_k\}_{k \in \mathbb{N}^*}$ where:*

- $G_1 = K_1$ and $\mathcal{S}_1 = \{V(G_1)\}$,
- for every $n \in \mathbb{N}^*$, we have $(G_{k+1}, \mathcal{S}_{k+1}) = \mathfrak{S}_{\mathfrak{B}}(G_k, \mathcal{S}_k)$.

An oriented Burling graph is any induced subgraph of a graph in the Burling sequence. A non-oriented Burling graph is any underlying graph of an oriented Burling graph.

It is worth noticing that every (oriented or non-oriented) Burling graph G inherits a set of stable sets, that is the set $\{S \cap V(G) : S \in \mathcal{S}_k\}$ where G is an induced subgraph of G_k , the k -th graph in the Burling sequence.

A breach in time. *The small change of adding an orientation to the definition of Burling graphs, based on the order of addition, plays an important role in the study of their structure. This will become clear in Chapter 7. To give a sense of how this will be useful, let us describe an example of such structural results: in an oriented Burling graph, a hole has two sources and two sinks and the sources have a common neighbor (see Corollary 7.31).*

In Figure 4.1, the first three graphs in the Burling sequence are represented. The edges of the graphs are represented as solid black and the dashed curves represent the stable sets. By definition, the graph C_5 is a Burling graph, because it is an induced subgraph of the third graph in the Burling sequence. One can see that C_6 and $K_{3,3}$ are also Burling graphs since they are induced subgraphs of the fourth and the sixth graphs in the Burling sequence respectively. Notice that neither of C_5 , C_6 , or $K_{3,3}$ is an element of the Burling sequence.

From the construction, it follows by induction on k , that G_k , the k -th graph in the Burling sequence, is triangle-free. Therefore, all Burling graphs are triangle-free. The next theorem shows that they also have arbitrarily large chromatic number, and thus the class of Burling graphs is not χ -bounded.

Theorem 4.3 ([Bur65], Theorem 11). *The chromatic number of G_k , the k -th graph in the Burling sequence, is k .*

Proof. Adopting the notations from the definition above, we prove the theorem by induction on k . For $k = 1$ the statement obviously holds. Assume that $\chi(G_k) = k$ and consider G_{k+1} .

First, let us show that G_{k+1} is $(k + 1)$ -colorable. Consider a k -coloring of G_k and apply the same coloring to every copy of G_k in G_{k+1} . Notice that this is possible because there is no edge between different copies of G_k in G_{k+1} . Then, assign a new color to every vertex of the form $v_{S,Q}$ added in Step 3 of the definition of $\mathfrak{S}_{\mathfrak{B}}$ function. This is also possible because such vertices are mutually non-adjacent. This gives a $(k + 1)$ -coloring of G_{k+1} .

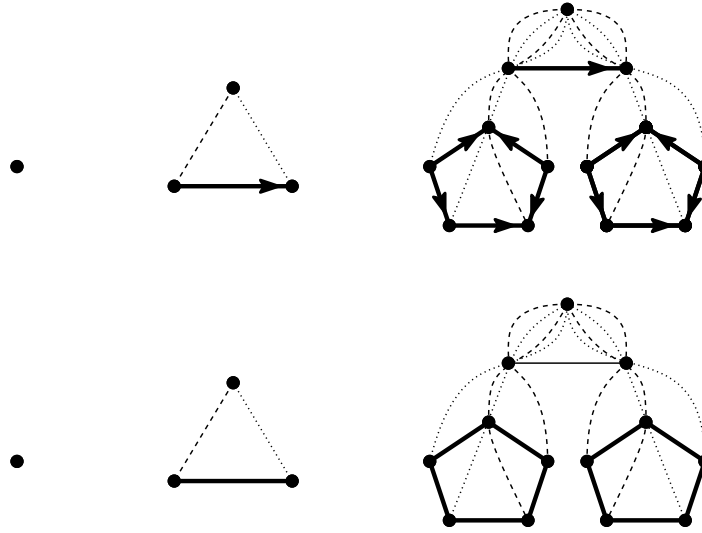

Figure 4.1: The first three graphs in the Burling sequence, as oriented graphs (on the top) and non-oriented graphs (on the bottom).

For the inverse inequality, we prove the following stronger statement: *In every coloring of the vertices of G_k , one of the stable sets in the family \mathcal{S}_k receives at least k colors.*

Consider a coloring of G_{k+1} . By the induction hypothesis, in the first copy of G_k in G_{k+1} , there exists a stable set $S \in \mathcal{S}_k$ which receives at least k colors. Again, by the induction hypothesis, in G_S , the copy of G_k associated to S , there exists a stable set $Q \in \mathcal{S}_S$ receiving k colors. Now either the k colors of S are the same as the k colors of Q , in which case $v_{S,Q}$ has a new color, and therefore $S \cup \{v_{S,Q}\} \in \mathcal{S}_{k+1}$ receives $k + 1$ different colors, or the colors in S and Q are different, in which case $S \cup Q \in \mathcal{S}_{k+1}$ receives $k + 1$ different colors. This completes the proof. \square

4.2 Derived graphs

In [PT23], Trotignon and the author define the class of *derived graphs*. We present this definition here.

Definition 4.4. *A Burling tree is a 4-tuple (T, r, ℓ, c) in which:*

1. T is a rooted tree and r is its root,
2. $\ell : V(T) \setminus L(T) \rightarrow V(T)$ is a function associating to each vertex v of T that is not a leaf, one child $\ell(v)$ of v , called the last-born of v ,

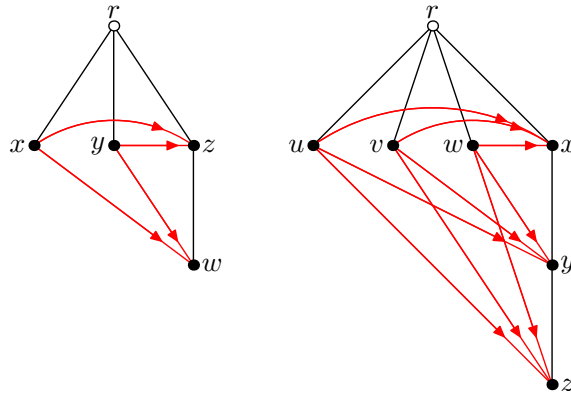

Figure 4.2: Complete bipartite graphs seen as derived graphs.

3. $c : V(T) \rightarrow \mathcal{P}(V(T))$ is a function defined on the vertices of T . If v is a non-last-born vertex in T other than the root, then c associates to v the vertex-set of a (possibly empty) branch in T starting at the last-born of $p(v)$. If v is a last-born or the root of T , then $c(v) = \emptyset$. We call c the choose-path function of T .

By abuse of notation, we may use T to denote the 4-tuple defined above.

Definition 4.5. The oriented graph G fully derived from the Burling tree (T, r, ℓ, c) is the oriented graph whose vertex-set is $V(T)$ and $uv \in A(G)$ if and only if $v \in c(u)$. A non-oriented graph G is fully derived from T if it is the underlying graph of the oriented graph fully derived from T .

A graph (resp. oriented graph) G is derived from a Burling tree T if it is an induced subgraph of a graph (resp. oriented graph) fully derived from T . The oriented or non-oriented graph G is called a derived graph if there exists a Burling tree T such that G is derived from T .

Notice that the set of all derived graphs (resp. oriented derived graphs) is closed under induced subgraph and isomorphism, thus it forms a class: the class of *derived graphs* (resp. *oriented derived graphs*).

Convention. In all figures, the tree T is represented with black edges while the arcs of the oriented graph G are represented in red. The last-born of a vertex of T is presented as its rightmost child. Moreover, shadow vertices, the vertices of T that are not in G , are represented in white.

Let us give some examples. In the Burling tree of the graph in the left of Figure 4.2, we have $c(x) = c(y) = \{z, w\}$. It shows that at least one orientation of C_4 is a derived graph. So, C_4 , as a non-oriented graph, is a derived graph. The

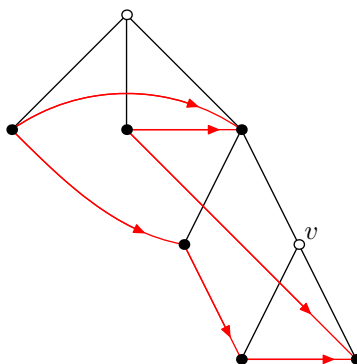

Figure 4.3: Cycle of length 6 seen as a derived graph

second graph shows that $K_{3,3}$ is a derived graph, and it is easy to generalize this construction to $K_{n,m}$ for all integers $n, m \geq 1$. In both graphs, the vertex r of T is a shadow vertex: it is not a vertex of G . Figure 4.3 is a presentation of an orientation of C_6 as a derived graph. Notice that, in this presentation, v is a shadow vertex. Generally, it is easy to see that any cycle C_k for $k \geq 4$ is a derived graph.

Notice that if a graph G is derived from T , the branches of T , restricted to the vertices of G , are stable sets of G . In particular, no edge of T is an edge of G .

A breach in time. We will see in Chapter 5 that we can define an appropriate sequence $\{T_k\}_{k \in \mathbb{N}^*}$ of Burling trees (called the tree-sequence), such that the graph fully derived from T_k is the k -th graph in the Burling sequence and the principal branches of T (the branches from the root to a leaf) form the stable sets in \mathcal{S}_k .

Remark 4.6. As mentioned in the introduction of this chapter, all the information of a derived graph G is encoded already in the Burling tree from which G is derived. We could indeed not define the derived graphs and only work with Burling trees. However, it is convenient to deal with graphs as the common object which encodes all the definitions in this chapter.

Let us now present some basic properties of oriented derived graphs. The rest of the properties will be postponed to Chapter 7 where we study the structure of these graphs.

Definition 4.7. Let G be an oriented graph derived from a Burling tree T . A vertex v in G is a top-left vertex if its distance in T to the root of T is minimum among all vertices of G , and one of the following holds:

1. v is not a last-born,
2. v is a last-born and every vertex of G whose distance in T to the root is minimum is also a last-born.

There might be more than one top-left vertex in a graph. For example, in the first graph of Figure 4.2, both vertices x and y are top-left vertices.

Lemma 4.8 ([PT23], Lemma 3.1). *Every non-empty oriented graph G derived from a Burling tree (T, r, ℓ, c) contains at least one top-left vertex and every such vertex is a source of G . Moreover, the neighborhood of a top-left vertex is a stable set.*

Proof. By the definition of top-left vertex, it exists in G . Let v be a top-left vertex of G . Suppose for the sake of contradiction that $uv \in A(G)$ for some vertex $u \in V(G)$. Thus v is a vertex in $c(u)$. Denote by $d(x)$ the distance in T of a vertex x to r . The fact that $v \in c(u)$ means that v is a descendant of a brother of u , and therefore $d(v) \geq d(u)$. Since v is a vertex that minimizes the distance to the root, we must have $d(v) = d(u)$, and in particular $p(v) = p(u)$. Notice that u and v cannot both be last-born. On the other hand, v is a last-born because u cannot be connected to one of its non-last-born brothers. This contradicts the definition of a top-left vertex. So $N(v) = N^+(v)$. It follows that $N(v)$ is included in a branch of T , and is therefore a stable set. \square

Lemma 4.9 ([PT23], Lemma 3.2). *An oriented derived graph has no directed cycles and its underlying graph has no triangles.*

Proof. Adding a source whose neighborhood is a stable set to an oriented graph with no directed cycle and no triangle does not create a triangle or a directed cycle. Since every induced subgraph of a derived graph is a derived graph, the statement follows from Lemma 4.8 by a trivial induction. \square

4.3 Abstract Burling graphs

Here, we define the class of *abstract Burling graphs*, first defined in [PT23].

Definition 4.10. *A Burling set is a triple $(S, \prec, \curvearrowright)$ where S is a non-empty set, \prec is a strict partial order on S , \curvearrowright is a binary relation on S that does not have directed cycles, and such that the following axioms hold:*

- (A1) *if $x \prec y$ and $x \prec z$, then either $y \prec z$ or $z \prec y$,*
- (A2) *if $x \curvearrowright y$ and $x \curvearrowright z$, then either $y \prec z$ or $z \prec y$,*
- (A3) *if $x \curvearrowright y$ and $x \prec z$, then $y \prec z$,*
- (A4) *if $x \curvearrowright y$ and $y \prec z$, then either $x \curvearrowright z$ or $x \prec z$.*

Notice that the tuple (S, \curvearrowright) is an oriented graph.

Definition 4.11. *An oriented graph G is an abstract Burling graph if there exists a partial order \prec on $V(G)$ such that $(V(G), \prec, A)$ forms a Burling set. A non-oriented abstract Burling graph is the underlying graph of an oriented abstract Burling graph.*

Notice that if $(S, \prec, \curvearrowright)$ is a Burling set and $G = (S, \curvearrowright)$ is its corresponding abstract Burling graph, then for every induced subgraph G' of G is of the form (S', \curvearrowright) for some $S' \subseteq S$. Moreover S' itself forms a Burling set with inherited relations \prec and \curvearrowright . So, the set of all (oriented or non-oriented) abstract Burling graphs forms a class of graphs.

Let us give an example of a Burling set. Let (T, r, ℓ, c) be a Burling tree, and set $V = V(T)$. For $x, y \in V$, we define $x \prec y$ if and only if x is a proper descendant of y in T and $x \curvearrowright y$ if and only if $y \in c(x)$. Notice that $x \curvearrowright y$ if and only if there is an arc from x to y in the oriented graph fully derived from (T, r, ℓ, c) .

We show that $(V, \prec, \curvearrowright)$ forms a Burling set. First, notice that the proper descendant relation on a rooted tree forms a strict partial order. Second, remember that by Lemma 4.9, the relation \curvearrowright has no directed cycles. Now we check Axioms (A1)-(A4). Let x, y , and z be three elements of V :

Axiom (A1): Suppose that $x \prec y$ and $x \prec z$. So both y and z are ancestors of x in T , so they are on the same branch and hence comparable with respect to \prec .

Axiom (A2): Suppose that $x \curvearrowright y$ and $x \curvearrowright z$. So $y, z \in c(x)$. Thus by definition, they are on the same branch and are comparable with respect to \prec .

Axiom (A3): Suppose that $x \curvearrowright y$ and $x \prec z$. So $y \in c(x)$ and thus y is a descendant of $p(x)$. On the other hand, z is an ancestor of x , so it is an ancestor of y too, and it is different from y . Hence $y \prec z$.

Axiom (A4): Suppose that $x \curvearrowright y$ and $y \prec z$. Let l be the last-born of $p(x)$. So y is a descendant of l , and z is an ancestor of y . Either z is a descendant of l too, in which case $x \curvearrowright z$ or z is a proper ancestor of l , in which case it is a proper ancestor of x too, i.e. $x \prec z$.

So, in particular, every derived graph is an abstract Burling graph. The converse is also true as we will show in Chapter 5.

Let us see another example of abstract Burling graphs.

Let A and B be two frames (i.e. borders of axis-parallel rectangles in \mathbb{R}^2). We write $A \curvearrowright B$, and say that the frame A enters the frame B , if $A \cap B$ has exactly two elements which are both on the right-side of B , but exactly one of them is on the top-side of A and one of them is on the bottom-side of A . See Figure 4.4.

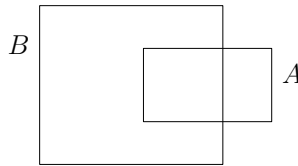

Figure 4.4: $A \curvearrowright B$, i.e. the frame A enters the frame B .

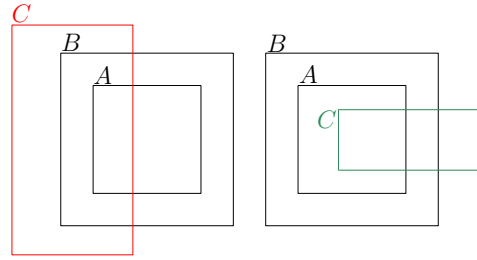

Figure 4.5: Left: the forbidden structure in strict frame graph, right: the allowed structure.

Definition 4.12. A family \mathcal{F} of frames (i.e. borders of axis-parallel rectangles in \mathbb{R}^2) is *strict* if the following constraints hold:

1. there are no three frames that are mutually intersecting,
2. corners of a frame do not coincide with any point of another frame,
3. if two distinct frames A and B intersect, then either $A \curvearrowright B$ or $B \curvearrowright A$,
4. if two distinct frames intersect, then no frame is (entirely) contained in the intersection of the interior of the two frames,
5. for any two frames A and B such that A is entirely inside the interior of B , if a frame C , different from A and B , intersects both, then C enters both A and B . See Figure 4.5.

The only possibility for two frames to intersect with these restrictions is shown in Figure 4.4. In such case, we say that the frame A *enters* the frame B .

A graph G is called a (non-oriented) *strict frame graph* if it is the intersection graph of a family \mathcal{F} of frames with the conditions above.

We write $A \prec B$ if A is a subset of B° . One can check that $(\mathcal{F}, \prec, \curvearrowright)$ is a Burling set and therefore a strict frame graph is an abstract Burling graph.

We do not contain the proof that $(\mathcal{F}, \prec, \curvearrowright)$ is a Burling set here, because the class of strict frame graphs is a special case of the constrained S -graphs defined in the next section, and we will see the proof of the fact that constrained S -graphs are Burling graphs in Chapter 5.

We would like to mention that by removing the last condition in the definition, we reach a strict superclass of strict frame graphs that is known as *restricted frame graphs* first defined in [KPW14] and later studied in [CELOdM16].

4.4 Constrained graphs and constrained S -graphs

4.4.1 Pouna sets and their territories

In this section, we define two classes of intersection graphs for a general family of sets that we call *Pouna sets*.

Definition 4.13. *A Pouna set is a compact and path-connected subset of \mathbb{R}^2 different from an axis-parallel rectangle.*

We recall that for a compact set A , the set $\mathbf{box}(A)$ is the (inclusion-wise) smallest closed rectangle in \mathbb{R}^2 containing A . Equivalently,

$$\mathbf{box}(A) = [\mathbf{l}(A), \mathbf{r}(A)] \times [\mathbf{b}(A), \mathbf{t}(A)].$$

Definition 4.14. *The territory of a Pouna set S , denoted by $\mathbf{ter}(S)$, is defined as follows:*

$$\mathbf{ter}(S) = \{(x, y) \in \mathbf{box}(S) \setminus S : \exists x' \in \mathbb{R} \text{ s.t. } x' > x \text{ and } (x', y) \in S\}.$$

Notice that the territory of a Pouna set is not necessarily a connected set.

Definition 4.15. *We say that a Pouna set S is strong if it has a non-empty territory.*

In Figure 4.6, some examples of strong Pouna sets and their territories are represented. In particular, a frame is an example of a strong Pouna set.

Convention. *In figures of Pouna sets, we do not always represent the territory as it is well-defined given the Pouna set. But whenever we represent the territory, we show the Pouna set in solid colors, and the territory in hatch pattern of the same color.*

Strong Pouna sets give us the possibility of using the properties of the territory in our definition, and they are not more restrictive than general Pouna sets as Lemma 4.18 below shows.

We first need a lemma whose proof can be found in Appendix C.

Lemma 4.16. *Let X be a topological space and let $A, B \subseteq X$. If B is connected, $B \cap A^\circ \neq \emptyset$, and $B \cap [X \setminus \bar{A}] \neq \emptyset$, then $B \cap \partial A \neq \emptyset$.*

Property 4.17. *If S a Pouna set, then $\mathbf{box}(S)^\circ \setminus S \neq \emptyset$.*

Proof. First of all, S is not a subset of an axis-aligned line-segment. So, the closure of $\mathbf{box}(S)^\circ$ is equal to $\mathbf{box}(S)$. Now, if $\mathbf{box}(S)^\circ \setminus S = \emptyset$, then $\mathbf{box}(S)^\circ \subseteq S \subseteq \mathbf{box}(S)$, and since S is closed, we have $S = \mathbf{box}(S)$, and S is an axis-aligned rectangle. \square

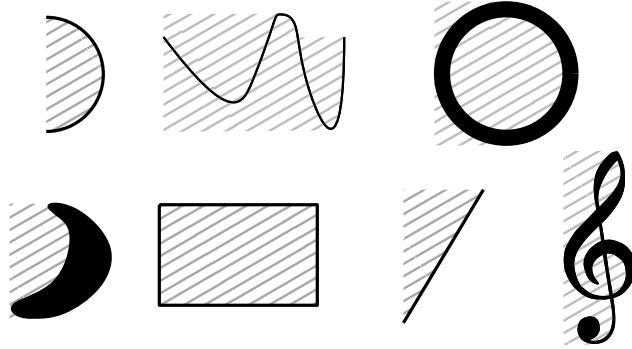

Figure 4.6: Examples of strong Pouna sets and their territories. The Pouna sets are shown in black and their territories in hatch.

Lemma 4.18. *For every Pouna set S , either S or its horizontal reflection is strong.*

Proof. Let $S' = T(S)$ be the horizontal reflection of S (thus, $T : (x, y) \mapsto (-x, y)$).

By Property 4.17, we can choose a point $p = (x, y) \in \mathbf{box}(S)^\circ \setminus S$. Let L be the horizontal line passing through p , and set A to be the closed half-plane consisting of the points on L and under L . Notice that $\mathbf{b}(S) < y < \mathbf{t}(S)$, so S has a point on the top-side of $\mathbf{box}(S)$, thus outside $A = \bar{A}$ and a point on the bottom-side of $\mathbf{box}(S)$, thus inside A° . Setting $B = S$ in the statement of Lemma 4.16, we conclude that $S \cap L \neq \emptyset$. In other words, there is a point $p = (x', y) \in \mathcal{S}$. If $x' > x$, then $p \in \mathbf{ter}(S)$, and S is strong. If $x' < x$, then $-x' > -x$. Notice that $(-x', y) \in S'$ and $(-x, y) \in \mathbf{box}(S') \setminus S'$. So, $(-x, y) \in \mathbf{ter}(S')$, and S' is strong. \square

Let S be a Pouna set. In [PKK⁺13], Pawlik, Kozik, Krawczyk, Lasoń, Micek, Trotter, and Walczak rediscover the Burling sequence as S -graphs. However, the class of S -graphs is a strict superclass of Burling graphs. In this section, we introduce the class of *constrained S -graph* that is a subclass of S -graphs which is exactly equal to the class of Burling graphs. This has been done for S equal a frame or a line segment in [PT23], and later for any Pouna set in [Pou22]. We also introduce the class of *constrained graphs* that is a subclass of intersection graphs of any Pouna sets (the sets do not need to be transformations of each other).

4.4.2 Constrained graphs

Let A and B be two strong Pouna sets. We write $A \prec B$ if $\mathbf{box}(A) \subseteq \mathbf{ter}(B)$.

We also write $A \curvearrowright B$ if A and B are distinct intersecting sets with the following properties:

- $\mathbf{l}(B) \leq \mathbf{l}(A) < \mathbf{r}(B) < \mathbf{r}(A)$,
- $\mathbf{b}(B) < \mathbf{b}(A) < \mathbf{t}(A) < \mathbf{t}(B)$,

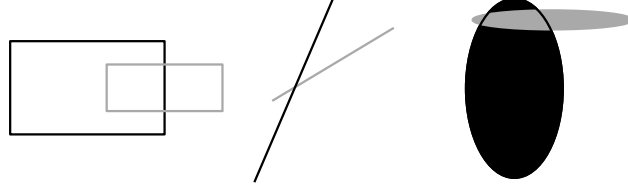

Figure 4.7: The relation $A \curvearrowright B$. In the figures above, A is shown in gray and B in black.

- $\{(x, y) \in A : x = \mathbf{l}(A)\} \subseteq \mathbf{ter}(B)$.

See Figure 4.7 for some examples.

Let \mathcal{F} be a non-empty and finite family of strong Pouna sets satisfying the following constraints:

- (C1) for every $A, B \in \mathcal{F}$, if $A \neq B$ and $A \cap B \neq \emptyset$, then, either $A \curvearrowright B$ or $B \curvearrowright A$.
- (C2) For every $A, B \in \mathcal{F}$, if $A \cap B = \emptyset$ and $A \cap \mathbf{ter}(B) \neq \emptyset$, then $A \prec B$.
- (C3) For every $A, B \in \mathcal{F}$, if $A \neq B$ and $A \cap B \neq \emptyset$, then there exists no $C \in \mathcal{F}$ such that $C \subseteq \mathbf{ter}(A) \cap \mathbf{ter}(B)$.
- (C4) There exist no $A, B, C \in \mathcal{F}$ such that $A \prec B$, $A \curvearrowright C$, and $B \curvearrowright C$.
- (C5) The maximum number of pairwise intersecting and distinct elements in \mathcal{F} is at most two.

Let \mathcal{F} be a finite family of strong Pouna sets satisfying (C1). We say that G is the *oriented intersection graph* of \mathcal{F} if $V(G) = \mathcal{F}$ and $A(G) = \{AB : A \curvearrowright B\}$. Notice that the underlying graph of G is the intersection graph of \mathcal{F} because for distinct element $A, B \in \mathcal{F}$, we have $A \cap B \neq \emptyset$ if and only if $A \curvearrowright B$ or $B \curvearrowright A$.

Definition 4.19. *An oriented graph (resp. graph) is called an oriented constrained graph (resp. a constrained graph) if it is isomorphic to the oriented intersection graph (resp. intersection graph) of a non-empty family of strong Pouna sets satisfying Constraints (C1)-(C5).*

A breach in time. *We will see in Chapter 5 that because of the Constraints (C1)-(C5), the triple $(\mathcal{F}, \prec, \curvearrowright)$ is a Burling set and thus constrained graphs are abstract Burling graphs.*

Strict frame graphs are examples of constrained graphs. In Figure 4.8, C_6 is represented as a constrained graph. The sets in this figure are all Pouna sets and their territories are represented in hatch.



Figure 4.8: C_6 as a constrained graph.

4.4.3 Constrained S -graphs

Definition 4.20. *Let S be a Pouna set. An oriented graph (resp. graph) is called an oriented constrained S -graph (resp. a constrained S -graph) if it is isomorphic to the oriented intersection graph (resp. intersection graph) of a non-empty family of \mathcal{F} of transformed copies of S that satisfies Constraints (C1)-(C5), as well as the following constraint:*

- (C6) *if S is strong, then all elements of F are positive transformed copies of S , and otherwise, they are all positive transformed copies of the horizontal reflection of S .*

Notice that the set of all oriented constrained S -graphs and the set of all constrained S -graphs both form hereditary classes of graphs.

By definition, every constrained S -graph is a constrained graph. However, as we will see in Chapter 5, the two classes are indeed equal, and in particular, the class of constrained S -graphs does not change for different sets S .

Remark 4.21. *Remember that for every Pouna set S , either S or its horizontal reflection is a strong Pouna set (see Lemma 4.18). Therefore, restricting our definition of constrained graphs and constrained S -graphs to strong Pouna sets instead of Pouna sets does not reduce the generality of the definition.*

Applied to a specific set S , the definition of constrained S -graphs becomes rather intuitive. For example, when S is the boundary of a rectangle in \mathbb{R}^2 , constrained S -graphs are exactly *strict frame graphs*. Also, when S is a non-vertical and non-horizontal line segment, constrained S -graphs are exactly *strict line-segment graphs* (defined in Section 6 of [PT23]).

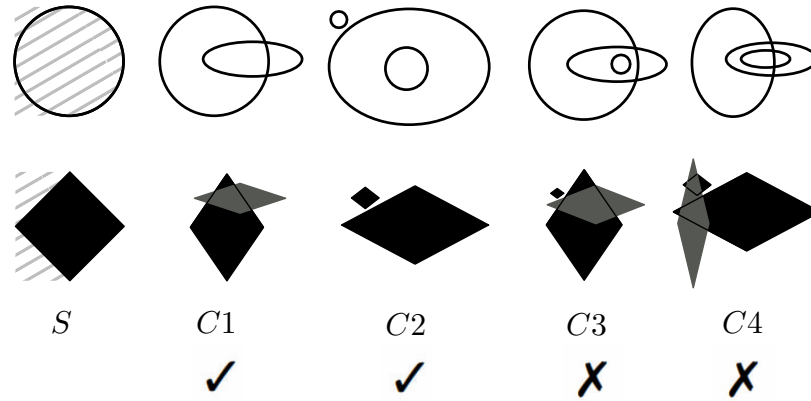

Figure 4.9: Examples of constrained S -graphs

See Figure 4.9 for two more examples of constrained S -graphs where S is a circle and when S is a square that is not axis-aligned. In each row of the figure, from left to right, the pictures represent the following:

- The first picture shows the set S (in solid color) and its territory (in hatch pattern). For the rest of the figures, we have not shown the territory anymore.
- The second picture shows the way that two sets can intersect, i.e. what is described by Constraint (C1).
- The third picture represents Constraint (C2). In other words, it shows that if two sets do not intersect but one has an intersection with the territory of the other, how they must be placed. Notice that in the first line, there are two possibilities to place a transformation of the circle in the territory of the other transformation of the circle with no intersection.
- The fourth picture shows the forbidden construction in Constraint (C3).
- The fifth picture shows the forbidden construction in Constraint (C4).
- Finally, we must keep in mind that there must not be three distinct sets that mutually intersect.

Figure 4.10 shows that C_6 and $K_{3,3}$ are Constrained S -graphs for S equal to a circle and a positively sloped line-segment respectively.

Remark 4.22. *A set of frames in \mathbb{R}^2 satisfies constraints (C1)-(C6) if and only if it is strict. So, strict frame graphs are constrained S -graphs.*

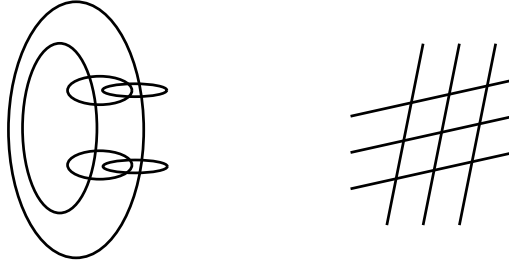

Figure 4.10: Left: C_6 as a constrained circle-graph. Right: $K_{3,3}$ as a constrained positively-sloped-line-segment-graph.

4.5 About definitions

In this short section, we discuss different aspects of the definitions introduced in this chapter.

Let us start by discussing the problem of showing that a graph is Burling. Let (G_k, \mathcal{S}_k) be the k -th element of the Burling sequence. Setting $|V(G_k)| = v_k$, and $|\mathcal{S}_k| = s_k$, for $k \in \mathbb{N}^*$, we have:

$$s_{k+1} = 2^{2^{k-1}-1} \quad \text{and} \quad v_{k+1} = (2^{2^{k-1}-1} + 1)v_k + 2^{2^k-2}.$$

So, both the number of vertices and the size of the stable sets have doubly exponential growth. This means that even for finding $K_{3,3}$ as a Burling graph, with the inductive definition of the Burling sequence, we need to find it in a graph with 23757552501 vertices.

On the other hand, showing that a graph is Burling by using the derived graph definition or the geometric definitions is easier. In this dissertation, we use derived graphs several times to show that some graphs are Burling graphs.

Abstract Burling graphs also, because of their generality, make good tools to prove that a graph is Burling or a class of graphs is a subclass of Burling graphs. Consider an oriented graph (G, A) (possibly an arbitrary graph in a class \mathcal{C}). To show that it is a Burling graph, it is enough to show that there is a partial order $<$ on $V(G)$ such that $(V(G), <, A)$ forms a Burling set. An example of such application is the proof that constrained graphs are abstract Burling graphs (and thus Burling graphs) in Section 5.4.

Another type of problem involving Burling graphs is to show that Burling graphs do not include a graph H or a set of graphs \mathcal{H} (see motivations for it, for example, in Chapter 10). The inductive definition, again, is not very suitable for such proofs, since one needs to keep track of the (inherited from the graphs in the sequence) stable sets. This makes the proofs based on induction more complicated than if one uses

other definitions, such as derived graphs, the induction is on the number of vertices of the graph, and not the index in a sequence of graphs.

Moreover, as we will see in the rest of this thesis, the derived graph definition, enables us to study the structure of the graphs in this class in more detail: The tree structure allowed us to encode at the same time the precise stable sets of any Burling graphs through the branches of the tree and the time that a vertex has been added the Burling sequence through the depth of the vertex in the tree (see Chapter 5). Moreover, the tree gives us some more tools to study star cutsets in Burling graphs (see Section 7.4), and to define some useful subclasses of Burling graphs, called k -Burling graphs (see Section 7.3) Finally, the combination of the tree structure and the orientation reveals the particularity of this orientation (see Section 7.5).

Chapter 5

Equivalence of definitions

5.1	The proof's outline	50
5.2	Derived graphs are Burling graphs	50
5.3	Burling graphs are constrained S -graphs	59
5.4	Constrained graphs are abstract Burling graphs	74
5.5	Abstract Burling graphs are derived graphs	75
5.6	Concluding the proof	78
5.7	A category theoretical view of this chapter	78

In this chapter, we prove that all definitions in Chapter 4 are equivalent. The whole chapter is dedicated to the proof of Theorem 5.1, broken into many sections. It is worth mentioning that many of the lemmas and insights from this chapter will be useful in the rest of this thesis as well.

In the last section of the chapter, using a category-theoretical language, we describe how the proofs of this chapter not only show an equality of the classes of graphs, but also provide a functor between the categories corresponding to them.

Theorem 5.1. *Let G be a finite oriented graph and S be any Pouna set. The following are equivalent:*

1. G is a derived graph,
2. G is a Burling graph,
3. G is a constrained S -graph,
4. G is a constrained graph,
5. G is an abstract Burling graph.

As a corollary of Theorem 5.1, we have that the classes of non-oriented derived graphs, Burling graphs, constrained S -graphs (for any Pouna set S), constrained graphs, and abstract Burling graphs are all equal as well.

5.1 The proof's outline

Since the proof of the theorem is long, we break it into different sections. The outline of the proof is as follows:

$$1 \xrightarrow{5.2} 2 \xrightarrow{5.3} 3 \implies 4 \xrightarrow{5.4} 5 \xrightarrow{5.5} 1.$$

Indeed, we prove a stronger result than Theorem 5.1. Let us explain how the proof works.

- 1 \implies 2 We prove that for any given Burling tree (T, r, ℓ, c) , there exists a pair (G, \mathcal{S}) of a Burling graph and its inherited stable set, and a function $f : V(T) \rightarrow V(G)$ that is structure preserving in the sense that the principle branches of T are sent to \mathcal{S} (so, the ancestor structure is preserved), and that the graph fully derived from T is isomorphic to G (so, the c relation is sent to the arc-set relation in G). See Lemma 5.9. As a result, every fully derived graph, and thus every derived graph, is a Burling graph.

Indeed, we define f only on a “generating set” (that we call the tree-sequence) $\{T_k\}_{k \geq 1}$, of Burling trees. But thanks to Lemma 5.8, the function f can be extended to all trees.

- 2 \implies 3 For proving this equivalence, we use an already existing construction of Burling graphs as S -graph from [PKK⁺13] and show that this construction satisfies (C1)-(C6). Thus, every Burling graph is a constrained S -graph.
- 3 \implies 4 This is obvious from the definition.
- 4 \implies 5 For a given set \mathcal{F} of strong Pouna sets, we prove that $(\mathcal{F}, \prec, \curvearrowright)$ form a Burling set, and that $(\mathcal{F}, \curvearrowright)$ is indeed the oriented intersection graph of \mathcal{F} . As a result, every constrained graph is an abstract Burling graph.
- 5 \implies 1 For every Burling set $(S, \prec, \curvearrowright)$, we show that there is a Burling tree (T, r, ℓ, c) and a function $f : S \rightarrow T$ that is structure preserving in the sense that the \prec relation is sent to the descendant relation and the \curvearrowright relation is sent to c relation.

5.2 Derived graphs are Burling graphs

In this section, we prove that every derived graph is a Burling graph. In order to do so, we first need to study some properties of Burling trees and to define some new notions.

The contents of this section are mainly from [PT23].

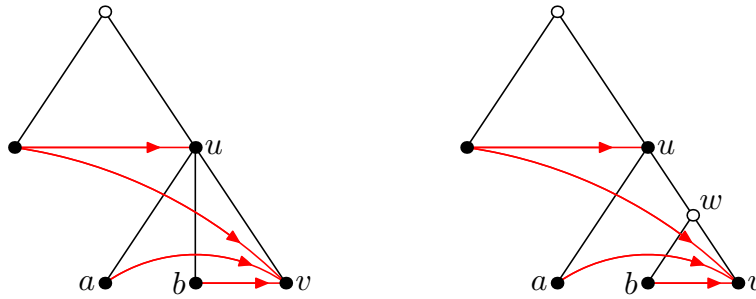
 Figure 5.1: Sliding b into uv

Some properties of Burling trees

Let G be an oriented graph derived from a Burling tree T . An arc uv of G is a *top-arc* with respect to T if v is the out-neighbor of u that is closest (in T) to the root of T . An arc uv of G is a *bottom-arc* with respect to T if v is the out-neighbor of u that is furthest (in T) from the root of T . Notice that we need to mention the Burling tree T for talking about top-arcs and bottom-arcs since the top-arcs and bottom-arcs of G with respect to different Burling trees from which G is derived might not be the same. We, however, omit “with respect to T ” when T is clear from the context.

Suppose that (T, r, ℓ, c) is a Burling tree, u is a non-leaf vertex of T and v is its last-born. Suppose that b is a non-last-born child of u . Consider the tree T' obtained from T by removing the edges uv and ub , and adding a vertex w adjacent to u , v , and b . Define $\ell'(u) = w$, $\ell'(w) = v$ and $\ell'(z) = \ell(z)$ for all non-leaf vertices $z \in T \setminus \{u\}$. Define $c'(z) = c(z) \cup \{w\}$ for every vertex $z \in V(T) \setminus \{b\}$ such that $v \in c(z)$ or $b \in c(z)$, define $c'(w) = \emptyset$, and define $c'(z) = c(z)$ otherwise. See Figure 5.1.

The Burling tree (T', r', ℓ', c') defined above is said to be obtained from (T, r, ℓ, c) by *sliding b into uv* (notice that the definition requires that v is a last-born).

Lemma 5.2. *If (T', r', ℓ', c') is obtained from (T, r, ℓ, c) by sliding a vertex into an edge, then any oriented graph derived from (T, r, ℓ, c) can be derived from (T', r', ℓ', c') . Moreover, for all arcs uv of G , we have that uv is a top-arc (resp. bottom-arc) of G with respect to T' if and only if it is a top-arc (resp. bottom-arc) of G with respect to T .*

Proof. Let G be derived from T . The first part of the statement follows directly from the fact that the function c is the restriction of c' to $V(G)$. The second part of the statement follows from the fact that for every vertex u , the order of its out-neighbors, with respect to their distance to the root has not changed, and that w is not a vertex of G . \square

The next lemma shows that all derived graphs can be derived from Burling trees with specific properties. This will reduce the technical difficulties in some proofs.

Lemma 5.3. *Let G be an oriented graph derived from a Burling tree (T, r, ℓ, c) . The graph G can be derived from a Burling tree (T', r', ℓ', c') such that:*

1. r' is not in $V(G)$,
2. every non-leaf vertex in T' has exactly two children,
3. no last-born of T' is in $V(G)$,
4. for all arcs uv of G , we have that uv is a top-arc (resp. bottom-arc) of G with respect to T' if and only if it is a top-arc (resp. bottom-arc) of G with respect to T .

Proof. Let us define (T', r', ℓ', c') from (T, r, ℓ, c) as follows. In what follows, we write T_i for (T_i, r_i, ℓ_i, c_i) where $i \in \{1, 2, 3, 4\}$.

Step 1. If $r \notin V(G)$, then Item 1 holds for T . Set $T_1 = T$. If $r \in V(G)$, build a tree T_1 by adding to T a new vertex r_1 adjacent to r . Define $\ell_1(r_1) = r$ and $\ell_1(v) = \ell(v)$ for all vertices v of T . Moreover set $c_1(r_1) = \emptyset$, and do not change the choose-path function on the rest of the vertices. Now, G can be derived from T_1 such that item 1 holds. Moreover, the top-arcs and bottom-arcs of G with respect to T_1 are the same as the ones with respect to T .

Step 2. Suppose that u is a non-leaf vertex of T_1 which has only one child. Build a tree T' by adding a new child v to u and define $c'(v) = \emptyset$. Notice that v is a leaf, so it does not have a last-born in T' . The graph G is also derived from T' . Apply this process until that every non-leaf vertex in T' has at least two children. Call the obtained Burling tree T_2 . So, G can be derived from T_2 . Notice that the top-arcs and bottom-arcs of G with respect to T_2 are the same as the ones with respect to T_1 and thus to T . Moreover, Item 1 holds for T_2 as well.

Step 3. Suppose that u is a vertex in T with at least three children, let v be the last-born of u and a, b be two distinct children of u other than v . We define a Burling tree T' by sliding b into the edge uv , and observe that the degree of u in T' is smaller than in T . And by Lemma 5.2, G can be derived from T' and that the top-arcs and the bottom-arcs stay the same. Notice that during this process we decrease the number of children of u , the new vertex w has two children, and we do not increase the number of children of any other vertex. Also, in applying this process on a vertex u , we do not decrease the number of children of any vertex other than u , and once again the new vertex that we create has two children. Hence the process terminates if we apply the same process until Item 2 of the lemma is satisfied. Call the Burling tree obtained by applying this process until Item 2 is satisfied T_3 . Notice that Item 1 still holds, and that the top-arcs and bottom-arcs of G with respect to T_3 are the same as the ones with respect to T .

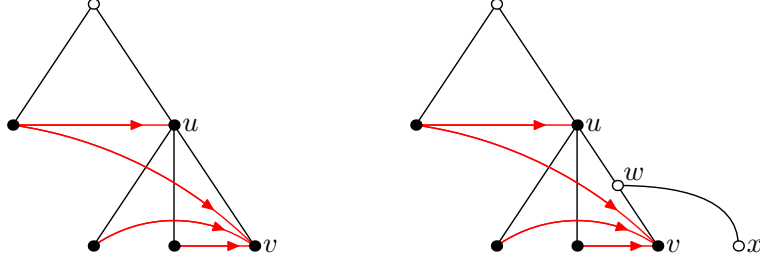
 Figure 5.2: Turning v into a non-last-born

Step 4. If v is a last-born of T that is in $V(G)$, then let u be the parent of v . Observe that $c(v) = \emptyset$. We build a tree T' by removing the edge uv , adding a new vertex w adjacent to u and v , and a new vertex x adjacent to w . Define $\ell'(u) = w$, $\ell'(w) = x$ and $\ell'(y) = \ell(y)$ for all non-leaf vertices y of $T \setminus u$. Define $c'(y) = c(y) \cup \{w\}$ for every vertex $y \in V(T)$ such that $v \in c(y)$ and $c'(y) = c(y)$ otherwise. We see that G can be derived from (T', r', ℓ', c') , and v is not a last-born in T' , so we have reduced the number of last-borns of the Burling tree in $V(G)$. Moreover, for every vertex u , the order of its out-neighbors, with respect to their distance to the root has not changed, and that w is not a vertex of G . Thus, the top-arcs and bottom-arcs remain the same. Apply this process until there is no last-born of the Burling tree in $V(G)$. See Figure 5.2. Call the Burling tree obtained at the end T_4 . Notice that Items 1 and 2 remain true for T_4 as well and that the top-arcs and bottom-arcs of G with respect to T_4 are the same as the ones with respect to T , so Item 4 holds for T_4 as well.

To finish, set $T' = T_4$, and observe that T' satisfies all the items of the lemma. \square

Tree sequence

A *principal branch* of a Burling tree (T, r, ℓ, c) is any branch starting in its root r and ending in one of its leaves. The *principal set* of (T, r, ℓ, c) is the set of all vertex-sets of the principal branches of T . We denote the principal set of T by $\mathcal{P}(T)$. Notice that there is a one-to-one correspondence between $\mathcal{P}(T)$ and $L(T)$, the set of leaves of T .

If a graph G is derived from a Burling tree T , then the restriction of each principal branch of T to the vertices of G , form a stable set in G . In particular, $\mathcal{P}(T)$, restricted to $V(G)$, is a set of stable sets of G .

We define a sequence $\{T_k\}_{k \geq 1}$ of Burling trees and we prove that the sequence $(T_k, \mathcal{P}_k)_{k \geq 1}$ of Burling trees and their principle sets is in correspondence to the sequence $(G_k, \mathcal{S}_k)_{k \geq 1}$ of Burling graphs. More precisely, we will show that the k -th oriented Burling graph, G_k , is isomorphic to the oriented graph fully derived from T_k , and S_k is the same as $\mathcal{P}_k = \mathcal{P}(T_k)$.

In order to define the mentioned sequence, we first define a function $\mathfrak{S}_{\bar{x}}$ on Burling trees.

Definition 5.4 ([PT23], Definition 4.2). *Let (T, r, ℓ, c) be a Burling tree, and let \mathcal{P} denote its principal set. We build a Burling tree (T', r', ℓ', c') with principal set \mathcal{P}' as follows:*

1. *Consider a copy of (T, r, ℓ, c) .*
2. *For each principal branch $P \in \mathcal{P}$ ending in the leaf l , pend a leaf l_P to l , and define $\ell'(l) = l_P$. Then add a copy $(T, r, \ell, c)_P$ of (T, r, ℓ, c) on l_P identifying its root with l_P . Denote the principal set of $(T, r, \ell, c)_P$ by \mathcal{P}_P .*
3. *For each copy $(T, r, \ell, c)_P$, corresponding to a leaf $l \in P$, and for each $Q \in \mathcal{P}_P$, add a new leaf $l_{P,Q}$ to l .*
4. *The tree obtained so far is T' , and r' is the same vertex as r in the first copy of (T, r, ℓ, c) .*
5. *To obtain ℓ' , extend the function ℓ naturally to the copies of (T, r, ℓ, c) , and notice that this, along with the definition of ℓ' on leaves of the first copy in Step 2, completes the definition of ℓ' .*
6. *To obtain c' , first extend the function c naturally to the copies of (T, r, ℓ, c) , and then also define $c'(l_{P,Q}) = Q$ for $P \in \mathcal{P}$ and $Q \in \mathcal{P}_P$.*
7. *Notice that the result is a Burling tree (T', r', ℓ', c') .*
8. *Observe that the principal branches of T' are of the form $P \cup Q$ or $P \cup \{l_{P,Q}\}$ for $P \in \mathcal{P}$ and $Q \in \mathcal{P}_P$. Thus $\mathcal{P}' = \{P \cup Q, P \cup \{l_{P,Q}\} : P \in \mathcal{P}, Q \in \mathcal{P}_P\}$.*

We denote (T', r', ℓ', c') by $\mathfrak{S}_{\bar{x}}(T, r, \ell, c)$. By abuse of notation, we may write $T' = \mathfrak{S}_{\bar{x}}(T)$.

Starting from T_1 , the one vertex Burling tree, and applying the $\mathfrak{S}_{\bar{x}}$ function iteratively, we reach a sequence $(T_k, r_k, \ell_k, c_k)_{k \in \mathbb{N}^*}$ of Burling trees that we call *the tree sequence*.

In Figure 5.3, the first three Burling trees in the tree sequence are represented. To show the choose-path function, we have also presented the oriented graphs fully derived from them.

In the rest of this section whenever we use the notation (G_k, \mathcal{S}_k) , we mean the k -th graph in the Burling sequence and its set of stable sets. Similarly, when we write (T_k, r_k, ℓ_k, c_k) , or simply T_k , we mean the k -th Burling tree in the tree sequence and we denote by $\mathcal{P}_k = \mathcal{P}(T_k)$ its principle set.

Let us present some properties of the tree sequence.

Lemma 5.5. *Let v be a vertex in $(T_k, r_k, \ell_k, c_k)_k$.*

1. *If v is not a leaf, then it has at least two children in T_k .*

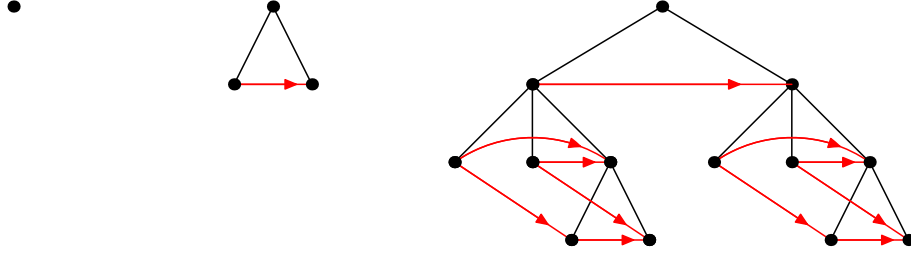

Figure 5.3: The first three Burling trees in the tree sequence and the oriented graphs fully derived from them.

2. If v is a non-last-born vertex in T_k which is not the root, then $c_k(v) \neq \emptyset$. In particular, the last-born brother of v is in $c_k(v)$.

Proof. We prove the lemma by induction on k . For $k = 1$, there is nothing to prove. Suppose that the statements are true for T_k where $k \geq 1$.

To prove the first item, let v be a vertex in $T_{k+1} = \mathfrak{S}_{\mathfrak{x}}(T_k)$ which is not a leaf. The vertex v appears in one of the copies of T_k , and because it is not a leaf, either it is a non-leaf vertex of a copy of T_k , and thus it has at least 2 children by the induction hypothesis, or it is a leaf of the main copy of T_k in T_{k+1} . But notice that as a leaf of the main copy of T_k , in the second step of Definition 5.4, it receives a child, and in the third step it receives at least one more child. So v has at least 2 children in T_{k+1} .

To prove the second item, let v be a non-last-born vertex in T_{k+1} other than its root. There are two possibilities:

First, v is a non-last-born vertex in one of the copies of T_k (either the main copy, or a copy corresponding to a principal branch). In this case, the results follows from the induction hypothesis.

Second, v is a vertex of the form $l_{P,Q}$ as in the third step of Definition 5.4. Then in the sixth step we define $c_{k+1}(v)$ to be Q which is not empty. \square

Now we define the notion of *extension* for Burling trees, which is, as we will see formally in Lemma 5.7, closely related to the notion of induced subgraph in fully derived graphs.

Definition 5.6. Let (T, r, ℓ, c) and (T', r', ℓ', c') be two Burling trees. We say that T' is an extension of T if there exists an injection φ from $V(T)$ to $V(T')$ with the following properties:

1. $\varphi(r) = r'$,
2. φ preserves ancestors, i.e. if u is an ancestor of v in T , then $\varphi(u)$ is an ancestor of $\varphi(v)$ in T' ,
3. φ preserves the last-born vertices, i.e. if $v \in V(T)$ is a last-born in T , then $\varphi(v)$ is a last-born in T' .

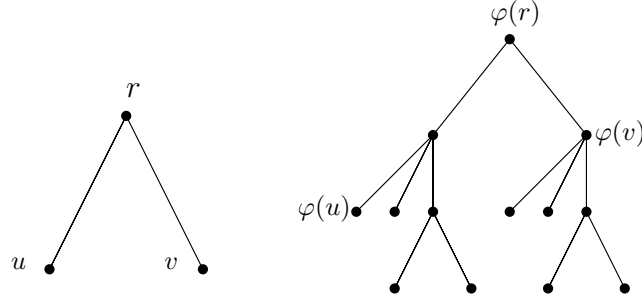

Figure 5.4: When $c(u) = \emptyset$, T_3 (right) is an extension of T (left)

4. φ preserves the choose-path function on T , i.e. for every vertex $v \in T$, we have $\varphi(c(v)) = c'(\varphi(v)) \cap \varphi(V(T))$.

Lemma 5.7. *Let G and G' be two oriented graphs fully derived from T and T' respectively. If T' is an extension of T , then G is an induced subgraph of G' .*

Proof. Let φ be the injection from $V(T)$ to $V(T')$. Since G and G' are fully derived from T and T' , $V(G) = V(T)$ and $V(G') = V(T')$. Thus φ can be seen as an injection from $V(G)$ to $V(G')$. By Property 4 in Definition 5.6, $v \in c(u)$ if and only if $\varphi(v) \in c'(\varphi(u))$. In other words, $uv \in A(G)$ if and only if $\varphi(u)\varphi(v) \in A(G')$. Thus, G is an induced subgraph of G' . \square

Next lemma shows that the tree sequence $(T_k)_{k \geq 1}$ contains all the Burling trees in the extension sense.

Lemma 5.8. *If (T, r, ℓ, c) is a Burling tree such that every non-leaf vertex has exactly two children, then there exist an integer $k \geq 1$ such that T_k is an extension of T .*

Proof. We prove the lemma by induction on the number of vertices of T .

For the induction step, the smallest possible T is a tree on three vertices: the root r , the last-born of the root v , and the other child of the root u . If $c(u) = \{v\}$, then T_2 is an extension of T . If $c(u) = \emptyset$, then T_3 is an extension of T as shown in Figure 5.4.

Suppose that the lemma is true for every Burling tree on at most n vertices. Suppose that T on $n > 1$ vertices is given.

Consider the set of all the vertices of T which have the maximum distance to r . Because every non-leaf vertex in T has two children, there is a non-last-born vertex x in this set. Notice that x has no children. Denote by p the parent of x and by y the last-born of p . Notice that y also has the maximum distance to the root, and thus both x and y are leaves of T .

Consider the tree (T', r, ℓ', c') , obtained from T by removing the two leaves x and y , and restricting the functions ℓ and c . By induction hypothesis, there exist k such

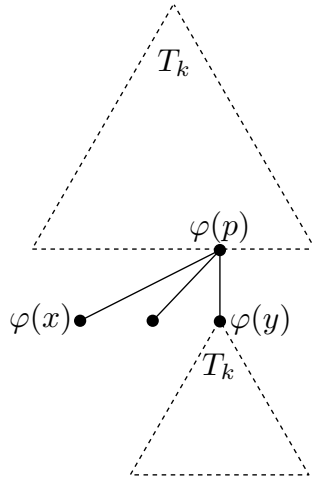

Figure 5.5: Case 1 of the proof of Lemma 5.8

that T_k is an extension of T . Let φ be the injection from $V(T)$ to $V(T_k)$. In the rest of the proof, we will define φ on x and y in order to extend φ to $V(T)$, in a way that all the four properties of Definition 5.6 remain satisfied.

Now there are two possible cases.

Case 1: $y \in c(x)$.

If $\varphi(p)$ is not a leaf of T_k , then define $\varphi(x)$ to be a non-last-born child of $\varphi(p)$, which exists by lemma 5.5, and define $\varphi(y)$ to be the last-born of $\varphi(p)$. By Lemma 5.5, $\varphi(y)$ is in $c_k(\varphi(x))$. Notice that this extension of ϕ has all the properties of Definition 5.6. Properties (1) to (3) are easy to verify, and for Property (4), notice that no descendant of $\varphi(y)$ is in the image of φ , thus $\varphi(c(x)) = \varphi(\{y\}) = \{\ell_k(p)\} = c_k(\varphi(y)) \cap im(\varphi)$.

If $\varphi(p)$ is a leaf of T_k , then consider T_{k+1} . In building T_{k+1} , every leaf of the first copy of T_k , including $\varphi(p)$, will receive a last-born and at least one non-last-born child. Define again $\varphi(x)$ to be a non-last-born child of $\varphi(p)$ and $\varphi(y)$ to be the last-born of $\varphi(p)$. See Figure 5.5. Notice that again φ has all the required properties. So T_{k+1} is an extension of T .

Case 2: $y \notin c(x)$.

If $\varphi(p)$ is not a leaf of T_k , by Lemma 5.5 it has at least two children. Choose two paths starting at two different children of $\varphi(p)$ and ending at two different leafs l and l' of T_k . In T_{k+1} , consider l and l' in the first copy of T_k . Define $\varphi(x)$ to be some non-last-born of l in T_{k+1} and $\varphi(y)$ to be the last-born of l' in T_{k+1} . See Figure 5.6, left. Notice that $l \neq l'$, thus $\varphi(y) \notin \varphi(x)$. The new function φ has all the required properties. Hence T_{k+1} is an extension of T .

If $\varphi(p)$ is a leaf of T_k , then consider T_{k+1} . In T_{k+1} , the vertex $\varphi(p)$ in the main copy of T_k has a last-born l and at least one non-last-born. Choose any non-last-born child of $\varphi(p)$ and denote it by n . Notice that n is a leaf of T_{k+1} . Thus in T_{k+2} , this

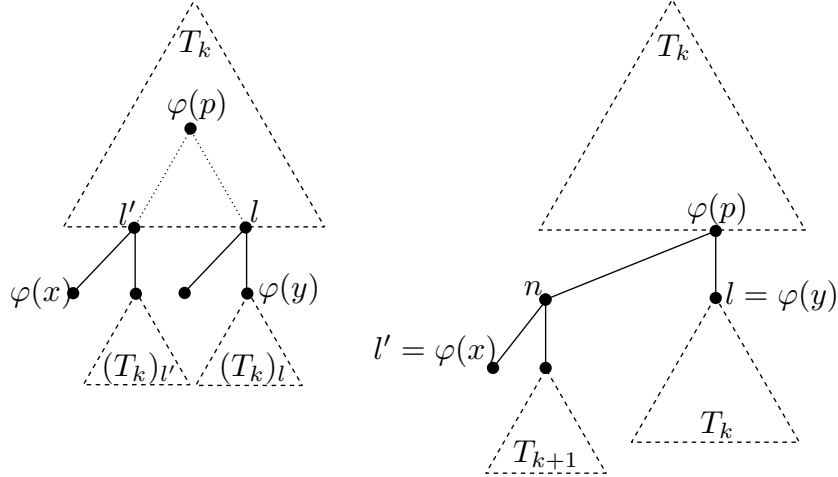

Figure 5.6: Case 2 of the proof of Lemma 5.8

vertex will have a some children, including at least one non-last-born, that we denote by l' . Notice that $l \notin c_{k+2}(l')$. Define $\varphi(x) = l'$ and $\varphi(y) = l$. See Figure 5.6, right. It is easy to check that φ has all the properties of Definition 5.6, so T_{k+2} is an extension of T . \square

Comparing Figure 5.3 and Figure 4.1, one sees that the first three graphs in the Burling sequence are isomorphic to the graphs fully derived from the first three Burling trees in the tree sequence. The next lemma shows that this is indeed true for every k .

Lemma 5.9. *For every $k \geq 1$, the oriented graph G_k is isomorphic to the oriented graph fully derived from T_k . Moreover, the isomorphism induces a bijection between the elements of \mathcal{S}_k and the elements of $\mathcal{P}_k = \mathcal{P}(T_k)$.*

Proof. We prove the lemma by induction on k . If $k = 1$, the statement holds. Suppose that G_k is isomorphic to the graph fully derived from T_k and \mathcal{S}_k is equal to \mathcal{P}_k .

To build T_{k+1} , to every leaf l of T_k , we add a new leaf and we pend a copy of T_k to this new leaf. Since every leaf in T_k identifies exactly one of the principal branches, or by the induction hypothesis, one stable set in \mathcal{S}_k , this step is equivalent to the second step of Definition 4.1. Then for each copy $(T_k)_P$ of T_k , we add $|\mathcal{P}_k| = |\mathcal{S}_k|$ new leaves to the leaf corresponding to the principal branch P . For a new vertex $l_{P,Q}$ corresponding to the branch $Q \in \mathcal{P}(T_k)_P$, we define the choose-path function to be $Q \in (T_k)_P$ which assures that in the graph fully derived from T , this vertex is

complete to Q . Thus these new vertices $l_{P,Q}$ are the vertices $v_{P,Q}$ that we add in the third step of Definition 4.2, and G_{k+1} is the graph fully derived from T_{k+1} .

Finally we notice that the vertex sets of the principal branches of T_{k+1} are exactly sets of the form $P \cup Q$ and $P \cup \{l_{P,Q}\}$ for $P \in P_k = \mathcal{S}_k$ and $Q \in (\mathcal{P}_k)_P = (\mathcal{S}_k)_P$. Thus $\mathcal{S}_{k+1} = \mathcal{P}_{k+1}$. \square

Main theorem

Theorem 5.10. *Every oriented derived graph is an oriented Burling graph.*

Proof. Let H be an oriented graph derived from a Burling tree T . By Lemma 5.3, we may assume that every non-leaf vertex in T has exactly two children. Notice that H is an induced subgraph of G , the oriented graph fully derived from T . By Lemma 5.8, there exists k such that T_k is an extension of T . Moreover, by Lemma 5.9, G_k is the graph fully derived from T_k . Thus by Lemma 5.7, G is an induced subgraph of G_k , and thus it is a Burling graph. Therefore, so is H . \square

5.3 Burling graphs are constrained S -graphs

In this section, we prove that Burling graphs are constrained S -graphs for every Pouna set S . To do so, we need to find a sequence $(\mathcal{F}_k)_{k \in \mathbb{N}^*}$ of families of Strong Pouna sets satisfying Constraints (C1)-(C6) such that the oriented intersection graph of \mathcal{F}_k is the k -th graph in the Burling sequence. In [PKK⁺13], Pawlik, Kozik, Krawczyk, Lasoń, Micek, Trotter, and Walczak introduce Burling graphs as S -graph for every Pouna set S . After repeating the construction from [PKK⁺13] (with slightly different terminology and details so it matches our earlier definitions), we show that it satisfies all Constraints (C1)-(C6). Before that, however, we need to introduce some geometric notions and to study some more properties of Pouna sets.

The contents of this chapter are mainly from [Pou22].

Some geometric notions and lemmas

Here, we define the geometric notions and lemmas that we need in the proofs of this section. The proofs of Lemmas 5.11, 5.12, and 5.13 are in Appendix C.

Let R be an axis-parallel rectangle. Let $A \subseteq \mathbb{R}^2$. We say that A *crosses* R vertically (resp. horizontally) if there exists a $\gamma : [0, 1] \rightarrow A \cap R$ such that $\gamma(0)$ and $\gamma(1)$ are respectively on the bottom-side and on the top-side (resp. on the left-side and on the right-side) of R .

Lemma 5.11. *Let $y_0, y_1 \in \mathbb{R}$ such that $y_0 \leq y_1$. For $i \in \{0, 1\}$, let L_i denote the line $y = y_i$ in \mathbb{R}^2 . Let $\gamma : [0, 1] \rightarrow \mathbb{R}^2$ be a continuous function such that for $i \in \{0, 1\}$, we*

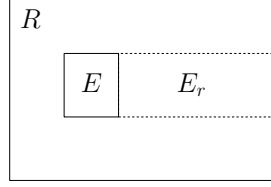

Figure 5.7: E_r is the right extension of E in R .

have $\gamma(i) \in L_i$. Then, there exist $x_0, x_1 \in [0, 1]$ such that $x_0 \leq x_1$ and the following hold:

- the path $\gamma' = \gamma|_{[x_0, x_1]}$ is always between or on the lines L_0 and L_1 , i.e. $\text{im}(\gamma') \subseteq \{(x, y) : y_0 \leq y \leq y_1\}$,
- for $i \in \{0, 1\}$, we have $\gamma'(i) \in L_i$.

Lemma 5.12. Let R and R' be two axis-aligned rectangles such that:

- $\text{l}(R') \leq \text{l}(R) \leq \text{r}(R) \leq \text{r}(R')$,
- $\text{b}(R) \leq \text{b}(R') \leq \text{t}(R') \leq \text{t}(R)$.

If a set A crosses R vertically, then it crosses R' vertically as well.

Lemma 5.13. Let R be a rectangle in \mathbb{R}^2 . Let $\alpha : [0, 1] \rightarrow R$ and $\beta : [0, 1] \rightarrow R$ be two paths joining the bottom side of R to its top side and the left side of R to its right side respectively. Then $\text{im}(\alpha) \cap \text{im}(\beta) \neq \emptyset$.

Some properties of Pouna sets

The following lemma shows that strong Pouna sets and their territories behave well under positive transformations. For some properties that are easy to check, we have provided the proof in Appendix C.

Property 5.14. Let S be a strong Pouna set and T be a positive transformation. Then, $\text{ter}(T(S)) = T(\text{ter}(S))$. In particular, $T(S)$ is strong.

The proof is in Appendix C.

Let B and E be two rectangles such that $E \subseteq B$. The right-extension of E in B is the rectangle E_r defined as follows:

$$E_r = [\text{r}(E), \text{r}(B)] \times [\text{b}(E), \text{t}(E)].$$

See Figure 5.7.

Definition 5.15. A subterritory for a strong Pouna set S is a non-empty closed rectangle E such that

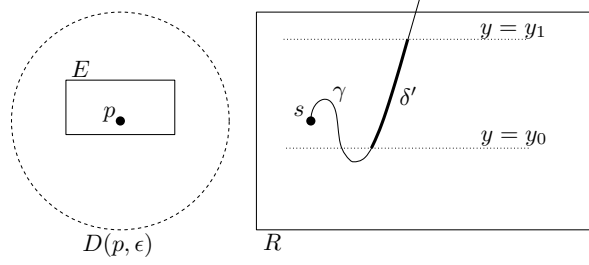

Figure 5.8: For proof of Lemma 5.16.

1. $E \subseteq \text{ter}(S)$,
2. $\mathfrak{l}(E) > \mathfrak{l}(S)$, $\mathfrak{r}(E) < \mathfrak{r}(S)$, $\mathfrak{b}(E) > \mathfrak{b}(S)$, and $\mathfrak{t}(E) < \mathfrak{t}(S)$,
3. S crosses the right extension of E vertically.

A strong Pouna set always has a subterritory, as we prove in the following lemma.

Lemma 5.16. *Every strong Pouna set has a subterritory.*

Proof. Let S be a strong Pouna set and let $B = \text{box}(S)$. By Property 4.17 there exist a point $p = (x_p, y_p) \in B^\circ \setminus S$. So, there is $\epsilon > 0$ such that $D(p, \epsilon) \subseteq B^\circ \setminus S$.

Let L_P be the ray $\{(x, y) : y = y_p, x \geq x_p\}$. Notice that $L_P \cap S$ is non-empty and compact. Let $s = (x_s, y_s)$ be the point in $L_P \cap S$ which obtains the value $\mathfrak{l}(L_P \cap S)$. Notice that $y_s = y_p$. Consider the following rectangle in B :

$$R = [x_s - \epsilon/2, \mathfrak{r}(S)] \times [y_s - \epsilon, y_s + \epsilon].$$

See Figure 5.8.

In particular, $s \in R^\circ$. Also, $R = \bar{R}$ does not intersect the border of B . On the other hand, there is a point s' of S on the top-side of B . Since S is a path-connected set, we must have a path γ from s to s' . By Lemma 4.16, the image of γ must intersect ∂B , and in particular in a point other than $(x_s - \epsilon/2, y_s)$ and $(\mathfrak{r}(S), y_s)$. So, $\text{im}(\gamma) \cap B$ is not a horizontal line. In particular, there are $y_0, y_1 \in \mathbb{R}$ such that $y_s - \epsilon \leq y_0 < y_1 \leq y_s + \epsilon$ and such that there is a path δ in R joining a point on the line $y = y_0$ to a point on the line $y = y_1$.

So, by Lemma 5.11, applied to δ , there is a path $\delta' : [0, 1] \rightarrow \mathbb{R}$ such that $\pi_2(\delta'(0)) = y_0$, $\pi_2(\delta'(1)) = y_1$, and $\text{im}(\delta') \subseteq [x_s - \epsilon/2, \mathfrak{r}(S)] \times [y_0, y_1]$.

Now, let E be a rectangle entirely inside $D(p, \epsilon)$ defined as follows:

$$E = [x_p - \epsilon/2, x_p + \epsilon/2] \times [(y_p + y_0)/2, (y_p + y_1)/2].$$

Notice that by Lemma 5.12, δ' crosses the right extension of E vertically. Clearly, E satisfies all other properties of subterritory as well. So, E is a subterritory of S . \square

The next property, whose proof is in Appendix C, shows that subterritories behave well under positive transformations.

Property 5.17. *If E is a subterritory of a strong Pouna set S , then for every positive transformation T , we have that $T(E)$ is a subterritory of $T(S)$.*

Finally, the following property states that positive transformations preserve the Constraints (C1)-(C6) of the definition of constrained S -graphs.

Property 5.18. *Let S be a strong Pouna set, and let \mathcal{F} be a finite family of transformed copies of S satisfying Constraints (C1)-(C6), then for every positive transformation T the family $\{T(S) : S \in \mathcal{F}\}$ also satisfies (C1)-(C6).*

Again, the proof is in Appendix C.

Construction of Pawlik, Kozik, Krawczyk, Lasoń, Micek, Trotter, and Walczak

Let S be a Pouna set, and let \mathcal{F} be a finite family of transformed copies of S . Set $\mathfrak{B} = \text{box}(\mathcal{F})$.

A *prob* for \mathcal{F} is a closed rectangle P such that: $P \subseteq \mathfrak{B}$ and $\mathfrak{r}(P) = \mathfrak{r}(\mathfrak{B})$. We denote the set $\{A \in \mathcal{F} : A \cap P \neq \emptyset\}$ by $N_{\mathcal{F}}(P)$, or $N(P)$ if there is no confusion.

Let P be a prob for \mathcal{F} . A *root* of P is a rectangle of the form $\{(x, y) \in P : x \leq x_0\}$, for some $x_0 \in (\mathfrak{l}(P), \mathfrak{r}(P))$, which does not intersect any element of \mathcal{F} . Notice that not every prob has a root, and that when a prob has a root, it has infinitely many roots. Moreover, the roots of a prob form a totally ordered set with inclusion.

The prob P is said to be *stable* if:

1. P has a root, and there exists a root R of P such that for every $A \in N(P)$, we have $R \subseteq \text{ter}(A)$,
2. the elements of $N(P)$ are mutually disjoint,
3. for every $A \in N(P)$, we have $\mathfrak{b}(A) < \mathfrak{b}(P)$ and $\mathfrak{t}(P) < \mathfrak{t}(A)$,
4. every $A \in N(P)$ crosses P .

Remark 5.19. *It is worth mentioning that the fourth item in the definition of stable prob does not follow from the three other items. In Figure 5.9, a prob P with a root R and $N(P) = \{A\}$ are shown. All items 1-3 of the definition hold here, but not item 4.*

What we call a stable prob in this thesis is similar to what is called a *prob* in [PKK⁺13].

Property 5.20. *Let P be a stable prob for a family \mathcal{F} of Pouna sets. Then, for every root R of P and for every $A \in N(P)$, we have $R \subseteq \text{ter}(A)$.*

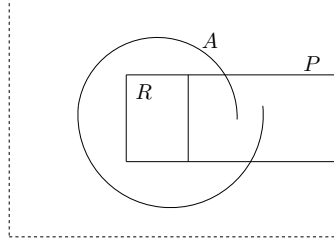

Figure 5.9: The fourth item in the definition of stable prob does not hold here.

Proof. Let R_0 be the root in the definition of stable prob. If $R \subseteq R_0$, the result is obvious. If not, let $p = (x, y) \in R \setminus R_0$. So, there exist $x_0 < x$ such that $p_0 = (x_0, y) \in R_0$. So, in particular $p_0 \in \text{ter}(A)$. Also, $p_0 \in R$, because $R_0 \subseteq R$. So, there exists $x' > x_0$ such that $p' = (x', y) \in A$. Since $p' \in A$, we have $p' \notin R$. So, in particular, $x' \neq x$. If $x' < x$, then x' is on the straight line joining p_0 and p . But $p_0, p \in R$ and R is convex, so $(x', y) \in R$, a contradiction. Hence $x' > x$. Now, to show that $p \in \text{ter}(A)$, it is enough to show that $p \in \text{box}(A) \setminus A$. But p being in R , is not in A . On the other hand, p is in on the straight line between p_0 and p' . Now because $p_0 \in \text{ter}(A) \subseteq \text{box}(A)$ and $p' \in A \subseteq \text{box}(A)$, we have $p \in \text{box}(A)$. This completes the proof. \square

Let E be a rectangle in $\text{box}(\mathcal{F})$. The prob *defined by* E in B is the prob P which is obtained by extending the right side of E to reach the border of B , i.e. $P = \{(x, y) \in B : \text{l}(E) \leq x \leq \text{r}(B), \text{b}(E) \leq y \leq \text{t}(E)\}$. Notice that if E does not intersect any member of \mathcal{F} , then it is a root for P .

From now on, fix a strong Pouna set S and a subterritory E of S . Also, from now on, for the transformed copy $S' = T(S)$, we consider the subterritory $T(E)$. Refer to Figure 5.10 for a visualization of the construction described hereunder, applied to a very simple 1-element family of a set S .

Let $(\mathcal{F}, \mathcal{P})$ be a tuple where \mathcal{F} is a family of transformed copies of S and \mathcal{P} is a set of probs of \mathcal{F} . We define an operation Γ where $(\mathcal{F}', \mathcal{P}') = \Gamma(\mathcal{F}, \mathcal{P})$ is obtained as follows:

- (S'1) For every $P \in \mathcal{P}$, let P^\uparrow and P^\downarrow be respectively the top one-third and the bottom one-third of P , i.e.

$$P^\uparrow = [\text{l}(P), \text{r}(P)] \times \left[\frac{\text{b}(P) + 2\text{t}(P)}{3}, \text{t}(P) \right]$$

and

$$P^\downarrow = [\text{l}(P), \text{r}(P)] \times \left[\text{b}(P), \frac{2\text{b}(P) + \text{t}(P)}{3} \right].$$

- (S'2) Set S_P to be a transformed copy of S where we first match the boundary of $\text{box}(S)$ on the boundary of P^\uparrow , and then we scale it horizontally by $\frac{2\text{w}(S)}{\text{l}(E) - \text{l}(S)}$

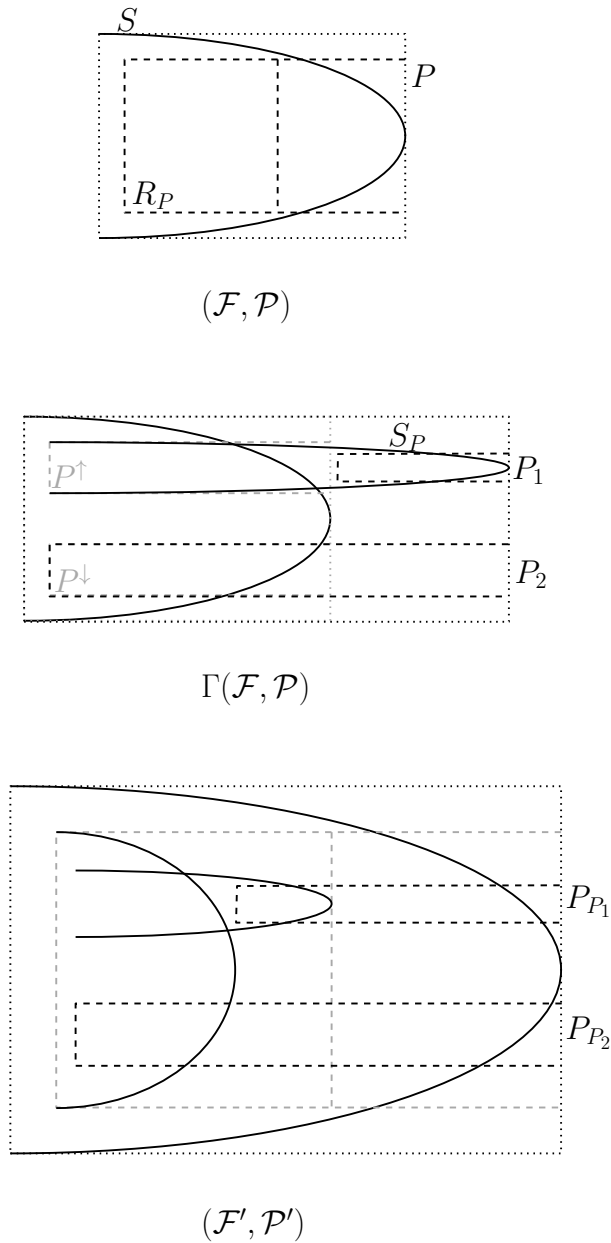

Figure 5.10: Construction of [PKK+13] applied to $(\mathcal{F}, \mathcal{P})$. The second line presents $\Gamma(\mathcal{F}, \mathcal{P})$ and the third line presents $(\mathcal{F}', \mathcal{P}') = \mathfrak{S}_{\mathfrak{F}}(\mathcal{F}, \mathcal{P})$. The shapes in gray are not parts of the object and are presented to make following the construction easier. The scales have changed to make the illustration clearer.

keeping the left-side of $\mathbf{box}(S)$ fixed. Formally, the transformation described above is $T_P = T_2 \circ T_1 : \mathbb{R}^2 \rightarrow \mathbb{R}^2$, where

$$T_1(x, y) = \left(\frac{\mathbf{w}(P^\dagger)}{\mathbf{w}(S)}x + \mathbf{l}(P^\dagger) - \frac{\mathbf{l}(S)\mathbf{w}(P^\dagger)}{\mathbf{w}(S)}, \frac{\mathbf{h}(P^\dagger)}{\mathbf{h}(S)}y + \mathbf{b}(P^\dagger) - \frac{\mathbf{b}(S)\mathbf{h}(P^\dagger)}{\mathbf{h}(S)} \right)$$

and

$$T_2(x, y) = \left(\frac{2\mathbf{w}(S)}{\mathbf{l}(E) - \mathbf{l}(S)}x + \mathbf{l}(P^\dagger)\left(1 - \frac{2\mathbf{w}(S)}{\mathbf{l}(E) - \mathbf{l}(S)}\right), y \right).$$

This transformation ensures that the subterritory of S_P , i.e. $T_P(E)$, is outside $\mathbf{box}(\mathcal{F})$ (See Property 5.23). Denote $T_P(E)$ by E_P .

- (S'3) Set $\mathcal{F}' = \mathcal{F} \cup \left(\cup_{P \in \mathcal{P}} S_P \right)$.
- (S'4) For $P \in \mathcal{P}$, denote by P_1 the prob for \mathcal{F}' defined by E_P , and denote by P_2 the prob for \mathcal{F}' defined by P^\downarrow .
- (S'5) Set $\mathcal{P}' = \{P_1, P_2 : P \in \mathcal{P}\}$.

Definition 5.21. *Let S be a strong Pouna set. Let \mathcal{F} be a family of positive transformed copies of S , and let \mathcal{P} be a set of its probs. We define $\mathfrak{S}_{\mathfrak{F}}(\mathcal{F}, \mathcal{P})$ as follows.*

- (S1) Set $(\mathcal{F}_0, \mathcal{P}_0) = \Gamma(\mathcal{F}, \mathcal{P})$.
- (S2) For every $P \in \mathcal{P}$, choose a root R_P . (To see that P has a root, see [PKK⁺13] or Theorem 5.27.) Create a transformed copy $(\mathcal{F}^P, \mathcal{P}^P)$ of $(\mathcal{F}_0, \mathcal{P}_0)$ such that $\mathbf{box}(\mathcal{F}^P)$ is matched to R_P . Formally, apply the transformation:

$$T'_P(x, y) = \left(\frac{\mathbf{w}(R_P)}{\mathbf{w}(B_P)}x + \mathbf{l}(R_P) - \frac{\mathbf{l}(B_P)\mathbf{w}(R_P)}{\mathbf{w}(B_P)}, \frac{\mathbf{h}(R_P)}{\mathbf{h}(B_P)}y + \mathbf{b}(R_P) - \frac{\mathbf{b}(B_P)\mathbf{h}(R_P)}{\mathbf{h}(B_P)} \right),$$

where $B_P = \mathbf{box}(\mathcal{F}^P)$.

- (S3) Set $\mathcal{F}' = \mathcal{F} \cup \left(\cup_{P \in \mathcal{P}} \mathcal{F}^P \right)$.
- (S4) Now, for $P \in \mathcal{P}$ and for $Q \in \mathcal{P}^P$, let P_Q be the prob for \mathcal{F} defined by Q .
- (S5) Set $\mathcal{P}' = \{P_Q : P \in \mathcal{P}, Q \in \mathcal{P}^P\}$.
The tuple $(\mathcal{F}', \mathcal{P}')$ is $\mathfrak{S}_{\mathfrak{F}}(\mathcal{F}, \mathcal{P})$.

Now, we can define a sequence $\{(\mathcal{F}_k, \mathcal{P}_k)\}_{k \geq 1}$ from [PKK⁺13], where \mathcal{F}_k is a family of positive transformed copies of S , and \mathcal{P}_k is a set of probs for \mathcal{F}_k .

Definition 5.22 (The construction from [PKK⁺13]). *For $k = 1$, set $\mathcal{F}_1 = \{S\}$ and $\mathcal{P}_1 = \{P\}$ where P is the prob defined by E . For every $k \in \mathbb{N}^*$, define $(\mathcal{F}_{k+1}, \mathcal{P}_{k+1}) = \mathfrak{S}_{\mathfrak{F}}(\mathcal{F}_k, \mathcal{P}_k)$.*

Let us state some properties about the construction of Pawlik, Kozik, Krawczyk, Lasoń, Micek, Trotter, and Walczak. The proof of Properties 5.23 and 5.24 can be found in Appendix C.

Property 5.23. *Adopting the notation from the definition of Γ , for every $P \in \mathcal{P}$, we have:*

1. *the transformation T_P is positive.*
2. *$\iota(E_P) > \mathfrak{r}(\mathbf{box}(F))$, so in particular, $E_P \cap \mathbf{box}(F) = \emptyset$.*

Property 5.24. *Let \mathcal{F} be a family of strong Pouna sets, and let \mathcal{P} be a set of probs for \mathcal{F} that are mutually disjoint. Setting $(\mathcal{F}', \mathcal{P}') = \Gamma(\mathcal{F}, \mathcal{P})$ and adopting the notation from the definition of Γ , we have that for every $P \in \mathcal{P}$:*

1. *if $Q \in \mathcal{P} \setminus \{P\}$, then $S_P \cap Q = \emptyset$, $S_P \cap S_Q = \emptyset$, and $\mathbf{tex}(S_P) \cap Q = \emptyset$,*
2. *$N_{\mathcal{F}'}(P_1) = \{S_P\}$,*
3. *$N_{\mathcal{F}'}(P_2) \subseteq N_{\mathcal{F}}(P)$ and $N_{\mathcal{F}'}(P_2) \subseteq \mathcal{F}$,*
4. *for every $A \in \mathcal{F}'$, we have $S_P \curvearrowright A$ if and only if $A \in N(P)$, and there exists no $B \in \mathcal{F}'$ such that $B \curvearrowright S_P$.*

Main theorem

Let \mathcal{C} be the class of oriented graphs generated by the intersection graphs of the families \mathcal{F}_k defined in Definition 5.22. This class is exactly the class of Burling graphs. Indeed, as has been mentioned in [PKK⁺13] (for the non-oriented case) the sequence of the intersection graphs of \mathcal{F}_k 's is exactly the sequence defined by Burling [Bur65] in 1965. The proof of this fact is not complicated but is long. However, for the sake of completeness, we included a sketch of the proof of the oriented version of this fact in Lemma 5.25.

Let S be a Pouna set. We say that (G, \mathcal{S}) , where G is an oriented graph and \mathcal{S} is a set of stable sets of G , is isomorphic to $(\mathcal{F}, \mathcal{P})$, where \mathcal{F} is a family of strong transformed copies of S and \mathcal{P} is a set of its probs, if there exists a function $\phi : V(G) \rightarrow \mathcal{F}$ such that:

1. *it induces an isomorphism between G and the oriented intersection graph of \mathcal{F} , i.e. for every $xy \in A(G)$, we have $\phi(x) \curvearrowright \phi(y)$,*
2. *it induces a bijection between \mathcal{S} and $N(\mathcal{P}) = \{N(P) : P \in \mathcal{P}\}$, i.e. for every $S \in \mathcal{S}$, we have*

$$\phi(S) \in N(\mathcal{P}),$$

and for every $P \in \mathcal{P}$, we have

$$\phi^{-1}(P) \in \mathcal{S}.$$

Lemma 5.25. *Let S be a strong Pouna set, G be an oriented graph, \mathcal{S} be a set of stable sets of G , \mathcal{F} be a family of positive transformed copies of S , and \mathcal{P} be a set of probs for \mathcal{F} . If (G, \mathcal{S}) is isomorphic to $(\mathcal{F}, \mathcal{P})$, then $\mathfrak{S}_{\mathfrak{B}}(G, \mathcal{S})$ is isomorphic to $\mathfrak{S}_{\mathfrak{F}}(\mathcal{F}, \mathcal{P})$.*

As a corollary, the oriented intersection graph of \mathcal{F}_k , as in Definition 5.21, is isomorphic to the k -th graph in the Burling sequence.

Proof. We adapt the notations from Definition 4.2 and Definition 5.21. Let $(G', \mathcal{S}') = \mathfrak{S}_{\mathfrak{B}}(G, \mathcal{S})$. For $S \in \mathcal{S}$, denote by \hat{G}_S the subgraph of G' induced by $V(G_S) \cup_{Q \in \mathcal{S}_S} \{v_{S,Q}\}$. In particular, G' is the disjoint union of the graphs \hat{G}_S and a copy of G .

By induction hypothesis, (G, \mathcal{S}) and $(\mathcal{F}, \mathcal{P})$ are isomorphic. Let ϕ be the isomorphism as in the definition. Let us extend ϕ to an isomorphism ϕ_S between $(\hat{G}_S, \mathcal{S}_S)$ and $(\mathcal{F}^{\phi(S)}, \mathcal{S}^{\phi(S)})$ for every $S \in \mathcal{S}$. Define $\phi(v_{S,Q}) = S_Q^{\phi(S)}$, i.e. the set added in step (S'2) for the prob Q .

Define $\phi' : V(G') \rightarrow \mathcal{F}'$ as the union of ϕ and all ϕ_S for $S \in \mathcal{S}$. Let us check that ϕ' has the two required properties.

First, let $xy \in A(G)$. If $x \notin \{v_{S,Q} : S \in \mathcal{S}, Q \in \mathcal{S}_S\}$, then the result follows from induction hypothesis. If $x = v_{S,Q}$ for some $S \in \mathcal{S}$ and $Q \in \mathcal{S}_S$, then $\phi_S(x) = S_Q^{\phi(S)}$. Moreover, by construction, $y \in Q$, so $\phi_S(y) \in \phi_S(Q)$. Therefore, by item (4) of Property 5.24, we have $\phi'(x) \curvearrowright \phi'(y)$.

Second, $\phi'(S \cup \{v_{S,Q}\}) = \phi(S) \cup \phi_S S_Q^{\phi(S)} = \phi(S)_1$, and $\phi'(S \cup Q) = \phi(S) \cup \phi_S(Q) = \phi(S)_2$. So, the second item holds as well, which completes the proof. \square

With the lemma above, we can prove that for any Pouna set S , an oriented Burling graphs (thus, here, a subgraphs of the oriented intersection graphs of some \mathcal{F}_k) is a constrained S -graph.

Lemma 5.26. *Let S be a strong Pouna set. Let \mathcal{F} be a family of transformed copies of S that satisfies Constraints (C1)-(C6). Let \mathcal{P} be a set of mutually disjoint stable probs of \mathcal{F} . If $(\mathcal{F}', \mathcal{P}') = \Gamma(\mathcal{F}, \mathcal{P})$, then*

1. *elements of \mathcal{P}' are mutually disjoint,*
2. *every element of \mathcal{P}' is a stable prob for \mathcal{F}' ,*
3. *\mathcal{F}' satisfies Constraints (C1)-(C6).*

Proof. We adopt the notation from the definition of Γ .

Set $\mathfrak{B} = \mathbf{bor}(\mathcal{F})$ and $\mathfrak{B}' = \mathbf{bor}(\mathcal{F}')$. Notice that $\mathbf{l}(\mathfrak{B}') = \mathbf{l}(\mathfrak{B})$, $\mathbf{b}(\mathfrak{B}') = \mathbf{b}(\mathfrak{B})$, and $\mathbf{t}(\mathfrak{B}') = \mathbf{t}(\mathfrak{B})$. However, $\mathbf{r}(\mathfrak{B}') > \mathbf{r}(\mathfrak{B})$.

Claim. *Elements of \mathcal{P}' are mutually disjoint.*

Corresponding to every $P \in \mathcal{P}$, there are two probs in \mathcal{P}' , that is, P_1 and P_2 . Notice that $P_1 \cap P_2 = \emptyset$. So, the fact that the probs in \mathcal{P}' are mutually disjoint implies directly by the same property for \mathcal{P} .

Claim. *Elements of \mathcal{P}' are stable probs for \mathcal{F}' .*

Fix $P \in \mathcal{P}$. We prove that both P_1 and P_2 are stable probs, and thus every prob in \mathcal{P}' is stable.

First, the prob P_1 is defined by a subterritory E_P . By Property 5.23, $E_P \cap \mathfrak{B} = \emptyset$. Therefore, for every $A \in \mathcal{F}$, we have $E_P \cap A = \emptyset$. Moreover, by definition of subterritory, $E_P \cap S_P = \emptyset$. Finally, since $E_P \subseteq P$, by Property 5.24, we have $E_P \cap S_Q = \emptyset$ for every $Q \in \mathcal{P} \setminus \{P\}$ as well. Thus E_P does not intersect any element of \mathcal{F}' . So, E_P is a root for P_1 .

Now, notice that by Property 5.24, we have $N(P_1) = \{S_P\}$, so item (2) of the definition of stable prob holds. Moreover, since E_P is a subterritory of S_P , we have

- $E_P \subseteq \mathbf{ter}(S_P)$,
- $\mathbf{b}(E_P) > \mathbf{b}(S_P)$ and $\mathbf{t}(E_P) < \mathbf{t}(S_P)$,
- S_P crosses P_1 vertically,

which proves item (1), (3), and (4) of the definition of stable prob, respectively. For item (3), we have used the facts that $\mathbf{b}(P_1) = \mathbf{b}(E_P)$ and $\mathbf{t}(P_1) = \mathbf{t}(E_P)$.

Second, by the hypothesis, P has a root. Let R be a root of P . Set $R^\downarrow = R \cap P^\downarrow$ and notice that R^\downarrow is a root of P^\downarrow , as a prob for \mathcal{F} . In particular, R^\downarrow does not intersect any element of \mathcal{F} . Now, let $A \in N_{\mathcal{F}'}(P_2)$. By Property 5.24, we have $A \in N_{\mathcal{F}}(P)$. Therefore, $R \subseteq \mathbf{ter}(A)$. Consequently, $R^\downarrow \subseteq \mathbf{ter}(A)$. This implies item (1) of the definition of stable prob. Moreover, since $A \in N_{\mathcal{F}}(P)$ and P is stable, we have

$$\mathbf{b}(A) < \mathbf{b}(P) = \mathbf{b}(P^\downarrow) = \mathbf{b}(P_2), \text{ and } \mathbf{t}(A) > \mathbf{t}(P) \geq \mathbf{t}(P^\downarrow) = \mathbf{t}(P_2),$$

which implies item (3) of the definition. Also, since A crosses P vertically, by Property 5.12, it crosses P^\downarrow vertically as well, which implies item (4) of the definition.

Now, assume that $A, B \in N_{\mathcal{F}'}(P_2)$ and $A \neq B$. Again, by Property 5.24, we have $A, B \in N_{\mathcal{F}}(P)$. Thus, $A \cap B = \emptyset$, implying item (2) of the definition. Hence, P_2 is a stable prob.

Now, we prove that \mathcal{F}' satisfies Constraints (C1)-(C6).

Claim. *\mathcal{F}' satisfies (C1).*

Let $A, B \in \mathcal{F}'$ be two distinct and intersecting transformed copies of S . Set $L_A = \{(x, y) \in A : x = \mathbf{l}(A)\}$. Notice that $\mathbf{l}(A) = \mathbf{l}(L_A)$.

If $A, B \in \mathcal{F}$, then the result holds because \mathcal{F} satisfies (C1). Furthermore, by Property 5.23, we cannot have $A, B \in \mathcal{F}' \setminus \mathcal{F}$. So, without loss of generality, assume $A \in \mathcal{F}' \setminus \mathcal{F}$, so $A = S_P$ for some $P \in \mathcal{P}$, and $B \in \mathcal{F}$. In particular, $B \subseteq \mathfrak{B}$, and by construction, $A \cap (\mathfrak{B} \setminus P^\uparrow) = \emptyset$. Hence, $B \cap P^\uparrow \neq \emptyset$, and therefore $B \in N_{\mathcal{F}}(P)$. Thus, by Property 5.24, for every root R of P , we have $R \subseteq \mathbf{ter}(B)$. Moreover, we have $\mathbf{b}(B) < \mathbf{b}(P)$ and $\mathbf{t}(B) > \mathbf{t}(P)$. Also, notice that by construction, for every

$\mathfrak{s} \in \{\mathfrak{l}, \mathfrak{r}, \mathfrak{b}, \mathfrak{t}\}$, we have $\mathfrak{s}(A) = \mathfrak{s}(P^\uparrow)$. Let $p = (x, y) \in L(A)$. So, $x = \mathfrak{l}(A)\mathfrak{l}(P)$ and $y \in (\mathfrak{b}(P), \mathfrak{t}(P))$. Moreover, $\mathfrak{b}(P) \leq \mathfrak{b}(A) \leq y \leq \mathfrak{t}(A) \leq \mathfrak{t}(P)$. Therefore, $(x, y) \in \{(x', y') \in P : x' = \mathfrak{l}(P)\}$. Consequently, $(x, y) \in R$. So, $L_A \subseteq R \subseteq \mathfrak{ter}(B)$.

Moreover, we have:

$$\begin{aligned} \mathfrak{l}(B) &= \mathfrak{l}(\mathfrak{box}(B)) \leq \mathfrak{l}(\mathfrak{ter}(B)) \leq \mathfrak{l}(L_A) \\ &= \mathfrak{l}(A) = \mathfrak{l}(P^\uparrow) = \mathfrak{l}(P) = \mathfrak{l}(R) < \mathfrak{r}(R) \\ &\leq \mathfrak{r}(\mathfrak{ter}(B)) \leq \mathfrak{r}(\mathfrak{box}(B)) = \mathfrak{r}(B) \stackrel{(a)}{\leq} \mathfrak{r}(\mathfrak{B}) \stackrel{(b)}{<} \mathfrak{r}(A), \end{aligned}$$

where (a) is because $B \in \mathcal{F}$, and (b) follows from Step (S'2) of the construction. Therefore $\mathfrak{l}(B) \leq \mathfrak{l}(A) < \mathfrak{r}(B) < \mathfrak{r}(A)$.

On the other hand,

$$\mathfrak{b}(B) < \mathfrak{b}(P) < \mathfrak{b}(P^\uparrow) = \mathfrak{b}(A) \stackrel{(c)}{<} \mathfrak{t}(A) = \mathfrak{t}(P) < \mathfrak{t}(B),$$

where (c) follow from the fact that A , a strong Pouna set, cannot be a subset of a horizontal line segment. Therefore $\mathfrak{b}(B) < \mathfrak{b}(A) < \mathfrak{t}(A) < \mathfrak{t}(B)$.

Hence, all the items in Constraint (C1) hold and $A \curvearrowright B$.

Claim. \mathcal{F}' satisfies (C2).

Let A and B be two disjoint sets in \mathcal{F}' such that $A \cap \mathfrak{ter}(B) \neq \emptyset$. We prove that $A, B \in \mathcal{F}$. For the sake of contradiction, assume that $\{A, B\} \not\subseteq \mathcal{F}$. There are three cases possible.

Case 1: $A, B \in \mathcal{F}'$. So, there exists $P, Q \in \mathcal{P}$ such that $P \neq Q$ and $A = S_P$ and $B = S_Q$. But in that case, by construction, $\mathfrak{box}(B) \subseteq Q$, and $A \subseteq P$. So, from $A \cap \mathfrak{ter}(B) \neq \emptyset$, we have $P \cap Q \neq \emptyset$, a contradiction.

Case 2: $A = S_P$ for some $P \in \mathcal{P}$, and $B \in \mathcal{F}$. Since $A \subseteq P$, form $A \cap \mathfrak{ter}(B) \neq \emptyset$ we deduce that $P \cap \mathfrak{ter}(B) \neq \emptyset$. Choose $p = (x, y) \in P \cap \mathfrak{ter}(B)$. Because by definition of Territory, there exists a point $p' = (x', y) \in B$ with $x' > x$. Now, because $B \subseteq F$, we have $p' \in \mathfrak{B}$ and therefore $p' \in P$. Hence $P \cap B \neq \emptyset$, i.e. $B \in N(P)$. Therefore, B crosses P vertically. Moreover, $A = S_P$ crosses P_1 and therefore P horizontally. So, by Lemma 5.13, we have $A \cap B \neq \emptyset$, a contradiction.

Case 3: $A \in \mathcal{F}$ and $B = S_P$ for some $P \in \mathcal{P}$. In this case $\mathfrak{ter}(B) \subseteq P$, and therefore $A \cap P \neq \emptyset$, i.e. $A \in N(P)$. So, A crosses P vertically. On the other hand, B crosses P_1 and thus P horizontally. Therefore, by Lemma 5.13, we have $A \cap B \neq \emptyset$, a contradiction.

Claim. \mathcal{F}' satisfies (C3).

Let $A, B \in \mathcal{F}$ be two distinct sets with non-empty intersection. For the sake of contradiction, assume that there exists $C \in \mathcal{F}$ such that $C \subseteq \mathfrak{ter}(A) \cap \mathfrak{ter}(B)$. We first show that $C \in \mathcal{F}$. Suppose not, so $C = S_P$ for some $P \in \mathcal{P}$. Since $C \subset P$, neither of A and B can be some set of the form S_Q . Therefore $A, B \in \mathcal{F}$. Now,

notice that $C \subseteq \mathbf{ter}(A) \subseteq \mathbf{box}(A)$. On the other hand, $\mathbf{box}(A) \subseteq \mathfrak{B}$, but $C \not\subseteq \mathfrak{B}$, a contradiction.

Now we prove that both A and B are in \mathcal{F} . Suppose not. Without loss of generality, assume that $A = S_P$ for some $P \in \mathcal{P}$. Since $C \subseteq \mathbf{ter}(A)$, we must have $C \in N(P)$. Therefore $\mathbf{b}(C) < \mathbf{b}(P) \leq \mathbf{b}(A)$. On the other hand, because $C \subseteq \mathbf{ter}(A) \subseteq \mathbf{box}(A)$, we have $\mathbf{b}(C) \geq \mathbf{b}(A)$, a contradiction. So, $A, B \in \mathcal{F}$ as well, and the result follows from the fact that \mathcal{F} satisfies (C3).

Claim. \mathcal{F}' satisfies (C4).

Fix $P \in \mathcal{P}$. Let us first prove that there exists no $A \in \mathcal{F}'$ such that $A \curvearrowright S_P$ or $S_P \prec A$. First, if $A \curvearrowright S_P$, then, in particular, $A \cap S_P \neq \emptyset$. Thus, by Property 5.24, we have $A \in \mathcal{F}$. Therefore, $\mathbf{r}(A) \leq \mathbf{r}(\mathcal{F}) < \mathbf{r}(P^\dagger) = \mathbf{r}(S_P)$. But on the other hand, $A \prec S_P$ implies $\mathbf{r}(A) > \mathbf{r}(S_P)$, a contradiction. Second, if $S_P \prec A$, then in particular $S_P \subseteq \mathbf{ter}(A)$. Also, by construction $S_P \subseteq P$. Therefore, $\mathbf{ter}(A) \cap P \neq \emptyset$. Hence, by Property 5.24, we have $A \in \mathcal{F}$. Therefore $\mathbf{r}(A) \leq \mathbf{r}(\mathcal{F}) < \mathbf{r}(P^\dagger) = \mathbf{r}(S_P)$. On the other hand, by Lemma 5.29, $S_P \prec A$ implies that $\mathbf{r}(S_P) < \mathbf{r}(A)$, a contradiction.

Now, for the sake of contradiction, assume that there exists $A, B, C \in \mathcal{F}'$ such that $A \prec B$, $A \curvearrowright C$, and $B \curvearrowright C$. From what we proved above, we know that $A, C \in \mathcal{F}$. Therefore, since \mathcal{F} satisfies (C4), we cannot have $B \in \mathcal{F}$. So, $B = S_P$ for some $P \in \mathcal{P}$. In particular $\mathbf{ter}(B) \subseteq \mathbf{box}(B) \subseteq P^\dagger$.

From $A \prec B$, we have $A \subseteq \mathbf{ter}(B) \subseteq P^\dagger \subseteq P$. Therefore, $A \in N_{\mathcal{F}}(P)$.

On the other hand, from $B \prec C$, we have $B \cap C \neq \emptyset$, therefore $C \cap P^\dagger \neq \emptyset$. So, $C \in N_{\mathcal{F}}(P)$.

So, A and C are two sets in $N_{\mathcal{F}}(P)$ that are not disjoint, which contradicts the fact that P is stable.

Claim. \mathcal{F}' satisfies (C5).

For the sake of contradiction, assume that A, B , and C are three sets in \mathcal{F}' that two by two intersect. At least one of the three sets must be in $\mathcal{F}' \setminus \mathcal{F}$, because (C5) holds for \mathcal{F} . Moreover, because of Property 5.24, at most one of the three sets is in $\mathcal{F}' \setminus \mathcal{F}$. So, without loss of generality, assume that $A = S_P$ for some $P \in \mathcal{P}$, and that $B, C \in \mathcal{F}$. But since $B \cap A \neq \emptyset$, we have $B \cap P \neq \emptyset$, i.e. $B \in N(P)$. Similarly, $C \in N(P)$. But $B \cap C \neq \emptyset$ contradicts the fact that P is stable for \mathcal{F} . Hence, (C5) holds for \mathcal{F}' .

Claim. \mathcal{F}' satisfies (C6).

By assumption, S is strong. So, it is enough to show that T_P , in Step (S'2), is a positive transformation for every $P \in \mathcal{P}$. This follows from the fact that T_p is positive, as shown in Property 5.23.

This completes the proof of the lemma. \square

Theorem 5.27. *Let S be a Pouna set. Every Burling graph is a constrained S -graph.*

Proof. For this proof, we adopt the notations in the definition of the construction of Pawlik, Kozik, Krawczyk, Lasoń, Micek, Trotter, and Walczak.

We may assume that S is a strong Pouna set, otherwise, we replace every S in this proof with the horizontal reflection of S . Fix a subterritory E of S (which exists, by Lemma 5.16), and apply the construction on it. For every $k \geq 1$, we know that \mathcal{F}_k is a family of transformed copies of S . We first prove that \mathcal{F}_k satisfies Constraints (C1)-(C6). To do so, we prove the following stronger statement by induction on k .

Statement 5.28. *For every $k \geq 1$, we have:*

1. *the elements of \mathcal{P}_k are mutually disjoint,*
2. *\mathcal{P}_k is a family of stable probs of \mathcal{F}_k ,*
3. *\mathcal{F}_k satisfies constraints (C1)-(C6).*

First of all, for $k = 1$, the first item of the statement follows from the fact that the fact that E is a subterritory of S . Statement (2) and (3) hold trivially, as $|\mathcal{F}_1| = 1$.

Now, assume that the statement holds for some $k \geq 1$, we prove that it holds for $k + 1$.

Notice that for every $P \in \mathcal{P}$, the transformation T'_P is positive, so the tuple $(\mathcal{F}^P, \mathcal{P}^P)$ in a positive transformed copy of $\Gamma(\mathcal{F}_k, \mathcal{P}_k)$. So, by Property 5.18, we know that

$$\text{for every } P \in \mathcal{P}, \text{ the family } \mathcal{F}^P \text{ satisfies Constraints (C1)-(C6).} \quad (5.1)$$

Moreover, it is easy to check the following:

for every $P \in \mathcal{P}$, the elements of \mathcal{P}^P are stable probs for \mathcal{F} and are mutually disjoint. (5.2)

Claim. *The elements of \mathcal{P}_k are mutually disjoint.*

Let P_Q and $P_{Q'}$ be two probs in \mathcal{P}_{k+1} . In order to show that these two probs are disjoint, it is enough to show that $(\mathbf{b}(Q), \mathbf{t}(Q))$ and $(\mathbf{b}(Q'), \mathbf{t}(Q'))$ are disjoint intervals. If $P = P'$, then this follows from (5.2), and if $P \neq P'$ from the fact that Q and Q' are inside the roots of P and P' respectively, and P and P' are disjoint by induction hypothesis.

Claim. *Every $P \in \mathcal{P}_{k+1}$ is a stable prob for \mathcal{F}_{k+1} .*

Let $P_Q \in \mathcal{P}_{k+1}$. Notice that $Q \in \mathcal{P}^P$ is a prob for \mathcal{F}^P . So, by (5.2), Q has a root R such that for every $A \in N_{\mathcal{F}^P}(Q)$, we have $R \subseteq \mathbf{ter}(A)$. So, item (1) of the definition of stable prob holds.

Set $N_1 = N_{\mathcal{F}^P}(Q)$ and $N_2 = N_{\mathcal{F}_{k+1}}(P)$.

The elements in $N_{\mathcal{F}_{k+1}}(P_Q)$ are either the neighbors of Q as a prob for \mathcal{F}^P , so they are in N_1 , or are outside R_P and thus are in N_2 . The elements in N_1 are mutually disjoint by (5.2) and the elements in N_2 are mutually disjoint by induction hypothesis. Finally, one element in N_1 and one element in N_2 are disjoint because the former is inside R_P and the latter does not intersect R_P . So, item (2) of the definition holds as well.

Now, fix $A \in N_{\mathcal{F}_{k+1}}(P_Q)$. If $A \in N_1$, then

$$\mathbf{b}(A) < \mathbf{b}(Q) = \mathbf{b}(P_Q), \text{ and } \mathbf{t}(A) > \mathbf{t}(Q) = \mathbf{t}(P_Q).$$

Moreover, there is a path in A crossing Q . So, the same path crosses P_Q as well.

If $A \in N_2$, then

$$\mathbf{b}(A) < \mathbf{b}(P) = \mathbf{b}(R_P) \leq \mathbf{b}(Q) = \mathbf{b}(P_Q),$$

and

$$\mathbf{t}(A) > \mathbf{t}(P) = \mathbf{t}(R_P) \geq \mathbf{t}(Q) = \mathbf{t}(P_Q).$$

Moreover, there is a path in A crossing P , so by Lemma 5.12, it crosses P_Q as well.

Now, we check that \mathcal{F}_{k+1} satisfies Constraints (C1)-(C6). In what follows, we use several times the fact that that by (5.1) and by induction hypothesis, the conditions hold when all the elements are chosen inside \mathcal{F}_k or inside \mathcal{F}^P for some $P \in \mathcal{P}_k$.

Moreover, notice that by induction hypothesis, elements of \mathcal{P}_k are disjoint. Now, because every $A \in \mathcal{F}^P$ is entirely inside P , we know that

$$\text{if } P \neq Q, \text{ then the elements of } \mathcal{F}^P \text{ are disjoint from the elements of } \mathcal{F}^Q. \quad (5.3)$$

Furthermore, for every $P \in \mathcal{P}_k$, the elements of \mathcal{F}^P are all inside R_P . Moreover, by definition of root, no element of \mathcal{F}_k intersect R_P , so,

$$\text{for every } P \in \mathcal{P}, \text{ the elements of } \mathcal{F}_k \text{ are disjoint from the elements of } \mathcal{F}^P. \quad (5.4)$$

Claim. \mathcal{F}_{k+1} satisfies (C1).

Let $A, B \in \mathcal{F}_{k+1}$ be two distinct elements such that $A \cap B \neq \emptyset$. By (5.3) and (5.3), either $A, B \in \mathcal{F}_k$ or there exists $P \in \mathcal{P}_k$ such that $A, B \in \mathcal{F}^P$. In the former case, by induction hypothesis, we have $A \curvearrowright B$ or $B \curvearrowright A$. In the latter case, by (5.1), we have $A \curvearrowright B$ or $B \curvearrowright A$.

Claim. \mathcal{F}_{k+1} satisfies (C2).

Let $A, B \in \mathcal{F}_{k+1}$ such that $A \cap B = \emptyset$ and $A \cap \mathbf{ter}(B) \neq \emptyset$. There are four cases possible:

Case 1: $A, B \in \mathcal{F}_k$, in which case the result follows from (5.1).

Case 2: $A \in \mathcal{F}_k$ and $B \in \mathcal{F}^P$ for some $P \in \mathcal{P}_k$.

This case is not possible, because $\mathbf{ter}(B) \subseteq \mathbf{bor}(B) \subseteq R_P$. However, $A \in \mathcal{F}_k$, so A does not intersect R_P as it is a root of a prob for \mathcal{F}_k .

Case 3: $A \in \mathcal{F}^P$ for some $P \in \mathcal{P}_k$ and $B \in \mathcal{F}_k$.

Since $A \subseteq R_P$, we have $R_P \cap \mathbf{ter}(B) \neq \emptyset$. Let $p = (x, y) \in R_P \cap \mathbf{ter}(B)$. By the definition of territory, there exists $x' > x$ such that $p = (x', y) \in B$. Moreover, since R_P is a root of P , we have $p' \in P$. So, $p' \in B \cap P$. Therefore, $B \in N_{\mathcal{F}_k}(P)$. Hence, by (5.2) and using Property 5.20, we have that every root of P is inside the territory of B . Hence, $A \subseteq R_P \subseteq \mathbf{ter}(B)$. So, the result holds.

Case 4: $A \in \mathcal{F}^P$ and $B \in \mathcal{F}^Q$ for $P, Q \in \mathcal{P}_k$. Let $p \in A \cap \text{ter}(B)$. So, in particular $p \in A \subseteq P$ and $p \in \text{ter}(B) \subseteq \text{box}(F^Q) \subseteq Q$. Therefore $P \cap Q \neq \emptyset$. Hence, by the induction hypothesis, we must have $P = Q$. So, the result follows from (5.1).

Claim. \mathcal{F}_{k+1} satisfies (C3).

Let $A, B \in \mathcal{F}_{k+1}$ be two distinct sets such that $A \cap B \neq \emptyset$. For the sake of contradiction, assume that there exists $C \in \mathcal{F}_{k+1}$ such that $C \subseteq \text{ter}(A) \cap \text{ter}(B)$.

First of all, by (5.3) and (5.4), there are only two possible cases for A and B : either $A, B \in \mathcal{F}_k$ or $A, B \in \mathcal{F}^P$ for some $P \in \mathcal{P}_k$.

Case 1: $A, B \in \mathcal{F}_k$. In this case, by induction hypothesis, we cannot have $C \in \mathcal{F}_k$. So, $C \in \mathcal{F}^P$ for some $P \in \mathcal{P}_k$. Consequently, $C \subseteq R_P$. Now, let $p = (x, y) \in C$. Since $C \subseteq \text{ter}(A)$, there exists $x' > x$ such that $p' = (x', y) \in A$. But also, $p' \in P$. Therefore $A \in N_{\mathcal{F}_k}(P)$. Similarly, we can show that $B \in N_{\mathcal{F}_k}(P)$. A contradiction with the fact that the elements in $N_{\mathcal{F}_k}(P)$ are mutually disjoint.

Case 2: $A, B \in \mathcal{F}^P$ for some $P \in \mathcal{P}_k$. Notice that

$$\text{ter}(A) \subseteq \text{box}(A) \subseteq \text{box}(\mathcal{F}^P) \subseteq R_P.$$

So, $C \subseteq R_P$. Therefore $C \in \mathcal{F}^P$ as well, and the result follows from (5.1).

Claim. \mathcal{F}_{k+1} satisfies (C4).

Assume, for the sake of contradiction, that there exists $A, B, C \in \mathcal{F}_{k+1}$ such that $A \prec B$, $A \curvearrowright C$, and $B \curvearrowright C$. By (5.3) and (5.4), since $A \cap C \neq \emptyset$ and $B \cap C \neq \emptyset$, either $A, B, C \in \mathcal{F}_k$ or $A, B, C \in \mathcal{F}^P$ for some $P \in \mathcal{P}_k$. The former is not possible because of induction hypothesis, and the latter because of (5.1). So, there exist no such triple.

Claim. \mathcal{F}_{k+1} satisfies (C5).

For the sake of contradiction, assume that there exist three distinct sets $A, B, C \in \mathcal{F}_{k+1}$ that are mutually intersecting. By induction hypothesis, such triple does not exist in \mathcal{F}_k . So, at least one of the sets is in \mathcal{F}^P for some $P \in \mathcal{P}_k$. But then, (5.3) and (5.4) imply that the three sets are all in \mathcal{F}^P , a contradiction with (5.1).

Claim. \mathcal{F}_{k+1} satisfies (C6). By assumptions, S is strong. Thus, we only need to show that every element of \mathcal{F}_{k+1} is a positive transformed copy of S . This is true since the elements of \mathcal{F}_k are positive transformed copies of S and the elements of each \mathcal{F}^P are also positive transformed copies of S , because by (5.1), the family \mathcal{F}^P satisfies (C6).

This finishes the proof of the statement.

To complete the proof of the theorem, it is enough to notice that thanks to Lemma 5.25, by Statement 1, the graphs in the Burling sequence are all constrained S -graphs, and that the class of constrained S -graphs is closed under induced subgraph. \square

5.4 Constrained graphs are abstract Burling graphs

The contents of this chapter are mainly from [Pou22].

Some properties of Pouna sets

Lemma 5.29. *Let A and B be two strong Pouna sets. If $A \prec B$, then*

1. $\mathfrak{r}(A) < \mathfrak{r}(B)$,
2. $\mathfrak{h}(A) \leq \mathfrak{h}(B)$.

Proof. To prove (1), let $r = \mathfrak{r}(A)$. Because A is compact, there exists a point (r, y) in A . Since $A \prec B$, we have $(r, y) \in \mathfrak{ter}(B)$. Therefore, there exists r' such that $r' > r$ and $(r', y) \in B$. Notice that, $r' \leq \mathfrak{r}(B)$. Hence, $\mathfrak{r}(A) < \mathfrak{r}(B)$.

To prove (2), notice that $A \subseteq \mathfrak{box}(A) \subseteq \mathfrak{ter}(B) \subseteq \mathfrak{box}(B)$. So, $\mathfrak{b}(A) \geq \mathfrak{b}(\mathfrak{box}(B)) = \mathfrak{b}(B)$ and $\mathfrak{t}(A) \leq \mathfrak{t}(\mathfrak{box}(B)) = \mathfrak{t}(B)$. Therefore, $\mathfrak{h}(A) = \mathfrak{t}(A) - \mathfrak{b}(A) \leq \mathfrak{t}(B) - \mathfrak{b}(B) = \mathfrak{h}(B)$. \square

We say that two strong Pouna sets A and B are *comparable* if one of the following happens: $A \curvearrowright B$, $B \curvearrowright A$, $A \prec B$, or $B \prec A$.

Lemma 5.30. *Let A and B be two strong Pouna sets in a family \mathcal{F} which satisfies Constraints (C1) and (C2). If $\mathfrak{ter}(A) \cap \mathfrak{ter}(B) \neq \emptyset$, then A and B are comparable.*

Proof. If $A \cap B \neq \emptyset$, then by Constraint (C1), either $A \curvearrowright B$ or $B \curvearrowright A$. So, we may assume $A \cap B = \emptyset$. Choose a point $p = (x, y) \in \mathfrak{ter}(A) \cap \mathfrak{ter}(B)$. There exists $x', x'' \in \mathbb{R}$, both bigger than x , such that $p' = (x', y) \in A$ and $p'' = (x'', y) \in B$. Since A and B are disjoint, $x' \neq x''$. First, assume that $x'' > x'$. Notice that $p' \notin B$ and that p' is on the straight line joining p and p'' , which are both points in $\mathfrak{box}(B)$. Therefore, $p' \in \mathfrak{box}(B)$. Consequently, $p' \in \mathfrak{ter}(B)$. Therefore $A \cap \mathfrak{ter}(B) \neq \emptyset$, and by Constraint (C2), we have $A \prec B$. Second, assume that $x'' < x$. With a similar argument, we deduce $B \prec A$. \square

Main Theorem

Theorem 5.31. *Every oriented constrained graph is an oriented abstract Burling graph.*

Proof. Let G be an oriented constrained graph. So, G is the oriented intersection graph of a non-empty and finite family \mathcal{F} of strong Pouna sets which satisfies Constraints (C1)-(C5). We prove that $(\mathcal{F}, \prec, \curvearrowright)$ is a Burling set.

Claim. *The relation \prec is a strict partial order.*

By Lemma 5.29, if $A \prec B$, then $r(A) < r(B)$. This implies that \prec is antisymmetric.

Now assume that $A \prec B$ and $B \prec C$. So, $\text{box}(A) \subseteq \text{ter}(B) \subseteq \text{box}(B) \subseteq \text{ter}(C)$. Thus $A \prec C$. So, \prec is transitive.

Being antisymmetric and transitive, \prec is a partial order.

Claim. *The relation \curvearrowright has no directed cycles.*

If $A \curvearrowright B$, then by definition, $r(B) < r(A)$. Thus, \curvearrowright cannot have any directed cycles.

Claim. *Axiom (A1) holds.*

Let $A \prec B$ and $A \prec C$. So, $A \subseteq \text{ter}(B) \cap \text{ter}(C)$, and in particular, $\text{ter}(B) \cap \text{ter}(C) \neq \emptyset$. So, by Lemma 5.30, B and C are comparable. However, because of Constraint (C3), we have $B \cap C = \emptyset$. So, either $B \prec C$ or $B \succ C$.

Claim. *Axiom (A2) holds.*

Let $A \curvearrowright B$ and $A \curvearrowright C$. So, the set $\{(x, y) \in A : x = \mathfrak{l}(A)\}$ is a subset of both $\text{ter}(B)$ and $\text{ter}(C)$. In particular, $\text{ter}(B) \cap \text{ter}(C) \neq \emptyset$, and therefore by Lemma 5.30, B and C are comparable. However, because of Constraint (C5), we have $B \cap C = \emptyset$. Therefore, either $B \prec C$ or $B \succ C$.

Claim. *Axiom (A3) holds.*

Let $A \curvearrowright B$ and $A \prec C$. Hence, by definition, $\mathfrak{r}(B) \leq \mathfrak{r}(A)$, and by Lemma 5.29, $\mathfrak{r}(A) < \mathfrak{r}(C)$. Consequently, $\mathfrak{r}(B) < \mathfrak{r}(C)$. So, if $B \cap C \neq \emptyset$, we must have $C \curvearrowright B$. But then $A \curvearrowright B$, $C \curvearrowright B$, and $A \prec C$ contradict Constraint (C4). Thus, $B \cap C = \emptyset$. Now, choose a point p in $A \cap B$. Since $A \subseteq \text{ter}(C)$, we have $p \in \text{ter}(C)$. Hence, $B \cap \text{ter}(C) \neq \emptyset$. Therefore, by Constraint (C2), we have $B \prec C$.

Claim. *Axiom (A4) holds.*

Let $A \curvearrowright B$ and $B \prec C$. So, by definition of \curvearrowright , we have $\mathfrak{h}(A) < \mathfrak{h}(B)$, and by Lemma 5.29, we have $\mathfrak{h}(B) < \mathfrak{h}(C)$. So, $\mathfrak{h}(A) < \mathfrak{h}(C)$. Hence, if $A \cap C \neq \emptyset$, we have $A \curvearrowright C$. On the other hand, if $A \cap C = \emptyset$, since $A \cap B \neq \emptyset$ and $B \subseteq \text{ter}(C)$, we have $A \cap \text{ter}(C) \neq \emptyset$. Therefore, by constraint (C2), $A \prec C$.

So, $(\mathcal{F}, \prec, \curvearrowright)$ is a Burling set. Finally, because of Constraint (C1), the oriented abstract Burling graph \hat{G} obtained from the Burling set $(\mathcal{F}, \prec, \curvearrowright)$ is indeed isomorphic to G , the oriented intersection graph of \mathcal{F} . So, G is an oriented abstract Burling graph. \square

5.5 Abstract Burling graphs are derived graphs

The contents of this section are mainly from [PT23].

Some properties of Burling sets

Lemma 5.32. *Let S be a Burling set, and let $x, y \in S$. At most one of the following holds: $x \curvearrowright y$, $y \curvearrowright x$, $x \prec y$, or $y \prec x$. In particular, $\curvearrowright \cap \prec = \emptyset$.*

Proof. Notice that if any of the four relations hold, then $x \neq y$, because \prec is a strict partial order and \curvearrowright has no directed cycle of length 1.

First suppose that $x \curvearrowright y$. Because \curvearrowright has no directed cycles, we cannot have $y \curvearrowright x$. Moreover, if $x \prec y$, then by Axiom (A3), we must have $y \prec y$, a contradiction. If $y \prec x$, then by Axiom (A4), we have either $x \curvearrowright x$ or $x \prec x$, in both cases, it is a contradiction.

It just remains to check that $x \prec y$ and $y \prec x$ cannot happen simultaneously, which is clear by the definition of strict partial orders. \square

Lemma 5.33. *Let $R = \curvearrowright \cup \prec$. The relation R has no directed cycle. In particular, R has some minimal element which is therefore minimal for both \curvearrowright and \prec .*

Proof. Suppose for the sake of contradiction that there is a cycle in R , and let x_1, x_2, \dots, x_n be a minimal cycle.

By definition, $n \neq 1$, and by Lemma 5.32, we have $n \neq 2$.

Now suppose that $n \geq 4$. Notice that none of \curvearrowright and \prec has a directed cycle, thus there exists $1 \leq i \leq n$, such that $x_i \curvearrowright x_{i+1}$ and $x_{i+1} \prec x_{i+2}$ (summations modulo n). Hence by Axiom (A4), we must have either $x_i \curvearrowright x_{i+2}$ or $x_i \prec x_{i+2}$. In any case, $x_i R x_{i+2}$, which is in contradiction to the minimality of the chosen directed cycle.

Finally, suppose that $n = 3$. Up to symmetry, we have $x_1 \curvearrowright x_2$ and $x_2 \prec x_3$, and therefore by Axiom (A4), we have $x_1 R x_3$. But because this is a cycle, we must have $x_3 R x_1$. This is in contradiction with Lemma 5.32.

So R has no directed cycle. So there exists a minimal element in R which is, by definition, a minimal element for both \curvearrowright and \prec . \square

We recall that in a given Burling set S , and for an element s in S , $[s\curvearrowright] = \{t \in S : s \curvearrowright t\}$, and $[s\prec] = \{t \in S : s \prec t\}$.

Lemma 5.34. *Let s be an element of a Burling set S . Then there exists an ordering of the elements of $[s\curvearrowright]$ such as u_1, u_2, \dots, u_k and an ordering of the elements of $[s\prec]$ such as v_1, v_2, \dots, v_l such that $u_1 \prec u_2 \prec \dots \prec u_k \prec v_1 \prec v_2 \prec \dots \prec v_l$.*

Proof. By Axiom (A2), all the elements of $[s\curvearrowright]$ form a chain $u_1 \prec u_2 \prec \dots \prec u_k$. Moreover, by Axiom (A1), all the elements of $[s\prec]$ also form a chain $v_1 \prec v_2 \prec \dots \prec v_l$. Finally, $u_k \prec v_1$ follows from Axiom (A3) since $s \curvearrowright u_k$ and $s \prec v_1$. \square

Main theorem

Theorem 5.35. *Every oriented abstract Burling graph is an oriented derived graph.*

Proof. Let G be an oriented abstract Burling graph obtained from a Burling set S .

We prove the following statement by induction on the number of elements of S .

Statement 5.36. *There exists a Burling tree (T, r, ℓ, c) such that $S \subseteq V(T)$, and for every two distinct elements x and y in S :*

1. $x \prec y$ if and only if x is a descendant of y in T ,
2. $x \curvearrowright y$ if and only if $y \in c(x)$ in T .

If $|S| = 1$, then the result obviously holds. Suppose that the statement holds for every Burling set on at most $k - 1$ elements, and let S be a Burling set on $k \geq 2$ elements.

Let $v \in S$ be a minimal element of $\curvearrowright \cup \prec$ which exists by Lemma 5.33. Set $S' = S \setminus \{v\}$. By the induction hypothesis, there exists a Burling tree (T', r', ℓ', c') such that $S' \subseteq V(T')$ and the two properties of the statement hold.

Now let $[v \curvearrowright] = \{u_1, u_2, \dots, u_m\}$ and $[v \prec] = \{w_1, w_2, \dots, w_n\}$ (both possibly empty). By Lemma 5.34, suppose without loss of generality that $u_1 \prec u_2 \prec \dots \prec u_m \prec w_1 \prec w_2 \prec \dots \prec w_n$. Thus by the induction hypothesis, they appear on the same branch of T' . So from the root to the leaf, they appear in this order: $w_n, \dots, w_1, u_n, \dots, u_1$. Now we consider two cases:

Case 1: $[v \prec] = \emptyset$. In this case, add a parent r to r' and define $\ell(r) = r'$. Then add v as a child of r . If $[v \curvearrowright] = \emptyset$, then define $c(v) = \emptyset$. Otherwise, let P be the set of vertices on the path between r' and u_1 , including both of them, and define $c(v) = P$. Call this new Burling tree T .

Case 2: $[v \prec] \neq \emptyset$. In this case, if w_1 is a leaf, and hence $[v \curvearrowright] = \emptyset$, then add v as a last-born child of w_1 and define $c(v) = \emptyset$. If w_1 is not a leaf, then add v as a non-last-born child of w_1 . If $[v \curvearrowright] = \emptyset$, define $c(v) = \emptyset$. Otherwise, let P be the set of vertices on the path between $\ell(w_1)$ and u_1 , and define $c(v) = P$. Call the obtained Burling tree T .

In both cases, we obviously have $S \subseteq V(T)$, so it remains to prove the two properties of the statement. For any two distinct elements of S which are both different from v , the result follows from the induction hypothesis. So consider v and an element u of S different from v . Notice that by minimality of v with respect to both relations, we have neither $u \curvearrowright v$ nor $u \prec v$ in S , and by the construction of T , in both cases, v is not in $c(u)$, and it has no descendant, so in particular, u is not a descendant of v . Moreover, by construction of T in both cases, if $v \prec u$ in S , then v is a descendant of u in T , and if $v \curvearrowright u$ in S , then $u \in c(v)$ in T .

Now suppose that x is an element of S , and in T , x is an ancestor of v , and thus we are necessarily in case 2. We prove that $v \prec x$. If $x = w_1$, then the result is immediate. Otherwise, x is an ancestor of w_1 . Thus by the induction hypothesis, $w_1 \prec x$. On the other hand, $v \prec w$. Since \prec is an strict partial order, $v \prec x$.

Finally, suppose that x is an element of S and in T , $x \in c(v)$. We show that $v \curvearrowright x$ in S . From $x \in c(v)$, we know that x is a vertex among the vertices of the path from the last-born of w_1 to u_1 . If $x = u_1$, then the result is immediate. If not, we have $v \curvearrowright u_1$ and $u_1 \prec x$. So by Axiom (A1), either $v \curvearrowright x$ or $v \prec x$. But the latter is not possible because otherwise from $v \prec x$ and the fact that $v \neq x$, we know that x is either w_1 or it is an ancestor of w_1 in T . But this is not possible, because

$x \in c(v)$.

To complete the proof we notice that G is exactly the subgraph of the graph derived from T , induced by the vertices of S . \square

5.6 Concluding the proof

Proof of Theorem 5.1. We have:

$$1 \xrightarrow{\text{Theorem 5.10}} 2 \xrightarrow{\text{Theorem 5.27}} 3 \xrightarrow{\text{by definition}} 4 \xrightarrow{\text{Theorem 5.31}} 5 \xrightarrow{\text{Theorem 5.35}} 1.$$

\square

5.7 A category theoretical view of this chapter

We close this chapter by a discussion about the proof of Theorem 5.1. We will see that we have proved something stronger than Theorem 5.1: that not only these graph classes are equal, but their structure-preserving morphisms are also preserved through the equivalences given in the proofs.

It might be easier to explain this from a category theoretical point of view. We keep this section very informal, with no proofs or details. First, because it will not be used in any other parts of the thesis, and second, because despite not being complicated, writing the details can be long. However, we believe that this presentation has the advantage of giving a global view on how this long proof works.

What we have seen so far can be viewed as the interaction of five categories that we introduce hereunder. Since the morphisms are all structure-preserving maps, the compositions and the units are the natural ones (i.e. the compositions of functions and the identity functions). In the category $S\text{-Sets}$ below, S is a fixed Pouna set.

BTrees Objects: partial Burling trees: tuples (T, r, ℓ, c, V) where (T, r, ℓ, c) is a Burling tree (Definition 4.4) and V is a subset of $V(T)$.

$Hom(A, B)$: extensions ϕ (Definition 5.6) from the Burling tree of $A = (T, r, \ell, c, V)$ to the Burling tree of $B = (T', r', \ell', c', V')$ such that $\phi(V) \subseteq \phi(V')$.

BGraphs Objects: Burling graphs and their inherited stable sets, i.e. pairs (G, \mathcal{S}) of a graph G and a set \mathcal{S} of stable sets of G such that G is an induced subgraph of a graph G_k in the Burling sequence (Definition 4.2) and \mathcal{S} is the restriction of \mathcal{S}_k to the vertex-set of G .

$Hom(A, B)$: graph morphisms that preserve the stable sets, i.e. if $A = (G, \mathcal{S})$ and $B = (G', \mathcal{S}')$, then $Hom(A, B)$ is the set of graph homomorphisms $\phi: V(G) \rightarrow V(G')$ such that $\phi(\mathcal{S}) \subseteq \mathcal{S}'$.

S -Sets Objects: finite families of transformed copies of S (see under S -graphs in Section 2.3) that satisfy constraints (C1)-(C6) (Definition 4.20).

$Hom(A, B)$: functions from A to B that preserve \curvearrowright and \prec , i.e. function $f : \mathcal{F} \rightarrow \mathcal{F}'$ such that for every $R \in \{\curvearrowright, \prec\}$ if $S, S' \in \mathcal{F}$ such that $S R S'$, then $f(S) R f(S')$.

PounaSets Objects: finite families of strong Pouna sets (Definition 4.15) that satisfy constraints (C1)-(C5) (Definition 4.19).

$Hom(A, B)$: functions from A to B that preserve \curvearrowright and \prec .

BSets Objects: Burling sets $(S, \prec, \curvearrowright)$ (Definition 4.10).

$Hom(A, B)$: functions from the underlying set of $A = (S, \prec, \curvearrowright)$ to the underlying set of $B = (S', \prec', \curvearrowright')$ that preserve the relations. Notice that, in particular, f is a graph homomorphism from the graph (S, \curvearrowright) to the graph (S', \curvearrowright') .

Now, each section of the proof in this chapter provides the existence of a functor from one category to the other.

Section 5.2 might be the trickiest one. We can define F_{12} to be a functor from **BTrees** to **BGraphs**. Let $A = (T, r, \ell, c, V)$ be an object in **BTrees**. We define $F_{12}(A)$ as follows: let H be the graph fully derived from T , and set $G = H[V]$, i.e. the subgraph of G induced by V . Also, denoting the principle branches of T by $\mathcal{P}(T)$, set $\mathcal{S} = \{P \cap V : P \in \mathcal{P}(T)\}$. Define $F_{12}(A) = (G, \mathcal{S})$. Also, when an extension $\phi \in Hom(A, B)$ is given, one can easily restrict it to find a morphism $F_{12}(\phi)$ from $F_{12}(A)$ to $F_{12}(B)$, Lemma 5.7 and Theorem 5.10 imply that F_{12} is well-defined and indeed is a functor.

The functor F_{23} from **BGraphs** to S -**Sets** also needs some explanations. Skipping details, we first need to mention that every family \mathcal{F} of transformed copies of S satisfying (C1)-(C6) is equivalent (in the sense described above) to a subset of some \mathcal{F}_k , where $\{(\mathcal{F}_k, \mathcal{P}_k)\}_{k \geq 1}$ is the sequence defined in Section 5.3 for the set S . So, following the lines of proofs in Section 5.3, we first need to find a functor F'_{23} from **BGraphs** to a category whose objects are equivalence classes of families of Pouna sets satisfying (C1)-(C5) with their inherited “probs” from $\{(\mathcal{F}_k, \mathcal{P}_k)\}_{k \geq 1}$ by sending (G, \mathcal{S}) to the class of \mathcal{F} (and its inherited probs) where G is the intersection graph of \mathcal{F} (the reason that this is well-defined is once again the definition of the equivalence classes). Then, decomposing F'_{23} with a forgetful functor from the latter category to S -**Sets** gives us F_{23} on the objects. For a morphisms in $Hom(A, B)$, we simply use the fact that each graph G is sent to the class of \mathcal{F} where G is the intersection graph of \mathcal{F} to send a graph morphism to a morphism in $Hom(F_{23}(A), F_{23}(B))$.

Defining F_{34} from S -**Sets** to **PounaSets** might be the easiest one among all, since we need it to be a natural forgetful functor.

To define F_{45} from **PounaSets** to **BSets** we simply send a family \mathcal{F} to the Burling set $(\mathcal{F}, \prec, \curvearrowright)$ where \curvearrowright and \prec are as defined at the beginning of Section 4.4.2. They extend naturally to morphisms.

Finally, to define F_{51} from **BSets** to **BTrees**. Following the proof of Statement 5.36, we can define F_{51} on the objects: for $A = (S, \prec, \curvearrowright)$, we define $F_{51}(A)$ to be the tuple (T, r, ℓ, c, S) as in Statement 5.36. Theorem 5.35 assures us that we can extend F_{51} to morphisms.

Chapter 6

Intersection graphs of boxes

As explained in the introduction, the first definition of Burling graphs introduced them as the intersection graph of boxes in \mathbb{R}^3 [Bur65]. In [PT23], Trotignon and the author defined the class of *strict box-graphs* that is a proper subclass of box-graphs (i.e. intersection graphs of axis-parallel boxes in \mathbb{R}^3) and is equal to the class of Burling graphs. Here, we describe this class.

Let \mathcal{F} be a strict family of frames (see Definition 4.12) in \mathbb{R}^2 . Let $\mathcal{I}(\mathbb{R})$ denote the set of all non-empty closed intervals in \mathbb{R} . Let $i : \mathcal{F} \rightarrow \mathcal{I}(\mathbb{R})$ be a function that to each frame A in \mathcal{F} associates an interval $i(A)$. We say that i is *compatible* with \mathcal{F} if for every $A, B \in \mathcal{F}$ we have:

1. if $A \curvearrowright B$, then $I_B \subsetneq I_A$,
2. if $A \prec B$, then $I_A \cap I_B = \emptyset$.

Lemma 6.1. *For every strict family \mathcal{F} of frames in \mathbb{R}^2 , there exists an interval function i compatible with \mathcal{F} .*

Proof. Let G denote the oriented intersection graph of S . By Theorem 5.1, G can be derived from a Burling tree (T, r, ℓ, c) . Moreover, by Lemma 5.3, we may assume that r is not in $V(G)$, every non-leaf vertex in T has exactly two children, and no last-born of T is in $V(G)$. So, every frame A of \mathcal{F} corresponds to a vertex $v_A \neq r$ of T that is not a last-born. Moreover, $A \prec B$ if and only if v_A is a descendant of v_B in T and $A \curvearrowright B$ if and only if $v_B \in c(v_A)$. So, in order to prove the lemma, it is enough to show that there exists $i' : V(T) \rightarrow \mathcal{I}(\mathbb{R})$ such that:

1. if $u \in c(v)$, then $I_u \subsetneq I_v$,
2. if u is a proper descendant of v then $I_u \cap I_v = \emptyset$.

We first define an injective function $f : V(T) \rightarrow \{1, 2, \dots, |V(T)|\}$ such that:

1. $f(r) = 1$,
2. for every non-leaf vertex v with the last-born child u and the non-last-born

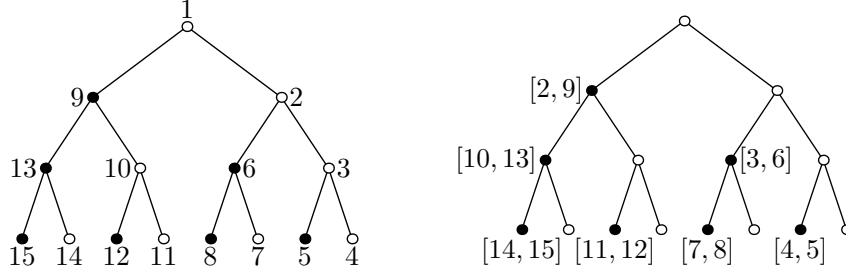

Figure 6.1: Intervals associated to the non-last-borns of a Burling tree.

child w , we have $f(u) = f(v) + 1$ and

$$f(w) = \max\{f(x) : x \text{ is a descendant of } u\} + 1.$$

To find such function one can perform a depth-first search on T starting at the root and giving priority to the last-borns, and assign to each vertex the step that it is seen in the algorithm. See Figure 6.1, left.

Notice that in particular, for a vertex v with the last-born child u and the non-last-born child w , we have $f(u) < f(w)$. So, $[f(u), f(w)] \in \mathcal{I}(\mathbb{R})$. Now, let $w \in V(G)$. So, w is a vertex of T that is neither r nor a last-born. It follows that w has a parent v . Set $u = \ell(v)$. Define $i'(w) = [f(u), f(w)]$.

Let us prove that i satisfies the two conditions claimed. Let $w, w' \in V(T)$ and suppose that $i(w) = [f(u), f(w)]$ and $i(w') = [f(u'), f(w')]$ with notation as above.

First, suppose that $w' \in c(w)$. Then, u' and w' are both descendant of u . So $f(u) < f(u') < f(w')$. And since w' is a descendant of u , $f(w') < f(w)$. Hence $[f(u'), f(w')] \subsetneq [f(u), f(w)]$.

Second, suppose that w is a proper descendant of w' . In this case, both u and w are descendant of w' , so by the properties of DFS, $f(u) > f(w')$. This implies that $[f(u), f(w)]$ and $[f(u'), f(w')]$ are disjoint. \square

Given a frame A in \mathbb{R}^2 and an interval $I \subseteq \mathbb{R}$, we can define a box B associated to A and I as follows: $B = \text{box}(A) \times I$.

For a set $S \subseteq \mathbb{R}^3$, we denote by $\rho_{1,2}(S)$ the set $\{(x, y) \mid (x, y, z) \in S\}$.

Definition 6.2. Let \mathcal{F} be a family of boxes in \mathbb{R}^3 . We say that \mathcal{F} is strict if the following happen:

1. The border of the images of the boxes in the xy plane forms a strict set of frames in the plane. Formally, the set $\mathcal{F}_0 = \{\partial(\rho_{1,2}(S)) \mid S \in \mathcal{B}\}$ forms a strict family of boxes in \mathbb{R}^2 .
2. The intervals of the boxes are compatible with \mathcal{F}_0 . Formally, the function $i : \mathcal{F}_0 \rightarrow \mathcal{I}(\mathbb{R})$ defined as $i(\rho_{1,2}(S)) = \rho_3(S)$ is compatible with \mathcal{F}_0 .

Definition 6.3. A graph G is a strict box-graph if it is isomorphic to the intersection graph of a strict family of boxes in \mathbb{R}^3 .

Now, let us prove that strict box graphs are also equal to Burling graphs.

Lemma 6.4. Suppose that a strict family F' of boxes is obtained from a strict family of frames F . Let $A, B \in S$ be frames, and A', B' be the respective boxes associated to them. Then, $A \cap B \neq \emptyset$ if and only if $A' \cap B' \neq \emptyset$. In particular, the intersection graph of S is isomorphic to the intersection graph of S' .

Proof. If A enters B , then $A' \cap B' \neq \emptyset$ because both the frames and the interval associated to them have a non-empty intersection. If A is inside B , then $A' \cap B' = \emptyset$ because the intervals associated to A and B are disjoint. If A and B are incomparable, then $A' \cap B' = \emptyset$ because $A^\circ \cap B^\circ = \emptyset$. \square

Theorem 6.5. The class of strict box graphs is equal to the class of Burling graphs.

Proof. Suppose that G is a Burling graph. Then, by Theorem 5.1, G is the intersection graph of a strict set \mathcal{F} of frames. By Lemma 6.1, a set of intervals compatible with S exists. Hence, by Lemma 6.4, G is isomorphic to a strict box graph.

Suppose conversely that G is a strict box graph. Then, by definition, it arises from a strict set of frames and a set of interval compatible with it. Hence, by Lemma 6.4, G is isomorphic to a strict frame graph. So by Theorem 5.1, G is a Burling graph. \square

Part III

Structure of Burling graphs

Chapter 7

Structure of Burling graphs

7.1	First observations about derived graphs	85
7.2	Operations on Burling graphs	86
7.3	k-Burling graphs	91
7.4	Star cutsets and decomposition theorem	100
7.5	Holes in Burling graphs	102

In this chapter, we study the structure of Burling graphs, mostly by using the derived graphs definition. Thanks to Theorem 5.1, from now on, we use the terms Burling graph and derived graph interchangeably.

Section 7.1 contains some basic observations about the class. In Section 7.2 we study the behavior of Burling graphs under some operations. Section 7.3 is about k -Burling graphs, which are subclasses of Burling graphs that are χ -bounded and form a hierarchy in the class of Burling graphs. In particular, we study 1-Burling graphs and 2-Burling graphs in detail. In Section 7.4 we study the star cutsets in Burling graphs and use this study to state and prove a decomposition theorem for the class. Finally, in Section 7.5, we analyze the orientation of holes in Burling graphs and study their interactions.

7.1 First observations about derived graphs

Lemma 7.1. *Every oriented Burling graph contains a source.*

Proof. Follows from Lemma 4.9. □

Lemma 7.2. *Suppose that G is an oriented graph derived from a Burling tree T . If $uv \in A(G)$, then $p(u)$ is an ancestor of $p(v)$.*

Proof. Follows directly from the definition of derived graphs. □

7.2 Operations on Burling graphs

In this section, we study subdivision and contraction of edges and adding leaves in Burling graphs. We show that adding a leaf always preserves the property of Being a Burling graph. We also give conditions under which we can subdivide some edges of a Burling graph and obtain another Burling graph.

A breach in time. *In Chapter 9, we study the closedness of Burling graphs under several operations, we show that this class is not closed under subdivision and contraction of edges, which justifies the need for the results in this section.*

7.2.1 Adding a leaf

Let us start by showing that adding a leaf preserves being a Burling graph. *Adding a leaf l to vertex v of a graph G* , is the operation of building a graph G' such that $V(G') = V(G) \cup \{l\}$ and $E(G') = E(G) \cup \{lv\}$. When G is an oriented graph, adding an in-leaf (resp. out-leaf) is adding a leaf to the underlying graph of G and orienting the new edge from l to v (resp. from v to l).

Theorem 7.3. *Let G be an oriented graph derived from a Burling tree (T, r, ℓ, c) . Let $v \in V(G)$. If G' is the graph obtained by adding an in-leaf or an out-leaf l to vertex v of G , then G' is a derived graph.*

Proof. By 5.3, we may assume that v is not the root of T . Let $p = p(v)$ in T . By 5.3, we may assume that v is not the last-born of p . Subdivide the edge pv of T once and call the new vertex p' . Add a new child l to p' to obtain a tree T' .

In case of in-leaf (resp. out-leaf), i.e. when $lv \in A(G')$ (resp. $vl \in A(G')$), define $\ell'(p') = v$ (resp. $\ell'(p') = l$), and for every $u \in V(T)$ different from p , set $\ell'(u) = \ell(u)$. Also, define $c'(l) = \{v\}$ (resp. $c'(l) = \{v\}$). For any vertex $u \in V(T)$, if $v \in c(u)$, define $c'(u) = c(u) \cup \{p'\}$, otherwise, set $c'(u) = c(u)$. Finally, set $c'(p') = \emptyset$. The tuple (T', r, ℓ', c') is a Burling tree, and G' is derived from T' . \square

Corollary 7.4. *The class of Burling graphs is closed under adding leaves.*

7.2.2 Subdivision

Now we study how to obtain new oriented Burling graphs by subdividing arcs of another Burling graph. Before starting the proofs, it is worth observing that in a Burling tree (T, r, ℓ, c) , when v is the last-born of some vertex u , one may obtain another Burling tree (T', r, ℓ', c') by setting $(T', r, \ell', c') = (T, r, \ell, c)$ and then applying the following transformations to T' . First, delete the edge uv from T' and add a new vertex w adjacent to u and v . Then set $\ell'(u) = w$ and $\ell'(w) = v$. To define c' , add w to all sets $c(x)$ that contain v . A fact that we do not state formally but

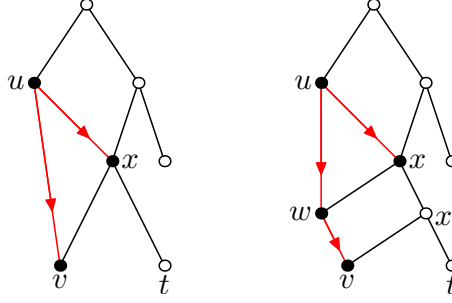

Figure 7.1: Subdividing a bottom-arc.

is easy to check and is implicit in some of the proofs below is that this new Burling tree T' is equivalent to T in the sense that every graph that can be derived from T can be derived from T' . This is simply because $V(G) \subseteq V(T) \subseteq V(T')$ and because for all $x \in V(G)$, $c(x) \cap V(G) = c'(x) \cap V(G)$.

Subdividing an arc uv into uwv in an oriented graph means removing the arc uv and adding instead a directed path uwv where w is a new vertex.

Top-subdividing an arc uv into wu and wv means removing uv and adding instead two arcs wv and wu where w is a new vertex.

Lemma 7.5. *Let G be an oriented graph derived from a Burling tree T and uv be a bottom-arc of G . The graph G' obtained from G by subdividing uv into uwv can be derived from a Burling tree T' in such a way that:*

- uw is a bottom-arc of G' ,
- wv is both a bottom-arc and a top-arc of G' ,
- every top-arc of G with respect to T (except uv) is a top-arc of G' with respect to T' ,
- every bottom-arc of G with respect to T (except uv) is a bottom-arc of G' with respect to T' .

Proof. By Lemma 5.3, we may assume that v is neither the root nor a last-born of T . Let x be the parent of v , and let t be the last-born of x . See Figure 7.1.

Build from T a Burling tree (T', r', ℓ', c') by removing the edge xt from T . Then add to T' a path $xx't$, and set $\ell'(x) = x'$, and $\ell'(x') = t$. Add to T' a new vertex w adjacent to x . Set $c'(u) = \{w\} \cup c(u) \setminus \{v\}$. Set $c'(w) = \{x', v\}$. Replace $c'(z)$ by $c'(z) \cup \{x'\}$ for all $z \neq v$ such that $t \in c(z)$ or $v \in c(z)$.

We see that the oriented graph G' obtained from G by subdividing arc uv into uwv can be derived from T' . \square

Lemma 7.6. *Let G be an oriented graph derived from a Burling tree T and uv be a top-arc of G such that u is a source of G . The graph G' obtained from G by top-subdividing uv can be derived from a Burling tree T' in such a way that:*

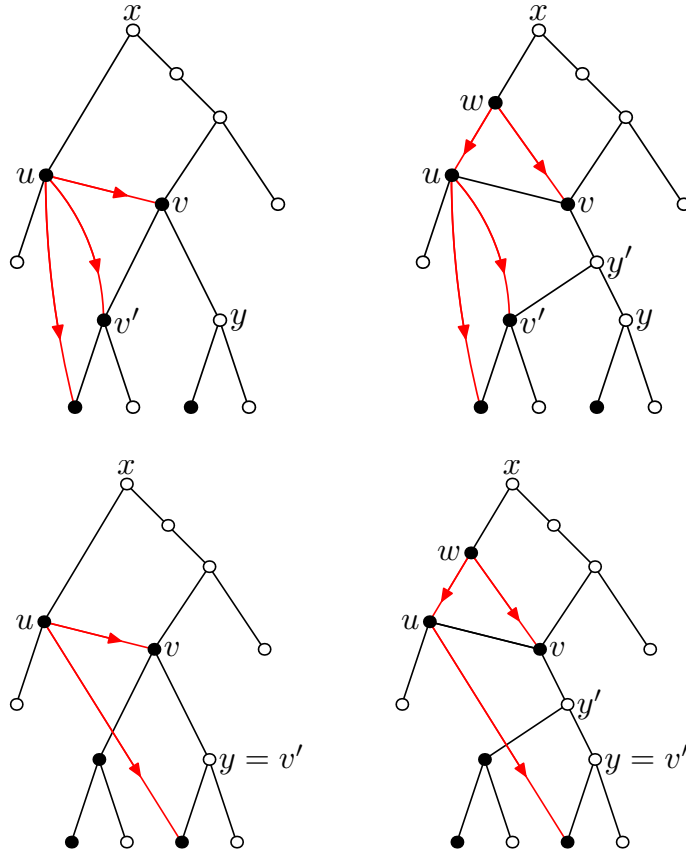

Figure 7.2: Top-subdividing a top-arc.

- wv is a top-arc,
- wu is a bottom-arc,
- every top-arc of G with respect to T (except uv) is a top-arc of G' with respect to T' ,
- every bottom-arc of G with respect to T (except wv) is a bottom-arc of G' with respect to T' .

Proof. Note that u is not a last-born since there exists an arc uv in G . Let x be the parent of u . Let y be the last-born of v (if v is a leaf of T , just add y to T). By Lemma 5.3, we may assume that y is not in G . Let v' be the child of v such that $v' \in c(u)$ (it is possible that $v' = y$ if no child of v is in $c(u)$, but in that case we just add y to $c(u)$). See Figure 7.2, where the cases $v' \neq y$ and $v' = y$ are represented. Notice that the proof below applies to the two cases at the same time.

Build from T a Burling tree (T', r', ℓ', c') by removing the edges xu , vv' and vy from T . Then add to T' the edge vu , the path $vy'y$ and the edge $y'v'$, and set $\ell'(v) = y'$

and $\ell'(y') = y$. Add to T' a new vertex w adjacent to x (in T'). Set $c'(u) = c(u) \setminus V(P)$ where P is the path of T' from x to v . Set $c'(w) = \{u\} \cup V(P) \setminus \{x\}$. Replace $c'(z)$ by $c'(z) \cup \{y'\}$ for all z such that $y \in c(z)$ or $v' \in c(z)$.

We see that the oriented graph G' obtained from G by top-subdividing uv into wu and wv can be derived from T' because $v \notin c'(u)$ and $u, v \in c'(w)$, and the rest of the arcs between the vertices of G have remained unchanged. Observe that v and u are the only vertices of G in $V(P) \setminus \{x\}$ since uv is a top-arc of G . Observe that no vertex z of G has u in $c(z)$ since u is a source of G . \square

Theorem 7.7. *Let G be an oriented Burling graph derived from a Burling tree T . Any graph obtained from G after performing the following operations is an oriented Burling graph:*

- *Replacing some bottom-arcs uv by a path of length at least 1, directed from u to v .*
- *Replacing some top-arcs uv such that u is a source of G by an arc wv and a path of length of length at least 1 from w to u .*

Proof. Clear by repeatedly applying Lemma 7.5 Lemma 7.6. \square

Let us now give some examples and applications of Theorem 7.7. In Figures 7.3 and 7.4, some oriented Burling graphs are represented. In the three figures, we have represented top-arcs such that one of their end-points is a source by dotted lines, bottom-arc by dashed lines, and the other arcs by solid lines. Therefore, by Theorem 7.7, by top-subdividing any of the dotted arcs and subdividing any of the dashed arcs, we obtain an oriented Burling graph. In Figure 7.3, the oriented graphs derived from the Burling trees from Figure 4.2 are represented. In Figure 7.4, a Burling tree, together with the oriented graph derived from it, is represented. By considering its underlying graph, we see how to obtain several subdivisions of K_4 , namely any subdivision in which every edge except uy and wy is possibly subdivided. As a consequence, all graphs arising from the three non-oriented graphs in Figure 7.5 by subdividing dashed edges are Burling graphs.

A breach in time. *We will see in Section 8.2 that Figure 7.4 provides all subdivisions of K_4 that are Burling graphs (see Theorem 8.5).*

7.2.3 Contraction

Lemma 7.8. *Let G be an oriented derived graph, and let uv be an arc such that $N^+(u) = \{v\}$ and $N^-(v) = \{u\}$. Then the graph G' obtained by contracting uv is also an oriented derived graph and the top-arcs (resp. bottom-arcs) of G except uv are the top-arcs (resp. bottom-arcs) of G' .*

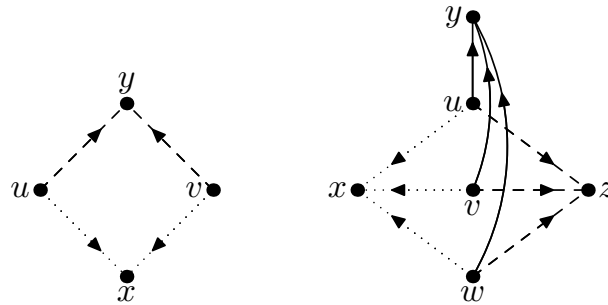

Figure 7.3: Complete bipartite graphs.

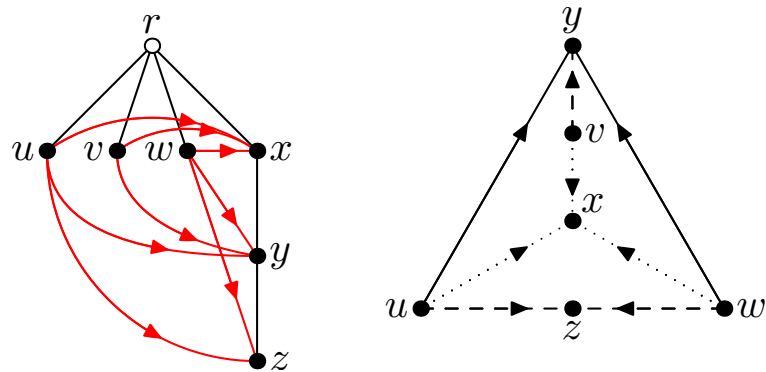

Figure 7.4: Subdivisions of K_4 .

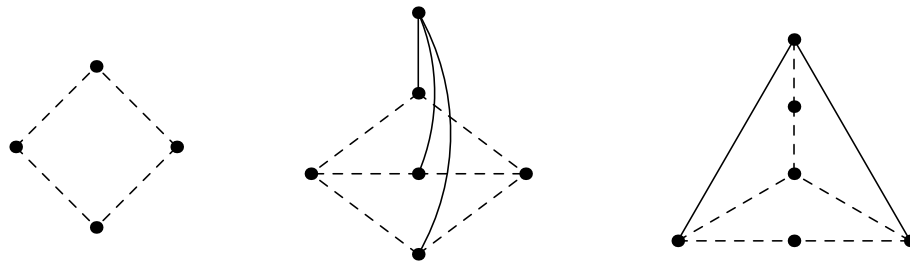

Figure 7.5: Subdivisions of non-oriented graphs.

Proof. Suppose that G is derived from the Burling tree (T, r, ℓ, c) . Let S be the vertex-set (possibly empty) of the path starting at the last-born of the parent of u and ending at the parent of v in T . Notice that $S \subseteq c(u)$, and since $c(u) \cap V(G) = \{v\}$, no vertex of S and no descendant of v in $c(u)$ is a vertex of G .

Define $c'(u) = S \cup c(v)$ and define $c'(w) = c(w)$ for any vertex w of T other than u . It is easy to see that (T, r, ℓ, c') is a Burling tree. The graph G' is derived from this new Burling tree. Indeed, G' is the subgraph of the graph fully derived from (T, r, ℓ, c') induced on $V(G) \setminus \{v\}$.

Finally, it is easy to see that no top-arcs or bottom-arcs are changed except for uv . \square

7.3 k -Burling graphs

Definition 7.9. Let $k \in \mathbb{N}$ be a non-negative integer. An oriented graph G is a oriented k -Burling graph if it can be derived from a Burling tree T such that on each branch of T , at most k vertices belong to G . In such a case, we say that G is derived from T as a k -Burling graph. A k -Burling graph is the underlying graph of an oriented k -Burling graph.

The empty graph is the unique 0-Burling graph. Notice that every k -Burling graph is a $k + 1$ -Burling graph as well. So, k -Burling graphs form a hierarchy inside the class of Burling graphs. We will see in this section that

- One can build all $k + 1$ -Burling graphs using k -Burling graphs following a particular procedure. (See sequential graphs Section 7.3.2.)
- The chromatic number of k -Burling graph is bounded (by $k + 1$) for each k (see Theorem 7.11). So, they are χ -bounded subclass of Burlign graphs.
- (oriented) 1-Burling graphs are exactly all (oriented) forest (see Theorem 7.12).
- (oriented) 2-connected 2-Burling graphs with no vertex of degree at most 1 are exactly (oriented) chandeliers (see Theorem 7.23).

A breach in time. In Section 7.4, we will see that all Burling graphs can be decomposed into 2-Burling graphs and a few other simple graphs. So, 2-Burling graphs are an important class in this hierarchy. See Theorem 7.30.

Definition 7.10. The nobility of an oriented graph is the smallest integer k such that G is a k -Burling graph. The nobility of a non-oriented Burling graph G is the smallest nobility of an oriented Burling graph G' such that G is the underlying graph of G' .

Let us see some examples. In Figure 7.6, G is an oriented Burling graph G . Indeed, two presentation of G as derived graphs (from Burling trees T_1 and T_2

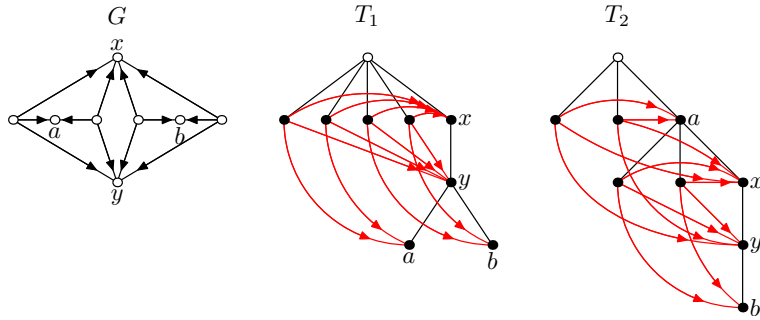

Figure 7.6: G can be derived from T_1 and T_2 .

respectively) is presented. Observe that G is derived from T_1 as a 3-Burling graph, and is derived from T_2 as a 4-Burling graph. Therefore, the notability of G is at most 3. However, we can see that the notability of G is at least 3 as well since it has a vertex of out-degree 3 (and the out-neighbors of a vertex must be on a common branch of the Burling tree).

In Figure 7.7, two oriented graphs G_1 and G_2 are represented. Since G_1 can be derived from T_1 , we see that G_1 is an oriented 2-Burling graph. In fact, the nobility of G_1 must be at least 2, because since c is a source of degree 2, its two out-neighbors must be on the same branch. Similarly, G_2 is an oriented 3-Burling graph and has nobility 3 (because of y being a source of degree 3). Hence, G is a 2-Burling graph (in fact it has nobility 2 since only forests have nobility 1, as we show in Theorem 7.12). This shows that an oriented graph (for instance G_2) may have a nobility different from the nobility of its underlying graph.

It should be pointed out that the nobility of an oriented graph may be strictly greater than its maximum out-degree, as shown on Figure 7.8. The graph G has three sources with out-neighborhood $\{1, 2, 3\}$, $\{2, 3, 4\}$ and $\{3, 4, 5\}$. It can be checked that at least four vertices among 1, 2, 3, 4 and 5 must lie on the same branch of any Burling tree from which G can be derived. So, the nobility of G is 4.

A graph or oriented graph G is said to be d -degenerate if every induced subgraph H of G has a vertex v with $d_H(v) \leq d$. By induction on $|V(G)|$, we can show that every d -degenerate graph is $(d + 1)$ -colorable.

Theorem 7.11. *Every k -Burling graph G is k -degenerate and thus is $(k + 1)$ -colorable.*

Proof. Assume G is derived from a Burling tree T as a k -Burling graph. For $k = 1$ the result is obvious. Fix $k \geq 1$. We proceed by induction on $|V(G)|$. If G has only one vertex, then it is clearly $(k + 1)$ -colorable. Now, assume that G has $n + 1$ vertices. Let v be a top-left vertex. Notice that all the neighbors of v are out-neighbors and thus lie on one branch of the tree. Therefore $d(v) \leq k$. So, the result follows from the induction hypothesis. \square

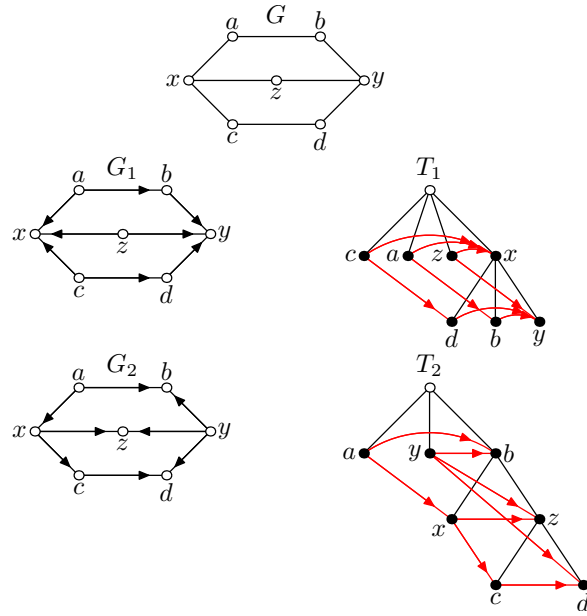

Figure 7.7: Nobility of a graph.

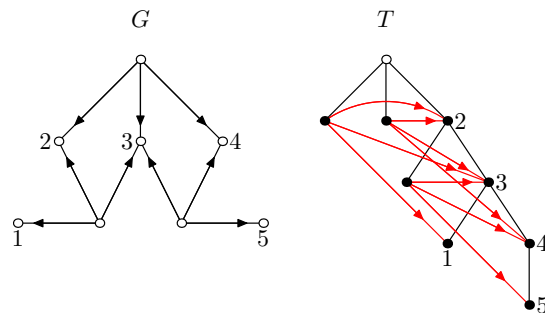

Figure 7.8: G has maximum out-degree 3 and nobility 4.

7.3.1 1-Burling graphs

Theorem 7.12. *An oriented graph G is an in-forest if and only if it is an oriented 1-Burling graph.*

Proof. Suppose that G is derived from a Burling tree T as a 1-Burling graph. By Lemma 7.1, every Burling graph contains a source and since the out-neighborhood of any vertex is included in a branch and G is 1-Burling, this source has degree at most 1. So, every 1-Burling oriented graph has a source of degree at most 1. This implies by an easy induction that every 1-Burling oriented graph is an in-forest.

To prove the converse statement, it is enough to check that for every 1-Burling graph G derived from a Burling tree (T, r, ℓ, c) and every vertex v of G , adding an in-neighbor u of v with degree 1 yields a 1-Burling graph G' . Here is how to construct G' . Build a rooted tree T' from T by adding a new root r' adjacent to r . Define for $V(T')$ the functions ℓ' and c' as equal to ℓ and c for vertices of T . Nominate r as the last-born child of r' and add u as a non-last-born child of r' . Then consider a branch B of T that contains v and set $c'(u) = B$. Note that by definition of 1-Burling graphs, $B \cap V(G) = \{v\}$. So G' is indeed derived from (T', r', ℓ', c') and it is clearly a 1-Burling graph. \square

7.3.2 Sequential graphs

Now that we know what 1-Burling graphs are, we can define the notion of *top-set* of a representation of a derived graph. This notion will be used in the rest of this section and in the next section. Here we just describe the notion and some facts about it.

Top-sets

Definition 7.13. *When G is derived from a Burling tree (T, r, ℓ, c) , we call the top-set of G the set S of all vertices v of G such that v is the unique vertex of G in the branch of T from r to v .*

Lemma 7.14. *If S is the top-set of the oriented graph G derived from a Burling tree, then $G[S]$ is an in-forest. Moreover, if G is a k -Burling graph ($k \geq 1$), then $G \setminus S$ is a $(k - 1)$ -Burling graph.*

Proof. By the definition of the top-sets, $G[S]$ is a 1-Burling graph, thus by Theorem 7.12, it is an in-Forest. and also $G \setminus S$ is a $(k - 1)$ -Burling graph since on each branch T , at most $k - 1$ vertices belong to $G \setminus S$. \square

When G is derived from a Burling tree T , every vertex u of G has a unique ancestor in the top-set of G . This ancestor is called the *top-ancestor* of u .

Lemma 7.15. *Let G be derived from a Burling tree (T, r, ℓ, c) . Let u and v be two vertices of G with top-ancestors u' and v' respectively. If uv is an arc of G then either:*

1. $u' = v'$, $u' \neq u$, and $v' \neq v$, or
2. $u = u'$ and $uv' \in A(G)$.

Proof. Suppose $u = u'$. So, $v \in c(u)$. The branch from r to v therefore contains $p(u)$, and since u is in the top-set, v' must be in the branch from $p(u)$ to v (and $v' \neq p(u)$). Hence, $v' \in c(u')$. So, $u = u'$ and $uv' \in A(G)$.

Suppose $u \neq u'$. So, u' is ancestor of $p(u)$. By Lemma 7.2, $p(u)$ is an ancestor of $p(v)$, so u' is an ancestor of v . Hence $u' = v'$. Also, $v \neq v'$ because u and v' are in the same branch. \square

k -sequential graphs

Top-sets suggest defining Burling graphs as the graphs obtained from the empty graph by repeatedly adding in-forests, with several precise rules about the arcs between them. A graph obtained after k steps of such a construction will be called a k -sequential graph, and we will prove that k -sequential graphs are k -Burling graphs. The advantage of k -sequential graphs is that they have no shadow vertices like in the definition of derived graphs. Also, they directly form a hereditary class. The price to pay, however, is that we have to maintain a set of stable sets in the inductive process.

Definition 7.16. *The (unique) 0-sequential graph is the pair (G, \mathcal{S}) where G is the empty graph (so $V(G) = \emptyset$) and $\mathcal{S} = \{\emptyset\}$.*

A k -sequential graph is any pair (G, \mathcal{S}) obtained as follows:

1. *Pick a (possibly empty) in-forest H .*
2. *For every vertex v of H , pick a $(k - 1)$ -sequential graph (H_v, \mathcal{R}_v) .*
3. *For every vertex u of H that is not a sink, consider the unique out-neighbor v of u , choose a stable set R in \mathcal{R}_v and add all possible arcs from u to R .*
4. *The previous steps define all the vertices and arcs of G .*
5. *Set $\mathcal{S} = \{\emptyset\} \cup \{\{v\} \cup R : v \in V(H), R \in \mathcal{R}_v\}$.*

We call an oriented graph G k -sequential if, for some set \mathcal{S} , (G, \mathcal{S}) is k -sequential. The in-forest H in the definition above is called the *base forest* of the k -sequential graph. Observe that the graph on one vertex is k -sequential for all $k \geq 1$ and the empty graph is k -sequential for all $k \geq 0$. The graph G in Figure 7.9 is a 2-sequential graph. The in-forest H is the subgraph of G induced by $\{a, b, c, d, e\}$. The graphs H_a , H_b , and H_c are shown in the figure, and they are all 1-sequential graphs.

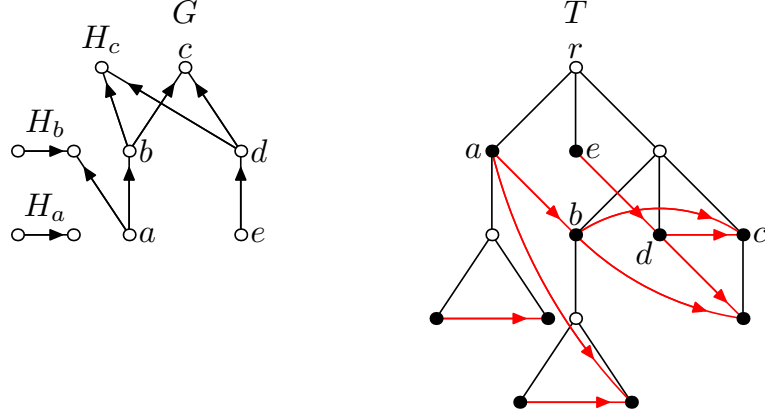

Figure 7.9: A Burling graph viewed as a sequential graph.

Theorem 7.17. *For all $k \in \mathbb{N}$, an oriented graph G is a k -Burling graph with top-set S if and only if it is a k -sequential graph with base forest H where $H = G[S]$.*

Proof. First, let G be a k -Burling graph derived from a Burling tree (T, r, ℓ, c) as a k -Burling graph, and let S be the top-set of G . We call a branch of T a *top-branch* if it contains r . We prove by induction on k that (G, S) is a k -sequential graph where

$$\mathcal{S} = \{\emptyset\} \cup \{S : S \text{ is the intersection of a top-branch of } T \text{ with } V(G)\}.$$

For $k = 0$, this is clear. Suppose that $k \geq 1$ and that the statement holds for $k - 1$. Let us prove that (G, \mathcal{S}) is a k -sequential graph, by building it as in Definition 7.16. Define $H = G[S]$ where S is the top-set of G . By Lemma 7.14, H is an in-forest.

For each vertex v of H , consider the Burling tree (T_v, v, ℓ_v, c_v) where T_v is induced by all descendants of v in T and ℓ_v, c_v are the restrictions to $V(T_v)$ of ℓ_v and c_v respectively. By the induction hypothesis, the subgraph of G which is derived from (T_v, v, ℓ_v, c_v) is a $(k - 1)$ -sequential graph, and we denote it by (H_v, \mathcal{R}_v) and

$$\mathcal{R}_v = \{\emptyset\} \cup \{S : S \text{ is the intersection of a top-branch of } T_v \text{ with } V(H_v)\}.$$

By Lemma 7.15, all arcs of G are either arcs of H , or arcs of H_v for some $v \in V(H)$, or arcs of the form uw where w is a descendant of v such $uv \in A(H)$. It follows that G can be obtained from H and the H_v 's by adding for every arc uv of H all arcs of the form uw where $w \in c(u) \cap (V(G) \setminus \{v\})$. It follows that for every vertex u of H that is not a sink and has the unique out-neighbor v , all possible arcs from u to R are added where $R = c(u) \cap (V(G) \setminus \{v\}) \in \mathcal{R}_v$. It follows that (G, \mathcal{S}) is a k -sequential graph.

Let us prove the converse statement. Consider a k -sequential graph (G, \mathcal{S}) obtained as in the definition from a base forest H and $(k - 1)$ -sequential graphs

(H_v, \mathcal{R}_v) for each $v \in V(H)$. We have to prove that G is a k -Burling graph and $V(H)$ is the top-set of G . We prove by induction on k that G can be derived from a Burling tree (T, r, ℓ, c) as a k -Burling graph such that

$$\mathcal{S} = \{S : S \text{ is the intersection of a top-branch of } T \text{ with } V(G)\}.$$

For $k = 0$, this is clear, so suppose $k \geq 1$ and the statement is true for $k-1$. So, G is obtained from H as in the definition of k -sequential graphs. By Theorem 7.12, H is a 1-Burling graph derived from a tree (T_H, r_H, ℓ_H, c_H) . By the induction hypothesis, for every $v \in V(H)$, H_v can be derived from a Burling tree (T_v, r_v, ℓ_v, c_v) and

$$\mathcal{R}_v = \{S : S \text{ is the intersection of a top-branch of } T_v \text{ with } V(H_v)\}.$$

We now build a Burling tree (T, r, ℓ, c) from T_H and the T_v 's. For every $v \in V(H)$, we add an edge from v to r_v . This defines T . We set $r = r_H$. We define the last-borns in T as inherited from the last-borns in T_H and the T_v 's, and declare r_v to be the last-born of v (except if v is not a leaf of T_H , in which case it keeps its last-born). For every vertex u of H that is not a sink, we consider the unique out-neighbor v of u , and the chosen set R in \mathcal{R}_v . We set $c(u) = \{v\} \cup R$. For every vertex u of H that is a sink, we set $c(u) = \emptyset$. For all other vertices, we define $c(u)$ as inherited from c_H or c_v . We that G can be derived from (T, r, ℓ, c) and

$$\mathcal{S} = \{S : S \text{ is the intersection of a top-branch of } T \text{ with } V(G)\}.$$

This completes the proof. \square

7.3.3 Pivots and antennas

Similar to top-set, the role of pivots and antennas will be clear in the next sections. Thus, here, we only define them and prove some lemmas about them.

Definition 7.18. *Suppose that G is derived from a Burling tree (T, r, ℓ, c) with top-set S , we call a pivot of G any sink of $G[S]$ and an antenna of G any source of $G[S]$.*

Let us start with some simple observations about pivots and antennas.

Lemma 7.19. *If G is derived from a Burling tree (T, r, ℓ, c) , then every pivot of G is a sink of G and every antenna of G is a source of G .*

Proof. Let S be the top-set of G . By Theorem 7.17, there exists k such that G is a k -sequential graph with base forest $H = G[S]$. By Lemma 7.15, if u is a pivot of G , there cannot be an arc uv in G , so u is a sink of G . Similarly, if v is an antenna of G , then Lemma 7.15 implies that there exists no arc wv in G . So, v is a source of G . \square

The following lemma makes the structure of a connected graph derived from a Burling tree more clear. In particular, it shows that the top-set is connected when the graph is connected.

Lemma 7.20. *If a connected oriented graph G is derived from a Burling tree (T, r, ℓ, c) with top-set S , then $G[S]$ is an in-tree (in particular G has a unique pivot). Moreover, no vertex of G is a strict descendant of an antenna of G .*

Proof. By Theorem 7.17, there exists an integer k such that G is a k -sequential graph with base forest $H = G[S]$. For the sake of contradiction, suppose that H is disconnected. Let X and Y be two connected components of H . By the definition of k -sequential graphs, X and Y are in distinct components of G , a contradiction to G being connected. So, H is connected and thus is an in-tree.

Again, for the sake of contradiction, let u be a strict descendant of an antenna of G . By the construction of k -sequential graphs, u and the unique pivot of G are in distinct connected components of G , a contradiction to G being connected. Therefore, no vertex of G is a strict descendant of an antenna of G . \square

Next, we can study the properties of the top-set under stronger connectivity assumptions.

An *in-star* is an in-tree whose unique sink is adjacent to all other vertices.

Lemma 7.21. *Let G be a connected oriented graph derived from a Burling tree (T, r, ℓ, c) . Suppose that G has no cut-vertex and no vertex of degree at most 1. Then the following statements hold:*

1. *The top-set of G is an in-star S with at least two leaves (so G has a unique pivot and its in-neighbors are the antennas of G).*
2. *All vertices of $S \setminus \{v\}$ are sources of G where v is the unique sink of S .*
3. *The pivot of G is an ancestor of all vertices of $V(G) \setminus S$.*

Proof. By Lemma 7.20, $G[S]$ is an in-tree. Let v be the sink of $G[S]$. If $G[S]$ is not an in-star, then there exists a directed path yxv in $G[S]$. By the construction of k -sequential graphs, we see that x is a cut-vertex of G that separates v from y . A contradiction. By Lemma 7.19, all vertices of $S \setminus \{v\}$ are sources of G because they are the antennas of G . Since G is connected, by Lemma 7.20, no vertex of G is a strict descendant of an antenna. Therefore, the pivot of G is an ancestor of all vertices of $V(G) \setminus S$. \square

7.3.4 2-Burling graphs

Recall that a leaf in an in-tree is any vertex with no children.

Definition 7.22. An oriented chandelier is any oriented graph G obtained from an in-tree G' whose root is of degree at least 2 by adding a vertex v and all arcs uv where u is a leaf of G' .

Observe that in the definition above, v is a sink and all its neighbors are sources of degree 2.

Theorem 7.23. An oriented graph is an oriented chandelier if and only if it is a connected 2-Burling graph with no cut-vertex and no vertex of degree at most 1.

Proof. First, suppose that G is an oriented chandelier. So G is clearly connected, has no cut-vertex, and has no vertex of degree at most 1. It remains to prove that it is a 2-Burling graph. Let G' and v be as in the definition of oriented chandelier. Let u_1, \dots, u_k be the leaves of G' , and for $i \in [k]$, let v_i be the neighbor of u_i in G (v_i 's are not necessarily distinct). Set $G'' = G' \setminus \{u_1, \dots, u_k\}$. Since in G' , the root has degree at least 2, G'' contains the root and thus is a non-empty in-tree. By Theorem 7.12, G'' can be derived from a Burling tree (T, r, ℓ, c) as a 1-Burling graph (i.e. on every branch of T , at most one vertex belongs to $V(G)$). Let us build a tree T' from T . Add a new root r' adjacent to r , and add k new children v_1, \dots, v_k to r' . This defines the rooted tree (T', r') . Then, define $\ell'(r') = r$ and for any vertex $x \in V(T') \setminus \{r', v_1, \dots, v_k\}$, we define $\ell'(x) = \ell(x)$. Notice that the vertices v_1, \dots, v_k are leaves in T' , thus ℓ' is not defined for them. Now, for every $i \in [k]$, let B_i be the branch of T starting at r and ending at u_i . Define $c'(v_i) = B_i$ and $c'(r') = \emptyset$. For every vertex $x \in V(T') \setminus \{r', v_1, \dots, v_k\}$, set $c'(x) = c(x)$. The tuple (T', r', ℓ', c') is a Burling tree. Renaming r as v , we see that G can be derived from T' . Indeed, G is the subgraph of the oriented graph fully derived from T' induced by $V(G'') \cup \{v, v_1, \dots, v_k\}$. Moreover, on each branch of T' , at most 2 vertices are in $V(G)$, thus G is a 2-Burling graph.

Conversely, suppose that G is a connected graph with no cut-vertex and no vertex of degree at most 1 that is derived as a 2-Burling graph from a Burling tree T . By Lemma 7.21, G has a unique pivot v , all antennas of G are in-neighbors of v , and the rest of the vertices of G are all descendants of v in T . In particular, considering v as a shadow vertex of T , we see that $G \setminus v$ is a 1-Burling graph. Therefore, by Theorem 7.12, $G \setminus v$ is an in-forest. On the other hand, since G has no vertex cut, $G \setminus v$ is connected and thus is an in-tree. Let r be the root of this in-tree. Since r cannot be of degree 1 in G , it has at least two in-neighbors. But v is not an in-neighbor of r (because it is among its ancestor). Therefore, in $G \setminus v$, the root r has at least 2 children. Moreover, if a leaf u of $G \setminus v$ is not adjacent to v in G , then, u has degree at most 1 in G , a contradiction. So, v is adjacent to all leaves of G' . Hence G is an oriented chandelier. \square

Remark 7.24. In the construction of oriented chandeliers in the proof above, v is the pivot of G and its neighbors are the antennas. The unique sink of $G \setminus v$ is called

the bottom of G . Note that every source of G is an antenna. The pivot and the bottom are the only sinks of G . Also, in the Burling tree T from which G is derived, every vertex of G except the antennas are descendants of the pivot.

To finish, let us prove that every chandelier is a 2-Burling graph, and thus a Burling graph, as well.

Lemma 7.25. *Every oriented chandelier G is an oriented 2-Burling graph.*

Proof. Adapting the notation from Definition 7.22, G contains an in-forest G' and a vertex v adjacent to every leaf of G' . By Theorem 7.12, G' can be derived from a Burling tree (T, r, ℓ, c) as a 1-Burling graph. Since G' has at least 3 vertices, $r \notin V(G')$. Let U be the set of all out-neighbors of the leaves of G' , i.e. $U = \cup_{u \in L(G')} N^+(u)$. In T , let a be the deepest common ancestor of all vertices in U . Let $b = \ell(a)$. Build a Burling tree (T', r', ℓ', c') by subdividing the edge ab in T once. Call the new vertex added from the subdivision v . Define $r' = r$. For every $w \neq \{a, v\}$, define $\ell'(w) = \ell(w)$, and define $\ell'(a) = v$ and $\ell'(v) = b$. Finally, for every $w \in V(T)$, if $b \in c(w)$, then define $c'(w) = c(w) \cup \{v\}$, otherwise define $c'(w) = c(w)$. Let H denote the oriented graph fully derived from T' . The subgraph of H induced by $V(G_0) \cup \{v\}$ is (isomorphic to) G . \square

7.4 Star cutsets and decomposition theorem

In this section, we study star cutsets in derived graphs. We also give a characterization problem for oriented Burling graphs: an oriented Burling graph either has a full in-star cutset, or is an oriented chandelier, or contains a vertex of degree at most 1. See Theorem 7.30. This can be seen as an oriented version of a result in [CELOdM16] (See Theorem 3.5 for the statement and some explanations).

Lemma 7.26. *Suppose that G is an oriented graph derived from a Burling tree T . Let v and w be two vertices of G such that v is an ancestor of w in T . Then every neighbor of w in G is either an in-neighbor of both v and w or a descendant of v .*

Proof. Let u be a neighbor of w in G . If u is an out-neighbor of w , then $p(w)$ is an ancestor of u . However, $p(w)$ is a descendant of v (possibly v itself). So u is a descendant of v . If u is an in-neighbor of w , then $p(u)$ is an ancestor of w , and therefore it is on the unique branch in T between w and the root. This branch includes v as well. There are two cases: either $p(u)$ is a descendant of v or $p(u)$ is an ancestor of v . In the former case, u is a descendant of v . In the latter case, u is an in-neighbor of v because u is connected to every vertex in the path between w and the last-born of $p(u)$, and v is on this path. \square

Lemma 7.27. *Suppose that G is an oriented graph derived from a Burling tree T . Let u , v , and w be three vertices of G such that w is a descendant of v and u is not a descendant of v . Then every path (not necessarily directed) in G between u and w contains an in-neighbor of v in G .*

Proof. Let P be a path in G from u to w . Since u is not a descendant of v while w is, P must contain an edge $u'w'$ such that u' is not a descendant of v while w' is. By Lemma 7.26 applied to v and w' , u' is a in-neighbor of v . \square

We recall that the definition of star cutsets is given in Section 2.4.

Lemma 7.28. *Suppose that G is an oriented graph derived from a Burling tree T . Let u , v , and w be three vertices of G appearing in this order along a branch of T . Then every path (not necessarily directed) in G from u to w goes through an in-neighbor of v in G .*

In particular, $N^-[v]$ is a full in-star cutset of G , and $N[v]$ is a full star cutset of G , which separates u and v .

Proof. Follows from Lemma 7.27, and u and w are in distinct connected components of $G \setminus N^-[v]$. \square

Lemma 7.29. *If a triangle-free oriented graph G has a cut-vertex, then either G has a full in-star cutset, or G has a vertex of degree at most 1.*

Proof. Let v be a cut-vertex of G . Let A and B be two connected components of $G \setminus v$. If $|A| \leq 1$ or $|B| \leq 1$, then G has a vertex of degree at most 1, so let us assume that $|A| \geq 2$ and $|B| \geq 2$. Notice that in particular, A and B each have at least one edge. Therefore, since G is triangle-free, A (resp. B) contains a non-neighbor a (resp. b) of v . It follows that a and b are in distinct connected components of $G \setminus N^-[v]$. So, G has a full in-star cutset centered at v . \square

A decomposition theorem for oriented Burling graphs

Now we can prove the following decomposition theorem.

Theorem 7.30. *If G is an oriented Burling graph, then either G has a full in-star cutset, or G is an oriented chandelier, or G contains a vertex of degree at most 1.*

Proof. Suppose that G has no vertex of degree at most 1. In particular, $|V(G)| \geq 3$. By Lemma 7.29, we may assume that G has no cut-vertex (in particular G is connected since $|V(G)| \geq 3$). We may assume that G is a 2-Burling graph, for otherwise some branch of T contains at least three vertices of G and by Lemma 7.28, G has a full in-star cutset. So, G is a connected 2-Burling graph with no cut-vertex and no vertex of degree at most 1. Hence by Theorem 7.23, G is an oriented chandelier. \square

Theorem 7.30 is the best possible in the sense that oriented chandeliers do not have full in-star cutsets.

7.5 Holes in Burling graphs

Studying holes in oriented Burling graphs, or more precisely, oriented derived graphs, can reveal several properties of their structure and help in understanding whether a graph is a Burling graph. If we forget about the orientation, there is not much to say. For every integer $n \geq 4$, the cycle of length n is a Burling graph: this is easy to see using the derived graph definition or the constrained graphs definition (see Figures 4.3 and 4.8). However, considering the oriented derived graphs, we see that not every orientation of C_n can be an oriented derived graph, and therefore, the holes in Burling graphs are restricted.

By Theorem 7.30, since a hole has no in-star cutset (whatever the orientation) and no vertex of degree 1, every hole in an oriented graph derived from a Burling tree T is an oriented chandelier. In particular, the explanations given in Remark 7.24 apply. Therefore, every hole H has four particular vertices that we describe here:

- two sources called the *antennas*,
- one common neighbor of the antennas that is also an ancestor in T of all the vertices but the antennas, called the *pivot*,
- one sink distinct from the pivot, called the *bottom*.

Every other vertex of H lies on a directed path from an antenna to the bottom. See Figure 7.10. Notice that the notions of pivot, antennas, and bottom coincide with the ones of chandeliers.

We call *subordinate* vertex of a hole any vertex distinct from its pivot and antennas (in particular, the bottom is subordinate).

We call a vertex of a hole a *singularity* if it is a sink or source in that hole.

Let us summarize the explanation above as a corollary of Theorem 7.30.

Corollary 7.31. *Every hole in an oriented Burling graph has exactly two sources and two sinks, and the two sources have a common neighbor.*

Lemma 7.32. *Let H be a hole in an oriented graph G derived from a Burling tree T . Let p be the pivot of H and C be the connected component of $G \setminus N^-[p]$ that contains $H \setminus N^-[p]$. Then every vertex of C is a descendant of p .*

Proof. Suppose for the sake of contradiction, that the statement does not hold. So, C contains a vertex u that is not a descendant of p . Since every vertex of $H \setminus N^-[p]$ is a descendant of p , there exists a descendant v of p in C . Let P be a path from u to v in C . By Lemma 7.27, P contains an in-neighbor of p . This contradicts the definition of C . \square

Now let us study the interaction of holes in Burling graphs. We categorize this interaction in three parts: informally, when two holes are joined by a path of length

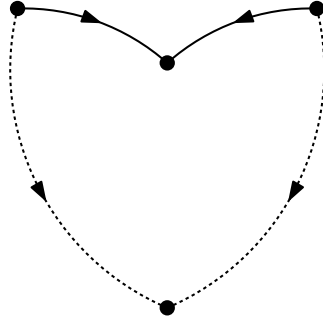

Figure 7.10: Orientation of a hole in a Burling graph. Dashed arcs can be subdivided.

at least 0 (dumbbells), when two holes have exactly one common edge (dominoes), and finally, when three holes form a theta.

Definition 7.33. A dumbbell is a graph made of path $P = x \dots x'$ (possibly $x = x'$), a hole H that goes through x , and a hole H' that goes through x' . Moreover, $V(H) \cap V(P) = \{x\}$, $V(H) \cap V(P') = \{x'\}$, $V(H) \cap V(H') = \{x\} \cap \{x'\}$ and there are no other edges than the edges of the path and the edges of the holes.

Informally, a dumbbell consists of two holes H and H' where one specific vertex of H is connected by a path P of length at least 0 to one specific vertex of H' .

Lemma 7.34. Suppose that a dumbbell with holes H , H' and path $P = x \dots x'$ as in the definition is the underlying graph of some oriented graph G derived from a Burling tree T . Then in G , either x is not a subordinate vertex of H or x' is not a subordinate vertex of H' .

Proof. Suppose, for the sake of contradiction, that the statement does not hold. So, the pivot p of H is in the interior of the path $H \setminus x$ and the pivot p' of H' is in the interior of the path $H' \setminus x'$. By Lemma 7.32 applied to H , every vertex of $G \setminus N[p]$ is a descendant of p in T (notice that $N[p] = N^-[p]$ since the pivot is a sink). By Lemma 7.32 applied to H' , every vertex of $G \setminus N[p']$ is a descendant of p' in T . It follows that p and p' are on the same branch of T . So, up to symmetry, we may assume that p is an ancestor of p' . Let q and r be three vertices of H such that p , q and r are consecutive along H . So, q is an antenna of H (because it is adjacent to the pivot), and r is a descendant of p . But also, by Lemma 7.32, r is also a descendant of p' . Thus p' is between p and r in some branch of T . Now because p and r are both in $c(q)$, so is p' . Hence q is adjacent to p' , a contradiction to the definition of dumbbells. \square

Definition 7.35. A domino is a graph made of one edge xy and two holes H_1 and H_2 that both go through xy . Moreover, $V(H_1) \cap V(H_2) = \{x, y\}$ and there are no other edges than the edges of the holes.

Informally, a domino consists of two holes H_1 and H_2 that have a common edge xy .

Lemma 7.36. Suppose that a domino with holes H_1 and H_2 , and edge xy as in the definition is the underlying graph of some oriented graph G derived from a Burling tree T . Then for some $z \in \{x, y\}$ and some $i \in \{1, 2\}$, z is the pivot of H_i and z is a subordinate vertex of H_{3-i} .

Proof. Let us first prove that one of x or y is the pivot of one of H_1 or H_2 . Assume, for the sake of contradiction, that the pivot p_1 of H_1 is in the path $H_1 \setminus \{x, y\}$ and the pivot p_2 of H_2 is in the path $H_2 \setminus \{x, y\}$. Without loss of generality, assume that yx is an arc of G . Notice that x is different from p_1 and p_2 . Moreover, it is not a neighbor of p_1 or p_2 , because it cannot be a source of H_1 or H_2 . Therefore, $x \in V(G) \setminus (N[p_1] \cup N[p_2])$. Applying Lemma 7.32 to H_1 and H_2 , we conclude that x is a descendant of both p_1 and p_2 . Therefore, up to symmetry, p_1 is a descendant of p_2 .

Let a and a' be the antennas of H_2 . Note that $a, a' \neq x$. Up to symmetry, suppose that x, a, p_2 , and a' appear in this order along H_2 . Let x' be the neighbor of a in $H \setminus p_2$ (so possibly, $x = x'$). Since x and x' are in the same component of $G \setminus (N[p_1] \cup N[p_2])$, we have that x' is a descendant of both p_1 and p_2 . And since $ax' \in A(G)$, we have $x' \in c(a)$, so $p_1 \in c(a)$ and $ap_1 \in A(G)$, a contradiction to the definition of dominoes. Hence, one of x or y is the pivot of one of H_1 or H_2 .

Up to symmetry, suppose that x is the pivot of H_1 . It remains to prove that x is a subordinate vertex of H_2 . First, x cannot be an antenna of H_2 because $yx \in A(G)$. Hence, we just have to prove that x is not the pivot of H_2 . Suppose, for the sake of contradiction, that x is the pivot of H_2 . It follows that y is an antenna of both H_1 of H_2 , so it is a source of G . Let y_1 and y_2 be the neighbors of y in $H_1 \setminus x$ and $H_2 \setminus x$ respectively. Vertices x, y_1 and y_2 are on the same branch B of T (because they are all in $c(y)$). Moreover, since y_1 and y_2 are not centers of star cutsets in G , by Lemma 7.27, in B , the vertex x appears between y_1 and y_2 . If y_2 is deeper than y_1 in T , then y_1 is an ancestor of x while being in the hole H_1 for which x is the pivot, a contradiction. On the other hand, if y_1 is deeper than y_2 in T , then y_2 is an ancestor of x while being in the hole H_2 for which x is the pivot, again a contradiction. This completes the proof of the lemma. \square

Definition 7.37. A theta is a graph made of three internally vertex-disjoint paths of length at least 2, each linking two vertices u and v called the apexes of the theta, and such that there are no other edges in the graph than those of the paths. A long theta is a theta such that all the paths between the two apexes of the theta have length at least 3.

Lemma 7.38. *Suppose a long theta with apexes u and v is the underlying graph of some oriented graph G derived from a Burling tree T . Then exactly one of u and v is the pivot of every hole of G .*

Proof. Let Q_1 , Q_2 , and Q_3 denote the set of the internal vertices of the first, the second, and the third path between u and v , respectively. In particular, $|Q_i| \geq 2$. For $i = 1, 2, 3$, let H_i be the hole induced by $Q_i \cup Q_{i+1} \cup \{u, v\}$ (with subscripts taken modulo 3) and let p_i , a_i , and a'_i denote the pivot and the two antennas of H_i , respectively.

For the sake of contradiction, assume that there is a hole in G , say H_1 , for which neither of u and v is a pivot. Without loss of generality, assume that $p_1 \in Q_1$. Also, notice that a_1 and a'_1 are the two neighbors of p_1 . Thus:

- (i) neither of a_1 and a'_1 are in Q_2 , and consequently, no vertex of Q_2 is a source in G ,
- (ii) because the underlying graph is a long theta, at least one of a_1 and a'_1 , say a_1 , is in Q_1 .

Now consider the hole H_2 . Since the theta is long, if p_2 is in $Q_2 \cup \{u, v\}$, then at least one antenna of H_2 must be in Q_2 which contradicts (i). Thus, $p_2 \in Q_3$. Therefore, with the same argument as before, at least one of a_2 and a'_2 , say a_2 also should be in Q_3 .

Finally, consider the hole H_3 . Notice that $a_1, p_1 \in Q_1$ respectively form a source and a sink for H_3 . On the other hand, $a_2, p_2 \in Q_3$ also, respectively form a source and a sink for H_3 . So, these are the four vertices of H that are not transitive, and therefore, at least three of these four vertices should be consecutive, which is impossible. This contradiction finishes the proof of the lemma. \square

Definition 7.39. *We say that a graph G admits a cordate orientation if it admits an orientation in which every hole of G is oriented as in Corollary 7.31, i.e. it has two sources and two sinks, and the sources have a common neighbor.*

A breach in time. *Using the terminology above, we saw that every Burling graph admits a cordate orientation. What about the converse: if a graph G admits a cordate orientation, is it a Burling graph? The answer is negative. In the next chapter, we introduce some examples of non-Burling graphs that admit cordate orientations. See, for example, flowers and Theta+ in Section 8.5.*

Chapter 8

Burling graphs and non-Burling graphs

8.1	Wheels	107
8.2	Subdivisions of K_4	109
8.3	Graphs whose subdivisions are not Burling	111
8.4	Almost no graph has a subdivision that is Burling . . .	123
8.5	Non-Burling graphs with Burling subdivisions	124

In Section 8.1, we prove that Burling graphs are wheel-free. In Section 8.2, we give a complete characterization of subdivisions of K_4 that are Burling and thus complete the studies started in [CELOdM16]. Sections 8.3 and 8.5 contain several new examples of non-Burling graphs. The difference between the examples of the two sections is that the examples in Section 8.3 are such that no subdivision of them is Burling. In Section 8.4, we show that this is indeed the case for almost all graphs. As described in the introduction, this has applications related to Scott’s conjecture. The examples of Section 8.5, are all examples of triangle-free non-Burling graphs that have some subdivisions that are Burling.

The examples in this chapter have three types of applications. First, each example demonstrates a general technique for proving that a graph is not Burling. Second, they allow us to derive results about the class of Burling graphs. We see examples of such applications in Chapter 9. Finally, they have applications outside the world of Burling graphs (e.g. in χ -boundedness). We postpone this third type of application to Chapter 10.

8.1 Wheels

We recall that a *wheel* is a graph made of hole H called the *rim* together with a vertex c called the *center* that has at least three neighbors in H . In this section, we show that no wheel is a Burling graph.

Theorem 8.1. *No wheel is a Burling graph.*

Proof. Suppose that a graph G is wheel with rim H and center c . Let v be the pivot of H , u and u' its antennas, and w its bottom. So, there is an edge-partition of H into a directed path P_u from u to w , a directed path $P_{u'}$ from u' to w and the edges uw and $u'v$.

We claim that c has at most one neighbor in P_u . Otherwise, c and a subpath P_u form a hole J , and since P_u is directed, this hole cannot contain two sources, a contradiction. Similarly, $P_{u'}$ contains at most one neighbor of c . Hence, the only possibility for c to have at least three neighbors in H is that c is adjacent to v , to one internal vertex of P_u and to one internal vertex of $P_{u'}$. Notice that c cannot be adjacent to u or u' otherwise there will be a triangle in G .

Two holes H_u and $H_{u'}$ of G , containing respectively u and u' , go through the edge vc , forming a domino. Since c is not adjacent to the sources of u and u' , it can be the pivot of neither H_u nor $H_{u'}$. Hence, by Lemma 7.36 v must be the pivot of either H_u or $H_{u'}$, say of H_u up to symmetry. Let x be the neighbor of c in P_u . Since v is the pivot of H_u , cx is an arc of G . Since x is not the pivot of H_u , by Lemma 7.36 x is the pivot of H_w , that is the hole of G containing c and w . Hence, x is a sink of H_v , a contradiction to P_u being directed from u to w . \square

The theorem above has been also proved independently by Davies [Dav21] in 2021, with a different technique. However, the first written proof of it that we are aware of is from 2020, in the master thesis of the author, see [Pou20] (which is the same proof that also appears in [PT23]).

Remark 8.2. *Wheels are restricted frame graphs. (see Theorem A.1 and Figure 7 in [CELOdM16]). So, wheels are among the examples which show that Burling graphs form a strict subclass of restricted frame graphs.*

Remark 8.3. *It is easy to see that wheels are critically non-Burling, i.e. removing any vertex from a wheel results in a Burling graph because removing a vertex from a wheel, possibly after removing also some vertices of degree 1, results in an underlying graph of an oriented chandelier. Moreover, the subdivisions of subgraphs of a wheel also can be Burling graphs. See Figure 8.1.*

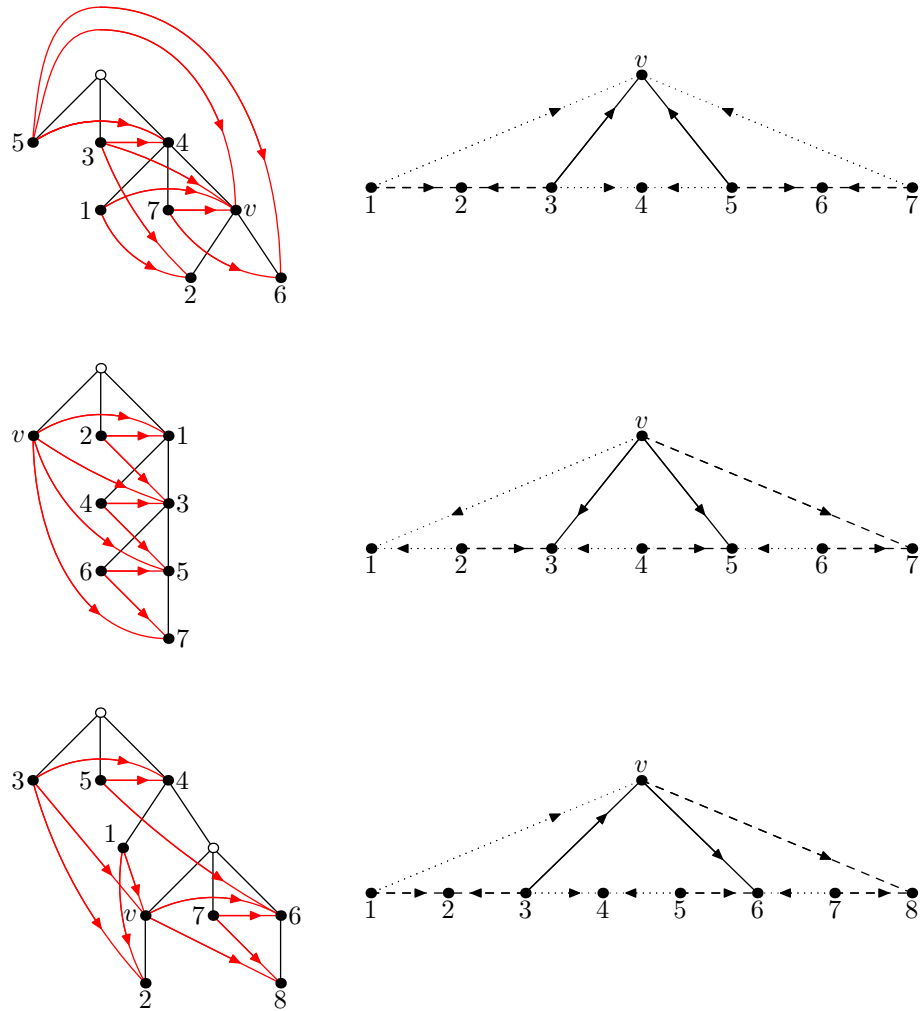

Figure 8.1: Burling graphs close to wheels. Dotted and dashed edges can be subdivided.

8.2 Subdivisions of K_4

In this section, we determine exactly which subdivisions of K_4 are Burling graphs and which are not.

We recalled the definition of restricted frame graphs from [CELOdM16] in Chapter 3 (see Definition 3.4). In [CELOdM16], Chalopin, Esperet, Li, and Ossona de Mendez, characterized subdivisions of K_4 that are restricted frame graphs.

Theorem 8.4 (Chalopin, Esperet, Li, and Ossona de Mendez). *Let G be a triangle-free subdivision of K_4 . Then G is a restricted frame graph if and only if one of the following happens:*

1. *at most 3 of the edges of the K_4 are subdivided to obtain G ,*
2. *exactly 4 edges of the K_4 is subdivided and the two non-subdivided edges share an end-point.*

Restricted frame graphs, however, are a superclass of Burling graphs, and it might be that some of the subdivisions of K_4 that are restricted frame graphs are not Burling graphs. It appears that this is the case. So, we characterize the subdivisions of K_4 that are Burling graphs.

Theorem 8.5. *Let G be a non-oriented graph obtained from K_4 by subdividing edges. Then G is a Burling graph if and only if G contains four vertices a, b, c , and d of degree 3 such that $ab, ac \in E(G)$ and $ad, bc \notin E(G)$.*

Proof. Suppose that G is a Burling graph. Let a, b, c and d be the four vertices of degree 3 of G . If $G[\{a, b, c, d\}]$ contains no vertex of degree at least 2, then G is isomorphic to one of the graphs represented in Figure 8.2, so G has no star cutset, a contradiction to Theorem 8.4. So, up to symmetry, we may assume that a has degree at least 2 in $G[\{a, b, c, d\}]$, so up to symmetry $ab, ac \in E(G)$. If $bc \in E(G)$, then G contains a triangle, a contradiction to Lemma 4.9. So, $bc \notin E(G)$. If $ad \in E(G)$, then G is a wheel, a contradiction to Theorem 8.1. So, $ad \notin E(G)$. We proved that $ab, ac \in E(G)$ and $ad, bc \notin E(G)$.

Conversely, if we suppose that $ab, ac \in E(G)$ and $ad, bc \notin E(G)$, then G is obtained by subdividing dashed edges of the graph represented in Figure 7.5. It is therefore a Burling graph as explained after the proof of Theorem 7.7. \square

Let G be a subdivision of K_4 , which is a Burling graph. We say that G is of type i , for $i = 2, 3, 4$, if exactly i edges of the K_4 are properly subdivided to obtain G . Notice that by Theorem 8.5, up to symmetry, there is only one possibility for the choice of the edges to subdivide for each type. See Figure 8.3.

Let us finish this section by proving a few more structural theorems about type 4 subdivisions of K_4 as derived graphs. The following results, as well as the previous ones, appear to be useful in proving the results of the next sections.

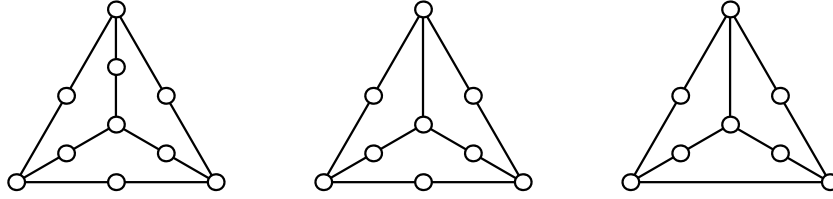

Figure 8.2: Some subdivisions of K_4 that are not Burling graphs.

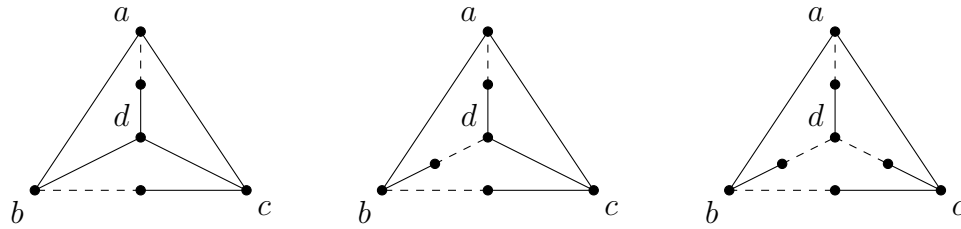

Figure 8.3: Subdivisions of K_4 that are Burling graphs. In order from left to right: type 2, type 3, and type 4. Only dashed edges can be subdivided.

We start with the fact that the type 4 subdivisions of K_4 are restricted in the way that they can be derived from a Burling tree. In particular, they always have a unique center of an in-star cutset, as shown in Lemma 8.6.

Lemma 8.6. *Let G be an oriented derived graph whose underlying graph is a type 4 subdivision of K_4 . If x is the common end-point of the two non-subdivided arcs, then x is the unique center of an in-star cutset in G . In particular, the two non-subdivided arcs are oriented toward x . See Figure 8.4.*

Proof. First, G has an in-star cutset due to Theorem 7.30 because it is not a chandelier and has no vertex of degree 1.

Moreover, if a vertex v is the center of an in-star cutset in G , then v is the center of a star cutset in the underlying graph of G . Since any vertex other than x cannot

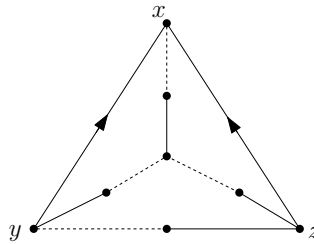

Figure 8.4: The vertex x is the unique center of an in-star cutset in G .

be the center of a star cutset in the underlying graph of G , x is the unique center of an in-star cutset in G . \square

Let G be a non-oriented derived graph. We call a vertex v a *global subordinate* vertex of G if for any oriented derived graph \tilde{G} for which G is the underlying graph, v is a subordinate vertex of some hole in \tilde{G} . Our goal is to prove that type 4 subdivisions of K_4 have a precise global subordinate vertex.

Lemma 8.7. *Let G be a type 4 subdivision of K_4 . Let x be the common end-point of the two non-subdivided edges of G , and let y and z be its degree 3 neighbors. For any subdivision G^* of G which is a derived graph, $yx, zx \in E(G^*)$, and for any $w \in \{y, z\}$, x is the pivot of exactly one of the two holes going through xw , and is a subordinate vertex of the other. In particular, x is a global subordinate vertex of G^* .*

Proof. If either of xy or xz are not edges of G^* , then by Theorem 8.5, G^* is not a derived graph and there is nothing to prove. So, suppose that $yx, zx \in E(G^*)$, and hence G^* is a derived graph, meaning that it is the underlying graph of an oriented derived graph. Consider this orientation on G^* . By Lemma 8.6, x is the only center of an in-star cutset in G^* . So, x is not the antenna of any hole in G^* . Consider the two holes passing through the arc xw in G^* and call them H_1 and H_2 . They form a domino, so by Lemma 7.36, for some $u \in \{x, w\}$ and for some $i \in \{1, 2\}$, u is the pivot of H_i and u is a subordinate vertex of H_{3-i} . Because the arc wx is oriented from w to x , then w cannot be the pivot of any of the two holes. Thus in G^* , the vertex x is the pivot of one of the two holes, and the subordinate vertex of another. \square

8.3 Graphs whose subdivisions are not Burling

In this section, we provide several examples of graphs G such that no subdivision of G is a Burling graph.

8.3.1 Complete graphs

We saw in Section 8.2 that some subdivisions of K_4 are Burling graphs. In this section, we prove that for $n \geq 5$, no subdivision of K_n is a Burling graph.

Lemma 8.8. *Let G be a triangle-free subdivision of K_5 . If all the subdivisions of K_4 in it are of types 2, 3, and 4, then G has one of the following forms:*

- (i) *type A: edges of a 4-cycle in G are not subdivided at all, and any other edge is subdivided at least once.*
- (ii) *type B: edges of a 5-cycle in G are not subdivided at all, and any other edge is subdivided at least once.*

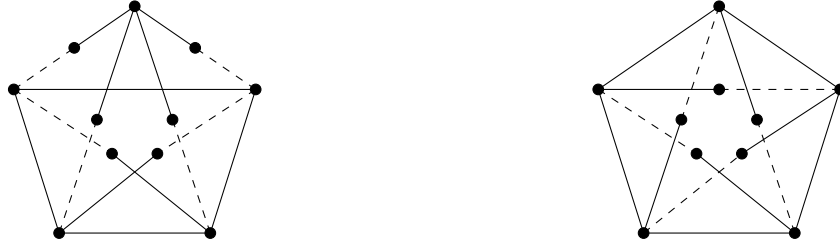

Figure 8.5: Subdivisions of K_5 , type A subdivision on the left and type B subdivision on the right. Only dashed edges can be subdivided.

See Figure 8.5.

Proof. Let $M = \{a, b, c, d, e\}$ be the set of vertices of G of degree 4. For $x \in M$, we denote by H_x the subdivision of K_4 containing $M \setminus \{x\}$ in G . By Lemma 8.5, for all $x \in M$, H_x is a type 2, 3, or 4 subdivision of K_4 . In particular, consider H_e . There are three cases:

Case 1. H_e is of type 2. Without loss of generality, let ac and bd be the subdivided edges of H_e . Let $v \in \{a, b, c, d\}$. If $ev \in E(G)$, then v is the center of a wheel in G , a contradiction. Thus, ev is subdivided, and G is a type A subdivision of K_5 .

Case 2. H_e is of type 3. Without loss of generality, let ab , ac , and bd be the subdivided edges of H_e . So, $ad, cd, bc \in E(G)$. If ce is not subdivided in G , then H_a is a wheel centered at c , a contradiction. Thus, ce is subdivided in G . Similarly, one can prove that de must be subdivided. Now, because H_d must be of type 2, 3, or 4, $be \in E(G)$. Then, because H_c must be of type 2, 3, or 4, $ae \in E(G)$. So, G is a type B subdivision of K_5 .

Case 3. H_e is of type 4. Without loss of generality, let ab , ac , ad , and bd be the subdivided edges of H_e . First of all, ce must be subdivided, otherwise, H_a will be a wheel centered at c . Secondly, because H_b should be of type 2, 3, or 4, we must have $de \in E(G)$. In the same way, because H_d should be of type 2, 3, or 4, we must have $be \in E(G)$. Finally, ae must be subdivided, otherwise, H_c will be a wheel centered at e . So, in this case, G is a type A subdivision of K_5 . \square

Lemma 8.9. *If G is a type A subdivision of K_5 , then it is not a derived graph.*

Proof. Let $\{a, b, c, d, e\}$ be the set of vertices of degree 4 in G . Without loss of generality, assume that $ab, bc, cd, da \in E(G)$. The graph H shown in Figure 8.6 is an induced subgraph of G .

Notice that H has no star cutset, it has no vertex of degree 1, and it is not a chandelier (because in H , for every vertex there is a cycle not containing it). Hence, by Theorem 7.30, H is not a derived graph, and thus, G is not a derived graph either. \square

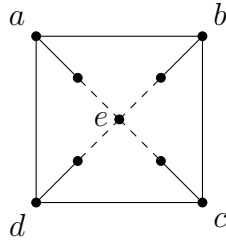

Figure 8.6: A subgraph of a type A subdivision of K_5 .

Lemma 8.10. *If G is a type B subdivision of K_5 , then it is not a derived graph.*

Proof. Let $M = \{a, b, c, d, e\}$ be the set of degree 4 vertices of G . Without loss of generality, we may assume that $ab, bc, cd, de, ea \in E(G)$. For $u, v \in M$, $u \neq v$, let P_{uv} denote the degree 2 vertices of the path replacing the edge uv when subdividing it. In particular $u, v \notin P_{uv}$. For simplicity in writing, we denote a hole of G by only naming the vertices of M in that hole, if there is no confusion.

For the sake of contradiction, suppose that G is a derived graph. So there is an orientation of G such that G is an oriented derived graph. From now on, consider G with this orientation. We denote the arcs of G in this orientation by $A(G)$.

Consider the hole $abcdea$ in G . Without loss of generality, by Corollary 7.31, we may assume that a and c are its sources, and b and e are its sinks.

Now, consider the hole $ecde$. Vertex d is neither a sink nor a source for this hole, and c also cannot be a sink of it because $cd \in A(G)$. Therefore, the two sinks of $ecde$ are among $P_{ce} \cup \{e\}$. Call them t_1 and t_2 , and without loss of generality assume $t_1 \in P_{ce}$.

Then, consider the hole $abca$. For this hole, a and c cannot be sinks because $ab, cd, \in A(G)$, and b is a sink. So, there is exactly one sink in P_{ac} , call it t_3 .

Finally, consider the hole $acea$. Notice that t_1 and t_3 are the two sinks of $acea$. If $t_2 \in P_{ce}$ then it will be a third sink for $acea$, a contradiction. If $t_2 = e$, let $f \in P_{ce}$ be the neighbor of e on the subdivided edge between c and e . Then $fe \in A(G)$, and since we also have $ae \in A(G)$, then again e will be a third sink for $acea$, a contradiction. So G is not a Burling graph. \square

Theorem 8.11. *Let $n \geq 5$ be an integer. The class of derived graphs contains no subdivision of K_n .*

Proof. Let us first prove the theorem for $n = 5$. Let G be a subdivision of K_5 . If it has a triangle, then it is not a derived graph. So, we may assume that G is triangle-free. If G includes a subdivision of K_4 as an induced subgraph, this subdivision of K_4 must be of type 2, 3, or 4, otherwise, by Lemma 8.5, G cannot be a derived graph. Thus, by Lemma 8.8, G is either a type A or a type B subdivision of K_5 . So, the result follows from Lemmas 8.9 and 8.10. Now, for $n > 5$, the result follows from

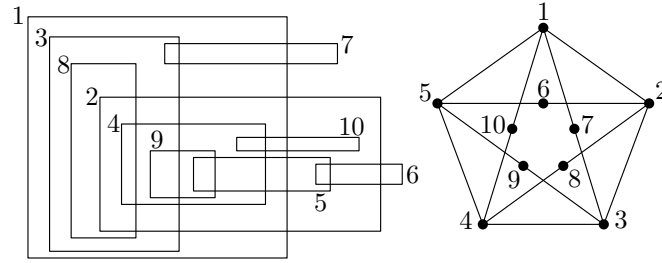

Figure 8.7: A type B subdivision of K_5 and its representation as a restricted frame graph.

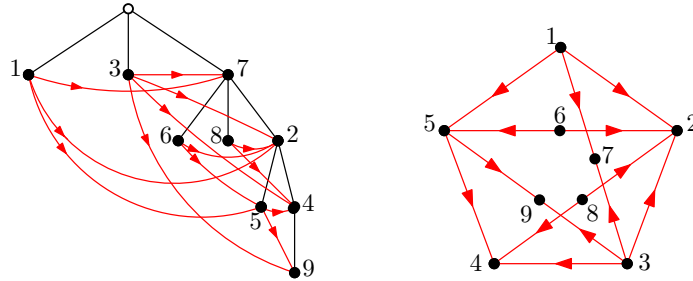

Figure 8.8: A type B subdivision of K_5 minus one vertex, shown as a derived graph

the fact that every subdivision of K_n contains a subdivision of K_5 as an induced subgraph. \square

Remark 8.12. *There are subdivisions of K_5 that are restricted frame graphs. Figure 8.7 represents a type B subdivision of K_5 as a restricted frame graph. Type A subdivisions of K_5 , however, are not restricted frame graphs (this follows from Theorem 3.3 of [CELOdM16], see Theorem 3.5.)*

Remark 8.13. *Let G be the graph shown in Figure 8.7. This graph is minimally non-Burling: if one removes one vertex of it, it becomes a Burling graph. By deleting a vertex of degree 4 (e.g. vertex 1), one obtains a type 3 subdivision of K_4 which is a Burling graph, and by deleting a vertex of degree 2 (e.g. vertex 10) one obtains a graph isomorphic to the underlying graphs of the derived graph represented in Figure 8.8.*

8.3.2 Necklaces

We remind that connecting two vertices by a path of length 0 means identifying the two vertices.

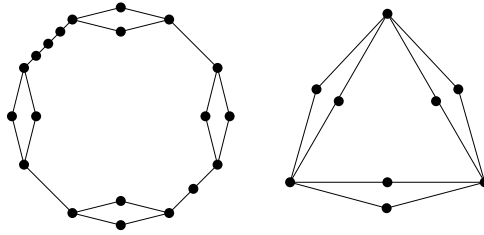

Figure 8.9: A 4-necklace (left) and a 3-necklace (right). Any edge of the two graphs can be subdivided.

Let B_1, B_2, \dots, B_m , ($m \geq 2$), be cycles of length at least 4. For $1 \leq i \leq m$, let a_i and b_i be two non-adjacent vertices of B_i . For $1 \leq i \leq m$, connect b_i and a_{i+1} by a path of length at least 0 (where $a_{m+1} = a_1$). The resulting graph G is called an m -necklace. A necklace graph is a graph which is an m -necklace for some $m \geq 2$. Each B_i is called a *bead* of G . We say that B_i is a *short* bead if a_i and b_i have a common neighbor. Notice that necklaces are triangle-free graphs. See Figure 8.9.

In this section, we characterize the necklaces which are Burling graph. Table 8.1 shows a summary of the results of this section.

	without star cutset	with star cutset
$m = 2$	Burling graph \Leftrightarrow the two beads have a common vertex (Lemma 8.15)	always Burling graph (Lemma 8.15)
$m = 3$	never Burling graph (Lemma 8.16)	Burling graph \Leftrightarrow there exists a short bead such that the two other beads have a common vertex (Lemma 8.16)
$m \geq 4$	never Burling graph (Lemma 8.17)	

Table 8.1: m -Necklaces and the class of Burling graphs.

Lemma 8.14. *A necklace graph G has a star cutset if and only if it has a short bead.*

Proof. If G has a short bead B_i , the common neighbor of a_i and b_i is the center of a star cutset. On the other hand, if G has no short bead, then it is easy to see that it does not have a star cutset. \square

Lemma 8.15. *A 2-necklace graph G is a derived graph if and only if it has a star cutset or its two beads have a common vertex.*

Proof. First, suppose that G is a derived graph. If it has a star cutset, we are done. Otherwise, because it has no vertex of degree 1, by Theorem 7.30, it should be a

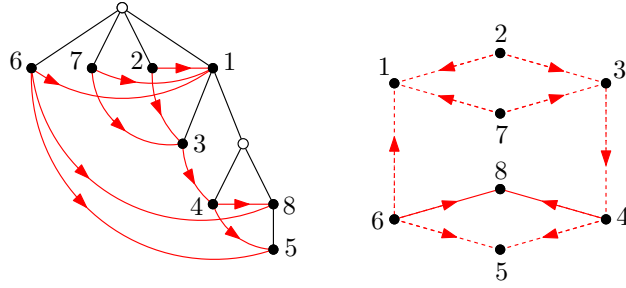

Figure 8.10: A 2-necklace presented as a derived graph

chandelier. In particular, there exists a vertex v in G which is contained in all cycles of G . So, the two beads of G both contain v .

Conversely, if the beads of G have a common vertex, then G is a chandelier (with the pivot being a common vertex of the two beads). So, it is a Burling graph by Lemma 7.25. If the beads of G do not have a common vertex, then G has a star cutset, and thus by Lemma 8.14, it has a short bead. Therefore, G can be obtained from the underlying graph of the graph shown in Figure 8.10 (right) by subdividing some (possibly none) of the dashed arcs. In Figure 8.10, a presentation of the graph on the right as a derived graph is shown. Notice that all the dashed arcs are either a top-arc starting in a source of G or a bottom-arc of G , so by Theorem 7.7, we may subdivide them. So, every 2-necklace with a short bead is a derived graph. \square

Lemma 8.16. *Let G be a 3-necklace. The graph G is a derived graph if and only if it has at least one short bead B and the two other beads have a vertex in common.*

In particular, if G has no star cutset, then it is not a derived graph.

Proof. First, assume that G is a derived graph and let B_i , $1 \leq i \leq 3$ be its beads. There is an orientation of G such that G with this orientation is an oriented derived graph. For each bead B_i , let P_i and Q_i denote the internal vertices of the two paths between a_i and b_i in B_i . We recall that a vertex of a hole is a singularity if it is a sink or source in that hole. Notice that each B_i is a hole in G , so by Corollary 7.31 it should have four singularities, and thus there is at least one of P_i and Q_i , say P_i , which contains at least one singularity of B_i . Denote this singularity by x_i . Let C be the cycle in G obtained by removing the vertices of Q_1 , Q_2 , and Q_3 . Notice that C is a hole in G , and that x_1 , x_2 , and x_3 are singularities for it. Let x_4 be the fourth singularity of C . Notice that three of the singularities of C should be consecutive vertices and that no two vertices among x_1 , x_2 , and x_3 are neighbors. So, x_4 should be the common neighbor of two of x_1 , x_2 , and x_3 , and x_4 cannot be inside Q_i 's or P_i 's. We assume without loss of generality that x_4 is a common neighbor of x_1 and x_2 . So, B_1 and B_2 have a common vertex which is $a_2 = b_1$. Thus, x_4 is the common vertex of B_1 and B_2 . This implies that x_1 and x_2 are the antennas of the hole C .

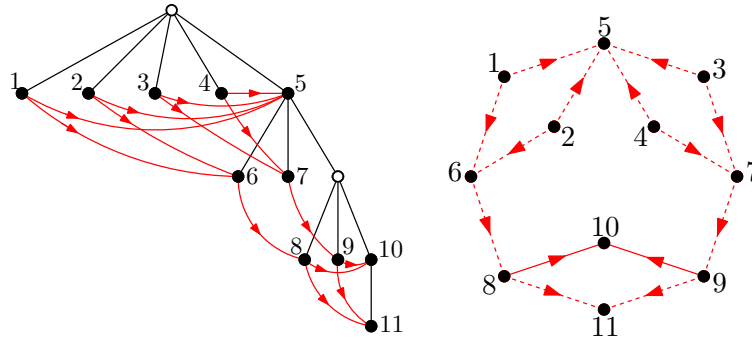

Figure 8.11: A 3-necklace presented as a derived graph.

So, C cannot have another antenna. In particular, P_3 contains no source. Also, Q_3 contains no source, because we can repeat the same argument by exchanging the role of P_3 and Q_3 . Thus, the antennas of B_3 should be a_3 and b_3 . Hence, they should have a common neighbor, and therefore B_3 is a short bead.

Now, suppose that G has two beads B_1 and B_2 with a common vertex, and a short bead B_3 . In such case, an orientation of G can be obtained from the graph in Figure 8.11 by first possibly contracting arc 6-8 or both arcs 6-8 and 7-9, and then subdividing some of the dashed arcs (including 6-8 and 7-9, if they are not contracted). By Lemma 7.8, we can contract one or both arcs 6-8 and 7-9, preserving the top-arcs and bottom-arcs. Then, all the dashed edges (including 6-8 and 7-9, if they are not contracted) are top-arcs starting at a source of the graph or bottom-arcs of the graph. So, we can subdivide them as many times as needed. So G is a derived graph.

Finally, notice that if G has no star cutset, then by Lemma 8.14 it cannot have a short bead, so it is not a derived graph. \square

Lemma 8.17. *Let G be an m -necklace graph. If $m \geq 4$, then G is not a derived graph.*

Proof. Assume, for the sake of contradiction, that G is a derived graph. So, it is the underlying graph of an oriented derived graph. Consider this orientation on G . Let B_1, B_2, \dots, B_m be the beads of G . Let P_i and Q_i be the internal vertices of the two paths between a_i and b_i on the bead B_i , $1 \leq i \leq m$. Each B_i is a hole in G and thus by corollary 7.31, it has four singularities. In particular, at least one of P_i and Q_i , say P_i , has at least one singularity. Let C be the cycle in G obtained by removing the vertices of $Q_i, 1 \leq i \leq m$, and notice that C is a hole in G . A singularity in P_i for B_i is also a singularity for C . But C should have exactly four singularities, so $m \leq 4$, and hence $m = 4$, and each P_i has exactly one singularity, and the singularities on P_i 's are exactly the singularities of C . Now, notice that three of the singularities of

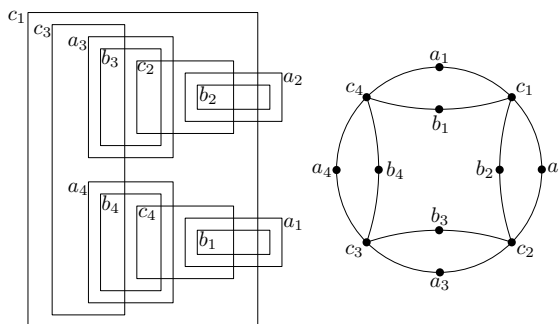

Figure 8.12: A 4-necklace, presented as a frame graph.

C should be consecutive vertices, which is not possible because no vertex of P_i is a neighbor of a vertex of P_j if $i \neq j$. This is a contradiction. So, G is not a Burling graph. \square

We can summarize all the lemmas above in the following theorem.

Theorem 8.18. *Let G be an m -necklace.*

1. *If $m = 1$, then G is a Burling graph.*
2. *If $m = 2$, then G is a Burling graph if and only if either it has a star cutset or the two beads of G have a common neighbor.*
3. *If $m = 3$, then G is a Burling graph if and only if there exists a short bead among its beads such that the two other beads have a common vertex.*
4. *If $m \geq 4$, then G is not a Burling graph.*

See Table 8.1.

Proof. Follows directly from Lemmas 8.15, 8.15, 8.16, and 8.17. \square

Remark 8.19. *Let G be a necklace. If G does not have a star cutset, then G is not even a restricted frame graph. This follows from Theorem 8.4. But if G has a star cutset, then it might be a restricted frame graph. See Figure 8.12 for an example of a non-Burling necklace which is a restricted frame graph.*

8.3.3 Dumbbells

Given two graphs G_1 and G_2 and two vertices $x_1 \in V(G_1)$ and $x_2 \in V(G_2)$, one can build a graph D as follows: first take the disjoint union of G_1 and G_2 and then connect x_1 and x_2 by a path of length at least 0, to obtain D . Any graph D built as above is called a *dumbbell* of G_1 and G_2 with respect to x_1 and x_2 . See Figure 8.13 for some examples.

Recall that in a non-oriented derived graph G , a vertex v a *global subordinate* vertex of G if for any oriented derived graph \tilde{G} for which G is the underlying graph, v is a subordinate vertex of some hole in \tilde{G} .

Theorem 8.20. *Let G_1 and G_2 be two derived graphs, and let $x_1 \in V(G_1)$ and $x_2 \in V(G_2)$. If x_i is a global subordinate vertex of G_i , for $i = 1, 2$, then any dumbbell D of G_1 and G_2 with respect to x_1 and x_2 is not a derived graph.*

Proof. Assume that D is a derived graph. By definition of global subordinate vertex, for $i = 1, 2$, there is a hole H_i in G_i for which x_i is a subordinate vertex. So, the dumbbell built by holes H_1 and H_2 and the path between x_1 and x_2 is an induced subgraph of D , and thus is a derived graph, a contradiction with Lemma 7.34. \square

Remark 8.21. *Notice that if one of G_1 or G_2 is not a derived graph, then the dumbbell of G_1 and G_2 with respect to any two vertices is not a derived graph, because Burling graphs are closed under taking induced subgraphs.*

Theorem 8.20 provides a tool for finding a new family of graphs that are not weakly pervasive. In particular, we can find examples of graphs with vertex-cuts.

We prove a lemma for thetas, similar to Lemma 8.7 for type 4 subdivision of K_4 .

Lemma 8.22. *Let G be a long theta with apexes u and v . If x is a vertex of degree 2 in G such that its two neighbors are also of degree 2, then x is a global subordinate vertex in any subdivision of G .*

Proof. By Lemma 7.38, for any derived graph \tilde{G} for which G is an underlying graph, there is $w \in \{u, v\}$ such that w is the pivot of all holes of \tilde{G} , and thus the antennas of all holes are among the neighbors of w . By assumptions, x is distinct from w and is not one of its neighbors. Thus, x is a global subordinate vertex of G . \square

Theorem 8.23. *Let G be a dumbbell of two graphs G_1 and G_2 with respect to x_1 and x_2 where for each $i \in \{1, 2\}$, the graph G_i and vertex x_i is one of the following:*

- G_i is any type 4 subdivision of K_4 and x_i is the common end-point of its two non-subdivided edges,
- G_i is any long theta and x_i is a degree 2 vertex in G_i whose neighbors are also of degree 2.

Then, no subdivision of G is not a Burling graph. See Figure 8.13.

Proof. If a subdivision of G_i is not a Burling graph, then neither is the dumbbell containing it. Otherwise, the result follows from Lemma 8.7 and Lemma 8.22 by applying Theorem 8.20. \square

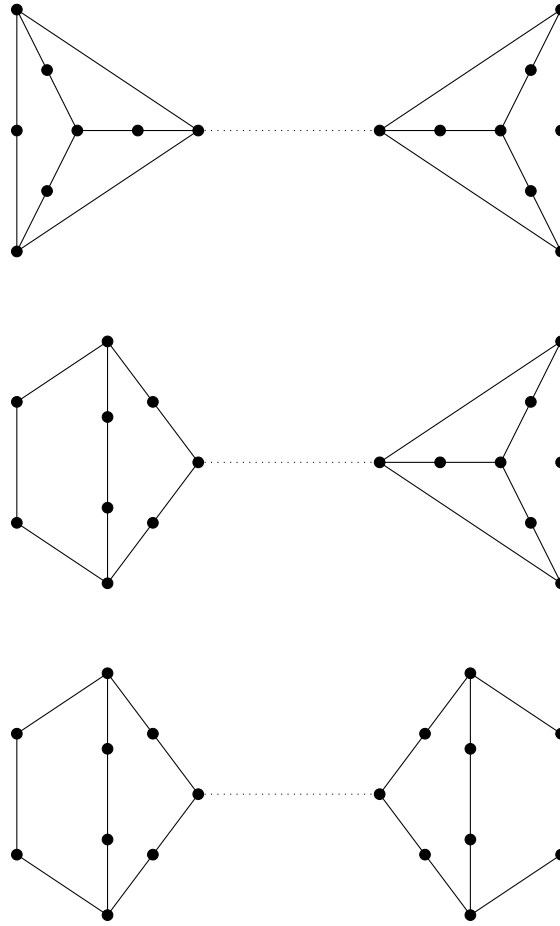

Figure 8.13: Some graphs that are not Burling graphs. One can subdivide any edge, or contract the dotted edges, and still have a graph that is not a Burling graph.

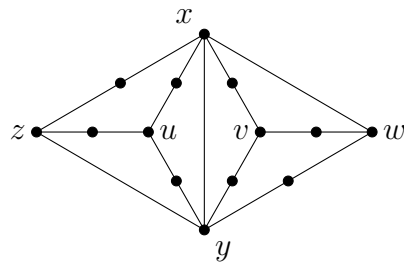

Figure 8.14: No subdivision of this graph is a Burling graph. Theorem 8.24.

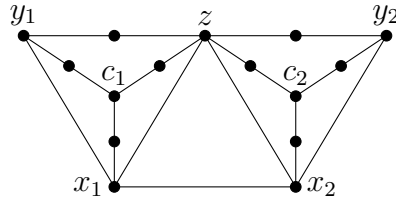

Figure 8.15: No subdivision of this graph is a Burling graph. Theorem 8.25.

8.3.4 Miscellaneous

First example

Theorem 8.24. *Let G be the graph shown in Figure 8.14. No subdivision of G is a derived graph.*

Proof. Let G^* be a subdivision of G . The graph G^* contains two subdivisions of K_4 as induced subgraphs: one whose degree 4 vertices are exactly $\{u, x, y, z\}$ and does not contain v and w , which we denote by H_l , and the other whose degree 4 vertices are exactly $\{v, x, y, w\}$ and does not contain u and z , which we denote by H_r .

If in constructing G^* , any of the edges xy , zy , or xw is subdivided, then G^* contains a subdivision of K_4 which, by Theorem 8.5, is not a Burling graph, so G^* is not a Burling graph. Hence, we may assume that $xy, zy, xw \in E(G^*)$.

For the sake of contradiction, assume that G^* is a derived graph, and consider its orientation as an oriented derived graph. Notice that H_l and H_r are also derived graph. But neither of H_r and H_l are chandeliers, so by Theorem 7.30, each of them should have an in-star cutset. Now by Lemma 8.6, the center of the in-star cutset of H_l can only be y , so the edge xy should be oriented from x to y in G^* . On the other hand, again by Lemma 8.6, the center of the in-star cutset of H_r can only be x , so the edge xy should be oriented from y to x in G^* . This contradiction shows that G^* is not a Burling graph. \square

Second example

Theorem 8.25. *Let G be the graph shown in Figure 8.15. No subdivision of G is a derived graph.*

Proof. Let G^* be a subdivision of G . If any of the edges x_1y_1 , x_1z , x_2y_2 , and x_2z are subdivided in G^* , then by Theorem 8.5, it contains a non-Burling subdivision of K_4 and thus is not a derived graph. So, we may assume that all those 4 edges are edges of G^* , in which case if $x_1x_2 \in E(G^*)$, then G^* has a triangle and thus is not a Burling graph. So, we may also assume that x_1x_2 is subdivided in G^* .

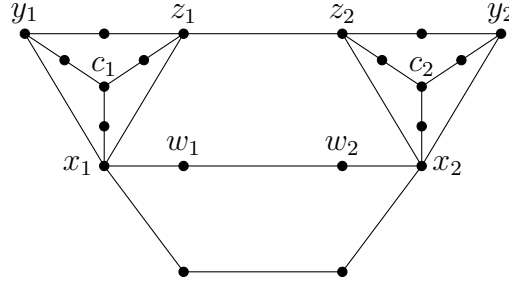

Figure 8.16: No subdivision of this graph is a Burling graph. Theorem 8.26.

For the sake of contradiction, consider any orientation on G^* which makes it an oriented derived graph, and let $A(G^*)$ be the set of the arcs of G^* . Let $i \in \{1, 2\}$. By Lemma 8.7, $y_i x_i, z x_i \in A(G^*)$. Also, by Lemma 8.7, x_i is the pivot of exactly one of the following two holes containing the edge $z x_i$: the hole containing the paths obtained by subdividing $x_i c_i$ and $c_i z$, and the hole containing $x_i y_i$ and the path obtained by subdividing the $y_i z$. Denote this hole by H_i . Now consider the hole H formed by $z x_1, z x_2$, and the path obtained by the subdivision of the edge $x_1 x_2$. The two holes H and H_i form a domino. Therefore, by Lemma 7.36, for some $u \in \{x_i, z\}$, u is a subordinate vertex of one of the holes and the pivot of the other. Notice that u cannot be z because $z x_i \in A(G^*)$. Thus $u = x_i$, and as x_i is the pivot of H_i , it is a subordinate vertex of H .

Therefore, in H , the vertex z is a source, and both its neighbors, namely x_1 and x_2 , are subordinate vertices of H . This contradicts Corollary 7.31. Thus, G^* is not a derived graph. \square

Third example

Theorem 8.26. *Let G be the graph shown in Figure 8.16. No subdivision of G is a derived graph.*

Proof. Let G^* be a subdivision of G . If any of the edges $x_1 y_1, x_1 z_1, x_2 y_2$, and $x_2 z_2$ are subdivided in G^* , then by Theorem 8.5, it contains a non-Burling subdivision of K_4 and thus is not a derived graph. So, we may assume that all those 4 edges are edges of G^* .

For the sake of contradiction, consider any orientation on G^* which makes it an oriented derived graph, and let $A(G^*)$ be the set of the arcs of G^* . Let $i \in \{1, 2\}$. By Lemma 8.7, $y_i x_i, z_i x_i \in A(G^*)$. Again By Lemma 8.7, x_i is the pivot of exactly one of the following two holes containing the edge $z_i x_i$: the hole containing the paths obtained by subdividing $x_i c_i$ and $c_i z_i$, and the hole containing $x_i y_i$ and the path obtained by subdividing the $y_i z_i$. Denote this hole by H_i . Now consider the hole H

passing through z_1x_1, z_2x_2 , the path obtained by the subdivision of the edge z_1z_2 , and the path $x_1w_1 \dots w_2x_2$. The two holes H and H_i form a domino. Therefore, by Lemma 7.36, for some $u \in \{x_i, z_i\}$, u is the subordinate vertex of one of the holes and the pivot of the other. Notice that u cannot be z because $z_ix_i \in A(G^*)$. Thus $u = x_i$, and as x_i is the pivot of H_i , it is a subordinate vertex of H . But by Lemma 7.38, either x_1 or x_2 should be the pivot of every hole in the long theta in G^* . This contradiction completes the proof. \square

8.4 Almost no graph has a subdivision that is Burling

Since Burling graphs are triangle-free, almost all graphs are not Burling. However, in this short section, we prove that almost all graphs have no Burling subdivision.¹

Let us start by fixing our model of random graphs. We use $\mathbb{G}(n, p_n)$ model, which, for a fixed $n \in \mathbb{N}$ and $p_n \in [0, 1]$, is a probability space $(\Omega_n, \mathcal{P}(\Omega_n), \mathbb{P}_n)$ where Ω_n is the set of all labeled graphs G with $V(G) = \{1, 2, \dots, n\}$ and \mathbb{P}_n is the edge-percolation probability measure, i.e. if $G \in \Omega_n$ with m edges, then we have $\mathbb{P}_n(G) = p_n^m(1 - p_n)^{\binom{n}{2} - m}$.

Let \mathcal{P} be a property of graphs that does not depend on the labeling of the vertices (e.g. being a Burling graph, having a clique of size at least 5, etc.), precisely, let P be a class of graphs. Let $X_n^P : \Omega_n \rightarrow \{0, 1\}$ be a random variable defined by $X_n^P = \mathbf{1}_{P \cap \Omega_n}$. In other words, $X_n^P(G) = 1$ if and only if G has property P . When we say that “almost all graphs have property P ” if

$$\lim_{n \rightarrow \infty} \mathbb{P}(X_n^P(G) = 1 \mid G \in \mathbb{G}(n, p_n)) = 1.$$

We state the following well-known theorem here and include the proof in Appendix C.

Lemma 8.27. *Let $p \in (0, 1]$. Then we have*

$$\lim_{n \rightarrow +\infty} \mathbb{P}(\omega(G) \geq 5 \mid G \in \mathbb{G}(n, p)) = 1.$$

In particular, Lemma 8.27 states that almost all graphs have a clique of size 5.

We say that a graph G is *strongly non-Burling* if no subdivision of G is a Burling graph.

Theorem 8.28. *Almost all graphs are strongly non-Burling.*

Proof. Notice that if G has a K_5 , then Theorem 8.11 implies that G is strongly non-Burling. So, the result follows from Lemma 8.27. \square

¹This was pointed out to the author by Paul Meunier.

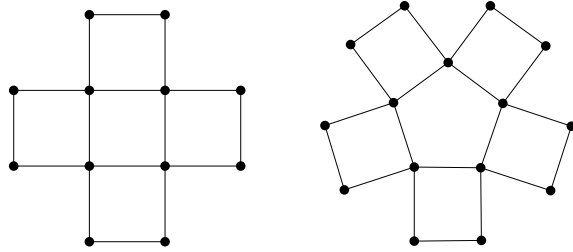

Figure 8.17: Examples of flowers.

8.5 Non-Burling graphs with Burling subdivisions

In this section, we give some examples of graphs that are not Burling and show that some of their subdivisions are Burling. It is noteworthy that the examples in this section all have star cutsets and thus we need to go beyond the method following from [CELOdM16], where all examples have no star cutsets.

Flowers

A *flower* is a graph G made of a hole H where every edge e is part of a hole H_e . Moreover, $V(H) \cap V(H_e) = e$, for all edges e, f of H , $V(H_e) \cap V(H_f) = e \cap f$, and the only edges and vertices of G are those of the H_e 's. In Figure 8.17, two examples of flowers are represented.

Theorem 8.29. *No flower is a Burling graph.*

Proof. Suppose G is a flower with a hole H as in the definition. Let v be the pivot of H , and u, w the two neighbors of v in H . So, H_{uv} and H form a domino, and by Lemma 7.36, one of the two vertices u and v should be the pivot of one of the two holes and a subordinate vertex of the other. Notice that u cannot be a pivot of any of the two holes because uv is an arc. So, v is a subordinate vertex of H_{uv} . Similarly, v is a subordinate vertex of H_{vw} . Hence, H_{vw} and H_{uv} contradict Lemma 7.34 (since H_{vw} and H_{uv} form a dumbbell). \square

Remark 8.30. *It is easy to see that every flower admits a cordate orientation. So, flowers are examples of graphs that show that there are graphs that admit cordate orientations but are not Burling graphs.*

Remark 8.31. *Flowers are vertex-critical non-Burling graphs. We leave this fact unproved for the general case. For flowers with 4 or 5 petals, however, this can be seen from Figure 8.18 (and noticing that Burling graphs are stable under adding leaves). Figure 8.18 also shows that some graphs close to flowers are Burling graphs.*

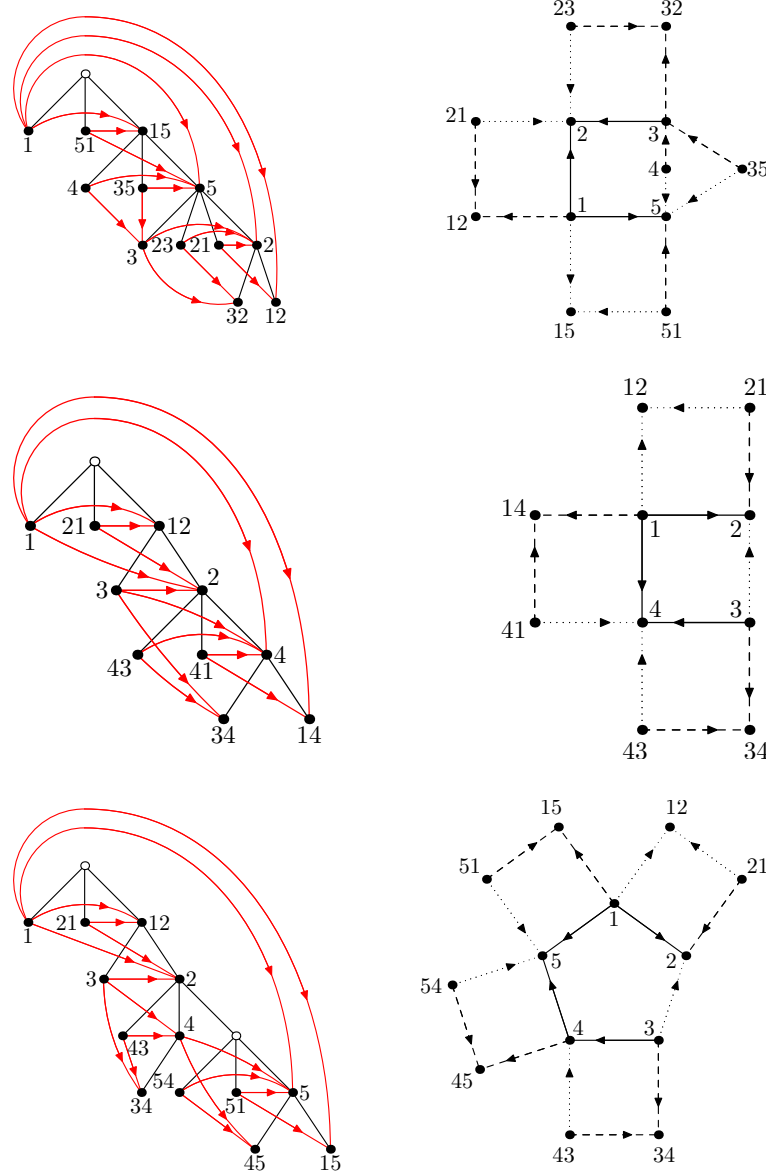

Figure 8.18: Burling graphs close to flowers. Dotted and dashed edges can be subdivided.

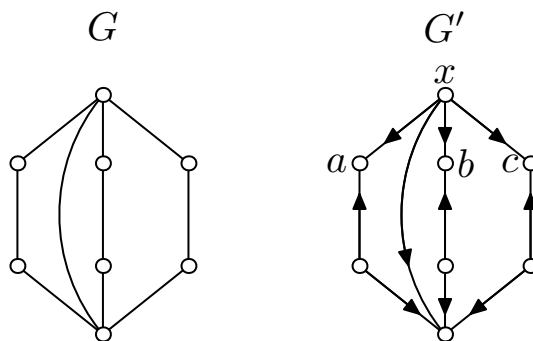

Figure 8.19: Theta+, non-Burling graph.

Notice that there are subdivisions of flowers that are Burling graphs. For example, see Figure 8.18 (top) which shows that there are subdivisions of a 4-petal flower that are Burling. Showing that for any flower, there are subdivisions that are Burling is similar, but we do not include a proof here.

Theta+

We call the (non-oriented) graph in Figure 8.19 (left) *theta+*.

Theorem 8.32. *Theta+ is not a Burling graph.*

Proof. For the sake of contradiction, suppose that G is a Burling graph. So, some orientation of G can be derived from a Burling tree. Hence, every C_4 of this orientation must contain a pivot, a bottom, and two antennas. One can check that with this condition, up to symmetry, the orientation of G is as G' shown in Figure 8.19, right. Note that a , b , and c are out-neighbors of x , so they must be on the same branch of the Burling tree. Therefore, by Lemma 7.27, one of a , b , or c must be the center of a full in-star cutset, a contradiction. \square

Remark 8.33. *Notice that theta+ is another example of graphs that admit cordate orientations, but are not Burling graphs.*

Remark 8.34. *Theta+ is a vertex-critical non-Burling graph. Removing one of the vertices of degree 4 yields to a tree (thus a Burling graph by Theorem 7.12), and removing any other vertex results in a chandelier (again a Burling graph, by Lemma 7.25).*

Notice that in the theta+, subdividing the edge between the two degree 4 vertices results in a chandelier, which is a Burling graph (by Lemma 7.25). So, there are subdivisions of theta+ that are Burling.

Chapter 9

More operations on Burling graphs

9.1	Subdivision and contraction	127
9.2	Gluing along cliques	128
9.3	Subgraphs and supergraphs	129
9.4	Dissolution of vertices	130
9.5	Substitution	130

In Section 7.2, we discussed three operations on Burling graphs: subdivision, contraction, and adding a leaf. In particular, we saw that Burling graphs are closed under adding a leaf, and for subdivision and contraction, we found some sufficient conditions under which subdividing or contracting an arc of a Burling graph results in another Burling graph. In this section, we study more operations on Burling graphs.

9.1 Subdivision and contraction

As promised in Section 7.2, let us show that Burling graphs are not closed under either of these operations.

The examples of Section 8.5 show that there are non-Burling with Burling subdivisions. This shows that Burling graphs are not closed under contraction of edges.

Moreover, we saw that some subdivisions of K_4 are Burling (see Theorem 8.5), but subdividing the same graph enough to obtain a (≥ 1) -subdivision of K_4 , we obtain a non-Burling graph. Thus Burling graphs are not closed under subdivision of edges.

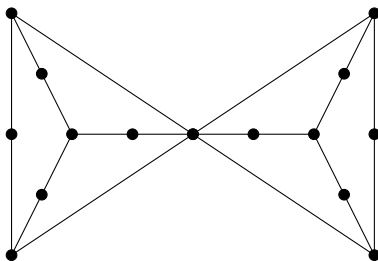

Figure 9.1: A non-Burling graph obtained by gluing two Burling graphs along a vertex.

9.2 Gluing along cliques

Let G_1 and G_2 be two graphs. For $i \in \{1, 2\}$, let $X_i \subseteq V(G_i)$ (possibly empty) be a clique in G_i . Moreover, assume $|X_1| = |X_2|$. *Gluing G_1 and G_2 along the cliques X_1 and X_2* is the operation of taking the disjoint union of G_1 and G_2 and then identifying each vertex of X_1 with a unique vertex of X_2 .

Burling graphs do not have cliques of size 3 or more, so we only need to study gluing along a clique of size 0 (or disjoint union), gluing along cliques of size 1 (also called gluing along a vertex), and gluing along a clique of size 2 (also called gluing along an edge).

We show that Burling graphs are closed under disjoint union, but not under gluing along a vertex or an edge.

9.2.1 Disjoint union

Observation 9.1. *Oriented Burling graphs are closed under disjoint union.*

Proof. Let G_1 and G_2 be two oriented Burling graphs. Since G_1 and G_2 are constrained graphs, one can consider \mathcal{F}_1 and \mathcal{F}_2 , two families of transformed copies of S such that G_i is the oriented intersection graph of \mathcal{F}_i . Moreover, one can assume that $\text{box}(\mathcal{F}_1)$ and $\text{box}(\mathcal{F}_2)$ are disjoint. Set $\mathcal{F} = \mathcal{F}_1 \sqcup \mathcal{F}_2$. It is easy to see that \mathcal{F} satisfies Constraints (C1)-(C5). The oriented intersection graph of \mathcal{F} is the disjoint union of G_1 and G_2 . \square

9.2.2 Gluing along a vertex

For $i \in \{1, 2\}$, let G_i be a type 4 subdivisions of K_4 . We proved in Section 8.2 that G_i is a Burling graph (see Theorem 8.5). Let $x_i \in V(G_i)$ be the unique vertex of G_i that has two degree 3 neighbors. Let G be the graph obtained by gluing G_1 and G_2 along x_1 and x_2 . We proved in Theorem 8.23 that G is not a Burling graph. See Figure Figure 9.1

Under some assumptions, however, the operation of gluing along a vertex preserves being Burling: for example, when G_1 is a complete graph on two vertices (see Section 7.2). The following lemma provides another sufficient condition for gluing along a vertex to preserve being Burling. Gluing two oriented derived graphs along a vertex that is an antenna in both also results in a derived graph.

Observation 9.2. *Let G and G' be two oriented graphs derived from Burling trees T and T' respectively. Let v be an antenna of G and v' be an antenna of G' . The oriented graph obtained by gluing G and G' along v and v' is an oriented derived graph.*

Sketch of proof. Let us only sketch the proof here. In T , let r'' be the last-born of the deepest neighbor of v in G (if r'' does not exist, just add a child to the deepest neighbor of v and call it r''). Add a leaf to r'' and identify r' , the root of T' , with this new leaf to build a new tree T'' . Turn v' into a shadow vertex. Define the last-borns appropriately. Define $c''(v')$ to be the union of $c(v)$, r'' , the leaf added to r'' , and $c'(v')$. Define c'' of other vertices appropriately. It is easy to see that the graph resulting from the gluing operation can be derived from T'' . \square

9.2.3 Gluing along an edge

Theorem 8.24 provides an example for the fact that the class of Burling graphs is not closed under gluing along one edge. The graph in Figure 8.14 is obtained by gluing two type 4 subdivisions of K_4 along an edge. The type 4 subdivisions of K_4 are Burling graphs by Theorem 8.5, but the graph in Figure 8.14 is not Burling as proved in Theorem 8.24.

9.3 Subgraphs and supergraphs

By definition, Burling graphs are closed under taking induced subgraphs, i.e. removing vertices. However, it is not the case for removing edges. In particular, Burling graphs are not closed under taking subgraphs. Let G be a wheel consisting of a rim of size 6 and a center adjacent to every other vertex of the wheel. The graph G is a subgraph of $K_{3,4}$, which is a Burling graph. However, G is not Burling by Theorem 8.1.

On the other hand, non-Burling graphs are not closed under taking induced subgraph and subgraph neither. The graph theta+ in Figure 8.19 is not a Burling graph (see Theorem 8.32), but removing the edge between the two apexes of the theta (i.e. the edge joining the two degree 4 vertices of the theta+) results in a chandelier, which is Burling. Also, every induced subgraph of it is a Burling graph.

9.4 Dissolution of vertices

Dissolution of a vertex v of degree 2 in a graph G is the operation of removing vertex v and joining its neighbors by an edge. Formally, it is to obtain a graph G' such that $V(G') = V(G) \setminus \{v\}$ and $E(G') = (E(G) \setminus \{vv_1, vv_2\}) \cup \{v_1v_2\}$ where v_1 and v_2 are the neighbors of v .

We saw in Section 8.5 that there are non-Burling graphs with some Burling subdivisions. Thus, in general, Burling graphs are not closed under dissolution of vertices.

In some particular cases, however, it is possible to dissolve a vertex of a Burling graph and obtain another Burling graph.

Observation 9.3. *Let G be an oriented graph derived from (T, r, ℓ, c) . If a vertex v of G has exactly one in-neighbor u and exactly one out-neighbor w , then the graph obtained from the dissolution of v in G , is a derived graph.*

Sketch of proof. Let us again only sketch the proof. Let $c(v) = V_1 = \{v_1, \dots, v_k\}$ and $c(u) = U_1 = \{u_1, \dots, u_l\}$ where v_i 's and u_i 's are in order from the least deep to the deepest in T . From the hypothesis, $V_1 \cap V(G) = \{w\}$ and $V_2 \cap V(G) = \{v\}$. Notice that v , having out-neighbors, cannot be a last-born, therefore $p(v) \in U_1$. Assume that $p(v) = u_s$ for some $s \in \{1, \dots, l\}$. Also the last-born of $p(v)$ is in V_1 . Indeed, $\ell(p(v)) = v_1$. Define $c'(u) = \{u_1, \dots, u_s, v_1, \dots, v_k\}$. set $c'(x) = c(x)$ for every $x \in V(T) \setminus \{u\}$. The graph obtained from the dissolution of v is derived from (T', r, ℓ, c') induced on $V(G) \setminus \{v\}$. \square

9.5 Substitution

Let G and H be two graphs. The graph obtained by *substituting* H for a vertex v in G is a graph G' where $V(G') = (V(G) \setminus \{v\}) \cup V(H)$, and

$$E(G') = E(G \setminus v) \cup V(H) \cup \{wu : w \in V(H), u \in N_G(v)\}.$$

where $G \setminus v = G[V(G) \setminus \{v\}]$.

Let G and H be Burling graphs, and $v \in V(G)$, we study whether G' defined as above is a Burling graph.

If v is an isolated vertex in G , then G' is the disjoint union of two Burling graphs $G \setminus v$ and H and thus is a Burling graph. So, let us assume that v is not an isolated vertex. On the other hand, if $E(H) \neq \emptyset$, then G' contains a triangle and thus is not a Burling graph. So, let us also assume that $E(H) = \emptyset$.

The operation of substituting a graph with no edge for v is also referred to as *duplicating* the vertex v , $|V(H)| - 1$ times.

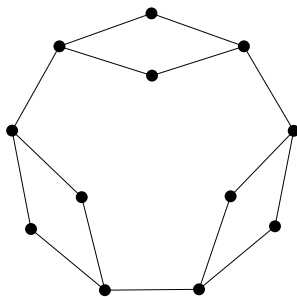

Figure 9.2: A non-Burling graph obtained from cycles by duplicating vertices.

Generally, even in the simple case of duplicating a vertex only once, this operation does not preserve being Burling. Let us give an example. Let G be a 3-necklace whose beads are all short and have no common vertices, e.g. the graph in Figure 9.2. By Theorem 8.18, G is not a Burling graph. However, G can be obtained from a cycle by three applications of duplicating vertices, so at some point, the duplication of a vertex in a Burling graph has created a non-Burling graph (one can indeed see easily that this happens in the last duplication).

The following observation is easy to prove, thus we only sketch the proof.

Observation 9.4. *Let G be an oriented graph derived from a Burling tree (T, r, ℓ, c) . Let v be a source or a sink in G . Then any graph G' obtained from duplication of v for any number of times is a derived graph as well.*

Sketch of proof. Let us sketch the proof. It is enough to prove the theorem for one time of duplication. By Lemma 5.3, we can assume that v is neither a last born nor the root. In case where v is a source, add a child v' to the parent of v to obtain a tree T' , and extend c to c' on T' by defining $c'(v') = c(v)$. In the case where v is a sink, subdivide the edge $vp(v)$ in T to obtain tree T' , and name the new vertex v' . Extend ℓ and to T' by defining $\ell(v') = v$. Moreover, for every vertex w , if $v \in c(w)$, define $c'(w) = c(w) \cup \{v'\}$ and $c'(w) = c(w)$, otherwise. In both cases, the graph G' is derived from T' . \square

The example of 3-necklace (Figure 9.2) shows that the observation above is the best possible.

Part IV

Applications and open problems

Chapter 10

Applications to χ -boundedness

10.1 Wheel-free graphs	133
10.2 Graphs that are not weakly pervasive	134
10.3 Almost no graph is weakly pervasive	136

With all the result we have proved in the previous chapters, we can use Burling graphs to conclude some results in χ -boundedness. The theorems here are immediate results of theorems in the previous chapters, but we find it useful to devote a chapter to these applications only.

10.1 Wheel-free graphs

As explained in the history of Burling graphs, in [Tro13], Trotignon asked the following question.

Question 10.1 (Trotignon, 2013). *Is the class of wheel-free graphs χ -bounded?*

A *k-wheel* is a wheel whose center has exactly k neighbors in its rim. In [SS20], made the following conjecture.

Conjecture 10.2 (Scott and Seymour, 2020). *The class of k -wheel-free graphs is χ -bounded.*

Theorem 8.1 (which states that Burling graphs are contained in wheel-free graphs) answers negatively to Question 10.1 and disproves Conjecture 10.2 since k -wheel-free graphs contain wheel-free graphs.

10.2 Graphs that are not weakly pervasive

Theorems of Section 8.3 provide several examples of graphs for which Scott's conjecture does not hold, i.e. of non-weakly pervasive graphs. Indeed, the idea is that if for a graph G , Burling graphs do not contain any subdivision of G , then G^* -free graphs contain Burling graphs, and therefore, G is not weakly pervasive. With this idea, we have the following results. See Figure 10.1 for some examples in this chapter.

To our knowledge some of the examples in this section are the first known weakly pervasive graphs with star cutsets, thus the methods here go beyond the previous ones such as [PKK⁺14, CELOdM16].

Theorem 10.3. *For every $n \geq 5$, the graph K_n is not a weakly pervasive graph.*

Proof. Follows from Theorem 8.11. □

Theorem 10.4. *Let G be an m -necklace graph. If any of the following happens, then G is not a weakly pervasive graph:*

1. $m = 2$, G has no star cutset, and the beads do not share a vertex,
2. $m = 3$ and G has no star cutset,
3. $m = 3$ and for every short bead B of G , the two other beads have no common vertex.
4. $m \geq 4$.

Proof. Let G be in one of the above four forms. Notice that a subdivision of G will also be in one of the above forms. So, by Theorem 8.18, neither G nor any of its subdivisions are Burling graphs. Notice that we have used the fact that having a short bead and having a star cutset are equivalent in necklaces (Lemma 8.14). So, G is not a weakly pervasive graph. □

Theorem 10.5. *Let G_1 and G_2 be two derived graphs and let x_1 and x_2 be global subordinate vertices in G_1 and G_2 respectively. Then, no dumbbell of G_1 and G_2 with respect to x_1 and x_2 is weakly pervasive.*

In particular, if for each $i \in \{1, 2\}$, the graph G_i and the vertex x_i are one of the following, then the resulting dumbbell is not weakly pervasive.

- G_i is any type 4 subdivision of K_4 and x_i is the common end-point of its two non-subdivided edges,
- G_i is any long theta and x_i is a degree 2 vertex in G_i whose neighbors are also of degree 2.

See Figure 8.13.

Proof. The first part follows from Theorem 8.20 and the second from Theorem 8.23 □

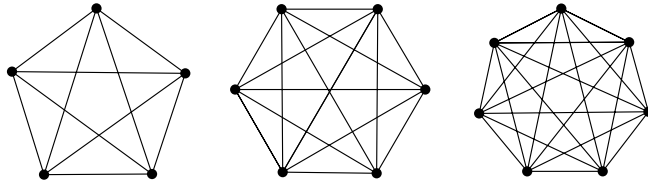

(a) complete graphs on at least 5 vertices - Theorem 10.3

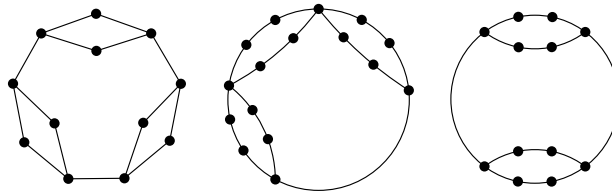

(b) some necklaces - Theorem 10.4

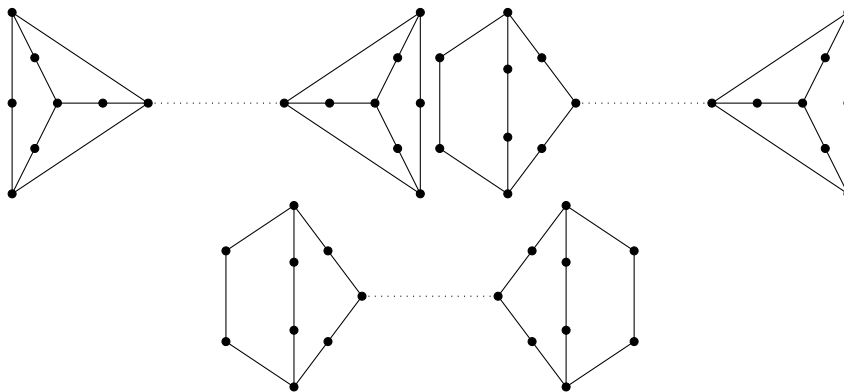

(c) dumbbells - Theorem 10.5

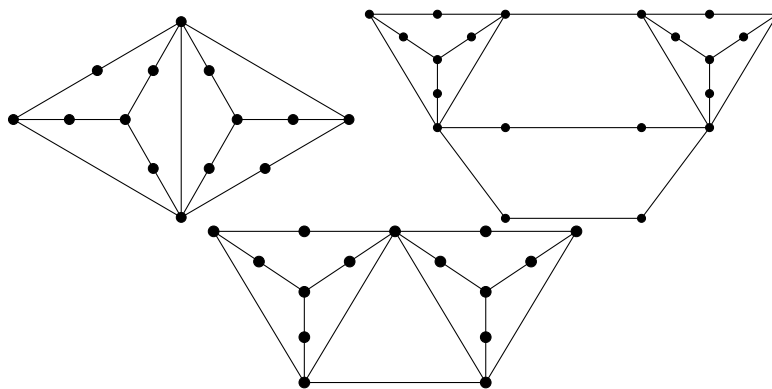

(d) some other graphs - Theorem 10.6

Figure 10.1: Some graphs that are not weakly pervasive. Dotted edges can be subdivided or contracted, and every other edge can be subdivided. For explanations, see the corresponding Theorems.

Theorem 10.6. *None of the three graphs in row (d) of Figure 10.1 are weakly pervasive.*

Proof. Immediate from Theorems 8.24, 8.25, and 8.26. □

10.3 Almost no graph is weakly pervasive

The following theorem seems to be folklore and can be obtained in different ways, using the other examples of graphs that are not weakly pervasive as well. However, for the sake of completeness, we include a proof here based on the results in this dissertation.

Theorem 10.7. *Almost all graphs do not satisfy Scott's conjecture.*

Proof. It follows immediately from Theorem 8.28 by noticing that if a graph is strongly non-Burling, i.e. none of its subdivisions is a Burling graph, then it is not weakly pervasive. □

Chapter 11

Open problems

11.1 Minimality	137
11.2 Burling graphs and weakly pervasive graphs	138
11.3 Deciding if a graph is Burling	138
11.4 Critical non-Burling graphs	139
11.5 Categories related to Burling graphs	139
11.6 Scott’s conjecture for graphs on 5 vertices	139
11.7 Operations on Burling graphs	140

11.1 Minimality

We saw that the advantage of Burling graphs over some other classes of triangle-free graphs of unbounded chromatic number is that they are a small class of graphs in the sense that there exist triangle-free graphs that are not Burling graphs (compared, for instance, to Mycielski graphs that generate all triangle-free graphs).

It is thus natural to ask whether there are proper subclasses of Burling graphs that are not χ -bounded.

Question 11.1. *Is there a Burling graph H such that the class of H -free Burling graphs is not χ -bounded?*

We remark that the class of $K_{m,m}$ -free Burling graphs is χ -bounded. The reason is the following theorem of Kühn and Osthus [KO04].

Theorem 11.2 (Kühn and Osthus, 2004). *For every graph H and every integer m , there exists an integer $d = d(H, m)$ such that every graph of average degree at least d contains either $K_{m,m}$ or a subdivision of H as an induced subgraph.*

Applying this theorem to $H = K_5$ and using Theorem 8.11 implies that $K_{m,m}$ -free Burling graphs form a χ -bounded class of graphs (because by theorem above, their average degree is less than d , so they are $(d - 1)$ -degenerate, and therefore d -colorable).

11.2 Burling graphs and weakly pervasive graphs

So far, the techniques to prove that a graph G is not weakly pervasive have had Burling graphs in their core. That is, to prove that G is not weakly pervasive, we prove that G^* -free graphs contain Burling graphs.

Question 11.3. *Are there Burling graphs that are not weakly pervasive?*

One way to work on Question 11.3 is to find new techniques to prove that a graph is not weakly pervasive.

Question 11.4. *Are there triangle-free graphs G that are not Burling but are weakly pervasive?*

A candidate for checking Question 11.4 is a wheel, e.g. a wheel W with a rim of size 6 and a center connected to every other vertex of the rim. From Theorem 8.1 we know that wheels, in particular W , are not Burling graphs, but it is not known whether W is a weakly pervasive graph or not. Remember that there are subdivisions of W that are Burling graphs (for example, some subdivisions of W are type 4 subdivisions of K_4 that are Burling graphs by Theorem 8.5).

11.3 Deciding if a graph is Burling

Question 11.5. *What is the complexity of deciding whether a graph belongs to the class of Burling graphs?*

A closely related problem is to study whether given a graph G , one can determine in polynomial time if G has a cordate orientation (Definition 7.39). Notice, however, that having a cordate orientation does not imply being Burling (see Section 8.5 for examples of non-Burling graphs with cordate orientations).

It is worth mentioning that some problems of recognizing superclasses of Burling graphs are NP-hard, e.g. recognizing intersection graphs of line segment-graphs and wheel-free graphs are both NP-hard (see [KM91] and [Sch10] for the former and [DTT14] for the latter).

11.4 Critical non-Burling graphs

Another question to ask is whether we can characterize Burling graphs in terms of their minimal forbidden induced subgraphs. From the explanations in Section 2.1, there is class \mathcal{H} of graphs such that G is a Burling graph if and only if it contains no graph in \mathcal{H} as an induced subgraph. The class \mathcal{H} is exactly the class containing all vertex-critical non-Burling graphs or, as is common to say, minimal forbidden induced subgraphs of Burling graphs. These are non-Burling graphs such that removing any vertex from them results in a Burling graph.

Question 11.6. *What are all the vertex-critical non-Burling graphs?*

Examples of minimal forbidden induced subgraphs of Burling graphs given throughout this thesis are flowers, wheels, some subdivisions of K_5 , Theta+, etc.

11.5 Categories related to Burling graphs

In Section 5.7, we introduced some categories related to Burling graphs (namely **BTrees**, **BGraphs**, **S-Sets**, **PounaSets**, and **BSets**). We also explained how the proofs in Chapter 5 introduce functors between these categories. It is natural to ask whether the functors introduced in that chapter are equivalences of categories. More generally, we ask the following:

Question 11.7. *Which of the categories **BTrees**, **BGraphs**, **S-Sets**, **PounaSets**, and **BSets** are equivalent?*

11.6 Scott's conjecture for graphs on 5 vertices

It is noteworthy that graphs on at most 4 vertices are all weakly pervasive (see [CPST11]). So, since K_5 is non-weakly pervasive, the minimum number of vertices of a graph that is not weakly pervasive is 5. Moreover, so far, K_5 is the only graph on 5 vertices that is proved to be non-weakly pervasive. So, it is natural to ask the following question.

Question 11.8. *Which graphs on 5 vertices are weakly pervasive?*

An example of a graph that is not known to be weakly pervasive or non-weakly pervasive is the graph obtained from K_5 by removing an edge (remember that some subdivisions of this graph are Burling, see Figure 8.8.) Examples of graphs on 5 vertices that are weakly pervasive are all trees [Sco97], bull (the graph obtained from a triangle by adding leaves to two distinct vertices) [CPST13], and K_4+ (the graph obtained from K_4 by subdividing one edge once) [ET19].

11.7 Operations on Burling graphs

In Chapter 9 we saw that Burling graphs are not closed under many operations, including subdivision, gluing along a vertex or an edge, dissolution of vertices, and substitution. For some of these operations, we also gave some sufficient conditions under which applying that operation on a Burling graph results in another Burling graph. However, there is still room to improve these results by finding more such conditions. Not only such studies help us to understand the structure of Burling graphs better, but also they might be helpful in recognition of Burling graphs. In particular, the following (purposefully openly stated) question can be of interest.

Question 11.9. *Under which conditions gluing two Burling graphs along a vertex or an edge results in a Burling graph?*

Part V
Appendix

Appendix A

Biography of James Perkins Burling

James Burling, the discoverer of Burling graphs, loved mathematics. He used to say, “given a choice, why would anybody be anything but a mathematician?” This section is devoted to some notes about his life and his journey as a mathematician.¹

James Perkins Burling, or Jim Burling, was born on May 29, 1930, in Baltimore, Maryland.

After school, Jim attended the same college his parents were educated in, Grinnell College in Iowa, to major in physics.

Right after graduating in 1952, he was drafted into the army for two years. His duty there was to do calculations using advanced calculators of the time, a job that he found extremely tedious and could not wait to finish.

During his undergraduate studies, Jim realized that what he liked about physics was mathematics. Hence, after the army, he started his master’s studies in mathematics at the State University of New York at Albany and received his degree in 1957.

After his master’s studies, he started teaching at the State University of New York at Oneonta. Soon, however, he decided to do a PhD in mathematics. He

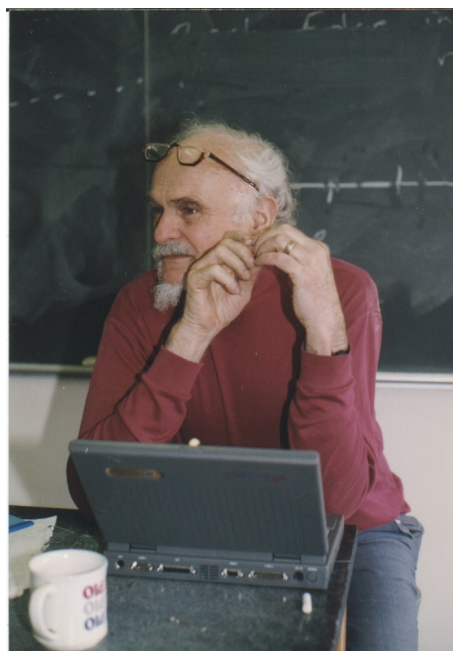

Figure A.1: James Burling in 1990s.

¹The information in this chapter is mainly from my interviews with Temple Burling, James Burling’s son.

started his PhD in geometry at the University of Colorado at Boulder: a choice that was affected by his interest in skiing. His supervisor was Aboulghassem Zirakzadeh, an Iranian mathematician, with whom Jim used to work very well.

During his PhD, Jim worked on a geometrical problem about polytopes in Euclidean space.² He, in particular, introduced a sequence of families of cuboids in \mathbb{R}^3 whose intersection graphs are now called after him: the Burling sequence, a work that later influenced much research. Even though Jim started his PhD in geometry, he gradually moved toward combinatorics and graph theory.

Simultaneously, he met Lee Chadbourne, an accomplished athlete who studied at the same university, and they got married. During the same time, they had both their children, Koren and Temple. He was a caring spouse and a supportive father.

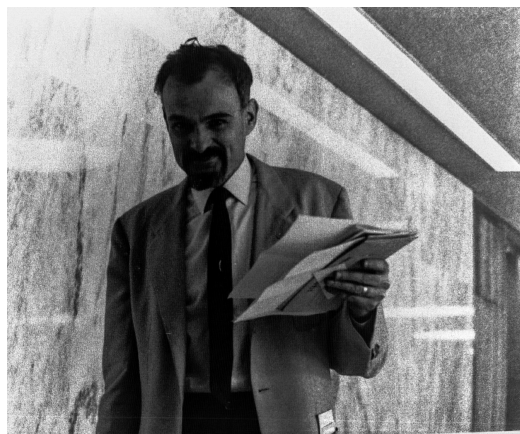

Figure A.2: James Burling in 1970s.

After obtaining his PhD in 1965, Burling started teaching at the State University of New York at Oswego where he was one of the founding members of the mathematics department. Before his retirement in 1995, he taught many courses at the University of Oswego, including combinatorics, number theory, calculus, and history of mathematics. He was a devoted teacher who admired teaching. He believed that teachers play a key role in students' success. It is noteworthy that his father and his children are also all educators.

In his last 15 years of teaching, he designed and taught a very successful course about the history of mathematics where his approach was to describe the evolution of ideas in mathematics: he liked to discover how mathematicians see the world and how mathematical thinking has evolved throughout history. He, therefore, saw his course as a course to develop mathematicians.

He enjoyed corresponding and spending time with mathematicians from all over the world. As an example, he met Paul Erdős on a sabbatical in Canada.

He retired in 1995, and his former student Margaret Groman took his chair which made him delighted.

At a time when the world was very different, he believed in gender equality, and he was showing it both in his private life and professional life. He, in particular, was very supportive of Lee's profession.³ At work too, he was insisting on making

²The problem that he was working on is explained in detail in Chapter 3.

³Lee was in the United States' field hockey team and was ranked number 1 in tennis in the United States in her age group for several years.

mathematics accessible to everyone, and in particular to women.

Jim Burling had a humble and humorous character. He used to name his cats after Greek mathematicians. He was a caring person. And he liked to share his interests with others. He enjoyed music, especially Bach and Mozart. He used to regularly go to symphonies and operas, and one of his common gifts to his children was a subscription to the symphony orchestra of their city. He loved nature and used to spend a lot of time with his family in nature. Above all, he loved mathematics. He wanted mathematics to be accessible to everyone, from all around the world, of any gender and all ages.

James Burling passed away on July 7th, 2005 at the age of 75. His name, however, remains alive in mathematics.

Appendix B

Intersection graphs that do not contain Burling graphs

In Section 2.3, we claimed the following theorem.

Theorem B.1. *There exists a class \mathcal{C} of intersection graphs of geometric objects that is not χ -bounded and does not contain Burling graphs.*

As promised in Section 2.3, we prove this claim in this appendix by giving an example of a class of intersection graphs that have unbounded chromatic number but has no inclusion relation with Burling graphs.

The class of *Contact graphs of boxes with unidirectional contacts*, or *CBU graphs* for short, is a class of intersection graphs of boxes with arbitrarily large chromatic number. A 3-dimensional version of it was first defined by Magnant and Martin in 2011 [CM11] and then generalized by Gonçalves, Limouzy, and Ochem in 2023 [GLO23]. Let us give their definition here.

Fix $d \geq 1$ and let \mathcal{F} be a family of axis-parallel boxes with non-empty interior in \mathbb{R}^d (denote its usual basis by e_1, e_2, \dots, e_d) such that for any two distinct boxes A and B in \mathcal{F} , the set $A \cap B$ is contained in a plane perpendicular to e_1 . In other words, any two distinct boxes are either disjoint or they intersect only on one of the faces of each that is perpendicular to e_1 . The intersection graph of such family \mathcal{F} is called a *d-CBU graph*.

Definition B.2. *A graph called a CBU graph if it is a d-CBU graph for some $d \geq 1$.*

Let us give an example. In Figure B.1, a wheel is shown as a 2-CBU graph.

In [GLO23] Gonçalves, Limouzy, and Ochem consider also an orientation for such graphs which helps them derive several conclusions about them. Here, however, we only work with the non-oriented case.

It is straightforward to check that the class of CBU-graphs is triangle-free (see Claim 1 in [GLO23]). Moreover, Magnant and Martin [CM11] proved that the class

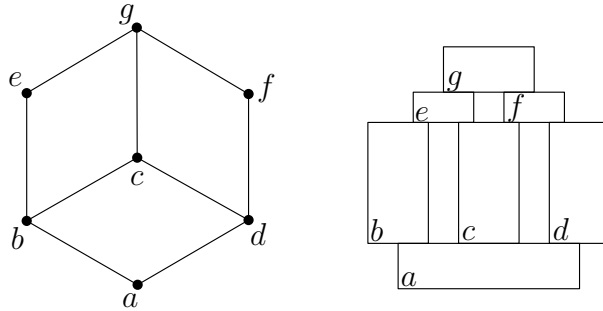

Figure B.1: A wheel presented as a 2-CBU graph.

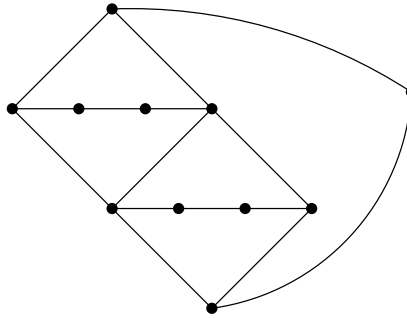

Figure B.2: The graph M , a Burling graph that is not a CBU graph.

of 3-CBU graphs has unbounded chromatic number (see Theorem 3 in [CM11]). Therefore so does the class of CBU graphs.

In this section, we prove the following which implies Theorem B.1.

Theorem B.3. *Neither of the two classes of CBU graphs and Burling graphs contains the other.*

To prove this, we first need a result from [GLO23]. For this section only, let M denote the graph in Figure B.2.

Theorem B.4 (Gonçalves, Limouzy, and Ochem 2023, Lemma 16 of [GLO23]). *The graph M in Figure B.2 is not a CBU graph.*

Now, let us show that the graph M is a Burling graph. To do so, we use the derived graph definition. In Figure B.3, we show that the presented orientation of M is a derived graph.

Now, we can prove Theorem B.3.

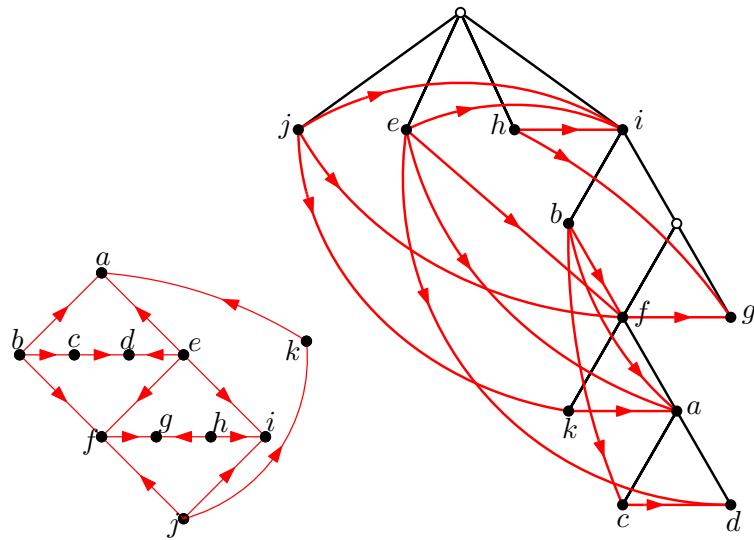

Figure B.3: The graph M presented as a derived graph.

Proof of Theorem B.3. As shown in Figure B.3, and orientation of the graph M is a derived graph, and therefore M is a Burling graph. However, by Theorem B.4 M is not a CBU graph.

On the other hand, the wheel in Figure B.1 is a CBU graph, but by Theorem 8.1, it is not a Burling graph. \square

Proof of Theorem B.1. It is implied directly from Theorem B.3. \square

Appendix C

Other proofs

C.1 Proof for Chapter 2

Proof of Theorem 2.17

Sketch of proof of Theorem 2.17. Suppose, for the sake of contradiction, that G is isomorphic to the intersection graph of a finite family \mathcal{F} of line segments in \mathbb{R}^2 . Let V' be the set of degree 2 vertices of G obtained after the subdivision of the edges of H . We are going to lose precision by referring to the vertices of G as line segments. Each $v \in V'$ intersects exactly two other line segments and in two distinct points, since (≥ 1)-subdivision of a graph is triangle-free. Therefore, we can assume, without loss of generality, that these two intersection points are the end-points of v .

Now, let u be a vertex in $V(G) \setminus V'$. So, $N(u) \subseteq V'$. Let $N(u) = \{v_1, \dots, v_d\}$ and let p_i be the intersection point of v_i and u . Let p_u be a point on u that is not in any other elements of \mathcal{F} . Since the graph is finite, it is possible to find injective paths $\gamma_{uv_i} : [0, 1] \rightarrow \mathbb{R}^2$ such that $\gamma_{uv_i}(0) = p_u$, $\gamma_{uv_i}(1) = p_i$, and the images of γ_{uv_i} 's are all disjoint but on p_u .

Finally, for two distinct vertices $u, u' \in V(G) \setminus V'$ that are adjacent vertices of H , let p_u and $p_{u'}$ be chosen as above. Also, let u, v_1, \dots, v_k, u' , $k \geq 1$, be the path between u and u' in G . By pasting lemma, there is an injective path in \mathbb{R}^2 between p_u and $p_{u'}$ whose image, with notation above, is $\gamma_{uv_1} \cup v_1 \cup \dots \cup v_k \cup \gamma_{u'v_k}$. These paths along with $\{p_u : u \in V(G) \setminus V'\}$ give a planar presentation of H , a contradiction. \square

Notice that the same idea of proof works if we replace line-segment in the statement with any path-connected compact subset of \mathbb{R}^2 .

We would also like to mention that in [Sin66], Sinden proved that a (≥ 1)-subdivision of K_5 is not an intersection graph of curves in the plane.

C.2 Proof for Chapter 4

Proof of Lemma 4.16

Proof of Lemma 4.16. Notice that

$$B = [B \cap A^\circ] \cup [B \cap (X \setminus \bar{A})] \cup [B \cap \partial A].$$

The sets, $B \cap A^\circ$ and $B \cap (X \setminus \bar{A})$ are both open in B and each is non-empty by the assumption. Moreover, their intersection is the empty set. So, if $B \cap \partial A \neq \emptyset$, then B can be written as the union of two non-empty and non-intersecting sets that are open in B , and thus B is not connected. \square

C.3 Proofs for Chapter 5

Proof of Lemma 5.11

Proof of Lemma 5.11. Let $X_0 = \gamma^{-1}(L_0) = \{x \in [0, 1] : \gamma(x) \in L_0\}$. Notice that X_0 is closed since it is the pre-image of a closed set under a continuous function, and is bounded. So, X_0 is compact. Moreover, $0 \in X_0$, so $X_0 \neq \emptyset$. Thus, we can set $x_0 = \max X_0$.

Set $\gamma'' = \gamma|_{[x_0, 1]}$, and let $X_1 = \gamma''^{-1}(L_1) = \{x \in [x_0, 1] : \gamma''(x) \in L_1\}$. Again, X_1 is compact, and it is non-empty since $1 \in X_1$. So, we can set $x_1 = \min X_1$.

Set $\gamma' = \gamma''|_{[x_0, x_1]}$. We prove that $im(\gamma') \subseteq \{(x, y) : y_0 \leq y \leq y_1\}$.

Assume, for the sake of contradiction, that there exists a point $t \in (x_0, x_1)$ such that $(\pi_2 \circ \gamma'')(t) \leq y_0$ or $(\pi_2 \circ \gamma'')(t) \geq y_1$. In the former case, by the intermediate value theorem, there exists $t' \geq t > x_0$ such that $(\pi_2 \circ \gamma'')(t') = y_0$. Thus $t' \in X_0$, contradicting the choice of x_0 . In the latter case, there exists $t' \leq t < x_1$ such that $(\pi_2 \circ \gamma'')(t') = y_0$. Thus $t' \in X_1$, contradicting the choice of x_1 .

The second point is clear from the choice of x_0 and x_1 . \square

Proof of Lemma 5.12

Proof of Lemma 5.12. Let $\gamma : [0, 1] \rightarrow R \cap A$ be the crossing path. By two times use of the intermediate theorem on the function $\pi_2 \circ \gamma$, we conclude that there exists x_0 and x_1 with $x_0 \leq x_1$ such that $\gamma(x_0)$ and $\gamma(x_1)$ are respectively on the bottom side-and the top-side of R' . Applying Lemma 5.11 to the path $\gamma|_{[x_0, x_1]}$ completes the proof of the lemma. \square

Proof of Lemma 5.13

We recall that an *arc* in a topological space X is a homeomorphism from a closed interval in \mathbb{R} to X . In particular, every arc is a path. We say that two

paths $\gamma_1 : [a_1, b_1] \rightarrow \mathbb{R}$ and $\gamma_2 : [a_2, b_2] \rightarrow \mathbb{R}$ are internally disjoint if their images do not intersect but possibly on common endpoints, i.e. for $i \in \{1, 2\}$, we have $\gamma_i((a_i, b_i)) \cap \text{im}(\gamma_{3-i}) = \emptyset$.

It is well known that K_5 is not a planar graph. In other words, if we have 5 distinct points in the plane and every two distinct points among them are joined by an arc, then at least two of these arcs are not internally disjoint. However, it is possible to replace the ‘‘arc’’ in the above statement with ‘‘path’’. This fact follows from the Flores-Van Kampen theorem. In the following presentation of this theorem from [Sar91], σ_k^d denotes the k -skeleton of the d -dimensional simplex.

Theorem C.1 (Flores-Van Kampen theorem; Flores [Flo32]; Van Kampen [VK33]). *For any continuous map $f : \sigma_{s-1}^{2s} \rightarrow \mathbb{R}^{2(s-1)}$ there exist a pair (s_1, s_2) of disjoint simplices of σ_{s-1}^{2s} such that $f(s_1) \cap f(s_2) \neq \emptyset$.*

Applying Theorem C.1 to $s = 2$ results in the desired statement as follows.

Corollary C.2. *Let S be a set of 5 distinct points in the plane such that for every $a, b \in S$ with $a \neq b$, there exists a path $\gamma_{a,b}$ joining a to b . Then, there are four distinct points $a, b, c, d \in S$ such that $\text{im}(\gamma_{a,b}) \cap \text{im}(\gamma_{c,d}) \neq \emptyset$.*

We believe that the following proof is folklore, but we could not find a reference for it.

Proof of Lemma 5.13. Assume, for the sake of contradiction, that $\text{im}(\alpha) \cap \text{im}(\beta) = \emptyset$. Set $a_0 = \alpha(0)$, $a_1 = \alpha(1)$, $b_0 = \beta(0)$, and $b_1 = \beta(1)$. Fix a real number $\epsilon > 0$. Let $\gamma_1, \gamma_2, \gamma_3$, and γ_4 be paths that respectively join b_1 to a_1 , a_1 to b_0 , b_0 to a_0 , and a_0 to b_1 such that every two paths among them are internally disjoint, the image of each of them is entirely outside R except for its endpoints, and all of them are entirely inside the rectangle

$$R' = [\mathbf{l}(R) - \epsilon, \mathbf{r}(R) + \epsilon] \times [\mathbf{b}(R) - \epsilon, \mathbf{t}(R) + \epsilon].$$

See Figure C.1.

Finally, choose a point c outside R' , and let $\delta_1, \delta_2, \delta_3$, and δ_4 be four paths from c to b_1, a_1, b_0 , and a_0 respectively. Choose δ_i 's such that they are two-by-two internally disjoint, and such that for each $i, j \in \{1, 2, 3, 4\}$, the two paths γ_i and δ_j are also internally disjoint.

The existence of the set $S = \{a_0, a_1, b_0, b_1, c\}$ of points and the paths $\{\hat{\alpha}, \hat{\beta}, \gamma_i, \delta_i : i \in \{1, 2, 3, 4\}\}$ contradicts Corollary C.2. \square

Proofs of Properties of Pouna sets

Proof of Property 5.14. Let $T : (x, y) \mapsto (ax + c, bx + d)$. Denote the inverse of T by T^{-1} .

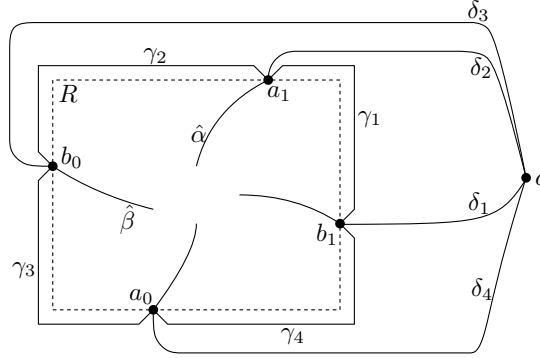

Figure C.1: Proof of Lemma 5.11: a planar embedding of K_5 .

If $(x, y) \in \mathbf{box}(S) \setminus S$, then

$$T(x, y) \in \mathbf{box}(S) \setminus S = T(\mathbf{box}(S)) \setminus T(S) = \mathbf{box}(T(S)) \setminus T(S).$$

Moreover, $x' > x$ implies $ax' + b > ax + b$. Therefore, $(x, y) \in \mathbf{ter}(S)$ implies $T(x, y) \in \mathbf{ter}(T(S))$. Hence, $\mathbf{ter}(S) \subseteq \mathbf{ter}(T(S))$.

To finish the proof, notice that $S = T^{-1}(T(S))$ and T^{-1} is also a positive transformation. Thus, by what precedes, $\mathbf{ter}(T(S)) \subseteq \mathbf{ter}(S)$. \square

Proof of Property 5.17. Set $S' = T(S)$ and $E' = T(E)$. We prove that the three items of the definition hold and E' is a subterritory of S' .

First, by Property 5.14, we have that $E' = T(E) \subseteq T(\mathbf{ter}(S)) = \mathbf{ter}(S')$. So the first item of the definition holds.

Second, since a and b are positive, for every compact set A we have

$$\begin{aligned} \mathfrak{l}(T)(A) &= \min\{x : (x, y) \in T(A)\} \\ &= \min\{x : \left(\frac{x-c}{a}, \frac{y-d}{b}\right) \in A\} \\ &= \min\{au + c : (u, v) \in E\} = a \cdot \mathfrak{l}(A) + c. \end{aligned}$$

In the equations above we have again used the change of variables $u = \frac{x-c}{a}$ and $v = \frac{y-d}{b}$. So,

$$\mathfrak{l}(E') = a \cdot \mathfrak{l}(E) + c < a \cdot \mathfrak{l}(S) + c = \mathfrak{l}(S').$$

The proof of the rest of the inequalities is similar. This proves the second item.

Finally, let P be the prob for $\mathbf{box}(S)$ defined by E and let $\gamma : [0, 1] \rightarrow S \cap P$ be the path connecting the top-side of P to the bottom-side of P . Denote by P' the prob for $\mathbf{box}(S')$ defined by E' . Notice that $P' = T(P)$. So, $T(S \cap P) = T(S) \cap T(P) = S' \cap P'$. Thus, the function $T \circ \gamma : [0, 1] \rightarrow S' \cap P'$ is a path entirely inside $S' \cap P'$. Moreover, since T sends the top-side (resp. bottom-side) of P to the top-side (resp. bottom-side)

of P' , we have that $(T \circ \gamma)(0)$ is on the top-side of P' and $(T \circ \gamma)(1)$ is on the bottom-side of P' , and this finishes the proof of the third item. \square

Proof of Property 5.18. Set $F' = \{T(S) : S \in \mathcal{F}\}$. Suppose that

$$T : (x, y) \mapsto (ax + c, by + d)$$

where $a > 0$ and $b > 0$.

First of all, notice that $A \cap B \neq \emptyset$ if and only if $T(A) \cap T(B) \neq \emptyset$. So, two sets $T(A)$ and $T(B)$ in \mathcal{F}' intersect if and only if A and B intersect in F .

Second, notice that for every set A , $\mathfrak{l}(T(A)) = a \cdot \mathfrak{l}(A) + c$. So, since $a > 0$, if $\mathfrak{l}(A) \leq \mathfrak{l}(B)$, then $\mathfrak{l}(T(A)) \leq \mathfrak{l}(T(B))$.

Third, if $A \subseteq B$, then $T(A) \subseteq T(B)$, because if $p \in T(A)$, then $p = (ax + c, by + d)$ for some $(x, y) \in A$. Now, since $(x, y) \in B$, we have $p \in T(B)$.

Fourth, notice that $\mathfrak{tr}(T(A)) = T(\mathfrak{tr}(A))$. This, along with the third fact implies that if $A \subseteq \mathfrak{tr}(B)$, then $T(A) \subseteq \mathfrak{tr}(T(B))$.

With the four facts above, it is easy to check that \mathcal{F}' satisfies Constraints (C1)-(C6). \square

Proofs of the Properties of the construction in Section 5.3

Proof of Property 5.23. The proof of (1) is immediate from the definition of T_P .

To prove (2), set $T_P : (x, y) \mapsto (ax + c, bx + d)$. We have

$$a = \frac{2\mathfrak{w}(S)}{\mathfrak{l}(E) - \mathfrak{l}(S)} \cdot \frac{\mathfrak{w}(P^\dagger)}{\mathfrak{w}(S)},$$

and

$$c = \frac{2\mathfrak{w}(S)}{\mathfrak{l}(E) - \mathfrak{l}(S)} \left(\mathfrak{l}(P^\dagger) - \frac{\mathfrak{l}(S)\mathfrak{w}(P^\dagger)}{\mathfrak{w}(S)} \right) + \mathfrak{l}(P^\dagger) \left(1 - \frac{2\mathfrak{w}(S)}{\mathfrak{l}(E) - \mathfrak{l}(S)} \right).$$

Now, notice that

$$\begin{aligned} \mathfrak{l}(T_P(E)) &= a \cdot \mathfrak{l}(E) + c \\ &= \mathfrak{l}(E) \cdot \frac{2\mathfrak{w}(S)\mathfrak{w}(P^\dagger)}{\mathfrak{w}(S)(\mathfrak{l}(E) - \mathfrak{l}(S))} + \frac{2\mathfrak{w}(S)\mathfrak{l}(P^\dagger)}{\mathfrak{l}(E) - \mathfrak{l}(S)} \\ &\quad - \mathfrak{l}(B_S) \cdot \frac{2\mathfrak{w}(S)\mathfrak{w}(P^\dagger)}{\mathfrak{w}(S)(\mathfrak{l}(E) - \mathfrak{l}(S))} + \mathfrak{l}(P^\dagger) - \frac{2\mathfrak{w}(S)\mathfrak{l}(P^\dagger)}{\mathfrak{l}(E) - \mathfrak{l}(S)} \\ &= \mathfrak{l}(P^\dagger) + (\mathfrak{l}(E) - \mathfrak{l}(S)) \frac{2\mathfrak{w}(S)\mathfrak{w}(P^\dagger)}{\mathfrak{w}(S)(\mathfrak{l}(E) - \mathfrak{l}(S))} \\ &> \mathfrak{l}(P^\dagger) + 2\mathfrak{w}(P^\dagger) = \mathfrak{r}(P^\dagger) + \mathfrak{w}(P^\dagger) > \mathfrak{r}(P^\dagger). \end{aligned}$$

To complete the proof, notice that $\mathfrak{r}(P^\dagger) = \mathfrak{r}(\mathfrak{box}(\mathcal{F}))$. \square

Proof of Property 5.24. Item (1) follows from the facts that $\mathbf{box}(S_P) \subseteq P$, $S_P \subseteq P$, $S_Q \subseteq Q$, and $P \cap Q = \emptyset$.

To prove (2), notice that by Property 5.23, we have $\mathfrak{l}(E_P) > \mathfrak{r}(\mathbf{box}(\mathcal{F}))$. Since P_1 is the prob defined by E_P , the prob P_1 is also outside $\mathbf{box}(\mathcal{F})$. So, for every $A \in \mathcal{F}$, we have $A \notin N_{\mathcal{F}'}(P_1)$. Moreover, by item (1) of this property, for every $Q \in \mathcal{P} \setminus \{P\}$, we have $S_Q \notin N_{\mathcal{F}'}(P_1)$. Finally, since E_P is a subterritory of S , by definition of $S_P \cap P_1 \neq \emptyset$. Therefore $N_{\mathcal{F}'}(P_1) = \{S_P\}$.

To prove (3), assume that $A \in \mathcal{F}'$ is of the form $A = S_Q$ for some Q . Case 1, $Q = P$, in which case $S_Q = S_P \subseteq P_1$, and since $P_1 \cap P_2 = \emptyset$, we have $A \notin N_{\mathcal{F}'}(P_2)$. Case 2, $Q \neq P$, and thus item (1) of this property implies that $A \notin N_{\mathcal{F}'}(P_2)$. Therefore, $N_{\mathcal{F}'}(P_2) \subseteq \mathcal{F}$.

Hence, $N_{\mathcal{F}'}(P_2) = N_{\mathcal{F}}(P_2)$. So, since $P_2 \cap \mathbf{box}(F) \subseteq P$, we have $N_{\mathcal{F}'}(P_2) \subseteq N_{\mathcal{F}}(P)$.

To prove (4), first notice that $\mathfrak{r}(S_P) > \mathfrak{r}(\mathcal{F})$, along with (1), imply that there exists no $B \in \mathcal{F}'$ such that $B \curvearrowright S_P$. Now, set $N(S_P)$ to be the set $\{A \in \mathcal{F}' : S_P \curvearrowright A\}$. by construction, $N(S_P) \subseteq N(P)$. Moreover, since S_P crosses P horizontally and all elements of $N(P)$ cross P vertically, by Lemma 5.13, S_P intersects all elements of $N(P)$. Moreover, if $A \in N(P)$, we have

$$\{(x, y) : x = \mathfrak{r}(S_P)\} = \{(x, y) : x = \mathfrak{r}(P^\uparrow)\} \subseteq \mathbf{ter}(A).$$

Finally,

$$\mathfrak{l}(A) \leq \mathfrak{l}(P^\uparrow) = \mathfrak{l}(S_P) < \mathfrak{r}(A) \leq \mathfrak{r}(\mathcal{F}) < \mathfrak{r}(S_P),$$

and

$$\mathfrak{b}(A) < \mathfrak{b}(P^\uparrow) = \mathfrak{b}(S_P) < \mathfrak{t}(S_P) = \mathfrak{t}(P^\uparrow) < \mathfrak{t}(A).$$

So, $A \curvearrowright N(P)$ for all $A \in N(P)$, and this completes the proof. \square

C.4 Proof for Chapter 8

Proof of Lemma 8.27

Using the same notations as in Section 8.4, we state the following two results from [Bol01]. In the second one, however, we have stated a special case of the theorem.

Theorem C.3 (Ballobás, Theorem 2.1 in [Bol01]). *Let $n \in \mathbb{N}$ and let P be a property closed under taking subgraph. If $p, q \in [0, 1]$ such that $p < q$, then*

$$\mathbb{P}(X_n^P(G) | G \in \mathbb{G}(n, p)) \leq \mathbb{P}(X_n^P(G) | G \in \mathbb{G}(n, q)).$$

From now on, we define X_n to be a random variable on $\mathbb{G}(n, p_n)$ which returns the number of distinct induced K_5 's in a graph G . So, $X_n(G) > 0$ if and only if $\omega(G) \geq 5$.

Theorem C.4 (Ballobás, Theorem 4.1 in [Bol01]). *Fix $c > 0$. Set $p_n = \min\{1, \frac{c}{\sqrt{n}}\}$ and $\lambda = \frac{c^{10}}{5!}$. Then for every $r \in \mathbb{N}$, we have*

$$\lim_{n \rightarrow +\infty} \mathbb{P}(X_n(G) = r \mid G \in \mathbb{G}(n, p_n)) = e^{-\lambda} \frac{\lambda^r}{r!}.$$

Now we can prove Lemma 8.27, that is prove that for $p \in (0, 1]$, we have

$$\lim_{n \rightarrow +\infty} \mathbb{P}(X_n(G) \geq 1 \mid G \in \mathbb{G}(n, p)) = 1.$$

Proof of Lemma 8.27. Fix $c > 0$ and define $p_n = \frac{c}{\sqrt{n}}$. For all n such that $p_n < p$, by Theorem C.3, we have:

$$\mathbb{P}(X_n(G) \geq 1 \mid G \in \mathbb{G}(n, p)) \geq \mathbb{P}(X_n(G) \geq 1 \mid G \in \mathbb{G}(n, p_n)). \quad (\text{C.1})$$

On the other hand, using Theorem C.4, we have:

$$\begin{aligned} \lim_{n \rightarrow \infty} \mathbb{P}(X_n(G) \geq 1 \mid G \in \mathbb{G}(n, p_n)) &= \lim_{n \rightarrow \infty} (1 - \mathbb{P}(X_n(G) = 0 \mid G \in \mathbb{G}(n, p_n))) \\ &= 1 - \exp\left(-\frac{c^{10}}{5!}\right). \end{aligned} \quad (\text{C.2})$$

So, from (C.1) and (C.2), we have

$$\liminf_{n \rightarrow \infty} \mathbb{P}(X_n(G) \geq 1 \mid G \in \mathbb{G}(n, p)) \geq 1 - \exp\left(-\frac{c^{10}}{5!}\right).$$

This being true for every $c > 0$, we conclude that

$$\liminf_{n \rightarrow +\infty} \mathbb{P}(X_n(G) \geq 1 \mid G \in \mathbb{G}(n, p)) = 1,$$

which implies the desired result. □

Summary in French

Cette thèse porte principalement sur la théorie de la χ -boundedness et la théorie géométrique des graphes. En particulier, nous mettons l'accent sur un sujet à l'intersection de ces deux domaines : les graphes de Burling. La classe des graphes de Burling, définie par Burling [Bur65] en 1965, est une classe de graphes sans triangle avec un nombre chromatique arbitrairement grand qui a fait l'objet de nombreuses recherches depuis les années 1960 jusqu'à aujourd'hui. Dans cette thèse, nous étudions les graphes de Burling sous différents aspects : leurs caractérisations, leur structure et leurs applications.

Nous donnons plusieurs caractérisations équivalentes des graphes de Burling avec différentes saveurs : une combinatoire (appelée graphes dérivés), une axiomatique (appelée graphes de Burling abstraits), et certaines géométriques (appelées graphes contraints). Les deux premières, qui sont les premières définitions non inductives des graphes de Burling, permettent d'obtenir de nouveaux résultats (voir ci-dessous). Historiquement, les graphes de Burling ont été considérés comme des sous-classes de graphes géométriques. Les caractérisations géométriques, en introduisant pour la première fois les graphes de Burling comme une exacte classe de graphes géométriques, complètent ce point de vue historique.

Nous étudions ensuite plusieurs propriétés structurelles des graphes de Burling en utilisant la définition des graphes dérivés. Entre autres résultats, nous donnons des théorèmes de décomposition, étudions la structure des trous dans les graphes de Burling et analysons les effets de plusieurs opérations sur la classe. En utilisant ces résultats, nous introduisons de nouvelles techniques pour fournir de nouveaux graphes sans triangle qui ne sont pas des graphes de Burling. En outre, nous prouvons des résultats probabilistes sur la taille de la classe.

Enfin, nous présentons quelques applications de nos résultats à la théorie de la χ -boundedness. Nous réfutons une conjecture de Scott et Seymour de [SS20] et répondons à une question de Trotignon de [Tro13], toutes deux concernant les graphes sans roue. Nous réalisons également la classification des graphes complets faiblement pervasifs, et fournissons de nouvelles familles de graphes non faiblement pervasifs (i.e. contre-exemples à la conjecture de Scott).

Une majeure partie de cette thèse est contenue dans [PT23, PT21a, PT21b] (travaux conjoints avec Nicolas Trotignon), dans [Pou22], et dans le mémoire de master de l'auteur [Pou20].

– *Mots-clés*: théorie des graphes, χ -boundedness, graphes de Burling, graphes d'intersection d'objets géométriques

Bibliography

- [AG60] Edgar Asplund and Branko Grünbaum. On a coloring problem. *Mathematica Scandinavica*, 8:181–188, 1960.
- [BM08] John Adrian Bondy and Uppaluri Siva Ramachandra Murty. *Graph Theory*. Springer Publishing Company, Incorporated, 1st edition, 2008.
- [Bol01] Béla Bollobás. *Random Graphs*. Cambridge Studies in Advanced Mathematics. Cambridge University Press, 2 edition, 2001.
- [Bur65] James Perkins Burling. On coloring problems of families of polytopes, Ph.D. thesis. *University of Colorado, Boulder*, 1965.
- [Cat79] Paul A Catlin. Hajós’ graph-coloring conjecture: variations and counterexamples. *Journal of Combinatorial Theory, Series B*, 26(2):268–274, 1979.
- [CELOdM16] Jérémie Chalopin, Louis Esperet, Zhentao Li, and Patrice Ossona de Mendez. Restricted frame graphs and a conjecture of Scott. *The Electronic Journal of Combinatorics*, 23(1), 2016.
- [Che12] Victor Chepoi. Nice labeling problem for event structures: A counterexample, 2012.
- [CM11] Daniel M. Martin Colton Magnant. Coloring rectangular blocks in 3-space. *Discussiones Mathematicae Graph Theory*, 31(1):161–170, 2011.
- [CPST11] Maria Chudnovsky, Irena Penev, Alex Scott, and Nicolas Trotignon. Excluding induced subdivisions of the bull and related graphs. *Journal of Graph Theory*, 71(1):49–68, sep 2011.
- [CPST13] Maria Chudnovsky, Irena Penev, Alex Scott, and Nicolas Trotignon. Substitution and χ -boundedness. *Journal of Combinatorial Theory, Series B*, 103(5):567–586, sep 2013.

-
- [Dav21] James Davies. Triangle-free graphs with large chromatic number and no induced wheel. *Journal of Graph Theory*, 2021.
- [dC47] F. de Carteblanche. The coloured cubes problem. *Eureka*, 9:9–11, 1947.
- [dC48] F. de Carteblanche. Solutions to problems in eureka no. 9: a three-colour problem. *Eureka*, 10:24, 1948.
- [Des54] Blanche Descartes. Advanced problems and solutions: k-chromatic graphs without triangles. *The American Mathematical Monthly*, 61(5):352–353, 1954.
- [Dir52] Gabriel Andrew Dirac. A property of 4-chromatic graphs and some remarks on critical graphs. *Journal of the London Mathematical Society*, s1-27(1):85–92, 1952.
- [DJM⁺18] Vida Dujmović, Gwenaël Joret, Pat Morin, Sergey Norin, and David R. Wood. Orthogonal tree decompositions of graphs. *SIAM Journal on Discrete Mathematics*, 32(2):839–863, 2018.
- [DTT14] Emilie Diot, Sébastien Tavenas, and N. Trotignon. Detecting wheels. *Applicable Analysis and Discrete Mathematics*, 8(1):111–122, 2014.
- [Erd59] Paul Erdős. Graph theory and probability. *Canadian Journal of Mathematics*, 11:34–38, 1959.
- [ET19] Louis Esperet and Nicolas Trotignon. Coloring graphs with no induced subdivision of K_4^+ , 2019.
- [FJM⁺18] Stefan Felsner, Gwenaël Joret, Piotr Micek, William T. Trotter, and Veit Wiechert. Burling graphs, chromatic number, and orthogonal tree-decompositions. *The Electronic Journal of Combinatorics*, 25(1), 2018.
- [Flo32] Antonio Flores. *Über die Existenz n-dimensionaler Komplexe, die nicht in den R^{2n} topologisch einbettbar sind.* na, 1932.
- [GLO23] Daniel Gonçalves, Vincent Limouzy, and Pascal Ochem. Contact graphs of boxes with unidirectional contacts, 2023.
- [Gyá73] András Gyárfás. On ramsey covering-numbers. *Colloquia Mathematica Societatis János Bolyai, Infinite and Finite Sets*, 10, 01 1973.

- [Gyá85] András Gyárfás. Problems from the world surrounding perfect graphs. (177), 1985.
- [GYZ13] Jonathan L. Gross, Jay Yellen, and Ping Zhang. *Handbook of Graph Theory, Second Edition*. 2nd edition, 2013.
- [Had43] Hugo Hadwiger. Über eine klassifikation der streckenkomplexe. *Vierteljschr. Naturforsch. Ges. Zurich*, 88(88):133–143, 1943.
- [Haj61] György Hajós. Über eine konstruktion nicht n -farbbarer graphen. *Martin-Luther-Univ, Halle-Wittenberg*, 1961.
- [KM91] Jan Kratochvíl and Jiří Matoušek. String graphs requiring exponential representations. *Journal of Combinatorial Theory, Series B*, 53(1):1–4, 1991.
- [KO04] Daniela Kühn and Deryk Osthus. Induced subdivisions in $K_{s,s}$ -free graphs of large average degree. *Combinatorica*, 24(2):287–304, Apr 2004.
- [KPW14] Tomasz Krawczyk, Arkadiusz Pawlik, and Bartosz Walczak. Coloring triangle-free rectangle overlap graphs with $O(\log \log n)$ colors. *Discrete & Computational Geometry*, 53(1):199–220, 2014.
- [KS94] Janos Komlos and Endre Szemerédi. Topological cliques in graphs ii. *Combinatorics, Probability & Computing*, 5:247–256, 1994.
- [Kur30] Casimir Kuratowski. Sur le problème des courbes gauches en topologie. *Fundamenta Mathematicae*, 15(1):271–283, 1930.
- [LMT12] Benjamin Lévêque, Frédéric Maffray, and Nicolas Trotignon. On graphs with no induced subdivision of K_4 . *Journal of Combinatorial Theory, Series B*, 102(4):924–947, jul 2012.
- [Mun00] James Raymond Munkres. *Topology*. Featured Titles for Topology. Prentice Hall, Incorporated, 2000.
- [Myc55] Jan Mycielski. Sur le coloriage des graphs. *Colloquium Mathematicum*, 3(2):161–162, 1955.
- [PKK⁺13] Arkadiusz Pawlik, Jakub Kozik, Tomasz Krawczyk, Michał Lasoń, Piotr Micek, William T Trotter, and Bartosz Walczak. Triangle-free geometric intersection graphs with large chromatic number. *Discrete & Computational Geometry*, 50(3):714–726, 2013.

-
- [PKK⁺14] Arkadiusz Pawlik, Jakub Kozik, Tomasz Krawczyk, Michał Lasoń, Piotr Micek, William T. Trotter, and Bartosz Walczak. Triangle-free intersection graphs of line segments with large chromatic number. *Journal of Combinatorial Theory, Series B*, 105:6–10, 2014.
- [Pou20] Pegah Pournajafi. Burling graphs revisited (rapport de stage de master 2). *ENS de Lyon*, 2020.
- [Pou22] Pegah Pournajafi. Burling graphs as intersection graphs. *arXiv:2211.06980*, 2022.
- [PT21a] Pegah Pournajafi and Nicolas Trotignon. Burling graphs revisited, part II: Structure. *European Journal of Combinatorics (to appear)*, 2021.
- [PT21b] Pegah Pournajafi and Nicolas Trotignon. Burling graphs revisited, part III: Applications to χ -boundedness. *European Journal of Combinatorics (to appear)*, 2021.
- [PT23] Pegah Pournajafi and Nicolas Trotignon. Burling graphs revisited, part I: New characterizations. *European Journal of Combinatorics*, 110:103686, 2023.
- [RST93] Neil Robertson, Paul Seymour, and Robin Thomas. Hadwiger’s conjecture for k -free graphs. *Combinatorica*, 13(3):279–361, 1993.
- [Sar91] Karanbir Singh Sarkaria. A generalized van kampen-flores theorem. *Proceedings of the American Mathematical Society*, 111(2):559–565, 1991.
- [Sch10] Marcus Schaefer. Complexity of some geometric and topological problems. In David Eppstein and Emden R. Gansner, editors, *Graph Drawing*, pages 334–344, Berlin, Heidelberg, 2010. Springer Berlin Heidelberg.
- [Sco97] Alex Scott. Induced trees in graphs of large chromatic number. *Journal of Graph Theory*, 24(4):297–311, 1997.
- [Sin66] Frank William Sinden. Topology of thin film rc circuits. *Bell System Technical Journal*, 45(9):1639–1662, 1966.
- [SS20] Alex Scott and Paul Seymour. A survey of χ -boundedness. *Journal of Graph Theory*, 95:473 – 504, 2020.

Bibliography

- [Sum81] David Sumner. Subtrees of a graph and the chromatic number. *The Theory and Applications of Graphs*, (G. Chartrand, ed.), page 557–576, 1981.
- [Tho05] Carsten Thomassen. Some remarks on Hajós’ conjecture. *Journal of Combinatorial Theory, Series B*, 93(1):95–105, 2005.
- [Tie05] Heinrich Tietze. Über das problem der nachbargebiete im raum. *Monatshefte für Mathematik und Physik*, 16:211–216, 1905.
- [Tro13] Nicolas Trotignon. Perfect graphs: a survey. *arXiv:1301.5149*, 2013.
- [VK33] Egbert R Van Kampen. Komplexe in euklidischen räumen. In *Abhandlungen aus dem Mathematischen Seminar der Universität Hamburg*, volume 9, pages 72–78. Springer, 1933.
- [Wag37] Klaus Wagner. Über eine eigenschaft der ebenen komplexe. *Mathematische Annalen*, 114:570–590, 1937.
- [Wag64] Klaus Wagner. Beweis einer abschwächung der hadwiger-vermutung. *Mathematische Annalen*, 153:139–141, 1964.

List of Figures

3.1	History of Burling graphs and their applications.	23
3.2	Figure from [Bur65]. The first three families in the sequence defined by Burling.	24
3.3	The first three graphs in the Burling sequence.	25
4.1	The first three graphs in the Burling sequence, as oriented graphs (on the top) and non-oriented graphs (on the bottom).	36
4.2	Complete bipartite graphs seen as derived graphs.	37
4.3	Cycle of length 6 seen as a derived graph	38
4.4	$A \curvearrowright B$, i.e. the frame A enters the frame B	40
4.5	Left: the forbidden structure in strict frame graph, right: the allowed structure. . .	41
4.6	Examples of strong Pouna sets and their territories. The Pouna sets are shown in black and their territories in hatch.	43
4.7	The relation $A \curvearrowright B$. In the figures above, A is shown in gray and B in black.	44
4.8	C_6 as a constrained graph.	45
4.9	Examples of constrained S -graphs	46
4.10	Left: C_6 as a constrained circle-graph. Right: $K_{3,3}$ as a constrained positively-sloped-line-segment-graph.	47
5.1	Sliding b into uv	51
5.2	Turning v into a non-last-born	53
5.3	The first three Burling trees in the tree sequence and the oriented graphs fully derived from them.	55
5.4	When $c(u) = \emptyset$, T_3 (right) is an extension of T (left)	56
5.5	Case 1 of the proof of Lemma 5.8	57
5.6	Case 2 of the proof of Lemma 5.8	58
5.7	E_r is the right extension of E in R	60
5.8	For proof of Lemma 5.16.	61
5.9	The fourth item in the definition of stable prob does not hold here.	63
5.10	Construction of [PKK ⁺ 13] applied to $(\mathcal{F}, \mathcal{P})$. The second line presents $\Gamma(\mathcal{F}, \mathcal{P})$ and the third line presents $(\mathcal{F}', \mathcal{P}') = \mathfrak{S}_{\mathfrak{F}}(\mathcal{F}, \mathcal{P})$. The shapes in gray are not parts of the object and are presented to make following the construction easier. The scales have changed to make the illustration clearer.	64

List of Figures

6.1	Intervals associated to the non-last-borns of a Burling tree.	82
7.1	Subdividing a bottom-arc.	87
7.2	Top-subdividing a top-arc.	88
7.3	Complete bipartite graphs.	90
7.4	Subdivisions of K_4	90
7.5	Subdivisions of non-oriented graphs.	90
7.6	G can be derived from T_1 and T_2	92
7.7	Nobility of a graph.	93
7.8	G has maximum out-degree 3 and nobility 4.	93
7.9	A Burling graph viewed as a sequential graph.	96
7.10	Orientation of a hole in a Burling graph. Dashed arcs can be subdivided.	103
8.1	Burling graphs close to wheels. Dotted and dashed edges can be subdivided.	108
8.2	Some subdivisions of K_4 that are not Burling graphs.	110
8.3	Subdivisions of K_4 that are Burling graphs. In order from left to right: type 2, type 3, and type 4. Only dashed edges can be subdivided.	110
8.4	The vertex x is the unique center of an in-star cutset in G	110
8.5	Subdivisions of K_5 , type A subdivision on the left and type B subdivision on the right. Only dashed edges can be subdivided.	112
8.6	A subgraph of a type A subdivision of K_5	113
8.7	A type B subdivision of K_5 and its representation as a restricted frame graph.	114
8.8	A type B subdivision of K_5 minus one vertex, shown as a derived graph	114
8.9	A 4-necklace (left) and a 3-necklace (right). Any edge of the two graphs can be subdivided.	115
8.10	A 2-necklace presented as a derived graph	116
8.11	A 3-necklace presented as a derived graph.	117
8.12	A 4-necklace, presented as a frame graph.	118
8.13	Some graphs that are not Burling graphs. One can subdivide any edge, or contract the dotted edges, and still have a graph that is not a Burling graph.	120
8.14	No subdivision of this graph is a Burling graph. Theorem 8.24.	120
8.15	No subdivision of this graph is a Burling graph. Theorem 8.25.	121
8.16	No subdivision of this graph is a Burling graph. Theorem 8.26.	122
8.17	Examples of flowers.	124
8.18	Burling graphs close to flowers. Dotted and dashed edges can be subdivided.	125
8.19	Theta+, non-Burling graph.	126
9.1	A non-Burling graph obtained by gluing two Burling graphs along a vertex.	128
9.2	A non-Burling graph obtained from cycles by duplicating vertices.	131
10.1	Some graphs that are not weakly pervasive. Dotted edges can be subdivided or contracted, and every other edge can be subdivided. For explanations, see the corresponding Theorems.	135
A.1	James Burling in 1990s.	142

A.2	James Burling in 1970s.	143
B.1	A wheel presented as a 2-CBU graph.	146
B.2	The graph M , a Burling graph that is not a CBU graph.	146
B.3	The graph M presented as a derived graph.	147
C.1	Proof of Lemma 5.11: a planar embedding of K_5	151

List of Notations

General notation

\mathbb{R}^*	non-zero real numbers
\mathbb{N}^*	non-zero natural numbers
$ A $	cardinality of set A
$\mathcal{P}(A)$	powerset of A
A°	interior of set A
\bar{A}	closure of set A
∂A	boundary of set A
$\mathbf{1}_A$	characteristic function of set A
$A \sqcup B$	disjoint union of sets A and B
ρ_i	projection on the i -th axis of \mathbb{R}^n
$im(f)$	image of a function f
$f _A$	restriction of a function f to a subset A of its domain
$[n]$	the set $\{1, 2, \dots, n\}$
$X \simeq Y$	isomorphism between two objects X and Y
$Hom(A, B)$	set of morphisms between two objects A and B of a category

Classes and families of graphs

P_n	path on n vertices
C_n	cycle on n vertices
K_n	complete graph on n vertices
G^*	set of subdivisions of G
$\text{Forb}(\mathcal{H})$	class of \mathcal{H} -free graphs

Graph parameters and notation

$V(G)$	vertex-set of graph G
$E(G)$	edge-set of graph G
$A(G)$	arc-set of oriented graph G
$d(v)$	degree of vertex v
$N(v)$	set of neighbors of vertex v
$N[v]$	closed neighborhood of v
$N^+(v)$	set of out-neighbors of v
$N^-(v)$	set of in-neighbors of v
$\chi(G)$	chromatic number of G
$\omega(G)$	clique number of G
$G[X]$	subgraph of G induced by X
$L(T)$	set of leaves of a tree T
ℓ	last-born function in a Burling tree
c	choose-path function in a Burling tree

Subsets of \mathbb{R}^2 and Pouna sets

$\mathfrak{l}(A)$	$\inf x$ such that $(x, y) \in A$
$\mathfrak{r}(A)$	$\sup x$ such that $(x, y) \in A$
$\mathfrak{b}(A)$	$\inf y$ such that $(x, y) \in A$
$\mathfrak{t}(A)$	$\sup y$ such that $(x, y) \in A$
$\mathfrak{w}(A)$	width of A , i.e. the length of $\rho_1(A)$
$\mathfrak{h}(A)$	height of A , i.e. the length of $\rho_2(A)$
$\mathfrak{box}(A)$	bounding box of A
$\mathfrak{ter}(A)$	territory of Pouna set A

Alphabetical Index

- \mathcal{H} -free graphs, 9
- S -graph, 15
- χ -binding, 11
- χ -bounded, 11
- χ -boundedness, 10
- d -CBU graphs, 145
- k -Burling graphs, 91
- k -colorable, 10
- k -path-width, 30
- k -sequential graphs, 95
 - base forest of, 95
- k -tree-width, 30
- k -width, 30
- 4-color theorem, 12

- abstract Burling graphs, 39
- adding a leaf, 86
- adjacent vertices, 6
- ancestor, 19
- antenna, 97
 - of a hole, 102
- arc, 149
 - bottom-arc, 51
 - top-arc, 51

- bottom, 100
- boundary, 20
- bounding box, 21
- box, 20
- branch, 19
 - principle, 19

- Burling graphs, 10, 25
- Burling sequence, 10, 25, 35
- Burling set, 39
- Burling successor function, 34
- Burling tree, 36

- CBU graph, 145
- chandelier
 - luxury, 27
- child, 19
- choose-path function, 37
- chromatic number, 10
- class, 8
 - generated, 9
 - hereditary, 9
 - of all graphs, 8
- clique, 9
- clique number, 9
- closure, 20
- compact, 20
- complete bipartite graph, 8
- complete graph, 8
- connected, 18
- connected component, 18
- constrained S -graphs, 45

- constrained graphs, 44
- contraction, 8
- cordate orientation, 105
- crossing, 59
- cycle, 8, 18

- degeneracy, 92
- degree
 - in-degree, 18
 - out-degree, 18
- derived graphs, 36
 - top-set of, 94
- descendant, 19
- dissolution, 130
- domino, 104
- dumbbell, 103

- event structure, 31
- extension, 55

- flower, 124
- forest, 11
- frame, 20
- frame graphs, 16

- girth, 11
- graph, 6
 - finite, 6
 - non-oriented, 7
 - planar, 6
- graph homomorphism, 7

- Gyárfás-Sumner
 - conjecture, 11
- Hadwiger's conjecture, 13
- hole, 18
- in-forest, 19
- in-star, 98
- in-star cutset
 - full, 18
- in-tree, 19
- induced subgraph, 8
- interior, 20
- intersection graph, 15
 - of geometrical objects, 15
 - oriented, 44
- isolated vertex, 18
- labeled graph, 7
- last-born, 36
- leaf, 18
 - of in-tree, 19
 - of rooted tree, 19
- minor, 9
- neighbor, 18
 - in-neighbor, 18
 - out-neighbor, 18
- notability, 91
- oriented chandelier, 99
- oriented graph, 7
 - finite, 7
- oriented graph
 - homomorphism, 7
- parent, 19
- path, 8, 18, 20
 - internally disjoint, 20
- path-connected, 20
- path-decomposition, 30
- perfect graph, 11
- pervasive, 12
- pivot, 97
 - of a hole, 102
- Poua sets, 20, 42
 - comparable, 74
 - strong, 42
- principle branch, 53
- principle set, 53
- prob, 62
 - defined by a rectangle, 63
 - root of, 62
 - stable, 62
- restricted frame graph, 27
- right extension, 60
- Scott's conjecture, 11
- simplex, 150
- singularity (of a hole), 102
- sink, 18
- source, 18
- stable set, 9
- star cutset, 18
 - full, 18
- strict box-graphs, 81, 83
- strict frame graphs, 41
- subdivision, 8
 - of arcs, 87
 - top-subdivision, 87
- subgraph, 8
 - induced, 8
 - induced by a set, 8
- subordinate
 - global, 111
 - of a hole, 102
- subterritory, 60
- territory, 42
- theta, 104
 - apex of, 104
 - long, 104
- theta+, 126
- top-ancestor, 94
- top-left vertex, 38
- transformation, 15
 - positive, 21
- transformed copy, 15
 - positive, 21
- tree, 18
 - rooted, 19
- tree sequence, 54
- tree-decomposition, 30
- triangle-free, 9
- underlying graph, 7
- weakly pervasive, 12
- wheel, 29, 107
 - k -wheel, 133
 - center of, 29
 - rim of, 29